

---

# Telemecanique Sensors

## The essential guide of Detection



Simply easy!

# Telemecanique Sensors

## Simply easy!

Founded over 90 years ago, **Telemecanique Sensors** specializes in sensors and sensor-related technology.

As a **global leader** in the sensors business, we help our customers select the right technology to get the best performance and reliability from their machines.



Focused on 3 core values – **Simplicity, Proximity and Expertise** – we have become experts in factory automation sensors as well as specialists in demanding applications, making our customers' lives **Simply easy!**

## Connect with the experts

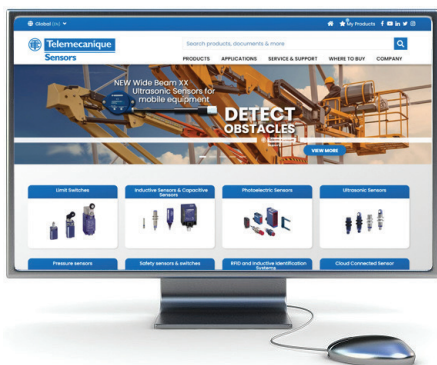

[www.tesensors.com](http://www.tesensors.com)

Telemecanique Sensors team is available for pre and post sales support. We become an extension of your team and share our expertise with you.

# Contents

<b>Innovation Focus</b> .....	2 to 3
A summary of recently released, cutting-edge products	
<b>Sensors Solutions by Application</b> .....	4 to 11
A guide applying our sensors to Material Handling, Railway, Mobile Lift, Hoisting, Water Pumping, and Escalator / Elevator applications.	
<b>Products</b>	
<b>Limit switches, XC</b> .....	12 to 21
Detection by contact of rigid objects	
<b>Sensors for pressure control, XM, ZM</b> .....	22 to 27
Detection by contact with fluid	
<b>Inductive proximity sensors, XS</b> .....	28 to 38
Detection without contact of metal objects	
<b>Capacitive proximity sensors, XT</b> .....	39
Detection of insulating materials or conductive materials	
<b>Photo-electric sensors, XU</b> .....	40 to 51
Detection without contact of any object	
<b>Ultrasonic sensors, XX</b> .....	52 to 54
Detection without contact of any object of any material	
<b>Cabling system, XZ</b> .....	55
Pre-wired female connectors	
<b>Radio frequency identification, XG</b> .....	56 to 58
13.56 MHz RFID detection	
<b>Cloud connected sensors, XIOT</b> .....	59
<b>Sensors for Safety</b> .....	60 to 76

# Telemecanique Sensors

## Innovation focus...

- Safety sensors and switches

The new **XUSL4M Range** of safety Light Curtains help protect machine operators while allowing the temporary suspension of safety-related functions for designed automated processes.



◀ The new **XCSR Range** of RFID contactless safety switches help secure hazardous areas. A high level of safety in a compact size, highly tamper-proof and easy to install.

- Wireless limit switches



◀ Wireless and battery-less limit switches are now available in miniature format! Enhance machine communication where cabling is difficult, expensive, or unwanted. The **XCMW Range** is also the perfect way to give mobile machines more freedom of movement.

- Mobile equipment limit switches



◀ Plugging quality and reliability into your mobile equipment has never been easier with **XCMV Limit switches**. The new line of XC limit switches has been engineered for quality and compatibility featuring a universal, flexible mounting design, compatible with both standard and miniature limit switches.

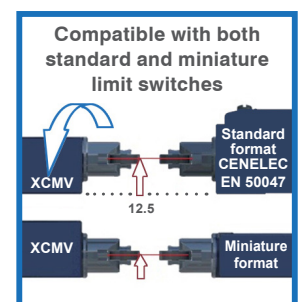

- Smart RFID system



◀ The new **XG Range** of Telemecanique Sensors RFID Readers strengthen the machine's safety via an innovative and easy-to-configure system. This new solution can be easily integrated into a control panel via a standard 22mm hole. It will allow each user the appropriate machine functions based on their assigned profile.

- Cloud Connected Sensors

The new **Cloud Connected Sensor XIOT** is the "**Simply easy!**" way to monitor your industrial assets! The XIOT captures event information at your remote locations and sends data to the internet cloud, which sends an alert directly to your phone or other mobile device.



- Ultrasonic sensors



◀ The innovative **XX Range** of software-configurable ultrasonic sensors now includes a wide beam sensor ideal for mobile equipment and material handling. This wide beam sensor detects in harsh environments, is highly immune to electromagnetic interference, and can be installed side-by-side for wider areas.

# Sensor Solutions for Material Handling Applications

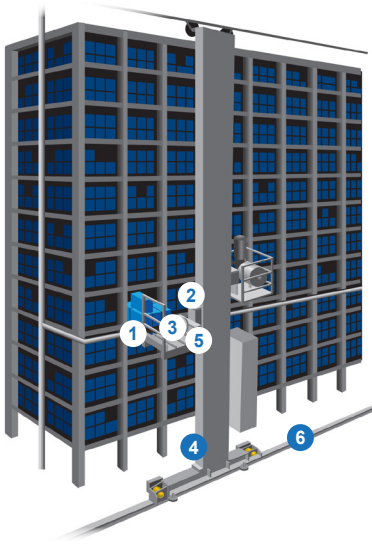

## Automated Storage and Retrieval Systems

- 1 **XS Cylindrical Inductive Sensor** verifies the table position to validate the movement authorization (See pages 29 & 35).
- 2 **XCMW Wireless & Battery-less Limit Switch** detects the compartment where the lift stops (See pages 20-21).
- 3 **XUM Miniature Photoelectric Sensor** verifies the presence of load on the table (See pages 41, 46, & 49).
- 4 **XUK Photoelectric Laser Sensor** measures distance for the translation travel (See pages 44-45).
- 5 **XG RFID System** provides traceability of bins in the warehouse (See page 56).
- 6 **XS Rectangular Inductive Sensor** detects an overtravel (See page 31).



## Conveyors

- 1 **XUM Miniature Photoelectric Sensor** detects the passage and presence of packages with background suppression (See pages 41, 46, & 49).
- 2 **XCMW Wireless & Battery-less Limit Switch** enables transferring of products from conveyor to conveyor without losing the exact direction orientation (See pages 20-21).
- 3 **XUSL4M Safety Light Curtains with Muting** efficiently detect machine operators with uninterrupted automation processes (See page 74).
- 4 **XCSR RFID Safety Sensor** shuts down the machine if the door opens (See page 68).
- 5 **XUB Cylindrical Photoelectric Sensor** detects the passage and presence of packages using a reflector (See pages 40 & 49).
- 6 **XX Ultrasonic Sensor** detects the passage and presence of objects regardless of their color, shape, or orientation (See pages 52-53).
- 7 **XG RFID System** provides traceability of packages in the warehouse (See page 56).
- 8 **XUY Photoelectric Roller Sensor** provides integrated, between-the-rollers detection of the passage and presence of any object (See page 45).
- 9 **XY2 Emergency Stop Cable Pull Switch** provides a readily-accessible, quick emergency stop (See pages 69-70).

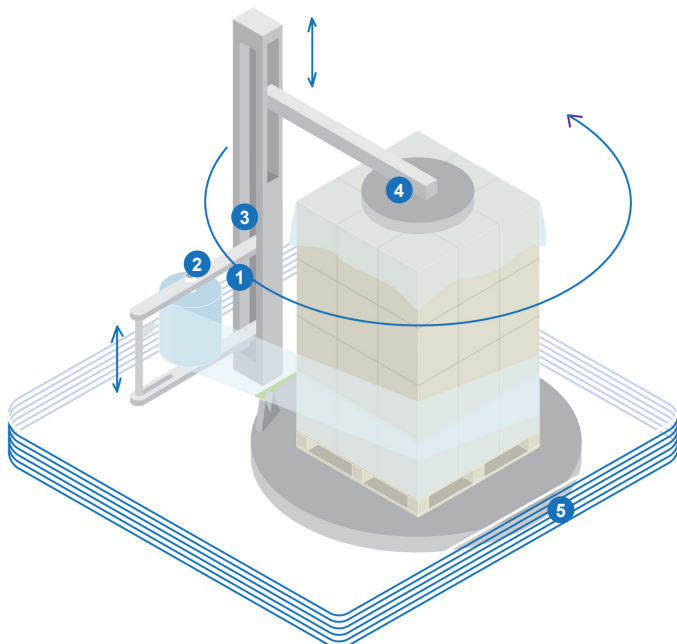
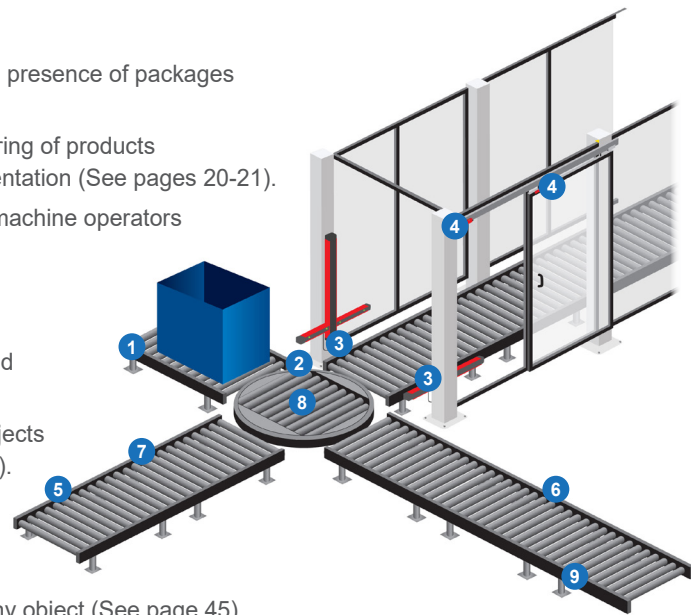

## Stretch Wrapper

- 1 **XUK Photoelectric Laser Sensor** detects the distance measurement to the pallet (See pages 44-45).
- 2 **XX Ultrasonic Sensor** detects the end of the film reel or film breakage (See pages 52-53).
- 3 **XCMD Miniature Limit Switch** detects the end positions (See pages 12-13).
- 4 **XUX Photoelectric Sensor** detects any package overhang (See pages 41 & 49).
- 5 **XUSL Safety Light Curtains** monitor the access of persons to hazardous machine zones (See pages 71-73).

# Sensor Solutions for Railway Applications



## Automatic Doors

- 1 XUK9 Photoelectric Sensor** detects passengers for doors inside the train (See page 41).
- 2 XCMD or XCMN Limit Switches** detect the position of doors on the train and on the platform (See pages 12-13).
- 3 XCKD Limit Switch** activates the folding step (See page 12).

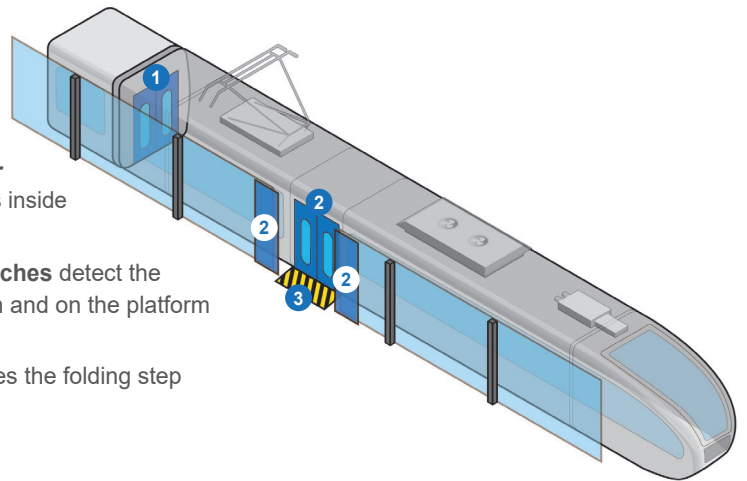

## Pantograph, Air Conditioning & Coupling Systems

- 1 XMLC Pressure Sensor** regulates the pressure of the pantograph mechanism (See page 25).
- 2 XMEP Pressure Sensor** regulates pressure in the air conditioning systems (See page 22).
- 3 XS618 Inductive Sensor** checks the position of the coupling trap doors (See page 29).

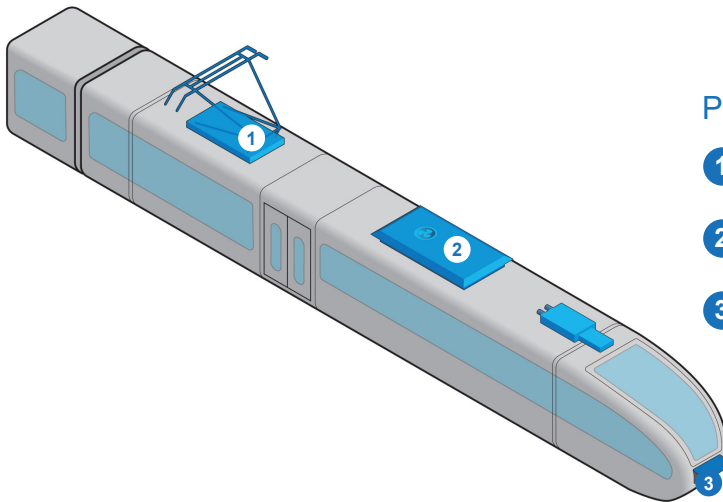

## Air Supply and Braking System

- 1 XMLA/B or XMEP Pressure Sensor** manages compressed air in the air supply systems (See pages 22 and 24-25).
- 2 XCMD Limit Switch or XS Inductive Sensor** controls the railroad turnout system (See pages 12-13 & 31).
- 3 XMLA/B or C Pressure Sensor** checks pressure in the braking systems (See pages 24-25).
- 4 XX Ultrasonic Sensor** detects the platform presence (See page 52).

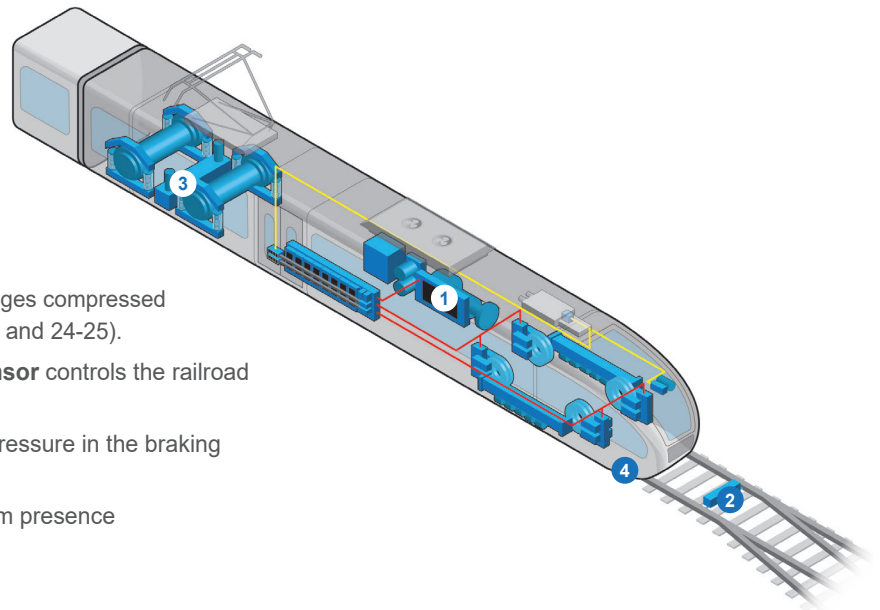

# Sensor Solutions for Mobile Lift Applications

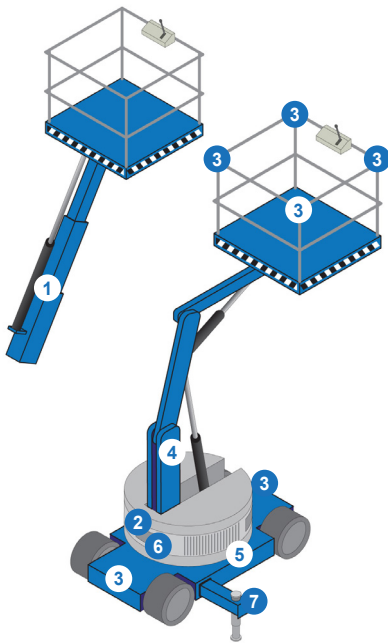
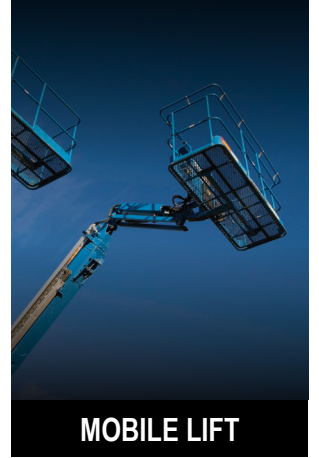

## Boom Lift Platforms

- 1 **XCKP or XCMD Limit Switch** detects the extension or retraction of the telescopic arm (See pages 12-13).
- 2 **XCKP Limit Switch** detects the rest position of the boom (See pages 12-13).
- 3 **XXW54 Wide Beam Ultrasonic Sensors** detect obstacles on or above the ground (See page 53).
- 4 **XCKP or XCMD Limit Switch** detects the boom position (See pages 12-13).
- 5 **XMEP Pressure Transmitter** monitors and regulates hydraulic pressure (See page 22).
- 6 **XS Inductive Sensors** detect the turret rotation (See page 35).
- 7 **XCMD Limit Switch** detects the deployment of stabilizers (See pages 12-13).

## Scissor Lift Platforms

- 1 **XCMD Limit Switch with XCMZ06 Accessory** monitors height (See pages 12-13).
- 2 **XMEP Pressure Sensor** monitors and regulates hydraulic pressure (See page 22).
- 3 **XCMV or XCKP Limit Switch** monitors wheel contact with the ground (See pages 12-13).
- 4 **XXW54 Wide Beam Ultrasonic Sensors** detect obstacles above and on the ground (See page 53).

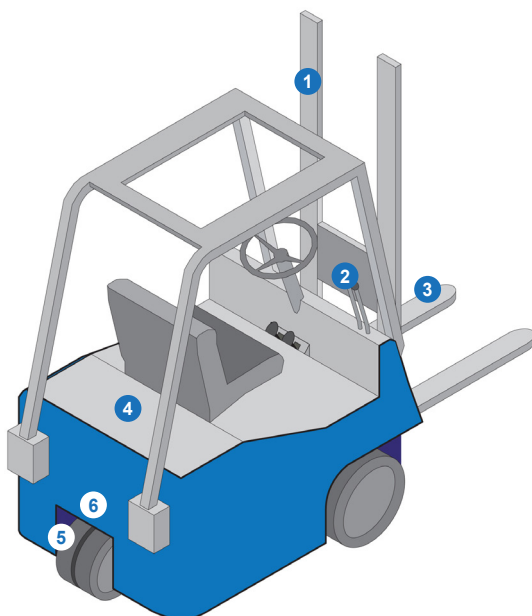
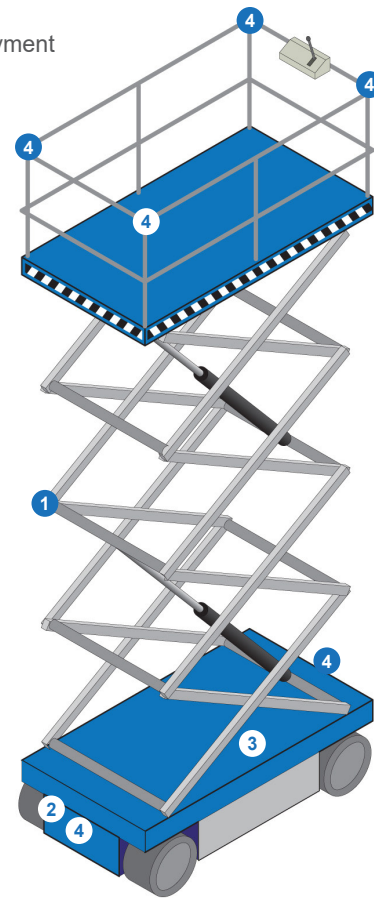

## Fork Lifts

- 1 **XCKP or XCMD Limit Switch** detects fork and travel position (See pages 12-13).
- 2 **XCMV Limit Switch** monitors the position of the operating mechanism (See page 12).
- 3 **XCMD Limit Switch** detects the distance between the two forks (See pages 12-13).
- 4 **XMEP Pressure Sensor** monitors and regulates hydraulic pressure (See page 22).
- 5 **XS Inductive Sensor** detects wheel position (See pages 30 & 35).
- 6 **XXW54 Wide Beam Ultrasonic Sensors** detects obstacles on the ground (See page 53).



# Sensor Solutions for Mobile Lift Applications



## Truck Loading Cranes

- 1 **XCMV or XCMD Limit Switch** detects the rest position of the arm (See pages 12-13).
- 2 **XMLR Sensor or XMEP Sensor with ZMLP Display** monitors and regulates hydraulic pressure (See pages 22-23).
- 3 **XS SIL2 Inductive Sensor** detects position of the stabilizer (See page 35).
- 4 **XCKD Limit Switch with XCKZ05 Accessory** detects the deployment of stabilizers (See pages 12-13).
- 5 **XS Inductive Sensor** detects the position of the rotary arm (See page 35).

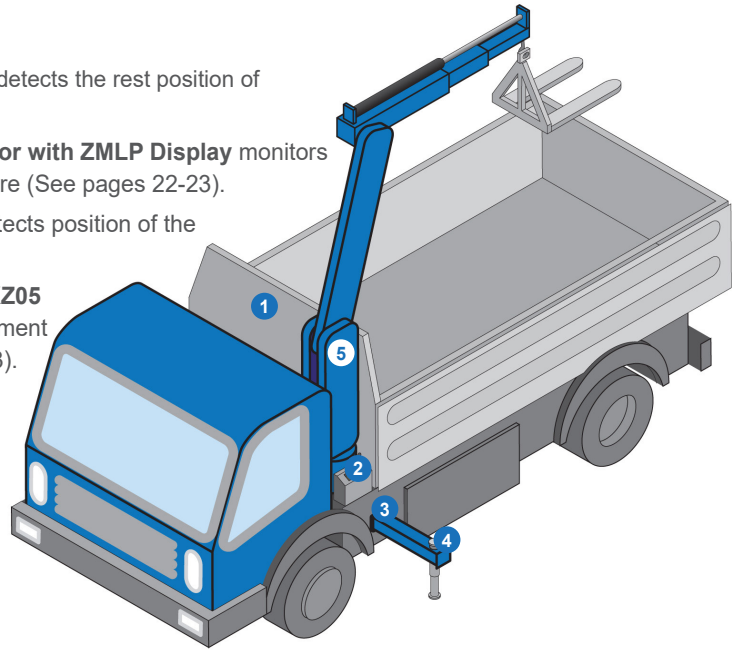

## Garbage Trucks

- 1 **XUSL Light Curtains** enables hand and people protection (See pages 71-73).
- 2 **XU2S Photoelectric Sensor** detects the shovel movement interruption (See page 71).
- 3 **XG RFID Systems** detect the driver's presence (See page 56).
- 4 **XMEP Pressure Transmitter** detects hydraulic pressure while compacting (See page 22).
- 5 **XS Inductive Sensor** detects the loader's end point (See page 35).
- 6 **XG RFID System** identifies the garbage (See page 56).
- 7 **XS Inductive Sensor** detects the presence of the operator (See page 35).
- 8 **XX Ultrasonic Sensor** detects obstacles on the road (See page 52).

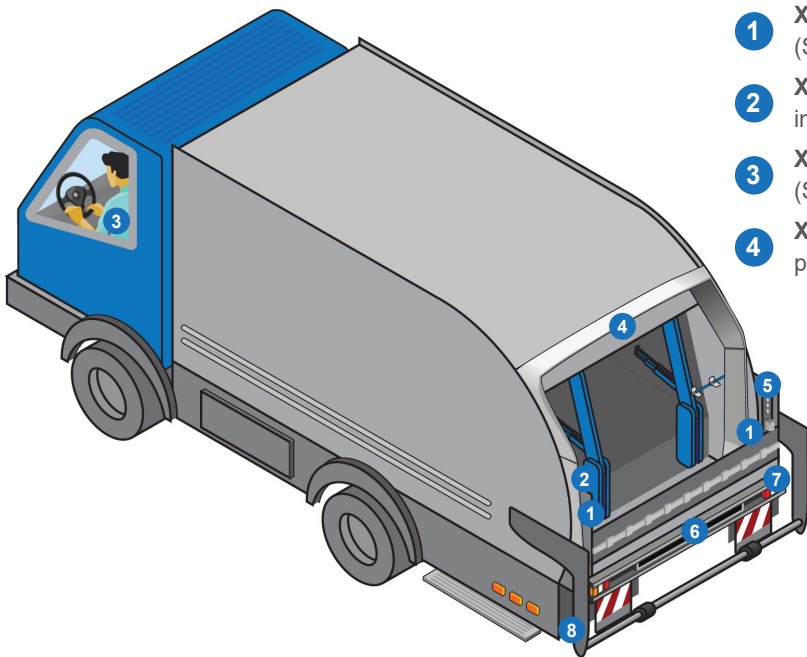

# Sensor Solutions for Hoisting Applications

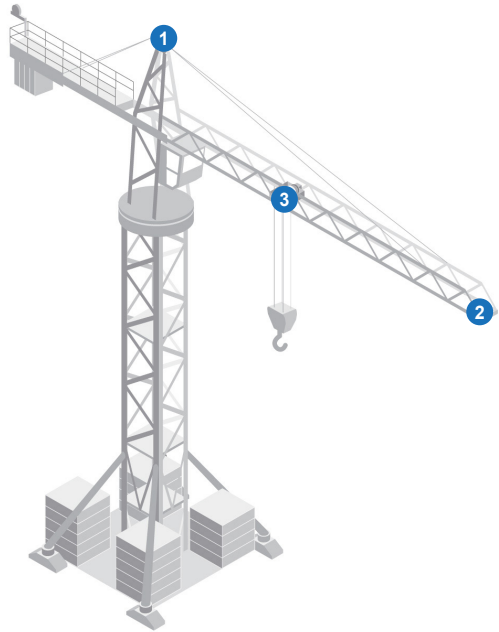
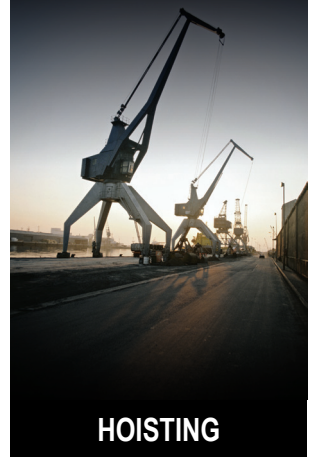

## Tower Cranes

- 1** **XCKM / XCR Limit Switch** detects specific position for overload or overtorque control (See pages 16 and 21).
- 2** **XF Limit Switch** detects any overtravel of trolley movement (See [www.tesensors.com](http://www.tesensors.com)).
- 3** **XCKVR / XCKMR Limit Switches** control stop and slow down of the horizontal movement (See pages 20-21).

## Overhead and Gantry Cranes

- 1** **XCKVR / XCKMR Limit Switches** control stop and slow down of the horizontal movement (See pages 20-21).
- 2** **XUX / XUK9T Photoelectric Sensors** detect other cranes; provide anticollision function (See pages 40, 41 & 45).
- 3** **XCKM / XCR Limit Switches** detect any over travel of the trolley movement (See pages 16 and 21).
- 4** **XF Limit Switch** detects any over travel of translation movement (See [www.tesensors.com](http://www.tesensors.com)).
- 5** **XF Limit Switch** detects an over up of the vertical movement (See [www.tesensors.com](http://www.tesensors.com)).

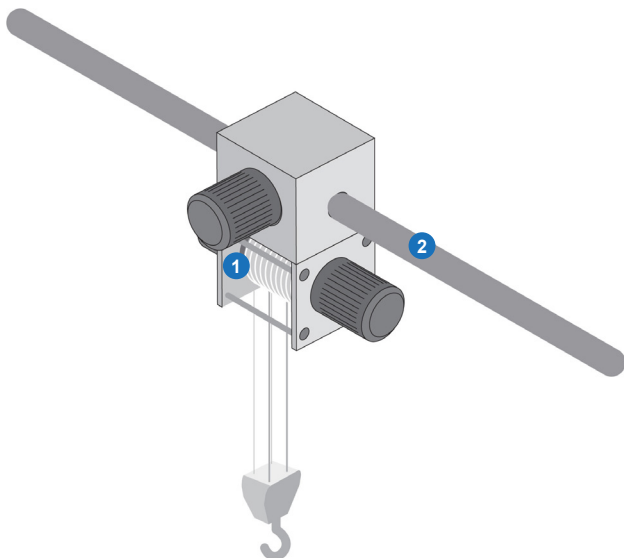
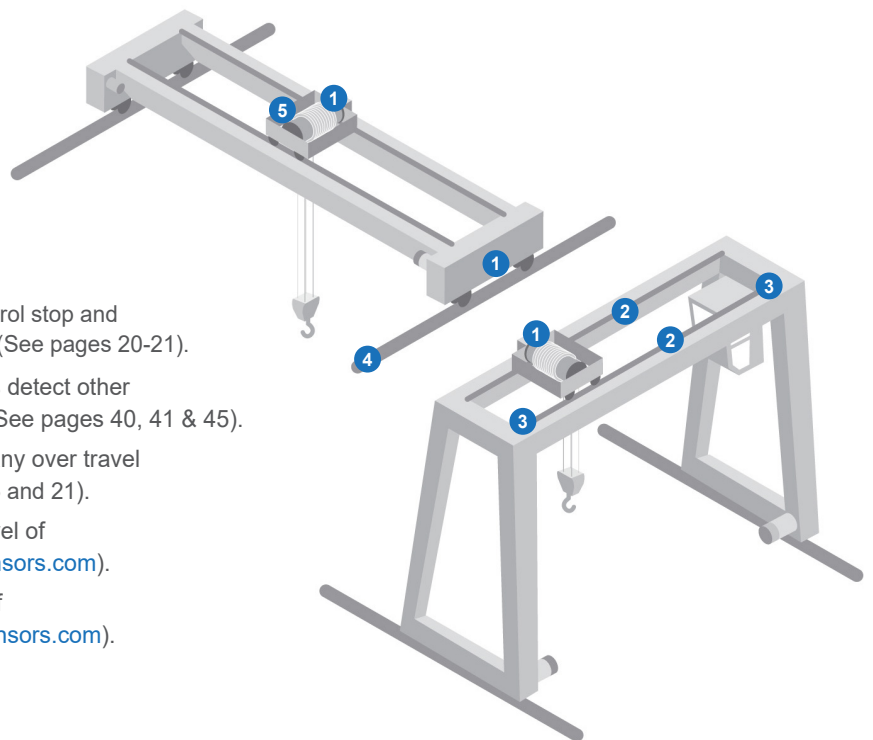

## Block Hoists

- 1** **XCMD Limit Switch** controls stop, up, and down of the vertical movement. Miniature switches are incorporated in the hoist winch. (See pages 12 & 13).
- 2** **XCR Limit Switch** controls the stop of the horizontal movement (See page 21).

# Sensor Solutions for Hoisting Applications

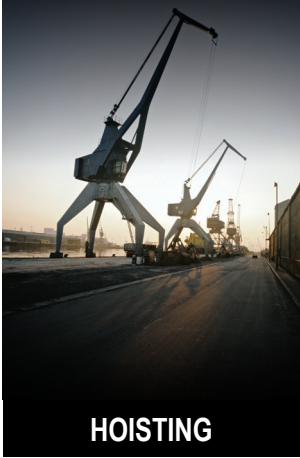

## Mobile Cranes

- 1 XMLR Pressure Sensor or XMEP Pressure Sensor with ZMLP Display** monitors and regulates hydraulic pressure (See pages 22-23).
- 2 XCKD Limit Switch with XCKZ05 Accessory** detects the deployment of the stabilizers (See pages 12-13).
- 3 XS Inductive Sensor** detects the position of the stabilizers (See pages 34-35).

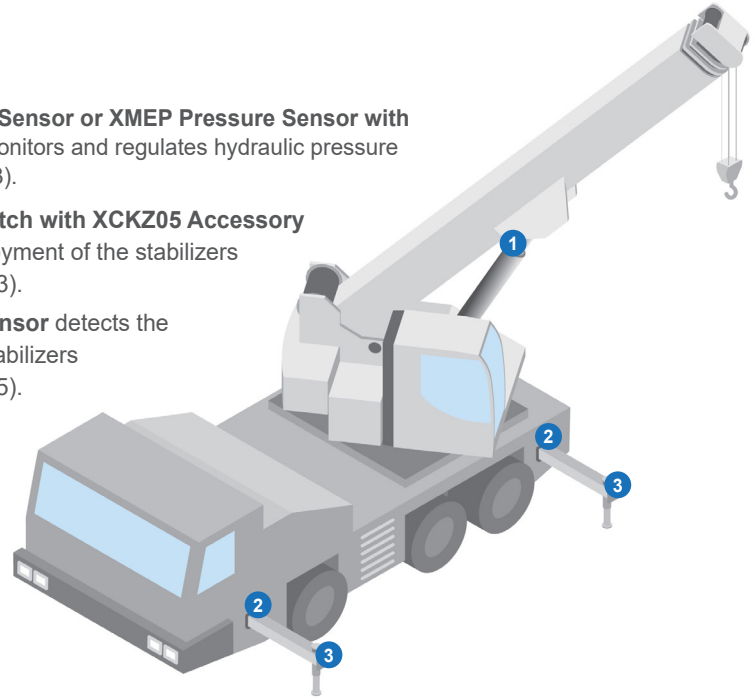

## Harbour Cranes

- 1 XS Inductive Sensor** detects any trolley position with resynchronization position (See pages 34-35).
- 2 XCKVR / XCKMR Limit Switches** controls the stop and slowdown of the horizontal movement (See pages 20-21).
- 3 XCKM / XCR Limit Switches** detect an over travel of trolley movement, detect anchoring of the long travel, and monitor the boom sequence (See pages 16 and 21).

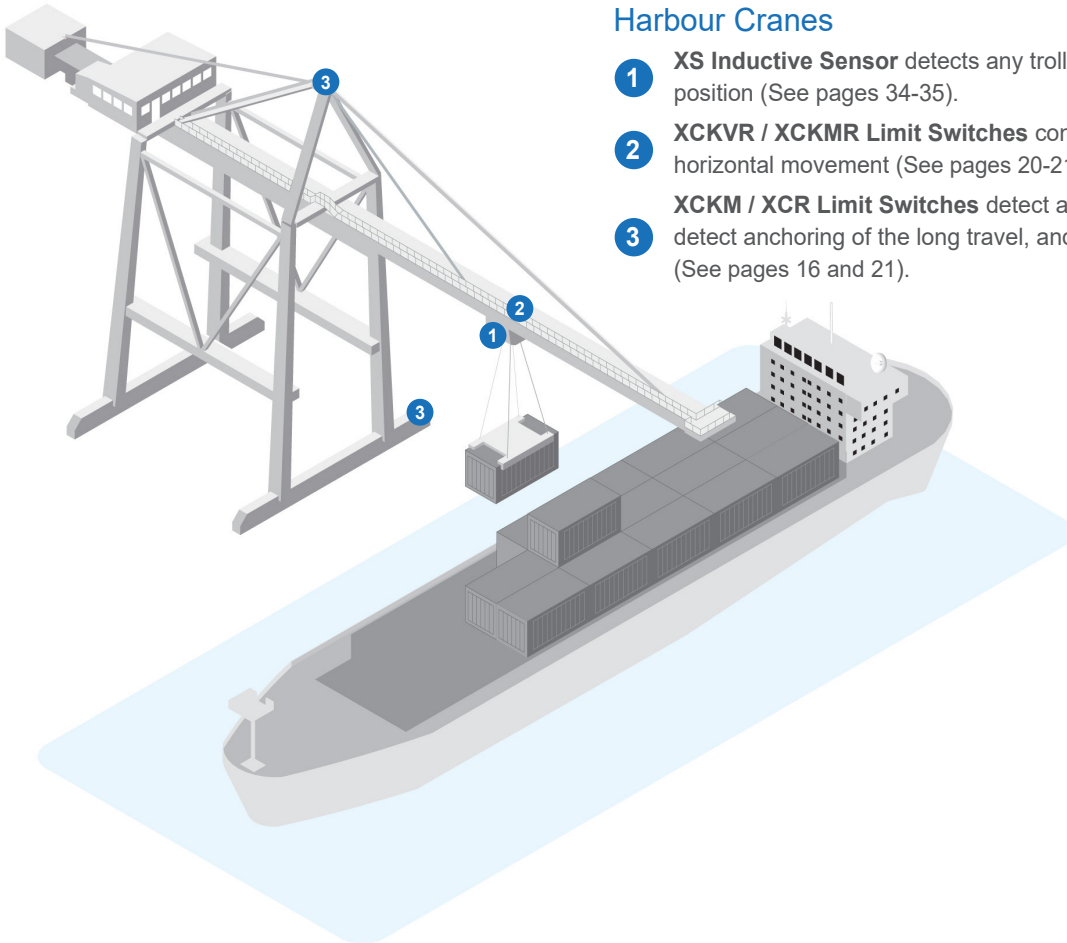

# Sensor Solutions for Water Pumping Applications

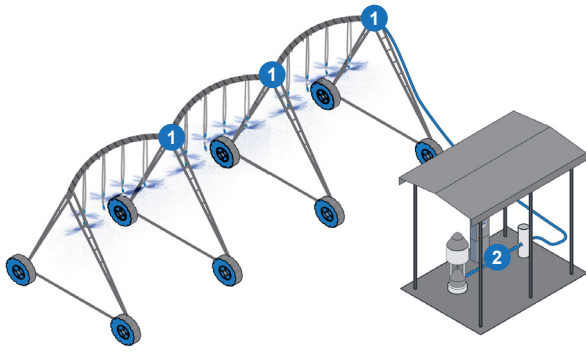

## Irrigation Systems

- 1 **XCMD Limit Switch** controls movement (See pages 12-13).
- 2 **XMLP Pressure Sensor** monitors and regulates hydraulic pressure (See page 22).

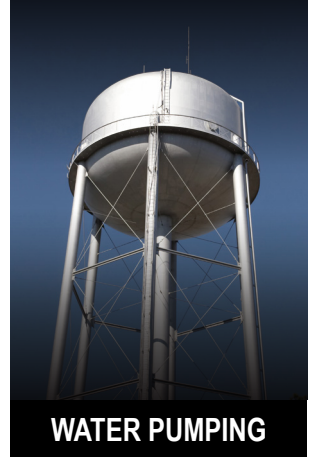

**WATER PUMPING**

## Fire Trucks

- 1 **XS Inductive Sensor** provides speed monitoring on the chemical mix pump (See pages 28-29).
- 2 **XCMD Limit Switch** controls the valve opening / closing (See pages 12-13).
- 3 **XCMD Limit Switch** checks to see if the hose is in place (See pages 12-13).
- 4 **XMLP Pressure Sensor** measures level in the water tank (See page 22).
- 5 **XMLP Pressure Sensor** measures water pressure for managing the chemical mix (See page 22).
- 6 **XCMD Limit Switch** controls door opening / closing (See pages 12-13).

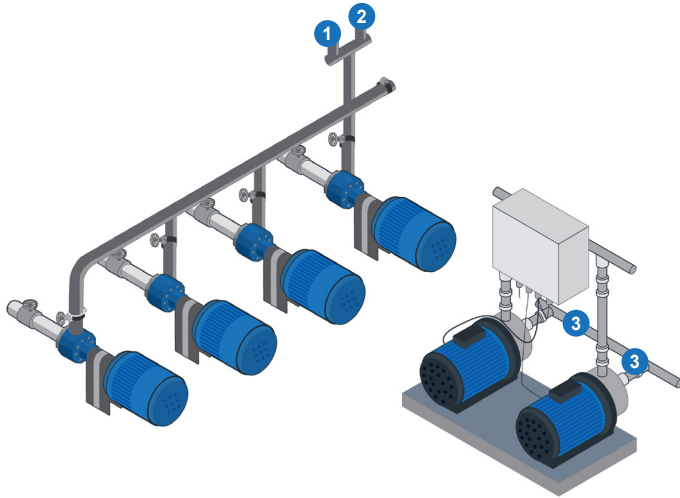

## Lifting and Boosting Stations

- 1 **XMLA or XMX Pressure Sensor** controls threshold fixing (See pages 24-26).
- 2 **XMLR Pressure Switch** regulates pressure (See page 23).
- 3 **XMP Pressure Sensor** monitors pressure threshold with electromechanical switch (See page 27).

## Water Storage Facilities & Access Control

- 1 **XXS30 / XXA30 Ultrasonic Sensor** monitors the water level (See page 53).
- 2 **XMLP Pressure Sensor + ZMLP Display** monitors pressure and provides a remote display (See pages 22-23).
- 3 **XGCS RFID Reader / Smart Antenna** automatically reads electronic badges/tags (See pages 56-57).
- 4 **XGHB Electronic Tag** stores data assigned to the individual tag owner (See page 56).

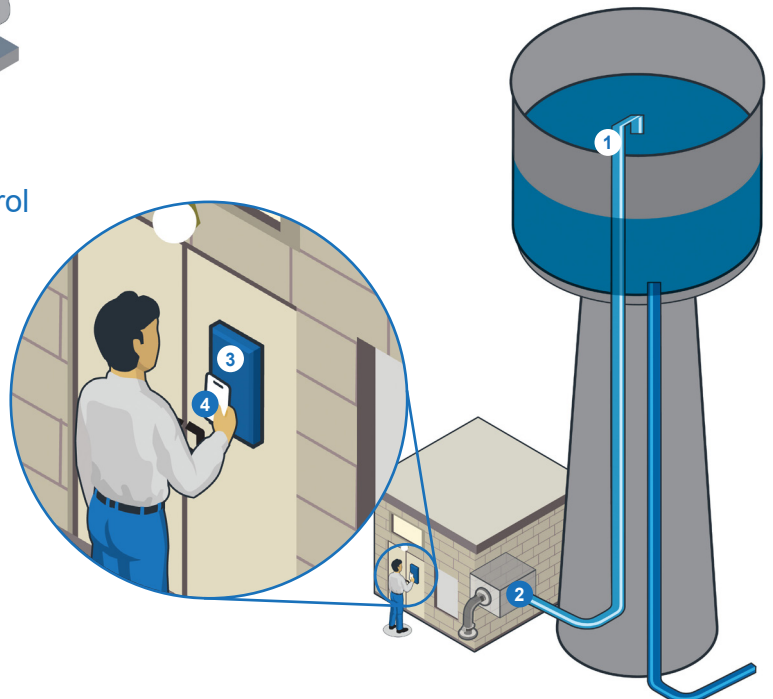



# Sensor Solutions for Escalator / Elevator Applications

## Escalators

- 1 **XU Photoelectric Sensor** detects entrance (See page 40).
- 2 **XS Inductive Sensor** monitors speed and direction of the main drive chain (See pages 34-35).
- 3 **XCKN/XCNT Limit Switch** monitors the open and close of the main brake (See [www.tesensors.com](http://www.tesensors.com)).
- 4 **XCNR IEC Limit Switch** monitors the tension of the drive chain (See [www.tesensors.com](http://www.tesensors.com)).
- 5 **XCKN/XCNT Limit Switch** detects any skirt panel deformity (See [www.tesensors.com](http://www.tesensors.com)).
- 6 **XCKN/XCNT Limit Switch** detects deformed or damaged steps (See [www.tesensors.com](http://www.tesensors.com)).
- 7 **XS Inductive Sensor** monitors handrail speed (See pages 34-35).

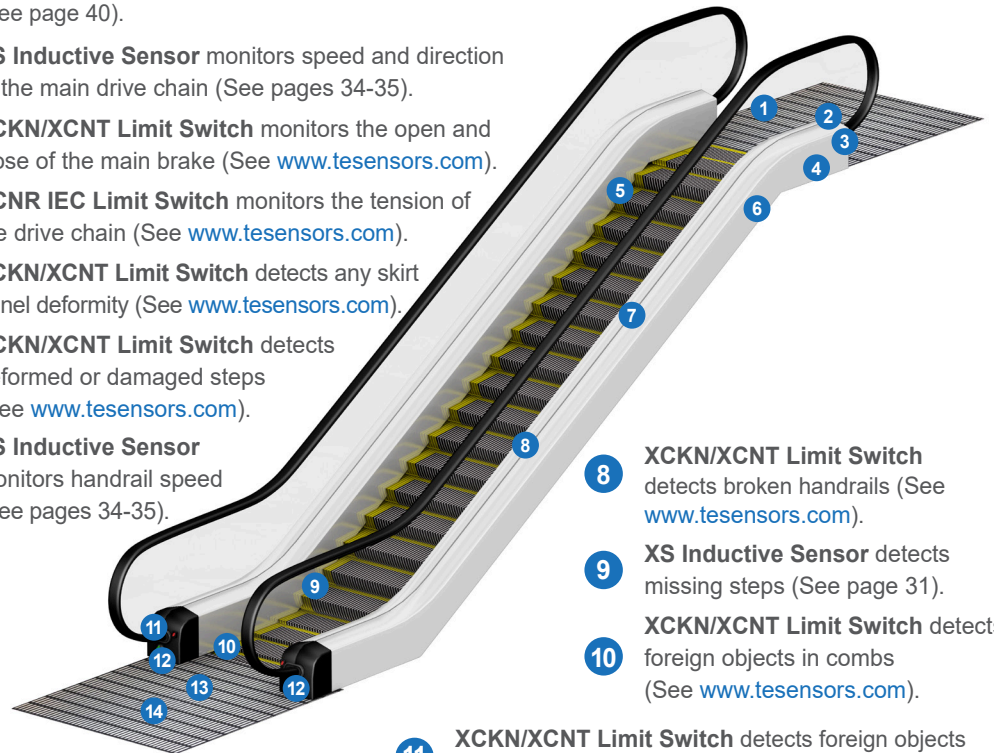

- 8 **XCKN/XCNT Limit Switch** detects broken handrails (See [www.tesensors.com](http://www.tesensors.com)).
- 9 **XS Inductive Sensor** detects missing steps (See page 31).
- 10 **XCKN/XCNT Limit Switch** detects foreign objects in combs (See [www.tesensors.com](http://www.tesensors.com)).
- 11 **XCKN/XCNT Limit Switch** detects foreign objects on handrail (See [www.tesensors.com](http://www.tesensors.com)).
- 12 **XX Ultrasonic Sensor** detects presence to activate escalator (See pages 52-53).
- 13 **XCNR IEC Limit Switch** monitors drive chain traction (See [www.tesensors.com](http://www.tesensors.com)).
- 14 **XS Inductive Sensor** detects the position of the access cover (See pages 30-31).

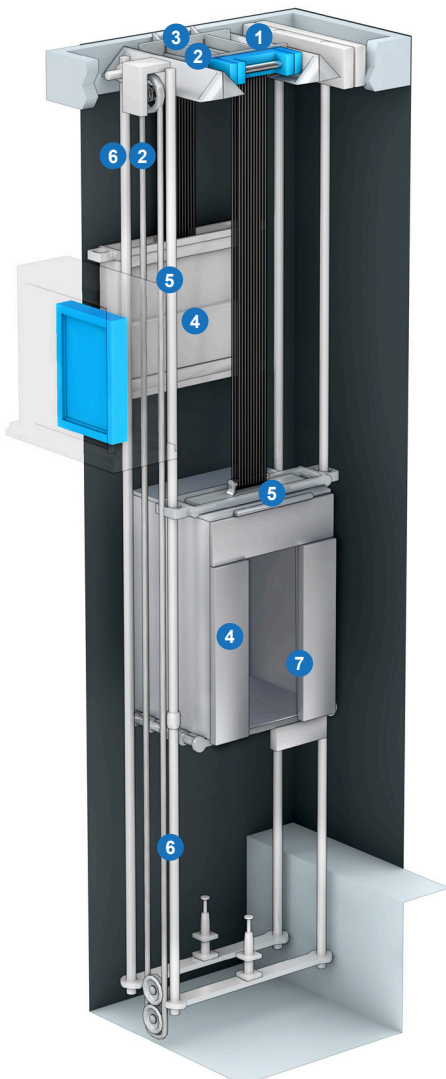

## Elevators

- 1 **XS Inductive Sensor** detects car position and/or motor speed (See pages 34-35).
- 2 **XIOT Cloud Connected Sensor** sends remote alerts when overrun or secure area access is detected (See page 59).
- 3 **XCS Safety Switch** secures access to maintenance area (See page 69).
- 4 **XU Photoelectric Sensor** detects anyone in doorway before closing (See pages 40-41).
- 5 **XCK IEC Limit Switch, XU Photoelectric Sensor, or XS Inductive Sensor** detects car positioning (See pages 20-21, 34-35, & 40-41).
- 6 **XCNR IEC Limit Switch** detects overrun (See [www.tesensors.com](http://www.tesensors.com)).
- 7 **XG Compact RFID Sensor** secures access to restricted levels (See pages 56-57).

# XC Limit switches

Compact and miniature, complete switches (variable composition, see pages 6-7)

## XCMD

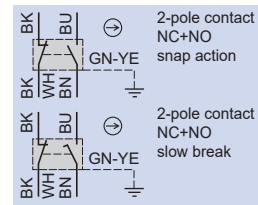

## XCKT

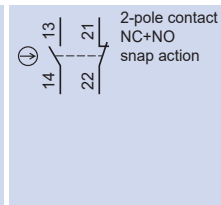

### Miniature XCMD metal, Pre-cabled; fixing by the body or by the head

Type of operator	Metal end plunger	Steel roller plunger	Thermoplastic roller lever	Steel roller lever	Variable length thermoplastic roller lever	M12 head metal end plunger	
Mechanical durability (millions of operating cycles)	10	10	10	10	10	10	
Actuation speed (in m/s)	0,5	0,5	1,5	1,5	1,5	0,5	
Switches conforming to standard IEC 947-5-1 section 3 ⊕	⊕	⊕	⊕	⊕	⊕	⊕	
Product certification	CE, UL, CSA, CCC						
Degree of protection conforming to IEC 60529	IP66 and IP67						
Rated operational characteristics (conforming to EN IEC 60947-5-1)	AC 15 ; B 300 (Ue = 240 V, Ie = 1,5 A) / DC 13 ; R 300 (Ue = 250 V, Ie = 0,1 A)						
Fixing centres (mm)	20					M12 x 1	
Body dimensions (mm) W x D x H	30 x 16 x 50						
Connection	Pre-cabled, adjustable direction, length = 1 m (other lengths available on request)						
Complete switch	2-pole NC+NO snap action	XCMD2110L1	XCMD2102L1	XCMD2115L1	XCMD2116L1	XCMD2145L1	XCMD21F0L1
	2-pole NC+NO break before make, slow break	XCMD2510L1	XCMD2502L1	XCMD2515L1	XCMD2516L1	XCMD2545L1	XCMD25F0L1
	Connector	M12					
Complete switch	NO+NC snap action (M12 - 5-pins)	XCMD2110C12	XCMD2102C12	XCMD2115C12	XCMD2116C12	XCMD2145C12	XCMD21F0C12
	1C/O snap action (M12 - 4-pins) (1)	XCMD2110M12	XCMD2102M12	XCMD2115M12	XCMD2116M12	XCMD2145M12	XCMD21F0M12
<b>New</b>	<b>Miniature mobile equipment metal range, Pre-cabled; fixing by the body or by the head</b>						
	Connector	AMP 4P					
Complete switch	NC+NO snap (2)	XCMD2110AM4	XCMD2102AM4	XCMD2115AM4			
	Connector	Deutsch DT04 4P					
Complete switch	NC+NO snap (2)	XCMV2110D44	XCMV2102D44	XCMV2115D44			
	Connector	M12					
Complete switch	NC+NO snap (2)	XCMV2110M12	XCMV2102M12	XCMV2115M12			

- Although their design is identical to the Pre-cabled switches, the switches incorporating an M12 4-pin connector cannot be marked ⊕ because they are single-pole C/O.
- Also available in NC + NO slow versions. Replace the first "1" with a "5". Example: XCMD2110AM4 becomes **XCMD2510AM4**.

## XCKP/XCKD

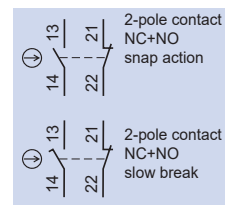

### Compact XCKD metal and XCKP plastic conforming to standard EN 50047

Type of operator	Metal end plunger	Steel roller plunger	Thermoplastic roller lever plunger, horizontal actuation (6)	M18 head metal end plunger	M18 head steel roller plunger	
Mechanical durability (millions of operating cycles)	15	10	15	10	10	
Actuation speed (in m/s)	0,5	0,5	1	0,5	0,5	
Switches conforming to standard IEC 947-5-1 section 3 ⊕	⊕	⊕	⊕	⊕	⊕	
Product certification	CE, CSA, CCC, EAC					
Degree of protection conforming to IEC 60529	IP66 and IP67					
Rated operational characteristics (conforming to EN IEC 60947-5-1)	AC 15 ; A 300 (Ue = 240 V, Ie = 3 A) / DC 13 ; Q 300 (Ue = 250 V, Ie = 0,27 A)					
Pre-cabled entry	1 tapped entry for ISO M16 x 1.5 pre-cabled gland (5) or M12 connector					
Fixing centres (mm)	20	20	20	M18 x 1	M18 x 1	
Body dimensions (mm) W x D x H	31 x 30 x 65					
<b>Metal switches</b>						
Complete switch	2-pole NC+NO snap action	XCKD2110P16	XCKD2102P16	XCKD2121P16	XCKD21H0P16	XCKD21H2P16
	2-pole NC+NO break before make, slow break	XCKD2510P16	XCKD2502P16	XCKD2521P16	-	XCKD25H2P16
	2-pole NC+NO snap action (M12-5-pins)	XCKD2110M12	XCKD2102M12	XCKD2121M12	XCKD21H0M12	XCKD21H2M12
<b>Plastic, double insulated switches</b>						
Complete switch	2-pole NC+NO snap action	XCKP2110P16	XCKP2102P16	XCKP2121P16	XCKP21H0P16	XCKP21H2P16
	2-pole NC+NO break before make, slow break	XCKP2510P16	XCKP2502P16	XCKP2521P16	-	-
	2-pole NC+NO snap action (M12-4-pins)	XCKP2110M12	XCKP2102M12	XCKP2121M12	-	-

(5) For Pg 11 pre-cabled entries, replace P16 by G11. Example: XCKD2110P16 becomes **XCKD2110G11**.  
For other pre-cabled entries, see customised assembly on page 7.

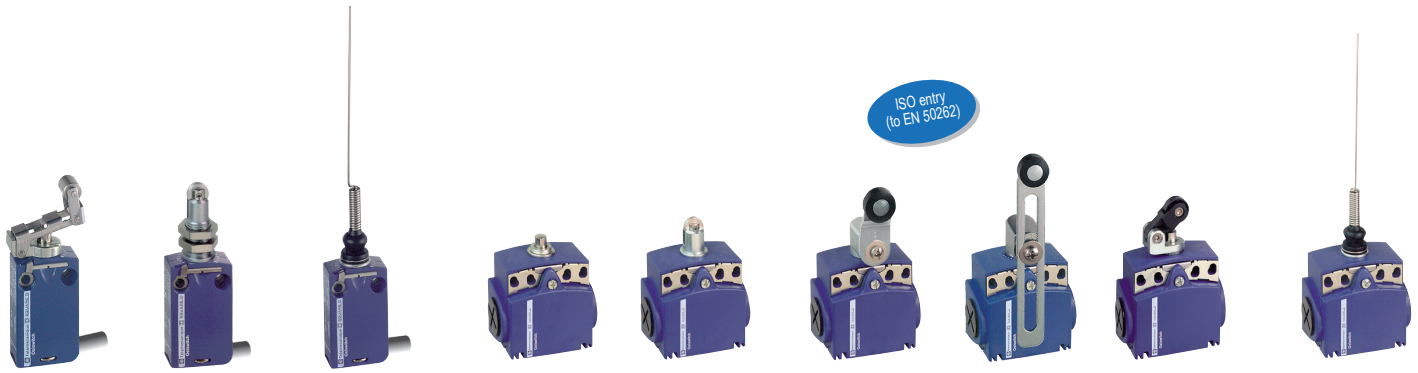

Compact XCKT plastic, 2 cable entries

Retractable steel roller lever plunger	M12 head steel roller plunger	"Cat's whisker"	Metal end plunger	Steel roller plunger	Thermoplastic roller lever	Variable length thermoplastic roller lever	Thermoplastic roller lever plunger, horizontal actuation (3)	"Cat's whisker"
10	10	5	15	10	10	10	15	5
0,5	0,1	1	0,5	0,5	1,5	1,5	1	1
⊖	⊕	–	⊕	⊕	⊕	⊕	⊕	–
CE, CSA, CCC, EAC								
IP66 and IP67								
AC 15 ; A 300 (Ue = 240 V, Ie = 3 A) / DC 13 ; Q 300 (Ue = 250 V, Ie = 0,27 A)								
20	M12 x 1	20	20 ou 40					
58 x 30 x 51								
2 tapped entries for ISO M16 x 1.5 pre-cabled gland (4)								
XCMD2124L1	XCMD21F2L1	XCMD2106L1	XCKT2110P16	XCKT2102P16	XCKT2118P16	XCKT2145P16	XCKT2121P16	XCKT2106P16
–	XCMD25F2L1	–	–	–	–	–	–	–
XCMD2124C12	XCMD21F2C12	XCMD2106C12	–	–	–	–	–	–
XCMD2124M12	XCMD21F2M12	XCMD2106M12	–	–	–	–	–	–

(3) Actuation in 1 direction

(4) For Pg 11 pre-cabled entries, replace P16 by G11. Example: XCKT2110P16 becomes **XCKT2110G11**.



Application - XCPR and XCDR with manual reset

Thermoplastic roller lever	Variable length Thermoplastic roller lever	Thermoplastic roller lever Ø 50 mm	"Cat's whisker"	Metal end plunger	Steel roller plunger	Thermoplastic roller lever plunger, horizontal actuation (6)	Thermoplastic roller lever plunger, vertical actuation (6)	Thermoplastic roller lever
10	10	10	5	1	1	1	1	1
1.5	1.5	1.5	1	0.5	0.5	1	1	1.5
⊖	⊕	⊕	–	⊕	⊕	⊕	⊖	⊕
CE, CSA, CCC, EAC								
IP66 and IP67								
AC 15 ; A 300 (Ue = 240 V, Ie = 3 A) / DC 13 ; Q 300 (Ue = 250 V, Ie = 0,27 A)								
1 tapped entry for ISO M20 x 1.5 pre-cabled gland (7)								
20	20	20	20	20	20	20	20	20
31 x 30 x 95								
XCKD2118P16	XCKD2145P16	XCKD2139P16	XCKD2106P16	–	–	–	–	–
XCKD2518P16	XCKD2545P16	XCKD2539P16	XCKD2506P16	–	–	–	–	–
XCKD2118M12	XCKD2145M12	XCKD2139M12	XCKD2106M12	–	–	–	–	–
XCKP2118P16	XCKP2145P16	XCKP2139P16	XCKP2106P16	XCPR2110P20	XCPR2102P20	XCPR2121P20	XCPR2127P20	XCPR2118P20
XCKP2518P16	XCKP2545P16	XCKP2539P16	–	XCPR2510P20	XCPR2502P20	XCPR2521P20	XCPR2527P20	XCPR2518P20
XCKP2118M12	XCKP2145M12	–	XCKP2106M12	–	–	–	–	–

(6) Actuation in 1 direction.

(7) For Pg 13.5 pre-cabled entries, replace P20 by G13. Example: XCPR2110P20 becomes **XCPR2110G13**.

For other pre-cabled entries, see customised assembly on page 7.

# XC Limit switches





## Customised assembly of miniature and compact

### Heads - common to miniature and compact bodies

#### Metal plunger and multi-directional heads









Description	Metal end plunger	Metal end plunger with protective elastomer boot	Steel roller plunger	Retractable steel roller lever plunger	Thermoplastic roller lever plunger, horizontal actuation
					
Reference	➔ ZCE10	➔ ZCE11	➔ ZCE02	➔ ZCE24 (2)	➔ ZCE21

#### Metal rotary heads and levers

Description	Rotary head without lever, spring return, for actuation from LH and RH side	Thermoplastic roller lever, track: 24/31 mm (ZCMD) 29/36 mm (ZCD/P/T)	Steel roller lever, track: 24/31 mm (ZCMD) 29/36 mm (ZCD/P/T)	Thermoplastic roller lever, track: 16/39 mm (ZCMD) 21/44 mm (ZCD/P/T)	Steel roller lever, track: 16/39 mm (ZCMD) 21/44 mm (ZCD/P/T)
					
Reference	➔ ZCE01	➔ ZCY15 (2)	➔ ZCY16 (2)	➔ ZCY25 (2)	➔ ZCY26 (2)
	(1) Recommended for use with bodies:: ZCD... / ZCP... / ZCT...			(2) Recommended for use with bodies: : ZCMD...	

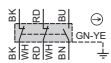
### Bodies

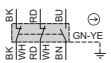
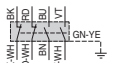
#### Miniature

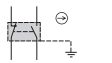
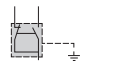
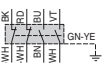
Type of contact																																							
																																							
Reference of metal body	ZCMD21	ZCMD39	ZCMD25	ZCMD37	ZCMD4D	—	ZCMD21C12	ZCMD21M12	—																														
Pre-cabled	<table border="1"> <tr> <td>L = 1 m</td> <td>—</td> <td>—</td> <td>—</td> <td>—</td> <td>—</td> <td>ZCMD21L1 (3)</td> <td>—</td> <td>—</td> <td>ZCMD41L1</td> </tr> <tr> <td>L = 2 m</td> <td>—</td> <td>—</td> <td>—</td> <td>—</td> <td>—</td> <td>ZCMD21L2 (3)</td> <td>—</td> <td>—</td> <td>ZCMD41L2</td> </tr> <tr> <td>L = 5 m</td> <td>—</td> <td>—</td> <td>—</td> <td>—</td> <td>—</td> <td>ZCMD21L5 (3)</td> <td>—</td> <td>—</td> <td>ZCMD41L5</td> </tr> </table>									L = 1 m	—	—	—	—	—	ZCMD21L1 (3)	—	—	ZCMD41L1	L = 2 m	—	—	—	—	—	ZCMD21L2 (3)	—	—	ZCMD41L2	L = 5 m	—	—	—	—	—	ZCMD21L5 (3)	—	—	ZCMD41L5
L = 1 m	—	—	—	—	—	ZCMD21L1 (3)	—	—	ZCMD41L1																														
L = 2 m	—	—	—	—	—	ZCMD21L2 (3)	—	—	ZCMD41L2																														
L = 5 m	—	—	—	—	—	ZCMD21L5 (3)	—	—	ZCMD41L5																														

(3) For contact 2-pole NC+NO slow break, replace 21 by 25. Example: ZCMD21L1 becomes ZCMD25L1

(4) For contact 2NC+NO or 2NC+2NO, replace 21 by 37, 39 or 4D. Example ZCMD21L1 becomes ZCMD4DL1

### Connection of miniature bodies

Specific Pre-cabled connection components						Option : PUR pre-wired M12 connector, L = 2 m (1)	
	for ZCMD21	for ZCMD39	for ZCMD25	for ZCMD37	for ZCMD4D	5-pin	4-pin
L = 1 m	ZCMC21L1	ZCMC39L1	ZCMC25L1	ZCMC37L1	ZCMC4DL1		
L = 2 m	ZCMC21L2	ZCMC39L2	ZCMC25L2	ZCMC37L2	ZCMC4DL2		
L = 5 m	ZCMC21L5	ZCMC39L5	ZCMC25L5	ZCMC37L5	ZCMC4DL5	XZCP1164L2	XZCP1141L2

➔ Positive opening operation.

(1) For PVC cable see page 47



Thermoplastic roller lever plunger, vertical actuation



⊕ ZCE27

M12 head metal end plunger



⊕ ZCEF0 (2)

M18 head metal end plunger



⊕ ZCEH0 (1)

M12 head steel roller plunger



⊕ ZCEF2 (2)

M18 head steel roller plunger



⊕ ZCEH2 (1)

Spring rod



ZCE08

Spring rod with plastic end



ZCE07

"Cat's whisker"



ZCE06

Thermoplastic roller lever, track: 20/36 mm (ZCMD) 24/40 mm (ZCD/P/T)



⊕ ZCY18 (1)

Steel roller lever, track: 20/36 mm (ZCMD) 24/40 mm (ZCD/P/T)



⊕ ZCY19 (1)

Ceramic roller lever



⊕ ZCY22

Variable length thermoplastic roller lever



⊕ ZCY45

Round, glass fibre rod lever Ø 3 mm L = 125 mm



ZCY55

Metal spring-rod lever



ZCY91

Thermoplastic roller lever Ø 50 mm



⊕ ZCY39

Adjustable thermoplastic roller lever Ø 50 mm



⊕ ZCY49

## Compact



Type of contact	⊕	⊕	⊕	⊕	⊕	⊕	⊕	⊕	⊕
	2-pole NC+NO Snap action	3-pole 2NC+1NO Snap action	2-pole NC+NO Slow break	2-pole NC+NC Slow break	2-pole NO+NO Slow break	2-pole NC+NC Snap action	3-pole 2NC+1NO Slow break	2-pole NC+NO - Snap action	
Ref. metal body	ZCD21	ZCD39	ZCD25	ZCD27	ZCD28	ZCD29	ZCD37	ZCD21M12	-
Ref. plastic body	ZCP21	ZCP39	ZCP25	ZCP27	ZCP28	ZCP29	ZCP37	-	ZCP21M12

## Connection of compact bodies

Interchangeable outlet for cable gland							Option : PUR prolongateur M12, L = 2 m (1)	
Description	For ISO M16 cable gland	For ISO M20 cable gland	For Pg 11 cable gland	For Pg 13.5 cable gland	For 1/2" NPT cable gland	For PF 1/2 (G12) cable gland		
Metal	ZCDEP16	ZCDEP20	ZCDEG11	ZCDEG13	ZCDEN12	ZCDEF12	XZCP1164L2	XZCP1141L2
Plastic	ZCPEP16	ZCPEP20	ZCPEG11	ZCPEG13	ZCPEN12	ZCPEF12		

(1) For PVC cable see page 47

# XC Limit switches

## Classic - XCKM, XCKL, complete switches

ISO entry  
(to EN 50262)



### XCKM

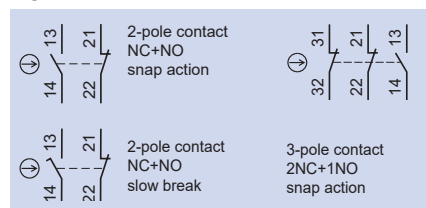

### Type XCKM metal, 3 cable entries, XCKL metal, 1 cable entry

Type of operator	Metal end plunger	Steel roller plunger	Roller lever plunger, horizontal actuation in 1 direction	Thermoplastic roller lever	"Cat's whisker"
Mechanical durability (millions of operating cycles)	20	20	20	15	10
Actuation speed (in m/s)	0,5	0,5	1,5	1,5	0,5
Product certification	CE, UL, CSA, CCC, EAC, C-TICK, BV				
Degree of protection conforming to IEC 60529	IP66				
Rated operational characteristics (conforming to EN IEC 60947-5-1)	AC 15 ; A 300 (Ue = 240 V, Ie = 3 A) / DC 13 ; Q 300 (Ue = 250 V, Ie = 0,27 A)				
Cable entry (1)	XCKM XCKL	3 tapped entries for ISO M20 x 1.5 cable gland (2 entries fitted with blanking plugs) 1 cable entry with cable gland			
Fixing centres (mm)	41				
Body dimensions (mm) W x D x H	XCKM / XCKL 64 x 30 x 64 / 52 x 30 x 72				

Complete switch	XCKM				
	2-pole NC+NO snap action	⊕ XCKM110H29	⊕ XCKM102H29	⊖ XCKM121H29	⊖ XCKM115H29 XCKM106H29
	2-pole NC+NO, break before make, slow break	⊕ XCKM510H29	⊕ XCKM502H29	⊖ XCKM521H29	⊖ XCKM515H29 -
Complete switch	XCKL				
	2-pole NC+NO snap action	⊕ XCKL110	⊕ XCKL102	⊖ XCKL121	⊖ XCKL115 XCKL106

1) For Pg 11 pre-cabled entries delete the reference suffix H29. Example : XCKM110H29 becomes **XCKM110**

## Classic - XCKM, XCKL, Customised assembly - Body/contact sub-assemblies



### Type XCKM metal, 3 pre-cabled entries

#### Type of contact

Reference of body with contact block	⊕ XCKM1H29	⊖ XCKM5H29	⊕ XCKMD39H29	⊖ XCKMD37H29
XCKL reference of body with contact block (2)	⊕ XCKL1	⊖ XCKL5	-	-
Reference of contact block only	⊕ XE2SP2151	⊖ XE2NP2151	⊕ XE3SP2141	⊖ XE3NP2141

(2) For cable entry 1/2" NPT, add H7. Example: XCKL1 becomes **XCKL1H7**. ⊕ Positive opening operation.

## Operating heads, complete or for customer assembly



Complete switch

=



Body/contact assembly

+



Head

+



Lever

### Rotary or multi-directional heads

metal head with thermoplastic roller lever

metal head with steel roller lever

with variable length thermoplastic roller lever (2)

with Ø 6 mm thermoplastic rod L = 200 mm (3)

with thermoplastic roller lever (3) for actuation from left AND right or left OR right

with "Cat's whisker"

with spring rod

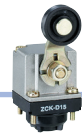

Reference

⊕ ZCKD15

⊕ ZCKD16

ZCKD41

ZCKD59

⊕ ZCKD31

ZCKD06

ZCKD08

### Plunger heads

with metal end plunger

with metal end plunger and protective boot

with steel roller plunger

with steel roller plunger and protective boot

with thermoplastic roller lever plunger, horizontal actuation in 1 direction

with steel roller lever plunger, horizontal actuation in 1 direction



Reference

⊕ ZCKD10

⊕ ZCKD109

⊕ ZCKD02

⊕ ZCKD029

⊕ ZCKD21

⊕ ZCKD23

### Rotary heads and separate levers

spring return, for actuation from left AND right or left OR right

lever with thermoplastic roller (2)

lever with steel roller (2)

variable length lever with thermoplastic roller (2)

variable length lever with steel roller (2)

rod, Ø 6 mm thermoplastic L = 200 mm (3)



Reference

⊕ ZCKD05

⊕ ZCKY31

⊕ ZCKY33

ZCKY41

ZCKY43

ZCKY59

(2) Adjustable throughout 360° in 5° steps, or in 90° steps by reversing the notched washer.

(3) Adjustable throughout 360° in 5° steps, or in 45° steps by reversing the lever mounting.

# XC Limit switches

## Industrial - XCKJ, complete switches

### XCKJ

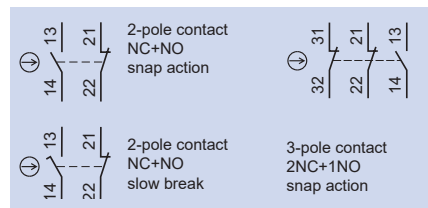

ISO entry  
(to EN 50262)

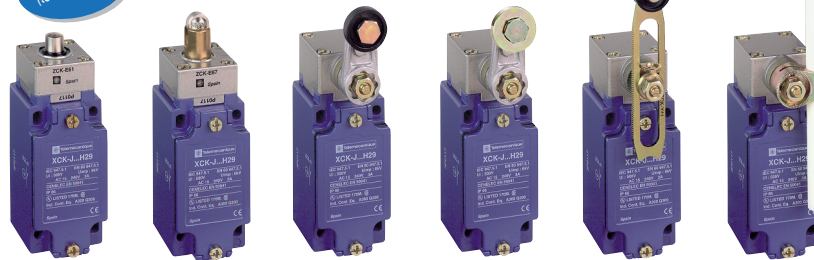

### Type XCKJ metal, fixed body, conforming to standard EN 50041

Type of operator	Metal end plunger	Steel roller plunger	Thermoplastic roller lever	Steel roller lever	Variable length thermoplastic roller lever	Polyamide Ø 6 mm rod lever L = 200 mm
Mechanical durability (millions of operating cycles)	30	25	30	30	30	30
Actuation speed (in m/s)	0,5	1	1,5	1,5	1,5	1,5
Product certification	CE, UL, CSA, CCC, EAC, C-TICK, BV					
Degree of protection conforming to IEC 60529	IP 66					
Rated operational characteristics (conforming to EN IEC 60947-5-1)	AC 15 ; A 300 (Ue = 240 V, Ie = 3 A) / DC 13 ; Q 300 (Ue = 250 V, Ie = 0,27 A).					
Cable entry (1)	1 tapped entry for ISO M20 x 1.5 cable gland					
Fixing centres (mm)	30 x 60					
Body dimensions (mm) W x D x H	40 x 44 x 77					

Complete switch	M20	2-pole NC+NO snap action	⊕ XCKJ161H29	⊕ XCKJ167H29	⊕ XCKJ10511H29	⊕ XCKJ10513H29	XCKJ10541H29	XCKJ10559H29
		2-pole NC+NO break before make, slow break	⊕ XCKJ561H29	⊕ XCKJ567H29	⊕ XCKJ50511H29	⊕ XCKJ50513H29	XCKJ50541H29	XCKJ50559H29
	1/2" NPT	2-pole NC+NO snap action	⊕ XCKJ161H7	⊕ XCKJ167H7	⊕ XCKJ10511H7	⊕ XCKJ10513H7	XCKJ10541H7	XCKJ10559H7
	M12 5P	2-pole NC+NO snap action	⊕ XCKJ161D	⊕ XCKJ167D	⊕ XCKJ10511D	⊕ XCKJ10513D	XCKJ10541D	XCKJ10559D

(1) For Pg 13.5 pre-cabled entry delete the reference suffix H29. Example: XCKJ161H29 becomes **XCKJ161**. ⊕ Positive opening operation.

## Industrial - XCKJ,

### Customised assembly - Body/contact sub-assemblies

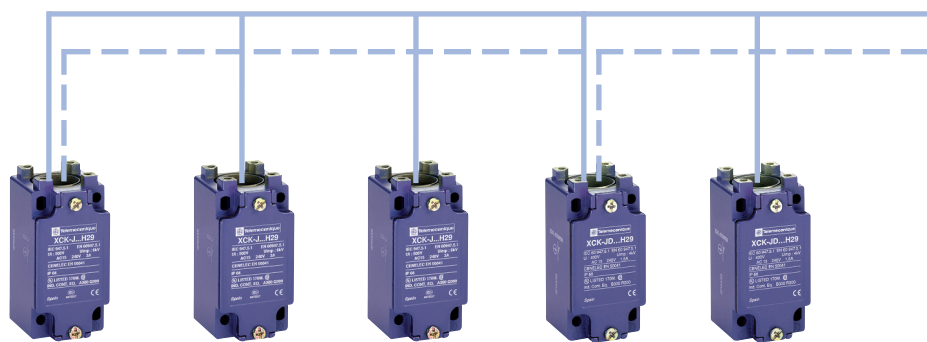

### Type XCKJ metal, 1 cable entry

Type of contact		⊕ XCKJ1H29	⊕ XCKJ5H29	ZCKJ2H29	⊕ XCKJD39H29	⊕ XCKJD37H29
		2-pole NC+NO snap action	2-pole NC+NO slow break	2 C/O snap action Simultaneous	3-pole 2NC+1NO snap action	3-pole 2NC+1NO slow break
Cable entry (1)		1 tapped entry for ISO M20 x 1.5 cable gland				
Reference of body with contact block	M20	⊕ ZCKJ1H29	⊕ ZCKJ5H29	ZCKJ2H29	⊕ ZCKJD39H29	⊕ ZCKJD37H29
	Pg13	⊕ ZCKJ1	⊕ ZCKJ5	ZCKJ2	-	-
	1/2" NPT	⊕ ZCKJ1H7	⊕ ZCKJ5H7	ZCKJ2H7	-	-
	M12 (5-pins)	⊕ ZCKJ1D	⊕ ZCKJ5D	-	-	-
Reference of contact block only		⊕ XE2SP2151	⊕ XE2NP2151	-	⊕ XE3SP2141	⊕ XE3NP2141

# Operating heads, complete or for customer assembly



Complete switch

=



Body/contact assembly

+



Head

+



Lever

## Plunger or multi-directional heads

with reinforced steel roller end plunger

with metal end plunger

with thermoplastic roller lever plunger, 1 direct. of actuation

with steel roller lever plunger, 1 direct. of actuation

with steel roller end plunger

with steel ball bearing end plunger

End steel roller plunger with protective boot



Reference

⊖ ZCKE67

⊖ ZCKE61

⊖ ZCKE21

⊖ ZCKE23

⊖ ZCKE62

⊖ ZCKE66

⊖ ZCKE629

with metal side plunger

Side steel roller plunger, horizontal

Side steel roller plunger, vertical

with spring rod

with "Cat's whisker"



Reference

⊖ ZCKE63

⊖ ZCKE64

ZCKE65

ZCKE08

ZCKE06

## Separate rotary heads and levers

spring return for actuation from left AND right or left OR right

lever with thermoplastic roller (2)

lever with steel roller (2)

variable length lever with thermoplastic roller (2)

variable length lever with steel roller (2)

rod, Ø 6 mm thermoplastic L = 200 mm (2)

square rod lever, round rod steel, U 3 mm L = 125 mm (2)

steel, Ø 3 mm L = 125 mm (2)

spring lever with thermoplastic end (3)

spring-metal rod lever



Reference

⊖ ZCKE05

⊖ ZCKY11

⊖ ZCKY13

ZCKY41

ZCKY43

ZCKY59

ZCKY51

ZCKY53

ZCKY81

ZCKY91

stay put for actuation from left AND right

forked arm lever with thermoplastic rollers, 1 track (2)

forked arm lever with thermoplastic rollers, 2 track (2)



Reference

ZCKE09

ZCKY71

ZCKY61

(2) Adjustable throughout 360° in 5° steps, or in 45° steps by reversing the lever mounting.  
 (3) Adjustable throughout 360° in 5° steps, or in 90° steps by reversing the notched washer.

# XC Limit switches

## Classic - XCKS, complete switches

**XCKS**

**XCKMR**

**XCR**

ISO entry (to EN 50262)

### Type XCKS plastic, double insulated, conforming to standard EN 50041

Type of operator	Metal end plunger	Steel roller plunger	Thermoplastic roller lever	Variable length thermoplastic roller lever	Rubber roller lever Ø 50 mm	Polyamide Ø 6 mm rod lever L = 200 mm
Mechanical durability (millions of operating cycles)	25	15	20	20	20	20
Actuation speed (in m/s)	0,5	0,5	1,5	1,5	1	1
Product certification	CE, UL, CSA, CCC, EAC					
Degree of protection conforming to IEC 60529	IP65 / IP67					
Rated operational characteristics (conforming to EN IEC 60947-5-1)	AC 15 ; A 300 (Ue = 240 V, Ie = 3 A) / DC 13 ; Q 300 (Ue = 250 V, Ie = 0,27 A)					
Cable entry	1 tapped entry for ISO M20 x 1.5 pre-cabled gland (1)					
Fixing centres (mm)	30 x 60					
Body dimensions (mm) W x D x H	XCKS : 40 x 37 x 78 / ZCKS: 40 x 36 x 73					

Complete switch	2-pole NC+NO snap action	↻ XCKS101H29	↻ XCKS102H29	↻ XCKS131H29	↻ XCKS141H29	XCKS139H29	XCKS159H29
	2-pole NC+NO break before make, slow break	↻ XCKS501H29	↻ XCKS502H29	↻ XCKS531H29	↻ XCKS541H29	XCKS539H29	XCKS559H29
Corps	2-pole NC+NO snap action	↻ ZCKS1H29	↻ ZCKS1H29	↻ ZCKS1H29	↻ ZCKS1H29	↻ ZCKS1H29	↻ ZCKS1H29
	2-pole NC+NO break before make, slow break	↻ ZCKS5H29	↻ ZCKS5H29	↻ ZCKS5H29	↻ ZCKS5H29	↻ ZCKS5H29	↻ ZCKS5H29
	3-pole 2NC+1NO snap action	↻ ZCKSD39H29	↻ ZCKSD39H29	↻ ZCKSD39H29	↻ ZCKSD39H29	↻ ZCKSD39H29	↻ ZCKSD39H29
Associated head (including operator)		↻ ZCKD01	↻ ZCKD02	↻ ZCKD31	↻ ZCKD41	ZCKD39	ZCKD59
Operating lever for rotary head		-	-	↻ ZCKY31	↻ ZCKY41	ZCKY39	ZCKY59
Complete switch	Snap-action 2-pole 2X (1 NC + 1 NO) contact	-	-	-	-	-	-
	Both contacts act in each direction of actuation	-	-	-	-	-	-
Complete switch	1 contact operates in each direction	-	-	-	-	-	-
	2 C/O staggered snap action contacts	-	-	-	-	-	-
Complete switch	2 x 2 pole NC+NC staggered, slow break contacts	-	-	-	-	-	-

↻ Positive opening operation. ZCKS have different designs (1) For Pg 13.5 Cable entry delete the reference suffix H29. Example: XCKS131H29 becomes **XCKS131**.

## Wireless & battery-less - XCMW



XCMW (Miniature format)					
Type of operator	Metal end plunger	Metal roller plunger	Plastic roller plunger	Metal roller lever	Variable length plastic roller lever
References of plastic body	XCMW110	XCMW102	XCMW115	XCMW116	XCMW145
Communication protocol	Zigbee (Green Power) to 2.4 Ghz (IEEE 802.15.4)				
Sensing distance	100 m free field / 300 m with relay antenna ZBRA1 / 25 m with receiver in metallic enclosure				
Product certification	EN/IEC 60947-5-1, EC directive 2004/108/EC, R&TTE directive 1999/5/EC, EAC, conformity to CE marking				
Radio agreement	FCC, IC				
Max switching operation / hour	3600/h				
Max force for set actuation	5 daN		0,5 N.m		
Fixing dimensions	30 x 70 mm				
Ambiant temperature operating // storage	-25°C + 55°C // -40°C + 70°C				
IP degree of protection IEC	IP66, IP67 according to IEN/IEC 60529				

## Severe duty for hoisting and materials handling applications XCKMR and XCR, complete switches



Types XCKMR and XCR "Application - hoisting, materials handling, conveying"

Square rod levers U 6 mm, "crossed"	Square rod levers U 6 mm, "crossed"	Square rod lever U 6 mm	Large roller rod lever Ø 50 mm	Square rod levers U 6 mm, "crossed" or "T"	Conveyor belt shift monitoring switches	
					Galvanised steel operating lever	Stainless steel operating lever
2	1	10	10	10	0,3	0,3
1,5	1,5	1,5	1,5	1,5	1,5	1,5
CE, CSA, CCC, EAC						
IP66		IP65		IP54		IP66
AC 15 ; A 300 (Ue = 240 V, Ie = 3 A) / DC 13 ; Q 300 (Ue = 250 V, Ie = 0,27 A)						
3 x ISO M20 x 1.5 entries		1x ISO M20x1.5 entry & 2 holes for ISO M20 cable gland		1 tapped entry for n° 13 pre-cabled gland (for ISO M20 x 1.5, adaptor DE9RA1620 must be ordered separately)		
61,5		85 x 75				105 x 70
118 x 59 x 77		116 x 66 x 77				85 x 87 x 146
-	-	-	-	-	-	-
-	-	-	-	-	-	-
-	-	-	-	-	-	-
-	-	-	-	-	-	-
-	-	-	-	-	-	-
-	-	-	-	-	-	-
-	-	-	-	-	-	-
-	-	-	-	-	-	-
-	-	-	-	-	-	-
-	-	-	⇒ XCRA11(2)	⇒ XCRA15	⇒ XCRE18(2)	-
-	-	-	⇒ XCRB11(2)	-	⇒ XCRF17(3)	-
-	-	-	-	-	-	-
-	-	-	-	-	XCRT115	XCRT315 (4)
XCKMR54D1H29 (2)	XCKVR54D1H29 (2)(5)	-	-	-	-	-

(2) Steel rods, L = 200 mm

(3) Steel "T" rods, L = 200 mm, W = 300 mm.

(4) Polyester enclosure<sup>2</sup>

(5) Plastic enclosure



### Receivers for wireless limit switches

Reference	XZBWR2STT24	ZBRRRC	ZBRRD	ZBRN1/2
Number of emitters	2	32	32	60
Number and Output type	2 x PNP +2 for diagnostic	4 x PNP	2 x relay RT	60 modbus TCP protocol and serial line
Supply voltage supply	24VDC (-15...+ 15%)		24...240V AC/DC (-10...+ 10%)	
Nominal current and voltage of output	0.2A / 24V DC		0.3A / 48V DC 3A / 120V AC according to IEC 90947-5-1 3A / 250V AC according to UL 508 & CSA C22.14	
Product and radio certification	EN/IEC 60947-5-1 conformity to CE marking	EN/IEC 60947-5-1, UL508, CSA C22.2 n° 14, CCC, EAC FCC, RSS, C-stick, ANATEL, SRRC conformity to CE marking		
Ambiant temperature operating // storage	-25°C +55°C // -40°C + 70°C			

### Packages with transmitter and receiver

Package	Reference
XCMW102 transmitter and ZBRRD receiver	XCMWD02
XCMW115 transmitter and ZBRRD receiver	XCMWD15

# XM Sensors for pressure control

## Electronic sensors XMLP Low pressure

For industrial applications  
(hydraulic circuits,  
water pumping)



Pressure range (bar) (1)	-1...0	0...0,5	0...1	0...2,5	0...4	0...6	-1...+1	-1...+5	
Fluids controlled	Hydraulic oils, air, fresh water								
Ambient air temperature	- 30... + 85°C								
Degree of protection	IP65 (EN175301-803-A), IP65, IP67, IP69K (M12 connector)								
Product certification	CE, cULus conforming to UL 61010-1, NSF61								
Voltage limits (V)	7...33 Vdc for 4...20 mA, 12...33 Vdc for 0...10 V								
Dimensions (mm) H x W x D	26 x 34,3 (M12), 26 x 55 (EN175301-803-A)								
Fluid connection (2)	G1/4A (male)								
Electrical connection (3)	M12 4-pin, EN175301-803-A								
Output type (4)	4...20 mA 2-wires technique, 0...10V 3-wires technique								
Analogue output 4...20 mA	M12 4-pins	XMLPM00GD21F	XMLP500MD21F	XMLP001GD21F	XMLP2D5GD21F	XMLP004GD21F	XMLP006GD21F	XMLPM01GD21F	XMLPM05GD21F
	EN175301-803-A	XMLPM00GC21F	XMLP500MC21F	XMLP001GC21F	XMLP2D5GC21F	XMLP004GC21F	XMLP006GC21F	XMLPM01GC21F	-
Analogue output 0...10 V	M12 4-pins	XMLPM00GD71F	-	-	-	XMLP004GD71F	-	-	-
	EN175301-803-A	-	-	-	-	-	-	-	-

(1) Also available with psi range (2) Also available with 1/4"-18NPT male or 7/16-20UNF female (3) Also available with 3-pins packard connector (4) Also available with 0.5...4.5 V ratiometric output Available in bulk packs for selling in lots of 25 pcs. Add Q suffix to the reference, ex: XMLP001GD21F becomes **XMLP001GD21FQ**

## Electronic sensors XMLP High pressure

For industrial applications  
(hydraulic circuits,  
HVAC)



Pressure range (bar) (1)	-1...+9	0...10	0...16	0...25	0...60	0...100	0...250	0...400	
Fluids controlled	Hydraulic oils, air, fresh water, gas, refrigeration fluids from - 30... + 135°C								
Ambient air temperature	- 30... + 85°C								
Degree of protection (IEC 60529)	IP65 (EN175301-803-A), IP65, IP67 and IP69K (connector M12)								
Product certification	CE, cULus conforming to UL61010-1, NSF61								
Voltage limits (V)	7...33 V DC for 4...20 mA, 12...33 V DC for 0...10 V								
Dimensions (mm) Ø x L	26 x 38 (M12), 26 x 60,5 (EN175301-803-A)								
Fluid connection (2)	G 1/4 A (male)								
Electrical connection (3)	connector M12 4-pins, EN 175301-803-A								
Output type (4)	4...20 mA, technique 2-wires, 0...10V, technique 3-wires								
Analogue output 4...20 mA	M12 4-pins	XMLPM09BD21F	XMLP010BD21F	XMLP016BD21F	XMLP025BD21F	XMLP060BD21F	XMLP100BD21F	XMLP250BD21F	XMLP400BD21F
	EN175301-803-A	XMLPM09BC21F	XMLP010BC21F	XMLP016BC21F	XMLP025BC21F	XMLP060BC21F	XMLP100BC21F	XMLP250BC21F	XMLP400BC21F
Analogue output 0...10 V	M12 4-pins	XMLPM09BD71F	XMLP010BD71F	XMLP016BD71F	XMLP025BD71F	-	-	XMLP250BD71F	XMLP400BD71F
	EN175301-803-A	-	XMLP010BC71F	XMLP016BC71F	-	-	-	XMLP250BC71F	XMLP400BC71F

(1) Also available with psi range (2) Also available with 1/4"-18NPT male or 7/16-20UNF female (3) Also available with 3-pins packard connector (4) Also available with 0.5...4.5 V ratiometric output. Available in bulk packs for selling in lots of 25 pcs. Add Q suffix to the reference, ex: XMLP001GD21F becomes **XMLP001GD21FQ**

## Electronic sensors XMEP

For mobile lift applications



Pressure range (bar) (1)	0...60	0...100	0...250	0...400	0...600	
Fluids controlled	Hydraulic oils, air, fresh water					
Operating temperature range	- 40... + 100°C					
Degree of protection	Up to IP69K					
Product certification	E2 certified					
Voltage limits (V)	Electromagnetic protection up to 100V/m					
Dimensions (mm) H x W	From 26mm x 38mm					
Fluid entry	G1/4A (male)					
Connectors (3)	Analogue output					
M12	0,5-4,5V	XMEP060BD11F	XMEP100BD11F	XMEP250BD11F	XMEP400BD11F	XMEP600BD11F
	4-20mA	XMEP060BD21F	XMEP100BD21F	XMEP250BD21F	XMEP400BD21F	XMEP600BD21F
	0-10V	XMEP060BD71F	XMEP100BD71F	XMEP250BD71F	XMEP400BD71F	XMEP600BD71F
Deutsch DT04-3P	0,5-4,5V	XMEP060BT11F	XMEP100BT11F	XMEP250BT11F	XMEP400BT11F	XMEP600BT11F
	4-20mA	XMEP060BT21F	XMEP100BT21F	XMEP250BT21F	XMEP400BT21F	XMEP600BT21F
	0-10V	XMEP060BT71F	XMEP100BT71F	XMEP250BT71F	XMEP400BT71F	XMEP600BT71F
AMP Superseal 1,5 3-Pin	0,5-4,5V	XMEP060BV11F	XMEP100BV11F	XMEP250BV11F	XMEP400BV11F	XMEP600BV11F
	4-20mA	XMEP060BV21F	XMEP100BV21F	XMEP250BV21F	XMEP400BV21F	XMEP600BV21F
	0-10V	XMEP060BV71F	XMEP100BV71F	XMEP250BV71F	XMEP400BV71F	XMEP600BV71F

For more fluid entry, output, and size options, visit [www.tesensors.com](http://www.tesensors.com)



# Electronic sensors XMLK

Electrical connection by EN 175301-803-A connector, M12 connector

For pumping applications



Pressure range (bar) (1)	0...6	0...10	0...16	0...25	0...6	0...10	0...16	0...25	
Fluids controlled	air, fresh water								
Ambient air temperature	0...+ 80°C								
Degree of protection (IEC 60529)	IP65								
Product certification	CE, UL, CSA								
Voltage limits (V)	8...33 V DC for 4...20 mA, 16,2...33V DC for 0...10 V								
Dimensions (mm) Ø x L	36 x 67,5 (not including connector)								
Fluid connection (2)	G 1/4" A (male)								
Electrical connection (3)	EN 175301-803-A				M12 3-pins male				
Output type (4)	4...20 mA, 2-wires technique, 0...10V, 3-wires technique								
Analogue output	4...20 mA	XMLK006B2C21	XMLK010B2C21	XMLK016B2C21	–	XMLK006B2D21	XMLK010B2D21	XMLK016B2D21	XMLK025B2D21
	0...10 V	XMLK006B2C71	XMLK010B2C71	XMLK016B2C71	XMLK025B2C71	XMLK006B2D71	XMLK010B2D71	XMLK016B2D71	XMLK025B2D71

(1) Also available with psi range. (2) Also available with 1/4"-18NPT male fluid entry. (3) Also available with 3-pins packard connector. (4) Other types of output; 0...5 V, 0...10 V, etc. Available in bulk packs for selling in lots. Add TQ suffix to the reference. ex: XMLK006B2C21 becomes **XMLK006B2C21TQ**.

# Electronic sensors XMLR

Electronic + Display



Adjustable pressure range (bar) (1)	-1...0	0...1	0...2,5	0...10	0...16	0...25	0...40	0...250	0...400	
Fluids controlled	Hydraulic oils, air, fresh water, refrigerant fluids, gas									
Ambient air temperature	- 20...+ 80°C									
Degree of protection (conforming to IEC 60529)	IP65, IP67 conforming to EN/IEC 60529									
Product certification	CE, cULus conforming to UL 61010-1, NSF61									
Voltage limits (V)	17...33 Vdc									
Dimensions (mm) H x W x D	93 x 41 x 42							88 x 41 x 42		
Fluid connection (2)	G1/4A (female)									
Electrical connection	M12 connector 4-pins or 5-pins									
Configurable with 4-digit display										
Analogue output	4...20 mA	XMLRM01G0T25	XMLR001G0T25	–	XMLR010G0T25	XMLR016G0T25	XMLR025G0T25	–	XMLR250M0T25	XMLR400M0T25
	0...10 V	XMLRM01G0T75	–	–	XMLR010G0T75	–	–	–	–	–
Analogue output + commutation	4...20 mA	XMLRM01G1P25	XMLR001G1P25	XMLR2D5G1P25	XMLR010G1P25	XMLR016G1P25	XMLR025G1P25	XMLR040G1P25	XMLR250M1P25	XMLR400M1P25
PNP - NO/NC programmable	0...10 V	XMLRM01G1P75	XMLR001G1P75	XMLR2D5G1P75	XMLR010G1P75	XMLR016G1P75	XMLR025G1P75	XMLR040G1P75	XMLR250M1P75	XMLR400M1P75
2 switching outputs PNP - NO/NC prog.		XMLRM01G2P05	XMLR001G2P05	XMLR2D5G2P05	XMLR010G2P05	XMLR016G2P05	XMLR025G2P05	XMLR040G2P05	XMLR250M2P05	XMLR400M2P05
Analogue+2 switching outputs	4...20 mA	XMLRM01G2P25	–	–	XMLR010G2P25	–	–	XMLR040G2P25	XMLR250M2P25	XMLR400M2P25
Possible differential (bar) (pressure switches)	Min.	0.03		0.08	0.3	0.48	0.8	1.2	7.5	12
	Max.	0.95		2.38	9.5	15	23.8	38	238	380
Maximum permissible accidental pressure		3	7.5	12	40	62	100	150	750	1200

(1) For other pressure ranges consult our web site.

(2) Also available with 1/4"-18NPT female fluid entry.



# Switch with display ZMLP

(Only usable with 4-20mA analogue output pressure transmitter)

Type of switching mode	Hysteresis	Windows
Displayed value range	-14,5 to 6000 with 27 selectable value ranges	
Degree of protection	IP65, IP67 and IP69K	
Product certification	CE cULus	
Supply voltage	24 VDC (17 ... 33 VDC)	
Electrical connection	Input: M12 female, 4-pins. Output: M12 male, 4-pins	
Analogue output	Switching output	
4...20 mA	PNP	ZMLPA1P2SH ZMLPA1P2SW
4...20 mA	NPN	ZMLPA1N2SH ZMLPA1N2SW
–	2 PNP	ZMLPA2P0SH –
–	2 PNP	ZMLPA2N0SH –

## Suitable female plug-in connectors

PUR Pre-wired connectors, L = 5 m (without LED) (1)  
(1) For PVC cable see page 47

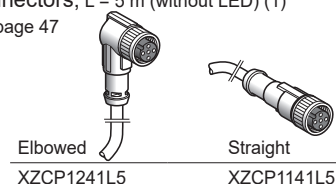

## Other connectors

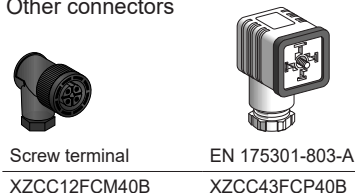

Screw terminal  
XZCC12FCM40B

EN 175301-803-A  
XZCC43FCP40B

Other versions: please consult our Customer Care Centre.

# XM Sensors for pressure control

## Electromechanical pressure and vacuum switches

### XMLA and XMLB

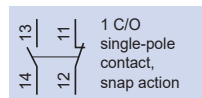

Size (bar)	-1	2.5
Environmental characteristics	Ambient air temperature (°C) : -25...+70 Degree of protection (conforming to IEC 60529) : IP66	
Rated operational characteristics (conforming to EN/IEC 60947-5-1)	AC-15 ; B300 (Ue = 240V, Ie = 1,5A - Ue = 120V, Ie = 3A) / DC-13 ; R300 (Ue = 250V, Ie = 0,1A)	
Product certification	CE, UL, CSA, CCC, BV, LROS, EAC	
Fluid connection	G 1/4" (female) (other connections possible, please consult us)	
Electrical connection	Screw terminals (1), tapped entry for ISO M20 x 1.5 cable gland - <a href="#">For n° 13 (DIN Pg 13.5) cable gland</a>	
Fluids controlled	Hydraulic oils, fresh water, air up to 70°C	Hydraulic oils, fresh water, air to 70°C

### Type XMLA - fixed differential, single threshold detection

Setting range (bar) of upper limit (PH): pressure switches	- 0,28...- 1 (4)	0,15...2,5
Dimensions (mm) H x W x D	113 x 35 x 75	158 x 55 x 77,5
With setting scale	1 C/O single-pole, snap action contact	
	XMLAM01V2S12	XMLA002A2S12
Natural differential (bar)	at low setting	0,13
subtract from PH to give PB	at high setting	0,13

### Type XMLB - adjustable differential, regulation between 2 thresholds

Setting range (bar) of upper limit (PH): pressure switches	- 0,14...- 1 (4)	0,3...2,5
With setting scale	1 C/O single-pole, snap action contact	
	XMLBM02V2S12	XMLB002A2S12
Possible differential (bar)	Min. at low setting	0,16
subtract from PH to give PB	Min. at high setting	0,21
	Max. at high setting	1,75

## XMLC and XMLD

### XMLC

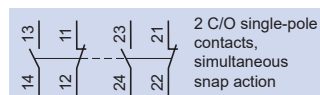

### XMLD

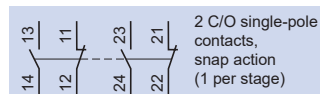

Fluids controlled	Hydraulic oils, fresh water, air up to 70°C	Hydraulic oils, fresh water, air up to 160°C
-------------------	---	--

### Type XMLC - adjustable differential, regulation between 2 thresholds

Setting range (bar) of upper limit (PH): pressure switches	0,14...- 1 (4)	0,3...2,5
Dimensions (mm) H x W x D	113 x 46 x 85	158 x 55 x 90
With setting scale	2 C/O single-pole, snap action contacts	
		XMLC002B2S12
Possible differential (bar)	Min. at low setting	0,13
subtract from PH to give PB	Min. at high setting	0,17
	Max. at high setting	2

### Type XMLD - fixed differential, dual stage, for detection at each threshold

Setting range (bar)	2nd stage switching point (PB2)	- 0,12...- 1 (4)	-
	1st stage switching point (PB1)	- 0,10...- 0,98	-
	Spread between 2 stages (PB2 - PB1)	- 0,02...- 0,88	-
Without setting scale	2 C/O single-pole, snap action contacts (1 per stage)	XMLDM02V1S12	-
Natural differential (bar)	at low setting	0,1 (2)	-
Subtract PH 1/2 to give PB 1/2	at high setting	0,1 (2)	-



4	10	20	35	70	160	300	500
---	----	----	----	----	-----	-----	-----

conforming to IEC 947-5-1 Annexe A, En 60 947-5-1

tapped entry, replace the last number of the reference (2) by 1 (example: XMLA010A2S12 becomes XMLA010A2S11)

Hydraulic oils, fresh water, air up to 70°C	Hydraulic oils up to 160°C
--	----------------------------

0,4...4	0,6...10	1...20	1,5...35	5...70	10...160	20...300	30...500
113 x 35 x 75	113 x 35 x 75	113 x 35 x 75	113 x 35 x 75	113 x 35 x 75	113 x 35 x 75	113 x 35 x 75	113 x 35 x 75
XMLA004A2S12	XMLA010A2S12	XMLA020A2S12	XMLA035A2S12	XMLA070D2S12	XMLA160D2S12	XMLA300D2S12	XMLA500D2S12
0,35	0,5	0,4	1,25	3	5,5	16,5	20
0,35	0,5	1	1,25	7,5	18	35	45

0,25...4	0,7...10	1,3...20	–	–	10...160	22...300	30...500
XMLB004A2S12	XMLB010A2S12	XMLB020A2S12	–	–	XMLB160D2S12	XMLB300D2S12	XMLB500D2S12
0,02	0,57	1	–	–	9,3	19,4	23
0,25	0,85	1,6	–	–	20,8	37	52,6
2,4	7,5	11	–	–	100	200	300

- (1) For electrical connection DIN 43650A (IP65), replace the suffix "S12" in the reference by "C11". Example XMLB010A2S12 becomes **XMLB010A2C11**
- (2) For vacuum switch: natural differential to be added to PB to give PH.
- (3) For vacuum switch: possible differential to be added to PB to give PH.
- (4) Setting range (bar) of lower limit (PB): vacuum switch.



Hydraulic oils, fresh water, air up to 160°C	Hydraulic oils up to 160°C
---	----------------------------

0,3...4	0,7...10	1,3...20	3,5...35	7...70	12...160	22...300	30...500
113 x 46 x 85	113 x 46 x 85	113 x 46 x 85	113 x 46 x 85	113 x 46 x 85	113 x 46 x 85	113 x 46 x 85	113 x 46 x 85
XMLC004B2S12	XMLC010B2S12	XMLC020B2S12	XMLC035B2S12	–	XMLC160D2S12	XMLC300D2S12	–
0,15	0,45	0,7	1	–	9	16	–
0,17	0,7	1	1,5	–	21	35	–
2,5	8	11	22	–	110	240	–

–	–	–	4,4...35	–	–	–	41...500
–	–	–	1,9...32,5	–	–	–	25...484
–	–	–	2,5...20,4	–	–	–	16...244
–	–	–	XMLD035B1S12	–	–	–	XMLD500D1S12
–	–	–	1,5	–	–	–	21
–	–	–	2,6	–	–	–	65

# XM Sensors for pressure control

## Electromechanical pressure switches XM, XMA

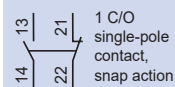

Setting range of upper limit (PH) (bar)	1...6	1,3...12	3,5...25
Fluids controlled	Air, water (fresh water, sea water) from 0...+70°C		
Ambient air temperature	-25...+70°C		
Degree of protection (conforming to IEC 60529)	IP54		
Rated operational characteristics (conforming to EN/IEC 60947-5-1)	AC-15 ; B300 (Ue = 240 V, Ie = 1,5 A - Ue = 120 V, Ie = 3 A) / DC-13 ; R300 (Ue = 250 V, Ie = 0,1 A)		
Product certification	CE, UL, CSA, CCC, EAC		
Dimensions (mm) H x W x D	106 x 57 x 98		126 x 57 x 98
Fluid connection	1/4" BSP female		
Electrical connection	Screw terminals, 2 tapped entries for n° 13 (DIN Pg 13.5) cable gland		

### Type XMX-with internal setting screw

Without setting scale, screw terminal connections		XMMA06L2135	XMMA12L2135	XMMA25L2135
1 C/O single-pole, snap action contact				
Possible differential (bar)	Min. at low setting	0,8	1	3,4
subtract from PH to give PB	Min. at high setting	1,2	1,7	4,5
	Max. at high setting	4,2	8,4	20

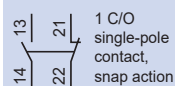

Setting range of upper limit (PH) (bar)	1...6	1,3...12	3,5...25
Fluids controlled	Air, water (fresh water, sea water) from 0...+70°C		
Ambient air temperature	-25...+70°C		
Degree of protection (conforming to IEC 60529)	IP54		
Rated operational characteristics (conforming to EN/IEC 60947-5-1)	AC-15 ; B300 (Ue = 240 V, Ie = 1,5 A - Ue = 120 V, Ie = 3 A) / DC-13 ; R300 (Ue = 250 V, Ie = 0,1 A)		
Product certification	CE, UL, CSA, CCC, EAC		
Dimensions (mm) H x W x D	113 x 57 x 98		133 x 57 x 98
Fluid connection	1/4" BSP female		
Electrical connection	Screw terminals, tapped entry for n° 13 (DIN Pg 13.5) cable gland		

### Type XMA with external setting screw (transparent cover)

Without setting scale, screw terminal connections		XMAV06L2135	XMAV12L2135	XMAV25L2135
1 C/O single-pole, snap action contact				
Possible differential (bar)	Min. at low setting	0,8	1	3,4
subtract from PH to give PB	Min. at high setting	1,2	1,7	4,5
	Max. at high setting	4,2	8,4	20

## Electromechanical pressure switches for power circuits, adjustable differential for regulation between 2 thresholds

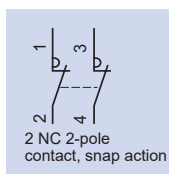

Degree of protection		IP 20			IP65	
		4,6	7	10,5	4,6	7
Size (bar)		1,4...4,6	2,8...7	5,6...10,5	1,4...4,6	2,8...7
Setting range of upper limit (PH) (bar)		1,4...4,6	2,8...7	5,6...10,5	1,4...4,6	2,8...7
Fluids controlled		Water (fresh water, sea water) from 0...+55°C				
Electrical connection		Screw terminals, 2 cable entries with grommet			Screw terminals, 2 tapped entries for n° 13 (DIN Pg 13.5) cable gland	
Product certification		CE, EAC				
Ambient air temperature		For operation : 0...+50°C.			For storage: - 30...+80°C	
Rated operational characteristics (conforming to EN/IEC 60947-5-1)		Ie = 10 A, Ue = 250 V AC				
Power rating of controlled motors	110 V	AC 2-pole, single-phase			0,75 kW (1 HP)	
		AC 2-pole, 3-phase			1,1 kW (1,5 HP)	
230 / 400 V		AC 2-pole, single-phase			1,5 kW (2 HP)	
		AC 2-pole, 3-phase			2,2 kW (3 HP)	
Dimensions (mm) H x W x D		96/105 x 72 x 102	94 x 72 x 102		115 x 72 x 106	115 x 72 x 106
Connection hydraulique	G 1/4 (BSP female)	FSG2	FYG22	FYG32	–	FYG22NE
	R 1/4 (BSP male)	FSG9	FYG29	–	–	–
	G 3/8 (BSP female) rotating nut	–	–	–	FSG2NEG	–
Possible differential subtract from PH to give PB	At low setting	1 min. - 2,1 max.	1,2 min. - 2,3 max.	1,9 min. - 3 max.	1 min. - 2,1 max.	1,2 min. - 2,3 max.
	At middle setting	1,1 min. - 2,2 max.	1,4 min. - 2,5 max.	2,1 min. - 3,2 max.	1,1 min. - 2,2 max.	1,4 min. - 2,5 max.
	At high setting	1,2 min. - 2,3 max.	1,6 min. - 2,7 max.	2,3 min. - 3,4 max.	1,2 min. - 2,3 max.	1,6 min. - 2,7 max.

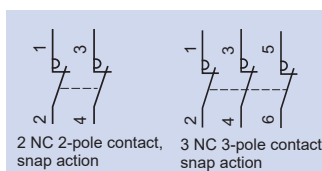

Size (bar)		6	12	25	
Setting range of upper limit (PH) (bar)		1...6	1,3...12	3,5...25	
Fluids controlled		Air, water (fresh water, sea water) from 0...+70°C			
Ambient air temperature		For fonctionnement : -25...+70°C. For stockage : -40...+70°C			
Decompression valve / ONOff knob		without	without	with	without
Fluid connection		G 1/4 (BSP female)	G 1/4 (BSP female)	4xG 1/4 (BSP female)	G 1/4 (BSP female)
Electrical connection		Screw terminals, 2 tapped entries for n° 13 (DIN Pg 13.5) cable gland			
Degree of protection		IP 54		IP 54	
Product certification		CE, EAC			
Rated insulation voltage		Ui = 500 V			
Electrical durability	Power	1,5 kW	400 V AC 3-phase : 1 000 000 operating cycles		
		2,2 kW	230 VAC 3-phase : 600 000 operating cycles		
		3 kW	400 V AC 3-phase : 700 000 operating cycles		
Dimensions (mm) H x W x D		106 x 57 x 97,5	106 x 57 x 97,5	138 x 57 x 97,5	126 x 57 x 97,5
Type of contacts	2 NC 2-pole, snap action contact	XMPA06B2131	XMPA12B2131	–	XMPA25B2131
	3 NC 3-pole, snap action contact	XMPA06C2131	XMPA12C2131	XMPE12C2431	–
Possible differential subtract from PH to give PB	Min. at low setting	0,8	1	1	3,4
	Min. at high setting	1,2	1,7	1,7	4,5
	Max. at high setting	4,2	8,4	8,4	20

# XS Inductive proximity sensors

## Cylindrical metal

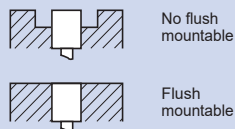

	Flush standard and increased range			
	M8		M12	
Nominal sensing distance $S_n$	1,5 mm	2,5 mm	2 mm	4 mm
Usable sensing distance $S$ (mm) flush mountable / No flush mountable	0 ... 1,2	0 ... 2	0...1,6	0 ... 3,2
Temperature range (°C)	- 25 ... + 70			
Product certification	CE, UL, CSA, CCC, C-TICK, E2 (2)			
Degree of protection (conforming to IEC 60529)	IP67		Pre-cabled: IP 69K conforming to DIN 40050, IP 68	

### Sensors for DC applications

Output function	NO	NC	A	B	A	B	A	B
Dimensions (mm) Ø x L Cable / Connector	M8 x 33 / M8 x 42				M12 x 35 / M12 x 50			
3-wires	PNP	Cable (2 m)	XS508B1P A L2	XS108B3P A L2	XS512B1P A L2	XS112B3P A L2	XS512B1P A L2	XS112B3P A L2
		Connector M8 / M12	XS508B1P A M8	XS108B3P A M8	XS512B1P A M12	XS112B3P A M12	XS512B1P A M12	XS112B3P A M12
	NPN	Cable (2m)	XS508B1N A L2	XS108B3N A L2	XS512B1N A L2	XS112B3N A L2	XS512B1N A L2	XS112B3N A L2
		Connector M8 / M12	XS508B1N A M8	XS108B3N A M8	XS512B1N A M12	XS112B3N A M12	XS512B1N A M12	XS112B3N A M12
2-wires	No polarised (1)	Cable (2 m)	XS508BSC A L2	XS608B3C A L2	XS512BSD A L2	XS612B3D A L2	XS512BSD A L2	XS612B3D A L2
		Connector M12	–	–	XS512BSD A M12	XS612B3D A M12	XS512BSD A M12	XS612B3D A M12
Supply voltage limits, min./max. (V) including ripple	10...36		10...36		10...36		10...36	
Switching capacity, max. (mA) 3-wires / 2-wires	200 / 100		200 / 100		200 / 100		200 / 100	
Overload and short-circuit protection (★) / LED output state indicator (⊗)	★ / ⊗		★ / ⊗		★ / ⊗		★ / ⊗	
Residual current, open state (mA)	≤ 0,5		≤ 0,5		≤ 0,5		≤ 0,5	
Voltage drop, closed state (V) at I nominal 3-wires / 2-wires	≤ 2 / ≤ 4		≤ 2 / ≤ 4		≤ 2 / ≤ 4		≤ 2 / ≤ 4	
Switching frequency (Hz) 3-wires / 2-wires	5000 / 4000		2500 / 3000		5000 / 4000		2500 / 2000	
Dimensions (mm) Ø x L Pre-cabled / Connector	M8 x 51 / M8 x 62				M12 x 53 / M12 x 62			
3-wires	PNP	Cable (2 m)	XS508BLP A L2	XS608B1P A L2	XS512BLP A L2	XS612B1P A L2	XS512BLP A L2	XS612B1P A L2
		Connector M12	XS508BLP A M12	XS608B1P A M12	XS512BLP A M12	XS612B1P A M12	XS512BLP A M12	XS612B1P A M12
	NPN	Cable (2 m)	XS508BLN A L2	XS608B1N A L2	XS512BLN A L2	XS612B1N A L2	XS512BLN A L2	XS612B1N A L2
		Connector M12	XS508BLN A M12	XS608B1N A M12	XS512BLN A M12	XS612B1N A M12	XS512BLN A M12	XS612B1N A M12
2-wires	No polarised	Cable (2 m)	XS508B1D A L2	XS608B1D A L2	XS512B1D A L2	XS612B1D A L2	XS512B1D A L2	XS612B1D A L2
		Connector M12	XS508B1D A M12	XS608B1D A M12	XS512B1D A M12	XS612B1D A M12	XS512B1D A M12	XS612B1D A M12
Supply voltage limits, min./max. (V) including ripple	10...58		10...58		10...58		10...58	
Switching capacity, max. (mA) 3-wires / 2-wires	200 / 100		200 / 100		200 / 100		200 / 100	
Overload and short-circuit protection (★) / LED output state indicator (⊗)	★ / ⊗		★ / ⊗		★ / ⊗		★ / ⊗	
Residual current, open state (mA) 2-wires	≤ 0,5		≤ 0,5		≤ 0,5		≤ 0,5	
Voltage drop, closed state (V) at I nominal 3-wires / 2-wires	≤ 2 / ≤ 4		≤ 2 / ≤ 4		≤ 2 / ≤ 4		≤ 2 / ≤ 4	
Switching frequency (Hz) 3-wires / 2-wires	5000 / 4000		2500 / 3000		5000 / 4000		2500 / 2000	

### Multi-current/multi-voltage sensors for AC/DC applications

Dimensions (mm) Ø x L Cable / Connector	–	–	M12 x 53 / M12 x 62	–
2-wires	Cable (2 m)	–	XS512B1M A L2	XS612B1M A L2
	Connector 1/2"-20 UNF	–	XS512B1M A U20	XS612B1M A U20
Supply voltage limits, min./max. (V) including ripple	–	–	20...264	20...264
Switching capacity, max (mA)	–	–	200	200
LED output state indicator (⊗)	–	–	⊗	⊗
Residual current, open state (mA)	–	–	≤ 0,8	≤ 0,8
Voltage drop, closed state (V) at I nominal	–	–	≤ 5,5	≤ 5,5
Switching frequency (Hz)	–	–	25 AC / 1000 DC	25 AC / 1000 DC

(1) polarised for M8 short

(2) E2 depending on the version, more details on [tesensors.com](http://tesensors.com)

### Accessories

#### Fixing for cylindrical sensors

Fixing clamp with indexing pin for cylindrical sensors



M8	XSZB108
M12	XSZB112
M18	XSZB118
M30	XSZB130

#### Suitable female plug-in connectors

	Straight	Elbowed
M8		
Metal ring	XZCC8FDM30S	XZCC8FCM30S
M12 (4-pins)		
Metal ring	XZCC12FDM40B	XZCC12FCM40B
Plastic ring	XZCC12FDP40B	XZCC12FCP40B



M18				M30				No flush increased range							
5 mm		8 mm		10 mm		15 mm		M8		M12		M18		M30	
0...4		0...6,4		0...8		0...12		0 ... 3,2		0...5.6/0...6.4		0...9.6/0...12		0...17.6 / 0...24	
- 25...+ 70								- 25...+ 70							
(with connector: IP67)								CE, UL , CSA , CCC , C-TICK, E2 (2)				Pre-cabled: IP 69K conforming to DIN 40050, IP 68 (with connector: IP67)			

A		A		A		A		A		A		A		A	
B		B		B		B		B		B		B		B	
M18 x 39 / M18 x 50				M30 x 43 / M30 x 55								M12 x 37 / M12 x 51		M18 x 41 / M18 x 51	
XS518B1PAL2	XS118B3PAL2	XS530B1PAL2	XS130B3PAL2	-	XS212B4PAL2	XS218B4PAL2									
XS518B1PAM12	XS118B3PAM12	XS530B1PAM12	XS130B3PAM12	-	XS212B4PAM12	XS218B4PAM12									
XS518B1NAL2	XS118B3NAL2	XS530B1NAL2	XS130B3NAL2	-	XS212B4NAL2	XS218B4PAL2									
XS518B1NAM12	XS118B3NAM12	XS530B1NAM12	XS130B3NAM12	-	XS212B4NAM12	XS218B4PAM12									
XS518BSDAL2	XS618B3DAL2	XS530BSDAL2	XS630B3DAL2	-											
XS518BSDAM12	XS618B3DAM12	XS530BSDAM12	XS630B3DAM12	-											
10...36	10...36	10...36	10...36	-	10...36	10...36									
200 / 100	200 / 100	200 / 100	200 / 100	-	200	200									
★ / ⊗	★ / ⊗	★ / ⊗	★ / ⊗	-	★ / ⊗	★ / ⊗									
≤ 0,5	≤ 0,5	≤ 0,5	≤ 0,5	-	≤ 0,5	≤ 0,5									
≤ 2 / ≤ 4	≤ 2 / ≤ 4	≤ 2 / ≤ 4	≤ 2 / ≤ 4	-	≤ 2	≤ 2									
2000 / 3000	1000 / 1000	1000 / 2000	500 / 500	-	2500	1000									

A		A		A		A		A		A		A		A			
B		B		B		B		B		B		B		B			
M18 x 62 / M18 x 74				M30 x 62				M8 x 51 / M8 x 61				M12 x 55 / M12 x 65		M18 x 62 / M18 x 74		M30 x 66 / M30 x 74	
XS518BLPAL2	XS618B1PAL2	XS530BLPAL2	XS630B1PAL2	XS608B4PAL2	XS612B4PAL2	XS618B4PAL2	XS630B5PAL2										
XS518BLPAM12	XS618B1PAM12	XS530BLPAM12	XS630B1PAM12	XS608B4PAM12 (3)	XS612B4PAM12	XS618B4PAM12	XS630B5PAM12										
XS518BLNAL2	XS618B1NAL2	XS530BLNAL2	XS630B1NAL2	XS608B4NAL2	XS612B4NAL2	XS618B4NAL2	XS630B5NAL2										
XS518BLNAM12	XS618B1NAM12	XS530BLNAM12	XS630B1NAM12	XS608B4NAM12 (3)	XS612B4NAM12	XS618B4NAM12	XS630B5NAM12										
XS518B1DAL2	XS618B1DAL2	XS530B1DAL2	XS630B1DAL2	-	-	-	-										
XS518B1DAM12	XS618B1DAM12	XS530B1DAM12	XS630B1DAM12	-	-	-	-										
10...58	10...58	10...58	10...58	10...58	10...58	10...58	10...58										
200 / 100	200 / 100	200 / 100	200 / 100	200 / -	200 / -	200 / -	200 / -										
★ / ⊗	★ / ⊗	★ / ⊗	★ / ⊗	★ / ⊗	★ / ⊗	★ / ⊗	★ / ⊗										
≤ 0,5	≤ 0,5	≤ 0,5	≤ 0,5	-	-	-	-										
≤ 2 / ≤ 4	≤ 2 / ≤ 4	≤ 2 / ≤ 4	≤ 2 / ≤ 4	≤ 2 / -	≤ 2 / -	≤ 2 / -	≤ 2 / -										
2000 / 3000	1000 / 1000	1000 / 2000	500 / 500	2500 / -	2500 / -	1000 / -	500 / -										

A		A		A		A		A		A		A		A	
B		B		B		B		B		B		B		B	
M18 x 62 / M18 x 73				M30 x 62 / M30 x 73								M18 x 60 / M18 x 72		M30 x 63 / M30 x 74	
XS518B1MAL2	XS618B1MAL2	XS530B1MAL2	XS630B1MAL2	-	-	-	-					XS618B4MAL2	XS630B4MAL2		
XS518B1MAU20	XS618B1MAU20	XS530B1MAU20	XS630B1MAU20	-	-	-	-					XS618B4MAU20	XS630B4MAU20		
20...264	20...264	20...264	20...264	-	-	-	-					20...264	20...264		
300 AC / 200 DC	300 AC / 200 DC	300 AC / 200 DC	300 AC / 200 DC	-	-	-	-					300 AC / 200 DC	300 AC / 200 DC		
⊗	⊗	⊗	⊗	-	-	-	-					⊗	⊗		
≤ 0,8	≤ 0,8	≤ 0,8	≤ 0,8	-	-	-	-					≤ 0,8	≤ 0,8		
≤ 5,5	≤ 5,5	≤ 5,5	≤ 5,5	-	-	-	-					≤ 5,5	≤ 5,5		
25 AC / 1000 DC	25 AC / 1000 DC	25 AC / 500 DC	25 AC / 500 DC	-	-	-	-					25 AC / 1000 DC	25 AC / 300 DC		

(3) Also available with M8 connector. Substitute "M12" for "M8" at the end of the reference.

PUR pre-wired connectors (1)		M8 (3-pins)		1/2"		M12 (4-pins)					
		Straight		Elbowed		Straight		Elbowed		Elbowed PNP LED	
 Straight Elbowed	2 m	XZCP0566L2	XZCP0666L2	2 m	XZCP1865L2	XZCP1965L2	2 m	XZCP1141L2	XZCP1241L2	XZCP1340L2	
	5 m	XZCP0566L5	XZCP0666L5	5 m	XZCP1865L5	XZCP1965L5	5 m	XZCP1141L5	XZCP1241L5	XZCP1340L5	
	10 m	XZCP0566L10	XZCP0666L10	10 m	XZCP1865L10	XZCP1965L10	10 m	XZCP1141L10	XZCP1241L10	XZCP1340L10	

(1) For PVC cable see page 47

# XS Inductive proximity sensors

## Rectangulars plastic

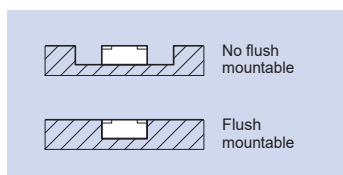

	∅ 8 x 22 x 8	∅ 15 x 32 x 8	∅ 26 x 26 x 13	∅ 40 x 40 x 15	∅ 80 x 80 x 26
Nominal sensing distance S <sub>n</sub>	2.5 mm	5 mm	10 mm	15 mm	40 mm
Operating zone (mm)	0...2	0...4	0...8	0...12	0...32
Fine adjustment zone (mm) flush mountable / No flush mountable	–	–	–	–	–
Suitability for flush mounting(metal environment)	flush mountable	flush mountable	flush mountable	flush mountable	flush mountable
Temperature range (°C)	- 25...+ 70	- 25...+ 70	- 25...+ 70	- 25...+ 70	- 25...+ 70
Product certification	CE	CE, UL, CSA, C-TICK			
Degree of protection (conforming to IEC 60529)	pre-cabled : IP68 (with connector : IP67)				

### Sensors for DC applications

Connection			Pre-cabled PvR (2 m)				
2-wires (No polarised)	NO or NC	programmable	–	–	–	–	–
2-wires No polarised	NO function		XS7J1A1DAL2	XS7F1A1DAL2	XS7E1A1DAL2 (3)	XS7C1A1DAL2 (3)	XS7D1A1DAL2 (3)
	NC function		XS7J1A1DBL2	–	XS7E1A1DBL2 (3)	XS7C1A1DBL2 (3)	XS7D1A1DBL2 (3)
4-wires	PNP	NO + NC complementary outputs	–	–	–	–	–
	NPN	NO + NC complementary outputs	–	–	–	–	–
3-wires	PNP	NO function	XS7J1A1PAL2	XS7F1A1PAL2	XS7E1A1PAL2 (3)	XS7C1A1PAL2 (3)	XS7D1A1PAL2 (3)
		NC function	XS7J1A1PBL2	XS7F1A1PBL2	XS7E1A1PBL2 (3)	XS7C1A1PBL2 (3)	XS7D1A1PBL2 (3)
	NPN	NO function	XS7J1A1NAL2	XS7F1A1NAL2	XS7E1A1NAL2 (3)	XS7C1A1NAL2 (3)	XS7D1A1NAL2 (3)
		NC function	–	–	XS7E1A1NBL2 (3)	XS7C1A1NBL2 (3)	XS7D1A1NBL2 (3)
Connection			M8		M12		
2-wires No polarised	NO function		XS7J1A1DAL01M8 (1)	XS7F1A1DAL01M8 (1)	XS7E1A1DAM8 (3)	XS7C1A1DAM8 (3)	XS7D1A1DAM12 (3)
	NC function		–	XS7F1A1DBL01M8 (1)	XS7E1A1DBM8 (3)	XS7C1A1DBM8 (3)	XS7D1A1DBM12 (3)
3-wires	PNP	NO function	XS7J1A1PAL01M8 (1)	XS7F1A1PAL01M8 (1)	XS7E1A1PAM8 (3)	XS7C1A1PAM8 (3)	XS7D1A1PAM12 (3)
		NC function	XS7J1A1PBL01M8 (1)	XS7F1A1PBL01M8 (1)	XS7E1A1PBM8 (3)	XS7C1A1PBM8 (3)	XS7D1A1PBM12 (3)
	NPN	NO function	–	XS7F1A1NAL01M8 (1)	XS7E1A1NAM8 (3)	XS7C1A1NAM8 (3)	XS7D1A1NAM12 (3)
		NC function	–	–	XS7E1A1NBM8 (3)	XS7C1A1NBM8 (3)	–
Supply voltage limits, min./max. (V) including ripple			10...36	10...36	10...36	10...36	10...36
Switching capacity, max (mA)			100	100	100	100	100
Short-circuit protect. (★) / Output state LED (⊗) / Power on LED (⊗)			★ / ⊗ / –	★ / ⊗ / –	★ / ⊗ / –	★ / ⊗ / –	★ / ⊗ / –
Voltage drop, closed state (V) at I nominal cable / Connector			≤ 4 / ≤ 2	≤ 4 / ≤ 2	≤ 2	≤ 2	≤ 2
Switching frequency (Hz) cable / Connector			4000 / 2000	5000 / 2000	1000	1000	100

### Multi-current/multi-voltage sensors for AC/DC applications

Connection							
2-wires	AC/DC	NO function	–	–	–	–	–
		NC function	–	–	–	–	–
	AC	NO or NC programmable	–	–	–	–	–
	AC/DC	NO or NC programmable	–	–	–	–	–
Connection							
2-wires	AC/DC	NO function	–	–	–	–	–
		NC function	–	–	–	–	–
Supply voltage limits, min./max. (V) including ripple			–	–	–	–	–
Switching capacity, max (mA)			–	–	–	–	–
Short-circuit protect. (★) / Output state LED (⊗) / Power on LED (⊗)			–	–	–	–	–
Residual current, open state (mA)			–	–	–	–	–
Voltage drop, closed state (V) at I nominal			–	–	–	–	–
Switching frequency (Hz)			–	–	–	–	–

(1) M8 connector on flying lead L = 0,15m

### Accessories

#### Suitable female plug-in connectors

M8	Straight	Elbowed
Metal ring	XZCC8FDM30S	XZCC8FCM30S
M12 (4-pins)		
Metal ring	XZCC12FDM40B	XZCC12FCM40B
Plastic ring	XZCC12FDP40B	XZCC12FCP40B





Ø 40 x 40 x 70		Ø 40 x 40 x 117		Ø 26 x 26 x 13	Ø 40 x 40 x 15	Ø 80 x 80 x 26
20 mm	40 mm	20 mm	40 mm	15 mm	25 mm	60 mm
0...16	0...32	0...16	0...32	0...8 / 0...12	0...12 / 0...20	0...32 / 0...48
flush mountable	No flush mountable	flush mountable	No flush mountable	5...10 / 5...15	8...15 / 8...25	20...40 / 20...60
- 25... + 70				flush mountable or No flush mountable via teach mode		
CE, UL, CSA, CCC, C-TICK, E2, for PNP versions: TUV Sil 2				CE, UL, CSA, CCC, C-TICK		
IP67 and IP69K				pre-cabled : IP68 (with connector : IP67)		

M12		Screw terminals (2)		Pre-cabled (2m)		
-	-	XS8C4A1DPP20	XS8C4A4DPP20	-	-	-
XS8C2A1DAM12	XS8C2A4DAM12	-	-	-	-	-
XS8C2A1DBM12	XS8C2A4DBM12	-	-	-	-	-
XS8C2A1PCM12	XS8C2A4PCM12	XS8C4A1PCP20	XS8C4A4PCP20	-	-	-
XS8C2A1NCM12	XS8C2A4NCM12	XS8C4A1NCP20	XS8C4A4NCP20	-	-	-
-	-	-	-	XS8E1A1PAL2 (3)	XS8C1A1PAL2 (3)	XS8D1A1PAL2 (3)
-	-	-	-	XS8E1A1PBL2 (3)	XS8C1A1PBL2 (3)	XS8D1A1PBL2 (3)
-	-	-	-	XS8E1A1NAL2 (3)	XS8C1A1NAL2 (3)	XS8D1A1NAL2 (3)
-	-	-	-	XS8E1A1NBL2 (3)	XS8C1A1NBL2 (3)	XS8D1A1NBL2 (3)
				M8		M12
-	-	-	-	-	-	-
-	-	-	-	-	-	-
-	-	-	-	XS8E1A1PAM8 (3)	XS8C1A1PAM8 (3)	XS8D1A1PAM12 (3)
-	-	-	-	XS8E1A1PBM8 (3)	XS8C1A1PBM8 (3)	XS8D1A1PBM12 (3)
-	-	-	-	XS8E1A1NAM8 (3)	XS8C1A1NAM8 (3)	XS8D1A1NAM12 (3)
-	-	-	-	-	XS8C1A1NBM8 (3)	XS8D1A1NBM12 (3)
12...48				10...36	10...36	10...36
4-wires version = 200	2-wires version = 1.5...100			100	200	200
4-wires version = ★ / ⊗ / ⊗	2-wires version = ★ / ⊗ / -			★ / ⊗ / ⊗	★ / ⊗ / ⊗	★ / ⊗ / ⊗
4-wires version = ≤ 2	2-wires version = ≤ 4			≤ 2	≤ 2	≤ 2
flush mountable : 300	No flush version : 200			2000	1000	150

1/2" - 20 UNF connector		Screw terminals (2)		Pre-cabled (2m)		
XS8C2A1MAU20	XS8C2A4MAU20	-	-	XS8E1A1MAL2	XS8C1A1MAL2	XS8D1A1MAL2
-	-	-	-	XS8E1A1MBL2	XS8C1A1MBL2	XS8D1A1MBL2
-	-	-	-	-	-	-
-	-	XS8C4A1MPP20	XS8C4A4MPP20	-	-	-
				1/2" - 20 UNF connector		
-	-	-	-	XS8E1A1MAL01U20 (3)	XS8C1A1MAL01U20 (3)	XS8D1A1MAU20 (3)
-	-	-	-	XS8E1A1MBL01U20 (3)	XS8C1A1MBL01U20 (3)	XS8D1A1MBU20 (3)
20...264				20...264	20...264	20...264
AC/DC version = 300 / 200				200 AC ou DC	300 AC / 200 DC	300 AC / 200 DC
- / ⊗ / -				- / ⊗ / ⊗	- / ⊗ / ⊗	- / ⊗ / ⊗
AC/DC version = ≤ 1.5				≤ 1.5	≤ 1.5	≤ 1.5
≤ 5.5				≤ 5.5	≤ 5.5	≤ 5.5
25 AC / 50 DC				2000	1000	150

(2) Sensors supplied without cable gland. Suitable cable gland: M20. Also available in 13P, 1/2" NPT output and M12, 7/8" connectors. (3) ECOLAB certified

PUR pre-wired connectors (1)		M8 (3-pins)		1/2"		M12 (4-pins)					
		Straight	Elbowed			Straight	Elbowed	Elbowed PNP LED			
		2 m	XZCP0566L2	XZCP0666L2	2 m	XZCP1865L2	XZCP1965L2	2 m	XZCP1141L2	XZCP1241L2	XZCP1340L2
		5 m	XZCP0566L5	XZCP0666L5	5 m	XZCP1865L5	XZCP1965L5	5 m	XZCP1141L5	XZCP1241L5	XZCP1340L5
		10 m	XZCP0566L10	XZCP0666L10	10 m	XZCP1865L10	XZCP1965L10	10 m	XZCP1141L10	XZCP1241L10	XZCP1340L10

(1) For PVC cable see page 47

# XS Inductive proximity sensors

## Cylindrical Plastic

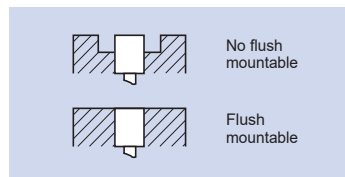

	M8	M12	M18	M30
Nominal sensing distance $S_n$	2,5 mm	4 mm	8 mm	15 mm
Operating zone (mm)	0...2	0...3,2	0...6,4	0...12
Suitability for flush mounting(metal environment)	Non flush mountable			
Temperature range (°C)	- 25...+ 70			
Product certification	CE, UL, CSA, CCC, C-TICK, ECOLAB			
Degree of protection (conforming to IEC 60529)	IP67	pre-cabled : IP68 (with connector : IP67)		

### Sensors for DC applications

Connection			Pre-cabled PvR (2 m)			
Dimensions (mm) Ø x L			M8 x 33	M12 x 33	M18 x 33,5	M30 x 40,5
3-wires	PNP	NO function	XS4P08PA340	XS4P12PA340	XS4P18PA340	XS4P30PA340
		NC function	–	XS4P12PB340	–	XS4P30PB340
	NPN	NO function	–	XS4P12NA340	XS4P18NA340	XS4P30NA340
		NC function	XS4P08NB340	–	–	–
Connection			M8	M12		
Dimensions (mm) Ø x L			M8 x 42	M12 x 48	M18 x 48	M30 x 50
3-wires	PNP	NO function	XS4P08PA340S	XS4P12PA340D	XS4P18PA340D	XS4P30PA340D
		NC function	–	XS4P12PB340D	XS4P18PB340D	XS4P30PB340D
	NPN	NO function	–	XS4P12NA340D	XS4P18NA340D	–
		NC function	–	–	XS4P18NB340D	–
Supply voltage limits, min./max. (V) including ripple			10...38	10...38	10...38	10...38
Switching capacity, max (mA)			200	200	200	200
Short-circuit protect. (★) / LED output state indicator (⊗)			★ / ⊗	★ / ⊗	★ / ⊗	★ / ⊗
Voltage drop, closed state (V) at I nominal			≤ 2	≤ 2	≤ 2	≤ 2
Switching frequency (Hz)			5000	5000	2000	1000

### Multi-current/multi-voltage sensors for AC/DC applications

Connection			Pre-cabled PvR (2 m)			
Dimensions (mm) Ø x L			M8 x 50	M12 x 50	M18 x 60	M30 x 60
2-wires	AC/DC	NO function	XS4P08MA230	XS4P12MA230	XS4P18MA230	XS4P30MA230
		NC function	XS4P08MB230	XS4P12MB230	XS4P18MB230	XS4P30MB230
not short-circuit protected (1)						
Connection			1/2"			
Dimensions (mm) Ø x L			M8 x 61	M12 x 61	M18 x 70	M30 x 70
2-wires	AC/DC	NO function	XS4P08MA230K	XS4P12MA230K	XS4P18MA230K	XS4P30MA230K
		NC function	XS4P08MB230K	XS4P12MB230K	XS4P18MB230K	XS4P30MB230K
not short-circuit protected (1)						
Supply voltage limits, min./max. (V) including ripple			20...264	20...264	20...264	20...264
Switching capacity, max (mA)			100	200	300 AC / 200 DC	300 AC / 200 DC
LED output state indicator (⊗)			⊗	⊗	⊗	⊗
Residual current, open state (mA)			≤ 0,6	≤ 0,6	≤ 0,6	≤ 0,6
Voltage drop, closed state (V) at I nominal			≤ 5,5	≤ 5,5	≤ 5,5	≤ 5,5
Switching frequency (Hz)			25 AC / 3000 DC	25 AC / 3000 DC	25 AC / 2000 DC	25 AC / 1000 DC

(1) For these sensors without short-circuit protection, it is essential to connect a 0.4 A quick-blow fuse in series with the load.

### Accessories

#### Fixing for cylindrical sensors

Fixing clamp with indexing pin for cylindrical sensors

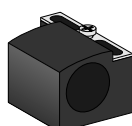

M8	XSZB108
M12	XSZB112
M18	XSZB118
M30	XSZB130

#### Suitable female plug-in connectors

M8	Straight
Metal ring	XZCC8FDM30S
M12 (4-pins)	
Metal ring	XZCC12FDM40B
Plastic ring	XZCC12FDP40B

Elbowed	
	XZCC8FCM30S
	XZCC12FCM40B
	XZCC12FCP40B

## Miniature cylindrical metal (assembly)



	Ø 4	M5	Ø 6,5	
Nominal sensing distance Sn	1 mm	1 mm	1,5 mm	2,5 mm
Operating zone (mm)	0...0,8	0...0,8	0...1,2	0...2
Suitability for flush mounting(metal environment)	flush mountable			
Temperature range (°C)	- 25...+ 70			
Product certification	CE, UL, CSA, CCC, C-TICK			
Degree of protection (conforming to IEC 60529)	IP67			

### Sensors for DC applications

Dimensions (mm) Ø x L		Ø 4 x 29	M5 x 29	Ø 6,5 x 33		
Connection		Pre-cabled PvR (2 m)				
3-wires	PNP	NO function	XS1L04PA310	XS1N05PA310	XS506B1PAL2	XS106B3PAL2
		NC function	–	–	XS506B1PBL2	XS106B3PBL2
	NPN	NO function	XS1L04NA310	XS1N05NA310	XS506B1NAL2	XS106B3NAL2
		NC function	–	–	XS506B1NBL2	XS106B3NBL2
2-wires (polarised)	NO function	–	–	XS506B3CAL2	XS606B3CAL2	
	NC function	–	–	XS506B3CBL2	XS606B3CBL2	
Dimensions (mm) Ø x L		Ø 4 x 41	M5 x 41	Ø 6,5 x 42		
Connection		M8				
3-wires	PNP	NO function	XS1L04PA310S	XS1N05PA311S (1)	XS506B1PAM8	XS106B3PAM8
		NC function	–	–	XS506B1PBM8	XS106B3PBM8
	NPN	NO function	–	XS1N05NA311S (1)	XS506B1NAM8	XS106B3NAM8
		NC function	–	–	XS506B1NBM8	XS106B3NBM8
Connection		M12				
Supply voltage limits, min./max. (V) including ripple		5...30	5...30	10...36		
Switching capacity, max. (mA) 3-wires / 2-wires		100 / –	100 / –	200 / 100		
Short-circuit protect. (★) / LED output state indicator (⊗)		★ / ⊗	★ / ⊗	★ / ⊗		
Voltage drop, closed state (V) at I nominal 3-wires / 2-wires		≤ 2 / –	≤ 2 / –	≤ 2 / ≤ 4		
Switching frequency (Hz) 3-wires / 2-wires		5000 / –	5000 / –	5000 / 4000	2500 / 3000	

(1) Stainless steel sensors, Sn = 0,8 mm

PUR pre-wired connectors (1)	M8 (3-pins)		1/2"		M12 (4-pins)					
		Straight	Elbowed		Straight	Elbowed		Straight	Elbowed	Elbowed PNP LED
 Straight Elbowed	2 m	XZCP0566L2	XZCP0666L2	2 m	XZCP1865L2	XZCP1965L2	2 m	XZCP1141L2	XZCP1241L2	XZCP1340L2
	5 m	XZCP0566L5	XZCP0666L5	5 m	XZCP1865L5	XZCP1965L5	5 m	XZCP1141L5	XZCP1241L5	XZCP1340L5
	10 m	XZCP0566L10	XZCP0666L10	10 m	XZCP1865L10	XZCP1965L10	10 m	XZCP1141L10	XZCP1241L10	XZCP1340L10

(1) For PVC cable see page 47

# XS Inductive proximity sensors

Multi-voltage with short-circuit protection

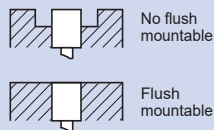

		M 12	M 18	M 30
Nominal sensing distance $S_n$	flush	2 mm	5 mm	10 mm
	No flush or increased flush	4 mm	8 mm	15 mm
Operating zone (mm)	flush	0...1,6	0...4	0...8
	No flush or increased flush	0...3,2	0...6,4	0...12
Suitability for flush mounting(metal environment)		Flush mountable ou No flush mountable depending on model		
Case M (metal) P (plastic)		M		
Temperature range (°C)		- 25...+ 70		
Degree of protection (conforming to IEC 60529)		IP68 (with connector : IP67)		
Product certification		CE, UL, CSA, CCC, C-TICK		
Dimensions (mm) Ø x L Cable (Connector)		M12 x 55 (M12 x 66)	M18 x 60 (M18 x 72)	M30 x 60 (M30 x 72)

## Sensors for DC applications

Connection						
4-wires	PNP	NO + NC	Flush	–	–	–
			increased flush			
			No flush	–	–	–
	NPN	NO + NC	Flush	–	–	–
			No flush	–	–	–
			PNP+NPN NO/NC programmable	Flush (metal)	–	–
			No flush (metal)	–	–	–
			No flush (plastic)	–	–	–
Connection						
4-wires	PNP	NO + NC	Flush	–	–	–
			increased flush			
			No flush	–	–	–
	NPN	NO + NC	Flush	–	–	–
			No flush	–	–	–
			PNP+NPN NO/NC programmable	Flush (metal)	–	–
			No flush (metal)	–	–	–
			No flush (plastic)	–	–	–
Supply voltage limits, min./max. (V) including ripple				–	–	–
Switching capacity, max (mA)				–	–	–
Short-circuit protection (★) / LED output state indicator (⊗)				–	–	–
Voltage drop, closed state (V) at I nominal				–	–	–
Switching frequency (Hz)				–	–	–

## Multi-current/multi-voltage sensors for AC/DC applications

Connection			Pre-cabled PvR (2 m)		
2-wires AC/DC	NO function	Flush	XS1M12MA250	XS1M18MA250	XS1M30MA250
		No flush	XS2M12MA250	XS2M18MA250	XS2M30MA250
	NC function	Flush	XS1M12MB250	XS1M18MB250	XS1M30MB250
		No flush	XS2M12MB250	XS2M18MB250	XS2M30MB250
Connection			1/2"-20UNF		
2-wires AC/DC	NO function	Flush	XS1M12MA250K	XS1M18MA250K	XS1M30MA250K
		No flush	XS2M12MA250K	XS2M18MA250K	XS2M30MA250K
	NC function	Flush	XS1M12MB250K	XS1M18MB250K	XS1M30MB250K
		No flush	–	XS2M18MB250K	XS2M30MB250K
Supply voltage limits, mini/maxi (V) 50-60 Hz			20...264		
Switching capacity, max (mA)			5...200		5...200 AC, 5...300 DC
LED output state indicator (⊗) / Power on LED (⊗)			⊗ / ⊗		
Residual current, open state (mA)			≤ 1,5		
Voltage drop, closed state (V) at I nominal			≤ 5,5		
Switching frequency (Hz)			25 AC, 4000 DC		25 AC, 2000 DC   25 AC, 2000 DC (1)

(1) 25 AC, 1000 DC for non flush Ø 30 mm.

PNP or NPN  
NO + NC Complementary outputs

PNP + NPN outputs,  
NO or NC programmable



M 8	M 12	M 18	M 30	M 12	M 18	M 30
1,5 mm	2 mm	5 mm	10 mm	2 mm	5 mm	10 mm
2,5 mm	4 mm	8 mm	15 mm	4 mm	8 mm	15 mm
0...1,2	0...1,6	0...4	0...8	0...1,6	0...4	0...8
0...2	0...3,2	0...6,4	0...12	0...3,2	0...6,4	0...12
flush mountable or no flush mountable depending on model				flush mountable or no flush mountable depending on model		
M				M ou P depending on model		
- 25...+ 70				- 25...+ 70		
IP67		IP68 (with connector : IP67)		IP68 (with connector : IP67)		
CE, UL, CSA, CCC, C-TICK, E2 - for versions PNP : TÜV SIL2 (SIL2 only for M12, M18, M30)						
M8 x 50 (M8 x 61)	M12 x 33 (M12 x 48)	M18 x 36.5 (M18 x 49)	M30 x 40.5 (M30 x 53)	M12 x 50 (M12 x 61)	M18 x 60 (M18 x 72)	M30 x 60 (M30 x 72)

Pre-cabled PvR (2 m)				Pre-cabled PvR (2 m)		
XS1M08PC410	XS1N12PC410	XS1N18PC410	XS1N30PC410	-	-	-
-	XS112B3PCL2	XS118B3PCL2	XS130B3PCL2	-	-	-
XS2M08PC410	-	-	-	-	-	-
XS1M08NC410	XS1N12NC410	-	XS1N30NC410	-	-	-
-	XS2N12NC410	-	-	-	-	-
-	-	-	-	XS1M12KP340	XS1M18KP340	XS1M30KP340
-	-	-	-	XS2M12KP340	XS2M18KP340	XS2M30KP340
-	-	-	-	XS4P12KP340	XS4P18KP340	XS4P30KP340
M12				M12		
XS1M08PC410D	XS1N12PC410D	XS1N18PC410D	XS1N30PC410D	-	-	-
-	XS112B3PCM12	XS118B3PCM12	XS130B3PCM12	-	-	-
XS2M08PC410D	-	-	-	-	-	-
-	-	-	XS1N30NC410D	-	-	-
-	-	XS2N18NC410D	-	-	-	-
-	-	-	-	XS1M12KP340D	XS1M18KP340D	XS1M30KP340D
-	-	-	-	XS2M12KP340D	XS2M18KP340D	XS2M30KP340D
-	-	-	-	XS4P12KP340D	XS4P18KP340D	XS4P30KP340D
10...36	9...36 for PNP version		-	10...36		
200	200		-	200		
★ / ⊗	★ / ⊗		-	★ / -		
≤ 2	≤ 2		-	≤ 2,6		
5000	5000	2000	1000	5000	2000	1000

PNP

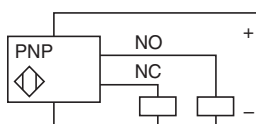

NPN

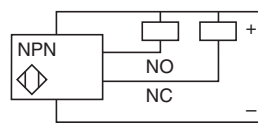

NO

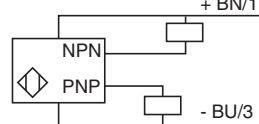

NC

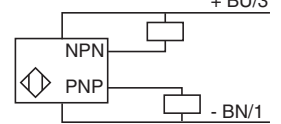

Accessories

Fixing clamps

With indexing pin for cylindrical sensors



M8	XSZB108
M12	XSZB112
M18	XSZB118
M30	XSZB130

Suitable female plug-in connectors, including PUR pre-wired versions (1)

length 5 m  
without LED

pre-wired  
Elbowed



pre-wired  
Straight

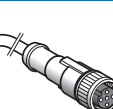

screw terminal



M8 (ou S)	XZCP0666L5
M12 (ou D)	XZCP1241L5
1/2" (ou K)	XZCP1965L5

XZCP0566L5
XZCP1141L5
XZCP1865L5

XZCC8FCM30S
XZCC12FCM40B
XZCC20FCM30B

(1) For PVC cable see page 47

# XS Inductive proximity sensors - Application

## Rotation control

Fixed sensing distance  
(for ferrous or no ferrous materials)

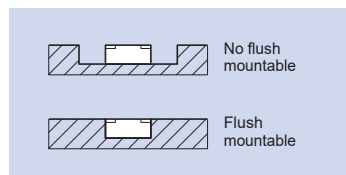

	26 x 26 x 13	40 x 40 x 15	M30
Nominal sensing distance Sn	10 mm	15 mm	10 mm
Operating zone (mm)	0...8	0...12	0...8
Suitability for flush mounting(metal environment)	flush mountable		
Case M (metal) P (plastic)	P	P	M
Temperature range (°C)	- 25...+ 60		
Degree of protection (conforming to IEC 60529)	IP67		
Product certification	CE, UL, CSA, CCC, C-TICK		
Dimensions (mm) Ø x L or W x H x D Cable (Connector)	26 x 26 x 13	40 x 40 x 15	M30 x 81
Maximum speed of passing object (impulses / min)	48000	48000	6000...48000 (1)
Adjustable frequency range (impulses / min)	6...6000	6...6000	6...150 / 120...3000 (1)

## Sensors for DC applications

Connection	Pre-cabled PvR (2 m)		
4 wires PNP/NPN NO/NC programmable	-	-	-
3-wires PNP NC function	slow version	-	XSAV11373
	fast version	-	XSAV12373
Output 0...10 V plastic	-	-	-
Output 4...20 mA	metal flush mountable	-	-
	plastic flush mountable	-	-
	plastic no flush mountable	-	-
Connection par connector	M8 ou M12		
4 wire PNP/NPN NO/NC programmable	-	-	-
3-wires PNP NC function	XS9E11RPBL01M12 (3)	XS9C11RPBL01M12 (3)	-
	Output 0...10 V	-	-
Output 4...20 mA	-	-	-
Supply voltage limits, min./max. (V) including ripple	10...36	10...36	10...58
Switching capacity, max (mA)	100	200	200
Short-circuit protect. (★) / LED output state indicator (⊗) / Power on LED (⊙)	★ / ⊗ / ⊙	★ / ⊗ / ⊙	★ / ⊗ / -
Linearity error	-	-	-
Voltage drop, closed state (V) at I nominal	≤ 2	≤ 2	≤ 2
Switching frequency (Hz)	-	-	-
Operating frequency (Hz)	-	-	-

## Multi-current/multi-voltage sensors for AC/DC applications

Connection	Pre-cabled PvR (2 m)		
2-wires AC/DC NC function	XS9E11RMBL01U20 (5)	XS9C11RMBL01U20 (5)	-
not short-circuit protected (2)NC function	slow version	-	XSAV11801
	fast version	-	XSAV12801
Supply voltage limits, mini/maxi (V) 50-60 Hz	20...264	20...264	20...264
Switching capacity, max (mA)	100	300 AC / 200 DC	300 AC / 200 DC
LED output state indicator (⊗) / Power on LED (⊙)	⊗ / ⊙	⊗ / ⊙	⊗ / -
Residual current, open state (mA)	≤ 1,5	≤ 1,5	≤ 1,5
Voltage drop, closed state (V) at I nominal	≤ 5,5	≤ 5,5	≤ 5,7
Switching frequency (Hz)	-	-	-

## Accessories

### Fixings

Fixing clamp with indexing pin  
for cylindrical sensors



M12	XSZB112
M18	XSZB118
M30	XSZB130

## Analogue (Position control)



	8 x 32 x 8	26 x 26 x 13	40 x 40 x 15	80 x 80 x 26	M12	M18	M30
	5 mm	10 mm	15 mm	40 mm	M: 2 mm / P: 4 mm	M: 5 mm / P: 8 mm	M: 10 mm / P: 15 mm
	1...4	1...10	2...15	5...40	M : 0,2...2 / P : 0,4...4	M : 0,5...5 / P : 0,8...8	M : 1...10 / P : 1,5...15
	flush mountable	flush mountable	flush mountable	flush mountable	flush / No flush mountable	flush / No flush mountable	flush / No flush mountable
	P	P	P	P	M ou P	M ou P	M ou P
	- 25...+ 60	- 25...+ 70	- 25...+ 70	- 25...+ 70	- 25...+ 70	- 25...+ 70	- 25...+ 70
	Pre - cabled : IP68 (with connector: IP67)				IP67		
	CE, UL, CSA, CCC, C-TICK						
	15 x 32 x 8	26 x 26 x 13	40 x 40 x 15	80 x 80 x 26	Ø 12 x 50	Ø 18 x 50	Ø 30 x 52.5
	-	-	-	-	-	-	-
	-	-	-	-	-	-	-

-	-	-	-	-	-	-	-
-	-	-	-	-	-	-	-
-	-	-	-	-	-	-	-
XS9F111A1L2	XS9E111A1L2 (6)	XS9C111A1L2 (6)	XS9D111A1L2 (6)	XS4P12AB110	XS4P18AB110	XS4P30AB110	
-	-	-	-	XS1M12AB120	XS1M18AB120	XS1M30AB120	
XS9F111A2L2	XS9E111A2L2 (6)	XS9C111A2L2 (6)	XS9D111A2L2 (6)	-	-	-	
-	-	-	-	XS4P12AB120	XS4P18AB120	XS4P30AB120	
M8 ou M12							
-	-	-	-	-	-	-	-
-	-	-	-	-	-	-	-
XS9F111A1L01M8 (4)(6)	XS9E111A1L01M12 (4)(6)	-	XS9D111A1M12 (6)	-	-	-	-
-	XS9E111A2L01M12 (4)(6)	XS9C111A2L01M12 (4)(6)	XS9D111A2M12 (6)	-	-	-	-
15...36	15...36	15...36	15...36	10...36 for XS...AB110 / 15...58 for XS...AB120 (6)			
-	-	-	-	-	-	-	-
-	-	-	-	-	-	-	-
± 1 V for 0...10 V version / ± 2 mA for 4...20 mA version							
-	-	-	-	-	-	-	-
-	-	-	-	-	-	-	-
2000	1000	1000	100	1500	500	300	

(1) 6...150 and 6000 impulses/min for XSAV11373 and XSAV11801 (slow version); 120...3000 and 48000 impulses/min for XSAV12373 and XSAV12801 (fast version).

(2) For these sensors without short-circuit protection, it is essential to connect a 0.4 A quick-blow fuse in series with the load.

(3) Flying lead (L = 0.15 m) with end mounted remote control incorporating M12 connector.

(4) Flying lead (L = 0.15 m) with end connector.

(5) Flying lead (L = 0.15 m) with end mounted remote control incorporating 1/2"-20 UNF connector.

(6) ECOLAB certified.

PUR pre-wired connectors (1)		M8 (3-pins)		1/2"		M12 (4-pins)				
		Straight	Elbowed		Straight	Elbowed		Straight	Elbowed	Elbowed PNP LED
	2 m	XZCP0566L2	XZCP0666L2	2 m	XZCP1865L2	XZCP1965L2	2 m	XZCP1141L2	XZCP1241L2	XZCP1340L2
	5 m	XZCP0566L5	XZCP0666L5	5 m	XZCP1865L5	XZCP1965L5	5 m	XZCP1141L5	XZCP1241L5	XZCP1340L5
	10 m	XZCP0566L10	XZCP0666L10	10 m	XZCP1865L10	XZCP1965L10	10 m	XZCP1141L10	XZCP1241L10	XZCP1340L10

(1) For PVC cable see page 47

### Suitable female plug-in connectors

M8	Straight	Elbowed
Steel ring	XZCC8FDM30S	XZCC8FCM30S
M12 (4-pins)		
Steel ring	XZCC12FDM40B	XZCC12FCM40B
Plastic ring	XZCC12FDP40B	XZCC12FCP40B

# XS Inductive proximity sensors - Application

## Food and beverage processing



Type	M12	M18	Ø 18 plain	M30
Nominal sensing distance Sn	7 mm	12 mm	12 mm	22 mm
Operating zone (mm)	0 ... 5,6	0 ... 9,6	0 ... 9,6	0 ... 17,6
Suitability for flush mounting(metal environment)	No-flush mountable			
Case M (metal) (1)	M stainless steel 316 L			
Product certification	CE, UL, CSA, CCC, C-TICK			
Temperature range (°C)	- 25...+ 85°C			
Degree of protection (conforming to IEC 60529)	pre-cabled : IP68 (with connector : IP67) and IP69K conforming to DIN 40050			

### Sensors for DC applications (solid-state output: transistor)

Connection			Pre-cabled, No poisonous PVC (2 m)			
Dimensions (mm)			M12 x 55	M18 x 60	Ø 18 x 60	M30 x 62
3-wires	PNP	NO function	XS212SAPAL2	XS218SAPAL2	XS2L2SAPAL2	XS230SAPAL2
	NPN	NO function	XS212SANAL2	XS218SANAL2	XS2L2SANAL2	XS230SANAL2
Connection			par connector M12			
Dimensions (mm)			M12 x 61	M18 x 70	Ø 18 x 70	M30 x 70
3-wires	PNP	NO function	XS212SAPAM12	XS218SAPAM12	XS2L2SAPAM12	XS230SAPAM12
	NPN	NO function	XS212SANAM12	XS218SANAM12	XS2L2SANAM12	XS230SANAM12
Supply voltage limits, min./max. (V) including ripple			10...36			
Switching capacity, max (mA)			≤ 200			
Switching frequency (Hz)			2500	1000	1000	500
Short-circuit protection (★) / LED output state indicator (⊗)			★ / ⊗	★ / ⊗	★ / ⊗	★ / ⊗
Voltage drop, closed state (V) at I nominal			≤ 2			

### Multi-current/multi-voltage sensors for AC/DC applications

Connection			Pre-cabled, No poisonous (2 m)			
Dimensions (mm)			–	M18 x 60	–	M30 x 62
2-wires (2)	AC/DC	NO function	–	XS218SAMAL2	–	XS230SAMAL2
	Connection			1/2"-20 UNF connector		
Dimensions (mm)			–	M18 x 72	–	M30 x 74
2-wires (2)	AC/DC	NO function	–	XS218SAMAU20	–	XS230SAMAU20
	Supply voltage limits, min./max. (V) 50-60 HZ			–	20 ... 264	–
Switching capacity, max (mA)			–	300 AC / 200 DC	–	300 AC / 200 DC
Switching frequency (Hz)			–	25 AC / 1000 DC	–	25 AC / 300 DC
LED output state indicator (⊗)			–	⊗	–	⊗
Voltage drop, closed state (V) at I nominal			–	≤ 5,5	–	≤ 5,5
Residual current, open state (mA)			–	≤ 0,8	–	≤ 0,8



(1) Plastic range available. M12, M18, M30: :  
To order, replace the second letter S in the reference by A  
(example: XS212SAPAL2 becomes **XS212AAPAL2**).

(2) For these sensors without short-circuit protection, it is essential to connect a 0.4 A quick-blow fuse in series with the load.

### Accessories

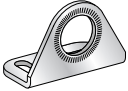
Fixing clamps		M12 pre-wired connector		M12 jumper cable	
Stainless steel		female, 4-pin, stainless steel clamping ring		male, 3-pins, stainless steel clamping ring	
	for sensor	Straight connector	5 m XZCPA1141L5	Straight connector	5 m XZCRA151140A5
	Ø 12				
	Ø 18				
	Ø 30	Elbowed connector	5 m XZCPA1241L5	<b>1/2" pre-wired connector</b>	
				Straight	5 m XZCP1865L5
				Elbowed	5 m XZCP1965L5



# XT Capacitive proximity sensors

Detection of insulating materials or  
conductive materials

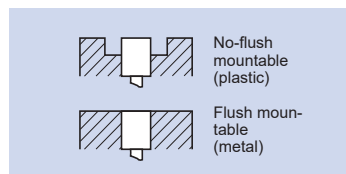

		Suitability for flush mtg.	M12	M18	M30	Ø 32 / 34
Nominal sensing distance Sn	flush mountable		2 mm	5 mm	10 mm	15 mm
	No flush mountable		—	8 mm	15 mm	20 mm
Operating zone Sa (mm) (2)	flush mountable		0...1,44	0...3,6	0...7,2	0...11
	No flush mountable		—	0...5,8	0...11	0...15
Case M (metal) P (plastic)	flush mountable		M	M	M	M
	No flush mountable		—	P	P	P
Product certification			CE, UKCA, cULus, EAC			
Temperature range (°C)			- 25...+ 70			
Degree of protection (conforming to IEC 60529)			IP67			
Dimensions (mm) Ø x L or H x W x D	Metal	Cable	M12 x 63	M18 x 70	M30 x 64	M32 x 80
		Connector	M12 x 75	M18 x 85	M30 x 81	—
	Plastic	Cable	—	M18 x 78	M30 x 75	—
		Connector	—	M18 x 92	M30 x 92	—

## Sensors for DC applications

Connection				Pre-cabled PVC (2 m)			
3-wires	PNP	NO function	Flush mountable	XT512B1PAL2	XT518B1PAL2	XT530B1PAL2	—
			No flush mountable	—	XT218A1PAL2	XT230A1PAL2	XT234A1PAL2
	Function NO+NC		Flush mountable	XT512B1PBL2	XT518B1PCL2	XT530B1PCL2	—
	NPN	NO function	Flush mountable	—	XT518B1NAL2	XT530B1NAL2	—
No flush mountable			—	XT218A1NAL2	XT230A1NAL2	—	
Connection				M12			
3-wires	PNP	Function NO+NC	Flush mountable	XT512B1PAM12	XT518B1PCM12	XT530B1PCM12	—
			No flush mountable	—	XT218A1PCM12	XT230A1PCM12	—
Supply voltage limits, min./max. (V) including ripple				10...30			
Switching capacity, max (mA)				200			
Short-circuit protection (★) / LED output state indicator (⊗)				★ / ⊗			
Voltage drop, closed state (V) at I nominal				≤ 2			
Switching frequency (Hz)				50	30	25	25

## Multi-current/multi-voltage sensors for AC applications

Connection				Pre-cabled PVC (2 m)			
2-wires AC (1)	NO function	Flush mountable	—	XT518B1FAL2	XT530B1FAL2	XT132B1FAL2	
		No flush mountable	—	XT218A1FAL2	XT230A1FAL2	XT232A1FAL2	
	NC function	Flush mountable	—	XT518B1FBL2	XT530B1FBL2	—	
		No flush mountable	—	—	XT230A1FBL2	XT232A1FBL2	
Connection				Screw terminals			
2-wires AC (1)	NO or NC programmable	Flush mountable	—	—	XT230A2MDB (4)	—	
Supply voltage limits, min./max.(V) 50-60 Hz				—	20...264	20...264	20...264
Switching capacity, max (mA)				—	300	—	—
LED output state indicator (⊗) / Power on LED (⊗)				⊗ / —			
Voltage drop, closed state (V) at I nominal				—	≤ 5,5	≤ 5,5	≤ 9
Switching frequency (Hz)				—	15	10	10

(1) For these sensors without short-circuit protection, it is essential to connect a 0.4 A quick-blow fuse in series with the load.



(2) The operating distance depends on the objet material.

(3) Only for detecting insulating materials.

(4) 24...240 VAC or 24 VDC supply (No flush mountable)

## Accessories

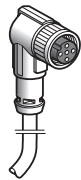
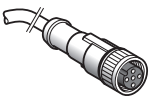
Suitable female plug-in connectors, including PUR pre-wired versions (1)

long. 5 m without DEL	pre-wired Elbowed		pre-wired Straight		screw terminal	
M12	XZCP1241L5		XZCP1141L5		XZCC12FCM40B	

(1) For PVC cable see page 47

# XU Photo-electric sensors

## General Purpose

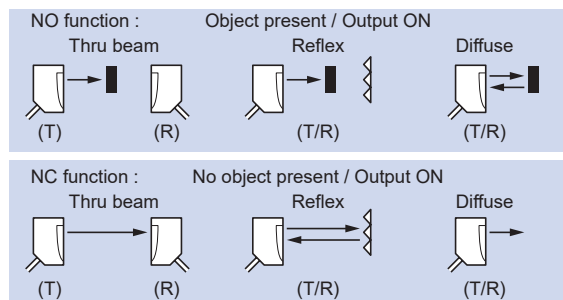

			M18 Metal (1) cable		M12 connector		M18 Plastic cable		M12 connector	
			A	B	A	B	A	B	A	B
Output function	NO									
	NC									
Diffuse	Sensing distance		0,6 m (2) (3)				0,6 m (2) (3)			
Output type	DC3 NO	PNP	XUB5BP ANL2	XUB5BP ANM12	XUB5AP A NL2	XUB5AP ANM12				
		NPN	XUB5BN ANL2	XUB5BN ANM12	XUB5AN ANL2	XUB5AN ANM12				
	AC/DC 1C/O relay		-		-		-		-	
Reflex Polarised	Sensing distance (4)		2 m				2 m			
Output type	DC3 NO	PNP	XUB9BP ANL2	XUB9BP ANM12	XUB9AP ANL2	XUB9AP ANM12				
		NPN	XUB9BN ANL2	XUB9BN ANM12	XUB9AN ANL2	XUB9AN ANM12				
	AC/DC 1C/O relay		-		-		-		-	
Reflex	Sensing distance (4)		4 m				4 m			
Output type	DC3 NO	PNP	XUB1BP ANL2	XUB1BP ANM12	XUB1AP ANL2	XUB1AP ANM12				
		NPN	XUB1BN ANL2	XUB1BN ANM12	XUB1AN ANL2	XUB1AN ANM12				
	AC/DC 1C/O relay		-		-		-		-	
Thru beam	Sensing distance		15 m				15 m			
Output type	DC3 NO	PNP	XUB2BP ANL2R	XUB2BP ANM12R	XUB2AP ANL2R	XUB2AP ANM12R				
		NPN	XUB2BN ANL2R	XUB2BN ANM12R	XUB2AN ANL2R	XUB2AN ANM12R				
	AC/DC 1C/O relay		-		-		-		-	
Thru beam Transmitter	DC		XUB2BKSNL2T	XUB2BKSNM12T	XUB2AKSNL2T	XUB2AKSNM12T				
	AC/DC		-		-		-		-	
Multimode	Sensing distance		Background suppression: : 0,12 m - Diffuse: 0,3 m Reflex polarised: : 3 m - Thru beam : 20 m							
Output type	DC3 NO/NC	PNP	XUB0BPSNL2	XUB0BPSNM12	XUB0APSNL2	XUB0APSNM12				
		NPN	XUB0BNSNL2	XUB0BNSNM12	XUB0ANSNL2	XUB0ANSNM12				
		PNP/NPN	-		-		-		-	
	AC/DC 1C/O relay		-		-		-		-	
Thru beam Transmitter	DC		XUB0BKSNL2T	XUB0BKSNM12T	XUB0AKSNL2T	XUB0AKSNM12T				
	AC/DC		-		-		-		-	

(1) Brass metal, available also in stainless steel, see page food/beverage processing series

(2) For a sensing distance 0,1 m without sensitivity adjustment, change digit 5 by 4 into the reference (ex: XUB5BPANL2 becomes **XUB4BPANL2**)

Fixing	M18 x1
Dimensions	pre-cabled / connectors M18 x 64 mm / M18 x 78 mm
Product certifications	CE, UL, CSA, C-TICK

### DC common characteristics

Supply voltage limits, min./max. (V) including ripple	10...36	10...36
Switching frequency (Hz)	500	500
Common characteristics for DC versions	Switching capacity, max (mA) : 100 / Overload and short-circuit protection (★) / LED output state	

### AC/DC common characteristics

Supply voltage limits, min./max. (V) including ripple	-	-
Switching frequency (Hz)	-	-
LED output state indicator (⊗) / power on LED (⊙)	-	-

## Accessories

### Reflectors

Reflectors (mm)	
	Ø 21 XUZC21
	24 x 21 XUZC24
	Ø 39 XUZC39
	Ø 80 XUZC80
	50 x 50 XUZC50
	100 x 100 XUZC100

### 3D fixings with ball joint



Bracket with ball joint for sensors and reflector XUZC50

for

XUB...	XUZB2003
XUM0...	XUZM2003
XUK...	XUZK2003
XUX...	XUZX2003

Protective housing with ball joint

for

XUK...	XUZK2004
XUX...	XUZX2004

M12 rod for ball joint

XUZ2001



Miniature Cable		Compact 50 x 50 mm Cable		Compact 92 x 71 mm	
M8 connector		M12 connector		Screw terminal	
NO or NC		NO or NC		NO or NC	
1.9 m (3)		1 m (3)		2,1 m (3)	
XUM5APXBL2	XUM5APXBM8	XUK5AP ANL2	XUK5AP ANM12	XUX5AP ANT16	XUX5AP ANM12
XUM5ANXBL2	XUM5ANXBM8	XUK5AN ANL2	XUK5AN ANM12	XUX5AN ANT16	XUX5AN ANM12
-	-	XUK5ARCNL2	-	XUX5ARCNT16	-
8 m (3)		5 m		11 m (3)	
XUM9APXBL2	XUM9APXBM8	XUK9AP ANL2	XUK9AP ANM12	XUX9AP ANT16	XUX9AP ANM12
XUM9ANXBL2	XUM9ANXBM8	XUK9AN ANL2	XUK9AN ANM12	XUX9AN ANT16	XUX9AN ANM12
-	-	XUK9ARCNL2	-	XUX9ARCNT16	-
		7 m		14 m (3)	
-	-	XUK1AP ANL2	XUK1AP ANM12	XUX1AP ANT16	XUX1AP ANM12
-	-	XUK1AN ANL2	XUK1AN ANM12	XUX1AN ANT16	XUX1AN ANM12
-	-	XUK1ARCNL2	-	XUX1ARCNT16	-
30 m (3)(5)		30 m		40 m (3)	
XUM2APXBL2	XUM2APXBM8	XUK2AP ANL2R	XUK2AP ANM12R	XUX2AP ANT16R	XUX2AP ANM12R
XUM2ANXBL2	XUM2ANXBM8	XUK2AN ANL2R	XUK2AN ANM12R	XUX2AN ANT16R	XUX2AN ANM12R
-	-	XUK2ARCNL2R	-	XUX2ARCNT16R	-
Transmitters are already included	Transmitters are already included	XUK2AKSNL2T	XUK2AKSNM12T	-	-
-	-	XUK2ARCNL2T	-	-	-
Background suppression: : 0,1 m - Diffuse: 0,4 m Reflex Polarised : 3 m - Thru beam : 10 m		Background suppression: : 0,28 m - Diffuse: 0,8 m Reflex Polarised : 4 m - Thru beam : 30 m		Background suppression: : 1,3 m - Diffuse: 2 m Reflex Polarised : 11 m - Thru beam : 40 m	
XUM0APSAL2	XUM0APSAM8	-	-	XUX0AKSAT16T	XUX0AKSAM12T
XUM0ANSAL2	XUM0ANSAM8	-	-	XUX0ARCTT16T	-
-	-	XUK0AKSAL2	XUK0AKSAM12	XUX0AKSAT16	XUX0AKSAM12
-	-	XUK0ARCTL2	-	XUX0ARCTT16	-
XUM0AKSAL2T	XUM0AKSAM8T	XUK0AKSAL2T	XUK0AKSAM12T	XUX0AKSAT16T	XUX0AKSAM12T
-	-	XUK0ARCTL2T	-	XUX0ARCTT16T	-
(3) with sensitivity adjustment		(5) Some references are available with Transmitter and Receiver together (ex: XUM2APSBL2)			
(4) with reflector XUZYC50 to be ordered separately					
Direct fixing centres 25.5, M3 screws 10,8 x 31,5 x 19,5 CE, UL, CSA, UKCA		Direct fixing centres 40 x 40, M4 screws 18 x 50 x 50 CE, UL, CSA, CCC, C-TICK		Direct fixing centres 30/38 to 40/50/74, M5 screws 30 x 92 x 71 CE, UL, CSA, CCC, C-TICK	
10...30		10...30		10...36	
1000		500		500	
LED output state indicator (⊗) : Yes / power on LED (⊗) : yes					
		20...264		20...264	
		20		20	
		⊗ / ⊗		⊗ / ⊗	

### Simple fixings

### Suitable female plug-in connectors, including PUR pre-wired versions (1)

Fixing support for M12 rod



XUZ2003

Single bracket

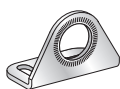

for	standard	with ball joint
XUB...	XUZA118 (stnls. steel)	XUZA218 (plastic)
XUM...	XUZA50	-
XUK...	XUZA51	-
XUX...	XUXZ2000	-

length. 5 m without LED



pre-wired Elbowed

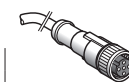

pre-wired Straight



Screw terminal

M8

XZCP1041L5

XZCP0941L5

XZCC8FCM40S

M12

XZCP1241L5

XZCP1141L5

XZCC12FCM40B

(1) For PVC cable see page 47

# XU Photo-electric sensors

## Optical forks without setting and frames

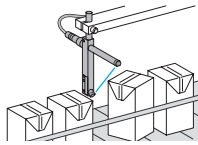
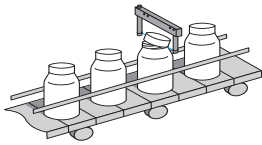

System		Thru-beam with modular red LED light source	
Output function	NO		A
	NC		B
Sensing distance		30...150 mm	
Minimum size of objet detected		0,8 mm	
Case M (metal)		M	
Temperature range (°C) / Degree of protection (conforming to IEC 60529)		- 10...+ 60 / IP65 and IP67	
Product certification		CE, cULus	

### Sensors for DC applications (solid-state output: transistor)

Connection				M8 connector 3-pins				Pre-cabled L = 2 m.						
Dimensions (mm)				A	B	C	D	A	B	C	D			
Transmitter / Receiver  	3-wires	NO function	PNP	XUVR0605P ANM8	50	60	74	77,5	XUVR0303PANL2	30	40	54	57,5	
			NPN	XUVR0605N ANM8										
			NO function	PNP	XUVR0608P ANM8	80	60	104		77,5				
				NPN	XUVR0608N ANM8									
			NO function	PNP	XUVR1212P ANM8	120	120	144		142				
				NPN	XUVR1212N ANM8									
			NO function	PNP	XUVR1218P ANM8	180	120	204		142				
				NPN	XUVR1218N ANM8									
			NO function	PNP	XUVA0505P ANM8	44	44	71		71				
				PNP	XUVA0808P ANM8	74	74	101		101				
				PNP	XUVA1212P ANM8	112	112	142		142				
				PNP	XUVA1515P ANM8	142	142	172		172				
Supply voltage limits, min./max. (V) including ripple				10...30										
Switching capacity, max (mA) / Switching frequency (Hz)				100/4kHz										
Short-circuit protect. (★) / LED output state indicator (⊗)				★ / ⊗										



System		Thru-beam with infrared emission				
Passageway dimensions		30 x 30 mm	60 x 60 mm	200 x 120 mm	200 x 180 mm	200 x 250 mm
Connection		M8 (4-pins)		M12 (4-pins)		
Minimum size of object to be detected	Ø 2 mm	XUVF30M8	XUVF60M8	-	-	-
	Ø 4 mm	-	-	XUVF120M12	XUVF180M12	XUVF250M12
	Ø 10 mm	-	-	XUYFRS120S	XUYFRS180S	XUYFRS250S
Type et Output function		4-wires, PNP and NPN Output function ON or OFF on passage of object, programmable				
Function type		Dynamic (XUVF30M8, XUVF60M8), Dynamic or static (XUVF120M12, XUVF180M12, XUVF250M12)				
Supply voltage limits, min./max. (V) including ripple		18...30				
Switching capacity, max (mA) / Switching frequency (Hz)		≤ 100 / 500 Hz				
Short-circuit protect. (★) / LED output state indicator (⊗)		★ / ⊗				

### Accessories

Suitable female PUR pre-wired plug-in connectors (1)		M8 (3-pins)		M8 (4-pins)		M12 (4-pins)			
		For optical forks without setting		For optical forks and frame with setting		For frame with setting			
		Straight	Elbowed	Straight	Elbowed	Straight	Elbowed		
 Straight Elbowed	2 m	XZCP0566L2	XZCP0666L2	2 m	XZCP0941L2	XZCP1041L2	2 m	XZCP1141L2	XZCP1241L2
	5 m	XZCP0566L5	XZCP0666L5	5 m	XZCP0941L5	XZCP1041L5	5 m	XZCP1141L5	XZCP1241L5

(1) For PVC cable see page 47

## Forks with teach mode (1)

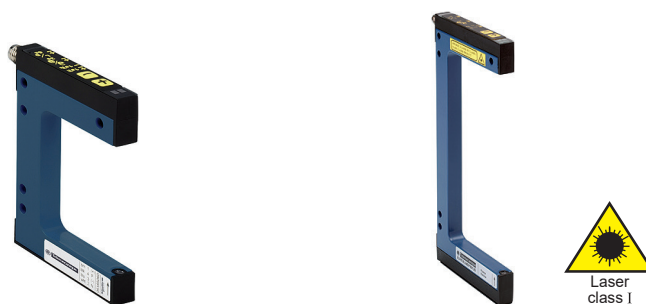

System, with teach mode	Thru beam	Thru beam laser
Sensing distance	2...120 mm	2...120 mm
Fixings (mm)	(see column E below)	
Minimum size of objet detected	0,2 mm	0,05 mm
Case M (metal) / Setting-up assistance LEDs ☉	M / ☉	
Temperature range (°C) / Degree of protection (conforming to IEC 60529)	-25...+60 / IP65	
Product certification	CE, cULus	

## Sensors for DC applications (solid-state output: transistor)

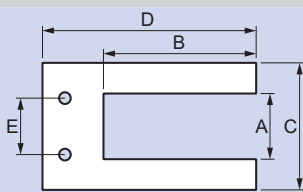
Connection	M8 connector - 4-pins														
Output type	3-wires PNP/NPN programmable NO / NC														
Dimensions (mm)															
Transmitter / Receiver	A	B	C	D	E	A	B	C	D	E	A	B	C	D	E
	XUYFANEP40002	2	42	32	57	14	XUYFALNEP40002	2	42	41	57	14			
	XUYFANEP60002	2	59		77		XUYFALNEP60002	2	59		77				
	XUYFANEP100002	2	95		110		XUYFALNEP100002	2	95		110				
	XUYFANEP40005	5	42	35	57	14	XUYFALNEP40005	5	42	44	57	14			
	XUYFANEP60005	5	59		77		XUYFALNEP60005	5	59		77				
	XUYFANEP100005	5	95		110		XUYFALNEP100005	5	95		110				
	XUYFANEP40015	15	42	45	57	27	XUYFALNEP40015	15	42	54	57	27			
	XUYFANEP60015	15	59		77		XUYFALNEP60015	15	59		77				
	XUYFANEP100015	15	95		110		XUYFALNEP100015	15	95		110				
	XUYFANEP40030	30	42	60	57	42	XUYFALNEP40030	30	42	69	57	42			
	XUYFANEP60030	30	59		77		XUYFALNEP60030	30	59		77				
	XUYFANEP100030	30	95		110		XUYFALNEP100030	30	95		110				
	XUYFANEP40050	50	42	80	57	40	XUYFALNEP40050	50	42	89	57	40			
	XUYFANEP60050	50	59		77		XUYFALNEP60050	50	59		77				
	XUYFANEP100050	50	95		110		XUYFALNEP100050	50	95		110				
	XUYFANEP40080	80	42	110	57	70	XUYFALNEP40080	80	42	119	57	70			
	XUYFANEP60080	80	59		77		XUYFALNEP60080	80	59		77				
	XUYFANEP100080	80	95		110		XUYFALNEP100080	80	95		110				
	XUYFANEP40120	120	42	150	57	110	XUYFALNEP40120	120	42	159	57	110			
	XUYFANEP60120	120	59		77		XUYFALNEP60120	120	59		77				
	XUYFANEP100120	120	95		110		XUYFALNEP100120	120	95		110				
Supply voltage limits, min./max. (V) including ripple	10...30										10...30				
Switching capacity, max (mA) / Switching frequency (Hz)	100/10kHz										100/10kHz				
Short-circuit protect. (★) / LED output state indicator (☉)	★ / ☉										★ / ☉				

(1) To order a fork without teach mode, delete A of the reference. Ex: XUYFANEP40002 becomes **XUYFNPEP40002**



System	Thru beam Ultrason	Thru beam
	Special transparent labels	For all other opaque labels
Sensing distance	3 mm version XUVU06M3PSNM8	XUVE04M3PSNM8
Switching frequency (Hz)	1500	10 000
Sensitivity adjustment	Numeric potentiometer (1)	Numeric potentiometer (1)
Connection	M8 (4-pins)	
Case M (metal) / Setting-up assistance LEDs ☉	M / ☉	
Temperature range (°C) / Degree of protection (conforming to IEC 60529)	+5...+55 / IP65	-20...+60 / IP65
Product certification	CE	CE, cULus

(1) remote adjustment available.

# XU Photo-electric sensors - Application

## Assembly series



Application	Accurate detection or very long sensing distance		Robustness and compactness	
System	Thru beam	Diffuse	Reflex	Diffuse contrast
Sensing distance	100 m (1)	0,07 m	10...1000 mm (2)	40...150 mm
Fixings (mm)	M18 x 1	M8 x 1	Directe, 2 trous M3, entraxe 24 mm	
Sensitivity adjustment	Teach mode	–	Teach mode	
Case M (metal) P (plastic) / Setting-up assistance LEDs ☉	P / ☉	M / –	P	
Temperature range (°C)	- 10...+ 45°C	- 25...+ 55	- 20...+ 60°C	
Degree of protection (conforming to IEC 60529)	IP67	IP67	IP67	
Product certification	CE, UL, CSA	CE, cULus	CE, cULus	
Dimensions (mm) Ø x L or H x W x D	Ø 18 x 64	Ø 8 x 40	20 x 35,8 x 12	

### Sensors for DC applications (solid-state output: transistor)

Connection	Connector	M 12	M 8 - 4-pins		
Transmitter / Receiver	3-wires PNP programmable NO / NC	XUBLAPCNM12	–	XUYBCO929LSP	XUYPCCO929LSP
	3-wires NPN programmable NO / NC	XUBLANCNM12	–	–	–
Supply voltage limits, min./max. (V) including ripple		10...30	10...30	10...30	10...30
Switching capacity, max (mA) / Switching frequency (Hz)		100 / 1500	100 / 700	100 / 1000	100 / 1000
Short-circuit protect. (★) / LED output state indicator (☉)		★ / ☉	★ / ☉	★ / ☉	★ / ☉

(1) or min. size of object: 0.2 mm

(2) With specific reflector XUY1111, format 50 x 50 mm. To be ordered separately.



Application	Miniature series sensors		compact 50x50mm			
System	Polarised preflex	Thru beam	Polarised preflex	Thru beam	Back ground suppression	Diffuse
Sensing distance	1...1.5 m (4)	4 m	12 m (7)	25 m	0.8 m	1.2 m
Sensitivity adjustment	potentiometer	potentiometer	Teach mode	Teach mode	potentiometer	Teach mode
P (plastic) / Setting-up assistance LEDs ☉	P / ☉					
Temperature range (°C) / Degree of protection (conforming to IEC 60529)	0...+ 50°C / IP65 and IP67		-20...+ 60°C / IP67 and IP69K			
Product certification	CE, cULus		CE, Ecolab			
Dimensions (mm) H x W x D	40 x 10 x 13.5		50 x 50 X 23			

### Sensors for DC applications (solid-state output: transistor)

Connection	M8 connector (5) - 4-pins		M12 connector - 4-pins				
	PNP	NO function	XUYBCO989SP	XUYRCO989SP	–	–	–
	NPN	NO function	XUYBCO989SN	XUYRCO989SN	–	–	–
	PNP/NPN	Programmable NO / NC			XUK9LAPSM12 (6)	XUK2LAPSM12R (6)	XUK8LAPPNM12 (6)
Émetteur	–	XUYECO989	–	XUK2LAKSM12T (6)	–	–	–
Supply voltage limits, min./max. (V) including ripple	10...30		12...30				
Switching capacity, max (mA) / Switching frequency (Hz)	100 / 500		100 / ≤ 2000	100 / ≤ 3500	100 / ≤ 1000	100 / ≤ 600	
Short-circuit protect. (★) / LED output state indicator (☉)	★ / ☉						

(4) 50 x 50 reflector included.

(5) For 2 m pre-cabled version, delete CO from the reference. (Example: XUYBCO989SP becomes **XUYB989SP** or XUYRCO989SP becomes **XUYR989SP**).

(6) Fixing bracket: XUZA51S to be ordered separately

(7) With reflector XUZC50HP to be ordered separately

## Materials handling series - Conveying Analogue output

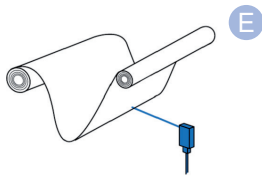

E Analogue output  
Position control

E

High access  
gain for resistance  
to accumulation of dirt

Application				
System	Diffuse	Reflex	Diffuse	Thru beam
Sensing distance	0,1...5 m	0,3...70 m (1)	0,05...0,40 m	50 m
Sensitivity adjustment	Teach mode		Potentiometer	
Case M (metal), P (plastic) / Setting-up assistance LEDs ☉	P / ☉		M / ☉	
Temperature range (°C) / Degree of protection (conforming to IEC 60529)	- 40...+ 50	- 10...+ 50	- 25...+ 55	
Degree of protection (conforming to IEC 60529)	IP67 and IP69K		IP67	
Product certification	CE, cULus		CE, UL, CSA	CE, UL, CSA, C-TICK
Dimensions (mm) Ø x L or H x W x D	50 x 50 x 23		M18 x 95	

### Sensors for DC applications

Connection	M12 - 5-pins	M12 - 8-pins	M12 - 4-pins	
Transmitter / Receiver	analogue 4-20 mA + 1 PNP/NPN	XUK8TAE2MM12 (4)	–	XU2M18AP20D (2)
	analogue 0 - 10 V + 1 PNP/NPN	XUK8TAE1MM12 (4)	–	–
	analogue 4-20mA + 2 PNP/NPN	–	XUK9TAH2MM12	–
	analogue 4-20mA	–	–	XU5M18AB20D
Supply voltage limits, min./max. (V) including ripple	18...30		10...30	
Switching capacity, max (mA) / Switching frequency (Hz)	100 / 500		20 / 20	
Short-circuit protect. (★) / LED output state indicator (☉)	★ / ☉		★ / ☉	

(1) with reflector XU2C250 to be ordered separately. (2) on white and grey object 0,2 ... 6m, on black object 0,2 ... 2,5m (3) 2 PNP outputs. (4) ECOLAB certified.

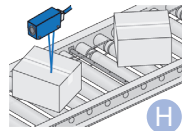
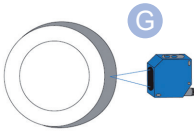
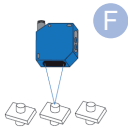

Application	F G		H
System	Diffuse, Analogue output 0-10 V		Diffuse
Sensing distance	40...60 mm	80...300 mm	0...100 mm
Minimum size of object	1 mm	1,5 X 3,5 mm	85 mm
Sensitivity adjustment	potentiometer		No
Case P (plastic) / Setting-up assistance LEDs ☉	P / ☉		Aluminium tube / ☉
Temperature range (°C)	0...+ 45°		- 10...+ 55
Product certification	CE, cULus		CE, cCSAus
Dimensions (mm) H x l x L	50 x 17 x 50		Tube Ø 12 , variable length from 200 to 900 mm (example 474 mm)

### Sensors for DC applications (solid-state output: transistor)

Connection	par connector M12	par connector M12	Remote M12 connector
Transmitter / Receiver 0...10 V	XUYPCO925L1ANSP	XUYPCO925L3ANSP	XUY474NB4H03M12
Supply voltage limits, min./max. (V) including ripple	18...28		18...30
Switching capacity, max	3 mA / Analogue output 0...10 V	3 mA / Analogue output 04...20 mA	100 mA
Switching frequency (Hz)	40		1000
Short-circuit protect. (★) / LED output state indicator (☉)	★ / ☉		★ / ☉

### Accessories

Suitable female PUR pre-wired plug-in connectors (1)						Female connectors	Fixing for XUE
M8 Straight	M12 Straight	M8 Elbowed	M12 Elbowed	5-pins M12	8-pins M12	M12 (5-pins)	
2 m XZCP0941L2	XZCP1141L2	XZCP1041L2	XZCP1241L2	XZCPV11V12L2	XZCP29P12L2	Straight XZCC12FCM50B	For compact
5 m XZCP0941L5	XZCP1141L5	XZCP1041L5	XZCP1241L5	XZCPV11V12L5	XZCP29P12L5	Elbowed XZCC12FDM50B	XUZA618

(1) For PVC cable see page 47

# XU Photo-electric sensors - Application Packaging series

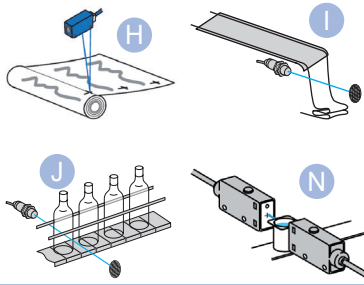

Application	H Contrast sensors	
System	Diffuse (with Teach mode)	Diffuse (with Teach mode)
Sensing distance	19 mm	9 mm (2)
Fixings (mm)	direct: fixing centres 40x40	direct : 21 x 28 vis M5
Sensitivity adjustment	Teach button	
Case M (metal) P (plastic) / Setting-up assistance LEDs ☉	P / ☉	M / ☉
Temperature range (°C) / Degree of protection (conforming to IEC 60529)	- 10...+ 55 / IP65	- 10...+ 55 / IP67
Product certification	CE, cULus	CE
Dimensions (mm) Ø x L or H x W x D	50 x 50 x 15	96 x 64 x 31

## Sensors for DC applications (solid-state output: transistor)

Connection	M12 connector		
Transmitter / Receiver	3-wires PNP	NO function	XUKR1PSMM12
	3-wires NPN	NO function	XUKR1NSMM12
	3-wires PNP / NPN	programmable NO / NC	XURK1KSMM12
Supply voltage limits, min./max. (V) including ripple	10...30		
Switching capacity, max (mA) / Switching frequency (Hz)	100 / 5000		

(1) Nominal sensing distance 50 m. Use between 10 and 20 cm, depending on application.  
 (2) 7 mm with XURZ02; 18 mm with XURZ01.



Application	I J			
System	Diffuse (manual)	Reflex (potentiometer)	Reflex (with teach mode) (50 x 50 reflector included)	
Sensing distance	0,02...0,08 m	0.1...2 m	0...1,4 m (4)	1,5 m
Fixings (mm)	M18x1	M3 holes, fixing centers 24	M18 x 1 (5)	direct: fixing ctrs. 40 x 40
Sensitivity adjustment	potentiometer	potentiometer	Teach button	
Case M (metal) P (plastic) / Setting-up assistance LEDs ☉	M / ☉	P / ☉	P / ☉	
Temperature range (°C) / Degree of protection (conforming to IEC 60529)	- 25...+ 55 / IP67	- 25...+ 55 / IP67	0...+ 55 / IP67	- 25...+ 55 / IP65
Product certification	CE, CSA, UL	CE, cURus	CE, UL, CSA, C-TICK	
Dimensions (mm) Ø x L ou H x l x L	Ø18 x 95	33 x 20 x 11	Ø18 x 64	50 x 50 x 18

## Sensors for DC applications (solid-state output: transistor)

Connection	Pre-cabled PVC (2 m)				
Transmitter / Receiver	3-wires PNP	programmable NO / NC	–	XUMTAPCNL2	XUBTAPSNL2 (5)(6)
	3-wires NPN	programmable NO / NC	–	XUMTANCNL2	XUBTANSNL2 (5)(6)
	3-wires PNP / NPN	programmable NO / NC	–	–	XUKT1KSML2
Connection	M12 connector		M8 connector	M12 connector	
Transmitter / Receiver	3-wires PNP	NO function	XU5M18U1D	–	–
	3-wires PNP	programmable NO / NC	–	XUMTAPCNM8 (3)	XUBTAPSNM12 (5)(6)
	3-wires NPN	programmable NO / NC	–	XUMTANCNM8	XUBTANSNM12 (5)(6)
	3-wires PNP / NPN	programmable NO / NC	–	–	XUKT1KSMM12
Supply voltage limits, min./max. (V) including ripple	10...30		10...30	10...32	10...30
Switching capacity, max (mA) / Switching frequency (Hz)	100 / 1000		100 / 1000	100 / 1000	100 / 1500

(3) also available with M12 remote connector with 0.3 m cable : replace M8 by L03M12.

(4) 0...0.8 m for versions with 90° head, to order replace the 8e digit N by W. Example XUBTAPSNL2 becomes **XUBTAPSWL2**

(5) Also available in stainless steel for food and beverage processing applications. To order, replace the letter A by S in the ref. Example: XUBTAPSNL2 becomes **XUBTSPSNL2**.

(6) ECOLAB certified.



## Food/beverage processing series



Stainless steel version for resistance to harsh agents

System	Multimode (3)	Polarised reflex 50x50 mm reflector included (2)	Diffuse (2)	Thru beam (2)
Sensing distance	(4)	3 / 2 m	0,15 / 0,10 m	20 / 15 m
Fixings (mm)	M18 x 1	M18 x 1	M18 x 1	M18 x 1
Case M (metal)	M (stainless steel)	M (stainless steel)	M (stainless steel)	M (stainless steel)
Temperature range (°C) / Degree of protection (conforming to IEC 60529)		- 25...+ 55 / IP67	- 25...+ 55 / IP67	- 25...+ 55 / IP67
Product certification	CE, UL, CSA, C-TICK			
Dimensions (mm) Ø x L	Ø 18 x 64	Ø18 x 62	Ø18 x 62	Ø18 x 64

### Sensors for DC applications (solid-state output: transistor)

Connection			Pre-cabled PvR (2 m)			
Transmitter / Receiver	3-wires PNP	programmable NO / NC	XUB0SPSNL2	XU9N18PP341	XU5N18PP341	XU2N18PP341
	3-wires NPN	programmable NO / NC	XUB0SNSNL2	XU9N18NP341	XU5N18NP341	XU2N18NP341
Connection			par connector M12			
Transmitter / Receiver	3-wires PNP	programmable NO / NC	XUB0SPSNM12	XU9N18PP341D	XU5N18PP341D	XU2N18PP341D
	3-wires NPN	programmable NO / NC	XUB0SNSNM12	XU9N18NP341D	XU5N18NP341D	XU2N18NP341D
Thru-beam transmitter accessory	pre-cabled (2 m)		XUB0SKSNL2T	–	–	–
	connector		XUB0SKSNM12T	–	–	–
Supply voltage limits, min./max. (V) including ripple			10...36	10...30	10...30	10...30
Switching capacity, max (mA) / Switching frequency (Hz)			100 / 250	100 / 500	100 / 500	100 / 500

(2) Also available with 90° head. To order, add the letter W after the numbers 341 in the reference. Example: XU9N18PP341 becomes **XU9N18PP341W** or **XU9N18PP341WD**.

(3) Also available with 90° head, to order replace the 8e digit N by W. Example XUB0SPSNL2 becomes **XUB0SPSWL2**

(4) Background suppression: 0.12 m - Diffuse: 0.3 m - Reflex polarised: 3 m - Thru beam: 20 m

### Accessories

Suitable female plug-in connectors, including PUR pre-wired versions (1)				Lenses for colour mark		
L = 5 m, without LED	Wired, Elbowed	Wired, Straight	Screw terminal	Lens for 18 mm sensing distance		Lens for 7 mm sensing distance
M8 (ou S) 4-pins	XZCP0666L5	XZCP0566L5	XZCC8FCM30S		XURZ01	
M12 (ou D) 4-pins	XZCP1241L5	XZCP1141L5	XZCC12FCM40B			XURZ02
M12 8-pins	–	XSZMCR03 (3 m)	–			

(1) For PVC cable see page 47

### Accessories

Pre-wired connectors		Ecolab reflector 50x50 (2)		Stainless steel fixing bracket	
L = 5 m	Elbowed XZCPA1241L5	Straight XZCPA1141L5	XUZC50CR	XUZA118 (for M18)	XUZA51S (for compact)

(2) Sensing distance for XUK9S: 3m with XUZC50CR or 6m with **XUZC50**.

# XU Photo-electric sensors with background suppression

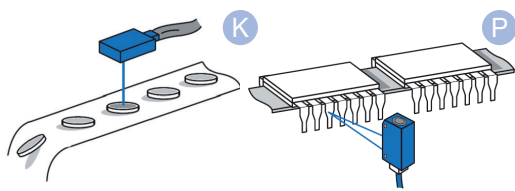

K

P

K

Application			
System	Background suppression	Diffuse with Background suppression	
		Sensing distance 1	Sensing distance 2
Sensing distance	1,5...80 mm	10...60 mm	30...110 mm
Minimum size of object	–	0,3 mm	0,7 mm
Fixing (mm)	2 x Ø 3 holes / fxg. ctrs. 14.5	direct: 2 M3 holes, fixing centres 24 mm	
Sensitivity adjustment	potentiometer	Teach mode	
Case P (plastic) / Setting-up assistance LEDs ☉	P / ☉	P	
Temperature range (°C) / Degree of protection (conforming to IEC 60529)	0...+50 / IP65 & IP67	- 20...+ 60°C / IP67	
Product certification	CE, cULus	CE, cULus	
Dimensions (mm) H x W x D	20 x 32 x 13	20 x 35,8 x 12	

## Sensors for DC applications (solid-state output: transistor)

Connection	M8 connector (1) - 4-pins		
Transmitter / Receiver	PNP	NO function	M8 connector- 4-pins
			–
	PNP	Programmable NO / NC	XUYPSCO929L1SP
			XUYPSCO929L2SP
Supply voltage limits, min./max. (V) including ripple	10...30		
Switching capacity, max (mA) / Switching frequency (Hz)	100 / 1000		
Short-circuit protect. (★) / LED output state indicator (☉)	★ / ☉		

(1) For 2 m pre-cabled connection delete CO from the reference. Example: XUYPS 989SP becomes **XUYPS989SP**.

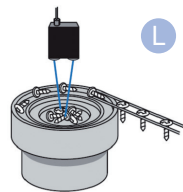
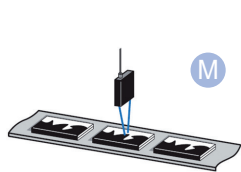

M

L

Application		
System	Background suppression	Background suppression, 2 chnls.
Sensing distance	50...300 mm	50...600 mm
Minimum size of object	0,5 mm	–
Fixings (mm)	direct: 2 M4 holes, ctrs. 54 mm	2 x Ø 4 holes, fixing ctrs. 54
Sensitivity adjustment	potentiometer	potentiometer
Case P (plastic) / Setting-up assistance LEDs ☉	P / ☉	P / ☉
Temperature range (°C) / Degree of protection (conforming to IEC 60529)	0...+ 50°C / IP65	0...+60 / IP40
Product certification	CE, cULus	
Dimensions (mm) H x W x D	60 x 60 x 18	60 x 60 x 18

## Sensors for DC applications (solid-state output: transistor) Sensors with overload and short-circuit protection

Connection	M8 connector	
Transmitter / Receiver	3-wires PNP / NPN	programmable NO / NC
	XUYPS1LCO965S	XUYPS2CO945S
Supply voltage limits, min./max. (V) including ripple	10...30	
Switching capacity, max (mA) / Switching frequency (Hz)	100 / 5000	

## Accessories

### PUR Pre-wired connectors (1)



Straight

Elbowed

M8 (4-pins)			M12 (4-pins)			7/8" (5-pins)	
	Straight	Elbowed		Straight	Elbowed		Straight
2 m	XZCP0941L2	XZCP1041L2	2 m	XZCP1141L2	XZCP1241L2	2 m	XZCP1764L2
5 m	XZCP0941L5	XZCP1041L5	5 m	XZCP1141L5	XZCP1241L5	5 m	XZCP1764L5

(1) For PVC cable see page

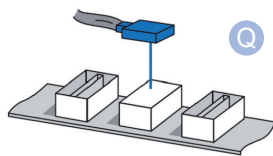

objects on conveyors



Application	objects on conveyors			
System	Diffuse with adjustable background suppression			
Max. / usable sensing distance	20...300 mm	0...1 m	0...5 m	2 m
Fixing (mm)	Fixing : M3 holes, fixing centers 24 mm	Direct fixing centres 40 x 40, M4 screws	2 x Ø 4.3 holes / fixing centres 30	Direct: fixing ctrs. 30/38 to 40/50/74 M5 screw
Sensitivity adjustment	potentiometer	-	Teach mode	-
Case P (plastic) / Setting-up assistance LEDs ☉	P / ☉	P / ☉	P / ☉	P / ☉
Temperature range (°C) / Degree of protection (conforming to IEC 60529)	- 25...+ 55 / IP67	- 25...+ 55 / IP65	- 40...+ 60 / IP67 & IP69K	- 25...+ 55 / IP67
Product certification	CE, cURus	CE, UL, CSA	CE, cULus	CE, UL, CSA
Dimensions (mm) H x W x D	33 x 20 x 11	50 x 50 x 18	50 x 50 x 23	92 x 30,5 x 71

### Sensors for DC applications (solid-state output: transistor). Sensors with overload and short-circuit protection

Connection			Pre-cabled	Pre-cabled PVC (2 m)	Screw terminals	
Transmitter / Receiver	3-wires PNP / NPN	programmable NO / NC	-	XUK8AKSNL2	-	XUX8AKSAT16
	PNP	programmable NO / NC	XUM8APXBL2	-	-	-
	NPN	programmable NO / NC	XUM8ANXBL2	-	-	-
Connection			M8 connector	M12 connector		
Transmitter / Receiver	3-wires PNP / NPN	programmable NO / NC	-	XUK8AKSNM12	XUK8TAKSMM12 (1)	XUX8AKSAM12
	PNP	programmable NO / NC	XUM8APXBM8	-	-	-
	NPN	programmable NO / NC	XUM8ANXBM8	-	-	-
Supply voltage limits, min./max. (V) including ripple				10...36	18...30	10...36
Switching capacity, max (mA) / Switching frequency (Hz)				100 / 250	100 / 500	100 / 150

(1) also existing with 2 independant outputs: XUK8TAKDMM12 (M12 - 5-pins).



System	Diffuse with adjustable background suppression		
Sensing distance	70...120 mm	10...750 mm	2 m
Fixing (mm)	M18 x 1	Direct fixing centres 40 x 40, M4 screws	Direct: fixing ctrs. 30/38 to 40/50/74 M5 screw
Sensitivity adjustment	potentiometer	Teach mode	-
Case M (metal) P (plastic) / Setting-up assistance LEDs ☉	M / ☉	P / ☉	P / ☉
Temperature range (°C) / Degree of protection (conforming to IEC 60529)	- 25...+ 55°C / IP67	- 25...+ 55°C / IP65	- 25...+ 55 / IP67
Product certification	CE, UL, CSA	CE, UL, CSA	CE, UL, CSA
Dimensions (mm) Ø x L or H x W x D	M18 x 82	50 x 18 x 50	92 x 30,5 x 71

### Multi-current/multi-voltage sensors for AC/DC applications

Connection			Cable L = 2m	Cable	Screw terminals
Transmitter / Receiver	AC/DC	NO function	XU8M18MA230	-	-
		Programmable NO / NC	-	XUK8ARCTL2	XUX8ARCTT16
Supply voltage limits, min./max. (V) including ripple			20...264	20...264	20...264
Switching capacity, max (mA) / Switching frequency (Hz)			200 / 25	3000 / 20	3000 / 20
Short-circuit protect. (★) / LED output state indicator (☉)			(1) / ☉	-	-

(1) Sensor not short-circuit protected. Therefore, it is essential to connect a 0.4 A quick-blow fuse in series with the load.

# XU Photo-electric sensors, fibre optic Amplifier



	+/- potentiometer	Teach	Teach + Timer
Max. / usable sensing distance	Depending on fibre used, plastic only		
Fixing (mm)	DIN rail or direct: fixing centres 25, M3 screws		
Sensitivity adjustment	+/- numeric potentiometer	using teach mode	+/- numeric potentiometer
Case P (plastic) / Setting-up assistance LEDs ☉	P / ☉	P / ☉	P / ☉
Temperature range (°C) / Degree of protection (conforming to IEC 60529)	0...+60 / IP65	- 10...+ 55 / IP65 (1)	0...+60 / IP65
Product certification	CE, cULus	CE, cULus, cURus	CE, cULus
Dimensions (mm) L x H x W	60 x 30 x 13	65 x 40 x 10	60 x 30 x 13

## Sensors for DC applications (solid-state output: transistor)

Connection	Pre-cabled PVC (2 m)		
References	3-wires PNP programmable NO / NC	-	XUDA1PSML2
Amplifier	3-wires NPN programmable NO / NC	-	XUDA1NSML2
Connection par connector	M8 connector - 4-pins		
References	3-wires PNP programmable NO / NC	-	XUDA1PSMM8
Amplifier	3-wires NPN programmable NO / NC	-	XUDA1NSMM8
	3-wires PNP/NPN programmable NO / NC	XUYAFVCO966S (Glass) XUYAFPCO966S (Plastic)	- - XUYAFVCO946S (Glass) XUYAFPCO946S (Plastic)
Supply voltage limits, min./max. (V) including ripple	10...30	10,8...26,4	10...30
Switching capacity, max (mA) / Switching frequency (Hz)	100 / 1000	100 / 1000	100 / 1000 time delayable
Short-circuit protect. (★) / LED output state indicator (☉)	★ / ☉	★ / ☉	★ / ☉

(1) IP65 with fibre Ø 1 / IP64 with fibre Ø 0,5

## Ecofibre system, assemble your own plastic fibres



Fibre Ø 1 mm	Length = 10 m	Length = 20 m
References	XUFZ910	XUFZ920

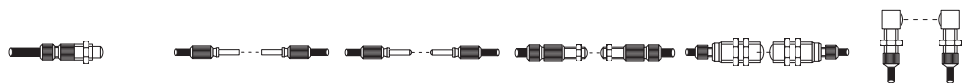

End fittings	70	200	800	1200	4000	1200
Sensing distance (mm)	70	200	800	1200	4000	1200
Type	with threaded end fitting	with plain end fitting Ø 3, L = 9 mm	with plain end fitting Ø 3, L = 9 mm	with threaded end fitting	with threaded end fitting	90° mirror, with threaded end fitting
Thread	M8 x 1, L = 10 mm	-	-	M6 x 1, L = 10 mm	M12 x 1, L = 25 mm	M6 x 1, L = 3 to 10 mm
Lens	Yes	No	Yes	Yes	Yes	Yes
References	XUYA110	XUYA210	XUYA211	XUYA212	XUYA213	XUYA220

## Accessories

For fibres plastic System Thru beam	For all system plastic fibre optics	Plug-in PUR pre-wired female connectors (1)
<b>Lenses</b> For increasing sensing distance (pair) XUFZ01 With 90° mirror (pair) XUFZ02	<b>Fibre trimmer</b> For trimming fibres to length (included with all fibre optics) XUFZ11 <b>Protective metal tubing</b> Length 1 m, for fibres with threaded end fittings For M4 thread XUFZ210 For M6 thread XUFZ310	Cable length 5 m, without LED pre-wired, elbowed pre-wired, straight XZCP1041L5 XZCP0941L5 (1) For PVC cable see page 47
<b>Fixing clamp with lens (set of 2)</b> Front screw fixing for fibre optics XUF-Z920 XUFZ04		

## Plastic fibre optic light guides (length 2 m)



	M4 / M2,6 (1)	M4/L = 90 mm	M3 / M2,6 (1)	Long range fibres with integrated lens M8 / L = 20 mm	Long range fibres M4 / M2,6 (1)	Flexible fibres M4 / M2,6 (1)
<b>System</b>	<b>Thru beam</b>					
Sensing distance (mm)	200 ou 1500 (2)	180	50 ou 1000 (2)	2500	300 ou 2000 (2)	100 ou 750 (2)
Fibre cross-section						
Fibre Ø (mm)	Ø 1	Ø 1	Ø 0,5	Ø 1	Ø 1,5	Ø 1
Sheath Ø (mm)	Ø 2,2	Ø 2,2	Ø 1	Ø 2,2	Ø 2,2	Ø 2,2
Temperature range (°C)	- 25...+ 60	- 25...+ 60	- 25...+ 60	- 25...+ 60	- 25...+ 60	- 25...+ 60
References	XUFN12301	XUFN12311	XUFN35301	XUFN2L01L2	XUFN2P01L2	XUFN2S01L2
Fixings	M4 x 0,7	M4 x 0,7	M3 x 0,5	M8 x 1,25	M2,6 x 0,45 / M4 x 0,7	M2,6 x 0,45 / M4 x 0,7

(1) Can be used with 90° mirror XUFZ02 (see preceding page).

(2) With lens accessory XUFZ01 (see preceding page).



	M6	M4 / M6	M6/L = 90 mm	M4 / M2,6
<b>System</b>	<b>Diffuse</b>			
Sensing distance (mm)	70	60	60	15
Fibre cross-section				
Fibre Ø (mm)	Ø 1	Ø1+16 Ø 0,265	Ø 1	Ø 0,5 + 4 Ø 0,23
Sheath Ø (mm)	Ø 2,2 x 2	Ø 2,2 x 2	Ø 2,2 x 2	Ø 1 x 2
Temperature range (°C)	- 25...+ 60	- 25...+ 60	- 25...+ 60	- 25...+ 60
References	XUFN05321	XUFN05323	XUFN05331	XUFN02323
Fixings	M6 x 0,75	M6 x 0,75 / M4 x 0,7	M6 x 0,75	M4 x 0,7

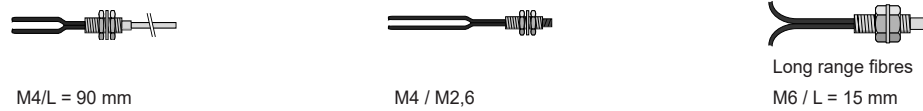

	M4/L = 90 mm	M4 / M2,6	Long range fibres M6 / L = 15 mm
<b>System</b>	<b>Diffuse</b>		
Sensing distance (mm)	18	18	95
Fibre cross-section			
Fibre Ø (mm)	Ø 0,5	Ø 0,5	Ø 1,5
Sheath Ø (mm)	Ø 1 x 2	Ø 1 x 2	Ø 2,2 x 2
Temperature range (°C)	- 25...+ 60	- 25...+ 60	- 25...+ 60
References	XUFN01331	XUFN01321	XUFN5P01L2
Fixings	M4 x 0,7	M4 x 0,7	M6 x 0,75

## Glass fibre optic light guides (length 0.6 m)

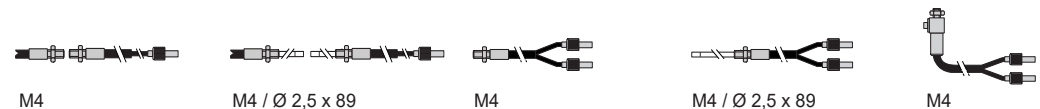

	M4		M4 / Ø 2,5 x 89	M4	M4 / Ø 2,5 x 89	M4
<b>System</b>	<b>Thru beam</b>			<b>Diffuse</b>		
Sensing distance (mm)	200			80		
Fibre cross-section						
End fitting	Straight	Adaptable		Straight	Adaptable	90°
Fibre Ø (mm)	1			1		
Sheath Ø (mm)	2,2			2,2		
Temperature range (°C)	PVC sheath : - 25...+ 60°C / Metal wound : - 25...+ 120°C / Flexible (stainless steel) : - 25...+ 200°C					
References	PVC sheath	XUYFVERSD61	–	XUYFVPSD61	XUYFVPSC61	XUYFVPSL61
	Metal wound	XUYFVERMD61	XUYFVERMC61	XUYFVPM61	XUYFVPMC61	XUYFVPM61
	Flexible stnl.steel	XUYFVERTD61	–	XUYFVPTD61	XUYFVPTC61	XUYFVPTL61

# XX Ultrasonic sensors

## Detection of any material

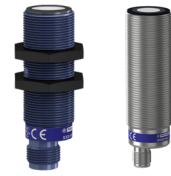

New

		M12	M18	M18 software-configurable
Nominal sensing distance Sn	Mode proximity or reflex	5 ou 10 cm depending on model	15 ou 50 cm depending on model	–
	Mode Thru beam	20 cm	61 ou 100 cm depending on model	–
	Window or proximity or reflex or pump	–	–	1m
Operating zone for proximity mode		0,64...5,1 cm (XX512A1...) 0,64...10,2 cm (XX512A2...)	1,9...15,2 cm (XX518A1...) 5,1...50,8 cm (XX518A3...)	0,105...1m
Sensitivity adjustment		Fixed	Adjustable using remote control for XX518 A3. Fixe for XX518A1, XXT18, XXR18	adjustable usign teach button or software
Case M (metal), P (plastic)		P	P	P or M
Product certification		CE, UL		CE, UL, ECOLAB, E2
Temperature range (°C)		- 20... + 65	0... + 50 (XX518A1...) - 20... + 65 (XX518A3...) 0... 60 (XXT18, XXR18)	-25...+70
Degree of protection (conforming to IEC 60529)		IP67		
Dimensions (mm) Ø x L		M12 x 50	M18 x 65	M18 x 52

### “Discrete” output for DC applications (24 V)

Connection			M8 connector	M12 connector	M12 connector
3-wires	PNP	NO function NO or NC	XX512A2PAM8 (10 cm)	XX518A3PAM12 (50 cm)	XX*18*1PM12 (4)
		NPN	XX512A2NAM8 (10 cm)	XX518A3NAM12 (50 cm)	–
4-wires	PNP/NPN	NO function	XX512A1KAM8 (5 cm)	XX518A1KAM12 (15 cm)	–

### Application - monitoring levels

2 emptying levels	PNP NO function	–	XX218A3PHM12 (50 cm) (2)	–
2 filling levels	PNP NO function	–	XX218A3PFM12 (50 cm) (2)	–
Supply voltage limits, min./max. (V) including ripple		10...28		10...30
Switching capacity, max (mA)		<100		
Short-circuit protection (★)		★		
LED output state indicator (⊗)		⊗		
Voltage drop, closed state (V) at I nominal		<1		<2
Switching frequency (Hz)		125	40/80 (XX518A1...)	11
Transmission frequency (kHz)		500		200

(1) Reflex mode only for sensor with adjustable sensitivity. (2) 1 NO (3) Brass metal versions and SS316L are also available

(4) XX|A|18|P|S|1PM12  
 XXS\*\* = straight version  
 XXA\*\* = angled version  
 XX\*30\*P = plastic  
 XX\*30\*S = stainless steel  
 XX\*30\*B = brass

### “Analogue” output for DC applications (24 V)

Connection			M12 connector	M12 connector	M12 connector
4-wires	Analogue	0...10 V output	–	XX918A3F1M12 (50 cm)	XX*18*1VM12 (4)
		4...20 mA output	–	XX918A3C2M12 (50 cm)	XX*18*1AM12 (4)
Supply voltage limits, min./max. (V) including ripple		–		10...28	10...30 (4...20mA) 14...30 (0...10V)
Short-circuit protection (★)		–		★	★
LED output state indicator (⊗)		–		⊗	⊗
Transmission frequency (kHz)		–		300	200

### Thru beam mode with “Discrete” output for DC applications (24 V)

Connection			M8 connector	M12 connector	M12 connector
4-wires	Receiver (NO/PNP + NO NPN)		XXR12A8KAM8	XXR18A3KAM12 (0,61 m) XXR18A4KAM12 (1 m)	–
		Receiver (NC/PNP + NC NPN)	XXR12A8KBM8	XXR18A3KBM12 (0,61 m) XXR18A4KBM12 (1 m)	–
	Transmitter		XXT12A8M8	XXT18A3M12 (0,61 m) XXT18A4M12 (1 m)	–

### Accessories

See page 45 for programming and connectors, and page 46 for fixing

# XX Ultrasonic sensors

Detection of any material



		M30 software-configurable				D54 Wide beam
Nominal sensing distance Sn	Mode proximity or reflex (1)	–	–	–	8m	3m (2)
	Window or proximity or reflex or pump	1m	2m	4m		
Operating zone for proximity mode		0,155...1m (M) 0,105...1m (P)	0,155...2m	0,420...4m	0,3...8 m	0,425...4m
Sensitivity adjustment		using teach button or software			Integrated push button	Software
Case M (metal), P (plastic)		M or P			P	P
Product certification		CE, cULus, ECOLAB			CE, cULus, ECOLAB, E2	CE, cULus, E2
Temperature range (°C)		-25...+70			-25...+70	-40...+70
Degree of protection (conforming to IEC 60529)		IP67			IP65 and IP67	IP67 and IP69K
Dimensions (mm) Ø x L		M30 x 88.25	M30 x 52 (1m plastic only)		M30 x 106	54 x 79 x 32.5

## “Discrete” output for DC applications (24 V)

Connection			M12 connector				
4-wires	PNP	NO or NC programmable	XX•30•1PM12 (3)	XX•30•2PM12 (3)	XXS30•4PM12 (3)	–	–
	2 x PNP	NO or NC programmable	–	–	–	XXS30P8PPM12	–
	2 x NPN	NO or NC programmable	–	–	–	XXS30P8NNM12	–
Supply voltage limits, min./max. (V) including ripple			10...30		10...30		
Switching capacity, max (mA)			<100				
Short-circuit protection (★)			★				
LED output state indicator (⊗)			⊗				
Voltage drop, closed state (V) at I nominal			<2				
Switching frequency (Hz)			11	5.5	2.7	2	
Transmission frequency (kHz)			120		80	75	

(1) Reflex mode only for sensor with adjustable sensitivity. (2) 3m by default as factory setting

## Proximity mode with “Analogue” output for DC applications (24 V)

Connection			M12 connector				
4-wires	Analogue	Output 0...10 V	XX•30•1VM12 (3)	XX•30•2VM12 (3)	XXS30•4VM12 (3)	XXS30P8VPM12	–
		Output 0.5...4.5 V	–	–	–	–	XXW54P3HP01DM6
		Output 4...20 mA	XX•30•1AM12 (3)	XX•30•2AM12 (3)	XXS30•4AM12 (3)	XXS30P8APM12	XXW54P3AP01DM6
Supply voltage limits, min./max. (V) including ripple			10...30 (4...20mA)		14...30 (0...10V)		9...32
Short-circuit protection (★)			★				
LED output state indicator (⊗)			⊗				
Transmission frequency (kHz)			120		80	75	48

(3) XX|A|30|P|1|PM12    XXS•• = straight version    XX•30•P = plastic  
 |S| |S|    XXA•• = angled version    XX•30•S = stainless steel  
 |B|    XX•30•B = brass

## Accessories

Programming		Suitable female plug-in connectors				
Remote control teach button for use with sensors XX•18A3•••, XX•V1•••, XX•V•••, XXS•••, XXA•••	XX Software XXZBOX01 Configuration interface XXZKIT01 Configuration Kit	Jumper for XXW54 XXZKITDM6	PUR Pre-wired connectors (4) Elbowed    Straight		Other connectors Screw terminal	
XXZPB100			L = 5m (without LED)			
			M 8	for XX512A1... for XX512A2...	XZCP1041L5    XZCP0941L5 XZCP0666L5    XZCP0566L5	XZCC8FCM40V XZCC8FCM30V
			M 12	for all sensors except XX512...	XZCP1241L5    XZCP1141L5	XZCC12FCM40B

(4) For PVC cable see page 47

For fixing see page 46

# XX Ultrasonic sensors

## Detection of any material



		Mini flat	Flat	Combined multi-fixing	Flat 80 x 80
Nominal sensing distance Sn	Mode proximity or reflex (1)	10 cm	25 cm	50 cm	1 m
	Mode Thru beam	20 cm	61 ou 100 cm conforming to model	–	–
Operating zone for proximity mode		0,62...10,2 cm	5,1...25,4 cm	5,1...50,8 cm	0,1...1 m
Sensitivity adjustment		Fixed	–	Adjustable using remote control	–
Case P (plastic)		P			
Product certification		CE, UL			
Temperature range (°C)		- 20...+ 65	0...+ 50	- 20...+ 65	0...+ 70
Degree of protection (conforming to IEC 60529)		IP67			
Dimensions (mm) Ø x L or H x W x D		33 x 19 x 7,6	74 x 30 x 16	M 18 / 18 x 33 x 60	80 x 80 x 34

### Proximity or Reflex (1) mode with “Discrete” output for DC applications (24 V)

Connection		M12 on 0.15 m flying lead 0,15m	M12			
3-wires	PNP	NO function	XX7F1A2PAL01M12	XX7K1A2PAM12	XX7V1A1PAM12	XX8D1A1PAM12
	NPN	NO function	XX7F1A2NAL01M12	–	XX7V1A1NAM12	XX8D1A1NAM12
Supply voltage limits, min./max. (V) including ripple		10...28				
Switching capacity, max (mA)		<100				
Short-circuit protection (★)		★				
LED output state indicator (⊗)		⊗				
Voltage drop, closed state (V) at I nominal		<1				
Switching frequency (Hz)		100	80	40	70	
Transmission frequency (kHz)		500	500	300	180	

(1) Reflex mode only for sensor with adjustable sensitivity.

### Proximity mode with “Analogue” output for DC applications (24 V)

Connection by connector			–	M12			
4-wires	Analogue	0...10 V output	–	–	XX9V1A1F1M12	XX9D1A1F1M12	
		4...20 mA output	–	–	XX9V1A1C2M12	XX9D1A1C2M12	
Supply voltage limits, min./max. (V) including ripple		–				10...28	
Short-circuit protection (★)		–				★	
LED output state indicator (⊗)		–				⊗	
Transmission frequency (kHz)		–				300	180

### Thru beam mode with “Discrete” output for DC applications (24 V)

Connection by connector		–			
4-wires	Receiver (NO/PNP + NO/NPN)	XXRF1A8KAM12L	XXRK1A3KAM12 (0,61m) XXRK1A4KAM12 (1m)	–	–
	Receiver (NC/PNP + NC/NPN)	–	XXRK1A3KBM12 (0,61m)	–	–
	Transmitter	XXTF1A8M12L	XXTK1A3M12 (0,61m) XXTK1A4M12 (1m)	–	–

## Accessories

### Fixings - 3D fixings with ball joint

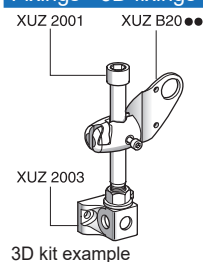

Bracket with ball joint for cylindrical sensors

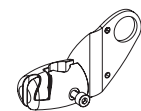

for	
Ø 12	XUZB2012
Ø 18	XUZB2003
Ø 30	XUZB2030

M12 rod for ball joint



XUZ2001

Fixing support for M12 rod

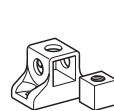

XUZ2003

### Simple fixings

90° fixing brackets

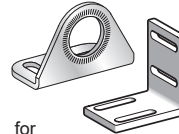

for	
Ø 12	XXZ12
Ø 18	XUZA118
Ø 30	XXZ30
XX7F	XXZ1933

Mounting plates for XX7K

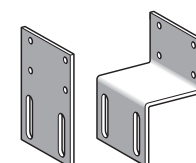

flat	XXZ3074F
cranked	XXZ3074S

See page 45 for programming and connectors



# XZ Cabling system

## Pre-wired female connectors



PVC cable  
M8 and M12 connector

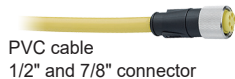

PVC cable  
1/2" and 7/8" connector

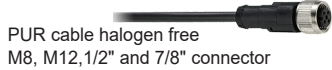

PUR cable halogen free  
M8, M12, 1/2" and 7/8" connector

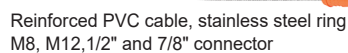

Reinforced PVC cable, stainless steel ring  
M8, M12, 1/2" and 7/8" connector

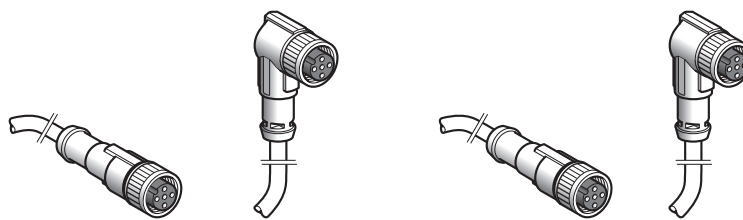

Connector Size		M8	M12	1/2"	7/8"
		Straight 3-pins	Elbowed 3-pins	Straight 4-pins	Elbowed 4-pins
References	PVC cable	XZCPV0566Lp	XZCPV0666Lp	XZCPV0941Lp	XZCPV1041Lp
	PUR cable	XZCP0566Lp	XZCP0666Lp	XZCP0941Lp	XZCP1041Lp
	PVC cable IP69K	XZCPA0566Lp	-	XZCPA0941Lp	-

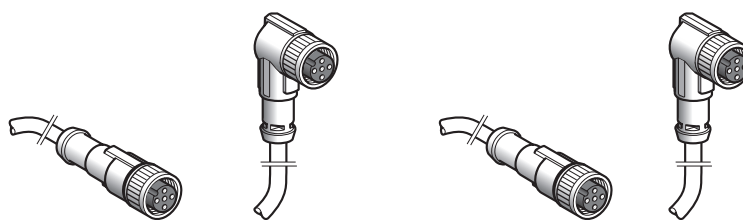

Connector Size		M12	1/2"	7/8"	
		Straight 4-pins	Elbowed 4-pins	Straight 5-pins	Elbowed 5-pins
References	PVC cable	XZCPV1141Lp	XZCPV1241Lp	XZCPV1164Lp	XZCPV1264Lp
	PUR cable	XZCP1141Lp	XZCP1241Lp	XZCP1164Lp	XZCP1264Lp
	PVC cable IP69K	XZCPA1141Lp	XZCPA1241Lp	XZCPA1164Lp	-

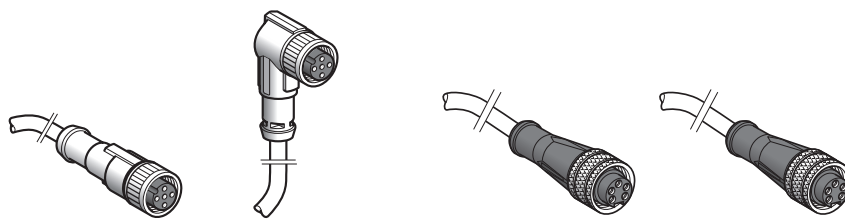

Connector Size		1/2"	7/8"		
		Straight 3-pins	Elbowed 3-pins	Straight 3-pins	Straight 5-pins
References	PVC cable	XZCPV1865Lp	XZCPV1965Lp	XZCPV1670Lp	-
	PUR cable	XZCP1865Lp	XZCP1965Lp	XZCP1670Lp	XZCP1764Lp
	PVC cable IP69K	XZCPA1865Lp	XZCPA1965Lp	-	-

Complete each reference by adding the length of cable, as 2 for 2 m, 5 for 5 m and 10 for 10 m,  
Eg: XZCPV1141L2 is pre-wired connector M12 connectors with 4 contacts and 2 m PVC cable

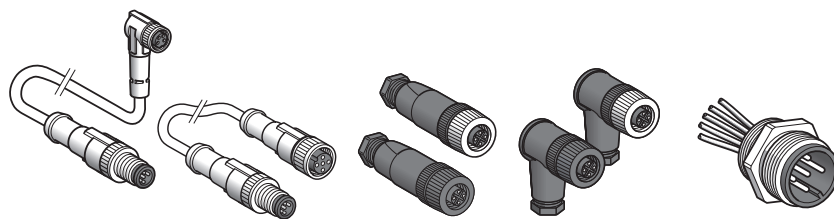

Other accessories	Jumpers	Connector	Receptacle
References	XZCR...	XZCC...	XZCE...

# XG Radio frequency identification

## 13.56 MHz RFID

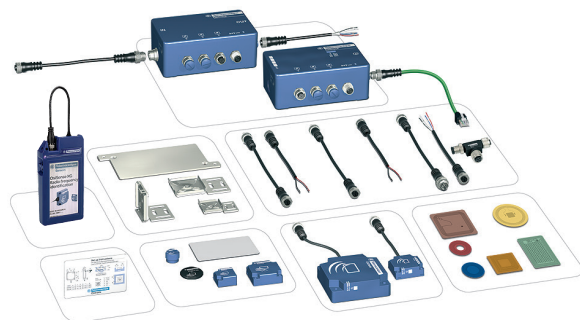

### Presentation

XG RFID is open to the majority of ISO 18000-3, ISO 15693 and ISO 14443 electronic tags. XG RFID integrates Modbus RTU, Uni-Telway, Modbus TCP/IP (using Ethernet box XGCSZ33ETH) and Profibus DP (with box XGCSZ33PDP) protocols.

The XG RFID offer comprises:

- 3 models of 13.56 MHz smart antenna (read/write)
- 12 models of 13.56 MHz electronic tags
- 1 portable RFID diagnostics terminal
- 3 models of network connection boxes plus connection and mounting accessories.

### Setting-up

XG RFID smart antenna are simple to set-up:

- Integrated RFID and network Function
- No programming
- Automatic detection of the RFID electronic tags (read or write)
- Automatic setting of the communication parameters (speed, format, parity, protocol, etc.)
- Configuration of the network address (1 to 15) using badge included with the smart antenna
- Low sensitivity to metal environments.

### Installation

The XG smart antenna easily integrate in flexible manufacturing production lines:

- quick connection using M12 connector
- screw fixing or clip-on mounting.



Smart antenna, 13,56 MHz		Flat form 40	Flat form 80
Dimensions (mm), W x H x D		40 x 40 x 15	80 x 80 x 26
Nominal sensing distance depending on tag (mm)		18 to 70	20 to 100
Type of associated tag		ISO 15693 and ISO 14443 standard tags. Automatic detection of the type of tag.	
Display		dual colour LED for the communication network, dual colour LED for the RFID communication	
Conformity to standards		CE, EN 301489-1, EN 301489-3, ETS 300330-1 and ETS 300330-2, FCC part 15 - UL	
Degree of protection conforming to IEC 60529		IP67	
Serial link	Type	RS 485	Ethernet (dual port)
	Protocol	Modbus et Uni-Telway	MODBUS TCP/IP et EtherNet/IP
	Speed (Bauds)	9600...115 200 (automatic detection)	10/100MB
Ambient air temperature (°C)		For fonctionnement : - 25...+ 70 °C, for stockage : - 40...+ 85 °C	
Nominal Supply voltage		24 VDC TBTP (Protective Extra Low Voltage)	
Connection		M12, 5-pins male, shielded connector on flying lead. Only for connection to the communication network and the supply	M12 (Ethernet) - M8 4-pins (Supply voltage)
References		XGCS4901201	XGCS8901201 XGCS850C201



Electronic tags		Format flat 40		Badge ISO (1)	Disque (3)	Format flat 26	Cylindrical
Dimensions (mm), W x H x D		40 x 40 x 15		54 x 85,5 x 0,8	Ø 30 x 3	26 x 26 x 13	M18 x 1 x 12
Type of memory		EEPROM	FRAM	EEPROM			
Memory capacity (bytes)		3 408	32 768	256	112	256	256
Nominal sensing distance (Read/Write)	With station XGCS49.	33	25	70	48	40	18
	With station XGCS89.	48	39	100	65	55	20
Time (ms)	Read	9,25+0,375xn(2)	6 + 0,25 x n (2)	12 + 0,825 x n (2)			
	Write	13 + 0,8 x n (2)	6 + 0,25 x n (2)	20 + 11,8 x n (2)		12 + 5,6 x n (2)	20 + 11,8 x n (2)
Degree of protection conforming to IEC 60529		IP68		IP65		IP68	
Standard supported		ISO 14443		ISO 15693			
Mounting on metal support		Yes		No		Yes	No
References		XGHB444345	XGHB443245	XGHB90E340	XGHB320345	XGHB221346	XGHB211345

(1) Customised versions on request. (2) n = number of 16-bit words. (3) Also exists in diameter 50.



Connection boxes	Ethernet Modbus TCP/IP box	Profibus box	EtherNet/IP box
Dimensions (mm), W x H x D	130 x 80 x 51	130 x 80 x 51	130 x 80 x 51
Protocols	Modbus TCP/IP	Profibus DP	EtherNet/IP
Supply voltage	24 VDC PELV. M12, 4-pins male, A coding, connector		
Conformity to standards	CE, UL	CE	CE
Station connection	M12, 5-pins female, A coding, connector		
Degree of protection conforming to IEC 60529	IP65		
References	XGSZ33ETH	XGSZ33PDP	XGSZ33EIP



Terminal	Portable 13.56 MHz RFID diagnostics terminal
Dimensions (mm), W x H x P	78 x 153 x 27
Function	Read/Write operations on electronic tags
Operating system	Proprietary OS
Conformity to standards	CE, FCC classe A, Part 15
Display	53 x 95 mm colour OLED touchscreen 272 x 480 pixels resolution
Degree of protection conforming to IEC 60529	IP 40
Memory	RAM 256 Mb
	Storage internal 2 GB + USB socket for memory stick
Reference	XGST2422 (battery, battery charger, 2 GB USB memory stick, and carrying case included with terminal). RFID reader to be ordered separately: XGCS4901201 (integrated reader) or XGW4F111 (remote reader)



Connection accessories	for Modbus network	Pre-wired connector	for Ethernet	Pre-wired connector	Pre-wired connector	"T" connector
Description	Modbus connecting cable M12 connectors Male / Female	M12 male / Bare wires	Ethernet connecting cable M12 male / RJ 45	Pre-wired supply connector M8 female	Pre-wired supply connector M12 female	Network M12 "T" connector 1 male / 2 female
Application	RS485 connection between a smart antenna and a connection box or between 2 Modbus boxes	Connection between a Modbus box and a Modbus / Uni-Telway network	Connection between an Ethernet box and the Ethernet network	24 VDC supply to Ethernet smart antenna XGCS850C201	24 VDC supply to connection boxes	For chaining of smart antennas on RS485 network
L = 2 m	TCSMCN1M1F2	TCSMCN1F2	XGSZ12E4503 (1)	XZCP0941L5 (3)	XGSZ09L2	TCSCN011M11F
L = 5 m	TCSMCN1M1F5	TCSMCN1F5	XGSZ12E4510 (2)	XZCP0941L2 (4)	XGSZ09L5	

(1) L = 3 m      (2) L = 10 m      (3) L = 5 m      (4) L = 2 m

Field expander	RS232/RS485 converter
To be associated with a smart antenna XGCS4901201 for conveying and handling applications	For connecting a PC to an XG RFID smart antenna
	
50 x 400 mm XGFEC540	250 x 250 mm XGFEC2525
	XGSZ24

# XG Radio frequency identification

## RFID 13,56 MHz, Fixing Ø 22 mm



RFID Stations 13,56 MHz, Fixing Ø 22 mm		Compact station for panel fixing (1)	Compact station for panel fixing with indicator light (1)	Standalone compact station for panel fixing (2)
Dimensions (mm) W x H x D		40 x 40 x 40		
Nominal sensing distance depending on tag (mm)		20 to 70		
Type of associated tag		ISO 15693 to ISO 14443 standard tags. Automatic detection of the type tag.		
Interface	Physical interface	RS485		PNP discrete output 300 mA protected against short-circuits and overloads
	Protocol	Modbus RTU		-
Display	For informing the operator	2 LEDs (7 selectable colors) driven by Modbus requests		
	For the communication	1 dual color LED (Modbus network activity)		1 dual color LED (output/status)
Conformity to standards		EN 301489-1, EN 301489-3, EN 300330-1 et EN 300330-2		
Degree of protection conforming to IEC 60529		IP 65		IP 65
Ambient air temperature (°C)		For function : - 25...+ 70 °C, for storage : - 40...+ 85 °C		For function : - 40...+ 70 °C, for storage : - 40...+ 85 °C
Nominal Supply voltage		24 TBTP (Protective Extra Low Voltage)		
Connection		1 connector M12 male, 5-pins		
References		XGCS490B201	XGCS49LB201	XGCS491B201

(1) Delivered with a fixing nut and a configuration badge for the network address.

(2) Delivered with a fixing nut - Configuration kit of badges for access control setup ref. **XGSZCNFAC** to order separately



Electronic tags		EEPROM type memory tag	ISO RFID card	ISO RFID card
Dimensions (mm) W x H x D		40 x 31 x 4,8	54 x 85.5 x 1	
Type of memory		EEPROM		
Memory capacity (bytes)		736	256	736
Nominal sensing distance (Read/Write)	With compact stations, Fixing Ø 22 mm	30 mm	70 mm	30 mm
Degree of protection		IP67	IP65	IP65
Supported standard		ISO 14443	ISO 15693	ISO 14443
Order by multiples of		10	25	
Reference		XGHBPB3345	XGHB90E340	XGHB90E341

# XIOT Cloud Connected Sensors



The groundbreaking Cloud-Connected Sensor technology from Telemecanique Sensors enables real-time remote monitoring from anywhere you can receive a signal!

## 1. The XIOT captures the event information at your remote locations

Whether you are monitoring the pressure threshold of an irrigation system, the emergency stop trigger on a long distance conveyor chain, or the opening of a lock on a secure gate or other industrial application, the information about the event is captured by the XIOT Cloud Connected Sensor.

## 2. Data and alerts are sent to the internet cloud

The information recorded by the sensor is sent to the internet cloud. This "smart alert" can then be immediately forwarded to any mobile device or platform anywhere you can receive a signal!

## 3. You receive the information on your computer or phone

In real time, from the convenience of your phone or other mobile device, you can get an overview of all your connected sensors and get alerts if there are any status changes on your installed base. These real time alarms, historical data, and data analytics about your connected assets are all available to multiple users through a secure, Cloud-Connected Sensor Application. The immediate information and data analysis provided by the Cloud Connected Sensors app help reduce operational downtime!



It's smart information at your fingertips!



## Three options to choose from

Description	Transmitter only XIOT11SE0MRCL	Prepaid 5-year access to cloud XIOT11SE5MRCL	Subscription services (1) XIOT11SERMRCL
1 standalone transmitter Activation magnet Instruction sheet	✓	✓	✓
5-year subscription to Sigfox LPWAN (2)	-	✓	-
Web interface to configure and display data	-	✓	✓
Smartphone apps for alert notifications (IOS and Android)	-	✓	✓
Connection to Telemecanique Sensors secure servers via external SCADA system for data processing	-	-	✓

(1) Pricing and terms and conditions available on the online payment site: <https://godigital.schneider-electric.com/smp/home/home-page>

(2) LPWAN: Low power wide area network

# Telemecanique Sensors safety products for your machine's entire life cycle

The Telemecanique Sensors range of safety products enhances safety throughout a machine's entire life cycle from design, manufacture, installation, adjustment, operation and servicing right through to decommissioning.

In addition to moral obligation and economic consequences, the law requires that machinery is safe in regard to accident prevention. Telemecanique Sensors offers an extensive range of safety products, compliant with international standards, designed to provide the most comprehensive protection for personnel and equipment.

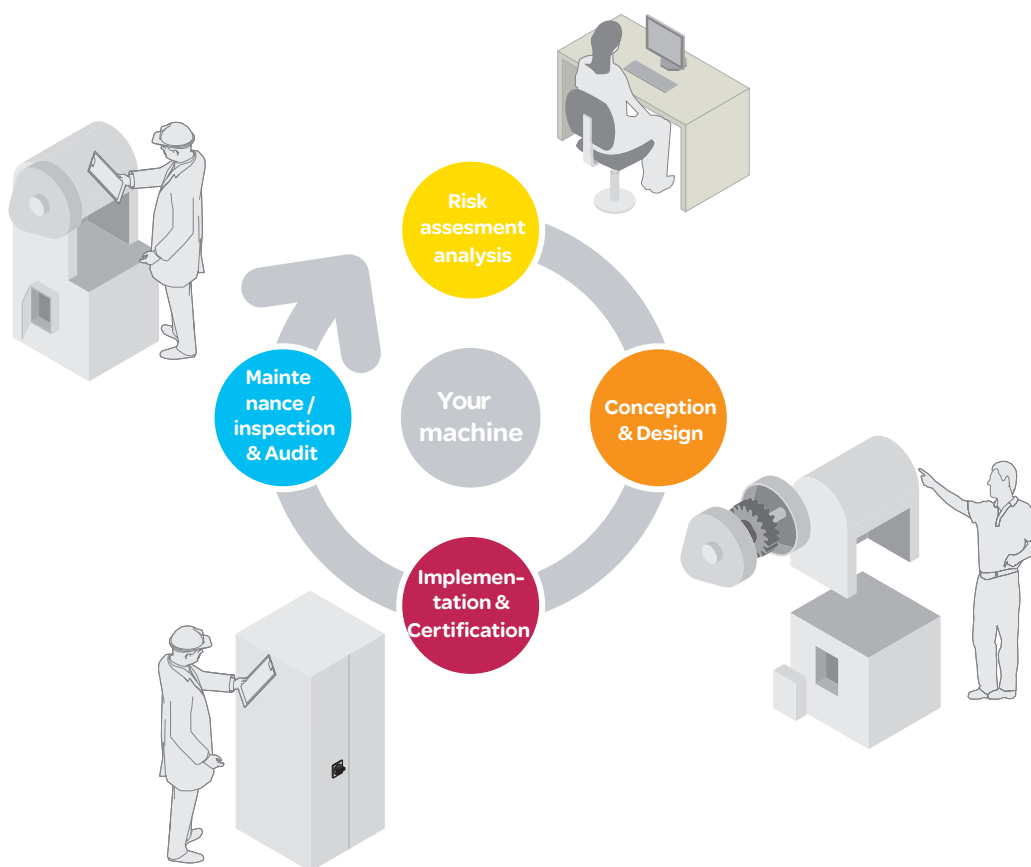

## > New machines - the Machinery Directive

The previous Machinery Directive 98/37/EC was elaborated to help manufacturers ensuring a minimum safety level for machinery and equipment sold within the EU (European Union).

From 29 December 2009 on, the new European Machinery Directive 2006/42/EC is effective. Machines must comply with the Essential Health and Safety Requirements (EHSRs) listed in Annex I of the Directive, thus setting a common minimum level of protection across the EEA (European Economic Area).

Machine manufacturers, or their authorised representatives within the EU, must ensure that the machine is compliant with all requirements from this Directive. This technical file is available to reinforce authorities requests as well as the CE marking must be affixed and a Declaration of Conformity has been signed before the machine may be placed on the market within the EU.

# Functional safety :

> Safety integrity level (SIL), Performance level (PL)

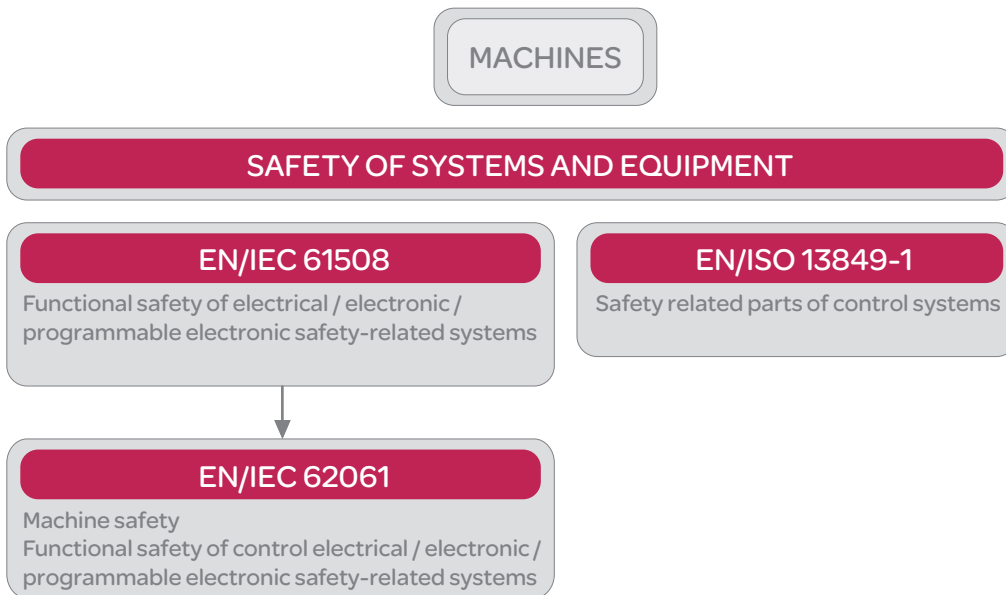

## Risk reduction according to EN/IEC 61508 and EN/ISO 13849-1

- **Safety** is achieved by risk reduction (for those hazards that cannot be designed-out).
- **Residual risk** is the risk remaining after protective measures have been taken.
- **Protective measures** realised by E/E/PE\* safety related systems contribute to risk reduction.

\* Electric / Electronic / Programmable electronic

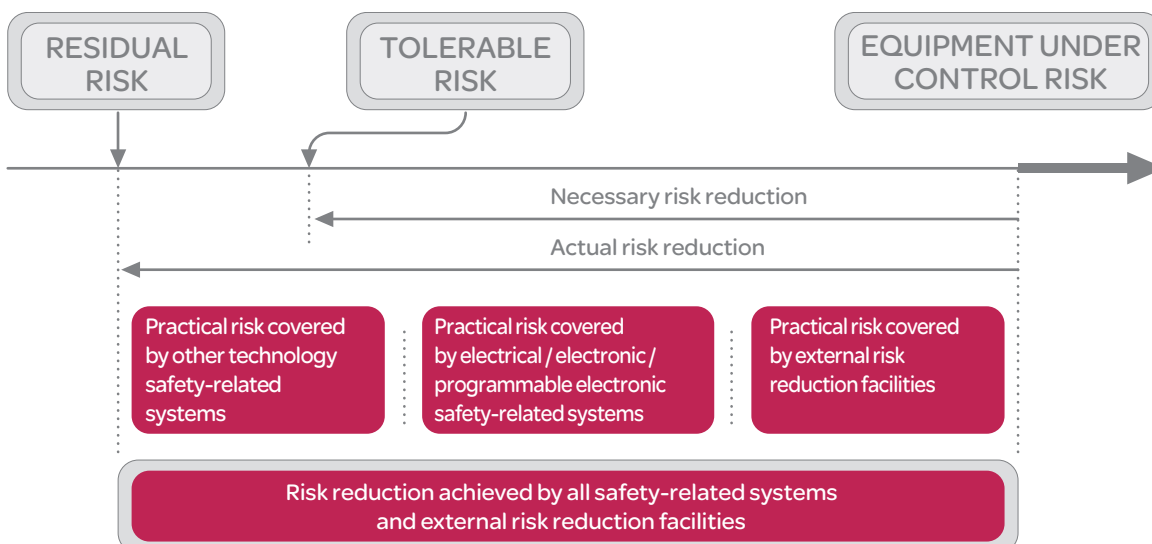

# Functional safety of machinery

## > Approach according to EN/IEC 62061

### Risk estimation for SIL assignment

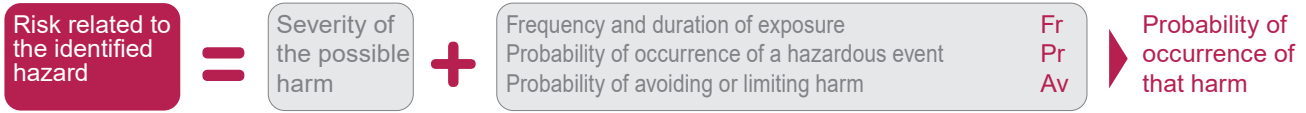

### Example of SIL assignment

This assignment should be carried by determining the risk parameters that are shown below in an example.

Consequences		Severity (Se)	
Irreversible: death, losing an eye or arm		4	
Irreversible: broken limb(s), losing a finger(s)		3	
Reversible: requiring attention from a medical practitioner		2	
Reversible: requiring first aid		1	

Frequency and duration of exposure (Fr)		Probability of occurrence		Probability (Pr)		Probability of avoiding or limiting harm (Av)	
Frequency of exposure	> 10 min	Very high	5	Likely	4	Impossible	5
1 h		Likely	4	Possible	3	Rarely	3
> 1 h to 1 day	5	Possible	3	Rarely	2	Probable	1
> 1 day to 2 weeks	4	Rarely	2	Negligible	1		
> 2 weeks to 1 year	3						
> 1 year	2						

Serial no.	Hazard	Se	Fr	Pr	Av	Cl
1	Hazard X	4	5	4	3	12
2						

Consequences	(Se)	Classe Cl					Frequency and duration		Probability of hzd. Event		Avoidance	
		3-4	5-7	8-10	11-13	14-15	Fr	Pr	Pr	Av	Av	
Death, losing an eye or arm	4	SIL 2	SIL 2	SIL 2	SIL 3	SIL 3	<= 1 hour	5	Common	5		
Permanent, losing fingers	3		OM	SIL 1	SIL 2	SIL 3	> 1 h to <= 1 day	5	Likely	4		
Reversible, medical attention	2			OM	SIL 1	SIL 2	> 1 day to <= 2 wks	4	Possible	3	Impossible	5
Reversible, first aid	1			OM	SIL 1	SIL 1	2 wks to <= 1 year	3	Rarely	2	Possible	3
							> 1 year	2	Negligible	1	Likely	1

In this example the SIL 3 must be achieved by the safety-related control function intended to reduce the risk related to the identified hazard.

### Determination of the SIL level achieved by the Safety-related control function (SRCF)

According to standard EN/IEC 62061 for each safety related control function, the SIL level is linked to:

- a target failure value for the probability of dangerous failure by hour of the SRCF: PFH<sub>D</sub>
- architectural constraints (hardware fault tolerance, diagnosis)
- a set of requirements related to the lifecycle of the safety related electrical control system

Safety integrity level (SIL)	Probability of a dangerous Failure per Hour PFH <sub>D</sub>
3	>10 <sup>-8</sup> to <10 <sup>-7</sup>
2	>10 <sup>-7</sup> to <10 <sup>-6</sup>
1	>10 <sup>-6</sup> to <10 <sup>-5</sup>

$\lambda_s$  = rate of safe failures,  
 $\lambda_{dd}$  = rate of detected dangerous failures,  
 $\lambda_{du}$  = rate of undetected dangerous failures  
 $\lambda_d = \lambda_{dd} + \lambda_{du}$

In practice, detected dangerous failure are dealt with by fault

- The rate of failures  $\lambda$  can be expressed as follows:  $\lambda = \lambda_s + \lambda_{dd} + \lambda_{du}$
- The calculation of the PFH<sub>D</sub> for a system or subsystem depends on several parameters:
  - the dangerous failure rate ( $\lambda_d$ ) of the subsystem elements
  - the fault tolerance (e.g. redundancy) of the system
  - the diagnostic test interval (T2)
  - the proof test interval (T1) or lifetime whichever is smaller
  - the susceptibility to common cause failures ( $\beta$ )
- For each of the four different logical architectures A to D there is a different formula to calculate the PFH<sub>D</sub>. (see EN/IEC 62061)
- For a simple system without redundancy and without diagnostic:  $PFH_D = \lambda_d \times 1/h$



## > Approach according to EN/ISO 13849-1

### Determination of the Performance Level requested (PLr)

Done using the risk graphic opposite

**S = Severity of injury**

S1 = Slight (normally reversible injury)

S2 = Serious (normally irreversible) injury including death

**F = Frequency and/or exposure time to the hazard**

F1 = Seldom to less often and/or the exposure time is short

F2 = Frequent to continuous and/or the exposure time is long

**P = Possibility of avoiding the hazard or limiting the harm**

P1 = Possible under specific conditions

P2 = Scarcely possible

**L = Low contribution to risk reduction**

**H = High contribution to risk reduction**

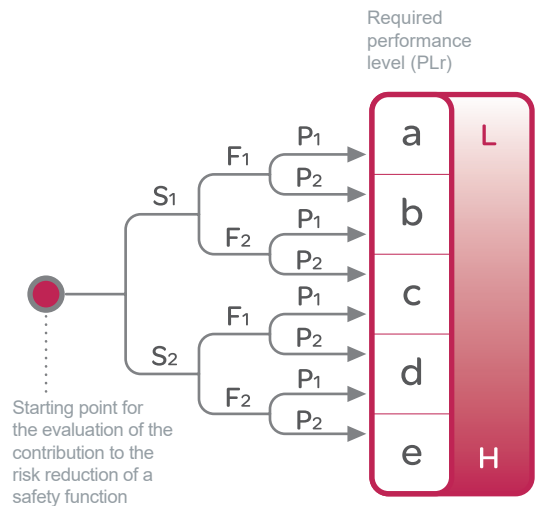

### Determination of the PL achieved by the Safety-related parts of control systems (SRP/CS)

According to standard EN/ISO 13849-1, the Performance level (PL) is linked to a target failure value of probability of dangerous failure per hour for each safety related control function.

Performance level (PL)	Probability of a dangerous Failure per Hour
a	$\geq 10^{-5} \dots < 10^{-4}$
b	$\geq 3 \times 10^{-6} \dots < 10^{-5}$
c	$\geq 10^{-6} \dots < 3 \times 10^{-6}$
d	$\geq 10^{-7} \dots < 10^{-6}$
e	$\geq 10^{-8} \dots < 10^{-7}$

For a SRP/CS (or a combination of SRP/CS) designed according to the requirements of the article 6, the PL could be estimated with the figure beside after estimation of several factors such as system structure (categorys), mechanism of failures detection [Diagnosis Coverage (DC)], components reliability [mean time to dangerous failure (MTTFd), Common Cause Failure (CCF)]...

- MTTF<sub>d</sub> of each channel = low
- MTTF<sub>d</sub> of each channel = medium
- MTTF<sub>d</sub> of each channel = high

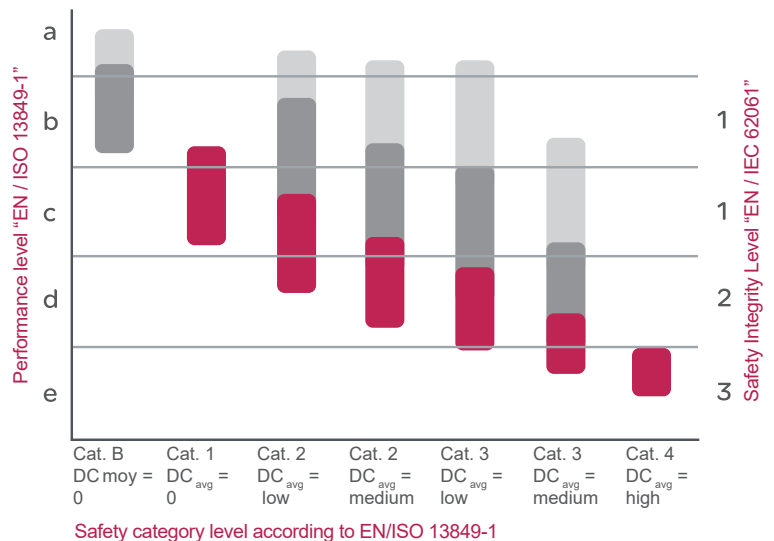

# Key-operated safety switches without solenoid and actuators

Illustration of contacts with the actuator inserted in the head of the switch

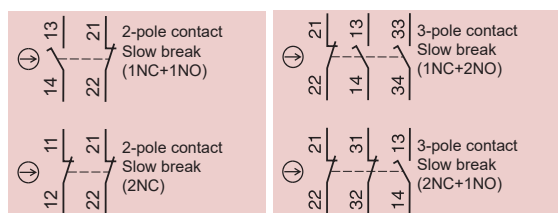

Without locking

Plastic, double insulated switches		Type XCSMP	Type XCSPA	Type XCSTA
Maximum safety level (3)		PL=e, category 4 conforming to EN/ISO 13849-1 et SIL CL3 conforming to EN/IEC 62061		
Actuation speed (min>max)		0,05m/s --> 1,5m/s	0,1m/s --> 0,5m/s	0,1m/s --> 0,5m/s
Rated operational characteristics (conforming to EN/IEC 60947-5-1)		AC 15, C 300 / DC 13, Q 300		
Degree of protection conforming to IEC 60529		IP67		
Reliability data B <sub>10d</sub>		5 000 000 value given for a service life of 20 years, limited by mechanical or contact wear		
Body + Head dimensions (mm) W x D x H		30 x 15 x 87 mm	30 x 30 x 93,5 mm	52 x 30 x 114,5 mm
Resistance to forcible withdrawal of actuator		8 N	10 N (1)	10 N (1)
Connection		pre-cabled, L = 2m	1 x ISO M16 entry.	1 x PG11 entry (5) 2 x ISO M16 entries. (5) (2)
Safety contacts	1NC+1NO break before make, slow break	XCSMP59L2 (↔)	XCSPA592 (↔)	XCSPA591 (↔) -
	2NC slow break	XCSMP79L2 (↔)	XCSPA792 (↔)	XCSPA791 (↔) -
	1NC+2NO break before make, slow break	-	XCSPA892 (↔)	XCSPA891 (↔) XCSTA592 (↔)
	2NC+1NO break before make, slow break	XCSMP70L2 (↔)	XCSPA992 (↔)	XCSPA991 (↔) XCSTA792 (↔)
	2NC+1NO snap action	-	XCSPA492 (↔)	XCSPA491 (↔) -
	3NC slow break	XCSMP80L2 (↔)	-	- XCSTA892 (↔)

- (1) In order to increase the resistance to 50 N, you must add the accessory XCSZ21 to the key actuators XCSZ12  
 (2) With entry for Pg 11 cable gland, replace the last digit in the reference by 1 (example: XCSTA592 becomes **XCSTA591**). Some PG11 references may not be available.  
 (5) To order a switch with 1 or 2 cable entries for 1/2" NPT conduit (one Pg11 tapped entry fitted with metal adapter DE9RA1012), replace the last number (2) by 3 in the selected reference. Example: XCSTA592 becomes **XCSTA593**. Some 1/2" NPT references may not be available.

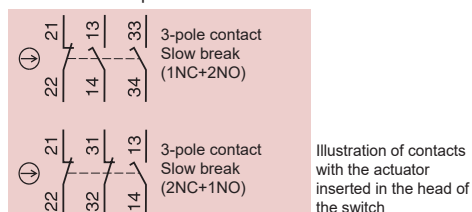

Without locking

With interlocking, manual unlocking  
By button By key lock

Interrupteurs metal to double isolation		Type XCSA	Type XCSB	Type XCSC
Maximum safety level (3)		PL=e, category 4 conforming to EN/ISO 13849-1 and SIL CL3 conforming to EN/IEC 62061		
Actuation speed (min>max)		0,01m/s --> 0,5m/s	0,01m/s --> 0,5m/s	
Rated operational characteristics (conforming to EN/IEC 60947-5-1)		AC 15, A 300 / DC 13, Q 300		
Degree of protection conforming to IEC 60529		IP67		
Reliability data B <sub>10d</sub>		XCSA: 5 000 000 XCSB/C: 3 000 000 values given for a service life of 20 years, limited by mechanical or contact wear		
Body + Head dimensions (mm) W x D x H		40 x 44 x 113,5 mm	52 x 44 x 113,5 mm	
Resistance to forcible withdrawal of actuator		20 N	F <sub>1max</sub> = 1500N ; F <sub>2h</sub> = 1150N (when locked)	
Connection (6)		1 x ISO M20 entry	1 x PG13,5 entry	1 x ISO M20 1 x PG13,5 entry
Safety contacts	1NC+2NO break before make, slow break	XCSA502 (↔)	XCSA501 (↔)	XCSB502 (↔) XCSC501 (↔)
	2NC+1NO break before make, slow break	XCSA702 (↔)	XCSA701 (↔)	XCSB702 (↔) XCSC701 (↔)
	3NC slow break	XCSA802 (↔)	XCSA801 (↔)	- XCSC801 (↔)

- (6) To order a switch with a 1/2" NPT cable entry, replace the last number (2) by 3 in the selected reference. Example: XCSA502 becomes **XCSA503**. Some 1/2" NPT references may not be available.  
 (3) Using an appropriate and correctly connected safety control unit.

## Accessories

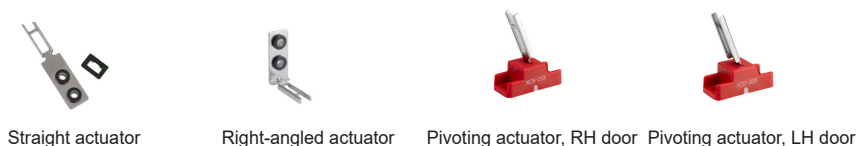

Straight actuator Right-angled actuator Pivoting actuator, RH door Pivoting actuator, LH door

For safety switches XCSMP	Actuators			
References	XCSZ81	XCSZ84	XCSZ83	XCSZ85



Straight actuator Wide actuator L=40 mm (4) Right-angled actuator Pivoting actuator Guard/door retainer

For safety switches XCSPA/TA	Actuators				Retaining device
References	XCSZ11	XCSZ12	XCSZ14	XCSZ13	XCSZ21

(4) For L = 29 mm, reference = XCSZ15.

# Key-operated safety switches with solenoid and actuators

Illustration of the main contacts with the actuator inserted in the head of the switch

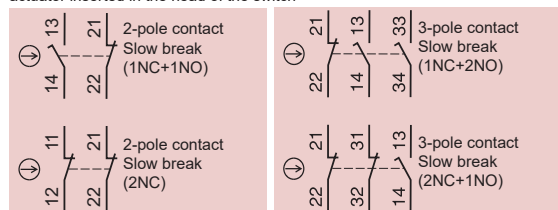

Safety interlock switches		Type XCSLF, metal		Type XCSLE, plastic	
Standard version and Connector version					
Maximum safety level (3)		PL=e, category 4 conforming to EN/ISO 13849-1 and SIL CL3 conforming to EN/IEC 62061			
Degree of protection conforming to IEC 60529		IP66 and IP67	IP65	IP66 and IP67	IP65
Reliability data B <sub>10d</sub>		5 500 000 value given for a service life of 20 years, limited by mechanical or contact wear			
Body + Head dimensions (mm) W x D x H		43,5 x 51 x 205 mm		43,5 x 51 x 205 mm	
Resistance to forcible withdrawal of actuator (Locked)		F <sub>1max</sub> = 3000 N, f <sub>zh</sub> = 2300 N		F <sub>1max</sub> = 1400 N, f <sub>zh</sub> = 1100 N	
Locking		on de-energization (1)		on de-energization (1)	
Supply voltage for the solenoid and the LEDs		24VAC/DC			
Material case		Zamak		Polyamide	
Wiring Connection (2)		3 x ISO M20	Connector M23 (4)	3 x ISO M20	Connector M23 (4)
Main and auxiliary contacts. (Main contacts actuated by the key. Auxiliary contacts actuated by the solenoid.)	1NC+1NO break before make, slow break	XCSLF2525312 →	–	XCSLE2525312 →	–
	2NC simultaneous, slow break	XCSLF2727312 →	–	XCSLE2727312 →	–
	1NC+2NO break before make, slow break	XCSLF3535312 →	XCSLF353531M3 →	XCSLE3535312 →	XCSLE353531M3 →
	2NC+1NO break before make, slow break	XCSLF3737312 →	XCSLF373731M3 →	XCSLE3737312 →	XCSLE373731M3 →
	3NC simultaneous, slow break	XCSLF3838312 →	XCSLF383831M3 →	XCSLE3838312 →	–

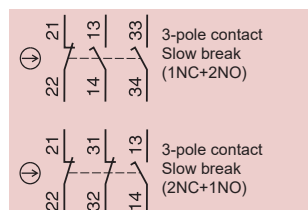

Illustration of the main contacts with the actuator inserted in the head of the switch



Safety interlock switches.		Type XCSLF, metal		
Push button version and Push button with connector version				
Maximum safety level (3)		PL=e, category 4 conforming to EN/ISO 13849-1 et SIL CL3 conforming to EN/IEC 62061		
Degree of protection conforming to IEC 60529		IP66	IP65	IP66
Reliability data B <sub>10d</sub>		5 500 000 value given for a service life of 20 years, limited by mechanical or contact wear		
Body + Head dimensions (mm) W x D x H		43,5 x 51 x 205 mm		
Resistance to forcible withdrawal of actuator		3 000 N		
Locking		on de-energization (1)		on de-energization (1)
Push button with or without key no. 455 to release		Without		With
Supply voltage for the solenoid and the LEDs (5)		24VAC/DC		
Material case		Zamak		
Connection (2)		3 x ISO M20	Connector M23 (4)	3 x ISO M20
Safety contacts	1NC+2NO break before make, slow break	XCSLF3535412 →	XCSLF353541M3 →	XCSLF3535612 →
	2NC+1NO break before make, slow break	XCSLF3737412 →	XCSLF373741M3 →	XCSLF3737612 →

(1) For locking on energisation of solenoid, please refer to [www.tesensors.com](http://www.tesensors.com)

(2) To order a switch with 3 1/2" NPT cable entries, replace the last number in the reference by 3. Example: XCSLF3535312 becomes **XCSLF3535313**. Some 1/2" NPT references may not be available.

(3) Using an appropriate and correctly connected safety control unit.

(4) Connector M23, 19 pins

(5) For 120V~ and 240V~ solenoid supply voltages, please refer to [www.tesensors.com](http://www.tesensors.com)

## Accessories



Straight actuator



Wide actuator



Pivoting actuator



Door lock

For safety switches XCSA/B/C/LE/LF	Actuators			Door lock
References	XCSZ01	XCSZ02	XCSZ03	XCSZ05

# Safety switches

## with rotary lever or spindle

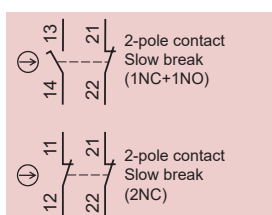

Stainless steel, elbowed (flush with rear of switch) lever    Stainless steel straight lever

Plastic switches (lever-operated)		XCSP				
		1 x ISO M16 cable entry (1) (2) (4)				
Maximum safety level (3)		PL=e, category 4 conforming to EN/ISO 13849-1 and SIL CL3 conforming to EN/IEC 62061				
Minimum torque (actuation / positive opening)		0,1 / 0,25 N.m				
Degree of protection		IP67				
Rated operational characteristics (conforming to EN/IEC 60947-5-1)		AC 15, A 300 / DC 13, Q 300				
Dimensions (body + head) W x D x H		30 x 30 x 160 mm				
Lever position		Lever to left	Lever centred	Lever to right	Lever to left or right	Lever centred
Tripping angle		5°				
Reliability data B <sub>10d</sub>		5 000 000 (value given for a service life of 20 years, limited by mechanical or contact wear)				
Complete switch	1NC+1NO break before make, slow break	XCSPL592 →	XCSPL582 →	XCSPL572 →	XCSPL562 →	XCSPL552 →
	2NC slow break	XCSPL792 →	XCSPL782 →	XCSPL772 →	XCSPL762 →	XCSPL752 →
	1NC+2NO slow break	–	–	–	XCSPL862 →	–
	2NC+1NO slow break	–	–	–	XCSPL962 →	–

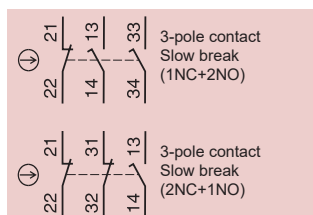

Stainless steel spindle  
30 mm length

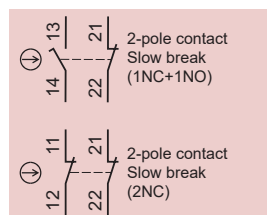

Stainless steel spindle  
30 mm length

Plastic switches (spindle-operated)		XCSTR	XCSPR
		2 x ISO M16 cable entries (1) (2) (4)	
Maximum safety level (3)		PL=e, category 4 conforming to EN/ISO 13849-1 and SIL CL3 conforming to EN/IEC 62061	
Minimum torque (actuation / positive opening)		0,1 / 0,45 N.m	0,1 / 0,25 N.m
Degree of protection		IP67	
Rated operational characteristics (conforming to EN/IEC 60947-5-1)		AC 15, A 300 / DC 13, Q 300	
Dimensions (body + head) W x P x H		52 x 30 x 117 mm	30 x 30 x 96 mm
Tripping angle		5°	
Reliability data B <sub>10d</sub>		5 000 000 (value given for a service life of 20 years, limited by mechanical or contact wear)	
Complete switch	1NC+2NO break before make, slow break	XCSTR552 →	–
	2NC+1NO break before make, slow break	XCSTR752 →	–
	1NC+1NO break before make, slow break	–	XCSPR552 →
	2NC slow break	–	XCSPR752 →
	2NC+1NO slow break	–	XCSPR952 →

- (1) With entry for Pg 11 cable gland, replace the last digit in the reference by 1 (Example: XCSPL592 becomes **XCSP1591**). Some Pg11 references may not be available.  
 (2) For entry for ISO M20 cable gland, also order adaptor DE9RA1620 (sold in lots of 5).  
 (3) Using an appropriate and correctly connected safety control unit.  
 (4) With entry for 1/2" NPT conduit, replace the last digit in the reference by 3 (Example: XCSPL592 becomes **XCSP3593**). Some 1/2" NPT references may not be available.

# Limit switches

## Safety limit switches

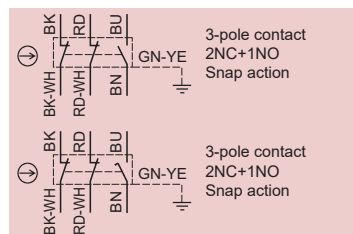

Metal end plunger



Roller plunger



Thermoplastic roller lever

Miniatures switches	Type XCSM metal cable length = 1 m (1)		
Maximum safety level (2)	PL=e, category 4 conforming to EN/ISO 13849-1 and SIL CL3 conforming to EN/IEC 62061		
Maximum actuation speed	0,5 m/s	0,5 m/s	1,5 m/s
Minimum force or torque (actuation / positive opening)	8,5 N / 42,5 N	7 N / 35 N	0,5 N.m / 0,1 N.m
Degree of protection	IP66 + IP67 + IP68	IP66 + IP67 + IP68	IP66 + IP67 + IP68
Dimensions (body + head) W x D x H	30 x 16 x 60 mm	30 x 16 x 70,5 mm	30 x 32 x 92,5 mm
Reliability data B <sub>10d</sub>	50 000 000 (value given for a service life of 20 years, limited by mechanical or contact wear)		
Complete switch	2NC+1NO snap action	XCSM3910L1 →	XCSM3902L1 →
	2NC+1NO slow break	XCSM3710L1 →	XCSM3702L1 →

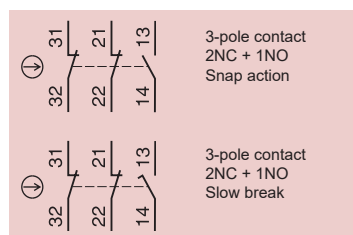

Metal plunger



Roller plunger



Thermoplastic roller lever



Metal end plunger



Roller plunger



Thermoplastic roller lever

Compact switches	Type XCSD metal 1 x ISO M20 x 1.5 cable entry (3) (4)			Type XCSP, plastic 1 x ISO M20 x 1.5 cable entry (2) (3) (4)		
Maximum safety level (2)	PL=e, category 4 conforming to EN/ISO 13849-1 and SIL CL3 conforming to EN/IEC 62061					
Maximum actuation speed	0,5 m/s	1,5 m/s	0,5 m/s	0,5 m/s	1,5 m/s	1,5 m/s
Minimum force or torque (actuation / positive opening)	15 N / 45 N	12 N / 36 N	10 N.m / 0,1 N.m	15 N / 45 N	12 N / 36 N	10 N.m / 0,1 N.m
Degree of protection	IP66 + IP67			IP66 + IP67		
Dimensions (body + head) W x D x H (mm)	34 x 34,5 x 89	34 x 34,5 x 99,5	34 x 43 x 121,5	34 x 34,5 x 89	34 x 34,5 x 99,5	34 x 43 x 121,5
Reliability data B <sub>10d</sub>	50 000 000 (value given for a service life of 20 years, limited by mechanical or contact wear)					
Complete switch	2NC+1NO snap action	XCSD3910P20	XCSD3902P20	XCSD3918P20	XCSP3910P20	XCSP3902P20
	2NC+1NO slow break	XCSD3710P20	XCSD3702P20	XCSD3718P20	—	—

(1) For a 2 m long cable, replace the last digit of the reference by 2 (example: XCSD3910L1 becomes **XCSD3910L2**).

For a 5 m long cable, replace the last digit of the reference by 5 (example: XCSD3910L1 becomes **XCSD3910L5**).

(2) Using an appropriate and correctly connected safety control unit.

(3) To order a switch with 1/2" NPT cable entry, replace P20 with N12. Example: XCSD3910P20 becomes **XCSD3910N12**. Some 1/2" NPT references may not be available.

(4) To order a switch with Pg13.5 cable entry, replace P20 with G13. Example: XCSD3702P20 becomes **XCSD3702G13**. Some Pg 13.5 references may not be available.

# RFID Technology

## RFID Safety contact-less switch XCSR



New



Type	Standalone	For series connection (Daisy-chain) (2) (3)	For point-to-point connection (Single)
Maximum safety level	PL=e, category4 conforming to EN/ISO 13849-1 and SIL 3 conforming to EN/IEC 61508 Possible functioning without association with a safety control unit	Functioning in combination with a safety control unit PL=e/Cat4 - SIL 3	
Coding level (conforming to ISO 14119)	High level (Unique code) (for every model)		
Contactors monitoring (EDM) / Start-Restart	embedded	Safety control unit management	
Degree of protection	IP65, IP66, IP67 and IP69K - Ecolab		
Outputs Safety OSSDs - maximum current	400 mA	200 mA	
Rated operational characteristics	Ue=24Vdc - 20%...+1%, Ie=60mA		
Dimensions (mm) W x H x D (Transponder)	50 x 15 x 15 mm		
Dimensions L x P x H (Reader)	108,3 x 30 x 15 mm	118,6 x 30 x 15 mm	108,3 x 30 x 15 mm
Assured operating sensing distance (Sao) (4)	10 mm		
Assured release sensing distance (Sar) (4)	35 mm		
Reliability data (PFH <sub>p</sub> /TM)	5.10 <sup>-10</sup> / 20 year		
Connection	Connector M12 male 8-pins	2 connectors M12 males 5-pins	Connector M12 male 5-pins
References			
Transponder + Reader matched in factory - Single matching - Start automatique + EDM	XCSRC11AM12 (1)		
Transponder + Reader matched in factory - Single matching - Start manual monitored + EDM	XCSRC11MM12 (1)		
Transponder + Reader matched in factory - Single matching		XCSRC12M12 (1)	XCSRC10M12 (1)

(1) For the versions allowing a new pairing (maximum 2 new pairings) of a blank transponder XCSRK2A3, replace the first reference digit '1' by '3'

For example, reference XCSRC10M12 becomes **XCSRC30M12**

As soon as a blank transponder has been paired, the former transponder is no longer valid. A blank transponder can be matched only once

(2) The using of the serial diagnosis unit XCSR210MDB is optionnal but highly recommanded. This diagnosis unit provides and localizes the state of every XCSR sensors of the chain (open/close safe guard status, presence of errors, cabling issue, ...).

(3) The first sensor of serial connexion must be coupled with the loopback chain adaptator XCSRZE

(4) Sao: assured operating distance. Sar: assured release distance.

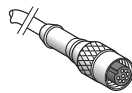

XZCP29P12Lpp

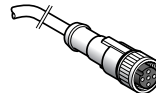

XZCP11V12Lp



XZCP12V12Lp

Type	Connection M12 - Pre-wired - for XCSR "Single" et "Daisy-chain" (1) XCSRC10M12 - XCSRC30M12 - XCSRC12M12 (1) and XCSRC32M12 (1)				
Pre-wired length (cable material : PUR)	2 m	5 m	10 m	20 m	
Connector M12 5-pins Female	Straight - Pre-wired	XZCP11V12L2	XZCP11V12L5	XZCP11V12L10	XZCP11V12L20
	90° - Pre-wired	XZCP12V12L2	XZCP12V12L5	XZCP12V12L10	XZCP12V12L20

Type	Connection M12 - Pre-wired - for XCSR "Standalone" XCSRC11AM12 - XCSRC31AM12 - XCSRC11MM12 and XCSRC31M12				
Pre-wired length (cable material : PUR)	2 m	5 m	10 m	20 m	
Connector M12 8-pins Female	Straight - Pre-wired	XZCP29P12L2	XZCP29P12L5	XZCP29P12L10	XZCP29P12L20
	90° - Pre-wired	XZCP53P12L2	XZCP53P12L5	XZCP53P12L10	XZCP53P12L20

Type	Connection 2xM12 - Jumpers for XCSR "Daisy-chain" XCSRC12M12 - XCSRC32M12					
Pre-wired length (cable material : PUR)	0.3 m	3 m	5 m	10 m	25 m	
2 connectors Straight female M12 5-pins	Pre-cabled for serial link directly between the sensors	XZCR1111064D03	XZCR1111064D3	XZCR1111064D5	XZCR1111064D10	XZCR1111064D25

(1) For the connection of the last safety switch of the chain (XCSRC12M12 or XCSRC32M12) to the safety control unit

# Coded magnetic technology

## Plastic coded magnetic switches

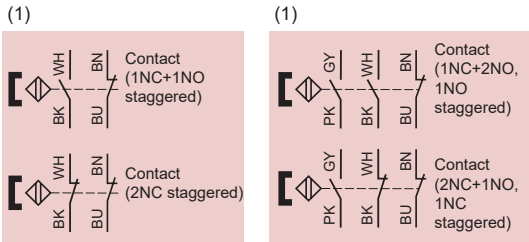

Plastic switches		Type XCSDM coded magnetic			Connector on flying lead, L = 15 cm (3)		
		Pre-cabled L = 2 m					
Maximum safety level (5)		PL=e, category4 conforming to EN/ISO 13849-1 et SIL 3 conforming to EN/IEC 61508					
Switches for actuation		face to face, face to side, side to side		face to face		face to face, face to side, side to side	
Degree of protection		IP66 + IP67 - Ecolab				IP66 + IP67 - Ecolab	
Type of contact		REED				REED	
Rated operational characteristics (conforming to EN/IEC 60947-5-1)		Ue = 24 VDC, Ie = 100 mA				Ue = 24 VDC, Ie = 100 mA	
Dimensions W x D x H		16 x 7 x 51 mm	25 x 13 x 88 mm	M30 x 38,5 mm	16 x 7 x 51 mm	25 x 13 x 88 mm	M30 x 38.5 mm
Operating zone (4)		Sao = 5 / Sar = 15		Sao = 8 / Sar = 20		Sao = 5 / Sar = 15 Sao = 8 / Sar = 20	
Reliability data B <sub>10d</sub>		50 000 000 (value given for a service life of 20 years, limited by mechanical or contact wear)					
Switch with coded magnet	1NC+1NO staggered	XCSDMC5902	XCSDMP5902	XCSDMR5902	XCSDMC590L01M8	XCSDMP590L01M12	XCSDMR590L01M12
	2NC staggered	XCSDMC7902	XCSDMP7902	XCSDMR7902	XCSDMC790L01M8	XCSDMP790L01M12	XCSDMR790L01M12
	1NC+2NO, 1NO staggered	-	XCSDMP5002	-	-	XCSDMP500L01M12	-
	2NC+1NO, 1NC staggered	-	XCSDMP7002	-	-	XCSDMP700L01M12	-

- (1) Illustration of contacts with the magnet in front of the switch.  
 (2) For version with LED indicator, replace the last 0 in the reference by 1 (example: XCSDMC5902 becomes **XCSDMC5912**).  
 (3) For associated pre-wired female connectors, please refer to the "Safety switches - XCS range" catalogue.  
 (4) Sao: assured operating distance. Sar: assured release distance.  
 (5) Using an appropriate and correctly connected safety control unit

# Emergency stops

## Emergency stop rope pull switches

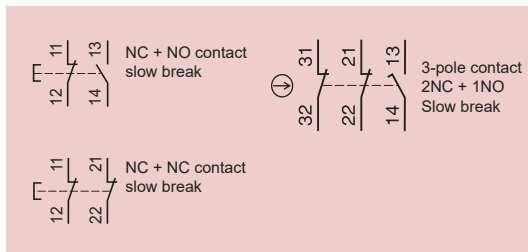

For operating cable length < 20 - 30m		Without indicator light		
		Pg 13.5 threaded cable entry		
Maximum safety level (2)		PL=e, category 4 conforming to EN/ISO 13849-1 and SIL3 conforming to EN/IEC 61508		
Mechanical life		100 000 cycles		
Shock / vibration resistance		50 gn / 10 gn		
Degree of protection		IP66 and IP67		
Conformity to standards		EN/IEC 60947-5-5, EN/ISO 13850, UL (NiSD) - CSA, CCC		
Dimensions W x D x H		200.9 x 40 x 64.2 mm		
Operating cable length		< 30 m		
Operating cable anchoring point		Straight		right side
Reliability data B <sub>10d</sub>		500 000 (value given for a service life of 20 years, limited by mechanical or contact wear)		
Contact	1 NC + 1 NO slow break	XY2CJS15 (4)	XY2CJR15 (4)	XY2CJL15 (4)
	1 NC + 1 NC slow break	XY2CJS17 (4)	XY2CJR17 (4)	XY2CJL17 (4)
	2 NC + 1 NO slow break	XY2CJS19 (4) (5)	XY2CJR19 (4) (5)	XY2CJL19 (4) (5)

- (2) Using an appropriate and correctly connected safety control unit. (4) For ISO M20 threaded cable entry version, add H29 to the end of the reference selected. Example: XY2CJS15 becomes **XY2CJS15H29**. (5) For 1/2" NPT threaded cable entry version, add H7 to the end of the reference selected. Example: XY2CJS19 becomes **XY2CJS19H7**.

# Emergency stops

## Emergency stop rope pull switches



Booted pushbutton reset



Key release pushbutton reset (key n° 421)



For operating cable length ≤ 30 m		Simple anchor, without indicator light 3 entries of pre-cabled Pg13.5 (4)(5)		with indicator light
Maximum safety level (2)		PL=e, category4 conforming to EN/ISO 13849-1 and SIL 3 conforming to EN/IEC 61508		
Mechanical life		800 000 cycles		
Shock / vibration resistance		50 gn / 10 gn		
Degree of protection		IP65		
Conformity to standards		EN/IEC 60947-5-5, EN/ISO 13850, UL NISD and CSA C 22-2 n° 14 (with suffix H7)		
Dimensions W x D x H		201 x 71 x 68 mm		
Operating cable length		≤ 30 m		
Operating cable anchoring point		To right or to left		
Reliability data B <sub>10d</sub>		4 000 000 (value given for a service life of 20 years, limited by mechanical or contact wear)		
Contact	1 NC + 1 NO slow break	XY2CH13250 (4) (5)	XY2CH13450 (4) (5)	XY2CH13253 (4)
	1 NC + 1 NC slow break	XY2CH13270 (4) (5)	XY2CH13470 (4) (5)	XY2CH13273
	2 NC + 1 NO slow break	XY2CH13290 (4) (5)	–	XY2CH13293 (4)



Booted pushbutton reset



Key release pushbutton reset (key n° 421)

For operating cable length ≤ 70 m		Simple anchor, without indicator light 3 plain holes with Pg13,5 or ISO M20 cable entries (3)(5)			
Maximum safety level (2)		PL=e, category 4 conforming to EN/ISO 13849-1 and SIL 3 conforming to EN/IEC 61508			
Mechanical life		60 000 cycles			
Shock / vibration resistance		50 gn / 10 gn			
Degree of protection		IP66			
Conformity to standards		EN/IEC 60947-5-5, EN/ISO 13850, UL NISD and CSA C 22-2 n° 14 (with suffix H7)			
Dimensions W x D x H		229 x 82 x 142 mm			
Pre-cabled length		≤ 70 m			
Operating cable anchoring point		To left	To right	To left	To right
Reliability data B10d		300 000 (value given for a service life of 20 years, limited by mechanical or contact wear)			
Contact	1 NC + 1 NO slow break	XY2CE2A250 (5)	XY2CE1A250 (5)	XY2CE2A450 (5)	XY2CE1A450
	1 NC + 1 NC slow break	XY2CE2A270 (5)	XY2CE1A270 (5)	XY2CE2A470	XY2CE1A470
	2 NC + 2 NO slow break	XY2CE2A290 (3) (5)	XY2CE1A290 (3) (5)	XY2CE2A490 (3)	XY2CE1A490 (3)



Booted pushbutton reset



Key release pushbutton reset (key n° 455)

For pre-cabled length ≤ 2X100 m		Double latching, without indicator lights 3 entries of pre-cabled ISO M20 or cable gland 13 (Pg13,5) (3) (5)			
Maximum safety level (2)		PL=e, category 4 conforming to EN/ISO 13849-1 and SIL 3 conforming to EN/IEC 61508			
Mechanical life		60 000 cycles			
Shock / vibration resistance		50 gn / 10 gn			
Degree of protection		IP66			
Conformity to standards		EN/IEC 60947-5-5, EN/ISO 13850, UL NISD and CSA C 22-2 n° 14 (with suffix H7)			
Dimensions W x D x H		327.4 x 82 x 142 mm			
Pre-cabled length		≥ 2 x 35 m et ≤ 2 x 100 m			
Bellows matter		Nitrile	Silicone	Nitrile	Silicone
Reliability data B <sub>10d</sub>		300 000 (value given for a service life of 20 years, limited by mechanical or contact wear)			
Contact	2 NC + 2 NO slow break	XY2CEDA290 (3) (5)	XY2CEDC290 (3)	XY2CEDA590 (3)	XY2CEDC590

(2) Use an appropriated and well connected control system

(3) With protected LED, supply voltage light 24 V or 130 V, add 6 at the end of the reference (Example: XY2CE1A290 becomes **XY2CE1A296**). / With DEL protected, Supply voltage indicator 230 V, add 7 at the end of the reference (Example: : XY2CE1A290 becomes **XY2CE1A297**)

(4) For the threaded entry cable version ISO M20, add H29 at the end of the reference. Example: : XY2CH13250 becomes **XY2CH13250H29**.

(5) For the threaded entry cable version 1/2" NPT, add H7 at the end of the reference. Example: : XY2CE2A250 becomes **XY2CE2A250H7**

## Accessories

Mounting kits	XY2CJ	XY2CH	XY2CE	XY2CED
References	XY2CZ9425 (1)	XY2CZ9330 (2)	XY2CZ9570 (3)	XY2CZ96200 (4)

(1) Kit contents: 1 galvanised cable L:30.5 (Ø 3.2 mm), quick tensioner, cable supports, and end spring.

(2) Kit contents: 1 galvanised cable L: 30.5 m (Ø 3.2 mm) and end spring.

(3) Kit contents: 1 galvanised cable L: 70.5 m (Ø 5 mm), turnbuckle, cable supports, cable end protectors and end spring.

(4) Kit contents: 2 galvanised cables L: 100.5m (D 5mm) and quick tensioners.



# Light curtains

## Type 2 conforming to IEC 61496-1 & IEC 61496-2

### Main features

- Automatic or Manual Start/Restart selectable by wiring
- External Device Monitoring (EDM) selectable by wiring
- Two maximum Sensing Distance selectable by wiring
- Test function (beam blocked state simulation)
- Led indicators for status and diagnosis
- Muting possible with dedicated Safety module XPSLCMUT1160
- 2 outputs solid-state PNP OSSD (\*)  
(NO when the sensing area is occupied)

(\*) Output Signal Switching Devices



Maximum safety level achieved by the solution EN ISO 13849-1 (3)		PLc/cat2	
Maximum safety level achieved by the solution IEC 61508/IEC 62061 (3)		SIL1/SILCL1	
Type IEC 61496-1 & IEC 61496-2		Type 2 Multi-beam, infrared transmission	
Nominal sensing distance (Sn)		0...4 m or 0...12 m selectable	
Resolution (detection capability)		30 mm (Hand detection)	2-3 or 4 (Body Detection)
Number of safety outputs		2 solid-state PNP	
Response time (depending on model)		4.5...22.5 ms	3...3.5 ms
Operating temperature range		-30°C...+55°C	
Degree of protection (1)		IP65 - IP67	
Connection		M12 Connector	
Reliability data		PFHd = 2.04E-8 to 8.98E-8	PFHd = 1.71E-8 to 2.02E-8
Mission time		TM = 20 year	
Height protected (mm)	160	XUSL2E30H016N	–
	260	XUSL2E30H026N	–
	310	XUSL2E30H031N	–
	460	XUSL2E30H046N	–
	510 - 2 beams	–	XUSL2E2BB051N
	610	XUSL2E30H061N	–
	760	XUSL2E30H076N	–
	810 - 3 beams	–	XUSL2E3BB081N
	910	XUSL2E30H091N	–
	910 - 4 beams	–	XUSL2E4BB091N
	1060	XUSL2E30H106N	–
	1210	XUSL2E30H121N	–
	1360	XUSL2E30H136N	–
	1510	XUSL2E30H151N	–
	1660	XUSL2E30H166N	–
1810	XUSL2E30H181N	–	

## Type 2 conforming to IEC 61496-1 and 2

### Light curtain functions

- Auto/Manual
- Monitoring of external switching devices  
(EDM: External Devices Monitoring),
- LED display of operating modes
- Integral muting function.

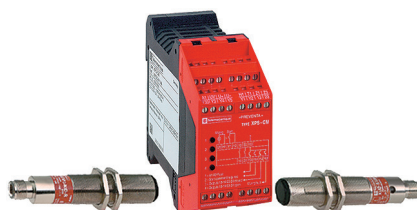

Maximum safety level achieved by the solution (EN/ISO 13849-1, EN/IEC 62061)		PLc/cat2, SILCL1 (For use with XPSCM1144* - See p70)	
Type		Single-beam with infrared emission	
Height protected (conforming to prEN 999)		up to 1200 mm (1 to 4 beams)	
Nominal sensing distance (Sn)		8 m	
Number of circuits	Safety	2"F"	
	Additional	4 solid-state	
Response time		< 25 ms	
Reliability data		PFHd = 4.6E -7 conforming to EN/IEC 61508 PFHd = 5.5E -7 conforming to EN/IEC 61508, with function "muting"	
Thru-beam pairs, axially aligned	Pre-cabled L = 5 m	PNP	XU2S18PP340L5 (2)
	M12 connector	PNP	XU2S18PP340D (2)

(1) Also exists in IP69k model, ECOLAB certified.

(2) For viewfinding to 90°, add W in the reference. Example XU2S18PP340L5 becomes **XU2S18PP340WL5**

(3) Achievable in standalone operation (without safety control unit).

# Light curtains

## Type 4 conforming to IEC 61496-1 & IEC 61496-2

### Main features

- Automatic or Manual Start/Restart selectable by wiring
- External Device Monitoring (EDM) selectable by wiring
- Two maximum Sensing Distance selectable by wiring
- Test function (beam blocked state simulation)
- Led indicators for status and diagnosis
- Muting possible with dedicated Safety module XPSLCMUT1160
- Integrated muting function available on XUSL4M\* range (see p68)
- 2 outputs solid-state PNP OSSD (\*)  
(NO when the sensing area is occupied)



(\*) Output Signal Switching Devices

Maximum Safety level achieved by the solution EN ISO 13849-1 (2)		PLe/cat4		
Maximum Safety level achieved by the solution IEC 61508/IEC 62061 (2)		SIL3/SILCL3		
Type IEC 61496-1 & IEC 61496-2		Type 4 Multi-beam, infrared transmission		
Nominal sensing distance (Sn)		0...3 m or 1...6 m selectable	0...4 m or 0...12 m selectable	0...4 m or 0...12 m selectable
Resolution (detection capability)		14 mm (Finger detection)	30 mm (Hand detection)	2-3 or 4 beams (Body Detection)
Number of safety outputs		2 solid-state PNP		
Response time (depending on model)		4...23.5 ms	4...22 ms	2.5...3 ms
Operating temperature range		-20°C...+55°C	-30°C...+55°C	
Degree of protection (1)		IP65 - IP67		
Connection		M12 Connector		
Reliability data (depending on model) conforming to EN/IEC 61508		PFHd = 1.03E-8 to 3.71E-8	PFHd = 7.08E-9 to 2.02E-8	PFHd = 6.89E-9 to 8.21E-9
Mission time		TM = 20 years		
Height protected (mm)	160	XUSL4E14F016N	XUSL4E30H016N	–
	260	–	XUSL4E30H026N	–
	310	XUSL4E14F031N	XUSL4E30H031N	–
	460	XUSL4E14F046N	XUSL4E30H046N	–
	510 - 2 beams	–	–	XUSL4E2BB051N
	610	XUSL4E14F061N	XUSL4E30H061N	–
	760	XUSL4E14F076N	XUSL4E30H076N	–
	810 - 3 beams	–	–	XUSL4E3BB081N
	910	XUSL4E14F091N	XUSL4E30H091N	–
	910 - 4 beams	–	–	XUSL4E4BB091N
	1060	XUSL4E14F106N	XUSL4E30H106N	–
	1210	XUSL4E14F121N	XUSL4E30H121N	–
	1360	XUSL4E14F136N	XUSL4E30H136N	–
	1510	XUSL4E14F151N	XUSL4E30H151N	–
	1660	XUSL4E14F166N	XUSL4E30H166N	–
	1810	XUSL4E14F181N	XUSL4E30H181N	–

Type		Long Range models For hand and body protection		
Nominal sensing distance (Sn)		0...10 m or 3...20 m selectable	0...10 m or 3...20 m selectable	
Operating temperature range		-20°C...+55°C		
Reliability data (depending on model) conforming to EN/IEC 61508		PFHd = 9.13E-9 to 2.29E-8	PFHd = 9.15E-9 to 1.08E-8	
Mission time (conforming to modèle)		3...13 ms		
Height protected (mm)	160	XUSL4E30H016L	–	–
	310	XUSL4E30H031L	–	–
	460	XUSL4E30H046L	–	–
	510 - 2 beams	–	–	XUSL4E2BB051L
	610	XUSL4E30H061L	–	–
	760	XUSL4E30H076L	–	–
	810 - 3 beams	–	–	XUSL4E3BB081L
	910	XUSL4E30H091L	–	–
	910 - 4 beams	–	–	XUSL4E4BB091L
	1060	XUSL4E30H106L	–	–
	1210	XUSL4E30H121L	–	–
	1360	XUSL4E30H136L	–	–
	1510	XUSL4E30H151L	–	–
	1660	XUSL4E30H166L	–	–
	1810	XUSL4E30H181L	–	–

(1) Also exists in IP69K model, ECOLAB certified.

(2) Achievable in standalone operation (without safety control unit)

# Light curtains

## Type 4 conforming to IEC 61496-1 & IEC 61496-2

### Main features

- Automatic or Manual Start/Restart selectable by wiring
- External Device Monitoring (EDM) selectable by wiring
- Two maximum Sensing Distance selectable by wiring
- Test function (beam blocked state simulation)
- Led indicators for status and diagnosis
- Muting possible with dedicated Safety module (XPSLCMUT1160)
- 2 outputs solid-state PNP OSSD (\*)  
(NO when the sensing area is occupied)



Type		Cascadable models - Master Segments (2)		
Nominal sensing distance (Sn)		0...3 m or 1...6 m selectable	0...4 m or 0...12 m selectable	0...4 m or 0...12 m selectable
Resolution (detection capability)		14 mm (Finger detection)	30 mm (Hand detection)	2-3 or 4 beams (Body Detection)
Number of circuits Safety		2 solid-state PNP		
Response time		Depends on the number and the model of segments used. See the "User Manual" for the calculation		
Operating temperature range		-20°C...+55°C	-30°C...+55°C	
Degree of protection		IP65 - IP67		
Connection		2xM12 Connector		
Reliability data (depending on model) conforming to EN/IEC 61508		PFHd = 1.27E-8 to 2E-8	PFHd = 9.47E-9 to 1.43E-8	PFHd = 6.89E-9 to 8.21E-9
Mission time		TM = 20 years		
Height protected (mm) (1)	310	XUSL4E14F031NM	–	–
	460	XUSL4E14F046NM	XUSL4E30H046NM	–
	510 - 2 beams	–	–	XUSL4E2BB051NM
	610	XUSL4E14F061NM	XUSL4E30H061NM	–
	760	XUSL4E14F076NM	XUSL4E30H076NM	–
	810 - 3 beams	–	–	XUSL4E3BB081NM
	910	–	XUSL4E30H091NM	–
	910 - 4 beams	–	–	XUSL4E4BB091NM
	1060	–	XUSL4E30H106NM	–

Type		Cascadable models - Slave1 Segments (2)		
Reliability data (depending on model) conforming to EN/IEC 61508		PFHd = 1.27E-8 to 2E-8	PFHd = 9.47E-9 to 1.43E-8	PFHd = 6.89E-9 to 8.21E-9
Response time		Depends on the number and the models of segments used. See the "User Manual" for the calculation		
Connection		M12 Connector		
Height protected (mm) (1)	310	XUSL4E14F031NS1	–	–
	460	XUSL4E14F046NS1	XUSL4E30H046NS1	–
	510 - 2 beams	–	–	XUSL4E2BB051NS1
	610	XUSL4E14F061NS1	XUSL4E30H061NS1	–
	760	XUSL4E14F076NS1	XUSL4E30H076NS1	–
	810 - 3 beams	–	–	XUSL4E3BB081NS1
	910	–	XUSL4E30H091NS1	–
	910 - 4 beams	–	–	XUSL4E4BB091NS1
	1060	–	XUSL4E30H106NS1	–

Type		Cascadable models - Slave2 Segments (2)		
Reliability data (depending on model) conforming to EN/IEC 61508		PFHd = 1.52E-8 to 2E-8	PFHd = 9.47E-9 to 1.43E-8	PFHd = 6.89E-9 to 8.21E-9
Response time		Depends on the number and the models of segments used. See the "User Manual" for the calculation		
Connection		2xM12 Connector		
Height protected (mm) (1)	310	–	–	–
	460	XUSL4E14F046NS2	XUSL4E30H046NS2	–
	510 - 2 beams	–	–	XUSL4E2BB051NS2
	610	XUSL4E14F061NS2	XUSL4E30H061NS2	–
	760	XUSL4E14F076NS2	XUSL4E30H076NS2	–
	810 - 3 beams	–	–	XUSL4E3BB081NS2
	910	–	XUSL4E30H091NS2	–
	910 - 4 beams	–	–	XUSL4E4BB091NS2
	1060	–	XUSL4E30H106NS2	–

(1) Other heights available on request

(2) Cable sold separately, please refer to Page 47

# Light curtains

## Type 4 conforming to IEC 61496-1 & IEC 61496-2

### Main features

- Integrated muting function
- Automatic or Manual Start/Restart selectable by wiring
- External Device Monitoring (EDM) selectable by wiring
- Two maximum Sensing Distance selectable by wiring
- Test function (beam blocked state simulation)
- Led indicators for status and diagnosis
- 2 outputs solid-state PNP OSSD (\*)  
(NO when the sensing area is occupied)
- (\*) Output Signal Switching Devices



Type		Integrated muting models (1) For body protection (2)	
Nominal sensing distance (Sn)		0...4 m or 0...12 m selectable	
Operating temperature range		-30°C...+55°C	
Package contents		Hardware and software configuration (with SoMute software), partial muting and integrated muting lamp	Hardware configuration only
Height protected (mm)	510 - 2 beams	XUSL4MA2BB051N	XUSL4MB2BB051N
	810 - 3 beams	XUSL4MA3BB081N	XUSL4MB3BB081N
	910 - 4 beams	XUSL4MA4BB091N	XUSL4MB4BB091N

(1) Possible association with pre-built/pre-adjusted muting arms XUSZAS\* (single beam muting sensors) and XUSZAM\* (multi-beam muting sensors).

(2) For hand detection, some models are available in 30mm and 40mm resolutions, in different protected heights.

## Cabling accessories

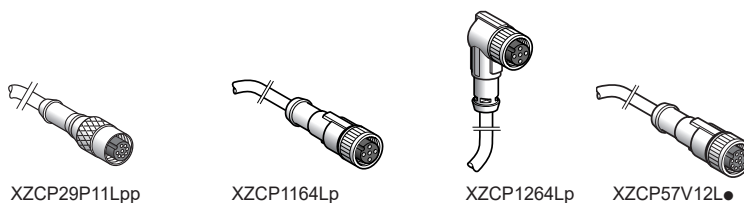

Type		M12 connector - Pre-wired						
PUR cable length		2 m	5 m	10 m	15 m	25 m		
M12 connector 5-pins Female	XUSL2E* / 4E* / 4M*	Straight - Pre-wired	For transmitter	XZCP1164L2	XZCP1164L5	XZCP1164L10	XZCP1164L15	XZCP1164L25
		90° - Pre-wired	For transmitter	XZCP1264L2	XZCP1264L5	XZCP1264L10	XZCP1264L15	XZCP1264L25
M12 connector 8-pins Female	XUSL2E* / 4E*	Straight - Pre-wired	For Receiver	XZCP29P11L2	XZCP29P11L5	XZCP29P11L10	XZCP29P11L15	XZCP29P11L25
		90° - Pre-wired	For Receiver	XZCP53P11L2	XZCP53P11L5	XZCP53P11L10	XZCP53P11L15	XZCP53P11L25
M12 connector 12-pins Female	XUSL4M*	Straight - Pre-wired	For Receiver		XZCP57V12L5	XZCP57V12L10	XZCP57V12L15	

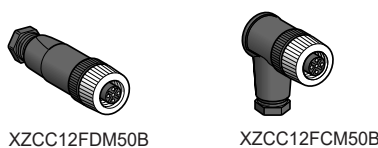

Type		M12 connector - with screw terminals	
Cable length		2 m	
M12 connector 5-pins Female	90° - 5 poles with screw terminals- cable gland	For transmitter	XZCC12FCM50B
	Straight - 5 poles with screw terminals- cable gland	For transmitter	XZCC12FDM50B
M12 connector 8-pins Female	90° - 8 poles with screw terminals- cable gland	For Receiver	XZCC12FCM80B
	Straight - 8 poles with screw terminals- cable gland	For Receiver	XZCC12FDM80B

Type		2xM12 connectors - Jumpers				
PUR cable length		0.3 m	3 m	5 m	10 m	25 m
2 straight M12 - Female/Female connectors - 5 poles	For Master/Slave cascadable	XZCR1111064D03	XZCR1111064D3	XZCR1111064D5	XZCR1111064D10	XZCR1111064D25

# Safety modules for monitoring

## Universal safety relays XPSU

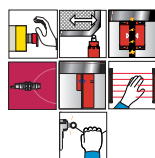

XPSUAF

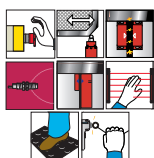

XPSUAK

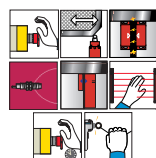

XPSUAT

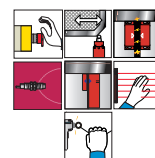

XPSUDN

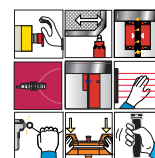

XPSUS



Maximum achievable safety level	PL e / Category 4 conforming to ISO 13849-1 SILCL3 conforming to IEC 62061 SIL3 conforming to IEC61508				
Number of outputs	3 NO 1 pulsed output	2 NO 1 redundant NC, 1 pulsed output	3 NO immediate 3 NO delayed (selectable from 0.1 s to 15 min. by 10 steps of 0.1 s which can be multiplied by 1, 10, 100, and 1,000) or immediate + 1 NC	3 NO 1 redundant NC, 1 pulsed output	2 NO 1 pulsed output
Display	6 LEDS	6 LEDS	8 LEDS	16 LEDS	6 LEDS
Supply voltage	24 V AC/DC and 48-240 V AC/DC				
Synchronization time between inputs	Selectable				
Input channels	2	2	3	12	4
Start input	Automatic, manual & monitored start				
Control configurable pulsed outputs	3 ON/OFF		4 ON/OFF	7 ON/OFF	3 ON/OFF
Module width	22.5 mm/0.886 in.		45 mm/1.77 in.	45 mm/1.77 in.	22.5 mm/0.886 in.

Complete references and other XPSU safety universal modules are available on [www.schneider-electric.com](http://www.schneider-electric.com)

# Safety relay for monitoring

## XU2S single beam Type 2 photoelectric sensors

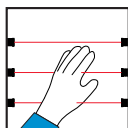

Maximum safety level of the solution attained (EN/ISO 13849-1, EN/IEC 62061)	PL c / Cat. 2, SILCL 1	
Number of circuits	Safety	2"F"
	Additional	4 solid-state
Display (number of LEDs)	4	
Width of housing	45 mm	
Integral Muting function	Yes	
For utilisation with	XU2S18*	
Supply voltage	24 VDC	XPSCM1144P (1)

(1) For version with non removable terminal block, delete the letter P from the end of the reference (example: XPSCM1144P becomes **XPSCM1144**).

# Modules for monitoring

## Modular safety controller XPSMCM

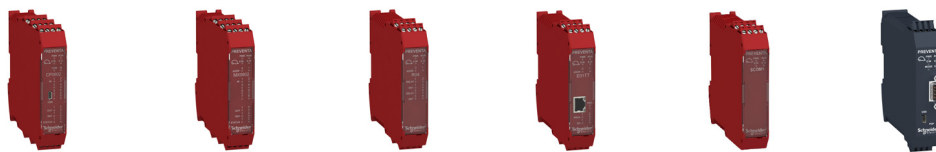
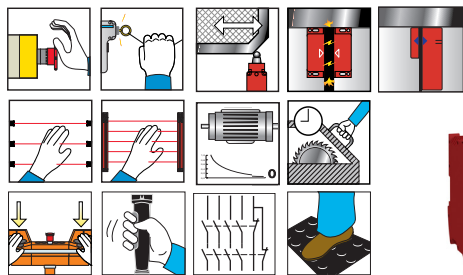

Maximum safety level reached by the solution	PL e / Cat. 4, SILCL 3 5 (EN/ISO 13849-1, EN/IEC 62061)					Without safety level
Function	Central Unit (CPU) (standalone) (2)	Extension units input/output	Extension units Outputs Relay	Extension units speed control	Extension units Communication	Extension units communication bus
Case dimensions	22,5 x 99 x 114,5					
References	XPSMCMCP0802 (1)	XPSMCMMX	XPSMCMER	XPSMCMEN	XPSMCMCO0000S	XPSMCMCO0000
Main characteristics	- 8 digitals inputs - 2 OSSD pairs 400 mA - 4 Test outputs - 2 Status outputs - 2 EDM inputs	- 8 digitals inputs - 2 OSSD pairs 400 mA - 4 Test outputs - 2 Status outputs - 2 EDM inputs	- 2 or 4 Safety relay outputs 2NO + 1NC (without connection to the extension bus) - 1 or 2 EDM inputs	- 1 or 2 Inputs for coder (TTL or HTL or Sin/Cos) or 1 or 2 Inputs for proximity sensors - 2 Outputs digital configurables	- for connection XPSMCMCP0802 to remote modules (≤ 50 m) - creation to 6 islands, with full length of 250 m and maximum 50 m between 2 communication modules	- for data exchange and network systems diagnosis or field-bus - available interfaces (CAN open, Ethernet IP, Modbus RTU, Modbus TCP, Profibus DP et USB)
References	XPSMCMC10804 (1)	XPSMCMCI	XPSMCMRO			
Main characteristics	- 8 digital inputs - 4 OSSD pairs 400mA - 4 Test outputs - 4 EDM inputs	- 8 or 16 digital inputs - 4 Test outputs	- 4 modules Safety relay outputs 2NO + 1NC (with onnection to the extension bus) - 4 Independent safety relay outputs and 4 EDM outputs corresponding			
References		XPSMCMDO				
Main characteristics	- Compatible with Extension module XPSMCMCI0400, channels analogic input	- 2 or 4 OSSD pairs 400 mA - 2 or 4 Status outputs - 2 or 4 EDM inputs	- 0 or 8 Status outputs			

(1) Configuration, Programming, simulation and documentation by means of an intuitive software (SoSafe)

(2) Extension units available (input, output, relay, speed control, communication).

More information on [schneider-electric.com](http://schneider-electric.com)

Discover our full offer on  
[www.tesensors.com](http://www.tesensors.com)

## Schneider Electric

Head office  
35, rue Joseph Monier - CS 30323  
92500 Rueil-Malmaison Cedex  
France

[www.tesensors.com](http://www.tesensors.com)

The information provided in this documentation contains general descriptions and/or technical characteristics of the performance of the products contained herein. This documentation is not intended as a substitute for and is not to be used for determining suitability or reliability of these products for specific user applications. It is the duty of any such user or integrator to perform the appropriate and complete risk analysis, evaluation and testing of the products with respect to the relevant specific application or use thereof. Neither Schneider Electric nor any of its affiliates or subsidiaries shall be responsible or liable for misuse of the information contained herein.

Design : IGS-CP  
Photos : Schneider Electric