

# Industrial Ethernet

Catalog

June 2019



***Ethernet***  
Ethernet

**Schneider**  
Electric

# Quick access to product information

## Get technical information about your product

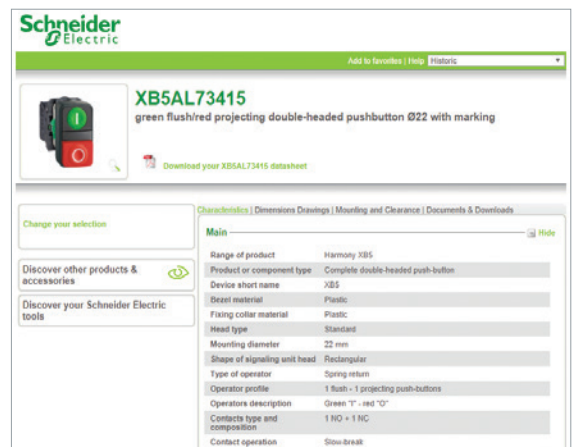
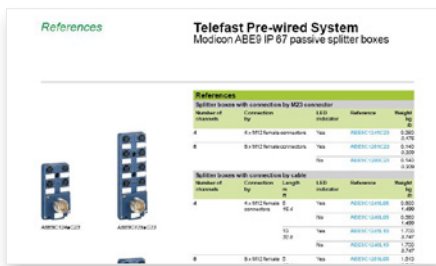

Each commercial reference presented in a catalog contains a hyperlink. Click on it to obtain the technical information of the product:

- Characteristics, Dimensions and drawings, Mounting and clearance, Connections and schemas, Performance curves
- Product image, Instruction sheet, User guide, Product certifications, End of life manual

## Find your catalog



- > With just 3 clicks, you can reach the Industrial Automation and Control catalogs, in both English and French
- > Download Digi-Cat with this [link](#)

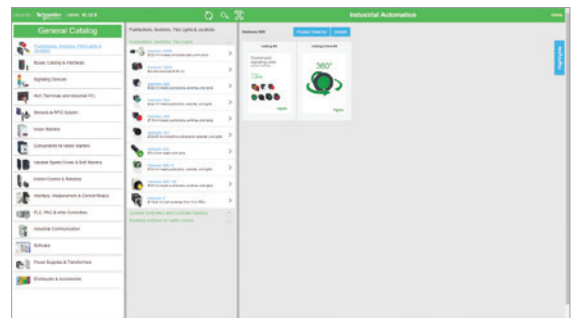

- Updated quarterly
- Embeds product selectors and configurators, 360° images, training centers
- Optimized search by commercial reference

## Select your training



- > Find the right [Training](#) for your needs on our Global website
- > Locate the training center with the selector tool, using this [link](#)

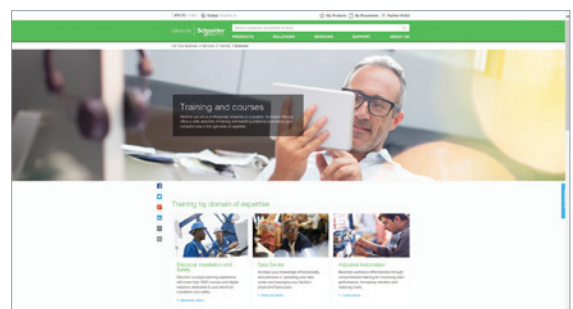

# General content

*Introduction to EcoStruxure Machine* ..... page 2

*Selection guide: controllers for industrial machines* ..... page 4

*Machine automation* ..... page 6

## Industrial Ethernet

### ■ For Modicon M221/M241/ M251 logic controllers, and Modicon M262 logic/motion controller

□ Communication protocols ..... page 8

□ Ethernet embedded on controllers and communication modules ..... page 9

□ Main devices supported ..... page 9

□ Web servers ..... page 10

□ Ethernet services ..... pages 10 to 12

□ Embedded Ethernet ports ..... page 13

□ Network characteristics ..... page 13

□ Industrial Ethernet architecture ..... page 14

□ Connection to Ethernet and Sercos III ..... page 15

### ■ For Modicon M258 logic controllers, and Modicon LMC058 / LMC078 motion controllers

□ Industrial Ethernet architecture ..... page 16

□ Connection to Ethernet ..... page 17

■ **Product reference index** ..... page 18

To be competitive in today's digital era, machine builders must be innovative. Smart machines, those that are better connected, more flexible, more efficient, and safe, are enabling machine builders to innovate in ways never before possible.

EcoStruxure, Schneider Electric's open, IoT-enabled architecture and platform, offers powerful solutions for the digital era. As part of this, EcoStruxure Machine brings powerful opportunities for machine builders and OEMs, empowering them to offer smart machines and compete in the new, digital era.

EcoStruxure Machine brings together key technologies for product connectivity and edge control on premises, and cloud technologies to provide analytics and digital services. EcoStruxure Machine helps you bring more innovation and added value to your customers throughout the entire machine life cycle.

**Innovation at Every Level for Machines is full systems across three layers:**

- Connected products  
Our connected products for measuring, actuating, device level monitoring, and control adhere to open standards to provide unmatched integration opportunities and flexibility
- Edge Control  
We are IIoT-ready with a proven set of tested and validated reference architectures that enable the design of end-to-end open, connected, and interoperable systems based on industry standards. Ethernet and OPC UA facilitates IT/OT convergence meaning machine builders reap benefits from web interfaces and cloud.

- Apps, Analytics & Services  
Seamless integration of machines to the IT layer allows the collection and aggregation of data ready for analysis – for machine builders and end users alike this means increased uptime and the ability to find information faster for more efficient operations and maintenance.

**These levels are completely integrated from shop floor to top floor. And we have cloud offers and end-to-end cybersecurity wrapped around.**

EcoStruxure Machine makes it easier for OEMs/ machine builders to offer their customers smarter machines. The advent of smart machines is driven by the changing needs of end users:

- Evolving workforce
- Reducing costs
- Dynamic markets
- Shorter life cycles
- Prioritizing safety and cybersecurity

EcoStruxure Machine provides one solution for the whole machine life cycle:





- With Smart Design & Engineering the time to market is reduced by up to 30% using our automated engineering and the simulation capabilities
- During Commissioning & Operation of the machine, resources such as energy, material and loss can be improved, and with seamless integration to the IT world efficiency can be improved by up to 40%
- Smart Maintenance & Services reduces the time for corrective actions up to 50%

# EcoStruxure™ Machine

Innovation At Every Level



\* The Schneider Electric industrial software business and AVEVA have merged to trade as AVEVA Group plc, a UK listed company. The Schneider Electric and Life is On trademarks are owned by Schneider Electric and are being licensed to AVEVA by Schneider Electric.

Applications	Type	Logic controller			Logic/Motion controller		Motion controller
	Specification	For hardwired architectures	For performance-demanding applications		For modular and distributed architectures	IIoT ready for performance machines	For automating machines/lines with 0 - 130 servo or robot axes
							
<b>Performance</b>		0.2 µs/inst	22 ns/inst		22 ns/inst	3...5 ns/inst	0.5...2 ns/inst
<b>Memory</b>		640 KB RAM, 2 MB Flash	64 MB RAM, 128 MB Flash		64 MB RAM, 128 MB Flash	256 MB RAM, 256 MB Flash	128 KB to 256 KB NV RAM 512 MB DDR2 to 1 GB DDR3L
<b>Supply voltage</b>		24 V --- or 100...240 V ~	24 V --- or 100...240 V ~		24 V ---	24 V ---	24 V ---
<b>Communication fieldbus and networks</b>	Embedded	<ul style="list-style-type: none"> <li>■ EtherNet/IP</li> <li>■ RS 232/RS 485 serial link</li> <li>■ USB mini-B programming port</li> </ul>	<ul style="list-style-type: none"> <li>■ Ethernet</li> <li>■ CANopen (master) and SAE J1939</li> <li>■ 2 serial links</li> <li>■ USB mini-B programming port</li> </ul>		<ul style="list-style-type: none"> <li>■ EtherNet/IP</li> <li>■ CANopen (master) and SAE J1939</li> <li>■ Serial link</li> <li>■ USB mini-B programming port</li> </ul>	<ul style="list-style-type: none"> <li>■ EtherNet/IP</li> <li>■ Sercos III</li> <li>■ Modbus TCP</li> <li>■ Serial link</li> <li>■ USB mini-B programming port</li> </ul>	<ul style="list-style-type: none"> <li>■ EtherNet/IP</li> <li>■ Sercos III</li> <li>■ CANopen</li> <li>■ Profibus</li> <li>■ Profinet</li> <li>■ EtherCAT</li> </ul>
	Optional	<ul style="list-style-type: none"> <li>■ 1 Serial Line</li> </ul>	<ul style="list-style-type: none"> <li>■ Ethernet</li> <li>■ Profibus DP</li> </ul>		<ul style="list-style-type: none"> <li>■ Ethernet</li> <li>■ Profibus DP</li> </ul>	<ul style="list-style-type: none"> <li>■ Ethernet</li> <li>■ CANopen</li> </ul>	<ul style="list-style-type: none"> <li>■ CANopen</li> <li>■ Profibus DP</li> <li>■ RT-Ethernet</li> </ul>
<b>Embedded I/O</b>	Input types	Up to 40 logic inputs Up to 2 analog inputs	Up to 24 logic inputs		–	4 fast digital inputs	Up to 20 digital inputs Up to 16 touch probe inputs Up to 4 interrupt inputs Up to 2 analog inputs
	Output types	Up to 16 relay outputs Up to 16 transistor outputs	Up to 16 transistor outputs		–	4 fast digital outputs	Up to 16 digital outputs Up to 2 analog outputs
<b>Synchronized axes</b>		–	–		–	Up to 16 synchronized axes	Up to 130 synchronized axes
<b>Configuration software</b>		EcoStruxure Machine Expert-Basic (1)	EcoStruxure Machine Expert V1.1 (2)		EcoStruxure Machine Expert V1.1 (2)	EcoStruxure Machine Expert V1.1	EcoStruxure Machine Expert V1.1 (2)
<b>Compatible expansion I/O module ranges (consult the catalog)</b>	Local I/O	● Modicon TM3 ( <a href="#">DIA3ED2140109EN</a> )	● Modicon TM3 ( <a href="#">DIA3ED2140109EN</a> )		● Modicon TM3 ( <a href="#">DIA3ED2140109EN</a> )	● Modicon TM3 ( <a href="#">DIA3ED2140109EN</a> )	–
	Remote I/O	● Modicon TM3 ( <a href="#">DIA3ED2140109EN</a> )	● Modicon TM3 ( <a href="#">DIA3ED2140109EN</a> )		● Modicon TM3 ( <a href="#">DIA3ED2140109EN</a> )	● Modicon TM3 ( <a href="#">DIA3ED2140109EN</a> )	–
	Distributed I/O on Ethernet	● Modicon TM3 ( <a href="#">DIA3ED2140109EN</a> )	● Modicon TM3 ( <a href="#">DIA3ED2140109EN</a> ) ● Modicon TM5 ( <a href="#">DIA3ED2131204EN</a> )		● Modicon TM3 ( <a href="#">DIA3ED2140109EN</a> ) ● Modicon TM5 ( <a href="#">DIA3ED2131204EN</a> )	● Modicon TM3 ( <a href="#">DIA3ED2140109EN</a> ) ● Modicon TM5 ( <a href="#">DIA3ED2131204EN</a> )	● Modicon TM5 ( <a href="#">DIA3ED2131204EN</a> )
	Distributed I/O on CANopen	–	–		–	● Modicon TM5 ( <a href="#">DIA3ED2131204EN</a> ) ● Modicon TM7 ( <a href="#">DIA3ED2140405EN</a> )	● Modicon TM5 ( <a href="#">DIA3ED2131204EN</a> ) ● Modicon TM7 ( <a href="#">DIA3ED2140405EN</a> )
	Distributed I/O on Sercos	–	–		–	● Modicon TM5 ( <a href="#">DIA3ED2131204EN</a> )	● Modicon TM5 ( <a href="#">DIA3ED2131204EN</a> )
	Safety I/O	⚡ Modicon TM3 ( <a href="#">DIA3ED2140109EN</a> )	⚡ Modicon TM3 ( <a href="#">DIA3ED2140109EN</a> )		⚡ Modicon TM3 ( <a href="#">DIA3ED2140109EN</a> )	⚡ Modicon TM3 ( <a href="#">DIA3ED2140109EN</a> ) ⚡ Modicon TM5 ( <a href="#">DIA3ED2131204EN</a> ) ⚡ Modicon TM7 ( <a href="#">DIA3ED2140405EN</a> )	⚡ Modicon TM5 ( <a href="#">DIA3ED2131204EN</a> ) ⚡ Modicon TM7 ( <a href="#">DIA3ED2140405EN</a> )
<b>Controller range</b>	<b>Modicon M221/M221 Book</b>	<b>Modicon M241</b>		<b>Modicon M251</b>	<b>Modicon M262</b>	<b>LMC Eco, LMC Pro2</b>	
<b>More details in catalog</b>	<a href="#">DIA3ED2140106EN</a>	<a href="#">DIA3ED2140107EN</a>		<a href="#">DIA3ED2140108EN</a>	<a href="#">DIA3ED2180503EN</a>	<a href="#">DIA7ED2160303EN</a>	

(1) Formerly named SoMachine Basic.

(2) Formerly named SoMachine, EcoStruxure Machine Expert merges both former software ranges, SoMachine and SoMachine Motion.



## Machine Automation

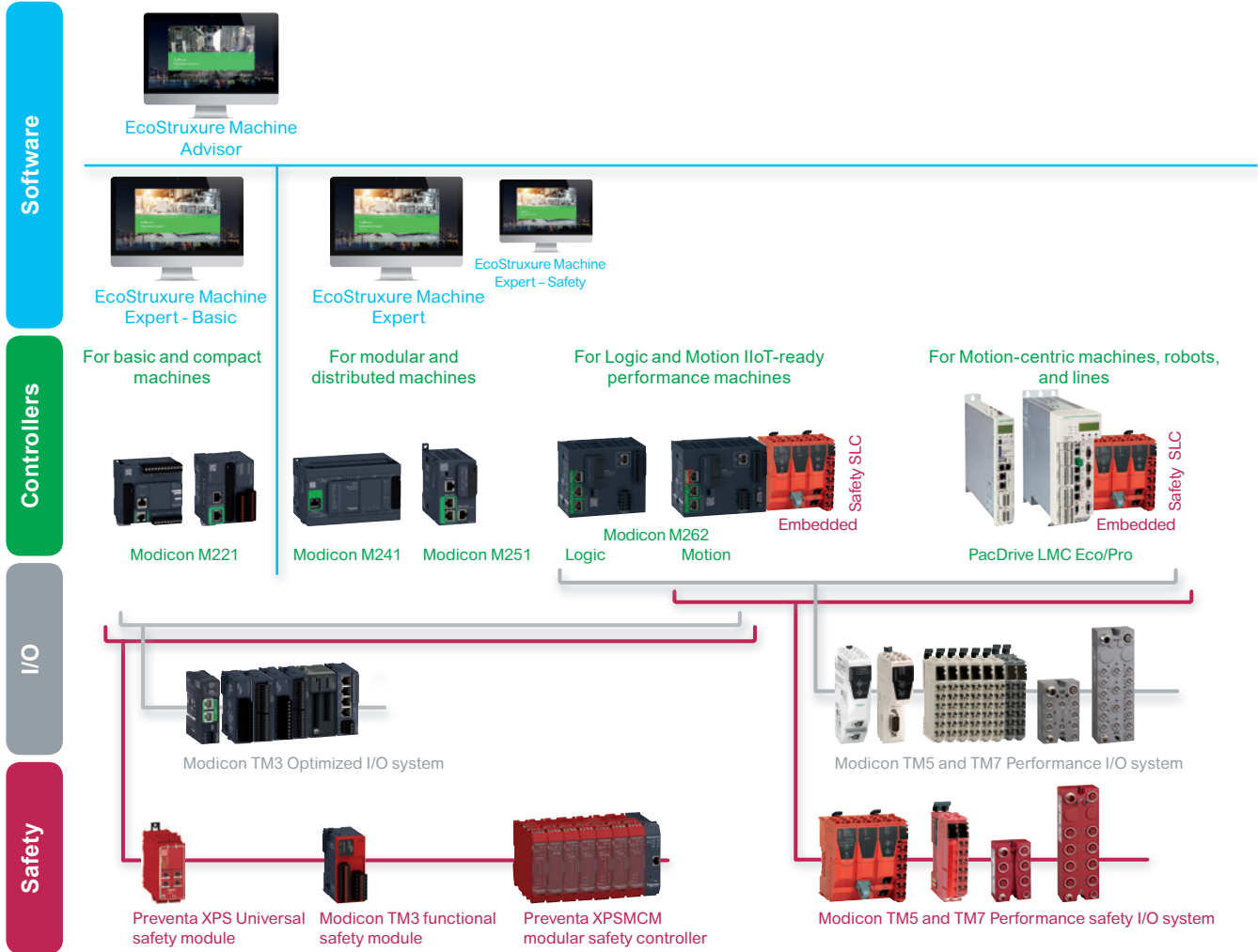

### Machine control

The scalability and consistency of I/O ranges allow you to select the right offer depending on your needs

Embedded Safety provides holistic solutions to Modicon M262 and PacDrive LMC controllers, increasing overall safety demand in Machine Automation

All these devices are managed within a single software, EcoStruxure Machine Expert, a powerful and collaborative engineering environment

- > From basic to motion- and robot-centric machines with the PacDrive 3 offer, Modicon controllers and solutions bring a consistent and scalable response to achieving flexibility, performance, productivity, and digitization.
- > Modicon TM3 Optimized I/O system for more compact and modular machines
- > Modicon TM5 for more performance-demanding machines, with Modicon TM7 for harsh environments; Both Performance I/O ranges (Modicon TM5 and TM7) allow safety functions to be implemented using the Modicon TM5CSLC safety logic controller
- > Preventa XPS Universal safety modules cover a wide range of safety functions, suitable for small applications with 4-5 safety functions, with diagnostic information provided to controllers via a single wire connection
- > Modicon TM3 safety functional modules are suitable for small applications covering E-Stop functions and diagnostics via TM3 bus
- > Preventa XPSMCM modular safety controllers are suitable for medium size applications with up to 20 safety functions and diagnostics via Modbus TCP, EtherNet/IP, EtherCAT, or Profinet
- > **EcoStruxure Machine Expert – Safety** optional add-on for programming safety logic controllers
- > **EcoStruxure Machine Expert – Basic** software for programming Modicon M221 logic controllers: an intuitive standalone environment accessible to basic skilled technicians
- > **EcoStruxure Machine Advisor** is a cloud-based services platform designed for machine builders to track machines in operation worldwide, monitor performance data, and resolve exceptional events, while reducing support costs by up to 50%

### Machine Automation

### Comprehensive Schneider offers for machine builders

- > Lexium servo drives, motors, and robotics are designed to control applications ranging from a single independent axis up to high-performance synchronized multi-axis machines requiring high-speed and precise positioning and movements



[Robotics](#)



[Integrated drives](#)



[Servo Drives & Motors](#)



[Steppers Drives & Motors](#)

- > The Lexium offer is designed for a broad range of motion-centric machines in applications such as [Packaging](#), [Material Handling](#), [Material Working](#), [Food and Beverage](#), and [Electronics](#)
- > Schneider Electric has developed Tested Validated & Documented Architectures (TVDA) applicable for generic machine control applications as well as for dedicated segment applications such as Packaging, Material Working, Material Handling, Hoisting, Pumping, or generic [Machine Control applications](#)

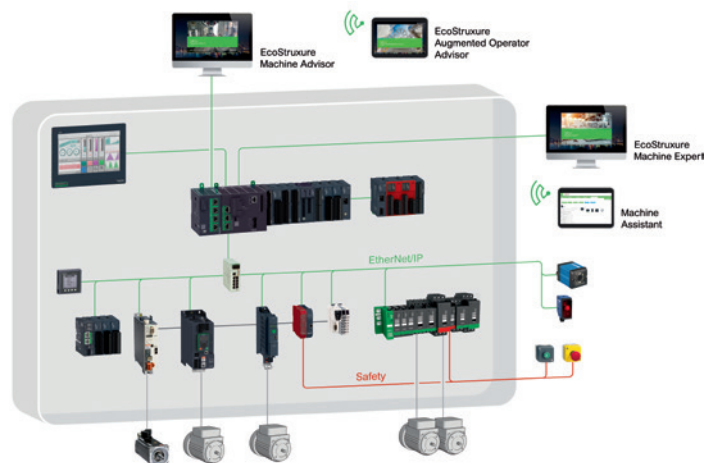

### Choose Schneider Electric to help secure your investment and benefit from worldwide services at every step of your project

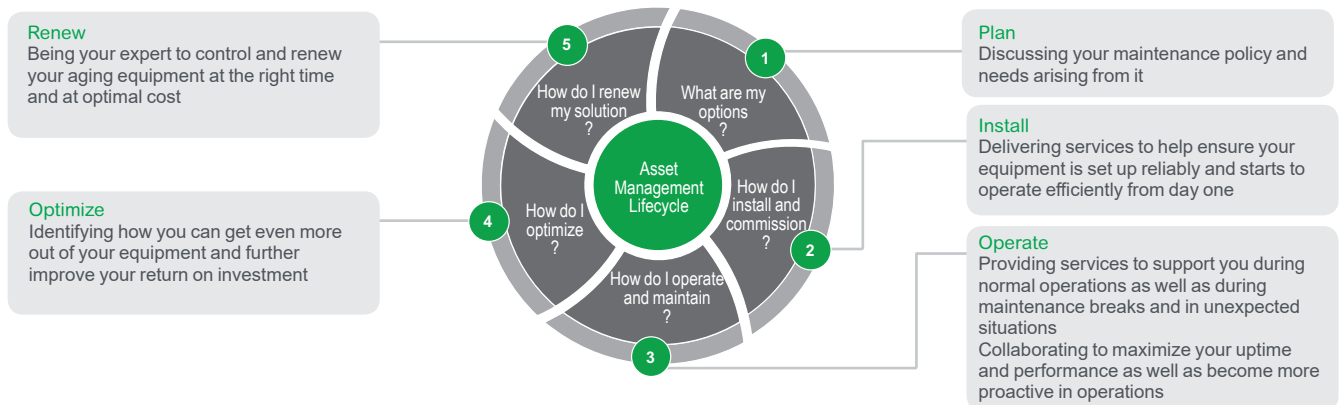

- > From planning and inception to modernization, we help ensure optimal technical and business performance. Our field service engineers combine 30+ years of manufacturer-level experience with the latest technology to bring innovation to every level of our offer, and every step of your project.
- > Our machine control dedicated services empower you to maximize your business infrastructure and face increasingly stringent demands on productivity, safety, equipment availability, and performance optimization.

# Industrial Ethernet

For Modicon M221, M241, and M251 logic controllers  
and Modicon M262 logic/motion controllers

Communication protocols

Industrial Ethernet is the term used to refer to industrial communication protocols that use standard Ethernet physical layers such as:

- EtherNet/IP
- Modbus TCP
- TCP and UDP
- Sercos III

It is possible to connect the following products to an Industrial Ethernet network:

- industrial products (industrial communication protocols), such as controllers, variable speed drives, robots, etc.
- products using TCP/UDP-based proprietary protocols
- dedicated motion control products (for synchronized axes)

It is possible to use different Industrial Ethernet protocols simultaneously on the same network.

## EtherNet/IP protocol

EtherNet/IP is an industrial communication protocol based on CIP (Common Industrial Protocol), owned and managed by the ODVA, an international independent standards organization ([www.odva.org](http://www.odva.org)).

- EtherNet/IP results from implementation of the CIP protocol on standard Ethernet. EtherNet/IP operates on the same equipment and the same infrastructure as Modbus TCP, and both protocols can be activated simultaneously and at any time on the network.
- EtherNet/IP is a robust protocol that allows the use of sophisticated equipment such as cameras, robots, etc.

### Advanced services and outstanding performance

EtherNet/IP is object-oriented. In each EtherNet/IP device, data is categorized as objects and each device can be associated with several types of object depending on its intended purpose. Equipment is integrated more easily thanks to predefined objects and standards.

The EtherNet/IP protocol uses an Originator/Adapter architecture for data exchange.

## Modbus TCP/IP protocol

Modbus has been the industry communication standard since 1979. During the internet revolution, Modbus was combined with Ethernet to form Modbus TCP, a completely open Ethernet protocol.

### Modbus TCP, simple and open

The Modbus application layer is simple and universally familiar with its 9 million installed connections.

- Thousands of manufacturers have already implemented this protocol. Many have already developed a Modbus TCP connection and numerous products are presently available.
- The simplicity of Modbus TCP enables any fieldbus device, such as an I/O module, to communicate over Ethernet without the need for a powerful microprocessor or a lot of internal memory.

### Modbus TCP, a standard

- The application protocol is identical on Modbus serial link and Modbus TCP; messages can be routed from one network to the other without converting the protocol.
- Since Modbus operates on the TCP higher layer, users benefit from IP routing, thus enabling devices located anywhere in the world to communicate without worrying about the distance between them. Modbus and Modbus TCP are recognized as a fieldbus by the international standard IEC/EN 61158. They also comply with the “national Chinese standard” managed by ITEI.

The Modbus TCP protocol uses a client/server architecture for data exchange.

## Sercos protocol

### Sercos III: universal communication for automation solutions

Sercos is a globally standardized open digital interface for communication between industrial controllers, motion controllers, I/O expansion modules, variable speed drives, encoders, safety logic controllers, and safety I/O expansion modules. Industrial automation needs real-time manufacturer-independent communication solutions.

- Sercos III real-time hardware supports motion control (Sercos) and communication (Ethernet) functions.
- Sercos III is a standard that is compliant with the Ethernet standard (IEEE 802.3 and ISO/IEC 8802-3).



# Industrial Ethernet

For Modicon M221, M241, and M251 logic controllers and Modicon M262 logic/motion controllers

Embedded Ethernet on controllers and communication modules, Main devices supported

## Embedded Ethernet on controllers and communication modules



Modicon M221/M221 Book



Modicon M241



Modicon M251



Modicon TM4ES4



Modicon M262 (TM262L●●●)



Modicon M262 (TM262M●●●)



Modicon TMS4ES4

The embedded Ethernet communication ports in Modicon M221/M221 book, M241, and M251 logic controllers, the Modicon M262 logic/motion controller, and Modicon TM4 and Modicon TMS communication modules optimize machine integration in the following types of factory network architecture:

- machine to devices (variable speed drives, remote I/O modules, HMI terminals) with the I/O Scanner function
- machine to machine with the NGVL function
- machine to supervisory system with the Modbus Client/Server, EtherNet/IP Adapter, and OPC UA Server function

Ethernet brings transparency to the factory, making it possible in particular to securely perform the following from any point on the network thanks to the firewall functions:

- program, monitor a controller or download an application
- access device parameters (variable speed drives, for example)

A simple web browser can be used to access machines anytime anywhere, using a tablet or smartphone, for example, using the web servers embedded in Modicon M241 and M251 controllers and Modicon M262 logic/motion controllers.

The built-in communication ports on TM262L●●● controllers and the TMS4ES4 module allow multiple communication with peripheral devices, the workshop, and the factory with no direct interaction between networks. These controllers are IIoT compatible.

Motion bus management on TM262M●●● controllers is based on the Sercos III real-time bus. This bus is used to synchronize a maximum of 16 axes and 24 nodes, and support the TM5CSLC safety logic controller with its Modicon TM5 safety I/O expansion modules.

Security can be enhanced through the use of VPN modems (see our Partner program on our website [www.schneider-electric.com](http://www.schneider-electric.com) > Products and Services > Automation and Control > Collaborative Automation Partner Program).

## Main devices supported

Equipment		Protocols supported				Integration tools in EcoStruxure Machine Expert software (1)
		TCP/UDP	Modbus TCP	EtherNet/IP	Sercos III	
Variable speed drives	Altivar 32	-	✓	✓	-	FDR, DTM, TVDA
	Altivar 320	-	✓	✓	-	FDR, DTM, TVDA
	Altivar 340S	-	✓	✓	✓	TVDA
	Altivar Process ATV600	-	✓	✓	-	FDR, DTM, TVDA
	Altivar 71	-	✓	✓	-	FDR, DTM, TVDA
	Altivar Process ATV900	-	✓	✓	-	FDR, DTM, TVDA
Servo drives	Lexium 32 M	-	✓	✓	-	FDR, DTM, TVDA
	Lexium 32 S	-	-	-	✓	FDR, TVDA
Integrated drives	Lexium ILA	-	✓	✓	-	FDR, libraries, TVDA
	Lexium ILE	-	✓	✓	-	FDR, libraries, TVDA
	Lexium ILS	-	✓	✓	-	FDR, libraries, TVDA
Radio frequency identification	XGC (2)	-	✓	✓	-	TVDA
Vision sensors	XUW (2)	-	-	✓	-	TVDA
Bus coupler module (for distributed I/O over Ethernet)	Modicon TM3BC	-	✓	✓	-	TVDA
Bus coupler module (for distributed I/O over Ethernet)	Modicon TM5	✓	-	✓	✓	TVDA
Modular safety controllers	Preventa XPSMCM	-	(3)	✓	-	TVDA for EtherNet/IP
Safety logic controllers	Modicon TM5CSLC100/200	-	-	-	-	-
Wireless batteryless pushbuttons (metal/plastic)	Harmony XB4R/XB5R	-	✓	-	-	DTM, libraries
Logic controllers	Modicon M221/M241/M251	✓	✓	✓	-	User parameters (for EtherNet/IP only), libraries
Logic/motion controllers	Modicon M262 (TM262L)	-	✓	✓	-	TVDA
	Modicon M262 (TM262M)	-	✓	✓	✓	TVDA
Equipment supplied with EDS file (1)		-	-	✓	-	User parameters
Generic device		✓	✓	✓	✓	User parameters (for EtherNet/IP only), libraries

(1) EcoStruxure Machine Expert software: please refer to catalog ref. [DIA3ED2180701EN](#).

- FDR: Fast Device Replacement
- DTM: Device Type Manager
- TVDA: Tested Validated Documented Architectures

(2) More information is available on our partner website [Telemecanique sensors](#).

(3) Integration as a generic device.

# Industrial Ethernet

For Modicon M221, M241, and M251 logic controllers and Modicon M262 logic/motion controllers

Web servers, Ethernet services

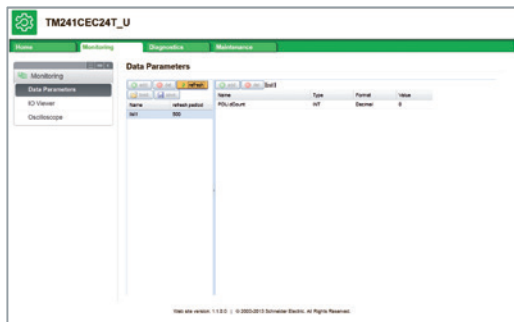

Preconfigured Web server



Viewer Web server

## Web servers

### Preconfigured Web server

Using a simple web browser available on PC, smartphone, or tablet, this server authorizes the following “ready-to-use” functions:

- With no prior programming
  - Display of the I/O states
  - Controller diagnostics, and of its expansion and communication modules
  - Communication port diagnostics
  - I/O Scanner function diagnostics
  - Maintenance and configuration functions (Ethernet/IP, firewall, etc.)
- After configuration
  - Display of data values
  - Display of the evolution of data values over time (oscilloscope function)

### Viewer Web server

The EcoStruxure Machine Expert programming software is used to create customized pages for viewing and monitoring devices. These pages can also be accessed on any mobile device such as a tablet or smartphone with any operating system (iOS, Android, Windows).

## Description of Ethernet services

### Network Global Variable List (NGVL)

The NGVL protocol allows a controller to share data with other controllers on a local Ethernet network (LAN) or subscribe to data published by other controllers that support the NGVL protocol, thus allowing synchronization between control platforms for example.

### I/O Scanner (Industrial Ethernet Manager)

The Industrial Ethernet Manager service is used to manage the exchange of remote I/O states over the Ethernet network after a simple configuration operation, with no need for special programming.

I/O scanning is performed transparently by means of read/write requests in accordance with the Modbus TCP or EtherNet/IP protocol, so we talk about the Scanner Manager on Modbus TCP or Scanner Manager on EtherNet/IP.

### Slave Modbus TCP

This function can be used to create a dedicated I/O table in the controller, which can be accessed via the Modbus TCP protocol and by a controller with the Modbus TCP I/O Scanner function.

### Fast Device Replacement (FDR)

This service uses standard address management technologies (BOOTP, DHCP) and the TFTP (Trivial File Transfer Protocol) file management service to simplify maintenance of Ethernet products.

The FDR service is used to replace a device with a new device; the device is detected, reconfigured, and automatically rebooted by the system.

### Access to files via FTP (File Transfer Protocol)

This service provides access to the controller files from, for example, a PC (FTP client) and is used to exchange files such as application programs, data, etc.

This service can be accessed even if the controller has no application program in its memory.

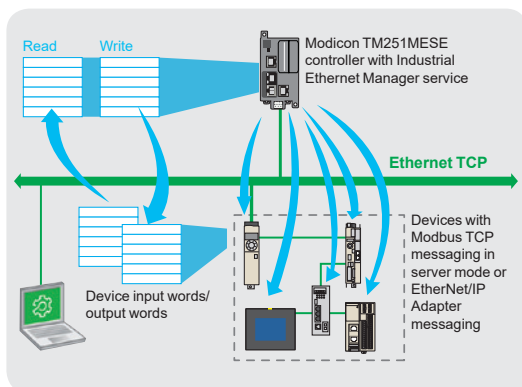

I/O Scanner (Industrial Ethernet Manager)

# Industrial Ethernet

For Modicon M221, M241, and M251 logic controllers  
and Modicon M262 logic/motion controllers

Ethernet services

## Description of Ethernet services *(continued)*

### Dynamic Host Configuration Protocol (DHCP)

This protocol can be used to automatically assign an address to a controller (client DHCP/BOOTP). This address can be:

- fixed and determined either in the EcoStruxure Machine Expert software or included in a post-configuration file
- assigned by a controller with the DHCP Server or BOOTP Server function (such as the **TM251MESE** logic controller)

### SNMP (Simple Network Management Protocol)

From a network management station, the SNMP protocol is used to monitor and control the Ethernet architecture components, meaning problems are diagnosed quickly.

The SNMP protocol is used to access configuration and management objects that are contained in the device MIBs (Management Information Bases).

Modicon M241 and M251 controllers support the "MIB 2 Standard" SNMP network management interface. This interface accesses a first level of network management; it enables the manager to identify the devices making up the architecture and retrieve general information about configuration and operation of the Ethernet Modbus TCP interfaces.

### IP address filter (Whitelisting)

IP addresses that are authorised to access the controller can be loaded in the controller from either an SD card or an FTP client.

### Locking communication protocols

EcoStruxure Machine Expert, NetManage (1), and SNMP communication protocols and Modbus, Web, and FTP servers can all be locked individually in EcoStruxure Machine Expert software.

### EtherNet/IP Adapter

This function can be used to create a dedicated I/O table in the controller that can be accessed via the EtherNet/IP protocol and by a controller with the EtherNet/IP Originator function. EtherNet/IP Adapter has the same role for EtherNet/IP as a Modbus TCP slave.

### EtherNet/IP Originator

Controllers with this function are responsible for exchanges with devices with the EtherNet/IP Adapter function. EtherNet/IP Originator has the same role for EtherNet/IP as a Modbus TCP master.

### SNTP Client

For synchronizing the clocks on controllers in the same network. The PLC synchronizes its time with an NTP/SNTP Server.

### DNS Client

This service is used to convert a domain name to the IP address of the machine with this name.

### OPC UA Server

OPC Unified Architecture (OPC UA) is an independent communication protocol for industrial automation applications. It is based on the client-server principle and allows sensors and actuators to communicate transparently with the ERP system or the cloud. The OPC UA Server is directly integrated in Modicon M241 and M251 controllers, allowing direct communication without passing via gateways and additional PCs with supervisory systems.

*(1) The NetManage function can automatically detect which controllers are present on the network. It also offers the option of straightforward connection to any controller present on the network in order to identify it physically by means of a visual or audible message and modify its parameters or manage the resident application.*

# Industrial Ethernet

For Modicon M221, M241, and M251 logic controllers and Modicon M262 logic/motion controllers

Ethernet services

Transparent Ready class and Functions									
	Logic controllers						Motion controller	Ethernet communication adapters	
	TM221ME●●●, TM221CE●●●	TM241C●●●	TM241CE●●●	TM251MES C	TM251MESE	TM262L●●●		TM262M●●●	TM4ES4 (1)
Transparent Ready class	A10	B20							
Internet protocol version	IPv4								
<b>Ethernet services</b>									
Programming, downloading, monitoring	–	–	–	–	–	–	–	–	–
Firmware update	–	–	–	–	–	–	–	–	–
Modbus TCP/IP Client/Server	–	–	–	–	–	–	–	–	–
Slave Modbus TCP	–	–	–	–	–	–	–	–	–
EtherNet/IP Adapter	–	–	–	–	–	Ethernet ports 1 and 2	Ethernet ports 1 and 2	–	–
EtherNet/IP Originator	–	–	–	–	Ethernet port 2	Ethernet ports 1 or 2 (4)	Ethernet ports 1 or 2 (4) (5)	–	–
Data exchange – NGVL and IEC VAR ACCESS	–	–	–	–	–	–	–	–	–
WEB server	–	–	–	–	–	–	–	–	–
SNMP network management MIB2 Client/Server	–	–	–	–	–	–	–	–	–
Scanner Manager on Modbus TCP	–	–	–	–	Ethernet port 2	Ethernet ports 1 or 2 (4)	Ethernet ports 1 or 2 (4) (5)	–	–
Scanner Manager on EtherNet/IP	–	–	–	–	Ethernet port 2	Ethernet ports 1 or 2 (4)	Ethernet ports 1 or 2 (4) (5)	–	–
FTP Client/Server file transfer	–	–	–	–	–	–	–	–	–
FTP Server file transfer/TLS (Transport Layer Security)	–	–	–	–	–	–	–	–	–
Sercos III	–	–	–	–	–	–	Ethernet port 1	–	–
Client DHCP dynamic configuration	–	–	–	–	Ethernet port 1	–	–	–	–
Server DHCP dynamic configuration	–	–	–	–	Ethernet port 2	–	–	–	–
FDR faulty device replacement	–	–	–	–	–	–	–	–	–
SMS	(2)	–	–	–	–	–	–	–	–
SQL Client (3)	–	–	–	–	–	–	–	–	–
Email sending and receipt, based on TCP/UDP library	–	–	–	–	–	–	–	–	–
DNS Client	–	–	–	–	–	–	–	–	–
SNTP Client	–	–	–	–	–	–	–	–	–
OPC UA Server	–	–	–	–	–	–	–	–	–
NGVL	–	–	–	–	–	–	–	–	–
Viewer Web server	–	–	–	–	–	–	–	–	–
Web system	–	–	–	–	–	–	–	–	–
<b>Safety functions</b>									
IP address filter (Whitelisting)	–	–	–	–	–	–	–	–	–
Locking communication protocols	–	–	–	–	–	–	–	–	–
Locking IP address routing	–	–	–	–	–	–	–	–	–

Available

(1) Switch function only: No service for TM251ME and TM241CE if not configured in EcoStruxure Machine Expert.

(2) With specific function block in application/programming software.

(3) For more information, please refer to catalog ref. [DIA3ED2180701EN](#).

(4) One Scanner Manager per controller.

(5) Number of devices limited to 6 on Ethernet port 1.

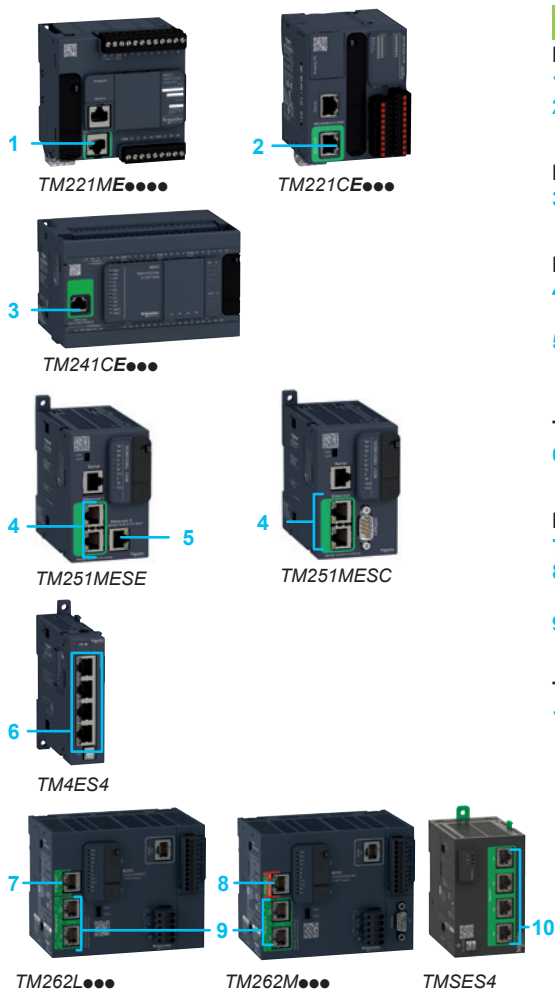

## Embedded Ethernet ports

### M221 logic controllers

- 1 On **TM221ME** controllers: 1x RJ45 Ethernet network connector
- 2 On **TM221CE** controllers: 1x RJ45 Ethernet network connector

### M241 logic controllers

- 3 On **TM241CE** controllers: 1x RJ45 Ethernet network connector

### M251 logic controllers

- 4 On **TM251MESE** and **TM251MESL** controllers: 2 connectors linked via an internal RJ45 switch for Ethernet "Machine or Factory" network
- 5 On **TM251MESE** controller: 1x RJ45 Ethernet "fieldbus" network connector (this port can be used with the Industrial Ethernet Manager function)

### TM4ES4 Ethernet switch communication module

- 6 4x RJ45 Ethernet network connectors

### M262 logic/motion controller

- 7 On **TM262L**: 1x RJ45 Ethernet 1 (EtherNet/IP) network connector
- 8 On **TM262M**: 1x RJ45 Ethernet 1 (Sercos III) network connector, plus EtherNet/IP or Modbus TCP network limited to 6 connected devices
- 9 2x RJ45 Ethernet 2 network connectors

### TMSES4 Ethernet communication module

- 10 4x RJ45 Ethernet network connectors

## Network characteristics

Modicon M241 and M251 controllers	
Topology	Daisy chain, star
Bandwidth	10/100 Mbps
EtherNet/IP Scanner performance	Up to 16 slave devices managed by the controller in 10 ms
Ethernet Modbus TCP Scanner performance	Up to 64 slave devices managed by the controller in 64 ms
Modicon M262 logic controllers (TM262L)	
Topology	Daisy chain, star
Bandwidth	10/1000 Mbps
EtherNet/IP Scanner performance (Ethernet 1 or 2)	TM262L10: up to 16 slave devices managed by the controller in 10 ms TM262L10: up to 64 slave devices managed by the controller in 40 ms TM262L20: up to 16 slave devices managed by the controller in 6 ms TM262L20: up to 64 slave devices managed by the controller in 20 ms
Ethernet Modbus TCP Scanner performance	Up to 64 slave devices
Modicon M262 motion controllers (TM262M)	
Topology	Daisy chain, star
Bandwidth	10/1000 Mbps
EtherNet/IP Scanner performance (Ethernet 2)	TM262M15: up to 16 slave devices managed by the controller in 10 ms TM262M15: up to 64 slave devices managed by the controller in 40 ms TM262M25/35: up to 16 slave devices managed by the controller in 6 ms TM262M25/35: up to 64 slave devices managed by the controller in 20 ms
Ethernet Modbus TCP Scanner performance	Up to 64 slave devices
Sercos III (Ethernet 1)	TM262M15: up to 4 synchronized axes/4 devices in 1 ms TM262M15: up to 4 synchronized axes/12 devices in 2 ms TM262M25: up to 4 synchronized axes/8 devices in 1 ms TM262M25: up to 8 synchronized axes/8 devices in 2 ms TM262M25: up to 8 synchronized axes/16 devices in 4 ms TM262M35: up to 8 synchronized axes/8 devices in 1 ms TM262M35: up to 16 synchronized axes/8 devices in 2 ms TM262M35: up to 16 synchronized axes/24 devices in 4 ms

Note: When EtherNet/IP and Modbus TCP devices are controlled simultaneously on the same network, a maximum of 16 devices (EtherNet/IP + Modbus TCP) can be controlled.



## Industrial Ethernet architecture

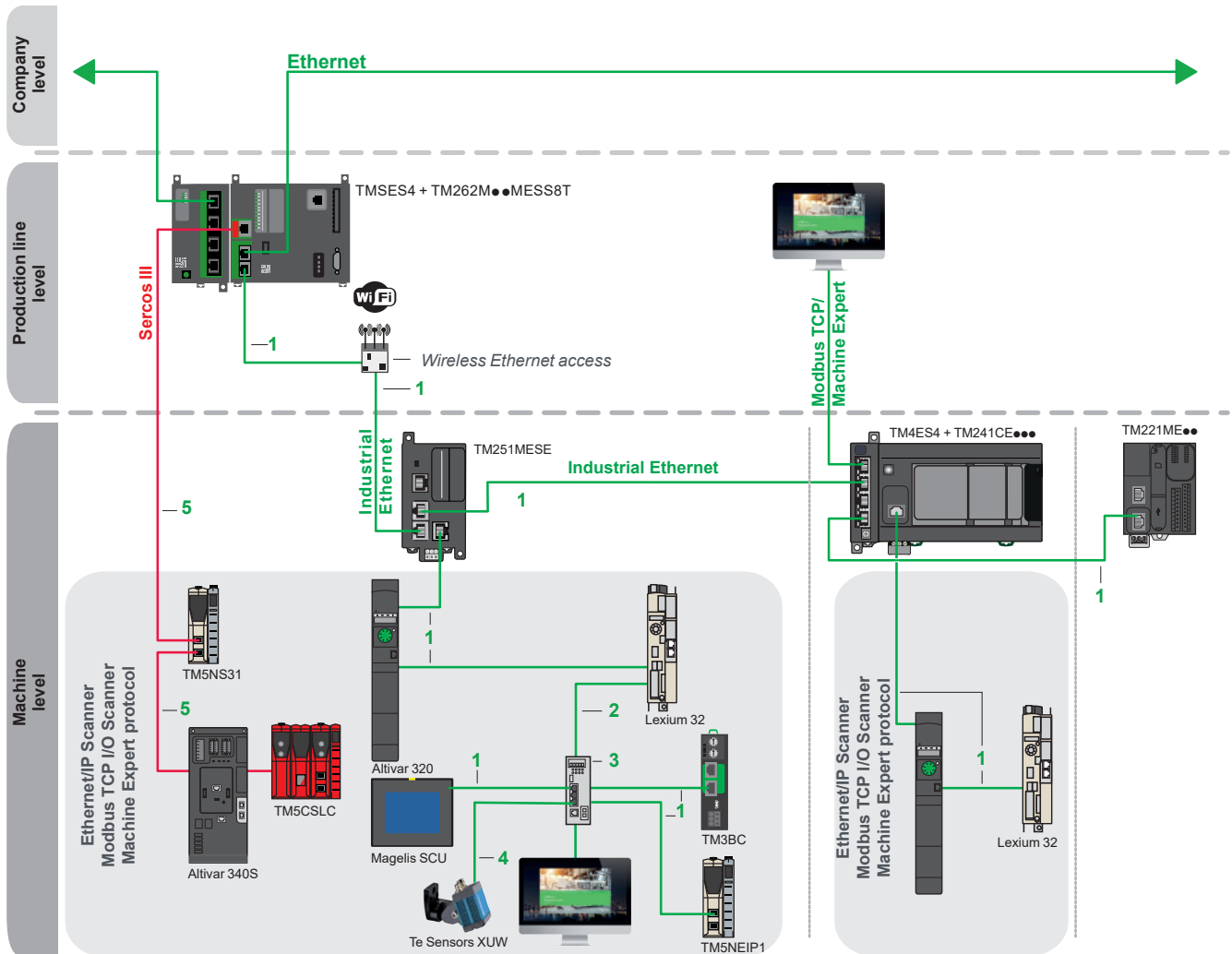

Items 1, 2, 3, and 5: See references on next page.

Item 4: Ethernet XGSZ●2E45●● extension cables (M12 straight/RJ45, shielded cable, straight cabling) for XUW vision sensors (1).

## Shielded copper connection cables

ConneXium shielded connection cables are available in two versions to meet the various current standards and approvals:

### ■ EIA/TIA 568 shielded twisted pair cables for CE market

These cables conform to:

- EIA/TIA-568 standard, category CAT 5E
- IEC 11801/EN 50173-1 standard, class D

Their fire resistance conforms to:

- NF C32-070 standard, class C2
- IEC 322/1 standards
- Low Smoke Zero Halogen (LSZH)

### ■ EIA/TIA 568 shielded twisted pair cables for UL market

These cables are:

- CEC type FT-1
- NEC type CM

A new range of ConneXium fully shielded preformed cordsets has been specially designed for use in harsh industrial environments.

These cordsets combine a category 5E shielded cable and RJ45 connectors reinforced with a metal profile. Please refer to catalog ref.

[DIA6ED2140903EN](http://DIA6ED2140903EN)

(1) More information is available on our partner website [Telemecanique sensors](http://Telemecanique sensors).

# Industrial Ethernet

For Modicon M221, M241, and M251 logic controllers and Modicon M262 logic/motion controllers

Connection to Ethernet and Sercos III

## References

### EIA/TIA 568 shielded twisted pair cables for C€ market

Description	Preassembled connectors	Item	Type	Length m (ft)	Reference	Weight kg/lb
Straight-through copper cables C€ compatible	2x RJ45 connectors For connection to terminal devices (DTE)	1	single	2 (6.56)	<a href="#">490NTW00002</a>	–
				5 (16.41)	<a href="#">490NTW00005</a>	–
				12 (39.37)	<a href="#">490NTW00012</a>	–
				40 (131.23)	<a href="#">490NTW00040</a>	–
				80 (262.467)	<a href="#">490NTW00080</a>	–
		1	ruggedized	1 (3.28)	<a href="#">TCSECE3M3M1S4</a>	–
				2 (6.56)	<a href="#">TCSECE3M3M2S4</a>	–
				3 (9.84)	<a href="#">TCSECE3M3M3S4</a>	–
				5 (16.40)	<a href="#">TCSECE3M3M5S4</a>	–
				10 (32.81)	<a href="#">TCSECE3M3M10S4</a>	–



TCSECE3M3M1S4

### Shielded twisted pair cables for UL market

Description	Preassembled connectors	Item	Type	Length m (ft)	Reference	Weight kg/lb
Straight-through copper cables UL compatible	2x RJ45 connectors For connection to terminal devices (DTE)	1	single	2 (6.56)	<a href="#">490NTW00002U</a>	–
				5 (16.40)	<a href="#">490NTW00005U</a>	–
				12 (39.37)	<a href="#">490NTW00012U</a>	–
				40 (131.23)	<a href="#">490NTW00040U</a>	–
				80 (262.47)	<a href="#">490NTW00080U</a>	–
		1	ruggedized	1 (3.28)	<a href="#">TCSECU3M3M1S4</a>	–
				2 (6.56)	<a href="#">TCSECU3M3M2S4</a>	–
				3 (9.84)	<a href="#">TCSECU3M3M3S4</a>	–
				5 (16.40)	<a href="#">TCSECU3M3M5S4</a>	–
				10 (32.81)	<a href="#">TCSECU3M3M10S4</a>	–

### Do it Yourself copper cable and connectors

The **ConneXium** "Do it Yourself" offer consists of 2 connector references (M12 and RJ45) and 1 cable reference - 300 m (984.25 ft) reel - enabling Ethernet 10/100 Mbps network cables to be made up in situ.

The maximum length of cables made up in this way is 80 m (262.47 ft). They are assembled using only a knife and wire cutters (no special tool is required).

Description	Characteristics	Item	Length m (ft)	Reference	Weight kg/lb
Ethernet copper cable 2 shielded twisted pairs 24 AWG	Conforming to the above-mentioned standards and approvals	2	300 (984.25)	<a href="#">TCSECN300R2</a>	–
RJ45 connector	Conforms to EIA/TIA-568-D	2	–	<a href="#">TCSEK3MDS</a>	–

### ConneXium unmanaged switches, 3, 4, and 5 ports, twisted pair and optical fiber

Description	Interfaces	Item	Reference	Weight kg/lb
ConneXium unmanaged switches	3x 10BASE-T/100BASE-TX ports (copper cable), RJ45 shielded connectors	3	<a href="#">TCSESU033FN0</a>	0.113/0.249
	■ 4x 10BASE-T/100BASE-TX ports (copper cable), RJ45 shielded connectors ■ 1x 100BASE-FX port (multimode optical fiber), SC duplex connector	3	<a href="#">TCSESU043F1N0</a>	0.120/0.265
	5x 10BASE-T/100BASE-TX ports (copper cable), RJ45 shielded connectors	3	<a href="#">TCSESU053FN0</a>	0.113/0.249

Other wiring components are available; please refer to the ConneXium catalog ref. [DIA6ED2140903EN](#).

### Sercos III cables

Description	Item	Length		Reference	Weight kg/lb
		m	ft		
Sercos III network cables Equipped with 2x RJ45 connectors	5	0.5	1.640	<a href="#">VW3E5001R005</a>	0.045/0.10
		1	3.281	<a href="#">VW3E5001R010</a>	0.065/0.14
		1.5	4.921	<a href="#">VW3E5001R015</a>	0.068/0.15
		2	6.562	<a href="#">VW3E5001R020</a>	0.081/0.18
		3	9.843	<a href="#">VW3E5001R030</a>	0.124/0.27
		5	16.404	<a href="#">VW3E5001R050</a>	0.199/0.44
		10	32.808	<a href="#">VW3E5001R100</a>	0.325/0.72
		15	49.213	<a href="#">VW3E5001R150</a>	0.610/1.34
		20	65.617	<a href="#">VW3E5001R200</a>	0.810/1.79
		25	82.021	<a href="#">VW3E5001R250</a>	1.020/2.25
		30	98.425	<a href="#">VW3E5001R300</a>	1.220/2.69
		40	131.234	<a href="#">VW3E5001R400</a>	3.100/6.83
		50	164.042	<a href="#">VW3E5001R500</a>	2.020/4.45



TCSESU053FN0



VW3E5001R005

## Industrial Ethernet or EtherNet/IP network architecture

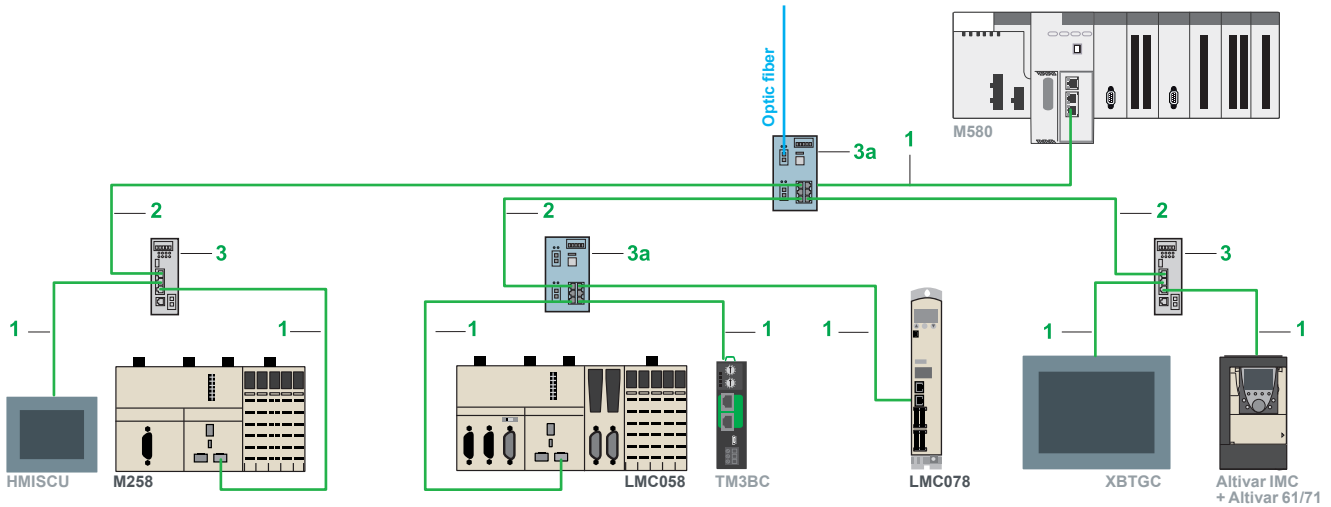

## Transparent Ready class and Functions

	M258 logic controllers	LMC058 motion controllers	LMC078 motion controllers
Transparent Ready class	B20		
Internet protocol version	IPV4		
<b>Ethernet Services</b>			
Programming, downloading, monitoring			
Firmware update			
Modbus TCP/IP (client & server)			
Modbus TCP slave			
EtherNet/IP target			
EtherNet/IP originator	-	-	-
Data exchange – NVGL and IEC VAR ACCESS			
WEB visu			
Web server			-
SNMP network management MIB2			
Scanner Manager on Modbus TCP	-	-	-
Scanner Manager on EtherNet/IP	-	-	-
FTP file transfer			
DHCP Client dynamic configuration			
DHCP Server dynamic configuration	-	-	-
FDR faulty device replacement	-	-	-
SMS			
<b>Security functions</b>			
IP address filter (Whitelisting)			
Locking communication protocols (fire wall)			
Locking IP address routing			

### Compatible

## References (1)

### Shielded copper connection cables

ConneXium shielded copper connection cables are available in two versions to comply with the different standards and approvals in force:

- Shielded twisted pair copper cables to standard EIA/TIA 568**  
 These cables conform to: standard EIA/TIA 568, category CAT 5E, and standard IEC 11801/EN 50173, class D.  
 Their flame resistance conforms to NFC 32070# classification C2, and standards IEC 322/1, Low Smoke Zero Halogen (LSZH).
- Shielded twisted pair copper cables, UL and CSA 22.1 approved**  
 These cables conform to standards UL and CSA 22.1. Their flame resistance conforms to NFPA 70.

### “Do It Yourself” cable and connectors

The ConneXium “Do It Yourself” range allows the user to make up Ethernet copper cables on site and to the required length. They are designed for cabling Ethernet 10/100 Mbit/s networks. The maximum length of cables made up in this way is 80 m. They can be assembled quickly using a knife and cutting pliers (no special tools are required).

Description	Conforming to	Length m (ft.)	Reference	Weight kg/ lb
Ethernet copper cable 2 shielded twisted pairs 24 AWG	The above-mentioned standards and approvals	300 (984,25)	<a href="#">TCSECN300R2</a>	-
RJ 45 connector	EIA/TIA-568-D	-	<a href="#">TCSEK3MDS</a>	-
M12 connector	IEC 60176-2-101	-	<a href="#">TCSEK1MDRS</a>	-

(1) Other versions (fibre optic, switches, ...): please consult our catalog ref. [DIA6ED2140903EN](#)



490NT●000●●



TCSESU043F1N0



TCSESM043F2C●0



499NMS/NSS25102



TCSESM083F2C●0



TCSESU051F0

**References (continued)**

**Shielded twisted pair cables to standard EIA/TIA568**

Description	Pre-formed at both ends	Item	Length m (ft.)	Reference	Weight kg/lb
<b>Straight cables</b>	2 x RJ45 connectors For connection to terminal equipment (DTE)	1	2 (6.562)	490NTW00002	—
		—	5 (16.404)	490NTW00005	—
		—	12 (39.370)	490NTW00012	—
		—	40 (131.234)	490NTW00040	—
		—	80 (262.467)	490NTW00080	—
<b>Crossover cables</b>	2 x RJ45 connectors For connection between hubs, switches and transceivers	2	5 (16.404)	490NTC00005	—
		—	12 (39.370)	490NTC00015	—
		—	40 (131.234)	490NTC00040	—
		—	80 (262.467)	490NTC00080	—

**Shielded twisted pair cables, UL and CSA 22.1 approved**

Description	Pre-formed at both ends	Item	Length m (ft.)	Reference	Weight kg/lb
<b>Straight cables</b>	2 x RJ45 connectors For connection to terminal equipment (DTE)	1	2 (6.562)	490NTW00002U	—
		—	5 (16.404)	490NTW00005U	—
		—	12 (39.370)	490NTW00012U	—
		—	40 (131.234)	490NTW00040U	—
		—	80 (262.467)	490NTW00080U	—
<b>Crossover cables</b>	2 x RJ45 connectors For connection between hubs, switches and transceivers	2	5 (16.404)	490NTC00005U	—
		—	40 (131.234)	490NTC00040U	—
		—	80 (262.467)	490NTC00080U	—

**Shielded twisted pair cable for IP 67 switch**

Description	Pre-formed at both ends	Item	Length m (ft.)	Reference	Weight kg/lb
<b>Straight cables</b>	1 x IP 67 4-way M12 connector and 1 x RJ45 connector	—	1 (3.281)	TCSECL1M3M1S2	—
		—	3 (9.843)	TCSECL1M3M3S2	—
		—	5 (16.404)	TCSECL1M3M5S2	—
		—	10 (32.808)	TCSECL1M3M10S2	—
		—	25 (82.021)	TCSECL1M3M25S2	—
		—	40 (131.234)	TCSECL1M3M40S2	—

**ConneXium hub**

Description	Number of ports		Item	Reference	Weight kg/lb
	Copper cable	Fibre optic			
<b>Twisted pair hub</b> 10BASE-T copper ports, RJ45 shielded connectors	4	—	3	499NEH10410	0.530 1.168

**ConneXium switches**

Description	Number of ports		Item	Manageable	Reference	Weight kg/lb
	Copper cable	Fibre optic				
<b>Optimized twisted pair switch</b> 10BASE-T/100BASE-TX copper ports, RJ45 shielded connectors 100BASE-FX optic port, SC connectors	3	—	3	No	TCSESU033FN0	0.113 0.249
	4	1	3	No	TCSESU043F1N0	0.120 0.265
	5	—	3	No	TCSESU053FN0	0.113 0.249
<b>Twisted pair switches</b> 10BASE-T/100BASE-TX copper ports, RJ45 shielded connectors	8	—	3	No	499NES18100	0.230 0.507
	8	—	3a	Yes	TCSESM083F23F0	0.410 0.904
<b>Twisted pair and fibre optic switches</b> 10BASE-T/100BASE-TX copper ports, RJ45 shielded connectors. 100BASE-FX optic ports, SC connectors	3	1, multimode	3a	Yes	TCSESM043F1CU0	0.400 0.882
	2	2, multimode	3a	Yes	TCSESM043F2CU0	0.400 0.882
	3	1, single-mode	3a	Yes	TCSESM043F1CS0	0.400 0.882
	2	2, single-mode	3a	Yes	TCSESM043F2CS0	0.400 0.882
	4	1, multimode	3	No	499NMS25101	0.330 0.728
	3	2, multimode	3	No	499NMS25102	0.335 0.739
	4	1, single-mode	3	No	499NSS25101	0.330 0.728
	3	2, single-mode	3	No	499NSS25102	0.335 0.739
	7	1, multimode	3a	Yes	TCSESM083F1CU0	0.410 0.904
	6	2, multimode	3a	Yes	TCSESM083F2CU0	0.410 0.904

<b>IP 67 twisted pair switch (1)</b> 10BASE-T/100BASE-TX copper ports, shielded M12 connectors (type D)	5	—	—	No	TCSESU051F0	0.210 0.463
---	---	---	---	----	-------------	----------------

(1) Require special cables with M12 connectors for their --- 24 V supply: XZCP1●64L●

<b>#</b>		
490NTC00005	17	TCSESU033FN0
490NTC00005U	17	
490NTC00015	17	TCSESU043F1N0
490NTC00040	17	
490NTC00040U	17	TCSESU051F0
490NTC00080	17	
490NTC00080U	17	TCSESU053FN0
490NTW00002	15	
	17	
490NTW00002U	15	<b>V</b>
	17	VW3E5001R005
490NTW00005	15	VW3E5001R010
	17	VW3E5001R015
490NTW00005U	15	VW3E5001R020
	17	VW3E5001R030
490NTW00012	15	VW3E5001R050
	17	VW3E5001R100
490NTW00012U	15	VW3E5001R150
	17	VW3E5001R200
490NTW00040	15	VW3E5001R250
	17	VW3E5001R300
490NTW00040U	15	VW3E5001R400
	17	VW3E5001R500
490NTW00080	15	
	17	
490NTW00080U	15	
	17	
499NEH10410	17	
499NES18100	17	
499NMS25101	17	
499NMS25102	17	
499NSS25101	17	
499NSS25102	17	
<b>T</b>		
TCSECE3M3M1S4	15	
TCSECE3M3M2S4	15	
TCSECE3M3M3S4	15	
TCSECE3M3M5S4	15	
TCSECE3M3M10S4	15	
TCSECL1M3M1S2	17	
TCSECL1M3M3S2	17	
TCSECL1M3M5S2	17	
TCSECL1M3M10S2	17	
TCSECL1M3M25S2	17	
TCSECL1M3M40S2	17	
TCSECN300R2	15	
	16	
TCSECU3M3M1S4	15	
TCSECU3M3M2S4	15	
TCSECU3M3M3S4	15	
TCSECU3M3M5S4	15	
TCSECU3M3M10S4	15	
TCSEK1MDRS	16	
TCSEK3MDS	15	
	16	
TCSESM043F1CS0	17	
TCSESM043F1CU0	17	
TCSESM043F2CS0	17	
TCSESM043F2CU0	17	
TCSESM083F1CS0	17	
TCSESM083F1CU0	17	
TCSESM083F2CS0	17	
TCSESM083F2CU0	17	
TCSESM083F23F0	17	





[www.schneider-electric.com/Machine control solutions](http://www.schneider-electric.com/Machine control solutions)

#### Schneider Electric Industries SAS

Head Office  
35, rue Joseph Monier  
F-92500 Rueil-Malmaison  
France

The information provided in this documentation contains general descriptions and/or technical characteristics of the performance of the products contained herein. This documentation is not intended as a substitute for and is not to be used for determining suitability or reliability of these products for specific user applications. It is the duty of any such user or integrator to perform the appropriate and complete risk analysis, evaluation and testing of the products with respect to the relevant specific application or use thereof. Neither Schneider Electric nor any of its affiliates or subsidiaries shall be responsible or liable for misuse of the information contained herein.

Design: Schneider Electric  
Photos: Schneider Electric