

Smart Panels

Digitized switchboards

Design and assembly guide



- Measure
- Connect
- Save



Tested
Validated
Documented
Architectures

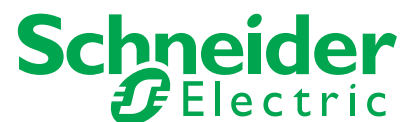



Dear customer,

Here is the new edition of Smart Panels switchboard assembly and installation guide.

Smart Panels make live in the same switchboard components of power and communication with their own circuits.

It is essential to comply with installation and implementation best practices, to avoid any risk of shut-down or malfunction due to insufficient distances between devices, temperature rise or electromagnetic compatibility, for example.

It is intended for use by panelbuilders in the factory and on-site and also by design engineers to integrate design rules, in compliance with IEC standards 61439-1&2. These rules are essential because the communication architecture must be defined very early in the design phase.

After a short review of basic rules, the guide develops more particularly the "auxiliary and low-power communication circuits" chapter.

Structured according to the logical procedure for switchboard building up to the test conducted before shipping, it includes Quality control check list at the end of each chapter, as well as a model form "Routine verification – testing report".



Introduction

Grouping most of the electrical protection, command and metering components, the switchboards are now significant sources of data locally displayed and sent via communication networks.

Smart Panels use reliable, simple to install and use displays, and Ethernet and Modbus interfaces on the Enerlin'X communication system.

Information is safely transmitted through the most efficient networks, to monitoring and control systems or on-line energy management services.

Structured into successive stages based on the chronological order of switchboard assembly, this guide presents more precisely all the best practices to apply when installing Enerlin'X, communication system for Smart Panels (see Enerlin'X catalogue: LV-CATENLX_EN). It illustrates them through examples of configurations made in Prisma G and Prisma P switchboards.

Before starting the mounting phases, ensure that the communication architecture constraints have been integrated in the design of the switchboard.

Mounting and connecting Enerlin'X switchgears are given with a lot of details and advice.

For this, the guide gives the key points, that affect the fundamental phases of implementation: assembling and covering enclosures, main busbars, installing the devices, power connection, auxiliary and low-power circuits connection.

As for all switchboards, IEC 61439-1&2 standard applies to Smart Panels and particularly dielectric tests.

At the end of each chapter, a quality control check list allows to check, step by step, the quality level.

Architecture example for medium size building



FDM128 switchboard display

See Enerlin'X catalogue.
The FDM128 is a large display, but requires very little depth. The anti-glare graphic screen is backlit for very easy reading even under poor ambient lighting and at sharp angles.



Switch Ethernet

Ethernet switch, 5 copper ports
Communication port protocol: Ethernet TCP/IP
Ethernet port: 10BASE-T/100BASE-TX - 5 ports copper cables
Max number of cascading switches: unlimited



24 V DC power supply

An external 24 V DC power supply is required for installations with communication, whatever the type of trip unit.
A single external 24 V DC supply may be used for the entire switchboard.
The required characteristics are:

- output voltage: 24 V DC $\pm 5\%$
- ripple: $\pm 1\%$.
- overvoltage category: OVC IV - as per IEC 60947-1.





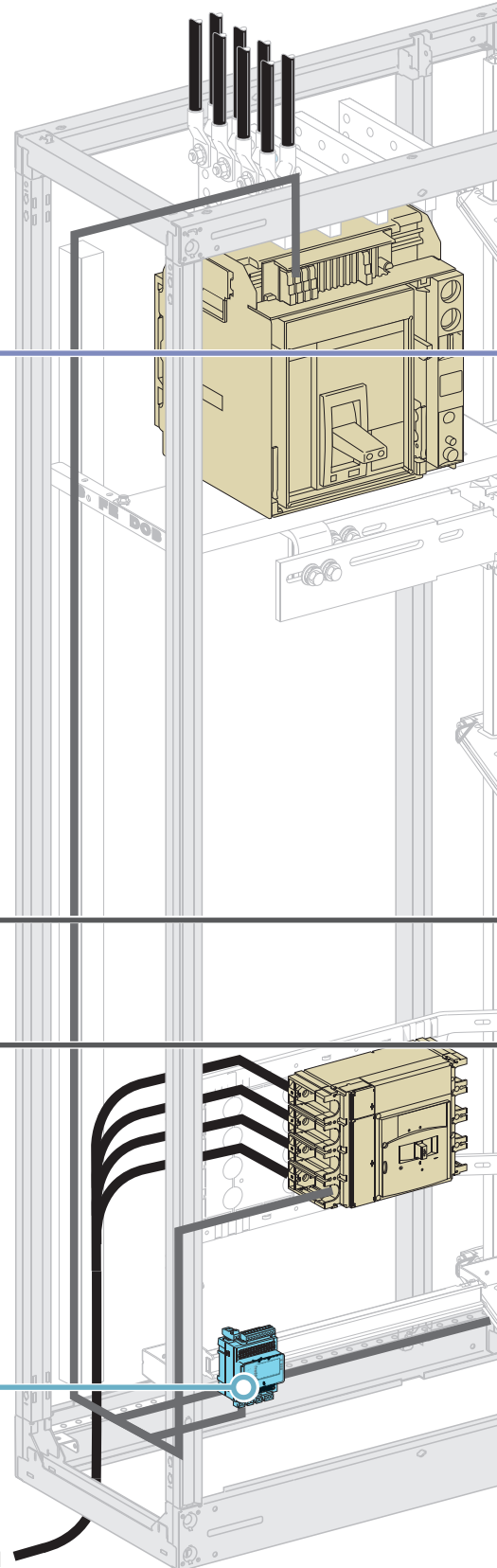

I/O application module

The I/O (Input/Output) application module for LV breaker is part of an ULP system with built-in functionalities and applications to enhance the application needs.
The ULP system architecture can be built without any restrictions using the wide range of circuit breakers.
The I/O application module is compliant with the ULP system specifications.
Two I/O application modules can be connected in the same ULP network.
The ranges of LV circuit breakers enhanced by the I/O application module are:

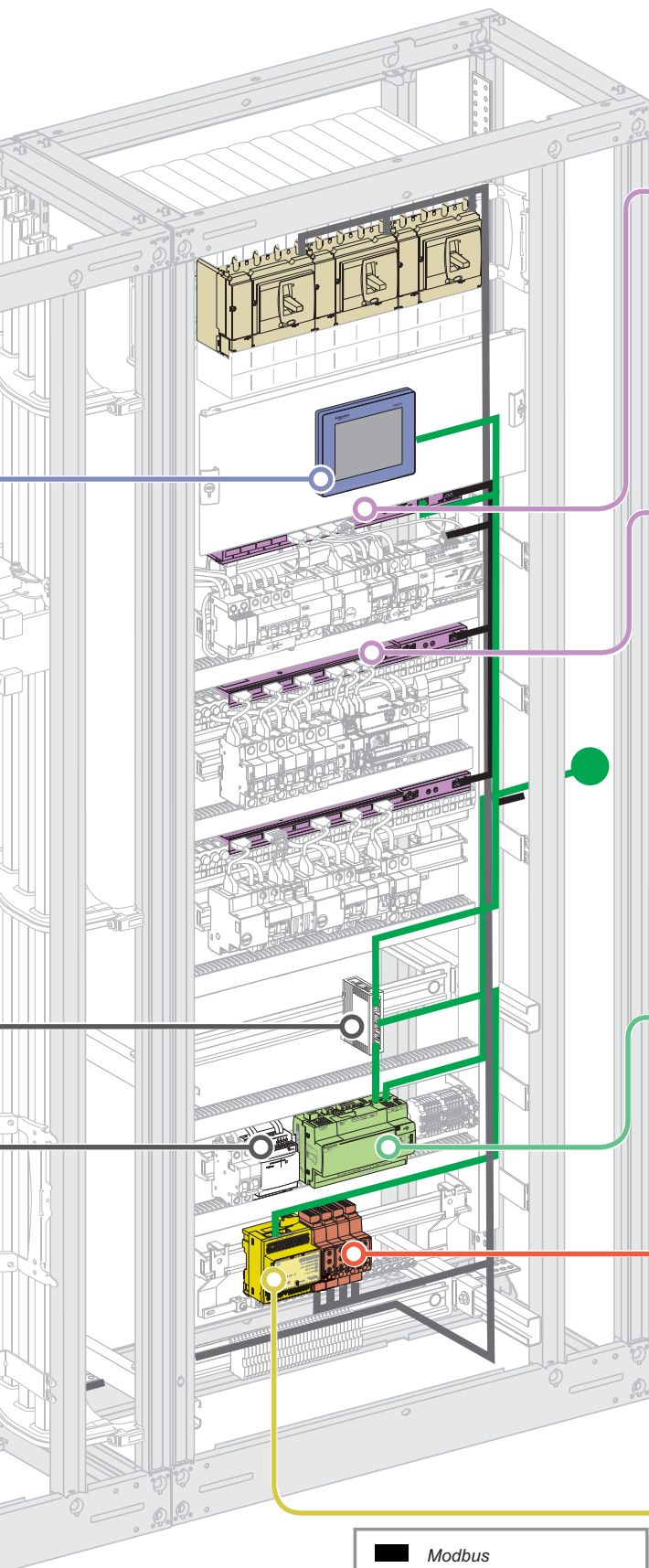
- Masterpact NW
- Masterpact NT
- Compact NS 1600b-3200 and NS630b-1600
- Compact NSX100-630





	Modbus
	Ethernet network
	ULP system

Acti 9 Smartlink Ethernet

Acti 9 Smartlink Ethernet collects data from Smartlink Modbus and transfers them via the Ethernet network.



Acti 9 Smartlink Modbus

Acti 9 Smartlink Modbus is used to transfer data from Acti 9 devices to a PLC or monitoring system via the communication system: Modbus serial line.



Com'X 200 energy server

Com'X 200 energy server is a compact, plug-and-play data logger that merges seamlessly with the Smart Panels energy management solution. It consolidates inputs from analog environmental sensors (e.g. temperature), digital readers (e.g. pulsed signals from smart energy or water meters, load running hours), and energy management equipment running over the Modbus protocol.



Designed for ease of implementation, data can be transmitted securely via Ethernet, Wi-Fi, or GPRS to any energy management platforms. The Com'X 200 energy server is scalable and can be easily adaptable to accommodate future upgrades. Com'X 200 is a perfect fit with our energy management services, enabling visualization, tracking, and analysis of energy data to support optimization of energy performance and cost management.

Module interface Modbus IFM

This module required for connection to the network, contains the Modbus address (1 to 99) declared by the user via the two dials in front. It automatically adapts (baud rate, parity) to the Modbus network in which it is installed.



It is equipped with a lock-out switch to enable or disable operations involving writing to Micrologic, i.e. reset, counter reset, setting modifications, device opening and closing commands, etc. There is a built-in test function to check the connections of the Modbus interface module with the Micrologic and FDM121 display unit.

IFE Ethernet interface module

The IFE Ethernet interface for LV circuit breaker enables an intelligent modular unit (IMU), for example a Masterpact NT/NW or Compact NSX circuit breaker to be connected to an Ethernet network.



Smart Panels switchboard in Prisma G

Architecture example for small size building

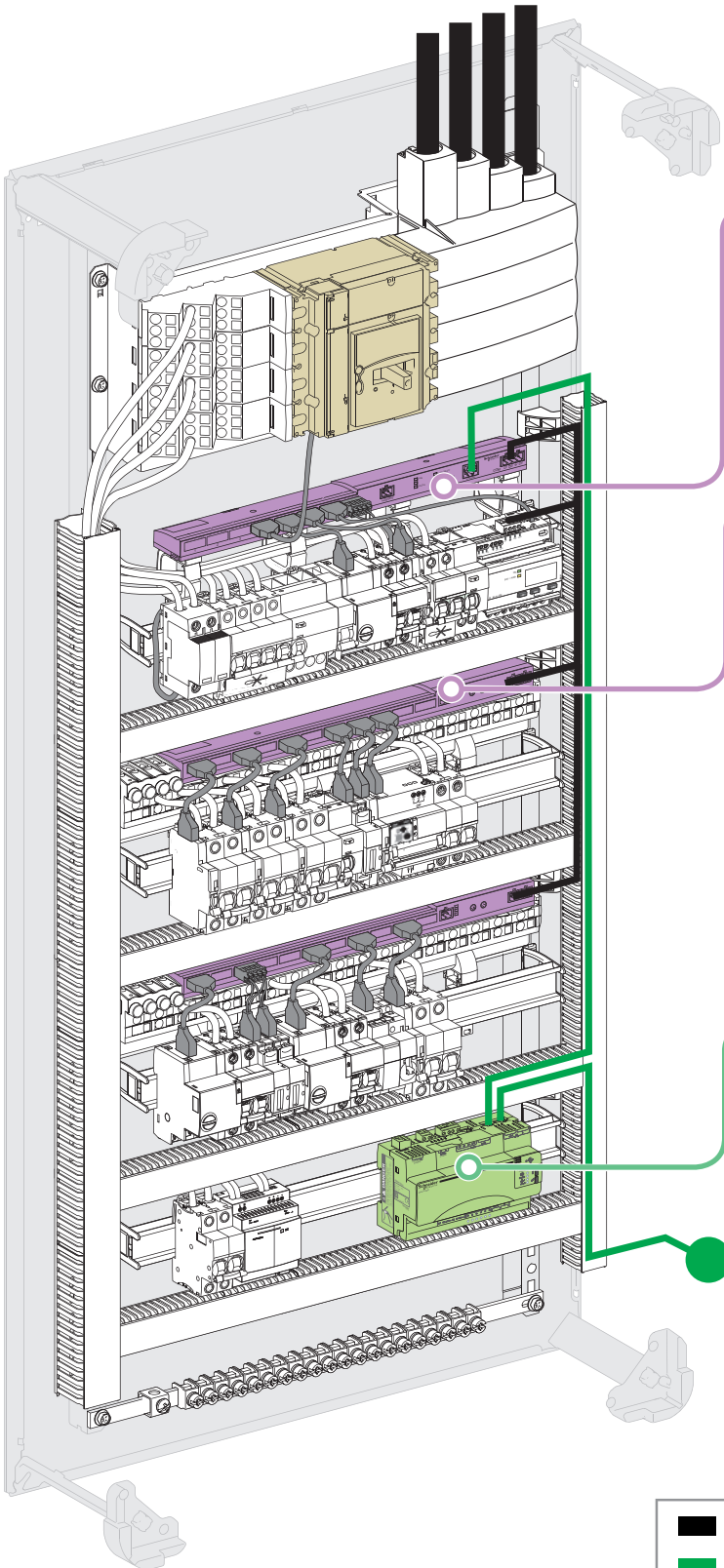

Acti 9 Smartlink Ethernet

Acti 9 Smartlink Ethernet collects data from Smartlink Modbus and transfers them via the Ethernet network.



Acti 9 Smartlink Modbus

Acti 9 Smartlink Modbus is used to transfer data from Acti 9 devices to a PLC or monitoring system via the communication system: Modbus serial line.



Energy Server Com'X 200

Com'X 200 energy server is a compact, plug-and-play data logger that merges seamlessly with the Smart Panels energy management solution. It consolidates inputs from analog environmental sensors (e.g. temperature), digital readers (e.g. pulsed signals from smart energy or water meters, load running hours), and energy management equipment running over the Modbus protocol.



Designed for ease of implementation, data can be transmitted securely via Ethernet, Wi-Fi, or GPRS to any energy management platforms. The Com'X 200 energy server is scalable and can be easily adaptable to accommodate future upgrades. Com'X 200 is a perfect fit with our energy management services, enabling visualization, tracking, and analysis of energy data to support optimization of energy performance and cost management.

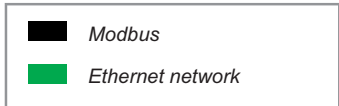

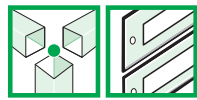

Assembly of enclosures

p. 8

1



Power busbar

p. 16

2



Installing the devices

p. 22

3



Power connections

p. 30

4



Auxiliary and low-power circuits

p. 38

5



Communication system test

p. 68

6



Factory quality inspection

p. 82

7



Appendices

p. 88

8

How to use the guide

- > This guide is structured into 8 successive stages based on the chronological order of assembly of communication switchboard.

Each of the workshop assembly phases up to transportation to the site and installation is described according to a 3-column page layout principle:

- 1- the left column states the **standard concerned**,
- 2- the middle column states trade **practices on theoretical or practical aspects**,
- 3- the right column illustrates these rules with **examples** from the Schneider Electric Prisma P and Prisma G switchboard ranges.

- > Symbols used in the guide

Navigation pictograms

To help you to use the guide

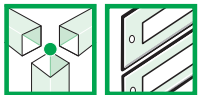

1 - Assembling and covering enclosures



2- Main busbars and forms



3 - Installing the devices



4 - Power connectors



5 - Auxiliary and low-power circuits



6 - Communication system test



7 - Factory quality inspection



8- Appendices

Information pictograms

To emphasise important information



Tip

Handy hints



Compliant



Non-compliant



Pre-assembled and universal switchboards



Switchboards to be assembled, in kit form

- > Mount all the devices, including those of Enerlin'X range, in accordance with the instructions given in the manufacturer's technical manuals.

Example



Follow the assembly order defined in the assembly guide or in the related instruction sheets:

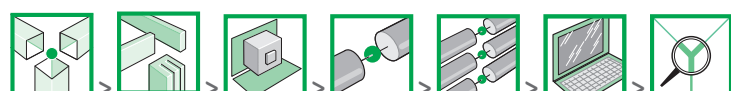

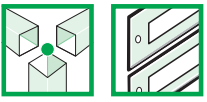

Assembly of enclosures

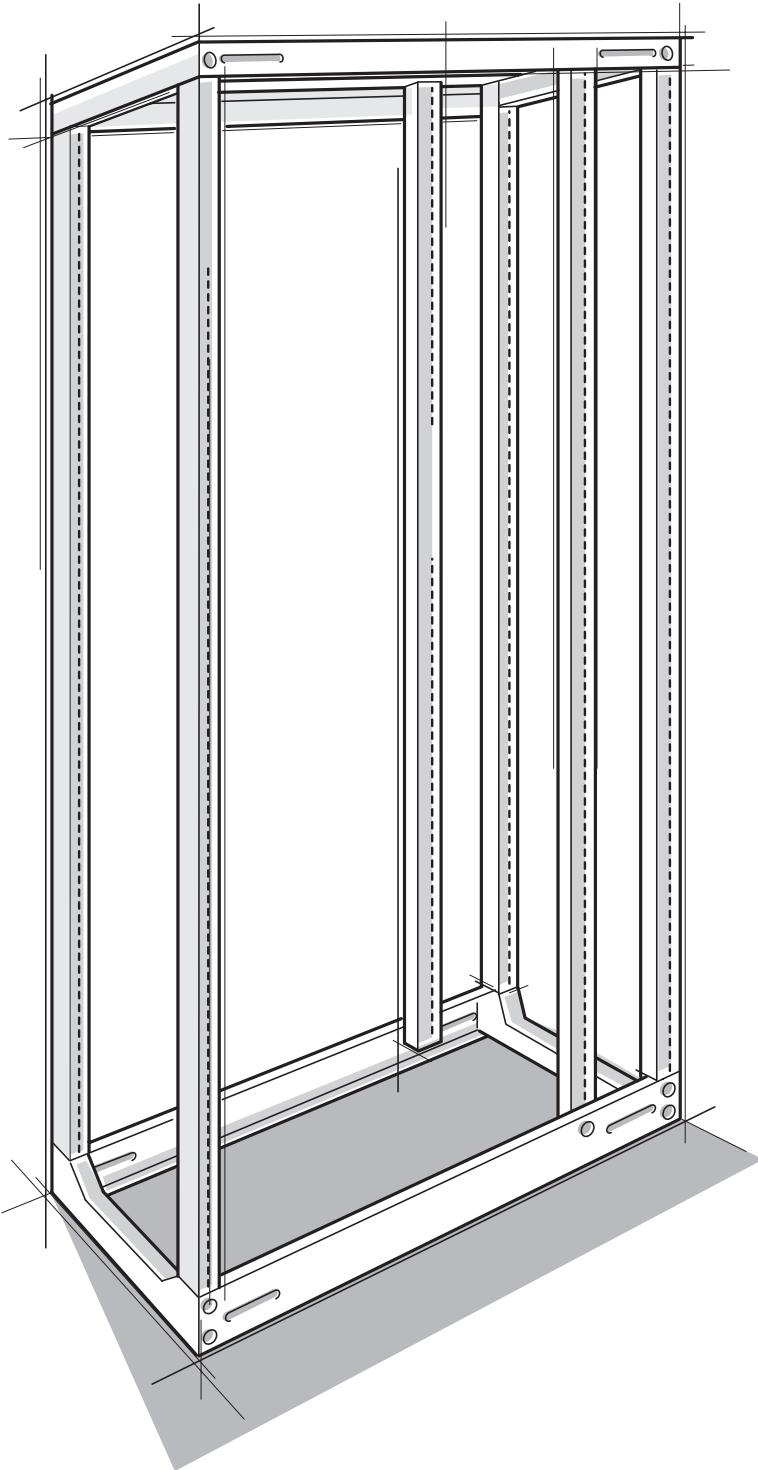

Enclosure structure



Standards



Good practice

1 All switchboards must be mounted according to the manufacturer's instructions using approved equipment, regardless of their type (kit to be mounted, pre-assembled or dedicated to large industrial sites).

Example



The assembly of enclosures delivered as kits is reliable and particularly fast. It may be done in the factory or on site. It simplifies storage and transportation.



Assembly using 12 highly accessible screws.

IEC 62208
(Empty enclosure standard)

2 Components of the enclosure structure, components contributing to the distribution of energy, as well as switchgear and controlgear must be provided and tested to withstand stresses due to:

- the weight of the switchgear and controlgear,
- electromechanical stress arising from a short-circuit,
- transport,
- vibrations,
- the switchboard environment (ambient temperature, humidity),
- seismic risk,
- electrical risk (internal arc).

These structural details also concern the various systems used to ensure the closing of doors, etc.

It must also ensure the protection of:

- the operator,
- the switchgear and controlgear against external influences.

Assembling enclosures in kit form



Standards



Good practice

1 Be careful not to damage the coating of metal parts during assembly.

IEC 62208

2 Universal enclosures are delivered already assembled. You must remove the panels to carry out wiring inside this type of enclosure. Take the necessary precautions in order not to damage the paintwork or screws and bolts when mounting and dismantling the panels.

3 Store the panels in such a way as to avoid all risks of deformation or deterioration of the paintwork.



Example



4 Always use the screws and bolts recommended by the enclosure manufacturer. You will obtain mechanical connections of excellent quality if you follow the guidelines provided by the manufacturers of the enclosure and the screws and bolts, especially concerning the tightening torques to apply. Incorrect tightening may result in deterioration of the fastening system or the part to be fastened.



Example

All the screws and bolts provided by Schneider Electric have the property class 8-8. This ensures excellent mechanical fastening that will not come loose with time. The appropriate tightening torques for the various screw and bolt diameters were determined by testing, with an accuracy of $\pm 10\%$.

Assembling enclosures in kit form



Standards



Good practice

5 It is necessary to connect the enclosures mechanically (number and type of fastening) as per the enclosure manufacturer's recommendations.



Example



Enclosure combination batches are available. They are used to mechanically connect enclosures to each other.

6 Depending on the IP degree of protection required for the switchboard, you may have to install a seal between enclosures to ensure that the original IP degree of protection is strictly maintained after the unit has been assembled.

7 Follow the manufacturer's instructions concerning the handling and transport of enclosures.



Example



A set of corner stays is provided for lifting and transporting assembled cubicles. It is fastened on the cubicle frame, in the axis of the uprights.

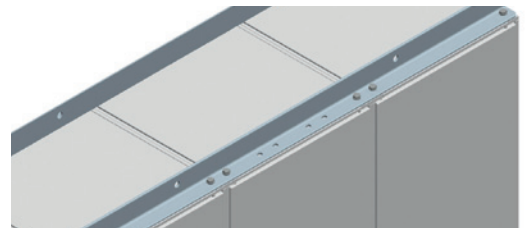

Theory

Standards Theory

IEC 60364
IEC 61439-1 and -2

1 The standard requires effective continuity of the exposed conductive parts of the switchboard:

- between each other,
- between them and the main protective conductor PE (equipotential bonding).

All exposed conductive parts of the switchboard must be connected to the earthing circuit, except for those that do not present a potential hazard for users (small fasteners such as screws or rivets).

You must measure the earthing continuity electrically in case of doubt.

> This topic is developed in chapter 3 - "Power busbar".

Example

Enclosure combination batches are available. They are used to mechanically connect enclosures to each other. In most cases, earthing continuity is obtained by the screws, nuts and bolts or by the assembly design.

To do this, you must:

- use only components, screws, nuts and bolts and accessories recommended by the manufacturer,
- comply with the assembly instructions given in the technical manuals,
- tighten the screws to the recommended torque.

Electrical continuity for fixed parts

Standards Good practice

1 If there is no specific system used, paint or any other insulating coating such as varnish will affect the electrical continuity between two assembled parts.

You must use screws fitted with washers (spikes or star washers). This system will scratch the paint up to the metal and thus ensure excellent electrical continuity.

Example

Screws + contact washers.

2 There are other systems for ensuring earthing continuity without using specific washers or adding earth braids:

- 1/4 turn screws,
- clips,
- self-tapping screws (serrated under the head).

Example

1/4 turn screw.

Electrical continuity of moving parts

 Standards  Good practice

IEC 60364
IEC 61439

 **Tip**
Never earth a class 2 device.

1 An earthing conductor must be fitted on all metal moving parts (door, panels, hinged front plates) that support electrical components with operating voltages of over 50 V.
Standard IEC 60364-5-54 defines the minimum cross-section of the connection based on the live conductors of the switchgear and controlgear installed on the moving part.

2 The earth conductor may be either an earthing wire or earthing braid:

- the switchboard does not have "sensitive" equipment in terms of electromagnetic compatibility: use a simple earthing wire,
- the switchboard has "sensitive" equipment in terms of electromagnetic compatibility: use an earthing braid that provides higher EMC protection and equipotential protection.

 **Example**
An earthing wire is supplied as a standard feature for doors accommodating HSI (Human Switchboard Interface) electrical components.



Earthing wire

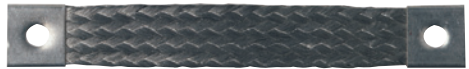

Earthing braid

3 There are three techniques for fastening an earthing wire or braid on a painted part:



- screw + contact washer,
- insert,
- welded stud.

Always place a contact washer between the earthing wire lug and the painted part.

4 **Special case: wire connection or earthing braid on a welded stud**
Protect the stud with a sleeve during the painting operation.

Note: the list of control points presented is not exhaustive.

It lists the minimum checks required and may be completed depending on the organisation in the workshop and/or recurrences of defects encountered.

 Minimum checks required	 Control resources	 Self-control
> Identification of the project	> Assembly drawings	<input type="checkbox"/>
> Identification of columns and quantity	> Assembly drawings	<input type="checkbox"/>
> Conformity with front panel drawings	> Assembly drawings	<input type="checkbox"/>
> Dimensions	> Assembly drawings	<input type="checkbox"/>
<input checked="" type="checkbox"/> > Quality of paints*	> Visual inspection	<input type="checkbox"/>
<input checked="" type="checkbox"/> > Protection degree**	> Visual inspection and technical documentation	<input type="checkbox"/>
<input checked="" type="checkbox"/> > Bonding continuity***	> Visual inspection and installation guide	<input type="checkbox"/>

(*) homogeneity, no scratches, deformations, etc.

(**) quality of washers

(***) screws, contact washers, etc.

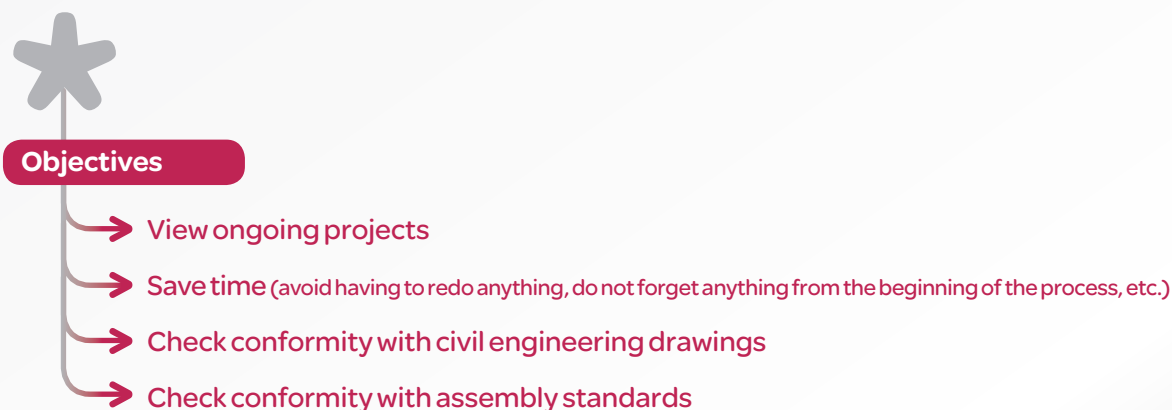

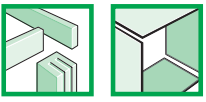

Power busbar

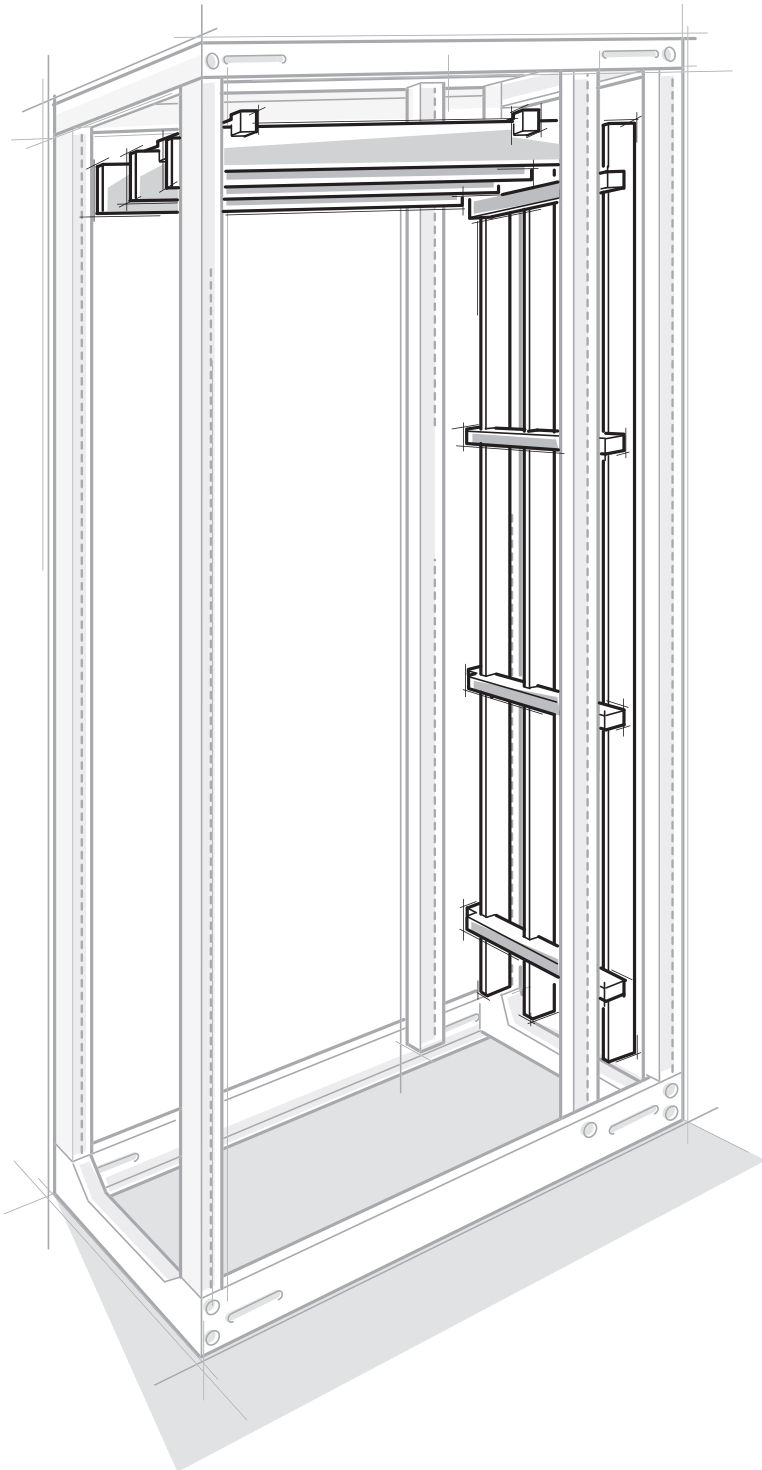

Foreword

 Standards  Theory

2

1 Power is distributed in switchboards through the following means:

- a **main busbar** that distributes power horizontally between the various switchboard columns. It may be installed on the top, middle or bottom of the switchboard depending on the type of switchboard, customer specifications and/or local practices,
- **distribution busbars** connected to the main busbar. They provide power to outgoing devices.

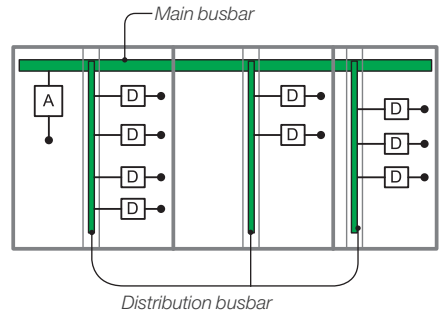

A: Incoming device
D: Outgoing device

IEC 61439-1

2 The following must be taken into account when choosing a power busbar:

- environmental characteristics of the switchboard (ambient temperature, IP degree of protection, pollution),
- type of switchboard installed regarding to validation test,
- characteristics of the client's power supply: on the top, middle or bottom,
- the rated current of the short-circuit: I_{cw} .

The installation of a power busbar consists in the following steps:

- select the busbar material,
- size it (busbar section, number of busbars per phase) and define its position in the switchboard based on the client's incoming devices,
- install it in compliance with the creepage and clearance distances of the standard,
- fasten it according to good practice.

3 The installation must ensure the protection of persons:

- against direct contact by installing the appropriate internal partitions (forms) or by installing live parts out of reach.
- against indirect contact by creating an equipotential bonding inside the switchboard (PE/PEN protective conductor and earthing of the grounding electrode conductors).

Example

Direct contact

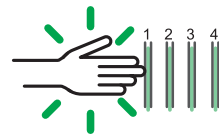

Contact of persons with live parts of electrical materials (conductors or energized parts).

Indirect contact



Contact of persons with conductive parts that are accidentally powered as a result of an insulation failure.

4 The current of a power busbar is measured using a current transformer (CT) such as a busbar passing current transformer.

The main role of the current transformer is to lower the value of the current to be measured to a value that is acceptable for metering devices (usually 1 to 5 A).



Choice of material



Standards



Good practice

1

The materials most often used are copper and aluminum because they offer the following characteristics:

- excellent electrical conductivity, excellent heat dissipation,
- good corrosion resistance,
- ease of installation.

NFA 51-118
NFA 51-419
EN 1652
ISO 1634

2

Choice of copper bars

Use Cu-ETP copper only, that complies with the following specifications:

Standard	Description
General description of material	
EN 13599	Cu-ETP R240
Standard international equivalent	
ISO 1634	Cu-ETP HB

The bars must be:

- rectilinear,
- free of scratches, traces of impact, marks or rust,
- qualified and with a compliance certificate.



Example



Schneider Electric copper bars are of Cu-ETP type (H12) and are qualified and compliant with the standard.

3

Choice of aluminum bars

When choosing aluminum bars, special attention must be paid:

- to the quality of the aluminum, which must provide a trade-off between mechanical withstand and electrical conductivity: aluminum is more resistive and has a lower mechanical resistance than copper of similar dimensions,
- to the quality of the surface coating (tin-plating) that guarantees excellent electrical contact and corrosion resistance,
- to heat stresses: the maximum utilization temperature is lower than that of copper (90 °C for bare aluminum, 105 °C for tin-plated aluminum and 140 °C for copper),
- connection constraints.

Busbar sizing

- Standards
- Good practice

1 Power busbars must be sized to withstand heat and dynamic stresses resulting from short-circuit currents that do not exceed the value of the rated short-circuit current.

Electrodynamic stress withstand depends mainly on the following:

- the intensity of the default current,
- the shape and cross-section of the bars,
- their location in the switchboard,
- their fastening method.

Example



Schneider Electric is proposing a new innovative range of busbars.

- They present the following advantages:
- greater performance (a single busbar can withstand ratings of up to 4000 A),
 - 50 % lighter than copper bars that achieve similar sections,
 - robust and flexible- higher resistance to short-circuit currents (100 kA/1s),
 - cheaper to mount and assemble,
 - vertical or horizontal installation,
 - a wide range of available profiles.

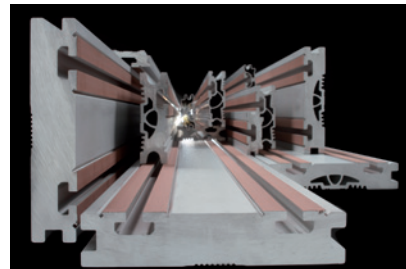

Linergy LGYE busbars.

IEC 61439-1
§8.6.1

i Tip
The various ratings and their names to be taken into account are defined in IEC 60947-2 and IEC 61439-1

2 Busbar manufacturers usually provide the information required for sizing power busbars. These figures must be used in calculating the cross-section of the busbar.

The busbar cross-section depends on:

- the rated current "In" to be conveyed in the busbar,
- the rated current of the short-circuit (permissible short-time withstand current): "Icw",
- the ambient temperature around the switchboard,
- the IP protection index of the enclosure,
- the rated diversity factor (RDF),
- the space reserved for future enhancements,
- the constraint defined by the trigger time of the protective device.

Caution: never under-size a busbar (risk of overheating).

IEC 61439-1
§3.8.10
§5.3.3
Appendix E

IEC 61439-2
§5.3.3

3 Generally, not all the devices connected to a busbar are used at full load or at the same time. It is therefore not necessary to size the busbar to transport the sum of rated currents of all the devices continuously.

The rated current "In" in the busbar must be calculated:

- by adding up the rated currents of all the connected devices,
- by multiplying the result by the diversity factor (RDF) defined by IEC 61439-1.









The value of the diversity factor depends on the number of devices connected to the busbar:

Number of devices	Diversity factor
2 and 3	0.9
4 and 5	0.8
6 to 9	0.7
10 +	0.6

Notes

Note: the list of control points presented is not exhaustive.

It lists the minimum checks required and may be completed depending on the organisation in the workshop and/or recurrences of defects encountered.

 Minimum checks required	 Control resources	 Self-control
 <ul style="list-style-type: none"> > Busbar cross-section and number <i>Note: to be done preferably when the busbars are installed</i> 	<ul style="list-style-type: none"> > Manufacturing file 	<input type="checkbox"/>
 <ul style="list-style-type: none"> > Manufacturing quality* <i>Note: to be done preferably after the bars are manufactured</i> 	<ul style="list-style-type: none"> > Installation guide 	<input type="checkbox"/>
 <ul style="list-style-type: none"> > Order and identification of phases 	<ul style="list-style-type: none"> > Technical documentation 	<input type="checkbox"/>
 <ul style="list-style-type: none"> > Creepage distance 	<ul style="list-style-type: none"> > Visual inspection and installation guide 	<input type="checkbox"/>
 <ul style="list-style-type: none"> > Clearances 	<ul style="list-style-type: none"> > Visual inspection and installation guide 	<input type="checkbox"/>
<ul style="list-style-type: none"> > Fastening of busbars** 	<ul style="list-style-type: none"> > Technical documentation 	<input type="checkbox"/>
 <ul style="list-style-type: none"> > Protection circuit*** 	<ul style="list-style-type: none"> > Manufacturing file, visual inspection, installation guide 	<input type="checkbox"/>
<ul style="list-style-type: none"> > Conformity of partitioning forms 	<ul style="list-style-type: none"> > Technical documentation, manufacturing file 	<input type="checkbox"/>
<ul style="list-style-type: none"> > Conformity and installation (current transformer) 	<ul style="list-style-type: none"> > Manufacturing file, installation guide 	<input type="checkbox"/>

(*) forming of bars (drilling, folding, cutting, etc.)

(**) number of supports, centre distance, etc.

(***) cross-section, identification, bonding continuity, etc.

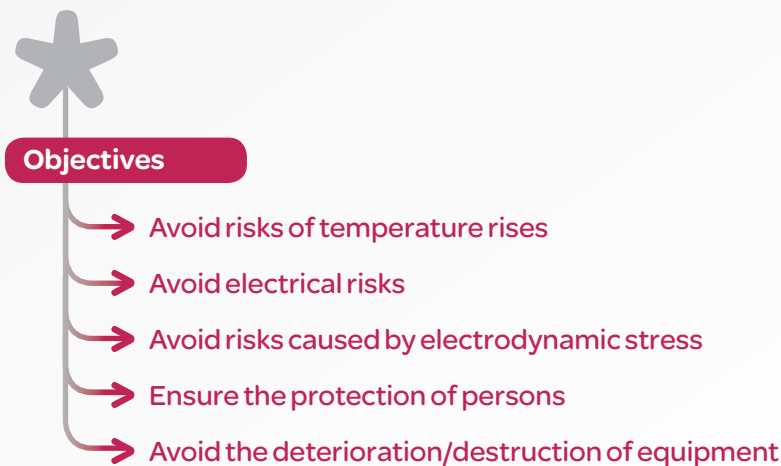



Installing the devices

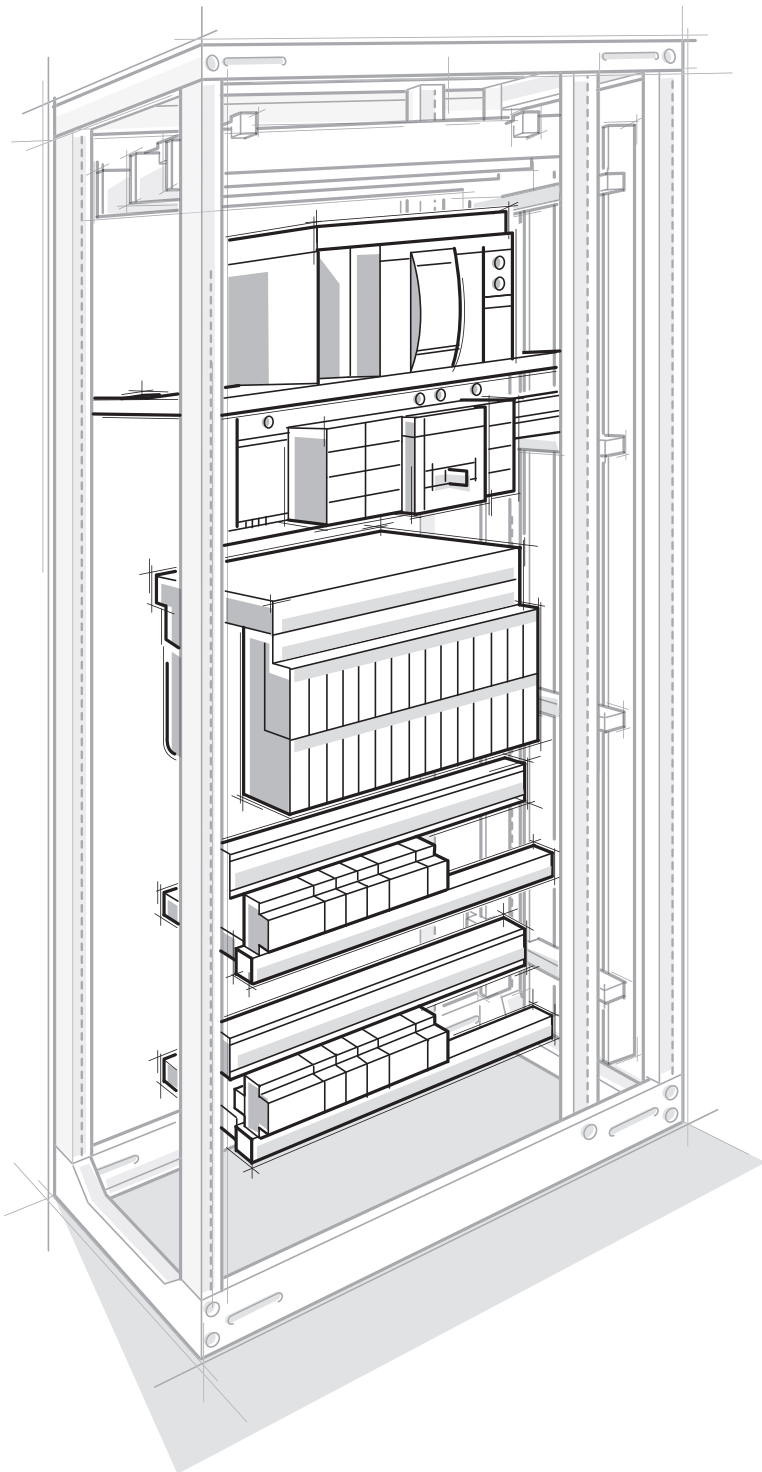

Foreword



Standards



Theory

1 The layout of devices must be designed taking into account:

- the entry/exit direction (from the top or from the bottom) of the customer's wires,
- the space available in the switchboard,
- heat constraints inside the switchboard.

> See the "Device Layout" section in this chapter.

2 The devices in the switchboard must be mounted, scrupulously following the instructions given in the switchgear manufacturers' guides. Special precautions must be taken when mounting door-mounted devices.

IEC 61439-1
§8.4

3 Operations in switchboards must be carried out by qualified persons who comply with all required safety measures. It is imperative to ensure the protection of operators against accidental direct contacts.

3

Positioning rules



Standards



Good practice

IEC 61439-1
Table 6

1

Define the layout of devices in the column based on constraints related to:

- the entry and exit points of the customer's wires (from the top, the bottom of the column or other specific configuration) and the position of the main busbars in order to have the shortest possible connections,
- the routing of prefabricated wires or connections at the input and output of the switchboard,
- the space required for the device to work correctly (volume of device, safety perimeter, connection pads, radius of curvature of wires, control units, etc.),
- the accessibility of the various control units and connection zones (side, rear, etc.) of devices,
- heat dissipation of devices that contributes to increasing the internal temperature of the column,
- the mutual thermal and electromagnetic influence between the main busbars and the devices,
- the maintenance or upgrade of the system (for example, enable the opening of the motorised control of a circuit breaker).

The resulting layout of the switchgear should also be studied to optimise connection zones, busbars, enclosure sizes, etc.

IEC 60480

2

Place devices with a high heat dissipation in the upper part of the switchboard to:

- avoid heating the entire switchgear installed in the column,
- maintain the performance of devices of lower power placed at the bottom to keep derating to a minimum,
- enable greater legibility of the electric layout.

i Tip

To maintain the internal temperature of the switchboard within the operating limits of most devices (< 70 °C), a forced ventilation of cubicles may be necessary, to replace derating, in order to optimise the volume of copper and reduce the cost

3

Several devices with a high heat dissipation may be installed in the same column if:

- the maximum internal temperature is observed (below the manufacturer's recommendations),
- the capacity of the busbars to convey the rated current is observed (see derating tables),
- the expected performance of each device is reached (see derating tables).

IEC 61439-1
Table 6

4

Comply with the temperature rise limits recommended by standard IEC 61439-1.

Positioning rules

Standards

IEC 61439-1
Table 6

Tip

For the electromagnetic compatibility of the switchboard, the use of separator sheets for all communicating devices is recommended.

Tip

Use separate routings for power cables and communication cables is recommended.

Good practice

5 To avoid serious malfunctions, do not install devices that are sensitive to temperature rises (e.g., control/command devices) near devices with high heat dissipation. It is recommended to separate the switchboard into two zones (high-power devices and low-power devices) to improve the efficiency of the installation. Installing the communicating devices at the bottom of the switchboard is recommended (see example given below).



Example

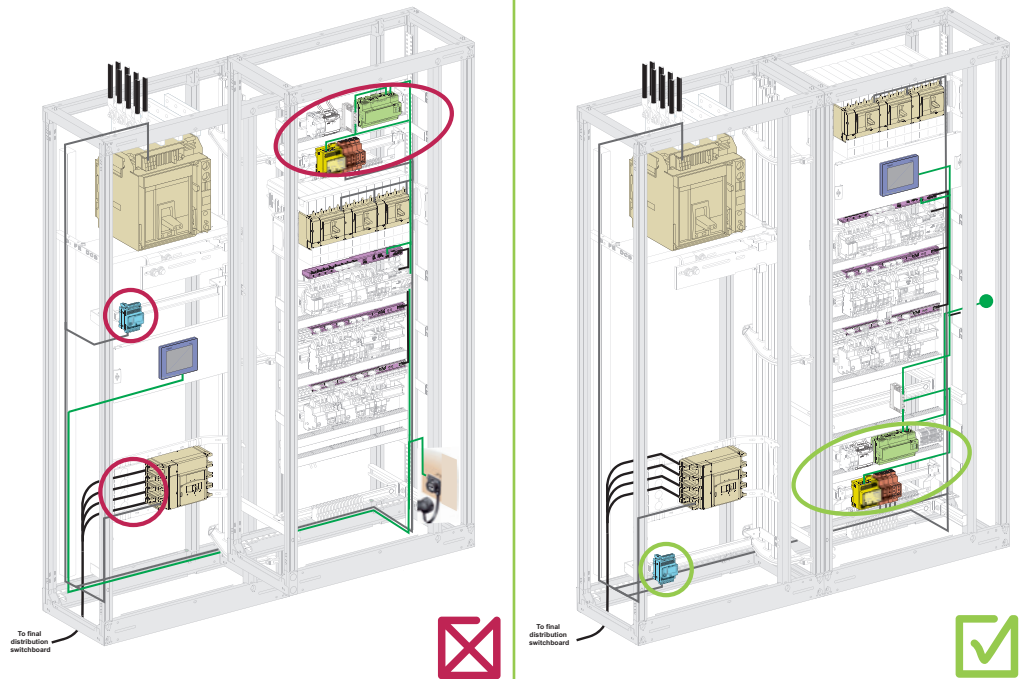

IEC 61439-1
IEC 60947-x

Tip

For tables with a high operating voltage of 690 V, you may have to install additional barriers to reduce the risk of sparking in case of a short-circuit.

6 Keep within the safety perimeter defined by the manufacturer for each device and make sure they are working properly:

- minimum distance between two devices,
- minimum distance of the device from surrounding components (frame, plate, etc.),
- minimum distance from powered live bars.

Positioning rules



Standards



Good practice

i Tip

The safety perimeter may be reduced by adding a cover, terminal cover, barrier, etc.

7

The safety perimeter is usually stated by the manufacturer in the device technical manual or the catalogues.

8

The safety perimeter is a zone where it is forbidden to:

- route wires other than those intended for the connection of the device itself,
- install other devices.

9

Connect the devices with care.
In particular:

- do not strip insulated flexible bars and connection cables too much, to avoid all risk of sparking between phases in the event of a short-circuit,
- position the lugs correctly on the connection pads,
- if necessary, install barriers, terminal covers or insulating sleeves between each phase.

 **Sleeves used for marking wires do not act as insulators.**

IEC 61439-1
§8.5.5

10

Position measurement devices requiring a visual inspection at a height comprised between 0.2 m and 2.2 m from the ground. Their exact position must be determined in consultation with the switchboard user.



Example



Positioning rules



Standards



Theory

1

Recommendation: In Smart Panels, Surge Protection device is highly recommended

Direct lightning to electrical distribution or indirect to the trees, ground or building parts generates a surge which the energy is great and can have dramatic consequences if Surge Protection is not installed in Smart Panels.

Surges are hardly observable and transient, they have multiple consequences on electronic equipment and installations. In many cases, surges cause malfunctions and damages: it is a stop of operation, loss of data or interrupted manufacturing process. The users have difficulties to investigate the causes.

Example



2

What are the consequences if Surge Protection is not installed in Smart Panels?

- Surge can damage electronic components, even vaporize conductors.
- There are no superposition of noise on analog signals that generate false indications (e.g. wrong temperature)
- Possibility of data loose or change in memories
- Lower transmission speed due to repetitions
- System reset, etc.

Example

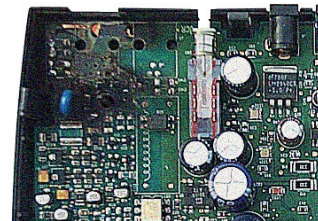

3

What are the devices in Smart Panels sensitive to surges?

Smart Panels devices has integrated MOV surge protection.

This protection prevents devices only against industrial surges and cannot withstand atmospheric surges.

Following devices of Smart Panels shall be protected by SPD - minimum Type 1+2, $I_{imp} = 12.5 \text{ kA}$ in incoming switchboard and Type 2, $I_{max} = 20 \text{ kA}$ in secondary distribution boards:

- Recloses, remote control mechanisms,
- Smart programmable relays,
- Power supplies,
- WEB servers,
- I/O application modules, etc.

Example



Installation advice



Standards



Good practice

1

Back-up protection

According to IEC 61643-11 it is required SPD overcurrent protection to be installed upstream, e.g.: circuit breaker or fuse, internal or external.



Example



Integrated back-up protection

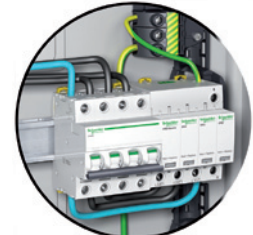

External back-up protection

2

Installation in "convenient or free space" place

Equipment installation design should be done in accordance to installation rules: cables length shall be less than 50 cm.



Example

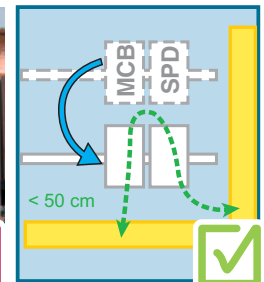
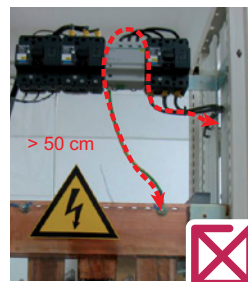

3

Installation to make "nice looking design"

Positioning of devices should be linked to installation rules: reduce length of cables < 50 cm and keep the loop area rule of reducing impact of magnetic fields created by lightning current.



Example

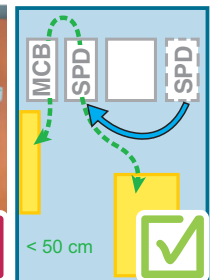
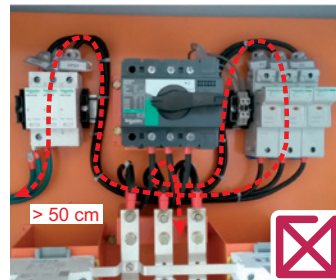

4

Mix of brands – no verification of coordination

Use of known brand SPD:
Coordination with backup protection (MCB) shall be tested and validated in laboratory
 > use coordinated SPD and protection, see page 91.



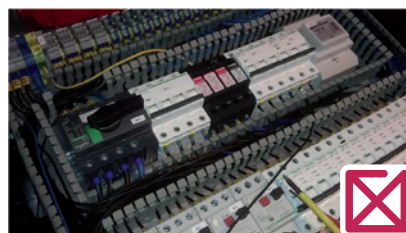

Example



Note: the list of control points presented is not exhaustive.

It lists the minimum checks required and may be completed depending on the organisation in the workshop and/or recurrences of defects encountered.

Minimum checks required			
Control points		Control resources	Self-control
<input checked="" type="checkbox"/>	> Conformity of the switchgear and controlgear* (placing of equipment and conformity of front panel)	> Manufacturing file	<input type="checkbox"/>
<input checked="" type="checkbox"/>	> Mechanical operation	> Switchgear and controlgear guide	<input type="checkbox"/>
<input checked="" type="checkbox"/>	> Accessibility of switchgear and controlgear (maintenance and operation)	> Switchgear and controlgear guide	<input type="checkbox"/>
<input checked="" type="checkbox"/>	> Fixing of switchgear and controlgear	> Switchgear & controlgear and system guide	<input type="checkbox"/>
<input checked="" type="checkbox"/>	> Customer connection	> Manufacturing file	<input type="checkbox"/>
<input checked="" type="checkbox"/>	> Compliance with safety perimeters	> Switchgear and controlgear guide	<input type="checkbox"/>
<input checked="" type="checkbox"/>	> IP degree of protection	> Manufacturing file (IP conformity), installation guide	<input type="checkbox"/>

(*) type, calibre, number of poles, accessories, etc.

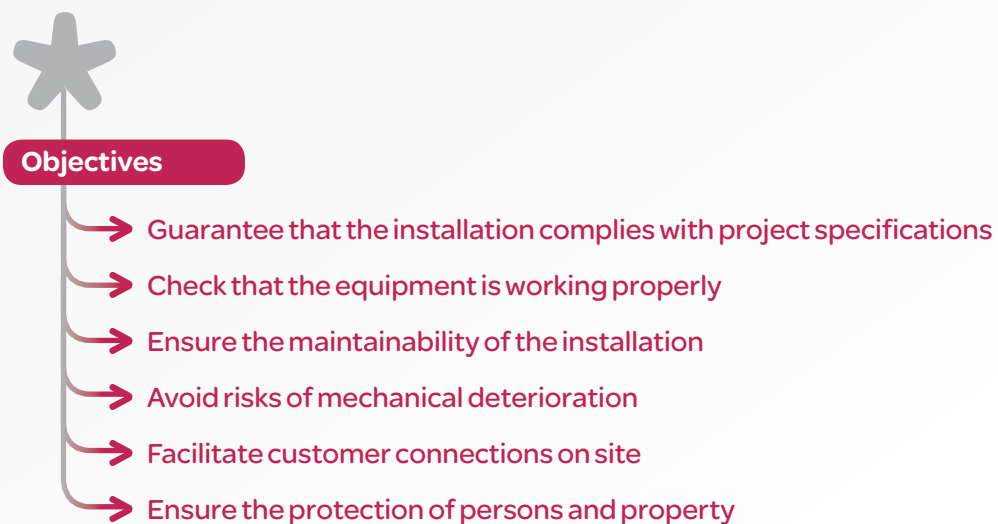

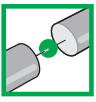

Power connections

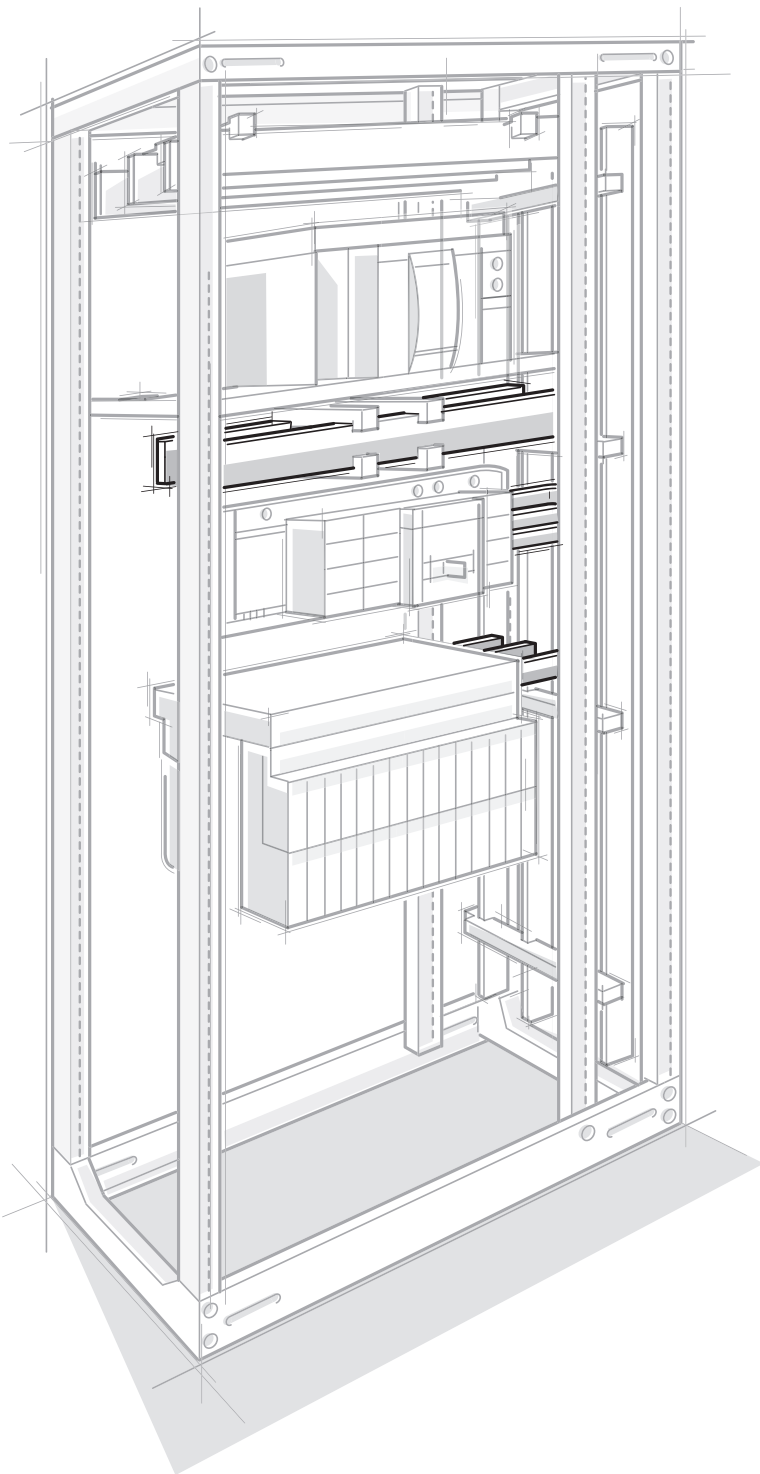

Foreword



Standards



Theory

1

Power connections can be obtained through:

- rigid bars (horizontal and vertical main busbars, transfer bars),
- insulated flexible bars,
- cables.

By convention, power circuits are circuits connected to conductors with a cross-section of over 6 mm².

The means of connection is chosen based on the switchgear electrical characteristics: (electrical power) and available space in the column.

> See the technical guides or manufacturer's data sheets to install the appropriate conductors.

2

All connections must be sufficiently sized to withstand electrical and thermal stresses.

Do not forget to take into account:

- the installation environment (pollution, ambient temperature, etc.),
- IP degree of protection of switchboard.

The conductor cross-section and the type of connection must be determined based on:

- the characteristics of the switchgear/controlgear to be connected,
- the length of the connection,
- the thermal environment of the connection.

> See:

- the technical guides or manufacturer's data sheets to size the conductors.
- the chapter 2 "Assembly of enclosures".

Foreword



Standards



Theory

i Tip

This sizing of a rigid busbar is developed in chapter 3 - Power busbars.

3

The creation of rigid busbars requires (cutting, punching, drilling, and folding) that requires a real expertise in order not to weaken or damage the intrinsic characteristics of the bars.

4

Rigid busbars must be assembled according to specific rules to ensure the quality of electrical contacts. The quality of an electrical contact depends on:

- the condition and size of the contact surfaces,
- the contact pressure.

5

Insulated flexible bars are primarily used for direct connections between transfer busbars and the switchgear/controlgear. Defining and installing them requires the same cares as for rigid busbars (≤ 630 A).

An incorrect choice and/or installation may:

- lead to a temperature rise,
- and disrupt or even damage connected or surrounding devices.

6

Cables may be used for all power connections. Nevertheless, connection becomes more difficult after a given power owing to:

- the limited space inside the switchboard,
- the large cable cross-section,
- the minimum radius of curvature to be complied with,
- the number of cables to install,
- the space needed for lugs.

General routing rules



Standards



Good practice

1 Power cables can be routed inside the switchboard:
 - using cable strands,
 - by individual installation.
 Do not place power cables in ducts or straps.

2 Do not route cables between or too close to power busbars to avoid a temperature rise and deterioration of the insulator.

3 Avoid all risks of damage or cutting of the insulating sleeve:
 - do not route cables on parts with sharp edges.
 - cables that are routed through a hole in a sheet must be protected with grommets, cable glands, gaskets, plastic rings, etc.



Tip

A damaged insulating sheath increases the risk of sparking and therefore of a short-circuit.

Example



Cable glands are used to protect cables from the hole in the sheet.



Tip

It is essential to comply with the permissible radius of curvature for each type of cable.

4 Comply with the general wiring rules described in the chapter.

Connection



Standards



Theory

1

Coordination between SPD and "smart devices"

In order to direct all surge current to SPD but not to internal surge protection of "smart devices" it is recommended to keep **up to 1.5 m cable distance**.



Example

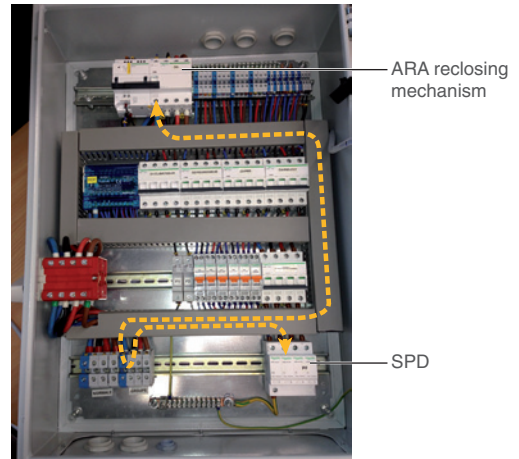

Power distribution board of telecom Base Transceiver Station

Installation



Standards



Good practice

1

Proper installation of SPD with backup protection:

- Connections of a SPD to the loads should be as short as possible in order to reduce the value of the voltage protection level (installed Up) on the terminals of the protected equipment.
- The total length of SPD connections to the network and the earth terminal block should not exceed 50 cm.



Example

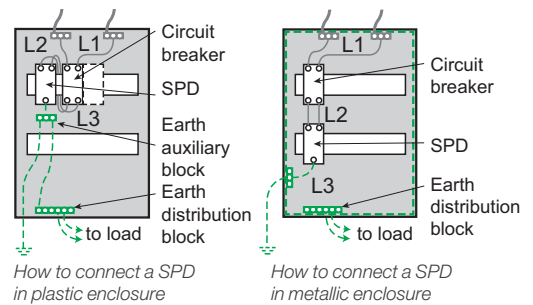

Tip

IEC 60364 recommends at the installation incoming end a minimum cross section of:
 - 4 mm² (Cu) for connection of Type 2 SPD;
 - 16 mm² (Cu) for connection of Type 1 SPD (presence of lightning protection system).

2

Minimum required cables cross section

The conductors' withstand to short-circuit currents: The conductor must resist a short-circuit current during the maximum protection system cutoff time.
 Connection of SPD is done in parallel to incoming switchboard disconnected with separate or integrated backup protection.

Installation



Standards



Good practice

3 Reduce of magnetic field impact

The incoming feeder phase, neutral and protection (PE) conductors should run one beside another in order to reduce the loop surface.

The incoming conductors of the SPD should be remote from the protected outgoing conductors to avoid polluting them by coupling.

The cables should be pinned against the metallic parts of the enclosure (if any) in order to minimize the surface of the frame loop and hence benefit from a shielding effect against EM disturbances.

Example

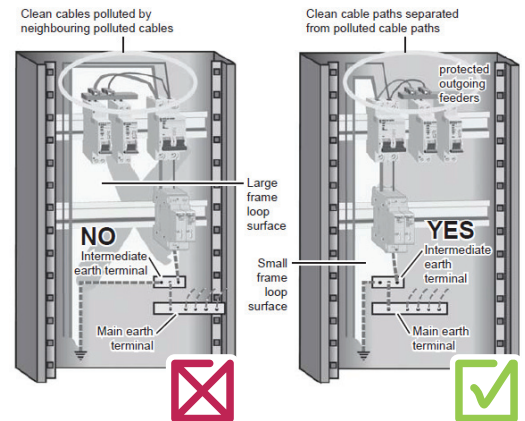

4

4 Surge protection device status remote monitoring

Monitoring SPD with Smartlink important to verify status of cartridge and backup protection, connecting to OF auxiliary contact.

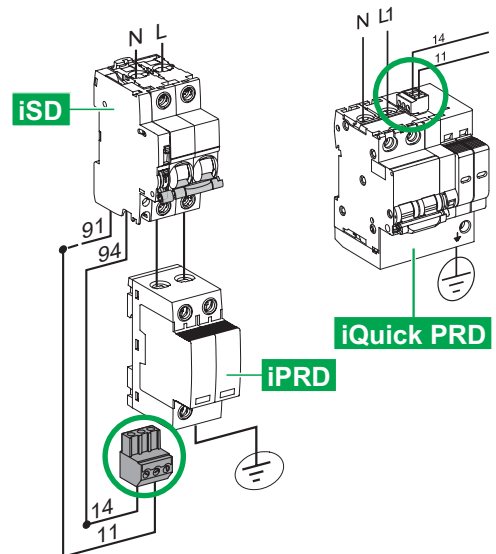
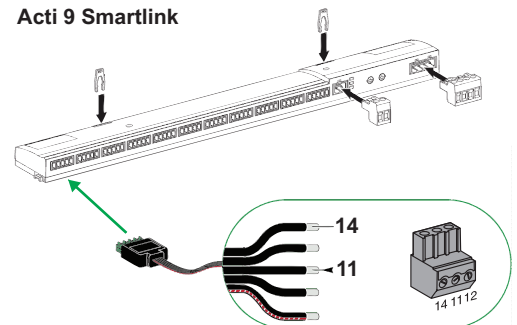

- iPRD / iPRF1 connection (stand alone SPD)
- iQuick PRD connection (SPD with integrated protection)

Acti 9 Smartlink



Note: the list of control points presented is not exhaustive.

It lists the minimum checks required and may be completed depending on the organisation in the workshop and/or recurrences of defects encountered.

Minimum checks required			
Control points		Control resources	Self-control
<input checked="" type="checkbox"/>	> Observance of conductor cross-sections	> Technical documentation	<input type="checkbox"/>
<input checked="" type="checkbox"/>	> Method of installing and fastening conductors	> Installation guide	<input type="checkbox"/>
<input checked="" type="checkbox"/>	> Cable characteristics (e.g. 1000 V, 105 °C)	> Customer requirements (specifications)	<input type="checkbox"/>
<input checked="" type="checkbox"/>	> Quality of power connections*	> Installation guide	<input type="checkbox"/>
<input checked="" type="checkbox"/>	> Tightening to torque	> Torque wrench, switchgear and controlgear guide, installation guide	<input type="checkbox"/>

(*) Surface state, drilling, conformity of fasteners, varnish, etc.

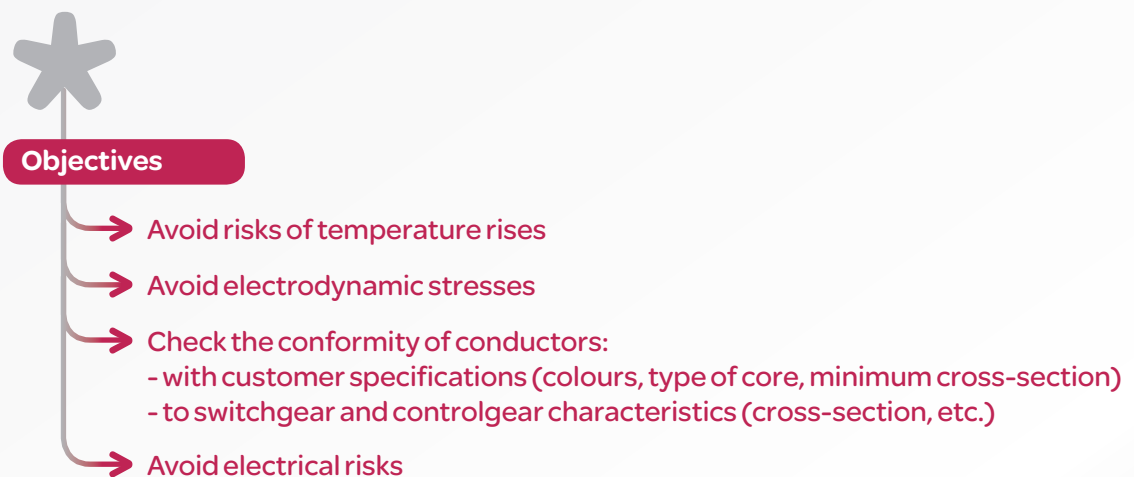

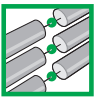

Auxiliary and low-power circuits

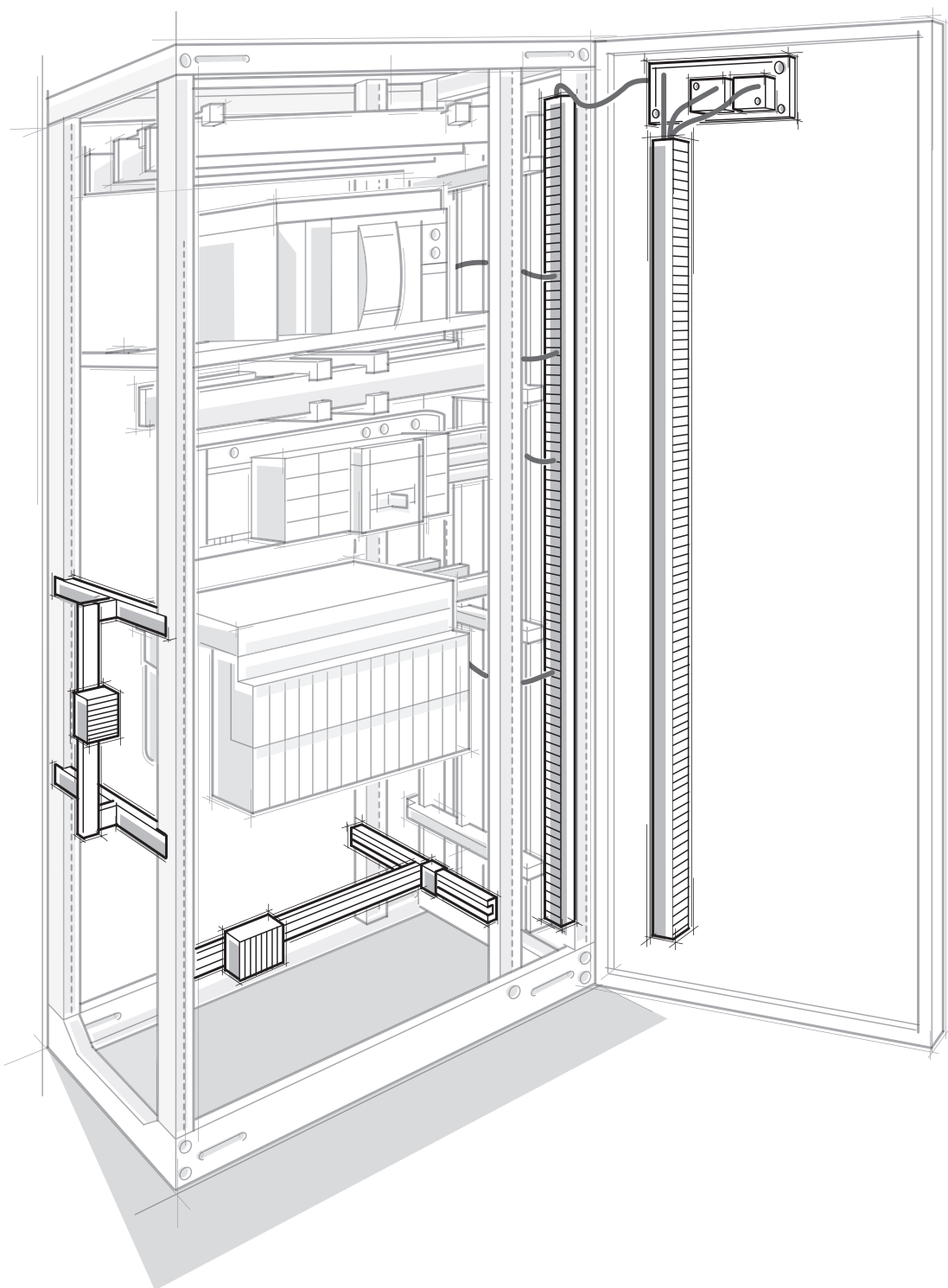

Foreword



Standards



Theory

1 Auxiliary and low-power circuits are:

- control and monitoring circuits: auxiliary power supplies, relays, contactor coils, circuit breaker remote controls, PLC inputs/outputs,
- communication circuits: Ethernet network, Modbus and ULP.

2 By convention, auxiliary and low-power circuits use cables with cross-sections of under 6 mm².
The conductor cross-section and the type of connection must be determined based on:

- the characteristics of the switchgear to be connected,
- the length of the connection,
- the thermal environment of the conductors,
- nominal range of upstream protective device.

3 Cables inside the switchboard can be routed using:

- ducts,
- straps,
- cable strands,
- by individual installation.

Ducts and straps must be preferred when there are a large number of auxiliary circuits. This choice provides the following advantages:

- improved efficiency in terms of heat exchanges,
- improved mechanical protection of cables,
- greater ease of installation,
- faster wiring,
- excellent scalability (easy to change and maintain).

Conversely, when there are few cables to connect, it may be more economically advisable to make strands.

i Tip

The use of steel or aluminum duct reinforces the immunity installation with respect to electromagnetic compatibility.

➤ Example

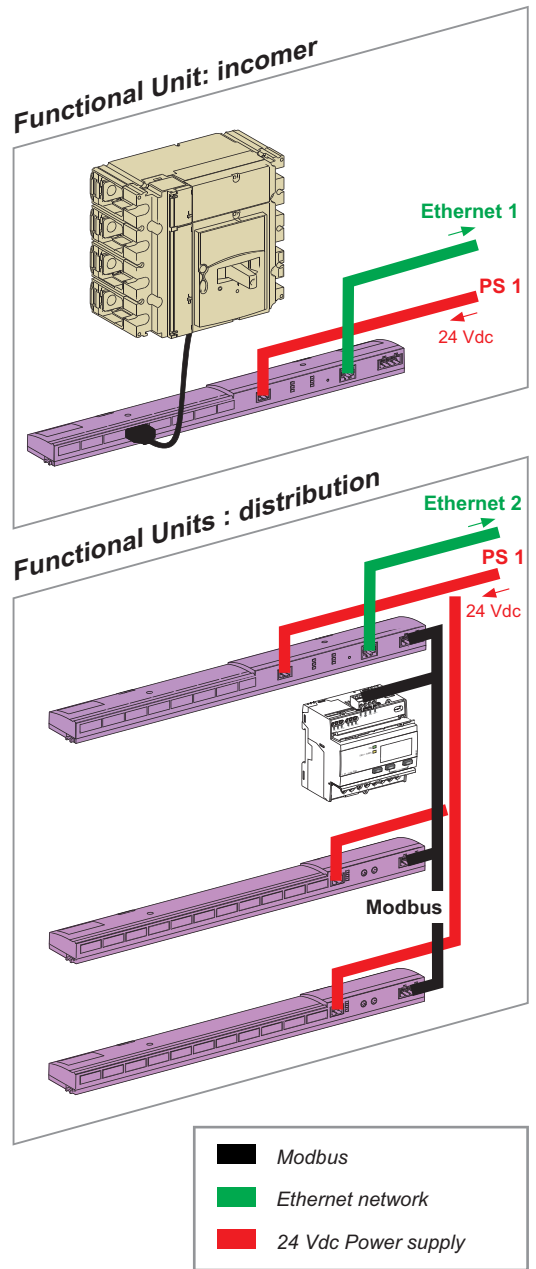

Foreword



Standards



Theory

4

Cables must be prepared using tools or machines in good working condition that are correctly calibrated. They must be connected according to trade practice to avoid all risks of temperature rise that may cause serious damage.

> See the "Connections" section in this chapter.

5

Given their sensitivity to electromagnetic disturbance, the communication switchgear installed must meet the requirements of the relevant immunity and emission standards.

> See the "Communicating circuits" section in this chapter.

6

Toroids are mounted on cables to detect leakage currents. They transmit a signal that is proportional to the current measured to the related receiver.

Toroids are fragile components. They must be installed in the switchboard according to professional good practice.

Tip

The circuit of the current measuring devices are generally realized with a wiring section $\geq 2.5 \text{ mm}^2$.

To improve the safety of circuits, cables reinforced insulation are used to reduce the risk of mechanical damage.

General circulation rules



Standards



Good practice

Tip

The routing of cables inside the enclosure may be organised as follows, "Cable ladder" wire running:

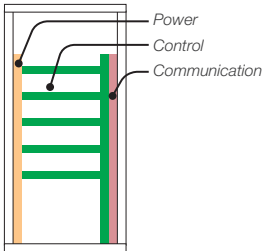

1

Use separate routings for auxiliary circuit and low power cables (cross-section $\leq 6 \text{ mm}^2$) and power cables (cross-section $< 6 \text{ mm}^2$). Moreover, given their sensitivity to electromagnetic disturbance, it is preferable to separate control/monitoring cables from communication cables.

Example



2

Do not route cables between or too close to power bars to avoid all risks:

- of a temperature rise in the cable,
- damage to the insulator,
- electromagnetic disturbance.

Example



The cables are routed too close to the power bars.

Tip

The deterioration of the insulating sleeve of a conductor will result in the deterioration of its dielectric characteristics and increases the risk of sparking and therefore of a short-circuit.

3

Avoid all risks of damage or cutting of the insulating sleeve:

- do not route cables on parts with sharp edges.
- protect cables that are routed through a hole in a sheet with grommets, cable glands, gaskets, plastic rings, etc.

Example

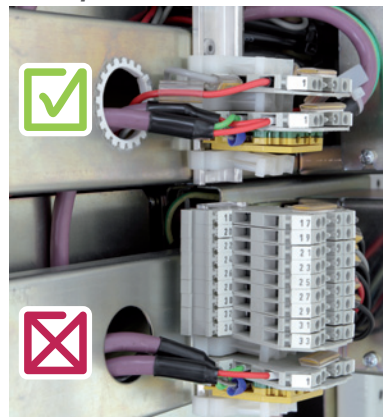

A plastic ring is used to protect cables from the hole in the sheet.

IEC 61439-1

In the specific case of a cable routed in a form sheet, make sure that the degree of protection is IP2X. Use a membrane gland plate to do this.

General circulation rules



Standards



Good practice

i Tip

The safety perimeter of a device is defined in chapter 4
- Installing switchgear and control gear.

4

Do not route the cables:

- in the device safety perimeter, e.g., installation of ducts above the circuit breaker gas evacuation areas,
- close to moving parts (handle, reset button, mechanical interlocking, rotary handle, etc.) where there is a risk of blocking the cable.



Example



The cables are routed too close to the rotary handle.

i Tip

The values of the permissible curvature radii are given by the cable suppliers.

They depend on the type:
- of core (copper or aluminium),
- of insulator.

5

Comply with the permissible radius of curvature for each type of cable.

Notably:

- provide for sufficient space for connecting the cables, with a **minimum** radius of curvature (6 to 8 times the external diameter of the cables),

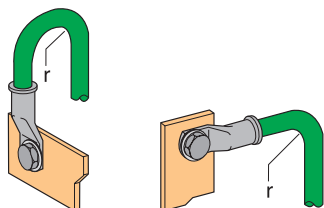

- no use of tools to bend the cable.

Failure to observe this recommendation may result in an abnormal temperature rise in the conductors.

Cable routing in ducts



Standards



Good practice

Tip

There are trunkings in halogen-free materials that do not generate toxic or corrosive gases in case of combustion.

1

Choose trunkings adapted to the cross-section and the number of cables that they are to hold.
Provide for a reserve for future extensions.
The final fill rate must not exceed 70 %.



Example

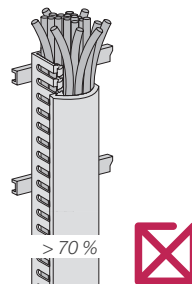

2

Never install a trunking in contact with or between power busbar conductors.

3

Define the number of fastening points of a trunking based on its mechanical characteristics and the fill rate. The trunking must be straight after fastening.
At any event, the centre distance between fastening points must not be more than 600 mm.



Example

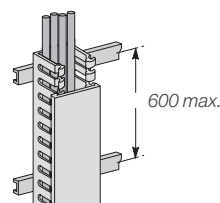

4

Fasten the trunking using rivets or plastic screws to reduce the risk of damaging the cables.



Example

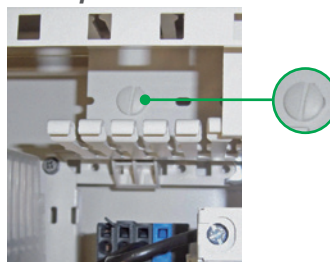

5

Do not tie cables inside the trunkings to facilitate heat dissipation.
Never stretch a wiring cable to avoid all risks of disconnecting the cable. As a rule, there must always be some slack between the duct outlet and the connection point.



Example

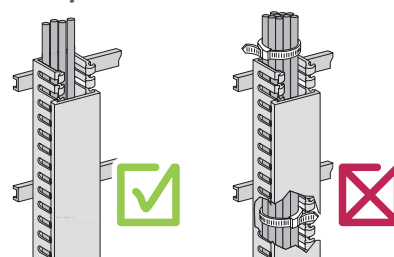

Cable routing in straps



Standards



Good practice

1 Cable straps are used to ensure faster installation, and facilitate the modification of operations and maintenance.

Choose the size of the straps based on the number of cables that they are to hold.

The final fill rate must not exceed 70 %.

2 Lock the straps on a modular rail or vertical mounting plate.

Fit a sufficiently large number of straps to ensure that cables are properly held in place: 1 strap approximately every 8 cm.



Example

In Schneider Electric enclosures, the possibility of installing horizontal and vertical straps optimise cable running and make it easier to read.

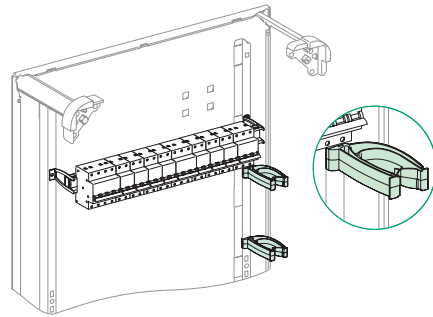

3 Do not tie cables running inside the straps to facilitate heat dissipation.

Cable stranding



Standards



Good practice

1 Choose ties that are adapted to the strand to be made. They must:

- be mechanically resistant enough to keep the cables fastened in case of a short-circuit,
- be of a length that is adapted to the strand circumference,
- be wide enough not to damage the cable insulating sleeve.

2 Fit a sufficiently large number of ties to ensure that cables are properly held in place.

Centre distance recommended according to strand diameter:

Diameter D of strand (in mm)	Distance L between ties	
	Mini (in mm)	Maxi (in mm)
< 20	60	120
Between 20 and 30	70	140
Between 31 and 45	90	180
Between 46 and 75	125	200

Strand fastening



Standards



Good practice

1

Never run a strand in contact with or between power busbar conductors to avoid temperature rise and damage to insulators.

2

If the cables of the strand don't meet the class 2 requirements, fasten the strand on insulation supports. If they are metal supports, insert an insulating wedge between the strand and each metal support. If cables meet the class 2 requirements you may fasten them directly on metal supports.

3

Strands must be run flush with doors, panels, swivelling front panels or panels that hold the switchgear in such a way as to reduce the risks of damaging or pinching the cables to a minimum.

The strand is protected mechanically by:

- a tubular plastic sleeve,
- a braided polyester sleeve,
- a spiral bearing.

Follow the recommendations below to mount the strand:

- make sure that the strand allows the movement of the moving part without any risk of damage to the cables.
- make sure that the cables are not subject to twisting or pulling. If necessary divide the strand to limit mechanical stresses.
- comply with the permissible radius of curvature.
- fasten the strand firmly on the fixed part (framework) as well as on the moving part (door, faceplate, panel, etc.).



Example



Routing between columns



Standards



Good practice

i Tip

You can interrupt a form to lay a trunking on condition that it is not possible to touch a live part with your hand or a tool.

1

There are two possible scenarios depending on the switchboard configuration:

- **limited number of columns and cables to connect:** it is preferable to connect the cables directly to the switchgear concerned. In this case, you have to protect conductors against risks of deterioration (strand protected by a polyester sleeve, cable tray or trunking),
- **large number of columns and cables to connect:** use terminal blocks to facilitate the installation and connection on site (faster and more reliable laying) and any maintenance operations.

In both cases:

- identify the cables with marks that are consistent with those of the switchboard to facilitate subsequent operations.



Example

Schneider Electric provides terminal blocks to be mounted on modular rails. They make it possible to connect cables of auxiliary circuits between two columns.

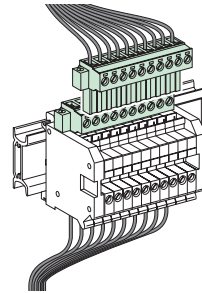

This type of terminal block can be disconnected. It enables fast connection and disconnection during maintenance.

2

For voltage collector power supply, choose an appropriate cable cross-section that will limit voltage drops (usually 6 mm²).

General rules



Standards



Good practice

1

Electrical connections must have absolute reliability to ensure that the switchboard is working properly.

A good quality connection means:

- a connection that is adapted to the cross-section of the conductor to connect,
- a conductor that has been stripped correctly,
- a crimping tool or machine that is in good condition and regularly calibrated,
- an operator qualified and trained for this operation,
- effective tightening.



Example

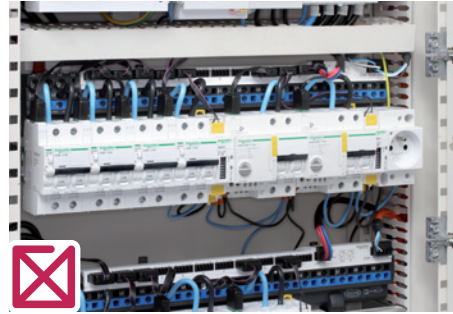

2

Cables must be formed (stripped, crimped) according to professional good practice, using appropriate equipment in good working condition that is correctly calibrated.



3

You may use different types of crimping connections:

- pre-insulated lugs,
- pre-insulated cable terminals,
- female clips,
- spade lugs.

4

Prefer the use of integrated connection accessories.

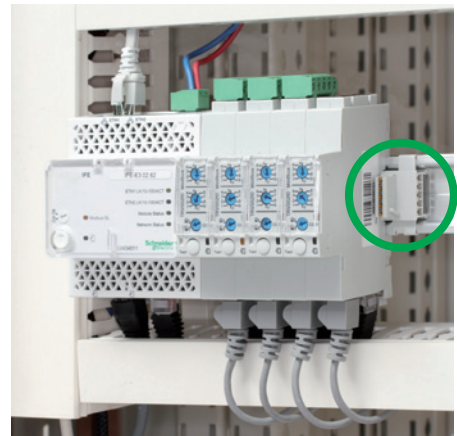

The stacker is used to connect the IFM without extra cable.

Connecting current transformers



Standards



Good practice

1

➤ The secondary circuit of a current transformer must never be open when the primary is energized.

High voltages may appear on the secondary circuit terminals. They present a hazard to persons and result in the deterioration of the transformer.

Observe the following recommendations to limit the risks of interrupting the transformer's secondary circuit:

- always connect the secondary circuit using round lugs,
- never use the terminal block to connect the secondary circuit.



Example

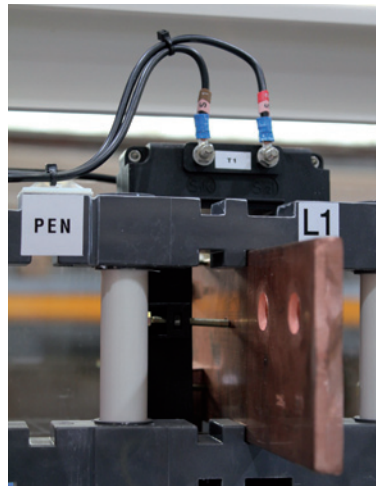

2

Place the current transformer as close as possible to the measuring device to avoid having cables that are too long.

Principle



Standards



Theory

1

The electromagnetic compatibility (EMC) of a switchboard is its ability to function in a disturbed environment while limiting its own disruptive emissions.

Electromagnetic disturbances are potential sources of malfunctioning for all electronic materials:

- regulators and measuring devices that deal with analogue signals,
- PLCs and communication interfaces that deal with digital signals.

Overall performance is obtained by:

- reducing disturbances at the source, which can also be from outside the switchboard,
- protecting information exchanged with the process throughout their routing in the switchboard,
- preserving the entry into the switchboard of radiated and conducted disturbances.

General rules



Standards



Good practice

1 The earthing mesh inside a switchboard is an essential parameter. All metal structures will be interconnected with an electric contact.

- Be careful of the various protective coatings, which are generally insulating.

IEC 61000-6-4

2 The communication switchgear installed must meet the requirements of the relevant immunity and emission standards.

- The wiring rules that follow are general ones. They do not replace the wiring guidelines given by the switchgear and controlgear manufacturer.

Example

Sensitivity of the various cable families

Family	Cables	Type of signal	EMC behaviour
1	Analogue	Power supply and measurement circuits of analogue sensors	Sensitive signals
2	Digital and Telecom	Digital circuits and data bus	These signals are sensitive. They are also disruptive for family 1
3	Relay	Dry-contact circuits with risks of re-priming	These signals are disruptive for families 1 and 2
4	Power supply	Power supply and power circuits	These signals are disruptive

Remark: a shielded cable is neither disruptive nor sensitive.

3 Use shielded cables or double shielded strands to protect circuits against radiated parasites. The metal armour must be earthed correctly. All free conductors in a cable (except for the analogue cable) must be systematically earthed at both ends.

Example

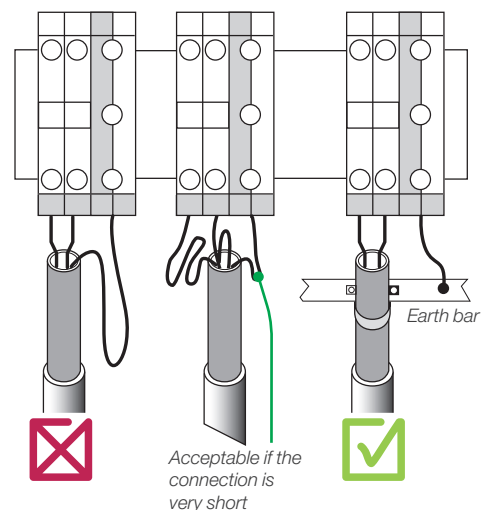

Earthing terminals with metal fastening system with modular rail.

Wiring rules



Standards



Good practice

1

General wiring recommendations

- Do not bend or damage the cables.
- Minimum bending radius: 10 x cable diameter.
- Avoid sharp angles of paths or passages of the cable.
- The connection of the shield of the cable must be as short as possible.
- Several shields can be connected together.
- Make a physical mark at the end of each cable.
- Identify the logical name and the address of each device.

Wiring must be in accordance with the following colours:

Wire type	Wire colour	
AC Power	Black	
Neutral	Light blue (RAL 5024)	
Control wire	24 V DC	Dark blue (RAL 5013)
	0 V DC	Gray (RAL 7001)
	24 V AC	Red
	0 V AC	Ivory (RAL 1015)
Earth	Green/Yellow	

2

Adjust the cable length to actual requirements. Cables must be as short as possible by avoiding the creation of loops that generate parasites currents resulting from magnetic fields.

Cables must be stripped as close as possible to the connection point.

➤ Example

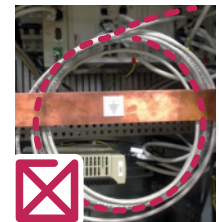
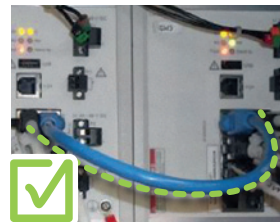

3

Avoid all earth loops: they are very sensitive to power magnetic fields.

➤ Example



Wiring rules



Standards



Good practice

4 Never position communication cables close to busbars or power cables.
- Use a flexible metal tubing.



1 Metallic tubing

- Secure the communication cable inside the metallic profile when possible, or stick it on metallic parts.

Example

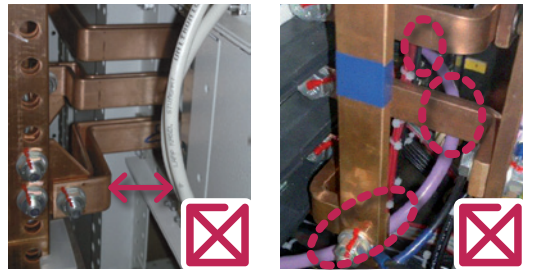
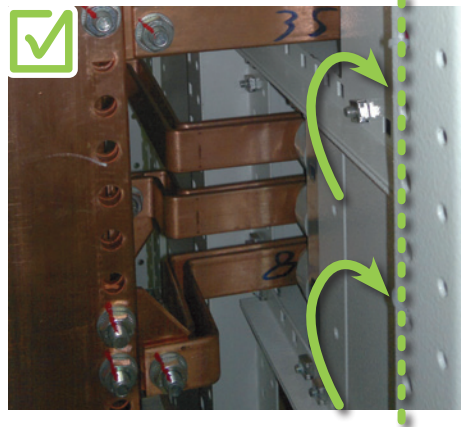

5

5 The presence of many earth structures in switchboards provides optimum protection. When routing to moving parts (doors, front plate), route the communication cable close to a hinge or earthing wire.

Example

Protective effect inside a switchboard:

- all the cables must be flattened against earthing structures,
- plastic cabling ducts can be used because they are installed on DIN rails connected to the switchboard earth.

Cables must be routed close to assembly points (hinges) or be doubled by an earthing wire.

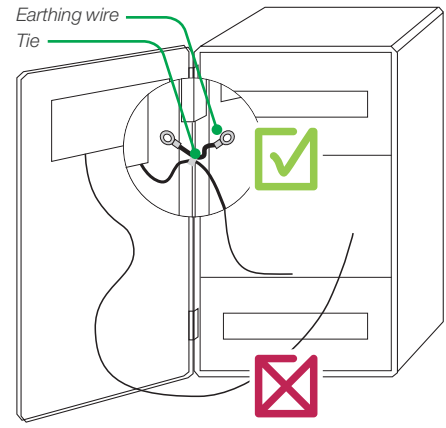

Wiring rules



Standards



Good practice

6 Divide the cables into three separate groups (power, command and communication) to let them be routed in separate paths. The routing of wires of groups 2 and 3 is tolerated in the same ducts. However, they should not be mixed in the same sheath or tightened into a single strand.

Example

To maintain the protective effect, we advise that you observe a ratio of the distance (d) between cables to the radius (R) of the largest cable of over 5.

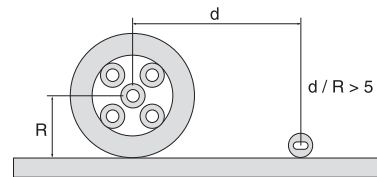

7 When communication cables have to cross over power cables (e.g. when drawer space is small), the angle between the two types of cables should be as close as possible to 90°.



- ① Power cable
- ② Communication cable
- ③ Right angle
- ④ Parallel cable routing (NOK)

8 The best possible path for a communication cable is as close as possible to an earthed plane, i.e. on the steel plates of cubicles.

Example

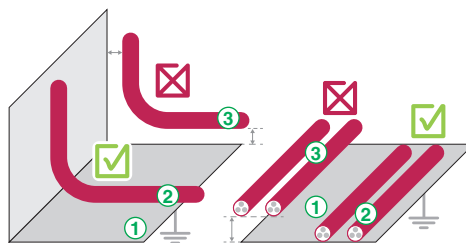

- ① Earthed metal plane
- ② Communication cable laid on the metal parts
- ③ Communication cable far from the metal parts (NOK)

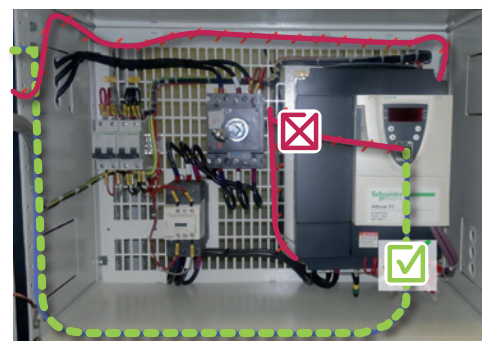
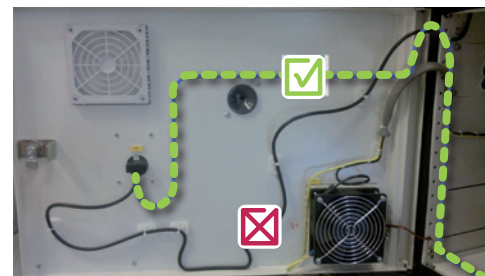

Screen continuity



Standards



Good practice

1

Do not use the connector pins to ensure screen continuity.

"Pig tails" are forbidden (very poor efficiency at high frequency).

Connect the cable screens directly on the metal plate:

- to reduce the common impedance,
- to divert disturbances directly to earth (outside the products).

Example

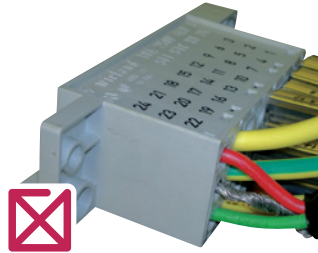

2

Earthing clip DIN rail mounted.

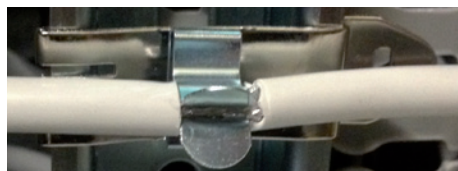

Screen continuity



Standards



Good practice

3

360° steel earthing clamp (do not use aluminium clamps).

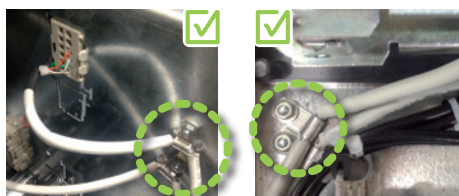

Clamp diameter shall be adapted to the cable screen diameter.

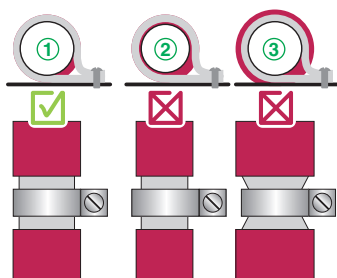

- ① Clamp adapted to screen diameter
- ② Clamp too large
- ③ Clamp too small.

4

Device with an open style connector



Add a heat shrink tubing at the screen cable end (to contain braid metallic particles).



5

Modbus tap earthing and bonding

Never let the tap isolated. Use an universal DIN rail fixing system.

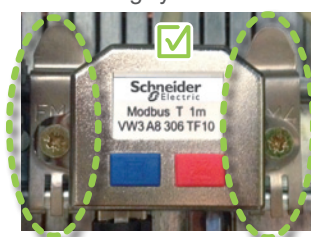

Earthing and bonding



Standards



Good practice

1

Electrical continuity

The electrical continuity between the drawer frame and the cubicle structure shall be obtained using the connector pins.

The connection length should be as short as possible.

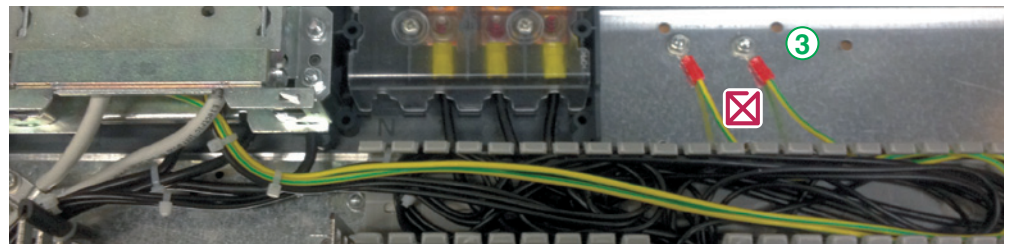
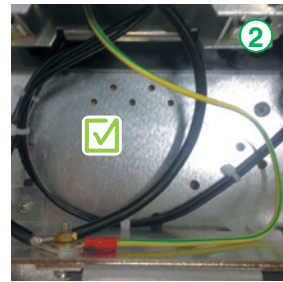
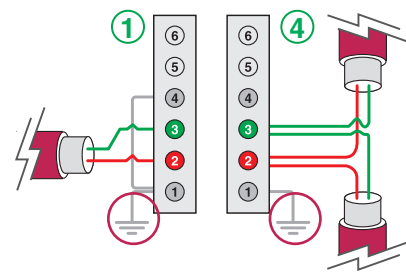

- ① Internal FU connector
- ② Connector earthing
- ③ Earthing connection too long
- ④ External FU connector
- ⑤ Earthing by a earth terminal DIN rail mounted.

2

Electromagnetic barrier

Connect together all the "earthing" contacts of the removable connector (= electromagnetic barrier) to the drawer earth.

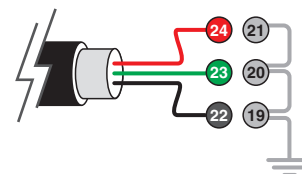
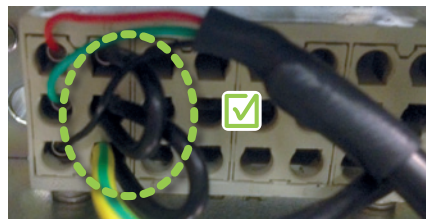

5

Relays and contactor coils disturbances



Standards



Good practice

1 AC and mostly DC coils relay, contactor, actuator could be very disturbing sources if no overvoltage protection is fitted in parallel with the coil.

- ① Coil relay
- ② U_n
- ③ Arcing voltage
- ④ NO arcing voltage
- ⑤ Transient Voltage Suppressor (TVS)

2 For DC and AC applications, the relay/contactor coils have to be protected to avoid significant disturbances. In this case, the energy stored inside the coil will be dissipated in the Transient Voltage Suppressor, as shown in the picture above on the right side.

Different types of Transient Voltage Suppressor (TVS) components could be used. The following table provides information.

Symbol	R-C network	For AC	For DC	Overtoltage limitation	Contact fall time
	R-C network	O	O	2 to 3 U_n	1 to 2 times the standard time
	Metal Oxide Varistor	O	O	< 3 U_n	1.1 to 1.5 times the standard time
	Transient Voltage Suppression Diode Bi directional	O	O	< 2 U_n	1.1 to 1.5 times the standard time

To be efficient, the TVS shall be installed closely to the coil.

Wiring of Ethernet network

Standards Good practice

Tip

Types:
 > FTP (Foil Twisted Pair): to forbid, risk of breakage if bended.
 > STP (Shielded Twisted Pair): suitable.
 > SFTP (Shielded Foil Twisted Pair): recommended.

1 Although there are 4 twisted pairs of wires, 10 Base-T / 100 Base-T Ethernet uses only 2 pairs: White/Orange (pins 1 & 2) and White/Green (pins 3 & 6).

As a minimum, an Ethernet line cable must be screened (overall braided screen) and screened also by a foil (SF/UTP).

There are different Ethernet topologies, they can be used separately or mixed.

Rules	Standard Ethernet
Maximum number of devices per network	No limits
Transmission rate	10/100 Mbit/s and 1 Gbit/s
Maximum length	Twisted pair 100 m - Multi-mode Fibre optic: 2 km - Mono-mode Fibre optic > 2 km
Cable type	Depends on the transmission rate

2 It is highly recommended to attach a communications wiring diagram in addition to the electrical wiring diagram.

Data to show in this diagram:

- network name and number of each link,
- name, address and location of the equipment,
- identified used ports for each switch,
- all the elements of the architecture (routers, switches, by-pass switch, etc.),
- cable length.

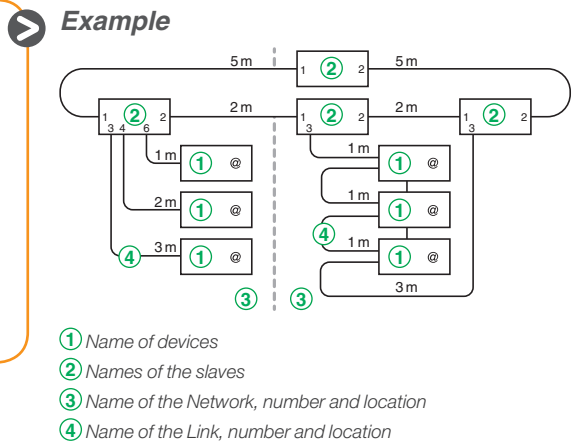

3 Detailed view of a good wiring

Use straight cable through connection in accordance with TIA/EIA-568-B (T568B) for the number of pins, number of pairs and color coding.

Pin N°	Pair N°	Color
1	1	White/Orange
2	1	Orange
3	2	White/Green
4 & 5	3	
6	2	Green
7 & 8	4	

Particular rules for Modbus RTU



Standards



Good practice

1 This chapter is dedicated to general rules on cable lengths, shielding, path and preparation to comply with EMC and communication specifications.

The Modbus RTU protocol (a.k.a. Modbus SL) is based on a Master-Slave concept. In the standard Modbus system, all the devices are connected to a main 3 wires cable. Two wires form a balanced twisted pair, on which bi-directional data are transmitted. The Modbus topology is a main cable with devices connected directly (daisy chaining) or by short derivation cables.

The main cable, a.k.a. "Bus", must be connected at its two extremities with Line Terminations. Generally speaking, the sum of all the derivation lengths must be lower than the length of the bus.

The "Common" circuit must be connected directly to protective ground, preferably at one point only for the entire bus. In general, this point is chosen either on the master device or on the polarization device.

A Modbus Serial Cable must be shielded. The shield must be connected to protective ground at both ends.

Rules	Standard Modbus RTU	Smart Panels
Maximum number of devices per bus	32 (without repeater)	8
Bus Speed	1200 bps to 115.2 Kbps	19.2 Kbps
Maximum bus length	1300 m (without repeaters) and depending on the transmission rate	1000 m
Maximum length of the sum of the derivations	Depends on the transmission rate	40 m
Cable type	TIA / EIA - 485 Standard	Ditto standard
Location of the terminations	Line termination at the 2 extremities of the bus (R or RC)	Line termination at the 2 extremities of the bus (Only R = 120 Ω)
Location of the polarization	The polarization is given by only one equipment at the beginning of the bus (in general: the master)	Ditto standard

2 It is highly recommended to attach a communications wiring diagram in addition to the electrical wiring diagram.

Data to show in this diagram:

- name, address and location of the equipment
- all the elements of the architecture (copper and fibre optic repeaters, coupling, bridges)
- Line Termination (LT)
- cable length.



Example

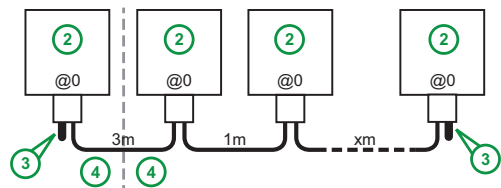

- ① Name of the master
- ② Names of the slaves
- ③ Line Termination
- ④ Name of the bus, number and location

Particular rules for Modbus RTU



Standards



Good practice

3 Detailed view of a good wiring

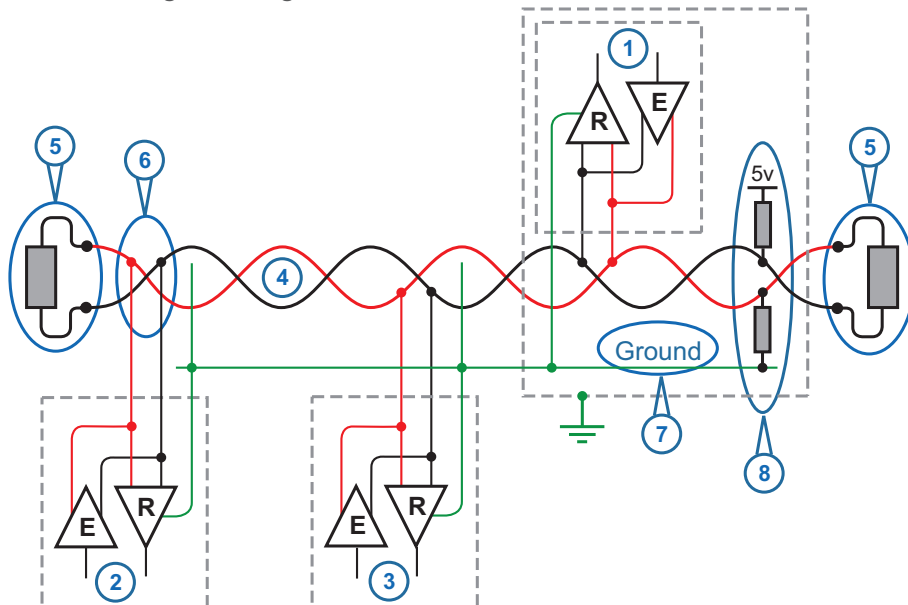

- ① Master
- ② Slave 1
- ③ Slave n
- ④ Balanced twisted pair
- ⑤ Line termination at the 2 extremities of the bus
- ⑥ Length of the main line > sum of slaves derivation lines
- ⑦ Ground signal to reference all the devices
- ⑧ Polarity resistor (generally integrated in the master)

4 General wiring recommendations

- Do not bend or damage the cables
- Minimum bending radius: 10 x cable diameter (about 75 mm in diameter)
- Avoid sharp angles of paths or passages of the cable
- The connection of the shield of the cable must be as short as possible
- Several shields can be connected together
- Make a physical mark at the end of each cable
- Identify the logical name and the logical address of each device
- Wiring must be in accordance with the following colours:

Wire type	Wire colour
AC POWER	BLACK
NEUTRAL	LIGHT BLUE (RAL 5024)
24 V DC control wire	DARK BLUE (RAL 5013)
0 V DC control wire	GRAY (RAL 7001)
24 V AC control wire	RED
0 V AC control wire	IVORY (RAL 1015)
Ground	GREEN / YELLOW

➤ Example



Architecture example for medium size building

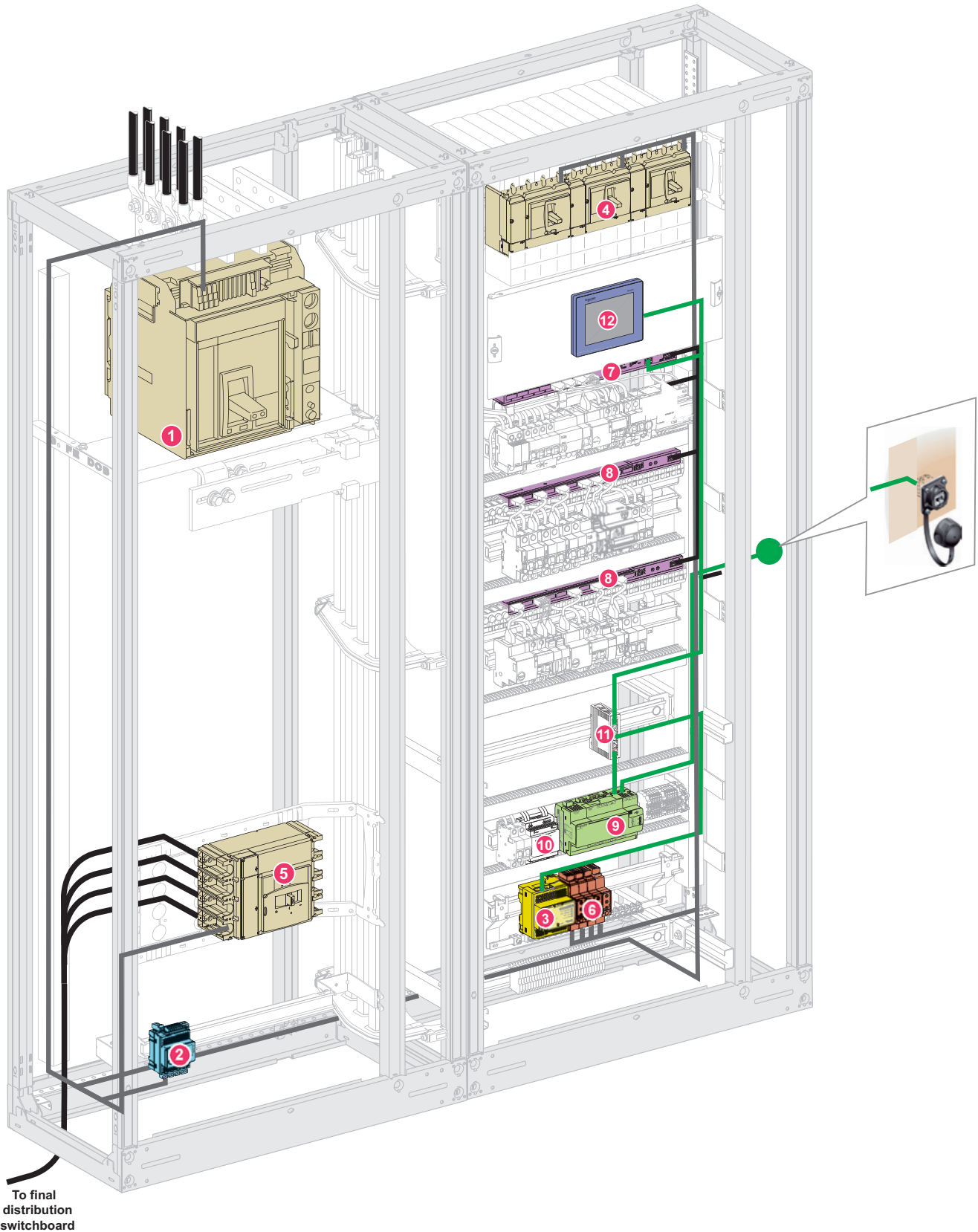

To final distribution switchboard

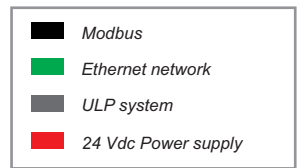
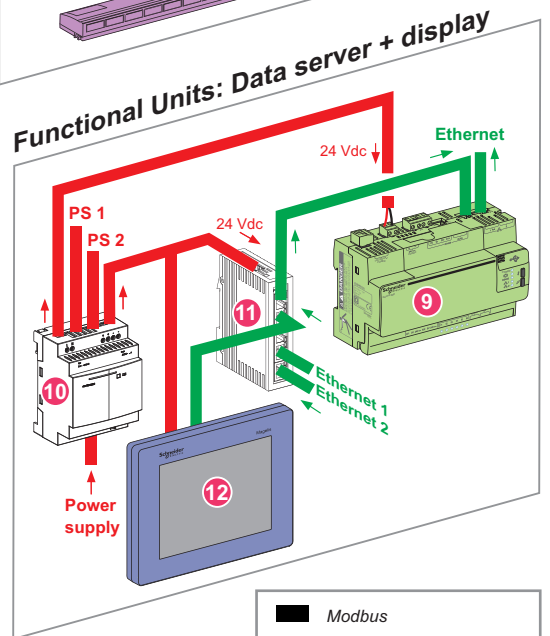
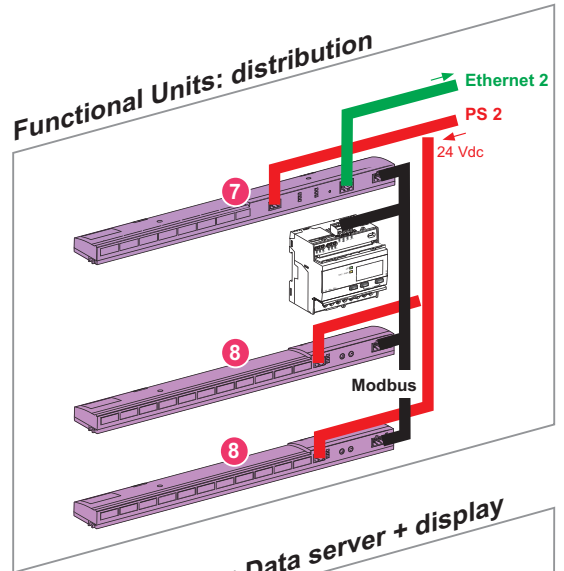
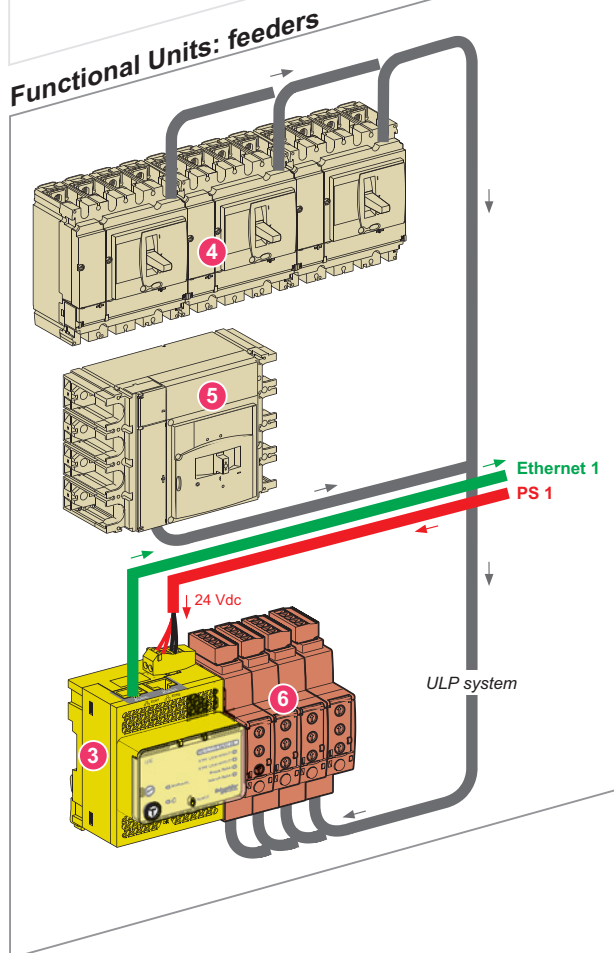
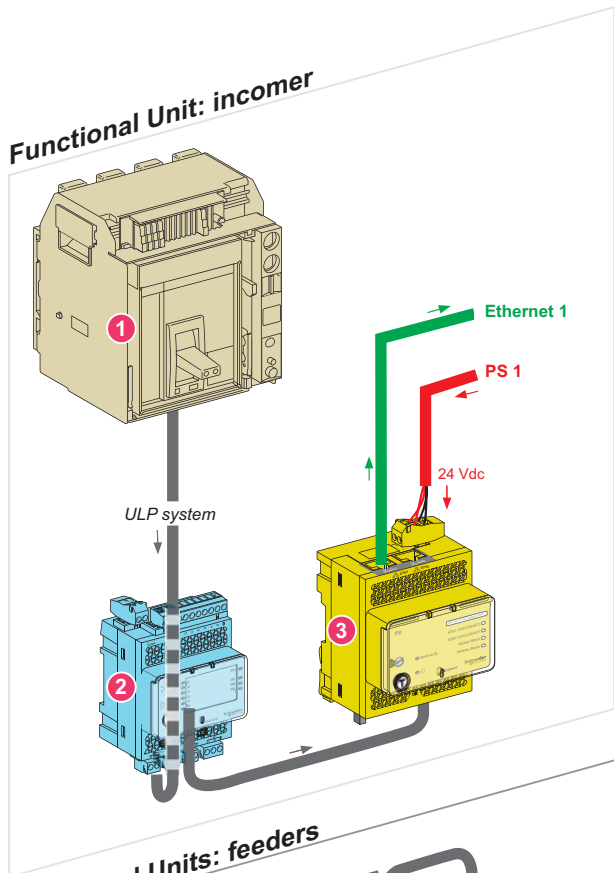

- 1 Compact NS1600 circuit breaker
- 2 I/O application module
- 3 IFE Ethernet interface module
- 4 Compact NSX250 circuit breaker
- 5 Compact NSX630 circuit breaker
- 6 IFM Modbus interface module
- 7 Acti9 Smartlink Ethernet
- 8 Acti9 Smartlink Modbus
- 9 Com'X200: Energy server
- 10 24 Vdc Power supply
- 11 Switch Ethernet
- 12 FDM128 Switchboard display unit

Architecture example for small size building

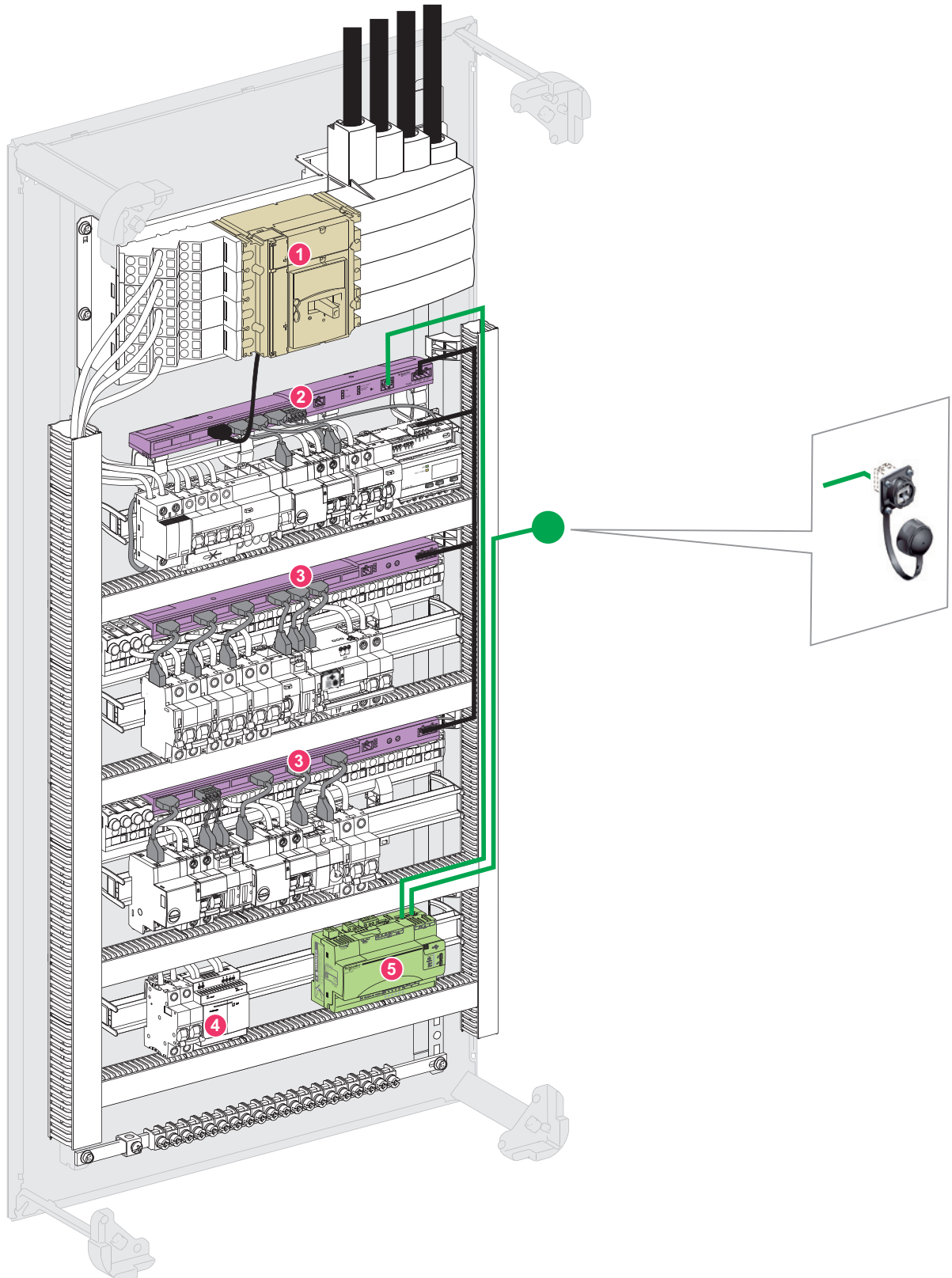

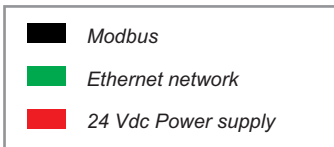
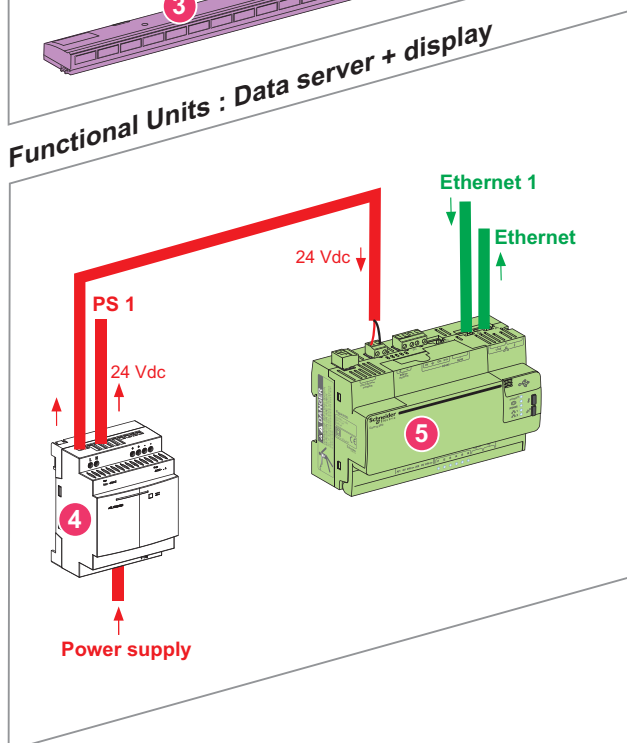
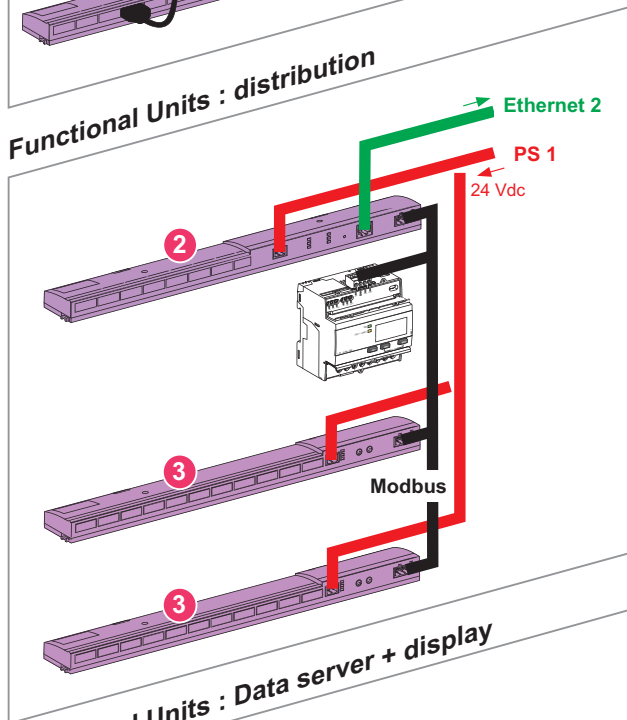
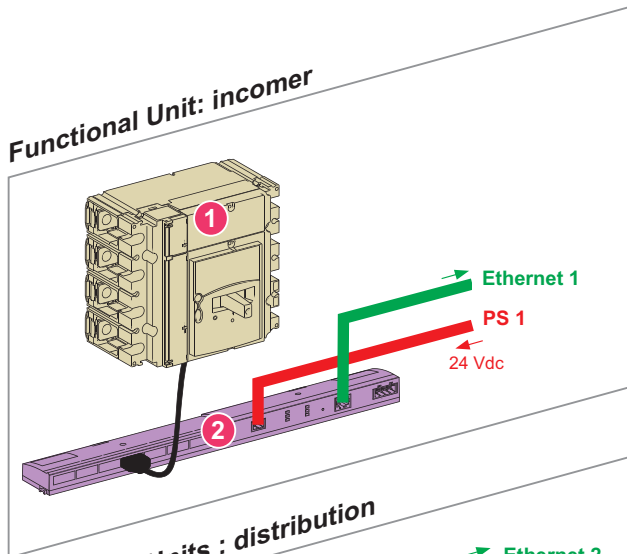



- 1 Compact NS1600 circuit breaker
- 2 Acti9 Smartlink Ethernet
- 3 Acti9 Smartlink Modbus
- 4 24 Vdc Power supply
- 5 Com'X200: Energy server

Note: the list of control points presented is not exhaustive.

It lists the minimum checks required and may be completed depending on the organisation in the workshop and/or recurrences of defects encountered.

 Minimum checks required	 Control resources	 Self-control
	> Compliance of wiring installation	> Installation guide <input type="checkbox"/>
<input checked="" type="checkbox"/>	> Crimping quality	> Installation guide <input type="checkbox"/>
<input checked="" type="checkbox"/>	> Compliance of communication cable installation	> Installation guide <input type="checkbox"/>
<input checked="" type="checkbox"/>	> Wiring cross-section and characteristics	> Customer requirements, installation guide <input type="checkbox"/>
<input checked="" type="checkbox"/>	> Modbus addressing	> Installation guide <input type="checkbox"/>
<input checked="" type="checkbox"/>	> Device connection	> Test button on ULP <input type="checkbox"/>
<input checked="" type="checkbox"/>	> Earthing continuity	> Installation guide <input type="checkbox"/>
<input checked="" type="checkbox"/>	> Communication of devices	> Internet browser <input type="checkbox"/>

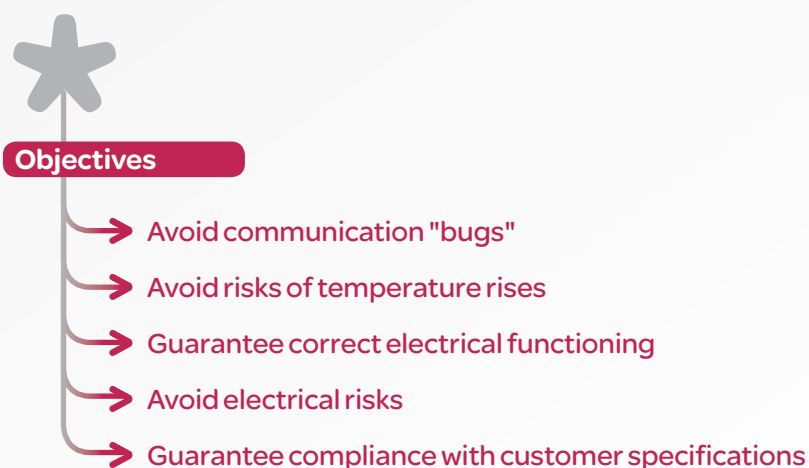



Communication system test

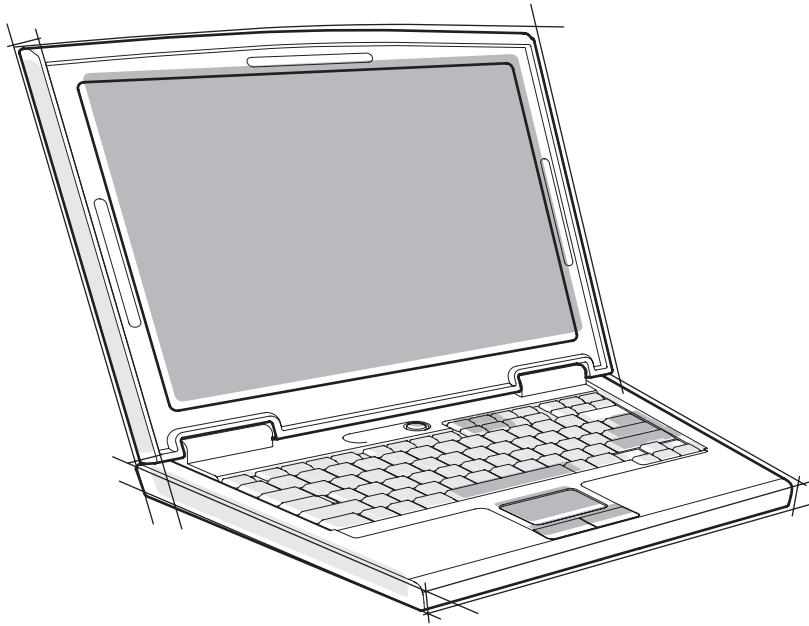

Configuration



Standards



Theory

1

The configuration and the check are carried out with configuration software tools or through devices' web pages based on the 2 configurations Prisma G and Prisma P. To go further on commissioning recommendation a specific guide is available: "TVDA - How can I configure a Smart Panels", see reference document list.

Smart Panels system can be configured thanks to:

- Software configuration tool (Acti 9 Smart Test, RSU)
- Device web pages.

Enerlin'X devices have web pages that allow an easy configuration of the system. However configuration tool may be useful for some advanced setting (protection setting, automatic check report...)

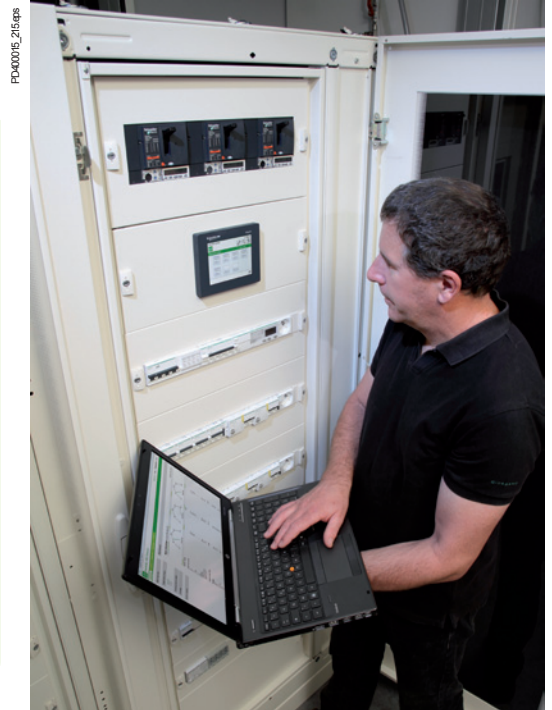

Ethernet discovery



Standards



Good practice

1

Enerlin'X devices provide an automatic discovery and identification over Ethernet network. This feature is called device profile for web services (DPWS) and is available by Windows 7. Connect your computer to your Smart Panels Ethernet network or individually to each device. Open the windows explorer:

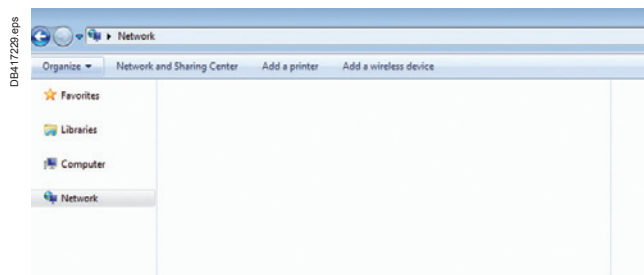

By clicking on network, connected devices appear automatically:

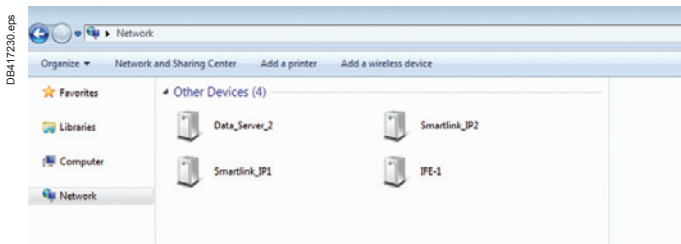

Then click on each devices to access it own web pages.

Note: connection via routers is forbidden for DPWS feature.

Hardware configuration



Standards



Theory

1

Acti 9 Smartlink Modbus

Ti24 connector

11 input/output channels

- Pin 1: 0 V
- Pin 2: I1 Input 1
- Pin 3: I2 Input 2
- Pin 4: Q Output
- Pin 5: +24 V DC

Modbus slave cabling

RS485 Modbus

- Pin 1: D1 Modbus
- Pin 2: D0 Modbus
- Pin 3: shielding
- Pin 4: common/0 V

Modbus slave addressing

with Thumbwheels (Modbus address must be unique)



Example



2

Acti 9 Smartlink Ethernet

Ti24 connector

7 input/output channels

- Pin 1: 0 V
- Pin 2: I1 Input 1
- Pin 3: I2 Input 2
- Pin 4: Q Output
- Pin 5: +24 V DC

Ethernet Cabling

100 base T – 1* RJ45

Modbus master cabling

RS485 Modbus

- Pin 1: D1 Modbus
- Pin 2: D0 Modbus
- Pin 3: shielding
- Pin 4: common/0 V



Example



Software configuration - Acti 9 Smart Test software



Standards



Good practice

This part details the Smartlink configuration and check that can be carried out either by Acti 9 Smart Test software or by web pages of Acti 9 Smartlink Ethernet. Smartlink devices must be connected correctly and all addressing are correct.

1

Launch Smart test and create your project:

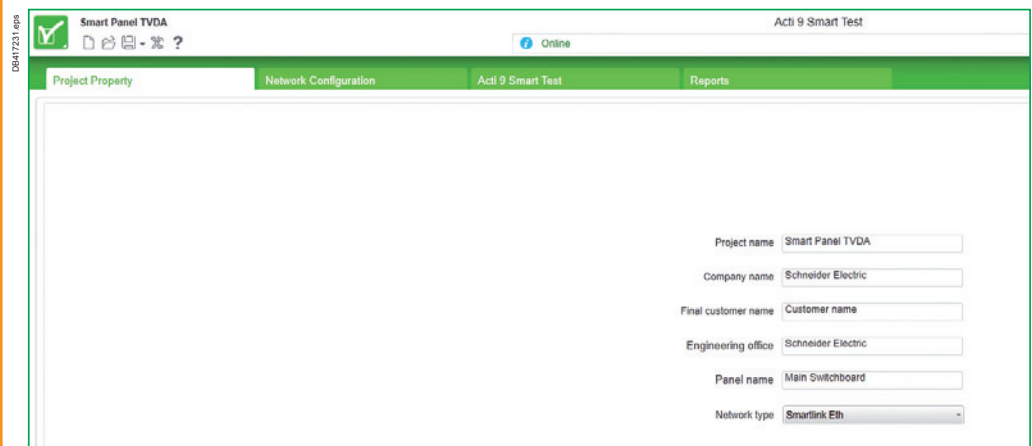

2

Network configuration

Go to "Online" mode and click on the icon to discover Acti 9 Smartlink Ethernet device (Ethernet DPWS feature).

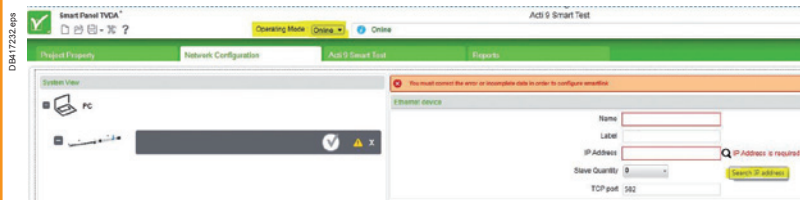

Connected Acti 9 Smartlink Ethernet appears automatically. Then identity of the master and of each slave must be declared:

Acti 9 Smartlink Ethernet (Modbus master): IP address, label, number of slaves,

Acti 9 Smartlink Modbus (Slave): Modbus address, label,

other Modbus (Slave): Modbus address, label: iEM3150 in our case.

The following illustration shows the expected configuration:

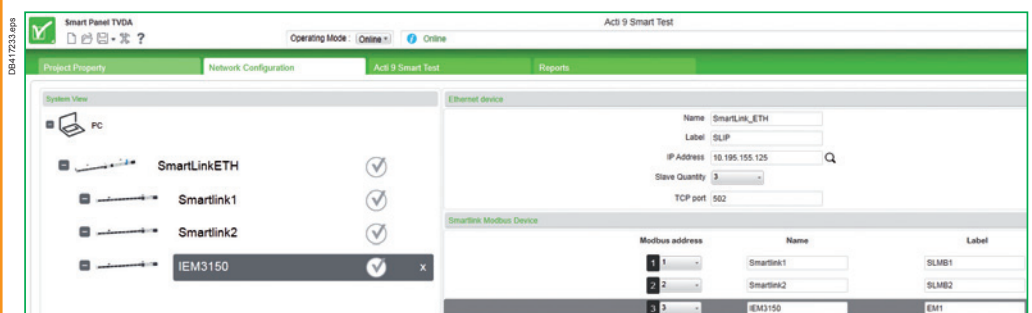

Software configuration - Acti 9 Smart Test software

Standards Good practice

3 Acti 9 Smart Test

The aim here is to carry out the association of Acti 9 connected devices and corresponding channel.

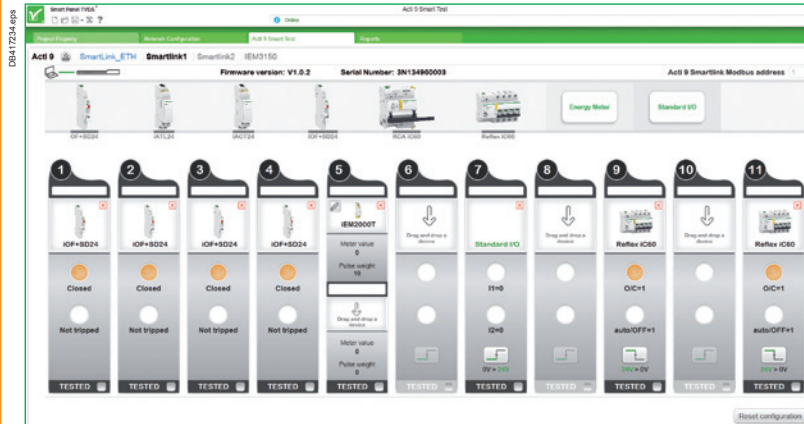

By drag and drop, associate the corresponding devices to each channel. Repeat this step for all the Acti 9 Smartlink devices.

4 Test report

Both communication and functional aspects of each Smartlink can be tested with the software. A report is automatically generated **which could be used as a contractual document in a project.**

Control test

For each channel which can be controlled (i.e. connected to a relay), the user makes the software generate an ON – OFF signal to the output. The result can be physically observed, and recorded in the Test report.

Monitoring test

For each channel which can be monitored (i.e. connected to a circuit breaker), the user activates open/close/trip on the circuit breaker. The result is displayed on the Test page and recorded in the Test report.

Example of test report

Ready to be saved or printed:

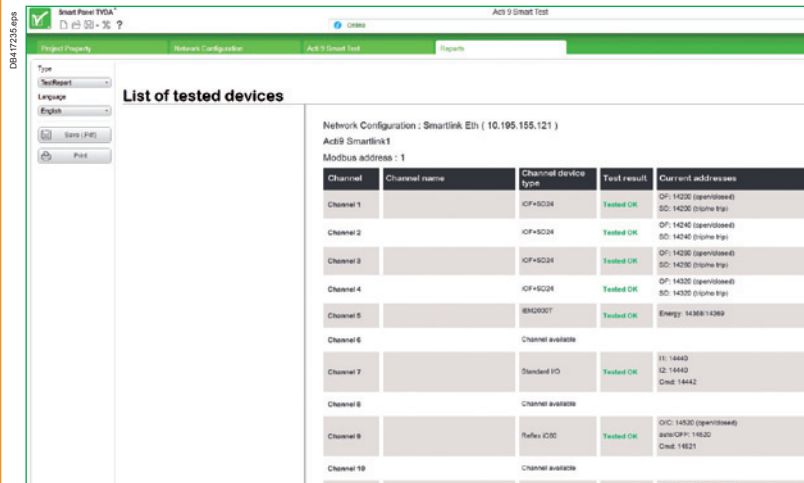

Software configuration - Web pages



Standards



Good practice

The same configuration process can be done from Acti 9 Smartlink Ethernet web pages.

1

Acti 9 Smartlink Ethernet web pages access

From Ethernet discovery feature (DPWS) open the Acti 9 Smartlink Ethernet web pages by clicking on Acti9_XXYYZZ and enter login and password to access the web pages:

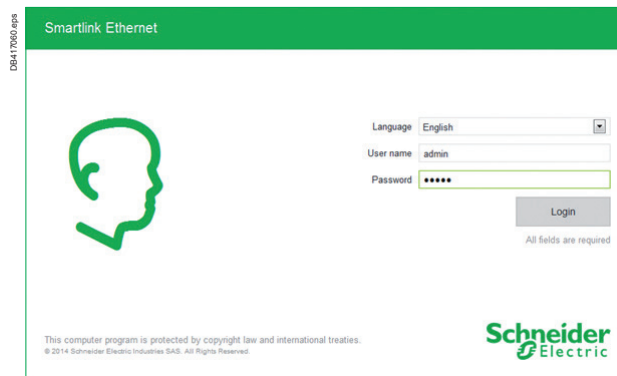

2

Network configuration

Fill all general and communication parameters of setting menu: Name, IP addressing, label.

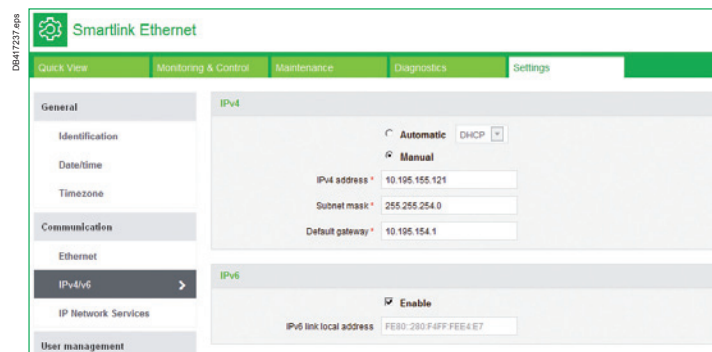

Then configure the Modbus slave devices: Name, Modbus addressing, label.

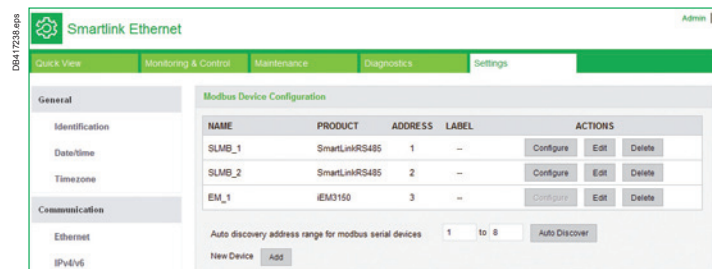

Modbus autodiscovery feature is available.

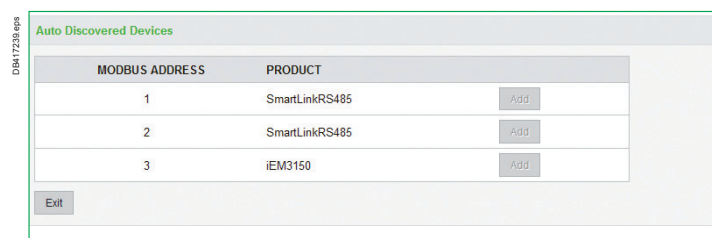

6

Software configuration - Web pages

Standards Good practice

3 Channel association

The aim here is to carry out the association of Acti 9 connected devices and corresponding channel. For each devices and each channel complete the device association.

ID	Device Name	Product	Status	Action
4	iC60_4	iOF+SD24	--	Yes Edit Delete
5	iEMT 2010_1	iEM2000T	--	Yes Edit Delete
9	Reflex_1	Reflex iC60	--	Yes Edit Delete
10	iEMT 2010_2	iEM2000T	--	Yes Edit Delete
11	Reflex_2	Reflex iC60	--	Yes Edit Delete

Edit Channel Settings

Name *

Label

Product *

Channel *

Quick View

* Required field

4 Test report

Both communication and functional aspects of each Acti 9 Smartlink can be checked with the web pages. A print screen is used to create a report:

Smartlink Ethernet

Quick View | Monitoring & Control | Maintenance | **Diagnostics** | Settings

General

Date/time

Communication

Ethernet

IP Network Services

Switchboard Architecture

Communication Products

Auxiliary Devices

NAME	STATUS	PRODUCT	PROTOCOL
Smartlink_IP1	Ok	Smartlink Ethernet	Modbus TCP
SLMB_1	Ok	SmartLinkRS485	Modbus Serial
SLMB_2	Ok	SmartLinkRS485	Modbus Serial
EM_1	Ok	iEM3150	Modbus Serial

Configuration of IFM



Standards



Good practice

1

Modbus addressing

Modbus addressing must be set with the two rotary switches symbolized with **X1** and **X10**. The symbol **X10** corresponds to the tens, and the symbol **X1** to the ones.



Example

To set the Modbus address to 4, proceed as follows:

IFM rotary switch:

- set the X10 switch to 0,
- set the X1 switch to 4,
- turn the padlock switch to the unlocked position.



2

ULP connection

The aim is to check the ULP system connection between IFM and circuit breaker, thanks to "ULP test button". Press the test button on IFM and check that IFM and associated Micrologic trip unit flash simultaneously (ON: 1000 ms/OFF: 1000 ms).



Example

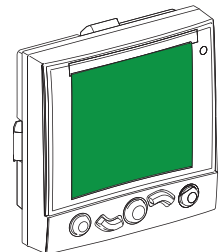
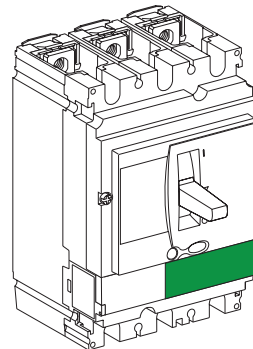
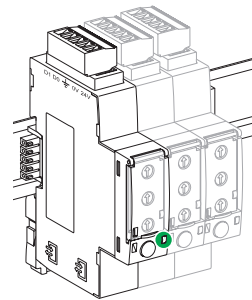

6

Hardware configuration - Configuration of IFE



Standards



Good practice

1

ULP connection

All connection configurations require the breaker ULP cord. The insulated NSX cord is mandatory for system voltages greater than 480 V \sim . When the second ULP RJ45 connector is not used, it must be closed with a ULP terminator.

The next step is to check the ULP system connection between IFE, I/O application module and circuit breaker, thanks to "ULP test button". Press the test button on IFE and check that IFE, I/O application module and associated Micrologic trip unit flash simultaneously (ON: 1000 ms/OFF: 1000 ms).



Example

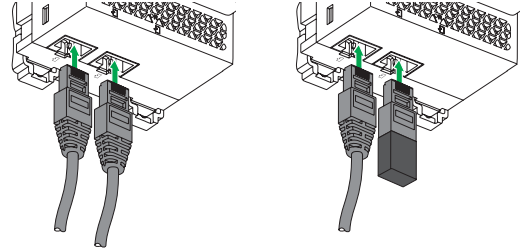

2

Ethernet connection

- IFE has two Ethernet ports E1 and E2.
- Ethernet Cabling,
100 base T – 2* RJ45 – E1 and E2
- Ethernet 1 and Ethernet 2 ports act as a non manageable switch.

Note: IFE doesn't support redundant Ethernet protocol (RSTP, MRP, Hyper Ring...).

IFE provides Ethernet daisy chain connection.

If daisy chain loop is requested an Ethernet loop manager must be used.

⚠ Be careful with ULP and Ethernet connection that use both RJ45 connector type. ULP system supply the 24 V DC to all connected devices so serious damage can occur in case of bad connection.

Software configuration - Configuration of IFE



Standards



Good practice

This part details the IFE configuration and test that is carried out by web pages. IFE device must be connected correctly and all addressing are correct.

1

IFE Ethernet web pages access

From Ethernet discovery feature (DPWS) open the IFE Ethernet web pages by clicking on IFE_XXYYZZ and enter login and password to access the web pages.



Example

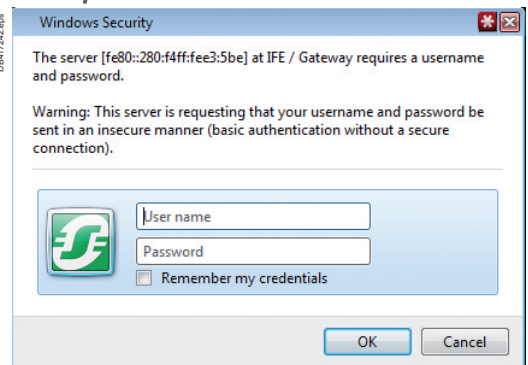

2

Ethernet network configuration

Fill all general and communication parameters of Setup menu: Name, IP addressing, Label.

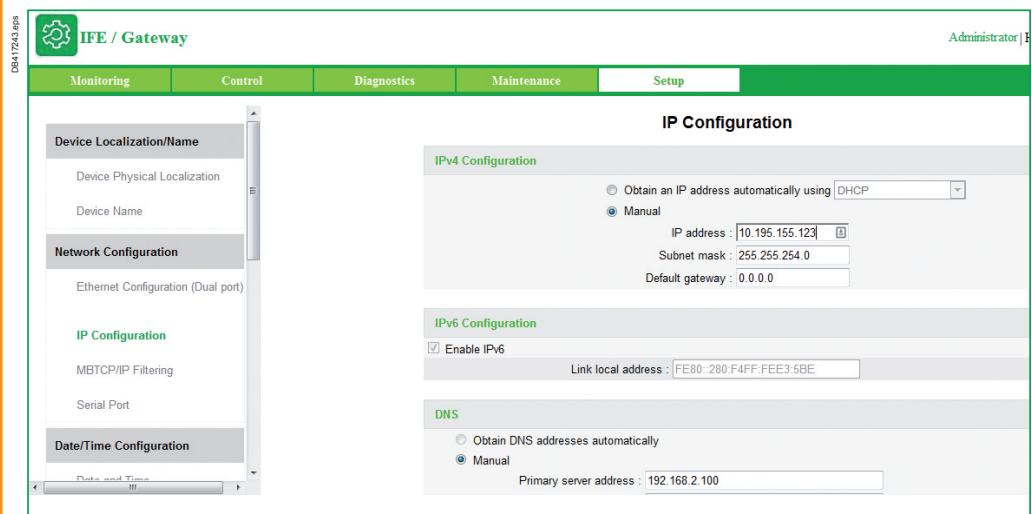

6

Software configuration - Configuration of IFE

Standards Good practice

3 Modbus configuration

Then configure the Modbus slave devices: Name, Modbus addressing.
The IFE provides an autodiscovery feature of connected Modbus serial slave devices.

The screenshot shows the 'Setup' tab of the IFE / Gateway configuration interface. A table lists the configured Modbus slave devices with the following data:

Serial Port	Device Type	Device Name	Address
ULP	Micrologic P	IFE_1	255
Serial Port	Compact NSX-E	IFM_1	1
Serial Port	Compact NSX-E	IFM_2	2
Serial Port	Compact NSX-E	IFM_3	3
Serial Port	Compact NSX-E	IFM_4	4
Serial Port	Modbus		
Serial Port	Modbus		
Serial Port	Modbus		
Serial Port	Modbus		
Serial Port	Modbus		
Serial Port	Modbus		
Serial Port	Modbus		
Serial Port	Modbus		

Buttons for 'Discover' and 'Apply' are visible at the bottom of the configuration area.

4 Test report

Both communication and functional aspects (Open/Close status and Open/Close control) can be tested with the web pages. A print screen of the web page can be used to create a report:

The screenshot shows the 'Diagnostics' tab of the IFE / Gateway configuration interface. A table titled 'Communications Check' displays the status of the configured devices:

Device	Device Type	Connection	Comms	Status
IFE_1	Micrologic P	ULP	----	----
IFM_1	Compact NSX-E	Serial Port	----	----
IFM_2	Compact NSX-E	Serial Port	----	----
IFM_3	Compact NSX-E	Serial Port	----	----
IFM_4	Compact NSX-E	Serial Port	----	----

A 'Check Device Status' button is located below the table.

Hardware configuration - I/O application module



Standards



Good practice

1

I/O application module identification setting

Two I/O application modules can be used for the same breaker connected on the ULP system (I/O application module 1 or I/O application module 2)

When two I/O application modules are connected in the same ULP network, the two I/O application modules are differentiated by the position of the switch located on the bottom of the I/O application module.



Example



Dip switch on position 1 for I/O application module 1 (factory setting).

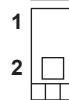

Dip switch on position 2 for I/O application module 2.

2

I/O application module predefined application

The application rotary switch enables the selection of a predefined application. It has 9 positions and each position is assigned to a predefined application.



Example

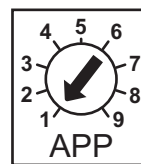

The factory-set position of the switch is predefined as application 1.

Application rotary switch position	Predefined application	Description
1	Cradle management	Monitors the position of the circuit breaker in the cradle
2	Circuit breaker operation	Controls the opening and closing of the circuit breaker by using the control mode (local or remote) and the close inhibit order
3	Cradle management and Energy Reduction Maintenance Setting (ERMS)	Monitors the position of inputs and controls the ERMS mode of the circuit breaker
4	Light and load control	Controls the light and load application.
5-8	Spare	Future evolution
9	Custom	Performs the user-defined applications with the I/O application module

Software configuration - I/O application module



Standards



Good practice

This part details the I/O application module check in the IFE web pages. IFE device and I/O application module must be connected correctly and all addressing are correct.

1

I/O application module test

Access to the monitoring web page of the IFE associated with the I/O application module:



The screenshot shows the 'IFE / Gateway' monitoring interface. The top navigation bar includes 'Monitoring', 'Control', 'Diagnostics', 'Maintenance', and 'Setup'. The 'Monitoring' section is active, displaying 'Real Time Data' for Reactive Energy (kVARh) and Apparent Energy (kVAh), both at 0. Below this, the 'Single Device Pages' section lists 'IFE_1' and its sub-modules 'IFM_1' through 'IFM_4'. The 'IO Readings' section is expanded to show 'IO Module 1' details. This section is divided into 'Inputs' and 'Outputs'.

Label	Value	Force/Unforce	Unit
Inputs			
Digital Input 1	Cradle connected position contact(CE)	0	UNFORCED
Digital Input 2	Cradle disconnected position contact(CD)	1	UNFORCED
Digital Input 3	Cradle test position contact(CT)	1	UNFORCED
Digital Input 4		0	UNFORCED
Digital Input 5		0	UNFORCED
Digital Input 6		0	UNFORCED
Outputs			
Digital Output 1		0	UNFORCED
Digital Output 2		0	UNFORCED
Digital Output 3		0	UNFORCED
Analog Inputs			
PT100			°C

A print screen of the web page can be used to create a report on the I/O application module correct installation.



Note: the list of control points presented is not exhaustive.

It lists the minimum checks required and may be completed depending on the organisation in the workshop and/or recurrences of defects encountered.

Minimum checks required			
	Control points	Control resources	Self-control
<input checked="" type="checkbox"/>	> Modbus addressing	> Installation guide	<input type="checkbox"/>
<input checked="" type="checkbox"/>	> Device connection	> Test button on ULP	<input type="checkbox"/>
<input checked="" type="checkbox"/>	> Earthing continuity	> Installation guide	<input type="checkbox"/>
<input checked="" type="checkbox"/>	> Communication of devices	> Internet browser	<input type="checkbox"/>



Objectives

-  Verify access to each communication devices
-  Verify the global health of the system
-  Provide a test report



Factory quality inspection

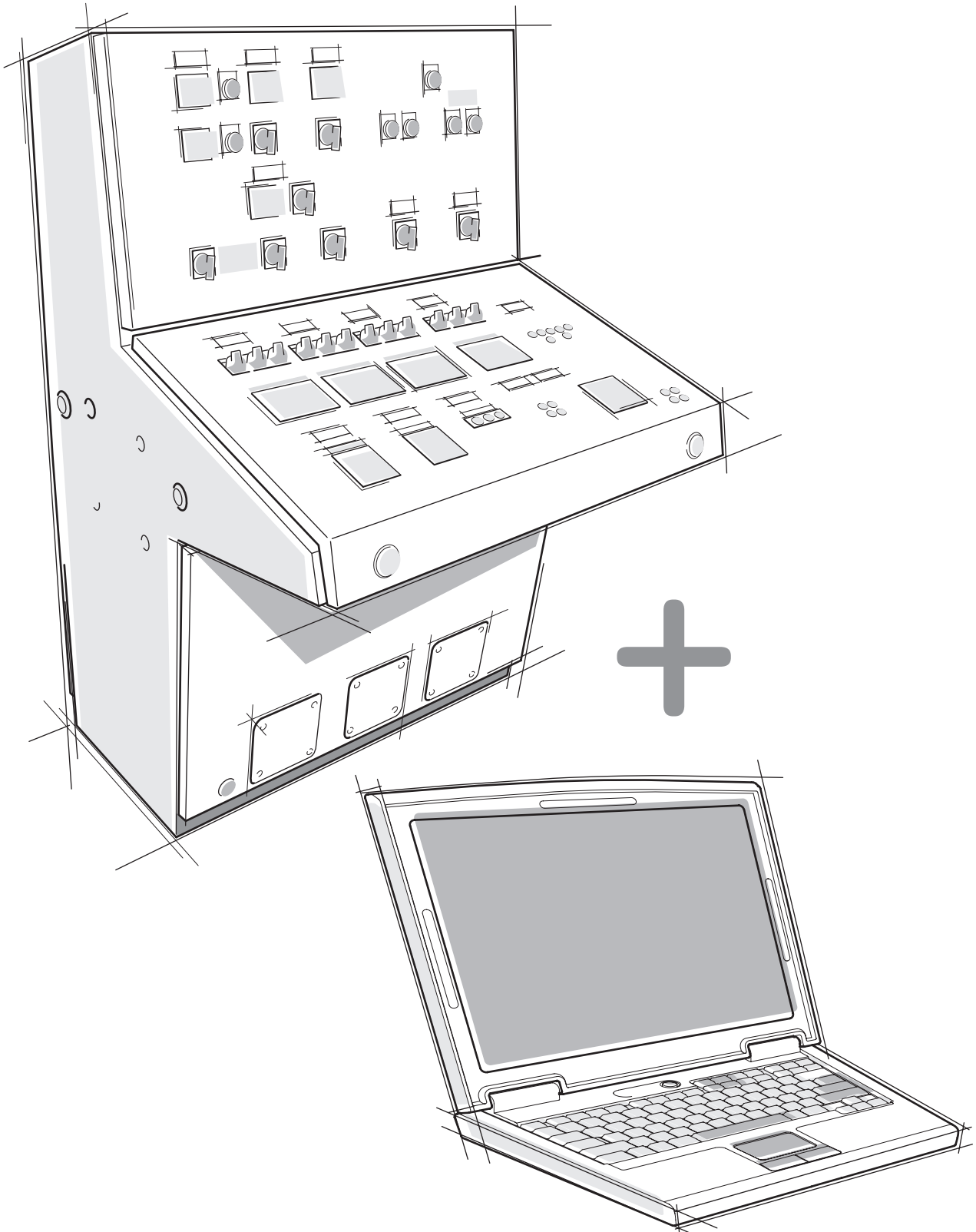

What does the standard IEC 61439-1 say about quality inspections

Routine verification

Routine verification is designed to detect materials and manufacturing defects and to ensure that the manufactured assembly is working properly. It is performed on each assembly.

Panelbuilders must determine whether routine is carried out during and/or after manufacturing.

If necessary, the routine verification must ensure that design verification is available.

Verification comprises two categories below:

1 "Construction" verifications (see sections 11.2 to 11.8 of the standard)

- 1 Degree of protection of enclosures
- 2 Clearances and creepage distances
- 3 Protection against electric shock and integrity of protective circuits
- 4 Incorporation of built-in components
- 5 Internal electrical circuits and connections
- 6 Terminals for external conductors
- 7 Mechanical operation

2 "Performance" verifications (see sections 11.9 to 11.10 of the standard)

- 1 Dielectric properties
- 2 Wiring, operational performance and function

What is the risk if the quality inspection is not conducted (during and/or after manufacturing)?

- Quality organisation does not comply with standard
- Customer not satisfied
- Hazardous installation
- Negative impact on the image of the panelbuilder and manufacturer
- Higher costs of intervention
- Operating loss (break in service continuity)
- Financial loss

Organise quality checks

Organise quality checks (self-checks) throughout the switchboard assembly and installation process, from acceptance of components until the delivery of the switchboard (see quality control check list opposite).



Benefits

- Increased accountability of operators
- Improved traceability
- Optimisation of installation rules
E.g. busbar tightening must be checked at the end of manufacturing (involves the dismantling of sheets, resulting in a significant loss of time).

Conduct a final quality inspection

In a secured area dedicated for this purpose (in particular during electrical checks).

Note: the final quality inspection must be performed by qualified and authorised personnel.



Documents required for the final inspection

- Check lists of quality checks (self-checks) conducted throughout the switchboard assembly and installation process
- Final inspection report
(See example provided in the guide on page 87)
Note: to be completed depending on the customer's specifications and requirements.
- Other useful documents: notification of non-compliance, check list of missing components, quality measurements
- Manufacturing file
- Switchgear guide
- Technical documentation

➤ To find out more about the final quality inspection, see the "Quality inspection guide" written by our experts.

Check list of checks to be made during the final quality inspection

Make sure that self-checks have been performed throughout the assembly and installation process or validated (e.g. by the line controller).

 Control points	 Control resources	 Final control
Compliance checks		
<ul style="list-style-type: none"> > Identification & column numbers > Type > Dimensions > Compliance of front panel, block diagram > Handling devices 	<ul style="list-style-type: none"> > Assembly drawing file > Customer specifications 	<input checked="" type="checkbox"/>
Visual checks		
<ul style="list-style-type: none"> > Paint (colour, homogeneity, finishing) > No scratches and deformations 	<ul style="list-style-type: none"> > Visual inspection 	<input checked="" type="checkbox"/>
Frame, structure		
<ul style="list-style-type: none"> > Functioning of doors, swivelling front panels > Locks (type, functioning) > IP degree of protection 	<ul style="list-style-type: none"> > Operating test > Specifications, visual inspection > Visual Inspection, technical guide 	<input checked="" type="checkbox"/>
Switchgear		
<ul style="list-style-type: none"> > Position > Fastening > Characteristics: nominal range, breaking capacity > Identification and marking > Safety perimeter > Mechanical operation > Mechanical indication (test position, connected, etc.) > Plugging-in and withdrawing procedure > Striker pin > Accessibility of switchgear > Ability to connect on terminals or pads > Accessibility for connection > Locking, foolproofing 	<ul style="list-style-type: none"> > Visual inspection > Visual inspection > Specifications, visual inspection > Specifications, visual inspection > Technical guide > Operating test > Operating test > Operating test > Operating test > Visual inspection > Visual inspection > Visual inspection > Visual inspection 	<input checked="" type="checkbox"/>
Busbars		
<ul style="list-style-type: none"> > Busbar cross-section > Coating and internal arc device > Busbar support (fastening device and number) > Marking > Compliance of joint blocks 	<ul style="list-style-type: none"> > Technical guide > Customer drawings and specifications file > Technical guide > Customer drawings and specifications file > Technical guide 	<input checked="" type="checkbox"/>
Cables & flexible bars		
<ul style="list-style-type: none"> > Cross-section and characteristics of conductors > Compliance of installation mode (fastening, sharp edges, etc.) > Auxiliary Power separation > EMC protection 	<ul style="list-style-type: none"> > Technical guide > Technical guide > Assembly and installation guide and communication guide > Assembly and installation guide and communication guide 	<input checked="" type="checkbox"/>
Connection		
<ul style="list-style-type: none"> > Compliance and quality of bolted connections (e.g. covering and fastener type) > Torque and marking > Crimping quality 	<ul style="list-style-type: none"> > Technical guide 	<input checked="" type="checkbox"/>
Protection of persons		
<ul style="list-style-type: none"> > Earth bar (cross-section and fastening) > Earthing braids > Forms > Bonding continuity > IP of measuring devices (fastened on doors) > Blanking shutters > Terminal guards and covers > Fastening of protective barriers 	<ul style="list-style-type: none"> > Technical guide and assembly technical guide 	<input checked="" type="checkbox"/>
Safety distances		
<ul style="list-style-type: none"> > Clearance > Creepage distances 	<ul style="list-style-type: none"> > Assembly and installation guide and visual inspection > Installation and assembly guide 	<input checked="" type="checkbox"/>
Dielectric check (power circuit)		
	<ul style="list-style-type: none"> > Insulation tester 	<input checked="" type="checkbox"/>

Please photocopy the check list before completing it



Check list of checks to be made during the final quality inspection

Control points	Control resources	Final control
Insulation check (power circuit)		
	> Megohmmeter	☑
Electrical compliance		
<ul style="list-style-type: none"> > Phase order > Voltages, control polarities > Distribution of polarities (inter-column connections) Functional tests: <ul style="list-style-type: none"> > Operating sequence (controls and signalling) > Checking of source transfer > Electrical and mechanical inter-locking > Checking of opening/closing orders of units > Trip tests (defects) > Information report (OF-SDE-SD) > Signalling (indicator lights, etc.) > Injection on protection and measurements (values, etc.) Measurement and protection: <ul style="list-style-type: none"> > Protection tests (fault tripping, etc.) > Injection on measuring devices (Pa, PWH, etc.) > CT winding direction Device settings (circuit monitors, protections, etc.) Automation and communication: <ul style="list-style-type: none"> > Equipment addressing > Network tests (read/write) > Verification of PLC inputs/outputs > Validation of the PLC (according to functional specifications) 	<ul style="list-style-type: none"> > Phasing test > Electric tests, voltmeter > Electric tests, voltmeter > Test consoles, injection test bench, etc. > Electric tests > Technical documentation > Customer specifications 	☑
Cleaning and preparation of columns		
<ul style="list-style-type: none"> > Functioning of doors, swivelling front panels > Locks (type, functioning) > IP degree of protection 		
Documentation related to switchboard		
<ul style="list-style-type: none"> > Switchboard building drawings > Installation and maintenance documents > Switchgear guides > List of shortages 		
Packaging		
<ul style="list-style-type: none"> > Compliance of the package Packing list > Compliance of packaging 	<ul style="list-style-type: none"> > Packing list > Compliance of packaging Contract terms 	



Objectives

- ➔ Avoid having to repeat the process from the beginning
- ➔ Meet the customer's specifications to the letter
- ➔ Provide a product of high quality, without defect, from the design phase to delivery

Model form "Routine verification - Testing report"

Manufacturer of the assembly:

Address:

Original Manufacturer:

Routine verification - checking report

Customer: Report No:

Project: Customer ref.:

Switchboard identification: Project ref.:

Equipment: Rev. Index:

Quantity:

Drawing No:

Checking program

Routine verification checks are carried out in compliance with the Std. IEC 61439-2

1. Construction Done

a. degree of protection of enclosures V

b. clearances and creepage distances V

c. protection against electric shock and integrity of protective circuits V & T

if electrical control indicate meter reference Ohm Value

d. incorporation of built-in components V

e. internal electrical circuits and connections V & T

f. terminals for external conductors V

g. mechanical operation T

V: visual
T: test

2. Performance

a. dielectric properties T

Meter Ref.

Circuits		Main circuits	Auxiliaries
Rated insulation voltage Ui	V		
Dielectric check voltage	V		

Option: up to 250 A, dielectric check can be replaced by insulating checks under 500 V:

Circuit		Main circuits	Auxiliaries
Applied voltage			
Insulation value			

b. wiring, operational performance and function T

Comments:

Having passed the above checks, the LV switchgear assembly under consideration is in compliance with the Std. IEC 61439-2 (IEC/EN 61439-2).

Customer representative	Quality inspector	Quality manager
Date	Date	Visa
Visa	Visa

Please photocopy the check list before completing it



Appendices



Foreword



Standards



Theory

IEC 60529
and IEC 62262

1

Enclosures must protect equipment against environmental risks and persons against accidental contact with a powered equipment part.



Example



2

The characteristics of the room in which the switchboard will be installed make it possible to:

- define an IK degree of protection,
- define an IP degree of protection,
- choose an appropriate switchboard type (kit, switchboard for critical applications, universal enclosure, etc.).

> Refer to the technical data of each type of table.

IK degree of protection



Standards



Theory

IEC 62262

1

International standard IEC 62262 defines an IK protection code as the ability of enclosures to resist external mechanical impacts on their entire surface.

IP degree of protection

Standards

Theory

IEC 60529

1 The IP code is made up of two characteristic digits:

- the first digit characterizes the protection of persons and equipment against the ingress of foreign solid bodies,
- the second digit characterizes protection against the ingress of water with harmful effects.

To improve the effective protection of persons against access to hazardous parts, the IP code may be completed by an additional letter.

This letter defines a higher protection than the one specified by the first digit of the IP code.

Example



Over and above existing rules, standards and recommendations, Schneider Electric recommends the use of IP/IK switchboards based on the French guide UTE C15-103 depending on applications (see the product catalogue).

2 The IP code must always be read and understood digit by digit and not as a whole.

1st digit		2nd digit		Additional letter
Protection of persons		Protection against the penetration of solid particles		
0	No protection	0	No protection	A Protected against access with the back of the hand
1	Protected against access with the back of the hand	1	Protected against solid bodies larger than 50 mm	B Protected against access with a finger of Ø 12 mm
2	Protected against access with a finger	2	Protected against solid bodies larger than 12.5 mm	C Protected against access with a tool of Ø 2.5 mm
3	Protected against access with a tool	3	Protected against solid bodies larger than 2.5 mm	D Protected against access with a wire of Ø 1 mm
4	Protected against access with a wire	4	Protected against solid bodies larger than 1 mm	
5	Protected against access with a wire	5	Protected against dust (no harmful deposit)	
6	Protected against access with a wire	6	Fully protected against dust	
		7	Protected against the effects of temporary immersion	
		8	Protected against the effects of continuous immersion	

3 When only personnel protection is worth mentioning, the two characteristic digits of the IP code are replaced by the letter X (example, IPXXB).



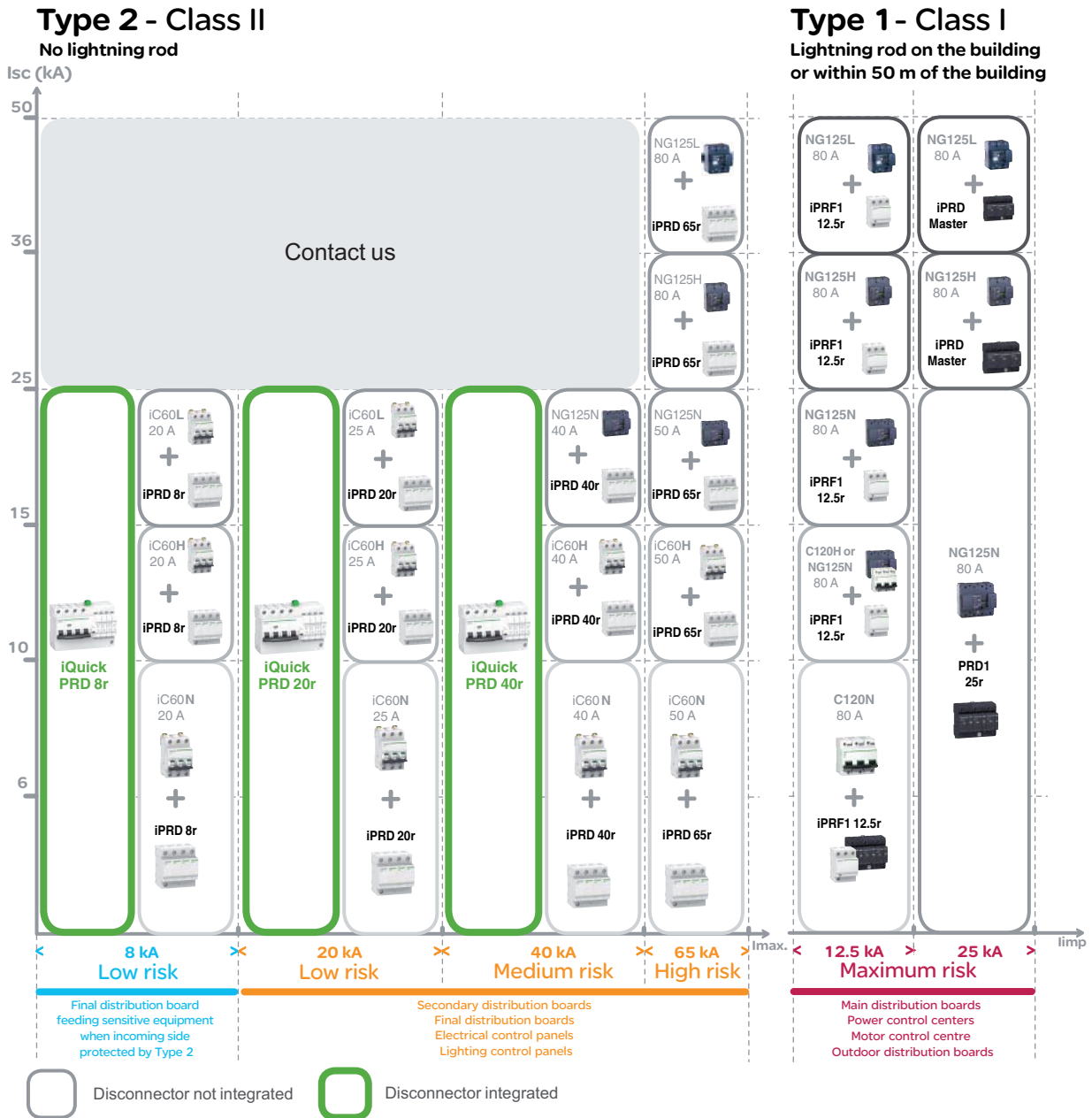



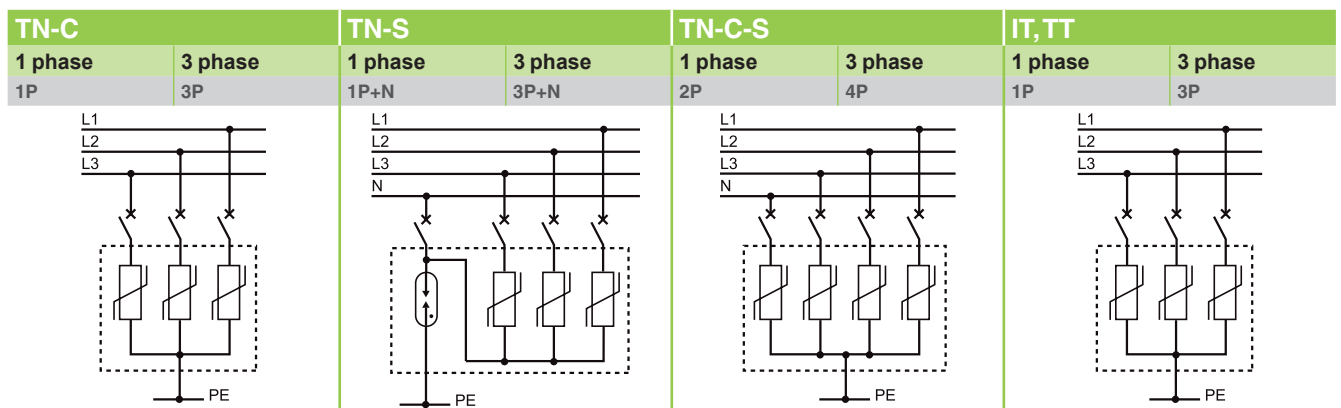

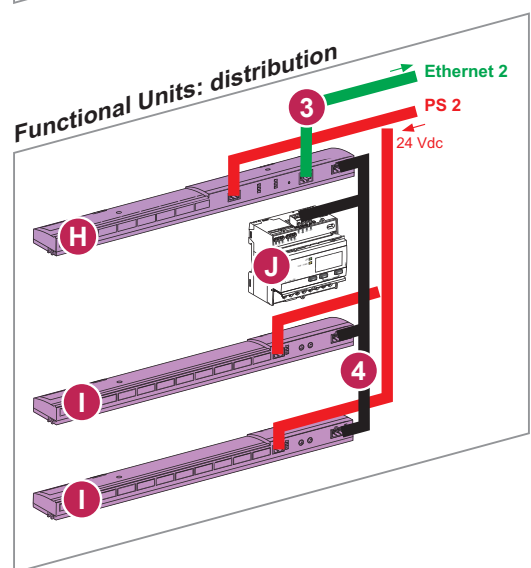
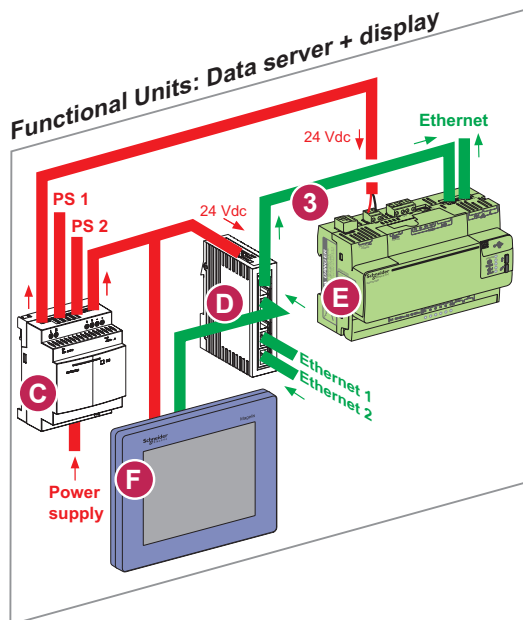
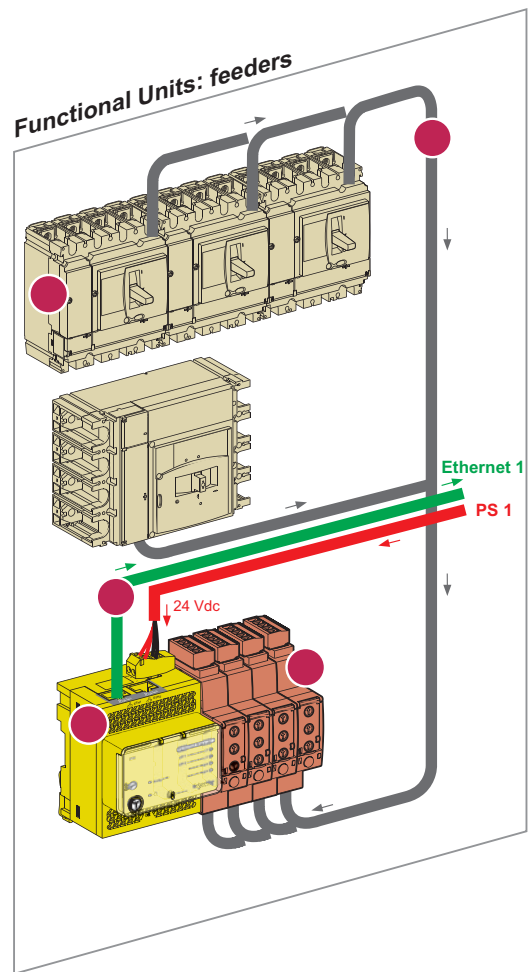
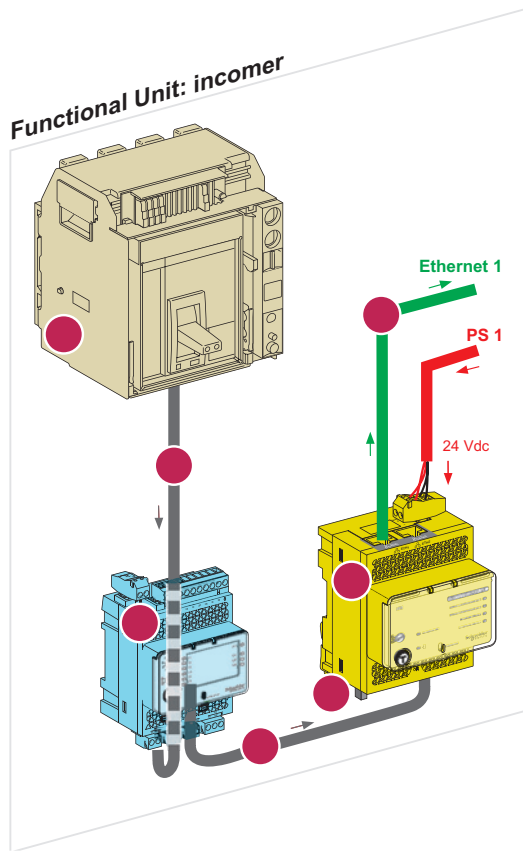
Selection of SPD and coordinated back-up protection

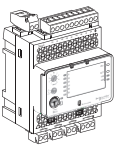
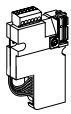
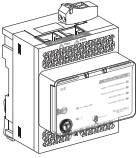
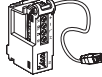

Selection of SPD number of poles basing on earthing system

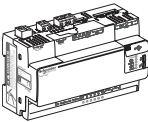

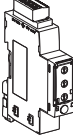

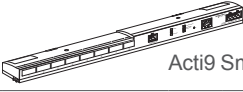
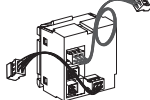
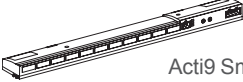
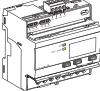
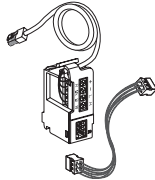
Description		Reference	Description		Reference
A	 I/O application module	LV434063	1	 Communicating device with BCM (Breaker Control Module) Internal terminal block	33106 33119
B	 IFE Ethernet interface for LV breaker	LV434010	2	 ULP cord, shielded cable	L = 0.35 m LV434195
	Ethernet interface for LV breakers and gateway	LV434011			L = 1.3 m LV434196
					L = 3 m LV434197
C	 24 Vdc Power supply Class B product recommended	ABL7RM24025	3	 Ethernet cable RJ45: ■ 10-100 mb ■ Length 100 m max ■ Cable RJ45, Category 6 SFTP, recommended	L = 1 m VDIP184546010
					L = 0.5 m VDIP184546005
D	 Switch Ethernet	TCS ESU 053SN0	4	 Modbus cable: ■ shielded twisted pair ■ RS485 standard + Power Supply ■ a roll of cable RS485, 4 wires (2 x RS485 + 2 power supply) with a length of 60 m	50965
E	 Com'X 200: Energy server	EBX200			
F	 Switchboard front display module FDM128	LV434128	5	 10 ULP line terminators	TRV00880
G	 IFM Modbus-SL interface module Stacker (set of 10)	TRV00210	6	 ULP cable, shielded cable	L = 0.3 m TRV00803
					L = 0.6 m TRV00806
					L = 1 m TRV00810
					L = 2 m TRV00820
					L = 3 m TRV00830
TRV00217		 5 RJ45 connectors female/female	TRV00870		
H	 Acti9 Smartlink Ethernet	A9MEA08	7	 Communicating device with BSCM (Breaker Status & Control Module)	LV434205
I	 Acti9 Smartlink Modbus	A9XMSB11			
J	 IEM3150	A9MEM3150	8	 NSX cord shielded cable	L = 0.35 m LV434200
					L = 1.3 m LV434201
					L = 3 m LV434202

Make the most of your energy™

www.schneider-electric.com

Schneider Electric Industries SAS

35, rue Joseph Monier
CS 30323
F- 92506 Rueil Malmaison Cedex
France

RCS Nanterre 954 503 439
Capital social 896 313 776 €
www.schneider-electric.com

*As standards, specifications and designs change
from time to time, please ask for confirmation of the
information given in this publication.*

Publishing: Schneider Electric Industries SAS
Photos: Schneider Electric Industries SAS



*This document has been
printed on ecological paper.*