

PacT Series

ComPacT NSX Circuit Breakers and Switch-Disconnectors 100-630 A

User Guide

PacT Series offers world-class breakers and switches

DOCA0187EN-00
01/2021



Legal Information

The Schneider Electric brand and any trademarks of Schneider Electric SE and its subsidiaries referred to in this guide are the property of Schneider Electric SE or its subsidiaries. All other brands may be trademarks of their respective owners.

This guide and its content are protected under applicable copyright laws and furnished for informational use only. No part of this guide may be reproduced or transmitted in any form or by any means (electronic, mechanical, photocopying, recording, or otherwise), for any purpose, without the prior written permission of Schneider Electric.

Schneider Electric does not grant any right or license for commercial use of the guide or its content, except for a non-exclusive and personal license to consult it on an "as is" basis. Schneider Electric products and equipment should be installed, operated, serviced, and maintained only by qualified personnel.

As standards, specifications, and designs change from time to time, information contained in this guide may be subject to change without notice.

To the extent permitted by applicable law, no responsibility or liability is assumed by Schneider Electric and its subsidiaries for any errors or omissions in the informational content of this material or consequences arising out of or resulting from the use of the information contained herein.

Table of Contents

Safety Information.....	7
About the Book.....	9
ComPacT NSX Circuit Breakers.....	10
ComPacT NSX Circuit Breaker Presentation	11
PacT Series Master Range.....	12
ComPacT NSX Range	13
Operating the Circuit Breaker.....	20
EcoStruxure Power Commission Software	22
De-Energizing the Circuit Breaker	23
Environmental Conditions.....	26
Circuit Breaker With Toggle Handle.....	29
Front Face Description	30
Opening, Closing, and Resetting the Circuit Breaker.....	31
Testing the Circuit Breaker.....	33
Locking the Circuit Breaker.....	35
Circuit Breaker With Rotary Handle.....	37
Front Face Description	38
Opening, Closing, and Resetting the Circuit Breaker.....	40
Testing a Circuit Breaker With Direct Rotary Handle	42
Locking a Circuit Breaker With Direct Rotary Handle.....	44
Testing a Circuit Breaker With Extended Rotary Handle	47
Locking a Circuit Breaker With Extended Rotary Handle	49
Motor-Operated Circuit Breakers	52
Front Face Description	53
Opening, Closing, and Resetting a Circuit Breaker With Motor Mechanism.....	55
Opening, Closing, and Resetting Circuit Breakers With Communicating Motor Mechanism	58
Locking the Circuit Breaker.....	59
ComPacT NSX Installation Accessories	61
Plug-in Circuit Breaker	62
Withdrawable Circuit Breaker	66
Accessories	73
ComPacT NSX Electrical Auxiliary and Accessory Devices	75
Electrical Auxiliary Device Summary	76
Indication Contacts	81
Wireless Indication Auxiliary	83
SDx Module	87
SDTAM Module (MicroLogic 2 M and 6 E-M).....	90
24 Vdc Power Supply Connector	93
BSCM Breaker Status Control Module.....	94
NSX Cord	98
Insulated NSX Cord	100
Control Auxiliaries.....	102
PowerTag Energy M250/M630.....	104
ComPacT NSX Trip Units	108
Fault Currents and Trip Units.....	109

Applications.....	110
Fault Currents in Electrical Distribution	111
Protection Against Overcurrents in Electrical Distribution	112
Protection Against Ground Faults.....	114
Protection for Motor-Feeders	116
TM-D, TM-G Thermal-Magnetic and MA Magnetic Trip Units	119
Thermal-Magnetic Trip Unit Summary	120
TM-D Thermal-Magnetic Trip Unit for 1P and 2P Circuit Breakers	123
TM-D Thermal-Magnetic Trip Unit for 1P Circuit Breakers 250 A	124
TM-D Thermal-Magnetic Trip Unit for 3P and 4P Circuit Breakers up to 63 A	125
TM-D Thermal-Magnetic Trip Unit for 3P and 4P Circuit Breakers from 80 A to 250 A	127
TM-G Thermal-Magnetic Trip Unit	130
MA Magnetic Trip Unit	132
Earth-Leakage Protection by VigiPacT Add-on.....	134
MicroLogic Electronic Trip Units.....	139
Characteristics of MicroLogic Electronic Trip Units.....	140
MicroLogic 2 Electronic Trip Units	146
MicroLogic 4 Electronic Trip Units	150
MicroLogic 1.3 M Electronic Trip Unit.....	156
MicroLogic 2 M Electronic Trip Unit	158
MicroLogic 2 G Electronic Trip Unit.....	161
MicroLogic 2 AB and 4 AB Electronic Trip Units.....	163
Maintenance Interfaces for MicroLogic Trip Units.....	165
MicroLogic Maintenance Interfaces.....	166
Pocket Battery.....	168
Stand-Alone USB Maintenance Interface.....	170
USB Maintenance Interface Connected to a PC	174
ComPacT NSX Circuit Breakers Operation	177
Commissioning	178
Maintaining the Circuit Breaker During Operation	185
Responding to a Trip.....	188
Troubleshooting	191
Appendices	193
Wiring Diagrams.....	194
Fixed Circuit Breakers	195
Plug-in / Withdrawable Circuit Breakers	198
Motor Mechanism	202
SDx Module With MicroLogic 2, 4, 5, 6, and 7 Trip Unit	204
SDTAM Module With MicroLogic 2-M or 6-M Trip Unit.....	206
Additional Characteristics	208
ComPacT NSX100-250 - Distribution Protection Tripping Curves	209
ComPacT NSX100-250 - Motor-Feeder Protection Tripping Curves	215
ComPacT NSX400-630 - Distribution Protection Tripping Curves	216

ComPacT NSX400-630 - Motor-Feeder Protection Tripping	
Curves	217
ComPacT NSX100-630 - Reflex Tripping	218
ComPacT NSX100-630 - Limitation Curves	219
Index	223

Safety Information

What's in This Part

Important Information

Read these instructions carefully, and look at the equipment to become familiar with the device before trying to install, operate, service, or maintain it. The following special messages may appear throughout this documentation or on the equipment to warn of potential hazards or to call attention to information that clarifies or simplifies a procedure.



The addition of this symbol to a "Danger" or "Warning" safety label indicates that an electrical hazard exists which will result in personal injury if the instructions are not followed.



This is the safety alert symbol. It is used to alert you to potential personal injury hazards. Obey all safety messages that follow this symbol to avoid possible injury or death.

DANGER

DANGER indicates a hazardous situation which, if not avoided, **will result in** death or serious injury.

WARNING

WARNING indicates a hazardous situation which, if not avoided, **could result in** death or serious injury.

CAUTION

CAUTION indicates a hazardous situation which, if not avoided, **could result in** minor or moderate injury.

NOTICE

NOTICE is used to address practices not related to physical injury.

Please Note

Electrical equipment should be installed, operated, serviced, and maintained only by qualified personnel. No responsibility is assumed by Schneider Electric for any consequences arising out of the use of this material.

A qualified person is one who has skills and knowledge related to the construction and operation of electrical equipment and its installation, and has received safety training to recognize and avoid the hazards involved.

CYBERSECURITY SAFETY NOTICE

⚠ WARNING

POTENTIAL COMPROMISE OF SYSTEM AVAILABILITY, INTEGRITY, AND CONFIDENTIALITY

- Change default passwords at first use to help prevent unauthorized access to device settings, controls, and information.
- Disable unused ports/services and default accounts to help minimize pathways for malicious attackers.
- Place networked devices behind multiple layers of cyber defenses (such as firewalls, network segmentation, and network intrusion detection and protection).
- Use cybersecurity best practices (for example, least privilege, separation of duties) to help prevent unauthorized exposure, loss, modification of data and logs, or interruption of services.

Failure to follow these instructions can result in death, serious injury, or equipment damage.

About the Book

Document Scope

The aim of this guide is to provide users, installers and maintenance personnel with the technical information needed to operate ComPacT NSX circuit breakers and switch-disconnectors in compliance with the IEC/EN standards.

Validity Note

This guide applies to ComPacT NSX circuit breakers and switch-disconnectors.

Online Information

The information contained in this guide is likely to be updated at any time. Schneider Electric strongly recommends that you have the most recent and up-to-date version available on www.se.com/ww/en/download.

Related Documents

Title of Documentation	Reference Number
<i>ComPacT NSX & NSXm Catalogue</i>	LVPEd221001EN
<i>ComPacT NSX MicroLogic 5/6/7 Electronic Trip Units - User Guide</i>	DOCA0188EN
<i>ComPacT NSX - Modbus Communication Guide</i>	DOCA0213EN
<i>Enerlin'X IO - Input/Output Application Module for One IEC Circuit Breaker - User Guide</i>	DOCA0055EN
<i>Enerlin'X IFE – Ethernet Switchboard Server – User Guide</i>	DOCA0084EN
<i>Enerlin'X IFE - Ethernet Interface for One IEC Circuit Breaker - User Guide</i>	DOCA0142EN
<i>ULP System (IEC Standard) - User Guide</i>	DOCA0093EN
<i>Selectivity, Cascading, and Coordination Guide</i>	LVPEd318033EN

ComPacT NSX Circuit Breakers

What's in This Part

ComPacT NSX Circuit Breaker Presentation	11
Circuit Breaker With Toggle Handle	29
Circuit Breaker With Rotary Handle	37
Motor-Operated Circuit Breakers	52

ComPacT NSX Circuit Breaker Presentation

What's in This Chapter

PacT Series Master Range	12
ComPacT NSX Range	13
Operating the Circuit Breaker	20
EcoStruxure Power Commission Software	22
De-Energizing the Circuit Breaker	23
Environmental Conditions	26

PacT Series Master Range

Future-proof your installation with Schneider Electric's low-voltage and medium-voltage PacT Series. Built on legendary Schneider Electric innovation, the PacT Series comprises world-class circuit breakers, switches, residual current devices and fuses, for all standard and specific applications. Experience robust performance with PacT Series within the EcoStruxure-ready switchgear, from 16 to 6300 A in low-voltage and up to 40.5 kV in medium-voltage.

ComPacT NSX Range

Description

The ComPacT NSX alternating current (AC) range consists of

- Circuit breakers and switch-disconnectors operating on alternating current:
 - 1-pole circuit breakers from 16 to 250 A, up to 240 Vac
 - 2-pole circuit breakers from 16 to 160 A, up to 690 Vac
 - 3 and 4-pole circuit breakers and switch-disconnectors from 16 to 630 A, up to 690 Vac
 - 3 and 4-pole circuit breakers 250 A and 400 A, up to 1 000 Vac
- A set of standard accessories and auxiliaries shared with the ComPacT NSX DC range

The ComPacT NSX range covers the following applications:

- Electrical distribution protection
- Special protection for receivers (for example, motors, transformers) or generators

The ComPacT NSX range is compliant with the following standards:

- IEC/EN 60947-2 for circuit breakers
- IEC/EN 60947-3 for switch-disconnectors
- IEC/EN 60947-2 and IEC/EN 60947-4-1 for motor protection circuit breakers
- UL 60947-4-1 for motor protection circuit breakers
- CSA-C22.2 No.60947-4-1 for motor protection circuit breakers

Convention

In this guide, the term *circuit breaker* covers circuit breakers and switch-disconnectors.

Circuit Breakers

The following performance levels are available:

Range	Current rating In									
	Performance	Icu (kA rms)	16 A	40 A	63 A	100 A	160 A	250 A	400 A	630 A
ComPacT NSX400-630	K	10								
	HB2	100								
	HB1	75								
	R	200								
	L	150								
	S	100								
	H	70								
	N	50								
F	30									

Range	Current rating In									
	Performance	Icu (kA rms)	16 A	40 A	63 A	100 A	160 A	250 A	400 A	630 A
ComPacT NSX100-250	HB2	100								
	HB1	75								
	R	200								
	L	150								
	S	100								
	H	70								
	N	50								
	F	36								
	B	25								

Icu in kA rms at 1000 Vac
 Icu in kA rms at 690 Vac
 Icu in kA rms at 415 Vac

Switch-Disconnectors

The switch-disconnector functions in the NA performance level.

For information about available switch-disconnectors, refer to LVPED221001EN
ComPacT NSX & NSXm Catalogue

Fixed Circuit Breaker

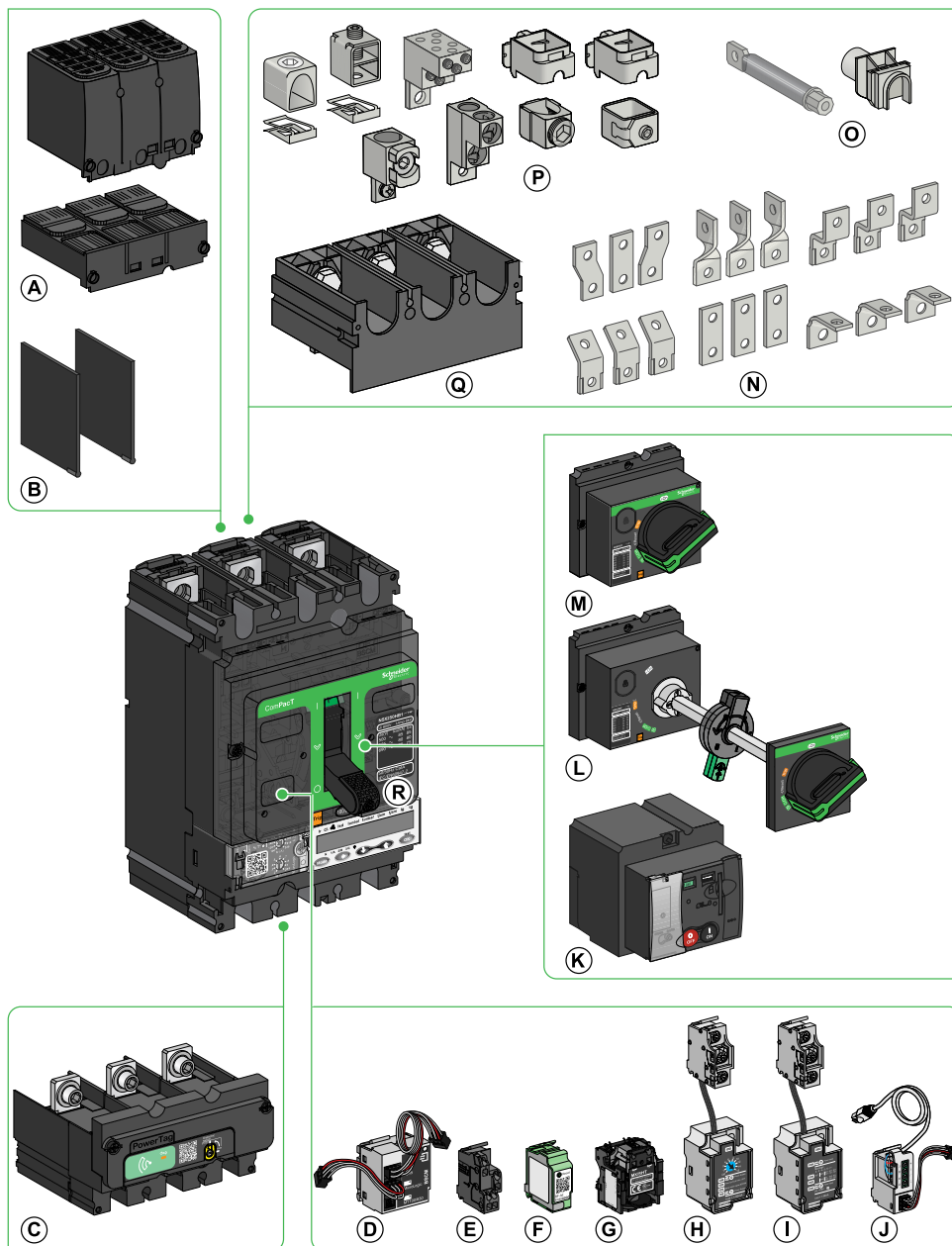

- A** Sealable terminal shields
- B** Interphase barriers
- C** PowerTag Energy M250 or M630
- D** BSCM module
- E** Indication contact
- F** Wireless indication auxiliary
- G** Voltage release
- H** SDTAM module
- I** SDx module

- J** NSX cord
- K** Motor mechanism
- L** Extended rotary handle
- M** Direct rotary handle
- N** Terminal extensions
- O** Rear connectors
- P** Cable connectors
- Q** One-piece spreader
- R** Toggle handle

Withdrawable or Plug-in Circuit Breaker

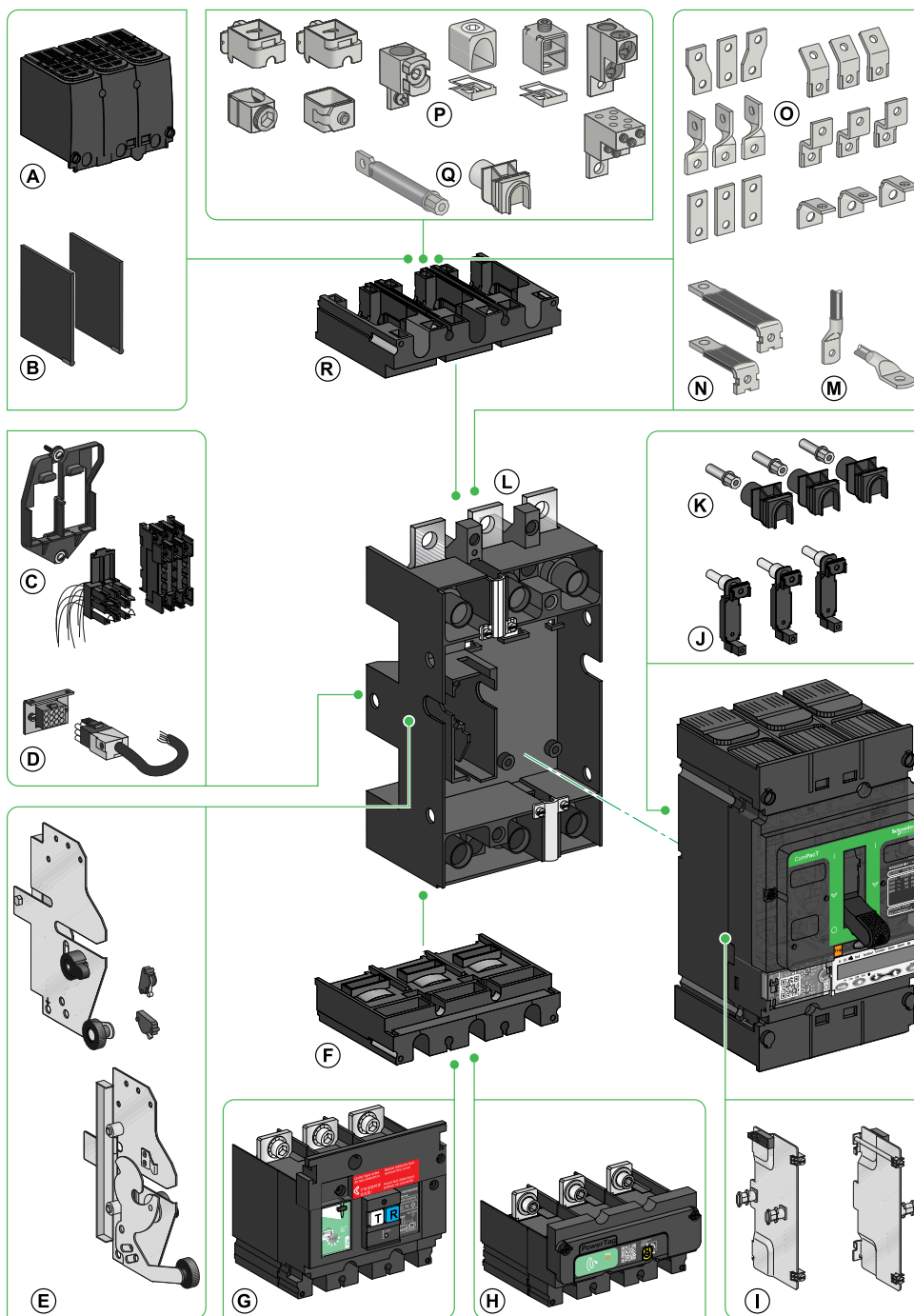

A Sealable long terminal shields for plug-in base

B Interphase barriers

C Automatic withdrawable auxiliary connector

D Manual auxiliary connector

E Chassis side plate for withdrawable circuit breaker

F Adapter

G VigiPacT Add-on Alarm

H PowerTag Energy M250 or M630

I Circuit-breaker side plate

J Power connections for circuit breaker with VigiPacT Add-on

K Power connections

L Circuit-breaker plug-in base

M Lugs

N Rear connectors

O Terminal extensions

P Cable connectors

Q Rear connectors

R Adapter

Trip Units and Trip Unit Accessories

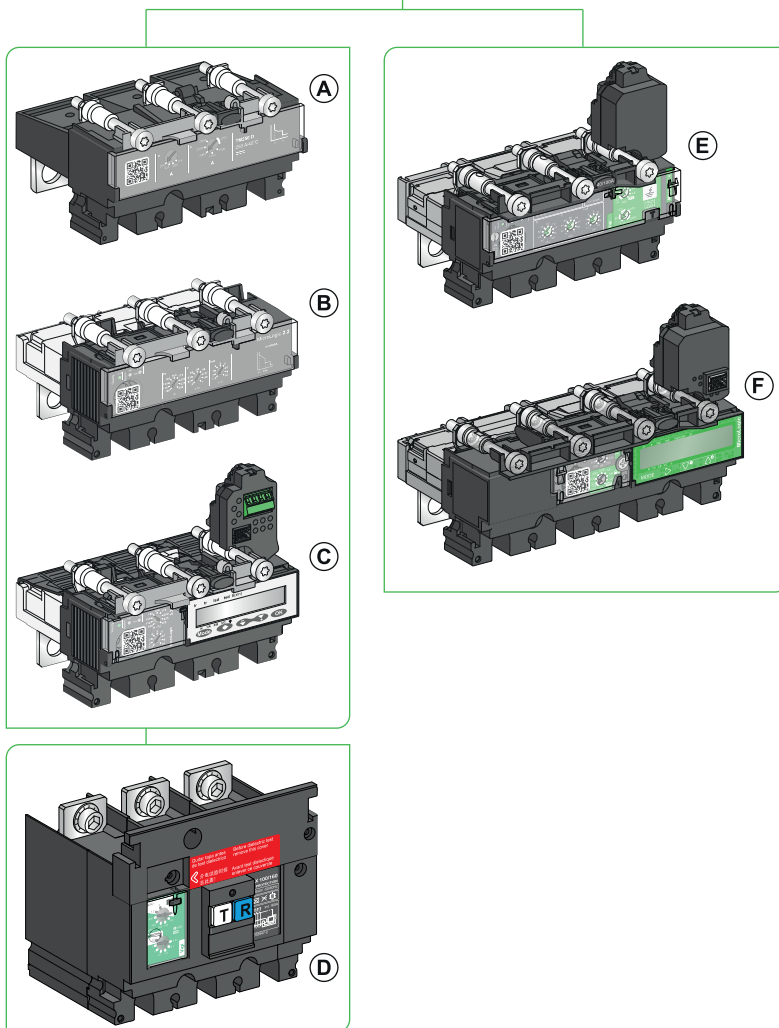
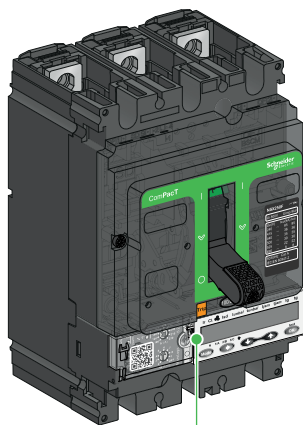

A TM-D, TM-G, or MA trip unit

B MicroLogic 1 or 2 trip unit

C MicroLogic 5 or 6 trip unit

D VigiPacT Add-on for additional earth-leakage protection or VigiPacT Add-on Alarm

E MicroLogic 4 trip unit with earth-leakage protection

F MicroLogic 7 trip unit with earth-leakage protection

Identification

The faceplate on the front of the circuit breaker identifies the circuit breaker and its characteristics.

The faceplate depends on the breaking performances:

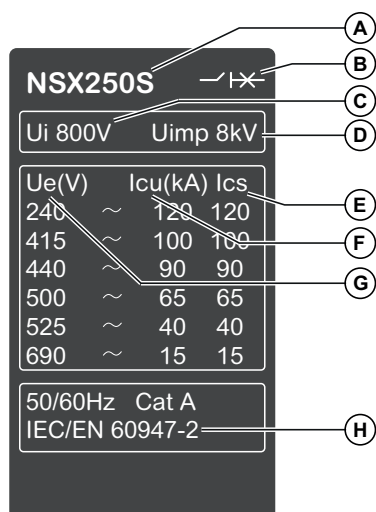

A Device size and rated current

B Type of device: circuit breaker or switch-disconnector, suitable for isolation

C Ui: rated insulation voltage

D Uimp: rated impulse withstand voltage

E Ics: rated service short-circuit breaking capacity

F Icu: rated ultimate short-circuit breaking capacity

G Ue: rated operational voltage

H Standards

NOTE: R, HB1, HB2, and K breaking performances are not compatible with MicroLogic 4 and 7 trip units.

NOTE: For extended rotary handles, open the door to view the faceplate label.

ComPacT NSX 400K 1000 Vac Circuit Breaker

The ComPacT NSX 400K circuit breaker is dedicated to applications up to 1000 Vac, photovoltaic systems at 800 Vac, wind turbines, and mining applications.

A ComPacT NSX 400K circuit breaker has the following characteristics:

- K breaking performance at 1000 Vac
- Ultimate breaking capacity Icu = 36 kA at 800 Vac; 10 kA at 1000 Vac
- Service breaking capacity Ics = 10 kA at 800/1000 Vac
- Supplied with a non-interchangeable MicroLogic 2.3 trip unit without test port
- Two adjustable ratings: 250 A and 400 A
- 3-pole and 4-pole

The following restrictions apply to ComPacT NSX 400K circuit breakers:

- Not compatible with plug-in base or chassis
- No communication available
- No reverse feeding. Top-fed only.

Dial Settings

The dial positions on the front of the trip unit set the circuit breaker pickup settings.

Example 1: TM-D thermal-magnetic trip unit

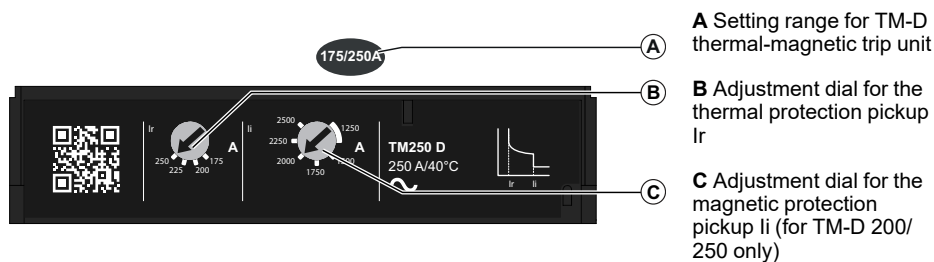

Example 2: MicroLogic 2 and MicroLogic 4 electronic trip units

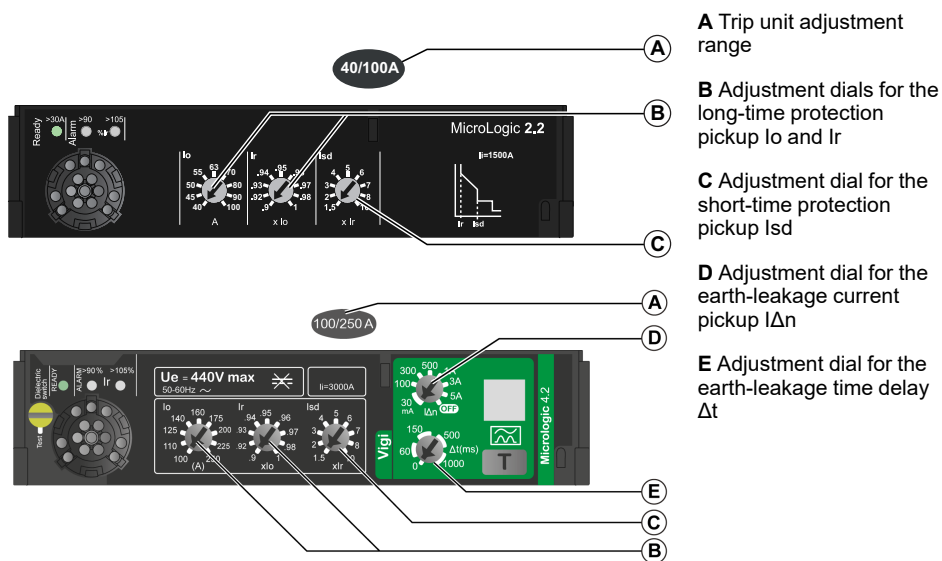

Trip Unit Settings

For MicroLogic 5, 6, and 7 electronic trip units, read all settings on the display unit. For more information, refer to DOCA0188EN, *ComPacT NSX MicroLogic 5/6/7 Electronic Trip Units - User Guide*.

Operating the Circuit Breaker

Circuit Breaker Operating Control Accessories

The following table shows the operating control accessories compatible with the ComPacT NSX circuit breakers. For more information, refer to LVPED221001EN *ComPacT NSX & NSXm Catalogue*.

Operating control accessory	NSX100			NSX160			NSX250		NSX400	NSX630
	1P	2P	3P/4P	1P	2P	3P/4P	1P	3P/4P	3P/4P	3P/4P
Toggle handle	✓	✓	✓	✓	✓	✓	✓	✓	✓	✓
Rotary handle	–	–	✓	–	–	✓	–	✓	✓	✓
Motor mechanism	–	–	✓	–	–	✓	–	✓	✓	✓
Communicating motor mechanism	–	–	✓	–	–	✓	–	✓	✓	✓

Handle Position

The handle position indicates the state of the circuit breaker:

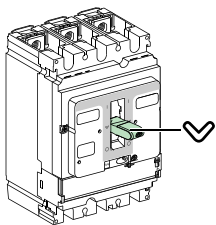
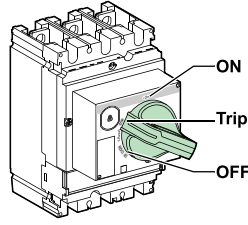
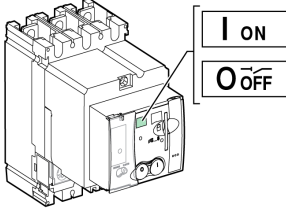
Toggle handle	Rotary handle	Motor mechanism
		
<ul style="list-style-type: none"> • I (ON): Circuit breaker closed. Closed manually. • O (OFF): Circuit breaker open. Opened manually. • Trip: Circuit breaker tripped. Tripped by the protection (trip unit or trip auxiliaries), the push-to-trip button, or the USB maintenance interface. 		<ul style="list-style-type: none"> • I (ON): Circuit breaker closed (in Auto or Manu mode). • O (OFF): Circuit breaker open or tripped (in Auto or Manu mode).

Load Indication

Circuit breakers equipped with a MicroLogic trip unit provide precise information of the state of the circuit breaker or the installation. This information can be used for the management and maintenance of the installation.

For example, if the pre-alarm or alarm indicator is lit, performing load shedding may prevent tripping due to circuit breaker overload.

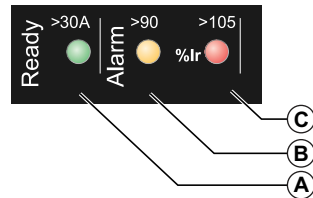

A The Ready LED (green) blinks slowly when the electronic trip unit is ready to provide protection.

B The overload pre-alarm LED (orange) shows a steady light when the load exceeds 90% of the I_r setting.

C The overload alarm LED (red) shows a steady light when the load exceeds 105% of the I_r setting.

Remote Indication

Information is available remotely:

- From the indication contacts
- From the wireless indication auxiliaries
- By using a communication network

These indication auxiliaries can be installed on site.

For more information about the remote indication and communication options, refer to the summary tables of auxiliaries, page 76 and to DOCA0188EN, *ComPacT NSX MicroLogic 5/6/7 Electronic Trip Units - User Guide*.

Remote Electrical Stop Command

The remote electrical stop command can be given by electrical control auxiliaries regardless of the control type in use.

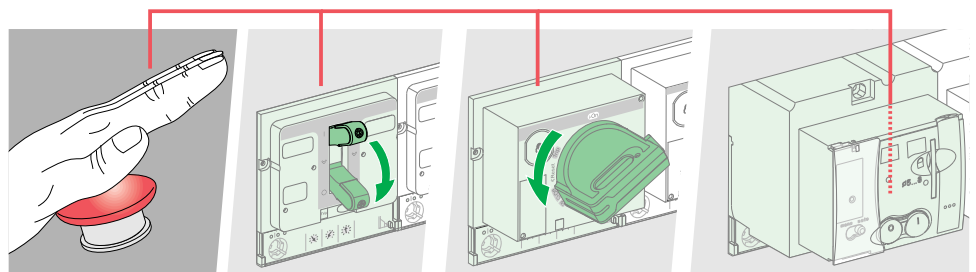

To obtain a remote electrical stop command, use:

- An MX shunt trip release, or
- An MN undervoltage trip release, or
- An MN undervoltage trip release with time-delay unit (the time-delay unit overcomes the problem of micro-cuts).

For more information about the electrical control auxiliaries, refer to the relevant topic, page 102.

NOTE: It is advisable to test operation of the remote electrical stop commands at regular intervals (every six months).

EcoStruxure Power Commission Software

Overview

EcoStruxure Power Commission software automatically discovers the smart devices and allows you to add the devices for an easy configuration. You can generate comprehensive reports as part of Factory Acceptance Test and Site Acceptance Test to replace your heavy manual work. Additionally, when the panels are under operation, any change of settings made can be easily identified by a yellow highlighter. This indicates the difference between the project and device values, and hence provides a system consistency during the operation and maintenance phase.

EcoStruxure Power Commission software enables the configuration of ComPacT NSX circuit breakers with the following modules, and accessories:

- MicroLogic trip units
- Communication interface modules: BSCM module, IFM interface, IFE interface, IFE server
- ULP modules: IO module, FDM121 display

EcoStruxure Power Commission software enables the configuration of the following gateways and wireless devices:

- EcoStruxure Panel Server
- PowerTag Link gateway
- PowerTag Energy module
- Wireless indication auxiliary

EcoStruxure Power Commission software is available at www.se.com

Key Features

EcoStruxure Power Commission software performs the following actions for the supported devices and modules:

- Create projects by device discovery
- Save the project in the EcoStruxure Power Commission cloud for reference
- Upload settings to the device and download settings from the device
- Compare the settings between the project and the device
- Perform control actions in a secured way
- Generate and print the device settings report
- Perform a communication wiring test on the entire project and generate and print test report
- View the communication architecture between the devices in a graphical representation
- View the measurements, logs, and maintenance information
- View the status of device and IO module
- View the alarm details
- Check the system firmware compatibility status
- Update to the latest device firmware
- Perform force trip and automatic trip curve test

De-Energizing the Circuit Breaker

Isolation Capacity

ComPacT NSX circuit breakers offer positive contact indication and are suitable for isolation in accordance with standards IEC/EN 60947-1 and 2. The **O (OFF)** position of the actuator is sufficient to isolate the circuit breaker concerned.

The following marking on the faceplate label indicates that the circuit breaker is capable of isolation:



To confirm this capability, standards IEC/EN 60947-1 and 2 require specific shock withstand tests.

ComPacT NSX circuit breakers can be locked in the **O (OFF)** position to allow work to be carried out with the power off in accordance with installation rules. The circuit breaker can only be locked in the open position if the circuit breaker is in the **O (OFF)** position.

NOTE: Locking a ComPacT NSX circuit breaker in the open position is sufficient to isolate the circuit breaker.

The locks depend on the type of actuator:

- For circuit breakers with toggle handles, refer to the locking accessories, page 35.
- For circuit breakers with rotary handles, refer to how to lock the circuit breaker with direct rotary handle, page 44 and how to lock the circuit breaker with extended rotary handle, page 49.
- For circuit breakers with motor mechanisms, refer to how to lock the circuit breaker, page 59.

Maintenance and Servicing Work on Installation

⚠️ DANGER

HAZARD OF ELECTRIC SHOCK, EXPLOSION, OR ARC FLASH

- Apply appropriate personal protective equipment (PPE) and follow safe electrical work practices. See NFPA 70E or CSA Z462 or local equivalent.
- This equipment must only be installed and serviced by qualified electrical personnel.
- Turn off all power supplying this equipment before working on or inside equipment.
- Always use a properly rated voltage sensing device to confirm that power is off.
- Replace all devices, doors, and covers before turning on power to this equipment.
- Repair the installation immediately if an insulation fault occurs during operation.

Failure to follow these instructions will result in death or serious injury.

Turn off all power supplying the equipment before working on or inside equipment. For a partial powering down of the installation, the installation and safety rules require clearly labeling and isolating the feed being worked on.

Maintenance Work Following Fault Trip

⚠ WARNING
<p>HAZARD OF CLOSING ON ELECTRICAL FAULT</p> <p>Do not close the circuit breaker again without first inspecting and, if necessary, repairing the downstream electrical equipment.</p> <p>Failure to follow these instructions can result in death, serious injury, or equipment damage.</p>

The fact that a protection has tripped does not remedy the cause of the fault detected on the downstream electrical equipment.

The following table describes the procedure to be followed after a fault trip:

Step	Action
1	Isolate the feed before inspecting the downstream electrical equipment.
2	Look for the cause of the detected fault.
3	Inspect and, if necessary, repair the downstream equipment.
4	Inspect the equipment in the event of a short-circuit trip.
5	Close the circuit breaker again.

For more information about restarting following a fault, refer to Responding to a trip.

Checking the Settings

Checking settings does not require any particular precautions. The checks must be carried out by a qualified person.

Testing the Circuit Breaker

⚠ CAUTION
<p>HAZARD OF NUISANCE TRIPPING</p> <p>Protection tests must be done by qualified electrical personnel.</p> <p>Failure to follow these instructions can result in injury or equipment damage.</p>

When testing circuit breaker trip mechanisms, precautions must be taken:

- To avoid disrupting operations.
- To avoid inappropriate actions or tripping of alarms.

For example, tripping the circuit breaker with the push-to-trip button or the LTU test software can lead to inappropriate fault indications or corrective actions (such as switching to a replacement power source).

Setting the Trip Unit

⚠ WARNING

HAZARD OF NUISANCE TRIPPING OR FAILURE TO TRIP

Protection setting adjustments must be done by qualified electrical personnel.

Failure to follow these instructions can result in death, serious injury, or equipment damage.

Modifying trip unit settings requires a thorough knowledge of the installation and safety rules.

Environmental Conditions

Ambient Temperature

The ambient temperature refers to the temperature of the air immediately surrounding the circuit breaker.

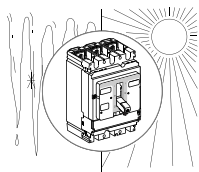

- Operation temperature
 - -25 to $+70$ °C (-13 to $+158$ °F): Normal operating temperature

NOTE: The minimum operating temperature for the earth-leakage fault indicator on the MicroLogic 4 and 7 trip unit is -15 °C (5 °F). Between -15 and -5 °C (5 and 23 °F), and when operating the device with an earth leakage fault and a very low load compared to the trip unit rating I_n , the earth leakage indicator may not work correctly (fault indication or reset).
 - -35 to -25 °C (-31 to -13 °F): Commissioning possible
- Storage temperature
 - -50 to $+85$ °C (-58 to $+185$ °F): Without MicroLogic trip unit
 - -40 to $+85$ °C (-40 to $+185$ °F): With liquid crystal MicroLogic trip unit or PowerTag Energy

Extreme Atmospheric Conditions

ComPacT NSX circuit breakers are designed to operate in industrial atmospheres as defined in standard IEC/EN 60947-2 for the highest level of pollution (level 3).

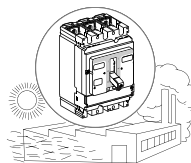

They are tested for extreme storage conditions according to the following standards:

Standard	Title
IEC/EN 60068-2-2	Dry heat, severity level $+85$ °C ($+185$ °F)
IEC/EN 60068-2-1	Dry cold, severity level -55 °C (-67 °F)
IEC/EN 60068-2-30	Damp heat, cyclic <ul style="list-style-type: none"> • temperature $+55$ °C ($+131$ °F) • relative humidity 95 %
IEC/EN 60068-2-52	Salt-mist test

To obtain the best use from the circuit breakers, install them in properly ventilated switchboards where excessive dust is not a problem.

Vibration

ComPacT NSX circuit breakers are tested against vibration.

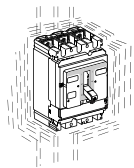

Conformity tests are carried out in accordance with standard IEC/EN 60068-2-6 at the levels of severity required by the merchant shipping regulatory bodies (IACS, Veritas, Lloyd namely):

- 2 Hz to 13.2 Hz with an amplitude of +/- 1 mm (+/- 0.04 in)
- 13.2 Hz to 100 Hz at a constant acceleration of 0.7 g

Electromagnetic Disturbances

ComPacT NSX circuit breakers are immune to electromagnetic disturbance.

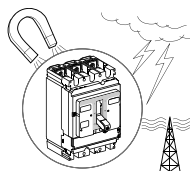

They comply with the requirements of the electromagnetic compatibility (EMC) standard:

Standard	Title
IEC/EN 60947-2 appendixes F and J	Overcurrent protection tests
IEC/EN 60947-2 appendixes B and J	Specific tests for earth-leakage protection

Check for compliance with EMC standards by testing for immunity to:

- Overvoltages produced by the operation of electromagnetic switchgear.
- Overvoltages produced by atmospheric disturbance that pass through the electrical network (for example, lightning).
- The use of apparatus emitting radio waves (such as radio transmitters, walkie-talkies, or radar).
- Electrostatic discharges produced by the operators themselves.

Conformity with EMC standards as described above helps to ensure that:

- The circuit breaker operates correctly in a disturbed environment:
 - Without nuisance tripping.
 - In accordance with the trip time.
- There is no disturbance to any type of industrial or commercial environment.

Altitude

ComPacT NSX circuit breakers are designed to operate within specification at altitudes of up to 2,000 m (6,600 ft).

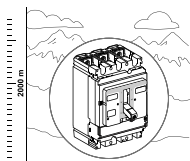

Above 2,000 m (6,600 ft) modifying the characteristics of the surrounding air (dielectric strength, cooling capacity) causes derating as follows:

Altitude (m/ft)	< 2,000 m (6,600 ft)	3,000 m (9,800 ft)	4,000 m (13,000 ft)	5,000 m (16,500 ft)
Maximum operating voltage (V)	690	590	520	460
Maximum operating voltage (V) for NSX400K	1000	886	790	696
Rated thermal current (A) at 40 °C (104 °F)	I_n	$0.96 \times I_n$	$0.93 \times I_n$	$0.9 \times I_n$

Circuit Breaker With Toggle Handle

What's in This Chapter

Front Face Description	30
Opening, Closing, and Resetting the Circuit Breaker	31
Testing the Circuit Breaker	33
Locking the Circuit Breaker	35

Front Face Description

Front Face

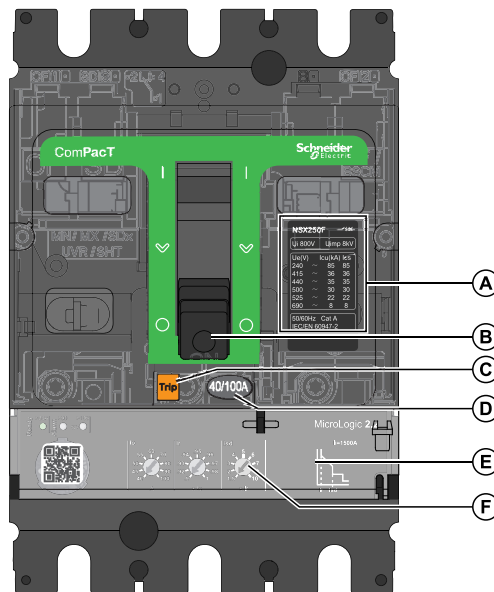

A Faceplate

B Toggle handle for opening, closing, and resetting

C Push-to-trip button

D Trip unit setting range

E Trip unit

F Trip unit adjustment dials

For more information about installation, consult the instruction sheets on the Schneider Electric website:

- NNZ4765407, ComPacT NSX100–250 circuit breakers and switch-disconnectors
- NNZ4765507, ComPacT NSX400–630 circuit breakers and switch-disconnectors

Opening, Closing, and Resetting the Circuit Breaker

Opening and Closing Locally

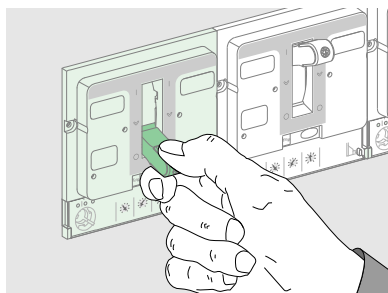

- To close the circuit breaker, move the toggle handle from the **O (OFF)** position to the **I (ON)** position.
- To open the circuit breaker, move the toggle handle from the **I (ON)** position to the **O (OFF)** position.

Resetting After a Trip on Electrical Fault

The circuit breaker has tripped on electrical fault, the toggle handle has moved from the **I (ON)** position to the Trip  position.

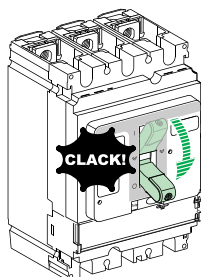

WARNING

HAZARD OF CLOSING ON ELECTRICAL FAULT

Do not close the circuit breaker again without first inspecting and, if necessary, repairing the downstream electrical equipment.

Failure to follow these instructions can result in death, serious injury, or equipment damage.

The fact that a circuit breaker has tripped does not remedy the cause of the fault detected on the downstream electrical equipment.

To reset after a fault trip:

Step	Action	Position
1	–	Isolate the feed (refer to maintenance and servicing work on installation, page 23) before inspecting the downstream electrical equipment.
2	–	Look for the cause of the detected fault.
3	–	Inspect and, if necessary, repair the downstream equipment.
4	–	Inspect the equipment in the event of a short-circuit trip.

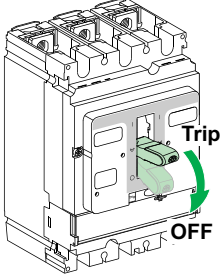
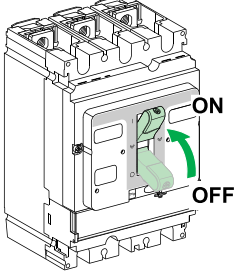
Step	Action		Position
5		<p>Reset the circuit breaker by moving the toggle handle to O (OFF).</p>	<p>O (OFF)</p>
6		<p>Close the circuit breaker by moving the toggle handle to I (ON).</p>	<p>I (ON)</p>

Testing the Circuit Breaker

Push-to-Trip Procedure

⚠ CAUTION

HAZARD OF NUISANCE TRIPPING

Device tests must only be done by qualified electrical personnel.

Failure to follow these instructions can result in injury or equipment damage.

When testing the trip mechanism take precautions against:

- Disrupting operations
- Activating inappropriate alarms
- Triggering unwanted actions

For example, tripping the circuit breaker with the push-to-trip button can lead to inappropriate fault indications or corrective actions (such as switching to an alternate power source).

Follow these steps to test the trip mechanism:

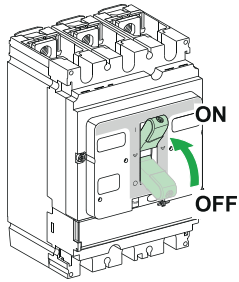
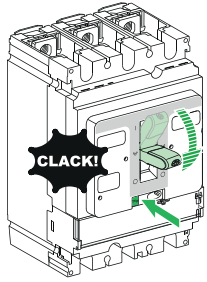
Step	Action		Position
1		Close the circuit breaker.	I (ON)
2		Press the push-to-trip button to trip the circuit breaker.	☑

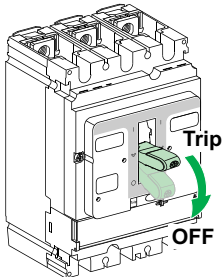
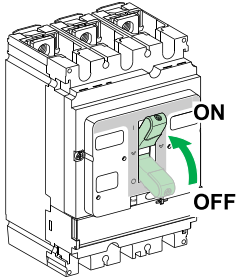
Step	Action		Position
3		<p>Reset the circuit breaker by moving the toggle handle to O (OFF).</p>	<p>O (OFF)</p>
4		<p>Close the circuit breaker by moving the toggle handle to I (ON).</p>	<p>I (ON)</p>

Locking the Circuit Breaker

Locking Accessories

⚠️⚠️ DANGER

HAZARD OF ELECTRIC SHOCK, EXPLOSION, OR ARC FLASH

When the circuit breaker toggle handle is locked in the **(O) OFF** position, always use a properly rated voltage sensing device to confirm that power is off before working on equipment.

Failure to follow these instructions will result in death or serious injury.

Use locking accessories to lock the toggle handle in the **I (ON)** or **O (OFF)** position.

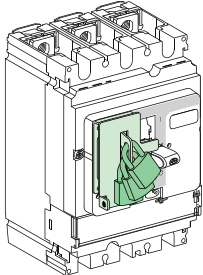
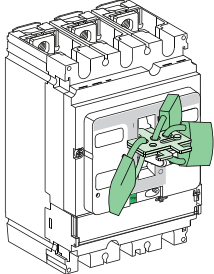
Accessory	Padlocks	
	Accessory that is part of the case	Use up to 3 padlocks (not supplied) 5–8 mm (0.2–0.3 in) in diameter
	Accessory that is detachable	Use up to 3 padlocks (not supplied) 5–8 mm (0.2–0.3 in) in diameter

NOTE: Locking the toggle handle in the **I (ON)** position does not disable the circuit breaker protection functions. If there is an electrical fault, the circuit breaker trips without altering its performance. When unlocked, the toggle handle moves to the **Trip** position. To return the circuit breaker to service, refer to how to open, close, and reset the circuit breaker, page 31.

Sealing Accessories

Use sealing accessories to prevent circuit breaker operations.

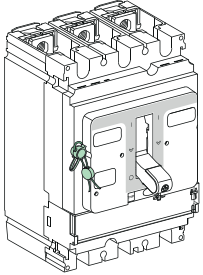
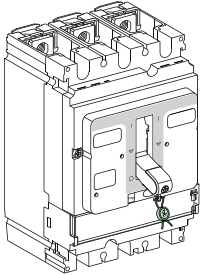
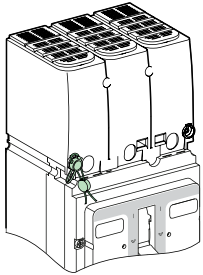
Seal		Prohibited operations
	Escutcheon mounting screw	<ul style="list-style-type: none"> • Dismantling the escutcheon • Accessing the auxiliaries • Dismantling the trip unit
	Transparent protective cover	<ul style="list-style-type: none"> • Altering trip unit settings • Accessing the test port for the trip units
	Mounting screw for terminal shields	Accessing the power connection (protection against direct contact)

Circuit Breaker With Rotary Handle

What's in This Chapter

Front Face Description	38
Opening, Closing, and Resetting the Circuit Breaker	40
Testing a Circuit Breaker With Direct Rotary Handle	42
Locking a Circuit Breaker With Direct Rotary Handle	44
Testing a Circuit Breaker With Extended Rotary Handle.....	47
Locking a Circuit Breaker With Extended Rotary Handle.....	49

Front Face Description

Front Face with Direct Rotary Handle

The circuit breaker operating controls, operation indicators, settings, and locking mechanisms for the direct rotary handle are on the front of the circuit breaker.

There are two models of rotary handle:

- Black handle for standard applications
- Red handle on yellow bezel for machine control applications

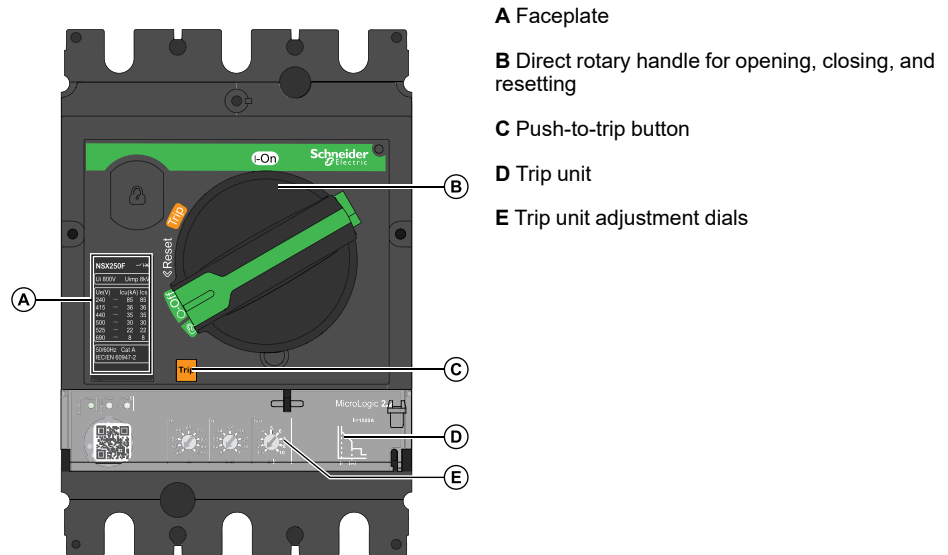

For more information about rotary handle configuration and installation, consult the instruction sheets on the Schneider Electric website:

- NNZ4765907, Direct mounted rotary handle for ComPacT NSX100-250
- NNZ4766407, Direct mounted rotary handle for ComPacT NSX400-630

Front Face with Extended Rotary Handle

For circuit breakers with an extended rotary handle:

- The circuit breaker operating controls are on the door escutcheon.
- The operation indicators and settings are only accessible when the door is open
- The locking mechanisms, page 49 are on the circuit breaker (optional) and on the door escutcheon (door closed).

There are two models of extended rotary handle:

- Black handle for standard applications
- Red handle on yellow bezel for machine control applications

Cabinet door open

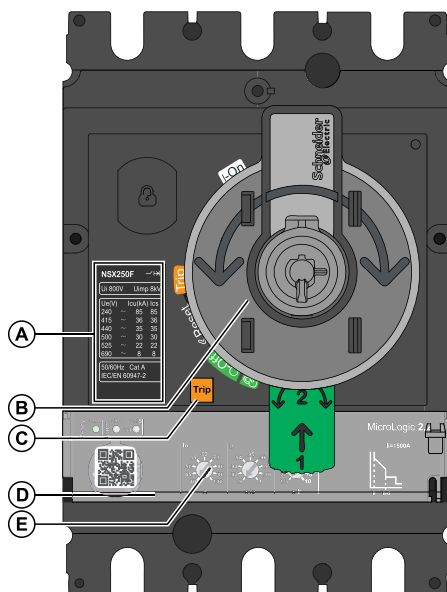

A Faceplate

B Open door shaft operator

C Push-to-trip button

D Trip unit

E Trip unit adjustment dials

Cabinet door closed

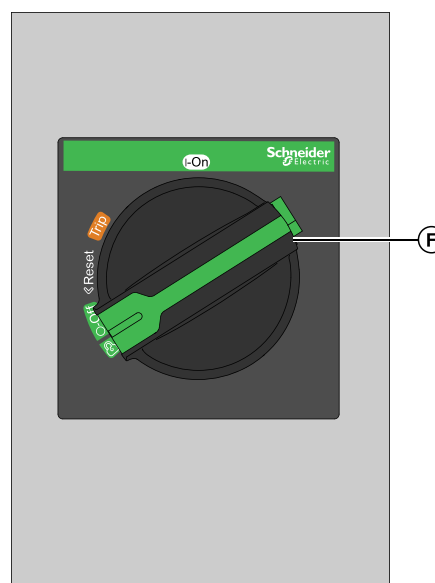

F Extended rotary handle for opening, closing, and resetting

For more information about extended rotary handle installation, consult the instruction sheets on the Schneider Electric website:

- NNZ4766007, Extended rotary handle for ComPacT NSX100-250
- NNZ4766507, Extended rotary handle for ComPacT NSX400-630

Opening, Closing, and Resetting the Circuit Breaker

Opening and Closing Locally

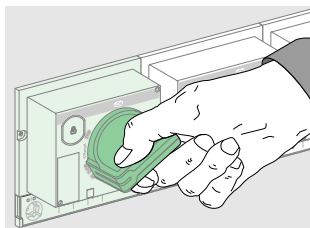

- To close the circuit breaker, turn the rotary handle clockwise from the **O (OFF)** position to the **I (ON)** position.
- To open the circuit breaker, turn the rotary handle counterclockwise from the **I (ON)** position to the **O (OFF)** position.

Resetting After a Trip on Electrical Fault

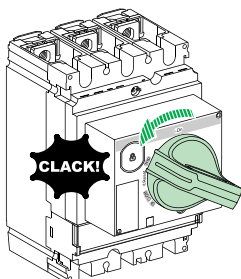

The circuit breaker has tripped on electrical fault, the rotary handle has moved from the **I (ON)** position to the **Trip** position.

▲ WARNING

HAZARD OF CLOSING ON ELECTRICAL FAULT

Do not close the circuit breaker again without first inspecting and, if necessary, repairing the downstream electrical equipment.

Failure to follow these instructions can result in death, serious injury, or equipment damage.

The fact that a circuit breaker has tripped does not remedy the cause of the fault detected on the downstream electrical equipment.

To reset after a fault trip:

Step	Action	Position
1	–	Isolate the feed, page 23 before inspecting the downstream electrical equipment.
2	–	Look for the cause of the detected fault.
3	–	Inspect and, if necessary, repair the downstream equipment.
4	–	Inspect the equipment in the event of a short-circuit trip.

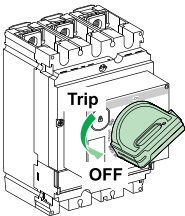
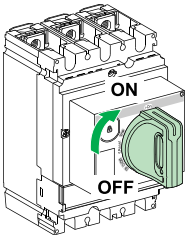
Step	Action	Position
5	 <p>Reset the circuit breaker by turning the rotary handle counterclockwise from the Trip position to O (OFF).</p>	O (OFF)
6	 <p>Close the circuit breaker by turning the rotary handle clockwise to I (ON).</p>	I (ON)

Testing a Circuit Breaker With Direct Rotary Handle

Push-to-Trip Procedure

⚠ CAUTION

HAZARD OF NUISANCE TRIPPING

Device tests must only be done by qualified electrical personnel.

Failure to follow these instructions can result in injury or equipment damage.

When testing the trip mechanism, take precautions against:

- Disrupting operations
- Activating inappropriate alarms
- Triggering unwanted actions

For example, tripping the circuit breaker with the push-to-trip button can lead to inappropriate fault indications or corrective actions (such as switching to an alternate power source).

Follow these steps to test the trip mechanism:

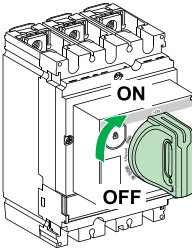
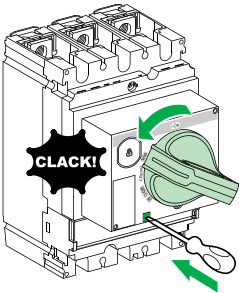
Step	Action	Position
1		Close the circuit breaker. I (ON)
2		Press the push-to-trip button: the circuit breaker trips. Trip

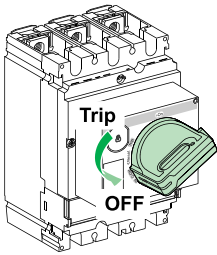
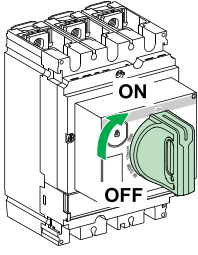
Step	Action	Position
3		Reset the circuit breaker by turning the rotary handle counterclockwise from the Trip position to O (OFF) .
4		Close the circuit breaker by turning the rotary handle clockwise to I (ON) .

Locking a Circuit Breaker With Direct Rotary Handle

Locking Accessories

Lock handle with up to three padlocks (not supplied) or a keylock.

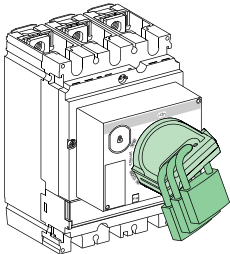
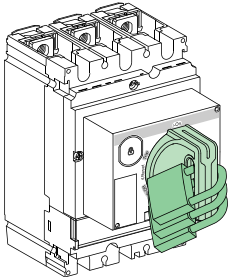
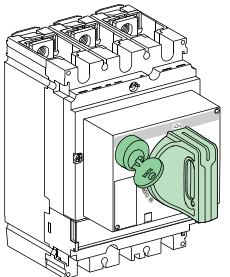
Accessory		Padlocks
	<p>Padlocking (standard) only in the O (OFF) position.</p>	<p>Lock handle with up to three padlocks (not supplied) with shackle diameters of 5–8 mm (0.2–0.3 in).</p>
	<p>Padlocking (after modification to the rotary handle during installation) in the two positions I (ON) and O (OFF).</p>	<p>Lock handle with up to three padlocks (not supplied) with shackle diameters of 5–8 mm (0.2–0.3 in).</p>
	<p>Keylocking with a Profalux® or Ronis® lock (optional).</p> <p>The circuit breaker can be locked in the O (OFF) position only or in the O (OFF) and I (ON) position, depending on the bolt chosen.</p>	<p>A Profalux or Ronis lock can be installed on site.</p> <p>Keylocking can be used at the same time as padlocking.</p>

NOTE: Locking the rotary handle in the **I (ON)** position does not disable the circuit breaker protection functions. If there is an electrical fault, the circuit breaker still trips. When unlocked, the handle moves to the **Trip** position. To return the circuit breaker to service, follow the [resetting instructions](#), page 40.

Door Locking (MCC Function)

Further options are offered with the direct rotary handle in the MCC function.

When the circuit breaker is in the **I (ON)** position, the direct rotary handle locks the door in the closed position.

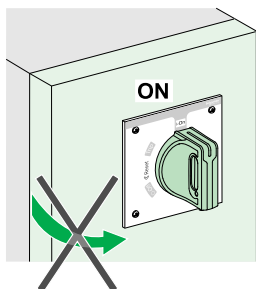

⚠ ⚠ DANGER**HAZARD OF ELECTRIC SHOCK, EXPLOSION, OR ARC FLASH**

Only qualified persons are authorized to disable the door lock.

Failure to follow these instructions will result in death or serious injury.

Temporarily disable this lock to open the door when the circuit breaker is in the I (ON) position.

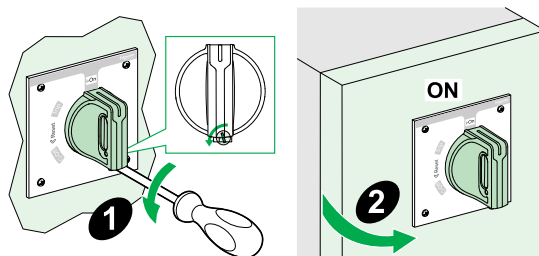

Disabling this lock requires modifying the rotary handle. Consult the instruction sheet NNZ4766107 *MCC conversion accessory for ComPacT NSX100–630*.

If the lock has been disabled, the following direct rotary handle functions are inoperative:

- Door locking
- Preventing the circuit breaker from being closed when the door is open

Preventing Circuit Breaker Closing When the Door Is Open

The door locking device can also help to prevent the direct rotary handle from being moved to the I (ON) position when the door is open.

Sealing Accessories

Use sealing accessories to prevent circuit breaker operations.

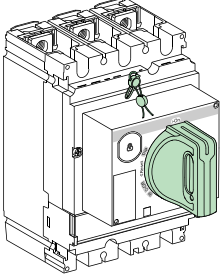
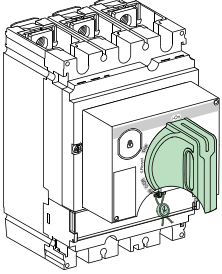
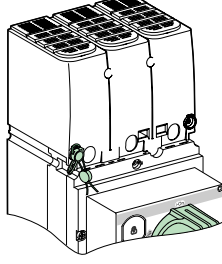
Seal		Prohibited operations
	<p>Escutcheon mounting screw</p>	<ul style="list-style-type: none"> • Dismantling the escutcheon • Accessing the auxiliaries • Dismantling the trip unit
	<p>Transparent protective cover</p>	<ul style="list-style-type: none"> • Altering trip unit settings • Accessing the test port for the trip units
	<p>Mounting screw for terminal shields</p>	<p>Accessing the power connection (protection against direct contact)</p>

Testing a Circuit Breaker With Extended Rotary Handle

Push-to-Trip Procedure

⚠ CAUTION

HAZARD OF NUISANCE TRIPPING

Device tests must only be done by qualified electrical personnel.

Failure to follow these instructions can result in injury or equipment damage.

When testing the trip mechanism take precautions against:

- Disrupting operations
- Activating inappropriate alarms
- Triggering unwanted actions

For example, tripping the circuit breaker with the push-to-trip button can lead to inappropriate fault indications or corrective actions (such as switching to an alternate power source).

There is no push-to-trip button on the door of a circuit breaker with a front extended rotary handle. To check the trip mechanism, the door must first be opened.

Follow these steps to test the trip mechanism:

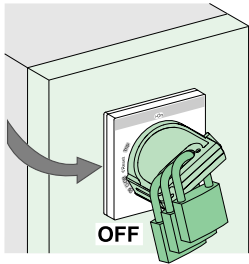
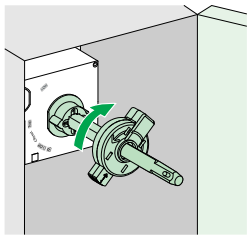
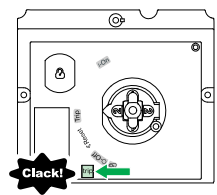
Step	Action	Position
1		<p>Switch the circuit breaker to the open O (OFF) position. Open the door.</p> <p style="text-align: right;">O (OFF)</p>
2		<p>Turn the circuit breaker from the O (OFF) position to the I (ON) position, using one of the following tools:</p> <ul style="list-style-type: none"> • An open door shaft operator (LV426937). • A flat wrench, taking care not to damage the extension shaft or its surface treatment. The extension shaft is a solid square section shaft, 10 x 10 mm (0.39 x 0.39 in). <p>The circuit breaker is ready for the test.</p> <p style="text-align: right;">I (ON)</p>
3		<p>Press the push-to-trip button. The circuit breaker trips.</p> <p style="text-align: right;">Trip</p>

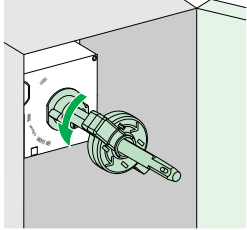
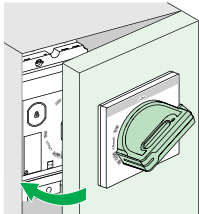
Step	Action	Position
4		<p>Use a special tool (refer to step 2) to turn the extension shaft counterclockwise and switch the circuit breaker from the Trip position to the O (OFF) position. The circuit breaker is in the open position.</p>
5		<p>Close the door.</p> <p>—</p>

Locking a Circuit Breaker With Extended Rotary Handle

Locking Accessories

The extended rotary handle offers several locking functions to:

- Prevent the rotary handle being operated.
- Prevent the door being opened.

Some locking functions can be disabled on different adaptations.

The handle can be locked with up to three padlocks (not supplied) or keylock.

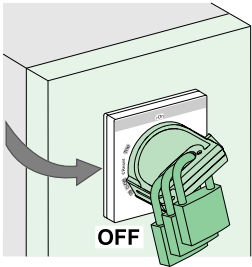
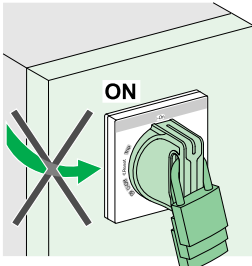
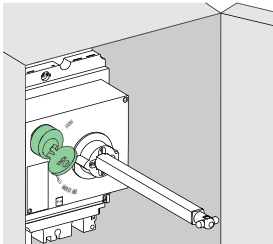
Accessory		Padlocks
	<p>Padlocking (standard) in the O (OFF) position.</p> <p>Padlocking the rotary handle in the O (OFF) position does not prevent the door from opening.</p>	<p>Lock rotary handle with up to three padlocks (not supplied) with shackle diameters of 5–8 mm (0.2–0.3 in).</p>
	<p>Padlocking (after modification to the rotary handle during installation) in the two positions I (ON) and O (OFF).</p> <p>There is a choice of two options when locking the rotary handle in the I (ON) position:</p> <ul style="list-style-type: none"> • Standard with the door opening locked. • As an option, door is not interlocked, and locking the rotary handle does not stop the door from opening. 	<p>Lock rotary handle with up to three padlocks (not supplied) with shackle diameters of 5–8 mm (0.2–0.3 in).</p>
	<p>Keylocking with a Profalux® or Ronis® lock (optional).</p> <p>The lock is mounted on the case inside the switchboard.</p> <p>Lock the circuit breaker in the O (OFF) position only or in the O (OFF) and I (ON) positions depending on the bolt chosen.</p>	<p>A Profalux or Ronis lock can be installed on site. Keylocking can be used at the same time as padlocking.</p>

NOTE: Locking the rotary handle in the **I (ON)** position does not disable the circuit breaker protection functions. If there is an electrical fault, the circuit breaker still trips. When unlocked, the rotary handle moves to the **Trip** position. To return the circuit breaker to service, follow the [resetting instructions](#), page 40.

Door Locking (MCC Function)

The extended rotary handle locks the door in the I (ON) position as standard.

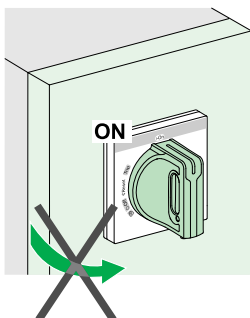

⚡ ⚠ DANGER

HAZARD OF ELECTRIC SHOCK, EXPLOSION, OR ARC FLASH

Only qualified persons are authorized to disable the door lock.

Failure to follow these instructions will result in death or serious injury.

Temporarily disable this lock to open the door when the circuit breaker is in the I (ON) position.

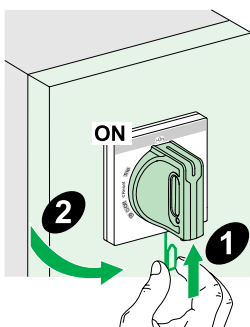

Disabling this lock requires modifying the rotary handle. Consult the instruction sheets:

- NNZ4766007, Extended rotary handle for ComPacT NSX100-250
- NNZ4766507, Extended rotary handle for ComPacT NSX400-630

Example: An application includes a circuit breaker for a switchboard incoming supply and several receiver circuit breakers with extended rotary handles installed behind the same door. Locking the door with a single rotary handle (incoming supply circuit breaker) simplifies maintenance work on the switchboard.

Key-Operated Locking Procedure

Keylocking can be done with circuit breaker in either the O (OFF) position or the I (ON) position.

Step	Action (circuit breaker in the O (OFF) position)	Action (circuit breaker in the I (ON) position)
1	Open the door.	Open the door by disabling the door locking device if necessary.
2	Use the keylock mounted on the case inside the switchboard to lock the rotary handle.	Use the keylock mounted on the case inside the switchboard to lock the rotary handle.
3	Close the door.	Close the door, disabling the door locking device if necessary.

Sealing Accessories

The sealing accessories, page 44 for circuit breakers with extended rotary handles are identical to those for circuit breakers with direct rotary handles.

Motor-Operated Circuit Breakers

What's in This Chapter

Front Face Description	53
Opening, Closing, and Resetting a Circuit Breaker With Motor Mechanism	55
Opening, Closing, and Resetting Circuit Breakers With Communicating Motor Mechanism.....	58
Locking the Circuit Breaker	59

Front Face Description

Front Face

The main controls, operation indicators, settings, and locking mechanisms are on the front of an electrically-operated circuit breaker (with motor mechanism).

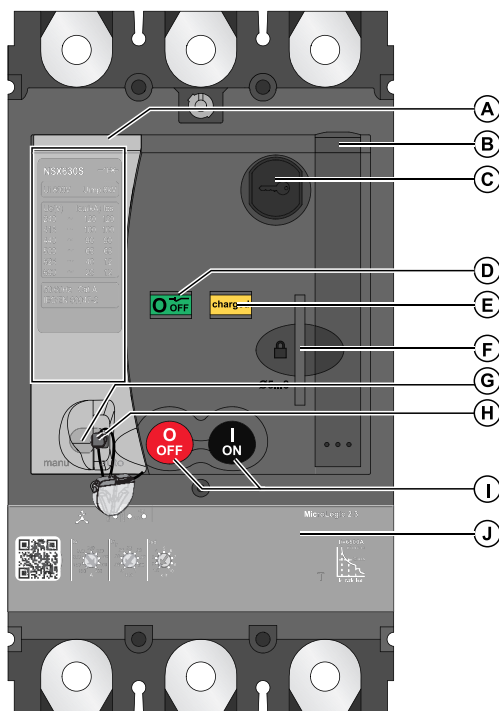

A Faceplate

B Charging handle

C Keylocking in **O (OFF)** position (option available for ComPacT NSX400-630 only)

D Main contacts position indicator

E Spring-charged and ready-to-close indicator

F Padlocking in **O (OFF)** position

G Manual/automatic operating mode selector

H Sealing accessory

I Closing (**I (ON)**) and opening (**O (OFF)**) pushbuttons

J Trip unit

For more information about motor mechanism installation, consult the instruction sheets on the Schneider Electric website:

- GHD16272AA, ComPacT NSX100-250 motor mechanism
- GHD16318AA, ComPacT NSX400-630 motor mechanism

Main Contacts Position Indicator

Indicator	Description
	The circuit breaker is closed.
	The circuit breaker is open or tripped.

NOTE: Use the SD or SDE auxiliary contact to distinguish the **Trip** position from the **O (OFF)** position.

Spring-Charged and Ready-to-Close Indicator

Indicator	Description
	Closing spring charged
	Closing spring discharged

NOTE: The closing spring only provides the necessary energy for circuit breaker closing. The circuit breaker mechanism supplies the energy for tripping.

Manu/Auto Selector

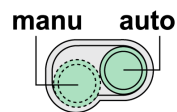

The Manu/Auto button selects the operating mode:

- In automatic operating mode, only electrical commands are executed.
- In manual operating mode, all electrical commands are disabled.

Opening, Closing, and Resetting a Circuit Breaker With Motor Mechanism

Introduction

The motor mechanism can open and close a circuit breaker remotely with electrical commands. There are many applications:

- Automation of electrical distribution to optimize operating costs
- Normal/standby source changeover: changes over to a replacement source to improve continuity of service
- Load shedding/reconnection to optimize tariff-based contracts

⚠ CAUTION

HAZARD OF REPEATED CLOSING ON ELECTRICAL FAULT

Do not modify the wiring diagrams for the motor mechanism.

Failure to follow these instructions can result in injury or equipment damage.

Wire the motor mechanism in strict accordance with the motor mechanism wiring diagram in the appendix.

In automatic operating mode, wiring the SDE contact helps to prevent the circuit breaker from resetting automatically on an electrical fault. For more information about the SDE contact, refer to the indication contacts.

Manual Operation: Opening, Closing, and Resetting Locally

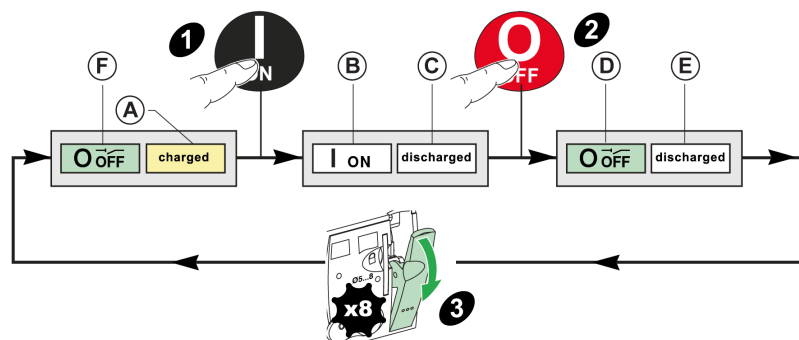

Move the selector to the **Manu** position.

Cycle of operation:



Manual Operation Description

Check that the spring-charged indicator is on **charged (A)**. If not, reset the circuit breaker.

Step	Action	Comment
1	Close the circuit breaker by pressing the closing pushbutton  .	When the circuit breaker is closed: <ul style="list-style-type: none"> The contact position indicator (B) changes to I (ON). The spring-charged indicator (C) changes to discharged.
2	Open the circuit breaker by pressing the opening pushbutton  .	When the circuit breaker is open: <ul style="list-style-type: none"> The contact position indicator (D) changes to O (OFF). The spring-charged indicator (E) stays on discharged.
3	Reset the circuit breaker: recharge the closing spring by operating the charging handle (eight times).	When the circuit breaker is ready to be closed: <ul style="list-style-type: none"> The contact position indicator (F) stays on O (OFF). The spring-charged indicator (A) changes to charged.

Automatic Operation: Opening, Closing, and Resetting Remotely

Move the selector to the **Auto** position.

Cycle of operation:

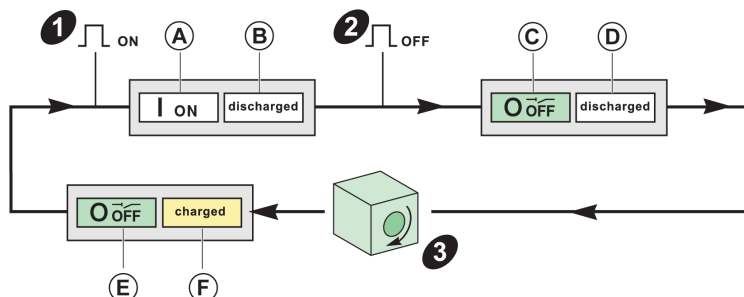

Automatic Operation Description

Step	Action	Comment
1	Close the circuit breaker by sending a close (ON) command.	When the circuit breaker is closed: <ul style="list-style-type: none"> The contact position indicator (A) changes to I (ON). The spring-charged indicator (B) changes to discharged.
2	Open the circuit breaker by sending an open (OFF) command.	When the circuit breaker is open: <ul style="list-style-type: none"> The contact position indicator (C) changes to O (OFF). The spring-charged indicator (D) stays on discharged.
3	Recharge the stored energy control by using one of the three reset modes, depending on the wiring diagram: <ul style="list-style-type: none"> Automatic reset Remote reset by using the pushbutton Manual reset by operating the charging handle 	The circuit breaker is ready to be closed: <ul style="list-style-type: none"> The contact position indicator (E) stays on O (OFF). The spring-charged indicator (F) changes to charged.

Resetting After a Trip on Electrical Fault

Resetting after a trip on electrical fault can only be done locally. When operating in automatic mode, return to manual operation to reset the circuit breaker.

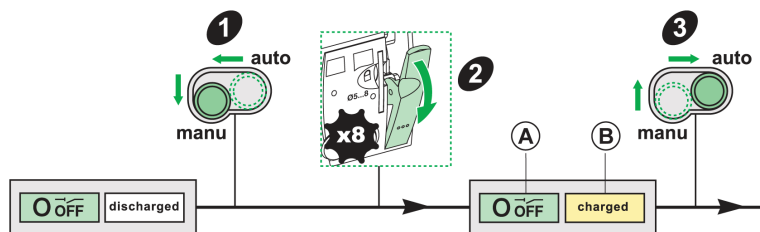

⚠ WARNING

HAZARD OF CLOSING ON ELECTRICAL FAULT

Do not close the circuit breaker again without first inspecting and, if necessary, repairing the downstream electrical equipment.

Failure to follow these instructions can result in death, serious injury, or equipment damage.

The fact that a protection has tripped the circuit breaker does not remedy the cause of the fault detected on the downstream electrical equipment.

To reset after a fault trip:

Step	Action
1	Isolate the feed, page 23 before inspecting the downstream electrical equipment.
2	With selector on Manu , operate the charging handle 8 times to reset the circuit breaker in ready-to-close position. Result: The spring-charged indicator changes to charged (B) and the internal mechanism goes from the Trip position to the O (OFF) position (A).
3	Lock the circuit breaker.
4	Look for the cause of the detected fault.
5	Inspect and, if necessary, repair the downstream equipment.
6	Inspect the equipment in the event of a short-circuit trip.
7	Reset and close the circuit breaker.

Opening, Closing, and Resetting Circuit Breakers With Communicating Motor Mechanism

Introduction

Manage the communicating motor mechanism with the communication network.

For this function, it is necessary to:

- Install a Breaker Status Control Module (BSCM), page 95 and the NSX cord, page 98.
- Use a communicating motor mechanism.

Connect the BSCM module to the communication network with the NSX cord:

- To receive closing, opening, and reset commands.
- To transmit the circuit breaker states: **O (OFF)**, **I (ON)**, Tripped by SDE.

NOTE: The communicating motor mechanism has a specific reference. For more information, refer to LVPED221001EN, *ComPacT NSX & NSXm Catalogue*.

The BSCM module can be configured using EcoStruxure Power Commission software, page 22.

The schematic for the communicating motor mechanism in the BSCM module can be configured. It must be created in strict accordance with the simplified motor mechanism schematic, page 203.

⚠ CAUTION

HAZARD OF REPEATED CLOSING ON ELECTRICAL FAULT

Do not modify the wiring diagrams for the motor mechanism.

Failure to follow these instructions can result in injury or equipment damage.

Manual Operation: Opening, Closing, and Resetting Locally

The process is the same as the standard motor mechanism.

Automatic Operation: Opening, Closing, and Resetting Remotely

The process is the same as the standard motor mechanism.

Resetting After a Trip on Electrical Fault

Without modifying the factory configuration, the process is the same as for the standard motor mechanism, page 57.

Using EcoStruxure Power Commission software to reconfigure resetting of the BSCM module, page 97 authorizes remote resetting after a trip on electrical fault on a circuit breaker with communicating motor mechanism.

Locking the Circuit Breaker

Locking Accessories

⚠️⚠️ DANGER

HAZARD OF ELECTRIC SHOCK, EXPLOSION, OR ARC FLASH

When the circuit breaker toggle handle is locked in the **(O) OFF** position, always use a properly rated voltage sensing device to confirm that power is off before working on equipment.

Failure to follow these instructions will result in death or serious injury.

Lock the mechanism with up to three padlocks (not supplied) or a keylock.

Both locking methods can be used at the same time.

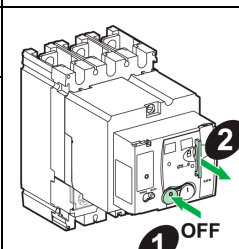
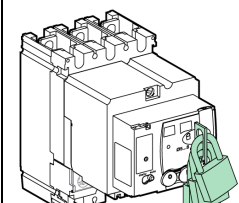
Step	Action	Comment	Result
1		Switch the circuit breaker to the O (OFF) position.	–
2		Pull out the tab	–
3		Lock the tab using: <ul style="list-style-type: none"> • Up to three padlocks 5-8 mm (0.2-0.3 in) in diameter. • A keylock (optional). 	The circuit breaker is locked. No commands in Auto mode or Manu mode are executed.

Sealing Accessories

Use sealing accessories to prevent circuit breaker operations.

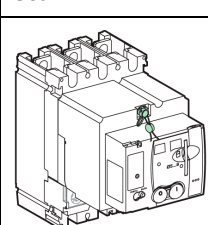
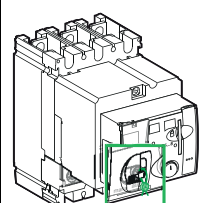
Seal		Prohibited operations
	Motor mechanism mounting screw	<ul style="list-style-type: none"> • Dismantling the escutcheon • Accessing the auxiliaries • Dismantling the trip unit
	Transparent cover for the motor mechanism	Accessing the manual/automatic selector (depending on its position, manual operation ⁽¹⁾ , or automatic operation is disabled).

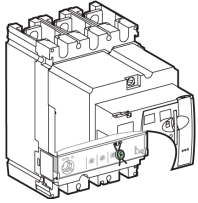
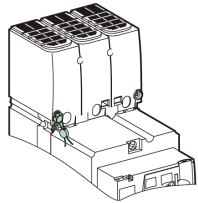
Seal		Prohibited operations
	<p>Transparent protective cover for the trip units</p>	<p>Altering any settings and accessing the test port.</p>
	<p>Mounting screw for terminal shields</p>	<p>Accessing the power connection (protection against direct contact)</p>
<p>(1) In this case no local operations are possible.</p>		

ComPacT NSX Installation Accessories

What's in This Part

Plug-in Circuit Breaker	62
Withdrawable Circuit Breaker	66
Accessories	73

Plug-in Circuit Breaker

Introduction

Plug-in base circuit breakers make it possible to:

- Extract and/or rapidly replace the circuit breaker without having to touch the connections on the base
- Allow for the addition of future circuits by installing bases that will be equipped with a circuit breaker at a later date
- Isolate the power circuits when the circuit breaker is mounted on or through a panel. It acts as a barrier for the connections of the plug-in base. Insulation is made complete by the mandatory short terminal shields on the circuit breaker, page 65.

The following types of circuit breaker can be installed in a plug-in base:

- 3P and 4P circuit breakers
- Circuit breakers with toggle handle, direct rotary handle, or extended rotary handle
- Motor-operated circuit breakers
- Circuit breakers with VigiPacT Add-on

NOTE: ComPacT NSX 400K circuit breakers cannot be installed in a plug-in base.

The plug-in circuit breaker is made up of the fixed circuit breaker and a plug-in kit, which includes:

- Plug-in base
- Power connections
- Short terminal shields
- Safety trip interlock

Disconnecting the Circuit Breaker

⚠️ DANGER

HAZARD OF ELECTRIC SHOCK, EXPLOSION, OR ARC FLASH

- Apply appropriate personal protective equipment (PPE) and follow safe electrical work practices. See NFPA 70E, CSA Z462, NOM-029-STPS, or local equivalent.
- This equipment must only be installed and serviced by qualified electrical personnel.
- The circuit breaker must be in the **O (OFF)** position.
- Do not use tools to disconnect or connect the circuit breaker.

Failure to follow these instructions will result in death or serious injury.

Follow this procedure to disconnect the circuit breaker:

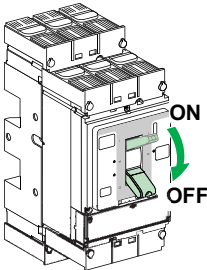
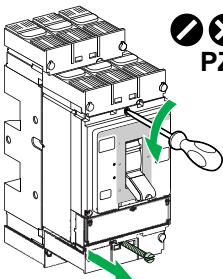
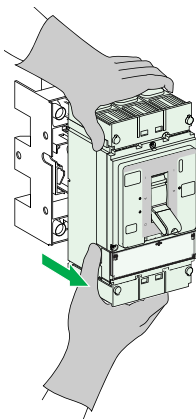
Step	Action
1	 <p>Switch the circuit breaker to the O (OFF) position.</p>
2	 <p>Remove both mounting screws.</p>
3	 <p>Pull out the circuit breaker, keeping it horizontal.</p>

NOTE:

- The auxiliary circuits automatically disconnect because of the connectors located on the base and at the rear of the circuit breaker.
- Open the circuit breaker before disconnecting it. If the circuit breaker is in the closed **I (ON)** position when disconnecting, a pre-trip mechanism trips the circuit breaker before the pins are disconnected.

Connecting the Circuit Breaker

DANGER

HAZARD OF ELECTRIC SHOCK, EXPLOSION, OR ARC FLASH

- Apply appropriate personal protective equipment (PPE) and follow safe electrical work practices. See NFPA 70E, CSA Z462, NOM-029-STPS, or local equivalent.
- This equipment must only be installed and serviced by qualified electrical personnel.
- The circuit breaker must be in the **O (OFF)** position.
- Do not use tools to disconnect or connect the circuit breaker.

Failure to follow these instructions will result in death or serious injury.

Follow this procedure to connect the circuit breaker:

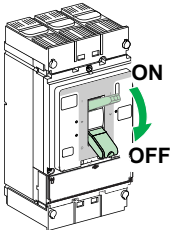
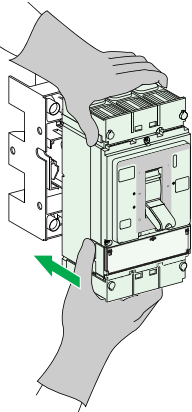
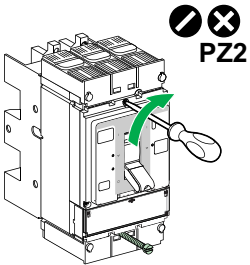
Step	Action	
1		Switch the circuit breaker to the O (OFF) position.
2		Connect the circuit breaker.
3		Replace both mounting screws. Tighten the screws to a torque of 2.5 N•m (22.1 lb-in).

NOTE:

- The auxiliary circuits automatically connect because of the connectors located on the base and at the rear of the circuit breaker.
- Open the circuit breaker before connecting it. If the circuit breaker is in the closed **I (ON)** position when connecting, the pre-trip mechanism trips the circuit breaker before the pins are connected.

Protection Against Direct Contact With Power Circuits

The following table shows plug-in circuit breaker configurations with the corresponding protection indices (IP):

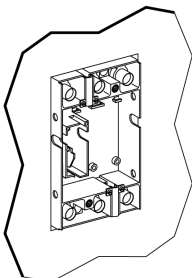
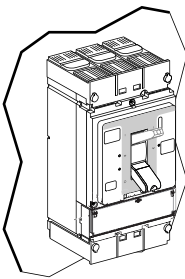
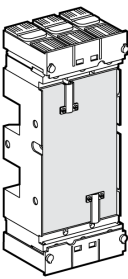
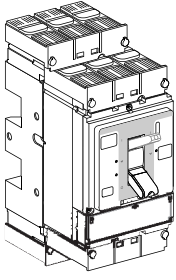
Configuration	Protection index	Description
	IP20	Built-in plug-in base: <ul style="list-style-type: none"> Without circuit breaker With circuit breaker without terminal shields
	IP40	Built-in plug-in base and circuit breaker with terminal shields.
	IP40	Plug-in base with adapter, terminal shields and blanking plate without circuit breaker: <ul style="list-style-type: none"> The adapter enables the use of all the connection accessories of the fixed circuit breaker. It is required to equip the plug-in circuit breaker with long and short terminal shields and interphase barriers. Terminal shields are mandatory for plug-in circuit breakers. Short terminal shields are supplied in the plug-in kit. They can be replaced by long terminal shields available as an option. The blanking plate is not supplied by Schneider Electric.
	IP40	Plug-in base with adapter and terminal shields, and circuit breaker with terminal shields.

For more information about configurations and installation, consult the instruction sheets on the Schneider Electric website:

- GHD16276AA, Plug-in base for ComPacT NSX100-250
- GHD16316AA, Plug-in base for ComPacT NSX400-630

Withdrawable Circuit Breaker

Introduction

In addition to the advantages provided by a plug-in base, installation of the circuit breaker on a chassis facilitates handling. Withdrawable chassis circuit breakers offer three positions, with transfer from one to the other after mechanical unlocking:

- Connected: the power circuits are connected.
- Disconnected: the power circuits are disconnected, the circuit breaker can be operated to check auxiliary operation.
- Removed: the circuit breaker is free and can be removed from the chassis.

The following types of circuit breaker can be installed in a chassis:

- 3P and 4P circuit breakers
- Circuit breakers with toggle handle, direct rotary handle, or extended rotary handle
- Motor-operated circuit breakers
- Circuit breakers with VigiPacT Add-on

NOTE: ComPacT NSX 400K circuit breakers cannot be installed in a chassis.

The withdrawable circuit breaker is made up of:

- The fixed circuit breaker
- A plug-in kit
- Two chassis side plates for the plug-in base
- Two chassis side plates for the circuit breaker

Disconnecting the Circuit Breaker

⚠️ DANGER

HAZARD OF ELECTRIC SHOCK, EXPLOSION, OR ARC FLASH

- Apply appropriate personal protective equipment (PPE) and follow safe electrical work practices. See NFPA 70E, CSA Z462, NOM-029-STPS, or local equivalent.
- This equipment must only be installed and serviced by qualified electrical personnel.
- The circuit breaker must be in the **O (OFF)** position.
- Do not use tools to disconnect or connect the circuit breaker.

Failure to follow these instructions will result in death or serious injury.

Follow this procedure to disconnect the circuit breaker:

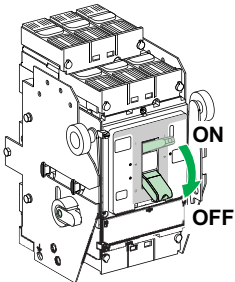
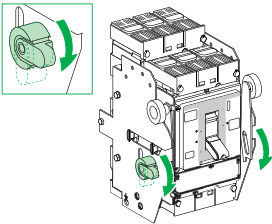
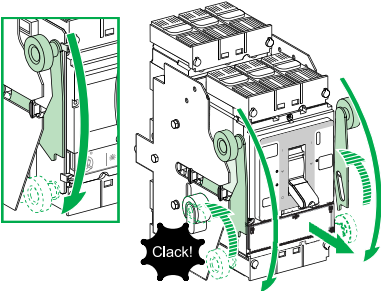
Step	Action
1	 <p>Switch the circuit breaker to the O (OFF) position.</p>
2	 <p>Move both locking levers down as far as they can go.</p>
3	 <p>Push down both operating handles at the same time until you hear a double-click from the locking levers (as the locking levers return to their original position).</p> <p>The circuit breaker is disconnected.</p>

NOTE:

- The auxiliary circuits can be:
 - Automatically disconnected because of the connectors located on the chassis and at the rear of the circuit breaker.
 - Left connected for a circuit breaker with a manual auxiliary connector.
- Open the circuit breaker before disconnecting it. If the circuit breaker is in the closed **I (ON)** position when disconnecting, a safety mechanism ensures that the poles open automatically by tripping the circuit breaker before the pins disconnect.

Removing the Circuit Breaker

DANGER

HAZARD OF ELECTRIC SHOCK, EXPLOSION, OR ARC FLASH

- Apply appropriate personal protective equipment (PPE) and follow safe electrical work practices. See NFPA 70E, CSA Z462, NOM-029-STPS, or local equivalent.
- This equipment must only be installed and serviced by qualified electrical personnel.
- The circuit breaker must be in the **O (OFF)** position.
- Do not use tools to disconnect or connect the circuit breaker.

Failure to follow these instructions will result in death or serious injury.

Follow this procedure to remove the circuit breaker:

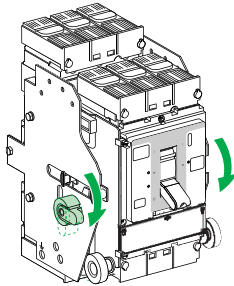
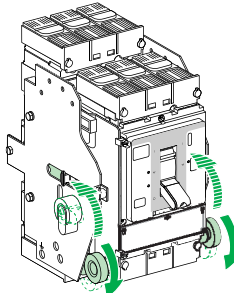
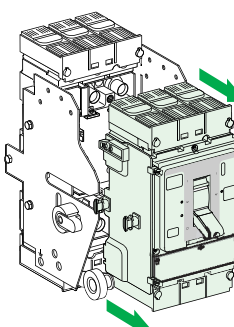
Step	Action
1	 <p>Move both locking levers down.</p>
2	 <p>Push down both operating handles as far as the next notch.</p>
3	 <p>Remove the circuit breaker, keeping it horizontal.</p>

Connecting the Circuit Breaker

⚠️ ⚠️ DANGER

HAZARD OF ELECTRIC SHOCK, EXPLOSION, OR ARC FLASH

- Apply appropriate personal protective equipment (PPE) and follow safe electrical work practices. See NFPA 70E, CSA Z462, NOM-029-STPS, or local equivalent.
- This equipment must only be installed and serviced by qualified electrical personnel.
- The circuit breaker must be in the **O (OFF)** position.
- Do not use tools to disconnect or connect the circuit breaker.

Failure to follow these instructions will result in death or serious injury.

Follow this procedure to connect the circuit breaker:

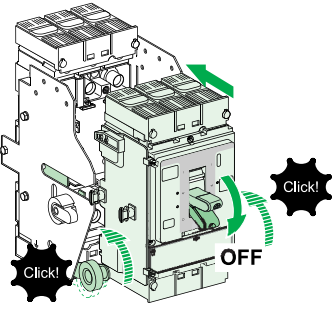
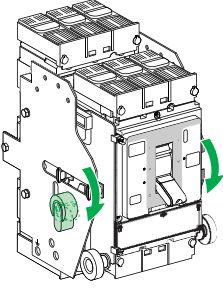
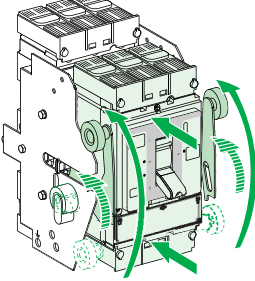
Step	Action	
1		<p>Switch the circuit breaker to the open O (OFF) position.</p> <p>Move both operating handles down to the low position on the chassis.</p> <p>Push in the circuit breaker until the locking levers clicks.</p>
2		<p>Move both locking levers forward.</p>
3		<p>Raise both locking levers at the same time.</p>

NOTE: Open the circuit breaker before connecting it. If the circuit breaker is in the closed **I (ON)** position when connecting, a mechanism opens the poles automatically by tripping the circuit breaker before the pins connect.

Withdrawable Circuit Breaker Protection Against Direct Contact With Power Circuits

The following table shows withdrawable circuit breaker configurations with the corresponding protection indices (IP):

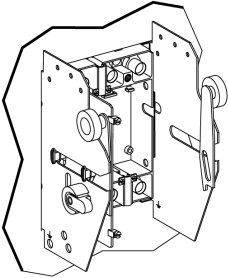
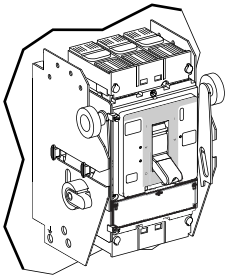
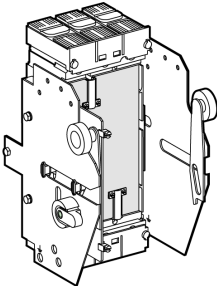
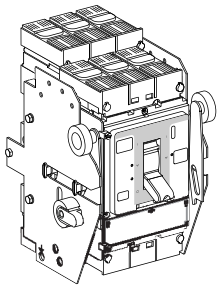
Configuration	Protection index	Description
	IP20	Built-in chassis: <ul style="list-style-type: none"> Without circuit breaker With circuit breaker without terminal shields
	IP40	Built-in chassis and circuit breaker with terminal shields.
	IP40	Chassis with adapter, terminal shields and blanking plate without circuit breaker: <ul style="list-style-type: none"> The adapter enables the use of all the connection accessories of the withdrawable circuit breaker. It is required to equip the withdrawable circuit breaker with long and short terminal shields and interphase barriers. Terminal shields are mandatory for withdrawable circuit breakers. Short terminal shields are supplied in the plug-in kit. They can be replaced by long terminal shields available as an option. The blanking plate is not supplied by Schneider Electric.
	IP40	Chassis with adapter and terminal shields, and circuit breaker with terminal shields.

For more information about configurations and installation, consult the instruction sheets on the Schneider Electric website:

- GHD16277AA, Chassis side plates for ComPacT NSX100-250
- GHD16317AA, Chassis side plates for ComPacT NSX400-630

Auxiliary Circuit Test with Circuit Breaker Disconnected (Optional)

The auxiliary circuit test function is possible with circuit breakers which have manual auxiliary connectors.

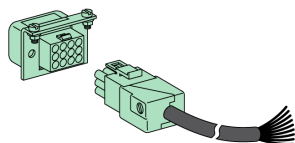

In the disconnected position, operate the circuit breaker (by the actuator or push-to-trip button) to check whether the auxiliary circuits are working correctly.

Disconnect the manual auxiliary connector (if the circuit breaker has one) before removing the circuit breaker.

Carriage Switches (Optional)

Two changeover contacts can be installed on the chassis:

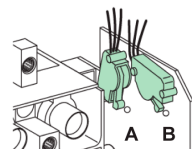

A Connected-position carriage switch (CE)

B Disconnected-position carriage switch (CD)

For more information about contact operation, refer to *control auxiliaries*, page 102.

Carriage switches, in conjunction with the IO module, provide the chassis management function, which is used to:

- Record and check the position of the moving part of the withdrawable circuit breaker in the chassis
- Provide information about preventive maintenance actions
- Notify the remote controller about the position of the withdrawable circuit breaker.

For more information about the chassis management function, refer to DOCA0055EN, *Enerlin'X IO - Input/Output Application Module for One IEC Circuit Breaker - User Guide*,

Locking the Chassis

The operating handle can be locked with up to four padlocks (not supplied) or keylock.

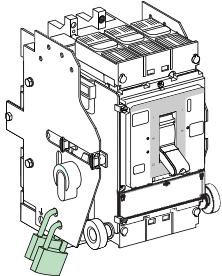
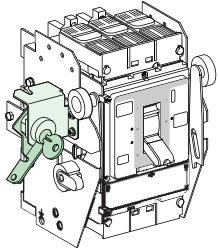
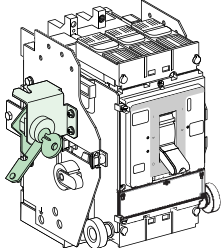
Illustration	Description
	<p>Lock the circuit breaker in disconnected position using up to four padlocks (not supplied) with a shackle diameter of 5–8 mm (0.2–0.3 in) to prevent connection.</p>
	<p>Lock the circuit breaker using a keylock (optional) in the connected position when the locking kit accessory is installed.</p>
	<p>Lock the circuit breaker using a keylock (optional) in the disconnected position when the locking kit accessory is installed.</p>

For more information about the accessory offer, refer to LVPED221001EN, *ComPacT NSX & NSXm Catalogue*.

Accessories

Accessories for ComPacT NSX Circuit Breakers

A comprehensive accessory offer is available for ComPacT NSX circuit breakers. Accessories can be installed on site to improve safety and ease of operation.

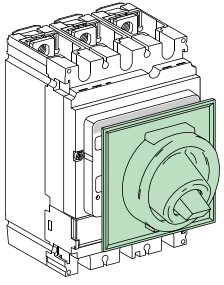
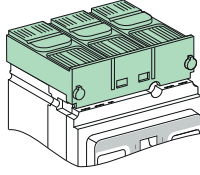
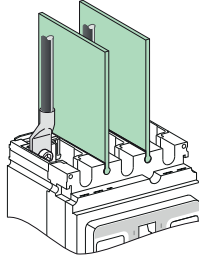
		
<p>Sealed boot for the toggle handle, providing IP43 protection on the front</p>	<p>Short or long terminal shields, providing IP40 protection</p>	<p>Flexible interphase barriers improving isolation between power connections</p>

For more information about the accessory offer, refer to LVPED221001EN, *ComPacT NSX & NSXm Catalogue*.

Long Terminal Shields with Precut Grids

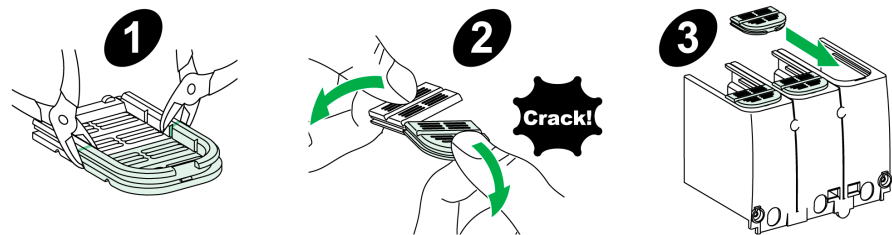

1 Cutting a grid

2 Adjusting the size of the grid

3 Inserting the grid in the terminal shield

Terminal shields with precut grids simplify the onsite connection of circuit breakers regardless of the number of conductors to be connected. The procedure for installing precut guides is described in the following instruction sheets on the Schneider Electric website:

- NNZ4765407, ComPacT NSX100–250 circuit breaker and switch-disconnector
- NNZ4765507, ComPacT NSX400–630 circuit breaker and switch-disconnector

Short Terminal Shields

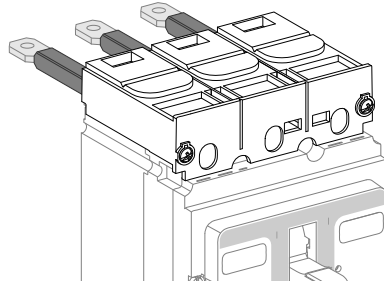

The procedure for installing short terminal shields is described in the following instruction sheets on the Schneider Electric website:

- NNZ4765407, ComPacT NSX100–250 circuit breaker and switch-disconnector
- NNZ4765507, ComPacT NSX400–630 circuit breaker and switch-disconnector

ComPacT NSX Electrical Auxiliary and Accessory Devices

What's in This Part

Electrical Auxiliary Device Summary	76
Indication Contacts	81
Wireless Indication Auxiliary	83
SDx Module	87
SDTAM Module (MicroLogic 2 M and 6 E-M)	90
24 Vdc Power Supply Connector	93
BSCM Breaker Status Control Module	94
NSX Cord	98
Insulated NSX Cord	100
Control Auxiliaries	102
PowerTag Energy M250/M630	104

Electrical Auxiliary Device Summary

Electrical Auxiliary Devices

The following table shows the electrical auxiliary devices that can be added to the ComPacT NSX circuit breakers. For more information, refer to LVPED221001EN, *ComPacT NSX & NSXm Catalogue*.

Electrical auxiliary device	NSX100			NSX160			NSX250		NSX400	NSX630
	1P	2P	3P/4P	1P	2P	3P/4P	1P	3P/4P	3P/4P	3P/4P
OF or SD auxiliary contact	–	✓	✓	–	✓	✓	–	✓	✓	✓
SDE auxiliary contact	–	–	✓	–	–	✓	–	✓	✓	✓
SDx module	–	–	✓	–	–	✓	–	✓	✓	✓
SDTAM module	–	–	✓	–	–	✓	–	✓	✓	✓
Wireless indication auxiliary	–	✓	✓	–	✓	✓	–	✓	✓	✓
MN undervoltage trip release	–	✓	✓	–	✓	✓	–	✓	✓	✓
MX shunt trip release	–	✓	✓	–	✓	✓	–	✓	✓	✓
BSCM breaker status control mode	–	–	✓	–	–	✓	–	✓	✓	✓
NSX cord	–	–	✓	–	–	✓	–	✓	✓	✓
24 Vdc power supply connector ⁽¹⁾	–	–	✓	–	–	✓	–	✓	✓	✓

(1) with MicroLogic 5, 6, and 7 trip units

Slots for Electrical Auxiliary Devices on ComPacT NSX100/160 2P Circuit Breakers

The following table shows the possible slots for electrical auxiliary devices mounted in the case. Only one auxiliary device can be installed per slot. For more information, refer to LVPED221001EN, *ComPacT NSX & NSXm Catalogue*.

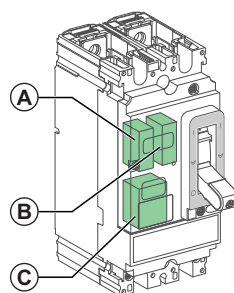

Name	Slot		
	A	B	C
OF1 (wired or wireless)	✓	–	–
SD (wired or wireless)	–	✓	–
MN	–	–	✓
MX	–	–	✓

Slots for Electrical Auxiliary Devices on ComPacT NSX100-250 3P/4P Circuit Breakers

The following table shows the possible slots for electrical auxiliary devices mounted in the case. Only one auxiliary device can be installed per slot. For more information, refer to LVPED221001EN, *ComPacT NSX & NSXm Catalogue*.

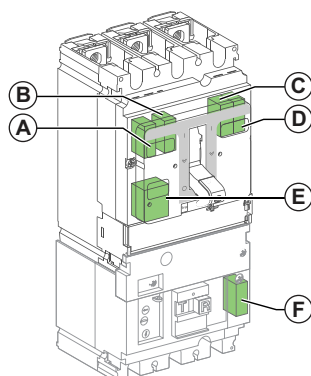

Name	Slot						Comments
	A	B	C	D	E	F	
Standard remote indication and control auxiliaries							
OF1 (wired or wireless)	✓	-	-	-	-	-	For all trip unit types and control types (toggle handle, rotary handle, or motor mechanism).
OF2 (wired or wireless)	-	-	-	✓	-	-	
SD (wired or wireless)	-	✓	-	-	-	-	
SDE (wired or wireless)	-	-	✓	-	-	-	
SDV (wired only)	-	-	-	-	-	✓	Indication contact in VigiPacT Add-on
MN	-	-	-	-	✓	-	For all trip unit types and control types (toggle handle, rotary handle, or motor mechanism).
MX	-	-	-	-	✓	-	
Remote indication on communication network							
BSCM	-	-	✓	✓	-	-	For connection of the BSCM module to the communication network.
NSX cord	-	✓	-	-	-	-	
NSX cord	-	-	-	✓	-	-	For connection of the MicroLogic 5, 6, and 7 trip units to the communication network when no BSCM module is installed.
Specific remote indication with MicroLogic trip units							
SDx	✓	-	-	-	✓	-	Including SDV for MicroLogic 4 and 7 trip units.
SDTAM	✓	-	-	-	✓	-	Only for circuit breakers with a MicroLogic 2 M or 6 E-M trip unit designed to protect motors.
24 Vdc power supply connector	-	-	-	✓	-	-	For connection of external power supply to MicroLogic 5, 6, and 7 trip units.

NOTE: It is not possible to install all the accessories at the same time on one trip unit. For example, the SDx module cannot be installed at the same time as an MN or MX release and the OF1 contact.

Slots for Electrical Auxiliary Devices on ComPacT NSX400-630 3P/4P Circuit Breakers

ComPacT NSX400-630 circuit breakers are exclusively equipped with MicroLogic trip units.

The following table shows the possible slots for the electrical auxiliary devices mounted in the case. For more information, refer to LVPED221001EN, *ComPacT NSX & NSXm Catalogue*.

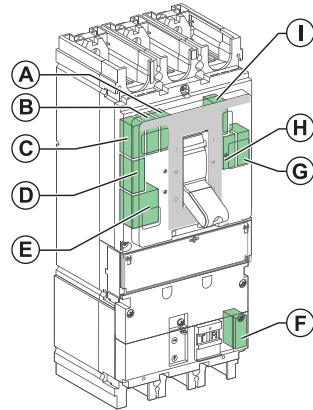



Name	Slot									Comments
	A	B	C	D	E	F	G	H	I	
Standard remote indication and control auxiliaries										
OF1 (wired or wireless)	–	–	✓	–	–	–	–	–	–	For all trip unit types and control types (toggle handle, rotary handle, or motor mechanism).
OF2 (wired or wireless)	–	✓	–	–	–	–	–	–	–	
OF3 (wired or wireless)	✓	–	–	–	–	–	–	–	–	
OF4 (wired or wireless)	–	–	–	–	–	–	✓	–	–	
SD (wired or wireless)	–	–	–	–	–	–	–	–	✓	
SDE (wired or wireless)	–	–	–	–	–	–	–	✓	–	
SDV (wired only)	–	–	–	–	–	✓	–	–	–	Indication contact in VigiPacT Add-on
MN	–	–	–	–	✓	–	–	–	–	For all trip unit types and control types (toggle handle, rotary handle, or motor mechanism).
MX	–	–	–	–	✓	–	–	–	–	
Remote indication on communication network										
BSCM	–	–	–	–	–	–	✓	✓	–	For connection of the BSCM module to the communication network.
NSX cord	–	–	–	–	–	–	✓	–	–	
NSX cord	–	–	–	–	–	–	–	–	✓	For connection of the MicroLogic 5, 6, and 7 trip units to the communication network when no BSCM module is installed.
Specific remote indication with MicroLogic trip units										
SDx	–	–	–	✓	✓	–	–	–	–	Including SDV for MicroLogic 4 and 7 trip units.
SDTAM	–	–	–	✓	✓	–	–	–	–	Only for circuit breakers with a MicroLogic 2 M or 6 E-M trip unit designed to protect motors.
24 Vdc power supply connector	–	–	–	–	–	–	✓	–	–	For connection of external power supply to the MicroLogic 5, 6, and 7 trip units.

NOTE: It is not possible to install all the accessories at the same time on one trip unit. For example, the SDx remote indication option cannot be installed at the same time as an MN or MX release.

Operation of the Indication Contacts

The following table shows the position of the indication contacts (or outputs) relative to the position of the actuator and main contacts.

		Position of the actuator and the main contacts								
		 ON	 Tripped						 OFF	
			Tripped by:		Trip unit ⁽²⁾					
		MN/MX	PT ⁽¹⁾	L		S or So	I	R	G	
Name	Position of indication contacts									
OF	✓	-	-	-	-	-	-	-	-	-
SD	-	✓	✓	✓	✓	✓	✓	✓	✓	-
SDE	-	-	-	✓	✓	✓	✓	✓	✓	-
SDV	-	-	-	-	-	-	-	✓	-	-
SDx outputs⁽³⁾										
SD2	SDT	-	-	-	✓	-	-	-	-	-
SD4	PAL	-	-	-	✓	-	-	-	-	-
	SDG	-	-	-	-	-	-	-	✓	-
	SDV	-	-	-	-	-	-	✓	-	-
SDTAM outputs										
SD2	Early make/ break SDT	-	-	-	✓✓	-	-	-	-	-
SD4		Contactor control								
✓: Contact closed, ✓✓: Early-make output (400 ms)										
(1) PT: Push-to-trip										
(2) L: Long-time protection										
S or So: Short-time protection										
I: Instantaneous protection										
R: VigiPacT Add-on protection (earth-leakage)										
G: Ground-fault protection										
(3) SDx output assignment can be customized for MicroLogic 5, 6, and 7 trip units, by using EcoStruxure Power Commission software.										

NOTE: The indication (changeover) contacts are represented in the switchboard by the state of the Normally Open (NO) contact.

The state of the NO contact is open:

- for OF contacts when the circuit breaker is in the **O (OFF)** position.
- for SD, SDE, and SDV contacts when the associated function is not active.

Sequence chart of the OF contacts relative to the main contacts

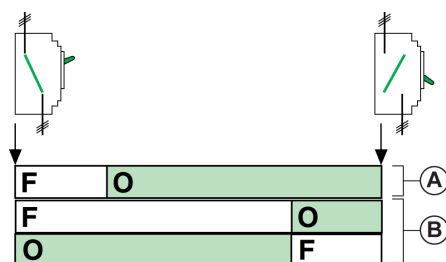

A Main contacts

B Position of OF changeover contacts

Operation of the Wireless Indication Auxiliaries

The wireless indication auxiliary provides the same information as a standard wired auxiliary contact in OF, SD, or SDE positions. The information is sent remotely to a gateway or panel server.

During commissioning of the wireless indication auxiliary, the user defines the type of information sent: Open/Close or Trip.

Indication Contacts

Introduction

One indicator contact model provides OF, SD, SDE, and SDV indication functions. The position of the contact inside the case determines the function.

Indication contacts are either under the front face of the circuit breaker, under the motor mechanism, or in the rotary handle. Installation is in a compartment isolated from the power circuits. There are two types:

- Standard contact with spring terminals

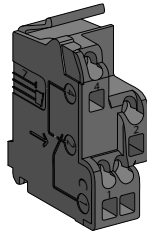

- Low-level contact with screw terminals

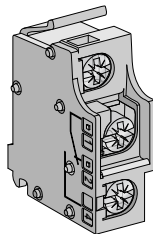

For more information about installation, consult the instruction sheet on the Schneider Electric website: [NNZ4314501 Indication Contacts](#)

Standard and Low-Level Contacts

Standard and low-level contacts are the common point changeover type.

NC NO



NC Normally Closed contact

NO Normally Open contact

The following table describes the operation of standard and low-level volt-free contacts:

Name	Definition
OF indication contact	Changeover: The NO contact is normally open when the circuit breaker is in the O (OFF) position.
SD indication contact	<p>Trip indication: The SD contact indicates that the circuit breaker has tripped due to:</p> <ul style="list-style-type: none"> • Long-time protection • Short-time protection • Ground-fault protection • Earth-leakage protection (trip by MicroLogic 4 or 7 trip unit, or by VigiPacT Add-on) • Operation of the MX or MN voltage releases • Operation of the push-to-trip button • Connecting/Disconnecting the circuit breaker • Manually opening the motor mechanism
SDE indication contact	<p>Electrical fault indication: The SDE contact indicates that the circuit breaker has tripped on an electrical fault due to:</p> <ul style="list-style-type: none"> • Long-time protection • Short-time protection • Ground-fault protection • Earth-leakage protection (trip by MicroLogic 4 or 7 trip unit, or by VigiPacT Add-on)
SDV indication contact	<p>Earth-leakage fault indication: The SDV contact indicates that the circuit breaker has tripped due to an earth-leakage fault detected by the earth-leakage protection of the VigiPacT Add-on.</p> <p>NOTE: Use the SDx module to indicate an earth-leakage fault detected by a MicroLogic 4 or 7 or MicroLogic 4 AL or 7 AL trip unit.</p>

Wireless Indication Auxiliary

Introduction

The wireless indication auxiliary provides remote and local information about the circuit breaker status.

The position of the wireless indication auxiliary inside the case, and the setting of the gateway or panel server, determine its function. The wireless indication auxiliary provides the following information remotely:

Position of wireless indication auxiliary	Information provided
OF slot	Open/close circuit breaker status
SD slot	Trip indication
SDE slot	Electrical fault indication

When in the SD slot, the wireless indication auxiliary can be configured to indicate a circuit breaker trip locally. The status LED blinks orange for eight hours.

The wireless indication auxiliary must be paired with a gateway or panel server.

The wireless indication auxiliary is powered by an internal battery. It sends a notification to indicate that the battery needs to be replaced.

For more information about installation, consult the instruction sheet on the Schneider Electric website: [NNZ8882801 Wireless Indication Auxiliary](https://www.schneider-electric.com/resources/technical-documents/NNZ8882801-Wireless-Indication-Auxiliary)

Description

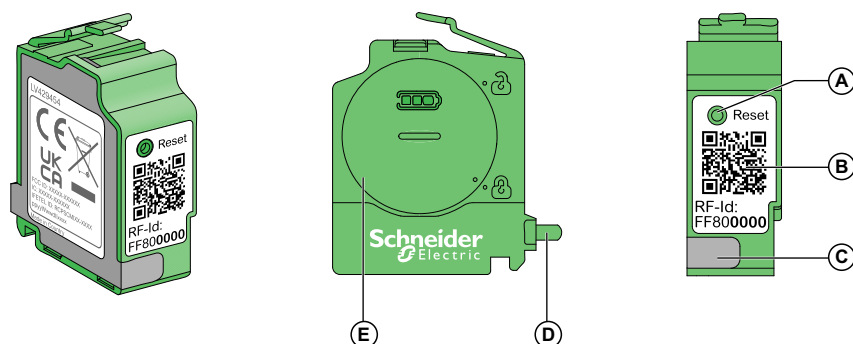

A Reset button

B QR code to access device information, including RF-Id address

C Status LED

D Actuator

E Battery cover

Reset Button



The reset button allows you to :

- Access setting mode to set the status LED indication mode
- Pair or unpair the wireless indication auxiliary

Status LED

A status LED on the wireless indication auxiliary provides the following information:

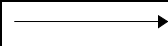
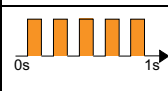
- Help with commissioning and maintenance steps
- Status of communication between wireless indication auxiliary and gateway or panel server
- Status of the wireless indication auxiliary
- Indication of circuit breaker trip (available when LED indication mode is ON).

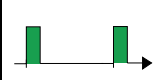
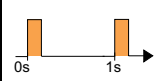
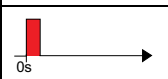
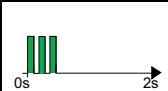
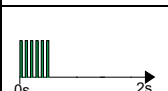
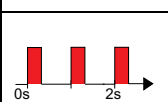
Status LED	Description	Action
	Wireless indication auxiliary switched off or not in communication with gateway or panel server.	None
	Wireless indication auxiliary in pairing mode, searching for a gateway or panel server.	Wait until the gateway or panel server is identified.
	Wireless indication auxiliary in identification mode.	Wait until wireless indication auxiliary is discovered in network.
	Wireless indication auxiliary in communication. One green flash at each frame sent.	None
	Trip indication when wireless indication auxiliary is in SD slot and configured in LED indication mode ON	Check tripping cause.
	Occasional loss of communication with the gateway or panel server.	Check communication setting with the gateway or panel server.
	Wireless indication auxiliary in setting mode, with LED indication mode set to OFF.	Set LED indication mode to ON by pressing the Reset button.
	Wireless indication auxiliary in setting mode, with LED indication mode set to ON.	Set LED indication mode to OFF by pressing the Reset button.
 Flashes only when actuator is activated	Battery out of power	Change the battery.

Commissioning

Commission the wireless indication auxiliary by using EcoStruxure Power Commission software or the webpages of the gateway or panel server.

NOTE: Check the firmware of the gateway before performing the commissioning of the wireless indication auxiliary. It is recommended to upgrade to the latest version available.

Step	Action
1	<p>Put the wireless indication auxiliary in pairing mode in one of the following ways:</p> <ul style="list-style-type: none"> • If the wireless indication auxiliary is not installed in the circuit breaker, press the reset button or the actuator. • If the wireless indication auxiliary is installed in the OF slot, open and close the circuit breaker. • If the wireless indication auxiliary is installed in the SD slot, open, close and action the push-to-trip button on the circuit breaker. • If the wireless indication auxiliary is installed in the SDE slot, open, close and trip the circuit breaker electrically. <p>Result: The status LED blinks orange. The wireless indication auxiliary stays in pairing mode for three minutes.</p>
2	<p>Pair the gateway or panel server with the wireless indication auxiliary by using EcoStruxure Power Commission software or the webpages of the gateway or panel server.</p> <p>Result: The status LED blinks green to indicate that the wireless indication auxiliary is paired.</p>
3	<p>Configure the wireless indication auxiliary by using EcoStruxure Power Commission software or the webpages of the gateway or panel server.</p>

Setting LED Indication Mode

Set the LED indication mode of the wireless indication auxiliary to ON to indicate a trip locally when the wireless indication auxiliary is installed in the SD slot. The LED indication mode is factory-set to OFF.

Follow this procedure to change the LED indication mode.

Step	Action
1	<p>Press the reset button.</p> <p>Result: The wireless indication auxiliary wakes up.</p>
2	<p>Press the reset button three times in less than two seconds.</p> <p>Result: The wireless indication auxiliary is in setting mode. the Status LED flashes three times every two seconds if LED indication mode is OFF, or six times every two seconds if LED indication mode is ON.</p>
3	<p>Press the reset button once to change the LED indication mode from OFF to ON, or from ON to OFF.</p>
4	<p>To exit setting mode, press the reset button for three seconds.</p> <p>NOTE: If the reset button is not pressed, the wireless indication auxiliary exits setting mode after two minutes.</p>

Replacing the Internal Battery

The wireless indication auxiliary sends a notification six months before the battery needs to be changed.

For more information about the spare battery, refer to LVPED221001EN, *ComPacT NSX & NSXm Catalogue*.

Follow this procedure to replace the internal battery.

Step	Action
1	<p>Remove the wireless indication auxiliary from its slot. Refer to NNZ8882801 <i>Wireless Indication Auxiliary Instruction Sheet</i>.</p>
2	<p>Remove the battery cover by turning it clockwise.</p>
3	<p>Remove the battery and recycle it.</p>
4	<p>Insert the new battery, following the guidelines marked in the battery compartment.</p>

Step	Action
5	Put back the battery cover and lock it by turning it anti-clockwise.
6	Reinstall the wireless indication auxiliary in its slot.
7	Put back the front cover of the circuit breaker.

Replacing the Wireless Indication Auxiliary

Follow this procedure to unpair the wireless indication auxiliary and delete it in EcoStruxure Power Commission software or the webpages of the gateway or panel server before replacing the wireless indication auxiliary.

Step	Action
1	Remove the wireless indication auxiliary from its slot. Refer to NNZ8882801 <i>Wireless Indication Auxiliary Instruction Sheet</i> .
2	Unpair the wireless indication auxiliary by pressing the reset button for at least three seconds and releasing, or by using EcoStruxure Power Commission software or the webpages of the gateway or panel server.
3	Install the new wireless indication auxiliary in its slot.
4	Pair the wireless indication auxiliary by following the procedure in <i>Commissioning</i> , page 84.
5	Put back the front cover of the circuit breaker.

SDx Module

Introduction

An SDx module can be used with ComPacT NSX circuit breakers equipped with MicroLogic trip units.

The SDx module receives data from the trip unit through an optical link:

- For MicroLogic 2 trip units, one output (non-configurable) for remote monitoring of the thermal trip alarm
- For MicroLogic 4 trip units, two outputs (non-configurable) for remote monitoring of:
 - The thermal trip alarm
 - The earth-leakage trip alarm
- For MicroLogic 5, 6, and 7, two outputs (configurable) for remote monitoring of alarms

Description

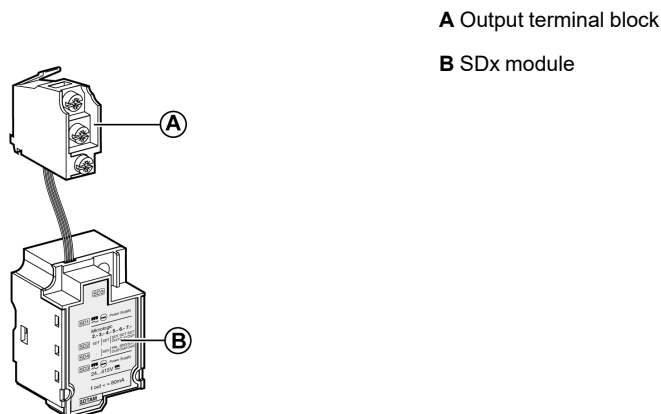

Installation

The slots used to install the SDx module depend on the circuit breaker type.

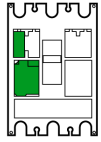
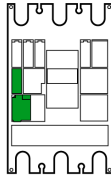
ComPacT NSX100-250	ComPacT NSX400-630
	

The SDx module cannot be installed at the same time as an MN/MX release and OF contact.

For more information about installation, consult the instruction sheet on the Schneider Electric website: [GHD16241AA](https://www.se.com/it/it/doc/GHD16241AA), ComPacT NSX100–630 - *SDx Output Module*.

Connection

Connect the SDx module and the outputs in strict accordance with the wiring diagram.

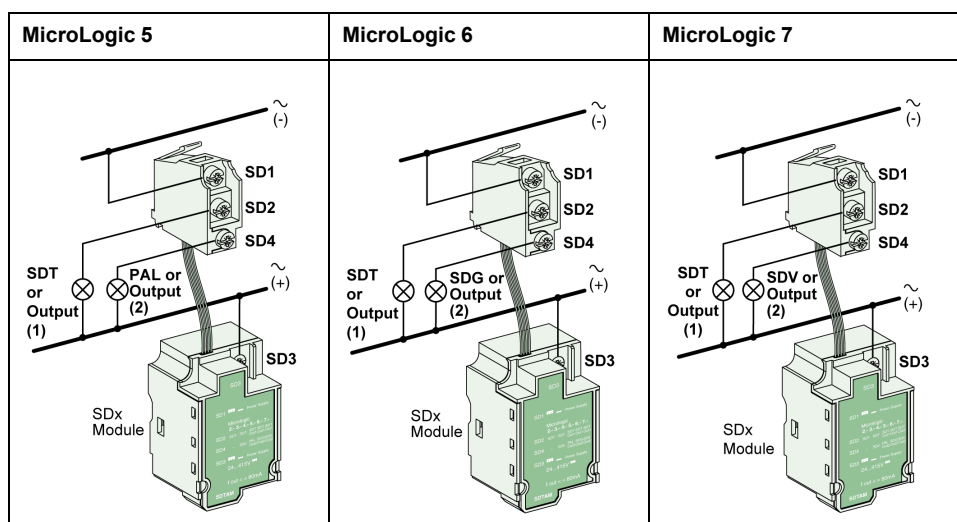
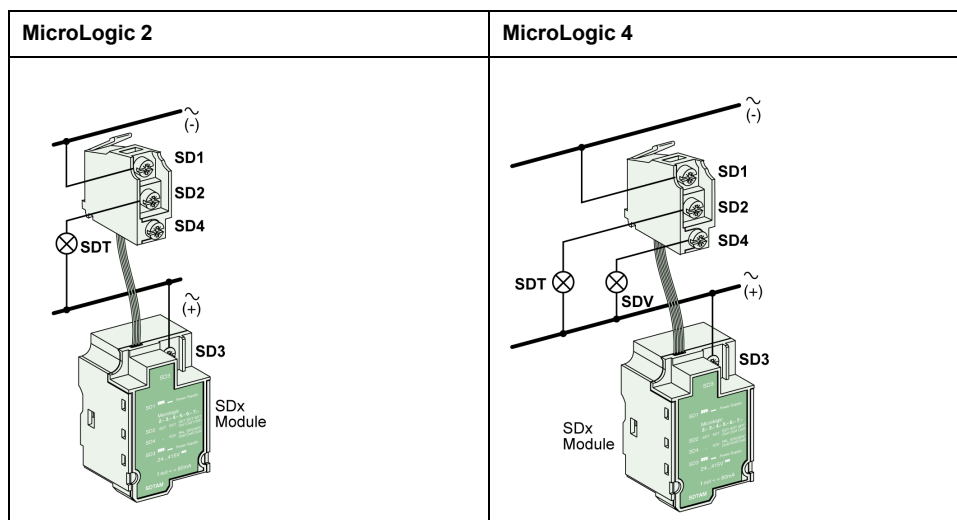

The characteristics of the SDx module outputs are:

- Voltage: 24–415 Vac/Vdc
- Current:
 - Active outputs: 80 mA maximum
 - Idle outputs: 0.25 mA

Output Assignment Factory Setting

The functions offered by the SDx module outputs depend on the type of trip unit installed with the module

MicroLogic	Output 1 (SD2/OUT1)	Output 2 (SD4/OUT2)
2	Thermal fault indication alarm (SDT)	Not available
4	Thermal fault indication alarm (SDT)	Earth-leakage fault indication alarm (SDV)
5	Thermal fault indication alarm (SDT)	Long-time pre-alarm (PAL Ir). Alarm activated as soon as the current in the load reaches 90% Ir.

MicroLogic	Output 1 (SD2/OUT1)	Output 2 (SD4/OUT2)
6	Thermal fault indication alarm (SDT)	Ground-fault indication alarm (SDG)
7	Thermal fault indication alarm (SDT)	Earth-leakage fault indication alarm (SDV)

NOTE: Outputs SDT, SDG, and SDV return automatically to their initial state when the circuit breaker closes.

Reconfiguring the SDx Module Outputs

Use EcoStruxure Power Commission software to reconfigure the assignment of SDx output 1 (SD2/OUT1) and output 2 (SD4/OUT2), when they are used with MicroLogic 5, 6, and 7 trip units.

For more information about the list of alarms and configuration options using EcoStruxure Power Commission software, refer to DOCA0188EN, *ComPacT NSX MicroLogic 5/6/7 Electronic Trip Units - User Guide*.

The operating mode of the outputs can be configured:

- Without latching
- With latching (the return to the initial state takes place by acknowledging the latched output using the communication network or the MicroLogic keypad)
- Time-delayed without latching (the return to the initial state takes place at the end of the time delay)
- Forced to the closed state (the return to the initial state takes place by acknowledging the latched output using the communication network or the MicroLogic keypad)
- Forced to the open state (the return to the initial state takes place by acknowledging the latched output using the communication network or the MicroLogic keypad)

SDTAM Module (MicroLogic 2 M and 6 E-M)

Introduction

An SDTAM module can be used with circuit breakers with a MicroLogic 2 M or 6 E-M trip unit designed to protect motors.

The SDTAM module receives data from the MicroLogic trip unit through an optical link and makes available two outputs assigned to manage tripping due to overload.

Description

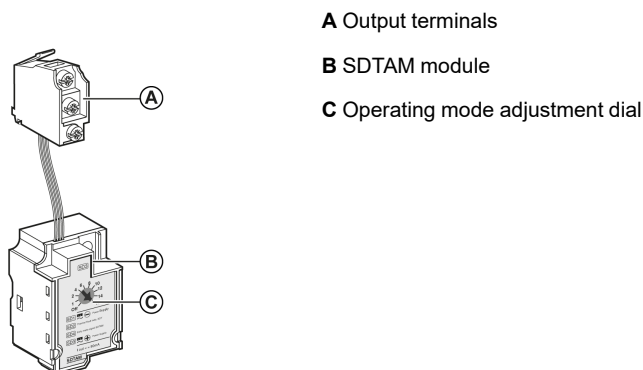

- A Output terminals
- B SDTAM module
- C Operating mode adjustment dial

Installation

The slots used to install the SDTAM module depend on the circuit breaker type.

ComPacT NSX100-250	ComPacT NSX400-630

The SDTAM module cannot be installed at the same time as an MN/MX release and OF contact.

For more information about installation, consult the instruction sheet on the Schneider Electric website: GHD16274AA ComPacT NSX100-630 – SDTAM Thermal Fault Module.

Connection

Connect the SDTAM module and the two outputs in strict accordance with the wiring diagram.

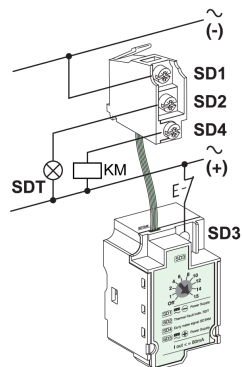

The characteristics of the SDTAM module outputs are:

- Voltage: 24–415 Vac/Vdc
- Current:
 - Active outputs: 80 mA maximum
 - Idle outputs: 0.25 mA

Output Assignment

Output 1 (SD2/OUT1): normally open, indicates thermal faults.

Output 2 (SD4/OUT2): normally closed, opens the contactor KM.

Outputs are activated 400 ms before the circuit breaker trips in the case of:

- Long-time protection
- Phase-unbalance protection
- Locked rotor protection (MicroLogic 6 E-M)
- Undercurrent protection (MicroLogic 6 E-M)

Contactor Control

Contactor control by the output 2 signal (SD4/OUT2) optimizes continuity of service and provides the following additional benefits:

- Lower risk of motor deterioration.
- Activation of the output indicates that the application is not working normally. Abnormal operation is not the result of an anomaly or internal fault in the motor-feeder.
- The cause of this abnormal operation can be temporary (for example, a voltage drop causing an overly long starting time).

When the cause of the overload or unbalance has disappeared, the equipment can be powered up again.

NOTE: To control a contactor with a consumption exceeding 80 mA, it is necessary to provide an interface (RBN or RTBT relay).

Operating Mode

The SDTAM module incorporates an operating mode adjustment dial:



To return the outputs to their initial state following activation:

- Manual (SDTAM dial in the OFF position) after canceling the module power supply
- Automatic (SDTAM dial on one of the time delay adjustment settings) following a time delay (set from 1 to 15 minutes to allow for the motor cooling time).

24 Vdc Power Supply Connector

Introduction

The 24 Vdc power supply connector connects the MicroLogic trip unit to an external 24 Vdc power supply to allow it to be powered when the circuit breaker is open or when the current is low (15 to 50 A depending on the rating).

The MicroLogic trip unit is powered by the current through the internal current transformers to provide the protection functions when the circuit breaker is closed.

An external 24 Vdc power supply is optional for:

- Modifying the settings when the circuit breaker is open.
- Displaying measurements when there is a low current through the closed circuit breaker.
- Displaying the trip cause and the breaking current when the circuit breaker is open after a trip.

Installation

The slots used to install the 24 Vdc power supply connector depend on the circuit breaker type.

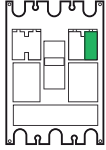
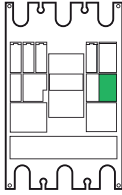
ComPacT NSX100-250	ComPacT NSX400-630
	

BSCM Breaker Status Control Module

Introduction

The BSCM Breaker Status Control Module can be used to send the following data via the communication network:

- Circuit breaker states from OF, SD, and SDE auxiliary contacts
- Control instructions for the communicating motor mechanism (if present): opening, closing, and resetting
- Information to assist the operator: storage of the last 10 events

Use the BSCM module with ComPacT NSX circuit breakers equipped with thermal-magnetic or MicroLogic electronic trip units and with all ComPacT NSX switch-disconnectors.

NOTE: The BSCM module cannot be installed in a ComPacT NSX 400K circuit breaker.

Installation of the BSCM module requires:

- The NSX cord
- Pre-installation of the communicating motor mechanism (if present)

For more information about integrating ComPacT NSX circuit breaker communication functions, refer to:

- DOCA0093EN, *ULP System (IEC Standard) - User Guide*
- DOCA0213EN, *ComPacT NSX - Modbus Communication Guide*

Description

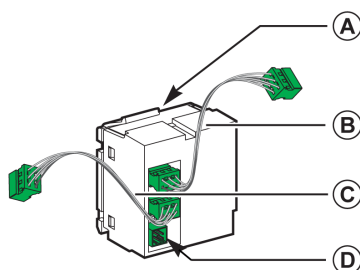

Mark-er	Data medium	Data transmitted	Comments
A	BSCM module microswitches	State of OF and SDE contacts	The BSCM module takes the place of the auxiliary contacts in the OF and SDE slots.
B	Connector for the NSX cord	Communication network and state of SD contact through the microswitch on the NSX cord	The NSX cord goes in the SD slot instead of the auxiliary contact.
C	Connector for the MicroLogic 5, 6, or 7 trip units	Communication network	Only with MicroLogic 5, 6, or 7 trip units
D	Connector for the communicating motor mechanism	Controlling the communicating motor mechanism Status of the communicating motor mechanism	Use the connector supplied with the communicating motor mechanism.

Installing the BSCM Module

The slots used to install the BSCM module depend on the circuit breaker type.

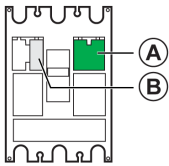
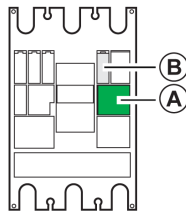
ComPacT NSX100-250	ComPacT NSX400-630
	
<p>A BSCM module</p> <p>B NSX cord</p>	

The BSCM module cannot be installed at the same time as an OF contact or the SDE contact.

The BSCM module can be installed on site.

For more information about installation, consult the instruction sheet on the Schneider Electric website: GHD16046AA ComPacT NSX100–630 – BSCM.

Connecting the BSCM Module







To install the BSCM module:

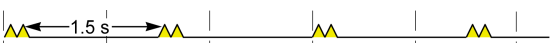

- Plug in the module.
- Connect the 4 connectors.

Setting Up the BSCM Module

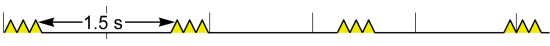
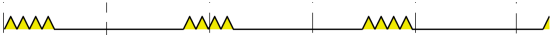
Setting up the BSCM module on the communication network requires no addressing.

LED Indication on BSCM Module

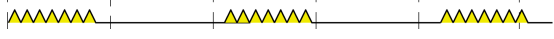
ULP LED	Mode	Action
	Nominal	None
	Conflict	Remove extra ULP module
	Degraded	Replace BSCM module at the next maintenance operation
	Test	None
	Non-critical firmware discrepancy	Upgrade firmware at the next maintenance operation
	Non-critical hardware discrepancy	Replace BSCM module at the next maintenance operation
	Configuration discrepancy	Install missing features

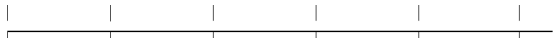
ULP LED	Mode	Action
	Critical firmware discrepancy	Use EcoStruxure Power Commission software to check the firmware and hardware compatibility and follow the recommended actions
	Critical hardware discrepancy	
	Stop	Replace BSCM module
	Power off	Check power supply

Data Provided by the BSCM Module

Configuration	Information	Can be reset
All circuit breakers with BSCM module	Count of the total number of times the circuit breaker opens and closes (count of OF contact operations). This counter (totalizer) cannot be reset.	No
	Count of the total number of times the circuit breaker opens and closes (count of OF contact operations) ⁽¹⁾	Yes
	Maximum number of times the circuit breaker can open and close ⁽²⁾	Yes
	Count of the number of fault trips by the circuit breaker (count of SD contact operations) ⁽¹⁾	Yes
	Count of the number of electrical fault trips by the circuit breaker (count of SDE contact operations) ⁽¹⁾	Yes
Circuit breakers with BSCM module and communicating motor mechanism	Count of the number of times the communicating motor mechanism opens ⁽¹⁾	No
	Count of the number of times the communicating motor mechanism closes ⁽¹⁾	Yes
	Maximum number of times the communicating motor mechanism closes ⁽²⁾	Yes
	Count of the number of times the communicating motor mechanism resets ⁽¹⁾	Yes
<p>(1) The user can modify the content of the counter if, for example, the BSCM module is installed or replaced during operation.</p> <p>(2) Overshooting the threshold results in a medium priority alarm. To acknowledge the alarm, modify the content of the counter or the value of the threshold.</p>		

Configuring the BSCM Module

To configure the BSCM module, use a PC running EcoStruxure Power Commission software and connected to the USB maintenance interface.

The USB maintenance interface must be connected:

- To the RJ45 connector of a ULP module (for example, IFM Modbus-SL interface).
- To the test port of MicroLogic 5, 6, and 7 trip units.

With EcoStruxure Power Commission software, you can configure:

- The maximum number of times the circuit breaker can open and close.
- The maximum number of times the communicating motor mechanism can close.

- The reset mode of the communicating motor mechanism.

Configuring the Resetting of the Communicating Motor Mechanism

⚠ CAUTION

HAZARD OF REPEATED CLOSING ON ELECTRICAL FAULT

Reconfiguring of the BSCM Breaker Status Control Module must be done only by qualified electrical personnel.

Failure to follow these instructions can result in injury or equipment damage.

The reset mode of the communicating motor mechanism can be configured using the EcoStruxure Power Commission software:

- **Enable Reset even if SDE** to authorize resetting of the mechanism using the communication network even after an electrical fault trip.
- **Enable Automatic Reset** to authorize automatic resetting after tripping by the MN, MX trip release, or push-to-trip button.
- **Enable Reset even if SDE** and **Enable Automatic Reset** to authorize automatic resetting even after an electrical fault trip.

NSX Cord

Introduction

The NSX cord connects a circuit breaker to the communication network.

The NSX cord can be used:

- By itself for communicating measurements and settings (only with MicroLogic 5, 6, and 7 trip units)
- Or with a BSCM module:
 - For communicating measurements and settings (only with MicroLogic 5, 6, and 7 trip units)
 - For communicating states (with standard and advanced trip units)

NOTE: The NSX cord cannot be installed in a ComPacT NSX 400K circuit breaker.

For more information about integrating ComPacT NSX circuit breaker communication functions, refer to:

- DOCA0093EN, *ULP System (IEC Standard) - User Guide*
- DOCA0213EN, *ComPacT NSX - Modbus Communication Guide*

Description

The NSX cord consists of a junction box, a cable equipped with an RJ45 connector, and a cable equipped with a screw terminal block.

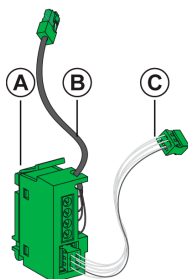

No.	Data medium	Data transmitted	Comments
A	NSX cord microswitch	State of SD contact	The NSX cord goes into the SD slot instead of the auxiliary contact.
B	Cable equipped with an RJ45 connector for connection to a ULP module.	Communication network	Three cable lengths are available: 0.3 m (9.84 ft), 1.3 m (4.27 ft), and 3 m (14.7 ft).
C	Internal link to the MicroLogic 5, 6, or 7 trip unit or the BSCM module	Communication network	With the BSCM module, the NSX cord also transmits the circuit breaker states.

The NSX cord also provides the 24 Vdc power supply:

- For the MicroLogic 5, 6, or 7 trip unit (without BSCM module)
- For the BSCM module (when this module is installed)

Installation

The slots used to install the NSX cord depend on the circuit breaker type.

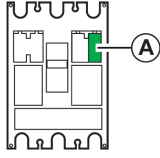
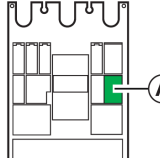
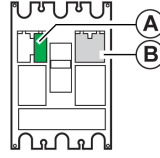
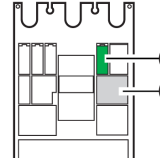
NSX cord used alone		NSX cord and BSCM module	
ComPacT NSX100-250	ComPacT NSX400-630	ComPacT NSX100-250	ComPacT NSX400-630
			
<p>A NSX cord</p> <p>B BSCM module</p>			

The NSX cord cannot be installed at the same time as the SD contact.

The NSX cord can be installed on site.

For more information about installation, consult the instruction sheet on the Schneider Electric website: [GHD16047AA ComPacT NSX100–630 – NSX Cord](http://www.se.com).

Communication with the NSX Cord

The NSX cord connects to the following ULP modules:

- IFM or IFE communication interface
- FDM121 display
- IO module

The figure below illustrates the connections from the NSX cord to the IFM Modbus-SL interface

Example 1: Connection of the IFM interface to the MicroLogic 5, 6, or 7 trip unit

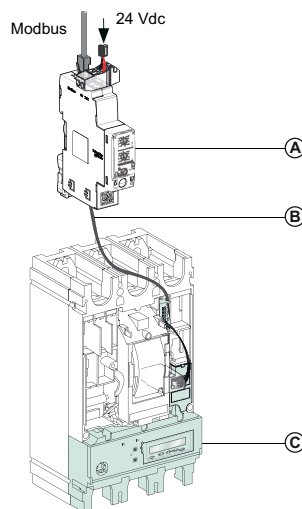

Example 2: Connection of the IFM interface to the BSCM module

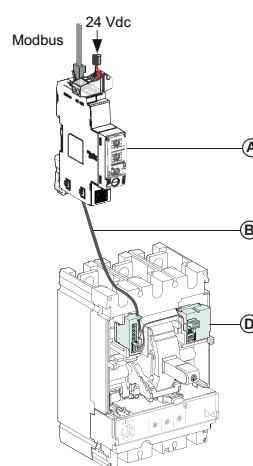

Example 3: Connection of the IFM interface to the BSCM module and the MicroLogic 5, 6, or 7 trip unit

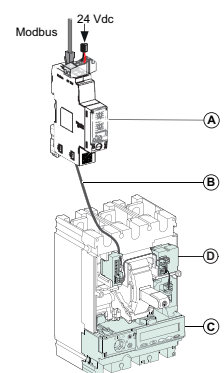

A IFM Modbus-SL interface for one circuit breaker

B NSX cord

C MicroLogic 5, 6, or 7 trip unit

D BSCM module

Insulated NSX Cord

Introduction

For system voltage greater than 480 Vac, an insulated variant of the NSX cord needs to be used, terminated by an electronic module with a female RJ45 connector. A ULP cord must be used to connect the insulated NSX cord electronic module to a ULP module.

The reference for the insulated NSX cord is LV434204.

The insulated NSX cord electronic module must be supplied with 24 Vdc in order to guarantee isolation of the ULP system.

NOTE: The insulated NSX cord cannot be installed in a ComPacT NSX 400K circuit breaker.

For more information about installation, consult the instruction sheet on the Schneider Electric website: [GHD16313AA ComPacT NSX100–630 – Insulated NSX Cord](#).

Electronic Module Characteristics

The following table summarizes the electronic module characteristics:

Characteristic	Value
Dimensions	27 x 27 x 27 mm
Mounting	On DIN rail
Degree of protection of the installed module	<ul style="list-style-type: none">On the front panel (wall-mounted enclosure): IP40On the connections (behind the enclosure door): IP20
Operating temperature	-25 to +70 °C
Power supply voltage	24 Vdc -20%/+10% (19.2–26.4 Vdc)
Consumption	<ul style="list-style-type: none">Typical: 20 mA/24 Vdc at 20 °CMaximum: 30 mA/19.2 Vdc at 60 °C

Insulated NSX Cord Connection

The NSX cord connects to a ULP module:

- IFM or IFE communication interface
- FDM121 display
- IO module

The figure below illustrates the connections from the insulated NSX cord to the Modbus-SL interface for one circuit breaker:

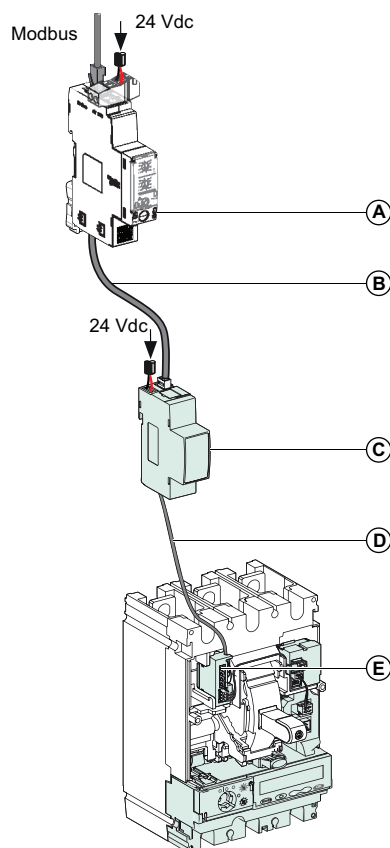

A IFM Modbus-SL interface for one circuit breaker

B RJ45 male/male ULP cable

C Insulated ULP module for system voltage greater than 480 Vac

D Insulated ULP cord for system voltage greater than 480 Vac

E Connector for ComPacT NSX circuit breaker internal connection

Control Auxiliaries

Control and Indication Contacts Installed Outside the Circuit Breaker

Control and indication contacts installed outside the case are contacts for specific applications. Refer to LVPED221001EN, *ComPacT NSX & NSXm Catalogue*.

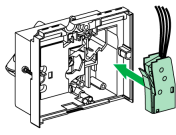
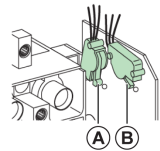
<p>CAM contacts</p> 	<p>Early-operation contacts</p> <p>Install in the rotary handle:</p> <ul style="list-style-type: none"> • Early-make contacts (CAF1, CAF2) actuate before the poles close when a circuit breaker manual command is given. • The early-break changeover contact (CAO1) actuates before the poles open when a circuit breaker manual command is given.
<p>Carriage switches</p> 	<p>Connected (CE)/Disconnected (CD) carriage switches</p> <p>Install on the chassis to indicate the position of the circuit breaker in the chassis:</p> <p>A Connected position carriage switch (CE)</p> <p>B Disconnected position carriage switch (CD)</p>

Operation of connected/disconnected carriage switches

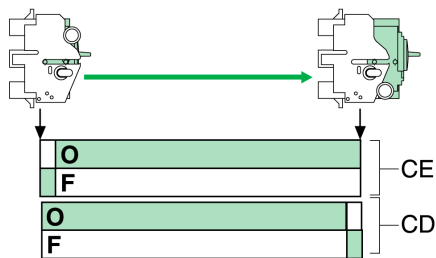

CE Connected position carriage switch

CD Disconnected position carriage switch

Voltage Trip Releases

Use voltage trip releases to trip circuit breakers deliberately using an electrical signal. Install these auxiliaries in the case under the front face.

The characteristics of these auxiliaries comply with the recommendations of the standard IEC/EN 60947-2.

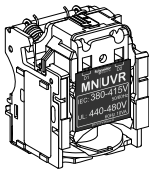
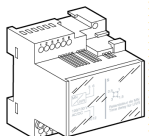
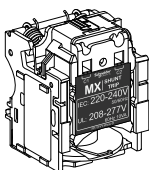
<p>MN</p> 	<p>MN undervoltage trip release</p> <p>This release:</p> <ul style="list-style-type: none"> • Trips the circuit breaker when the voltage is less than 0.35 times the rated voltage U_n. If the voltage is between 0.35 and 0.7 times the rated voltage U_n, tripping is possible but not guaranteed. Above 0.7 times the rated voltage U_n, tripping is impossible. • Closes the circuit breaker again once the voltage reaches 0.85 times the rated voltage. <p>Use this type of trip release for fail-safe emergency stops.</p>
<p>Time-delay unit</p> 	<p>Time-delay unit for MN undervoltage trip release</p> <p>The time-delay unit eliminates nuisance tripping of an undervoltage trip release due to transient voltage dips lasting < 200 ms.</p> <p>There are two types of time-delay units: adjustable or fixed.</p>
<p>MX</p> 	<p>MX shunt trip release</p> <p>This release trips the circuit breaker when the voltage exceeds 0.7 times the rated voltage U_n.</p>

For more information about installation, consult the instruction sheet on the Schneider Electric website: [NNZ4291701](#), *MN or MX Voltage Releases*.

PowerTag Energy M250/M630

Introduction

The PowerTag Energy M250/M630 is designed for molded case circuit breakers and switch-disconnectors (ComPacT NSX and TeSys GV5/GV6) for 3P and 3P+N electrical networks.

The PowerTag Energy M250/M630 is mounted directly on the bottom side of the circuit breaker or VigiPacT Add-on if any. For a PowerTag Energy M250/M630 mounted on a plug-in base, the PowerTag Energy M250/M630 must be installed on the top or bottom of the base, depending on the configuration. For more information, refer to CA908058E PowerTag Energy Selection Guide.

Thanks to its integrated design, the PowerTag Energy M250/M630 does not require any specific wiring and is compatible with the same connection accessories than the device it is mounted on.

The PowerTag Energy M250/M630 must be associated with a concentrator or gateway.

For more information about installation, consult the instruction sheets on the Schneider Electric website:

- QGH46815 *PowerTag Energy M250 3P/3P+N*
- QGH46820 *PowerTag Energy M630 3P/3P+N*
- MFR37601 *PowerTag Energy M250/M630 3P/3P+N – ComPacT NSX100-250/400-630 Plug-in Base*

Description

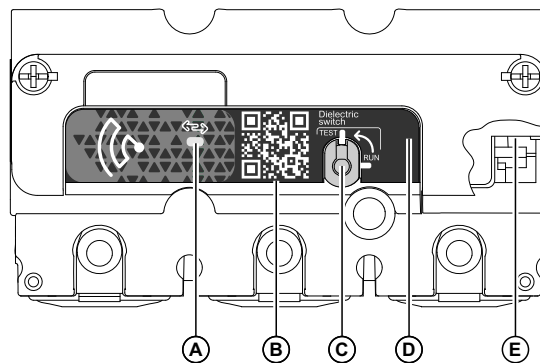

A Status LED

B QR code to access device information including wireless address





C Switch to disconnect PowerTag Energy supply from the phases, used when performing a panel dielectric test

D Wireless address

E Neutral voltage picking (on PowerTag Energy 3P only)

Status LED

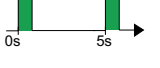
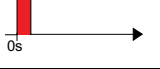
Use the LED indication to confirm that the PowerTag Energy M250/M630 is working during commissioning or maintenance operations.

Status LED	Description	Action
	PowerTag Energy M250/M630 switched off.	None or check power supply depending on operation type.
	PowerTag Energy M250/M630 searching a concentrator or gateway.	Wait until the concentrator or gateway is identified.
	PowerTag Energy M250/M630 in identification mode.	Wait until PowerTag Energy M250/M630 is in network.
	PowerTag Energy M250/M630 in network. Normal communication with the concentrator or gateway.	None
	Occasional loss of communication.	Check communication setting with the concentrator or gateway.
	Loss of communication with the concentrator or gateway.	Check communication setting with the concentrator or gateway.
	Internal error detected.	Replace the PowerTag Energy M250/M630 .

Data Available

The following table lists data available for the following PowerTag Energy M250/M630:

- PowerTag Energy M250/M630 3P without neutral connection
- PowerTag Energy M250/M630 3P with neutral connection or PowerTag Energy M250/M630 3P+N

Data	Measurement	PowerTag Energy M250/M630	
		3P without neutral connection	3P with neutral connection 3P+N
Current	RMS current on phase A	✓	✓
	RMS current on phase B	✓	✓
	RMS current on phase C	✓	✓
Voltage	RMS phase-to-phase voltage A-B	✓	✓
	RMS phase-to-phase voltage B-C	✓	✓
	RMS phase-to-phase voltage C-A	✓	✓
	RMS phase-to-neutral voltage A-N	–	✓
	RMS phase-to-neutral voltage B-N	–	✓
	RMS phase-to-neutral voltage C-N	–	✓
Power	Active power on phase A	–	✓
	Active power on phase B	–	✓
	Active power on phase C	–	✓
	Total active power	✓	✓
	Total reactive power	✓	✓
	Total apparent power (arithmetic)	✓	✓
Power factor	Total power factor	✓	✓
Frequency	AC frequency	✓	✓
Device temperature	Device internal temperature	✓	✓
Energy	Total active energy delivered + count positively, non resettable	✓	✓
	Total active energy received, non resettable	✓	✓
	Active energy on phase A delivered + received, non resettable	–	✓
	Active energy on phase B delivered + received, non resettable	–	✓
	Active energy on phase C delivered + received, non resettable	–	✓
	Partial active energy delivered, resettable	✓	✓
	Partial active energy received, resettable	✓	✓
	Partial reactive energy delivered, resettable	✓	✓
	Partial reactive energy received, resettable	✓	✓
Alarm	Alarms <ul style="list-style-type: none"> • Voltage loss • Current overload at voltage loss 	✓	✓
	RMS current on phase A at voltage loss ¹	✓	✓
	RMS current on phase B at voltage loss ¹	✓	✓
	RMS current on phase C at voltage loss ¹	✓	✓

¹ Last RMS current measured when voltage loss occurred

Commissioning

Commission the PowerTag Energy M250/M630 by using EcoStruxure Power Commission software or the webpages of the gateway or concentrator, if any.

NOTE: Check the firmware of the gateway before performing the commissioning of PowerTag Energy M250/M630 . It is recommended to upgrade to the latest version available.

For automatic pairing the PowerTag Energy M250/M630 must be powered and the Status LED must be flashing fast orange.

If the LED is flashing fast red (loss of communication status), use the dielectric test switch to reset the PowerTag Energy M250/M630 . If the PowerTag Energy M250/M630 is not paired within two minutes, it returns to loss of communication status.

If the LED is blinking green, PowerTag Energy M250/M630 is already paired with a gateway. Unpair it before pairing with a new gateway.

ComPacT NSX Trip Units

What's in This Part

Fault Currents and Trip Units.....	109
TM-D, TM-G Thermal-Magnetic and MA Magnetic Trip Units	119
Earth-Leakage Protection by VigiPacT Add-on	134
MicroLogic Electronic Trip Units	139

Fault Currents and Trip Units

What's in This Chapter

Applications	110
Fault Currents in Electrical Distribution	111
Protection Against Overcurrents in Electrical Distribution	112
Protection Against Ground Faults	114
Protection for Motor-Feeders	116

Applications

The Two Main Types of Application Requiring Protection

ComPacT NSX circuit breaker trip units offer protection for all applications due to the great flexibility of their settings.

Two types of application are taken into consideration:

- Electrical distribution protection
- Special protection for receivers (for example, motors, transformers) or generators

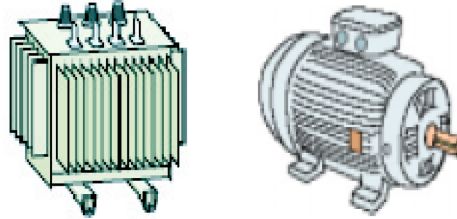

Fault Currents in Electrical Distribution

The Fault Current Types

There are four types of fault current, divided into two categories:

- The overcurrent category:
 - Overload currents
 - Short-circuit currents
- The ground fault category:
 - Low intensity ground faults
 - High intensity ground faults

The Overcurrent Category

The main characteristics and associated risks are described below:

- Overload currents:

These are mainly due to problems with excessive loads on receivers. For example, operating too many consumers in a workshop at the same time (lighting, heating, power) can bring about an electrical distribution overload.

The main risks from overload currents are gradual deterioration in equipment, or a fire.
- Short-circuit currents:

These can be due to deterioration in the plant or within a receiver. For example, a short-circuit between two phases in the winding of a motor being operated in severe conditions (vibration, damp and/or corrosive atmosphere).

The risks associated with short-circuit currents are the instantaneous deterioration of equipment, a fire, or even an explosion due to the high energy level at the site of the short-circuit.

The Ground Fault Category

Ground faults can be due to abnormal aging of the plant, of a load or conductors, that have deteriorated in damp conditions.

The intensity of such fault currents depends on the ground connection diagram used. These currents can be:

- Very low in value, that is, well below the rated feed current in the TT system (these are known as leakage currents or residual ground fault currents).
- High in value, that is, identical to a short-circuit current in the TN-S system (these are known as ground fault currents).

Whatever the value of ground leakage currents, they present a very grave risk of electrocution or fire.

Protection Against Overcurrents in Electrical Distribution

ComPacT NSX Circuit Breaker Overcurrent Trip Units

ComPacT NSX circuit breaker trip units are designed to handle overcurrents (overload currents and short-circuit currents) and in certain cases, ground fault currents.

- Pickup adjustments are calculated relative to the downstream circuit to be protected.
- Time delay adjustments are calculated in relation to the protection management (coordination).

NOTE: The protection plan is based on coordination of the protections - and in particular on selectivity. This can be achieved by time delays (time-related selectivity) while complying with ammeter- and power-related selectivity rules.

There are two types of trip unit:

- Thermal-magnetic trip units for ComPacT NSX100-250 circuit breakers
- MicroLogic electronic trip units for ComPacT NSX100-630 circuit breakers

Standard Settings for Overcurrent Protections

Standard IEC/EN 60947-2 states the trip characteristics at the circuit breaker limits.

The following table summarizes the recommendations of standard IEC/EN 60947-2 for the circuit breaker protection function:

Protection function	Setting recommendations
Long-time protection	<p>Long-time protection of the <i>inverse time</i> type (with I^2t constant):</p> <ul style="list-style-type: none"> • No trip for a current below 105% of I_r • Trip in less than two hours for a current equal to: <ul style="list-style-type: none"> ◦ 120% of I_r for an electronic trip unit ◦ 130% of I_r for a thermal-magnetic trip unit <p>For a higher fault current, the trip time is inversely proportional to the fault current value.</p>
Short-time protection	<p>Short-time protection is <i>definite time</i>:</p> <ul style="list-style-type: none"> • No trip for a current below 80% of the short time setting • Trip for a current equal to 120% of the short time setting <p>The trip time is:</p> <ul style="list-style-type: none"> • Less than 0.2 s for a short time protection with no time delay • Equal to the value of the time delay t_{sd} for a protection with time delay
Instantaneous protection	<p>Instantaneous protection is <i>definite time</i>:</p> <ul style="list-style-type: none"> • No trip for a current below 80% of the instantaneous setting • Trip for a current equal to 120% of the instantaneous setting <p>The trip time is less than 0.2 s.</p>

The Neutral Conductor

The installation rules closely define the type of protection to be used having regard to:

- Potential overcurrents (overloads and short-circuits).
- Conductors to be protected.
- Simultaneous cutoff of all conductors including the neutral conductor (multi-pole breaking).

NOTE: All three of the phase conductors must be protected at all times. The neutral conductor (if it is distributed and identical to the phases in size, that is, full neutral) is normally protected by the phase protection.

Description of the Neutral Protection

The neutral must have specific protection if:

- It is reduced in size compared to the phases.
- Nonlinear loads generating third order harmonics and multiples thereof are installed.

It may be necessary to cut off the neutral for functional reasons (multiple source diagram) or safety reasons (working with power off).

To summarize, the neutral conductor can be:

- Non-distributed (3P).
- Distributed, not cut off and not protected (3P).
- Distributed, not cut off but protected (3P with ENCT option). Refer to DOCA0188EN, *ComPacT NSX MicroLogic 5/6/7 Electronic Trip Units - User Guide*.
- Distributed, cut off and protected (4P).

ComPacT NSX trip units are suitable for all protection types.

ComPacT NSX	Possibilities	Neutral protection
3P	3P, 3D	None
3P + ENCT	3P, 3D	None
	3P, 3D + N/2	Half neutral
	3P, 3D + N	Full neutral
	3P, 3D + OSN ⁽¹⁾	Oversized neutral
4P	4P, 3D	None
	4P, 3D + N/2	Half neutral
	4P, 4D	Full neutral
	4P, 4D + OSN ⁽¹⁾	Oversized neutral
<p>(1) OSN (OverSized Neutral) protection is used when high third harmonic (and multiples of the third harmonic) currents are present. OSN protection is installed on MicroLogic 5, 6, and 7 trip units. Refer to DOCA0188EN, <i>ComPacT NSX MicroLogic 5/6/7 Electronic Trip Units - User Guide</i>.</p> <p>P: Breaking pole, D: Pole protected by the trip unit, N: Neutral protection.</p>		

Protection Against Ground Faults

Introduction

Protection against ground faults is provided by:

- Earth-leakage protection in the case of low intensity fault currents (fault current limitation is linked to ground connection diagram TT or TN-S). Earth-leakage protection is provided by:
 - Earth-leakage protection embedded in MicroLogic 4 and 7 trip units.
 - VigiPacT Add-on earth-leakage protection module added to the circuit breaker.
- Ground-fault protection embedded in MicroLogic 6 trip units in the case of high intensity fault currents (this protection can be used only with ground connection diagram TN-S)

Embedded Earth-Leakage Protection

Earth-leakage protection is embedded within the MicroLogic 4 and 7 trip units.

The maximum value of $I\Delta n$ depends on the circuit breaker frame size:

Circuit breaker frame size	100 - 250	400 - 630
Maximum value $I\Delta n$	5 A	10 A

The range provides two types of device:

- Trip devices trip on an earth-leakage fault
- Alarm devices measure and signal an earth-leakage fault without tripping:
 - On the front face
 - Through the SDx output contact

The following illustrations show the two types of MicroLogic 4 trip units:

MicroLogic 4 trip

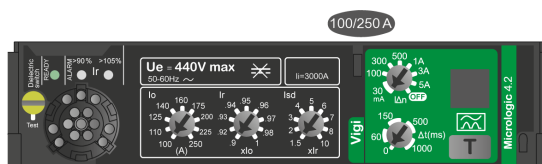

MicroLogic 4 alarm

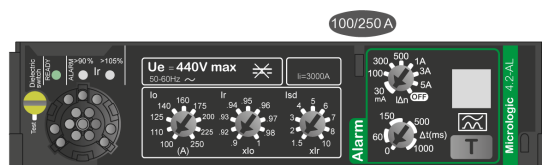

For more information about MicroLogic 7, refer to DOCA0188EN, *ComPacT NSX MicroLogic 5/6/7 Electronic Trip Units - User Guide*.

Earth-Leakage Protection with VigiPacT Add-on

The VigiPacT Add-on is external to the trip unit and is designed to provide earth-leakage protection for the following situations:

- For system voltages up to 550 Vac
- For breaking capacity over 150 kA

The VigiPacT Add-on can be installed on ComPacT NSX circuit breakers with thermal, thermal-magnetic, or MicroLogic 2, 5, and 6 trip units.

Illustration of VigiPacT Add-on installed on a ComPacT NSX circuit breaker

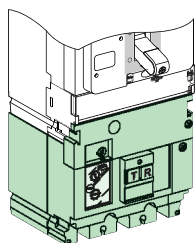

Ground-Fault Protection

Ground-fault protection is embedded in MicroLogic 6 trip units. For more information, refer to DOCA0188EN, *ComPacT NSX MicroLogic 5/6/7 Electronic Trip Units - User Guide*.

Setting the Earth-Leakage Protection

Installation standards require or recommend particular sensitivity and trip time values for earth-leakage protection:

Type of protection	$I\Delta n$	Δt	Installation standards
Protection against direct contact	$\leq 30 \text{ mA}$	$\leq 40 \text{ ms}^{(1)}$	Required
Fire protection	$\leq 300 \text{ mA}$ or $\leq 500 \text{ mA}$	$\leq 40 \text{ ms}^{(1)}$	Required if necessary
Protection against indirect contact	$I\Delta n$	$\leq 1 \text{ s}$	Lowest possible recommended values of $I\Delta n$ and Δt (the value of $I\Delta n$ depends on the ground resistance)
(1) Value of Δt for a fault current $\geq 10 I\Delta n$			

Setting the Ground-Fault Protection

Installation standards (in particular the NEC - National Electrical Code - defining installation rules in the USA) require or recommend the pickup and trip time values for ground-fault protection.

Location	I_g	t_g	NEC
On the incoming supply to the low voltage distribution (and for $I_n > 1,000 \text{ A}$)	$\leq 1,200 \text{ A}$	–	Required
	$\leq 3,000 \text{ A}$	$\leq 1 \text{ s}$	Required
Downstream of the low voltage distribution	I_g	–	Lowest possible recommended values for I_g

Protection for Motor-Feeders

Structure of a Motor-Feeder

Direct-on-line starting is the most widely used type of motor-feeder.

The direct-on-line starting motor-feeder can comprise up to four different items of switchgear providing one or more functions. It must also incorporate the specific characteristics of the application.

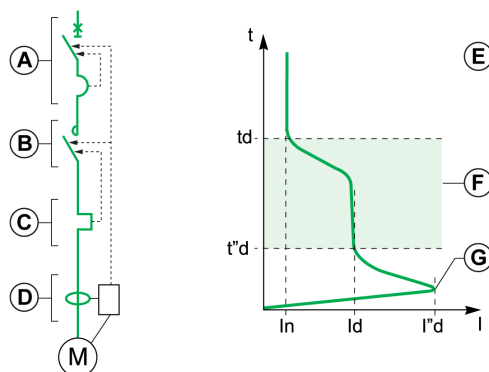

- A** Switchgear for short-circuit protection
- B** Control gear
- C** Switchgear for overload protection
- D** Switchgear for ground-fault protection
- E** Characteristic $t = f(I)$ of an asynchronous D.O.L. starting motor
- F** Starting phase
- G** Current peak on activation

Characteristics Defined by Standard IEC/EN 60947-4-1

A motor-feeder must satisfy the general rules of standard IEC/EN 60947-4-1, in particular the rules concerning the protection of contactors and motor-feeders.

In the matter of protection, this standard defines:

- Coordination of motor-feeder protections
- Thermal relay trip classes
- Insulation coordination

Coordination According to Standard IEC/EN 60947-4-1

Two types of coordination are allowed: type 1 coordination or type 2 coordination.

- In type 1 coordination, deterioration of the contactor and relay is accepted under the two following conditions:
 - The contactor or starter does not represent a danger to people or installations.
 - The starter can operate correctly when parts have been repaired or replaced.
- In type 2 coordination, some slight welding of the contactor or starter contacts is allowed if, following type 2 coordination tests:
 - They are easy to separate
 - The control and protection switchgear functions then work without the need for repair

To ensure type 2 coordination, standard IEC/EN 60947-4-1 lays down three I_d fault current tests intended to check that the equipment behaves correctly in overload and short-circuit conditions.

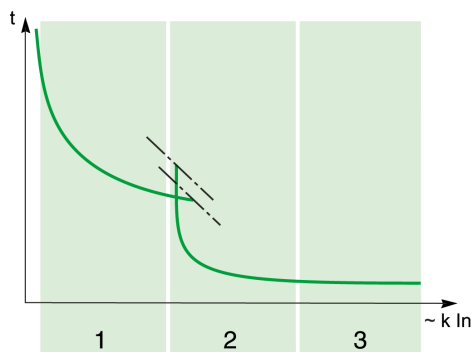

- 1 Overload zone $I_d < 10 I_n$
- 2 Impedant short-circuit zone $10 I_n < I_d < 50 I_n$
- 3 Short-circuit zone $I_d > 50 I_n$

Thermal Relay Trip Classes

The four thermal relay trip classes are 5, 10, 20 and 30 (values correspond to the maximum relay trip time in seconds at $7.2 I_n$).

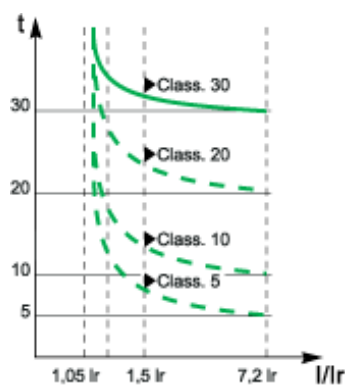

Standard trip time values

Class	$1.05 I_n$	$1.2 I_n$	$1.5 I_n$	$7.2 I_n$
5	$t > 2$ hours	$t > 2$ hours	$t < 2$ minutes	$0.5 \text{ s} \leq t \leq 5 \text{ s}$
10	$t > 2$ hours	$t > 2$ hours	$t < 4$ minutes	$4 \text{ s} \leq t \leq 10 \text{ s}$
20	$t > 2$ hours	$t > 2$ hours	$t < 8$ minutes	$6 \text{ s} \leq t \leq 20 \text{ s}$
30	$t > 2$ hours	$t > 2$ hours	$t < 12$ minutes	$9 \text{ s} \leq t \leq 30 \text{ s}$

Classes 5 and 10 are most commonly used. Classes 20 and 30 concern applications in which motor starting conditions are difficult.

Additional Protection

Depending on the application and the operating constraints, additional protection may be required concerning:

- Phase unbalance or phase loss
- Locked rotor
- Undercurrent
- Long starts

ComPacT NSX Motor Circuit Breakers

ComPacT NSX motor circuit breakers incorporate MA thermal-magnetic trip units and MicroLogic type M electronic trip units.

Protection functions by trip unit type

Protection	Trip unit type			
	MA	MicroLogic 1.3 M	MicroLogic 2 M	MicroLogic 6 E-M
Overloads	–	–	✓	✓
Short-circuits	✓	✓	✓	✓
Insulation faults (ground-fault protection)	–	–	–	✓
Phase unbalance or phase loss	–	–	✓	✓
Locked rotor	–	–	–	✓
Undercurrent	–	–	–	✓
Long starts	–	–	–	✓

The protection against insulation faults in the MicroLogic 6 E-M trip unit is the ground-fault protection type.

Type 1 and 2 coordination tests have been carried out with motor-feeder components in respect of all ComPacT NSX motor circuit breakers.

Trip classes by trip unit type

Class	Trip unit type			
	MA	MicroLogic 1.3 M	MicroLogic 2 M	MicroLogic 6 E-M
5	–	–	✓	✓
10	–	–	✓	✓
20	–	–	✓	✓
30	–	–	–	✓

Trip Unit Long-Time Protection

The pickup setting I_r for trip unit long-time protection is expressed in amperes:

- This value corresponds to the operating current used in the motor application
- The maximum I_r setting corresponds to the trip unit rating I_n

TM-D, TM-G Thermal-Magnetic and MA Magnetic Trip Units

What's in This Chapter

Thermal-Magnetic Trip Unit Summary	120
TM-D Thermal-Magnetic Trip Unit for 1P and 2P Circuit Breakers	123
TM-D Thermal-Magnetic Trip Unit for 1P Circuit Breakers 250 A	124
TM-D Thermal-Magnetic Trip Unit for 3P and 4P Circuit Breakers up to 63 A	125
TM-D Thermal-Magnetic Trip Unit for 3P and 4P Circuit Breakers from 80 A to 250 A	127
TM-G Thermal-Magnetic Trip Unit	130
MA Magnetic Trip Unit	132

Thermal-Magnetic Trip Unit Summary

Introduction

Thermal-magnetic trip units are designed to provide protection for distribution or for specific applications.

Identification	Type of protection
TM-D	Thermal-magnetic trip unit
TM-G	Thermal-magnetic trip unit with low pickup (for protecting generators, very long feeds)
MA	Magnetic-only trip unit (for example, for protecting motors, transformers)

The following table shows the trip units compatible with the ComPacT NSX circuit breakers. For more information, refer to LVPED221001EN, *ComPacT NSX & NSXm Catalogue*.

Trip units	Built-in / Interchangeable	NSX100			NSX160			NSX250		NSX400	NS-X630
		1P	2P	3P/4P	1P	2P	3P/4P	1P	3P/4P	3P/4P	3P/4P
NA (switch-disconnector)	Built-in	–	–	–	–	–	–	–	–	✓	✓
TM-D	Built-in	✓	✓	–	✓	✓	–	✓	–	–	–
TM-D	Interchangeable	–	–	✓	–	–	✓	–	–	–	–
TM-AC	Built-in	–	–	–	–	–	–	–	–	✓	✓
TM-AC	Interchangeable	–	–	✓	–	–	✓	–	✓	–	–
TM-G	Interchangeable	–	–	✓	–	–	✓	–	✓	–	–
MA	Interchangeable	–	–	✓	–	–	✓	–	✓	–	–

Protections and Settings of Thermal-Magnetic Trip Units

The adjustment dials are on the front of the trip units:

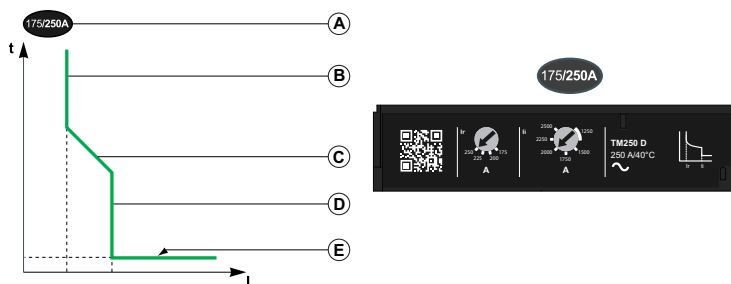

Item	Parameter	Description	Type ⁽¹⁾		
			TM-D	TM-G	MA
A	–	Trip unit setting range: minimum setting/ maximum setting. Trip unit rating I_n corresponds to the maximum value of the setting range.	O	O	O
B	I_r	Thermal protection pickup	✓	✓	–
C	t_r	Thermal protection time delay	O	O	–
D	I_i	Magnetic protection pickup	✓/O	O	✓

Item	Parameter	Description	Type ⁽¹⁾		
			TM-D	TM-G	MA
E	–	Magnetic protection time delay	O	O	O

(1) Functions:
 ✓: Adjustable
 O: Non-adjustable
 ✓/O: Adjustable or non-adjustable according to the trip unit rating
 –: Not present

Upgradeability of Thermal-Magnetic Trip Units

⚠ WARNING

HAZARD OF DESTRUCTION OF THE MICROLOGIC TRIP UNIT

It is mandatory to use snap-off screws LV429513 to install a MicroLogic trip unit.

Failure to follow these instructions can result in death, serious injury, or equipment damage.

Upgradeability of trip units depends on the circuit breaker type:

- For 1 or 2 poles, trip units are built-in.
- For 3 or 4 poles, trip units are interchangeable.

NOTE: In ComPacT NSX circuit breakers with R, HB1, HB2, and K breaking performances, the trip units are not interchangeable.

Onsite swapping of trip units is simple and reliable:

- No connections to make
- No special tools (for example, calibrated torque wrench)
- Compatibility of trip units provided by mechanical cap
- Torque limited screw provides proper mounting (see drawing below)

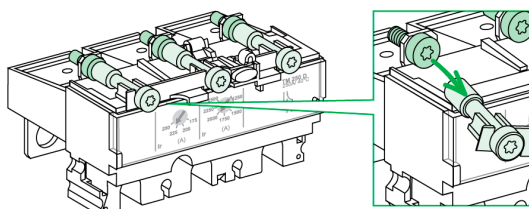

The design of the trip units limits the risk of incorrect tightening or oversights. The simplicity of the swapping process means that it is easy to make the necessary adjustments as operation and maintenance processes evolve.

NOTE: When the trip unit has been mounted by this means, the trip unit can still be removed: the screw head is accessible. When a trip unit is reinstalled after being removed, it is mandatory to use torque limiting snap-off screws LV429513 for the reinstallation.

Sealing the Protection

The transparent cover on thermal-magnetic trip units can be sealed to prevent modification of the protection settings:

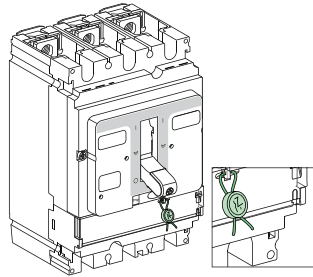

TM-D Thermal-Magnetic Trip Unit for 1P and 2P Circuit Breakers

Introduction

The TM-D thermal-magnetic trip unit for 1P/2P circuit breakers up to 160 A are built-in trip units.

They are designed for AC and DC general-purpose applications.

The TM-D built-in 1P/2P trip units provide:

- fixed thermal threshold
- fixed magnetic pickup

Setting the Thermal Protection

The thermal protection pickup I_r cannot be adjusted and equals the value shown below:

Trip unit rating I_n (A) at 40 °C (104 °F)	16	20	25	32	40	50	63	80	100	125	160
Fixed Pickup I_r (A) at 40 °C (104 °F)	16	20	25	32	40	50	63	80	100	125	160

Setting the Magnetic Protection

The magnetic protection pickup cannot be adjusted and equals the value shown below:

Trip unit rating I_n (A)		16	20	25	32	40	50	63	80	100	125	160
Fixed pickup I_i (A) \pm 20%	DC value	260	260	400	400	700	700	700	800	1,000	1,200	1,250

TM-D Thermal-Magnetic Trip Unit for 1P Circuit Breakers 250 A

Introduction

TM-D thermal-magnetic trip units for 1P circuit breakers 250 A are built-in trip units.

They are designed for AC applications.

TM-D built-in 1P trip units provide:

- fixed thermal threshold
- fixed magnetic pickup

Setting the Thermal Protection

The thermal protection pickup I_r cannot be adjusted and equals the value shown below:

Trip unit rating I_n (A) at 40 °C (104 °F)	160	200	250
Fixed pickup I_r (A) at 40 °C (104 °F)	160	200	250

Setting the Magnetic Protection

The magnetic protection pickup I_i cannot be adjusted and equals the value shown below:

Trip unit rating I_n (A)	160	200	250
Fixed pickup I_i (A) \pm 20%	850	850	850

TM-D Thermal-Magnetic Trip Unit for 3P and 4P Circuit Breakers up to 63 A

Introduction

TM-D thermal-magnetic trip units for 3P/4P circuit breakers up to 63 A are interchangeable trip units.

They are designed for AC and DC general-purpose applications.

The TM-D interchangeable 3P/4P trip units provide:

- adjustable thermal threshold
- fixed magnetic pickup

Description

The setting range and adjustment dials are on the front of the trip unit.

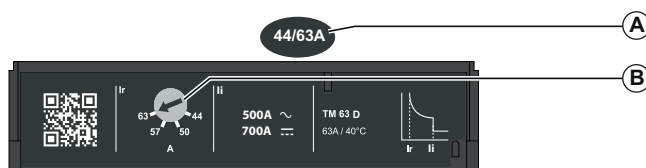

A Setting range for TM-D thermal-magnetic 3P/4P trip unit

B Adjustment dial for the thermal protection pickup I_r

Setting the Thermal Protection

The thermal protection pickup I_r is set by a 4-setting dial.

Turning the thermal protection adjustment dial (**A**) modifies the trip curve as shown (**B**).

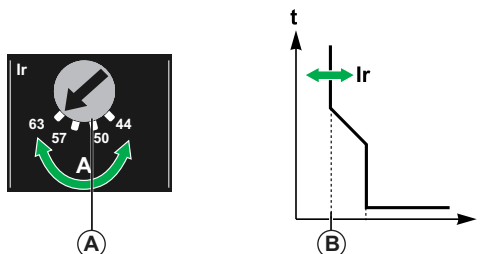

The following table shows the values of the pickup I_r (in amperes) for thermal protection (values indicated on the dial) with respect to every trip unit rating, relative to the position of the dial I_r .

Trip unit rating I_n (A) at 40 °C (104 °F)	16	25	32	40	50	63
Pickup I_r (A) at 40 °C (104 °F)	11	18	22	28	35	44
	13	20	26	32	40	50
	14	23	29	36	45	57
	16	25	32	40	50	63

Setting the Magnetic Protection

The magnetic protection pickup I_i cannot be adjusted and equals the value shown below:

Trip unit rating I_n (A)		16	25	32	40	50	63
Fixed pickup I_i (A) +/- 20%	DC value	260	400	550	700	700	700

TM-D Thermal-Magnetic Trip Unit for 3P and 4P Circuit Breakers from 80 A to 250 A

Introduction

The TM-D thermal-magnetic trip unit is designed to protect conductors in commercial and industrial electrical distribution.

The trip unit exists in two configurations:

- 3P, 3D
- 4P, 3D

Description

The adjustment dials are on the front of the trip unit:

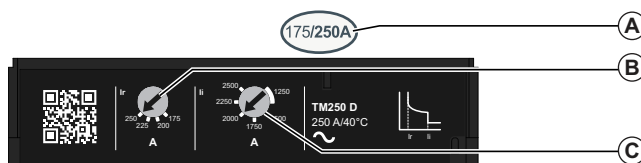

A Setting range for the TM-D thermal-magnetic trip unit

B Adjustment dial for the thermal protection pickup I_r

C Adjustment dial for the magnetic protection pickup I_i (for TM-D 200/250 only)

Setting the Thermal Protection

The thermal protection pickup I_r is set by a 4-setting dial.

Turning the thermal protection adjustment dial (**A**) modifies the trip curve as shown (**B**).

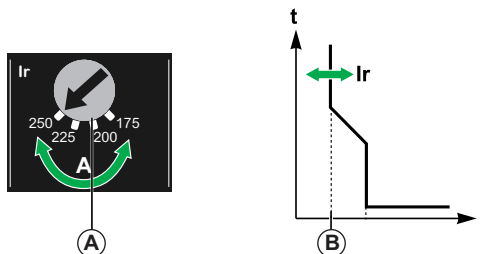

The following table shows the values of the pickup I_r (in amperes) for thermal protection (values indicated on the dial) with respect to every trip unit rating, relative to the position of the dial.

Trip unit rating I_n (A)	16	25	32	40	50	63	80	100	125	160	200	250
Pickup I_r (A)	11	18	22	28	35	44	56	70	88	112	140	175
	13	20	26	32	40	50	64	80	100	128	160	200
	14	23	29	36	45	57	72	90	113	144	180	225
	16	25	32	40	50	63	80	100	125	160	200	250

Setting the Magnetic Protection on Trip Units with I_n from 80 A to 160 A

For trip units rated below 200 A, the magnetic protection pickup cannot be adjusted and equals the value shown below:

Trip unit rating I_n (A)	16	25	32	40	50	63	80	100	125	160
Pickup I_i (A) +/- 20%	190	300	400	500	500	500	640	800	1250	1250

Setting the Magnetic Protection on Trip Units with I_n from 200 A to 250 A

For trip units rated between 200 A and 250 A, the magnetic protection pickup I_i is set using a 6-setting dial.

Turning the magnetic protection adjustment dial (A) modifies the trip curve as shown (B).

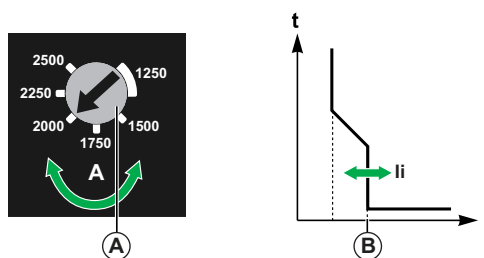

The following table shows the values of the pickup I_i (in amperes) for magnetic protection (values indicated on the dial), relative to the position of the I_i dial:

Trip unit rating I_n (A)	200	250
Pickup I_i (A) +/- 20%	1000	1250
	1200	1500
	1400	1750
	1600	2000
	1800	2250
	2000	2500

Example of Application

Protection of a feed with the following characteristics:

- Power supplied by a 1,250 kVA transformer - 400 V, 4%
- Protection of a distribution box located 15 m away, the loads on which are mainly for lighting (incandescent bulbs), heating, and small machines

The value of the calculated rated current (load consumption) is $I_n = 175$ A.

The following illustration shows the installation diagram:

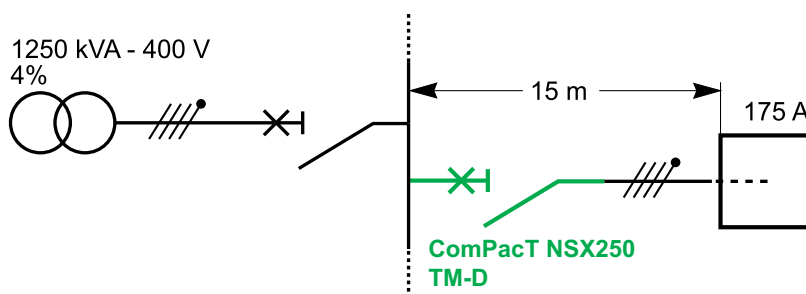

Calculations performed on the installation in accordance with the regulations can be used to determine the characteristics of the appropriate ComPacT NSX circuit breaker to install (calculations performed using the Ecostruxure Power Design – Ecodial software).

The following table presents the circuit breaker selection:

Installation	Chosen ComPacT NSX	Comments
In = 175 A	ComPacT NSX250	Determination of case size
Distributed neutral	4P, 3D	Full neutral and linear loads
Isc = 28.5 kA	F	Icu performance can be read from rating plate
Ikmin = 14.0 kA	–	–

The following table shows the trip unit protection settings:

Installation	Chosen trip unit	Comments
In = 175 A	TM-D 200, Ir set to 180 A	Optimizing the choice
	TM-D 250, Ir set to 175 A	Necessary if extensions envisaged
Ikmin = 14.0 kA	Ii = 2,000 A or 2,500 A	Natural adjustment to the Ii protection for distribution, compatible with: <ul style="list-style-type: none"> • Inrush currents (no trip) • Short-circuit protection (trip)

TM-G Thermal-Magnetic Trip Unit

Introduction

The TM-G thermal-magnetic trip unit has low thermal and magnetic pickups. It is designed to protect long conductors and/or distribution systems powered by generators.

There is one configuration of this trip unit: 3P, 3D.

Description

The adjustment dial is on the front of the trip unit:

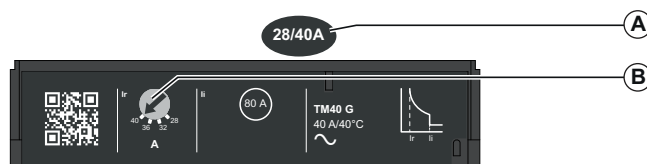

A Setting range for the TM-G thermal-magnetic trip unit

B Adjustment dial for the thermal protection pickup I_r

Setting the Thermal Protection

The thermal protection pickup I_r is set by a 4-setting dial.

Turning the thermal protection adjustment dial **(A)** modifies the trip curve as shown **(B)**.

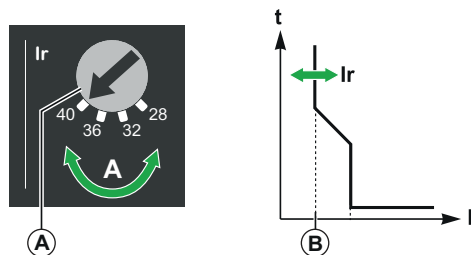

The following table shows the values of the pickup I_r (in amperes) for thermal protection (values indicated on the dial) with respect to every trip unit rating, relative to the position of the dial I_r .

Trip unit rating I_n (A)	16	25	40	63
Pickup I_r (A)	11	18	28	44
	13	20	32	50
	14	23	36	57
	16	25	40	63

Setting the Magnetic Protection

The magnetic protection pickup I_i cannot be adjusted and equals the value shown below:

Trip unit rating I_n (A)	16	25	40	63
Pickup I_i (A) +/- 20%	64	80	80	125

Example of Application

Protection of an incoming feed with the following characteristics:

- Power supplied by a generator defined by:
 - Generator power 40 kVA - 400 V, giving an operating current of 58 A
 - Subtransient reactance: 30%
- Generator protection. The loads mainly consist of heating and lighting (incandescent bulbs). The neutral is distributed.

The following illustration shows the installation diagram:

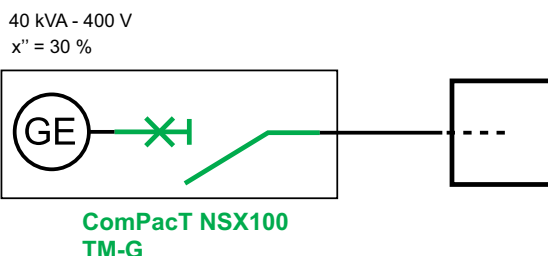

Calculations performed on the installation in accordance with the regulations have determined the characteristics of the appropriate ComPacT NSX circuit breaker to install (calculations performed using the Ecostruxure Power Design – Ecodial software).

The following table presents the circuit breaker selection:

Installation	Chosen ComPacT NSX	Comments
In = 57 A	ComPacT NSX100	Determination of case size
Distributed neutral	4P, 3D	Full neutral and linear loads
Isc = 0.3 kA	B	Icu performance can be read from rating plate
Ikmin = 0.25 kA	TM-G	Generator protection circuit breaker

The following table presents the trip unit protections settings:

Installation	Chosen trip unit	Comments
In = 57 A	TM-G 63, Ir set to 57 A	Thermal protection Ir setting
Ikmin = 0.25 kA	Ii = 125 A	Low pickup magnetic protection Ii cannot be adjusted

MA Magnetic Trip Unit

Introduction

The MA trip unit has a high magnetic pickup. It is designed to provide motor-feeders with short-circuit protection.

The MA trip unit can be used to create a type 1 or type 2 coordination motor-feeder.

Description

The adjustment dial is on the front of the trip unit:

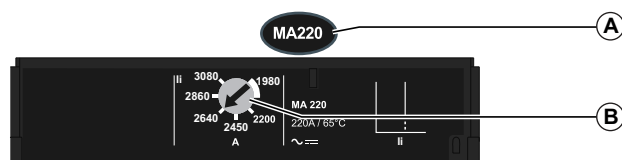

A MA magnetic trip unit rating

B Adjustment dial for the magnetic protection pickup I_i

Setting the Magnetic Protection

The magnetic protection pickup I_i is set by:

- A 9-setting dial for 2.5 A to 50 A ratings
- A 6-setting dial for 100 A to 220 A ratings

Turning the magnetic protection adjustment dial **(A)** modifies the trip curve as shown **(B)**.

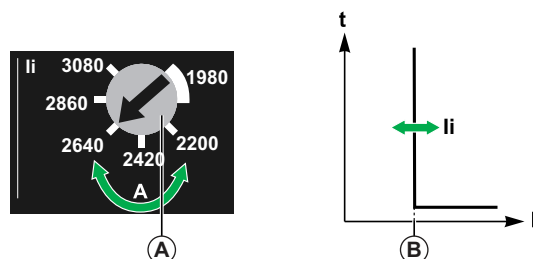

The following table shows the values of the pickup I_i (in amperes) for magnetic protection (values indicated on the dial) with respect to every trip unit rating, relative to the position of the dial I_i :

Trip unit rating I_n (A)	2.5	6.3	12.5	25	50	100	150	220
Pickup I_i (A) +/- 20%	15	38	75	150	300	–	–	–
	18	44	88	175	350	–	–	–
	20	50	100	200	400	–	–	–
	23	57	113	225	450	900	1350	1980
	25	63	125	250	500	1000	1500	2200
	28	69	138	275	550	1100	1650	2420
	30	76	150	300	600	1200	1800	2640
	33	82	163	325	650	1300	1950	2860
	35	88	175	350	700	1400	2100	3080

Example of Application

Protection of a motor-feeder with the following characteristics:

- Power supplied by a 1,250 kVA transformer - 400 V, 4%
- Protection of a motor application defined by:
 - 3-component motor-feeder (circuit breaker, thermal relay, contactor)
 - Direct-on-line starting
 - Motor power 110 kW, that is, $I_n = 196$ A
 - Type 2 coordination

The following illustration shows the installation diagram:
1022

Calculations performed on the installation in accordance with the regulations can be used to determine the characteristics of the appropriate ComPacT NSX circuit breaker to install (calculations performed using the Ecostruxure Power Design – Ecodial software).

The following table presents the circuit breaker selection:

Installation	Chosen ComPacT NSX	Comments
$I_n = 196$ A	ComPacT NSX250 MA 220	Determination of case size
$I_{sc} = 28.5$ kA	F	I_{cu} performance can be read from rating plate
$I_{kmin} = 14.8$ kA	–	–

The following table shows the trip unit protection settings:

Installation	Chosen trip unit	Comments
$I_{kmin} = 14.8$ kA Transient current = 14 I_n , that is, 2,800 A	$I_i = 2,860$ A	The I_{sd} protection setting is compatible with: <ul style="list-style-type: none"> • Transient startup currents • Short-circuit protection

Earth-Leakage Protection by VigiPacT Add-on

Introduction

Earth-leakage protection by VigiPacT Add-on provides protection against very low insulation fault currents. If there is an insulation fault, the VigiPacT Add-on causes the circuit breaker to trip very rapidly by acting directly on the circuit breaker mechanism.

The two VigiPacT versions for earth-leakage protection are as follows:

- The VigiPacT Add-on measures the earth-leakage current and the circuit breaker trips when earth-leakage is detected.
- The VigiPacT Add-on Alarm measures the earth-leakage current and indicates an earth-leakage fault on the front face (**ALARM** LED flashing red).

VigiPacT Add-on Front Face

The settings and controls are on the front face of the VigiPacT Add-on.

VigiPacT Add-on

VigiPacT Add-on Alarm

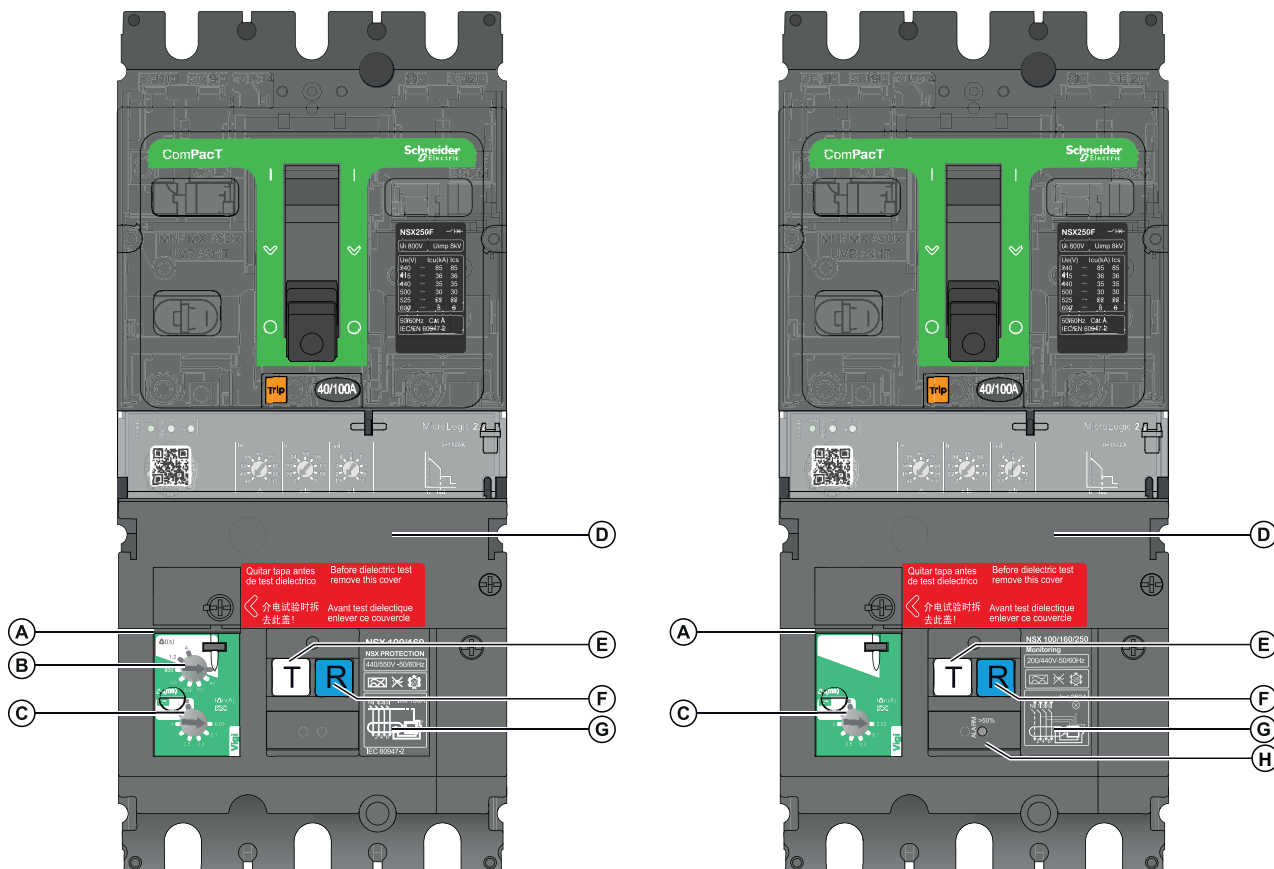

- A** Protective cover for settings
- B** Intentional delay adjustment dial: Δt
- C** Sensitivity pickup adjustment dial: $I\Delta n$
- D** Protective cover for connections
- E** Test pushbutton
- F** Reset pushbutton
- G** Faceplate label
- H** Alarm LED

Installation

The VigiPacT Add-on must be installed directly downstream terminals of the ComPacT NSX circuit breaker. Install the VigiPacT Add-on on the trip unit.

For more information about installation, consult the instruction sheets on the Schneider Electric website:

- PHA60738, VigiPacT Add-on for ComPacT NSX100-250
- PHA60739, VigiPacT Add-on for ComPacT NSX400-630

Use an intermediate terminal shield to provide protection against direct contact with the circuit breaker downstream connection block.

VigiPacT Add-on and VigiPacT Add-on Alarm can be installed on ComPacT NSX100-630 circuit breakers with the following characteristics:

- 3P or 4P
- Fixed, plug-in, or withdrawable
- Equipped with a magnetic, thermal-magnetic, or MicroLogic 2, 5, or 6 trip unit.
- Circuit breakers with toggle handle, rotary handle, or motor mechanism

NOTE: VigiPacT Add-on and VigiPacT Add-on Alarm are not compatible with ComPacT NSX circuit breakers with R, HB1, HB2 or K breaking performances.

A circuit breaker with VigiPacT Add-on can be installed on a mounting plate, chassis, or base.

For the circuit breaker plug-in base version:

- The VigiPacT Add-on Alarm can be mounted under the plug-in base. Do not mount a VigiPacT Add-on under the plug-in base.
- It is mandatory to mount short terminal shields (commercial reference LV429515 or LV429516) on the circuit breaker and VigiPacT Add-on.

In a 3-phase installation with an uninterrupted neutral, a 4-pole VigiPacT Add-on with connection of the neutral cable can be installed by using an adaptation accessory (commercial reference LV429214).

The VigiPacT Add-on can be equipped with an auxiliary contact (SDV) to remotely signal tripping due to an earth-leakage fault.

Setting the Earth-Leakage Sensitivity

The VigiPacT Add-on helps to protect personnel and equipment.

⚡ ⚠ DANGER

HAZARD OF ELECTRIC SHOCK, EXPLOSION, OR ARC FLASH

Setting adjustments to the VigiPacT Add-on must be done only by qualified electrical personnel.

Failure to follow these instructions will result in death or serious injury.

Set the sensitivity ($I\Delta n$) using the dial on the front face. The sensitivity value is in amperes.

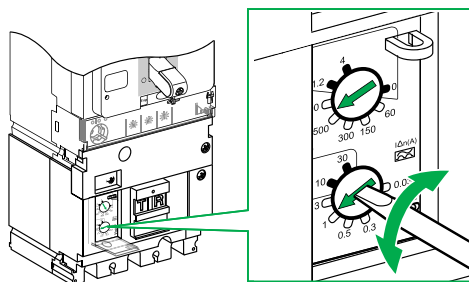

The sensitivity can be set on the VigiPacT Add-on and on the VigiPacT Add-on Alarm.

Pickup $I\Delta n$	0.03 A	0.1 A	0.3 A	0.5 A	1 A	3 A	10 A	30 A
--------------------	--------	-------	-------	-------	-----	-----	------	------

NOTE: The VigiPacT Add-on (trip version only) for South Africa has a different range of setting values, as follows:

Pickup $I_{\Delta n}$ (RSA)	0.03 A	0.06 A	0.25 A	0.375 A	0.5 A	3 A	10 A	30 A
-----------------------------------	--------	--------	--------	---------	-------	-----	------	------

Setting the Intentional Delay

Set the intentional delay (Δt) using the dial on the front face.

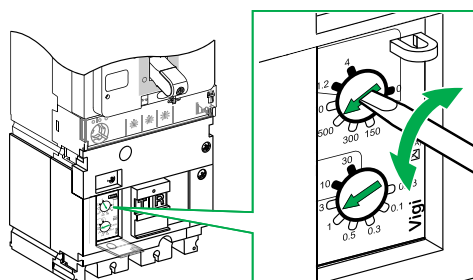

The intentional delay can be set on the VigiPacT Add-on only.

When $I_{\Delta n}$ is set to 30 mA, the intentional delay Δt is always 0 ms regardless of the position of the dial (instantaneous tripping).

When $I_{\Delta n}$ is set above 30 mA, the time delay Δt can be adjusted to the following values:

- 0 ms
- 60 ms
- 150 ms
- 300 ms
- 500 ms
- 800 ms
- 1.2 s
- 4 s

Testing the Earth-Leakage Protection

⚡ ⚠ DANGER

HAZARD OF ELECTRIC SHOCK, EXPLOSION, OR ARC FLASH

Take all measures necessary to avoid the risk of electrocution when the external power supply voltage is greater than 30 Vac.

Failure to follow these instructions will result in death or serious injury.

A test pushbutton (**T**) is on the front of the VigiPacT Add-on and VigiPacT Add-on Alarm. Pressing the test button creates a real ground fault that fully tests the circuit breaker.

- In the case of the VigiPacT Add-on, pressing the test button trips the circuit breaker and the pushbutton (**R**) pops out.
- In the case of the VigiPacT Add-on Alarm, continuously pressing the test button for 1 second causes the **ALARM** earth-leakage LED to flash red and the reset pushbutton (**R**) pops out. The LED turns off after releasing the test button.

If the circuit breaker does not trip, or the **ALARM** earth-leakage LED does not flash red, check that the circuit breaker is energized. If the circuit breaker is energized correctly, and has not tripped or indicated the earth-leakage fault, replace the VigiPacT Add-on or VigiPacT Add-on Alarm.

Test the earth-leakage protection at regular intervals. Schneider Electric recommends that the test is carried out:

- Every three months in case of absence of local regulation.
- Once a month for devices in corrosive, dusty, or harsh environments.

Resetting the Circuit Breaker After an Earth-Leakage Fault Trip

After an earth-leakage fault trip, the circuit breaker cannot be closed again until the VigiPacT Add-on or VigiPacT Add-on Alarm has been reset by pressing the reset pushbutton (**R**).

Insulation and Dielectric Strength Tests

There is a specific procedure for carrying out the insulation and dielectric strength tests on equipment with a VigiPacT Add-on, page 181.

Sealing Accessories for Earth-Leakage Protection

Use sealing accessories to prevent the following operations:

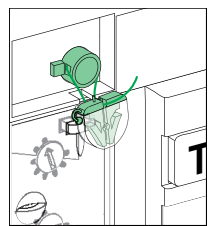
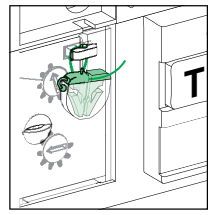
Seal	Description	Prohibited operation
	Seals VigiPacT Add-on mounting screw	Dismantling of the VigiPacT Add-on
	Seals transparent protective cover for the settings	Modification of the VigiPacT Add-on settings

MicroLogic Electronic Trip Units

What's in This Chapter

Characteristics of MicroLogic Electronic Trip Units	140
MicroLogic 2 Electronic Trip Units	146
MicroLogic 4 Electronic Trip Units	150
MicroLogic 1.3 M Electronic Trip Unit	156
MicroLogic 2 M Electronic Trip Unit	158
MicroLogic 2 G Electronic Trip Unit	161
MicroLogic 2 AB and 4 AB Electronic Trip Units	163

Characteristics of MicroLogic Electronic Trip Units

Introduction

MicroLogic electronic trip units provide the following functions:





- Protection of the electrical distribution or specific applications
- Measurement of instantaneous values and measurement of average values (demand) for electrical quantities
- Kilowatt hour metering
- Operational assistance such as peak demand, customized alarms, and operation counters
- Communication

Identification

Identify the trip unit installed on the circuit breaker by using the four characters on the front face:

MicroLogic 6.3 E-M

| | | |
X Y Z T

	Protection (X)	Case (Y)	Measurements (Z)	Application (T)
				
	1 SI 2 LS ₀ I 4 LS ₀ IR 5 LSI 6 LSIG 7 LSIR	2 ComPacT NSX100/ 160/250 3 ComPacT NSX400/ 630	– No measurement E Energy	– Distribution G Generator AB Subscriber M Motor Z 16 Hz 2/3 AL Alarm
Examples				
MicroLogic 1.3	SI	400 or 630 A	–	Distribution
MicroLogic 2.2 G	LS ₀ I	100, 160 or 250 A	–	Generator
MicroLogic 2.3	LS ₀ I	400 or 630 A	–	Distribution
MicroLogic 2.3 M	LS ₀ I	400 or 630 A	–	Motor
MicroLogic 4.2	LS ₀ IR	100, 160 or 250 A	–	Distribution including trip on earth leakage
MicroLogic 4.3 AL	LS ₀ I	400 or 570 A	–	Distribution including alarm on earth leakage
MicroLogic 5.3 E	LSI	400 or 630 A	Energy	Distribution
MicroLogic 6.3 E-M	LSIG	400 or 630 A	Energy	Motor
MicroLogic 7.2 E-AL	LSI	100, 160 or 250 A	Energy	Distribution including alarm on earth leakage
MicroLogic 7.3 E	LSIR	400 or 630 A	Energy	Distribution including trip on earth leakage
Type of protection: I Instantaneous L Long-time S₀ Short-time (time delay cannot be adjusted) S Short-time G Ground-fault R Residual (earth-leakage)				

Distribution Trip Unit

The following figure and table define the protection functions for distribution-type MicroLogic trip units.

MicroLogic 5 and 6

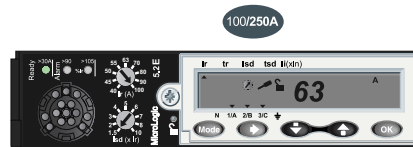

MicroLogic 7

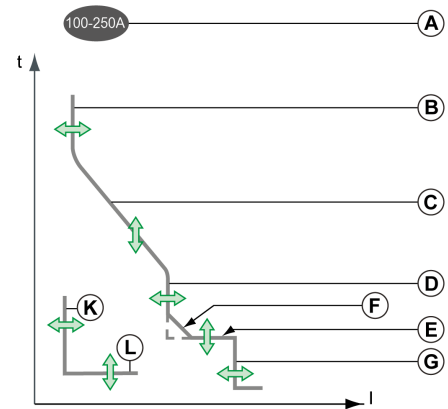
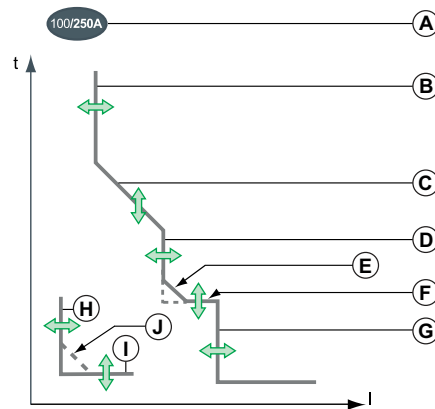
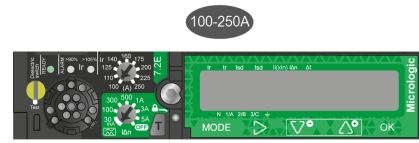

Item	Parameter	Description	MicroLogic ⁽¹⁾					
			2	4	5	6	7	
A	–	Trip unit setting range: minimum setting/maximum setting. The trip unit rating I_n corresponds to the maximum value of the I_r setting range.	O	O	O	O	O	
B	I_r	Long-time protection pickup	L	✓	✓	✓	✓	✓
C	t_r	Long-time protection time delay		O	O	✓	✓	✓
D	I_{sd}	Short-time protection pickup	S	✓	✓	✓	✓	✓
E	t_{sd}	Short-time protection time delay		O	O	✓	✓	✓
F	I^2t ON/OFF	Short-time protection I^2t curve in ON or OFF position		–	–	✓	✓	✓
G	I_i	Instantaneous protection pickup	I	O	O	✓	✓	✓
H	I_{lg}	Ground-fault protection pickup	G	–	–	–	✓	–
I	t_g	Ground-fault protection time delay		–	–	–	✓	–
J	I^2t ON/OFF	Ground-fault protection I^2t curve in ON or OFF position		–	–	–	✓	–
K	$I_{\Delta n}$	Earth-leakage protection pickup	R	–	✓	–	–	✓
L	Δt	Earth-leakage protection time delay		–	✓	–	–	✓
(1) Functions: ✓: Adjustable O: Fixed –: Not present								

Thermal Memory

The thermal memory is used to simulate temperature build-up and cooling in conductors caused by current variations, according to a time constant. In the event of an overload, the trip units with a thermal memory memorize the build-up

temperature caused by the current. Memorizing the build-up temperature leads to a reduction in the trip time.

All MicroLogic trip units incorporate a thermal memory as standard:

- For MicroLogic 2 and 4 trip units, the time constant is 15 minutes.
- For MicroLogic 5, 6, and 7 trip units, the time constant is 20 minutes.

Motor Trip Units

The following figure and table define the protection functions for MicroLogic type M trip units.

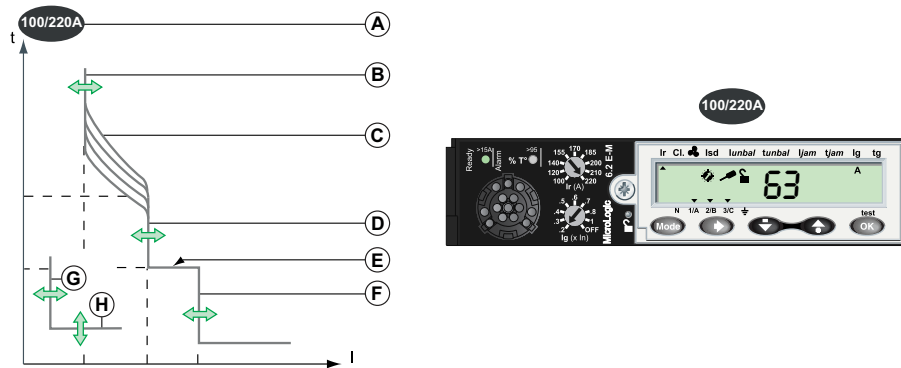

Item	Parameter	Description	MicroLogic type M		
			1.3	2	6 E
A	–	Trip unit setting range: minimum setting/ maximum setting. The trip unit rating I_n corresponds to the maximum value of the setting range.	O	O	O
B	I_r	Long-time protection pickup	–	✓	✓
C	Class	Long-time protection trip class	–	✓	✓
D	I_{sd}	Short-time protection pickup	✓	✓	✓
E	t_{sd}	Short-time protection time delay	O	O	O
F	I_i	Instantaneous protection pickup	O	O	O
G	I_g	Ground-fault protection pickup	–	–	✓
H	t_g	Ground-fault protection time delay	–	–	✓
–	I_{unbal}	Phase-unbalance protection pickup	–	O	✓
–	t_{unbal}	Phase-unbalance protection time delay	–	O	✓

(1) Functions:
 ✓: Adjustable
 O: Fixed
 –: Not present



Motor Trip Unit: Additional Protection

MicroLogic type M trip units (in particular MicroLogic 6 E-M) also incorporate additional protection for the motor application. For more information, refer to DOCA0188EN, *ComPacT NSX MicroLogic 5/6/7 Electronic Trip Units - User Guide*.

Indication LEDs

Indication LEDs on the front of the trip unit indicate its operational state.

The LEDs and their meaning depend on the type of MicroLogic trip unit.

Type of MicroLogic trip unit	Description
<p>Distribution</p> 	<ul style="list-style-type: none"> Ready LED (green): Blinks slowly when the electronic trip unit is ready to provide protection. Overload pre-alarm LED (orange): Shows a steady light when the load exceeds 90% of the Ir setting. Overload alarm LED (red): Shows a steady light when the load exceeds 105% of the Ir setting.
<p>Motor</p> 	<ul style="list-style-type: none"> Ready LED (green): Blinks slowly when the electronic trip unit is ready to provide protection. Overload temperature alarm LED (red): Shows a steady light when the motor thermal image exceeds 95% of the Ir setting. <p>The MicroLogic 1.3 M trip unit, which provides short-time protection only, displays the Ready LED (green).</p>

The indication LEDs function for circuit breaker load currents:

- Above 15 A on a MicroLogic trip unit rated 40 A
- Above 30 A on MicroLogic trip units rated > 40 A

The limit value is indicated on the front panel, above the Ready LED of the MicroLogic trip unit.

NOTE: For the MicroLogic 4 and 7 trip units, the protection functions are supplied by a second power supply, in addition to the current transformer supply. The Ready LED blinks irrespective of the load, indicating that the standard protection functions are operational.

To activate the **Ready** LED when the load current is below the limit value, you can:

- Install a 24 Vdc external power supply module which allows the trip unit to be monitored continuously, even when the circuit breaker is open. For more information, refer to LVPED221001EN, *ComPacT NSX & NSXm Catalogue*.
- Or, during maintenance visits, connect the pocket battery, page 168 to monitor the trip unit.

NOTE: If the pre-alarm and alarm LEDs keep lighting up, perform load shedding to avoid tripping due to a circuit breaker overload.

Test Port

MicroLogic trip units come with a test port specifically for testing trip unit operation, page 165.



This port is designed for:

- Connecting the pocket battery for local MicroLogic testing
- Connecting the USB maintenance interface for testing, setting the MicroLogic trip unit, or for installation diagnostics

NOTE: The test port is capped on the ComPacT NSX 400K circuit breaker.

▲ WARNING

HAZARD OF REDUCED INSULATION DISTANCES

On a ComPacT NSX 400K circuit breaker, do not remove the cap on the MicroLogic test port.

Failure to follow these instructions can result in death, serious injury, or equipment damage.

Interchangeability of MicroLogic Trip Units

Onsite replacement of trip units is simple:

- No connections to make
- No special tools (for example, calibrated torque wrench)
- Compatibility of trip units provided by mechanical cap
- Torque limited screw provides correct torque

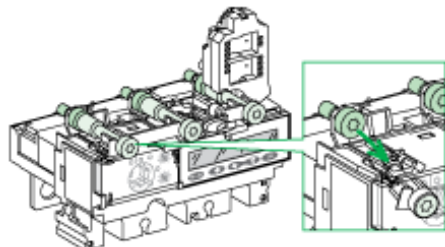

The simplicity of the replacement process means that it is easy to make the necessary adjustments as operation and maintenance processes evolve.

NOTE: The screw head is accessible when the trip unit is installed, so the trip unit can still be removed.

NOTE: On ComPacT NSX circuit breakers with NA, R, HB1, HB2, and K breaking performances the trip units are not interchangeable.

Sealing the Protection

Seal the transparent cover on MicroLogic trip units to prevent modification of the protection.

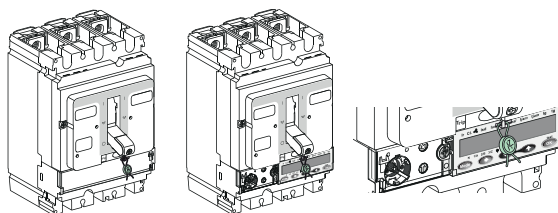

On MicroLogic 5, 6, and 7 trip units, it is possible to use the keypad, with the cover sealed, to read the protection settings and measurements.

MicroLogic 2 Electronic Trip Units

Introduction

The MicroLogic 2 electronic trip unit is designed to protect conductors in commercial and industrial electrical distribution.

In 4-pole circuit breakers, neutral protection is set on the MicroLogic trip unit by using a three-position dial:

- 4P 3D: neutral unprotected
- 4P 3D + N/2: neutral protection at half the value of the phase pickup, that is, $0.5 \times I_r$
- 4P 4D: neutral fully protected at I_r

Description

The adjustment dials and indications are on the front face.

MicroLogic 2.2 3P version

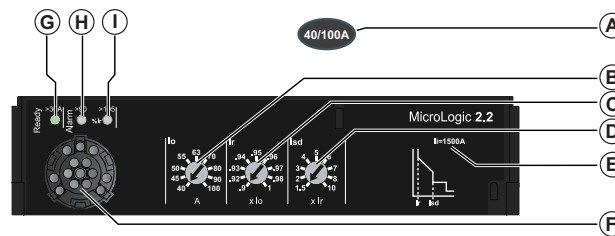

- A** MicroLogic electronic trip unit setting range
- B** Adjustment dial for the long-time protection pickup I_0
- C** Fine-tuning dial for the long-time protection pickup I_r
- D** Adjustment dial for the short-time protection pickup I_{std}
- E** Value of instantaneous protection pickup I_i

MicroLogic 2.2 4P version

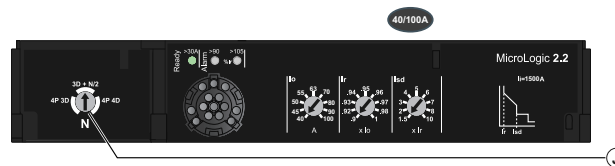

- F** Test port
- G** Ready LED (green)
- H** Overload pre-alarm LED (orange): $90\% I_r$
- I** Overload alarm LED (red): $105\% I_r$
- J** Selection dial for setting the neutral protection (4P only)

The trip unit rating I_n corresponds to the maximum value of the setting range.

NOTE: The ComPacT NSX400K circuit breaker is equipped with a non-interchangeable MicroLogic 2.3 trip unit with no test port.

Setting the Long-Time Protection

The long-time protection pickup I_r is set by using two multi-position dials.

- The preset dial allows the pickup to be preset to the value I_0 (displayed in amperes on the dial).
The maximum preset value (maximum setting on preset dial) equals the trip unit rating I_n .
- The adjustment dial can be used to fine-tune the pickup I_r (value displayed in multiples of I_0 on the dial).

Step	Action
1	Set both adjustment dials to maximum (for I_0 : to the value I_n (A); for I_r : to 1).
2	Turn the I_0 adjustment dial higher than the value required. The I_r setting value is: I_0 setting (A).

Step	Action
3	Turn the fine-tuning dial to specify the value of I_r from $0.9 \times I_o$ to I_o .
4	The I_r setting value is: I_o (A) setting \times fine tuning.

The time delay t_r for long-time protection cannot be adjusted.

The following table shows the value of the time delay t_r for long-time protection (in seconds) according to the overload current (in multiples of I_r):

at $1.5 \times I_r$	at $6 \times I_r$	at $7.2 \times I_r$
$t_r = 400$ s	$t_r = 16$ s	$t_r = 11$ s

Setting the Short-Time Protection

The short-time protection pickup I_{sd} is set by using a multi-position dial.

The setting value is expressed in multiples of I_r .

Step	Action
1	Set the long-time protection first: the setting pickup is I_r .
2	Turn the I_{sd} adjustment dial to the value required. The I_{sd} value is adjustable from $1.5 I_r$ to $10 I_r$.
3	$I_{sd} = I_{sd}$ setting $\times I_r$.

The precision range is $\pm 15\%$.

The time delay t_r for short-time protection cannot be adjusted:

- Non-trip time: 20 ms
- Maximum breaking time: 80 ms.

Setting the Instantaneous Protection

The pickup I_i for instantaneous protection cannot be adjusted.

The following table shows the value of the pickup I_i for instantaneous protection (in amperes) according to the trip unit rating I_n :

Trip unit rating I_n (A)	40	100	160	250	400	630
Pickup I_i (A) $\pm 15\%$	600	1500	2400	3000	4800	6930

The time delay for instantaneous protection cannot be adjusted:

- Non-trip time: 0 ms
- Maximum breaking time: 50 ms.

Setting the Neutral Protection (4P Only)

The neutral selection dial gives a choice of three values for the neutral long-time and short-time protection pickups.

The following table shows the values of the pickup for neutral long-time protection (in multiples of I_r) and neutral short-time protection (in multiples of I_{sd}) according to the dial position:

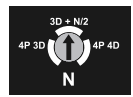
Dial	Dial position	Long-time pickup value for neutral protection	Short-time pickup value for neutral protection
	4P 3D	no pickup	no pickup
	4P 3D + N/2	$I_r/2$	$I_{sd}/2$
	4P 4D	I_r	I_{sd}



The time delay for the neutral long-time protection and short-time protection is the same as that for the phases.

Example of Setting the Long-Time Protection

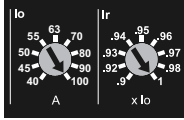
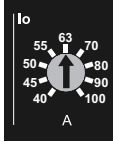
Setting the long-time protection pickup I_r to 63 A on a MicroLogic 2.2 rated I_n 100 A (see diagram below).

Step		Action
1		I_o is positioned on 100 A and I_r on 1 ($\times I_o$): factory setting.
2		I_o is set to 63 A.
3	—	Adjustment not needed; I_r fine-tuning stays at setting 1
4	—	I_r is set to 63 A \times 1.

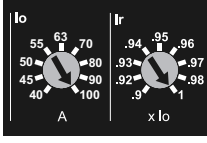
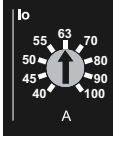
A precise coordination calculation indicates that the desirable value is $I_r = 60$ A.

Step		Action
1		I_o is positioned at 100 A and I_r at 1 ($\times I_o$).
2		I_o is set to 63 A.
3		Setting calculation: $60 \text{ A} = 0.95 \times 63 \text{ A}$ Fine-tune I_r on setting 0.95.
4	—	I_r is set to 63 A \times 0.95 (= 59.9 A).

The actions in steps (2) and (3) on the adjustment dials modify the trip curves as shown:

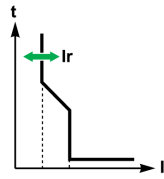

Example of Setting the Short-Time Protection

Setting the short-time protection pickup I_{sd} to 400 A on a MicroLogic 2.2 rated (In) 100 A on a 50 A feed (see diagram below)

Step		Action
1		The setting pickup I_r for long-time protection is equal to the feeder operating current, that is, $I_r = 50$ A.
2		Setting calculation: $400 \text{ A} = 8 \times 50 \text{ A}$ Position the I_{sd} adjustment dial on setting 8.
3	—	I_{sd} is set to $50 \text{ A} \times 8 (= 400 \text{ A})$.

The action in step (2) on the adjustment dial modifies the trip curve as shown:

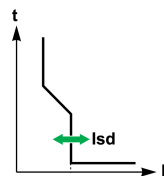

MicroLogic 4 Electronic Trip Units

Introduction

The MicroLogic 4 electronic trip unit is designed to protect:

- Conductors in commercial and industrial electrical distribution.
- Goods and people in commercial and industrial electrical distribution.

On 4-pole circuit breakers, neutral protection is set on the MicroLogic trip unit by using a three-position dial:

- 4P 3D: neutral unprotected
- 4P 3D + N/2: neutral protection at half the value of the phase pickup, $0.5 \times I_r$ (not available on MicroLogic trip unit with $I_n \leq 40 \text{ A}$)
- 4P 4D: neutral fully protected at I_r

The MicroLogic 4 electronic trip unit is available in two versions for earth-leakage detection:

- The Trip version trips when earth-leakage is detected.
- The Alarm version measures the earth-leakage current and indicates an earth-leakage fault on the front face with the earth-leakage fault indicator, which changes from gray to yellow.

When the SDx module is present, it signals an earth-leakage fault remotely.

Description

The adjustment dials and indications are on the front face.

MicroLogic 4.2 3P Trip version

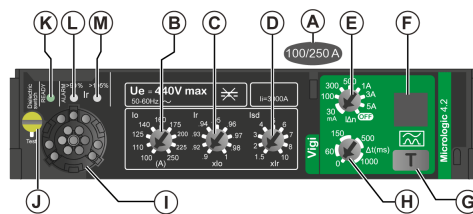

MicroLogic 4.2AL 3P Alarm version

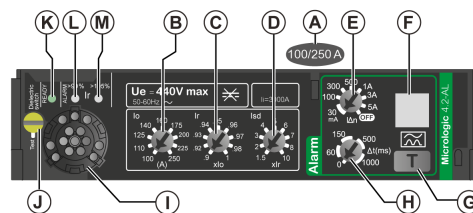

A MicroLogic electronic trip unit setting range

B Adjustment dial for the long-time protection pickup I_r

C Fine-tuning dial for the long-time protection pickup I_r

D Adjustment dial for the short-time protection pickup I_{sd}

E Adjustment dial for the earth-leakage current pickup $I_{\Delta n}$

F Earth-leakage fault indicator: yellow when earth-leakage fault is detected

G Test button (T) for periodic earth-leakage function test

H Adjustment dial for the earth-leakage time delay Δt

I Test port

J Switch to disconnect the trip unit supply from the phases, used when performing a panel dielectric test

K Ready LED (green)

L Overload alarm LED (orange): 90% I_r

M Overload alarm LED (red): 105% I_r

The trip unit rating I_n corresponds to the maximum value of the setting range.

Setting the Long-Time Protection

The long-time protection pickup I_r is set by using two multi-position dials.

- The preset dial allows the pickup to be preset to the value I_0 (displayed in amperes on the dial).

The maximum preset value (maximum setting on preset dial) equals the trip unit rating value I_n .

- The adjustment dial can be used to fine-tune the pickup I_r (value displayed in multiples of I_o on the dial).

Step	Action
1	Set both adjustment dials to maximum (for I_o : to the value I_n (A); for I_r : to 1).
2	Turn the I_o adjustment dial higher than the value required. The I_r setting value is: I_o setting (A).
3	Turn the fine-tuning dial to specify the value of I_r from 0.9 I_o to I_o .
4	The I_r setting value is: I_o (A) setting x fine tuning.

The time delay t_r for long-time protection cannot be adjusted.

The following table shows the value of the time delay t_r for long-time protection (in seconds) according to the overload current (in multiples of I_r)

at 1.5 x I_r	at 6 x I_r	at 7.2 x I_r
$t_r = 400$ s	$t_r = 16$ s	$t_r = 11$ s

The precision range is -20%, +0%.

Setting the Short-Time Protection

The short-time protection pickup I_{sd} is set by using a multi-position dial.

The setting value is expressed in multiples of I_r .

Step	Action
1	Set the long-time protection first: the setting pickup is I_r .
2	Turn the I_{sd} adjustment dial to the value required. The I_{sd} value is adjustable from 1.5 x I_r to 10 x I_r .
3	$I_{sd} = I_{sd}$ setting x I_r .

The precision range is +/- 15%.

The time delay t_r for short-time protection cannot be adjusted:

- Non-trip time: 20 ms
- Maximum breaking time: 80 ms.

Setting the Instantaneous Protection

The pickup I_i for instantaneous protection cannot be adjusted.

The following table shows the value of the pickup I_i for instantaneous protection (in amperes) according to the trip unit rating I_n :

Trip unit rating I_n (A)	40	100	160	250	400	630
Pickup I_i (A) +/- 15%	600	1500	2400	3000	4800	6930

The time delay for instantaneous protection cannot be adjusted:

- Non-trip time: 0 ms
- Maximum breaking time: 50 ms.

Setting the Neutral Protection (4P Only)

The neutral selection dial gives a choice of three values for the neutral long-time and short-time protection pickups.

The following table shows the values of the pickup for neutral long-time protection (in multiples of I_r) and neutral short-time protection (in multiples of I_{sd}) according to the dial position:

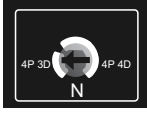
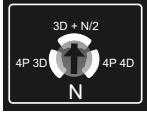
Trip unit rating I_n (A)	Dial	Dial position	Long-time pickup value for neutral protection	Short-time pickup value for neutral protection
40		4P 3D	no pickup	no pickup
		4P 4D	I_r	I_{sd}
100 - 160 - 250		4P 3D	no pickup	no pickup
		4P 3D + N/2	$I_r/2$	$I_{sd}/2$
		4P 4D	I_r	I_{sd}

The time delay for the neutral long-time protection and short-time protection is the same as that for the phases.

Setting the Earth-Leakage Protection

The earth-leakage protection $I_{\Delta n}$, type A, is set by using a multi-position dial.

The following table shows the value of the pickup $I_{\Delta n}$ for earth-leakage protection according to the trip unit rating I_n :

Trip unit rating I_n (A)	Pickup $I_{\Delta n}$								
40, 100, 160, and 250 A	30 mA	30 mA	100 mA	300 mA	500 mA	1 A	3 A	5 A	OFF
400 and 570 A ⁽¹⁾	300 mA	300 mA	500 mA	1 A	3 A	5 A	10 A	10 A	OFF

(1) Maximum setting at 570 A for thermal reasons, to be adapted with breaking block up to 630 A

The OFF setting annuls any earth-leakage protection and the circuit breaker behaves as a standard circuit breaker for cable protection.

Setting the earth-leakage protection to OFF can be used to inhibit earth-leakage protection during periods of setting, commissioning, testing and maintenance.

Setting the Earth-Leakage Protection Time Delay

The time delay of the earth-leakage protection is set by using a multi-position dial.

When $I_{\Delta n}$ is set to 30 mA, the time delay Δt is always 0 ms regardless of the position of the dial (instantaneous tripping).

When $I_{\Delta n}$ is set above 30 mA, the time delay Δt can be adjusted to the following values:

- 0 ms
- 60 ms
- 150 ms
- 500 ms
- 1000 ms

Testing the Earth-Leakage Protection

The earth-leakage protection must be tested regularly by using the test button (T). Pressing the test button simulates a real leakage current passing through the toroid, and the earth-leakage fault indicator displays the following symbol:



When the earth-leakage protection pickup $I_{\Delta n}$ is set to the **OFF** position, pressing the test button has no effect.

In the case of the Trip version of MicroLogic 4, pressing the test button trips the circuit breaker.

In the case of the Alarm version of MicroLogic 4, pressing the test button causes the earth-leakage indicator to change to yellow.

If the circuit breaker does not trip, or the earth-leakage indicator does not change to yellow, check that the circuit breaker is energized. If the circuit breaker is energized correctly, and has not tripped or indicated the earth-leakage fault, replace the MicroLogic 4 trip unit.

Resetting the Circuit Breaker After an Earth-leakage Fault Trip

Resetting the circuit breaker after an earth-leakage fault trip depends on the version:

- For the Trip version, reset the circuit breaker by moving the handle from **Trip** to **O (OFF)** position, and then to **I (ON)** position.
- For the Alarm version, press the test button (T) for three seconds.

For Trip and Alarm versions, the earth-leakage fault indicator changes back to gray after the reset.

Examples of Setting the Long-Time Protection

Example 1: Setting the long-time protection pickup I_r to 140 A on a MicroLogic 4.2 trip unit rated I_n 250 A:

Step		Action
1		I_0 is positioned on 250 A and I_r on 1 ($\times I_0$) (factory setting).
2		Set I_0 to 140 A.
3	–	I_r fine-tuning stays at setting 1 and I_r is set to 140 A \times 1

Example 2: Setting the long-time protection pickup I_r to 133 A on a MicroLogic 4.2 trip unit rated I_n 250 A:

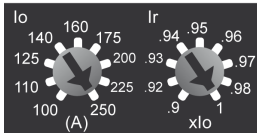
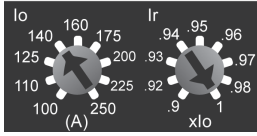
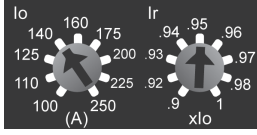
Step		Action
1		I_0 is positioned on 250 A and I_r on 1 (x I_0) (factory setting).
2		Set I_0 to 140 A.
3		Setting calculation: $133 \text{ A} = 0.95 \times 140 \text{ A}$ Fine-tune I_r on setting 0.95.
4	–	I_r is set to $140 \text{ A} \times 0.95 = 133 \text{ A}$.

The actions in steps (2) and (3) on the adjustment dials modify the trip curves as shown:

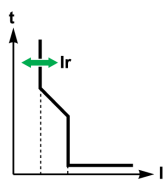

Example of Setting the Short-Time Protection

Setting the short-time protection pickup I_{sd} to 400 A on a MicroLogic 4.2 rated I_n 250 A on a 133 A feed:

Step		Action
1	–	The setting pickup I_r for long-time protection is equal to the feeder operating current, that is, $I_r = 133 \text{ A}$.
2		Setting calculation: $399 \text{ A} = 3 \times 133 \text{ A}$ Position the I_{sd} adjustment dial on setting 3.
3	–	I_{sd} is set to $133 \text{ A} \times 3 = 399 \text{ A}$.

The action in step (2) on the adjustment dial modifies the trip curve as shown:

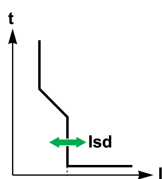

Example of Setting the Earth-Leakage Protection

Setting the earth-leakage protection pickup $I\Delta n$ to 1 A with a tripping time delay of 500 ms on a MicroLogic 4.2 rated I_n 250 A:

Step	Action
1	Set the adjustment dial for the earth-leakage current protection $I\Delta n$ to 1 A.
2	Set the adjustment dial for the earth-leakage time delay Δt to 500 ms.

MicroLogic 1.3 M Electronic Trip Unit

Introduction

The MicroLogic 1.3 M electronic trip unit with high short-time protection pickup provides motor-feeders with short-circuit protection. Two ratings are available, 320 A and 500 A.

Use the MicroLogic 1.3 M electronic trip unit to create a type 1 or type 2 coordination motor-feeder.

Description

The adjustment dial and indication are on the front face.

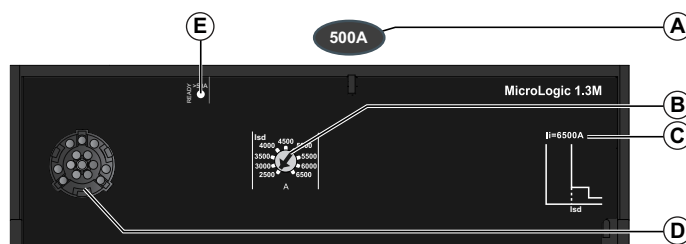

- A MicroLogic trip unit rating
- B Adjustment dial for the short-time protection pickup I_{sd}
- C Instantaneous protection pickup I_i
- D Test port
- E Ready LED (green)

Setting the Short-Time Protection

Set the short-time protection pickup I_{sd} using a 9-setting dial.

Turning the pickup I_{sd} adjustment dial modifies the curves as shown.

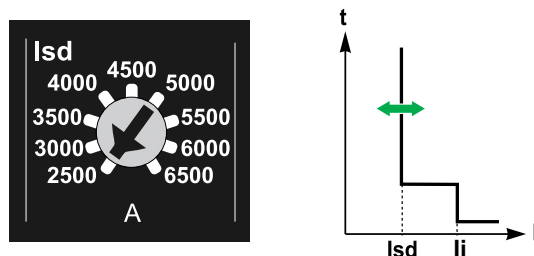

The following table shows the values of the pickup I_{sd} (in amperes) for short-time protection (values indicated on the dial) relative to the position of the I_{sd} dial and the values of the pickup I_i for instantaneous protection.

Trip unit rating I_n	Pickup I_{sd} (A)										Pickup I_i (A)
	1600	1920	2240	2560	2880	3200	3520	3840	4160	4800	
320 A	1600	1920	2240	2560	2880	3200	3520	3840	4160	4800	4800
500 A	2500	3000	3500	4000	4500	5000	5500	6000	6500	6500	6500

The precision range is +/- 15%.

Example of Application

The following is an example of a motor-feeder application:

- Power supplied by a 1,250 kVA transformer, 400 V, 4%
- Downstream power supply of a motor-feeder with the following characteristics:
 - 3-component motor-feeder (circuit breaker, thermal relay, contactor)
 - Direct-on-line starting
 - Motor power 160 kW ($I_n = 280\text{ A}$)
 - Type 2 coordination

Installation diagram:

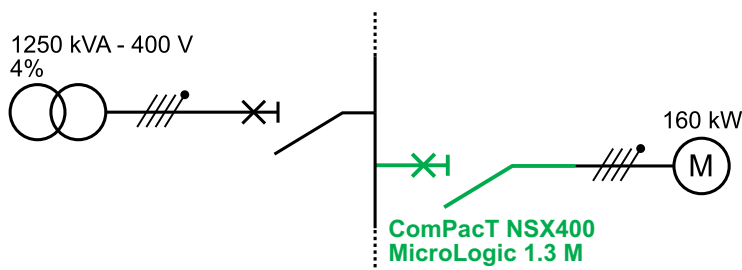

Use calculations performed on the installation in accordance with the regulations to determine the characteristics of the appropriate ComPacT NSX circuit breakers to install (calculations performed using the Ecostruxure Power Design – Ecodial software).

Circuit breaker selection

Installation	Circuit breaker	Comments
$I_n = 280\text{ A}$	ComPacT NSX400 with MicroLogic 1.3 M 320	Motor circuit breaker, case size
$I_{sc} = 28.5\text{ kA}$	F	Read the I_{cu} performance from faceplate label
$I_k \text{ min} = 18.3\text{ kA}$	–	–

Trip unit protection

Installation	Trip unit setting	Comments
$I_k \text{ min} = 18.3\text{ kA}$ Inrush current = $14 I_n$	$I_{sd} = 4,160\text{ A}$	The I_{sd} protection setting is compatible with: <ul style="list-style-type: none"> • Transient startup currents • Short-circuit protection

MicroLogic 2 M Electronic Trip Unit

Introduction

The MicroLogic 2 M electronic trip unit is suitable for protecting motor-feeders on standard applications. The thermal trip curves are calculated for self-ventilated motors.

The MicroLogic 2 M electronic trip unit can be used to create a type 1 or type 2 coordination motor-feeder.

Description

The adjustment dials and indications are on the front face.

MicroLogic 2.2 M

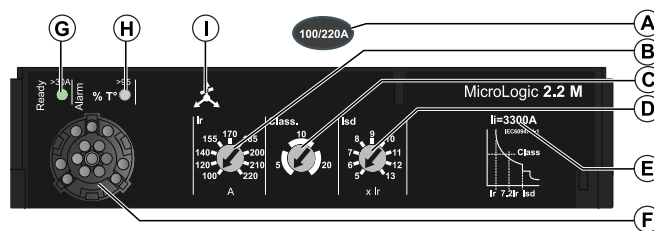

- A** MicroLogic electronic trip unit setting range
- B** Adjustment dial for the long-time protection pickup I_r
- C** Selection dial for the long-time protection time delay class
- D** Adjustment dial for the short-time protection pickup I_{sd}
- E** Value of instantaneous protection pickup I_i
- F** Test port
- G** Ready LED (green)
- H** Alarm LED
- I** Phase-unbalance

The trip unit rating I_n corresponds to the maximum value of the setting range.

Setting the Long-Time Protection

The long-time protection is set by 2 dials according to the starting characteristics of the application.

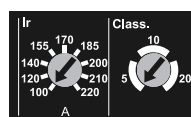

- The long-time protection pickup I_r is set using a multi-position dial.
The maximum setting value (maximum setting on adjustment dial) equals the trip unit rating value I_n .

The following table shows the values of the pickup I_r (in amperes) for long-time protection that are displayed directly on the dial with respect to every trip unit rating.

Trip unit rating I_n (A)	25	50	100	150	220	320	500
Pickup I_r (A)	12	25	50	70	100	160	250
	14	30	60	80	120	180	280
	16	32	70	90	140	200	320

Trip unit rating I _n (A)	25	50	100	150	220	320	500
	18	36	75	100	155	220	350
	20	40	80	110	170	240	380
	22	42	85	120	185	260	400
	23	45	90	130	200	280	440
	24	47	95	140	210	300	470
	25	50	100	150	220	320	500

- The long-time protection time delay class is set by using a multi-position dial: the choice of class is 5, 10 and 20.

The following table shows the value of the trip time delay depending on the current in the load for all 3 classes:

Current in the load	Class		
	5	10	20
	Trip time delay t _r (in seconds)		
1.5 x I _r	120	240	400
6 x I _r	6.5	13.5	26
7.2 x I _r	5	10	20

The precision range is - 20%, + 0%.

Setting the Short-Time Protection

The pickup for short-time protection is set by using a multi-position dial. It is displayed in multiples of I_r

Step	Action
1	Set the long-time protection first: the setting pickup is I _r (A).
2	Turn the I _{sd} adjustment dial to the value required (the setting range is: 5 to 13 x I _r in steps of I _r (9 settings)).
3	I _{sd} is set to I _r (A) x I _{sd} setting.

The precision range is +/- 15%.

The short-time protection time delay cannot be adjusted: 30 ms.

Setting the Instantaneous Protection

The following table shows the pickup I_i values (in amperes) according to the trip unit rating I_n.

	Trip unit rating I _n (A)						
	25	50	100	150	220	320	500
Pickup I _i (A)	425	750	1500	2250	3300	4800	7500

The precision range is +/- 15%.

Phase-Unbalance Protection

MicroLogic 2 M trip units incorporate a protection against phase-unbalance. The characteristics are:

- Protection not adjustable
- Pickup: 30% phase-unbalance (the precision range is +/- 20%)

- Overshoot time: 4 s in steady state, 0.7 s during startup

Example: A phase-unbalance exceeding 30% for longer than 4 s in steady state causes the protection to trip.

Contactor Opening Command

Trip units fitted with an SDTAM module, page 90 can use output 2 (SD4) from this module to activate the contactor opening command for the motor-feeder before the circuit breaker trips.

Example of Application

Protection of a motor-feeder with the following characteristics:

- Power supplied by a 1,250 kVA transformer - 400 V, 4%
- Protection of a motor application defined by:
 - 2-component motor-feeder (circuit breaker, contactor)
 - Direct-on-line starting
 - Motor power 110 kW, that is, $I_n = 196$ A
 - Type 2 coordination
 - The application constraints dictate a slow startup

Installation diagram

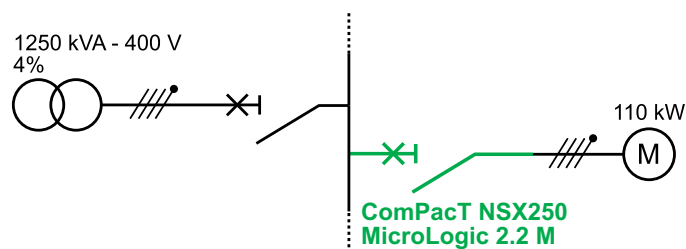

Calculations performed on the installation in accordance with the regulations have determined the characteristics of the appropriate ComPacT NSX to install (calculations performed using the Ecostruxure Power Design – Ecodial software).

Installation diagram

Installation	Chosen ComPacT NSX	Comments
$I_n = 196$ A	ComPacT NSX250 MicroLogic 2.2 M 220	Motor circuit breaker, case size
$I_{sc} = 28.5$ kA	F	Icu performance can be read from rating plate
$I_k \text{ min} = 14.8$ kA	–	–

Trip unit protection settings

Installation	Trip unit setting	Comments
$I_n = 196$ A	MicroLogic 2.2 M 220 set to 200 A	MicroLogic trip unit setting
Slow starting	Set in class 20	Long-time protection trip class
$I_k \text{ min} = 14.8$ kA Transient = 14 I_n	$I_{sd}/I_n > 12$ or $I_{sd} > 2,400$ A	I_{sd} protection setting compatible with: <ul style="list-style-type: none"> • Transient startup currents • Short-circuit protection

MicroLogic 2 G Electronic Trip Unit

Introduction

The MicroLogic 2 G electronic trip unit is used to protect distribution systems powered by generators or distribution systems with long cables.

Description

The adjustment dials and indications are on the front face.

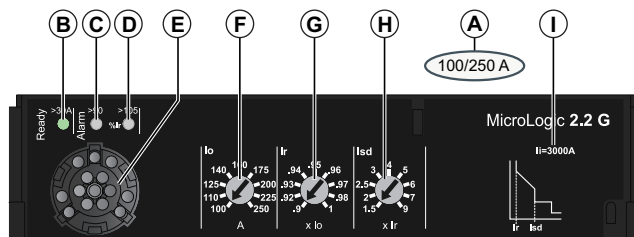

- A** MicroLogic 2G electronic trip unit setting range
- B** Ready LED (green)
- C** Overload pre-alarm LED (orange): 90% I_r
- D** Overload alarm LED (red): 105% I_r
- E** Test port
- F** Preset dial for the long-time protection pickup I_o
- G** Fine-tuning dial for the long-time protection pickup I_r
- H** Adjustment dial for the short-time protection pickup I_{sd}
- I** Value of instantaneous protection pickup I_i

The trip unit rating I_n corresponds to the maximum value of the setting range.

Setting the Long-Time Protection

The long-time protection pickup I_r is set using two multi-position dials.

- The preset dial allows the pickup to be preset to the value I_o (displayed in amperes on the dial).
The maximum preset value (maximum setting on preset dial) equals the trip unit rating value I_n .
- The adjustment dial can be used to fine-tune the pickup I_r (value displayed in multiples of I_o on the dial).

Step	Action
1	Set both adjustment dials to maximum (for I_o : to the value I_n (A); for I_r : to 1).
2	Turn the I_o preset dial higher than the value required. The I_r setting value is: I_o setting (A).
3	Turn the fine-tuning dial to adjust the value of I_r from $0.9 \times I_o$ to I_o .
4	The I_r setting value is: I_o (A) setting \times fine tuning.

The time delay t_r for long-time protection cannot be adjusted.

The following table shows the value of the time delay t_r for long-time protection (in seconds) according to the overload current (in multiples of I_r):

Current in the load I_n	Trip time delay
$1.5 \times I_r$	15 s
$6 \times I_r$	0.5 s
$7.2 \times I_r$	0.35 s

The precision range is - 20%, + 0%.

Setting the Short-Time Protection

The short-time protection pickup I_{sd} is set by a multi-position dial.

The setting value is expressed in multiples of I_r .

Step	Action
1	Set the long-time protection first: the setting pickup is I_r (A).
2	Turn the I_{sd} adjustment dial to the value required. The I_{sd} value is adjustable from $1.5 \times I_r$ to $9 \times I_r$.
3	I_{sd} is set to I_r (A) \times I_{sd} setting.

The precision range is +/- 10%.

The time delay t_r for short-time protection cannot be adjusted:

- Non-trip time: 140 ms
- Maximum breaking time: 200 ms.

Setting the Instantaneous Protection

The pickup I_i for instantaneous protection cannot be adjusted.

The following table shows the value of the pickup I_i for instantaneous protection (in amperes) according to the trip unit rating I_n :

Trip unit rating I_n (A)	40	100	160	250
Pickup I_i (A)	600	1500	2400	3000

The precision range is +/- 15%.

The time delay for instantaneous protection cannot be adjusted:

- Non-trip time: 15 ms
- Maximum breaking time: 50 ms.

MicroLogic 2 AB and 4 AB Electronic Trip Units

Introduction

The MicroLogic 2 AB and 4 AB electronic trip units are used in public distribution to limit the intensity provided to the subscriber according to the contract signed up for.

The MicroLogic 2 AB and 4 AB electronic trip units exist in 4-pole configuration only. They have the same characteristics as MicroLogic 2 and 4 respectively, with specific ratings and long-time protection settings.

Description

The adjustment dials and indications are on the front face.

- **MicroLogic 2 AB**

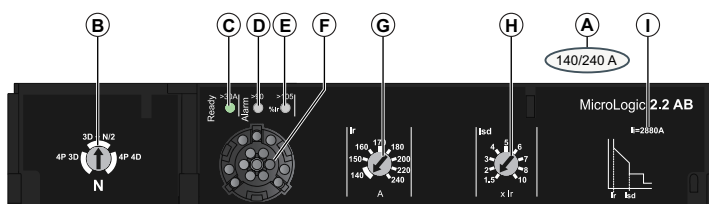

- **MicroLogic 4 AB**

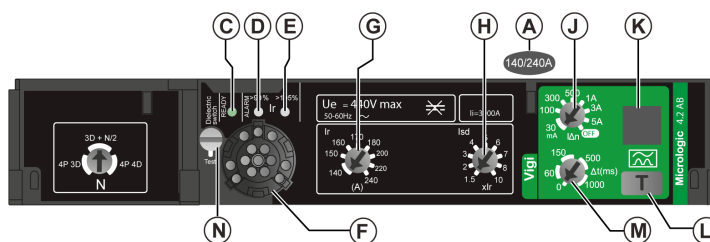

- A** MicroLogic electronic trip unit setting range
- B** Selection dial for setting the neutral protection
- C** Ready LED (green)
- D** Overload pre-alarm LED (orange): 90% I_r
- E** Overload alarm LED (red): 105% I_r
- F** Test port
- G** Adjustment dial for the long-time protection pickup I_r
- H** Adjustment dial for the short-time protection pickup I_{sd}
- I** Value of instantaneous protection pickup I_i
- J** Adjustment dial for the earth-leakage protection pickup $I_{\Delta n}$
- K** Earth-leakage fault indicator: yellow when earth-leakage fault is detected
- L** Test button (T) for periodic earth-leakage function test
- M** Adjustment dial for earth-leakage time delay Δt
- N** Switch to disconnect trip unit supply from the phases, used when performing a panel dielectric test

The trip unit rating I_n corresponds to the maximum value of the adjustment range.

Setting the Long-Time Protection

The long-time protection pickup I_r is set by using a multi-position dial. The maximum setting value (maximum setting on adjustment dial) equals the trip unit rating value I_n .

The following table shows for every trip unit rating the values of the pickup I_r (in amperes) for long-time protection that are displayed directly on the dial.

Trip unit rating I_n (A)	Pickup I_r (A)							
100	40	40	50	60	70	80	90	100
160	90	100	110	120	130	140	150	160
240	140	150	160	170	180	200	220	240
400	260	280	300	320	340	360	380	400

The long-time protection time delay cannot be adjusted. The following table shows the value of the trip time delay according on the current in the load:

Current in the load I_n	Trip time delay
$1.5 \times I_r$	15 s
$6 \times I_r$	0.5 s
$7.2 \times I_r$	0.35 s

Other Protection Settings

For all other protection settings on MicroLogic 2 AB trip units, refer to MicroLogic 2 Electronic Trip Units, page 146.

For all other protection settings on MicroLogic 4 AB trip units, refer to MicroLogic 4 Electronic Trip Units, page 150.

Maintenance Interfaces for MicroLogic Trip Units

What's in This Part

MicroLogic Maintenance Interfaces	166
Pocket Battery	168
Stand-Alone USB Maintenance Interface	170
USB Maintenance Interface Connected to a PC	174

MicroLogic Maintenance Interfaces

Description of Requirements

A 24 Vdc power supply is needed to carry out local checks on a trip unit. These can also be done using the maintenance interface:

Maintenance interface	Availability on the trip unit
24 Vdc external power supply module	✓ ⁽¹⁾
Pocket battery for MicroLogic	✓ ⁽²⁾
Stand-alone USB maintenance interface	✓ ⁽²⁾
USB maintenance interface connected to a PC with EcoStruxure Power Commission software	✓ ⁽²⁾
USB maintenance interface connected to a PC with LTU software	✓ ⁽²⁾
(1) Possible on MicroLogic 5, 6, and 7 trip units	
(2) Not available on MicroLogic 2.3 trip unit installed in a ComPacT NSX 400K circuit breaker.	

The following table shows the different checking functions of each maintenance interface:

Maintenance interface	Setting	Checking	Testing	Saving settings
24 Vdc external power supply module	✓	✓ ⁽¹⁾	–	–
Pocket battery	✓	✓ ⁽¹⁾	–	–
Stand-alone USB maintenance interface	✓	✓ ⁽¹⁾	✓ ⁽²⁾	–
USB maintenance interface connected to a PC with EcoStruxure Power Commission software	✓	✓	✓ ⁽²⁾	✓
USB maintenance interface connected to a PC with LTU software	✓	✓	✓	✓
(1) In full for MicroLogic trip units 5, 6, and 7 (for MicroLogic 2 and 4 trip units, only the position of the dials is checked)				
(2) Only on tripping via the push-to-trip button				

Checking Settings

Settings can be checked without the need for any particular precautions. It is recommended that they be carried out by a qualified person.

Testing the Circuit Breaker Mechanism

⚠ CAUTION
HAZARD OF NUISANCE TRIPPING
Protection tests must be done by qualified electrical personnel.
Failure to follow these instructions can result in injury or equipment damage.

When testing the circuit breaker trip mechanism, the necessary precautions must be taken:

- Not to disrupt operations
- Not to trip inappropriate alarms or actions

Modifying Settings

▲ WARNING

HAZARD OF NUISANCE TRIPPING OR FAILURE TO TRIP

Protection setting adjustments must be done by qualified electrical personnel.

Failure to follow these instructions can result in death, serious injury, or equipment damage.

Modifying settings requires a thorough knowledge of the installation characteristics and safety rules.

Pocket Battery

Introduction

Use the pocket battery for the local inspection and testing of MicroLogic trip units.

NOTE: The pocket battery cannot be used with the MicroLogic 2.3 trip unit installed in a ComPacT NSX 400K circuit breaker.

Description

The pocket battery contains two batteries which connect to the test port on MicroLogic electronic trip units.

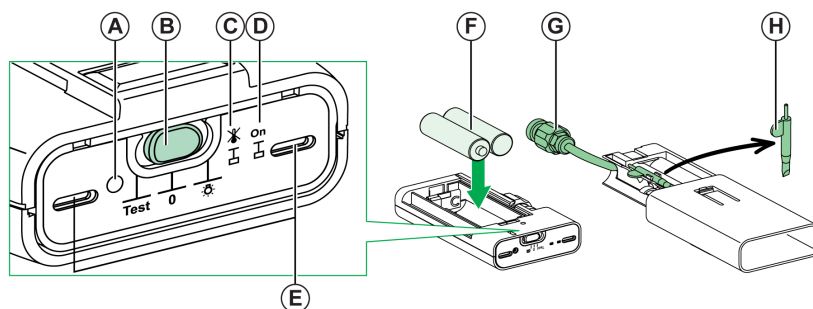

A Inhibit thermal memory button

B 3-position slide switch:

Left = Test position; Center = OFF; Right = pocket flashlight

C Yellow LED for checking thermal memory inhibition

D Green LED for checking battery status

E Two illumination LEDs

F Two 1.5 V type AA batteries (not supplied)

G Connector for connecting to the test port on the MicroLogic trip unit

H Stylus/screwdriver

Pocket Flashlight Function

To use the module as a pocket flashlight, move the slide switch (**C**, above) to the pocket flashlight position (right).

Preparing the Equipment

To prepare the equipment before carrying out maintenance:

Step	Action
1	Slide open the protective cover to access the trip unit connector.
2	Click the pocket battery connector into the test port on the MicroLogic trip unit.
3	Move the slide switch to the Test position (left).
4	Check the battery status: the green LED must be on.

Inspection and Checking

To inspect the trip unit after preparing the equipment:

Step	Action
1	Check that the green Ready LED on the MicroLogic trip unit is blinking. The blinking indicates that all the MicroLogic trip unit functions are in a satisfactory operational state (internal self-test).
2	On the display unit for MicroLogic 5, 6, and 7 trip units, check the setting values by using the navigation buttons to display the protection parameters mode. Refer to DOCA0188EN, <i>ComPacT NSX MicroLogic 5/6/7 Electronic Trip Units - User Guide</i> . NOTE: The screen backlighting is not activated in order to optimize battery life (4 hours).
3	Scroll down and check the different settings. For example, for the MicroLogic 5 trip unit: <ul style="list-style-type: none"> • Ir (A) • IN (A) (if present) long-time • tr (s) • Isd (A) • IN (A) (if present) short-time • tsd (ms) with/without I²t • li (A) The settings can be modified.

Inhibit Thermal Memory Function (Exclusive Level Maintenance)

The **Inhibit thermal memory** button temporarily cancels the thermal memory, page 142. This inhibition is necessary in order to obtain a true measurement of the long-time protection time delay tr during tripping tests by primary current injection. This operation forms part of Exclusive level maintenance, and requires a specialist maintenance service, page 185.

To carry out the test after preparing the equipment:

Step	Action
1	Switch the circuit breaker to the I (ON) position.
2	Move the slide switch to the OFF position (center).
3	Press the button for inhibiting the thermal memory, using the stylus.
4	The yellow confirmation LED and the green LED light up. The thermal memory on the trip unit is inhibited for 15 minutes.

NOTE: Thermal memory inhibition is immediately canceled (the yellow confirmation LED goes out) if, in the course of running the test, the slide switch is moved to another position or the pocket battery is disconnected from the test port.

Stand-Alone USB Maintenance Interface

Introduction

Use the stand-alone USB maintenance interface for the following:

- Maintenance checks and inspections
- Tripping tests
- The inhibition functions required for tripping tests by primary current injection (Exclusive level maintenance)

A USB maintenance interface kit comprising the USB maintenance interface and its accessories is available. For more information, refer to LVPED221001EN, *ComPacT NSX & NSXm Catalogue*.

NOTE: The USB maintenance interface cannot be used with the MicroLogic 2.3 trip unit installed in a ComPacT NSX 400K circuit breaker.

Description of USB Maintenance Interface Kit

The USB maintenance interface kit comprises the following elements:

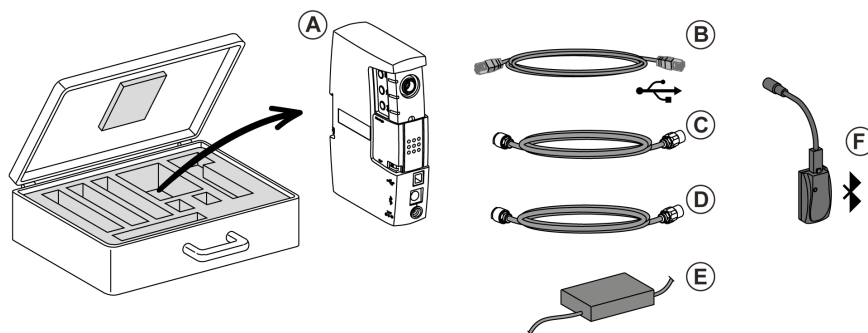

A USB maintenance interface

B Standard USB cord for connection to the PC

C Special cord for connecting the USB maintenance interface to the test port on the trip unit

D Standard RJ45 cord for connecting the USB maintenance interface to a ULP module

E USB maintenance interface power supply unit

F Bluetooth/Modbus option for USB maintenance interface to be ordered separately.

Description of USB Maintenance Interface

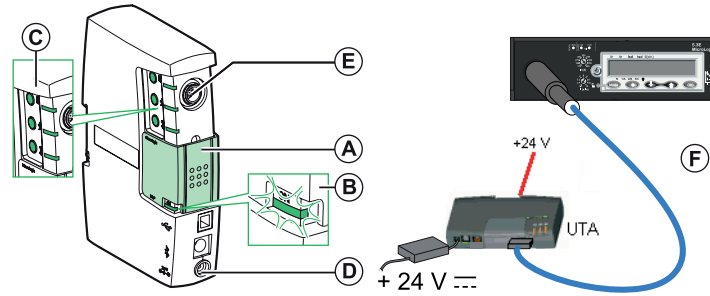

- A** Mechanical cap in central position
- B** Green ON LED
- C** Test buttons (3) with LEDs (3)
- D** Connection socket for special cord connecting USB maintenance interface to the test port on trip unit
- E** Connection socket for power supply unit
- F** Special cord for connecting the USB maintenance interface to the test port on the trip unit

Preparing the Equipment

Prepare the equipment before carrying out maintenance:

Step	Action
1	Position the USB maintenance interface sliding mechanical cap in the central position.
2	Connect the 24 Vdc power cord: the green ON LED lights up.
3	Click the USB maintenance interface connector into the test port on the MicroLogic trip unit.

Inspection and Checking

Check and inspect the trip unit after preparing the equipment

Step	Action
1	Check that the green Ready LED on the MicroLogic trip unit is blinking. This means that all the MicroLogic trip unit functions are in a satisfactory operational state (internal self-test).
2	On the display unit for MicroLogic 5, 6, and 7 trip units, check the setting values by using the navigation buttons to display the Reading protection parameters mode. For more information, refer to DOCA0188EN, <i>ComPacT NSX MicroLogic 5/6/7 Electronic Trip Units - User Guide</i> .
3	Scroll down and check the values of the different settings (for example, MicroLogic 5 trip unit): <ul style="list-style-type: none"> • I_r (A) • I_N (A) (if present) long-time • t_r (s) • I_{sd} (A) • I_N (A) (if present) short-time • t_{sd} (ms) with/without I²t • I_i (A) The settings can be modified.

The Three Test Functions

Tests are carried out with the aid of the three test buttons. The associated LEDs provide confirmation.

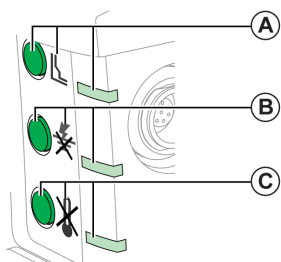

A Electrical push-to-trip test button with pictogram and red confirmation LED

B Inhibit ground-fault protection button with pictogram and yellow confirmation LED

C Inhibit thermal memory button with pictogram and yellow confirmation LED

Tripping Test Using the Electrical Push-to-Trip Button

The electrical push-to-trip button causes an electronic trip in the circuit breaker. This test is used to check the electronic and mechanical circuit breaker controls.

Carry out the test after preparing the equipment:

Step	Action
1	Switch the circuit breaker to the I (ON) position.
2	To trip the circuit breaker, press the electrical push-to-trip button.
3	<p>The red confirmation LED on the USB maintenance interface lights up and goes off immediately.</p> <p>The circuit breaker trips:</p> <ul style="list-style-type: none"> The control mechanism moves to the tripped position:  (with toggle handle), Trip (rotary handle), or OFF (motor mechanism). The green Ready LED on the MicroLogic trip unit continues blinking. <p>The screen on MicroLogic 5, 6, and 7 trip unit stays unchanged.</p>
4	<p>Reset the control mechanism.</p> <p>The circuit breaker is ready.</p>

Inhibit Ground-Fault Protection (Exclusive Level Maintenance)

The **Inhibit ground-fault protection** button temporarily cancels this protection (MicroLogic 6) and the thermal memory: it is then possible to inject the test current on each phase separately and calculate the true time delay tr.

Carry out the test after preparing the equipment:

Step	Action
1	Switch the circuit breaker to the I (ON) position.
2	Press the button to inhibit the ground-fault protection.
3	<p>The yellow confirmation LEDs for ground-fault protection and thermal memory inhibition show a steady light.</p> <p>Ground-fault protection and the thermal memory on the trip unit are inhibited for 15 minutes.</p>

Step	Action
4	Press the button to inhibit the ground-fault protection again (before 15 minutes).
5	The yellow confirmation LEDs for ground-fault protection and thermal memory inhibition go out. Ground-fault protection and the thermal memory on the trip unit are reactivated.

Inhibiting the ground-fault protection also causes the ZSI (Zone Selective Interlocking) function to be forced (if this option is present on the trip unit). This forcing prevents the time delay for short-time protection t_{sd} from being taken out of commission during the tests.

NOTE: It is not possible to inhibit earth-leakage protection using the USB maintenance interface. Earth-leakage protection on MicroLogic 4 and 7 can be inhibited by turning the earth-leakage setting dial IΔn on the MicroLogic trip unit to the OFF position.

Inhibit Thermal Memory Function (Exclusive Level Maintenance)

The **Inhibit thermal memory** button temporarily cancels the thermal memory. This inhibition is necessary in order to obtain a true measurement of the long-time protection time delay t_r during tripping tests by primary current injection. This operation, which is Exclusive level maintenance, is reserved for a specialist maintenance service, page 185.

Carry out the test after preparing the equipment:

Step	Action
1	Switch the circuit breaker to the I (ON) position.
2	Press the button to inhibit the thermal memory.
3	The yellow confirmation LED shows a steady light. The thermal memory on the trip unit is inhibited for 15 minutes.
4	Press the button to inhibit the thermal memory again (before 15 minutes).
5	The yellow confirmation LED goes out. The thermal memory on the trip unit is reactivated.

Inhibiting the thermal memory also restricts the ZSI function (if this option is present on the trip unit). This prevents the time delay for short-time protection t_{sd} and time delay for ground-fault protection t_g (MicroLogic 6) from being taken out of commission during the tests.

USB Maintenance Interface Connected to a PC

Description

Use the USB maintenance interface connected to a PC to carry out the complete range of checks, tests and adjustments on the MicroLogic trip unit.

There are two possible ways to connect the PC to the USB maintenance interface:

- Using the USB port
- Using the Bluetooth/Modbus option

Two software packages are available for different purposes:

- EcoStruxure Power Commission software, page 22 for protection settings
- LTU software for protection tests

NOTE: The USB maintenance interface cannot be used with the MicroLogic 2.3 trip unit installed in a ComPacT NSX 400K circuit breaker.

LTU Software

The LTU (Local Test Utility) software is MicroLogic trip unit test software. It is compliant with all MicroLogic trip units mounted on ComPacT NSX or PowerPacT circuit breakers. LTU software enables the user to:

- Fill in identification information
- Run manual tests of the protection settings
- Run automatic tests of the protection settings
- Simulate alarms (with MicroLogic 5, 6, and 7 trip units)
- Display measured currents
- Test the ZSI (Zone Selective Interlocking) function
- Print test reports
- Display tripping curves

NOTE: LTU software does not test the earth-leakage protection function available on MicroLogic 4 and 7 trip units.

LTU software is available in 32 and 64-bit versions for the following operating systems:

- Microsoft Windows® 7
- Microsoft Windows® 10

For more information, refer to *LTU Online Help*.

LTU software is available at www.se.com.

Connection Using USB Port



A PC running EcoStruxure Power Commission or LTU software

B USB maintenance interface

C Trip unit test port

D MicroLogic cord for connecting the USB maintenance interface to the test port on the trip unit

E USB standard connection cable from the USB maintenance interface to the PC

NOTE: If the USB port does not supply enough power to energize the MicroLogic trip unit and the USB maintenance interface, the three test LEDs on the USB maintenance interface start to blink. In such cases, provide energy to the USB maintenance interface from the power supply module supplied with the USB maintenance interface kit.

Connection Using Bluetooth/Modbus Option

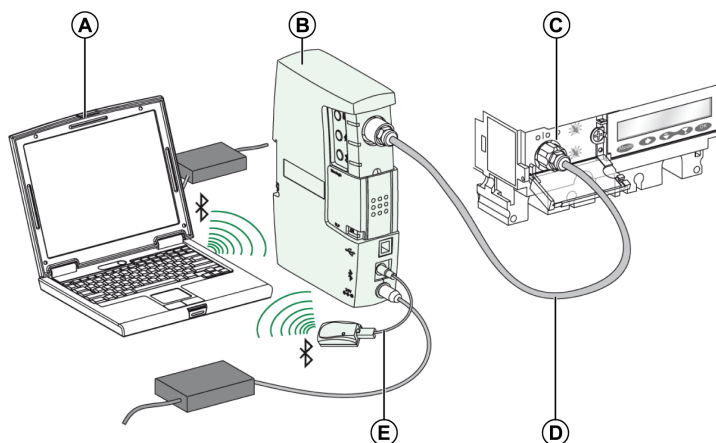

A PC running EcoStruxure Power Commission or LTU software

B USB maintenance interface

C Trip unit test port

D MicroLogic cord for connecting the USB maintenance interface to the test port on the trip unit

E PS/2/RJ45 cord for Bluetooth/Modbus option, on the USB maintenance interface

NOTE: Use the power supply unit supplied with the kit.

NOTE: Connect the Bluetooth/Modbus option firmly to the PS/2 connector on the USB maintenance interface. Do not force the mechanical cap in order to use the RJ45 connection on the USB maintenance interface. It is used for the ULP connection method only.

ComPacT NSX Circuit Breakers Operation

What's in This Part

Commissioning	178
Maintaining the Circuit Breaker During Operation.....	185
Responding to a Trip	188
Troubleshooting	191

Commissioning

List of Checks and Inspections

⚡ ⚠ DANGER

HAZARD OF ELECTRIC SHOCK, EXPLOSION, OR ARC FLASH

- Apply appropriate personal protective equipment (PPE) and follow safe electrical work practices. See NFPA 70E or CSA Z462 or local equivalent.
- This equipment must only be installed and serviced by qualified electrical personnel.
- Turn off all power supplying this equipment before working on or inside equipment.
- Always use a properly rated voltage sensing device to confirm that power is off.
- Replace all devices, doors, and covers before turning on power to this equipment.
- Repair the installation immediately if an insulation fault occurs during operation.

Failure to follow these instructions will result in death or serious injury.

When starting up new equipment, or following lengthy downtime, a general check takes just a few minutes. Such a check reduces the risk of a malfunction due to error or oversight.

The following table indicates the checks and inspections to be performed according to the event:

	A	B	C	D	E	F	G	H	I	J
Before commissioning	✓	✓	✓	✓	✓	✓	✓	–	✓	✓
Periodically during operation, page 185	✓	–	–	✓	✓	✓	✓	✓	✓	✓
After carrying out work on the switchboard	–	✓	✓	✓	✓	✓	✓	✓	✓	✓
Periodically during lengthy downtime	–	✓	–	✓	✓	–	✓	–	✓	✓
Following lengthy downtime	–	✓	–	✓	✓	✓	✓	✓	✓	✓
Following lengthy downtime and modification to the switchboard	✓	✓	✓	✓	✓	✓	✓	✓	✓	✓
A Insulation and dielectric strength tests B Inspect switchboard C Check compliance with the diagram D Inspect mechanical equipment E Check connections F Check mechanical operation G Check electronic trip units and VigiPacT Add-on devices H Check pairing of the wireless devices with gateway or panel server I Check communication J Clean equipment										

A: Insulation and Dielectric Strength Tests

⚠ CAUTION
HAZARD OF EQUIPMENT DAMAGE
Insulation and dielectric strength tests must only be carried out by qualified electrical personnel.
Failure to follow these instructions can result in injury or equipment damage.

Insulation and dielectric strength tests are carried out before the switchboard is delivered. These tests are subject to the currently applicable standards.

Dielectric strength tests impose great stress on the equipment and can cause damage if performed incorrectly. In particular:

- Reduce the value used for the test voltage according to the number of consecutive tests on the same piece of equipment
- Disconnect electronic equipment if necessary

NOTE: MicroLogic trip units can be left connected, even if equipped with voltage measurement (ENVV option).

A: Insulation and Dielectric Strength Tests on MicroLogic 4 and 7 Trip Units



NOTICE
HAZARD OF TRIP UNIT DETERIORATION
<ul style="list-style-type: none"> • Turn the dielectric switch to the Test position (horizontal) when performing a dielectric test. • Turn the switch back to the original position after the dielectric test. • Do not close the protective cover during the dielectric test.
Failure to follow these instructions can result in equipment damage.

The MicroLogic 4 and 7 trip units have a second power supply (in addition to the power source provided by the current transformers) to power the earth-leakage protection even when the current demand is low. This power supply must be switched off when carrying out dielectric tests.

To switch off this power supply on the MicroLogic 4 trip unit during a dielectric test, follow this procedure.

NOTE: This procedure is the same for the MicroLogic 7 trip unit.

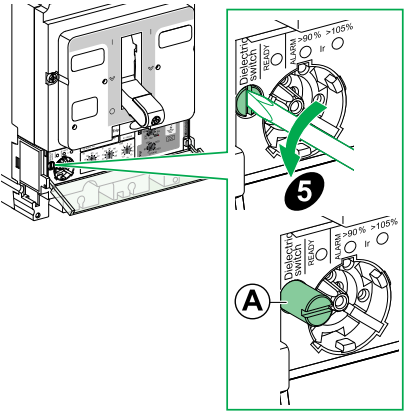
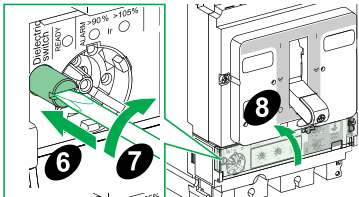
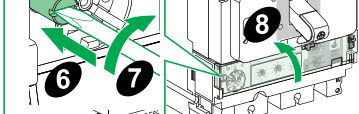
Step	Action	
1	Remove any seal on the protective cover of the trip unit.	
2	Open the protective cover of the trip unit by inserting a screwdriver under the clip.	
3	Push the tip of the screwdriver up to release the clip.	
4	The cover opens.	

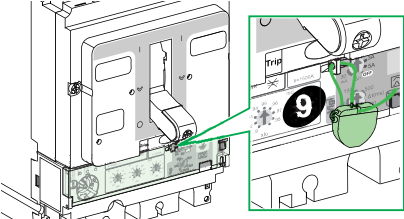
Step	Action	
5	<p>To enable a dielectric test to be carried out, turn the dielectric switch (A) counterclockwise from the vertical position to the Test position (horizontal) by using a flat screwdriver.</p> <p>Result: The switch pops out when the screwdriver is removed.</p> <p>NOTE: Do not close the protective cover during the test.</p>	
6	<p>After carrying out a dielectric test, put the switch back to the vertical position: First, push in the switch.</p>	
7	<p>Keeping the switch pushed in, turn it clockwise from the Test position to the vertical position.</p> <p>Result: The switch stays retracted when the screwdriver is removed.</p>	
8	<p>Close the protective cover by clipping it back into place.</p>	
9	<p>Replace the seal.</p>	
10	<p>After performing the dielectric test, carry out an earth-leakage test, page 153.</p>	<p>—</p>

⚠ WARNING

LOSS OF EARTH-LEAKAGE PROTECTION

The dielectric switch must be in the retracted position while the circuit breaker is in use.

Failure to follow these instructions can result in death, serious injury, or equipment damage.

A: Insulation and Dielectric Strength Tests on VigiPacT Add-on Devices

⚡ ⚠ DANGER

HAZARD OF ELECTRIC SHOCK, EXPLOSION, OR ARC FLASH

- Apply appropriate personal protective equipment (PPE) and follow safe electrical work practices.
- Insulation and dielectric strength tests must only be carried out by qualified electrical personnel.
- Disconnect all power sources before performing maintenance inspections. Assume that all circuits are live until they are de-energized, tested, grounded, and tagged. Consider all sources of power, including the possibility of backfeeding and control power.
- Always use a properly rated voltage sensing device to confirm that power is off.
- Replace all devices, doors, and covers before turning on power to this equipment.
- The protective cover for the connections must be reconnected without fail following dielectric tests.

Failure to follow these instructions will result in death or serious injury.

⚠ CAUTION

HAZARD OF EQUIPMENT DAMAGE

Disconnect the protective cover on the front of the VigiPacT Add-on before performing insulation and dielectric strength tests.

Failure to follow these instructions can result in injury or equipment damage.

VigiPacT Add-on and VigiPacT Add-on Alarm are electronic devices which need to be disconnected before dielectric tests. Follow this procedure before carrying out a dielectric test:

Step	Action	
1	Before carrying out a dielectric test, remove any seal from the VigiPacT Add-on mounting screw then unscrew the screws from the protective cover for the connections (A): <ul style="list-style-type: none"> • Two screws for 3P circuit breakers • Three screws for 4P circuit breakers 	
2	Remove the protective cover. NOTE: Removing the protective cover on the front of the module (A) automatically disconnects the VigiPacT Add-on.	
3	After carrying out a dielectric test, put the protective cover (A) back into place. NOTE: If the protective cover is not put back: <ul style="list-style-type: none"> • There is a risk of direct contact with connections. • There is a risk of an insulation fault downstream. 	
4	Tighten the screws of the protective cover.	
5	Replace the seal.	—
6	After performing the dielectric test, carry out an earth-leakage test, page 137.	—

A: Dielectric Strength Tests with PowerTag Energy

NOTICE

HAZARD OF POWERTAG M250/M630 DETERIORATION

- Turn the dielectric switch to the position TEST (A) when performing a dielectric test.
- Turn the dielectric switch back to the position RUN (B) after the dielectric test.

Failure to follow these instructions can result in equipment damage.

PowerTag Energy is an electronic device which needs to be disconnected before dielectric tests. Follow this procedure before carrying out a dielectric test:

Step	Action	
1	To enable a dielectric test to be carried out, turn the dielectric switch (A) counterclockwise from the vertical position to the TEST position (horizontal) by using a flat screwdriver. Result: The switch pops out when the screwdriver is removed.	
2	After carrying out a dielectric test, put the switch back to the vertical position: First, push in the switch.	
3	Keeping the switch pushed in, turn it clockwise from the TEST position to the RUN position (vertical). Result: The switch stays retracted when the screwdriver is removed.	

B: Inspect Switchboard

Check that the circuit breakers are installed:

- In a clean environment without waste from assembling the equipment (such as wiring, tools, shavings, metallic particles)
- In a properly ventilated switchboard (unobstructed ventilation grills)

C: Check Compliance with the Diagram

Check that the circuit breakers comply with the installation diagram, page 18:

- Identification of the feeds on the front of the circuit breakers
- Rating and breaking capacity (indications on the faceplate label)
- Identification of the trip units (type, rating)
- Presence of additional functions (VigiPacT Add-on earth-leakage protection, motor mechanism, rotary handle, control or indication auxiliaries, locking, sealing)
- Protection settings (overload, short-circuit, earth-leakage):
 - Thermal-magnetic and MicroLogic 2 and 4 electronic trip units: visually check the position of the adjustment dials
 - MicroLogic 5, 6 and 7 electronic trip units: visually check the position of the adjustment dials for the main settings and use EcoStruxure Power Commission software to check in detail

NOTE: Circuit breakers fitted with a VigiPacT Add-on require an intermediate terminal shield for the earth-leakage protection to function correctly.

D: Inspect Mechanical Equipment

Visually inspect the general state of the circuit breaker. Check the following items:

- Terminal shields and interphase barriers
- Escutcheon
- Trip unit
- Case
- Chassis

Check the equipment integrity: a circuit breaker found with a cracked case or burn marks must be immediately taken out of service and replaced.

Check the mounting and mechanical strength:

- Of circuit breakers in the switchboard.
- Of auxiliaries and accessories on the circuit breakers:
 - Rotary handles or motor mechanisms
 - Installation accessories (such as terminal shields and escutcheons)
- Of the chassis (withdrawable circuit breaker)
- Of locks, padlocks and padlock support tabs

E: Check Connections

Check the tightening torque of the power connections and auxiliary circuit connections, as described in the instruction sheets.

F: Check Mechanical Operation

Check the circuit breaker mechanical operation, page 10:

- Opening, closing and resetting
- Tripping with the push-to-trip button
- Tripping by MN/MX control auxiliaries
- Opening, closing, resetting by motor mechanism in automatic and manual mode

G: Check Electronic Trip Units and VigiPacT Add-on Devices

Check that the following are working correctly:

- MicroLogic electronic trip units, with the aid of special maintenance interfaces:
 - Pocket battery
 - USB maintenance interface

NOTE: For trip units without test port, check the functions of the trip unit using primary injection.
- OF, SD or SDE indication contacts
- SDx or SDTAM modules
- VigiPacT Add-on devices and SDV indication contact, by operating the test button T on the front (this test checks the whole measurement system and tripping on earth-leakage faults)
- Wireless indication auxiliaries

H: Check Pairing of Wireless Devices with Gateway or Panel Server

Check that wireless communication with gateway or panel server is working correctly:

- For PowerTag Energy, page 104, LED is blinking green each time data is sent (every 5 seconds by default)
- For wireless indication auxiliaries, page 83, LED is blinking green each time data is sent (every 8 hours, or when status changes).

I: Check Communication

Check that the communication through the communication network works correctly. Refer to DOCA0093EN, *ULP System (IEC Standard) - User Guide*.

J: Clean Equipment

To avoid dust deposits that could affect the circuit breaker mechanical operation, clean the circuit breakers when performing maintenance:

- For non-metallic parts: always use a dry cloth. Do not use cleaning products.
- For metallic parts: preferably use a dry cloth. If a cleaning product must be used, do not apply or splash the product onto non-metallic parts.

Maintaining the Circuit Breaker During Operation

Introduction

The electrical switchboard and all its equipment continue to age whether they operate or not. This aging process is due mainly to environmental influences and operating conditions.

To help ensure that circuit breaker retains the operating and safety characteristics specified in the catalogue for the whole of its service life:

- Install the circuit breaker in optimum environmental and operating conditions (described in the following table).
- Have routine inspections and regular maintenance done by qualified electrical personnel.

Environmental and Operating Conditions

The environmental conditions previously described refer to harsh operating environments, page 26.

The following table describes the optimum environmental and operating conditions:

Environmental and operating factor	Comments
Temperature	Average annual temperature outside the switchboard: < 25 °C (77 °F).
Loading	Loading remains < 80% of In 24 hours a day.
Harmonics	The harmonic current per phase is < 30% of In.
Humidity	The relative humidity is < 70%.
Corrosive atmosphere (SO ₂ , NH ₃ , H ₂ S, Cl ₂ , NO ₂)	Install the circuit breaker in environmental category 3C1 or 3C2 (IEC/EN 60721-3-3).
Saline environment	Install the circuit breaker in an environment free of salt mist.
Dust	The dust level is low: protect the circuit breaker within a switchboard fitted with filters or IP 54 ventilated.
Vibration	Continuous vibration is < 0.2 g.

The maintenance programs apply to optimum environmental and operating conditions. Outside these limits circuit breakers are subject to accelerated aging which can quickly lead to malfunctions.

Regular Preventive Maintenance

Maintenance recommendations for each device are intended to maintain the equipment or subassemblies in a satisfactory operational state for their useful service life.

There are three recommended maintenance levels.

The following table summarizes maintenance operations for the three preventive maintenance programs:

Maintenance program	Maintenance description	Performed by
Basic end-user maintenance	Visual inspection and functional testing, replacement of inoperative accessories.	<ul style="list-style-type: none"> Trained and qualified end-user personnel Trained and qualified maintenance services provider personnel Schneider Electric field service representative
Standard end-user maintenance	Basic end-user maintenance, plus operational servicing and subassembly tests.	<ul style="list-style-type: none"> Trained and qualified maintenance services provider personnel Schneider Electric field service representative
Manufacturer maintenance	Standard end-user maintenance, plus diagnostics and part replacements by Schneider Electric Services.	Schneider Electric field service representative

If all environmental conditions are more favorable than normal, maintenance intervals can be longer than the ones in normal environmental and operating conditions (for example, Advanced level tasks can be carried out every 3 years).

If any one of the conditions is more severe, perform maintenance more frequently. For advice, contact Schneider Electric Services.

Functions linked specifically to safety require particular maintenance intervals.

NOTE: Regularly test that the remote safety commands work. For example, test at least every six months.

Maintenance Operations Required

⚠ CAUTION	
HAZARD OF EQUIPMENT DAMAGE	
Insulation and dielectric strength tests must only be carried out by qualified electrical personnel.	
Failure to follow these instructions can result in injury or equipment damage.	

Maintenance operation mainly consists of checks and inspections A, D, E, F, G, I, and J as defined for the commissioning phase, page 178.

Letter - maintenance operation	Maintenance operation	Year 1	Year 2	Year 3	Year 4	Year 5
A	Insulation and dielectric strength tests, page 179	✓	✓	✓	✓	✓
D	Inspect mechanical equipment, page 183	✓	✓	✓	✓	✓
E	Check connections, page 183	✓	✓	✓	✓	✓
–	Measurement of insulation resistance	✓	✓	✓	✓	✓
F	Check mechanical operation, page 183 NOTE: Check tripping by MN/MX twice a year	✓	✓	✓	✓	✓
–	Replace MN/MX trip releases	–	–	–	–	✓

Letter - maintenance operation	Maintenance operation	Year 1	Year 2	Year 3	Year 4	Year 5
G	Check trip units and VigiPacT Add-on, page 183 NOTE: Check tripping by VigiPacT Add-on at regular intervals: <ul style="list-style-type: none"> • Every three months in case of absence of local regulation. • Once a month for devices in corrosive, dusty, or harsh environment. 	✓	✓	✓	✓	✓
–	Check the trip curves of the MicroLogic trip units with LTU software	–	✓	–	✓	✓
–	Check the characteristics of the trip unit by primary injection	–	–	–	–	✓
I	Check communication, page 184	✓	✓	✓	✓	✓
–	Check the closing time, opening time and voltage release characteristics	✓	✓	✓	✓	✓
J	Clean equipment, page 184	✓	✓	✓	✓	✓

For detailed definition of the maintenance operations, contact Schneider Electric Services.

Maintenance Following Short-Circuit Trip

Test a circuit breaker in severe conditions, in accordance with standard IEC/EN 60947-2, to check that it can break a short-circuit current at maximum permissible value three times.

After a short-circuit fault, it is necessary to:

- Carefully clean off any traces of black smoke. The smoke particles can conduct electricity.
- Check the power connections and control wires.
- Operate the circuit breaker at least five times at zero load.

Responding to a Trip

Taking Precautions Before Responding to a Trip

⚡ ⚠ DANGER

HAZARD OF ELECTRIC SHOCK, EXPLOSION, OR ARC FLASH

- Apply appropriate personal protective equipment (PPE) and follow safe electrical work practices. See NFPA 70E or CSA Z462 or local equivalent.
- This equipment must only be installed and serviced by qualified electrical personnel.
- Turn off all power supplying this equipment before working on or inside equipment.
- Always use a properly rated voltage sensing device to confirm that power is off.
- Replace all devices, doors, and covers before turning on power to this equipment.
- Repair the installation immediately if an insulation fault occurs during operation.

Failure to follow these instructions will result in death or serious injury.

Identifying the Cause of the Trip



Local and remote indication provides information on the probable cause of a trip. In particular, the MicroLogic 5, 6 or 7 trip units provides specific information about the cause of the fault detected. For more information, refer to DOCA0188EN, *ComPacT NSX MicroLogic 5/6/7 Electronic Trip Units - User Guide*.





The causes are of several types:

- Fault detected on the installation
- Fault detected due to a malfunction
- Intentional tripping

Trip Following a Fault on the Installation

The control mechanism is positioned on , Trip.

Indication			Probable cause
TM-D	MicroLogic 2 and 4	MicroLogic 5, 6, and 7	
SD	SD	SD and information on the display 	Tripped manually by: <ul style="list-style-type: none"> • Push-to-trip test • Manually opening the motor mechanism • Disconnecting the circuit breaker from plug-in base with circuit breaker in ON position • MN or MX releases
SD and SDE	SD, SDE, and SDT	SD, SDE, and SDT and information on the display 	<ul style="list-style-type: none"> • TM-D: Tripped on electrical fault, cause unknown • MicroLogic 2 and 4: Tripped by long-time protection • MicroLogic 5 and 6: Tripped by long-time protection (or example, on phase 1 at 930 A, as shown)
	SD and SDE	SD and SDE and information on the display	<ul style="list-style-type: none"> • TM-D: Tripped on electrical fault, cause unknown

Indication			Probable cause
TM-D	MicroLogic 2 and 4	MicroLogic 5, 6, and 7	
			<ul style="list-style-type: none"> MicroLogic 2 and 4: Tripped by short-time or instantaneous protection (short-circuit) MicroLogic 5, 6 and 7: Tripped by short-time or instantaneous protection (short-circuit) on short-circuit (for example, on phase 2 at 18 kA, as shown)
	SD, SDE, and SDx	MicroLogic 7 SD, SDE, and SDx and information on the display 	<ul style="list-style-type: none"> MicroLogic 4: Tripped by earth-leakage protection MicroLogic 7: Tripped by earth-leakage protection
SD, SDE, and SDV Button R on VigiPacT Add-on in the out position	SD, SDE, and SDV Button R on VigiPacT Add-on in the out position	MicroLogic 5 SD, SDE, and SDV Button R on VigiPacT Add-on in the out position and information on the display 	<ul style="list-style-type: none"> TM-D: Tripped by earth-leakage protection MicroLogic 2: Tripped by earth-leakage protection MicroLogic 5 and 6: Tripped by earth leakage protection (no other faults reported)
–	–	MicroLogic 6 SD, SDE, and SDG and information on the display 	<ul style="list-style-type: none"> MicroLogic 6: Tripped by ground-fault protection

Maintenance of the Equipment Following Trip on Fault

The fact that the protection has tripped does not remedy the cause of the fault on the downstream equipment.

⚠ WARNING
<p>HAZARD OF CLOSING ON ELECTRICAL FAULT</p> <p>Do not close the circuit breaker again without first inspecting and, if necessary, repairing the downstream electrical equipment.</p> <p>Failure to follow these instructions can result in death, serious injury, or equipment damage.</p>

Isolate the feed before inspecting the electrical equipment downstream of the protection.

Perform the following tasks after a short-circuit:

- Carefully clean off any traces of black smoke. The smoke particles can conduct electricity.
- Check the power connections and control wires.
- Operate the circuit breaker at least five times at zero load.

Depending on the type of fault, perform maintenance inspections, page 178 on all or part of the equipment where the fault occurred:

- Minor faults:
 - Tripped by long-time protection

- Tripped by earth-leakage protection

Following repairs, checks D, E, F, and G must be carried out.

- Serious or destructive faults:
 - Tripped due to unknown electrical fault
 - Tripped by short-time protection
 - Tripped by ground-fault protection

Following repairs, checks A, B, D, E, F, and G must be carried out. Check the circuit breaker that tripped, page 185 before being returned to service.

NOTE: Checks, tests, and inspections must be carried out by qualified electrical personnel.

If restarting is a high priority (for example, a safety installation), the defective part of the installation must be isolated and locked in order to carry out this maintenance.

Troubleshooting

Introduction

Troubleshooting operations are described in the following tables, with the checks or repairs to be carried out in relation to the probable causes of the malfunction indicated. They are classified into the following events:

- Repetitive tripping
- Circuit breaker fails to close (manually operated circuit breaker)
- Circuit breaker fails to close (motor-operated circuit breaker)
- MicroLogic 5, 6 and 7 fault screens

Repetitive Tripping

Indication	Probable cause	Checks or repairs
SD	Supply voltage to the MN undervoltage trip release is too low or subject to significant variations	Check the power supply for the release (for example, a supply powering motors with high power ratings may be unstable). If so, connect the release to a clean or stable supply.
	Supply voltage to an MX shunt trip release applied unintentionally	Check that the release connection is correct compared to the installation diagram.
SD, SDE	Operating temperature too high	Check the switchboard ventilation and the temperature in the room.
SD, SDE, SDV Earth-leakage fault indicator (MicroLogic 4) Information on display screen (MicroLogic 7) Button R on VigiPacT Add-on in the out position (MicroLogic 5 and 6 with VigiPacT Add-on)	Inappropriate earth-leakage protection setting (MicroLogic 4 and 7 or VigiPacT Add-on)	Check the value of the natural leakage current. Depending on the results: <ul style="list-style-type: none"> • Isolate the equipment with excessive natural leakage current • Or raise the earth-leakage (VigiPacT Add-on) protection setting, observing the safety rules.
	Transient insulation fault on the equipment	Check whether the fault coincides with commissioning an item of equipment. Depending on the results: <ul style="list-style-type: none"> • Repair the faulty equipment • Isolate the equipment with excessive natural leakage current • Or raise the earth-leakage (VigiPacT Add-on) protection setting, observing the safety rules.
SD, SDE Screen TriP (available only in MicroLogic 5, 6, and 7) then StoP	Operating temperature too high	Check the switchboard ventilation and the temperature in the room.



Circuit Breaker Fails to Close (Manually Operated Circuit Breaker)



Indication	Probable cause	Checks or repairs
SD	MX shunt trip release energized MN undervoltage trip release not energized	Check that the release connection is correct compared to the installation diagram.
OF	Circuit breaker interlocked	Check the installation and interlock diagram (mechanical or electrical) for both circuit breakers.

Circuit Breaker Fails to Close (Motor-Operated Circuit Breaker)

Indication	Probable cause	Checks or repairs
OF	Close instruction not operational	Check the Auto position of the selector on the front of the circuit breaker. Also check: <ul style="list-style-type: none"> • The power supply to the motor mechanism, the motor voltage • The voltage at the motor terminals on the motor mechanism • The close command path

MicroLogic 5, 6, and 7 Fault Screens

The following table shows the checks or repairs to be carried out according to the MicroLogic 5, 6, and 7 fault screens. For more information, refer to DOCA0188EN, *ComPacT NSX MicroLogic 5/6/7 Electronic Trip Units - User Guide*.

Indication	Probable cause	Checks or repairs
Screen TriP then StoP 	Serious fault on the MicroLogic trip unit: the trip unit can no longer provide protection	Change the trip unit urgently. The circuit breaker cannot be reset.
Screen Err 	Fault on the MicroLogic trip unit	Change the trip unit on the next maintenance visit. The trip unit can still provide protection.
Screen Out 	Acknowledgment of a latching alarm which has not been reset on the SDx module	Check the cause of the alarm and use the OK button to carry out the reset.

Appendices

What's in This Part

Wiring Diagrams	194
Additional Characteristics	208

Wiring Diagrams

What's in This Chapter

Fixed Circuit Breakers	195
Plug-in / Withdrawable Circuit Breakers	198
Motor Mechanism.....	202
SDx Module With MicroLogic 2, 4, 5, 6, and 7 Trip Unit.....	204
SDTAM Module With MicroLogic 2-M or 6-M Trip Unit	206

Fixed Circuit Breakers

Introduction

The diagrams are shown with circuits de-energized, all devices open, connected, and charged, and relays in normal position.

Terminals shown in green () must be connected by the customer.

Power and MicroLogic

3P or 4P

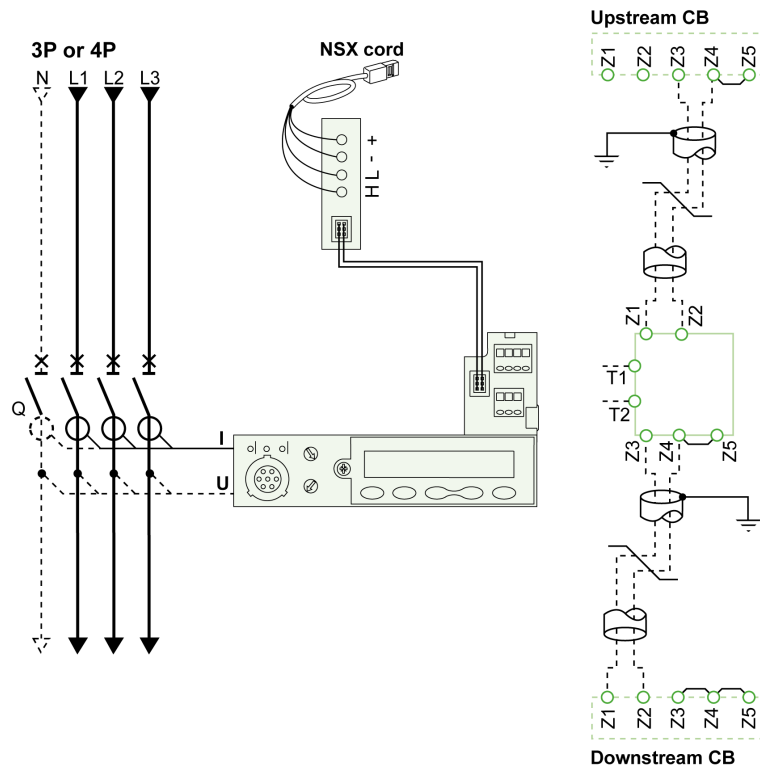

3P + N

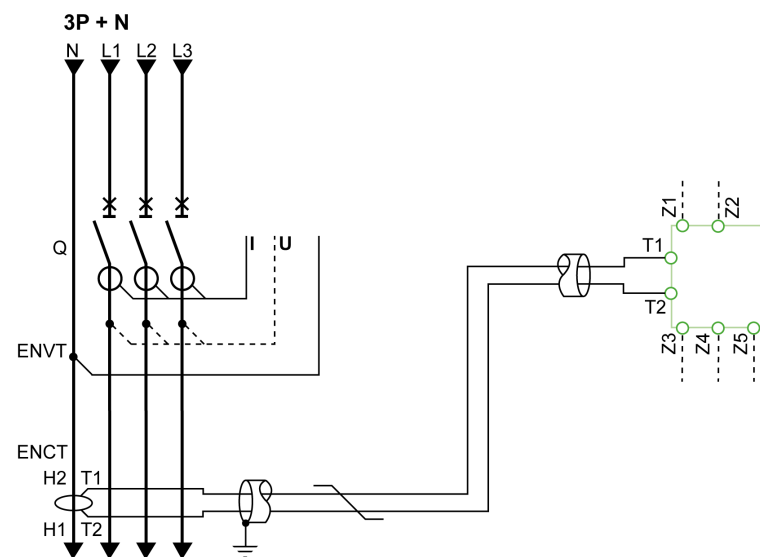

Type	Item	Description
Communication	H(WH) L(BL)	Data

Type	Item	Description
	-(BK) +(RD)	24 Vdc power supply
ZSI (Zone selective interlocking)	Z1	Zone selective interlocking OUT SOURCE
	Z2	Zone selective interlocking OUT
	Z3 ⁽¹⁾	Zone selective interlocking IN SOURCE
	Z4 ⁽¹⁾	Zone selective interlocking IN ST (short-time)
	Z5 ⁽¹⁾	Zone selective interlocking IN GF (ground-fault)
ENCT	–	External neutral current transformer: <ul style="list-style-type: none"> Shielded cable with 1 twisted pair (T1, T2) Shielding earthed at one end only (CT end) Connection: <ul style="list-style-type: none"> L = 30 cm max Maximum length = 10 m Cable size = 0.4 to 1.5 mm² Recommended cable: Belden 8441 or equivalent
ENVT ⁽²⁾	–	External neutral voltage tap for connection to the neutral via a 3P circuit breaker
(1) For ComPacT NSX400/630 only (2) Not compatible with MicroLogic type M trip units (motor trip units).		

Remote Operation

The diagrams are shown with circuits de-energized, all devices open, connected, and charged, and relays in normal position.

Terminals shown in green () must be connected by the customer.

With motor mechanism (MT)

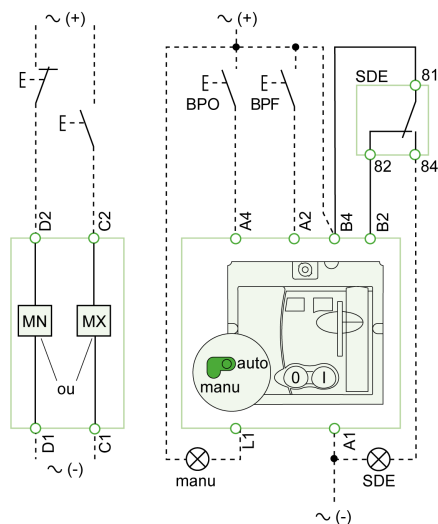

With communicating motor mechanism (MTc)

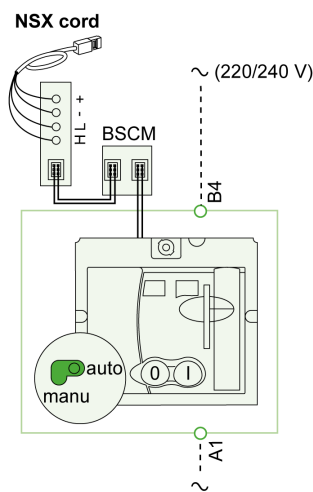

Type	Item	Description
Voltage release	MN	Undervoltage trip release
	MX	Shunt trip release
Motor mechanism (MT)	A4	Opening order
	A2	Closing order
	B4, A1	Motor mechanism power supply
	L1	Manual position (manu)

Type	Item	Description
	B2	SDE interlocking (mandatory for correct operation)
	BPO	Opening pushbutton
	BPF	Closing pushbutton
Communicating motor mechanism (MTc)	B4, A1	Motor mechanism power supply
	BSCM	Breaker status control module

Indication Contacts

The diagrams are shown with circuits de-energized, all devices open, connected, and charged, and relays in normal position.

Terminals shown in green () must be connected by the customer.

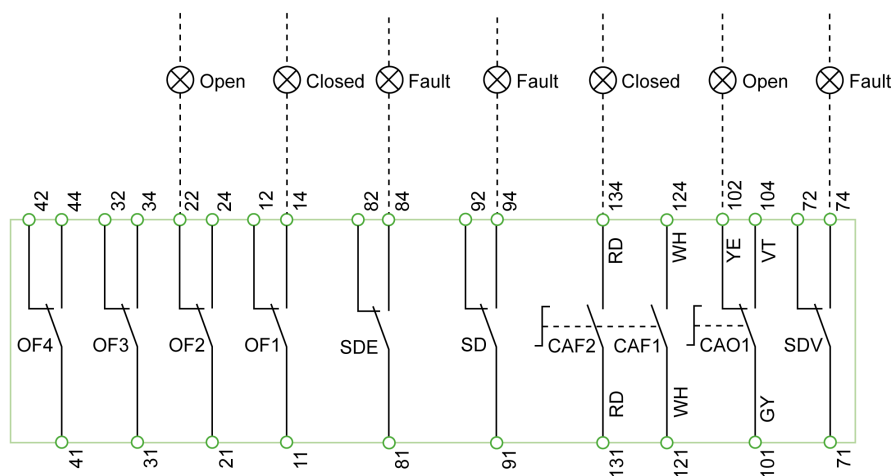

Indication contacts	Description
OF2/OF1	Circuit breaker ON/OFF indication contacts
OF4/OF3	Circuit breaker ON/OFF indication contacts (ComPacT NSX400/630)
SDE	Fault-trip indication contact (short-circuit, overload, ground-fault, earth-leakage)
SD	Trip-indication contact
CAF2/CAF1	Early-make contact (rotary handle only)
CAO1	Early-break contact (rotary handle only)
SDV	Earth-leakage fault trip indication contact (VigiPacT Add-on)

Color code for auxiliary wiring	Description
RD	Red
WH	White
YE	Yellow
VT	Violet
GY	Gray
BK	Black
OR	Orange
GN	Green
BL	Blue

Plug-in / Withdrawable Circuit Breakers

Introduction

The diagrams are shown with circuits de-energized, all devices open, connected, and charged, and relays in normal position.

Terminals shown in green (/) must be connected by the customer.

Power and MicroLogic

3P or 4P

3P + N

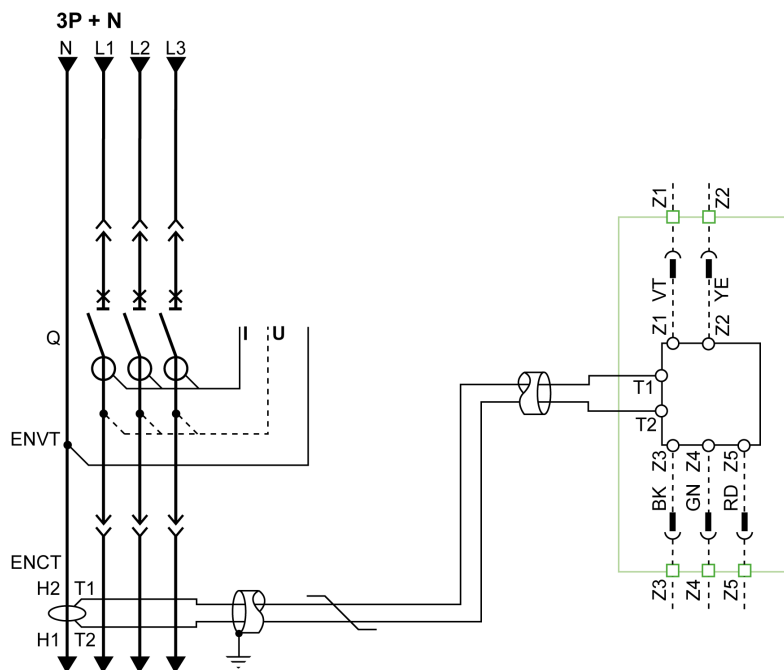

Type	Item	Description
Communication	H(WH) L(BL)	Data
	-(BK) +(RD)	24 Vdc power supply
ZSI (Zone selective interlocking)	Z1	Zone selective interlocking OUT SOURCE
	Z2	Zone selective interlocking OUT
	Z3 ⁽¹⁾	Zone selective interlocking IN SOURCE
	Z4 ⁽¹⁾	Zone selective interlocking IN ST (short-time)
	Z5 ⁽¹⁾	Zone selective interlocking IN GF (ground-fault)
ENCT	–	External neutral current transformer: <ul style="list-style-type: none"> • Shielded cable with 1 twisted pair (T1, T2) • Shielding earthed at one end only (CT end) Connection: <ul style="list-style-type: none"> • L = 30 cm max • Maximum length = 10 m • Cable size = 0.4 to 1.5 mm² • Recommended cable: Belden 8441 or equivalent
ENVT	–	External neutral voltage tap for connection to the neutral via a 3P circuit breaker
(1) For ComPacT NSX400/630 only		

Remote Operation

The diagrams are shown with circuits de-energized, all devices open, connected, and charged, and relays in normal position.

Terminals shown in green (/) must be connected by the customer.

With motor mechanism (MT)

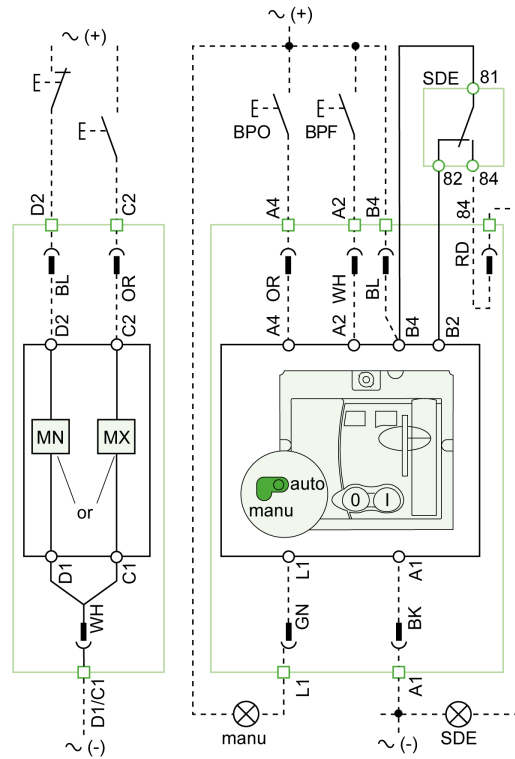

With communicating motor mechanism (MTc)

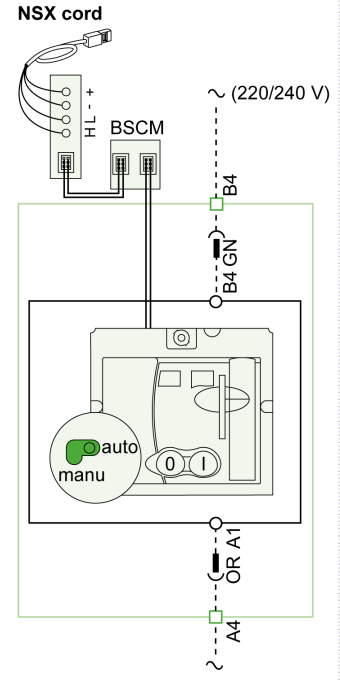

Type	Item	Description
Voltage release	MN	Undervoltage trip release
	MX	Shunt trip release
Motor mechanism (MT)	A4	Opening order
	A2	Closing order
	B4, A1	Motor mechanism power supply
	L1	Manual position (manu)
	B2	SDE interlocking (mandatory for correct operation)
	BPO	Opening pushbutton
	BPF	Closing pushbutton
Communicating motor mechanism (MTc)	B4, A1	Motor mechanism power supply
	BSCM	Breaker status control module

Indication Contacts

The diagrams are shown with circuits de-energized, all devices open, connected, and charged, and relays in normal position.

Terminals shown in green (/) must be connected by the customer.

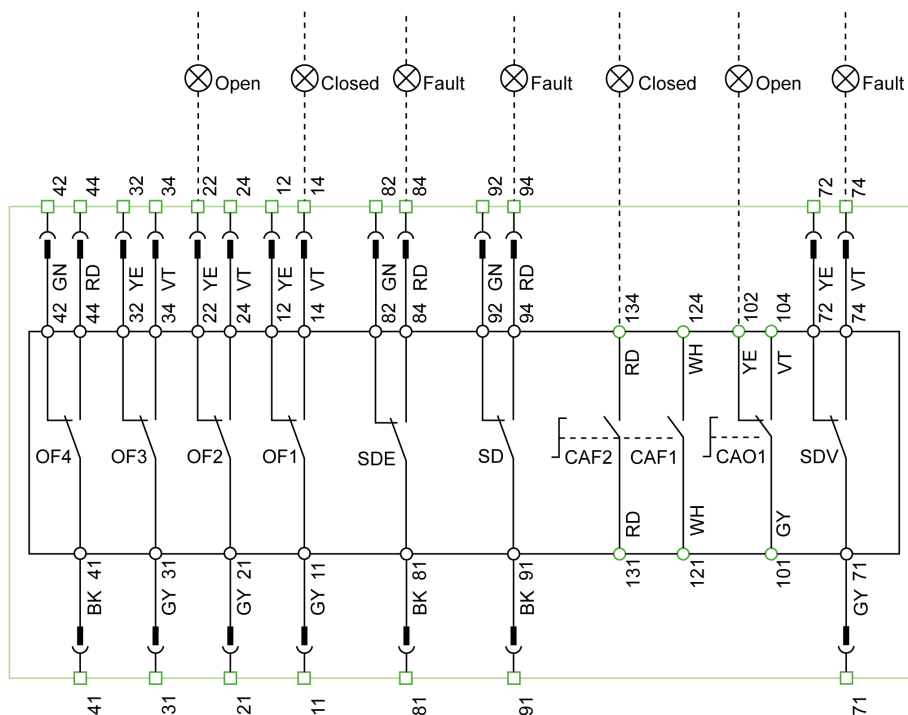

Indication contacts	Description
OF2/OF1	Circuit breaker ON/OFF indication contacts
OF4/OF3	Circuit breaker ON/OFF indication contacts (ComPacT NSX400/630)
SDE	Fault-trip indication contact (short-circuit, overload, ground-fault, earth-leakage)
SD	Trip-indication contact
CAF2/CAF1	Early-make contact (rotary handle only)
CAO1	Early-break contact (rotary handle only)
SDV	Earth-leakage fault trip indication contact (VigiPacT Add-on)

Color code for auxiliary wiring	Description
RD	Red
WH	White
YE	Yellow
VT	Violet
GY	Gray
BK	Black
OR	Orange
GN	Green
BL	Blue

Carriage Switches

The diagrams are shown with circuits de-energized, all devices open, connected, and charged, and relays in normal position.

Terminals shown in green () must be connected by the customer.

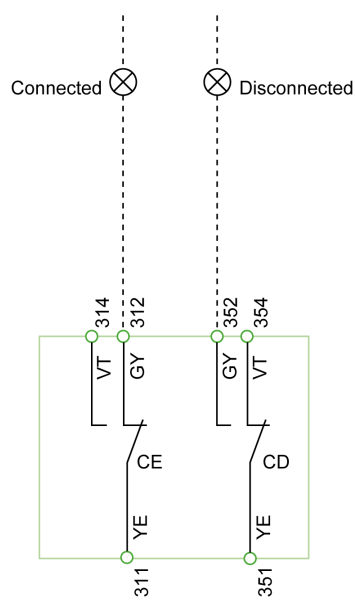

Carriage switches	Description
CD	Disconnected position contact
CE	Connected position contact

Color code for auxiliary wiring	Description
YE	Yellow
VT	Violet
GY	Gray

Motor Mechanism

Introduction

The diagrams are shown with circuits de-energized, all devices open, connected, and charged, and relays in normal position.

Terminals shown in green () must be connected by the customer.

After tripping initiated by the push-to-trip button or by the MN undervoltage trip release or the MX shunt trip release, circuit breaker reset can be:

- automatic
- remote
- manual

Following tripping due to an electrical fault (with an SDE contact), reset must be carried out manually.

Motor Mechanism (MT) With Reset

Motor mechanism wiring diagrams:

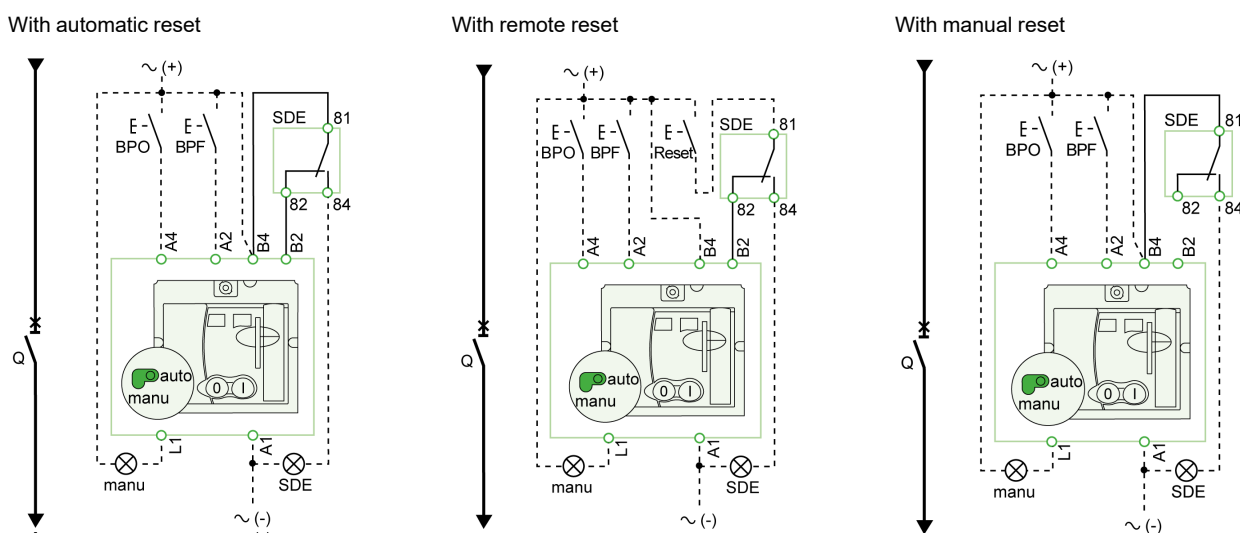

Item	Description
Q	Circuit breaker
A4	Opening order
A2	Closing order
B4, A1	Motor mechanism power supply
L1	Manual position (manu)
B2	SDE interlocking (mandatory for correct operation)
BPO	Opening pushbutton
BPF	Closing pushbutton
SDE	Electrical-fault indication contact (short-circuit, overload, ground-fault, earth-leakage)

Communicating Motor Mechanism (MTc)

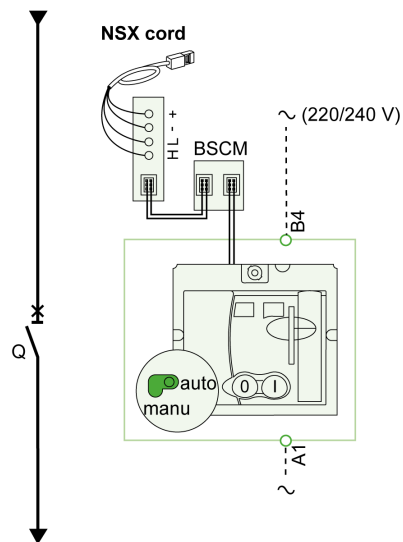

Opening, closing and reset orders are transmitted via the communication network. The **Enable automatic reset** and **Enable reset even if SDE** parameters must be set using EcoStruxure Power Commission software via the screen, by clicking the blue text.

Auto/manu is a switch on the front of the motor mechanism.

Terminals shown in green () must be connected by the customer.

Item	Description
Q	Circuit breaker
B4, A1	Motor mechanism power supply
BSCM	Breaker status control module

SDx Module With MicroLogic 2, 4, 5, 6, and 7 Trip Unit

Introduction

The diagram is shown with circuits de-energized, all devices open, connected and charged and relays in normal position.

Terminals shown in green () must be connected by the customer.

Connection

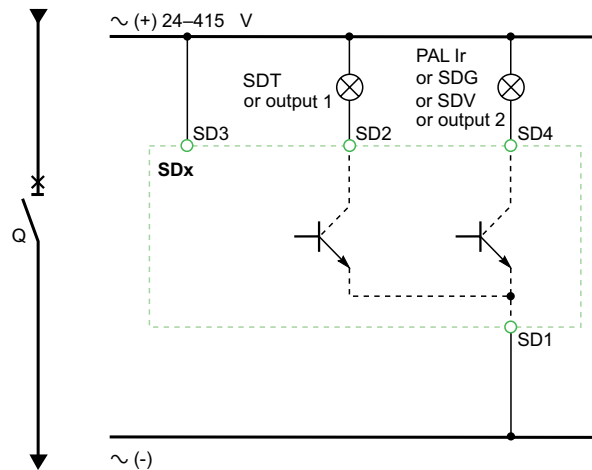

Item	Description
SD1	SDx-module power supply
SD3	
SD2	Output 1 (80 mA max.)
SD4	Output 2 (80 mA max.)

MicroLogic	SD2	SD4
MicroLogic 2	SDT	-
MicroLogic 4	SDT	SDV
MicroLogic 5	SDT or output 1	PAL Ir or output 2
MicroLogic 6	SDT or output 1	SDG or output 2
MicroLogic 7	SDT or output 1	SDV or output 2

Operation

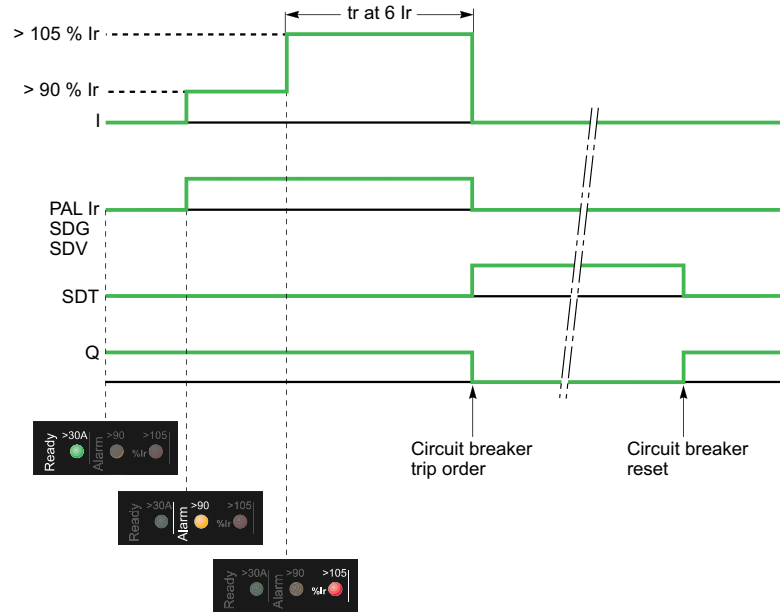

Item	Description
I	Charge current
PAL Ir	Thermal overload pre-alarm
SDG	Ground-fault signal
SDT	Thermal-fault signal
SDV	Residual current trip signal (for earth-leakage function)
Q	Circuit breaker

SDTAM Module With MicroLogic 2-M or 6-M Trip Unit

Introduction

The diagram is shown with circuits de-energized, all devices open, connected and charged and relays in normal position.

Terminals shown in green () must be connected by the customer.

Connection

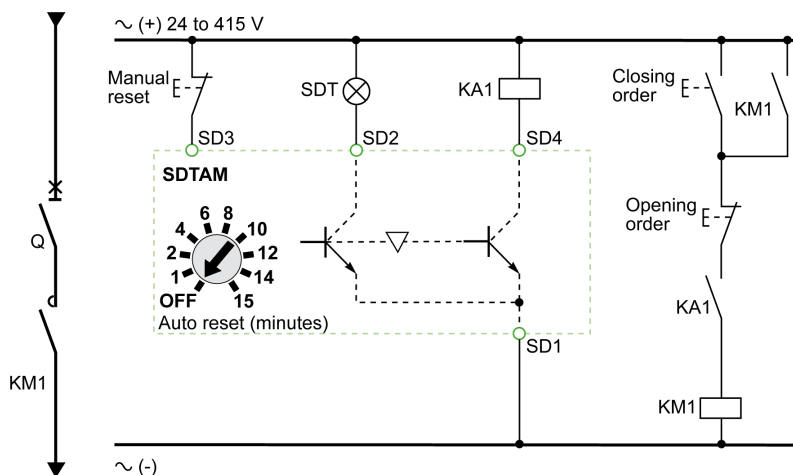

Item	Description
SD1, SD3	SDTAM-module power supply
SD2	Thermal-fault signal output (80 mA max.)
SD4	Contactor-control output (80 mA max.)

MicroLogic	SD2	SD4
MicroLogic 2-M	SDT	KA1
MicroLogic 6 E-M	SDT	KA1

Operation

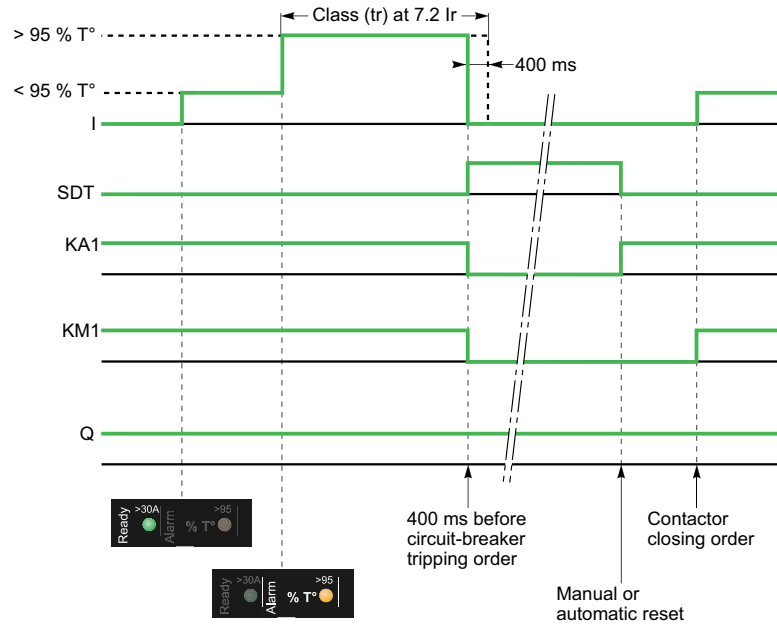

Item	Description
I	Charge current
KA1	Auxiliary relay (e.g. RBN or RTBT relay)
KM1	Motor contactor
SDT	Thermal-fault signal
Q	Circuit breaker

Additional Characteristics

What's in This Chapter

ComPacT NSX100-250 - Distribution Protection Tripping Curves	209
ComPacT NSX100-250 - Motor-Feeder Protection Tripping Curves	215
ComPacT NSX400-630 - Distribution Protection Tripping Curves	216
ComPacT NSX400-630 - Motor-Feeder Protection Tripping Curves	217
ComPacT NSX100-630 - Reflex Tripping	218
ComPacT NSX100-630 - Limitation Curves	219

ComPacT NSX100-250 - Distribution Protection Tripping Curves

TMD Magnetic Trip Units

For all TMD curves:

Values are given for 40 °C ambient, $I_r = 1 \times I_n$, 3 poles loaded, cold start.

For $I_r = k \times I_n$, read the time corresponding to $1/k$ times given current.

For 1 pole tripping, read the time corresponding to 0.85 times given current.

For hot start ($0.9 \times I_r$), divide max. time by 2, min. time by 4.

TM16D

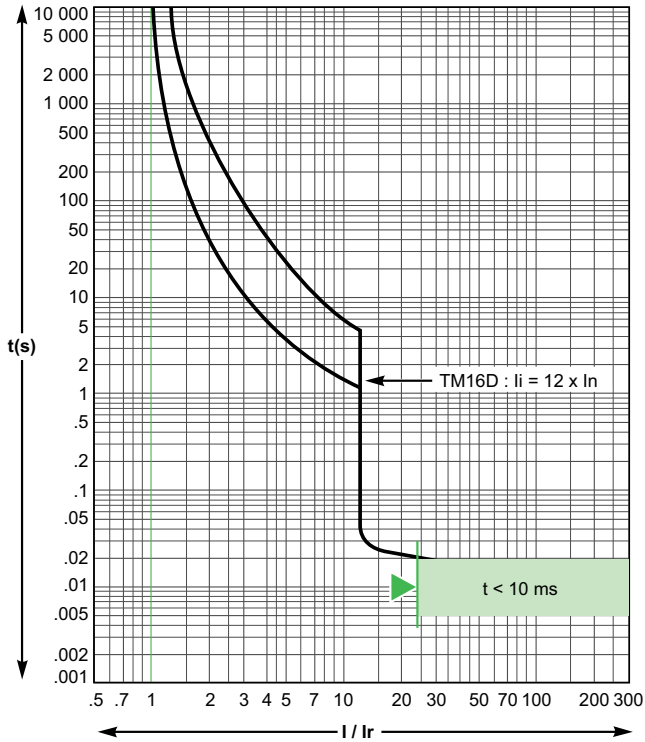

TM25D

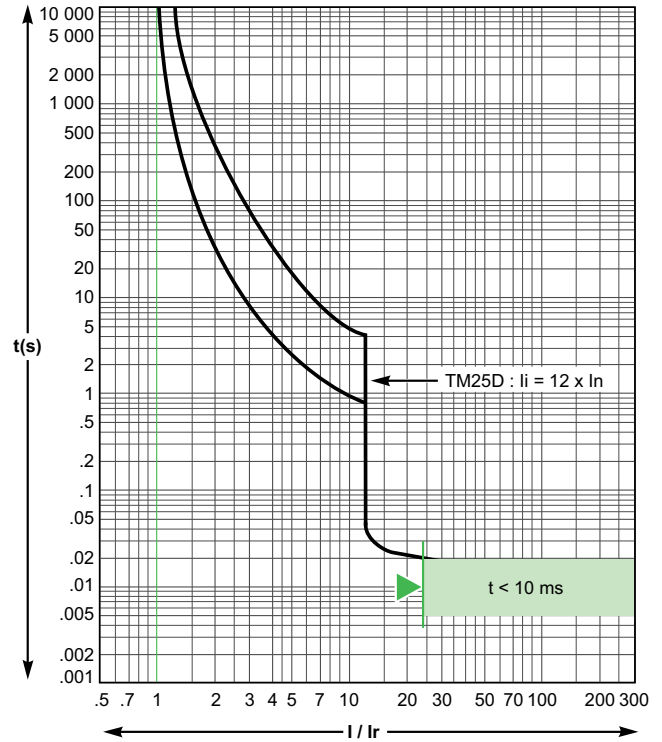

Reflex tripping

TM32D

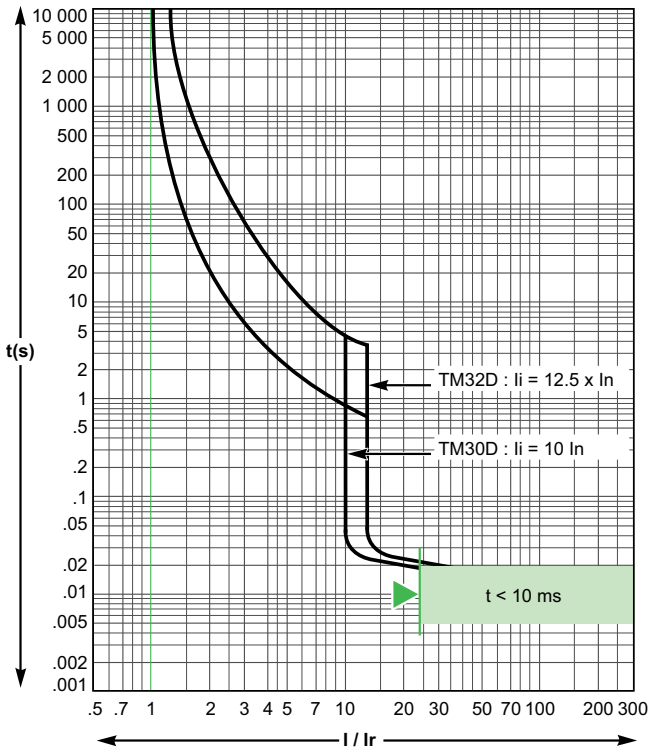

Reflex tripping

TM40D

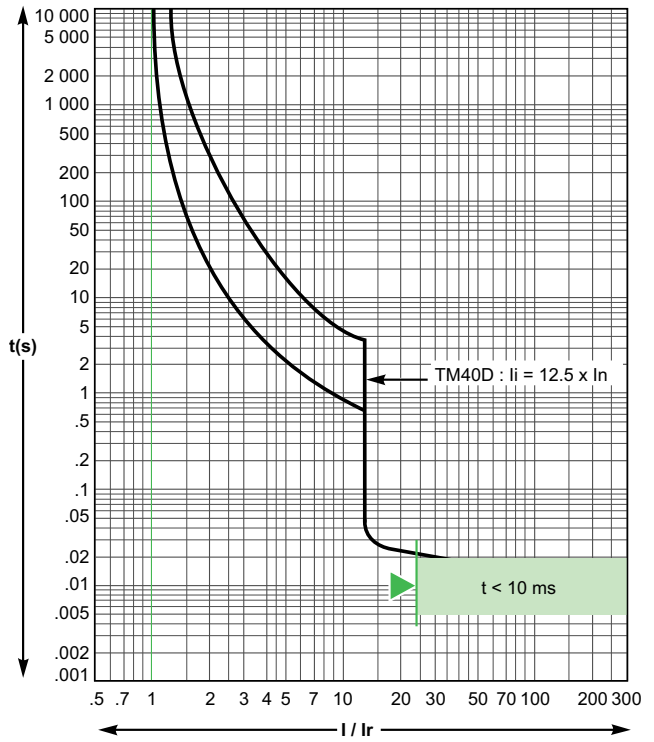

TM50D

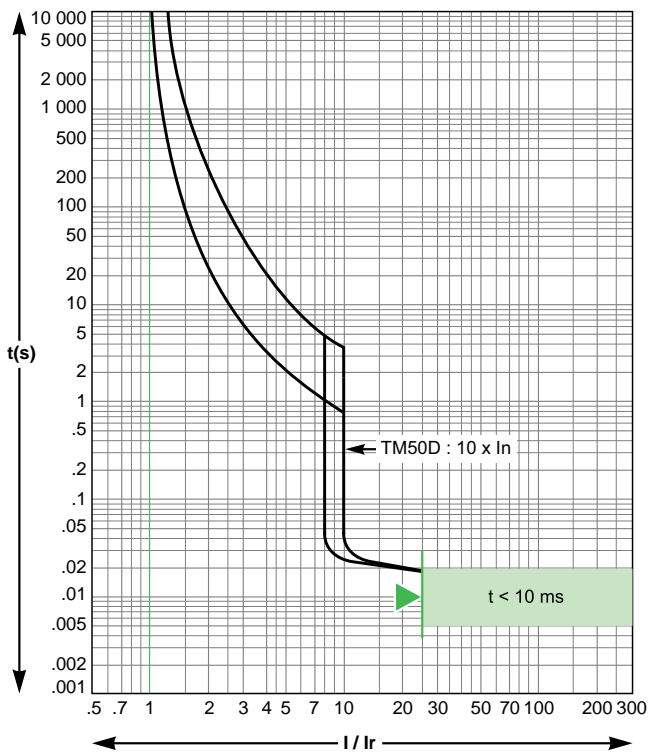

Reflex tripping

TM63D

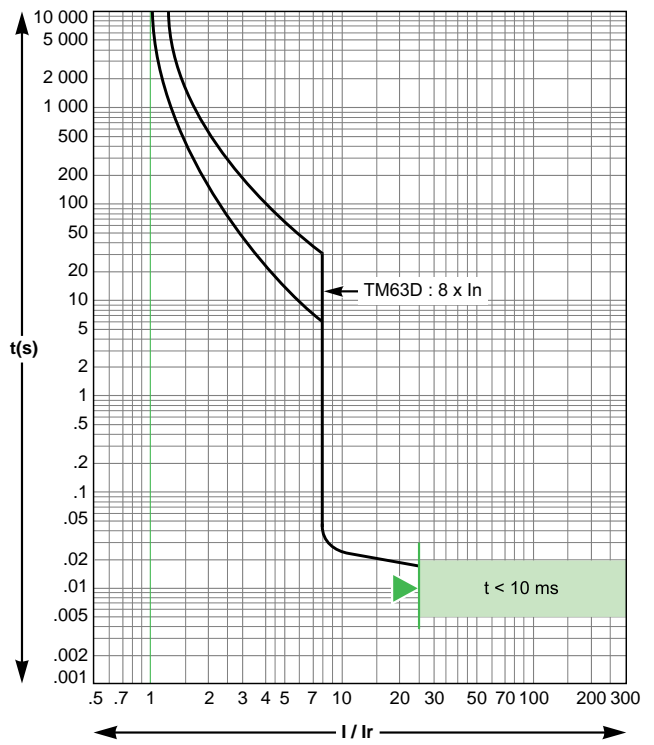

TM80D / TM100D

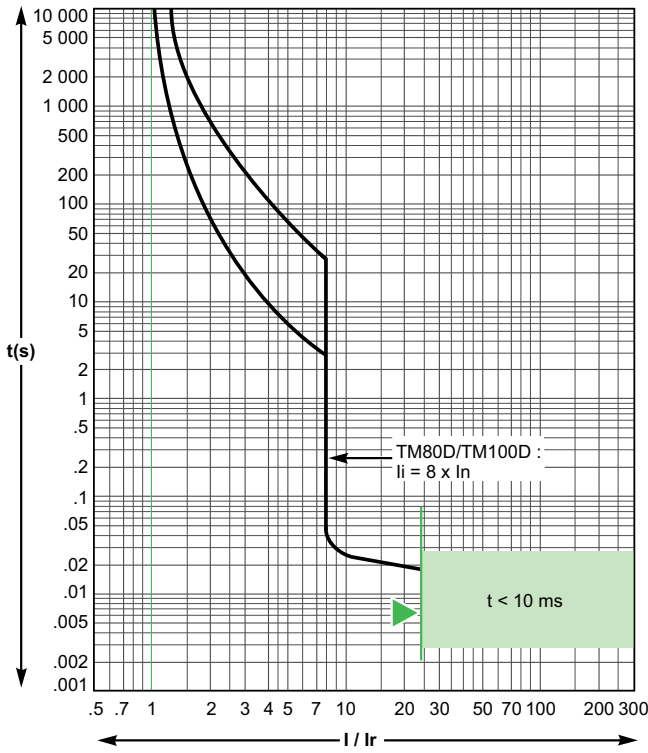

Reflex tripping

TM125D / TM160D

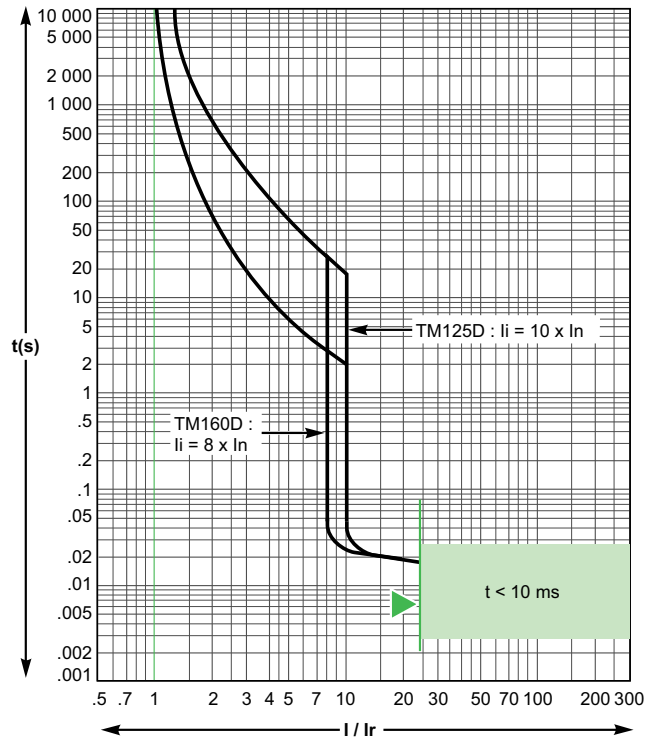

TM200D / TM250D

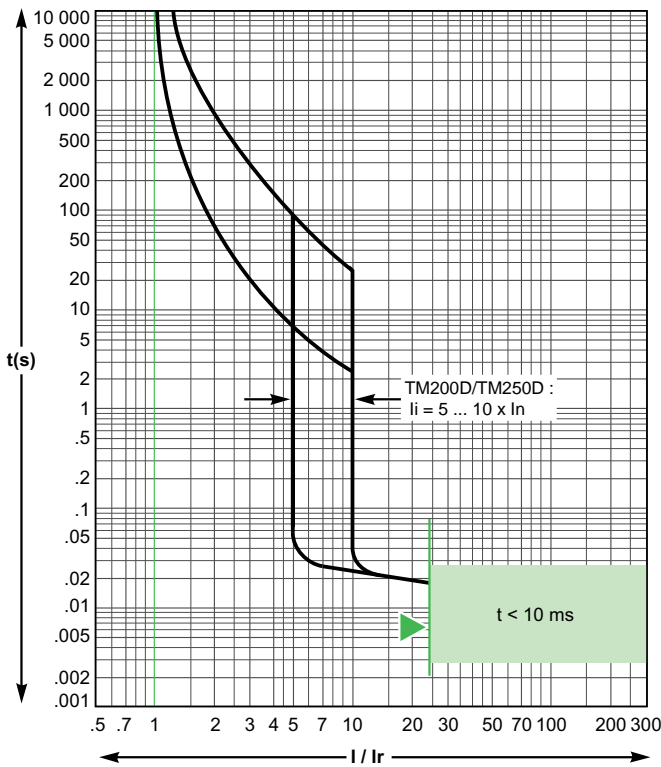

Reflex tripping

TMG Magnetic Trip Units

TM16G

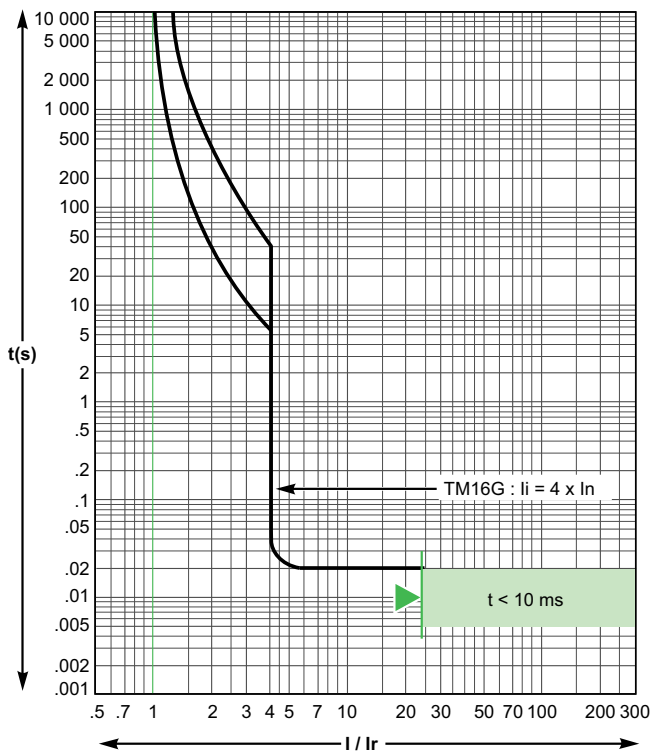

TM25G

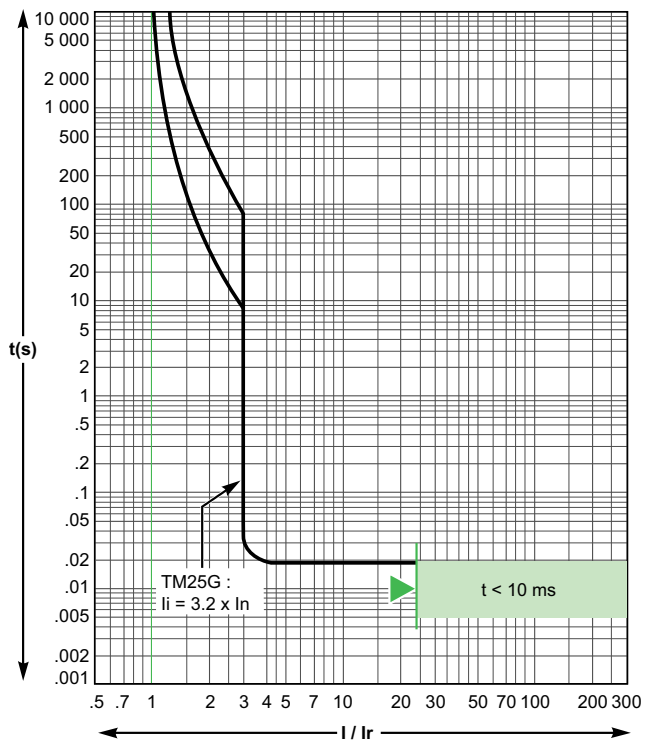

Reflex tripping

TM40G

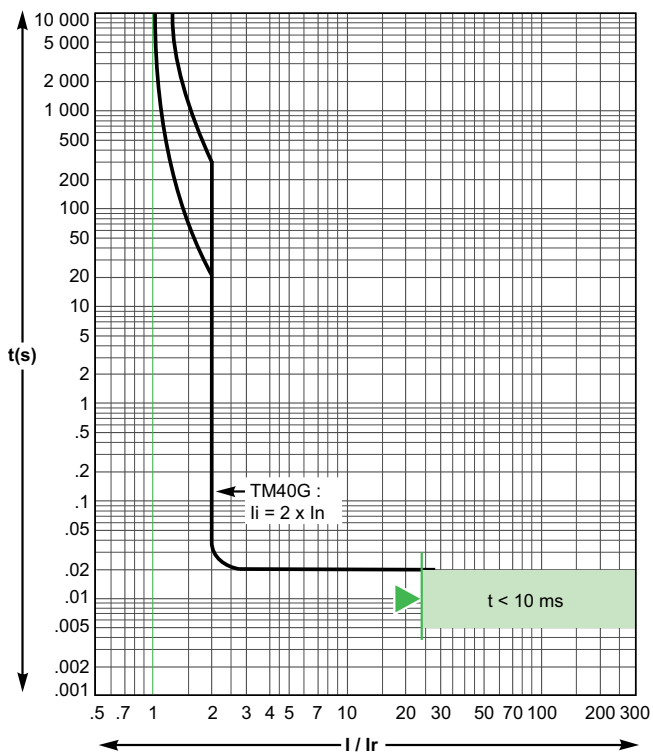

TM63G

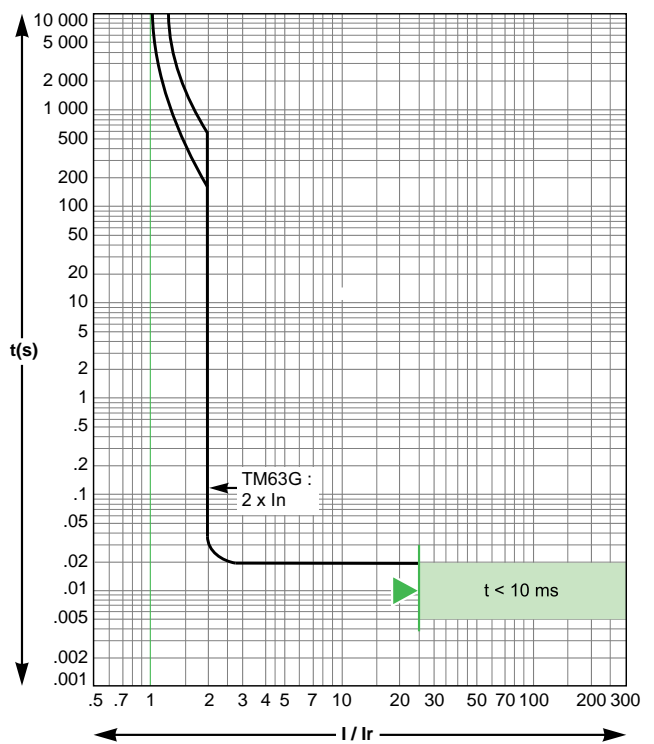

Reflex tripping

TM80G

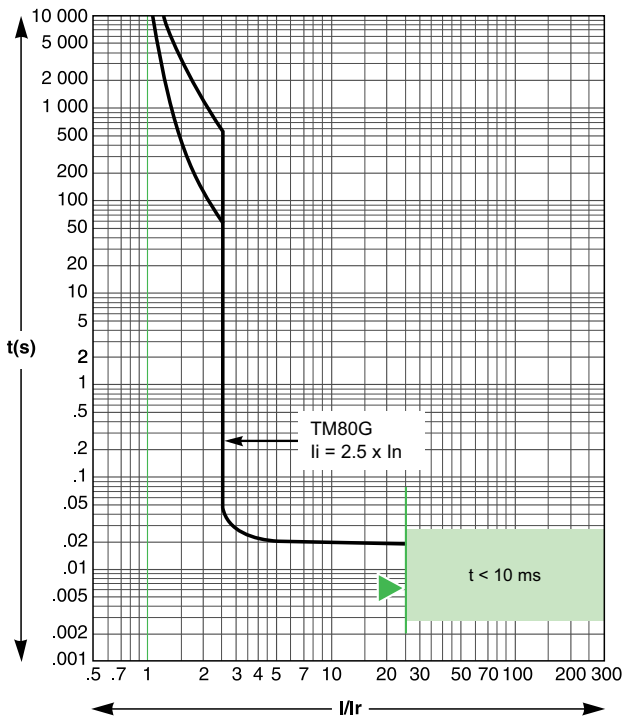

TM100G

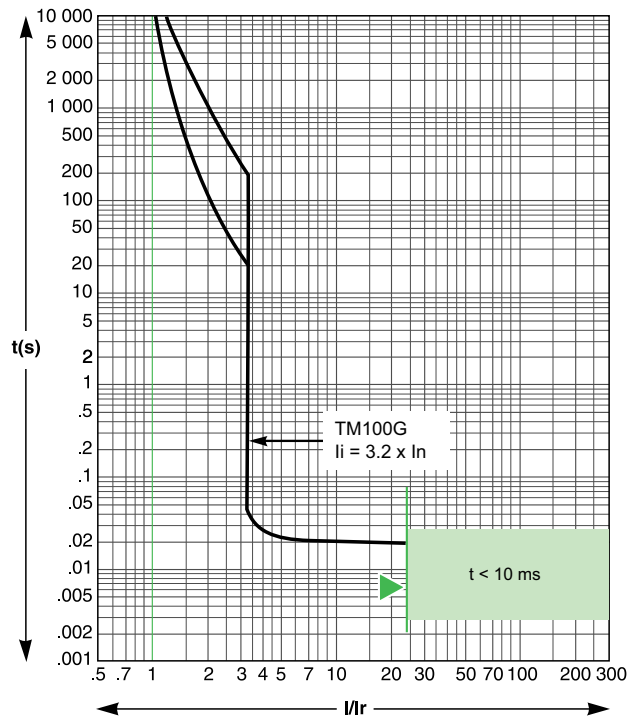

TM125G

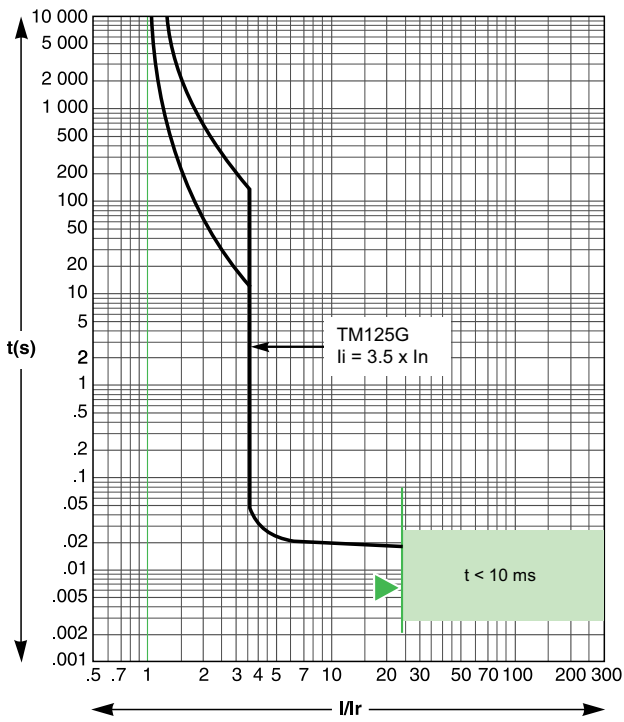

TM160G

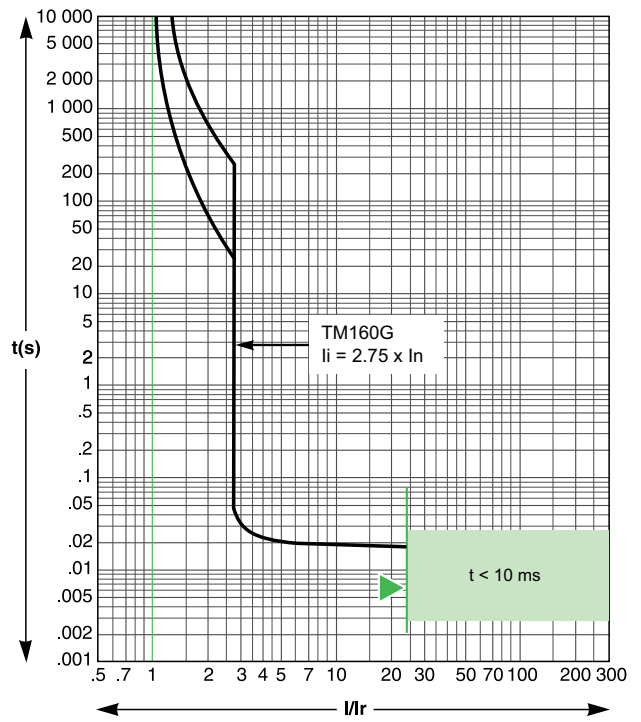

TM200G

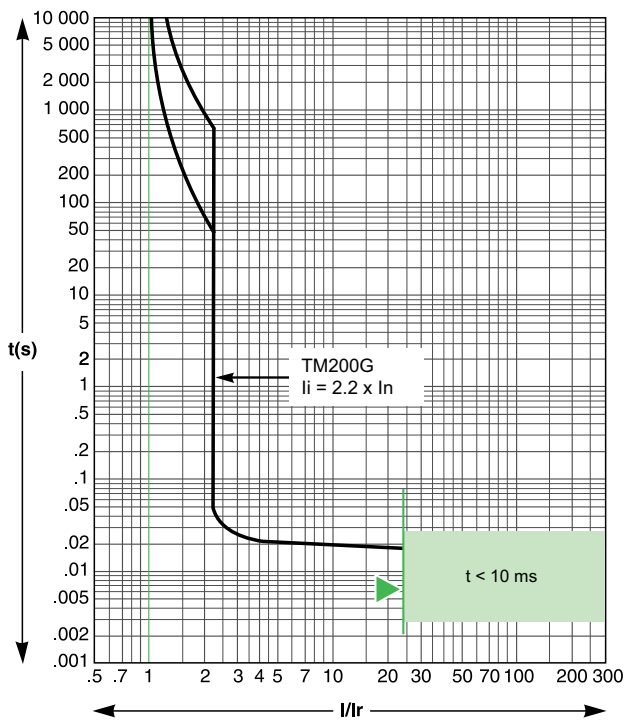

Reflex tripping

TM250G

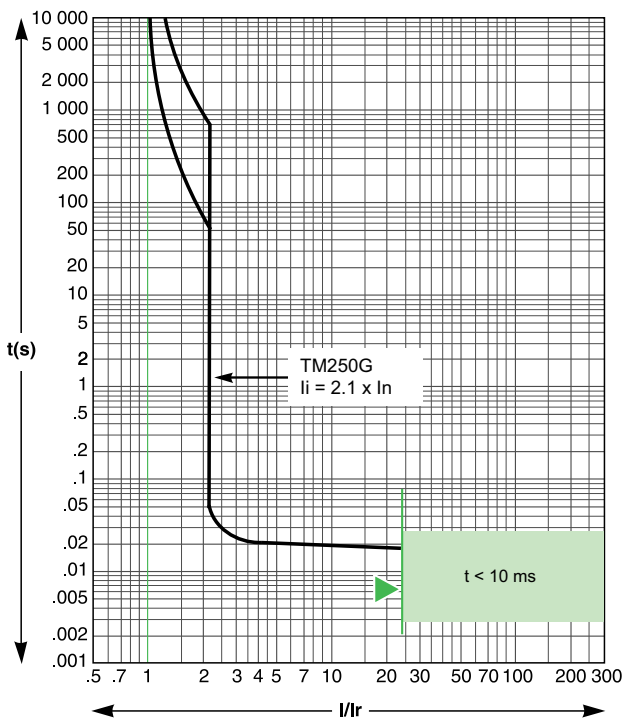

MicroLogic 2.2 and 4.2 Electronic Trip Units

MicroLogic 2.2 and 4.2 - 40-160 A

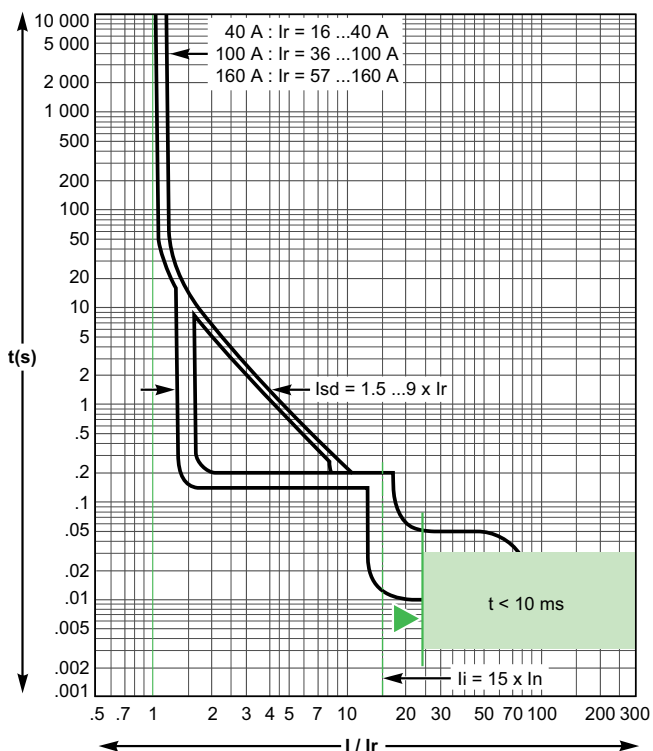

Reflex tripping

MicroLogic 2.2 and 4.2 - 250 A

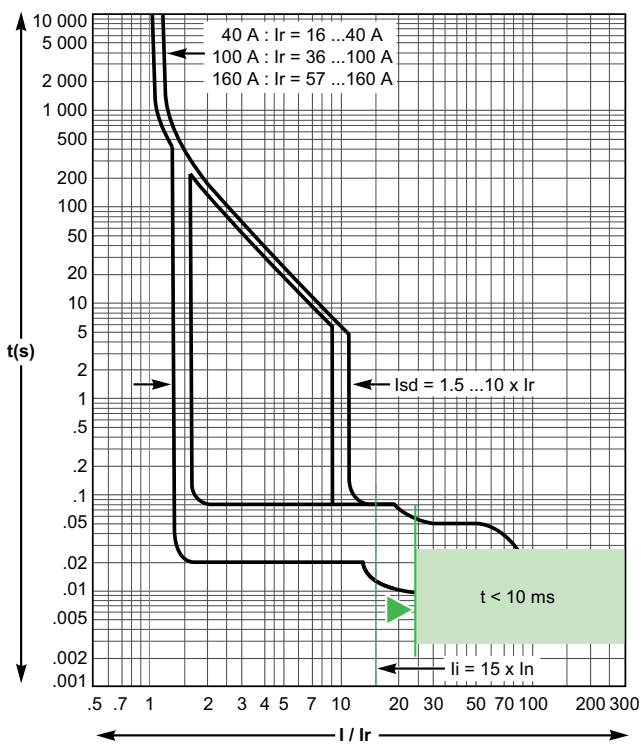

ComPacT NSX100-250 - Motor-Feeder Protection Tripping Curves

MA Magnetic Trip Units

MA2.5-MA100

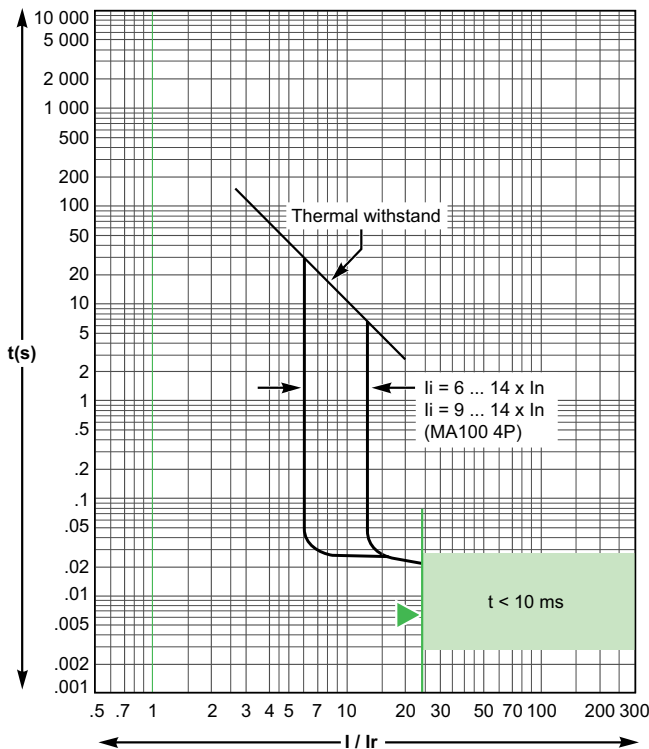

Reflex tripping

MA150 and MA220

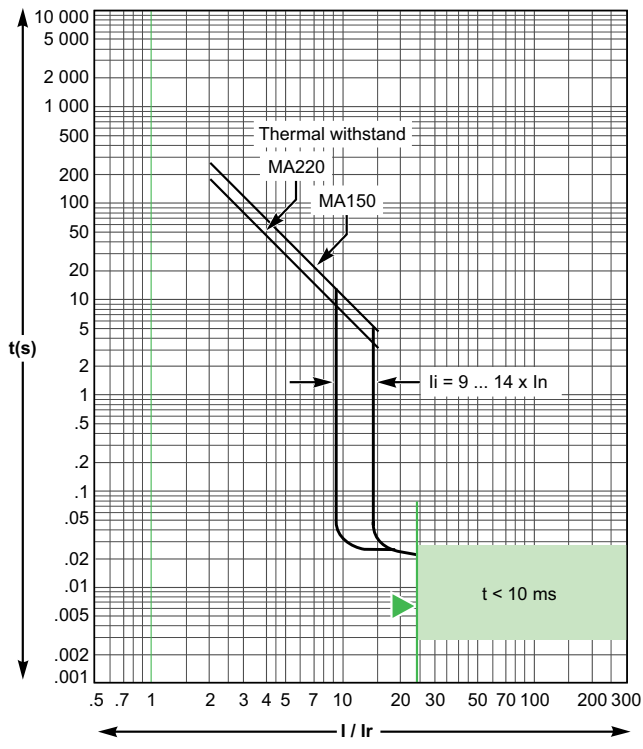

MicroLogic 2.2 M Electronic Trip Units

MicroLogic 2.2 M - 25 A

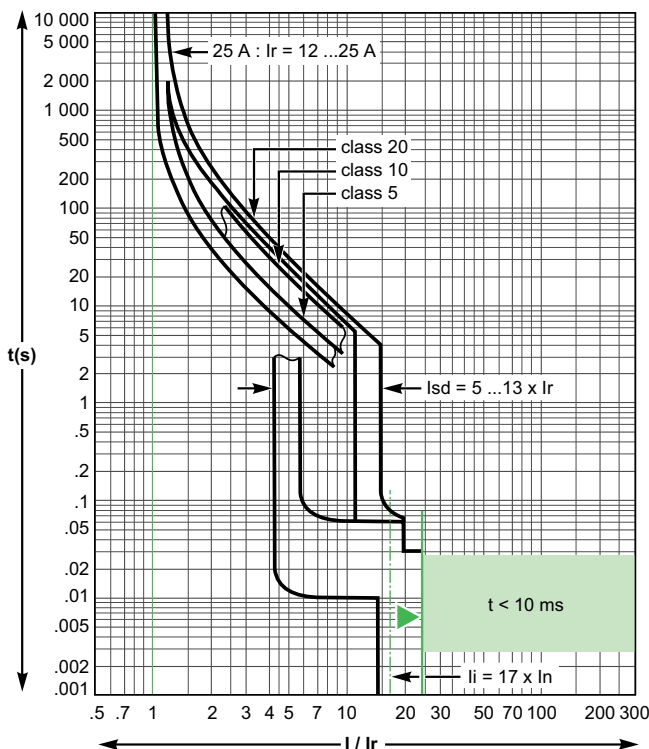

Reflex tripping

MicroLogic 2.2 M - 50-220 A

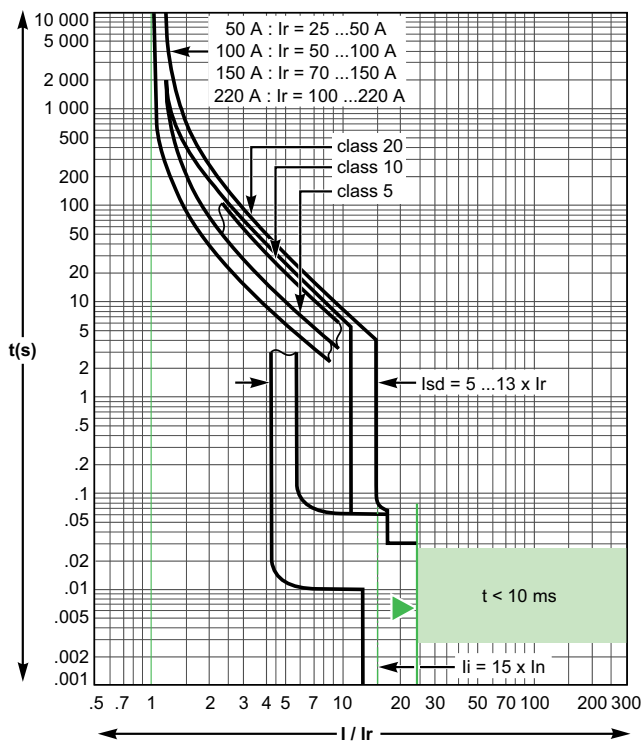

ComPacT NSX400-630 - Distribution Protection Tripping Curves

MicroLogic 2.3 and 4.3 Electronic Trip Units

MicroLogic 2.3 and 4.3 - 250-400 A

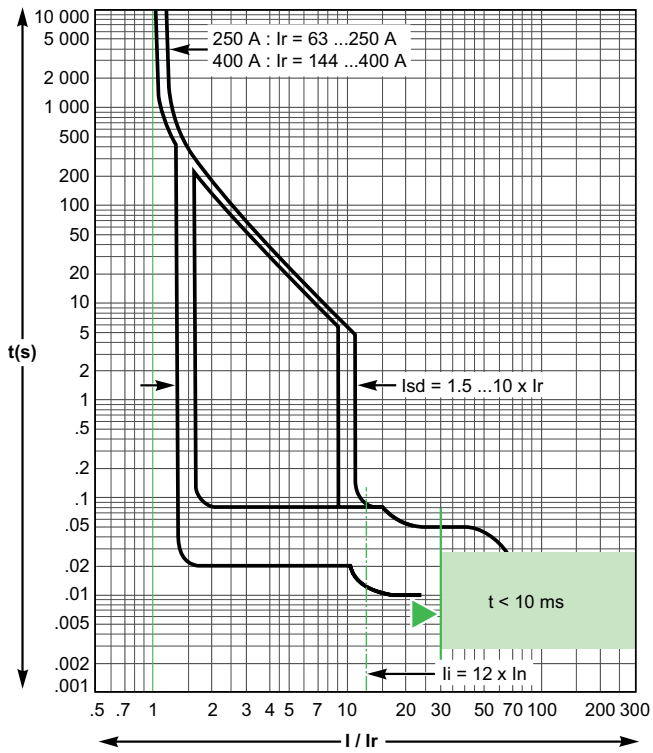

Reflex tripping

MicroLogic 2.3 and 4.3 - 630 A

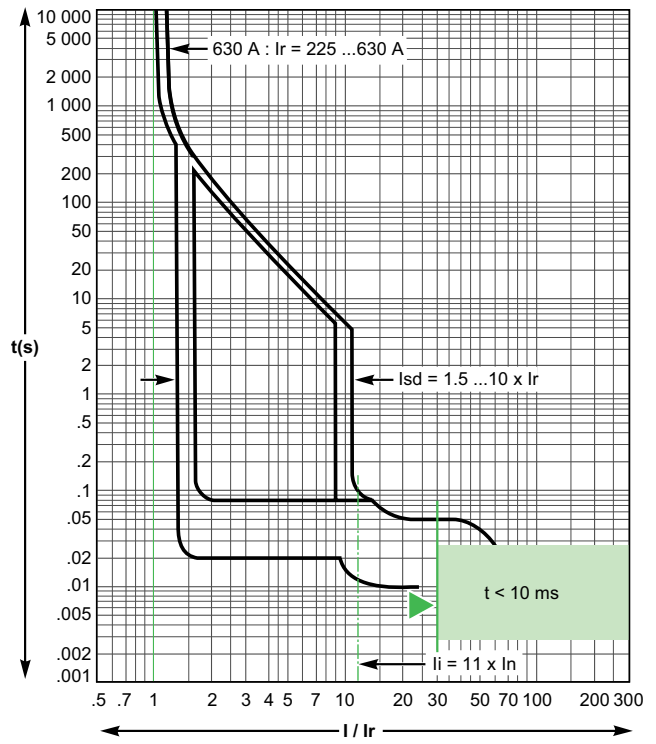

ComPacT NSX400-630 - Motor-Feeder Protection Tripping Curves

MicroLogic 1.3 and 2.3 M Electronic Trip Units

MicroLogic 1.3 M - 320 A

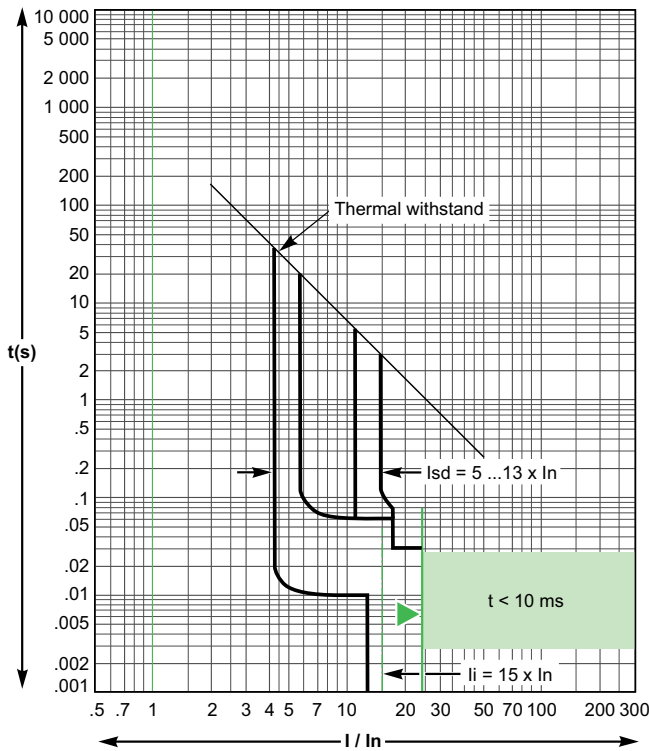

Reflex tripping

MicroLogic 1.3 M - 500 A

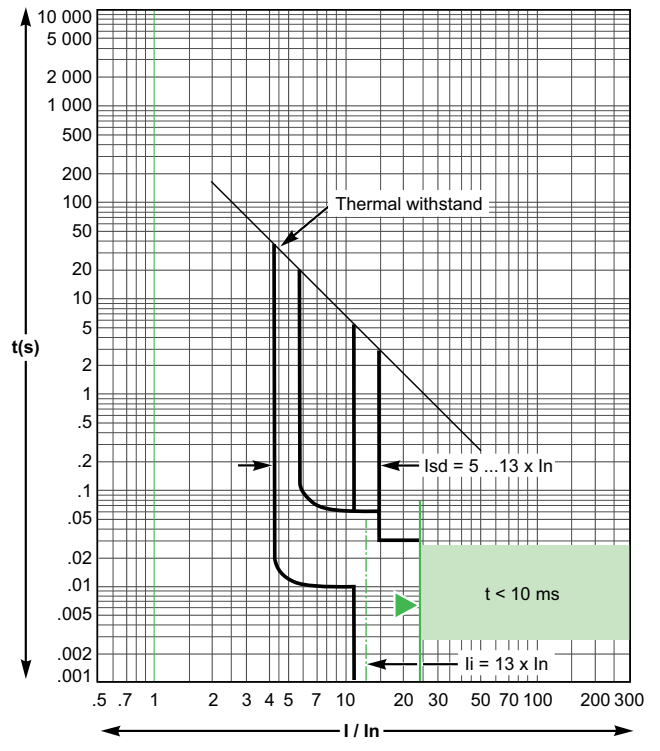

MicroLogic 2.3 M - 320 A

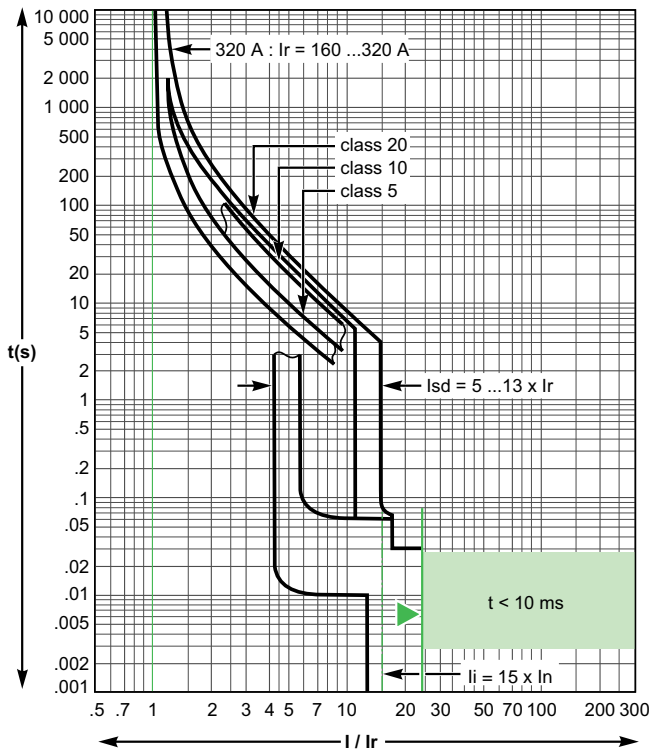

Reflex tripping

MicroLogic 2.3 M - 500 A

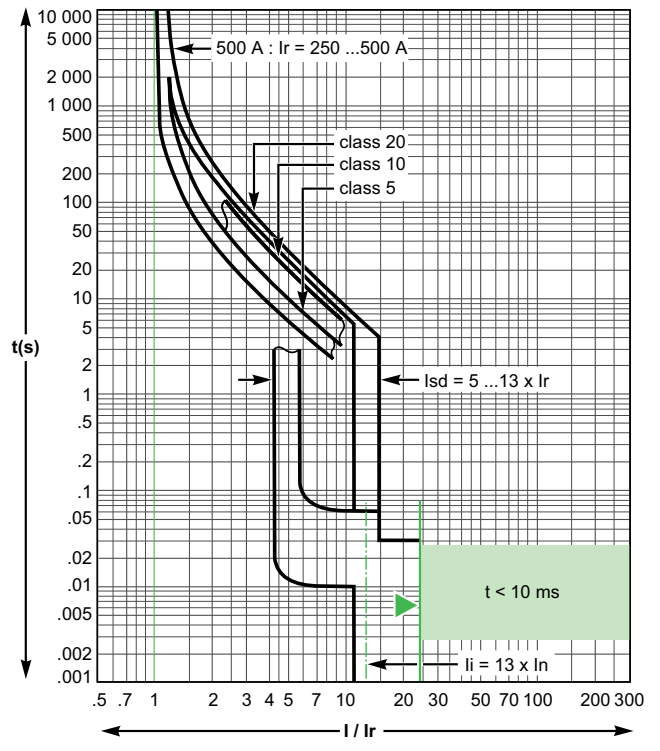

ComPacT NSX100-630 - Reflex Tripping

Presentation

ComPacT NSX circuit breakers incorporate the exclusive reflex-tripping system.

This system breaks very high fault currents.

The circuit breaker is mechanically tripped via a “piston” actuated directly by the short-circuit.

For high short-circuits, this system provides a faster break, thereby ensuring selectivity.

Reflex-tripping curves are exclusively a function of the circuit breaker rating.

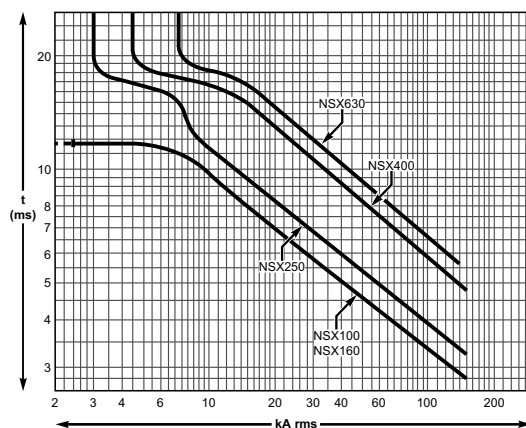

ComPacT NSX100-630 - Limitation Curves

Presentation

The limiting capacity of a circuit breaker is its aptitude to let through a current, during a short-circuit, that is less than the prospective short-circuit current.

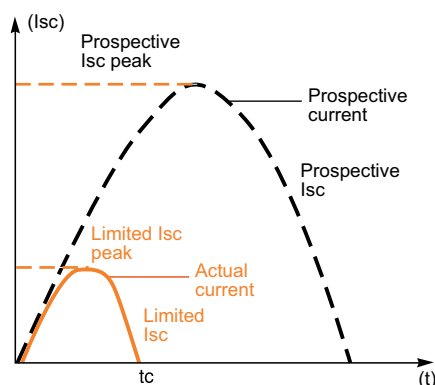

The exceptional limiting capacity of the ComPacT NSX range is due to the rotating double-break technique (very rapid natural repulsion of contacts and the appearance of two arc voltages in-series with a very steep wave front).

Ics = 100% Icu

The exceptional limiting capacity of the ComPacT NSX range greatly reduces the forces created by faults in devices.

The result is a major increase in breaking performance.

In particular, the service breaking capacity Ics is equal to 100% of Icu.

The Icu value, defined by standard IEC/EN 60947-2, is guaranteed by tests comprising the following steps:

- Break the circuit three times consecutively with a fault current equal to 100% of Icu
- Check that the circuit breaker continues to function normally, that is:
 - It conducts the rated current without abnormal temperature rise.
 - Protection functions perform within the limits specified by the standard.
 - Suitability for isolation is not impaired.

Longer Service Life of Electrical Installations

Current-limiting circuit breakers greatly reduce the negative effects of short-circuits on installations.

- Thermal effects:
Reduced temperature rise in conductors, therefore longer service life for cables.
- Mechanical effects:
Reduces electrodynamic forces, therefore less risk of electrical contacts, or busbar being deformed or broken.
- Electromagnetic effects:
Reduction in disturbances for measuring devices located near electric circuits.

Economy by Means of Cascading

Cascading is a technique directly derived from current limiting. Circuit breakers with breaking capacities less than the prospective short-circuit current may be installed downstream of a limiting circuit breaker. The breaking capacity is reinforced by the limiting capacity of the upstream circuit breaker. It follows that substantial savings can be made on downstream equipment and enclosures.

Nevertheless, the following limitation curves cannot be used to estimate cascading performance of two circuit breakers. For more information on reinforced breaking capacity, refer to the cascading tables in LVPED318033EN *Selectivity, Cascading, and Coordination Guide*.

Current and Energy Limiting Curves

The limiting capacity of a circuit breaker is expressed by two curves which are a function of the prospective short-circuit current (the current which would flow if no protection devices were installed):

- The actual peak current (limited current)
- Thermal stress (A^2s), that is, the energy dissipated by the short-circuit in a condition with a resistance of 1Ω .

Example: What is the real value of a 150 kA rms prospective short-circuit (i.e. 330 kA peak) limited by an NSX250L upstream?

The answer is 30 kA peak. Refer to *Current-limiting Curves*, page 221.

Maximum Permissible Cable Stresses

The table below indicates the maximum permissible thermal stresses for cables depending on their insulation, conductor (Cu or Al), and their cross-sectional area (CSA). CSA values are given in mm^2 and thermal stresses in A^2s .

CSA	Conductor	1.5 mm ²	2.5 mm ²	4 mm ²	6 mm ²	10 mm ²
PVC	Cu	2.97x10 ⁴	8.26x10 ⁴	2.12x10 ⁵	4.76x10 ⁵	1.32x10 ⁶
	Al	–	–	–	–	5.41x10 ⁵
PRC	Cu	4.1x10 ⁴	1.39x10 ⁵	2.92x10 ⁵	6.56x10 ⁵	1.82x10 ⁶
	Al	–	–	–	–	7.52x10 ⁵

CSA	Conductor	16 mm ²	25 mm ²	35 mm ²	50 mm ²
PVC	Cu	3.4x10 ⁶	8.26x10 ⁶	1.62x10 ⁷	3.31x10 ⁷
	Al	1.39x10 ⁶	3.38x10 ⁶	6.64x10 ⁶	1.35x10 ⁷
PRC	Cu	4.69x10 ⁶	1.39x10 ⁷	2.23x10 ⁷	4.56x10 ⁷
	Al	1.93x10 ⁶	4.7x10 ⁶	9.23x10 ⁶	1.88x10 ⁷

Example: Is a Cu/PVC cable with a CSA of 10 mm² adequately protected by an NSX160F? The table above indicates that the permissible stress is 1.32x10⁶ A²s.

All short-circuit currents at the point where an NSX160F ($I_{cu} = 35 \text{ kA}$) is installed are limited with a thermal stress less than 6x10⁵ A²s. Refer to *Energy-limiting Curves*, page 221.

Cable protection is therefore ensured up to the limit of the breaking capacity of the circuit breaker.

Current-limiting Curves

Voltage 400/440 Vac	Voltage 660/690 Vac
Limited short-circuit current (kÅ peak)	Limited short-circuit current (kÅ peak)

Energy-limiting Curves

Voltage 400/440 Vac	Voltage 660/690 Vac
Limited energy	Limited energy

Index

A

accessory slots	77
auxiliaries contacts	
control	102
auxiliary contacts	
operation	79
auxiliary devices	61

B

BSCM	
configuration	96
connection	95
data provided	96
data sent	96
description	94
installation	95
setup	95

C

carriage switches	71
checks	
startup	178
trip unit	169
circuit breaker	
accessory slots	77
close	31
face	30
locking	35
maintenance	185
open	31
operation	177
plug-in	62
reset	31
startup	178
testing	24, 33
circuit breakers	
functions	13
motor operated	52
close	31
communicating motor mechanism	58
motor mechanism	55
rotary handle	40
communicating motor mechanism	
close	58
open	58
reset	58
connection	
plug-in circuit breaker	64
withdrawable circuit breaker	69
contact opening	160
control contacts	102

D

disconnecting plug-in circuit breaker	63
disconnecting withdrawable circuit breaker	67
distribution trip unit	142

E

electrical accessories	61
------------------------------	----

I

indication contacts	
accessory slots	77
operation	79
indication LEDs	143

L

locking	
circuit breaker	35

M

MicroLogic trip units	139
1.3 M	156
characteristics	140
distribution	142
identification	140
motor	143
upgradeability	145
motor trip units	143

O

open	31
------------	----

P

plug-in circuit breaker	62
connections	64
direct contact protection	65
disconnection	63

R

removing withdrawable circuit breaker	68
reset	31

S

SDTAM module	
connection	90
description	90
installation	90
SDx module	
connection	88
default output assignment	88
description	87
installation	87
reconfiguring outputs	89
sealing	
trip units	145
sealing accessories	36
seals	145
servicing	
at installation	23
setting	25
trip unit	25
short-time protection	
MicroLogic 1.3 M	156
MicroLogic 1.3 M trip unit	156

T

testing	
---------	--

circuit breaker 24, 33

U

upgradeability 145

W

wireless indication auxiliary
operation 80
withdrawable circuit breaker
connections 69
disconnection 67
removal 68

Schneider Electric
35 rue Joseph Monier
92500 Rueil Malmaison
France

+ 33 (0) 1 41 29 70 00

www.se.com

As standards, specifications, and design change from time to time,
please ask for confirmation of the information given in this publication.

© 2021 – Schneider Electric. All rights reserved.

DOCA0187EN-00