

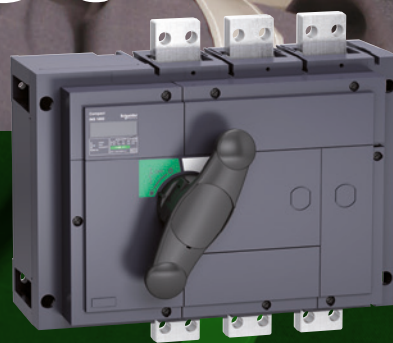

# Compact

**Catalogue 2018**  
Switch-disconnectors  
INS/INV40 to 2500 A



• WEB2 cat.2018

[schneider-electric.com](http://schneider-electric.com)

Life Is On

**Schneider**  
Electric





# Green Premium™

Endorsing eco-friendly products in the industry



## Green Premium™ Product

Green Premium is the only label that allows you to effectively develop and promote an environmental policy whilst preserving your business efficiency. This ecolabel guarantees compliance with up-to-date environmental regulations, but it does more than this.

Over 75% of Schneider Electric manufactured products have been awarded the Green Premium ecolabel



Discover what we mean by green ...

**Check your products!**

Schneider Electric's Green Premium ecolabel is committed to offering transparency, by disclosing extensive and reliable information related to the environmental impact of its products:

### RoHS

Schneider Electric products are subject to RoHS requirements at a worldwide level, even for the many products that are not required to comply with the terms of the regulation. Compliance certificates are available for products that fulfil the criteria of this European initiative, which aims to eliminate hazardous substances.

### REACH

Schneider Electric applies the strict REACH regulation on its products at a worldwide level, and discloses extensive information concerning the presence of SVHC (Substances of Very High Concern) in all of its products.

### PEP: Product Environmental Profile

Schneider Electric publishes complete set of environmental data, including carbon footprint and energy consumption data for each of the lifecycle phases on all of its products, in compliance with the ISO 14025 PEP ecopassport program. PEP is especially useful for monitoring, controlling, saving energy, and/or reducing carbon emissions.

### EoLI: End of Life Instructions

Available at the click of a button, these instructions provide:

- Recyclability rates for Schneider Electric products.
- Guidance to mitigate personnel hazards during the dismantling of products and before recycling operations.
- Parts identification for recycling or for selective treatment, to mitigate environmental hazards/ incompatibility with standard recycling processes.

# Compact INS/INV

Optimize your solution with field-proven & high-performance switch-disconnectors

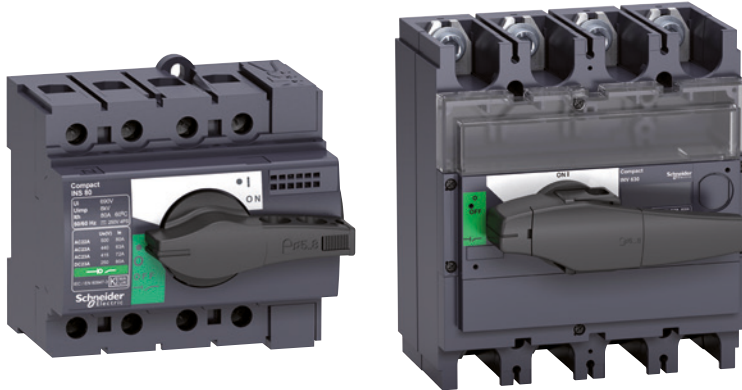

## Standards

Compact INS/INV Switch Disconnectors comply with

- International Standards:
  - IEC/EN 60947-1: General rules
  - IEC/EN 60947-3: Switch-disconnectors
- Marine certifications:
  - American Bureau of Shipping
  - Bureau Veritas
  - Det Norske Veritas - Germanischer Lloyd
  - Lloyd's Register of Shipping
  - Nippon Kaiji Kyokai
  - China Classification Societies
  - Registro Italiano Navale
  - Korean Register of shipping
  - Russian Maritime Registers of Shipping
- UL489 and CSA C22.2 N°5-02 & N°5-13 standards. INSE and INSJ versions only.

## High performances

- No derating for all performances in accordance with IEC60947-3 criteria:
  - $I_{th} = I_{the} = I_e$  up to 60°

## Functions and characteristics

www.schneider-electric.com

### Switch-disconnector selection Compact INS40 to 160



Compact INS40 to 80 switch-disconnector.

#### Compact INS switch-disconnectors

Number of poles

#### Electrical characteristics as defined by IEC 60947-1 / 60947-3 and EN 60947-1 / 60947-3

Conventional thermal current (A)	$I_{th}$	at 60 °C
Conventional thermal current in enclosure	$I_{the}$	at 60 °C
Rated insulation level (V)	$U_i$	AC 50/60 Hz
Impulse-withstand voltage (kV)	$U_{imp}$	
Rated operational voltage (V)	$U_e$	AC 50/60 Hz
		DC
Rated operational voltage AC20 and DC20 (V)		AC 50/60 Hz
Rated operational current (A)	$I_e$	Electrical AC 50/60 Hz

## Total coordination with Masterpact MTZ, NT, NW, Compact NS, Compact NSX and Compact NSXm

- The switch must be chosen according to:
  - the characteristics of the network on which it is installed,
  - the location and the application,
  - coordination with the upstream protection devices (in particular overload and short-circuit).

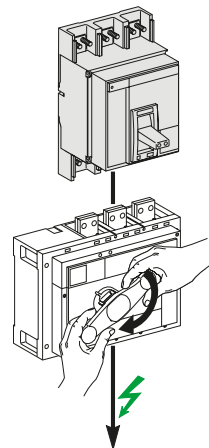

# Design easy-to-install solutions

## Large range of accessories

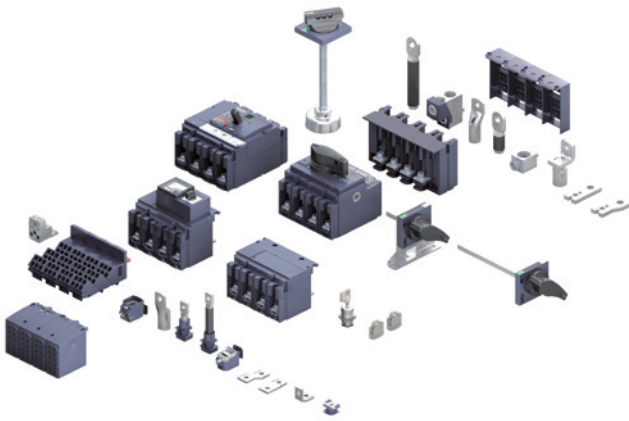

- Positive contact indication or Visible break
- Rotary, front and lateral, direct and extended handles
- locking and interlocking functions
- Installation accessories on symmetrical rails and backplate
- Connection accessories to cables or bars
- Enclosures
- Complete source-changeover assembly

## Easy to connect to Linergy devices

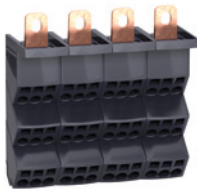

Quick distribution blocks for direct installation on the mounting plates

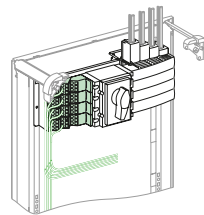

Horizontally

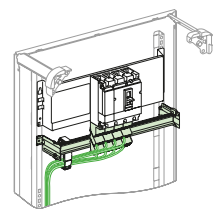

Vertically

## Upgrade easily to smarter functions

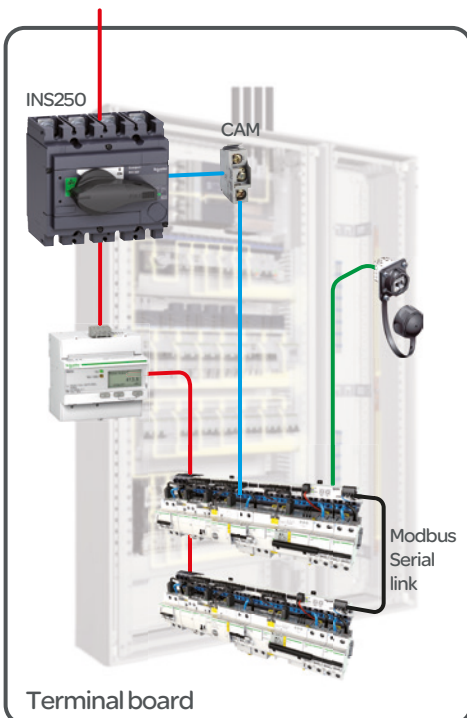

Indications & measurements auxiliaries and connection to Smart Panels:

- Compact is an internal part of EcoStruxure™ Power - Schneider's open, interoperable, lot-enabled system architecture.
- You can add Powertag NSX to your switch disconnector in order to get energy measurement and alarming. As Compact INS/INV is part of the Smart Panels system, all measurement provided by Compact INS/INV + Powertag NSX can be digitized for transmission to local and remote management software and solutions. When incorporated into Smart Panels, these data can be computed by energy management software, enabling through analysis of energy consumptions across the building and identification of potential savings

Ethernet network

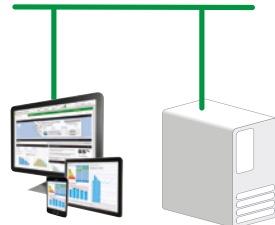

- Ethernet
- Modbus
- Supply
- Communication



# Grow your business with better solutions

Choose the installation that best suits your needs

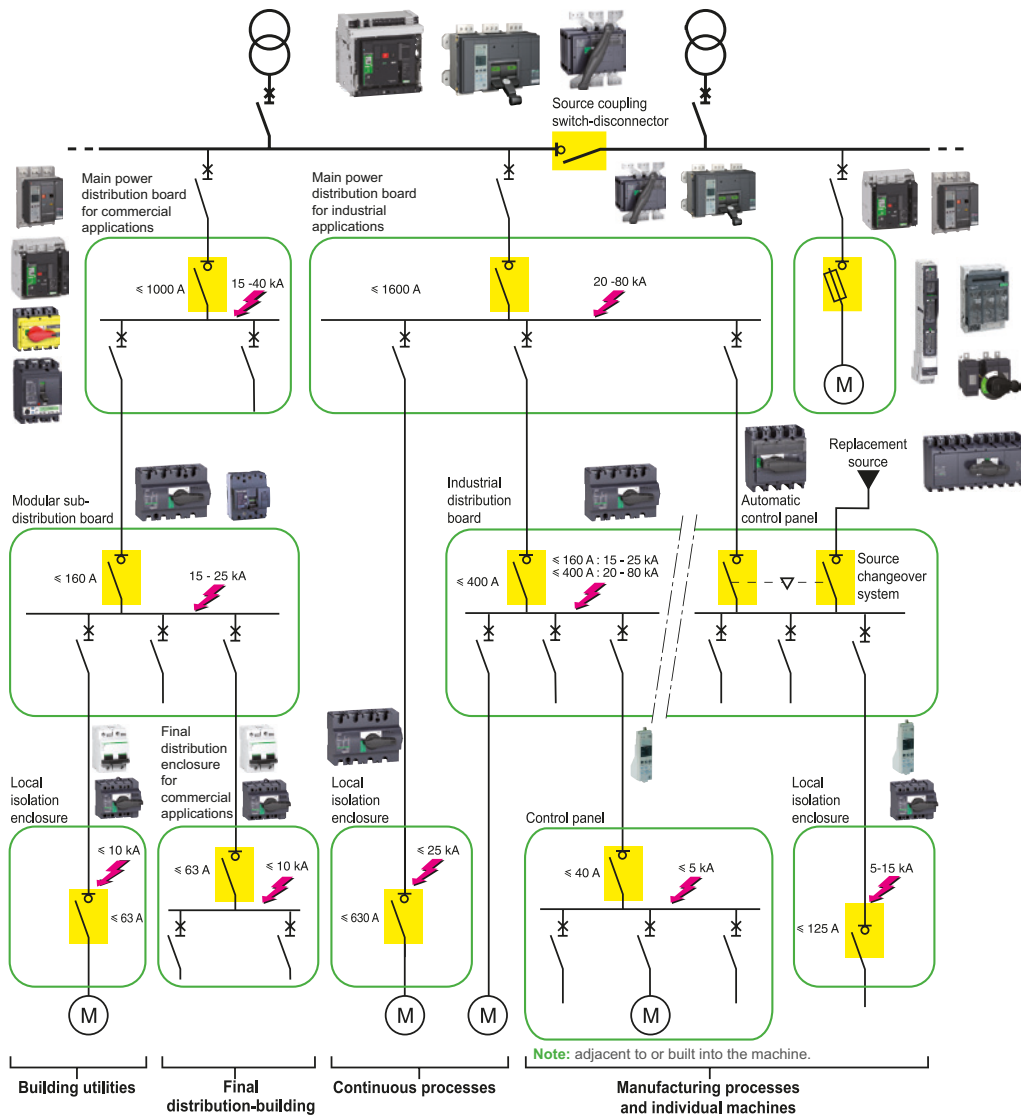

## Less stock space needed

- Common accessories for Compact INS/INV and Compact NSX
- Less product references













## Energy availability thanks to the power-system protection

- Isolation of components under fault

# Overview

The complete range	40 A	63 A	80 A	100 A	125 A	160 A	200 A	250 A
Modular profile	INS40	INS63	INS80PV	INS100	INS125	INS160		
				INS250-100	INS250-160	INS250-200	INS250	
	INSE 40-80							

## Compact INS

Switch-disconnectors with positive contact indication				
				
Emergency-off switch-disconnectors with positive contact indication				

Mounting on backplate	INV100	INV160	INV200	INV250
-----------------------	--------	--------	--------	--------

## Compact INV

Switch-disconnectors with visible break	
Emergency-off switch-disconnectors with visible break	



320 A 400 A 500 A 630 A 630b A 800 A 1000 A 1250 A 1600 A 2000 A 2500 A

INS320 INS400 INS500 INS630 INS630b INS800 INS1000 INS1250 INS1600 INS2000 INS2500  
 INSJ400

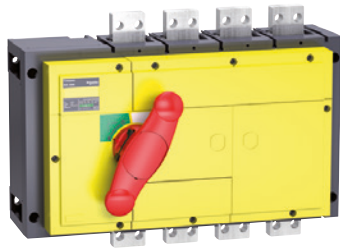

INV320 INV400 INV500 INV630 INV630b INV800 INV1000 INV1250 INV1600 INV2000 INV2500

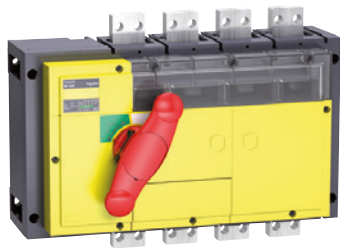

# Who else covers ...

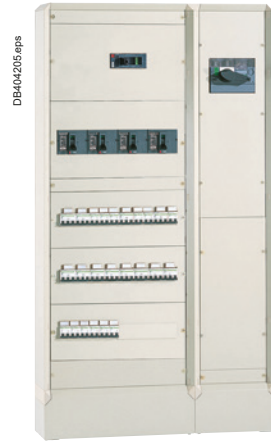

## Local isolation enclosures

- Current ratings: up to 63 A for commercial and 630 A for industrial applications
  - Schneider Electric switch-disconnectors
  - Compact INS40 to 160 and I modular switches
  - Compact INS/INV
  - Schneider Electric switch-disconnectors
- Vario 12 to 175 A

## Control panels

- Current ratings: up to 63/80 A
- Schneider Electric switch-disconnectors:
  - Compact INS
- Schneider Electric switch-disconnectors
  - Vario

## Sub-distribution boards

- Current ratings: up to 160 A
- Schneider Electric switch-disconnectors:
  - Compact INS/INV
  - Compact NSXm

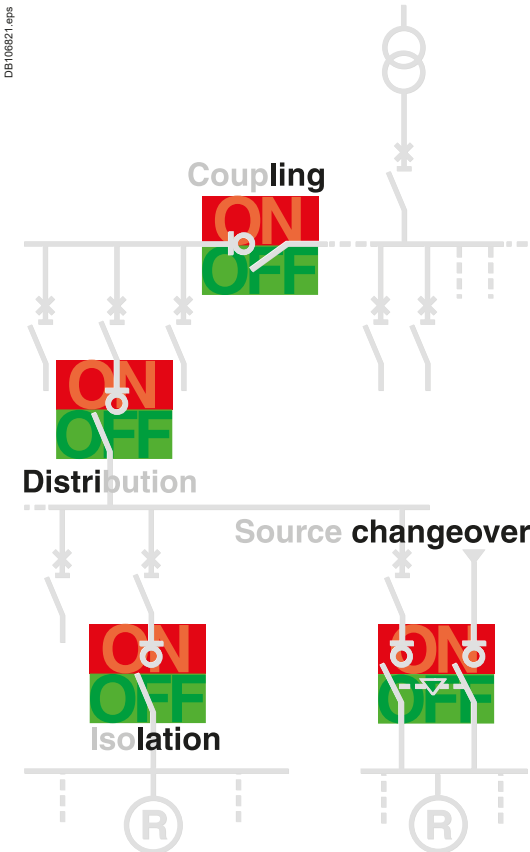

Local isolation  
Industrial or commercial

Final distribution

Sub-distribution

Power distribution



# ...so many applications?

PD096007\_L70\_SE.eps



## Industrial switchboards and automatic control panels

- Current ratings: up to 400 A
- Schneider Electric switch-disconnectors:
  - Compact INS/INV

PB111807\_104.eps



## Main power distribution boards for commercial and industrial applications

- Current ratings:
  - 400 to 1000 A for commercial applications
  - 400 to 1600 A for industrial applications
- Schneider Electric switch-disconnectors:
  - Compact INS/INV
  - Compact NSX NA
  - Compact NS NA
  - Masterpact MTZ1 HA, MTZ2 NA/HA/HA10, MTZ3 HA

# A complete offering ...

## Power Distribution Incomers for Critical Applications



Masterpact MTZ2



Micrologic 5.0 X



Masterpact MTZ1



## Power Distribution Incomers for Large Buildings

DB404194.eps



Compact NS1600NA

PB11151E\_42.eps



Compact INS2000



Compact NS2000



# ...for all your needs

## Sub Distribution Incomers for Mid Size Buildings



PB1104826\_eps



Compact NSX400NA

PB1114489\_43\_eps



Transferpack FMX (complete source-changeover assembly)

PB111484\_L20\_eps



Compact INV400



Compact INS400



Fupact ISFL



Fupact ISFT



Fupact INF

## Final Distribution Outgoers and Local isolation and control devices for Small Buildings



PB104825\_eps



Compact NSX250NA

PB114888\_L=30\_eps



NSXmNA

9262\_SE\_20\_eps



Vario

PB107817\_17\_eps



Acti 9

PB111439\_L22\_eps



Compact INV250

PB111402\_15\_eps



Compact INS80



20Q1  
GENERAL

20QF1  
DEPART 1

Life Is on  
www.schneider-electric.com

# Select and order your Compact INS/INV

## 1 I design

### Ecodial software

Optimize the choice of equipment-sizing installations with several and different types of power supplies

## 3 I build

### Easy installation

Simple and flexible installation with field-installable accessories and auxiliaries

## 2 I configure

### Ecoreal software (supports switchboards up to 630 A)

Configure your switchboard with the devices that match your criteria

Generate a quote with a bill of materials, price and 3D views of the configured switchboard

### Eplan software

Compact INS/INV are available in Unity Software with Eplan.

## 4 I operate and maintain

### More security

Isolation ensured when locked by up to three padlocks or lead-sealed in the OFF position

### More continuity of service

Total coordination ensured with Compact, Acti9 and Masterpact products.





# Ethernet-ready Smart Panels

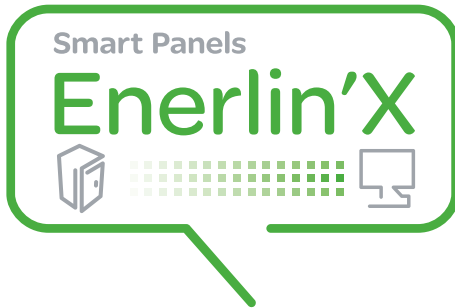

Ethernet-ready Smart Panels enable electrical distribution control and expertise. 'Protect' - 'Measure' - 'Connect' are the 3 pillars of their technology.

PB 115758.psd



## 4- Act

## 3- Connect

### Give a voice to the panel

Secured Ethernet network data transmission is now part of the intrinsic design of protection and metering devices.

## 2- Measure

### Keeping a close eye on energy flows

The switchboard plays a key role in capturing building-related data, by gathering the critical protection and metering components.

## 1- Protect

### Electrical protection is at the core of Smart Panel

Reliable and high-performance technology is present in every breaker and every residual current device.



# Future savings, peace-of-mind

Access to Smart Panel status, values, is essential for taking advantages of monitoring and management services, locally or remotely.

## Act in small/medium buildings

with FDM 128, Com'X 510, Power View, EcoStruxure™ Facility Expert

PB11801-80.eps



Electrical device monitoring and control with FDM 128, locally



### Optimizing energy-efficiency

- Visualize, record energy consumption and WAGES.
- Comply with regulation.

DD385918.ai



Com'X 510 web pages direct display, or Cloud based pages from other devices with Power View.



### Improving continuity of service

- Get instant notifications.
- Manage with assets-maintenance platform.
- Get and analyze data for quick crisis-recovery.

DD385919.ai

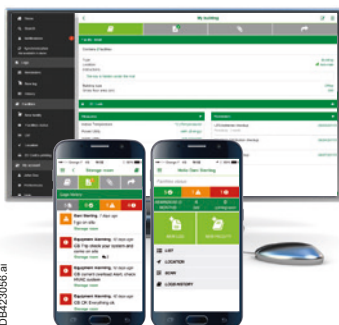

Distance management with EcoStruxure™ Facility Expert on Smartphone, tablet, PC



### Increasing maintenance efficiency

- Operate preventive maintenance tools.
- Follow maintenance & planning.
- Provide business owner instant access to maintenance reports.

# Day-to-day energy management

For simply dealing with building user's needs and energy constraints. EcoStruxure™ Building Management provides electrical management, monitoring and energy accounting.

## Act in large non-critical buildings

with EcoStruxure™ Energy Expert

DB425660.ai



### Managing equipment & key assets

- Check operating status, faults on custom on-line diagrams.

DB425661.ai



### Monitoring electrical network

- Observe voltage disturbances, harmonics on graphics.
- Read power factor.

DB425334.ai



### Accounting energy

- Record power meter data on dashboards.
- Allocate energy consumption with costs.
- Follow conservation goals.

# Power availability & quality, energy performance

Energy decisions are often crucial in large critical buildings, they must be informed. EcoStruxure™ Power Monitoring Expert (software for PC) collects Smart Panels values to provide expert analysis.

## Act in large critical buildings

with EcoStruxure™ Power Monitoring Expert

DB425657.ai



### Analysing Power Events

- Speed up downtime crisis recovery.
- Determine incident root cause, events sequence.
- Troubleshoot power quality issues.

DB425658.ai



### Monitoring Power quality

- Be alerted of equipment affected by power quality issue.
- Compare power quality against industry standards.
- Collect facts for future discussion with Utility.

DB425659.ai



### Analysing Energy Performance

- Evaluate building energy saving performance.
- Identify underperforming loads.
- Analyze Energy Conservation Measures (ECMs) according to ISO 50001 program.



[1] EcoStruxure™ Power Monitoring Expert, <http://pmedemo.biz/web/>  
ID: demo & Password: demo

# Compact INS/INV, NS, NSX and NSXm

## Overview of applications

The Compact range circuit breakers, switch-disconnectors and source-changeovers are the best choice for all standards and specific applications.

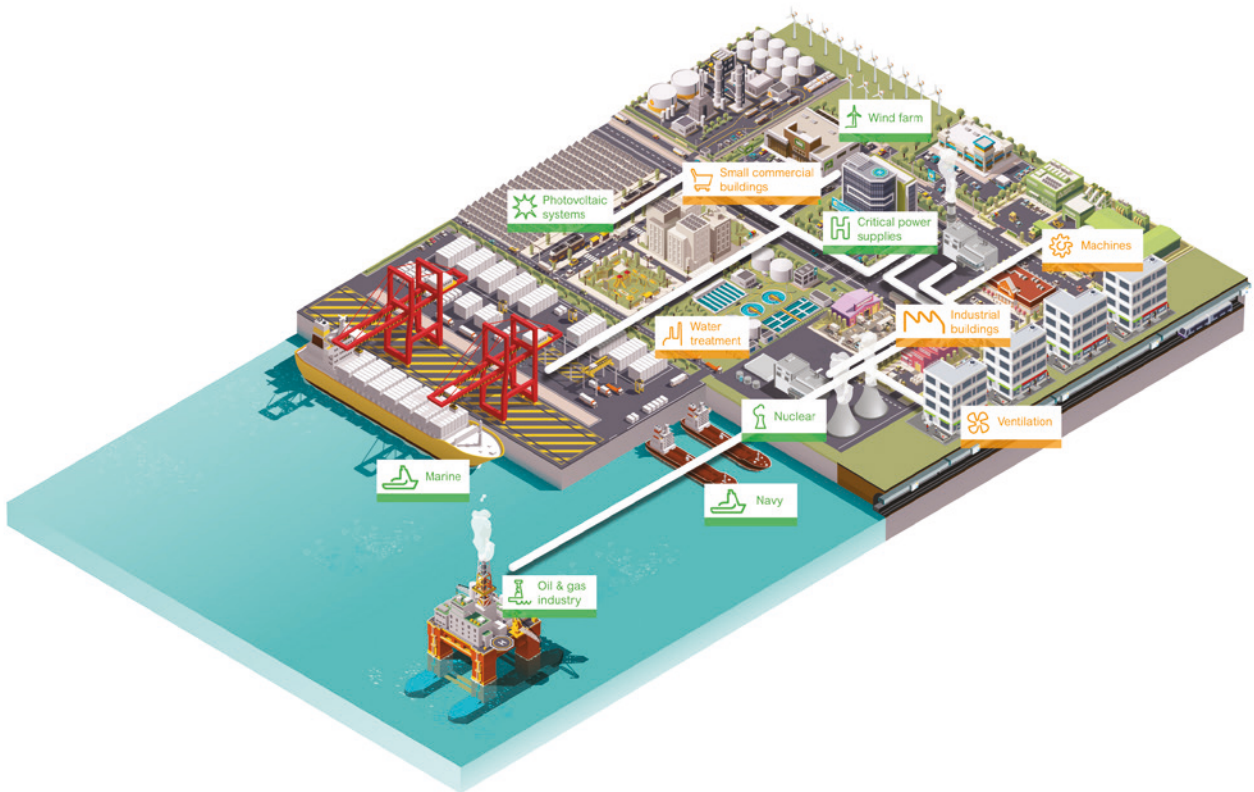

### > Compact NS



LVPED211021EN

### > Compact NSXm & NSX



LVPED217032EN

### > Transferpack (Source-changeover systems)



LVPED216028EN

### > Compact NSX, Compact INS/INV, Masterpack NW DC - DC PV



LVPED208006EN

### > Fupact



LVPED216031EN

### > Complementary technical information



LVPED308005EN



# General contents

## Compact INS/INV

Functions and characteristics

A

Installation recommendations

B

Dimensions and connection

C

Complementary technical information

D

Catalogue numbers

E



RIG  
TWO

BE AWARE  
STOP STOP  
STOP STOP  
STOP STOP  
STOP STOP

Production Reporting Worksheet									
Well No.	Product	Volume	Unit	Start	End	Time	Temp	Pressure	Notes
001	Oil	100	Barrels	10/1/20	10/2/20	08:00	120	100	Normal
002	Gas	50	Barrels	10/1/20	10/2/20	08:00	120	100	Normal
003	Water	200	Barrels	10/1/20	10/2/20	08:00	120	100	Normal
004	Oil	150	Barrels	10/1/20	10/2/20	08:00	120	100	Normal
005	Gas	75	Barrels	10/1/20	10/2/20	08:00	120	100	Normal
006	Water	300	Barrels	10/1/20	10/2/20	08:00	120	100	Normal
007	Oil	120	Barrels	10/1/20	10/2/20	08:00	120	100	Normal
008	Gas	60	Barrels	10/1/20	10/2/20	08:00	120	100	Normal
009	Water	250	Barrels	10/1/20	10/2/20	08:00	120	100	Normal
010	Oil	180	Barrels	10/1/20	10/2/20	08:00	120	100	Normal

# Functions and characteristics

- General characteristics .....A-2
- Compact NSX accessories and auxiliaries
  - Additional measurement module: PowerTag NSX ..... A-6
- Enerlin'X digital system
  - Overview ..... A-10
- Specific application ..... A-12
- Switch-disconnector selection
  - Compact INS40 to 160 ..... A-14
  - Compact INS250-100 to 630 ..... A-18
  - Compact INS630b to 2500 ..... A-22
  - Compact INSE80 and INSJ400 ..... A-26
  - Compact INV100 to 630 ..... A-28
  - Compact INV630b to 2500 ..... A-33
- Electrical and mechanical accessories
  - Compact INS40 to 80 ..... A-36
  - Compact INS100 to 160 ..... A-37
  - Compact INS250-100 to 630
  - Compact INV100 to 630 ..... A-38
  - Compact INS320 to 630
  - Compact INV320 to 630 ..... A-39
  - Compact INS630b to 1600
  - Compact INV630b to 1600 ..... A-40
  - Compact INS2000 to 2500
  - Compact INV2000 to 2500 ..... A-41
  - UL489/CSA22.2 standards ..... A-46
- Manual source-changeover systems ..... A-48
- Selection guide for DC switch-disconnectors ..... A-50
- Connection accessories ..... A-51
- Lineryg DS
  - Screw distribution blocks ..... A-54
- Lineryg DX
  - Quick distribution blocks ..... A-56
- Lineryg DP
  - Quick distribution blocks ..... A-58
- Installation ..... A-60



- Other chapters**
- Installation recommendations ..... B-1
- Dimensions and connection ..... C-1
- Complementary technical information ..... D-1
- Catalogue numbers ..... E-1

The Compact INS and INV switches are non-automatic switches with rotary handles.

**Note:** non-automatic switches do not provide overcurrent or short circuit protection and therefore must be protected by a suitable circuit breaker or fuse.

A

DB11488.eps

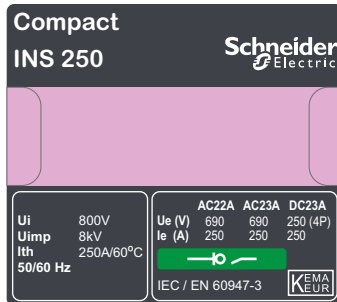

Ith: conventional thermal current.  
 Ui: rated insulation voltage.  
 Uimp: rated impulse-withstand voltage.  
 Ue: rated operational voltage.  
 Ie: rated operational current.  
 suitable for isolation.

### Conformity with standards

■ Compact INS/INV switch-disconnectors and auxiliaries comply with the following standards and international recommendations:

- IEC 60947-1: general rules
- IEC 60947-3: switches, disconnectors, switch-disconnectors, etc.
- IEC 60947-5.1 and following: control-circuit devices and switching elements; automatic-control components.

In that these standards and recommendations are applied in most countries, Compact INS/INV switch-disconnectors and auxiliaries comply with European (EN 60947-1, EN 60947-3, EN 60947-5-1)

- CCC (China)
- EAC (Customs Union)

■ the specifications of the Marine Classification companies (American Bureau of Shipping, Bureau Veritas, Det Norske Veritas –Germanischer Lloyd, Lloyd Register of Shipping, Nippon Kaiji Kyokai, China Classification Societies, Registro Italiano Navale, Korean Register of shipping, Russian Maritime registers of Shipping) .

■ Compact INS/INV switch-disconnectors and auxiliaries are suitable for the control of machine-tools in that they comply with the recommendations issues by the CNOMO organization.

### Easy Rotary Handle Operation

Rotary handles are designed to offer easy operation, yet high performance in interruption of currents. The handle is front-mounted with optional handle extensions.

### Installation in class II switchboards

All Compact INS/INV switch-disconnectors are class II front-face devices. They may be installed through the door of class II switchboards (as per standard IEC 60664) without downgrading switchboard insulation. Installation requires no special operations even when the switch-disconnector is equipped with rotary handles.

### Environmental withstand capacity (tropicalisation)

Compact INS/INV switch-disconnectors meet the environmental requirements of the following standards:

- IEC 60068-2-1 - dry cold (-55 °C)
- IEC 60068-2-1 - dry heat (+85 °C)
- IEC 60068-2-30 - damp heat (95 % relative humidity at +55 °C)
- IEC 68-2-52 (level 2) - salt mist.

### Degree of pollution

The Compact INS/INV range is certified for operation in pollution-degree 3 environments as defined by IEC standard 60947 for industrial environments.

### Ambient temperature

#### Operating-temperature range

- Compact INS/INV switch-disconnectors may be used between -25 °C and +70 °C.
- Switch-disconnectors should be put into service under the normal, ambient operating temperatures indicated above. Exceptionally, they may be put into service when the ambient temperature is between -35 °C and -25 °C.

#### Storage-temperature range

Compact INS/INV switch-disconnectors may be stored in their original packing between -50 °C and +85 °C.

### Environmental protection

Compact INS/INV switch-disconnectors take into account important concerns for environmental protection. Most components are recyclable. Insulating parts making up the Compact INS/INV switch-disconnectors are marked as specified in applicable environmental standards.

DB43247.eps

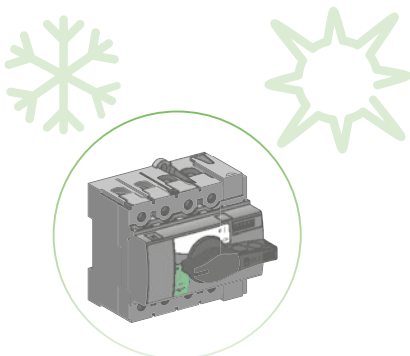



### Altitude

Compact INS/INV switch-disconnectors are designed to operate at their rated values at altitudes under 2000 metres.

Above 2000 metres, the changes in the characteristics of the ambient air (electrical resistance, cooling capacity) result in a reduction of the characteristics below.

Altitude (m)	2000	3000	4000	5000
Dielectric resistance voltage (V)	3500	3150	2500	2100
Rated insulation voltage (V)	750	700	600	500
Maximum utilisation voltage (V)	690	550	480	420
Rated current (A) at 60 °C	1 x I <sub>n</sub>	0.96 I <sub>n</sub>	0.93 I <sub>n</sub>	0.9 I <sub>n</sub>

### Vibrations

Compact INS/INV switch-disconnectors are guaranteed against electromagnetic or mechanical vibrations.

Tests are carried out in compliance with standard IEC 68-2-6 for the levels required by merchant-marine inspection organisations (Veritas, Lloyd's, etc.):

- 2 to 13.2 Hz: amplitude ±1 mm
- 13.2 to 100 Hz: constant acceleration 0.7 g.

Excessive vibration may cause tripping, breaks in connections or damage to mechanical parts.

### Electromagnetic compatibility

Compact INS/INV switch-disconnectors are protected against:

- overvoltages caused by devices that generate electromagnetic disturbances
- overvoltages caused by atmospheric disturbances or by a distribution-system outage (e.g. failure of a lighting system) and devices emitting radio waves (radios, walkie-talkies, radar, etc.).

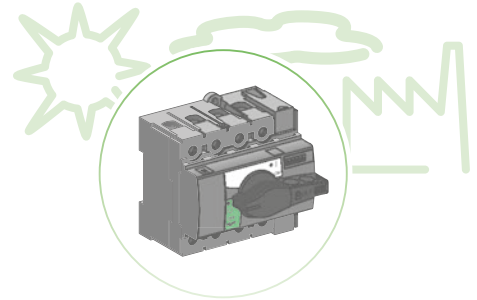

DB432448.eps

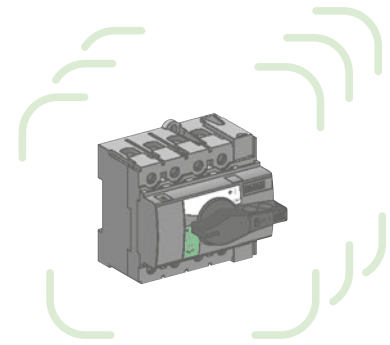

DB432449.eps

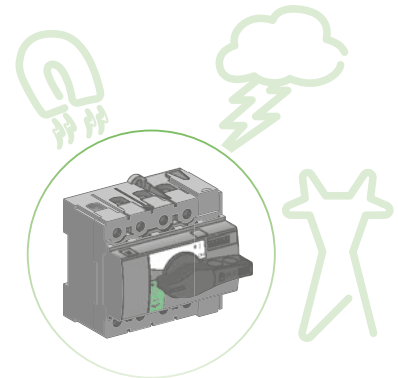

DB432450.eps

A



Switch-disconnector in dedicated enclosure IP66 with specific extended handle

### Degree of protection

Compact INS/INV switch-disconnectors offer the following protection characteristics depending on the installation conditions:

- IP: degree of protection (standard IEC 60529)
- IK: protection against external mechanical impacts (standard EN 50102).

<p><b>IP40 IK07</b></p> <p>DB105443.eps</p> <p>Bare switch-disconnector with terminal shields.</p>	<p><b>IP40 IK07</b></p> <p>DB105444.eps</p> <p>Switch-disconnector in cabinet or enclosure (direct handle).</p>	<p><b>IP55 IK08</b></p> <p>DB414050.eps</p> <p>Switch-disconnector in cabinet or enclosure (extended handle).</p>
<p><b>IP66 IK10</b></p> <p>DB425922.eps</p> <p>Switch-disconnector in dedicated enclosure with specific handle.</p>		

### Suitable for isolation with positive contact indication



All Compact INS/INV switch-disconnectors are suitable for isolation as defined in IEC standards 60947-1 and 3. The mechanical design of Compact switches ensures the position of the handle always reflects the position of the main contacts:

- the isolation position corresponds to the O (OFF) position
- the operating handle cannot indicate the OFF position unless the contacts are actually open
- padlocking in the OFF position is not possible unless the contacts are actually open.

Installation of an extended handle does not alter the suitability for isolation. The isolation function is certified by tests guaranteeing:

- the mechanical reliability of the position-indication system
  - the absence of leakage currents
  - overvoltage withstand capacity between upstream and downstream connections.
- The Compact switch-disconnector range can be used as disconnecting mean.

### Suitable for isolation with visible break

The physical separation of the main contacts is directly visible through a transparent cover.

The Compact INV range offers both positive contact indication and visible break.

### Emergency-off switch-disconnector

This switch-disconnector can be used as an emergency-off device. For this application, it must be easily visible, accessible and identifiable (see standards and rules concerning the safety of machines VDE 0660, VDE 0113, CNOMO, etc.). For easy identification, the emergency-off switch-disconnector uses special colours stipulated by the standards and different from those of the standard version:

- yellow for the front face of the device
- red for the handle.

The electrical and mechanical performance characteristics of Compact INS/INV emergency-off switch-disconnector are the same as those of the standard version. The emergency-off switch-disconnectors are available in positive contact indication and visible-break versions.



Suitable for isolation with positive contact indication.



Suitable for isolation with visible break.

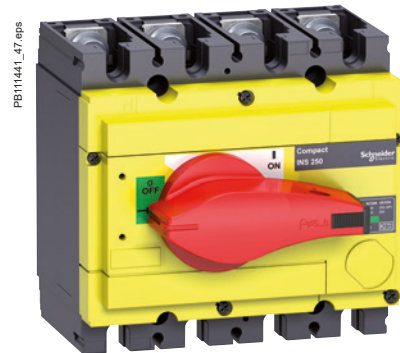

INS250 emergency-off switch-disconnector.

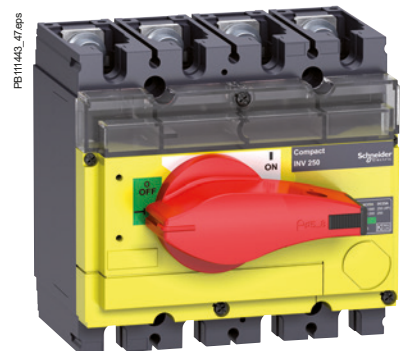

INV250 emergency-off switch-disconnector.



# Compact NSX accessories and auxiliaries

## Additional measurement module: PowerTag NSX

A

PowerTag NSX is a Compact NSX wireless-communication modules for 3P and 3P+N electrical networks, mounted directly on the bottom side of the circuit breaker or the Vigi add-on. PowerTag NSX provides capability to measure energy, monitor voltage loss, and trigger alarms. It then delivers useful data for monitoring and diagnosis of the associated circuit breaker through Smartlink concentrator.

In combination with PowerTag Acti9, you can take advantage of a full wireless class 1 solution to monitor energy and to be aware in case of voltage loss or alarming at any level of a distribution panel, being able to take immediately the right actions in case of electrical issue. In addition to monitoring and alarming, PowerTag solution provides a complete knowledge of real time electrical values with a rich and accurate data transfer every 5 seconds.

PowerTag energy sensors can be quickly and easily installed in new or existing panels at any time. Compared to traditional metering solutions, installation time and commissioning are much shorter with no wiring, hence an error proof high density solution and a built-in class 1 accuracy.



PowerTag NSX.

### Functions

PowerTag NSX energy sensor measures the following values in accordance with the IEC 61557-12 standard:

- Energy (4 quadrants):
  - Active energy (kWh): total and partial, delivered and received.
  - Active energy per phase (kWh): total.
  - Reactive energy (VARh): partial, delivered and received.
- Power:
  - Active power (W): total and per phase
  - Reactive power (VAR): total
  - Apparent power (VA): total.
- Voltages (V): phase-to-phase (U12, U23, U31) and phase-to-neutral (V1N, V2N, V3N)
- Currents (A): per phase (I1, I2, I3)
- Frequency
- Power factor
- Voltage loss alarm:
  - PowerTag energy sensor sends a "voltage loss" alarm and the current-per-phase value before being de-energized,
  - At "voltage loss", PowerTag adds an overload alarm if the current is higher than the rated current of the associated protective device.

### Installation

The module is self-powered and is installed directly on the bottom side of the circuit breaker or Vigi add-on terminals. It communicates wirelessly to SmartLink which can concentrate data for up to 20 PowerTag in the same panel.

PowerTag NSX 3P has to be used with 3P devices, and an external neutral voltage tap is provided in case of the installation has a neutral to provide phase-to-neutral voltages, active energy per phase and power per phase. PowerTag 3P+N has to be used with 4P devices.

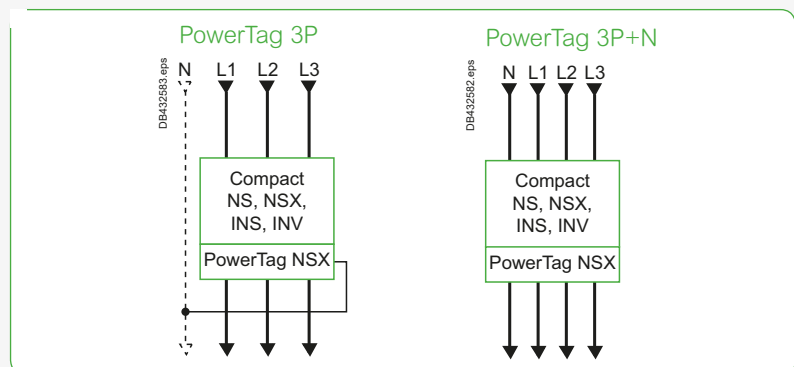

PowerTag NSX modules are compatible with Compact NSX100/160/250, Compact NSX400/630, Compact INS250-100A to 250A, Compact INS320/400/500/630, Compact INV100/160/200/250, Compact INV320/400/500/630, Compact NS100/160/250 and Compact NS400/630.

In case of retrofit, following points have to be checked:

- Clearance to be able to add PowerTag module (see dimensions in chapter E) and to respect bending radius of cables
- Condition of power connectors: to be replaced if damaged
- Tightening torques depending of the connector used



# Compact NSX accessories and auxiliaries

## Additional measurement module: PowerTag NSX



### Integration in Smartlink

Smartlink concentrate wirelessly data from PowerTag and make them available over Ethernet:

#### For Commercial & Building applications

##### Acti9 Smartlink SI D (Monitoring)



A9XMWA20

##### Acti9 Smartlink SI B (Monitoring & Control)

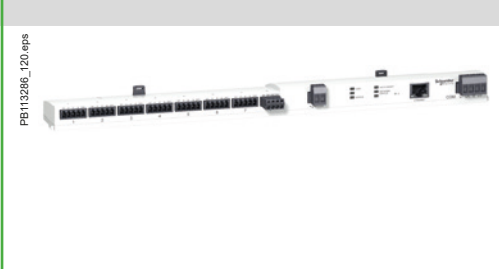

A9XMZA08

#### For Small Business applications

##### Acti9 Smartlink EL D (Monitoring)



A9XELC10

Smartlink embedded web pages allow:

- to do commissioning
- to display measured values
- to set and display alarms and pre-alarms.

Refer to the concentrator catalogue for more information.

### Commissioning

Commissioning can be done very easily:

- for Smartlink EL: with a smartphone
- for Smartlink SI: with embedded webpages or with Ecoreach which provides a test report for system integration with all the Modbus registers, including bits and descriptions associated

# Compact NSX accessories and auxiliaries

## Additional measurement module: PowerTag NSX

### Metering and monitoring

Acti 9 Smartlink SI D (Ethernet)

### Metering, monitoring and control

Acti 9 Smartlink SI B (Ethernet)

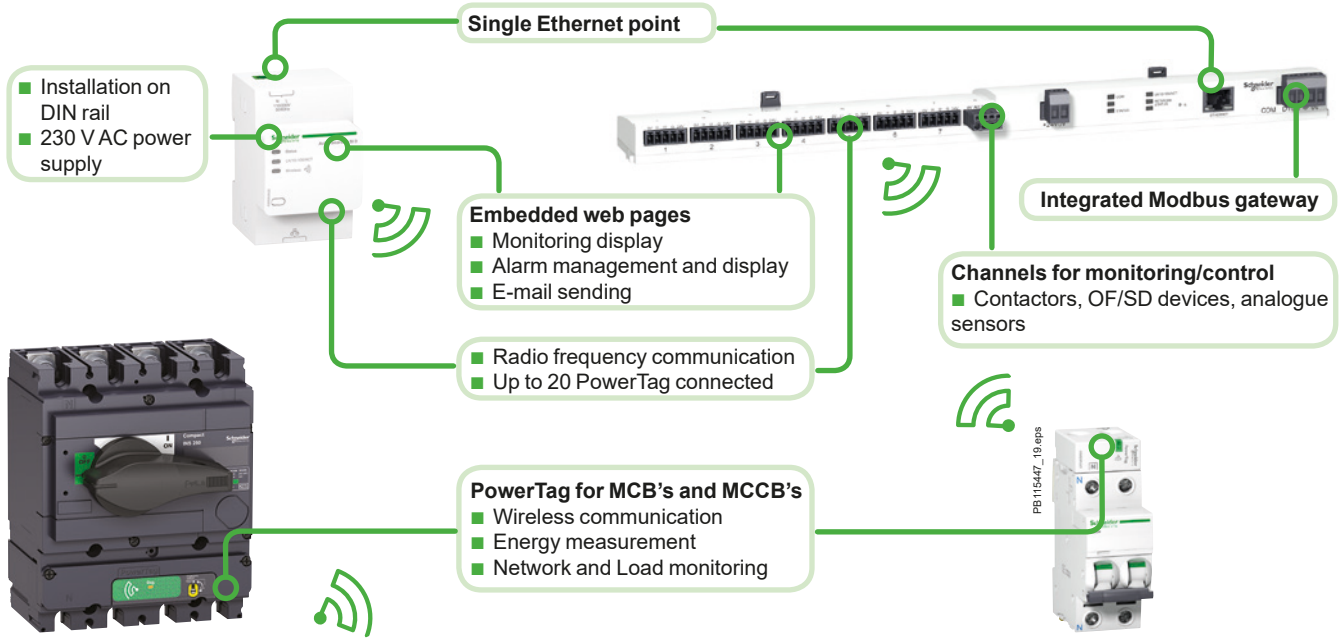

## Technical characteristics

### Main characteristics

Rated voltage	Un	Phase-to-neutral	230 VAC ± 20 %
		Phase-to-phase	400 VAC ± 20 %
Frequency			50/60 Hz
Operating current	In		250 A / 630 A
Maximum operating current			1.2 x In
Saturation current			2 x In
Maximum consumption			3.7 VA
Starting current	Ist		160 mA / 400 mA
Base current	Ib		40 A / 100 A

### Additional characteristics

Operating temperature			-25 °C to +70 °C
Storage temperature			-50 °C to +85 °C
Oversvoltage category		As per IEC 61010-1	Cat. IV
Measuring category		As per IEC 61010-2-30	Cat. III
Pollution degree			3
Altitude			Up to 2000m without derating <sup>[1]</sup>
Degree of protection device			IP20 IK07

### Radio-frequency communication

ISM band 2.4 GHz			2.4 GHz to 2.4835 GHz
Channels		As per IEEE 802.15.4	11 to 26
Isotropic Radiated Power		Equivalent (EIRP)	0 dBm
Maximum transmission time			< 5 ms
Channel occupancy		For 1 device	messages sent every 5 seconds

### Characteristics of measuring functions

Function	Symbol	Performance as per IEC 61557-12		Measuring range (250 A / 630 A)
		Class	Measuring range (250 A / 630 A)	
Active power (per phase, total)	P	1	4 to 250 A / 10 to 630 A	88 W to 416 kW / 221 W to 1048 kW
Total reactive power	Q <sub>A</sub>	2		88 VAR to 416 kVAR / 221 VAR to 1048 kVAR
Total apparent power	S <sub>A</sub>	2		88 VA to 416 kVA / 221 VA to 1048 kVA
Active Energy (per phase, total, partial)	E <sub>a</sub>	1		0 to 281.10 <sup>9</sup> kWh
Total reactive Energy	E <sub>rA</sub>	2		0 to 281.10 <sup>9</sup> kVARh
Frequency	f	1	45 to 55 Hz	45 to 65 Hz
Phase current	I	1	8 to 250 A / 20 to 630 A	160 mA to 500 A / 400 mA to 1260 A
Voltages (Line to Line)	U	0.5	Un ± 20 %	320 to 480 VAC
Power factor (arithmetic)	PF <sub>A</sub>	1	From 0.5 inductive to 0.8 capacitive	-1 to 1

[1] Above 2000m, please consult us.

# Compact NSX accessories and auxiliaries

## Additional measurement module: PowerTag NSX

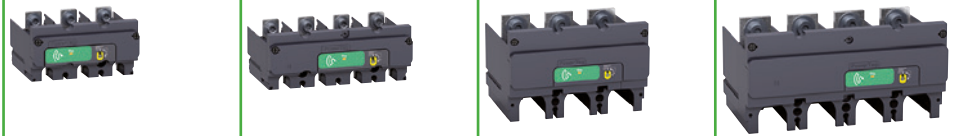

Products (AC network)		Mounting position	250 3P	250 3P+N	630 3P	630 3P+N
<b>Compact</b>						
<b>Circuit breakers</b>						
<b>NSX100/160/250</b>	3P	Bottom	☑	-	-	-
<b>B/F/N/H/S/L/R Fixed</b>	4P	Bottom	-	☑	-	-
<b>NSX400/630</b>	3P	Bottom	-	-	☑	-
<b>F/N/H/S/L/R Fixed</b>	4P	Bottom	-	-	-	☑
<b>NSX100/160/250</b>	3P	Top / Bottom	☑	-	-	-
<b>B/F/N/H/S/L/R Plug-In (mounted on the base)</b>	4P	Top / Bottom	-	☑ [1]	-	-
<b>NSX400/630</b>	3P	Top / Bottom	-	-	☑ [2]	-
<b>F/N/H/S/L/R Plug-In (mounted on the base)</b>	4P	Top / Bottom	-	-	-	☑ [1] [2]
<b>NS100/160/250</b>	3P	Bottom	☑	-	-	-
<b>N/SX/H/L Fixed</b>	4P	Bottom	-	☑	-	-
<b>NS400/630</b>	3P	Bottom	-	-	☑	-
<b>N/H/L Fixed</b>	4P	Bottom	-	-	-	☑
<b>NS100/160/250</b>	3P	Top / Bottom	☑	-	-	-
<b>N/SX/H/L Plug-in</b>	4P	Top / Bottom	-	☑ [1]	-	-
<b>NS400/630</b>	3P	Top / Bottom	-	-	☑ [2]	-
<b>N/H/L Plug-in</b>	4P	Top / Bottom	-	-	-	☑ [1] [2]
<b>Circuit breakers equipped with Vigi block</b>						
<b>NSX100/160/250</b>	3P	Bottom	☑	-	-	-
<b>B/F/N/H/S/L/R Fixed</b>	4P	Bottom	-	☑	-	-
<b>NSX400/630</b>	3P	Bottom	-	-	☑	-
<b>F/N/H/S/L/R Fixed</b>	4P	Bottom	-	-	-	☑
<b>NSX100/160/250</b>	3P	Top	☑	-	-	-
<b>B/F/N/H/S/L/R Plug-In (mounted on the base)</b>	3P	Top	-	-	☑ [2]	-
<b>NSX400/630</b>	3P	Top	-	-	☑ [2]	-
<b>F/N/H/S/L/R Plug-In (mounted on the base)</b>	3P	Top	-	-	☑ [2]	-
<b>Switches</b>						
<b>INS250/INV - 100/160/200/250</b>	3P	Bottom	-	☑	-	-
	4P	Top / Bottom	-	☑ [1]	-	-
<b>INS/INV - 320/400/500/630</b>	3P	Bottom	-	-	-	☑
	4P	Top / Bottom	-	-	-	☑ [1]

[1] neutral on the right when mounted on top side

[2] when plate mounted, need to add an intercalary under the PowerTag module with following dimensions:

A

# Functions and characteristics

## Enerlin'X digital system

### Overview

Enerlin'X communication system provides access to status, electrical values and devices control using Ethernet and Modbus SL communication protocols.

**Ethernet** has become the universal link between switchboards, computers and communication devices inside the building. The large amount of information which can be transferred makes the connection of Enerlin'X digital system to hosted web services of Schneider Electric a reality. More advantages are offered to integrators thanks to configuration web pages available remotely or on the local Ethernet network.





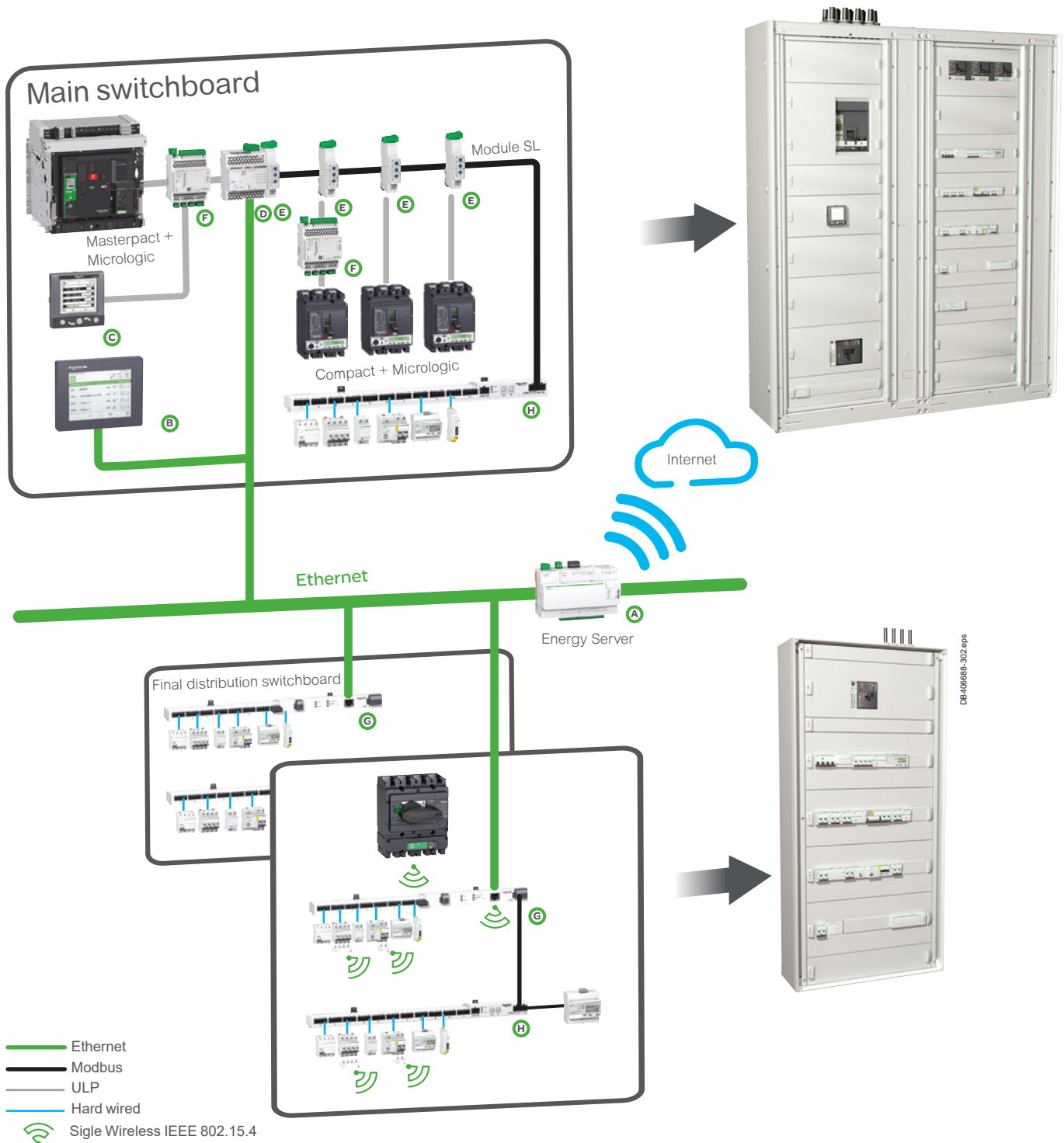



**Modbus SL** is the most widely used communication protocol in industrial networks. It operates in master-slave mode. The devices (slaves) communicate one after the other with a gateway (master).

A





# Functions and characteristics Enerlin'X digital system Overview

Enerlin'X digital devices and displays							
	Name	Function	Port (to device) (to server)		Inputs	Outputs	Cial. Ref.
A	 Com'X 210	Energy data logger + Ethernet Gateway	Ethernet Modbus Master, Zigbee (to wireless meters)	Ethernet cable + WiFi	64 devices: 6 binary 2 analog 32 Modbus devices + other Ethernet devices (Modbus TCP)	-	EBX210
	Com'X 510 24 V DC + PoE	Energy server + Ethernet Gateway				-	EBX510
B	 FDM128	Ethernet LCD colour touch screen	-	Ethernet		-	LV434128
C	 FDM121	LCD display for circuit breaker	ULP	-	1 circuit breaker	-	TRV00121
D	 IFE Switchboard server	Switchboard server	Modbus Master & ULP	Ethernet	20 circuit breakers	-	LV434002
	IFE interface	Ethernet interface for circuit breakers	ULP	Ethernet	1 circuit breaker	-	LV434001
E	 IFM	Modbus interface for circuit breaker	ULP	Modbus Slave	1 circuit breaker	-	LV434000
F	 I/O	Input/Output application module for circuit breaker	ULP	ULP	6 binary 1 analog (PT100 sensor)	3	LV434063
G	 Acti 9 Smartlink SI B Ethernet wireless	Ethernet server for I/O and Modbus slave devices	Modbus Master & Wireless to PowerTag	Ethernet	14 binary 2 analog	7	A9XMZA08
H	 Acti 9 Smartlink Modbus slave	Modbus interface with Input/Output functions	-	Modbus Slave	22 binary	11	A9XMSB11

**Ethernet Gateway or Interface:** routes an internal traffic (ULP or other protocole) to the Internet, the outgoing messages are coded with Modbus TCPIP protocol.

**Server (Switchboard, Energy):** routes the internal traffic to the Internet. Other complementary functions such as data logging and storage. Provides devices status and energy trends on internal web pages...



PB11141C\_L35.eps



Compact INSE80.

A

PB111487\_L38.eps



Compact INSJ400.

PB111403\_L42.eps

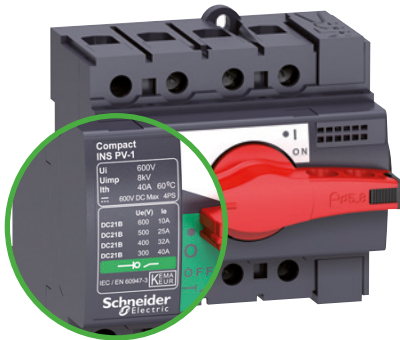

Compact INS PV-1.

PB104853.eps



### OEM application

The INSE/INSJ circuit breakers are ideal for industrial and OEM applications. They are UL489 and CSA C22.2 N°5-02 for INSE and C22.2 N°5-13 for INSJ certified.

### Photovoltaic application

No matter the size or scale of the project, Schneider Electric, has a photovoltaic solution to fit your needs. Fast ROI, high efficiency – it's all a part of our offer as the world leader in energy management.

The INS PV-1 is a direct current switch-disconnector dedicated to array isolation and control with Voc until 600 V DC.

#### Product used

Description	Current	Reference	Weight (kg)
INS PV-1 switch-disconnector	40 A	<b>28907</b>	0.657

#### Compact

#### INS80 PV

Number of poles	4 serial poles		
<b>Electrical characteristics</b>			
Conventional thermal current (A)	Ith		
Conventional thermal current in enclosure (A) Ithe			
Rated insulation level (DC V)	Ui		
Impulse-withstand voltage (kV)	Uimp		
Rated operational voltage (DC V)	Ue		
Rated operational voltage DC21B (V)			
Rated operational current (A)	Ie	Electrical DC	
	DC21B	600	
	DC21B	500	
	DC21B	400	
	DC21B	300	
Rated duties	Uninterrupted duty -		
	Intermittent duty Class 120 - 60 %		
Short-circuit making capacity (kA peak)	Icm		
Short-time withstand current (A rms)	Icw		
Suitability for isolation	Yes		
Durability (O-C cycles)	Mechanical	20000	
	Electrical DC	600 V 1500	
Positive contact indication	Yes		
Visible break	-		
Emergency-off switch-disconnector	Yes		
Degree of pollution	3		

### High performances applications (tunnel...)

- Well suited to harsh environment
- The enclosed switch-disconnector compact INS250-200A 3P offers IP66 and IK10 degrees of protection in both versions steel and stainless steel.
- The switch-disconnector has been successfully tested by third party F200 (during more than 2 hours at 200 °C) according with European Fire Regulation EN12101-3:20002. After the heating test, the current carrying path is still operating ensuring power supply even in case of fire.
- The individual enclosure is equipped with:
  - cover, screwed
  - 2 cable-gland M50 up and down for power supply
  - provides location for 2 cable-gland M20 for electrical auxiliaries early break and make outputs (provided within the enclosure)
  - 4 adjustable fixing brackets
  - IP66 extended rotary handle.



A

## Functions and characteristics

# Switch-disconnector selection

## Compact INS40 to 160

PB11402\_30.eps



Compact INS40 to 80 switch-disconnector.

PB11403\_30.eps



Compact INS40 to 80 emergency-off switch-disconnector.

PB11406\_42.eps



Compact INS100 to 160 switch-disconnector.

PB11407\_42.eps



Compact INS100 to 160 emergency-off switch-disconnector.

### Compact INS switch-disconnectors

Number of poles

#### Electrical characteristics as defined by IEC 60947-1 / 60947-3 and EN 60947-1 / 60947-3

Conventional thermal current (A)	<b>I<sub>th</sub></b>	at 60 °C
Conventional thermal current in enclosure	<b>I<sub>the</sub></b>	at 60 °C
Rated insulation level (V)	<b>U<sub>i</sub></b>	AC 50/60 Hz
Impulse-withstand voltage (kV)	<b>U<sub>imp</sub></b>	
Rated operational voltage (V)	<b>U<sub>e</sub></b>	AC 50/60 Hz DC
Rated operational voltage AC20 and DC20 (V)		AC 50/60 Hz

Rated operational current (A)	<b>I<sub>e</sub></b>	<b>Electrical AC 50/60 Hz</b>	220-240 V
			380-415 V
			440-480 V
			500 V
			660-690 V

<b>Electrical DC</b>	125 V (2P in series)
	250 V (4P in series)

Rated operational power AC23 (kW)	<b>Electrical AC 50/60 Hz</b>	220-240 V
		380-415 V
		440 V
		500-525 V
		660-690 V

Rated duties	Uninterrupted duty
	Intermittent duty
Short-circuit making capacity (kA peak)	<b>I<sub>cm</sub></b> Min. (switch-disconnector alone)
	Max. (with upstream protection circuit breaker)
Short-time withstand current (A rms)	<b>I<sub>cw</sub></b> 1 s
	3 s
	20 s
	30 s

Suitability for isolation	
Durability (O-C cycles)	Mechanical
	<b>Electrical AC 50/60 Hz</b>
	220-240 V
	380-415 V
	440 V
500 V	
690 V	
<b>Electrical DC</b>	250 V

Positive contact indication
Visible break
Emergency-off switch-disconnector
Degree of pollution

#### Upstream protection

See the "Complementary technical information" page D-1.



# Switch-disconnector selection

## Compact INS40 to 160

INS40		INS63		INS80		INS100		INS125		INS160	
3-4		3-4		3-4		3-4		3-4		3-4	
<b>47-3</b>											
40		63		80		100		125		160	
40		63		80		100		125		160	
690		690		690		800		800		800	
8		8		8		8		8		8	
500		500		500		690		690		690	
250		250		250		250		250		250	
690		690		690		750		750		750	
<b>AC22A</b>	<b>AC23A</b>	<b>AC22A</b>	<b>AC23A</b>	<b>AC22A</b>	<b>AC23A</b>	<b>AC22A</b>	<b>AC23A</b>	<b>AC22A</b>	<b>AC23A</b>	<b>AC22A</b>	<b>AC23A</b>
40	40	63	63	80	80	100	100	125	125	160	160
40	40	63	63	80	72	100	100	125	125	160	160
40	40	63	63	80	63	100	100	125	125	160	160
40	32	63	40	80	40	100	100	125	125	160	160
-	-	-	-	-	-	100	63	125	80	160	100
<b>DC22A</b>	<b>DC23A</b>	<b>DC22A</b>	<b>DC23A</b>	<b>DC22A</b>	<b>DC23A</b>	<b>DC22A</b>	<b>DC23A</b>	<b>DC22A</b>	<b>DC23A</b>	<b>DC22A</b>	<b>DC23A</b>
40	40	63	63	80	80	100	100	125	125	160	160
40	40	63	63	80	80	100	100	125	125	160	160
11	15	22	22	22	22	22	22	37	37	45	45
20	30	37	37	37	37	45	45	55	55	75	75
22	30	37	37	37	37	55	55	55	55	90	90
18,5	22	22	22	22	22	55	55	75	75	110	110
-	-	-	-	-	-	55	55	75	75	90	90
⊙	⊙	⊙	⊙	⊙	⊙	⊙	⊙	⊙	⊙	⊙	⊙
Class 120 - 60 %		Class 120 - 60 %		Class 120 - 60 %		Class 120 - 60 %		Class 120 - 60 %		Class 120 - 60 %	
15		15		15		20		20		20	
75		75		75		154		154		154	
3000		3000		3000		5500		5500		5500	
1730		1730		1730		3175		3175		3175	
670		670		670		1230		1230		1230	
550		550		550		1000		1000		1000	
⊙	⊙	⊙	⊙	⊙	⊙	⊙	⊙	⊙	⊙	⊙	⊙
20000		20000		20000		15000		15000		15000	
<b>AC22A</b>	<b>AC23A</b>	<b>AC22A</b>	<b>AC23A</b>	<b>AC22A</b>	<b>AC23A</b>	<b>AC22A</b>	<b>AC23A</b>	<b>AC22A</b>	<b>AC23A</b>	<b>AC22A</b>	<b>AC23A</b>
1500	1500	1500	1500	1500	1500	1500	1500	1500	1500	1500	1500
1500	1500	1500	1500	1500	1500	1500	1500	1500	1500	1500	1500
1500	1500	1500	1500	1500	1500	1500	1500	1500	1500	1500	1500
1500	1500	1500	1500	1500	1500	1500	1500	1500	1500	1500	1500
-	-	-	-	-	-	1500	1500	1500	1500	1500	1500
<b>DC22A</b>	<b>DC23A</b>	<b>DC22A</b>	<b>DC23A</b>	<b>DC22A</b>	<b>DC23A</b>	<b>DC22A</b>	<b>DC23A</b>	<b>DC22A</b>	<b>DC23A</b>	<b>DC22A</b>	<b>DC23A</b>
1500	1500	1500	1500	1500	1500	1500	1500	1500	1500	1500	1500
⊙	⊙	⊙	⊙	⊙	⊙	⊙	⊙	⊙	⊙	⊙	⊙
-	-	-	-	-	-	-	-	-	-	-	-
⊙	⊙	⊙	⊙	⊙	⊙	⊙	⊙	⊙	⊙	⊙	⊙
3	3	3	3	3	3	3	3	3	3	3	3
-	-	-	-	-	-	-	-	-	-	-	-



# Switch-disconnector selection

## Compact INS40 to 160

A

### Compact INS switch-disconnectors

#### Installation

Fixed, front connection

Fixed, rear connection

On symmetrical rails

On a backplate

#### Connection

By cables To bare cable connectors

By cables with lugs Directly to terminals

To spreaders

To vertical-connection adapters via cable-lug adapters

Flat-facing bars Directly to terminals

To spreaders

Edgewise bars To vertical-connection adapters

#### Indication and measurement auxiliaries

Auxiliary contacts

Voltage-presence indicator

Current-transformer module

Ammeter module

#### Control, locking and interlocking

Control Direct front rotary handle

Extended front rotary handle

Direct lateral rotary handle

Extended lateral rotary handle

Locking By keylock  
By padlocks

Interlocking By keylock  
Mechanical

Complete source-changeover assembly

Operating torque (Nm) (typical value for 3-4 poles with front handle)

#### Installation and connection accessories

Bare cable connectors

Rear connectors

Terminal extensions

Spreaders

One-piece spreader

Terminal shrouds

Terminal shields

Interphase-barrier

Front panel escutcheons

Coupling accessories

Tightening torque for electrical connections (Nm)

#### Dimensions and weights

Overall dimensions H x W x D (mm) 3 poles

4 poles

Approximate weight (kg) 3 poles

4 poles

#### Enclosure dimensions for lthe

H x W x D (mm)

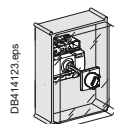
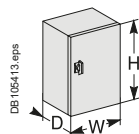

H x W x D (mm)

# Switch-disconnector selection

## Compact INS40 to 160

A

INS40	INS63	INS80	INS100	INS125	INS160
○	○	○	○	○	○
-	-	-	○	○	○
○	○	○	-	-	-
○	○	○	○	○	○
○	○	○	○	○	○
-	-	-	○	○	○
-	-	-	-	-	-
-	-	-	-	-	-
○	○	○	○	○	○
-	-	-	-	-	-
-	-	-	-	-	-
○	○	○	○	○	○
-	-	-	-	-	-
-	-	-	-	-	-
○	○	○	○	○	○
-	-	-	-	-	-
-	-	-	-	-	-
○	○	○	○	○	○
○	○	○	○	○	○
○	○	○	○	○	○
○	○	○	○	○	○
-	-	-	-	-	-
○	○	○	○	○	○
-	-	-	-	-	-
-	-	-	-	-	-
0.7 < Nm < 1.3	0.7 < Nm < 1.3	0.7 < Nm < 1.3	1.4 < Nm < 2	1.4 < Nm < 2	1.4 < Nm < 2
○	○	○	○	○	○
-	-	-	-	-	-
-	-	-	-	-	-
-	-	-	-	-	-
○	○	○	○	○	○
○	○	○	○	○	○
○	○	○	○	○	○
-	-	-	-	-	-
-	-	-	-	-	-
5	5	5	8	8	8
85 x 90 x 62.5	85 x 90 x 62.5	85 x 90 x 62.5	100 x 135 x 62.5	100 x 135 x 62.5	100 x 135 x 62.5
85 x 90 x 62.5	85 x 90 x 62.5	85 x 90 x 62.5	100 x 135 x 62.5	100 x 135 x 62.5	100 x 135 x 62.5
0.5	0.5	0.5	0.8	0.8	0.8
0.6	0.6	0.6	0.9	0.9	0.9
350 X 350 X 270	350 X 350 X 270	350 X 350 X 270	350 X 350 X 270	350 X 350 X 270	350 X 350 X 270
270 x 180 x 185	270 x 180 x 185	270 x 180 x 185	270 x 180 x 185	270 x 180 x 185	270 x 180 x 185

# Switch-disconnector selection

## Compact INS250-100 to 630

A

PB111440\_52.eps



Compact INS250 switch-disconnector.

PB111441\_47.eps

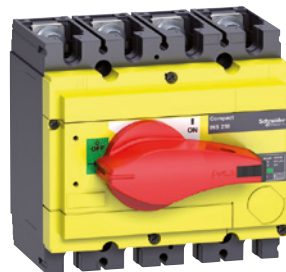

Compact INS250 emergency-off switch-disconnector.

PB111492\_49.eps



Compact INS630 switch-disconnector.

PB111493\_49.eps

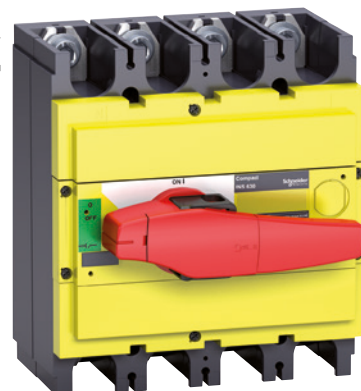

Compact INS630 emergency-off switch-disconnector.

### Compact INS switch-disconnectors

Number of poles

#### Electrical characteristics as defined by IEC 60947-1 / 60947-3 and EN 60947-1 / 60947-3

Conventional thermal current (A)	<b>I<sub>th</sub></b>	at 60 °C
Conventional thermal current in enclosure	<b>I<sub>the</sub></b>	at 60 °C
Rated insulation level (V)	<b>U<sub>i</sub></b>	AC 50/60 Hz
Impulse-withstand voltage (kV)	<b>U<sub>imp</sub></b>	
Rated operational voltage (V)	<b>U<sub>e</sub></b>	AC 50/60 Hz DC
Rated operational voltage AC20 and DC20 (V)		AC 50/60 Hz
Rated operational current (A)	<b>I<sub>e</sub></b>	<b>Electrical AC 50/60 Hz</b>
		220-240 V
		380-415 V
		440-480 V
		500-525 V
		660-690 V
		<b>Electrical DC</b>
		125 V (2P in series)
		250 V (4P in series)
Rated operational power AC23 (kW)		<b>Electrical AC 50/60 Hz</b>
		220-240 V
		380-415 V
		440 V
		500-525 V
		660-690 V

Rated duties		Uninterrupted duty
		Intermittent duty
Short-circuit making capacity (kA peak)	<b>I<sub>cm</sub></b>	Min. (switch-disconnector alone)
		Max. (with upstream protection circuit breaker)
Short-time withstand current (A rms)	<b>I<sub>cw</sub></b>	1 s
		3 s
		20 s
		30 s

Suitability for isolation		
Durability (O-C cycles)		<b>Mechanical</b>
		<b>Electrical AC 50/60 Hz</b>
		440 V
		500 V
		690 V
		<b>Electrical DC</b>
		250 V

Positive contact indication	
Visible break	
Emergency-off switch-disconnector	
Degree of pollution	

#### Upstream protection

See the "Complementary technical information" page D-1.

[1] 550 A (DC).



# Switch-disconnector selection

## Compact INS250-100 to 630



INS250-100		INS250-160		INS250-200		INS250		INS320		INS400		INS500		INS630		
3-4		3-4		3-4		3-4		3-4		3-4		3-4		3-4		
100		160		200		250		320		400		500		630		
100		160		200		250		320		400		500		630 <sup>[1]</sup>		
800		800		800		800		800		800		800		800		
8		8		8		8		8		8		8		8		
690		690		690		690		690		690		690		690		
250		250		250		250		250		250		250		250		
750		750		750		750		750		750		750		750		
<b>AC22A</b>	<b>AC23A</b>	<b>AC22A</b>	<b>AC23A</b>	<b>AC22A</b>	<b>AC23A</b>	<b>AC22A</b>	<b>AC23A</b>	<b>AC22A</b>	<b>AC23A</b>	<b>AC22A</b>	<b>AC23A</b>	<b>AC22A</b>	<b>AC23A</b>	<b>AC22A</b>	<b>AC23A</b>	
100	100	160	160	200	200	250	250	320	320	400	400	500	500	630	630	
100	100	160	160	200	200	250	250	320	320	400	400	500	500	630	630	
100	100	160	160	200	200	250	250	320	320	400	400	500	500	630	630	
100	100	160	160	200	200	250	250	320	320	400	400	500	500	630	630	
<b>DC22A</b>	<b>DC23A</b>	<b>DC22A</b>	<b>DC23A</b>	<b>DC22A</b>	<b>DC23A</b>	<b>DC22A</b>	<b>DC23A</b>	<b>DC22A</b>	<b>DC23A</b>	<b>DC22A</b>	<b>DC23A</b>	<b>DC22A</b>	<b>DC23A</b>	<b>DC22A</b>	<b>DC23A</b>	<b>DC23B</b>
100	100	160	160	200	200	250	250	320	320	400	400	500	500	630	630	
100	100	160	160	200	200	250	250	320	320	400	400	500	500	550	550	630
100	100	160	160	200	200	250	250	320	320	400	400	500	500	550	550	630
22	45	55	75	90	110	132	150	185	220	250	355	400	560	200	315	
45	75	90	110	132	160	210	250	400	500	500	500	500	500	400	400	
55	90	110	132	160	220	250	250	400	400	400	400	400	400	400	400	
55	110	132	160	210	220	250	250	400	400	400	400	400	400	400	400	
55	90	160	210	250	400	400	400	400	400	400	400	400	400	400	400	
⊙	⊙	⊙	⊙	⊙	⊙	⊙	⊙	⊙	⊙	⊙	⊙	⊙	⊙	⊙	⊙	
Class 120 - 60 %	Class 120 - 60 %	Class 120 - 60 %	Class 120 - 60 %	Class 120 - 60 %	Class 120 - 60 %	Class 120 - 60 %	Class 120 - 60 %	Class 120 - 60 %	Class 120 - 60 %	Class 120 - 60 %	Class 120 - 60 %	Class 120 - 60 %	Class 120 - 60 %	Class 120 - 60 %	Class 120 - 60 %	
30	30	30	30	30	50	50	50	50	50	50	50	50	50	50	50	
330	330	330	330	330	330	330	330	330	330	330	330	330	330	330	330	
8500	8500	8500	8500	8500	20000	20000	20000	20000	20000	20000	20000	20000	20000	20000	20000	
4900	4900	4900	4900	4900	11500	11500	11500	11500	11500	11500	11500	11500	11500	11500	11500	
2200	2200	2200	2200	2200	4900	4900	4900	4900	4900	4900	4900	4900	4900	4900	4900	
1800	1800	1800	1800	1800	4000	4000	4000	4000	4000	4000	4000	4000	4000	4000	4000	
⊙	⊙	⊙	⊙	⊙	⊙	⊙	⊙	⊙	⊙	⊙	⊙	⊙	⊙	⊙	⊙	
15000	15000	15000	15000	15000	10000	10000	10000	10000	10000	10000	10000	10000	10000	10000	10000	
<b>AC22A</b>	<b>AC23A</b>	<b>AC22A</b>	<b>AC23A</b>	<b>AC22A</b>	<b>AC23A</b>	<b>AC22A</b>	<b>AC23A</b>	<b>AC22A</b>	<b>AC23A</b>	<b>AC22A</b>	<b>AC23A</b>	<b>AC22A</b>	<b>AC23A</b>	<b>AC22A</b>	<b>AC23A</b>	
1500	1500	1500	1500	1500	1500	1500	1500	1500	1500	1500	1500	1500	1500	1500	1500	
1500	1500	1500	1500	1500	1500	1500	1500	1500	1500	1500	1500	1500	1500	1500	1500	
1500	1500	1500	1500	1500	1500	1500	1500	1500	1500	1500	1500	1500	1500	1500	1500	
<b>DC22A</b>	<b>DC23A</b>	<b>DC22A</b>	<b>DC23A</b>	<b>DC22A</b>	<b>DC23A</b>	<b>DC22A</b>	<b>DC23A</b>	<b>DC23A</b>	<b>DC23B</b>	<b>DC23A</b>	<b>DC23B</b>	<b>DC23A</b>	<b>DC23B</b>	<b>DC23A</b>	<b>DC23B</b>	
1500	1500	1500	1500	1500	1500	1500	1500	1000	-	1000	-	1000	-	1000	200	
⊙	⊙	⊙	⊙	⊙	⊙	⊙	⊙	⊙	⊙	⊙	⊙	⊙	⊙	⊙	⊙	
-	-	-	-	-	-	-	-	-	-	-	-	-	-	-	-	
⊙	⊙	⊙	⊙	⊙	⊙	⊙	⊙	⊙	⊙	⊙	⊙	⊙	⊙	⊙	⊙	
3	3	3	3	3	3	3	3	3	3	3	3	3	3	3	3	
-	-	-	-	-	-	-	-	-	-	-	-	-	-	-	-	

# Switch-disconnector selection

## Compact INS250-100 to 630

A

### Compact INS switch-disconnectors

#### Installation

Fixed, front connection

Fixed, rear connection

On symmetrical rails

On a backplate

#### Connection

By cables To bare cable connectors

By cables with lugs Directly to terminals

To spreaders

To vertical-connection adapters via cable-lug adapters

Flat-facing bars Directly to terminals

To spreaders

Edgewise bars To vertical-connection adapters

#### Indication and measurement auxiliaries

Auxiliary contacts

PowerTag NSX

Voltage-presence indicator

Current-transformer module

Ammeter module

#### Control, locking and interlocking

Control Direct front rotary handle

Extended front rotary handle

Direct lateral rotary handle

Extended lateral rotary handle

Locking By keylock

By padlocks

Interlocking By keylock

Mechanical

Complete source-changeover assembly

Operating torque (Nm) (typical value for 3-4 poles with front handle)

#### Installation and connection accessories

Bare cable connectors

Rear connectors

Terminal extensions

Spreaders

One-piece spreader

Terminal shrouds

Terminal shields

Interphase-barrier

Front panel escutcheons

Coupling accessories

Tightening torque for electrical connections (Nm)

#### Dimensions and weights

Overall dimensions H x W x D (mm) 3 poles

4 poles

Approximate weight (kg) 3 poles

4 poles

#### Enclosure dimensions for Ithe

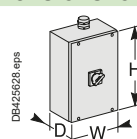
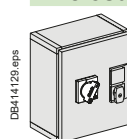

H x W x D (mm)

H x W x D (mm) (IP66)

Enclosed switch-disconnectors

Compact INS 250-200 3P IP66

for tight performances application <sup>[1]</sup>

H x W x D (mm)

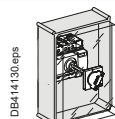

[1] Available in August 2017 for Nordic countries.

# Switch-disconnector selection

## Compact INS250-100 to 630

A

	INS250-100	INS250-160	INS250-200	INS250	INS320	INS400	INS500	INS630
	<input checked="" type="checkbox"/>	<input checked="" type="checkbox"/>	<input checked="" type="checkbox"/>	<input checked="" type="checkbox"/>	<input checked="" type="checkbox"/>	<input checked="" type="checkbox"/>	<input checked="" type="checkbox"/>	<input checked="" type="checkbox"/>
	<input checked="" type="checkbox"/>	<input checked="" type="checkbox"/>	<input checked="" type="checkbox"/>	<input checked="" type="checkbox"/>	<input checked="" type="checkbox"/>	<input checked="" type="checkbox"/>	<input checked="" type="checkbox"/>	<input checked="" type="checkbox"/>
	-	-	-	-	-	-	-	-
	<input checked="" type="checkbox"/>	<input checked="" type="checkbox"/>	<input checked="" type="checkbox"/>	<input checked="" type="checkbox"/>	<input checked="" type="checkbox"/>	<input checked="" type="checkbox"/>	<input checked="" type="checkbox"/>	<input checked="" type="checkbox"/>
	<input checked="" type="checkbox"/>	<input checked="" type="checkbox"/>	<input checked="" type="checkbox"/>	<input checked="" type="checkbox"/>	<input checked="" type="checkbox"/>	<input checked="" type="checkbox"/>	<input checked="" type="checkbox"/>	<input checked="" type="checkbox"/>
	<input checked="" type="checkbox"/>	<input checked="" type="checkbox"/>	<input checked="" type="checkbox"/>	<input checked="" type="checkbox"/>	<input checked="" type="checkbox"/>	<input checked="" type="checkbox"/>	<input checked="" type="checkbox"/>	<input checked="" type="checkbox"/>
	-	-	-	-	-	-	-	-
	<input checked="" type="checkbox"/>	<input checked="" type="checkbox"/>	<input checked="" type="checkbox"/>	<input checked="" type="checkbox"/>	<input checked="" type="checkbox"/>	<input checked="" type="checkbox"/>	<input checked="" type="checkbox"/>	<input checked="" type="checkbox"/>
	<input checked="" type="checkbox"/>	<input checked="" type="checkbox"/>	<input checked="" type="checkbox"/>	<input checked="" type="checkbox"/>	<input checked="" type="checkbox"/>	<input checked="" type="checkbox"/>	<input checked="" type="checkbox"/>	<input checked="" type="checkbox"/>
	-	-	-	-	<input checked="" type="checkbox"/>	<input checked="" type="checkbox"/>	<input checked="" type="checkbox"/>	<input checked="" type="checkbox"/>
	<input checked="" type="checkbox"/>	<input checked="" type="checkbox"/>	<input checked="" type="checkbox"/>	<input checked="" type="checkbox"/>	<input checked="" type="checkbox"/>	<input checked="" type="checkbox"/>	<input checked="" type="checkbox"/>	<input checked="" type="checkbox"/>
	<input checked="" type="checkbox"/>	<input checked="" type="checkbox"/>	<input checked="" type="checkbox"/>	<input checked="" type="checkbox"/>	<input checked="" type="checkbox"/>	<input checked="" type="checkbox"/>	<input checked="" type="checkbox"/>	<input checked="" type="checkbox"/>
	<input checked="" type="checkbox"/>	<input checked="" type="checkbox"/>	<input checked="" type="checkbox"/>	<input checked="" type="checkbox"/>	<input checked="" type="checkbox"/>	<input checked="" type="checkbox"/>	<input checked="" type="checkbox"/>	<input checked="" type="checkbox"/>
	<input checked="" type="checkbox"/>	<input checked="" type="checkbox"/>	<input checked="" type="checkbox"/>	<input checked="" type="checkbox"/>	<input checked="" type="checkbox"/>	<input checked="" type="checkbox"/>	<input checked="" type="checkbox"/>	<input checked="" type="checkbox"/>
	<input checked="" type="checkbox"/>	<input checked="" type="checkbox"/>	<input checked="" type="checkbox"/>	<input checked="" type="checkbox"/>	<input checked="" type="checkbox"/>	<input checked="" type="checkbox"/>	<input checked="" type="checkbox"/>	<input checked="" type="checkbox"/>
	<input checked="" type="checkbox"/>	<input checked="" type="checkbox"/>	<input checked="" type="checkbox"/>	<input checked="" type="checkbox"/>	<input checked="" type="checkbox"/>	<input checked="" type="checkbox"/>	<input checked="" type="checkbox"/>	<input checked="" type="checkbox"/>
	<input checked="" type="checkbox"/>	<input checked="" type="checkbox"/>	<input checked="" type="checkbox"/>	<input checked="" type="checkbox"/>	<input checked="" type="checkbox"/>	<input checked="" type="checkbox"/>	<input checked="" type="checkbox"/>	<input checked="" type="checkbox"/>
	<input checked="" type="checkbox"/>	<input checked="" type="checkbox"/>	<input checked="" type="checkbox"/>	<input checked="" type="checkbox"/>	<input checked="" type="checkbox"/>	<input checked="" type="checkbox"/>	<input checked="" type="checkbox"/>	<input checked="" type="checkbox"/>
	<input checked="" type="checkbox"/>	<input checked="" type="checkbox"/>	<input checked="" type="checkbox"/>	<input checked="" type="checkbox"/>	<input checked="" type="checkbox"/>	<input checked="" type="checkbox"/>	<input checked="" type="checkbox"/>	<input checked="" type="checkbox"/>
	<input checked="" type="checkbox"/>	<input checked="" type="checkbox"/>	<input checked="" type="checkbox"/>	<input checked="" type="checkbox"/>	<input checked="" type="checkbox"/>	<input checked="" type="checkbox"/>	<input checked="" type="checkbox"/>	<input checked="" type="checkbox"/>
	<input checked="" type="checkbox"/>	<input checked="" type="checkbox"/>	<input checked="" type="checkbox"/>	<input checked="" type="checkbox"/>	<input checked="" type="checkbox"/>	<input checked="" type="checkbox"/>	<input checked="" type="checkbox"/>	<input checked="" type="checkbox"/>
	<input checked="" type="checkbox"/>	<input checked="" type="checkbox"/>	<input checked="" type="checkbox"/>	<input checked="" type="checkbox"/>	<input checked="" type="checkbox"/>	<input checked="" type="checkbox"/>	<input checked="" type="checkbox"/>	<input checked="" type="checkbox"/>
	<input checked="" type="checkbox"/>	<input checked="" type="checkbox"/>	<input checked="" type="checkbox"/>	<input checked="" type="checkbox"/>	<input checked="" type="checkbox"/>	<input checked="" type="checkbox"/>	<input checked="" type="checkbox"/>	<input checked="" type="checkbox"/>
	<input checked="" type="checkbox"/>	<input checked="" type="checkbox"/>	<input checked="" type="checkbox"/>	<input checked="" type="checkbox"/>	<input checked="" type="checkbox"/>	<input checked="" type="checkbox"/>	<input checked="" type="checkbox"/>	<input checked="" type="checkbox"/>
	<input checked="" type="checkbox"/>	<input checked="" type="checkbox"/>	<input checked="" type="checkbox"/>	<input checked="" type="checkbox"/>	<input checked="" type="checkbox"/>	<input checked="" type="checkbox"/>	<input checked="" type="checkbox"/>	<input checked="" type="checkbox"/>
	<input checked="" type="checkbox"/>	<input checked="" type="checkbox"/>	<input checked="" type="checkbox"/>	<input checked="" type="checkbox"/>	<input checked="" type="checkbox"/>	<input checked="" type="checkbox"/>	<input checked="" type="checkbox"/>	<input checked="" type="checkbox"/>
	<input checked="" type="checkbox"/>	<input checked="" type="checkbox"/>	<input checked="" type="checkbox"/>	<input checked="" type="checkbox"/>	<input checked="" type="checkbox"/>	<input checked="" type="checkbox"/>	<input checked="" type="checkbox"/>	<input checked="" type="checkbox"/>
	<input checked="" type="checkbox"/>	<input checked="" type="checkbox"/>	<input checked="" type="checkbox"/>	<input checked="" type="checkbox"/>	<input checked="" type="checkbox"/>	<input checked="" type="checkbox"/>	<input checked="" type="checkbox"/>	<input checked="" type="checkbox"/>
	<input checked="" type="checkbox"/>	<input checked="" type="checkbox"/>	<input checked="" type="checkbox"/>	<input checked="" type="checkbox"/>	<input checked="" type="checkbox"/>	<input checked="" type="checkbox"/>	<input checked="" type="checkbox"/>	<input checked="" type="checkbox"/>
	<input checked="" type="checkbox"/>	<input checked="" type="checkbox"/>	<input checked="" type="checkbox"/>	<input checked="" type="checkbox"/>	<input checked="" type="checkbox"/>	<input checked="" type="checkbox"/>	<input checked="" type="checkbox"/>	<input checked="" type="checkbox"/>
	<input checked="" type="checkbox"/>	<input checked="" type="checkbox"/>	<input checked="" type="checkbox"/>	<input checked="" type="checkbox"/>	<input checked="" type="checkbox"/>	<input checked="" type="checkbox"/>	<input checked="" type="checkbox"/>	<input checked="" type="checkbox"/>
	<input checked="" type="checkbox"/>	<input checked="" type="checkbox"/>	<input checked="" type="checkbox"/>	<input checked="" type="checkbox"/>	<input checked="" type="checkbox"/>	<input checked="" type="checkbox"/>	<input checked="" type="checkbox"/>	<input checked="" type="checkbox"/>
	<input checked="" type="checkbox"/>	<input checked="" type="checkbox"/>	<input checked="" type="checkbox"/>	<input checked="" type="checkbox"/>	<input checked="" type="checkbox"/>	<input checked="" type="checkbox"/>	<input checked="" type="checkbox"/>	<input checked="" type="checkbox"/>
	<input checked="" type="checkbox"/>	<input checked="" type="checkbox"/>	<input checked="" type="checkbox"/>	<input checked="" type="checkbox"/>	<input checked="" type="checkbox"/>	<input checked="" type="checkbox"/>	<input checked="" type="checkbox"/>	<input checked="" type="checkbox"/>
	<input checked="" type="checkbox"/>	<input checked="" type="checkbox"/>	<input checked="" type="checkbox"/>	<input checked="" type="checkbox"/>	<input checked="" type="checkbox"/>	<input checked="" type="checkbox"/>	<input checked="" type="checkbox"/>	<input checked="" type="checkbox"/>
	<input checked="" type="checkbox"/>	<input checked="" type="checkbox"/>	<input checked="" type="checkbox"/>	<input checked="" type="checkbox"/>	<input checked="" type="checkbox"/>	<input checked="" type="checkbox"/>	<input checked="" type="checkbox"/>	<input checked="" type="checkbox"/>
	<input checked="" type="checkbox"/>	<input checked="" type="checkbox"/>	<input checked="" type="checkbox"/>	<input checked="" type="checkbox"/>	<input checked="" type="checkbox"/>	<input checked="" type="checkbox"/>	<input checked="" type="checkbox"/>	<input checked="" type="checkbox"/>
	<input checked="" type="checkbox"/>	<input checked="" type="checkbox"/>	<input checked="" type="checkbox"/>	<input checked="" type="checkbox"/>	<input checked="" type="checkbox"/>	<input checked="" type="checkbox"/>	<input checked="" type="checkbox"/>	<input checked="" type="checkbox"/>
	<input checked="" type="checkbox"/>	<input checked="" type="checkbox"/>	<input checked="" type="checkbox"/>	<input checked="" type="checkbox"/>	<input checked="" type="checkbox"/>	<input checked="" type="checkbox"/>	<input checked="" type="checkbox"/>	<input checked="" type="checkbox"/>
	<input checked="" type="checkbox"/>	<input checked="" type="checkbox"/>	<input checked="" type="checkbox"/>	<input checked="" type="checkbox"/>	<input checked="" type="checkbox"/>	<input checked="" type="checkbox"/>	<input checked="" type="checkbox"/>	<input checked="" type="checkbox"/>
	<input checked="" type="checkbox"/>	<input checked="" type="checkbox"/>	<input checked="" type="checkbox"/>	<input checked="" type="checkbox"/>	<input checked="" type="checkbox"/>	<input checked="" type="checkbox"/>	<input checked="" type="checkbox"/>	<input checked="" type="checkbox"/>
	<input checked="" type="checkbox"/>	<input checked="" type="checkbox"/>	<input checked="" type="checkbox"/>	<input checked="" type="checkbox"/>	<input checked="" type="checkbox"/>	<input checked="" type="checkbox"/>	<input checked="" type="checkbox"/>	<input checked="" type="checkbox"/>
	<input checked="" type="checkbox"/>	<input checked="" type="checkbox"/>	<input checked="" type="checkbox"/>	<input checked="" type="checkbox"/>	<input checked="" type="checkbox"/>	<input checked="" type="checkbox"/>	<input checked="" type="checkbox"/>	<input checked="" type="checkbox"/>
	<input checked="" type="checkbox"/>	<input checked="" type="checkbox"/>	<input checked="" type="checkbox"/>	<input checked="" type="checkbox"/>	<input checked="" type="checkbox"/>	<input checked="" type="checkbox"/>	<input checked="" type="checkbox"/>	<input checked="" type="checkbox"/>
	<input checked="" type="checkbox"/>	<input checked="" type="checkbox"/>	<input checked="" type="checkbox"/>	<input checked="" type="checkbox"/>	<input checked="" type="checkbox"/>	<input checked="" type="checkbox"/>	<input checked="" type="checkbox"/>	<input checked="" type="checkbox"/>
	<input checked="" type="checkbox"/>	<input checked="" type="checkbox"/>	<input checked="" type="checkbox"/>	<input checked="" type="checkbox"/>	<input checked="" type="checkbox"/>	<input checked="" type="checkbox"/>	<input checked="" type="checkbox"/>	<input checked="" type="checkbox"/>
	<input checked="" type="checkbox"/>	<input checked="" type="checkbox"/>	<input checked="" type="checkbox"/>	<input checked="" type="checkbox"/>	<input checked="" type="checkbox"/>	<input checked="" type="checkbox"/>	<input checked="" type="checkbox"/>	<input checked="" type="checkbox"/>
	<input checked="" type="checkbox"/>	<input checked="" type="checkbox"/>	<input checked="" type="checkbox"/>	<input checked="" type="checkbox"/>	<input checked="" type="checkbox"/>	<input checked="" type="checkbox"/>	<input checked="" type="checkbox"/>	<input checked="" type="checkbox"/>
	<input checked="" type="checkbox"/>	<input checked="" type="checkbox"/>	<input checked="" type="checkbox"/>	<input checked="" type="checkbox"/>	<input checked="" type="checkbox"/>	<input checked="" type="checkbox"/>	<input checked="" type="checkbox"/>	<input checked="" type="checkbox"/>
	<input checked="" type="checkbox"/>	<input checked="" type="checkbox"/>	<input checked="" type="checkbox"/>	<input checked="" type="checkbox"/>	<input checked="" type="checkbox"/>	<input checked="" type="checkbox"/>	<input checked="" type="checkbox"/>	<input checked="" type="checkbox"/>
	<input checked="" type="checkbox"/>	<input checked="" type="checkbox"/>	<input checked="" type="checkbox"/>	<input checked="" type="checkbox"/>	<input checked="" type="checkbox"/>	<input checked="" type="checkbox"/>	<input checked="" type="checkbox"/>	<input checked="" type="checkbox"/>
	<input checked="" type="checkbox"/>	<input checked="" type="checkbox"/>	<input checked="" type="checkbox"/>	<input checked="" type="checkbox"/>	<input checked="" type="checkbox"/>	<input checked="" type="checkbox"/>	<input checked="" type="checkbox"/>	<input checked="" type="checkbox"/>
	<input checked="" type="checkbox"/>	<input checked="" type="checkbox"/>	<input checked="" type="checkbox"/>	<input checked="" type="checkbox"/>	<input checked="" type="checkbox"/>	<input checked="" type="checkbox"/>	<input checked="" type="checkbox"/>	<input checked="" type="checkbox"/>
	<input checked="" type="checkbox"/>	<input checked="" type="checkbox"/>	<input checked="" type="checkbox"/>	<input checked="" type="checkbox"/>	<input checked="" type="checkbox"/>	<input checked="" type="checkbox"/>	<input checked="" type="checkbox"/>	<input checked="" type="checkbox"/>
	<input checked="" type="checkbox"/>	<input checked="" type="checkbox"/>	<input checked="" type="checkbox"/>	<input checked="" type="checkbox"/>	<input checked="" type="checkbox"/>	<input checked="" type="checkbox"/>	<input checked="" type="checkbox"/>	<input checked="" type="checkbox"/>
	<input checked="" type="checkbox"/>	<input checked="" type="checkbox"/>	<input checked="" type="checkbox"/>	<input checked="" type="checkbox"/>	<input checked="" type="checkbox"/>	<input checked="" type="checkbox"/>	<input checked="" type="checkbox"/>	<input checked="" type="checkbox"/>
	<input checked="" type="checkbox"/>	<input checked="" type="checkbox"/>	<input checked="" type="checkbox"/>	<input checked="" type="checkbox"/>	<input checked="" type="checkbox"/>	<input checked="" type="checkbox"/>	<input checked="" type="checkbox"/>	<input checked="" type="checkbox"/>
	<input checked="" type="checkbox"/>	<input checked="" type="checkbox"/>	<input checked="" type="checkbox"/>	<input checked="" type="checkbox"/>	<input checked="" type="checkbox"/>	<input checked="" type="checkbox"/>	<input checked="" type="checkbox"/>	<input checked="" type="checkbox"/>
	<input checked="" type="checkbox"/>	<input checked="" type="checkbox"/>	<input checked="" type="checkbox"/>	<input checked="" type="checkbox"/>	<input checked="" type="checkbox"/>	<input checked="" type="checkbox"/>	<input checked="" type="checkbox"/>	<input checked="" type="checkbox"/>
	<input checked="" type="checkbox"/>	<input checked="" type="checkbox"/>	<input checked="" type="checkbox"/>	<input checked="" type="checkbox"/>	<input checked="" type="checkbox"/>	<input checked="" type="checkbox"/>	<input checked="" type="checkbox"/>	<input checked="" type="checkbox"/>
	<input checked="" type="checkbox"/>	<input checked="" type="checkbox"/>	<input checked="" type="checkbox"/>	<input checked="" type="checkbox"/>	<input checked="" type="checkbox"/>	<input checked="" type="checkbox"/>	<input checked="" type="checkbox"/>	<input checked="" type="checkbox"/>
	<input checked="" type="checkbox"/>	<input checked="" type="checkbox"/>	<input checked="" type="checkbox"/>	<input checked="" type="checkbox"/>	<input checked="" type="checkbox"/>	<input checked="" type="checkbox"/>	<input checked="" type="checkbox"/>	<input checked="" type="checkbox"/>
	<input checked="" type="checkbox"/>	<input checked="" type="checkbox"/>	<input checked="" type="checkbox"/>	<input checked="" type="checkbox"/>	<input checked="" type="checkbox"/>	<input checked="" type="checkbox"/>	<input checked="" type="checkbox"/>	<input checked="" type="checkbox"/>
	<input checked="" type="checkbox"/>	<input checked="" type="checkbox"/>	<input checked="" type="checkbox"/>	<input checked="" type="checkbox"/>	<input checked="" type="checkbox"/>	<input checked="" type="checkbox"/>	<input checked="" type="checkbox"/>	<input checked="" type="checkbox"/>
	<input checked="" type="checkbox"/>	<input checked="" type="checkbox"/>	<input checked="" type="checkbox"/>	<input checked="" type="checkbox"/>	<input checked="" type="checkbox"/>	<input checked="" type="checkbox"/>	<input checked="" type="checkbox"/>	<input checked="" type="checkbox"/>
	<input checked="" type="checkbox"/>	<input checked="" type="checkbox"/>	<input checked="" type="checkbox"/>	<input checked="" type="checkbox"/>	<input checked="" type="checkbox"/>	<input checked="" type="checkbox"/>	<input checked="" type="checkbox"/>	<input checked="" type="checkbox"/>
	<input checked="" type="checkbox"/>	<input checked="" type="checkbox"/>	<input checked="" type="checkbox"/>	<input checked="" type="checkbox"/>	<input checked="" type="checkbox"/>	<input checked="" type="checkbox"/>	<input checked="" type="checkbox"/>	<input checked="" type="checkbox"/>
	<input checked="" type="checkbox"/>	<input checked="" type="checkbox"/>	<input checked="" type="checkbox"/>	<input checked="" type="checkbox"/>	<input checked="" type="checkbox"/>	<input checked="" type="checkbox"/>	<input checked="" type="checkbox"/>	<input checked="" type="checkbox"/>
	<input checked="" type="checkbox"/>	<input checked="" type="checkbox"/>	<input checked="" type="checkbox"/>	<input checked="" type="checkbox"/>	<input checked="" type="checkbox"/>	<input checked="" type="checkbox"/>	<input checked="" type="checkbox"/>	<input checked="" type="checkbox"/>
	<input checked="" type="checkbox"/>	<input checked="" type="checkbox"/>	<input checked="" type="checkbox"/>	<input checked="" type="checkbox"/>	<input checked="" type="checkbox"/>	<input checked="" type="checkbox"/>	<input checked="" type="checkbox"/>	<input checked="" type="checkbox"/>
	<input checked="" type="checkbox"/>	<input checked="" type="checkbox"/>	<input checked="" type="checkbox"/>	<input checked="" type="checkbox"/>	<input checked="" type="checkbox"/>	<input checked="" type="checkbox"/>	<input checked="" type="checkbox"/>	<input checked="" type="checkbox"/>
	<input checked="" type="checkbox"/>	<input checked="" type="checkbox"/>	<input checked="" type="checkbox"/>	<input checked="" type="checkbox"/>	<input checked="" type="checkbox"/>	<input checked="" type="checkbox"/>	<input checked="" type="checkbox"/>	<input checked="" type="checkbox"/>
	<input checked="" type="checkbox"/>	<input checked="" type="checkbox"/>	<input checked="" type="checkbox"/>	<input checked="" type="checkbox"/>	<input checked="" type="checkbox"/>	<input checked="" type="checkbox"/>	<input checked="" type="checkbox"/>	<input checked="" type="checkbox"/>
	<input checked="" type="checkbox"/>	<input checked="" type="checkbox"/>	<input checked="" type="checkbox"/>	<input checked="" type="checkbox"/>	<input checked="" type="checkbox"/>	<input checked="" type="checkbox"/>	<input checked="" type="checkbox"/>	<input checked="" type="checkbox"/>
	<input checked="" type="checkbox"/>	<input checked="" type="checkbox"/>	<input checked="" type="checkbox"/>	<input checked="" type="checkbox"/>	<input checked="" type="checkbox"/>	<input checked="" type="checkbox"/>	<input checked="" type="checkbox"/>	<input checked="" type="checkbox"/>
	<input checked="" type="checkbox"/>	<input checked="" type="checkbox"/>	<input checked="" type="checkbox"/>	<input checked="" type="checkbox"/>	<input checked="" type="checkbox"/>	<input checked="" type="checkbox"/>	<input checked="" type="checkbox"/>	<input checked="" type="checkbox"/>
	<input checked="" type="checkbox"/>	<input checked="" type="checkbox"/>	<input checked="" type="checkbox"/>	<input checked="" type="checkbox"/>	<input checked="" type="checkbox"/>	<input checked="" type="checkbox"/>	<input checked="" type="checkbox"/>	<input checked="" type="checkbox"/>
	<input checked="" type="checkbox"/>	<input checked="" type="checkbox"/>	<input checked="" type="checkbox"/>	<input checked="" type="checkbox"/>	<input checked="" type="checkbox"/>	<input checked="" type="checkbox"/>	<input checked="" type="checkbox"/>	<input checked="" type="checkbox"/>
	<input checked="" type="checkbox"/>	<input checked="" type="checkbox"/>	<input checked="" type="checkbox"/>	<input checked="" type="checkbox"/>	<input checked="" type="checkbox"/>	<input checked="" type="checkbox"/>	<input checked="" type="checkbox"/>	<input checked="" type="checkbox"/>
	<input checked="" type="checkbox"/>	<input checked="" type="checkbox"/>	<input checked="" type="checkbox"/>	<input checked="" type="checkbox"/>	<input checked="" type="checkbox"/>	<input checked="" type="checkbox"/>	<input checked="" type="checkbox"/>	<input checked="" type="checkbox"/>
	<input checked="" type="checkbox"/>	<input checked="" type="checkbox"/>	<input checked="" type="checkbox"/>	<input checked="" type="checkbox"/>	<input checked="" type="checkbox"/>	<input checked="" type="checkbox"/>	<input checked="" type="checkbox"/>	<input checked="" type="checkbox"/>
	<input checked="" type="checkbox"/>	<input checked="" type="checkbox"/>	<input checked="" type="checkbox"/>	<input checked="" type="checkbox"/>	<input checked="" type="checkbox"/>	<input checked="" type="checkbox"/>	<input checked="" type="checkbox"/>	<input checked="" type="checkbox"/>
	<input checked="" type="checkbox"/>	<input checked="" type="checkbox"/>	<input checked="" type="checkbox"/>	<input checked="" type="checkbox"/>	<input checked="" type="checkbox"/>	<input checked="" type="checkbox"/>	<input checked="" type="checkbox"/>	<input checked="" type="checkbox"/>
	<input checked="" type="checkbox"/>	<input checked="" type="checkbox"/>	<input checked="" type="checkbox"/>	<input checked="" type="checkbox"/>	<input checked="" type="checkbox"/>	<input checked="" type="checkbox"/>	<input checked="" type="checkbox"/>	<input checked="" type="checkbox"/>
	<input checked="" type="checkbox"/>	<input checked="" type="checkbox"/>	<input checked="" type="checkbox"/>	<input checked="" type="checkbox"/>	<input checked="" type="checkbox"/>	<input checked="" type="checkbox"/>	<input checked="" type="checkbox"/>	<input checked="" type="checkbox"/>
	<input checked="" type="checkbox"/>	<input checked="" type="checkbox"/>	<input checked="" type="checkbox"/>	<input checked="" type="checkbox"/>	<input checked="" type="checkbox"/>	<input checked="" type="checkbox"/>	<input checked="" type="checkbox"/>	<input checked="" type="checkbox"/>
	<input checked="" type="checkbox"/>	<input checked="" type="checkbox"/>	<input checked="" type="checkbox"/>	<input checked="" type="checkbox"/>	<input checked="" type="checkbox"/>	<input checked="" type="checkbox"/>	<input checked="" type="checkbox"/>	<input checked="" type="checkbox"/>
	<input checked="" type="checkbox"/>	<input checked="" type="checkbox"/>	<input checked="" type="checkbox"/>	<input checked="" type="checkbox"/>	<input checked="" type="checkbox"/>	<input checked="" type="checkbox"/>	<input checked="" type="checkbox"/>	<input checked="" type="checkbox"/>
	<input checked="" type="checkbox"/>	<input checked="" type="checkbox"/>	<input checked="" type="checkbox"/>	<input checked="" type="checkbox"/>	<input checked="" type="checkbox"/>	<input checked="" type="checkbox"/>	<input checked="" type="checkbox"/>	<input checked="" type="checkbox"/>
	<input checked="" type="checkbox"/>	<input checked="" type="checkbox"/>	<input checked="" type="checkbox"/>	<input checked="" type="checkbox"/>	<input checked="" type="checkbox"/>	<input checked="" type="checkbox"/>	<input checked="" type="checkbox"/>	<input checked="" type="checkbox"/>
	<input checked="" type="checkbox"/>	<input checked="" type="checkbox"/>	<input checked="" type="checkbox"/>	<input checked="" type="checkbox"/>	<input checked="" type="checkbox"/>	<input checked="" type="checkbox"/>	<input checked="" type="checkbox"/>	<input checked="" type="checkbox"/>
	<input checked="" type="checkbox"/>	<input checked="" type="checkbox"/>	<input checked="" type="checkbox"/>	<input checked="" type="checkbox"/>	<input checked="" type="checkbox"/>	<input checked="" type="checkbox"/>	<input checked="" type="checkbox"/>	<input checked="" type="checkbox"/>
	<input checked="" type="checkbox"/>	<input checked="" type="checkbox"/>	<input checked="" type="checkbox"/>	<input checked="" type="checkbox"/>	<input checked="" type="checkbox"/>	<input checked="" type="checkbox"/>	<input checked="" type="checkbox"/>	<input checked="" type="checkbox"/>
	<input checked="" type="checkbox"/>	<input checked="" type="checkbox"/>	<input checked="" type="checkbox"/>	<input checked="" type="checkbox"/>	<input checked="" type="checkbox"/>	<input checked="" type="checkbox"/>	<input checked="" type="checkbox"/>	<input checked="" type="checkbox"/>
	<input checked="" type="checkbox"/>	<input checked="" type="checkbox"/>	<input checked="" type="checkbox"/>	<input checked="" type="checkbox"/>	<input checked="" type="checkbox"/>	<input checked="" type="checkbox"/>	<input checked="" type="checkbox"/>	<input checked="" type="checkbox"/>
	<input checked="" type="checkbox"/>	<input checked="" type="checkbox"/>	<input checked="" type="checkbox"/>	<input checked="" type="checkbox"/>	<input checked="" type="checkbox"/>	<input checked="" type="checkbox"/>	<input checked="" type="checkbox"/>	<input checked="" type="checkbox"/>
	<input checked="" type="checkbox"/>	<input checked="" type="checkbox"/>	<input checked="" type="checkbox"/>	<input checked="" type="checkbox"/>	<input checked="" type="checkbox"/>	<input checked="" type="checkbox"/>	<input checked="" type="checkbox"/>	<input checked="" type="checkbox"/>
	<input checked="" type="checkbox"/>	<input checked="" type="checkbox"/>	<input checked="" type="checkbox"/>	<input checked="" type="checkbox"/>	<input checked="" type="checkbox"/>	<input checked="" type="checkbox"/>	<input checked="" type="checkbox"/>	<input checked="" type="checkbox"/>
	<input checked="" type="checkbox"/>	<input checked="" type="checkbox"/>	<input checked="" type="checkbox"/>	<input checked="" type="checkbox"/>	<input checked="" type="checkbox"/>	<input checked="" type="checkbox"/>	<input checked="" type="checkbox"/>	<input checked="" type="checkbox"/>
	<input checked="" type="checkbox"/>	<input checked="" type="checkbox"/>	<input checked="" type="checkbox"/>	<input checked="" type="checkbox"/>	<input checked="" type="checkbox"/>	<input checked="" type="checkbox"/>	<input checked="" type="checkbox"/>	<input checked="" type="checkbox"/>
	<input checked="" type="checkbox"/>	<input checked="" type="checkbox"/>	<input checked="" type="checkbox"/>	<input checked="" type="checkbox"/>	<input checked="" type="checkbox"/>	<input checked="" type="checkbox"/>	<input checked="" type="checkbox"/>	<input checked="" type="checkbox"/>
	<input checked="" type="checkbox"/>	<input checked="" type="checkbox"/>	<input checked="" type="checkbox"/>	<input checked="" type="checkbox"/>	<input checked="" type="checkbox"/>	<input checked="" type="checkbox"/>	<input checked="" type="checkbox"/>	<input checked="" type="checkbox"/>
	<input checked="" type="checkbox"/>	<input checked="" type="checkbox"/>	<input checked="" type="checkbox"/>	<input checked="" type="checkbox"/>	<input checked="" type="checkbox"/>	<input checked="" type="checkbox"/>	<input checked="" type="checkbox"/>	<input checked="" type="checkbox"/>
	<input checked="" type="checkbox"/>	<input checked="" type="checkbox"/>	<input checked="" type="checkbox"/>	<input checked="" type="checkbox"/>	<input checked="" type="checkbox"/>	<input checked="" type="checkbox"/>	<input checked="" type="checkbox"/>	<input checked="" type="checkbox"/>
	<input checked="" type="checkbox"/>	<input checked="" type="checkbox"/>	<input checked="" type="checkbox"/>	<input checked="" type="checkbox"/>	<input checked="" type="checkbox"/>	<input checked="" type="checkbox"/>	<input checked="" type="checkbox"/>	<input checked="" type="checkbox"/>
	<input checked="" type="checkbox"/>	<input checked="" type="checkbox"/>	<input checked="" type="checkbox"/>	<input checked="" type="checkbox"/>	<input checked="" type="checkbox"/>	<input checked="" type="checkbox"/>	<input checked="" type="checkbox"/>	<input checked="" type="checkbox"/>
	<input checked="" type="checkbox"/>	<input checked="" type="checkbox"/>	<input checked="" type="checkbox"/>	<input checked="" type="checkbox"/>	<input checked="" type="checkbox"/>	<input checked="" type="checkbox"/>	<input checked="" type="checkbox"/>	<input checked="" type="checkbox"/>
	<input checked="" type="checkbox"/>	<input checked="" type="checkbox"/>	<input checked="" type="checkbox"/>	<input checked="" type="checkbox"/>	<input checked="" type="checkbox"/>	<input checked="" type="checkbox"/>	<input checked="" type="checkbox"/>	<input checked="" type="checkbox"/>
	<input checked="" type="checkbox"/>	<input checked="" type="checkbox"/>	<input checked="" type="checkbox"/>	<input checked="" type="checkbox"/>	<input checked="" type="checkbox"/>	<input checked="" type="checkbox"/>	<input checked="" type="checkbox"/>	<input checked="" type="checkbox"/>
	<input checked="" type="checkbox"/>	<input checked="" type="checkbox"/>	<input checked="" type="checkbox"/>	<input checked="" type="checkbox"/>	<input checked="" type="checkbox"/>	<input checked="" type="checkbox"/>	<input checked="" type="checkbox"/>	<input checked="" type="checkbox"/>
	<input checked="" type="checkbox"/>	<input checked="" type="checkbox"/>	<input checked="" type="checkbox"/>	<input checked="" type="checkbox"/>	<input checked="" type="checkbox"/>	<input checked="" type="checkbox"/>	<input checked="" type="checkbox"/>	<input checked="" type="checkbox"/>
	<input checked="" type="checkbox"/>	<input checked="" type="checkbox"/>	<input checked="" type="checkbox"/>	<input checked="" type="checkbox"/>	<input checked="" type="checkbox"/>	<input checked="" type="checkbox"/>	<input checked="" type="checkbox"/>	<input checked="" type="checkbox"/>
	<input checked="" type="checkbox"/>	<input checked="" type="checkbox"/>	<input checked="" type="checkbox"/> </					

# Switch-disconnector selection

## Compact INS630b to 2500

PE111510\_45.eps



Compact INS1600 switch-disconnector.

PE111511\_45.eps



Compact INS1600 emergency-off switch-disconnector.

PE111512\_72.eps



Compact INS2500 switch-disconnector.

### Compact INS switch-disconnectors

Number of poles

#### Electrical characteristics as defined by IEC 60947-1 / 60947-3 and EN 60947-1 / 60947-3

Conventional thermal current (A)	<b>I<sub>th</sub></b>	at 60 °C
Conventional thermal current in enclosure	<b>I<sub>the</sub></b>	at 60 °C
Rated insulation level (V)	<b>U<sub>i</sub></b>	AC 50/60 Hz
Impulse-withstand voltage (kV)	<b>U<sub>imp</sub></b>	
Rated operational voltage (V)	<b>U<sub>e</sub></b>	AC 50/60 Hz DC
Rated operational voltage AC20 and DC20 (V)		AC 50/60 Hz
Rated operational current (A)	<b>I<sub>e</sub></b>	<b>Electrical AC 50/60 Hz</b>

220-240 V

380-415 V

440-480 V

500-525 V

660-690 V

#### Electrical DC

125 V (2P in series)

250 V (4P in series)

Rated operational power AC23 (kW)	<b>Electrical AC 50/60 Hz</b>
	220-240 V
	380-400 V
	415 V
	500-525 V
	660-690 V

Rated duties	Uninterrupted duty
	Intermittent duty
Short-circuit making capacity (kA peak)	<b>I<sub>cm</sub></b> Min. (switch-disconnector alone) Max. (with upstream protection circuit breaker)
Short-time withstand current (kA rms)	<b>I<sub>cw</sub></b> 0.5 s 0.8 s 1 s 3 s 20 s 30 s

Suitability for isolation	
Durability (O-C cycles)	<b>Mechanical</b> <b>Electrical AC 50/60 Hz</b>
	220-240 V
	380-415 V
	440-480 V
	500-525 V
	660-690 V

Positive contact indication	
Visible break	
Emergency-off switch-disconnector	
Degree of pollution	
	<b>Electrical DC</b>
	125 V (2P) 250 V (4P)

Upstream protection	
---------------------	--

See the "Complementary technical information" page D-1.

[1] For vertical connection busbars only. For horizontal connection busbars, see derating charts in "Installation recommendations" see page B-24.



# Functions and characteristics

## Switch-disconnector selection

### Compact INS630b to 2500



INS630b			INS800			INS1000			INS1250			INS1600			INS2000			INS2500		
3-4			3-4			3-4			3-4			3-4			3-4			3-4		
630			800			1000			1250			1600 <sup>[1]</sup>			2000			2500		
630			800			1000			1250			1600 <sup>[1]</sup>			2000			2500		
1000			1000			1000			1000			1000			1000			1000		
12			12			12			12			12			12			12		
690			690			690			690			690			690			690		
250			250			250			250			250			250			250		
800			800			800			800			800			800			800		
AC21A	AC22A	AC23A	AC21A	AC22A	AC23A	AC21A	AC22A	AC23A	AC21A	AC22A	AC23A	AC21B	AC22B	AC23A	AC21B	AC22B	AC23B	AC21B	AC22B	AC23B
630	630	630	800	800	800	1000	1000	1000	1250	1250	1250	1600	1600	1250	2000	2000	-	2500	2500	-
												1450	1450							
630	630	630	800	800	800	1000	1000	1000	1250	1250	1250	1600	1600	1250	2000	2000	-	2500	2500	-
												1450	1450							
630	630	630	800	800	800	1000	1000	1000	1250	1250	1250	1600	1600	1250	2000	2000	-	2500	2500	-
												1250	1250							
630	630	630	800	800	800	1000	1000	1000	1250	1250	1250	1600	1600	1250	2000	2000	-	2500	2500	-
												1250	1250							
DC21A	DC22A	DC23A	DC21A	DC22A	DC23A	DC21A	DC22A	DC23A	DC21A	DC22A	DC23A	DC21A	DC22A	DC23A	DC21B	DC22B	DC23B	DC21B	DC22B	DC23B
630/2	630/2	630/2	800/2	800/2	800/2	1000/2	1000/2	1000/2	1250/2	1250/2	1250/2	1600/2	1600/2	1600/2	2000/2	2000/2	-	2500/2	2500/2	-
630/4	630/4	630/4	800/4	800/4	800/4	1000/4	1000/4	1000/4	1250/4	1250/4	1250/4	1600/4	1600/4	1600/4	2000/4	2000/4	-	2500/4	2500/4	-
250			250			315			400			400			-			-		
400			400			560			710			710			-			-		
500			500			630			800			800			-			-		
560			560			710			900			900			-			-		
710			710			900			-			-			-			-		
☉			☉			☉			☉			☉			☉			☉		
Class 120 - 60 %			Class 120 - 60 %			Class 120 - 60 %			Class 120 - 60 %			Class 120 - 60 %			Class 120 - 60 %			Class 120 - 60 %		
75			75			75			75			75			105			105		
330			330			330			330			330			330			330		
50			50			50			50			50			50			50		
42			42			42			42			42			50			50		
35			35			35			35			35			50			50		
20			20			20			20			20			30			30		
10			10			10			10			10			13			13		
8			8			8			8			8			11			11		
☉			☉			☉			☉			☉			☉			☉		
5000			3000			3000			3000			3000			3000			3000		
AC21A	AC22A	AC23A	AC21A	AC22A	AC23A	AC21A	AC22A	AC23A	AC21A	AC22A	AC23A	AC21B	AC22B	AC23A	AC21B	AC22B	AC23B	AC21B	AC22B	AC23B
1000	1000	1000	500	500	500	500	500	500	500	500	500	100	100	500	100	100	-	100	100	-
												500	500							
1000	1000	1000	500	500	500	500	500	500	500	500	500	100	100	500	100	100	-	100	100	-
												500	500							
1000	1000	1000	500	500	500	500	500	500	500	500	500	100	100	500	100	100	-	100	100	-
												500	500							
1000	1000	1000	500	500	500	500	500	500	500	500	500	100	100	500	100	100	-	100	100	-
												500	500							
DC21A	DC22A	DC23A	DC21A	DC22A	DC23A	DC21A	DC22A	DC23A	DC21A	DC22A	DC23A	DC21A	DC22A	DC23B	DC21B	DC22B	DC23B	DC21B	DC22B	DC23B
1000	1000	1000	500	500	500	500	500	500	500	500	500	500	500	500	100	100	-	100	100	-
1000	1000	1000	500	500	500	500	500	500	500	500	500	500	500	500	100	100	-	100	100	-
☉			☉			☉			☉			☉			☉			☉		
-			-			-			-			-			-			-		
☉			☉			☉			☉			☉			☉			☉		
3			3			3			3			3			3			3		
-			-			-			-			-			-			-		

# Switch-disconnector selection

## Compact INS630b to 2500

A

### Compact INS switch-disconnectors

#### Installation

Fixed, front connection

Fixed, rear connection

On symmetrical rails

On a backplate

#### Connection

By cables

To bare cable connectors

By cables with lugs

Directly to terminals

To spreaders

To vertical-connection adapters via cable-lug adapters

Flat-facing bars

Directly to terminals

To spreaders

Edgewise bars

To vertical-connection adapters

#### Indication and measurement auxiliaries

Auxiliary contacts

Voltage-presence indicator

Current-transformer module

Ammeter module

#### Control, locking and interlocking

Control

Direct front rotary handle

Extended front rotary handle

Direct lateral rotary handle

Extended lateral rotary handle

Locking

By keylock

By padlocks

Interlocking

By keylock

Mechanical

Complete source-changeover assembly

Operating torque (Nm) (typical value for 3-4 poles with front handle)

#### Installation and connection accessories

Bare cable connectors

Rear connectors

Terminal extensions

Spreaders

One-piece spreader

Terminal shrouds

Terminal shields

Interphase-barrier

Front panel escutcheons

Coupling accessories

Tightening torque for electrical connections (Nm)

#### Dimensions and weights

Overall dimensions H x W x D (mm)

3 poles

4 poles

Approximate weight (kg)

3 poles

4 poles

#### Enclosure dimensions for lthe

H x W x D (mm)

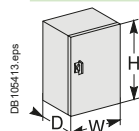

# Functions and characteristics

## Switch-disconnector selection

### Compact INS630b to 2500

A

	INS630b	INS800	INS1000	INS1250	INS1600	INS2000	INS2500
	○	○	○	○	○	○	○
	○	○	○	○	○	○	○
	-	-	-	-	-	-	-
	○	○	○	○	○	○	○
	-	-	-	-	-	-	-
	-	-	-	-	-	○	○
	-	-	-	-	-	-	-
	○	○	○	○	○	-	-
	○	○	○	○	○	○	○
	○	○	○	○	○	-	-
	○	○	○	○	○	-	-
	○	○	○	○	○	○	○
	-	-	-	-	-	-	-
	-	-	-	-	-	-	-
	-	-	-	-	-	-	-
	○	○	○	○	○	○	○
	○	○	○	○	○	○	○
	-	-	-	-	-	-	-
	-	-	-	-	-	-	-
	○	○	○	○	○	○	○
	○	○	○	○	○	○	○
	-	-	-	-	-	-	-
	-	-	-	-	-	-	-
	30	30	30	30	30	60	60
	-	-	-	-	-	-	-
	-	-	-	-	-	-	-
	○	○	○	○	○	○	○
	○	○	○	○	○	○	○
	-	-	-	-	-	-	-
	-	-	-	-	-	-	-
	○	○	○	○	○	○	○
	○	○	○	○	○	○	○
	○	○	○	○	○	○	○
	-	-	-	-	-	-	-
	50	50	50	50	50	50	50
	300 x 340 x 146.5	300 x 340 x 146.5	300 x 340 x 146.5	300 x 340 x 146.5	300 x 340 x 146.5	440 x 347.5 x 227.5	440 x 347.5 x 227.5
	300 x 410 x 146.5	300 x 410 x 146.5	300 x 410 x 146.5	300 x 410 x 146.5	300 x 410 x 146.5	440 x 462.5 x 227.5	440 x 462.5 x 227.5
	14	14	14	14	14	35	35
	18	18	18	18	18	45	45
	-	-	-	-	-	-	-

# Switch-disconnector selection

## Compact INSE80 and INSJ400

A



Compact INSE80.



Compact INSJ400.

### INSE/INSJ switch specifications

#### Reverse Connection

Compact INSE/INSJ switches may be wired with the supply power coming from either side with no reduction in performance.

#### Neutral Pole Position

In Compact switches, the neutral pole is located on the left-hand side. On the INSE/INSJ switch, the four poles are identical and the neutral pole can therefore be located on the right-hand side by masking the existing label and adding an appropriate label on the right.

### Electrical characteristics

#### Compact INSE/INSJ

Number of poles

#### UL489 - Electrical characteristic

Rated operational voltage

Impulse-withstand voltage

Short circuit rating when protected by any protective device 600 V AC

Short circuit rating when protected by circuit breaker 240 V AC

480 V AC

600 V AC

Short circuit rating when protected by fuses 600 V AC

Current rating at 60 °C

Positive contact indication

Endurance (operation O-CO)	Total
	Electrical
	Mechanical

#### Connection

Front connection

Busbar or compression lug

Bare wire connector	1 cable
	1-2 cables

Rear connection

Busbar or compression lug

Cable range temperature

Cable range for base wire	1 cable
	1-2 cables

Torques

Terminal shrouds

Terminal shields

Phase barriers

#### Mounting

Mounting on 35 mm symmetrical rail

Mounting on backplate

#### Accessories

Auxiliary contacts <sup>[1]</sup>

Rotary handle	Direct front
	Extended front
	Direct lateral
	Extended lateral
Locking	By padlocks
	By keylock

Escutcheons

#### Dimensions and Weight

Overall dimensions 3 poles/4 poles

H x W x D (mm)

Approximate weight 3 poles

(kg) 4 poles

[1] Common points changeover contact.

[2] CAM (early break or early make) common point changeover contact.

# Functions and characteristics

## Switch-disconnector selection

### Compact INSE80 and INSJ400



	INSE80-40 A	INSE80-60 A	INSE80-80 A	INSJ400-250 A	INSJ400-400 A
	3-4			3-4	
	600 V AC 8 kV 10 kA rms 100 kA rms 65 kA rms 18 kA rms Schneider Electric circuit breaker PowerPact H 100 A 50 kA rms. specific class T or RK 100 A			600 V AC 8 kV 20 kA rms 150 kA rms 100 kA rms 25 kA rms Schneider Electric circuit breaker PowerPact L 400 A 50 kA rms. specific class T or RK 400 A	
	40 A	60 A	80 A	250 A	400 A
	<input checked="" type="radio"/>			<input checked="" type="radio"/>	
	10000			6000	
	6000 full load			1000 full load	
	4000			5000	
	<input checked="" type="radio"/>			<input checked="" type="radio"/>	
	<input checked="" type="radio"/>			<input checked="" type="radio"/>	
	-			<input checked="" type="radio"/>	
	-			<input checked="" type="radio"/>	
	Al/Cu 75 °C and 90 °C 14 to 4 AWG Cu/Al 3 to 2 AWG Cu/Al			Al/Cu 75 °C and 90 °C 2 AWG to 600 kcmil Cu 2 AWG to 500 kcmil Al 4/0 AWG à / to 350 kcmil Cu 4/0 AWG à / to 500 kcmil Al 32 Nm/275 lb-in	
	-			-	
	10 Nm/88 lb-in			-	
	Option			Option	
	Option			Option	
	Option			Option	
	<input checked="" type="radio"/>			<input checked="" type="radio"/>	
	<input checked="" type="radio"/>			<input checked="" type="radio"/>	
	-			-	
	Option			Option	
	Standard, up to 3 padlocks, position OFF only			Standard, up to 3 padlocks, position OFF only	
	-			Option	
	-			<input checked="" type="radio"/>	
	100 x 135 x 62,5 (without direct handle) 3.94 x 5.31 x 2.46 in.			205 x 185 x 130 (without direct handle) 8.07 x 7.28 x 5.12 in.	
	0,8 (1.76 lbs)			4,6 (10.12 lbs)	
	0,9 (1.98 lbs)			4,9 (10.78 lbs)	



# Switch-disconnector selection

## Compact INV100 to 630

A



Compact INV250 switch-disconnector.

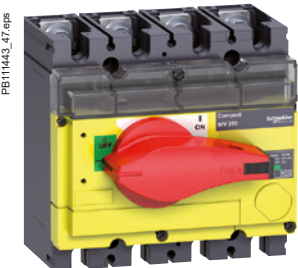

Compact INV250 emergency-off switch-disconnector.



Compact INV630 switch-disconnector.

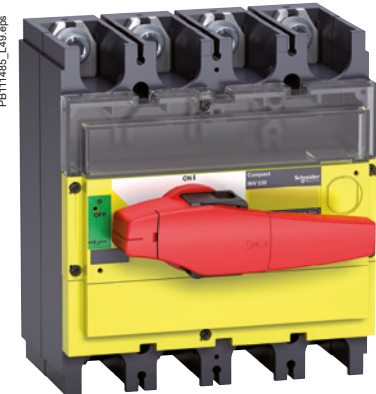

Compact INV630 emergency-off switch-disconnector.

### Compact INV switch-disconnectors

Number of poles

#### Electrical characteristics as defined by IEC 60947-1 / 60947-3 and EN 60947-1 / 60947-3

Conventional thermal current (A)	<b>I<sub>th</sub></b>	at 60 °C
Conventional thermal current in enclosure	<b>I<sub>the</sub></b>	at 60 °C
Rated insulation level (V)	<b>U<sub>i</sub></b>	AC 50/60 Hz
Impulse-withstand voltage (kV)	<b>U<sub>imp</sub></b>	
Rated operational voltage (V)	<b>U<sub>e</sub></b>	AC 50/60 Hz DC
Rated operational voltage AC20 and DC20 (V)		AC 50/60 Hz
Rated operational current (A)	<b>I<sub>e</sub></b>	<b>Electrical AC 50/60 Hz</b>
		220-240 V
		380-415 V
		440-480 V
		500-525 V
		660-690 V
		<b>Electrical DC</b>
		125 V (2P in series)
		250 V (4P in series)

Rated operational power AC23 (kW)	<b>Electrical AC 50/60 Hz</b>
	220-240 V
	380-415 V
	440 V
	500-525 V
	660-690 V

Rated duties	Uninterrupted duty
	Intermittent duty
Short-circuit making capacity (kA peak)	<b>I<sub>cm</sub></b>
	Min. (switch-disconnector alone)
	Max. (with upstream protection circuit breaker)
Short-time withstand current (A rms)	<b>I<sub>cw</sub></b>
	1 s
	3 s
	20 s
	30 s

Suitability for isolation	
Durability (O-C cycles)	<b>Mechanical</b>
	<b>Electrical AC 50/60 Hz</b>
	440 V
	500 V
	690 V
	<b>Electrical DC</b>
	250 V

- Positive contact indication
- Visible break
- Emergency-off switch-disconnector
- Degree of pollution

#### Upstream protection

See the "Complementary technical information" page D-1.

[1] 550 A (DC).

# Switch-disconnector selection

## Compact INV100 to 630



INV100			INV160			INV200			INV250			INV320			INV400			INV500			INV630			
3-4			3-4			3-4			3-4			3-4			3-4			3-4			3-4			
100			160			200			250			320			400			500			630			
100			160			200			250			320			400			500			630 <sup>(1)</sup>			
800			800			800			800			800			800			800			800			
8			8			8			8			8			8			8			8			
690			690			690			690			690			690			690			690			
250			250			250			250			250			250			250			250			
750			750			750			750			750			750			750			750			
AC21A	AC22A	AC23A	AC21A	AC22A	AC23A	AC21A	AC22A	AC23A	AC21A	AC22A	AC23A	AC21A	AC22A	AC23A	AC21A	AC22A	AC23A	AC21A	AC22A	AC23A	AC21A	AC22A	AC23A	
100	100	100	160	160	160	200	200	200	250	250	250	320	320	320	400	400	400	500	500	500	630	630	630	
100	100	100	160	160	160	200	200	200	250	250	250	320	320	320	400	400	400	500	500	500	630	630	630	
100	100	100	160	160	160	200	200	200	250	250	250	320	320	320	400	400	400	500	500	500	630	630	630	
100	100	100	160	160	160	200	200	200	250	250	250	320	320	320	400	400	400	500	500	500	630	630	630	
DC21A	DC22A	DC23B	DC21A	DC22A	DC23B	DC21A	DC22A	DC23B	DC21A	DC22A	DC23B	DC21A	DC22A	DC23A	DC21A	DC22A	DC23A	DC21A	DC22A	DC23A	DC21A	DC22A	DC23A/DC23B	
100	100	100	160	160	160	200	200	200	250	250	250	320	320	320	400	400	400	500	500	500	550	550	550/630	
100	100	100	160	160	160	200	200	200	250	250	250	320	320	320	400	400	400	500	500	500	550	550	550/630	
22			45			55			75			90			110			132			200			
45			75			90			132			160			200			250			315			
55			90			110			150			185			220			250			400			
55			110			132			132			220			250			355			400			
55			90			160			160			250			400			500			560			
●			●			●			●			●			●			●			●			
Class 120 - 60 %			Class 120 - 60 %			Class 120 - 60 %			Class 120 - 60 %			Class 120 - 60 %			Class 120 - 60 %			Class 120 - 60 %			Class 120 - 60 %			
30			30			30			30			50			50			50			50			
330			330			330			330			330			330			330			330			
8500			8500			8500			8500			20000			20000			20000			20000			
4900			4900			4900			4900			11500			11500			11500			11500			
2200			2200			2200			2200			4900			4900			4900			4900			
1800			1800			1800			1800			4000			4000			4000			4000			
●			●			●			●			●			●			●			●			
15000			15000			15000			15000			10000			10000			10000			10000			
AC22A	AC23A	AC22A	AC23A	AC22A	AC23A	AC22A	AC23A	AC22A	AC23A	AC21A	AC22A	AC23A	AC21A	AC22A	AC23A	AC21A	AC22A	AC23A	AC21A	AC22A	AC23A	AC21A	AC22A	AC23A/AC23B
1500	1500	1500	1500	1500	1500	1500	1500	1500	1500	1000	1000	1000	1000	1000	1000	1000	1000	1000	1000	1000	1000	1000	1000	1000
1500	1500	1500	1500	1500	1500	1500	1500	1500	1500	1000	1000	1000	1000	1000	1000	1000	1000	1000	1000	1000	1000	1000	1000	1000/200
1500	1500	1500	1500	1500	1500	1500	1500	1500	1500	1000	1000	1000	1000	1000	1000	1000	1000	1000	1000	1000	1000	1000	1000	1000/200
DC22A	DC23A	DC22A	DC23A	DC22A	DC23A	DC22A	DC23A	DC22A	DC23A	DC21A	DC22A	DC23A	DC21A	DC22A	DC23A	DC21A	DC22A	DC23A	DC21A	DC22A	DC23A	DC21A	DC22A	DC23A/DC23B
1500	1500	1500	1500	1500	1500	1500	1500	1500	1500	1000	1000	1000	1000	1000	1000	1000	1000	1000	1000	1000	1000	1000	1000	1000/200
●			●			●			●			●			●			●			●			
●			●			●			●			●			●			●			●			
●			●			●			●			●			●			●			●			
3			3			3			3			3			3			3			3			
-			-			-			-			-			-			-			-			

# Switch-disconnector selection

## Compact INV100 to 630

A

### Compact INV switch-disconnectors

#### Installation

Fixed, front connection

Fixed, rear connection

On symmetrical rails

On a backplate

#### Connection

By cables To bare cable connectors

By cables with lugs Directly to terminals

To spreaders

To vertical-connection adapters via cable-lug adapters

Flat-facing bars Directly to terminals

To spreaders

Edgewise bars To vertical-connection adapters

#### Indication and measurement auxiliaries

Auxiliary contacts

PowerTag NSX

Voltage-presence indicator

Current-transformer module

Ammeter module

#### Control, locking and interlocking

Control Direct front rotary handle

Extended front rotary handle

Direct lateral rotary handle

Extended lateral rotary handle

Locking By keylock

By padlocks

Interlocking By keylock

Mechanical

Complete source-changeover assembly

Operating torque (Nm) (typical value for 3-4 poles with front handle)

#### Installation and connection accessories

Bare cable connectors

Rear connectors

Terminal extensions

Spreaders

One-piece spreader

Terminal shrouds

Terminal shields

Interphase-barrier

Front panel escutcheons

Coupling accessories

Tightening torque for electrical connections (Nm)

#### Dimensions and weights

Overall dimensions H x W x D (mm) 3 poles

4 poles

Approximate weight (kg) 3 poles

4 poles

#### Enclosure dimensions for the

H x W x D (mm)

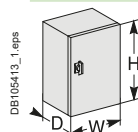

H x W x D (mm)

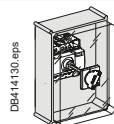



# Switch-disconnector selection

## Compact INV630b to 2500

PB111512\_45\_eps



Compact INV1600 switch-disconnector.

PB111513\_45\_eps

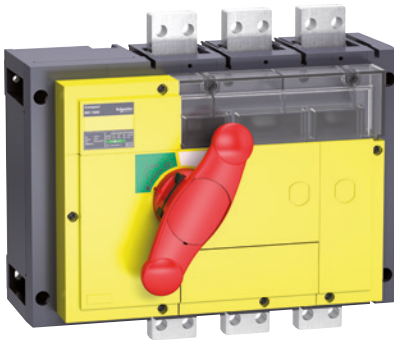

Compact INV1600 emergency-off switch-disconnector.

PB111519\_L62\_eps



Compact INV2500 switch-disconnector.

### Compact INV switch-disconnectors

Number of poles

#### Electrical characteristics as defined by IEC 60947-1 / 60947-3 and EN 60947-1 / 60947-3

Conventional thermal current (A)	<b>I<sub>th</sub></b>	at 60 °C
Conventional thermal current in enclosure	<b>I<sub>the</sub></b>	at 60 °C
Rated insulation level (V)	<b>U<sub>i</sub></b>	AC 50/60 Hz
Impulse-withstand voltage (kV)	<b>U<sub>imp</sub></b>	
Rated operational voltage (V)	<b>U<sub>e</sub></b>	AC 50/60 Hz DC
Rated operational voltage AC20 and DC20 (V)		AC 50/60 Hz

Rated operational current (A)	<b>I<sub>e</sub></b>	<b>Electrical AC 50/60 Hz</b>
		220-240 V
		380-415 V
		440-480 V
		500-525 V
		660-690 V
		<b>Electrical DC</b>
		125 V (2P in series)
		250 V (4P in series)

Rated operational power AC23 (kW)	<b>Electrical AC 50/60 Hz</b>
	220-240 V
	380-400 V
	415 V
	500-525 V
	660-690 V

Rated duties	Uninterrupted duty
	Intermittent duty
Short-circuit making capacity (kA peak)	<b>I<sub>cm</sub></b>
	Min. (switch-disconnector alone)
	Max. (with upstream protection circuit breaker)
Short-time withstand current (kA rms)	<b>I<sub>cw</sub></b>
	0.5 s
	0.8 s
	1 s
	3 s
	20 s
	30 s

Suitability for isolation	
Durability (O-C cycles)	<b>Mechanical</b>
	<b>Electrical AC 50/60 Hz</b>
	220-240 V
	380-415 V
	440-480 V <sup>[1]</sup>
	500-525 V
	660-690 V
	<b>Electrical DC</b>
	125 V (2P)
	250 V (4P)

Positive contact indication	
Visible break	
Emergency-off switch-disconnector	
Degree of pollution	

#### Upstream protection

See the "Complementary technical information" page D-1.

[1] For vertical connection busbars only. For horizontal connection busbars, see derating charts in "Installation recommendations" page B-24.



# Switch-disconnector selection

## Compact INV630b to 2500



INV630b			INV800			INV1000			INV1250			INV1600			INV2000			INV2500		
3-4			3-4			3-4			3-4			3-4			3-4			3-4		
630			800			1000			1250			1600 <sup>[1]</sup>			2000			2500		
630			800			1000			1250			1600 <sup>[1]</sup>			2000			2500		
1000			1000			1000			1000			1000			1000			1000		
12			12			12			12			12			12			12		
690			690			690			690			690			690			690		
250			250			250			250			250			250			250		
800			800			800			800			800			800			800		
AC21A	AC22A	AC23A	AC21A	AC22A	AC23A	AC21A	AC22A	AC23A	AC21A	AC22A	AC23A	AC21B	AC22B	AC23A	AC21B	AC22B	AC23B	AC21B	AC22B	AC23B
630	630	630	800	800	800	1000	1000	1000	1250	1250	1250	1600	1600	1250	2000	2000	-	2500	2500	-
630	630	630	800	800	800	1000	1000	1000	1250	1250	1250	1450	1450	1250	2000	2000	-	2500	2500	-
630	630	630	800	800	800	1000	1000	1000	1250	1250	1250	1450	1450	1250	2000	2000	-	2500	2500	-
630	630	630	800	800	800	1000	1000	1000	1250	1250	1250	1250	1250	1250	2000	2000	-	2500	2500	-
630	630	630	800	800	800	1000	1000	1000	1250	1250	1250	1600	1600	1250	2000	2000	-	2500	2500	-
630	630	630	800	800	800	1000	1000	1000	1250	1250	1250	1250	1250	1250	2000	2000	-	2500	2500	-
DC21A	DC22A	DC23A	DC21A	DC22A	DC23A	DC21A	DC22A	DC23A	DC21A	DC22A	DC23A	DC21A	DC22A	DC23A	DC21B	DC22B	DC23B	DC21B	DC22B	DC23B
630/2	630/2	630/2	800/2	800/2	800/2	1000/2	1000/2	1000/2	1250/2	1250/2	1250/2	1600/2	1600/2	1600/2	2000/2	2000/2	-	2500/2	2500/2	-
630/4	630/4	630/4	800/4	800/4	800/4	1000/4	1000/4	1000/4	1250/4	1250/4	1250/4	1600/4	1600/4	1600/4	2000/4	2000/4	-	2500/4	2500/4	-
250	250	250	400	400	400	560	560	560	710	710	710	900	900	900	-	-	-	-	-	-
400	400	400	560	560	560	710	710	710	900	900	900	-	-	-	-	-	-	-	-	-
500	500	500	630	630	630	800	800	800	900	900	900	-	-	-	-	-	-	-	-	-
560	560	560	710	710	710	900	900	900	-	-	-	-	-	-	-	-	-	-	-	-
710	710	710	900	900	900	-	-	-	-	-	-	-	-	-	-	-	-	-	-	-
☉	☉	☉	☉	☉	☉	☉	☉	☉	☉	☉	☉	☉	☉	☉	☉	☉	☉	☉	☉	☉
Class 120 - 60 %			Class 120 - 60 %			Class 120 - 60 %			Class 120 - 60 %			Class 120 - 60 %			Class 120 - 60 %			Class 120 - 60 %		
75			75			75			75			75			105			105		
330			330			330			330			330			330			330		
50	50	50	50	50	50	50	50	50	50	50	50	50	50	50	50	50	50	50	50	50
42	42	42	42	42	42	42	42	42	42	42	42	42	42	42	50	50	50	50	50	50
35	35	35	35	35	35	35	35	35	35	35	35	35	35	35	50	50	50	50	50	50
20	20	20	20	20	20	20	20	20	20	20	20	20	20	20	30	30	30	30	30	30
10	10	10	10	10	10	10	10	10	10	10	10	10	10	10	13	13	13	13	13	13
8	8	8	8	8	8	8	8	8	8	8	8	8	8	8	11	11	11	11	11	11
☉	☉	☉	☉	☉	☉	☉	☉	☉	☉	☉	☉	☉	☉	☉	☉	☉	☉	☉	☉	☉
5000			3000			3000			3000			3000			3000			3000		
AC21A	AC22A	AC23A	AC21A	AC22A	AC23A	AC21A	AC22A	AC23A	AC21A	AC22A	AC23A	AC21B	AC22B	AC23A	AC21B	AC22B	AC23B	AC21B	AC22B	AC23B
1000	1000	1000	500	500	500	500	500	500	500	500	500	100	100	500	100	100	-	100	100	-
1000	1000	1000	500	500	500	500	500	500	500	500	500	500	500	500	100	100	-	100	100	-
1000	1000	1000	500	500	500	500	500	500	500	500	500	500	500	500	100	100	-	100	100	-
1000	1000	1000	500	500	500	500	500	500	500	500	500	500	500	500	100	100	-	100	100	-
1000	1000	1000	500	500	500	500	500	500	500	500	500	500	500	500	100	100	-	100	100	-
DC21A	DC22A	DC23A	DC21A	DC22A	DC23A	DC21A	DC22A	DC23A	DC21A	DC22A	DC23A	DC21A	DC22A	DC23B	DC21B	DC22B	DC23B	DC21B	DC22B	DC23B
1000	1000	1000	500	500	500	500	500	500	500	500	500	500	500	500	100	100	-	100	100	-
1000	1000	1000	500	500	500	500	500	500	500	500	500	500	500	500	100	100	-	100	100	-
☉	☉	☉	☉	☉	☉	☉	☉	☉	☉	☉	☉	☉	☉	☉	☉	☉	☉	☉	☉	☉
3	3	3	3	3	3	3	3	3	3	3	3	3	3	3	3	3	3	3	3	3
-	-	-	-	-	-	-	-	-	-	-	-	-	-	-	-	-	-	-	-	-

# Switch-disconnector selection

## Compact INV630b to 2500

A

### Compact INV switch-disconnectors

#### Installation

Fixed, front connection

Fixed, rear connection

On symmetrical rails

On a backplate

#### Connection

By cables	To bare cable connectors
By cables with lugs	Directly to terminals
	To spreaders
	To vertical-connection adapters via cable-lug adapters
Flat-facing bars	Directly to terminals
	To spreaders
Edgewise bars	To vertical-connection adapters

#### Indication and measurement auxiliaries

Auxiliary contacts

Voltage-presence indicator

Current-transformer module

Ammeter module

#### Control, locking and interlocking

Control	Direct front rotary handle
	Extended front rotary handle
	Direct lateral rotary handle
	Extended lateral rotary handle
Locking	By keylock
	By padlocks
Interlocking	By keylock
	Mechanical

Complete source-changeover assembly

Operating torque (Nm) (typical value for 3-4 poles with front handle)

#### Installation and connection accessories

Bare cable connectors

Rear connectors

Terminal extensions

Spreaders

One-piece spreader

Terminal shrouds

Terminal shields

Interphase-barrier

Front panel escutcheons

Coupling accessories

Tightening torque for electrical connections (Nm)

#### Dimensions and weights

Overall dimensions H x W x D (mm)	3 poles
	4 poles
Approximate weight (kg)	3 poles
	4 poles

#### Enclosure dimensions for lthe

H x W x D (mm)

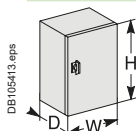

# Switch-disconnector selection

## Compact INV630b to 2500

A

	INV630b	INV800	INV1000	INV1250	INV1600	INV2000	INV2500
	⊙	⊙	⊙	⊙	⊙	⊙	⊙
	⊙	⊙	⊙	⊙	⊙	⊙	⊙
	-	-	-	-	-	-	-
	⊙	⊙	⊙	⊙	⊙	⊙	⊙
	-	-	-	-	-	-	-
	-	-	-	-	-	⊙	⊙
	-	-	-	-	-	-	-
	⊙	⊙	⊙	⊙	⊙	-	-
	⊙	⊙	⊙	⊙	⊙	⊙	⊙
	⊙	⊙	⊙	⊙	⊙	-	-
	⊙	⊙	⊙	⊙	⊙	-	-
	⊙	⊙	⊙	⊙	⊙	-	-
	⊙	⊙	⊙	⊙	⊙	⊙	⊙
	-	-	-	-	-	-	-
	-	-	-	-	-	-	-
	-	-	-	-	-	-	-
	⊙	⊙	⊙	⊙	⊙	⊙	⊙
	⊙	⊙	⊙	⊙	⊙	⊙	⊙
	-	-	-	-	-	-	-
	-	-	-	-	-	-	-
	⊙	⊙	⊙	⊙	⊙	⊙	⊙
	⊙	⊙	⊙	⊙	⊙	⊙	⊙
	⊙	⊙	⊙	⊙	⊙	⊙	⊙
	-	-	-	-	-	-	-
	-	-	-	-	-	-	-
	30	30	30	30	30	60	60
	-	-	-	-	-	-	-
	-	-	-	-	-	-	-
	⊙	⊙	⊙	⊙	⊙	⊙	⊙
	⊙	⊙	⊙	⊙	⊙	⊙	⊙
	-	-	-	-	-	-	-
	-	-	-	-	-	-	-
	⊙	⊙	⊙	⊙	⊙	⊙	⊙
	⊙	⊙	⊙	⊙	⊙	⊙	⊙
	⊙	⊙	⊙	⊙	⊙	⊙	⊙
	-	-	-	-	-	-	-
	50	50	50	50	50	50	50
	300 x 340 x 146.5	300 x 340 x 146.5	300 x 340 x 146.5	300 x 340 x 146.5	300 x 340 x 146.5	440 x 347.5 x 227.5	440 x 347.5 x 227.5
	300 x 410 x 146.5	300 x 410 x 146.5	300 x 410 x 146.5	300 x 410 x 146.5	300 x 410 x 146.5	440 x 462.5 x 227.5	440 x 462.5 x 227.5
	14	14	14	14	14	35	35
	18	18	18	18	18	45	45
	-	-	-	-	-	-	-

## Functions and characteristics

# Electrical and mechanical accessories

## Compact INS40 to 80

DB432320.eps

A

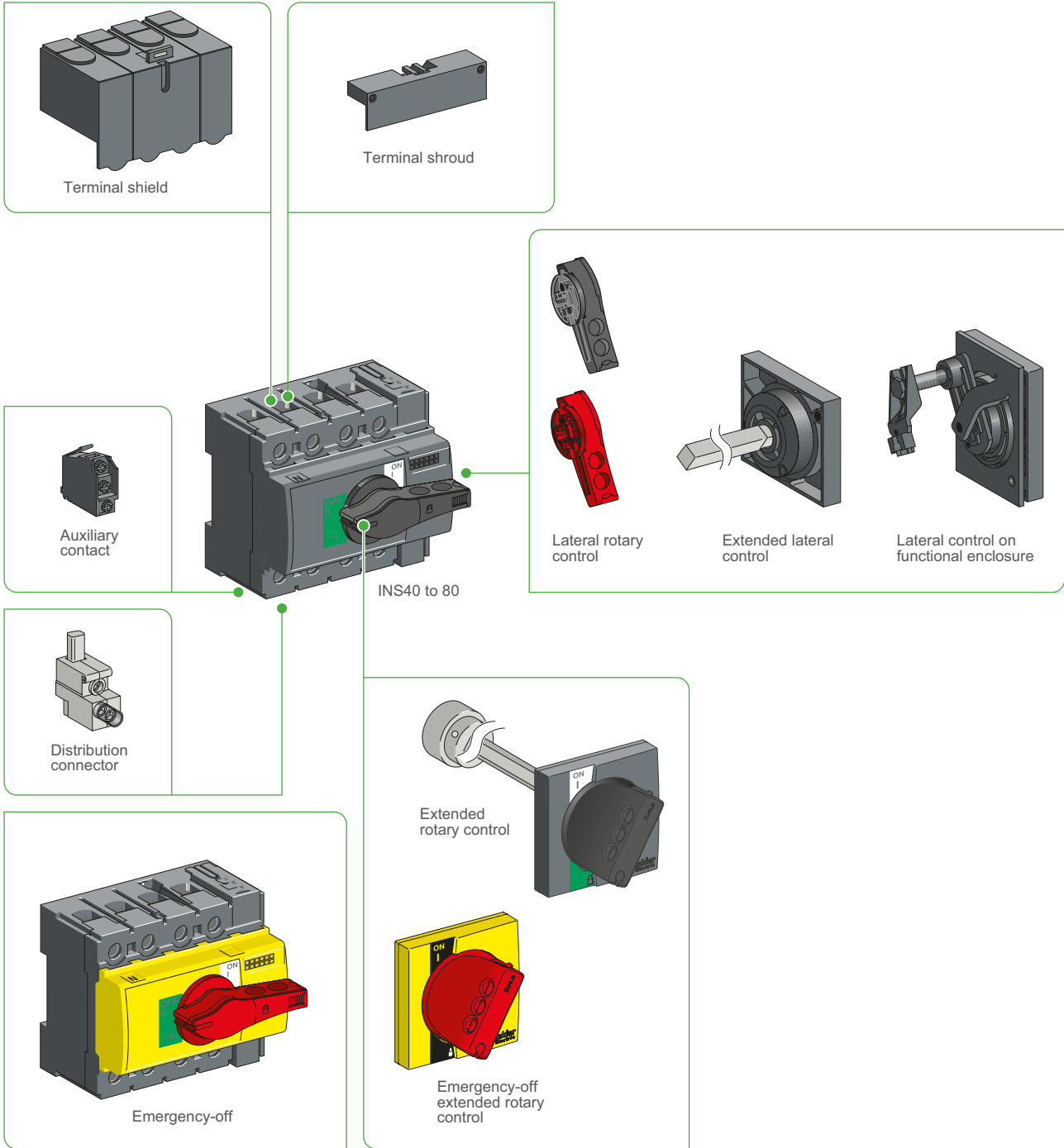

# Electrical and mechanical accessories

## Compact INS100 to 160



DB432321 eps

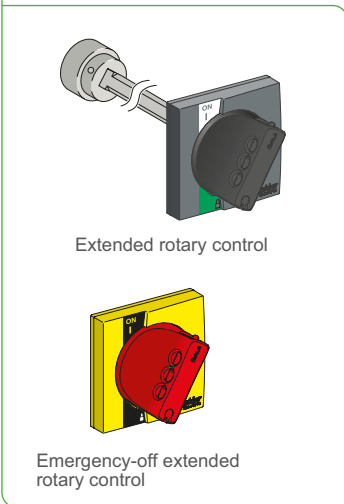
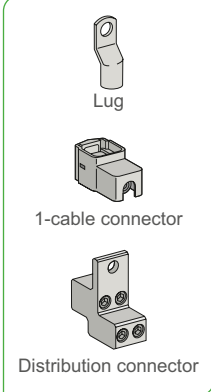
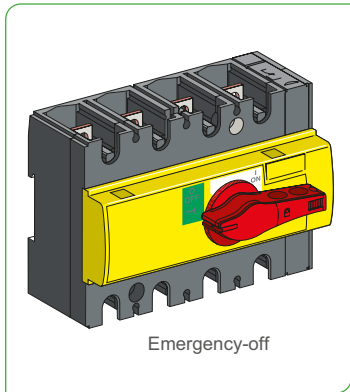
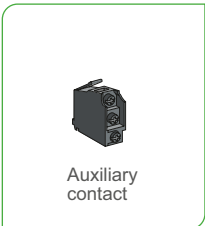
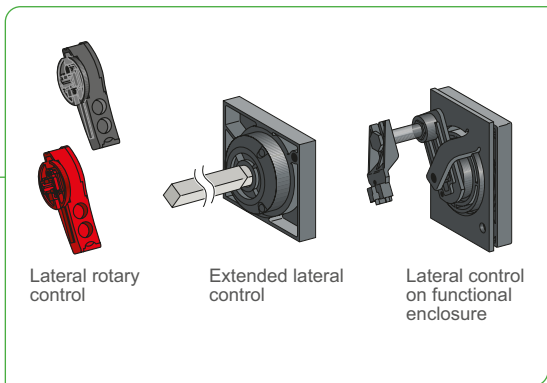
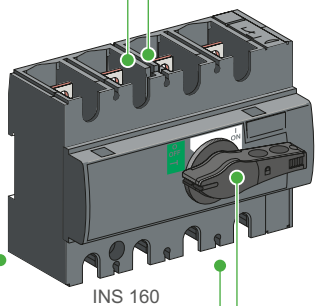
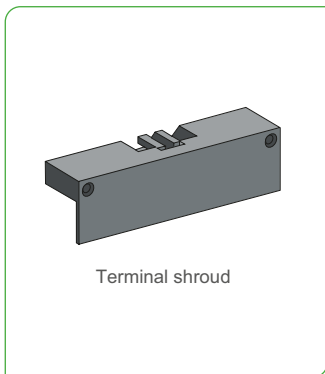
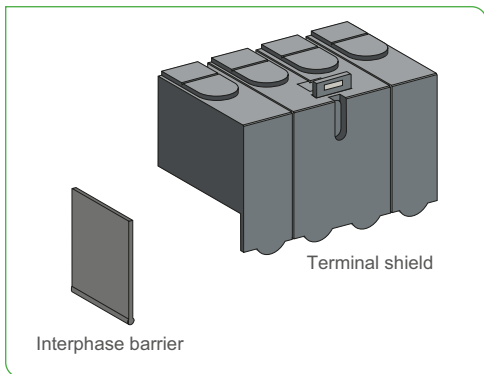



Functions and characteristics

# Electrical and mechanical accessories

Compact INS250-100 to 630

Compact INV100 to 630

DB432322.eps

A

Connection accessories  
compatibles with INS320 to 630

Voltage-presence indicator    Interphase barrier    Long terminal shield

Interphase barrier    Long terminal shield

Enclosure IP66 [2]

Rear connection    Lug    Spreader    One-piece spreader  
Right-angle terminal extension    Cable connector    DC connection

Rear connection    Lug    Spreader  
Right-angle terminal extension    Edgewise terminal    Cable connector

Emergency-off  
Emergency-off  
INV250

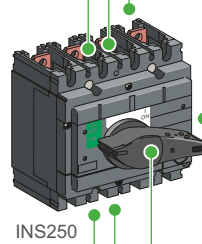

Auxiliary contact

Locking by keylock

Emergency-off extended rotary control  
Extended lateral rotary control  
Direct lateral rotary control  
Handle support

Power Tag    Ammeter module  
Current transformer module

Coupling accessory  
Short terminal shield

Lateral rotary control    Emergency-off extended rotary control  
Escutcheon

[1] Connectors 240 mm<sup>2</sup> INS (only for 250) /INV 100 to 250.  
[2] IP66 enclosed switch 200A.

# Electrical and mechanical accessories

Compact INS320 to 630

Compact INV320 to 630

DB432323\_epps

Rear connection    Lug    Spreader    Right-angle terminal extension  
Edgewise terminal    Cable connector    DC connection

Voltage-presence indicator    Interphase barrier    Long terminal shield

Auxiliary contact

Locking by keylock

Emergency-off  
Emergency-off  
INV630

INS630

PowerTag  
Current transformer module  
Ammeter module

Coupling accessory  
Short terminal shield

Extended rotary control  
Emergency-off extended rotary control  
Escutcheon



# Functions and characteristics

## Electrical and mechanical accessories

### Compact INS630b to 1600

### Compact INV630b to 1600

DB432324.eps

A

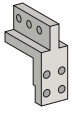

Vertical connection adapter



Spreader

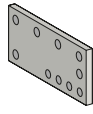

Cable lug adapter

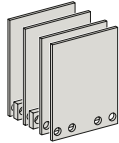

Connection DC



Interphase barrier

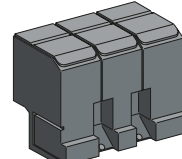

Terminal shield

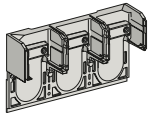

Base for terminal shield

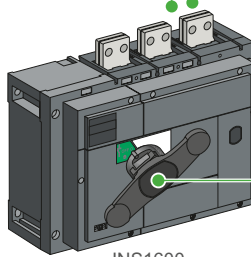

INS1600

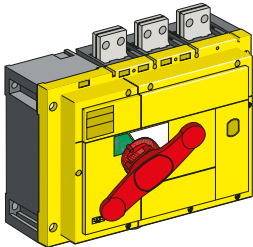

Emergency-off

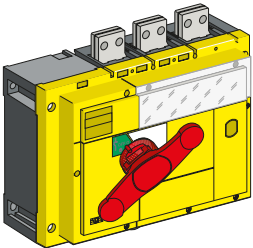

Emergency-off

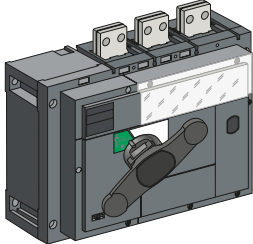

INV1600

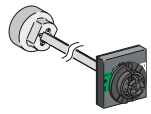

Extended rotary control

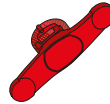

Emergency-off extended rotary control

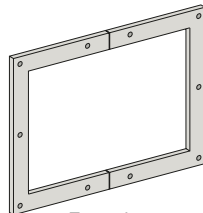

Escutcheon



Auxiliary contact



Locking by keylock

# Electrical and mechanical accessories

Compact INS2000 to 2500

Compact INV2000 to 2500

DB432325.eps

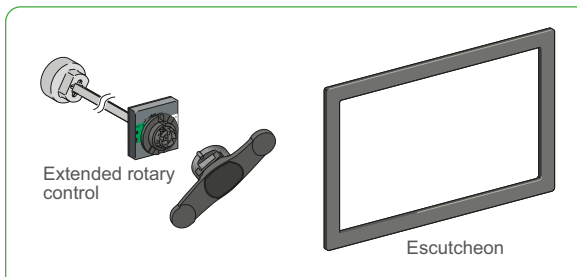
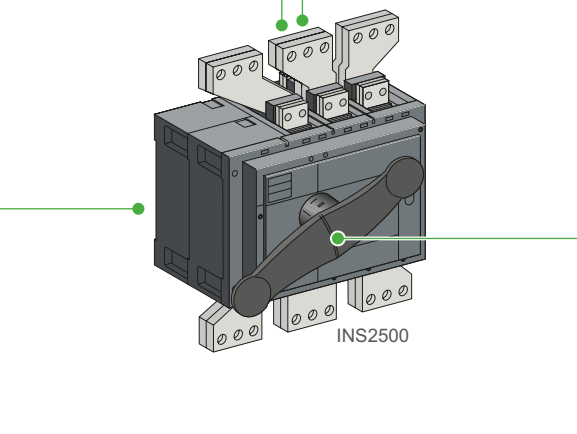
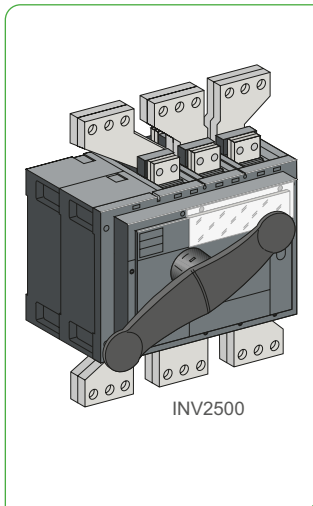
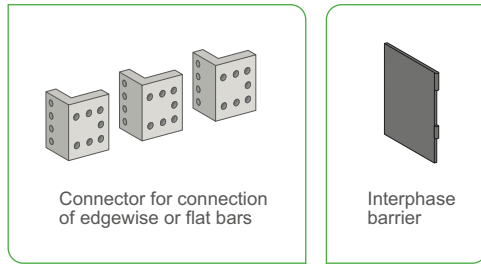

# Electrical and mechanical accessories

A



Compact INV250 with PowerTag.



Compact INV250 with ammeter module.

## Indications and measurement

### PowerTag NSX measurement module

For Compact INS250 to 630 and INV100 to 630.

#### Function

Provides capability to measure energy, monitor voltage loss and trigger alarms. Refer to page A-6 for further details.

#### Installation

- The module is self-powered and mounted directly on the bottom side of the switch disconnecter. On 4P, it can be mounted on top side with neutral on the right.
  - Degree of protection IP20 IK05
- Refer to page A-6 for further details regarding integration in Smartlink and configuration with Ecoeach.

#### Electrical characteristics

Accuracy class 1.

### Ammeter module

For Compact INS250 to 630 and INV100 to 630.

#### Function

Measures and displays the current of each phase (phase selection by a three-position switch on the front) on a dial-type ammeter.

#### Installation

- Connects directly to the downstream terminals of the switch-disconnector (except on a INS250 with a direct handle).
- Ammeter clips into module in any of four 90° positions, i.e. can be installed of devices mounted both vertically and horizontally.
- Degree of protection: IP40, IK04.
- Class II insulation between front and power circuits.

#### Electrical characteristics

Accuracy: class 4.5.

### Current-transformer module

For Compact INS250 to 630 and INV100 to 630.

#### Function

The module enables direct connection of a measurement device such as an ammeter or a Digipact power meter (not supplied).

#### Installation

- Connects directly to the downstream terminals of the switch-disconnector.
- Degree of protection: IP40, IK07.
- Class II insulation between front and power circuits.
- Connection via six built-in terminals for cables with a cross-sectional area of 2.5 mm<sup>2</sup>.

#### Electrical characteristics

- Current transformer with 5 A secondary winding.
  - Class 3 for the following values of consumed output power.
- Accuracy:
- 100 A rating: 1.6 VA
  - 150 A rating: 3 VA
  - 250 A rating: 5 VA
  - 400/630 A rating: 8 VA.

### Current-transformer module with voltage measurement outputs

For direct connection of a digital power monitoring unit: Power Meter PM700, PM800, etc. (not supplied).

#### Installation

- Mounts directly on the downstream terminals of the circuit breaker.
- Degree of protection: IP40, IK04.
- Class II insulation of front with respect to the power circuits.
- Built-in connectors for cables from 1.5 to 2.5 mm<sup>2</sup>.

#### Electrical characteristics

- Rated operational voltage U<sub>e</sub>: 530 V.
- Frequencies of measured values: 50... 60 Hz.
- Three CTs with 5 A secondary windings for the rated primary current I<sub>N</sub>.
- class 0.5 to 1 for rated power consumption values at the output:
  - 125 A, 150 A and 250 A ratings: class 1 for 1.1 VA
  - 400/600 A rating: class 0.5 for 2 VA
- use a cable of 2.5 mm<sup>2</sup> section up to 2.5 m long.
- Four voltage measurement outputs including protection with automatic reset
- voltage measurement output impedance 3500 W ±25 %, maximum current 1 mA.



# Electrical and mechanical accessories

## Voltage presence indicator

The indicator detects and indicates that circuit breaker terminals are supplied with power.

### Installation

- In the long or short terminal shields, via the knockouts.
- Upstream or downstream of the circuit breaker.
- Degree of protection: IP40, IK04.

### Electrical characteristics

Operates on all networks with voltages ranging from 220 et 550 V AC.

## Auxiliary contacts

### Compact INS and INV

One or four common-point changeover contacts can be used to remote switch-disconnector status information for indications, electrical interlocking, relays, etc.

### Functions

Each contact may be used for the following functions:

- OF (ON/OFF): indicates the position of the switch-disconnector poles
- CAM (early-make or early-break function): indicates the position of the handle. Used in particular for:
  - CAO early-break switch (auxiliary contacts open before the main contacts), used, for example, to automatically open a circuit breaker or a contactor before opening the Compact INS
  - CAF early-make switch (auxiliary contacts close before the main contacts)
- switching of very small loads. A "low-level" version of the auxiliary contacts exists for switching very small loads (for example, to control a PLC or electronic circuits).

### Standards

The auxiliary contacts comply with international standard IEC 60947-5-1.

### Installation

They simply snap in under the auxiliaries cover (supplied as standard) of the switch-disconnector.

### Insulation

Sealable auxiliary shield to protect against direct contact with power circuits.

### Electrical characteristics of auxiliary contacts for Compact INS and INV

Contact	Standard				Low level			
	AC		DC		AC		DC	
Rated thermal current (A)	6				5			
Minimum load	100 mA at 24 V				1 mA at 4 V			
Utilisation category (IEC 60947-5-1)	AC12	AC15	DC12	DC14	AC12	AC15	DC12	DC14
Operational current (A) 24 V	6	6	6	1	5	3	5	1
48 V	6	6	2.5	0.2	5	3	2.5	0.2
110 V	6	5	0.6	0.05	5	2.5	0.6	0.05
200/240 V	6	4	-	-	5	2	-	-
250 V	-	-	0.3	0.03	5	-	0.3	0.03
380/440 V	6	2	-	-	5	1.5	-	-
480 V	6	1.5	-	-	5	1	-	-
660/690 V	6	0.1	-	-	-	-	-	-

## Compact INS40 to 2500, INV100 to 2500

### Possible combinations

Compact	OF block	CAM block (CAO/CAF)
INS40 to 160	-	2
INS250	-	2
INS400 to 630	3	and 1
INS630b to 1600	3	and 1
INS2000 to 2500	3	and 1



Auxiliary contacts for Compact INS and INV

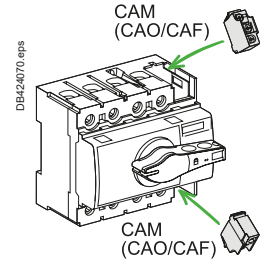

Compact INS40 to 160.

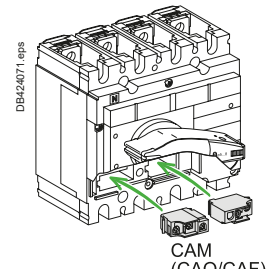

Compact INS250 and INV100 to 250.

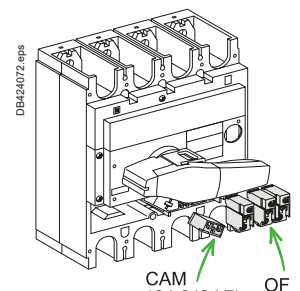

Compact INS/INV320 to 630.

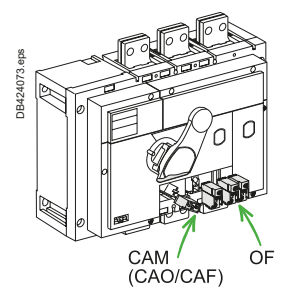

Compact INS/INV800 to 1600.

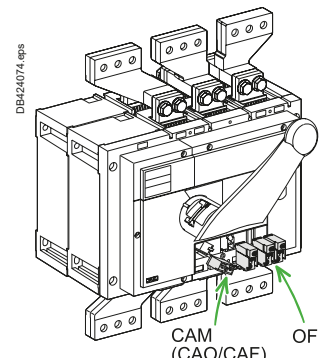

Compact INS/INV2000 to 2500.



# Electrical and mechanical accessories

A



Compact INS160 with lateral direct rotary handle.



Compact INS250 with lateral extended rotary handle.



Compact INS250 with front extended rotary handle.



Compact INS630 with front extended rotary handle.

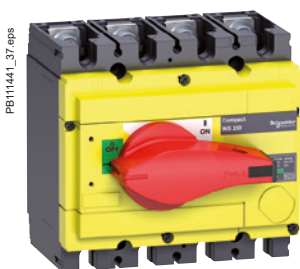

Compact INS250 emergency-off version with front direct rotary handle.

## Rotary handle

### Compact INS and INV

There are two types of rotary handle:

- direct rotary handle
- extended rotary handle.

There are two models:

- standard with a black handle
- with a red handle and yellow front for machine-tool control, in accordance with VDE standard.

	INS40-160	INS250 INV100-250	INS/INV 320-630	INS/INV 630b-1600	INS/INV 2000-2500
<b>Standard rotary handle</b>					
Front direct	Standard	Standard	Standard	Standard	Standard
Lateral direct	Standard	With conversion	No	No	No
Front extended	Optional	Optional	Optional	Optional	Optional
Lateral extended	Optional <sup>[1]</sup>	Optional	No	No	No
<b>Red and yellow rotary handle for emergency-off switch-disconnectors</b>					
Front direct	Standard	Standard	Standard	Standard	No <sup>[2]</sup>
Lateral direct	Standard	With conversion	No	No	No
Front extended	Optional	Optional	Optional	Optional	No <sup>[2]</sup>
Lateral extended	Optional <sup>[1][3]</sup>	Optional <sup>[3]</sup>	No	No	No

[1] Two models for universal enclosures and for Prisma G enclosures.

[2] Emergency-off versions not available for INS/INV2000-2500.

[3] The basic switch-disconnector must be the emergency-off (red and yellow) version.

### Direct rotary handle

- Degree of protection IP40.IK07.
- The switch-disconnector may be locked in the OFF position by one to three padlocks, hasp diameter 5 to 8 mm (not supplied).

### Models

- Standard switch-disconnector: with black handle.
- Emergency-off version with red handle and yellow front for machine-tool control.

### Extended rotary handle

- Makes it possible to operate the switch-disconnector, installed inside a switchboard, from the front or side of the switchboard. The extended rotary handle may be installed on the front or the side of the switch-disconnector. Degree of protection IP55.IK08.
- IP66, IK08 specific extended front rotary handle for INS250-200A.

### Operation

- Suitability for isolation is maintained.
- Door opening is prevented when the switch-disconnector is in ON position (for front handle only).
- The switch-disconnector may be locked in the OFF position by one to three padlocks, hasp diameter 5 to 8 mm (not supplied). Locking prevents opening of the switchboard door (for front handle only).

### Models

- Standard switch-disconnector: with black handle.
- Emergency-off: with red handle and yellow front for machine-tool control.

### Installation

The extended rotary handle is made up of:

- An assembly that replaces the direct rotary handle on the Compact INS/INV switch-disconnector (secured by screws).
- An assembly (handle and front plate) to be mounted on the door or the side of the switchboard. This assembly is always secured in the same position, whether the switch-disconnector is installed vertically or horizontally.
- An adjustable extension shaft (see page C-6 to page C-9).

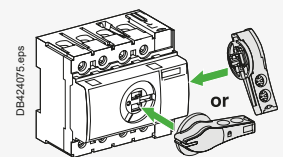

Direct rotary handle on INS40 to 160.

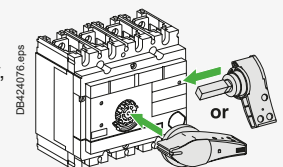

Direct rotary handle on INS250 and INV100 to 250.

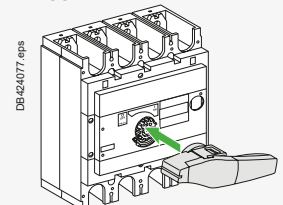

Direct rotary handle on INS/INV320 to 630.

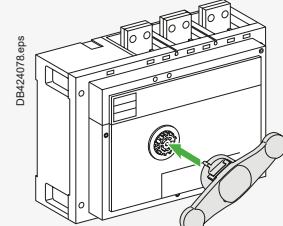

Direct rotary handle on INS/INV630 to 1600.

# Electrical and mechanical accessories

## Disabling device closing

### Padlocking

- INS40 to 2500 A.
- INV100 to 2500 A.

#### Switch-disconnectors may be locked in the OFF position

The handle is designed for locking by up to three padlocks (not supplied). Locking in the OFF position guarantees isolation as defined by the IEC 60947-3 standard. The handle may also be lead-sealed in the OFF position.

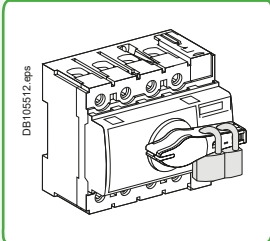

### Keylocking

- INS250-100 to 2500 A.
- INV100 to 2500 A.

INS250 to 630, INV100 to 630 or INV1000 to 2500 switch-disconnectors may be locked in the OFF position using a keylock (optional) that may be installed in the hole prepared for that purpose on the front of the devices.

The key may not be removed when the switch-disconnector is in the ON position. Keylocks can also be fitted on switch-disconnectors equipped with extended rotary handles.

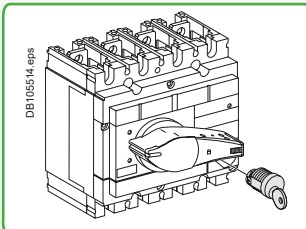

Padlocked Compact INS250 switch-disconnector.



### INS/INV switch-disconnectors

	INS40 to 80		INS80 to 160		INS250-100 to 250 INV100 to 250		INS320 to 630 INV320 to 630		INS630b to 1600 INV630b to 1600		INV2000 to 2500 INS2000 to 2500	
	OFF	ON	OFF	ON	OFF	ON	OFF	ON	OFF	ON	OFF	ON
Locking by padlocks	●	○	●	○	●	○	●	○	●	○	●	○
Locking by keylock	-	-	-	-	●	○	●	○	●	○	●	○
Door locking <sup>[1]</sup>	-	●	-	●	-	●	-	●	-	●	-	●
Door lock defeat <sup>[1]</sup>	-	● [2]	-	● [2]	-	● [2]	-	● [2]	-	● [2]	-	● [2]
Door locking device padlocked <sup>[1]</sup>	●	-	●	-	●	-	●	-	●	-	●	-
Lead-sealable handle	●	○	●	○	●	○	●	○	●	○	●	○

● Standard. ○ By simple modification of the standard rotary handle.

[1] With extended rotary control. [2] Using a special tool.

# Electrical and mechanical accessories

## UL489/CSA22.2 standards

PB111410\_L35.eps



Compact INSE80.

PB111437\_L38.eps



Compact INSJ400.

### Electrical and mechanical accessories

#### Auxiliary contacts

Two to four common-point changeover contacts can be used to remote switch-disconnector status information for indications, electrical interlocking, relays, etc.

#### Ammeter module

Measures and displays the current of each phase (phase selection by a three-position switch on the front) on a dial-type ammeter.

#### Current-transformer module

Measure phase currents for display by an ammeter or a Digipact module.

#### Rotary handles (standard)

Suitability for isolation is maintained.

#### Direct rotary handle

The switch-disconnector may be locked in the OFF position by one to three padlocks, hasp diameter 5 to 8 mm (not supplied).

Standard models: black handle.

#### Extended rotary handle

Makes it possible to operate the switch-disconnector, installed inside a switchboard, from the front or side of the switchboard.

The extended rotary handle may be installed on the front or the side of the switch-disconnector.

### Insulation accessories

Compact INSE/INSJ may be equipped with insulation accessories in option:

- terminal shrouds
- terminal shields
- interphase barriers.

A

# Functions and characteristics

## Electrical and mechanical accessories

### UL489/CSA22.2 standards



#### Compact INSE80

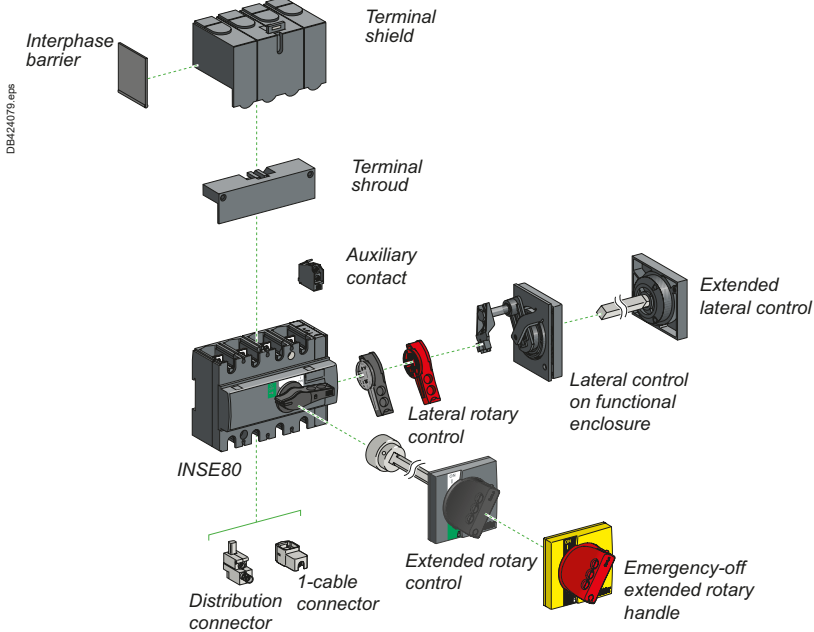

#### Compact INSJ400

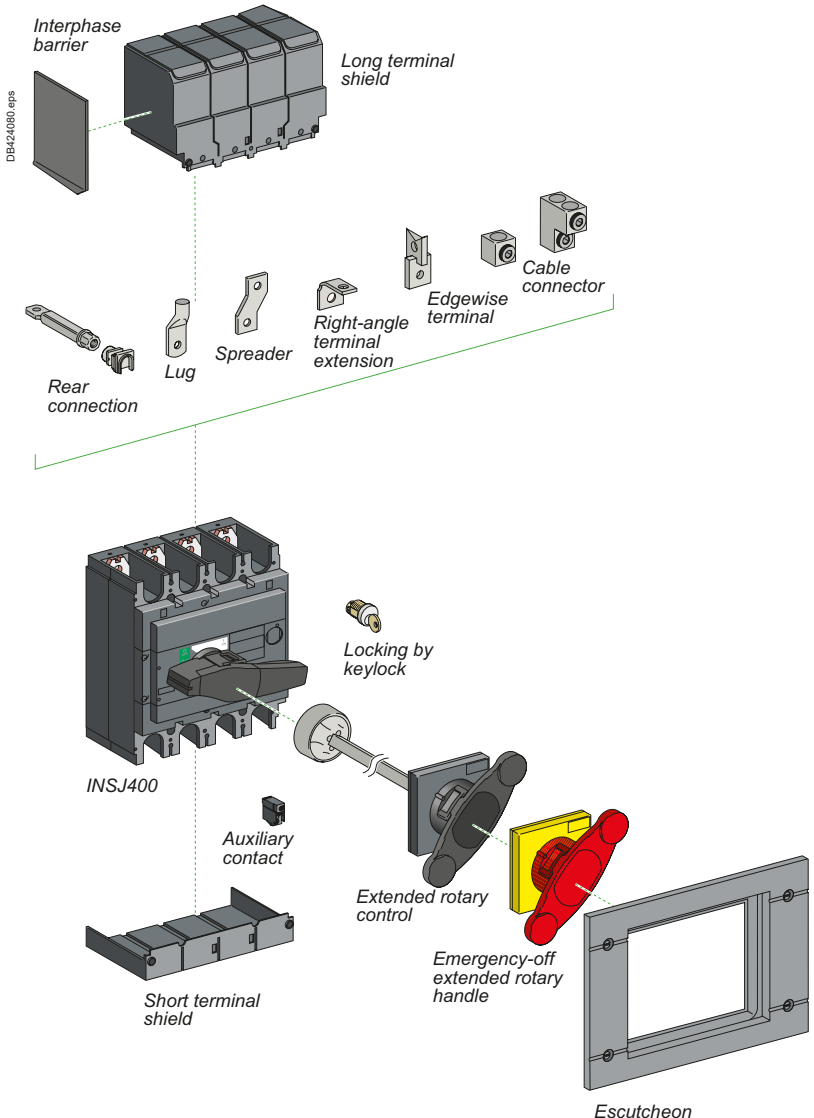



# Manual source-changeover systems

A source-changeover system is made up of two switch-disconnectors or circuit breakers that are mechanically interlocked.

The mechanism prevents the simultaneous connection (even transient) of both sources. Switching from one source to the other can be achieved by:

- a keylock-type interlocking system
- a mechanical interlocking system
- a complete source-changeover assembly.

A

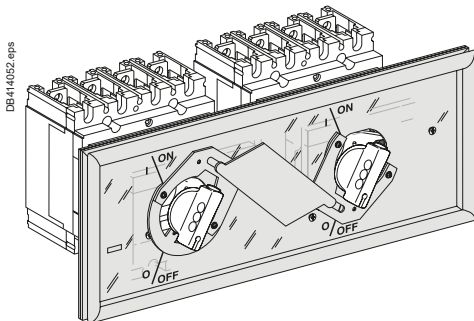
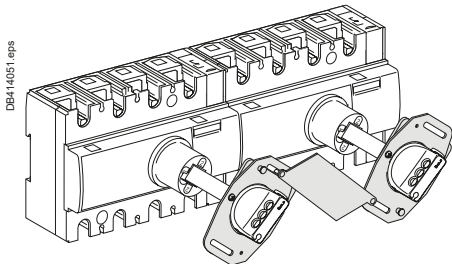
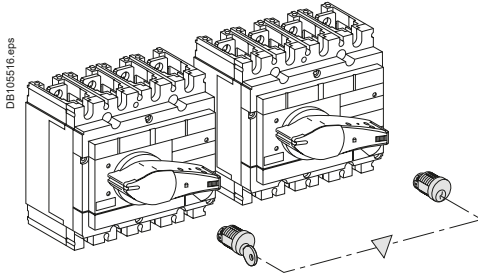

## Possible positions

Normal	1	0	0
Replacement	0	1	0

Source-changeover	INS40...160	INS250 INV100...250	INS320...630 INV320...630	INS630b...2500
By keylock	-	●	●	●
Mechanical	●	●	●	-
Complete assembly	-	●	●	-

## Interlocking of two devices using keylocks and a captive key

Interlocking is based on two identical keylocks with a single key and a keylock adapter (different for each device). This solution enables interlocking between two devices that are physically distant or that have very different characteristics.

## Interlocking of two devices with rotary handles

The direct or extended rotary handles are padlocked with the devices in the OFF position. The mechanism prevents simultaneous closing of the devices, but allows them to be opened.

## Possible combinations of "Normal" and "Replacement" source INS40 to 160 switch-disconnectors

"Normal N"	"Replacement" R					
	INS40	INS63	INS80	INS100	INS125	INS160
<b>Compact INS [1]</b>						
<b>INS40</b>						
Ratings 40 A	●	●	●	●	●	●
<b>INS63</b>						
Ratings 63 A	●	●	●	●	●	●
<b>INS80</b>						
Ratings 80 A	●	●	●	●	●	●
<b>INS100</b>						
Ratings 100 A	●	●	●	●	●	●
<b>INS125</b>						
Ratings 125 A	●	●	●	●	●	●
<b>INS160</b>						
Ratings 160 A	●	●	●	●	●	●

[1] With extended rotary handles only.

## Possible combinations of "Normal" and "Replacement" source INS/INV100 to 250 switch-disconnectors

"Normal N"	"Replacement" R			
	INS250-100 INV100	INS250-160 INV160	INS250-200 INV200	INS250-250 INV250
<b>INS250-100/INV100</b>				
Ratings 100 A	●	●	●	●
<b>INS250-160/INV160</b>				
Ratings 160 A	●	●	●	●
<b>INS250-200/INV200</b>				
Ratings 200 A	●	●	●	●
<b>INS250-250/INV250</b>				
Ratings 250 A	●	●	●	●
<b>INS320/INV320</b>				
Ratings 320 A	○			○
<b>INS400/INV400</b>				
Ratings 400 A				
<b>INS500/INV500</b>				
Ratings 500 A				
<b>INS630/INV630</b>				
Ratings 630 A	○			○

○ 250 A and 630 A ratings can be mixed by using INS320/630 rotary handle interlocking system.

[2] Possible with INV, but visible-break function is significantly impaired.



# Manual source-changeover systems

## Interlocking of two devices with rotary handles

Possible combinations of "Normal" and "Replacement" source INS/INV320 to 630 switch-disconnectors

"Normal N"	"Replacement" R			
Compact INS /INV <sup>[1]</sup>	INS320 INV320	INS400 INV400	INS500 INV500	INS630 INV630
<b>INS250-100/INV100</b> Ratings 100 A	○	○	○	
<b>INS250-160/INV160</b> Ratings 160 A				
<b>INS250-200/INV200</b> Ratings 200 A				
<b>INS250-250/INV250</b> Ratings 250 A	○			○
<b>INS320/INV320</b> Ratings 320 A	●	●	●	●
<b>INS400/INV400</b> Ratings 400 A	●	●	●	●
<b>INS500/INV500</b> Ratings 500 A	●	●	●	●
<b>INS630/INV630</b> Ratings 630 A	●	●	●	●

○ 250 A and 630 A ratings can be mixed by using INS320/630 rotary handle interlocking system.

[1] Possible with INV, but visible-break function is significantly impaired.

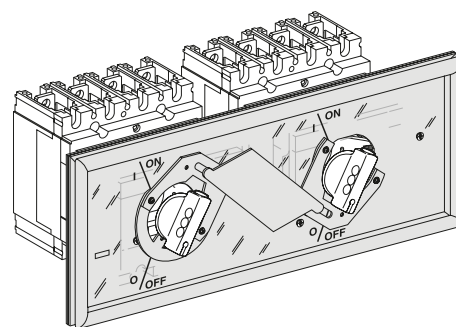

DB414053.eps



# Selection guide for DC switch-disconnectors

## Solutions depending on the distribution system and the voltage

### Type of distribution system

Type	Earthed	Mid-point connected to earth	Isolated
Source	One polarity (negative here) connected to earth (or exposed conductive parts)	Mid-point connected to earth	Isolated polarities
Protected polarities	1 (disconnection of 1P)	2 (disconnection of 2P)	2
Diagrams, connection method	<p>DB108614 eps</p>	<p>DB108615 eps</p>	<p>DB108616 eps</p>

## Series connection of poles

### Selection of switch-disconnectors and pole connection

Compact INS/INV				
24 V ≤ Un ≤ 125 V	<p>DB424094 eps</p> <p>Two-pole [1].</p>	<p>DB424095 eps</p> <p>Three-pole.</p>	<p>DB424096 eps</p> <p>Two-pole [2].</p>	<p>DB424097 eps</p> <p>Four-pole.</p>
125 V < Un ≤ 250 V	<p>DB424098 eps</p> <p>Four-pole.</p>	<p>DB424099 eps</p> <p>Four-pole.</p>	<p>DB424100 eps</p> <p>Four-pole.</p>	Not applicable

[1] A 3P switch-disconnectors can be used if a 2P version does not exist. In this case, connect pole 1 and pole 2, or pole 2 and pole 3 with dedicated connection accessory.

[2] A 3P switch-disconnectors can be used if a 2P version does not exist. In this case, connection accessory is not necessary and the central pole is not connected.

## Parallel connection of poles

### Selection of switch-disconnectors and pole connection

Compact INS/INV				
Un ≤ 63 V	<p>DB424101 eps</p> <p>Two, three-pole, 2, 3P in parallel, four-pole, 4P in parallel.</p>	<p>DB424102 eps</p> <p>Four-pole, 2 x 2P in parallel.</p>	<p>DB424102 eps</p> <p>Four-pole, 2 x 2P in parallel.</p>	<p>DB424102 eps</p> <p>Four-pole, 2 x 2P in parallel.</p>
63 V < Un ≤ 125 V	<p>DB424103 eps</p> <p>Four-pole, 2 x 2P in parallel, connected in series.</p>	Not applicable	<p>DB424102 eps</p> <p>Four-pole, 2 x 2P in parallel.</p>	Not applicable

### One-piece spreader

Connection of large cables may require an increase in the distance between the switch-disconnector terminals. The one-piece spreader is an accessory that can also be fitted on Compact circuit breakers. It offers the following features:

- increases the pitch of the switch-disconnector terminals to correspond to that of the upstream device
- compatible with all the connection and insulation accessories available for the upstream device (connectors, terminal extensions, etc.)
- enhances insulation between phases in comparison with standard spreaders.

	INS250 INV100 to 250	INS320 to 630 INV320 to 630
Pitch <b>without</b> spreaders (mm)	35	45
Pitch <b>with</b> standard spreaders (mm)	45	52.5 or 70
Pitch <b>with</b> one-piece spreader (mm)	45	-

### Mounting

When equipped with a one-piece spreader, INS and INV switch-disconnectors may be installed either at the back of a switchboard or on the front panel with a front alignment base.

- Devices with different frame sizes can thus be aligned in the switchboard.
- The same mounting plate can be used for all devices (including Compact circuit breakers).

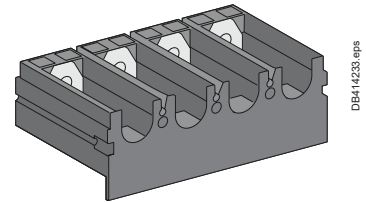
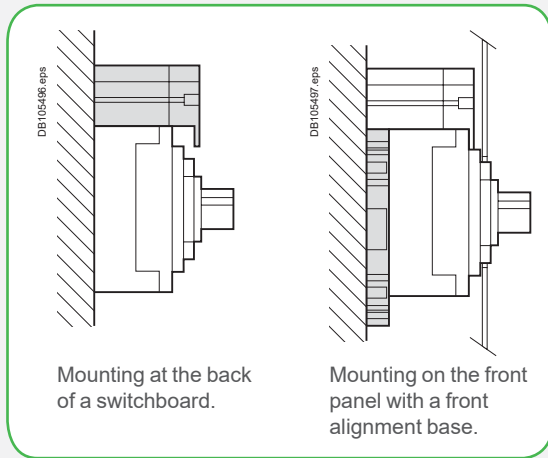

One-piece spreader.

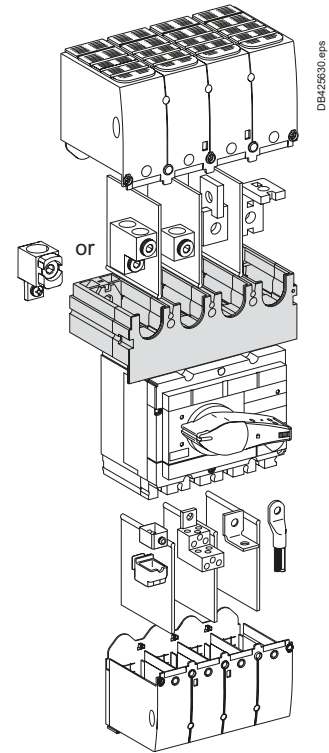

Connection and insulation accessories are identical to those for Compact.



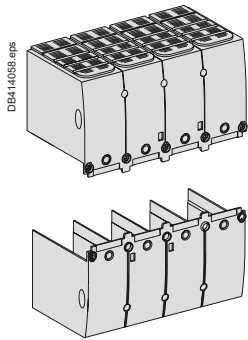

Terminal shields  
 for Compact INS and INV.

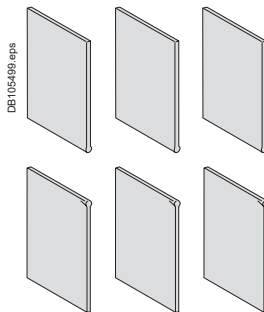

Interphase-barrier  
 for Compact INS and INV.

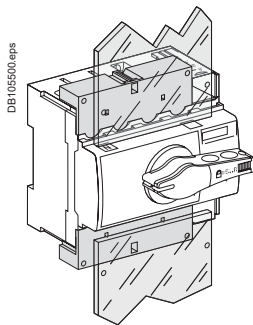

Terminal shrouds  
 for Compact INS40 to 160  
 (with insulating plate to  
 avoid contact with the  
 conductors).

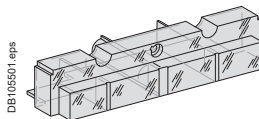

Spare viewport  
 for Compact INV.

## Insulation of live parts

### Terminal shields for INS and INV switch-disconnectors

Lead-sealable insulation accessories used to protect against direct contact with power circuits.

- Degree of protection: IP40, IK07.
- Supplied with lead-sealing accessories.

### Interphase-barrier for INS/INV

■ Safety accessories providing maximum insulation between the phases of the power connection.

- Easy installation by snapping into the case.
- May be combined with all other connection accessories, except the terminal shields and terminal shrouds.

### Terminal shrouds for INS40 to INS160

These insulation accessories are used for protection against direct contact with live connection screws. It is also possible to attach an insulating plate (not supplied) to the shrouds to avoid any contact with the power conductors.

### Spare viewport for Compact INV switch-disconnectors

Viewports are darkened by the electrical arc. A new viewport may be installed to maintain the visible-break function.



**Note:** If  $500\text{ V} \leq U \leq 690\text{ V}$ , interphase-barrier or long terminal shields are mandatory.

### Coupling accessory for complete source-changeover assembly

This accessory simplifies connection of bars or cables with lugs when coupling two Compact INS/INV 100 to 630 switch-disconnectors of the same size.

Pitch between outgoing terminals:

- Compact INS250 and INV100 to 250: 35 mm
- Compact INS/INV320 to 630: 45 mm.

### Connection and insulation accessories

The coupling accessory may be fitted with the same connection and insulation accessories as the coupled circuit breakers or switch-disconnectors.

Possible combinations	Downstream coupling	
	Possible	Pitch of outgoing terminals (mm)
<b>Manual source-changeover</b>		
INS250 (100 to 250 A) with rotary handle	●	35
INS400/630 (320 to 630 A) with rotary handle	●	45

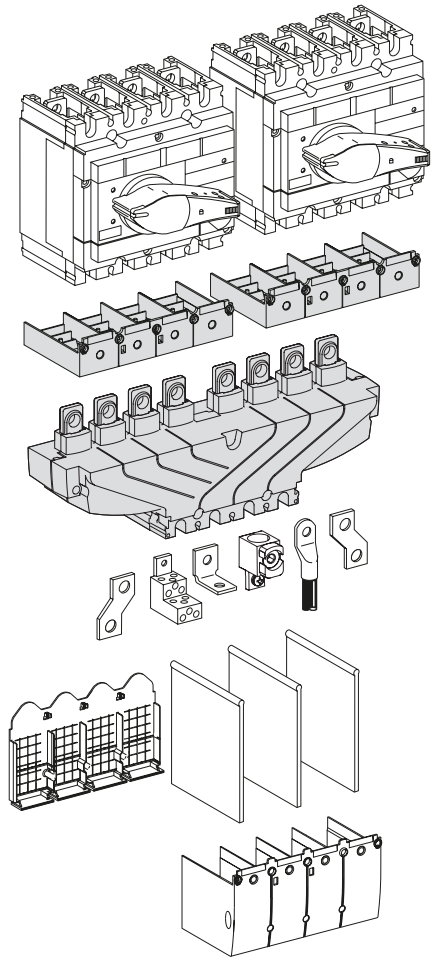

DBA425568.eps



# Linergy DS

## Screw distribution blocks

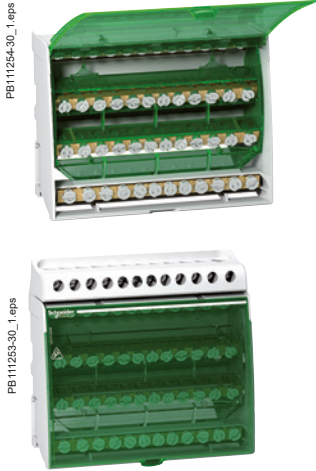

### IEC/EN 60947-7-1, IEC/EN 61439-1 & 2 (inside Prisma System)





#### Description

- Single-pole or four-pole distribution block that can be installed on a standard DIN rail or on a mounting plate.
- Compatible with Prisma G and P, Pragma, Mini Pragma and Resbo series switchboards.
- Incomers and feeders are connected to screw terminals that accept rigid or flexible cables with ferrule.
- Optional: additional neutral terminal strip for four-pole distribution block.

#### Advantages

- Simplified power supply for main incomers.
- Easy phase balancing.
- Easy, effortless cabling due to excellent accessibility.
- Visible cabling.
- Insulation between phases.
- The single-pole distribution blocks are adjacent and bridgeable via the second incoming hole for parallel connection.

#### Screw distribution blocks

Number of poles	1P			4P
				
Rating	125 A	160 A	250 A	100 A
Total connection capacity	10	13	14	4 x 7
<b>Terminal capacity</b>				
Diameter	2 x Ø9.5 mm 2 x Ø7.5 mm 6 x Ø5.8 mm -	2 x Ø12 mm 3 x Ø7.5 mm 8 x Ø5.8 mm -	1 x Ø15.3 mm 1 x Ø10 mm 4 x Ø6 mm 8 x Ø7.5 mm	2 x Ø7.5 mm 5 x Ø5.5 mm - -
Rated peak withstand current (I <sub>pk</sub> /60 ms)	25 kA	36 kA	60 kA	14 kA
Rated peak withstand current (I <sub>pk</sub> /6 ms)	-	-	-	24 kA
Rated short-time withstand current (I <sub>cc</sub> ) (IEC/EN 60947-7-1)	36 kA	36 kA	36 kA	20 kA
Width (number of 9 mm pitches)	3	4	5	8
Dimension (H x W x D)	85 x 27 x 50.5	85 x 36 x 50.5	85 x 45 x 50.5	100 x 71 x 50.5
Weight (g)	125	163	239	210
Neutral terminal strip (optional)	-	-	-	LGYN1007
Catalogue numbers	<b>LGY112510</b>	<b>LGY116013</b>	<b>LGY125014</b>	<b>LGY410028</b>



# Functions and characteristics

## Linergy DS

### Screw distribution blocks

DB40805\_1.eps



On LGY412560 and LGY416048 references.  
Input cabling facilitated by side terminals.

### Technical data

#### Common characteristics

To IEC/EN 60947-7-1 and IEC/EN 61439-1 & 2

Rated insulation voltage (Ui)	500 V AC
Rated operational voltage (Ue)	230 V AC (L/N) 440 V AC (L/L)
Rated impulse withstand voltage (Uimp)	8 kV
Rated conditional short-circuit current of an assembly	Up to the breaking capacity of Schneider Electric feeder circuit breakers, even in cascading configuration
Network frequency	50/60 Hz
Pollution degree	3
Overvoltage category	III

#### Additional technical characteristics

Reference temperature	40 °C
Operating temperature	-25 °C to 55 °C
Dielectric withstand (IEC/EN 60947-1)	2500 V AC



			Neutral terminal strip		
125 A		160 A	100 A	125 A	
4 x 12	4 x 15	4 x 12	7	12	15
1 x Ø9 mm	1 x Ø9.5 mm	1 x Ø12 mm	2 x Ø7.5 mm	1 x Ø9 mm	1 x Ø9.5 mm
7 x Ø7.5 mm	3 x Ø8.5 mm	3 x Ø9 mm	5 x Ø5.5 mm	7 x Ø7.5 mm	3 x Ø8.5 mm
4 x Ø6.5 mm	11 x Ø6.5 mm	8 x Ø7.5 mm	-	4 x Ø6.5 mm	11 x Ø6.5 mm
-	-	-	-	-	-
18 kA	18 kA	22 kA	-	-	-
26 kA	28 kA	36 kA	-	-	-
36 kA	36 kA	36 kA	-	-	-
14	20	18	7	14	17
100 x 126 x 50.5	100 x 162 x 50.5	100 x 174 x 50.5	20 x 70 x 35	20 x 125 x 35	20 x 155 x 35
390	559	567	63	111	149
LGYN12512	LGYN12515	LGYN12512	-	-	-
<b>LGY412548</b>	<b>LGY412560</b>	<b>LGY416048</b>	<b>LGYN1007</b>	<b>LGYN12512</b>	<b>LGYN12515</b>

### Terminal technical data

Type	PZ2 screw							
Diameter	Ø5.5 mm	Ø5.8 mm	Ø6 mm	Ø6.5 mm	Ø7.5 mm	Ø8.5 mm	Ø9 mm	Ø9.5 mm
Section rigid cable	1.5 to 16 mm <sup>2</sup>	1.5 to 16 mm <sup>2</sup>	1.5 to 16 mm <sup>2</sup>	1.5 to 16 mm <sup>2</sup>	2.5 to 25 mm <sup>2</sup>	6 to 35 mm <sup>2</sup>	10 to 35 mm <sup>2</sup>	10 to 35 mm <sup>2</sup>
Section flexible cable or with ferrule	1.5 to 10 mm <sup>2</sup>	1.5 to 10 mm <sup>2</sup>	1.5 to 10 mm <sup>2</sup>	1.5 to 10 mm <sup>2</sup>	1.5 to 16 mm <sup>2</sup>	4 to 25 mm <sup>2</sup>	4 to 25 mm <sup>2</sup>	6 to 35 mm <sup>2</sup>
Tightening torque	2 N.m	2 N.m	2 N.m	2 N.m	2 N.m	2 N.m	2.5 N.m	2.5 N.m
Type	Hc screw							
Diameter	Ø9.5 mm	Ø10 mm	Ø12 mm					Ø15.3 mm
Section rigid cable	10 to 35 mm <sup>2</sup>	1.5 to 50 mm <sup>2</sup>	25 to 70 mm <sup>2</sup>					35 to 120 mm <sup>2</sup>
Section flexible cable or with ferrule	6 to 35 mm <sup>2</sup>	1.5 to 35 mm <sup>2</sup>	16 to 50 mm <sup>2</sup>					25 to 95 mm <sup>2</sup>
Tightening torque	8 N.m	4 N.m	1P: 10 N.m	4P: 5 N.m				14 N.m

# Linergy DX

## Quick distribution blocks



PB104495-7, eps



PB111415-19, r, eps

### IEC 60947-7-1, IEC 61439-2 (inside Prisma System)

#### Description

- Downstream circuits are connected from the front, to spring terminals.
- Contact pressure automatically adapts to the size of the conductor.
- Contacts are insensitive to vibrations and thermal variations.
- Only one cable (flexible or rigid) can be inserted per terminal.

#### Quick distribution blocks

Number of poles	4P, incomers from top	4P, incomers from bottom
	 PB104495-6, eps	 PB104500-6, eps
Rated operational current at 40 °C (Ie)	63 A	63 A
Rated conditional short-circuit current of an assembly (Isc)	The reinforced breaking capacity due to cascading in circuit breaker combinations is maintained. The worst-case situations have been tested.	The reinforced breaking capacity due to cascading in circuit breaker combinations is maintained. The worst-case situations have been tested.
Rated peak withstand current (Ipk)	-	-
Rated insulation voltage (Ui)	500 V AC	500 V AC
Rated operational voltage (Ue)	440 V AC	440 V AC
Rated impulse withstand voltage (Uimp)	6 kV	6 kV
Rated short-time withstand current (Icc)	150 kA	150 kA
Thermal stress (A².s)	-	-
Rated operational frequency	50/60 Hz	50/60 Hz
Degree of protection	IPxxB	IPxxB
Incoming terminals	1 tunnel terminal 25²/phase	1 tunnel terminal 25²/phase
Total connection capacity, outgoing terminals	24 connections: 4 x 6²/phase 12 x 6²/neutral	24 connections: 4 x 6²/phase 12 x 6²/neutral
Dimensions (H x W x D)	96.5 x 72 x 62 8 x 9 mm pitch	96.5 x 72 x 62 8 x 9 mm pitch
Installation	Clipped onto a DIN rail	Clipped onto a DIN rail
Other		
Standard for installation inside Prisma	IEC 61439-2	IEC 61439-2
Glow-wire 60695-2-11	960 °C	960 °C
Degree of pollution	3	3
<b>Catalogue numbers</b>	<b>04040</b>	<b>04041</b>

#### Accessories

<b>Catalogue numbers</b>	-	-
--------------------------	---	---

[1] To be adapted with reference 28947 and 28948 fir INS160.

# Functions and characteristics



## Linergy DX

### Quick distribution blocks

### Advantages

- A reliable electrical connection, no maintenance required (tightness guaranteed over time).
- Quick connection.
- Easy phase balancing.
- Ease of rewiring if the switchboard is expanded or modified.

A

4P		1P	
			
125 A	160 A	160 A	
20 kA/60 ms max according to IEC 61439-1	20 kA/60 ms max according to IEC 61439-1	32 kA	
20 kA	20 kA	24 kA	
750 V AC	750 V AC	750 V AC	
690 V AC	690 V AC	690 V AC	
8 kV	8 kV	8 kV	
150 kA	150 kA	150 kA	
2.025 x 10 <sup>7</sup>	2.025 x 10 <sup>7</sup>	3.025 x 10 <sup>7</sup>	
50/60 Hz	50/60 Hz	50/60 Hz	
IPxxB	IPxxB	IPxxB	
1 tunnel terminal 35 <sup>2</sup> /phase	Supplied with a prefabricated flexible connection (with lugs) designed for INS100/160 switch-disconnector installed on the left or right	1 tunnel terminal 70 <sup>2</sup> /phase	
52 connections: 7 x 4 <sup>2</sup> /phase 3 x 6 <sup>2</sup> /phase 2 x 10 <sup>2</sup> /phase 1 x 16 <sup>2</sup> /phase (screw terminal)	52 connections: 7 x 4 <sup>2</sup> /phase 3 x 6 <sup>2</sup> /phase 2 x 10 <sup>2</sup> /phase 1 x 16 <sup>2</sup> /phase (screw terminal)	6 connections: 6 x 16 <sup>2</sup> /phase	
127 x 108 x 48 8 x 9 mm pitch	127 x 108 x 48 8 x 9 mm pitch	95 x 36 x 70 4 x 9 mm pitch	
Screwed to plain or slotted backplate or onto DIN rail	Screwed to plain or slotted backplate or onto DIN rail	Onto DIN rail	
Possible to combine 2 terminal blocks (2nd terminal block supplied from enclosed terminals in the 1st, I <sub>max</sub> of 2nd terminal block: 80 A)			
IEC 61439-2	IEC 61439-2	IEC 61439-2	
960 °C	960 °C	960 °C	
3	3	3	
<b>04045</b>	<b>04046</b> <sup>[1]</sup>	<b>04031</b>	
4 x 125 A flexible connections, L = 240 mm with 1 end fitting for tunnel terminals.		4 x 160 A flexible connections, L = 380 mm with 2 x 45 mm <sup>2</sup> end fittings for tunnel terminals	
<b>04047</b> <sup>[1]</sup>		<b>04149</b>	

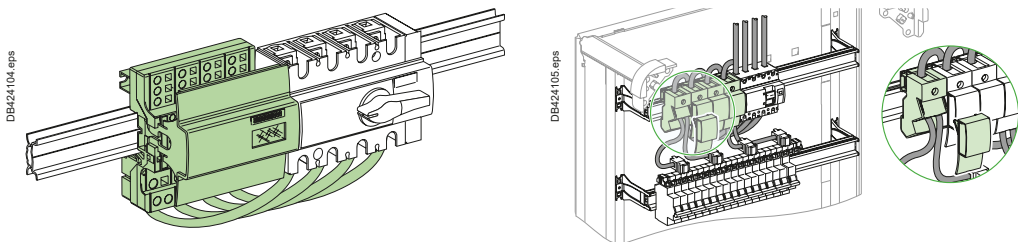

# Linergy DP

## Quick distribution blocks

PB11455-30-r\_eps

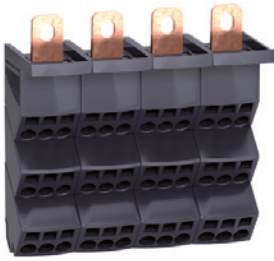

A

### IEC 60947-7-1, IEC 61439-1 & 2 (inside Prisma System)





#### Description

■ The Linergy DP quick distribution block is designed for installation directly downstream of Compact NSX and INS up to 250 A. It can also be clipped onto a modular rail.

#### Advantages

- It is quick to mount in the horizontal position. Electrical connections are made directly to the device terminals.
- It is the same width as the devices and does not take up any additional space in the switchboard.
- The connection terminals are slanted to facilitate cable entry and avoid exceeding the bending radius of the flexible and rigid cables.

#### Quick distribution blocks for Compact devices

Number of poles	3P	4P	3P	4P
				
Rated operational current (Ie)	250 A	250 A	250 A	250 A
Rated peak withstand current (Ipk)	30 kA	30 kA	150 kA	150 kA
Rated short-time current (Icc)	150 kA	150 kA	150 kA	150 kA
Thermal stress (A <sup>2</sup> .s)	7.225 x 10 <sup>7</sup>	7.225 x 10 <sup>7</sup>		
Total connection capacity, outgoing terminals	27 connections: 4 x 10 <sup>2</sup> /phase 6 x 16 <sup>2</sup> /phase	36 connections: 4 x 10 <sup>2</sup> /phase 6 x 16 <sup>2</sup> /phase	2 connections: 2 x 35 <sup>2</sup> /pole	2 connections: 2 x 35 <sup>2</sup> /pole
Incomer terminals	1 cable lug 120 mm <sup>2</sup> per pole			
Dimensions (H x W x D)	105 x 138 x 63	140 x 138 x 64		
Installation	On mounting plate or DIN rail		On mounting plate	
Product certifications	ASEFA - KEMA			
Standard for installation inside Prisma	IEC 61439-1-2			
Glow-wire 60695-2-11	960 °C			
Catalogue numbers	04033	04034	04155	04156

#### Additional block

		
Description	2 x 35 <sup>2</sup> 3P for Linergy DP 250 A	2 x 35 <sup>2</sup> 4P for Linergy DP 250 A
Catalogue numbers	04155	04156

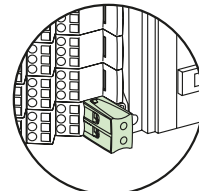
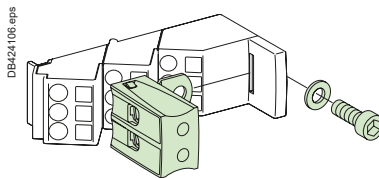

# Functions and characteristics

## Linergy DP

### Quick distribution blocks



### Technical data

#### Common characteristics

Rated conditional short-circuit current of an assembly (Isc)		The reinforced breaking capacity due to cascading in circuit-breaker combinations is maintained. The worst-case situations have been tested.
Rated insulation voltage (Ui)		750 V AC
Rated operational voltage (Ue)		690 V AC
Rated impulse withstand voltage (Uimp)		8 kV
Network frequency		50/60 Hz
Degree of protection		IPxxB
Degree of pollution		3
Overtoltage category		III

#### Additional technical characteristics

Reference temperature		40 °C
Operating temperature		-25 °C to 55 °C

### Installation

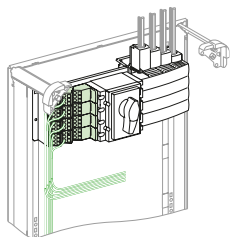

DB424107.eps  
 Directly on the mounting plates of horizontally mounted Compact **NSX100/250** and Compact **INS250** devices in the enclosures.

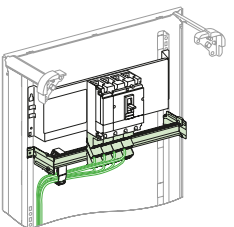

DB424108.eps  
 It can also be mounted downstream of vertically mounted Compact **NSX100/250** and Compact **INS250** devices in the enclosures. In this case, the Linergy DP is mounted on a depth-adjustable modular rail.

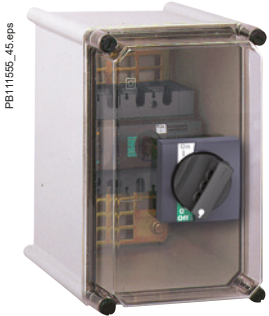

Local isolation enclosure.

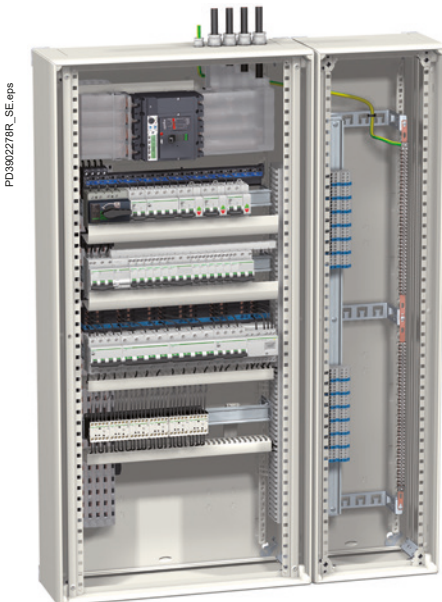

Power distribution incomer in a Prisma G enclosure.



Power distribution incomer in a Prisma G IP30 enclosure.

Compact INS and INV switch-disconnectors offer a number of rational installation solutions to optimise available space inside enclosures. They may be installed in individual enclosures or as incomers in power distribution or control panels.

- Compact INS40 to 160 switch-disconnectors have a standard 45 mm high front and may be clipped onto a Multifix or symmetrical rail. They may be installed in all modular enclosures, including Pragma, Prisma, etc.
- Compact INS250 to 630 and INV100 to 630 switch-disconnectors may be installed on mounting plates or rails. Installation as incomers in Prisma power distribution cubicles is very flexible:
  - the mounting plates are the same as those used for Compact NSX circuit breakers and are identical for direct and extended handles
  - installation in 300 mm ducts is possible for ratings up to 630 A.

### Individual enclosures

- Each individual enclosure includes:
  - a door with a cut-out
  - a mounting plate
  - accessories required for extended front or lateral rotary handle
  - removable plates (without holes) for cable entry.
 The Compact INS switch-disconnector must be order separately.

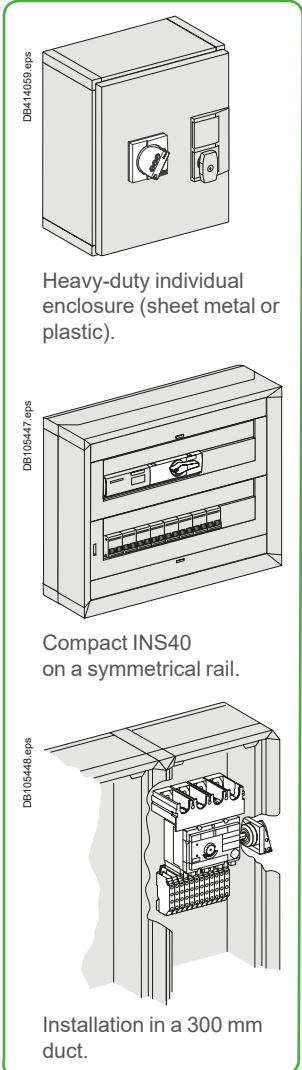

### Pragma modular enclosures

- The enclosures in the Pragma range are:
  - made of self-extinguishing insulating material
  - supplied with all accessories (terminal blocks, blanking plates, etc.)
  - rated class 2.

### Prisma G metal enclosures

- The metal enclosures in the Prisma G range are highly adaptable to the type of installation:
  - basic enclosure
  - multifix rail
  - modular front plates
  - distribution accessories
  - ducts for running cables or installing terminals
  - plain or transparent doors.



Front-panel escutcheons

**Escutcheons for switch-disconnectors and ammeter modules**  
Mounted on switchboard panel from the front using four screws.

Identification labels

Compact INS40 to 160 switch-disconnectors may receive Telemecanique prefabricated labels, catalogue number AB1- (eight characters). Compact INS250 to 630 and INV100 to 630 switch-disconnectors are supplied as standard with a clip-on label for handwritten indications. These devices also come with a nameplate into which a label can be inserted.

Individual enclosures

Compact INS and INV switch-disconnectors equipped with a front handle may be installed in individual enclosures. All fixed, front connections are possible, except right-angle and edgewise terminal extensions. Spreaders may be installed in the enclosures intended for Compact INS250 to 630 and INV100 to 630 switch-disconnectors.

**Heavy-duty steel (or stainless steel) individual enclosure for Compact INS250 (IP66, IK10)**

- Steel (or stainless steel) cover,
- Screwed
- Extended front rotary handle IP66
- 2 CAM (early make or break function) wired with terminal bloc NSY. (see page A-12).

**Heavy-duty metal individual enclosure for Compact INS (IP55, IK08)**

- Metal enclosure.
- Door with keylock and cut-out for switch-disconnector rotary handle.
- Extended rotary front handle.
- Device mounting plate.
- Removable plate (without holes) for cable entry through bottom.

**Heavy-duty insulating individual enclosure for Compact INS and INV (IP55, IK08)**

- Thermoplastic enclosure.
- Transparent cover, screwed, lead sealable, with cut-out for switch-disconnector rotary handle.
- Extended rotary front handle.
- Device mounting plate.
- Removable plates (without holes) for cable entry through bottom and/or top.

Dimensions

Steel - Stainless steel IP66	H x W x D
Compact INS250-200	445 x 300 x 200

Metal enclosures	H x W x D
Compact INS40 to 160	350 x 350 x 260
Compact INS250	450 x 350 x 260
Compact INV100 to 250	
Compact INS320 to 630	650 x 350 x 260
Compact INV320 to 630	

Insulating enclosures	H x W x D
Compact INS40 to 160	180 x 270 x 185
Compact INS250	360 x 270 x 235
Compact INV100 to 250	
Compact INS320 to 630	720 x 360 x 235
Compact INV320 to 630	



Escutcheon for switch-disconnectors.

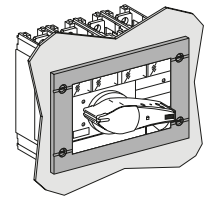

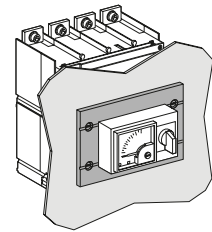
Escutcheon for ammeter modules.

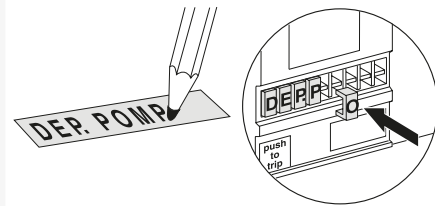

PB115815.eps



PB103593-40.eps



PB119231.eps



DB105521.eps

B

## Installation recommendations

Operating principle.....	B-2
Possible installation positions and mounting techniques.....	B-4
Implementation.....	B-5
Compact INS40 to 80.....	B-6
Compact INS100 to 160.....	B-7
Compact INS250-100 to 250 Compact INV100 to 250.....	B-8
Compact INS320 to 630 Compact INV320 to 630....	B-12
Compact INS630b to 1600 .....	B-16
Connection accessories .....	B-18
Compact INS2000 to 2500 Compact INV2000 to 2500.....	B-22
Use at high temperatures.....	B-24

B

### Other chapters

Functions and characteristics .....	A-1
Dimensions and connection .....	C-1
Complementary technical information .....	D-1
Catalogue numbers .....	E-1

# Operating principle

## INS40 to 250 - INV100 to 250

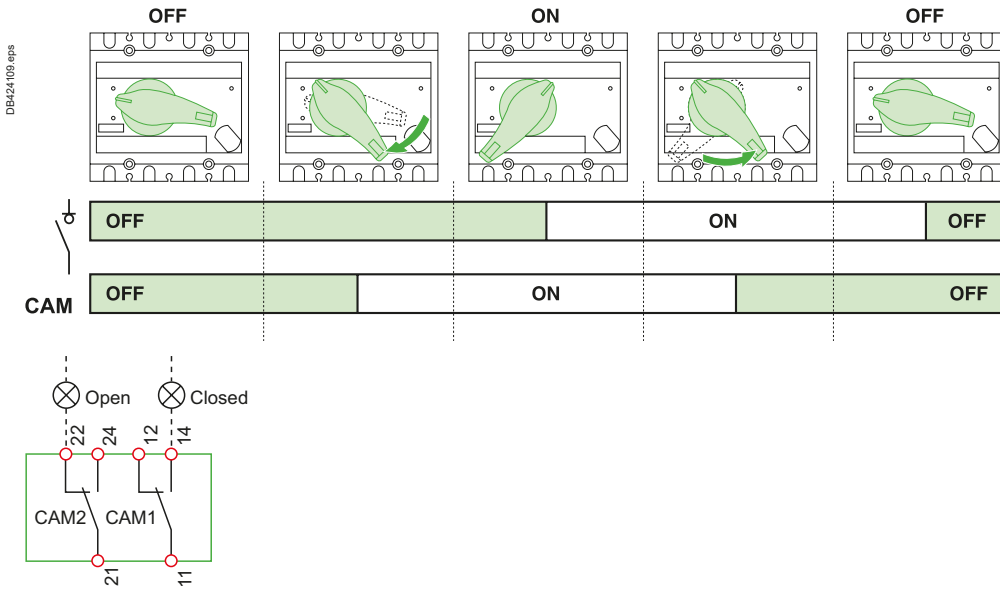

## INS320 to 630 - INV320 to 630

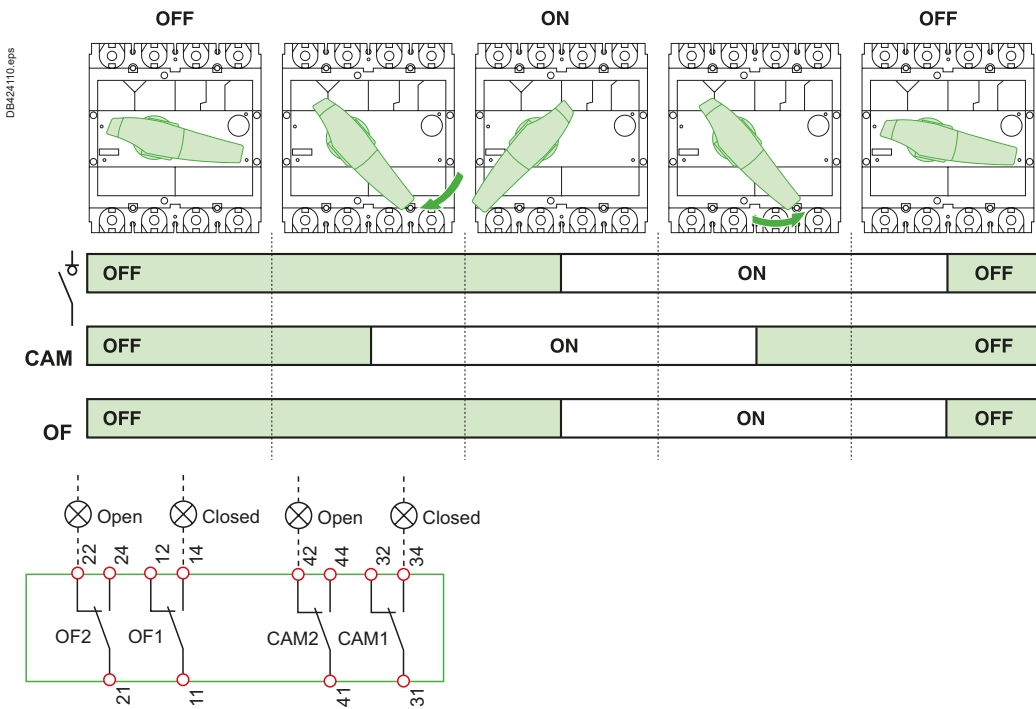

B

### INS630b to 2500 - INV630b to 2500

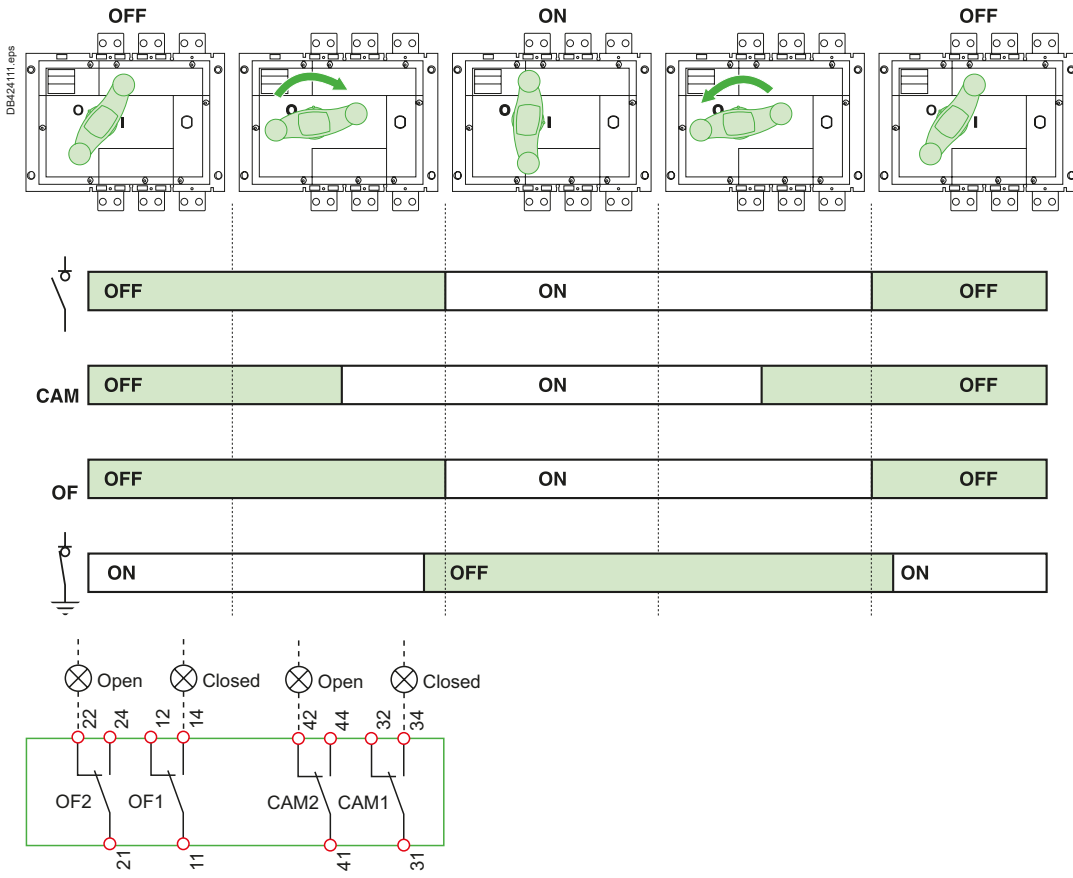

B

# Possible installation positions and mounting techniques

B

## Possible installation positions

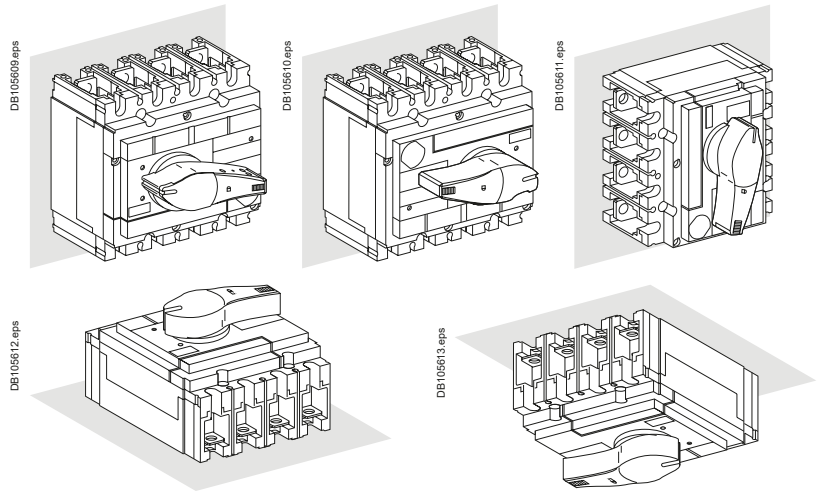

## Possible mounting

### INS40 to 160

Symmetrical rail

Plain mounting plate

Slotted mounting plate

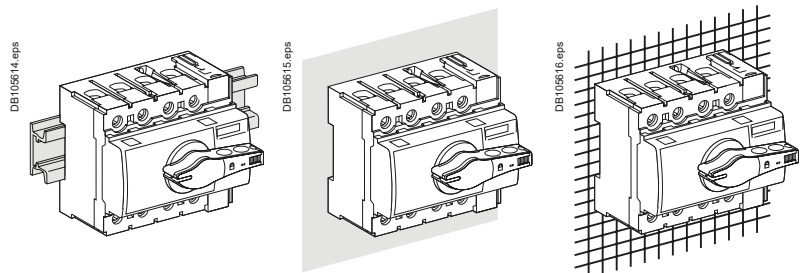

### INS250-100 to 630 - INV100 to 630

Rails

Plain mounting plate

Slotted mounting plate

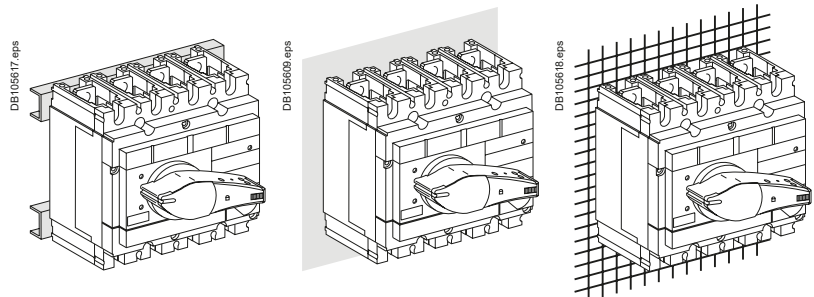

### INS/INV630b to 2500

Rails

Plain mounting plate

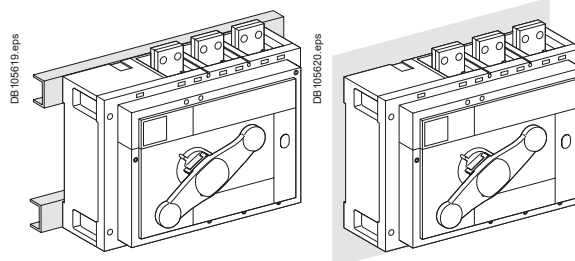



### Reverse supply

Compact INS/INV switch-disconnectors may be supplied indifferently via the top or bottom terminals, without any reduction in performance.

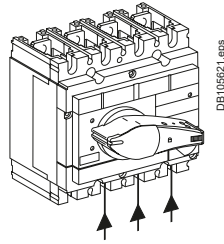

### Neutral pole position

On Schneider Electric switch-disconnectors, the neutral pole is traditionally located on the left-hand side. On the INS and INV ranges, the four poles are identical and the neutral pole can therefore be located on the right-hand side simply by adding an appropriate label.

### Conductor materials and electrodynamic forces

Compact INS/INV switch-disconnectors may be connected using either bare copper, tinned copper or tinned aluminium conductors (flexible or rigid bars, cables). In the event of a short-circuit, thermal and electrodynamic forces are exerted on the conductors. The conductors must therefore be adequately sized and suitably supported.

Note that the terminals of electrical devices (switch-disconnectors, contactors, circuit breakers, etc.) should not be considered to contribute to the support of the conductors.

### Cables ties and flexible bars

The table below indicates the maximum distances between cable ties depending on the prospective short-circuit current.

Care must be taken not to exceed a distance of 400 mm between ties mechanically secured to the switchboard frame.

Type of tie	"Panduit" type					"Sarel" type		
	Width: 4.5 mm Max. load: 22 kg Colour: white					Width: 9 mm Max. load: 90 kg Colour: black		
Max. distance between ties (mm)	200	100	50	350	200	100	70	50 (double ties)
Short-circuit current (kA rms)	10	15	20	20	27	35	45	100

**Note:** for cables  $\geq 50 \text{ mm}^2$ , 9 mm wide ties must be used.

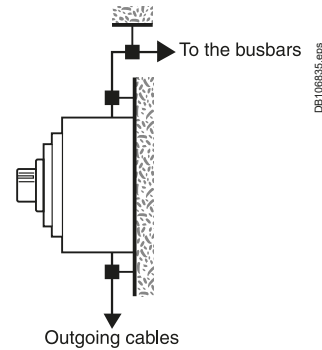

# Installation recommendations

## Compact INS40 to 80

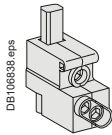
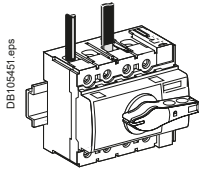
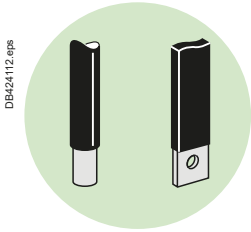

Distribution connector.

B

If  $500\text{ V} \leq U \leq 690\text{ V}$ , long terminal shields are mandatory.

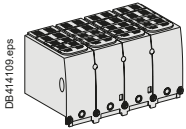

Terminal shields.

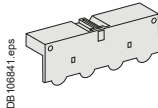

Terminal shrouds.

### Front connection of bare copper and aluminium cables

Compact INS40 to INS80 switch-disconnectors are equipped as standard with connectors for bare copper or aluminium cables (1.5 to 50 mm<sup>2</sup> rigid cables, 1.5 to 35 mm<sup>2</sup> flexible cables)

#### Distribution connector

This connector screws directly into the switch-disconnector terminals for connection of three cables of the following types:

- 1 to 10 mm<sup>2</sup> flexible cables<sup>[1]</sup>
- 1.5 to 16 mm<sup>2</sup> rigid cables.

#### Pole pitch

18 mm

		Standard device	With distribution connector	
	Bars	e (mm)	≤ 15	
		L (mm)	13	
	Lugs	L (mm)	≤ 10	
		S (mm <sup>2</sup> )	1.5 to 50 rigid	1.5 to 16 rigid
		Cu / Al	1.5 to 35 flexible	1 to 10 flexible <sup>[1]</sup>
	Torque	(Nm)	5	2

[1] Connection of 1.5 to 4 mm<sup>2</sup> flexible cables requires crimped or auto-crimping ferrules.

### Insulation of live parts

- With long terminal shields.
- With terminal shrouds.

## Front connection of insulated bars and cables with crimped lugs

Compact INS100 to INS160 switch-disconnectors are equipped as standard with terminals comprising nuts with M6 screws for direct connection of insulated bars or cables with lugs.

### Lugs

The special lugs for copper cables may be used for cables with cross-sectional areas up to 95 mm<sup>2</sup>. Secure the lugs by hexagonal crimping or punching. Lugs are supplied with interphase-barrier and are compatible with the terminal shields.

### Pole pitch

30 mm

### Dimensions



Bars	d (mm)	≤ 10
	e (mm)	2...6.4
	L (mm)	≤ 21
Lugs	L (mm)	15
	Ø (mm)	≥ 6.2
Torque	(Nm)	8

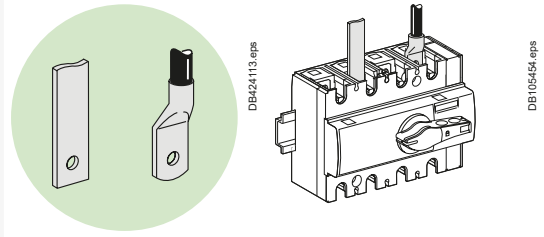

DB105454.eps

DB105457.eps

DB105459.eps

DB423225.eps

## Front connection of bare copper and aluminium cables

- 1-cable connectors snap directly onto the device terminals (1 to 10 mm<sup>2</sup> flexible cables<sup>[1]</sup>)
- Distribution connectors for 4 flexible cables (1.5 to 25 mm<sup>2</sup> rigid cables or 1.5 to 16 mm<sup>2</sup> flexible cables<sup>[1]</sup>) are screwed directly to the device terminals. These connectors are supplied with interphase-barrier (mandatory installation) which may be replaced by long terminal shields
- Linergy DX distribution block supplied via tunnel terminals. Provides 12 screwless spring type and 1 screw type outgoing terminals.

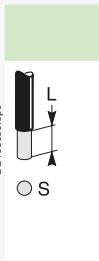

	1-cable connector		Distribution connector
Lugs	L (mm)	15	15
	S (mm <sup>2</sup> )	1.5 to 35 rigid	50 to 95 rigid
	Cu / Al	1.5 to 35 flexible <sup>[1]</sup>	50 to 95 flexible
	Torque (Nm)	10	3
			1.5 to 16 flexible <sup>[1]</sup>
<b>Linergy DX</b>			
Torque (Nm)	Supply: 5 Nm		
	Distribution: 3 Nm		

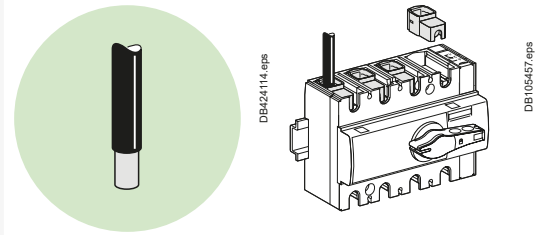

1-cable connector.

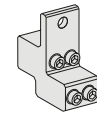

Distribution connector.



Connectors 240 mm<sup>2</sup>.

[1] Connection of 1.5 to 4 mm<sup>2</sup> flexible cables requires crimped or auto-crimping ferrules.

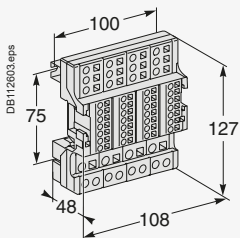

Linergy DX 125 and 160 A.

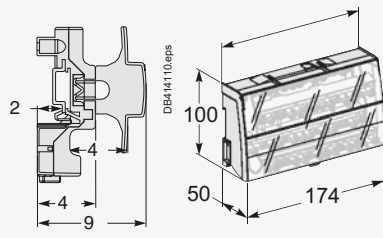

Multi-stage distribution block (e.g. LGY416048).

## Insulation of live parts

- With long terminal shields.
- With terminal shrouds.
- Interphase-barrier:
  - distribution blocks, lugs, right-angle/straight/edgewise terminal extensions and spreaders are supplied with interphase-barrier
  - interphase-barrier may be positioned horizontally or vertically
  - they may be replaced by long terminal shields.

If 500 V ≤ U ≤ 690 V, interphase-barrier or long terminal shields are mandatory.

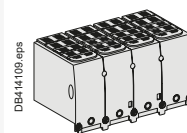

Terminal shields.

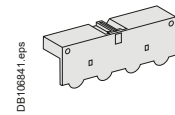

Terminal shrouds.

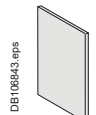

Interphase-barrier.

# Compact INS250-100 to 250 Compact INV100 to 250

B

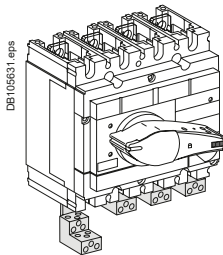
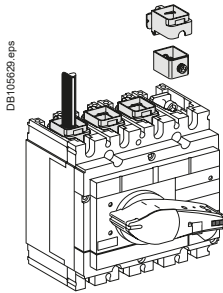
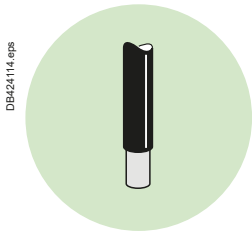

1-cable connector.

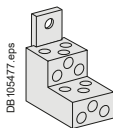

Distribution connector.



Connectors 240 mm<sup>2</sup>.

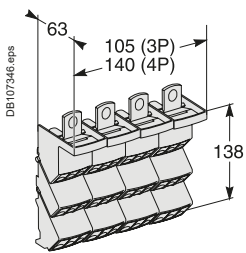

Linergy DP 250 A distribution block.

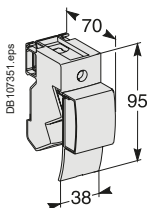

Linergy DX 160 A.

## Front connection of bare copper and aluminium cables

Bare-cable connectors for Compact INS/INV switch-disconnectors may be used for both copper and aluminium cables.

### 1-cable connectors

The connectors snap directly on to the device terminals or clip onto right-angle and straight terminal extensions as well as spreaders. These connectors are supplied with interphase-barrier.

Material: steel connector I ≤ 160 A and tinned aluminium connector I ≤ 250 A.

### 6-cable distribution connectors

These connectors are screwed directly to device terminals. These connectors are supplied with interphase-barrier (mandatory installation) which may be replaced by long terminal shields. Each connector can receive six cables with cross-sectional areas ranging from 1.5 to 35 mm<sup>2</sup> each.

Material: tinned aluminium.

### Linergy DP distribution blocks, for 6 or 9 rigid or flexible cables

The Linergy DP connects directly to the device terminals and is used to connect up to six or nine flexible or rigid cables with cross-sectional areas not exceeding 10 mm<sup>2</sup>, to each pole. Connection is made to spring terminals without screws.

	1-cable connector	Steel ≤ 160 A	Aluminium ≤ 250 A	
DB105630.eps 	L (mm)	20	20	
	S (mm <sup>2</sup> ) Cu / Al	1.5...95 <sup>[1]</sup>	25...50	70...95 120...185
	Torque (Nm)	12	20	26 26
<b>Distribution connector, 6 cables Cu or Al</b>				
DB105630.eps 	L (mm)	15 or 30		
	S (mm <sup>2</sup> ) Cu / Al	1.5...6 <sup>[1]</sup>	8...35	
	Torque (Nm)	4	6	
<b>Linergy DP distribution block, 6 or 9 cables</b>				
DB105630.eps 	L (mm)	12		
	S (mm <sup>2</sup> ) Cu / Al	1.5...10		

[1] Connection of 1.5 to 4 mm<sup>2</sup> flexible cables requires crimped or auto-crimping ferrules.

## Dimensions

### 1-cable connector

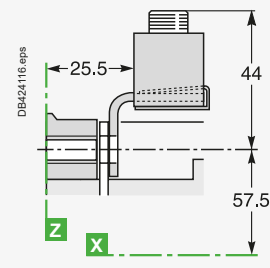
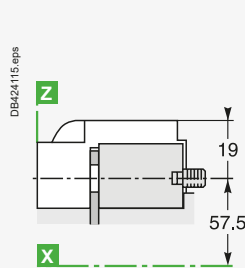

### Distribution connector, 6 cables

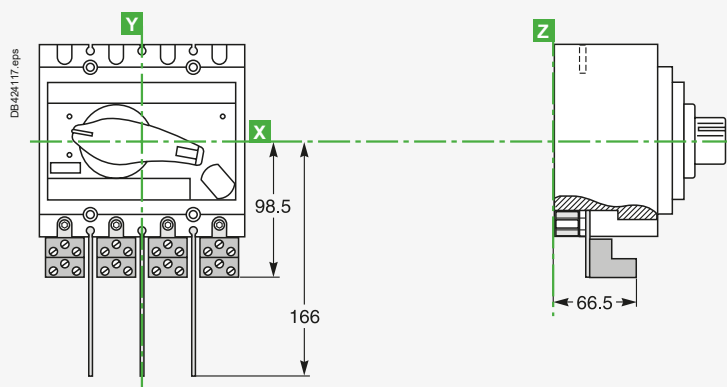

# Compact INS250-100 to 250 Compact INV100 to 250

## Front connection of insulated bars and cables with crimped lugs

Compact INS250-100 to INS250 and INV100 to 250 switch-disconnectors are equipped as standard with terminals receiving snap-in nuts and M8 screws for direct connection of insulated bars or cables with lugs.

### Lugs

- The small lugs for copper cables may be used for cables with the following cross-sectional areas 120, 150 or 185 mm<sup>2</sup> (secure the lugs by hexagonal crimping or punching).
- The small lugs for aluminium cables may be used for cables with the following cross-sectional areas 150 or 185 mm<sup>2</sup> (secure the lugs by hexagonal crimping).

### Pole pitch

35 mm

### Dimensions



Bars	d (mm)	≤ 10
	e (mm)	≤ 6
	L (mm)	≤ 25
	Ø (mm)	≥ 10
Lugs	L (mm)	≤ 25
	Ø (mm)	≥ 10
Torque	(Nm)	15

### Dimensions

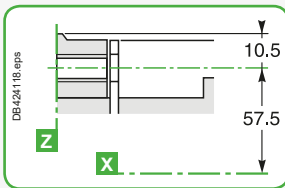

## Insulation of live parts

- With short or long terminal shields.
- Interphase-barrier:
  - distribution blocks, lugs, right-angle/straight/edgewise terminal extensions and spreaders are supplied with interphase-barrier
  - interphase-barrier may be positioned horizontally or vertically
  - they may be replaced by long terminal shields.
- One-piece spreader: the one-piece spreader increases the pitch to correspond to that of the upstream device and provides protection against direct contact (see page A-51).

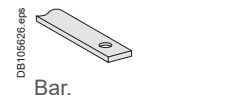
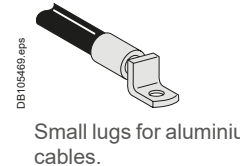
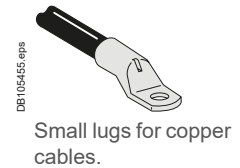
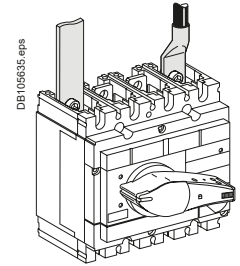
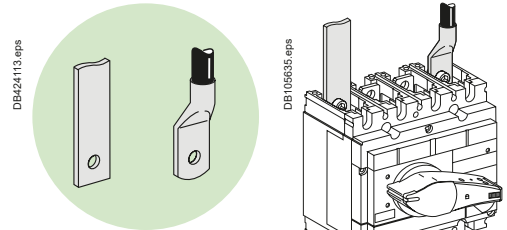

B

If  $500\text{ V} \leq U \leq 690\text{ V}$ , interphase-barrier or short or long terminal shields are mandatory.

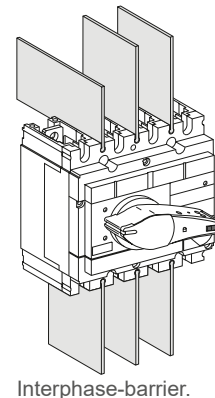

Interphase-barrier.

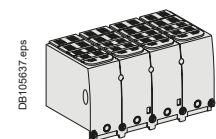

Terminal shields.

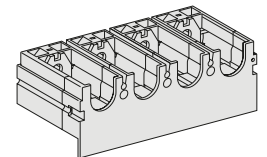

One-piece spreader.

# Compact INS250-100 to 250 Compact INV100 to 250

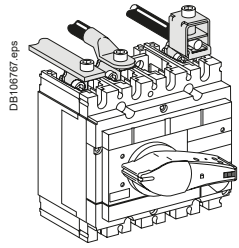
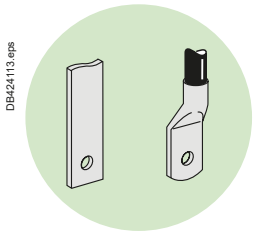

B

## Front connection with accessories

### Straight terminal extensions

Material: tinned copper.

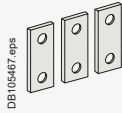

Connection of two cables with lugs.

### Right-angle extensions

Material: tinned copper.

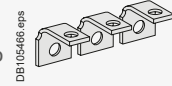

Insulation stripping lengths and tightening torques for cables, bare bars and cables with lugs are identical to those for direct connection to devices.

### Spreader

Material: tinned copper.

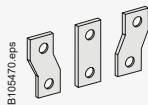

Connection of two cables with lugs.

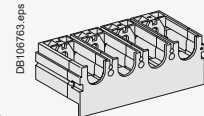

One-piece spreader.

## Pole pitch

45 mm

## Dimensions

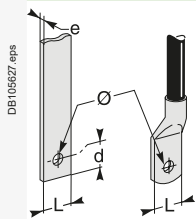

Bars	d (mm)	≤ 10
	e (mm)	≤ 6
	L (mm)	≤ 25
	Ø (mm)	8.5
Lugs	L (mm)	≤ 25
	Ø (mm)	8.5
Torque	(Nm)	15 [1]

[1] Tightening torque for spreader.

Spreaders, straight terminal extensions and right-angle terminal extensions are supplied with interphase-barrier.

### Right-angle terminal extensions

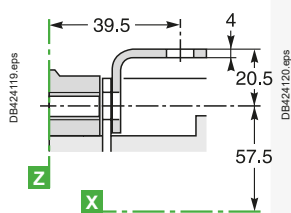

## Dimensions

Spreader and straight terminal extensions

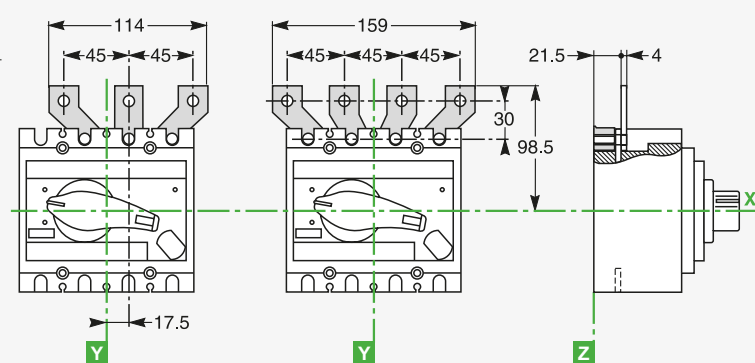

One-piece spreader 3P/4P

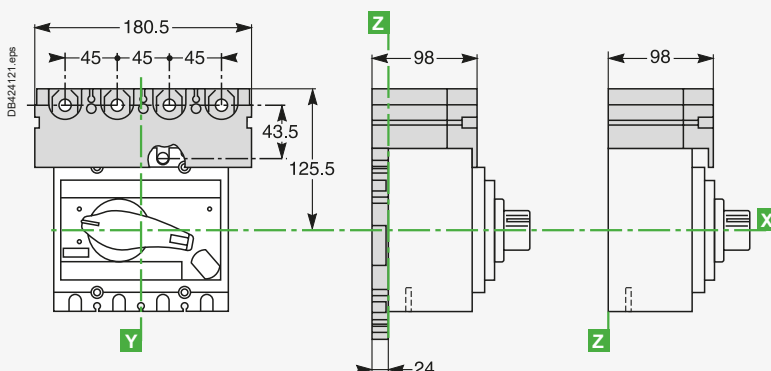



# Compact INS250-100 to 250 Compact INV100 to 250

## Rear connection

The rear connections are simply fitted to the device connection terminals. All combinations of rear connection lengths and positions are possible on a given switch-disconnector. The switch-disconnector is mounted on a backplate. For the connection of cables without lugs, the 1-cable connectors for Compact INS100-250 to INS250 and INV100 to 250 may be simply clipped onto the rear connections.

### Bars or cables with crimped lugs

Compact INS250-100 to INS250 and INV100 to 250 switch-disconnectors may be equipped with long or short rear connections, or a mix of the two. The connections may be positioned flat, on edge or at 45° angles, or any combination thereof. Material of rear connections: tinned copper.

#### Pole pitch

35 mm

#### Dimensions

	Bars	d (mm)	≤ 10
		e (mm)	≤ 6
		L (mm)	≤ 25
		Ø (mm)	≥ 8
	Lugs	L (mm)	≤ 25
		Ø (mm)	≥ 8
	Torque	(Nm)	5 <sup>[1]</sup>

[1] Tightening torque for rear connections.

#### Dimensions

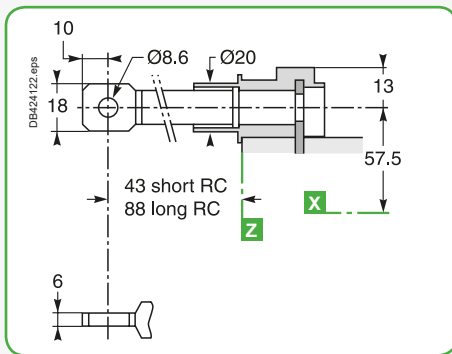

### Bare cables (copper or aluminium)

The rear connections may be equipped with 1-cable connectors secured by clips.

	1-cable connector	Steel ≤ 160 A	Aluminium ≤ 250 A
L (mm)		20	20
S (mm <sup>2</sup> ) Cu / Al		1.5...95 <sup>[1]</sup>	120...185
Torque (Nm)		12	26
<b>Distribution connector, 6 cables Cu or Al</b>			
L (mm)		15 or 30	
S (mm <sup>2</sup> ) Cu / Al		1.5...6 <sup>[1]</sup>	8...35
Torque (Nm)		4	6

[1] Connection of 1.5 to 4 mm<sup>2</sup> flexible cables requires crimped or auto-crimping ferrules.

Insulation stripping lengths and tightening torques for cables, bare bars and cables with lugs are identical to those for direct connection to devices.

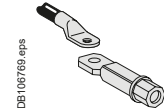
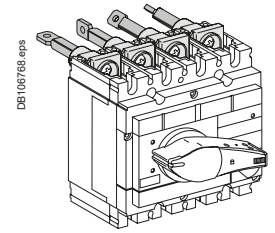
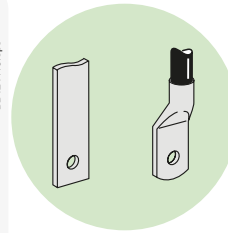

Connection of bars or cables with lugs.

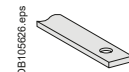

Bar.

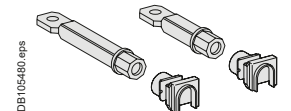

Two lengths.

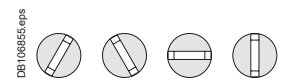

Four positions.

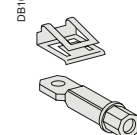
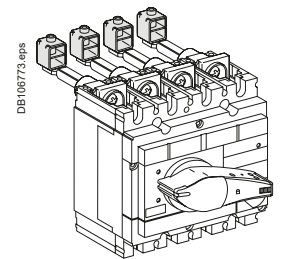

Rear connection with bar.

B

# Compact INS320 to 630 Compact INV320 to 630

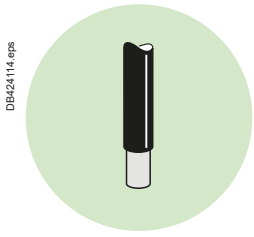

DB424114.eps

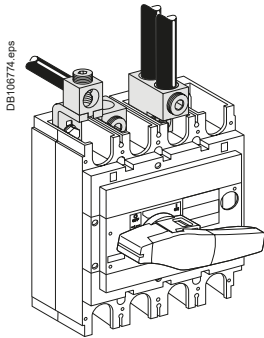

DB106774.eps

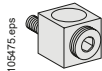

DB105475.eps

1-cable connector.

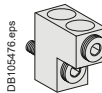

DB105476.eps

2-cable connector.

B

## Front connection of bare copper and aluminium cables

Bare-cable connectors for Compact INS/INV switch-disconnectors may be used for both copper and aluminium cables.

### 1-cable and 2-cable connectors

1-cable and 2-cable connectors, made of tinned aluminium for copper and aluminium cables, are screwed to the device terminals or to right-angle terminal extensions. These connectors are supplied with interphase-barrier.

	1-cable connector	2-cable connector
Torque (Nm)	31	31



DB105630.eps

## Dimensions

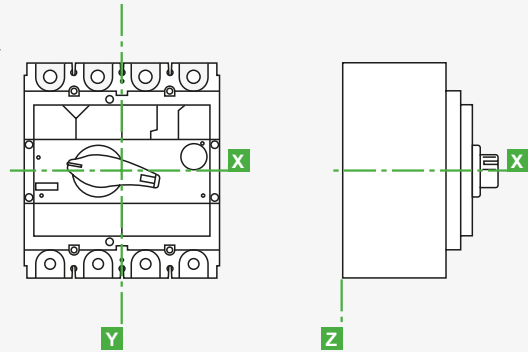

1-cable connector

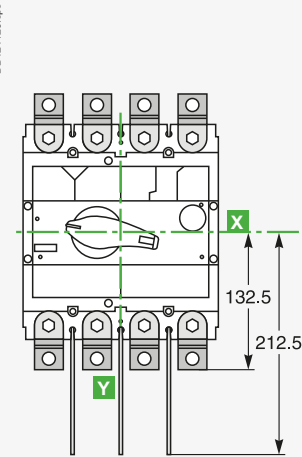

DB424123.eps

2-cable connector

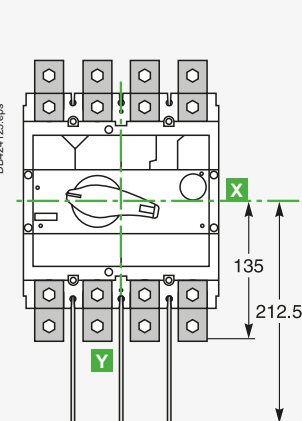

DB424125.eps

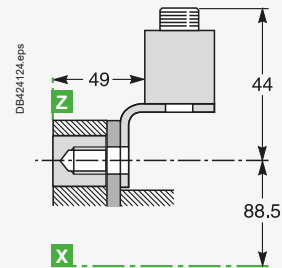

DB424124.eps

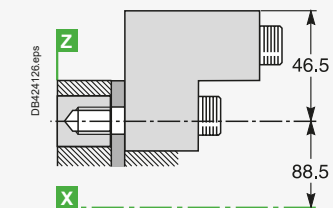

DB424126.eps

# Compact INS320 to 630 Compact INV320 to 630

## Front connection of insulated bars and cables with crimped lugs

Compact INS320 to 630 and INV320 to 630 switch-disconnectors are equipped as standard with terminals receiving snap-in nuts and M10 screws for direct connection of bars or cables with lugs.

### Lugs

- The small lugs for copper cables may be used for cables with the following cross-sectional areas 240 or 300 mm<sup>2</sup> (secure the lugs by hexagonal crimping or punching).
- The small lugs for aluminium cables may be used for cables with the following cross-sectional areas 240 or 300 mm<sup>2</sup> (secure the lugs by hexagonal crimping).

### Pole pitch

45 mm

### Dimensions

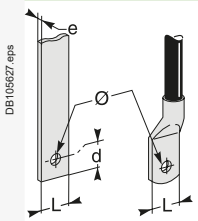

Bars	d (mm)	≤ 15
	e (mm)	3 ≤ e ≤ 10
	L (mm)	≤ 32
	Ø (mm)	≥ 10
Lugs	L (mm)	≤ 32
	Ø (mm)	≥ 10
Torque	(Nm)	50

### Dimensions

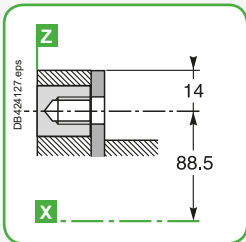

## Insulation of live parts

- With short or long terminal shields.
- Interphase-barrier:
  - distribution blocks, lugs, right-angle/straight/edgewise terminal extensions and spreaders are supplied with interphase-barrier
  - interphase-barrier may be positioned horizontally or vertically
  - they may be replaced by long terminal shields.

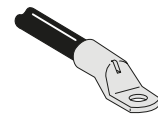
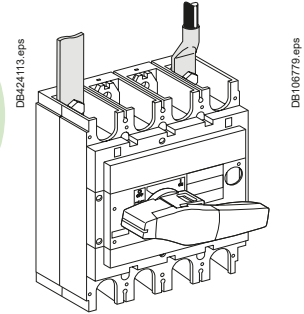
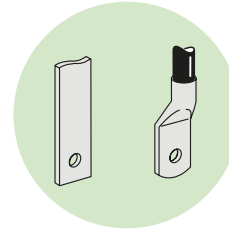

Small lugs for copper cables.

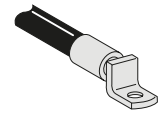

Small lugs for aluminium cables.

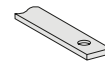

Bar.

If  $500\text{ V} \leq U \leq 690\text{ V}$ , interphase-barrier or short or long terminal shields are mandatory.

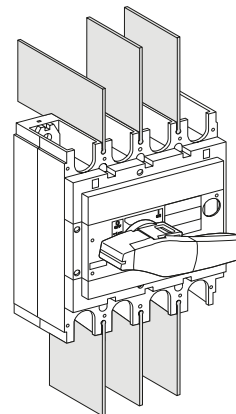

Interphase-barrier.

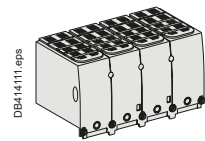

Terminal shields.

# Compact INS320 to 630 Compact INV320 to 630

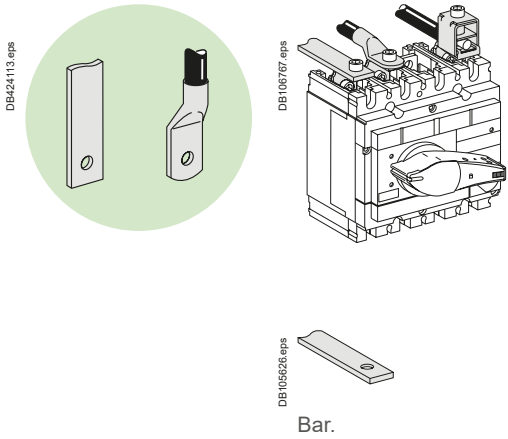

B

### Front connection with accessories

**Spreader**  
Material: tinned copper.

**Edgewise terminal extensions**  
Material: tinned copper.

**Right-angle extensions**  
Material: tinned copper.  
Installation on upstream terminals.

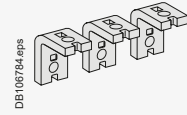
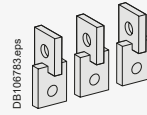
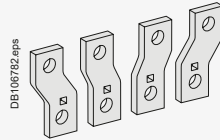

#### Pole pitch

Without spreader	45 mm
With spreader	52.5 or 70 mm

#### Dimensions

#### With spreader With edgewise terminal ext.

	Bars	d (mm)	e (mm)	L (mm)	Ø (mm)
Bars		≤ 15	3 ≤ e ≤ 10	≤ 32	> 10.5
		≤ 15	3 ≤ e ≤ 10	≤ 32	> 10.5
		≤ 15	3 ≤ e ≤ 10	≤ 32	> 10.5
Lugs		≤ 32	≤ 32	≤ 32	10.5
		≤ 32	≤ 32	≤ 32	10.5
Torque		50 [1]	50 [1]	50 [1]	50 [1]
		50 [1]	50 [1]	50 [1]	50 [1]

[1] Tightening torque for spreader.

Spreaders, straight terminal extensions and right-angle terminal extensions are supplied with interphase-barrier.

#### Dimensions

Edgewise terminal extensions

Right-angle terminal extensions

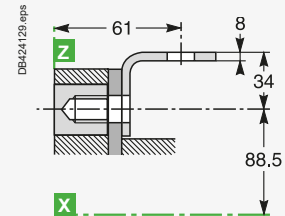
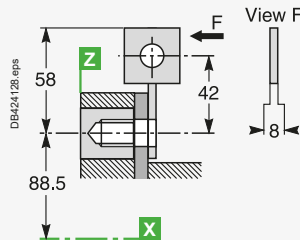

Spreader

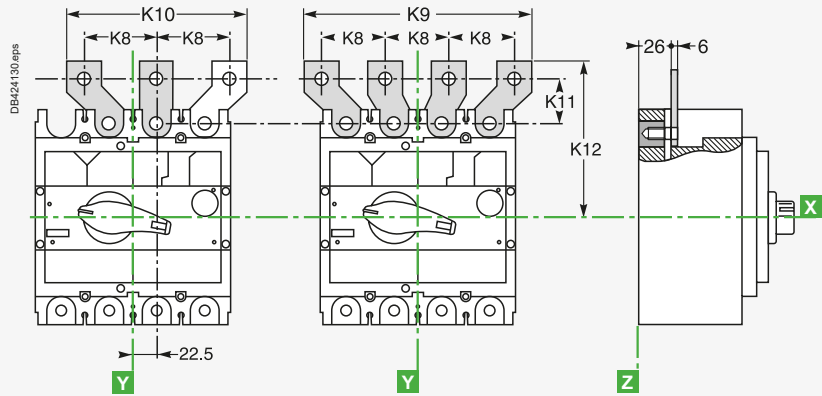

Type		K8	K9	K10	K11	K12
Spreader	Width in mod. of 52.5 mm	52.5	187.5	135	39	142.5
	Width in mod. of 70 mm	70	240	170	52.5	156

# Compact INS320 to 630 Compact INV320 to 630

## Rear connection

The rear connections are simply fitted to the device connection terminals. All combinations of rear connection lengths and positions are possible on a given switch-disconnector. The switch-disconnector is mounted on a backplate.

### Bars or cables with crimped lugs

Compact INS320 to 630 and INV320 to 630 switch-disconnectors may be equipped with long or short rear connections, or a mix of the two. The connections may be positioned flat, on edge or at 45° angles, or any combination thereof. Material of rear connections: tinned copper.

### Dimensions

	Bars	d (mm)	≤ 15
		e (mm)	3 ≤ e ≤ 10
		L (mm)	≤ 32
		Ø (mm)	> 10.5
	Lugs	L (mm)	≤ 32
		Ø (mm)	≥ 10.5
	Torque	(Nm)	20 <sup>[1]</sup>

[1] Tightening torque for rear connections.

### Dimensions

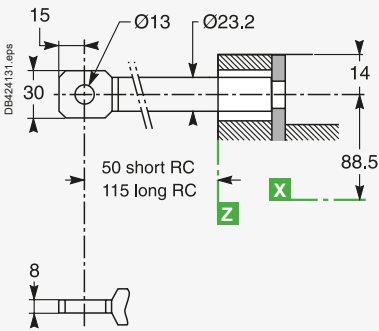

### Bare cables (copper or aluminium)

The rear connections may be equipped with 1-cable connectors secured by clips. Insulation stripping lengths and tightening torques for cables, bare bars and cables with lugs are identical to those for direct connection to devices.

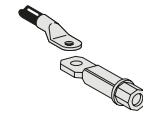
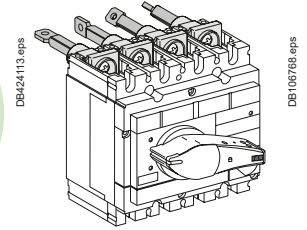
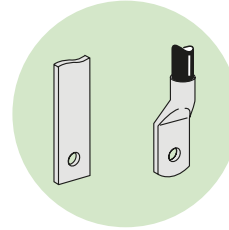

Connection of bars or cables with lugs.

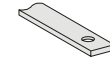

Bar.

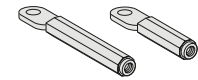

Two lengths.

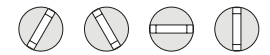

Four positions.

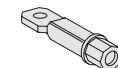
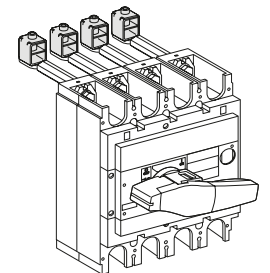

Rear connection with bar.

B

# Compact INS630b to 1600

# Compact INV630b to 1600

DB424131 eps

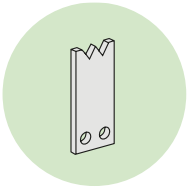

DB105487 eps

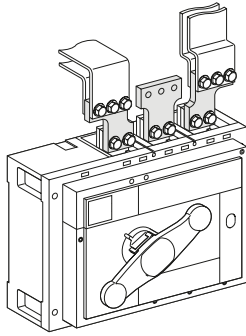

DB105482 eps

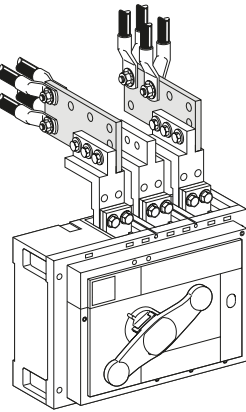

DB105402 eps

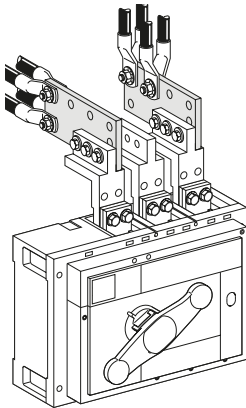

2-cable connector.

## Connections

There are many solutions to connect bars:

- vertical connection adapters to connect edgewise bars
- spreaders with a 95 mm pole pitch to increase the clearance between bars.

### Spreaders

Spreaders increase the pole pitch of a switch-disconnector for greater clearance between the bars. They are not compatible with terminal shields.

DB105488 eps

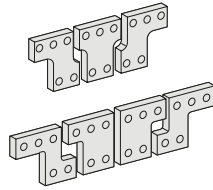

Spreaders.

### Vertical connection adapters

For connection of edgewise bars.

DB105489 eps

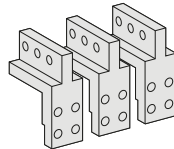

Vertical connection adapters.

### Adapters for cables with crimped lugs

Cable-lug adapters are used in conjunction with vertical connection adapters.

They may be used to connect one to four cables ( $S \leq 300 \text{ mm}^2$ ) with crimped lugs.

To ensure adequate mechanical strength, the cable-lug adapters must be secured together by spacers.

DB106783 eps



Lugs for copper cables.

DB105491 eps

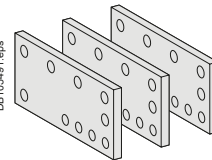

Adapters for cables with crimped lugs.

### Pole pitch

Without spreader	70 mm
With spreader	95 mm

Dimensions		With spreader	With vertical connection adapters	With cable lug adapters
Bars	d (mm)	12.5	$\leq 12.5$	-
	e (mm)	$3 \leq e \leq 10$	$3 \leq e \leq 10$	-
	L (mm)	$\leq 80$	$\leq 80$	-
	$\varnothing$ (mm)	12	$> 12$	-
Lugs	L (mm)	-	-	$\leq 40$
	$\varnothing$ (mm)	-	-	$\leq 12$
Torque	(Nm)	50 <sup>[1]</sup>	50	50 <sup>[1]</sup>

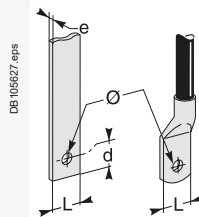

[1] Tightening torque for spreader.



# Installation recommendations

## Compact INS630b to 1600

## Compact INV630b to 1600

### Front connection of insulated bars

#### Connection of bars

Compact INS/INV switch-disconnectors are equipped with terminals for direct connection of bars.

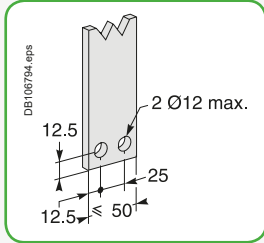

### Insulation of live parts

- With terminal shields.
- Interphase-barrier:
  - interphase-barrier may be positioned horizontally or vertically
  - they may be replaced by long terminal shields.

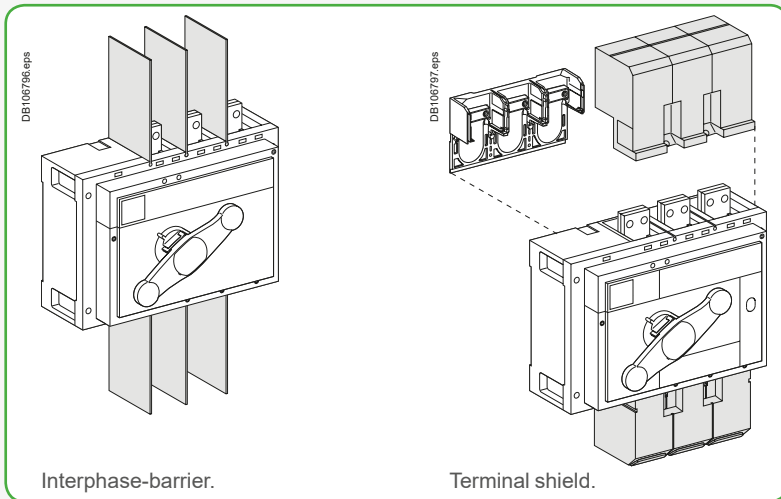

Interphase-barrier.

Terminal shield.

### Compatibility of terminal shields + base for connections

	Base	Terminal shields	Spreader	Interphase-barrier
Base	-	YES	YES	NO
Terminal shields	YES	-	NO	NO
Spreader	NO	NO	-	YES
Interphase-barrier	NO	NO	YES	-

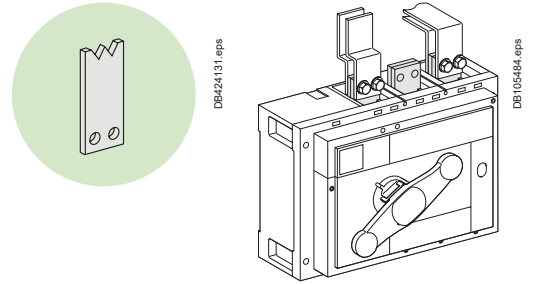

If  $500\text{ V} \leq U \leq 690\text{ V}$ , interphase-barrier or short or long terminal shields are mandatory.

B

# Installation recommendations

## Connection accessories

Series connection of poles for direct current applications.

With Compact INS/INV switch-disconnectors, it is easy to create a large number of series pole arrangements using prefabricated connections mounted on site during equipment installation.

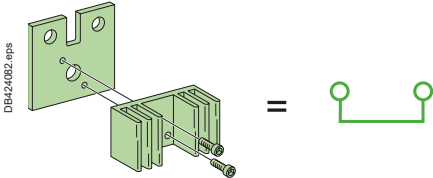

One type of connection per frame size, two catalogue numbers for all series connections.

B

### Examples of series connection

#### Three-pole devices

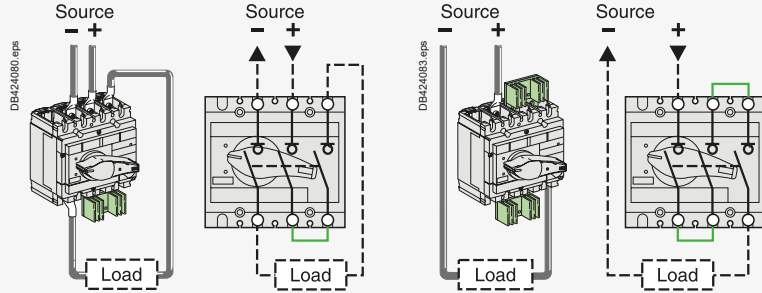

#### Four-pole devices

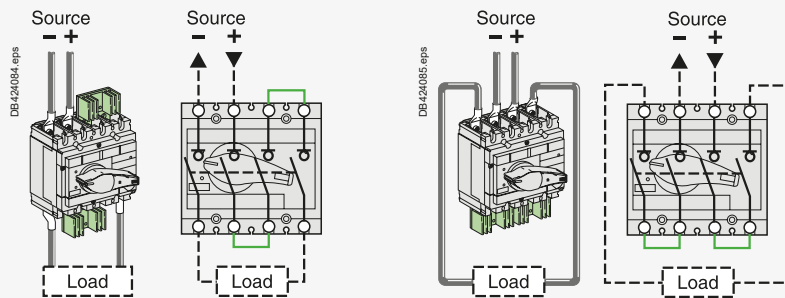

### Great flexibility for connections

- Indifferent connection of polarities, from left to right or right to left.
- Indifferent connection of upstream and downstream cables to top or bottom terminals.
- Series connection of poles is possible by upstream/downstream connections. Creation of the connections is the responsibility of the panel builder or the installer.

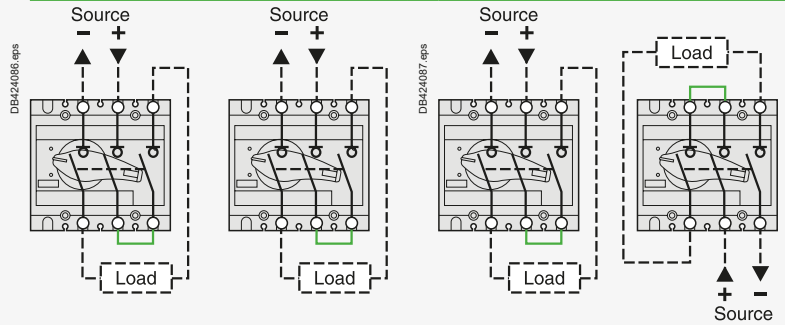

Indifferent connection of polarities.

Upstream/downstream connections to top or bottom connectors.

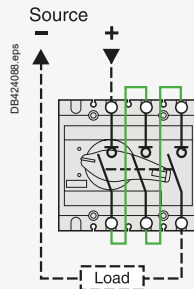

Series connection of poles is possible by upstream/downstream connections (user made).

Parallel connection of poles for direct current applications.

### Examples of parallel connection

#### Three-pole devices

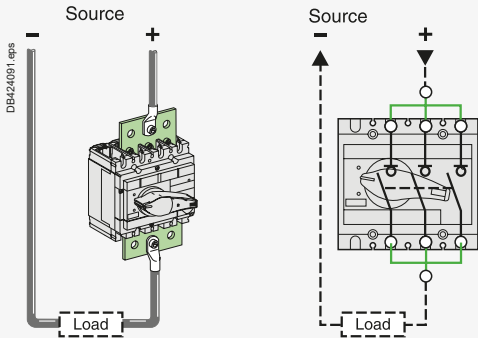

#### Four-pole devices (2 x 2 poles in parallel)

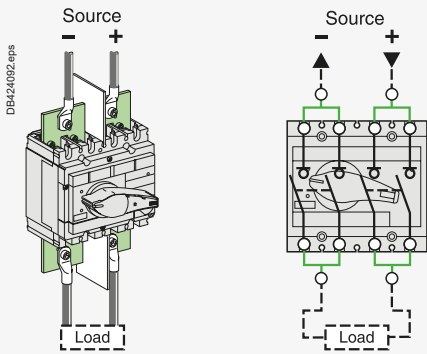

#### It is possible to mix series and parallel connections

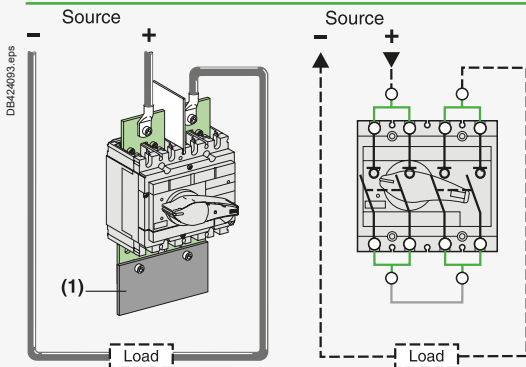

**Note:** creation of the additional connection (1) is the responsibility of the panel builder or the installer.

#### Great flexibility for connections

- Indifferent connection of polarities, from left to right or right to left.
- Indifferent connection of upstream and downstream cables to top or bottom terminals.

The exceptional performance levels of Compact INS/INV switch-disconnectors mean the poles can be parallel connected. This technique virtually doubles, triples or quadruples the current rating depending on the type of circuit breaker and thus reduces the cost of solutions.

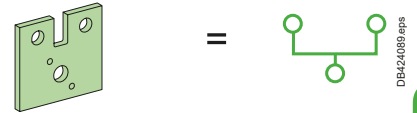

B

Parallel pole connection accessories are identical to those for series connections. They are equipped with heat sinks. Customer connections are made directly to the connection plates after removing the heat sinks.

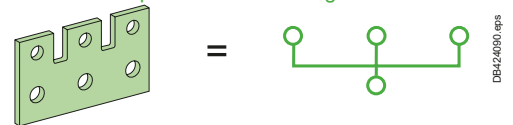

Specific connections are required for parallel connection of three poles.

## Installation recommendations

# Compact INS630b to 1600 Compact INV630b to 1600

### Dimensions

#### Connection with spreaders

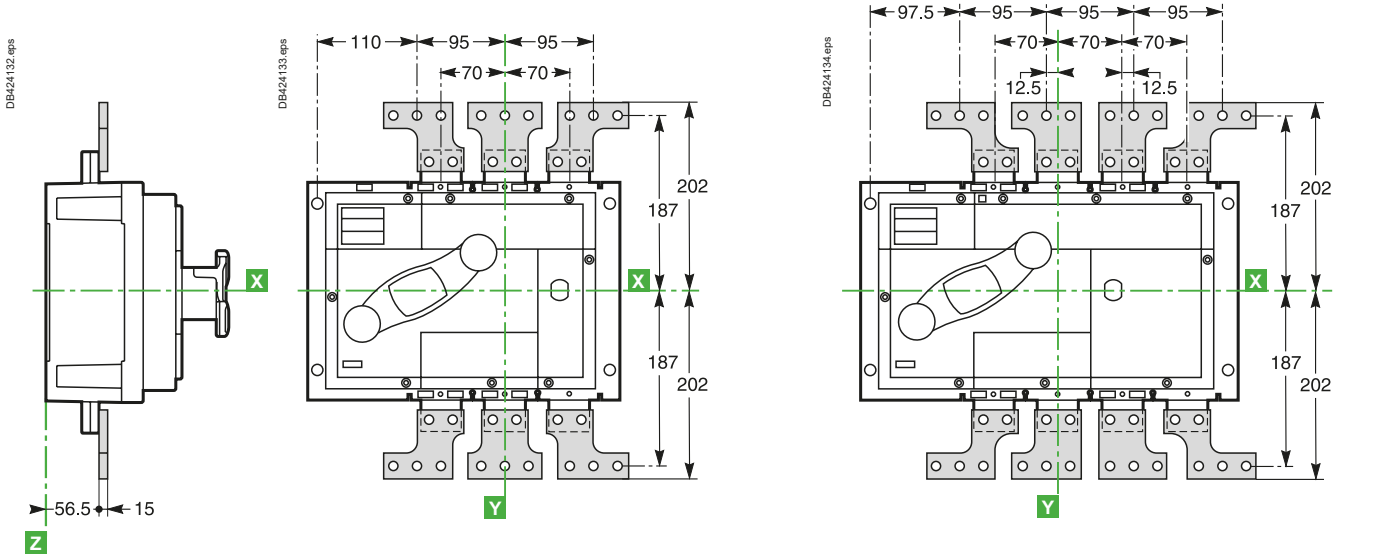

#### Spreader details

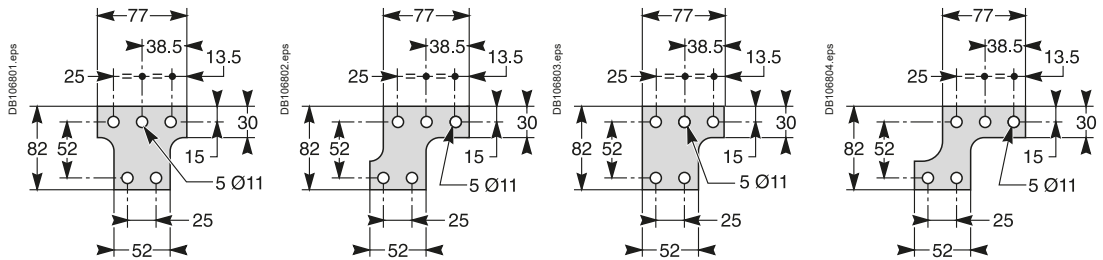

For 3P switch-disconnectors.

For 4P switch-disconnectors.

#### Connection with vertical connection adapters

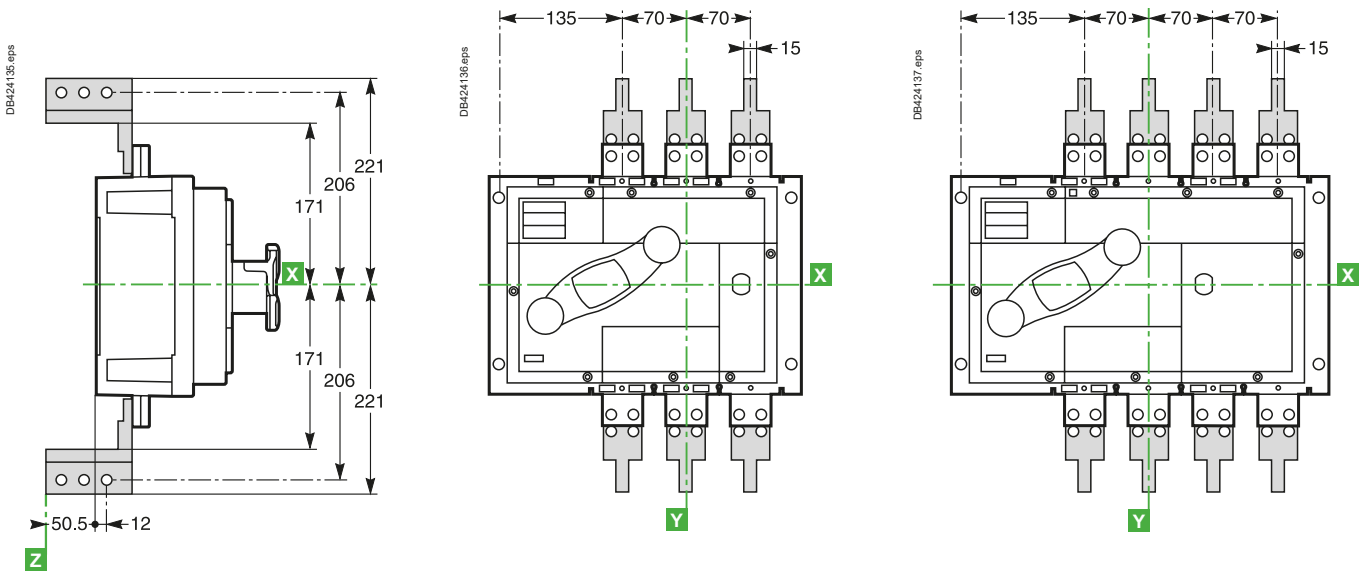

#### Connector details

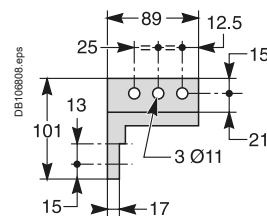

**Note:** lines **X** and **Y** indicate the axes of symmetry of the switch-disconnector.  
Reference plane **Z** corresponds to the back of the switch-disconnector.  
2 connection possibilities on vertical connection adapters (21 mm between centres).  
Recommended connection screws: M10 class 8.8.  
Tightening torque: 50 Nm with contact washer.

# Installation recommendations

## Compact INS630b to 1600

## Compact INV630b to 1600

### Connection with vertical connection adapters

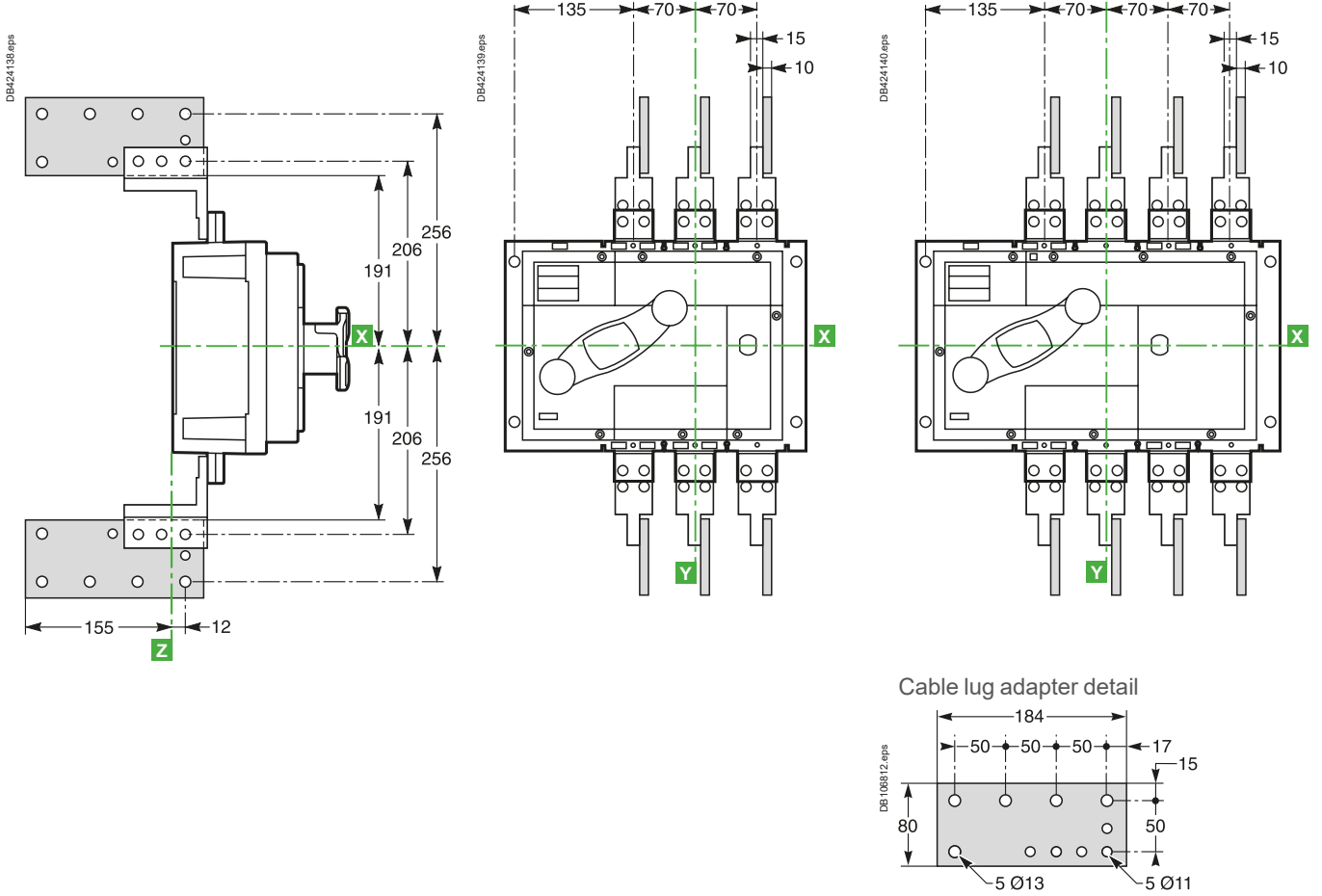

B

# Compact INS2000 to 2500 Compact INV2000 to 2500

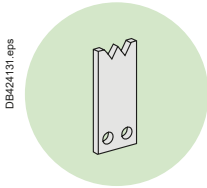

## Front connection of insulated bars

### Connection of bars

Compact INS/INV switch-disconnectors are equipped with terminals for direct connection of bars.

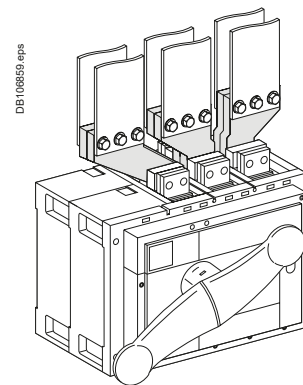
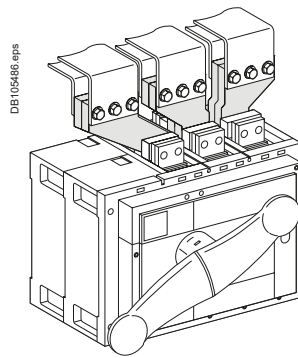
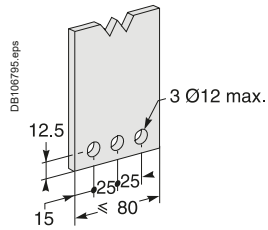

## Connector for connection of edgewise bars

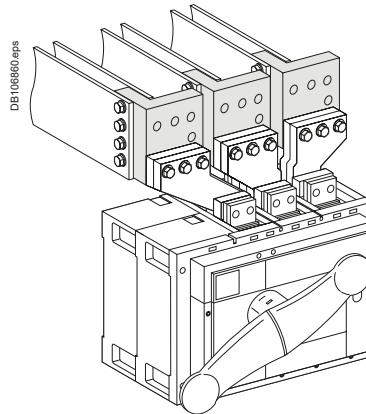

If  $500\text{ V} \leq U \leq 690\text{ V}$ , interphase-barrier are mandatory.

## Insulation of live parts

Interphase-barrier

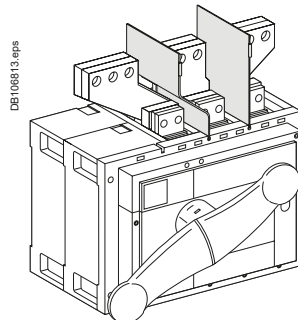



# Installation recommendations

## Compact INS2000 to 2500

## Compact INV2000 to 2500

### Dimensions

#### Connection with spreaders

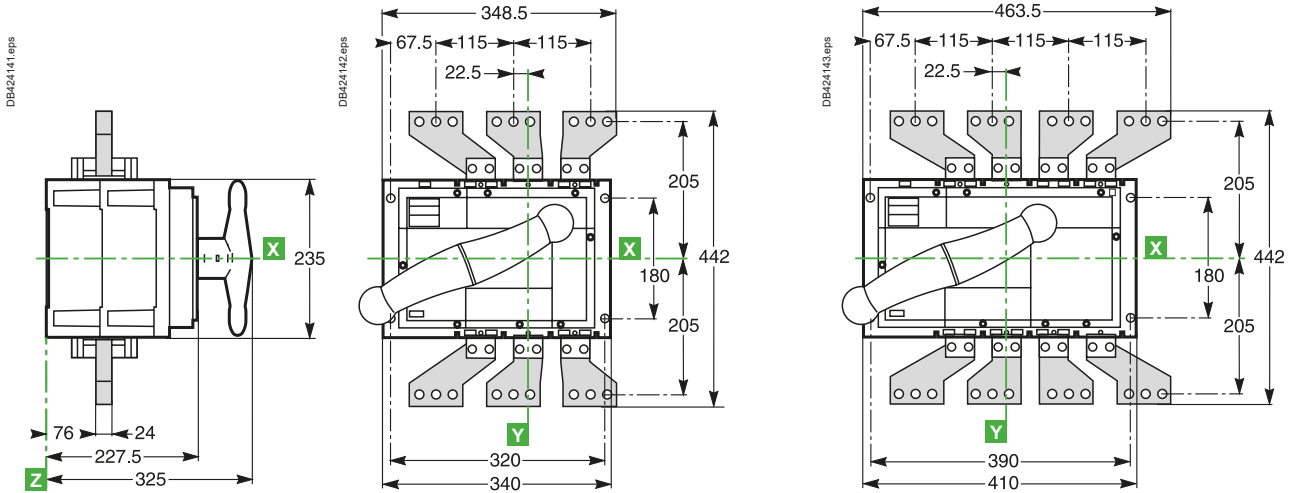

B

#### Spreader details

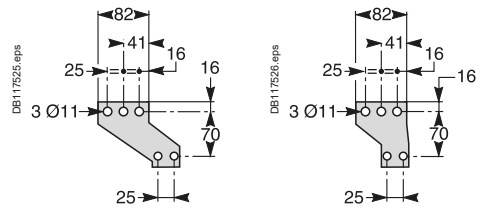

For 3P and 4P switch-disconnectors.

#### Connection with spreaders

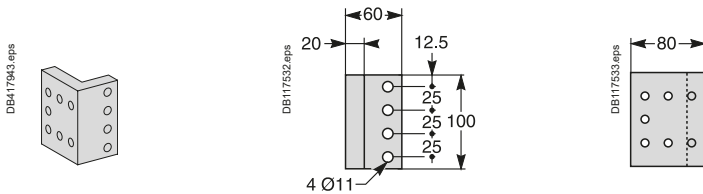

**Note:** lines **X** and **Y** indicate the axes of symmetry of the switch-disconnector.  
Reference plane **Z** corresponds to the back of the switch-disconnector.

# Use at high temperatures

## Power dissipated and resistance per pole

<b>Compact INS</b>	<b>40</b>	<b>63</b>	<b>80</b>	<b>100</b>	<b>125</b>	<b>160</b>		
Rating (A)	40	63	80	100	125	160		
Resistance per pole (mΩ)	0.3	0.3	0.3	0.2	0.2	0.2		
Power dissipated per pole (W)	0.5	1.2	1.9	2	3.1	5.1		
<b>Compact INS/INV</b>	<b>100</b>	<b>160</b>	<b>200</b>	<b>250</b>	<b>320</b>	<b>400</b>	<b>500</b>	<b>630</b>
Rating (A)	100	160	200	250	320	400	500	630
Resistance per pole (mΩ)	0.15	0.15	0.15	0.15	0.06	0.06	0.06	0.06
Power dissipated per pole (W)	1.5	4	6	9.5	6.1	9.6	15	24
<b>Compact INS/INV</b>	<b>800</b>	<b>1000</b>	<b>1250</b>	<b>1600</b>	<b>2000</b>	<b>2500</b>		
Rating (A)	800	1000	1250	1600	2000	2500		
Resistance per pole (mΩ)	0.024	0.024	0.024	0.024	0.012	0.012		
Power dissipated per pole (W)	16	24	38	62	48	75		

## Temperature derating

<b>Compact INS</b>	<b>40</b>	<b>63</b>	<b>80</b>	<b>100</b>	<b>125</b>	<b>160</b>		
--------------------	-----------	-----------	-----------	------------	------------	------------	--	--

### Front connection with bare-cable connectors or lugs

Thermal current Ith at	60 °C	40	63	80	100	125	160		
	65 °C	40	63	80	100	125	160		
	70 °C	40	63	80	100	125	150		

<b>Compact INS/INV</b>	<b>100</b>	<b>160</b>	<b>200</b>	<b>250</b>	<b>320</b>	<b>400</b>	<b>500</b>	<b>630</b>
------------------------	------------	------------	------------	------------	------------	------------	------------	------------

### Front connection / rear connection

Thermal current Ith at	60 °C	100	160	200	250	320	400	500	630
	65 °C	100	160	200	250	320	400	500	590
	70 °C	100	160	200	250	320	400	500	550

### Front connection with right-angle terminal extension + bare-cable connectors

Thermal current Ith at	55 °C	100	160	200	250	320	400	500	630
	60 °C	100	160	200	250	320	400	500	590
	65 °C	100	160	200	250	320	400	500	550
	70 °C	100	160	200	240	320	400	500	510

### Front connection / rear connection with ammeter or CT module

Thermal current Ith at	40 °C	100	160	200	250	320	400	500	600
	50 °C	100	160	200	250	320	400	500	575
	55 °C	100	160	200	250	320	400	500	540
	60 °C	100	160	200	240	320	400	500	505
	65 °C	100	160	200	230	320	400	480	480
	70 °C	100	160	200	210	320	400	450	450

<b>Compact INS/INV</b>	<b>630b</b>	<b>800 with or without term. shield</b>	<b>1000 with or without term. shield</b>	<b>1250 with term. shield</b>	<b>without term. shield</b>	<b>1600 with term. shield</b>	<b>without term. shield</b>	<b>2000 with term. shield</b>	<b>2500 without term. shield</b>
------------------------	-------------	---	--	-------------------------------	-----------------------------	-------------------------------	-----------------------------	-------------------------------	----------------------------------

### Direct connection by flat-facing bars

Thermal current Ith at	40 °C	630	800	1000	1250	1250	1600	1600	2000	2500
	45 °C	630	800	1000	1250	1250	1570	1600	2000	2500
	50 °C	630	800	1000	1250	1250	1500	1550	2000	2500
	55 °C	630	800	1000	1250	1250	1420	1470	2000	2500
	60 °C	630	800	1000	1250	1250	1340	1390	2000	2500
	65 °C	630	800	1000	1250	1250	1250	1300	2000	2500
	70 °C	630	800	1000	1060	1210	1060	1210	2000	2400

### Connection by flat-facing bars via spreaders, without terminal shields

Thermal current Ith at	40 °C	630	800	1000	1250	1600		-	-
	45 °C	630	800	1000	1250	1600		-	-
	50 °C	630	800	1000	1250	1580		-	-
	55 °C	630	800	1000	1250	1500		-	-
	60 °C	630	800	1000	1250	1420		-	-
	65 °C	630	800	1000	1250	1330		-	-
	70 °C	630	800	1000	1240	1240		-	-

### Connection of edgewise bars via vertical connection adapters or cables via vertical connection adapters with cable-lug adapters

Thermal current Ith at	40 °C	630	800	1000	1250	1600	1600	-	-
	45 °C	630	800	1000	1250	1600	1600	-	-
	50 °C	630	800	1000	1250	1600	1600	-	-
	55 °C	630	800	1000	1250	1600	1600	-	-
	60 °C	630	800	1000	1250	1600	1600	-	-
	65 °C	630	800	1000	1250	1520	1560	-	-
	70 °C	630	800	1000	1250	1410	1450	-	-

[1] INS/INV1600: 4 bars 50 x 5. [2] INS/INV1600: 3 bars 80 x 5.

Note: thermal current Ith in Amps (QA).

## Dimensions and connection

Compact INS40 to 160 .....	C-2
Compact INS250-100 to 630 Compact INV100 to 630.....	C-5
Compact INS630b to 1600 Compact INV630b to 1600.....	C-10
Compact INS2000 to 2500 Compact INV2000 to 2500.....	C-12
<b>Mechanical interlocks for direct and extended handles</b> INS40 to 630, INV100 to 630 .....	C-14
<b>Installation of downstream coupling</b> INS250-100 to 630, INV100 to 630.....	C-15
<b>Front-panel accessories</b> INS250-100 to 2500, INV100 to 2500.....	C-16
<b>Parallel or series connection accessories for direct current</b> Compact INS250-100 to 250 Compact INV100 to 250 .....	C-17
<b>Parallel or series connection accessories for direct current</b> Compact INS320 to 630 Compact INV320 to 630 .....	C-19



<b>Other chapters</b>	
Functions and characteristics .....	A-1
Installation recommendations .....	B-1
Complementary technical information .....	D-1
Catalogue numbers .....	E-1

### Dimensions

#### Front handle

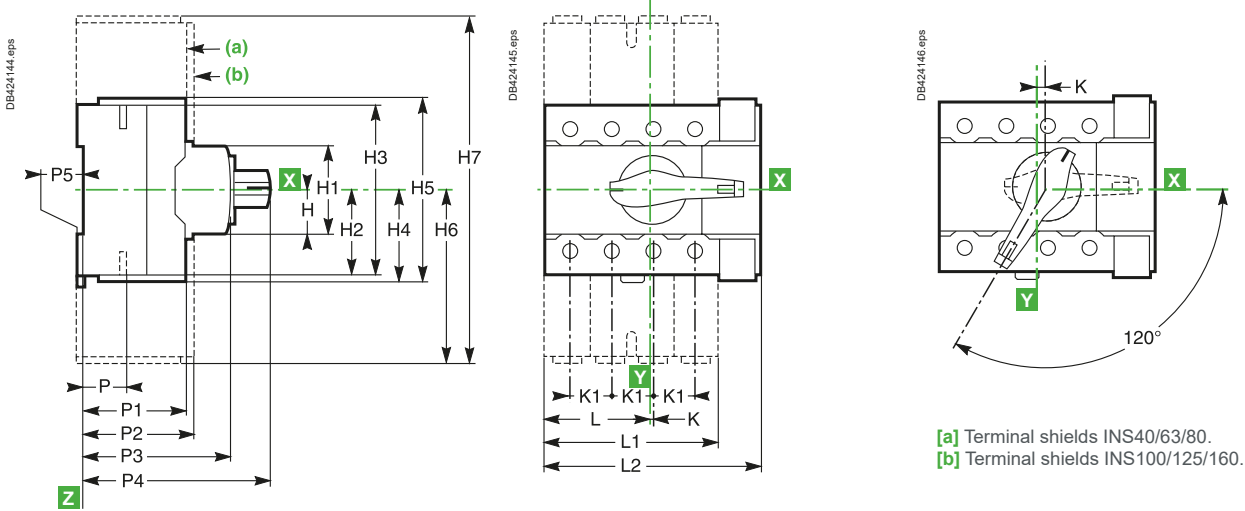

[a] Terminal shields INS40/63/80.  
[b] Terminal shields INS100/125/160.

#### Dimensions (mm)

Type	H	H1	H2	H3	H4	H5	H6	H7	K	K1	L	L1	L2	P	P1	P2	P3	P4	P5
INS40/63/80	22.5	45	40.5	81	42.5	85	73.5	147	1	18	46	73	90	23.3	43	47	62.5	79	5
INS100/125/160	22.5	45	50	100	50	100	110	220	7.5	30	75	119	135	21.5	45	47	62.5	79	5

#### Extended front handle

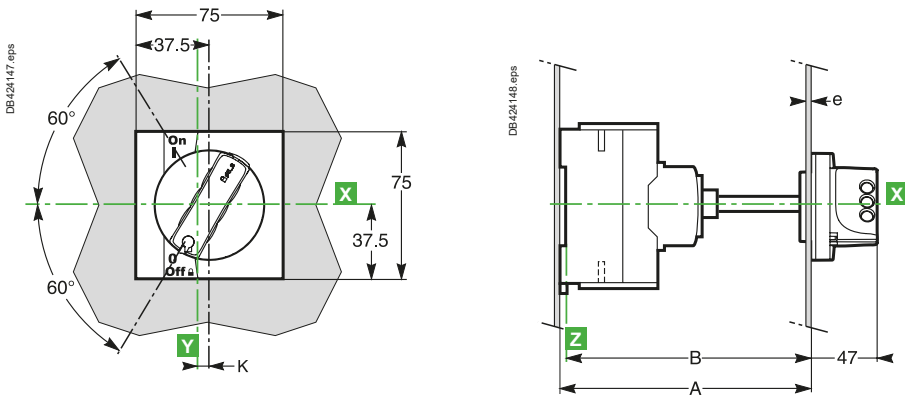

#### Dimensions (mm)

Type	A (on back plate)		B (on rail)	
	Min.	Max.	Min.	Max.
INS40/63/80	128	519	123	514
INS100/125/160	128	519	123	514

Type	e	K	Length of shaft
INS40/63/80	1...3	1	A - 69
INS100/125/160	1...3	7.5	A - 69

#### Door or front panel cutout for front handle

##### Direct

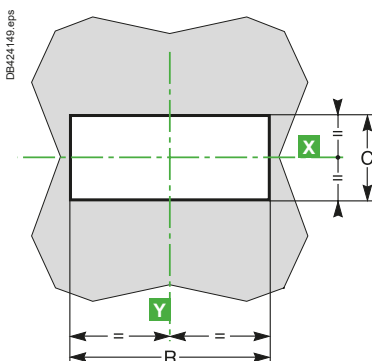

##### Extended

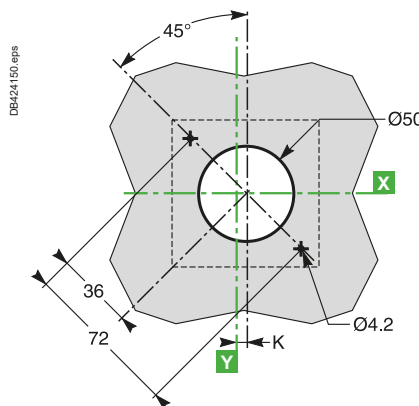

#### Dimensions (mm)

Type	C	R	K
INS40/63/80	47	92	1
INS100/125/160	47	137	7.5

Note: lines X and Y indicate the axes of symmetry of the switch-disconnector.  
Reference plane Z corresponds to the back of the switch-disconnector.

## Dimensions

### Lateral handle

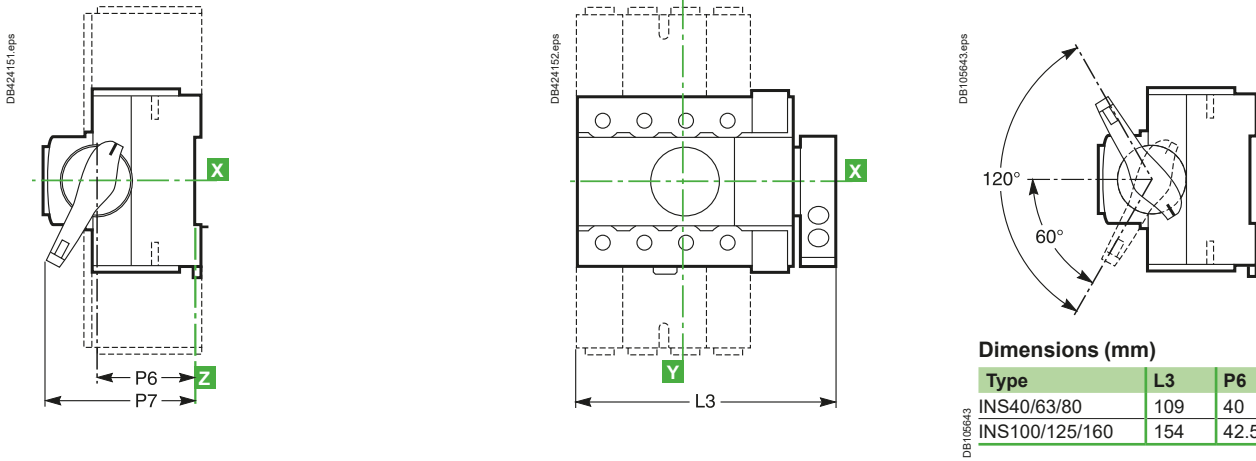

### Extended lateral handle

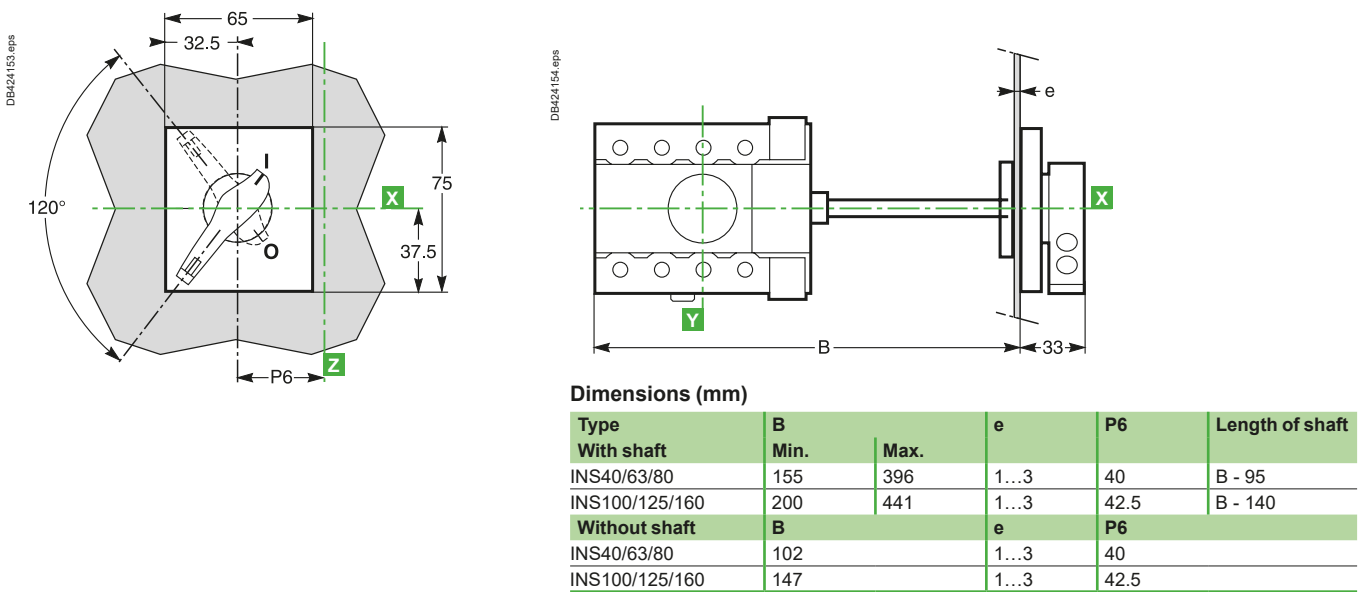

### Lateral handle for functional enclosure

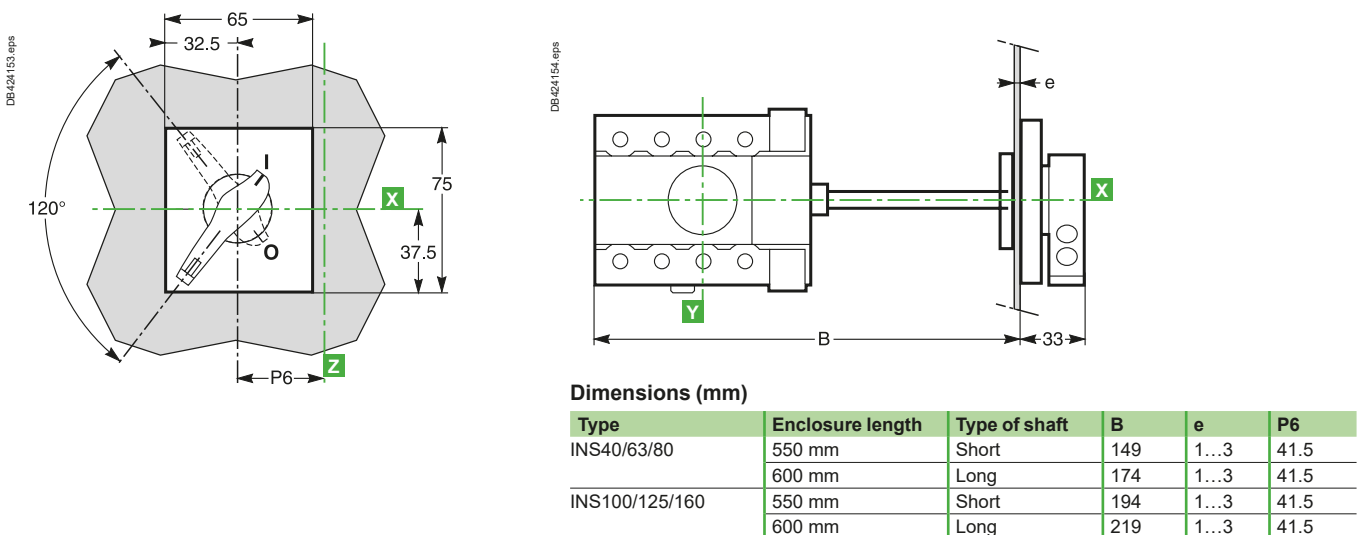

### Dimensions

#### Front panel cutout for extended handle

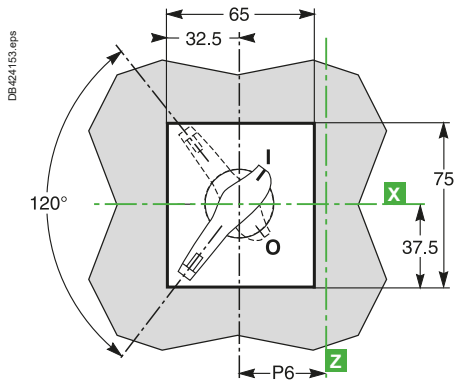

#### Dimensions (mm)

Type	P6
INS40/63/80	40
INS100/125/160	42.5

### C

#### Installation

##### On a backplate

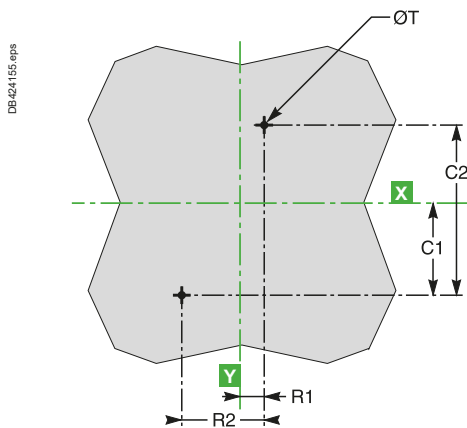

##### On rail

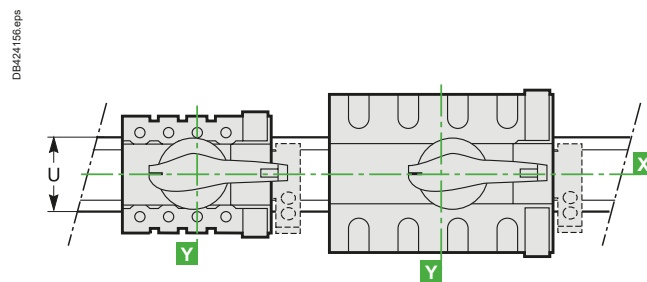

#### Dimensions (mm)

Type	C1	C2	R1	R2	ØT	U
INS40/63/80	40	80	10	36	4.5	35
INS100/125/160	37.5	75	22.5	60	4.5	35

# Dimensions and connection

## Compact INS250-100 to 630

## Compact INV100 to 630

### Dimensions

#### Front handle

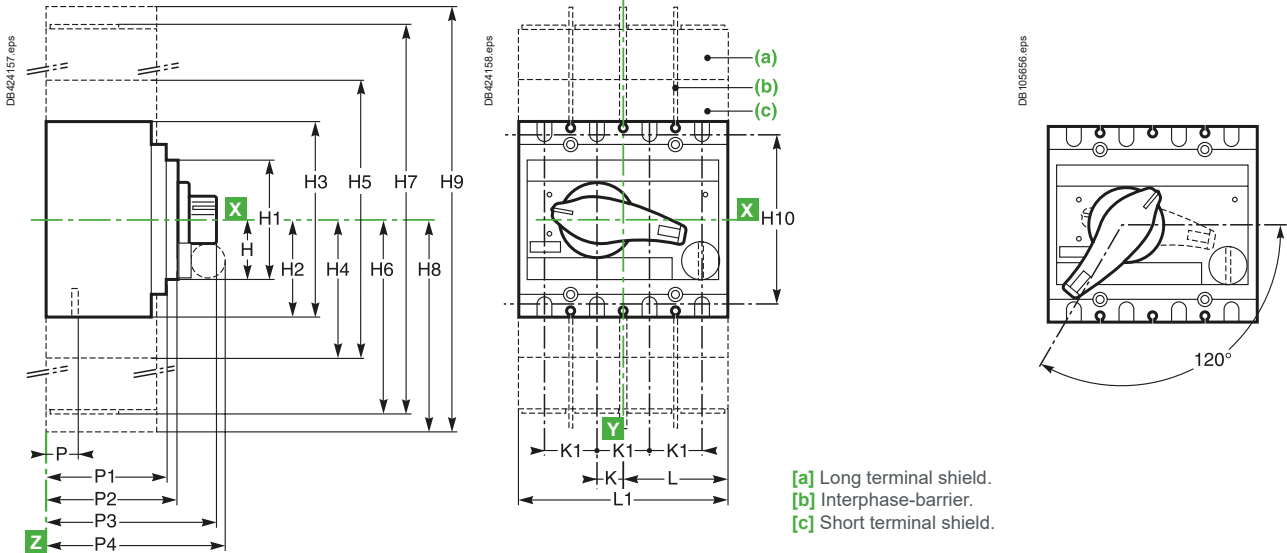

#### Dimensions (mm)

Type	H	H1	H2	H3	H4	H5	H6	H7	H8	H9	H10	K	K1	L	L1	P	P1	P2	P3	P4	
INS250	40	80	68	136	82	164	133	266	166	332	115	17.5	35	70	140	21.5	86	96	131	138	
INV100/250																					
INS320/630	61.5	123	102.5	205	118	236	175	350	212.5	425	177	22.5	45	92.5	185	26	110	120	160.4	162	
INV320/630																					

#### Extended front handle

INS250-100 to 250 and INV100 to 250

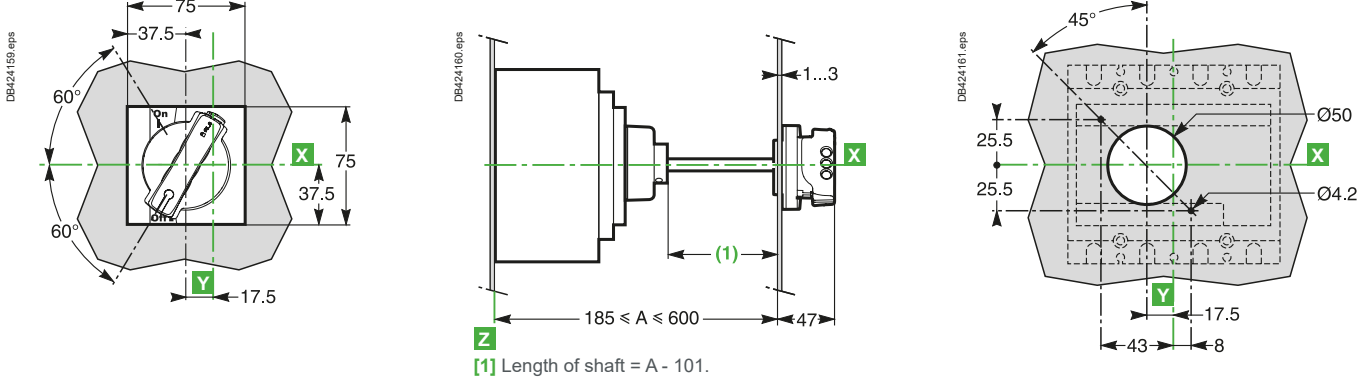

INS320 to 630 and INV320 to 630

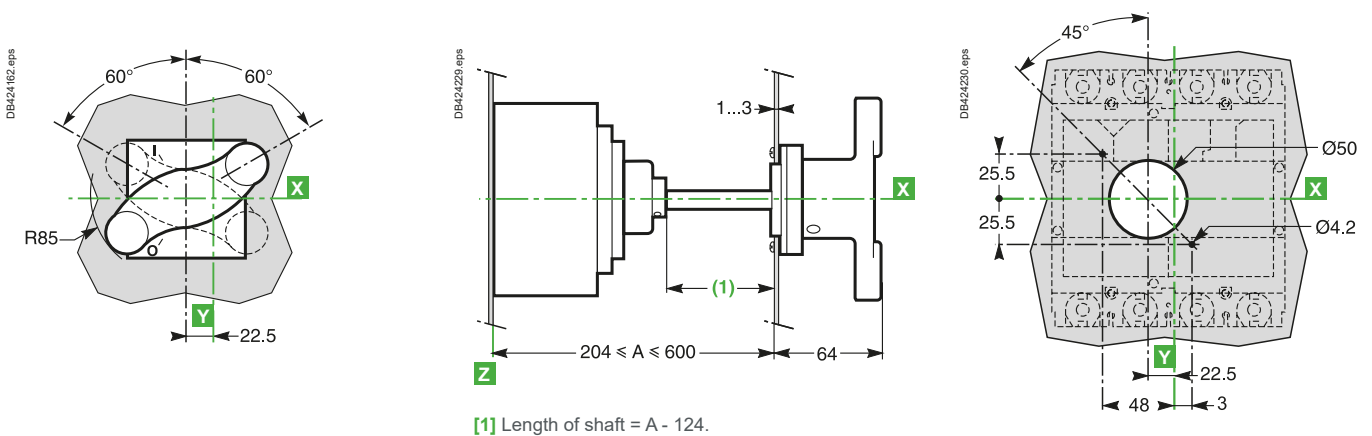

**Note:** Lines **X** and **Y** indicate the axes of symmetry of the switch-disconnector.  
Reference plane **Z** corresponds to the back of the switch-disconnector.



Dimensions and connection

# Compact INS250-100 to 630 Compact INV100 to 630

Door or front panel cutout for front handle

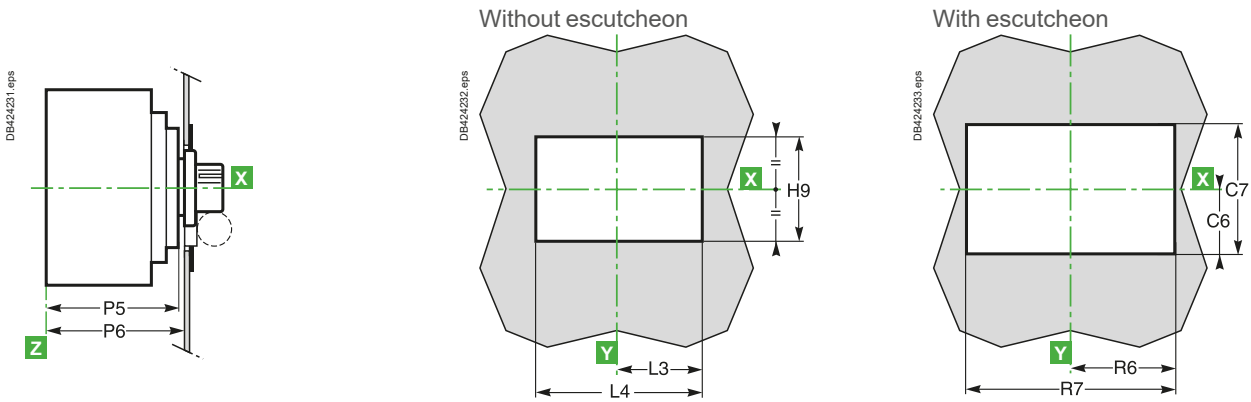

Dimensions (mm)

Type	C6	C7	H9	L3	L4	P5	P6	R6	R7
INS/INV100 to 250	51.5	103	82	66	132	96	98	81	162
INS/INV320 to 630	76.5	153	125	86	172	120	122	101	202

Installation

On panel fixed/FC

On panel fixed/RC

On rail

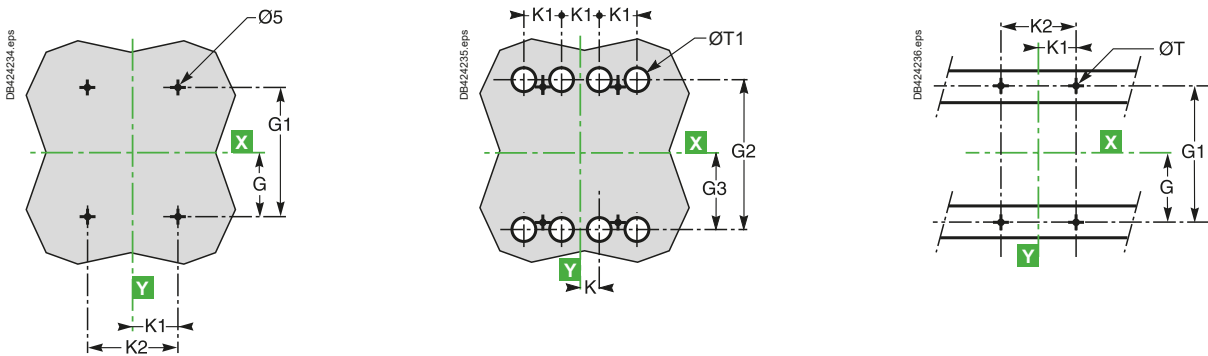

Dimensions (mm)

Type	G	G1	G2	G3	K	K1	K2	ØT	ØT1
INS/INV100 to 250	50	100	115	57.5	17.5	35	70	6	24
INS/INV320 to 630	75	150	177	88.5	22.5	45	90	6	32

Front panel cutout

Switch-disconnector equipped with a voltage-presence indicator

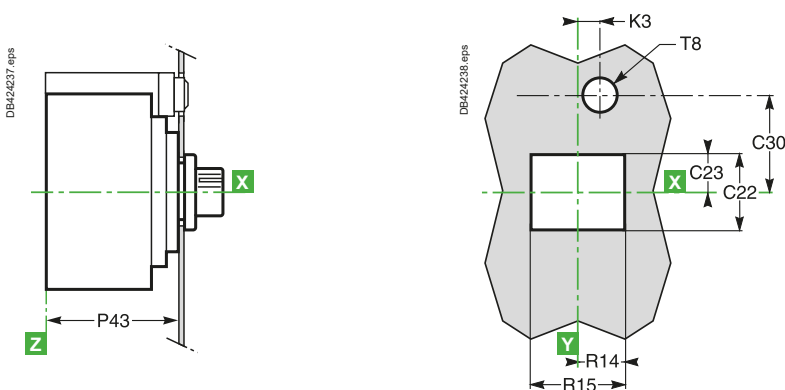

Dimensions (mm)

Type	P43	R14	R15	C22	C23	C30	T8	K3
INS/INV100 to 250	98	65	132	82	40	58.5	31	18
INS/INV320 to 630	122	86	172	125	62.85	97	31	22.7

# Dimensions and connection

## Compact INS250-100 to 630

## Compact INV100 to 630

### Dimensions

#### Lateral handle (only for INS250-100 to 250 and INV100 to 250)

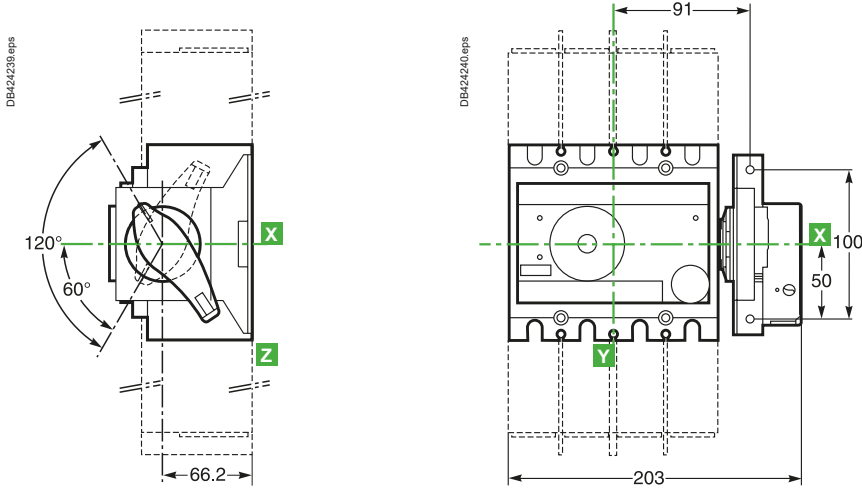

#### Extended lateral handle (only for INS250-100 to 250 and INV100 to 250)

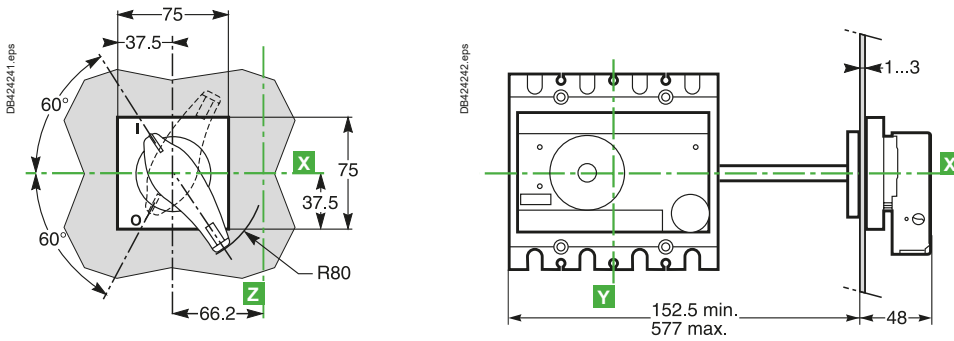

#### Door or front panel cutout for lateral handle (only for INS250-100 to 250 and INV100 to 250)

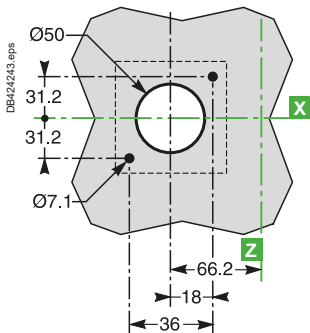

Dimensions and connection

# Compact INS250-100 to 630

# Compact INV100 to 630

## Dimensions

### Switch-disconnector with ammeter module

### Switch-disconnector equipped with current transformer / PowerTag NSX module

Direct handle  
(INS250/INV100 to 250)

Extended handle

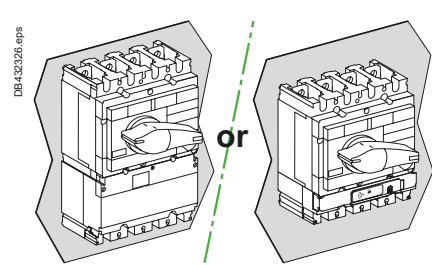
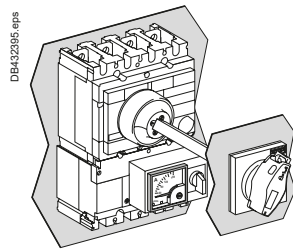
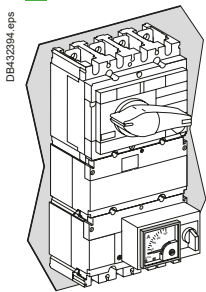
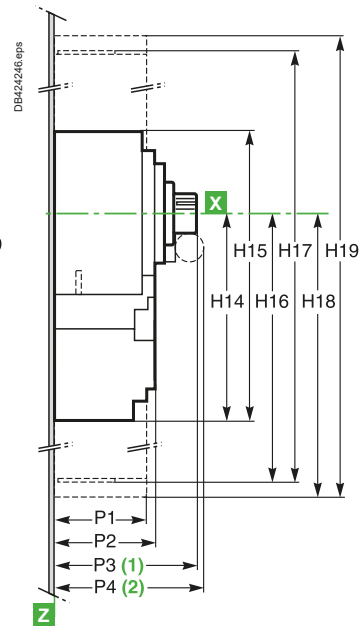
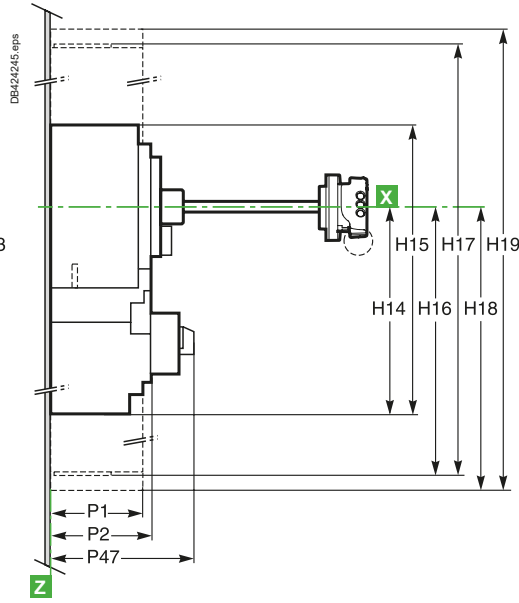
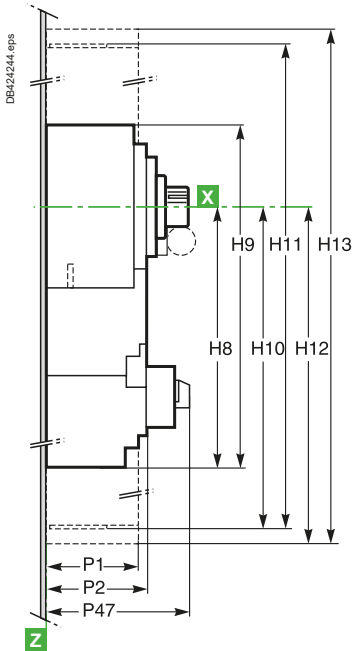

- [1] To front of direct handle.
- [2] To front of key.

### Front panel cutout

### Switch-disconnector with ammeter module

Direct handle  
(INS250/INV100 to 250)

Extended handle

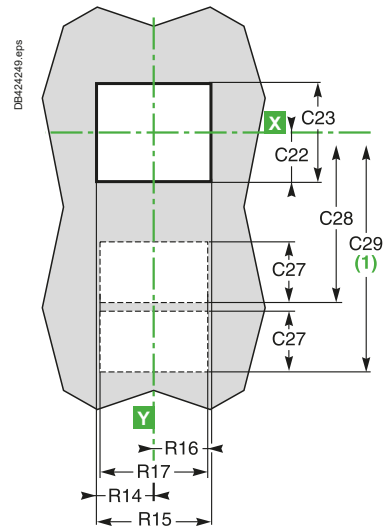
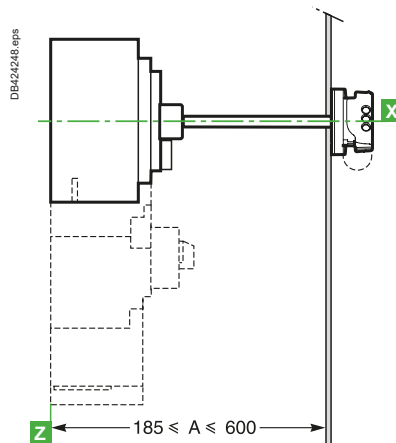
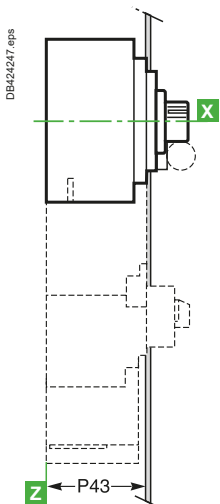

- [1] Only for INS250/INV100 to 250 with direct handle and ammeter module.

# Dimensions and connection

## Compact INS250-100 to 630

## Compact INV100 to 630

### Installation

(for INS250 direct rotary handle equipped with ammeter module or current transformer)

#### On a backplate

Fixed front connection

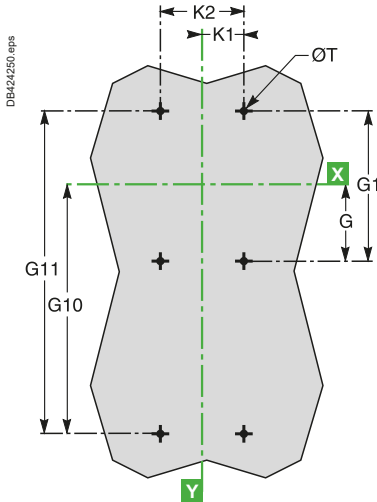

Fixed rear connection

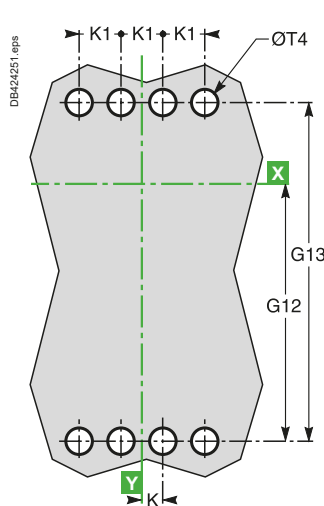

#### On rails

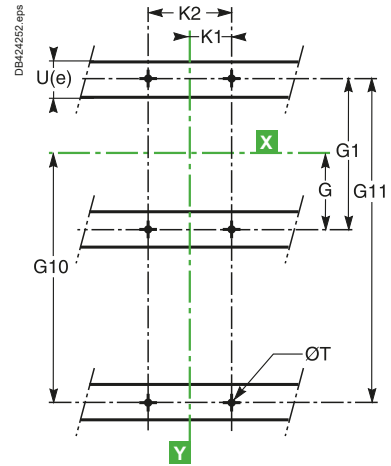

### Installation (for extended rotary handle equipped with ammeter module)

#### On a backplate

Fixed front connection

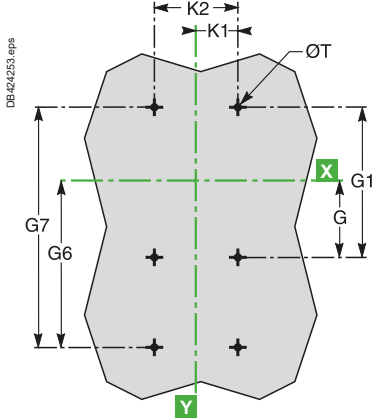

Fixed rear connection

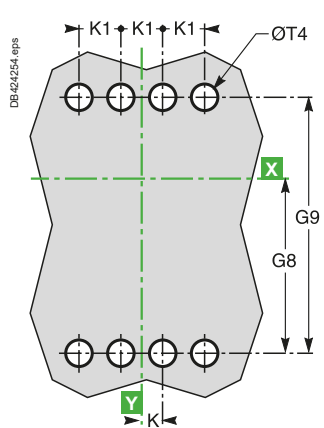

#### On rails

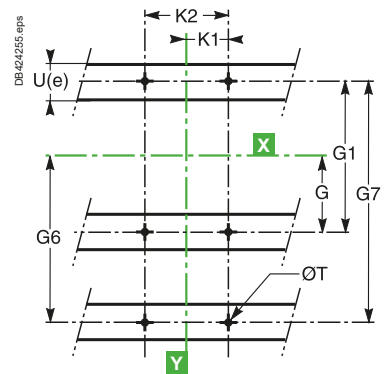

#### Dimensions (mm)

Type	C22	C23	C27	C28	C29	G	G1	G6	G7	G8	G9	G10	G11	G12	G13
INS/INV100 to 250	41	82	56.5	187	195	50	100	125	175	132.5	190	200	250	207.5	265
INS/INV320 to 630	63.5	127	56.5	162	-	75	150	175	250	188.5	277	175	250	188.5	277

Type	H8	H9	H10	H11	H12	H13	H14	H15	H16	H17	H18	H19
INS/INV100 to 250	216	282	279.5	410	297.5	446	141	207	205	334	223	370
INS/INV320 to 630	-	-	-	-	-	-	202.5	305	310.5	521.5	217.5	530

Type	H14	H15	H16	H17	H18	H19	G6	G7	G8	G9
INS/INV100 to 250 with PowerTag NSX	108	176	173	306	206	372	90	140	97.5	155
INS/INV320 to 630 with PowerTag NSX	167.5	270	240	415	277.5	490	140	215	153.5	242

Type	K	K1	K2	P1	P2	P3	P4	P43	P47	R14	R15	R16	R17	ØT	ØT4	U(e)
INS/INV100 to 250	17.5	35	70	81	86	131	138	89	137	48.5	97	46.5	93	6	24	≤ 32
INS/INV320 to 630	22.5	45	90	95.5	110	160.4	162	112	162	64.5	129	64.5	93	6	32	≤ 32

# Dimensions and connection

## Compact INS630b to 1600

## Compact INV630b to 1600

### Dimensions

#### Direct front handle

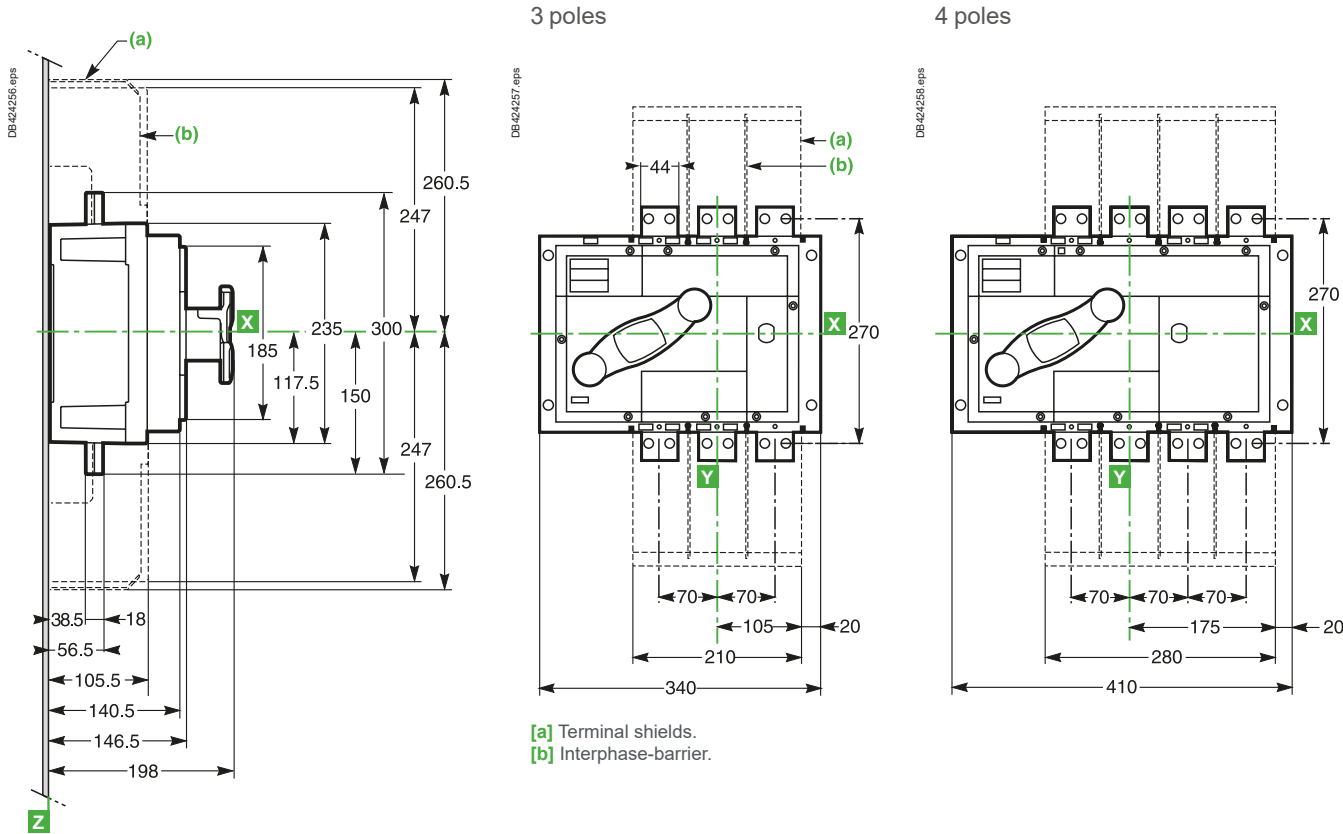

#### Door or front panel cutout for extended handle

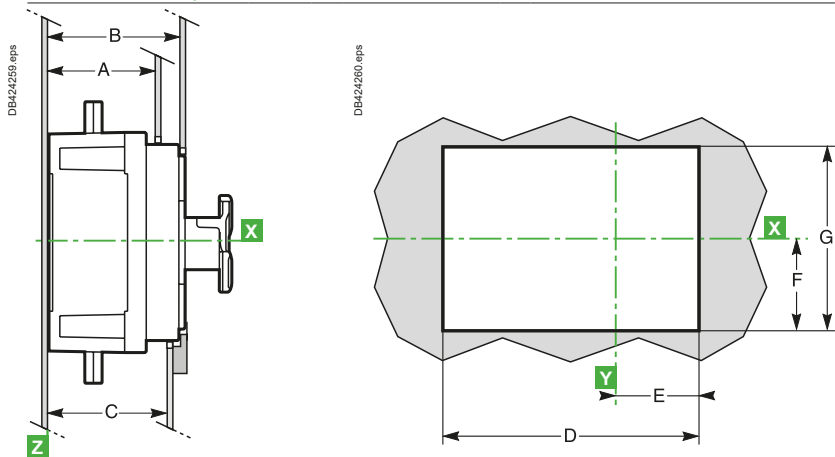

#### Cutout for switch-disconnector cover (mm)

Type	A	D	E	F	G
3P	107	299	103	108	216
4P	107	369	173	108	216

#### Cutout for switch-disconnector front (mm)

Type	B	D	E	F	G
3P	142	274	90.5	95.5	191
4P	142	344	160.5	95.5	191

#### Cutout for escutcheon (mm)

Type	C	D	E	F	G
3P	132	330	120	123	246
4P	132	400	190	123	246

Note: Lines X and Y indicate the axes of symmetry of the switch-disconnector. Reference plane Z corresponds to the back of the switch-disconnector.

# Compact INS630b to 1600 Compact INV630b to 1600

## Extended front handle

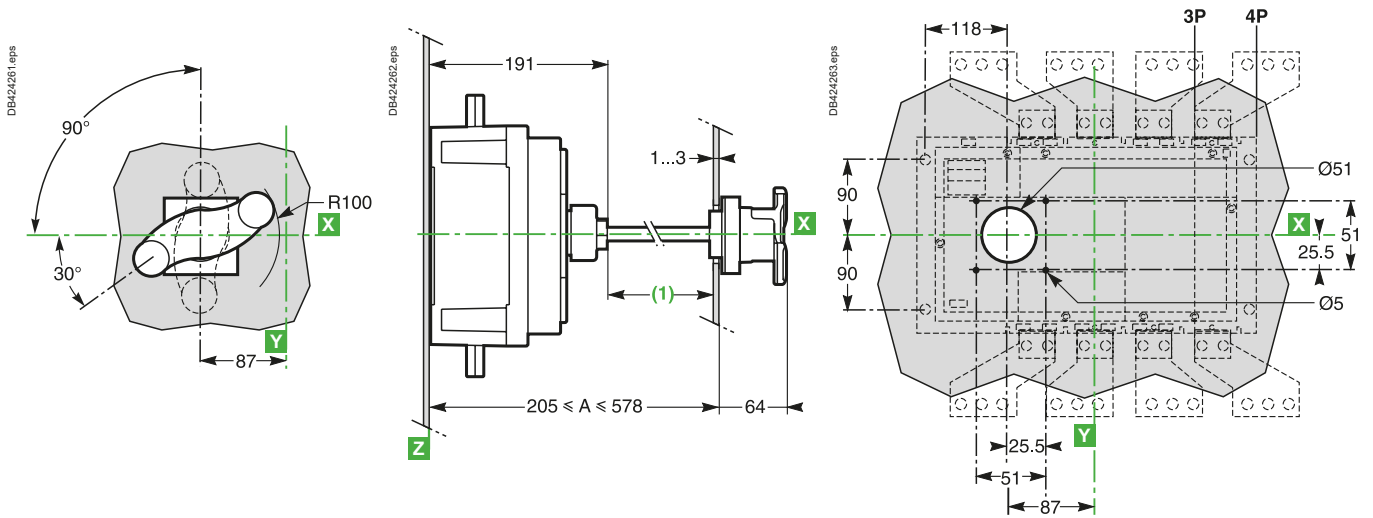

[1] Length of shaft = A - 151.

## Installation

### On backplate

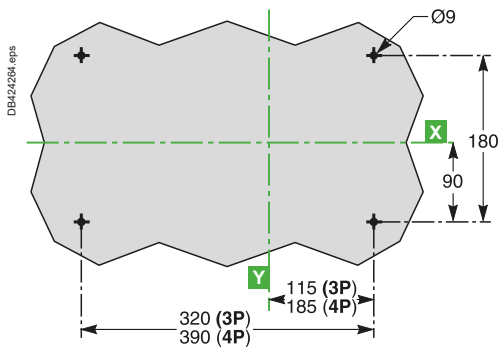

### On rail

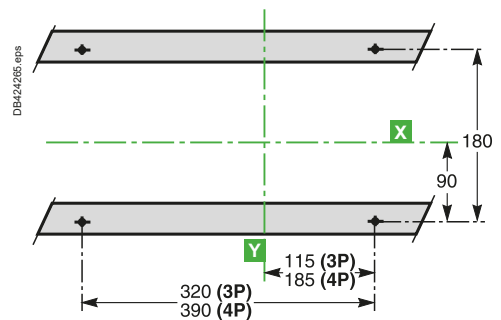

# Compact INS2000 to 2500 Compact INV2000 to 2500

## Dimensions

### Direct front handle

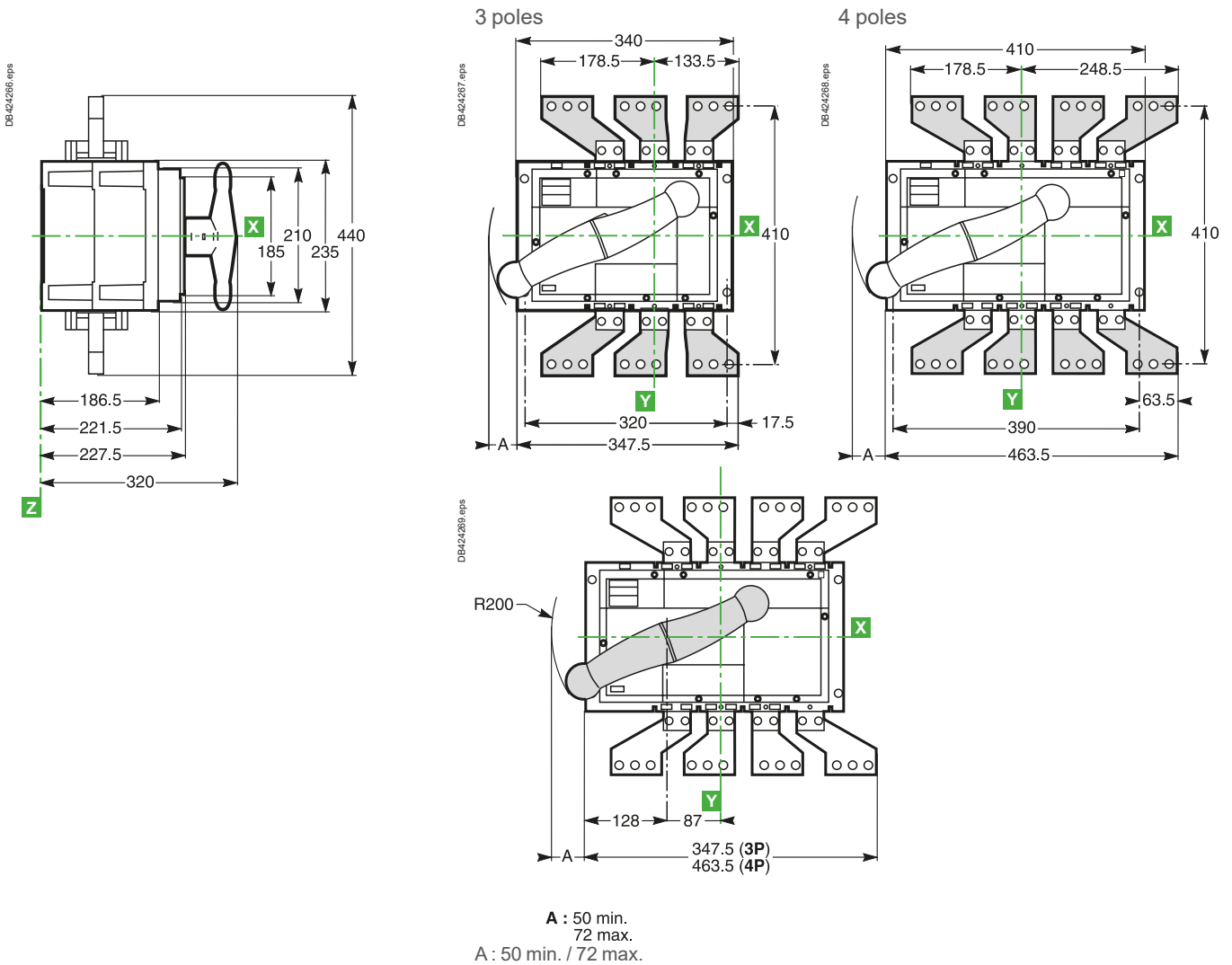

### Door or front panel cutout for front handle

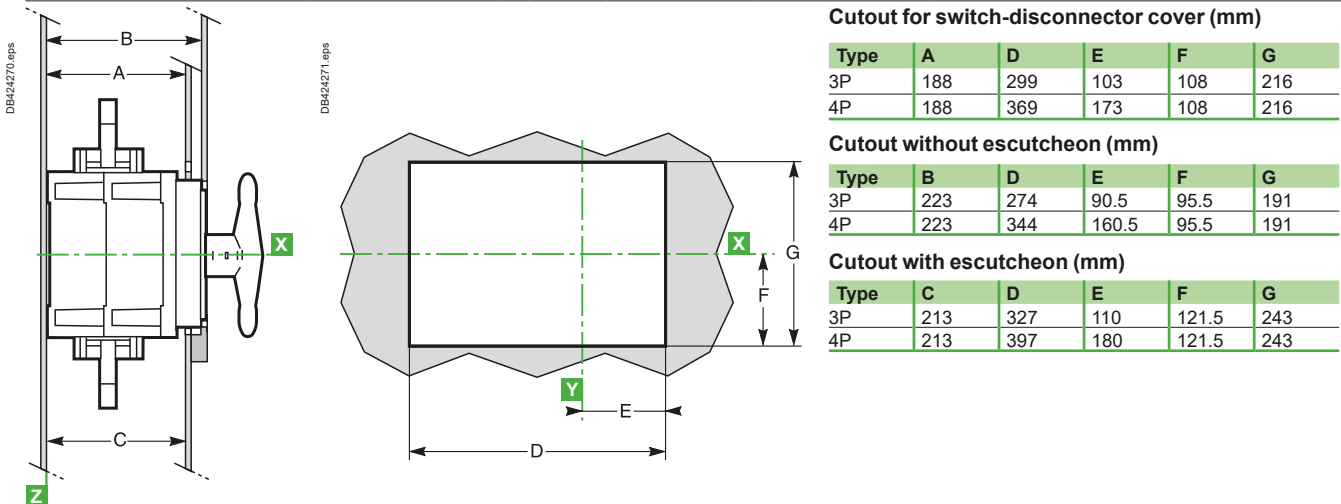

Note: Lines X and Y indicate the axes of symmetry of the switch-disconnector. Reference plane Z corresponds to the back of the switch-disconnector.



# Dimensions and connection

## Compact INS2000 to 2500

## Compact INV2000 to 2500

### Extended front handle

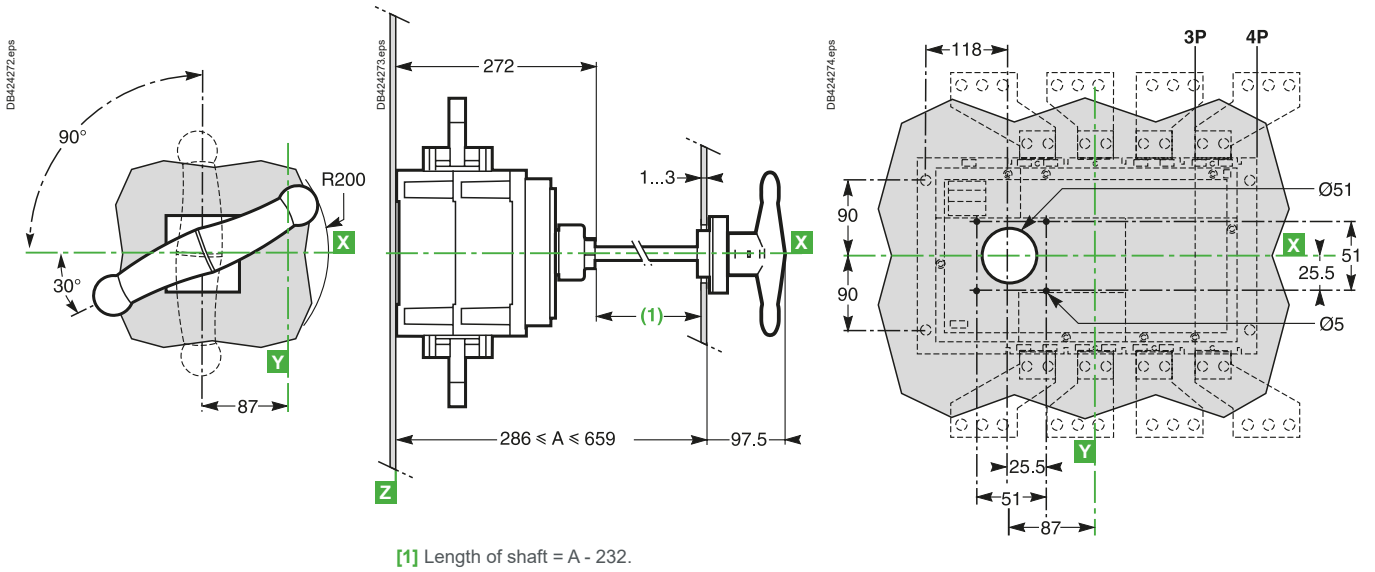

### Installation

#### On backplate

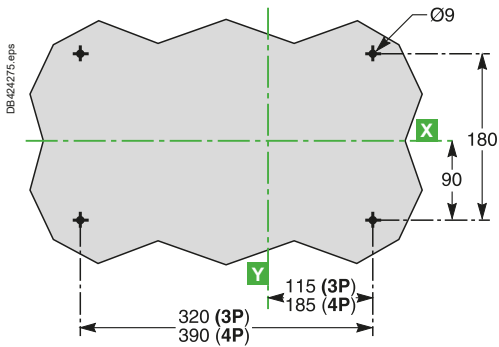

# Mechanical interlocks for direct and extended handles

## INS40 to 630, INV100 to 630

### Dimensions for direct handle (INS250-100 to 630 and INV100 to 630)

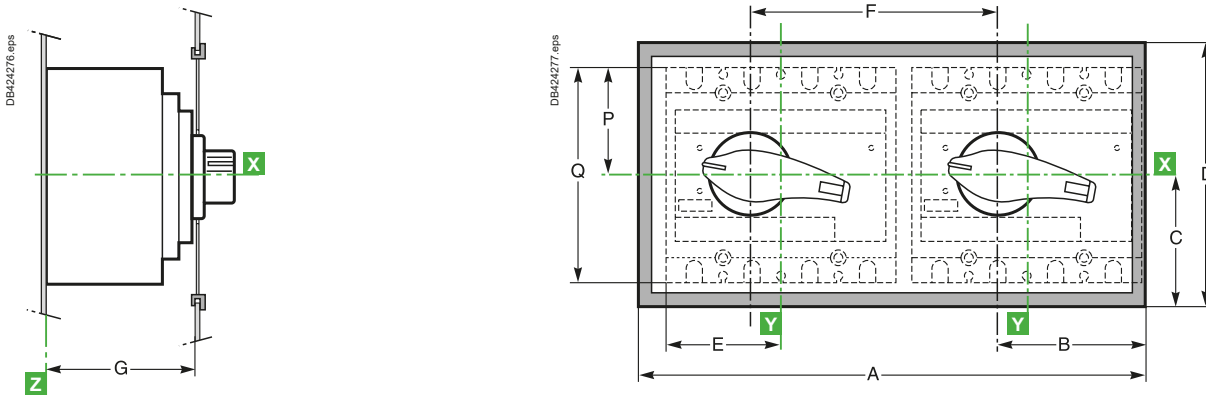

### Door cutout

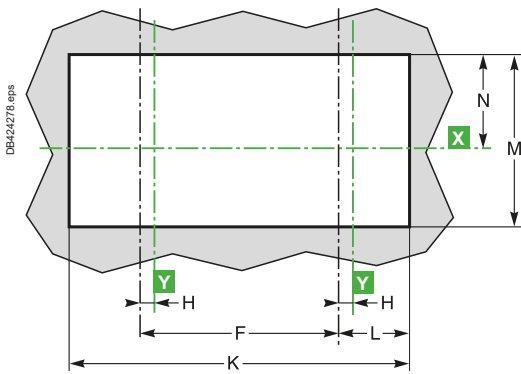

### Dimensions (mm)

Type	A	B	C	D	E	F	G	H	K	L	M	N	P	Q
INS250	325	90	87.5	175	70	156	106	17.5	295	75.5	150	75	68	136
INV100/250														
INS320/630	416	115	100	200	92.5	210	130	22.5	386	100	175	74.5	102.5	205
INV320/630														

### Dimensions for extended handle (INS250-100 to 630 and INV100 to 630)

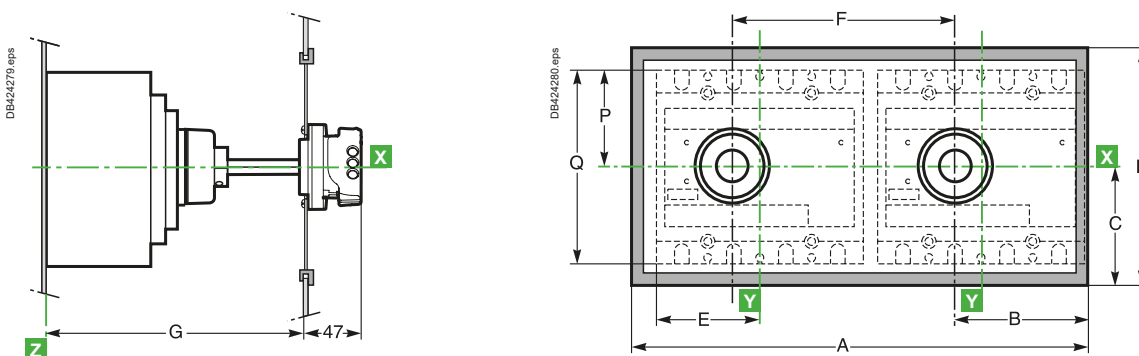

### Door cutout

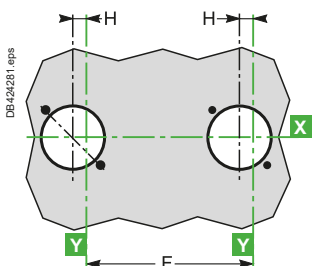

### Dimensions (mm)

Type	A	B	C	D	E	F	G	H	P	Q	
INS40/80	-	-	-	-	46	156	155	396	-	45	90
INS100/160	-	-	-	-	70	156	128	519	-	50	100
INS250	325	90	87.5	175	70	156	185	600	17.5	68	136
INV100/250											
INS320/630	416	115	100	200	92.5	210	204	600	22.5	102.5	205
INV320/630											

Note: Lines X and Y indicate the axes of symmetry of the switch-disconnector. Reference plane Z corresponds to the back of the switch-disconnector.

# Installation of downstream coupling

## INS250-100 to 630, INV100 to 630

### Dimensions

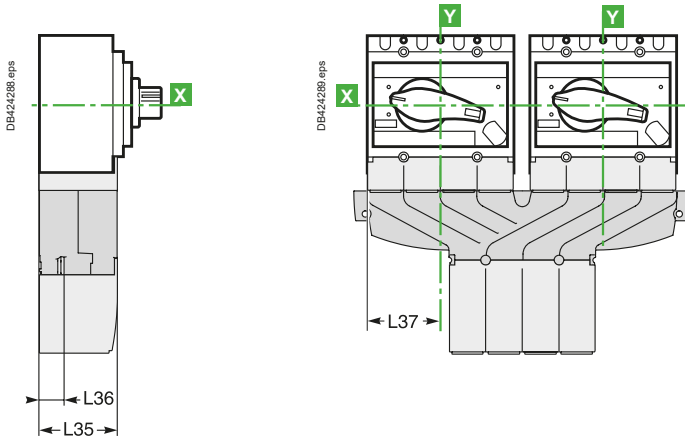

### Dimensions

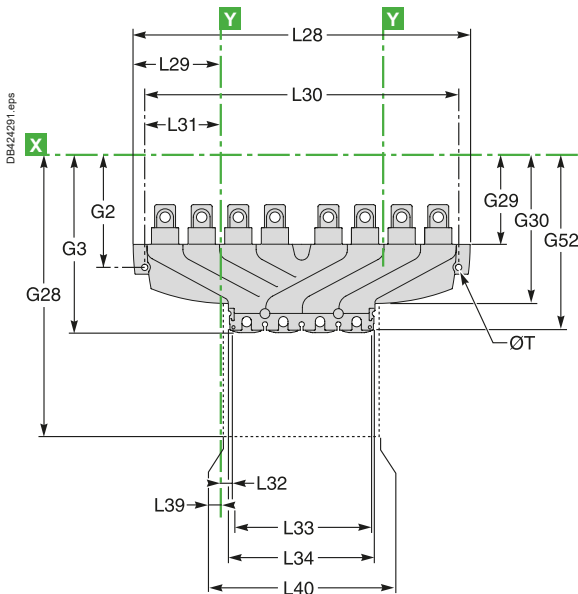

### Connection

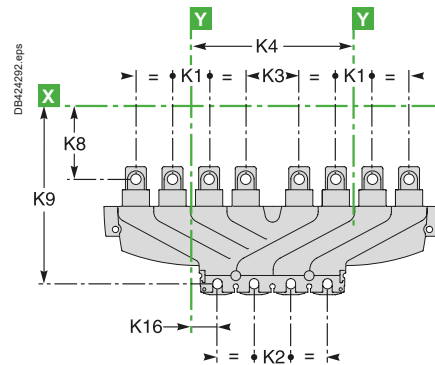

### Dimensions (mm)

Type	G2	G3	G28	G29	G30	G52	K1	K2	K3	K4	K8	K9	K16
INS250-100/160/200/250	105.5	169	232	83.5	140	165.5	35	35	51	156	57.5	157.5	25.5
INS320/400/500/630	141	240.7	313	119	195.6	240	45	45	75	210	88.5	225.7	37.5

### Dimensions (mm)

Type	L28	L29	L30	L31	L32	L33	L34	L35	L36	L37	L39	L40	ØT
INS250-100/160/200/250	320	83	300	72	12.8	130.5	139.5	74.5	21.5	70	8.5	140	6
INS320/400/500/630	425	107.5	400	95	17.35	175.3	184.7	98.5	26	92.5	12.65	184.7	6

**Note:** Lines X and Y indicate the axes of symmetry of the switch-disconnector. Reference plane Z corresponds to the back of the switch-disconnector.

# Front-panel accessories

INS250-100 to 2500, INV100 to 2500

## Front-panel escutcheon

### For switch-disconnectors

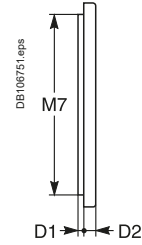
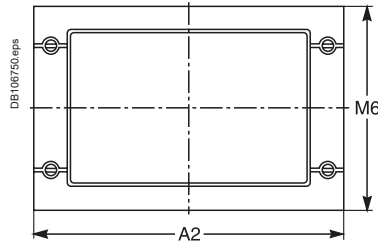
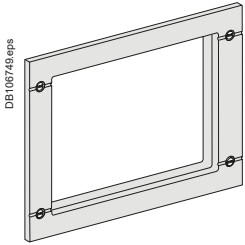

Dimensions (mm)

Type	A2	D1	D2	M6	M7
INS250	174	3.5	6.5	114	101
INV100/250					
INS320/630	215.5	3.5	6.5	164	151
INV320/630					
INS630b/2500 3P	346	3.5	11.5	257.5	242 x 326.5
INV630b/2500 4P	416	3.5	11.5	257.5	242 x 396.5

### For ammeter module

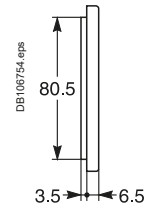
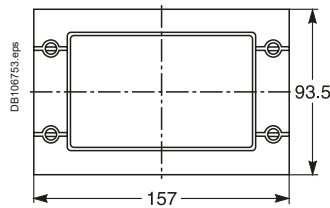
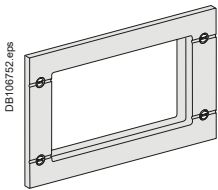

### Front alignment (only for INS/INV250-100)

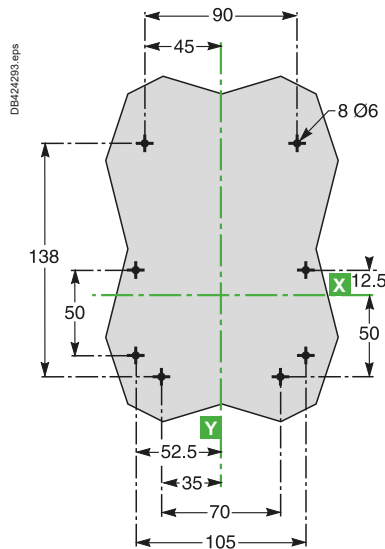
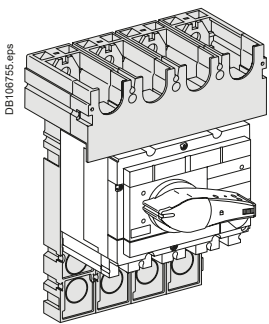

Note: Lines X and Y indicate the axes of symmetry of the switch-disconnector. Reference plane Z corresponds to the back of the switch-disconnector.

# Parallel or series connection accessories for direct current

## Compact INS250-100 to 250

## Compact INV100 to 250

### With series connections

#### 3P

	Terminal shield	1 x LV438326					Terminal shield	1 x LV438326	
Terminal extension	1 x LV438328				Terminal extension	2 x LV438328			

#### 4P

	Terminal shield	1 x LV438327					Terminal shield	1 x LV438326	
Terminal extension	2 x LV438328				Terminal extension	2 x LV438328			

	Terminal shield	1 x LV438327 + 1 x LV438326		
Terminal extension	3 x LV438328			

### Accessories

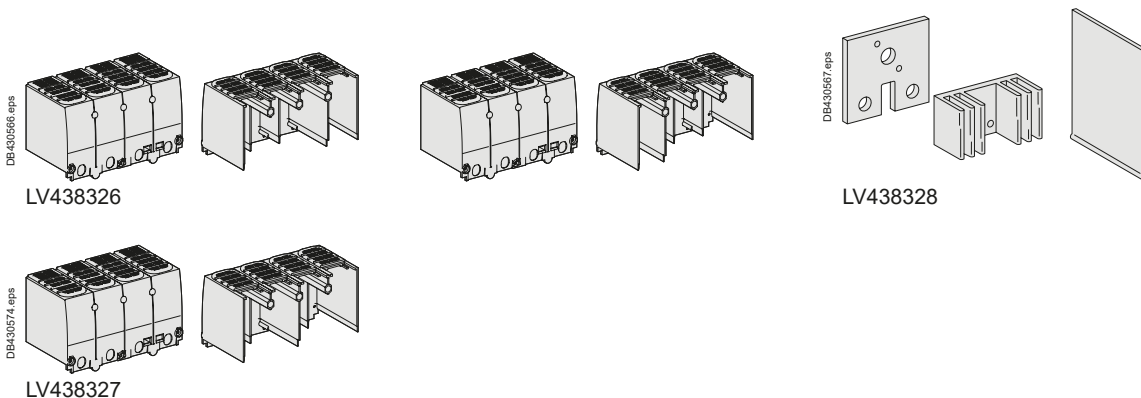

Dimensions and connection

# Parallel or series connection accessories for direct current

## Compact INS250-100 to 250

## Compact INV100 to 250

With parallel connections

3P

Terminal shield	-
Terminal extension	2 x LV438329

4P

Terminal shield	N/A
Terminal extension	4 x LV438328

Accessories

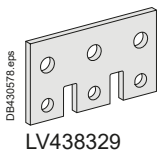

# Parallel or series connection accessories for direct current

## Compact INS320 to 630

## Compact INV320 to 630

### With series connections

#### 3P

<p>DB430561.eps 58.5 407 203.5 23 X Z</p>	<p>DB430562.eps 7.5 75 Source + - + Load X Y</p>	<p>DB430564.eps 7.5 75 75 37.5 Source + - + Load X Y</p>
<p>Terminal shield Terminal extension</p>	<p>1 x LV438295 + 1 x LV432594 1 x LV438338</p>	<p>1 x LV438295 + 1 x LV438294 2 x LV438338</p>

#### 4P

<p>DB430561.eps 58.5 407 203.5 23 X Z</p>	<p>DB430568.eps 75 75 7.5 Source + - + Load X Y</p>	<p>DB430590.eps 7.5 75 75 37.5 Source + - + Load X Y</p>
<p>Terminal shield Terminal extension</p>	<p>1 x LV438294 + 1 x LV432594 2 x LV438338</p>	<p>1 x LV438294 + 1 x LV438295 2 x LV438338</p>

<p>DB430561.eps 58.5 407 203.5 23 X Z</p>	<p>DB430562.eps 75 75 7.5 Source + - + Load X Y</p>
<p>Terminal shield Terminal extension</p>	<p>1 x LV438293 + 1 x LV438294 3 x LV438338</p>





Dimensions and connection

# Parallel or series connection accessories for direct current

## Compact INS320 to 630

## Compact INV320 to 630

Accessories

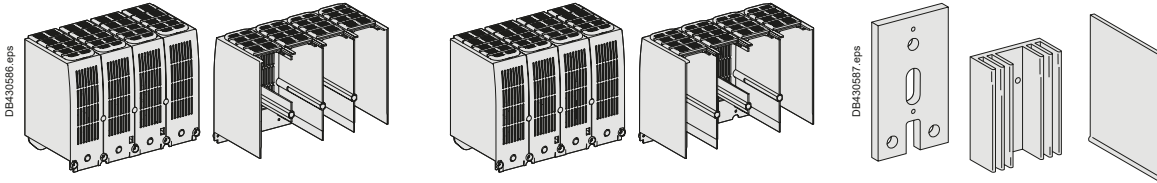

LV438294 and LV438295

LV438338

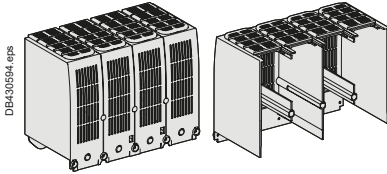

LV438293

With parallel connections

4P

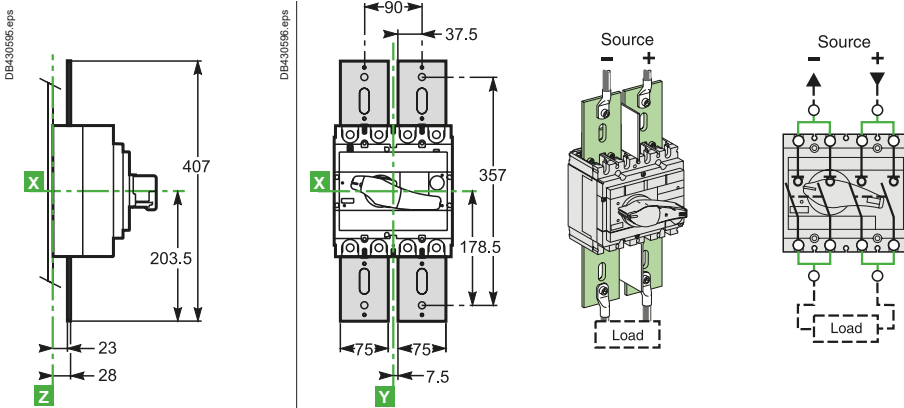

- Terminal shield: N/A or 1 x LV438327 (if you use LV438307)
- Terminal extension: 4 x LV438338 (proposal replace by 1 x LV438307)

Accessories

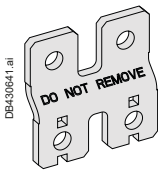

LV438307

# Complementary technical information

## Switch-disconnector - Circuit breaker coordination

Upstream: iC60, C120, NG125  
 Downstream: Compact INS40 to INS250, INV100 to INV250 ..... D-2

Upstream: Compact NSXm  
 Downstream: Compact INS40 to 250, Compact INV100 to 250 .... D-3

Upstream: Compact NSX100 to 250  
 Downstream: Compact INS40 to INS250, INV100 to INV250 ..... D-4

Upstream: Compact NSX400 to 630  
 Downstream: Compact INS/INV100 to 630..... D-5

Upstream: Compact NS630b to 3200, Masterpact MTZ1  
 Downstream: Compact INS/INV500 to 2500..... D-6

Upstream: Masterpact MTZ2  
 Downstream: Compact INS/INV500 to 2500..... D-7

Upstream: Compact NSXm, Compact NSX100 to 250  
 Downstream: Compact INS40 to 250, Compact INV100 to 250 .... D-8

Upstream: Compact NSX400 to 630  
 Downstream: Compact INS/INV100 to 630..... D-10

Upstream: Compact NS630b to 3200, Masterpact MTZ1/2  
 Downstream: Compact INS/INV500 to 2500..... D-11

Upstream: Compact NSX400 to 630  
 Downstream: Compact INS/INV100 to 630..... D-12

Upstream: Compact NS630b to 3200, Masterpact MTZ1/2  
 Downstream: Compact INS/INV 500 to 2500..... D-13

Upstream: Compact NSX100 to 630  
 Downstream: Compact INS/INV500 to 1000 ..... D-14

## Switch-disconnector - Fuse coordination

Upstream: gG, aM, BS fuses  
 Downstream: Compact INS40 to 630, INV100 to 360 ..... D-15



**Other chapters**

Functions and characteristics ..... A-1  
 Installation recommendations ..... B-1  
 Dimensions and connection ..... C-1  
 Catalogue numbers ..... E-1

# Switch-disconnector - Circuit breaker coordination

Upstream: iC60, C120, NG125

Downstream: Compact INS40 to INS250, INV100 to INV250

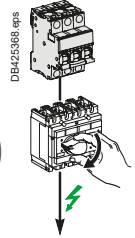

$U_e \leq 415 \text{ V AC}$

Downstream	Switch-disconnector	INS40	INS63	INS80	INS100	INS 250-100 INV100	INS125	INS160	INS 250-160 INV160	INS 250-200 INV200	INS250 INV250
	Ith (A) 60°	40	63	80	100	100	125	160	160	250	250
	Icw (kA)	3	3	3	5.5	8.5	5.5	5.5	8.5	8.5	8.5
	Icm (kA)	15	15	15	20	30	20	20	30	30	30

Upstream	Rating	Icu (kA)	Switch-disconnector conditional short-circuit current and related making capacity									
Circuit breaker	Rating	415 V										
<b>iC60N</b> B-C-D Curves	≤ 32	10	T	T	T	T	T	T	T	T	T	T
	40	10	T	T	T	T	T	T	T	T	T	T
	50	10		T	T	T	T	T	T	T	T	T
	63	10		T	T	T	T	T	T	T	T	T
<b>iC60H</b> B-C-D Curves	≤ 32	15	T	T	T	T	T	T	T	T	T	T
	40	15	T	T	T	T	T	T	T	T	T	T
	50	15		T	T	T	T	T	T	T	T	T
	63	15		T	T	T	T	T	T	T	T	T
<b>iC60L</b> B-C-D-K-Z Curves	≤ 25	25	T	T	T	T	T	T	T	T	T	T
	32	20	T	T	T	T	T	T	T	T	T	T
	40	20		T	T	T	T	T	T	T	T	T
	50	15		T	T	T	T	T	T	T	T	T
	63	15		T	T	T	T	T	T	T	T	T
<b>C120N</b> B-C-D Curves	63	10		T	T	T	T	T	T	T	T	T
	80	10			T	T	T	T	T	T	T	T
	1P 240V	100				T	T	T	T	T	T	T
	2, 3, 4P 415 V	125					T	T	T	T	T	T
<b>C120H</b> B-C-D Curves	63	20		T	T	T	T	T	T	T	T	T
	80	20			T	T	T	T	T	T	T	T
	1P 240V	100				T	T	T	T	T	T	T
	2, 3, 4P 415 V	125					T	T	T	T	T	T
<b>NG125N</b> B-C-D Curves	≤ 40	25	T	T	T	T	T	T	T	T	T	T
	63	25		T	T	T	T	T	T	T	T	T
	80	25			T	T	T	T	T	T	T	T
	100	25				T	T	T	T	T	T	T
<b>NG125H</b> C Curves	≤ 40	36	T	T	T	T	T	T	T	T	T	T
	63	36		T	T	T	T	T	T	T	T	T
	80	36			T	T	T	T	T	T	T	T
	100	36				T	T	T	T	T	T	T
<b>NG125L</b> B-C-D Curves	≤ 40	50	T	T	T	T	T	T	T	T	T	T
	63	50		T	T	T	T	T	T	T	T	T
	80	50			T	T	T	T	T	T	T	T

- T : Protection of the switch-disconnector is ensured but combination not very relevant
- T : Switch-disconnector is totally coordinated up to Icu of circuit breaker installed on supply side
- 36/75 : Switch-disconnector is protected up to 36 kA rms / 75 kA
- : Protection of the switch-disconnector is not ensured

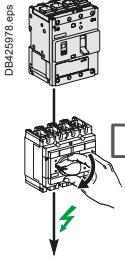

# Switch-disconnector - Circuit breaker coordination

Upstream: Compact NSXm

Downstream: Compact INS40 to 250, Compact INV100 to 250

Ue ≤ 440 V AC

Downstream	Switch-disconnector	INS40	INS63	INS80	INS100	INS250-100 INV100	INS125	INS160	INS250-160 INV160	INS250-200 INV200	INS250 INV250
	Ith A 60°	40	63	80	100	100	125	160	160	200	200
	Icw (kA)	3	3	3	5.5	8.5	5.5	5.5	8.5	8.5	8.5
	Icm (kA)	15	15	15	20	30	20	20	30	30	30

Upstream	Icu (kA)		Ir	Switch-disconnector conditional short-circuit current and related making capacity											
	415 V	440 V													
<b>NSXm E</b> TMD, Micrologic	16	10	Ir ≤ 40	T	T	T	T	T	T	T	T	T	T	T	T
			Ir ≤ 50		T	T	T	T	T	T	T	T	T	T	T
					T	T	T	T	T	T	T	T	T	T	T
						T	T	T	T	T	T	T	T	T	T
							T	T	T	T	T	T	T	T	T
								T	T	T	T	T	T	T	T
									T	T	T	T	T	T	T
<b>NSXm B</b> TMD, Micrologic	25	20	Ir ≤ 40	T	T	T	T	T	T	T	T	T	T	T	T
			Ir ≤ 50		T	T	T	T	T	T	T	T	T	T	T
					T	T	T	T	T	T	T	T	T	T	
						T	T	T	T	T	T	T	T	T	
							T	T	T	T	T	T	T	T	
								T	T	T	T	T	T	T	
									T	T	T	T	T	T	
<b>NSXm F</b> TMD, Micrologic	36	35	Ir ≤ 40	T	T	T	T	T	T	T	T	T	T	T	T
			Ir ≤ 50		T	T	T	T	T	T	T	T	T	T	T
					T	T	T	T	T	T	T	T	T	T	
						T	T	T	T	T	T	T	T	T	
							T	T	T	T	T	T	T	T	
								T	T	T	T	T	T	T	
									T	T	T	T	T	T	
<b>NSXm N</b> TMD, Micrologic	50	50	Ir ≤ 40	36/75	36/75	36/75	T	T	T	T	T	T	T	T	T
			Ir ≤ 50		36/75	36/75	T	T	T	T	T	T	T	T	T
				36/75	36/75	T	T	T	T	T	T	T	T	T	
					36/75	36/75	T	T	T	T	T	T	T	T	
						36/75	T	T	T	T	T	T	T	T	
							T	T	T	T	T	T	T	T	
									T	T	T	T	T	T	
<b>NSXm H</b> TMD, Micrologic	70	65	Ir ≤ 40	36/75	36/75	36/75	T	T	T	T	T	T	T	T	T
			Ir ≤ 50		36/75	36/75	T	T	T	T	T	T	T	T	T
				36/75	36/75	T	T	T	T	T	T	T	T	T	
					36/75	T	T	T	T	T	T	T	T	T	
						T	T	T	T	T	T	T	T	T	
							T	T	T	T	T	T	T	T	
									T	T	T	T	T	T	

- T : Protection of the switch-disconnector is ensured but combination not very relevant
- T : Switch-disconnector is totally coordinated up to Icu of circuit breaker installed on supply side
- 36/75 : Switch-disconnector is protected up to 36 kA rms / 75 kA
- : Protection of the switch-disconnector is not ensured



# Switch-disconnector - Circuit breaker coordination

Upstream: Compact NSX100 to 250

Downstream: Compact INS40 to INS250, INV100 to INV250

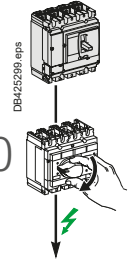

$U_e \leq 440 \text{ V AC}$

Downstream	Switch-disconnector	INS40	INS63	INS80	INS100	INS250-100 INV100	INS125	INS160	INS250-160 INV160	INS250-200 INV200	INS250 INV250
		Ith A 60°	40	63	80	100	100	125	160	160	200
Icw (kA)		3	3	3	5.5	8.5	5.5	5.5	8.5	8.5	8.5
Icm (kA)		15	15	15	20	30	20	20	30	30	30

Upstream circuit breaker	Icu (kA)			Ir	Switch-disconnector conditional short-circuit current and related making capacity																
	415V	440V																			
<b>NSX100B</b> <b>NSX160B</b> TMD / TMG / Micrologic	25	20	Ir ≤ 40	T	T	T	T	T	T	T	T	T	T	T	T	T	T				
				Ir ≤ 63	T	T	T	T	T	T	T	T	T	T	T	T	T	T	T		
					Ir ≤ 80		T	T	T	T	T	T	T	T	T	T	T	T	T	T	
						Ir ≤ 100			T	T	T	T	T	T	T	T	T	T	T	T	T
							Ir ≤ 125				T	T	T	T	T	T	T	T	T	T	T
<b>NSX250B</b> TMD / TMG / Micrologic	25	20	Ir ≤ 40	T	T	T		T	T	T	T	T	T	T	T	T	T	T			
				Ir ≤ 63	T	T	T	T	T	T	T	T	T	T	T	T	T	T	T		
					Ir ≤ 80		T	T	T	T	T	T	T	T	T	T	T	T	T	T	
						Ir ≤ 100			T	T	T	T	T	T	T	T	T	T	T	T	T
							Ir ≤ 125				T	T	T	T	T	T	T	T	T	T	T
<b>NSX100F</b> <b>NSX160F</b> TMD / TMG / Micrologic	36	35	Ir ≤ 40	36/75	36/75	36/75		T	T	T	T	T	T	T	T	T	T				
				Ir ≤ 63		36/75		36/75	T	T	T	T	T	T	T	T	T	T	T		
					Ir ≤ 80			36/75	T	T	T	T	T	T	T	T	T	T	T		
						Ir ≤ 100				T	T	T	T	T	T	T	T	T	T	T	
							Ir ≤ 125					T	T	T	T	T	T	T	T	T	T
<b>NSX250F</b> TMD / TMG / Micrologic	36	35	Ir ≤ 40	25/52	25/52	25/52		T	T	T	T	T	T	T	T	T	T				
				Ir ≤ 63		25/52		25/52	T	T	T	T	T	T	T	T	T	T			
					Ir ≤ 80			25/52	T	T	T	T	T	T	T	T	T	T			
						Ir ≤ 100				T	T	T	T	T	T	T	T	T			
							Ir ≤ 125					T	T	T	T	T	T	T	T		
<b>NSX100N/H</b> <b>NSX160N/H</b> TMD / TMG / Micrologic	50/70	50/65	Ir ≤ 40	25/52	25/52	25/52		T	T	T	T	T	T	T	T	T					
				Ir ≤ 63		25/52		25/52	T	T	T	T	T	T	T	T					
					Ir ≤ 80			25/52	T	T	T	T	T	T	T						
						Ir ≤ 100				T	T	T	T	T	T						
							Ir ≤ 125					T	T	T	T	T					
<b>NSX250N/H</b> TMD / TMG / Micrologic	50/70	50/65	Ir ≤ 40	25/52	25/52	25/52		T	T	T	T	T	T	T	T						
				Ir ≤ 63		25/52		25/52	T	T	T	T	T	T	T						
					Ir ≤ 80			25/52	T	T	T	T	T	T							
						Ir ≤ 100				T	T	T	T	T							
							Ir ≤ 125					T	T	T	T						
<b>NSX100S/L/R</b> TMD / TMG / Micrologic	100/ 150/ 200	90/ 130/ 200	Ir ≤ 40	36/75	36/75	36/75		65/143	T	65/143	65/143	T	T	T							
				Ir ≤ 63		36/75		36/75	65/143	T	65/143	65/143	T	T							
					Ir ≤ 80			36/75	65/143	T	65/143	65/143	T	T							
						Ir ≤ 100				65/143	T	65/143	65/143	T							
							<b>NSX160S/L</b> TMD / TMG / Micrologic	100/ 150	90/ 130	Ir ≤ 40	36/75	36/75	36/75	65/143	T	65/143	65/143	T	T		
Ir ≤ 63		36/75	36/75	65/143	T	65/143					65/143	T	T								
	Ir ≤ 80			36/75	65/143	T					65/143	65/143	T								
		Ir ≤ 100				65/143					T	65/143	65/143	T							
			Ir ≤ 125									T	65/143	65/143	T						
<b>NSX250S/L/R</b> TMD / TMG / Micrologic	100/ 150/ 200	90/ 130/ 200		Ir ≤ 40	25/52	25/52	25/52	65/143	T	65/143	65/143	T	T								
					Ir ≤ 63		25/52	25/52	65/143	T	65/143	65/143	T								
			Ir ≤ 80					25/52	65/143	T	65/143	65/143	T								
						Ir ≤ 100				65/143	T	65/143	65/143	T							
							Ir ≤ 125					T	65/143	65/143	T						
Ir ≤ 160						65/143		65/143	T												

- T : Protection of the switch-disconnector is ensured but combination not very relevant
- T : Switch-disconnector is totally coordinated up to Icu of circuit breaker installed on supply side
- 36/75 : Switch-disconnector is protected up to 36 kA rms / 75 kA
- : Protection of the switch-disconnector is not ensured

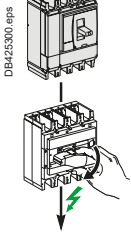

# Switch-disconnector - Circuit breaker coordination

Upstream: Compact NSX400 to 630

Downstream: Compact INS/INV100 to 630

$U_e \leq 440 \text{ V AC}$

Downstream	Switch-disconnector	INS100	INS250-100	INS125	INS160	INS250-160	INS250-200	INS250-INV250	INS320	INS400	INS500	INS630	INS630b
		100	100 INV100	125	160	160 INV160	200	250	320	400	500	630	630
	Ith A 60°	100	100	125	160	160	200	250	320	400	500	630	630
	Icw (kA)	5.5	8.5	5.5	5.5	8.5	8.5	8.5	20	20	20	20	35
	Icm (kA)	20	30	20	20	30	30	30	50	50	50	50	75

Upstream Circuit breaker	Icu (kA)		Setting Ir	Switch-disconnector conditional short-circuit current and related making capacity											
	415 V	440 V		INS100	INS250-100	INS125	INS160	INS250-160	INS250-200	INS250-INV250	INS320	INS400	INS500	INS630	INS630b
NSX400F NSX630F Micrologic	36	30	Ir = 100 [1]	16/32	T	16/32	16/32	T	T	T	T	T	T	T	T
			Ir ≤ 160			16/32	T	T	T	T	T	T	T	T	T
			Ir ≤ 200					T	T	T	T	T	T	T	T
			Ir ≤ 250						T	T	T	T	T	T	T
			Ir ≤ 320							T	T	T	T	T	T
			Ir ≤ 400								T	T	T	T	T
			Ir ≤ 500									T	T	T	T
NSX400N NSX630N Micrologic	50	42	Ir = 100 [1]	16/32	36/75	16/32	16/32	36/75	36/75	36/75	T	T	T	T	T
			Ir ≤ 160				16/32	36/75	36/75	36/75	T	T	T	T	T
			Ir ≤ 200						36/75	36/75	T	T	T	T	T
			Ir ≤ 250							36/75	T	T	T	T	T
			Ir ≤ 320								T	T	T	T	T
			Ir ≤ 400									T	T	T	T
			Ir ≤ 500										T	T	T
NSX400H NSX630H Micrologic	70	65	Ir = 100 [1]	16/32	36/75	16/32	16/32	36/75	36/75	36/75	T	T	T	T	T
			Ir ≤ 160				16/32	36/75	36/75	36/75	T	T	T	T	T
			Ir ≤ 200						36/75	36/75	T	T	T	T	T
			Ir ≤ 250							36/75	T	T	T	T	T
			Ir ≤ 320								T	T	T	T	T
			Ir ≤ 400									T	T	T	T
			Ir ≤ 500										T	T	T
NSX400S NSX630S Micrologic	100	90	Ir = 100 [1]	16/32	36/75	16/32	16/32	36/75	36/75	36/75	T	T	T	T	T
			Ir ≤ 160				16/32	36/75	36/75	36/75	T	T	T	T	T
			Ir ≤ 200						36/75	36/75	T	T	T	T	T
			Ir ≤ 250							36/75	T	T	T	T	T
			Ir ≤ 320								T	T	T	T	T
			Ir ≤ 400									T	T	T	T
			Ir ≤ 500										T	T	T
NSX400L NSX630L Micrologic	150	130	Ir = 100 [1]	16/32	36/75	16/32	16/32	36/75	36/75	36/75	T	T	T	T	T
			Ir ≤ 160				16/32	36/75	36/75	36/75	T	T	T	T	T
			Ir ≤ 200						36/75	36/75	T	T	T	T	T
			Ir ≤ 250							36/75	T	T	T	T	T
			Ir ≤ 320								T	T	T	T	T
			Ir ≤ 400									T	T	T	T
			Ir ≤ 500										T	T	T
NSX400R NSX630R Micrologic	200	200	Ir = 100 [1]	16/32	36/75	16/32	16/32	36/75	36/75	36/75	150/330	150/330	150/330	150/330	T
			Ir ≤ 160				16/32	36/75	36/75	36/75	150/330	150/330	150/330	150/330	T
			Ir ≤ 200						36/75	36/75	150/330	150/330	150/330	150/330	T
			Ir ≤ 250							36/75	150/330	150/330	150/330	150/330	T
			Ir ≤ 320								150/330	150/330	150/330	150/330	T
			Ir ≤ 400									150/330	150/330	150/330	T
			Ir ≤ 500										150/330	150/330	T
Ir ≤ 630											150/330	T			

**T** : Protection of the switch-disconnector is ensured but combination not very relevant

**T** : Switch-disconnector is totally coordinated up to Icu of circuit breaker installed on supply side

**36/75** : Switch-disconnector is protected up to 36 kA rms / 75 kA

: Protection of the switch-disconnector is not ensured

[1] NSX400 with Micrologic 250 A can be set down to 100 A.

# Switch-disconnector - Circuit breaker coordination

Upstream: Compact NS630b to 3200, Masterpact MTZ1

Downstream: Compact INS/INV500 to 2500

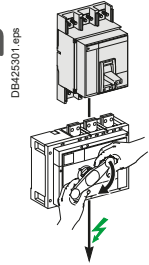

$U_e \leq 440 \text{ V AC}$

Downstream	Switch-disconnector	INS500	INS630	INS630b	INS800	INS1000	INS1250	INS1600	INS2000	INS2500	
		INV500	INV630	INV630b	INV800	INV1000	INV1250	INV1600	INV2000	INV2500	
		Ith A 60°	500	630	630	800	1000	1250	1600	2000	2500
		Icw (kA)	20	20	35	35	35	35	35	50	50
Icm (kA)	50	50	75	75	75	75	75	105	105		

Upstream Circuit breaker	Icu (kA)		Setting Ir	Switch-disconnector conditionnal short-circuit current and related making capacity									
	415 V	440 V		20/50	20/50	35/75	35/75	35/75	35/75	35/75	35/75	35/75	50/105
NS630bN	50	50	Ir ≤ 500	20/50	20/50	35/75	35/75	35/75	35/75	35/75	35/75	T	T
NS800N			Ir ≤ 630		20/50	35/75	35/75	35/75	35/75	35/75	35/75	T	T
NS1000N			Ir ≤ 800				35/75	35/75	35/75	35/75	35/75	T	T
NS1250N			Ir ≤ 1000					35/75	35/75	35/75	35/75	T	T
NS1600N			Ir ≤ 1250						35/75	35/75	35/75	T	T
			Ir ≤ 1600							35/75	35/75	T	T
NS630bH	70	65	Ir ≤ 500	20/50	20/50	35/75	35/75	35/75	35/75	35/75	35/75	50/105	50/105
NS800H			Ir ≤ 630		20/50	35/75	35/75	35/75	35/75	35/75	35/75	50/105	50/105
NS1000H			Ir ≤ 800				35/75	35/75	35/75	35/75	35/75	50/105	50/105
NS1250H			Ir ≤ 1000					35/75	35/75	35/75	35/75	50/105	50/105
NS1600H			Ir ≤ 1250						35/75	35/75	35/75	50/105	50/105
			Ir ≤ 1600							35/75	35/75	50/105	50/105
NS630bL	150	130	Ir ≤ 500	50/105	50/105	T	T	T	T	T	T	T	T
NS800L			Ir ≤ 630		50/105	T	T	T	T	T	T	T	T
NS1000L			Ir ≤ 800				T	T	T	T	T	T	T
			Ir ≤ 1000					T	T	T	T	T	T
NS630bLB	200	200	Ir ≤ 500	90/200	90/200	T	T	T	T	T	T	T	T
NS800LB			Ir ≤ 630		90/200	T	T	T	T	T	T	T	T
			Ir ≤ 800				T	T	T	T	T	T	T
NS1600bN	70	65	Ir ≤ 1250						35/75	35/75	50/105	50/105	
NS2000N			Ir ≤ 1600							35/75	50/105	50/105	
NS2500N			Ir ≤ 2000								50/105	50/105	
NS3200N			Ir ≤ 2500									50/105	
NS1600bH	85	85	Ir ≤ 1250						35/75	35/75	50/105	50/105	
NS2000H			Ir ≤ 1600							35/75	50/105	50/105	
NS2500H			Ir ≤ 2000								50/105	50/105	
NS3200H			Ir ≤ 2500									50/105	
MTZ1 06H1	42	42	Ir ≤ 500	20/50	20/50	35/75	35/75	35/75	35/75	35/75	35/75	T	T
MTZ1 08H1			Ir ≤ 630		20/50	35/75	35/75	35/75	35/75	35/75	35/75	T	T
MTZ1 10H1			Ir ≤ 800				35/75	35/75	35/75	35/75	35/75	T	T
MTZ1 12H1			Ir ≤ 1000					35/75	35/75	35/75	35/75	T	T
MTZ1 16H1			Ir ≤ 1250						35/75	35/75	35/75	T	T
			Ir ≤ 1600							35/75	35/75	T	T
MTZ1 06H2	50	50	Ir ≤ 500	20/50	20/50	35/75	35/75	35/75	35/75	35/75	35/75	T	T
MTZ1 08H2			Ir ≤ 630		20/50	35/75	35/75	35/75	35/75	35/75	35/75	T	T
MTZ1 10H2			Ir ≤ 800				35/75	35/75	35/75	35/75	35/75	T	T
MTZ1 12H2			Ir ≤ 1000					35/75	35/75	35/75	35/75	T	T
MTZ1 16H2			Ir ≤ 1250						35/75	35/75	35/75	T	T
			Ir ≤ 1600							35/75	35/75	T	T
MTZ1 06H3	66	66	Ir ≤ 500	20/50	20/50	35/75	35/75	35/75	35/75	35/75	35/75	50/105	50/105
MTZ1 08H3			Ir ≤ 630		20/50	35/75	35/75	35/75	35/75	35/75	35/75	50/105	50/105
MTZ1 10H3			Ir ≤ 800				35/75	35/75	35/75	35/75	35/75	50/105	50/105
MTZ1 12H3			Ir ≤ 1000					35/75	35/75	35/75	35/75	50/105	50/105
MTZ1 16H3			Ir ≤ 1250						35/75	35/75	35/75	50/105	50/105
			Ir ≤ 1600							35/75	35/75	50/105	50/105
MTZ1 06L1	150	130	Ir ≤ 500	50/105	50/105	100/220	100/220	100/220	100/220	100/220	100/220	100/220	100/220
MTZ1 08L1			Ir ≤ 630		50/105	100/220	100/220	100/220	100/220	100/220	100/220	100/220	100/220
MTZ1 10L1			Ir ≤ 800				100/220	100/220	100/220	100/220	100/220	100/220	100/220
			Ir ≤ 1000					100/220	100/220	100/220	100/220	100/220	100/220

- T : Protection of the switch-disconnector is ensured but combination not very relevant
- T : Switch-disconnector is totally coordinated up to Icu of circuit breaker installed on supply side
- 36/75 : Switch-disconnector is protected up to 36 kA rms / 75 kA
- : Protection of the switch-disconnector is not ensured



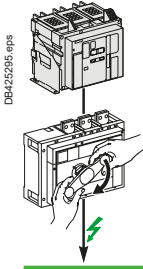

# Switch-disconnector - Circuit breaker coordination

Upstream: Masterpact MTZ2

Downstream: Compact INS/INV500 to 2500

$U_e \leq 440 \text{ V AC}$

Downstream	Switch-disconnector	INS500 INV500	INS630 INV630	INS630b INV630b	INS800 INV800	INS1000 INV1000	INS1250 INV1250	INS1600 INV1600	INS2000 INV2000	INS2500 INV2500
	Ith A 60°	500	630	630	800	1000	1250	1600	2000	2500
	Icw (kA)	20	20	35	35	35	35	35	50	50
	Icm (kA)	50	50	75	75	75	75	75	105	105

Upstream Circuit breaker	Icu (kA)		Setting I <sub>r</sub>	Switch-disconnector conditionnal short-circuit current and related making capacity									
	415 V	440 V		20/50	20/50	35/75	35/75	35/75	35/75	35/75	35/75	T	T
MTZ2 08N1	42	42	I <sub>r</sub> ≤ 500	20/50	20/50	35/75	35/75	35/75	35/75	35/75	35/75	T	T
MTZ2 10N1			I <sub>r</sub> ≤ 630		20/50	35/75	35/75	35/75	35/75	35/75	35/75	T	T
MTZ2 12N1			I <sub>r</sub> ≤ 800				35/75	35/75	35/75	35/75	35/75	T	T
MTZ2 16N1			I <sub>r</sub> ≤ 1000					35/75	35/75	35/75	35/75	T	T
MTZ2 20N1			I <sub>r</sub> ≤ 1250						35/75	35/75	35/75	T	T
			I <sub>r</sub> ≤ 1600							35/75	35/75	T	T
			I <sub>r</sub> ≤ 2000								35/75	T	T
MTZ2 08H1	66	66	I <sub>r</sub> ≤ 500	20/50	20/50	35/75	35/75	35/75	35/75	35/75	50/105	50/105	
MTZ2 10H1			I <sub>r</sub> ≤ 630		20/50	35/75	35/75	35/75	35/75	35/75	50/105	50/105	
MTZ2 12H1			I <sub>r</sub> ≤ 800				35/75	35/75	35/75	35/75	50/105	50/105	
MTZ2 16H1			I <sub>r</sub> ≤ 1000					35/75	35/75	35/75	50/105	50/105	
MTZ2 20H1			I <sub>r</sub> ≤ 1250						35/75	35/75	50/105	50/105	
MTZ2 25H1			I <sub>r</sub> ≤ 1600							35/75	35/75	50/105	
			I <sub>r</sub> ≤ 2000								50/105	50/105	
			I <sub>r</sub> ≤ 2500									50/105	
MTZ2 08H2	100	100	I <sub>r</sub> ≤ 500	20/50	20/50	35/75	35/75	35/75	35/75	35/75	50/105	50/105	
MTZ2 10H2			I <sub>r</sub> ≤ 630		20/50	35/75	35/75	35/75	35/75	35/75	50/105	50/105	
MTZ2 12H2			I <sub>r</sub> ≤ 800				35/75	35/75	35/75	35/75	50/105	50/105	
MTZ2 16H2			I <sub>r</sub> ≤ 1000					35/75	35/75	35/75	50/105	50/105	
MTZ2 20H2			I <sub>r</sub> ≤ 1250						35/75	35/75	50/105	50/105	
MTZ2 25H2			I <sub>r</sub> ≤ 1600						35/75	35/75	50/105	50/105	
MTZ2 20H3	150	150	I <sub>r</sub> ≤ 2000								50/105	50/105	
MTZ2 25H3			I <sub>r</sub> ≤ 2500									50/105	

- T : Protection of the switch-disconnector is ensured but combination not very relevant
- T : Switch-disconnector is Totally coordinated up to I<sub>cu</sub> of circuit breaker installed on supply side
- 36/75 : Switch-disconnector is protected up to 36 kA rms / 75 kA
- : Protection of the switch-disconnector is not ensured



# Switch-disconnector - Circuit breaker coordination

Upstream: Compact NSXm, Compact NSX100 to 250

Downstream: Compact INS40 to 250, Compact INV100 to 250

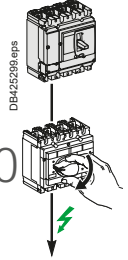

Ue: 500-525 V AC

Downstream	Switch-disconnector	INS100	INS250-100 INV100	INS125	INS160	INS250-160 INV160	INS250-200 INV200	INS250 INV250
	Ith A 60°	100	100	125	160	160	200	250
	Icw (kA)	5.5	8.5	5.5	5.5	8.5	8.5	8.5
	Icm (kA)	20	30	20	20	30	30	30

Upstream Circuit breaker	Icu (kA)		Ir	Switch-disconnector conditional short-circuit current and related making capacity						
	500 V	525 V								
NSXm E/B TMD	8/10	-	Ir ≤ 40	T	T	T	T	T	T	T
			Ir ≤ 50	T	T	T	T	T	T	
			Ir ≤ 63	T	T	T	T	T	T	
NSXm F TMD	15	10	Ir ≤ 40	T	T	T	T	T	T	T
			Ir ≤ 50	T	T	T	T	T	T	
			Ir ≤ 63	T	T	T	T	T	T	
NSXm N TMD	25	15	Ir ≤ 40	T	T	T	T	T	T	T
			Ir ≤ 50	T	T	T	T	T	T	
			Ir ≤ 63	T	T	T	T	T	T	
NSXm H TMD	30	22	Ir ≤ 40	T	T	T	T	T	T	T
			Ir ≤ 50	T	T	T	T	T	T	
			Ir ≤ 63	T	T	T	T	T	T	
NSX100B NSX160B NSX250B TMD / TMG / Micrologic	15	-	Ir ≤ 100	T	T	T	T	T	T	T
			Ir ≤ 125			T	T	T	T	
			Ir ≤ 160			T	T	T	T	
			Ir ≤ 200				T	T	T	
NSX100F NSX160F NSX250F TMD / TMG / Micrologic	25	22	Ir ≤ 100	T	T	T	T	T	T	
			Ir ≤ 125			T	T	T	T	
			Ir ≤ 160			T	T	T	T	
			Ir ≤ 200				T	T	T	
NSX100N NSX160N NSX250N TMD / TMG / Micrologic	36	35	Ir ≤ 100	22/46	T	22/46	T	T	T	
			Ir ≤ 125			22/46	T	T	T	
			Ir ≤ 160			T	T	T		
			Ir ≤ 200				T	T		
NSX100H NSX160H NSX250H TMD / TMG / Micrologic	50	35	Ir ≤ 100	22/46	T	22/46	T	T	T	
			Ir ≤ 125			22/46	T	T	T	
			Ir ≤ 160			T	T	T		
			Ir ≤ 200				T	T		
NSX100S NSX160S NSX250S TMD / TMG / Micrologic	65	40	Ir ≤ 100	22/46	T	22/46	T	T	T	
			Ir ≤ 125			22/46	T	T	T	
			Ir ≤ 160			T	T	T		
			Ir ≤ 200				T	T		
NSX100L NSX160L NSX250L TMD / TMG / Micrologic	70	50	Ir ≤ 100	22/46	T	22/46	T	T	T	
			Ir ≤ 125			22/46	T	T	T	
			Ir ≤ 160			T	T	T		
			Ir ≤ 200				T	T		
NSX100R NSX250R TMD / TMG / Micrologic	80	65	Ir ≤ 100	22/46	T	22/46	T	T	T	
			Ir ≤ 125			22/46	T	T	T	
			Ir ≤ 160			T	T	T		
			Ir ≤ 200				T	T		
			Ir ≤ 250						T	

- T : Protection of the switch-disconnector is ensured but combination not very relevant
- T : Switch-disconnector is totally coordinated up to Icu of circuit breaker installed on supply side
- 36/75 : Switch-disconnector is protected up to 36 kA rms / 75 kA
- : Protection of the switch-disconnector is not ensured

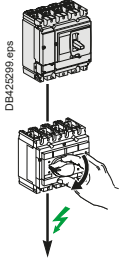

# Switch-disconnector - Circuit breaker coordination

Upstream: Compact NSXm, Compact NSX100 to 250  
Downstream: Compact INS40 to 250, Compact INV100 to 250

Ue: 690 V AC

Downstream	Switch-disconnector	INS100	INS250-100 INV100	INS125	INS160	INS250-160 INV160	INS250-200 INV200	INS250 INV250
	Ith A 60°	100	100	125	160	160	200	200
	Icw (kA)	5.5	8.5	5.5	5.5	8.5	8.5	8.5
	Icm (kA)	20	30	20	20	30	30	30

Upstream Circuit breaker	Icu (kA) 690 V	Ir	Switch-disconnector conditional short-circuit current and related making capacity						
NSXm N TMD	10	Ir ≤ 40	T	T	T	T	T	T	T
		Ir ≤ 50	T	T	T	T	T	T	T
		Ir ≤ 63	T	T	T	T	T	T	T
NSXm H TMD	10	Ir ≤ 40	T	T	T	T	T	T	T
		Ir ≤ 50	T	T	T	T	T	T	T
		Ir ≤ 63	T	T	T	T	T	T	T
NSX100F NSX160F NSX250F TMD / TMG / Micrologic	8	Ir ≤ 100	T	T	T	T	T	T	T
		Ir ≤ 125			T	T	T	T	T
		Ir ≤ 160				T	T	T	T
		Ir ≤ 200						T	T
		Ir ≤ 250							T
NSX100N NSX160N NSX250N TMD / TMG / Micrologic	10	Ir ≤ 100	T	T	T	T	T	T	T
		Ir ≤ 125			T	T	T	T	T
		Ir ≤ 160				T	T	T	T
		Ir ≤ 200						T	T
		Ir ≤ 250							T
NSX100H NSX160H NSX250H TMD / TMG / Micrologic	10	Ir ≤ 100	T	T	T	T	T	T	T
		Ir ≤ 125			T	T	T	T	T
		Ir ≤ 160				T	T	T	T
		Ir ≤ 200						T	T
		Ir ≤ 250							T
NSX100S NSX160S NSX250S TMD / TMG / Micrologic	15	Ir ≤ 100	T	T	T	T	T	T	T
		Ir ≤ 125			T	T	T	T	T
		Ir ≤ 160				T	T	T	T
		Ir ≤ 200						T	T
		Ir ≤ 250							T
NSX100L NSX160L NSX250L TMD / TMG / Micrologic	20	Ir ≤ 100	T	T	T	T	T	T	T
		Ir ≤ 125			T	T	T	T	T
		Ir ≤ 160				T	T	T	T
		Ir ≤ 200						T	T
		Ir ≤ 250							T
NSX100R NSX250R TMD / TMG / Micrologic	45	Ir ≤ 100	20/40	T	20/40	20/40	T	T	T
		Ir ≤ 125			20/40	20/40	T	T	T
		Ir ≤ 160				20/40	T	T	T
		Ir ≤ 200						T	T
		Ir ≤ 250							T

- T : Protection of the switch-disconnector is ensured but combination not very relevant
- T : Switch-disconnector is totally coordinated up to Icu of circuit breaker installed on supply side
- 36/75 : Switch-disconnector is protected up to 36 kA rms / 75 kA
- : Protection of the switch-disconnector is not ensured



# Switch-disconnector - Circuit breaker coordination

Upstream: Compact NSX400 to 630

Downstream: Compact INS/INV100 to 630

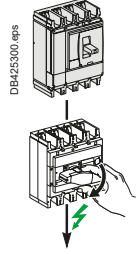

Ue: 500-525 V AC

Downstream	Switch-Disconnector	INS250-100 INV100	INS250-160 INV160	INS250-200 INV200	INS250 INV250	INS320 INV320	INS400 INV400	INS500 INV500	INS630 INV630	INS630b INV630b
		Ith A 60°	100	160	200	250	320	400	500	630
	Icw (kA)	8.5	8.5	8.5	8.5	20	20	20	20	35
	Icm (kA)	30	30	30	30	50	50	50	50	75

Upstream	Icu (kA)		Ir	Switch-disconnector conditionnal short-circuit current and related making capacity									
	500 V	525 V		INS250-100 INV100	INS250-160 INV160	INS250-200 INV200	INS250 INV250	INS320 INV320	INS400 INV400	INS500 INV500	INS630 INV630	INS630b INV630b	
NSX400F NSX630F Micrologic	25	20	Ir = 100 <sup>[1]</sup>	T	T	T	T	T	T	T	T	T	
			Ir ≤ 160		T	T	T	T	T	T	T	T	
			Ir ≤ 200			T	T	T	T	T	T	T	
			Ir ≤ 250				T	T	T	T	T	T	
			Ir ≤ 320					T	T	T	T	T	
			Ir ≤ 400						T	T	T	T	
			Ir ≤ 500							T	T	T	
NSX400N NSX630N Micrologic	30	22	Ir = 100 <sup>[1]</sup>	25/52	25/52	25/52	25/52	T	T	T	T	T	
			Ir ≤ 160		25/52	25/52	25/52	T	T	T	T	T	
			Ir ≤ 200			25/52	25/52	T	T	T	T	T	
			Ir ≤ 250				25/52	T	T	T	T	T	
			Ir ≤ 320					T	T	T	T	T	
			Ir ≤ 400						T	T	T	T	
			Ir ≤ 500							T	T	T	
NSX400H NSX630H Micrologic	50	35	Ir = 100 <sup>[1]</sup>	25/52	25/52	25/52	25/52	T	T	T	T	T	
			Ir ≤ 160		25/52	25/52	25/52	T	T	T	T	T	
			Ir ≤ 200			25/52	25/52	T	T	T	T	T	
			Ir ≤ 250				25/52	T	T	T	T	T	
			Ir ≤ 320					T	T	T	T	T	
			Ir ≤ 400						T	T	T	T	
			Ir ≤ 500							T	T	T	
NSX400S NSX630S Micrologic	65	40	Ir = 100 <sup>[1]</sup>	25/52	25/52	25/52	25/52	T	T	T	T	T	
			Ir ≤ 160		25/52	25/52	25/52	T	T	T	T	T	
			Ir ≤ 200			25/52	25/52	T	T	T	T	T	
			Ir ≤ 250				25/52	T	T	T	T	T	
			Ir ≤ 320					T	T	T	T	T	
			Ir ≤ 400						T	T	T	T	
			Ir ≤ 500							T	T	T	
NSX400L NSX630L Micrologic	70	50	Ir = 100 <sup>[1]</sup>	25/52	25/52	25/52	25/52	T	T	T	T	T	
			Ir ≤ 160		25/52	25/52	25/52	T	T	T	T	T	
			Ir ≤ 200			25/52	25/52	T	T	T	T	T	
			Ir ≤ 250				25/52	T	T	T	T	T	
			Ir ≤ 320					T	T	T	T	T	
			Ir ≤ 400						T	T	T	T	
			Ir ≤ 500							T	T	T	
NSX400R NSX630R Micrologic	80	65	Ir = 100 <sup>[1]</sup>	25/52	25/52	25/52	25/52	T	T	T	T	T	
			Ir ≤ 160		25/52	25/52	25/52	T	T	T	T	T	
			Ir ≤ 200			25/52	25/52	T	T	T	T	T	
			Ir ≤ 250				25/52	T	T	T	T	T	
			Ir ≤ 320					T	T	T	T	T	
			Ir ≤ 400						T	T	T	T	
			Ir ≤ 500							T	T	T	

- T : Protection of the switch-disconnector is ensured but combination not very relevant
- T : Switch-disconnector is totally coordinated up to Icu of circuit breaker installed on supply side
- 36/75 : Switch-disconnector is protected up to 36 kA rms / 75 kA
- : Protection of the switch-disconnector is not ensured

[1] NSX400 with Micrologic 250 A can be set down to 100 A.

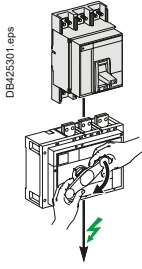

# Switch-disconnector - Circuit breaker coordination

Upstream: Compact NS630b to 3200, Masterpact MTZ1/2  
Downstream: Compact INS/INV500 to 2500

Ue: 500-525 V AC

Downstream	Switch-disconnector	INS500 INV500	INS630 INV630	INS630b INV630b	INS800 INV800	INS1000 INV1000	INS1250 INV1250	INS1600 INV1600	INS2000 INV2000	INS2500 INV2500
	Ith A 60°	500	630	630	800	1000	1250	1600	2000	2500
	Icw (kA)	20	20	35	35	35	35	35	50	50
	Icm (kA)	50	50	75	75	75	75	75	105	105

Upstream Circuit breaker	Icu (kA) 500-525 V	I <sub>r</sub>	Switch-disconnector conditional short-circuit current and related making capacity									
			INS500 INV500	INS630 INV630	INS630b INV630b	INS800 INV800	INS1000 INV1000	INS1250 INV1250	INS1600 INV1600	INS2000 INV2000	INS2500 INV2500	
NS630bN NS800N NS1000N NS1250N NS1600N	40	I <sub>r</sub> ≤ 500	20/50	20/50	35/75	35/75	35/75	35/75	35/75	35/75	T	T
		I <sub>r</sub> ≤ 630		20/50	35/75	35/75	35/75	35/75	35/75	35/75	T	T
		I <sub>r</sub> ≤ 800				35/75	35/75	35/75	35/75	35/75	T	T
		I <sub>r</sub> ≤ 1000					35/75	35/75	35/75	35/75	T	T
		I <sub>r</sub> ≤ 1250 I <sub>r</sub> ≤ 1600						35/75	35/75	35/75	T	T
NS630bH NS800H NS1000H NS1250H NS1600H	50	I <sub>r</sub> ≤ 500	20/50	20/50	35/75	35/75	35/75	35/75	35/75	35/75	T	T
		I <sub>r</sub> ≤ 630		20/50	35/75	35/75	35/75	35/75	35/75	35/75	T	T
		I <sub>r</sub> ≤ 800				35/75	35/75	35/75	35/75	35/75	T	T
		I <sub>r</sub> ≤ 1000					35/75	35/75	35/75	35/75	T	T
		I <sub>r</sub> ≤ 1250 I <sub>r</sub> ≤ 1600						35/75	35/75	35/75	T	T
NS630bL NS800L NS1000L	100	I <sub>r</sub> ≤ 500	36/75	36/75	T	T	T	T	T	T	T	T
		I <sub>r</sub> ≤ 630		36/75	T	T	T	T	T	T	T	T
		I <sub>r</sub> ≤ 800				T	T	T	T	T	T	T
		I <sub>r</sub> ≤ 1000					T	T	T	T	T	T
NS630bLB NS800LB	100	I <sub>r</sub> ≤ 500	70/154	70/154	T	T	T	T	T	T	T	T
		I <sub>r</sub> ≤ 630		70/154	T	T	T	T	T	T	T	T
		I <sub>r</sub> ≤ 800				T	T	T	T	T	T	T
NS1600bN NS2000N NS2500N NS3200N	65	I <sub>r</sub> ≤ 1250						35/75	35/75	50/105	50/105	
		I <sub>r</sub> ≤ 1600							35/75	50/105	50/105	
		I <sub>r</sub> ≤ 2000								50/105	50/105	
		I <sub>r</sub> ≤ 2500									50/105	
MTZ1 06H1/H2 MTZ1 08H1/2 MTZ1 10H1/2 MTZ1 12H1/2 MTZ1 16H1/2	42	I <sub>r</sub> ≤ 500	20/50	20/50	35/75	35/75	35/75	35/75	35/75	35/75	T	T
		I <sub>r</sub> ≤ 630		20/50	35/75	35/75	35/75	35/75	35/75	35/75	T	T
		I <sub>r</sub> ≤ 800				35/75	35/75	35/75	35/75	35/75	T	T
		I <sub>r</sub> ≤ 1000					35/75	35/75	35/75	35/75	T	T
		I <sub>r</sub> ≤ 1250 I <sub>r</sub> ≤ 1600						35/75	35/75	35/75	T	T
MTZ1 06L1 MTZ1 08L1 MTZ1 10L1	100	I <sub>r</sub> ≤ 500	36/75	36/75	T	T	T	T	T	T	T	T
		I <sub>r</sub> ≤ 630		36/75	T	T	T	T	T	T	T	T
		I <sub>r</sub> ≤ 800				T	T	T	T	T	T	T
		I <sub>r</sub> ≤ 1000					T	T	T	T	T	T
MTZ2 08N1 MTZ2 10N1 MTZ2 12N1 MTZ2 16N1 MTZ2 20N1	42	I <sub>r</sub> ≤ 500	20/50	20/50	35/75	35/75	35/75	35/75	35/75	35/75	T	T
		I <sub>r</sub> ≤ 630		20/50	35/75	35/75	35/75	35/75	35/75	35/75	T	T
		I <sub>r</sub> ≤ 800				35/75	35/75	35/75	35/75	35/75	T	T
		I <sub>r</sub> ≤ 1000					35/75	35/75	35/75	35/75	T	T
		I <sub>r</sub> ≤ 1250						35/75	35/75	35/75	T	T
		I <sub>r</sub> ≤ 1600 I <sub>r</sub> ≤ 2000							35/75	35/75	T	T
MTZ2 08 MTZ2 10 MTZ2 12 MTZ2 16 MTZ2 20 MTZ2 25 MTZ2 32 MTZ2 40	H1/H/H3/L1 66/85/130	I <sub>r</sub> ≤ 500	20/50	20/50	35/75	35/75	35/75	35/75	35/75	50/105	50/105	
		I <sub>r</sub> ≤ 630		20/50	35/75	35/75	35/75	35/75	35/75	50/105	50/105	
		I <sub>r</sub> ≤ 800				35/75	35/75	35/75	35/75	50/105	50/105	
		I <sub>r</sub> ≤ 1000					35/75	35/75	35/75	50/105	50/105	
		I <sub>r</sub> ≤ 1250						35/75	35/75	50/105	50/105	
		I <sub>r</sub> ≤ 1600							35/75	50/105	50/105	
		I <sub>r</sub> ≤ 2000								50/105	50/105	
		I <sub>r</sub> ≤ 2500									50/105	

**T** : Protection of the switch-disconnector is ensured but combination not very relevant

**T** : Switch-disconnector is totally coordinated up to I<sub>cu</sub> of circuit breaker installed on supply side

36/75 : Switch-disconnector is protected up to 36 kA rms / 75 kA

: Protection of the switch-disconnector is not ensured

# Switch-disconnector - Circuit breaker coordination

Upstream: Compact NSX400 to 630

Downstream: Compact INS/INV100 to 630

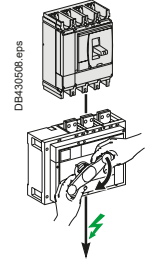

Ue: 690 V AC

Downstream	Switch-disconnector	INS500 INV500	INS630 INV630	INS630b INV630b	INS800 INV800	INS1000 INV1000	INS1250 INV1250	INS1600 INV1600	INS2000 INV2000	INS2500 INV2500
	Ith A 60°	630	630	630	800	1000	1250	1600	2000	2500
	Icw (kA)	20	20	35	35	35	35	35	50	50
	Icm (kA)	50	50	75	75	75	75	75	105	105

Upstream Circuit breaker 690 V	Icu (kA)	Ir	Switch-disconnector conditional short-circuit current and related making capacity									
			INS500 INV500	INS630 INV630	INS630b INV630b	INS800 INV800	INS1000 INV1000	INS1250 INV1250	INS1600 INV1600	INS2000 INV2000	INS2500 INV2500	
NSX400F NSX630F Micrologic	10	Ir = 100 <sup>[1]</sup>	T	T	T	T	T	T	T	T	T	
		Ir ≤ 160		T	T	T	T	T	T	T	T	
		Ir ≤ 200			T	T	T	T	T	T	T	
		Ir ≤ 250				T	T	T	T	T	T	
		Ir ≤ 320					T	T	T	T	T	
		Ir ≤ 400						T	T	T	T	
		Ir ≤ 500							T	T	T	
NSX400N NSX630N Micrologic	10	Ir = 100 <sup>[1]</sup>	T	T	T	T	T	T	T	T	T	
		Ir ≤ 160		T	T	T	T	T	T	T	T	
		Ir ≤ 200			T	T	T	T	T	T	T	
		Ir ≤ 250				T	T	T	T	T	T	
		Ir ≤ 320					T	T	T	T	T	
		Ir ≤ 400						T	T	T	T	
		Ir ≤ 500							T	T	T	
NSX400H NSX630H Micrologic	20	Ir = 100 <sup>[1]</sup>	T	T	T	T	T	T	T	T	T	
		Ir ≤ 160		T	T	T	T	T	T	T	T	
		Ir ≤ 200			T	T	T	T	T	T	T	
		Ir ≤ 250				T	T	T	T	T	T	
		Ir ≤ 320					T	T	T	T	T	
		Ir ≤ 400						T	T	T	T	
		Ir ≤ 500							T	T	T	
NSX400S NSX630S Micrologic	25	Ir = 100 <sup>[1]</sup>	T	T	T	T	T	T	T	T	T	
		Ir ≤ 160		T	T	T	T	T	T	T	T	
		Ir ≤ 200			T	T	T	T	T	T	T	
		Ir ≤ 250				T	T	T	T	T	T	
		Ir ≤ 320					T	T	T	T	T	
		Ir ≤ 400						T	T	T	T	
		Ir ≤ 500							T	T	T	
NSX400L NSX630L Micrologic	35	Ir = 100 <sup>[1]</sup>	25/52	25/52	25/52	25/52	T	T	T	T	T	
		Ir ≤ 160		25/52	25/52	25/52	T	T	T	T	T	
		Ir ≤ 200			25/52	25/52	T	T	T	T	T	
		Ir ≤ 250				25/52	T	T	T	T	T	
		Ir ≤ 320					T	T	T	T	T	
		Ir ≤ 400						T	T	T	T	
		Ir ≤ 500							T	T	T	
NSX400R NSX630R Micrologic	45	Ir = 100 <sup>[1]</sup>	25/52	25/52	25/52	25/52	T	T	T	T	T	
		Ir ≤ 160		25/52	25/52	25/52	T	T	T	T	T	
		Ir ≤ 200			25/52	25/52	T	T	T	T	T	
		Ir ≤ 250				25/52	T	T	T	T	T	
		Ir ≤ 320					T	T	T	T	T	
		Ir ≤ 400						T	T	T	T	
		Ir ≤ 500							T	T	T	

- T : Protection of the switch-disconnector is ensured but combination not very relevant
- T : Switch-disconnector is totally coordinated up to Icu of circuit breaker installed on supply side
- 36/75 : Switch-disconnector is protected up to 36 kA rms / 75 kA
- : Protection of the switch-disconnector is not ensured

[1] NSX400 with Micrologic 250 A can be set down to 100 A.

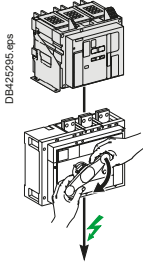

# Switch-disconnector - Circuit breaker coordination

Upstream: Compact NS630b to 3200, Masterpact MTZ1/2  
Downstream: Compact INS/INV 500 to 2500

Ue: 690 V AC

Downstream	Switch-disconnector	INS500 INV500	INS630 INV630	INS630b INV630b	INS800 INV800	INS1000 INV1000	INS1250 INV1250	INS1600 INV1600	INS2000 INV2000	INS2500 INV2500
	Ith A 60°	630	630	630	800	1000	1250	1600	2000	2500
	Icw (kA)	20	20	35	35	35	35	35	50	50
	Icm (kA)	50	50	75	75	75	75	75	105	105

Upstream Circuit breaker	Icu (kA) 690 V	I <sub>r</sub>	Switch-disconnector conditional short-circuit current and related making capacity								
			INS500 INV500	INS630 INV630	INS630b INV630b	INS800 INV800	INS1000 INV1000	INS1250 INV1250	INS1600 INV1600	INS2000 INV2000	INS2500 INV2500
NS630bN NS800N NS1000N NS1250N NS1600N	30	I <sub>r</sub> ≤ 500	20/50	20/50	35/75	35/75	35/75	35/75	35/75	T	T
		I <sub>r</sub> ≤ 630		20/50	35/75	35/75	35/75	35/75	35/75	T	T
		I <sub>r</sub> ≤ 800				35/75	35/75	35/75	35/75	T	T
		I <sub>r</sub> ≤ 1000					35/75	35/75	35/75	T	T
		I <sub>r</sub> ≤ 1250 I <sub>r</sub> ≤ 1600						35/75 35/75	35/75 35/75	T T	T T
NS630bH NS800H NS1000H NS1250H NS1600H	42	I <sub>r</sub> ≤ 500	20/50	20/50	35/75	35/75	35/75	35/75	35/75	50/105	50/105
		I <sub>r</sub> ≤ 630		20/50	35/75	35/75	35/75	35/75	35/75	50/105	50/105
		I <sub>r</sub> ≤ 800				35/75	35/75	35/75	35/75	50/105	50/105
		I <sub>r</sub> ≤ 1000					35/75	35/75	35/75	50/105	50/105
		I <sub>r</sub> ≤ 1250 I <sub>r</sub> ≤ 1600						35/75 35/75	35/75 35/75	50/105 50/105	50/105 50/105
NS630bLB NS800LB	75	I <sub>r</sub> ≤ 500	70/154	70/154	T	T	T	T	T	T	T
		I <sub>r</sub> ≤ 630		70/154	T	T	T	T	T	T	T
		I <sub>r</sub> ≤ 800				T	T	T	T	T	T
NS1600bN NS2000N NS2500N NS3200N	65	I <sub>r</sub> ≤ 1250						35/75	35/75	50/105	50/105
		I <sub>r</sub> ≤ 1600							35/75	50/105	50/105
		I <sub>r</sub> ≤ 2000								50/105	50/105
		I <sub>r</sub> ≤ 2500									50/105
MTZ1 06H1/H2 MTZ1 08H1/2 MTZ1 10H1/2 MTZ1 12H1/2 MTZ1 16H1/2	42	I <sub>r</sub> ≤ 500	20/50	20/50	35/75	35/75	35/75	35/75	35/75	T	T
		I <sub>r</sub> ≤ 630		20/50	35/75	35/75	35/75	35/75	35/75	T	T
		I <sub>r</sub> ≤ 800				35/75	35/75	35/75	35/75	T	T
		I <sub>r</sub> ≤ 1000					35/75	35/75	35/75	T	T
		I <sub>r</sub> ≤ 1250 I <sub>r</sub> ≤ 1600						35/75 35/75	35/75 35/75	T T	T T
MTZ1 06L1 MTZ1 08L1 MTZ1 10L1	25	I <sub>r</sub> ≤ 500	T	T	T	T	T	T	T	T	T
		I <sub>r</sub> ≤ 630		T	T	T	T	T	T	T	T
		I <sub>r</sub> ≤ 800				T	T	T	T	T	T
		I <sub>r</sub> ≤ 1000					T	T	T	T	T
MTZ2 08N1 MTZ2 10N1 MTZ2 12N1 MTZ2 16N1 MTZ2 20N1	42	I <sub>r</sub> ≤ 500	20/50	20/50	35/75	35/75	35/75	35/75	35/75	T	T
		I <sub>r</sub> ≤ 630		20/50	35/75	35/75	35/75	35/75	35/75	T	T
		I <sub>r</sub> ≤ 800				35/75	35/75	35/75	35/75	T	T
		I <sub>r</sub> ≤ 1000					35/75	35/75	35/75	T	T
		I <sub>r</sub> ≤ 1250						35/75	35/75	T	T
		I <sub>r</sub> ≤ 1600 I <sub>r</sub> ≤ 2000							35/75 35/75	T T	T T
MTZ2 08 MTZ2 10 MTZ2 12 MTZ2 16 MTZ2 20 MTZ2 25 MTZ2 32 MTZ2 40	H1/H2/H3/L1 66/85/100/100	I <sub>r</sub> ≤ 500	20/50	20/50	35/75	35/75	35/75	35/75	35/75	50/105	50/105
		I <sub>r</sub> ≤ 630		20/50	35/75	35/75	35/75	35/75	35/75	50/105	50/105
		I <sub>r</sub> ≤ 800				35/75	35/75	35/75	35/75	50/105	50/105
		I <sub>r</sub> ≤ 1000					35/75	35/75	35/75	50/105	50/105
		I <sub>r</sub> ≤ 1250						35/75	35/75	50/105	50/105
		I <sub>r</sub> ≤ 1600							35/75	50/105	50/105
		I <sub>r</sub> ≤ 2000								50/105	50/105
		I <sub>r</sub> ≤ 2500									50/105

- T : Protection of the switch-disconnector is ensured but combination not very relevant
- T : Switch-disconnector is totally coordinated up to I<sub>cu</sub> of circuit breaker installed on supply side
- 36/75 : Switch-disconnector is protected up to 36 kA rms / 75 kA
- : Protection of the switch-disconnector is not ensured





# Switch-disconnector - Circuit breaker coordination

Upstream: Compact NSX100 to 630

Downstream: Compact INS/INV500 to 1000

U<sub>e</sub>: 500-525 V AC

U<sub>e</sub>: 690 V AC

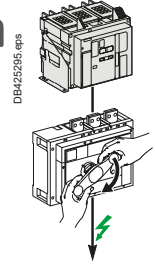

Downstream	Switch-disconnector	NSX100NA	NSX160NA	NSX250NA	NSX400NA	NSX630NA
	I <sub>th</sub> A 60°	100	160	250	400	630
	I <sub>cw</sub> (kA)	1.8	2.5	3.5	5	6
	I <sub>cm</sub> (kA)	2.6	3.6	4.9	7.1	8.5

Upstream Circuit breaker	I <sub>cu</sub> (kA)			I <sub>r</sub>	Switch-disconnector conditional short-circuit current and related making capacity				
	500 V	525 V	690 V						
NSX100B NSX160B NSX250B TMD / TMG / Micrologic	15	-	-	I <sub>r</sub> ≤ 50	T	T	T	T	T
				I <sub>r</sub> ≤ 100	T	T	T	T	T
				I <sub>r</sub> ≤ 160		T	T	T	T
				I <sub>r</sub> ≤ 250			T	T	T
NSX100F NSX160F NSX250F TMD / TMG / Micrologic	25	22	8	I <sub>r</sub> ≤ 50	T	T	T	T	T
				I <sub>r</sub> ≤ 100	T	T	T	T	T
				I <sub>r</sub> ≤ 160		T	T	T	T
				I <sub>r</sub> ≤ 250			T	T	T
NSX400F NSX630F Micrologic	25	20	10	I <sub>r</sub> = 100 [1]	T	T	T	T	T
				I <sub>r</sub> ≤ 160		T	T	T	T
				I <sub>r</sub> ≤ 250			T	T	T
				I <sub>r</sub> ≤ 400				T	T
NSX100N NSX160N NSX250N TMD / TMG / Micrologic	36	35	10	I <sub>r</sub> ≤ 50	T	T	T	T	T
				I <sub>r</sub> ≤ 100	T	T	T	T	T
				I <sub>r</sub> ≤ 160		T	T	T	T
				I <sub>r</sub> ≤ 250			T	T	T
NSX400N NSX630N Micrologic	30	22	10	I <sub>r</sub> = 100 [1]	T	T	T	T	T
				I <sub>r</sub> ≤ 160		T	T	T	T
				I <sub>r</sub> ≤ 250			T	T	T
				I <sub>r</sub> ≤ 400				T	T
NSX100H NSX160H NSX250H TMD / TMG / Micrologic	50	35	10	I <sub>r</sub> ≤ 50	T	T	T	T	T
				I <sub>r</sub> ≤ 100	T	T	T	T	T
				I <sub>r</sub> ≤ 160		T	T	T	T
				I <sub>r</sub> ≤ 250			T	T	T
NSX400H NSX630H Micrologic	50	35	20	I <sub>r</sub> = 100 [1]	T	T	T	T	T
				I <sub>r</sub> ≤ 160		T	T	T	T
				I <sub>r</sub> ≤ 250			T	T	T
				I <sub>r</sub> ≤ 400				T	T
NSX100S NSX160S NSX250S TMD / TMG / Micrologic	65	40	15	I <sub>r</sub> ≤ 50	T	T	T	T	T
				I <sub>r</sub> ≤ 100	T	T	T	T	T
				I <sub>r</sub> ≤ 160		T	T	T	T
				I <sub>r</sub> ≤ 250			T	T	T
NSX400S NSX630S Micrologic	65	40	25	I <sub>r</sub> = 100 [1]	T	T	T	T	T
				I <sub>r</sub> ≤ 160		T	T	T	T
				I <sub>r</sub> ≤ 250			T	T	T
				I <sub>r</sub> ≤ 400				T	T
NSX100L NSX160L NSX250L TMD / TMG / Micrologic	70	50	20	I <sub>r</sub> ≤ 50	T	T	T	T	T
				I <sub>r</sub> ≤ 100	T	T	T	T	T
				I <sub>r</sub> ≤ 160		T	T	T	T
				I <sub>r</sub> ≤ 250			T	T	T
NSX400L NSX630L Micrologic	70	50	35	I <sub>r</sub> = 100 [1]	T	T	T	T	T
				I <sub>r</sub> ≤ 160		T	T	T	T
				I <sub>r</sub> ≤ 250			T	T	T
				I <sub>r</sub> ≤ 400				T	T
				I <sub>r</sub> ≤ 630					T

**T** : Protection of the switch-disconnector is ensured but combination not very relevant

**T** : Switch-disconnector is totally coordinated up to I<sub>cu</sub> of circuit breaker installed on supply side

□ : Protection of the switch-disconnector is not ensured

[1] NSX400 with Micrologic 250 A can be set down to 100 A.



# Switch-disconnector - Fuse coordination

Upstream: gG, aM, BS fuses

Downstream: Compact INS40 to 630, INV100 to 630

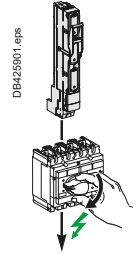

$U_e \leq 690 \text{ V AC}$

Downstream	Switch-Disconnector	Compact INS 40 - 160			Compact INS250 Compact INV				Compact INS Compact INV			
		100	125	160	100	160	200	250	320	400	500	630
	$I_{th} (A) 60^\circ$	100	125	160	100	160	200	250	320	400	500	630
	$I_{cw} (kA)$	5.5	5.5	5.5	8.5	8.5	8.5	8.5	20	20	20	20
	$I_{cm} (kA)$	20	20	20	30	30	30	30	50	50	50	50

Upstream												
Fuse type	Rating											
gG fuse link without overload relay	25	T	T	T	T	T	T	T	T	T	T	T
	32	T	T	T	T	T	T	T	T	T	T	T
	40	T	T	T	T	T	T	T	T	T	T	T
	50	T	T	T	T	T	T	T	T	T	T	T
	63	T	T	T	T	T	T	T	T	T	T	T
	80	T	T	T	T	T	T	T	T	T	T	T
	100	T	T	T	T	T	T	T	T	T	T	T
	125	T	T	T	T	T	T	T	T	T	T	T
	160	T	T	T	T	T	T	T	T	T	T	T
	200	T	T	T	T	T	T	T	T	T	T	T
	225-250	T	T	T	T	T	T	T	T	T	T	T
	300-315	T	T	T	T	T	T	T	T	T	T	T
	355	T	T	T	T	T	T	T	T	T	T	T
	400	T	T	T	T	T	T	T	T	T	T	T
	450	T	T	T	T	T	T	T	T	T	T	T
500	T	T	T	T	T	T	T	T	T	T	T	
gG fuse link with overload relay	40	T	T	T	T	T	T	T	T	T	T	T
	50-63	T	T	T	T	T	T	T	T	T	T	T
	80	T	T	T	T	T	T	T	T	T	T	T
	100	T	T	T	T	T	T	T	T	T	T	T
	125	T	T	T	T	T	T	T	T	T	T	T
	160	T	T	T	T	T	T	T	T	T	T	T
	200	T	T	T	T	T	T	T	T	T	T	T
	225-250	T	T	T	T	T	T	T	T	T	T	T
	300	T	T	T	T	T	T	T	T	T	T	T
	315	T	T	T	T	T	T	T	T	T	T	T
	355	T	T	T	T	T	T	T	T	T	T	T
	400-450	T	T	T	T	T	T	T	T	T	T	T
	500	T	T	T	T	T	T	T	T	T	T	T
	630	T	T	T	T	T	T	T	50/105	50/105	50/105	50/105
	800	T	T	T	T	T	T	T	T	T	T	T
aM Fuse link with overload relay	40	T	T	T	T	T	T	T	T	T	T	T
	50 - 63	T	T	T	T	T	T	T	T	T	T	T
	80	T	T	T	T	T	T	T	T	T	T	T
	100	T	T	T	T	T	T	T	T	T	T	T
	125	T	T	T	T	T	T	T	T	T	T	T
	160	T	T	T	T	T	T	T	T	T	T	T
	200	T	T	T	T	T	T	T	T	T	T	T
	225	T	T	T	T	T	T	T	T	T	T	T
	250	T	T	T	T	T	T	T	T	T	T	T
	300-315	T	T	T	T	T	T	T	T	T	T	T
	355-400	T	T	T	T	T	T	T	T	T	T	T
	450	T	T	T	T	T	T	T	50/105	50/105	50/105	50/105
	500	T	T	T	T	T	T	T	50/105	50/105	50/105	50/105
	630	T	T	T	T	T	T	T	T	T	T	30/63

- T : Protection of the switch-disconnector is ensured but combination not very relevant
- T : Switch-disconnector is totally coordinated up to  $I_{cu}$  of circuit breaker installed on supply side
- 36/75 : Switch-disconnector is protected up to 36 kA rms / 75 kA
- : Protection of the switch-disconnector is not ensured

Note: Current limitation characteristics can be significantly different from one manufacturer to another. This table can not dispense to check selected fuse characteristics.

# Catalogue numbers

<b>INS40 to 160</b>	
Complete fixed/FC device and accessories .....	E-2
Accessories .....	E-3
<b>INS250-100 to 630</b>	
Complete fixed/FC device and accessories .....	E-5
<b>INS250-100 to 630</b>	
Complete fixed/FC device and accessories .....	E-6
<b>INV100 to 630</b>	
Complete fixed/FC device and specific accessories .....	E-7
<b>INS250-100 to 250 and INV100 to 250</b>	
Accessories .....	E-8
<b>INS320 to 630 and INV320 to 630</b>	
Accessories .....	E-11
<b>INS630b to 2500</b>	
Complete fixed/FC device and accessories .....	E-13
Complete fixed/FC device and specific accessories .....	E-14
<b>INS630b to 2500 and INV630b to 2500</b>	
Accessories .....	E-15
<b>INSE80 (40 to 80 A) molded case switch UL489/CSA C22-2 N° 5.2</b>	
Complete fixed/FC device and accessories .....	E-17
<b>INSJ400 (250 to 400 A) molded case switch UL489/ CSA C22-2 N° 5.2</b>	
Complete fixed/FC device and accessories .....	E-19

### Other chapters

Functions and characteristics .....	A-1
Installation recommendations .....	B-1
Dimensions and connection .....	C-1
Complementary technical information .....	D-1

# INS40 to 160

## Complete fixed/FC device and accessories

### Compact INS40 to 160 standard version with black handle

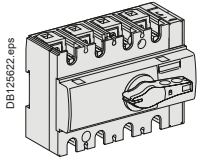
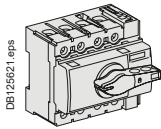

Compact INS40	3P	28900	4P	28901
Compact INS63		28902		28903
Compact INS80		28904		28905
Compact INS80PV - Photovoltaic		-		28907
<hr/>				
Compact INS100	3P	28908	4P	28909
Compact INS125		28910		28911
Compact INS160		28912		28913

### Compact INS40 to 160 with red handle and yellow front

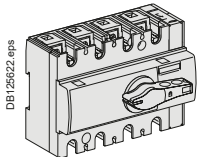
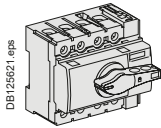

Compact INS40	3P	28916	4P	28917
Compact INS63		28918		28919
Compact INS80		28920		28921
<hr/>				
Compact INS100	3P	28924	4P	28925
Compact INS125		28926		28927
Compact INS160		28928		28929

### Individual enclosures

#### IP55 heavy-duty sheetmetal enclosure

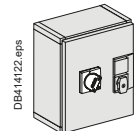

For INS40 to INS160 with extended standard rotary handle	31208
For INS40 to INS160 with extended red handle on yellow front	31209

#### IP55 heavy-duty insulating enclosure

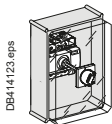

For INS40 to INS160 with extended standard rotary handle	28967
For INS40 to INS160 with extended red handle on yellow front	28968

### Linery distribution blocks

#### Linery DX distribution block 4P

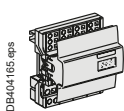

INS40 to 63	63 A, 4 incoming terminals (4 x 25 mm <sup>2</sup> ) + 24 outgoing spring terminals (24 x 6 mm <sup>2</sup> )	Upstream incoming connection	04040
		Downstream incoming connection	04041
INS40 to 125	125 A, 4 incoming terminals (4 x 35 mm <sup>2</sup> ) + 12 outgoing spring terminals (7 x 4 mm <sup>2</sup> + 3 x 6 mm <sup>2</sup> + 2 x 10 mm <sup>2</sup> ) + 1 outgoing tunnel terminal (16 mm <sup>2</sup> )		04045
INS100 to 160	4 prefabricated connections 125 A, 35 mm <sup>2</sup> , l = 210 mm 160 A, 4 incoming terminals (4 x 35 mm <sup>2</sup> ) + 12 outgoing spring terminals (7 x 4 mm <sup>2</sup> + 3 x 6 mm <sup>2</sup> + 2 x 10 mm <sup>2</sup> ) + 1 outgoing tunnel terminal (16 mm <sup>2</sup> ) with 4 prefabricated connections		04047
			04046

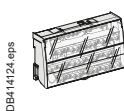

#### Multi-stage Linery DS distribution block 4P



INS100 to 160	100 A, 4 x 7 holes (3 x 10 mm <sup>2</sup> + 3 x 16 mm <sup>2</sup> + 1 x 25 mm <sup>2</sup> )	LGY410028
	125 A, 4 x 12 holes (4 x 16 mm <sup>2</sup> + 7 x 25 mm <sup>2</sup> + 1 x 35 mm <sup>2</sup> )	LGY412548
	125 A, 4 x 15 holes (11 x 16 mm <sup>2</sup> + 3 x 25 mm <sup>2</sup> + 1 x 35 mm <sup>2</sup> )	LGY412560
	160 A, 4 x 12 holes (1 x 70 mm <sup>2</sup> + 3 x 35 mm <sup>2</sup> + 8 x 25 mm <sup>2</sup> )	LGY416048
Neutral terminal strip	100 A, 4 x 7 holes (2 x 25 mm <sup>2</sup> + 5 x 16 mm <sup>2</sup> )	LGYN1007
	125 A, 4 x 12 holes (1 x 35 mm <sup>2</sup> + 7 x 25 mm <sup>2</sup> + 4 x 16 mm <sup>2</sup> )	LGYN12512
	125 A, 4 x 15 holes (4 x 35 mm <sup>2</sup> + 11 x 25 mm <sup>2</sup> )	LGYN12515

### Connection accessories (cont.)

#### Connectors for bare Cu or Al cables

	Snap-in	INS100 to 160 S ≤ 95 mm <sup>2</sup>	Set of 3	<b>28947</b>
			Set of 4	<b>28948</b>
	Distribution connector for 3 rigid cables up to 16 mm <sup>2</sup> or 3 flexible cables up to 10 mm <sup>2</sup>	INS40 to 80	Set of 3	<b>19096</b> <sup>[1]</sup>
			Set of 4	<b>19091</b> <sup>[1]</sup>
	Distribution connector for 4 rigid cables up to 25 mm <sup>2</sup> or 4 flexible cables up to 16 mm <sup>2</sup>	INS100 to 160	Set of 3	<b>28949</b>
			Set of 4	<b>28950</b>

#### Crimp lugs for copper cables

	For 95 mm <sup>2</sup> cables with interphase barriers	INS100 to 160	Set of 3	<b>28951</b>
			Set of 4	<b>28952</b>

#### Terminal shrouds

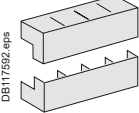
	INS40 to 80	3P/4P	Set of 2	<b>28955</b>
			INS100 to 160	3P/4P

#### Terminal shields

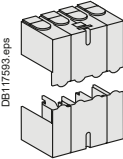
	INS40 to 80	3P/4P	Set of 2	<b>28957</b>
	INS100 to 160	3P/4P	Set of 2	<b>28958</b>

#### Interphase barriers

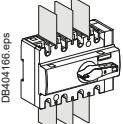
	INS100 to 160	3P/4P	Set of 6	<b>28959</b>
---	---------------	-------	----------	--------------

### Electrical auxiliaries

#### Auxiliary contacts

	1 CAF / CAO standard (early make or break)	INS40 to 160	<b>29450</b>
	1 CAF / CAO low level (early make or break)	INS40 to 160	<b>29452</b>

### Rotary handles

#### Direct front control or lateral control

#### Accessories for conversion to extended rotary handles

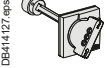
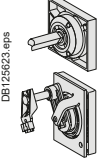
				Built-in
	Front control (handle included)	For black handle	INS40 to 160	<b>LV428941</b>
		For red handle on yellow front	INS40 to 160	<b>LV428942</b>
	Lateral control (handle not included)	For black handle	INS40 to 160	<b>28943</b>
		For red handle on yellow front	INS40 to 160 <sup>[2]</sup>	<b>28944</b>
	Lateral control on PRAGMA F functional enclosure <sup>[3]</sup> (handle not included)	For black handle	INS40 to 160	<b>28945</b>
		For red handle on yellow front	INS40 to 160 <sup>[2]</sup>	<b>28946</b>

[1] The terminal shield 28957 can't be used with this connector.

[2] For red/yellow switch versions only.

[3] Not available with Prisma.

E

# INS40 to 160 Accessories

## Locking and interlocking

### Handle locking

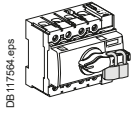

By 1 to 3 padlocks (OFF position), hasp dia. 5 to 8 mm, or by lead seals

**Built-in**

### Interlocking for extended rotary handles

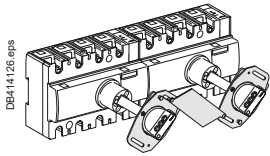

Mechanical interlocking for INS40 to INS160

**28953**

### Spare parts

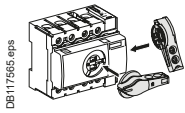

Black handle

**28962**

Red handle

<sup>[1]</sup> **28963**

[1] For red/yellow switch versions only.



# Catalogue numbers INS250-100 to 630 Complete fixed/FC device and accessories

## Compact INS250 to 630 standard version with black handle

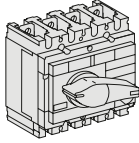
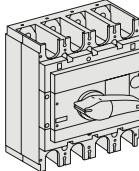
DB404168.eps 		3P	4P
	Compact INS250-100A	<b>31100</b>	<b>31101</b>
	Compact INS250-160A	<b>31104</b>	<b>31105</b>
	Compact INS250-200A	<b>31102</b>	<b>31103</b>
	Compact INS250	<b>31106</b>	<b>31107</b>
DB404169.eps 		3P	4P
	Compact INS320	<b>31108</b>	<b>31109</b>
	Compact INS400	<b>31110</b>	<b>31111</b>
	Compact INS500	<b>31112</b>	<b>31113</b>
	Compact INS630	<b>31114</b>	<b>31115</b>

## Compact INS250 to 630 with red handle and yellow front

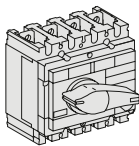
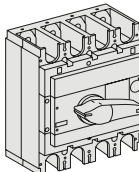
DB404168.eps 		3P	4P
	Compact INS250-100A	<b>31120</b>	<b>31121</b>
	Compact INS250-160A	<b>31124</b>	<b>31125</b>
	Compact INS250-200A	<b>31122</b>	<b>31123</b>
	Compact INS250	<b>31126</b>	<b>31127</b>
DB404169.eps 		3P	4P
	Compact INS320	<b>31128</b>	<b>31129</b>
	Compact INS400	<b>31130</b>	<b>31131</b>
	Compact INS500	<b>31132</b>	<b>31133</b>
	Compact INS630	<b>31134</b>	<b>31135</b>

## Downstream coupling accessories

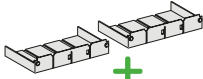
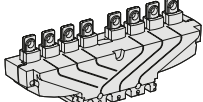
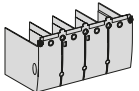
DB101062.eps 	Short terminal shields (1 pair) + "normal" source/"replacement" source		
	INS250/INS250		3/4P <b>LV429359</b>
DB413292.eps 	INS320 to INS630/INS320 to INS630		<b>LV432620</b>
	Long terminal shields (1 piece)		
DB403921.eps 	INS250 long terminal shield		<b>LV429518</b>
	INS320 to INS630		
	Long terminal shield, 45 mm (1 piece)		<b>LV432594</b>
	Long terminal shield for spreaders, 52.5 mm (1 piece)		<b>LV432596</b>



# INS250-100 to 630

## Complete fixed/FC device and accessories

### Individual enclosures

#### IP55 heavy-duty sheetmetal enclosure

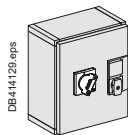

For INS250-100 to 250 with extended standard rotary handle	<b>31210</b>
For INS250-100 to 250 with extended red rotary handle on yellow front	<b>31211</b>
For INS320 to 630 with extended standard rotary handle	<b>31212</b>
For INS320 to 630 with extended red rotary handle on yellow front	<b>31213</b>

#### IP55 heavy-duty insulating enclosure

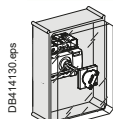

For INS250-100 to 250 with extended standard rotary handle	<b>31204</b>
For INS250-100 to 250 with extended red rotary handle on yellow front	<b>31205</b>
For INS320 to 630 with extended standard rotary handle	<b>31206</b>
For INS320 to 630 with extended red rotary handle on yellow front	<b>31207</b>

#### IP66

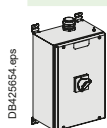

Enclosed disconnecter switch 200 A 3P in Steel IP66 enclosure	<b>LV431228</b> <sup>[1] [2]</sup>
Enclosed disconnecter switch 200 A 3P in Stainless steel IP66 enclosure	<b>LV431229</b> <sup>[1] [2]</sup>
Rotary handle	<b>LV431052</b> <sup>[2]</sup>

[1] Only available for Norway, Sweden, Denmark, Finland).

[2] Available in september 2017.

Complete fixed/FC device and specific accessories

Compact INV100 to 630 standard version with black handle

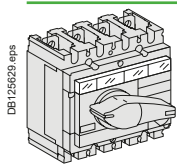

	3P	4P
Compact INV100	<b>31160</b>	<b>31161</b>
Compact INV160	<b>31164</b>	<b>31165</b>
Compact INV200	<b>31162</b>	<b>31163</b>
Compact INV250	<b>31166</b>	<b>31167</b>

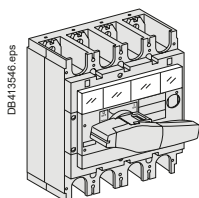

	3P	4P
Compact INV320	<b>31168</b>	<b>31169</b>
Compact INV400	<b>31170</b>	<b>31171</b>
Compact INV500	<b>31172</b>	<b>31173</b>
Compact INV630	<b>31174</b>	<b>31175</b>

Compact INV100 to 630 with red handle and yellow front

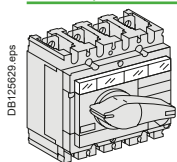

	3P	4P
Compact INV100	<b>31180</b>	<b>31181</b>
Compact INV160	<b>31184</b>	<b>31185</b>
Compact INV200	<b>31182</b>	<b>31183</b>
Compact INV250	<b>31186</b>	<b>31187</b>

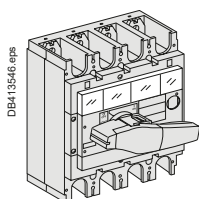

	3P	4P
Compact INV320	<b>31188</b>	<b>31189</b>
Compact INV400	<b>31190</b>	<b>31191</b>
Compact INV500	<b>31192</b>	<b>31193</b>
Compact INV630	<b>31194</b>	<b>31195</b>

Individual enclosures

IP55 heavy-duty insulating enclosure

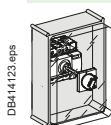

For INV100 to 250 with extended standard rotary handle	<b>31204</b>
For INV100 to 250 with extended red rotary handle on yellow front	<b>31205</b>
For INV320 to 630 with extended standard rotary handle	<b>31206</b>
For INV320 to 630 with extended red rotary handle on yellow front	<b>31207</b>

Combination with Compact NSX devices for "tarif jaune / tarif vert"

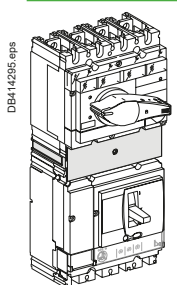

INV100 to 250 combination with NSX250	<b>31066</b>
INV320 to 630 combination with NSX250	<b>31067</b>
Front alignment base for INV320 to 630 combination with NSX250	<b>LV431064</b>
INV320 to 630 combination with NSX400/630	<b>31068</b>

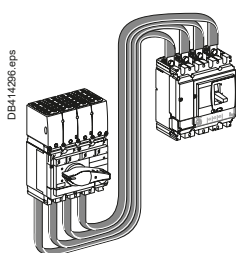











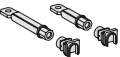
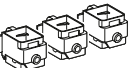
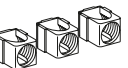
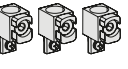

Flexible connection assembly for vertical INV100 to 250 with horizontal NSX250 <sup>[1]</sup>	<b>04443</b>
Flexible connection assembly for vertical INV100 to 250 with horizontal Vigi NSX250 <sup>[1]</sup>	<b>04444</b>
Flexible connection assembly for vertical INV320 to 630 with horizontal NSX250/400/630 <sup>[1]</sup>	<b>04445</b>
Flexible connection assembly for vertical INV320 to 630 with horizontal Vigi NSX250/400/630 <sup>[1]</sup>	<b>04446</b>
Flexible connection assembly for vertical INV100 to 250 with vertical NSX250 beside	<b>31071</b>
Flexible connection assembly for vertical INV320 to 630 with vertical NSX400/630 beside	<b>31072</b>
Flexible connection assembly for vertical INV320 to 630 with vertical NSX250 beside	<b>31093</b>

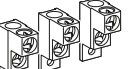
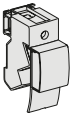
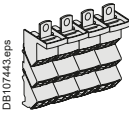
[1] Valid for new Prisma only.

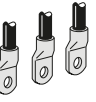

# INS250-100 to 250 and INV100 to 250 Accessories

## Connection accessories

Rear connections					
	Short (1 pair)			<b>LV429235</b>	
	Long (1 pair)			<b>LV429236</b>	
Cable connectors					
	Snap-on, for cables:	Steel: 1.5 to 95 mm <sup>2</sup> ; ≤ 160 A	Set of 3	<b>LV429242</b>	
			Set of 4	<b>LV429243</b>	
		Aluminium: 25 to 95 mm <sup>2</sup> ; ≤ 250 A	Set of 3	<b>LV429227</b>	
			Set of 4	<b>LV429228</b>	
		Aluminium: 120 to 185 mm <sup>2</sup> ; ≤ 250 A	Set of 3	<b>LV429259</b>	
			Set of 4	<b>LV429260</b>	
		Aluminium: 120 to 240 mm <sup>2</sup> ; ≤ 250 A	Set of 3	<b>LV429244</b>	
			Set of 4	<b>LV429245</b>	
	Tab connector for voltage tap on 185 mm <sup>2</sup> cable connector		Set of 10	<b>LV429348</b>	
	Clip for cable connector		Set of 10	<b>LV429241</b>	
	Distribution connector for six 1.5 to 35 mm <sup>2</sup> cables with interphase barriers		Set of 3	<b>LV429248</b>	
			Set of 4	<b>LV429249</b>	
	Aluminium connectors for 2 cables: 2 x (50 to 120 mm <sup>2</sup> ); ≤ 250 A		Set of 3	<b>LV429218</b>	
			Set of 4	<b>LV429219</b>	
Linergy DX and DP distribution block					
	Linergy DX 160 A	For 6 cables (16 mm <sup>2</sup> ) per pole <sup>[1]</sup>	1P	<b>04031</b>	
	Linergy DP 250 A	For 9 cables (6 x 10 mm <sup>2</sup> + 3 x 16 mm <sup>2</sup> ) per pole <sup>[1]</sup>	3P	<b>04033</b>	
			4P	<b>04034</b>	
			Additional blocks of 2 x 35 mm <sup>2</sup> per pole <sup>[1]</sup>	3P	<b>04155</b>
				4P	<b>04156</b>
Linergy DS distribution block					
	Linergy DS 250 A	For 14 holes (1 x 15.3 mm <sup>2</sup> + 1 x 10 mm <sup>2</sup> + 4 x 6 mm <sup>2</sup> + 8 x 7.5 mm <sup>2</sup> )	1P	<b>LG125014</b>	
Terminal extensions (supplied with 2 or 3 interphase barriers)					
	Right-angle terminal extensions <sup>[1]</sup>		Set of 3	<b>LV429261</b>	
			Set of 4	<b>LV429262</b>	
	Straight terminal extensions <sup>[1]</sup>		Set of 3	<b>LV429263</b>	
			Set of 4	<b>LV429264</b>	
Spreaders (for upstream or downstream connection)					
	Separate for each pole		3P	<b>LV431563</b>	
			4P	<b>LV431564</b>	
	One-piece Front alignment base for one-piece spreader (when mounting with LV432594 and LV432596, refer installation <a href="#">page C-16</a> )		3/4P	<b>LV431061</b>	
			3/4P	<b>LV431064</b>	
Crimp lugs for copper cables (supplied with 2 or 3 interphase barriers)					
	For 120 mm <sup>2</sup> cables		Set of 3	<b>LV429252</b>	
			Set of 4	<b>LV429256</b>	
	For 150 mm <sup>2</sup> cables		Set of 3	<b>LV429253</b>	
			Set of 4	<b>LV429257</b>	
	For cable 185 mm <sup>2</sup> cables		Set of 3	<b>LV429254</b>	
			Set of 4	<b>LV429258</b>	
Crimp lugs for aluminium cables (supplied with 2 or 3 interphase barriers)					
	For 150 mm <sup>2</sup> cables		Set of 3	<b>LV429504</b>	
			Set of 4	<b>LV429505</b>	
	For 185 mm <sup>2</sup> cables		Set of 3	<b>LV429506</b>	
			Set of 4	<b>LV429507</b>	

[1] Supplied with 2 or 3 interphase barriers.

# INS250-100 to 250 and INV100 to 250 Accessories

## Connection accessories

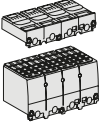

### Terminal shields

	1 Short	3/4 P	LV429516
	1 Long	3/4 P	LV429518

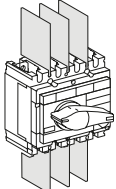
### Interphase barriers

		Set of 6	LV429329

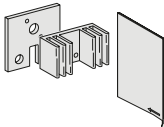
## Special connection accessories for INS250-100 to 250DC and INV100 to 250DC

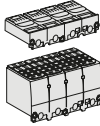
	Terminal extensions for series or parallel connection of two poles <sup>[1]</sup>	1 connection plate equipped with heat sink + 1 interphase barrier	LV438328
	<p>[1] Series connection of:</p> <p>2 poles = 1 terminal extension</p> <p>3 poles = 2 terminal extensions</p> <p>4 poles = 3 terminal extensions</p> <p>Parallel connection of:</p> <p>2 poles = 2 terminal extensions</p> <p>4 poles = 4 terminal extensions</p>		
	Terminal extensions for parallel connection of three poles:		
	Parallel connection of:	3 poles = set of 2 terminal extensions	LV438329
	4P terminal shields for series connection of poles	Set of 1	LV438326
	4P terminal shields for parallel connection of poles (2P/4P)	Set of 1	LV438327

## Electrical auxiliaries

### Auxiliary contacts (changeover type)

	CAM (early make or break)	29450
	Low level CAM (early make or break)	29452

## Indication and measurement modules

### PowerTag NSX

	Rating (A)	250
	3P+N (suitable for Compact INS/INV) 3P or 4P	LV434021

### Ammeter module (4P)

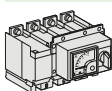
	Adaptation kit (compulsory for devices with direct front handles)	31081
	Rating (A)	100
		150
		250
		LV431566

### Current transformer module and voltage output (4P)

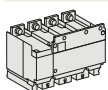
	Rating (A)	100
		150
		250
		LV429462
		LV430562
		LV431570

### Current transformer module (4P)

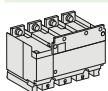
	Rating (A)	100
		150
		250
		LV429458
		LV430558
		LV431568

### Voltage presence indicator

	Rating (A)	250	LV429325
---	------------	-----	----------

# INS250-100 to 250 and INV100 to 250

## Accessories

### Rotary handles

#### Front control

DB414127.eps



Direct for INS/INV250	<b>Built-in</b>
Extended	
For INS/INV250 with standard rotary handle	<b>LV431050</b>
For INS/INV250 with red handle on yellow front	<sup>[1]</sup> <b>LV431051</b>
For INS/INV250 with standard rotary handle equipped with gasket (to use with IP66 enclosure)	<b>LV431052</b>
For complete source changeover assembly	<b>31055</b>

#### Lateral control

DB125262A.eps

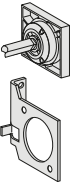

Direct lateral control for INS/INV250	
Lateral support	<b>31054</b>
+ standard lateral control assembly	<b>31057</b>
or + red and yellow lateral control assembly	<sup>[1]</sup> <b>31058</b>
Extended lateral control for INS/INV250	
Standard lateral control assembly	<b>31057</b>
Red and yellow lateral control assembly	<sup>[1]</sup> <b>31058</b>

### Locking and interlocking for INS/INV and source changeover systems

#### Locking for INS/INV

DB125225.eps

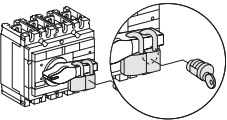

Handle locking by 1 to 3 padlocks (in OFF position)	<b>Built-in</b>
By keylock	
Keylocking device	2 x <b>31087</b>
+ Ronis 1351B.500 keylock	<b>41940</b>
or + Profalux KS5 B24 D4Z keylock	<b>42888</b>

#### Interlocking with key (2 keylocks / 1 key)

DB101549.eps

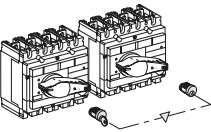

By 2 keylocks	
INS250 keylocking device	2 x <b>31087</b>
INS320-630 keylocking device	2 x <b>31088</b>
+ Ronis 1351B.500 keylock	2 x <b>41950</b>
or + Profalux KS5 B24 D4Z keylock	2 x <b>42878</b>

#### Interlocking for INS/INV with direct or extended rotary handle

DB414128B.eps

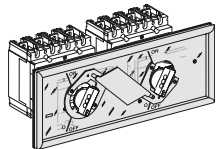

Mechanical interlocking for INS250	<b>31073</b>
------------------------------------	--------------

### Installation accessories

#### Front panel escutcheons

DB117586C.eps



For INS/INV	<b>31079</b>
For ammeter module, IP40	<b>LV429318</b>

#### Lead seal accessories

**LV429375**

### Spare parts

12 snap-in nuts for fixed/FC(M8)	<b>LV430554</b>
100 identification labels	<b>29314</b>
Bag of screws	<b>LV429312</b>
Black handle	<b>31082</b>
Red handle	<sup>[1]</sup> <b>31083</b>
Viewport for INV100/160/250	<b>31089</b>

[1] For red/yellow switch versions only.

# INS320 to 630 and INV320 to 630



## Accessories

### Connection accessories

#### Rear connections

	Short (1 pair)	LV432475
	Long (1 pair)	LV432476

#### Cable connectors

	For 1 cable, 35 mm <sup>2</sup> to 300 mm <sup>2</sup>	Set of 3	LV432479 <sup>[1]</sup>
		Set of 4	LV432480 <sup>[2]</sup>
	For 2 cables, 35 mm <sup>2</sup> to 240 mm <sup>2</sup>	Set of 3	LV432481 <sup>[1]</sup>
		Set of 4	LV432482 <sup>[2]</sup>
	Tab connector for voltage tap on cable connector	Set of 10	LV429348

<sup>[1]</sup> Kit comprising 2 interphase barriers.

<sup>[2]</sup> Kit comprising 3 interphase barriers.

#### Terminal extensions (supplied with 2 or 3 interphase barriers)

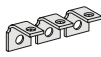
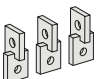
	Right-angle terminal extensions	Set of 3	LV432484
		Set of 4	LV432485
	Edgewise terminal extensions	Set of 3	LV432486
		Set of 4	LV432487

#### Spreaders (for upstream or downstream connection)

	One-piece	52.5 mm	3P	LV432490
			4P	LV432491
	70 mm	3P	LV432492	
		4P	LV432493	

#### Crimp lugs for copper cables (supplied with 2 or 3 interphase barriers)

	For 240 mm <sup>2</sup> cables	Set of 3	LV432500
		Set of 4	LV432501
	For 300 mm <sup>2</sup> cables	Set of 3	LV432502
		Set of 4	LV432503

#### Crimp lugs for aluminium cables (supplied with 2 or 3 interphase barriers)

	For 240 mm <sup>2</sup> cables	Set of 3	LV432504
		Set of 4	LV432505
	For 300 mm <sup>2</sup> cables	Set of 3	LV432506
		Set of 4	LV432507

#### Terminal shields

	1 Short	3/4P	LV432592
	1 Long	3/4P	LV432594
	1 Long for 52.5 mm spreader (supplied with insulating plate)	3/4P	LV432596

#### Interphase barriers

	Set of 6	LV432570
---	----------	----------

#### Special connection accessories for INS/INV320 to 630DC

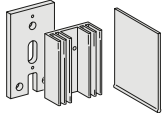
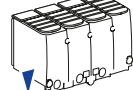
	Terminal extensions for series or parallel connection of two poles <sup>[3]</sup>	1 connection plate equipped with heat sink + 1 interphase barrier	LV438338
	<sup>[3]</sup> Series connection of: 2 poles = 1 terminal extension 3 poles = 2 terminal extensions 4 poles = 3 terminal extensions	Parallel connection of: 2 poles = 2 terminal extensions 4 poles = 4 terminal extensions	
	4P terminal shields for series connection of poles	Set of 2	LV438346
	4P terminal shields for series connection of poles	Set of 2	LV438337





# INS320 to 630 and INV320 to 630 Accessories

## Electrical auxiliaries

### Auxiliary contacts (changeover type)

DB117563.eps



1 OF/CAF/CAO (early make or break)	<b>29450</b>
1 OF/CAF/CAO low level (early make or break)	<b>29452</b>

## Indication and measurement modules

### PowerTag NSX

DB432372.eps

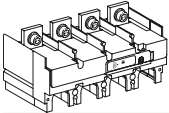

Rating (A)	630
3P+N (suitable for compact INS/INV 3P or 4P)	<b>LV434023</b>

### Ammeter module (4P)

DB604176.eps

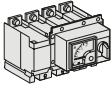

Rating (A)	400	<b>LV432656</b>
	630	<b>LV432856</b>

### Current transformer module (4P)

DB604177.eps

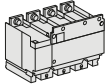

Rating (A)	400	<b>LV432658</b>
	630	<b>LV432858</b>
	400 with voltage output	<b>LV432654</b>
	630 with voltage output	<b>LV432862</b>

### Voltage presence indicator

DB105170.eps



Rating (A)	630	<b>LV432566</b>
------------	-----	-----------------

## Rotary handles

### Extended front control

DB604165.eps

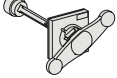

For INS320/400/630 with standard rotary handle	<b>31052</b>
For INS320/400/630 with red handle on yellow front	<b>31053</b>
For complete source changeover assembly	<b>31055</b>

## Locking and interlocking for INS/INV and source changeover systems

### Locking for INS/INV

DB604188.eps

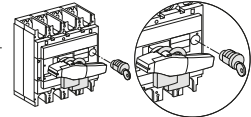

Handle locking by 1 to 3 padlocks (in OFF position)	<b>Built-in</b>
By keylock	<b>31088</b>
Keylocking device	<b>41940</b>
+ Ronis 1351B.500 keylock	<b>42888</b>
or + Profalux KS5 B24 D4Z keylock	

### Interlocking with key (2 keylocks / 1 key)

DB101549.eps

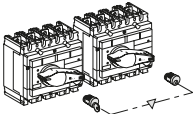

By 2 keylocks	INS250 keylocking device	2 x	<b>31087</b>
	INS320-630 keylocking device	2 x	<b>31088</b>
	+ Ronis 1351B.500 keylock	2 x	<b>41950</b>
	or + Profalux KS5 B24 D4Z keylock	2 x	<b>42878</b>

### Interlocking for INS/INV with direct or extended rotary handle

DB604187.eps

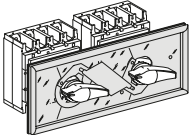

Mechanical interlocking for INS320/400/630	<b>31074</b>
--	--------------

## Installation accessories

### Front panel escutcheons

DB117566.eps



For INS/INV	<b>31080</b>
For ammeter module, IP40	<b>LV429318</b>

### Lead seal accessories

**LV429375**

## Spare parts

100 labels	<b>29314</b>
Bag of screws	<b>LV432552</b>
Black handle	<b>31084</b>
Red handle	<b>31085</b>
Viewport for INV320/400/630	<b>31090</b>

[1] For red/yellow switch versions only.

# Catalogue numbers INS630b to 2500

## Complete fixed/FC device and accessories

### Compact INS630b to 2500 standard version with black handle

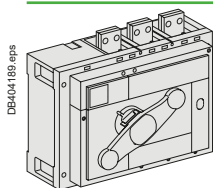

	3P	4P
Compact INS630b	<b>31342</b>	<b>31343</b>
Compact INS800	<b>31330</b>	<b>31331</b>
Compact INS1000	<b>31332</b>	<b>31333</b>
Compact INS1250	<b>31334</b>	<b>31335</b>
Compact INS1600	<b>31336</b>	<b>31337</b>

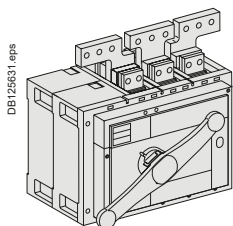

Compact INS2000	<b>31338</b>	<b>31339</b>
Compact INS2500	<b>31340</b>	<b>31341</b>

### Compact INS800 to 1600 with red handle and yellow front

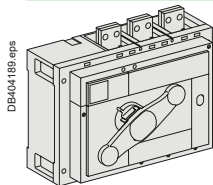

	3P	4P
Compact INS800	<b>31344</b>	<b>31345</b>
Compact INS1000	<b>31346</b>	<b>31347</b>
Compact INS1250	<b>31348</b>	<b>31349</b>
Compact INS1600	<b>31350</b>	<b>31351</b>



# INV630b to 2500

## Complete fixed/FC device and specific accessories

### Compact INV630b to 2500 standard version with black handle

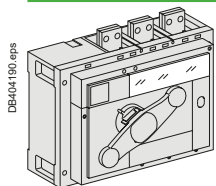

	3P	4P
Compact INV630b	<b>31370</b>	<b>31371</b>
Compact INV800	<b>31358</b>	<b>31359</b>
Compact INV1000	<b>31360</b>	<b>31361</b>
Compact INV1250	<b>31362</b>	<b>31363</b>
Compact INV1600	<b>31364</b>	<b>31365</b>

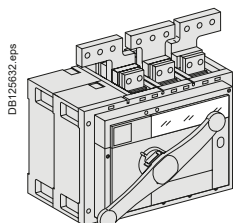

Compact INV2000	<b>31366</b>	<b>31367</b>
Compact INV2500	<b>31368</b>	<b>31369</b>

### Compact INV800 to 1600 with red handle and yellow front

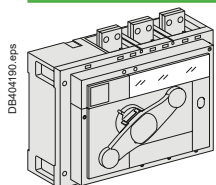

	3P	4P
Compact INV800	<b>31372</b>	<b>31373</b>
Compact INV1000	<b>31374</b>	<b>31375</b>
Compact INV1250	<b>31376</b>	<b>31377</b>
Compact INV1600	<b>31378</b>	<b>31379</b>

### Combination with Compact NS devices (for "tarif vert")

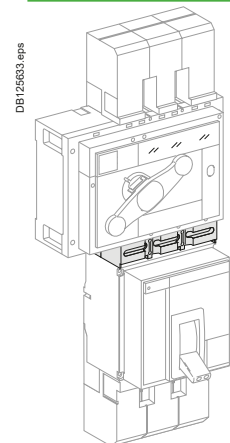

	3P	4P
INV630b/1000/1250 combination with NS800/1000/1250	<b>31385</b>	<b>31386</b>
Terminal shield	<b>31313</b>	<b>31314</b>

E

# Catalogue numbers

## INS630b to 2500 and INV630b to 2500

### Accessories

#### Connection accessories



##### Vertical connection adapters

	INS/INV630b-1600	3P	Set of 3	<b>31301</b>
		4P	Set of 4	<b>31302</b>

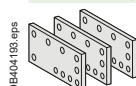
##### Cable lug adapters

	INS/INV630b-1600	3P	Set of 3	<b>33644</b>
		4P	Set of 4	<b>33645</b>

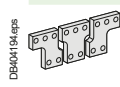
##### Busbar connection (not compatible with terminal shield)

	INS/INV630b-1600	3P	Set of 3	<b>31305</b>
		4P	Set of 4	<b>31306</b>
	1 right angle connector for busbar (edgewise) to INS2000/2500			<b>31310</b>

#### Insulation accessories

##### Base for terminal shield (not compatible with interphase barriers)

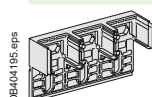
	INS/INV630b-1600	3P		<b>31307</b>
		4P		<b>31308</b>

##### Terminal shield

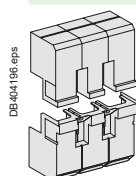
	INS/INV630b-1600	3P		<b>LV433638</b>
		4P		<b>LV433639</b>

##### Interphase barriers (not compatible with terminal shield and base)

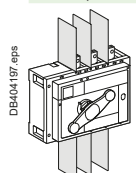
	INS/INV630b-1600	4P	Set of 6	<b>31315</b>
	INS/INV2000/2500	4P	Set of 6	<b>31319</b>

#### Electrical auxiliaries

##### Auxiliary contacts (changeover type) INS/INV630b-2500

	1 OF/CAF/CAO standard (early make or break)			<b>29450</b>
	1 OF/CAF/CAO low level (early make or break)			<b>29452</b>

##### Extended front control

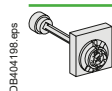
	INS/INV630b-2500	For standard rotary handle (handle not included)		<b>31288</b>
	INS/INV630b-1600	For red handle on yellow front (handle not included)	[1]	<b>31289</b>

[1] For red/yellow switch versions only.

E

# INS630b to 2500 and INV630b to 2500

## Accessories

### Locking and interlocking

#### Locking for INS/INV630b to 2500

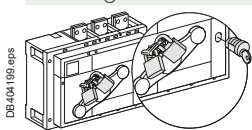

Handle locking by 1 to 3 padlocks (in OFF position)	<b>Built-in</b>
By keylock	<b>31291</b>
Keylocking device	<b>41940</b>
+ Ronis 1351B.500 keylock	<b>42888</b>
or + Profalux KS5 B24 D4Z keylock	

#### Interlocking for INS/INV630b to 2500

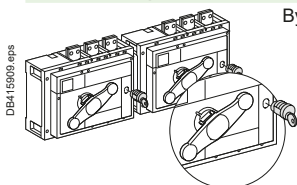

By keylock	Keylocking device	2 x	<b>31291</b>
	+ Ronis 1351B.500 keylock (1 key)	2 x	<b>41950</b>
	or + Profalux KS5 B24 D4Z keylock (1 key)	2 x	<b>42878</b>

### Installation accessories

#### Escutcheon

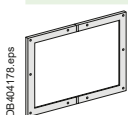

INS630b-2500	3P/4P	<b>31295</b>
--------------	-------	--------------

#### Lead seal accessories

**31316**

### Spare parts

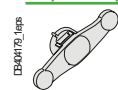

INS/INV630b-1600	Black handle		<b>31296</b>
	Red handle	[1]	<b>31297</b>
INS/INV2000-2500	Black handle		<b>31298</b>
Spare zamack piece for black handle INS/INV 2000-2500			<b>LV431285</b>



Viewport for INV630b/2500	3P	<b>31293</b>
	4P	<b>31294</b>

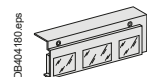

[1] For red/yellow switch versions only.

# INSE80 (40 to 80 A) molded case switch UL489/CSA C22-2 N° 5.2

## Complete fixed/FC device and accessories

### Compact INSE80 (40 to 80 A) standard version with black handle

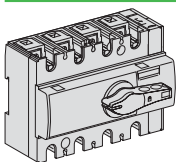
 DB114737.eps	Compact INSE80	40 A	3P	28994	4P	28995
		60 A		28996		28997
		80 A		28998		28999

### Individual enclosures

#### IP55 heavy-duty sheetmetal enclosure [1]

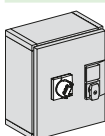
 DB114122.eps	For INSE80-40 A to INSE80-80 A with extended standard rotary handle	31208
	For INSE80-40 A to INSE80-80 A with extended red handle on yellow front	31209

#### IP55 heavy-duty insulating enclosure [1]



 DB114123.eps	For INSE80-40 A to INSE80-80 A with extended standard rotary handle	28967
	For INSE80-40 A to INSE80-80 A with extended red handle on yellow front	28968

### Connection accessories

#### Multi-stage Linergy DS distribution block (for bare cables)

 DB114124.eps	INSE80-40 A to	125 A, 4 x 10 holes (5 x 10 mm <sup>2</sup> + 4 x 16 mm <sup>2</sup> + 1 x 35 mm <sup>2</sup> )	LGY412548
	INSE80-80 A [1]	125 A, 4 x 17 holes (8 x 10 mm <sup>2</sup> + 8 x 16 mm <sup>2</sup> + 1 x 35 mm <sup>2</sup> )	LGY412560

#### Connectors for bare Cu or Al cables

 DB117559.eps	Snap-on	INSE80-40 A to INSE80-80 A	Set of 3	28947
		1.5 to 95 mm <sup>2</sup>	Set of 4	28948
		12 AWG to 3/0 AWG C4/AL		
 DB117561.eps	Distribution connector for	INSE80-40 A to INSE80-80 A [1]	Set of 3	28949
		4 rigid cables up to 25 mm <sup>2</sup> or 4 flexible cables up to 16 mm <sup>2</sup>	Set of 4	28950

#### Crimp lugs for copper cables [1]

 DB117562.eps	For 95 mm <sup>2</sup> cables with interphase barriers	INSE80-40 A to INSE80-80 A	Set of 3	28951
			Set of 4	28952

#### Terminal shrouds

 DB117562.eps	INSE80-40 A to INSE80-80 A	3P/4P	Set of 2	28956
---	----------------------------	-------	----------	-------

#### Terminal shieldsé

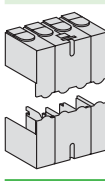
 DB117593	INSE80-40 A to INSE80-80 A	3P/4P	Set of 2	28958
---	----------------------------	-------	----------	-------

[1] Not UL Listed.



# INSE80 (40 to 80 A) molded case switch UL489/CSA C22-2 N° 5.2

## Complete fixed/FC device and accessories

### Connection accessories (cont.)

#### Interphase barriers

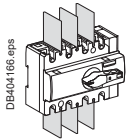

INSE80-40 A to INSE80-80 A	3P/4P	Set of 6	<b>28959</b>
----------------------------	-------	----------	--------------

### Electrical auxiliaries

#### Auxiliary contacts



1 CAF / CAO (standard)	INSE80-40 A to INSE80-80 A	<b>29450</b>
1 CAF / CAO (low level)	INSE80-40 A to INSE80-80 A	<b>29452</b>

### Rotary handles

#### Accessories for conversion to extended rotary handles

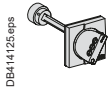

Front control (handle included)	For black handle	INSE80-40 A to INSE80-80 A	<b>LV428941</b>
	For red handle on yellow front	INSE80-40 A to INSE80-80 A	<b>LV428942</b>
Lateral control (handle not included)	For black handle	INSE80-40 A to INSE80-80 A	<b>28943</b>
	For red handle on yellow front + red handle <sup>[2]</sup>	INSE80-40 A to INSE80-80 A	<b>28944</b>

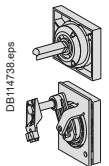

Lateral control on PRAGMA F functional enclosure <sup>[3]</sup> (handle not included)	For black handle	INSE80-40 A to INSE80-80 A	<b>28945<sup>[3]</sup></b>
	For red handle on yellow front <sup>[2]</sup>	INSE80-40 A to INSE80-80 A	<b>28946</b>

### Locking and interlocking

#### Handle locking

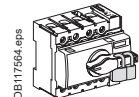

By 1 to 3 padlocks (OFF position), hasp dia. 5 to 8 mm, or by lead seals	<b>Built-in</b>
--	-----------------

#### Interlocking for extended rotary handles

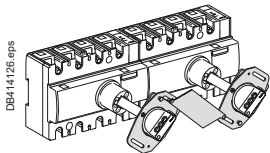

Mechanical <sup>[1]</sup>	<b>28953</b>
---------------------------	--------------

### Spare parts

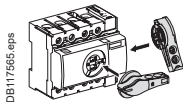

Black handle	<b>28962</b>
Red handle <sup>[2]</sup>	<b>28963</b>

[1] Not UL listed.  
[2] For red/yellow switch versions only.  
[3] Not available with Prisma.



# INSJ400 (250 to 400 A) molded case switch UL489/ CSA C22-2 N° 5.2

## Complete fixed/FC device and accessories

### Compact INSJ400 (250 A to 400 A) standard version with black handle

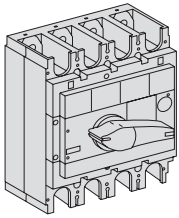
		3P	4P
	Compact INSJ400-250 A	<b>31118</b>	<b>31119</b>
	Compact INSJ400-400 A	<b>31136</b>	<b>31137</b>

### Individual enclosures

#### IP55 heavy-duty sheetmetal enclosure <sup>[1]</sup>

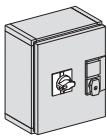
	For INSJ400-250 to 400 A with extended standard rotary handle	<b>31212</b>
	For INSJ400-250 to 400 A with extended red rotary handle on yellow front	<b>31213</b>

#### IP55 heavy-duty insulating enclosure <sup>[1]</sup>

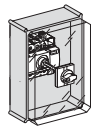
	For INSJ400-250 to 400 A with extended standard rotary handle	<b>31206</b>
	For INSJ400-250 to 400 A with extended red rotary handle on yellow front	<b>31207</b>

### Connection accessories

#### Rear connections

	Short (1 pair)	<b>LV432475</b>
	Long (1 pair)	<b>LV432476</b>

#### Cable connectors

	For 1 cable, 35 mm <sup>2</sup> to 300 mm <sup>2</sup>	Set of 3	<b>LV432479</b>
		Set of 4	<b>LV432480</b>
	For 2 cables, 35 mm <sup>2</sup> to 240 mm <sup>2</sup>	Set of 3	<b>LV432481</b>
		Set of 4	<b>LV432482</b>
	Tab connector for voltage tap on cable connector	Set of 10	<b>LV429348</b>

#### Terminal extensions (supplied with 2 or 3 interphase barriers)

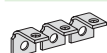
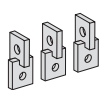
	Right-angle terminal extensions	Set of 3	<b>LV432484</b>
		Set of 4	<b>LV432485</b>
	Edgewise terminal extensions	Set of 3	<b>LV432486</b>
		Set of 4	<b>LV432487</b>

#### Spreaders (for upstream or downstream connection)

	One-piece	52.5 mm	3P	<b>LV432490</b>
			4P	<b>LV432491</b>
		70 mm	3P	<b>LV432492</b>
			4P	<b>LV432493</b>

#### Crimp lugs for copper cables (supplied with 2 or 3 interphase barriers) <sup>[1]</sup>

	For 240 mm <sup>2</sup> cables	Set of 3	<b>LV432500</b>
		Set of 4	<b>LV432501</b>
	For 300 mm <sup>2</sup> cables	Set of 3	<b>LV432502</b>
		Set of 4	<b>LV432503</b>

#### Crimp lugs for aluminium cables (supplied with 2 or 3 interphase barriers) <sup>[1]</sup>

	For 240 mm <sup>2</sup> cables	Set of 3	<b>LV432504</b>
		Set of 4	<b>LV432505</b>
	For 300 mm <sup>2</sup> cables	Set of 3	<b>LV432506</b>
		Set of 4	<b>LV432507</b>

[1] Not UL Listed.



# INSJ400 (250 to 400 A) molded case switch UL489/CSA C22-2 N° 5.2

## Complete fixed/FC device and accessories

### Connection accessories (cont.)

#### Terminal shields

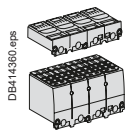

1 Short	3/4P	<b>LV432592</b>
1 Long	3/4P	<b>LV432594</b>
1 Long for 52.5 mm spreader (supplied with insulating plate)	3/4P	<b>LV432596</b>

#### Interphase barriers

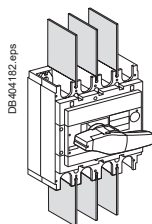

Set of 6	<b>LV432570</b>
----------	-----------------

### Electrical auxiliaries

#### Auxiliary contacts (changeover type)



OF or CAM (early make or break)	<b>29450</b>
OF or CAM low level (early make or break)	<b>29452</b>

### Rotary handles

#### Extended front control

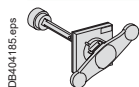

For INSJ400-250 to 400 A with standard rotary handle	<b>31052</b>
For INSJ400-250 to 400 A with red handle on yellow front + red handle <sup>[1]</sup>	<b>31053</b>
	<b>31085</b>

### Locking and interlocking and source changeover systems

#### Locking

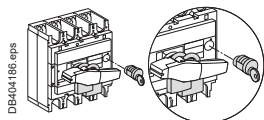

Handle locking by 1 to 3 padlocks (in OFF position)	<b>Built-in</b>
By keylock	<b>31088</b>
Keylocking device	<b>41940</b>
+ Ronis 1351B.500 keylock	<b>42888</b>
or + Profalux KS5 B24 D4Z keylock	

#### Interlocking with key (2 keylocks / 1 key)

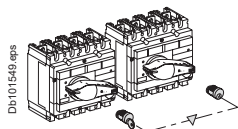

By 2 keylocks	INSJ400-250 to 400 A keylocking device	2 x	<b>31088</b>
	+ Ronis 1351B.500 keylock	2 x	<b>41950</b>
	or + Profalux KS5 B24 D4Z keylock	2 x	<b>42878</b>

#### Interlocking with direct or extended rotary handle

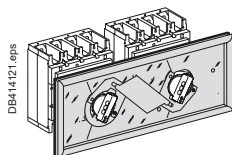

Mechanical interlocking for INSJ400-250 to 400 A	<b>31074</b>
--	--------------

### Installation accessories

#### Front panel escutcheons

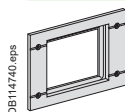

<b>31080</b>
--------------

#### Lead seal accessories

<b>LV429375</b>
-----------------

### Spare parts

100 labels	<b>29314</b>
Bag of screws	<b>32552</b>
Black handle	<b>31084</b>
Red handle <sup>[1]</sup>	<b>31085</b>

[1] For red/yellow switch versions only.

E

# Notes

E



Life Is On



**Schneider Electric Industries SAS**

35, rue Joseph Monier  
CS 30323  
92506 Rueil Malmaison Cedex  
France

RCS Nanterre 954 503 439  
Capital social 896 313 776 €  
[www.schneider-electric.com](http://www.schneider-electric.com)

LVPED213024EN • WEB2 cat.2018

ART. 059563

© 2018 - Schneider Electric. All Rights Reserved.

All trademarks are owned by Schneider Electric Industries SAS or its affiliated companies.