

## OptiLine 70 Trunking - Al & PVC

Exploded View

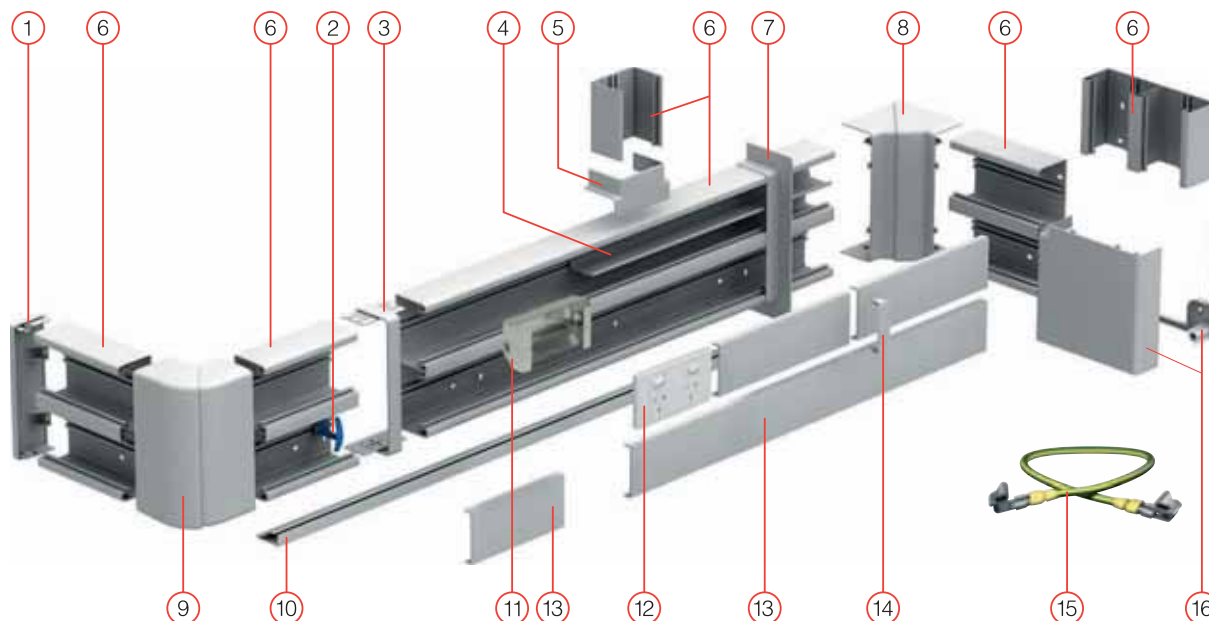

### Components

- |  |   |
|--|---|
| 1. Stop end                                      | 9. Adjustable external corner             |
| 2. Cable retainer                                | 10. Sealing strip                         |
| 3. Joint cover piece (including jointing pieces) | 11. Power/data shroud                     |
| 4. Cable shelf                                   | 12. Clipsal 2000 series                   |
| 5. T-piece                                       | 13. Front cover                           |
| 6. Trunking base                                 | 14. Joint cover piece for front cover     |
| 7. Wall/ceiling frame                            | 15. Earthing kit (for aluminium trunking) |
| 8. Adjustable internal corner                    | 16. Bend 90°, including wall fixing       |

Aluminium Trunking + Lid (Natural Anodised)	ISM111550	ISM11250	ISM11350	ISM11450	ISM11550
<b>Dimensions (mm)</b>	80 x 55 x 2000	95 x 55 x 2000	120 x 55 x 2000	155 x 55 x 2000	185 x 55 x 2000
<b>Pack Qty</b>	3	3	3	2	2
<b>Accessories</b>					
<b>Internal Corner</b>	ISM11151	ISM11251	ISM11351	ISM11451	ISM11551
<b>External Corner</b>	ISM11152	ISM11252	ISM11352	ISM11452	ISM11552
<b>90° Flat Bend Kit</b>	ISM11153	ISM11253	ISM11353	ISM11453	ISM11553
<b>Stop End (Pack Qty 2)</b>	ISM11154	ISM11254	ISM11354	ISM11454	ISM11554
<b>Wall/ceiling frame</b>	ISM11155	ISM11255	ISM11355	ISM11455	ISM11555
<b>Joint cover piece kit</b>	ISM11156	ISM11256	ISM11356	ISM11456	ISM11556
<b>T-piece</b>	ISM11157 (Suits 80 x 55 Riser)				
<b>Front cover</b>	ISM11950 (2000mm length, Pack Qty 12)				
<b>Cable retainer</b>	ISM11901 (Pack Qty 5)				
<b>Cable shelf</b>					
<b>Joint cover piece for front cover</b>	ISM11951 (Pack Qty 5)				
<b>Jointing piece</b>					
<b>Sealing strip</b>	ISM10905 (2000mm length, Pack Qty 12)				
<b>Removal tool</b>	CPL5900900				
<b>Jointing/Earth piece</b>	ISM10955 (Pack Qty 10)				
<b>Earthing clamp</b>	ISM10952 (Pack Qty 20)				
<b>Earthing kit, 200mm</b>	ISM10953 (Pack Qty 10)				
<b>Earthing kit, 300mm</b>	ISM10954 (Pack Qty 10)				
<b>Module device adaptor for 1-3 modular devices</b>	ISM15005				
<b>Snap-in shroud kit</b>	MDEOLSPTD				
<b>Cable bending protection</b>	INS12310				

## OptiLine 70 Trunking - AI & PVC

### Capacity & Dimensions

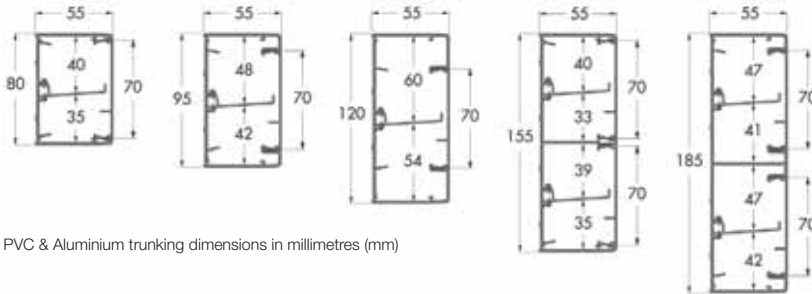

PVC & Aluminium trunking dimensions in millimetres (mm)

#### 80mm x 55mm, 95mm x 55mm and 120mm x 55mm without outlets.

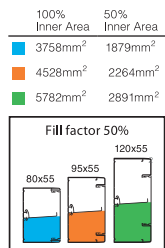

#### 155x55 without outlets.

100% Inner Area	50% Inner Area
3671mm <sup>2</sup>	1836mm <sup>2</sup>
3671mm <sup>2</sup>	1836mm <sup>2</sup>

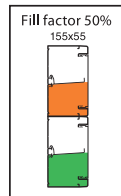

#### 185x55 without outlets.

100% Inner Area	50% Inner Area
4407mm <sup>2</sup>	2204mm <sup>2</sup>
4407mm <sup>2</sup>	2204mm <sup>2</sup>

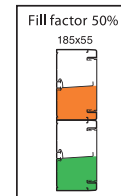

#### 80mm x 55mm, 95mm x 55mm and 120mm x 55mm with outlets.

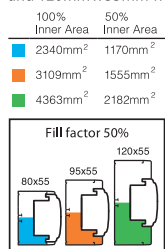

#### 155x55 with outlets.

100% Inner Area	50% Inner Area
2253mm <sup>2</sup>	1127mm <sup>2</sup>
2253mm <sup>2</sup>	1127mm <sup>2</sup>

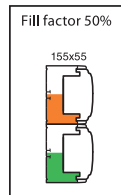

#### 185x55 with outlets.

100% Inner Area	50% Inner Area
2989mm <sup>2</sup>	1495mm <sup>2</sup>
2989mm <sup>2</sup>	1495mm <sup>2</sup>

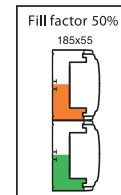

PVC Trunking + Lid (White RAL 9010)	ISM11100	ISM11200	ISM11300	ISM11400	ISM11500
Dimensions (mm)	80 x 55 x 2000	90 x 55 x 2000	120 x 55 x 2000	155 x 55 x 2000	185 x 55 x 2000
Pack Qty	6	6	6	4	4
Accessories					
Internal Corner	ISM11101	ISM11201	ISM11301	ISM11401	ISM11501
External Corner	ISM11102	ISM11202	ISM11302	ISM11402	ISM11502
90° Flat Bend Kit	ISM11103	ISM11203	ISM11303	ISM11403	ISM11503
Stop End (Pack Qty 2)	ISM11104	ISM11204	ISM11304	ISM11404	ISM11504
Wall/ceiling frame	ISM11105	ISM11205	ISM11305	ISM11405	ISM11505
Joint cover piece kit	ISM11106	ISM11206	ISM11306	ISM11406	ISM11506
T-piece	ISM11107				
Front cover	ISM11900 (2000mm length, Pack Qty 12)				
Cable retainer	ISM10901 (Pack Qty 5)				
Cable shelf	ISM10902 (1000mm length, Pack Qty 24)				
Joint cover piece for front cover	ISM11903 (Pack Qty 5)				
Jointing piece	ISM11904 (Pack Qty 10)				
Sealing strip	ISM10905 (2000mm length, Pack Qty 12)				
Removal tool	CPL5900900				
Module device adaptor for 1-3 modular devices	ISM15000				
Snap-in shroud kit	MDEOLSPTD				
Cable bending protection	INS12310				

Clipsal Cable Management invites Architects and Engineers to avail themselves of our obligation free advisory and design drafting service to assist with planning the most economical and functional duct system suitable for a particular project. Any infringements to patents or registered designs applied for or granted will be liable to prosecution.