



























OLD MODEL		NEW MODEL		If replacing an existing fan, the following may also be required.
	6105-0 Window exhaust, 200mm Air Movement - 260m ³ /hr, 45W		7105A Window exhaust 200mm Air Movement - 600m ³ /hr, 35W	No accessories required
	6106-0 Wall exhaust, 200mm Air Movement - 260m ³ /hr, 45W		7106A Wall exhaust 200mm Air Movement - 600m ³ /hr, 35W	Qty 2 x 7100WP Wall plates
	6107-0 Window exhaust, 200mm Air Movement - 260m ³ /hr, 45W		7107A Window exhaust 200mm, pull cord Air Movement - 600m ³ /hr, 35W	No accessories required
	6108-0 Wall exhaust, 200mm Air Movement - 260m ³ /hr, 45W		7108A Wall exhaust 200mm, pull cord Air Movement - 600m ³ /hr, 35W	Qty 2 x 7100WP Wall plates
	6109-0 Wall exhaust, 250mm Air Movement - 440m ³ /hr, 66W		7106A Wall exhaust 200mm Air Movement - 600m ³ /hr, 35W	Qty 2 x 7100WP Wall plates
	6110-0 Wall exhaust, 250mm Air Movement - 428m ³ /hr, 66W		7106A Wall exhaust 200mm Air Movement - 600m ³ /hr, 35W	Qty 2 x 7100WP Wall plates
	6111-0 Window exhaust, 250mm Air Movement - 490m ³ /hr, 66W		7107A Window exhaust 200mm, pull cord Air Movement - 600m ³ /hr, 35W	Replacement glass may be required.
	AWE150 Wall exhaust 150mm Air Movement - 132m ³ /hr, 30W		7008A Wall exhaust 150mm, pull cord Air Movement - 360m ³ /hr, 40W	No accessories required
	BVWE200 Wall exhaust, 200mm - Brick Veneer Air Movement - 174m ³ /hr, 28W		7008A Wall exhaust 150mm, pull cord, brick veneer Air Movement - 360m ³ /hr, 40W	
	BVWE250 Wall exhaust, 250mm - Brick Veneer Air Movement - 203-450m ³ /hr, 35-40W		7108A Wall exhaust 200mm, pull cord, brick veneer Air Movement - 600m ³ /hr, 35W	Qty 2 x 7100WP Wall plates Touch-up paint may be required.
	DBWE200 Wall exhaust, 200mm - Double Brick Air Movement - 174m ³ /hr, 28W		7008A Wall exhaust 150mm, pull cord, double brick Air Movement - 360m ³ /hr, 40W	
	DBWE250 Wall exhaust, 250mm - Double Brick Air Movement - 203-450m ³ /hr, 35-40W		7108A Wall exhaust 200mm, pull cord, double brick Air Movement - 600m ³ /hr, 35W	Qty 2 x 7100WP Wall plates Touch-up paint may be required.
	SLWE200 Wall exhaust, 210mm - Slimline Air Movement - 240m ³ /hr, 30W		7106A Wall exhaust 200mm Air Movement - 600m ³ /hr, 35W	Qty 2 x 7100WP Wall plates
	TWE250 Wall exhaust, 250mm - Timber stud Air Movement - 203-450m ³ /hr, 35-40W		7108A Wall exhaust 200mm, pull cord, timber stud Air Movement - 600m ³ /hr, 35W	Qty 2 x 7100WP Wall plates
	WE200 Window exhaust, 200mm, pull cord switch Air Movement - 174m ³ /hr, 28W		7007A Window exhaust 150mm, pull cord Air Movement - 360m ³ /hr, 40W	
	WE250 Window exhaust, 250mm, pull cord switch Air Movement - 203-450m ³ /hr, 35-40W		7107A Window exhaust 200mm, pull cord Air Movement - 600m ³ /hr, 35W	Replacement glass may be required.

technical information

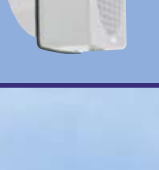

150mm EXHAUST FANS

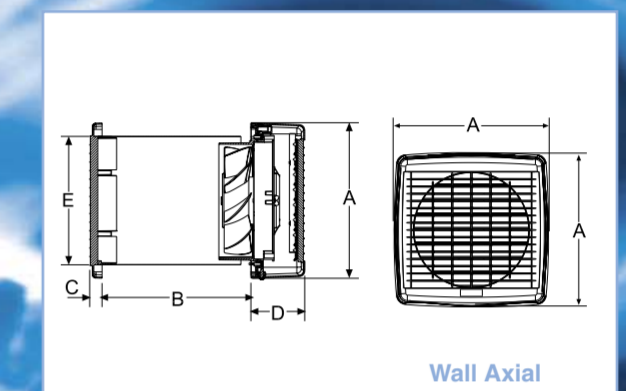
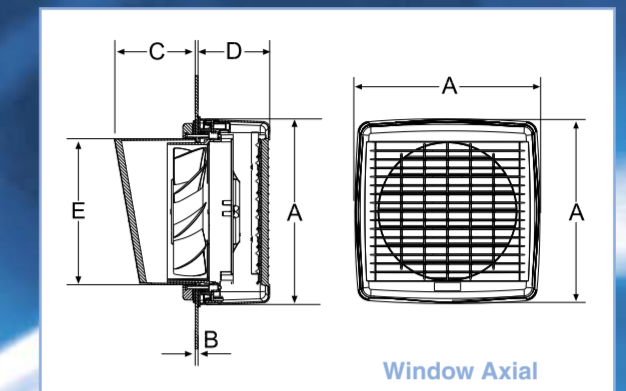
Fan Type - Axial	150mm Window	150mm Wall
Catalogue numbers	7005A & 7007A	7006A & 7008A
Cubic metres per hour	360m ³ /hr	360m ³ /hr
Litres per second	100 l/s	100 l/s
Overall intake size (A)	245 x 245mm	245 x 245mm
Window/Wall depth (B)*	4-32mm	110 - 310mm
External protrusion (C)	95mm	20mm
Room protrusion (D)	95mm	83mm
Duct diameter size (E)	172mm	172mm
Hole size diameter or sq.	213mm	180mm or
Shutter operation	7005A -Automatic 7007A -Pull-cord	7006A -Automatic 7008A -Pull-cord
Fan diameter	148mm	148mm
Number of speeds	1	1
Rated voltage	230-240V	230-240V
Watts	45W	45W
Full load current	0.27A	0.27A
Motor type	Sleeve bearing	Sleeve bearing
Decibel level at 3 metres	49dBA	49dBA

* Up to 32mm can be achieved by using additional fastening bolts supplied with fan (standard depth 14mm).

200mm EXHAUST FANS

Fan Type - Axial	200mm Window	200mm Wall
Catalogue numbers	7105A & 7107A	7106A & 7108A
Cubic metres per hour	600m ³ /hr	600m ³ /hr
Litres per second	167 l/s	167 l/s
Overall intake size (A)	271 x 271mm	271 x 271mm
Window/Wall depth (B)*	4-32mm	110 - 310mm
External protrusion (C)	95mm	20mm
Room protrusion (D)	105mm	93mm
Duct diameter size (E)	210mm	220mm
Hole size diameter or sq.	230mm	230mm
Shutter operation	7105A -Automatic 7107A -Pull-cord	7106A -Automatic 7108A -Pull-cord
Fan diameter	188mm	188mm
Number of speeds	1	1
Rated voltage	230-240V	230-240V
Watts	38W	38W
Full load current	0.18A	0.18A
Motor type	Ball-bearing	Ball-bearing
Decibel level at 3 metres	50dBA	50dBA

* Up to 32mm can be achieved by using additional fastening bolts supplied with fan (standard depth 14mm).

SUITS WALLS
110 - 310mm THICK

SUITS WINDOWS
4 - 32mm THICK

REFRESHINGLY POWERFUL