



Acti9 DB

Catalog 2023

se.com

Life Is On



Design

- Clean design
- Premium finish
- Intuitive door operation
- Robust locking mechanism
 - Clear indication of Lock and Unlock position.
 - Door locking w.r.t. frame

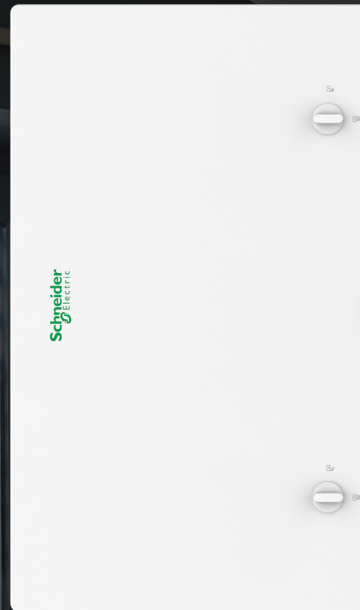

Safety, Performance and Reliability



- Type tested system as per IEC61439-3 NABL



- Galvanized Steel (GI) raw material

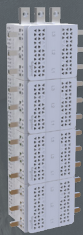

- Performance enhancement with new and improved fishbone for VTPN offer



- Uninterrupted power supply with new Isobar system

Flexibility in Installation

Removable Gland plate with reduced number of Screws

Plastic Stud for ease and safe removal of Centre Plate

Revolutionary Gasket: Enhanced IP protection and higher service life over typical traditional gasket

Door Earthing to be connected to the center plate for increased protection

Full length Plastering Guide on all 4 sides, common for Single and Double Door

Maximized Wiring Space

Removable Chassis (Cassette type) with fixed N-bar

N-bar with shroud for additional protection

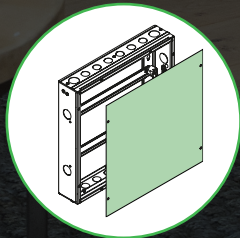

DB Supplied with Cement Spill Protector

Insulated Phase Busbars

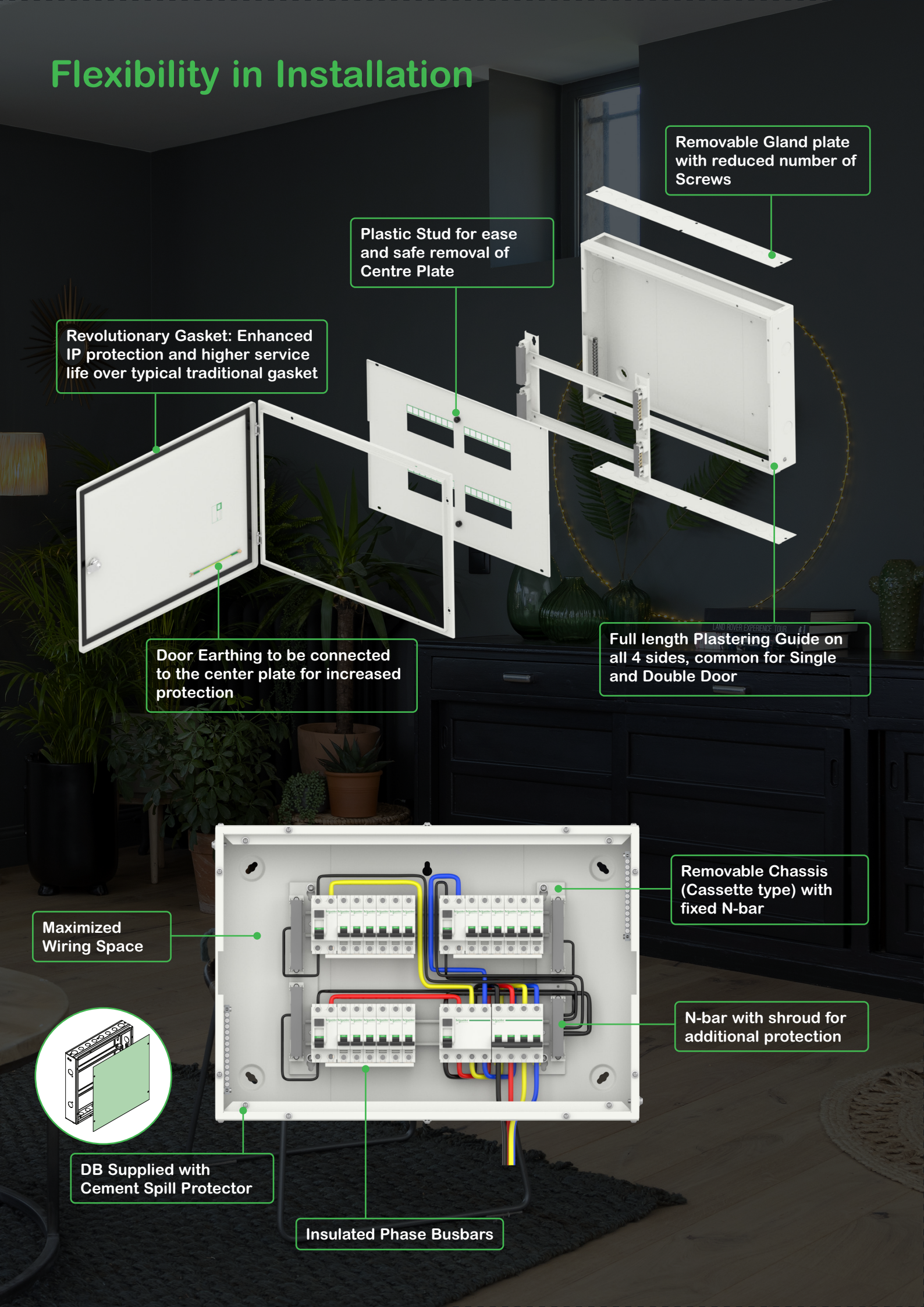

Customer focused Offer



New PSG DB

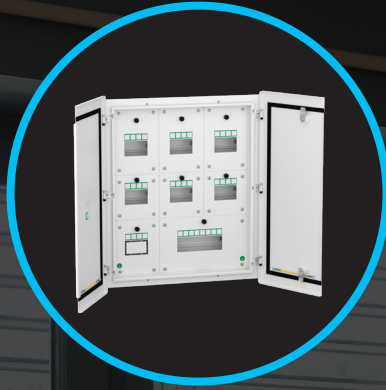

1.6 mm DB

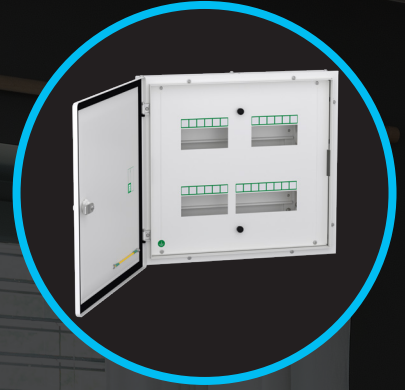

PPI DB



New VTPN DB



New Isobar DB



Acti9 Isobar Pan Assembly System

Innovation

Through market leading innovations for over a quarter of a century, Isobar distribution system have offered new levels of performance which enhances safety, reliability, efficiency and connectivity.

Acti9 Isobar's unique busbar disconnection system permits unused outgoing poles to be electrically isolated from the main supply via a Off-load switch. The result is enhanced protection against direct electrical contact with live parts during testing, commissioning, and retrofit applications. The off-load switch is directly adjacent to the outgoing busbar terminal and device, ensuring that the correct off-load contact for that circuit is switched.

Applications

Ideal for Installations where Power availability is Critical.

- Commercial Buildings
- Hospitals
- Data centers
- Telecommunications
- Manufacturing centers



Safe

- Isolate unused poles with Off-load Switch
- Fully insulated construction
- Supports compliance to IEC 61439 standards



Flexible

- Phase to Neutral conversion for outgoing poles
- Wide range of Incomers and auxilliary devices
- Wide range of Incomers with connection kits



Efficient

- Compact installation with vertical distribution
- Easy to install with Acti9 Modular devices
- Lesser Cabling, neater installation



Connected

- Easy to upgrade with PowerTag solution
- Easy Integration with Ecostruxure solution
- Stay connected & monitor remotely



Sustainable

- Meet your sustainable energy targets
- Green Premium Offer
- Sustainable packaging

Fully encapsulated busbar system

Non removable interlock to prevent operation unless an outgoing device is fitted

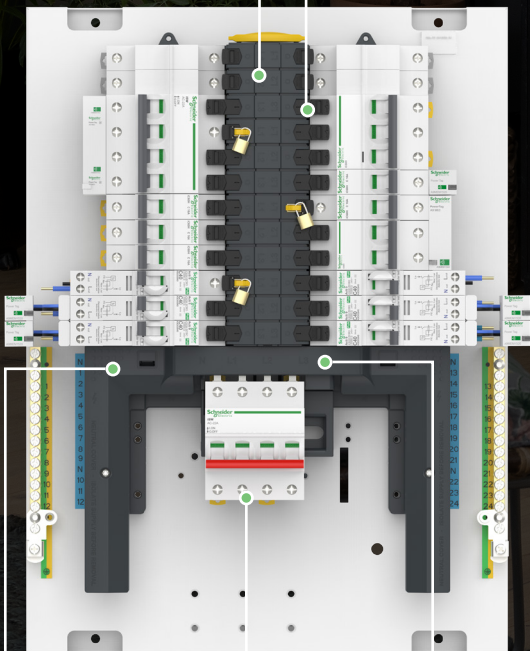

Shrouded neutral bars

Wide range of incomers

Fully shrouded connection when main switch is fitted

Isobar Pan Assembly

The Isobar chassis is available in two types, the TNA and PEV, which come in various sizes from 12 to 72 poles with numerous accessories and are adaptable to most commercial and industrial applications.

Isobar Off Load Switch is compliant to IEC 60947-3 ensuring unused outgoing ways are isolated. The Pan assembly supports the compliance as per IEC 61439.

Technical Specifications

Main characteristics	Performance
Main Busbar Current Rating (In)	250 A
Rated operational voltage (Ue)	400V/415 V
Rated frequency	50/60 Hz
Rated Insulation voltage (Ui)	500 V
Rated impulse withstand voltage (Uimp)	6 kV
Unconditional (Icw)	25 kA/100 ms
Busbar Short circuit Withstand Rating at 230/240V ; 400V/415V	17 kA/200 ms
Conditional Short circuit Current Rating (Icc)	25 kA*
Pollution degree	3
Endurance (O-C) Isobar switch disconnecter	3000
Overvoltage category	IV
Operating temperature	-35 ... +70 °C
Storage teperature	-40 ... +80 °C

* For typical assembly configuration ratings please contact customer care

Commercial References

PEV - Pan Assembly with Neutral distribution

Pan assemblies – 3 phase for switchboard mounting supplied with earths and neutral bars. With flexibility of converting phase to neutral on outgoing poles.

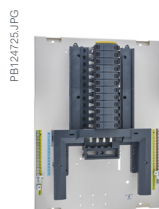

PEV Version CR	No of Single Poles
SEA9BN4PEV	12
SEA9BN6PEV	18
SEA9BN8PEV	24
SEA9BN12PEV	36
SEA9BN16PEV	48
SEA9BN18PEV	54
SEA9BN24PEV	72

TNA - Pan Assembly without Neutral distribution

Pan assemblies - 3 phase for switchboard mounting without earth and neutral bars. Do not have option to convert phase to neutral for outgoing poles and incomer connection kits.



TNA Version CR	No of Single Poles
SEA9BN4TNA	12
SEA9BN6TNA	18
SEA9BN8TNA	24
SEA9BN12TNA	36
SEA9BN16TNA	48
SEA9BN18TNA	54
SEA9BN24TNA	72

Distributed Neutral kits

Accessories to convert phase to neutral on outgoing circuits of PEV Pan Assembly



Part Reference	Description	No of Ways
SEA9NB4	Distributed neutral kit for 4 way TP&N	12
SEA9NB6	Distributed neutral kit for 6 way TP&N	18
SEA9NB8	Distributed neutral kit for 8 way TP&N	24
SEA9NB12	Distributed neutral kit for 12 way TP&N	36
SEA9NB16	Distributed neutral kit for 18 way TP&N	48
SEA9NB24	Distributed neutral kit for 24 way TP&N	54
SEA9NKIT	Phase to Neutral coversion kit (pack of 4)	

Accessories



SEA9NPB250TB



SEA9BINCKIT

Commercial reference	Description
SEA9BINCKIT	Incomer Compact NSX / INS connection kit for use with SEA9NPB250TB
SEA9NPB250TB	250 A incoming terminal block for PEV type Pan Assembly
A9XPT920	Set of 20 tooth caps
SEA9BP	Blank pole
SEA9ISOPLA	Slider padlocking
SEA9P125SPKIT	125 A Single phasing kit 4 pole
SEA9250SPEV	250 A Single phasing kit 4 pole
SEA9TB1001	100 A 1 pole terminal block
NSNL250	250 A 1 pole neutral block
SEA9BSHEV	Incomer Compact NSX /INS Short connection kit



A9XPT920



SEA9BP



SEA9250SPEV



SEA9TB1001

Dimension (mm)

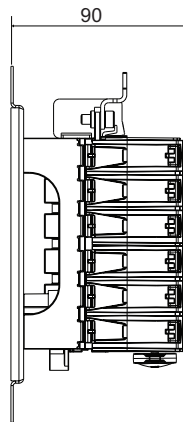
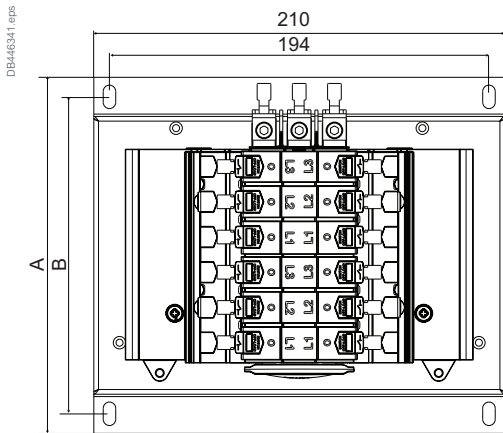

TNA Version		
Part No	A	B
SEA9BN4TNA	182	162
SEA9BN6TNA	236	216
SEA9BN8TNA	290	270
SEA9BN12TNA	398	378
SEA9BN16TNA	506	486
SEA9BN18TNA	560	540
SEA9BN24TNA	722	702

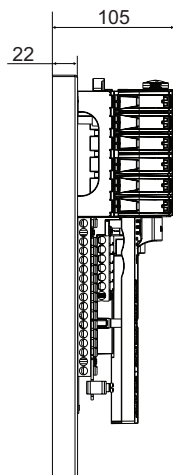
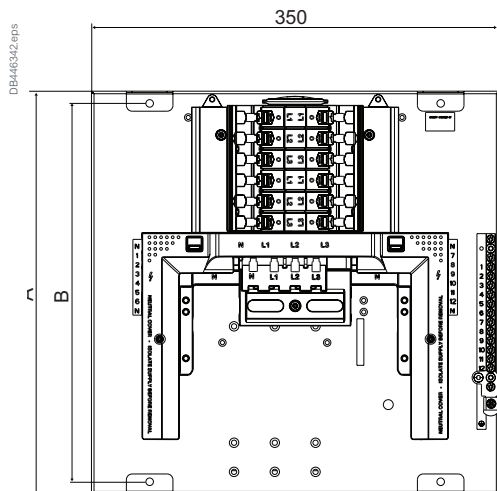

PEV Version		
Part No	A	B
SEA9BN4PEV	346	325
SEA9BN6PEV	421	400
SEA9BN8PEV	471	450
SEA9BN12PEV	571	550
SEA9BN16PEV	671	650
SEA9BN18PEV	746	725
SEA9BN24PEV	896	875

Technical Specification, CR table and Dimension

SPN DBs

- SPN DB for distribution of Single Phase and Neutral supply.

Technical Specifications

Feature	Requirements
System	Acti9
Variant	Single Phase Neutral (SPN)
Standards	IEC 61439-3
Certification/Quality label	NABL
Current Rating	Up to 63 A
Operating Voltage (Ue)	240 V AC
Insulation Voltage (Uimp)	500 V AC
Impulse Voltage (Vimp)	4 kV AC
Frequency	50 Hz
Busbar Rating	63 A
Protection device type	Incoming: 2P - RCCB/RCBO/Isolator/MCB Outgoing: 1P - MCBs
Degree of Protection	Double Door IP43 & Single Door IP30 - IEC 60529 Double Door IK09 & Single Door IK08 - IEC 62262
Mounting Method	Surface/Flush
Enclosure Material	Standard Acti9 DB material (GI + CRCA)
Enclosure Color	White (RAL 9003)
Architecture	4 Piece (Double Door)
Door Type	Reversible
Door Knob	Rotary Knob
Gland Plates	Removable on top & bottom
Knock-outs	Knockout on all 4 sides
Provided Equipment	Cement Spill Protector Pole Fillers Earth Bar Neutral Bar Neutral Cable Fork type Bus Bar
Non Standard Option	Yes. Click Custom DB Enquiry format



A9HSNS06



A9HSND06

Dimension (mm)

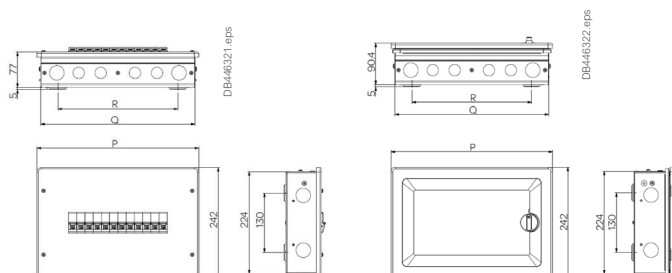

SPN DBs - Single Door - IP30			
No of Ways	P	Q	R
6	246	229	154
8	282	265	190
12	354	337	262
18	462	445	370

SPN DBs - Double Door - IP43			
No of Ways	P	Q	R
6	246	229	154
8	282	265	190
12	354	337	262
18	462	445	370

Commercial References

Description	Total Module Cutout (Incomer + Outgoing)	Single Door (IP30)	Double Door (IP43)	Double Door - 1.6mm (IP43)
6 way	2 + 4	A9HSNS06	A9HSND06	A9HSND06Z
8 way	2 + 6	A9HSNS08	A9HSND08	A9HSND08Z
12 way	2 + 10	A9HSNS12	A9HSND12	A9HSND12Z
18 way	2 + 16	A9HSNS18	A9HSND18	A9HSND18Z

TPN DBs

- Standard TPN DBs for distribution of Three Phase and Neutral supply.
- Per Phase Isolation (PPI) options also available for TPN DBs.

Technical Specifications

Feature	Requirements
System	Acti9
Variant	Three Phase Neutral (TPN)
Standards	IEC 61439-3
Certification/Quality label	NABL
Current Rating	Up to 63 A
Operating Voltage (Ue)	415 V AC
Insulation Voltage (Uimp)	500 V AC
Impulse Voltage (Vimp)	4 kV AC
Frequency	50 Hz
Busbar Rating	63 A
Protection device type	Incoming: 4P - RCCB/RCBO/Isolator/ MCB Sub Incoming: 2P - RCCB/RCBO (for PPI) Outgoing: 1P - MCBs
Degree of Protection	Double Door IP43 & Single Door IP30 - IEC 60529 Double Door IK09 & Single Door IK08 - IEC 62262
Mounting Method	Surface/Flush
Enclosure Material	Standard Acti9 DB material (GI + CRCA)
Enclosure Color	White (RAL 9003)
Architecture	4 Piece (Double Door)
Door Type	Reversible
Door Knob	Rotary Knob
Chassis Type	Removable
Gland Plates	Removable on top & bottom
Knock-outs	Knockout on all 4 sides
Provided Equipment for Standard TPN DB	Cement Spill Protector Pole Fillers Earth Bar*2 Neutral Bar*2 RYB Cables, Neutral Cables Fork type Bus Bars
Provided Equipment for PPI TPN DB	Cement Spill Protector Pole Fillers Earth Bar*2 Neutral Bar*4 RYB Cables, Neutral Cables Fork type Bus Bars
Non Standard Option	Yes. Click Custom DB Enquiry format



Dimension (mm)

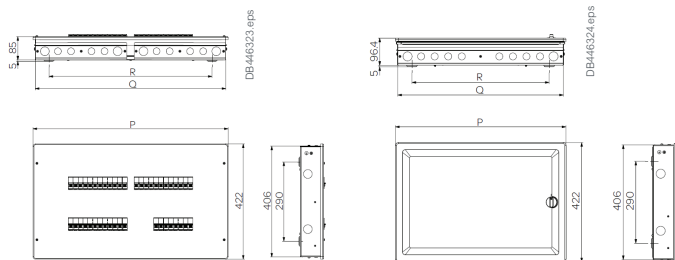

TPN DBs - Single Door - IP30			
No of Ways	P	Q	R
4	424	407	306
6	460	443	342
8	604	587	486
12	716	699	598

TPN DBs - Double Door - IP43			
No of Ways	P	Q	R
4 (Eco)	388	371	270
4	424	407	306
6	460	443	342
8	604	587	486
12	716	699	598

Commercial References

Description	Total Module Cutout (Incomer + Outgoing)	Single Door (IP30)	Double Door (IP43)	Double Door - 1.6mm (IP43)	Double Door - PPI* (IP43)
4 way Eco	4 + (3*4)	-	A9HTND04E	-	-
4 way	8 + (3*4)	A9HTNS04	A9HTND04	A9HTND04Z	-
6 way	8 + (3*6)	A9HTNS06	A9HTND06	A9HTND06Z	A9HTPI06
8 way	8 + (3*8)	A9HTNS08	A9HTND08	A9HTND08Z	A9HTPI08
12 way	8 + (3*12)	A9HTNS12	A9HTND12	A9HTND12Z	A9HTPI12

Flexi Tier DBs

- Flexi DBs gives total flexibility to mount any type and size of Modular devices as per load requirement.

Technical Specifications

Feature	Requirements
System	Acti9
Variant	Flexi Tier
Standards	IEC 61439-3
Certification/Quality label	NABL
Current Rating	Up to 63 A
Operating Voltage (Ue)	415 V AC
Insulation Voltage (Uimp)	500 V AC
Impulse Voltage (Vimp)	4 kV AC
Frequency	50 Hz
Busbar Rating	63 A
Protection device type	Incoming: 4P - RCCB/RCBO/Isolator/ MCB Sub Incoming: 2P - RCCB/RCBO (for PPI) Outgoing: 1P - MCBs
Degree of Protection	Double Door IP43 - IEC 60529 Double Door IK09 - IEC 62262
Mounting Method	Surface/Flush
Enclosure Material	Standard Acti9 DB material (GI + CRCA)
Enclosure Color	White (RAL 9003)
Architecture	4 Piece (Double Door)
Door Type	Reversible
Door Knob	Rotary Knob
Chassis Type	Removable
Gland Plates	Removable on top & bottom
Knock-outs	Knockout on all 4 sides
Provided Equipment for Standard Tier DB	Cement Spill Protector Pole Fillers Earth Bar*2 Neutral Bar*2
"Provided Equipment for PPI Tier DB"	Cement Spill Protector Pole Fillers Earth Bar*2 Neutral Bar*4 RYB Cables Neutral Cables Fork type Bus Bars
Non Standard Option	Yes. Click Custom DB Enquiry format



Dimension (mm)

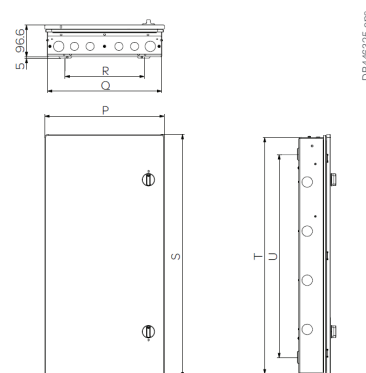

TIER DBs - Double Door - IP43						
No of Rows	P	Q	R	S	T	U
2	421	405	275	424	405	300
3	421	405	275	530.6	512	435
4	366	350	240	740.6	722	620
4	436	420	300	740.6	722	620

Commercial References

Description	Total Module Cutout (no. of rows x No. of modules per row)	"Double Door (IP43)"	Double Door - 1.6mm (IP43)	Double Door - PPI* (IP43)
2 Tier 24 Modules	2 x 12	A9HFD224	-	-
3 Tier 36 Modules	3 x 12	A9HFD336	-	-
4 Tier 40 Modules	4 x 10	A9HFD440	A9HFD440Z	A9HFPI10
4 Tier 56 Modules	4 x 14	A9HFD456	A9HFD456Z	A9HFPI14

Phase Segregated DBs

- Phase Segregated DBs provide total safety for installer and maintenance engineer, by compartmentalizing each Phase and separating Incomer, Sub-Incomer and Outgoing.
- Offers better continuity of supply in case of earth faults and maintenance at DB level.

Technical Specifications

Feature	Requirements
System	Acti9
Variant	Phase Segregated (PSG)
Standards	IEC 61439-3
Certification/Quality label	NABL
Current Rating	Up to 63 A
Operating Voltage (Ue)	415 V AC
Insulation Voltage (Uimp)	500 V AC
Impulse Voltage (Vimp)	4 kV AC
Frequency	50 Hz
Busbar Rating	63 A
Protection device type	Incoming: 4P - RCCB/RCBO/Isolator/MCB Incoming: 100 A MCCB 3P/4P Compact NSX or EasyPact CVS Sub Incoming: 2P - RCCB/RCBO Outgoing: 1P MCBs
Degree of Protection	Double Door IP43 - IEC 60529 Double Door IK09 - IEC 62262
Mounting Method	Surface/Flush
Enclosure Material	Standard Acti9 DB material (GI + CRCA)
Enclosure Color	White (RAL 9003)
Architecture	4 Piece (Double Door)
Door Type	Reversible
Door Knob	Rotary Knob
No. of Segments	Modular Incomer: 8 Segments MCCB Incomer: 7 Segments
Gland Plates	Removable on top & bottom
Knock-outs	Knockout on all 4 sides
Provided Equipment	Cement Spill Protector Pole Fillers Earth Bar Neutral Bar RYB Cables Neutral Cables Fork type Bus Bars
Non Standard Option	Yes. Click Custom DB Enquiry format

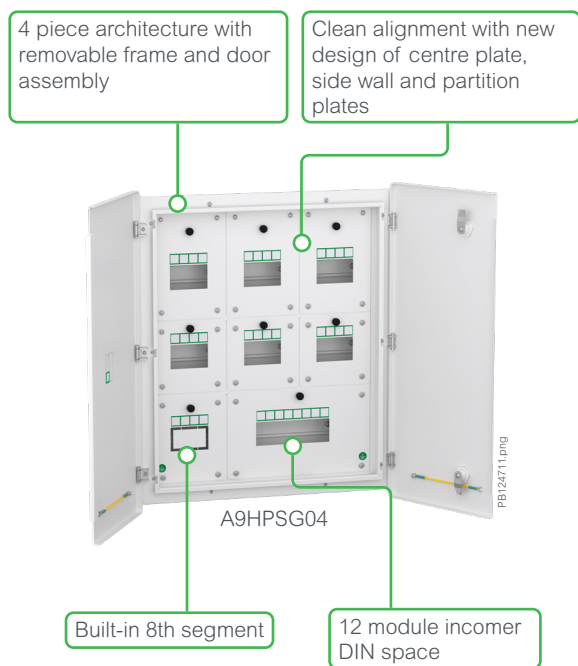

Dimension (mm)

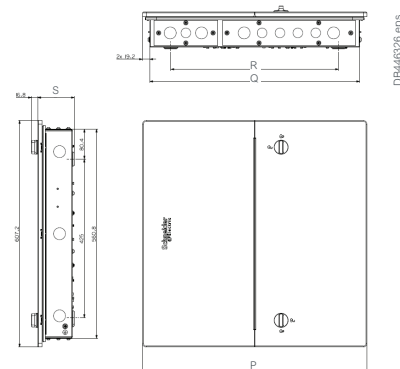

Phase Segregated (PSG) DBs - Double Door - IP43				
No of Ways	P	Q	R	S
4	506	467.4	354	98.6
6	602	563.4	450	98.6
8	710	671.4	558	98.6
12	926	887.4	774	98.6
12 (MCCB)	926	887.4	774	135.6

Commercial References

Description	Total Module Cutout (Additional segment + Incomer + Sub-incomer + Outgoing)	Double Door (IP43)	Double Door - 1.6mm (IP43)
4 way	4 + 8 + (3*4) + (3*4)	A9HPSG04	A9HPSG04Z
6 way	4 + 12 + (3*4) + (3*6)	A9HPSG06	A9HPSG06Z
8 way	4 + 12 + (3*4) + (3*8)	A9HPSG08	A9HPSG08Z
12 way	4 + 12 + (3*4) + (3*12)	A9HPSG12	A9HPSG12Z
12 way MCCB	0 + 100A MCCB + (3*4) + (3*12)	A9HPSG12M	-

Vertical TPN DBs (VTPN DBs)

- Ideal solution to distribute power supply to the three Phase loads and for higher incoming current up to 250A.

Technical Specifications

Feature	Requirements
System	Acti9
Variant	Vertical Three Phase Neutral (VTPN)
Standards	IEC 61439-3
Certification/Quality label	NABL
Current Rating	Up to 63 A for Modular incomer Up to 250 A for MCCB incomer
Operating Voltage (Ue)	415 V AC
Insulation Voltage (Uimp)	500 V AC
Impulse Voltage (Vimp)	4 kV AC
Frequency	50 Hz
Outgoing link rating	63 A
Short Circuit Withstand for Fishbone	Up to 100 A - 17 kA, 250 mS Up to 250 A - 25 kA, 500 mS
Protection device type	Incoming: 4P - RCCB/RCBO/Isolator/ MCB Incoming: 3P/4P MCCB Compact NSX or EasyPact CVS Outgoing: 1P/3P MCBs
Degree of Protection	Double Door IP43 - IEC 60529 Double Door IK09 - IEC 62262
Mounting Method	Surface/Flush
Enclosure Material	Standard Acti9 DB material (GI + CRCA)
Enclosure Color	White (RAL 9003)
Architecture	3 Piece (Double Door)
Door Type	Reversible
Door Knob	Rotary Knob
Gland Plates	Removable on top & bottom
Knock-outs	Knockout on all 4 sides
Provided Equipment	Pole Fillers Earth Bar, Neutral Bar Neutral terminal block (MCCB Incoming Only)
Non Standard Option	Yes. Click Custom DB Enquiry format



Dimension (mm)

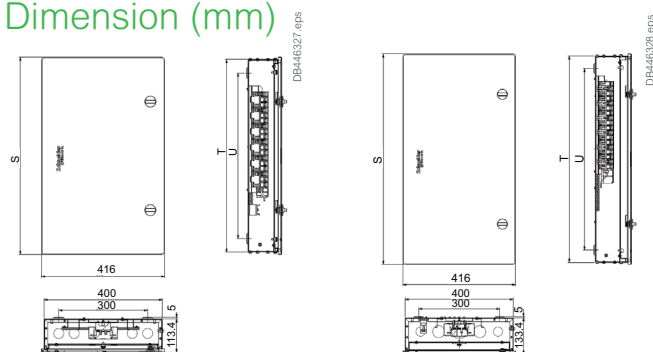

VTPN DBs (Modular Incomer) - Double Door - IP43				VTPN DBs (MCCB Incomer) - Double Door - IP43			
No of Ways	S	T	U	No of Ways	S	T	U
4	438	422	330	4	558	552	460
8	558	552	460	8	667	652	560
12	668	652	560	12	777	762	670

Commercial References

Description	Total Module Cutout (Incomer + Outgoing)	Double Door (IP43)
4 way	12 + 12	A9HVM04
8 way	12 + 24	A9HVM08
12 way	12 + 36	A9HVM12
4 way	100A MCCB + 12	A9HVN04L
8 way	100A MCCB + 24	A9HVN08L
12 way	100A MCCB + 36	A9HVN12L
4 way	160A MCCB + 12	A9HVN04M
8 way	160A MCCB + 24	A9HVN08M
12 way	160A MCCB + 36	A9HVN12M
8 way	250A MCCB + 24	A9HVN08H
12 way	250A MCCB + 36	A9HVN12H

Metal Enclosure

- Metal Enclosure to mount individual Modular Device feeding directly to the load.

Technical Specifications

Feature	Requirements
System	Acti9
Variant	Metal Enclosure (ME)
Standards	IEC 61439-3
Certification/Quality label	NABL
Current Rating	Up to 63 A
Operating Voltage (Ue)	240 V AC
Insulation Voltage (Uimp)	500 V AC
Impulse Voltage (Vimp)	4k V AC
Frequency	50 Hz
Degree of Protection	Single Door IP30 - IEC 60529 Single Door IK08 - IEC 62262
Mounting Method	Surface/Flush
Enclosure Material	Standard Acti9 DB material (GI + CRCA)
Enclosure Color	White (RAL 9003)
Architecture	3 Piece (Single Door)
Gland Plates	Non removable on top & bottom
Knock-outs	Knockout on all sides
Provided Equipment	Pole Fillers
Non Standard Option	Yes. Click Custom DB Enquiry format



Dimension (mm)

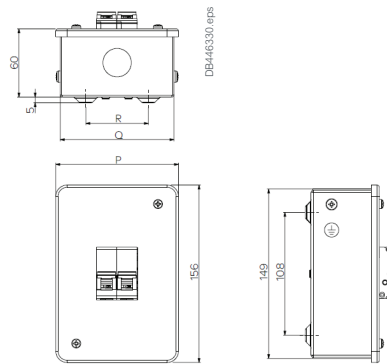

Metal Enclosures			
No. of Ways	P	Q	R
2	108	100	55
4	138	130	78

Commercial References

Description	Total Module Cutout	Single Door (IP30)
2 way	2	A9HMES02
4 way	4	A9HMES04

TVTEL

Technical Specifications

Feature	Requirements
System	Acti9
Variant	TVTEL & ONT BOX
Current Rating	Up to 63 A
Operating Voltage (Ue)	240 V AC
Frequency	50 Hz
Degree of Protection	IP30 - IEC 60529
Mounting Method	Surface/Flush
Enclosure Material	Standard Acti9 DB material (GI + CRCA)
Enclosure Color	White (RAL 9003)
Architecture	4 Piece (Double Door)
Gland Plates	Removable on top & bottom (A9HTVTEL) Non Removable (A9HOTVTEL)
Knock-outs	Knockout on all 4 sides
Non Standard Option	Yes. Click Custom DB Enquiry format



A9HTVTEL



A9HOTVTEL

Commercial References

Reference	Description
A9HTVTEL	Acti9 DB TVTEL BOX 1mm IP30
A9HOTVTEL	Acti9 DB TVTEL & ONT BOX 1.2MM IP30

Dimension (mm)

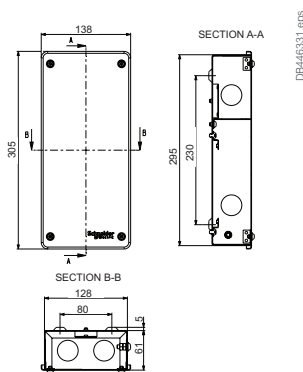

A9HTVTEL

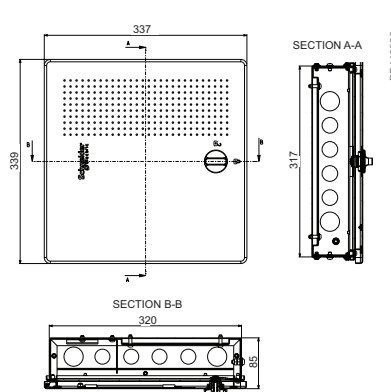

A9HOTVTEL

Metal Clad P&S Units and PK P&S Units (with provision to mount PK socket)

- Enclosure supplied with Electra Metal Plug and Socket and provision to mount modular protection device to feed directly to the end load.
- Plug and Socket Unit with provision to mount PK Panel mounted straight socket and modular protection device to feed directly to the end load.

Technical Specifications

Feature	Requirements
System	Acti9
Variant	Plug and Socket Enclosure (P&S)
Current Rating	Up to 63 A
Operating Voltage (Ue)	240 V AC
Frequency	50 Hz
Degree of Protection	Single Door IP30 - IEC 60529 Single Door IK08 - IEC 62262
Mounting Method	Surface/Flush
Enclosure Material	Standard Acti9 DB material (GI + CRCA)
Enclosure Color	White (RAL 9003)
Architecture	3 Piece (Single Door)
Gland Plates	Non Removable
Knock-outs	Only on Sides
Provided Equipment	Pole Fillers
Non Standard Option	Yes. Click Custom DB Enquiry format



A9HMS210



A9HKS316

Dimension (mm)

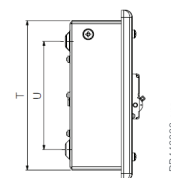
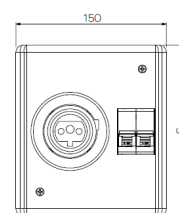
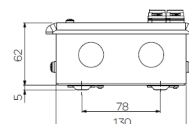

Metal - Plug and Socket Unit

Commercial References

Metal - Plug and Socket Unit

Description	Total Module Cutout	Single Door (IP30)
10A 1P+N+E P&S	2	A9HMS210
20A 1P+N+E P&S	2	A9HMS220
30A 3P+E P&S	3	A9HMS330

PK - Plug and Socket Unit

Description	Total Module Cutout	Single Door (IP30)
16A 3P PK P&S	2	A9HKS316
32A 3P PK P&S	2	A9HKS332
32A 5P PK P&S	4	A9HKS532
63A 5P PK P&S	4	A9HKS563

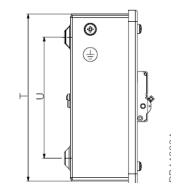
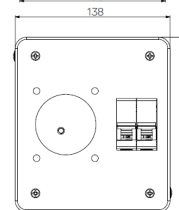
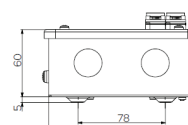

PK - Plug and Socket Unit

Metal - Plug and Socket Unit			
No of Ways	S	T	U
1	170	149	108
2	170	149	108
4	305	284	230

PK - Plug and Socket Unit			
No of Ways	S	T	U
2	156	149	108
2	156	149	108
4	305	284	230
4	305	284	230

Accessories

Ref. No.	Description
A9HRL901	Rotary lock
A9HRL902	Key Lock
A9PF8	Pole Filler 8 Modules
R9XFH112	Fork type busbar 1 Pole 12 Modules
R9XFH212	Fork type busbar 2 Pole 12 Modules
R9XFH312	Fork type busbar 3 Pole 12 Modules
R9XFH412	Fork type busbar 4 Pole 12 Modules
R9XFH157	Fork type busbar 1 Pole 57 Modules
R9XFH257	Fork type busbar 2 Pole 57 Modules
R9XFH357	Fork type busbar 3 Pole 57 Modules
R9XFH457	Fork type busbar 4 Pole 57 Modules
R9XE210	Set of 10 end caps 2P
R9XE310	Set of 10 end caps 3P
R9XE410	Set of 10 end caps 4P



A9HRL902



R9XFH212



R9XE210

Wire Way Box for Double Door IP43 DBs

Ref. No.	DB Type Description	DB Desc
A9HSND06WB	SPN DB	6 way
A9HSND08WB	SPN DB	8 way
A9HSND12WB	SPN DB	12 way
A9HSND18WB	SPN DB	18 way
A9HTND04EWB	TPN DBs	4 way eco
A9HTND04WB	TPN DBs	4 way
A9HTND06WB	TPN DBs	6 way
A9HTND08WB	TPN DBs	8 way
A9HTND12WB	TPN DBs	12 way
A9HFD224WB	Flexi Tier DBs	2 Tier 24 Modules
A9HFD336WB	Flexi Tier DBs	3 Tier 36 Modules
A9HFD440WB	Flexi Tier DBs	4 Tier 40 Modules
A9HFD456WB	Flexi Tier DBs	4 Tier 56 Modules
A9HPSG04WWB	Phase Segregated DBs	4 way
A9HPSG06WWB	Phase Segregated DBs	6 way
A9HPSG08WWB	Phase Segregated DBs	8 way
A9HPSG12WWB	Phase Segregated DBs	12 way
A9HPSG12MWWB	Phase Segregated DB (MCCB i/c)	12 way with MCCB I/c
A9HVMXXWB	VTPN DBs with Modular incomer	4 / 8 / 12 way
A9HVNXXWB	VTPN DBs with MCCB incomer	4 / 8 / 12 way
A9HVMXXEB	Extension Box for VTPN DB (Modular i/c) (18 modules)	4 / 8 / 12 way
A9HVNXXEB	Extension Box for VTPN DB (MCCB i/c) (18 modules)	4 / 8 / 12 way

Custom DB Enquiry Format

Acti9

Enquiry No: (Auto Generated)	<input type="text"/>	Date:	<input type="text"/>
Customer Name:	<input type="text"/>	Project:	<input type="text"/>
Sales person Name:	<input type="text"/>	Consultant:	<input type="text"/>
Branch:	<input type="text"/>	No of enquiries you have sent in this month:	<input type="text"/>

Degree of Protection:	<input type="text"/>	CRCA thickness (gauge) :	<input type="text"/>
Nearest Preferred standard design:	<input type="text"/>	Color (RAL no.):	<input type="text"/>

Incomer (rating & slots) :	Product Desc	Ref. No.	No. of Modules (1M=18mm) or Total and Mounting Dim for Non-Modular Devices
Total Incomer Modules			

Sub-incomer (rating & slots):	Product Desc	Ref. No.	No. of Modules (1M=18mm) @ Each Phase
Total Sub-Incomer Modules @ Each Phase			

Outgoing Slots	Device	Qty	No. of Modules (1M=18mm)
	SP MCB		
	DP MCB		
	TP MCB		
	FP MCB		
	Modular Contactor		
	Time Switch		
	Voltmeter / Ammeter		
	RYB Indicator		
Total Outgoing Modules			

Shorting links / Phase Busbar	Type	Modules / Ways	Qty
	SP		
	DP		
	TP		
	FP		

PDF drawing required: Delivery required within

Please specify any other details required

Lock Arrangement	<input style="width: 100%;" type="text"/>
Wire Way Box	<input style="width: 100%;" type="text"/>

Total Order Qty:

Comments:

Notes:



Green Premium™

Endorsing eco-friendly products in the industry



Green Premium is the only label that allows you to effectively develop and promote an environmental policy whilst preserving your business efficiency. This ecolabel guarantees compliance with up-to-date environmental regulations, but it does more than this.

Over 75% of Schneider Electric manufactured products have been awarded the Green Premium ecolabel



Discover what we mean by green ...

Check your products!

Schneider Electric's Green Premium ecolabel is committed to offering transparency, by disclosing extensive and reliable information related to the environmental impact of its products:

RoHS

Schneider Electric products are subject to RoHS requirements at a worldwide level, even for the many products that are not required to comply with the terms of the regulation. Compliance certificates are available for products that fulfil the criteria of this European initiative, which aims to eliminate hazardous substances.

REACH

Schneider Electric applies the strict REACH regulation on its products at a worldwide level, and discloses extensive information concerning the presence of SVHC (Substances of Very High Concern) in all of its products.

PEP: Product Environmental Profile

Schneider Electric publishes complete set of environmental data, including carbon footprint and energy consumption data for each of the lifecycle phases on all of its products, in compliance with the ISO 14025 PEP ecopassport program. PEP is especially useful for monitoring, controlling, saving energy, and/or reducing carbon emissions.

EoLI: End of Life Instructions

Available at the click of a button, these instructions provide:

- Recyclability rates for Schneider Electric products
- Guidance to mitigate personnel hazards during the dismantling of products and before recycling operations
- Parts identification for recycling or for selective treatment, to mitigate environmental hazards/ incompatibility with standard recycling processes

Life Is On



Schneider Electric Industries SAS

35, rue Joseph Monier
CS 30323
92506 Rueil Malmaison Cedex
France

RCS Nanterre 954 503 439
Capital social 896 313 776 €
www.se.com

06-2023
CA909013E

© 2023 - Schneider Electric. All Rights Reserved.
All trademarks are owned by Schneider Electric Industries SAS or its affiliated companies.

This document has been
printed on recycled paper

