

# Control and signaling units Ø 30

Harmony 9001K & 9001SK range  
 Pushbuttons, switches and pilot lights  
 with chromium plated metal bezel  
 Complete units 9001K

## Complete units

### Contact functions

#### Pushbuttons, spring return

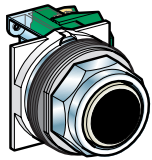

#### Flush push

9001KR1●●● See page 10

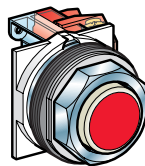

#### Projecting push

9001KR3●●● See page 10

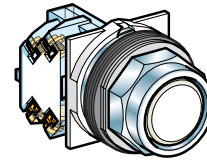

#### Recessed push (high guard)

9001KR2●●● See page 10

### Mushroom head pushbuttons

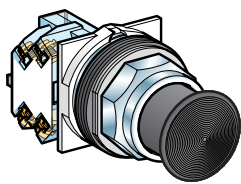

Spring return Ø 35/1.38 in., Ø 40/1.58 in., Ø 57/2.24 in., or Ø 60/2.36 in.

9001KR2●●H13 See page 10

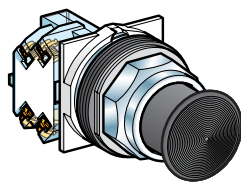

Latching Ø 35/1.38 in., Ø 40/1.58 in., Ø 41/1.61 in., Ø 57/2.24 in., or Ø 60/2.36 in.

9001KR●●● See page 10

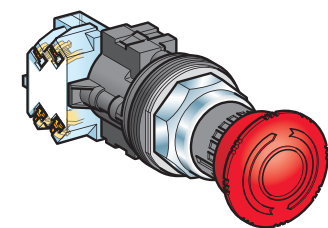

#### Turn to release, trigger action

9001KR16 See page 10

### Selector switches, key switches and joystick controllers

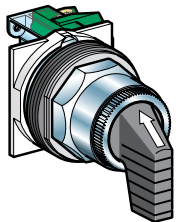

#### Selector switches, long black handle

9001KS●●FBH●● See page 11

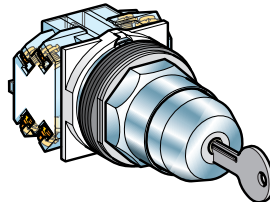

#### Key switches

9001KS●●K●H●● See page 11

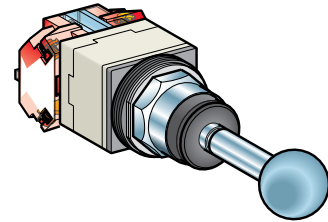

#### Joystick controllers

9001K●●H● See page 17

### Booted pushbuttons and wobblestick (with accessories)

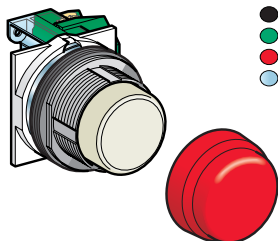

#### Booted pushbuttons

9001KR●●● + 9001KU● See pages 10 and 24

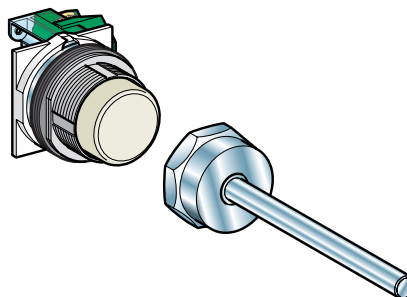

#### Wobblestick

9001KR●●● + 9001K8 See pages 10 and 24

### Light functions

#### Pilot lights

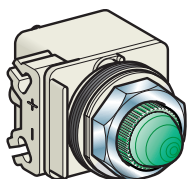

#### BA 9s base mounted super bright LED

9001KP●●● See page 12

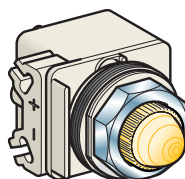

#### BA 9s incandescent bulb

9001KP●●● See page 12

Presentation:  
page 4

References:  
page 10

# Control and signaling units Ø 30

Harmony 9001K & 9001SK range  
 Pushbuttons, switches and pilot lights  
 with chromium plated metal bezel  
 Complete units 9001K

## Complete units

### Combined contact and light functions

#### Illuminated pushbuttons, spring return

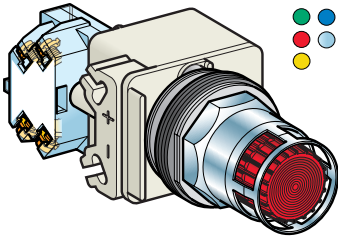

Flush push, super bright LED

9001K●L●●● See page 13

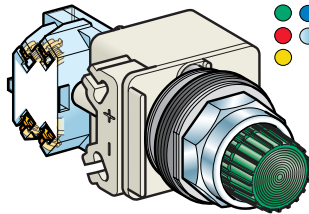

Projecting push

9001K2L●●● See page 14

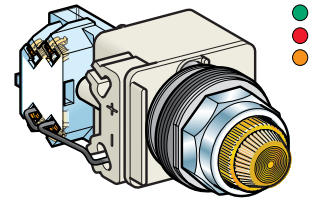

"Push to test", projecting push, super bright LED

9001KT●●●31 See page 15

#### Ø 41/1.61 in. mushroom head illuminated pushbuttons, super bright LED

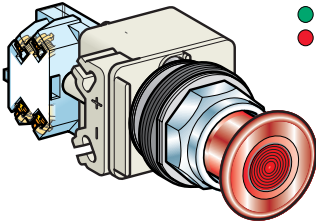

2-position, push-pull

9001KR9P●●● See page 15

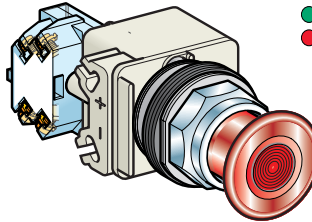

3-position, push-pull

9001KR8P●●● See page 15

## Separate components and accessories

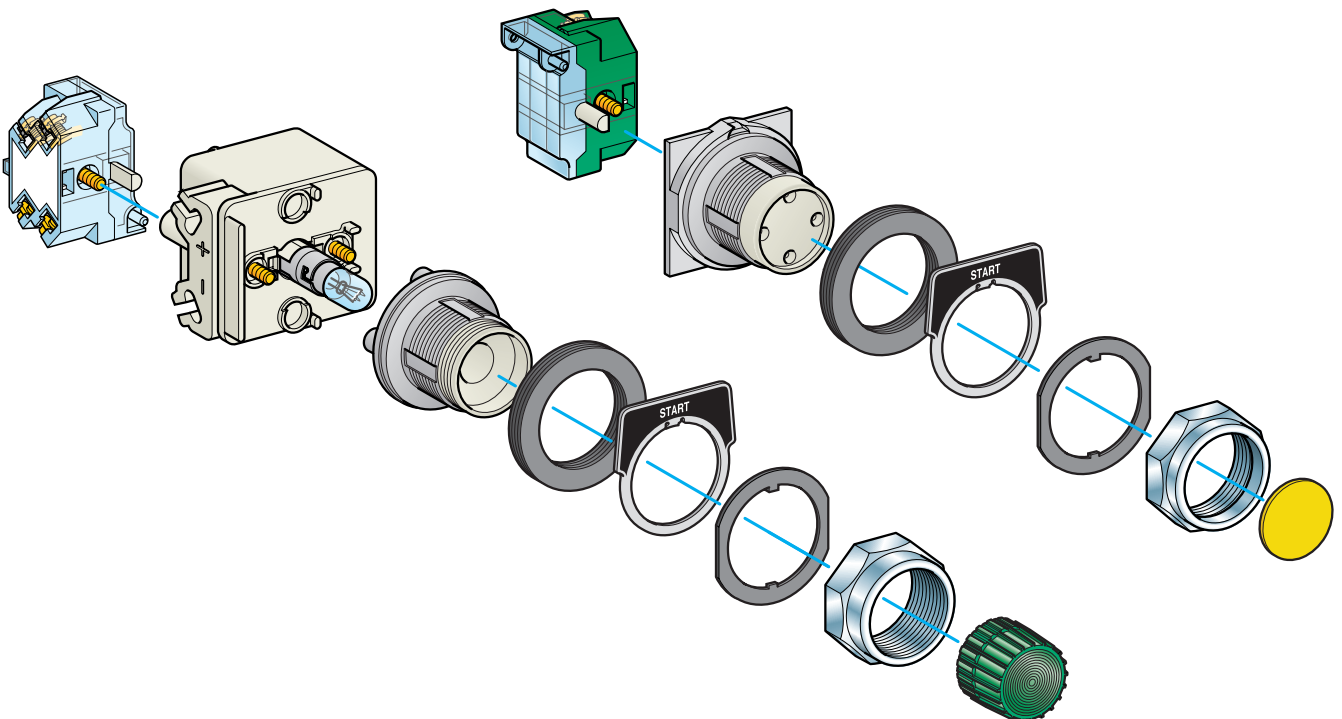

# Control and signaling units Ø 30

Harmony 9001K & 9001SK range  
 Pushbuttons, switches and pilot lights  
 with double insulated bezel  
 Complete units 9001SK

## Complete units

### Contact functions

#### Pushbuttons, spring return

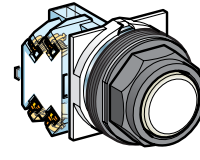

#### Flush push

9001SKR1●●● See page 18

#### Projecting push

9001SKR3●●● See page 18

#### Recessed push (high guard)

9001SKR2●●● See page 18

### Mushroom head pushbuttons

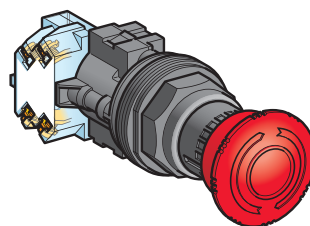
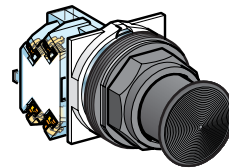
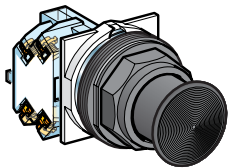

#### Spring return Ø 35/1.38 in., or Ø 57/2.24 in.

9001SKR2●●H13 See page 18

#### Latching Ø 35/1.38 in., Ø 41/1.61 in., or Ø 57/2.24 in.

9001SKR●●● See page 18

#### Turn to release, trigger action

9001SKR16 See page 18

### Selector switches

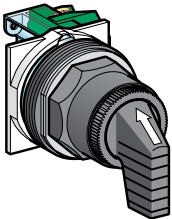

#### Selector switches, long black handle

9001SKS●●FBH●● See page 20

### Booted pushbuttons and wobblestick (with accessories)

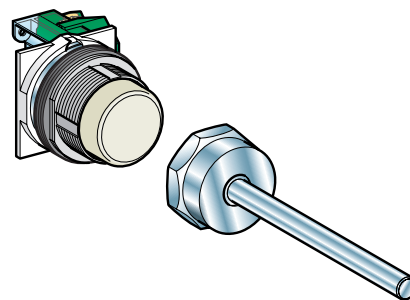
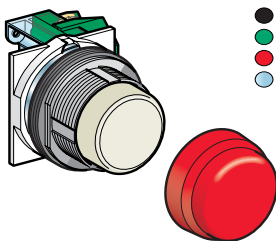

#### Booted pushbuttons

9001SKR●●● + 9001KU● See pages 24 and 18

#### Wobblestick

9001SKR●●● + 9001K8 See pages 24 and 18

### Light functions

#### Pilot lights



#### BA 9s base mounted super bright LED

9001SKP●●● See page 19

#### BA 9s incandescent bulb

9001SKP●●● See page 19

# Control and signaling units Ø 30

Harmony 9001K & 9001SK range  
 Pushbuttons, switches and pilot lights  
 with double insulated bezel  
 Complete units 9001SK

## Complete units

### Combined contact and light functions

#### Illuminated pushbuttons, spring return

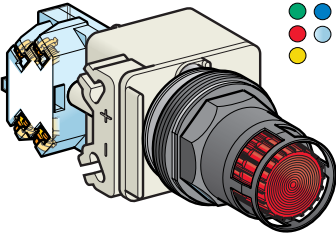

Flush push  
 9001SK1L●●● See page 20

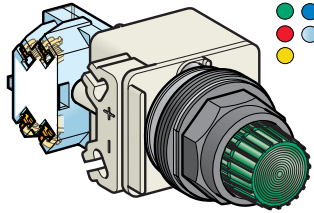

Projecting push  
 9001SK2L●●● See page 21

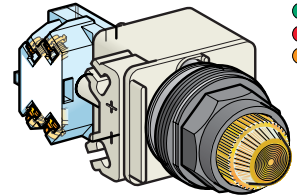

"Push to test", projecting push  
 9001SKT●●●31 See page 22

#### Ø 41/1.61 in. mushroom head illuminated pushbuttons

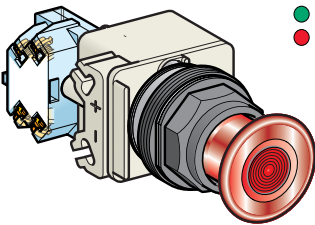

2-position, push-pull  
 9001SKR9P●●● See page 23

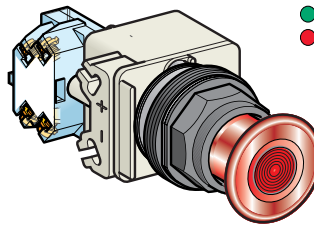

3-position, push-pull  
 9001SKR8P●●● See page 23

## Separate components and accessories

