

# Altivar Soft Starter ATS490

## Soft Starter for Asynchronous Motors

ATEX/IECEx manual for applications in explosive gas atmosphere or in the presence of combustible dust

BQT74920.02  
06/2025



# Legal Information

The information provided in this document contains general descriptions, technical characteristics and/or recommendations related to products/solutions.

This document is not intended as a substitute for a detailed study or operational and site-specific development or schematic plan. It is not to be used for determining suitability or reliability of the products/solutions for specific user applications. It is the duty of any such user to perform or have any professional expert of its choice (integrator, specifier or the like) perform the appropriate and comprehensive risk analysis, evaluation and testing of the products/solutions with respect to the relevant specific application or use thereof.

The Schneider Electric brand and any trademarks of Schneider Electric SE and its subsidiaries referred to in this document are the property of Schneider Electric SE or its subsidiaries. All other brands may be trademarks of their respective owner.

This document and its content are protected under applicable copyright laws and provided for informative use only. No part of this document may be reproduced or transmitted in any form or by any means (electronic, mechanical, photocopying, recording, or otherwise), for any purpose, without the prior written permission of Schneider Electric.

Schneider Electric does not grant any right or license for commercial use of the document or its content, except for a non-exclusive and personal license to consult it on an "as is" basis.

Schneider Electric reserves the right to make changes or updates with respect to or in the content of this document or the format thereof, at any time without notice.

**To the extent permitted by applicable law, no responsibility or liability is assumed by Schneider Electric and its subsidiaries for any errors or omissions in the informational content of this document, as well as any non-intended use or misuse of the content thereof.**

# Table of Contents

Safety Information.....	5
Qualification of Personnel .....	6
Intended Use.....	6
Product related information .....	6
About the document .....	11
Document scope .....	11
Validity note .....	11
Related Documents .....	12
Terminology .....	13
EC Declaration of Conformity .....	14
Certification for functional safety .....	14
Contact us .....	15
Description .....	16
Functional Safety and ATEX/IECEx applications .....	16
Applications for explosive atmosphere (ATEX) .....	17
Ex zones.....	17
ATEX Marking .....	19
Wiring Diagrams For ATEX Applications.....	20
General .....	20
Ex Installation Case 1: Single soft starter with motor thermal switch.....	21
Ex Installation Case 2: Single soft starter with motor thermal switch and with Safety Module Type Preventa XPSUAB.....	22
Ex Installation Case 3: Single soft starter with PTC and control unit .....	24
Ex Installation Case 4: Single soft starter with PTC and control unit and with Safety Module Type Preventa XPSUAB.....	25
Glossary .....	27



# Safety Information

## Important Information

Read these instructions carefully, and look at the equipment to become familiar with the device before trying to install, operate, service, or maintain it. The following special messages may appear throughout this documentation or on the equipment to warn of potential hazards or to call attention to information that clarifies or simplifies a procedure.



The addition of this symbol to a “Danger” or “Warning” safety label indicates that an electrical hazard exists which will result in personal injury if the instructions are not followed.



This is the safety alert symbol. It is used to alert you to potential personal injury hazards. Obey all safety messages that follow this symbol to avoid possible injury or death.

<b>⚠ DANGER</b>
<b>DANGER</b> indicates a hazardous situation which, if not avoided, <b>will result in</b> death or serious injury.

<b>⚠ WARNING</b>
<b>WARNING</b> indicates a hazardous situation which, if not avoided, <b>could result in</b> death or serious injury.

<b>⚠ CAUTION</b>
<b>CAUTION</b> indicates a hazardous situation which, if not avoided, <b>could result in</b> minor or moderate injury.

<b>NOTICE</b>
<b>NOTICE</b> is used to address practices not related to physical injury.

## Please Note

Electrical equipment should be installed, operated, serviced, and maintained only by qualified personnel. No responsibility is assumed by Schneider Electric for any consequences arising out of the use of this material.

A qualified person is one who has skills and knowledge related to the construction and operation of electrical equipment and its installation, and has received safety training to recognize and avoid the hazards involved.

## Qualification of Personnel

Only appropriately trained persons who are familiar with and understand the contents of this manual and all other pertinent product documentation are authorized to work on and with this product. In addition, these persons must have received safety training to recognize and avoid hazards involved. These persons must have sufficient technical training, knowledge and experience and be able to foresee and detect potential hazards that may be caused by using the product, by changing the settings and by the mechanical, electrical and electronic equipment of the entire system in which the product is used. All persons working on and with the product must be fully familiar with all applicable standards, directives, and accident prevention regulations when performing such work.

## Intended Use

This product is intended for industrial use according to this manual.

The product may only be used in compliance with all applicable safety standard and local regulations and directives, the specified requirements and the technical data. The product must be installed outside the hazardous Ex zone. Prior to using the product, you must perform a risk assessment in view of the planned application. Based on the results, the appropriate safety measures must be implemented. Since the product is used as a component in an entire system, you must ensure the safety of persons by means of the design of this entire system (for example, machine design). Any use other than the use explicitly permitted is prohibited and can result in hazards.

## Product related information

**Read and understand these instructions before performing any procedure with this soft starter.**

### **DANGER**

#### **HAZARD OF ELECTRIC SHOCK, EXPLOSION, OR ARC FLASH**

- Only appropriately trained persons who are familiar with and fully understand the contents of the present manual and all other pertinent product documentation and who have received all necessary training to recognize and avoid hazards involved are authorized to work on and with this equipment.
- Installation, adjustment, repair and maintenance must be performed by qualified personnel.
- Verify compliance with all local and national electrical code requirements as well as all other applicable regulations with respect to grounding of all equipment.
- Only use properly rated, electrically insulated tools and measuring equipment.
- Do not touch unshielded components or terminals with voltage present.
- Prior to performing any type of work on the equipment, block the motor shaft to prevent rotation.
- Insulate both ends of unused conductors of the motor cable.

**Failure to follow these instructions will result in death or serious injury.**

**⚠️⚠️ DANGER****HAZARD OF ELECTRIC SHOCK, EXPLOSION, OR ARC FLASH**

Before performing work on the equipment:

- Use all required personal protective equipment (PPE).
- Disconnect all power, including external control power that may be present. Take into account that the circuit breaker or main switch does not de-energize all circuits.
- Place a "Do Not Turn On" label on all power switches related to the equipment.
- Lock all power switches in the open position.
- Verify the absence of voltage using a properly rated voltage sensing device.

Before applying voltage to the equipment:

- Verify that the work has been completed and that the entire installation cannot cause hazards.
- If the mains input terminals and the motor output terminals have been grounded and short-circuited, remove the ground and the short circuits on the mains input terminals and the motor output terminals.
- Verify proper grounding of all equipment.
- Verify that all protective equipment such as covers, doors, grids is installed and/or closed.

**Failure to follow these instructions will result in death or serious injury.**

**⚠️⚠️ DANGER****HAZARD OF ELECTRIC SHOCK, EXPLOSION, OR ARC FLASH**

- Never operate energized switch with door open.
- Turn off switch before removing or installing fuses or making load side connections.
- Do not use renewable link fuses in fused switches.

**Failure to follow these instructions will result in death or serious injury.**

Damaged products or accessories may cause electric shock or unanticipated equipment operation.

**⚠️⚠️ DANGER****ELECTRIC SHOCK OR UNANTICIPATED EQUIPMENT OPERATION**

Do not use damaged products or accessories.

**Failure to follow these instructions will result in death or serious injury.**

Contact your local Schneider Electric sales office if you detect any damage whatsoever.

This equipment has been designed to operate outside of any hazardous location. Only install this equipment in zones known to be free of a hazardous atmosphere.

**⚠️ DANGER****POTENTIAL FOR EXPLOSION**

Install and use this equipment in non-hazardous locations only.

**Failure to follow these instructions will result in death or serious injury.**

Your application consists of a whole range of different interrelated mechanical, electrical, and electronic components, the device being just one part of the application. The device by itself is neither intended to nor capable of providing the entire functionality to meet all safety-related requirements that apply to your application. Depending on the application and the corresponding risk assessment to be conducted by you, a whole variety of additional equipment is required such as, but not limited to, external monitoring devices, guards, etc.

As a designer/manufacturer of machines, you must be familiar with and observe all standards that apply to your machine. You must conduct a risk assessment and determine the appropriate Performance Level (PL) and/or Safety Integrity Level (SIL) and design and build your machine in compliance with all applicable standards. In doing so, you must consider the interrelation of all components of the machine. In addition, you must provide instructions for use that enable the user of your machine to perform any type of work on and with the machine such as operation and maintenance in a safe manner.

The present document assumes that you are fully aware of all normative standards and requirements that apply to your application. Since the device cannot provide all safety-related functionality for your entire application, you must ensure that the required Performance Level and/or Safety Integrity Level is reached by installing all necessary additional equipment.

## **⚠ WARNING**

### **INSUFFICIENT PERFORMANCE LEVEL/SAFETY INTEGRITY LEVEL AND/OR UNINTENDED EQUIPMENT OPERATION**

- Conduct a risk assessment according to EN ISO 12100 and all other standards that apply to your application.
- Use redundant components and/or control paths for all critical control functions identified in your risk assessment.
- Implement all monitoring functions required to avoid any type of hazard identified in your risk assessment, for example, slipping or falling loads.
- Verify that the service life of all individual components used in your application is sufficient for the intended service life of your overall application.
- Perform extensive commissioning tests for all potential error situations to verify the effectiveness of the safety-related functions and monitoring functions implemented, for example, but not limited to, speed monitoring by means of encoders, short circuit monitoring for all connected equipment, correct operation of brakes and guards.
- Perform extensive commissioning tests for all potential error situations to verify that the load can be brought to a safe stop under all conditions.

**Failure to follow these instructions can result in death, serious injury, or equipment damage.**

Product may perform unexpected movements because of incorrect wiring, incorrect settings, incorrect data or other errors.

## **⚠ WARNING**

### **UNANTICIPATED EQUIPMENT OPERATION**

- Carefully install the wiring in accordance with the EMC requirements.
- Do not operate the product with unknown or unsuitable settings or data.
- Perform a comprehensive commissioning test.

**Failure to follow these instructions can result in death, serious injury, or equipment damage.**

<b>▲ WARNING</b>
<p><b>LOSS OF CONTROL</b></p> <ul style="list-style-type: none"> <li>• The designer of any control scheme must consider the potential failure modes of control paths and, for critical control functions, provide a means to achieve a safe state during and after a path failure. Examples of critical control functions are emergency stop, overtravel stop, power outage and restart.</li> <li>• Separate or redundant control paths must be provided for critical control functions.</li> <li>• System control paths may include communication links. Consideration must be given to the implications of unanticipated transmission delays or failures of the link.</li> <li>• Observe all accident prevention regulations and local safety guidelines (1).</li> <li>• Each implementation of the product must be individually and thoroughly tested for proper operation before being placed into service.</li> </ul> <p><b>Failure to follow these instructions can result in death, serious injury, or equipment damage.</b></p>

(1) For USA: Additional information, refer to NEMA ICS 1.1 (latest edition), Safety Guidelines for the Application, Installation and Maintenance of Solid State Control.

Machines, controllers, and related equipment are usually integrated into networks. Unauthorized persons and malware may gain access to the machine as well as to other devices on the network/fieldbus of the machine and connected networks via insufficiently secure access to software and networks.

<b>▲ WARNING</b>
<p><b>UNAUTHORIZED ACCESS TO THE MACHINE VIA SOFTWARE AND NETWORKS</b></p> <ul style="list-style-type: none"> <li>• In your hazard and risk analysis, consider all hazards that result from access to and operation on the network/fieldbus and develop an appropriate cyber security concept.</li> <li>• Verify that the hardware infrastructure and the software infrastructure into which the machine is integrated as well as all organizational measures and rules covering access to this infrastructure consider the results of the hazard and risk analysis and are implemented according to best practices and standards covering IT security and cyber security (such as: ISO/IEC 27000 series, Common Criteria for Information Technology Security Evaluation, ISO/ IEC 15408, IEC 62351, ISA/IEC 62443, NIST Cybersecurity Framework, Information Security Forum - Standard of Good Practice for Information Security, SE recommended Cybersecurity Best Practices*).</li> <li>• Verify the effectiveness of your IT security and cyber security systems using appropriate, proven methods.</li> </ul> <p><b>Failure to follow these instructions can result in death, serious injury, or equipment damage.</b></p>

(\*) : SE Recommended Cybersecurity Best Practices can be downloaded on [SE.com](http://SE.com).

<b>▲ WARNING</b>
<p><b>LOSS OF CONTROL</b></p> <p>Perform a comprehensive commissioning test to verify that communication monitoring properly detects communication interruptions.</p> <p><b>Failure to follow these instructions can result in death, serious injury, or equipment damage.</b></p>

This product meets the EMC requirements according to the standard IEC 60947-4-2. This device has been designed for environment A. Use of this product in a domestic environment (B environment) may cause unwanted radio interference.

## **⚠️⚠️ WARNING**

### **RADIO INTERFERENCE**

- In a domestic environment (B environment), this product may cause radio interference in which case supplementary mitigation measures may be required.

**Failure to follow these instructions can result in death, serious injury, or equipment damage.**

## **NOTICE**

### **DESTRUCTION DUE TO INCORRECT MAINS VOLTAGE**

Before switching on and configuring the product, verify that it is approved for the mains voltage.

**Failure to follow these instructions can result in equipment damage.**

# About the document

## Document scope

The purpose of this document is to explain how the STO (Safe Torque Off) safety function allows the ATS490 soft starter to control and command motors installed in explosive atmospheres (Ex zones\* 1/21, or zones 2/22).

\*ATEX zones following ATEX directive 2014/34/UE.

## Validity note

Original instructions and information given in the present document have been written in English (before optional translation).

**NOTE:** The products listed in the document are not all available at the time of publication of this document online. The data, illustrations and product specifications listed in the guide will be completed and updated as the product availabilities evolve. Updates to the guide will be available for download once products are released onto the market.

This documentation is valid only for ATS490.

The characteristics that are presented in this manual should be the same as those characteristics that appear online. In line with our policy of constant improvement, we may revise content over time to improve clarity and accuracy. If you see a difference between the manual and online information, use the online information as your reference.

The technical characteristics of the devices described in the present document also appear online. To access the information online:

Step	Action
1	Go to the Schneider Electric home page <a href="http://www.se.com">www.se.com</a> .
2	In the Search box type the reference of the product or the name of a product range. <ul style="list-style-type: none"> <li>• Do not include blank spaces in the reference or product range.</li> <li>• To get information on grouping similar modules, use asterisks (*).</li> </ul>
3	If you entered a reference, go to the Product Datasheets search results and click on the reference that interests you.  If you entered the name of a product range, go to the Product Ranges search results and click on the product range that interests you.
4	If more than one reference appears in the Products search results, click on the reference that interests you.
5	Depending on the size of your screen, you may need to scroll down to see the data sheet.
6	To save or print a data sheet as a .pdf file, click <b>Download XXX product datasheet</b> .

## Related Documents

Use your tablet or your PC to quickly access detailed and comprehensive information on all our products on [www.se.com](http://www.se.com) The Internet site provides the information you need for products and solutions:

- The whole catalog for detailed characteristics and selection guides
- The CAD files to help design your installation, available in over 20 different file formats
- All software and firmware to maintain your installation up to date
- A large quantity of White Papers, Environment documents, Application solutions, Specifications... to gain a better understanding of our electrical systems and equipment or automation
- And finally all the User Guides related to your soft starter, listed below:

## Catalog

Title of documentation	Reference number
Catalog: Altivar Soft Starter ATS490	DIA2ED2240603EN (English) DIA2ED2240603FR (French)

## Documentations

Title of documentation	Reference number
ATS490 Getting Started	PKR63410 (English), PKR63411 (French) PKR63412 (Spanish), PKR63413 (Italian) PKR63414 (German), PKR63415 (Chinese) PKR63416 (Portuguese), PKR63417 (Turkish)
ATS490 Getting Started Manual Annex for UL	PKR63418 (English)
ATS490 User Manual	PKR52680 (English), PKR52681 (French) PKR52682 (Spanish), PKR52683 (Italian) PKR52684 (German), PKR52685 (Chinese) PKR52686 (Portuguese), PKR52687 (Turkish)
ATS490 Embedded Safety Function Manual	PKR63419 (English)
ATS490 ATEX Manual	BQT74920 (English)
ATS490 Embedded Modbus RTU Manual	PKR63421 (English)
ATS490 EtherNet Manual	PKR63423 (English)
ATS490 PROFIBUS DP Manual (VW3A3607)	PKR63425 (English)
ATS490 CANopen Manual (VW3A3608, VW3A3618, VW3A3628)	PKR63426 (English)
ATS490 PROFINET Manual (VW3A3647)	PKR63424 (English)
ATS490 Communication Parameter Addresses	PKR63420 (English)
Recommended Cybersecurity Best Practices	CS-Best-Practices-2019–340 (English)

You can download there technical publications and other technical information from our website at [www.se.com/en/download](http://www.se.com/en/download).

## Videos

Title of documentation	Reference number
Video: Getting Started with ATS490	FAQ000263202 (English)

## Software

Title of documentation	Reference number
SoMove: FDT	SoMove FDT (English, French, German, Spanish, Italian, Chinese)
ATS490: DTM	ATS490 DTM Library EN (English – to be installed first) ATS490 DTM Lang FR (French) ATS490 DTM Lang SP (Spanish) ATS490 DTM Lang IT (Italian) ATS490 DTM Lang DE (German) ATS490 DTM Lang CN (Chinese)

## Terminology

The technical terms, terminology, and the corresponding descriptions in this manual normally use the terms or definitions in the relevant standards.

In the area of soft starters this includes, but is not limited to, terms such as error, error message, failure, fault, fault reset, protection, safe state, safety function, warning, warning message, and so on.

Among others, these standards include:

European standards:

- IEC 60947–1 Low–Voltage Switchgear and Control Gear – General rules
- IEC 60947–4–2 Semiconductor Motor controllers, Starters and Soft Starters
- IEC 60529 Degrees of protection provided by enclosures (IP Code)  
Safety of machinery – Electrical equipment of machines – General requirements
- IEC 60664–1 Insulation coordination for equipment within low-voltage supply systems – Principles, requirements, and tests
- IEC 61000–4–2/–4–3/4–4/4–5/4–6/4–11/4–12 Electromagnetic Compatibility
- IEC 60721–3 Classification of environmental conditions
- IEC 61131–2: Programmable controllers – Part 2: Equipment requirements and tests
- IEC 60068: Environmental testing
- IEC 61158 series: Industrial communication networks – Fieldbus specifications
- IEC 61784 series: Industrial communication networks – Profiles
- IEC 62443: Security for industrial automation and control systems

European Community directives:

- 86/188/EEC Protection of Workers for the Risks Related to Exposure to Noise at Work
- 2014/35/EU Low Voltage Directive
- 2014/30/EU EMC Directive
- 2006/42/EC Machine Directive

North American standards:

- UL 60947-4-2: Low-Voltage Switchgear and Control gear – Part 4-2: Contactors and Motor-Starters – AC Semiconductor Motor Controllers and Starters

Other standards:

- ISO 12100:2010: Safety of machinery – General principles for design – Risk assessment and risk reduction
- GB/T 14078.6-2016: Low-Voltage Switchgear and Control Gear - - Part 4-2: Contactors and motor starters - - AC Semiconductor Motor Controllers and Starters (including Soft Starters)
- IEC 61800-9-2: Adjustable speed electrical power drive systems – Part 9-2: Ecodesign for power drive systems, motor starters, power electronics and their driver applications – Energy efficiency indicators for power drive systems and motor starters

In addition, the term zone of operation is used in conjunction with the description of specific hazards, and is defined as it is for a hazard zone or danger zone in the EC Machinery Directive (2006/42/EC) and in ISO 12100-1.

Also see the glossary at the end of this manual.

## EC Declaration of Conformity

The EC Declaration of Conformity can be obtained on [www.se.com](http://www.se.com)

## Certification for functional safety

Compliance with a safety-related control system using the principles of IEC 61508, 60204 or the ISO 13849-1, as well as the IEC 62061 for process systems and machinery.

The defined safety function is:

- SIL-1 capability in compliance with IEC 61508 series Ed.2
- Performance Level **c** in compliance with ISO 13849-1
- *Compliant with Category 2 of International standard ISO 13849-1*

Also refer to **Safety function capability** Chapter in the ATS490 Embedded Safety Manual PKR63419.

The safety demand mode of operation is considered in high demand or continuous mode of operation according to the IEC 61800-5-2 standard.

The certificate for functional safety is accessible on [www.se.com](http://www.se.com)

## Contact us

Select your country on [www.se.com/contact](http://www.se.com/contact).

Schneider Electric Industries SAS

Head Office

35, rue Joseph Monier

92500 Rueil-Malmaison

France

# Description

## Functional Safety and ATEX/IECEx applications

### General

The soft starter ATS490 integrates the STO (Safe Torque Off) safety function which shuts off the motor torque safely. The use of the STO safety function allows the soft starter to be installed as a part of the safety-related electrical, electronic and programmable electronic control systems, dedicated to the safety of a machine or an industrial process.

The use of the STO safety function is required for the soft starter ATS490 to control and command motors installed in explosive atmospheres ATEX and IECEx.

The STO safety function is an ATEX and IECEx. certified function, according to ATEX 94/9/EC directive and 2014/34/EU directive.

The integrated safety function is compatible and certified following the information given in the [Certification for Functional Safety](#) section, page 14. It complies also with the EN 50495 (2010): Safety devices required for the safe functioning of equipment with respect to explosion risks.

### Monitoring of the ATEX Motor

The STO input is connected to the switching system which is embedded in the thermal sensor of the ATEX motor (or connected to the switching system of the control system if ATEX sensors of PTC type are used).

The soft starter ATS490 intended to be used to command and control asynchronous motors shall be installed only outside potentially explosive atmospheres for the protection of explosion-protected motors.

### Relevant standard

Complies with:

- EN 50495 (2010) Safety devices required for the safe functioning of equipment with respect to explosion risks.
- ATEX certificat.
- IEC 60079\_0 (2017) Safety devices required for the design, construction, testing, and marking of electrical equipment used in explosive atmospheres.
- IEC/TS 60079\_42 (2019) Technical specification provides guidance on the assessment of the ignition and other potential hazards for electrical equipment in explosive atmospheres.

# Applications for explosive atmosphere (ATEX)

## Ex zones

### Classification

The European directive 1999/92/EC (also called ATEX 137, or directive for protection of workers) classifies the Ex zones and the type of products that they are compatible with. The user should define the Ex zone in which the ATEX motor will be installed.

This equipment has been designed to operate outside of any hazardous location. Only install this equipment in zones known to be free of a hazardous atmosphere.

<b>⚠ DANGER</b>			
<b>POTENTIAL FOR EXPLOSION</b>			
Install and use this equipment in non-hazardous locations only.			
<b>Failure to follow these instructions will result in death or serious injury.</b>			

Different wiring diagrams for installation are suggested in this document. They are compatible with the use of motors in Ex zones 1/21 or 2/22

The following table summarizes characteristics related to each Ex zone\*

Atmosphere	Zone	Definition	Presence of explosive atmosphere per year
Gas	0	Explosive atmosphere is present continuously, for long periods or frequently due to malfunctions	> 1000 h
Dust	20		
Gas	1	Explosive atmosphere is likely to occur due to expected malfunctions	10...1000 h
Dust	21		
Gas	2	Explosive atmosphere is unlikely to occur or, if occurring, is likely to only be of short duration and not in normal duty	< 10 h
Dust	22		

**NOTE:** Neither electrical equipment nor motors can be installed in Ex zone 0 or 20.

\*ATEX zones following ATEX directive 2014/34/UE.

## General

The European directives 94/9/EC and 2014/34/UE (also called ATEX 95, or product directive) defines applicable requirements for ATEX products and requirements for procedure of certification.

OEMs, installers, users are responsible for the choice and the commissioning of the products they use in order to realize the ATEX protection of systems that they design or systems that they implement.

- The motor needs to be ATEX certified EX "d" and compatible for use in zone 1/21 or 2/22.
- The motor shall be equipped with thermal sensor(s) with embedded switching system ATEX certified, or shall be equipped with thermal sensor(s) ATEX certified, associated to a control unit (Level of protection intrinsic safety "i"), which is to be also ATEX certified.

**NOTE:** Usually, the control unit is designed to be used outside the hazardous Ex zone. Then it is possible to install the control unit near the soft starter, outside the hazardous Ex zone.

The switching system, embedded into the thermal sensor, or included into the control unit of the thermal protection of the ATEX motor, shall be connected to the STO input of the soft starter ATS490. When the excessive temperature of the ATEX motor is reached, the control system triggers the STO safety function. The electrical power of the motor is removed to help to ensure a temperature of the motor frame below the maximum temperature depending on the gas or the dust atmosphere in which the ATEX motor is installed.

When the ATEX/IECEx application needs to apply the STO safety function, and prevent automatic restart, then a safety module (type Preventa) is to be used. The suggested wiring diagrams describe how the switching system, embedded into the thermal sensor or included into the control unit, is connected to the safety module. The output of the safety module must be connected to the STO input of the soft starter ATS490.

# ATEX Marking

## Identification

The soft starter ATS490, ATEX/IECEx certified, can be recognized by the specific marking reproduced hereafter:

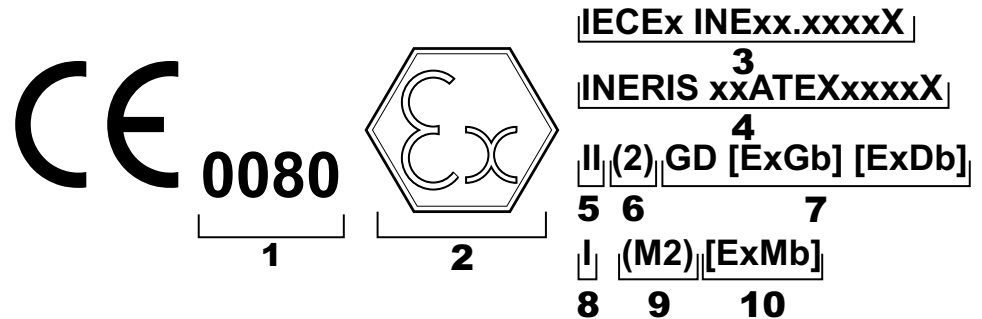

- 0080** is the identification number of the notified body INERIS, which has delivered the notifications for systems of production quality assurance of production lines for drives, in compliance with the standard EN 13980.
- Logo related to the identification of an ATEX product.
- IECEx INEEx.xxxxX** is the identification code of the EC Type examination certificate issued by the notified body IECEx to demonstrate the compliance of the soft starter with the requirements of the IEC 60079-19 directive.
- INERIS xxATEXxxxxX** is the identification code of the EC Type examination certificate issued by the notified body INERIS to demonstrate the compliance of the soft starter with the requirements of the ATEX 94/9/EC directive.
- II** relates to the use of products for ATEX application in surface industries.
- (2)** Parenthesis identifies the soft starter ATS490 as a product associated with the control & command of an ATEX motor installed in a hazardous zone. The number 2 identifies the ATEX motor as a product of category 2 for use in Ex zones 1 or 21. Motors of category 3 for use in Ex zones 2 or 22 are also covered by this marking.
- [ExGb]** and **G**: for Gas, is related to ATEX applications in atmospheres with explosive gas.  
**[ExDb]** and **D**: for Dust, is related to ATEX applications in atmospheres with a mixture of explosive dust.
- I** relates to the use of products for ATEX application in mines.
- (M2)** Parenthesis identifies the soft starter ATS490 as a product associated with the control & command of an ATEX motor installed in a hazardous zone. The number 2 identifies the ATEX motor as a product of category 2 for use in Ex zones 1 or 21.
- [ExMb]**: for Methane and Dust, is related to ATEX applications in atmospheres with explosive gas and mixture explosive dust.

# Wiring Diagrams For ATEX Applications

## General

### Requirements

Requirements provided by the ATEX standards for installation should be fulfilled. Also follow the requirements below:

- IEC 60079-14 Electrical installations design, selection and erection, for applications in atmospheres with explosive gas,
- local regulation, cabling rules for applications in atmospheres with presence of gas or dust.

### Wiring Diagrams Presentation

Schemes suggested in this document for installation and commissioning of the soft starter ATS490 for ATEX applications are based on thermal sensors (for example a PTC sensor) embedded in the ATEX motor and an intrinsic safety "i" control unit. The control unit is a device which converts in a switching function the variation of the characteristic of a thermal sensor.

### ATEX Periodic test

The complete functional safety loop (which starts from the ATEX motor thermal sensor up to the STO safety function embedded in the soft starter), shall be activated at least once a year for preventive maintenance purposes, in order to check that the electrical power is always automatically removed from the motor in case of excessive temperature.

### Shielded Cables on I/O

#### **⚠ WARNING**

##### **UNANTICIPATED EQUIPMENT OPERATION**

- Use shielded cables for all digital and analog I/O signals and communication signals.
- Ground cable shields at a single point.
- Route communication cables and I/O cables separately from power cables.

**Failure to follow these instructions can result in death, serious injury, or equipment damage.**

# Ex Installation Case 1: Single soft starter with motor thermal switch

## Description

- ATEX motor in Zone 1 or 21 or 2 or 22 (following wiring diagram).
- STO inputs used for thermal protection of the ATEX motor, SIL1 capability according to IEC 61508.
- Thermal protection of the ATEX motor by using an ATEX thermal switch.

## Wiring Diagram For Ex Zone 1 or 21

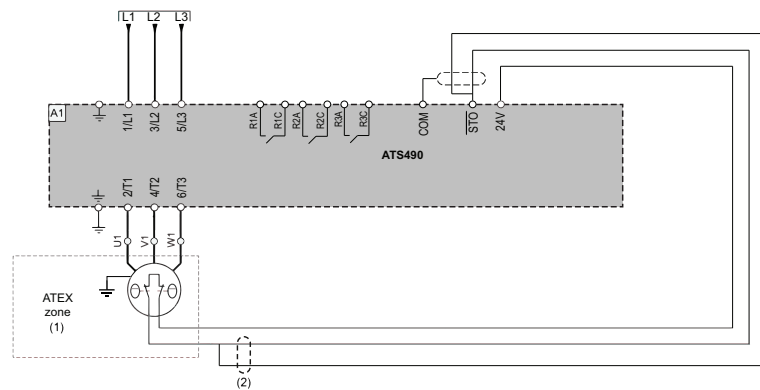

1. Ex Zone 1 or 21. ATEX Motor type “d” with embedded type “d” thermal switches. These thermal switches must fulfill the reinforced insulation according to IEC 61800-5-1.
2. Cable and wiring following IEC 60079-14 standard. STO cables must be shielded and run apart from the supply cable.

## Wiring Diagram For Ex Zone 2 or 22

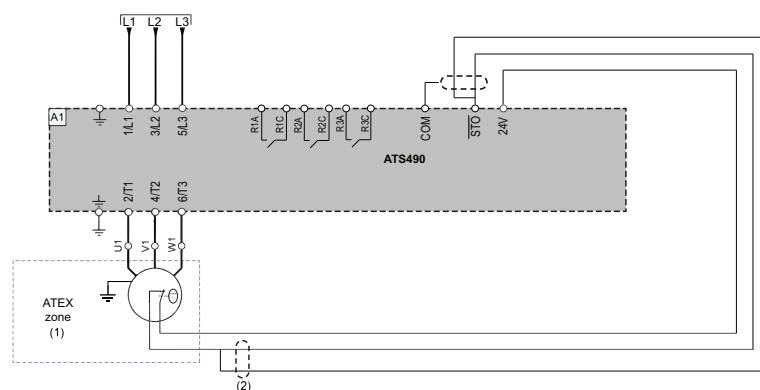

1. Ex Zone 2 or 22. ATEX Motor type “d” with embedded type “d” thermal switches. These thermal switches must fulfill the reinforced insulation according to IEC 61800-5-1.
2. Cable and wiring following IEC 60079-14 standard. STO cables must be shielded and run apart from the supply cable.

## Ex Installation Case 2: Single soft starter with motor thermal switch and with Safety Module Type Preventa XPSUAB

### Description

- ATEX motor in Zone 1 or 21 or 2 or 22 (following wiring diagram).
- STO input used for thermal protection of the ATEX motor, SIL 1 capability according to IEC 61508.
- Thermal protection of the ATEX motor by using an ATEX thermal switch.

### Wiring Diagram For Zone 1 or 21

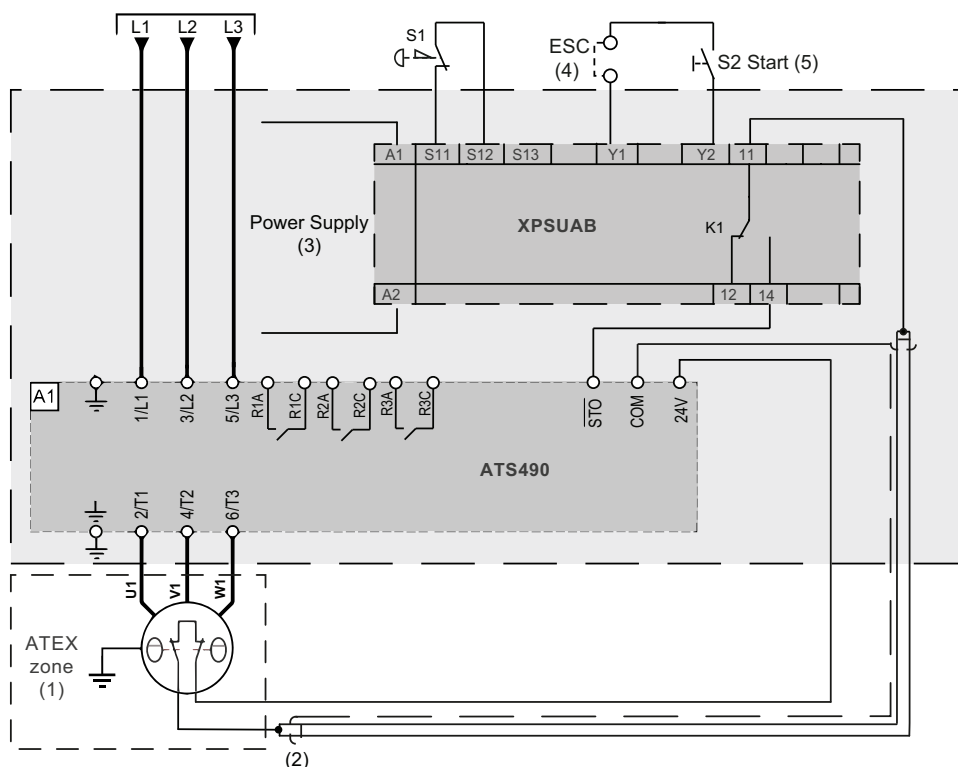

1. Ex Zone 1 or 21. ATEX Motor type "d" with embedded type "d" thermal switches. These thermal switches must fulfill the reinforced insulation according to IEC 61800-5-1.
2. Cable and wiring following IEC 60079-14 standard. STO cables must be shielded and run apart from the supply cable.
3. Refer to the XPSUAB Safety Module User Manual EIO0000003454 for more information on the power supply.
4. External Start Condition **ESC** is used to add external starting conditions.
5. On power-up or after an emergency stop, rearm the XPSUAB safety module using push-button S2.

## Wiring Diagram For Zone 2 or 22

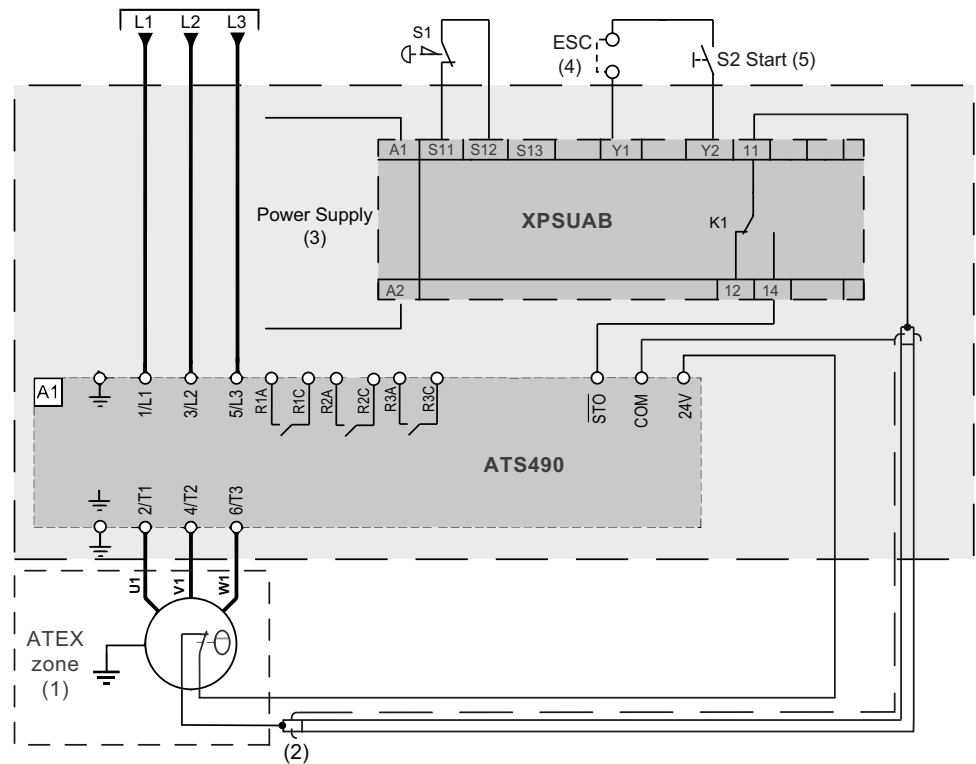

1. Ex Zone 2 or 22. ATEX Motor type “d” with embedded type “d” thermal switches. These thermal switches must fulfill the reinforced insulation according to IEC 61800-5-1.
2. Cable and wiring following IEC 60079-14 standard. STO cables must be shielded and run apart from the supply cable.
3. Refer to the XPSUAB Safety Module User Manual EIO0000003454 for more information on the power supply.
4. External Start Condition **ESC** is used to add external starting conditions.
5. On power-up or after an emergency stop, rearm the XPSUAB safety module using push-button S2.

## Ex Installation Case 3: Single soft starter with PTC and control unit

### Description

- ATEX motor in Zone 1 or 21 or 2 or 22
- STO inputs used for protection of the ATEX motor sensor only, SIL1 capability according to IEC 61508.
- Thermal protection of the ATEX motor by using an ATEX thermal sensor (PTC type, without embedded switching system), and a control unit for the PTC conversion, including the switching system.

### Wiring Diagram

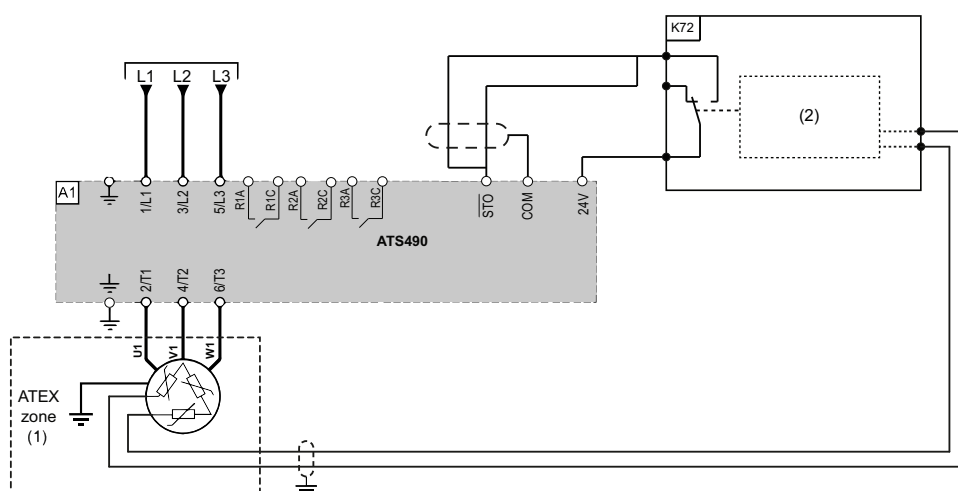

1. Ex Zone 1 or 21 or 2 or 22 with at least 1 thermal sensor PTC type
2. ATEX certified Control unit conversion / insulation / switching system with Level of protection intrinsic safety "i".

**(K72)** ATEX certified PTC relay

# Ex Installation Case 4: Single soft starter with PTC and control unit and with Safety Module Type Preventa XPSUAB

## Description

- ATEX motor in Zone 1 or 21 or 2 or 22
- STO input used for protection of the ATEX motor, SIL 1 capability according to IEC 61508 and for functional safety SIL3 capability according to IEC61508, stop category 0 according to IEC 60204-1, and category 3 PL e according to ISO 13849-1.
- Thermal protection of the ATEX motor by using an ATEX thermal sensor (PTC type, without embedded switching system), and a control unit for the PTC conversion, including the switching system

## Wiring Diagram

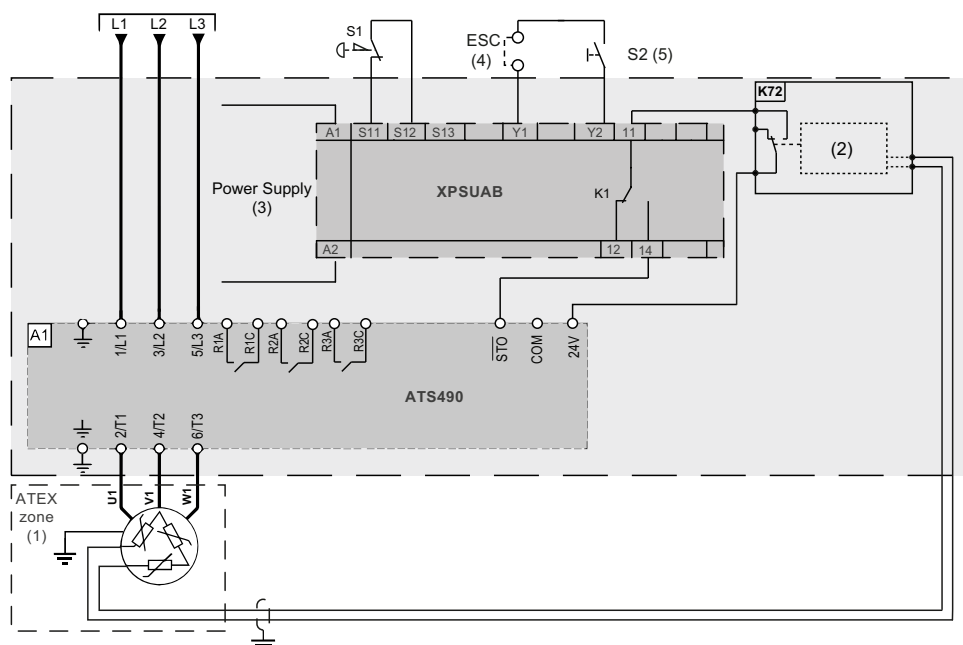

1. Ex Zone 1 or 21 or 2 or 22 with at least 1 thermal sensor PTC type
2. ATEX certified Control unit conversion / insulation / switching system. **(K72)** ATEX certified PTC relay.
3. Refer to the XPSUAB Safety Module User Manual EIO0000003454 for more information on the power supply.
4. External Start Condition **ESC** is used to add external starting conditions.
5. On power-up or after an emergency stop, rearm the XPSUAB safety module using push-button S2.



# Glossary

## O

### **OEM:**

Original Equipment Manufacturer

## P

### **PTC:**

Positive Temperature Coefficient. PTC thermistor probes integrated in the motor or application to measure its temperature

## S

### **STO:**

Safe Torque Off: No power that could cause torque or force is supplied to the motor

Schneider Electric  
35 rue Joseph Monier  
92500 Rueil Malmaison  
France

+ 33 (0) 1 41 29 70 00

[www.se.com](http://www.se.com)

As standards, specifications, and design change from time to time, please ask for confirmation of the information given in this publication.

© 2025 Schneider Electric. All rights reserved.

BQT74920.02 – 03/2025