

Protection

Circuit protection / Earth leakage protection

Electrical auxiliaries for iC60, iID, iC40, iCV40, iID40, iDPN Vigi, iSW-NA

■ The electrical auxiliaries are combined with iC60, iC40, iCV40, iDPN Vigi circuit breakers, iID, iID40 residual current circuit breakers, remote tripping switch disconnecter iSW-NA; they enable tripping or remote indication of their position (open/closed/tripped) upon a fault.

■ They are fastened by clips (without tools) to the left side of the breaker.

■ The iOF/SD+OF auxiliary is a 2-in-1 product: via a mechanical selector switch, it provides two contacts, OF+SD or OF+OF.

■ The iOF+SD24 auxiliary can report open/closed (OF) status information and intentional or fault tripping of the associated device (SD) to the Acti9 Smartlink or a programmable logic controller via the Ti24 interface (24 V DC).

Tripping auxiliaries:

IEC/EN 60947-1

- iMN: undervoltage release
- iMNs: delayed undervoltage release
- iMNx: undervoltage release, independant from supply voltage
- iMX: shunt release
- iMX+OF: shunt release with open/close contact.

EN 50550

- iMSU: overvoltage release.

Indication auxiliaries:

IEC/EN 60947-5-1

- iOF: open/close contact
- iSD: fault indicating contact
- iOF/SD+OF: open/close contact and switchable OF or SD contact
- iOF+SD24: open/close contact OF and default indicating contact SD with Ti24 interface.

IEC/EN 60947-5-4

- iOF+SD24: open/close contact OF and default indicating contact SD with Ti24 interface.

DB404939





DB404940



Circuit protection / Earth leakage protection

Electrical auxiliaries for iC60, iID, iC40, iCV40, iID40, iDPN Vigi, iSW-NA (cont.)

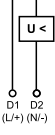
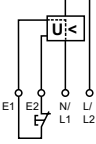

		Tripping						
Auxiliaries		iMN		iMNs		iMNx		
Type		Undervoltage release						
		Instantaneous		Delayed		Independent of the supply voltage		
								
Function		<ul style="list-style-type: none"> Trips the device with which it is combined when its input voltage decreases (between 70 % and 35 % Un). Prevents device closing again until its input voltage is restored 		<ul style="list-style-type: none"> Not tripping on transient voltage dip (up to 0.2 s) 		<ul style="list-style-type: none"> Tripping of the associated device by opening of the control circuit (e.g. push-button, dry contact) A drop in the supply voltage does not trip the associated device A locking push-button control allows the circuit protected (e.g. machine control) to be placed in safety configuration 		
Wiring diagrams								
Use		<ul style="list-style-type: none"> Emergency stoppage by normally closed push button Improve the safety of power supply circuits for several machines by preventing "uncontrolled" restarting 				<ul style="list-style-type: none"> Emergency stoppage with fail-safe principle Insensitive to control circuit voltage variation to increase service continuity Important: Before any servicing operation switch off the mains power supply (voltage presence at terminals E1/E2) 		
Catalogue numbers		A9A26960	A9A27108	A9A26961	A9A26959	A9A26963	A9A26969	A9A26971
iC60, iID, iC40, iCV40, iID40, iDPN Vigi, iSW-NA		■	■	■	■	■	■	■
iC60, iID double terminals		■	■	■	■	■	■	■
iC60 RCBO, iKQE RCBO		■	■	■	■	■	■	■
Technical specifications		220...240 V AC		24 V AC	48 V AC	115 V AC	220...240 V AC	
Rated voltage (Ue)			24 V DC	48 V CC				380...415 V AC
Standardised operating and non-response to voltage times (Ua)*		-	-	-	-	-	-	-
Maximum operating time		-	-	-	-	-	-	-
Minimum non-response time		-	-	-	-	-	-	-
Operating frequency		50/60 Hz			400 Hz	50/60 Hz	50/60 Hz	
Red mechanical indicator		On front face				On front face	On front face	
Test function		-				-	-	
Width in 9 mm modules		2				2	2	
Operating current		-				-	-	
Number of contacts		-				-	-	
Operating temperature		-35...+70°C				-35...+70°C	-35...+70°C	
Storage temperature		-40...+85°C				-40...+85°C	-40...+85°C	

*(Ua)
 Voltages measured between the phase and the neutral conductor, at which the iMSU device must control the associated protective device.

Protection

Circuit protection / Earth leakage protection



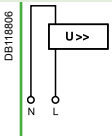
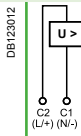
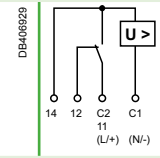

Electrical auxiliaries for iC60, iID, iC40, iCV40, iID40, iDPN Vigi, iSW-NA (cont.)

iMSU					iMX			iMX+OF					
Overvoltage release					Shunt release								
					With Open/Close auxiliary contact								
													
<ul style="list-style-type: none"> Switches off the power supply by opening the breaker with which it is combined, in the event that the phase/neutral voltage is exceeded (loss of neutral). For a four-phase network, use three iMSU tripping auxiliaries. 					<ul style="list-style-type: none"> Trips the associated device when it is powered on 								
					<ul style="list-style-type: none"> Includes an open/close contact (OF) to indicate the "open" or "closed" position of the device 								
													
<ul style="list-style-type: none"> Protection of equipment against overvoltages on the electrical network (neutral conductor break) Voltage monitoring between phase and neutral conductors 					<ul style="list-style-type: none"> Emergency stoppage by normally open push button 			<ul style="list-style-type: none"> Emergency stoppage by normally open push button Remote indication of the position of the associated device 					
A9A26500					A9A26476		A9A26477	A9A26478	A9A26946	A9A26947	A9A26948		
■					■		■	■	■	■	■		
■					■		■	■	■	■	■		
■					■		■	■	■	■	■		
230 V AC					100...415 V AC		48 V AC	12...24 V AC	100...415 V AC	48 V AC	12...24 V AC		
-					110...130 V DC		48 V DC	12...24 V DC	110...130 V DC	48 V DC	12...24 V DC		
255 V AC					275 V AC	300 V AC	350 V AC	400 V AC	-				
No tripping					15 s	5 s	0.75 s	0.20 s	-				
					3 s	1 s	0.25 s	0.07 s	-				
50/60 Hz					50/60 Hz					50/60 Hz			
On front face					On front face					On front face			
-					-					-			
2					2					2			
-					-					10 mA mini, 6 A maxi			
										≤ 24 V DC			
										48 V DC			
										≤ 130 V DC			
										≤ 240 V AC			
										415 V AC			
										1 NO/NC			
-35...+70°C					-35...+70°C					-35...+70°C			
-40...+85°C					-40...+85°C					-40...+85°C			

Protection

Circuit protection / Earth leakage protection

Electrical auxiliaries for iC60, iID, iC40, iCV40, iID40, iDPN Vigi, iSW-NA (cont.)

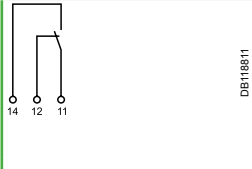
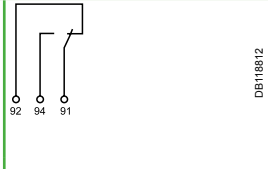
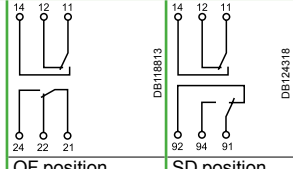
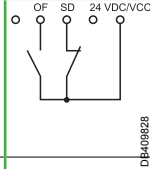
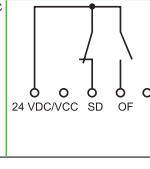
		Indication			
Auxiliaries	iOF	iSD	iOF/SD+OF	iOF+SD24	
Type	Open/close auxiliary contact	Fault indicating contact	Double open/close or fault indicating contact	Double open/close and fault indicating contact	
	 <p>PB104474-35</p>	 <p>PB104475-35</p>	 <p>PB104475-35</p>	 <p>PB107750-35</p>	 <p>A9A26898-35</p>
Function	<ul style="list-style-type: none"> Changeover contact indicates "open" or "closed" position of the device 	<ul style="list-style-type: none"> Changeover contact indicates position of the device; upon: <ul style="list-style-type: none"> electrical fault action on tripping auxiliary Same indication as VISI-TRIP 	<ul style="list-style-type: none"> The iOF/SD+OF auxiliary is a 2-in-1 product: via a mechanical selector switch, it provides two contacts, OF+SD or OF+OF 	<ul style="list-style-type: none"> 2 contacts (1 NO + 1 NC) can report the signalling information of the associated device to the Acti9 Smartlink or a programmable logic controller: <ul style="list-style-type: none"> electrical fault actuation of the tripping auxiliary "Open" or "Closed" position of the associated device 	
Wiring diagrams	 <p>DB118810</p>	 <p>DB118811</p>	 <p>DB118812 DB118813</p>	 <p>DB1124319</p>	 <p>DB409828</p>
Use	Remote indication of the position of the associated device	Remote indication of tripping upon a fault of the associated device	Remote indication of position and/or tripping upon a fault of the associated device	Remote indication of position and tripping upon a fault of the associated device	
Catalogue numbers	A9A26924 A9A26869	A9A26927 A9A26855	A9A26929	A9A26897 A9A26898	
iC60, iID, iID40, iDPN Vigi, iSW-NA	■	■	■	■	
iC40, iCV40	■	■	■ if no comb busbar	■	
iC60, iID double terminals	■	■	■	■	
iC60 RCBO, iKQE RCBO	■	■	■	■	
Technical specifications					
Rated voltage (Ue)	24...415 V AC 24...130 V DC	24...415 V AC 24...130 V DC	24...415 V AC 24...130 V DC	- 24 V DC	
Operating frequency	50/60 Hz	50/60 Hz	50/60 Hz	-	
Red mechanical indicator	-	On front face	On front face	On front face	
Test function	On toggle	On toggle	On toggle	On toggle	
Width in 9 mm modules	1	1	1	1	
Operating current	10 mA mini, 6 A maxi 24 V DC 6 A 48 V DC 2 A 60 V DC 1,5 A 130 V DC 1 A 24...240 V AC 6 A 415 V AC 3 A			2 mA mini, 100 mA maxi	
Number of contacts	1 NO/NC	1 NO/NC	1 NO/NC + 1 NO/NC	1 NO/NC	
Operating temperature	-35...+70°C	-35...+70°C	-35...+70°C	-25...+70°C	
Storage temperature	-40...+85°C	-40...+85°C	-40...+85°C	-40...+85°C	

Offer to be adapted by the country

ComReady

Electrical auxiliaries for iC60, iID, iC40, iCV40, iID40, iDPN Vigi, iSW-NA (cont.)

Connection

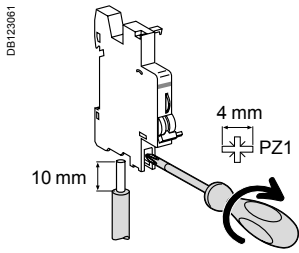

Type	Tightening torque	Copper cables		Multi-cables	
		Rigid	Flexible	Rigid	Cables with ferrule
Indication auxiliaries	1 N.m	1 to 4 mm ²	0.5 to 2,5 mm ²	2 x 2.5 mm ²	2 x 1.5 mm ²
Tripping auxiliaries	1 N.m	1 to 6 mm ²	0.5 to 4 mm ²	2 x 2.5 mm ²	2 x 2.5 mm ²

Ti24 connector connection

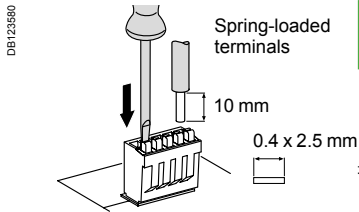

Type	Catalogue numbers	Copper cables	
		Rigid	Flexible
Ti24 interface	A9XC2412	1 x 0.5 to 1.5 mm ²	1 x 0.5 to 1.5 mm ²

Ti24 prefabricated cables connection

Type	Catalogue numbers	Length
Connection for Acti9 Smartlink		
6 prefabricated	A9XCAS06	100 mm
	A9XCAM06	160 mm
	A9XCAH06	450 mm
	A9XCAL06	870 mm
Connection for PLC type terminals		
6 long prefabricated on a single side	A9XCAU06	870 mm
1 long prefabricated on a single side	A9XCAC01	4000 mm
12 connectors, 5-pins (Ti24)	A9XC2412	-

PB107754-10



PB107755-14



DB404941

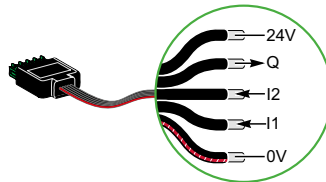

PB107756-7



Protection

Circuit protection / Earth leakage protection

Electrical auxiliaries for iC60, iID, iC40, iCV40, iID40, iDPN Vigi, iSW-NA (cont.)

Technical data

Weight (g)

Electrical auxiliaries	
Type	Weight (g)
iMN	69
iMNs	72
iMNx	79
iMSU	68
iMX	64
iMX+OF	68
iOF	32
iSD	33
iOF/SD+OF	43
iOF+SD24	25

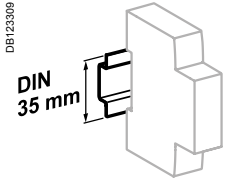

Clip on DIN rail 35 mm.

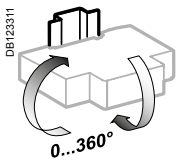

Indifferent position of installation.

Dimensions (mm)

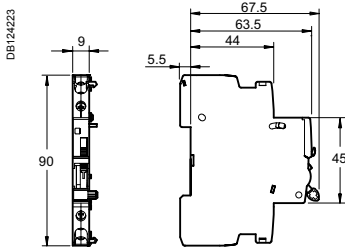

iOF/SD+OF

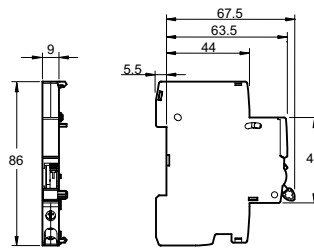

iOF, iSD

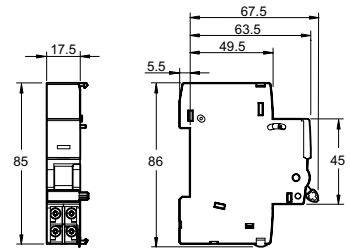

iMN, iMNs, iMNx, iMSU, iMX, iMX+OF

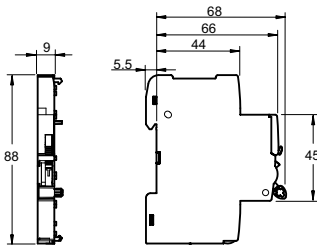

iOF+SD24 (A9A26897)

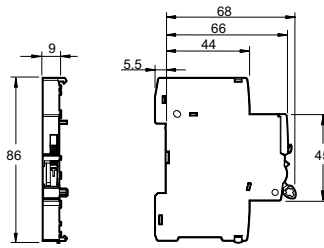

iOF+SD24 (A9A26898)

iMDU electrical auxiliary for Reflex iC60 or RCA iC60



A9C18195

The voltage matching module allows safety voltages of 24 and 48 V AC/DC to be used on the control inputs.

- Only connects to the Reflex iC60 circuit breakers remote controlled by a 220-240 V control voltage
- Galvanic isolation 6000 V
- Maximum combined power between terminals P and Y1/Y2: 100 mA at 230 V and 25°C.

Catalogue numbers

Auxiliary iMDU		
Type	Width in 9 mm modules	
iMDU	A9C18195	1

Diagram

An iMDU electrical auxiliary allows up to a maximum of five Reflex iC60 to be controlled simultaneously at the same input Y1 or Y2.

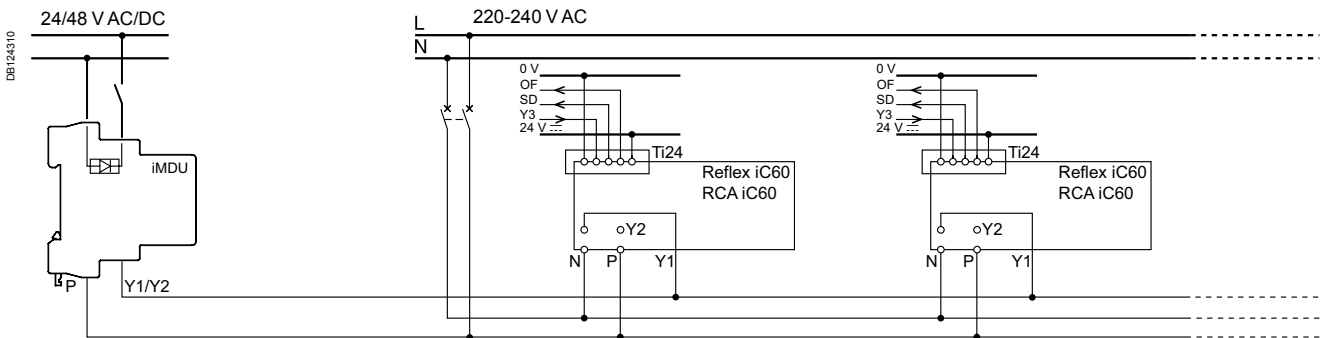

Dimensions (mm)

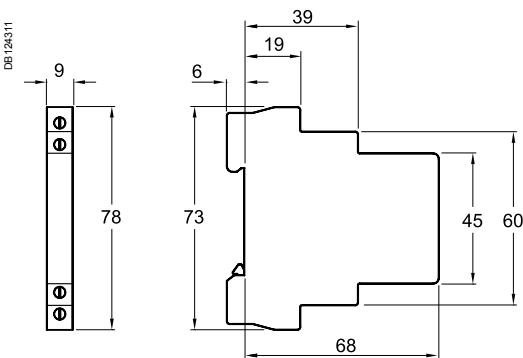

Connection

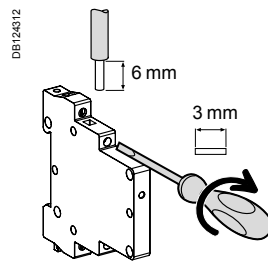

Type	Tightening torque	Copper cables	
		Rigid	Flexible or with ferrule
iMDU	1 N.m	1.5 mm ²	1.5 mm ²

Technical data

Main characteristics		
Control circuit voltage	24...48 V AC/DC	
Insulation voltage (Ui)	500 V	
Additional characteristics		
Degree of protection (IEC 60529)	Device only	IP20
	Device in modular enclosure	IP40
Operating temperature	Insulation class II	
Storage temperature	-20°C to +60°C	
Tropicalization	-40°C to +80°C	
Weight	Treatment 2 (relative humidity 95 % at 55°C)	
	53 g	

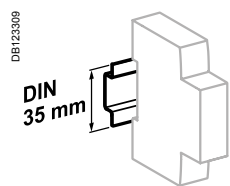

Clip on DIN rail 35 mm.

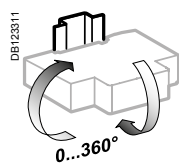

Indifferent position of installation.

Electrical auxiliaries for iC60, iID, iC40, iCV40, iID40, iDPN Vigi, iSW-NA (cont.)



Indice	Date	Modification	Name
5.4	3/04/2018	Translate title of page 3 in english	Sonovision
5.3	26/03/2018	Add iC40, iCV40, iID40 compatibility and delete pictograms page 7	Sonovision
5.2	31/08/2017	Added iC60 RCBO, iKQE RCBO compatibility	Sonovision
5.1	1/06/2017	Changed compatibility of A9A26898 page 4 (not compatibility for Double terminals)	Sonovision
5.0	29/03/2017	New charte	Sonovision
4.4	6/02/2017	Added A9A26898 product page 4	Sonovision
4.3	16/03/2016	Added Installation diagrams pages 6-7	Sonovision
4.2	11/01/2016	Changed Rated voltage (Ue) 24...415 V AC and Opening current contact values Changed "Ti24 prefabricated cables connection" table	Sonovision
4.1	10/04/2015	Added A9A27108 iMN product	Sonovision
4.0	1/10/2014	Changed iMNx and iMX+OF electrical diagrams	Sedoc
3.2	10/01/2014	Changed A9XCAU06 drawing	Sedoc
3.1	28/06/2013	Changed iOF+SD24 technical data page 6: 50 mA maxi to 100 mA maxi. Changed standards page 1. Deleted association table.	Sedoc
3.0	30/10/2012	Changed iOF+SD24 text page 6 and iMDU electrical diagram page 9	Sedoc
2.9	23/08/2012	Changed association table page 2	Sedoc
2.8	6/07/2012	Changed I mini 24 V DC for iMX+OF, iOF, iSD, iOF/SD+OF	Sedoc
2.7	4/04/2012	Inversion of cat. no A9A26855 and A9A26869	Sedoc
2.6	28/02/2012	Changed iOF+SD24 technical data page 6 and photos page 2	Sedoc
2.5	16/02/2012	Changed photo prefabricated cable and deleted TI 24 ferrule connection and iMDU diagram	Sedoc
2.4	06/01/2012	Change iMNx and iMX+OF diagrams and characteristics	Sedoc
2.3	7/12/2011	Deleted iMSU cat. no. A9A26479, change A9A26979 by A9A26500- Add iMDU product	Sedoc
2.2	13/10/2011	Change iOF+SD24 photo	Sedoc
2.1	09/06/2011	Add iC60 and iID double terminals and iOF+SD24 and iDPN Vigi products	Sedoc
2.0	06/06/2011	InDesign CS5	Sedoc
1.4	07/02/2011	Changed (iMNx ou iMN ou iMSU) by (iMN, iMNs, iMNx ou iMX, iMX+OF ou iMSU)	Sedoc
1.3	21/09/2010	Add iSW-NA product	Sedoc