



Acti9

Low voltage

Catalogue 07/2019

The efficiency you deserve

se.com

Life Is On

Schneider
Electric

Circuit protection

Neutral breaking circuit breakers

iC40, iC40 XA CA901051E 1

Circuit breakers up to 63 A

iC60a CA901010E 16

iC60N CA901002E 21

iC60N double terminals CA901019E 30

iC60H CA901003E 35

iC60H double terminals CA901020E 44

iC60L CA901004E 48

iK60 (B curve) CA901006E 51

iK60 (C curve) CA901007E 54

iK60 Biconnect CA901027E 61

Circuit breakers up to 125 A

C120a, N, H (RSA) CA901017E 72

C120N CA901015E 78

C120H CA901016E 82

High performance circuit breakers

NG125a CM901027E 85

NG125N CM901028E 89

NG125H CM901029E 95

NG125L CM901030E 99

Direct current circuit breakers

C60H-DC CA901024E 105

C60PV-DC CA901031E 108

C60NA-DC CA901032E 112

SW60-DC CA901030E 116

C120NA-DC CA901043E 120

Motor protection circuit breakers

P25M CM901026E 124

iC60LMA CA901005E 129

NG125LMA CM901031E 132

Fuses

STI isolatable fuse-carriers CA901026E 136

DO fuse disconnectors switches (projet Dido) CA901035E 139

Fuse holder with indicator light SBI CM901034E 141

Residual current protection

Choice of earth leakage protection devices

Overview of the earth leakage protection product range CA902000E 144

CA902011E 146

Residual current circuit breakers

iID CA902002E 149

iID double terminals CA902018E 164

iID B type CA902055E 170

iID K CA902007E 178

iID K biconnect CA902027E 184

iID40 CA902052E 191

RCCB-ID 125 A CM902001E 194

Add-on residual current devices for circuit breakers

Vigi iC40, Vigi iCG40 CA902053E 197

Vigi iC60 CA902005E 203

Vigi iC60 double terminals CA902019E 224

Vigi C120 CA902016E 230

Vigi NG125 CM902008E 235

Residual current devices

iDPN Vigi CA902026E 245

iCV40 CA902051E 252

DPNa Vigi, DPN N Vigi CA902014E 259

DPN Vigi K CA902032E 263

DPN N Vigi CA902037E 265

REDs, REDtest CM902017E 267

Fire protection

Fire prevention unit by arc monitoring

iARC CA901040E 274

iARC (China) CA901053E 276

iDPN arc CA901048E 278

iDPN ARC (China) CA901052E 280

iARC DPNN (China) CA901049E 282

RCBO iDPN VigiARC ELE (China) CA902057E 284

Load protection (surge arrester)

LV surge arresters

iPRF1 - PRF1 - PRD1 CA903005E 286

iPF CA903001E 292

iPFK CA903011E 296

iPRD Acti9 CA903008E 300

iPRD (white product) CA903002E 304

iQuick PRD CA903003E 308

iQuick PF CA903004E 311

Surge arresters for telephon and computer networks

iPRC/iPRI CA903006E 313

iPRE CA903016E 315

Surge arresters for photovoltaic installations

iPRD-DC PV (white product) CA903007E 316

iPRD-PV-DC CA903009E 319

Disconnection**Switch-disconnectors**

iSW Acti9	CA904027E	323
SW Biconnect switches	CA904030E	329

Trip switch-disconnectors

iSW-NA	CA904013E	334
NG125NA	CM901035E	336

Install, connection, power distribution**Accessories / Auxiliaries**

Accessories and auxiliaries for iC40, iCV40, iC40 XA, iCV40 XA, iDD40	CA907015E	342
---	-----------	-----

Accessories and auxiliaries for iC60, iID, iSW-NA, Reflex iC60, RCA, ARA	CA907000E	346
--	-----------	-----

Accessories and auxiliaries for C120, Vigi C120, DPN, C60H-DC	CA907013E	353
Accessories and auxiliaries for NG125 devices	CM907004E	361

Circuit breakers and residual current devices accessories

Accessories for iC60, iID, iC40, iC40 XA, iCV40, iCV40 XA, iID40, iDPN Vigi, iSW-NA, Reflex iC60, RCA, ARA, iSW	CA907001E	362
---	-----------	-----

Accessories for DT60	CA907011E	368
----------------------	-----------	-----

Accessories for C120, DPN, DPN Vigi, C60H-DC devices	CA907012E	370
--	-----------	-----

Accessories for NG125 devices	CM907006E	374
-------------------------------	-----------	-----

Comb busbars and devices feeders

VDIS Vertical distribution blocks 125 A	CA907036E	376
---	-----------	-----

Vertical comb busbars	CA907018E	378
-----------------------	-----------	-----

18 mm comb busbars, connection to the top	CA907026E	380
---	-----------	-----

Selection guide: 18 mm comb busbars, connection to the top	CA908048E	390
--	-----------	-----

Comb busbars selection guide connection to the bottom	CA907027E	402
---	-----------	-----

Linery DX : Quick distribution blocks	LIN003	410
---------------------------------------	--------	-----

Linery FM: Quick device feeders	LIN022	412
---------------------------------	--------	-----

Linery DS: Devices feeders	CA907023E	414
----------------------------	-----------	-----

Load control and monitoring**Acti9 control system**

PowerTag Link	CA907030E	417
---------------	-----------	-----

PowerTag Link C	CA907035E	419
-----------------	-----------	-----

Smartlink SI B	CA907032E	431
----------------	-----------	-----

PowerTag Energy 63 A	CA907029E	439
----------------------	-----------	-----

PowerTag Control	CA907037E	446
------------------	-----------	-----

PowerTag Ambient for Temperature	CA907042E	451
----------------------------------	-----------	-----

PowerTag Selection Guide	CA908058E	453
--------------------------	-----------	-----

Monitoring and control of protections**Indication and tripping**

Electrical auxiliaries for iC60, iID, iC40, iC40 XA, iCV40, iCV40 XA, iID40, iDPN Vigi, iSW-NA	CA907002E	459
--	-----------	-----

Electrical auxiliaries for C120, DPN, DPN Vigi, ID, C60H-DC	CA907008E	467
---	-----------	-----

Electrical auxiliaries for NG125 devices	CM907005E	473
--	-----------	-----

Remote control

RCA remote controls for iC60 circuit breakers	CA904011E	477
---	-----------	-----

Automatic reclosers

ARA automatic reclosers for iC60 and iID	CA904010E	482
--	-----------	-----

Electrical circuit control**Manual control**

iPB pushbuttons	CA904003E	487
-----------------	-----------	-----

iSSW linear switches	CA904004E	488
----------------------	-----------	-----

DIN rail selector switches iCMB, iCMD, iCME, iCMC, iCMV and iCMA	CA904024E	490
--	-----------	-----

Button holders	CA907007E	493
----------------	-----------	-----

Electrical control

Reflex iC60 integrated control circuit breakers	CA904012E	494
---	-----------	-----

iCT contactors	CA904007E	499
----------------	-----------	-----

iTL impulse relays	CA904008E	532
--------------------	-----------	-----

TL impulse relays	CA904020E	547
-------------------	-----------	-----

CT contactors	CA904021E	553
---------------	-----------	-----

TL impulse relays TL40	CA904046E	559
------------------------	-----------	-----

CT contactors CT40	CA904047E	562
--------------------	-----------	-----

TL+ impulse relays	CA904018E	565
--------------------	-----------	-----

CT+ contactors	CA904019E	567
----------------	-----------	-----

Indication**Indicators**

iIL indicator lights	CA904006E	569
----------------------	-----------	-----

iSO bells and iRO buzzers	CA904014E	570
---------------------------	-----------	-----

iTR transformers	CA904015E	571
------------------	-----------	-----

Lighting, time and energy management

Relays iRTA, iRTB, iRTC, iRTH, iRTL, iRTMF, iRBN, iRTBT, iRLI, iERL, iRCP, iRCI, iRCU, iRCC	CA904022E	574
---	-----------	-----

CDS load-shedding	CA904023E	583
-------------------	-----------	-----

Modular iPC power sockets	CA904017E	589
---------------------------	-----------	-----

Twilight and time switches, timers, thermostats

IC twilight switches	LSB02323EN	591
----------------------	------------	-----

IHP, ITM time switches	LSB02322EN	600
------------------------	------------	-----

MIN timers	LSB02321EN	615
------------	------------	-----

STD, STU dimmers	LSB02325EN	619
------------------	------------	-----

TH4, TH7, THP1, THP2 thermostats	LSB02324EN	627
----------------------------------	------------	-----

Protection, Circuit protection

Acti9 iC40 circuit breakers

4500 A / 6 kA



IEC/EN 60947-2
IEC/EN 60898-1

As per the above standards:
Circuit breakers combine the following functions:

- circuit protection against short-circuit currents,
- circuit protection against overload currents,
- suitable for isolation.



Catalog numbers

Acti9 iC40 circuit breakers							
Type	1P+N		3P		3P+N		
Auxiliaries	Catalog module CA907002						
Vigi	Catalog module CA902053						
Rating (In)	B curve	C curve	C curve	D curve	B curve	C curve	D curve
2 A	-	A9P52602	-	-	-	-	-
4 A	-	A9P52604	-	-	-	-	-
6 A	A9P42606	A9P52606	A9P52306	A9P62306	A9P42706	A9P52706	A9P62706
10 A	A9P42610	A9P52610	A9P52310	A9P62310	A9P42710	A9P52710	A9P62710
13 A	A9P42613	A9P52613	-	-	-	-	-
16 A	A9P42616	A9P52616	A9P52316	A9P62316	A9P42716	A9P52716	A9P62716
20 A	A9P42620	A9P52620	A9P52320	A9P62320	A9P42720	A9P52720	A9P62720
25 A	A9P42625	A9P52625	A9P52325	A9P62325	A9P42725	A9P52725	A9P62725
32 A	A9P42632	A9P52632	A9P52332	A9P62332	A9P42732	A9P52732	A9P62732
40 A	A9P42640	A9P52640	A9P52340	A9P62340	A9P42740	A9P52740	A9P62740
Width in 9-mm modules	2		6		6		
Accessories	Catalog modules CA907001 and CA907015						
Comb busbars	Catalog module CA907026						
PowerTag energy sensors	Catalog modules CA907029 and CA908058						

Protection, Circuit protection

Acti9 iC40 circuit breakers 4500 A / 6 kA

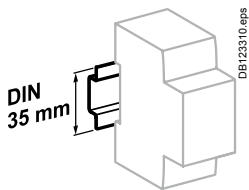

Clip on DIN rail 35 mm.

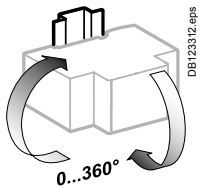

Indifferent position of installation.

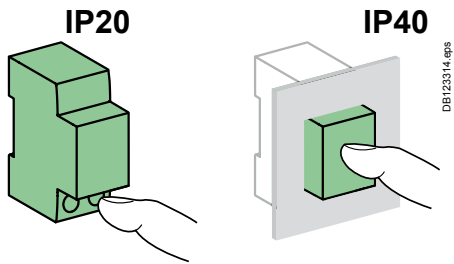

Dimensions (mm)

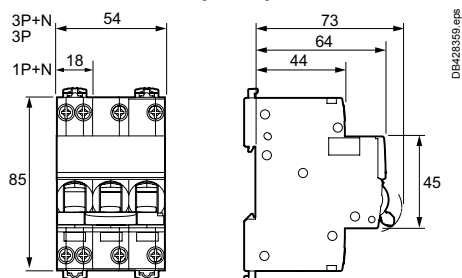

Technical data

Main characteristics		Acti9 iC40	
Insulation voltage (Ui)	Phase-to-neutral	400 V	
	Phase-to-phase	440 V	
Voltage rating (Ue)	Phase-to-neutral	230 V	
	Phase-to-phase	400 V	
Operating frequency		50/60 Hz	
According to IEC/EN 60898-1			
Limitation class		3	
Rated breaking capacity (Icn)		4500 A	
Service breaking capacity (Ics)		100 % Icn	
Rated breaking and making capacity on a single pole (Icn1)		Icn1 = Icn	
Magnetic tripping	B curve	3 to 5 In	
	C curve	5 to 10 In	
	D curve	10 to 14 In	
Operating temperature		30°C	
According to IEC/EN 60947-2			
Rated impulse withstand voltage (Uimp)		4 kV	
Breaking capacity (Icu)		6 kA	
Service breaking capacity (Ics)		75 % Icu	
Magnetic tripping	B curve	4 In ±20 %	
	C curve	8 In ±20 %	
	D curve	12 In ±20 %	
Operating temperature		50°C	
Pollution degree		3	
Additional characteristics			
Degree of protection (IEC 60529)	Device only	IP20	
	Device in modular enclosure	IP40 Insulation class II	
Endurance (O-C)	Electrical	≤ 20 A	20000 cycles
		≥ 25 A	10000 cycles
	Mechanical		20000 cycles
Operating temperature		-25°C to +70°C	
Storage temperature		-40°C to +85°C	

Weight (g)

Circuit breakers		Acti9 iC40
Type		
1P+N		120
3P		340
3P+N		345

Protection, Circuit protection

Acti9 iC40F circuit breakers

6000 A / 6 kA



Country approval pictogram

IEC/EN 60947-2**IEC/EN 60898-1**

As per the above standards:
Circuit breakers combine the following functions:

- circuit protection against short-circuit currents,
- circuit protection against overload currents,
- suitable for isolation.



Catalog numbers

Acti9 iC40F circuit breakers

Type	1P+N
Auxiliaries	Catalog module CA907002
Vigi	Catalog module CA902053
Rating (In)	C curve
2 A	A9P53602
6 A	A9P53606
10 A	A9P53610
16 A	A9P53616
20 A	A9P53620
25 A	A9P53625
32 A	A9P53632
40 A	A9P53640
Width in 9-mm modules	2
Accessories	Catalog modules CA907001 and CA907015
Comb busbars	Catalog module CA907026
PowerTag energy sensors	Catalog modules CA907029 and CA908058

Protection, Circuit protection

Acti9 iC40F circuit breakers

6000 A / 6 kA

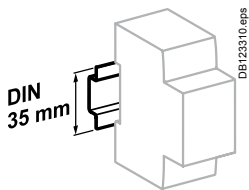

Clip on DIN rail 35 mm.

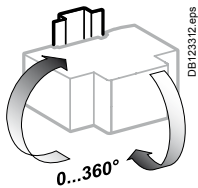

Indifferent position of installation.

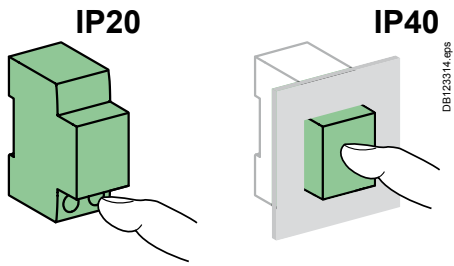

Dimensions (mm)

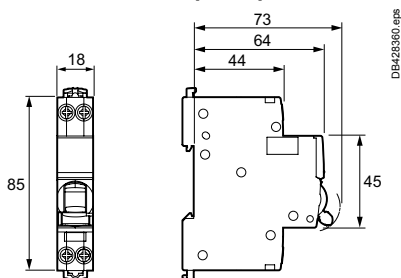

Technical data

Main characteristics		Acti9 iC40F	
Insulation voltage (Ui)		400 V	
Voltage rating (Ue)		230 V	
Operating frequency		50/60 Hz	
According to IEC/EN 60898-1			
Limitation class		3	
Rated breaking capacity (Icn)		6000 A	
Service breaking capacity (Ics)		100 % Icn	
Rated breaking and making capacity on a single pole (Icn1)		Icn1 = Icn	
Magnetic tripping	C curve	5 to 10 In	
Operating temperature		30°C	
According to IEC/EN 60947-2			
Rated impulse withstand voltage (Uimp)		4 kV	
Breaking capacity (Icu)		6 kA	
Service breaking capacity (Ics)		75 % Icu	
Magnetic tripping	C curve	8 In ±20 %	
Operating temperature		50°C	
Pollution degree		3	
Additional characteristics			
Degree of protection (IEC 60529)	Device only	IP20	
	Device in modular enclosure	IP40	
Endurance (O-C)	Electrical	≤ 20 A	20000 cycles
		≥ 25 A	10000 cycles
	Mechanical	20000 cycles	
Operating temperature		-25°C to +70°C	
Storage temperature		-40°C to +85°C	

Weight (g)

Circuit breakers		Acti9 iC40F
Type		120
1P+N		

Protection, Circuit protection

Acti9 iC40N circuit breakers

6000 A / 10 kA



IEC/EN 60947-2
IEC/EN 60898-1

As per the above standards:
Circuit breakers which combine the following functions:

- circuit protection against short-circuit currents,
- circuit protection against overload currents,
- suitable for isolation.



Catalog numbers

Acti9 iC40N circuit breakers								
Type	1P+N			3P		3P+N		
Auxiliaries	Catalog module CA907002							
Vigi	Catalog module CA902053							
Rating (In)	B curve	C curve	D curve	C curve	D curve	B curve	C curve	D curve
2 A	-	A9P54602	A9P64602	-	-	-	-	-
4 A	-	A9P54604	-	-	-	-	-	-
6 A	A9P44606	A9P54606	A9P64606	A9P54306	A9P64306	A9P44706	A9P54706	A9P64706
10 A	A9P44610	A9P54610	A9P64610	A9P54310	A9P64310	A9P44710	A9P54710	A9P64710
13 A	A9P44613	A9P54613	A9P64613	A9P54313	A9P64313	A9P44713	A9P54713	A9P64713
16 A	A9P44616	A9P54616	A9P64616	A9P54316	A9P64316	A9P44716	A9P54716	A9P64716
20 A	A9P44620	A9P54620	A9P64620	A9P54320	A9P64320	A9P44720	A9P54720	A9P64720
25 A	A9P44625	A9P54625	A9P64625	A9P54325	A9P64325	A9P44725	A9P54725	A9P64725
32 A	A9P44632	A9P54632	A9P64632	A9P54332	A9P64332	A9P44732	A9P54732	A9P64732
40 A	A9P44640	A9P54640	A9P64640	A9P54340	A9P64340	A9P44740	A9P54740	A9P64740
Width in 9-mm modules	2			6		6		
Accessories	Catalog modules CA907001 and CA907015							
Comb busbars	Catalog module CA907026							
PowerTag energy sensors	Catalog modules CA907029 and CA908058							

Protection, Circuit protection

Acti9 iC40N circuit breakers 6000 A / 10 kA

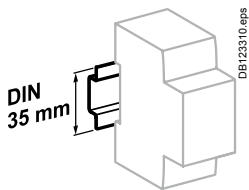

Clip on DIN rail 35 mm.

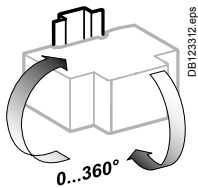

Indifferent position of installation.

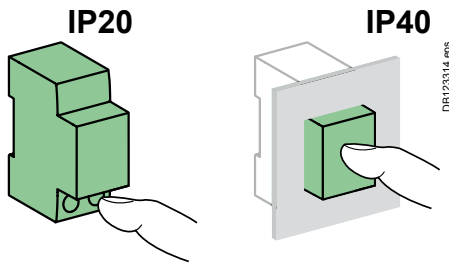

Dimensions (mm)

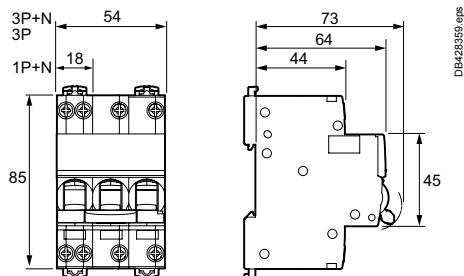

Technical data

Main characteristics		Acti9 iC40N	
Insulation voltage (Ui)	Phase-to-neutral	400 V	
	Phase-to-phase	440 V	
Voltage rating (Ue)	Phase-to-neutral	230 V	
	Phase-to-phase	400 V	
Operating frequency		50/60 Hz	
According to IEC/EN 60898-1			
Limitation class		3	
Rated breaking capacity (Icn)		6000 A	
Service breaking capacity (Ics)		100 % Icn	
Rated breaking and making capacity on a single pole (Icn1)		Icn1 = Icn	
Magnetic tripping	B curve	3 to 5 In	
	C curve	5 to 10 In	
	D curve	10 to 14 In	
Operating temperature		30°C	
According to IEC/EN 60947-2			
Rated impulse withstand voltage (Uimp)		4 kV	
Breaking capacity (Icu)		10 kA	
Service breaking capacity (Ics)	3P	75 % Icu	
	1P+N, ≤ 25 A	75 % Icu	
	3P+N, ≥ 32 A	50 % Icu	
Magnetic tripping	B curve	4 In ±20 %	
	C curve	8 In ±20 %	
	D curve	12 In ±20 %	
Operating temperature		50°C	
Pollution degree		3	
Additional characteristics			
Degree of protection (IEC 60529)	Device only	IP20	
	Device in modular enclosure	IP40 Insulation class II	
Endurance (O-C)	Electrical	≤ 20 A	20000 cycles
		≥ 25 A	10000 cycles
	Mechanical	20000 cycles	
Operating temperature		-25°C to +70°C	
Storage temperature		-40°C to +85°C	

Weight (g)

Circuit breakers		Acti9 iC40N
Type		
1P+N		120
3P		340
3P+N		345

Protection, Circuit protection

Acti9 iC40H circuit breakers

10000 A



IEC/EN 60898-1

As per the above standard:
Circuit breakers which combine the following functions:

- circuit protection against short-circuit currents,
- circuit protection against overload currents,
- suitable for isolation.



Catalog numbers

Acti9 iC40H circuit breakers

Type	1P+N	3P+N
	DB406477:eps	DB406479:eps
Auxiliaries	Catalog module CA907002	
Vigi	Catalog module CA902053	
Rating (In)	C curve	C curve
6 A	A9P55606	A9P55706
10 A	A9P55610	A9P55710
13 A	A9P55613	A9P55713
16 A	A9P55616	A9P55716
25 A	A9P55625	A9P55725
32 A	A9P55632	A9P55732
Width in 9-mm modules	2	6
Accessories	Catalog modules CA907001 and CA907015	
Comb busbars	Catalog module CA907026	
PowerTag energy sensors	Catalog modules CA907029 and CA908058	

Protection,
Circuit protection

Acti9 iC40H circuit breakers
10000 A

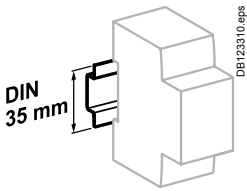

Clip on DIN rail 35 mm.

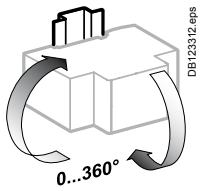

Indifferent position of installation.

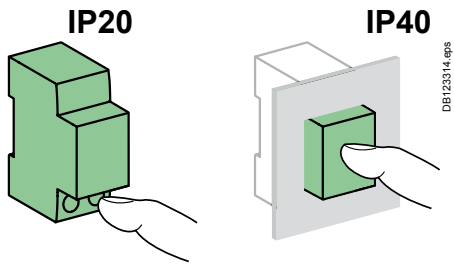

Dimensions (mm)

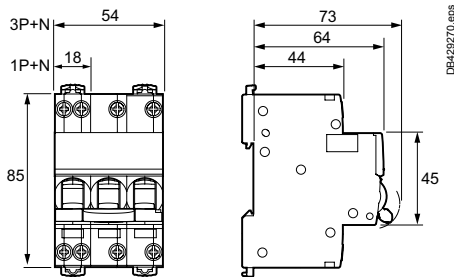

Technical data

Main characteristics		Acti9 iC40H	
Insulation voltage (Ui)	Phase-to-neutral	400 V	
	Phase-to-phase	440 V	
Voltage rating (Ue)	Phase-to-neutral	230 V	
	Phase-to-phase	400 V	
Operating frequency		50/60 Hz	
According to IEC/EN 60898-1			
Limitation class		3	
Rated breaking capacity (Icn)		10000 A	
Service breaking capacity (Ics)		75 % Icn	
Rated breaking and making capacity on a single pole (Icn1)		6000 A	
Magnetic tripping		5 to 10 In	
Operating temperature		30°C	
Pollution degree		3	
Additional characteristics			
Degree of protection (IEC 60529)	Device only	IP20	
	Device in modular enclosure	IP40 Insulation class II	
Endurance (O-C)	Electrical	≤ 20 A	20000 cycles
		≥ 25 A	10000 cycles
	Mechanical	20000 cycles	
Operating temperature		-25°C to +70°C	
Storage temperature		-40°C to +85°C	

Weight (g)

Circuit breakers		Acti9 iC40H
Type		
1P+N		120
3P+N		345

Protection, Circuit protection Acti9 iC40 circuit breakers

- Automatic cable guiding in the correct position: terminals with guard
- Reinforced cable pull-out strength: serrated terminals
- Where there is a comb tooth, the connection of cables of cross section 16 mm² remains possible
- Assembly and disassembly with comb busbar in place by operating toggle latches at the top and bottom of the products
- INSULATED TERMINALS IP20**
- VISI-TRIP window**
Fault tripping is indicated by a red mechanical indicator on the front face
- INSULATED TERMINALS IP20**
- VISI-SAFE window**
Positive contact indication
A green strip on the toggle indicates full opening of all the poles
Downstream maintenance operations can be carried out in better safety conditions
Padlocking possible
- MARKINGS**
Area for marking by 12 mm high label on the front panel
- MARKINGS**
Area for 4 marking clips alongside the downstream terminal

Connection

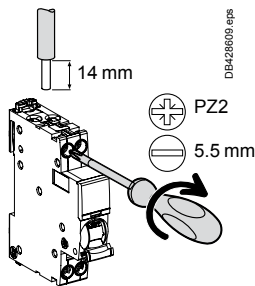

Type	Connection	Tightening torque	Comb busbar	Copper cables	
				Rigid	Flexible or with ferrule
Acti9 iC40	Top	2 N.m	■	1 to 16 mm ²	1 to 10 mm ²
	Bottom		■		

- Connection by comb busbar or cables (as per EN 50027).
- Where there is a comb tooth, the connection of cables of cross section 16 mm² remains possible.
- See Choice of Comb busbars (CA908048).

Protection,
Circuit protection

Acti9 iC40 XA circuit breakers

4500 A / 6 kA

IEC/EN 60947-2

IEC/EN 60898-1

As per the above standards:

Circuit breakers which combine the following functions:

- circuit protection against short-circuit currents,
- circuit protection against overload currents,
- suitable for isolation.



6 A à 16 A



20 A à 40 A



Catalog numbers

Acti9 iC40 XA circuit breakers

Type	1P+N	3P+N	
Auxiliaries	Catalog module CA907002		
Vigi	Catalog module CA902053		
Connection	Top	Screwless	Screwless
	Bottom	Screwless	Screw
Rating (In)	C curve	C curve	C curve
6 A	A9PS2606	-	A9PS2706
10 A	A9PS2610	-	A9PS2710
13 A	A9PS2613	-	-
16 A	A9PS2616	-	A9PS2716
20 A	-	A9PS2620	A9PS2720
25 A	-	A9PS2625	A9PS2725
32 A	-	A9PS2632	A9PS2732
40 A	-	A9PS2640	A9PS2740
Width in 9-mm modules	2	6	
Accessories	Catalog modules CA907001 and CA907015		
Comb busbars	Compatible only with Acti9 iC40 comb busbars Catalog module CA907026		
PowerTag energy sensors	Catalog modules CA907029 and CA908058		

Acti9 iC40 XA circuit breakers

4500 A / 6 kA

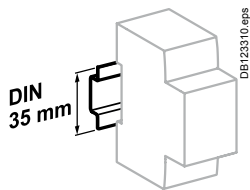

Clip on DIN rail 35 mm.

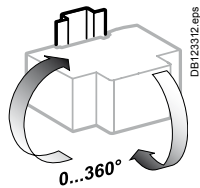

Indifferent position of installation.

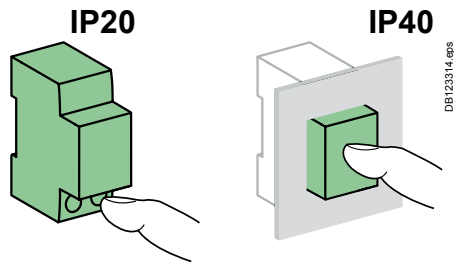

Technical data

Main characteristics		Acti9 iC40 XA	
Insulation voltage (Ui)	Phase-to-neutral	400 V	
	Phase-to-phase	440 V	
Voltage rating (Ue)	Phase-to-neutral	230 V	
	Phase-to-phase	400 V	
Operating frequency		50/60 Hz	
According to IEC/EN 60898-1			
Limitation class		3	
Rated breaking capacity (Icn)		4500 A	
Service breaking capacity (Ics)		100 % Icn	
Rated breaking and making capacity on a single pole (Icn1)		Icn1 = Icn	
Magnetic tripping		5 to 10 In	
Operating temperature		30°C	
According to IEC/EN 60947-2			
Rated impulse withstand voltage (Uimp)		4 kV	
Breaking capacity (Icu)		6 kA	
Service breaking capacity (Ics)		75 % Icu	
Magnetic tripping		8 In ±20 %	
Operating temperature		50°C	
Pollution degree		3	
Additional characteristics			
Degree of protection (IEC 60529)	Device only	IP20	
	Device in modular enclosure	IP40	
Endurance (O-C)	Electrical	≤ 20 A	20000 cycles
		≥ 25 A	10000 cycles
	Mechanical		20000 cycles
Operating temperature		-25°C to +70°C	
Storage temperature		-40°C to +85°C	

Dimensions (mm)

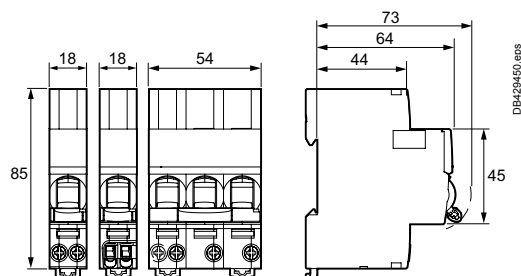

Weight (g)

Circuit breakers		Acti9 iC40 XA
Type		
1P+N		115
3P+N		335

Protection,
Circuit protection

Acti9 iC40N XA circuit breakers

6000 A / 10 kA

IEC/EN 60947-2

IEC/EN 60898-1

As per the above standards:

Circuit breakers which combine the following functions:

- circuit protection against short-circuit currents,
- circuit protection against overload currents,
- suitable for isolation.



6 A à 16 A



20 A à 40 A



Catalog numbers

Acti9 iC40N XA circuit breakers			
Type	1P+N		3P+N
Auxiliaries	Catalog module CA907002		
Vigi	Catalog module CA902053		
Connection	Top	Screwless	Screwless
	Bottom	Screwless	Screw
Rating (In)	C curve	C curve	C curve
6 A	A9PS4606	-	A9PS4706
10 A	A9PS4610	-	A9PS4710
13 A	A9PS4613	-	A9PS4713
16 A	A9PS4616	-	A9PS4716
20 A	-	A9PS4620	A9PS4720
25 A	-	A9PS4625	A9PS4725
32 A	-	A9PS4632	A9PS4732
40 A	-	A9PS4640	A9PS4740
Width in 9-mm modules	2		6
Accessories	Catalog modules CA907001 and CA907015		
Comb busbars	Compatible only with Acti9 iC40 comb busbars Catalog module CA907026		
PowerTag energy sensors	Catalog modules CA907029 and CA908058		

Acti9 iC40N XA circuit breakers

6000 A / 10 kA

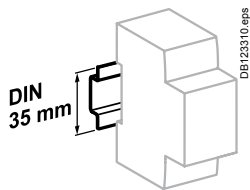

Clip on DIN rail 35 mm.

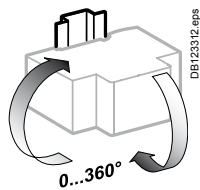

Indifferent position of installation.

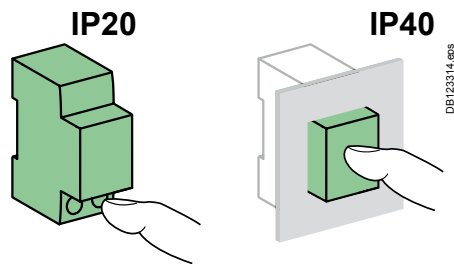

Technical data

Main characteristics		Acti9 iC40N XA	
Insulation voltage (Ui)	Phase-to-neutral	400 V	
	Phase-to-phase	440 V	
Voltage rating (Ue)	Phase-to-neutral	230 V	
	Phase-to-phase	400 V	
Operating frequency		50/60 Hz	
According to IEC/EN 60898-1			
Limitation class		3	
Rated breaking capacity (Icn)		6000 A	
Service breaking capacity (Ics)		100 % Icn	
Rated breaking and making capacity on a single pole (Icn1)		Icn1 = Icn	
Magnetic tripping		5 to 10 In	
Operating temperature		30°C	
According to IEC/EN 60947-2			
Rated impulse withstand voltage (Uimp)		4 kV	
Breaking capacity (Icu)		10 kA	
Service breaking capacity (Ics)	≤ 25 A	75 % Icu	
	≥ 32 A	50 % Icu	
Magnetic tripping		8 In ±20 %	
Operating temperature		50°C	
Pollution degree		3	
Additional characteristics			
Degree of protection (IEC 60529)	Device only	IP20	
	Device in modular enclosure	IP40 Insulation class II	
Endurance (O-C)	Electrical	≤ 20 A	20000 cycles
		≥ 25 A	10000 cycles
	Mechanical	20000 cycles	
Operating temperature		-25°C to +70°C	
Storage temperature		-40°C to +85°C	

Dimensions (mm)

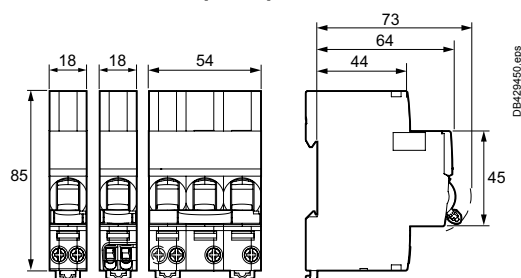

Weight (g)

Circuit breakers		Acti9 iC40N XA
Type		
1P+N		115
3P+N		335

Protection, Circuit protection Acti9 iC40 XA circuit breakers

VISI-TRIP window

- Fault tripping is indicated by a red mechanical indicator on the front face

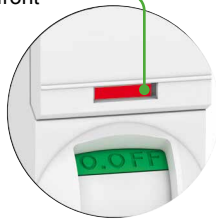

DB428587.eps

- Screwless connection
- Compatible only with Acti9 horizontal comb busbars 9 mm modules (catalog module CA907026)

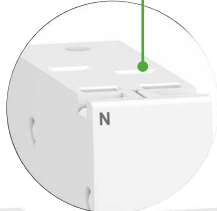

DB429448.eps



DB428354.eps

Markings

- Area for marking by 12 mm high label on the front panel

- Test point

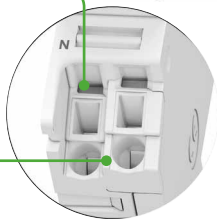

DB429449.eps

- Screwless connection
- Tool-less connection for rigid cables and flexible cables with ferrule
- One connection point per pole



DB428355.eps

VISI-SAFE window

Positive contact indication

- A green strip on the toggle indicates full opening of all the poles
- Downstream maintenance operations can be carried out in better safety conditions
- Padlocking possible

Markings

- Area for 4 marking clips alongside the downstream terminal

- Automatic cable guiding in the correct position: terminals with guard
- Insulated terminals IP20
- Reinforced cable pull-out strength: serrated terminals

Connection

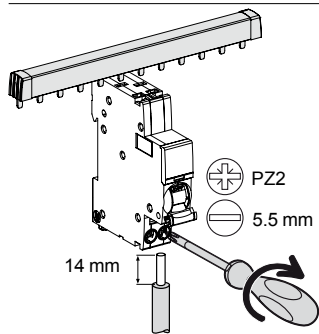
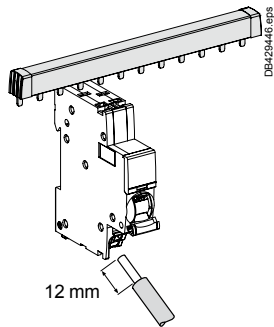

Connection	Tightening torque	Comb busbar	Copper cables		
			Rigid	Flexible	Flexible with ferrule
Top screwless	-	■ (1)		-	-
Bottom screwless	-	-	1 to 4 mm ²	1 to 4 mm ²	1 to 2,5 mm ² 2,4 x 2,4 mm maxi
Top screwless	-	■ (1)	-	-	-
Bottom with screw	2 N.m	-	1 to 16 mm ²	1 to 10 mm ²	1 to 10 mm ²

■ Connection by comb busbar or cables (as per EN 50027).

(1) Top connection by specific comb busbar only and connection by cables possible only with the models of comb busbars with connectors (See Choice of Comb busbars CA908048).

Protection Circuit protection iC60a circuit breakers, (curve C)

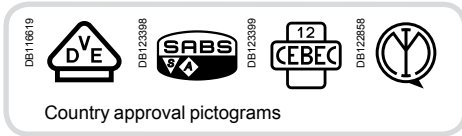

IEC/EN 60947-2
IEC/EN 60898-1



- iC60a circuit breakers are multi-standard circuit breakers which combine the following functions:
 - circuit protection against short-circuit currents,
 - circuit protection against overload currents,
 - suitable for industrial isolation according to IEC/EN 60947-2, standard.
 - fault tripping indication by a red mechanical indicator in circuit breaker front face.

Alternating current (AC) 50/60 Hz			
Breaking capacity (Icu) according to IEC/EN 60947-2			Service breaking capacity (Ics)
	Voltage (Ue)		
Ph/Ph (2P, 3P, 4P)	220 to 240 V	380 to 415 V	
Ph/N (1P)		220 to 240 V	
Rating (In) 1 to 63 A	10 kA	6 kA	100 % of Icu
Breaking capacity (Icn) according to IEC/EN 60898-1			
	Voltage (Ue)		
Ph/Ph	400 V		
Ph/N	230 V		
Rating (In) 1 to 63 A	4500 A		

Catalogue numbers

iC60a circuit breaker

Type		1P	2P
Auxiliaries		Remote tripping and indication, module CA907000 and CA907002	Remote tripping and indication, module CA907000 and CA907002
Vigi iC60		Vigi iC60 add-on residual current device, module CA902005	Vigi iC60 add-on residual current device, module CA902005
Rating (In)	Quality label (1)	Curve C	Curve C
1 A		A9F64101	A9F64201
2 A		A9F64102	A9F64202
3 A		A9F64103	A9F64203
4 A		A9F64104	A9F64204
6 A		A9F64106	A9F64206
10 A		A9F64110	A9F64210
13 A		A9F64113	A9F64213
16 A		A9F64116	A9F64216
20 A		A9F64120	A9F64220
25 A		A9F64125	A9F64225
32 A		A9F64132	A9F64232
40 A		A9F64140	A9F64240
50 A		A9F64150	A9F64250
63 A		A9F64163	A9F64263
Width in 9-mm modules		2	4
Accessories		Module CA907000 and CA907001	Module CA907000 and CA907001

(1) Information to be provided by the country.

iC60a circuit breakers, (curve C) (cont.)

PB104433-40

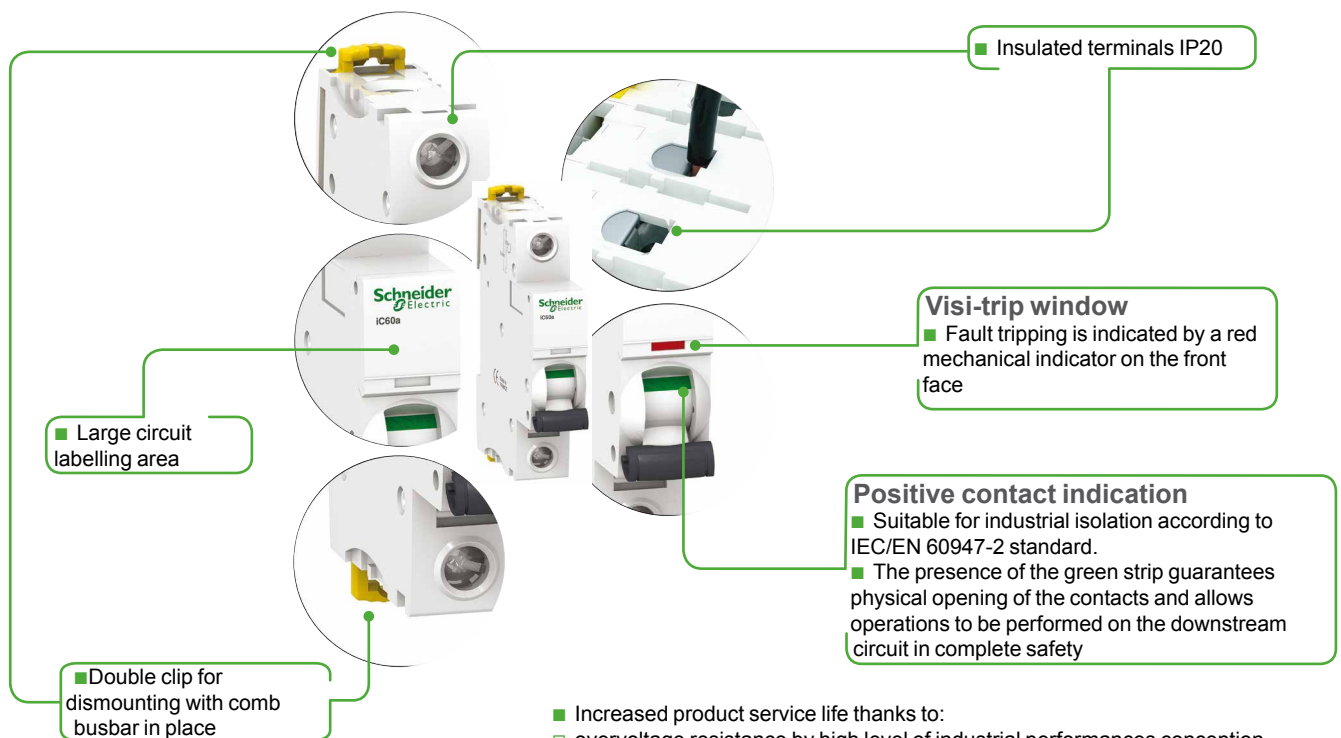

- Increased product service life thanks to:
 - overvoltage resistance by high level of industrial performances conception (pollution degree, rated impulse withstand voltage and insulation voltage),
 - high performance limitation (see limitation curves),
 - fast closing independent of the speed of actuation of the toggle.
- Remote indication, open/closed/tripped, by optional auxiliary contacts.
- Top or bottom electrical feeding.

3P	4P
Remote tripping and indication, module CA907000 and CA907002	Remote tripping and indication, module CA907000 and CA907002
Vigi iC60 add-on residual current device, module CA902005	Vigi iC60 add-on residual current device, module CA902005
Curve C	Curve C
A9F64301	A9F64401
A9F64302	A9F64402
A9F64303	A9F64403
A9F64304	A9F64404
A9F64306	A9F64406
A9F64310	A9F64410
A9F64313	A9F64413
A9F64316	A9F64416
A9F64320	A9F64420
A9F64325	A9F64425
A9F64332	A9F64432
A9F64340	A9F64440
A9F64350	A9F64450
A9F64363	A9F64463
6	8
Module CA907000 and CA907001	Module CA907000 and CA907001

Protection
Circuit protection

iC60a circuit breakers, curve C) (cont.)

Connection

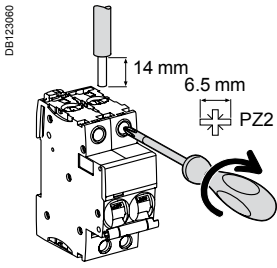

Rating	Tightening torque	Without accessory		With accessories			
		Rigid	Flexible or with ferrule	50 mm ² Al terminal	Screw-on connection for ring terminal	Rigid cables	Flexible cables
1 to 25 A	2 N.m	DB1122945	DB1122946	DB1122935	DB118789	DB118787	
32 to 63 A	3.5 N.m	1 to 25 mm ²	1 to 16 mm ²	-	Ø 5 mm	-	-
		1 to 35 mm ²	1 to 25 mm ²	50 mm ²		3 x 16 mm ²	3 x 10 mm ²

Technical data

Main characteristics		
According to IEC/EN 60947-2		
Insulation voltage (U _i)		500 V AC
Pollution degree		3
Rated impulse withstand voltage (U _{imp})		6 kV
Thermal tripping	Reference temperature	50 °C
	Temperature derating	See module CA908007
Magnetic tripping	C curve	8 I _n ± 20 %
Utilization category		A
According to IEC/EN 60898-1		
Limitation class		3
Rated making and breaking capacity of an individual pole (I _{cn1})		I _{cn1} = I _{cn}
Additional characteristics		
Degree of protection (IEC 60529)	Device only	IP20
	Device in modular enclosure	IP40
Endurance (O-C)	Electrical	10,000 cycles
	Mechanical	20,000 cycles
Overvoltage category (IEC 60364)		IV
Operating temperature		-35°C to +70°C
Storage temperature		-40°C to +85°C
Tropicalization (IEC 60068-1)		Treatment 2 (relative humidity 95 % to 55°C)

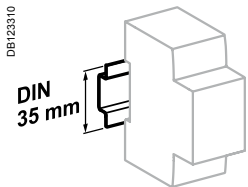

Clip on DIN rail 35 mm.

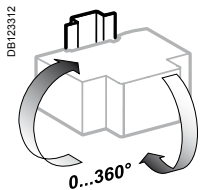

Indifferent position of installation.

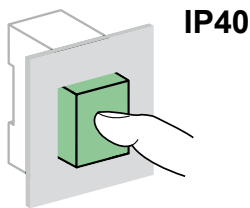
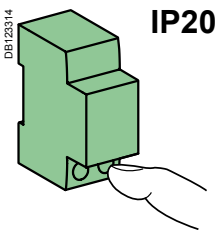

iC60a circuit breakers, (curve C) (cont.)

Weight (g)

Circuit-breaker	
Type	iC60a
1P	125
2P	250
3P	375
4P	500

Dimensions (mm)

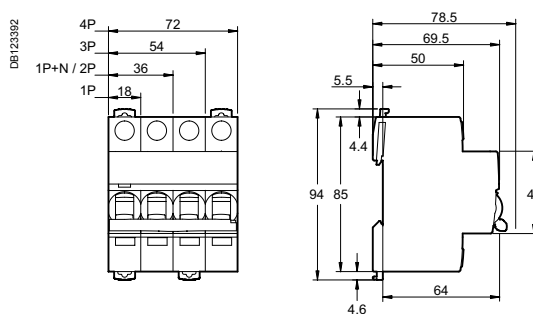

Protection

Circuit protection

iC60N

Contents



Schneider Electric's range of circuit breakers consists of different products (A, B, C) to enable it to be the most competitive range possible in each country, allowing for the special characteristics of each market:

- usual installation procedure
- price
- accreditations by local bodies.

Variants

Offers		Pages
Offer A	Catalog numbers	22
Offer B	Catalog numbers	24
Offer C	Catalog numbers	26
Common pages		28

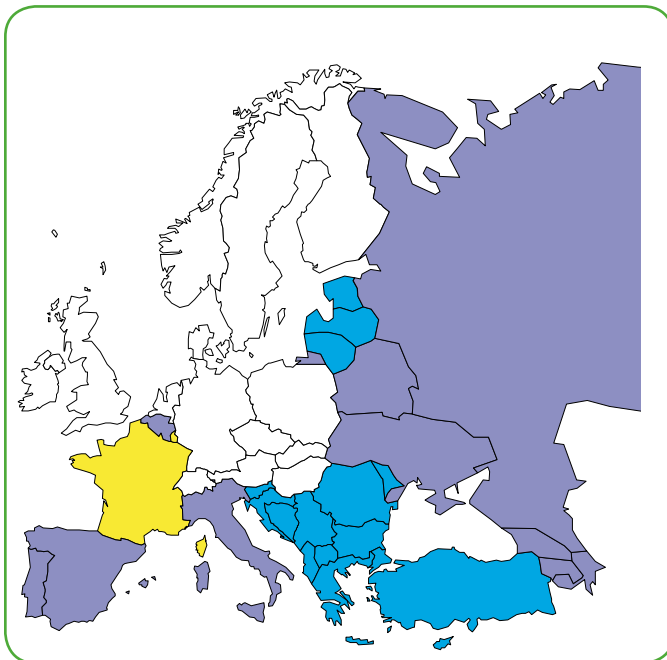

Only the product range to be marketed in your country and validated by the local product manager, in agreement with his Final Distribution (FD) partner should be retained. The others will be removed before publication.

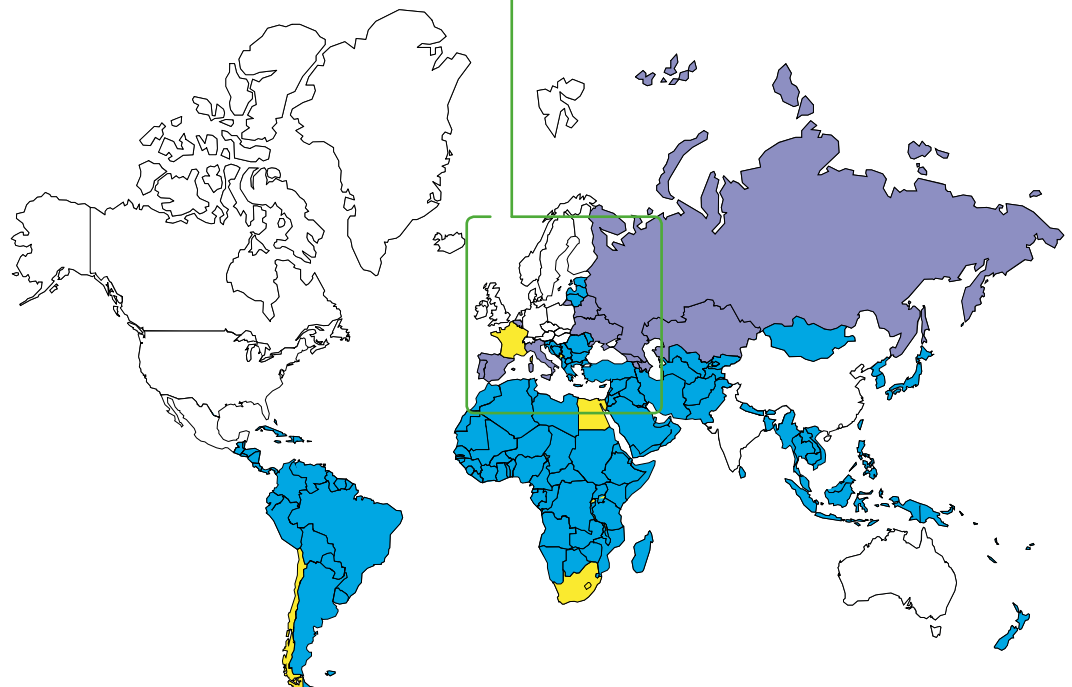

Protection Circuit protection iC60N circuit breakers (curve B, C, D)



IEC/EN 60947-2 IEC/EN 60898-1

As per the above standards:

- iC60N circuit breakers are multi-standard circuit breakers which combine the following functions:
 - circuit protection against short-circuit currents,
 - circuit protection against overload currents,
 - suitable for industrial isolation according to IEC/EN 60947-2, standard.
 - fault tripping indication by a red mechanical indicator in circuit breaker front face.



Alternating current (AC) 50/60 Hz

Breaking capacity (Icu) according to IEC/EN 60947-2	Voltage (Ue)				Service breaking capacity (Ics)
	12 to 133 V	220 to 240 V	380 to 415 V	440 V	
Ph/Ph (2P, 3P, 4P)	12 to 133 V	220 to 240 V	380 to 415 V	440 V	100 % of Icu 75 % of Icu
Ph/N (1P, 1P+N)	12 to 60 V	100 to 133 V	220 to 240 V	-	
Rating (In)	0.5 to 4 A	50 kA	50 kA	50 kA	
	6 to 63 A	36 kA	20 kA	10 kA	6 kA

Breaking capacity (Icn) according to IEC/EN 60898-1

Breaking capacity (Icn) according to IEC/EN 60898-1	Voltage (Ue)	
	Ph/Ph	Ph/N
Rating (In)	0.5 to 63 A	6000 A

Direct current (DC)

Breaking capacity (Icu) according to IEC/EN 60947-2	Voltage (Ue)					Service breaking capacity (Ics)
	Between +/-	≤ 72 V	≤ 125 V	≤ 180 V	≤ 250 V	
Number of poles	1P	2P	3P	4P		
Rating (In)	0.5 to 63 A	15 kA	10 kA	10 kA	10 kA	100 % of Icu

Offer selection see page 21

Offer A

This sticker must be removed before publishing

Catalog numbers

iC60N circuit breaker

Type	1P	1P+N																																																																																																																																
Auxiliaries	Remote tripping and indication, catalog modules CA907000 and CA907002	Remote tripping and indication, catalog modules CA907000 and CA907002																																																																																																																																
Vigi iC60	Vigi iC60 add-on residual current device, catalog module CA902005	Vigi iC60 add-on residual current device, catalog module CA902005																																																																																																																																
Rating (In)	<table border="1"> <thead> <tr> <th>Curve</th> <th>B</th> <th>C</th> <th>D⁽¹⁾</th> </tr> </thead> <tbody> <tr><td>0.5 A⁽¹⁾</td><td>A9F73170</td><td>A9F74170</td><td>A9F75170</td></tr> <tr><td>1 A⁽¹⁾</td><td>A9F73101</td><td>A9F74101</td><td>A9F75101</td></tr> <tr><td>2 A⁽¹⁾</td><td>A9F73102</td><td>A9F74102</td><td>A9F75102</td></tr> <tr><td>3 A⁽¹⁾</td><td>A9F73103</td><td>A9F74103</td><td>A9F75103</td></tr> <tr><td>4 A⁽¹⁾</td><td>A9F73104</td><td>A9F74104</td><td>A9F75104</td></tr> <tr><td>6 A</td><td>A9F76106</td><td>A9F77106</td><td>A9F75106</td></tr> <tr><td>10 A</td><td>A9F76110</td><td>A9F77110</td><td>A9F75110</td></tr> <tr><td>13 A⁽¹⁾</td><td>A9F73113</td><td>A9F74113</td><td>A9F75113</td></tr> <tr><td>16 A</td><td>A9F76116</td><td>A9F77116</td><td>A9F75116</td></tr> <tr><td>20 A</td><td>A9F76120</td><td>A9F77120</td><td>A9F75120</td></tr> <tr><td>25 A</td><td>A9F76125</td><td>A9F77125</td><td>A9F75125</td></tr> <tr><td>32 A</td><td>A9F76132</td><td>A9F77132</td><td>A9F75132</td></tr> <tr><td>40 A</td><td>A9F76140</td><td>A9F77140</td><td>A9F75140</td></tr> <tr><td>50 A</td><td>A9F76150</td><td>A9F77150</td><td>A9F75150</td></tr> <tr><td>63 A</td><td>A9F76163</td><td>A9F77163</td><td>A9F75163</td></tr> </tbody> </table>	Curve	B	C	D ⁽¹⁾	0.5 A ⁽¹⁾	A9F73170	A9F74170	A9F75170	1 A ⁽¹⁾	A9F73101	A9F74101	A9F75101	2 A ⁽¹⁾	A9F73102	A9F74102	A9F75102	3 A ⁽¹⁾	A9F73103	A9F74103	A9F75103	4 A ⁽¹⁾	A9F73104	A9F74104	A9F75104	6 A	A9F76106	A9F77106	A9F75106	10 A	A9F76110	A9F77110	A9F75110	13 A ⁽¹⁾	A9F73113	A9F74113	A9F75113	16 A	A9F76116	A9F77116	A9F75116	20 A	A9F76120	A9F77120	A9F75120	25 A	A9F76125	A9F77125	A9F75125	32 A	A9F76132	A9F77132	A9F75132	40 A	A9F76140	A9F77140	A9F75140	50 A	A9F76150	A9F77150	A9F75150	63 A	A9F76163	A9F77163	A9F75163	<table border="1"> <thead> <tr> <th>Curve</th> <th>B</th> <th>C</th> <th>D⁽¹⁾</th> </tr> </thead> <tbody> <tr><td>0.5 A⁽¹⁾</td><td>A9F73670</td><td>A9F74670</td><td>A9F75670</td></tr> <tr><td>1 A⁽¹⁾</td><td>A9F73601</td><td>A9F74601</td><td>A9F75601</td></tr> <tr><td>2 A⁽¹⁾</td><td>A9F73602</td><td>A9F74602</td><td>A9F75602</td></tr> <tr><td>3 A⁽¹⁾</td><td>A9F73603</td><td>A9F74603</td><td>A9F75603</td></tr> <tr><td>4 A⁽¹⁾</td><td>A9F73604</td><td>A9F74604</td><td>A9F75604</td></tr> <tr><td>6 A</td><td>A9F76606</td><td>A9F77606</td><td>A9F75606</td></tr> <tr><td>10 A</td><td>A9F76610</td><td>A9F77610</td><td>A9F75610</td></tr> <tr><td>13 A⁽¹⁾</td><td>A9F73613</td><td>A9F74613</td><td>A9F75613</td></tr> <tr><td>16 A</td><td>A9F76616</td><td>A9F77616</td><td>A9F75616</td></tr> <tr><td>20 A</td><td>A9F76620</td><td>A9F77620</td><td>A9F75620</td></tr> <tr><td>25 A</td><td>A9F76625</td><td>A9F77625</td><td>A9F75625</td></tr> <tr><td>32 A</td><td>A9F76632</td><td>A9F77632</td><td>A9F75632</td></tr> <tr><td>40 A</td><td>A9F76640</td><td>A9F77640</td><td>A9F75640</td></tr> <tr><td>50 A</td><td>A9F76650</td><td>A9F77650</td><td>A9F75650</td></tr> <tr><td>63 A</td><td>A9F76663</td><td>A9F77663</td><td>A9F75663</td></tr> </tbody> </table>	Curve	B	C	D ⁽¹⁾	0.5 A ⁽¹⁾	A9F73670	A9F74670	A9F75670	1 A ⁽¹⁾	A9F73601	A9F74601	A9F75601	2 A ⁽¹⁾	A9F73602	A9F74602	A9F75602	3 A ⁽¹⁾	A9F73603	A9F74603	A9F75603	4 A ⁽¹⁾	A9F73604	A9F74604	A9F75604	6 A	A9F76606	A9F77606	A9F75606	10 A	A9F76610	A9F77610	A9F75610	13 A ⁽¹⁾	A9F73613	A9F74613	A9F75613	16 A	A9F76616	A9F77616	A9F75616	20 A	A9F76620	A9F77620	A9F75620	25 A	A9F76625	A9F77625	A9F75625	32 A	A9F76632	A9F77632	A9F75632	40 A	A9F76640	A9F77640	A9F75640	50 A	A9F76650	A9F77650	A9F75650	63 A	A9F76663	A9F77663	A9F75663
Curve	B	C	D ⁽¹⁾																																																																																																																															
0.5 A ⁽¹⁾	A9F73170	A9F74170	A9F75170																																																																																																																															
1 A ⁽¹⁾	A9F73101	A9F74101	A9F75101																																																																																																																															
2 A ⁽¹⁾	A9F73102	A9F74102	A9F75102																																																																																																																															
3 A ⁽¹⁾	A9F73103	A9F74103	A9F75103																																																																																																																															
4 A ⁽¹⁾	A9F73104	A9F74104	A9F75104																																																																																																																															
6 A	A9F76106	A9F77106	A9F75106																																																																																																																															
10 A	A9F76110	A9F77110	A9F75110																																																																																																																															
13 A ⁽¹⁾	A9F73113	A9F74113	A9F75113																																																																																																																															
16 A	A9F76116	A9F77116	A9F75116																																																																																																																															
20 A	A9F76120	A9F77120	A9F75120																																																																																																																															
25 A	A9F76125	A9F77125	A9F75125																																																																																																																															
32 A	A9F76132	A9F77132	A9F75132																																																																																																																															
40 A	A9F76140	A9F77140	A9F75140																																																																																																																															
50 A	A9F76150	A9F77150	A9F75150																																																																																																																															
63 A	A9F76163	A9F77163	A9F75163																																																																																																																															
Curve	B	C	D ⁽¹⁾																																																																																																																															
0.5 A ⁽¹⁾	A9F73670	A9F74670	A9F75670																																																																																																																															
1 A ⁽¹⁾	A9F73601	A9F74601	A9F75601																																																																																																																															
2 A ⁽¹⁾	A9F73602	A9F74602	A9F75602																																																																																																																															
3 A ⁽¹⁾	A9F73603	A9F74603	A9F75603																																																																																																																															
4 A ⁽¹⁾	A9F73604	A9F74604	A9F75604																																																																																																																															
6 A	A9F76606	A9F77606	A9F75606																																																																																																																															
10 A	A9F76610	A9F77610	A9F75610																																																																																																																															
13 A ⁽¹⁾	A9F73613	A9F74613	A9F75613																																																																																																																															
16 A	A9F76616	A9F77616	A9F75616																																																																																																																															
20 A	A9F76620	A9F77620	A9F75620																																																																																																																															
25 A	A9F76625	A9F77625	A9F75625																																																																																																																															
32 A	A9F76632	A9F77632	A9F75632																																																																																																																															
40 A	A9F76640	A9F77640	A9F75640																																																																																																																															
50 A	A9F76650	A9F77650	A9F75650																																																																																																																															
63 A	A9F76663	A9F77663	A9F75663																																																																																																																															
Width in 9-mm modules	2	4																																																																																																																																
Accessories	Catalog modules CA907000 and CA907001	Catalog modules CA907000 and CA907001																																																																																																																																

(1) VDE approved only.

Protection Circuit protection

iC60N circuit breakers (curve B, C, D) (cont.)

PB10434-40



■ Insulated terminals IP20

■ Large circuit labelling area

Visi-trip window
■ Fault tripping is indicated by a red mechanical indicator on the front face

■ Double clip for dismounting with comb busbar in place

Positive contact indication
■ Suitable for industrial isolation according to IEC/EN 60947-2 standard.
■ The presence of the green strip guarantees physical opening of the contacts and allows operations to be performed on the downstream circuit in complete safety

- Increased product service life thanks to:
 - overvoltage resistance by high level of industrial performances conception (pollution degree, rated impulse withstand voltage and insulation voltage),
 - high performance limitation (see limitation curves),
 - fast closing independent of the speed of actuation of the toggle.
- Remote indication, open/closed/tripped, by optional auxiliary contacts.
- Top or bottom electrical feeding.

	2P			3P			4P		
E45094				E46095			E46097		
	Remote tripping and indication, catalog module CA907000 and CA907002			Remote tripping and indication, catalog module CA907000 and CA907002			Remote tripping and indication, catalog module CA907000 and CA907002		
	Vigi iC60 add-on residual current device, catalog module CA902005			Vigi iC60 add-on residual current device, catalog module CA902005			Vigi iC60 add-on residual current device, catalog module CA902005		
	Curve			Curve			Curve		
	B	C	D ⁽¹⁾	B	C	D ⁽¹⁾	B	C	D ⁽¹⁾
	A9F73270	A9F74270	A9F75270	A9F73370	A9F74370	A9F75370	A9F73470	A9F74470	A9F75470
	A9F73201	A9F74201	A9F75201	A9F73301	A9F74301	A9F75301	A9F73401	A9F74401	A9F75401
	A9F73202	A9F74202	A9F75202	A9F73302	A9F74302	A9F75302	A9F73402	A9F74402	A9F75402
	A9F73203	A9F74203	A9F75203	A9F73303	A9F74303	A9F75303	A9F73403	A9F74403	A9F75403
	A9F73204	A9F74204	A9F75204	A9F73304	A9F74304	A9F75304	A9F73404	A9F74404	A9F75404
	A9F76206	A9F77206	A9F75206	A9F76306	A9F77306	A9F75306	A9F76406	A9F77406	A9F75406
	A9F76210	A9F77210	A9F75210	A9F76310	A9F77310	A9F75310	A9F76410	A9F77410	A9F75410
	A9F73213	A9F74213	A9F75213	A9F73313	A9F74313	A9F75313	A9F73413	A9F74413	A9F75413
	A9F76216	A9F77216	A9F75216	A9F76316	A9F77316	A9F75316	A9F76416	A9F77416	A9F75416
	A9F76220	A9F77220	A9F75220	A9F76320	A9F77320	A9F75320	A9F76420	A9F77420	A9F75420
	A9F76225	A9F77225	A9F75225	A9F76325	A9F77325	A9F75325	A9F76425	A9F77425	A9F75425
	A9F76232	A9F77232	A9F75232	A9F76332	A9F77332	A9F75332	A9F76432	A9F77432	A9F75432
	A9F76240	A9F77240	A9F75240	A9F76340	A9F77340	A9F75340	A9F76440	A9F77440	A9F75440
	A9F76250	A9F77250	A9F75250	A9F76350	A9F77350	A9F75350	A9F76450	A9F77450	A9F75450
	A9F76263	A9F77263	A9F75263	A9F76363	A9F77363	A9F75363	A9F76463	A9F77463	A9F75463
	4			6			8		
	Catalog modules CA907000 and CA907001			Catalog modules CA907000 and CA907001			Catalog modules CA907000 and CA907001		

Protection Circuit protection iC60N circuit breakers (curve B, C, D)

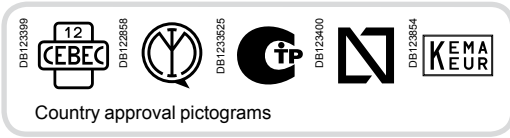

IEC/EN 60947-2 IEC/EN 60898-1

As per the above standards:

- iC60N circuit breakers are multi-standard circuit breakers which combine the following functions:
 - circuit protection against short-circuit currents,
 - circuit protection against overload currents,
 - suitable for industrial isolation according to IEC/EN 60947-2, standard.
 - fault tripping indication by a red mechanical indicator in circuit breaker front face.



Alternating current (AC) 50/60 Hz

Breaking capacity (Icu) according to IEC/EN 60947-2	Voltage (Ue)				Service breaking capacity (Ics)	
	12 to 133 V	220 to 240 V	380 to 415 V	440 V		
Ph/Ph (2P, 3P, 4P)	12 to 133 V	220 to 240 V	380 to 415 V	440 V	100 % of Icu	
Ph/N (1P, 1P+N)	12 to 60 V	100 to 133 V	220 to 240 V	-		
Rating (In)	0.5 to 4 A	50 kA	50 kA	50 kA		25 kA
	6 to 63 A	36 kA	20 kA	10 kA	6 kA	75 % of Icu

Breaking capacity (Icn) according to IEC/EN 60898-1

Breaking capacity (Icn) according to IEC/EN 60898-1	Voltage (Ue)	
	Ph/Ph	Ph/N
Ph/Ph	400 V	
Ph/N		230 V
Rating (In)	0.5 to 63 A	
	6000 A	

Direct current (DC)

Breaking capacity (Icu) according to IEC/EN 60947-2	Voltage (Ue)					Service breaking capacity (Ics)
	Between +/-	12 to 60 V	≤ 72 V	≤ 125 V	≤ 180 V	
		1P		2P	3P	4P
Rating (In)	0.5 to 63 A	15 kA	10 kA	10 kA	10 kA	10 kA
		100 % of Icu				

Offer selection see page 21

Offer B

This sticker must be removed before publishing

Catalog numbers

iC60N circuit breaker

Type	1P	1P+N																																																																																																						
Auxiliaries	Remote tripping and indication, catalog modules CA907000 and CA907002	Remote tripping and indication, catalog modules CA907000 and CA907002																																																																																																						
Vigi iC60	Vigi iC60 add-on residual current device, catalog module CA902005	Vigi iC60 add-on residual current device, catalog module CA902005																																																																																																						
Rating (In)	<table border="1"> <thead> <tr> <th colspan="3">Curve</th> </tr> <tr> <th>B</th> <th>C</th> <th>D⁽¹⁾</th> </tr> </thead> <tbody> <tr><td>0.5 A⁽¹⁾</td><td>A9F73170</td><td>A9F74170</td></tr> <tr><td>1 A⁽¹⁾</td><td>A9F73101</td><td>A9F74101</td></tr> <tr><td>2 A⁽¹⁾</td><td>A9F73102</td><td>A9F74102</td></tr> <tr><td>3 A⁽¹⁾</td><td>A9F73103</td><td>A9F74103</td></tr> <tr><td>4 A⁽¹⁾</td><td>A9F73104</td><td>A9F74104</td></tr> <tr><td>6 A</td><td>A9F78106</td><td>A9F79106</td></tr> <tr><td>10 A</td><td>A9F78110</td><td>A9F79110</td></tr> <tr><td>13 A⁽¹⁾</td><td>A9F73113</td><td>A9F74113</td></tr> <tr><td>16 A</td><td>A9F78116</td><td>A9F79116</td></tr> <tr><td>20 A</td><td>A9F78120</td><td>A9F79120</td></tr> <tr><td>25 A</td><td>A9F78125</td><td>A9F79125</td></tr> <tr><td>32 A</td><td>A9F78132</td><td>A9F79132</td></tr> <tr><td>40 A</td><td>A9F78140</td><td>A9F79140</td></tr> <tr><td>50 A</td><td>A9F78150</td><td>A9F79150</td></tr> <tr><td>63 A</td><td>A9F78163</td><td>A9F79163</td></tr> </tbody> </table>	Curve			B	C	D ⁽¹⁾	0.5 A ⁽¹⁾	A9F73170	A9F74170	1 A ⁽¹⁾	A9F73101	A9F74101	2 A ⁽¹⁾	A9F73102	A9F74102	3 A ⁽¹⁾	A9F73103	A9F74103	4 A ⁽¹⁾	A9F73104	A9F74104	6 A	A9F78106	A9F79106	10 A	A9F78110	A9F79110	13 A ⁽¹⁾	A9F73113	A9F74113	16 A	A9F78116	A9F79116	20 A	A9F78120	A9F79120	25 A	A9F78125	A9F79125	32 A	A9F78132	A9F79132	40 A	A9F78140	A9F79140	50 A	A9F78150	A9F79150	63 A	A9F78163	A9F79163	<table border="1"> <thead> <tr> <th colspan="3">Curve</th> </tr> <tr> <th>B</th> <th>C</th> <th>D⁽¹⁾</th> </tr> </thead> <tbody> <tr><td>0.5 A⁽¹⁾</td><td>A9F73670</td><td>A9F74670</td></tr> <tr><td>1 A⁽¹⁾</td><td>A9F73601</td><td>A9F74601</td></tr> <tr><td>2 A⁽¹⁾</td><td>A9F73602</td><td>A9F74602</td></tr> <tr><td>3 A⁽¹⁾</td><td>A9F73603</td><td>A9F74603</td></tr> <tr><td>4 A⁽¹⁾</td><td>A9F73604</td><td>A9F74604</td></tr> <tr><td>6 A</td><td>A9F78606</td><td>A9F79606</td></tr> <tr><td>10 A</td><td>A9F78610</td><td>A9F79610</td></tr> <tr><td>13 A⁽¹⁾</td><td>A9F73613</td><td>A9F74613</td></tr> <tr><td>16 A</td><td>A9F78616</td><td>A9F79616</td></tr> <tr><td>20 A</td><td>A9F78620</td><td>A9F79620</td></tr> <tr><td>25 A</td><td>A9F78625</td><td>A9F79625</td></tr> <tr><td>32 A</td><td>A9F78632</td><td>A9F79632</td></tr> <tr><td>40 A</td><td>A9F78640</td><td>A9F79640</td></tr> <tr><td>50 A</td><td>A9F78650</td><td>A9F79650</td></tr> <tr><td>63 A</td><td>A9F78663</td><td>A9F79663</td></tr> </tbody> </table>	Curve			B	C	D ⁽¹⁾	0.5 A ⁽¹⁾	A9F73670	A9F74670	1 A ⁽¹⁾	A9F73601	A9F74601	2 A ⁽¹⁾	A9F73602	A9F74602	3 A ⁽¹⁾	A9F73603	A9F74603	4 A ⁽¹⁾	A9F73604	A9F74604	6 A	A9F78606	A9F79606	10 A	A9F78610	A9F79610	13 A ⁽¹⁾	A9F73613	A9F74613	16 A	A9F78616	A9F79616	20 A	A9F78620	A9F79620	25 A	A9F78625	A9F79625	32 A	A9F78632	A9F79632	40 A	A9F78640	A9F79640	50 A	A9F78650	A9F79650	63 A	A9F78663	A9F79663
Curve																																																																																																								
B	C	D ⁽¹⁾																																																																																																						
0.5 A ⁽¹⁾	A9F73170	A9F74170																																																																																																						
1 A ⁽¹⁾	A9F73101	A9F74101																																																																																																						
2 A ⁽¹⁾	A9F73102	A9F74102																																																																																																						
3 A ⁽¹⁾	A9F73103	A9F74103																																																																																																						
4 A ⁽¹⁾	A9F73104	A9F74104																																																																																																						
6 A	A9F78106	A9F79106																																																																																																						
10 A	A9F78110	A9F79110																																																																																																						
13 A ⁽¹⁾	A9F73113	A9F74113																																																																																																						
16 A	A9F78116	A9F79116																																																																																																						
20 A	A9F78120	A9F79120																																																																																																						
25 A	A9F78125	A9F79125																																																																																																						
32 A	A9F78132	A9F79132																																																																																																						
40 A	A9F78140	A9F79140																																																																																																						
50 A	A9F78150	A9F79150																																																																																																						
63 A	A9F78163	A9F79163																																																																																																						
Curve																																																																																																								
B	C	D ⁽¹⁾																																																																																																						
0.5 A ⁽¹⁾	A9F73670	A9F74670																																																																																																						
1 A ⁽¹⁾	A9F73601	A9F74601																																																																																																						
2 A ⁽¹⁾	A9F73602	A9F74602																																																																																																						
3 A ⁽¹⁾	A9F73603	A9F74603																																																																																																						
4 A ⁽¹⁾	A9F73604	A9F74604																																																																																																						
6 A	A9F78606	A9F79606																																																																																																						
10 A	A9F78610	A9F79610																																																																																																						
13 A ⁽¹⁾	A9F73613	A9F74613																																																																																																						
16 A	A9F78616	A9F79616																																																																																																						
20 A	A9F78620	A9F79620																																																																																																						
25 A	A9F78625	A9F79625																																																																																																						
32 A	A9F78632	A9F79632																																																																																																						
40 A	A9F78640	A9F79640																																																																																																						
50 A	A9F78650	A9F79650																																																																																																						
63 A	A9F78663	A9F79663																																																																																																						
Width in 9-mm modules	2	4																																																																																																						
Accessories	Catalog modules CA907000 and CA907001	Catalog modules CA907000 and CA907001																																																																																																						

(1) VDE approved only.

Protection Circuit protection

iC60N circuit breakers (curve B, C, D) (cont.)

PB104434-40

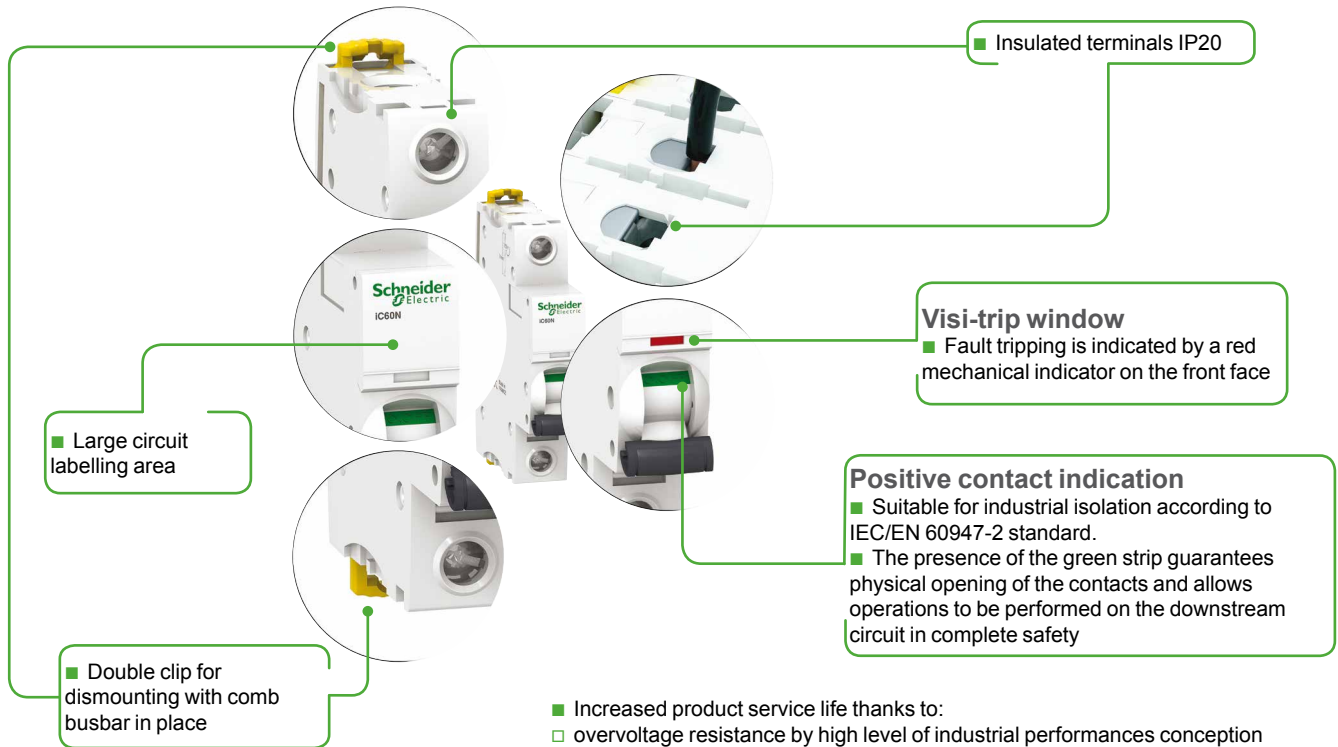

- Increased product service life thanks to:
 - overvoltage resistance by high level of industrial performances conception (pollution degree, rated impulse withstand voltage and insulation voltage),
 - high performance limitation (see limitation curves),
 - fast closing independent of the speed of actuation of the toggle.
- Remote indication, open/closed/tripped, by optional auxiliary contacts.
- Top or bottom electrical feeding.

2P			3P			4P		
E46094			E46095			E46097		
Remote tripping and indication, catalog modules CA907000 and CA907002			Remote tripping and indication, catalog modules CA907000 and CA907002			Remote tripping and indication, catalog modules CA907000 and CA907002		
Vigi iC60 add-on residual current device, catalog module CA902005			Vigi iC60 add-on residual current device, catalog module CA902005			Vigi iC60 add-on residual current device, catalog module CA902005		
Curve			Curve			Curve		
B	C	D ⁽¹⁾	B	C	D ⁽¹⁾	B	C	D ⁽¹⁾
A9F73270	A9F74270	A9F75270	A9F73370	A9F74370	A9F75370	A9F73470	A9F74470	A9F75470
A9F73201	A9F74201	A9F75201	A9F73301	A9F74301	A9F75301	A9F73401	A9F74401	A9F75401
A9F73202	A9F74202	A9F75202	A9F73302	A9F74302	A9F75302	A9F73402	A9F74402	A9F75402
A9F73203	A9F74203	A9F75203	A9F73303	A9F74303	A9F75303	A9F73403	A9F74403	A9F75403
A9F73204	A9F74204	A9F75204	A9F73304	A9F74304	A9F75304	A9F73404	A9F74404	A9F75404
A9F78206	A9F79206	A9F75206	A9F78306	A9F79306	A9F75306	A9F78406	A9F79406	A9F75406
A9F78210	A9F79210	A9F75210	A9F78310	A9F79310	A9F75310	A9F78410	A9F79410	A9F75410
A9F73213	A9F74213	A9F75213	A9F73313	A9F74313	A9F75313	A9F73413	A9F74413	A9F75413
A9F78216	A9F79216	A9F75216	A9F78316	A9F79316	A9F75316	A9F78416	A9F79416	A9F75416
A9F78220	A9F79220	A9F75220	A9F78320	A9F79320	A9F75320	A9F78420	A9F79420	A9F75420
A9F78225	A9F79225	A9F75225	A9F78325	A9F79325	A9F75325	A9F78425	A9F79425	A9F75425
A9F78232	A9F79232	A9F75232	A9F78332	A9F79332	A9F75332	A9F78432	A9F79432	A9F75432
A9F78240	A9F79240	A9F75240	A9F78340	A9F79340	A9F75340	A9F78440	A9F79440	A9F75440
A9F78250	A9F79250	A9F75250	A9F78350	A9F79350	A9F75350	A9F78450	A9F79450	A9F75450
A9F78263	A9F79263	A9F75263	A9F78363	A9F79363	A9F75363	A9F78463	A9F79463	A9F75463
4			6			8		
Catalog modules CA907000 and CA907001			Catalog modules CA907000 and CA907001			Catalog modules CA907000 and CA907001		

Protection Circuit protection iC60N circuit breakers (curve B, C, D)



IEC/EN 60947-2 IEC/EN 60898-1

As per the above standards:

- iC60N circuit breakers are multi-standard circuit breakers which combine the following functions:
 - circuit protection against short-circuit currents,
 - circuit protection against overload currents,
 - suitable for industrial isolation according to IEC/EN 60947-2, standard.
 - fault tripping indication by a red mechanical indicator in circuit breaker front face.

Alternating current (AC) 50/60 Hz

Breaking capacity (Icu) according to IEC/EN 60947-2	Voltage (Ue)				Service breaking capacity (Ics)
	Ph/Ph (2P, 3P, 4P)	12 to 133 V	220 to 240 V	380 to 415 V 440 V	
Ph/N (1P, 1P+N)	12 to 60 V	100 to 133 V	220 to 240 V	-	100 % of Icu 75 % of Icu
Rating (In)	0.5 to 4 A	50 kA	50 kA	50 kA 25 kA	
	6 to 63 A	36 kA	20 kA	10 kA 6 kA	

Breaking capacity (Icn) according to IEC/EN 60898-1	Voltage (Ue)	
	Ph/Ph	400 V
Ph/N	230 V	
Rating (In)	0.5 to 63 A 6000 A	

Breaking capacity (Icu) according to IEC/EN 60947-2	Voltage (Ue)					Service breaking capacity (Ics)
	Between +/-	12 to 60 V	≤ 72 V	≤ 125 V	≤ 180 V	
Number of poles	1P			2P	3P	4P
Rating (In)	0.5 to 63 A	15 kA	10 kA	10 kA	10 kA	10 kA

Offer selection see page 21

Offer

This sticker must be removed before publishing

Catalog numbers

iC60N circuit breaker						
Type	1P			1P+N		
Auxiliaries	Remote tripping and indication, catalog modules CA907000 and CA907002			Remote tripping and indication, catalog modules CA907000 and CA907002		
Vigi iC60	Vigi iC60 add-on residual current device, catalog module CA902005			Vigi iC60 add-on residual current device, catalog module CA902005		
Rating (In)	Curve			Curve		
	B	C	D	B	C	D
0.5 A	A9F73170	A9F74170	A9F75170	A9F73670	A9F74670	A9F75670
1 A	A9F73101	A9F74101	A9F75101	A9F73601	A9F74601	A9F75601
2 A	A9F73102	A9F74102	A9F75102	A9F73602	A9F74602	A9F75602
3 A	A9F73103	A9F74103	A9F75103	A9F73603	A9F74603	A9F75603
4 A	A9F73104	A9F74104	A9F75104	A9F73604	A9F74604	A9F75604
6 A	A9F73106	A9F74106	A9F75106	A9F73606	A9F74606	A9F75606
10 A	A9F73110	A9F74110	A9F75110	A9F73610	A9F74610	A9F75610
13 A	A9F73113	A9F74113	A9F75113	A9F73613	A9F74613	A9F75613
16 A	A9F73116	A9F74116	A9F75116	A9F73616	A9F74616	A9F75616
20 A	A9F73120	A9F74120	A9F75120	A9F73620	A9F74620	A9F75620
25 A	A9F73125	A9F74125	A9F75125	A9F73625	A9F74625	A9F75625
32 A	A9F73132	A9F74132	A9F75132	A9F73632	A9F74632	A9F75632
40 A	A9F73140	A9F74140	A9F75140	A9F73640	A9F74640	A9F75640
50 A	A9F73150	A9F74150	A9F75150	A9F73650	A9F74650	A9F75650
63 A	A9F73163	A9F74163	A9F75163	A9F73663	A9F74663	A9F75663
Width in 9-mm modules	2			4		
Accessories	Catalog modules CA907000 and CA907001			Catalog modules CA907000 and CA907001		

Protection Circuit protection iC60N circuit breakers (curve B, C, D) (cont.)

PB10434-40

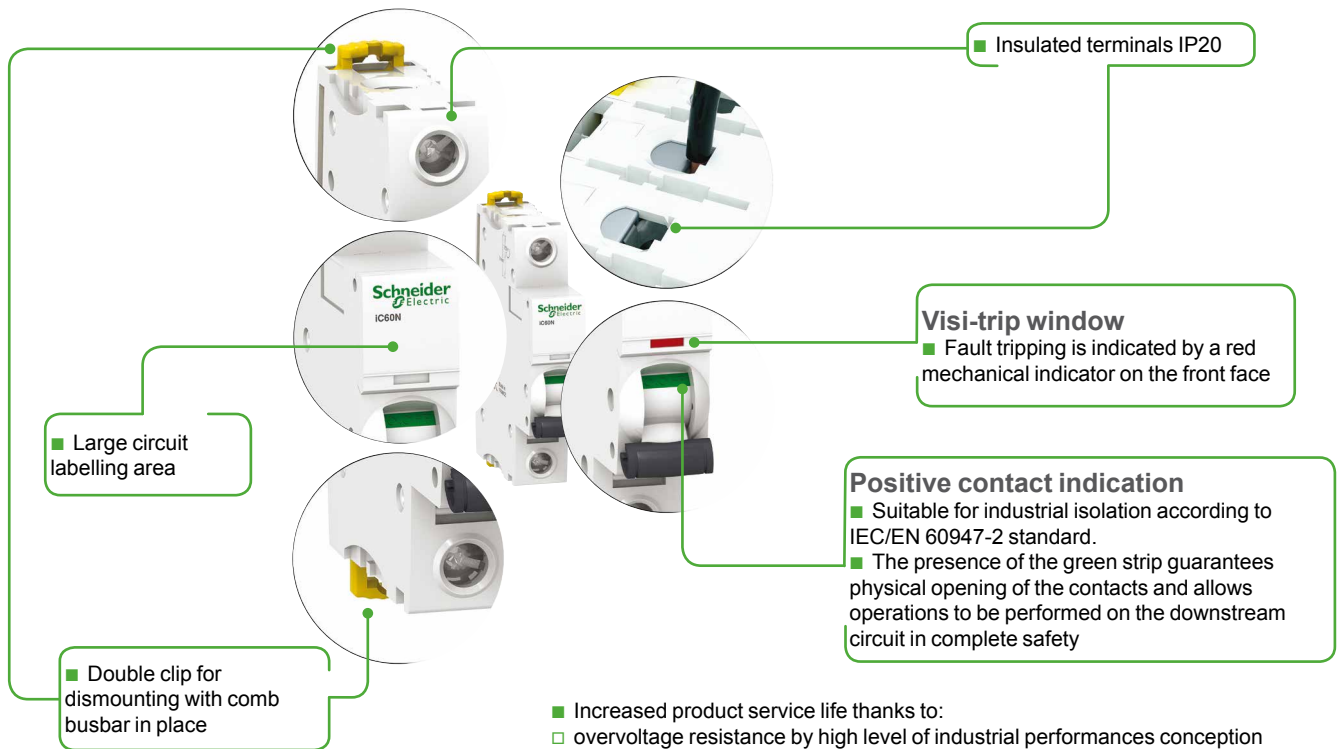

- Increased product service life thanks to:
 - overvoltage resistance by high level of industrial performances conception (pollution degree, rated impulse withstand voltage and insulation voltage),
 - high performance limitation (see limitation curves),
 - fast closing independent of the speed of actuation of the toggle.
- Remote indication, open/closed/tripped, by optional auxiliary contacts.
- Top or bottom electrical feeding.

2P				3P			4P		
E46094 				E46095 			E46097 		
Remote tripping and indication, catalog modules CA907000 and CA907002				Remote tripping and indication, catalog modules CA907000 and CA907002			Remote tripping and indication, catalog modules CA907000 and CA907002		
Vigi iC60 add-on residual current device, catalog module CA902005				Vigi iC60 add-on residual current device, catalog module CA902005			Vigi iC60 add-on residual current device, catalog module CA902005		
Curve				Curve			Curve		
B	C	D		B	C	D	B	C	D
A9F73270	A9F74270	A9F75270		A9F73370	A9F74370	A9F75370	A9F73470	A9F74470	A9F75470
A9F73201	A9F74201	A9F75201		A9F73301	A9F74301	A9F75301	A9F73401	A9F74401	A9F75401
A9F73202	A9F74202	A9F75202		A9F73302	A9F74302	A9F75302	A9F73402	A9F74402	A9F75402
A9F73203	A9F74203	A9F75203		A9F73303	A9F74303	A9F75303	A9F73403	A9F74403	A9F75403
A9F73204	A9F74204	A9F75204		A9F73304	A9F74304	A9F75304	A9F73404	A9F74404	A9F75404
A9F73206	A9F74206	A9F75206		A9F73306	A9F74306	A9F75306	A9F73406	A9F74406	A9F75406
A9F73210	A9F74210	A9F75210		A9F73310	A9F74310	A9F75310	A9F73410	A9F74410	A9F75410
A9F73213	A9F74213	A9F75213		A9F73313	A9F74313	A9F75313	A9F73413	A9F74413	A9F75413
A9F73216	A9F74216	A9F75216		A9F73316	A9F74316	A9F75316	A9F73416	A9F74416	A9F75416
A9F73220	A9F74220	A9F75220		A9F73320	A9F74320	A9F75320	A9F73420	A9F74420	A9F75420
A9F73225	A9F74225	A9F75225		A9F73325	A9F74325	A9F75325	A9F73425	A9F74425	A9F75425
A9F73232	A9F74232	A9F75232		A9F73332	A9F74332	A9F75332	A9F73432	A9F74432	A9F75432
A9F73240	A9F74240	A9F75240		A9F73340	A9F74340	A9F75340	A9F73440	A9F74440	A9F75440
A9F73250	A9F74250	A9F75250		A9F73350	A9F74350	A9F75350	A9F73450	A9F74450	A9F75450
A9F73263	A9F74263	A9F75263		A9F73363	A9F74363	A9F75363	A9F73463	A9F74463	A9F75463
4				6			8		
Catalog modules CA907000 and CA907001				Catalog modules CA907000 and CA907001			Catalog modules CA907000 and CA907001		

iC60N circuit breakers (curve B, C, D) (cont.)

Connection

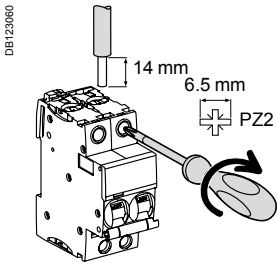

Rating	Tightening torque	Without accessory		With accessories		
		Rigid	Flexible or with ferrule	50 mm ² Al terminal	Screw-on connection for ring terminal	Multi-cables terminal
0.5 to 25 A	2 N.m	DB122945	DB122946	DB122935	DB118789	DB118787
32 to 63 A	3.5 N.m	1 to 25 mm ²	1 to 16 mm ²	-	Ø 5 mm	-
		1 to 35 mm ²	1 to 25 mm ²	50 mm ²		3 x 16 mm ²
						3 x 10 mm ²

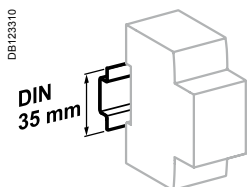

Clip on DIN rail 35 mm.

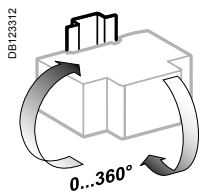

Indifferent position of installation.

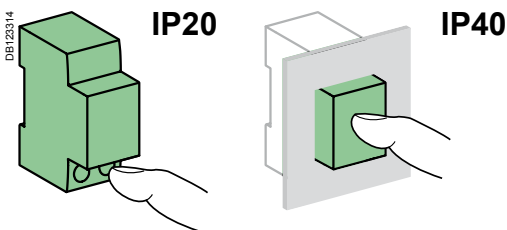

Technical data

Main characteristics		
According to IEC/EN 60947-2		
Insulation voltage (U _i)		500 V AC
Pollution degree		3
Rated impulse withstand voltage (U _{imp})		6 kV
Thermal tripping	Reference temperature	50 °C
	Temperature derating	See module CA908007
Magnetic tripping	B curve	4 I _n ± 20 %
	C curve	8 I _n ± 20 %
	D curve	12 I _n ± 20 %
Utilization category		A
According to IEC/EN 60898-1		
Limitation class		3
Rated making and breaking capacity of an individual pole (I _{cn1})		I _{cn1} = I _{cn}
Additional characteristics		
Breaking capacity under 1 pole with IT 380-415 V isolated neutral system (case of double fault)	40 A	4 kA
	50/63 A	3 kA
Degree of protection (IEC 60529)	Device only	IP20
	Device in modular enclosure	IP40
Endurance (O-C)	Electrical	10,000 cycles
	Mechanical	20,000 cycles
Overvoltage category (IEC 60364)		IV
Operating temperature		-35°C to +70°C
Storage temperature		-40°C to +85°C
Tropicalization (IEC 60068-1)		Treatment 2 (relative humidity 95 % to 55°C)

Weight (g)

Circuit-breaker	
Type	iC60N
1P	125
2P	250
3P	375
4P	500

Dimensions (mm)

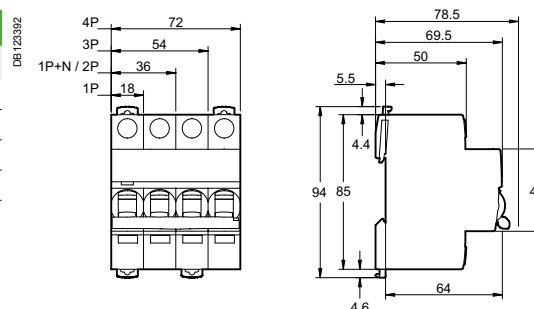

Protection Circuit protection

iC60N double terminals circuit breakers (curve B, C, D)

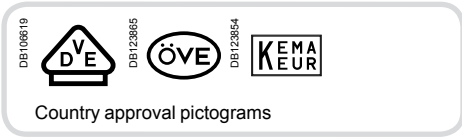

IEC/EN 60947-2 IEC/EN 60898-1

- iC60N double tunnel terminals circuit breakers are multi-standard circuit breakers which combine the following functions:
 - circuit protection against short-circuit currents,
 - circuit protection against overload currents,
 - suitable for industrial isolation according to IEC/EN 60947-2, standard.
 - fault tripping indication by a red mechanical indicator in circuit breaker front face.

Alternating current (AC) 50/60 Hz

Breaking capacity (Icu) according to IEC/EN 60947-2	Voltage (Ue)				Service breaking capacity (Ics)
	12 to 133 V	220 to 240 V	380 to 415 V	440 V	
Ph/Ph (2P, 3P, 3P+N, 4P)					100 % of Icu 75 % of Ics
Ph/N (1P, 1P+N)	12 to 60 V	100 to 133 V	220 to 240 V	-	
Rating (In)	0.5 to 4 A 6 to 63 A	50 kA 36 kA	50 kA 20 kA	50 kA 10 kA	25 kA 6 kA

Breaking capacity (Icn) according to IEC/EN 60898-1

Breaking capacity (Icn) according to IEC/EN 60898-1	Voltage (Ue)	
	Ph/Ph	Ph/N
Rating (In)	0.5 to 63 A	6000 A

Direct current (DC)

Breaking capacity (Icu) according to IEC/EN 60947-2	Voltage (Ue)					Service breaking capacity (Ics)
	Between +/-	12 to 60 V	≤ 72 V	≤ 125 V	≤ 180 V	
Number of poles	1P		2P	3P	4P	100 % of Icu
Rating (In)	1 to 63 A	15 kA	10 kA	10 kA	10 kA	

Catalogue numbers

iC60N double terminals circuit breaker

Type	1P	1P+N	2P
Auxiliaries	Remote tripping and indication, module CA907000 and CA907002	Remote tripping and indication, module CA907000 and CA907002	Remote tripping and indication, module CA907000 and CA907002
Vigi iC60	Vigi iC60 add-on residual current device, module CA902005	Vigi iC60 add-on residual current device, module CA902005	Vigi iC60 add-on residual current device, module CA902005
Rating (In)	Curve B C D	Curve B C	Curve B C D
0.5 A	- A9F04170 A9F05170	- A9F04670	- A9F04270 A9F05270
1 A	A9F03101 A9F04101 A9F05101	- A9F04601	- A9F04201 A9F05201
2 A	A9F03102 A9F04102 A9F05102	- A9F04602	A9F03202 A9F04202 A9F05202
3 A	- A9F04103 A9F05103	- A9F04603	- A9F04203 A9F05203
4 A	A9F03104 A9F04104 A9F05104	- A9F04604	A9F03204 A9F04204 A9F05204
6 A	A9F03106 A9F04106 A9F05106	A9F03606 A9F04606	A9F03206 A9F04206 A9F05206
10 A	A9F03110 A9F04110 A9F05110	A9F03610 A9F04610	A9F03210 A9F04210 A9F05210
13 A	A9F03113 A9F04113 A9F05113	A9F03613 A9F04613	A9F03213 A9F04213 A9F05213
16 A	A9F03116 A9F04116 A9F05116	A9F03616 A9F04616	A9F03216 A9F04216 A9F05216
20 A	A9F03120 A9F04120 A9F05120	A9F03620 A9F04620	A9F03220 A9F04220 A9F05220
25 A	A9F03125 A9F04125 A9F05125	A9F03625 A9F04625	A9F03225 A9F04225 A9F05225
32 A	A9F03132 A9F04132 A9F05132	A9F03632 A9F04632	A9F03232 A9F04232 A9F05232
40 A	A9F03140 A9F04140 A9F05140	A9F03640 A9F04640	A9F03240 A9F04240 A9F05240
50 A	A9F03150 A9F04150 A9F05150	A9F03650 A9F04650	A9F03250 A9F04250 A9F05250
63 A	A9F03163 A9F04163 A9F05163	A9F03663 A9F04663	A9F03263 A9F04263 A9F05263
Width in 9-mm modules	2	4	4
Accessories	Modules CA907000 and CA907001	Modules CA907000 and CA907001	Modules CA907000 and CA907001

Protection Circuit protection

iC60N double terminals circuit breakers (curve B, C, D) (cont.)

- Insulated terminals IP20**
- Double terminals**
 - For top or bottom connections:
 - by cable,
 - by comb busbar
- Large circuit labelling area**
- Double clip locking** allowing tool-free removal, front panel side, with the comb busbar in position
- Visi-trip window**
 - Fault tripping is indicated by a red mechanical indicator on the front face
- Positive contact indication**
 - Suitable for industrial isolation according to IEC/EN 60947-2 standard
 - The presence of the green strip guarantees physical opening of the contacts and allows operations to be performed on the downstream circuit in complete safety
- Increased product service life thanks to:**
 - overtolerance resistance by high level of industrial performances conception (pollution degree, rated impulse withstand voltage and insulation voltage),
 - high performance limitation (see limitation curves),
 - fast closing independent of the speed of actuation of the toggle.
 - Remote indication, open/closed/tripped, by optional auxiliary contacts.
 - Top or bottom electrical feeding.

3P			3P+N			4P		
Remote tripping and indication, module CA907000 and CA907002			Remote tripping and indication, module CA907000 and CA907002			Remote tripping and indication, module CA907000 and CA907002		
Vigi iC60 add-on residual current device, module CA902005			Vigi iC60 add-on residual current device, module CA902005			Vigi iC60 add-on residual current device, module CA902005		
Curve			Curve			Curve		
B	C	D	B	C	B	C	D	
-	A9F04370	A9F05370	-	A9F04770	-	A9F04470	A9F05470	
-	A9F04301	A9F05301	-	A9F04701	-	A9F04401	A9F05401	
A9F03302	A9F04302	A9F05302	-	A9F04702	-	A9F04402	A9F05402	
-	A9F04303	A9F05303	-	A9F04703	-	A9F04403	A9F05403	
-	A9F04304	A9F05304	-	A9F04704	-	A9F04404	A9F05404	
A9F03306	A9F04306	A9F05306	A9F03706	A9F04706	A9F03406	A9F04406	A9F05406	
A9F03310	A9F04310	A9F05310	A9F03710	A9F04710	A9F03410	A9F04410	A9F05410	
A9F03313	A9F04313	A9F05313	A9F03713	A9F04713	A9F03413	A9F04413	A9F05413	
A9F03316	A9F04316	A9F05316	A9F03716	A9F04716	A9F03416	A9F04416	A9F05416	
A9F03320	A9F04320	A9F05320	A9F03720	A9F04720	A9F03420	A9F04420	A9F05420	
A9F03325	A9F04325	A9F05325	A9F03725	A9F04725	A9F03425	A9F04425	A9F05425	
A9F03332	A9F04332	A9F05332	A9F03732	A9F04732	A9F03432	A9F04432	A9F05432	
A9F03340	A9F04340	A9F05340	A9F03740	A9F04740	A9F03440	A9F04440	A9F05440	
A9F03350	A9F04350	A9F05350	A9F03750	A9F04750	A9F03450	A9F04450	A9F05450	
A9F03363	A9F04363	A9F05363	A9F03763	A9F04763	A9F03463	A9F04463	A9F05463	
6			8		8			
Modules CA907000 and CA907001			Modules CA907000 and CA907001			Modules CA907000 and CA907001		

Protection
Circuit protection

iC60N double terminals circuit breakers (curve B, C, D) (cont.)

Connection between double terminal circuit breakers

With comb busbar at the back/cables at the front

Without comb busbar at the back/cables at the front

DBA04815



		Back	Front	
Rating	Tightening torque	Comb busbar	Copper cables	
		Thickness of the teeth	Rigid	Flexible or with ferrule
0.5 to 25 A	2 N.m	1.5 mm	DB122945	DB122946
32 to 63 A	3.5 N.m	1.5 mm	1 to 25 mm ²	1 to 16 mm ²
			1 to 25 mm ²	1 to 25 mm ²

Between double terminal circuit breakers and single-terminal circuit breakers

Cables at the back/comb busbar at the front

DBA04817



		Back	Front	
Rating	Tightening torque	Copper cables		Comb busbar
		Rigid	Flexible or with ferrule	Thickness of the teeth
0.5 to 25 A	2 N.m	DB122945	DB122946	1.5 mm
32 to 63 A	3.5 N.m	1 to 16 mm ²	1 to 10 mm ²	1.5 mm
		1 to 16 mm ²	1 to 10 mm ²	1.5 mm

■ Connection by comb busbar or by cable (according to EN 50027).

Connection

DB123847

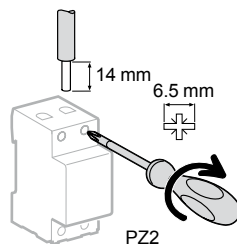

With accessories

Rating	50 mm ² AI terminal	Screw-on connection for ring terminal	Multi-cables terminal	
			Rigid cables	Flexible cables
0.5 to 25 A	DB122935	DB118789	DB118787	-
32 to 63 A	50 mm ²	Ø 5 mm	3 x 16 mm ²	3 x 10 mm ²

Protection Circuit protection

iC60N double terminals circuit breakers (curve B, C, D) (cont.)

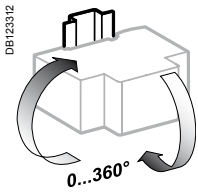

Indifferent position of installation.

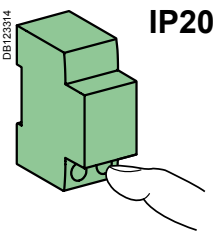

IP20

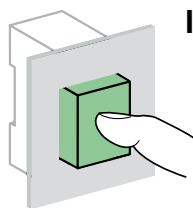

IP40

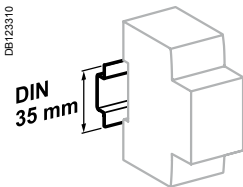

Clip on DIN rail 35 mm.

Technical data

Main characteristics		
According to IEC/EN 60947-2		
Insulation voltage (Ui)		500 V AC
Pollution degree		3
Rated impulse withstand voltage (Uimp)		6 kV
Thermal tripping	Reference temperature	50°C
	Temperature derating	See module CA908007
Magnetic tripping	B curve	4 In ± 20 %
	C curve	8 In ± 20 %
	D curve	12 In ± 20 %
Utilization category		A
According to IEC/EN 60898-1		
Limitation class		3
Rated making and breaking capacity of an individual pole (Icn1)		Icn1 = Icn
Additional characteristics		
Degree of protection (IEC 60529)	Device only	IP20
	Device in modular enclosure	IP40 Insulation class II
Endurance (O-C)	Electrical	10,000 cycles
	Mechanical	20,000 cycles
Overvoltage category (IEC 60364)		IV
Operating temperature		-35°C to +70°C
Storage temperature		-40°C to +85°C
Tropicalization (IEC 60068-1)		Treatment 2 (relative humidity 95 % to 55°C)

Disassembly double terminals iC60 circuit breaker with the comb busbar in position

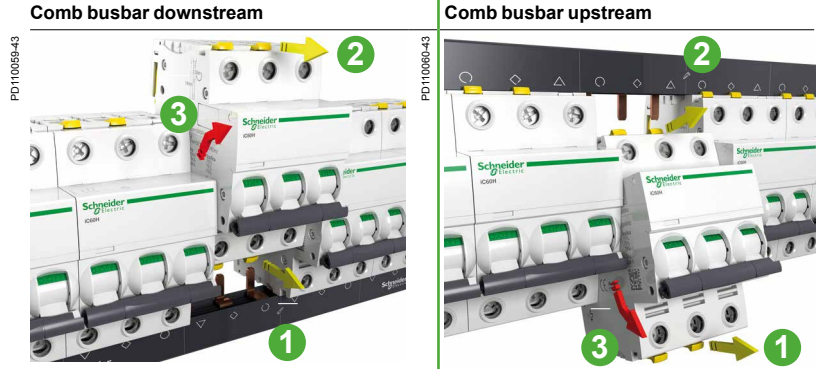

- 1- Pull lower "clip locking"
- 2- Pull upper "clip locking"
- 3- Remove the circuit breaker

Dimensions (mm)

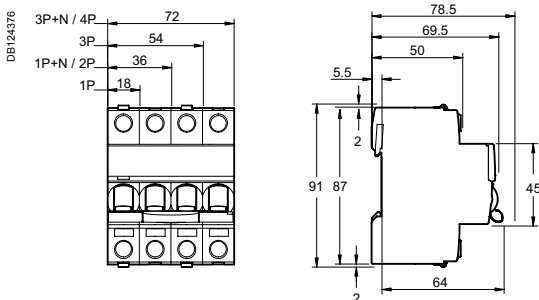

Weight (g)

Circuit-breaker	
Type	iC60N
1P	125
2P (1P+N)	250
3P	375
4P (3P+N)	500



Schneider Electric's range of circuit breakers consists of different products (A, B, C) to enable it to be the most competitive range possible in each country, allowing for the special characteristics of each market:

- usual installation procedure
- price
- accreditations by local bodies.

Variants

Offers		Pages
Offer A	Catalogue numbers	36
Offer B	Catalogue numbers	38
Offer C	Catalogue numbers	40
Common pages		42

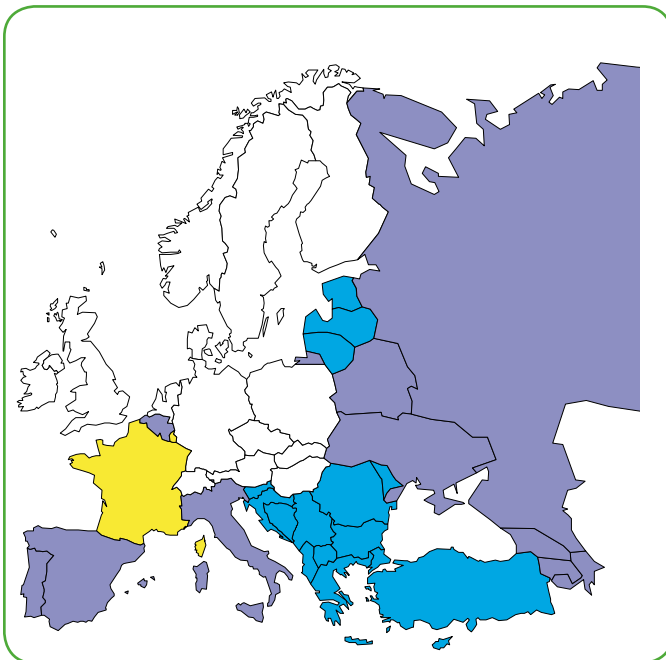

Only the product range to be marketed in your country and validated by the local product manager, in agreement with his Final Distribution (FD) partner should be retained. The others will be removed before publication.

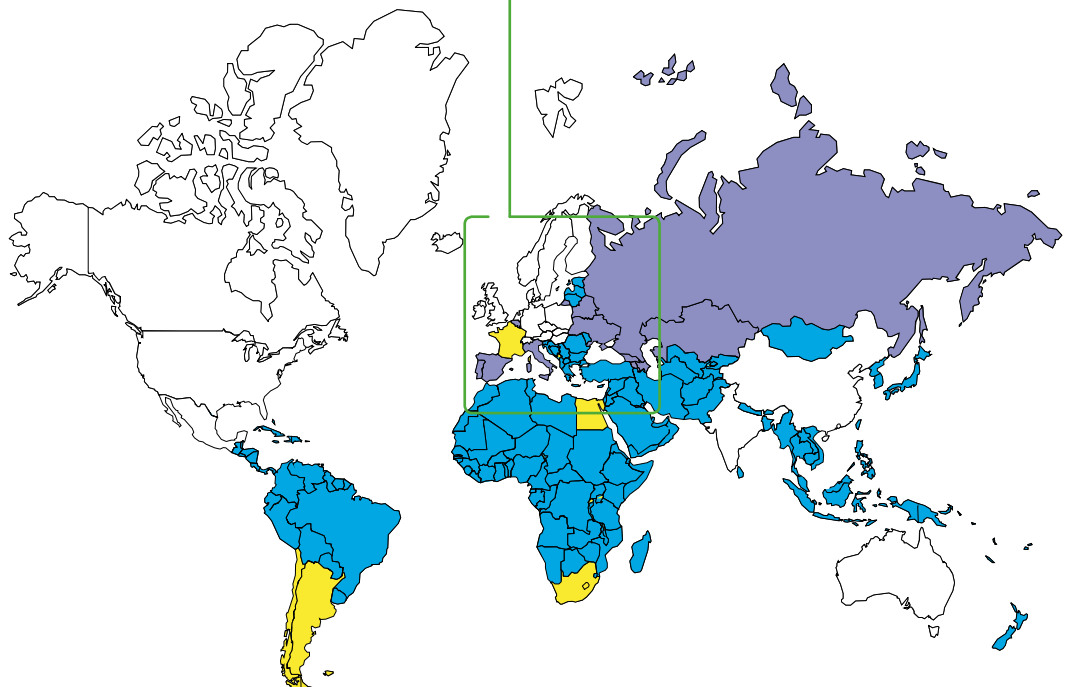

Protection Circuit protection iC60H circuit breakers (curve B, C, D)



IEC/EN 60947-2 IEC/EN 60898-1

- iC60H circuit breakers are multi-standard circuit breakers which combine the following functions:
 - circuit protection against short-circuit currents,
 - circuit protection against overload currents,
 - suitable for industrial isolation according to IEC/EN 60947-2, standard.
 - fault tripping indication by a red mechanical indicator in circuit breaker front face.



Alternating current (AC) 50/60 Hz

Breaking capacity (Icu) according to IEC/EN 60947-2	Voltage (Ue)				Service breaking capacity (Ics)
	12 to 133 V	220 to 240 V	380 to 415 V	440 V	
Ph/Ph (2P, 3P, 4P)	12 to 133 V	220 to 240 V	380 to 415 V	440 V	100 % of Icu
Ph/N (1P, 1P+N)	12 to 60 V	100 to 133 V	220 to 240 V	-	
Rating (In)	0.5 to 4 A	70 kA	70 kA	50 kA	50 % of Icu
	6 to 63 A	42 kA	30 kA	10 kA	

Breaking capacity (Icn) according to IEC/EN 60898-1	Voltage (Ue)	
	400 V	230 V
Ph/Ph	400 V	
Ph/N	230 V	
Rating (In)	0.5 to 63 A	10000 A

Direct current (DC)						
Breaking capacity (Icu) according to IEC/EN 60947-2	Voltage (Ue)					Service breaking capacity (Ics)
	Between +/-	12 to 60 V	≤ 72 V	≤ 125 V	≤ 180 V	
Number of poles	1P			2P	3P	4P
Rating (In)	0.5 to 63 A	20 kA	15 kA	15 kA	15 kA	15 kA

Offer A

Offer selection see page 35

This sticker must be removed before publishing

Catalogue numbers

iC60H circuit breaker

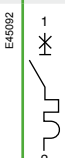
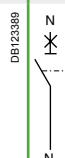
Type	1P			1P+N		
						
Auxiliaries	Remote tripping and indication, module CA907000 and CA907002			Remote tripping and indication, module CA907000 and CA907002		
Vigi iC60	Vigi iC60 add-on residual current device, module CA902005			Vigi iC60 add-on residual current device, module CA902005		
Rating (In)	Curve			Curve		
	B	C	D ⁽¹⁾	B	C	D ⁽¹⁾
0.5 A ⁽¹⁾	A9F83170	A9F84170	A9F85170	A9F83670	A9F84670	A9F85670
1 A ⁽¹⁾	A9F83101	A9F84101	A9F85101	A9F83601	A9F84601	A9F85601
2 A ⁽¹⁾	A9F83102	A9F84102	A9F85102	A9F83602	A9F84602	A9F85602
3 A ⁽¹⁾	A9F83103	A9F84103	A9F85103	A9F83603	A9F84603	A9F85603
4 A ⁽¹⁾	A9F83104	A9F84104	A9F85104	A9F83604	A9F84604	A9F85604
6 A	A9F86106	A9F87106	A9F85106	A9F86606	A9F87606	A9F85606
10 A	A9F86110	A9F87110	A9F85110	A9F86610	A9F87610	A9F85610
13 A ⁽¹⁾	A9F83113	A9F84113	A9F85113	A9F83613	A9F84613	A9F85613
16 A	A9F86116	A9F87116	A9F85116	A9F86616	A9F87616	A9F85616
20 A	A9F86120	A9F87120	A9F85120	A9F86620	A9F87620	A9F85620
25 A	A9F86125	A9F87125	A9F85125	A9F86625	A9F87625	A9F85625
32 A	A9F86132	A9F87132	A9F85132	A9F86632	A9F87632	A9F85632
40 A	A9F86140	A9F87140	A9F85140	A9F86640	A9F87640	A9F85640
50 A	A9F86150	A9F87150	A9F85150	A9F86650	A9F87650	A9F85650
63 A	A9F86163	A9F87163	A9F85163	A9F86663	A9F87663	A9F85663
Width in 9-mm modules	2			4		
Accessories	Module CA907000 and CA907001			Module CA907000 and CA907001		

(1) VDE approved only.

Protection

Circuit protection

iC60H circuit breakers (curve B, C, D) (cont.)

PB104495-40

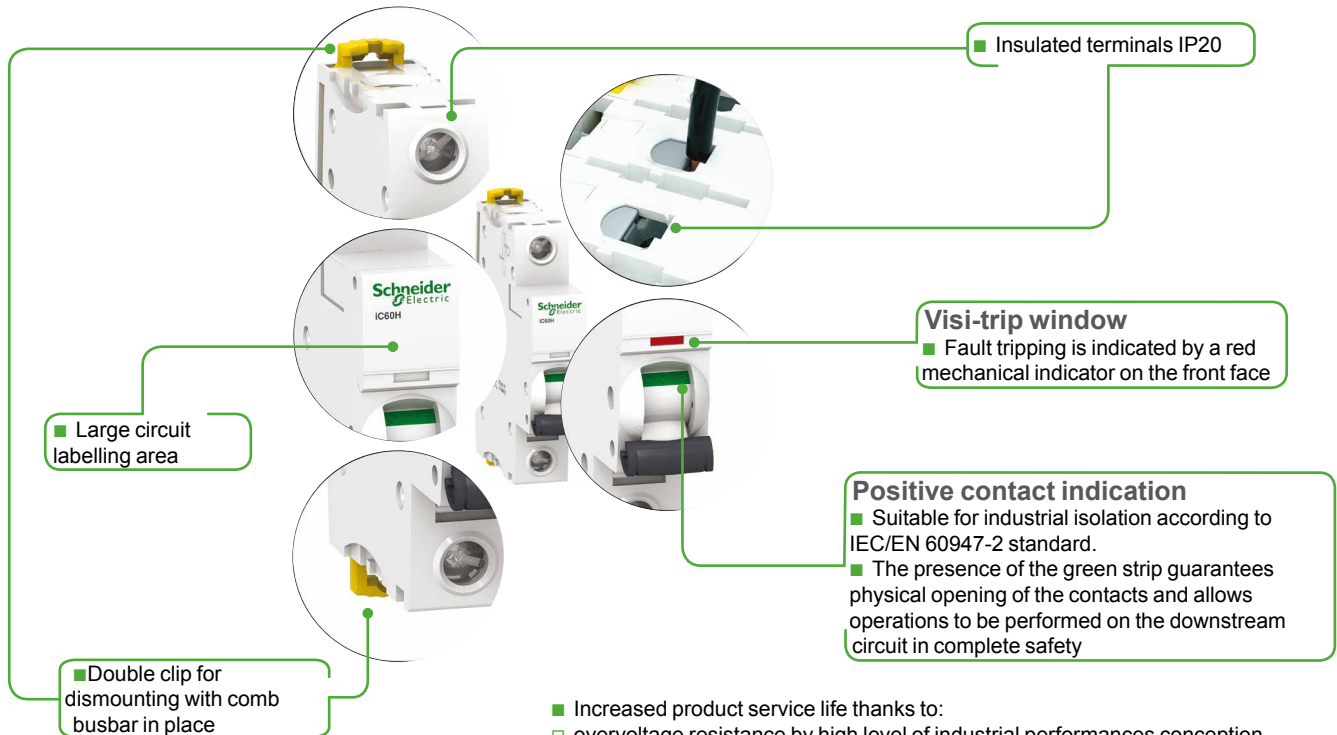

- Increased product service life thanks to:
 - overvoltage resistance by high level of industrial performances conception (pollution degree, rated impulse withstand voltage and insulation voltage),
 - high performance limitation (see limitation curves),
 - fast closing independent of the speed of actuation of the toggle.
- Remote indication, open/closed/tripped, by optional auxiliary contacts.
- Top or bottom electrical feeding.

2P			3P			4P			
E-6094 			E-6095 			E-6097 			
Remote tripping and indication, module CA907000 and CA907002			Remote tripping and indication, module CA907000 and CA907002			Remote tripping and indication, module CA907000 and CA907002			
Vigi iC60 add-on residual current device, module CA902005			Vigi iC60 add-on residual current device, module CA902005			Vigi iC60 add-on residual current device, module CA902005			
Curve			Curve			Curve			
	B	C	D ⁽¹⁾	B	C	D ⁽¹⁾	B	C	D ⁽¹⁾
	A9F83270	A9F84270	A9F85270	A9F83370	A9F84370	A9F85370	A9F83470	A9F84470	A9F85470
	A9F83201	A9F84201	A9F85201	A9F83301	A9F84301	A9F85301	A9F83401	A9F84401	A9F85401
	A9F83202	A9F84202	A9F85202	A9F83302	A9F84302	A9F85302	A9F83402	A9F84402	A9F85402
	A9F83203	A9F84203	A9F85203	A9F83303	A9F84303	A9F85303	A9F83403	A9F84403	A9F85403
	A9F83204	A9F84204	A9F85204	A9F83304	A9F84304	A9F85304	A9F83404	A9F84404	A9F85404
	A9F86206	A9F87206	A9F85206	A9F86306	A9F87306	A9F85306	A9F86406	A9F87406	A9F85406
	A9F86210	A9F87210	A9F85210	A9F86310	A9F87310	A9F85310	A9F86410	A9F87410	A9F85410
	A9F83213	A9F84213	A9F85213	A9F83313	A9F84313	A9F85313	A9F83413	A9F84413	A9F85413
	A9F86216	A9F87216	A9F85216	A9F86316	A9F87316	A9F85316	A9F86416	A9F87416	A9F85416
	A9F86220	A9F87220	A9F85220	A9F86320	A9F87320	A9F85320	A9F86420	A9F87420	A9F85420
	A9F86225	A9F87225	A9F85225	A9F86325	A9F87325	A9F85325	A9F86425	A9F87425	A9F85425
	A9F86232	A9F87232	A9F85232	A9F86332	A9F87332	A9F85332	A9F86432	A9F87432	A9F85432
	A9F86240	A9F87240	A9F85240	A9F86340	A9F87340	A9F85340	A9F86440	A9F87440	A9F85440
	A9F86250	A9F87250	A9F85250	A9F86350	A9F87350	A9F85350	A9F86450	A9F87450	A9F85450
	A9F86263	A9F87263	A9F85263	A9F86363	A9F87363	A9F85363	A9F86463	A9F87463	A9F85463
4	Module CA907000 and CA907001			6	Module CA907000 and CA907001			8	Module CA907000 and CA907001

Protection Circuit protection iC60H circuit breakers (curve B, C, D)



IEC/EN 60947-2 IEC/EN 60898-1

- iC60H circuit breakers are multi-standard circuit breakers which combine the following functions:
 - circuit protection against short-circuit currents,
 - circuit protection against overload currents,
 - suitable for industrial isolation according to IEC/EN 60947-2, standard.
 - fault tripping indication by a red mechanical indicator in circuit breaker front face.

Alternating current (AC) 50/60 Hz

Breaking capacity (Icu) according to IEC/EN 60947-2	Voltage (Ue)				Service breaking capacity (Ics)
	Ph/Ph (2P, 3P, 4P)	12 to 133 V	220 to 240 V	380 to 415 V	
Ph/N (1P, 1P+N)	12 to 60 V	100 to 133 V	220 to 240 V	-	
Rating (In)	0.5 to 4 A	70 kA	70 kA	70 kA	50 kA
	6 to 63 A	42 kA	30 kA	15 kA	10 kA

Breaking capacity (Icn) according to IEC/EN 60898-1	
Ph/Ph	Voltage (Ue)
Ph/Ph	400 V
Ph/N	230 V
Rating (In)	0.5 to 63 A
	10000 A

Direct current (DC)						
Breaking capacity (Icu) according to IEC/EN 60947-2	Voltage (Ue)					Service breaking capacity (Ics)
	Between +/-	12 to 60 V	≤ 72 V	≤ 125 V	≤ 180 V	
Number of poles	1P			2P	3P	4P
Rating (In)	0.5 to 63 A	20 kA	15 kA	15 kA	15 kA	15 kA

Offer selection see page 35

Offer B

This sticker must be removed before publishing

Catalogue numbers

iC60H circuit breaker						
Type	1P			1P+N		
Auxiliaries	Remote tripping and indication, module CA907000 and CA907002			Remote tripping and indication, module CA907000 and CA907002		
Vigi iC60	Vigi iC60 add-on residual current device, module CA902005			Vigi iC60 add-on residual current device, module CA902005		
Rating (In)	Curve			Curve		
	B	C	D ⁽¹⁾	B	C	D ⁽¹⁾
0.5 A ⁽¹⁾	A9F83170	A9F84170	A9F85170	A9F83670	A9F84670	A9F85670
1 A ⁽¹⁾	A9F83101	A9F84101	A9F85101	A9F83601	A9F84601	A9F85601
2 A ⁽¹⁾	A9F83102	A9F84102	A9F85102	A9F83602	A9F84602	A9F85602
3 A ⁽¹⁾	A9F83103	A9F84103	A9F85103	A9F83603	A9F84603	A9F85603
4 A ⁽¹⁾	A9F83104	A9F84104	A9F85104	A9F83604	A9F84604	A9F85604
6 A	A9F88106	A9F89106	A9F85106	A9F88606	A9F89606	A9F85606
10 A	A9F88110	A9F89110	A9F85110	A9F88610	A9F89610	A9F85610
13 A ⁽¹⁾	A9F83113	A9F84113	A9F85113	A9F83613	A9F84613	A9F85613
16 A	A9F88116	A9F89116	A9F85116	A9F88616	A9F89616	A9F85616
20 A	A9F88120	A9F89120	A9F85120	A9F88620	A9F89620	A9F85620
25 A	A9F88125	A9F89125	A9F85125	A9F88625	A9F89625	A9F85625
32 A	A9F88132	A9F89132	A9F85132	A9F88632	A9F89632	A9F85632
40 A	A9F88140	A9F89140	A9F85140	A9F88640	A9F89640	A9F85640
50 A	A9F88150	A9F89150	A9F85150	A9F88650	A9F89650	A9F85650
63 A	A9F88163	A9F89163	A9F85163	A9F88663	A9F89663	A9F85663
Width in 9-mm modules	2			4		
Accessories	Module CA907000 and CA907001			Module CA907000 and CA907001		

(1) VDE approved only.

Protection Circuit protection

iC60H circuit breakers (curve B, C, D) (cont.)

PB104495-40

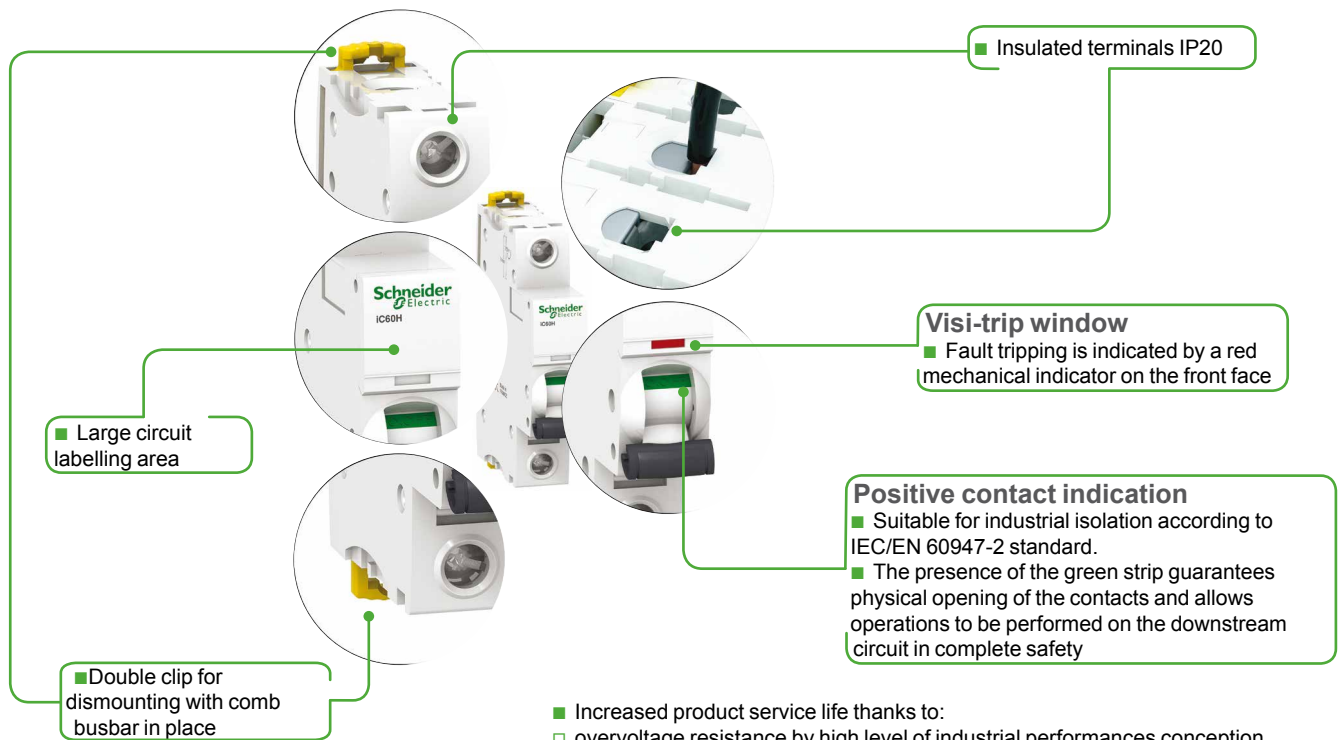

- Increased product service life thanks to:
 - overvoltage resistance by high level of industrial performances conception (pollution degree, rated impulse withstand voltage and insulation voltage),
 - high performance limitation (see limitation curves),
 - fast closing independent of the speed of actuation of the toggle.
- Remote indication, open/closed/tripped, by optional auxiliary contacts.
- Top or bottom electrical feeding.

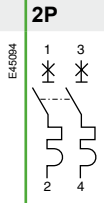
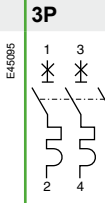
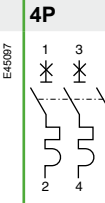
2P			3P			4P		
								
Remote tripping and indication, module CA907000 and CA907002			Remote tripping and indication, module CA907000 and CA907002			Remote tripping and indication, module CA907000 and CA907002		
Vigi iC60 add-on residual current device, module CA902005			Vigi iC60 add-on residual current device, module CA902005			Vigi iC60 add-on residual current device, module CA902005		
Curve			Curve			Curve		
B	C	D ⁽¹⁾	B	C	D ⁽¹⁾	B	C	D ⁽¹⁾
A9F83270	A9F84270	A9F85270	A9F83370	A9F84370	A9F85370	A9F83470	A9F84470	A9F85470
A9F83201	A9F84201	A9F85201	A9F83301	A9F84301	A9F85301	A9F83401	A9F84401	A9F85401
A9F83202	A9F84202	A9F85202	A9F83302	A9F84302	A9F85302	A9F83402	A9F84402	A9F85402
A9F83203	A9F84203	A9F85203	A9F83303	A9F84303	A9F85303	A9F83403	A9F84403	A9F85403
A9F83204	A9F84204	A9F85204	A9F83304	A9F84304	A9F85304	A9F83404	A9F84404	A9F85404
A9F88206	A9F89206	A9F85206	A9F88306	A9F89306	A9F85306	A9F88406	A9F89406	A9F85406
A9F88210	A9F89210	A9F85210	A9F88310	A9F89310	A9F85310	A9F88410	A9F89410	A9F85410
A9F83213	A9F84213	A9F85213	A9F83313	A9F84313	A9F85313	A9F83413	A9F84413	A9F85413
A9F88216	A9F89216	A9F85216	A9F88316	A9F89316	A9F85316	A9F88416	A9F89416	A9F85416
A9F88220	A9F89220	A9F85220	A9F88320	A9F89320	A9F85320	A9F88420	A9F89420	A9F85420
A9F88225	A9F89225	A9F85225	A9F88325	A9F89325	A9F85325	A9F88425	A9F89425	A9F85425
A9F88232	A9F89232	A9F85232	A9F88332	A9F89332	A9F85332	A9F88432	A9F89432	A9F85432
A9F88240	A9F89240	A9F85240	A9F88340	A9F89340	A9F85340	A9F88440	A9F89440	A9F85440
A9F88250	A9F89250	A9F85250	A9F88350	A9F89350	A9F85350	A9F88450	A9F89450	A9F85450
A9F88263	A9F89263	A9F85263	A9F88363	A9F89363	A9F85363	A9F88463	A9F89463	A9F85463
4			6			8		
Module CA907000 and CA907001			Module CA907000 and CA907001			Module CA907000 and CA907001		

Protection Circuit protection

iC60H circuit breakers (curve B, C, D)

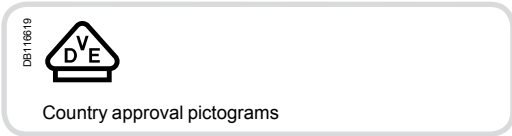

IEC/EN 60947-2 IEC/EN 60898-1

- iC60H circuit breakers are multi-standard circuit breakers which combine the following functions:
 - circuit protection against short-circuit currents,
 - circuit protection against overload currents,
 - suitable for industrial isolation according to IEC/EN 60947-2, standard.
 - fault tripping indication by a red mechanical indicator in circuit breaker front face.

Alternating current (AC) 50/60 Hz

Breaking capacity (Icu) according to IEC/EN 60947-2	Voltage (Ue)				Service breaking capacity (Ics)
	12 to 133 V	220 to 240 V	380 to 415 V	440 V	
Ph/Ph (2P, 3P, 4P)	12 to 133 V	220 to 240 V	380 to 415 V	440 V	100 % of Icu 50 % of Ics
Ph/N (1P, 1P+N)	12 to 60 V	100 to 133 V	220 to 240 V	-	
Rating (In) 0.5 to 4 A	70 kA	70 kA	70 kA	50 kA	100 % of Icu 50 % of Ics
6 to 63A	42 kA	30 kA	15 kA	10 kA	

Breaking capacity (Icn) according to IEC/EN 60898-1	Voltage (Ue)	
	400 V	230 V
Ph/Ph	400 V	230 V
Ph/N	230 V	10000 A
Rating (In) 0.5 to 63 A	10000 A	

Direct current (DC)						
Breaking capacity (Icu) according to IEC/EN 60947-2	Voltage (Ue)					Service breaking capacity (Ics)
	12 to 60 V	≤ 72 V	≤ 125 V	≤ 180 V	≤ 250 V	
Between +/-	12 to 60 V	≤ 72 V	≤ 125 V	≤ 180 V	≤ 250 V	100 % of Icu
Number of poles	1P		2P	3P	4P	
Rating (In) 0.5 to 63 A	20 kA	15 kA	15 kA	15 kA	15 kA	

Offer selection see page 35
Offer C
This sticker must be removed before publishing

Catalogue numbers

iC60H circuit breaker

Type	1P			1P+N		
Auxiliaries	Remote tripping and indication, module CA907000 and CA907002			Remote tripping and indication, module CA907000 and CA907002		
Vigi iC60	Vigi iC60 add-on residual current device, module CA902005			Vigi iC60 add-on residual current device, module CA902005		
Rating (In)	Curve			Curve		
	B	C	D	B	C	D
0.5 A	A9F83170	A9F84170	A9F85170	A9F83670	A9F84670	A9F85670
1 A	A9F83101	A9F84101	A9F85101	A9F83601	A9F84601	A9F85601
2 A	A9F83102	A9F84102	A9F85102	A9F83602	A9F84602	A9F85602
3 A	A9F83103	A9F84103	A9F85103	A9F83603	A9F84603	A9F85603
4 A	A9F83104	A9F84104	A9F85104	A9F83604	A9F84604	A9F85604
6 A	A9F83106	A9F84106	A9F85106	A9F83606	A9F84606	A9F85606
10 A	A9F83110	A9F84110	A9F85110	A9F83610	A9F84610	A9F85610
13 A	A9F83113	A9F84113	A9F85113	A9F83613	A9F84613	A9F85613
16 A	A9F83116	A9F84116	A9F85116	A9F83616	A9F84616	A9F85616
20 A	A9F83120	A9F84120	A9F85120	A9F83620	A9F84620	A9F85620
25 A	A9F83125	A9F84125	A9F85125	A9F83625	A9F84625	A9F85625
32 A	A9F83132	A9F84132	A9F85132	A9F83632	A9F84632	A9F85632
40 A	A9F83140	A9F84140	A9F85140	A9F83640	A9F84640	A9F85640
50 A	A9F83150	A9F84150	A9F85150	A9F83650	A9F84650	A9F85650
63 A	A9F83163	A9F84163	A9F85163	A9F83663	A9F84663	A9F85663
Width in 9-mm modules	2			4		
Accessories	Module CA907000 and CA907001			Module CA907000 and CA907001		

Protection

Circuit protection

iC60H circuit breakers (curve B, C, D) (cont.)

PB104495-40

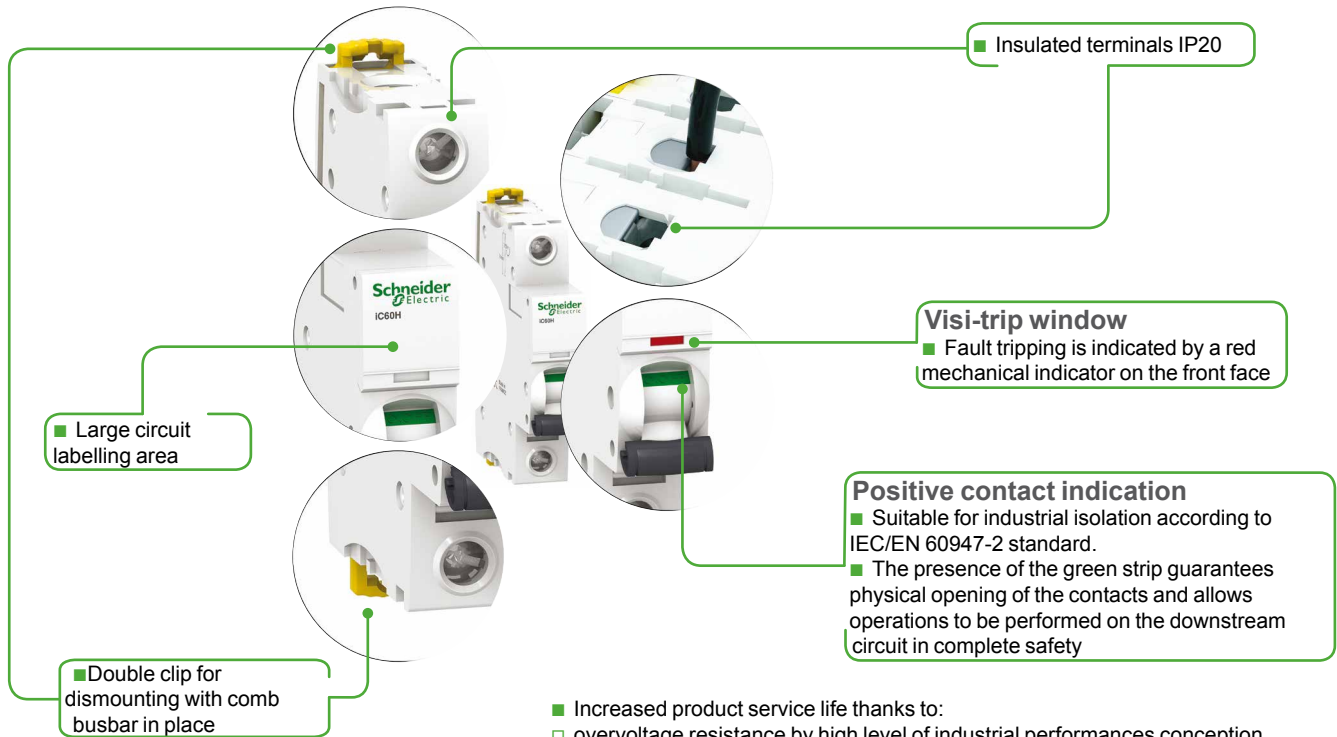

- Increased product service life thanks to:
 - overvoltage resistance by high level of industrial performances conception (pollution degree, rated impulse withstand voltage and insulation voltage),
 - high performance limitation (see limitation curves),
 - fast closing independent of the speed of actuation of the toggle.
- Remote indication, open/closed/tripped, by optional auxiliary contacts.
- Top or bottom electrical feeding.

2P			3P			4P		
E-46004			E-46006			E-46007		
Remote tripping and indication, module CA907000 and CA907002			Remote tripping and indication, module CA907000 and CA907002			Remote tripping and indication, module CA907000 and CA907002		
Vigi iC60 add-on residual current device, module CA902005			Vigi iC60 add-on residual current device, module CA902005			Vigi iC60 add-on residual current device, module CA902005		
Curve			Curve			Curve		
B	C	D	B	C	D	B	C	D
A9F83270	A9F84270	A9F85270	A9F83370	A9F84370	A9F85370	A9F83470	A9F84470	A9F85470
A9F83201	A9F84201	A9F85201	A9F83301	A9F84301	A9F85301	A9F83401	A9F84401	A9F85401
A9F83202	A9F84202	A9F85202	A9F83302	A9F84302	A9F85302	A9F83402	A9F84402	A9F85402
A9F83203	A9F84203	A9F85203	A9F83303	A9F84303	A9F85303	A9F83403	A9F84403	A9F85403
A9F83204	A9F84204	A9F85204	A9F83304	A9F84304	A9F85304	A9F83404	A9F84404	A9F85404
A9F83206	A9F84206	A9F85206	A9F83306	A9F84306	A9F85306	A9F83406	A9F84406	A9F85406
A9F83210	A9F84210	A9F85210	A9F83310	A9F84310	A9F85310	A9F83410	A9F84410	A9F85410
A9F83213	A9F84213	A9F85213	A9F83313	A9F84313	A9F85313	A9F83413	A9F84413	A9F85413
A9F83216	A9F84216	A9F85216	A9F83316	A9F84316	A9F85316	A9F83416	A9F84416	A9F85416
A9F83220	A9F84220	A9F85220	A9F83320	A9F84320	A9F85320	A9F83420	A9F84420	A9F85420
A9F83225	A9F84225	A9F85225	A9F83325	A9F84325	A9F85325	A9F83425	A9F84425	A9F85425
A9F83232	A9F84232	A9F85232	A9F83332	A9F84332	A9F85332	A9F83432	A9F84432	A9F85432
A9F83240	A9F84240	A9F85240	A9F83340	A9F84340	A9F85340	A9F83440	A9F84440	A9F85440
A9F83250	A9F84250	A9F85250	A9F83350	A9F84350	A9F85350	A9F83450	A9F84450	A9F85450
A9F83263	A9F84263	A9F85263	A9F83363	A9F84363	A9F85363	A9F83463	A9F84463	A9F85463
4			6			8		
Module CA907000 and CA907001			Module CA907000 and CA907001			Module CA907000 and CA907001		

Protection Circuit protection

iC60H circuit breakers (curve B, C, D) (cont.)

Connection

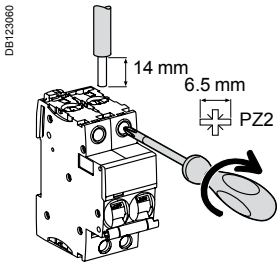

Rating	Tightening torque	Without accessory		With accessories			
		Rigid	Flexible or with ferrule	50 mm ² Al terminal	Screw-on connection for ring terminal	Rigid cables	Flexible cables
0.5 to 25 A	2 N.m						-
32 to 63 A	3.5 N.m	1 to 25 mm ²	1 to 16 mm ²	-	∅ 5 mm	-	-
		1 to 35 mm ²	1 to 25 mm ²	50 mm ²		3 x 16 mm ²	3 x 10 mm ²

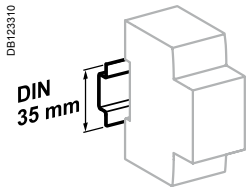

Clip on DIN rail 35 mm.

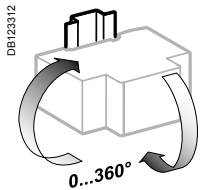

Indifferent position of installation.

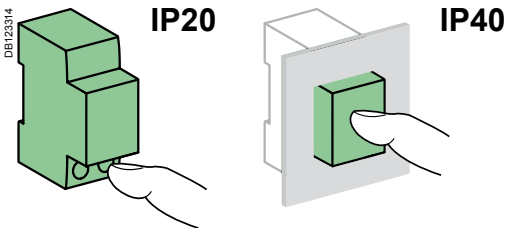

Technical data

Main characteristics		
According to IEC/EN 60947-2		
Insulation voltage (U _i)		500 V AC
Pollution degree		3
Rated impulse withstand voltage (U _{imp})		6 kV
Thermal tripping	Reference temperature	50 °C
	Temperature derating	See module CA908007
Magnetic tripping	B curve	4 I _n ± 20 %
	C curve	8 I _n ± 20 %
	D curve	12 I _n ± 20 %
Utilization category		A
According to IEC/EN 60898-1		
Limitation class		3
Rated making and breaking capacity of an individual pole (I _{cn1})		I _{cn1} = I _{cn}
Additional characteristics		
Breaking capacity under 1 pole with IT 380-415 V isolated neutral system (case of double fault)	40 A	4 kA
	50/63 A	3 kA
Degree of protection (IEC 60529)	Device only	IP20
	Device in modular enclosure	IP40 Insulation class II
Endurance (O-C)	Electrical	10,000 cycles
	Mechanical	20,000 cycles
Overvoltage category (IEC 60364)		IV
Operating temperature		-35°C to +70°C
Storage temperature		-40°C to +85°C
Tropicalization (IEC 60068-1)		Treatment 2 (relative humidity 95 % to 55°C)

Weight (g)

Circuit-breaker	
Type	iC60H
1P	125
2P	250
3P	375
4P	500

Dimensions (mm)

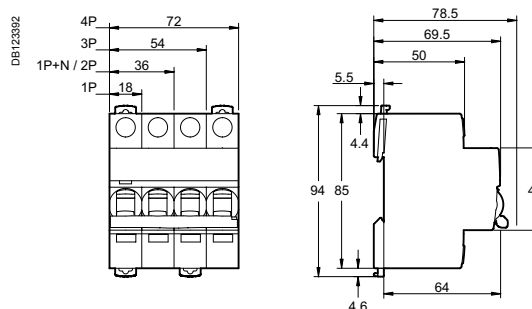

iC60H double terminals circuit breakers (curve B, C, D)



IEC/EN 60947-2 IEC/EN 60898-1

- iC60H double terminal terminals circuit breakers are multi-standard circuit breakers which combine the following functions:
 - circuit protection against short-circuit currents,
 - circuit protection against overload currents,
 - suitable for industrial isolation according to IEC/EN 60947-2, standard.
 - fault tripping indication by a red mechanical indicator in circuit breaker front face.



Alternating current (AC) 50/60 Hz

Breaking capacity (Icu) according to IEC/EN 60947-2	Voltage (Ue)				Service breaking capacity (Ics)	
	Ph/Ph (2P, 3P, 4P)	12 to 133 V	220 to 240 V	380 to 415 V 440 V		
Ph/N (1P, 1P+N)	12 to 60 V	100 to 133 V	220 to 240 V	-		
Rating (In)	0.5 to 4 A	70 kA	70 kA	70 kA	50 kA	100 % of Icu
	6 to 40 A	42 kA	30 kA	15 kA	10 kA	50 % of Icu
	50/63 A	42 kA	30 kA	15 kA	10 kA	50 % of Icu

Breaking capacity (Icn) according to IEC/EN 60898-1

Breaking capacity (Icn) according to IEC/EN 60898-1	Voltage (Ue)	
	Ph/Ph	400 V
Ph/N	230 V	
Rating (In)	0.5 to 63 A	10000 A

Direct current (DC)

Breaking capacity (Icu) according to IEC/EN 60947-2	Voltage (Ue)					Service breaking capacity (Ics)
	Between +/-	12 to 60 V	≤ 72 V	≤ 125 V	≤ 180 V ≤ 250 V	
Number of poles	1P		2P	3P	4P	
Rating (In)	1 to 63 A	20 kA	15 kA	15 kA	15 kA	100 % of Icu

Catalogue numbers

iC60H double terminals circuit breaker

Type	1P	1P+N	2P
Auxiliaries	Remote tripping and indication, module CA907000 and CA907002	Remote tripping and indication, module CA907000 and CA907002	Remote tripping and indication, module CA907000 and CA907002
Vigi iC60	Vigi iC60 add-on residual current device, module CA902005	Vigi iC60 add-on residual current device, module CA902005	Vigi iC60 add-on residual current device, module CA902005
Rating (In)	Curve		
	B	C	D
0.5 A	-	A9F07170	A9F08170
1 A	-	A9F07101	A9F08101
2 A	-	A9F07102	A9F08102
3 A	-	A9F07103	A9F08103
4 A	-	A9F07104	A9F08104
6 A	A9F06106	A9F07106	A9F08106
10 A	A9F06110	A9F07110	A9F08110
13 A	A9F06113	A9F07113	A9F08113
16 A	A9F06116	A9F07116	A9F08116
20 A	A9F06120	A9F07120	A9F08120
25 A	A9F06125	A9F07125	A9F08125
32 A	A9F06132	A9F07132	A9F08132
40 A	A9F06140	A9F07140	A9F08140
50 A	A9F06150	A9F07150	A9F08150
63 A	A9F06163	A9F07163	A9F08163
Width in 9-mm modules	2		4
Accessories	Modules CA907000 and CA907001		Modules CA907000 and CA907001

Protection Circuit protection

iC60H double terminals circuit breakers (curve B, C, D) (cont.)

Insulated terminals IP20

Double terminals
 ■ For top or bottom connections:
 □ by cable,
 □ by comb busbar

Large circuit labelling area

Double clip locking allowing tool-free removal, front panel side, with the comb busbar in position

Visi-trip window
 ■ Fault tripping is indicated by a red mechanical indicator on the front face

Positive contact indication
 ■ Suitable for industrial isolation according to IEC/EN 60947-2 standard
 ■ The presence of the green strip guarantees physical opening of the contacts and allows operations to be performed on the downstream circuit in complete safety

■ Increased product service life thanks to:
 □ overvoltage resistance by high level of industrial performances conception (pollution degree, rated impulse withstand voltage and insulation voltage),
 □ high performance limitation (see limitation curves),
 □ fast closing independent of the speed of actuation of the toggle.
 ■ Remote indication, open/closed/tripped, by optional auxiliary contacts.
 ■ Top or bottom electrical feeding.

3P				4P			
Remote tripping and indication, module CA907000 and CA907002				Remote tripping and indication, module CA907000 and CA907002			
Vigi iC60 add-on residual current device, module CA902005				Vigi iC60 add-on residual current device, module CA902005			
Curve				Curve			
B	C	D		B	C	D	
-	A9F07370	A9F08370		-	A9F07470	A9F08470	
-	A9F07301	A9F08301		-	A9F07401	A9F08401	
-	A9F07302	A9F08302		-	A9F07402	A9F08402	
-	A9F07303	A9F08303		-	A9F07403	A9F08403	
-	A9F07304	A9F08304		-	A9F07404	A9F08404	
A9F06306	A9F07306	A9F08306		A9F06406	A9F07406	A9F08406	
A9F06310	A9F07310	A9F08310		A9F06410	A9F07410	A9F08410	
A9F06313	A9F07313	A9F08313		A9F06413	A9F07413	A9F08413	
A9F06316	A9F07316	A9F08316		A9F06416	A9F07416	A9F08416	
A9F06320	A9F07320	A9F08320		A9F06420	A9F07420	A9F08420	
A9F06325	A9F07325	A9F08325		A9F06425	A9F07425	A9F08425	
A9F06332	A9F07332	A9F08332		A9F06432	A9F07432	A9F08432	
A9F06340	A9F07340	A9F08340		A9F06440	A9F07440	A9F08440	
A9F06350	A9F07350	A9F08350		A9F06450	A9F07450	A9F08450	
A9F06363	A9F07363	A9F08363		A9F06463	A9F07463	A9F08463	
6				8			
Modules CA907000 and CA907001				Modules CA907000 and CA907001			

Protection
Circuit protection

iC60H double terminals circuit breakers (curve B, C, D) (cont.)

Connection between double terminal circuit breakers

With comb busbar at the back/cables at the front

Without comb busbar at the back/cables at the front

DB404815



		Back	Front	
Rating	Tightening torque	Comb busbar	Copper cables	
		Thickness of the teeth	Rigid	Flexible or with ferrule
0.5 to 25 A	2 N.m	1.5 mm	1 to 25 mm ²	1 to 16 mm ²
32 to 63 A	3.5 N.m	1.5 mm	1 to 25 mm ²	1 to 25 mm ²

Between double terminal circuit breakers and single-terminal circuit breakers

Cables at the back/comb busbar at the front

DB404817



		Back	Front	
Rating	Tightening torque	Copper cables		Thickness of the teeth
		Rigid	Flexible or with ferrule	
0.5 to 25 A	2 N.m	1 to 16 mm ²	1 to 10 mm ²	1.5 mm
32 to 63 A	3.5 N.m	1 to 16 mm ²	1 to 10 mm ²	1.5 mm

■ Connection by comb busbar or by cable (according to EN 50027).

Connection

DB123847

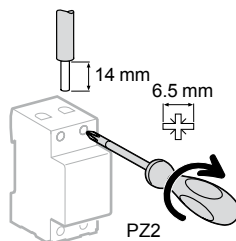

		With accessories		
Rating	50 mm ² AI terminal	Screw-on connection for ring terminal	Multi-cables terminal	
		Rigid cables	Flexible cables	
0.5 to 25 A	-	Ø 5 mm	-	-
32 to 63 A	50 mm ²	-	3 x 16 mm ²	3 x 10 mm ²

Protection Circuit protection

iC60H double terminals circuit breakers (curve B, C, D) (cont.)

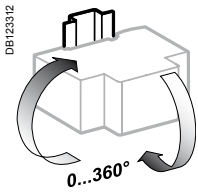

Indifferent position of installation.

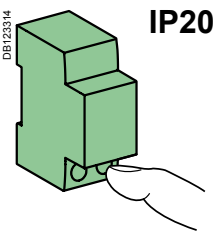

IP20

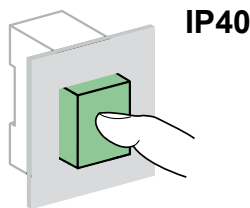

IP40

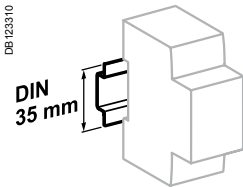

Clip on DIN rail 35 mm.

Technical data

Main characteristics		
According to IEC/EN 60947-2		
Insulation voltage (Ui)		500 V AC
Pollution degree		3
Rated impulse withstand voltage (Uimp)		6 kV
Thermal tripping	Reference temperature	50°C
	Temperature derating	See module CA908007
Magnetic tripping	B curve	4 In ± 20 %
	C curve	8 In ± 20 %
	D curve	12 In ± 20 %
Utilization category		A
According to IEC/EN 60898-1		
Limitation class		3
Rated making and breaking capacity of an individual pole (Icn1)		Icn1 = Icn
Additional characteristics		
Degree of protection (IEC 60529)	Device only	IP20
	Device in modular enclosure	IP40 Insulation class II
Endurance (O-C)	Electrical	10,000 cycles
	Mechanical	20,000 cycles
Overvoltage category (IEC 60364)		IV
Operating temperature		-35°C to +70°C
Storage temperature		-40°C to +85°C
Tropicalization (IEC 60068-1)		Treatment 2 (relative humidity 95 % to 55°C)

Disassembly double terminals iC60 circuit breaker with the comb busbar in position

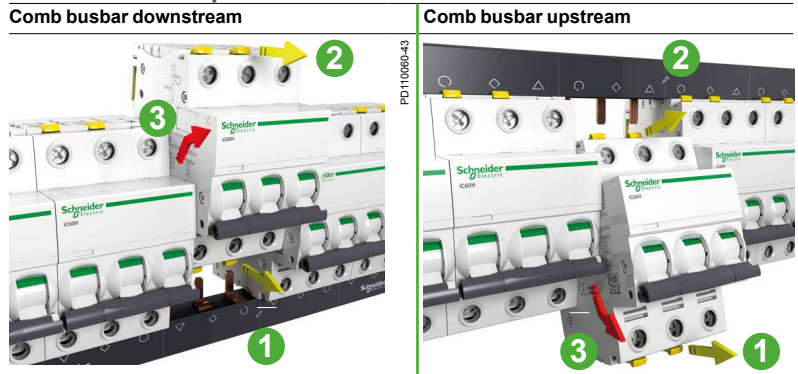

- 1- Pull lower "clip locking"
- 2- Pull upper "clip locking"
- 3- Remove the circuit breaker

Dimensions (mm)

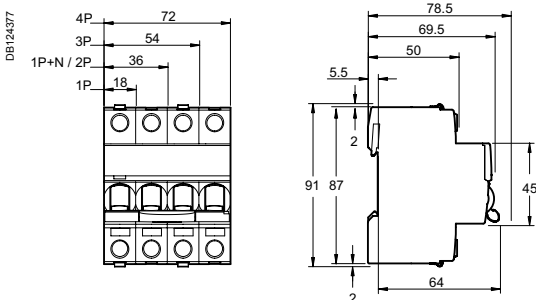

Weight (g)

Circuit-breaker	
Type	iC60H
1P	125
2P (1P+N)	250
3P	375
4P	500

Protection Circuit protection iC60L circuit breakers (curve B, C, K, Z)



IEC/EN 60947-2 IEC/EN 60898-1 up to 40 A

- iC60L circuit breakers are multi-standard circuit breakers which combine the following functions:
 - circuit protection against short-circuit currents,
 - circuit protection against overload currents,
 - suitable for industrial isolation according to IEC/EN 60947-2, standard.
 - fault tripping indication by a red mechanical indicator in circuit breaker front face.

Alternating current (AC) 50/60 Hz

Breaking capacity (Icu) according to IEC/EN 60947-2						Service breaking capacity (Ics)
		Voltage (Ue)				
Ph/Ph (2P, 3P, 4P)		12 to 133 V	220 to 240 V	380 to 415 V	440 V	100 % of Icu
Ph/N (1P)		12 to 60 V	100 to 133 V	220 to 240 V	-	
Rating (In)	0.5 to 4 A	100 kA	100 kA	100 kA	70 kA	100 % of Icu
	6 to 25 A	70 kA	50 kA	25 kA	20 kA	50 % of Icu ⁽¹⁾
	32 / 40 A	70 kA	36 kA	20 kA	15 kA	50 % of Icu
	50 / 63 A	70 kA	30 kA	15 kA	10 kA	50 % of Icu

Breaking capacity (Icn) according to IEC/EN 60898-1	
Voltage (Ue)	
Ph/Ph	400 V
Ph/N	230 V
Rating (In)	0.5 to 40 A 15000 A

Direct current (DC)

Breaking capacity (Icu) according to IEC/EN 60947-2						Service breaking capacity (Ics)	
		Voltage (Ue)					
Between +/-		12 to 60 V	≤ 72 V	≤ 125 V	≤ 180 V	≤ 250 V	100 % of Icu
Number of poles		1P		2P	3P	4P	
Rating (In)		0.5 to 63 A	25 kA	20 kA	20 kA	20 kA	20 kA

Catalogue numbers

iC60L circuit breaker

Type	1P	2P							
Auxiliaries	Remote tripping and indication, module CA907000 and CA907002		Remote tripping and indication, module CA907000 and CA907002						
Vigi iC60	Vigi iC60 add-on residual current device, module CA902005		Vigi iC60 add-on residual current device, module CA902005						
Rating (In)	Quality label (2)		Curve						
			B	C	K	Z			
0.5 A		A9F93170	A9F94170	A9F95170	A9F92170	A9F93270	A9F94270	A9F95270	A9F92270
1 A		A9F93101	A9F94101	A9F95101	A9F92101	A9F93201	A9F94201	A9F95201	A9F92201
1.6 A		-	-	A9F95172	A9F92172	-	-	A9F95272	A9F92272
2 A		A9F93102	A9F94102	A9F95102	A9F92102	A9F93202	A9F94202	A9F95202	A9F92202
3 A		A9F93103	A9F94103	A9F95103	A9F92103	A9F93203	A9F94203	A9F95203	A9F92203
4 A		A9F93104	A9F94104	A9F95104	A9F92104	A9F93204	A9F94204	A9F95204	A9F92204
6 A		A9F93106	A9F94106	A9F95106	A9F92106	A9F93206	A9F94206	A9F95206	A9F92206
10 A		A9F93110	A9F94110	A9F95110	A9F92110	A9F93210	A9F94210	A9F95210	A9F92210
16 A		A9F93116	A9F94116	A9F95116	A9F92116	A9F93216	A9F94216	A9F95216	A9F92216
20 A		A9F93120	A9F94120	A9F95120	A9F92120	A9F93220	A9F94220	A9F95220	A9F92220
25 A		A9F93125	A9F94125	A9F95125	A9F92125	A9F93225	A9F94225	A9F95225	A9F92225
32 A		A9F93132	A9F94132	A9F95132	A9F92132	A9F93232	A9F94232	A9F95232	A9F92232
40 A		A9F93140	A9F94140	A9F95140	A9F92140	A9F93240	A9F94240	A9F95240	A9F92240
50 A		A9F93150	A9F94150	A9F95150 ⁽³⁾	A9F92150	A9F93250	A9F94250	A9F95250	A9F92250
63 A		A9F93163	A9F94163	A9F95163 ⁽³⁾	A9F92163	A9F93263	A9F94263	A9F95263	A9F92263
Width in 9-mm modules	2		4						
Accessories	Module CA907000 and CA907001		Module CA907000 and CA907001						

(1) 100 % of Icu for ratings 6 to 25 A under Ue 100 to 133 V AC Ph/Ph and Ue 12 to 60 V AC Ph/N.
 (2) Information to be provided by the country.
 (3) Without approval.

Protection Circuit protection

iC60L circuit breakers (curve B, C, K, Z) (cont.)

PB 104436-40



- Increased product service life thanks to:
 - overvoltage resistance by high level of industrial performances conception (pollution degree, rated impulse withstand voltage and insulation voltage),
 - high performance limitation (see limitation curves),
 - fast closing independent of the speed of actuation of the toggle.
- Remote indication, open/closed/tripped, by optional auxiliary contacts.
- Top or bottom electrical feeding.

3P					4P										
E-6095					E-6097										
	Remote tripping and indication, module CA907000 and CA907002					Remote tripping and indication, module CA907000 and CA907002									
Vigi iC60 add-on residual current device, module CA902005					Vigi iC60 add-on residual current device, module CA902005										
Curve					Curve										
B		C		K		Z		B		C		K		Z	
A9F93370	A9F94370	A9F95370	A9F92370	A9F93470	A9F94470	A9F95470	A9F92470								
A9F93301	A9F94301	A9F95301	A9F92301	A9F93401	A9F94401	A9F95401	A9F92401								
-	-	A9F95372	A9F92372	-	-	A9F95472	A9F92472								
A9F93302	A9F94302	A9F95302	A9F92302	A9F93402	A9F94402	A9F95402	A9F92402								
A9F93303	A9F94303	A9F95303	A9F92303	A9F93403	A9F94403	A9F95403	A9F92403								
A9F93304	A9F94304	A9F95304	A9F92304	A9F93404	A9F94404	A9F95404	A9F92404								
A9F93306	A9F94306	A9F95306	A9F92306	A9F93406	A9F94406	A9F95406	A9F92406								
A9F93310	A9F94310	A9F95310	A9F92310	A9F93410	A9F94410	A9F95410	A9F92410								
A9F93316	A9F94316	A9F95316	A9F92316	A9F93416	A9F94416	A9F95416	A9F92416								
A9F93320	A9F94320	A9F95320	A9F92320	A9F93420	A9F94420	A9F95420	A9F92420								
A9F93325	A9F94325	A9F95325	A9F92325	A9F93425	A9F94425	A9F95425	A9F92425								
A9F93332	A9F94332	A9F95332	A9F92332	A9F93432	A9F94432	A9F95432	A9F92432								
A9F93340	A9F94340	A9F95340	A9F92340	A9F93440	A9F94440	A9F95440	A9F92440								
A9F93350	A9F94350	A9F95350	A9F92350	A9F93450	A9F94450	A9F95450	A9F92450								
A9F93363	A9F94363	A9F95363	A9F92363	A9F93463	A9F94463	A9F95463	A9F92463								
4				6											
Module CA907000 and CA907001				Module CA907000 and CA907001											

iC60L circuit breakers (curve B, C, K, Z) (cont.)

Connection

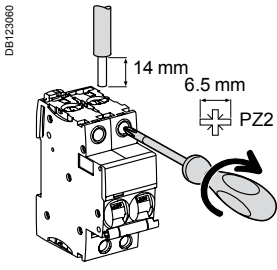

		Without accessory		With accessories			
Rating	Tightening torque	Copper cables		50 mm ² Al terminal	Screw-on connection for ring terminal	Multi-cables terminal	
		Rigid	Flexible or with ferrule			Rigid cables	Flexible cables
0.5 to 25 A	2 N.m	DB1123945	DB1123946	DB1123935	DB118789	DB118787	
32 to 63 A	3.5 N.m	1 to 25 mm ²	1 to 16 mm ²	-	Ø 5 mm	-	-
		1 to 35 mm ²	1 to 25 mm ²	50 mm ²		3 x 16 mm ²	3 x 10 mm ²

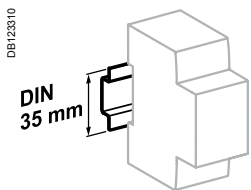

Clip on DIN rail 35 mm.

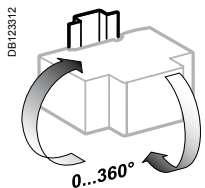

Indifferent position of installation.

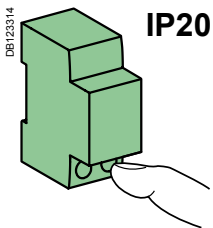

IP20

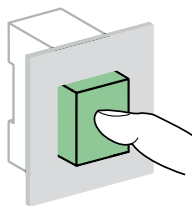

IP40

Technical data

Main characteristics

According to IEC/EN 60947-2

Insulation voltage (U _i)	500 V AC	
Pollution degree	3	
Rated impulse withstand voltage (U _{imp})	6 kV	
Thermal tripping	Reference temperature	50 °C
	Temperature derating	See module CA908007
Magnetic tripping	B curve	4 I _n ± 20 %
	C curve	8 I _n ± 20 %
	K curve	12 I _n ± 20 %
	Z curve	3 I _n ± 20 %
Utilization category	A	

According to IEC/EN 60898-1

Rated making and breaking capacity of an individual pole (I _{cn1})	I _{cn1} = I _{cn}	
--	------------------------------------	--

Additional characteristics

Breaking capacity under 1 pole with IT 380-415 V isolated neutral system (case of double fault)	40 A	4 kA
	50/63 A	3 kA
Degree of protection (IEC 60529)	Device only	IP20
	Device in modular enclosure	IP40
		Insulation class II
Endurance (O-C)	Electrical	10,000 cycles
	Mechanical	20,000 cycles
Overvoltage category (IEC 60364)	IV	
Operating temperature	-35°C to +70°C	
Storage temperature	-40°C to +85°C	
Tropicalization (IEC 60068-1)	Treatment 2 (relative humidity 95 % to 55°C)	

Weight (g)

Circuit-breaker	
Type	iC60L
1P	125
2P	250
3P	375
4P	500

Dimensions (mm)

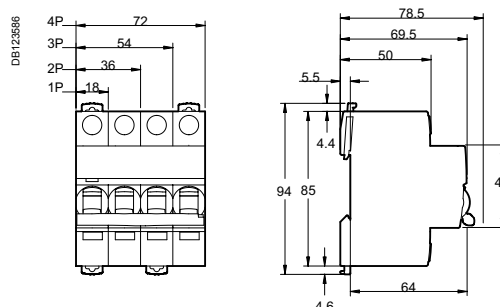

Protection Circuit protection iK60N circuit breakers (curve B)

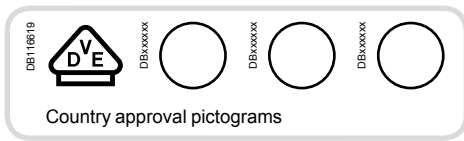

IEC/EN 60898-1



- iK60N circuit breakers are circuit breakers which combine the following functions:
 - circuit protection against short-circuit currents,
 - circuit protection against overload currents,
 - disconnection, opening and closing.

iK60N circuit breaker 50/60 Hz		
Breaking capacity in short circuit (Icn) as per IEC/EN 60898-1		Service breaking capacity (Ics) 100 % of Icn
Ph/Ph	400 V	
Ph/N	230 V	
Rating (In) 1 to 63 A	6000 A	

Catalogue numbers

iK60N circuit breaker					
Type	1P	1P+N	2P	3P	4P
Auxiliaries	Without auxiliaries	Without auxiliaries	Without auxiliaries	Without auxiliaries	Without auxiliaries
Vigi iC60	Without Vigi iC60	Without Vigi iC60	Without Vigi iC60	Without Vigi iC60	Without Vigi iC60
Rating (In)	Curve B	Curve B	Curve B	Curve B	Curve B
1 A	A9K23101	A9K23601	A9K23201	-	-
2 A	A9K23102	A9K23602	A9K23202	-	-
3 A	A9K23103	A9K23603	A9K23203	-	-
4 A	A9K23104	A9K23604	A9K23204	-	-
6 A	A9K23106	A9K23606	A9K23206	A9K23306	A9K23406
10 A	A9K23110	A9K23610	A9K23210	A9K23310	A9K23410
16 A	A9K23116	A9K23616	A9K23216	A9K23316	A9K23416
20 A	A9K23120	A9K23620	A9K23220	A9K23320	A9K23420
25 A	A9K23125	A9K23625	A9K23225	A9K23325	A9K23425
32 A	A9K23132	A9K23632	A9K23232	A9K23332	A9K23432
40 A	A9K23140	A9K23640	A9K23240	A9K23340	A9K23440
50 A	A9K23150	A9K23650	A9K23250	A9K23350	A9K23450
63 A	A9K23163	A9K23663	A9K23263	A9K23363	A9K23463
Operating frequency	50/60 Hz	50/60 Hz	50/60 Hz	50/60 Hz	50/60 Hz
Width in 9-mm modules	2	4	4	6	8
Accessories	Padlocking device cat. no. A9A26970				

Protection

Circuit protection

iK60N circuit breakers (curve B) (cont.)

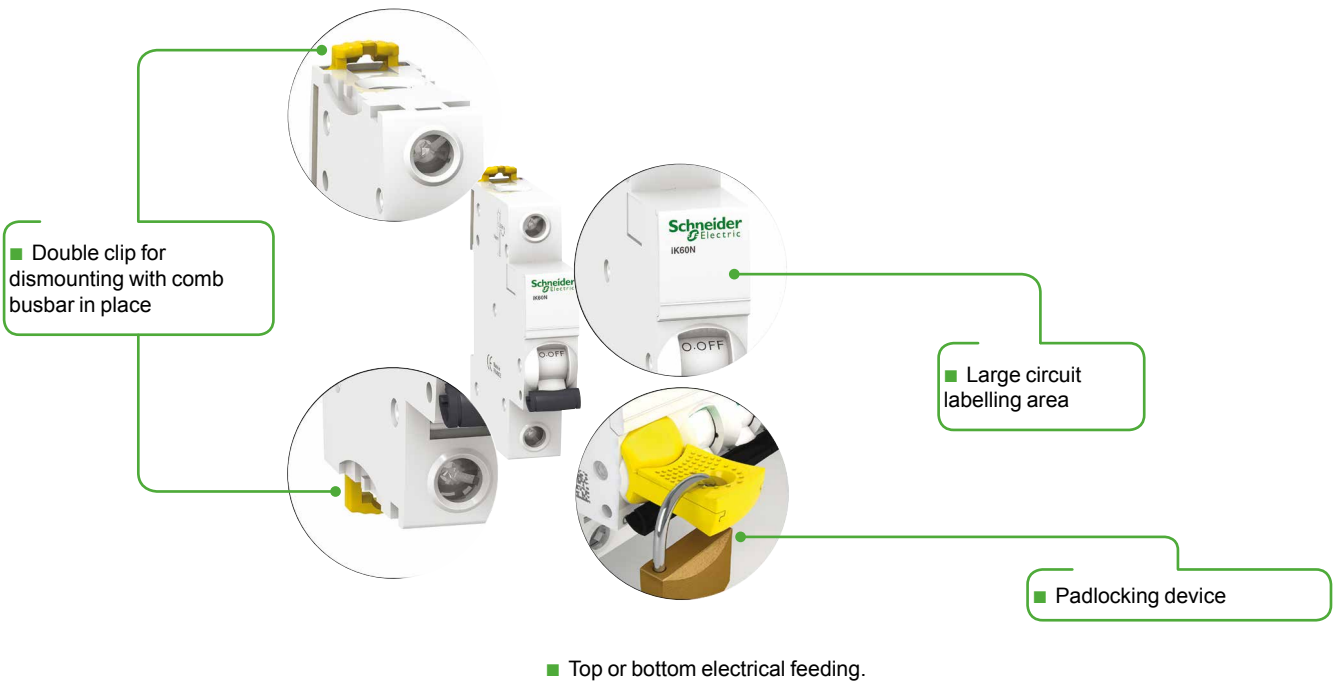

PB10434-40

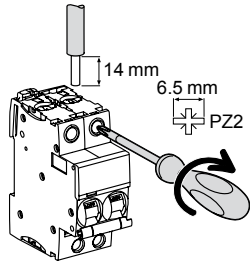

Connection

DB123060



Type	Rating	Tightening torque	Copper cables	
			Rigid	Flexible or with ferrule
B curve	1 to 25 A	2 N.m	 DB122945	 DB122946
	32 to 63 A	3.5 N.m		

Protection Circuit protection iK60N circuit breakers (curve B) (cont.)

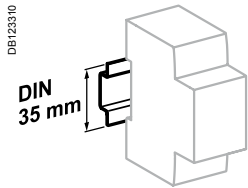

Clip on DIN rail 35 mm.

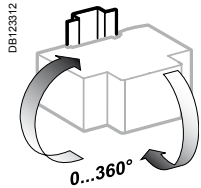

Indifferent position of installation.

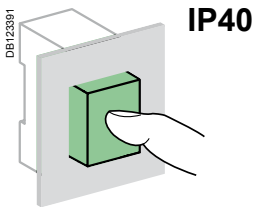

Technical data

Main characteristics		
According to IEC/EN 60898-1		
Insulation voltage (Ui)		440 V AC
Pollution degree		2
Rated impulse withstand voltage (Uimp)		4 kV
Thermal tripping	Reference temperature	30°C
	Temperature derating	See module CA908007
Magnetic tripping	B curve	3 to 5 In
Limitation class		3
Rated making and breaking capacity of an individual pole (Icn1)		Icn1 = Icn
Additional characteristics		
Degree of protection (IEC 60529)	Device in modular enclosure	IP40 Insulation class II
Endurance (O-C)	Electrical	10,000 cycles
	Mechanical	20,000 cycles
Overvoltage category (IEC 60364)		III
Operating temperature		-25°C to +60°C
Storage temperature		-40°C to +85°C

Weight (g)

Circuit-breaker	
Type	iK60N
1P	100
2P	200
3P	300
4P	400

Dimensions (mm)

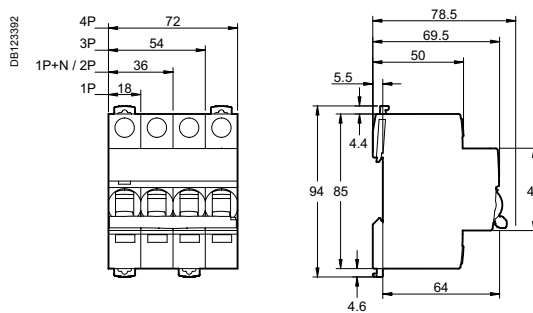



Protection

Circuit protection

iK60N (curve C)

Contents

Schneider Electric's range of circuit breakers consists of different products (A, B, C) to enable it to be the most competitive range possible in each country, allowing for the special characteristics of each market:

- usual installation procedure
- price
- accreditations by local bodies.

Variants

Offers		Pages
Offer A	Catalogue numbers	55
Offer B	Catalogue numbers	56
Offer C	Catalogue numbers	57
Offer D	Argentina	58
Common pages		59

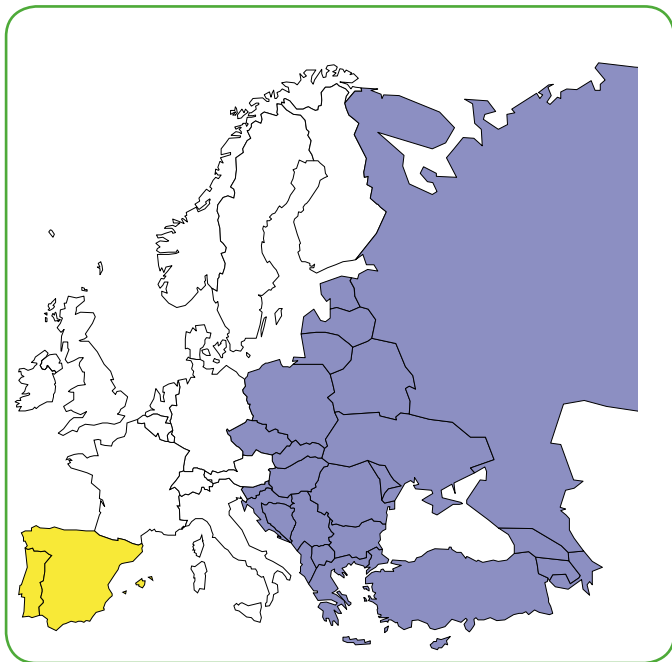

Only the product range to be marketed in your country and validated by the local product manager, in agreement with his Final Distribution (FD) partner should be retained. The others will be removed before publication.

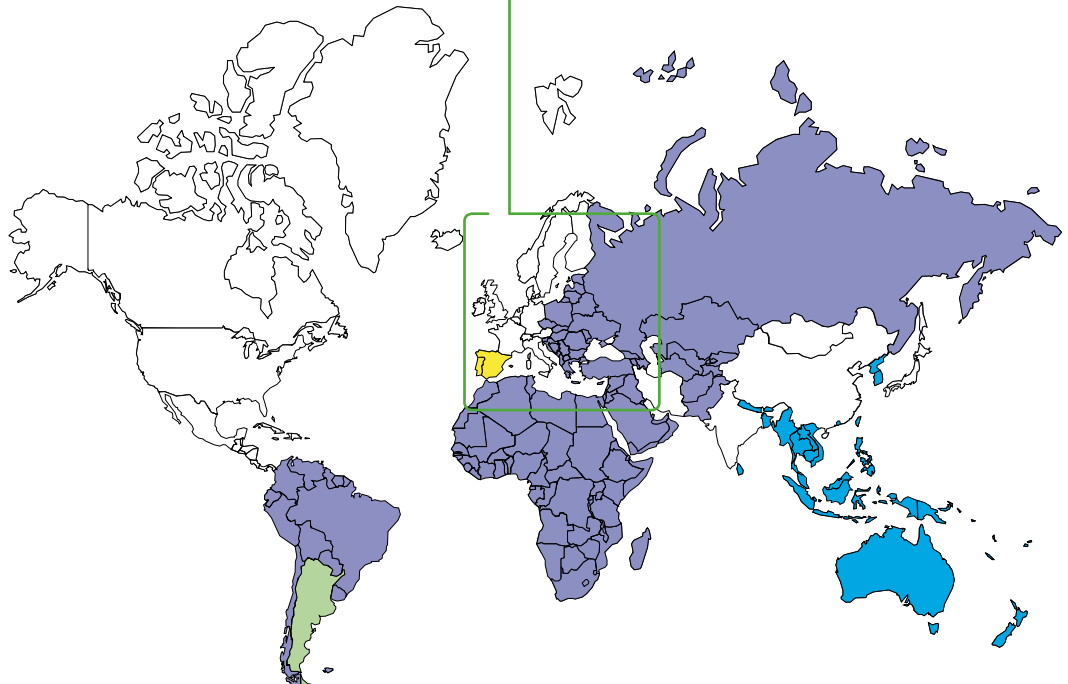

Protection Circuit protection iK60N circuit breakers (curve C)

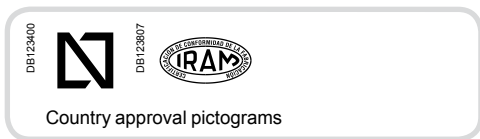

IEC/EN 60898-1



As per the above standard:

- iK60N circuit breakers are circuit breakers which combine the following functions:
 - circuit protection against short-circuit currents,
 - circuit protection against overload currents,
 - disconnection, opening and closing.

iK60N circuit breaker 50/60 Hz		Service breaking capacity (Ics)
Breaking capacity in short circuit (Icn) as per IEC/EN 60898-1		
Ph/Ph	400 V	100 % of Icn
Ph/N	230 V	
Rating (In) 1 to 63 A	6000 A	

Catalog numbers

iK60N circuit breakers						
Type	1P	1P+N	2P	3P	3P+N	4P
Auxiliaries	Without auxiliaries					
Vigi iC60	Without Vigi iC60					
Rating (In)	Curve	Curve	Curve	Curve	Curve	Curve
	C	C	C	C	C	C
1 A ⁽¹⁾	A9K24101	A9K24601	A9K24201	-	-	-
2 A ⁽¹⁾	A9K24102	A9K24602	A9K24202	-	-	-
3 A ⁽¹⁾	A9K24103	A9K24603	A9K24203	-	-	-
4 A ⁽¹⁾	A9K24104	A9K24604	A9K24204	-	-	-
6 A	A9K17106	A9K17606	A9K17206	A9K17306	A9K24706	A9K17406
10 A	A9K17110	A9K17610	A9K17210	A9K17310	A9K24710	A9K17410
16 A	A9K17116	A9K17616	A9K17216	A9K17316	A9K24716	A9K17416
20 A	A9K17120	A9K17620	A9K17220	A9K17320	A9K24720	A9K17420
25 A	A9K17125	A9K17625	A9K17225	A9K17325	A9K24725	A9K17425
32 A	A9K17132	A9K17632	A9K17232	A9K17332	A9K24732	A9K17432
40 A ⁽¹⁾	A9K24140	A9K24640	A9K24240	A9K24340	A9K24740	A9K24440
50 A ⁽¹⁾	A9K24150	A9K24650	A9K24250	A9K24350	A9K24750	A9K24450
63 A ⁽¹⁾	A9K24163	A9K24663	A9K24263	A9K24363	A9K24763	A9K24463
Operating frequency	50/60 Hz	50/60 Hz	50/60 Hz	50/60 Hz	50/60 Hz	50/60 Hz
Width in 9-mm modules	2	4	4	6	8	8
Accessories	Padlocking device cat. no. A9A26970					

(1) VDE and RT approved, excepted 3P+N products.

Protection

Circuit protection

iK60N circuit breakers (curve C)

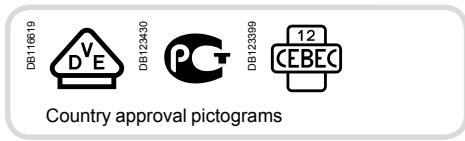

IEC/EN 60898-1



As per the above standard:

- iK60N circuit breakers are circuit breakers which combine the following functions:
 - circuit protection against short-circuit currents,
 - circuit protection against overload currents,
 - disconnection, opening and closing.

iK60N circuit breaker 50/60 Hz

Breaking capacity in short circuit (Icn) as per IEC/EN 60898-1		Service breaking capacity (Ics) 100 % of Icn
Ph/Ph	400 V	
Ph/N	230 V	
Rating (In) 1 to 63 A	6000 A	

Catalog numbers

iK60N circuit breakers					
Type	1P	1P+N	2P	3P	4P
Auxiliaries	Without auxiliaries				
Vigi iC60	Without Vigi iC60				
Rating (In)	Curve	Curve	Curve	Curve	Curve
	C	C	C	C	C
1 A	A9K24101	A9K24601	A9K24201	-	-
2 A	A9K24102	A9K24602	A9K24202	-	-
3 A	A9K24103	A9K24603	A9K24203	-	-
4 A	A9K24104	A9K24604	A9K24204	-	-
6 A	A9K24106	A9K24606	A9K24206	A9K24306	A9K24406
10 A	A9K24110	A9K24610	A9K24210	A9K24310	A9K24410
13 A	A9K24113	A9K24613	A9K24213	A9K24313	A9K24413
16 A	A9K24116	A9K24616	A9K24216	A9K24316	A9K24416
20 A	A9K24120	A9K24620	A9K24220	A9K24320	A9K24420
25 A	A9K24125	A9K24625	A9K24225	A9K24325	A9K24425
32 A	A9K24132	A9K24632	A9K24232	A9K24332	A9K24432
40 A	A9K24140	A9K24640	A9K24240	A9K24340	A9K24440
50 A	A9K24150	A9K24650	A9K24250	A9K24350	A9K24450
63 A	A9K24163	A9K24663	A9K24263	A9K24363	A9K24463
Operating frequency	50/60 Hz	50/60 Hz	50/60 Hz	50/60 Hz	50/60 Hz
Width in 9-mm modules	2	4	4	6	8
Accessories	Padlocking device cat. no. A9A26970				

Protection

Circuit protection

iK60N circuit breakers (curve C)

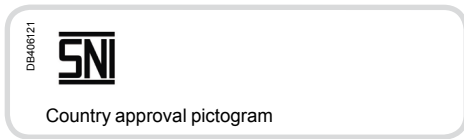

IEC/EN 60898-1



As per the above standard:

- iK60N circuit breakers are circuit breakers which combine the following functions:
 - circuit protection against short-circuit currents,
 - circuit protection against overload currents,
 - disconnection, opening and closing.

iK60N circuit breaker 50/60 Hz		Service breaking capacity (Ics)
Breaking capacity in short circuit (Icn) as per IEC/EN 60898-1		
Ph/Ph	400 V	100 % of Icn
Ph/N	230 V	
Rating (In) 6 to 63 A	6000 A	

Catalog numbers

iK60N circuit breakers				
Type	1P	2P	3P	4P
Auxiliaries	Without auxiliaries			
Vigi IC60	Without Vigi IC60			
Rating (In)	Curve	Curve	Curve	Curve
	C	C	C	C
1 A	A9K24101	-	-	-
2 A	A9K24102	-	-	-
3 A	A9K24103	-	-	-
4 A	A9K24104	-	-	-
6 A	A9K27106	A9K27206	A9K24306	A9K24406
10 A	A9K27110	A9K27210	A9K24310	A9K24410
16 A	A9K27116	A9K27216	A9K24316	A9K24416
20 A	A9K27120	A9K27220	A9K24320	A9K24420
25 A	A9K27125	A9K27225	A9K24325	A9K24425
32 A	A9K27132	A9K27232	A9K24332	A9K24432
40 A	A9K24140	A9K24240	A9K24340	A9K24440
Operating frequency	50/60 Hz	50/60 Hz	50/60 Hz	50/60 Hz
Width in 9-mm modules	2	4	6	8
Accessories	Padlocking device cat. no. A9A26970			

iK60N circuit breakers (curve C)



IEC/EN 60898-1



As per the above standard:

- iK60N circuit breakers are circuit breakers which combine the following functions:
 - circuit protection against short-circuit currents,
 - circuit protection against overload currents,
 - disconnection, opening and closing.

iK60N circuit breaker 50/60 Hz		
Breaking capacity in short circuit (I _{cn}) as per IEC/EN 60898-1		Service breaking capacity (I _{cs})
Ph/Ph	400 V	100 % of I _{cn}
Ph/N	230 V	
Rating (I _n) 6 to 63 A	6000 A	

Catalog numbers

iK60N circuit breakers				
Type	1P	2P	3P	4P
	E45092	E45094	E45095	E45097
Auxiliaries	Without auxiliaries			
Vigi IC60	Without Vigi IC60			
Rating (I _n)	Curve C	Curve C	Curve C	Curve C
6 A	A9K24106	A9K24206	A9K24306	A9K24406
10 A	A9K24110	A9K24210	A9K24310	A9K24410
16 A	A9K24116	A9K24216	A9K24316	A9K24416
20 A	A9K24120	A9K24220	A9K24320	A9K24420
25 A	A9K24125	A9K24225	A9K24325	A9K24425
32 A	A9K24132	A9K24232	A9K24332	A9K24432
40 A	A9K24140	A9K24240	A9K24340	A9K24440
50 A	A9K24150	A9K24250	A9K24350	A9K24450
63 A	A9K24163	A9K24263	A9K24363	A9K24463
Operating frequency	50/60 Hz		50/60 Hz	
Width in 9-mm modules	2	4	6	8
Accessories	Padlocking device cat. no. A9A26970			

Protection

Circuit protection

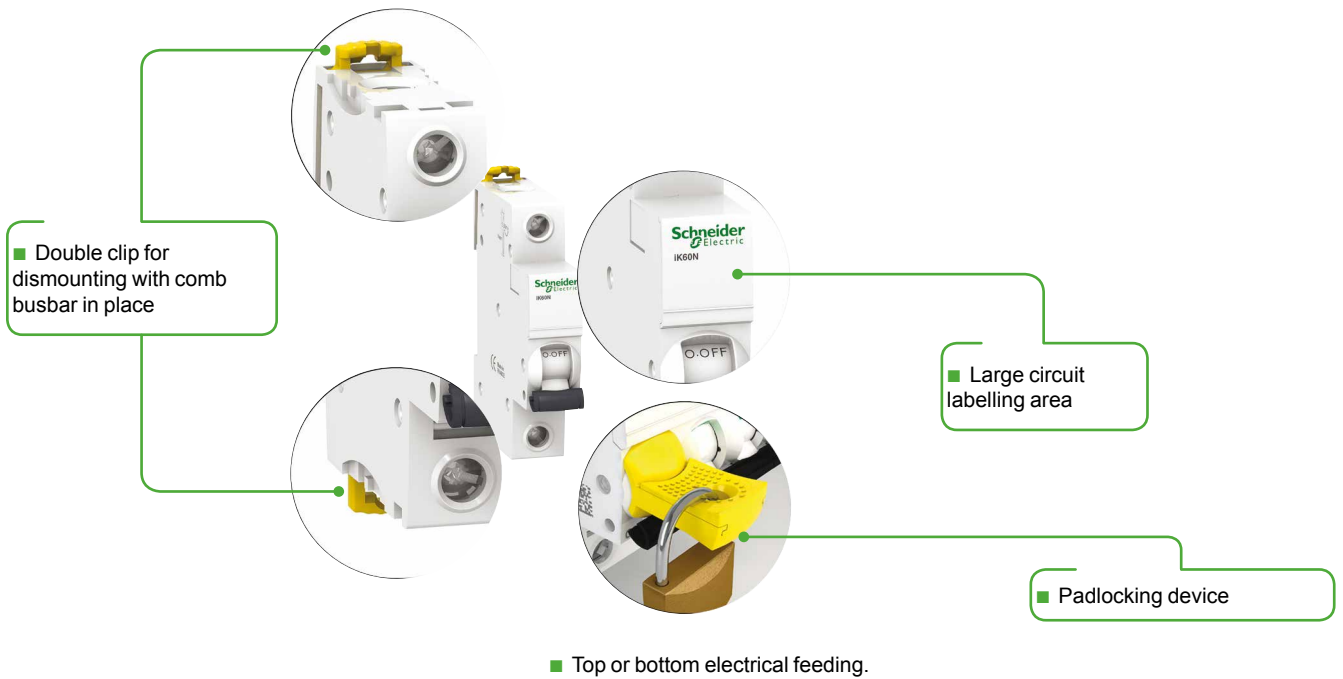

iK60N circuit breakers (curve C) (cont.)

PB10434-40

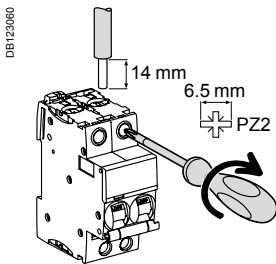

Connection



Type	Rating	Tightening torque	Copper cables	
			Rigid	Flexible or with ferrule
C curve	1 to 32 A	2 N.m		
	40 to 63 A	3.5 N.m		
			1 to 35 mm ²	1 to 25 mm ²

Protection Circuit protection iK60N circuit breakers (curve C) (cont.)

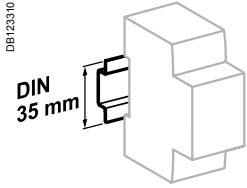

Clip on DIN rail 35 mm.

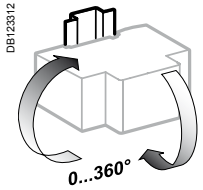

Position d'installation indifférente.

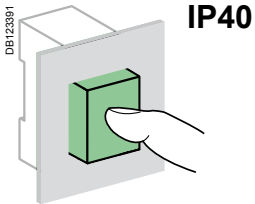

Technical data

Main characteristics		
According to IEC/EN 60898-1		
Insulation voltage (Ui)		440 V AC
Pollution degree		2
Rated impulse withstand voltage (Uimp)		4 kV
Thermal tripping	Reference temperature	30°C
	Temperature derating	See module CA908007
Magnetic tripping	C curve	5 to 10 In
Limitation class		3
Rated making and breaking capacity of an individual pole (Icn1)		Icn1 = Icn
Additional characteristics		
Degree of protection (IEC 60529)	Device in modular enclosure	IP40 Insulation class II
Endurance (O-C)	Electrical	10,000 cycles
	Mechanical	20,000 cycles
Overvoltage category (IEC 60364)		III
Operating temperature		-25°C to +60°C
Storage temperature		-40°C to +85°C

Weight (g)

Circuit-breaker	
Type	iK60N
1P	100
2P (1P+N)	200
3P	300
4P (3P+N)	400

Dimensions (mm)

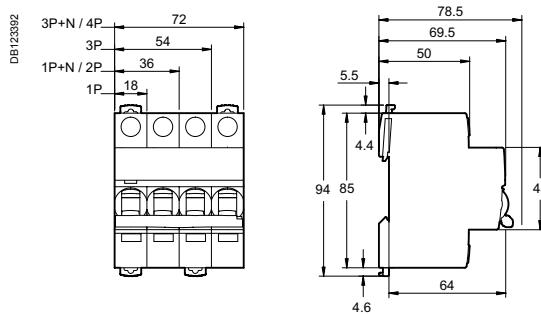

Protection

Circuit protection

K60 Biconnect circuit breakers



Schneider Electric's range of K60 Biconnect circuit breakers consists of different products (A, B, C) to enable it to be the most competitive range possible in each country, allowing for the special characteristics of each market:

- usual installation procedure
- price
- accreditations by local bodies.

Variants

Offers	Catalogue numbers	Pages
Offer A	Catalogue numbers	page 62
Offer B	Catalogue numbers	page 65
India		
Offer C	Catalogue numbers	page 68
Singapour		

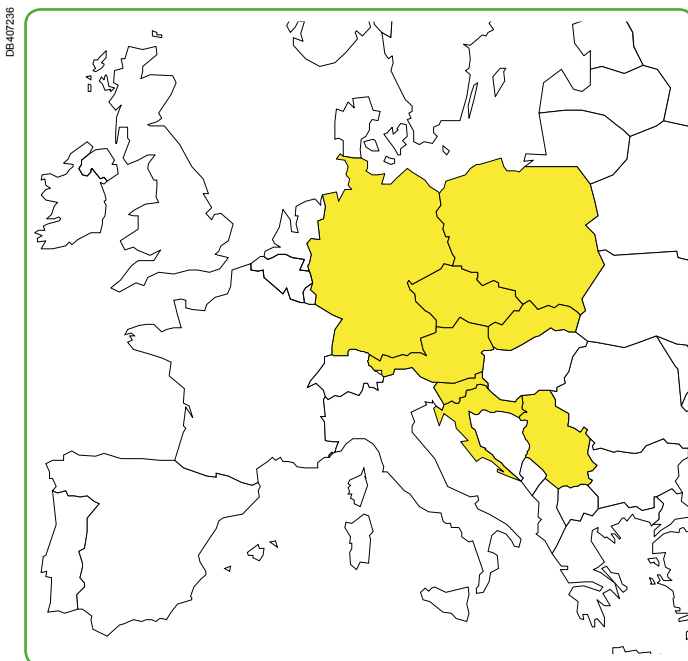

Only the product range to be marketed in your country and validated by the local product manager, in agreement with his Final Distribution (FD) partner should be retained. The others will be removed before publication.

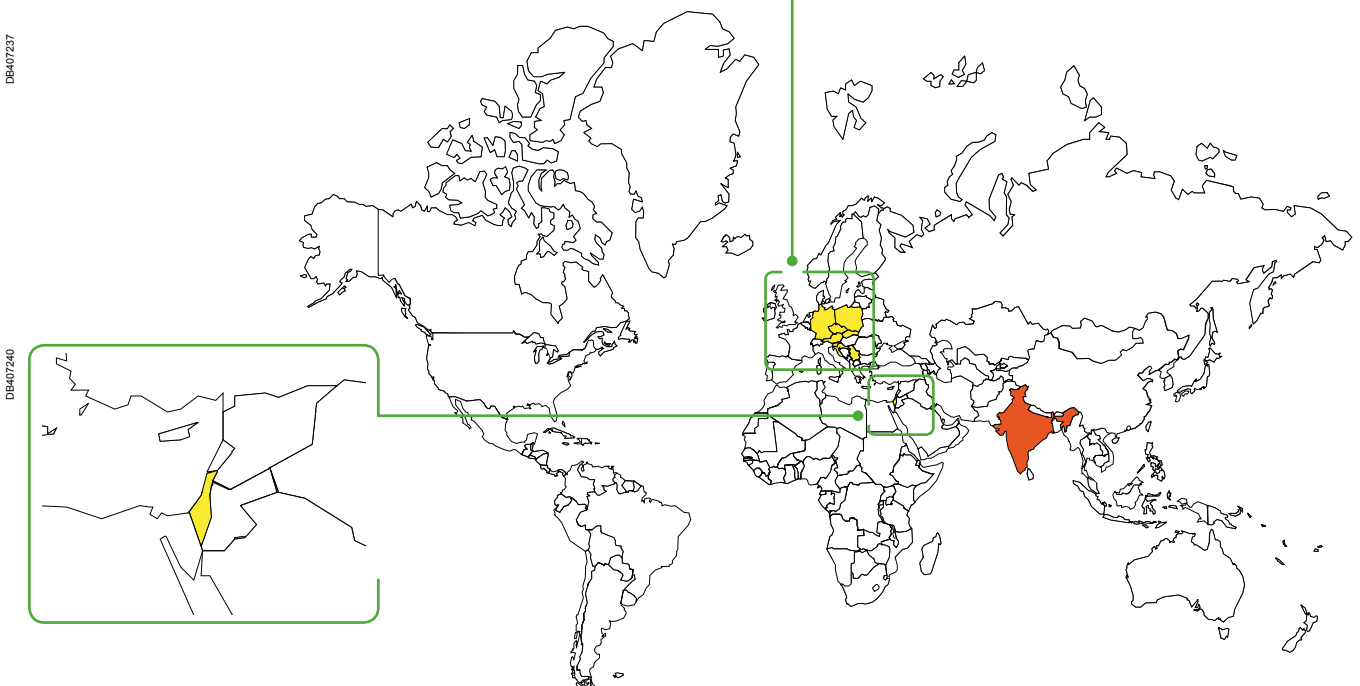

Protection Circuit protection K60N Biconnect circuit breakers

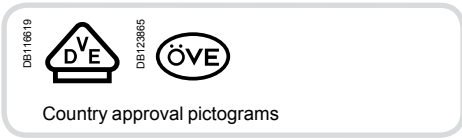

IEC/EN 60898-1

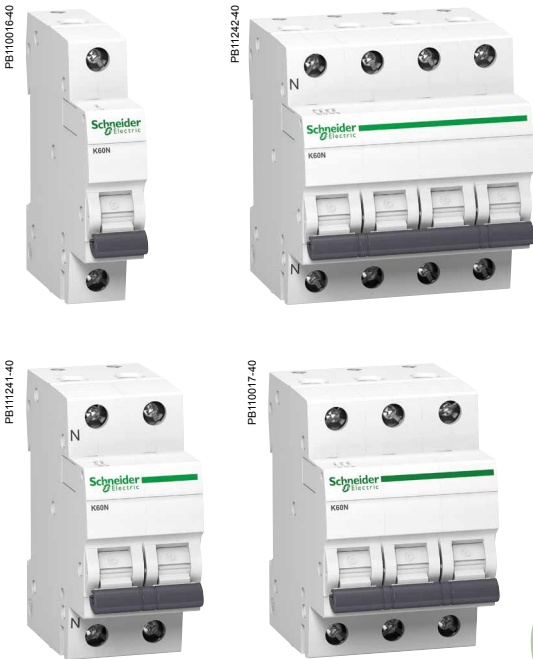

- K60N Biconnect circuit breakers are circuit breakers which combine the following functions:
 - circuit protection against short-circuit currents,
 - circuit protection against overload currents,
 - disconnection, opening and closing.

K60N Biconnect circuit breaker 50/60 Hz

Breaking capacity in short circuit (Icn) as per IEC/EN 60898-1		Service breaking capacity (Ics) 100 % of Icn
Ph/Ph	400 V	
Ph/N	230 V	
Rating (In)	2 to 40 A	6000 A



Catalogue numbers

K60N Biconnect circuit breaker								
Type	1P		1P+N		3P		3P+N	
Auxiliaries	Without auxiliaries		Without auxiliaries		Without auxiliaries		Without auxiliaries	
Rating (In)	Curve		Curve		Curve		Curve	
	B	C	B	C	B	C	C	
2 A	-	A9K02102	-	-	-	-	-	-
4 A	-	A9K02104	-	-	-	-	-	-
6 A	A9K01106	A9K02106	-	-	A9K01306	A9K02306	-	-
10 A	A9K01110	A9K02110	-	-	A9K01310	A9K02310	-	-
13 A	A9K01113	A9K02113	A9K01613	A9K02613	-	A9K02313	A9K02713	-
16 A	A9K01116	A9K02116	A9K01616	A9K02616	A9K01316	A9K02316	A9K02716	-
20 A	A9K01120	A9K02120	-	-	A9K01320	A9K02320	-	-
25 A	A9K01125	A9K02125	-	-	A9K01325	A9K02325	-	-
32 A	A9K01132	A9K02132	-	-	A9K01332	A9K02332	-	-
40 A	A9K01140	A9K02140	-	-	A9K01340	A9K02340	-	-
Width in 9-mm modules	2	2	4	4	6	6	8	
Accessories	Padlocking device cat. no. 26970							

K60N Biconnect circuit breakers (cont.)

PB110016-60

■ Reinforced cable pull-out strength: serrated terminals

■ Fast closing independent of the speed of actuation of the toggle.



0572091_SE-33



Padlocking device

■ Padlocking possible for work to be carried out on live parts

Connection



- Downstream by Biconnect comb busbar
- Upstream/downstream by tunnel terminals

DB-405041

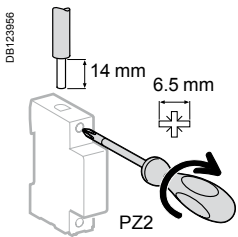

Connection



Type	Rating	Tightening torque	Copper cables	
			Rigid	Flexible or with ferrule
K60N Biconnect	2 to 25 A	2 N.m	DB122545 	DB122546 
	32 - 40 A	3.5 N.m	0.5 to 35 mm ²	0.5 to 25 mm ²

■ Connection by comb busbar or cables (conforms to EN 50027).

Offer selection see page 61

Offer A

This sticker must be removed before publishing

Protection
Circuit protection

K60N Biconnect circuit breakers (cont.)

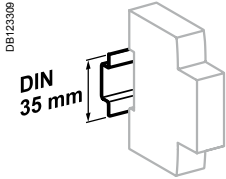

Clip on DIN rail 35 mm.

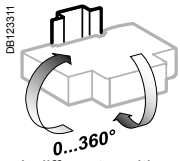

Indifferent position of installation.

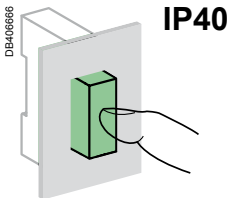

Technical data

Main characteristics		
Insulation voltage (Ui)	Phase-to-phase	440 V AC
Voltage rating (Ue)	Phase-to-neutral	230 V AC
	Phase-to-phase	400 V AC
Magnetic tripping	B curve	3 to 5 In ■
	C curve	5 to 10 In ■
According to EN 60898-1		
Limitation class		3
Rated breaking capacity (Icn)		6000 A
Service breaking capacity (Ics)		100 % Icn
Rated breaking and making capacity on a single pole (Icn1)		Icn1 = Icn
Additional characteristics		
Degree of protection (IEC 60529)	Device in modular enclosure	IP40 Insulation class II
Endurance (O-C)	Electrical ≤ 20 A	20,000 cycles
	≥ 25 A	10,000 cycles
	Mechanical	20,000 cycles
Operating temperature		-25°C to +70°C
Storage temperature		-40°C to +70°C
Tropicalization (IEC 60068-1)		Treatment 2 (relative humidity 95% at 55°C)

Weight (g)

Circuit-breaker	
Type	K60N Biconnect
1P	120
1P+N	240
3P	360
3P+N	480

Offer selection see page 61

Offer A

This sticker must be removed before publishing

Dimensions (mm)

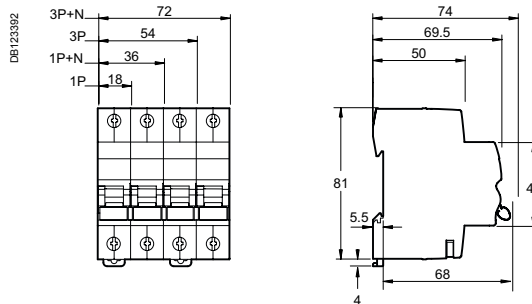

K60H Biconnect circuit breakers

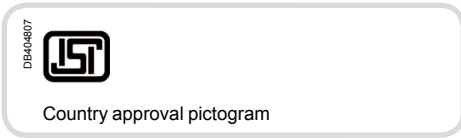

IS/IEC 60898-1
IEC/EN 60898-1

- K60H Biconnect circuit breakers are circuit breakers which combine the following functions:
 - circuit protection against short-circuit currents,
 - circuit protection against overload currents,
 - disconnection, opening and closing.



K60H Biconnect circuit breaker 50/60 Hz

Breaking capacity in short circuit (Icn) as per IEC/EN 60898-1		Service breaking capacity (Ics)
Ph/Ph	415 V	75 % of Icn
Ph/N	240 V	
Rating (In)	1 to 63 A	



Catalogue numbers

K60H Biconnect circuit breaker						
Type	1P		2P		3P	4P
Auxiliaries	Without auxiliaries					
Rating (In)	Curve		Curve		Curve	Curve
	B	C	B	C	C	C
1 A	-	A9KF71101	-	A9KF71201	A9KF71301	A9KF71401
2 A	-	A9KF71102	-	A9KF71202	A9KF71302	A9KF71402
3 A	-	A9KF71103	-	A9KF71203	A9KF71303	A9KF71403
4 A	-	A9KF71104	-	A9KF71204	A9KF71304	A9KF71404
6 A	A9KF21106	A9KF71106	A9KF21206	A9KF71206	A9KF71306	A9KF71406
10 A	A9KF21110	A9KF71110	A9KF21210	A9KF71210	A9KF71310	A9KF71410
16 A	A9KF21116	A9KF71116	A9KF21216	A9KF71216	A9KF71316	A9KF71416
20 A	A9KF21120	A9KF71120	A9KF21220	A9KF71220	A9KF71320	A9KF71420
25 A	A9KF21125	A9KF71125	A9KF21225	A9KF71225	A9KF71325	A9KF71425
32 A	A9KF21132	A9KF71132	A9KF21232	A9KF71232	A9KF71332	A9KF71432
40 A	-	A9KF71140	-	A9KF71240	A9KF71340	A9KF71440
50 A	-	A9KF71150	-	A9KF71250	A9KF71350	A9KF71450
63 A	-	A9KF71163	-	A9KF71263	A9KF71363	A9KF71463
Width in 9-mm modules	2		4		6	8
Accessories	Padlocking device cat. no. 26970					

Protection
Circuit protection

K60H Biconnect circuit breakers (cont.)

■ Reinforced cable pull-out strength: serrated terminals

■ Fast closing independent of the speed of actuation of the toggle.

PB114837-60



DB404823

057200L_SE-33

Padlocking device

■ Padlocking possible for work to be carried out on live parts

Connection

- Downstream by Biconnect comb busbar
- Upstream/downstream by tunnel terminals

DB406041



Connection

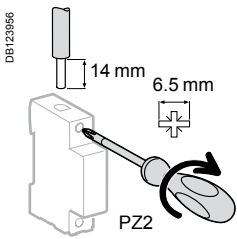

Type	Rating	Tightening torque	Copper cables	
			Rigid	Flexible or with ferrule
K60H Biconnect	1 to 25 A	2 N.m	DB122545	DB122546
	32 to 63 A	3.5 N.m	0.5 to 35 mm ²	0.5 to 25 mm ²

Offer selection see page 61

Offer B

This sticker must be removed before publishing

Protection
Circuit protection

K60H Biconnect circuit breakers (cont.)

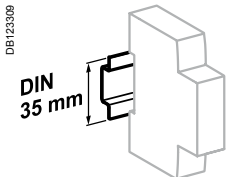

Clip on DIN rail 35 mm.

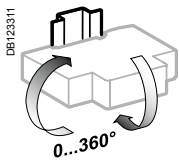

Indifferent position of installation.

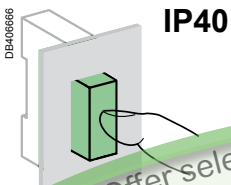

Offer selection see page 61

Offer B

This sticker must be removed before publishing

Technical data

Main characteristics		
Insulation voltage (Ui)	Phase-to-phase	500 V AC
Voltage rating (Ue)	Phase-to-neutral	240 V AC
	Phase-to-phase	415 V AC
Rated impulse withstand voltage (Uimp)		4 kV
Magnetic tripping	B curve	3 to 5 In
	C curve	5 to 10 In
According to EN 60898-1		
Limitation class		3
Rated breaking capacity (Icn)		10,000 A
Service breaking capacity (Ics)		75 % Icn
Rated breaking and making capacity on a single pole (Icn1)		Icn1 = Icn
Additional characteristics		
Degree of protection (IEC 60529)	Device in modular enclosure	IP40 Insulation class II
	Degree of pollution	2
Endurance (O-C)	Electrical	≤ 20 A
		≥ 25 A
	Mechanical	20,000 cycles
Operating temperature		-5°C to +55°C
Storage temperature		-25°C to +85°C
Tropicalization (IEC 60068-1)		Treatment 2 (relative humidity 95% at 55°C)

Circuit-breaker	
Type	K60H Biconnect
1P	120
2P	240
3P	360
4P	480

Dimensions (mm)

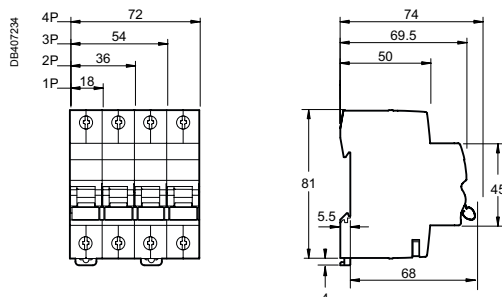

Protection Circuit protection K60N Biconnect circuit breakers

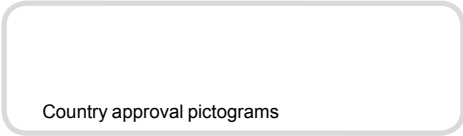

IEC/EN 60898-1



- K60N Biconnect circuit breakers are circuit breakers which combine the following functions:
 - circuit protection against short-circuit currents,
 - circuit protection against overload currents,
 - disconnection, opening and closing.

K60N Biconnect circuit breaker 50/60 Hz		
Breaking capacity in short circuit (I_{cn}) as per IEC/EN 60898-1		Service breaking capacity (I_{cs}) 100 % of I _{cn}
Ph/Ph	400 V	
Ph/N	230 V	
Rating (I_n)	6 to 63 A	6000 A

Offer selection see page 61

Offer C

This sticker must be removed before publishing

Catalogue numbers

K60N Biconnect circuit breaker									
Type	1P		2P		3P		4P		
Auxiliaries	Without auxiliaries		Without auxiliaries		Without auxiliaries		Without auxiliaries		
Rating (I_n)	Curve		Curve		Curve		Curve		
	B	C	B	C	B	C	B	C	
6 A	A9K01106	A9K02106	A9K01206	A9K02206	A9K01306	A9K02306	A9K01406	A9K02406	
10 A	A9K01110	A9K02110	A9K01210	A9K02210	A9K01310	A9K02310	A9K01410	A9K02410	
16 A	A9K01116	A9K02116	A9K01216	A9K02216	A9K01316	A9K02316	A9K01416	A9K02416	
20 A	A9K01120	A9K02120	A9K01220	A9K02220	A9K01320	A9K02320	A9K01420	A9K02420	
32 A	A9K01132	A9K02132	A9K01232	A9K02232	A9K01332	A9K02332	A9K01432	A9K02432	
40 A	A9K01140	A9K02140	A9K01240	A9K02240	A9K01340	A9K02340	A9K01440	A9K02440	
50 A	A9K01150	A9K02150	A9K01250	A9K02250	A9K01350	A9K02350	A9K01450	A9K02450	
63 A	A9K01163	A9K02163	A9K01263	A9K02263	A9K01363	A9K02363	A9K01463	A9K02463	
Width in 9-mm modules	2		4		6		8		
Accessories	Padlocking device cat. no. 26970								

K60H Biconnect circuit breakers

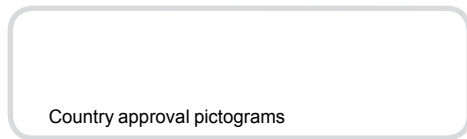

IEC/EN 60898-1



- K60H Biconnect circuit breakers are circuit breakers which combine the following functions:
 - circuit protection against short-circuit currents,
 - circuit protection against overload currents,
 - disconnection, opening and closing.

K60H Biconnect circuit breaker 50/60 Hz		
Breaking capacity in short circuit (I _{cn}) as per IEC/EN 60898-1		Service breaking capacity (I _{cs})
Ph/Ph	400 V	75 % of I _{cn}
Ph/N	230 V	
Rating (I _n)	6 to 63 A	



Catalogue numbers

K60H Biconnect circuit breaker								
Type	1P		2P		3P		4P	
Auxiliaries	Without auxiliaries		Without auxiliaries		Without auxiliaries		Without auxiliaries	
Rating (I_n)	Curve		Curve		Curve		Curve	
	B	C	B	C	B	C	B	C
6 A	A9K11106	A9K12106	A9K11206	A9K12206	A9K11306	A9K12306	A9K11406	A9K12406
10 A	A9K11110	A9K12110	A9K11210	A9K12210	A9K11310	A9K12310	A9K11410	A9K12410
16 A	A9K11116	A9K12116	A9K11216	A9K12216	A9K11316	A9K12316	A9K11416	A9K12416
20 A	A9K11120	A9K12120	A9K11220	A9K12220	A9K11320	A9K12320	A9K11420	A9K12420
32 A	A9K11132	A9K12132	A9K11232	A9K12232	A9K11332	A9K12332	A9K11432	A9K12432
40 A	A9K11140	A9K12140	A9K11240	A9K12240	A9K11340	A9K12340	A9K11440	A9K12440
50 A	A9K11150	A9K12150	A9K11250	A9K12250	A9K11350	A9K12350	A9K11450	A9K12450
63 A	A9K11163	A9K12163	A9K11263	A9K12263	A9K11363	A9K12363	A9K11463	A9K12463
Width in 9-mm modules	2		4		6		8	
Accessories	Padlocking device cat. no. 26970							

Protection
Circuit protection

K60 Biconnect circuit breakers (cont.)

■ Reinforced cable pull-out strength: serrated terminals

■ Fast closing independent of the speed of actuation of the toggle.

PB114837-60



DB404823

057209J_SE-33

Padlocking device

■ Padlocking possible for work to be carried out on live parts

Connection



■ Downstream by Biconnect comb busbar
■ Upstream/downstream by tunnel terminals

DB407861

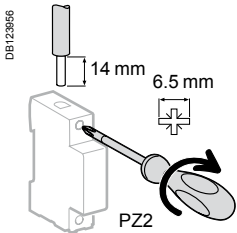

Connection



Type	Rating	Tightening torque	Copper cables	
			Rigid	Flexible or with ferrule
K60 Biconnect	6 to 20 A	2 N.m	DB122945 	DB122946 
	32 to 63 A	3.5 N.m	0.5 to 25 mm ²	0.5 to 16 mm ²
			0.5 to 35 mm ²	0.5 to 25 mm ²

■ Connection by comb busbar or cables (conforms to EN 50027).

Offer selection see page 61

Offer C

This sticker must be removed before publishing

K60 Biconnect circuit breakers (cont.)

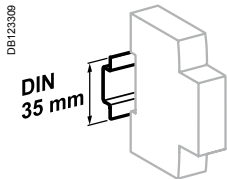

Clip on DIN rail 35 mm.

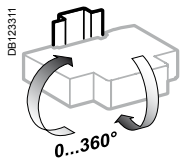

Indifferent position of installation.

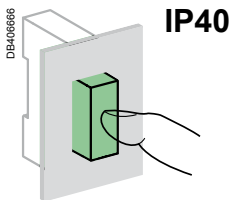

Offer selection see page 61

Offer C

This sticker must be removed before publishing

Technical data

Main characteristics		K60N	K60H
Insulation voltage (Ui)	Phase-to-phase	440 V AC	
Voltage rating (Ue)	Phase-to-neutral	230 V AC	
	Phase-to-phase	400 V AC	
Magnetic tripping	B curve	3 to 5 I _n	■
	C curve	5 to 10 I _n	■
According to EN 60898-1			
Limitation class		3	
Rated breaking capacity (I _{cn})		6000 A	10000 A
Service breaking capacity (I _{cs})		100 % of I _{cn}	75 % of I _{cn}
Rated breaking and making capacity on a single pole (I _{cn1})		I _{cn1} = I _{cn}	
Additional characteristics			
Degree of protection (IEC 60529)	Device in modular enclosure	IP40	
Endurance (O-C)	Electrical	≤ 20 A	20,000 cycles
		≥ 32 A	10,000 cycles
	Mechanical	20,000 cycles	
Operating temperature		-5°C to +55°C	
Storage temperature		-25°C to +85°C	
Tropicalization (IEC 60068-1)		Treatment 2 (relative humidity 95% at 55°C)	

Weight (g)

Circuit-breaker	
Type	K60 Biconnect
1P	120
2P	240
3P	360
4P	480

Dimensions (mm)

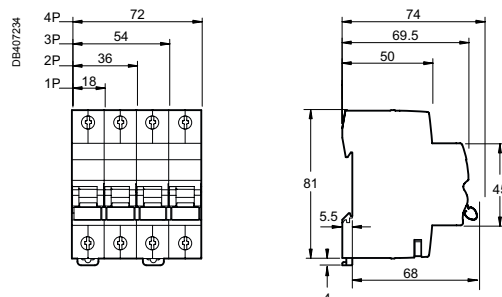

Protection Circuit protection

C120a circuit breakers (curves C, D)

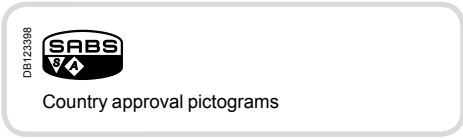

IEC/EN 60947-2

C120a circuit breakers are multistandard circuit breakers that combine the following functions:

- circuit protection against short-circuit currents,
- circuit protection against overload currents,
- suitability for isolation in the industrial sector to IEC/EN 60947-2,
- fault tripping and indication by adding auxiliaries.

Alternating current (AC) 50/60 Hz

Breaking capacity (Icu) to IEC/EN 60947-2		Service breaking capacity (Ics)
Type	Voltage (V)	
1P, 2P, 3P, 4P	230 to 400 V	100 % of Icu
Rating (In) 80 and 100 A	5 kA	



Catalogue numbers

C120a circuit breaker						
Type	1P		2P	3P		4P
Auxiliaries	Remote indication and tripping, module CA907008 and CA907013		Remote indication and tripping, module CA907008 and CA907013	Remote indication and tripping, module CA907008 and CA907013		Remote indication and tripping, module CA907008 and CA907013
Vigi C120	Vigi C120 add-on residual current device, module CA902016		Vigi C120 add-on residual current device, module CA902016	Vigi C120 add-on residual current device, module CA902016		Vigi C120 add-on residual current device, module CA902016
Rating (In)	Curve C D		Curve C	Curve C D		Curve C
80 A	A9N60708	A9N60720	A9N60711	A9N60714	A9N60723	A9N60717
100 A	A9N60709	A9N60721	A9N60712	A9N60715	A9N60724	A9N60718
Width in 9-mm modules	3		6	9		12
Accessories	Module CA907012 and CA907013		Module CA907012 and CA907013	Module CA907012 and CA907013		Module CA907012 and CA907013

C120N circuit breakers (curves C, D)

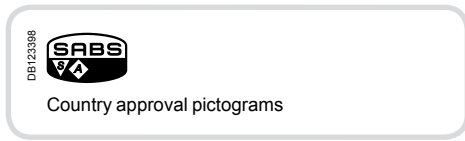

IEC/EN 60947-2

C120N circuit breakers are multistandard circuit breakers that combine the following functions:

- circuit protection against short-circuit currents,
- circuit protection against overload currents,
- suitability for isolation in the industrial sector to IEC/EN 60947-2,
- fault tripping and indication by adding auxiliaries.

Alternating current (AC) 50/60 Hz		
Breaking capacity (Icu) to IEC/EN 60947-2		Service breaking capacity (Ics)
Type	Voltage (V)	
1P, 2P, 3P, 4P	230 to 400 V	75 % of Icu
Rating (In)	80 and 100 A 10 kA	

Direct current (DC)					
Breaking capacity (Icu) according to IEC/EN 60947-2					Service breaking capacity (Ics)
Between +/-	Voltage (Ue)				
	12 to 125 V ≤ 144 V	≤ 250 V	≤ 375 V	≤ 500 V	100 % of Icu
Number of poles	1P	2P	3P	4P	
Rating (In)	80 and 100 A	15 kA	10 kA	10 kA	

Catalogue numbers

C120N circuit breaker									
Type	1P		2P		3P		4P		
Auxiliaries	Remote indication and tripping, module CA907008 and CA907013		Remote indication and tripping, module CA907008 and CA907013		Remote indication and tripping, module CA907008 and CA907013		Remote indication and tripping, module CA907008 and CA907013		
Vigi C120	Vigi C120 add-on residual current device, module CA902016		Vigi C120 add-on residual current device, module CA902016		Vigi C120 add-on residual current device, module CA902016		Vigi C120 add-on residual current device, module CA902016		
Rating (In)	Curve C D		Curve C D		Curve C D		Curve C D		
80 A	A9N60729	A9N60745	A9N60733	A9N60749	A9N60737	A9N60753	A9N60741	A9N60757	
100 A	A9N60730	A9N60746	A9N60734	A9N60750	A9N60738	A9N60754	A9N60742	A9N60758	
Width in 9-mm modules	3		6		9		12		
Accessories	Module CA907012 and CA907013		Module CA907012 and CA907013		Module CA907012 and CA907013		Module CA907012 and CA907013		

Protection

Circuit protection

C120H circuit breakers (curve C)

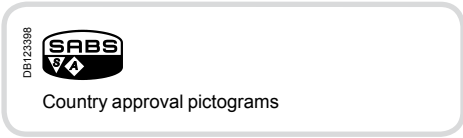

IEC/EN 60947-2

C120H circuit breakers are multistandard circuit breakers that combine the following functions:

- circuit protection against short-circuit currents,
- circuit protection against overload currents,
- suitability for isolation in the industrial sector to IEC/EN 60947-2,
- fault tripping and indication by adding auxiliaries.

Alternating current (AC) 50/60 Hz		
Breaking capacity (Icu) to IEC/EN 60947-2		Service breaking capacity (Ics)
Type	Voltage (V)	
1P	230 to 400 V	50 % of Icu
Rating (In)	80 and 100 A	

Direct current (DC)						
Breaking capacity (Icu) according to IEC/EN 60947-2						Service breaking capacity (Ics)
Between +/-	Voltage (Ue)					
	12 to 125 V	≤ 144 V	≤ 250 V	≤ 375 V	≤ 500 V	100 % of Icu
Number of poles	1P		2P	3P	4P	
Rating (In)	80 and 100 A	20 kA	15 kA	15 kA	15 kA	

Catalogue numbers

C120H circuit breaker				
Type	1P	2P	3P	4P
Auxiliaries	Remote indication and tripping, module CA907008 and CA907013	Remote indication and tripping, module CA907008 and CA907013	Remote indication and tripping, module CA907008 and CA907013	Remote indication and tripping, module CA907008 and CA907013
Vigi C120	Vigi C120 add-on residual current device, module CA902016	Vigi C120 add-on residual current device, module CA902016	Vigi C120 add-on residual current device, module CA902016	Vigi C120 add-on residual current device, module CA902016
Rating (In)	Curve C	Curve C	Curve C	Curve C
80 A	A9N60777	A9N60781	A9N60785	A9N60789
100 A	A9N60778	A9N60782	A9N60786	A9N60790
Width in 9-mm modules	3	6	9	12
Accessories	Module CA907012 and CA907013	Module CA907012 and CA907013	Module CA907012 and CA907013	Module CA907012 and CA907013

Protection

Circuit protection

C120 circuit breakers

PB107817-40

■ Terminals insulated to IP20



■ Location for 4 clip-on terminal markers



Positive contact indication

- Suitability for isolation in the industrial sector to IEC/EN 60947-2.
- The presence of the green strip guarantees that the contacts open physically and allows work to be carried out safely on the downstream circuit.

- Longer product service life thanks to:
 - good overvoltage withstand capacity: products designed to offer a high industrial performance level (degree of pollution, rated impulse withstand voltage and insulation voltage).
 - high limitation performances (see limitation curves).
 - fast closure independent of toggle operating speed.
- Remote indication of the open/closed/tripped state by auxiliary contacts (optional).
- Power supply from above or below.

Protection Circuit protection C120 circuit breakers (cont.)

Connection

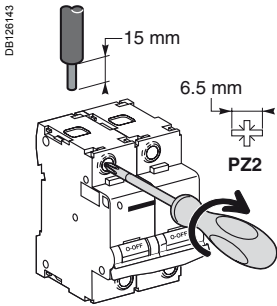

Rating	Tightening torque	Without access.		With accessories			
		Rigid/ semi-rigid	Flexible or with ferrule	50 mm ² Al Terminal	Screw-on connection for ring terminal ⁽¹⁾	Rigid cables	Flexible cables
		DB122845	DB122846	DB122835	DB118789	DB118787	
80 and 100 A	3.5 N.m	1.5 to 50 mm ²	1.5 to 35 mm ²	16 to 50 mm ²	Ø 5 mm	3 x 16 mm ²	3 x 10 mm ²

(1) For lugs up to 63 A, front or rear access.

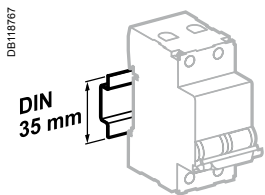

Clips onto 35 mm DIN rail.

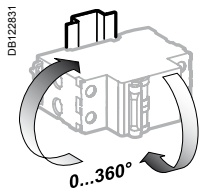

Any installation position.

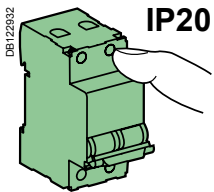

IP20

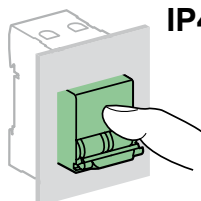

IP40

Technical data

Main characteristics

To IEC/EN 60947-2

Insulation voltage (Ui)	500 V AC	
Degree of pollution	3	
Rated impulse withstand voltage (Uimp)	6 kV	
Thermal tripping	Reference temperature	50°C
Magnetic tripping	Curve C	8 In ± 20 %
	Curve D	12 In ± 20 %
Limitation class	3	

Additional characteristics

Degree of protection (IEC 60529)	Device only	IP20
	Device in a modular enclosure	IP40
Endurance (O-C)	Electrical	5000 cycles (O-C)
	Mechanical	20000 cycles
Operating temperature	-30°C to +70°C	
Storage temperature	-40°C to +80°C	
Tropicalisation (IEC 60068-1)	Treatment 2 (relative humidity 95 % at 55°C)	

Weight (g)

Circuit breaker

Type	C120
1P	205
2P	410
3P	615
4P	820

Dimensions (mm)

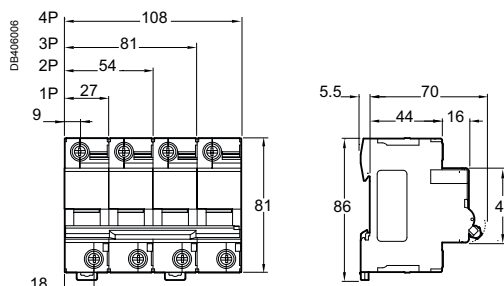

Protection

Circuit protection

C120N circuit breakers (curves B, C, D)

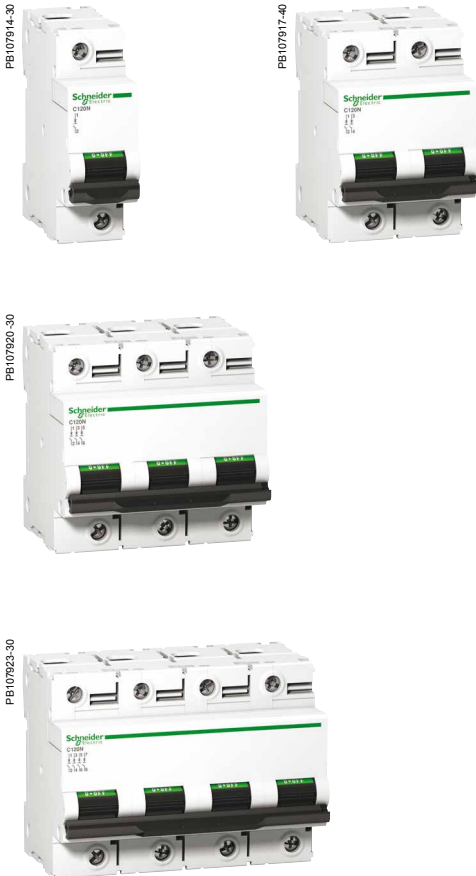

IEC/EN 60898-1

C120N circuit breakers are multistandard circuit breakers that combine the following functions:

- circuit protection against short-circuit currents,
- circuit protection against overload currents,
- suitability for isolation in the industrial sector to IEC/EN 60947-2,
- fault tripping and indication by adding auxiliaries.

Alternating current (AC) 50/60 Hz

Breaking capacity (Icu) to IEC/EN 60947-2						Service breaking capacity (Ics)
Type	Voltage (V)					
1P	12 to 130 V	220 to 240 V	380 to 415 V	440 V		75 % of Icu
Rating (In) 63 to 125 A	20 kA	10 kA	3 kA ⁽¹⁾	-		
2P/3P/4P	12 to 130 V	220 to 240 V	380 to 415 V	440 V		75 % of Icu
63 to 125 A	-	20 kA	10 kA	6 kA		

Breaking capacity (Icn) to IEC/EN 60898-1

Type	Voltage (V)		Service breaking capacity (Ics)
1P, 2P, 3P, 4P	230 to 400 V		
Rating (In) 63 to 125 A	10000 A		

(1) One-pole breaking capacity in IT isolated neutral system (double fault).

Direct current (DC)

Breaking capacity (Icu) according to IEC/EN 60947-2							Service breaking capacity (Ics)
Between +/-	Voltage (Ue)						
	12 to 125 V	≤ 144 V	≤ 250 V	≤ 375 V	≤ 500 V		
Number of poles	1P	2P	3P	4P		100 % of Icu	
Rating (In) 63 to 125 A	15 kA	10 kA	10 kA	10 kA	10 kA		

Catalogue numbers

C120N circuit breaker

Type	1P	2P
Auxiliaries	Remote indication and tripping, module CA907008 and CA907013	Remote indication and tripping, module CA907008 and CA907013
Vigi C120	Vigi C120 add-on residual current device, module CA902016	Vigi C120 add-on residual current device, module CA902016
Rating (In)	Curve	Curve
	B C D	B C D
63 A	A9N18340	A9N18356
80 A	A9N18341	A9N18357
100 A	A9N18342	A9N18358
125 A	A9N18343	A9N18359
Width in 9-mm modules	3	6
Accessories	Module CA907012 and CA907013	Module CA907012 and CA907013

(1) Country France only

Protection Circuit protection

C120N circuit breakers (curves B, C, D) (cont.)

PB107817-40

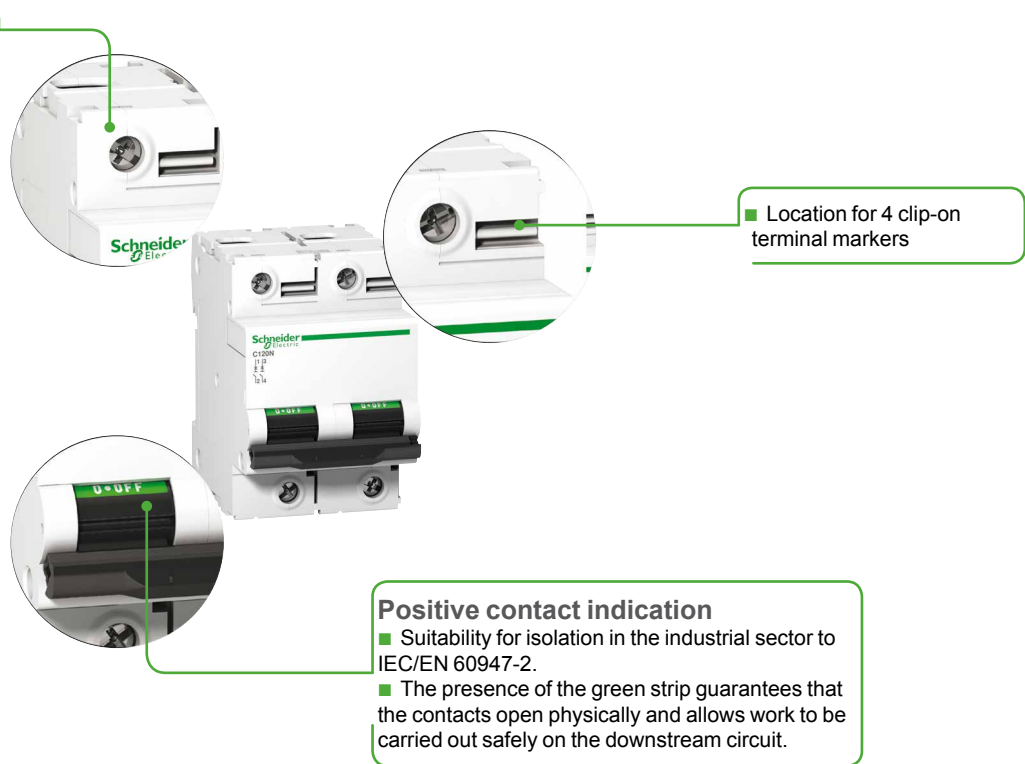

- Longer product service life thanks to:
 - good overvoltage withstand capacity: products designed to offer a high industrial performance level (degree of pollution, rated impulse withstand voltage and insulation voltage).
 - high limitation performances (see limitation curves).
 - fast closure independent of toggle operating speed.
- Remote indication of the open/closed/tripped state by auxiliary contacts (optional).
- Power supply from above or below.

3P				4P		
Remote indication and tripping, module CA907008 and CA907013				Remote indication and tripping, module CA907008 and CA907013		
Vigi C120 add-on residual current device, module CA902016				Vigi C120 add-on residual current device, module CA902016		
Curve				Curve		
B	C	D	B	C	D	
A9N18348	A9N18364	A9N18386	A9N18352	A9N18371	A9N18390	
A9N18349	A9N18365	A9N18387	A9N18353	A9N18372	A9N18391	
A9N18350	A9N18367	A9N18388	A9N18354	A9N18373(1)	A9N18392	
A9N18351	A9N18369	A9N18389	A9N18355	A9N18374	A9N18392	
				A9N18375(1)		
				A9N18376	A9N18393	
				A9N18377(1)		
9				12		
Module CA907012 and CA907013				Module CA907012 and CA907013		

Protection
Circuit protection

C120N circuit breakers (curves B, C, D) (cont.)

Connection

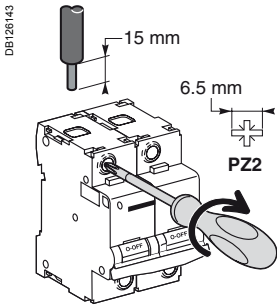

Rating	Tightening torque	Without access.		With accessories			
		Rigid/semi-rigid	Flexible or with ferrule	50 mm ² Al Terminal	Screw-on connection for ring terminal ⁽¹⁾	Rigid cables	Flexible cables
63 to 125 A	3.5 N.m	DB122845	DB122846	DB122835	DB118789	DB118787	
		1.5 to 50 mm ²	1.5 to 35 mm ²	16 to 50 mm ²	Ø 5 mm	3 x 16 mm ²	3 x 10 mm ²

(1) For lugs up to 63 A, front or rear access.

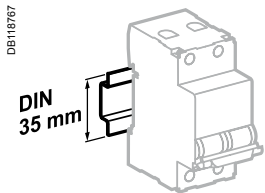

Clips onto 35 mm DIN rail.

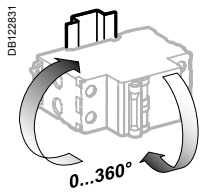

Any installation position.

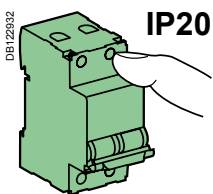

IP20

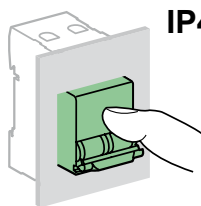

IP40

Technical data

Main characteristics

To IEC/EN 60947-2

Insulation voltage (U _i)	500 V AC	
Degree of pollution	3	
Rated impulse withstand voltage (U _{imp})	6 kV	
Thermal tripping	Reference temperature	50°C

To IEC/EN 60898-1

Magnetic tripping	Curve B	3 and 5 I _n
	Curve C	5 and 10 I _n
	Curve D	10 and 14 I _n
Limitation class		3

Additional characteristics

Degree of protection (IEC 60529)	Device only	IP20	
	Device in a modular enclosure	IP40	
Endurance (O-C)	Electrical	63 A	10000 cycles (O-C)
		80...125 A	5000 cycles (O-C)
	Mechanical	20000 cycles	
Operating temperature		-30°C to +70°C	
Storage temperature		-40°C to +80°C	
Tropicalisation (IEC 60068-1)		Treatment 2 (relative humidity 95 % at 55°C)	

Weight (g)

Circuit breaker

Type	C120N
1P	205
2P	410
3P	615
4P	820

Dimensions (mm)

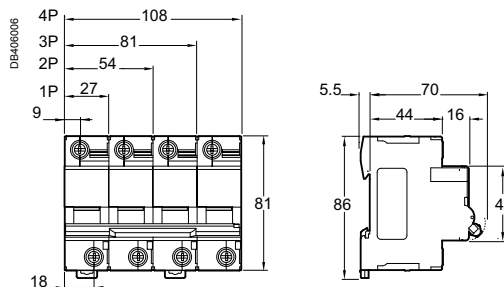

Protection

Circuit protection

C120H circuit breakers (curves B, C, D)



IEC/EN 60898-1

C120H circuit breakers are multistandard circuit breakers that combine the following functions:

- circuit protection against short-circuit currents
- circuit protection against overload currents
- suitability for isolation in the industrial sector to IEC/EN 60947-2
- fault tripping and indication by adding auxiliaries.

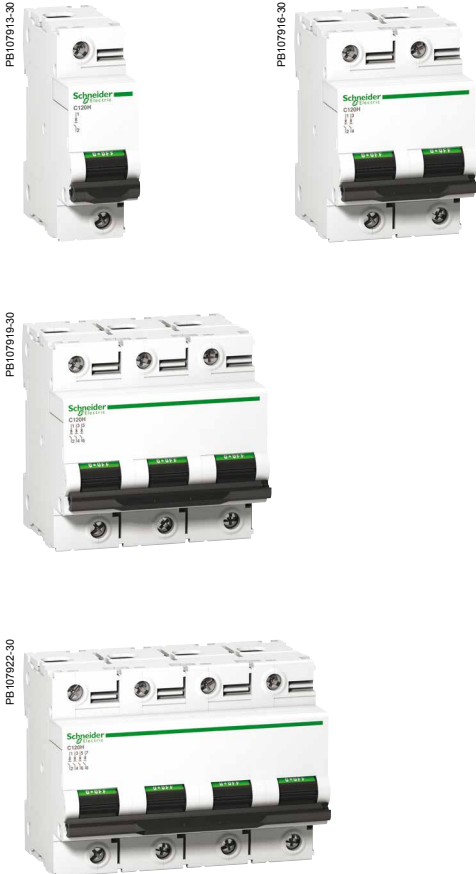

Alternating current (AC) 50/60 Hz

Breaking capacity (Icu) to IEC/EN 60947-2						Service breaking capacity (Ics)
Type	Voltage (V)					
1P	12 to 130 V	220 to 240 V	380 to 415 V	440 V		50 % of Icu
Rating (In) 63 to 125 A	30 kA	15 kA	4,5 kA ⁽¹⁾	-		
2P, 3P, 4P	12 to 130 V	220 to 240 V	380 to 415 V	440 V		50 % of Icu
63 to 125 A	-	30 kA	15 kA	10 kA		

Breaking capacity (Icn) to IEC/EN 60898-1

Type	Voltage (V)		Service breaking capacity (Ics)
1P, 2P, 3P, 4P	230 to 400 V		
Rating (In) 63 to 125 A	15000 A		

⁽¹⁾ One-pole breaking capacity in IT isolated neutral system (double fault).

Direct current (DC)

Breaking capacity (Icu) according to IEC/EN 60947-2							Service breaking capacity (Ics)
Between +/-	Voltage (Ue)						
	12 to 125 V	≤ 144 V	≤ 250 V	≤ 375 V	≤ 500 V		
Number of poles	1P	2P	3P	4P			
Rating (In) 63 to 125 A	20 kA	15 kA	15 kA	15 kA	15 kA	100 % of Icu	

Catalogue numbers

C120H circuit breaker

Type	1P	2P
Auxiliaries	Remote indication and tripping, module CA907008 and CA907013	Remote indication and tripping, module CA907008 and CA907013
Vigi C120	Vigi C120 add-on residual current device, module CA902016	Vigi C120 add-on residual current device, module CA902016
Rating (In)	Curve	Curve
	B C D	B C D
63 A	A9N18401 A9N18445 A9N18489	A9N18412 A9N18456 A9N18500
80 A	A9N18402 A9N18446 A9N18490	A9N18413 A9N18457 A9N18501
100 A	A9N18403 A9N18447 A9N18491	A9N18414 A9N18458 A9N18502
125 A	A9N18404 A9N18448 A9N18492	A9N18415 A9N18459 A9N18503
Width in 9 mm modules	3	6
Accessories	Module CA907012 and CA907013	Module CA907012 and CA907013

Protection Circuit protection

C120H circuit breakers (curves B, C, D) (cont.)

PB107916-40

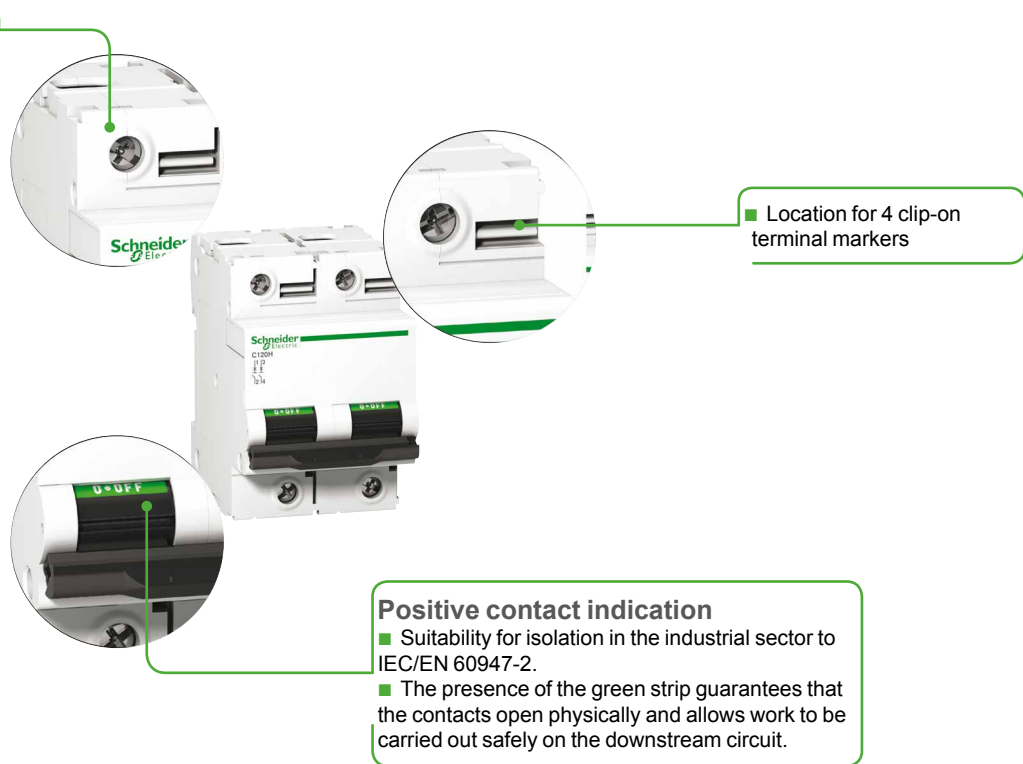

- Longer product service life thanks to:
 - good overvoltage withstand capacity: products designed to provide a high industrial performance level (degree of pollution, rated impulse withstand voltage and insulation voltage).
 - high limitation performances (see limitation curves).
 - fast closure independent of toggle operating speed.
- Remote indication of the open/closed/tripped state by auxiliary contacts (optional).
- Power supply from above or below.

3P				4P		
Remote indication and tripping, module CA907008 and CA907013				Remote indication and tripping, module CA907008 and CA907013		
Vigi C120 add-on residual current device, module CA902016				Vigi C120 add-on residual current device, module CA902016		
Curve				Curve		
B		C		D		
A9N18423		A9N18467		A9N18511		A9N18434
A9N18424		A9N18468		A9N18512		A9N18435
A9N18425		A9N18469		A9N18513		A9N18436
A9N18426		A9N18470		A9N18514		A9N18437
9				12		
Module CA907012 and CA907013				Module CA907012 and CA907013		

Protection
Circuit protection

C120H circuit breakers (curves B, C, D) (cont.)

Connection

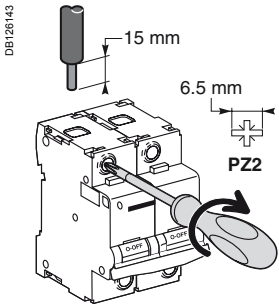

Rating	Tightening torque	Without access.		With accessories			
		Rigid	Flexible or with ferrule	50 mm ² Al term.	Screw-on connection for ring terminal ⁽¹⁾	Rigid cables	Flexible cables
63 to 125 A	3.5 N.m	DB122945	DB122946	DB122935	DB118769	DB118767	
		1.5 to 50 mm ²	1.5 to 35 mm ²	16 to 50 mm ²	Ø 5 mm	3 x 16 mm ²	3 x 10 mm ²

(1) For lugs up to 63 A, front or rear accessories.

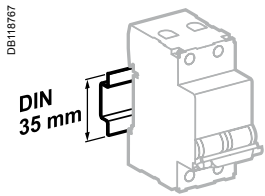

Clips onto 35 mm DIN rail.

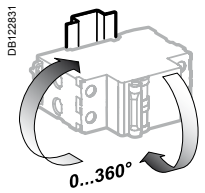

Any installation position.

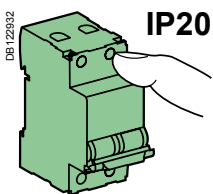

IP20

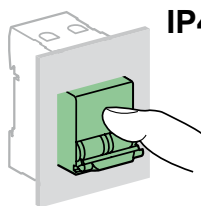

IP40

Technical data

Main characteristics

To IEC/EN 60947-2

Insulation voltage (U _i)	500 V AC
Degree of pollution	3
Rated impulse withstand voltage (U _{imp})	6 kV
Thermal tripping	Reference temperature
	50°C

To IEC/EN 60898-1

Magnetic tripping	Curve B	3 and 5 I _n
	Curve C	5 and 10 I _n
	Curve D	10 and 14 I _n
Limitation class		3

Additional characteristics

Degree of protection (IEC 60529)	Device only	IP20	
	Device in a modular enclosure	IP40 (IPXXD)	
Endurance (O-C)	Electrical	63 A	10000 cycles (O-C)
		80...125 A	5000 cycles (O-C)
	Mechanical		20000 cycles
Operating temperature		-30°C to +70°C	
Storage temperature		-40°C to +80°C	
Tropicalisation (IEC 60068-1)		Treatment 2 (relative humidity 95% at 55°C)	

Weight (g)

Circuit breaker

Type	C120H
1P	205
2P	410
3P	615
4P	820

Dimensions (mm)

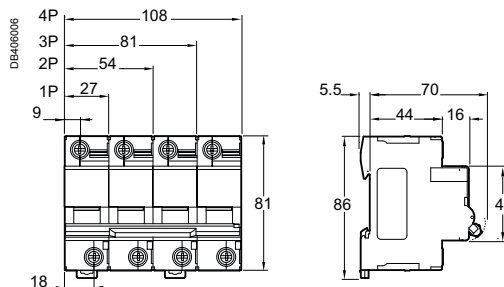

NG125a circuit breakers (curve C)

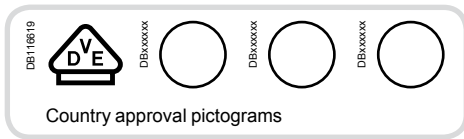

IEC/EN 60947-2

- NG125a circuit breakers are circuit breakers which combine the following functions:
 - circuit protection against short-circuit currents,
 - circuit protection against overload currents,
 - suitability for isolation in the industrial sector to IEC/EN 60947-2,
 - tripping upon fault is indicated by a red mechanical state indicator light on the front face of the circuit breaker.



NG125a 3P



NG125a 4P

Alternating current (AC) 50/60 Hz			
Breaking capacity (Icu) to IEC/EN 60947-2			Service breaking capacity (Ics)
Ph/Ph (3P, 4P)	Voltage (Ue)		
	380 to 415 V	500 V	75 % of Icu
Rating (In)	80 to 125 A	16 kA / 8 kA	

Direct current (DC)			
Breaking capacity (Icu) to IEC/EN 60947-2			Service breaking capacity (Ics)
Voltage (Ue)			
	≤ 375 V	≤ 500 V	100 % of Icu
Number of poles	3P	4P	
Rating (In)	80 to 125 A	20 kA / 20 kA	

Catalogue numbers

NG125a circuit breaker			
Type	3P		4P
Auxiliaries	Remote indication and tripping, module CM907004 and CM907005		
Vigi NG125	Vigi NG125 add-on residual current device, module CM902008		
Rating (In)	Quality label ⁽¹⁾	Curve C	Curve C
80 A		18603	18607
100 A		18604	18608
125 A		18605	18609
Width in 9 mm modules		9	12
Accessories	Module CM907004 and CM907006		

(1) Information to be supplied by the country concerned.

NG125a circuit breakers (curve C) (cont.)

Connection

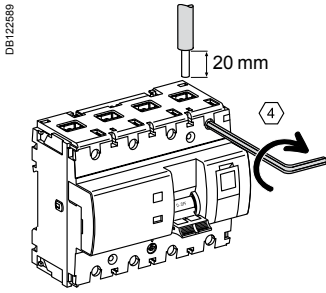

Rating	Tightening torque	Without accessories		With accessories				
		Copper cables	70 mm ² Al terminal	Screw-on connection for ring terminal	Small ring terminal	Multi-cable terminal		
		Rigid	Flexible or with ferrule	Rigid single cables		Rigid cables	Flexible cables	
80 to 125 A	6 N.m	DB1123445	DB1123446	DB1123410	DB1123488	DB118769	DB118767	
		16 to 70 mm ²	10 to 50 mm ²	25 to 70 mm ²	2 x 35 mm ² 1 x 50 mm ²	1 x 70 mm ²	3 x 16 mm ²	3 x 10 mm ²

■ Upstream voltage taps for each pole, by 6.35 mm Fast-on terminal.

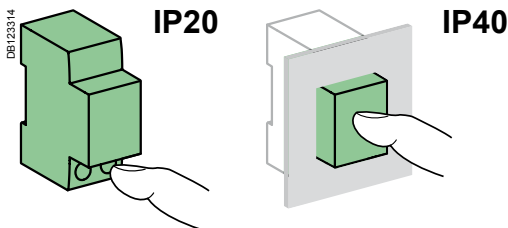
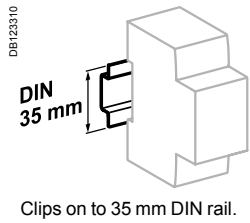

Technical data

Main characteristics		
According to IEC/EN 60947-2		
Insulation voltage (Ui)		690 V AC
Degree of pollution		3
Rated impulse withstand voltage (Uimp)		8 kV
Thermal tripping	Reference temperature	40°C
Magnetic tripping (Ii)	Curve C	8 In ± 20 %
Utilization category		A
Additional characteristics		
Degree of protection (IEC 60529)	Device only	IP20
	Device in modular enclosure	IP40
Endurance (O-C)	Electrical	5000 cycles
	Mechanical	20,000 cycles
Operating temperature		-30°C to +70°C
Storage temperature		-40°C to +70°C
Tropicalization (IEC 60068-1)		Treatment 2 (relative humidity of 95 % at 55°C)

NG125a circuit breakers (curve C) (cont.)

Weight (g)

Circuit breaker	
Type	NG125a
3P	720
4P	960

Dimensions (mm)

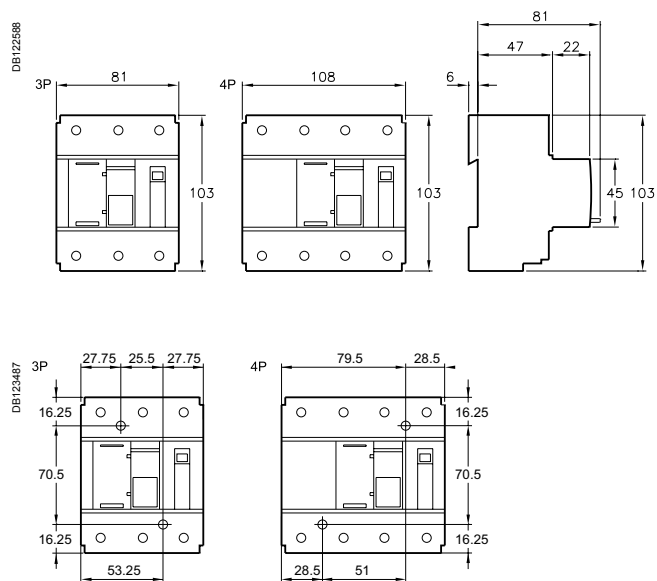

Spacing for mounting on panel

Protection

Circuit protection

NG125a circuit breakers (curve C) (cont.)

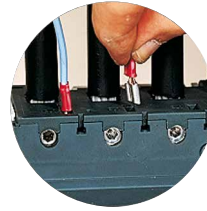

- Voltage taps:
 - auxiliaries power supply
 - measurement
 - emergency stop
 - remote reporting

- Cable strength:
 - ribbed cage
 - terminal depth
 - tightening by Allen hex key

- Test button to check satisfactory operation of the tripping mechanism



- Pull-out strength:
 - metallic lock

- Impact and vibration resistance:
 - high-strength enclosure
 - IK 05

- Integrated padlocking device



- Central manual control, 3 positions:
 - ON
 - tripped on fault
 - open

- Circuit breaker tripped indicator

- Positive contact indication:
 - suitability for isolation in the industrial sector to IEC/EN 60947-2
 - she presence of the green strip guarantees that the contacts open physically and allows work to be carried out safely on the downstream circuit

- Longer product service life due to:
 - good overvoltage withstand capacity,
 - high limitation performances,
 - fast closure independent of the speed of actuation of the toggle.

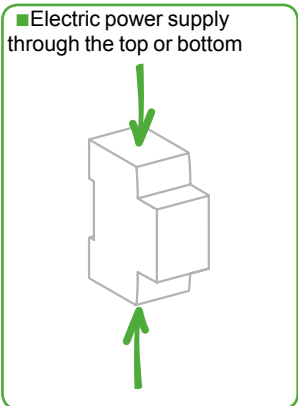

068914N_SE-90

DB122483

Protection

Circuit protection

NG125N

Table of contents



The Schneider Electric circuit breaker range comprises various offers (A, B) so as to be as competitive as possible in each country, taking into account the specific features of each market:

- Installation customs
- Price
- Approval by local organizations.

Variants

Offers		Pages
Offer A	Catalogue numbers	90
Offer B	Catalogue numbers	91
Common pages		92



Only the product range to be marketed in your country and validated by the local product manager, in agreement with his Final Distribution (FD) partner should be retained. The others will be removed before publication.

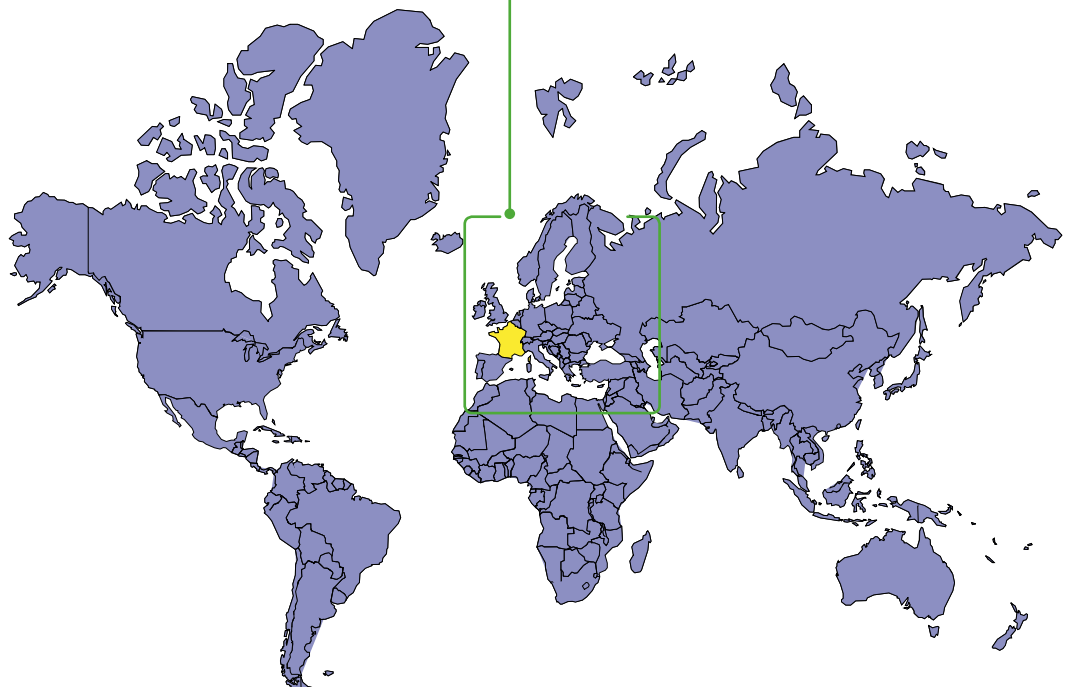

Protection Circuit protection

NG125N circuit breakers (curves B, C, D)

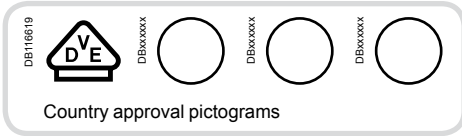

IEC/EN 60947-2

■ NG125N circuit breakers are circuit breakers which combine the following functions:

- circuit protection against short-circuit currents,
- circuit protection against overload currents,
- ability for isolation in the industrial sector to IEC/EN 60947-2,
- tripping upon fault is indicated by a red mechanical state indicator light on the front face of the circuit breaker.



NG125N 1P



NG125N 2P



NG125N 3P



NG125N 4P

Alternating current (AC) 50/60 Hz							Service breaking capacity (Ics)		
Breaking capacity (Icu) to IEC/EN 60947-2									
Ph/Ph (2P, 3P, 3P+N, 4P)	Voltage (Ue)					Service breaking capacity (Ics)			
	110 to 130 V	220 to 240 V	220 to 240 V	380 to 415 V	440 V		500 V		
Rating (In)	10 to 125 A	50 kA	25 kA	50 kA	6 kA ⁽²⁾	25 kA	20 kA	10 kA	75 % of Icu

Direct current (DC)						Service breaking capacity (Ics)	
Breaking capacity (Icu) according to IEC/EN 60947-2							
Number of poles	Voltage (Ue)					Service breaking capacity (Ics)	
	12 to 125 V	≤ 144 V	≤ 250 V	≤ 375 V	≤ 500 V		
Rating (In)	10 to 125 A	25 kA	20 kA	20 kA	20 kA	20 kA	100 % of Icu

Catalogue numbers

NG125N circuit breaker										
Type	1P	2P		3P			3P+N	4P		
	E45092 	E45094 	E45095 	E45096 			E45097 			
Auxiliaries	Remote indication and tripping, module CM907004 and CM907005									
Vigi NG125	Vigi NG125 add-on residual current device, module CM902008									
Rating (In)	Quality label (1)	Curve C	Curve C	Curve B	Curve C	Curve D	Curve C	Curve B	Curve C	Curve D
10 A		18610	18621	-	18632	-	-	-	18649	-
16 A		18611	18622	-	18633	-	-	-	18650	-
20 A		18612	18623	-	18634	-	-	-	18651	-
25 A		18613	18624	-	18635	-	-	-	18652	-
32 A		18614	18625	-	18636	-	-	-	18653	-
40 A		18615	18626	-	18637	-	-	-	18654	-
50 A		18616	18627	-	18638	-	-	-	18655	-
63 A		18617	18628	-	18639	-	-	-	18656	-
80 A		18618	18629	18663	18641	18669	18646	18666	18657	18672
100 A		-	-	18664	18643	18670	18647	18667	18659	18673
125 A		-	-	18665	18645	18671	18648	18668	18661	18674
Width in 9 mm modules	3	6	9				12	12		
Accessories	Module CM907004 and CM907006									

(1) Information to be supplied by the country concerned.

(2) Breaking capacity under 1 pole in IT isolated neutral system (case of a double fault).

NG125N circuit breakers (curves B, C, D) (cont.)

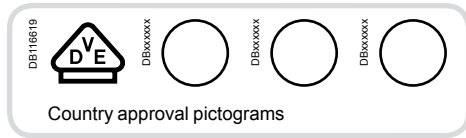

IEC/EN 60947-2

■ NG125N circuit breakers are circuit breakers which combine the following functions:

- circuit protection against short-circuit currents,
- circuit protection against overload currents,
- ability for isolation in the industrial sector to IEC/EN 60947-2,
- tripping upon fault is indicated by a red mechanical state indicator light on the front face of the circuit breaker.



NG125N 1P



NG125N 2P



NG125N 3P



NG125N 4P

Alternating current (AC) 50/60 Hz									
Breaking capacity (Icu) to IEC/EN 60947-2									
Ph/Ph (2P, 3P, 4P)	Voltage (Ue)				Service breaking capacity (Ics)				
	110 to 130 V	220 to 240 V	220 to 240 V	380 to 415 V	440 V	500 V			
Rating (In)	10 to 125 A	50 kA	25 kA	50 kA	6 kA ⁽²⁾	25 kA	20 kA	10 kA	75 % of Icu

Direct current (DC)							
Breaking capacity (Icu) according to IEC/EN 60947-2							
	Voltage (Ue)				Service breaking capacity (Ics)		
	12 to 125 V	≤ 144 V	≤ 250 V	≤ 375 V		≤ 500 V	
Number of poles	1P	2P	3P	4P			
Rating (In)	10 to 125 A	25 kA	20 kA	20 kA	20 kA	20 kA	100 % of Icu

Catalogue numbers

NG125N circuit breaker										
Type	1P	2P	3P	3P+N	4P					
Auxiliaries	Remote indication and tripping, module CM907004 and CM907005									
Vigi NG125	Vigi NG125 add-on residual current device, module CM902008									
Rating (In)	Quality label ⁽¹⁾	Curve C	Curve C	Curve B	Curve C	Curve D	Curve C	Curve B	Curve C	Curve D
10 A		18610	18621	-	18632	-	-	-	18649	-
16 A		18611	18622	-	18633	-	-	-	18650	-
20 A		18612	18623	-	18634	-	-	-	18651	-
25 A		18613	18624	-	18635	-	-	-	18652	-
32 A		18614	18625	-	18636	-	-	-	18653	-
40 A		18615	18626	-	18637	-	-	-	18654	-
50 A		18616	18627	-	18638	-	-	-	18655	-
63 A		18617	18628	-	18639	-	-	-	18656	-
80 A		18618	18629	18663	18640	18669	18646	18666	18658	18672
100 A		-	-	18664	18642	18670	18647	18667	18660	18673
125 A		-	-	18665	18644	18671	18648	18668	18662	18674
Width in 9 mm modules	3	6	9				12	12		
Accessories	Module CM907004 and CM907006									

(1) Information to be supplied by the country concerned.

(2) Breaking capacity under 1 pole in IT isolated neutral system (case of a double fault).

NG125N circuit breakers (curves B, C, D) (cont.)

Weight (g)

Circuit breaker	
Type	NG125N
1P	240
2P	480
3P	720
3P+N	960
4P	960

Dimensions (mm)

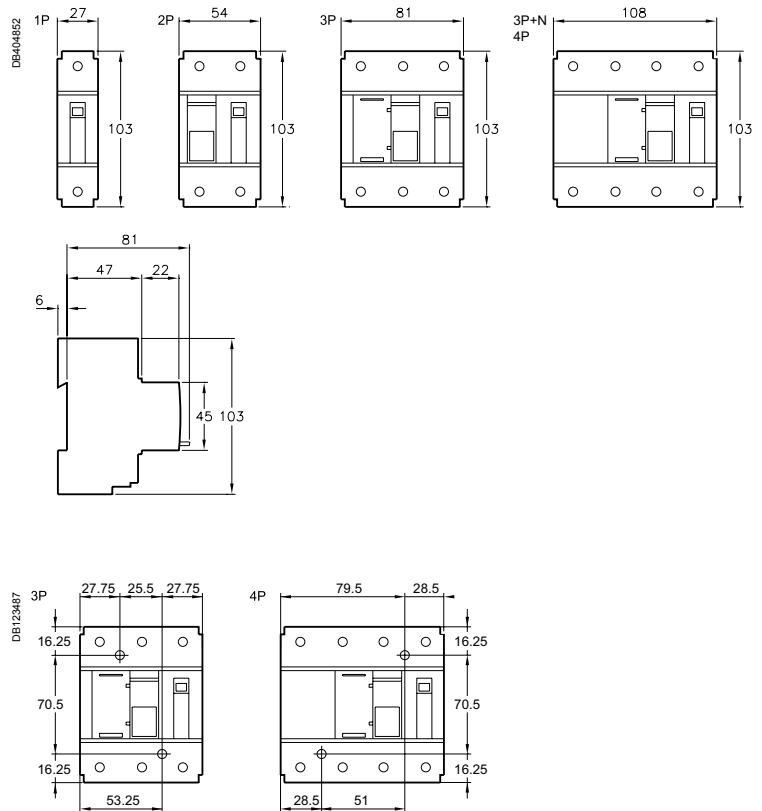

Spacing for mounting on panel

Protection
Circuit protection

NG125N circuit breakers (curves B, C, D) (cont.)

056918N_SE-90

DB12483



- 3P, 4P 80 A**
- Voltage taps:
 - auxiliaries power supply
 - measurement
 - emergency stop
 - remote reporting

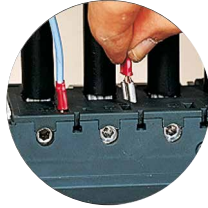

- 1P, 2P**
- Padlocking in position: O or I, manual control is inhibited, tripping is enabled

- Cable strength:
 - ribbed cage
 - terminal depth
 - tightening by Allen hex key (NG125 80 A)

- Test button to check satisfactory operation of the tripping mechanism



- Pull-out strength
 - metallic lock

- Impact and vibration resistance:
 - high-strength enclosure
 - IK 05

- 3P, 4P**
- Integrated padlocking device



- Central manual control, 3 positions:
 - ON
 - tripped on fault
 - open

- Circuit breaker tripped indicator

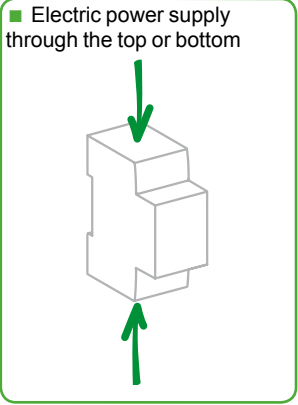

- Positive contact indication:
 - suitability for isolation in the industrial sector to IEC/EN 60947-2
 - the presence of the green strip guarantees that the contacts open physically and allows work to be carried out safely on the downstream circuit

- Longer product service life due to:
 - good overvoltage withstand capacity,
 - high limitation performances,
 - fast closure independent of the speed of actuation of the toggle.

NG125H circuit breakers (curve C)

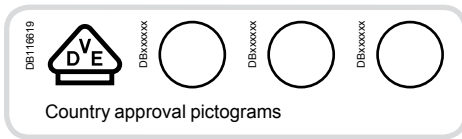

IEC/EN 60947-2

■ NG125H circuit breakers are circuit breakers which combine the following functions:

- circuit protection against short circuit currents,
- circuit protection against overload currents,
- suitability for isolation in the industrial sector to IEC/EN 60947-2,
- tripping upon fault is indicated by a red mechanical state indicator light on the front face of the circuit breaker.



NG125H 1P



NG125H 2P



NG125H 3P



NG125H 4P

Alternating current (AC) 50/60 Hz							
Breaking capacity (Icu) to IEC/EN 60947-2							Service breaking capacity (Ics)
Ph/Ph (2P, 3P, 4P)	Voltage (Ue)						
	-	-	220 to 240 V	-	380 to 415 V	440 V	500 V
Ph/N (1P)	110 to 130 V	220 to 240 V	-	380 to 415 V	-	-	-
Rating (In)	10 to 80 A	70 kA	36 kA	70 kA	9 kA ⁽²⁾	36 kA	30 kA
						12 kA	75 % of Icu

Direct current (DC)						
Breaking capacity (Icu) according to IEC/EN 60947-2						Service breaking capacity (Ics)
	Voltage (Ue)					
	12 to 125 V	≤ 144 V	≤ 250 V	≤ 375 V	≤ 500 V	
Number of poles	1P		2P	3P	4P	
Rating (In)	10 to 80 A	36 kA	25 kA	25 kA	25 kA	100 % of Icu

Catalogue numbers

NG125H circuit breaker				
Type	1P	2P	3P	4P
	E46902 1 2	E46904 1 3 2 4	E46905 1 3 5 2 4 6	E46907 1 3 5 7 2 4 6 8
Auxiliaries	Remote indication and tripping, module CM907004 and CM907005			
Vigi NG125	Vigi NG125 add-on residual current device, module CM902008			
Rating (In)	Quality label ⁽¹⁾	Curve C	Curve C	Curve C
10 A		18705	18714	18723
16 A		18706	18715	18724
20 A		18707	18716	18725
25 A		18708	18717	18726
32 A		18709	18718	18727
40 A		18710	18719	18728
50 A		18711	18720	18729
63 A		18712	18721	18730
80 A		18713	18722	18731
Width in 9 mm modules		3	6	9
Accessories	Module CM907004 and CM907006			

(1) Information to be supplied by the country concerned.

(2) Breaking capacity under 1 pole in IT isolated neutral system (case of a double fault).

NG125H circuit breakers (curve C) (cont.)

Connection

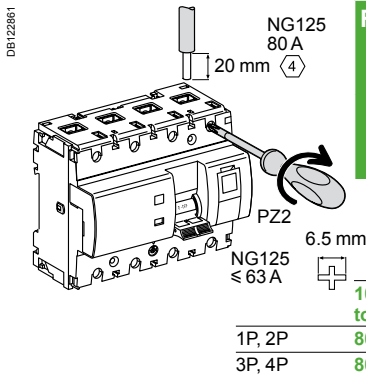

Rating	Tightening torque	Without accessories		With accessories				
		Copper cables	70 mm ² Al terminal	Screw-on connection for ring terminal	Small ring terminal	Multi-cable terminal		
		Rigid	Flexible or with ferrule	Rigid single cables		Rigid cables	Flexible cables	
		DB1122945	DB1122946	DB1123410	DB1123488	DB1182769	DB1182767	
		1.5 to 50 mm ²	1.5 to 35 mm ²	-	-	-	3 x 16 mm ²	3 x 10 mm ²
1P, 2P	3.5 N.m	16 to 70 mm ²	10 to 50 mm ²	-	2 x 35 mm ² 1 x 50 mm ²	1 x 70 mm ²		
3P, 4P	6 N.m			25 to 70 mm ²				

■ On 3P and 4P 80 A: upstream voltage taps for each pole, by 6.35 mm Fast-on terminal.

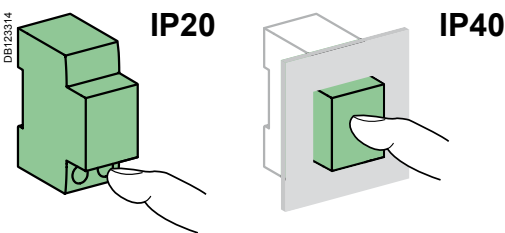
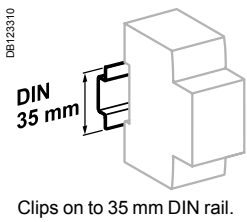

Technical data

Main characteristics

According to IEC/EN 60947-2

Insulation voltage (U _i)	690 VAC	
Degree of pollution	3	
Rated impulse withstand voltage (U _{imp})	8 kV	
Thermal tripping	Reference temperature	40°C
Magnetic tripping (I _i)	Curve C	8 I _n ± 20 %
Utilization category		A

Additional characteristics

Degree of protection (IEC 60529)	Device only	IP20
	Device in modular enclosure	IP40
Endurance (O-C)	Electrical	≤ 63 A: 10,000 cycles ≥ 63 A: 5000 cycles
	Mechanical	20,000 cycles
Operating temperature		-30°C to +70°C
Storage temperature		-40°C to +70°C
Tropicalization (IEC 60068-1)		Treatment 2 (relative humidity of 95 % at 55°C)

NG125H circuit breakers (curve C) (cont.)

Weight (g)

Circuit breaker	
Type	NG125H
1P	240
2P	480
3P	720
4P	960

Dimensions (mm)

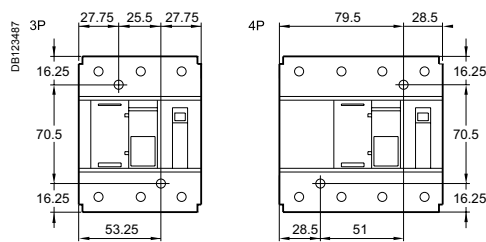
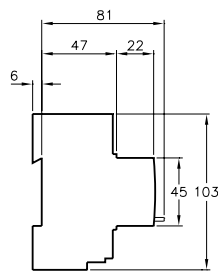
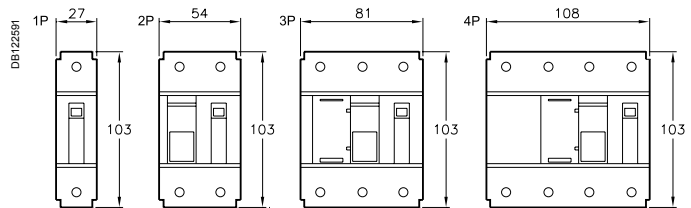

Spacing for mounting on panel

Protection Circuit protection

NG125H circuit breakers (curve C) (cont.)

056918N_SE-90

- 3P, 4P 80 A**
- Voltage taps:
 - auxiliaries power supply
 - measurement
 - emergency stop
 - remote reporting

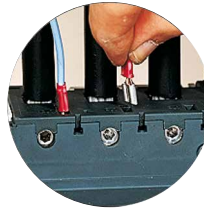

- Cable strength:
 - ribbed cage
 - terminal depth
 - tightening by Allen hex key (NG125 80 A)

- 1P, 2P**
- Padlocking in position: O or I, manual control is inhibited, tripping is enabled

- Test button to check satisfactory operation of the tripping mechanism

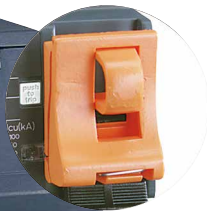

- Pull-out strength
 - metallic lock



- 3P, 4P**
- Integrated padlocking device

- Impact and vibration resistance:
 - high-strength enclosure
 - IK 05

- Circuit breaker tripped indicator

- Central manual control, 3 positions:
 - ON
 - tripped on fault
 - open

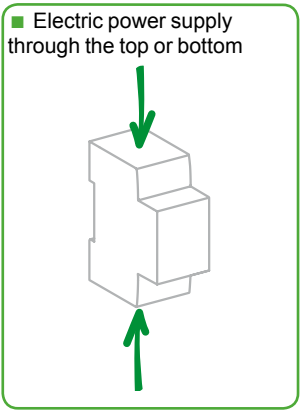

- Positive contact indication:
 - suitability for isolation in the industrial sector to IEC/EN 60947-2
 - the presence of the green strip guarantees that the contacts open physically and allows work to be carried out safely on the downstream circuit

- Longer product service life due to:
 - good overvoltage withstand capacity,
 - high limitation performances,
 - fast closure independent of the speed of actuation of the toggle.

DB 129493

Protection

Circuit protection

NG125L

Table of contents



The Schneider Electric circuit breaker range comprises various offers (A, B) so as to be as competitive as possible in each country, taking into account the specific features of each market:

- Installation customs
- Price
- Approval by local organizations.

Variants

Offers		Pages
Offer A	Catalogue numbers	100
Offer B	Catalogue numbers	101
Common pages		102

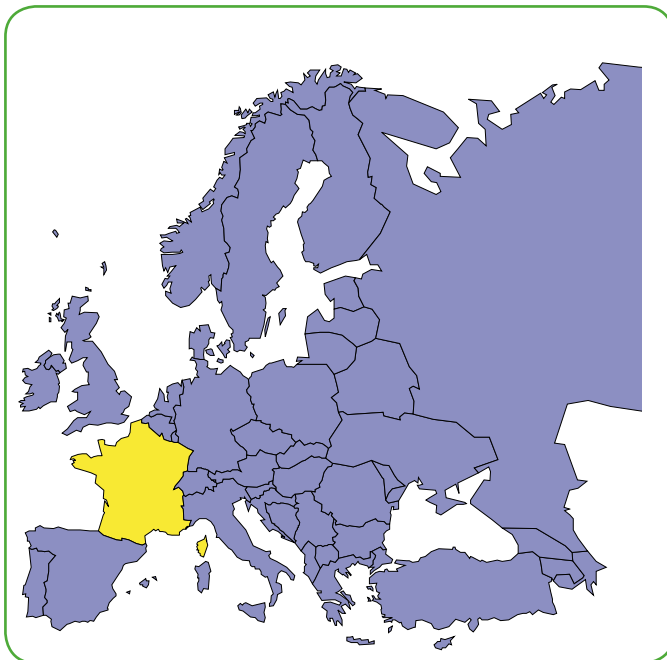

Only the product range to be marketed in your country and validated by the local product manager, in agreement with his Final Distribution (FD) partner should be retained. The others will be removed before publication.

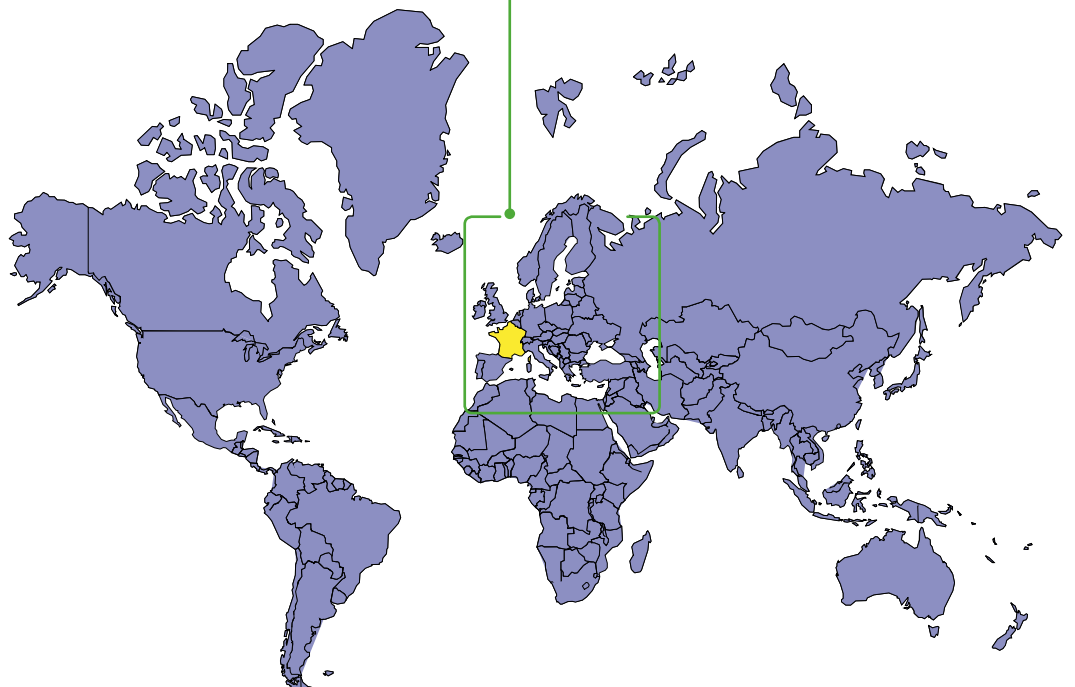

Protection
Circuit protection

NG125L circuit breakers (curves B, C, D) (cont.)

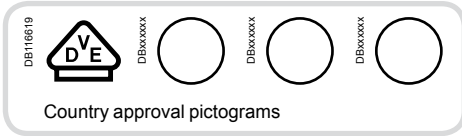

IEC/EN 60947-2

■ NG125L circuit breakers are circuit breakers which combine the following functions:

- circuit protection against short-circuit currents;
- circuit protection against overload currents;
- suitability for isolation in the industrial sector to IEC/EN 60947-2;
- tripping upon fault is indicated by a red mechanical state indicator light on the front face of the circuit breaker.



NG125L 1P

NG125L 2P



NG125L 3P



NG125L 4P

Alternating current (AC) 50/60 Hz

Breaking capacity (Icu) to IEC/EN 60947-2

Voltage (Ue)	Voltage (Ue)					Service breaking capacity (Ics)
	110 to 130 V	220 to 240 V	220 to 240 V	380 to 415 V	440 V 500 V	
Ph/Ph (2P, 3P, 4P)	-	-	100 kA	12.5 kA ⁽²⁾	50 kA	75 % of Icu
Ph/N (1P)	100 kA	50 kA	100 kA	12.5 kA ⁽²⁾	50 kA	75 % of Icu
Rating (In)	10 to 80 A	10 to 80 A	10 to 80 A	10 to 80 A	10 to 80 A	75 % of Icu

Direct current (DC)

Breaking capacity (Icu) according to IEC/EN 60947-2

Voltage (Ue)	Voltage (Ue)					Service breaking capacity (Ics)
	12 to 125 V	≤ 144 V	≤ 250 V	≤ 375 V	≤ 500 V	
Number of poles	1P	2P	3P	4P		100 % of Icu
Rating (In)	10 to 80 A	50 kA	36 kA	36 kA	36 kA	100 % of Icu

Catalogue numbers

NG125L circuit breaker													
Type	1P			2P			3P			4P			
Auxiliaries	Remote indication and tripping, module CM907004 and CM907005												
Vigi NG125	Vigi NG125 add-on residual current device, module CM902008												
Rating (In)	Quality label (1)	Curve			Curve			Curve			Curve		
		B	C	D	B	C	D	B	C	D	B	C	D
10 A		18741	18777	18830	18750	18788	18839	18759	18799	18848	18768	18821	18857
16 A		18742	18778	18831	18751	18789	18840	18760	18800	18849	18769	18822	18858
20 A		18743	18779	18832	18752	18790	18841	18761	18801	18850	18770	18823	18859
25 A		18744	18780	18833	18753	18791	18842	18762	18802	18851	18771	18824	18860
32 A		18745	18781	18834	18754	18792	18843	18763	18803	18852	18772	18825	18861
40 A		18746	18782	18835	18755	18793	18844	18764	18804	18853	18773	18826	18862
50 A		18747	18783	18836	18756	18794	18845	18765	18805	18854	18774	18827	18863
63 A		18748	18784	18837	18757	18795	18846	18766	18806	18855	18775	18828	18864
80 A		18749	18785	18838	18758	18796	18847	18767	18807	18856	18776	18829	18865
Width in 9 mm modules		3			6			9			12		
Accessories		Module CM907004 and CM907006											

(1) Information to be supplied by the country concerned.

(2) Breaking capacity under 1 pole in IT isolated neutral system (case of a double fault).

NG125L circuit breakers (curves B, C, D)

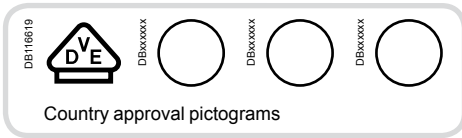

IEC/EN 60947-2

- NG125L circuit breakers are circuit breakers which combine the following functions:
 - circuit protection against short-circuit currents;
 - circuit protection against overload currents;
 - suitability for isolation in the industrial sector to IEC/EN 60947-2;
 - tripping upon fault is indicated by a red mechanical state indicator light on the front face of the circuit breaker.



NG125L 1P

NG125L 2P

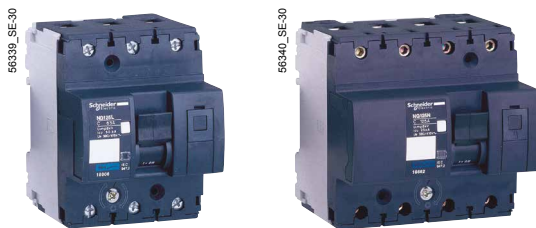

NG125L 3P

NG125L 4P

Alternating current (AC) 50/60 Hz									
Ph/Ph (2P, 3P, 4P)	Breaking capacity (Icu) to IEC/EN 60947-2						Service breaking capacity (Ics)		
	Voltage (Ue)								
	-	-	220 to 240 V	-	380 to 415 V	440 V	500 V		
Ph/N (1P)	110 to 130 V	220 to 240 V	-	380 to 415 V	-	-	-		
Rating (In)	10 to 80 A	100 kA	50 kA	100 kA	12.5 kA ⁽²⁾	50 kA	40 kA	15 kA	75 % of Icu

Direct current (DC)						
Number of poles	Breaking capacity (Icu) according to IEC/EN 60947-2					Service breaking capacity (Ics)
	Voltage (Ue)					
	12 to 125 V	≤ 144 V	≤ 250 V	≤ 375 V	≤ 500 V	
Number of poles	1P	2P	3P	4P		
Rating (In)	10 to 80 A	50 kA	36 kA	36 kA	36 kA	100 % of Icu

Catalogue numbers

NG125L circuit breaker													
Type	1P			2P			3P			4P			
	<p>E449032</p>			<p>E449094</p>			<p>E449095</p>			<p>E449097</p>			
Auxiliaries	Remote indication and tripping, module CM907004 and CM907005												
Vigi NG125	Vigi NG125 add-on residual current device, module CM902008												
Rating (In)	Quality label ⁽¹⁾	Curve			Curve			Curve			Curve		
		B	C	D	B	C	D	B	C	D	B	C	D
10 A		18741	18777	18830	18750	18788	18839	18759	18799	18848	18768	18810	18857
16 A		18742	18778	18831	18751	18789	18840	18760	18800	18849	18769	18811	18858
20 A		18743	18779	18832	18752	18790	18841	18761	18801	18850	18770	18812	18859
25 A		18744	18780	18833	18753	18791	18842	18762	18802	18851	18771	18813	18860
32 A		18745	18781	18834	18754	18792	18843	18763	18803	18852	18772	18814	18861
40 A		18746	18782	18835	18755	18793	18844	18764	18804	18853	18773	18815	18862
50 A		18747	18783	18836	18756	18794	18845	18765	18805	18854	18774	18816	18863
63 A		18748	18784	18837	18757	18795	18846	18766	18806	18855	18775	18817	18864
80 A		18749	18785	18838	18758	18796	18847	18767	18807	18856	18776	18818	18865
Width in 9 mm modules		3			6			9			12		
Accessories		Module CM907004 and CM907006											

(1) Information to be supplied by the country concerned.

(2) Breaking capacity under 1 pole in IT isolated neutral system (case of a double fault).

NG125L circuit breakers (curves B, C, D) (cont.)

Weight (g)

Circuit breaker	
Type	NG125L
1P	240
2P	480
3P	720
4P	960

Dimensions (mm)

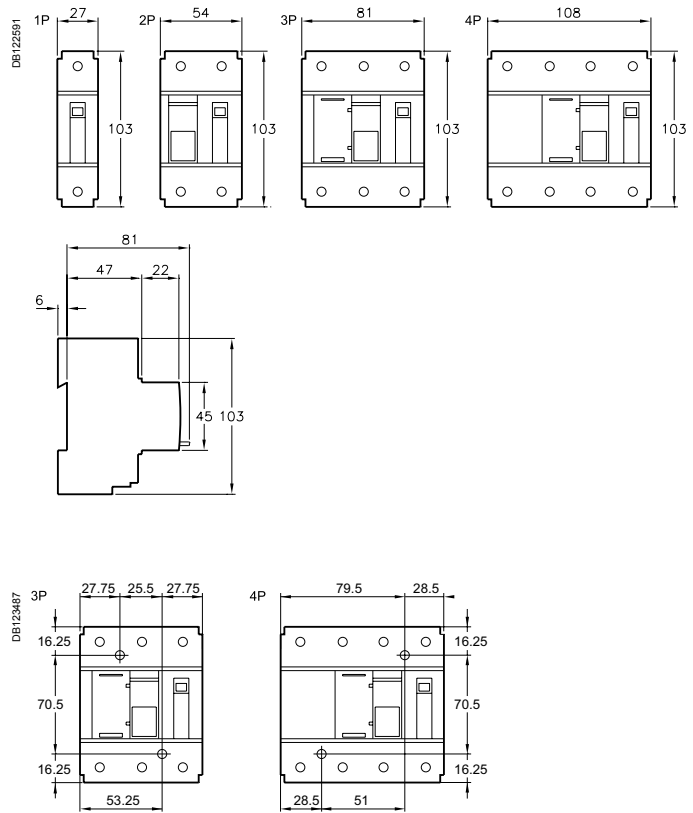

Spacing for mounting on panel

Protection Circuit protection

NG125L circuit breakers (curves B, C, D) (cont.)

06591BN_SE-90

DB123493



- 3P, 4P 80 A**
- Voltage taps:
 - auxiliaries power supply
 - measurement
 - emergency stop
 - remote reporting

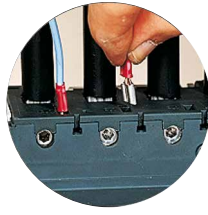

- Cable strength:
- ribbed cage
 - terminal depth
 - tightening by Allen hex key (NG125 80 A)

- 1P, 2P**
- Padlocking in position: O or I, manual control is inhibited, tripping is enabled

- Test button to check satisfactory operation of the tripping mechanism



- Pull-out strength
- metallic lock

- Impact and vibration resistance:
- high-strength enclosure
 - IK 05

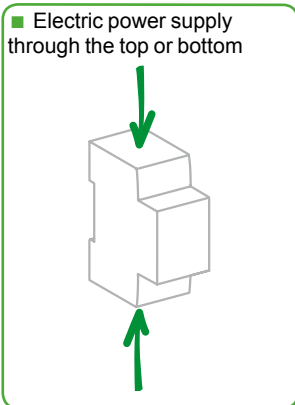

- Circuit breaker tripped indicator

- Positive contact indication:
- suitability for isolation in the industrial sector to IEC/EN 60947-2
 - the presence of the green strip guarantees that the contacts open physically and allows work to be carried out safely on the downstream circuit

- Longer product service life due to:
- good overvoltage withstand capacity,
 - high limitation performances,
 - fast closure independent of the speed of actuation of the toggle.

- 3P, 4P**
- Integrated padlocking device

- Central manual control, 3 positions:
- ON
 - tripped on fault
 - open

C60H-DC, C curve

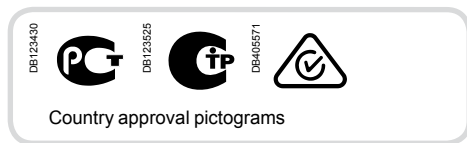

IEC 60947-2

The C60H-DC supplementary protectors are used in direct current circuits (Industrial control and automations, transport, renewable energy...). They combine the following functions of circuit protection against short-circuit and overload currents, control and isolation.

Direct current (DC)						
Breaking capacity (Icu) according to IEC 60947-2						Rated service breaking capacity (Ics)
Type	110 V	220 V	250 V	440 V	500 V	
1P	110 V	220 V	250 V	440 V	500 V	75 % Icu
Rating 0.5 to 63 A	20 kA	10 kA	6 kA	-	-	
2P (in series)	110 V	220 V	250 V	440 V	500 V	75 % Icu
0.5 to 63 A	-	20 kA	20 kA	10 kA	6 kA	

Catalogue numbers

C60H-DC		
Type	1P	2P
	<p>DB116688</p> <p>Supply from above or below, observing the polarity</p>	<p>DB124110</p> <p>Supply from above</p> <p>DB124111</p> <p>Supply from below</p>
Auxiliaries	Remote signalisation and tripping, module CA907008	
Rating (In)	Curve C	Curve C
0.5 A	A9N61500	A9N61520
1 A	A9N61501	A9N61521
2 A	A9N61502	A9N61522
3 A	A9N61503	A9N61523
4 A	A9N61504	A9N61524
5 A	A9N61505	A9N61525
6 A	A9N61506	A9N61526
10 A	A9N61508	A9N61528
13 A	A9N61509	A9N61529
15 A	A9N61510	A9N61530
16 A	A9N61511	A9N61531
20 A	A9N61512	A9N61532
25 A	A9N61513	A9N61533
30 A	A9N61514	A9N61534
32 A	A9N61515	A9N61535
40 A	A9N61517	A9N61537
50 A	A9N61518	A9N61538
63 A	A9N61519	A9N61539
Number of modules of 9 mm	2	4
Accessories	Modules CA907013 and CA907012	

C60H-DC (cont.), C curve

Connection

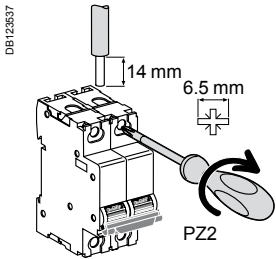

Rating	Tightening torque	Without accessory		With accessories			
		Copper cables		50 mm ² Al terminal	Screw-on connection for ring terminal	Multi-cables terminal	
		Rigid / Stranded	Flexible or with ferrule			Rigid cables	Flexible cables
≤ 25 A	2.5 N.m	DB122945	DB122946	DB122935	DB118789	DB118787	
> 25 A	3.5 N.m	1 to 25 mm ²	1 to 16 mm ²	-	∅ 5 mm	-	-
		1 to 35 mm ²	1 to 25 mm ²	50 mm ²		3 x 16 mm ²	3 x 10 mm ²

Multi-cables connection

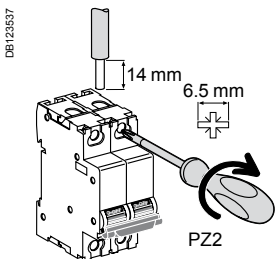

Rating	Tightening torque	Without accessory			
		2 Copper cables		3 Multi-cables / Different wires	
		Rigid / Stranded	Flexible or with ferrule	Flexible / Stranded	Flexible / Stranded / Rigid
≤ 25 A	2.5 N.m	DB122945	DB122946	DB118787	
> 25 A	3.5 N.m	2 x 1 mm ² to 2 x 10 mm ²		3 x 1 mm ²	2 x 2.5 mm ² + 1 x 1.5 mm ²
		2 x 1 mm ² to 2 x 16 mm ²		3 x 4 mm ²	2 x 10 mm ² + 1 x 6 mm ²

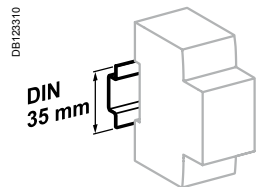

Clip on DIN rail 35 mm.

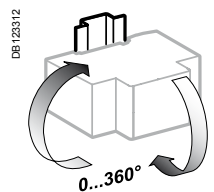

Indifferent position of installation.

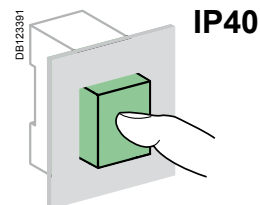

Technical data

- Tripping curves: C curve - Overcurrent protection for any type of application.
- Positive break indication - the green strip indicates that all the poles are open and allows work to be carried out on the downstream circuit in complete safety.
- Suitable for isolation as defined in IEC 60947-2.
- Increase in the service life of the product: thanks to fast closure independent of the speed of action on the handle.
- Current limitation in the event of a fault: fast opening of the contacts prevents the loads from being destroyed in the event of a short-circuit.

Main characteristics

According to IEC 60947-2

Insulation voltage (Ui)		500 V DC
Rated voltage (Un)	1P	250 V DC
	2P	500 V DC
Operating voltage (Ue)	1P	24...250 V DC
	2P	24...500 V DC
Pollution degree		3
Rated impulse withstand voltage (Uimp) under frame		6 kV
Magnetic tripping (Ii)		8.5 In (± 20 %) (compatible with curve C)

Additional characteristics

Degree of protection (IEC 60529)	Device in modular enclosure	IP40
Utilization category		A (no delay in accordance with IEC 60947-2 standards)
Endurance (O-C)	Electrical	3,000 cycles (where L/R=2 ms) 6,000 cycles where the circuit is resistive
	Mechanical	20,000 cycles
Tropicalization (IEC 60068-2)		Treatment 2 (relative humidity 95 % at 55°C)
Operating temperature		-25°C to 70°C
Storage temperature		-40°C to 85°C



Failure to match polarity during connection may lead to a fire hazard and/or serious injury.

- The connection polarity must be observed (marked on the front panel).
- Use only with direct current.

C60H-DC (cont.), C curve

Weight (g)

Circuit-breaker	
Type	C60H-DC
1P	128 g
2P	256 g

Dimensions (mm)

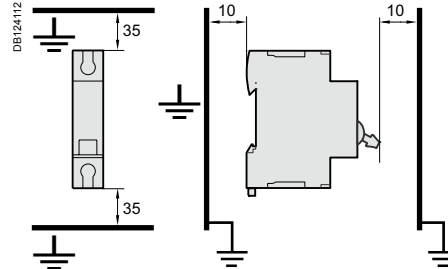
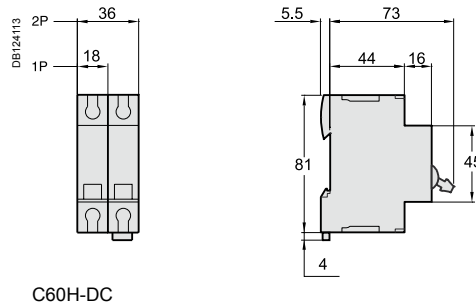

Details of minimum distance between circuit-breaker and earthed metal parts for circuit-breaker intended for use without enclosure.

DC circuit supplementary protectors for photovoltaic installations

C60PV-DC

PB109403-50



The C60PV-DC is a DC circuit breaker dedicated to multi string photovoltaic installations.

This circuit breaker is designed to protect the cables located between each string of photovoltaic modules and the photovoltaic inverter against overloads and short circuits (see application diagram).

Combined with a switch (of the C60NA-DC type, for example), the C60PV-DC will be installed in a string PV protection enclosure at the end of each string of photovoltaic modules.

It can be locked (by a padlocking device) in OFF position as a safety measure for removal of the PV inverter.

Since a fault current can flow in the reverse direction to the operating current, the C60PV-DC can detect and protect against any bidirectional current.

To ensure the safety of the installation, it is necessary, depending on the various types of application, to combine the C60PV-DC with:

- a residual current device at the AC end,
- a fault passage detector (insulation monitoring device) at the DC end
- an earth protection circuit breaker at the DC end (see Practical Advice CA908035).

In all cases, fast action on site will be required to clear the fault (protection not ensured in the event of a double fault).

C60PV-DC is not polarity sensitive: (+) and (-) wires can be inverted without any risk.

The C60PV-DC is delivered with three inter-pole barriers to provide increased isolation distance between two adjacent connectors.

IEC / EN 60947-2



DB404840



Main characteristics

Operating voltage (Ue)	800 V DC
Rated insulation voltage (Ui)	1,000 V DC
Breaking capacity (Icu)	1.5 kA
Impulse voltage (Uimp)	6 kV
Electrical connection	By the bottom for In and Out
Number of poles	2P
Number of modules of 9 mm	8

Diagrams

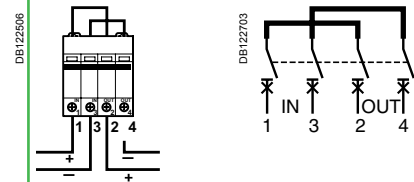

Standards	IEC 60947-2 EN 60947-2
-----------	---------------------------

Rating (A)	Catalogue numbers	
	Curve B	Curve C
1	-	A9N61653
2	-	A9N61654
3	-	A9N61655
5	-	A9N61656
8	A9N61657	-
10	A9N61650	-
13	A9N61658	-
15	A9N61659	-
16	A9N61651	-
20	A9N61652	-
25	A9N61660	-
Auxiliaries	See modules CA907008 and CA907013	

DC circuit supplementary protectors for photovoltaic installations

C60PV-DC (cont.)

Application diagram

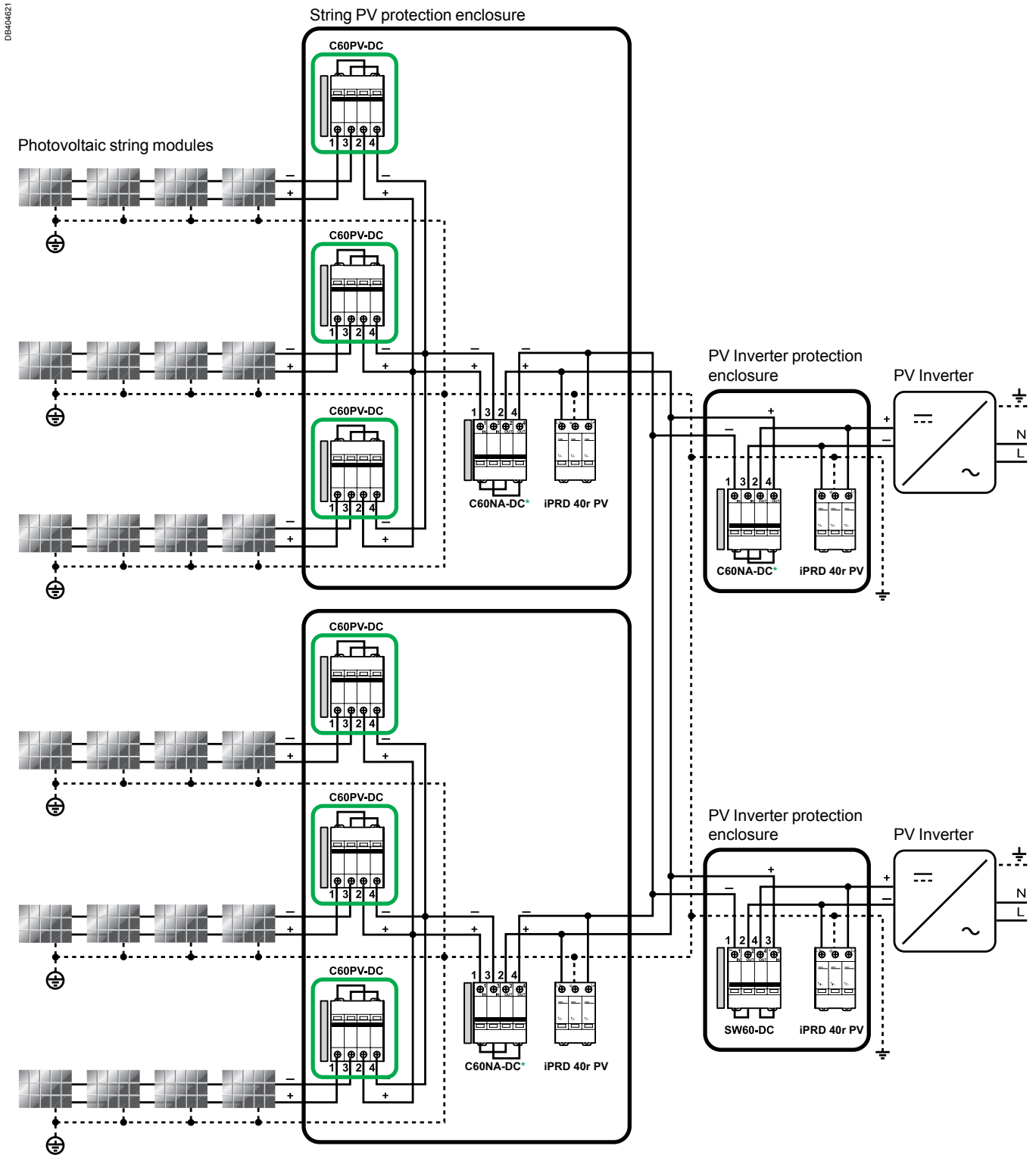

MN, MX, MNx, MN \square , MX+OF, OF, SD, OF+SD/OF, OF+SD24

*C60NA-DC:
20 A/1000 V DC or
32 A/800 V DC or
50 A/700 V DC

DC circuit supplementary protectors for photovoltaic installations C60PV-DC (cont.)

Technical data

- Position contact indication - suitability for isolation according to IEC/EN 60947-2 standard.
- The presence of the green strip guarantees physical opening of the contacts and allows operations to be performed on the downstream circuit in complete safety.
- Increased product service life thanks to fast closing independent of the speed of actuation of the toggle.
- Pre-wired product: Input / Output on the same side.

Main characteristics

Rated service breaking capacity (Ics)		100 % of the Icu
Magnetic tripping (Ii)	Ratings 1...5 A	8.5 In (± 20 %) (compatible with curve C)
	Ratings 8...25 A	5.7 In (± 20 %) (compatible with curve B)
Endurance (O-C)	Electrical	1,500 cycles (where L/R=2 ms)
	Mechanical	20,000 cycles
Mechanical		20,000 cycles
Degree of pollution		2
Category		A (no delay in accordance with IEC / EN 60947-2 standards)
Degree of protection (IEC 60529)	Device in modular enclosure	IP40
Tropicalisation		Relative humidity: 95 % at 55°C in accordance with IEC 60068-2 and GB 14048.2 standards
Temperature	Operating	-25°C to 70 °C
	Storage	-40°C to 85°C

Additional characteristics

Rating (A)	Voltage drop (mV)	Impedance (mΩ)	Power loss (W)
1	9200	9200	9.2
2	5104	2552	10.2
3	2980	993.3	8.9
5	2000	400	10
8	1384	173	11.1
10	680	68	6.8
13	572	44	7.4
15	600	40	9
16	648	40.5	10.4
20	588	29.4	11.8
25	488	19.5	12.2

Derating table (A)

C60PV-DC Rating	Ambient temperature (°C)																				
	-30	-25	-20	-15	-10	-5	0	+5	+10	+15	+20	+25	+30	+35	+40	+45	+50	+55	+60	+65	+70
1 A	1.18	1.17	1.15	1.14	1.12	1.1	1.09	1.07	1.05	1.04	1.02	1	0.98	0.96	0.94	0.92	0.9	0.88	0.86	0.84	0.82
2 A	2.54	2.5	2.45	2.41	2.36	2.31	2.26	2.21	2.16	2.11	2.06	2	1.94	1.88	1.82	1.76	1.7	1.63	1.56	1.48	1.41
3 A	3.78	3.71	3.65	3.58	3.51	3.45	3.38	3.3	3.23	3.16	3.08	3	2.92	2.84	2.75	2.66	2.57	2.48	2.38	2.27	2.17
5 A	6	5.92	5.83	5.74	5.66	5.57	5.48	5.39	5.29	5.2	5.1	5	4.9	4.8	4.69	4.58	4.47	4.36	4.24	4.12	4
8 A	9.64	9.5	9.36	9.22	9.08	8.93	8.78	8.63	8.48	8.32	8.16	8	7.83	7.67	7.49	7.31	7.13	6.95	6.76	6.56	6.36
10 A	12.6	12.4	12.2	11.9	11.7	11.5	11.2	11	10.8	10.5	10.3	10	9.7	9.4	9.2	8.9	8.6	8.2	7.9	7.6	7.2
13 A	15.5	15.3	15.1	14.8	14.6	14.4	14.2	14	13.7	13.5	13.2	13	12.7	12.5	12.2	12	11.7	11.4	11.1	10.8	10.5
15 A	18.6	18.3	18	17.7	17.4	17.1	16.7	16.4	16.1	15.7	15.4	15	14.6	14.3	13.9	13.5	13.0	12.6	12.2	11.7	11.2
16 A	19.4	19.1	18.9	18.6	18.3	18.0	17.6	17.3	17.0	16.7	16.3	16	15.7	15.3	14.9	14.6	14.2	13.8	13.4	13.0	12.5
20 A	24.1	23.7	23.4	23.0	22.7	22.3	21.9	21.6	21.2	20.8	20.4	20	19.6	19.2	18.7	18.3	17.9	17.4	16.9	16.4	15.9
25 A	30.4	29.9	29.5	29.0	28.5	28.1	27.6	27.1	26.6	26.1	25.5	25	24.5	23.9	23.3	22.7	22.1	21.5	20.9	20.2	19.6

DC circuit supplementary protectors for photovoltaic installations C60PV-DC (cont.)

Technical data (cont.)

Moreover it is recommended to use:

- a terminal Screw Shield snaps onto the front of the C60PV-DC protective devices to provide greater insulation of the terminal screws
- a spacer clips 9 mm in each side to provide isolation.

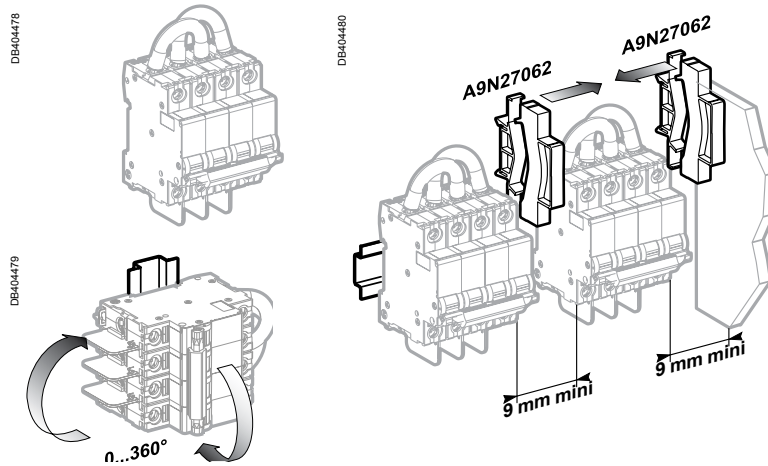

⚠ Required to have a 9 mm space isolation in each side"

Weight (g)

Circuit breaker	
Type	C60PV-DC
	545

Dimensions (mm)

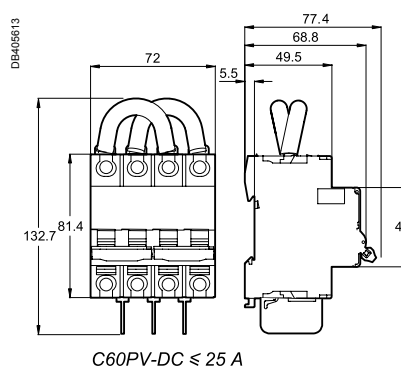

Connection

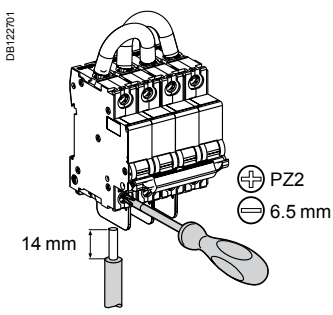

Rating	Tightening torque	Without accessory		With accessories	
		Copper cables UL 486A file no. #E216919		50 mm ² Cu/Al Terminal	Ring tongue terminal screw connection
		Rigids	Flexibles with ferrule		
≤ 25 A	2.5 N.m	DB112804 	DB112805 	DB118725 	DB118726
		1 to 25 mm ²	1 to 16 mm ²	50 mm ²	Ø 5 mm

DC main switch for photovoltaic installations

C60NA-DC

PB108404-50



The C60NA-DC is a direct current switch-disconnector dedicated to disconnection of the string of photovoltaic modules and the PV inverter.

It is designed to isolate the string of photovoltaic modules and the inverter from the rest of the photovoltaic installation for maintenance operations in complete safety.

Combined with a circuit breaker (of the C60PV-DC type, for example), the C60NA-DC will be installed in a string PV protection enclosure close to the strings of photovoltaic modules. It can also be installed near the PV inverter.

It can be locked (by a padlocking device) in OFF position to ensure safety during maintenance operations.

Since a fault current can flow in the reverse direction to the normal operating current, the C60NA-DC can switch a multi-directional current.

C60NA-DC is not polarity sensitive: (+) and (-) wires can be inverted without any risk.

The C60NA-DC is delivered with three inter-pole barriers to provide increased isolation distance between two adjacent connectors.

IEC / EN 60947-3



DB404541

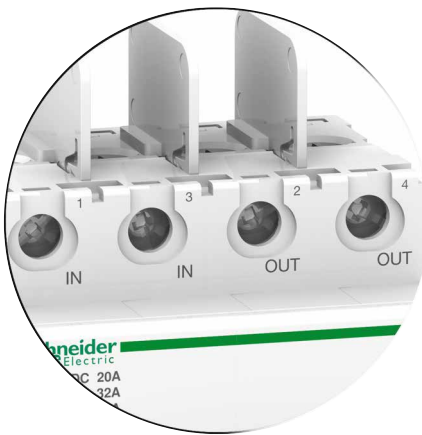

Main characteristics	
Operating voltage (Ue)	20 A: 1000 V CC
	32 A: 800 V CC
	50 A: 700 V CC
Rated insulation voltage (Ui)	1,000 V DC
Rated operational current (Ie)	50 A
Impulse voltage (Uimp)	6 kV
Permissible rated short-time withstand current (Icw)	600 A
Rated short-circuit closing current (Icm)	1 kA
Electrical connection	By the top for In and Out
Number of poles	2P
Number of modules of 9 mm	8
Diagrams	
Standards	IEC 60947-3 EN 60947-3
Catalogue number	A9N61690
Auxiliaries	See modules CA907008 and CA907013

Additional characteristics			
Rating (A)	Voltage drop (mV)	Impedance (mΩ)	Power loss (W)
20 A	100	5.02	2
32 A	151	5.02	5.14
50 A	251	5.02	12.55

DC main switch for photovoltaic installations C60NA-DC (cont.)

Application diagram

DB404622

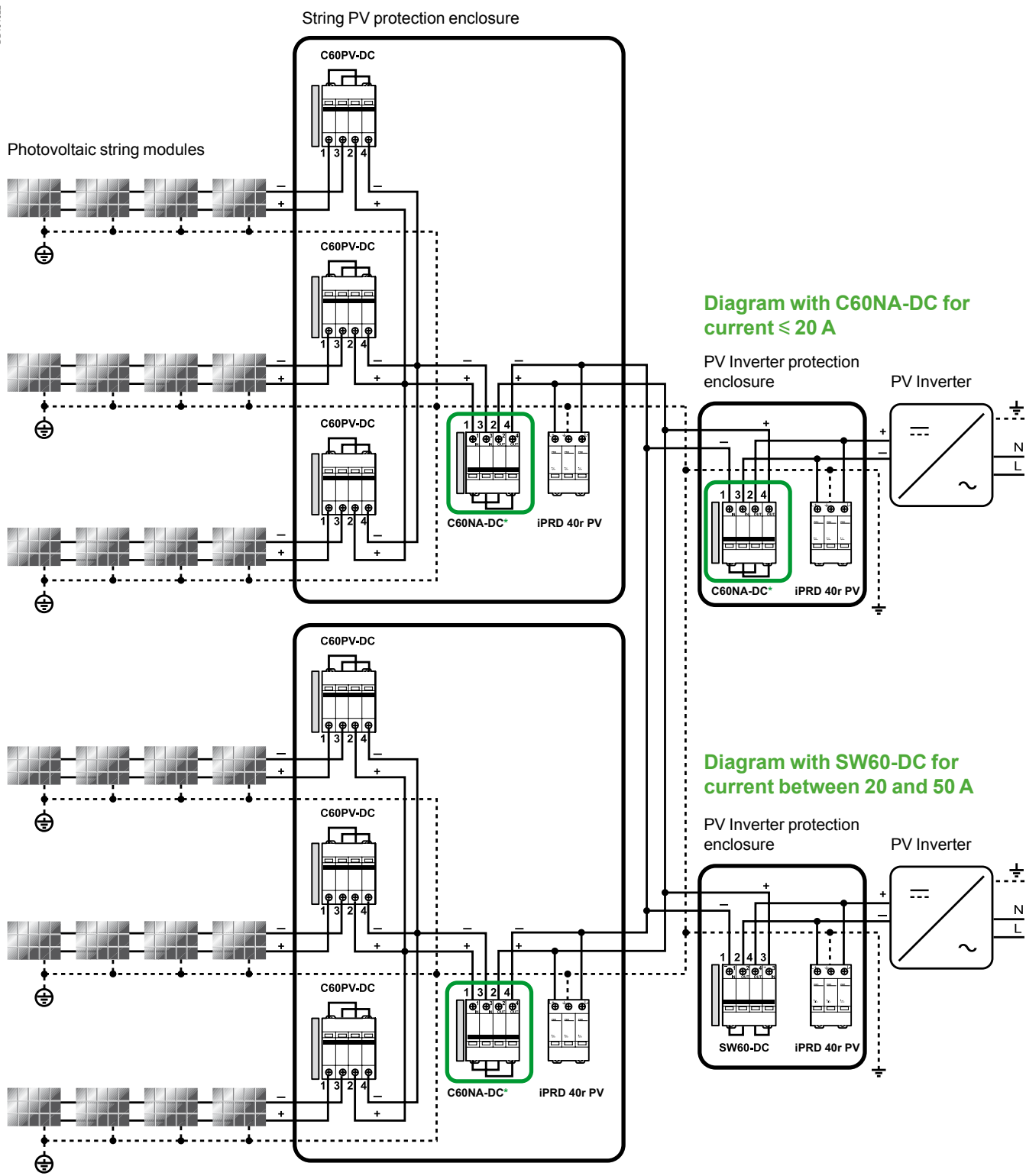

Diagram with C60NA-DC for current ≤ 20 A

Diagram with SW60-DC for current between 20 and 50 A

*C60NA-DC:
20 A/1000 V DC or
32 A/800 V DC or
50 A/700 V DC

MN, MX, MNx, MN \square , MX+OF,
OF, SD, OF+SD/OF, OF+SD24

DC main switch for photovoltaic installations

C60NA-DC (cont.)

Technical data

- Position contact indication - suitability for isolation according to IEC/EN 60947-3 standard.
- The presence of the green strip guarantees physical opening of the contacts and allows operations to be performed on the downstream circuit in complete safety.
- Increased product service life thanks to fast closing independent of the speed of actuation of the toggle.
- Pre-wired product: Input / Output on the same side.

Endurance (O-C)	Electrical	300 cycles
	Mechanical	20,000 cycles
Degree of pollution		2
Category		DC21B
Degree of protection (IEC 60529)	Device in modular enclosure	IP40
Tropicalisation		Relative humidity: 95 % at 55°C in accordance with IEC 60068-2 and GB 14048.2 standards
Temperature	Operating	-25°C to 70°C
	Storage	-40°C to 85°C

Derating table (A)												
C60NA-DC	Ambient temperature (°C)											
Rating	+5	+10	+15	+20	+25	+30	+35	+40	+45	+50	+60	+70
50 A	63	61	60	58	56	54	52	50	48	46	41	35

Moreover it is recommended to use:

- a terminal Screw Shield snaps onto the front of the C60NA-DC protective devices to provide greater insulation of the terminal screws
- a Spacer clips 9 mm in each side to provide isolation.

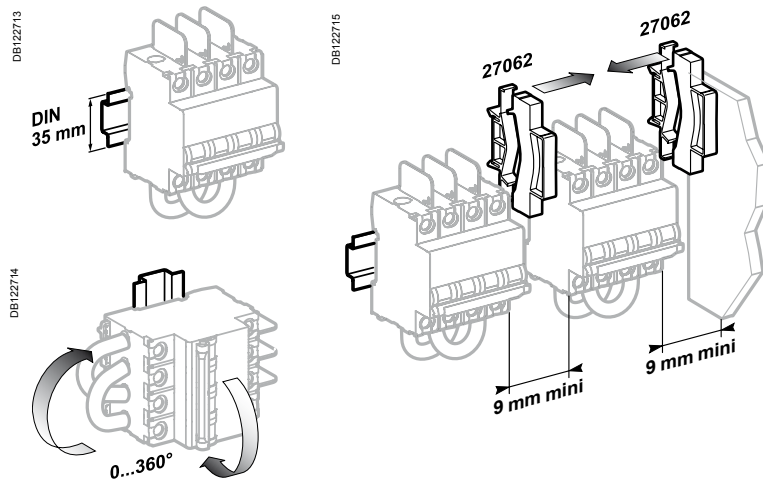

⚠ Required to have a 9 mm space isolation in each side"

DC main switch for photovoltaic installations C60NA-DC (cont.)

Technical data (cont.)

Weight (g)

Switch disconnecter	
Type	C60NA-DC
	530

Dimensions (mm)

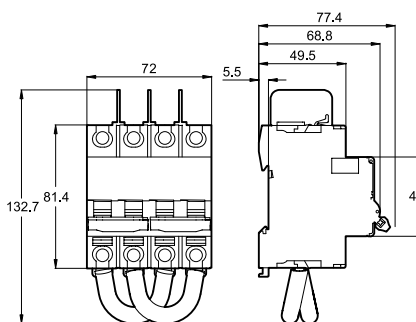

C60NA-DC

Connection

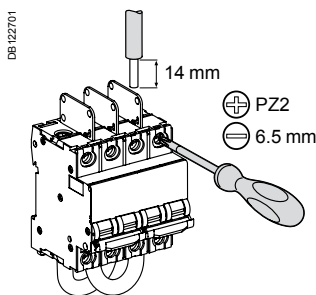

Rating	Tightening torque	Without accessory		With accessories			
		Copper cables UL 486A file no. #E216919		50 mm ² Cu/Al Terminal	Screw on connection for ring terminal	Multi-cables terminal	
		Rigids	Flexibles with ferrule			Rigid cables	Flexible cables
50 A	3.5 N.m	DB112804 	DB112805 	DB118755 	DB118756 	DB118757 	
		1 to 35 mm ²	1 to 25 mm ²	50 mm ²	Ø 5 mm	3 x 16 mm ²	3 x 10 mm ²

DC main switch for photovoltaic installations

Switch SW60-DC

PB109406-50



The SW60-DC is a direct current switch-disconnector dedicated to disconnection of the string of photovoltaic modules and the PV inverter.

It is designed to isolate the inverter from the rest of the photovoltaic installation for maintenance operations in complete safety.

Combined with a circuit breaker (of the C60PV-DC type, for example) and a switch (of the C60NA-DC type, for example), the SW60-DC will be installed in the string PV protection enclosure close to the PV inverter (see application diagram).

It can be locked (by a padlocking device) in OFF position to ensure safety when removing the PV inverter.

SW60-DC is polarity sensitive: (+) and (-) has to be respected for connection.

The SW60-DC is delivered with three inter-pole barrier to provide increased isolation distance between two adjacent connectors.

IEC / EN 60947-3



DB9404842

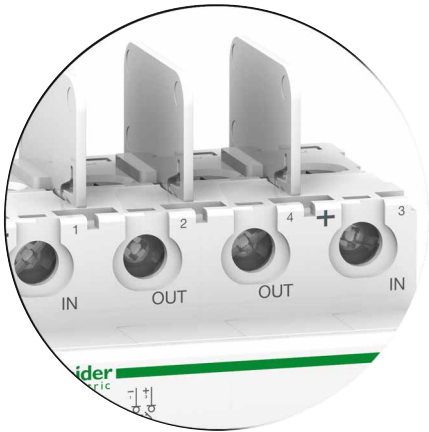

General technical data

Operating voltage (Ue)	1000 V DC
Rated insulation voltage (Ui)	1000 V DC
Rated operational current (Ie)	50 A
Impulse voltage (Uimp)	6 kV
Permissible rated short-time withstand current (Icw)	600 A
Rated short-circuit closing current (Icm)	1 kA
Electrical connection	By the top for In and Out
Number of poles	2P
Number of modules of 9 mm	8
Diagrams	
Standards	IEC 60947-3 EN 60947-3
Catalogue number	A9N61699

DC main switch for photovoltaic installations

Switch SW60-DC (cont.)

Applications

DE404639

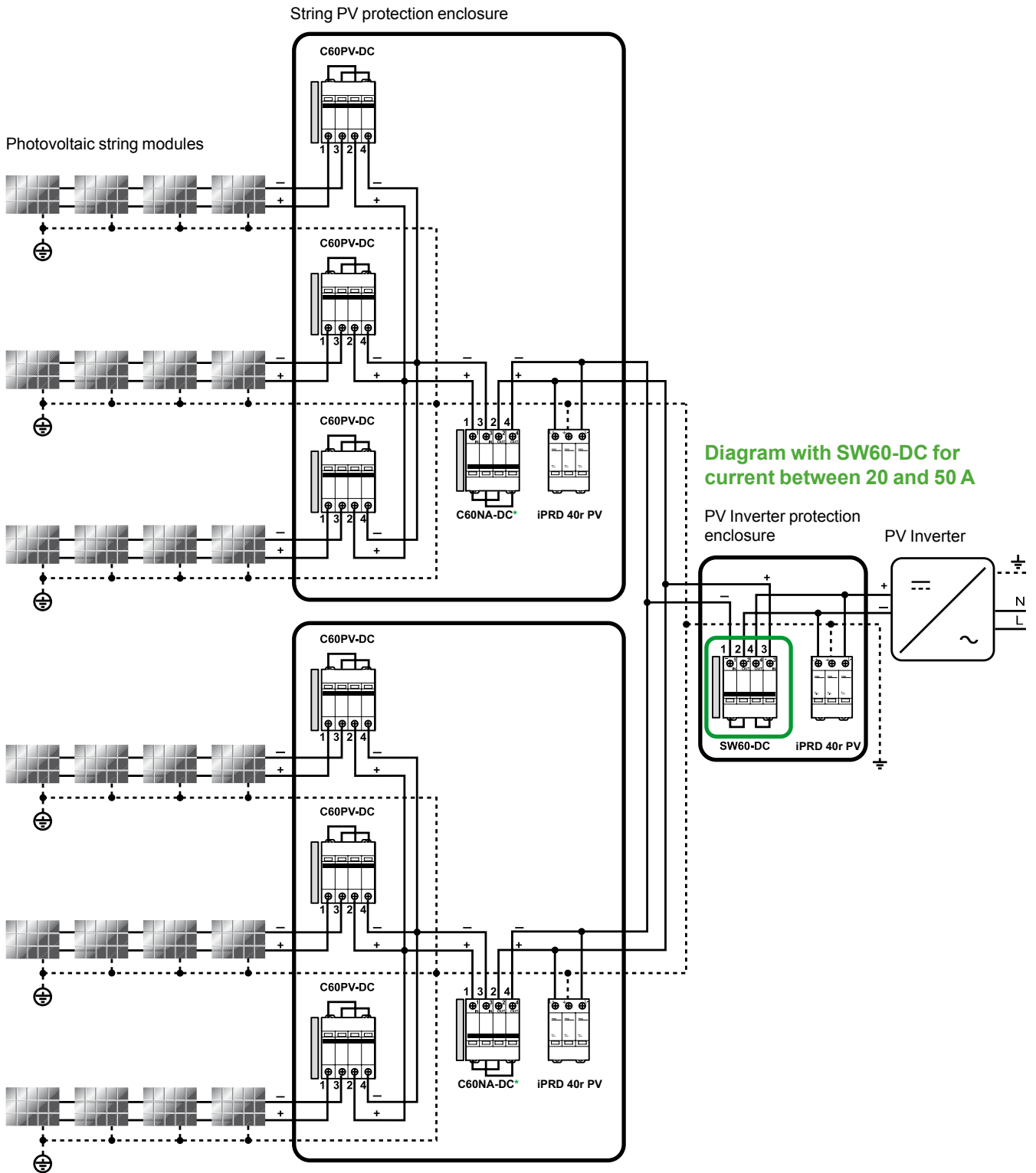

Diagram with SW60-DC for current between 20 and 50 A

*C60NA-DC:
20 A/1000 V DC or
32 A/800 V DC or
50 A/700 V DC

MN, MX, MNx, MN \square , MX+OF,
OF, SD, OF+SD/OF, OF+SD24

DC main switch for photovoltaic installations

Switch SW60-DC (cont.)

Technical data

- Position contact indication - suitability for isolation according to IEC/EN 60947-3 standard.
- The presence of the green strip guarantees physical opening of the contacts and allows operations to be performed on the downstream circuit in complete safety.
- Increased product service life thanks to fast closing independent of the speed of actuation of the toggle.
- Pre-wired product: Input / Output on the same side.

Main characteristics

Endurance (O-C)	Electrical	1,500 cycles
	Mechanical	20,000 cycles
Degree of pollution		2
Category		DC21A
Degree of protection (IEC 60529)	Device in modular enclosure	IP40
Tropicalisation		Relative humidity: 95 % at 55°C in accordance with IEC 60068-2 and GB 14048.2 standards
Temperature	Operating	-25°C to 70°C
	Storage	-40°C to 85°C
	Rating adjustment	40°C

Additional characteristics

Rating (A)	Voltage drop (mV)	Impedance (mΩ)	Power loss (W)
50 A	251	5.02	12.54

Derating table (A)

SW60PV-DC	Ambient temperature (°C)											
Rating	+5	+10	+15	+20	+25	+30	+35	+40	+45	+50	+60	+70
50 A	63	61	60	58	56	54	52	50	48	46	41	35

Moreover it is recommended to use:

- a terminal Screw Shield snaps onto the front of the SW60-DC protective devices to provide greater insulation of the terminal screws.
- a Spacer clips 9 mm in each side to provide isolation.

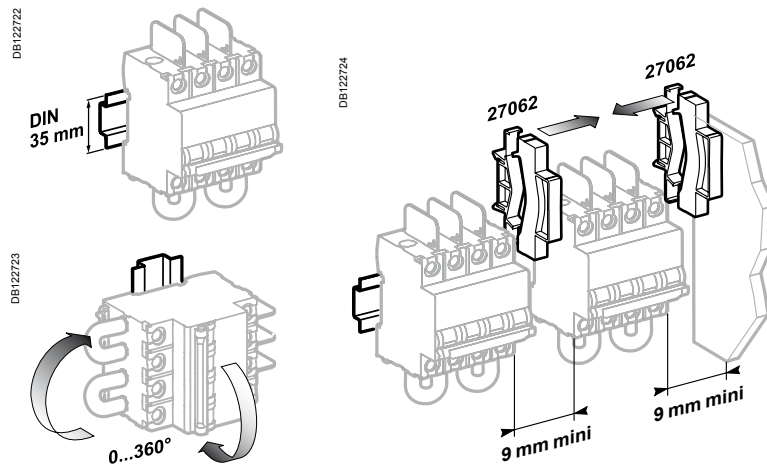

⚠ 9 mm spacers must be used on both sides of the device to create a local ventilation space around the product.

⚠ Failure to match polarity during connection may lead to a fire hazard and/or serious injury. The connection polarity must be observed (marked on the front panel). Use only with direct current.

DC main switch for photovoltaic installations

Switch SW60-DC (cont.)

Technical data (cont.)

Weight (g)

Switch disconnecter	
Type	SW60-DC
	530

Dimensions (mm)

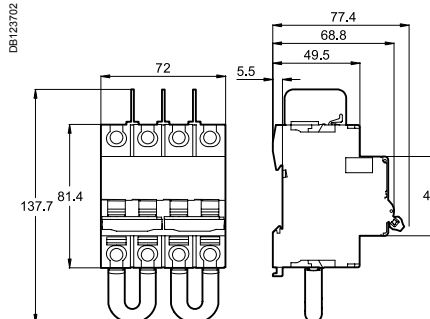

SW60-DC

Connection

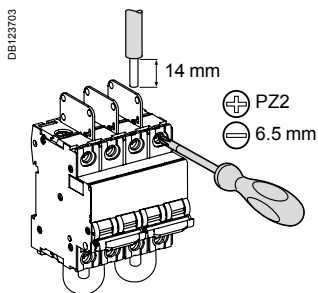

Rating	Tightening torque	Without accessory		With accessories			
		Copper cables UL 486A file no. #E216919		50 mm ² Cu/Al Terminal	screw on connection for ring terminal	Multi-cables terminal	
		Rigids	Flexibles with ferrule			Rigid cables	Flexible cables
50 A	3.5 N.m	 DE112804	 DE112805	 DE119755	 DE119756	 DE119757	 DE119757
		1 to 35 mm ²	1 to 25 mm ²	50 mm ²	Ø 5 mm	3 x 16 mm ²	3 x 10 mm ²

DC main switch for photovoltaic installations C120NA-DC



Country approval pictograms

IEC / EN 60947-3

PB113148-50



The C120NA-DC is a direct current switch-disconnector dedicated to disconnection of the string of photovoltaic modules and the PV inverter.

It is designed to isolate the string of photovoltaic modules and the inverter from the rest of the photovoltaic installation for maintenance operations in complete safety.

The C120NA-DC will be installed in a string PV protection enclosure close to the strings of photovoltaic modules. It can also be installed near the PV inverter.

It can be locked (by a padlocking device) in OFF position to ensure safety during maintenance operations.
Since a fault current can flow in the reverse direction to the normal operating current, the C120NA-DC can switch a multi-directional current.

Connection

■ The C120NA-DC is not polarity sensitive: (+) and (-) wires can be inverted without any risk.

Isolation distance

■ The C120NA-DC is delivered with three inter-pole barriers to provide increased isolation distance between two adjacent connectors



Prewired

■ The cables cross-section is suitable
■ The tightening torque is mastered

DC main switch for photovoltaic installations

C120NA-DC (cont.)

Main characteristics	
Operating voltage (Ue)	1000 V DC
Rated insulation voltage (Ui)	1000 V DC
Rated operational current (Ie)	100 A
Impulse voltage (Uimp)	6 kV
Permissible rated short-time withstand current (Icw)	1.5 kA / 500 ms
Rated short-circuit closing current (Icm)	1 kA
Electrical connection	By the top for In and Out
Number of poles	2P
Number of modules of 9 mm	12
Diagrams	
Standards	IEC 60947-3 EN 60947-3
Catalogue number	A9N61701
Auxiliaries	See modules CA907008 and CA907013

Additional technical data

- Position contact indication - suitability for isolation according to IEC/EN 60947-3 standard.
- The presence of the green strip guarantees physical opening of the contacts and allows operations to be performed on the downstream circuit in complete safety.
- Increased product service life thanks to fast closing independent of the speed of actuation of the toggle.
- Prewired product: Input / Output on the same side.

Endurance (O-C)	Electrical	300 cycles
	Mechanical	20,000 cycles
Degree of pollution		2
Category		DC21B
Tropicalisation		Relative humidity: 95 % at 55°C in accordance with IEC 60068-2 and GB 14048.2 standards
Temperature	Operating	-25°C to 70 °C
	Storage	-40°C to 85°C

Derating table (A)

C120NA-DC	Ambient temperature (°C)											
Rating	+5	+10	+15	+20	+25	+30	+35	+40	+45	+50	+60	+70
100 A	113	111	110	108	106	104	102	100	98	96	91	85

DC main switch for photovoltaic installations C120NA-DC (cont.)

Upstream connection

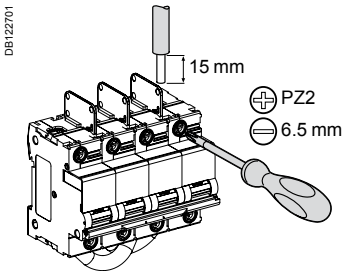

Tightening torque	Without accessory		With accessories			
	Copper cables Rigid	Copper cables Flexibles with ferrule	50 mm ² Cu/Al Terminal	Screw on connection for ring terminal	Multi-cables terminal	
					Rigid cables	Flexible cables
3.5 N.m	DB112845 	DB112846 	DB118755 	DB118756 	DB118757 	
	35 to 50 mm ²	25 to 35 mm ²	50 mm ²	Ø 5 mm	3 x 16 mm ²	3 x 10 mm ²

Downstream connection

Prewired delivered product: **Do not remove**

Moreover it is recommended to use:

- a terminal Screw Shield snaps onto the front of the C120NA-DC protective devices to provide greater insulation of the terminal screws
- a Spacer clips 9 mm in each side to provide isolation.

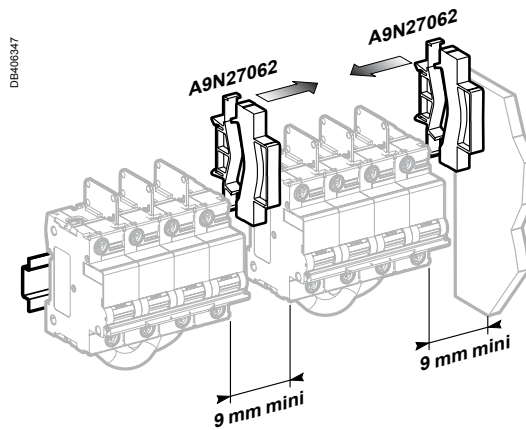
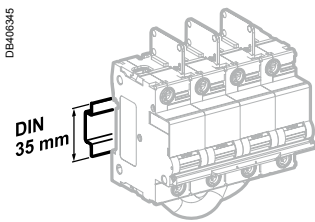

⚠ Required: to have a 9 mm space isolation in each side"

Weight (g)

Switch disconnector	
Type	C120NA-DC 910

Dimensions (mm)

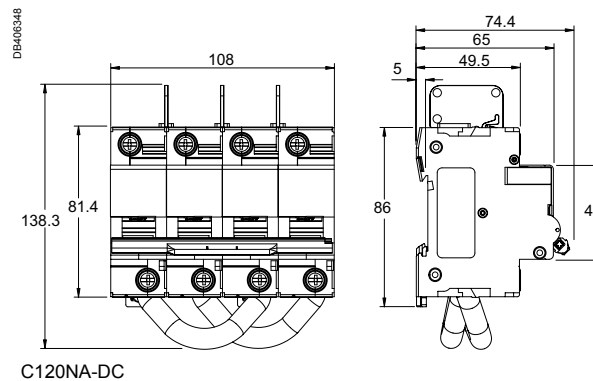

DC main switch for photovoltaic installations C120NA-DC (cont.)

Application diagram

DE940328

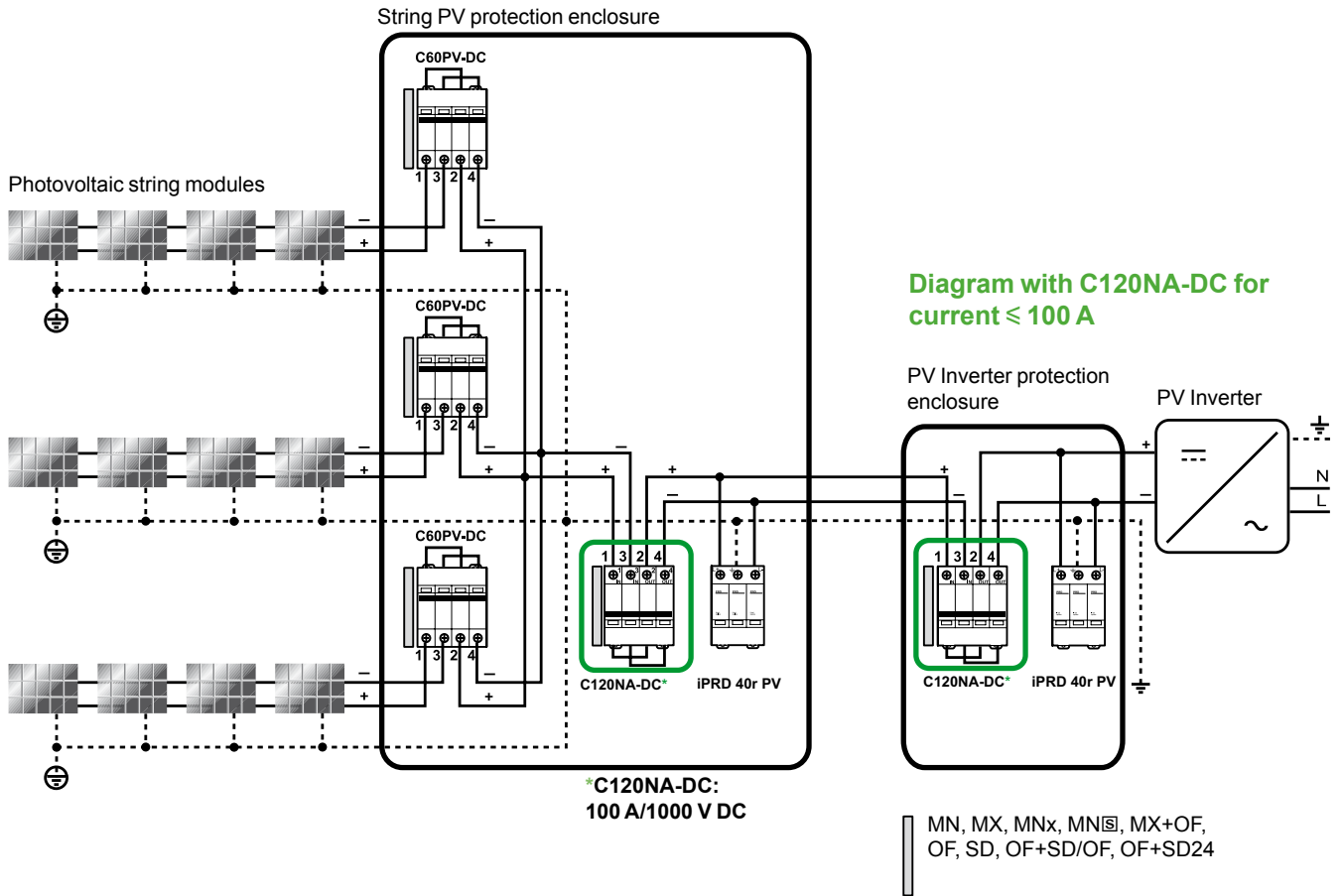

Load protection Motor starter protection

P25M

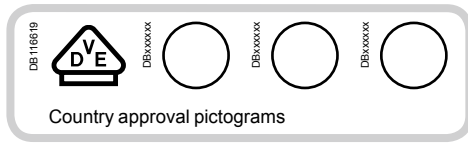

IEC 60947-2 and IEC 60947-4-1 (in combination)

They protect single-phase or three-phase motors with manual local control. This protection includes:

- isolation
- manual or remote control
- short-circuit protection (magnetic)
- overload protection (thermal).

Breaking capacity to IEC 60947-2

Rating (A)	Voltage (V)										
	230...240		400...415		440		500		690		
	Icu kA	Ics %	Icu kA	Ics %	Icu kA	Ics %	Icu kA	Ics %	Icu kA	Ics %	
0.16 to 1.6	Unlimited									3	75
2.5	Unlimited									3	75
4	Unlimited									3	75
6.3	Unlimited									50	100
10	Unlimited									15	100
14	Unlimited									15	50
18	Unlimited									15	50
23	50	100	15	40	6	50	4	75	3	75	
25	50	100	15	40	6	50	4	75	3	75	

The limiting unit increases the breaking capacity up to 100 kA at 415 V.

Catalogue numbers

Type	Standardised power (kW) of three-phase 50/60 Hz motors in category AC3						Rating In (A)	Setting	Power loss by the 3 poles (W)	Cat. no.	Width in 9 mm modules
	Voltage (V AC)										
3P	230	400	415	440	500	690					
	-	-	-	-	-	-	0.16	0.1-0.16	5.4	21100	5
	-	-	-	-	-	-	0.25	0.16-0.25	5.2	21101	5
	-	-	-	-	-	-	0.40	0.25-0.40	5.3	21102	5
	-	-	-	-	-	-	0.37	0.40-0.63	5.5	21103	5
	-	-	-	0.37	0.37	0.55	1.0	0.63-1	5.9	21104	5
	-	0.37	-	0.55	0.75	1.1	1.6	1-1.6	5.9	21105	5
	0.37	0.75	1.1	1.1	1.1	1.5	2.5	1.6-2.5	5.9	21106	5
	0.75	1.5	1.5	1.5	2.2	3	4.0	2.5-4	6.5	21107	5
	1.1	2.2	2.2	3	3.7	4	6.3	4-6.3	5.0	21108	5
	2.2	4	4	4	5.5	7.5	10	6-10	6.9	21109	5
	3	5.5	5.5	7.5	9	11	14	9-14	7.4	21110	5
	4	7.5	9	9	10	15	18	13-18	6.4	21111	5
	5.5	9	11	11	11	18.5	23	17-23	7.5	21112	5
	5.5	11	11	11	15	22	25	20-25	7.4	21113	5

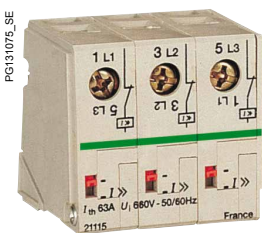

Limiting unit

Type	Rating In (A)	Cat. no.	Width in 9 mm modules
3P	63	21115	5

P25M

Connection

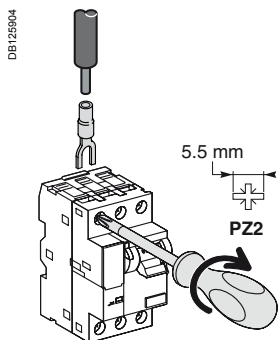

Tightening torque	Terminal clamps		With insulated connector	Limiting unit
	Rigid Cu	Flexible Cu	Flexible Cu	Tunnel terminals
1.7 N.m.	2 x 1 ... 6 mm ²		2 x 1.5 ... 6 mm ²	1 x 25 mm ² or 2 x 10 mm ²

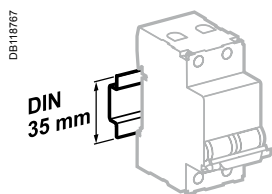

Mounted on 35 mm DIN rail.

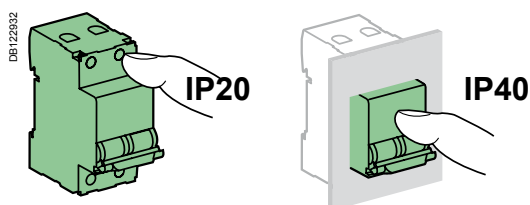
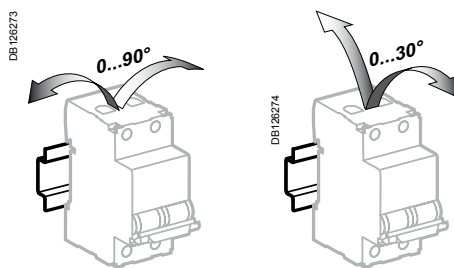

Weight (g)

P25M	260
Limiting unit	130

Technical data

Electrical characteristics	
Operating voltage (Ue)	690 V AC
Insulation voltage (Ui)	690 V
Rated impulse withstand voltage (Uimp)	6 kV
Endurance (O-C)	Electrical AC3
Thermal trip unit	100,000 cycles
Settings	Sensitive to missing phase
	Factory < settings range
	Simultaneously on the front face
	On current drawn in nominal operation
Ratings (In)	0.16 to 25 A adjustable
Temperature compensation	-20 °C to +40 °C in an enclosure
Magnetic trip unit	12 x the In rating (±20 %)

Other characteristics	
Padlocking device on the front face	
Tropicalisation	Treatment 2 (relative humidity 95 % at 55 °C)
Operating temperature	-20 ...+60 °C
Storage temperature	-40 ...+80 °C

Rated operating current (Ie) of auxiliary contacts under the rated operating voltage (Ue)					
Operating voltage (Ue)		Operating current			
(V AC)	(V DC)	Position contact		fault tripping contact	
		AC 15 (AAC)	DC 13 (A DC)	AC 14 (AAC)	DC 13 (A DC)
415	220	2.2	0.5	-	-
240	110	3.3	1.3	-	-
130	60	4.5	3	0.5	0.15
48	48	6	5	1	0.3
24	24	-	6	1.5	1

Dimensions (mm)

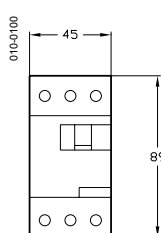

Circuit breaker

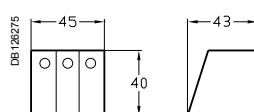
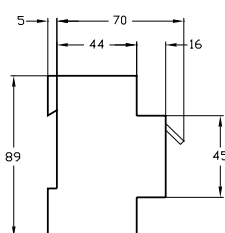

Limiting unit only

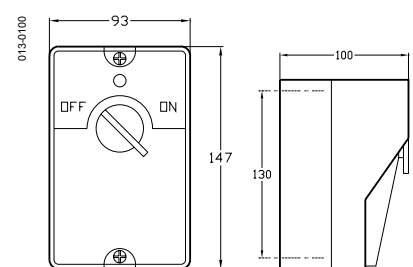

Insulating enclosure

Load protection

Motor starter protection

P25M

Electrical auxiliaries

Connection

Cables			
	Rigid	Flexible	Flexible with ferrule
Mini	1 x 1 to 2.5 mm ²	1 x 0.75 to 2.5 mm ²	1 x 0.75 to 1.5 mm ²
Maxi	2 x 1 to 2.5 mm ²	2 x 0.75 to 2.5 mm ²	2 x 0.75 to 1.5 mm ²
Tightening torque	1.4 N.m		

The electrical auxiliaries allow remote tripping or position or fault indication of the PM25 circuit breakers.

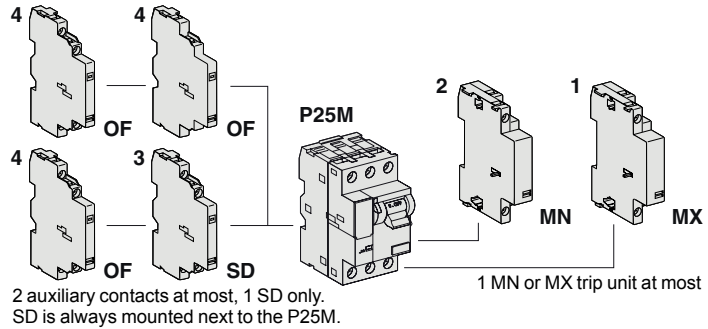

Catalogue numbers

Trip units

	Type	Control voltage (V AC)	Width in 9 mm modules	Cat. no.
1 MX shunt release				
<ul style="list-style-type: none"> Emergency stoppage by normally open push button Causes tripping of the associated device when powered 		220...240	2	21127
		380...415	2	21128
2 MN undervoltage release				
<ul style="list-style-type: none"> Emergency stoppage by normally closed push button Ensures the safety of power supply circuits for several machines by preventing untimely restarting Causes tripping of the circuit breaker with which it is associated when its input voltage decreases (between 70% and 35% of Un) Prevents closing of the device until its input voltage has been restored 		220...240	2	21129
		380...415	2	21130

Auxiliary contacts

	Type	Width in 9 mm modules	Cat. no.
3 Position and fault tripping indication contacts			
F + SD.F		1	21118
O + SD.F		1	21119
F + SD.O		1	21120
O + SD.O		1	21121
4 Position contacts			
O + F		1	21117
F + F		1	21116

"O ": normally closed contact
 "F ": normally open contact
 SD: contact indicating the position of the associated device in the event of an electrical fault
 SD.F: to indicate a closed contact fault
 SD.O: to indicate an open contact fault

Load protection

Motor starter protection

P25M

Accessories

Accessories make it easier to integrate the circuit breakers and extend their use.

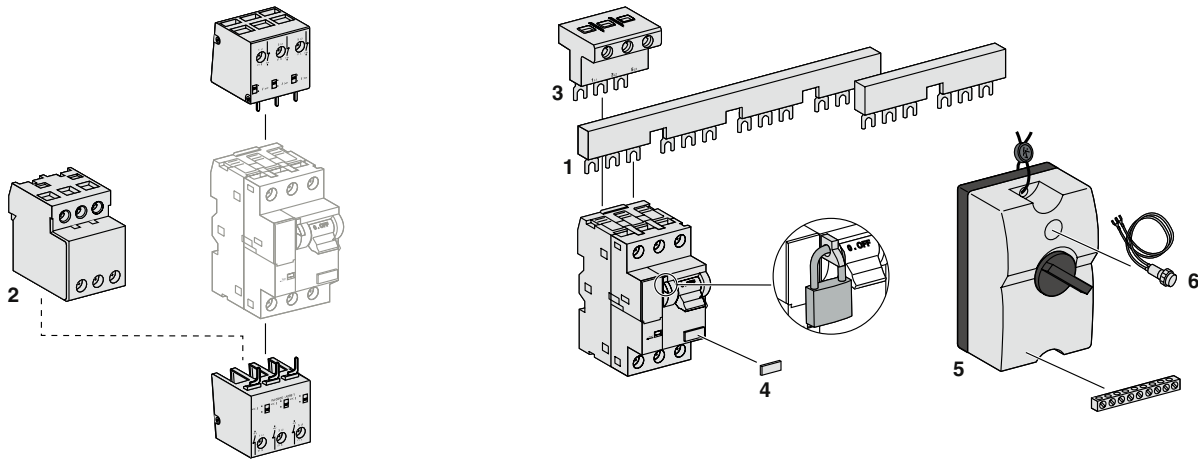

Catalogue numbers

	Type	Cat. no.
1 Comb busbars		
	2 P25M feeders	GV2G254
	4 P25M feeders	GV2G454
	Protection end-piece	GV2G10
2 Downstream terminal block		
		GV2G05+LA9E07
	GV2G05: Downstream terminal block LA9E07: Cover for downstream terminal block	
3 Insulated connector		
		GV2G09
4 Clip-on terminal markers		
	see module CM907003E	
5 Insulating enclosure		
Individual installation of a P25M circuit breaker with an auxiliary contact block and trip unit. Double insulation \square and sealed to IP55. L = 93, H = 147, P = 100 (mm)		21133
6 Neon indicator light		
230-240 V AC	Green	GV2SN23
	Red	GV2SN24
400-415 V AC	Green	GV2SN33
	Red	GV2SN34

Load protection

Motor starter protection

P25M

Practical advice

Choice of motor supply cable cross-section

- The motor starting current and permissible voltage drop must be taken into account when choosing the cross-section.
- The cable must accept a current at least equal, when used continuously, to the sum of $I_n + I_d/3$ where:
v I_n : rated current,
v I_d : starting current (4 to 8 I_n), depending on the motors.

Voltage drop

- The voltage drop permitted between the source and the motor concerned is 5% for public distribution networks and 8% for subscriber or transformer substations.
- If the torque of the machine to be driven is low at startup, simply check the voltage drop for the rated current of the motor.
- If the startup torque is high (grain crushers, goods lift, etc.), check the voltage drop for the starting current.

Protection of the motor supply line

- All circuits and motors must be protected against overloads and short-circuits.

Connecting the circuit breaker for use with a single-phase motor

- Two circuit breaker poles must be connected in series.

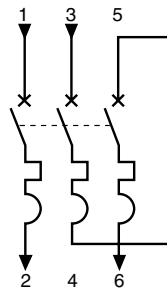

Protection / Motor protection

iC60L circuit breakers instantaneous circuit breakers (ICB) (curve MA)

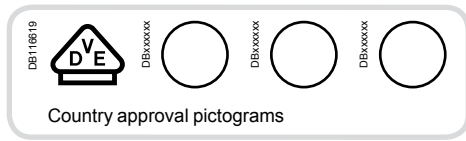

IEC/EN 60947-2



- iC60L curve MA circuit breakers combine the following functions:
 - circuit protection against short-circuit currents,
 - suitability for industrial isolation according to IEC/EN 60947-2, standard,
 - fault tripping indication by a red mechanical indicator in circuit breaker front face,
 - to be associated with overload protection for motor.

Alternating current (AC) 50/60 Hz					
Breaking capacity (Icu) according to IEC/EN 60947-2				Service breaking capacity (Ics)	
Ph/Ph (2P, 3P)	Voltage (Ue)				
Rating (In)	1.6 to 16 A	220 to 240 V	380 to 415 V	440 V	50 % of Icu
	25 à 40 A	30 kA	20 kA	15 kA	50 % of Icu
		30 kA	15 kA	10 kA	

Catalogue numbers

iC60L instantaneous trip circuit breaker		
Type	2P	3P
Auxiliaries	Remote tripping and indication, module CA907000 and CA907002	Remote tripping and indication, module CA907000 and CA907002
Vigi iC60	Vigi iC60 add-on residual current device, module CA902005	Vigi iC60 add-on residual current device, module CA902005
Rating (In)	Curve MA	Curve MA
Quality label (1)		
1.6 A	A9F90272	A9F90372
2.5 A	A9F90273	A9F90373
4 A	A9F90204	A9F90304
6.3 A	A9F90276	A9F90376
10 A	A9F90210	A9F90310
12.5 A	A9F90282	A9F90382
16 A	A9F90216	A9F90316
25 A	A9F90225	A9F90325
40 A	A9F90240	A9F90340
Width in 9-mm modules	4	6
Accessories	Module CA907000 and CA907001	Module CA907000 and CA907001

(1) Information to be provided by the country.

Protection / Motor protection

iC60L circuit breakers instantaneous circuit breakers (ICB) (curve MA) (cont.)

PB10434-40

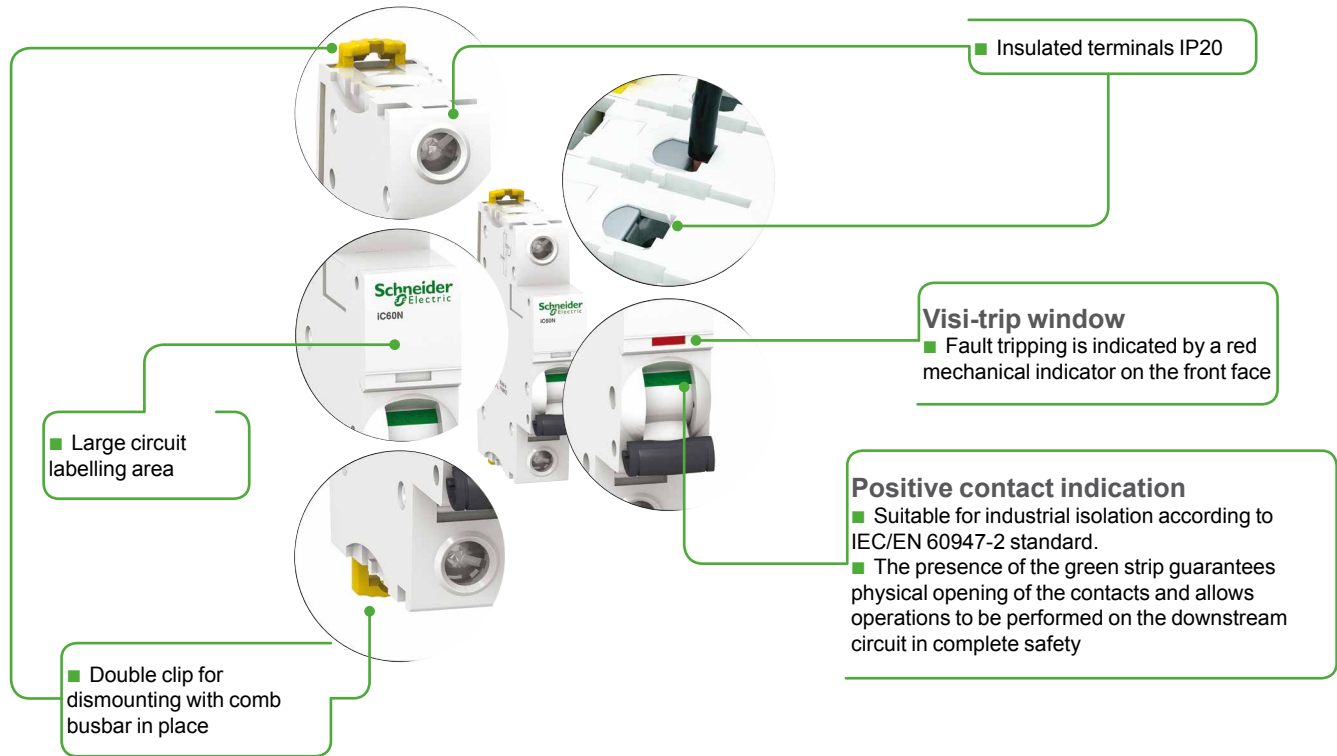

- Increased product service life thanks to:
 - overvoltage resistance by high level of industrial performances conception (pollution degree, rated impulse withstand voltage and insulation voltage),
 - high performance limitation (see limitation curves),
 - fast closing independent of the speed of actuation of the toggle.
- Remote indication, open/closed/tripped, by optional auxiliary contacts.
- Top or bottom electrical feeding.

Protection / Motor protection

iC60L circuit breakers instantaneous circuit breakers (ICB) (curve MA) (cont.)

Connection

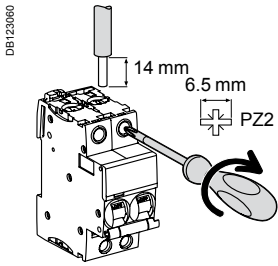

Rating	Tightening torque	Without accessory		With accessories		
		Rigid	Flexible or with ferrule	50 mm ² Al terminal	Screw-on connection for ring terminal	Multi-cables terminal
1.6 to 16 A	2 N.m	DBI122945	DBI122946	DBI122935	DBI18789	DBI18787
25 to 40 A	3.5 N.m	1 to 25 mm ²	1 to 16 mm ²	-	∅ 5 mm	-
		1 to 35 mm ²	1 to 25 mm ²	50 mm ²		3 x 16 mm ²
						3 x 10 mm ²

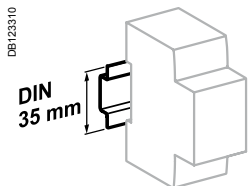

Clip on DIN rail 35 mm.

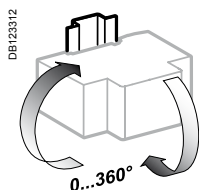

Indifferent position of installation.

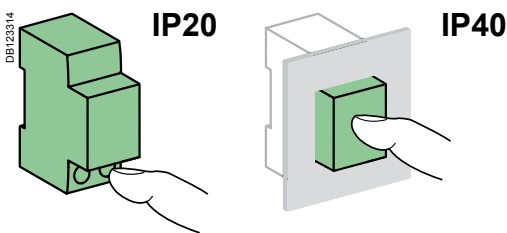

Technical data

Main characteristics		
According to IEC/EN 60947-2		
Insulation voltage (Ui)		500 V AC
Pollution degree		3
Rated impulse withstand voltage (Uimp)		6 kV
Thermal tripping	Reference temperature	50 °C
	Temperature derating	See module CA908007
Magnetic tripping	MA curve	12 In ± 20 %
Utilization category		A
Additional characteristics		
Degree of protection (IEC 60529)	Device only	IP20
	Device in modular enclosure	IP40
Endurance (O-C)	Electrical	10,000 cycles
	Mechanical	20,000 cycles
Overvoltage category (IEC 60364)		IV
Operating temperature		-35°C to +70°C
Storage temperature		-40°C to +85°C
Tropicalization (IEC 60068-1)		Treatment 2 (relative humidity 95 % to 55°C)

Weight (g)

Circuit-breaker	
Type	iC60L
2P	250
3P	375

Dimensions (mm)

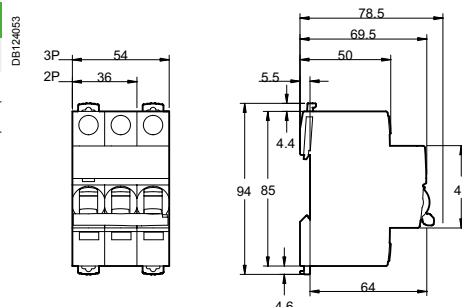

NG125LMA circuit breakers (curve MA)

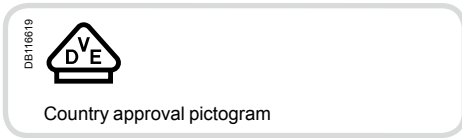

IEC/EN 60947-2

- NG125LMA circuit breakers combine the following functions:
 - circuit protection against short-circuit currents,
 - suitability for industrial isolation according to IEC/EN 60947-2, standard,
 - fault tripping indication by a red mechanical indicator in circuit breaker front face,
 - they must be associated with overload protection for motor.



NG125LMA 2P



NG125LMA 3P

Alternating current (AC) 50/60 Hz					
Breaking capacity (Icu) to IEC/EN 60947-2					
Ph/Ph (2P, 3P)	Voltage (Ue)				Service breaking capacity (Ics)
	220 to 240 V	380 to 415 V	440 V	500 V	
Rating (In) 4 to 80 A (trip units)	100 kA	50 kA	40 kA	15 kA	75 % of Icu

Catalogue numbers

NG125LMA circuit breaker					
Type			2P	3P	
Auxiliaries			Remote indication and tripping, module CM907004 and CM907005		
Vigi NG125			Vigi NG125 add-on residual current device, module CM902008		
Rating (In)	Quality label ⁽¹⁾	Magn. I (A)	Curve MA	Curve MA	
4 A		50	18868	18879	
6.3 A		75	18869	18880	
10 A		120	18870	18881	
12.5 A		150	18871	18882	
16 A		190	18872	18883	
25 A		300	18873	18884	
40 A		480	18874	18885	
63 A		750	18875	18886	
80 A		960	18876	18887	
Width in 9 mm modules			6	9	
Accessories			Module CM907004 and CM907006		

(1) Information to be supplied by the country concerned.

NG125LMA circuit breakers (curve MA) (cont.)

Connection

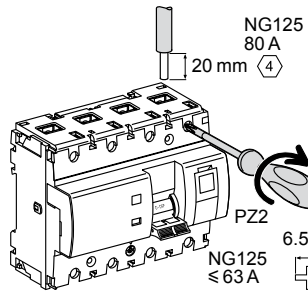

DB122861

NG125 80 A 20 mm (4)

PZ2 6.5 mm

NG125 ≤ 63 A

Rating	Tightening torque	Without accessories		With accessories				
		Copper cables	70 mm ² Al terminal	Screw-on connection for ring terminal	Small ring terminal	Multi-cable terminal		
		Rigid	Flexible or with ferrule	Rigid single cables		Rigid cables	Flexible cables	
4 to 63 A	3.5 N.m	DB122845	DB122846	DB123410	DB123488	DB118768	DB118767	3 x 16 mm ² 3 x 10 mm ²
2P 80 A	6 N.m	16 to 70 mm ²	10 to 50 mm ²	-	2 x 35 mm ² 1 x 50 mm ²	1 x 70 mm ²		
3P 80 A				25 to 70 mm ²				

■ On 3P 80 A: upstream voltage taps for each pole, by 6.35 mm Fast-on terminal.

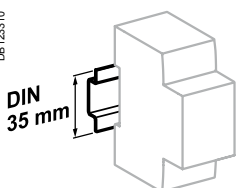

Clips on to 35 mm DIN rail.

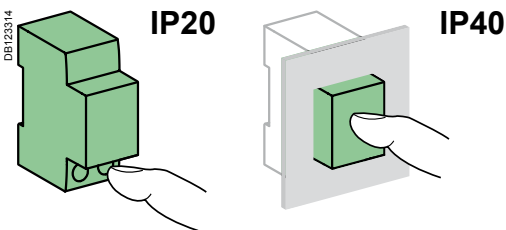

Technical data

Main characteristics		
According to IEC/EN 60947-2		
Insulation voltage (U _i)		690 V AC
Degree of pollution		3
Rated impulse withstand voltage (U _{imp})		8 kV
Thermal tripping	Reference temperature	40°C
Magnetic tripping (I _i)	MA curve	12 I _n ± 20 %
Utilization category		A
Additional characteristics		
Degree of protection (IEC 60529)	Device only	IP20
	Device in modular enclosure	IP40
Endurance (O-C)	Electrical	10,000 cycles
	Mechanical	20,000 cycles
Operating temperature		-30°C to +70°C
Storage temperature		-40°C to +70°C
Tropicalization (IEC 60068-1)		Treatment 2 (relative humidity of 95 % at 55°C)

NG125LMA circuit breakers (curve MA) (cont.)

Weight (g)

Circuit breaker	
Type	NG125LMA
2P	480
3P	720

Dimensions (mm)

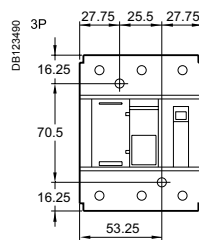
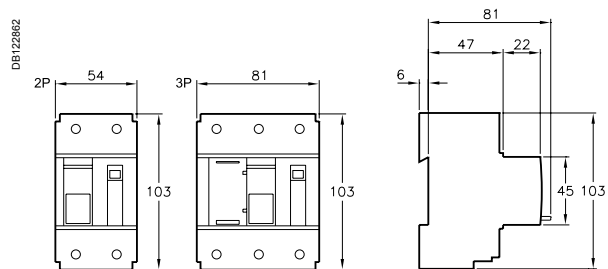

Spacing for mounting on panel

Protection Motor protection

NG125LMA circuit breakers (curve MA) (cont.)

056P16N_SE-90

DB123483

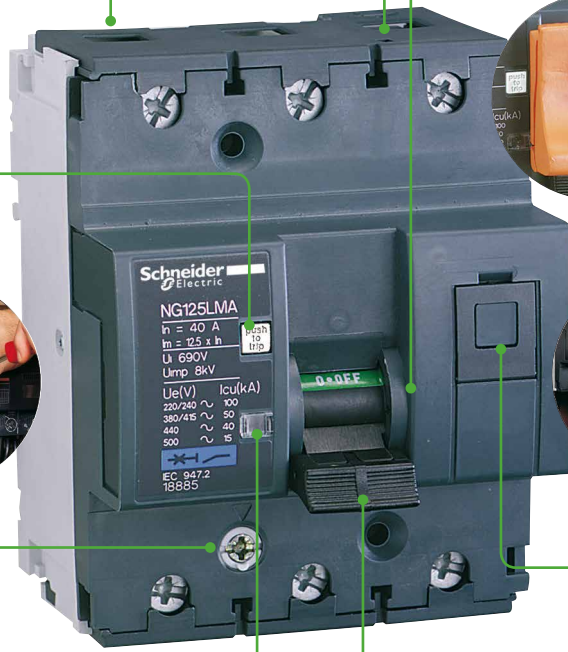

- Cable strength:
 - ribbed cage
 - terminal depth
 - tightening by Allen hex key (NG125 80 A)

- 3P 80 A**
- Voltage taps:
 - auxiliaries power supply
 - measurement
 - emergency stop
 - remote reporting

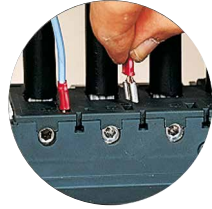

- Padlocking in position: O or I, manual control is inhibited, tripping is enabled

- Test button to check satisfactory operation of the tripping mechanism



- 3P**
- Pull-out strength:
 - metallic lock

- 3P**
- Integrated padlocking device

- Impact and vibration resistance:
 - high-strength enclosure
 - IK 05

- Central manual control, 3 positions:
 - ON
 - tripped on fault
 - open

- Circuit breaker tripped indicator

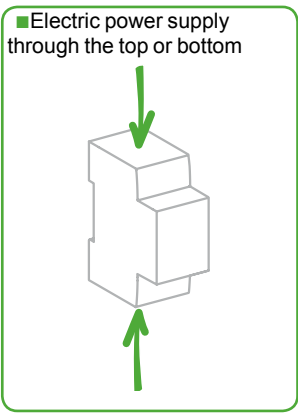

- Positive contact indication:
 - suitability for isolation in the industrial sector to IEC/EN 60947-2
 - the presence of the green strip guarantees that the contacts open physically and allows work to be carried out safely on the downstream circuit

- Longer product service life due to:
 - good overvoltage withstand capacity,
 - high limitation performances,
 - fast closure independent of the speed of actuation of the toggle.

Circuit protection

Tertiary sector, Industry

STI isolatable fuse-carriers



STI	Cartridges
IEC/EN 60947-3, IEC/EN 60269-2	IEC 60269-1, IEC 60269-2, NF C 60-200-2

- The STI isolatable fuse-carriers provide overload and short-circuit protection.
- They are used for tertiary and industrial applications requiring a high breaking capacity.
- They perform the isolation function and must not be used as switches.
- To be equipped with aM or gG (gL - gl) type fuse cartridge without striker, with or without fuse blowing indicator.







The general purpose fuse (**gG fuse**) provides overload and short-circuit protection. The fuse for motor application (**aM fuse**) only provides short-circuit protection. It is used for protection of loads with a high peak current (motors, transformer primaries, etc.).

Catalogue numbers

Fuse cartridge (Type F)

Type	Rating	Voltage rating (Ue)	Short-circuit current (Isc)			
			aM	gG	aM	gG
 8.5 x 31.5 mm	2 A	400 V AC	20 kA	20 kA	DF2BA0200	DF2BN0200
	4 A	400 V AC	20 kA	20 kA	DF2BA0400	DF2BN0400
	6 A	400 V AC	20 kA	20 kA	DF2BA0600	DF2BN0600
	8 A	400 V AC	20 kA	20 kA	DF2BA0800	DF2BN0800
	10 A	400 V AC	20 kA	20 kA	DF2BA1000	DF2BN1000
10.3 x 38 mm	2 A	500 V AC	120 kA	120 kA	DF2CA02	DF2CN02
	4 A	500 V AC	120 kA	120 kA	DF2CA04	DF2CN04
	6 A	500 V AC	120 kA	120 kA	DF2CA06	DF2CN06
	10 A	500 V AC	120 kA	120 kA	DF2CA10	DF2CN10
	16 A	500 V AC	120 kA	120 kA	DF2CA16	DF2CN16
	20 A	500 V AC	-	120 kA	-	DF2CN20
	25 A	500 V AC	-	120 kA	-	DF2CN25

STI fuse holder

Type	Network type				
	1P	1P+N	2P	3P	3P+N
 DB112797					
	8.5 x 31.5 mm	A9N15635	A9N15645	A9N15650	A9N15655
10.3 x 38 mm	A9N15636	A9N15646	A9N15651	A9N15656	A9N15658
Width in 9 mm module	2	2	4	6	6

STI isolatable fuse-carriers (cont.)

230 V neon indicator light (Option)

- Indicates fuse blowing (off in normal operation and lit red after fuse blowing)
- 400 V maxi

1P+N, 3P+N

- Phase opening causes compulsory opening of the neutral
- The phase opens before the neutral on isolation and closes after the neutral on circuit closing
- Small dimensions:
 - 1P+N in 18 mm
 - 3P+N in 54 mm

Clip-on markers

- Used to identify:
 - either on the front face
 - or on the downstream terminals

Padlocking device

- Locks the toggle in the "open" or "closed" position. Used with an 8 mm max. diameter padlock (not supplied):
 - only one padlock for 1P, 1P+N and 2P products (on the left pole)
 - and two padlocks on the 3P and 3P+N products (on every extremity)



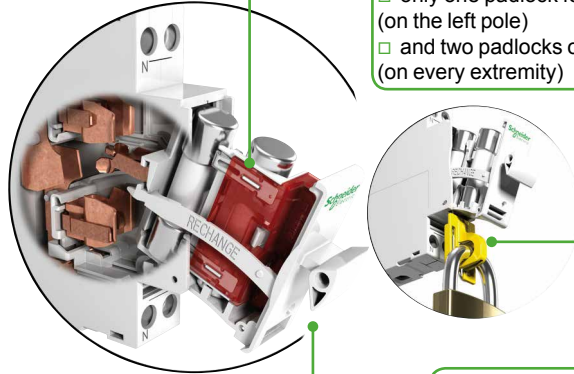

Fuse-carrier

- Captive
- Additional housing is provided for a spare fuse

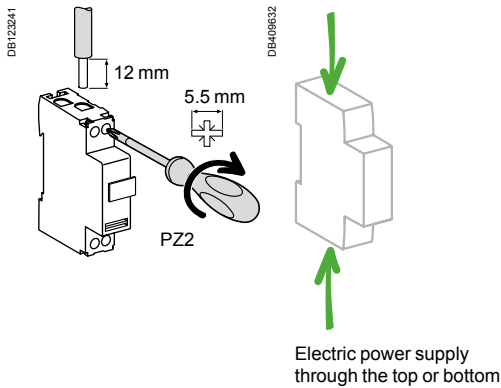

Connection



Tightening torque	Without accessory			With accessories
	Copper cables			Screw-on connection for ring terminal
	Rigid	Flexible with ferrule	without ferrule	
2 N.m	DB1123H45  0.75 to 10 mm ² 2 x 0.75 mm ² to 2 x 4 mm ²	DB1123F54  0.5 to 6 mm ² 2 x 0.5 mm ² to 2 x 4 mm ²	DB1123E53  1 to 6 mm ² 2 x 1 mm ² to 2 x 4 mm ²	DB1187E89  Ø 5 mm

1 Screw-on connection for ring terminal 27053

Mounting accessories

2	Comb busbar	See modules	CA907026, CA907027
3	Padlocking device		15669
4	Neon indicator light	1 piece blister	15668
5	Clip-on terminal markers	See module	CA907012

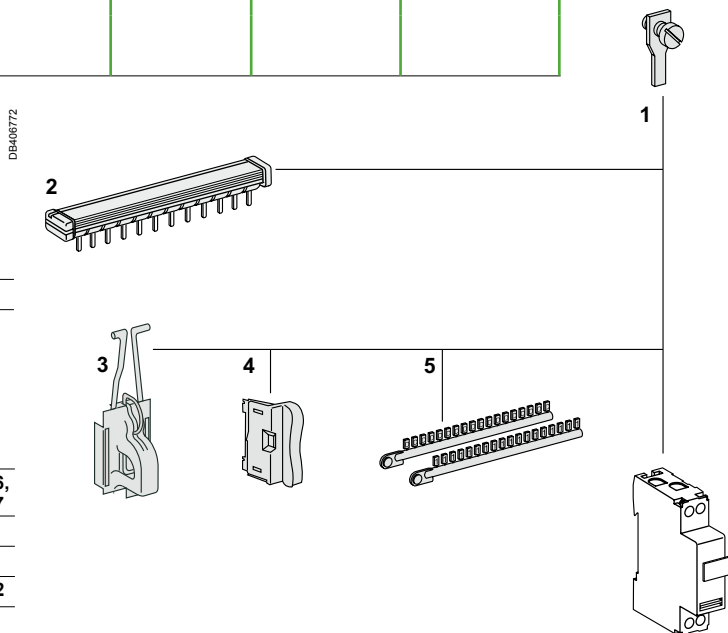

STI isolatable fuse-carriers (cont.)

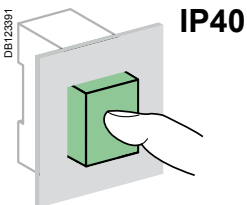
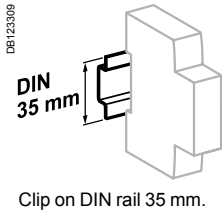

Technical data

Main characteristics	
Insulation voltage (Ui)	500 V
Breaking capacity according to IEC 60947-2 ≤ 400 V	8 kA
Pollution degree	3
Operating frequency	50/60 Hz

Additional characteristics		
Degree of protection	Device in modular enclosure	IP40
		Insulation class II
Operating temperature		-20°C to +60°C
Storage temperature		-40°C to +80°C

Maximum dissipated power per pole of STI isolatable fuse-carriers			
Fuse cartridge type		I _{th}	P _{max}
8.5 x 31.5 mm	aM	10 A	2.5 W
	gG	20 A	2.5 W
10.3 x 38 mm	aM	16 A	3 W
	gG	25 A	3 W

Maximum dissipated power per fuse cartridges			
Fuse cartridge type		I _{th}	P _{max}
8.5 x 31.5 mm	aM	2 to 10 A	0.9 W
	gG	2 to 10 A	2.5 W
10.3 x 38 mm	aM	2 to 25 A	1.2 W
	gG	2 to 25 A	3 W

Dimensions (mm)

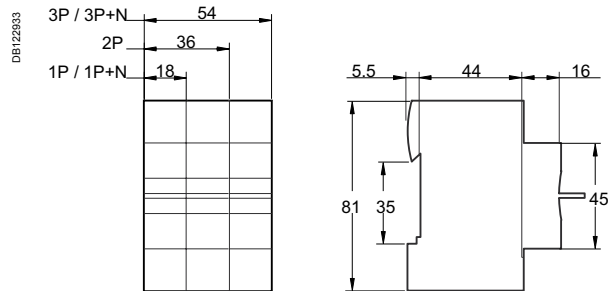

STI

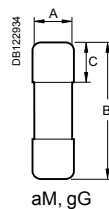

aM, gG

aM, gG fuse cartridge			
Type	A	B	C
8.5 x 31.5 mm	8.5	31.5	10.3
10.3 x 38 mm	10.3	38	10.5

D0 fuse disconnectors switches

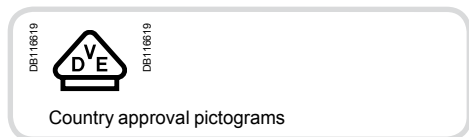

IEC/EN 60947-1, IEC/EN 60947-3, IEC 60269-1,
IEC 60269-3,
VDE 0660-100, VDE 0660-107



- The plug-in fuse switches disconnectors D01 and the switches disconnectors fuse D02 provide protection against overloads and short circuits.
- They are used for service sector and industrial applications.
- Depending on the versions, they should be provided with D01 or D02 type cartridges.

Accessories

- The D02 gauges allow you to limit the rating of the fuses, depending on the model used, from 20 A to 50 A.

Catalogue numbers

Fuse disconnectors switches								
Type	1P	1P+N	2P	3P	3P+N			
	D01	D01	D02	D02	D01	D02	D01	D02
	DB405042 1 2	DB405043 1 N 2 N	DB405438 1 N 2 N	DB405044 1 3 2 4	DB405045 1 3 5 2 4 6	DB405439 1 3 5 2 4 6	DB405046 1 3 5 N 2 4 6 N	DB405440 1 3 5 N 2 4 6 N
D01 fuse switches disconnectors								
Rating (In)								
10 A	-	MGN01610	-	-	-	MGN01710		
13 A	-	MGN01613	-	-	-	MGN01713		
16 A	-	MGN01616	-	-	MGN01316	MGN01716		
Width in 9 mm modules	-	4	-	-	6	8		
D02 switches disconnectors fuse								
Rating (In)								
63 A	MGN02163	MGN02663	MGN02263	MGN02363	MGN02763			
Width in 9 mm modules	3	6	6	9	12			



Accessories for D02 switches disconnectors fuse			
Type	Rating	Colour	
Fuse gauge	20 A	Blue	MGN09120
	25 A	Yellow	MGN09125
	32-35-40 A	Black	MGN09135
	50 A	White	MGN09150

D02 : Gauges

- These allow fitting of fuses from 20 A to 50 A

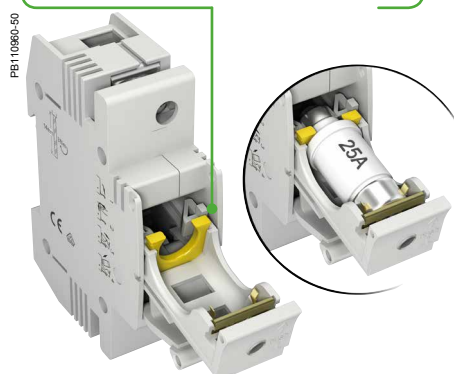

Connection

- Upstream/downstream by tunnel terminals
- For D01: by 18 mm forked comb busbar

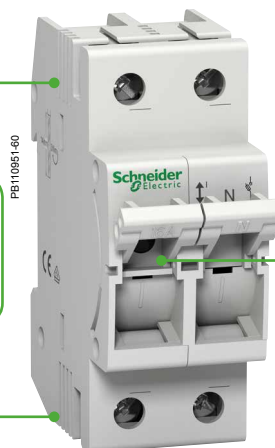

Blown-fuse indicator

D0 fuse disconnectors switches (cont.)

Connection

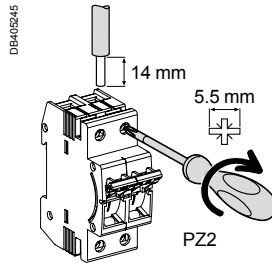

Type	Tightening torque	Copper cables	
		Rigid	Flexible or with ferrule
D01	2 N.m	1.5 to 25 mm ²	1.5 to 16 mm ²
D02	3 N.m	1.5 to 35 mm ²	1.5 to 25 mm ²

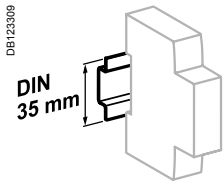

Clip on DIN rail 35 mm.

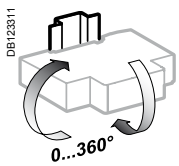

Indifferent position of installation.

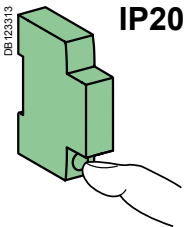

IP20

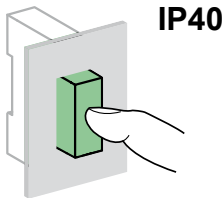

IP40

Technical data

Main characteristics		D01	D02
Operating voltage (Ue)		230/400 V AC	230/400 V AC 110 V DC (2P)
Operating frequency (Hz)		45-62 Hz	45-62 Hz
Service breaking capacity (Isc)		AC	50 kA
		DC	- 8 kA
Rated insulation voltage (Ui)		400 V	400 V
Rated impulse withstand voltage (Ui)		6000 V	6000 V
Utilization category (IEC 60947-3)		400 V AC	AC-22A
		110 V DC (2P)	- DC-22B (63 A)
		48 V DC (1P)	- DC-22A (63 A)
Endurance (O-C)		Electrical	1500 cycles
		Mechanical	10,000 cycles
Degree of protection		Device only	IP20
		Device in modular enclosure	IP40
Operating temperature		-5°C to +40°C	
Storage temperature		-25°C to +55°C	

Additional characteristics

Dimensions (mm)

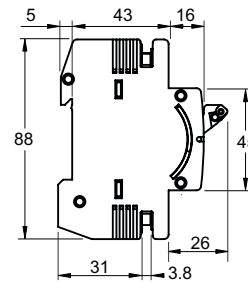
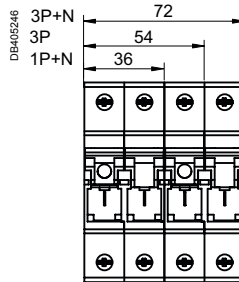

D01 fuse switches disconnectors

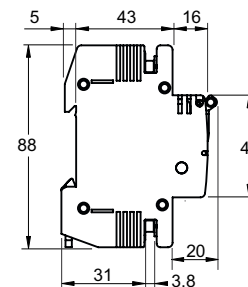
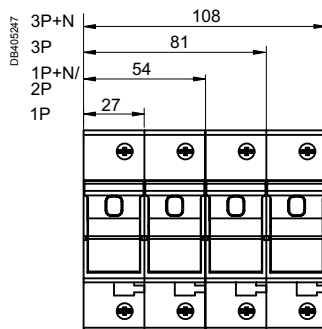

D02 switches disconnectors fuse

Circuit protection

Tertiary sector, Industry

SBI fuse holder with indicator light

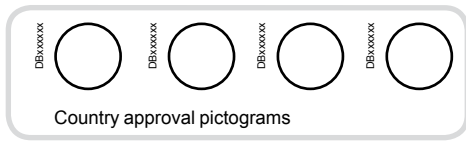

IEC EN 60947-3



MGN15707



MGN15712



MGN15714



MGN15718

- SBI fuse holders provide overload and short-circuit protection.
- They are used for industrial applications requiring a high breaking capacity.
- They perform the isolation function and must not be used as switches.
- They are equipped with an indicator light indicating blowing of the fuse cartridge: to be equipped with aM or gG (gL-gI) type fuse cartridge without striker. The general purpose fuse (gG fuse) provides overload and short-circuit protection. The fuse for motor application (**aM fuse**) only provides short-circuit protection. It is used for protection of loads with a high peak current (motors, transformer primaries, etc.).

Catalogue numbers

Fuse cartridge					SBI fuse holder							
Type	Rating	Voltage rating (Ue)	Short-circuit current (Isc)		Network type							
			aM	gG	aM	gG	N	1P	1P+N ⁽¹⁾	2P	3P	3P+N ⁽¹⁾
14 x 51 mm 	10 A	690 V CA	120 kA	120 kA	DF2EA10	DF2EN10	MGN15708	MGN15707	MGN15709	MGN15710	MGN15711	MGN15712
	12 A	690 V CA	120 kA	-	DF2EA12	-						
	16 A	690 V CA	120 kA	120 kA	DF2EA16	DF2EN16						
	20 A	690 V CA	120 kA	120 kA	DF2EA20	DF2EN20						
	25 A	690 V CA	120 kA	120 kA	DF2EA25	DF2EN25						
	32 A	500 V CA	120 kA	120 kA	DF2EA32	DF2EN32						
	40 A	500 V CA	120 kA	120 kA	DF2EA40	DF2EN40						
	50 A	400 V CA	120 kA	120 kA	DF2EA50	DF2EN50						
22 x 58 mm	32 A	690 V CA	80 kA	80 kA	DF2FA32	DF2FN32	MGN15714	MGN15713	MGN15715	MGN15716	MGN15717	MGN15718
	40 A	690 V CA	80 kA	80 kA	DF2FA40	DF2FN40						
	50 A	690 V CA	80 kA	80 kA	DF2FA50	DF2FN50						
	63 A	690 V CA	80 kA	80 kA	DF2FA63	DF2FN63						
	80 A	690 V CA	80 kA	80 kA	DF2FA80	DF2FN80						
	100 A	400 V CA	120 kA	120 kA	DF2FA100	DF2FN100						
	125 A	400 V CA	120 kA	-	DF2FA125	-						

Operating frequency: 50/60 Hz

(1) The neutral pole comes equipped with a locked tube.

Circuit protection Tertiary sector, Industry

SBI fuse holder with indicator light (cont.)

Connection

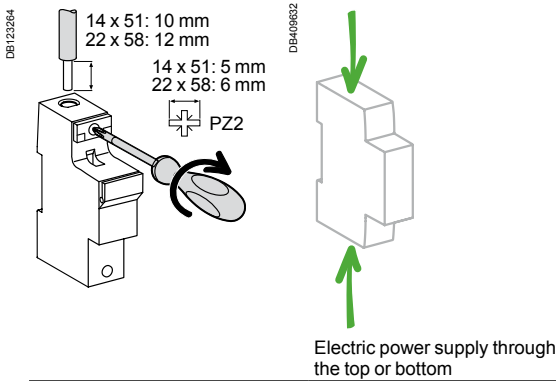

Type of fuse cartridge	Tightening torque	Copper cables		Multi-cables terminal	
		Rigid	Flexible or with ferrule	Rigid cables	Flexible cables
	DB122545				
14 x 51 mm	3.5 N.m	2.5 to 25 mm ²	2.5 to 25 mm ²	2.5 to 10 mm ²	2.5 to 10 mm ²
22 x 58 mm	3.5 N.m	2.5 to 35 mm ²	2.5 to 35 mm ²	2.5 to 25 mm ²	2.5 to 16 mm ²

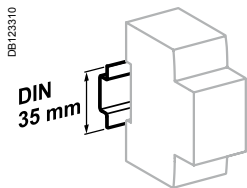

Clip on DIN rail 35 mm.

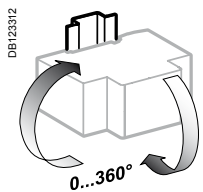

Indifferent position of installation.

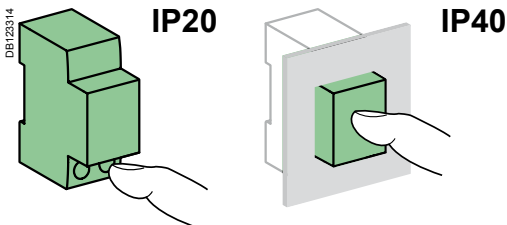

Technical data

Main characteristics	
Insulation voltage (U _i)	690 V
Utilization category	AC20B isolation by switching the drawer, must not be operated under load

Additional characteristics	
Degree of protection	Device only: IP20 Device in modular enclosure: IP40
Operating temperature	-20°C to +60°C
Storage temperature	-40°C to +80°C
Cartridge blowing signalling	By indicator light ON (neon)

Maximum permissible characteristics of the fuse cartridges:

Fuse cartridge type		I _{th}	P _{max} *
14 x 51 mm	aM	50 A	3 W
	gG	50 A	5 W
22 x 58 mm	aM	125 A	9.5 W
	gG	100 A	9.5 W

*P_{max}: maximum dissipated power per fuse cartridge.

SBI fuse holder with indicator light (cont.)

Dimensions (mm)

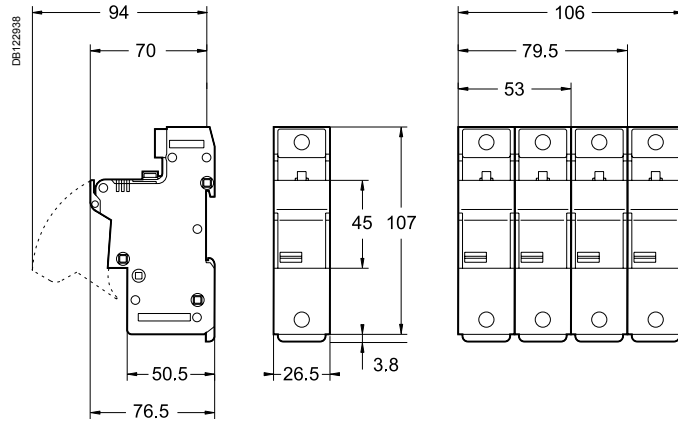

14 x 51 mm

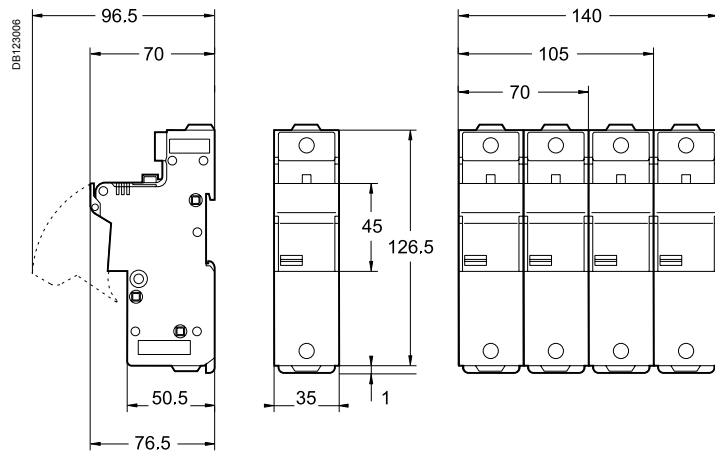

22 x 58 mm

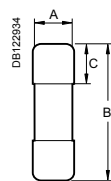

aM, gG

aM, gG fuse cartridge			
Type	A	B	C
14 x 51 mm	14.3	51	13.8
22 x 58 mm	22.2	58	16.2

Choice of earth leakage protection devices



Choice of sensitivity

The sensitivity of an earth leakage protection device depends mainly on the function it has to perform:

- Protection from electric shock by direct contact.
- Protection from electric shock by indirect contact.
- Protection from fire due to current leakage.

The following table gives a reminder of:

- The circuits that must be protected against these various risks (obligation or recommendation).
- The type of earth leakage protection device to be used in each case, its sensitivity, and its location in the distribution diagram.

Type of protection	Standard requirements		Additional Schneider Electric recommendations	Sensitivity (I Δ n)		
	National standard <i>To be filled in according to the country standard</i>	International standard IEC 60364		30 mA (*)	100 mA to 3000 mA (depending on the earthing system)	300 mA (or 500 mA)
Protection from electric shock by direct contact						
 DB123167	To be filled in according to the country standard	Power supply for <ul style="list-style-type: none"> ■ General-purpose power sockets, up to 20 A ■ Appliances in the vicinity of a bathtub, shower, pond or swimming pool ■ Portable appliances for outdoor use, up to 32 A ■ Lighting To be modified according to national obligations (above)	None	Setup in final distribution switchboard <ul style="list-style-type: none"> ■ Residual current device protecting a circuit ■ Residual current circuit breaker protecting a group of circuits 		
Protection from electric shock by indirect contact						
 DB123168	To be filled in according to the country standard	The entire power distribution system, except for devices: <ul style="list-style-type: none"> ■ With class II insulation ■ Operating at Safety Extra Low Voltage (class III) To be modified according to national obligations (above)	None	If ground continuity is not ensured over the time	Setup in final distribution switchboard <ul style="list-style-type: none"> ■ Residual current circuit breaker or device, on incoming feeder Setup in subdistribution board or main switchboard <ul style="list-style-type: none"> ■ Residual current device protecting a circuit ■ Residual current device or circuit breaker protecting a group of circuits ■ On incoming feeder: residual current circuit breaker or device 	
Protection from fire due to current leakage						
 DB123169	To be filled in according to the country standard	<ul style="list-style-type: none"> ■ High-risk premises: <ul style="list-style-type: none"> □ explosion (BE3) □ fire (BE2) ■ Agricultural and horticultural buildings ■ Equipment for fairs, exhibitions and shows ■ Temporary outdoor recreational installations To be modified according to national obligations (above)	<ul style="list-style-type: none"> ■ Dilapidated buildings or electrical installations ■ Humid atmospheres: agricultural buildings, public swimming pools ■ Presence of chemical agents 		Setup in final distribution switchboard <ul style="list-style-type: none"> ■ Residual current circuit breaker or device, on incoming feeder Setup in subdistribution board or main switchboard <ul style="list-style-type: none"> ■ Residual current device protecting each circuit to a high-risk zone ■ Residual current device or circuit breaker protecting a group of circuits ■ On incoming feeder: residual current circuit breaker or device 	

(*) The 10 mA sensitivity is useful for certain very specific applications, where there is a risk that someone could sustain a non-dangerous current (10 to 30 mA) without being able to get free. Example: healthcare equipment for hospital beds. Generally, devices with this very high sensitivity are liable to cause frequent tripping, due to the natural leakage currents of the installation.

Choice of earth leakage protection devices (cont.)

Interference immunity

Schneider Electric provides various equipment technologies capable of overcoming the consequences of interference of all kinds.

Operating conditions		Examples	Types					
			AC	A	A-SI	F	B	
Loads								
	With no special characteristics	<ul style="list-style-type: none"> General-purpose power sockets Incandescent lighting Household appliances: microwave oven, dishwasher, clothes dryer Electric heating, water heater 	■	■	■	■	■	
	Including a rectifier	Single phase	<ul style="list-style-type: none"> Household appliances: induction cooking appliances, washing machines (variable speed) Single-phase variable speed drives 	-	■	■	■	■
		Three phase	<ul style="list-style-type: none"> Three-phase variable speed industrial drives Three-phase uninterruptible power supplies 	-	-	-	-	■
	Generating high-frequency interference (current peaks, harmonics)	<ul style="list-style-type: none"> Fluorescent lighting powered by extra low voltage transformer, by electronic ballast Variable luminosity lighting Powerful IT equipment Single-phase variable speed industrial drives Air conditioning Telecommunications equipment Capacitor banks 	-	-	■	■	■	
Including an anti-harmonic filter in the power supply	<ul style="list-style-type: none"> Microcomputer systems Computer peripherals (printers, scanners, etc.) 	-	-	■	-	■		
Electrical environment								
	Vicinity of equipment generating transient overvoltages	<ul style="list-style-type: none"> High-powered switching devices Reactive energy compensation banks 	-	-	■	■	■	
	Circuits powered by an uninterruptible power supply "Isolated neutral" (IT) earthing system	<ul style="list-style-type: none"> Backed-up networks 	-	-	■	-	■	
	Major risk of lightning strokes	<ul style="list-style-type: none"> Buildings protected by a lightning protection system Mountainous or humid regions Regions with high keraunic level 	-	-	■	■	■	
Atmosphere								
	Ambient temperature which could be less than -5°C	-	-	■	■	■	■	
	Severe environments whose code varies between AF2 and AF4 according to IEC 60364-5-51	<ul style="list-style-type: none"> Indoor swimming pools Yacht harbours, marinas, camping grounds Water treatment Chemical industries, heavy industries, paper mills Mines and cellars, road tunnels Markets, stock raising, food processing industries 	-	-	■ (1)	-	-	

(1) Atmospheres with high concentrations of chemicals or dust: see tables 1 and 2 in the CA908015E catalog module for description of corrosive atmosphere classes and appropriate additional protection.





Selectivity

Residual current devices of average sensitivity (100 mA and more) are available in a selective (S) and delayed (R) version. This option ensures that, in the event of an earth fault downstream of the installation, only the defective part is switched off. The table below shows (in green) which upstream/downstream equipment combinations provide this selectivity.

Sensitivity (mA) - Downstream		Sensitivity (mA) - Upstream												
		Instantaneous						Selective S			Delayed R			
		30	100	300	500	1000	3000	100	300	500	1000	3000	1000	3000
	Instantaneous	30	-	-	-	-	-	-	-	-	-	-	-	-
		100	-	-	-	-	-	-	-	-	-	-	-	-
		300	-	-	-	-	-	-	-	-	-	-	-	-
		500	-	-	-	-	-	-	-	-	-	-	-	-
		1000	-	-	-	-	-	-	-	-	-	-	-	-
		3000	-	-	-	-	-	-	-	-	-	-	-	-
Selective S	100	-	-	-	-	-	-	-	-	-	-	-	-	
	300	-	-	-	-	-	-	-	-	-	-	-	-	
	500	-	-	-	-	-	-	-	-	-	-	-	-	
	1000	-	-	-	-	-	-	-	-	-	-	-	-	
	3000	-	-	-	-	-	-	-	-	-	-	-	-	
Delayed R	1000	-	-	-	-	-	-	-	-	-	-	-	-	
	3000	-	-	-	-	-	-	-	-	-	-	-	-	

Overview of the earth leakage protection product range

Selection guide

Type		Residual current circuit breakers			
		iID K	iID	RCCB-ID 125 A	RCCB-ID type B
					
Standards		IEC/EN 61008	IEC/EN 61008	IEC/EN 61008-1 and VDE 0664	IEC/EN 61008 and VDE 0664
Voltage (V)	Ue	230/400	110/230 230/400	230/400	230/400
Number of poles	1P+N	–	–	–	–
	2P	■	■	■	–
	3P	–	–	–	–
	4P	■	■	■	■
Type	AC	■	–	■	–
	A	–	■	■	–
	S/I	–	–	■	–
	B	–	–	–	■
Impulse voltage (kV)	Uimp	4	6	4	4
Insulation voltage (V)	Ui	440	500	500	400
Current rating (A)	In	25 - 40 - 63	63	16 to 100	125
Frequency (Hz)		50/60	50	50	50
Rated breaking capacity (A)	Icn	–	–	–	–
Rated conditional short-circuit current	Inc	4500	10000	10000	10000
Rated residual breaking and making capacity (A)	(IΔm)	10 In (500 A min.)	1500	1500	1250
Sensitivity (mA)	(IΔn)				
	10	–	–	■	–
	30	■	■	■	■
	100	–	–	■	–
	300	■	–	■	■
	500	–	–	■	■
	1000	–	–	–	–
	3000	–	–	–	–
	300 \square	–	–	■	■
	500 \square	–	–	–	–
1000 \square	–	–	–	–	
3000 \square	–	–	–	–	
Electrical characteristics					
Curves	B	–	–	–	–
	C	–	–	–	–
	D	–	–	–	–
	L	–	–	–	–
	K	–	–	–	–
	MA	–	–	–	–
For more details, see module		CA902007	CA902002	CM902001	CM902002
Accessories	–	–	CA907000, CA907001	CM902001	CM902002
Auxiliaries	–	–	CA907000, CA907002	CM902001	CM902002

Inc: rated conditional short-circuit current

Value of the alternating component of the prospective current that a residual current circuit breaker protected by an appropriate short-circuit protective device (SCPD) mounted in series can withstand in specified conditions of use.

IΔc: rated residual short-circuit current

Value of the alternating component of the prospective residual current that a residual current circuit breaker protected by an appropriate short-circuit protective device (SCPD) mounted in series can withstand in specified conditions of use.

Im: rated making and breaking capacity

Value of the alternating component of the prospective current that a residual current circuit breaker is capable of establishing or interrupting in specified conditions of use.

IΔm: rated making and breaking capacity

Value of the alternating component of the prospective residual current that a residual current circuit breaker is capable of establishing and withstanding during its opening time and interrupting in specified conditions of use and behaviour.

SCPD

Short-circuit protective device (a fuse in the case of our markings): this is the max. fuse that can be used to resist the value $I_{nc} = I_{\Delta c}$.

Protection

Earth leakage protection

Overview of the earth leakage protection product range (cont.)

Selection guide

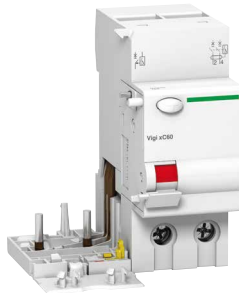
Type		Residual current circuit breakers	Add-on residual current devices
		xID	Vigi xC60
			
		PB11081F-3E	PB11082C-40
Standards		IEC/EN 61008	IEC/EN 61009
Voltage (V)	Ue	230/400	230/400
Number of poles	1P+N	–	–
	2P	■	■
	3P	–	–
	4P	■	■
Type	AC	■	■
	A	–	–
	S/I	■	–
	B	–	–
Impulse voltage (kV)	Uimp	6	6
Insulation voltage (V)	Ui	440	500
Current rating (A)	In	25 - 40 - 63 - 80	25 - 63
Frequency (Hz)		50/60	50/60
Rated breaking capacity (A)	Icn	–	–
Rated conditional short-circuit current	Icn	10,000	–
Rated residual breaking and making capacity (A)	(Δm)	10 In (500 A min.)	–
Curve		–	–
Sensitivity (mA)	(Δn)	–	–
	10	–	–
	30	■	■
	100	■	■
	300	■	■
	500	–	–
	1000	–	–
	3000	–	–
	300 \square	■	–
	500 \square	–	–
	1000 \square	–	–
3000 \square	–	–	
Electrical characteristics			
Curves	B	–	Depending on circuit breaker used
	C	–	
	D	–	
	L	–	
	K	–	
	MA	–	
For more details, see module		CA902028	CA902029
Accessories		CA907012	CA907012
Auxiliaries		CA907008	CA907008



Protection

Earth leakage protection

iID

Contents

Schneider Electric's range of residual current circuit breakers consists of different products (A, B, C, D) to enable it to be the most competitive range possible in each country, allowing for the special characteristics of each market:

- usual installation procedure
- price
- accreditations by local bodies.

Variants

Offers		Pages
Offer A	Catalogue numbers	150
Offer B	Catalogue numbers	153
Offer C	Catalogue numbers	156
Offer D	Catalogue numbers	159
Common pages		162

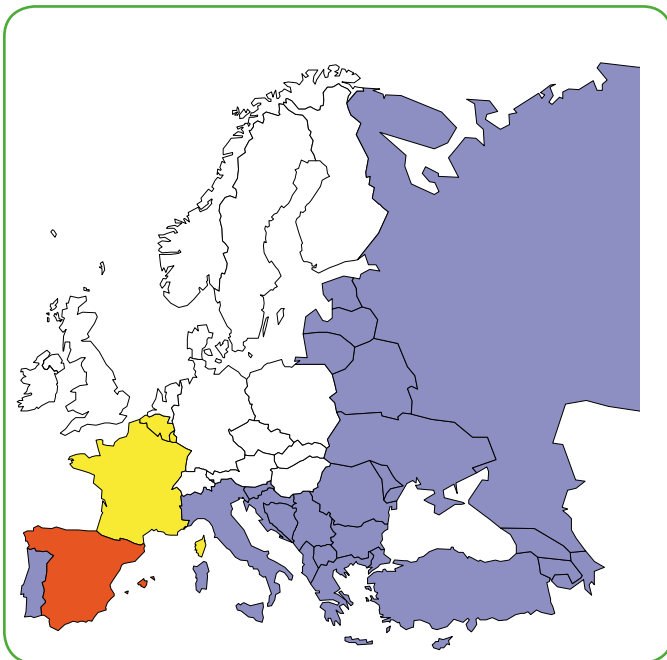

Only the product range to be marketed in your country and validated by the local product manager, in agreement with his Final Distribution (FD) partner should be retained. The others will be removed before publication.

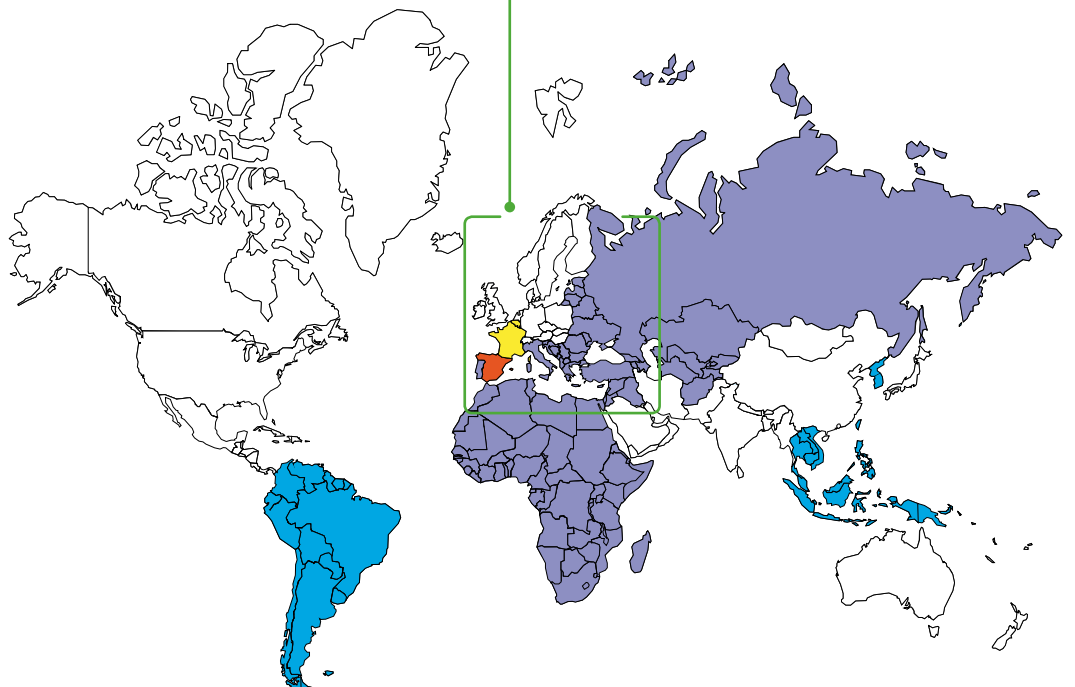

Protection Earth leakage protection iID residual current circuit breakers (AC type)



IEC/EN 61008-1



- The iID residual current circuit breakers provide:
 - protection of persons against electric shock by direct contact (≤ 30 mA),
 - protection of persons against electric shock by indirect contact (≥ 100 mA),
 - protection of installations against the risk of fire (300 mA or 500 mA).

Offer selection see page 149

Offer A

This sticker must be removed before publishing

Catalogue numbers

iID residual current circuit breakers for 230/400 V network

Type	AC								Width in 9 mm module
Auxiliaries	Module CA907002								
2P	Sensitivity	10 mA	30 mA	100 mA	300 mA	500 mA	300 mA 	500 mA 	
	Rating	16 A	A9R10216	-	-	-	-	-	4
		25 A	A9R10225	A9R11225	-	A9R14225	A9R16225	-	
		40 A	-	A9R11240	A9R12240	A9R14240	A9R16240	-	
		63 A	-	A9R11263	A9R12263	A9R14263	A9R16263	A9R15263	
		80 A	-	A9R11280	A9R12280	A9R14280	-	A9R15280	
		100 A	-	A9R11291	A9R12291	A9R14291	-	A9R15291	
4P	Sensitivity	10 mA	30 mA	100 mA	300 mA	500 mA	300 mA 	500 mA 	
	Rating	25 A	-	A9R11425	-	A9R14425	A9R16425	-	8
		40 A	-	A9R11440	A9R12440	A9R14440	A9R16440	A9R15440	
		63 A	-	A9R11463	A9R12463	A9R14463	A9R16463	A9R15463	
		80 A	-	A9R11480	A9R12480	A9R14480	A9R16480	A9R15480	
		100 A	-	A9R11491	A9R12491	A9R14491	-	A9R15491	
Voltage rating (Ue)	2P	230 - 240 V							
	4P	400 - 415 V							
Operating frequency	50/60 Hz								
Accessories	Module CA907000 and CA907001								

Protection Earth leakage protection iID residual current circuit breakers (A type)

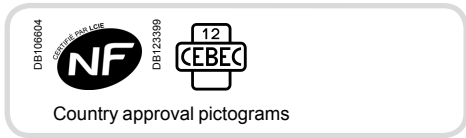

IEC/EN 61008-1



- The iID residual current circuit breakers provide:
 - protection of persons against electric shock by direct contact (≤ 30 mA),
 - protection of persons against electric shock by indirect contact (≥ 100 mA),
 - protection of installations against the risk of fire (300 mA or 500 mA).

Catalogue numbers

iID residual current circuit breakers for 230/400 V network

Type	A		Module CA907002						Width in 9 mm module
Auxiliaries	Module CA907002								
2P	Rating	Sensitivity	10 mA	30 mA	100 mA	300 mA	500 mA	300 mA	
	16 A	A9R20216	-	-	-	-	-	-	4
	25 A	A9R20225	A9R01225	-	-	A9R04225	-	-	
	40 A	-	A9R01240	-	-	A9R04240	-	A9R05240	
	63 A	-	A9R01263	-	-	A9R04263	-	A9R05263	
	100 A	-	A9R01291	-	-	A9R04291	-	A9R05291	
	25 A	-	A9R01425	-	-	A9R04425	-	-	8
	40 A	-	A9R01440	A9R22440	-	A9R04440	A9R26440	A9R05440	
	63 A	-	A9R01463	A9R22463	-	A9R04463	A9R26463	A9R05463	
	80 A	-	A9R21480	-	-	A9R24480	-	A9R25480	
	100 A	-	A9R01491	-	-	A9R04491	A9R26491	A9R05491	
Voltage rating (Ue)	2P	230 - 240 V							
	4P	400 - 415 V							
Operating frequency	50/60 Hz								
Accessories	Module CA907000 and CA907001								

iID residual current circuit breakers for 110/230 V network

Type	A		Module CA907002		Width in 9 mm module
Auxiliaries	Module CA907002				
2P	Rating	Sensitivity	30 mA		
	63 A	A9R08263			4
	63 A	A9R08463			8
Voltage rating (Ue)	2P	110 V			
	4P	230 V			
Operating frequency	50/60 Hz				
Accessories	Module CA907000 and CA907001				

Offer selection see page 149

Offer A

This sticker must be removed before publishing

Protection Earth leakage protection iLD residual current circuit breakers (SI type)



IEC/EN 61008-1



- The iLD residual current circuit breakers provide:
 - protection of persons against electric shock by direct contact (≤ 30 mA),
 - protection of persons against electric shock by indirect contact (≥ 300 mA),
 - protection of installations against the risk of fire (300 mA or 500 mA).

The **SI** type provides increased immunity from electrical interference and polluted or corrosive environments.



Offer selection see page 149

Offer A

This sticker must be removed before publishing

Catalogue numbers

iLD residual current circuit breakers for 230/400 V network

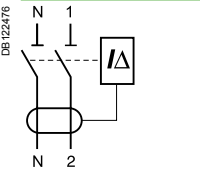
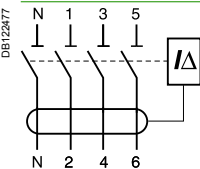
Type		SI 					Width in 9 mm module
Auxiliaries		Module CA907002					
2P		Sensitivity	10 mA	30 mA	300 mA	300 mA 	500 mA 
	Rating	16 A	-	-	-	-	4
		25 A	A9R30225	A9R31225	-	-	-
		40 A	-	A9R31240	-	A9R35240	-
		63 A	-	A9R31263	-	A9R35263	-
		100 A	-	-	-	A9R35291	-
	Rating	25 A	-	A9R31425	-	-	8
		40 A	-	A9R31440	-	A9R35440	A9R37440
		63 A	-	A9R31463	A9R34463	A9R35463	A9R37463
		80 A	-	A9R31480	-	A9R35480	A9R37480
		100 A	-	A9R31491	A9R34491	A9R35491	-
Voltage rating (Ue)		2P	230 - 240 V				
		4P	400 - 415 V				
Operating frequency		50/60 Hz					
Accessories		Module CA907000 and CA907001					

Protection Earth leakage protection iLD residual current circuit breakers (AC type)

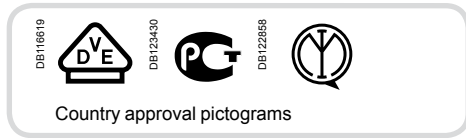

IEC/EN 61008-1



- The iLD residual current circuit breakers provide:
 - protection of persons against electric shock by direct contact (≤ 30 mA),
 - protection of persons against electric shock by indirect contact (≥ 100 mA),
 - protection of installations against the risk of fire (300 mA or 500 mA).

Offer selection see page 149

Offer B

This sticker must be removed before publishing

Catalogue numbers

iLD residual current circuit breakers for 230/400 V network									
Type	AC								Width in 9 mm module
Auxiliaries	Module CA907002								
2P	Sensitivity	10 mA	30 mA	100 mA	300 mA	500 mA	300 mA	500 mA	
	Rating	16 A	A9R10216	-	-	-	-	-	4
		25 A	A9R10225	A9R41225	-	A9R44225	A9R16225	-	
		40 A	-	A9R41240	A9R12240	A9R44240	A9R16240	-	
		63 A	-	A9R41263	A9R12263	A9R44263	A9R16263	A9R15263	
		80 A	-	A9R11280	A9R12280	A9R14280	-	A9R15280	
		100 A	-	A9R11291	A9R12291	A9R14291	-	A9R15291	
	Rating	25 A	-	A9R41425	-	A9R44425	A9R16425	-	8
		40 A	-	A9R41440	A9R12440	A9R44440	A9R16440	A9R15440	
		63 A	-	A9R41463	A9R12463	A9R44463	A9R16463	A9R15463	
		80 A	-	A9R11480	A9R12480	A9R14480	A9R16480	A9R15480	
		100 A	-	A9R11491	A9R12491	A9R14491	-	A9R15491	
Voltage rating (Ue)	2P	230 - 240 V							
	4P	400 - 415 V							
Operating frequency	50/60 Hz								
Accessories	Module CA907000 and CA907001								

Protection Earth leakage protection iID residual current circuit breakers (A type)

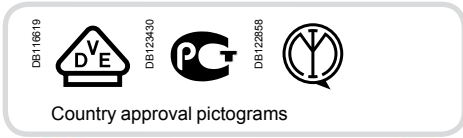

IEC/EN 61008-1

- The iID residual current circuit breakers provide:
 - protection of persons against electric shock by direct contact (≤ 30 mA),
 - protection of persons against electric shock by indirect contact (≥ 100 mA),
 - protection of installations against the risk of fire (300 mA or 500 mA).

Catalogue numbers

iID residual current circuit breakers for 230/400 V network

Type	A							Width in 9 mm module	
Auxiliaries	Module CA907002								
2P	Sensitivity	10 mA	30 mA	100 mA	300 mA	500 mA	300 mA		
	Rating	16 A	A9R20216	-	-	-	-	4	
		25 A	A9R20225	A9R21225	-	-	A9R24225		
		40 A	-	A9R21240	-	-	A9R24240		
		63 A	-	A9R21263	-	-	A9R24263		
		100 A	-	A9R21291	-	-	A9R24291		
	Rating	25 A	-	A9R21425	-	A9R24425	-	8	
		40 A	-	A9R21440	A9R22440	A9R24440	A9R26440		
		63 A	-	A9R21463	A9R22463	A9R24463	A9R26463		
		80 A	-	A9R21480	-	A9R24480	-		
		100 A	-	A9R21491	-	A9R24491	A9R26491		
Voltage rating (Ue)	2P	230 - 240 V							
	4P	400 - 415 V							
Operating frequency	50/60 Hz								
Accessories	Module CA907000 and CA907001								

iID residual current circuit breakers for 110/230 V network

Type	A		Width in 9 mm module
Auxiliaries	Module CA907002		
2P	Sensitivity	30 mA	
	Rating	63 A	A9R08263
	Rating	63 A	A9R08463
Voltage rating (Ue)	2P	110 V	
	4P	230 V	
Operating frequency	50/60 Hz		
Accessories	Module CA907000 and CA907001		

Offer selection see page 149

Offer B

This sticker must be removed before publishing

Protection Earth leakage protection iID residual current circuit breakers (SI type)

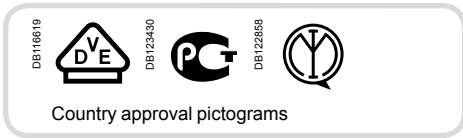

IEC/EN 61008-1



- The iID residual current circuit breakers provide:
 - protection of persons against electric shock by direct contact (≤ 30 mA),
 - protection of persons against electric shock by indirect contact (≥ 300 mA),
 - protection of installations against the risk of fire (300 mA or 500 mA).

The **SI** type provides increased immunity from electrical interference and polluted or corrosive environments.



Catalogue numbers

iID residual current circuit breakers for 230/400 V network								
Type	SI						Width in 9 mm module	
Auxiliaries	Module CA907002							
2P 	Sensitivity Rating	10 mA	30 mA	300 mA	300 mA	500 mA	4	
		16 A	-	-	-	-		-
		25 A	A9R30225	A9R61225	-	-		-
		40 A	-	A9R61240	-	A9R35240		-
		63 A	-	A9R61263	-	A9R35263		-
		100 A	-	-	-	A9R35291		-
4P 	Sensitivity Rating	10 mA	30 mA	300 mA	300 mA	500 mA	8	
		25 A	-	A9R61425	-	-		-
		40 A	-	A9R61440	-	A9R35440		A9R37440
		63 A	-	A9R61463	A9R34463	A9R35463		A9R37463
		80 A	-	A9R31480	-	A9R35480		A9R37480
		100 A	-	A9R31491	A9R34491	A9R35491		-
Voltage rating (Ue)	2P	230 - 240 V						
	4P	400 - 415 V						
Operating frequency	50/60 Hz							
Accessories	Module CA907000 and CA907001							

Protection Earth leakage protection iID residual current circuit breakers (AC type)

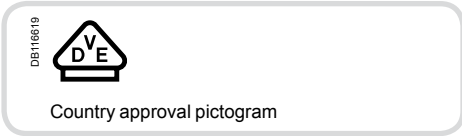

IEC/EN 61008-1



- The iID residual current circuit breakers provide:
 - protection of persons against electric shock by direct contact (≤ 30 mA),
 - protection of persons against electric shock by indirect contact (≥ 100 mA),
 - protection of installations against the risk of fire (300 mA or 500 mA).

Offer selection see page 149

Offer C

This sticker must be removed before publishing

Catalogue numbers

iID residual current circuit breakers for 230/400 V network									
Type	AC								Width in 9 mm module
Auxiliaries	Module CA907002								
2P	Sensitivity	10 mA	30 mA	100 mA	300 mA	500 mA	300 mA	500 mA	
	Rating	16 A	A9R10216	-	-	-	-	-	4
		25 A	A9R10225	A9R71225	-	A9R74225	A9R16225	-	
		40 A	-	A9R71240	A9R12240	A9R74240	A9R16240	-	
		63 A	-	A9R71263	A9R12263	A9R74263	A9R16263	A9R15263	-
		80 A	-	A9R11280	A9R12280	A9R14280	-	A9R15280	-
		100 A	-	A9R11291	A9R12291	A9R14291	-	A9R15291	-
	Rating	25 A	-	A9R71425	-	A9R74425	A9R16425	-	8
		40 A	-	A9R71440	A9R12440	A9R74440	A9R16440	A9R15440	A9R17440
		63 A	-	A9R71463	A9R12463	A9R74463	A9R16463	A9R15463	A9R17463
		80 A	-	A9R11480	A9R12480	A9R14480	A9R16480	A9R15480	A9R17480
		100 A	-	A9R11491	A9R12491	A9R14491	-	A9R15491	-
Voltage rating (Ue)	2P	230 - 240 V							
	4P	400 - 415 V							
Operating frequency	50/60 Hz								
Accessories	Module CA907000 and CA907001								

Protection Earth leakage protection iID residual current circuit breakers (A type)

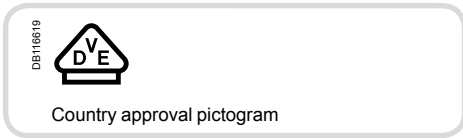

IEC/EN 61008-1

- The iID residual current circuit breakers provide:
 - protection of persons against electric shock by direct contact (≤ 30 mA),
 - protection of persons against electric shock by indirect contact (≥ 100 mA),
 - protection of installations against the risk of fire (300 mA or 500 mA).

Catalogue numbers

iID residual current circuit breakers for 230/400 V network										
Type	A								Width in 9 mm module	
Auxiliaries	Module CA907002									
2P	Sensitivity	10 mA	30 mA	100 mA	300 mA	500 mA	300 mA			
	Rating	16 A	A9R20216	-	-	-	-	-	4	
		25 A	A9R20225	A9R51225	-	-	A9R54225	-		
		40 A	-	A9R51240	-	-	A9R54240	-	A9R25240	
		63 A	-	A9R51263	-	-	A9R54263	-	A9R25263	
		100 A	-	A9R21291	-	-	A9R24291	-	A9R25291	
	Rating	25 A	-	A9R51425	-	-	A9R54425	-	8	
		40 A	-	A9R51440	A9R22440	-	A9R54440	A9R26440	A9R25440	
		63 A	-	A9R51463	A9R22463	-	A9R54463	A9R26463	A9R25463	
		80 A	-	A9R21480	-	-	A9R24480	-	A9R25480	
		100 A	-	A9R21491	-	-	A9R24491	A9R26491	A9R25491	
Voltage rating (Ue)	2P	230 - 240 V								
	4P	400 - 415 V								
Operating frequency	50/60 Hz									
Accessories	Module CA907000 and CA907001									

iID residual current circuit breakers for 110/230 V network										
Type	A								Width in 9 mm module	
Auxiliaries	Module CA907002									
2P	Sensitivity	30 mA								
	Rating	63 A	A9R08263							4
	Rating	63 A	A9R08463							8
Voltage rating (Ue)	2P	110 V								
	4P	230 V								
Operating frequency	50/60 Hz									
Accessories	Module CA907000 and CA907001									

Offer selection see page 149

Offer C

This sticker must be removed before publishing

Protection Earth leakage protection iID residual current circuit breakers (SI type)

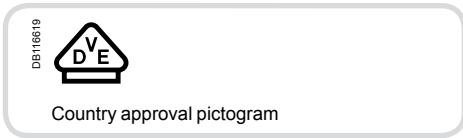

IEC/EN 61008-1



- The iID residual current circuit breakers provide:
 - protection of persons against electric shock by direct contact (≤ 30 mA),
 - protection of persons against electric shock by indirect contact (≥ 300 mA),
 - protection of installations against the risk of fire (300 mA or 500 mA).

The **SI** type provides increased immunity from electrical interference and polluted or corrosive environments.





Offer selection see page 149

Offer C

This sticker must be removed before publishing

Catalogue numbers

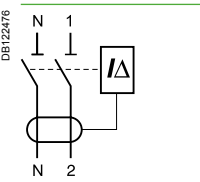
iID residual current circuit breakers for 230/400 V network

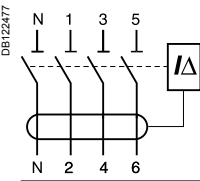
Type		SI 					Width in 9 mm module	
Auxiliaries		Module CA907002						
2P		Sensitivity	10 mA	30 mA	300 mA	300 mA 	500 mA 	
	Rating	16 A	-	-	-	-	4	
		25 A	A9R30225	A9R91225	-	-		
		40 A	-	A9R91240	-	A9R35240		
		63 A	-	A9R91263	-	A9R35263		
		100 A	-	-	-	A9R35291		
4P		Sensitivity	10 mA	30 mA	300 mA	300 mA 	500 mA 	
	Rating	25 A	-	A9R91425	-	-	8	
		40 A	-	A9R91440	-	A9R35440		A9R37440
		63 A	-	A9R91463	A9R34463	A9R35463		A9R37463
		80 A	-	A9R31480	-	A9R35480		A9R37480
		100 A	-	A9R31491	A9R34491	A9R35491		-
Voltage rating (Ue)		2P	230 - 240 V					
		4P	400 - 415 V					
Operating frequency		50/60 Hz						
Accessories		Module CA907000 and CA907001						

Protection Earth leakage protection iID residual current circuit breakers (AC type)

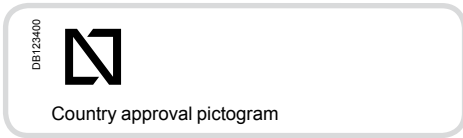

IEC/EN 61008-1



- The iID residual current circuit breakers provide:
 - protection of persons against electric shock by direct contact (≤ 30 mA),
 - protection of persons against electric shock by indirect contact (≥ 100 mA),
 - protection of installations against the risk of fire (300 mA or 500 mA).

Offer selection see page 149

Offer D

This sticker must be removed before publishing

Catalogue numbers

iID residual current circuit breakers for 230/400 V network										
Type	AC								Width in 9 mm module	
Auxiliaries	Module CA907002									
2P	Sensitivity	10 mA	30 mA	100 mA	300 mA	500 mA	300 mA	500 mA		
	Rating	16 A	A9R10216	-	-	-	-	-	4	
		25 A	A9R10225	A9R81225	-	A9R84225	A9R16225	-		
		40 A	-	A9R81240	A9R12240	A9R84240	A9R16240	-		
		63 A	-	A9R81263	A9R12263	A9R84263	A9R16263	A9R15263	-	
		80 A	-	A9R11280	A9R12280	A9R14280	-	A9R15280	-	
		100 A	-	A9R11291	A9R12291	A9R14291	-	A9R15291	-	
	Sensitivity	10 mA	30 mA	100 mA	300 mA	500 mA	300 mA	500 mA		
	Rating	25 A	-	A9R81425	-	A9R84425	A9R16425	-	8	
		40 A	-	A9R81440	A9R12440	A9R84440	A9R16440	A9R15440	A9R17440	
		63 A	-	A9R81463	A9R12463	A9R84463	A9R16463	A9R15463	A9R17463	
		80 A	-	A9R11480	A9R12480	A9R14480	A9R16480	A9R15480	A9R17480	
		100 A	-	A9R11491	A9R12491	A9R14491	-	A9R15491	-	
Voltage rating (Ue)	2P	230 - 240 V								
	4P	400 - 415 V								
Operating frequency	50/60 Hz									
Accessories	Module CA907000 and CA907001									

Protection Earth leakage protection iID residual current circuit breakers (A type)

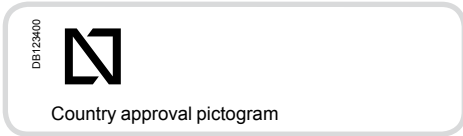

IEC/EN 61008-1



- The iID residual current circuit breakers provide:
 - protection of persons against electric shock by direct contact (≤ 30 mA),
 - protection of persons against electric shock by indirect contact (≥ 100 mA),
 - protection of installations against the risk of fire (300 mA or 500 mA).

Catalogue numbers

iID residual current circuit breakers for 230/400 V network

Type		A							Width in 9 mm module	
Auxiliaries		Module CA907002								
2P		Sensitivity	10 mA	30 mA	100 mA	300 mA	500 mA	300 mA		
	Rating	16 A	A9R20216	-	-	-	-	-	4	
		25 A	A9R20225	A9R21225	-	A9R24225	-	-		
		40 A	-	A9R21240	-	A9R24240	-	A9R25240		
		63 A	-	A9R21263	-	A9R24263	-	A9R25263		
		100 A	-	A9R21291	-	A9R24291	-	A9R25291		
4P		Sensitivity	10 mA	30 mA	100 mA	300 mA	500 mA	300 mA		
	Rating	25 A	-	A9R21425	-	A9R24425	-	-	8	
		40 A	-	A9R21440	A9R22440	A9R24440	A9R26440	A9R25440		
		63 A	-	A9R21463	A9R22463	A9R24463	A9R26463	A9R25463		
		80 A	-	A9R21480	-	A9R24480	-	A9R25480		
		100 A	-	A9R21491	-	A9R24491	A9R26491	A9R25491		
Voltage rating (Ue)		2P	230 - 240 V							
		4P	400 - 415 V							
Operating frequency		50/60 Hz								
Accessories		Module CA907000 and CA907001								

iID residual current circuit breakers for 110/230 V network

Type		A		Width in 9 mm module
Auxiliaries		Module CA907002		
2P		Sensitivity	30 mA	
	Rating	63 A	A9R08263	4
4P		Sensitivity	30 mA	
	Rating	63 A	A9R08463	8
Voltage rating (Ue)		2P	110 V	
		4P	230 V	
Operating frequency		50/60 Hz		
Accessories		Module CA907000 and CA907001		

Offer selection see page 149

Offer D

This sticker must be removed before publishing

Protection Earth leakage protection iID residual current circuit breakers (SI type)

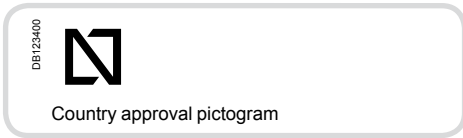

IEC/EN 61008-1



- The iID residual current circuit breakers provide:
 - protection of persons against electric shock by direct contact (≤ 30 mA),
 - protection of persons against electric shock by indirect contact (≥ 300 mA),
 - protection of installations against the risk of fire (300 mA or 500 mA).

The **SI** type provides increased immunity from electrical interference and polluted or corrosive environments.



Catalogue numbers

iID residual current circuit breakers for 230/400 V network							
Type	SI						Width in 9 mm module
Auxiliaries	Module CA907002						
2P	Sensitivity	10 mA	30 mA	300 mA	300 mA 	500 mA 	
	Rating	16 A	-	-	-	-	4
		25 A	A9R30225	A9R61225	-	-	
		40 A	-	A9R61240	-	A9R35240	
		63 A	-	A9R61263	-	A9R35263	
		100 A	-	-	-	A9R35291	
4P	Sensitivity	10 mA	30 mA	300 mA	300 mA 	500 mA 	
	Rating	25 A	-	A9R61425	-	-	8
		40 A	-	A9R61440	-	A9R35440	A9R37440
		63 A	-	A9R61463	A9R34463	A9R35463	A9R37463
		80 A	-	A9R31480	-	A9R35480	A9R37480
		100 A	-	A9R31491	A9R34491	A9R35491	-
Voltage rating (Ue)	2P	230 - 240 V					
	4P	400 - 415 V					
Operating frequency	50/60 Hz						
Accessories	Module CA907000 and CA907001						

Protection Earth leakage protection

iID residual current circuit breakers (AC, A, SI types)

Connection

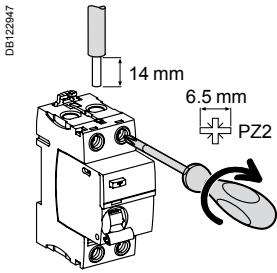

Type	Tightening torque	Without accessory		With accessories*			
		Copper cables		50 mm ² Al terminal	Screw-on connection for ring terminal	Multi-cables terminal	
		Rigid	Flexible or with ferrule			Rigid cables	Flexible cables
iID	3.5 N.m	1 to 35 mm ²	1 to 25 mm ²	50 mm ²	Ø 5 mm	3 x 16 mm ²	3 x 10 mm ²

* See module CA907000

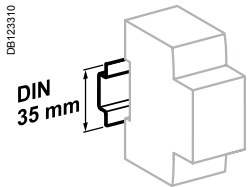

Clip on DIN rail 35 mm.

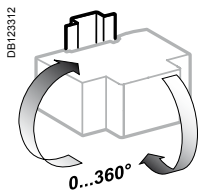

Indifferent position of installation.

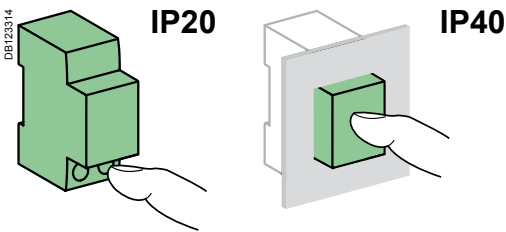

Technical data

Main characteristics		
Insulation voltage (U _i)		500 V
Pollution degree		3
Rated impulse withstand voltage (U _{imp})		6 kV
According to IEC/EN 61008-1		
Making and breaking capacity (I _m /I _{Δm})		1500 A
Surge current withstand (8/20 μs) without tripping	AC and A types (no selective Ⓜ)	250 Å
	AC, A types (selective Ⓜ)	3 kÅ
	SI type	3 kÅ
Conditional rated short circuit current (I _{nc} /I _{Δc})	With iC60N/H/L	Equal to breaking capacity of iC60
	With fuse	10,000 A
Behaviour in case of voltage drop		Residual current protection down to 0 V according to IEC/EN 61008-1 § 3.3.4
Additional characteristics		
Degree of protection	Device only	IP20
	Device in modular enclosure	IP40
Endurance (O-C)	Electrical (AC1) 16 to 63 A	15,000 cycles
		80 to 100 A
	Mechanical	20,000 cycles
Operating temperature	AC type	-5°C to +60°C
	A and SI types	-25°C to +60°C
Storage temperature		-40°C to +85°C

Weight (g)

Residual current circuit breakers	
Type	iID
2P	210
4P	370

Dimensions (mm)

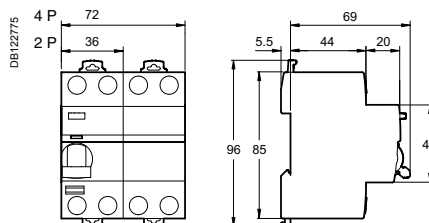

Protection

Earth leakage protection

iID residual current circuit breakers (AC, A, SI types)

(cont.)

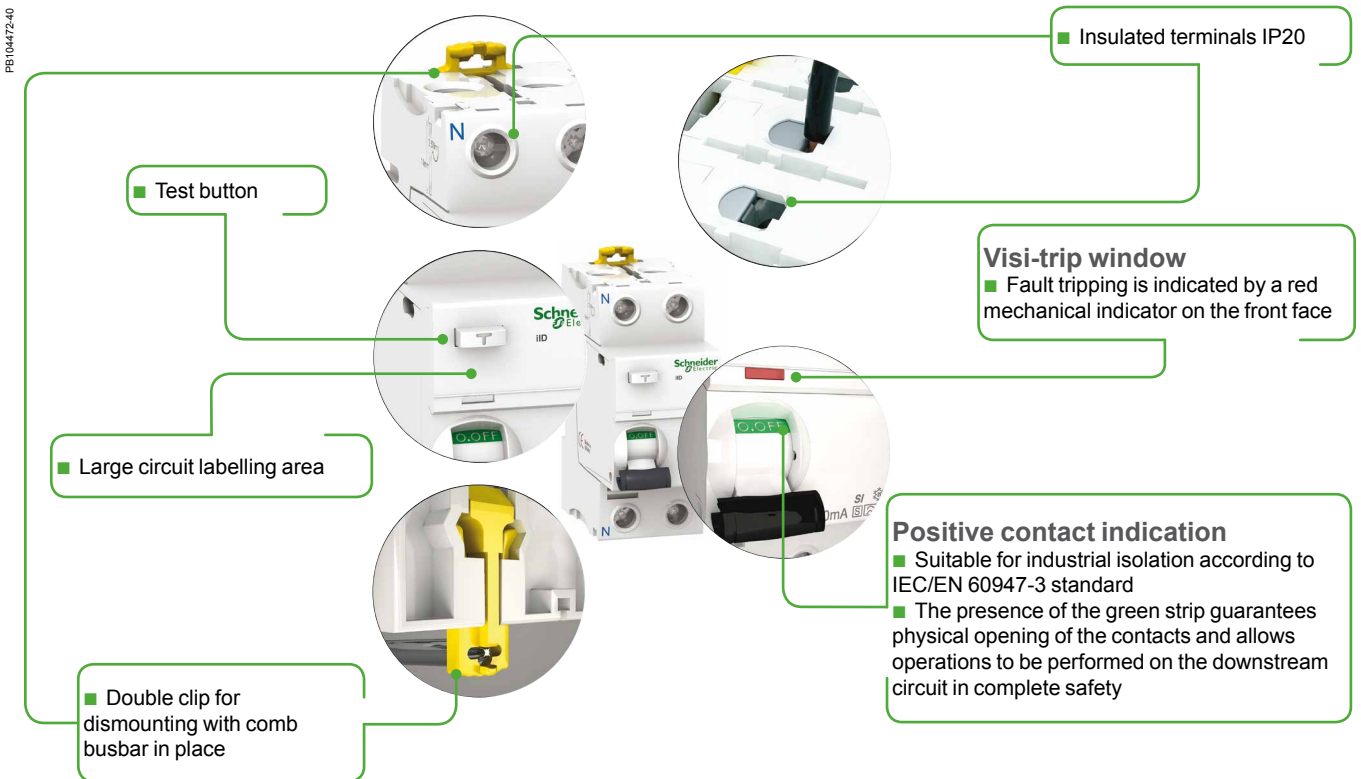

SI type

The **SI** type provides increased immunity from electrical interference and polluted or corrosive environments.

Protection Earth leakage protection

iID double terminals residual current circuit breakers (AC type)

IEC/EN 61008-1



KEMA KEUR approval, only for 2P/4P 25 A to 63 A catalogue numbers.



- The iID double tunnel terminals residual current circuit breakers provide:
 - protection of persons against electric shock by direct contact (≤ 30 mA),
 - protection of persons against electric shock by indirect contact (≥ 100 mA),
 - protection of installations against the risk of fire (300 mA).

Catalogue numbers

iID double terminals residual current circuit breakers											
Type	AC									Width in 9 mm module	
Product	iID										
Auxiliaries	Can accept auxiliaries, module CA907002										
2P	Sensitivity	10 mA	30 mA	30 mA Type G	100 mA	100 mA 	100 mA Type G	300 mA	300 mA 		
	Rating	25 A	A9Z10225	A9Z11225	-	-	-	A9Z14225	-	4	
		40 A	-	A9Z11240	A9Z76240	A9Z12240	-	A9Z77240	A9Z14240	A9Z15240	
		63 A	-	A9Z11263	A9Z76263	A9Z12263	-	A9Z77263	A9Z14263	A9Z15263	
		80 A	-	A9Z11280	-	A9Z12280	-	-	A9Z14280	A9Z15280	
		100 A	-	A9Z11291	-	A9Z12291	-	-	A9Z14291	A9Z15291	
4P	Sensitivity	10 mA	30 mA	30 mA Type G	100 mA	100 mA 	100 mA Type G	300 mA	300 mA 		
	Rating	25 A	-	A9Z11425	-	-	-	A9Z14425	-	8	
		40 A	-	A9Z11440	-	A9Z12440	-	-	A9Z14440	A9Z15440	
		63 A	-	A9Z11463	-	A9Z12463	-	-	A9Z14463	A9Z15463	
		80 A	-	A9Z11480	A9Z76480	A9Z12480	-	A9Z77480	A9Z14480	A9Z15480	
		100 A	-	A9Z11491	A9Z76491	A9Z12491	-	A9Z77491	A9Z14491	A9Z15491	
4P Type THV	Sensitivity	10 mA	30 mA	30 mA Type G	100 mA	100 mA 	100 mA Type G	300 mA	300 mA 		
	Rating	40 A	-	A9Z71440	A9Z78440	A9Z72440	A9Z73440	A9Z79440	A9Z74440	A9Z75440	8
		63 A	-	A9Z71463	A9Z78463	A9Z72463	A9Z73463	A9Z79463	A9Z74463	A9Z75463	
Voltage rating (Ue)	2P	230 - 240 V									
	4P	400 - 415 V									
Operating frequency	50/60 Hz										
Accessories	Module CA907000 and CA907001										

Protection Earth leakage protection iID double terminals residual current circuit breakers (A type)

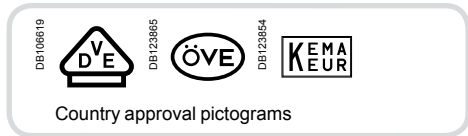

Country approval pictograms

KEMA KEUR approval, only for 2P/4P 25 A to 63 A catalogue numbers.

IEC/EN 61008-1



- The iID double tunnel terminals residual current circuit breakers provide:
 - protection of persons against electric shock by direct contact (≤ 30 mA),
 - protection of persons against electric shock by indirect contact (≥ 100 mA),
 - protection of installations against the risk of fire (300 mA or 500 mA).

Catalogue numbers

iID double terminals residual current circuit breakers											
Type	A iID										Width in 9 mm module
Product											
Auxiliaries	Can accept auxiliaries, module CA907002										
2P	Sensitivity	10 mA	30 mA	30 mA Type G	100 mA	100 mA	100 mA Type G	300 mA	300 mA	500 mA	
	Rating	16 A	A9Z20216	-	-	-	-	-	-	-	4
		25 A	A9Z20225	A9Z21225	-	-	-	A9Z24225	-	-	
		40 A	-	A9Z21240	A9Z81240	A9Z22240	-	A9Z82240	A9Z24240	A9Z25240	-
		63 A	-	A9Z21263	A9Z81263	A9Z22263	-	-	A9Z24263	A9Z25263	-
		80 A	-	A9Z21280	-	A9Z22280	-	-	A9Z24280	A9Z25280	-
		100 A	-	A9Z21291	-	A9Z22291	-	-	A9Z24291	A9Z25291	-
	Rating	25 A	-	A9Z21425	-	-	-	A9Z24425	-	A9Z26425	8
		40 A	-	A9Z21440	-	A9Z22440	-	-	A9Z24440	A9Z25440	A9Z26440
		63 A	-	A9Z21463	-	A9Z22463	-	-	A9Z24463	A9Z25463	A9Z26463
		80 A	-	A9Z21480	A9Z81480	A9Z22480	-	-	A9Z24480	A9Z25480	A9Z26480
		100 A	-	A9Z21491	A9Z81491	A9Z22491	-	A9Z82491	A9Z24491	A9Z25491	A9Z26491
	Rating	40 A	-	A9Z81440	A9Z91440	A9Z82440	A9Z83440	A9Z92440	-	-	8
		63 A	-	A9Z81463	A9Z91463	A9Z82463	A9Z83463	A9Z92463	-	-	
Voltage rating (Ue)	2P	230 - 240 V									
	4P	400 - 415 V									
Operating frequency	50/60 Hz										
Accessories	Module CA907000 and CA907001										

Protection Earth leakage protection

iID double terminals residual current circuit breakers (SI type)

IEC/EN 61008-1



KEMA KEUR approval, only for 2P/4P 25 A to 63 A catalogue numbers.



- The iID double tunnel terminals residual current circuit breakers provide:
 - protection of persons against electric shock by direct contact (≤ 30 mA),
 - protection of persons against electric shock by indirect contact (≥ 100 mA),
 - protection of installations against the risk of fire (300 mA).

The SI type provides increased immunity from electrical interference and polluted or corrosive environments.

Catalogue numbers

iID double terminals residual current circuit breakers								
Type	SI						Width in 9 mm module	
Product	iID							
Auxiliaries	Can accept auxiliaries, module CA907002							
	Sensitivity	10 mA	30 mA	100 mA	100 mA	300 mA		
DB122476 	Rating	25 A	A9Z30225	A9Z31225	-	-	4	
		40 A	-	A9Z31240	A9Z32240	-		
		63 A	-	A9Z31263	A9Z32263	-		
		80 A	-	A9Z31280	A9Z32280	-		
		100 A	-	A9Z31291	A9Z32291	-		
DB122477 	Rating	25 A	-	A9Z31425	-	-	8	
		40 A	-	A9Z31440	A9Z32440	-		
		63 A	-	A9Z31463	A9Z32463	-		
		80 A	-	A9Z31480	A9Z32480	-		
		100 A	-	A9Z31491	A9Z32491	-		
DB122477 Type THV 	Rating	40 A	-	-	-	A9Z93440	8	
		63 A	-	-	-	A9Z93463		
Voltage rating (Ue)	2P	230 - 240 V						
	4P	400 - 415 V						
Operating frequency	50/60 Hz							
Accessoires	Module CA907000 and CA907001							

Protection

Earth leakage protection

iID double terminals residual current circuit breakers (AC, A, SI types) (cont.)

Connection between double-terminal protection devices

With comb busbar at the back/cables at the front

Without comb busbar at the back/cables at the front

DB404815



		Back	Front	
Rating	Tightening torque	Comb busbar	Copper cables	
		Thickness of the teeth	Rigid	Flexible or with ferrule
All	3.5 N.m	1.5 mm	DB122945 	DB122946

Connection between double-terminal and single-terminal protection devices

Cables at the back/comb busbar at the front

DB404817



		Back	Front	
Rating	Tightening torque	Copper cables		Comb busbar
		Rigid	Flexible or with ferrule	Thickness of the teeth
All	3.5 N.m	DB122945 	DB122946 	1.5 mm

■ Connection by comb busbar or by cable (according to EN 50027).

Connection

DB123947

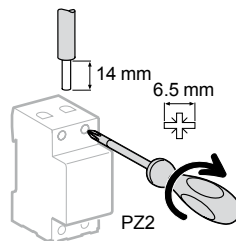

		With accessories		
Rating	50 mm ² Al terminal	Screw-on connection for ring terminal	Multi-cables terminal	
			Rigid cables	Flexible cables
All	50 mm ²	DB118769 	DB118767 	
		Ø 5 mm	3 x 16 mm ²	3 x 10 mm ²

Protection Earth leakage protection

iID double terminals residual current circuit breakers (AC, A, SI types)

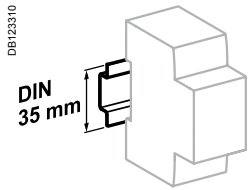

Clip on DIN rail 35 mm.

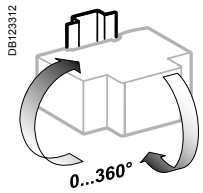

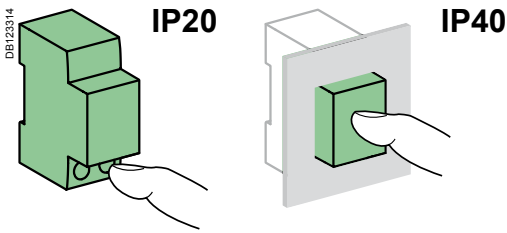

Indifferent position of installation.

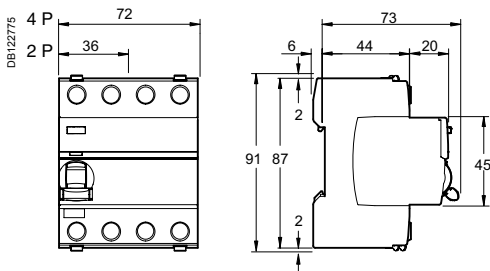

Dimensions (mm)

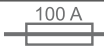

Technical data

Main characteristics		
Insulation voltage (U _i)		500 V
Pollution degree		3
Rated impulse withstand voltage (U _{imp})		6 kV
According to IEC/EN 61008-1		
Making and breaking capacity (I _m /I _{Δm})		1500 A
Surge current withstand (8/20 μs) without tripping	AC and A types (no selective Ⓢ)	250 Å
	AC, A types (selective Ⓢ)	3 kÅ
	SI type	3 kÅ
Conditional rated short circuit current (I _{nc} /I _{Δc})	With iC60N/H/L	Equal to breaking capacity of iC60
	With fuse 	10,000 A
Behaviour in case of voltage drop 		Residual current protection down to 0 V according to IEC/EN 61008-1 § 3.3.4
Additional characteristics		
Degree of protection	Device only	IP20
	Device in modular enclosure	IP40 Insulation class II
Endurance (O-C)	Electrical (AC1)	16 to 63 A
		80 to 100 A
	Mechanical	20,000 cycles
Operating temperature	AC type	-5°C to +60°C
	A and SI types 	-25°C to +60°C
Storage temperature		-40°C to +85°C

Weight (g)

iID double terminals residual current circuit breakers	
Type	iID
2P	210
4P	370

Protection

Earth leakage protection

iID double terminals residual current circuit breakers (AC, A, SI types) (cont.)



PB107413-60

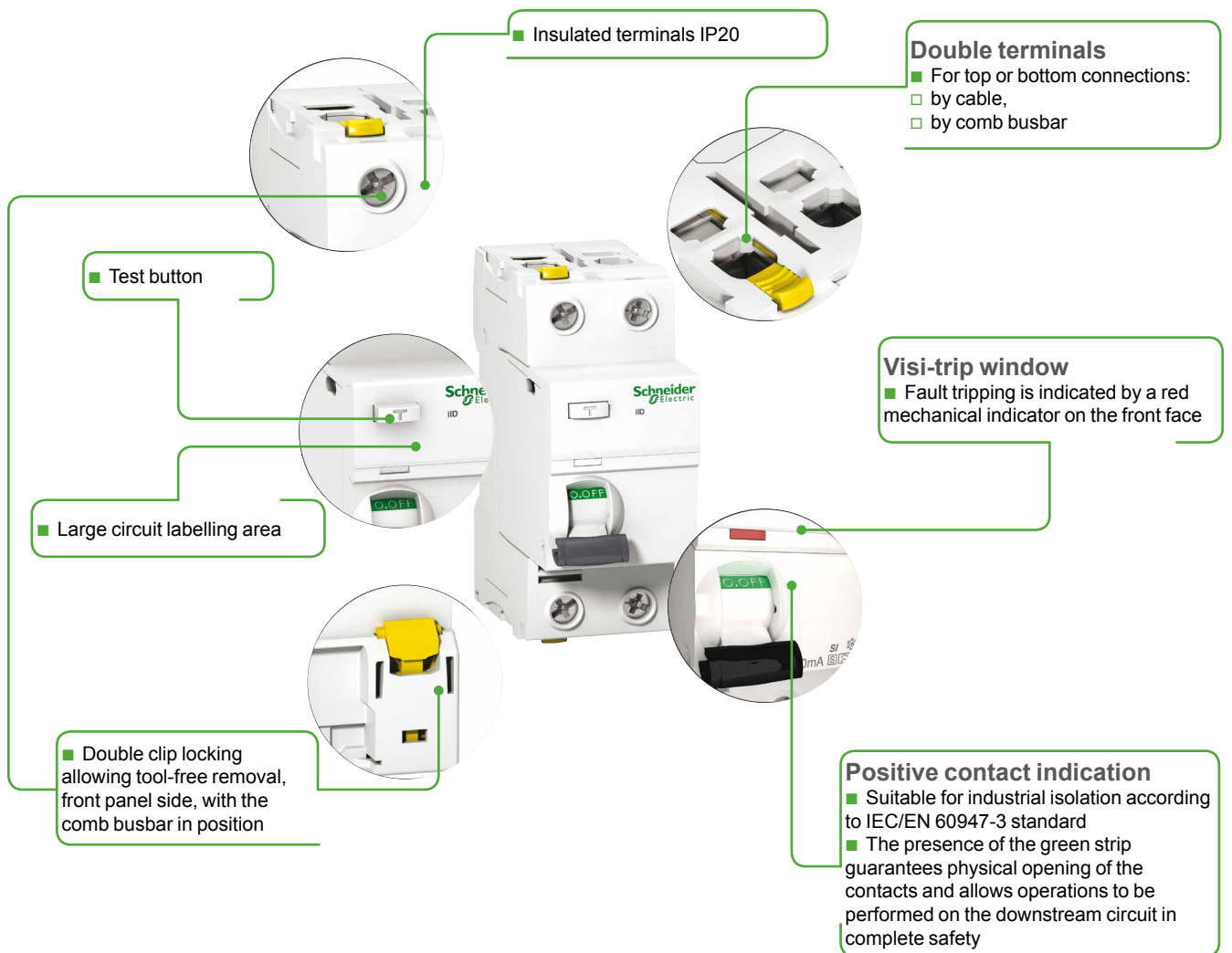

SI type

The SI type provides increased immunity from electrical interference and polluted or corrosive environments.

Protection

Earth leakage protection

Acti9 iID B type EV and Acti9 iID B-SI type RCCB

Contents



Schneider Electric's range of residual current circuit breakers consists of different products (A, B, C, D) to enable it to be the most competitive range possible in each country, allowing for the special characteristics of each market:

- usual installation procedure
- price
- accreditations by local bodies.

Variants

Offers		Pages
Offer A	Catalog numbers	171
International except Belgium		
Offer B	Catalog numbers	172
Electric vehicle, international except Belgium		
Offer C	Catalog numbers	173
Belgium		
Offer D	Catalog numbers	175
Electric vehicle, Belgium		
Common pages		176

Only the product range to be marketed in your country and validated by the local product manager, in agreement with his Final Distribution (FD) partner should be retained. The others will be removed before publication.

Protection Earth leakage protection

Acti9 iID B-SI type residual current circuit breakers (RCCB)

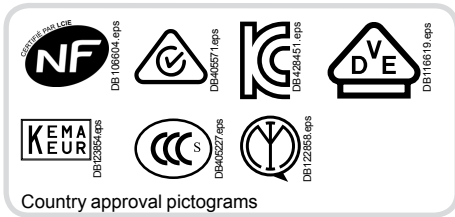

IEC/EN 61008-2-1
IEC/EN 62423
IEC 61543
VDE 0664

As per the above standards:

- The Acti9 iID B-SI type residual current circuit breakers provide:
 - protection of persons against electric shock by direct contact (30 mA),
 - protection of persons against electric shock by indirect contact (≥ 300 mA),
 - protection of installations against the risk of fire (300 mA or 500 mA).

B-SI type

The Acti9 iID B-SI type residual current circuit breakers provide:

- protection in the event of a continuous earth fault current on networks generated by:
 - controllers and variable speed drives,
 - battery chargers and inverters, such as used in photovoltaic application,
 - backed-up power supplies.

■ They include protection against earth fault currents:

- sinusoidal AC residual currents (AC type),
- pulsed DC residual currents (A type),
- multi frequency residual current (F type).

■ The use of Acti9 iID B-SI type residual current circuit breaker can be made mandatory, according to standards applicable in country.

■ For applications using 3-poles drives, such as:

- crane,
- lift,
- HVAC,
- pumping system.

B type is needed.

For more information, see earth leakage protection guide CA908066E.

■ The Acti9 iID B-SI type works optimally with the variable speed drives manufactured by Schneider Electric, even with a long cable length between motor and variable speed drive (up to 50 m).

■ SI technology is embedded in Acti9 iID B-SI type residual current circuit breaker, providing increased immunity from electrical interference and polluted environments.

■ The Acti9 iID B-SI type is compatible with Schneider Electric AC and A types wired in parallel or in series in the installation, following coordination tables (refer to earth leakage protection guide CA908066E).



Offer selection see page 170

Offer A

Catalog numbers

Acti9 iID B-SI type residual current circuit breaker							
Type	B-SI				Width in 9 mm module		
	Sensitivity	30 mA	300 mA	300 mA	500 mA		
2P 	Rating	25 A	A9Z61225	A9Z64225	-	8	
		40 A	A9Z61240	A9Z64240	-		
		63 A	A9Z61263	A9Z64263	-		
Voltage rating (Ue)		230 V					
Operating frequency		50 Hz					
4P 	Rating	25 A	A9Z61425	A9Z64425	-	8	
		40 A	A9Z61440	A9Z64440	A9Z65440		A9Z66440
		63 A	A9Z61463	A9Z64463	A9Z65463		A9Z66463
		80 A	A9Z61480	A9Z64480	A9Z65480		A9Z66480
Voltage rating (Ue)		400 V					
Operating frequency		50 Hz					

Protection
Earth leakage protection

Acti9 iID B type EV residual current circuit breakers (RCCB) for Electric Vehicle

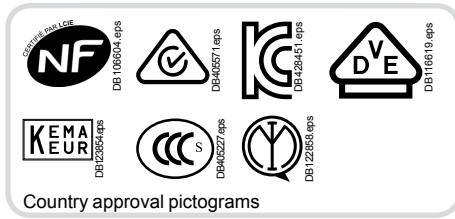

IEC/EN 61008-2-1
IEC/EN 62423
IEC 61543
VDE 0664

As per the above standards:

- The Acti9 iID B type EV residual current circuit breakers provide:
 - protection of persons against electric shock by direct contact (30 mA),
 - protection of persons against electric shock by indirect contact,
 - protection of installations against the risk of fire.

B type

The Acti9 iID B type EV residual current circuit breakers provide:

- protection in the event of a continuous earth fault current on networks generated by electric car charging station.

- The use of Acti9 iID B type EV residual current circuit breaker can be made mandatory, according to standards applicable in country.

- The Acti9 iID B type EV is compatible with Schneider Electric AC and A types wired in parallel or in series in the installation, following coordination tables (refer to earth leakage protection guide CA908066E).



Offer selection see page 170

Offer B

This sticker must be removed before publishing

Catalog numbers

Acti9 iID B type EV residual current circuit breakers			
Type		B	Width in 9 mm module
	Sensitivity	30 mA	8
	Rating 16 A	A9Z51216	
	25 A	A9Z51225	
	40 A	A9Z51240	
Voltage rating (Ue)		230 V	
Operating frequency		50 Hz	
	Sensitivity	30 mA	8
	Rating 40 A	A9Z51440	
	63 A	A9Z51463	
	Voltage rating (Ue)		
Operating frequency		50 Hz	

Protection

Earth leakage protection

Acti9 iID B-SI type residual current circuit breakers (RCCB)



A9261226-40.eps



A9261426-40.eps



PB104488-14.eps

IEC/EN 61008-2-1

IEC/EN 62423

IEC 61543

VDE 0664

As per the above standards:

- The Acti9 iID B-SI type residual current circuit breakers provide:
 - protection of persons against electric shock by direct contact (30 mA),
 - protection of persons against electric shock by indirect contact (≥ 300 mA),
 - protection of installations against the risk of fire (300 mA or 500 mA).

B-SI type

The Acti9 iID B-SI type residual current circuit breakers provide:

- protection in the event of a continuous earth fault current on networks generated by:
 - controllers and variable speed drives,
 - battery chargers and inverters, such as used in photovoltaic application,
 - backed-up power supplies.
- They include protection against earth fault currents:
 - sinusoidal AC residual currents (AC type),
 - pulsed DC residual currents (A type),
 - multi frequency residual current (F type).

■ The use of Acti9 iID B-SI type residual current circuit breaker can be made mandatory, according to standards applicable in country.

- For applications using 3-poles drives, such as:
 - crane,
 - lift,
 - HVAC,
 - pumping system.

B type is needed.

For more information, see earth leakage protection guide CA908066E.

■ The Acti9 iID B-SI type works optimally with the variable speed drives manufactured by Schneider Electric, even with a long cable length between motor and variable speed drive (up to 50 m).

■ SI technology is embedded in Acti9 iID B-SI type residual current circuit breaker, providing increased immunity from electrical interference and polluted environments.

■ The Acti9 iID B-SI type is compatible with Schneider Electric AC and A types wired in parallel or in series in the installation, following coordination tables (refer to earth leakage protection guide CA908066E).

Accessories

- 4P sealable screw shield.

Offer selection see page 170

Offer C

This sticker must be removed before publishing

Acti9 iID B-SI type residual current circuit breakers (RCCB) (cont.)

Catalog numbers

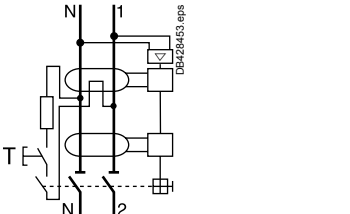
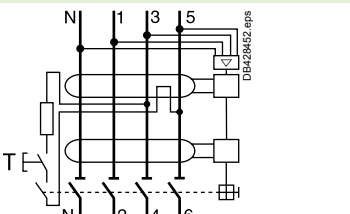
Acti9 iID B-SI type residual current circuit breakers							
Type	B-SI 				Width in 9 mm module		
	Rating	25 A	A9Z61225	A9Z64225	-	-	8
		40 A	A9Z61240	A9Z64240	-	-	
		63 A	A9Z61263	A9Z64263	-	-	
		Sensitivity 30 mA 300 mA 300 mA 500 mA					
Voltage rating (Ue)			230 V				
Operating frequency			50 Hz				
	Rating	25 A	A9Z61425	A9Z64425	-	-	8
		40 A	A9Z61440	A9Z64440	A9Z65440	A9Z66440	
		63 A	A9Z61463	A9Z64463	A9Z65463	A9Z66463	
		80 A	A9Z61480	A9Z64480	A9Z65480	A9Z66480	
		Sensitivity 30 mA 300 mA 300 mA 500 mA					
Voltage rating (Ue)			400 V				
Operating frequency			50 Hz				

(*) Supplied with screw shield accessory.

Accessory		
Type	Number of pole	Ref. no.
Screw shield (set of 20) for upstream or downstream	4P	A9A26981

Offer selection see page 170

Offer C

This sticker must be removed before publishing

Protection Earth leakage protection Acti9 iID B type EV residual current circuit breakers (RCCB) for Electric Vehicle



A9Z51216-40 eps



A9Z51440-40 eps



PBI04488-14 eps

IEC/EN 61008-2-1
IEC/EN 62423
IEC 61543
VDE 0664

As per the above standards:

- The Acti9 iID B type EV residual current circuit breakers provide:
 - protection of persons against electric shock by direct contact (30 mA),
 - protection of persons against electric shock by indirect contact,
 - protection of installations against the risk of fire.

B type

The Acti9 iID B type EV residual current circuit breakers provide:

- protection in the event of a continuous earth fault current on networks generated by:
 - electric car charging station.

■ The use of Acti9 iID B type EV residual current circuit breaker can be made mandatory, according to standards applicable in country.

■ The Acti9 iID B type EV is compatible with Schneider Electric AC and A types wired in parallel or in series in the installation, following coordination tables (refer to earth leakage protection guide CA908066E).

Accessories

- 4P sealable screw shield.

Offer selection see page 170

Offer D

This sticker must be removed before publishing

Catalog numbers

Acti9 iID B type EV residual current circuit breakers						
Type		B 	Width in 9 mm module			
2P 	Sensitivity 30 mA Rating 16 A 25 A 40 A	A9Z51216	8			
		A9Z51225				
		A9Z52225*				
		A9Z51240				
Voltage rating (Ue)		230 V				
Operating frequency		50 Hz				
4P 	Sensitivity 30 mA Rating 40 A 63 A	A9Z51440	8			
		A9Z51463				
		Voltage rating (Ue)		400 V		
		Operating frequency		50 Hz		

(*) Supplied with screw shield accessory.

Accessory		
Type	Number of pole	Ref. no.
Screw shield (set of 20) for upstream or downstream	4P	A9A26981

Protection Earth leakage protection

Acti9 iID B type EV and Acti9 iID B-SI type residual current circuit breakers (RCCB)

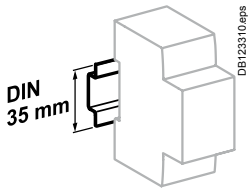

Clip on DIN rail 35 mm.

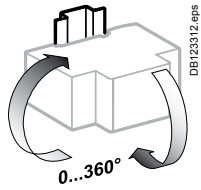

Indifferent position of installation.

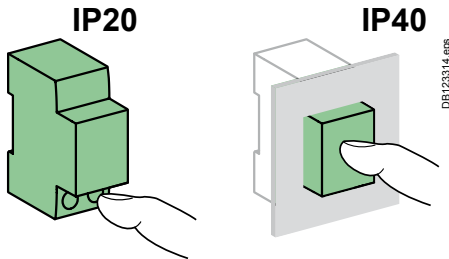

Technical data

Electrical characteristics		
Insulation voltage (Ui)	2P	250 V
	4P	500 V
Pollution degree	3	
Rated impulse withstand voltage (Uimp)	6 kV	
According to IEC/EN 61008-2-1		
Making and breaking capacity (Im/IΔm)	1500 A	
Surge current withstand (8/20 μs) without tripping	No selective <input type="checkbox"/>	3 kA
	Selective <input type="checkbox"/>	5 kA
Conditional rated short circuit current (Inc/IΔc)	With 100 A gG fuse	10,000 A
Additional characteristics		
Degree of protection (IEC 60529)	Device only	IP20
	Device in modular enclosure	IP40 Insulation class II
Endurance (O-C)	Electrical	≤ 63 A: 15,000 cycles > 63 A: 10,000 cycles
	Mechanical	20,000 cycles
Range of test button operating voltage	30 mA	2P: 180...270 V AC 4P: 300...450 V AC
	300, 500 mA	2P: 140...330 V AC 4P: 220...450 V AC
Impulse withstand according to IEC 60068-2-27	15 g	
Vibration withstand according to IEC 60068-2-6	3 g	
Electromagnetic compatibility	According to IEC 61543	
Operating temperature	-25°C to +60°C	
Storage temperature	-40°C to +85°C	
Dissipated power	Module CA908009	

Dielectric test

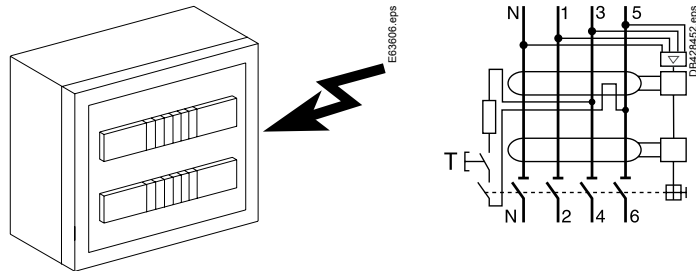

⚠ To perform the dielectric test, disconnect terminals:
 4P: 1, 3, 5 and 2, 4, 6
 2P: 1 and 2

Weight (g)

Residual current circuit breakers	
Type	iID
2P	350
4P	415

Dimensions (mm)

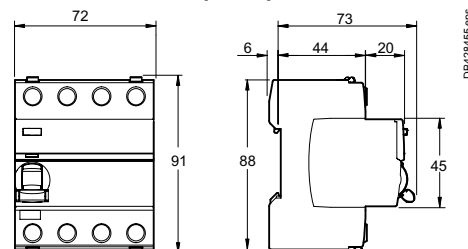

Protection Earth leakage protection

Acti9 iID B type EV and Acti9 iID B-SI type residual current circuit breakers (RCCB) (cont.)

Connection

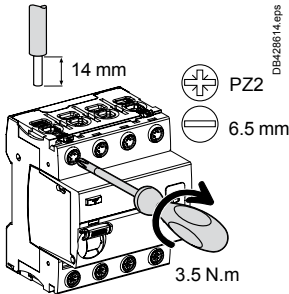

Rating	Without accessory				With accessories			
	Back		Front		50 mm ² Al terminal	Screw-on connection for ring terminal	Multi-cables terminal	
	Rigid	Flexible or with ferrule	Rigid	Flexible or with ferrule			Rigid cables	Flexible cables
All	DB122945.eps 1 to 25 mm ²	DB122946.eps 1 to 16 mm ²	DB122945.eps 1 to 35 mm ²	DB122946.eps 1 to 25 mm ²	DB122935.eps 50 mm ²	DB118789.eps Ø 5 mm	DB118787.eps 3 x 16 mm ²	3 x 10 mm ²

Accessories: modules CA907000 and CA907001

- Insulated terminals IP20**
 - DB428594.eps
 - DB428595.eps
- Double terminals**
 - For top or bottom connections:
 - by cable,
 - by comb busbar
- Double clip locking** allowing tool-free removal, front panel side, with the comb busbar in position
- Test button**
 - DB428598.eps
- Large circuit labelling area**
- Voltage presence LED**
 - For an optimal use of the LED, Acti9 iID must be power supplied by top connections
 - LED indication (powered by top connections):
 - On: powered and ready
 - Off: not powered
- VISI-TRIP window**
 - Fault tripping is indicated by a red mechanical indicator on the front face
- VISI-SAFE window**
 - Positive contact indication**
 - A green strip on the toggle indicates full opening of all the poles
 - Padlocking possible



Schneider Electric's range of residual current circuit breakers consists of different products (A, B, C, D, E) to enable it to be the most competitive range possible in each country, allowing for the special characteristics of each market:

- usual installation procedure
- price
- accreditations by local bodies.

Variants

Offers		Pages
Offer A	France	179
Offer B/C	Other countries	180
Offer D	Spain	181
Offer E	Finland	182
Common pages		183

Only the product range to be marketed in your country and validated by the local product manager, in agreement with his Final Distribution (FD) partner should be retained. The others will be removed before publication.

Protection Earth leakage protection iID K residual current circuit breakers

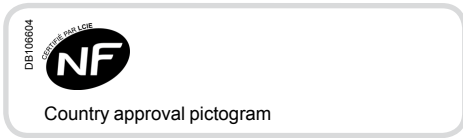

IEC/EN 61008-1

As per the above standard:

- The iID K residual current circuit breakers provide:
 - protection of persons against electric shock by direct contact (30 mA),
 - protection of persons against electric shock by indirect contact (300 mA),
 - protection of installations against the risk of fire (300 mA).



Catalogue numbers

iID K residual current circuit breakers					
Type	Product	AC		Width in 9-mm modules	
		iID K			
Auxiliaries	Without auxiliaries				
		Sensitivity	30 mA	300 mA	
2P 	Rating	25 A	A9R55225	A9R56225	4
		40 A	A9R55240	A9R56240	
4P 	Rating	25 A	A9R55425	A9R56425	8
		40 A	A9R55440	A9R56440	
Voltage rating (Ue)	2P	230 - 240 V			
	4P	400 - 415 V			
Operating frequency	50/60 Hz				

Offer A

Offer selection see page 178

This sticker must be removed before publishing

PB104497-40

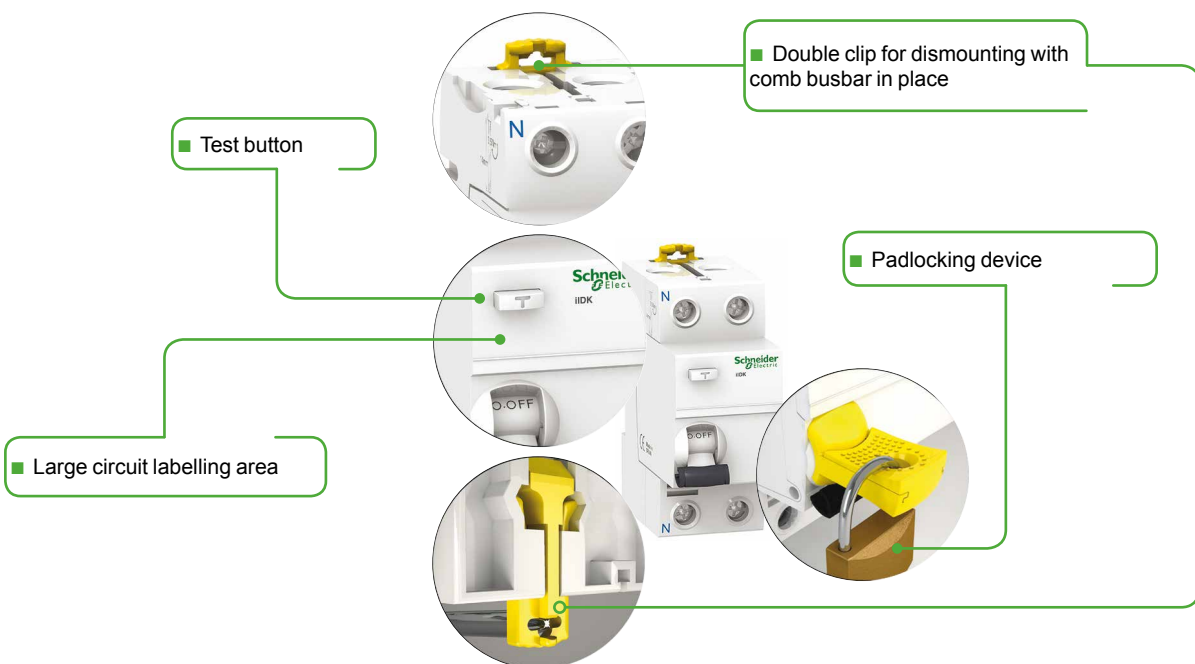

Protection Earth leakage protection iID K residual current circuit breakers



IEC/EN 61008-1

As per the above standard:

- The iID K residual current circuit breakers provide:
 - protection of persons against electric shock by direct contact (30 mA),
 - protection of persons against electric shock by indirect contact (300 mA),
 - protection of installations against the risk of fire (300 mA).



Catalogue numbers

iID K residual current circuit breakers

Type	Product	AC		Width in 9-mm modules	
		iID K			
Auxiliaries		Without auxiliaries			
2P		Sensitivity	30 mA	300 mA	
Rating	25 A	A9R50225	A9R75225	4	
	40 A	A9R50240	A9R75240		
4P		Sensitivity	30 mA	300 mA	
Rating	25 A	A9R50425	A9R75425	8	
	40 A	A9R50440	A9R75440		
	63 A	A9R70463	A9R75463		
Voltage rating (Ue)		2P	230 - 240 V		
		4P	400 - 415 V		
Operating frequency		50/60 Hz			

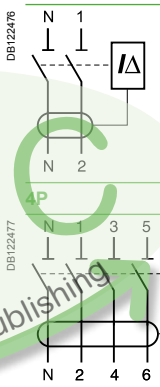

Offer selection see page 178

Offer B, C

This sticker must be removed before publishing

PB104487-40

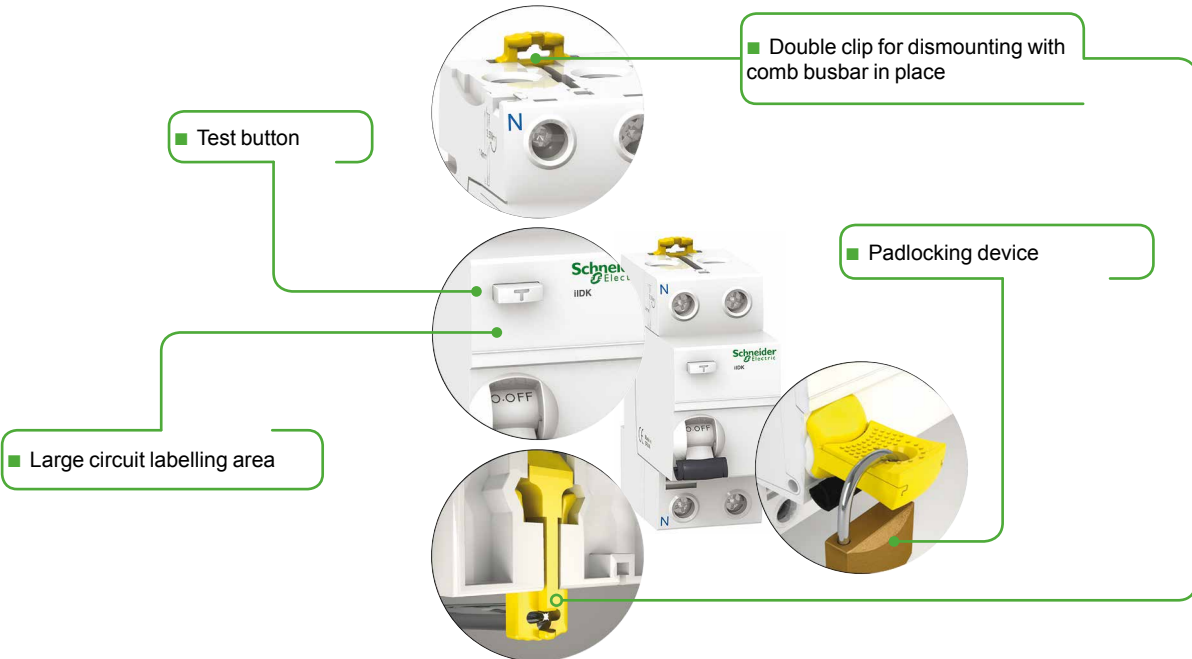

Protection Earth leakage protection iID K residual current circuit breakers

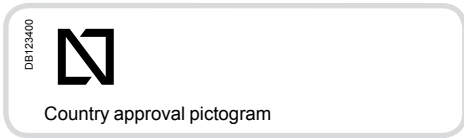

IEC/EN 61008-1

As per the above standard:

- The iID K residual current circuit breakers provide:
 - protection of persons against electric shock by direct contact (30 mA),
 - protection of persons against electric shock by indirect contact (300 mA),
 - protection of installations against the risk of fire (300 mA).



Catalogue numbers

iID K residual current circuit breakers					
Type	AC		Width in 9-mm modules		
Product	iID K				
Auxiliaries	Without auxiliaries				
	Sensitivity	30 mA	300 mA		
2P 	Rating	25 A	A9R60225	A9R75225	4
		40 A	A9R60240	A9R75240	
4P 	Rating	25 A	A9R50425	A9R75425	8
		40 A	A9R50440	A9R75440	
		63 A	A9R70463	A9R75463	
Voltage rating (Ue)	2P	230 - 240 V			
	4P	400 - 415 V			
Operating frequency	50/60 Hz				

Offer D

Offer selection see page 178

This sticker must be removed before publishing

PB104497-40

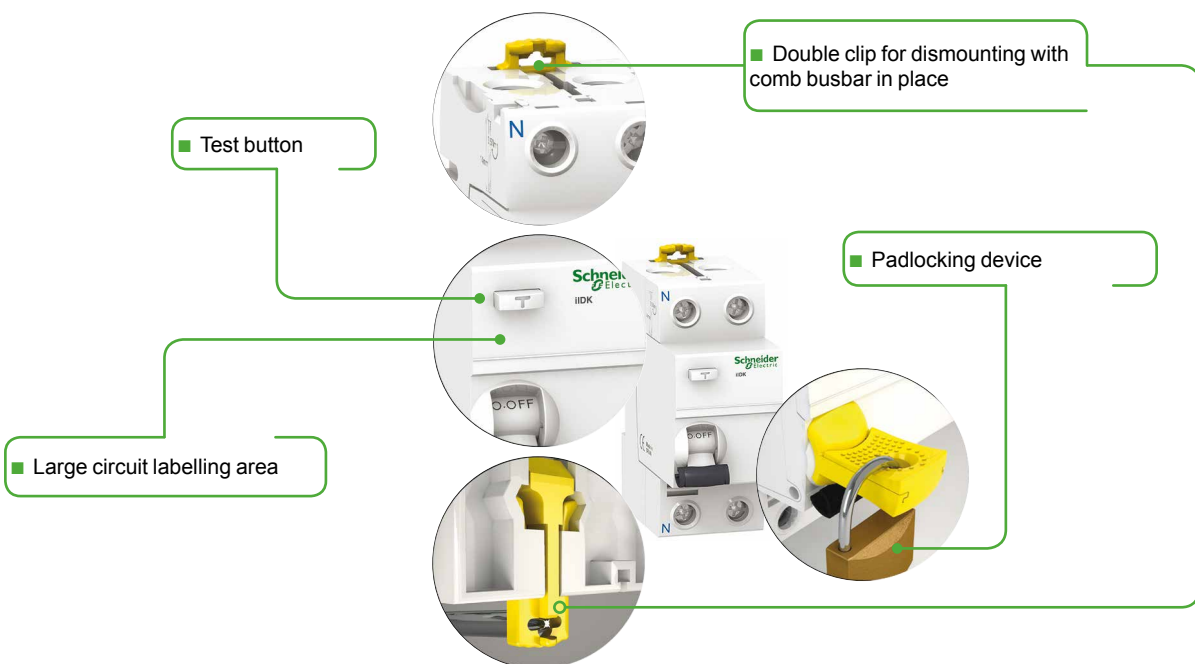

Protection Earth leakage protection iID K residual current circuit breakers

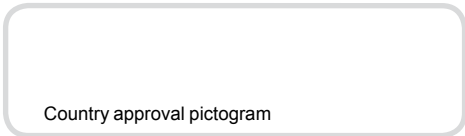

IEC/EN 61008-1

As per the above standard:

- The iID K residual current circuit breakers provide:
 - protection of persons against electric shock by direct contact,
 - protection of persons against electric shock by indirect contact,
 - protection of installations against the risk of fire.



Catalogue numbers

iID K residual current circuit breakers

Type	A		Width in 9-mm modules
Product	iID K		
Auxiliaries	Without auxiliaries		
2P	Sensitivity	30 mA	
	Rating	25 A	4
		40 A	
4P	Sensitivity	30 mA	
	Rating	25 A	8
		40 A	
Voltage rating (Ue)	2P	230 - 240 V	
	4P	400 - 415 V	
Operating frequency	50/60 Hz		

Offer selection see page 178

Offer E

This sticker must be removed before publishing.

PB104497-40

- Test button
- Large circuit labelling area
- Double clip for dismantling with comb busbar in place
- Padlocking device

iID K residual current circuit breakers (cont.)

Connection

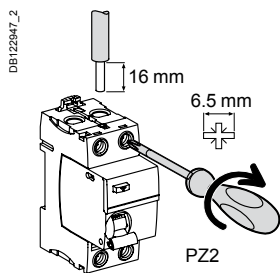

Type	Tightening torque	Copper cables	
		Rigid	Flexible or with ferrule
iID K	3.5 N.m	1 to 35 mm ²	1 to 25 mm ²

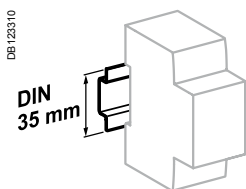

Clip on DIN rail 35 mm.

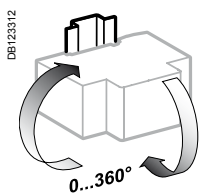

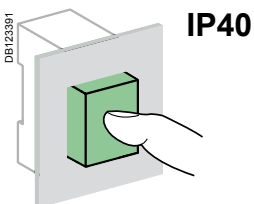

Indifferent position of installation.



Technical data

Main characteristics

According to IEC/EN 61008-1

Insulation voltage (U _i)	440 V
Pollution degree	2
Rated impulse withstand voltage (U _{imp})	4 kV
Making and breaking capacity (I _m /I _{Δm})	25 to 40 A 63 A
Surge current withstand (8/20 μs) without tripping	Up to 200 Å
Conditional rated short circuit current (I _{nc} /I _{Δc})	With iC60N/H/L, iK60N 6000 A
	With fuse 
Behaviour in case of voltage drop	 Residual current protection down to 0 V according to IEC/EN 61008-1 § 3.3.4

Additional characteristics

Degree of protection	Device in modular enclosure	IP40
Endurance (O-C)	Electrical	2000 cycles (AC1)
	Mechanical	5000 cycles
Operating temperature		-5°C to +60°C
Storage temperature		-40°C to +85°C

Weight (g)

Residual current circuit breakers

Type	iID K
2P	210
4P	370

Dimensions (mm)

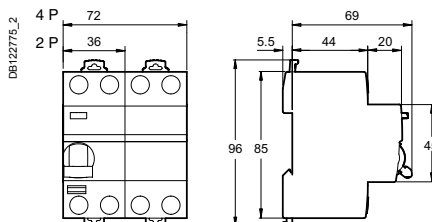

Protection

Earth leakage protection

Acti9 ID K Biconnect residual current circuit breakers



Schneider Electric's range of Acti9 ID K Biconnect residual current circuit breakers consists of different products (A, B, C, D) to enable it to be the most competitive range possible in each country, allowing for the special characteristics of each market:

- usual installation procedure
- price
- accreditations by local bodies.

Variants

Offers	Catalog numbers	Pages
Offer A	Catalog numbers	page 185
Offer B	Catalog numbers	page 186
Common pages offers A and B		page 187
Offer C	Catalog numbers	page 188
India		
Offer D	Catalog numbers	page 189
Singapore		
Common pages offers C and D		page 190

DE408951

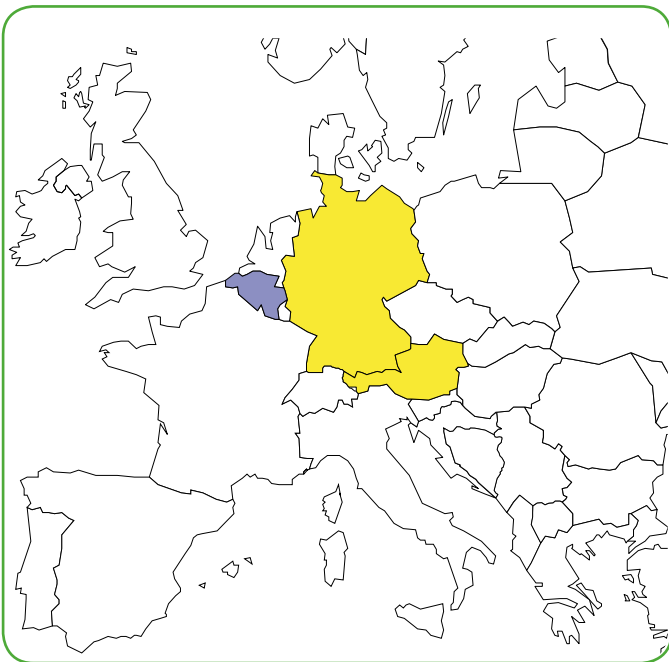

Only the product range to be marketed in your country and validated by the local product manager, in agreement with his Final Distribution (FD) partner should be retained. The others will be removed before publication.

DE408950

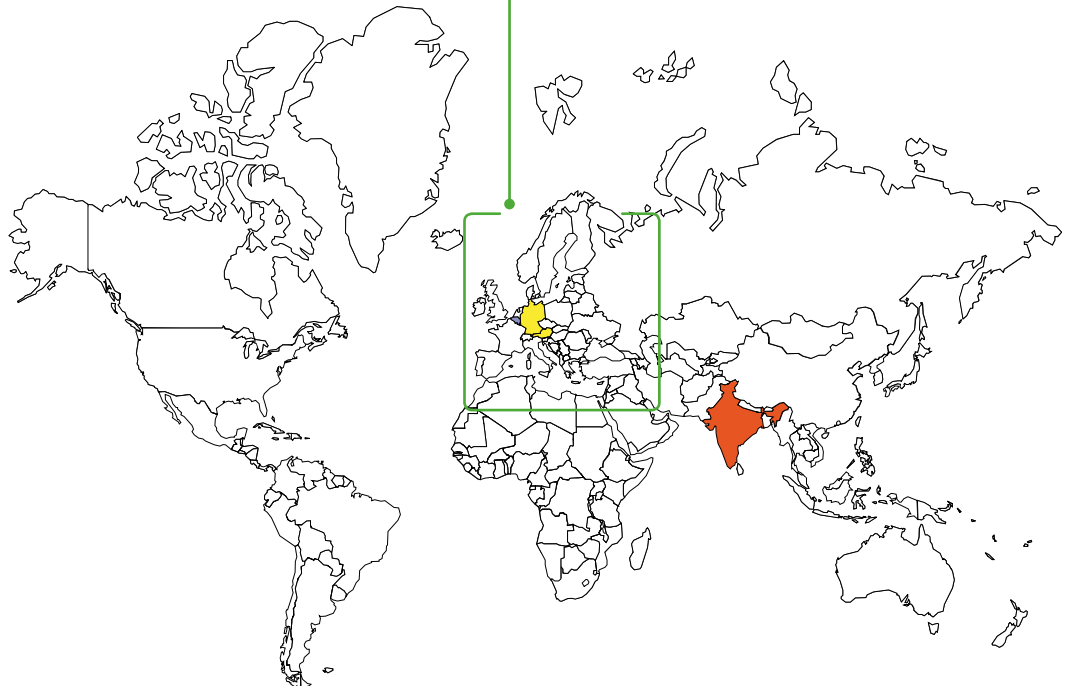

Protection Earth leakage protection Acti9 ID K Biconnect residual current circuit breakers (cont.)



IEC/EN 61008-1

As per the above standard:

- The Acti9 ID K Biconnect residual current circuit breakers offer the following functions:
 - protection of persons against electric shock by direct contact (30 mA),
 - protection of persons against electric shock by indirect contact (300 mA),
 - protection of installations against the risks of fire (300 mA).



Catalog numbers

Acti9 ID K Biconnect residual current circuit breakers						
Type		AC		A		Width in 9 mm modules
2P 	Sensitivity	30 mA	300 mA	30 mA	300 mA	4
	Rating	25 A A9Z05225	-	A9Z01225	-	
	40 A A9Z05240	-	-	A9Z01240	-	
4P 	Sensitivity	30 mA	300 mA	30 mA	300 mA	8
	Rating	25 A A9Z05425	-	A9Z01425	-	
	40 A A9Z05440	A9Z06440	A9Z01440	A9Z04440		
	63 A A9Z05463	A9Z06463	A9Z01463	A9Z04463		
Operating voltage (Ue)	2P	230 - 240 V				
	4P	400 - 415 V				
Operating frequency	50 Hz					
PowerTag energy sensors	Catalog modules CA907029 and CA908058					

Offer selection see page 184

Offer A

This sticker must be removed before publishing

Catalog numbers

Acti9 ID K Biconnect residual current circuit breakers Type G			
Type		A THV	Width in 9 mm modules
4P 	Sensitivity	30 mA Type G	8
	Rating	40 A A9Z09440	
Operating voltage (Ue)	400 - 415 V		
Operating frequency	50 Hz		
PowerTag energy sensors	Catalog modules CA907029 and CA908058		

Protection
Earth leakage protection

Acti9 ID K Biconnect residual current circuit breakers (cont.)

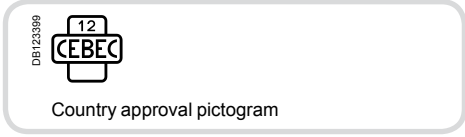

IEC/EN 61008-1

As per the above standard:

■ The Acti9 ID K Biconnect residual current circuit breakers offer the following functions:

- protection of persons against electric shock by direct contact (30 mA),
- protection of persons against electric shock by indirect contact (300 mA),
- protection of installations against the risks of fire (300 mA).

■ Delivered with sealable screw shield (lead sealing wire diameter: mini 1.5 mm, maxi 1.7 mm).

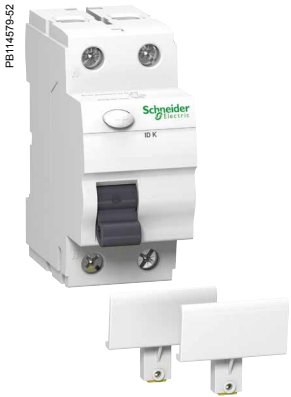

Catalog numbers

Acti9 ID K Biconnect residual current circuit breakers				
Type	A			Width in 9 mm modules
2P DB122476	Sensitivity	30 mA	300 mA	4
	Rating	40 A 63 A	A9Z02240 A9Z02263	
4P DB122477	Sensitivity	30 mA	300 mA	8
	Rating	40 A 63 A	A9Z02440 A9Z02463	
Operating voltage (Ue)	2P	230 - 240 V		
	4P	400 - 415 V		
Operating frequency	50 Hz			
PowerTag energy sensors	Catalog modules CA907029 and CA908058			

Offer selection see page 184

Offer B

This sticker must be removed before publishing

Protection

Earth leakage protection

Acti9 ID K Biconnect residual current circuit breakers (cont.)

PB10018-40

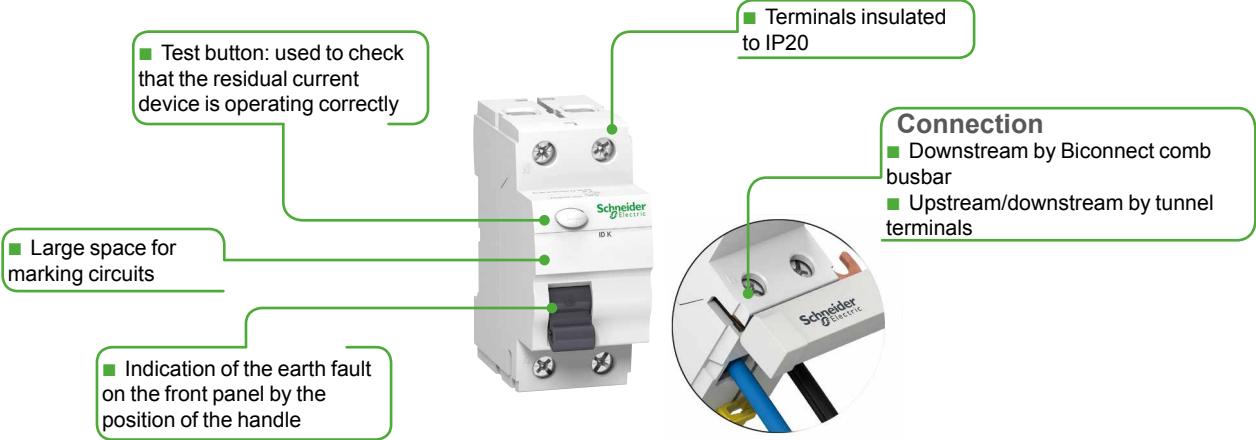

Connection

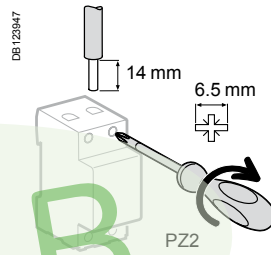

Type	Tightening torque	Copper cables	
		Rigid	Flexible or with ferrule
Acti9 ID K Biconnect	3.5 N.m	DB122946 1 to 35 mm ²	DB122946 1 to 25 mm ²

Connection by comb busbar or cables (conforms to EN 50027).

Technical data

Main characteristics

Insulation voltage (U _i)	440 V
Degree of pollution	2
Rated impulse withstand voltage (U _{imp})	4 kV
Making and breaking capacity (I _m /I _{Δm})	500 A
Impulse current withstand (8/20 μs) without tripping	Up to 200 Å
Conditional rated short-circuit current (I _{nc} /I _{Δc})	With circuit breaker: 6000 A With fuse: 4500 A
Behaviour in case of voltage drop	Residual current protection down to 0 V according to IEC/EN 61008-1 § 3.3.4

Additional characteristics

Degree of protection	Device only: IP20 Device in a modular enclosure: IP40
Endurance (O-C)	Electrical: 2000 cycles (AC1) Mechanical: 5000 cycles
Operating temperature	AC type: -5°C to +40°C A type: -25°C to +40°C
Storage temperature	-30°C to +70°C

Offer selection see page 184

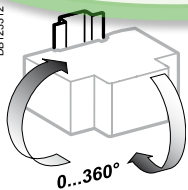
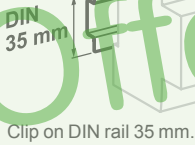

Indifferent position of installation.

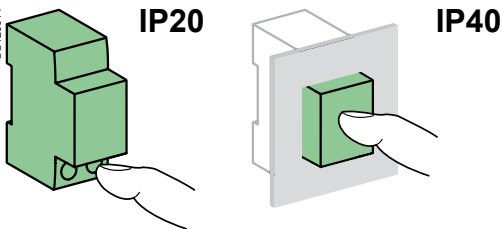

Weight (g)

Residual current circuit breakers	
Type	Acti9 ID K Biconnect
2P	180
4P	350

Dimensions (mm)

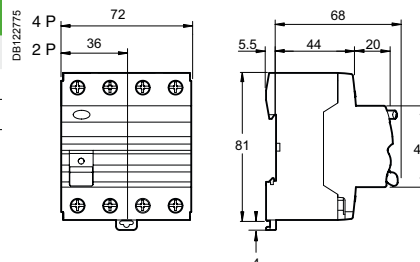

Protection
Earth leakage protection

Acti9 ID K Biconnect residual current circuit breakers (cont.)



IS 12640 (Part 1) IEC/EN 61008-1

As per the above standards:

- The Acti9 ID K Biconnect residual current circuit breakers offer the following functions:
 - protection of persons against electric shock by direct contact (30 mA),
 - protection of persons against electric shock by indirect contact (≥ 100 mA),
 - protection of installations against the risks of fire (300 mA).

Catalog numbers

Acti9 ID K Biconnect residual current circuit breakers						
Type	AC			Width in 9 mm modules		
	Sensitivity	30 mA	100 mA	300 mA		
2P DB122476	Rating	25 A	A9KR11225	A9KR12225	4	
		40 A	A9KR11240	A9KR12240		A9KR14225
		63 A	A9KR11263	A9KR12263		A9KR14263
4P DB122477	Rating	25 A	A9KR11425	A9KR12425	A9KR14425	8
		40 A	A9KR11440	A9KR12440	A9KR14440	
		63 A	A9KR11463	A9KR12463	A9KR14463	
Operating voltage (Ue)	2P	240 V				
	4P	415 V				
Operating frequency	50 Hz					
PowerTag energy sensors	Catalog modules CA907029 and CA908058					

Offer selection see page 184

Offer C

This sticker must be removed before publishing

Connection

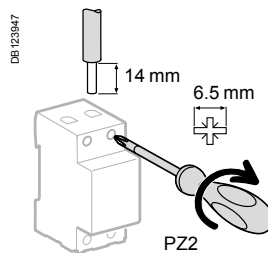

Type	Tightening torque	Copper cables	
		Rigid	Flexible or with ferrule
Acti9 ID K Biconnect	3.5 N.m	 DB 122945 1 to 35 mm ²	 DB 122946 1 to 25 mm ²

Protection Earth leakage protection

Acti9 ID K Biconnect residual current circuit breakers (cont.)

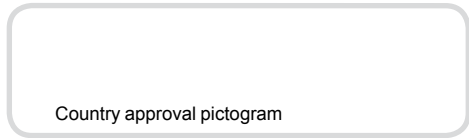

IEC/EN 61008-1

As per the above standard:

- The Acti9 ID K Biconnect residual current circuit breakers offer the following functions:
 - protection of persons against electric shock by direct contact (30 mA),
 - protection of persons against electric shock by indirect contact (≥ 100 mA),
 - protection of installations against the risks of fire (300 mA).



Catalog numbers

Acti9 ID K Biconnect residual current circuit breakers						
Type	AC				Width in 9 mm modules	
		Sensitivity				
		30 mA	100 mA	300 mA		
2P DB122476	Rating	25 A	A9KR13225	-	A9KR16225	4
		40 A	A9KR13240	A9KR15240	A9KR16240	
		63 A	A9KR13263	A9KR15263	A9KR16263	
4P DB122477	Rating	40 A	A9KR13440	A9KR15440	A9KR16440	8
		63 A	A9KR13463	A9KR15463	A9KR16463	
Operating voltage (Ue)	2P	240 V				
	4P	415 V				
Operating frequency	50 Hz					
PowerTag energy sensors	Catalog modules CA907029 and CA908058					

Offer selection see page 184

Offer D

This sticker must be removed before publishing

Connection

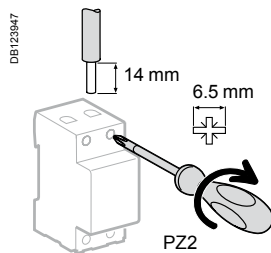

Type	Tightening torque	Copper cables	
		Rigid	Flexible or with ferrule
Acti9 ID K Biconnect	3.5 N.m	 DB122945 1 to 35 mm ²	 DB122946 1 to 25 mm ²

Protection
Earth leakage protection

Acti9 ID K Biconnect residual current circuit breakers (cont.)

PE110018-40

- Test button: used to check that the residual current device is operating correctly
- Large space for marking circuits
- Indication of the earth fault on the front panel by the position of the handle
- Terminals insulated to IP20
- **Connection**
 - Downstream by Biconnect comb busbar
 - Upstream/downstream by tunnel terminals

Offer selection see page 184

Offer C, D

This sticker must be removed before publishing

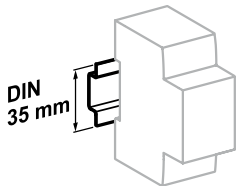

Clip on DIN rail 35 mm.

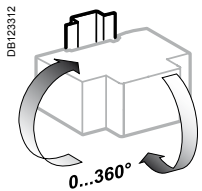

Indifferent position of installation.

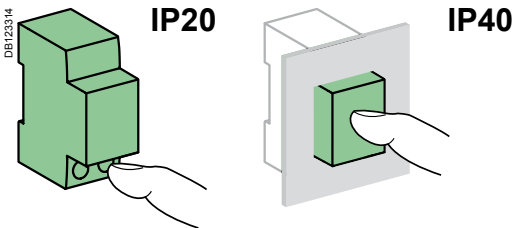

Technical data

Main characteristics		
Insulation voltage (Ui)		440 V
Degree of pollution		2
Rated impulse withstand voltage (Uimp)		4 kV
Making and breaking capacity (Im/IΔm)	25 - 40 A	500 A
	63 A	630 A
Impulse current withstand (8/20 μs) without tripping		Up to 200 Å
Conditional rated short-circuit current (Inc/IΔc)	With circuit breaker	6000 A
	With fuse	4500 A
Behaviour in case of voltage drop		Residual current protection down to 0 V according to IEC/EN 61008-1 § 3.3.4
Additional characteristics		
Degree of protection	Device only	IP20
	Device in a modular enclosure	IP40
		Insulation class II
Endurance (O-C)	Electrical	4000 cycles (AC1)
	Mechanical	5000 cycles
Operating temperature	AC type	-5°C to +55°C
Storage temperature		-25°C to +85°C
Tropicalization (IEC 60068-2-30)		Treatment 2 (relative humidity 95% at 55°C)

Weight (g)

Residual current circuit breakers	
Type	Acti9 ID K Biconnect
2P	180
4P	350

Dimensions (mm)

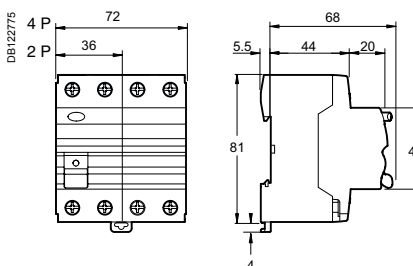

Protection, Earth leakage protection

Acti9 iID40 residual current circuit breakers bottom connection

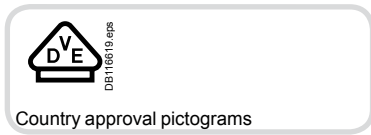

CEI/EN 61008-2-1

As per the above standard:

■ The residual current circuit breakers offer the following earth leakage protection functions:

- protection of persons against electric shock by direct contact (30 mA),
- protection of persons against electric shock by indirect contact (300 mA),
- protection of installations against the risk of fire (300 mA)

A-SI type

The A-SI type provides increased immunity from electrical interference and polluted or corrosive environments.

Catalog numbers

Acti9 iID40 residual current circuit breakers							
Type		AC	A	A-SI			Width in 9-mm modules
Electrical auxiliaries, Remote control		Catalog modules CA907002 and CA904010					
1P+N	Sensitivity	30 mA	300 mA	30 mA	30 mA	300 mA	
	Rating 25 A	A9R63625	A9R73625	A9R43625	A9R83625	-	4
	40 A	A9R63640	A9R73640	A9R43640	A9R83640	-	
	63 A	A9R63663	A9R73663	-	-	-	
	Rating 25 A	A9R63725	A9R73725	A9R43725	A9R83725	-	8
	40 A	A9R63740	A9R73740	A9R43740	A9R83740	-	
	63 A	A9R63763	A9R73763	A9R43763	A9R83763	A9R93763	
Voltage rating (Ue)	1P+N	230 - 240 V AC					
	3P+N	400 - 415 V AC					
Operating frequency	50/60 Hz						
Accessories	Catalog modules CA907001 and CA907015						
Comb busbars	Catalog module CA907026						
PowerTag energy sensors	Catalog modules CA907029 and CA908058						

Protection, Earth leakage protection

Acti9 iID40 residual current circuit breakers bottom connection

Technical data

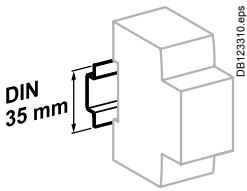

Clip on DIN rail 35 mm.

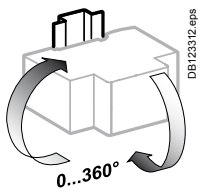

Indifferent position of installation.

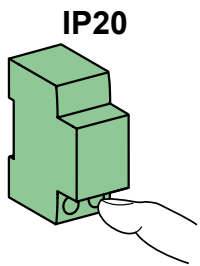

IP20

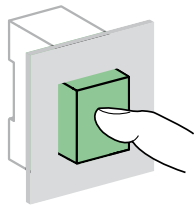

IP40





Main characteristics		
Insulation voltage (Ui)		500 V AC
Voltage rating (Ue)	Phase-to-neutral	230 V AC
	Phase-to-phase	400 V AC
Rated impulse withstand voltage (Uimp)		6 kV

According to IEC/EN 61008-2-1		
Rated residual breaking and making capacity (IΔm)		1.5 kA
Breaking and making capacity (Im)		1.5 kA
Conditional rated short circuit current (Inc/IΔc)	With circuit breaker	Equal to breaking capacity of the circuit breaker
	25/40 A	With fuse 80 A
	63 A	With fuse 100 A
8/20 μs impulse withstand without tripping	AC and A types	250 Å
	A-SI type	3 kÅ
Behaviour in case of voltage drop		Residual current protection down to 0 V according to IEC/EN 61009-1 § 3.3.8

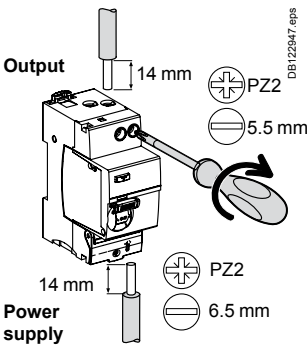
Additional characteristics		
Degree of protection (IEC 60529)	Device only	IP20
	Device in modular enclosure	IP40
Endurance (O-C)	Electrical (AC1)	15000 cycles
	Mechanical	20000 cycles
Operating temperature	AC type	-5°C to +60°C
	A, A-SI type	-25°C to +60°C
Storage temperature		-40°C to +85°C

Connection



	Comb busbar	Tightening torque	Without accessory		With accessories*			
			Copper cables		50 mm ² Al terminal	Screw-on connection for ring terminal	Multi-cables terminal	
			Rigid	Flexible or with ferrule			Rigid cables	Flexible cables
								
Top	■	2 N.m	1 to 16 mm ²	1 to 10 mm ²	-	Ø 5 mm	-	-
Bottom	-	3.5 N.m	1 to 35 mm ²	1 to 25 mm ²	50 mm ²	Ø 5 mm	3 x 16 mm ²	3 x 10 mm ²

* see Catalog modules CA907001 and CA907015

Weight (g)

Residual current circuit breakers	
Type	Acti9 iID40
1P+N	195
3P+N	360

Dimensions (mm)

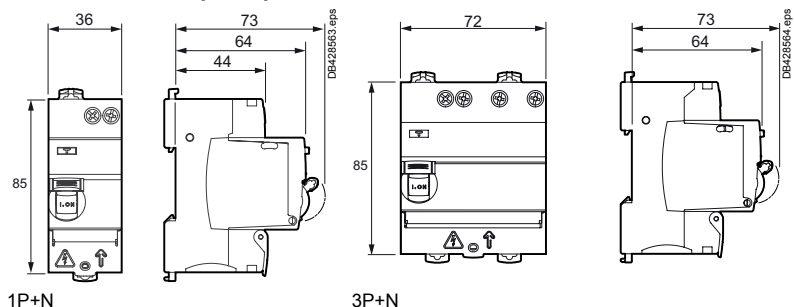

Protection, Earth leakage protection

Acti9 iLD40 residual current circuit breakers bottom connection



PB119567-45.eps

■ Double clip for dismounting with comb busbar in place

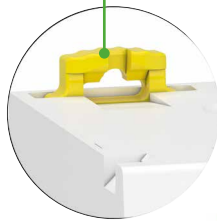

PB119566-40.eps

■ Insulated terminals IP20

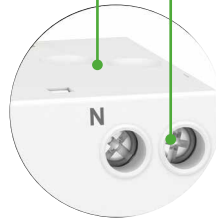

DE428467.eps

Output terminals

- Direct power supply of the outgoing by comb busbar
- Compatible with Acti9 horizontal comb busbars with 9 mm modules (catalog module CA907026)

■ Test button

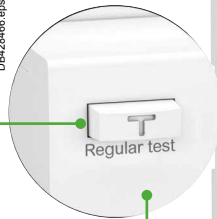

DB428468.eps

VISI-TRIP window

- Fault tripping is indicated by a red mechanical indicator on the front face

- Indication flap of connection direction
- Sealing possible



DB428468.eps

Power supply terminals

- 25 mm² flexible

■ Large circuit labelling area



DB428469.eps

VISI-SAFE window

Positive contact indication

- A green strip on the toggle indicates full opening of all the poles
- Downstream maintenance operations can be carried out in better safety conditions
- Padlocking possible

Protection Earth leakage protection

RCCB-ID 125 A residual current circuit breaker (AC, A, SI, B types)

IEC/EN 61008-1
VDE 0664

As per the above standards:

- The RCCB-ID 125 A residual current circuit breakers provide:
 - protection of persons against electric shock by direct contact (30 mA),
 - protection of persons against electric shock by indirect contact (≥ 100 mA),
 - protection of installations against the risk of fire (300 mA or 500 mA).

The **SI** type provides increased immunity from electrical interference and polluted or corrosive environments.

B type

■ The RCCB-ID B type residual current circuit breakers provide specific protection of three-phase installations and people even in the presence of DC fault currents on the network generated by:

- 3-poles controllers and variable speed drives,
- 3-poles battery chargers and inverters,
- 3-poles backed-up power supplies.

Instantaneous

It ensures instantaneous tripping (without time delay).

Selective

It ensures total discrimination with a non-selective RCD placed downstream.

OFsp auxiliary

■ Electrical indication: by OFsp auxiliary mounted to the left, it has a double changeover switch indicating the "open" or "closed" position of the RCCB-ID 125 A.



Accessories

- 2P and 4P sealable screw shield.



Catalogue numbers

RCCB-ID 125 A residual current circuit breakers

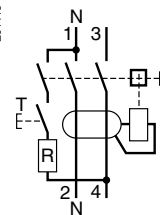
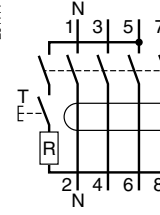
Type		AC 				A 				
		30 mA	100 mA	300 mA	500 mA	30 mA	300 mA	300 mA 	500 mA	
2P 	Sensitivity									
	Rating	125 A	16966	-	16967	-	16970	16971	-	-
4P 	Sensitivity									
	Rating	125 A	16905	16906	16907	16908	16924	16926	16925	16927
Voltage rating (Ue)		2P	230 V							
		4P	400 V							
Operating frequency		50 Hz								

Protection

Earth leakage protection

RCCB-ID 125 A residual current circuit breaker (AC, A, SI, B types) (cont.)

Catalogue numbers

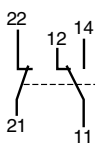

Auxiliary				Width in 9 mm module
Type				
	Contact OFsp	Contact	Voltage	16940
		1 A	110 V DC	
		6 A	230 V AC (AC15)	

Accessory		
Type	Number of pole	
Screw shield (set of 10) for upstream or downstream	2P	16938
	4P	16939

Connection

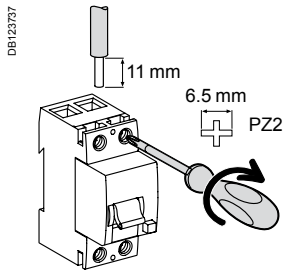
■ By tunnel terminals for:



Type	Tightening torque	Copper cables	
		Rigid	Flexible or with ferrule
			
RCCB-ID	3 N.m	1 x 1.5 to 50 mm ² 2 x 1.5 to 16 mm ²	1 x 1.5 to 35 mm ² 2 x 1.5 to 16 mm ²
OFsp	0.8 N.m	1 to 1.5 mm ²	1 to 1.5 mm ²

							Width in 9 mm module
SI		B					
30 mA	300 mA	-	-	-	-	-	4
16972	16973	-	-	-	-	-	
30 mA	300 mA	30 mA	300 mA	300 mA	500 mA		8
16920	16921	16763	16764	16765	16766		

Protection

Earth leakage protection

RCCB-ID 125 A residual current circuit breaker (AC, A, SI, B types) (cont.)

OFsp contact status, depending on the position of the residual current circuit breaker

Type				
RCCB-ID 125 A	Closed	■	-	-
	Open	-	■	-
	Tripped on fault	-	-	■
Contact OFsp	22/21	Open	Closed	Closed
	12/11			
	14/11	Closed	Open	Open



Indication of the status of the RCCB-ID via the 3-position toggle and front panel indicator

- Open (toggle in high position and green indicator)
- Closed (toggle in low position and red indicator)
- Tripped on fault (toggle in middle position and green indicator)

Technical data

Electrical characteristics			
Insulation voltage (Ui)		400 V	
Pollution degree		3	
Rated impulse withstand voltage (Uimp)		4 kV	
According to IEC/EN 61008-1			
Making and breaking capacity (Im/IΔm)		1250 A	
Surge current withstand (8/20 μs) without tripping	AC and A types (no selective ☐)	250 A	
	SI and B types (no selective ☐)	3 kA	
	AC, A, SI and B types (selective ☐)	3 kA	
Conditional rated short circuit current (Inc/IΔc)	With FU 125 A gG fuse	10,000 A	
Behaviour in case of voltage drop		Residual current protection down to 0 V according to IEC/EN 61008-1 § 3.3.4	
Additional characteristics			
Degree of protection	Device only	IP20	
	Device in modular enclosure	IP40	
Endurance (O-C)	Electrical	> 2 000 cycles	
	Mechanical	> 5 000 cycles	
Operating temperature		-25°C to +40°C	
	Storage temperature	AC, A, SI types: -40°C to +85°C B type: -40°C to +60°C	
Range of test button operating voltage	30 mA	2P	160...250 V AC
		4P	250...440 V AC
	100, 300, 500 mA	2P	185...250 V AC
		4P	185...440 V AC

Dielectric test

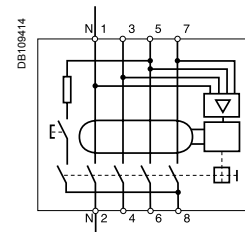
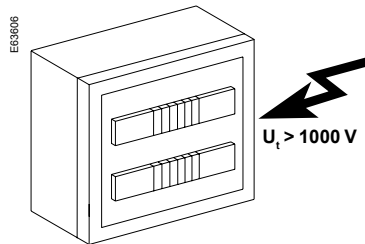

⚠ To perform the dielectric test, disconnect terminals 3, 5, 7 and 4, 6, 8.

Weight (g)

Residual current circuit breakers and auxiliary		
Type	RCCB-ID 125 A	OFsp
2P	230	40
4P AC, A and SI types	420	
B type	500	

Dimensions (mm)

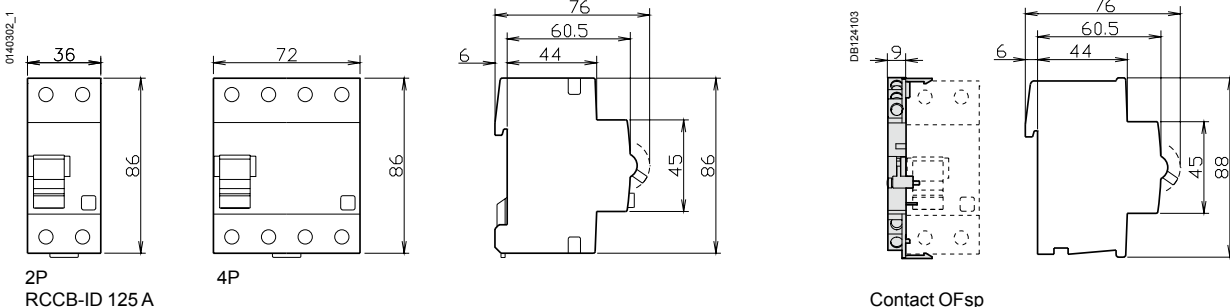

Protection, Earth leakage protection

Acti9 Vigi iC40 add-on residual current devices "Outgoer"



IEC/EN 61009-2-1

As per the above standard:

The residual current devices offer the following earth leakage protection functions:

- protection of persons against electric shock by direct contact (30 mA),
- protection of persons against electric shock by indirect contact (300 mA),
- protection of installations against the risk of fire (300 mA)
- Circuit protection is ensured by a circuit breaker associated to the Vigi add-on.

A-SI type

The A-SI type provides increased immunity from electrical interference and polluted or corrosive environments.



Catalog numbers

Acti9 Vigi iC40 add-on residual current devices "Outgoer"								
Type		AC	A		A-SI		Width in 9 mm modules	
Auxiliaries		Without auxiliaries						
1P+N		Sensitivity	30 mA	300 mA	30 mA	300 mA	30 mA	300 mA
	Rating	25 A	A9Y82625	A9Y83625	A9Y80625	A9Y81625	A9Y84625	A9Y85625
		25 A type G	-	-	A9Y87625	-	-	-
		40 A	A9Y82640	A9Y83640	A9Y80640	A9Y81640	A9Y84640	A9Y85640
3P		Sensitivity	30 mA	300 mA	30 mA	300 mA	30 mA	300 mA
	Rating	25 A	A9Y82325	A9Y83325	A9Y80325	A9Y81325	A9Y84325	A9Y85325
		40 A	A9Y82340	A9Y83340	A9Y80340	A9Y81340	A9Y84340	A9Y85340
3P+N		Sensitivity	30 mA	300 mA	30 mA	300 mA	30 mA	300 mA
	Rating	25 A	A9Y82725	A9Y83725	A9Y80725	A9Y81725	A9Y84725	A9Y85725
		40 A	A9Y82740	A9Y83740	A9Y80740	A9Y81740	A9Y84740	A9Y85740
Accessories			Catalog modules CA907001 and CA907015					
PowerTag energy sensors			Catalog modules CA907029 and CA908058					

Protection, Earth leakage protection

Acti9 Vigi iC40 add-on residual current devices "Outgoer"

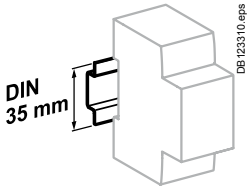

Clip on DIN rail 35 mm.

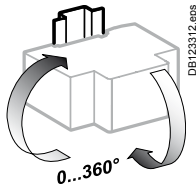

Indifferent position of installation.

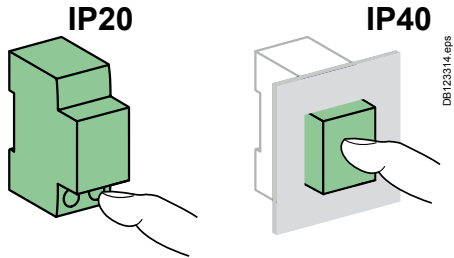

Dimensions (mm)

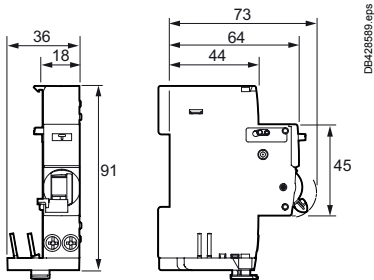

Acti9 Vigi iC40 "Outgoer" 1P+N

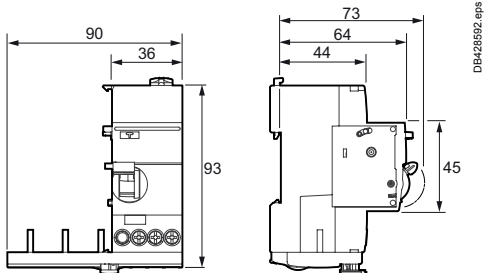

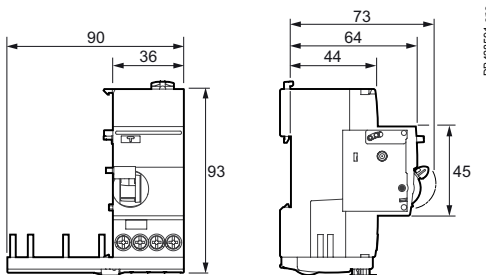

Acti9 Vigi iC40 "Outgoer" 3P



Acti9 Vigi iC40 "Outgoer" 3P+N

Technical data

Main characteristics		
According to IEC/EN 61009-2-1		
Insulation voltage (Ui)	Phase-to-neutral	400 V
	Phase-to-phase	440 V
Voltage rating (Ue)	Phase-to-neutral	230 V
	Phase-to-phase	400 V
Operating frequency		50/60 Hz
8/20 μs impulse withstand without tripping	AC, A types	250 Å
	A-SI type	3 kÅ
Pollution degree		3
Behaviour in case of voltage drop		Residual current protection down to 0 V according to IEC/ EN 61009-1 § 3.3.8
Rated impulse withstand voltage (Uimp)		4 kV
Additional characteristics		
Degree of protection (IEC 60529)	Device only	IP20
	Device in modular enclosure	IP40
Operating temperature	AC type	-5°C to +60°C
	A, A-SI types	-25°C to +60°C
		
Storage temperature		-40°C to +85°C



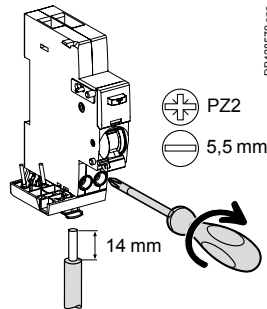

Connection

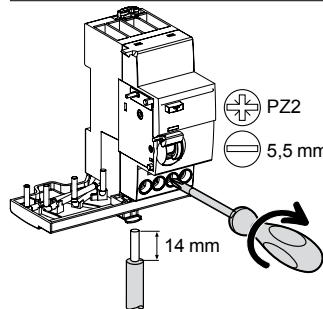

Acti9 Vigi iC40 1P+N



Acti9 Vigi iC40 3P, 3P+N

Tightening torque	Copper cables	
	Rigid	Flexible or with ferrule
2 N.m	 1 to 16 mm ²	 1 to 10 mm ²
2 N.m	 1 to 16 mm ²	 1 to 10 mm ²

Weight (g)

Add-on residual current devices	
Type	Acti9 Vigi iC40
1P+N	85
3P	155
3P+N	160

Protection, Earth leakage protection

Acti9 Vigi iC40 add-on residual current devices "Outgoer"

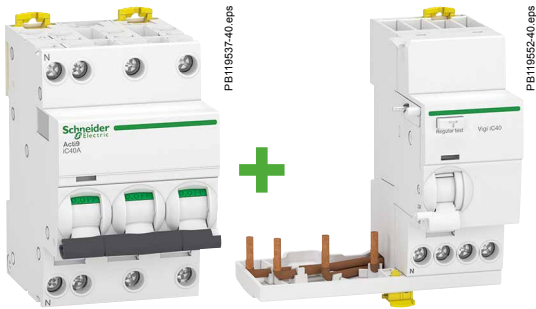

Circuit breaker + Vigi association

Circuit breaker	Vigi 25 A	Vigi 40 A
2 A to 25 A	■	■
32 A - 40 A	-	■

■ Double clip for dismounting with comb busbar in place



DB428853.eps

■ Clear space to allow comb busbar installation

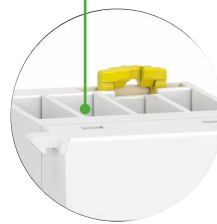

DB428854.eps

■ Large circuit labelling area

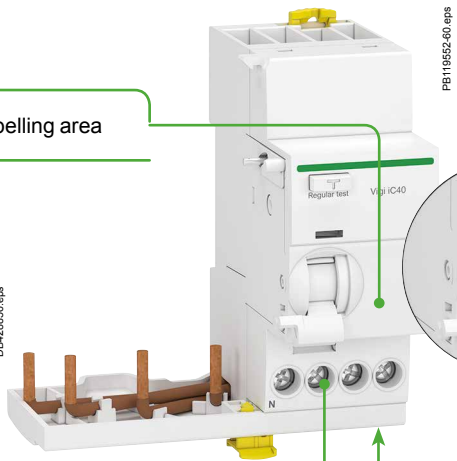

PB119552-40.eps

VISI-TRIP window

■ Fault tripping is indicated by a red mechanical indicator on the front face



DB428855.eps

■ Test button



DB428856.eps

■ Insulated terminals IP20

Protection, Earth leakage protection

Acti9 Vigi iCG40 add-on residual current devices "Group feeder"



IEC/EN 61009-2-1

As per the above standard:

The residual current devices offer the following earth leakage protection functions:

- protection of persons against electric shock by direct contact (30 mA),
- protection of persons against electric shock by indirect contact (300 mA),
- protection of installations against the risk of fire (300 mA)
- Circuit protection is ensured by a circuit breaker associated to the Vigi add-on.

■ On Vigi 3P+N add-on residual current devices, it is possible to power supply another row of products from the downstream connections of the Vigi add-on.

■ Type \square residual current devices ensure full discrimination with downstream high-sensitivity (30 mA) differential devices.

A-SI type

The A-SI type provides increased immunity from electrical interference and polluted or corrosive environments.

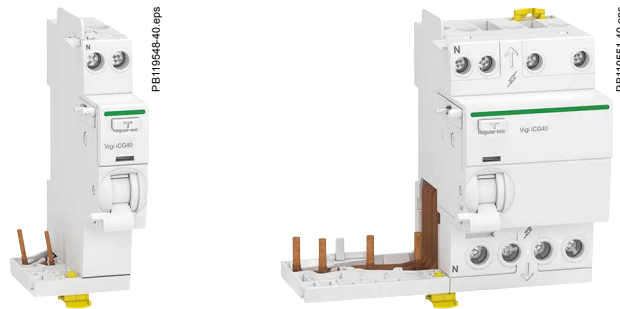

Catalog numbers

Acti9 Vigi iCG40 add-on residual current devices "group feeder"										
Type	AC			A		A-SI			Width in 9 mm modules	
Auxiliaries	Without auxiliaries									
1P+N	Sensitivity	30 mA	300 mA	30 mA	300 mA	30 mA	300 mA	300 mA \square		
	Rating	25 A	A9Y72625	A9Y73625	A9Y70625	A9Y71625	A9Y74625	A9Y75625	-	2
		40 A	A9Y72640	A9Y73640	A9Y70640	A9Y71640	A9Y74640	A9Y75640	A9Y76640	
	Rating	25 A	A9Y72725	A9Y73725	A9Y70725	A9Y71725	A9Y74725	A9Y75725	-	4
		40 A	A9Y72740	A9Y73740	A9Y70740	A9Y71740	A9Y74740	A9Y75740	A9Y76740	
Accessories	Catalog modules CA907001 and CA907015									
PowerTag energy sensors	Catalog modules CA907029 and CA908058									

Protection, Earth leakage protection

Acti9 Vigi iCG40 add-on residual current devices "Group feeder"

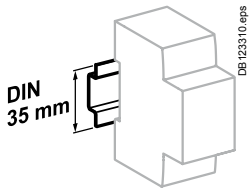

Clip on DIN rail 35 mm.

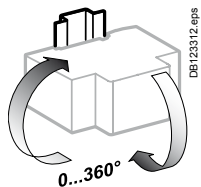

Indifferent position of installation.

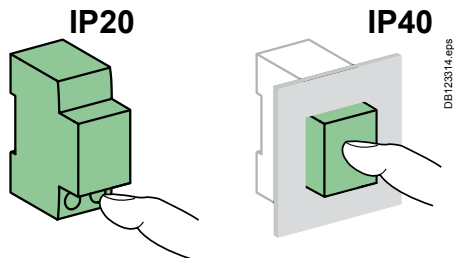

Dimensions (mm)

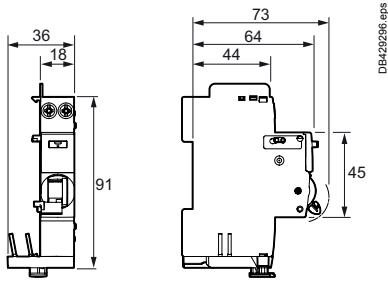



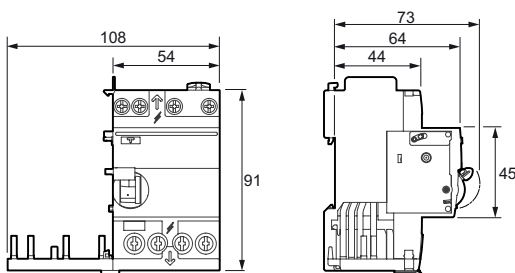

Acti9 Vigi iCG40 "Group feeder" 1P+N



Acti9 Vigi iCG40 "Group feeder" 3P+N

Technical data

Main characteristics		
According to IEC/EN 61009-2-1		
Insulation voltage (Ui)	Phase-to-neutral	400 V
	Phase-to-phase	440 V
Insulation voltage (Ui)	Phase-to-neutral	230 V
	Phase-to-phase	400 V
Operating frequency		50/60 Hz
8/20 µs impulse withstand without tripping	AC, A types	250 Å
	A-SI type (not selective )	3 kÅ
	A-SI type (selective )	3 kÅ
Degré de pollution		3
Behaviour in case of voltage drop		Residual current protection down to 0 V according to IEC/ EN 61009-1 § 3.3.8
Rated impulse withstand voltage (Uimp)		4 kV
Additional characteristics		
Degree of protection (IEC 60529)	Device only	IP20
	Device in modular enclosure	IP40
Operating temperature	AC type	-5°C to +60°C
	A, A-SI types 	-25°C to +60°C
Storage temperature		-40°C to +85°C

Connection

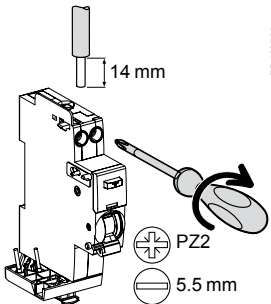
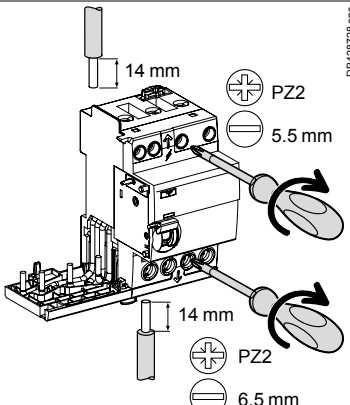
	Tightening torque	Copper cables	
		Rigid	Flexible or with ferrule
 <p>Acti9 Vigi iCG40 1P+N</p>	2 N.m	1 to 16 mm ²	1 to 10 mm ²
 <p>Acti9 Vigi iCG40 3P+N</p>	2 N.m	1 to 16 mm ²	1 to 10 mm ²

Weight (g)

Add-on residual current devices	
Type	Acti9 Vigi iCG40
1P+N	90
3P+N	235

Protection, Earth leakage protection

Acti9 Vigi iCG40 add-on residual current devices "Group feeder"

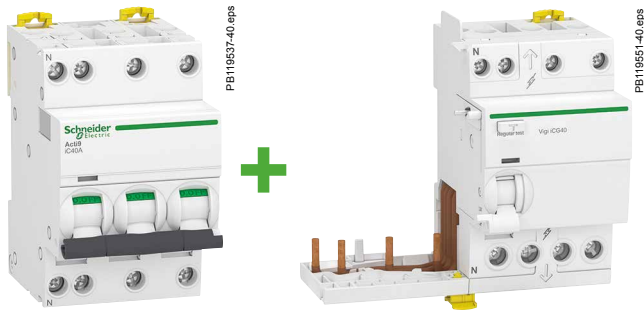

Circuit breaker + Vigi association

Circuit breaker	Vigi 25 A	Vigi 40 A
2 A to 25 A	■	■
32 A - 40 A	-	■

■ Double clip for dismantling with comb busbar in place

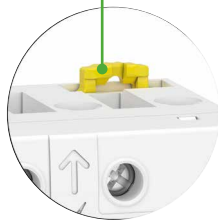

DB428565.eps

■ Insulated terminals IP20

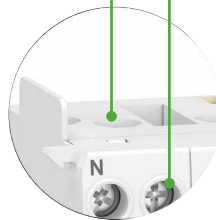

DB428568.eps

Output terminals

- Direct power supply of the outgoing by comb busbar
- Compatible with Acti9 horizontal comb busbars with 9 mm modules (catalog module CA907026)

■ Test button



DB428566.eps

VISI-TRIP window

- Fault tripping is indicated by a red mechanical indicator on the front face



DB428567.eps

■ Large circuit labelling area

3P+N "Group feeder"

- Capability on the 3P+N Group feeder, to power supply another group of products from the downstream connections of the Vigi add-on

Protection

Earth leakage protection

Vigi iC60

Contents



Schneider Electric's range of add-on residual current devices consists of different products (A, B, C, D, E) to enable it to be the most competitive range possible in each country, allowing for the special characteristics of each market:

- usual installation procedure
- price
- accreditations by local bodies.

Variants

Offers	Catalogue numbers	Pages
Offer A	Catalogue numbers	204 and 212
Offer B	Catalogue numbers	207 and 212
Offer C	Catalogue numbers	211 and 212
Offer D Quick Vigi	Catalogue numbers	213 and 221
Offer E Quick Vigi	Catalogue numbers	217 and 221
Common pages		222

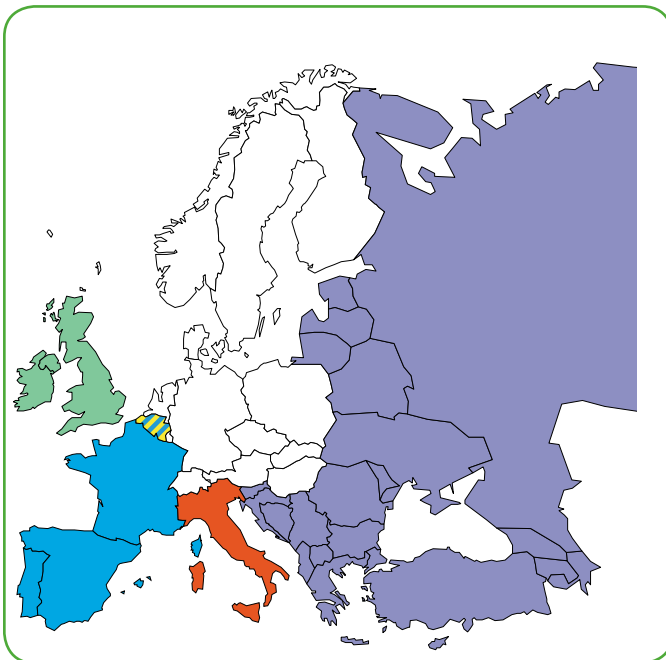

Only the product range to be marketed in your country and validated by the local product manager, in agreement with his Final Distribution (FD) partner should be retained. The others will be removed before publication.

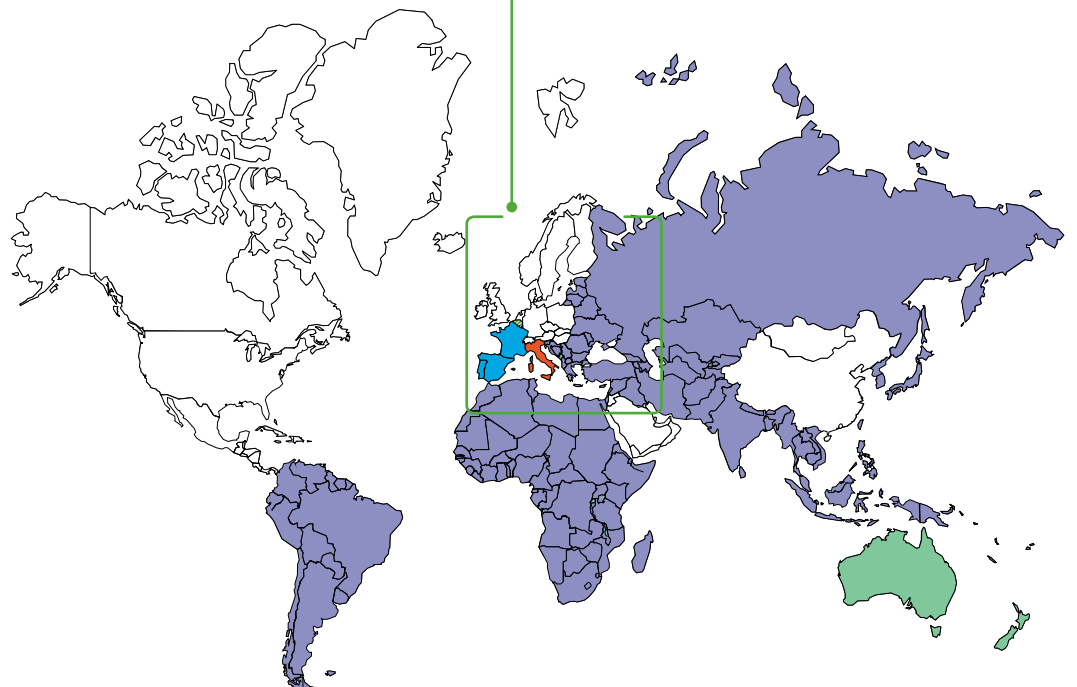

Protection Earth leakage protection

Vigi iC60 add-on residual current devices (AC type)

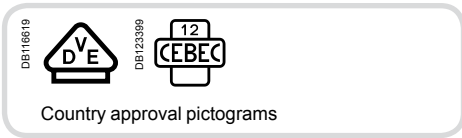

IEC/EN 61009-1

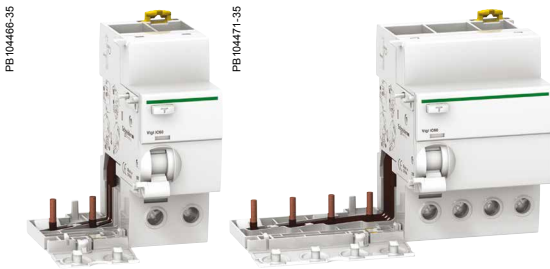

- Combined with iC60 circuit breaker, the Vigi iC60 provide:
 - protection of persons against electric shock by direct contact (≤ 30 mA),
 - protection of persons against electric shock by indirect contact (≥ 100 mA),
 - protection of installations against the risk of fire (300 mA or 500 mA).

Catalogue numbers

Vigi iC60 add-on residual current devices for 230/400 V network										
Type	AC								Width in 9 mm modules	
Auxiliaries	Without auxiliaries									
2P	Sensitivity	10 mA	30 mA	100 mA	300 mA	500 mA	300 mA	1000 mA		
 DB122462	Rating	25 A	A9V10225	A9V11225	A9V12225	A9V14225	A9V16225	-	3	
		40 A	-	A9V11240	-	A9V14240	A9V16240	-	4	
		63 A	-	A9V11263	A9V12263	A9V14263	A9V16263	A9V15263	A9V19263	4
 DB122463	Sensitivity	10 mA		30 mA	100 mA	300 mA	500 mA	300 mA	1000 mA	
	Rating	25 A	-	A9V11325	-	A9V14325	A9V16325	-	-	6
		40 A	-	A9V11340	-	A9V14340	A9V16340	-	-	7
	63 A	-	A9V11363	-	A9V14363	A9V16363	A9V15363	A9V19363	7	
 DB122464	Sensitivity	10 mA		30 mA	100 mA	300 mA	500 mA	300 mA	1000 mA	
	Rating	25 A	-	A9V11425	A9V12425	A9V14425	A9V16425	-	-	6
		40 A	-	A9V11440	-	A9V14440	A9V16440	-	-	7
	63 A	-	A9V11463	A9V12463	A9V14463	A9V16463	A9V15463	A9V19463	7	
Voltage rating (Ue)	2P	230 - 240 V								
	3P-4P	400 - 415 V								
Operating frequency	50/60 Hz									
Accessories	Module CA907000									

Offer selection see page 203

Offer A

This sticker must be removed before publishing

Vigi iC60 add-on residual current devices for 110 V network											
Type	AC								Width in 9 mm modules		
Auxiliaries	Without auxiliaries										
2P	Sensitivity	30 mA	300 mA								
 DB122462	Rating	25 A	A9V01225	A9V04225							3
		40 A	A9V01240	A9V04240							4
		63 A	A9V01263	A9V04263							4
Voltage rating (Ue)	110 V										
Operating frequency	50/60 Hz										
Accessories	Module CA907000										

Protection Earth leakage protection Vigi iC60 add-on residual current devices (A type)



IEC/EN 61009-1



- Combined with iC60 circuit breaker, the Vigi iC60 provide:
 - protection of persons against electric shock by direct contact (30 mA),
 - protection of persons against electric shock by indirect contact (≥ 100 mA),
 - protection of installations against the risk of fire (300 mA or 500 mA).

Catalogue numbers

Vigi iC60 add-on residual current devices for 230/400 V network								
Type	A							Width in 9 mm modules
Auxiliaries		Without auxiliaries						
2P		Sensitivity	30 mA	100 mA	300 mA	500 mA	300 mA	1000 mA
 DB122462	Rating	25 A	A9V21225	A9V22225	A9V24225	A9V26225	-	-
		63 A	A9V21263	A9V22263	A9V24263	A9V26263	A9V25263	A9V29263
 DB122463	Rating	25 A	A9V21325	A9V22325	A9V24325	A9V26325	-	-
		63 A	A9V21363	-	A9V24363	A9V26363	A9V25363	A9V29363
 DB122464	Rating	25 A	A9V21425	A9V22425	A9V24425	A9V26425	-	-
		63 A	A9V21463	A9V22463	A9V24463	A9V26463	A9V25463	A9V29463
Voltage rating (Ue)	2P	230 - 240 V						
	3P-4P	400 - 415 V						
Operating frequency	50/60 Hz							
Accessories	Module CA907000							

Offer selection see page 203

Offer A

This sticker must be removed before publishing

Vigi iC60 add-on residual current devices for 400 V network			
Type	A		Width in 9 mm modules
Auxiliaries		Without auxiliaries	
2P		Sensitivity	30 mA
 DB122462	Rating	63 A	A9V07263
Voltage rating (Ue)	400 - 415 V		
Operating frequency	50/60 Hz		
Accessories	Module CA907000		

Protection Earth leakage protection

Vigi iC60 add-on residual current devices (A-SI type)



IEC/EN 61009-1

PB10466-35

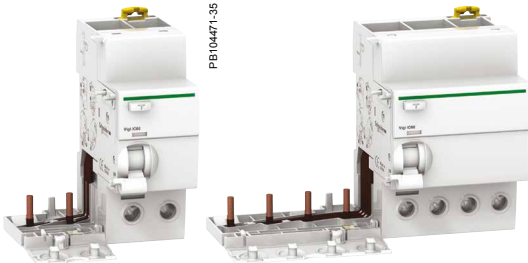

- Combined with iC60 circuit breaker, the Vigi iC60 provide:
 - protection of persons against electric shock by direct contact (≤ 30 mA),
 - protection of persons against electric shock by indirect contact (≥ 300 mA),
 - protection of installations against the risk of fire (300 mA).

The A-SI type provides increased immunity from electrical interference and polluted or corrosive environments.

Catalogue numbers

Vigi iC60 add-on residual current devices for 230/400 V network						
Type	A-SI					Width in 9 mm modules
Auxiliaries		Without auxiliaries				
Sensitivity		10 mA	30 mA	300 mA	1000 mA	
 DB122462	Rating	25 A	A9V30225	A9V31225	-	3
		40 A	-	A9V31240	-	4
		63 A	-	A9V31263	A9V35263	A9V39263
 DB122463	Rating	25 A	-	A9V31325	-	6
		40 A	-	A9V31340	-	7
		63 A	-	A9V31363	A9V35363	A9V39363
 DB122464	Rating	25 A	-	A9V31425	-	6
		40 A	-	A9V31440	-	7
		63 A	-	A9V31463	A9V35463	A9V39463
Voltage rating (Ue)		2P	230 - 240 V			
		3P-4P	400 - 415 V			
Operating frequency		50/60 Hz				
Accessories		Module CA907000				

Vigi iC60 add-on residual current devices for 230 V network						
Type	A-SI					Width in 9 mm modules
Auxiliaries		Without auxiliaries				
Sensitivity		30 mA				
 DB122462	Rating	63 A			A9V71363	7
 DB122464	Rating	63 A			A9V71463	7
Voltage rating (Ue)		230 V				
Operating frequency		50/60 Hz				
Accessories		Module CA907000				

Offer selection see page 203

Offer A

This sticker must be removed before publishing

Protection Earth leakage protection Vigi iC60 add-on residual current devices (AC type)



IEC/EN 61009-1

PB104466-3S

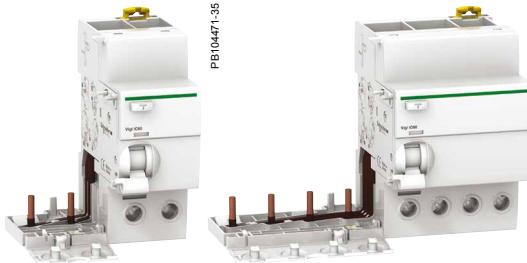

PB104471-3S

- Combined with iC60 circuit breaker, the Vigi iC60 provide:
 - protection of persons against electric shock by direct contact (≤ 30 mA),
 - protection of persons against electric shock by indirect contact (≥ 100 mA),
 - protection of installations against the risk of fire (300 mA or 500 mA).

Catalogue numbers

Vigi iC60 add-on residual current devices for 230/400 V network										
Type	AC								Width in 9 mm modules	
Auxiliaries	Without auxiliaries									
2P	Sensitivity	10 mA	30 mA	100 mA	300 mA	500 mA	300 mA	1000 mA		
<p>DB122402</p>	Rating	25 A	A9V10225	A9V41225	A9V12225	A9V44225	A9V16225	-	3	
		40 A	-	A9V41240	-	A9V44240	A9V16240	-	4	
		63 A	-	A9V41263	A9V12263	A9V44263	A9V16263	A9V15263	A9V19263	4
<p>DB122403</p>	Rating	25 A	-	A9V41325	-	A9V44325	A9V16325	-	6	
		40 A	-	A9V41340	-	A9V44340	A9V16340	-	7	
		63 A	-	A9V41363	-	A9V44363	A9V16363	A9V15363	A9V19363	7
<p>DB122404</p>	Rating	25 A	-	A9V41425	A9V12425	A9V44425	A9V16425	-	6	
		40 A	-	A9V41440	-	A9V44440	A9V16440	-	7	
		63 A	-	A9V41463	A9V12463	A9V44463	A9V16463	A9V15463	A9V19463	7
Voltage rating (Ue)	2P	230 - 240 V								
	3P-4P	400 - 415 V								
Operating frequency	50/60 Hz									
Accessories	Module CA907000									

Offer selection see page 203

Offer B

This sticker must be removed before publishing

Protection
Earth leakage protection

Vigi iC60 add-on residual current devices (AC type)
(cont.)

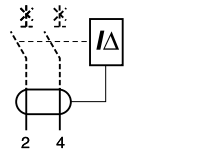
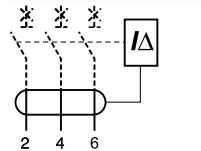
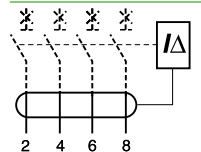
Vigi iC60 add-on residual current devices for 110/230 V network				
Type	AC 		Width in 9 mm modules	
Auxiliaries	Without auxiliaries			
2P	Sensitivity	30 mA	300 mA	
	Rating	25 A	A9V01225	A9V04225
		40 A	A9V01240	A9V04240
		63 A	A9V01263	A9V04263
3P	Sensitivity	30 mA	300 mA	
	Rating	25 A	A9V81325	-
		63 A	A9V81363	-
4P	Sensitivity	30 mA	300 mA	
	Rating	25 A	A9V81425	-
		63 A	A9V81463	-
Voltage rating (Ue)	2P	110 V		
	3P-4P	230 V		
Operating frequency	50/60 Hz			
Accessories	Module CA907000			

Offer selection see page 203

Offer B

This sticker must be removed before publishing

Protection Earth leakage protection Vigi iC60 add-on residual current devices (A type)



IEC/EN 61009-1

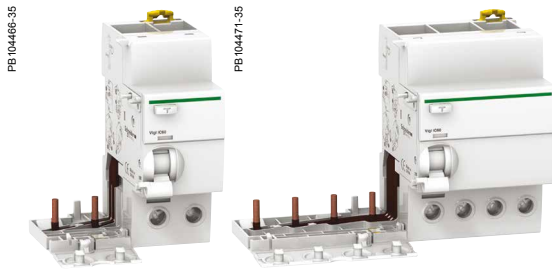

- Combined with iC60 circuit breaker, the Vigi iC60 provide:
 - protection of persons against electric shock by direct contact (30 mA),
 - protection of persons against electric shock by indirect contact (≥ 100 mA),
 - protection of installations against the risk of fire (300 mA or 500 mA).

Catalogue numbers

Vigi iC60 add-on residual current devices for 230/400 V network								
Type	A							Width in 9 mm modules
Auxiliaries	Without auxiliaries							
2P	Sensitivity	30 mA	100 mA	300 mA	500 mA	300 mA	1000 mA	
 DB122462 Rating	25 A	A9V51225	A9V22225	A9V54225	A9V26225	-	-	3
	63 A	A9V51263	A9V22263	A9V54263	A9V26263	A9V25263	A9V29263	4
 DB122463 Rating	25 A	A9V51325	A9V22325	A9V54325	A9V26325	-	-	6
	63 A	A9V51363	-	A9V54363	A9V26363	A9V25363	A9V29363	7
 DB122464 Rating	25 A	A9V51425	A9V22425	A9V54425	A9V26425	-	-	6
	63 A	A9V51463	A9V22463	A9V54463	A9V26463	A9V25463	A9V29463	7
Voltage rating (Ue)	2P	230 - 240 V						
	3P-4P	400 - 415 V						
Operating frequency	50/60 Hz							
Accessories	Module CA907000							

Offer selection see page 203

Offer B

This sticker must be removed before publishing

Vigi iC60 add-on residual current devices for 400 V network			
Type	A		Width in 9 mm modules
Auxiliaries	Without auxiliaries		
2P	Sensitivity	30 mA	
 DB122462 Rating	63 A	A9V07263	4
Voltage rating (Ue)	400 - 415 V		
Operating frequency	50/60 Hz		
Accessories	Module CA907000		

Protection Earth leakage protection

Vigi iC60 add-on residual current devices (A-SI type)



IEC/EN 61009-1

PB104466-35

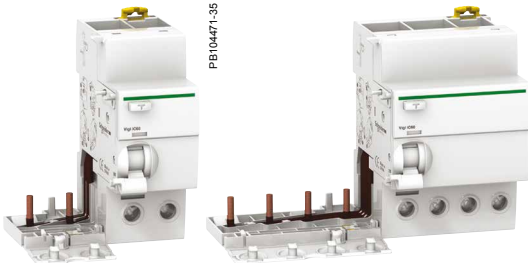

PB104471-35

- Combined with iC60 circuit breaker, the Vigi iC60 provide:
 - protection of persons against electric shock by direct contact (≤ 30 mA),
 - protection of persons against electric shock by indirect contact (≥ 300 mA),
 - protection of installations against the risk of fire (300 mA).

The A-SI type provides increased immunity from electrical interference and polluted or corrosive environments.

Catalogue numbers

Vigi iC60 add-on residual current devices for 230/400 V network						
Type	A-SI					Width in 9 mm modules
Auxiliaries	Without auxiliaries					
2P	Sensitivity	10 mA	30 mA	300 mA	1000 mA	
 DB122462	Rating	25 A	A9V30225	A9V61225	-	3
		40 A	-	A9V61240	-	4
		63 A	-	A9V61263	A9V65263	A9V39263
 DB122463	Rating	25 A	-	A9V61325	-	6
		40 A	-	A9V61340	-	7
		63 A	-	A9V61363	A9V65363	A9V39363
 DB122464	Rating	25 A	-	A9V61425	-	6
		40 A	-	A9V61440	-	7
		63 A	-	A9V61463	A9V65463	A9V39463
Voltage rating (Ue)	2P	230 - 240 V				
	3P-4P	400 - 415 V				
Operating frequency	50/60 Hz					
Accessories	Module CA907000					

Vigi iC60 add-on residual current devices for 230 V network							
Type	A-SI					Width in 9 mm modules	
Auxiliaries	Without auxiliaries						
3P	Sensitivity	30 mA					
 DB122462	Rating	63 A				A9V71363	7
 DB122464	Rating	63 A				A9V71463	7
Voltage rating (Ue)	230 V						
Operating frequency	50/60 Hz						
Accessories	Module CA907000						

Offer selection see page 203

Offer B

This sticker must be removed before publishing

Protection Earth leakage protection Vigi iC60 add-on residual current devices (type A)

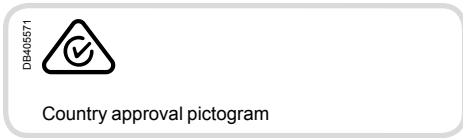

IEC/EN 61009-1

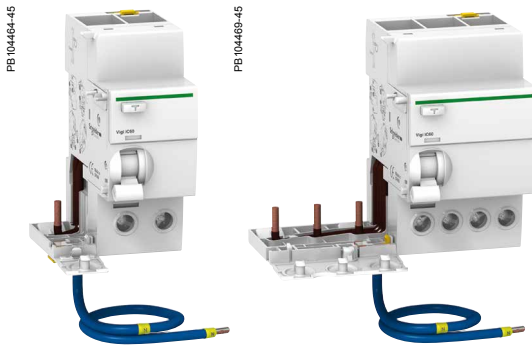

- Combined with iC60 circuit breaker, the Vigi iC60 provide:
 - protection of persons against electric shock by direct contact (30 mA),
 - protection of persons against electric shock by indirect contact (≥ 100 mA),
 - protection of installations against the risk of fire (300 mA).

Catalogue numbers

Vigi iC60 add-on residual current devices for 230/400 V network					
Type	A				Width in 9 mm modules
Auxiliaries	Without auxiliaries				
2P	Sensitivity	30 mA	100 mA	300 mA	
<p>DB122462</p>	Rating 63 A	A9V02663	A9V03663	A9V06663	4 4
4P	Sensitivity	30 mA	100 mA	300 mA	
<p>DB122464</p>	Rating 63 A	A9V02763	-	A9V06763	7
Voltage rating (Ue)	2P	230 - 240 V			
	4P	400 - 415 V			
Operating frequency	50/60 Hz				
Accessories	Module CA907000				

Offer selection see page 203

Offer C

This sticker must be removed before publishing

Vigi iC60 add-on residual current devices for 110 V network					
Type	A				Width in 9 mm modules
Auxiliaries	Without auxiliaries				
2P	Sensitivity	30 mA			
<p>DB122462</p>	Rating 63 A	A9V01663	4		
Voltage rating (Ue)	110 V				
Operating frequency	50/60 Hz				
Accessories	Module CA907000				

Protection
Earth leakage protection

Vigi iC60 add-on residual current devices
(AC, A, A-SI types) (cont.)

PB104556-51

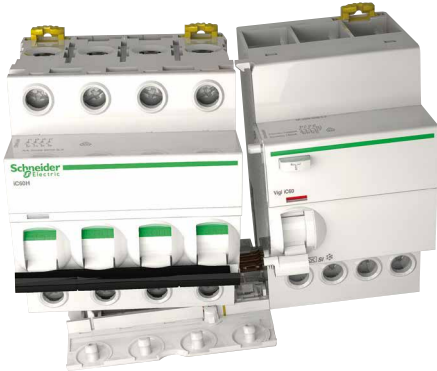

Association iC60a, N, H, L + Vigi iC60

iC60	Vigi iC60 25 A	Vigi iC60 40 A	Vigi iC60 63 A
0.5 A to 25 A	■	■	■
32 A - 40 A	NO	■	■
50 A - 63 A	NO	NO	■

Association iC60L-MA + Vigi iC60

iC60	Vigi iC60 25 A	Vigi iC60 40 A	Vigi iC60 63 A
1.6 A to 16 A	■	■	■
25 A	NO	■	■
40 A	NO	NO	■



Combining iC60 L-MA units with Vigi modules of higher rating.

Offer selection see page 203

Offer A, B, C

This sticker must be removed before publishing

PB 104466-40

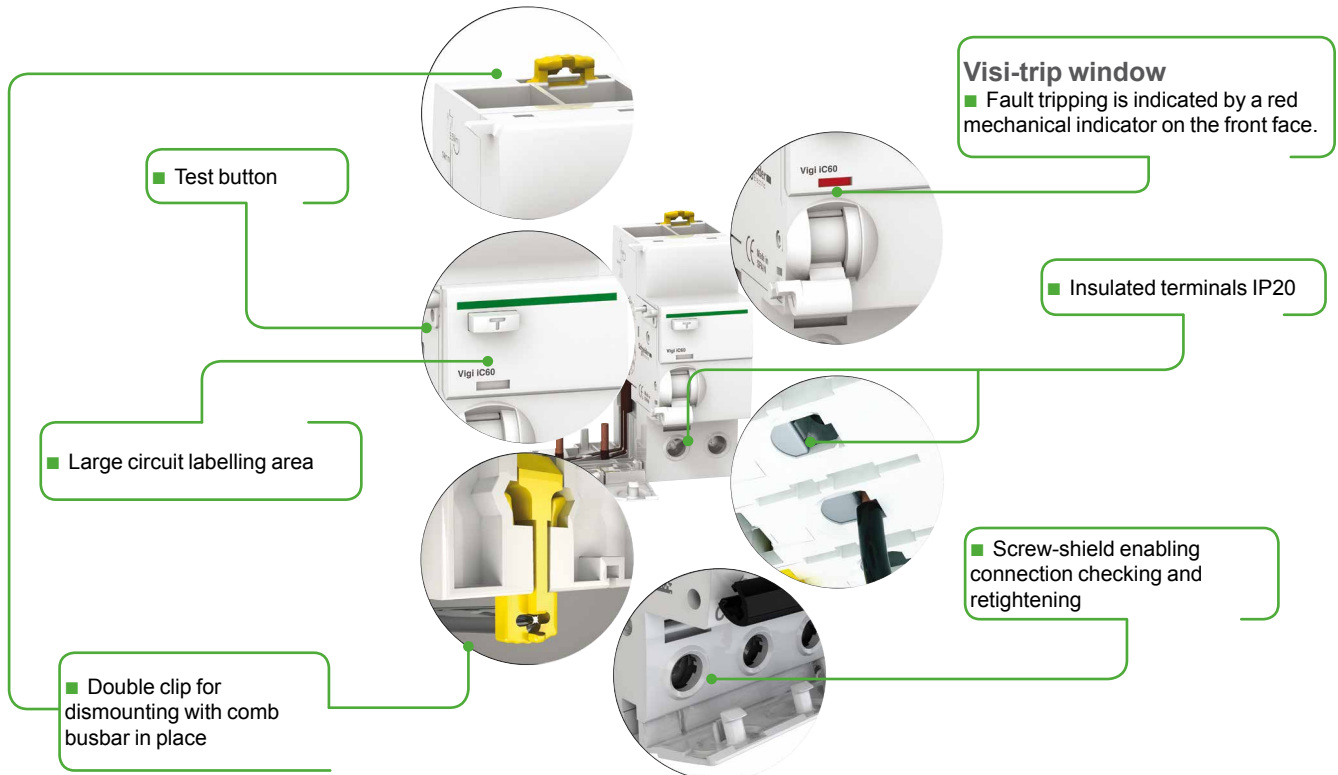

A-SI type

The A-SI type provides increased immunity from electrical interference and polluted or corrosive environments.

Protection Earth leakage protection

Vigi iC60 add-on residual current devices (AC type)



IEC/EN 61009-1

DB123811



- Combined with iC60 circuit breaker, the Vigi iC60 provide:
 - protection of persons against electric shock by direct contact (≤ 30 mA),
 - protection of persons against electric shock by indirect contact (≥ 100 mA),
 - protection of installations against the risk of fire (300 mA or 500 mA).

Catalogue numbers

Vigi iC60 add-on residual current devices for 230/400 V network										
Type	AC								Width in 9 mm modules	
Auxiliaries	Without auxiliaries									
2P	Sensitivity	10 mA	30 mA	100 mA	300 mA	500 mA	300 mA	1000 mA		
<p>DB122462</p>	Rating	25 A	A9Q10225	A9Q11225	A9Q12225	A9Q14225	A9Q16225	-	3	
		40 A	-	A9Q11240	-	A9Q14240	A9Q16240	-	4	
		63 A	-	A9V11263	A9V12263	A9V14263	A9V16263	A9V15263	A9V19263	4
<p>DB122463</p>	Rating	25 A	-	A9Q11325	-	A9Q14325	A9Q16325	-	6	
		40 A	-	A9Q11340	-	A9Q14340	A9Q16340	-	7	
		63 A	-	A9V11363	-	A9V14363	A9V16363	A9V15363	A9V19363	7
<p>DB122464</p>	Rating	25 A	-	A9Q11425	A9Q12425	A9Q14425	A9Q16425	-	6	
		40 A	-	A9Q11440	-	A9Q14440	A9Q16440	-	7	
		63 A	-	A9V11463	A9V12463	A9V14463	A9V16463	A9V15463	A9V19463	7
Voltage rating (Ue)	2P	230 - 240 V								
	3P-4P	400 - 415 V								
Operating frequency	50/60 Hz									
Accessories	Module CA907000									

Offer selection see page 203

Offer D Quick

This sticker must be removed before publishing

Vigi iC60 add-on residual current devices (AC type) (cont.)

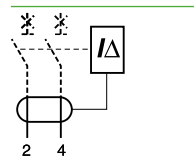
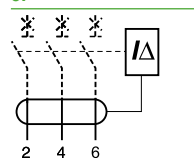
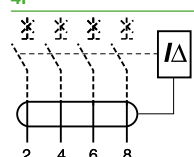
Vigi iC60 add-on residual current devices for 110/230 V network					
Type	AC 		Width in 9 mm modules		
Auxiliaries	Without auxiliaries				
	Sensitivity	30 mA	300 mA		
 <p>DB122462</p>	Rating	25 A	A9Q01225	A9Q04225	3
		40 A	A9Q01240	A9Q04240	4
		63 A	A9V01263	A9V04263	4
	Rating	25 A	A9Q81325	-	6
		63 A	A9V81363	-	7
	Rating	25 A	A9Q81425	-	6
		63 A	A9V81463	-	7
Voltage rating (Ue)	2P	110 V			
	3P-4P	230 V			
Operating frequency			50/60 Hz		
Accessoires			Module CA907000		

Offer selection see page 203

Offer D Quick

This sticker must be removed before publishing

Protection Earth leakage protection Vigi iC60 add-on residual current devices (A type)



IEC/EN 61009-1

DB123811



- Combined with iC60 circuit breaker, the Vigi iC60 provide:
 - protection of persons against electric shock by direct contact (30 mA),
 - protection of persons against electric shock by indirect contact (≥ 100 mA),
 - protection of installations against the risk of fire (300 mA or 500 mA).

Catalogue numbers

Vigi iC60 add-on residual current devices for 230/400 V network									
Type	A							Width in 9 mm modules	
Auxiliaries	Without auxiliaries								
2P	Sensitivity	30 mA	100 mA	300 mA	500 mA	300 mA	1000 mA		
 DB122462	Rating	25 A	A9Q21225	A9Q22225	A9Q24225	A9Q26225	-	3	
		63 A	A9V21263	A9V22263	A9V24263	A9V26263	A9V25263	A9V29263	4
 DB122463	Rating	25 A	A9Q21325	A9Q22325	A9Q24325	A9Q26325	-	6	
		63 A	A9V21363	-	A9V24363	A9V26363	A9V25363	A9V29363	7
 DB122464	Rating	25 A	A9Q21425	A9Q22425	A9Q24425	A9Q26425	-	6	
		63 A	A9V21463	A9V22463	A9V24463	A9V26463	A9V25463	A9V29463	7
Voltage rating (Ue)	2P	230 - 240 V							
	3P-4P	400 - 415 V							
Operating frequency	50/60 Hz								
Accessories	Module CA907000								

Offer selection see page 203

Offer D Quick

This sticker must be removed before publishing

Protection Earth leakage protection

Vigi iC60 add-on residual current devices (A-SI type)



DB123811

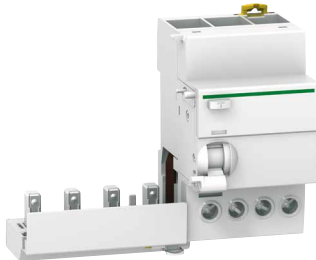

IEC/EN 61009-1

- Combined with iC60 circuit breaker, the Vigi iC60 provide:
 - protection of persons against electric shock by direct contact (≤ 30 mA),
 - protection of persons against electric shock by indirect contact (≥ 300 mA),
 - protection of installations against the risk of fire (300 mA).

The A-SI type provides increased immunity from electrical interference and polluted or corrosive environments.

Catalogue numbers

Vigi iC60 add-on residual current devices for 230/400 V network						
Type	A-SI				Width in 9 mm modules	
Auxiliaries	Without auxiliaries					
2P	Sensitivity	10 mA	30 mA	300 mA 	1000 mA 	
 DB122462	Rating	25 A	A9Q30225	A9Q31225	-	3
		40 A	-	A9Q31240	-	4
		63 A	-	A9V31263	A9V35263	4
3P	Sensitivity	10 mA	30 mA	300 mA 	1000 mA 	
 DB122463	Rating	25 A	-	A9Q31325	-	6
		40 A	-	A9Q31340	-	7
		63 A	-	A9V31363	A9V35363	7
4P	Sensitivity	10 mA	30 mA	300 mA 	1000 mA 	
 DB122464	Rating	25 A	-	A9Q31425	-	6
		40 A	-	A9Q31440	-	7
		63 A	-	A9V31463	A9V35463	7
Voltage rating (Ue)	2P	230 - 240 V				
	3P-4P	400 - 415 V				
Operating frequency	50/60 Hz					
Accessories	Module CA907000					

Vigi iC60 add-on residual current devices for 230 V network						
Type	A-SI				Width in 9 mm modules	
Auxiliaries	Without auxiliaries					
3P	Sensitivity	30 mA				
 DB122462	Rating	63 A		A9V71363	7	
4P	Sensitivity	30 mA				
 DB122464	Rating	63 A		A9V71463	7	
Voltage rating (Ue)	230 V					
Operating frequency	50/60 Hz					
Accessories	Module CA907000					

Offer selection see page 203

Offer D Quick

This sticker must be removed before publishing

Protection Earth leakage protection

Vigi iC60 add-on residual current devices (AC type)

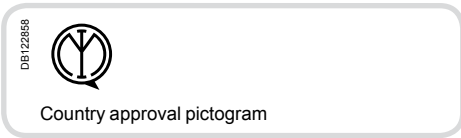

IEC/EN 61009-1

DB122811



- Combined with iC60 circuit breaker, the Vigi iC60 provide:
 - protection of persons against electric shock by direct contact (≤ 30 mA),
 - protection of persons against electric shock by indirect contact (≥ 100 mA),
 - protection of installations against the risk of fire (300 mA or 500 mA).

Catalogue numbers

Vigi iC60 add-on residual current devices for 230/400 V network										
Type	AC								Width in 9 mm modules	
Auxiliaries	Without auxiliaries									
2P	Sensitivity	10 mA	30 mA	100 mA	300 mA	500 mA	300 mA	1000 mA		
<p>DB122462</p>	Rating	25 A	A9Q41225	A9Q12225	A9Q44225	A9Q16225	-	-	3	
		40 A	-	A9Q41240	-	A9Q44240	A9Q16240	-	4	
		63 A	-	A9V41263	A9V12263	A9V44263	A9V16263	A9V15263	A9V19263	4
<p>DB122463</p>	Rating	25 A	-	A9Q41325	-	A9Q44325	A9Q16325	-	6	
		40 A	-	A9Q41340	-	A9Q44340	A9Q16340	-	7	
		63 A	-	A9V41363	-	A9V44363	A9V16363	A9V15363	A9V19363	7
<p>DB122464</p>	Rating	25 A	-	A9Q41425	A9Q12425	A9Q44425	A9Q16425	-	6	
		40 A	-	A9Q41440	-	A9Q44440	A9Q16440	-	7	
		63 A	-	A9V41463	A9V12463	A9V44463	A9V16463	A9V15463	A9V19463	7
Voltage rating (Ue)	2P	230 - 240 V								
	3P-4P	400 - 415 V								
Operating frequency	50/60 Hz									
Accessories	Module CA907000									

Offer selection see page 203

Offer E Quick

This sticker must be removed before publishing

Vigi iC60 add-on residual current devices (AC type) (cont.)

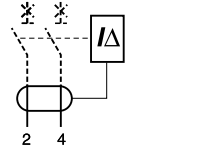
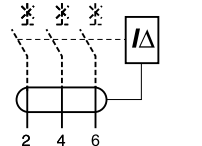
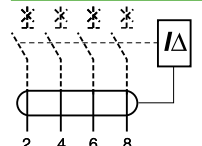
Vigi iC60 add-on residual current devices for 110/230 V network					
Type	AC 		Width in 9 mm modules		
Auxiliaries	Without auxiliaries				
	Sensitivity	30 mA	300 mA		
 <p>DB1224G2</p>	Rating	25 A	A9Q01225	A9Q04225	3
		40 A	A9Q01240	A9Q04240	4
		63 A	A9Q01263	A9Q04263	4
	Rating	25 A	A9Q81325	-	6
		63 A	A9V81363	-	7
	Rating	25 A	A9Q81425	-	6
		63 A	A9V81463	-	7
Voltage rating (Ue)	2P	110 V			
	3P-4P	230 V			
Operating frequency	50/60 Hz				
Accessoires	Module CA907000				

Offer selection see page 203

Offer E Quick

This sticker must be removed before publishing

Protection Earth leakage protection Vigi iC60 add-on residual current devices (A type)

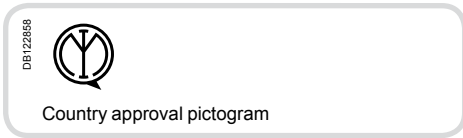

IEC/EN 61009-1

DB123811

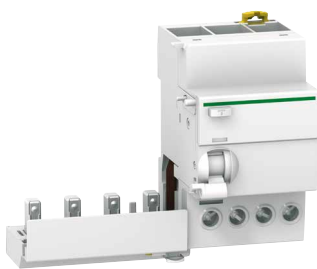

- Combined with iC60 circuit breaker, the Vigi iC60 provide:
 - protection of persons against electric shock by direct contact (30 mA),
 - protection of persons against electric shock by indirect contact (≥ 100 mA),
 - protection of installations against the risk of fire (300 mA or 500 mA).

Offer selection see page 203

Offer E Quick

This sticker must be removed before publishing

Catalogue numbers

Vigi iC60 add-on residual current devices for 230/400 V network									
Type	A							Width in 9 mm modules	
Auxiliaries	Without auxiliaries								
2P	Sensitivity	30 mA	100 mA	300 mA	500 mA	300 mA	1000 mA		
 DB12462	Rating	25 A	A9Q51225	A9Q22225	A9Q54225	A9Q26225	-	3	
		63 A	A9V51263	A9V22263	A9V54263	A9V26263	A9V25263	A9V29263	4
 DB12463	Rating	25 A	A9Q51325	A9Q22325	A9Q54325	A9Q26325	-	6	
		63 A	A9V51363	-	A9V54363	A9V26363	A9V25363	A9V29363	7
 DB12464	Rating	25 A	A9Q51425	A9Q22425	A9Q54425	A9Q26425	-	6	
		63 A	A9V51463	A9V22463	A9V54463	A9V26463	A9V25463	A9V29463	7
Voltage rating (Ue)	2P	230 - 240 V,							
	3P-4P	400 - 415 V							
Operating frequency	50/60 Hz								
Accessories	Module CA907000								

Protection Earth leakage protection

Vigi iC60 add-on residual current devices (A-SI type)

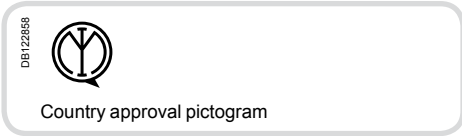

DB123811



IEC/EN 61009-1

- Combined with iC60 circuit breaker, the Vigi iC60 provide:
 - protection of persons against electric shock by direct contact (≤ 30 mA),
 - protection of persons against electric shock by indirect contact (≥ 300 mA),
 - protection of installations against the risk of fire (300 mA).

The A-SI type provides increased immunity from electrical interference and polluted or corrosive environments.

Catalogue numbers

Vigi iC60 add-on residual current devices for 230/400 V network						
Type	A-SI					Width in 9 mm modules
Auxiliaries		Without auxiliaries				
Sensitivity		10 mA	30 mA	300 mA	1000 mA	
DB122462 	Rating	25 A	A9Q30225	A9Q61225	-	3
		40 A	-	A9Q61240	-	4
		63 A	-	A9V61263	A9V65263	4
DB122463 	Rating	25 A	-	A9Q61325	-	6
		40 A	-	A9Q61340	-	7
		63 A	-	A9V61363	A9V65363	7
DB122464 	Rating	25 A	-	A9Q61425	-	6
		40 A	-	A9Q61440	-	7
		63 A	-	A9V61463	A9V65463	7
Voltage rating (Ue)		2P	230 - 240 V			
		3P-4P	400 - 415 V			
Operating frequency		50/60 Hz				
Accessories		Module CA907000				

Vigi iC60 add-on residual current devices for 230 V network							
Type	A-SI					Width in 9 mm modules	
Auxiliaries		Without auxiliaries					
Sensitivity		30 mA					
DB122462 	Rating	63 A				A9V71363	7
DB122464 	Rating	63 A				A9V71463	7
Voltage rating (Ue)		230 V					
Operating frequency		50/60 Hz					
Accessories		Module CA907000					

Offer selection see page 203

Offer E Quick

This sticker must be removed before publishing

Protection

Earth leakage protection

Vigi iC60 add-on residual current devices (AC, A, A-SI types) (cont.)

DE123612



Association iC60a, N, H, L + Vigi iC60

iC60	Vigi iC60 25 A	Vigi iC60 40 A	Vigi iC60 63 A
0.5 A to 25 A	■	■	■
32 A - 40 A	NO	■	■
50 A - 63 A	NO	NO	■

Association iC60L-MA + Vigi iC60

iC60	Vigi iC60 25 A	Vigi iC60 40 A	Vigi iC60 63 A
1.6 A to 16 A	■	■	■
25 A	NO	■	■
40 A	NO	NO	■



Combining iC60 L-MA units with Vigi modules of higher rating.

Offer selection see page 203

Offer D, E Quick

This sticker must be removed before publishing

DE123515

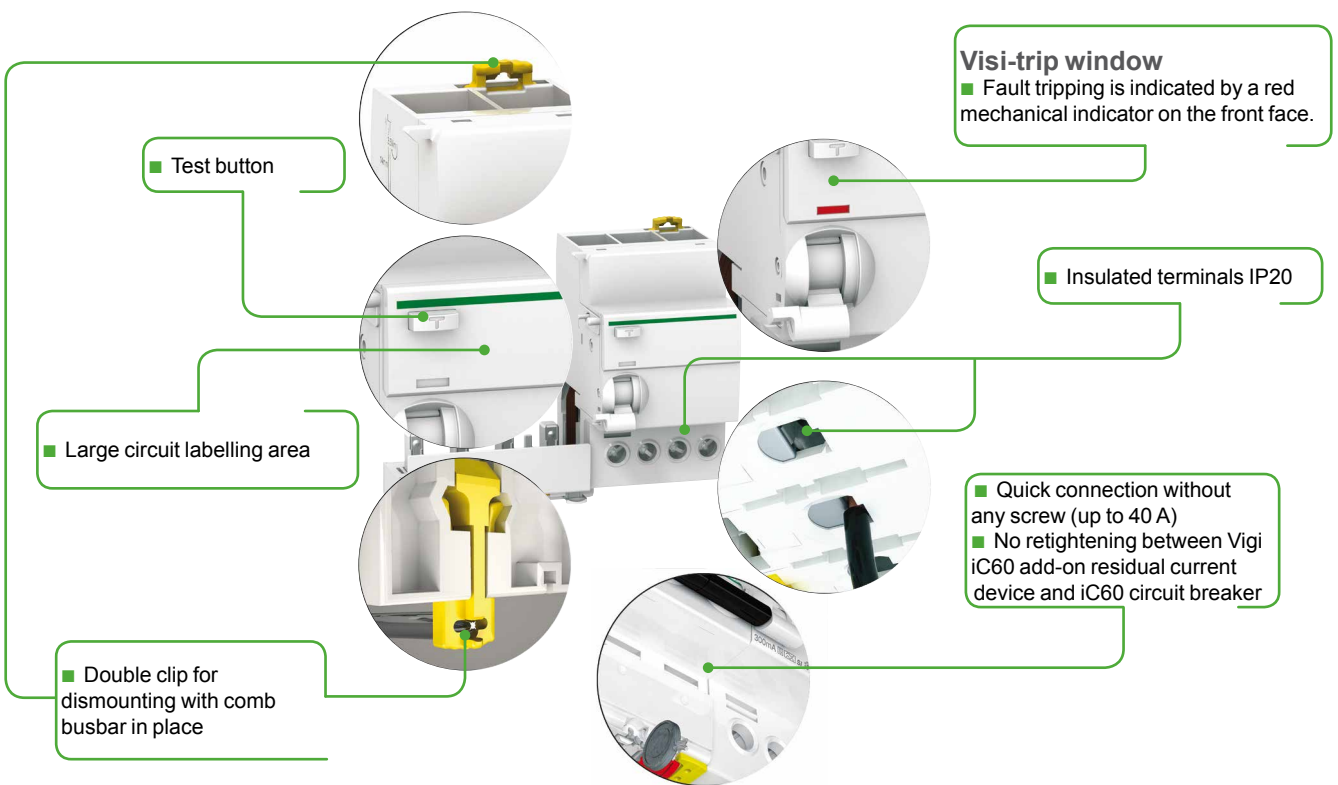

A-SI type

The A-SI type provides increased immunity from electrical interference and polluted or corrosive environments.

Protection

Earth leakage protection

Vigi iC60 add-on residual current devices (AC, A, A-SI types) (cont.)

Connection

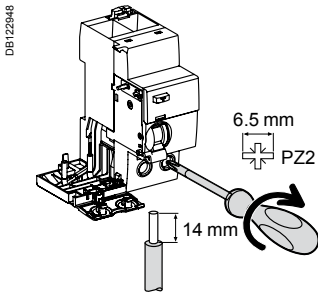

Type	Rating	Tightening torque	Copper cables	
			Rigid	Flexible or with ferrule
Vigi iC60	25 A	2 N.m	1 to 25 mm ²	1 to 16 mm ²
	40 to 63 A	3.5 N.m	1 to 35 mm ²	1 to 25 mm ²

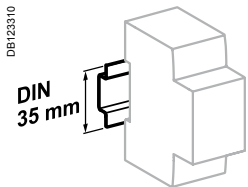

Clip on DIN rail 35 mm.

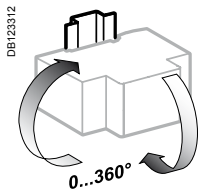

Indifferent position of installation.

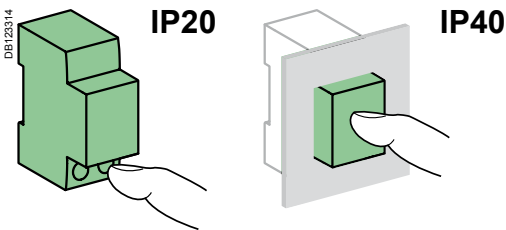

Technical data

Main characteristics		
Insulation voltage (U _i)		500 V
Pollution degree		3
Rated impulse withstand voltage (U _{imp})		6 kV
According to IEC/EN 61009-1		
Surge current withstand (8/20 μs) without tripping	AC and A types (no selective ☒)	250 Å
	AC, A types (selective ☒)	3 kÅ
	A-SI type	3 kÅ
Behaviour in case of voltage drop		Residual current protection down to 0 V according to IEC/EN 61009-1 § 3.3.8
Additional characteristics		
Degree of protection	Device only	IP20
	Device in modular enclosure	IP40
Operating temperature	AC type	-5°C to +60°C
	A and A-SI types	-25°C to +60°C
Storage temperature		-40°C to +85°C

Protection

Earth leakage protection

Vigi iC60 add-on residual current devices (AC, A, A-SI types) (cont.)

Weight (g)

Add-on residual current devices	
Type	Vigi iC60
2P	165
3P	210
4P	245

Dimensions (mm)

Vigi iC60 25 A

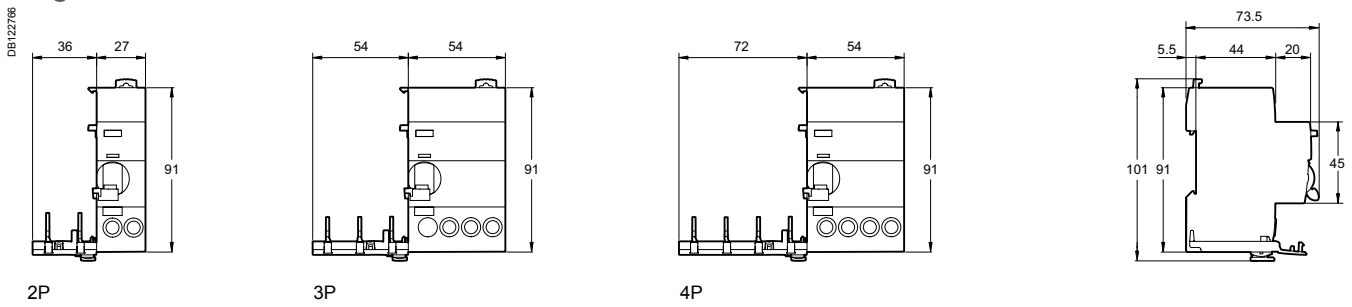

Vigi iC60 40 and 63 A

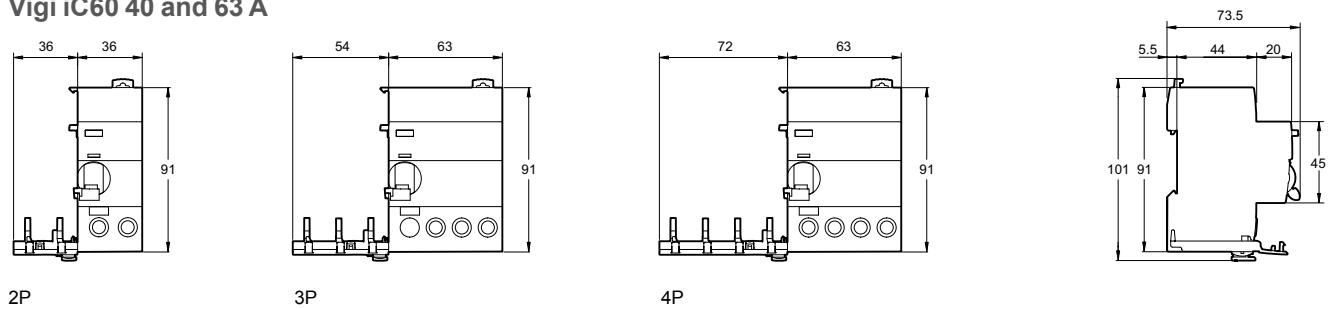

Protection Earth leakage protection

Vigi iC60 add-on residual current devices for iC60 double terminals (AC type)

IEC/EN 61009-1



- Combined with iC60 double tunnel terminals circuit breaker, the Vigi iC60 provide:
 - protection of persons against electric shock by direct contact (≤ 30 mA),
 - protection of persons against electric shock by indirect contact (≥ 100 mA),
 - protection of installations against the risk of fire (300 mA).



Catalogue numbers

Vigi iC60 add-on residual current devices							
Type	AC						
Product	Vigi iC60						
Auxiliaries	Without auxiliaries						
		Sensitivity	10 mA	30 mA	100 mA	300 mA	
2P DB405510	Rating	25 A	A9W10225	A9W11225 A9W01225*	A9W12225	A9W14225	3
		63 A	-	A9W11263	A9W12263	A9W14263	4
3P DB122483	Rating	25 A	-	A9W11325	-	A9W14325	6
		63 A	-	A9W11363	-	A9W14363	7
4P DB409511	Rating	25 A	-	A9W11425	A9W12425	A9W14425	6
		63 A	-	A9W11463	A9W12463	A9W14463	7
Voltage rating (Ue)	2P	230 - 240 V Except * 130 V					
	3P-4P	400 - 415 V					
Operating frequency	50/60 Hz						
Accessories	Module CA907000						

Protection Earth leakage protection

Vigi iC60 add-on residual current devices for iC60 double terminals (A type)

IEC/EN 61009-1

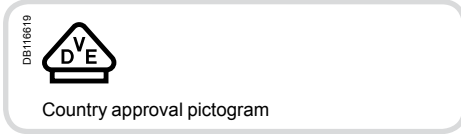

- Combined with iC60 double tunnel terminals circuit breaker, the Vigi iC60 provide:
 - protection of persons against electric shock by direct contact (30 mA),
 - protection of persons against electric shock by indirect contact (≥ 100 mA),
 - protection of installations against the risk of fire (300 mA or 500 mA).



Catalogue numbers

Vigi iC60 add-on residual current devices								
Type	A						Width in 9 mm modules	
Product	Vigi iC60							
Auxiliaries	Without auxiliaries							
	Sensitivity	30 mA	100 mA	300 mA	300 mA	500 mA		
DB110619 	Rating	25 A	A9W21225	A9W22225	A9W24225	-	A9W26225	3
		63 A	A9W21263	A9W22263	A9W24263	A9W25263	A9W26263	4
DB122463 	Rating	25 A	A9W21325	-	A9W24325	-	A9W26325	6
		63 A	A9W21363	-	A9W24363	A9W25363	A9W26363	7
DB124651 	Rating	25 A	A9W21425	A9W22425	A9W24425	-	A9W26425	6
		63 A	A9W21463	A9W22463	A9W24463	A9W25463	A9W26463	7
Voltage rating (Ue)	2P	230 - 240 V						
	3P-4P	400 - 415 V						
Operating frequency	50/60 Hz							
Accessories	Module CA907000							

Protection Earth leakage protection

Vigi iC60 add-on residual current devices for iC60 double terminals (SI type)

IEC/EN 61009-1



- Combined with iC60 double tunnel terminals circuit breaker, the Vigi iC60 provide:
 - protection of persons against electric shock by direct contact (≤ 30 mA),
 - protection of persons against electric shock by indirect contact (≥ 300 mA),
 - protection of installations against the risk of fire (300 mA).

The **SI** type provides increased immunity from electrical interference and polluted or corrosive environments.



Catalogue numbers

Vigi iC60 add-on residual current devices						
Type	SI					Width in 9 mm modules
Product	Vigi iC60					
Auxiliaries	Auxiliaries					
DB104510 	Sensitivity Rating	25 A	10 mA	30 mA	300 mA	3
		63 A	A9W30225	A9W31225	-	A9W35263
DB123463 	Sensitivity Rating	25 A	10 mA	30 mA	300 mA	6
		63 A	-	A9W31325	-	A9W35363
DB104511 	Sensitivity Rating	25 A	10 mA	30 mA	300 mA	6
		63 A	-	A9W31425	-	A9W35463
Voltage rating (Ue)	2P	230 - 240 V				
	3P-4P	400 - 415 V				
Operating frequency	50/60 Hz					
Accessories	Module CA907000					

Protection Earth leakage protection

Vigi iC60 add-on residual current devices for iC60 double terminals (AC, A, SI types)

Connection

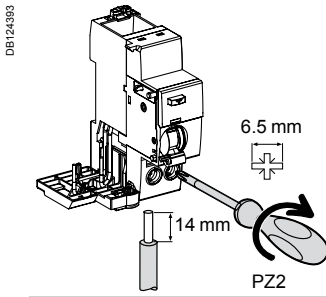

Type	Rating	Tightening torque	Copper cables	
			Rigid	Flexible or with ferrule
Vigi iC60	25 A	2 N.m	1 to 25 mm ²	1 to 16 mm ²
	63 A	3.5 N.m	1 to 35 mm ²	1 to 25 mm ²

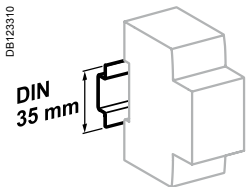

Clip on DIN rail 35 mm.

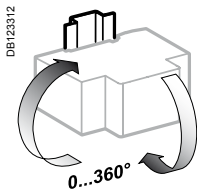

Indifferent position of installation.

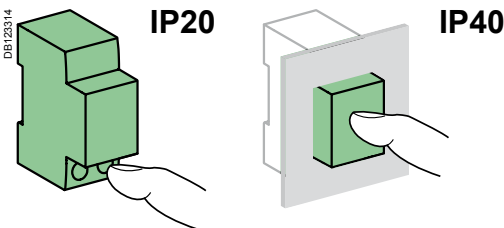

Technical data

Main characteristics		
Insulation voltage (U _i)		500 V
Pollution degree		3
Rated impulse withstand voltage (U _{imp})		6 kV
According to IEC/EN 61009-1		
Surge current withstand (8/20 μs) without tripping	AC and A types (no selective)	250 Å
	AC, A types (selective \square)	3 kÅ
	SI type	3 kÅ
Behaviour in case of voltage drop		Residual current protection down to 0 V according to IEC/EN 61009-1 § 3.3.8
Additional characteristics		
Degree of protection	Device only	IP20
	Device in modular enclosure	IP40
Operating temperature	AC type	-5°C to +60°C
	A and SI types	-25°C to +60°C
Storage temperature		-40°C to +85°C

Protection
Earth leakage protection

Vigi iC60 add-on residual current devices for iC60 double terminals (AC, A, SI types) (cont.)

Weight (g)

Add-on residual current devices	
Type	Vigi iC60
2P	165
3P	210
4P	245

Dimensions (mm)

Vigi iC60 25 A

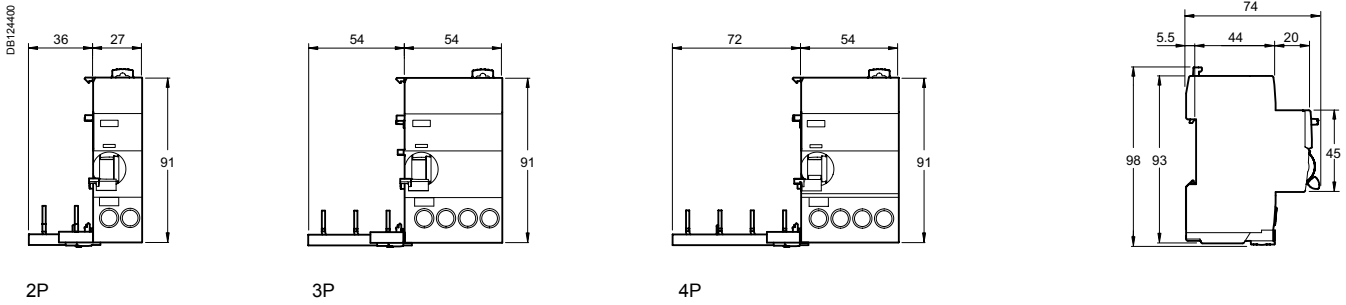

Vigi iC60 63 A

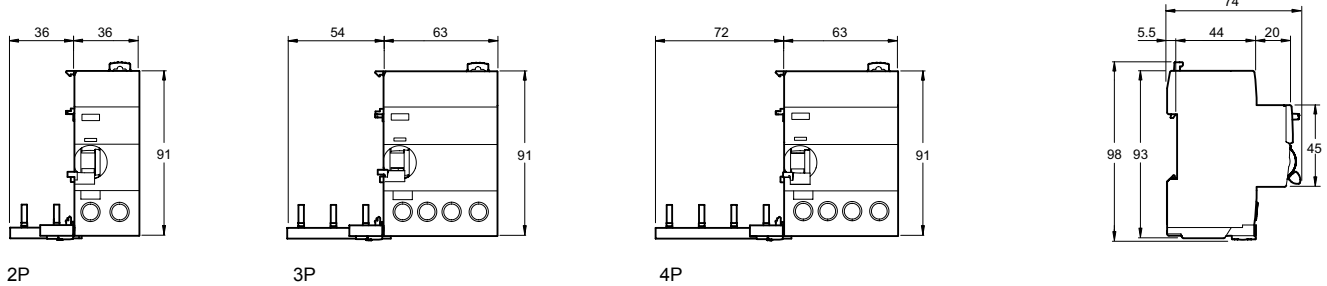

Protection Earth leakage protection

Vigi iC60 add-on residual current devices for iC60 double terminals (AC, A, SI types) (cont.)

DE124384



Association iC60N, H + Vigi iC60

iC60	Vigi iC60 25 A	Vigi iC60 63 A
0.5 A to 25 A	■	■
32 A - 40 A	NO	■
50 A - 63 A	NO	■

PB10716-60

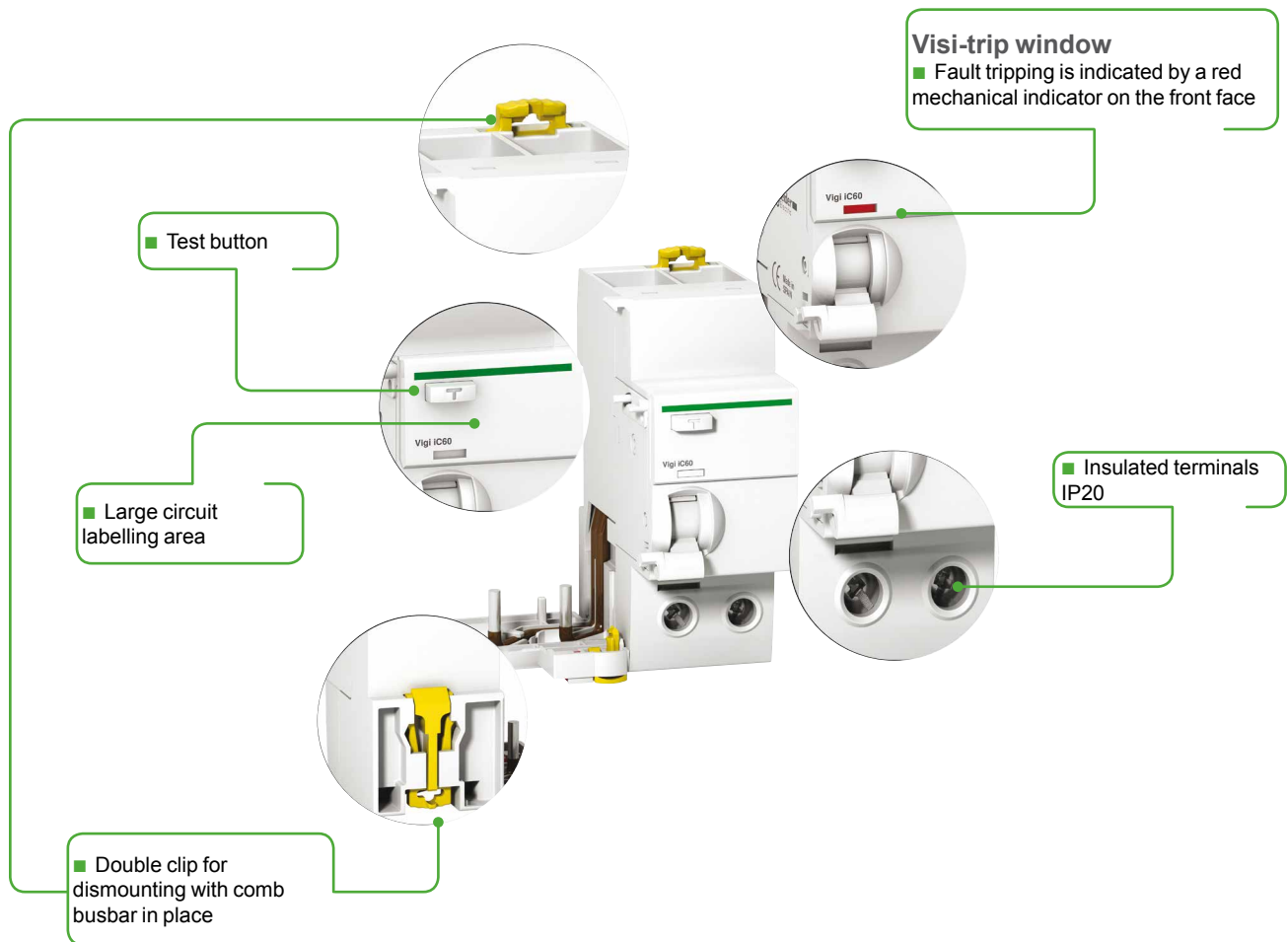

Type SI

The SI type provides increased immunity from electrical interference and polluted or corrosive environments.

Protection Earth leakage protection

Vigi C120 add-on residual current devices (type AC)

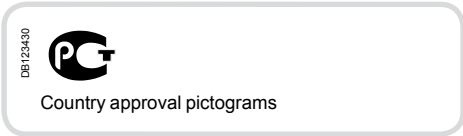

EN 61009

When a Vigi C120 device is combined with a C120 circuit breaker, it provides the following functions:

- protection of persons against electric shock by direct contact (30 mA),
- protection of persons against electric shock by indirect contact (≥ 300 mA),
- protection of installations against fire hazards (300 mA to 1000 mA).



2P



3P



4P

Catalogue numbers

Vigi C120 add-on residual current devices							
Type	AC	Vigi C120					Width in 9 mm modules
Product	Without auxiliary						
Auxiliaries	Without auxiliary						
2P	Sensitivity	30 mA	300 mA	500 mA	300 mA	1000 mA	
		A9N18563	A9N18564	A9N18565	A9N18544	A9N18545	7
3P	Sensitivity	30 mA	300 mA	500 mA	300 mA	1000 mA	
		A9N18566	A9N18567	A9N18568	A9N18546	A9N18547	10
4P	Sensitivity	30 mA	300 mA	500 mA	300 mA	1000 mA	
		A9N18569 A9N18542 ⁽¹⁾	A9N18570 A9N18543 ⁽¹⁾	A9N18571	A9N18548	A9N18549	10
Operating voltage (Ue)	2P	230 - 240 V					
	3P-4P	400 - 415 V					
Operating frequency	50/60 Hz						
Accessories	Module CA907012 and CA907013						

(1) specific offer for France

Protection Earth leakage protection

Vigi C120 add-on residual current devices (type A)

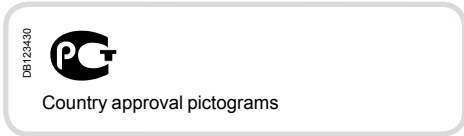

EN 61009

When a Vigi C120 device is combined with a C120 circuit breaker, it provides the following functions:

- protection of persons against electric shock by direct contact (30 mA),
- protection of persons against electric shock by indirect contact (≥ 300 mA),
- protection of installations against fire hazards (300 mA to 1000 mA).



2P













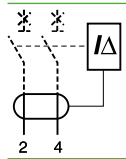

3P

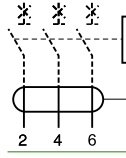

4P

Catalogue numbers

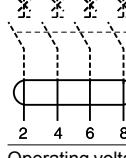
Vigi C120 add-on residual current devices								
Type		A 						Width in 9 mm modules
Product		Vigi C120						
Auxiliaries		Without auxiliary						
2P	Sensitivity	30 mA	300 mA	500 mA	300 mA 	500 mA 	1000 mA 	
		A9N18572	A9N18573	A9N18574	-	-	-	7
3P	Sensitivity	30 mA	300 mA	500 mA	300 mA 	500 mA 	1000 mA 	
		A9N18575	A9N18576	A9N18577	-	-	-	10
4P	Sensitivity	30 mA	300 mA	500 mA	300 mA 	500 mA 	1000 mA 	
		A9N18578	A9N18579	A9N18580	A9N18587	A9N18588	A9N18589	10
Operating voltage (Ue)	2P	230 - 240 V						
	3P-4P	400 - 415 V						
Operating frequency		50/60 Hz						
Accessories		Module CA907012 and CA907013						

Protection Earth leakage protection

Vigi C120 add-on residual current devices (type A-SI)

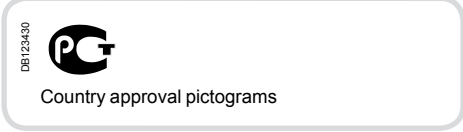

EN 61009

When a Vigi C120 device is combined with a C120 circuit breaker, it provides the following functions:

- protection of persons against electric shock by direct contact (30 mA),
- protection of persons against electric shock by indirect contact (≥ 300 mA),
- protection of installations against fire hazards (300 mA to 1000 mA).

Special feature of type A-SI :

They are appropriate for operating in environments with:

- high risk of nuisance tripping: frequent lightning strikes, IT system, presence of electronic ballasts, frequency converters, presence of switchgear incorporating lighting type interference filters, computer system, etc.
- blind sources:
 - presence of harmonics or high frequency rejections
 - presence of DC components: diodes, diode bridges, switch-mode power supplies, etc.
- protected against nuisance tripping caused by transient voltage surges (lightning strike, operation of switchgear on the network, etc.)

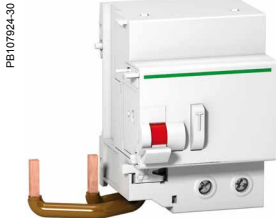

2P



3P



4P

Catalogue numbers

Vigi C120 add-on residual current devices								
Type	A-SI						Width in 9 mm modules	
Product	Vigi C120							
Auxiliaries	Without auxiliary							
2P Sensitivity	30 mA A9N18591	300 mA A9N18592	500 mA -	300 mA A9N18556	1000 mA A9N18557		7	
3P Sensitivity	30 mA A9N18594	300 mA A9N18595	500 mA -	300 mA A9N18558	1000 mA A9N18559		10	
4P Sensitivity	30 mA A9N18597 A9N18554 ⁽¹⁾	300 mA A9N18598 A9N18555 ⁽¹⁾	500 mA A9N18599	300 mA A9N18560	1000 mA A9N18561		10	
Operating voltage (Ue)	2P	230 - 240 V						
	3P-4P	400 - 415 V						
Operating frequency	50 Hz							
Accessories	Module CA907012 and CA907013							

(1) specific offer for France

Protection

Earth leakage protection

Vigi C120 add-on residual current devices (types AC, A and A-SI)

Connection

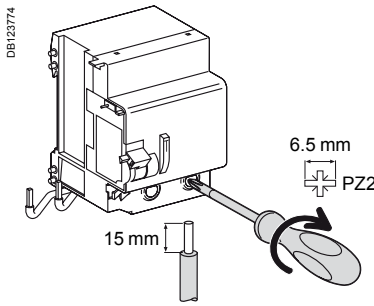

Type	Sensitivity	Tightening torque	Copper cables	
			Rigid	Flexible or with ferrule
Vigi C120	30...1000 mA	3.5 N.m	1 to 50 mm ²	1 to 35 mm ²

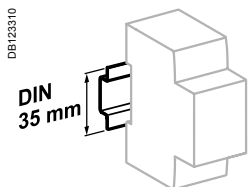

Clips onto 35 mm DIN rail.

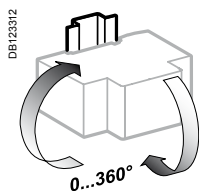

Any installation position.

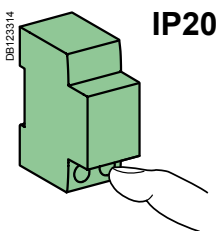

IP20

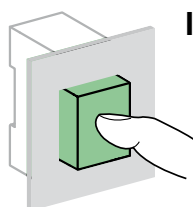

IP40

Technical data

Main characteristics

To IEC 60947-2

Insulation voltage (U _i)	500 V AC
Degree of pollution	3
Rated impulse withstand voltage (U _{imp})	6 kV

To EN 61009

Impulse current withstand (8/20 μs) without tripping	Types AC and A (non-selective ☒)	250 Å
	Types AC and A (selective ☒)	3 kÅ
	Types A-SI (non-selective ☒)	3 kÅ
	Types A-SI (selective ☒)	5 kÅ

Additional characteristics

Degree of protection	Device only	IP20
	Device in a modular enclosure	IP40
Operating temperature	Type AC	-5 °C to +60 °C
	Types A and A-SI	-25 °C to +60 °C
Storage temperature		-40 °C to +85 °C

Weight (g)

Add-on residual current devices

Type	Vigi C120
2P	325
3P	500
4P	580

Dimensions (mm)

C120 + Vigi C120

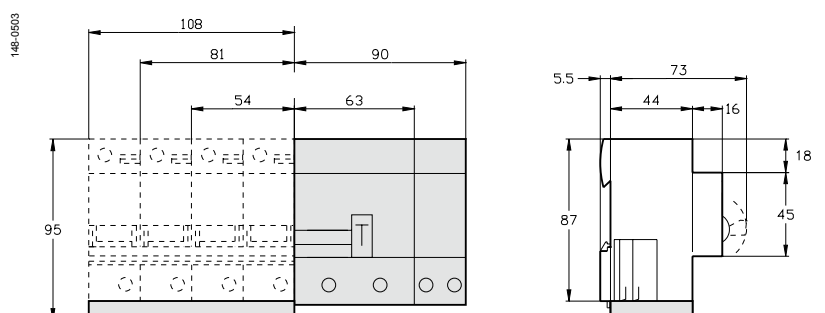

Protection

Earth leakage protection

Vigi C120 add-on residual current devices (types AC, A and A-SI) (cont.)

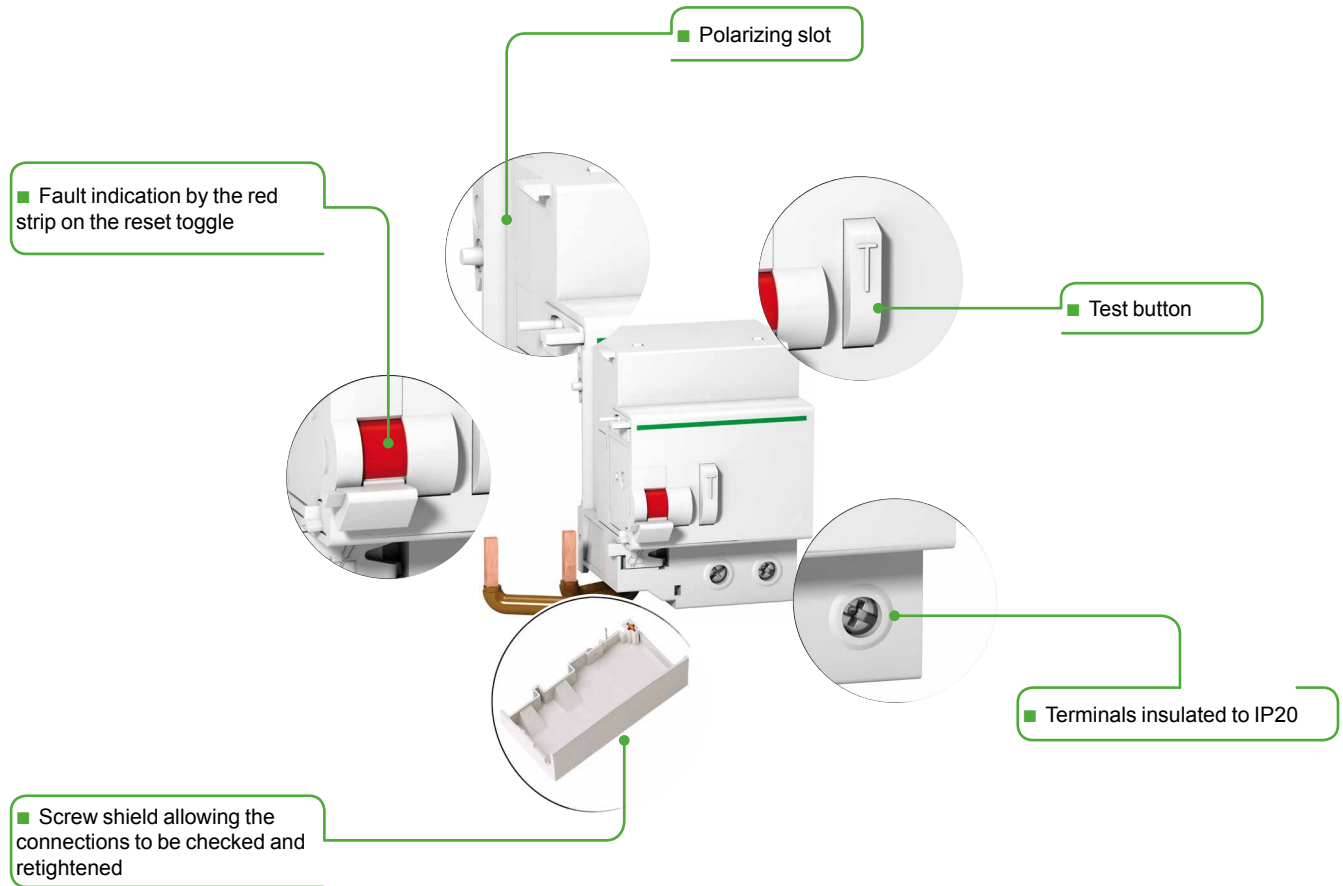

Type A-SI

The A-SI type provides increased immunity from electrical interference and polluted or corrosive environments.

Protection

Earth leakage protection

Vigi NG125

Contents



Schneider Electric's range of add-on residual current devices consists of different products (A, B) to enable it to be the most competitive range possible in each country, allowing for the special characteristics of each market:

- usual installation procedure
- price
- accreditations by local bodies.

Variants

Offers		Pages
Offer A	Catalogue numbers	236
Offer B	Catalogue numbers	239
Common pages		242

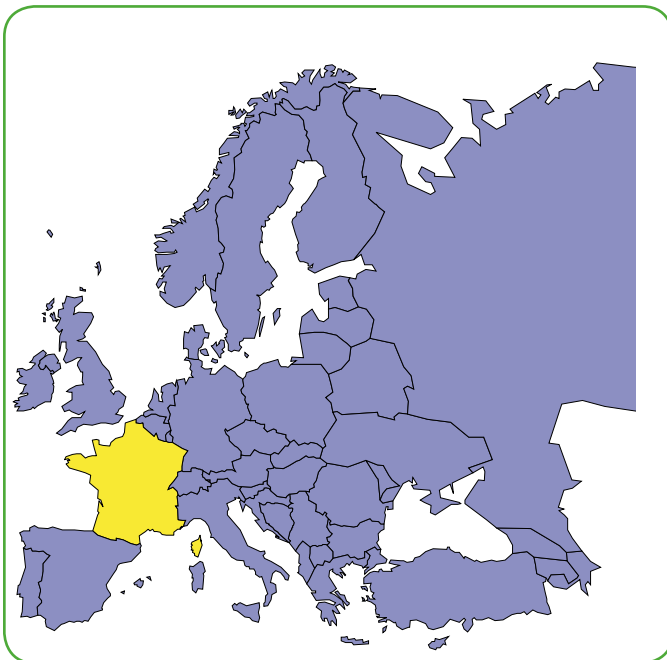

Only the product range to be marketed in your country and validated by the local product manager, in agreement with his Final Distribution (FD) partner should be retained. The others will be removed before publication.

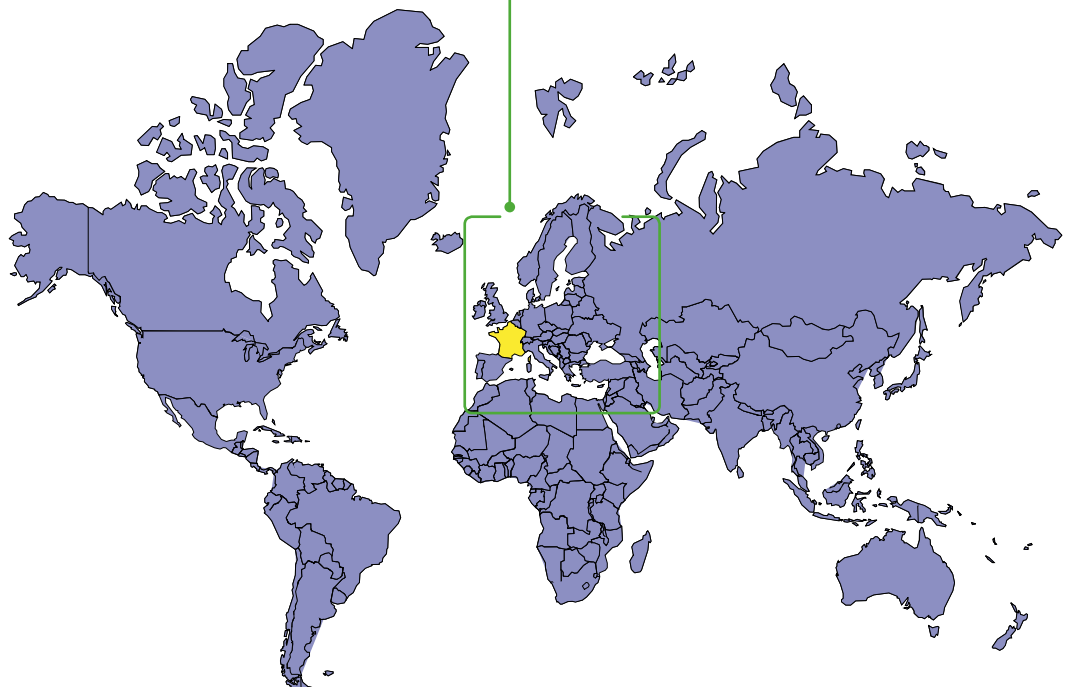

Protection
Earth leakage protection

Vigi NG125 add-on residual current devices (AC type)

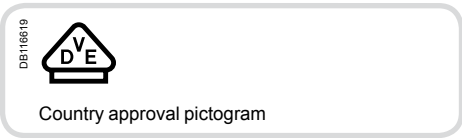

IEC/EN 61009-1

PB 103984-40

Offer selection see page 235

PB 103984-40

PB 103986-40

Offer A

This sticker must be removed before publishing

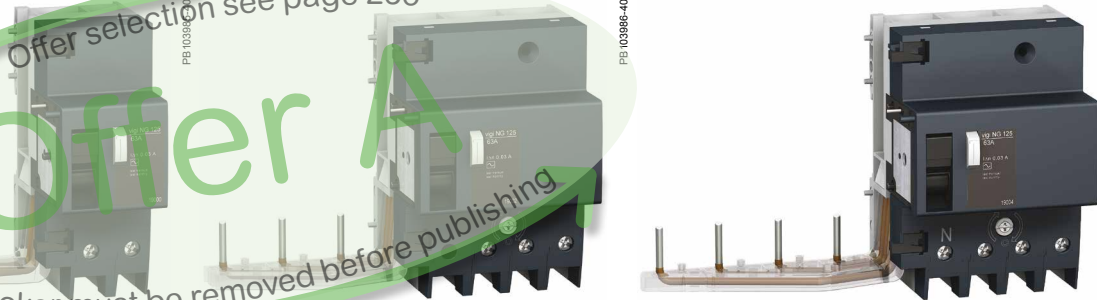

- When it is combined with an NG125 circuit breaker, the Vigi NG125 add-on residual current device offers the following functions:
 - protection of persons against electric shocks by direct contact (30 mA),
 - protection of persons against electric shocks by indirect contact (300 mA),
 - protection of installations against fire risks (300 mA).

Catalogue numbers

Vigi NG125 add-on residual current devices					
Type	AC		Vigi NG125		Width in 9 mm modules
Product	Without auxiliaries				
Auxiliaries					
2P	Sensitivity		30 mA	300 mA	
	Rating	63 A	19000	19001	5
3P	Sensitivity		30 mA	300 mA	
	Rating	63 A	19002	19003	9
4P	Sensitivity		30 mA	300 mA	
	Rating	63 A	19004	19005	9
Voltage rating (Ue)			230 - 240 V, 400 - 415 V		
Operating frequency			50/60 Hz		
Accessories			Module CM907006		

Vigi NG125 add-on residual current devices (A type)

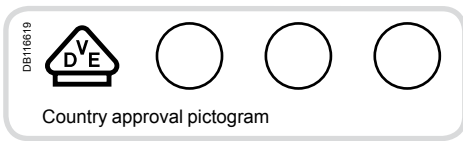

IEC/EN 61009-1

054383M-40

Offer selection see page 235

Offer A

This sticker must be removed before publishing



- When it is combined with an NG125 circuit breaker, the Vigi NG125 add-on residual current device offers the following functions:
 - protection of persons against electric shocks by direct contact (30 mA),
 - protection of persons against electric shocks by indirect contact (≥ 300 mA),
 - protection of installations against fire risks (300 mA or 500 mA).

Catalogue numbers

Vigi NG125 add-on residual current devices								
Type	A							Width in 9 mm modules
Product	Vigi NG125							
Auxiliaries	Module CM907005							
2P	Sensitivity	30 mA	300 mA	300 mA 	1000 mA 	300...1000 I/S	300...3000 I/S/R	
 DB122462	Rating 63 A	19011 19008 (1)	19012 19009 (1)	19030	19031	-	-	5
3P	Sensitivity	30 mA	300 mA	300 mA 	1000 mA 	300...1000 I/S	300...3000 I/S/R	
 DB122463	Rating 63 A	19013	19014	19032	19033	-	-	9
	125 A	19039 19050 (2)	-	-	-	19044	19036 19053 (2)	11
							19047 19055 (2)	11
4P	Sensitivity	30 mA	300 mA	300 mA 	1000 mA 	300...1000 I/S	300...3000 I/S/R	
 DB122464	Rating 63 A	19017	19018	19034	19035	-	-	9
	125 A	19041 19051 (2)	19042	-	-	19045	19037 19054 (2)	11
							19048 19056 (2)	11
Voltage rating (Ue)		230 - 240 V, 400 - 415 V Except: (1) 110...220 V and (2) 440...500 V						
Operating frequency		50/60 Hz						
Accessories		Module CM907006						

Protection
Earth leakage protection

Vigi NG125 add-on residual current devices (SI type)

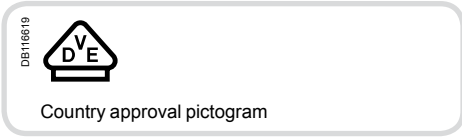

IEC/EN 61009-1

067484-40

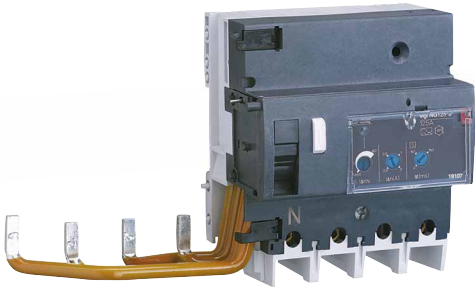

■ When it is combined with an NG125 circuit breaker, the Vigi NG125 add-on residual current device offers the following functions:

- protection of persons against electric shocks by direct contact (30 mA),
- protection of persons against electric shocks by indirect contact (≥ 300 mA),
- protection of installations against fire risks (300 mA or 500 mA).

SI types are appropriate for operating in environments with:

- High risk of nuisance tripping: frequent lightning strikes, IT system, presence of electronic ballasts, frequency converters, presence of switchgear incorporating lighting type interference filters, computer system, etc.
- Blind sources
- presence of harmonics or high frequency rejections,
- presence of DC components: diodes, diode bridges, switch-mode power supplies, etc.
- Protected against nuisance tripping caused by transient voltage surges (lightning strike, operation of switchgear on the network, etc.).

Offer selection see page 235

Offer A

This sticker must be removed before publishing

Catalogue numbers

Vigi NG125 add-on residual current devices					
Type			SI	Width in 9 mm modules	
Product			Vigi NG125		
Auxiliaries			Module CM907005		
3P	Sensitivity		30 mA	300...3000 I/S/R	
	Rating	125 A	19100	19106	11
4P	Sensitivity		30 mA	300...3000 I/S/R	
	Rating	125 A	19101	19107	11
Voltage rating (Ue)			230 - 240 V, 400 - 415 V		
Operating frequency			50/60 Hz		
Accessories			Module CM907006		

Vigi NG125 add-on residual current devices (AC type)

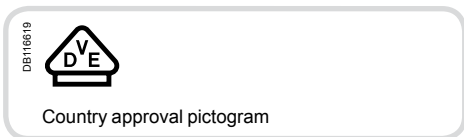

IEC/EN 61009-1



- When it is combined with an NG125 circuit breaker, the Vigi NG125 add-on residual current device offers the following functions:
 - protection of persons against electric shocks by direct contact (30 mA),
 - protection of persons against electric shocks by indirect contact (300 mA),
 - protection of installations against fire risks (300 mA).

Offer selection see page 235

Offer B

This sticker must be removed before publication

Catalogue numbers

Vigi NG125 add-on residual current devices					
Type	AC		Vigi NG125		Width in 9 mm modules
Product	Without auxiliaries		30 mA	300 mA	
Auxiliaries	Sensitivity		Without auxiliaries		
2P	Sensitivity		30 mA	300 mA	
	Rating	63 A	19000	19001	5
3P	Sensitivity		30 mA	300 mA	
	Rating	63 A	19002	19003	9
4P	Sensitivity		30 mA	300 mA	
	Rating	63 A	19004	19005	9
Voltage rating (Ue)			230 - 240 V, 400 - 415 V		
Operating frequency			50/60 Hz		
Accessories			Module CM907006		

Protection
Earth leakage protection

Vigi NG125 add-on residual current devices (A type)

IEC/EN 61009-1

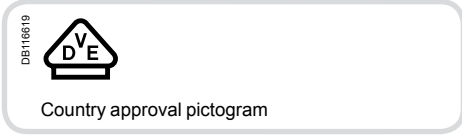

054383M-40

PE103988-40

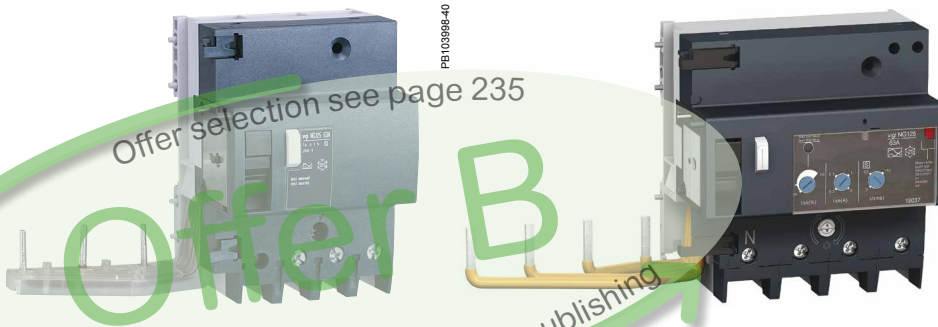

Offer selection see page 235

This sticker must be removed before publishing

- When it is combined with an NG125 circuit breaker, the Vigi NG125 add-on residual current device offers the following functions:
 - protection of persons against electric shocks by direct contact (30 mA),
 - protection of persons against electric shocks by indirect contact (≥ 300 mA),
 - protection of installations against fire risks (300 mA or 500 mA).

Catalogue numbers

Vigi NG125 add-on residual current devices									
Type	A								Width in 9 mm modules
Product	Vigi NG125								
Auxiliaries	Module CM907005								
		Sensitivity	30 mA	300 mA	300 mA	1000 mA	300...1000 I/S	300...3000 I/S/R	
DB122462 	Rating	63 A	19010 19008 (1)	19012 19009 (1)	19030	19031	-	-	5
		125 A	19039	-	-	-	19044	19047 19055 (2)	11
DB122463 	Rating	63 A	19013	19014	19032	19033	-	-	9
		125 A	19039	-	-	-	19044	19047 19055 (2)	11
DB122464 	Rating	63 A	19015	19016	19034	19035	-	-	9
		125 A	19041	19042	-	-	19046	19049 19056 (2)	11
Voltage rating (Ue)			230 - 240 V, 400 - 415 V Except: (1) 110...220 V and (2) 440...500 V						
Operating frequency			50/60 Hz						
Accessories			Module CM907006						

Vigi NG125 add-on residual current devices (SI type)

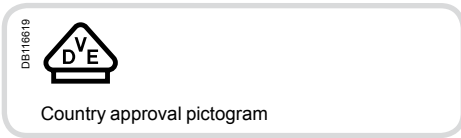

IEC/EN 61009-1

067484-40

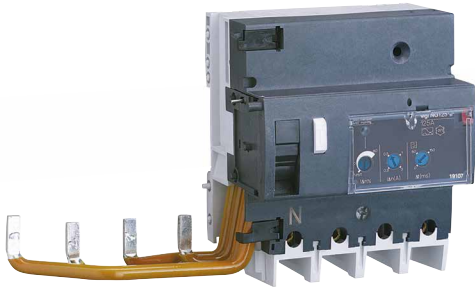

- When it is combined with an NG125 circuit breaker, the Vigi NG125 add-on residual current device offers the following functions:
 - protection of persons against electric shocks by direct contact (30 mA),
 - protection of persons against electric shocks by indirect contact (≥ 300 mA),
 - protection of installations against fire risks (300 mA or 500 mA).

SI types are appropriate for operating in environments with:

- High risk of nuisance tripping: frequent lightning strikes, IT system, presence of electronic ballasts, frequency converters, presence of switchgear incorporating lighting type interference filters, computer system, etc.
- Blind sources
 - presence of harmonics or high frequency rejections,
 - presence of DC components: diodes, diode bridges, switch-mode power supplies, etc.
- Protected against nuisance tripping caused by transient voltage surges (lightning strike, operation of switchgear on the network, etc.).

Offer selection see page 235

Offer B

This sticker must be removed before publishing

Catalogue numbers

Vigi NG125 add-on residual current devices					
Type			SI	Width in 9 mm modules	
Product			Vigi NG125		
Auxiliaries			Module CM907005		
3P	Sensitivity		30 mA	300...3000 I/S/R	
	Rating	125 A	19100	19106	11
4P	Sensitivity		30 mA	300...3000 I/S/R	
	Rating	125 A	19101	19107	11
Voltage rating (Ue)			230 - 240 V, 400 - 415 V		
Operating frequency			50/60 Hz		
Accessories			Module CM907006		

Protection Earth leakage protection

Vigi NG125 add-on residual current devices (AC, A, SI types)

Connection

DB123404		Rating Tightening torque	Without accessories			With accessories	
			Copper cables	70 mm ² Al terminal	Screw clamp terminal	Screw-on connection for ring terminal	
						Rigid	Flexible or with ferrule
DB123405		63 A 125 A	3.5 N.m 6 N.m	1.5 to 50 mm² 16 to 70 mm²	1 to 35 mm² 10 to 50 mm²	-	25 to 70 mm² 2 x 35 mm² 1 x 50 mm²
DB123406		Pre-alarm	1 N.m	2 x 2.5 mm²	2 x 1.5 mm²	2 x 1.5 mm²	-

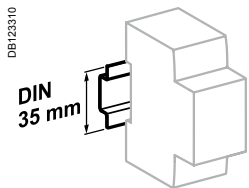

Clip on DIN rail 35 mm.

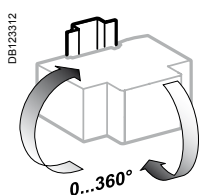

Indifferent position of installation.

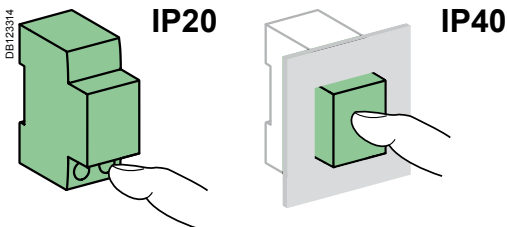

Technical data

Main characteristics		
Insulation voltage (U _i)		690 V
Pollution degree		3
Rated impulse withstand voltage (U _{imp})		8 kV
According to IEC/EN 61009-1		
Surge current withstand (8/20 μs) without tripping	Selective <input type="checkbox"/> or R	5 kA
	Instantaneous	3 kA
Behaviour in case of voltage drop		Residual current protection down to 0 V according to IEC/EN 61009-1 § 3.3.8
Additional characteristics		
Degree of protection	Device only	IP20
	Device in modular enclosure	IP40
Operating temperature	AC type	-5°C to +60°C
	A and SI types	-25°C to +60°C
Storage temperature		-40°C to +85°C
Additional characteristics		
Vigi 125 A and adjustable		
Plug-in auxiliaries	MXV	Remote tripping
	SDV	Indication of tripping upon earth fault
Adjustable Vigi		
Sensitivity adjustable by notch (IΔn)		300, 500, 1000, 3000 mA
Tripping time	Instantaneous	
	Selective <input type="checkbox"/>	60 ms
	Time-delayed	150 ms
Leakage current indication on 3P and 4P 300...3000 I/S/R (pre-alarm)		On front face by LED
		Remote, by potential-free normally-open contact 250 V - 1 A (low level)
		Threshold setting by potentiometer from 10 % to 50 % of IΔn
Disconnection essential for dielectric test		By integral pushbutton

Protection

Earth leakage protection

Vigi NG125 add-on residual current devices (AC, A, SI types) (cont.)

Weight (g)

Add-on residual current devices			
Number of 9 mm modules	2P	3P	4P
5 modules	250	-	-
9 modules	-	410	450
11 modules	-	750	800

Dimensions (mm)

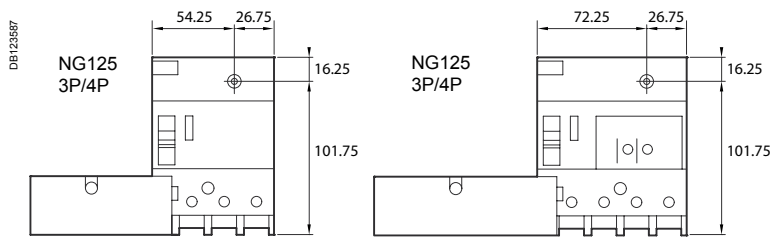
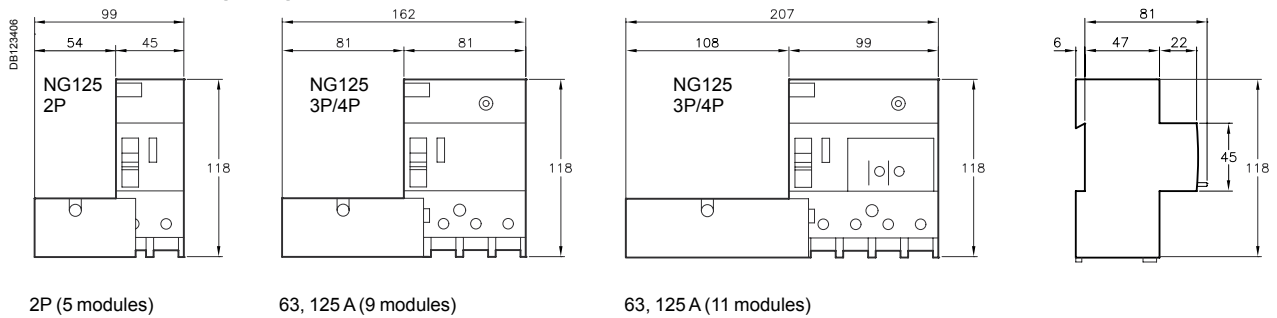

Spacing for mounting on panel

Protection

Earth leakage protection

Vigi NG125 add-on residual current devices (AC, A, SI types) (cont.)

058341_SE-50



Association NG125 + Vigi NG125

	Vigi NG125 63 A	Vigi NG125 125 A
NG125 ≤ 63 A	■	NO
NG125 80...125 A*	NO	■

(*) No Vigi add-on residual current device for 2P circuit breakers of rating 80 A.

FB10446-40

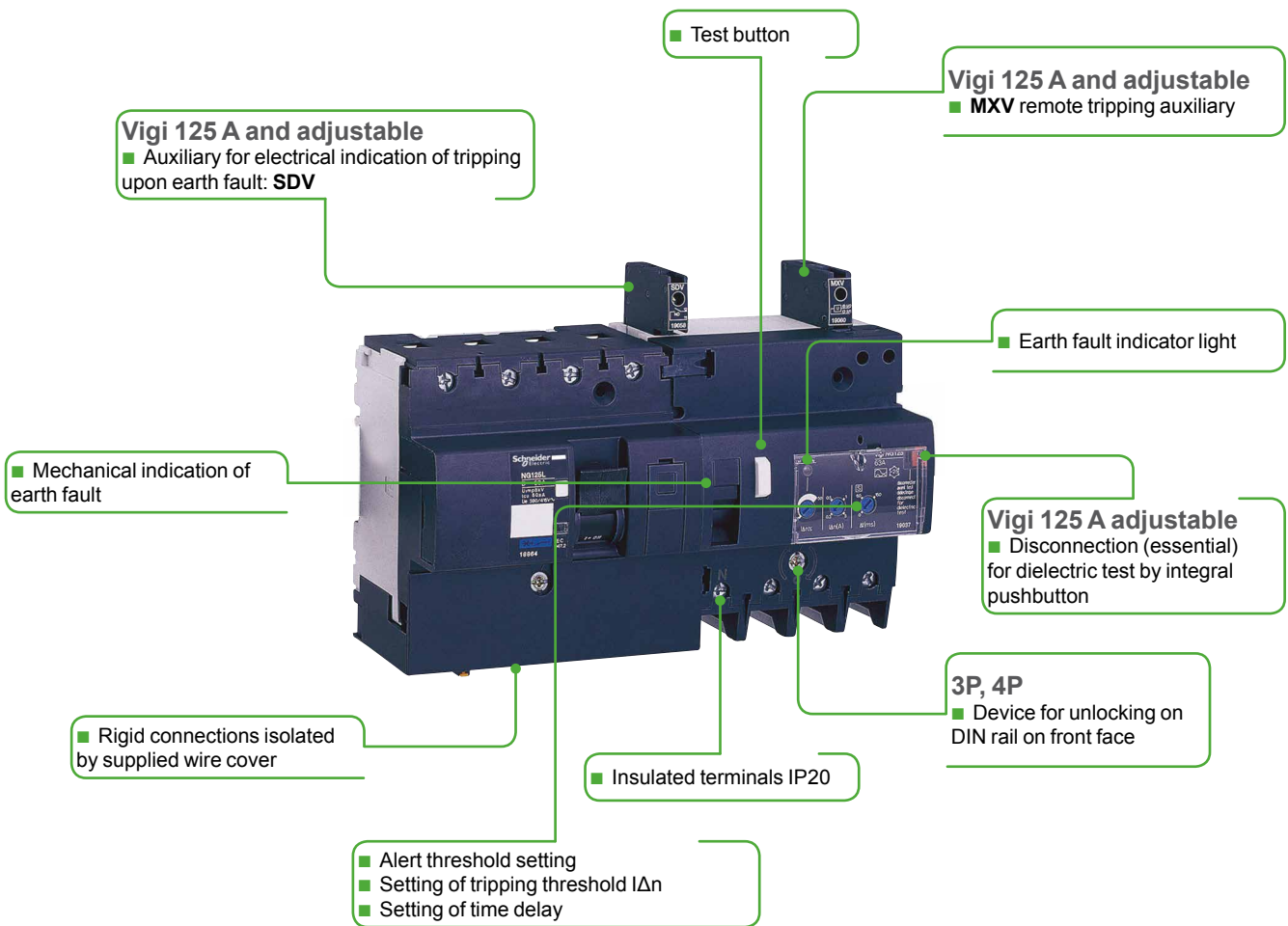

SI type

SI types are appropriate for operating in environments with:

- High risk of nuisance tripping: frequent lightning strikes, IT system, presence of electronic ballasts, frequency converters, presence of switchgear incorporating lighting type interference filters, computer system, etc.
- Blind sources
- presence of harmonics or high frequency rejections,
- presence of DC components: diodes, diode bridges, switch-mode power supplies, etc.
- Protected against nuisance tripping caused by transient voltage surges (lightning strike, operation of switchgear on the network, etc.).



Protection Earth leakage protection iDPN Vigi Contents

Schneider Electric's range of residual current devices consists of different products (A, B, C) to enable it to be the most competitive range possible in each country, allowing for the special characteristics of each market:

- usual installation procedure
- price
- accreditations by local bodies.

Variants

Offers	Catalogue numbers	Pages
Offer A	Catalogue numbers	247
Offer B	Catalogue numbers	249
Austria		
Offer C	Catalogue numbers	250
Brasil		
Common pages		251

DE406602

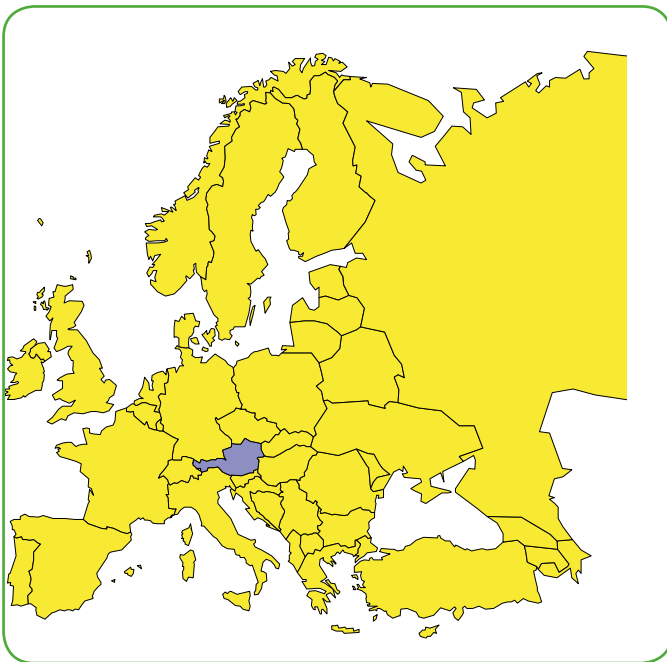

Only the product range to be marketed in your country and validated by the local product manager, in agreement with his Final Distribution (FD) partner should be retained. The others will be removed before publication.

DE406601

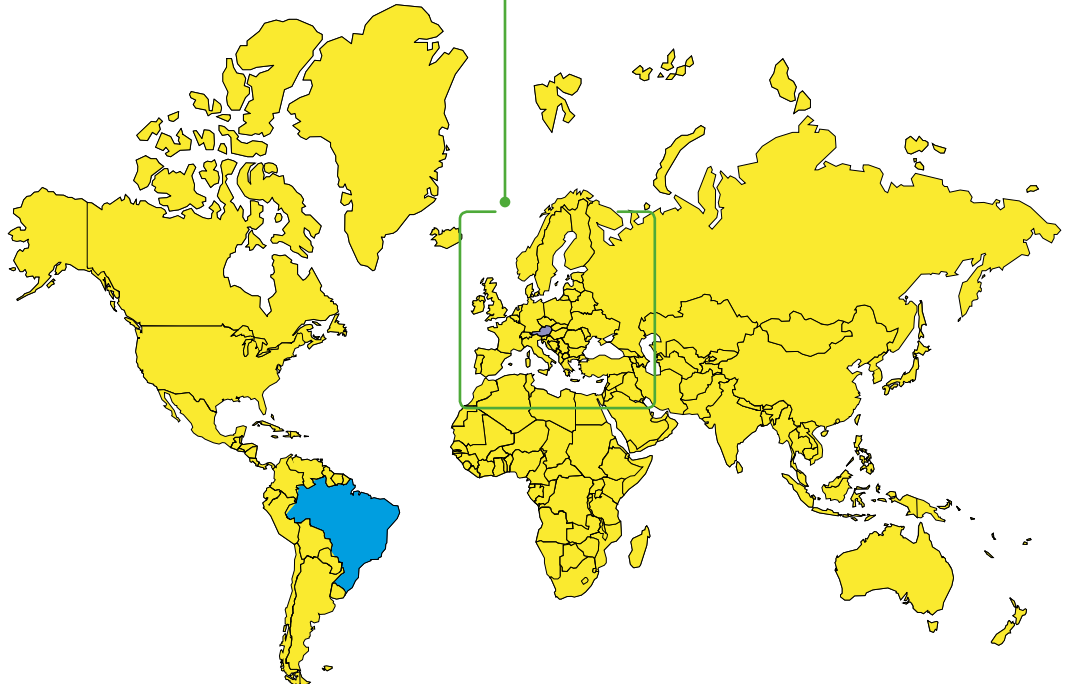

Protection Earth leakage protection Residual current devices iDPN Vigî



IEC/EN 61009-1



iDPNa Vigî



iDPN H Vigî



iDPN N Vigî

- The iDPN Vigî residual current device provide complete protection for final circuits (against overcurrents and insulation faults):
 - protection for users against electric shocks by direct contacts (≤ 30 mA),
 - protection for users against electric shocks by indirect contacts (300 mA),
 - protection of the installations against fire risks (300 mA).
- The A-SI range has been designed to maintain a network with optimum safety and continuity of service in installations disturbed by:
 - extreme atmospheric conditions,
 - harmonic generating loads,
 - transient operating currents.

Offer selection see page 245

Offer A

This sticker must be removed before publishing

Catalogue numbers

iDPNa Vigî 4500

Type	AC	A	Width in 9 mm modules		
Auxiliaries	Module CA907000 and CA907013				
1P+N Curve B	Sensitivity	30 mA	300 mA		
	Rating (In)	10 mA	30 mA		
	6 A	A9D51606	-	A9D54606	
	10 A	A9D51610	-	A9D54610	
	13 A	-	-	A9D54613	
	16 A	A9D51616	-	A9D54616	
	20 A	A9D51620	-	A9D54620	
	25 A	A9D51625	-	A9D54625	
	32 A	A9D51632	-	A9D54632	
40 A	A9D51640	-	A9D54640		
1P+N Curve C	Sensitivity	30 mA	300 mA		
	Rating (In)	10 mA	30 mA		
	6 A	A9D34606	A9D44606	-	A9D35606
	10 A	A9D34610	A9D44610	A9D05610	A9D35610
	13 A	-	-	-	A9D35613
	16 A	A9D34616	A9D44616	A9D05616	A9D35616
	20 A	A9D34620	A9D44620	-	A9D35620
	25 A	A9D34625	A9D44625	-	A9D35625
	32 A	A9D34632	A9D44632	-	A9D35632
40 A	A9D34640	A9D44640	-	A9D35640	
Voltage rating (Ue)	230...240 V AC				
Operating frequency	50 Hz				
Accessories	Module CA907000 and CA907001, comb busbars CA907013				

Residual current devices iDPN Vigi (cont.)

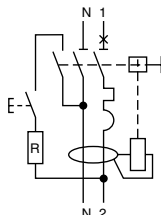
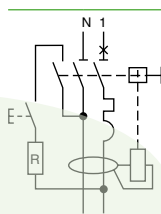

Catalogue numbers

iDPN N Vigi 6000				
Type	A 		Width in 9 mm modules	
Auxiliaries	Module CA907000 and CA907013			
1P+N Curve B	Sensitivity 30 mA		4	
	Rating (In)	10 A		A9D06610
		16 A		A9D06616
		20 A		A9D06620
1P+N Curve C	Sensitivity 30 mA		4	
	Rating (In)	10 A		A9D01610
		16 A		A9D01616
		20 A		A9D01620
Voltage rating (Ue)		110 V AC		
Operating frequency		50 Hz		
Accessories		Module CA907000 and CA907001, comb busbars CA907013		

Offer selection see page 245

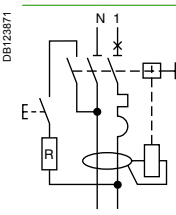
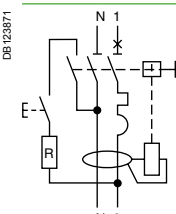

Offer A

This sticker must be removed before publishing

iDPN N Vigi 6000												
Type	AC 			A 				A-SI 			Width in 9 mm modules	
Auxiliaries	Module CA907000 and CA907013											
1P+N Curve B	Sensitivity		30 mA	300 mA	10 mA	30 mA	100 mA	300 mA	30 mA	100 mA	300 mA	4
	Rating (In)	4 A	A9D55604	A9D68604	-	A9D56604	A9D60604	A9D69604	-	-	-	
		6 A	A9D55606	A9D68606	-	A9D56606	A9D60606	A9D69606	-	-	-	
		10 A	A9D55610	A9D68610	A9D08610	A9D56610	A9D60610	A9D69610	-	-	-	
		13 A	-	-	-	A9D56613	A9D60613	A9D69613	-	-	-	
		16 A	A9D55616	A9D68616	A9D08616	A9D56616	A9D60616	A9D69616	-	-	-	
		20 A	A9D55620	A9D68620	-	A9D56620	A9D60620	A9D69620	-	-	-	
		25 A	A9D55625	A9D68625	-	A9D56625	A9D60625	A9D69625	-	-	-	
		32 A	A9D55632	A9D68632	-	A9D56632	A9D60632	A9D69632	-	-	-	
		40 A	A9D55640	A9D68640	-	A9D56640	A9D60640	A9D69640	-	-	-	
1P+N Curve C	Sensitivity		30 mA	300 mA	10 mA	30 mA	100 mA	300 mA	30 mA	100 mA	300 mA	4
	Rating (In)	6 A	A9D31606	A9D41606	-	A9D32606	A9D52606	A9D42606	A9D33606	A9D53606	A9D43606	
		10 A	A9D31610	A9D41610	A9D02610	A9D32610	A9D52610	A9D42610	A9D33610	A9D53610	A9D43610	
		13 A	-	-	-	A9D32613	A9D52613	A9D42613	A9D33613	A9D53613	A9D43613	
		16 A	A9D31616	A9D41616	A9D02616	A9D32616	A9D52616	A9D42616	A9D33616	A9D53616	A9D43616	
		20 A	A9D31620	A9D41620	-	A9D32620	A9D52620	A9D42620	A9D33620	A9D53620	A9D43620	
		25 A	A9D31625	A9D41625	-	A9D32625	A9D52625	A9D42625	A9D33625	A9D53625	A9D43625	
		32 A	A9D31632	A9D41632	-	A9D32632	A9D52632	A9D42632	A9D33632	A9D53632	A9D43632	
		40 A	A9D31640	A9D41640	-	A9D32640	A9D52640	A9D42640	A9D33640	A9D53640	A9D43640	
		Voltage rating (Ue)		230...240 V AC								
Operating frequency		50 Hz										
Accessories		Module CA907000 and CA907001, comb busbars CA907013										

Residual current devices iDPN Vigi (cont.)

Catalogue numbers

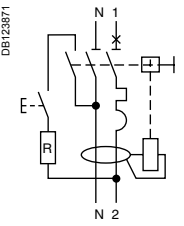
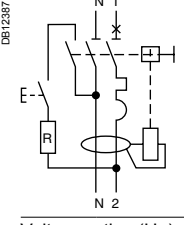
iDPN H Vigi 10000							
Type		A 		A-SI 		Width in 9 mm modules	
Auxiliaries		Module CA907000 and CA907013					
1P+N	Curve B	Sensitivity	30 mA	300 mA	30 mA	300 mA	
	Rating (In)	6 A	A9D07606	-	-	-	4
		10 A	A9D07610	-	-	-	
		16 A	A9D07616	-	-	-	
		20 A	A9D07620	-	-	-	
		25 A	A9D07625	-	-	-	
		32 A	A9D07632	-	-	-	
	Rating (In)	6 A	A9D37606	A9D47606	A9D38606	A9D48606	4
		10 A	A9D37610	A9D47610	A9D38610	A9D48610	
		16 A	A9D37616	A9D47616	A9D38616	A9D48616	
		20 A	A9D37620	A9D47620	A9D38620	A9D48620	
		25 A	A9D37625	A9D47625	A9D38625	A9D48625	
		32 A	A9D37632	A9D47632	A9D38632	A9D48632	
Voltage rating (Ue)		230...240 V AC					
Operating frequency		50 Hz					
Accessories		Module CA907000 and CA907001, comb busbars CA907013					

Offer selection see page 245

Offer A

This sticker must be removed before publishing

Protection

Earth leakage protection

Residual current devices iDPN Vigi (cont.)

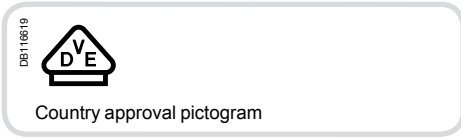

iDPN N Vigi

IEC/EN 61009-1

- The iDPN Vigi residual current device provide complete protection for final circuits (against overcurrents and insulation faults):
 - protection for users against electric shocks by direct contacts (30 mA),
 - protection for users against electric shocks by indirect contacts (100 mA),
 - protection of the installations against fire risks (100 mA).

Catalogue numbers

iDPN N Vigi G Type 6000			
Type	AC		Width in 9 mm modules
Auxiliaries	Module CA907000 and CA907013		
1P+N Curve C	Sensitivity	30 mA	
	Rating (In)	6 A	A9D62606
		10 A	A9D62610
		13 A	A9D62613
		16 A	A9D62616
Voltage rating (Ue)		230...240 V AC	
Operating frequency		50 Hz	
Auxiliaries	Module CA907000 and CA907001, comb busbars CA907013		

Catalogue numbers

iDPN N Vigi G Type 10000			
Type	A		Width in 9 mm modules
Auxiliaries	Module CA907000 and CA907013		
1P+N Curve B	Sensitivity	30 mA	
	Rating (In)	13 A	A9D07713
		16 A	A9D07716
1P+N Curve C	Sensitivity	30 mA	
	Rating (In)	13 A	A9D37713
		16 A	A9D37716
Voltage rating (Ue)		230...240 V AC	
Operating frequency		50 Hz	
Auxiliaries	Module CA907000 and CA907001, comb busbars CA907013		

Offer selection see page 245

Offer B

This sticker must be removed before publishing

Protection Earth leakage protection Residual current devices iDPN Vigi (cont.)

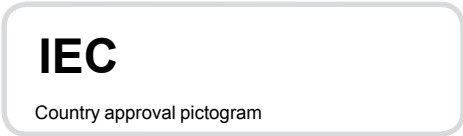

IEC/EN 61009-1



iDPN N Vigi

- The iDPN Vigi residual current device provide complete protection for final circuits (against overcurrents and insulation faults):
- protection for users against electric shocks by direct contacts (30 mA),

Catalogue numbers

iDPN N Vigi 6000			
Type	AC		Width in 9 mm modules
Auxiliaries		Module CA907000 and CA907013	
1P+N	Curve C	Sensitivity 30 mA	
	Rating (In)	6 A	A9D61606
		10 A	A9D61610
		16 A	A9D61616
		20 A	A9D61620
		25 A	A9D61625
		32 A	A9D61632
40 A	A9D61640		
Voltage rating (Ue)		110...240 V AC	
Operating frequency		50 Hz	
Accessories		Module CA907000 and CA907001, comb busbars CA907013	



Residual current devices iDPN Vigi (cont.)

DB405956-40

■ Fast contact closure

■ Insulated terminals IP20

Visi-trip double window

- Fault tripping circuit breaker is indicated by a red mechanical indicator on the front face.
- Earth fault is indicated by a red mechanical indicator on the front face

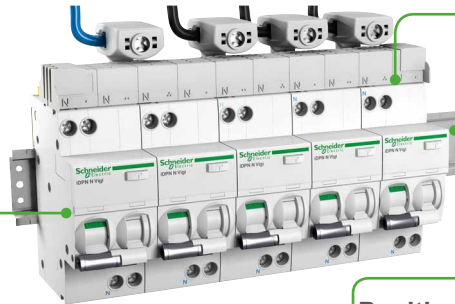

■ Test button

Positive contact indication

- A green strip on the toggle guarantees opening of all the poles in safety conditions (padlocking possible) for work to be carried out on live parts

DB123310

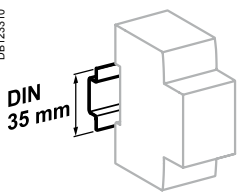

Clip on DIN rail 35 mm.

DB123312

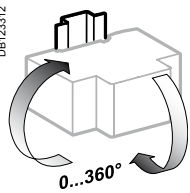

Indifferent position of installation.

DB123314

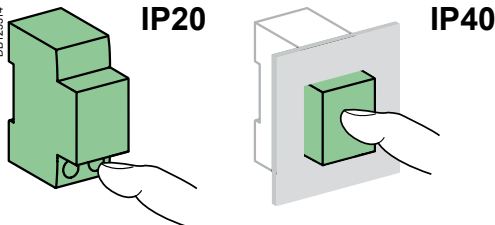

Connection

DB 123847

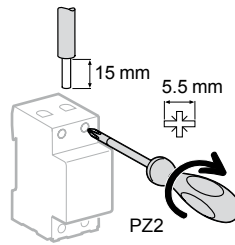

Rating	Tightening torque	Copper cables	
		Rigid	Flexible or with ferrule
4 to 40 A	2 N.m	1 to 16 mm ²	1 to 10 mm ²

Technical data

Main characteristics				
Type	iDPNa Vigi	iDPN N Vigi	iDPN H Vigi	
Insulation voltage (U _i)	400 V AC			
Pollution degree	3			
Rated impulse withstand voltage (U _{imp})	4 kV			
Setting temperature for ratings	30°C			
Magnetic tripping	Curve B	Between 3 and 5 I _n		
	Curve C	Between 5 and 10 I _n		
According to IEC/EN 61009-1				
Limitation class	3			
Rated breaking capacity (I _{cn})	4500 A	6000 A	10,000 A	
Rated residual breaking and making capacity (I _{Δm})	4500 A	6000 A	10,000 A	
8/20 μs impulse withstand	Type AC	250 Å	250 Å	250 Å
	Type A	250 Å	250 Å	250 Å
	Type A-SI	-	3 kÅ	3 kÅ

Behaviour in case of voltage drop Residual current protection down to 0 V according to IEC/EN 61009-1 § 3.3.8

Additional characteristics				
Earth leakage protection with instantaneous tripping		10, 30, 300 mA	10, 30, 100, 300 mA	30, 300 mA
Degree of protection (IEC 60529)	Device only	IP20		
	Device in modular enclosure	IP40		
Endurance (O-C)	Electrical	≤ 20 A	20,000 cycles	
		≥ 25 A	10,000 cycles	
	Mechanical	20,000 cycles		
		Overvoltage category (IEC 60364)		
Operating temperature	Type AC	-5°C to +60°C		
	Type A, A-SI	-25°C to +60°C		
Storage temperature	-40°C to +85°C			
Tropicalization (IEC 60068-1)	Treatment 2 (relative humidity 95 % to 55°C)			

Weight (g)

Residual current device	
Type	iDPN Vigi
1P+N	125

Dimensions (mm)

DB124454

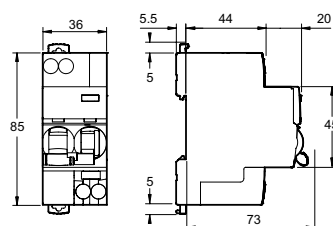

Protection, Earth leakage protection

Acti9 iCV40 residual current devices RCBO 4500 A



IEC/EN 61009-2-1

As per the above standard:

The residual current devices offers the following functions of earth leakage protection and circuit protection.

- Earth leakage protection:
 - protection of persons against electric shock by direct contact (≤ 30 mA),
 - protection of persons against electric shock by indirect contact (300 mA),
 - protection of installations against the risk of fire (300 mA).
- Circuit protection:
 - circuit protection against short-circuit currents,
 - circuit protection against overload currents,
 - disconnection.



Catalog numbers

Acti9 iCV40 RCBO - B curve				
Type		A	Width in 9-mm modules	
Auxiliaries		Catalog module CA907002		
1P+N	Sensitivity	30 mA		
	Rating	6 A	4	
		10 A		A9DG2610
		16 A		A9DG2616
Accessories		Catalog modules CA907001 and CA907015		
Comb busbars		Catalog module CA907026		
PowerTag energy sensors		Catalog modules CA907029 and CA908058		

Catalog numbers

Acti9 iCV40 RCBO - C curve							
Type		AC		A		Width in 9-mm modules	
Auxiliaries		Catalog module CA907002					
1P+N	Sensitivity	30 mA	300 mA	10 mA	30 mA		
	Rating	6 A	A9DE2606	A9DE6606	-	4	
		10 A	A9DE2610	A9DE6610	A9DC9610		A9DC2610
		13 A	-	-	-		A9DC2613
		16 A	A9DE2616	A9DE6616	A9DC9616		A9DC2616
		20 A	A9DE2620	A9DE6620	-		-
		25 A	A9DE2625	A9DE6625	-		-
		32 A	A9DE2632	A9DE6632	-		-
		40 A	A9DE2640	A9DE6640	-		-
Accessories		Catalog modules CA907001 and CA907015					
Comb busbars		Catalog module CA907026					
PowerTag energy sensors		Catalog modules CA907029 and CA908058					

Protection, Earth leakage protection

Acti9 iCV40 residual current devices RCBO 4500 A

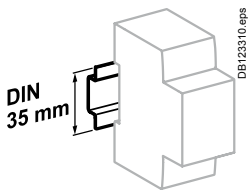

Clip on DIN rail 35 mm.

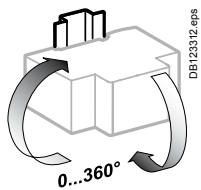

Indifferent position of installation.

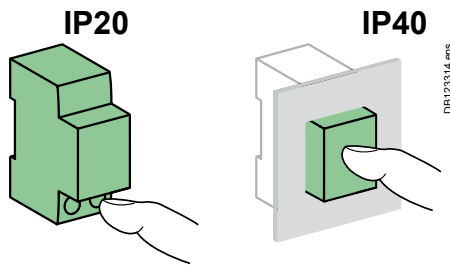

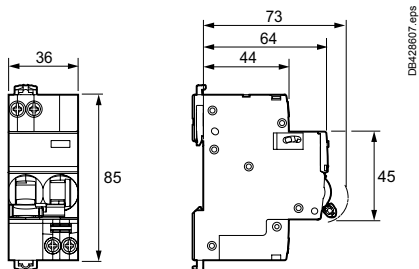

Dimensions (mm)



Residual current devices 1P+N

Technical data

Main characteristics			
Insulation voltage (Ui)	Phase-to-neutral	400 V	
	Phase-to-phase	440 V	
Voltage rating (Ue)	Phase-to-neutral	230 V	
	Phase-to-phase	400 V	
Operating frequency		50/60 Hz	
According to EN 61009-2-1			
Rated impulse withstand voltage (Uimp)		4 kV	
Magnetic tripping	B curve	3 to 5 In	
	C curve	5 to 10 In	
Operating temperature		30°C	
Limitation class		3	
Rated breaking capacity (Icn)		4500 A	
Service breaking capacity (Ics)		100 % Icn	
Rated residual breaking and making capacity (IΔm)	IEC 61009-2-1	500 A	
	EN 61009-2-1	4500 A	
8/20 μs impulse withstand without tripping	AC type	250 Å	
	A type	250 Å	
Pollution degree		3	
Behaviour in case of voltage drop	 DB4407011.eps	Residual current protection down to 0 V according to NF/EN 61009-1 § 3.3.8	
Additional characteristics			
Degree of protection (IEC 60529)	Device only	IP20	
	Device in modular enclosure	IP40 Insulation class II	
Endurance (O-C)	Electrical	≤ 25 A	20000 cycles
		≥ 32 A	10000 cycles
	Mechanical		20000 cycles
Operating temperature	AC type	-5°C to +60°C	
	A type  DB4406211.eps	-25°C to +60°C	
Storage temperature		-40°C to +85°C	

Weight (g)

Residual current devices	
Type	Acti9 iCV40 RCBO
1P+N	210

Protection, Earth leakage protection

Acti9 iCV40N residual current devices RCBO 6000 A

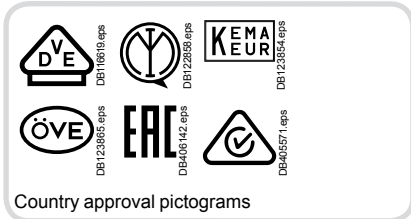

Country approval pictograms



CEI/EN 61009-2-1

As per the above standard:

The residual current devices offers the following functions of earth leakage protection and circuit protection.

- Earth leakage protection:
 - protection of persons against electric shock by direct contact (≤ 30 mA),
 - protection of persons against electric shock by indirect contact (300 mA),
 - protection of installations against the risk of fire (300 mA).
- Circuit protection:
 - circuit protection against short-circuit currents,
 - circuit protection against overload currents,
 - disconnection.

A-SI type

The A-SI type provides increased immunity from electrical interference and polluted or corrosive environments.

Catalog numbers

Acti9 iCV40N RCBO - B curve								
Type		AC		A			Width in 9-mm modules	
Auxiliaries		Catalog module CA907002						
1P+N	Sensitivity	30 mA	300 mA	10 mA	30 mA	100 mA		
	Rating 6 A	A9DH3606	A9DH7606	-	A9DG3606	-	4	
	10 A	A9DH3610	A9DH7610	A9DGA610	A9DG3610	-		
	13 A	-	-	-	A9DG3613	-		
	16 A	A9DH3616	A9DH7616	A9DGA616	A9DG3616	-		
	20 A	A9DH3620	A9DH7620	-	-	-		
	25 A	A9DH3625	A9DH7625	-	-	-		
	32 A	A9DH3632	A9DH7632	-	-	A9DGB632		
40 A	A9DH3640	A9DH7640	-	-	A9DGB640			
3P+N	Sensitivity	30 mA	300 mA	10 mA		100 mA		
	Rating 10 A	A9DH3710	-	-	A9DG3710	-	10	
	13 A	-	-	-	A9DG3713	-		
	16 A	A9DH3716	-	-	A9DG3716	-		
Accessories		Catalog modules CA907001 and CA907015						
Comb busbars		Catalog module CA907026						
PowerTag energy sensors		Catalog modules CA907029 and CA908058						

Acti9 iCV40N RCBO - C curve										
Type		AC		A			A-SI		Width in 9-mm modules	
Auxiliaries		Catalog module CA907002								
1P+N	Sensitivity	30 mA	300 mA	10 mA	30 mA	100 mA	30 mA	300 mA		
	Rating 6 A	A9DE3606	A9DE7606	-	A9DC3606	-	-	A9DF3606	A9DF7606	4
	10 A	A9DE3610	A9DE7610	A9DCA610	A9DC3610	-	A9DC7610	A9DF3610	A9DF7610	
	13 A	-	-	-	A9DC3613	-	A9DC7613	A9DF3613	-	
	13 A type G	-	-	-	A9DCG613	-	-	-	-	
	16 A	A9DE3616	A9DE7616	A9DCA616	A9DC3616	-	A9DC7616	A9DF3616	A9DF7616	
	20 A	A9DE3620	A9DE7620	-	A9DC3620	-	-	A9DF3620	A9DF7620	
	25 A	A9DE3625	A9DE7625	-	A9DC3625	-	-	A9DF3625	A9DF7625	
	32 A	A9DE3632	A9DE7632	-	A9DC3632	A9DCB632	-	A9DF3632	A9DF7632	
40 A	A9DE3640	A9DE7640	-	A9DC3640	A9DCB640	-	A9DF3640	A9DF7640		
3P+N	Sensitivity	30 mA	300 mA	10 mA	30 mA	100 mA	300 mA	30 mA	300 mA	
	Rating 10 A	A9DE3710	A9DE7710	-	A9DC3710	-	A9DC7710	A9DF3710	-	10
	13 A	-	-	-	A9DC3713	-	-	A9DF3713	-	
	16 A	A9DE3716	A9DE7716	-	A9DC3716	-	A9DC7716	A9DF3716	-	
	20 A	A9DE3720	A9DE7720	-	A9DC3720	-	-	A9DF3720	-	
	25 A	A9DE3725	A9DE7725	-	A9DC3725	-	-	A9DF3725	-	
	32 A	A9DE3732	A9DE7732	-	A9DC3732	-	-	A9DF3732	-	
40 A	A9DE3740	A9DE7740	-	A9DC3740	-	-	A9DF3740	-		
Accessories		Catalog modules CA907001 and CA907015								
Comb busbars		Catalog module CA907026								
PowerTag energy sensors		Catalog modules CA907029 and CA908058								

Protection, Earth leakage protection

Acti9 iCV40N residual current devices RCBO 6000 A

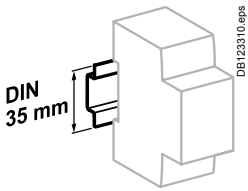

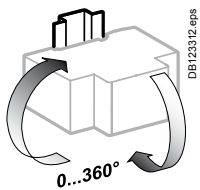

Clip on DIN rail 35 mm.

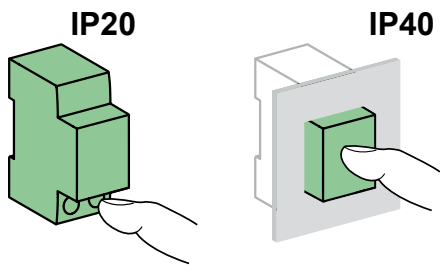

Indifferent position of installation.



Technical data

Main characteristics			
Insulation voltage (Ui)	Phase-to-neutral		400 V
	Phase-to-phase		440 V
Voltage rating (Ue)	Phase-to-neutral		230 V
	Phase-to-phase		400 V
Operating frequency			50/60 Hz
According to EN 61009-2-1			
Rated impulse withstand voltage (Uimp)			4 kV
Magnetic tripping	B curve		3 to 5 In
	C curve		5 to 10 In
Operating temperature			30°C
Limitation class			3
Rated breaking capacity (Icn)			6000 A
Service breaking capacity (Ics)			100 % Icn
Rated residual breaking and making capacity (IΔm)	1P+N	IEC 61009-2-1	500 A
		EN 61009-2-1	4500 A
	3P+N	IEC/EN 61009-2-1	3000 A
8/20 μs impulse withstand without tripping	AC type		250 Å
	A type		250 Å
	A-SI type		3 kÅ
Pollution degree			3
Behaviour in case of voltage drop			Residual current protection down to 0 V according to NF/EN 61009-1 § 3.3.8
Additional characteristics			
Degree of protection (IEC 60529)	Device only		IP20
	Device in modular enclosure		IP40 Insulation class II
Endurance (O-C)	Electrical	≤ 25 A	20000 cycles
		≥ 32 A	10000 cycles
	Mechanical		20000 cycles
Operating temperature	AC type		-5°C to +60°C
	A, A-SI types		-25°C to +60°C
Storage temperature			-40°C to +85°C

Dimensions (mm)

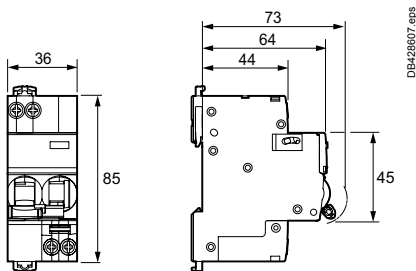

Residual current devices 1P+N

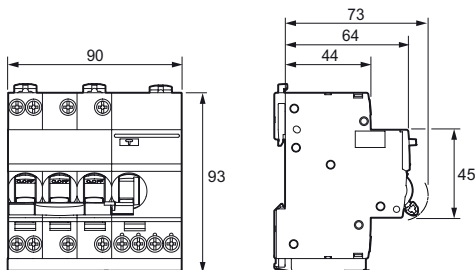

Residual current devices 3P+N

Weight (g)

Residual current devices		
Type	Acti9 iCV40N RCBO	
1P+N		210
3P+N		500

Protection, Earth leakage protection

Acti9 iCV40H residual current devices RCBO 10000 A

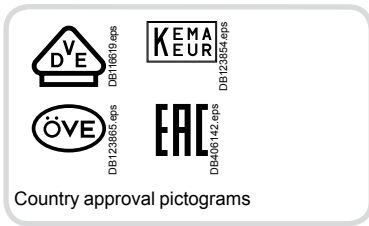

CEI/EN 61009-2-1

As per the above standard:

The residual current devices offers the following functions of earth leakage protection and circuit protection.

- Earth leakage protection:
 - protection of persons against electric shock by direct contact (30 mA),
 - protection of persons against electric shock by indirect contact (300 mA),
 - protection of installations against the risk of fire (300 mA).
- Circuit protection:
 - circuit protection against short-circuit currents,
 - circuit protection against overload currents,
 - disconnection.

A-SI type

The A-SI type provides increased immunity from electrical interference and polluted or corrosive environments.



Catalog numbers

Acti9 iCV40H RCBO - B curve							
Type	A		Width in 9-mm modules				
Auxiliaries	Catalog module CA907002						
1P+N	Sensitivity 30 mA						
	Rating	6 A	A9DG4606	4			
		10 A	A9DG4610				
		16 A	A9DG4616				
		20 A	A9DG4620				
		25 A	A9DG4625				
		32 A	A9DG4632				
Accessories	Catalog modules CA907001 and CA907015						
Comb busbars	Catalog module CA907026						
PowerTag energy sensors	Catalog modules CA907029 and CA908058						

Catalog numbers

Acti9 iCV40H RCBO - C curve								
Type	AC		A		A-SI		Width in 9-mm modules	
Auxiliaries	Catalog module CA907002							
1P+N	Rating	Sensitivity 30 mA	300 mA	30 mA	300 mA	30 mA	300 mA	4
	6 A	A9DE4606	A9DE8606	A9DC4606	A9DC8606	A9DF4606	A9DF8606	
	10 A	A9DE4610	A9DE8610	A9DC4610	A9DC8610	A9DF4610	A9DF8610	
	16 A	A9DE4616	A9DE8616	A9DC4616	A9DC8616	A9DF4616	A9DF8616	
	20 A	A9DE4620	A9DE8620	A9DC4620	A9DC8620	A9DF4620	A9DF8620	
	25 A	A9DE4625	A9DE8625	A9DC4625	A9DC8625	A9DF4625	A9DF8625	
	32 A	A9DE4632	A9DE8632	A9DC4632	A9DC8632	A9DF4632	A9DF8632	
3P+N	Rating	Sensitivity 30 mA	300 mA	30 mA	300 mA	30 mA	300 mA	10
	6 A	-	-	A9DC4706	-	-	-	
	10 A	-	-	A9DC4710	-	-	-	
	13 A	-	-	A9DC4713	-	-	-	
	16 A	-	-	A9DC4716	-	-	-	
	20 A	-	-	A9DC4720	-	-	-	
	25 A	-	-	A9DC4725	-	-	-	
	32 A	-	-	A9DC4732	-	-	-	
Accessories	Catalog modules CA907001 and CA907015							
Comb busbars	Catalog module CA907026							
PowerTag energy sensors	Catalog modules CA907029 and CA908058							

Protection, Earth leakage protection

Acti9 iCV40H residual current devices RCBO 10000 A

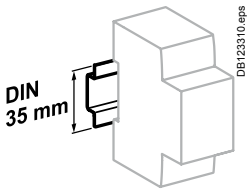

Clip on DIN rail 35 mm.

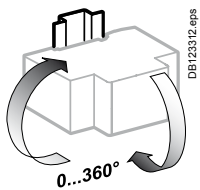

Indifferent position of installation.

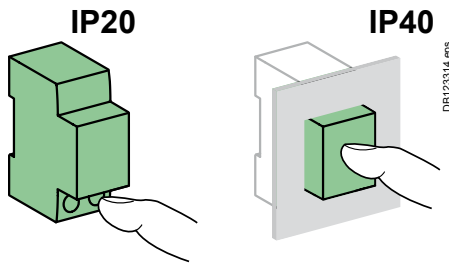

Dimensions (mm)

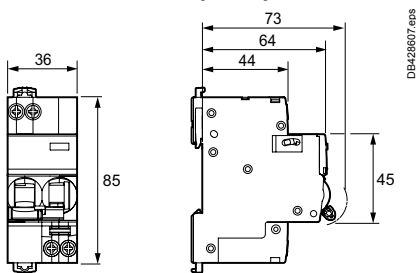

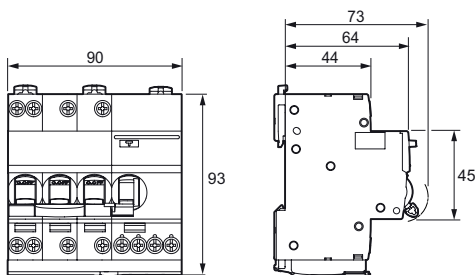

Residual current devices 1P+N



Residual current devices 3P+N

Technical data

Main characteristics			
Insulation voltage (Ui)	Phase-to-neutral	400 V	
	Phase-to-phase	440 V	
Voltage rating (Ue)	Phase-to-neutral	230 V	
	Phase-to-phase	400 V	
Operating frequency	50/60 Hz		
According to EN 61009-2-1			
Rated impulse withstand voltage (Uimp)	4 kV		
Magnetic tripping	B curve	3 to 5 In	
	C curve	5 to 10 In	
Operating temperature	30°C		
Limitation class	3		
Rated breaking capacity (Icn)	10000 A		
Service breaking capacity (Ics)	75 % Icn		
Rated residual breaking and making capacity (IΔm)	1P+N	IEC 61009-2-1	500 A
		EN 61009-2-1	4500 A
	3P+N	EC/EN 61009-2-1	3000 A
8/20 μs impulse withstand without tripping	AC type	250 Å	
	A type	250 Å	
	A-SI type	3 kÅ	
Pollution degree	3		
Behaviour in case of voltage drop			Residual current protection down to 0 V according to NF/EN 61009-1 § 3.3.8
Additional characteristics			
Degree of protection (IEC 60529)	Device only	IP20	
	Device in modular enclosure	IP40 Insulation class II	
Endurance (O-C)	Electrical	≤ 25 A	20000 cycles
		32 A	10000 cycles
Operating temperature	Mechanical	20000 cycles	
	AC type	-5°C to +60°C	
	A, A-SI types	-25°C to +60°C	
			
Storage temperature	-40°C to +85°C		

Weight (g)

Residual current devices	
Type	Acti9 iCV40H RCBO
1P+N	210
3P+N	500

Protection, Earth leakage protection Acti9 iCV40 residual current devices RCBO

■ Automatic cable guiding in the correct position: terminals with guard

■ Reinforced cable pull-out strength: serrated terminals

■ Assembly and disassembly with comb busbar in place by operating toggle latches at the top and bottom of the products

■ Where there is a comb tooth, the connection of cables of cross section 16 mm² remains possible

■ Clear space to allow comb busbar installation

■ Insulated terminals IP20

Markings

■ Area for marking by 12 mm high label on the front panel

Markings

■ Area for 4 marking clips alongside the downstream terminal

VISI-TRIP window

■ Fault tripping is indicated by a red mechanical indicator on the front face



VISI-SAFE window

Positive contact indication

- A green strip on the toggle indicates full opening of all the poles
- Downstream maintenance operations can be carried out in better safety conditions
- Padlocking possible

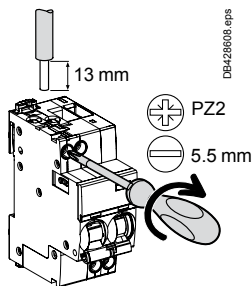
Connection



Type	Connection	Tightening torque	Comb busbar	Copper cables	
				Rigid	Flexible or with ferrule
Acti9 iCV40	Top	2 N.m	■	 1 to 16 mm ²	 1 to 10 mm ²
	Bottom		■		

- Connection by comb busbar or cables (as per EN 50027).
- Where there is a comb busbar tooth, the connection of cables of cross section 16 mm² remains possible.
- See Comb busbars Choice guide (CA908048).

Protection / Earth leakage protection

Residual current devices DPNa Vigi and DPN N Vigi

Contents



The Schneider Electric residual current device range comprises various offers (A, B) to enable it to be the most competitive range possible in each country, allowing for the special characteristics of each market:

- usual installation procedure
- price
- accreditations by local bodies.

Variants

Offers		Pages
Offer A	Catalogue numbers	260
Offer B	Catalogue numbers	261
Common pages		262



Only the product range to be marketed in your country and validated by the local product manager, in agreement with his Final Distribution (FD) partner should be retained. The others will be removed before publication.



Protection
Earth leakage protection

Residual current devices DPNa Vigi and DPN N Vigi
(cont.)

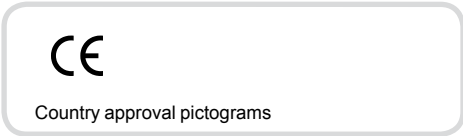

IEC/EN 61009-1

- The DPN Vigi residual current device provides complete protection for final circuits (against overcurrents and insulation faults):
 - protection for people against electric shocks by direct contacts (30 mA),
 - protection for people against electric shocks by indirect contacts (300 mA),
 - protection of installations against risk of fire (300 mA).
- The SI range has been designed to maintain a network with optimum safety and continuity of service in installations disturbed by:
 - extreme atmospheric conditions,
 - harmonic generating loads,
 - transient switching currents.

Catalogue numbers

DPNa Vigi 4500			
Type	A		
Auxiliaries	Module CA907013 and CA907008		
1P+N C curve	Sensitivity	10 mA	
	Rating (In)	10 A	A9N19304
		16 A	A9N19305
Voltage rating (Ue)		230 V AC	
Operating frequency		50/60 Hz	
Accessories	Module CA907013 and CA907012		

Offer A

Offer selection see page 259

This sticker must be removed before publishing

Catalogue numbers

DPN N Vigi 6000					
Type	AC		SI		Width in 9-mm modules
Auxiliaries	Module CA907013 and CA907008				
1P+N B curve	Sensitivity	30 mA		300 mA	
	Rating (In)	4 A	A9N19650	-	-
		6 A	A9N19651	A9N19671	-
		10 A	A9N19653	A9N19673	-
		13 A	-	-	-
		16 A	A9N19655	A9N19675	-
		20 A	A9N19656	A9N19676	-
		25 A	A9N19657	A9N19677	-
		32 A	A9N19658	A9N19678	-
	40 A	A9N19659	A9N19679	-	
1P+N C curve	Sensitivity	30 mA		300 mA	
	Rating (In)	6 A	A9N19661	A9N19681	A9N19631
		10 A	A9N19663	A9N19683	A9N19632
		13 A	-	-	A9N19633
		16 A	A9N19665	A9N19685	A9N19634
		20 A	A9N19666	A9N19686	A9N19635
		25 A	A9N19667	A9N19687	A9N19636
		32 A	A9N19668	A9N19688	A9N19637
		40 A	A9N19669	A9N19689	A9N19638
Voltage rating (Ue)		230 V AC			
Operating frequency		50/60 Hz			
Accessories	Module CA907013 and CA907012				

Protection
Earth leakage protection

Residual current devices DPNa Vigi and DPN N Vigi
(cont.)

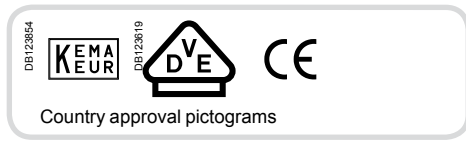

IEC/EN 61009-1

■ The DPN Vigi residual current device provides complete protection for final circuits (against overcurrents and insulation faults) it ensure the protection for people against electric shocks by direct contacts.



Catalogue numbers

DPNa Vigi [4500]				
Type	A		Width in 9-mm modules	
Auxiliaries	Module CA907013 and CA907008			
1P+N C curve	Sensitivity	30 mA		
	Rating (In)	10 A	4	
		13 A		A9N19533
		16 A		A9N19534
Voltage rating (Ue)		230 V AC		
Operating frequency		50/60 Hz		
Accessories		Module CA907013 and CA907012		

Catalogue numbers

DPN N Vigi [6000]				
Type	A		Width in 9-mm modules	
Auxiliaries	Module CA907013 and CA907008			
1P+N B curve	Sensitivity	30 mA		
	Rating (In)	6 A	4	
		10 A		A9N19754
		13 A		A9N19755
		16 A		A9N19756
		20 A		A9N19757
		25 A		A9N19758
		32 A		A9N19759
	40 A	A9N19760		
1P+N C curve	Sensitivity	30 mA		
	Rating (In)	6 A	4	
		10 A		A9N19772
		13 A		A9N19773
		16 A		A9N19774
		20 A		A9N19775
		25 A		A9N19780
		32 A		A9N19777
	40 A	A9N19778		
Voltage rating (Ue)		230 V AC		
Operating frequency		50/60 Hz		
Accessories		Module CA907013 and CA907012		

Offer selection see page 259

Offer B

This sticker must be removed before publishing

Protection
Earth leakage protection

Residual current devices DPNa Vigi and DPN N Vigi (cont.)

Positive contact indication

■ A green strip on the toggle guarantees opening of all the poles in safety conditions (padlocking possible) for work to be carried out on live parts

■ Fast closing

■ Display of earth fault on the front panel by position of toggle

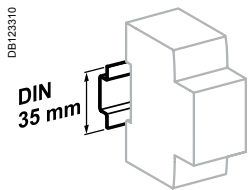
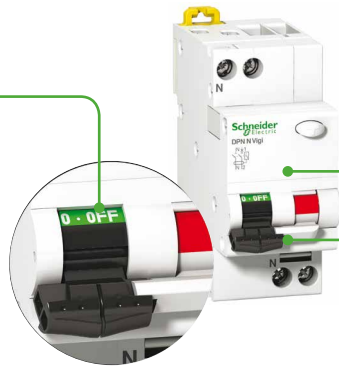

Clip on DIN rail 35 mm.

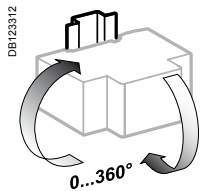

Indifferent position of installation.

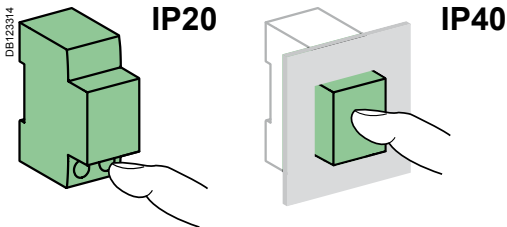

Connection

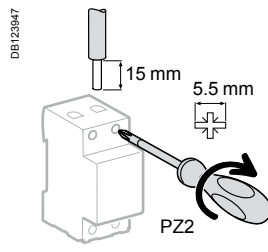

Rating	Tightening torque	Copper cables	
		Rigid	Flexible or with ferrule
4 to 40 A	2 N.m	1 to 16 mm ²	1 to 10 mm ²

Technical data

Main characteristics		
Type	DPNa Vigi	DPN N Vigi
Insulation voltage (U _i)	400 V AC	
Pollution degree	3	
Rated impulse withstand voltage (U _{imp})	4 kV	
Setting temperature for ratings	30°C	
Earth leakage protection with instantaneous tripping	10, 30 mA	30, 300 mA
Magnetic tripping	B curve	-
	C curve	Between 5 and 10 I _n
Utilization category	A	
Insulation class	2	
8/20 μs impulse withstand current	AC type	250 Å
	A type	250 Å
	SI type	3 kÅ

According to IEC/EN 61009-1		
Limitation class	3	
Rated breaking capacity (I _{cn})	4500 A	6000 A
Rated residual breaking and making capacity (I _{Δm})	4500 A	6000 A
Behaviour in case of voltage drop	Residual current protection down to 0 V according to IEC/EN 61009-1 § 3.3.8	

Additional characteristics		
Degree of protection (IEC 60529)	Device only	IP20
	Device in modular enclosure	IP40
Endurance (O-C)	Electrical	≤ 20 A: 20,000 cycles ≥ 25 A: 10,000 cycles
	Mechanical	20,000 cycles
	Overvoltage category (IEC 60364)	IV
Operating temperature	AC type	-5°C to +60°C
	A, SI type	-25°C to +60°C
Storage temperature	-30°C to +70°C	
Tropicalization (IEC 60068-1)	Treatment 2 (relative humidity of 95% at 55°C)	

Weight (g)

Residual current device		
Type	DPNa Vigi	DPN N Vigi
1P+N	125	125

Dimensions (mm)

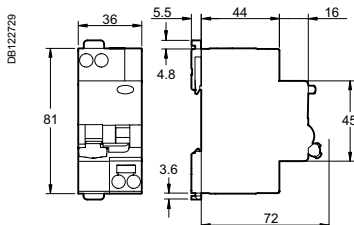

Protection

Earth leakage protection

Residual current devices DPN Vigi K

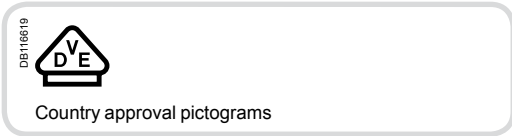

IEC/EN 61009-1



DPN Vigi K

■ The residual current devices DPN Vigi K provides complete protection of final circuits (overcurrents and insulation faults) and the protection of people against electric shocks by direct contacts (30 mA).

- Fast closing.
- Positive break indication.
- Display of earth fault on the front panel by position of toggle.

Catalogue numbers

DPN Vigi K		AC	A	Width in 9-mm modules	
Type		30 mA	30 mA		
1P+N Curve B 	Rating	10 A	16 A	20 A	4
		A9D22610	A9D22616	A9D22620	
		A9D23610	A9D23616	A9D23620	
		A9D22620	A9D23620	A9D23620	
1P+N Curve C 	Rating	10 A	16 A	20 A	4
		A9D20610	A9D20616	A9D20620	
		A9D21610	A9D21616	A9D21620	
		A9D20620	A9D21620	A9D21620	
Voltage rating (Ue)		230 V AC			
Operating frequency		50 Hz			

Connection

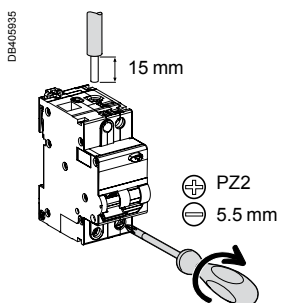

Type	Rating	Tightening torque	Copper cables	
			Rigid	Flexible or with ferrule
DPN Vigi K	10 to 20 A	Phase	1 to 25 mm ²	1 to 16 mm ²
		Neutral	1 to 16 mm ²	1 to 10 mm ²

Protection Earth leakage protection

Residual current devices DPN Vigi K (cont.)

The DPN Vigi K residual current device can be installed in the middle of a line of K60 circuit breakers. The phase can be powered via the biconnect comb busbar, the neutral is powered via a cable.

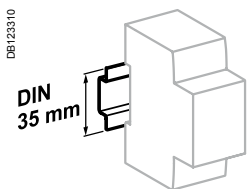
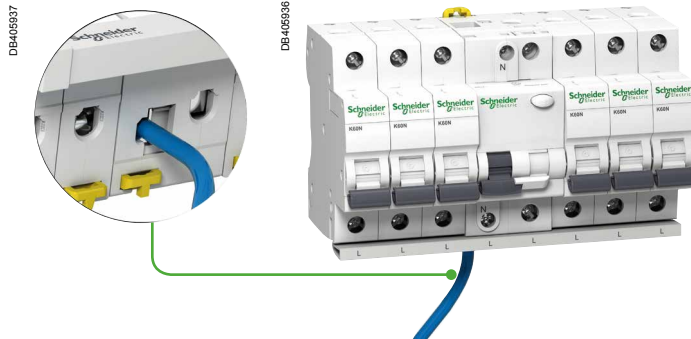

Clip on DIN rail 35 mm.

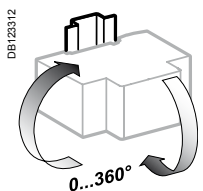

Indifferent position of installation.

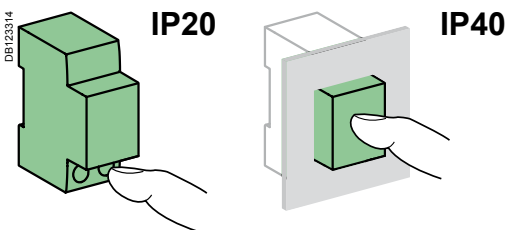

Technical data

Main characteristics	
Insulation voltage (Ui)	400 V
Pollution degree	3
Rated impulse withstand voltage (Uimp)	4 kV
Setting temperature for ratings	30°C
Tripping curve	Curve B Curve C
	Between 3 and 5 In Between 5 and 10 In

According to IEC/EN 61009-1	
Limitation class	3
Rated breaking capacity (Icn)	6000 A
Rated residual breaking and making capacity (IΔm)	4500 A
8/20 μs impulse withstand without tripping	AC type A type
	250 Å 250 Å
Behaviour in case of voltage drop	Residual current protection down to 0 V according to IEC/EN 61009-1 § 3.3.8

Additional characteristics	
Degree of protection	Device only Device in modular enclosure
	IP20 IP40 Insulation class II
Endurance (O-C)	Electrical Mechanical
	20000 cycles 20000 cycles
Overvoltage category (O-C)	III
Service temperature	AC type A type
	-5°C to +40°C -25°C to +40°C
Storage temperature	-30°C to +70°C
Tropicalization	Treatment 2 (relative humidity 95 % at 55°C)

Weight (g)

Residual current device	
Type	DPN Vigi K
1P+N	125

Dimensions (mm)

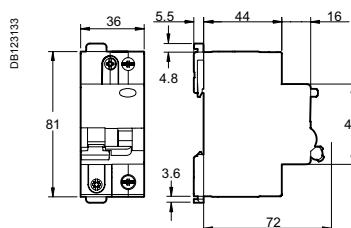

DPN Vigi K

Protection

Earth leakage protection

Residual current devices DPN N Vigi

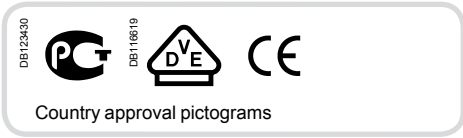

IEC/EN 61009-1



DPN N Vigi

- The DPN N Vigi residual current device provide complete protection for final circuits (against overcurrents and insulation faults):
 - protection for users against electric shocks by direct contacts (30 mA),
 - protection for users against electric shocks by indirect contacts (300 mA),
 - protection of the installations against fire risks (300 mA).
- The SI range has been designed to maintain a network with optimum safety and continuity of service in installations disturbed by:
 - extreme atmospheric conditions,
 - harmonic generating loads,
 - transient operating currents.

Catalogue numbers

DPN N Vigi 6000							
Type	AC	A		SI		Width in 9 mm modules	
Auxiliaries	Module CA907013 and CA907008						
3P+N Curve B	Sensitivity	30 mA	300 mA	30 mA	300 mA	30 mA	
	Rating (In)	6 A	-	6 A	-	-	10
	10 A	A9D55706	-	A9D56706	-	-	
	13 A	A9D55710	-	A9D56710	-	-	
	16 A	-	-	A9D56713	-	-	
	20 A	A9D55716	-	A9D56716	-	-	
	25 A	A9D55720	-	A9D56720	-	-	
	32 A	A9D55725	-	A9D56725	-	-	
	40 A	A9D55732	-	A9D56732	-	-	
40 A	A9D55740	-	A9D56740	-	-	-	
	Rating (In)	6 A	-	6 A	-	-	10
	10 A	A9D31706	-	A9D32706	-	-	
	13 A	A9D31710	A9D41710	A9D32710	A9D42710	A9D33710	
	16 A	-	-	A9D32713	-	A9D33713	
	20 A	A9D31716	A9D41716	A9D32716	A9D42716	A9D33716	
	25 A	A9D31720	A9D41720	A9D32720	A9D42720	A9D33720	
	32 A	A9D31725	A9D41725	A9D32725	A9D42725	A9D33725	
	40 A	A9D31732	A9D41732	A9D32732	A9D42732	A9D33732	
40 A	A9D31740	A9D41740	A9D32740	A9D42740	A9D33740		
Voltage rating (Ue)	400 V AC						
Operating frequency	50 Hz						
Accessories	Module CA907013						

- Fast contact closure
- Possibility of mixing iDPN Vigi 1P+N and DPN Vigi 3P+N devices on the same row and on the same comb busbar.
- Insulated terminals IP20
- Double clip for dismounting with comb busbar in place
- Test button
- Positive contact indication
 - A green strip on the toggle guarantees opening of all the poles in safety conditions (padlocking possible) for work to be carried out on live parts

Protection

Earth leakage protection

Residual current devices DPN N Vigi (cont.)

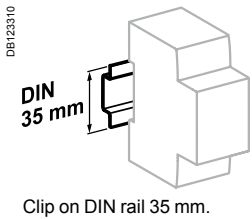

Clip on DIN rail 35 mm.

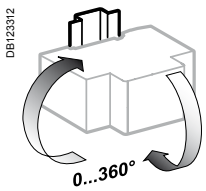

Indifferent position of installation.

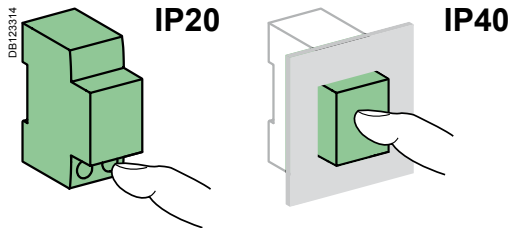

Connection

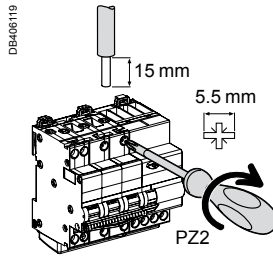

Rating	Tightening torque	Copper cables	
		Rigid	Flexible or with ferrule
6 to 40 A	2 N.m	0.75 to 16 mm ²	0.33 to 10 mm ²

Technical data

Main characteristics

Type	DPN N Vigi
Insulation voltage (U _i)	440 V AC
Pollution degree	3
Rated impulse withstand voltage (U _{imp})	4 kV
Setting temperature for ratings	30°C
Magnetic tripping	Curve B Curve C
	Between 3 and 5 I _n Between 5 and 10 I _n

According to IEC/EN 61009-1

Limitation class	3
Rated breaking capacity (I _{cn})	6000 A
Rated residual breaking and making capacity (I _{Δm})	6000 A
8/20 μs impulse withstand	Type AC: 250 Å Type A: 250 Å Type SI: -

Behaviour in case of voltage drop Residual current protection down to 0 V according to IEC/EN 61009-1 § 3.3.8

Additional characteristics

Earth leakage protection with instantaneous tripping	30, 300 mA
Degree of protection (IEC 60529)	Device only: IP20 Device in modular enclosure: IP40 Insulation class II
Endurance (O-C)	Electrical: ≤ 20 A: 20,000 cycles ≥ 25 A: 10,000 cycles Mechanical: 20,000 cycles
Overvoltage category (IEC 60364)	III
Operating temperature	Type AC: -5°C to +60°C Type A, SI: -25°C to +60°C
Storage temperature	-40°C to +70°C
Tropicalization (IEC 60068-1)	Treatment 2 (relative humidity 95 % to 55°C)

Weight (g)

Residual current device	
Type	DPN N Vigi
3P+N	498

Dimensions (mm)

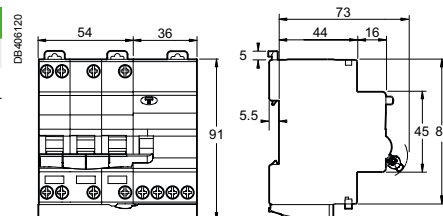

Protection

Earth leakage protection

Automatic recloser

REDs, REDtest

DB1122858  **IMQ only for REDs, cat. no. 18264, 18265, 18266, 18267, 18268, 18269, 18687 and 18689**
Country approval pictogram



REDs 2P



REDs 4P



REDtest

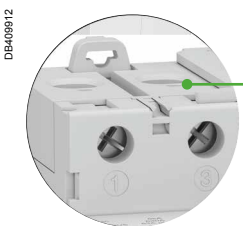

■ REDs 2P, 4P: supply from above or below

EN 50557

The REDs and the REDtest, **RE**sidual current **D**evice recloser, is made up of a residual current device and a recloser.

The **REDs** and **REDtest RESidual current Devices** offer the following functions:

- protection of people against direct and indirect contacts
- protection of installations against insulation faults
- disconnection of on-load electric circuits, already protected against overloads and short-circuits
- automatic restart after insulation monitoring of the downstream circuit.

REDtest provides the following additional functions:

- automatic and periodical test of the device, without breaking downstream circuit (REDtest).

Only used on TT and TN-S earthing grounding systems.

Residual current circuit breakers	2P	4P
Making and breaking capacity, rated residual current ($I\Delta m = I_m$)	630 A	630 A

Catalogue numbers

REDs residual current circuit breakers REDs

A type 				Width in mod. of 9 mm
2P	Sensitivity	30 mA	300 mA	

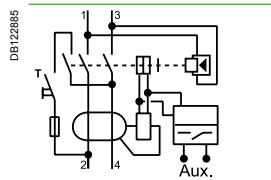

Rating	25 A	18687	18688	8
	40 A	18689	18690	
	63 A	18691	18692	

Voltage rating (Ue)	230 V		
Frequency rating	50Hz		

4P	Sensitivity	30 mA	300 mA	
Rating	25 A	18264	18265	14
	40 A	18266	18267	
	63 A	18268	18269	
	100 A	-	18270	

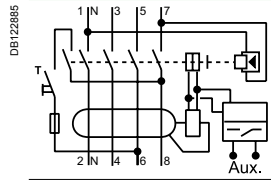

Voltage rating (Ue)	400 V		
Frequency rating	50 Hz		

REDtest residual current circuit breakers

A type 				Width in mod. of 9 mm
2P	Sensitivity	30 mA		

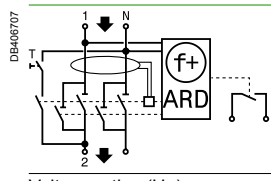

Rating	25 A	18280		10
	40 A	18281		

Voltage rating (Ue)	230 V		
Frequency rating	50 Hz		

Protection

Earth leakage protection

Automatic recloser

REDs, REDtest (cont.)

Coordination table, max short-circuit current (kA rms)

Circuit-breakers, fuse / A type REDs, REDtest coordination

Upstream		Circuit-breakers										Fuses			
Downstream		DPN		iC60N / C120N				iC60H, L / C120H, L / NG125N, H, L				gG			
Products	Ratings (A)	0.5 to 40	0.5 to 40	0.5 to 25	32 - 40	50 - 63	80 - 100	0.5 to 25	32 - 40	50 - 63	80 - 100	gG 25	gG 40	gG 63	gG 100
REDs Type A 2P															
	25	6	10	10	-	-	-	10	-	-	-	10	-	-	-
	40	6	10	10	10	-	-	15	10	-	-	15	10	-	-
	63	-	-	10	10	10	-	15	15	10	-	25	15	10	-
REDs Type A 4P															
	25	6	10	10	-	-	-	10	-	-	-	10	-	-	-
	40	6	10	10	10	-	-	15	10	-	-	15	10	-	-
	63	-	-	10	10	10	-	15	10	10	-	25	15	10	-
	100	-	-	10	10	10	10	15	15	15	10	25	25	15	10
REDtest Type A 2P															
	25	6	6	6	-	-	-	6	-	-	-	6	-	-	-
	40	6	6	10	6	-	-	10	6	-	-	10	6	-	-

DB122893

		Circuit-breaker (MCB) or Fuse (FU)			
		≤ 25 A	≤ 40 A	≤ 63 A	≤ 100 A
REDs / REDtest	25 A	■	—	—	—
	40 A	■	■	—	—
REDs	63 A	■	■	■	—
	100 A	■	■	■	■

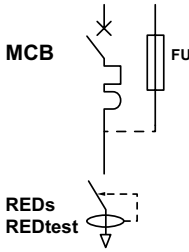

Operation

REDs

The REDs operates in the residual current device mode, without automatic restart, when the sliding cover is open, i.e. to the right in the Auto Off position (Fig. 1).

The automatic restart mode and the Autotest are activated, when the sliding cover is closed, i.e. to the left in the Auto On position (Fig. 2).

Test

! This is only possible in manual mode, i.e. sliding cover open in the Auto Off position. You can then manually test the device by pressing the Test key. The downstream installation is then temporarily broken. You must then manually reclose the RED by activating the O-I lever to power supply the downstream circuit.

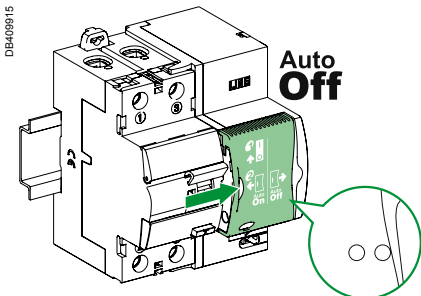

Fig. 1

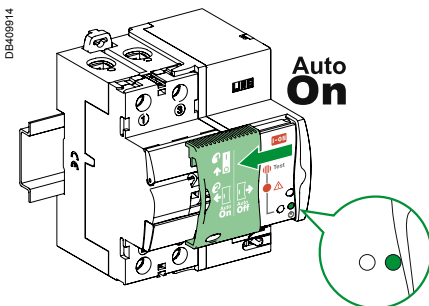

Fig. 2

REDtest

■ The REDtest carries out automatic testing of earth leakage protection every months.

The test consists in opening and reclosing the REDtest, during which time continuity of supply of the downstream installation is guaranteed.

Autotest: after checking installation insulation, the REDtest monitors its residual current device, without breaking the downstream power supply (bypass by bypass contact).

Protection

Earth leakage protection

Automatic recloser

REDs, REDtest (cont.)

Operation ON mode: temporary network fault

REDs, REDtest

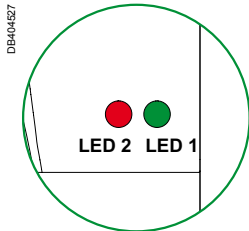

(*) Reclosing time:
 REDtest 2P: 10 s
 REDs 2P: 90 s
 REDs 4P: 10 s

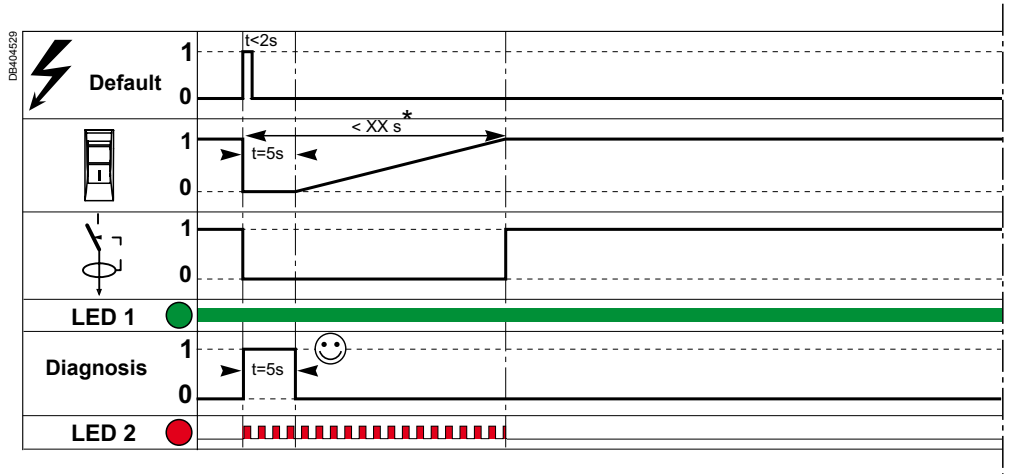

The built-in automatic recloser automatically recloses the residual current device after checking insulation of the downstream circuit.

Rd: lower level of insulation resistance, if $R < R_d$ = no reclose

Rdo: higher level of insulation resistance, if $R_d > R_{do}$ = reclose

Operation ON mode: long network fault

REDs

If the circuit is faulty, the switch is prohibited from reclosing. After a time delay of 2 minutes, the downstream circuit insulation is rechecked.

There are then two possibilities:

- the installation is still faulty (the resistance to earth is lower than Rd): in this case a new check will be carried out in 2 minutes.
- the fault was temporary and has disappeared (the resistance to earth is higher than Rdo): the recloser automatically recloses the REDs.

$I\Delta n$	30 mA	300 mA
Rd	16 kΩ	5 kΩ
Rdo	8 kΩ	2.5 kΩ

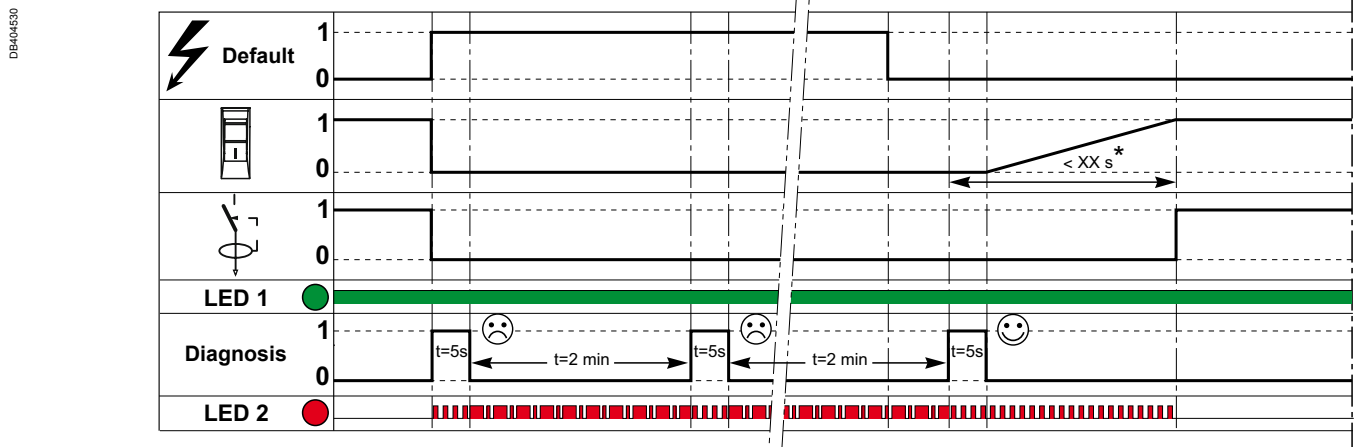

(*) Reclosing time:
 REDs 2P: 90 s
 REDs 4P: 10 s

Protection
 Earth leakage protection
 Automatic recloser
REDs, REDtest (cont.)

Operation ON mode: long network fault (cont.)

REDtest

If the circuit is faulty for a length of time "greater than 5 seconds", the switch is prohibited from reclosing.

- The installation is faulty: the earth resistance is lower than Rd.

$I\Delta n$	30 mA
Rd	70 kΩ
Rdo	20 kΩ

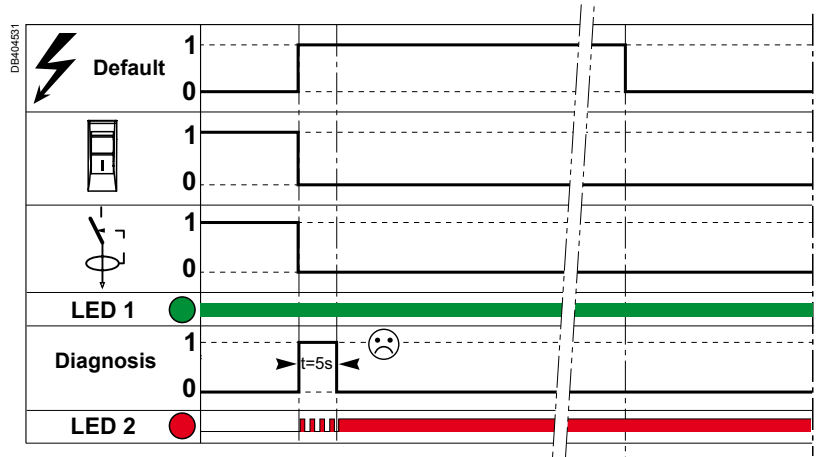

Connection

Type	Tightening torque	Copper cables	
		Rigid	Flexible or with ferrule
 DB123947 PZ1 / PZ2	2 N.m	 DB122946 35 mm ²	 DB122946 35 mm ²
 DB409924 PZ0 9 mm	0.4 N.m	2.5 mm ²	2.5 mm ²
 DB409925 PZ0 9 mm	0.4 N.m	2.5 mm ²	2.5 mm ²
 DB409926 PZ0 5 mm 0.6...3.5 mm	0.5 N.m	2.5 mm ²	2.5 mm ²

Connection by tunnel terminal with guard

Protection

Earth leakage protection

Automatic recloser

REDs, REDtest (cont.)

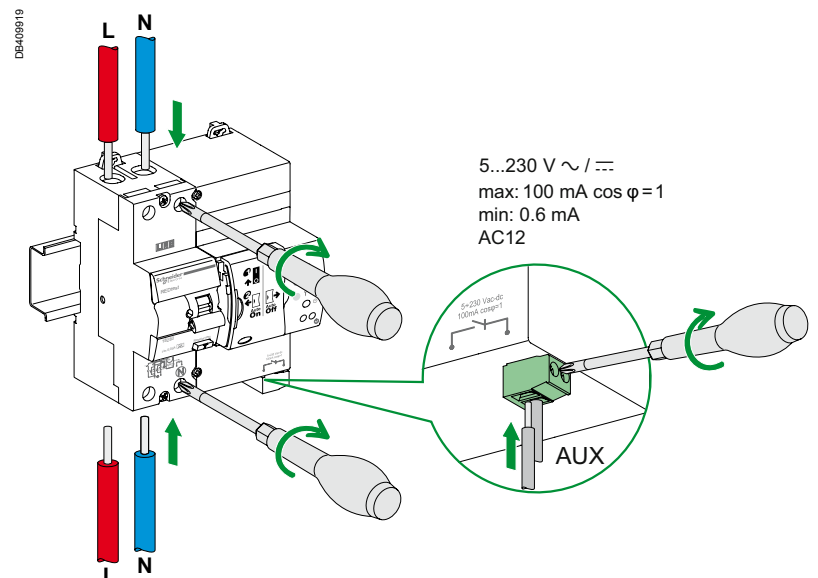
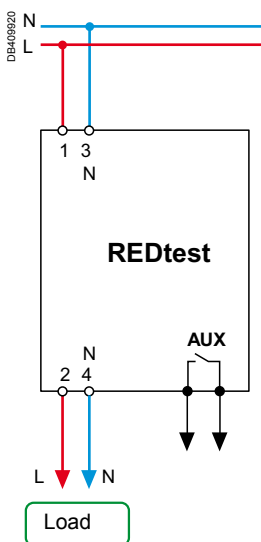
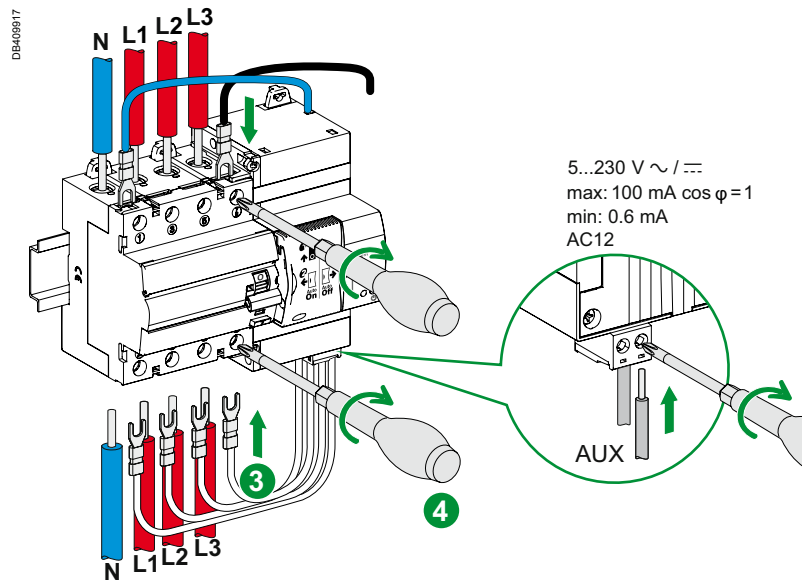
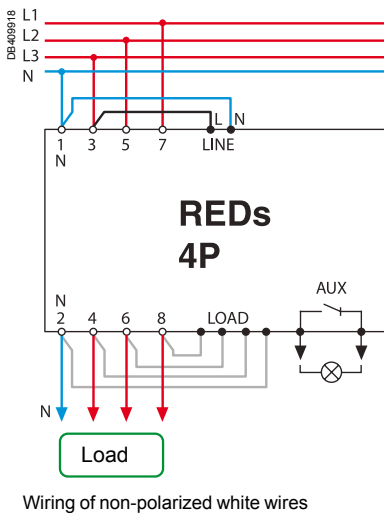
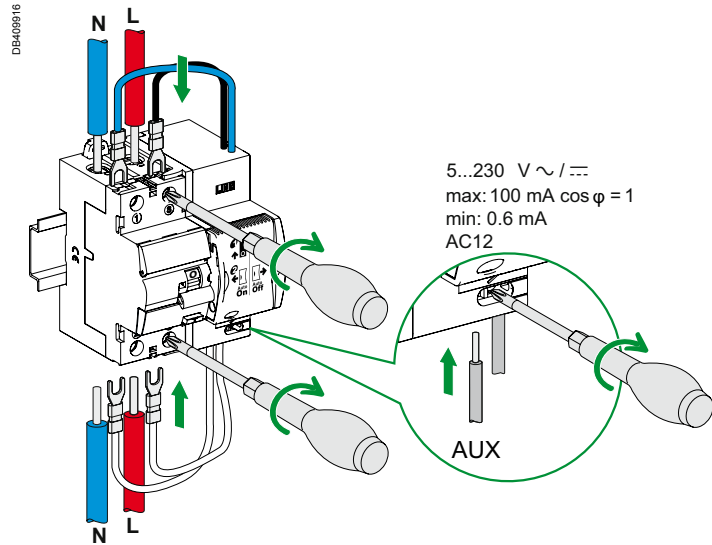
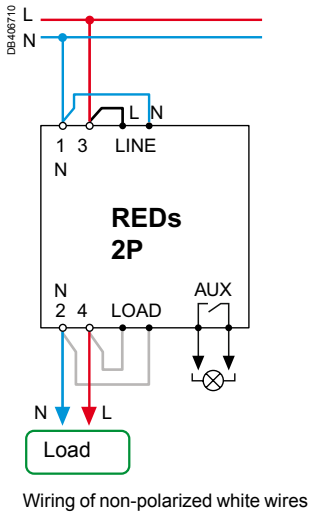

Protection

Earth leakage protection

Automatic recloser

REDs, REDtest (cont.)

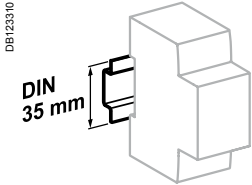

Clip on DIN rail 35 mm.

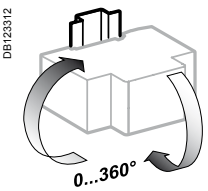

Indifferent position of installation.

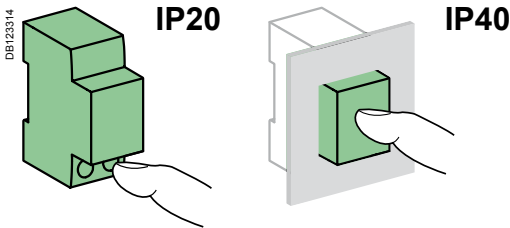

Technical data.

Main characteristics	2P		4P
Common technical data	REDtest	REDs	REDs
Earthing grounding systems	TT and TN-S only		
Impulse withstand voltage (Uimp)	4 kV		
Insulation voltage (Ui)	500 V		
8/20 µs wave immunity level	250 Å		
Tropicalization	Treatment 2 (relative humidity: 95 % at 55°C)		
Operating temperature	-5°C to +40°C		
Storage temperature	-20°C to +60°C		
Protection class	IP20 at terminals		
Additional characteristics			
Residual current device			
Tripping time	$\Delta t_n \leq 300 \text{ ms}$ $5 \Delta t_n \leq 40 \text{ ms}$		
Number of cycles (O-C)	1 000		4 000
Fixed sensitivity releases for all ratings	Instantaneous release		
Test button min operating voltage	195 V	100 V	170 V
Behaviour in case of voltage drop	Residual current protection down to 0 V according to IEC/EN 61008-1 § 3.3.4		
Recloser			
Max duration of a restart cycle	< 10 s	< 90 s	< 10 s
Maximum number of consecutive restart attempts (if no earth fault)	3		
Min interval between 2 closings	180 s		30 s
Insulation fault presence monitoring	Yes		
Insulation fault diagnosis	If fault: stopping of the restart cycle	If fault: diagnosis every 2 minutes with stopping of the restart cycle	
Stopping restart cycle if insulation fault present	Yes	Yes, during 15 minutes	
Not operating resistance to earth (Rd)	20 kΩ	8 kΩ (30 mA), 2.5 kΩ (300 mA)	
Operating resistance to earth (Rdo)	70 kΩ	16 kΩ (30 mA), 5 kΩ (300 mA)	
Power consumed by the electronics	8 VA	0 VA	
Indication			
Status indication	Mechanical: by O-I (open-closed) 2-position lever ■ Electrical: by 2 indicator lights on the front panel: □ left: red/yellow LED □ right: green LED Remote: by 1 built-in auxiliary contact		
Auxiliary contact			
Voltage rating (Ue)	5...230 V AC/DC		
Insulation voltage (Ui)	350 V		
Current rating (In)	Min: 0.6 mA Max: 100 mA, power factor = 1		
Utilization category	AC12		
Type	Configurable	NO or NC	Intermittent 1 Hz/30 s or NO or NC
Connection by tunnel terminal	Flexible or rigid cable: max 2.5 mm ²		

Protection
 Earth leakage protection
 Automatic recloser
REDs, REDtest (cont.)

Weight (g)

Reclosers	2P	4P
REDs	330	<ul style="list-style-type: none"> ■ 25/40 A: 630 ■ 63 A: 650 ■ 100 A: 650
REDtest	370	-

Dimensions (mm)

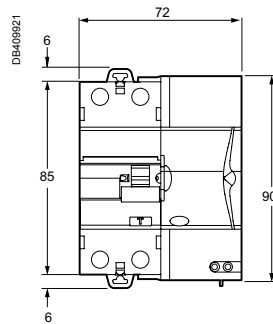

REDs 2P

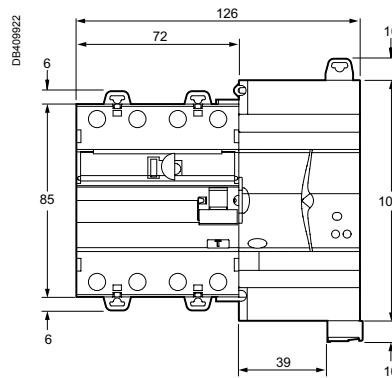

REDs 4P

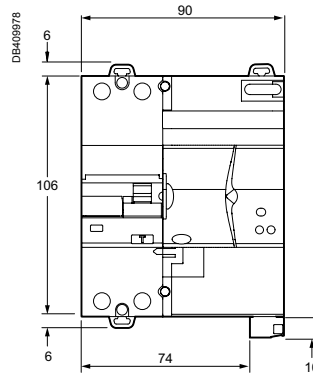

REDtest

Protection / Circuit protection

Arc fault detection device iARC



Country approval pictograms



iARC is an arc fault detection device which aims to reduce the risk of electrical fire. By continuously analyzing a large number of electrical parameters, it detects the appearance of electric arcs that are responsible for starting fires. It isolates the circuit concerned which reduce flame appearance occurrence.

The European installation standard IEC 60364- 4-42, recommends the use of AFDD to protect against arc fault in final circuit:

- in locations with sleeping accommodations (e.g., hotels, nursing homes, bedrooms in homes)
- in locations with risks of fire due to high quantities of flammable materials (e.g., barns, wood-working shops, stores of combustible materials)
- in locations with combustible constructional materials (e.g., wooden buildings)
- in fire propagating structures (e.g. high rise buildings)
- in locations where irreplaceable goods are housed (e.g., museums).

More specifically, the installation of iARC is highly recommended to protect circuits with highest risk of fire, such as:

- protruding cables (risk of knocks)
- outside cables (greater risk of deterioration)
- unprotected cables in secluded areas (like storage rooms)
- aging, deteriorating wiring or wiring for which the connection boxes are inaccessible.

iARC must not be installed on circuits requiring a high level of continuity of service.

iARC is not compatible with ATEX regulations.

IEC/EN 62606 (Europe)

General requirements for arc detection devices.

- iARC monitors electric arcs that occur in cables and connections and cause a fire. These arcs are the result of localised cable deterioration or loose connections
- It is used for three types of situations that can result in a fire:
 - parallel arc: insulation problems between two live conductors that cause a resistive short-circuit, too weak to be detected by a circuit breaker and with no earth leakage that would be detected by an earth-leakage protection device,
 - series arc: a damaged conductor or connection that causes part of the current to pass into its carbonised insulation due to a local rise in temperature,
 - overheating of electronic components in loads, when exposed to an overvoltage for several seconds.
- It combines the following functions:
 - protection against fire hazards by detection of abnormal electric arcs,
 - protection against load fire hazards due to slow overvoltages,
 - circuit opening and positive break indication (green strip),
 - fire hazard tripping indication via the front panel indicator,
 - device self-diagnostics via the test button.
- Installed in series with a MCB or a RCBO, max. 25 A, it protects Phase-Neutral or Phase-Phase circuits, in full coordination under short-circuit conditions up to a rated breaking capacity (Icn) of 10,000 A.

Catalogue numbers

iARC			
Arc Fault Detection Device (AFDD) to IEC/EN 62606		Width in 9 mm modules	
1P+N	Rating 25 A (In)	A9FDD225	4
Operating voltage		230 V AC	
Operating frequency		50 Hz	

DB406204

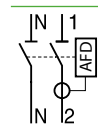

Connection

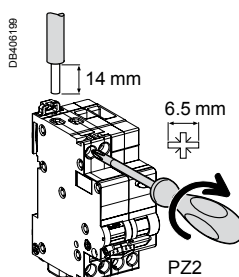

Tightening torque	Copper cables only	
	Rigid	Flexible or with ferrule
2 N.m	DB122945 1 x 1 to 16 mm ² 2 x 1 to 2.5 mm ²	DB122946 1 x 1 to 10 mm ² 2 x 1 to 2.5 mm ²

Arc fault detection device iARC (cont.)



PB111222-50



Test button
■ For device self-diagnostic

Positive break indication
■ A green strip on the handle indicates that all the poles are open for insulation

Red square indicator
■ Fire hazard tripping indication via a "red" status indicator

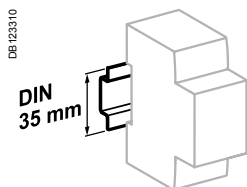

Clip on DIN rail 35 mm.

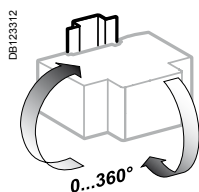

Indifferent position of installation.

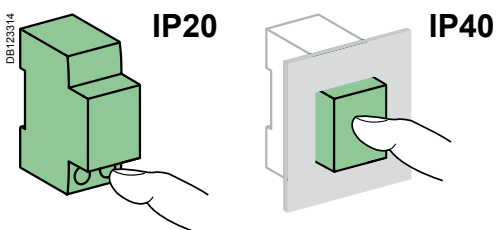

Technical data

Main characteristics		2.5 A	5 A	10 A	16 A	25 A
Tripping time/arc current value with $U_n = 230$ V AC (to IEC/EN 62606)	Arc current	2.5 A	5 A	10 A	16 A	25 A
	Max. operating time	1 s	0.5 s	0.25 s	0.15 s	0.14 s
Overvoltage tripping time (neutral conductor break)		400 V AC, 200 ms				
Insulation voltage (U_i)		400 V AC				
Degree of pollution		2				
Rated impulse withstand voltage (U_{imp})		4 kV				
Rated making and breaking capacity (I_m)		500 A				
Overvoltage category		III				
Coordinated with an upstream circuit breaker	Max. rating	25 A				
	Curve	B or C				
	Rated breaking capacity (I_{cn})	Up to 10,000 A				
Additional characteristics						
Degree of protection	Device alone	IP20				
	Device in a modular enclosure	IP40 Insulation class II				
Endurance (O-C)	Electrical	≤ 20 A	20,000 cycles			
		25 A	10,000 cycles			
	Mechanical		20,000 cycles			
Operating temperature		-25°C to +60°C				
Storage temperature		-40°C to +85°C				
Tropicalization (to IEC/EN 62606)		Severity B (to IEC 60068-2-30) during 28 days				

Weight (g)

Arc fault detection device	
Type	iARC
1P+N	198

Dimensions (mm)

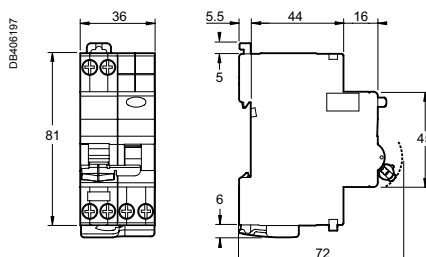

Protection / Circuit protection

Arc fault detection switch Acti9 iARC

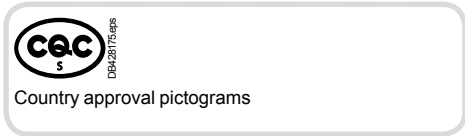

Arc fault detection switch Acti9 iARC reduces the risk of electrical fires. By continuously analysing a large number of electrical parameters, it detects the appearance of electric arcs that are responsible for starting fires. It automatically isolates the circuit concerned before the first flame appears.

The new installation standard JGJ16, recommends the use of AFDD to protect outlet socket circuits and lighting circuits against arc fault in final circuit:

- shopping mall
- supermarket
- assembly occupancies
- location for storing combustible goods.

More specifically, the installation of Acti9 iARC is highly recommended to protect circuits with highest risk of fire, such as:

- protruding cables (risk of knocks)
- outside cables (greater risk of deterioration)
- unprotected cables in secluded areas (like storage rooms)
- aging, deteriorating wiring or wiring for which the connection boxes are inaccessible.

Acti9 iARC must not be installed on circuits requiring a high level of continuity of service.

Acti9 iARC is not compatible with ATEX regulations.

GB/T 31143

General requirements for arc fault detection devices.

Arc fault detection switch Acti9 iARC monitors electric arcs that occur in cables and connections and cause a fire. These arcs are the result of localised cable deterioration or loose connections.

- It is used for three types of situations that can result in a fire:
 - parallel arc detection: insulation problems between two live conductors that cause a resistive short-circuit, too weak to be detected by a circuit breaker and with no earth leakage that would be detected by an earth-leakage protection device,
 - series arc detection: a damaged conductor or connection that causes part of the current to pass into its carbonised insulation due to a local rise in temperature,
 - overheating of electronic components in loads, when exposed to an overvoltage for several seconds.
- It combines the following functions:
 - protection against fire hazards by detection of abnormal electric arcs,
 - protection against load fire hazards due to slow overvoltages (network overvoltage),
 - fire hazard tripping indication via the front panel indicator,
 - device diagnosis via the test button,
 - automatic test at every switch on and at 10 hours,
 - positive contact indication (green strip),
 - tripping faults diagnosis by LED blinking in front face.
- Installed in series with a MCB or a RCBO, max. 25 A, it protects Phase-Neutral or Phase-Phase circuits, in full coordination under short-circuit conditions up to a rated breaking capacity of 10,000 A.
- Product is reverse feeding: it can be supplied either by the top or the bottom.

Catalogue numbers

Acti9 iARC			
Arc fault detection switch			Width in 9 mm modules
1P+N			
	Rating 25 A (In)	A9TS2225	4
Operating voltage	230 V AC		
Operating frequency	50 Hz		

Connection

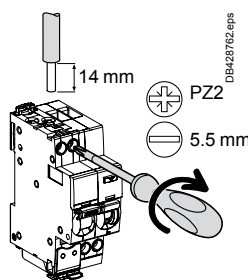

Tightening torque	Copper cables only	
	Rigid	Flexible or with ferrule
2 N.m		
	1 x 1 to 16 mm ²	1 x 1 to 10 mm ²

Arc fault detection switch Acti9 iARC (cont.)



VISI-TRIP windows

- Arc and overvoltage fault tripping are indicated by red mechanical indicators

Multi-function button

- For tripping diagnosis
- For device test

VISI-SAFE window

Positive contact indication

- A green strip on the toggle indicates full opening of all the poles
- Padlocking possible

Diagnosis LED

- Tripping faults diagnosis by orange LED blinking

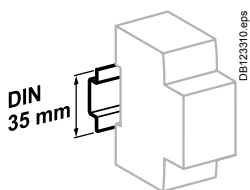

Clip on DIN rail 35 mm.

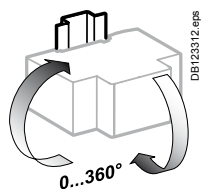

Indifferent position of installation.

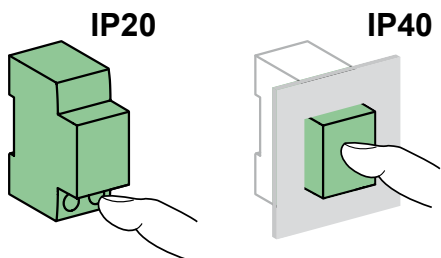

Technical data

Main characteristics

Tripping time/arc current value with $U_n = 230\text{ V AC}$ (to GB/T 31143)	Arc current	3 A	6 A	13 A	20 A	25 A
	Max. operating time	1 s	0.5 s	0.25 s	0.15 s	0.14 s
Overvoltage tripping threshold (neutral conductor break)	275 V AC \pm 5 V					
Insulation voltage (U_i)	400 V AC					
Degree of pollution	2					
Rated impulse withstand voltage (U_{imp})	4 kV					
Rated making and breaking capacity (I_m)	500 A					
Overvoltage category	II					
Coordinated with an upstream circuit breaker	Max. rating	25 A				
	Curve	B or C				
	Rated breaking capacity	Up to 10,000 A				

Additional characteristics

Degree of protection	Device alone	IP20
	Device in a modular enclosure	IP40
Endurance (O-C)	Electrical	10,000 cycles
	Mechanical	20,000 cycles
Operating temperature	-25°C to +60°C	
Storage temperature	-40°C to +80°C	
Tropicalization (to GB/T 31143)	Severity B (to GB/T 2423.4) during 28 days	

Weight (g)

Arc fault detection switch	
Type	Acti9 iARC
1P+N	240

Dimensions (mm)

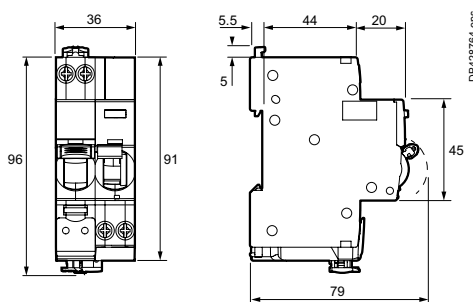

Protection / Circuit protection

Arc fault detection circuit breaker iDPN N Arc



The iDPN N Arc is an arc fault detection device with protection against overload and short-circuit currents, which aims to reduce the risk of electrical fire.

By continuously analyzing a large number of electrical parameters, it detects the appearance of electric arcs that are responsible for starting fires. It isolates the circuit concerned which reduces flame appearance occurrence.

The European installation standard IEC 60364-4-42, recommends the use of AFDD to protect against arc fault in final circuit:

- in locations with sleeping accommodations (e.g., hotels, nursing homes, bedrooms in homes)
- in locations with risks of fire due to high quantities of flammable materials (e.g., barns, wood-working shops, stores of combustible materials)
- in locations with combustible constructional materials (e.g., wooden buildings)
- in fire propagating structures (e.g. high rise buildings)
- in locations where irreplaceable goods are housed (e.g., museums).

More specifically, the installation of iDPN N Arc is highly recommended to protect circuits with highest risk of fire, such as:

- protruding cables (risk of knocks)
- outside cables (greater risk of deterioration)
- unprotected cables in secluded areas (like storage rooms)
- aging, deteriorating wiring or wiring for which the connection boxes are inaccessible.

iDPN N Arc must not be installed on circuits requiring high level of continuity of service.

The iDPN N Arc is not compatible with ATEX regulations.

IEC 60898-1

Circuit breakers for the protection against the overload (residential and similar installations).

IEC/EN 62606

General requirements for arc detection devices.

- In addition to protection against overloads and short circuits, the iDPN N Arc monitors for electric arcs that occur in cables and connections, that may cause a fire. These arcs are the result of localised cable deterioration or loose connections.
- It is used for three types of situations that can result in a fire:
 - parallel arc: insulation problems between two live conductors that cause a resistive short-circuit, too weak to be detected by a circuit breaker and with no earth leakage to be detected by a residual current circuit breaker,
 - series arc: a damaged conductor or connection that causes part of the current to flow through its carbonised insulation due to a local rise in temperature,
 - overheating of electronic components in loads, when exposed to an overvoltage for several seconds.
- It combines the following functions:
 - circuit protection against overload and short-circuit currents (circuit breaker function),
 - protection against fire hazards by detection of abnormal electric arcs,
 - protection against load fire hazards due to slow overvoltages (network overvoltage),
 - fire hazard tripping indication via the front panel indicator,
 - device self-diagnostics via the test button,
 - positive contact indication (green strip).
- The iDPN N Arc should be installed in the place of the circuit's final protection device.

Catalogue numbers

iDPN N Arc 6000			
Arc Fault Detection Devices (AFDD) to IEC/EN 62606			Width in 9 mm modules
1P+N		B curve	C curve
	Rating (In)	6 A	A9FDB606
		10 A	A9FDB7610
		13 A	A9FDB7613
		16 A	A9FDB7616
		20 A	A9FDB620
		25 A	A9FDB625
Operating voltage	230 V AC		
Operating frequency	50 Hz		

Connection

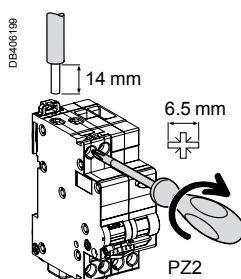

Tightening torque	Copper cables only	
	Rigid	Flexible or with ferrule
2 N.m	 1 x 1 to 16 mm ² 2 x 1 to 2.5 mm ²	 1 x 1 to 10 mm ² 2 x 1 to 2.5 mm ²

Arc fault detection circuit breaker iDPN N Arc (cont.)



PB110631-50

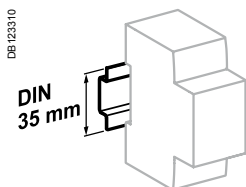
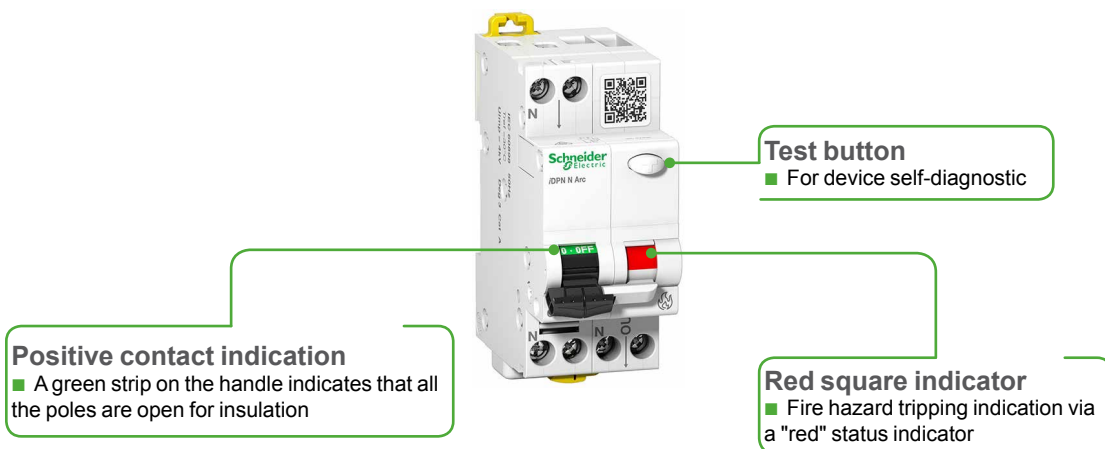

Clip on DIN rail 35 mm.

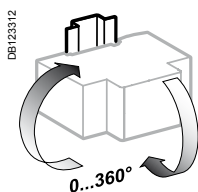

Indifferent position of installation.

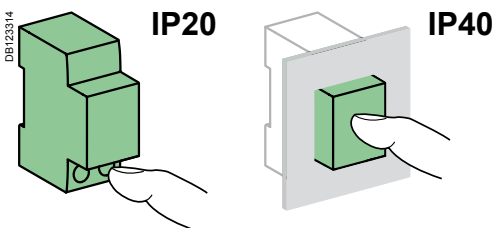

Technical data

Main characteristics						
Tripping time/arc current value with $U_n = 230$ V AC (to IEC/EN 62606)	Arc current	2.5 A	5 A	10 A	16 A	25 A
	Max. operating time	1 s	0.5 s	0.25 s	0.15 s	0.14 s
Overvoltage tripping time (neutral conductor break)		400 V AC, 200 ms				
Insulation voltage (U_i)		400 V AC				
Degree of pollution		2				
Rated impulse withstand voltage (U_{imp})		4 kV				
Overvoltage category		III				
Limitation class		3				
Thermal tripping	Reference temperature	30°C				
Magnetic tripping	Curve B	Between 3 and 5 I_n				
	Curve C	Between 5 and 10 I_n				
Rated breaking capacity (I_{cn})		6 000 A				
Additional characteristics						
Degree of protection	Device alone	IP20				
	Device in a modular enclosure	IP40 Insulation class II				
Endurance (O-C)	Electrical	≤ 20 A	20,000 cycles			
		25 A	10,000 cycles			
	Mechanical	20,000 cycles				
Operating temperature		-25°C to +60°C				
Storage temperature		-40°C to +85°C				
Tropicalization (to IEC/EN 62606)		Severity B (to IEC 60068-2-30) during 28 days				

Weight (g)

Arc fault detection circuit breaker	
Type	iDPN N Arc
1P+N	198

Dimensions (mm)

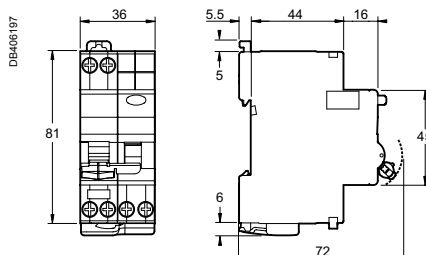

Protection / Circuit protection

Arc fault detection circuit breaker Acti9 iDPN ARC



Acti9 iDPN ARC is an arc fault detection device with overload and short-circuit protection, which aims to reduce the risk of electrical fire.

By continuously analyzing a large number of electrical parameters, it detects the appearance of electric arcs that are responsible for starting fires. It isolates the circuit concerned which reduces flame appearance occurrence.

The new installation standard JGJ16, recommends the use of AFDD to protect outlet socket circuits and lighting circuits against arc fault in final circuit:

- shopping mall
- supermarket
- assembly occupancies
- location for storing combustible goods.

More specifically, the installation of Acti9 iDPN ARC is highly recommended to protect circuits with highest risk of fire, such as:

- protruding cables (risk of knocks)
- outside cables (greater risk of deterioration)
- unprotected cables in secluded areas (like storage rooms)
- aging, deteriorating wiring or wiring for which the connection boxes are inaccessible.

Acti9 iDPN ARC must not be installed on circuits requiring a high level of continuity of service.

Acti9 iDPN ARC is not compatible with ATEX regulations.

GB/T 10963.1

Circuit breakers for the protection against the overcurrent (residential and similar installations).

GB/T 31143

General requirements for arc fault detection devices.

In addition to protection against overloads and short circuits, the Acti9 iDPN ARC monitors for electric arcs that occur in cables and connections, that may cause a fire. These arcs are the result of localised cable deterioration or loose connections.

- It is used for three types of situations that can result in a fire:
 - parallel arc detection: insulation problems between two live conductors that cause a resistive short-circuit, too weak to be detected by a circuit breaker and with no earth leakage to be detected by a residual current circuit breaker,
 - series arc detection: a damaged conductor or connection that causes part of the current to flow through its carbonised insulation due to a local rise in temperature,
 - overheating of electronic components in loads, when exposed to an overvoltage for several seconds.

- It combines the following functions:
 - circuit protection against overload and short-circuit currents (circuit breaker function),
 - protection against fire hazards by detection of abnormal electric arcs,
 - protection against load fire hazards due to slow overvoltages (network overvoltage),
 - fire hazard tripping indication via the front panel indicator,
 - device diagnosis via the test button,
 - automatic test at every switch on and at 10 hours,
 - positive contact indication (green strip),
 - tripping faults diagnosis by LED blinking in front face.

The Acti9 iDPN ARC should be installed as the circuit's final protection device.

Product is reverse feeding: it can be supplied either by the top or the bottom.

Catalogue numbers

Acti9 iDPN ARC C curve				Width in 9 mm modules		
Arc Fault Detection Devices (AFDD) to GB/T 31143						
1P+N		iDPNa ARC 4500	iDPNn ARC 6000	iDPNH ARC 10000		
	Rating (In)	6 A	A9TPL606	A9TPM606	A9TPN606	4
		10 A	A9TPL610	A9TPM610	A9TPN610	
		16 A	A9TPL616	A9TPM616	A9TPN616	
		20 A	A9TPL620	A9TPM620	A9TPN620	
		25 A	A9TPL625	A9TPM625	A9TPN625	
Operating voltage		230 V AC				
Operating frequency		50 Hz				

Connection

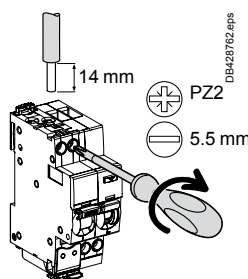

Tightening torque	Copper cables only	
	Rigid	Flexible or with ferrule
2 N.m		
	1 x 1 to 16 mm ²	1 x 1 to 10 mm ²

Arc fault detection circuit breaker Acti9 iDPN ARC (cont.)



VISI-SAFE window

Positive contact indication

- A green strip on the toggle indicates full opening of all the poles
- Padlocking possible

Multi-function button

- For tripping diagnosis
- For device test

VISI-TRIP window

- Short circuit and overload fault tripping is indicated by a red mechanical indicator

VISI-TRIP window

- Arc and overvoltage fault tripping are indicated by a red mechanical indicator

Diagnosis LED

- Tripping faults diagnosis by orange LED blinking

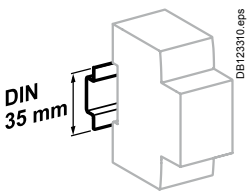

Clip on DIN rail 35 mm.

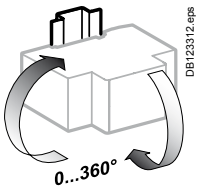

Indifferent position of installation.

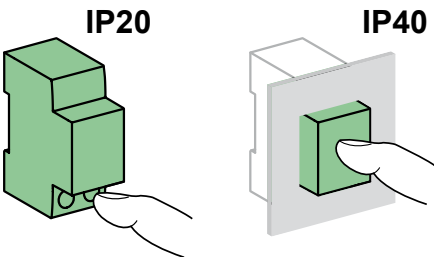

Technical data

Main characteristics

Tripping time/arc current value with $U_n = 230\text{ V AC}$ (to GB/T 31143)	Current before arc (RMS)	3 A	6 A	13 A	20 A	25 A
	Max. operating time	1 s	0.5 s	0.25 s	0.15 s	0.14 s
Overvoltage tripping threshold (neutral conductor break)		275 V AC $\pm 5\text{ V}$				
Insulation voltage (U_i)		400 V AC				
Degree of pollution		2				
Rated impulse withstand voltage (U_{imp})		4 kV				
Overvoltage category		II				
Limitation class		3				
Thermal tripping	Reference temperature	30°C				
Magnetic tripping	Curve C	Between 5 and 10 I_n				
Rated breaking capacity (I_{cn})	iDPNa ARC	4 500 A				
	iDPNN ARC	6 000 A				
	iDPNH ARC	10 000 A				

Additional characteristics

Degree of protection (to GB/T 4208)	Device alone	IP20
	Device in a modular enclosure	IP40 Insulation class II
Endurance (O-C)	Electrical $\leq 20\text{ A}$	20,000 cycles
	25 A	10,000 cycles
	Mechanical	20,000 cycles
Operating temperature		-25°C to +60°C
Storage temperature		-40°C to +80°C
Tropicalization (to GB/T 31143)		Severity B (to GB/T 2423.4) during 28 days

Weight (g)

Arc fault detection circuit breaker

Type	Acti9 iDPN ARC
1P+N	237

Dimensions (mm)

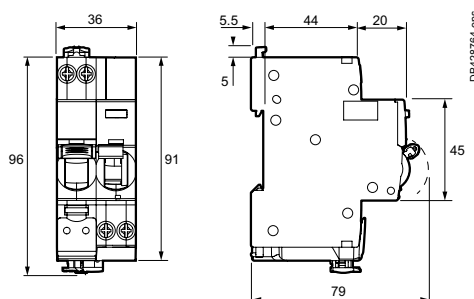

Protection / Circuit protection

Arc fault detection circuit breaker iARC DPNN

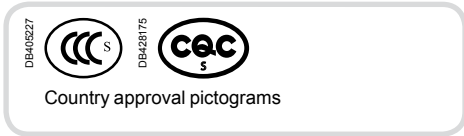

iARC DPNN is an arc fault detection device with overload and short-circuit protection, which aims to reduce the risk of electrical fire.

By continuously analyzing a large number of electrical parameters, it detects the appearance of electric arcs that are responsible for starting fires. It isolates the circuit concerned which reduce flame appearance occurrence.

The new installation standard JGJ16, recommends the use of AFDD to protect outlet socket circuits and lighting circuits against arc fault in final circuit:

- shopping mall
- supermarket
- assembly occupancies
- location for storing combustible goods

More specifically, the installation of iARC DPNN is highly recommended to protect circuits with highest risk of fire, such as:

- protruding cables (risk of knocks)
- outside cables (greater risk of deterioration)
- unprotected cables in secluded areas (like storage rooms)
- aging, deteriorating wiring or wiring for which the connection boxes are inaccessible.

iARC DPNN must not be installed on circuits requiring a high level of continuity of service.

iARC DPNN is not compatible with ATEX regulations.

GB/T 10963.1

Circuit breakers for the protection against the overload (residential and similar installations).

GB/T 31143

General requirements for arc detection devices.

■ In addition to protection against overloads and short circuits, the iARC DPNN monitors for electric arcs that occur in cables and connections, that may cause a fire. These arcs are the result of localised cable deterioration or loose connections.

■ It is used for three types of situations that can result in a fire:

- parallel arc detection: insulation problems between two live conductors that cause a resistive short-circuit, too weak to be detected by a circuit breaker and with no earth leakage to be detected by a residual current circuit breaker,
- series arc detection: a damaged conductor or connection that causes part of the current to flow through its carbonised insulation due to a local rise in temperature,
- overheating of electronic components in loads, when exposed to an overvoltage for several seconds.

■ It combines the following functions:

- circuit protection against overload and short-circuit currents (circuit breaker function),
- protection against fire hazards by detection of abnormal electric arcs,
- protection against load fire hazards due to slow overvoltages (network overvoltage),
- fire hazard tripping indication via the front panel indicator,
- device self-diagnostics via the test button,
- positive contact indication (green strip).

■ The iARC DPNN should be installed in the place of the circuit's final protection device.

Catalogue numbers

iARC DPNN 6000		Arc Fault Detection Devices (AFDD) to GB/T 31143		Width in 9 mm modules
	Rating (In) 10 A 16 A 20 A 25 A	C curve		4
		A9FDN610		
		A9FDN616		
		A9FDN620		
		A9FDN625		
Operating voltage		230 V AC		
Operating frequency		50 Hz		

Connection

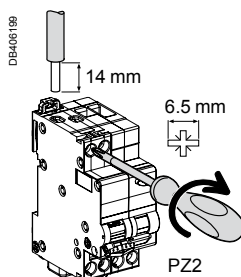

Tightening torque	Copper cables only	
	Rigid	Flexible or with ferrule
2 N.m		
	1 x 1 to 16 mm ² 2 x 1 to 2.5 mm ²	1 x 1 to 10 mm ² 2 x 1 to 2.5 mm ²

Arc fault detection circuit breaker iARC DPNN (cont.)



DB409118-50

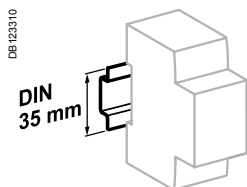

Clip on DIN rail 35 mm.

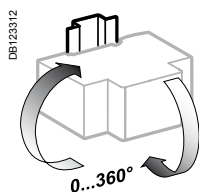

Indifferent position of installation.

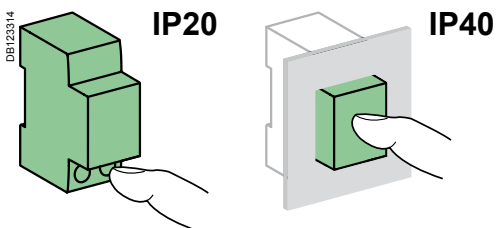

Technical data

Main characteristics

Tripping time/arc current value with $U_n = 230$ V AC (to GB/T 31143)	Current before arc (RMS)	3 A	6 A	13 A	20 A	25 A
	Max. operating time	1 s	0.5 s	0.25 s	0.15 s	0.14 s
Overvoltage tripping time (neutral conductor break)		400 V AC, 200 ms				
Insulation voltage (U_i)		400 V AC				
Degree of pollution		2				
Rated impulse withstand voltage (U_{imp})		4 kV				
Overvoltage category		III				
Limitation class		3				
Thermal tripping	Reference temperature	30°C				
Magnetic tripping	Curve C	Between 5 and 10 I_n				
Rated breaking capacity (I_{cn})		6 000 A				

Additional characteristics

Degree of protection	Device alone	IP20
	Device in a modular enclosure	IP40 Insulation class II
Endurance (O-C)	Electrical ≤ 20 A	20,000 cycles
	25 A	10,000 cycles
	Mechanical	20,000 cycles
Operating temperature		-25°C to +60°C
Storage temperature		-40°C to +85°C
Tropicalization (to GB/T 31143)		Severity B (to GB/T 2423.4) during 28 days

Weight (g)

Arc fault detection circuit breaker	
Type	iARC DPNN
1P+N	198

Dimensions (mm)

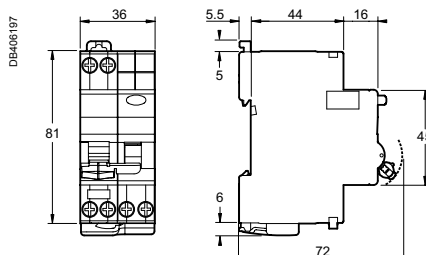

Protection / Earth leakage protection

Arc fault detection RCBO Acti9 iDPN VigiARC ELE



Acti9 iDPN VigiARC ELE is an arc fault detection device with overload, short circuit and residual current protection, which aims to reduce the risk of electrical fire.

By continuously analyzing a large number of electrical parameters, it detects the appearance of electric arcs that are responsible for starting fires. It isolates the circuit concerned which reduces flame appearance occurrence.

The new installation standard JGJ16, recommends the use of AFDD to protect outlet socket circuits and lighting circuits against arc fault in final circuit:

- shopping mall
- supermarket
- assembly occupancies
- location for storing combustible goods

More specifically, the installation of Acti9 iDPN VigiARC ELE is highly recommended to protect circuits with highest risk of fire, such as:

- protruding cables (risk of knocks)
- outside cables (greater risk of deterioration)
- unprotected cables in secluded areas (like storage rooms)
- aging, deteriorating wiring or wiring for which the connection boxes are inaccessible.

Acti9 iDPN VigiARC ELE must not be installed on circuits requiring a high level of continuity of service.

Acti9 iDPN VigiARC ELE is not compatible with ATEX regulations.

GB/T 31143

General requirements for arc fault detection devices.

GB/T 16917.1

Residual current operated circuit-breakers with integral overcurrent protection for household and similar uses (RCBOs).

- The Acti9 iDPN VigiARC ELE residual current device provides a protection for final circuits against overcurrents and insulation faults (protection for people against electric shocks).
- In addition to these protections, the Acti9 iDPN VigiARC ELE monitors for electric arcs that occur in cables and connections, that may cause a fire. These arcs are the result of localised cable deterioration or loose connections.
- It is used for three types of situations that can result in a fire:
 - parallel arc detection: insulation problems between two live conductors that cause a resistive short-circuit, too weak to be detected by a circuit breaker and with no earth leakage to be detected by a residual current circuit breaker,
 - series arc detection: a damaged conductor or connection that causes part of the current to flow through its carbonised insulation due to a local rise in temperature,
 - overheating of electronic components in loads, when exposed to an overvoltage for several seconds.
- It combines the following functions:
 - circuit protection against overload and short-circuit currents (circuit breaker function),
 - protection for people against electric shocks by direct contacts and indirect contacts (30 mA),
 - protection against fire hazards by detection of abnormal electric arcs,
 - protection against load fire hazards due to slow overvoltages (network overvoltage),
 - fire hazard tripping indication via the front panel indicator,
 - device diagnosis via the test button,
 - automatic test at every switch on and at 10 hours,
 - positive contact indication (green strip),
 - tripping faults diagnosis by LED blinking in front face.
- The Acti9 iDPN VigiARC ELE should be installed in the place of the circuit's final protection device.
- Product is reverse feeding: it can be supplied either by the top or the bottom.

Catalogue numbers

Acti9 iDPN VigiARC ELE, C curve, 30 mA, type A				Width in 9 mm modules	
Arc Fault Detection Devices (AFDD) to GB/T 31143					
1P+N	iDPNa VigiARC ELE 4500	iDPNN VigiARC ELE 6000	iDPNH VigiARC ELE 10000		
	Rating (In)	6 A	10 A	16 A	4
		A9T44606	A9T45606	A9T46606	
		A9T44610	A9T45610	A9T46610	
		A9T44616	A9T45616	A9T46616	
		A9T44620	A9T45620	A9T46620	
	A9T44625	A9T45625	A9T46625		
Operating voltage	230 V AC				
Operating frequency	50 Hz				

Connection

Tightening torque	Copper cables only	
	Rigid	Flexible or with ferrule
2 N.m		
	1 x 1 to 16 mm ²	1 x 1 to 10 mm ²

Arc fault detection RCBO Acti9 iDPN VigiARC ELE (cont.)



VISI-SAFE window

Positive contact indication

- A green strip on the toggle indicates full opening of all the poles
- Padlocking possible

Multi-function button

- For tripping diagnosis
- For device test

VISI-TRIP window

- Short circuit and overload fault tripping is indicated by a red mechanical indicator

VISI-TRIP window

- Fault tripping (Earth fault, Arc fault, overvoltage) are indicated by a red mechanical indicator

Diagnosis LED

- Tripping faults diagnosis by orange LED blinking

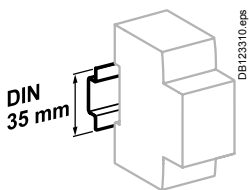
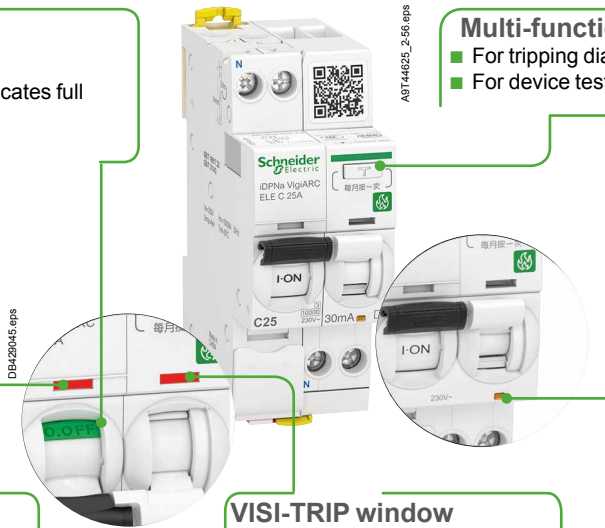

Clip on DIN rail 35 mm.

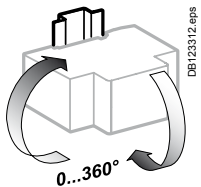

Indifferent position of installation.

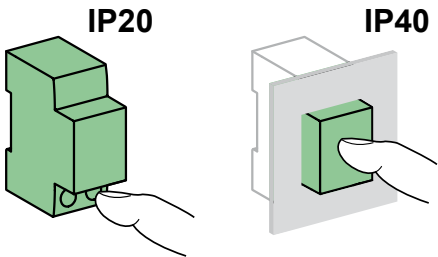

Technical data

Main characteristics

Tripping time/arc current value with $U_n = 230$ V AC (to GB/T 31143)	Current before arc (RMS) Max. operating time	3 A	6 A	13 A	20 A	25 A
		1 s	0.5 s	0.25 s	0.15 s	0.14 s
Overvoltage tripping threshold (neutral conductor break)		275 V AC ± 5 V				
Insulation voltage (U_i)		400 V AC				
Degree of pollution		2				
Rated impulse withstand voltage (U_{imp})		4 kV				
Overvoltage category		II				
Thermal tripping	Reference temperature	30°C				
Magnetic tripping	Curve C	Between 5 and 10 In				
According to GB/T 16917.1						
Limitation class		3				
Rated breaking capacity (I_{cn})	iDPNa VigiARC ELE	4 500 A				
	iDPNN VigiARC ELE	6 000 A				
	iDPNH VigiARC ELE	10 000 A				
8/20 μ s impulse withstand current	A type	3 kA				

Additional characteristics

Earth leakage protection with instantaneous tripping	30 mA, type A					
Degree of protection (to GB/T 4208)	Device alone	IP20				
	Device in a modular enclosure	IP40				
Endurance (O-C) (IEC 60529)	Electrical ≤ 20 A	20,000 cycles				
		25 A	10,000 cycles			
	Mechanical	20,000 cycles				
Operating temperature	-25°C to +60°C					
Storage temperature	-40°C to +80°C					
Tropicalization (to GB/T 31143)	Severity B (to GB/T 2423.4) during 28 days					

Weight (g)

Arc fault detection RCBO

Type	RCBO Acti9 iDPN VigiARC ELE
1P+N	237

Dimensions (mm)

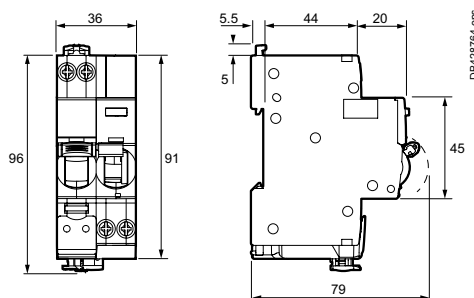

Protection Load protection

iPRF1 12.5r/PRD1 35r/PRD1 25r/PRD1 Master Type 1 and 2 LV surge arresters

The Type 1 range of surge arresters meets the normative withstand capability of current wave type 10/350 μ s (8/20 μ s for Type 2 surge arresters).

It is suitable for use with TT, TN-S, TN-C and IT earthing connection systems (neutral point connection).

In addition, the PRD1 35r surge arrester covers the 400 V IT system.

iPRF1 12.5r and PRD1 surge arresters are fitted with a remote transfer contact to send "end-of-life indication" information.

PRD1 surge arresters are fitted with easy-to-replace withdrawable cartridges.

iPRF1 12.5r/PRD1 35r/PRD1 25r/PRD1 Master

The Type 1 surge arrester is recommended for electrical installations in the service sector and industrial buildings protected by a lightning conductor or by a meshed cage.

It protects electrical installations against direct lightning strikes.

It is used to conduct the direct lightning current, propagating from the earth conductor to the network conductors.

It must be installed with an upstream disconnection device, such as a fuse or circuit-breaker, whose breaking capacity must be at least equal to the maximum prospective short-circuit current at the installation point.

iPRF1 12.5r and PRD1 25r surge arresters also provide Type 2 protection and protect the electrical installation by finely clipping the lightning wave overvoltages.

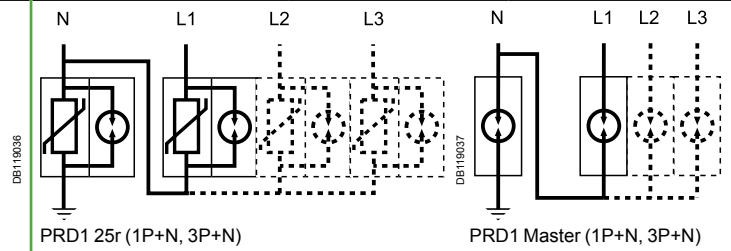
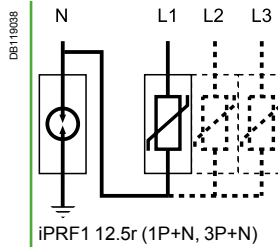

Type	Product solution	
Fixed surge arrester	1P+N	3P+N
	iPRF1 12.5r T1, T2	A9L16632 A9L16634
Cartridge surge arrester	1P+N	3P+N
	PRD1 25r T1 + T2	16330 16332
	PRD1 Master T1	16361 16363
PRD1 35r T1		

Protection
Load protection

iPRF1 12.5r/PRD1 35r/PRD1 25r/PRD1 Master
Type 1 and 2 LV surge arresters (cont.)

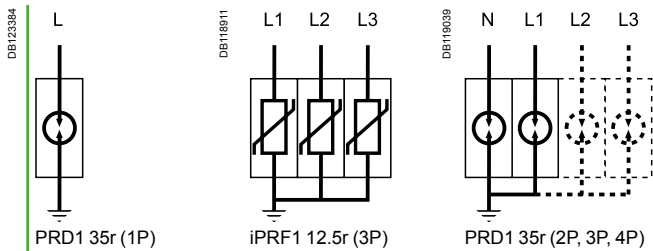

				Earthing system	Recommended accessory
1P	2P	3P	4P	TT, TN-S	
		A9L16633		TN-C	

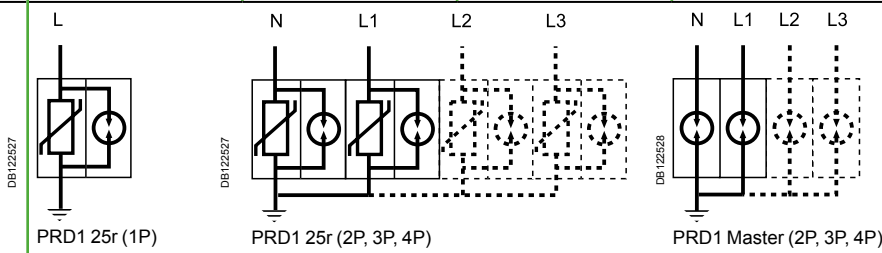

1P	2P	3P	4P	Earthing system	Recommended accessory
				TT, TN-S	
16329	2 x 16329		4 x 16329	TT, TN-C	
		16331		TN-C	
				TT, TN-S	
16360	2 x 16360		4 x 16360	TT, TN-C	
		16362		TN-C	
	2 x 16649			IT distributed neutral, TT, TN-S	16643
16649		3 x 16649		IT non-distributed neutral, TN-C	16644
			4 x 16649	IT distributed neutral	16645

iPRF1 12.5r/PRD1 35r/PRD1 25r/PRD1 Master Type 1 and 2 LV surge arresters (cont.)

Type	Nb. of poles	Width modules	I imp (kA) (10/350) Impulse current	I max (kA) (8/20) Maximum discharge current	In - kA Nominal discharge current	Up - kV Voltage protection level	Un - (V) Rated voltage network	Uc - V Maximum continuous operating voltage (L-N)/(N-PE)	Cat. no.
Fixed surge arrester		9 mm modules							
iPRF1 12.5r	Type 1 + 2								
	1P+N	4	12.5 (L-N)/50 (N-PE)	50	25	≤ 1.5	230	350/255	A9L16632
	3P	8	12.5	50	25	≤ 1.5	230/400	350	A9L16633
	3P+N	8	12.5 (L-N)/50 (N-PE)	50	25	≤ 1.5	230/400	350/255	A9L16634
Withdrawable surge arrester									
PRD1 25r	Type 1 + 2								
	1P	4	25	40	25	≤ 1.5	230	350	16329
	1P+N	8	25 (L-N)/100 (N-PE)	40	25	≤ 1.5	230	350/350	16330
	3P	12	25	40	25	≤ 1.5	230/400	350	16331
	3P+N	16	25 (L-N)/100 (N-PE)	40	25	≤ 1.5	230/400	350/350	16332
PRD1 Master	Type 1								
	1P	4	25	50	25	≤ 1.5	230	350	16360
	1P+N	8	25 (L-N)/100 (N-PE)	50	25	≤ 1.5/2.5	230	350/350	16361
	3P	12	25	50	25	≤ 1.5	230/400	350	16362
	3P+N	16	25 (L-N)/100 (N-PE)	50	25	≤ 1.5/2.5	230/400	350/350	16363
PRD1 35r	Type 1								
	1P	4	35	50	35	≤ 2.5	400/690 (TN) 400 (IT)	440	16649
Spare cartridge									
C1 Master-350	-	4	-	-	25	≤ 1.5	-	350	16314
C1 25-350	-	23 mm	-	-	25	≤ 1.5	-	350	16315
C2 40-350	-	12 mm	-	-	20	≤ 1.5	-	350	16316
C1 Neutral-350	-	4	-	-	-	-	-	350	16317
C1 35-440	-	4	-	-	35	≤ 2.5	-	440	16318



C1 Neutral-350



DB12370

Surge arresters	Spare cartridge		Neutral
	Phase Type 1	Type 2	
PRD1 25r			
PRD1 25r 1P	16315	16316	-
PRD1 25r 1P+N	16315	16316	16317
PRD1 25r 3P	3 x 16315	3 x 16316	-
PRD1 25r 3P+N	3 x 16315	3 x 16316	16317
PRD1 Master			
PRD1 Master 1P	16314	-	-
PRD1 Master 1P+N	16314	-	16317
PRD1 Master 3P	3 x 16314	-	-
PRD1 Master 3P+N	3 x 16314	-	16317
PRD1 35r			
PRD1 35r 1P	1 x 16318	-	-
PRD1 35r 2P	2 x 16318	-	-
PRD1 35r 3P	3 x 16318	-	-
PRD1 35r 4P	4 x 16318	-	-

Accessories		
Type	Number of poles (18 mm)	
Wiring comb busbars for 2 x 1P	4	16643
Wiring comb busbars for 3 x 1P	6	16644
Wiring comb busbars for 4 x 1P	8	16645
200 mm flexible cable	-	16646

iPRF1 12.5r/PRD1 35r/PRD1 25r/PRD1 Master Type 1 and 2 LV surge arresters (cont.)

Technical data

		iPRF1 12.5r	PRD1 35r	PRD1 25r	PRD1 Master
Operating frequency		50 Hz	50/60 Hz	50 Hz	50 Hz
Degree of protection	Front panel	IP40	IP40	IP40	IP40
	Terminals	IP20	IP20	IP20	IP20
	Impacts	IK05	IK05	IK05	IK05
Response time		≤ 25 ns	≤ 100 ns	≤ 25 ns	≤ 100 ns
Short circuit withstand (I _{scsr})		50 kA	50 kA	25 kA	50 kA
Temporary overvoltage withstand (U _T)	U _T (L-N)	335 V AC/5 s	580 V AC/5 s	415 V AC/5 s	415 V AC/5 s
	U _T (N-PE)	1200 V AC/200 ms	800 V AC/120 min	1200 V AC/200 ms	1200 V AC/200 ms
Temporary overvoltage Safe failure mode (U _T)	U _T (L-N)	440 V AC/120 min	1640 V AC/200 ms	440 V AC/120 min	440 V AC/120 min
Ground residual current (I _{PE})	I _{PE} (N-PE)	0.004 mA	≤ 0.005 mA	≤ 0.01 mA for 1P+N, 3P+N	≤ 0.01 mA for 1P+N, 3P+N
Follow current interrupting rating (I _f)	I _f (L-N)	-	50 kA	25 kA/264 V AC 3 kA/350 V AC	50 kA
	I _f (N-PE)	100 A	-	100 A	100 A
End-of-life indication		Green: correct operation Red: at end of life	White: correct operation Red: at end of life	White: correct operation Red: at end of life	White: correct operation Red: at end of life
	Remote notification	1.5 A/250 V AC	1 A/250 V AC ≤ 1 A/30 V DC	1 A/250 V AC ≤ 1 A/30 V DC	1 A/250 V AC ≤ 1 A/30 V DC
By tunnel terminal	Rigid cable	10...35 mm ²	16...35 mm ²	10...35 mm ²	10...35 mm ²
	Flexible cable	10...25 mm ²	10...25 mm ²	10...25 mm ²	10...25 mm ²
Operating temperature		-25°C to +60°C	-40°C to +80°C	-40°C to +80°C	-40°C to +80°C
Humidity range		5 % to 95 %	5 % to 95 %	5 % to 95 %	5 % to 95 %
Standards		IEC 61643-11: 2011 T1, T2 EN 61643-11: 2012 Type 1 + Type 2	IEC 61643-11 T1 EN 61643-11 Type 1	IEC 61643-11: 2011 T1, T2 EN 61643-11: 2012 Type 1 + Type 2	IEC 61643-11: 2011 T1 EN 61643-11: 2012 Type 1
Approvals		CE, EAC	CE	CE, KEMA-KEUR	CE, KEMA-KEUR

Choice of disconnector / surge arrester

Type	I imp: impulse current	Isc: prospective short-circuit current at the installation point				
		10 kA		15 kA	25 kA	36 kA
iPRF1 12.5r	12.5 kA	C120N 80 A curve C or Compact NSX100B 100 A *	C120H 80 A curve C or Compact NSX100B 100 A *	NG125N 80 A curve C or Compact NSX100B 100 A *	NG125H 80 A curve C or Compact NSX100F 100 A *	NG125L 80 A curve C or Compact NSX100N 100 A *
PRD1 35r	35 kA	Compact NSX160B 160 A			Compact NSX160F 160 A	Compact NSX160N 160 A
PRD1 25r	25 kA	Compact NSX100B 100 A			-	
PRD1 Master	25 kA	Compact NSX100B 100 A			Compact NSX100F 100 A	Compact NSX100N 100 A

(*) For lightning impulse current withstand

PR113736-90

PRD1 25r / PRD1 Master / PRD1 35r Reversible

■ The surge arrester base can be turned over to allow the phase/neutral/earth cables to enter through either the top or the bottom

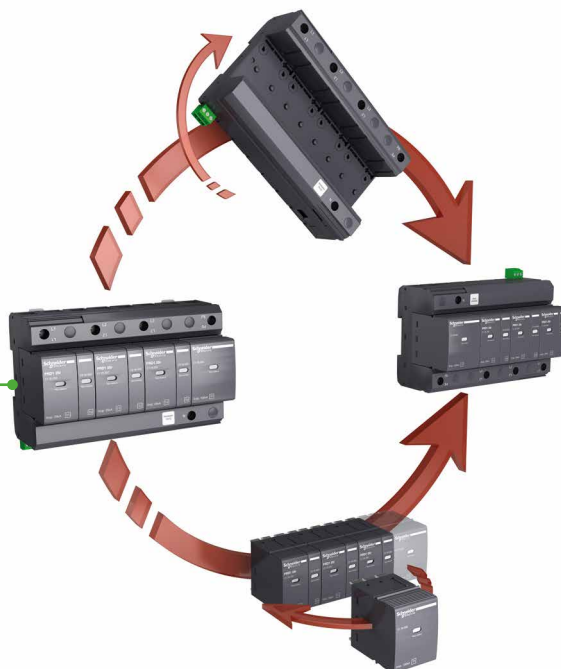

Protection
Load protection

iPRF1 12.5r/PRD1 35r/PRD1 25r/PRD1 Master
Type 1 and 2 LV surge arresters (cont.)

Dimensions (mm)

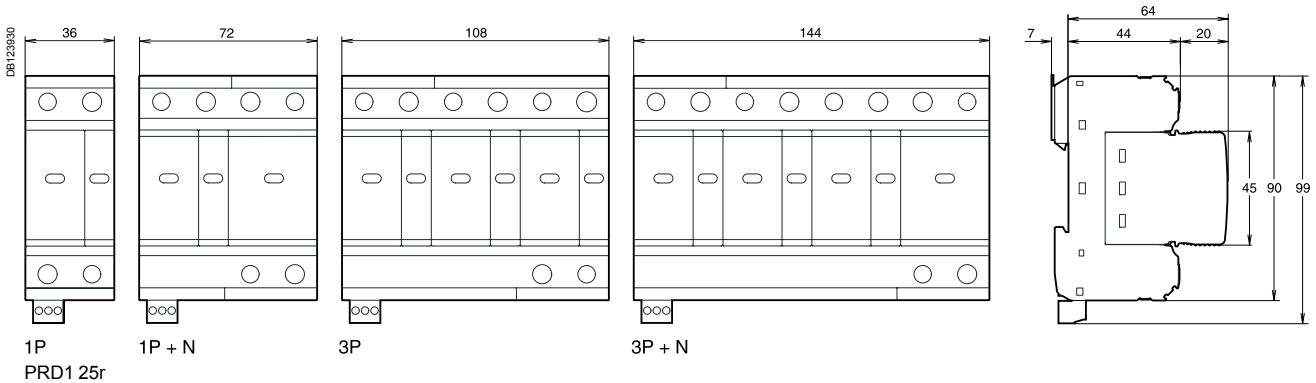
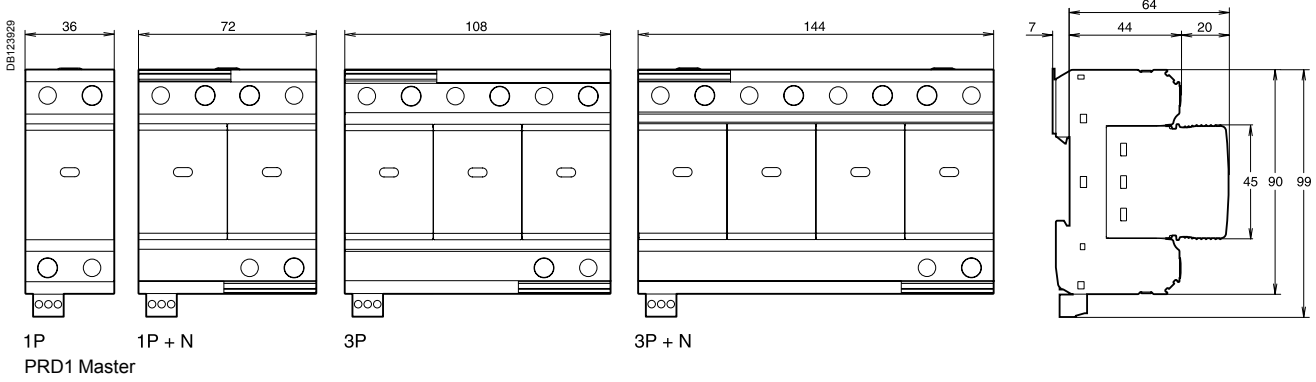
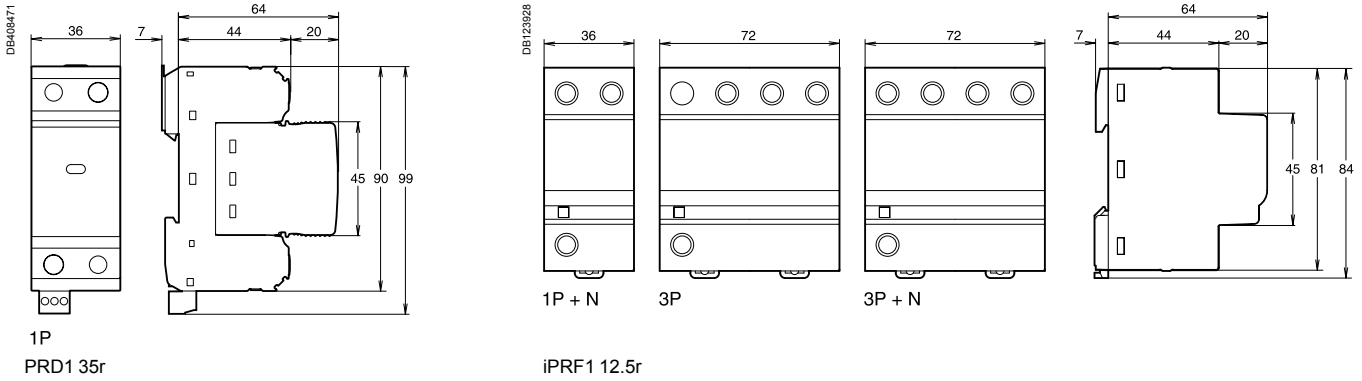

Weight (g)

Surge arresters				
Type	iPRF1 12,5r	PRD1 35r	PRD1 25r	PRD1 Master
1P	-	401	334	394
1P+N	290	-	725	774
3P	590	-	1010	1175
3P+N	590	-	1338	1535
Cartridge	Neutral	-	229	229
	Phase	-	-	242

Protection

Load protection

iPF surge arresters

Type 2 or 3 LV surge arresters

The iPF multi-pole single-piece surge arrester range is adapted for earthing systems: TT, TN-S, TN-C.

Type 2 surge arresters are tested with a 8/20 μ s current wave.

Type 3 surge arresters are tested with a 12/50 μ s and 8/20 μ s combined wave.

Each surge arrester in the range has a specific application:

- **incoming protection (type 2):**
 - the iPF65(r) is recommended for a very high risk level (strongly exposed site)
 - the iPF40(r) is recommended for a high risk level
 - the iPF20 is recommended for a medium risk level
- **secondary protection (type 2 or 3):**
 - the iPF8 ensures secondary protection of loads to be protected and is placed in cascade with the incoming surge arresters. This surge arrester is required when the loads to be protected are at a distance of more than 10 m from the incoming surge arrester.

The iPF surge arresters with “r” indication have remote transfer of the information: “surge arrester to be replaced”.



1P+N.



3P+N.

Rated discharge current (I _{max}) / Nominal discharge current (I _n)	Type of protection		Network							
	Incoming	Secondary (type 2 or 3)	1P+N	3P+N	1P	2P	3P	4P		
65 kA / 20 kA										
Very high risk level	iPF65				A9L15683					
			A9L15684			A9L15584				
								A9L15581		
					A9L15685					
					A9L15586					
									A9L15585	
40 kA / 15 kA										
High risk level	iPF40				A9L15686					
			A9L15687			A9L15587				
								A9L15582		
					A9L15690					
					A9L15688					
									A9L15590	
							A9L15588			
20 kA / 5 kA										
Medium risk level	iPF20				A9L15691					
			A9L15692			A9L15592				
								A9L15597		
					A9L15693					
							A9L15593			
8 kA / 2.5 kA										
Secondary protection: placed near the loads to be protected when they are at a distance of more than 10 m from the incoming surge arrester		iPF8			A9L15694					
			A9L15695			A9L15595				
							A9L15598			
			A9L15696							
								A9L15596		

Surge arrester/circuit breaker association	
Type of surge arrester	Associated circuit breaker
iPF65	Curve C 50 A
iPF40	Curve C 40 A
iPF20	Curve C 25 A
iPF8	Curve C 20 A

Protection

Load protection

iPF surge arresters

Type 2 or 3 LV surge arresters (cont.)

	Earthing system	Transfer	Surge arrester name	Width in mod. of 9 mm	Up - (kV) Voltage protection level			Un - (V) Rated voltage network	Uc - (V) Maximum continuous operating voltage		
					CM*		DM*		CM*		DM*
					L/±	N/±	L/N		L/±	N/±	L/N
iPF65											
	TT & TN		iPF65 1P	2	≤ 1.5	-	-	230	340	-	-
	TT & TN-S		iPF65 1P+N	4	-	≤ 1.5	≤ 1.5		-	260	340
	TN-C		iPF65 2P		≤ 1.5	≤ 1.5	-		340	340	-
	TN-C		iPF65 3P	8	≤ 1.5	-	-	230/400	340	-	-
	TT & TN-S	■	iPF65r 3P+N		-	≤ 1.5	≤ 1.5		-	260	340
	TT & TN-S		iPF65 3P+N		-	≤ 1.5	≤ 1.5		-	260	340
	TN-C	■	iPF65r 4P		≤ 1.5	≤ 1.5	-		340	340	-
iPF40											
	TT & TN		iPF40 1P	2	≤ 1.5	-	-	230	340	-	-
	TT & TN-S		iPF40 1P+N	4	-	≤ 1.5	≤ 1.5		-	260	340
	TN-C		iPF40 2P		≤ 1.5	≤ 1.5	-		340	340	-
	TN-C		iPF40 3P	8	≤ 1.5	-	-	230/400	340	-	-
	TT & TN-S	■	iPF40r 3P+N		-	≤ 1.5	≤ 1.5		-	260	340
	TT & TN-S		iPF40 3P+N		-	≤ 1.5	≤ 1.5		-	260	340
	TN-C	■	iPF40r 4P		≤ 1.5	≤ 1.5	-		340	340	-
	TN-C		iPF40 4P		≤ 1.5	≤ 1.5	-		340	340	-
iPF20											
	TT & TN		iPF20 1P	2	≤ 1.1	-	-	230	340	-	-
	TT & TN-S		iPF20 1P+N	4	-	≤ 1.5	≤ 1.1		-	260	340
	TN-C		iPF20 2P		≤ 1.1	≤ 1.1	-		340	340	-
	TN-C		iPF20 3P	8	≤ 1.1	-	-	230/400	340	-	-
	TT & TN-S		iPF20 3P+N		-	≤ 1.5	≤ 1.1		-	260	340
	TN-C		iPF20 4P		≤ 1.1	≤ 1.1	-		340	340	-
iPF8 (1) Type 2 / Type 3											
	TT & TN		iPF8 1P	2	≤ 1 / ≤ 1.1	-	-	230	340	-	-
	TT & TN-S		iPF8 1P+N	4	-	≤ 1.5 / ≤ 1.2	≤ 1 / ≤ 1.1		-	260	340
	TN-C		iPF8 2P		≤ 1 / ≤ 1.1	≤ 1 / ≤ 1.1	-		340	340	-
	TN-C		iPF8 3P	8	≤ 1 / ≤ 1.1	-	-	230/400	340	-	-
	TT & TN-S		iPF8 3P+N		-	≤ 1.5 / ≤ 1.2	≤ 1 / ≤ 1.1		-	260	340
	TN-C		iPF8 4P		≤ 1 / ≤ 1.1	≤ 1 / ≤ 1.1	-		340	340	-

* **CM**: common mode (phase to earth and neutral to earth). * **DM**: differential mode (phase to neutral). **(1) Uoc**: combined waveform voltage: 10 kV.

Protection
Load protection

iPF surge arresters

Type 2 or 3 LV surge arresters (cont.)

Connection

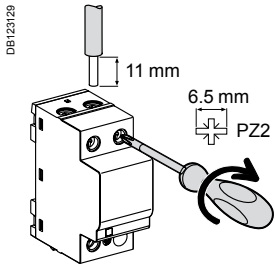

Type	Tightening torque	Copper cables	
		Rigid	Flexible or with ferrule
iPF	3.5 N.m	25 mm ² max.	16 mm ² max.

Technical data

Main characteristics		
Operating frequency	50/60 Hz	
Operating voltage (Ue)	230/400 V AC	
Permanent operating current (Ic)	< 1 mA	
Response time	< 25 ns	
End of life indication: by green/red indicator light	Green	In operation
	Red	At end of life
End of life remote indication	By contact NO, NC 250 V / 0.25 A	
Additional characteristics		
Operating temperature	-25°C to +60°C	
Type of connection terminals	Tunnel terminals, 2.5 to 35 mm ²	
Standards	IEC 61643-1 <u>T2</u> and EN 61643-11 Type 2	

Weight (g)

Surge arrester	
Type	iPF
1P	125
2P	210
3P	335
4P	420

Dimensions (mm)

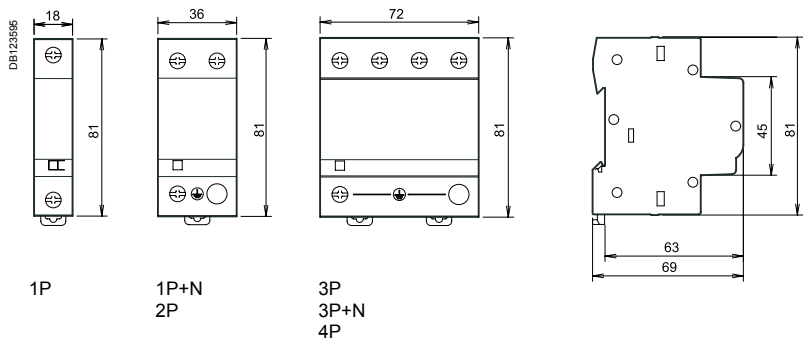

Protection

Load protection

iPF K surge arresters

Type 2 LV surge arresters



Each surge arrester in the range has a specific application:

- **incoming protection (type 2):**
 - the iPF K 65 is recommended for a very high risk level (strongly exposed site),
 - the iPF K 40 is recommended for a high risk level,
 - the iPF K 20 is recommended for a medium risk level.

The iPF K multi-pole single-piece surge arrester range is adapted for earthing systems: TT, TN-S, TN-C.
Type 2 surge arresters are tested with a 8/20 μ s current wave.



1P



1P+N



3P



3P+N

Rated discharge current (I _{max}) / Nominal discharge current (I _n)	Type of protection	Network			
		DB12294Z N L1 L2 L3	DB12294Z N L1 L2 L3	DB40787 L1 L2 L3	DB40787 L1 L2 L3
	Incoming	1P+N	3P+N	1P	3P
65 kA / 20 kA					
Very high risk level	iPF K 65		A9L15586		
40 kA / 15 kA					
High risk level	iPF K 40	A9L15687		A9L15686	
			A9L15688		A9L15582
20 kA / 5 kA					
Medium risk level	iPF K 20	A9L15692		A9L15691	
			A9L15693		A9L15597

Surge arrester/circuit breaker association

Type of surge arrester	Associated circuit breaker (1 to 4 poles protected) (I _{sc} ≤ 6 kA)
iPF K 65	iK60N Curve C 50 A
iPF K 40	iK60N Curve C 40 A
iPF K 20	iK60N Curve C 20 A

Protection

Load protection

iPF K surge arresters

Type 2 LV surge arresters (cont.)

	Earthing system	Surge arrester name	Width in mod. of 9 mm	Up - (kV) Voltage protection level			Un - (V) Rated voltage network	Uc - (V) Maximum continuous operating voltage		
				CM*		DM*		CM*		DM*
				L/±	N/±	L/N		L/±	N/±	L/N
iPF K 65										
	TT & TN-S	iPF K 65 3P+N		-	≤ 1.5	≤ 1.5		-	260	340
iPF K 40										
	TN	iPF K 40 1P	2	≤ 1.5	-	-	230	340	-	-
	TT & TN-S	iPF K 40 1P+N	4	-	≤ 1.5	≤ 1.5		-	260	340
	TN-C	iPF K 40 3P	8	≤ 1.5	-	-	230/400	340	-	-
	TT & TN-S	iPF K 40 3P+N		-	≤ 1.5	≤ 1.5		-	260	340
iPF K 20										
	TN	iPF K 20 1P	2	≤ 1.1	-	-	230	340	-	-
	TT & TN-S	iPF K 20 1P+N	4	-	≤ 1.5	≤ 1.1		-	260	340
	TN-C	iPF K 20 3P	8	≤ 1.1	-	-	230/400	340	-	-
	TT & TN-S	iPF K 20 3P+N		-	≤ 1.5	≤ 1.1		-	260	340

* **CM**: common mode (phase to earth and neutral to earth). * **DM**: differential mode (phase to neutral). **(1) Uoc**: combined waveform voltage: 10 kV.

Connection

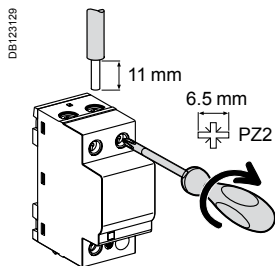

Type	Tightening torque	Copper cables	
		Rigid	Flexible or with ferrule
iPF K	3.5 N.m	DB122545 25 mm ² max.	DB122546 16 mm ² max.

Protection

Load protection

iPF K surge arresters

Type 2 LV surge arresters (cont.)

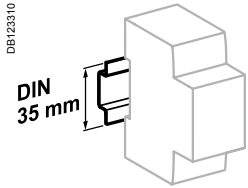

Clip on DIN rail 35 mm.

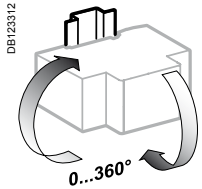

Indifferent position of installation.

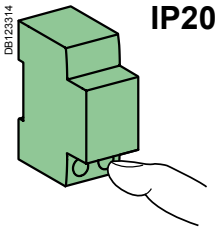

IP20

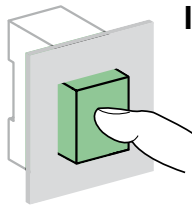

IP40

Technical data

Main characteristics		
Operating frequency		50/60 Hz
Rated voltage network (Un)		230/400 V AC ±10 %
Permanent operating current (Ic)		< 5 mA
Response time		< 25 ns
Short circuit withstand (I _{SCCR})		25 kA (50 Hz)
Temporary overvoltage withstand (U _T)	LV network	U _T (L-N) 337 V AC / 5 s
		U _T (L-PE) 442 V AC / 120 min
Temporary overvoltage withstand (U _T)	HV network	U _T (N-PE) 1200 V AC / 200 ms
		U _T (L-PE) 1453 V AC / 200 ms
Ground residual current (I _{PE})	I _{PE} (L-PE)	1P: ≤ 5 mA
		3P: ≤ 25 mA
	I _{PE} (N-PE)	3 µA for 1P+N, 3P+N
Operation indication by mechanical indicator	Green	In operation
	Red	At end of life
Additional characteristics		
Degree of protection (IEC 60529)	Device only	IP20 (built-in)
	Device in modular enclosure	IP40
Operating temperature		-25°C to +60°C
Humidity range		5 % to 95 %
Standards		IEC 61643-11: 2011 T2

Weight (g)

Surge arrester	
Type	iPF K
1P	125
1P+N	210
3P	335
3P+N	420

Dimensions (mm)

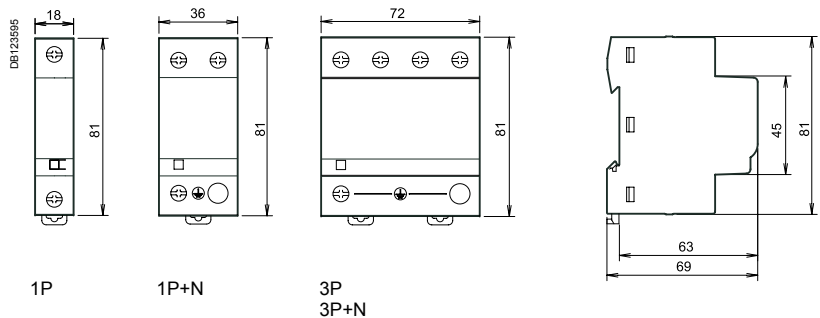

Protection

Load protection

iPRD surge arresters

Type 2 or 3 LV withdrawable surge arresters



iPRD withdrawable surge arresters allow quick replacement of damaged cartridges.
 Type 2 surge arresters are tested with a 8/20 µs current wave.
 Type 3 surge arresters are tested with a 1.2/50 µs and 8/20 µs combined wave.

Each surge arrester in the range has a specific application:

- **incoming protection (type 2):**
 - the iPRD65r is recommended for a very high risk level (strongly exposed site)
 - the iPRD40(r) is recommended for a high risk level
 - the iPRD20(r) is recommended for a medium risk level
- **secondary protection (type 2 or 3):**
 - the iPRD8(r) ensures secondary protection of loads to be protected and is placed in cascade with the incoming surge arresters. This surge arrester is required when the loads to be protected are at a distance of more than 10 m from the incoming surge arrester.

The iPRD surge arresters with “r” indication have remote transfer of the information: “cartridge to be replaced”.

Catalogue number iPRD surge arresters



2P



4P

Rated discharge current (Imax)	Nominal discharge current (In)	Type of protection		Network					
		Incoming	Secondary	1P+N	3P+N	1P	2P	3P	4P
iPRD65									
65 kA Very high risk level (strongly exposed site)	20 kA	iPRD65				A9L65101 A9L65121			
				A9L65501			A9L65201		
								A9L65301 A9L65321	
					A9L65601				
									A9L65401
iPRD40									
40 kA High risk level	15 kA	iPRD40				A9L40101 A9L40100			
				A9L40501 A9L40500					
							A9L40201 A9L40200		
								A9L40301 A9L40321 A9L40300	
					A9L40601 A9L40600				
									A9L40401 A9L40421 A9L40400
iPRD20									
20 kA Medium risk level	5 kA	iPRD20				A9L20100			
				A9L20501 A9L20500					
							A9L20200		
								A9L20300 A9L20321	
					A9L20601 A9L20600				
									A9L20400 A9L20421
iPRD8									
8 kA Secondary protection: placed near the loads to be protected when they are at a distance of more than 10 m from the incoming surge arrester	2.5 kA	iPRD8				A9L08100			
				A9L08501 A9L08500					
							A9L08200		
								A9L08300 A9L08321	
					A9L08601 A9L08600				
									A9L08400 A9L08421

iPRD surge arresters

Type 2 or 3 LV withdrawable surge arresters (cont.)



Cartridge

Spare cartridges iPRD

Type	Spare cartridges for	Cat. no
iPRD 65-350	iPRD65r	A9L65102
iPRD 40-350	iPRD40, iPRD40r	A9L40102
iPRD 20-350	iPRD20, iPRD20r	A9L20102
iPRD 8-350	iPRD8, iPRD8r	A9L08102
iPRD Neutral	All products (1P+N, 3P+N)	A9L00002

Spare cartridges iPRD IT

Type	Spare cartridges for	Cat. no
C 65-460	iPRD65r IT	A9L65122
C 40-460	iPRD40r IT	A9L40122
C 20-460	iPRD20r IT	A9L20122
C 8-460	iPRD8r IT	A9L08122

	Earthing system	Transfer	Surge arrester name	Width in mod. of 9 mm	Up - (kV) Voltage protection level			Un - (V) Rated voltage network	Uc - (V) Maximum continuous operating voltage		
					CM*		DM*		CM*		DM*
					L/±	N/±			L/N	L/±	
iPRD65											
A9L65101	TT & TN	■	iPRD65r 1P	2	≤ 1.5	-	-	230	350	-	-
A9L65121	IT	■	iPRD65r 1P IT	2	≤ 2.3	-	-	230	460	-	-
A9L65501	TT & TN-S	■	iPRD65r 1P+N	4	-	≤ 1.4	≤ 1.5	230/400	-	260	350
A9L65201	TN-C-S	■	iPRD65r 2P	4	≤ 1.5	≤ 1.5	-	230/400	350	350	-
A9L65301	TN-C	■	iPRD65r 3P	6	≤ 1.5	-	-	230/400	350	-	-
A9L65321	IT	■	iPRD65r 3P IT	6	≤ 2.3	-	-	230/400	460	-	-
A9L65601	TT & TN-S	■	iPRD65r 3P+N	8	-	≤ 1.4	≤ 1.5	230/400	-	260	350
A9L65401	TN-C-S	■	iPRD65r 4P	8	≤ 1.5	≤ 1.5	-	230/400	350	350	-
iPRD40											
A9L40101	TT & TN	■	iPRD40r 1P	2	≤ 1.6	-	-	230	350	-	-
A9L40100	TT & TN	■	iPRD40 1P	2	≤ 1.6	-	-	230	350	-	-
A9L40501	TT & TN-S	■	iPRD40r 1P+N	4	-	≤ 1.4	≤ 1.6	230/400	-	260	350
A9L40500	TT & TN-S	■	iPRD40 1P+N	4	-	≤ 1.4	≤ 1.6	230/400	-	260	350
A9L40201	TN-C-S	■	iPRD40r 2P	4	≤ 1.6	≤ 1.6	-	230/400	350	350	-
A9L40200	TN-C-S	■	iPRD40 2P	4	≤ 1.6	≤ 1.6	-	230/400	350	350	-
A9L40301	TN-C	■	iPRD40r 3P	6	≤ 1.6	-	-	230/400	350	-	-
A9L40321	IT	■	iPRD40r 3P IT	6	≤ 2.2	-	-	230/400	460	-	-
A9L40300	TN-C	■	iPRD40 3P	6	≤ 1.6	-	-	230/400	350	-	-
A9L40601	TT & TN-S	■	iPRD40r 3P+N	8	-	≤ 1.4	≤ 1.6	230/400	-	260	350
A9L40600	TT & TN-S	■	iPRD40 3P+N	8	-	≤ 1.4	≤ 1.6	230/400	-	260	350
A9L40401	TN-C-S	■	iPRD40r 4P	8	≤ 1.6	≤ 1.6	-	230/400	350	350	-
A9L40421	IT	■	iPRD40r 4P IT	8	≤ 2.2	≤ 2.2	-	230/400	460	-	-
A9L40400	TN-C-S	■	iPRD40 4P	8	≤ 1.6	≤ 1.6	-	230/400	350	350	-
iPRD20											
A9L20100	TT & TN	■	iPRD20 1P	2	≤ 1.2	-	-	230	350	-	-
A9L20501	TT & TN-S	■	iPRD20r 1P+N	4	-	≤ 1.4	≤ 1.2	230/400	-	260	350
A9L20500	TT & TN-S	■	iPRD20 1P+N	4	-	≤ 1.4	≤ 1.2	230/400	-	260	350
A9L20200	TN-C-S	■	iPRD20 2P	4	≤ 1.2	≤ 1.2	-	230/400	350	350	-
A9L20300	TN-C	■	iPRD20 3P	6	≤ 1.2	-	-	230/400	350	-	-
A9L20321	IT	■	iPRD20r 3P IT	6	≤ 1.8	-	-	230/400	460	-	-
A9L20601	TT & TN-S	■	iPRD20r 3P+N	8	-	≤ 1.4	≤ 1.2	230/400	-	260	350
A9L20600	TT & TN-S	■	iPRD20 3P+N	8	-	≤ 1.4	≤ 1.2	230/400	-	260	350
A9L20400	TN-C-S	■	iPRD20 4P	8	≤ 1.2	≤ 1.2	-	230/400	350	350	-
A9L20421	IT	■	iPRD20r 4P IT	8	≤ 1.8	≤ 1.8	-	230/400	460	-	-
iPRD8 (1) Type 2 / Type 3 (1)											
A9L08100	TT & TN	■	iPRD8 1P	2	≤ 1.2	-	-	230	350	-	-
A9L08501	TT & TN-S	■	iPRD8r 1P+N	4	-	≤ 1.4	≤ 1.2	230/400	-	260	350
A9L08500	TT & TN-S	■	iPRD8 1P+N	4	-	≤ 1.4	≤ 1.2	230/400	-	260	350
A9L08200	TN-C-S	■	iPRD8 2P	4	≤ 1.2	≤ 1.2	-	230/400	350	350	-
A9L08300	TN-C	■	iPRD8 3P	6	≤ 1.2	-	-	230/400	350	-	-
A9L08321	IT	■	iPRD8r 3P IT	6	≤ 1.6 / ≤ 1.8	-	-	230/400	460	-	-
A9L08601	TT & TN-S	■	iPRD8r 3P+N	8	-	≤ 1.4	≤ 1.2	230/400	-	260	350
A9L08600	TT & TN-S	■	iPRD8 3P+N	8	-	≤ 1.4	≤ 1.2	230/400	-	260	350
A9L08400	TN-C-S	■	iPRD8 4P	8	≤ 1.2	≤ 1.2	-	230/400	350	350	-
A9L08421	IT	■	iPRD8r 4P IT	8	≤ 1.6 / ≤ 1.8	≤ 1.6 / ≤ 1.8	-	230/400	460	-	-

* CM: common mode (phase to earth and neutral to earth). * DM: differential mode (phase to neutral). (1) Uoc: combined waveform voltage: 10 kV.

iPRD surge arresters

Type 2 or 3 LV withdrawable surge arresters

Connection iPRD surge arresters

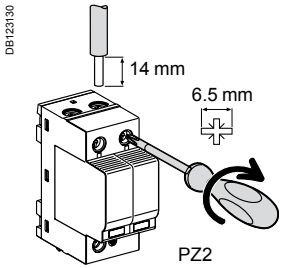

Type	Tightening torque	Copper cables	
		Rigid	Flexible or with ferrule
iPRD	3.5 N.m	2.5 to 25 mm ²	4 to 16 mm ²

Technical data iPRD surge arresters

Main characteristics	iPRD	iPRD IT
Operating frequency	50/60 Hz	
Operating voltage (U _e)	230/400 V AC ±10 %	
Permanent operating current (I _c)	< 1 mA	
Response time	< 25 ns	
Short circuit current rating (I _{sc})	50 kA (50 Hz)	-
Short circuit current rating (I _{sc}), case of double fault	-	5 kA (50 Hz)
Temporary overvoltage withstand (U _T)	U _T (L-N) 442 V AC / 120 min	337 V AC / 5 s 337 V AC / 5 s
Temporary overvoltage	U _T (N-PE) 1200 V AC / 200 ms	1455 V AC / 200 ms
Safe failure mode (U _T)	U _T (L-PE) 1455 V AC / 200 ms	1455 V AC / 200 ms
Ground residual current (I _{PE})	I _{PE} (L-PE) 600 µA for 1P, 2P, 3P, 4P	
	I _{PE} (N-PE) 3 µA for 1P+N, 3P+N	-
Satisfactory operation indication:	White	In operation
by mechanical indicator	Red	Cartridge must be replaced
Remote indication of satisfactory operation		By contact NO, NC 250 V / 0.25 A
Additional characteristics		
Degree of protection (IEC 60529)	Device only Device in modular enclosure	IP20 (built-in) IP40
Operating temperature	-25°C to +60°C	
Storage temperature	-40°C to +85°C	
Humidity range	5 % to 95 %	
Type of connection terminals	Tunnel terminals, 2.5 to 35 mm ²	
Standards	IEC 61643-11: 2011 T2 , T3 and EN 61643-11: 2012 Type 2, Type 3	

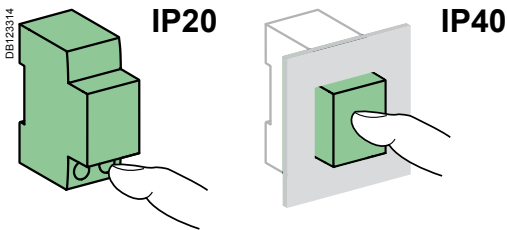

Surge arrester/circuit breaker association

Surge arrester	Associated circuit breaker		
	iPRD		iPRD IT
	I _{sc} ≤ 25 kA	I _{sc} ≤ 50 kA	I _{sc} (IT 400 V AC) ≤ 5 kA
iPRD65	Curve C 50 A	Curve C 63 A	Curve C 25 A
iPRD40	Curve C 40 A	Curve C 63 A	Curve C 20 A
iPRD20	Curve C 20 A	Curve C 63 A	Curve C 10 A
iPRD8	Curve C 10 A	Curve C 63 A	Curve C 10 A

iPRD dimensions (mm)

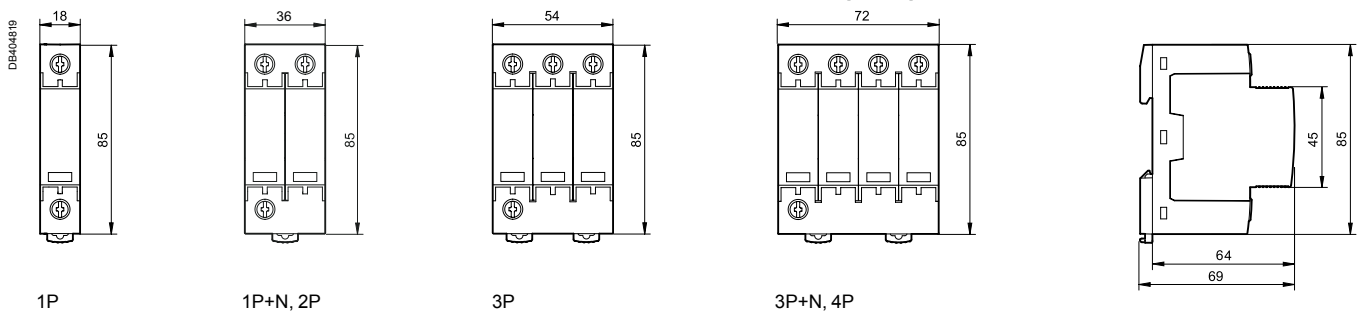

Weight (g)

Surge arrester	
Type	iPRD
1P	119
1P+N, 2P	220
3P	340
3P+N, 4P	450

Protection

Load protection

iPRD surge arresters

Type 2 or 3 LV withdrawable surge arresters (cont.)

iPRD surge arresters

PB1102281-80

Satisfactory operation indication
 ■ By mechanical indicator
 □ white: operating
 □ red: cartridge must be replaced



Terminals
 ■ IP20

■ Transfer to Acti 9 Smartlink

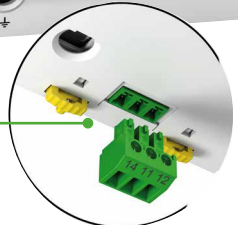

Connection iPRD surge arrester with its short circuit disconnecter

TT / TN-S

Power supply through the top
 Connection with cables

PB1102289-50



Surge arrester iPRD 3P+N + iC60N 3P+N

Reversible
 ■ The surge arrester base can be turned over to allow the phase/neutral/earth cables to enter through either the top or the bottom

TT / TN-S

Power supply through the bottom
 Connection with comb busbar

PB110783-50



Surge arrester iPRD 3P+N + iC60N 3P+N

PB1102287-30

IT/TNC-S with neutral

Power supply through the top
 Connection with comb busbar

PB1107290-50



Surge arrester iPRD 4P + iC60N 4P

PB110794-50

IT/TNC-S with neutral

Power supply through the bottom
 Connection with comb busbar



Surge arrester iPRD 4P + iC60N 4P

Protection Load protection

iPRD surge arresters

Type 2 or 3 LV withdrawable surge arresters

iPRD withdrawable surge arresters allow quick replacement of damaged cartridges.



1P+N



3P



3P+N



Cartridge

Rated discharge current (Imax) / Nominal discharge current (In)	Type of protection	Network							
		Incoming		Secondary		1P+N	3P+N	1P	2P

65 kA / 20 kA											
Very high risk level (strongly exposed site)	iPRD65						A9L16555				
							A9L16556				
		A9L16557							A9L16442		
										A9L16558	
										A9L16443	
				A9L16559							

40 kA / 15 kA												
High risk level	iPRD40						A9L16561					
							A9L16566					
		A9L16562							A9L16444			
		A9L16567							A9L16667			
										A9L16445		
										A9L16568		
										A9L16563		
				A9L16564								A9L16597
				A9L16569								A9L16664
												A9L16669

20 kA / 5 kA											
Medium risk level	iPRD20						A9L16571				
		A9L16672									
		A9L16572							A9L16446		
										A9L16447	
										A9L16573	
				A9L16674							
				A9L16574							
											A9L16599
									A9L16673		

8 kA / 2.5 kA											
Secondary protection: placed near the loads to be protected when they are at a distance of more than 10 m from the incoming surge arrester	iPRD8						A9L16576				
		A9L16677									
		A9L16577							A9L16448		
										A9L16449	
										A9L16578	
				A9L16679							
				A9L16579							
											A9L16678
											A9L16680

Spare cartridges		
Type	Spare cartridges for	Cat. no
C 65-460	iPRD65r IT	A9L16682
C 65-340	iPRD65r	A9L16681
C 40-460	iPRD40r IT	A9L16684
C 40-340	iPRD40, iPRD40r	A9L16685
C 20-460	iPRD20r IT	A9L16686
C 20-340	iPRD20, iPRD20r	A9L16687
C 8-460	iPRD8r IT	A9L16688
C 8-340	iPRD8, iPRD8r	A9L16689
C neutral	All products	A9L16691

Surge arrester/circuit breaker association			
Surge arrester	Associated circuit breaker		
	iPRD		iPRD IT
	Isc ≤ 25 kA	Isc ≤ 50 kA	Isc (IT 400 V AC) ≤ 5 kA
iPRD65	Curve C 50 A	Curve C 63 A	Curve C 25 A
iPRD40	Curve C 40 A	Curve C 63 A	Curve C 20 A
iPRD20	Curve C 20 A	Curve C 63 A	Curve C 10 A
iPRD8	Curve C 10 A	Curve C 63 A	Curve C 10 A

Protection

Load protection

iPRD surge arresters

Type 2 or 3 LV withdrawable surge arresters (cont.)

	Earthing system	Transfer	Surge arrester name	Width in mod. of 9 mm	Up - (kV) Voltage protection level			Un - (V) Rated voltage network	Uc - (V) Maximum continuous operating voltage		
					CM*		DM*		CM*		DM*
					L/±	N/±	L/N		L/±	N/±	L/N
iPRD65											
	IT	■	iPRD65r 1P IT	2	≤ 2	-	-	230	460	-	-
	TT & TN	■	iPRD65r 1P		≤ 1.5	-	-		340	-	-
	TT & TN-S	■	iPRD65r 1P+N	4	-	≤ 1.5	≤ 1.5		-	260	340
	TN-C	■	iPRD65r 2P		≤ 1.5	≤ 1.5	-	340	340	-	
	IT	■	iPRD65r 3P IT	6	≤ 2	-	-	230/400	460	-	-
	TN-C	■	iPRD65r 3P		≤ 1.5	-	-		340	-	-
	TT & TN-S	■	iPRD65r 3P+N	8	-	≤ 1.5	≤ 1.5		-	260	340
	TN-C	■	iPRD65r 4P		≤ 1.5	≤ 1.5	-	340	340	-	
iPRD40											
	TT & TN	■	iPRD40r 1P	2	≤ 1.4	-	-	230	340	-	-
	TT & TN		iPRD40 1P		≤ 1.4	-	-		340	-	-
	TT & TN-S	■	iPRD40r 1P+N	4	-	≤ 1.4	≤ 1.4		-	260	340
	TT & TN-S		iPRD40 1P+N		-	≤ 1.4	≤ 1.4	-	260	340	
	TN-C	■	iPRD40r 2P		≤ 1.4	≤ 1.4	-	340	340	-	
	TN-C		iPRD40 2P		≤ 1.4	≤ 1.4	-	340	340	-	
	TN-C	■	iPRD40r 3P	6	≤ 1.4	-	-	230/400	340	-	-
	TN-C		iPRD40 3P		≤ 1.4	-	-		340	-	-
	IT	■	iPRD40r 3P IT		≤ 2	-	-		460	-	-
	TT & TN-S	■	iPRD40r 3P+N	8	-	≤ 1.4	≤ 1.4	-	260	340	
	TT & TN-S		iPRD40 3P+N		-	≤ 1.4	≤ 1.4	-	260	340	
	IT	■	iPRD40r 4P IT		≤ 2	≤ 2	-	460	460	-	
	TN-C	■	iPRD40r 4P		≤ 1.4	≤ 1.4	-	340	340	-	
	TN-C		iPRD40 4P		≤ 1.4	≤ 1.4	-	340	340	-	
iPRD20											
	TT & TN		iPRD20 1P	2	≤ 1.1	-	-	230	340	-	-
	TT & TN-S	■	iPRD20r 1P+N	4	-	≤ 1.4	≤ 1.1		-	260	340
	TT & TN-S		iPRD20 1P+N		-	≤ 1.4	≤ 1.1		-	260	340
	TN-C		iPRD20 2P		≤ 1.1	≤ 1.1	-	340	340	-	
	TN-C		iPRD20 3P	6	≤ 1.1	-	-	230/400	340	-	-
	IT	■	iPRD20r 3P IT		≤ 1.6	-	-		460	-	-
	TT & TN-S	■	iPRD20r 3P+N	8	-	≤ 1.4	≤ 1.1		-	260	340
	TT & TN-S		iPRD20 3P+N		-	≤ 1.4	≤ 1.1	-	260	340	
	IT	■	iPRD20r 4P IT		≤ 1.6	≤ 1.6	-	460	460	-	
	TN-C		iPRD20 4P		≤ 1.1	≤ 1.1	-	340	340	-	
iPRD8 (1) Type 2 / Type 3											
	TT & TN		iPRD8 1P	2	≤ 1 / ≤ 1	-	-	230	340	-	-
	TT & TN-S	■	iPRD8r 1P+N	4	-	≤ 1.4 / ≤ 1	≤ 1 / ≤ 1.1		-	260	340
	TT & TN-S		iPRD8 1P+N		-	≤ 1.4 / ≤ 1	≤ 1 / ≤ 1.1		-	260	340
	TN-C		iPRD8 2P		≤ 1 / ≤ 1	≤ 1 / ≤ 1	-	340	340	-	
	TN-C		iPRD8 3P	6	≤ 1 / ≤ 1	-	-	230/400	340	-	-
	IT	■	iPRD8r 3P IT		≤ 1.4 / ≤ 1.6	-	-		460	-	-
	TT & TN-S	■	iPRD8r 3P+N	8	-	≤ 1.4 / ≤ 1	≤ 1 / ≤ 1.1		-	260	340
	TT & TN-S		iPRD8 3P+N		-	≤ 1.4 / ≤ 1	≤ 1 / ≤ 1.1	-	260	340	
	IT	■	iPRD8r 4P IT		≤ 1.4 / ≤ 1.6	≤ 1.4 / ≤ 1.6	-	460	460	-	
	TN-C		iPRD8 4P		≤ 1 / ≤ 1	≤ 1 / ≤ 1	-	340	340	-	

* **CM**: common mode (phase to earth and neutral to earth). * **DM**: differential mode (phase to neutral). (1) **Uoc**: combined waveform voltage: 10 kV.

Protection
Load protection

iPRD surge arresters

Type 2 or 3 LV withdrawable surge arresters (cont.)

Connection

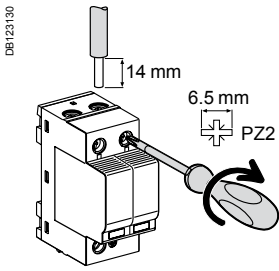

Type	Tightening torque	Copper cables	
		Rigid	Flexible or with ferrule
iPRD	2 N.m	2.5 to 25 mm ²	2.5 to 16 mm ²

Technical data

Main characteristics		
Operating frequency	50/60 Hz	
Operating voltage (Ue)	230/400 V AC	
Permanent operating current (Ic)	< 1 mA	
Response time	< 25 ns	
End of life indication: by mechanical indicator	White	In operation
	Red	At end of life
End of life remote indication	By contact NO, NC 250 V / 0.25 A	
Additional characteristics		
Operating temperature	-25°C to +60°C	
Type of connection terminals	Tunnel terminals, 2.5 to 35 mm ²	
Standards	IEC 61643-1 [T2] and EN 61643-11 Type 2	

Weight (g)

Surge arrester	
Type	iPRD
1P	115
2P	220
3P	340
4P	450

Dimensions (mm)

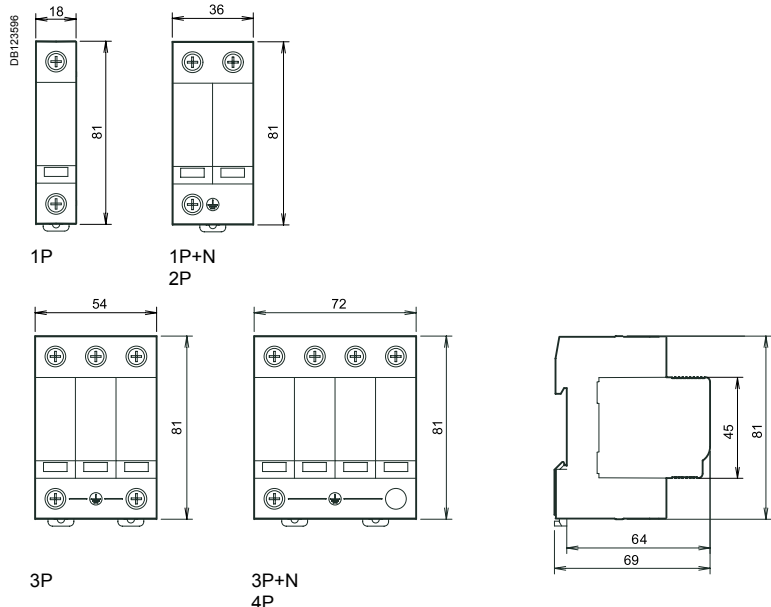

Surge protection
Load protection

Withdrawable surge arrester iQuick PRD Type 2 or Type 3

Withdrawable surge arrester iQuick PRD allow damaged cartridges to be replaced quickly. They offer remote reporting of the "cartridge must be changed" message.

EN 61643-11: 2012 Type 2, IEC 61643-11: 2011 **T2**

They protect electrical and electronic equipment against lightning-induced surges. Withdrawable surge arrester iQuick PRD surge arresters are prewired, incorporating their end-of-life disconnecter.

Each surge arrester in the range has a specific use:

- **incoming protection (type 2):**
 - iQuick PRD40r is recommended for a high risk level
 - iQuick PRD20r is recommended for a moderate risk level
- **secondary protection (type 2 or 3):**
 - iQuick PRD8r provides secondary protection for the loads to be protected and is cascade-mounted with the incoming surge arresters. This surge arrester is required as close as possible to the loads to be protected when they are located more than 10 metres away from the incoming surge arrester.

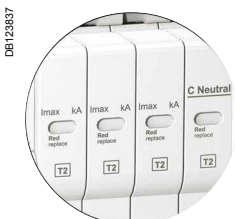

Replacement cartridges.

Maximum discharge current (Imax) / Nominal discharge current (In)	Type of protection		Network		
	Incoming protection	Secondary protection	1P+N	3P+N	3P
40 kA / 20 kA					
High risk level	iQuick PRD40r		A9L16292		A9L16293
				A9L16294	
20 kA / 5 kA					
Moderate risk level	iQuick PRD20r		A9L16295		A9L16296
				A9L16297	
8 kA / 2 kA					
Secondary protection: placed near the loads to be protected when they are at a distance of more than 10 m from the incoming surge arrester		iQuick PRD8r	A9L16298		A9L16299
				A9L16300	

Replacement cartridges		
Type	Replacement cartridges for	Cat. no.
C 40-350	iQuick PRD40r	A9L16310
C 20-350	iQuick PRD20r	A9L16311
C 8-350	iQuick PRD8r	A9L16312
C neutral-350	All products	A9L16313

Surge protection
Load protection

Withdrawable surge arrester iQuick PRD Type 2 or Type 3 (cont.)

Connection

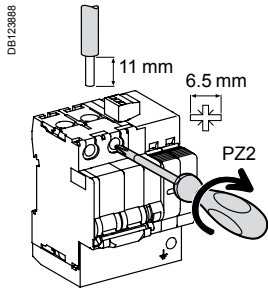

Type	Tightening torque	Copper cables	
		Rigid	Flexible or with ferrule
iQuick PRD Ph / N 8r/20r Ph / N 40r ⊕	2.5 N.m		
		2.5 to 25 mm ²	2.5 to 25 mm ²
		2.5 to 35 mm ² 25 mm ² max.	2.5 to 35 mm ² 25 mm ² max.

	Earthing system	Transfert	Name of surge arrester	Width in 9 mm modules	Up – (kV) Voltage protection level		Un - (V) Rated voltage network	Uc – (V) Maximum continuous operating voltage	
					CM*	DM*		CM*	DM*
iQuick PRD40r									
	TT & TN-S	■	1P+N	8	≤ 1.7	≤ 2.5	230	264	350
	TN-C	■	3P	13	-	≤ 2.5	230/400	-	-
	TT & TN-S	■	3P+N	15	≤ 1.7	≤ 2.5		264	350
iQuick PRD20r									
	TT & TN-S	■	1P+N	8	≤ 1.7	≤ 1.7	230	264	350
	TN-C	■	3P	13	-	≤ 1.5	230/400	-	-
	TT & TN-S	■	3P+N	15	≤ 1.5	≤ 1.5		264	350
iQuick PRD8r (2)					Type 2 / Type 3				
	TT & TN-S	■	1P+N	8	≤ 1.7/1,5	≤ 1.2/1.4	230	264	350
	TN-C	■	3P	13	-	≤ 1.2/1.4	230/400	-	-
	TT & TN-S	■	3P+N	15	≤ 1.7/1,5	≤ 1.2/1.4		264	350

* **CM** common mode (between neutral and earth). * **DM**: differential mode (between phase and neutral).
 (1) Up (MCB + SPD): total value measured between Modular Circuit Breaker (MCB) terminal block and PE surge arrester device terminal block (SPD).
 (2) Uoc: open-circuit voltage in combined wave: 10 kV.

Accessories

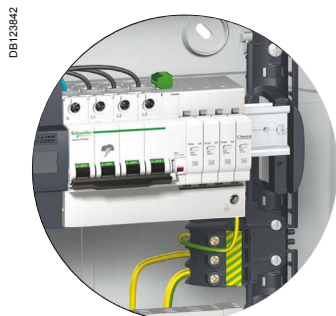

Pragma: the earth terminal block needs 1 support kit and 1 terminal block kit.

Earth terminal block support

Type			Cat. no.
Support kit	L = 4 blocks	Batch of 1	PRA90053
25 mm ² terminal block kit	L = 1 block	Batch of 5	PRA90046

Withdrawable surge arrester iQuick PRD Type 2 or Type 3 (cont.)

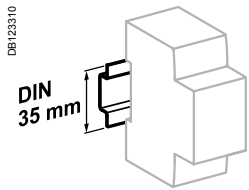

Clip on DIN rail 35 mm.

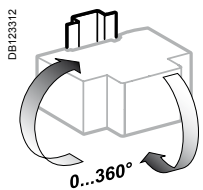

Indifferent position of installation.

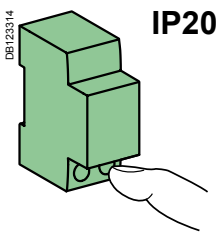

IP20

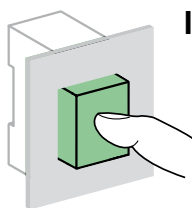

IP40

Technical data

Main characteristics		
Operating frequency	50/60 Hz	
Operating voltage (Ue)	230/400 V AC	
Disconnecter short-circuit withstand (Isc)	iQuick PRD 8r/20r	25 kA (50 Hz)
	iQuick PRD 40r	20 kA (50 Hz)
Temporary overvoltage withstand (U _r)	U _r (L-N)	415 V AC / 5 s
	U _r (N-PE)	1200 V AC / 200 ms
Temporary overvoltage withstand Safe failure mode (U _r)	U _r (L-N)	440 V AC / 120 min
Permanent operating current (Ic)	< 1 mA	
Response time	< 25 ns	
Status indication	By the cartridges	White Red
	By white mechanical indicator/handle ON	Operational
	By red mechanical indicator/handle OFF	At end of life
Remote indication end of life	By the NO/NC remote indication contact 250 V AC / 2 A	
Additional characteristics		
Degree of protection	Device only	IP20, IK05
	Device in modular enclosure	IP40
Operating temperature	-25°C to +60°C	
Storage temperature	-40°C to +80°C	
Humidity range	5 % to 95 %	
Certifications	NF, KEMA KEUR	

Weight (g)

Surge arresters		
Type	iQuick PRD8r/20r	iQuick PRD40r
1P+N	435	445
3P	665	700
3P+N	810	850

Dimensions (mm)

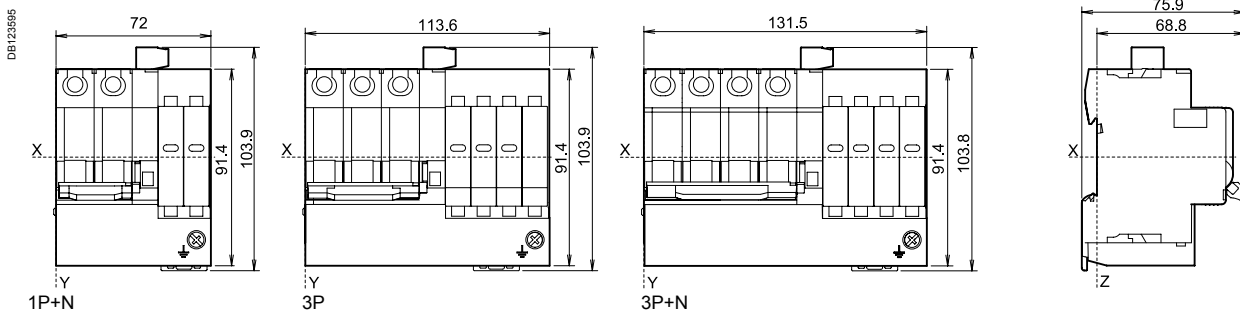

Surge protection Load protection Surge arrester iQuick PF Type 2



The iQuick PF multi-pole single-piece surge arrester range is adapted for earthing systems: TT, TN-S.

Type 2 surge arresters are tested with a 8/20 μ s current wave.



EN 61643-11: 2012 Type 2, IEC 61643-11: 2011 **T2**

Protects electrical and electronic equipment against indirect overvoltage due to the lighting effect.

Coordination with selective version "SI" and **T2** types.

The iQuick PF is precabled. It incorporates its end of life safety disconnecter and an earthing terminal block.

Accessories supplied

- Terminal and 16 mm² cable for connection to the earth bar of the enclosure (supplied mounted).
- 1 lug to crimp for 16 mm² earthing cable.
- iQuick PF 1P+N: 2 connection accessories for the electrical link between the surge arrester and the incoming residual current circuit breaker:
 - 1 mounted, centre distance between axes: 9 mm,
 - 1 supplied, centre distance between axes: 18 mm.

Maximum discharge current (Imax) / Nominal discharge current (In)	Network		Earthing system	Width in 9 mm modules	Up – (kV) Voltage protection level (*)	Un - (V) Rated voltage network	Uc – (V) Maximum continuous operating voltage
10 kA / 5 kA							
	1P+N	3P+N					
iQuick PF	A9L16617	A9L16618	TT & TN-S	4	1.5	230	275
			TT & TN-S	10	1.5	230/400	275

(*) common mode of protection (between phase/earth and neutral/earth) and differential mode of protection (between phase and neutral).

Remote auxiliary IEC 60947-5-1

The remote auxiliary iSR allows to remote the iQuick PF operating status.



Auxiliary				Width in mod. of 9 mm
Type	Contact	Voltage (Ue)		
iSR	3A	415 V CA	A9L16619	1

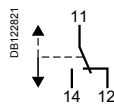

Connection

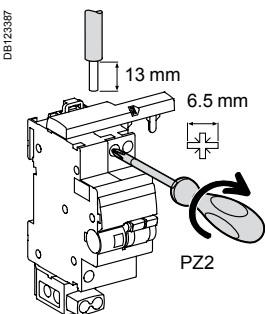

Type	Tightening torque	Copper cables		
		Rigid	Flexible or with ferrule	
iQuick PF	Ph / N ⊥	2 N.m	1 to 16 mm ²	1 to 16 mm ²
			10 to 25 mm ²	10 to 25 mm ²
iSR	⊥	1.2 N.m	16 mm ² max.	16 mm ² max.

Surge arrester iQuick PF Type 2 (cont.)

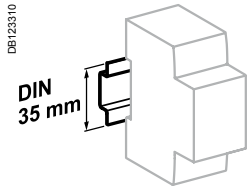

Clip on DIN rail 35 mm.

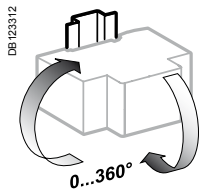

Indifferent position of installation.

Technical data

Main characteristics		
Operating frequency		50 Hz
Operating voltage (U _e)		230/400 V AC
Integrated breaking capacity (I _{sc} at 50 Hz)		6 kA
Temporary overvoltage withstand (U _T)	U _T (L-N)	337 V AC / 5 s
	U _T (L-PE)	442 V AC / 5 s
Temporary overvoltage withstand Safe failure mode (U _T)	U _T (N-PE)	1200 V AC / 200 ms
Ground residual current (I _{PE})	I _{PE} (N-PE)	30 µA
Status indication:	Mechanical indicator white/handle ON	Operational
	Mechanical indicator red/handle OFF	At end of life
Remote indication end of life		By iSR auxiliary
Additional characteristics		
Degree of protection	Device only	IP20
	Device in modular enclosure	IP40
Operating temperature		-25°C to +70°C
Storage temperature		-40°C to +80°C
Humidity range		5 % to 95 %

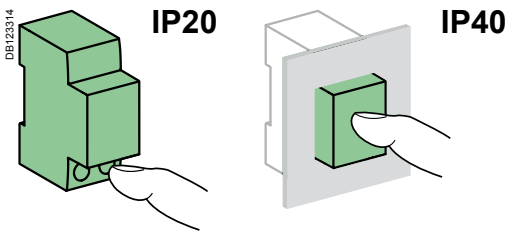

Weight (g)

Surge arresters	
Type	iQuick PF
1P+N	370
3P+N	640

Dimensions (mm)

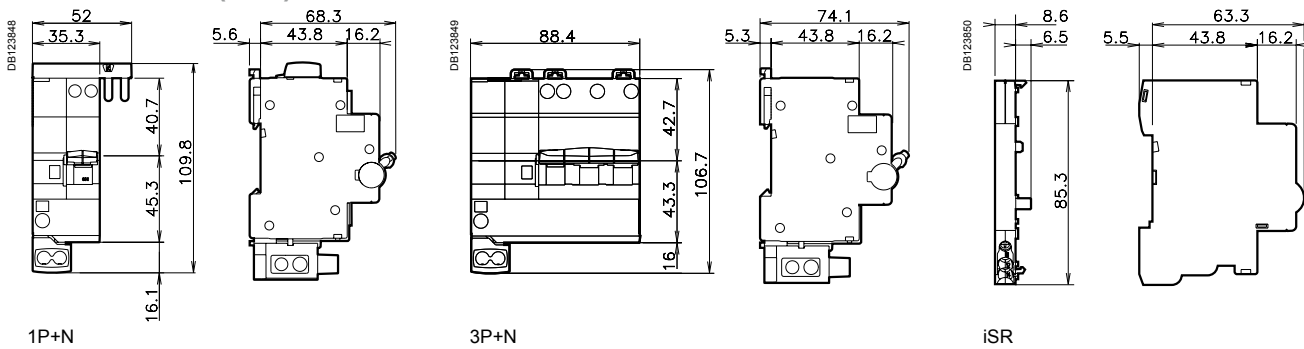

Protection Load protection iPRC, iPRI surge arresters

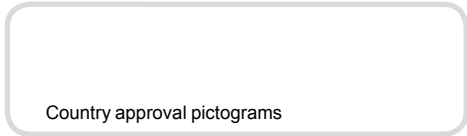

Protection against overvoltages related to lightning strikes.



Analogue telephone line protection: the iPRC surge arrester wired in series to the private installation input protects the telephones, the PABX, the modems (including ADSL), etc.

Protection for 2 low-current lines without common potential or 4 lines with common reference potential: the iPRI protects the measuring instrument and PLC "sensor" inputs and the DC power supply inputs up to 53 V and AC power supply inputs up to 37 V. The input current must not exceed 300 mA.

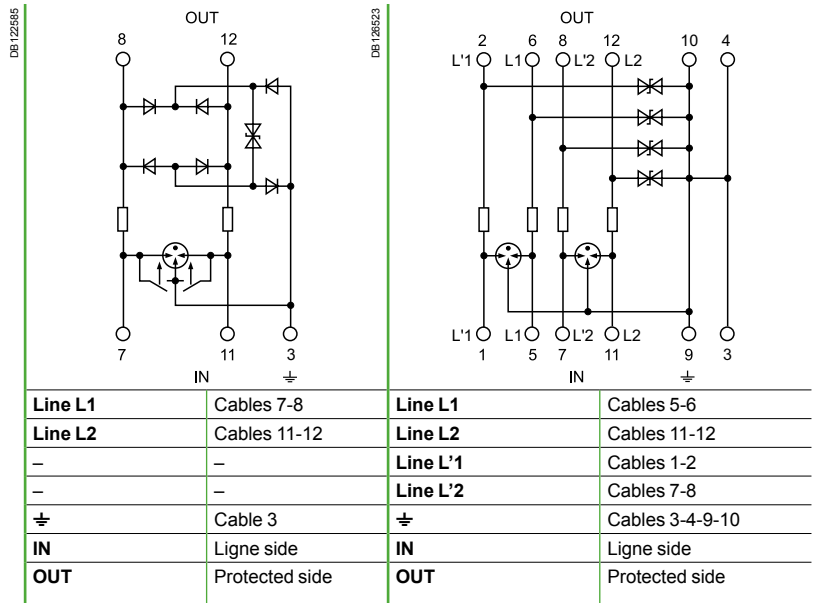

Catalogue numbers

Surge arresters	iPRC	iPRI
Mains voltage (Un)	<130 V AC	48 V DC
Analogue telephone system	■	–
Telephone transmitter	■	–
Digital telephone system	–	■
Automation network	–	■
VLV load power supply (12...48 V)	–	■
xDSL compatibility	■	–
Cat. no..	A9L16337	A9L16339
Width in 9 mm modules	2	2

Diagrams

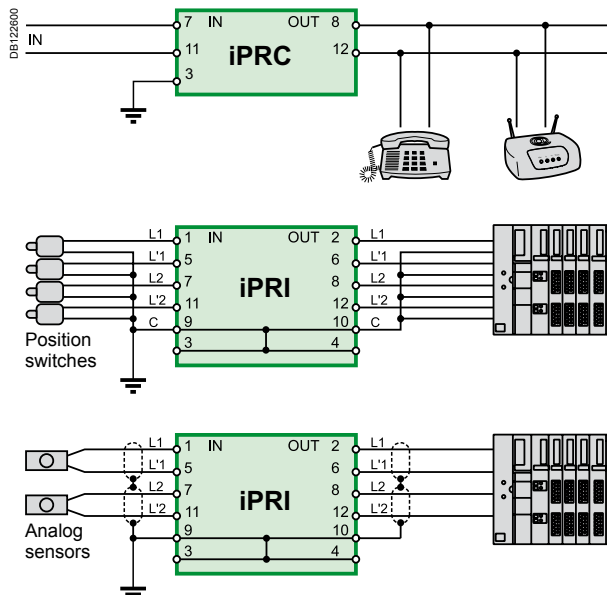

iPRC, iPRI surge arresters (cont.)

Connection

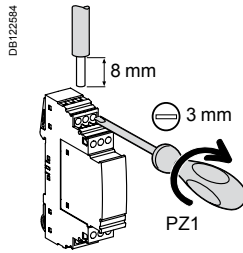

Tightening torque	Copper cables	
	Rigid	Flexible or with ferrule
0.8 N.m	0.2 to 4 mm ²	0.2 to 2,5 mm ²

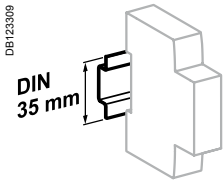

Clip on DIN rail 35 mm.

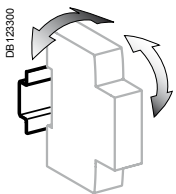

± 30° vertical.

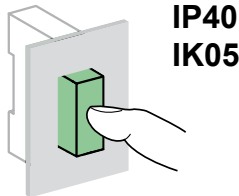
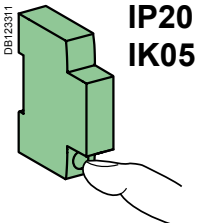

Technical data

Main characteristics			
		iPRC	iPRI
Number of protected lines		2	2
Test category	IEC/EN	C1, C2, C3, D1, B2	C1, C2, C3, D1, B2
Maximum continuous voltage (Uc)		180 V DC, 130 V AC	53 V DC, 37 V AC
Limitation voltage (Up)		300 V	70 V
Rated discharge current (8/20) (In)		10 kA	10 kA
Maximum discharge current (8/20) (Imax)		18 kA	10 kA
Response time		< 500 ns	≤ 1 ns
Nominal impulse current		100 A	70 A
Rated current (I _N)		450 mA (up to 45°C)	300 mA (up to 45°C)
Series resistor		2.2 Ω	4.7 Ω
End-of-life information by		Loss of dialling tone	Loss of transmission
Additional characteristics			
Degree of protection	Device only	IP20	IP20
	Device in modular enclosure	IP40	IP40
	IK	05	05
Operating temperature		-25°C to +60°C	-25°C to +60°C
Storage temperature		-40°C to +85°C	-40°C to +85°C

Weight (g)

Surge arresters		
Type	iPRC	iPRI
	25	65

Dimensions (mm)

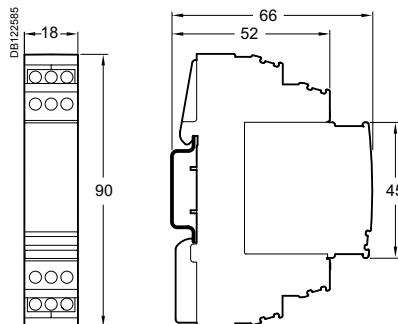

Protection

Load protection

Acti9 iPRE surge arrester

Surge arrester for Ethernet RJ45 sockets



Country approval pictograms

Fine surge protection of Ethernet line Cat. 6



iPRE

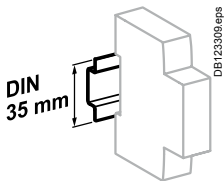

Clip on DIN rail 35 mm.

Weight (g)

Surge arresters	
Type	Acti9 iPRE
	105

Dimensions (mm)

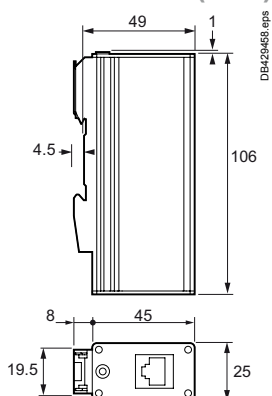

IEC/EN 61643-21

As per the above standard:

iPRE Ethernet line protection

The Acti9 iPRE RJ45 surge arrester protects the Internet line for residential, buildings and industry applications.

Telecommunication equipment are very exposed to lightning overvoltages as they often have long cables which behave like antennas to such surge lightnings and electrostatic discharges created by switching transients in buildings. The interfaces operate with low signal levels at high frequencies. This makes them particularly sensitive to surge voltages and can lead to the destruction of IT systems.

Short response times are essential to quickly limit the surge voltages without deteriorating signal quality. Wired in series to the private installation input, it allows better data exchange between computers and peripheral devices.

- Acti9 iPRE is suitable for category 5 & 6 Ethernet cabling system, high speed data networks up to 250 MHz.
- Acti9 iPRE is delivered with an earthing cable which provides protective grounding in computer rooms.
- Acti9 iPRE is DIN rail mounted.
- RJ45 system-specific connection.

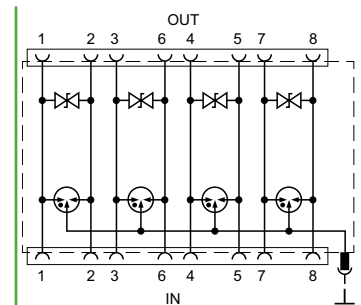

IN	Line side
OUT	Protected side

Catalog number

Surge arresters	Acti9 iPRE
Catalog number	A9L16441

Technical data

Main characteristics	
	Acti9 iPRE
Connections (input - output)	RJ45/RJ45
Test category	IEC/EN C1, C2, D1
Maximum continuous operating voltage (Uc)	6.5 V DC
Voltage protection level at In Line-Line (Up)	35 V
Voltage protection level at In Line-Ground	500 V
Rated discharge current (8/20 μs) (In)	2.5 kA
Maximum discharge current (8/20 μs) (Imax)	10 kA
Nominal impulse current (10/350 μs) (Iimp)	1 kA
Rated load current (I _L)	300 mA (up to 45°C)
Response time	1 ns
Insertion attenuation at 250 MHz	3 db
End-of-life information by	Loss of transmission
Additional characteristics	
Degree of protection (IEC 60529)	IP20
Operating temperature	-40°C to +70°C
Storage temperature	-40°C to +70°C

Protection / Load protection

iPRD-DC surge arresters

Withdrawable surge arresters type 2 for photovoltaic applications

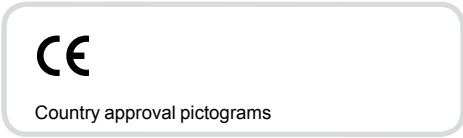

IEC 61643-1 **T2**
 EN 61643-11 Type 2
 UTE C 61740-51 **T2**
 prEN 50539-11 **T2**



iPRD-DC40r 600PV

iPRD-DC direct current surge arresters are designed to protect against overvoltages due to a lightning strike: of the "DC" input to the inverter and of photovoltaic panels.

It should be installed in a switchboard inside the building. If the switchboard is located outside, it must be weatherproof.

Withdrawable iPRD-DC surge arresters allow damaged cartridges to be replaced quickly. They offer remote reporting of the "cartridge must be changed" message.

Catalogue numbers

Internal diagram	Imax (kA) Maximum discharge current	In (kA) Nominal discharge current	Up (kV) Protection level			U _{CPV} (V) ⁽¹⁾ Maximum steady state voltage			Width in module of 9 mm	Cat. no.
			L+/ \neq	L-/ \neq	L+/L-	L+/ \neq	L-/ \neq	L+/L-		
iPRD-DC40r 600PV										
	40	15	1.6	1.6	2.8	600	600	840	6	A9L16434
iPRD-DC40r 1000PV										
	40	15	3.9	3.9	3.9	1000	1000	1000	6	A9L16436

(1) U_{cpv} ≥ 1.2 x U_{oc stc} (U_{oc stc}: maximum no-load voltage of the photovoltaic generator "photovoltaic module manufacturer's data")

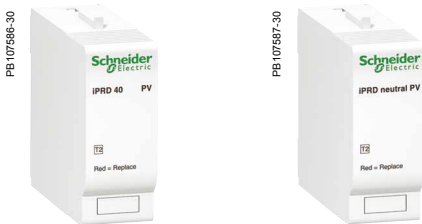

Replacement cartridges

Replacement cartridges		
Type	Replacement cartridges for	Cat. no.
C 40-600PV	iPRD-DC40r 600PV	A9L16683
C 40-1000PV	iPRD-DC40r 1000PV	A9L16692
C neutral PV	iPRD-DC40r 600PV	A9L16690

iPRD-DC surge arresters

Withdrawable surge arresters type 2 for photovoltaic applications (cont.)

Connection

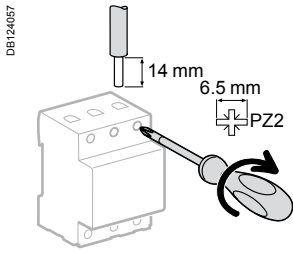

Type	Tightening torque	Copper cables	
		Rigid	Flexible or with ferrule
iPRD-DC	2 N.m	2.5 to 25 mm ²	2.5 to 16 mm ²

Depending on the distance between the "generator" part and the "conversion" part, it may be necessary to install two surge arresters or more, to ensure protection of each of the two parts.

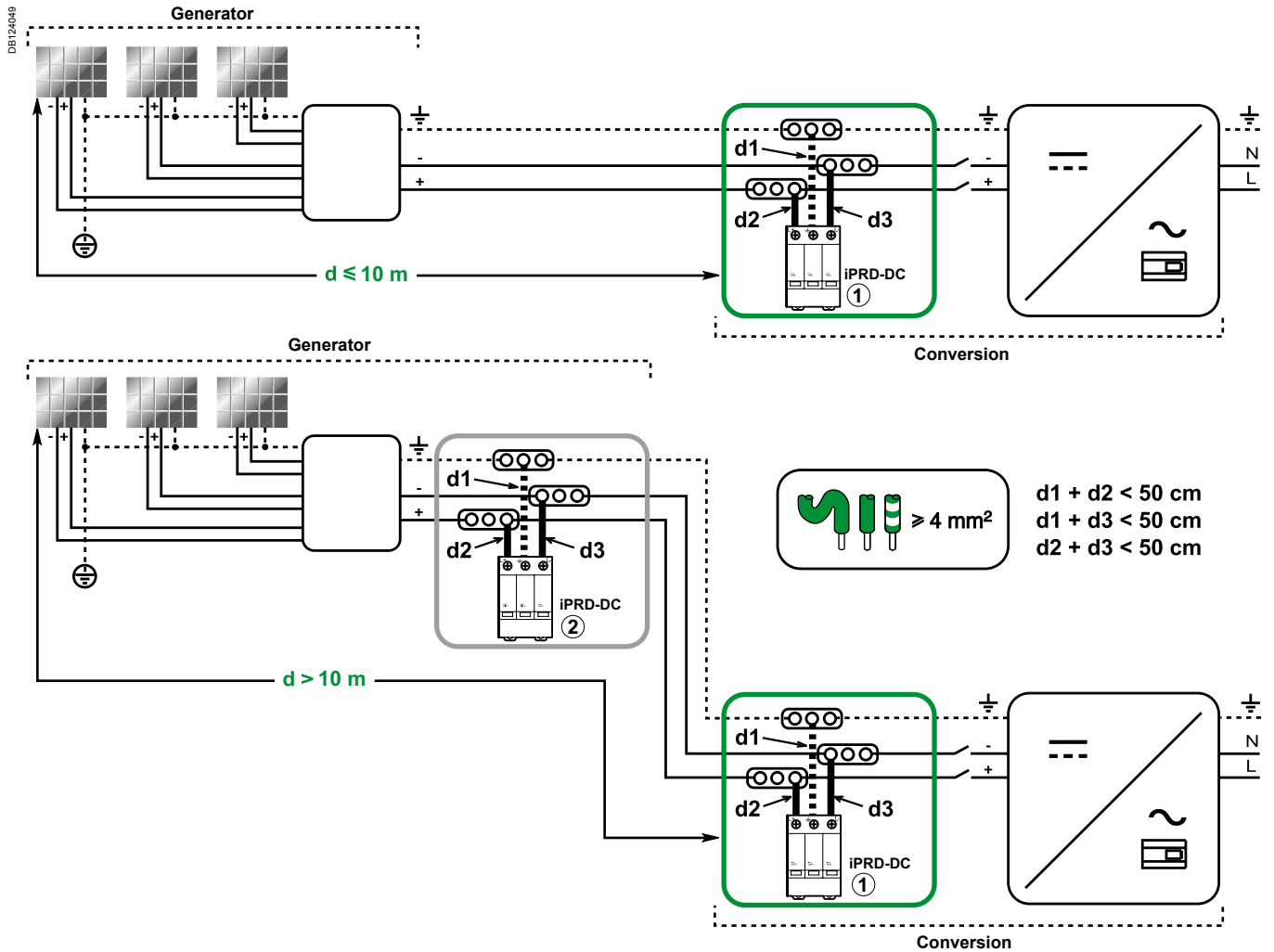

Protection / Load protection

iPRD-DC surge arresters

Withdrawable surge arresters type 2 for photovoltaic applications (cont.)

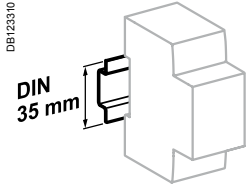

Clip on DIN rail 35 mm.

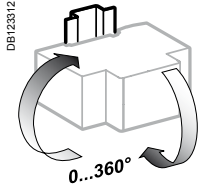

Indifferent position of installation.

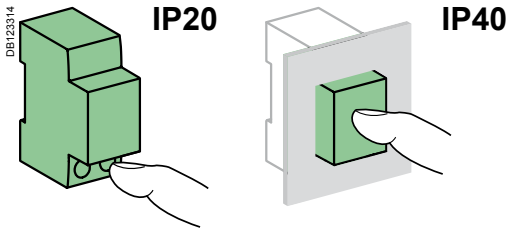

Technical data

Main characteristics			
Type of network	Isolated direct current		
Temps de réponse	< 25 ns		
Short circuit current (I _{SCPV})	30 A		
Type of surge arresters	Type 2		
End-of-life indication mode	Circuit opened by integrated thermal disconnecter		
Additional characteristics			
Degree of protection (IEC 60529)	Device only	IP20	
	Device in modular enclosure	IP40	
	Chocs	IK03	
End-of-life indication	By the cartridges	White	Operational
		Red	At end of life
By the NO/NC remote indication contact 250 V AC / 0.25 A			
Operating temperature	-25°C to +60°C		
Storage temperature	-40°C to +85°C		
Tropicalization (IEC 60068-1)	Treatment 2 (relative humidity of 95 % at 55°C)		

Weight (g)

Surge arresters	
Type	
iPRD-DC40r 600PV	400
iPRD-DC40r 1000PV	400

Dimensions (mm)

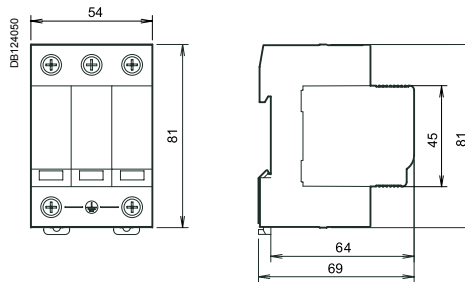

Protection / Load protection

iPRD PV-DC surge arresters

Withdrawable surge arresters type 2 for photovoltaic applications



UTE C 61740-51 T2
EN 50539-11: 2013 T2



iPRD 40r 800PV

iPRD PV-DC direct current surge arresters are designed to protect against overvoltages due to a lightning strike: of the "DC" input to the inverter and of photovoltaic panels.

It should be installed in a switchboard inside the building. If the switchboard is located outside, it must be weatherproof.

Withdrawable iPRD PV-DC surge arresters allow damaged cartridges to be replaced quickly.

The surge arrester base can be turned over to allow the phase/neutral/earth cables to enter through either the top or the bottom
They offer remote reporting of the "cartridge must be changed" message.

Catalogue numbers

Internal diagram	I_{Total} (kA) Total discharge current	I_n (kA) Nominal discharge current	U_p (kV) Protection level L+/-, L-/-, L+/L-	U_{CPV} (V) ⁽¹⁾ Maximum continuous operating voltage L+/-, L-/-, L+/L-	Width in module of 9 mm	Cat. no.
	40	15	3	800	6	A9L40271
	40	15	3.9	1000	6	A9L40281

(1) $U_{cpv} \geq 1.2 \times U_{oc\ stc}$ ($U_{oc\ stc}$: maximum no-load voltage of the photovoltaic generator "photovoltaic module manufacturer's data")



Replacement cartridges

Replacement cartridges		
Type	Replacement cartridges for	Cat. no.
C 40-800PV	iPRD 40r 800PV	A9L40172
C 40-1000PV	iPRD 40r 1000PV	A9L40182

Protection / Load protection

iPRD PV-DC surge arresters

Withdrawable surge arresters type 2 for photovoltaic applications (cont.)

Connection

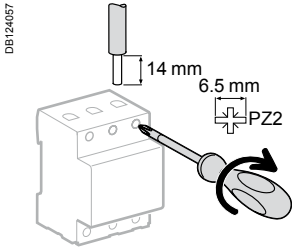

Type	Tightening torque	Copper cables	
		Rigid	Flexible or with ferrule
iPRD PV-DC	3.5 N.m	2.5 to 25 mm ²	2.5 to 16 mm ²

Depending on the distance between the "generator" part and the "conversion" part, it may be necessary to install two surge arresters or more, to ensure protection of each of the two parts.

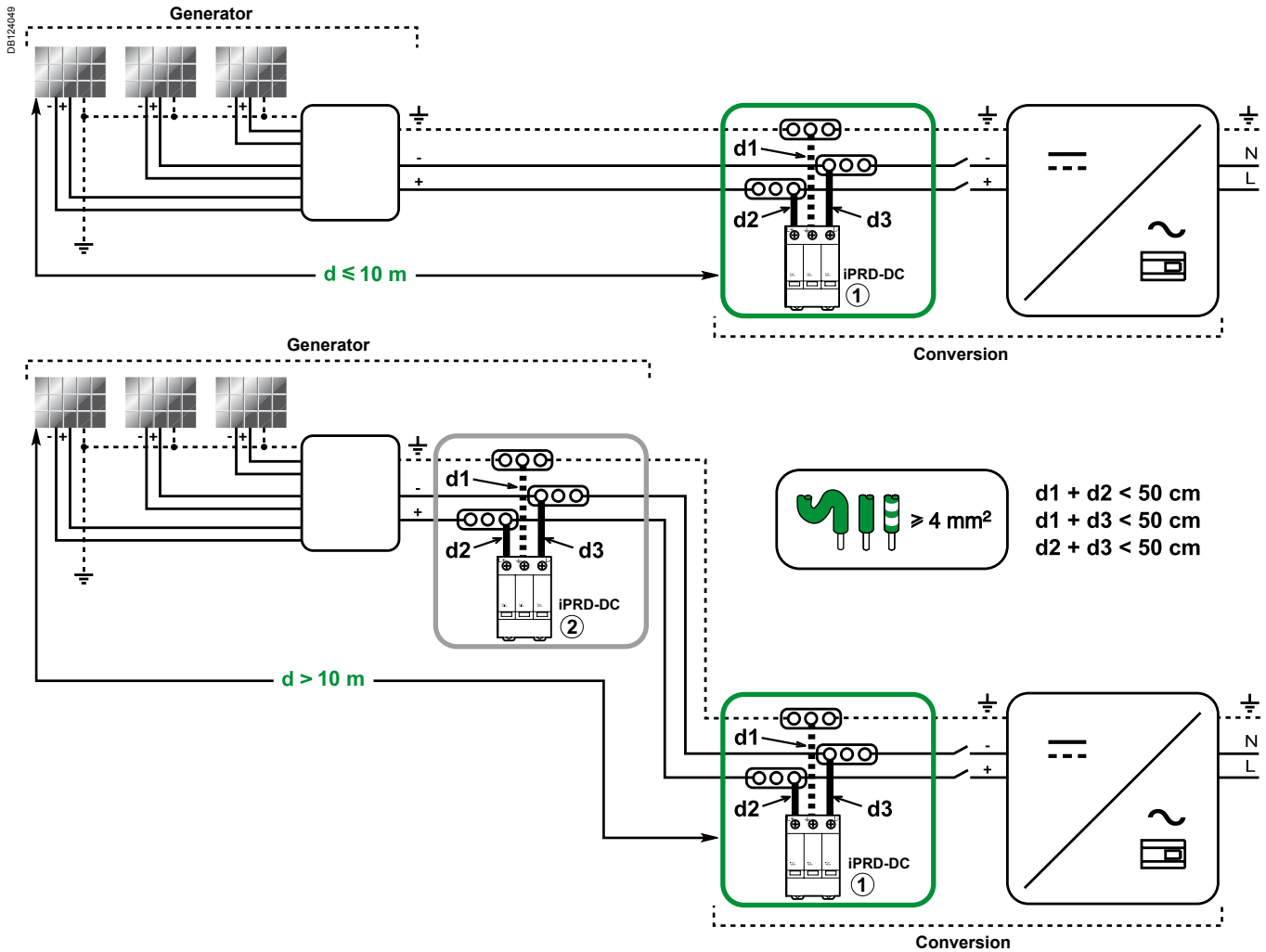

iPRD PV-DC surge arresters

Withdrawable surge arresters type 2 for photovoltaic applications

Application diagram

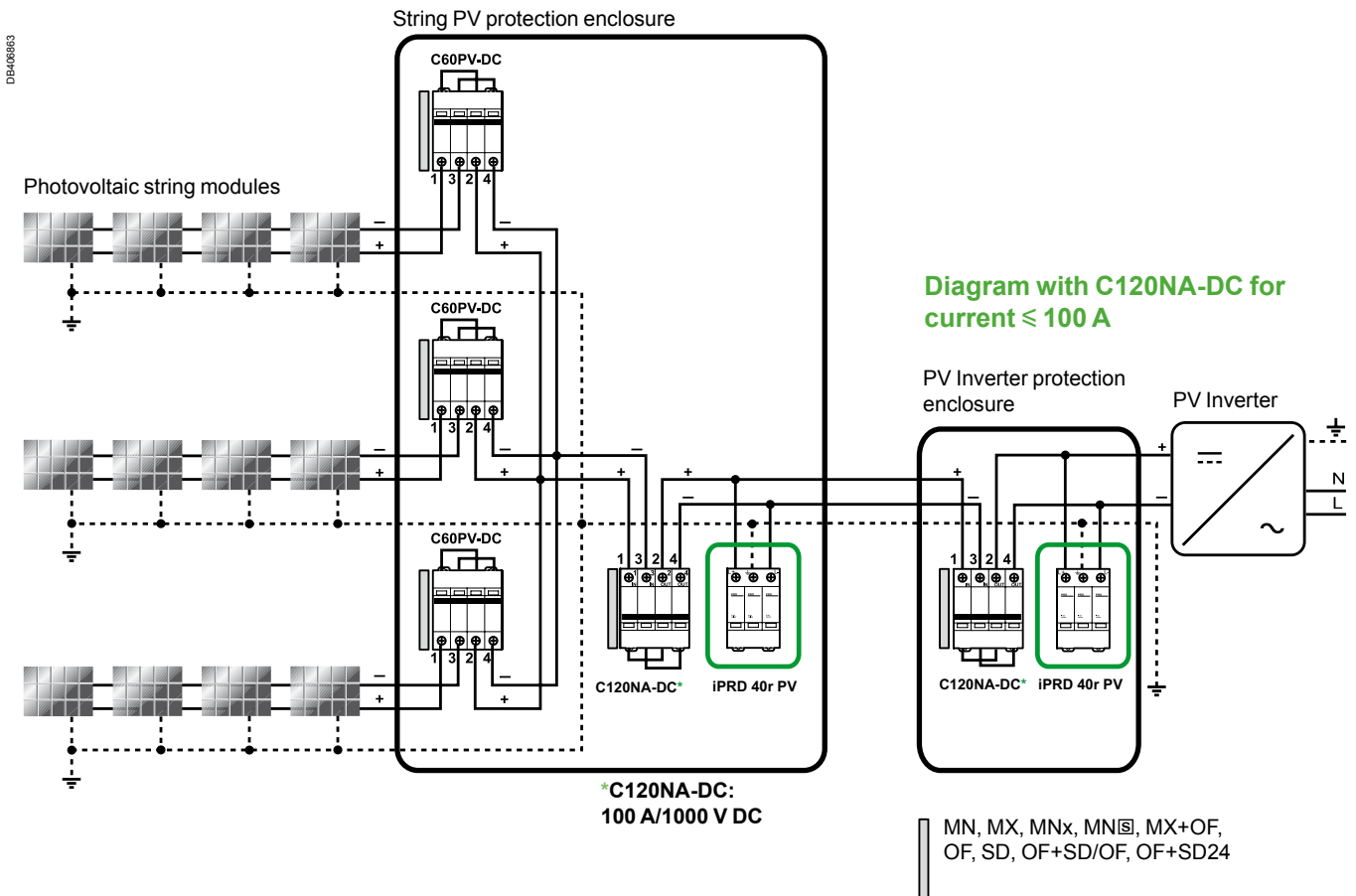

Protection / Load protection

iPRD PV-DC surge arresters

Withdrawable surge arresters type 2 for photovoltaic applications (cont.)

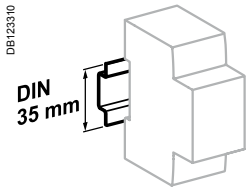

Clip on DIN rail 35 mm.

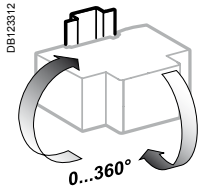

Indifferent position of installation.

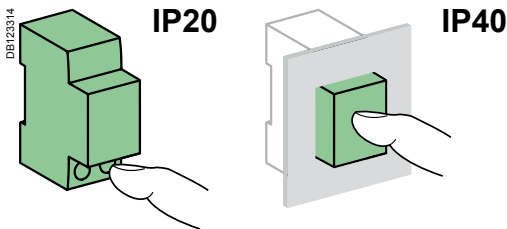

Technical data

Main characteristics			
Type of network	Isolated direct current		
Maximum continuous operating voltage (U_{OPV})	iPRD 40r 800PV	800 V	
	iPRD 40r 1000PV	1000 V	
Response time	< 25 ns		
Permanent operating current (I_c)	< 1 mA		
Short circuit current (I_{SCPV})	200 A		
Type of surge arresters	Type 2		
Ground residual current	I_{PE} (AC)	600 μ A	
	I_{PE} (DC)	60 μ A	
End-of-life indication mode	Circuit opened by integrated thermal disconnecter		
Additional characteristics			
Degree of protection (IEC 60529)	Device only	IP20	
	Device in modular enclosure	IP40	
	Chocs	IK03	
Satisfactory operation indication	By the cartridges	White	Operational
		Red	Cartridge must be replaced
		By the NO/NC remote indication contact 250 V AC / 0.25 A	
Operating temperature	-25°C to +60°C		
Storage temperature	-40°C to +85°C		
Humidity range	5 % to 95 %		
Standards	UTE C 61740-51 T2 EN 50539-11: 2013 T2		

Weight (g)

Surge arresters	
Type	Weight (g)
iPRD 40r 800PV	400
iPRD 40r 1000PV	400

Dimensions (mm)

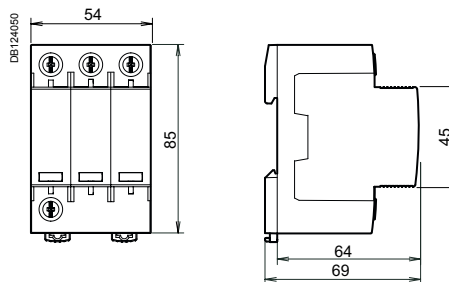

Control

Local control

iSW switches

Contents



Schneider Electric's range of switches consists of different products (A, B) to enable it to be the most competitive range possible in each country, allowing for the special characteristics of each market:

- usual installation procedure
- price
- accreditations by local bodies.

Variants

Offers		Pages
Offer A	Catalog numbers	324, 326
Offer B	Catalog numbers	325, 327
Common pages		328

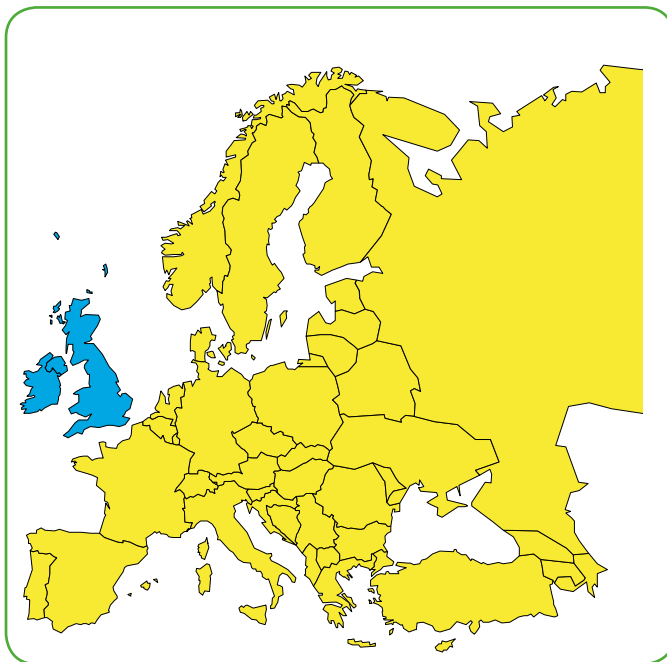

Only the product range to be marketed in your country and validated by the local product manager, in agreement with his Final Distribution (FD) partner should be retained. The others will be removed before publication.

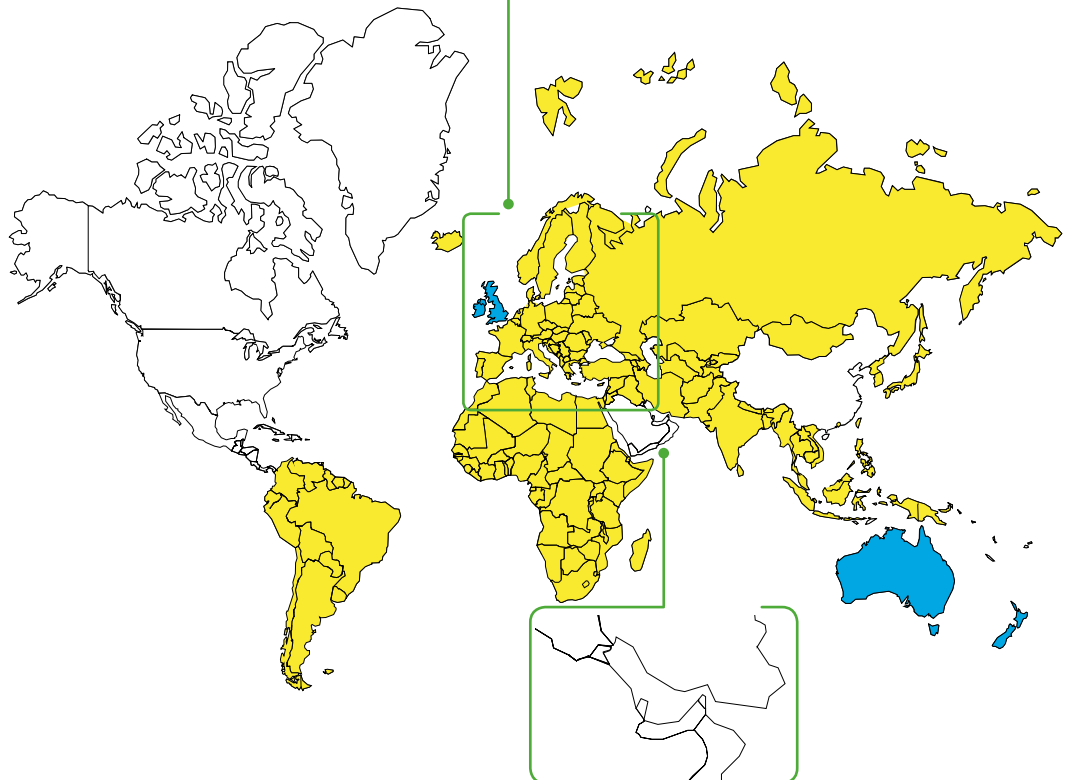

Control

Local control

iSW switches (cont.)



IEC/EN 60947-3

As per the above standard:

The switch-disconnectors combine the following functions:

- Control (opening and closing of circuits under load).

iOF auxiliary

- Mounted on the left, it indicates the "open" or "closed" position of the switch and has a normally open (NO) or normally closed (NC) contact.



Catalog numbers

40 to 125 A iSW switch-disconnectors				
Type				Width in 9 mm modules
1P				
	Rating	Voltage (Ue)		2
	40 A	240 V AC	A9S65140	
	63 A	240 V AC	A9S65163	
	100 A	240 V AC	A9S65191	
125 A	240 V AC	A9S65192		
2P				
	Rating	Voltage (Ue)		4
	40 A	415 V AC	A9S65240	
	63 A	415 V AC	A9S65263	
	100 A	415 V AC	A9S65291	
125 A	415 V AC	A9S65292		
3P				
	Rating	Voltage (Ue)		6
	40 A	415 V AC	A9S65340	
	63 A	415 V AC	A9S65363	
	100 A	415 V AC	A9S65391	
125 A	415 V AC	A9S65392		
4P				
	Rating	Voltage (Ue)		8
	40 A	415 V AC	A9S65440	
	63 A	415 V AC	A9S65463	
	100 A	415 V AC	A9S65491	
125 A	415 V AC	A9S65492		
Operating frequency		50/60 Hz		
Accessories		Catalog modules CA907000 and CA907001		

Offer selection see page 323

Offer A

This sticker must be removed before publishing



Auxiliary			
Type			Width in 9 mm modules
iOF			1
	Voltage (Ue)		
	240...415 V AC		
24...130 V DC		A9A26924	

Control

Local control

iSW switches (cont.)



IEC/EN 60947-3
BSEN 60947-3
AS/NZS 60947-3

As per the above standards:





The switch-disconnectors combine the following functions:
 ■ Control (opening and closing of circuits under load).

iOF auxiliary

■ Mounted on the left, it indicates the "open" or "closed" position of the switch and has a normally open (NO) or normally closed (NC) contact.



Catalog numbers

40 to 125 A iSW switch-disconnectors				
Type				Width in 9 mm modules
1P 	Rating	Voltage (Ue)		2
	40 A	240 V AC	A9S66140	
	63 A	240 V AC	A9S66163	
	100 A	240 V AC	A9S66191	
	125 A	240 V AC	A9S66192	
2P 	40 A	415 V AC	A9S66240	4
	63 A	415 V AC	A9S66263	
	100 A	415 V AC	A9S66291	
	125 A	415 V AC	A9S66292	
3P 	40 A	415 V AC	A9S66340	6
	63 A	415 V AC	A9S66363	
	100 A	415 V AC	A9S66391	
	125 A	415 V AC	A9S66392	
3P+N 	125 A	415 V AC	A9S66792	8
4P 	40 A	415 V AC	A9S66440	8
	63 A	415 V AC	A9S66463	
	100 A	415 V AC	A9S66491	
	125 A	415 V AC	A9S66492	
Operating frequency		50/60 Hz		
Accessories		Catalog modules CA907000 and CA907001		

Offer selection see page 323

Offer B

This sticker must be removed before publishing



Auxiliary			
Type			Width in 9 mm modules
iOF 	Voltage (Ue)		1
	240...415 V AC		
		A9A26924	
		24...130 V DC	

Control
Local control
iSW switches (cont.)

- Insulated terminals IP20
- Large circuit labelling area
- Double clip for dismantling with comb busbar in place
- VISI-SAFE window**
Positive contact indication
 - Suitable for industrial isolation according to IEC/EN 60947-2 standard.
 - A green strip on the toggle indicates full opening of all the poles

Offer selection see page 323

Offer A

This sticker must be removed before publishing

Dimensions (mm)

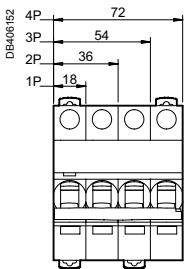

iSW

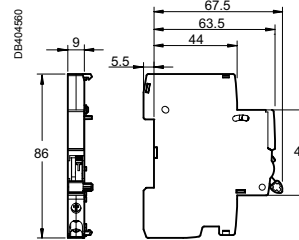
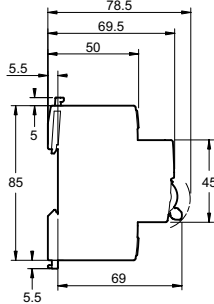

iOF

Control

Local control

iSW switches (cont.)

■ Large circuit labelling area



■ Clip for dismounting

■ Insulated terminals IP20



VISI-SAFE window

Positive contact indication

- Suitable for industrial isolation according to IEC/EN 60947-2 standard.
- A green strip on the toggle indicates full opening of all the poles

Offer selection see page 323

Offer B

This sticker must be removed before publishing

Dimensions (mm)

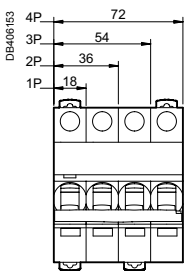

iSW

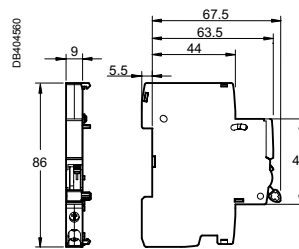
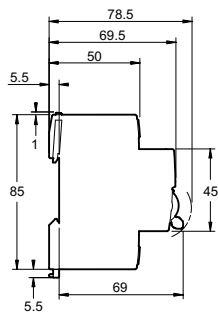

iOF



Control

Local control



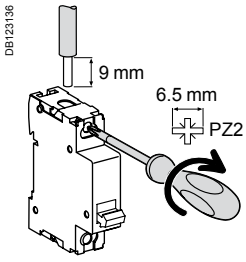

iSW switches (cont.)

Connection

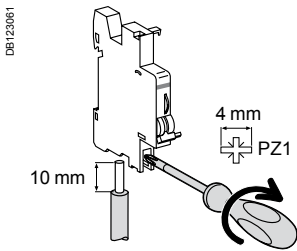

Type	Rating	Tightening torque	Copper cables	
			Rigid	Flexible or with ferrule
iSW	40 to 125 A	3.5 N.m	 ≤ 50 mm ²	 ≤ 35 mm ²



Type	Tightening torque	Copper cables		Multi-cables terminal	
		Rigid	Flexible	Rigid cables	Cables with ferrule
iOF	1 N.m	 1 to 4 mm ²	 0.5 to 2.5 mm ²	 2 x 2.5 mm ²	 2 x 1.5 mm ²

Technical data

Main characteristics		
Insulation voltage (Ui)	500 V AC	
Pollution degree	3	
Power circuit		
Rated impulse withstand voltage (Uimp)	6 kV	
Operating category	AC - 22 A	
Permissible rated short-time withstand current (Icw)	1500 A	
Conditional rated short-circuit current (Inc)	10 kA according to IEC 60947-3	
Rated short-circuit closing current (Icm)	5 kA	
Direct current use		
iSW 40/63 A		
Operating category	DC-22A	
Voltage rating (Ue)	48 V DC	
	110 V DC with 2 poles in series	
Additional characteristics		
Degree of protection	Device only	IP20
	Device in modular enclosure	IP40
Endurance (O-C)	Mechanical	20,000 cycles
		Electrical
		80 A - 100 A 10,000 cycles
		125 A 2 500 cycles
Operating temperature	-25°C to +60°C	
Storage temperature	-40°C to +85°C	
Tropicalization	Treatment 2 (relative humidity 95% at 55°C)	

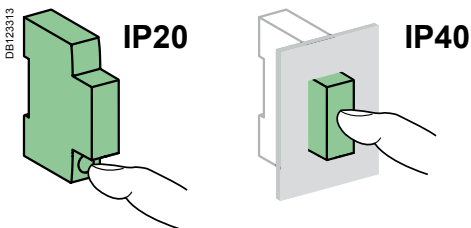

iOF characteristics		
Rated voltage (Ue)	240...415 V AC	
	24...130 V DC	
Operating frequency	50/60 Hz	
Operating current	24 V DC	6 A
	48 V DC	2 A
	60 V DC	1.5 A
	130 V DC	1 A
	240 V AC	6 A
	415 V AC	3 A
Number of contacts	1 NO/NC	
Operating temperature	-35°C to +70°C	
Storage temperature	-40°C to +85°C	

Control

Local control

SW Biconnect switches



Schneider Electric's range of SW Biconnect switches consists of different products (A, B) to enable it to be the most competitive range possible in each country, allowing for the special characteristics of each market:

- usual installation procedure
- price
- accreditations by local bodies.

Variants

Offers		Pages
Offer A	Catalogue numbers	page 330
Offer B	Catalogue numbers	page 332
India		

DE407236

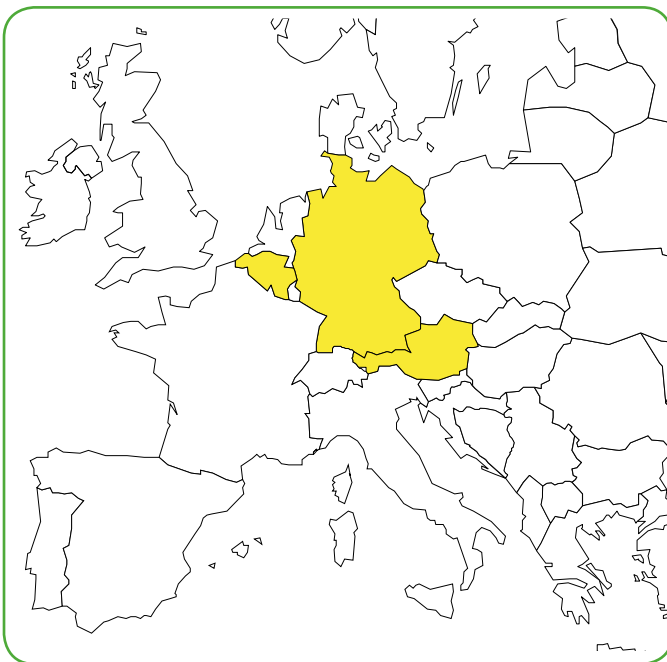

Only the product range to be marketed in your country and validated by the local product manager, in agreement with his Final Distribution (FD) partner should be retained. The others will be removed before publication.

DE407237

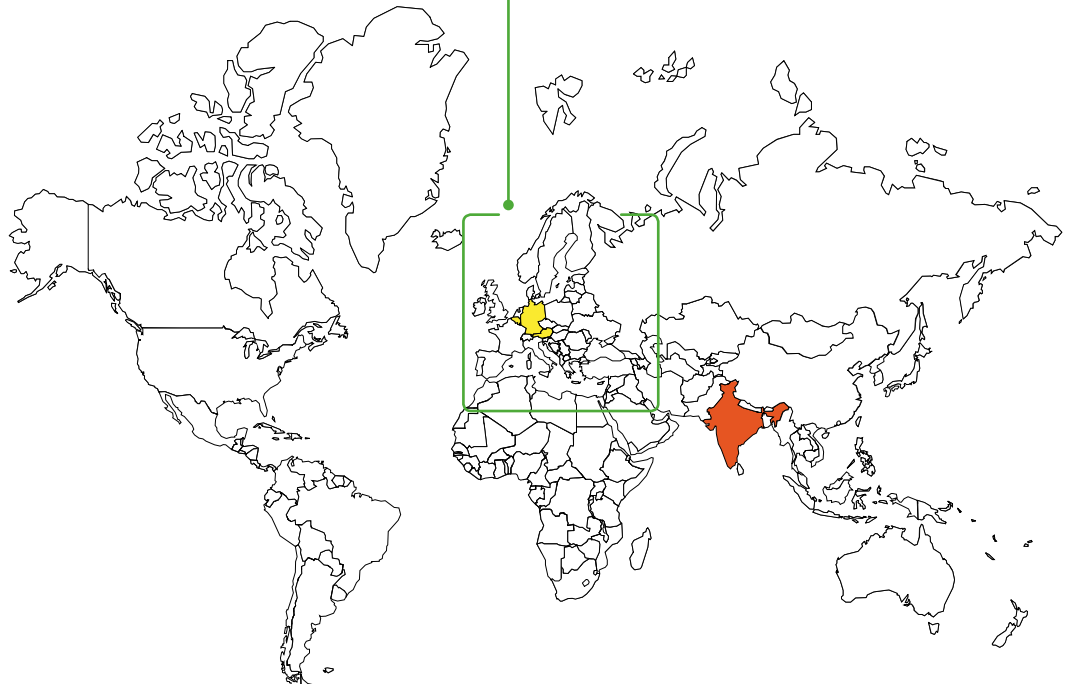

Control Local control SW Biconnect switches

Country approval pictograms

IEC 60947-3

Control and disconnection of on-load electrical circuits already protected against overloads and short-circuits.



Catalogue numbers

Biconnect switch-disconnectors				
Type	Rating	Voltage (Ue)	Width in 9 mm modules	
1P DB118998	63 A	240 V AC	A9S62163	2
3P DB119000	63 A	415 V AC	A9S62363	6
Operating frequency			50/60 Hz	

Offer selection see page 329

Offer A

This sticker must be removed before publishing

- Cable automatically guided to the correct position: terminals with guard
- Insulated terminals IP20

Connection

- Downstream by Biconnect comb busbar
- Upstream/downstream by tunnel terminals

- Manual control on front face by O-I lever

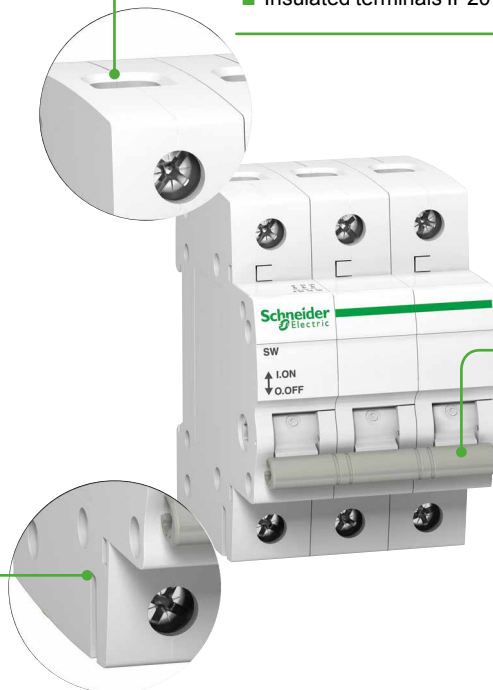

Control

Local control

SW Biconnect switches (cont.)

Connection

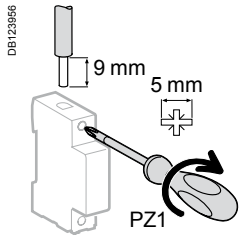

Type	Tightening torque	Copper cables	
		Rigid	Flexible or with ferrule
		DBI22945	DBI22946
SW Biconnect	3.5 N.m	≤ 50 mm ²	≤ 35 mm ²

■ Connection by comb busbar or cables (as per EN 50027).

Technical data

Main characteristics		
Insulation voltage (Ui)		500 VAC
Pollution degree		3
Power circuit		
Rated impulse withstand voltage (Uimp)		6 kV
Operating category		AC-22 A
Permissible rated short-time withstand current (Icw)		1260 A
Conditional rated short-circuit current (Inc)		6 kA according to IEC 60947-3
Rated short-circuit closing current (Icm)		4.2 kA
Additional characteristics		
Degree of protection	Device only	IP20
	Device in modular enclosure	IP40
Endurance (O-C)	Mechanical	50,000 cycles
	Electrical	20,000 cycles
Operating temperature		-20°C to +50°C
Storage temperature		-40°C to +70°C
Tropicalization		Treatment 2 (relative humidity 95% at 55°C)

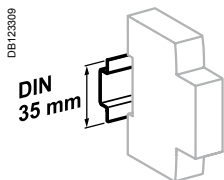

Clip on DIN rail 35 mm.

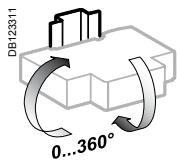

Indifferent position of installation.

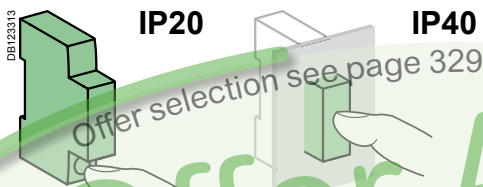

Offer A

This sticker must be removed before publishing

Weight (g)

Biconnect switch-disconnectors	
Type	SW Biconnect
1P	75
3P	230

Dimensions (mm)

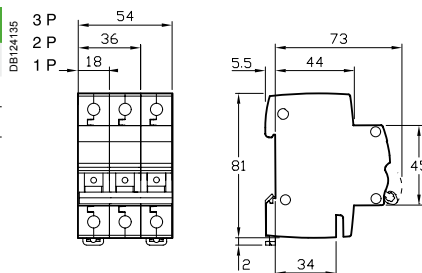

SW Biconnect

Control Local control SW Biconnect switches (cont.)

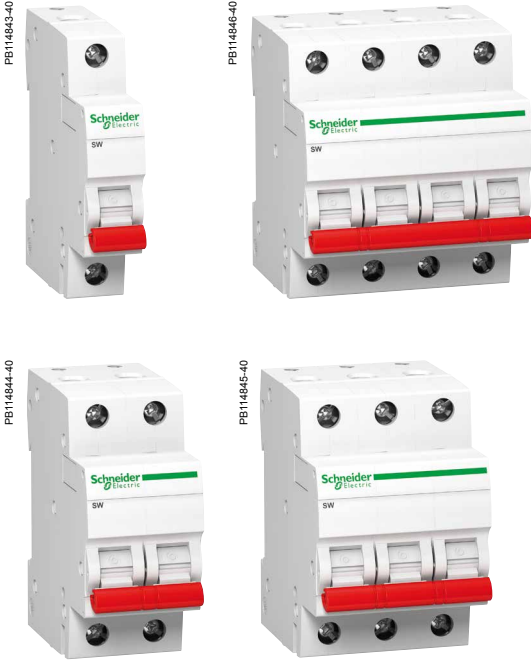

Country approval pictogram



IS/IEC 60947-3

Control and disconnection of on-load electrical circuits already protected against overloads and short-circuits.

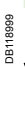
Catalogue numbers

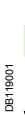
Biconnect switch-disconnectors				
Type	Rating (In)	Voltage (Ue)		Width in 9 mm modules
1P 	40 A	240 V AC	A9KS15140	2
	63 A	240 V AC	A9KS15163	
2P 	40 A	415 V AC	A9KS15240	4
	63 A	415 V AC	A9KS15263	
	80 A	415 V AC	A9KS15280	
3P 	40 A	415 V AC	A9KS15340	6
	63 A	415 V AC	A9KS15363	
4P 	40 A	415 V AC	A9KS15440	8
	63 A	415 V AC	A9KS15463	
	80 A	415 V AC	A9KS15480	
Operating frequency			50/60 Hz	

DB407251

Offer selection see page 329

Offer B

This sticker must be removed before publishing

- Cable automatically guided to the correct position: terminals with guard
- Insulated terminals IP20

DB407252

Connection

- Downstream by Biconnect comb busbar
- Upstream/downstream by tunnel terminals



- Manual control on front face by O-I lever

Control

Local control

SW Biconnect switches (cont.)

Connection

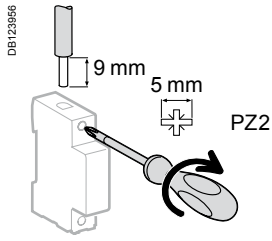

Type	Tightening torque	Copper cables	
		Rigid	Flexible or with ferrule
SW Biconnect	3.5 N.m	1 to 35 mm ²	1 to 25 mm ²

■ Connection by comb busbar or cables (as per EN 50027).

Technical data

Main characteristics		
Insulation voltage (U _i)	500 V AC	
Pollution degree	2	
Power circuit		
Rated impulse withstand voltage (U _{imp})	4 kV	
Operating category	AC-22 A	
Permissible rated short-time withstand current (I _{cs})	12 In for 300 ms	
Rated short-circuit closing current (I _{cm})	40 - 63 A	15 In
	80 A	1 kA
Additional characteristics		
Degree of protection	Device only	IP20
	Device in modular enclosure	IP40
Endurance (O-C)	Mechanical	20,000 cycles
	Electrical	10,000 cycles
Operating temperature	-5°C to +55°C	
Storage temperature	-25°C to +85°C	
Tropicalization	Treatment 2 (relative humidity 95% at 55°C)	

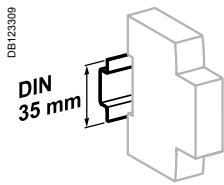

Clip on DIN rail 35 mm.

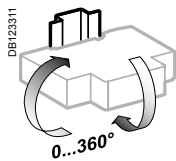

Indifferent position of installation.

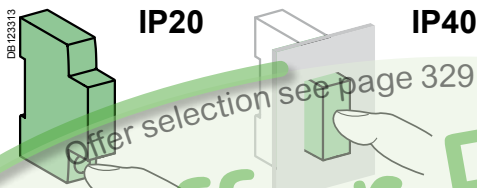

Offer selection see page 329

Offer B

This sticker must be removed before publishing

Weight (g)

Biconnect switch-disconnectors	
Type	SW Biconnect
1P	120
2P	240
3P	360
3P	480

Dimensions (mm)

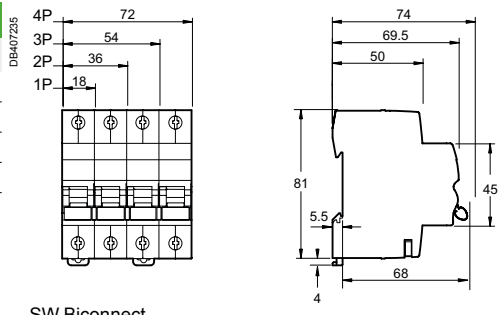

SW Biconnect

Control

Switch-disconnectors remote tripping types iSW-NA

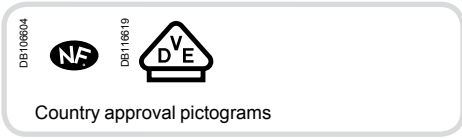

Positive break indication

- Suitability for isolation in the industrial sector to IEC/EN 60947-3.
- The presence of the green strip guarantees that the contacts open physically and allows work to be carried out safely on the downstream circuit.





IEC/EN 60947-3

The iSW-NA trip switch-disconnectors combine the following functions:

- control (opening and closing of circuits under load)
- isolation.

They are designed for switchboard or cubicle incoming units in the tertiary and industry sectors, with the possibility of remote tripping via a coil.

Catalogue numbers

iSW-NA			
Type			Width in 9 mm modules
1P+N 	Rating		
	40 A	A9S70640	4
	63 A	A9S70663	
	80 A	A9S70680	
100 A	A9S70690		
3P+N 	40 A	A9S70740	8
	63 A	A9S70763	
	80 A	A9S70780	
	100 A	A9S70790	
Voltage rating (Ue)	1P+N	230-240 V AC	
	3P+N	400-415 V AC	
Operating frequency		50/60 Hz	
Auxiliaries*		Module CA907000 and CA907002	
Accessories		Module CA907000 and CA907001	

 * Electrical auxiliaries must be installed to the left of the switch-disconnector. The iSD auxiliary contact must be combined with an auxiliary device (iMN, iMX, iMX+OF): it indicates that the switch-disconnector has been tripped open..

Switch-disconnectors remote tripping types iSW-NA (cont.)

Connection

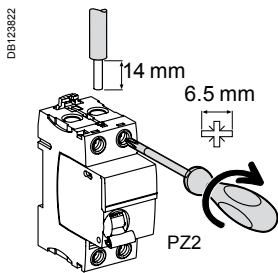

Type	Tightening torque	Without accessory		With accessories*			
		Copper cables		50 mm ² Al terminal	Screw-on connection for ring terminal	Multi-cables terminal	
		Rigid	Flexible or with ferrule			Rigid cables	Flexible cables
iSW-NA	3.5 N.m	DB122945 1 to 35 mm ²	DB122946 1 to 25 mm ²	DB122935 50 mm ²	DB118789 Ø 5 mm	DB118787 3 x 16 mm ² / 3 x 10 mm ²	

* See module CA907000

Technical data

Main characteristics	iSW-NA	
	40/63 A	80/100 A
According to IEC 60947-3		
Insulation voltage (U _i)	500 V AC	
Pollution degree	3	
Rated impulse withstand voltage (U _{imp})	6 kV	
Operating category	AC22A	
Permissible rated short-time withstand current (I _{cw})	20 In/1s	15 In/1s
Rated short-circuit making (I _{cm})	5 kA	
Conditional rated short circuit current (I _{nc} /I _{Δc})	Equal to breaking capacity of iC60	
	With iC60N/H/L	6000 A
	With fuse	
Additional characteristics		
Degree of protection	Device only	IP20
	Device in modular enclosure	IP40
		Insulation class II
Endurance (O-C)	Electrical	15,000 cycles
	Mechanical	20,000 cycles
Operating temperature	-35°C to +70°C	
Storage temperature	-40°C to +85°C	
Tropicalization	Treatment 2 (relative humidity 95 % at 55°C)	

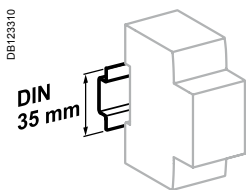

Clip on DIN rail 35 mm.

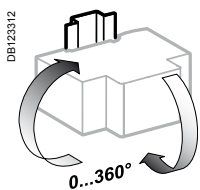

Indifferent position of installation.

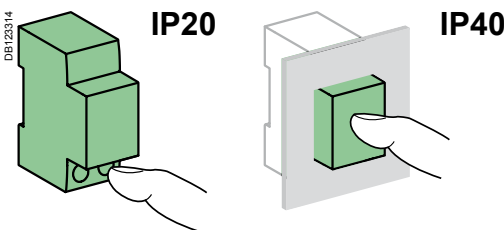

Dimensions (mm)

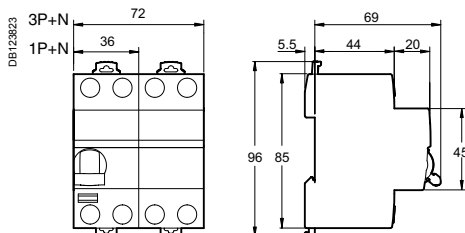

Weight (g)

Switch-disconnectors	
Type	iSW-NA
1P+N	170
3P+N	300

Protection

Switch up to 125 A

NG125NA

Table of contents



The Schneider Electric range of switches up to 125 A comprises various offers (A, B) so as to be as competitive as possible in each country, taking into account the specific features of each market:

- installation customs
- price
- approval by local organizations.

Variants

Offers		Pages
Offer A	Catalogue numbers	337
Offer B	Catalogue numbers	338
Common pages		339

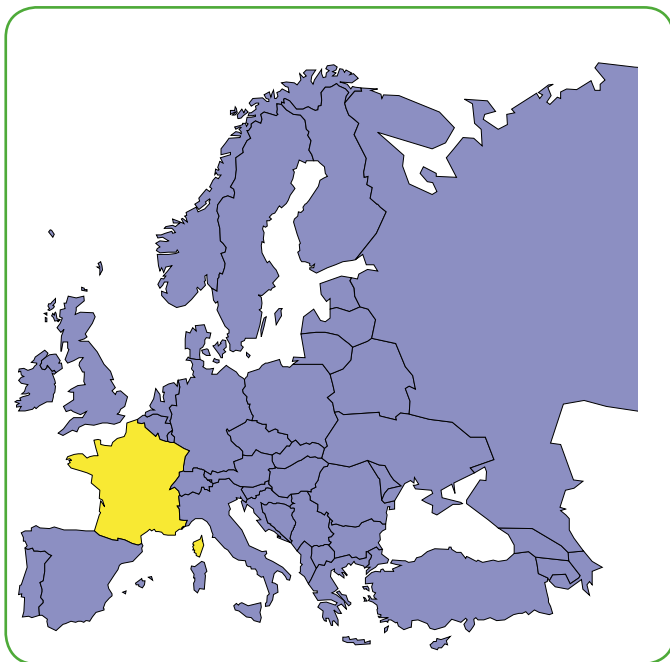

Only the product range to be marketed in your country and validated by the local product manager, in agreement with his Final Distribution (FD) partner should be retained. The others will be removed before publication.

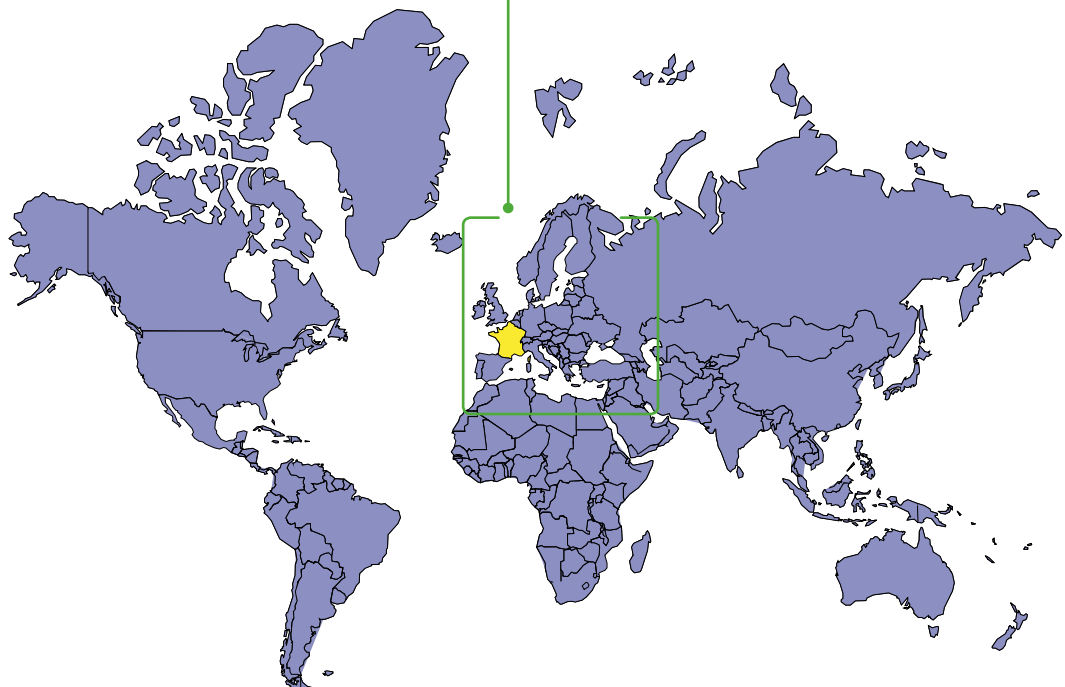

Protection Switch up to 125 A NG125NA switches

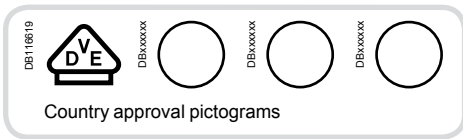

IEC/EN 60947-3

- The NG125NA is a switch-disconnector with free tripping for making and breaking under load.
- It is especially suitable for the modular enclosure incoming feeder with remote breaking (e.g. emergency cutoff).



NG125NA 3P



NG125NA 4P

Offer selection see page 336

Offer A

Catalogue numbers

NG125NA switches

Type

3P

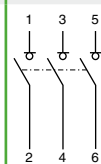

3P+N

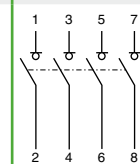

Auxiliaries

Remote indication and tripping, module CM907004 and CM907005

Rating (In) Quality label (1)

Rating (In)	Quality label (1)	3P	3P+N
63 A		18889	18897
80 A		18890	18898
100 A		18891	18899
125 A		18892	18900
Width in 9 mm modules		9	12
Accessories		Module CM907004 and CM907006	

(1) Information to be supplied by the country concerned.

Protection Switch up to 125 A NG125NA switches (cont.)

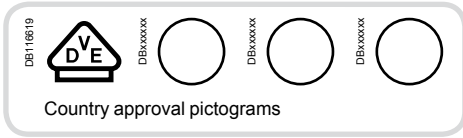

IEC/EN 60947-3

- The NG125NA is a switch-disconnector with free tripping for making and breaking under load.
- It is especially suitable for the modular enclosure incoming feeder with remote breaking (e.g. emergency cutoff).



NG125NA 3P



NG125NA 4P

Offer selection see page 336

Offer B

Catalogue numbers
NG125NA switches

This sticker must be removed before publishing

Type	3P	3P+N
Auxiliaries	Remote indication and tripping, module CM907005	
Rating (In)	Quality label (1)	
63 A	18889	18893
80 A	18890	18894
100 A	18891	18895
125 A	18892	18896
Width in 9 mm modules	9	12
Accessories	Module CM907006	

(1) Information to be supplied by the country concerned.

Protection Switch up to 125 A NG125NA switches (cont.)

Connection

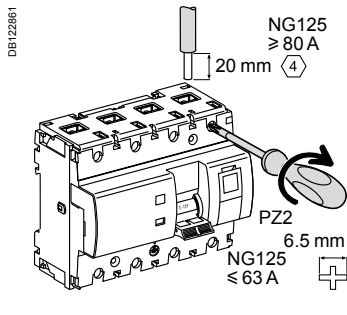

Rating	Tightening torque	Without accessories			With accessories				
		Copper cables		70 mm ² Al terminal	Screw-on connection for ring terminal	Small ring terminal	Multi-cable terminal		
		Rigid	Flexible or with ferrule				Rigid cables	Flexible cables	
		DB122945	DB122946	DB123410					
63 A	3.5 N.m	1.5 to 50 mm ²	1.5 to 35 mm ²	-	-	-	3 x 16 mm ²	3 x 10 mm ²	
80 to 125 A	6 N.m	16 to 70 mm ²	10 to 50 mm ²	25 to 70 mm ²	2 x 35 mm ² 1 x 50 mm ²	1 x 70 mm ²			

■ For rating ≥ 80 A: upstream voltage taps for each pole, by 6.35 mm Fast-on terminal.

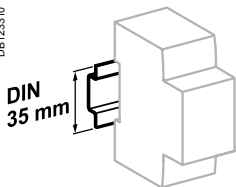

Clips onto 35 mm DIN rail.

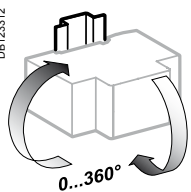

Any installation position.

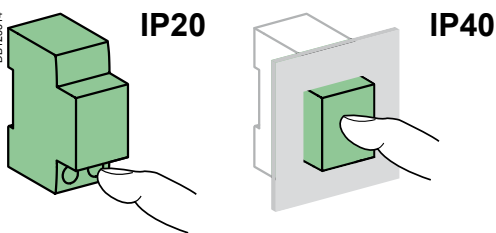

Technical data

Main characteristics			
According to IEC/EN 60947-3			
Max. voltage rating (Ue)	500 V AC		
Insulation voltage (Ui)	690 V AC		
Degree of pollution	3		
Rated impulse withstand voltage (Uimp)	8 kV		
Short time withstand current (50 ms) Icw	1.5 kA		
Rated short-circuit closing current (Icm)	2 kA		
Utilization category	AC22A/B - AC23B		
Additional characteristics			
Degree of protection	Device only	IP20	
	Device in modular enclosure	IP40	
Endurance (O-C)		Category A	Category B
Electrical (except AC20 and DC20)	≤ 100 A	1500 cycles	300 cycles
	125 A	1000 cycles	200 cycles
Mechanical		20,000 cycles	
Operating temperature		-30°C to +70°C	
Storage temperature		-40°C to +70°C	
Tropicalization (IEC 60068-1)		Treatment 2 (relative humidity of 95% at 55°C)	

Protection Switch up to 125 A NG125NA switches (cont.)

Weight (g)

Switch	
Type	NG125NA
3P	720
4P	960

Dimensions (mm)

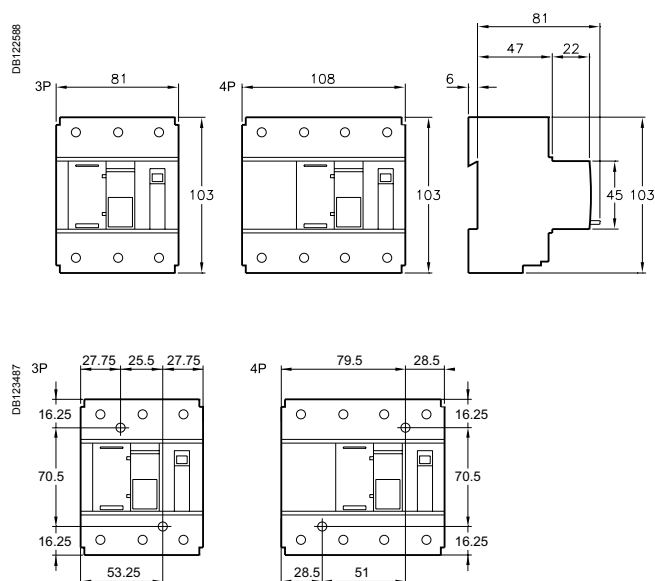

Spacing for mounting on panel

Protection Switch up to 125 A NG125NA switches (cont.)

056909N_SE-2011-90

- For rating ≥ 80 A**
- Voltage taps:
 - auxiliaries power supply
 - measurement
 - emergency stop
 - remote reporting

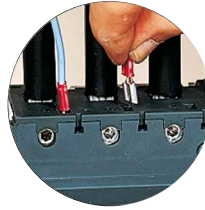

- Cable strength:
 - ribbed cage
 - terminal depth
 - tightening by Allen hex key (NG125 ≥ 80 A)

- Integrated padlocking device

- Test button to check satisfactory operation of the tripping mechanism

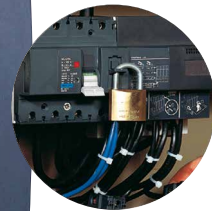

- Pull-out strength:
 - metallic lock

- Impact and vibration resistance:
 - high-strength enclosure
 - IK 05

- Circuit breaker tripped indicator

- Central manual control, 3 positions:
 - ON
 - tripped on fault
 - open

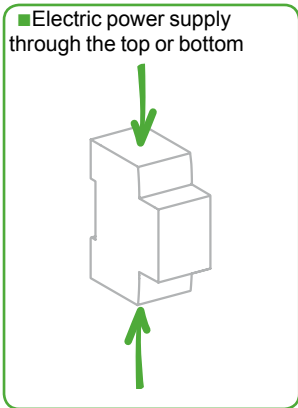

DB123493

- Positive contact indication:
 - suitability for isolation in the industrial sector to IEC/EN 60947-3;
 - the presence of the green strip guarantees that the contacts open physically and allows work to be carried out safely on the downstream circuit.

- Longer product service life due to:
 - good overvoltage withstand capacity;
 - high limitation performances;
 - fast closure independent of the speed of actuation of the toggle.

Protection

Circuit protection / Earth leakage protection

Accessories and auxiliaries for iC40, iCV40

Connection accessories

See module CA907001

7	Screw-on connection for ring terminal	27053
8	Comb busbar	See module CA907026

Mounting accessories

See module CA907001

9	Padlocking device	A9A26970
19	Padlocking devices (left)	A9A26380
	(right)	A9A26381(1)
10	Clip-on terminal markers	See module CA907001

(1) only for iC40

Security accessories

See module CA907001

11	9 mm spacer	A9A27062
----	-------------	----------

Spare part

See module CA907001

12	Locking clip	A9A27052
----	--------------	----------

Electrical auxiliaries

See module CA907002

Indication		
2	iSD fault indicating contact	A9A26927
3	iOF open/close auxiliary contact	A9A26924
4	iOF/SD+OF auxiliary contact (OF+SD or OF+OF)	See module CA907002
5	iOF+SD24 auxiliary contact	See module CA907002

Tripping devices

1	iMN undervoltage release or iMNs undervoltage release delayed or iMNx undervoltage release with external feeding or shunt release iMX, iMX+OF overvoltage release iMSU	See module CA907002
---	--	---------------------

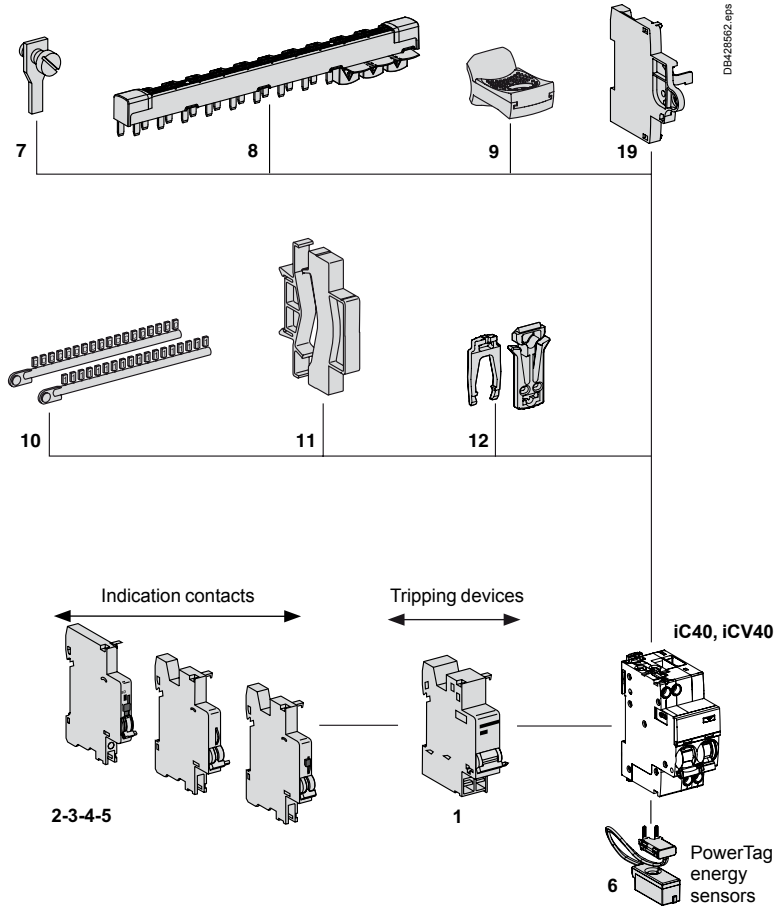

Note Tripping devices must be installed first.
 If two tripping devices: the iMN must be installed first
 Indication auxiliaries: respect specified position for SD functions.

PowerTag energy sensors

6	Energy sensors PowerTag A9 P63	See module CA907029
---	--------------------------------	---------------------

Assembly rule

The mounting order and the number for the various auxiliaries must be complied with.
 The tripping auxiliaries (iMN, iMX, iMSU...) must be mounted first **1** as close as possible to the main device.
 Then at the left, the indicating auxiliaries (iOF, iSD...) must be mounted **2** then **3**, complying with the following association table.

Indicating auxiliaries		Tripping auxiliaries		Device
3	+ 2	+ 1		
1 (iOF/SD+OF or iOF+SD24 or iSD)	1 iOF/SD+OF	1 (iMN, iMNs, iMNx or iMX, iMX+OF or iMSU)	iC40, iCV40	
1 iOF	1 (iSD or iOF or iOF/SD+OF)	2 (iMN, iMNs, iMNx or iMX, iMX+OF or iMSU)		
-	1 iOF+SD24	2 (iMN, iMNs, iMNx or iMX, iMX+OF or iMSU)		
-	-	3 iMSU		
1 iSD	1 iSD	1 (iMN, iMNs, iMNx or iMX, iMX+OF or iMSU)		

Protection

Circuit protection / Earth leakage protection

Accessories and auxiliaries for iC40 XA, iCV40 XA

Connection accessories

See module CA907001

7	Screw-on connection for ring terminal	27053
8	Comb busbar	See module CA907026

Mounting accessories

See module CA907001

9	Padlocking device	A9A26970
19	Padlocking devices (left)	A9A26380
	(right)	A9A26381(2)
10	Clip-on terminal markers	See module CA907001

(2) for iC40 XA with bottom screw connections only

Security accessories

See module CA907001

11	9 mm spacer	A9A27062
----	-------------	----------

Spare part

See module CA907001

12	Locking clip	A9A27052
----	--------------	----------

Electrical auxiliaries

See module CA907002

Indication		
2	iSD fault indicating contact	A9A26927
3	iOF open/close auxiliary contact	A9A26924
5	iOF+SD24 auxiliary contact	See module CA907002

Tripping devices		
1	iMN undervoltage release or iMNs undervoltage release delayed or iMNx undervoltage release with external feeding or shunt release iMX, iMX+OF overvoltage release iMSU	See module CA907002

PowerTag energy sensors		
6	Energy sensors PowerTag A9 P63	See module CA907029

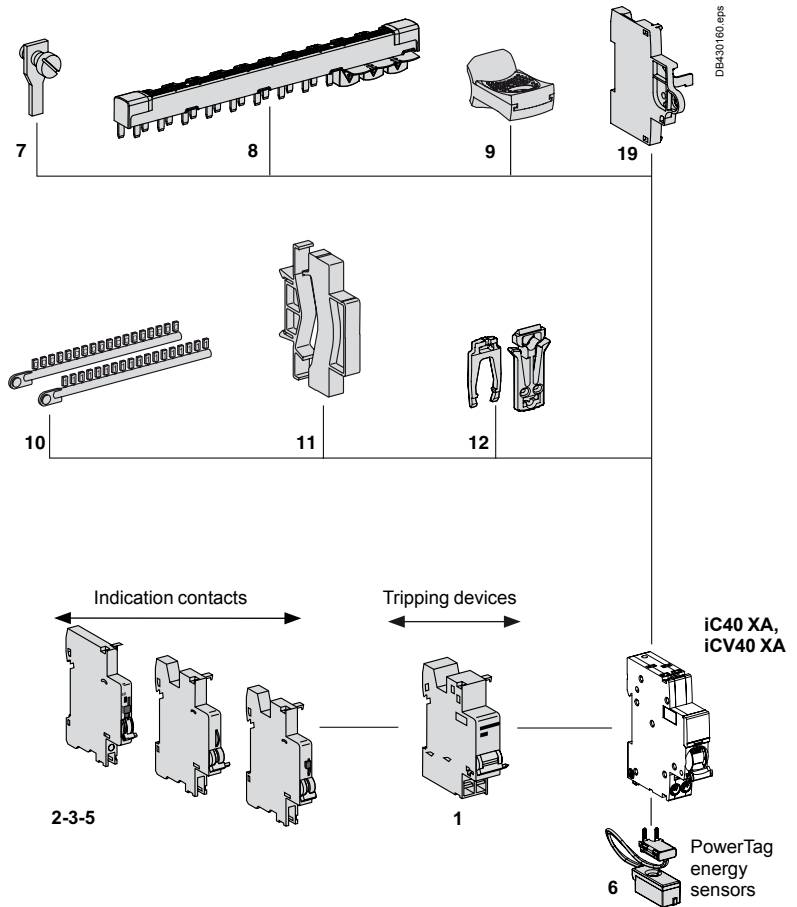

Note Tripping devices must be installed first.
If two tripping devices: the iMN must be installed first
Indication auxiliaries: respect specified position for SD functions.

Assembly rule

The mounting order and the number for the various auxiliaries must be complied with.

The tripping auxiliaries iMN, iMX, iMSU... must be mounted first **1** as close as possible to the main device.

Then at the left, the indicating auxiliaries (iOF, iSD...) must be mounted **2** then **3**, complying with the following association table.

Indicating auxiliaries		Tripping auxiliaries		Device
3	+ 2	+ 1		
-	1 (iOF+SD24 or iSD)	1 (iMN, iMNs, iMNx or iMX, iMX+OF or iMSU)	iC40 XA, iCV40 XA	
1 iOF	1 (iSD or iOF)	2 (iMN, iMNs, iMNx or iMX, iMX+OF or iMSU)		
-	1 iOF+SD24	2 (iMN, iMNs, iMNx or iMX, iMX+OF or iMSU)		
-	-	3 iMSU		
1 iSD	1 iSD	1 (iMN, iMNs, iMNx or iMX, iMX+OF or iMSU)		

Protection

Circuit protection / Earth leakage protection

Accessories and auxiliaries iID40

Connection accessories

See module CA907001

7	Screw-on connection for ring terminal	27053
8	Comb busbar	See module CA907026
13	Multi-cable terminal	See module CA907001
14	Al terminal	27060

Mounting accessories

See module CA907001

9	Padlocking device	A9A26970
19	Padlocking device (left)	A9A26380
10	Clip-on terminal markers	See module CA907001

Security accessories

See module CA907001

11	9 mm spacer	A9A27062
15	Interpole barrier	See module CA907001
16	Screw shield	See module CA907001
17	Terminal shield	See module CA907001

Spare parts

See module CA907001

12	Locking clip	A9A27052
18	Flap	See module CA907001

Electrical auxiliaries

See module CA907002

Signalisation		
2	iSD fault indicating contact	A9A26927
3	iOF open/close auxiliary contact	A9A26924
4	iOF/SD+OF auxiliary contact (OF+SD or OF+OF)	See module CA907002
5	iOF+SD24 auxiliary contact	See module CA907002

Déclencheurs		
1	iMN undervoltage release or iMNs undervoltage release delayed or iMNx undervoltage release with external feeding or shunt release iMX, iMX+OF overvoltage release iMSU	See module CA907002

PowerTag energy sensors		
6	Energy sensors PowerTag A9 P63	See module CA907029

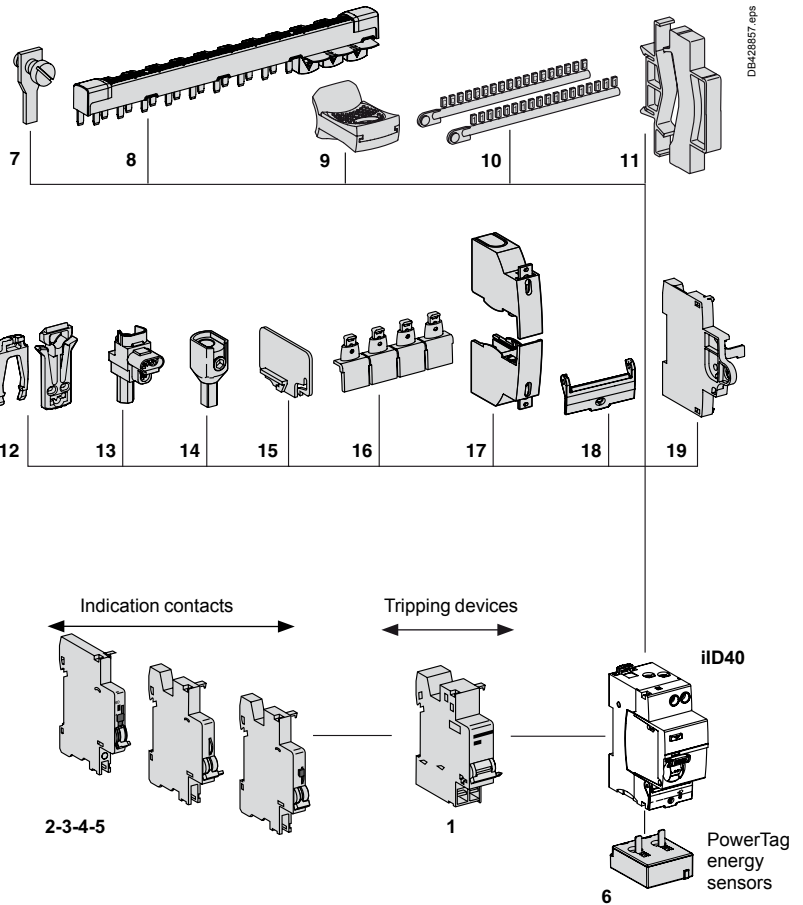

Note Tripping devices must be installed first.
 If two tripping devices: the iMN must be installed first
 Indication auxiliaries: respect specified position for SD functions.

Assembly rule

The mounting order and the number for the various auxiliaries must be complied with. The tripping auxiliaries iMN, iMX, iMSU... must be mounted first **1** as close as possible to the main device. Then at the left, the indicating auxiliaries (iOF, iSD...) must be mounted **2** then **3**, complying with the following association table.

Indicating auxiliaries		Tripping auxiliaries		Device
3	+ 2	+ 1		
1 (iOF/SD+OF or iOF+SD24 or iSD)	1 iOF/SD+OF	1 (iMN, iMNs, iMNx or iMX, iMX+OF or iMSU)	iID40	
1 iOF	1 (iSD or iOF or iOF/SD+OF)	2 (iMN, iMNs, iMNx or iMX, iMX+OF or iMSU)		
-	1 iOF+SD24	2 (iMN, iMNs, iMNx or iMX, iMX+OF or iMSU)		
-	-	3 iMSU		
1 iSD	1 iSD	1 (iMN, iMNs, iMNx or iMX, iMX+OF or iMSU)		

Protection

Circuit protection / Earth leakage protection

Accessorisation / Auxiliarisation iC60, iLD, Vigi iC60, iSW-NA

Connection accessories

See module CA907001

9	Splitter blocks Linergy FM	See module	LIN022
	Linergy DX	See module	LIN003
10	50 mm ² Al terminal		27060
11	Screw-on connection for ring terminal		27053
12	Multi-cables terminal	4 parts	19091
		3 parts	19096
13	Comb busbar	See modules	CA907026, CA907027

Mounting accessories

See module CA907001

14	Sealable terminal shields for top and bottom connection	1P (set of 2)	A9A26975
		2P (set of 2)	A9A26976
		3P	1P + 2P
		4P	2P + 2P
15	Interpole barrier (set of 10)	A9A27001	
16	Screw shields 4P (set of 20)	A9A26981	
16"	Screw shields Vigi iC60 (set of 12)	A9A26982	
17	Clip-on terminal markers	See module	CA907001
18	9 mm spacer	A9A27062	
19	Padlocking device (set of 10)	A9A26970	
20	Plug-in base	A9A27003	
21	Rotary handle	Black handle	A9A27005
		Red handle	A9A27006
		No handle	A9A27008

Electrical auxiliaries

See module CA907002

Indication

4	iOF/SD+OF auxiliary contact (OF+SD or OF+OF combination switch)	A9A26929
5	iSD fault indicating contact	A9A26927
6	iOF open/close auxiliary contact	A9A26924
7	iOF+SD24 auxiliary contact	See module CA907002

Control

8	iMDU voltage matching auxiliary	A9C18195
---	---------------------------------	----------

Tripping devices

2	iMN undervoltage release or iMNs undervoltage release delayed or iMNx undervoltage release with external feeding	See module CA907002
3	Shunt release iMX, iMX+OF overvoltage release iMSU	See module CA907002

PowerTag energy sensors

22	Energy sensors PowerTag A9 M63, F63	See module CA907029
----	-------------------------------------	---------------------

Vigi iC60

1	Vigi iC60 add-on residual current device	See module CA902005
	Double terminals Vigi iC60 add-on residual current device	See module CA902019

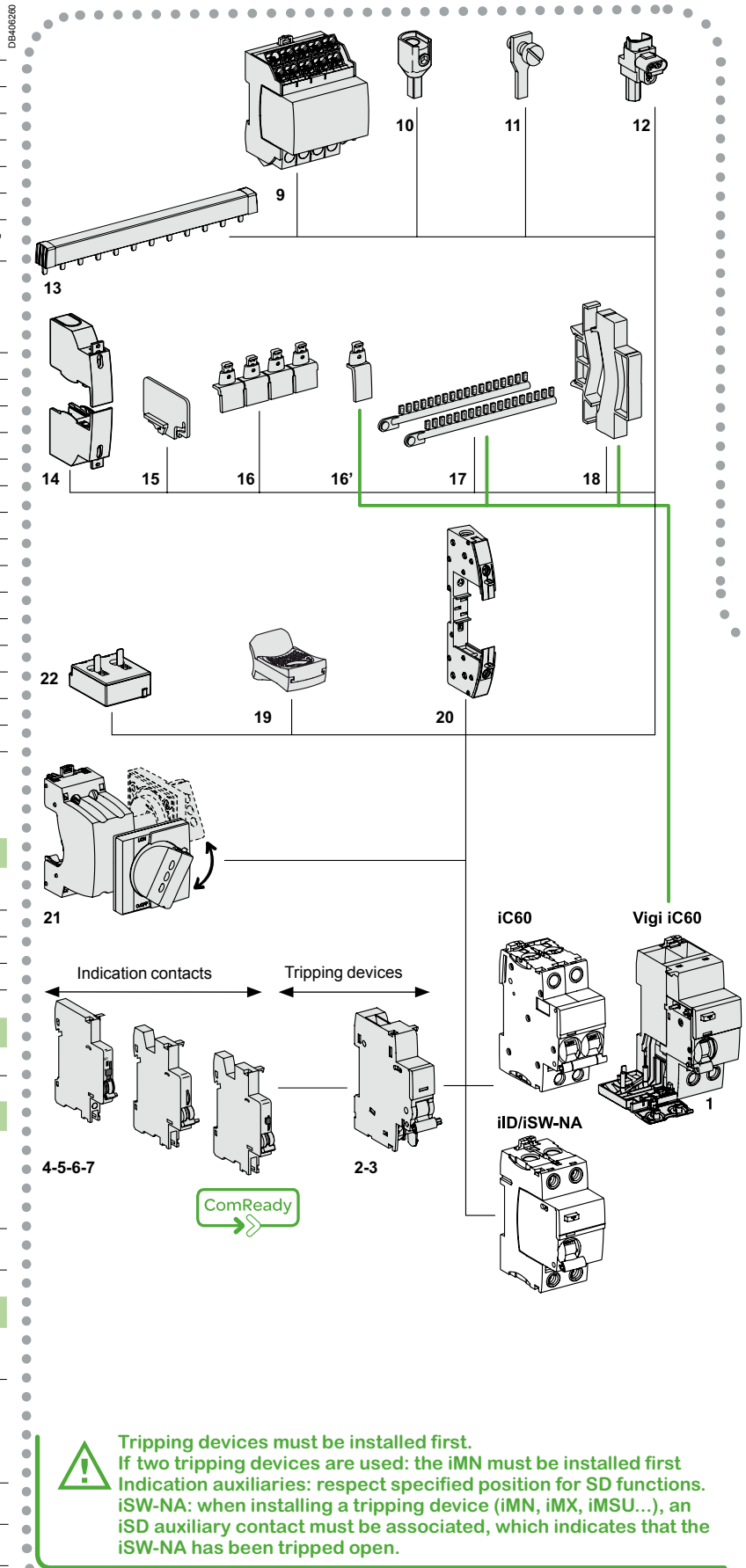

Protection

Circuit protection / Earth leakage protection

Accessorisation / Auxiliarisation iC60, iID, Vigi iC60, iSW-NA (cont.)

Assembly rule

The mounting order and the number for the various auxiliaries must be complied with.

The tripping auxiliaries (iMN, iMX, iMSU...) should be mounted first **1** as close as possible to the main device.

Then at the left, the indicating auxiliaries (iOF, iSD) should be mounted **2** then **3** complying with the following association table.

Indicating auxiliaries 3	+ 2	Tripping auxiliaries + 1	Remote control	Device	Vigi iC60
1 (iOF/SD+OF or iOF+SD24 or iSD)	1 iOF/SD+OF	1 (iMN, iMNs, iMNx or iMX, iMX+OF or iMSU)	-	iC60, iID, iSW-NA	Vigi iC60
1 iOF	1 (iSD or iOF or iOF/SD+OF)	2 (iMN, iMNs, iMNx or iMX, iMX+OF or iMSU)			
-	1 iOF+SD24	2 (iMN, iMNs, iMNx or iMX, iMX+OF or iMSU)			
-	-	3 iMSU			
1 iSD	1 iSD	1 (iMN, iMNs, iMNx or iMX, iMX+OF or iMSU)	ARA, RCA	iC60	Vigi iC60
-	1 (iSD or iOF or iOF/SD+OF or iOF+SD24)	1 (iMN, iMNs, iMNx or iMX, iMX+OF or iMSU)			
1 iOF	1 (iSD or iOF or iOF/SD+OF)	-			
-	1 (iSD or iOF or iOF/SD+OF or iOF+SD24)	1 (iMN, iMNs, iMNx or iMX, iMX+OF or iMSU) maxi	ARA	iID	-
1 iOF	1 (iSD or iOF or iOF/SD+OF)	-			

DB-04784

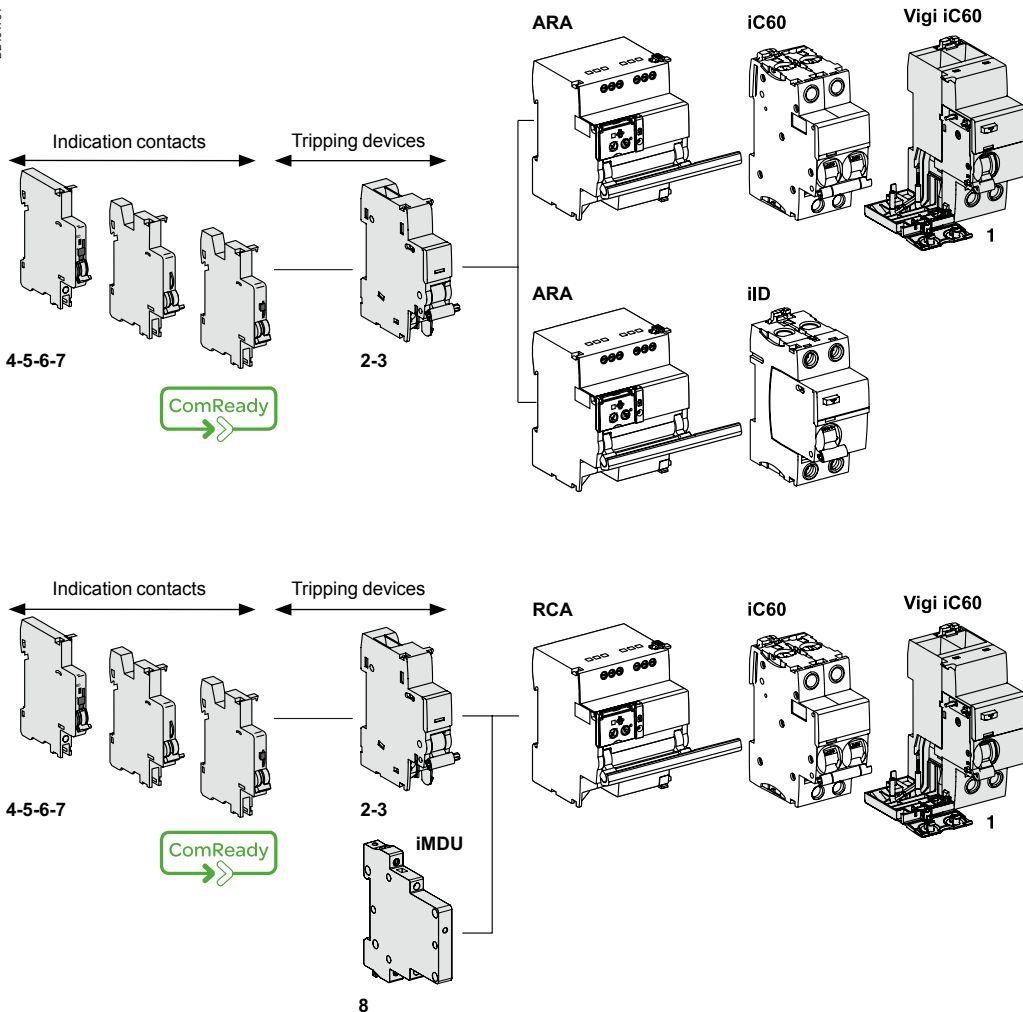

Protection

Circuit protection / Earth leakage protection

Accessorisation / Auxiliarisation Reflex iC60

Connection accessories

See module CA907001

3	Splitter blocks	Linergy FM	See module	LIN022
		Linergy DX	See module	LIN003
4	50 mm ² Al terminal			27060
5	Screw-on connection for ring terminal			27053
6	Multi-cables terminal	4 parts		19091
		3 parts		19096
7	Comb busbar		See modules	CA907026, CA907027

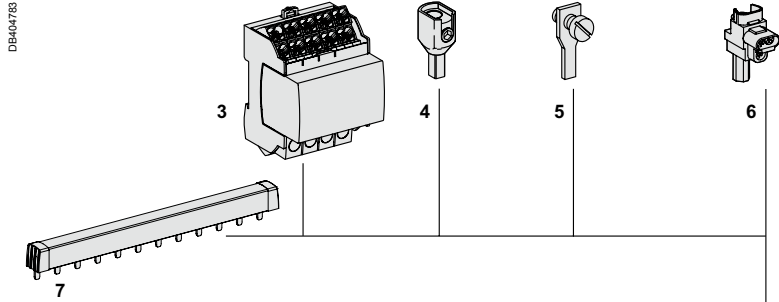

Mounting accessories

See module CA907001

8	Sealable terminal shields for top and bottom connection	1P (set of 2)	A9A26975
		2P (set of 2)	A9A26976
		3P	1P + 2P
		4P	2P + 2P
9	Interpole barrier	(set of 10)	A9A27001
10	Screw shields	4P (set of 20)	A9A26981
11	Clip-on terminal markers		See module CA907001
12	9 mm spacer		A9A27062
13	Padlocking device	(set of 10)	A9A26970

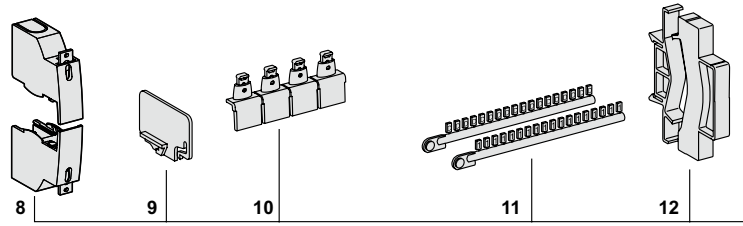

Electrical auxiliary

See module CA907002

Control

2	iMDU voltage matching auxiliary	A9C18195
---	---------------------------------	----------

iMDU

Reflex iC60

Vigi iC60

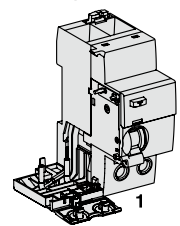
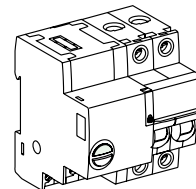
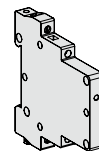

2

1

Vigi iC60

See module CA907005

1	Vigi iC60 add-on residual current device	See module	CA902005
---	--	------------	----------

Control Local control

Accessorisation / Auxiliarisation iSW

Connection accessories

See module CA907001

2	Splitter blocks	Linergy FM	See module	LIN022
		Linergy DX	See module	LIN003
3	50 mm² Al terminal			27060
4	Screw-on connection for ring terminal			27053
5	Multi-cables terminal	4 parts		19091
		3 parts		19096
6	Comb busbar		See modules	CA907026, CA907027

DB44785

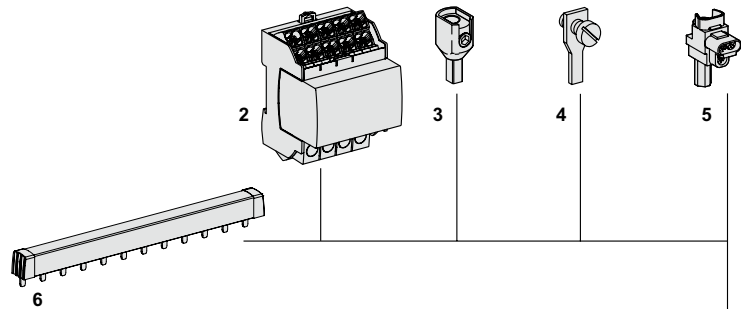

Mounting accessories

See module CA907001

7	Sealable terminal shields for top and bottom connection	1P (set of 2)	A9A26975
		2P (set of 2)	A9A26976
		3P	1P + 2P
		4P	2P + 2P
8	Interpole barrier	(set of 10)	A9A27001
9	Clip-on terminal markers		See module CA907001
10	9 mm spacer		A9A27062
11	Padlocking device	(set of 10)	A9A26970
12	Plug-in base		A9A27003
13	Rotary handle	Black handle	A9A27005
		Red handle	A9A27006
		No handle	A9A27008

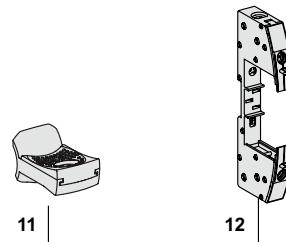
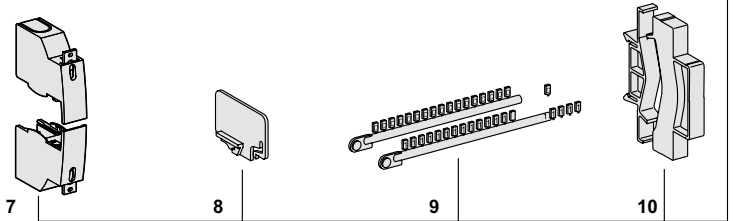

Electrical auxiliaries

See module CA907002

Indication		
1	iOF open/close auxiliary contact	A9A26924

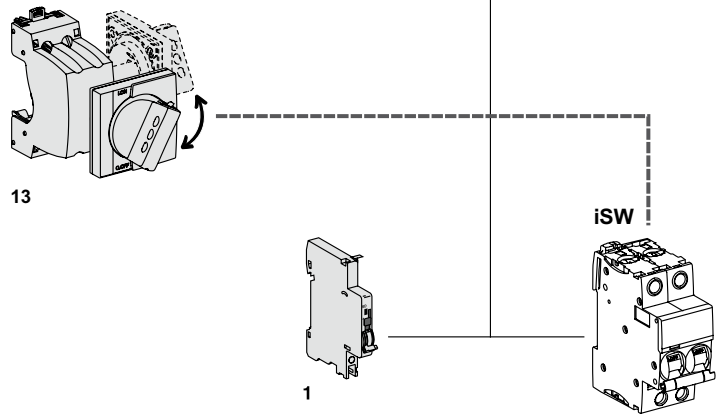

Protection

Circuit protection / Earth leakage protection

Accessorisation / Auxiliarisation iDPN Vigi

Connection accessories

See module CA907001

6	Screw-on connection for ring terminal	27053
7	Comb busbar	See modules CA907026, CA907027

Mounting accessories

See module CA907001

8	Padlocking device (set of 10)	A9A26970
9	Clip-on terminal markers	See module CA907001
10	9 mm spacer	A9A27062

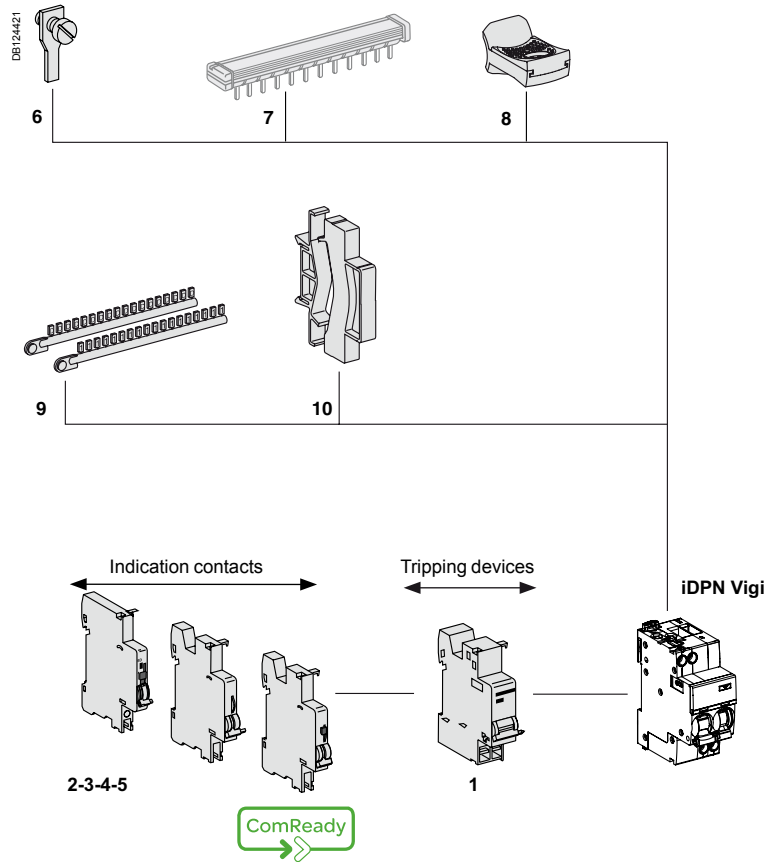

Electrical auxiliaries

See module CA907002

Indication

2	iOF/SD+OF auxiliary contact (OF+SD or OF+OF combination switch)	A9A26929
3	iSD fault indicating contact	A9A26927
4	iOF open/close auxiliary contact	A9A26924
5	iOF+SD24 auxiliary contact	See module CA907002

Tripping devices

1	iMN undervoltage release or iMNs undervoltage release delayed or iMNx undervoltage release with external feeding or shunt release iMX, iMX+OF overvoltage release iMSU	See module CA907002
---	--	---------------------

! Tripping devices must be installed first. If two tripping devices are used: the iMN must be installed first. Indication auxiliaries: respect specified position for SD functions.

Assembly rule

The mounting order and the number for the various auxiliaries must be complied with.

The tripping auxiliaries iMN, iMX, iMSU... should be mounted first **1** as close as possible to the main device.

Then at the left, the indicating auxiliaries (iOF, iSD) should be mounted **2** then **3** complying with the following association table.

Indicating auxiliaries 3		Tripping auxiliaries 1		Device
	+ 2		+ 1	
1 (iOF/SD+OF or iOF+SD24 or iSD)	1 iOF/SD+OF	1 (iMN, iMNs, iMNx or iMX, iMX+OF or iMSU)	iDPN Vigi	
1 iOF	1 (iSD or iOF or iOF/SD+OF)	2 (iMN, iMNs, iMNx or iMX, iMX+OF or iMSU)		
-	1 iOF+SD24	2 (iMN, iMNs, iMNx or iMX, iMX+OF or iMSU)		
-	-	3 iMSU		
1 iSD	1 iSD	1 (iMN, iMNs, iMNx or iMX, iMX+OF or iMSU)		

Accessorisation / Auxiliarisation iC60 Disbo and iKQ

Connection accessories

See module CA907021

6	50 mm ² Al terminal	27060
7	Screw-on connection for ring terminal	27053
8	Multi-cables terminal	4 parts 19091
		3 parts 19096

Mounting accessories

See module CA907021

9	Sealable terminal shields for top and bottom connection	1P (set of 2) A9A26975
		2P (set of 2) A9A26976
		3P 1P + 2P
		4P 2P + 2P
10	Screw shields	4P (set of 20) A9A26981
10"	Screw shields Vigi iC60	(set of 12) A9A26982
11	Clip-on terminal markers	See module CA907021
12	9 mm spacer	A9A27063
13	Padlocking device	(set of 10) A9A26970
14	Padlocking device for Isobar enclosure	(set of 10) A9A26972
15	Interpole barrier	(set of 10) A9A27001

Electrical auxiliaries

See module CA907002

Indication

4	iSD fault indicating contact	A9A26927
5	iOF open/close auxiliary contact	A9A26924

Tripping devices

2	iMN undervoltage release or iMNs undervoltage release delayed or iMNx undervoltage release with external feeding	See module CA907002
3	Shunt release iMX, iMX+OF overvoltage release iMSU	See module CA907002

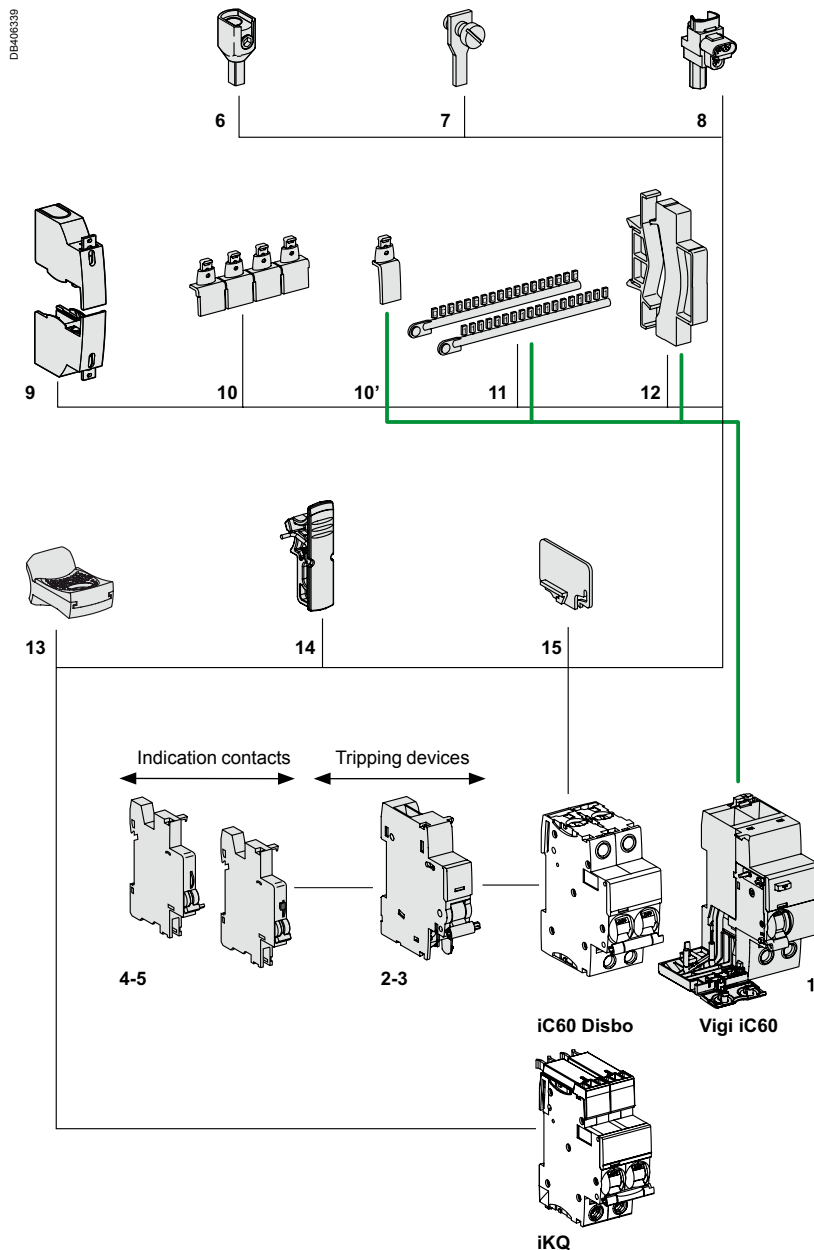

Vigi iC60

1	Vigi iC60 add-on residual current device	See module CA902005
---	--	---------------------



Tripping devices must be installed first.
If two tripping devices are used: the iMN must be installed first
Indication auxiliaries: respect specified position for SD functions.

Assembly rule

The mounting order and the number for the various auxiliaries must be complied with.

The tripping auxiliaries (iMN, iMX, iMSU...) should be mounted first **1** as close as possible to the main device.

Then at the left, the indicating auxiliaries (iOF, iSD) should be mounted **2** then **3** complying with the following association table.

Indicating auxiliaries		Tripping auxiliaries		Device	Vigi iC60
3	+ 2	+ 1			
1 iOF	1 (iSD or iOF)	2 (iMN, iMNs, iMNx or iMX, iMX+OF or iMSU)	iC60 Disbo	Vigi iC60	
-	-	3 iMSU	iKQ	Vigi iC60	

Protection

Circuit protection / Earth leakage protection

Accessorisation / Auxiliarisation iC60 RCBO and iKQE RCBO

Connection accessories

See module CA907021

5	Screw-on connection for ring terminal	27053
---	---------------------------------------	-------

Mounting accessories

See module CA907021

6	Padlocking device (set of 10)	A9A27049
7	Clip-on terminal markers	See module CA907021
8	9 mm spacer	A9A27063

Electrical auxiliaries

See module CA907002

Indication

3	iSD fault indicating contact	A9A26927
4	iOF open/close auxiliary contact	A9A26924

Tripping devices

1	iMN undervoltage release or iMNs undervoltage release delayed or iMNx undervoltage release with external feeding	See module CA907002
2	Shunt release iMX, iMX+OF overvoltage release iMSU	See module CA907002

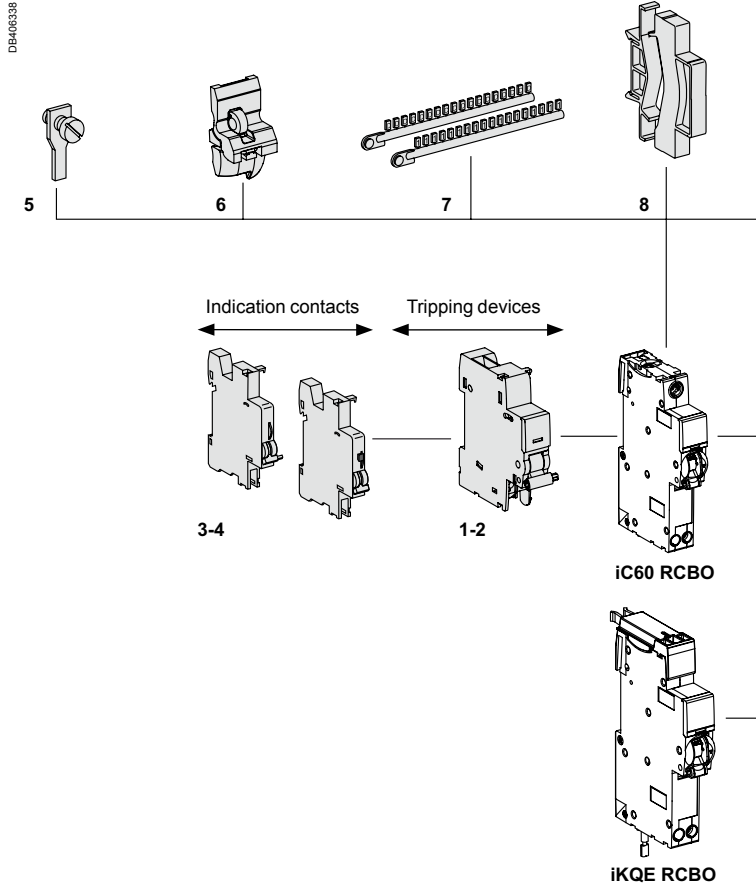

⚠ Tripping devices must be installed first.
If two tripping devices are used: the iMN must be installed first
Indication auxiliaries: respect specified position for SD functions.

Assembly rule

The mounting order and the number for the various auxiliaries must be complied with.

The tripping auxiliaries (iMN, iMX, iMSU...) should be mounted first **1** as close as possible to the main device.

Then at the left, the indicating auxiliaries (iOF, iSD) should be mounted **2** then **3** complying with the following association table.

Indicating auxiliaries 3		Tripping auxiliaries 1		Device
	+ 2	+	1	
1 iOF	1 (iSD or iOF)	2 (iMN, iMNs, iMNx or iMX, iMX+OF or iMSU)		iC60 RCBO
-	-	3 iMSU		iKQE RCBO

Protection

Circuit protection / Earth leakage protection

Accessories and Auxiliaries for C120, Vigi C120 devices

Connection accessories

See module CA907012

7	Multi-cable terminal	4 parts	19091
		3 parts	19096
8	Screw-on connection for ring terminal	8 parts	27053
9	Terminal for rear connector		18528
10	50 mm ² Al terminal		27060
11	Comb busbar	See module	LIN001

Mounting accessories

See module CA907012

12	Sealable terminal shields for top and bottom connection	1P (set of 2)	18526
13	Interpole barrier	(set of 10)	27001
14	Screw shields	4P (set of 2)	18527
15	Clip-on terminal markers	See module	CA907012
16	9 mm spacer		A9N27062
17	Padlocking device		27145
18	Plug-in base ⁽¹⁾		26997
19	Rotary handle	Removable extended handle	27047
		Fixed handle	27048
		Operating sub-assembly ⁽²⁾	27046

(1) For 1P, centreline between two rows: 200 mm
 (2) A complete rotary handle consists of a circuit-breaker operating sub-assembly, cat. no. 27046, a handle cat. no. 27047 or a handle cat. no. 27048.

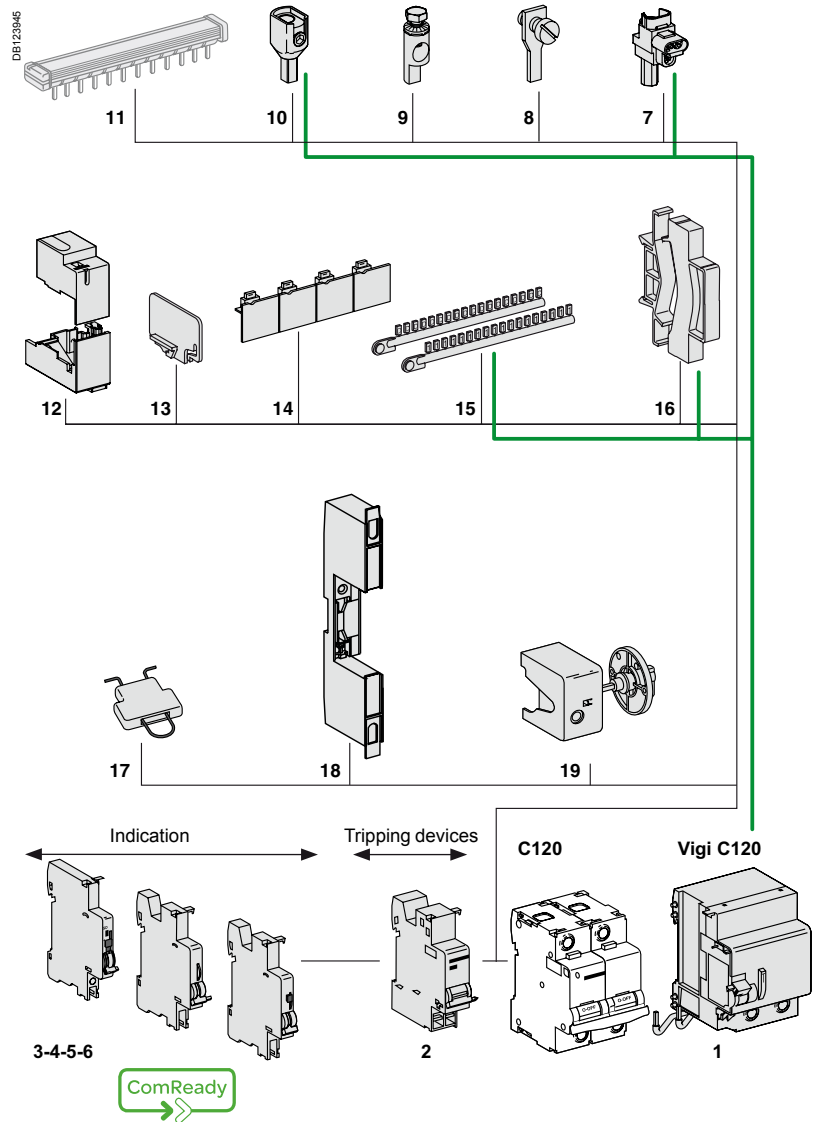

Electrical auxiliaries

See module CA907008

Indication		
3	SD fault indicating contact	A9N26927
4	OF+SD24 auxiliary contact	A9N26899
5	OF open/close auxiliary contact	A9N26924
6	OF+SD/OF auxiliary contact (OF+SD or OF+OF combination switch)	A9N26929

Tripping		
2	MN, MNx, MN \square undervoltage release, MSU overvoltage release or MX, MX + OF shunt release	See module CA907008

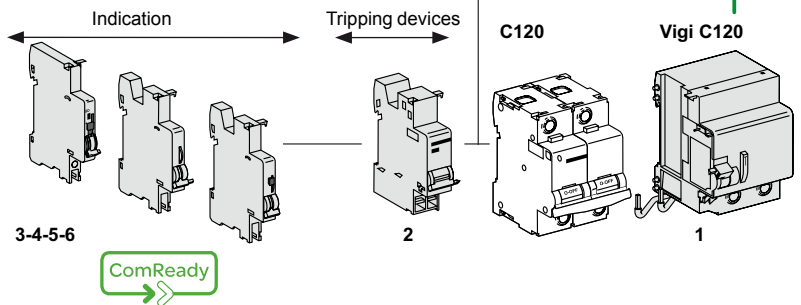

⚠ Tripping devices must be installed first.
If two tripping devices are used: the MN must be installed first
Indication auxiliaries: respect specified position for SD functions.

Vigi C120

See module CA902016

1	Vigi C120 add-on residual current device	See module	CA902016
---	--	------------	----------

Assembly rule

The mounting order and the number for the various auxiliaries must be complied with. The tripping auxiliaries MN, MX, MSU... should be mounted first **1** as close as possible to the main device. Then at the left, the indicating auxiliaries (OF, SD) should be mounted **2** then **3** complying with the following association table.

Indicating auxiliaries		Tripping auxiliaries		Device	Vigi C120
3	+ 2	+ 1			
1 (OF+SD/OF or OF+SD24)	1 OF+SD/OF	1 (MN, MNx, MN \square or MX, MX+OF or MSU)	C120	Vigi C120	
1 OF	1 (OF+SD/OF or SD or OF)	2 (MN, MNx, MN \square or MX, MX+OF or MSU)			
-	1 OF+SD24	2 (MN, MNx, MN \square or MX, MX+OF or MSU)			
-	-	3 MSU			

Protection

Circuit protection / Earth leakage protection

Accessories and Auxiliaries for C120NA-DC devices

Connection accessories

See module CA907012

6	50 mm ² Al terminal	27060
7	Terminal for rear connector	18528
8	Screw-on connection for ring terminal	8 parts 27053
9	Multi-cable terminal	4 parts 19091
		3 parts 19096

Mounting accessories

See module CA907012

10	Sealable terminal shields for top and bottom connection	1P (set of 2)	18526
11	Interpole barrier	(set of 10)	27001
12	Screw shields	4P (set of 2)	18527
13	Clip-on terminal markers	See module	CA907012
14	9 mm spacer		A9N27062
15	Padlocking device		27145
16	Rotary handle		
		Removable extended handle	27047
		Fixed handle	27048
		Operating sub-assembly ⁽¹⁾	27046

(1) A complete rotary handle consists of a circuit-breaker operating sub-assembly, cat. no. 27046, a handle cat. no. 27047 or a handle cat. no. 27048.

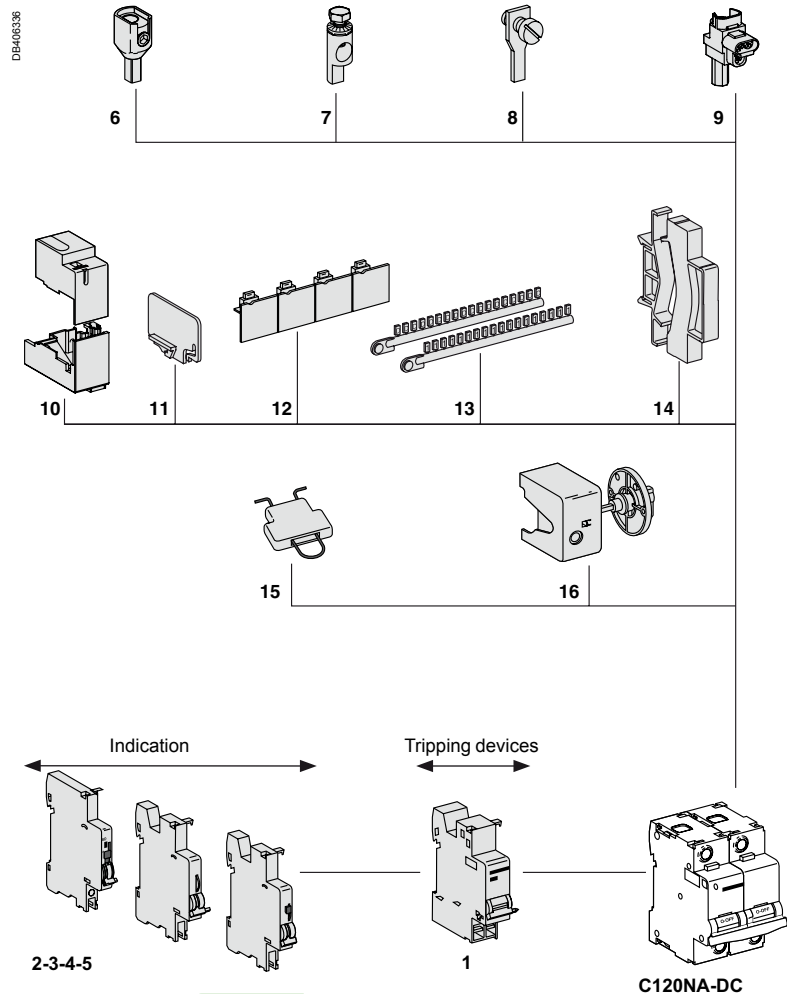

Electrical auxiliaries

See module CA907008

Indication		
2	SD fault indicating contact	A9N26927
3	OF+SD24 auxiliary contact	A9N26899
4	OF open/close auxiliary contact	A9N26924
5	OF+SD/OF auxiliary contact (OF+SD or OF+OF combination switch)	A9N26929

Tripping		
1	MN, MNx, MN [□] undervoltage release or MX, MX + OF shunt release	See module CA907008



Tripping devices must be installed first. If two tripping devices are used: the MN must be installed first. Indication auxiliaries: respect specified position for SD functions.

Assembly rule

The mounting order and the number for the various auxiliaries must be complied with.

The tripping auxiliaries (MN, MX...) should be mounted first **1** as close as possible to the main device.

Then at the left, the indicating auxiliaries (OF, SD) should be mounted **2** then **3** complying with the following association table.

Indicating auxiliaries 3		Indicating auxiliaries + 2		Indicating auxiliaries + 1		Device
1 (OF+SD/OF or OF+SD24)	1 OF+SD/OF	1 (MN, MNx, MN [□] or MX, MX+OF)	C120NA-DC			
1 OF	1 (OF+SD/OF or SD or OF)	2 (MN, MNx, MN [□] or MX, MX+OF)				
-	1 OF+SD24	2 (MN, MNx, MN [□] or MX, MX+OF)				

Protection Circuit protection Accessories and Auxiliaries for C60 devices

Connection accessories

See module CA907012

6	Insulated connector	See module	LIN001
7	Comb busbar	See module	LIN001
8	50 mm ² Al terminal		27060
9	Ring tongue terminal screw connection		27053
10	Ring tongue terminal connections kit Ø 5 mm, (upstream/downstream)		17400
11	Insulated distribution terminal	4 parts 3 parts	19091 19096

DB406488

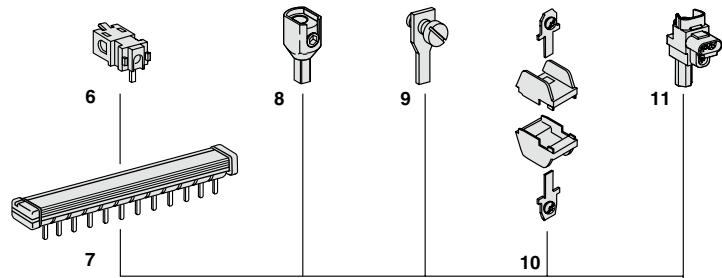

Mounting accessories

See module CA907012

12	Sealable terminal shield	See module	CA907012
13	Inter-pole barrier		27001
14	Rotary handle		
	Switching sub-assembly		27046
	Disconnectable handle		27047
	Fixed handle		27048
15	Screw shield	See module	26981
16	Padlocking accessory (to be locked in the "open" position)		26970
17	Spacer		A9N27062
18	Plug-in base		26996
19	Marker strip	See module	CA907012

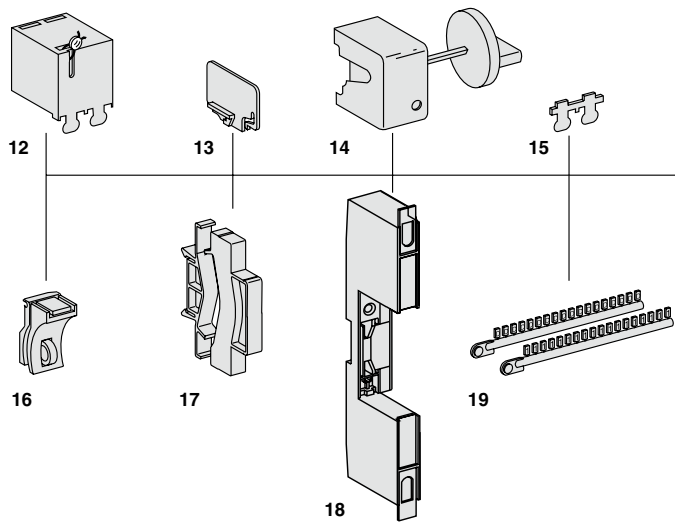

(1) A complete rotary handle consists of a circuit-breaker operating sub-assembly, cat. no. 27046, a handle cat. no. 27047 or a handle cat. no. 27048.

Electrical auxiliaries

See module CA907008

Indication		
2	SD fault indicating contact	A9N26927
3	OF+SD24 auxiliary contact	A9N26899
4	OF open/close auxiliary contact	A9N26924
5	OF+SD/OF auxiliary contact (OF+SD or OF+OF combination switch)	A9N26929

Tripping		
1	MN, MNx, MN [⊗] undervoltage release, MSU overvoltage release or MX, MX + OF shunt release	See module CA907008

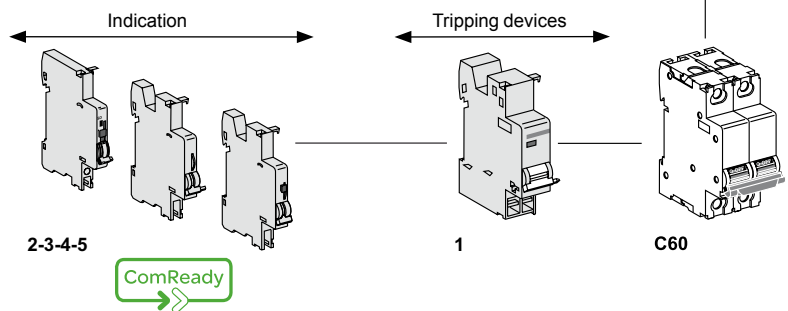

! Tripping devices must be installed first.
If two tripping devices are used: the MN must be installed first
Indication auxiliaries: respect specified position for SD functions.

Assembly rule

The mounting order and the number for the various auxiliaries must be complied with.

The tripping auxiliaries (MN, MX...) should be mounted first **1** as close as possible to the main device.

Then at the left, the indicating auxiliaries (OF, SD) should be mounted **2** then **3** complying with the following association table.

Indicating auxiliaries 3		Indicating auxiliaries 2		Indicating auxiliaries 1		Device
1 (OF+SD/OF or OF+SD24)	1 OF+SD/OF	1 (MN, MNx, MN [⊗] or MX, MX+OF or MSU)				C60
1 OF	1 (OF+SD/OF or SD or OF)	2 (MN, MNx, MN [⊗] or MX, MX+OF or MSU)				
-	1 OF+SD24	2 (MN, MNx, MN [⊗] or MX, MX+OF or MSU)				
-	-	3 MSU				

Protection

Earth leakage protection

Accessories and Auxiliaries for ID devices

Connection accessories

See module CA907012

7	Insulated connector	See module	LIN001
8	Comb busbar	See module	LIN001
9	50 mm ² Al terminal		27060
10	Ring tongue terminal screw connection		27053
11	Ring tongue terminal connections kit Ø 5 mm, (upstream/downstream)		17400
12	Insulated distribution terminal	4 parts	19091
		3 parts	19096

Mounting accessories

See module CA907012

13	Sealable terminal shield	See module	CA907012
14	Inter-pole barrier		27001
15	Screw shield		26981
16	Padlocking accessory (to be locked in the "open" position)		26970
17	Spacer		A9N27062
18	Plug-in base		26996
19	Marker strip	See module	CA907012

Electrical auxiliaries

See module CA907008

Indication		
1	OF.S auxiliary contact	A9N26923
3	SD fault indicating contact	A9N26927
4	OF+SD24 auxiliary contact	A9N26899
5	OF open/close auxiliary contact	A9N26924
6	OF+SD/OF auxiliary contact (OF+SD or OF+OF combination switch)	A9N26929

Tripping		
2	MN, MNx, MN [⊗] undervoltage release, MSU overvoltage release or MX, MX + OF shunt release	See module CA907008

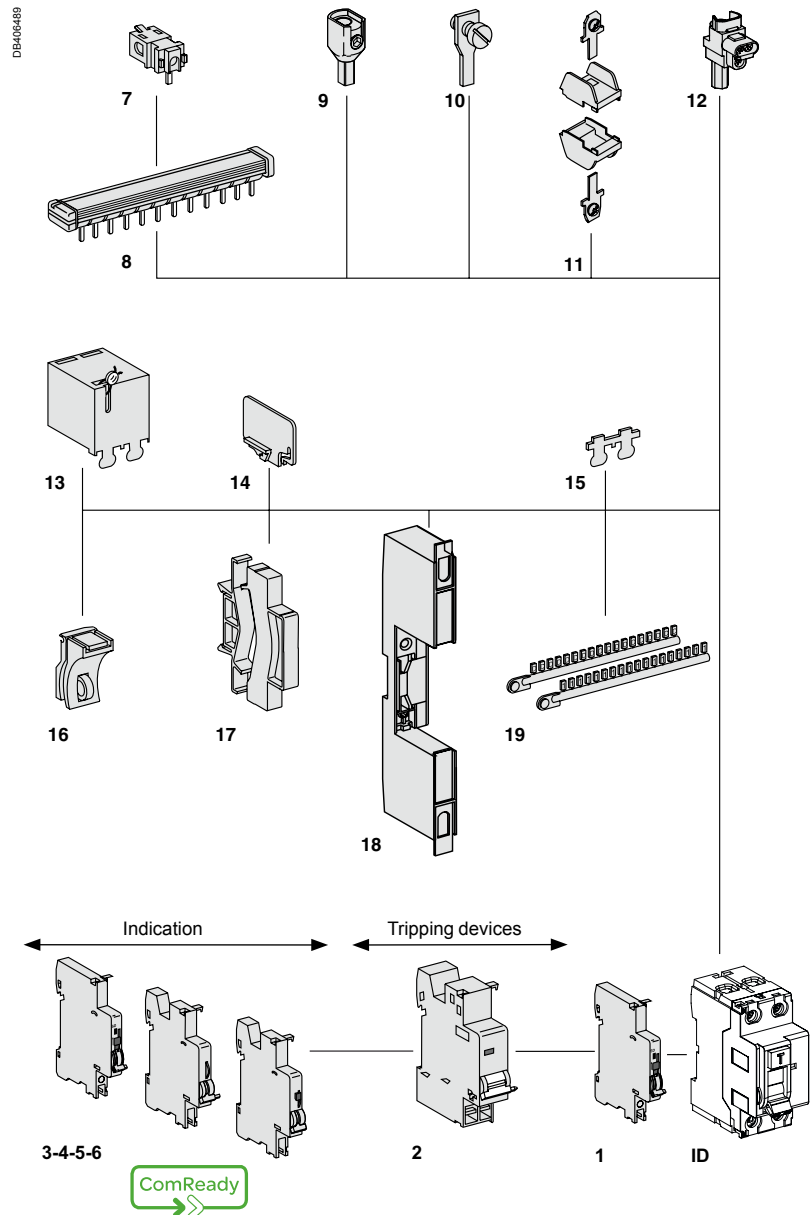

⚠ Tripping devices must be installed first.
If two tripping devices are used: the MN must be installed first
Indication auxiliaries: respect specified position for SD functions.

Assembly rule

The mounting order and the number for the various auxiliaries must be complied with.

The tripping auxiliaries MN, MX...) should be mounted first **1** as close as possible to the main device.

Then at the left, the indicating auxiliaries (OF, SD) should be mounted **2** then **3** complying with the following association table.

Indicating auxiliaries 3		Indicating auxiliaries 2		Indicating auxiliaries 1		Device
-		1 (OF+SD/OF or OF or OF+SD24)		2 (MN, MNx, MN [⊗] or MX, MX+OF or MSU)		
1 OF		1 OF		1 (MN, MNx, MN [⊗] or MX, MX+OF or MSU)		

Protection

Circuit protection / Earth leakage protection

Accessories and Auxiliaries for DPN, DPN Vigi devices

Connection accessories

See module CA907012

6	Screw-on connection for ring terminal	8 parts	27053
7	Comb busbar	See module	LIN001

Mounting accessories

See module CA907012

8	Padlocking device	26970
9	Clip-on terminal markers	See module CA907012
10	9 mm spacer	A9N27062
11	Rotary handle for DPN, DPN Vigi 3P, 4P	
	Removable extended handle	27047
	Fixed handle	27048
	Operating sub-assembly ⁽¹⁾	27046

(1) A complete rotary handle consists of a circuit-breaker operating sub-assembly, cat. no. 27046, a handle cat. no. 27047 or a handle cat. no. 27048.

Electrical auxiliaries

See module CA907008

Indication		
2	SD fault indicating contact	A9N26927
3	OF+SD24 auxiliary contact	A9N26899
4	OF open/close auxiliary contact	A9N26924
5	OF+SD/OF auxiliary contact (OF+SD or OF+OF combination switch)	A9N26929

Tripping		
1	MN, MNx, MN \square undervoltage release, MSU overvoltage release or MX, MX + OF shunt release	See module CA907008

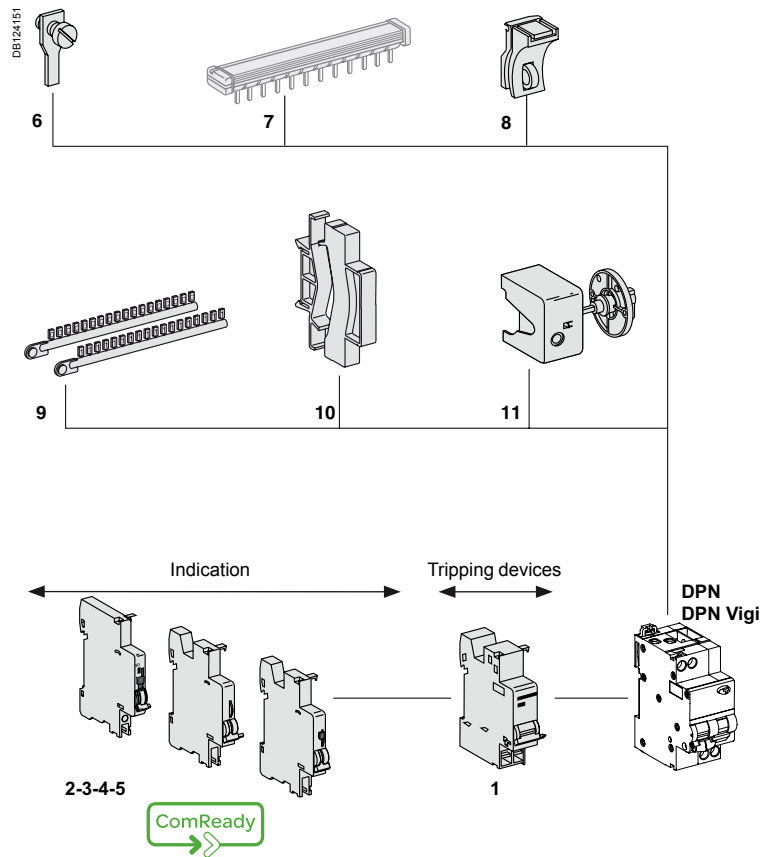

! Tripping devices must be installed first.
If two tripping devices are used: the MN must be installed first
Indication auxiliaries: respect specified position for SD functions.

Assembly rule

The mounting order and the number for the various auxiliaries must be complied with.

The tripping auxiliaries MN, MX, MSU...) should be mounted first **1** as close as possible to the main device.

Then at the left, the indicating auxiliaries (OF, SD) should be mounted **2** then **3** complying with the following association table.

Indicating auxiliaries 3		Indicating auxiliaries + 2		Indicating auxiliaries + 1		Device
1 (OF+SD/OF or OF+SD24)		1 OF+SD/OF		1 (MN, MNx, MN \square or MX, MX+OF or MSU)		
1 OF		1 (OF+SD/OF or SD or OF)		2 (MN, MNx, MN \square or MX, MX+OF or MSU)		
-		1 OF+SD24		2 (MN, MNx, MN \square or MX, MX+OF or MSU)		
-		-		3 MSU		

Protection

Circuit protection / Earth leakage protection

Accessories and Auxiliaries for C60H-DC devices

Connection accessories

See module CA907012

7	Insulated connector	See module LIN001
8	Comb busbar	See module LIN001
9	50 mm ² Al terminal	27060
10	Ring tongue terminal screw connection	27053
11	Ring tongue terminal connections kit Ø 5 mm, (upstream/downstream)	17400
12	Insulated distribution terminal	4 parts 19091 3 parts 19096

DB12415

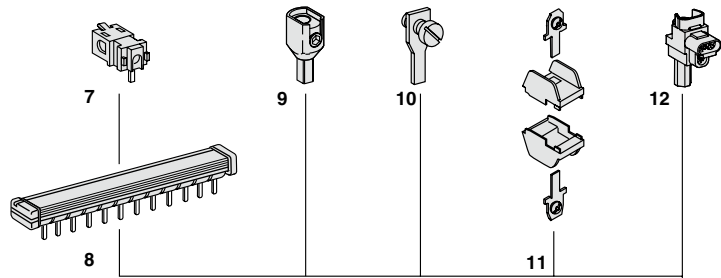

Mounting accessories

See module CA907012

13	Sealable terminal shield	See module CA907012
14	Inter-pole barrier	27001
15	Rotary handle	
	Switching sub-assembly	27046
	Disconnectable handle	27047
	Fixed handle	27048
16	Screw shield	See module CA907012
17	Padlocking accessory (to be locked in the "open" position)	26970
18	Spacer	A9N27062
19	Plug-in base	26996
20	Marker strip	See module CA907012

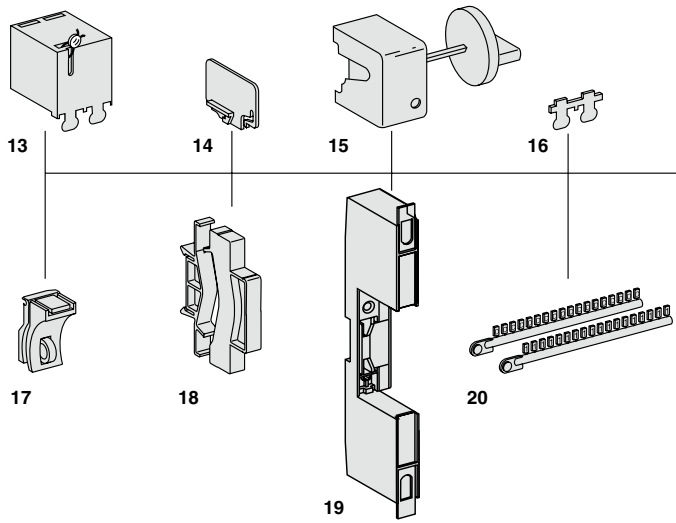

(1) A complete rotary handle consists of a circuit-breaker operating sub-assembly, cat. no. 27046, a handle cat. no. 27047 or a handle cat. no. 27048.

Electrical auxiliaries

See module CA907008

Indication		
3	SD fault indicating switch	A9N26927
4	OF+SD24 auxiliary contact	A9N26899
5	OF open/closed contact	A9N26924
6	OF+SD/OF auxiliary contact (OF+SD or OF+OF combination switch)	A9N26929

Tripping		
1	MN, MNx, MN \square undervoltage release	See module CA907008
2	MX, MX + OF shunt release	See module CA907008

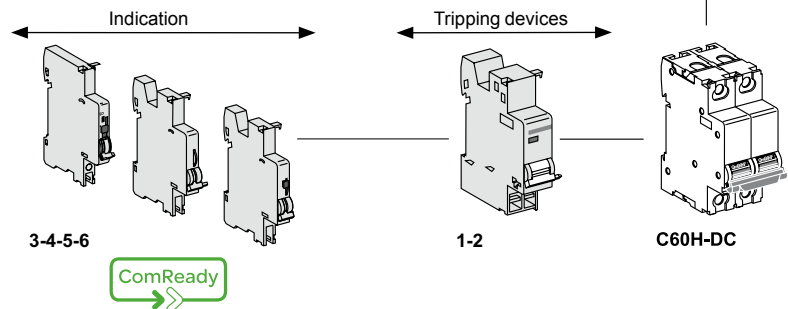

Tripping devices must be installed first.
If two tripping devices are used: the MN must be installed first
Indication auxiliaries: respect specified position for SD functions.

Assembly rule

The mounting order and the number for the various auxiliaries must be complied with.

The tripping auxiliaries MN, MX...) should be mounted first **1** as close as possible to the main device.

Then at the left, the indicating auxiliaries (OF, SD) should be mounted **2** then **3** complying with the following association table.

Indicating auxiliaries 3		Indicating auxiliaries 2		Indicating auxiliaries 1		Device
1 (OF+SD/OF or OF+SD24)		1 OF+SD/OF		1 (MN, MNx, MN \square or MX, MX+OF)		
1 OF		1 (OF+SD/OF or SD or OF)		2 (MN, MNx, MN \square or MX, MX+OF)		
-		1 OF+SD24		2 (MN, MNx, MN \square or MX, MX+OF)		

Accessories and Auxiliaries for iSW devices

Connection accessories

See module CA907012

1	Insulated connector	See module LIN001
2	Comb busbar	See module LIN001
3	50 mm ² Al terminal	27060
4	Ring tongue terminal screw connection	27053
5	Ring tongue terminal connections kit Ø 5 mm, (upstream/downstream)	17400
6	Insulated distribution terminal	4 parts 19091 3 parts 19096

iSW 40...125 A

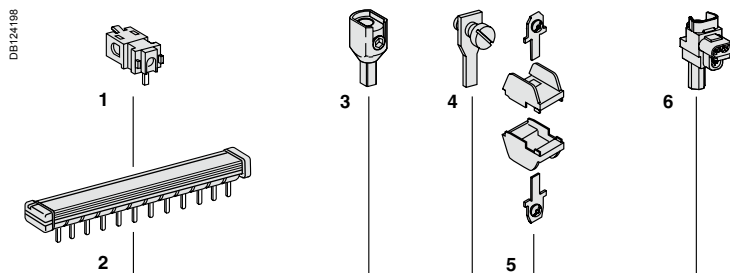

Mounting accessories

See module CA907012

7	Sealable terminal shield	See module CA907012
8	Inter-pole barrier	27001
9	Rotary handle	
	Switching sub-assembly	27046
	Disconnectable handle	27047
	Fixed handle	27048
10	Screw shield	See module CA907012
11	Padlocking accessory (to be locked in the "open" position)	26970
12	Spacer	A9N27062
13	Plug-in base	26996

(1) A complete rotary handle consists of a circuit-breaker operating sub-assembly, cat. no. 27046, a handle cat. no. 27047 or a handle cat. no. 27048.

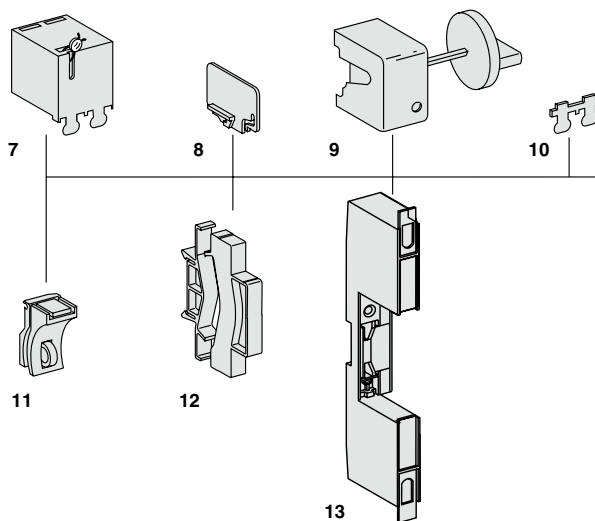

Electrical auxiliary

See module iSW CA904005

Indication

14	OF iSW open/closed contact	A9A15096
----	----------------------------	----------

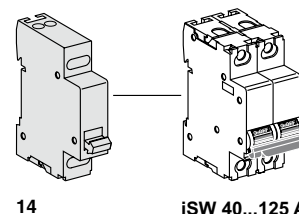

iSW 20...32 A

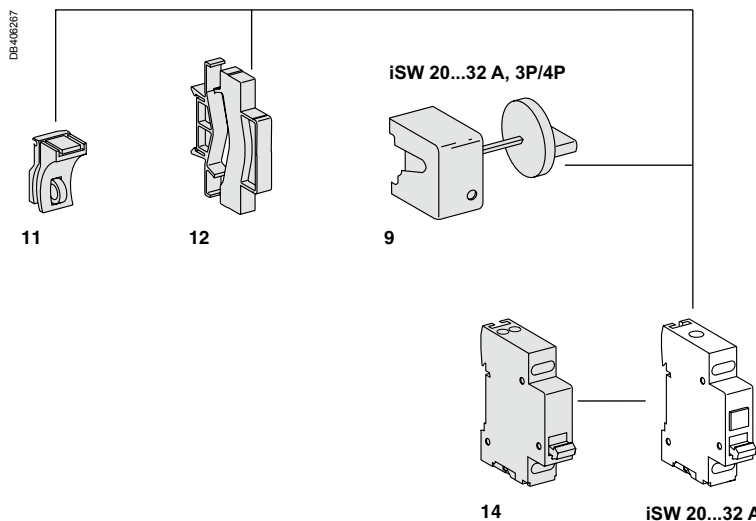

Protection Circuit protection

Accessories and Auxiliaries for SW60-DC, C60NA-DC, C60PV-DC devices

Connection accessories

See module CA907012

7	50 mm ² Al terminal	27060
8	Ring tongue terminal screw connection	27053
9	Insulated distribution terminal	19091
	3 parts	19096

Mounting accessories

See module CA907012

10	Inter-pole barrier	27001
11	Screw shield	26981
12	Padlocking accessory (to be locked in the "open" position)	26970
13	Spacer	A9N27062
14	Marker strip	See module CA907012

Electrical auxiliaries

See module CA907008

Indication		
3	SD fault indicating switch	A9N26927
4	OF+SD24 auxiliary contact	A9N26899
5	OF open/closed contact	A9N26924
6	OF+SD/OF auxiliary contact (OF+SD or OF+OF combination switch)	A9N26929

Tripping		
1	MN, MNx, MN \square undervoltage release	See module CA907008
2	MX, MX + OF shunt release	See module CA907008

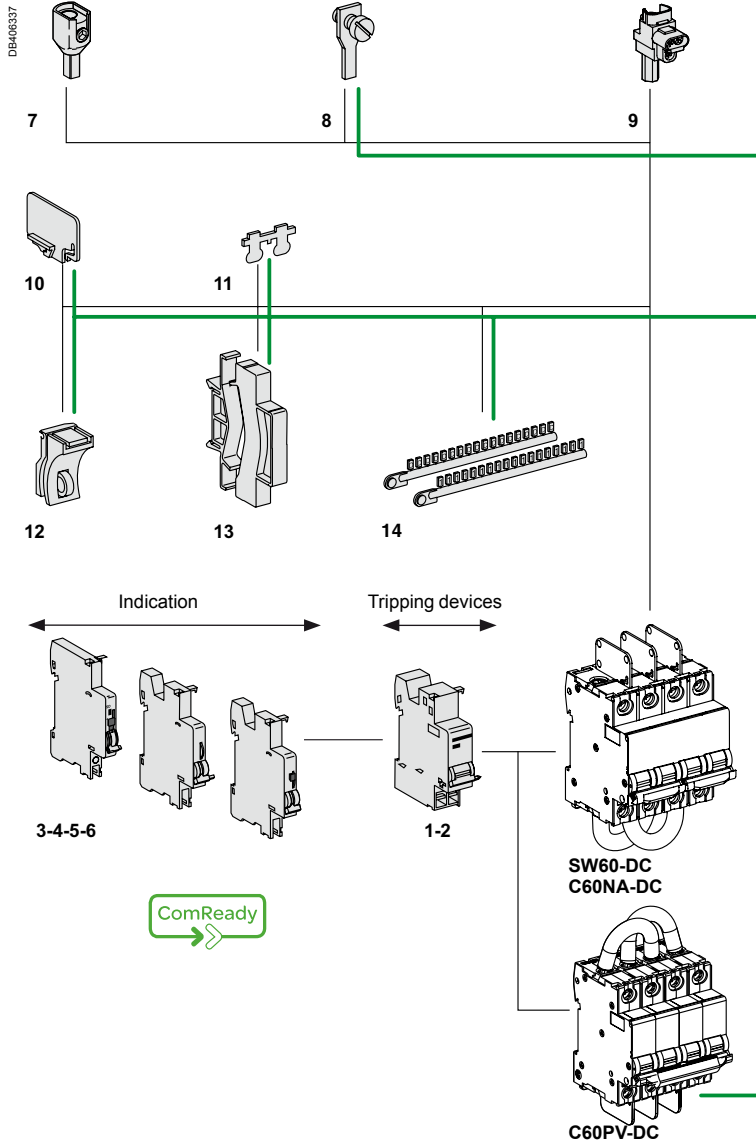

Tripping devices must be installed first.
If two tripping devices are used: the MN must be installed first
Indication auxiliaries: respect specified position for SD functions.

Assembly rule

The mounting order and the number for the various auxiliaries must be complied with.

The tripping auxiliaries MN, MX...) should be mounted first **1** as close as possible to the main device.

Then at the left, the indicating auxiliaries (OF, SD) should be mounted **2** then **3** complying with the following association table.

Indicating auxiliaries 3		Indicating auxiliaries 2		Indicating auxiliaries 1		Device
1 (OF+SD/OF or OF+SD24)	1 OF+SD/OF	1 (MN, MNx, MN \square or MX, MX+OF)				
1 OF	1 (OF+SD/OF or SD or OF)	2 (MN, MNx, MN \square or MX, MX+OF)				
-	1 OF+SD24	2 (MN, MNx, MN \square or MX, MX+OF)				

Protection

Circuit protection / Earth leakage protection

Accessories and auxiliaries for NG125 devices

Connection

6	Comb busbar	see cat. no.	CA907026, CA907027
7	Splitter blocks	Linergy DX 125 A	see cat. no. LIN003
8	70 mm ² Al terminal		19095
9	Multi-cable terminal	4 parts	19091
		3 parts	19096
10	Screw-on connection for ring	125 A (pack of 4)	19093
11	Small ring terminal	(pack of 4)	19094

Mounting accessories

12	Sealable terminal shield (upstream/downstream)	1P	19080
		2P	19081
		3P	19082
		4P	19083
13	Residual current device terminal shield (upstream of circuit breaker / downstream of Vigi device)	63 A 2P	19074
		3P	19075
		3P adjustable	19077
		4P	19076
		4P adjustable	19078
14	Circuit breaker screw shield	125 A 3P	19077
		4P	19078
		1P (pack of 10)	19084
		2P	19085
15	Rotary handle	3P	19086
		4P	19087
		Extended standard Black	19088
		Extended safety Red handle, yellow	19089
16	Padlocking device	Direct standard Black	19092
		Direct safety Red handle, yellow background	19097
17	White toggle	(pack of 10)	19099

Electrical auxiliaries

Indication		
3	Fault indicating auxiliary contact OF+SD	19072
	Open/closed auxiliary contact OF+OF	19071

Tripping devices		
2	Undervoltage release MN or undervoltage release with external power supply MNx	see cat. no. CM907005
	Shunt release MX+OF	see cat. no. CM907005



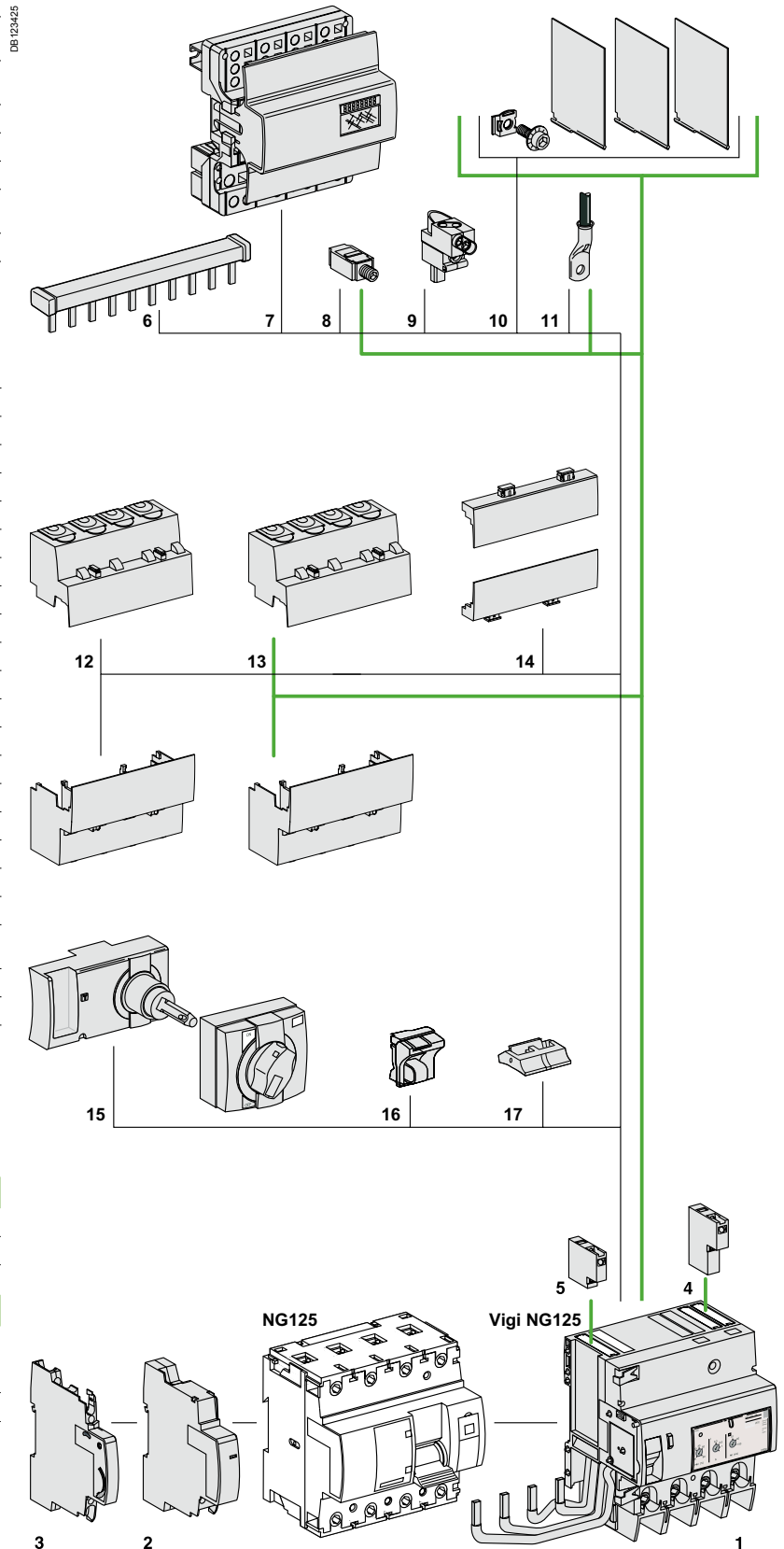

Vigi NG125

1	Vigi NG125 add-on residual current device	see cat. no. CM902008
4	MXV	see cat. no. CM907005
5	SDV	see cat. no. CM907005



Circuit protection / Earth leakage protection

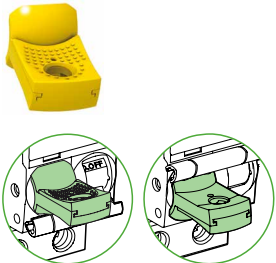





Accessories for iC60, iID, iC40, iC40 XA, iCV40, iCV40 XA, iID40, iDPN Vigi, iSW-NA, Reflex iC60, RCA, ARA, iSW

Mounting						
Accessories	Rotary handle			Plug-in base	Padlocking device	
	 <small>PE104608-35</small>			 <small>PE104608-35</small>	 <small>PE104402-15</small> <small>DB123599</small>	
	 <small>PE106207-10</small>					
Function	<p>Front or side-mounted control</p> <ul style="list-style-type: none"> ■ Degree of protection: IP55 rotary handle ■ Installation: <ul style="list-style-type: none"> □ the control mechanism is mounted on the device □ the rotary handle is fixed to the front or side of the enclosure ■ Front-mounted (on door or faceplate) ■ Prevents the door from opening when the device is in the ON position (can be deactivated) ■ Can be padlocked when the device is in the "open" position (can be padlocked with the device in the "closed" position subject to adaptation) ■ Can be locked by padlock of (dia. 5 to 8 mm), not supplied with the device ■ Pushbutton: iID test available in the front face of the rotary handle 			<ul style="list-style-type: none"> ■ The Laser Square tool brings the accuracy to align the breaker and the rotary handle 	<p>Allows a breaker to be removed or replaced quickly, without handling the connections</p> <ul style="list-style-type: none"> ■ Degree of protection: IP20 ■ Consists of: <ul style="list-style-type: none"> □ a base to be fastened on a rail (or panel) □ 2 "blades" to be fastened in the device's terminals ■ Connection: tunnel terminals for cable up to 35 mm² rigid, 25 mm² flexible, ■ Installation: <ul style="list-style-type: none"> □ in universal enclosure □ on horizontal rail ■ Height: 178 mm ■ Not compatible with Vigi iC60 and auxiliaries ■ Can be locked by padlock of (dia. 6 mm), not supplied with the device 	<p>Used to padlock a breaker in open or closed position</p> <ul style="list-style-type: none"> ■ Padlock diameter: 3 to 6 mm ■ Sealable (max. diameter: 1.2 mm) ■ Locking in ON position does not prevent tripping of the breaker in the event of faults ■ Suitable for IEC/EN 60947-2 compliant disconnection
Catalogue numbers	A9A27005	A9A27006	A9A27008	GVAPL01	A9A27003 (1 per pole)	A9A26970
	Operating sub-assembly					
	+	+				
	Black handle	Red handle	No handle			
Set of	1	1	1	1	1	10
Suitability						
iC60	■ 2P, 3P, 4P					■
iSW	■ 2P, 3P, 4P					■
iC60 + Vigi iC60	■ 2P, 3P, 4P					■
iID	■				■ ≤ 63 A	■
iC40, iC40 XA	-					■
iCV40, iCV40 XA	-					■
iDPN Vigi	-					■
iID40	-					■
Reflex iC60 or RCA+iC60 or ARA+iC60	-					■
ARA+iID	-					■
iSW-NA	■				■ ≤ 63 A	■

Protection

Circuit protection / Earth leakage protection

Accessories for iC60, iID, iC40, iC40 XA, iCV40, iCV40 XA, iID40, iDPN Vigi, iSW-NA, Reflex iC60, RCA, ARA, iSW (cont.)

			Spare part				
			Wall mounting	Locking clips	Flap		
Side					2P	4P	
A9A26380-40	A9A26381-40	PE104492-15		A9A27052-25		A9A27056-15	A9A27057-15
							
Can be used to padlock a breaker in open position <ul style="list-style-type: none"> Attached directly to the circuit breaker, it cannot be lost Padlock diameter: 6 mm 		Can be used for wall mounted installation of any 18 mm DIN rail devices <ul style="list-style-type: none"> Degree of protection: IP40 Sealable: (max. diameter: 1.5 mm) 		Top and bottom locking clips for monoconnect product		Indication flap of connection direction	
A9A26380	A9A26381	15359		A9A27052	A9A27056	A9A27057	
Left-hand mounting	Right-hand mounting						
1	1	1		10	1	1	
■	■	<ul style="list-style-type: none"> All products up to 18 mm Except iCT 		■	-	-	-
-	-			-	-	-	-
-	-			-	-	-	-
■	-			-	-	-	-
■	■ (1)			■	-	-	-
■	-			■	-	-	-
-	-			-	-	-	-
■	-			■	■	■	■
-	-			-	-	-	-
-	-			-	-	-	-
-	-			-	-	-	-

(1) iC40 XA compatible only with bottom screw connections.

Protection

Circuit protection / Earth leakage protection

Accessories for iC60, iID, iC40, iC40 XA, iCV40, iCV40 XA, iID40, iDPN Vigi, iSW-NA, Reflex iC60, RCA, ARA, iSW (cont.)

Security						
Accessories	Screw shield		Terminal shield		Inter-pole barrier	Spacer
 PB104489-14	 PB104489-14	 PB104502-35	 PB104503-35	 PB104494-30	 PB104493-35	
Function						
	Prevents any contact with the connecting screws <ul style="list-style-type: none"> Upgrades degree of protection to IP20D Sealable, max. diameter 1.2 mm 		Prevents any contact with the terminals <ul style="list-style-type: none"> Upgrades degree of protection to IP20D Sealable, max. diameter 1.2 mm Set of two, for power supply and output terminals For 3 poles: A9A26975 + A9A26976 For 4 poles: 2 X A9A26976 		Enhances insulation between connections: cables, terminals, lugs, etc	<ul style="list-style-type: none"> Used to: <ul style="list-style-type: none"> complete rows separate devices. Width: 1 x 9 mm module Allows cable routing from one row to another, (above and below), up to 6 mm²
Catalogue numbers	A9A26982	A9A26981	A9A26975	A9A26976	A9A27001	A9A27062
Set of	12 x 1 pole	20 x 4 poles (splittable)	2 x 1 pole	2 x 2 poles	10	5
Suitability						
iC60	-	■	■	■	■	■
iSW	-	-	■	■	■	■
Vigi iC60	■	-	-	-	-	■
Vigi iC40, Vigi iCG40	-	-	-	-	-	■
iID	-	■	-	■	■	■
iC40, iC40 XA	-	-	-	-	-	■
iCV40, iCV40 XA	-	-	-	-	-	■
iDPN Vigi	-	-	-	-	-	■
iID40	-	■ (2)	-	■ (2)	■ only on power supply terminals (bottom)	■
Reflex iC60 or RCA+iC60 or ARA+iC60	-	■	■	■	■	■
ARA+iID	-	■	-	■	■	■
iSW-NA	-	■	-	■	■	■

(2) compatible only with power supply terminals (bottom), having removed the indication flap of connection direction.

Circuit protection / Earth leakage protection

Accessories for iC60, iID, iC40, iC40 XA, iCV40, iCV40 XA, iID40, iDPN Vigi, iSW-NA, Reflex iC60, RCA, ARA, iSW (cont.)

		Connection			
Accessories		Multi-cable terminal		50 mm ² Al terminal	Screw-on connection for ring terminal
Function		For 3 copper cables: ■ Rigid up to 16 mm ² ■ Flexible up to 10 mm ²		For aluminium cables from 16 to 50 mm ²	For lug tipped cables, front or rear mounting
Catalogue numbers	19091	19096		27060	27053
Set of	4	3		1	8
Suitability					
iC60 ≤ 25 A Reflex iC60 ≤ 25 A	–	–		–	■
iC60 >25 A Reflex iC60 40 A, iSW	■	■		■	■
Vigi iC60	–	–		–	–
iID	■	■		■	■
iC40, iC40 XA	–	–		–	■ (3)
iCV40, iCV40 XA	–	–		–	■ (4)
iDPN Vigi	–	–		–	■
iID40	■ only on power supply terminals (bottom)	■ only on power supply terminals (bottom)		■ only on power supply terminals (bottom)	■
iSW-NA	■	■		■	■
Tightening torque	2 N.m			10 N.m	2 N.m
Length stripping	11 mm			13 mm	–
Tools to use	Dia. 5 mm or PZ2			Hc 1/5" or 5 mm	Dia. 5mm

(3) only with screw connections.

(4) only with screw connections on MCB side and on Vigi side for iCV40 1P+N.

Marking

Accessories		Clip-on terminal markers					
Used for connection identification							
Catalogue numbers	0 : AB1-R0 1 : AB1-R1 2 : AB1-R2 3 : AB1-R3 4 : AB1-R4	5 : AB1-R5 6 : AB1-R6 7 : AB1-R7 8 : AB1-R8 9 : AB1-R9	A : AB1-GA B : AB1-GB C : AB1-GC D : AB1-GD E : AB1-GE F : AB1-GF G : AB1-GG H : AB1-GH I : AB1-GI	J : AB1-GJ K : AB1-GK L : AB1-GL M : AB1-GM N : AB1-GN O : AB1-GO P : AB1-GP Q : AB1-GQ R : AB1-GR	S : AB1-GS T : AB1-GT U : AB1-GU V : AB1-GV W : AB1-GW X : AB1-GX Y : AB1-GY Z : AB1-GZ	+ : AB1-R12 - : AB1-R13 Blank: AB1-RV	
Set of	250						

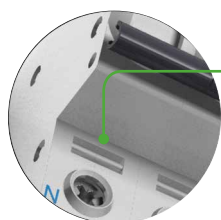

■ 4 markers max. per zone

Protection

Circuit protection / Earth leakage protection

Accessories for iC60, iID, iC40, iC40 XA, iCV40, iCV40 XA, iID40, iDPN Vigi, iSW-NA, Reflex iC60, RCA, ARA, iSW (cont.)

Dimensions (mm)

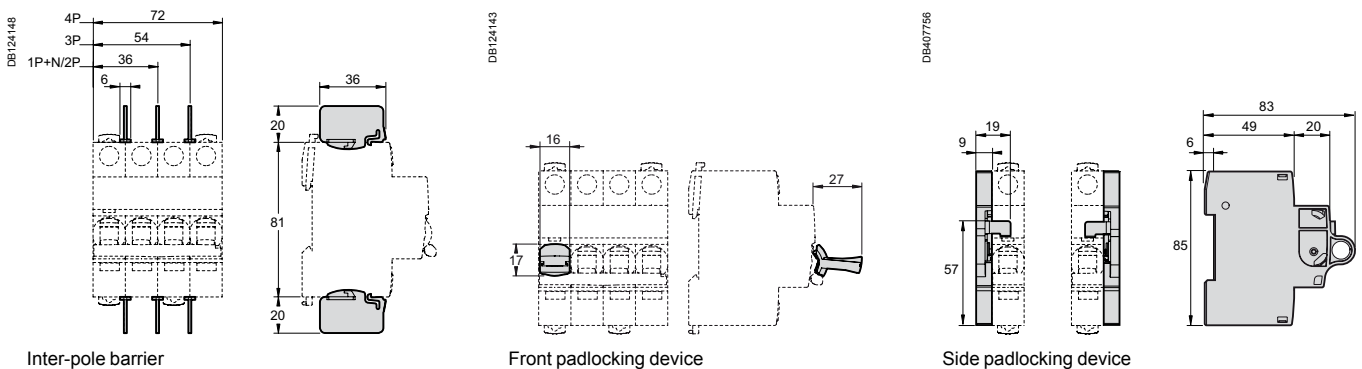
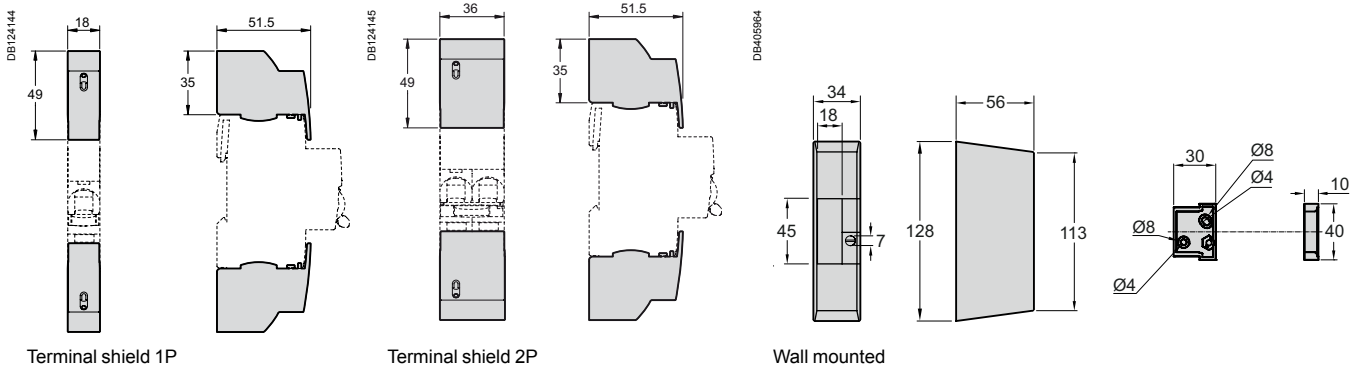
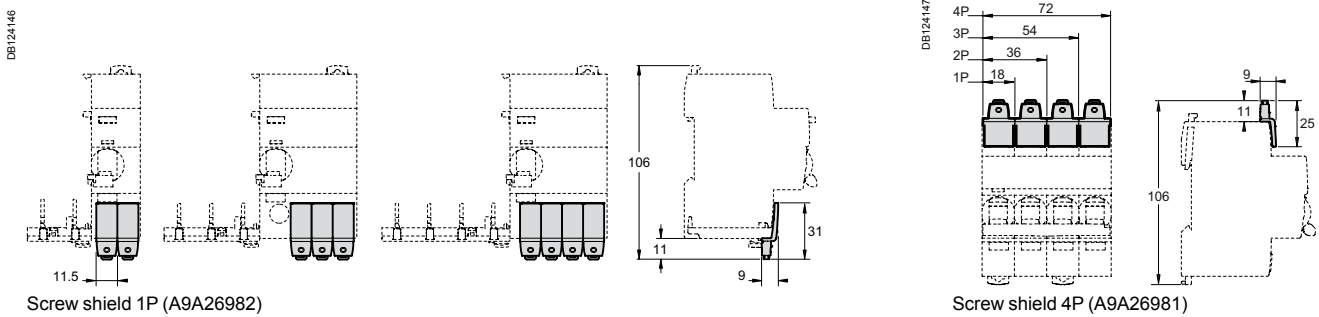
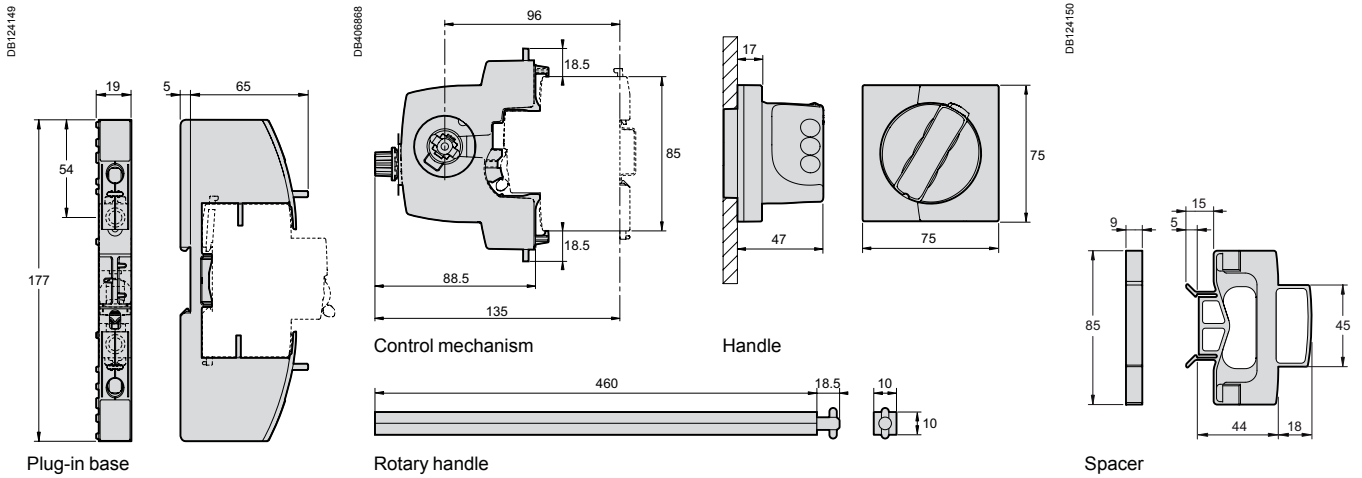

Protection

Circuit protection / Earth leakage protection

Accessories for iC60, iID, iC40, iC40 XA, iCV40, iCV40 XA, iID40, iDPN Vigi, iSW-NA, Reflex iC60, RCA, ARA, iSW (cont.)

Rotary handle installation

Dimensions (mm)

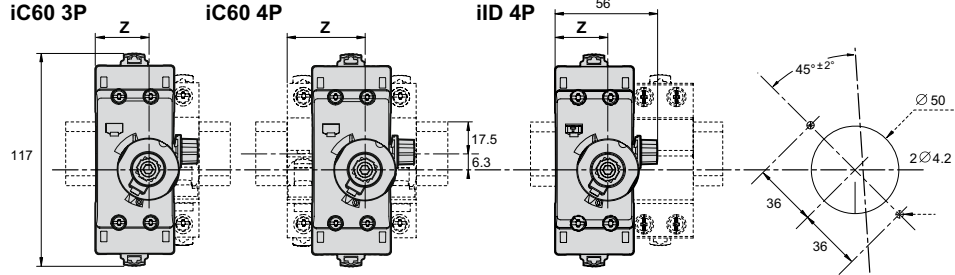
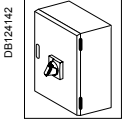

iC60	Z (mm)
2P	25.3
2P + Vigi	25.3
3P	25.3
3P + Vigi	43
4P	43
4P + Vigi	43

iID	Z (mm)
2P	25.3
4P	25.3

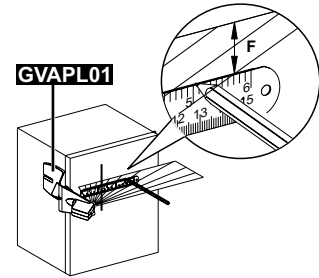
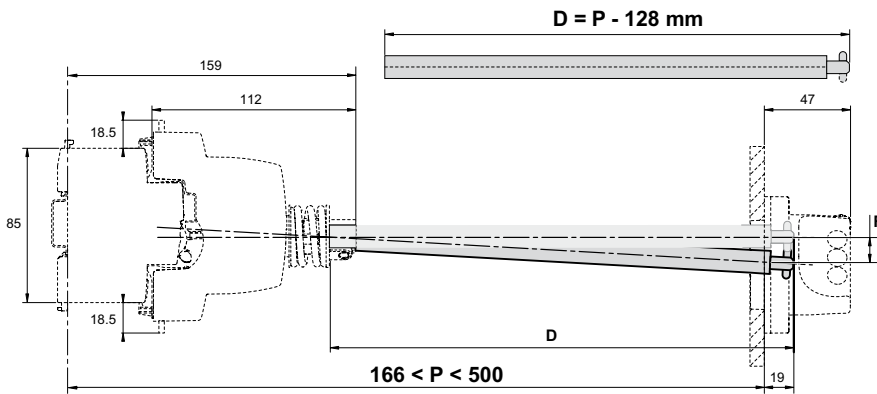

P (mm)	F (mm)
300	5
500	11

Rotary handle: front mounted control

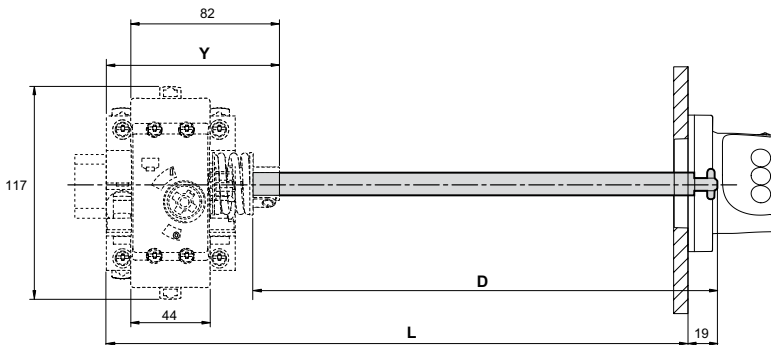
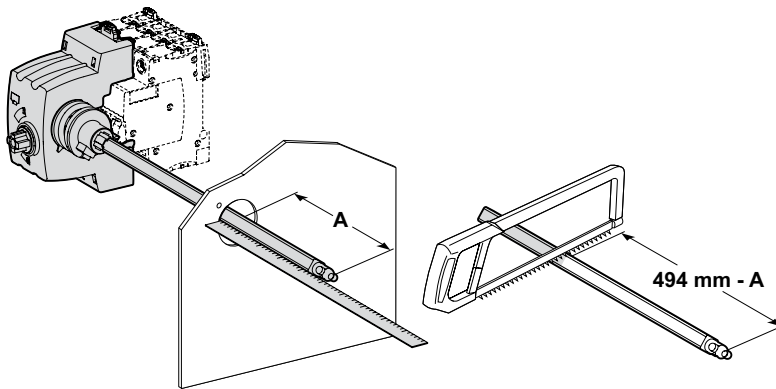
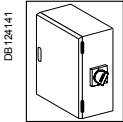

iC60	X (mm)	Y (mm)
2P	44.5	76.8
2P + Vigi	44.5	76.8
3P	44.5	76.8
3P + Vigi	62	94.5
4P	62	94.5
4P + Vigi	62	94.5

iID/iSW-NA	X (mm)	Y (mm)
2P	44.5	76.8
4P	44.5	76.8







Rotary handle: side mounted control

Protection

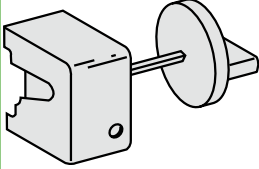
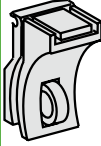
Circuit protection

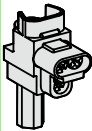
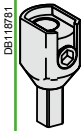
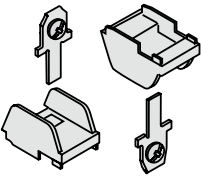
Accessories for DT60

		Installation		
Accessories	Rotary handle	Padlocking device		
				
Function				
	Front or side control of circuit breakers <ul style="list-style-type: none"> Degree of protection: IP40, IK10 A complete rotary handle consists of: <ul style="list-style-type: none"> a circuit-breaker operating sub-assembly, cat. no. 27046, a handle cat. no. 27047 or a handle cat. no. 27048 Installation: <ul style="list-style-type: none"> the circuit-breaker operating sub-assembly cat. no. 27046 is fixed to the circuit breaker the removable handle cat. no. 27047 is mounted on the removable front panel or on the enclosure door the fixed handle cat. no. 27048 is fixed to the front or side panel of the enclosure 			Used to padlock a circuit breaker in the "open" or "closed" position <ul style="list-style-type: none"> Diameter of the padlock: 8 mm max. Locking in the ON position does not prevent the circuit breaker from tripping in the event of a fault Isolation: in conformity with IEC/EN 60947-2
Cat. numbers	27046	27047	27048	26970
Set of	1	1	1	2
Number of pôle	-	-	-	-
DT60	■	■	■	■

		Connection		
Accessories	Multi-cable terminal	50 mm ² Al terminal	Connection kit for ring terminals	
				
Function				
	For 3 copper cables: <ul style="list-style-type: none"> Rigid up to 16 mm² Flexible up to 10 mm² 	For 16 to 50 mm² aluminium cables	For terminal up to 63 A, front or rear access (screw Ø 5 mm) <ul style="list-style-type: none"> It incorporates a "conductive" part and an "insulating" part which ensures the phase-to-phase clearance 	
				
Cat. numbers	19091	19096	27060	17400
Set of	4	3	1	2
DT60	■	■	■	■
Tightening torque	2 N.m	10 N.m	2 N.m	2 N.m
Stripping length	11 mm	13 mm	-	-
Tools to be used	Diameter 5 mm or PZ2	Hc 1/5" or 5 mm	Diameter 5 mm	Diameter 5 mm

Protection

Circuit protection

Accessories for DT60 (cont.)

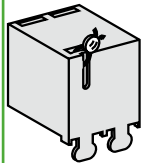
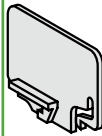
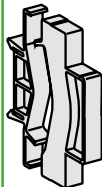

Safety

	Screw shield	Terminal shield	Interpole barrier	Spacer
				
	<p>Prevents all contact with the fixing screws</p> <ul style="list-style-type: none"> The degree of protection becomes IP40 Sealable Dividable 	<p>Prevents all contact with the terminals</p> <ul style="list-style-type: none"> Degree of protection IP40 Sealable, max. diameter 1.2 mm 	<p>Improves the insulation between the connections: cables, terminals, lugs, etc.</p>	<ul style="list-style-type: none"> Used to: <ul style="list-style-type: none"> complete the rows separate the devices Width: 1 x 9 mm module Allows cables to be routed from one row to another (above and below), up to 6 mm²
	26981	26978	27001	A9N27062
	2	2	10	1
	4P	4P	-	-
	■	■	■	■

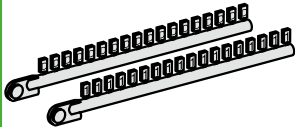
Identification





Accessories	Clip-on terminal marker strip					
						
Function	For connection identification					
Cat. numbers	0: AB1-R0 1: AB1-R1 2: AB1-R2 3: AB1-R3 4: AB1-R4	5: AB1-R5 6: AB1-R6 7: AB1-R7 8: AB1-R8 9: AB1-R9	A: AB1-GA B: AB1-GB C: AB1-GC D: AB1-GD E: AB1-GE F: AB1-GF G: AB1-GG H: AB1-GH I: AB1-GI	J: AB1-GJ K: AB1-GK L: AB1-GL M: AB1-GM N: AB1-GN O: AB1-GO P: AB1-GP Q: AB1-GQ R: AB1-GR	S: AB1-GS T: AB1-GT U: AB1-GU V: AB1-GV W: AB1-GW X: AB1-GX Y: AB1-GY Z: AB1-GZ	+ : AB1-R12 - : AB1-R13 Blank: AB1-RV
Set of	250					
DT60	■ 6 markers max. on front face					

Accessories for C60, C120, DPN, DPN Vigi, C60H-DC, SW60-DC, C60NA-DC, C60PV-DC, ID, iSW devices









		Installation						
Accessories		Rotary handle		Plug-in base		Padlocking device		
								
Function		<p>Front or side control of 2, 3 and 4-pole circuit breakers</p> <ul style="list-style-type: none"> ■ Degree of protection: IP40 ■ A complete rotary handle consists of: <ul style="list-style-type: none"> □ a circuit-breaker operating sub-assembly, cat. no. 27046, □ a handle cat. no. 27047 or a handle cat. no. 27048 ■ Installation: <ul style="list-style-type: none"> □ the circuit-breaker operating sub-assembly cat. no. 27046 is fixed to the circuit breaker □ the removable handle cat. no. 27047 is mounted on the removable front panel or on the enclosure door □ the fixed handle cat. no. 27048 is fixed to the front or side panel of the enclosure 		<p>Allows a circuit breaker to be quickly removed or replaced, without touching the connections</p> <ul style="list-style-type: none"> ■ Degree of protection: IP20 ■ It consists of: <ul style="list-style-type: none"> □ a base to be fixed to a rail (or panel) □ 2 "blades" to be fixed in the device terminals ■ Connection: tunnel terminals for cables up to 50 mm² (rigid) or 35 mm² (flexible) ■ Installation: <ul style="list-style-type: none"> □ on backplate □ on a horizontal rail ■ Centreline between two rows: 200 mm ■ Only on the circuit breaker, without a Vigi device or auxiliary ■ Padlocking option (8 mm dia. padlock not supplied) 		<p>Used to padlock a circuit breaker in the "open" or "closed" position</p> <ul style="list-style-type: none"> ■ Diameter of the padlock: 8 mm max. ■ Locking in the ON position does not prevent the circuit breaker from tripping in the event of a fault ■ Isolation: in conformity with IEC/EN 60947-2. 		
Cat. numbers		27047 Removable extended handle	27048 Fixed handle	27046 Operating sub-assembly	26996 (1 per pole)	26997 (1 per pole)	27145	26970
Set of		1	1	1	1	1	4	2
Suitable for the following devices:								
C60	■ 2P, 3P, 4P	■	■	■	■	■	■	■
C120, C120NA-DC	■ 2P, 3P, 4P	■	■	■	■ ≤ 63 A	■	■	■
C120 + Vigi C120	■ 2P, 3P, 4P	■	■	■	■	■	■	■
DPN, DPN Vigi	■ 3P, 4P	■	■	■	■	■	■	■
C60H-DC	■ 2P	■	■	■	■	■	■	■
SW60-DC, C60NA-DC, C60PV-DC	—	■	■	■	■	■	■	■
ID	—	■	■	■ ≤ 63 A	■	■	■	■
iSW	■ iSW ≥ 4 modules of 9 mm	■	■	■ iSW 40 to 63 A	■	■	■	■

Accessories for C60, C120, DPN, DPN Vigi, C60H-DC, SW60-DC, C60NA-DC, C60PV-DC, ID, iSW devices (cont.)

Safety

Accessories	Screw shield		Terminal shield			Interpole barrier	Spacer
 056870_SE-33 PE124114	 056889_SE-38		 DE123898			 PE104485-35	
Function	Prevents all contact with the fixing screws <ul style="list-style-type: none"> The degree of protection becomes IP40 Sealable, max. diameter 1.2 mm Dividable 		Prevents all contact with the terminals <ul style="list-style-type: none"> Degree of protection becomes IP40 Sealable, max. diameter 1.2 mm <ul style="list-style-type: none"> 1P 1P 2P 3P: 1 x 26975 + 1 x 26976 4P: 2 x 26976 			Improves the insulation between the connections: cables, terminals, lugs, etc.	<ul style="list-style-type: none"> Used to: <ul style="list-style-type: none"> complete the rows separate the devices Width: 1 x 9 mm module Allows that 2 cables are routed from one row to another (above and below), up to 6 mm²
Cat. numbers	18527	26981	18526	26975	26976	27001	A9N27062
Set of	2 (4P dividable)		2 (for upstream/downstream terminal)			10	1
Suitable for the following devices:							
C60	–	■	–	■	■	■	■
C120, C120NA-DC	■	–	■	–	–	■	■
Vigi C120	–	–	–	–	–	–	■
DPN, DPN Vigi	–	–	–	–	–	–	■
C60H-DC	–	■	–	■	■	■	■
SW60-DC, C60NA-DC, C60PV-DC	–	■	–	–	–	■	■
ID	–	■	–	■	■	■	■
iSW	–	■ iSW 40 to 125 A	–	■ iSW 40 to 125 A	■ iSW 40 to 125 A	■ iSW 40 to 125 A	■

Accessories for C60, C120, DPN, DPN Vigi, C60H-DC, SW60-DC, C60NA-DC, C60PV-DC, ID, iSW devices (cont.)

		Connection				
Accessories	Multi-cable terminal	50 mm ² Al terminal	Screw-on connection for ring terminal	Connection kit for ring terminals	Terminal for rear connector	
						
Function		For 3 copper cables: ■ Rigid up to 16 mm ² ■ Flexible up to 10 mm ²	For 16 to 50 mm² aluminium cables	For lug tipped cables, front or rear mounting	For terminal up to 63 A, front or rear access (screw Ø 5 mm) ■ It incorporates a "conductive" part and an "insulating" part which ensures the phase-to-phase clearance	For cable up to 50 mm² or by terminal ■ Supplied with a 1P terminal shield
						
Cat. numbers	19091	19096	27060	27053	17400	18528
Set of	4	3	1	8	2	2
Suitable for the following devices:						
C60 ≤ 25 A	-	-	-	■	■	-
C60 > 25 A	■	■	■	■	■	-
C120, C120NA-DC	■	■	■	■	-	■
Vigi C120	■	■	■	-	-	-
DPN, DPN Vigi	-	-	-	■	-	-
C60H-DC, ID	■	■	■	■	■	-
iSW 40 to 125 A	■	■	■	■	■	-
SW60-DC, C60NA-DC	■	■	■	■	-	-
C60PV-DC	-	-	-	■	-	-
Tightening torque	2 N.m		10 N.m	2 N.m	-	-
Stripping length	11 mm		13 mm	-	-	-
Tools to be used	Diameter 5 mm or PZ2		Hc 1/5" or 5 mm	Diameter 5 mm	Diameter 5 mm	13 mm spanner

Identification

Accessories

Clip-on terminal marker strip

031204D_SEE23



Function

For connection identification

Cat. numbers	0: AB1-R0	A: AB1-GA	K: AB1-GK	U: AB1-GU
	1: AB1-R1	B: AB1-GB	L: AB1-GL	V: AB1-GV
	2: AB1-R2	C: AB1-GC	M: AB1-GM	W: AB1-GW
	3: AB1-R3	D: AB1-GD	N: AB1-GN	X: AB1-GX
	4: AB1-R4	E: AB1-GE	O: AB1-GO	Y: AB1-GY
	5: AB1-R5	F: AB1-GF	P: AB1-GP	Z: AB1-GZ
	6: AB1-R6	G: AB1-GG	Q: AB1-GQ	+ : AB1-R12
	7: AB1-R7	H: AB1-GH	R: AB1-GR	- : AB1-R13
	8: AB1-R8	I: AB1-GI	S: AB1-GS	Blank : AB1-RV
	9: AB1-R9	J: AB1-GJ	T: AB1-GT	
Set of	250			

Suitable for the following devices:

C60, ID	■ 4 markers max. per pole
C120, C120NA-DC	■ 4 markers max. per pole
Vigi C120	■ 4 markers max. per device
DPN, DPN Vigi	■ 4 markers max. per pole
C60H-DC, SW60-DC, C60NA-DC, C60PV-DC	■ 4 markers max. per pole

Protection

Circuit protection

Earth leakage protection

Accessories for NG125 devices

		Mounting				
Accessories	Rotary handle		Toggle	Padlocking device		
Function						
	Extended rotary handle <ul style="list-style-type: none"> Degree of protection: rotary button IP55 Front installation: Prevents door opening when the circuit breaker is in position O Keeps disconnection Padlocking possible when the device is in position O Padlock diameter: 3 to 6 mm 		Direct rotary handle <ul style="list-style-type: none"> Front installation Keeps disconnection Padlocking possible when the device is in position O Padlock diameter: 3 to 6 mm 		White toggle <ul style="list-style-type: none"> Allows visual distinction of a switchboard incoming device 	Allows padlocking: <ul style="list-style-type: none"> In position I or O of NG125 1P or 2P circuit breakers In position I of NG125 3P or 4P circuit breakers or switches Padlock: dia. 5 to 8 mm (not supplied) <p>Note: NG125 3P/4P circuit breakers and switches are provided with padlocking in position O (disconnected) as original equipment.</p>
Catalogue numbers	19088 Extended standard black	19089 Extended safety	19092 Direct standard black	19097 Direct safety red handle yellow background	19099 White toggle	19090
Pack of	1		1	1	10	1
Suitable for the following devices:						
NG125	<ul style="list-style-type: none"> 3P, 4P 				<ul style="list-style-type: none"> 3P, 4P 	
Vigi NG125	-		-	-	-	-

		Connection			
Accessories	Multi-cable terminal	70 mm ² Al terminal	Screw-on connection for ring terminal	Small ring terminal	
Function					
	For 3 copper cables: <ul style="list-style-type: none"> Rigid up to 16 mm² Flexible up to 10 mm² 	For single rigid aluminium cables from 25 to 70 mm²	Installation: <ul style="list-style-type: none"> Upstream or downstream Connection ratings 80 to 125 A: <ul style="list-style-type: none"> copper terminal: <ul style="list-style-type: none"> flexible cable up to 35 mm² rigid cable up to 50 mm² bars: 16 x 3 mm, 15 x 4 mm, 16 x 4 mm small ring terminal Phase-to-phase insulation voltage: U_i = 1000 V 	Connection ratings 80 to 125 A: <ul style="list-style-type: none"> Flexible copper cable: 50 mm² Rigid copper cable: 70 mm² 	
Cat. nos.	19091	19096	19095	19093	19094
Pack of	4	3	4	4	4
NG125			<ul style="list-style-type: none"> 3P, 3P+N, 4P: 80, 100, 125 A 	<ul style="list-style-type: none"> 80, 100, 125 A 	<ul style="list-style-type: none"> 80, 100, 125 A
Vigi NG125	-	-	<ul style="list-style-type: none"> 125 A 	<ul style="list-style-type: none"> 125 A 	<ul style="list-style-type: none"> 125 A
Tightening torque	2 N.m		6 N.m	6 N.m	6 N.m
Stripping length	11 mm		-	-	-
Tools to be used	Diameter 5 mm or PZ2		Hc 4 mm	Hc 4 mm	-

Protection

Circuit protection

Earth leakage protection

Accessories for NG125 devices (cont.)

Safety

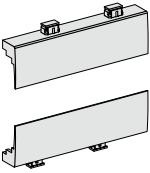
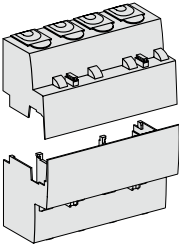
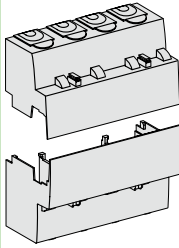
Accessories	Screw shield				Circuit breaker terminal shield				RCD terminal shield						
															
Function	<ul style="list-style-type: none"> ■ Prevents any contact with the connection screws ■ Protection against direct contact: <ul style="list-style-type: none"> □ IP40: on front panel □ IP20: at the connection level ■ Class II in steel or plastic enclosures ■ Sealing possible (max. diameter: 1.2 mm). 				<ul style="list-style-type: none"> ■ Prevents any contact with the terminals ■ Installation: mounted upstream and downstream of circuit breaker ■ Phase-to-phase insulation voltage $U_i = 1000\text{ V}$ ■ Protection against direct contact IP40 ■ Class II in steel or plastic enclosures (up to 440 V) ■ Sealing possible (max. diameter: 1.2 mm) 				<ul style="list-style-type: none"> ■ Installation: is mounted upstream of the circuit breaker and downstream of the Vigi device ■ Phase-to-phase insulation voltage $U_i = 1000\text{ V}$ ■ Protection against direct contact: IP40 ■ Class II in steel or plastic enclosures (up to 440 V) ■ Sealing possible (max. diameter: 1.2 mm) 						
	1P	2P	3P	4P	1P	2P	3P	4P	63 A				125 A		
									2P	3P	3P adjustable	4P	4P adjustable	3P	4P
Catalogue numbers	19084	19085	19086	19087	19080	19081	19082	19083	19074	19075	19077	19076	19078	19077	19078
Pack of	10				Set of 1 upstream / 1 downstream				Set of 1 upstream / 1 downstream						
Suitable for the following devices:															
NG125	■				■				■				■		
Vigi NG125	-				-				■				■		

Acti9 VDIS vertical distribution blocks 125 A



A9XPK707



A9XPK714

IEC/EN 60947-7-1

IEC/EN 61439-2

As per the above standards:



Description

- 4P distribution blocks with quick connections.
- Designed for both rigid cables and flexible cables with or without ferrules.
- Push-in technology.
- Optimised installation in Pragma 24 (surface mounting), Resi9 24 (surface mounting), Prisma G and Prisma Pack.
- Only two versions to cover all configurations.

Technical data

Number of poles	4P	4P
Operating current at 40°C (Ie)	125 A	125 A
Operating voltage (Ue)	250/440 V AC	250/440 V AC
Operating frequency	50/60 Hz	50/60 Hz
Rated insulation voltage (Ui)	500 V AC	500 V AC
Rated impulse withstand voltage (Uimp)	6 kV	6 kV
Rated peak withstand current at 20 ms (Ipk)	20 kA	20 kA
Rated conditional short-circuit current withstand (Isc)	Up to breaking capacity of Schneider Electric outgoing circuit breakers, Acti9 iC60 and Acti9 iC40, even when reinforced by cascading implementation	
Pollution degree	3	3
Degree of protection	IPxxB	IPxxB
Total connection capacity at outgoing terminals	7 for each phase 12 for neutral	14 for each phase 24 for neutral
Weight (g)	1140	2040
Catalog numbers	A9XPK707	A9XPK714

Accessories

Type	Accessory	Spare parts
		
Designation	Prisma vertical mounting accessories	Locking clips for Pragma installation
Set of	4	10
Catalog numbers	A9XPKV04	A9XPKL10

Dimensions (mm)

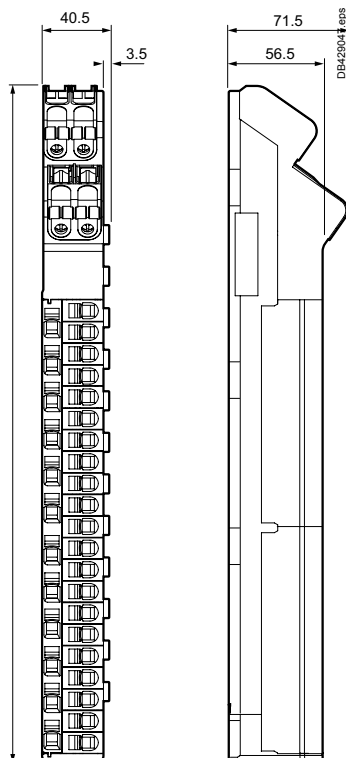

A9XPK707: 408

A9XPK714: 680

Selection Guide

Mounting type	A9XPK707		A9XPK714	
	Direct	with A9XPKV04 accessory	Direct	with A9XPKV04 accessory
Pragma 24, surface mounted enclosures				
1, 2, 3 rows	-	-	-	-
4, 5 rows	■	-	-	-
6 rows	■	-	■	-
Resi9 24, surface mounted enclosures				
3 rows	-	-	-	-
4, 5 rows	■	-	-	-
6 rows	■	-	■	-
Prisma G				
< 12 modules	-	-	-	-
≥ 12 and < 18 modules	-	■	-	-
≥ 18 modules	-	■	-	■
Prisma Pack				
< 4 rows	-	-	-	-
≥ 4 and < 6 rows	-	■	-	-
≥ 6 rows	-	■	-	■

Acti9 VDIS vertical distribution blocks 125 A

Advantages

- High reliability of cabling thanks to spring terminals.
- Fast and simplified distribution thanks to a direct and frontal access to head of groups and groups of devices.
- Space release on Din Rail thanks to side installation.
- Time saving thanks to screwless and push-in technology.
- Easy phase balancing.
- Easy extensions and modifications.
- Numerous Ph+N load connections.

Power supply

- Four-poles tunnel terminals with screw clamping
- Cable per connection point:
 - flexible from 10 to 35 mm²
 - flexible with insulated ferrule from 10 to 35 mm²
 - stranded from 10 to 35 mm²

Distribution connections

- Connection to spring terminals through the front
- A single cable per connection point:
 - rigid from 1.5 to 10 mm²
 - stranded from 4 to 16 mm²
 - flexible from 1.5 to 16 mm²
 - flexible with ferrule from 1.5 to 16 mm²
- Push-in spring for toolless connection for both rigid and flexible cables with ferrules
- Maintenance free
- Connections:
 - A9XPK707: 7 per phase, 12 neutral
 - A9XPK714: 14 per phase, 24 neutral

Installation

- Clip-on directly in Pragma supports, locking clips included
- Clip-on in Prisma vertical mounting accessories A9XPKV04

Stripping length

- Rigid or flexible

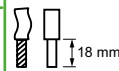

Flexible with ferrule

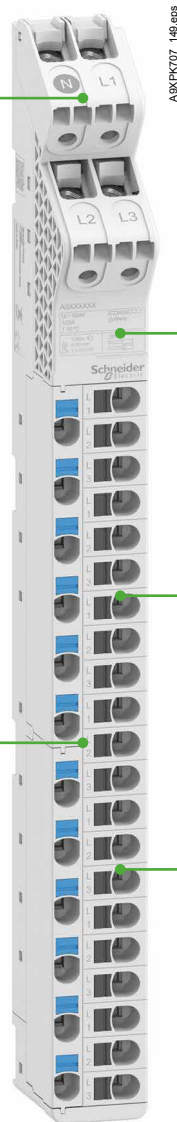





Protection

Circuit protection

Earth leakage protection

Vertical comb busbars

		Comb busbars				
Accessories		Vertical comb busbars				
						
Function	Comb busbars make it easier to implement Schneider Electric products. <ul style="list-style-type: none"> ■ They provide a 2P supply to the main incomers from one row to the next: □ centreline between rows: 125 mm or 150 mm, depending on the model □ distances between terminals: 9 mm or 18 mm, depending on the model 					
Use	<ul style="list-style-type: none"> ■ Direct power supply to circuit breaker or residual current circuit breaker terminals 					
Catalogue numbers	14900	14901	14909	14910	14911	
Distance between upstream terminals	9 mm		18 mm		18 mm	
Distance between downstream terminals	9 mm		9 mm		18 mm	
Centreline between rows	125 mm	150 mm	125 mm	125 mm	150 mm	
Technical specifications						
Rated voltage (Ue)	415 V					
Insulation voltage (Ui)	500 V					
Permissible current at 40°C	80 A					
Short-circuit current withstand	Compatible with the breaking capacity of Schneider Electric modular circuit breakers					
Fire resistance to IEC 695-2-1	Self-extinguishing: 850°C 30 s					
Standards	IEC 60664-1					
Colour	RAL 7035 (light grey)	RAL 7016 (anthracite grey)	RAL 7035 (light grey)	RAL 7035 (light grey)	RAL 7016 (anthracite grey)	

Horizontal comb busbars 18 mm modules for Acti9: iC60, iK60



Acti9 iC60, iK60	18 mm poles, cuttable				
Number of poles	1P	1P+N	3P	4P	3 (N+P)
Type	L1, ...	NL, ...	L1L2L3, ...	NL1L2L3, ...	NL1NL2NL3, ...
Set of	1	1	1	1	1
Catalogue numbers					
6 modules of 18 mm	A9XPH106	A9XPH206 (*)	A9XPH306	-	-
8 modules of 18 mm	-	A9XPH208 (*)	-	A9XPH408	-
9 modules of 18 mm	-	-	A9XPH309	-	-
10 modules of 18 mm	-	A9XPH210 (*)	-	-	-
12 modules of 18 mm	A9XPH112	A9XPH212 (*)	A9XPH312	A9XPH412	A9XPH512
16 modules of 18 mm	-	-	A9XPH316	A9XPH416	-
18 modules of 18 mm	-	A9XPH218 (*)	A9XPH318	-	A9XPH518
20 modules of 18 mm	-	-	A9XPH320	-	-
24 modules of 18 mm	A9XPH124	A9XPH224 (*)	A9XPH324	A9XPH424	A9XPH524
57 modules of 18 mm	A9XPH157	A9XPH257 (*)	A9XPH357	A9XPH457	A9XPH557

(*) **CAUTION**

INCOMPATIBILITY BETWEEN TWO-POLE COMB BUSBARS AND FOUR-POLE DEVICES

- Never connect a two-pole busbar to a four-pole device, as this will result in a multi-phase bolted short circuit.
- Always check that the head of group circuit breaker is in good working condition before connecting a comb busbar.

Failure to follow these instructions can result in injury or equipment damage.

Technical data	
Operating current (Ie) at 40°C	100 A
Short circuit current (Isc)	Compatible with the breaking capacity of Schneider Electric circuit breakers
Rated insulation voltage (Ui)	500 V AC
Operating voltage (Ue)	415 V AC
Pollution degree	3
Fire resistance IEC 60695-2-1	Self-extinguishing at 960°C 30 secondes
Color	RAL9003

Horizontal comb busbars 18 mm modules for Acti9: iC60, iK60 (cont.)



Cuttable comb busbars, 18 mm modules, with 9 mm auxiliary					
Aux+1P	Aux+2P	Aux+3P	Aux+4P	3 (Aux+1P)	3 (Aux+N+1P)
AuxL1, ...	AuxL1L2, ...	AuxL1L2L3, ...	AuxNL1L2L3, ...	AuxL1AuxL2AuxL3, ...	AuxNL1AuxNL2AuxNL3, ...
1	1	1	1	1	1
-	-	-	-	-	-
-	-	-	-	-	-
-	-	-	-	-	-
-	-	-	-	-	-
-	-	-	-	-	-
-	-	-	-	-	-
-	-	-	-	-	-
-	-	-	-	-	-
-	-	-	-	-	-
A9XAH157	A9XAH257	A9XAH357	A9XAH457	A9XAH657	A9XAH557

End-pieces

- insulate end of comb busbar

Connectors

- facilitate comb busbar power supply

Accessories						
Number of poles	1P Aux+1P	1P+N Aux+2P	3P Aux+3P 3 (Aux+1P)	4P/3 (N+P) Aux+4P 3 (Aux+N+1P)	-	-
	End-pieces				Tooth covers	Connectors
	Lateral end-pieces providing IP20 protection				Insulate teeth that have been left free	Monoconnect
	Comb busbar power supply. Horizontal in-comer on each side. For 35 mm ² cable. Tightening torque 4 N.m					
Set of	10	10	10	10	20	4
Catalogue numbers	A9XPE110	A9XPE210	A9XPE310	A9XPE410	A9XPT920	A9XPCM04

Horizontal comb busbars 18 mm modules for Acti9: iC60 + Vigī iC60

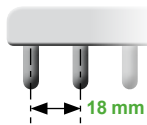

IEC 60947-7-1, IEC 61439-2



+



25 A



40 A-63 A

Acti9 Vigī iC60 1P+N	18 mm poles, cuttable	
Number of poles	3 (N+P)	
Type	NL1NL2NL3, ...	NL1NL2NL3, ...
Set of	1	1
Rating of Vigī	25 A	40 A - 63 A
Catalogue numbers		
21 modules of 18 mm	A9XPF521	-
24 modules of 18 mm	-	A9XPF524

Technical data	
Operating current at (Ie) 40°C	100 A
Short circuit current (Isc)	Compatible with the breaking capacity of Schneider Electric circuit breakers
Rated insulation voltage (Ui)	500 V AC
Operating voltage (Ue)	415 V AC
Pollution degree	3
Fire resistance IEC 60 695-2-1	Self-extinguishing at 960°C 30 secondes
Color	RAL9003

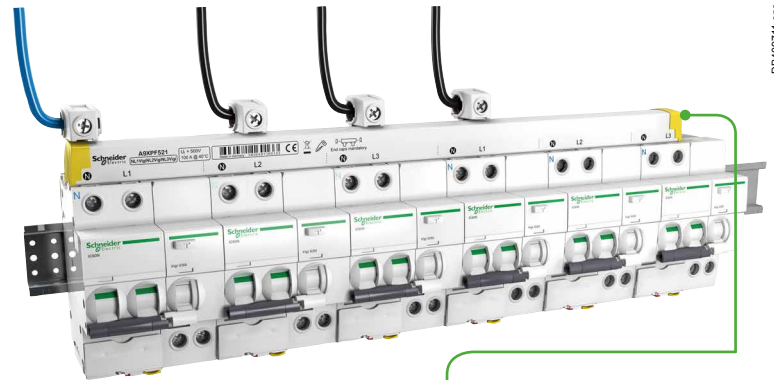

End-pieces
 ■ insulate end of comb busbar

Accessories			
Number of poles	3 (N+P)	-	-
	End-pieces	Tooth covers	Connectors
	Lateral end-pieces providing IP20 protection	Insulate teeth that have been left free	Monoconnect Comb busbar power supply. Horizontal incomer on each side. For 35 mm ² cable. Tightening torque 4 N.m
Set of	10	20	4
Catalogue numbers	A9XPE410	A9XPT920	A9XPCM04

Complementary technical information

Horizontal comb busbars 9 mm modules for Acti9: iC40, iC40 XA, iCV40, iCV40 XA, iDPN Vigi, Vigi iC40, Vigi iCG40

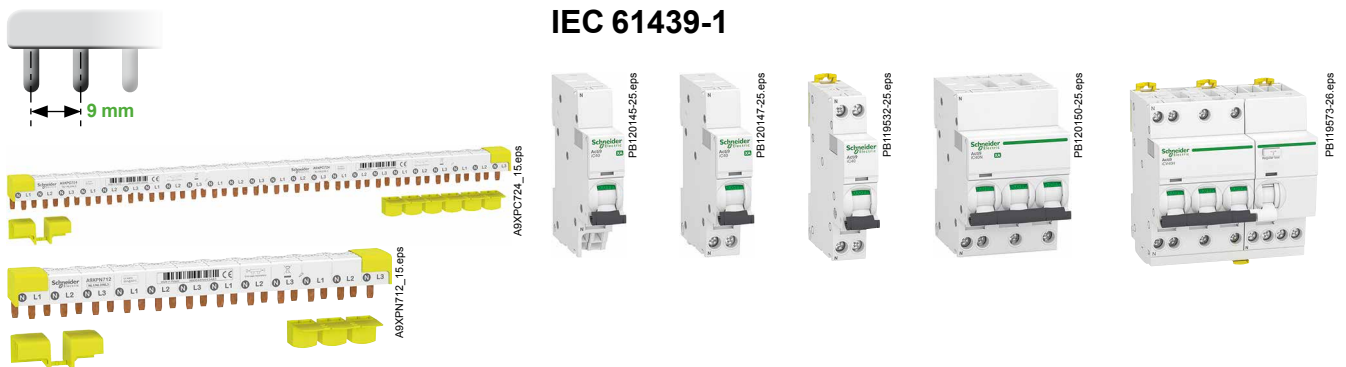

Acti9 iC40, iC40 XA, iCV40, iCV40 XA, iDPN, iDPN Vigi, Vigi iC40, Vigi iCG40		9 mm poles, cuttable					
Number of poles		1P+N			3 (N+P)		
Number of 18 mm modules		12	24	48	12	24	48
Supplied accessories	Tooth covers (for 3 modules of 18 mm)	1	2	-	1	2	-
	End-pieces	4	4	-	4	4	-
Catalogue numbers		A9XPC612 (*)	A9XPC624 (*)	A9XPC648 (*)	A9XPC712	A9XPC724	A9XPC748

(*) **CAUTION**
INCOMPATIBILITY BETWEEN TWO-POLE COMB BUSBARS AND FOUR-POLE DEVICES
 - Never connect a two-pole comb busbar to a four-pole device, as this will result in a multi-phase bolted short circuit.
 - Always check that the head of group circuit breaker is in good working condition before connecting a comb busbar.
Failure to follow these instructions can result in injury or equipment damage.

Acti9 iC40, iC40 XA, iCV40, iCV40 XA, iDPN, iDPN Vigi, Vigi iC40, Vigi iCG40	With 9 mm auxiliary			
Number of poles	Aux+N+1P	3 (Aux+N+1P)	Aux+N+1P+Vigi	3 (Aux+N+1P+Vigi)
Number of 18 mm modules	48	48	48	48
Catalogue numbers	A9XPA648	A9XPA748	A9XPV648	A9XPV748

Technical data		
Operating current at 40°C	(Ie)	80 A
Short circuit current	(Isc)	Compatible with the breaking capacity of Acti9 Schneider Electric circuit breakers
Rated insulation voltage	(Ui)	400 V AC (Ph/N) - 440 V AC (Ph/Ph)
Operating voltage	(Ue)	230 V AC (Ph/N) - 400 V AC (Ph/Ph)
Degree of protection		IP20
Pollution degree		3
Fire resistance IEC 60695-2-1		Self-extinguishing at 960°C 30 secondes
Color		RAL 9003

Complementary technical information

Horizontal comb busbars 9 mm modules for Acti9: iC40, iC40 XA, iCV40, iCV40 XA, iDPN, iDPN Vigi, Vigi iC40, Vigi iCG40 (cont.)

■ Allows the mix of devices with different number of poles (1P+N, 3P, 3P+N)

End-pieces
■ insulate end of comb busbar

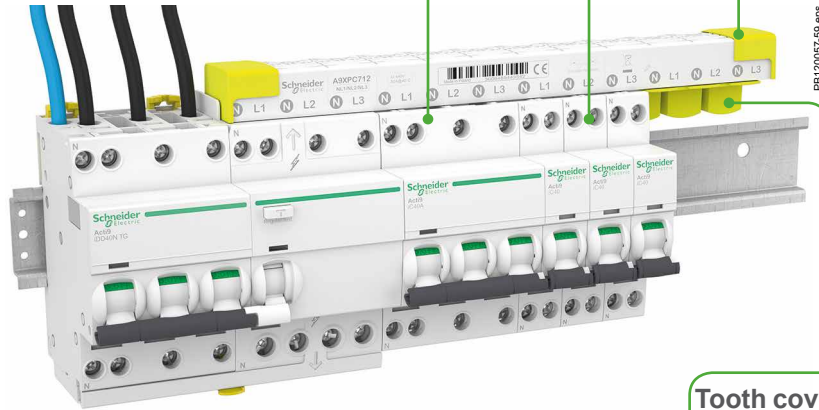

Tooth covers
■ insulate teeth that have been left free

Accessories

Number of poles	1P+N	3 (N+P)		
	End-pieces		Tooth covers (3 x 18 mm modules)	Connectors
Set of	40	40	12	4
Catalogue numbers	A9X21094	A9X21095	A9X21096	A9XPCM04

Connectors
■ facilitate comb busbar power supply

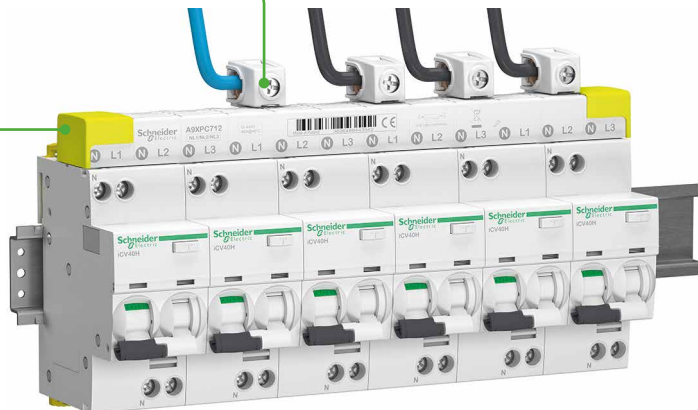

End-pieces
■ insulate end of comb busbar

Horizontal comb busbars with integrated connectors, 9 mm modules for Acti9: iC40, iC40 XA, iCV40, iCV40 XA

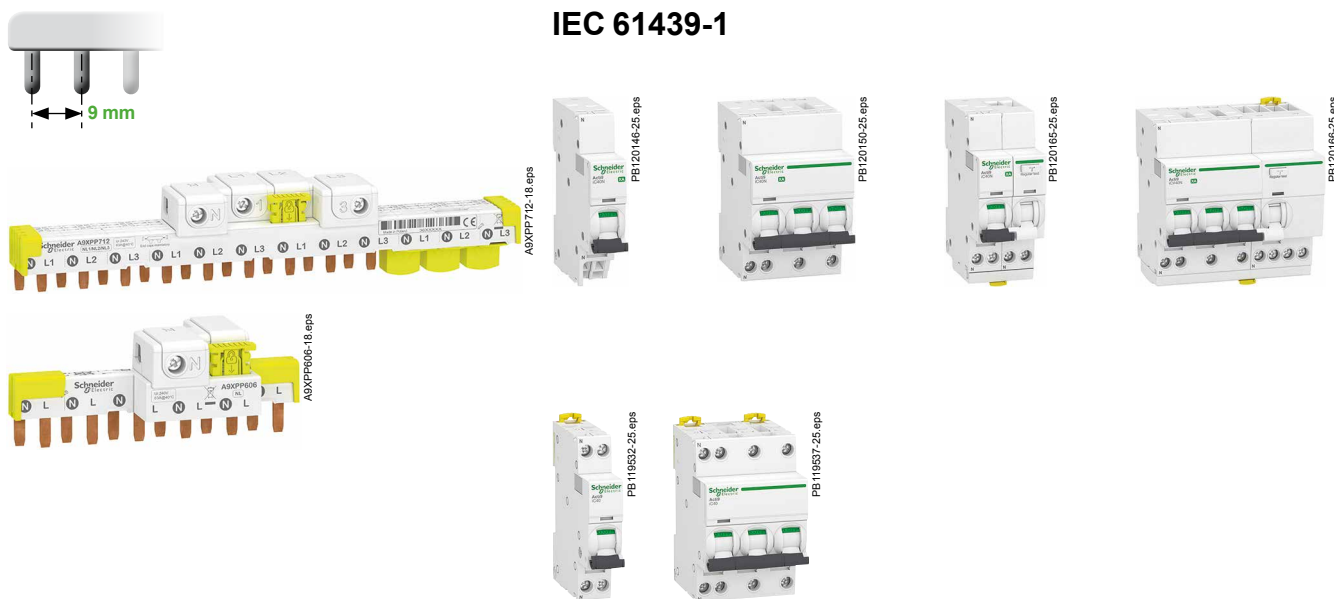

Acti9 iC40, iC40 XA, iCV40, iCV40 XA		9 mm poles, cuttable				
Number of poles	1P+N			3 (N+P)		
Number of 18 mm modules	6	12	24	12	24	
Supplied accessories	Tooth covers (for 3 modules of 18 mm)					
	-	1	2	1	2	
	End-pieces					
	4	4	4	4	4	
Catalogue numbers	A9XPP606 (*)	A9XPP612 (*)	A9XPP624 (*)	A9XPP712	A9XPP724	

(*) **CAUTION**
INCOMPATIBILITY BETWEEN TWO-POLE COMB BUSBARS AND FOUR-POLE DEVICES
 - Never connect a two-pole comb busbar to a four-pole device, as this will result in a multi-phase bolted short circuit.
 - Always check that the head of group circuit breaker is in good working condition before connecting a comb busbar.
Failure to follow these instructions can result in injury or equipment damage.

Technical data		
Operating current at 40°C	(Ie)	63 A
Short circuit current	(Isc)	Compatible with the breaking capacity of Acti9 Schneider Electric circuit breakers
Rated insulation voltage	(Ui)	400 V AC (Ph/N) - 440 V AC (Ph/Ph)
Operating voltage	(Ue)	230 V AC (Ph/N) - 400 V AC (Ph/Ph)
Degree of protection		IP20
Pollution degree		3
Fire resistance IEC 60695-2-1		Self-extinguishing at 960°C 30 secondes
Color		RAL 9003

Complementary technical information

Horizontal comb busbars with integrated connectors, 9 mm modules for Acti9: iC40, iC40 XA, iCV40, iCV40 XA (cont.)

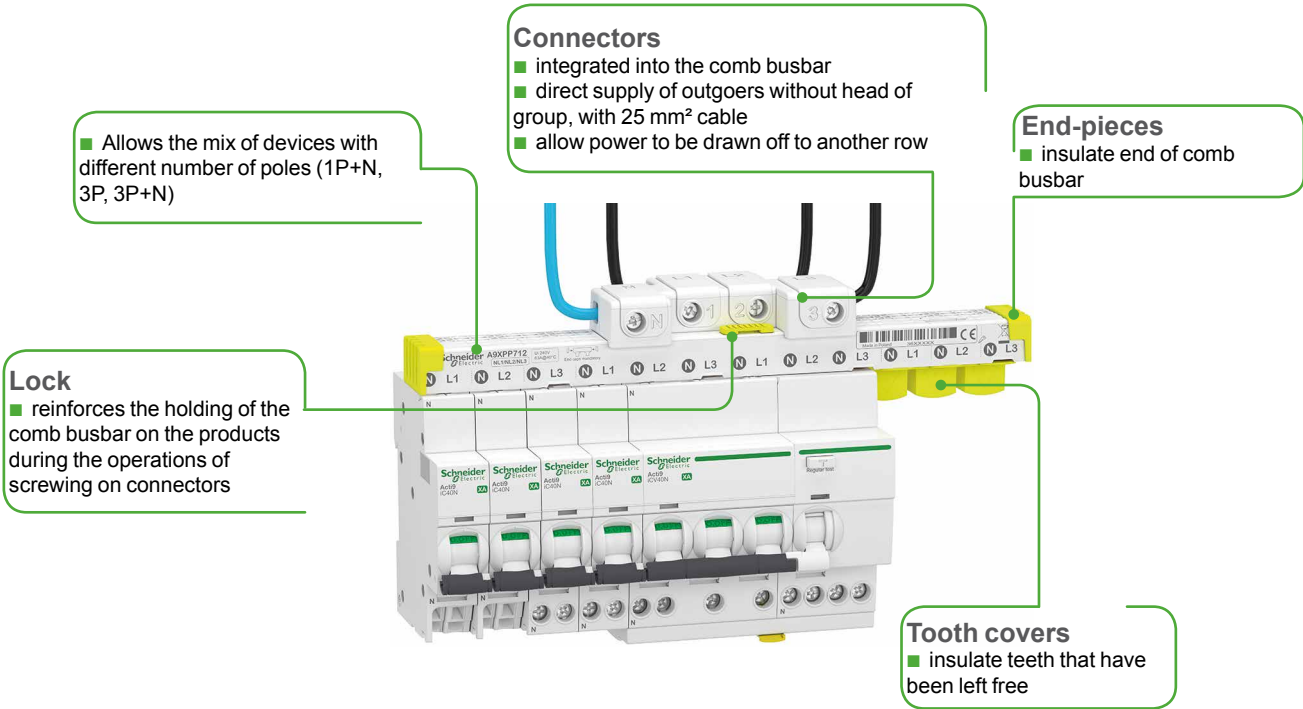

Accessories			
Number of poles	1P+N	3 (N+P)	
	End-pieces		Tooth covers (3 x 18 mm modules)
Set of	40	40	12
Catalogue numbers	A9X21094	A9X21095	A9X21096

Horizontal comb busbars 9 mm modules for Acti9: iCT

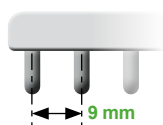

IEC 61439-1

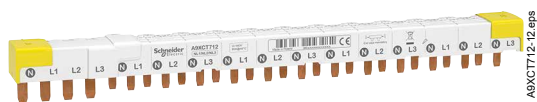

A9XCT712-12.eps



A9C24765-35.eps

Acti9 iCT		9 mm poles, cuttable
Number of poles		Head of group 4P + 3 (N+P)
Number of 18 mm modules		12
Supplied accessories	Tooth covers (for 3 modules of 18 mm) End-pieces	1 4
Catalogue numbers		A9XCT712

Technical data		
Operating current at 40°C	(Ie)	80 A
Short circuit current	(Isc)	Compatible with the breaking capacity of Acti9 Schneider Electric circuit breakers
Rated insulation voltage	(Ui)	400 V AC (Ph/N) - 440 V AC (Ph/Ph)
Operating voltage	(Ue)	230 V AC (Ph/N) - 400 V AC (Ph/Ph)
Degree of protection		IP20
Pollution degree		3
Fire resistance IEC 60695-2-1		Self-extinguishing at 960°C 30 secondes
Color		RAL 9003

Complementary technical information

Horizontal comb busbars 9 mm modules for Acti9: iCT (cont.)

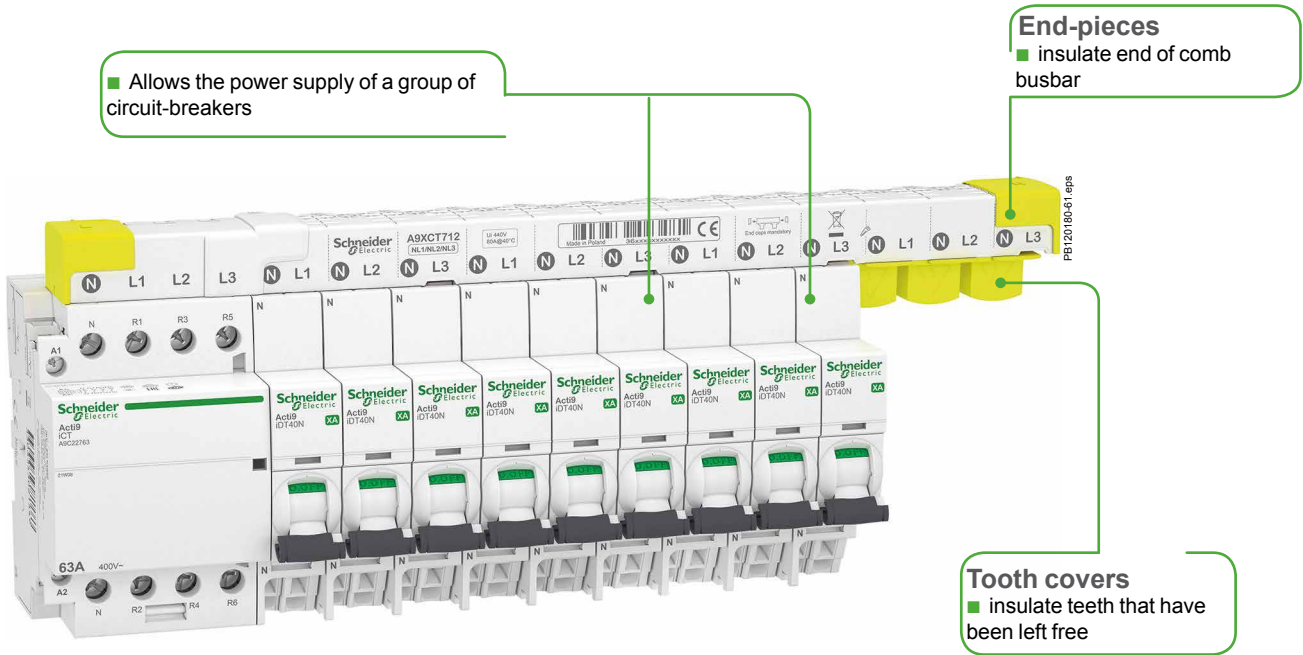

Accessories		
Number of poles	3 (N+P)	
		
	End-pieces	Tooth covers (3 x 18 mm modules)
Set of	40	12
Catalogue numbers	A9X21095	A9X21096

Complementary technical information

Horizontal comb busbars 27 mm modules for C120, NG125

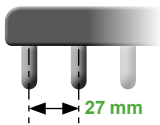

IEC 60664-1

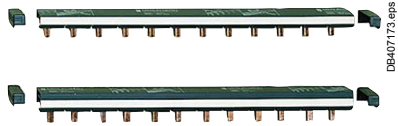

C120, NG125		27 mm poles, cuttable			
Number of poles	1P	2P	3P	4P	
Number of 27 mm modules	16	16	15	16	
Set of	1				
Catalogue numbers	14811	14812	14813	14814	

Technical data	
Operating current at 40°C (Ie)	125 A
Short circuit current (Isc)	Compatible with the breaking capacity of Schneider Electric circuit breakers
Rated insulation voltage (Ui)	620 V AC
Operating voltage (Ue)	500 V AC
Pollution degree	3
Fire resistance IEC 60695-2-1	Self-extinguishing at 960°C 30 secondes
Color	RAL 7016 (anthracite grey)

Power supply
 ■ directly in the circuit breaker terminals



End-pieces
 ■ insulate end of comb busbar

Tooth covers
 ■ insulate teeth that have been left free

Accessories	
Number of poles	1P, 2P, 3P, 4P
	Tooth covers Insulate teeth that have been left free
Set of	20
Catalogue numbers	14818

Complementary technical information

Choice guide

Contents



Schneider Electric's range of comb busbars consists of different products (A, B, C, D) to enable it to be the most competitive range possible in each country, allowing for the special characteristics of each market:

- usual installation procedure
- price
- accreditations by local bodies.

Variants

Offers		Pages
Common pages		391
Offer A	Circuit breakers 1P and 3P	393
Offer B	Circuit breakers 1P+N and 3P+N	395
Offer C	iC40, iC40 XA, iCV40, iCV40 XA, iDPN, iDPN Vigi, Vigi iC40, Vigi iCG40	398
Offer D	C120 and NG125	401

Comb busbar assembly recommendation

Acti9

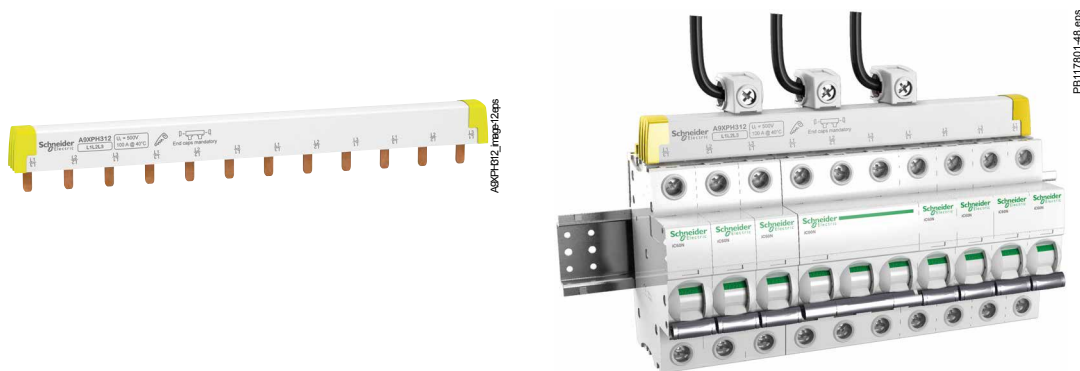

Cutting to length

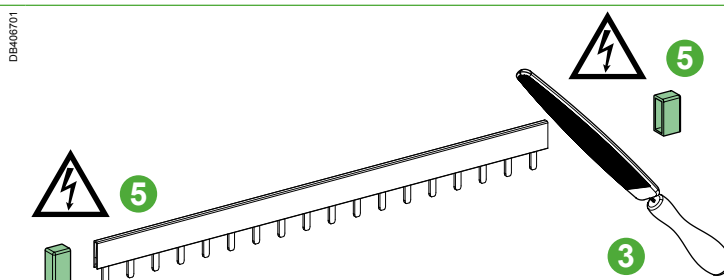
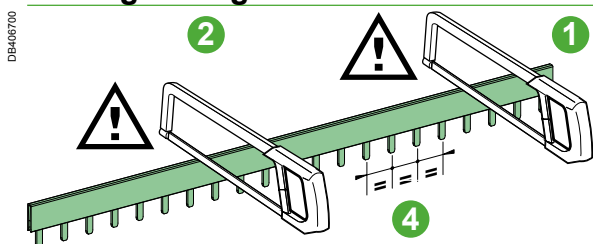

1- Cut perpendicularly (no angle > 10°) to the desired length using a circular miter saw for cutting metals.
 2- Maintain the direction of cutting from left to right.
 If this recommendation is not complied with, the copper busbar holding system is no longer active.

3- It is recommended to deburr after cutting.
 4- Check the regularity of the teeth spacing. Do not extract the copper terminals.

5- **Mandatory end-pieces after cutting the comb busbar.**

Direct power supply

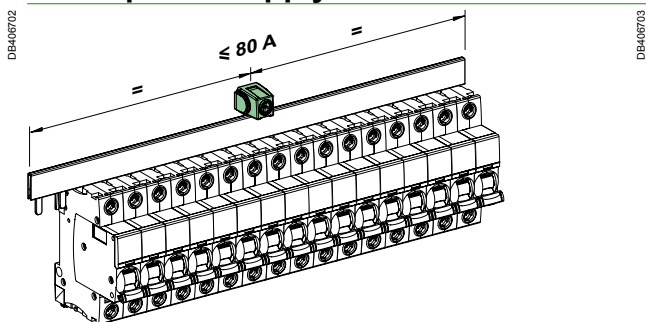

- Power supply ≤ 80 A by 1 connection point.
- Preferably choose the center of the comb busbar.

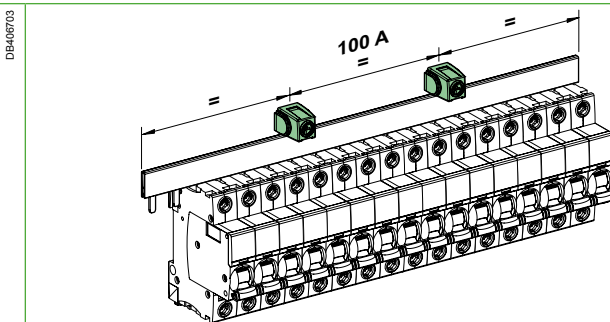

- 100 A power supply by 2 connection points mandatory.

Power supply by iID "group feeder" ≤ 80 A

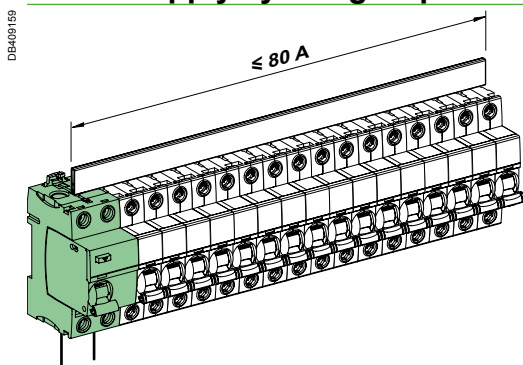

- RCCB "group feeder" ≤ 80 A: direct power supply by the RCCB.

Comb busbar assembly recommendation

Acti9 (cont.)

General

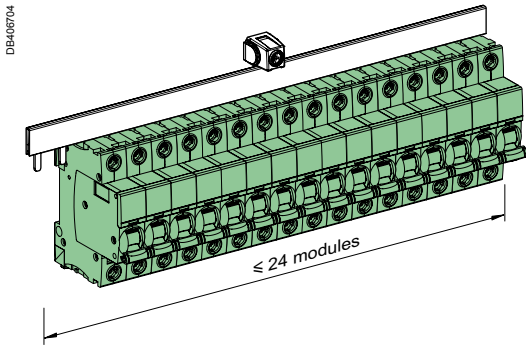

■ The quantity of products is not infinite, after 24 modules it is not possible to guarantee assembly.

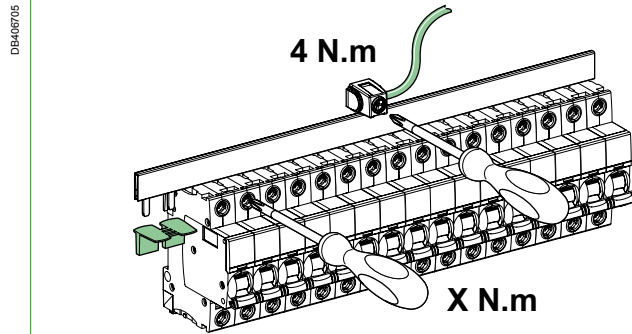

- Tightening to the recommended torque.
- Avoid tinning on the cable terminations, since tin has high resistivity.
- The comb teeth left unassigned should be isolated with tooth-cover end-pieces.

Plug-in base

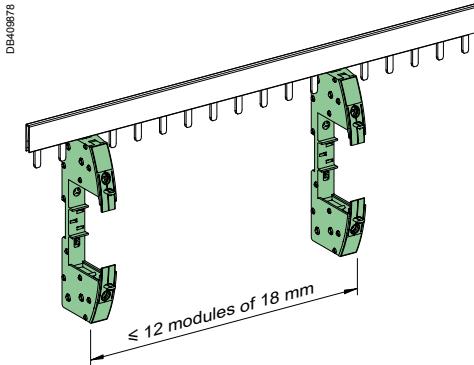

■ Special case: plug-in base (Cat. no. A9A27003), ≤ 12 x 18 mm modules.

Choice guide

Connection to the top

Circuit breakers iC60: 1P and 3P

Offer selection see page 390
Offer A
 This sticker must be removed before publishing

Circuit breakers iC60 1P		
Type: L, ...	Number of 18 mm modules	Cat. no.
	6	A9XPH106
	12	A9XPH112
	24	A9XPH124
	57	A9XPH157

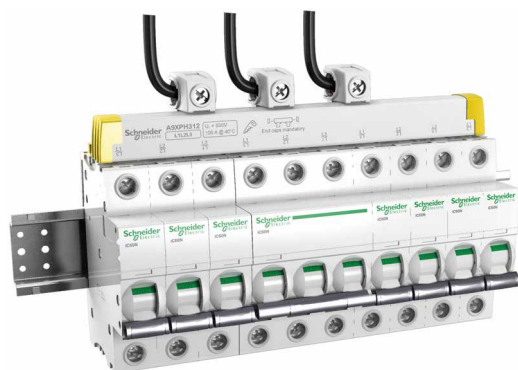

Circuit breakers iC60 1P or 3P (3 phases)		
Type: L1L2L3, ...	Number of 18 mm modules	Cat. no.
	6	A9XPH306
	9	A9XPH309
	12	A9XPH312
	16	A9XPH316
	18	A9XPH318
	20	A9XPH320
	24	A9XPH324
57	A9XPH357	

Circuit breakers iC60 1P + Auxiliaries 9 mm		
Type: L, ...	Number of 18 mm modules	Cat. no.
	57	A9XAH157

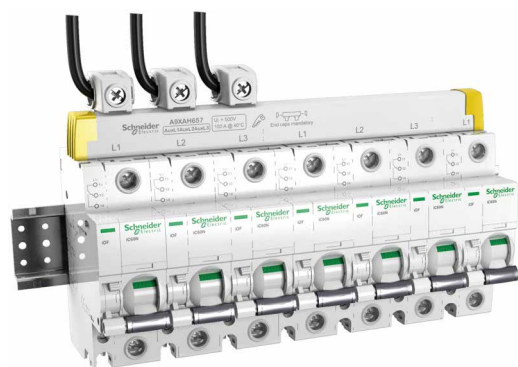

Circuit breakers iC60 1P + Auxiliaries 9 mm		
Type: AuxL1AuxL2AuxL3, ...	Number of 18 mm modules	Cat. no.
	57	A9XAH657

Complementary technical information

Choice guide

Connection to the top

Circuit breakers iC60: 1P and 3P (cont.)

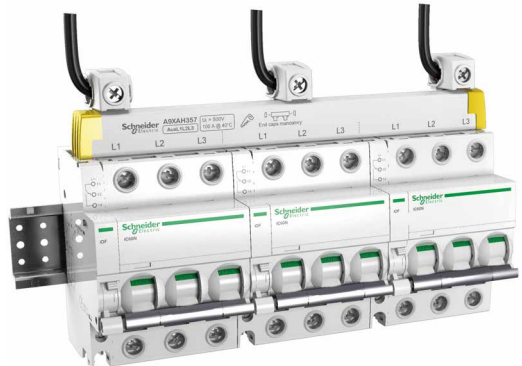

Circuit breakers iC60 3P with Auxiliaries 9 mm			Number of 18 mm modules	Cat. no.	
Type: AuxL1L2L3, ...					
PB117903-49.eps				57	A9XAH357
	<p style="text-align: center;">Auxiliary</p>				

Offer selection see page 390

Offer A

This sticker must be removed before publishing

Choice guide

Connection to the top

Circuit breakers iC60: 1P+N, 2P and 4P

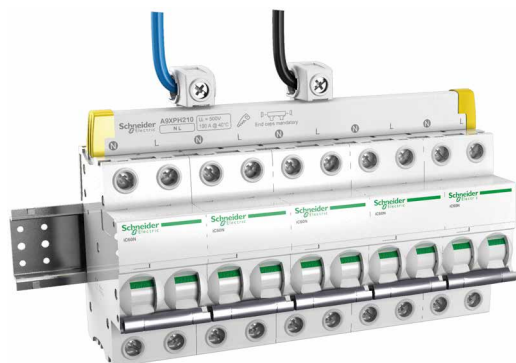

PB117804-47.eps

Circuit breakers 1P+N, 2P

Type: NL, ...	Number of 18 mm modules	Cat. no.
	6	A9XPH206 (*)
	8	A9XPH208 (*)
	10	A9XPH210 (*)
	12	A9XPH212 (*)
	18	A9XPH218 (*)
	24	A9XPH224 (*)
	57	A9XPH257 (*)

(*) CAUTION
INCOMPATIBILITY BETWEEN 1P+N COMB BUSBARS AND 3P+N DEVICES
 - Never connect a 1P+N comb busbar to a 3P+N device, as this will result in a multi-phase bolted short circuit.
 - Always check that the head of group circuit breaker is in good working condition before connecting a comb busbar.
Failure to follow these instructions can result in injury or equipment damage.

Circuit breakers 1P+N (Neutral + 3 phases)

Type: NL1NL2NL3, ...	Number of 18 mm modules	Cat. no.
	12	A9XPH512
	18	A9XPH518
	24	A9XPH524
	57	A9XPH557

PB117805-48.eps



RCCB 3P+N + circuit breakers iC60 1P+N

Type: NL1L2L3NL1NL2NL3, ...	Number of 18 mm modules	Cat. no.
	10	A9XPH810
	12	A9XPH812
	14	A9XPH814
	16	A9XPH816

Montage ATHEMA01.jpg

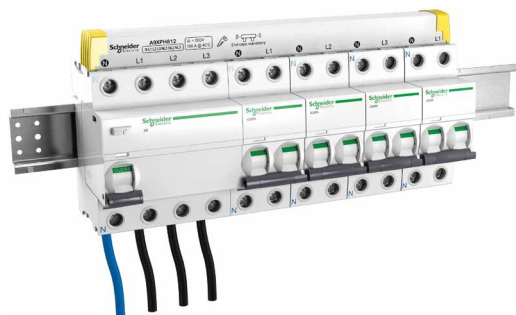

Circuit breakers 2P + Auxiliaries 9 mm (Aux + Neutral + Phase)

Type: AuxL1L2, ...	Number of 18 mm modules	Cat. no.
	57	A9XAH257

PB117821-37.eps

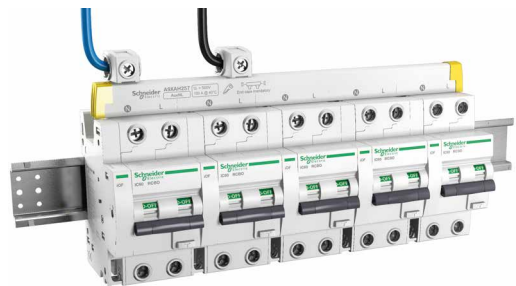

Choice guide

Connection to the top

Circuit breakers iC60: 1P+N, 2P and 4P (cont.)

Offer selection see page 390
Offer B
 This sticker must be removed before publishing

Circuit breakers 1P+N + Auxiliaries 9 mm (Aux + Neutral + 3 phases)

Type: AuxNL1AuxNL2AuxNL3, ...	Number of 18 mm modules	Cat. no.
	57	A9XAH557

Circuit breakers 1P+N + Vigi iC60 25 A

Type: NL1NL2NL3, ...	Number of 18 mm modules	Cat. no.
	21	A9XPF521

Circuit breakers 1P+N + Vigi iC60 40 or 63 A

Type: NL1NL2NL3, ...	Number of 18 mm modules	Cat. no.
	24	A9XPF524

Circuit breakers 1P+N + Vigi iC60 25 A + Auxiliaries 9 mm

Type: AuxNL1AuxNL2AuxNL3, ...	Number of 18 mm modules	Cat. no.
	24	A9XPF524

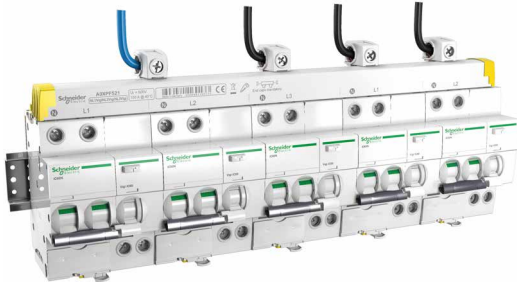

PB117806-27.eps



PB117807-30.eps



PB117806-29.eps

Choice guide

Connection to the top

Circuit breakers iC60: 1P+N, 2P and 4P (cont.)



PB117089-42-0ps

Offer B

Offer selection see page 390

This sticker must be removed before publishing

Circuit breakers 3P+N

Type: NL1L2L3, ...	Number of 18 mm modules	Cat. no.
	8	A9XPH408
	12	A9XPH412
	16	A9XPH416
	24	A9XPH424
	57	A9XPH457

Circuit breakers 3P+N + Auxiliaries 9 mm

Type: AuxNL1L2L3, ...	Number of 18 mm modules	Cat. no.
	57	A9XAH457

Circuit breakers 3P+N + Vigi iC60 25 A (3 modules) + 2 spacers

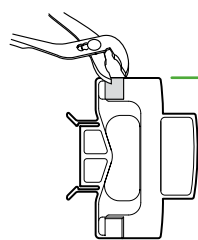

Remove the partition of the spacer of the center

Type: NL1L2L3, ...	Number of 18 mm modules	Cat. no.
	12	A9XPH412
	24	A9XPH424
	57	A9XPH457

Circuit breakers 3P+N + Vigi iC60 40 or 63 A (3.5 modules) + 1 spacer

Type: NL1L2L3, ...	Number of 18 mm modules	Cat. no.
	12	A9XPH412
	24	A9XPH424
	57	A9XPH457

Choice guide

Connection to the top - Circuit breakers

Acti9 iC40, iC40 XA, iCV40, iCV40 XA, iDPN, iDPN Vigi, Vigi iC40, Vigi iCG40

Circuit breakers iC40, iC40 XA, iDPN 1P+N

Type: NL, ...	No. of 18 mm modules	Cat. no.
	12	A9XPC612 (*)
	24	A9XPC624 (*)
	48	A9XPC648 (*)

Circuit breakers iCV40, iCV40 XA, iDPN Vigi, Vigi iC40, Vigi iCG40 1P+N

Type: NL, ...	No. of 18 mm modules	Cat. no.
	12	A9XPC612 (*)
	24	A9XPC624 (*)
	48	A9XPC648 (*)

Circuit breakers iC40, iC40 XA, iDPN 1P+N with comb busbar 3P+N

Type: NL1L2L3, ...	No. of 18 mm modules	Cat. no.
	12	A9XPC712
	24	A9XPC724
	48	A9XPC748

Circuit breakers iCV40, iCV40 XA, iDPN Vigi, Vigi iC40, Vigi iCG40 1P+N with comb busbar 3P+N

Type: NL1L2L3, ...	No. of 18 mm modules	Cat. no.
	12	A9XPC712
	24	A9XPC724
	48	A9XPC748

(*) **CAUTION**

INCOMPATIBILITY BETWEEN 1P+N COMB BUSBARS AND 3P+N DEVICES

- Never connect a 1P+N comb busbar to a 3P+N device, as this will result in a multi-phase bolted short circuit.
- Always check that the head of group circuit breaker is in good working condition before connecting a comb busbar.

Failure to follow these instructions can result in injury or equipment damage.

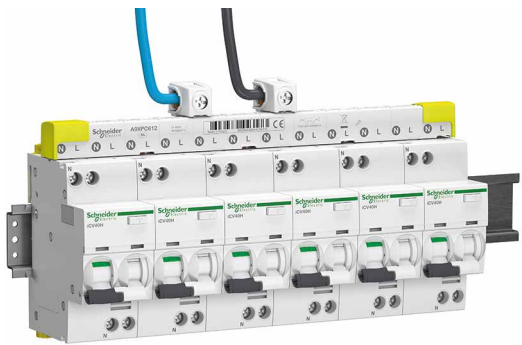

PB11877-44.eps

Offer selection see page 390

Offer C

This sticker must be removed before publishing

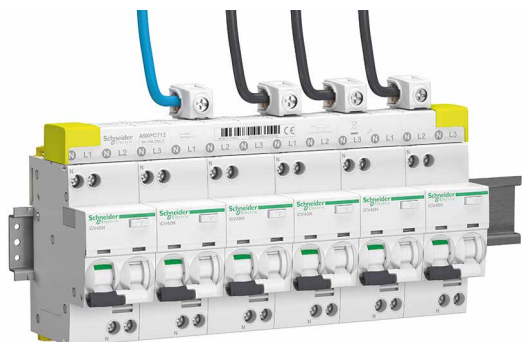

PB11877-44.eps

Choice guide

Connection to the top - Circuit breakers

Acti9 iC40, iCV40, iDPN, iDPN Vigi (cont.)

(*) **CAUTION**

INCOMPATIBILITY BETWEEN 1P+N COMB BUSBARS AND 3P+N DEVICES

- Never connect a 1P+N comb busbar to a 3P+N device, as this will result in a multi-phase bolted short circuit.
- Always check that the head of group circuit breaker is in good working condition before connecting a comb busbar.

Failure to follow these instructions can result in injury or equipment damage.



Circuit breakers iC40, iC40 XA, iDPN 1P+N		
Type: NL, ... with integrated connectors	No. of 18 mm modules	Cat. no.
	6	A9XPP606 (*)
	12	A9XPP612 (*)
	24	A9XPP624 (*)

Circuit breakers iCV40, iCV40 XA, iDPN Vigi, Vigi iC40, Vigi iCG40 1P+N		
Type: NL, ... with integrated connectors	No. of 18 mm modules	Cat. no.
	6	A9XPP606 (*)
	12	A9XPP612 (*)
	24	A9XPP624 (*)

Circuit breakers iC40, iC40 XA, iDPN 1P+N with comb busbar 3P+N		
Type: NL1L2L3, ... with integrated connectors	No. of 18 mm modules	Cat. no.
	12	A9XPP712
	24	A9XPP724

Circuit breakers iCV40, iCV40 XA, iDPN Vigi, Vigi iC40, Vigi iCG40 1P+N with comb busbar 3P+N		
Type: NL1L2L3, ... with integrated connectors	No. of 18 mm modules	Cat. no.
	12	A9XPP712
	24	A9XPP724

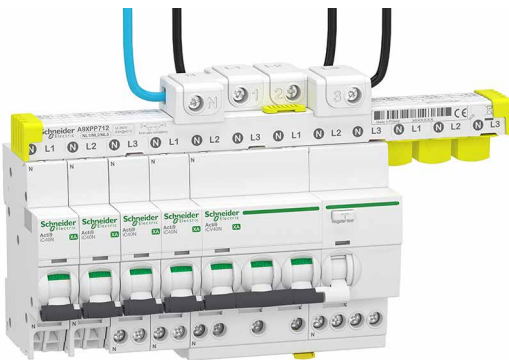

Choice guide

Connection to the top - Circuit breakers

Acti9 iC40, iC40 XA, iCV40, iDPN, iDPN Vigi, Vigi iC40, Vigi iCG40 (cont.)

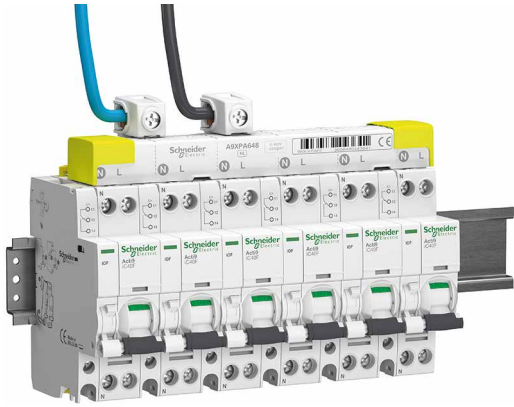

Circuit breakers iC40, iC40 XA, iDPN 1P+N + Auxiliaries 9 mm

Type: AuxNL, ...	No. of 18 mm modules	Cat. no.
	48	A9XPA648

Circuit breakers iC40, iC40 XA, iDPN 1P+N with comb busbar 3P+N + Auxiliaries 9 mm

Type: AuxNL1AuxNL2AuxNL3, ...	No. of 18 mm modules	Cat. no.
	48	A9XPA748

Circuit breakers iCV40, iCV40 XA, (iC40+Vigi), (iC40 XA+Vigi), (iDPN+Vigi), Vigi iC40, Vigi iCG40 1P+N + Auxiliaries 9 mm

Type: AuxNL, ...	No. of 18 mm modules	Cat. no.
	48	A9XPV648

Circuit breakers iCV40, iCV40 XA, (iC40+Vigi), (iC40 XA+Vigi), (iDPN+Vigi), Vigi iC40, Vigi iCG40 1P+N with comb busbar 3P+N + Auxiliaries 9 mm

Type: AuxNL1AuxNL2AuxNL3, ...	No. of 18 mm modules	Cat. no.
	48	A9XPV748

Offer C

Offer selection see page 390

This sticker must be removed before publishing

Choice guide

Connection to the top

Circuit breakers C120 and NG125



Circuit breakers C120 or NG125 1P		
Type: L, ...	Number of 27 mm modules	Cat. no.
	16	14811

Circuit breakers C120 or NG125 2P		
Type: L1L2, ...	Number of 27 mm modules	Cat. no.
	16	14812

Circuit breakers C120 or NG125 3P		
Type: L1L2L3, ...	Number of 27 mm modules	Cat. no.
	15	14813



Circuit breakers C120 or NG125 4P		
Type: NL1L2L3, ...	Number of 27 mm modules	Cat. no.
	16	14814

Biconnect horizontal comb busbars 18 mm modules

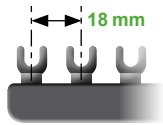

IEC 60664-1



Acti9 K60 biconnect	18 mm poles, cuttable					
Number of poles	1P			2P		
Type	L1,...			L1L2,...		
Set of	1			1		
Number of 18 mm modules	12	18	57	12	18	57
Catalogue numbers	R9XFH112	R9XFH118	R9XFH157	R9XFH212	R9XFH218	R9XFH257



Technical data	
Operating current at 40°C (Ie)	63 A
Cross section	10 mm ²
Short circuit current (Isc)	Compatible with the breaking capacity of Schneider Electric circuit breakers
Rated insulation voltage (Ui)	500 V AC
Operating voltage (Ue) L/N	230 V AC
	L/L 400 V AC
Pollution degree	3
Fire resistance IEC 695-2-1	Self-extinguishing at 960°C 30 secondes
Color	RAL 9003

End-pieces
 ■ essential to ensure the correctly comb busbars insulation



Tooth covers
 ■ Insulate teeth that have been left free



Biconnect horizontal comb busbars 18 mm modules (cont.)

3P						4P			Head of group + 3 (N+P)	3 (N+P)															
																									
L1L2L3,...						NL1L2L3,...			NL1L2L3 / NL1NL2NL3,...	NL1NL2NL3,...															
1						1			1	1															
6		9		11		12		18		57		12		18		57									
R9XFH306		R9XFH309		R9XFH311		R9XFH312		R9XFH318		R9XFH357		R9XFH412		R9XFH418		R9XFH457		R9XFH518G		R9XFH512		R9XFH518		R9XFH557	

Accessories

Number of poles	1P	2P	3P	4P	
					
	End-pieces				Tooth covers
Set of	10				20
Catalogue numbers	R9XE110	R9XE210	R9XE310	R9XE410	R9XT20

Horizontal comb busbars 18 mm modules for Acti9: iC60



Acti9 iC60	18 mm poles, cuttable				
Number of poles	1P	1 (N+P)	3P	4P	3 (N+P)
	L1	N L1	L1 L2 L3	N L1 L2 L3	N L1 N L2 N L3
Type	L1,...	NL1,...	L1L2L3,...	NL1L2L3,...	NL1NL2NL3,...
Set of	1	1	1	1	1
Catalogue numbers					
6 modules of 18 mm	A9XPH106	A9XPH206	A9XPH306	-	-
8 modules of 18 mm	-	A9XPH208	-	A9XPH408	-
9 modules of 18 mm	-	-	A9XPH309	-	-
10 modules of 18 mm	-	A9XPH210	-	-	-
11 modules of 18 mm	-	-	A9XPH311	-	-
12 modules of 18 mm	A9XPH112	A9XPH212	A9XPH312	A9XPH412	A9XPH512
16 modules of 18 mm	-	-	A9XPH316	A9XPH416	-
18 modules of 18 mm	-	A9XPH218	A9XPH318	-	A9XPH518
20 modules of 18 mm	-	-	A9XPH320	-	-
24 modules of 18 mm	A9XPH124	A9XPH224	A9XPH324	A9XPH424	A9XPH524
57 modules of 18 mm	A9XPH157	A9XPH257	A9XPH357	A9XPH457	A9XPH557

Technical data





Operating current at 40°C (Ie)	100 A
Cross section	16 mm ²
Short circuit current (Isc)	Compatible with the breaking capacity of Schneider Electric circuit breakers
Rated insulation voltage (Ui)	500 V AC
Operating voltage (Ue)	415 V AC
Pollution degree	3
Fire resistance IEC 695-2-1	Self-extinguishing at 960°C 30 secondes
Color	RAL 9003

End-pieces
 ■ essential to ensure the correctly comb busbars insulation

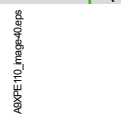

Tooth covers
 ■ Insulate teeth that have been left free

Accessories

Number of poles	1P Aux+1P	2P Aux+2P	3P Aux+3P 3 (Aux+1P)	4P Aux+4P 3 (Aux+N+1P)		
						
	End-pieces				Tooth covers	
	Lateral end-pieces providing IP20 protection				Insulate teeth that have been left free	
					Connectors	
					Double terminal	
					Comb busbar power supply. Horizontal in-comer on each side. For 35 mm ² cable. Tightening torque 4 N.m	
Set of	10	10	10	10	20	4
Catalogue numbers	A9XPE110	A9XPE210	A9XPE310	A9XPE410	A9XPT920	A9XPCD04

Horizontal comb busbars 18 mm modules for Acti9: iC60 (cont.)



Cuttable comb busbars, 18 mm modules, with 9 mm auxiliary

Aux+1P	Aux+2P	Aux+3P	Aux+4P	3 (Aux+1P)	3 (Aux+N+1P)
Aux. L1	Aux. L1 L2	Aux. L1 L2 L3	Aux. N L1 L2 L3	Aux. L1 Aux. L2 Aux. L3	Aux. N L1 Aux. N L2 Aux. N L3
AuxL1,...	AuxL1L2,...	AuxL1L2L3,...	AuxNL1L2L3,...	AuxL1AuxL2AuxL3,...	AuxNL1AuxNL2AuxNL3,...
1	1	1	1	1	1
-	-	-	-	-	-
-	-	-	-	-	-
-	-	-	-	-	-
-	-	-	-	-	-
-	-	-	-	-	-
-	-	-	-	-	-
-	-	-	-	-	-
-	-	-	-	-	-
-	-	-	-	-	-
-	-	-	-	-	-
A9XAH157	A9XAH257	A9XAH357	A9XAH457	A9XAH657	A9XAH557

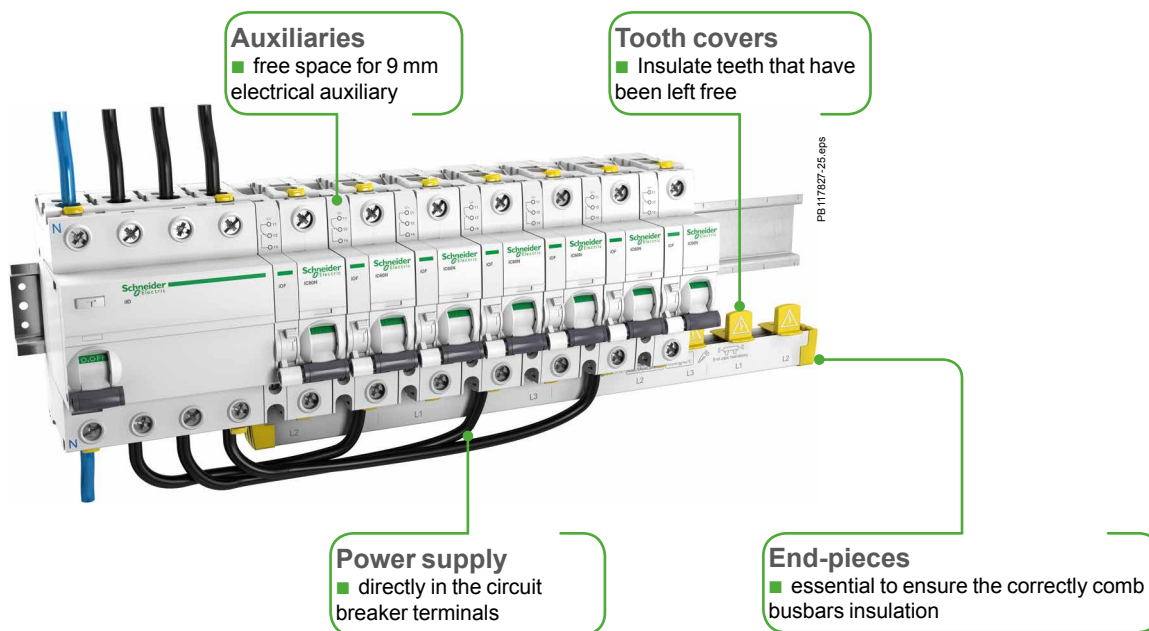

Complementary technical information

Horizontal comb busbars 18 mm modules for Acti9: iLD



Acti9 iLD	18 mm poles, iLD 4P / iC60 1P+N				
Number of poles	Head of group + 3 (N+P)				
Type	NL1L2L3 / NL1NL2NL3,...				
Set of	1				
Number of 18 mm modules	10	12	14	16	22
Cat. no.	A9XPH810	A9XPH812	A9XPH814	A9XPH816	A9XPH822

Technical data		
Operating current at 40°C	(Ie)	80 A
Cross section		16 mm ²
Short circuit current	(Isc)	Compatible with the breaking capacity of Schneider Electric circuit breakers
Rated insulation voltage	(Ui)	500 V AC
Operating voltage	(Ue)	230 V AC (Ph/N) / 400 V AC (Ph/Ph)
Rated impulse withstand voltage	(Uimp)	6 kV
Degree of protection IEC 60529		IP20
Pollution degree		3
Fire resistance IEC 695-2-1		Self-extinguishing at 960°C 30 secondes
Colour		RAL 9003

End-pieces
 ■ essential to ensure the correctly comb busbars insulation



Accessories		
Use	Lateral end-pieces providing IP20 protection mounted on each side of the comb busbar	Insulate teeth that have been left free
Set of	10	20
Cat. no.	A9XPE410	A9XPT920

Complementary technical information

Horizontal comb busbars 9 mm modules for Acti9: iDPN, iDPN Vigi

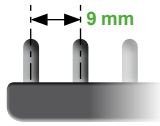

IEC 60947-7-1, IEC 61439-1

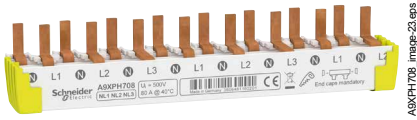

Acti9 iDPN, iDPN Vigi		9 mm poles						
Number of poles	1 (N+P)			3 (N+P)				
Type	NL1,...			NL1NL2NL3,...				
Set of	1			1				
Number of 18 mm modules	12	24	8	12	16	20	24	
Catalogue numbers	A9XPH612	A9XPH624	A9XPH708	A9XPH712	A9XPH716	A9XPH720	A9XPH724	

Technical data	
Operating current at 40°C (Ie)	80 A
Cross section	16 mm ²
Short circuit current (Isc)	Compatible with the breaking capacity of Schneider Electric circuit breakers
Rated insulation voltage (Ui)	500 V AC
Operating voltage (Ue)	230 V AC 230 V AC (Ph/N) / 400 V AC (Ph/Ph)
Degree of protection IEC 60529	IP20
Pollution degree	3
Fire resistance IEC 695-2-1	Self-extinguishing at 960°C 30 secondes
Color	RAL 9003

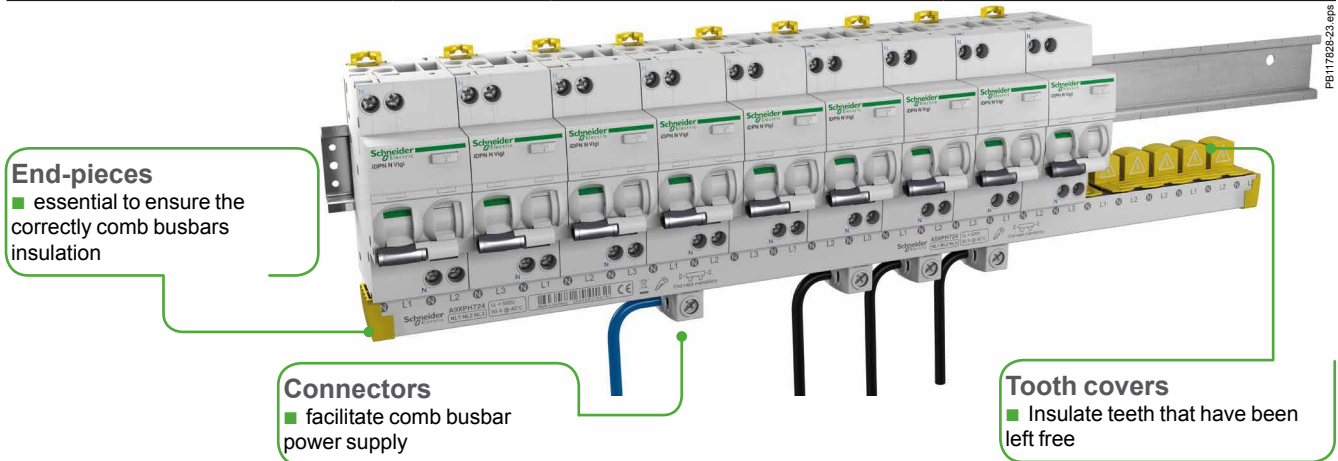

Accessories					
Number of poles	1P+N	3P+N	For 1P+N comb busbars	For 3P+N comb busbars	
	End-pieces Lateral end-pieces providing IP20 protection		Connectors Comb busbar power supply. Horizontal in-come on each side. For 35 mm ² cable. Tightening torque 4 N.m		Tooth covers Insulate teeth that have been left free
Set of	10		4		20
Catalogue numbers	A9XPE210	A9XPE410	A9XPC604	A9XPCM04	A9XPT620

Complementary technical information

Horizontal comb busbars 27 mm modules for C120, NG125

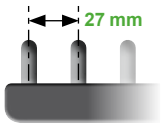

IEC 60664-1



C120, NG125		27 mm poles, cuttable			
Number of poles	1P	2P	3P	4P	
	L1	L1 L2	L1 L2 L3	N L1 L2 L3	
Type	L1,...	L1L2,...	L1L2L3,...	NL1L2L3,...	
Set of	1				
Number of 27 mm modules	16	16	15	16	
Catalogue numbers	14811	14812	14813	14814	

Technical data	
Operating current at 40°C (Ie)	125 A
Short circuit current (Isc)	Compatible with the breaking capacity of Schneider Electric circuit breakers
Rated insulation voltage (Ui)	620 V AC
Operating voltage (Ue)	500 V AC
Degree of protection	3
Fire resistance IEC 695-2-1	Self-extinguishing at 960°C 30 secondes
Color	RAL 7016 (anthracite grey)

End-pieces

- essential to ensure the correctly comb busbars insulation



Tooth covers

- Insulate teeth that have been left free

Power supply

- directly in the circuit breaker terminals

Accessories	
Number of poles	1P, 2P, 3P, 4P
	Tooth covers Insulate teeth that have been left free
Set of	20
Catalogue numbers	14818



IEC 60947-7-1, IEC 61439-2



Description

- Downstream circuits are connected from the front, to spring terminals.
- Contact pressure automatically adapts to the size of the conductor.
- Contacts are insensitive to vibrations and thermal variations.
- Only one cable (flexible or rigid) can be inserted per terminal.

Quick distribution blocks



Number of poles		4P, incomers from top	4P, incomers from bottom
Rated operational current at 40 °C (Ie)		63 A	63 A
Rated conditional short-circuit current of an assembly (Isc)		The reinforced breaking capacity due to cascading in circuit breaker combinations is maintained. The worst-case situations have been tested.	The reinforced breaking capacity due to cascading in circuit breaker combinations is maintained. The worst-case situations have been tested.
Rated insulation voltage (Ui)		500 V AC	500 V AC
Rated operational voltage (Ue)		440 V AC	440 V AC
Rated impulse withstand voltage (Uimp)		6 kV	6 kV
Rated short-time withstand current (Icw)		-	-
Rated operational frequency		50/60 Hz	50/60 Hz
Degree of protection		IPxxB	IPxxB
Incoming terminals		1 tunnel terminal 25 ² /phase	1 tunnel terminal 25 ² /phase
Total connection capacity, outgoing terminals		24 connections: 4 x 6 ² /phase 12 x 6 ² /neutral	24 connections: 4 x 6 ² /phase 12 x 6 ² /neutral
Dimensions (H x W x D)		96.5 x 72 x 62 8 x 9 mm pitch	96.5 x 72 x 62 8 x 9 mm pitch
Installation		Clipped onto a DIN rail	Clipped onto a DIN rail
Other			
Standard for installation inside Prisma		IEC 61439-2	IEC 61439-2
Glow-wire 60695-2-11		960 °C	960 °C
Degree of pollution		3	3
References		04040	04041

Accessories

References	-	-
-------------------	---	---

Advantages

- A reliable electrical connection, no maintenance required (tightness guaranteed over time).
- Quick connection.
- Easy phase balancing.
- Ease of rewiring if the switchboard is expanded or modified.

4P	1P
	
125 A	160 A
20 kA/60 ms max according to IEC 61439-1	20 kA/60 ms max according to IEC 61439-1
750 V AC	750 V AC
690 V AC	690 V AC
8 kV	8 kV
4.5 kA rms/1 s	4.5 kA rms/1 s
50/60 Hz	50/60 Hz
IPxxB	IPxxB
1 tunnel terminal 35 ² /phase	1 tunnel terminal 35 ² /phase
52 connections: 7 x 4 ² /phase 3 x 6 ² /phase 2 x 10 ² /phase 1 x 16 ² /phase (screw terminal)	52 connections: 7 x 4 ² /phase 3 x 6 ² /phase 2 x 10 ² /phase 1 x 16 ² /phase (screw terminal)
127 x 108 x 48 8 x 9 mm pitch	127 x 108 x 48 8 x 9 mm pitch
Screwed to plain or slotted backplate or onto DIN rail	Screwed to plain or slotted backplate or onto DIN rail
Possible to combine 2 terminal blocks (2 nd terminal block supplied from enclosed terminals in the 1 st , I _{max} of 2 nd terminal block: 80 A)	Possible to combine 2 terminal blocks (2 nd terminal block supplied from enclosed terminals in the 1 st , I _{max} of 2 nd terminal block: 80 A)
IEC 61439-2	IEC 61439-2
960 °C	960 °C
3	3
04045	04046

125 A flexible connectors (4)	Copper spacer (batch of 4)
04047	04037

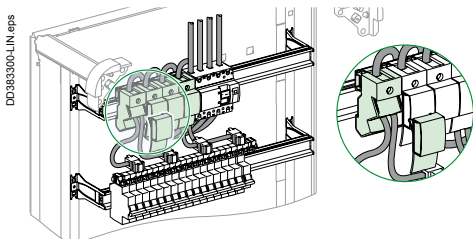
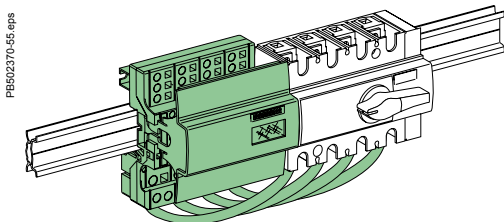



IEC 60947-7-1, IEC 61439-2



Description

- Distribution over full rows of modular devices.
- The distribution block is generally supplied by busbars in enclosures and cubicles.
- Easy phase balancing.
- Mix of devices and functions in the same row.
- Installation ≥ 160 A: clipped onto the back of a modular rail or screwed onto a solid or pre-slotted plate.

Distribution blocks

Number of poles		4P	4P	
				
		63 A	80 A	
Rated peak withstand current (Ipk)		15 kA	15 kA	
Rated conditional short-circuit current of an assembly (Isc)		The cascading reinforced breaking capacity when combining circuit breakers is maintained. The worst-case scenarios have been tested. The characteristics are exactly right for the connected devices. Circuit breakers and switches still have their temperature derating curves, and their whole performance is maintained.		
Rated insulation voltage (Ui)		500 V AC	500 V AC	
Rated operational voltage (Ue)		440 V AC	440 V AC	
Rated impulse withstand voltage (Uimp)		6 kV	6 kV	
Maximum current (Imax)		-	-	
Rated operational frequency		50/60 Hz		
Degree of protection		IPxxB		
Lenght	In 9 mm modules	24	48	
	In 18 mm modules	12	24	
Upstream connection capacity		Tunnel terminals for cables up to 25 mm ²		
Downstream connection capacity, cable to be used without ferrules	Max. 4 mm ²	Phase	2	7
		Neutral	4	13
	Max. 6 mm ²	Phase	2	2
		Neutral	4	4
Max. 10 mm ²	Phasesw	-	-	
	Neutral	-	-	
Accessories included	Pre-stripped copper connections	10 of 4 mm ² + 6 of 6 mm ² (L = 100 mm)		
	Protective cover			
	Screws and nuts			
References		04008	04004	

Installation

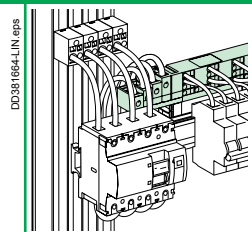

Clipped onto the back of a modular rail, or screw fixing

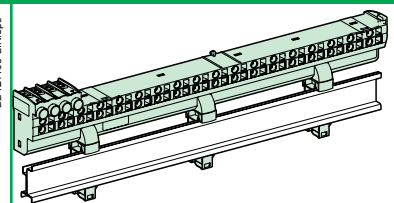



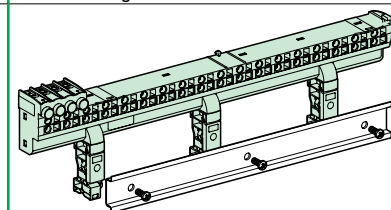

Clipped onto the back of a modular rail, or screw fixing





Can be mounted in Pragma Evolution enclosures and in Prisma Pack 160

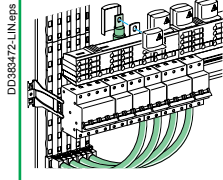
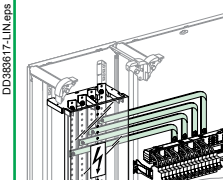

4P	2P	3P	4P	4P
				
160 A 27 kA	200 A 25 kA	200 A 25 kA	200 A 30 kA	200 A 27 kA
The cascading reinforced breaking capacity when combining circuit breakers is maintained. The worst-case scenarios have been tested.				
750 V AC	750 V AC	750 V AC	750 V AC	750 V AC
690 V AC	690 V AC	690 V AC	690 V AC	690 V AC
8 kV	8 kV	8 kV	8 kV	8 kV
50 A for feeder for 10 mm ² cable/63 A for feeder for 2 cables of 10 mm ²				
50/60 Hz				
IPxxB				
24	48			72
12	24			36
Direct on directing pads by 50 mm ² cables or by 20 x 3 flexible bar with a prefabricated connection from busbar				
-	-			
-	-			
6	12			
6	18			
20 of 4 mm ² + 6 of 6 mm ² (L = 100 mm)				
For pads (IPxxB)				
For pads				
04018	04012	04013	04014	04026

Connections to the distribution block

				
4P 200 A connection (supplied with fixing accessories)	4P 200 A connection (supplied with fixing accessories)	4P 200 A connection (supplied with fixing accessories)	4P 160 A connection for Linergy FM 1/2 row	
Allows power supply from	Linergy BW busbar	Linergy BS sheathed busbar	Linergy BS rear busbar	Switchgear
References	04021	04024	04029	04030

Spare parts

	
4 covers for 160/200 A Linergy FM rows	
Reference	01202

Linergy DS

Screw distribution blocks



IEC/EN 60947-7-1, IEC/EN 61439-1 & 2

Description

- Single-pole or four-pole distribution block that can be installed on a standard DIN rail or on a mounting plate.
- Compatible with Prisma G and P, Pragma, Mini Pragma and Resbo series switchboards.
- Incomers and feeders are connected to screw terminals that accept rigid or flexible cables with ferrule.
- Optional: additional neutral terminal strip for four-pole distribution block.

Advantages

- Simplified power supply for main incomers.
- Easy phase balancing.
- Easy, effortless cabling due to excellent accessibility.
- Visible cabling.
- Insulation between phases.
- The single-pole distribution blocks are adjacent and bridgeable via the second incoming hole for parallel connection.

Screw distribution blocks

Number of poles	1P			4P
				
Rated operational current	125 A	160 A	250 A	100 A
Total connections capacity	10	13	14	4 x 7
Terminal capacity				
Diameter	2 x Ø 9.5 mm	2 x Ø 12 mm	1 x Ø 15.3 mm	2 x Ø 7.5 mm
	2 x Ø 7.5 mm	3 x Ø 7.5 mm	1 x Ø 10 mm	5 x Ø 5.5 mm
	6 x Ø 5.8 mm	8 x Ø 5.8 mm	4 x Ø 6 mm	-
	-	-	8 x Ø 7.5 mm	-
Rated peak withstand current (I _{pk} /60 ms)	25 kÅ	36 kÅ	60 kÅ	14 kÅ
	(I _{pk} /6 ms)	-	-	24 kÅ
Rated short-time withstand current (I _{cw}) (IEC/EN 60947-7-1)	4.2 kA rms/1 s	8.4 kA rms/1 s	14.4 kA rms/1 s	3 kA rms/1 s
Width (number of 9 mm pitches)	3	4	5	8
Dimension (H x W x D)	85 x 27 x 50.5	85 x 36 x 50.5	85 x 45 x 50.5	100 x 71 x 50.5
Weight (g)	125	163	239	210
Neutral terminal strip (optional)	-	-	-	LGYN1007
References	LGY112510	LGY116013	LGY125014	LGY410028

Linergy distribution systems

Distribution blocks

Linergy DS

Screw distribution blocks

DS40005_1.eps



On LGY412560 and LGY416048 references.
Input cabling facilitated by side terminals.

Technical data

Common characteristics

To IEC/EN 60947-7-1 and IEC/EN 61439-1 & 2

Rated insulation voltage (Ui)	500 V AC
Rated operational voltage (Ue)	230 V AC (Ph/N) 440 V AC (Ph/Ph)
Rated impulse withstand voltage (Uimp)	8 kV
Rated conditional short-circuit current of an assembly	Up to the breaking capacity of Schneider Electric feeder circuit breakers, even in cascading configuration
Network frequency	50/60 Hz
Pollution degree	3
Overvoltage category	III

Additional technical characteristics

Reference temperature	40 °C
Operating temperature	-25 °C to 55 °C
Dielectric withstand (IEC/EN 60947-1)	2500 V AC

			Neutral terminal strip			
PB111244-20_1.eps	PB111245-20_1.eps	PB111246-20_1.eps	PB111247-20_1.eps	PB111248-20_1.eps	PB111249-20_1.eps	
125 A		160 A	100 A	125 A		
4 x 12	4 x 15	4 x 12	7	12	15	
1 x Ø 9 mm	1 x Ø 9.5 mm	1 x Ø 12 mm	2 x Ø 7.5 mm	1 x Ø 9 mm	1 x Ø 9.5 mm	
7 x Ø 7.5 mm	3 x Ø 8.5 mm	3 x Ø 9 mm	5 x Ø 5.5 mm	7 x Ø 7.5 mm	3 x Ø 8.5 mm	
4 x Ø 6.5 mm	11 x Ø 6.5 mm	8 x Ø 7.5 mm	-	4 x Ø 6.5 mm	11 x Ø 6.5 mm	
-	-	-	-	-	-	
18 kA	18 kA	22 kA	-	-	-	
26 kA	28 kA	36 kA	-	-	-	
4.2 kA rms/1 s	4.2 kA rms/1 s	8.4 kA rms/1 s	-	-	-	
14	20	18	7	14	17	
100 x 126 x 50.5	100 x 162 x 50.5	100 x 174 x 50.5	20 x 70 x 35	20 x 125 x 35	20 x 155 x 35	
390	559	567	63	111	149	
LGYN12512	LGYN12515	LGYN12512	-	-	-	
LGY412548	LGY412560	LGY416048	LGYN1007	LGYN12512	LGYN12515	

Terminal technical data

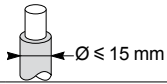
Type	PZ2 screw							
Diameter	Ø 5.5 mm	Ø 5.8 mm	Ø 6 mm	Ø 6.5 mm	Ø 7.5 mm	Ø 8.5 mm	Ø 9 mm	Ø 9.5 mm
Section rigid cable	1.5 to 16 mm ²	1.5 to 16 mm ²	1.5 to 16 mm ²	1.5 to 16 mm ²	2.5 to 25 mm ²	6 to 35 mm ²	10 to 35 mm ²	10 to 35 mm ²
Section flexible cable or with ferrule	1.5 to 10 mm ²	1.5 to 10 mm ²	1.5 to 10 mm ²	1.5 to 10 mm ²	1.5 to 16 mm ²	4 to 25 mm ²	4 to 25 mm ²	6 to 35 mm ²
Tightening torque	2 N.m	2 N.m	2 N.m	2 N.m	2 N.m	2 N.m	2.5 N.m	2.5 N.m
Type	Hc screw							
Diameter	Ø 9.5 mm	Ø 10 mm	Ø 12 mm		Ø 15.3 mm			
Section rigid cable	10 to 35 mm ²	1.5 to 50 mm ²	25 to 70 mm ²		35 to 120 mm ²			
								
Section flexible cable or with ferrule	6 to 35 mm ²	1.5 to 35 mm ²	16 to 50 mm ²		25 to 95 mm ²			
Tightening torque	8 N.m	4 N.m	1P: 9 N.m	4P: 5 N.m	14 N.m			

Linergy distribution systems

Distribution blocks

Linergy DS

Dimensions

Dimensions (mm)

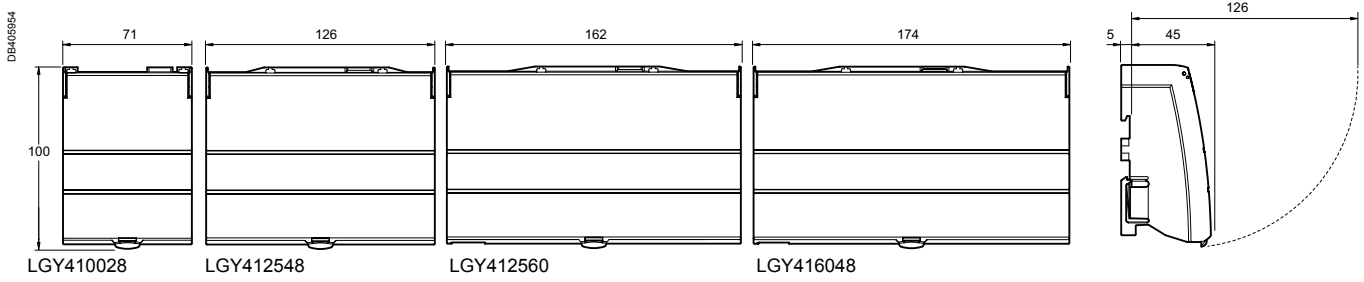
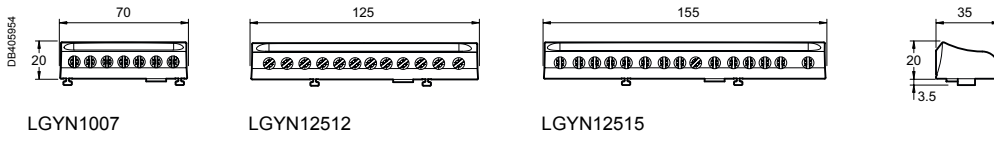
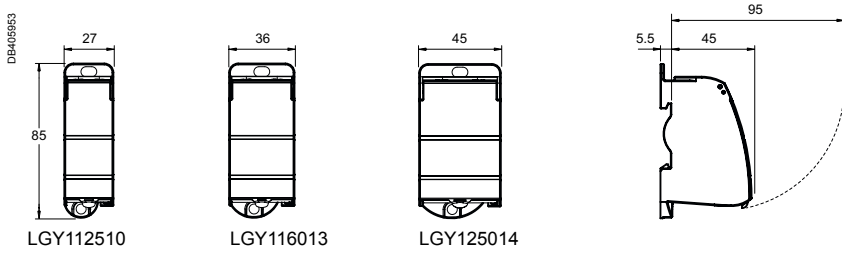



Country approval pictograms



A9XMWD20



Ethernet connection concentrator (Modbus TCP/IP) for wireless devices with data display web pages.

The associated PowerTag energy sensors allow alarms to be managed via email for terminal loads, and energy, power, current and voltage to be measured accurately in real time.

The associated PowerTag Control modules are designed to monitor a circuit and notify wirelessly to the concentrator the information status of a contact (OF, SD, CT or TL position indication...).

The entire system can easily be installed in existing LV equipments using Multi9/Acti9/Compact NSX type circuit breakers.

Data transmitted:

- Total and partial energy.
- Active power, apparent power, phase-to-phase and phase-to-neutral voltage.
- Currents I1, I2, I3.
- Power factor (cos phi).
- Voltage loss and overload information.
- Control order to a circuit.
- Information status of a contact.

Functions

Acti9 PowerTag Link permits:

- Concentration of PowerTag (covered ranges Acti9 iC40/iC60, Multi9 and Compact NSX) wireless energy sensor data.
- Ethernet connection via the RJ45 port.
- Load monitoring:
 - alarm sent by the energy sensor in the event of a voltage loss,
 - pre-alarms on predefined thresholds (50 %, 80 %) or customized thresholds (thresholds on currents, power, voltages and cumulative energies),
 - load running time counter,
 - power synthesis (kW).
- Alarm management on current/voltage/load level thresholds by e-mail.
- Send control orders to PowerTag Control output to operate a load remotely.
- Collect status of contact from PowerTag Control input.
- Display of alarms and pre-alarms on Acti9 PowerTag Link embedded web pages.
- Easy integration into system with Com'X 200, Com'X 510 and other Schneider Electric software and third-party Building Management Systems (BMS) thanks to EcoStruxure Power Commission report in pdf format. This report provides dynamically all the Modbus registers and associated meanings for an easy integration into the system.
- Remote metering capability using the Acti9 PowerTag Link monitoring page.

Installation

- On DIN rail (width 54 mm).
- 230 V AC power supply.

Testing and start-up

- Pairing of wireless devices must be performed via the EcoStruxure Power Commission software, freely available by downloading.
- The software makes it possible, in particular, to attribute to each circuit a name, a use and the current rating (useful for alarms).

Catalog numbers



Acti9 PowerTag Link

Type		Width in 9-mm modules
Ethernet concentrator (Modbus TCP/IP) up to 20 wireless devices	A9XMWD20	6
Ethernet concentrator (Modbus TCP/IP) up to 100 wireless devices	A9XMWD100	

Commissioning software: EcoStruxure Power Commission (*)

- Configuration and communication test of wireless devices
 - Editing of a complete test report (pdf) with the Modbus communication registers for easy integration into a supervision system
 - Windows XP, Windows 7, Windows 8 and Windows 10 compatible
 - Downloadable from: https://www.schneider-electric.com/ww/en/download/document/Ecoreach_Installer
- (*): new name of Ecoreach software



DB-405140



Acti9 PowerTag Link

Compatible products
Circuit breakers and switches:

- Acti9, Multi9, DT60
- Compact NSX

See catalog module CA908058

Acti9 PowerTag Link

- Installation on DIN rail
- 230 V AC power supply

Wireless communication

- No wiring required
- Up to 100 sensors connected

PowerTag Energy sensor

Ethernet connector

- 100 Base T - RJ45

PowerTag Control I/O module



Technical characteristics

Main characteristics		
Supply voltage	Us	110/230 V AC ± 20 %, 2 A
Frequency		50/60 Hz
Power consumption		5 VA
Communication interface		Ethernet 10/100 BASE-T, Cable length ≤ 100 m Cat.6 STP
Wireless communication		Up to 100 PowerTag sensors
Integrated connection type		DHCP client (Ethernet port)
Local indication	Product state	Green, orange and red LED
	Ethernet state (LAN ST)	Green, orange and red LED
Overvoltage category		III
Radio-frequency communication ISM band 2.4 GHz		2.4 GHz to 2.4835 GHz
Degree of protection (IEC 60068-2-30)	Device only	IP20
	Device in modular enclosure	IP40 Insulation class II
Fire resistance		650°C, 30 s
Environment		In compliance with the RoHS directive REACH Regulations

Weight (g)

Acti9 PowerTag Link	
Type	
Acti9 PowerTag Link	133

Dimensions (mm)

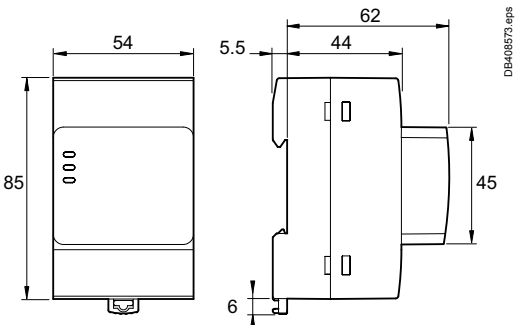

Acti9 PowerTag Link

Additional characteristics		
Operating temperature		-25°C to +60°C
Storage temperature		-40°C to +85°C
Pollution degree		2
Tropicalization (IEC 60068-2-30)		Treatment 2 (relative humidity of 93 % at 40°C)
Operating altitude		0 to 2000 m
Electromagnetic compatibility	Reference standards	
	Immunity	EN 55035
	Emissions	EN 55032
	Electromagnetic compatibility and Radio spectrum Matters (ERM)	EN 300328 EN 301489-1 EN 301489-17

Acti9 PowerTag Link C



Country approval pictograms



Acti9 PowerTag Link C



PowerTag A9 M63 1P+W (A9MEM1520)



PowerTag A9 M63 3P (A9MEM1540)



PowerTag A9 F63 3P+N (A9MEM1570)

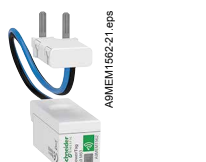

PowerTag A9 P63 1P+N (A9MEM1562)



PowerTag C IO 230V (A9XMC1D3)



PowerTag Ambient for Temperature (A9XST114)



PowerTag NSX (LV434020)



PowerTag NSX (LV434023)

Functions

Acti9 PowerTag Link C is a concentrator that connects the switchboard to the Facility Expert SB smartphone app. It permits:

- Load monitoring with PowerTag wireless energy sensors:
 - load state monitoring,
 - energy measurement.
- Temperature monitoring with PowerTag Ambient for Temperature.
- Sending of control orders to PowerTag Control output to operate a load remotely.
- Collection of status of contact from PowerTag Control input.
- Maximum of 20 wireless devices connected.

Configuration, testing and setup

- Connected devices are configured and communication is tested via the "mySchneider Electrician eSetup" app.

Catalog numbers

Acti9 PowerTag Link C		
Type	Set of	
Acti9 PowerTag Link C	1	A9XELC10

Connectable devices

PowerTag A9 M63, P63, F63				
Type	Mounting	Cat. no.	P63 for Acti 9 and Multi9 Phase/Neutral	F63 for other products
1P+wire	Top or bottom	M63 for Acti9 and Multi9 Monoconnect A9MEM1520	-	-
1P+N	Top	A9MEM1521	A9MEM1561	-
	Bottom	A9MEM1522	A9MEM1562	-
	Top or bottom	-	-	A9MEM1560
1P+N RCBO	Bottom	-	A9MEM1563	-
3P	Top or Bottom	A9MEM1540	-	-
		A9MEM1543	-	-
3P+N	Top	A9MEM1541	A9MEM1571	-
	Bottom	A9MEM1542	A9MEM1572	-
	Top or bottom	-	-	A9MEM1570

PowerTag Control	
Type	Cat. no.
IO 230V	A9XMC1D3

PowerTag Ambient for Temperature	
Type	Cat. no.
Temperature	A9XST114

PowerTag NSX		
Type	Description	Cat. no.
3P	250 A	LV434020
	630 A	LV434022
3P+N	250 A	LV434021
	630 A	LV434023

Note: for additional information and list of Schneider Electric compatible devices, refer to the selection guide CA908058E.

Monitoring and measurement for small business

Acti9 PowerTag Link C (continued)



Example of an installation with PowerTag compatible A9XELC10

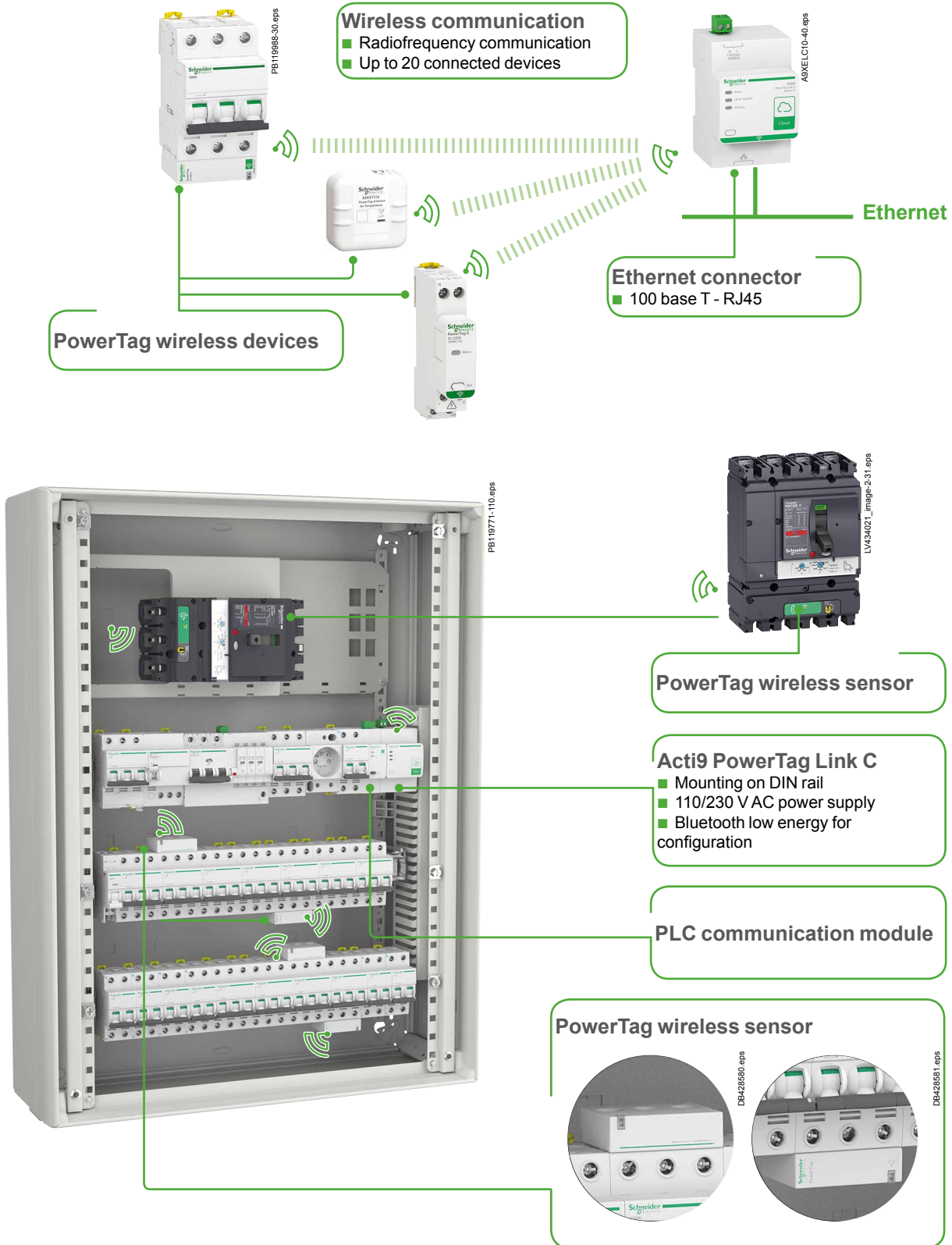



3 options for connecting Acti9 PowerTag Link C to an Internet router

Direct RJ45

Ethernet cable

- 1 Acti9 PowerTag Link C
- 2 Ethernet cable
- 3 Internet router



DE429669.eps

Wifi router

- 1 Acti9 PowerTag Link C
- 2 Ethernet cable
- 3 Wifi router
- 4 Internet router

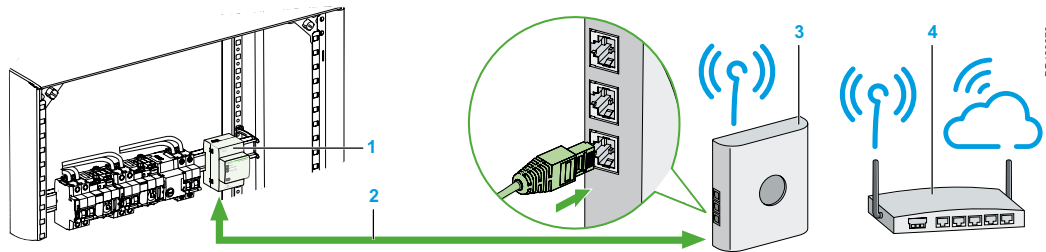

DB429670.eps

Power Line Carrier (PLC)

PLC with 2 PLC plugs

- 1 Acti9 PowerTag Link C
- 2 Ethernet cable
- 3 PLC adapter
- 4 Internet router

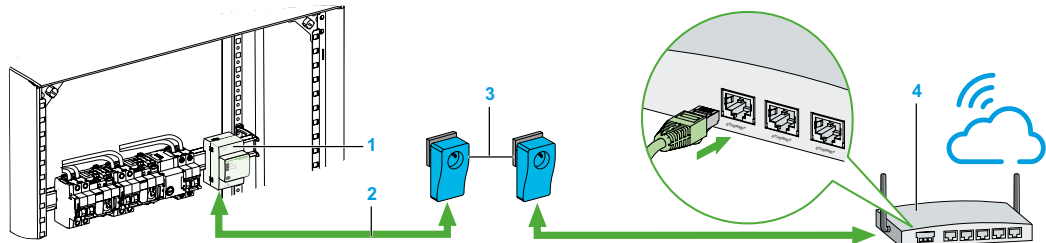

DB429671.eps

PLC with 1 PLC DIN rail adapter and 1 PLC plug



EER31700_Image-3B.eps

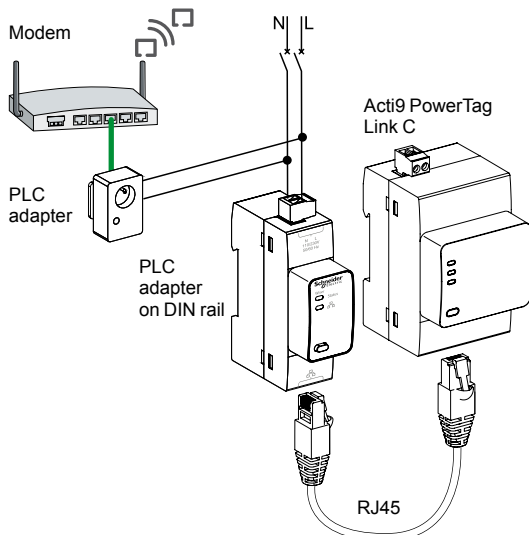

DE429445_Modifie.eps

Type	Cat. no.
PLC adapter on DIN rail	EER31710

Acti9 PowerTag Link C (continued)



Technical characteristics

Power supply		
Rated		<ul style="list-style-type: none"> ■ 110/230 V AC ± 15% ■ Non-isolated with protection against voltage reversals to -28.8 V---
Maximum input current		1.5 A
Voltage limit		19.2...28.8 V--- with ripple
Maximum inrush current		3 A
Overvoltage category		OVC III
No-load consumption		100 mA
Environmental characteristics		
Temperature	Operating (horizontal)	-25°C...+60°C
	Storage	-40°C...+85°C
Tropicalization		Treatment 2 (relative humidity: 93 % at 40°C)
Resistance to voltage dips		10 ms, class 3 as per IEC 61000-4-29
Degree of protection	Front panel	IP40
	Box	IP20
Degree of pollution		2
Compliance with SELV specifications		Yes
Altitude	Operating	0...2000 m
	Storage	0...3000 m
Vibration resistance	As per IEC 60068-2-6	1 g / ± 3.5 mm - 5 Hz to 300 Hz - 10 cycles
Shock resistance	As per IEC 60068-2-27	15 g / 11 ms
Immunity to electrostatic discharge	As per IEC 61000-4-2	<ul style="list-style-type: none"> ■ Air: 8 kV ■ Contact: 4 kV
Immunity to radiated magnetic fields	As per IEC 61000-4-3	10 V/m - 80 MHz to 3 GHz
Immunity to fast transients	As per IEC 61000-4-4	<ul style="list-style-type: none"> ■ 1 kV for Ethernet communication ■ 2 kV for 24 V--- power supply - 5 kHz - 100 kHz
Immunity to conducted magnetic fields	As per IEC 61000-4-6	10 V from 150 kHz to 80 MHz
Immunity to magnetic fields at mains frequency	As per IEC 61000-4-8	<ul style="list-style-type: none"> ■ 30 A/m continuous ■ 100 A/m pulsed
Resistance to corrosive atmospheres	As per IEC 60721-3-3	Level 3C2 on H ₂ S / SO ₂ / NO ₂ / Cl ₂
Fire resistance	For live parts	At 960°C 30 s / 30 s as per IEC 60 695-2-10 and IEC 60 695-2-11
	For other parts	At 650°C 30 s / 30 s as per IEC 60 695-2-10 and IEC 60 695-2-11
Salt spray mist	As per IEC 60068-2-52	Severity 2
Environment		In compliance with RoHS directives
Overvoltage	As per IEC 61000-4-5	<ul style="list-style-type: none"> ■ Power supply: 0.5 kV ■ Ethernet: 1 kV
Conducted emissions	IEC 61131-2, CISPR	Class A: (0.15 to 30 MHz)
Radiated emissions	IEC 61131-2, CISPR	Class A: (30 to 1000 MHz)
Mean time between failures		More than 1 M hours
Additional characteristics		
Mounting position		Horizontal or vertical
Ethernet characteristics		
Type of interface module		Ethernet
Transmission	Ethernet	<ul style="list-style-type: none"> ■ Transfer rate: 10/100 Mbit/s ■ Medium: straight shielded cable, STP or S/FTP, Cat 5e or 6, RJ45 connector
Turnaround time		1 ms
Maximum cable length		100 m
Type of bus connector		RJ45 (shielded)
Number of Ethernet ports		1
Radiofrequency characteristics		
Radio communication ISM band		2.4 to 2.4835 GHz
Number of channels		11 to 26 (IEEE 802.15.4)
Equivalent isotropically radiated power (EIRP)		0 dBm
Number of radiofrequency devices		Up to 20 PowerTag energy sensors
RF standard		ETSI / EN 300328 v2.1.1 ETSI / EN 301489-17 v3.2.0

Monitoring and measurement for small business

Acti9 PowerTag Link C (continued)



Dimensions (mm)

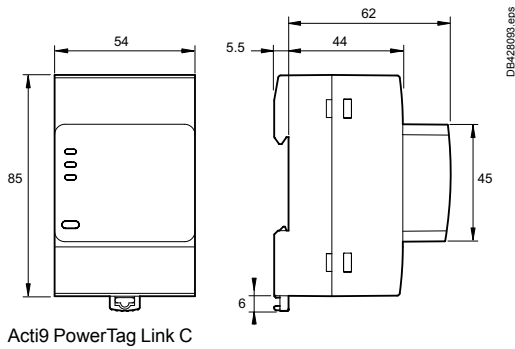

Weight (g)

Smartlink	
Type	
Acti9 PowerTag Link C	133

Connection

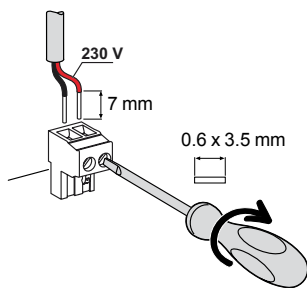

Terminal	Tightening torque	Copper cables		
		Rigid	Flexible	Flexible with ferrule
DB428033.eps		DB122845.eps	DB122853.eps	DB122854.eps
Power supply connector	0.8 Nm	0.2 to 1.5 mm ²	0.2 to 1.5 mm ²	0.2 to 1.5 mm ²

Installation

- On DIN rail (width 54 mm).
- 230 V AC power supply.



Country approval pictograms



Acti9 Smartlink EL B

PB113286-modifie-66.eps

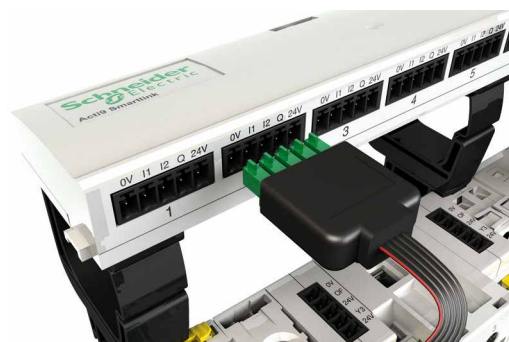

PB107797-44.eps

Functions

Acti9 Smartlink EL B is a gateway that connects the switchboard to the Facility Expert SB smartphone app.

- Circuit breakers, residual current circuit breakers, residual current devices:
 - open/closed state,
 - tripped state.
- Contactors, impulse relays:
 - opening control,
 - closing control,
 - open/closed state.
- RCA remote control:
 - reset control after tripping,
 - open/closed state,
 - tripped state.
- Pulse power meters:
 - number of pulses recorded,
 - pulse value setting (e.g. kWh).
- Analogue sensors:
 - temperature sensor,
 - humidity sensor,
 - CO₂ detector,
 - etc.

When Acti9 Smartlink EL B is switched on and the Internet connection is available, communication automatically adjusts to Ethernet (Cloud) communication parameters.



DB428685-76.eps

Configuration, testing and setup

- Connected devices are configured and communication and cabling are tested via the "mySchneider Electrician eSetup" app.



Acti9 Smartlink EL B

PB113286-modif1e-66.eps



Wifer

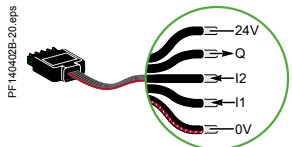

A9XCAU06

DB428089.eps



24 V DC power supply

ABL8MEM24003-30.eps

Catalog numbers

Smartlink			
Type		Set of	
Acti9 Smartlink EL B		1	A9XELC08
Supplied with	Connector for 4-pin analogue input	1	
	24 V DC power supply connector	1	
	Mounting kit	1	A9XMFA04
Mounting kit	DIN rail (4 feet, 4 straps, 4 adapters)	1	A9XMFA04
	Back panel (2 angle brackets)	1	A9XMBP02
	Pragma and Kaedra mounting (see table below)	1	A9XMVA01
	Accessories		
Wifer, wifer adapter for setup if no wifer available		1	TCSEGWB13FA0
Prefabricated cables			
With 2 connectors	100 mm	6	A9XCAS06
	160 mm	6	A9XCAM06
	450 mm	6	A9XCAH06
	870 mm	6	A9XCAL06
With 1 connector	870 mm	6	A9XCAU06
	4000 mm	1	A9XCAC01
Connectors	5-pin connectors (Ti24)	12	A9XC2412
24 V DC power supply	With iATL, iACT or RCA	1	ABL8MEM24012
	Without iATL, iACT or RCA	1	ABL8MEM24003

Connectable devices

With Ti24 interface		
Type	Cat. no.	Description
iACT24	A9C15924	Low-level control and indication auxiliary for iCT contactors
iATL24	A9C15424	Low-level control and indication auxiliary for iTL impulse relays
iOF+SD24	A9A26897	Low-level indication auxiliary for iC60, iID, ARA, RCA, iSW-NA
	A9A26898	
RCA	A9N26899	Low-level indication auxiliary for C60, C120, DPN, RCCB/iD, C60H-DC
	See module CA904011	

Without Ti24 interface

Power meters with pulse output e.g. iEM2000T
 Impulse meters complying with the IEC 62053-21 standard

With analogue outputs

Temperature and humidity sensors with 0-10 V or 4-20 mA output
 CO₂ detectors with 0-10 V or 4-20 mA output



iACT24

PB107751-34.eps



iATL24

PB107752-34.eps



iOF+SD24

PB107750-36.eps



RCA

PB108263-35.eps



iEM3110

PB108412-35.eps



iEM2000T

PB110836-35.eps

Example of an installation

24 modules min.

150 mm min.

1 analogue input channel
 ■ Example: temperature sensor connection

24 V DC power supply

Prefabricated cables
 ■ For devices **without** Ti24 interface

Prefabricated cables
 ■ For devices **with** Ti24 interface
 ■ Simplified and faster cabling

Ti24 connector
7 input/output channels
 Input protected against voltage reversals
 Output protected by current limitation

- Pin 1: 0 V
- Pin 2: I1 Input 1
- Pin 3: I2 Input 2
- Pin 4: Q output
- Pin 5: +24 V DC

24 V DC power supply connector
 Input protected against voltage reversals

- Pin 1: 0 V
- Pin 2: +24 V DC

Ethernet + Cloud connector
 100 base T - RJ45

Analogue connector
 2 configurable input points
 0-10 V or 4-20 mA

- Pin 1: 0 V
- Pin 2: AI1 Input 1
- Pin 3: AI2 Input 2
- Pin 4: +24 V DC

Status indication
 ■ Indication of the operation of the communication system and the status of Smartlink EL B

Not used

Options for connecting Acti9 Smartlink EL B to an Internet router

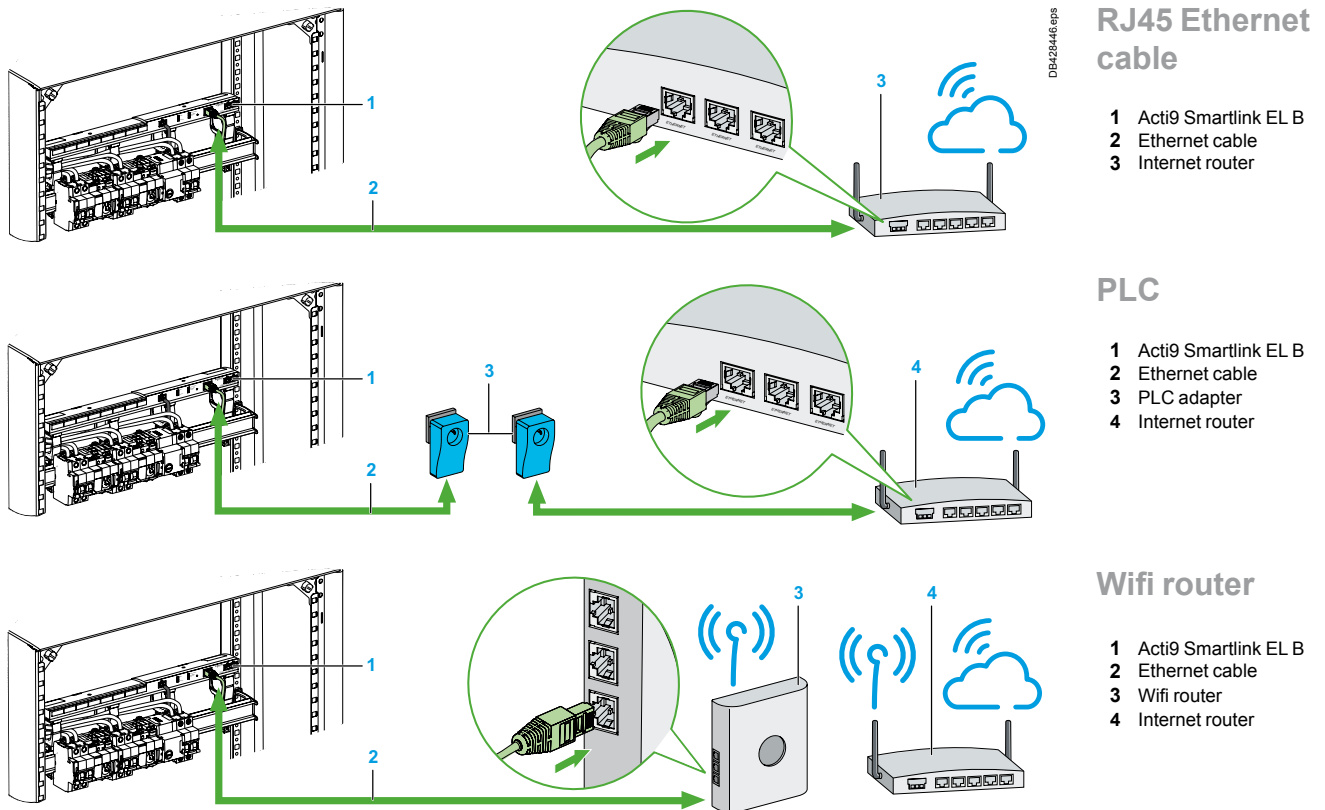

Option for connecting a PLC module to a switchboard using a DIN adapter

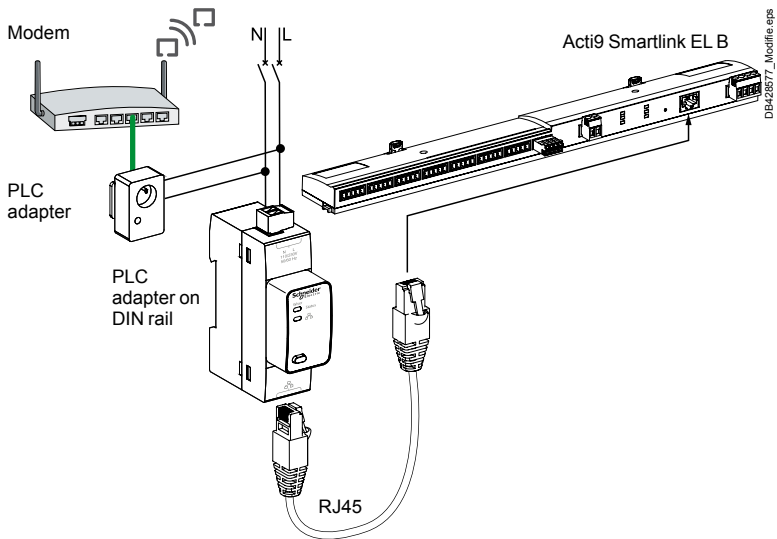

Type	Cat. no.
PLC adapter on DIN rail	EER31710

Acti9 Smartlink EL B (continued)

Technical characteristics

Power supply		
Rated		24 V DC \pm 20%
Maximum input current		1.5 A
Maximum inrush current		3 A
Overvoltage category		OVC II
No-load consumption		110 mA
Meter		
Capacity		2 ³² pulses per input
Digital input characteristics		
Number of channels		7 x 2-input channels Device with TI24 interface: 1 channel, 2 inputs used Device without TI 24 interface: (power meter, impulse meter) 1 input used
Type of input		Current collector Type 1, IEC 61131-2
Maximum cable length		500 m
Rated voltage		24 V DC
Voltage limits		24 V DC \pm 20%
Rated current		2.5 mA
Maximum current		5 mA
Filtering time	State 1	2 ms
	State 0	2 ms
Isolation		No isolation between channels
Voltage reversal protection		Yes
Analogue input characteristics		
Number		2
Type		Separate configuration for each input: 0-10 V or 4-20 mA
Measuring accuracy		1/100 full scale
Resolution		12 bits
Acquisition time		500 ms
Isolation		No isolation between channels
Power supply		0-24 V DC
Type of cable		Shielded twisted pair
Maximum cable length		30 m
Protection		Short-circuit protection
Output characteristics		
Number of output channels		7
Type of output		24 V DC - 0.1 A current source
Maximum cable length		500 m
Rated voltage	Voltage	24 V DC
	Maximum current	100 mA
Filtering time	State 1	2 ms
	State 0	2 ms
Voltage drop (voltage at state 1)		1 V max
Maximum inrush current		500 mA
Leakage current		0.1 mA
Overvoltage protection		33 V DC

Technical characteristics (continued)

Environmental characteristics		
Temperature	Operating	-25°C...+60°C (if vertical mounting, limited to 50°C)
	Storage	-40°C...+80°C
Tropicalization		Treatment 2 (relative humidity: 93 % at 40°C)
Resistance to voltage dips		10 ms, class 3 as per IEC 61000-4-29
Degree of protection		IP20
Degree of pollution		3
Altitude	Operating	0...2000 m
Vibration resistance	As per IEC 60068-2-6	1 g / ± 3.5 mm - 5 Hz to 300 Hz - 10 cycles
Shock resistance	As per IEC 60068-2-2-7	15 g / 11 ms
Immunity to electrostatic discharge	As per IEC 61000-4-2	<ul style="list-style-type: none"> ■ Air: 8 kV ■ Contact: 4 kV
Immunity to radiated magnetic fields	As per IEC 61000-4-3	10 V/m - 80 MHz to 3 GHz
Immunity to fast transients	As per IEC 61000-4-4	<ul style="list-style-type: none"> ■ 1 kV for inputs/outputs ■ 1 kV for the communication bus ■ 2 kV for 24 V DC power supply - 5 kHz - 100 kHz
Immunity to conducted magnetic fields	As per IEC 61000-4-6	10 V from 150 kHz to 80 MHz
Immunity to magnetic fields at mains frequency	As per IEC 61000-4-8	30 A/m
Resistance to corrosive atmospheres	As per IEC 60721-3-3	Level 3C2 on H ₂ S / SO ₂ / NO ₂ / Cl ₂
Fire resistance	For live parts	At 960°C 30 s / 30 s as per IEC 60 695-2-10
	For other parts	At 650°C 30 s / 30 s as per IEC 60 695-2-10
Salt spray mist	As per IEC 60068-2-52	Severity 2
Environment		In compliance with RoHS directives
Additional characteristics		
Memory backup period		10 years
Prefabricated cable characteristics		
Dielectric strength		1 kV / 5 min
Minimum draw-out resistance		20 N
Ethernet characteristics		
Link		10/100 Mbit/s Ethernet
Turnaround time		1 ms
Maximum cable length		100 m
Type of bus connector		RJ45 (shielded)
Number of Ethernet ports		1

Dimensions (mm)

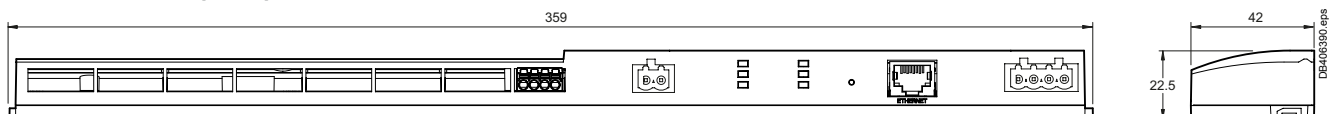

Acti9 Smartlink EL B

Weight (g)

Smartlink

Type

Acti9 Smartlink EL B	180
----------------------	-----

Connection

	Terminal	Tightening torque	Copper cables		
			Rigid	Flexible	Flexible with ferrule
<p>Connector cat. no.: A9XC2412</p>	Ti24 interface	Spring-loaded terminals	0.5 to 1.5 mm ²	0.5 to 1.5 mm ²	-
	Analogue connector	0.8 Nm	0.1 to 1.5 mm ²	0.1 to 1.5 mm ²	0.1 to 1.5 mm ²
	Power supply connector	0.8 Nm	0.2 to 1.5 mm ²	0.2 to 1.5 mm ²	0.2 to 1.5 mm ²

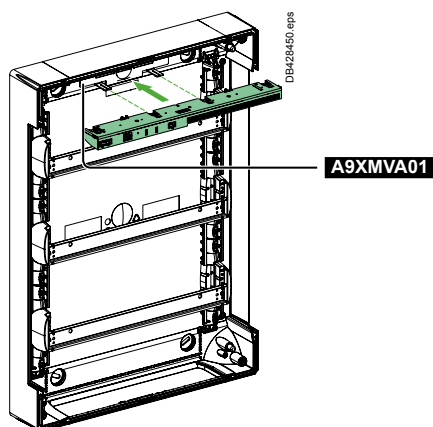

Pragma enclosure horizontal mounting

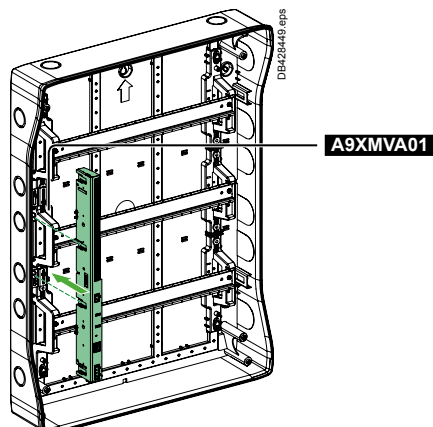

Kaedra enclosure vertical mounting

Installation

- Horizontal mounting in switchboards by fitting behind the DIN rail using mounting kit **A9XMFA04**:
 - width 24 modules per row,
 - minimum spacing between rails 150 mm.
- Mounting in Pragma and Kaedra enclosures with mounting kit **A9XMVA01** (see table below).

Installation in Kaedra and Pragma enclosures	Kit A9XMVA01	
	Vertical	Horizontal
Kaedra		
13M 3R	☑	
18M 3R	☑	
18M 1R, 2R, 3R, 4R		☑
Pragma		
13M 3R,4R	☑	
18M 3R,4R	☑	
18M 1R, 2R, 3R, 4R		☑
24M 1R, 2R		☑
24M 3R, 4R, 5R, 6R	☑	☑



CE

Country approval pictograms

PB107797-47



DB404502



IEC/EN 61131-2

The Acti9 Smartlink SI B is an open system that remotely measures, balances, monitors and controls final distribution.

It is designed to fit into tertiary building projects and integrates perfectly in a Building Management System or an Energy Management System.

It consists of:

- a Modbus Slave version (Acti9 Smartlink Modbus)
- a Modbus Master version (Acti9 Smartlink SI B) with the following functions: radio hub, Modbus gateway and embedded web server: this provides web pages for configuring the system, and real-time monitoring of values (status of circuit breakers, energy meters, alarms and monitoring and control). These modules transmit data to a PLC or monitoring system.

The system supports

- Alarm monitoring on current, voltage, power factor, tripping, power, consumption thresholds and their transmission by email.
- Monitoring and control via web pages of loads, energy and power by zone and by usage.
- Single access point for a full analysis of the status of switchboard power distribution (measurements, protection status, temperature, consumption, alarms, control and monitoring).

Functions

Transmission of data collected by Acti9 switchgear assemblies

- Circuit breakers, residual current circuit breakers and residual current devices:
 - open/closed state, tripped state,
 - number of opening/closing cycles,
 - number of tripping actions.
- Contactors, impulse relays, Reflex iC60:
 - opening and closing control,
 - open/closed state,
 - number of opening/closing cycles,
 - total period of operation of the load (device closed).
- Remote controlled circuit breaker/Reflex iC60:
 - opening control ,
 - closing control ,
 - contactor open/closed state,
 - circuit breaker open/closed state,
 - number of opening/closing cycles,
 - total period of operation of the load.
- Pulse meters (energy, water, gas, etc.):
 - number of pulses recorded,
 - pulse value setting (default: 10 Wh),
 - total consumption recorded,
 - possibility of resetting energy meters.
- Digital inputs/outputs.

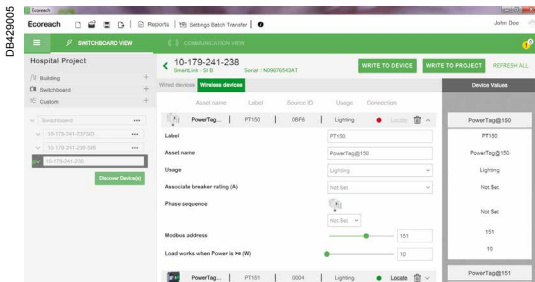

Functions (cont.)

Transmission of additional data collected by Acti9 Smartlink SI B

- Power meters (Modbus slaves).
- Analog sensors:
 - CO₂ sensor,
 - light sensor,
 - humidity sensor,
 - temperature sensor,
 - any 0..10 V or 4..20 mA compatible sensor.
- PowerTag wireless-communication energy sensors (Compact NSX, Acti9 iC60, iC40, DT60, DT40 ranges):
 - total and partial energy,
 - active power, phase-to-phase voltage, phase-to-neutral,
 - currents I1, I2, I3,
 - power factor,
 - voltage loss and overload information.
- Load monitoring:
 - alarm sent by the sensor in the event of a voltage loss,
 - pre-alarms on predefined thresholds (50 %, 80 %) or customized thresholds (thresholds on currents, power, voltages and cumulative energies),
 - load running time counter.
- Alarm management on current/voltage/load level thresholds by e-mail.
- Display of alarms and pre-alarms on Acti9 Smartlink SI B embedded web pages.
- Easy integration into any upper system using Com'X 210, Com'X 510 and other Schneider Electric software and third-party Building Management Systems (BMS's) thanks to the EcoStruxure Power Commission report in pdf format. A report provides dynamically all the Modbus registers and associated meanings for an easy integration into the system.
- Remote metering capability using the Acti9 Smartlink SI B monitoring page.

All the data are stored in memory: number of cycles, consumption, period of operation, even in the event of a power interruption.

Acti9 Smartlink can also exchange data with any device having 24 V DC digital inputs/outputs (e.g. low-level contacts 29452 for position of the Compact NSX). No configuration of the products connected to the Ti24 channels is required.

At power up, Acti9 Smartlink Modbus adapts automatically to the communication parameters of the Modbus master (PLC, supervisor, etc.).

Installation

- Assembly in switchboards:
 - width 24 modules per row,
 - minimum spacing between rails 150 mm.
- Mounting on:
 - DIN rail with mounting kit **A9XMFA04**,
 - Linergy FM 80 A, with bolts provided,
 - Linergy FM 200 A, with mounting kit **A9XM2B04**,
 - back of enclosure with mounting kit **A9XMBP02**,
- Installation in Pragma and Kaedra enclosures with mounting kit **A9XMVA01**.

Test

- The communication and cabling test on the connected devices can be performed using the EcoStruxure Power Commission software.

Commissioning software: EcoStruxure Power Commission (*)

- Configuration and communication test of wired and wireless devices 
 - Editing of a complete test report (pdf) with the Modbus communication registers for easy integration into a supervision system
 - Windows XP, Windows 7, Windows 8 and Windows 10 compatible
 - Downloadable from: https://www.schneider-electric.com/ww/en/download/document/Ecoreach_Installer
- (*): new name of Ecoreach software



Acti9 Smartlink SI B



Acti9 Smartlink Modbus

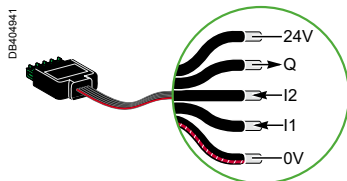

A9XCAU06

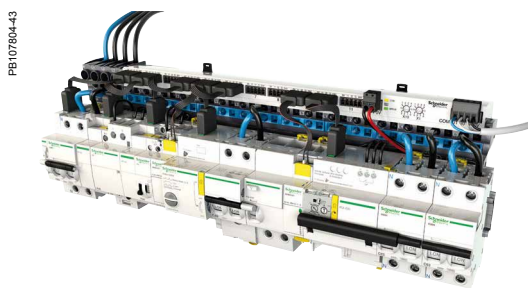

Catalogue numbers

Acti9 Smartlink

Type	Set of	
Acti9 Smartlink SI B	1	A9XMZA08
Supplied with		
4-pin connector for analog inputs	1	
Modbus connector	1	
24 V DC power supply connector	1	
Bolts for mounting on Linergy FM 80	2	
Acti9 Smartlink Modbus	1	A9XMSB11
Supplied with		
Modbus connector	1	
24 V DC power supply connector	1	
Bolts for mounting on Linergy FM 80	2	

Accessories

USB/Modbus connecting cables for Acti9 Smartlink test	1	A9XCATM1
Prefabricated cables		
With 2 connectors		
100 mm	6	A9XCAS06
160 mm	6	A9XCAM06
450 mm	6	A9XCAH06
870 mm	6	A9XCAL06
With 1 connector		
870 mm	6	A9XCAU06
4000 mm	1	A9XCAC01
Connectors	5-pin connectors (Ti24)	12 A9XC2412
Mounting kit	DIN rail (4 feet, 4 earthing straps, 4 adapters)	1 A9XMFA04
	Linergy FM 200 A (4 adapters)	1 A9XM2B04
	Back of enclosure (2 brackets)	1 A9XMBP02
	Vertical for Kaedra enclosures	1 A9XMVA01
	Vertical or horizontal for Pragma enclosures	
Spare parts	Bolts for Linergy FM 80 A (2 bolts)	1 A9XMLA02

Connectable devices

With Ti24 interface

Type	Reference	Description
iACT24	A9C15924	Low-level control and indication auxiliary for iCT contactors
iATL24	A9C15424	Low-level control and indication auxiliary for iTL impulse relays
iOF+SD24	A9A26897 A9A26898	Low-level indication auxiliary for iC60, iID, ARA, RCA, iSW-NA
OF+SD24	A9N26899	Low-level indication auxiliary for C60, C120, DPN, RCCB/ID, C60H-DC
RCA iC60	See module CA904011	Remote control with Ti24 interface
Reflex iC60	See module CA904012	Reflex iC60 with Ti24 interface

Without Ti24 interface

Power meters with pulse output, e.g. iEM2000T
Pulse meters complying with the IEC 62053-21 standard
24 V DC indicator lamps, Harmony range type XVL
All loads not exceeding 100 mA, 24 V DC
Timers, thermostats, time switches, load shedding devices
All 24 V DC auxiliary contacts, IEC 61131-2 type 1

With Modbus connector systems

Power meters: iEM3150, iEM3250, iEM3350, iEM3155, iEM3255, iEM3355, all Modbus slave RS485 equipment

With wireless-communication systems

PowerTag energy sensors *. See catalog module CA907029E

With analog outputs

Any 0...10 V and 4...20 mA compatible sensor (temperature, humidity, luminosity, etc.)

(* for additional information and a list of Schneider Electric compatible devices, refer to the selection guide CA908058E.



Example of an installation

Modbus master

- Acti9 Smartlink SI B

Ethernet link

- Ethernet 10/100 MB, Modbus TCP server

Wireless communication

- No additional wiring
- Up to 20 sensors connected

Analog inputs

- 2 analog inputs, 0..10 V or 4..20 mA, e.g.: connection of a temperature probe

Modbus slave

- Acti9 Smartlink Modbus

Modbus communication

- Up to 8 Acti9 Smartlink Modbus or other Modbus slaves connected

Prefabricated cables

- Simplified and faster cabling

Ethernet network connection

Acti9 Smartlink SI B has an embedded Web server used to display data showing the state of circuit breakers, energy meters, power data, phase unbalance and current alarms.

Manual control is also possible via the Web page.

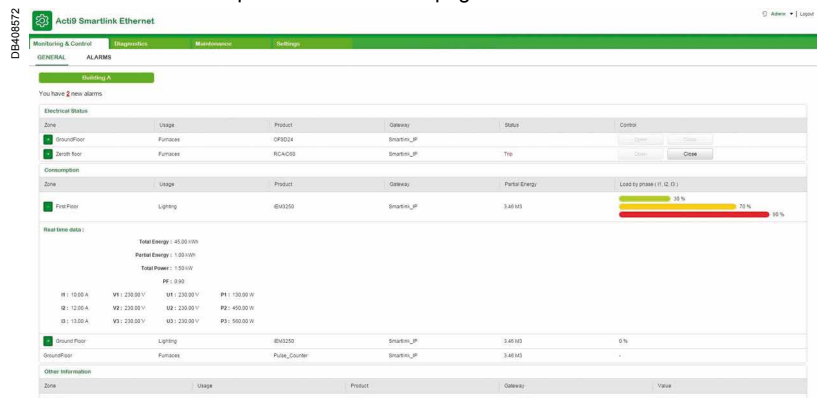

■ The Web server sets the parameters of the connection to the network servers (SNTP, SMTP), as well as the parameters of user emails and of the connection to the Facility Hero.com service



Acti9 Smartlink SI B (A9XMZA08)

Ti24 connector
7 input/output channels
Input protected against voltage reversals
Output protected by current limiting

- Pin 1: 0 V
- Pin 2: I1 Input 1
- Pin 3: I2 Input 2
- Pin 4: Q Output
- Pin 5: +24 V DC

24 V DC power supply connector
Input protected against voltage reversals

- Pin1: 0 V
- Pin2: +24 V DC

Ethernet connector
100 Base T - RJ45

Indication

- Indication of operation of the communication system and the state of the Acti9 Smartlink SI B

Serial port connector
Modbus (Master) RS485

- Pin 1: D1 Modbus
- Pin 2: D0 Modbus
- Pin 3: shielding
- Pin 4: common/0 V

Analog connector
2 configurable input points, either 0-10 V or 4-20 mA

- Pin 1: 0 V
- Pin 2: AI1 Input 1
- Pin 3: AI2 Input 2
- Pin 4: +24 V DC

20 PowerTag energy sensors
Radio-frequency communication

- ISM band 2.4 GHz (2.4 GHz to 2.4835 GHz)
- Channels 11 to 16 as per IEEE 802.15.4

Note: Acti9 Smartlink SI B and the PowerTag must be installed in the same switchboard

ASMEM1624-18

Acti9 Smartlink Modbus (A9XMSB11)

Ti24 connector
11 input/output channels
Input protected against voltage reversals
Output protected by current limiting

- Pin 1: 0 V
- Pin 2: I1 Input 1
- Pin 3: I2 Input 2
- Pin 4: Q Output
- Pin 5: +24 V DC

24 V DC power supply connector
Input protected against voltage reversals

- Pin1: 0 V
- Pin2: +24 V DC

Serial port connector
Modbus (Master) RS485

- Pin 1: D1 Modbus
- Pin 2: D0 Modbus
- Pin 3: shielding
- Pin 4: common/0 V

Indication

- indication of operation of the communication system and the state of the Acti9 Smartlink Modbus

Thumbwheels

- Definition of the address in the Modbus network



Common technical characteristics

Power supply		
Nominal		24 V DC \pm 20 %
Maximum input current		1.5 A
Maximum inrush current		3 A
Meter		
Capacity		2 ³² pulses per input
Input characteristics		
Number of channels	Acti9 Smartlink Modbus (A9XMSB11)	11 2-input channels
	Acti9 Smartlink SI B (A9XMZA08)	7 2-input channels
Type of input		Current collector Type 1 IEC 61131-2
Maximum cable length		500 m
Rated voltage		24 V DC
Voltage limits		24 V DC \pm 20 %
Rated current		2.5 mA
Maximum current		5 mA
Filtering time	A l'état 1	2 ms
	A l'état 0	2 ms
Isolation		No isolation between channels
Negative sequence voltage protection		Yes
Output characteristics		
Number of output channels	Acti9 Smartlink Modbus (A9XMSB11)	11
	Acti9 Smartlink SI B (A9XMZA08)	7
Type of output		24 V DC - 0.1 A current source
Maximum cable length		500 m
Rated voltage	Voltage	24 V DC
	Maximum current	100 mA
Filtering time	In state 1	2 ms
	In state 0	2 ms
Voltage drop (voltage in state 1)		1 V max
Maximum inrush current		500 mA
Leakage current		0.1 mA
Overvoltage protection		33 V DC
Environmental characteristics		
Temperature	Operating	-25°C ... +60°C (if vertical mounting, limited to 50°C)
	Storage	-40°C ... +80°C
Tropicalization		Treatment 2 (relative humidity of 93 % at 40°C)
Resistance to voltage dips		10 ms, class 3 as per IEC 61000-4-29
Degree of protection		IP20
Pollution degree		3
Altitude	Operating	0 ... 2000 m
Vibration resistance	As per IEC 60068.2.6	1 g / \pm 3.5 mm - 5 Hz to 300 Hz - 10 cycles
Shock resistance	As per IEC 60068.2.27	15 g / 11 ms
Immunity to electrostatic discharge	As per IEC 61000-4-2	Air: 8 kV Contact: 4 kV
Immunity to radiated magnetic fields	As per IEC 61000-4-3	10 V/m - 80 MHz to 3 GHz
Immunity to fast transients	As per IEC 61000-4-4	1 kV for inputs/outputs and Modbus communication. 2 kV for 24 V DC power supply - 5 kHz - 100 kHz
Immunity to conducted magnetic fields	As per IEC 61000-4-6	10 V from 150 kHz to 80 MHz
Immunity to magnetic fields at mains frequency	As per IEC 61000-4-8	30 A/m
Resistance to corrosive atmospheres	As per IEC 60721-3-3	Level 3C2 on H ₂ S / SO ₂ / NO ₂ / Cl ₂
Fire resistance	For live parts	At 960°C 30 s / 30 s as per IEC 60 695-2-10 and IEC 60 695-2-11
	For other parts	At 650°C 30 s / 30 s as per IEC 60 695-2-10 and IEC 60 695-2-11
Salt spray test	As per IEC 60068.2.52	Severity 2
Environment		In compliance with the RoHS directive
Prefabricated cable characteristics		
Dielectric strength		1 kV / 5 min
Minimum draw-out resistance		20 N
Electromagnetic compatibility		
Reference standards	Immunity	EN 55024
	Emissions	EN 55022
	Electromagnetic compatibility and Radio spectrum Matters (ERM)	EN 300328 EN 301489-1 EN 301489-17



Acti9 Smartlink Modbus (A9XMSB11) technical characteristics

Characteristics of the Modbus link		
Link	Modbus, RTU, RS485 serial connection	
Transmission	Transfer rate	9600 baud ... 19200 baud, self-adaptable
	Medium	Shielded cable, double twisted pair
Protocol	Master/Slave	
Type of device	Slave	
Modbus addressing range	1 to 99	
Maximum length of the bus	1000 m	
Type of bus connector	4-pin connector	

Acti9 Smartlink SI B (A9XMZA08) technical characteristics

Characteristics of the Ethernet link		
Link	Ethernet 10/100 MB	
Protocol	Modbus TCP server	
	http (web pages)	
Addressing mode	Static and dynamic (supplied, by default, in dynamic mode)	
Gateway characteristics		
Protocol	Modbus TCP/IP -> Modbus SL	
Number of Modbus slaves	8	
Modbus addressing range	1 to 247	
Characteristics of the Modbus Master link		
Link	Modbus, RTU, RS485 serial connection	
Transmission	Transfer rate	9600 bauds ... 19200 bauds
	Medium	Shielded cable, double twisted pair
Maximum length of the bus	1000 m	
Type of bus connector	4-pin connector	
Characteristics of analog inputs		
Number	2	
Type	Independent settings for each input, either 0-10 V or 4-20 mA	
Measuring accuracy	1/100 full scale	
Resolution	12 bits	
Acquisition time	500 ms	
Isolation	No isolation between channels	
Power supply	0-24 V DC	
Cable type	Shielded cable, twisted pair	
Maximum cable length	30 m	
Protection	Short-circuit protection	
Characteristics of the wireless-communication link		
Compatible devices	PowerTag energy sensors	
Maximum number of sensors	20	
Radio-frequency communication	2.4 GHz to 2.4835 GHz at 0 dBm	

Dimensions (mm)

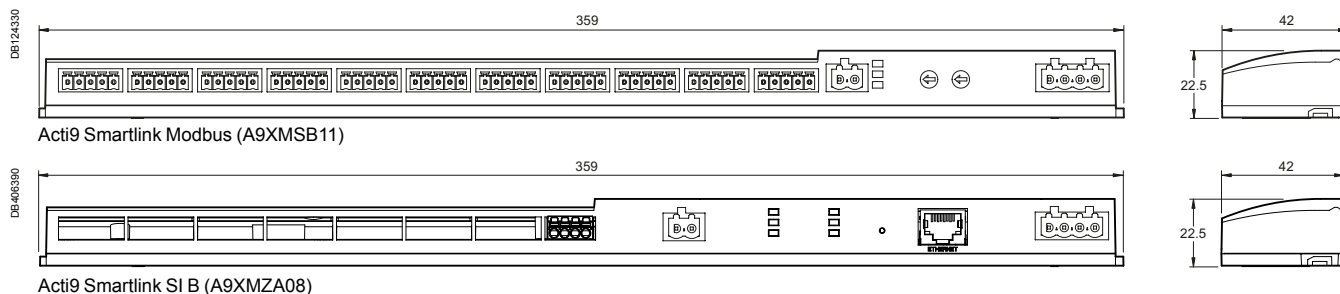

Weight (g)

Acti9 Smartlink	
Type	
Acti9 Smartlink Modbus (A9XMSB11)	195
Acti9 Smartlink SI B (A9XMZA08)	180

Monitoring, control and measurement

Acti9 Smartlink SI B (cont.)



Connection

	Terminal	Tightening torque	Copper cables		
			Rigid	Flexible	Flexible with ferrule
<p>DB123560</p> <p>10 mm 0.4 x 2.5 mm Connector ref: A9XC2412</p>	Ti24 interface	Spring-loaded terminals	DB122945 0.5 to 1.5 mm ²	DB123953 0.5 to 1.5 mm ²	DB123954 -
<p>DB406517</p> <p>24 V 0 V AI2 AI1 7 mm 0.6 x 3.5 mm</p>	Analog connector	0.8 N.m	0.1 to 1.5 mm ²	0.1 to 1.5 mm ²	0.1 to 1.5 mm ²
<p>DB124331</p> <p>0 V 24 V 7 mm 0.6 x 3.5 mm</p>	Power supply connector	0.8 N.m	0.2 to 1.5 mm ²	0.2 to 1.5 mm ²	0.2 to 1.5 mm ²
<p>DB405141</p> <p>0 V D0 = A⁻ / Rx⁻, A / Tx⁻ D1 = B⁻ / Rx⁺, B / Tx⁺ 7 mm 0.6 x 3.5 mm</p>	Modbus connector	0.8 N.m	0.25 mm ²	0.25 mm ²	0.25 mm ²
<p>DB405142</p> <p>1 2 ≤ 50 mm ≤ 20 mm</p>					

PowerTag Acti9 63 A

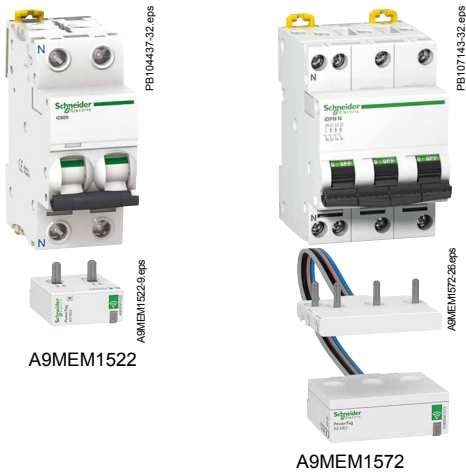

IEC 61557-12 PMD/DD/K55/1

PowerTag is a wireless-communication energy sensor

PowerTag energy sensor is designed specifically for Energy Management, Load Monitoring and Power Availability applications.

With its compact design and innovative concept, PowerTag fits directly on the protective device and as a result has no impact on DIN rail occupancy and switchboard size.

Voltage and current are therefore measured directly at the same point on the circuit to be monitored, providing accurate measurement and relevant information such as voltage loss.

PowerTag energy sensor incorporates every feature required to perform accurate real-time measurements (U, V, I, P and PF) and metering values (Ea). Used together with a concentrator to collect and process the data, it provides circuit monitoring and diagnosis down to load level.

- Wireless-communication technology simplifies switchboard wiring and commissioning operations: no wiring is required for the PowerTag to communicate with the concentrator.
- System scalability: PowerTag energy sensor can be quickly and easily installed in new or existing panels at any time.
- Different designs of the PowerTag energy sensor are available to ensure it fits the protective device on which it is mounted.
- PowerTag Acti9 63 A is compatible with the Acti9 and Multi9 ranges as per the selection guide CA908058.

Functions

PowerTag energy sensor measures the following values in accordance with the IEC 61557-12 standard

- Active energy (class 1), total and partial (kWh), delivered and received.
- Real-time measurement values:
 - phase-to-neutral and phase-to-phase voltages (V),
 - current per phase (A),
 - active power, total and per phase (W),
 - apparent power total (VA),
 - power factor.
- Voltage loss alarms:
 - PowerTag energy sensor sends a "voltage loss" alarm and the current-per-phase value before being de-energized,
 - at "voltage loss", PowerTag adds an overload alarm if the current is higher than the rated current of the associated protective device.

Note: Functions listed above depends on concentrator.

Main associated concentrators (*)

For Commercial & Building applications

Acti9 PowerTag Link	Acti9 PowerTag Link HD	Acti9 Smartlink SI B
A9XMWD20 (1)	A9XMWD100	A9XMZA08
(1) Replace Smartlink SI D (A9XMWA20)		

For Small Business applications

Acti9 PowerTag Link C
A9XELC10

(*) Refer to Selection Guide for complete compatibility (CA908058)
Refer to the concentrator catalogs for more information (CA907030, CA907032, CA907035).



Mounting positions

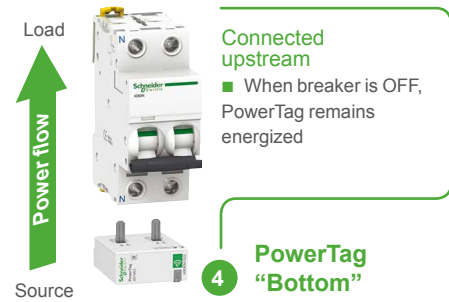
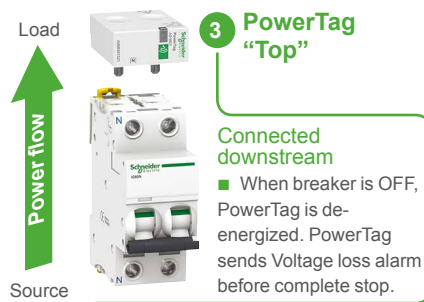
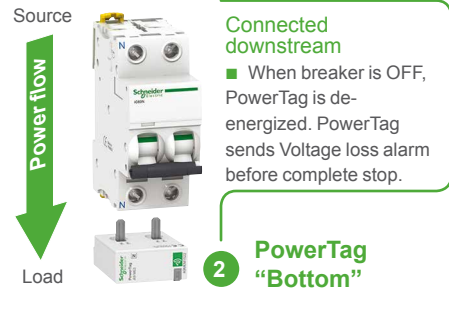
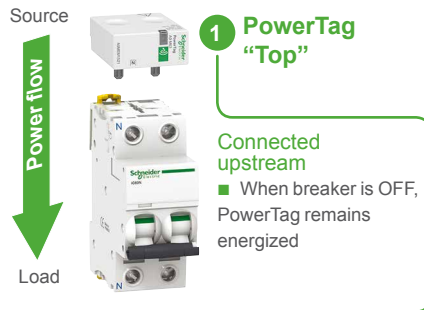

Note:

- In association with a contactor, a Variable Speed Drive or a motor starter: PowerTag can ONLY be installed UPSTREAM these devices.
- Some PowerTag can be installed either on the TOP or on the BOTTOM of the protective devices.
- Check the possible mounting position as indicated in the "Catalog numbers" chapter.

Connection	Features
Upstream Preferred installation to take full benefit of voltage loss in diagnosing the load	1 ■ Energy management: consumption in kWh 4 ■ Load monitoring: real-time measurements
Downstream Preferred installation to take full benefit of voltage loss in diagnosing the load	2 ■ Energy management: consumption in kWh 3 ■ Load monitoring: real-time measurements 3 ■ Power availability: voltage loss

Energy management and load monitoring

PowerTag Acti9 63 A (cont.)



A9MEM1520



A9MEM1521



A9MEM1540



A9MEM1522



A9MEM1543



A9MEM1541



A9MEM1542



A9MEM1561



A9MEM1562



A9MEM1563



A9MEM1571

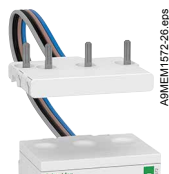

A9MEM1572



A9MEM1560



A9MEM1573



A9MEM1570

Catalog numbers

PowerTag A9 M63

PowerTag for Acti9 and Multi9 **Monoconnect** offers: "Single-terminal" circuit breakers, RCDs and switches with **18 mm pitch between phase and neutral**, rating less than or equal to 63 A.

PowerTag A9 M63			
Type	Mounting	Short description	Cat. no.
1P+wire	Top or bottom	PowerTag A9 M63 1PW	A9MEM1520
1P+N	Top	PowerTag A9 M63 1PN T	A9MEM1521
	Bottom	PowerTag A9 M63 1PN B	A9MEM1522
3P	Top or bottom	PowerTag A9 M63 3P	A9MEM1540
3P+N	Top	PowerTag A9 M63 3P 230V LL	A9MEM1543 (1)
	Bottom	PowerTag A9 M63 3PN T	A9MEM1541
	Bottom	PowerTag A9 M63 3PN B	A9MEM1542

Designed to fit the following devices: iC60, Reflex iC60, DT60, iLD.
For additional information and the list of Schneider Electric compatible devices and concentrators, refer to the selection guide CA908058.

(1) Not compatible with Acti9 Smartlink SI D (A9XMWA20) and Acti9 Smartlink SI B (A9XMZA08)

PowerTag A9 P63

PowerTag for Acti9 and Multi9 **PhaseNeutral** offers: "Single-terminal" circuit breakers, RCDs and switches at **pitch of 9 mm between phase and neutral**, rating less than or equal to 63 A.

PowerTag A9 P63			
Type	Mounting	Short description	Cat. no.
1P+N	Top	PowerTag A9 P63 1PN T	A9MEM1561
1P+N	Bottom	PowerTag A9 P63 1PN B	A9MEM1562
1P+N RCBO	Bottom	PowerTag A9 P63 1PN B for RCBO	A9MEM1563
3P+N	Top	PowerTag A9 P63 3PN T	A9MEM1571
3P+N	Bottom	PowerTag A9 P63 3PN B	A9MEM1572

Designed to fit the following devices: DT40, iDPN, C40, i DPN Vigi.
For additional information and the list of Schneider Electric compatible devices and concentrators, refer to the selection guide CA908058.

PowerTag A9 F63

PowerTag **Flex** for other devices and specific installations, rating less than or equal to 63 A.

PowerTag A9 F63			
Type	Mounting	Short description	Cat. no.
1P+N	Top or bottom	PowerTag A9 F63 1PN	A9MEM1560
3P	Top or bottom	PowerTag A9 F63 3P	A9MEM1573 (2)
3P+N	Top or bottom	PowerTag A9 F63 3PN	A9MEM1570

Designed to fit the following devices: Vigi iDT40, Vigi iC40, Vigi iC60, iC60 double terminal, iLD double terminal.
For additional information and the list of Schneider Electric compatible devices and concentrators, refer to the selection guide CA908058.

(2) Not compatible with Acti9 PowerTag Link C (A9XELC10), Acti9 Smartlink SI D (A9XMWA20) and Acti9 Smartlink SI B (A9XMZA08)

PowerTag Acti9 63 A (cont.)



Technical characteristics

Main characteristics

Rated voltage	Un	Phase-to-neutral	230 V AC \pm 20 %
		Phase-to-phase	400 V AC \pm 20 %
		Phase-to-phase (A9MEM1543)	230 V AC \pm 20 %
Frequency			50/60 Hz
Maximum current	I _{max}		63 A
Base current	I _b		10 A
Saturation current			130 A
Maximum consumption		1P+N	\leq 1 VA
		3P/3P+N	\leq 2 VA
Starting current	I _{st}		40 mA

Additional characteristics

Operating temperature			-25°C to +60°C
Storage temperature			-40°C to +85°C
Overvoltage category	As per IEC 61010-1		Cat. III
Measuring category	As per IEC 61010-2-30		Cat. III
Pollution degree			3
Altitude			\leq 2000 m
Degree of protection	Device only		IP20
		IK	05

Radio-frequency communication

ISM band 2.4 GHz			2.4 GHz to 2.4835 GHz
Channels	As per IEEE 802.15.4		11 to 26
Isotropic Radiated Power	Equivalent (EIRP)		0 dBm
Maximum transmission time			< 5 ms
Channel occupancy	Messages sent every		5 seconds minimum

Characteristics of measuring functions

Function		Performance category as per IEC 61557-12	Measuring range
Active power	P	1	9 W to 63 kW
Active energy	E _a	1	Total and partial 0 to 99999999.9 kWh
Current	I	1	2 A to 63 A
Voltage	U	0.5	Un \pm 20 %
Power factor	PFA	1	0 to 1



Connection of PowerTag A9 M63

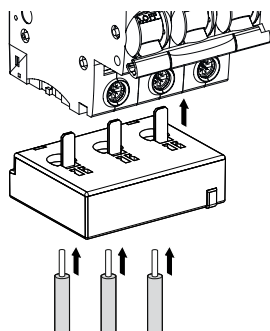

Stripping length	Copper cables					
	Rigid		Flexible		Flexible with ferrule	
18 mm	1.5 to 16 mm ² AWG: 16...6	2 x 1.5 to 2.5 mm ² AWG: 16...14	1.5 to 16 mm ² AWG: 16...6	2 x 1.5 to 2.5 mm ² AWG: 16...14	-	-
18 mm	-	-	-	-	1.5 to 16 mm ² AWG: 16...6	2 x 1.5 to 2.5 mm ² AWG: 16...14

■ Mounting with 18 mm ferrule recommended.

Dimensions (mm)

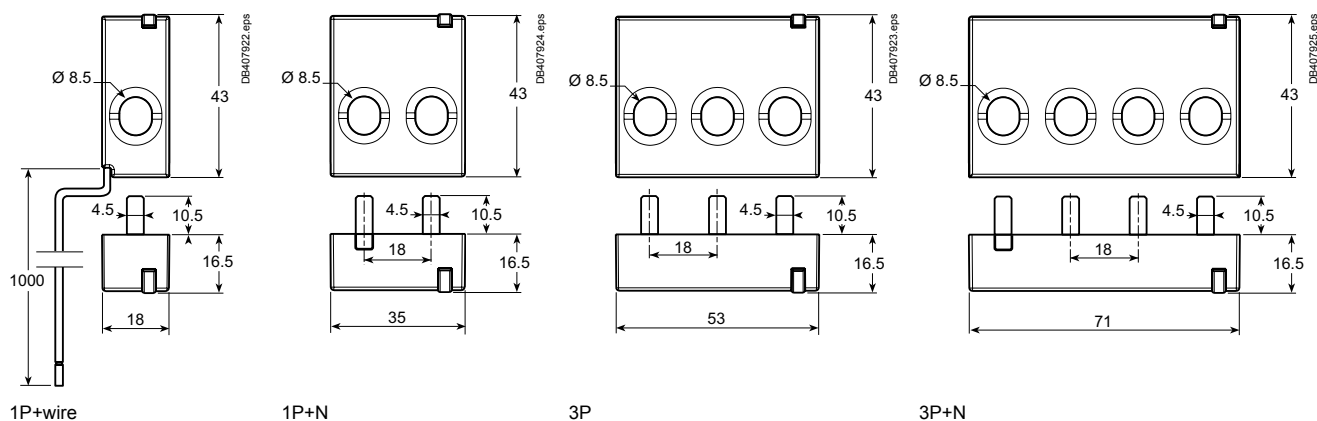

Weight (g)

PowerTag A9 M63	
Type	Weight (g)
1P+wire	16.4
1P+N	17.5
3P	28
3P+N	35



Connection of PowerTag A9 P63

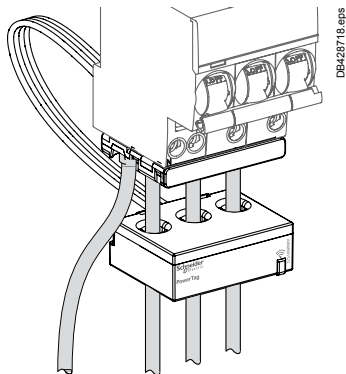

Copper cables					
Rigid		Flexible		Flexible with ferrule	
1.5 to 16 mm ² AWG: 16...6	2 x 1.5 to 2.5 mm ² AWG: 16...14	1.5 to 16 mm ² AWG: 16...6	2 x 1.5 to 2.5 mm ² AWG: 16...14	-	-
-	-	-	-	1.5 to 16 mm ² AWG: 16...6	2 x 1.5 to 2.5 mm ² AWG: 16...14

■ Stripping length: respect the stripping length stated on the device the PowerTag is associated with.

Dimensions (mm)

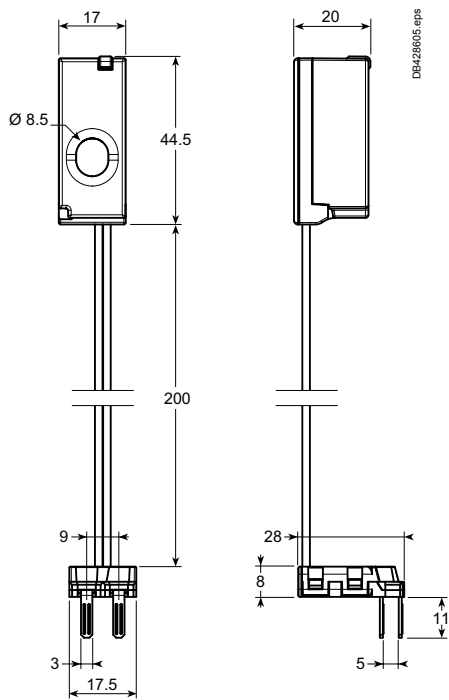

1P+N

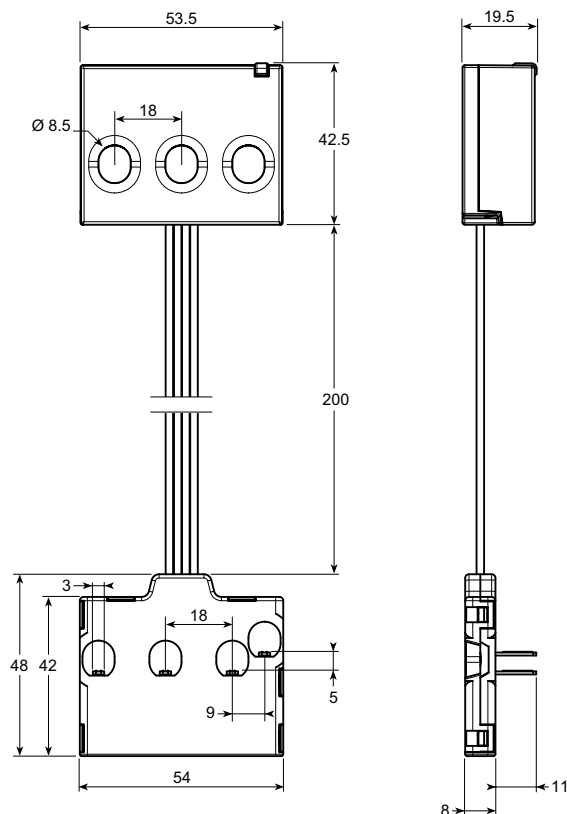

3P+N

Weight (g)

PowerTag A9 P63	
Type	
1P+N	42
3P+N	71



Connection of PowerTag A9 F63

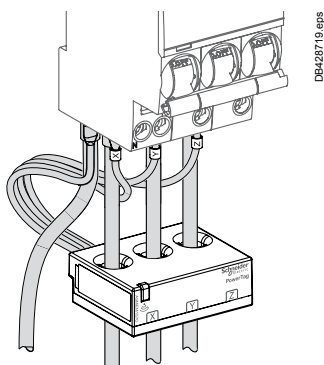

Copper cables					
Rigid		Flexible		Flexible with ferrule	
1.5 to 16 mm ² AWG: 16...6	2 x 1.5 to 2.5 mm ² AWG: 16...14	1.5 to 16 mm ² AWG: 16...6	2 x 1.5 to 2.5 mm ² AWG: 16...14	-	-
-	-	-	-	1.5 to 16 mm ² AWG: 16...6	2 x 1.5 to 2.5 mm ² AWG: 16...14

■ Stripping length: respect the stripping length stated on the device the PowerTag is associated with.

Dimensions (mm)

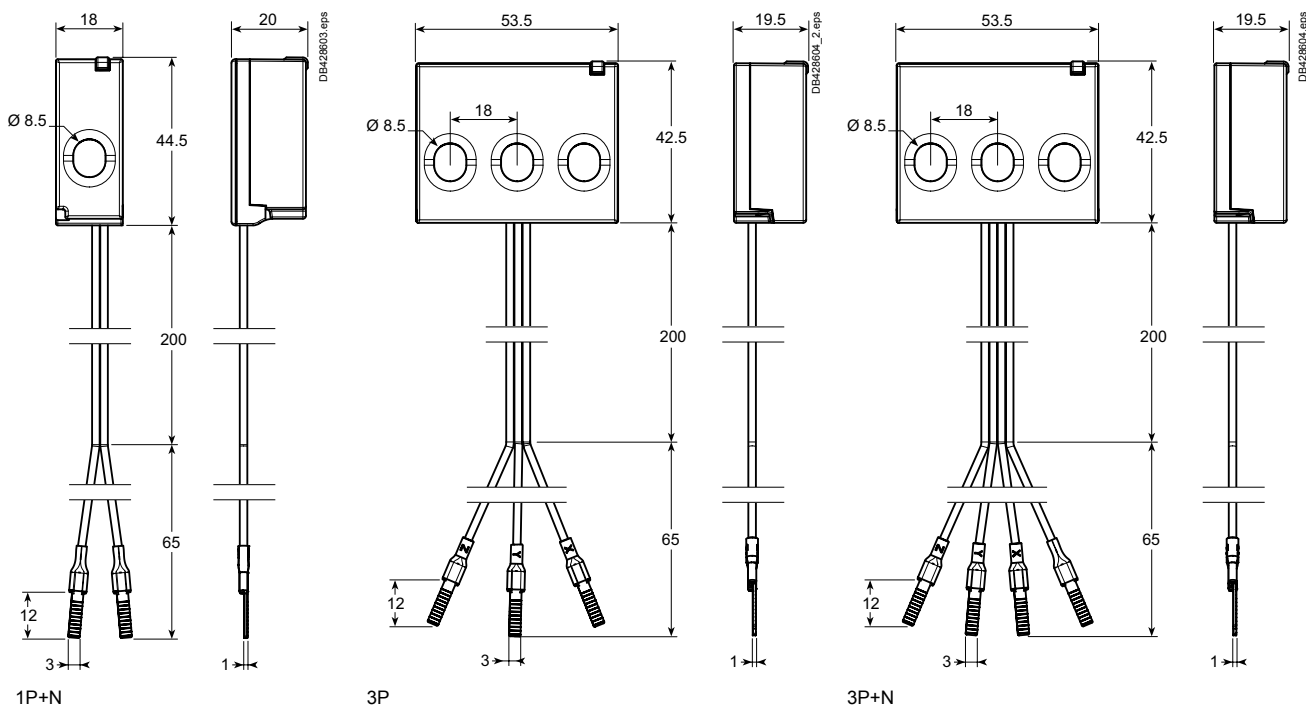

Weight (g)

PowerTag A9 F63	
Type	Weight (g)
1P+N	46
3P	63
3P+N	65



PowerTag C IO 230V



PowerTag C 2DI 230V

PowerTag Control are **wireless-communication modules** designed specifically for Control and Monitoring applications. They are part of PowerTag System and Wiser System, allowing to turn easily a distribution board into a connected panel.

PowerTag Control is designed to monitor a circuit, notifying wirelessly to the concentrator the information status of a contact (OF, SD, CT or TL position indication...).

Depending on its functionalities, PowerTag Control can operate a load remotely through a contactor, an impulse relay... thanks to wireless control orders from the concentrator.

Refer to the selection guide to select the right module as per the application required.

- Wireless-communication technology simplifies cabling and commissioning operations: no wiring is required for the PowerTag Control modules to communicate with the concentrator.
- System scalability: PowerTag Control modules can be easily installed in new or existing panels at any time with simple commissioning operation.
- PowerTag Control modules are DIN rail mounted.



PowerTag C IO 230V



Acti9 PowerTag Link C

Associated concentrators

For Residential applications

Wiser IP Module



EER31800

For Commercial & Building applications

PowerTag Link



A9XMWD20

PowerTag Link HD



A9XMWD100

For Small Business applications

Acti9 PowerTag Link C



A9XELC10

Refer to the concentrators catalog for more information.

Load control and monitoring

PowerTag Control (cont.)



Selection guide

Application	PowerTag C IO 230V		PowerTag C 2DI 230V	
	Control ⁽¹⁾	Monitoring / Back loop ⁽²⁾	Control ⁽¹⁾	Monitoring ⁽²⁾
Digital input 230 V AC	-	1	-	2
Digital output 230 V AC	1	-	-	-
Compatible with	Circuit 2 A Max - 230 V AC: - Contactors 230 V AC - Impulse relays 230 V AC - RCA (cat no A9C7011x) ...	Dry contact 230 V AC: - iACTs - iATLs ...	-	Dry contact 230 V AC: - OF 230 V AC - SD 230 V AC - OF/SD 230 V AC ...
Width in 9-mm modules	2		2	
Catalog numbers	A9XMC1D3		A9XMC2D3	

(1) To operate a circuit remotely (2) To notify a status remotely

Principle diagrams

PowerTag C IO 230V

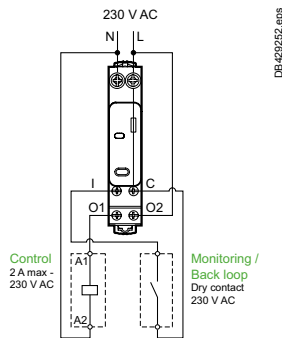

PowerTag C 2DI 230V

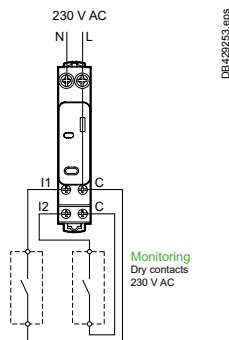

Load control and monitoring

PowerTag Control (cont.)

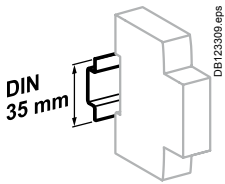

Clip on DIN rail 35 mm.

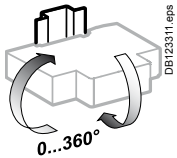

Indifferent position of installation.

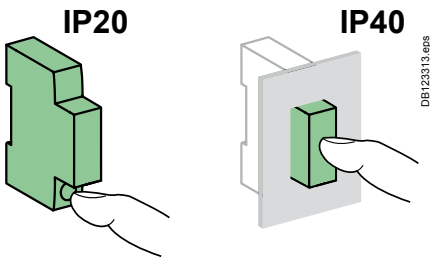

Technical characteristics

Main characteristics

Power supply	230 V AC \pm 20%	
Frequency	50/60 Hz	
Maximum consumption	IO	\leq 2 VA
	2DI	\leq 3 VA
Operating temperature	-25°C to +60°C	
Storage temperature	-40°C to +85°C	
Relative humidity (60068-2-78)	93 % at 40°C	
Overvoltage category	As per IEC 61010-1	Cat. III
Altitude	\leq 2000 m	
Pollution degree	3	
Degree of protection according to IEC 60529	Front face	IP40
	Casing	IP20
	IK	05

Characteristics of inputs and outputs

Digital input

Type	230 V AC, dry contact
------	-----------------------

Digital output

Type	230 V AC, dry contact
Relay type	Normally open or normally closed ⁽³⁾
Applicable voltage on output	230 V AC \pm 20%
Minimum/maximum current on output	10 mA / 2 A
Type of output order	Pulse or latch ⁽³⁾
Pulse length in control mode with impulse relay	Nominal: 300 ms

Radio-frequency communication

ISM band 2.4 GHz	2.4 GHz to 2.4835 GHz	
Channels	As per IEEE 802.15.4	11 to 26
Isotropic Radiated Power	Equivalent (EIRP)	0 dBm
Channel occupancy	Messages sent	<ul style="list-style-type: none"> ■ On event ■ Periodically (5s nominal)

(3) Setting adjustable

Dimensions (mm)

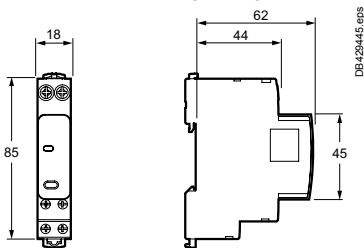

Weight (g)

PowerTag C

PowerTag C IO 230 V	80
PowerTag C 2DI 230 V	75

Connection

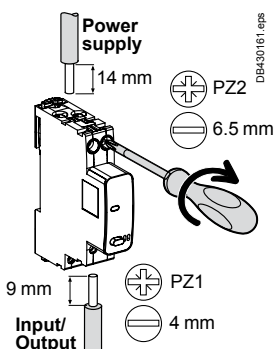

Terminals	Tightening torque	Copper cables		
		Rigid	Flexible	Flexible with ferrule
Power supply (Top)	2 N.m	1 to 16 mm ² (AWG: 18...6)	0.5 to 10 mm ² (AWG: 21...8)	-
Input/Output (Bottom)	1 N.m	1x: 1 to 6 mm ² (AWG: 18...10) 2x: 1.5 to 2.5 mm ² (AWG: 16...14)	1x: 0.5 to 4 mm ² (AWG: 21...12) 2x: 1.5 to 2.5 mm ² (AWG: 16...14)	1x: 0.5 to 4 mm ² (AWG: 21...12) 2x: -

Load control and monitoring

PowerTag Control (cont.)



PowerTag C IO module

- Compatible with horizontal comb busbars 9 mm modules
- Automatic cable guiding in the correct position: terminals with guard

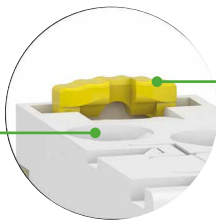

- Assembly and disassembly by operating toggle latches at the top and bottom of the products

- Status LED**
- Provide information about PowerTag C status

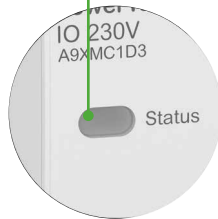

- Insulated terminals IP20



- Logo**
- Wireless communication device



- Push button**
- Local output control
 - Decommissioning

- Monitoring / Back loop circuit**
- "I" digital input terminal
 - "C" common powered terminal 230 V AC

- Control circuit**
- Logical output relay
 - "O" output terminals 230 V AC - 2 A max.

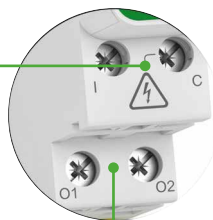

Load control and monitoring PowerTag Control (cont.)



PowerTag C 2DI module

- Compatible with horizontal comb busbars 9 mm modules
- Automatic cable guiding in the correct position: terminals with guard

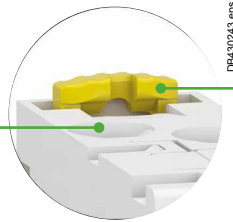

DB430243.eps

- Assembly and disassembly by operating toggle latches at the top and bottom of the products

Status LED

- Provide information about PowerTag C status

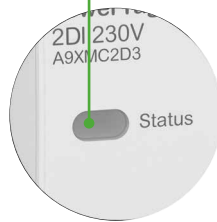

DB430244.eps

- Insulated terminals IP20



A9XMC2D3_image2.65.eps

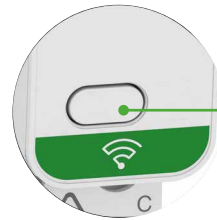

DB430245.eps

- Decommissioning

Logo

- Wireless communication device



DB430242.eps

Monitoring circuits

- "I" digital input terminals
- "C" common powered terminals 230 V AC

PowerTag Ambient for Temperature



PowerTag Ambient for Temperature



ZBRA1 relay antenna

IEC 60950, EN 61000-6-1, EN 61000-6-3, EN 61326-1, EN 62311:2007, ETSI EN 301 489-1, ETSI EN 301 489-17, ETSI EN 300 328

As per the above standard: **PowerTag Ambient for Temperature are wireless-communication modules** designed specifically to collect temperatures measures for Monitoring applications. They are part of PowerTag System, thanks to wireless-communication to the PowerTag Link C concentrator.

The PowerTag Ambient for Temperature is to be placed directly in the targeted location (cold room/ fridge...) to monitor. The sensor transmits information to the concentrator every 2 minutes. The sensor also stores 1 measure per hour in order to enable the generation of HACCP compliant automated temperature reports.

- Wireless-communication technology simplifies cabling and commissioning operations: no wiring is required for the PowerTag Ambient for Temperature modules to communicate with the concentrator, up to 100 m open field.
- System scalability: PowerTag Ambient for Temperature modules can be easily installed at any time with simple commissioning operation.
- PowerTag Ambient for Temperature modules work on battery and can be installed with double-side tape, clamp or screw.
- Depending on the setup of the electrical panel where the PowerTag Link C is located, the quality of the signal can be improved by a repeater.

Accessory

- Relay antenna (signal repeater)

Catalog number

PowerTag Ambient for Temperature	
PowerTag Ambient for Temperature (set of 4)	A9XST114
Accessory	
Relay antenna, AC/DC, 5m cable output	ZBRA1

Associated concentrator

For Small Business applications

Acti9 PowerTag Link C	
A9XELC10	

Refer to the concentrator catalog for more information.

PowerTag Ambient for Temperature (cont.)



Technical characteristics

Main characteristics		
Measurement range		-30°C to +55°C ± 1°C
Battery duration		2 years
Operating temperature		-30°C to +55°C
Storage temperature		-30°C to +55°C
Operating/storage humidity		0...95 % Relative Humidity
Degree of protection		IP65
Radio-frequency communication		
Operating frequency		2.405 GHz
Maximum output power		4 dBm
Channel occupancy	Messages sent	every 2 minutes

Dimensions (mm)

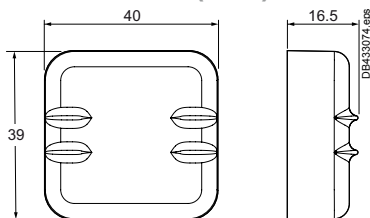

Weight (g)

PowerTag Ambient for Temperature (set of 4)	60
---	----

PowerTag

Selection guide for product compatibility*
(Compatibility for terminal not equipped with comb busbar)

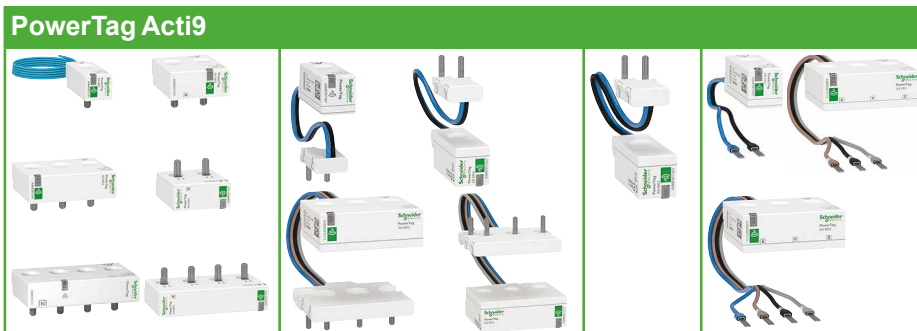

Products (AC network)	Mounting position	A9 M63	A9 P63	A9 P63 RCBO	A9 F63
Acti9/Multi9					
Circuit breakers					
iC60/iK60/DT60	Top	✓	-	-	-
	Bottom	✓	-	-	-
iC60 (double terminal)	Top	-	-	-	✓
	Bottom	-	-	-	✓
iC40	Top	-	✓	-	-
	Bottom	-	✓	-	-
DT40/iDPN/C40	Top	-	✓	-	-
	Bottom	-	✓	-	-
C120 ≤ 63 A NG125 ≤ 63 A	Top	-	-	-	✓ (1)
	Bottom	-	-	-	✓ (1)
iC65N-K (China) iC65 (China)	Top	✓	-	-	-
	Bottom	✓	-	-	-
iDPN (China)	Top	-	✓	-	-
	Bottom	-	✓	-	-
iKQ (1P+W PowerTag on each pole)	Top	NA	-	-	-
	Bottom	✓ (1P+W only)	-	-	-
N40	Top	-	✓	-	-
	Bottom	-	✓	-	-
Reflex iC60	Top	✓	-	-	-
	Bottom	✓	-	-	-
Reflex XC40	Top	✓	-	-	-
	Bottom	-	-	-	✓ (1)
C32/C45/C60/C65/K60/T60/ C60-OEM	Top	✓	-	-	-
	Bottom	✓	-	-	-
Circuit breakers equipped with Vigi module					
iC60/iC65/iC60/iC65N-K with Vigi module	Top	✓ (CB)	-	-	-
	Bottom	-	-	-	✓ (Vigi) (1)
iC40 with Vigi iCG40	Top CB	-	✓ (CB)	-	-
	Top (Vigi)	-	✓ (Vigi 1P+N) (2)	-	-
	Bottom (Vigi)	-	-	-	✓ (Vigi 3P+N)
iC40 with "outgoer" Vigi module	Top	-	✓ (CB)	-	-
	Bottom	-	-	-	✓ (Vigi)
DT40/DPN/C40 with "group feeder" Vigi module	Top CB	-	✓ (CB)	-	-
	Top Vigi	-	✓ (Vigi 1P+N)	-	✓ (Vigi 3P+N)
DT40/DPN/C40 with "outgoer" Vigi module	Top	-	✓ (CB)	-	-
	Bottom	-	-	-	✓ (Vigi)
DT60 with Vigi TG60	Top CB	✓ (CB) only A9MEM1541	-	-	-
	Top Vigi	-	-	-	✓ (Vigi) (1)

(1) You may need to change the voltage measurement cable terminals of the PowerTag F63 by other cable ends (wire AWG22/0.33 mm²) for a more suitable connection to this product.

(2) Product usually associated with a comb busbar

(*) Refer to the product catalogue for technical characteristics

PowerTag

Selection guide for product compatibility* (cont.)
(Compatibility for terminal not equipped with comb busbar)

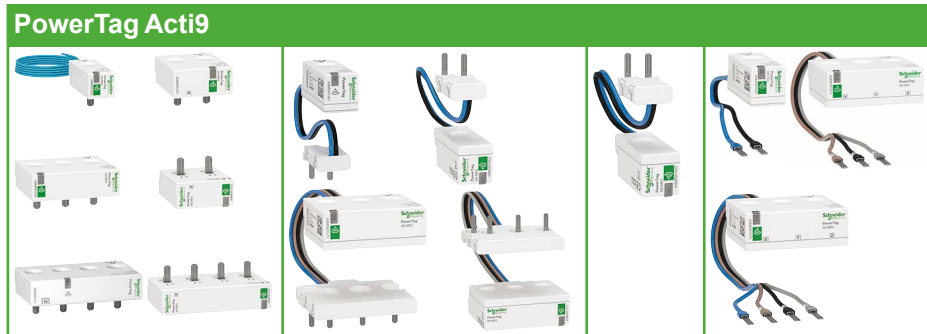

Products (AC network)	Mounting position	A9 M63	A9 P63	A9 P63 RCBO	A9 F63
Acti9/Multi9					
Residual current devices					
iID/iID K	Top	✓	-	-	-
	Bottom	✓	-	-	-
iID (double terminal)	Top	-	-	-	✓
	Bottom	-	-	-	✓
iID40	Top	-	☑ 1P+N (2)	-	☑ 3P+N (2)
	Bottom	✓	-	-	-
iDPN Vigi "outgoer" 1P+N	Top	-	✓	-	-
	Bottom	-	✓	-	-
iC60H RCBO/iC60H2 RCBO/ IKQE RCBO	Top	NA (fishbone)	-	-	-
	Bottom	-	-	✓	-
iC60 RCBO	Top	✓	-	-	-
	Bottom	✓	-	-	-
iCV40 "outgoer" 1P+N	Top	-	✓	-	-
	Bottom	-	✓	-	-
iCV40 "outgoer" 3P+N	Top	-	✓	-	-
	Bottom	-	-	-	✓
DPN Vigi/DT40 Vigi/C40 Vigi "outgoer" 1P+N	Top	-	✓	-	-
	Bottom	-	✓	-	-
DPN Vigi/DT40 Vigi/C40 Vigi/ iDPN Vigi "outgoer" 3P+N	Top	-	✓	-	-
	Bottom	-	-	-	✓
DPN Vigi K	Top	-	-	-	✓ (1)
	Bottom	-	-	-	✓ (1)
N40 Vigi "outgoer"	Top	-	✓	-	-
	Bottom	-	✓	-	-
iDc/ITG40/C40	Top Left	-	✓	-	-
	Top Right	-	✓	-	-
DCP Vigi	Top	✓	-	-	-
	Bottom	✓	-	-	-
C60H RCBO (Multi9)	Top	NA (fishbone)	-	-	-
	Bottom	-	-	✓	-
ID ≤ 63 A/iD K biconnect/ ID Type B ≤ 63 A	Top	✓	-	-	-
	Bottom	✓	-	-	-
RED/REDS/REDTest	Top	-	-	-	✓ (1)
	Bottom	-	-	-	✓ (1)

(1) You may need to change the voltage measurement cable terminals of the PowerTag F63 by other cable ends (wire AWG22/0.33 mm²) for a more suitable connection to this product.
(2) Product usually associated with a comb busbar

(*) Refer to the product catalogue for technical characteristics

PowerTag

Selection guide for product compatibility* (cont.)
(Compatibility for terminal not equipped with comb busbar)

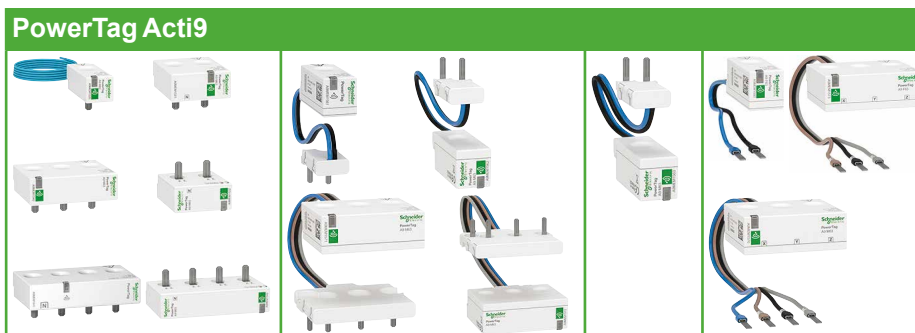





Products (AC network)	Mounting position	A9 M63	A9 P63	A9 P63 RCBO	A9 F63
Acti9/Multi9 Switches					
iSW ≤ 63 A	Top	✓	-	-	-
	Bottom	✓	-	-	-
iSW-NA ≤ 63 A	Top	✓	-	-	-
	Bottom	✓	-	-	-
iSW 20/32 A	Top	-	-	-	✓
	Bottom	-	-	-	✓
i-NA ≤ 63 A	Top	✓	-	-	-
	Bottom	✓	-	-	-
NG125 NA ≤ 63 A	Top	-	-	-	✓ (1)
	Bottom	-	-	-	✓ (1)
Fuse disconnectors					
STI	Top	-	✓	-	-
	Bottom	-	✓	-	-
SBI 14x51/SBI 22x58 ≤ 63 A	Top	-	-	-	✓ (1)
	Bottom	-	-	-	✓ (1)
D01/D02	Top	-	-	-	✓ (1)
	Bottom	-	-	-	✓ (1)
TeSys					
Circuit breakers					
GV2	Top	-	-	-	✓ (1) (2)
	Bottom	-	-	-	✓ (1) (2)
GV3 ≤ 63 A	Top	-	-	-	✓ (1) (2)
	Bottom	-	-	-	✓ (1) (2)
Contactors					
LC1D ≤ 63 A	Top	-	-	-	✓ Upstream only (1)
	Bottom	-	-	-	-

(1) You may need to change the voltage measurement cable terminals of the PowerTag F63 by other cable ends (wire AWG22/0.33 mm²) for a more suitable connection to this product.
(2) PowerTag Energy sensors withstand motor starting in-rush currents. Environmental mission profile : Buildings as per 60721-3-3.

(*) Refer to the product catalogue for technical characteristics

PowerTag

Selection guide for product compatibility* (cont.)

			PowerTag NSX			
						
Products (AC network)		Mounting position	250 3P	250 3P+N	630 3P	630 3P+N
Compact						
Circuit breakers						
NSX100/160/250 B/F/N/H/S/L/R Fixed	3P	Bottom	☑	-	-	-
	4P	Bottom	-	☑	-	-
NSX400/630 F/N/H/S/L/R Fixed	3P	Bottom	-	-	☑	-
	4P	Bottom	-	-	-	☑
NSX100/160/250 B/F/N/H/S/L/R Plug-In (mounted on the base)	3P	Top / Bottom	☑	-	-	-
	4P	Top / Bottom	-	☑ (3)	-	-
NSX400/630 F/N/H/S/L/R Plug-In (mounted on the base)	3P	Top / Bottom	-	-	☑ (4)	-
	4P	Top / Bottom	-	-	-	☑ (3) (4)
NS100/160/250 N/ SX/H/L Fixed	3P	Bottom	☑	-	-	-
	4P	Bottom	-	☑	-	-
NS400/630 N/H/L Fixed	3P	Bottom	-	-	☑	-
	4P	Bottom	-	-	-	☑
NS100/160/250 N/ SX/H/L Plug-In (mounted on the base)	3P	Top / Bottom	☑	-	-	-
	4P	Top / Bottom	-	☑ (3)	-	-
NS400/630 N/H/L Plug-In (mounted on the base)	3P	Top / Bottom	-	-	☑ (4)	-
	4P	Top / Bottom	-	-	-	☑ (3) (4)
Circuit breakers equipped with Vigi block						
NSX100/160/250 B/F/N/H/S/L/R Fixed	3P	Bottom	☑	-	-	-
	4P	Bottom	-	☑	-	-
NSX400/630 F/N/H/S/L/R Fixed	3P	Bottom	-	-	☑	-
	4P	Bottom	-	-	-	☑
NSX100/160/250 B/F/N/H/S/L/R Plug-In (mounted on the base)	3P	Top	☑	-	-	-
NSX400/630 F/N/H/S/L/R Plug-In (mounted on the base)	3P	Top	-	-	☑ (4)	-
Switches						
INS250/INV - 100/160/200/250	3P	Bottom	-	☑	-	-
	4P	Top / Bottom	-	☑ (3)	-	-
INS/INV - 320/400/500/630	3P	Bottom	-	-	-	☑
	4P	Top / Bottom	-	-	-	☑ (3)







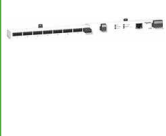

(3) neutral on the right when mounted on top side

(4) when plate mounted, need to add a 4 mm intercalary under the PowerTag module (see Compact NSX catalog)

(*). Refer to the product catalogue for technical characteristics

PowerTag

Selection guide for concentrator compatibility*

Concentrators						
						
	Acti9 PowerTag Link C A9XELC10	Acti9 Smartlink SI B A9XMZA08	Acti9 Smartlink SI D A9XMWA20	Acti9 PowerTag Link A9XMWD20	Acti9 PowerTag Link HD A9XMWD100	
PowerTag Acti9 M63						
	A9MEM1520	✓	✓	✓	✓	✓
	A9MEM1521	✓	✓	✓	✓	✓
	A9MEM1522	✓	✓	✓	✓	✓
	A9MEM1540	✓	✓	✓	✓	✓
	A9MEM1541	✓	✓	✓	✓	✓
	A9MEM1542	✓	✓	✓	✓	✓
	A9MEM1543	✓	-	-	✓	✓
PowerTag Acti9 P63						
	A9MEM1561	✓	✓	✓	✓	✓
	A9MEM1562	✓	✓	✓	✓	✓
	A9MEM1563	✓	✓	✓	✓	✓
	A9MEM1571	✓	✓	✓	✓	✓
	A9MEM1572	✓	✓	✓	✓	✓
PowerTag Acti9 F63						
	A9MEM1560	✓	✓	✓	✓	✓
	A9MEM1573	-	-	-	✓	✓
	A9MEM1570	✓	✓	✓	✓	✓
PowerTag NSX						
	LV434020	✓	✓	✓	✓	✓
	LV434021	✓	✓	✓	✓	✓
	LV434022	✓	✓	✓	✓	✓
	LV434023	✓	✓	✓	✓	✓

(*) Refer to the product catalogue for technical characteristics

Protection

Circuit protection / Earth leakage protection

Electrical auxiliaries for iC60, iID, iC40, iC40 XA, iCV40, iCV40 XA, iID40, iDPN Vigi, iSW-NA

- The electrical auxiliaries are combined with iC60, iC40, iC40 XA, iCV40, iCV40 XA, iDPN Vigi circuit breakers, iID, iID40 residual current circuit breakers, remote tripping switch disconnecter iSW-NA; they enable tripping or remote indication of their position (open/closed/tripped) upon a fault.
- They are fastened by clips (without tools) to the left side of the breaker.
- The iOF/SD+OF auxiliary is a 2-in-1 product: via a mechanical selector switch, it provides two contacts, OF+SD or OF+OF.
- The iOF+SD24 auxiliary can report open/closed (OF) status information and intentional or fault tripping of the associated device (SD) to the Acti9 Smartlink or a programmable logic controller via the Ti24 interface (24 V DC).

Tripping auxiliaries:

IEC/EN 60947-1

- iMN: undervoltage release
- iMNs: delayed undervoltage release
- iMNx: undervoltage release, independant from supply voltage
- iMX: shunt release
- iMX+OF: shunt release with open/close contact.

EN 50550

- iMSU: overvoltage release.

Indication auxiliaries:

IEC/EN 60947-5-1

- iOF: open/close contact
- iSD: fault indicating contact
- iOF/SD+OF: open/close contact and switchable OF or SD contact
- iOF+SD24: open/close contact OF and default indicating contact SD with Ti24 interface.

IEC/EN 60947-5-4

- iOF+SD24: open/close contact OF and default indicating contact SD with Ti24 interface.

DB404939





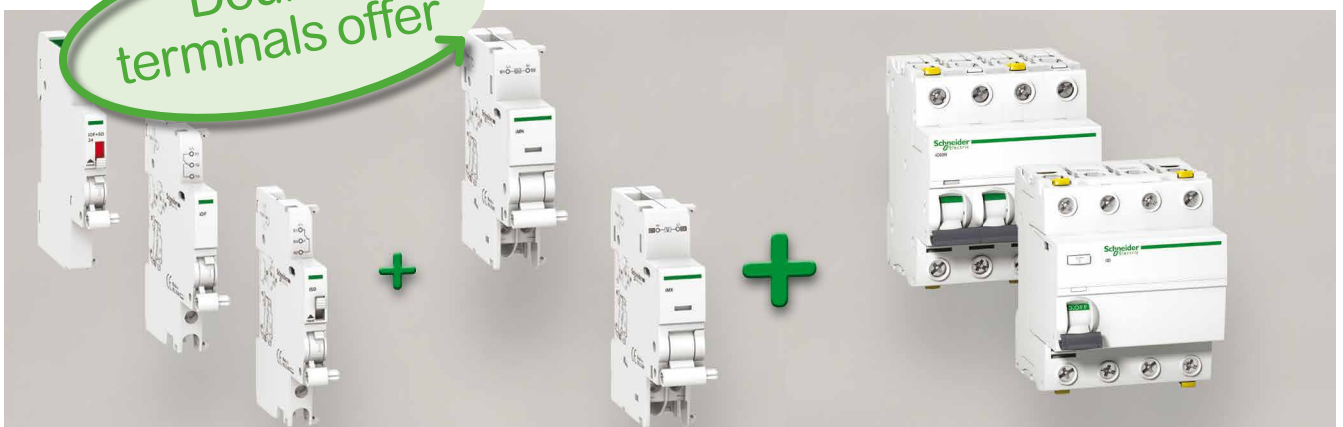

DB404940

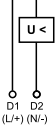

Circuit protection / Earth leakage protection

Electrical auxiliaries for iC60, iID, iC40, iC40 XA, iCV40, iCV40 XA, iID40, iDPN Vigi, iSW-NA (cont.)

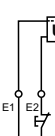

		Tripping							
Auxiliaries		iMN		iMNs		iMNx			
Type		Undervoltage release							
		Instantaneous		Delayed		Independent of the supply voltage			
									
Function		<ul style="list-style-type: none"> Trips the device with which it is combined when its input voltage decreases (between 70 % and 35 % Un). Prevents device closing again until its input voltage is restored 		<ul style="list-style-type: none"> Not tripping on transient voltage dip (up to 0.2 s) 		<ul style="list-style-type: none"> Tripping of the associated device by opening of the control circuit (e.g. push-button, dry contact) A drop in the supply voltage does not trip the associated device A locking push-button control allows the circuit protected (e.g. machine control) to be placed in safety configuration 			
Wiring diagrams									
Use		<ul style="list-style-type: none"> Emergency stoppage by normally closed push button Improve the safety of power supply circuits for several machines by preventing "uncontrolled" restarting 				<ul style="list-style-type: none"> Emergency stoppage with fail-safe principle Insensitive to control circuit voltage variation to increase service continuity Important: Before any servicing operation switch off the mains power supply (voltage presence at terminals E1/E2) 			
Catalogue numbers		A9A26960	A9A27108	A9A26961	A9A26959	A9A26963	A9A26969	A9A26971	
iC60, iID, iID40, iDPN Vigi, iSW-NA		■	■	■	■	■	■	■	
iC40, iCV40		■	■	■	■	■	■	■	
iC40 XA, iCV40 XA		■	■	■	■	■	■	■	
iC60, iID double terminals		■	■	■	■	■	■	■	
iC60 RCBO, iKQE RCBO		■	■	■	■	■	■	■	
Technical specifications		220...240 V AC		24 V AC	48 V AC	115 V AC	220...240 V AC		380...415 V AC
Rated voltage (Ue)		-		24 V DC	48 V CC	-	-		-
Standardised operating and non-response to voltage times (Ua)*		-		-	-	-	-		-
Maximum operating time		-		-	-	-	-		-
Minimum non-response time		-		-	-	-	-		-
Operating frequency		50/60 Hz			400 Hz	50/60 Hz	50/60 Hz		
Red mechanical indicator		On front face				On front face		On front face	
Test function		-				-		-	
Width in 9 mm modules		2				2		2	
Operating current		-				-		-	
Number of contacts		-				-		-	
Operating temperature		-35...+70°C				-35...+70°C		-35...+70°C	
Storage temperature		-40...+85°C				-40...+85°C		-40...+85°C	

*(Ua)
 Voltages measured between the phase and the neutral conductor, at which the IMSU device must control the associated protective device.

Protection



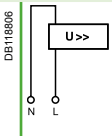
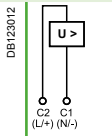
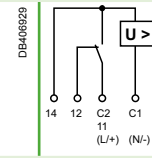

Circuit protection / Earth leakage protection

Electrical auxiliaries for iC60, iID, iC40, iC40 XA, iCV40, iCV40 XA, iID40, iDPN Vigti, iSW-NA (cont.)

iMSU						iMX			iMX+OF		
Overvoltage release						Shunt release			With Open/Close auxiliary contact		
											
<ul style="list-style-type: none"> Switches off the power supply by opening the breaker with which it is combined, in the event that the phase/neutral voltage is exceeded (loss of neutral). For a four-phase network, use three iMSU tripping auxiliaries. 						<ul style="list-style-type: none"> Trips the associated device when it is powered on 			<ul style="list-style-type: none"> Includes an open/close contact (OF) to indicate the "open" or "closed" position of the device 		
											
<ul style="list-style-type: none"> Protection of equipment against overvoltages on the electrical network (neutral conductor break) Voltage monitoring between phase and neutral conductors 						<ul style="list-style-type: none"> Emergency stoppage by normally open push button 			<ul style="list-style-type: none"> Emergency stoppage by normally open push button Remote indication of the position of the associated device 		
A9A26500						A9A26476	A9A26477	A9A26478	A9A26946	A9A26947	A9A26948
■						■	■	■	■	■	■
■						■	■	■	■	■	■
■						■	■	■	■	■	■
■						■	■	■	■	■	■
■						■	■	■	■	■	■
■						■	■	■	■	■	■
230 V AC						100...415 V AC	48 V AC	12...24 V AC	100...415 V AC	48 V AC	12...24 V AC
-						110...130 V DC	48 V DC	12...24 V DC	110...130 V DC	48 V DC	12...24 V DC
255 V AC		275 V AC	300 V AC	350 V AC	400 V AC	-	-	-	-	-	-
No tripping		15 s	5 s	0.75 s	0.20 s	-	-	-	-	-	-
		3 s	1 s	0.25 s	0.07 s	-	-	-	-	-	-
50/60 Hz						50/60 Hz			50/60 Hz		
On front face						On front face			On front face		
-						-			-		
2						2			2		
-						-			10 mA mini, 6 A maxi		
-						-			≤ 24 V DC 6 A		
-						-			48 V DC 2 A		
-						-			≤ 130 V DC 1 A		
-						-			≤ 240 V AC 6 A		
-						-			415 V AC 3 A		
-						-			1 NO/NC		
-35...+70°C						-35...+70°C			-35...+70°C		
-40...+85°C						-40...+85°C			-40...+85°C		

Circuit protection / Earth leakage protection

Electrical auxiliaries for iC60, iID, iC40, iC40 XA, iCV40, iCV40 XA, iID40, iDPN Vigi, iSW-NA (cont.)

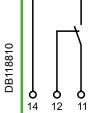
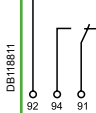
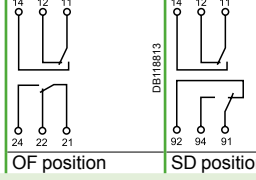
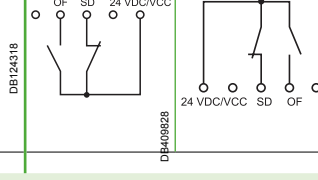
		Indication						
Auxiliaries		iOF	iSD	iOF/SD+OF	iOF+SD24			
Type		Open/close auxiliary contact	Fault indicating contact	Double open/close or fault indicating contact	Double open/close and fault indicating contact			
		 <p>PB104474-35</p>	 <p>PB104475-35</p>	 <p>PB104475-35</p>	 <p>PB107750-35 A9A26898-35</p>			
<p><i>- Offer to be adapted by the country</i></p>								
Function		<ul style="list-style-type: none"> Changeover contact indicates "open" or "closed" position of the device 	<ul style="list-style-type: none"> Changeover contact indicates position of the device; upon: <ul style="list-style-type: none"> electrical fault action on tripping auxiliary Same indication as VISI-TRIP 	<ul style="list-style-type: none"> The iOF/SD+OF auxiliary is a 2-in-1 product: via a mechanical selector switch, it provides two contacts, OF+SD or OF+OF 	<ul style="list-style-type: none"> 2 contacts (1 NO + 1 NC) can report the signalling information of the associated device to the Acti9 Smartlink or a programmable logic controller: <ul style="list-style-type: none"> electrical fault actuation of the tripping auxiliary "Open" or "Closed" position of the associated device 			
Wiring diagrams		 <p>DB118810</p>	 <p>DB118811</p>	 <p>DB118812 DB118813</p>	 <p>DB124319 DB409828</p>			
Use		<ul style="list-style-type: none"> Remote indication of the position of the associated device 	<ul style="list-style-type: none"> Remote indication of tripping upon a fault of the associated device 	<ul style="list-style-type: none"> Remote indication of position and/or tripping upon a fault of the associated device 	<ul style="list-style-type: none"> Remote indication of position and tripping upon a fault of the associated device 			
Catalogue numbers		A9A26924	A9A26869	A9A26927	A9A26855	A9A26929	A9A26897	A9A26898
iC60, iID, iID40, iDPN Vigi, iSW-NA		■	-	■	-	■	■	■
iC40, iCV40		■	-	■	-	■ if no comb busbar	■	■
iC40 XA, iCV40 XA		■	-	■	-	-	-	■
iC60, iID double terminals		-	■	-	■	■	■	-
iC60 RCBO, iKQE RCBO		■	-	■	-	-	-	-
Technical specifications								
Rated voltage (Ue)		24...415 V AC		24...415 V AC		24...415 V AC		-
		24...130 V DC		24...130 V DC		24...130 V DC		24 V DC
Operating frequency		50/60 Hz		50/60 Hz		50/60 Hz		-
Red mechanical indicator		-		On front face		On front face		On front face
Test function		On toggle		On toggle		On toggle		On toggle
Width in 9 mm modules		1		1		1		1
Operating current		10 mA mini, 6 A maxi						2 mA mini, 100 mA maxi
		24 V DC 6 A						
		48 V DC 2 A						
		60 V DC 1,5 A						
		130 V DC 1 A						
		24...240 V AC 6 A						
		415 V AC 3 A						
Number of contacts		1 NO/NC		1 NO/NC		1 NO/NC + 1 NO/NC		1 NO/NC
Operating temperature		-35...+70°C		-35...+70°C		-35...+70°C		-25...+70°C
Storage temperature		-40...+85°C		-40...+85°C		-40...+85°C		-40...+85°C

Electrical auxiliaries for iC60, iID, iC40, iC40 XA, iCV40, iCV40 XA, iID40, iDPN Vigi, iSW-NA (cont.)

Connection

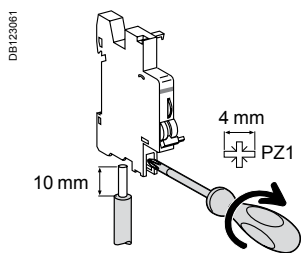

Type	Tightening torque	Copper cables		Multi-cables	
		Rigid	Flexible	Rigid	Cables with ferrule
Indication auxiliaries	1 N.m	1 to 4 mm ²	0.5 to 2,5 mm ²	2 x 2.5 mm ²	2 x 1.5 mm ²
Tripping auxiliaries	1 N.m	1 to 6 mm ²	0.5 to 4 mm ²	2 x 2.5 mm ²	2 x 2.5 mm ²

Ti24 connector connection

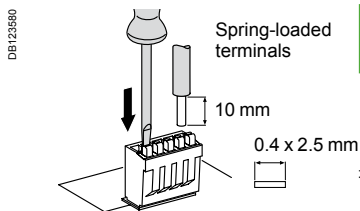

Type	Catalogue numbers	Copper cables	
		Rigid	Flexible
Ti24 interface	A9XC2412	1 x 0.5 to 1.5 mm ²	1 x 0.5 to 1.5 mm ²

Ti24 prefabricated cables connection

Type	Catalogue numbers	Length
Connection for Acti9 Smartlink		
6 prefabricated	A9XCAS06	100 mm
	A9XCAM06	160 mm
	A9XCAL06	450 mm
	A9XCAL06	870 mm
Connection for PLC type terminals		
6 long prefabricated on a single side	A9XCAU06	870 mm
1 long prefabricated on a single side	A9XCAC01	4000 mm
12 connectors, 5-pins (Ti24)	A9XC2412	-

PB107754-10



PB107755-14



DB404941

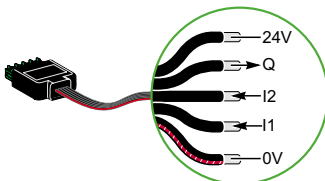

PB107756-7



Protection

Circuit protection / Earth leakage protection

Electrical auxiliaries for iC60, iID, iC40, iC40 XA, iCV40, iCV40 XA, iID40, iDPN Vigi, iSW-NA (cont.)

Technical data

Weight (g)

Electrical auxiliaries	
Type	
iMN	69
iMNs	72
iMNx	79
iMSU	68
iMX	64
iMX+OF	68
iOF	32
iSD	33
iOF/SD+OF	43
iOF+SD24	25

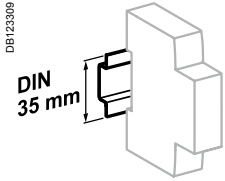

Clip on DIN rail 35 mm.

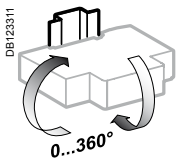

Indifferent position of installation.

Dimensions (mm)

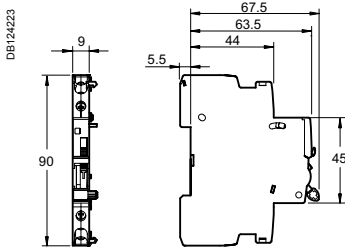

iOF/SD+OF

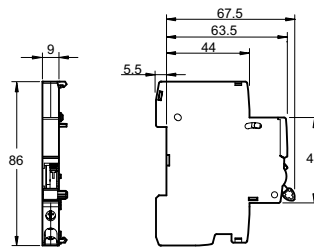

iOF, iSD

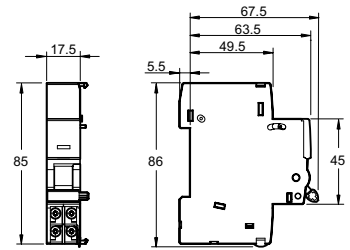

iMN, iMNs, iMNx, iMSU, iMX, iMX+OF

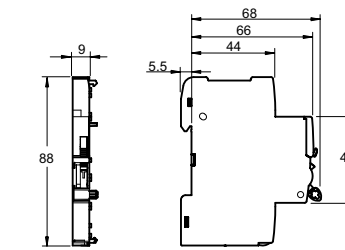

iOF+SD24 (A9A26897)

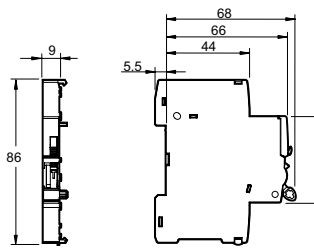

iOF+SD24 (A9A26898)

iMDU electrical auxiliary for Reflex iC60 or RCA iC60



A9C18195

The voltage matching module allows safety voltages of 24 and 48 V AC/DC to be used on the control inputs.

- Only connects to the Reflex iC60 circuit breakers remote controlled by a 220-240 V control voltage
- Galvanic isolation 6000 V
- Maximum combined power between terminals P and Y1/Y2: 100 mA at 230 V and 25°C.

Catalogue numbers

Auxiliary iMDU		
Type	Width in 9 mm modules	
iMDU	A9C18195	1

Diagram

An iMDU electrical auxiliary allows up to a maximum of five Reflex iC60 to be controlled simultaneously at the same input Y1 or Y2.

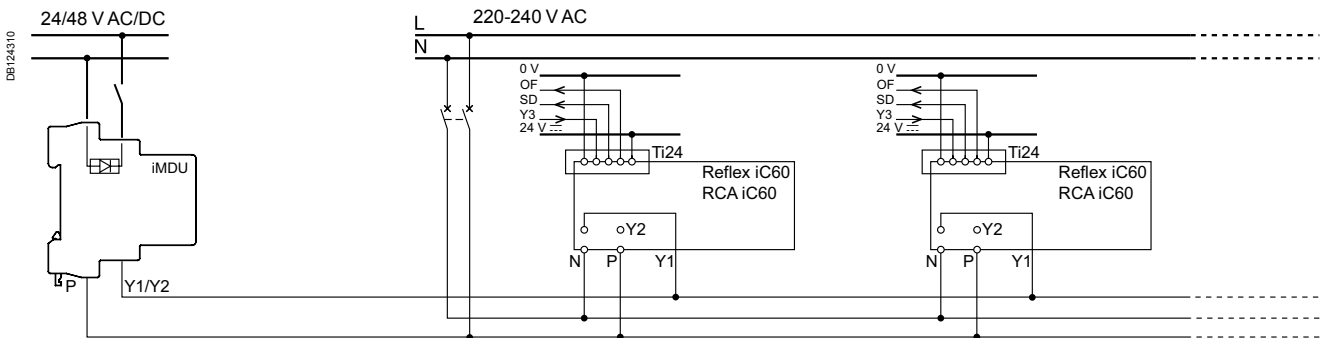

Dimensions (mm)

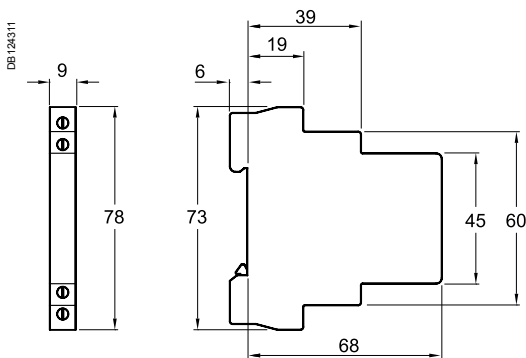

Connection

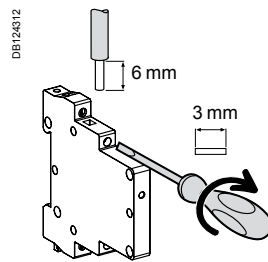

Type	Tightening torque	Copper cables	
		Rigid	Flexible or with ferrule
iMDU	1 N.m	1.5 mm ²	1.5 mm ²

Technical data

Main characteristics		
Control circuit voltage	24...48 V AC/DC	
Insulation voltage (Ui)	500 V	
Additional characteristics		
Degree of protection (IEC 60529)	Device only	IP20
	Device in modular enclosure	IP40
Operating temperature	Insulation class II	
Storage temperature	-20°C to +60°C	
Tropicalization	-40°C to +80°C	
Weight	Treatment 2 (relative humidity 95 % at 55°C)	
	53 g	

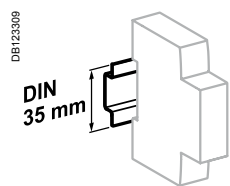

Clip on DIN rail 35 mm.

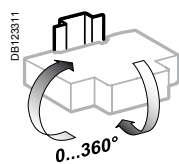

Indifferent position of installation.

Protection

Circuit protection / Earth leakage protection

Electrical auxiliaries for C60, C120, DPN, DPN Vigi, ID, C60H-DC, SW60-DC, C60PV-DC, C60NA-DC, C120NA-DC

- The electrical auxiliaries provide the remote tripping or position (open/closed/tripped) indication functions of these devices in the event of a fault.
- They clip on (no tool required) to the left-hand side of the associated device.
- The OF+SD/OF auxiliary is a two-in-one product: a mechanical selector switch is used to select one of two contacts: OF+SD or OF+OF.
- The OF+SD24 auxiliary can report open/closed (OF) status information and intentional or fault tripping of the associated device (SD) to the Acti 9 Smartlink or a programmable logic controller via the Ti24 interface (24 V DC).



■ The electrical auxiliaries are not compatible with ID residual current circuit breakers of type B.

Tripping auxiliaries:

IEC/EN 60947-1

- MN: undervoltage release
- MN \overline{S} : delayed undervoltage release
- MNx: undervoltage release, independent of the supply voltage
- MX: shunt release
- MX+OF: shunt release with open/closed contact.

EN 50550

- MSU: overvoltage release.

Indication auxiliaries:

IEC/EN 60947-5-1



- OF.S: open/closed contact for ID
- OF: open/closed contact
- SD: fault indicating contact
- OF+SD/OF: choice of open/closed contact and OF or SD contact via the selector switch
- OF+SD24: open/close contact OF and cfault indicating contact SD with Ti24 interface.

IEC/EN 60947-5-4

- OF+SD24: open/close contact OF and cfault indicating contact SD with Ti24 interface.

Circuit protection / Earth leakage protection

Electrical auxiliaries for C60, C120, DPN, DPN Vigi, ID, C60H-DC, SW60-DC, C60PV-DC, C60NA-DC, C120NA-DC (cont.)

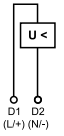
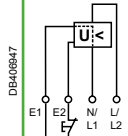

		Tripping					
Auxiliaries		MN		MN [Ⓢ]		MN _x	
Type		Undervoltage release					
		Instantaneous		Delayed		Independent of the supply voltage	
PE107151-30				PE107152-30			
PE107149-30							
Function		<ul style="list-style-type: none"> Causes the device with which it is associated to trip when its input voltage decreases (between 70 % and 35 % of U_n). Prevents the device from closing until its input voltage has been restored 		<ul style="list-style-type: none"> No tripping in the event of transient voltage dips (up to 0.2 s) 		<ul style="list-style-type: none"> Tripping of the associated device by opening of the control circuit (e.g. push-button, dry contact) A drop in the supply voltage does not trip the associated device A locking push-button control allows the circuit protected (e.g. machine control) to be placed in safety configuration 	
Wiring diagrams							
Utilization		<ul style="list-style-type: none"> Emergency stop via a normally-closed pushbutton Ensures the safety of the power supply circuits of several machines by preventing accidental startups 				<ul style="list-style-type: none"> Fail-safe emergency stop Insensitive to the variation in the control circuit voltage to improve continuity of service Important: Before any servicing operation switch off the mains power supply (voltage presence at terminals E1/E2) 	
Catalogue numbers		A9N26960	A9N26961	A9N26959	A9N26963	A9N26969	A9N26971
C60, C120, DPN, DPN Vigi, ID		■	■	■	■	■	■
C60H-DC, SW60-DC, C60PV-DC, C60NA-DC, C120NA-DC		■	■	■	■	■	■
Technical specifications							
Rated voltage (U _e)	V AC	220...240	48	115	220...240	230	400
	V DC	–	48	–	–	–	–
Standardised operating and non-response to voltage times (U _a)*		–	–	–	–	–	–
Maximum operating time		–	–	–	–	–	–
Minimum non-response time		–	–	–	–	–	–
Operating frequency	Hz	50/60		400	50/60	50/60	
		On front face			On front face	On front face	
Mechanical state indicator light, red		On front face			On front face	On front face	
Test function		–			–	–	
Width in 9 mm modules		2			2	2	
Operating current		–			–	–	
Number of contacts		–			–	–	
Operating temperature	°C	-25...+50			-25...+50	-25...+50	
	°C	-40...+85			-40...+85	-40...+85	
Storage temperature		–			–	–	
Standards							
IEC/EN 60947-1		■			■	■	
IEC/EN 60947-5-1		–			–	–	
EN 60947-2		■			■	■	
EN 62019-2 ⁽¹⁾		–			–	–	

(1) For C120, DPN.

*(U_a): Voltages measured between the phase and the neutral conductor, at which the MSU device must control the associated protective device.

Circuit protection / Earth leakage protection

Electrical auxiliaries for C60, C120, DPN, DPN Vigi, ID, C60H-DC, SW60-DC, C60PV-DC, C60NA-DC, C120NA-DC (cont.)

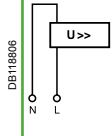
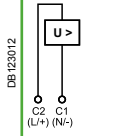
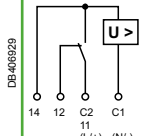
MSU						MX			MX+OF		
Voltage threshold release						Shunt release			With Open/Close auxiliary contact		
											
<ul style="list-style-type: none"> Cuts off the power supply by opening the device with which it is associated when the phase/neutral voltage is exceeded (loss of neutral). For a four-phase network, use three MSU tripping auxiliaries 						<ul style="list-style-type: none"> Trips the associated device when it is powered on 			<ul style="list-style-type: none"> Includes an open/close contact (OF) to indicate the "open" or "closed" position of the breaker 		
											
<ul style="list-style-type: none"> Protection of the devices against overvoltages on the electrical network (break in the neutral conductor) Monitoring the voltage between the phase conductor and the neutral conductor 						<ul style="list-style-type: none"> Emergency stop via a normally-open pushbutton. 			<ul style="list-style-type: none"> Emergency stop via a normally-open pushbutton Remote indication of the position of the associated device 		
A9N26500						A9N26476	A9N26477	A9N26478	A9N26946	A9N26947	A9N26948
-						■	■	■	■	■	■
-						■	■	■	■	■	■
230						100...415	48	12...24	100...415	48	12...24
-						110...130	48	12...24	110...130	48	12...24
255 V AC						-	-	-	-	-	-
275 V AC						-	-	-	-	-	-
300 V AC						-	-	-	-	-	-
350 V AC						-	-	-	-	-	-
400 V AC						-	-	-	-	-	-
No tripping						-	-	-	-	-	-
15 s						-	-	-	-	-	-
5 s						-	-	-	-	-	-
0.75 s						-	-	-	-	-	-
0.20 s						-	-	-	-	-	-
3 s						-	-	-	-	-	-
1 s						-	-	-	-	-	-
0.25 s						-	-	-	-	-	-
0.07 s						-	-	-	-	-	-
50/60						50/60			50/60		
On front face						On front face			On front face		
-						-			-		
2						2			2		
-						-			10 mA mini, 6 A maxi		
-						-			≤ 24 V DC	6 A	
-						-			48 V DC	2 A	
-						-			≤ 130 V DC	1 A	
-						-			≤ 240 V AC	6 A	
-						-			415 V AC	3 A	
-						-			1 NO/NC		
-25...+50						-25...+50			-25...+50		
-40...+85						-40...+85			-40...+85		
■						■			■		
-						-			-		
-						-			-		
-						-			-		
-						-			-		

Protection

Circuit protection / Earth leakage protection

Electrical auxiliaries for C60, C120, DPN, DPN Vigi, ID, C60H-DC, SW60-DC, C60PV-DC, C60NA-DC, C120NA-DC (cont.)

		Indication				
Auxiliaries		OF.S	OF	SD	OF+SD/OF	OF+SD24
Type		Open/closed auxiliary contact	Open/closed auxiliary contact	Fault indicating contact	Double open/closed or fault indicating contact	Double open/close and fault indicating contact
Function		<ul style="list-style-type: none"> Changeover contact indicating the "open" or "closed" position of the associated device <p>⚠ Compulsory for the addition of tripping or indication auxiliaries on a residual current circuit breaker ID</p>	<ul style="list-style-type: none"> Changeover contact indicating the "open" or "closed" position of the associated device 	<ul style="list-style-type: none"> Changeover contact indicating the position of the associated device in the event of: <ul style="list-style-type: none"> □ electrical fault □ action on the tripping auxiliary <p>⚠ Not compatible with a ID residual current circuit breaker, use an OF+SD/OF in the SD position</p>	<ul style="list-style-type: none"> The OF+SD/OF auxiliary is a two-in-one product: choice of OF + SD or OF + OF contact via the selector switch 	<ul style="list-style-type: none"> 2 contacts (1 NO + 1 NC) can report the signalling information of the associated device to the Acti 9 Smartlink or a programmable logic controller: <ul style="list-style-type: none"> □ electrical fault □ actuation of the tripping auxiliary □ "Open" or "Closed" position of the associated device
Wiring diagrams						
Utilization		<ul style="list-style-type: none"> Remote indication of the position of the associated device 	<ul style="list-style-type: none"> Remote indication of the position of the associated device 	<ul style="list-style-type: none"> Remote fault tripping indication of the associated device 	<ul style="list-style-type: none"> Remote position and/or fault tripping indication of the associated device 	<ul style="list-style-type: none"> Remote indication of position and tripping upon a fault of the associated breaker
Catalogue numbers		A9N26923	A9N26924	A9N26927	A9N26929	A9N26899
ID		■	■	■	■	■
C60, C120, DPN, DPN Vigi, C60H-DC, C60H-DC, SW60-DC, C60PV-DC, C60NA-DC, C120NA-DC		—	■	■	■	■
Technical specifications						
Rated voltage (Ue)	V AC	24...415	24...415	24...415	24...415	—
	V DC	24...130	24...130	24...130	24...130	24
Operating frequency	Hz	50/60	50/60	50/60	50/60	—
		—	—	On front face	On front face	On front face
Test function		—	On front face	On front face	On front face	On toggle
Width in 9 mm modules		1	1	1	1	1
Operating current	10 mA mini, 6 A maxi	—	—	—	—	2 mA mini, 100 mA maxi
	24 V DC	—	6 A	—	—	—
	48 V DC	—	2 A	—	—	—
	60 V DC	—	1.5 A	—	—	—
	130 V DC	—	1 A	—	—	—
	24...240 V AC	—	6 A	—	—	—
Number of contacts		1 NO/NC	1 NO/NC	1 NO/NC	1 NO/NC + 1 NO/NC	1 NO + 1 NC
	Operating temperature	°C	-25...+50	-25...+50	-25...+50	-25...+50
Storage temperature	°C	-40...+85	-40...+85	-40...+85	-40...+85	-40...+85
Standards						
IEC/EN 60947-1		—	—	—	—	—
IEC/EN 60947-5-1		■	■	■	■	■ IEC 60947-5-4
EN 60947-2		—	—	—	—	—
EN 62019-2 ⁽¹⁾		■	■	■	■	—

(1) For C120, DPN.

Protection

Circuit protection / Earth leakage protection

Electrical auxiliaries for C60, C120, DPN, DPN Vigi, ID, C60H-DC, SW60-DC, C60PV-DC, C60NA-DC, C120NA-DC (cont.)

Connection

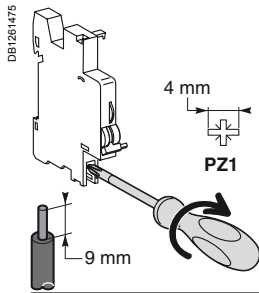

Type	Tightening torque	Copper cables	
		Rigid	Flexible or with ferrule
Indication and tripping auxiliaries	1 N.m	0.5 to 2.5 mm ²	2 x 1.5 mm ²

Ti24 connector connection

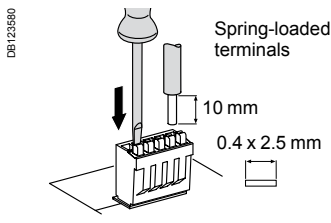

Type	Catalogue numbers	Copper cables	
		Rigid	Flexible
Ti24 interface	A9XC2412	1 x 0.5 to 1.5 mm ²	1 x 0.5 to 1.5 mm ²

Ti24 prefabricated cables connection

Type	Catalogue numbers	Length
Connection for Acti 9 Smartlink		
PB107754-10 	A9XCAS06	100 mm
	A9XCAM06	160 mm
	A9XCAH06	450 mm
	A9XCAL06	870 mm
Connection for PLC type terminals		
PB107755-14 	A9XCAU06	870 mm
	A9XCAC01	4000 mm
DB404941 		
PB107756-7 	A9XC2412	-

Protection

Circuit protection / Earth leakage protection

Electrical auxiliaries for C60, C120, DPN, DPN Vigi, ID, C60H-DC, SW60-DC, C60PV-DC, C60NA-DC, C120NA-DC (cont.)

Dimensions

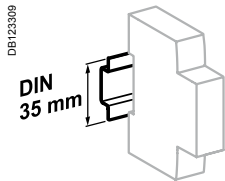
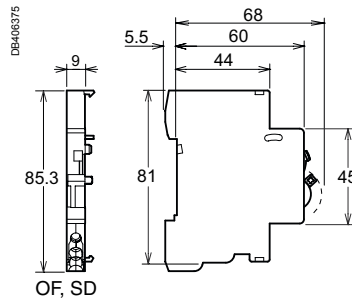
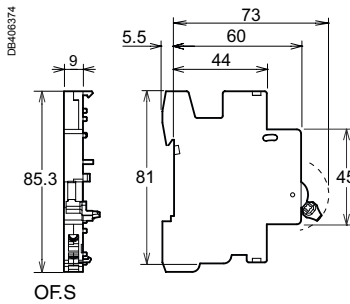
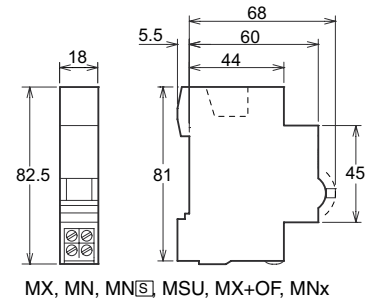
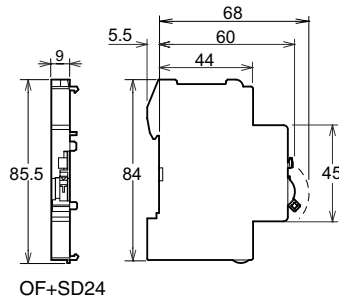
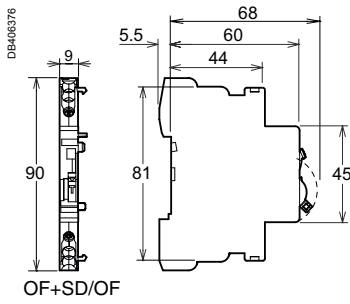

Clip on DIN rail 35 mm.

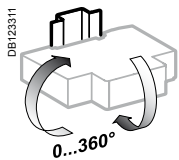

Indifferent position of installation.

Weight (g)

Electrical auxiliaries	
Type	Weight (g)
MN	66
MN \square	66
MNx	73
MSU	66
MX	60
MX+OF	65
O.F.S	33
OF	30
SD	30
OF+SD/OF	38
OF+SD24	28

Protection

Circuit protection

Electrical auxiliaries for NG125 devices

- The electrical auxiliaries are combined with NG125 circuit breakers and NG125 switch-disconnectors; they provide the remote tripping or position (open/closed/tripped) indication functions of these devices in the event of a fault.
- They clip on (no tool required) to the left-hand side of the associated device.

IEC/EN 60947-2

- Tripping auxiliaries:
 - MN: undervoltage release
 - MNx: undervoltage release, independent of the supply voltage
 - MX+OF: shunt release with open/closed contact
 - MXV: shunt release for Vigi add-on residual current device.

IEC/EN 60947-5-1

- Indication contacts:
 - OF+OF: open/closed contact
 - OF+SD: fault indicating contact
 - MX+OF: shunt release with open/closed contact.



Combination table

Electrical auxiliaries		Device
Indication auxiliaries 2 (OF+OF or OF+SD)	Tripping auxiliaries Max. quantity + 1 (MX+OF or MN or MNx)	058602N_SE-30  NG125

Connection

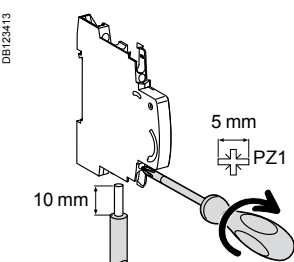

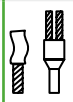
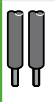
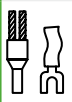

Type	Tightening torque	Copper cables		Multi-cable terminal	
		Rigid	Flexible or with ferrule	Flexible or rigid cables	Cables with ferrule
Indication contacts	1 N.m	DB122845 	DB123411 	DB123011 	DB123412 
Tripping auxiliaries	1 N.m	0.5 to 2.5 mm ²	0.5 to 1.5 mm ²	2 x 2.5 mm ²	2 x 1.5 mm ²

Electrical auxiliaries for NG125 devices and for Vigi NG125 add-on residual current devices (cont.)



		Tripping							
Auxiliaries		MN			MNx		MX+OF		
Type		Undervoltage release						Shunt release	
		Instantaneous			Independent of the supply voltage		With open/closed auxiliary contact		
Function		<ul style="list-style-type: none"> Causes tripping of the device with which it is combined when its input voltage decreases (between 70% and 35% of U_n). Prevents closing of the device until its input voltage has been restored 			<ul style="list-style-type: none"> Tripping of the associated device by opening of the control circuit (e.g. push-button, dry contact) A drop in the supply voltage does not trip the associated device A locking push-button control allows the circuit protected (e.g. machine control) to be placed in safety configuration 		<ul style="list-style-type: none"> Causes tripping of the associated device when powered Includes an open/closed contact (OF) to indicate the "open" or "closed" position of the associated device 		
Wiring diagrams									
Utilization		<ul style="list-style-type: none"> Emergency stop by normally-closed pushbutton Ensures safety of the power supply circuits for several machines by preventing untimely restarting 			<ul style="list-style-type: none"> Fail-safe emergency stop Insensitive to variations in the control circuit voltage for improved continuity of service Important: Before any servicing operation switch off the mains power supply (voltage presence at terminals E1/E2) 		<ul style="list-style-type: none"> Provided with a self-interrupting contact 		
Catalogue numbers		19067	19069	19070	19061	19064	19065	19066	19063
Technical specifications									
Rated voltage (U_e)	V AC	230...240	48	—	220...240	230...415	48...130	24	12
	V DC	—	—	48	—	110...130	48	24	12
Operating frequency	Hz	50/60			50/60	50/60			
Mechanical state indicator light, red		On front face			On front face	On front face			
Width in 9 mm modules		2			4	2			
Current rating		—			—	415 V AC		3 A	
		—			—	≤ 240 V AC		6 A	
		—			—	130 V DC		1 A	
		—			—	≤ 48 V DC		3 A	
Number of contacts		—			—	—			
Operating temperature	°C	-25...+60			-25...+60	-25...+60			
Storage temperature	°C	-40...+85			-40...+85	-40...+85			

Electrical auxiliaries for NG125 devices and for Vigi NG125 add-on residual current devices (cont.)

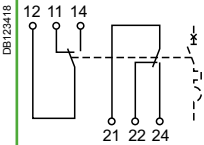
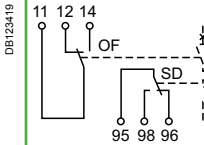
Indication

OF+OF		OF+SD	
Auxiliary contact		Fault indicating contact	
			
<ul style="list-style-type: none"> ■ Double changeover contact indicating "open" or "closed" position of the associated device 		<ul style="list-style-type: none"> ■ Double changeover contact indicating: <ul style="list-style-type: none"> □ the position of the associated device in the event of: <ul style="list-style-type: none"> - electrical fault - actuation of the tripping auxiliary □ the "open" or "closed" position of the associated device 	
			
<ul style="list-style-type: none"> ■ Remote indication of the position of the associated device 		<ul style="list-style-type: none"> ■ Remote indication of tripping upon a fault of the associated device 	
19071		19072	
-		-	
-		-	
50/60		50/60	
-		-	
1		1	
415 V AC 3 A		415 V AC 3 A	
≤ 240 V AC 6 A		≤ 240 V AC 6 A	
130 V DC 1 A		130 V DC 1 A	
≤ 48 V DC 3 A		≤ 48 V DC 3 A	
2 NO/NC		2 NO/NC	
-25...+60		-25...+60	
-40...+85		-40...+85	

Electrical auxiliaries for NG125 devices and for Vigi NG125 add-on residual current devices (cont.)

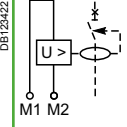
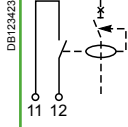
		Indication	
Auxiliaries		MXV	SDV
Type		Shunt release	Vigi fault indicating contact
			
Function		<ul style="list-style-type: none"> At power up, actuates tripping of a circuit breaker or residual current circuit breaker It is provided with a self-interrupting contact 	<ul style="list-style-type: none"> Normally-closed or normally-open contact indicating tripping upon an earth fault (including tripped by MXV)
Wiring diagrams			
Utilization		<ul style="list-style-type: none"> Adaptable to 125 A Vigi add-on residual current device, all types, and to 63 A Vigi add-on residual current device, adjustable Impulse withstand voltage: 6 kV High-impedance input: use an iACTp if the leakage current in the control unit exceeds 1 mA (e.g. illuminated pushbutton) 	
Catalogue numbers		19060	19058 19059
Suitable for the following devices:			
NG125		–	–
Vigi NG125		■	■
Technical specifications			
Rated voltage (Ue)	V AC	110...240	250
	V DC	110	–
Operating frequency	Hz	50/60	50/60
Number of contacts		–	1 NO 1 NC
Current rating		–	0.1 to 1 A (AC14)
Operating temperature	°C	-25...+60	-25...+60
Storage temperature	°C	-40...+85	-40...+85

Control

Remote control

RCA remote controls

For iC60 circuit breakers



The RCA remote control system allows:

- Remote electrical control (opening and closing) of circuit breakers with or without Vigi add-on RCD, with or without auxiliary.
- Circuit-breaker resetting after tripping, in accordance with safety principles and the regulations in force.
- Local control by operating handle.
- Circuit placing in safety configuration by padlocking.

2 choices of operation after tripping:

- A: Enabling of remote circuit-breaker resetting;
- B: Inhibition of remote resetting.

The version with Ti24 interface allows:

- Direct interfacing of remote control with a programmable logic controller (PLC), a supervision system and any other communication device, having inputs/outputs in 24 V DC (control, OF and SD indications).
- Fast, reliable connection of the remote control to the Acti 9 Smartlink thanks to the prefabricated cables.
- Remote indication by "OF" potential-free contact.
- Provision of 2 operating modes, "1 and 3".

The iMDU auxiliary allows RCA control in 24/48 V AC/DC.

Catalogue numbers

RCA remote control			
Type			Width in 9 mm modules
For circuit breakers 1P, 1P+N, 2P	Voltage		
Without Ti24 interface	230 V AC, 50/60 Hz	A9C70112	7
With Ti24 interface	230 V AC, 50/60 Hz	A9C70122	7
For 3P, 4P circuit breakers			
Without Ti24 interface	230 V AC, 50/60 Hz	A9C70114	7
With Ti24 interface	230 V AC, 50/60 Hz	A9C70124	7
Auxiliaries		See module CA907000 and CA907002	

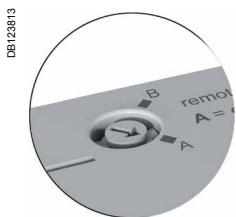

Without Ti24 interface

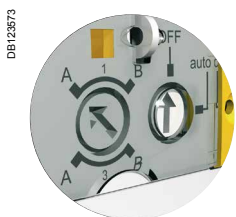

With Ti24 interface

Legend		Application
Type		
OFF		All remote control inhibited
auto	A	Circuit breaker remote reclosing after tripping allowed
	B	Circuit breaker remote reclosing after tripping inhibited
Green indicator lamp		Remote control possible
Orange indicator lamp		Remote control impossible
1 (Ti24)		Mode 1
3 (Ti24)		Mode 3
Y1		Latched order local control
Y2		Impulse-type or latched order local control (depending on mode)
Y3		Latched order centralized control

Control

Remote control

RCA remote controls (cont.)

For iC60 circuit breakers

Standard RCA

The orders received on terminals Y1 and Y2 are taken into account progressively in their order of arrival.

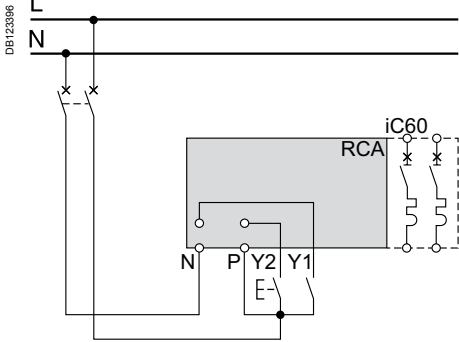

RCA Ti24

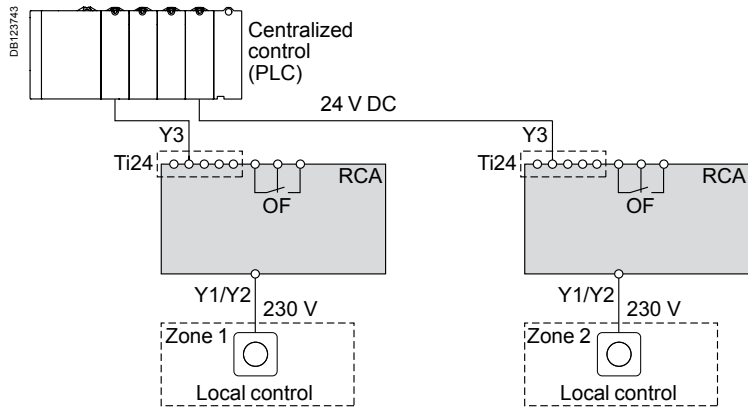

Mode 1: Locally or centrally controlled circuit-breaker opening/closing

- The orders come from various control points, and they are taken into account in their order of arrival
- Y1: Latched order local control
- Y2: Impulse-type local control
- Y3: Latched order centralized control

RCA Ti24 mode 1

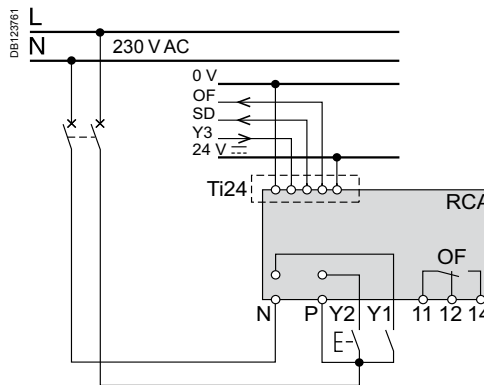

Mode 3: Centrally controlled opening/closing + local override

- 3 positions allowing a choice between override and centralized control:
- Y1: Latched order local control
- Y2: Latched order local control
- Y3: Latched order centralized control

RCA Ti24 mode 3

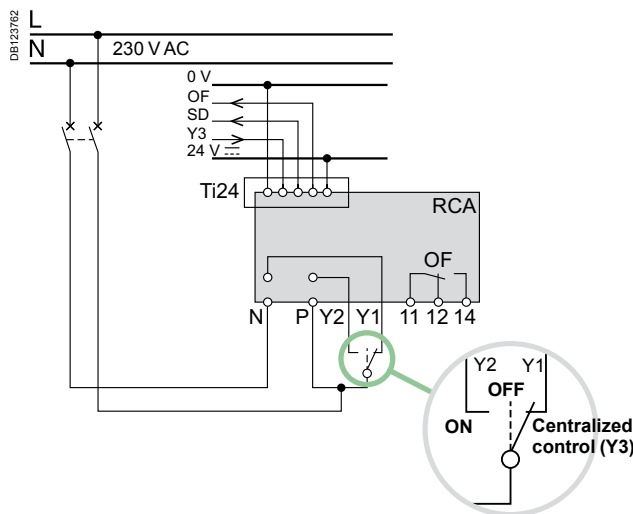

Control

Remote control

RCA remote controls (cont.)

For iC60 circuit breakers

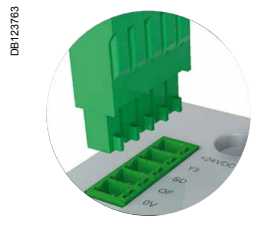
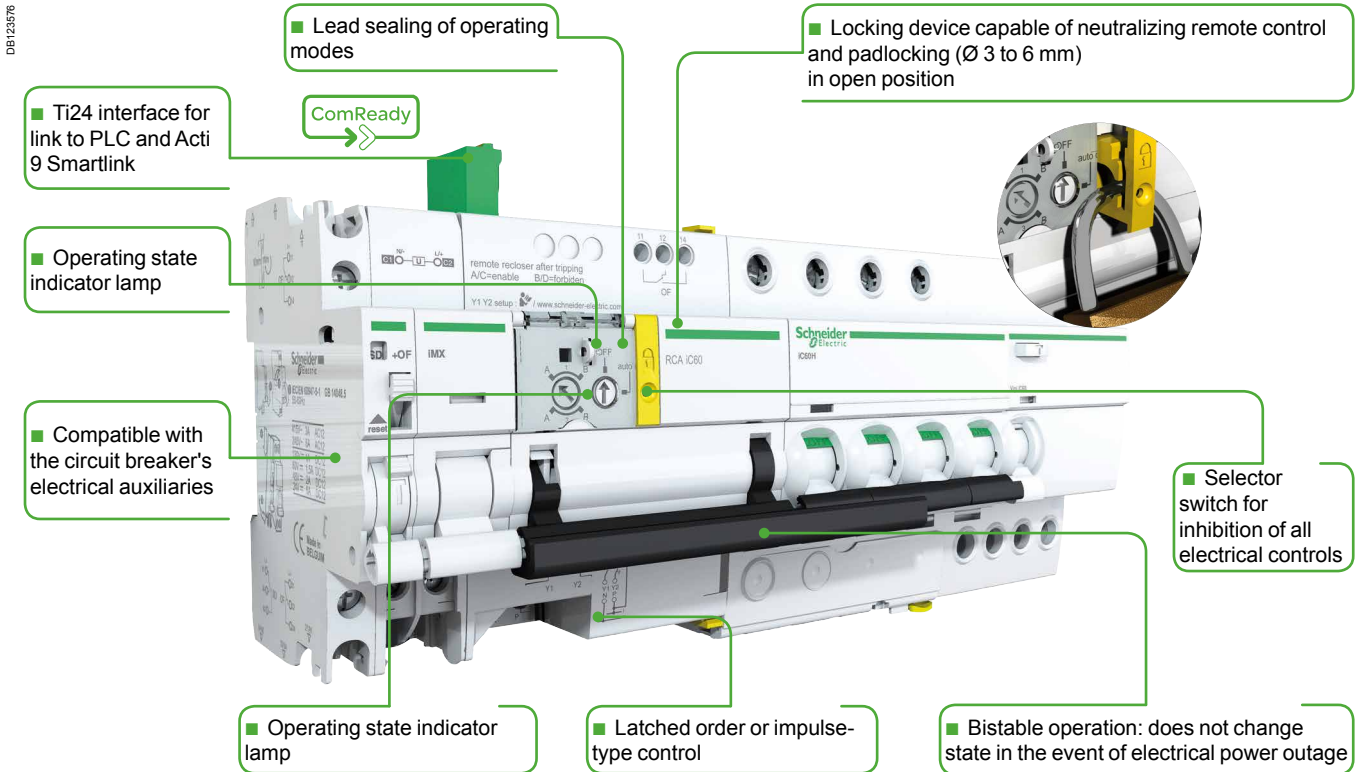

Legend	
Type	Application
+24VDC	V DC power supply
Y3	Latched order centralized control
SD	Circuit-breaker tripping information
OF	Control circuit state information (open/closed)
0 V	V DC power supply

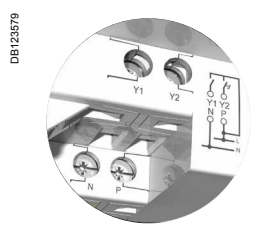
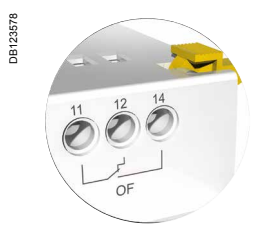

Y1	Latched order local control
Y2	Impulse-type or latched order local control (depending on mode)
N	230 V AC power supply
P	
OF	Circuit-breaker state indication contact (open/closed)

Control Remote control

RCA remote controls (cont.)

For iC60 circuit breakers

Connection

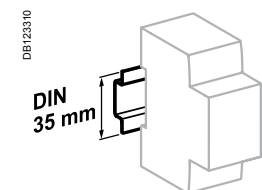
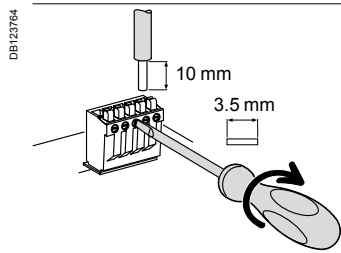
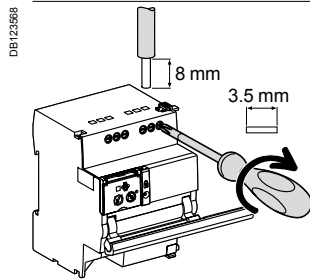
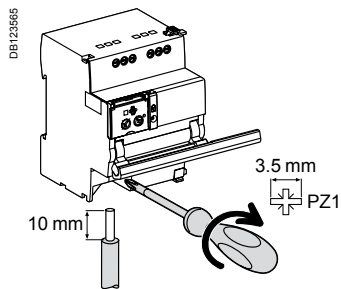

Clip on DIN rail 35 mm.

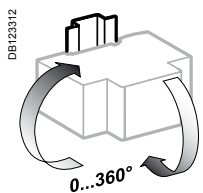

Indifferent position of installation.

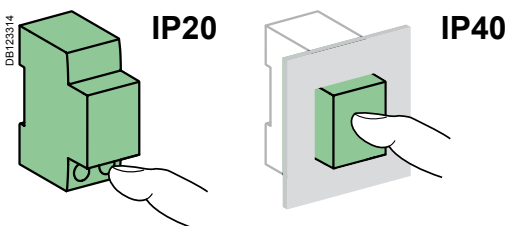

Without accessories

Terminal	Tightening torque	Copper cables		
		Rigid	Flexible	Flexible with ferrule
Power supply (N/P) Inputs (Y1/Y2)	1 N.m	0.5 to 10 mm ² 2 x 0.5 to 2 x 2.5 mm ²	0.5 to 6 mm ² 2 x 0.5 to 2 x 2.5 mm ²	0.5 to 4 mm ² 2 x 0.5 to 2 x 2.5 mm ²
Outputs (OF)	0.7 N.m	0.5 to 2.5 mm ² 2 x 0.5 to 2 x 1.5 mm ²	0.5 to 2.5 mm ² 2 x 0.5 to 2 x 1.5 mm ²	0.5 to 1.5 mm ² 2 x 0.5 to 2 x 1.5 mm ²
Ti24 interface	Spring-loaded terminals	0.5 to 1.5 mm ²	0.5 to 1.5 mm ²	-

Technical data

Control circuit		
Supply voltage (Ue) (N/P)		230 V AC, 50/60 Hz
Control voltage (Uc)	Type 1 inputs (Y1/Y2)	230 V AC (as per IEC 61131-2)
Min. duration of control order (Y2)		≥ 200 ms
Response time (Y2)		< 500 ms
Consumption		≤ 1 W
Thermal self-protection with automatic Reset against overheating of the control circuit due to an abnormal number of operations		
Endurance (O-C) (RCA combined with a circuit breaker)		
Electrical/Mechanical		10,000 cycles
Indication / Remote control		
Potential free changeover contact output (OF)	Min.	24 V AC/DC, 10 mA
	Max.	230 V AC, 1 A
Input (Y1/Y2)	230 V AC	5 mA
Ti24 interface (as per IEC 61131)		
Type 1 input (Y3)	24 V DC	5.5 mA
Output (OF and SD)	24 V DC	In max.: 100 mA
Additional characteristics		
Degree of protection (IEC 60529)	Device only	IP20
	Device in a modular enclosure	IP40 Insulation class II
Insulation voltage (Ui)		400 V
Degree of pollution (IEC 60947)		3
Rated impulse withstand voltage (Uimp)		6 kV
Operating temperature		-25°C to +60°C
Storage temperature		-40°C to +70°C
Tropicalization		Treatment 2 (relative humidity of 93 % at +40°C)

RCA remote controls (cont.)

For iC60 circuit breakers

Weight (g)

Remote controls	
Type	RCA
For 1P, 1P+N, 2P circuit breakers	400
For 3P, 3P+N, 4P circuit breakers	430

Dimensions (mm)

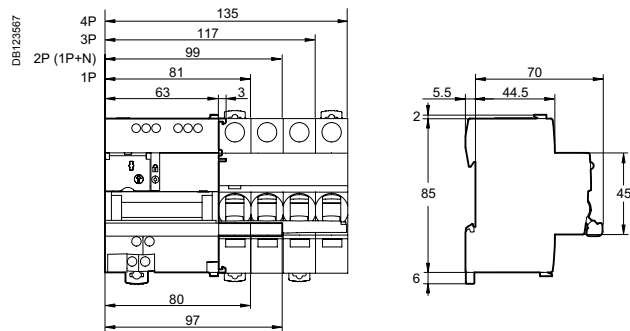

Control
Remote control

ARA automatic reclosers

For iC60 circuit breakers and iID residual current circuit breakers



ARA iC60



ARA iID

The ARA reclosing auxiliary can:

- Perform automatic reclosing of the associated protection device, after tripping.
- Increase the availability of installations without supervision, isolated, hard of access and demanding very great availability (mobile telephony systems, motorways, pumping stations, airports, railways, meteorological stations, service stations, automatic teller machines, public lighting, tunnels, etc.), by restoring them to operation without intervention by personnel in the event of a transient fault (atmospheric disturbances, industrial overvoltages, etc.).
- For the ARA iC60, the operator can choose predefined reclosing program which allows the safety and availability of facilities to be reconciled taking into account the facility's environment.
- The circuit is placed in safety configuration by the padlocking device.

Catalogue numbers

ARA iC60				
For circuit breaker				Width in 9 mm modules
1P, 1P+N, 2P	Number of programs	Voltage		
	4	230 V AC, 50/60 Hz	A9C70132	7
3P, 4P	4	230 V AC, 50/60 Hz	A9C70134	7
ARA iID				
For residual current circuit breaker				Width in 9 mm modules
2P	Number of programs	Voltage		
	1	230 V AC, 50/60 Hz	A9C70342	7
4P	1	230 V AC, 50/60 Hz	A9C70344	7
Auxiliaries			See module CA907000 and CA907002	

Diagram

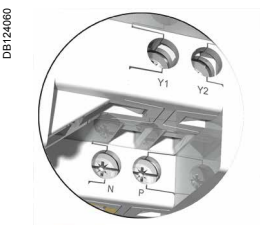
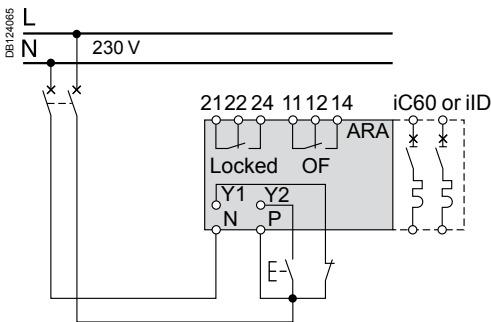

ARA iC60

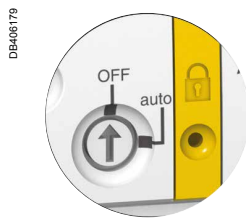

ARA iID

Legend		
Type	Application	
1	2	Choice of program (ARA iC60)
4	3	
Y1	"Remote" inhibition of automatic reclosing	
Y2	Remote control of final reclosing	
N	230 V power supply	
P		
Locked		Automatic recloser inhibition indication contact
OF		Indicates the state of the circuit breaker or residual current circuit breaker (opened or closed)
Indicator lamp	Flashing green	ARA automatic recloser operational
	Flashing red	Reclosing cycle in progress
	Fixed red	ARA automatic recloser locked at end of reclosing cycle: circuit breaker or residual current circuit breaker tripped (open)
	Flashing orange	ARA automatic recloser not operational

ARA automatic reclosers (cont.)

For iC60 circuit breakers and iID residual current circuit breakers





Operating principle

The ARA automatic recloser makes a number of attempts at reclosing depending on the program chosen by the user.

The program includes the following settings:

- A time delay before reclosing (TA).
- A reinitialization time delay (TB).
- A maximum number of reclosing attempts.

If, following these attempts, the fault is still present, the device places itself in waiting for manual reclosing, or final remote reclosing (Y2).

ARA iC60		Number of reclosing attempts	Delay before reclosing	Check time	Final reclosing Y2
			TA	TB	
Program					
DB124061 	1	1	10 s	6 min.	Once after inhibition
	2				
	3				
	4				
DB124062 	1	3	10 s 1 min. 3 min.	2 min. 6 min. 6 min.	
	2				
	3				
	4				
DB124063 	1	5	10 s 1 min. 3 min. 3 min. 3 min.	2 min. 6 min. 6 min. 6 min. 6 min.	
	2				
	3				
	4				
DB124064 	1	5	10 s 1 min. 3 min. 4 min. 5 min.	2 min. 6 min. 8 min. 10 min. 12 min.	
	2				
	3				
	4				

ARA iID		Number of reclosing attempts	Delay before reclosing	Check time	Final reclosing Y2
			TA	TB	
Only 1 program available	15	10 s 20 s 40 s 3 min. ...	30 min. 30 min. ...	Once per cycle	

ARA automatic reclosers (cont.)

For iC60 circuit breakers and iID residual current circuit breakers

ARA iC60 operating diagram

DB040439

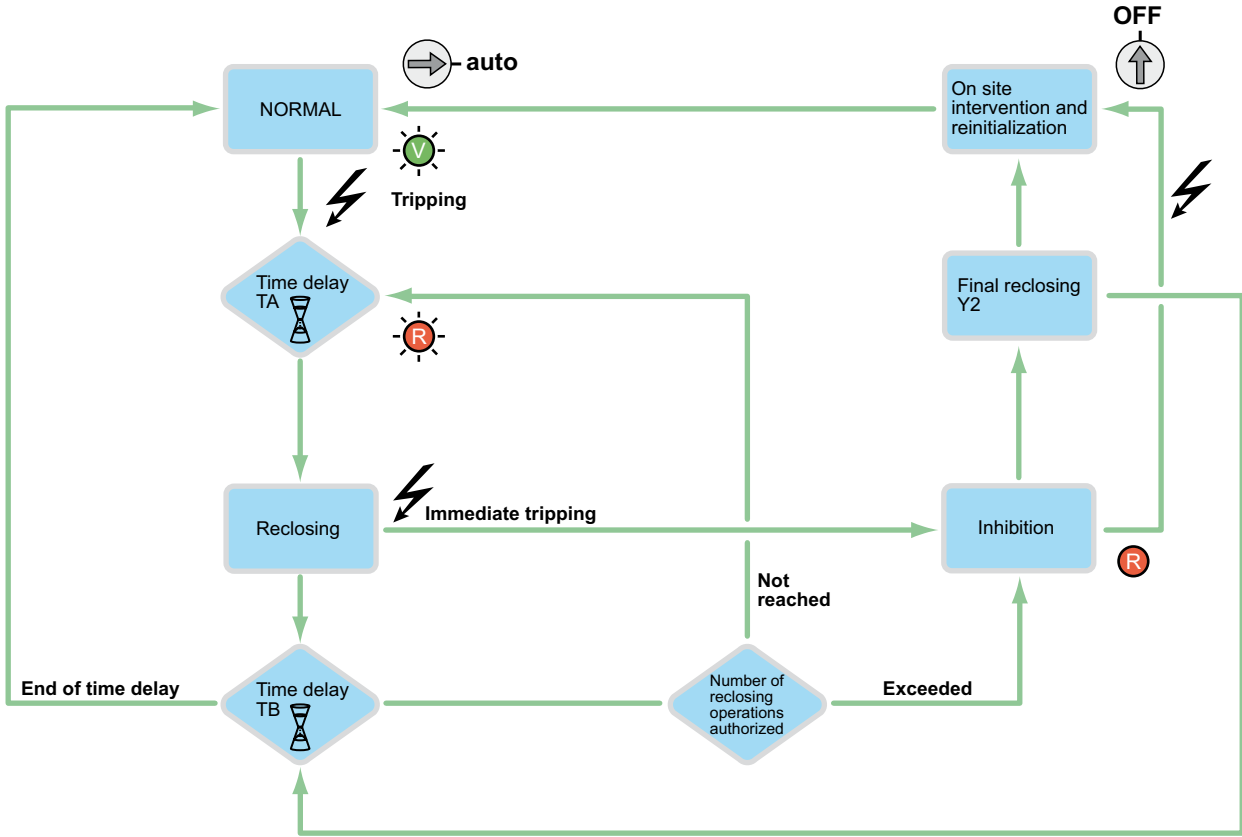

ARA iID operating diagram

DB040438

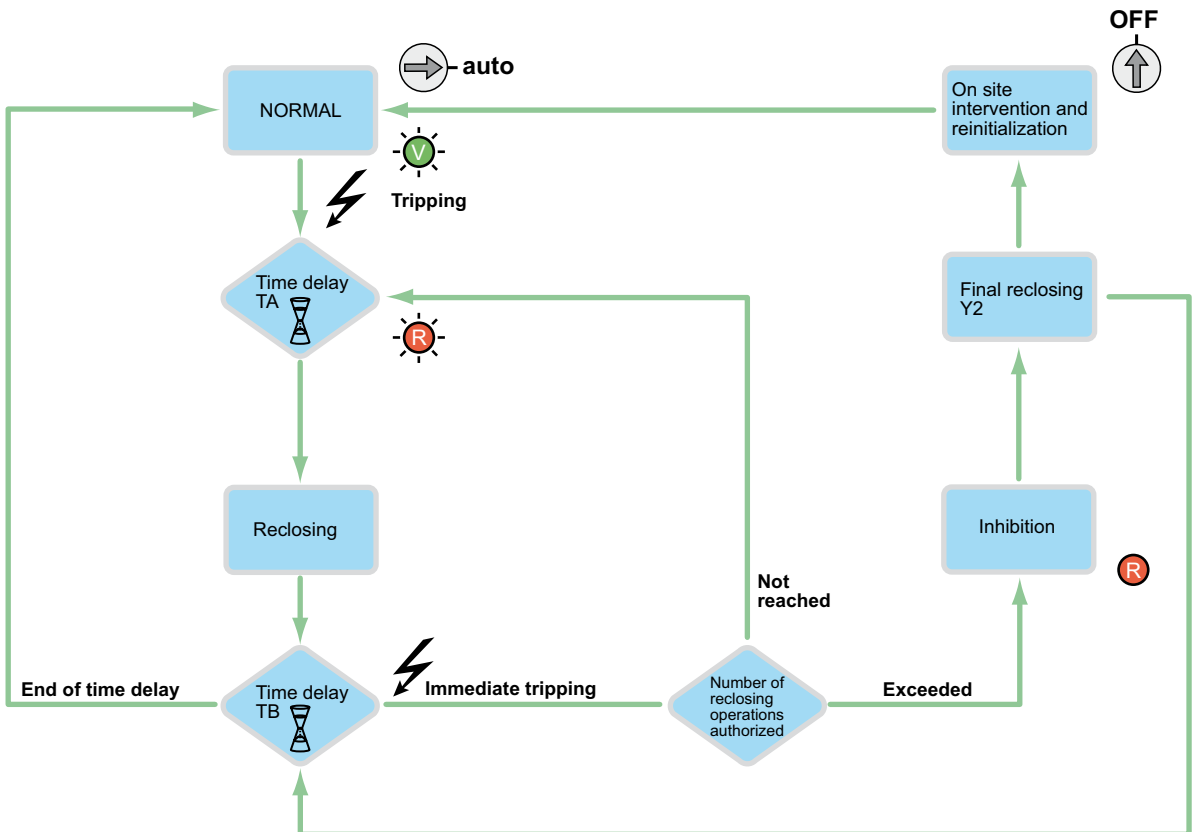

ARA automatic reclosers (cont.)

For iC60 circuit breakers and iLD residual current circuit breakers

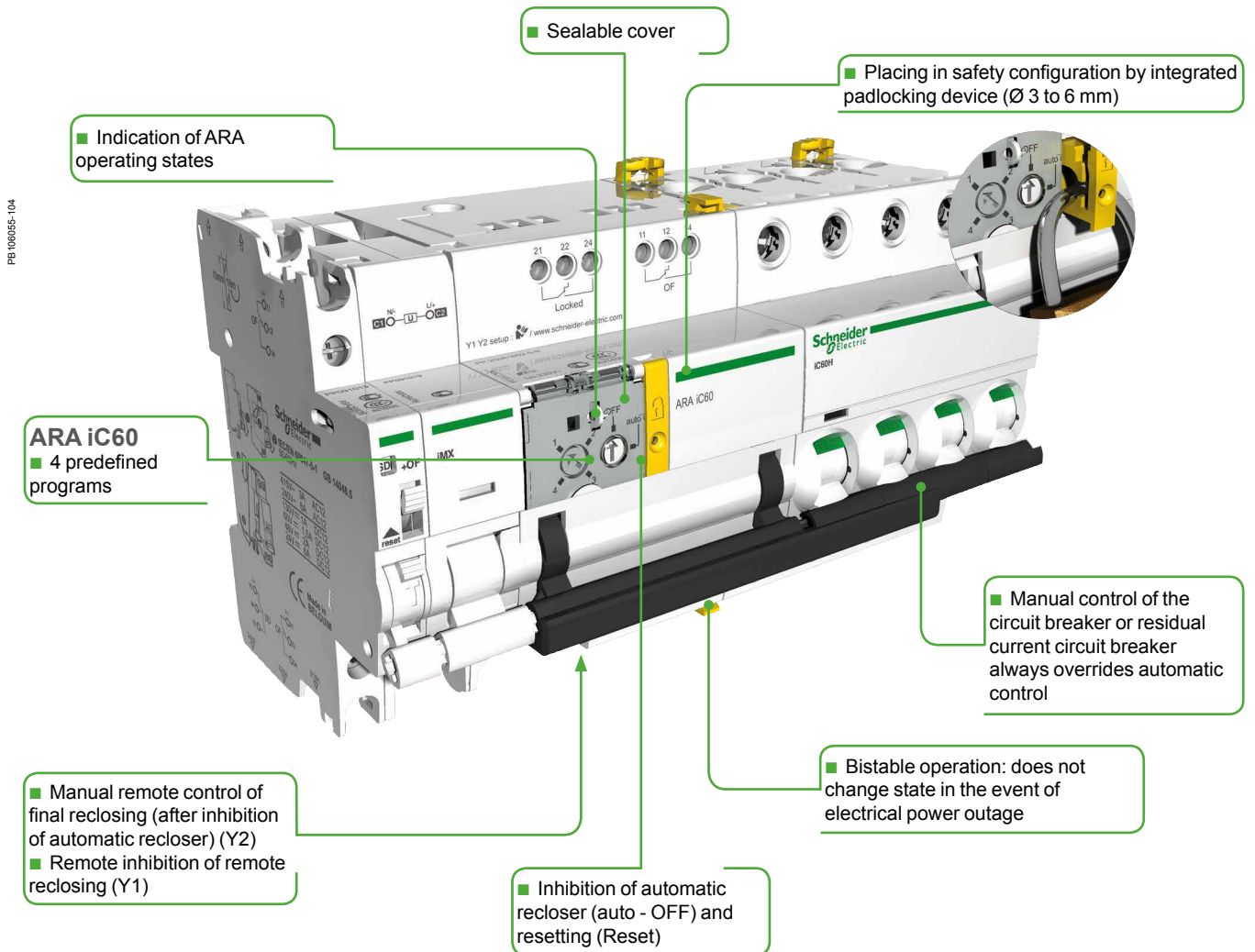

PB 006095-104

Control Remote control

ARA automatic reclosers (cont.)

For iC60 circuit breakers and iLD residual current circuit breakers

Connection

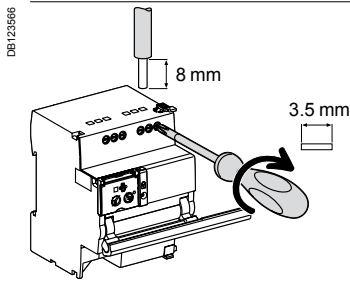
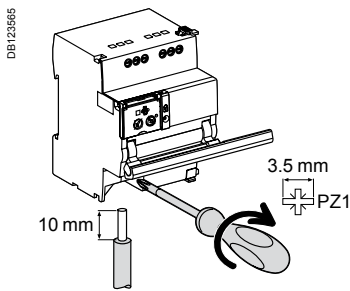

Terminal	Tightening torque	Copper cables		
		Rigid	Flexible	Flexible with ferrule
Power supply (N/P) Inputs (Y1/Y2)	1 N.m	0.5 to 10 mm ² 2 x 0.5 to 2 x 2.5 mm ²	0.5 to 6 mm ² 2 x 0.5 to 2 x 2.5 mm ²	0.5 to 4 mm ² 2 x 0.5 to 2 x 2.5 mm ²
Outputs (OF/Locked)	0.7 N.m	0.5 to 2.5 mm ² 2 x 0.5 to 2 x 1.5 mm ²	0.5 to 2.5 mm ² 2 x 0.5 to 2 x 1.5 mm ²	0.5 to 1.5 mm ² 2 x 0.5 to 2 x 1.5 mm ²

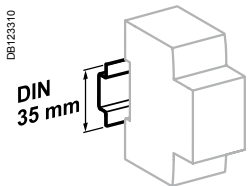

Clip on DIN rail 35 mm.

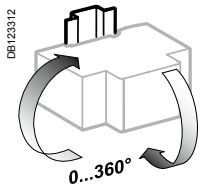

Indifferent position of installation.

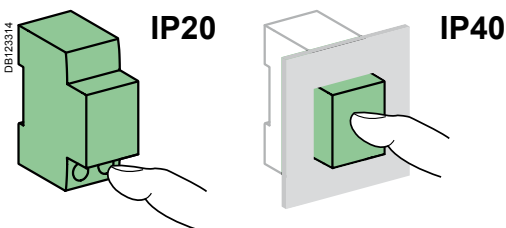

Technical data

Control circuit		
Supply voltage (U _e) (N/P)		230 V AC, 50/60 Hz
Control voltage (U _c)	Type 1 inputs (Y1/Y2)	230 V AC (as per IEC 61131-2)
Min. duration of control order (Y2)		≥ 200 ms
Response time (Y2)		< 500 ms
Consumption		< 2 W
Endurance (O-C) (ARA combined with a circuit breaker)		
Electrical		5000 cycles
Indication / Remote control		
Potential-free changeover contact output (OF/Locked)	Min.	24 V AC/DC, 10 mA
	Max.	230 V AC, 1 A
Input (Y1/Y2)	230 V AC	5 mA
Additional characteristics		
Degree of protection (IEC 60529)	Device only	IP20
	Device in a modular enclosure	IP40
Insulation voltage (U _i)		400 V
Degree of pollution (IEC 60947)		3
Rated impulse withstand voltage (U _{imp})		6 kV
Operating temperature		-25°C to +60°C
Storage temperature		-40°C to +70°C
Tropicalization		Treatment 2 (relative humidity of 93 % at +40°C)

Weight (g)

Automatic reclosers	
Type	ARA
For 1P, 1P+N, 2P circuit breakers or iLD residual current circuit breaker	440
For 3P, 4P circuit breakers	470

Dimensions (mm)

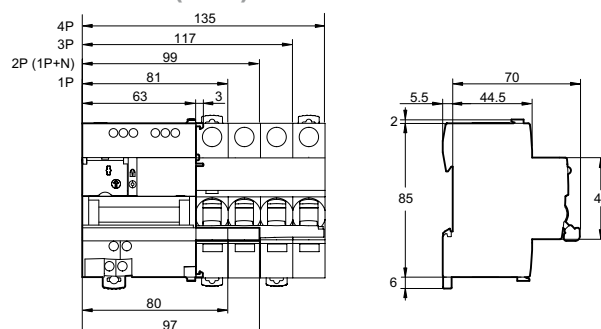

Control

Local control

iPB pushbuttons

IEC 60669-1 and IEC 60947-5-1

■ iPB pushbuttons are used to control electric circuits by means of pulses.

Catalogue numbers

iPB pushbuttons																		
Type	Single				Double		Single + indicator light											
Diagram	1 NC 3 E-7 4		1 NO 1 E-7 2		1 NO + 1 NC 1 3 E-7 2 4		1 NO / 1 NC 1 3 E-7 E-7 2 4		1 NO / 1 NO 1 3 E-7 E-7 2 4		1 NO 1 X1 E-7 2 X2		1 NC 3 X1 E-7 4 X2		1 NO 1 X1- E-7 2 X2+		1 NC 3 X1- E-7 4 X2+	
Pushbutton Colour	Grey	Red	Grey	Grey	Green/red	Grey/grey	Grey	Grey	Grey	Grey	Grey	Grey	Grey	Grey	Grey	Grey		
Indicator light Power supply	-	-	-	-	-	-	110...230 V AC		12...48 V AC/DC									
Indicator light Colour	-	-	-	-	-	-	Green	Red	Green	Red	Green	Red	Green	Red	Green	Red		
Cat. no.	A9E18030		A9E18031	A9E18032	A9E18033	A9E18034	A9E18035	A9E18036	A9E18037	A9E18038	A9E18039							
Width in 9 mm modules	2				2		2											

Connection

Tightening torque	Copper cables	
	Rigid	Flexible or with ferrule
1 N.m	0.5 mm ² min. 2 x 2.5 mm ² max.	0.5 mm ² min. 2 x 2.5 mm ² max.

- Phase-separated wall that can be divided to allow the teeth of all types of comb busbar to pass through.
- Staggered terminals to simplify connection.

Dimensions (mm)

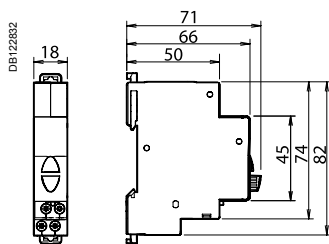

Technical data

Main characteristics	
Pollution degree	3
Power circuit	
Voltage rating (Ue)	250 V AC
Current rating (Ie)	20 A
Additional characteristics	
Endurance (O-C)	30,000 operations AC22 (cos φ = 0.8)
Operating temperature	-35°C... +70°C
Storage temperature	-40°C... +80°C
Tropicalization	Treatment 2 (relative humidity 95 % at 55°C)
LED indicator light	Consumption: 0.3 W Service life: 100,000 hours of constant lighting efficiency Maintenance-free indicator light (non-interchangeable LEDs)

Control



Local control

iSSW linear switches

IEC 60669-1 and IEC 60947-5-1

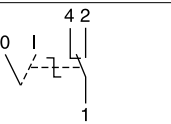
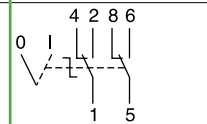
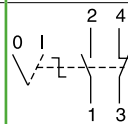
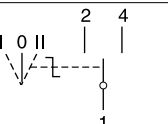
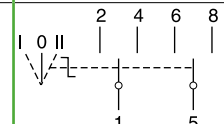

■ iSSW linear switches are used for the manual control of electric circuits.

Catalogue numbers

iSSW linear switches					
Type	2 positions			3 positions	
					
Contact	1 changeover switch	2 changeover switches	1 NO + 1NC	1 changeover switch	2 changeover switches
Diagram					
Cat. no.	A9E18070	A9E18071	A9E18072	A9E18073	A9E18074
Width in 9 mm modules	2	4	2	2	4

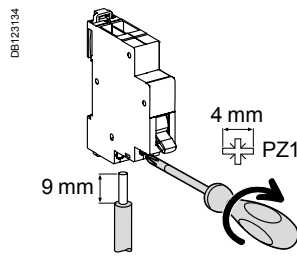
Connection



Tightening torque	Copper cables	
	Rigid	Flexible or with ferrule
1 N.m	 0.5 mm ² min. 2 x 2.5 mm ² max.	 0.5 mm ² min. 2 x 2.5 mm ² max.

- Phase-separated wall that can be divided to allow the teeth of all types of comb busbar to pass through.
- Staggered terminals to simplify connection.

Dimensions (mm)

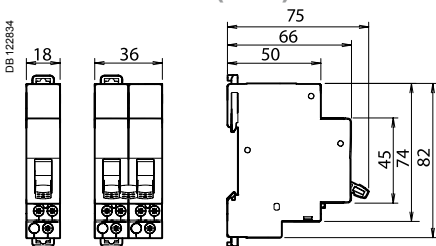



Technical data

Main characteristics	
Pollution degree	3
Power circuit	
Voltage rating (Ue)	250 V AC
Current rating (Ie)	20 A
Additional characteristics	
Endurance (O-C)	30,000 cycles AC22 (cos φ = 0.8)
Operating temperature	-20°C... +50°C
Storage temperature	-40°C... +70°C
Tropicalization	Treatment 2 (relative humidity 95 % at 55°C)

DIN rail selector switches

iCMB, iCMD, iCME, iCMC, iCMV and iCMA

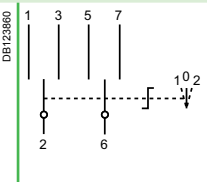
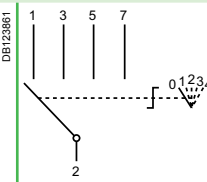
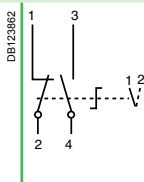
		Control																													
Selector switches		iCMB	iCMD	iCME																											
Type		Two-pole with zero setting	4-way	2-way for electronic circuits																											
In compliance with standards		IEC 60947-3 (EN 60947-3) VDE 0660 part. 107 UL	IEC 60947-3 (EN 60947-3) VDE 0660 part. 107 UL	IEC 60947-3 (EN 60947-3) VDE 0660 part. 107 UL																											
																															
Function		<ul style="list-style-type: none"> This two-pole selector switch with zero setting allows manual control of a circuit with 2-way operation (non-locking) with a stop position 	<ul style="list-style-type: none"> This 4-way selector switch allows control of a circuit with operating priorities 	<ul style="list-style-type: none"> This 2-way selector switch is used specially for the control of electronic circuits of low voltage and current level 																											
Wiring diagrams																															
Use		<p>Example: electrically controlled metal screen:</p> <ul style="list-style-type: none"> position 1 = raising position 0 = stop position 2 = lowering <p>Zero setting product, positions 1 and 2 must be maintained on the rotative handle by the operator</p>	<p>Example: fan control:</p> <ul style="list-style-type: none"> position 0 = stop position 1 = override operation, slow speed position 2 = override operation, high speed position 3 = remote control position 4 = automatic operation 	<ul style="list-style-type: none"> Voltage range from 30 mV to 600 V AC 																											
Catalogue numbers		A9E15120	A9E15121	A9E15122																											
Technical specifications																															
Rated voltage (Ue)	V AC	415	415	See following table																											
Maximum operating voltage	V	440	440	440																											
Rating	A	10	10	See following table																											
Operating frequency	Hz	50/60	50/60	50/60																											
Width in 9-mm modules		4	4	4																											
Breaking capacity (resistive load)		–	–	<table border="1"> <thead> <tr> <th></th> <th>V AC</th> <th>V DC</th> </tr> </thead> <tbody> <tr> <td>1 V</td> <td>5 A</td> <td>3 A</td> </tr> <tr> <td>12 V</td> <td>1.2 A</td> <td>0.7 A</td> </tr> <tr> <td>24 V</td> <td>0.7 A</td> <td>0.4 A</td> </tr> <tr> <td>48 V</td> <td>0.45 A</td> <td>0.25 A</td> </tr> <tr> <td>110 V</td> <td>0.25 A</td> <td>0.13 A</td> </tr> <tr> <td>240 V</td> <td>0.15 A</td> <td>0.08 A</td> </tr> <tr> <td>300 V</td> <td>0.13 A</td> <td>0.07 A</td> </tr> <tr> <td>440 V</td> <td>0.1 A</td> <td>0.05 A</td> </tr> </tbody> </table>		V AC	V DC	1 V	5 A	3 A	12 V	1.2 A	0.7 A	24 V	0.7 A	0.4 A	48 V	0.45 A	0.25 A	110 V	0.25 A	0.13 A	240 V	0.15 A	0.08 A	300 V	0.13 A	0.07 A	440 V	0.1 A	0.05 A
	V AC	V DC																													
1 V	5 A	3 A																													
12 V	1.2 A	0.7 A																													
24 V	0.7 A	0.4 A																													
48 V	0.45 A	0.25 A																													
110 V	0.25 A	0.13 A																													
240 V	0.15 A	0.08 A																													
300 V	0.13 A	0.07 A																													
440 V	0.1 A	0.05 A																													
Operating temperature	°C	-20...+55	-20...+55	-20...+55																											
Storage temperature	°C	-25...+80	-25...+80	-25...+80																											

DDIN rail selector switches

iCMB, iCMD, iCME, iCMC, iCMV and iCMA (cont.)

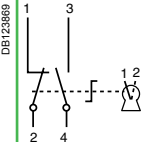
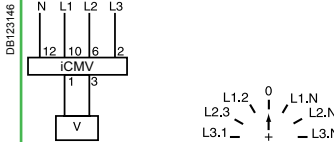
	iCMC	iCMV	iCMA
	2-way key-actuated	7-position voltmeter	4-position ammeter
	IEC 60947-3 (EN 60947-3) VDE 0660 part. 107 UL	IEC 60947-3 (EN 60947-3) VDE 0660 part. 107 UL	IEC 60947-3 (EN 60947-3) VDE 0660 part. 107 UL
			
	<ul style="list-style-type: none"> 2-way key-actuated selector switch (key Ronis 601 type) with locking in one or the other position 	<ul style="list-style-type: none"> This 7-position voltmeter selector switch makes it possible, with a single voltmeter, to measure in succession the voltages (phase-to-phase and phase-to-neutral) of a three-phase circuit 	<ul style="list-style-type: none"> This 4-position ammeter selector switch makes it possible, with a single ammeter (using current transformers), to measure in succession the currents of a three-phase circuit
			
	-	-	-
	A9E15123	15125	15126
	415	415	415
	440	440	440
	10	10	10
	50/60	50/60	
	4	4	4
	-	-	-
	-	-	-
	-20...+55	-20...+55	-20...+55
	-25...+80	-25...+80	-25...+80

DIN rail selector switches

iCMB, iCMD, iCME, iCMC, iCMV and iCMA (cont.)

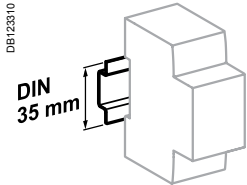

Clip on DIN rail 35 mm.

Connection

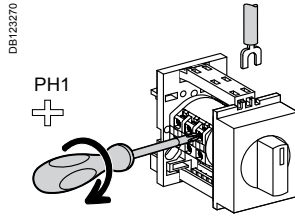

Tightening torque	Copper cables
0.35 N.m	Flexible or rigid with ferrule
	DB122545 < 1.5 mm ²

- Connection by jumper terminals with captive screws.

Technical data

Additional characteristics		
Degree of protection	Device only	IP20
Endurance (O-C)	Electrical	1,000,000 switching operations
	Mechanical	2,000,000 switching operations (AC21A-3 x 440 V)

Weight (g)

Selector switches	
Type	
iCMA	58
iCMB	58
iCMC	70
iCMD	58
iCME	44
iCMV	58

Dimensions (mm)

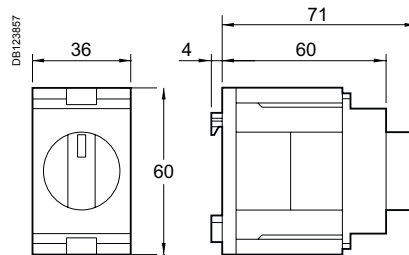

Local control Control Button holders

They can be attached to a symmetrical 35 mm rail, in modular cabinets or enclosures, for control and indications auxiliaries: push-buttons, emergency stops, switches, light indicators; for tertiary and industrial applications.



A9A1511

A9A1512

Catalogue numbers

Button holders		
Type		Width in 9 mm modules
Ø 22 mm button holder	A9A1511	6
Universal support	A9A1512	6

Technical data

Main characteristics	Button holder	Universal support
For buttons, switches and indicators with metal or plastic flange Ø 22 of the Schneider Electric XB4 / XB5 type	■	-
For buttons, indicators, light emitting diodes (LED), potentiometers	-	■
Drilling diameter	Ø 22.3 mm	Easy drilling, to be adapted depending on use
Colour	White RAL 9003	
Self-extinguishing insulating material		
Depth under rail 60 mm (same as products)		

Dimensions (mm)

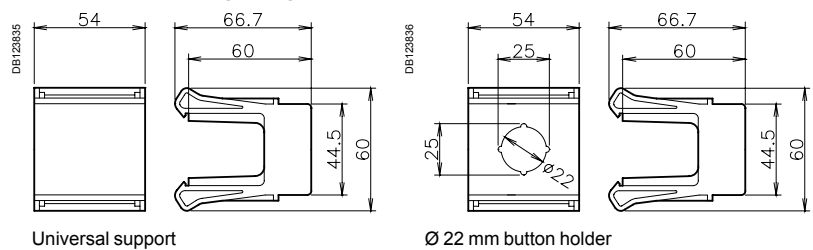

Universal support

Ø 22 mm button holder

Reflex iC60N, iC60H (curves B, C, D)

Country approval pictograms

IEC/EN 60947-2

The Reflex iC60 devices are integrated control circuit breakers which combine the following main functions in a single device:

- Remote control by latched and/or impulse-type order according to the 3 operating modes to be chosen by the user.
- Circuit breaker, to provide:
 - circuit protection against short-circuit currents,
 - circuit protection against overload currents,
 - disconnection in the industrial sector.

Resetting after a fault is performed manually, by the resetting handle.

The Ti24 interface allows direct interfacing of the Reflex iC60 with a PLC, to:

- Execute remote control (Y3).
- Indicate the state of the control circuit (O/C) and circuit-breaker state information (auto/OFF).
- Connect in a fast way and sure the Reflex iC60 to the Acti 9 Smartlink thanks to the prefabricated cables.

The iMDU auxiliary allows the Reflex iC60 to be controlled in 24/48 V AC/DC.



Alternating current (AC) 50/60 Hz

Ultimate breaking capacity (Icu) as per IEC/EN 60947-2			Service breaking capacity (Ics)
Ph/Ph (2P, 3P, 4P)	Voltage (Ue)		
	220 to 240 V	380 to 415 V	
Reflex iC60N			
Rating (In)	10 to 40 A	20 kA	10 kA
	63 A	20 kA	10 kA
			75 % of Icu
			50 % of Icu
Reflex iC60H			
Rating (In)	10 to 40 A	30 kA	15 kA
			50 % of Icu

Catalogue numbers

Reflex iC60 circuit breaker									
Type	2P			3P			4P		
	Curve			Curve			Curve		
Rating (In) for AC1 use	B	C	D	B	C	D	B	C	D
Reflex iC60N									
10 A	A9C61210	A9C62210	A9C63210	A9C61310	A9C62310	A9C63310	A9C61410	A9C62410	A9C63410
16 A	A9C61216	A9C62216	A9C63216	A9C61316	A9C62316	A9C63316	A9C61416	A9C62416	A9C63416
25 A	A9C61225	A9C62225	A9C63225	A9C61325	A9C62325	A9C63325	A9C61425	A9C62425	A9C63425
40 A	A9C61240	A9C62240	-	A9C61340	A9C62340	-	A9C61440	A9C62440	-
63 A	A9C61263	A9C62263	-	A9C61363	A9C62363	-	A9C61463	A9C62463	-
Reflex iC60H									
10 A	A9C64210	A9C65210	A9C66210	A9C64310	A9C65310	A9C66310	A9C64410	A9C65410	A9C66410
16 A	A9C64216	A9C65216	A9C66216	A9C64316	A9C65316	A9C66316	A9C64416	A9C65416	A9C66416
25 A	A9C64225	A9C65225	A9C66225	A9C64325	A9C65325	A9C66325	A9C64425	A9C65425	A9C66425
40 A	A9C64240	A9C65240	-	A9C64340	A9C65340	-	A9C64440	A9C65440	-
Width in 9 mm modules	9			11			13		
Vigi iC60	Vigi iC60 add-on residual current device, module CA902005			Vigi iC60 add-on residual current device, module CA902005			Vigi iC60 add-on residual current device, module CA902005		
iMDU auxiliary	See module CA907000 and CA907002			See module CA907000 and CA907002			See module CA907000 and CA907002		
Accessories	See module CA907000 and CA907001			See module CA907000 and CA907001			See module CA907000 and CA907001		

Control, remote control

Integrated control circuit breakers

Reflex iC60N, iC60H (curves B, C, D) (cont.)

■ Tripping and disconnection device capable of:

- disconnecting and padlocking (Ø 3 to 6 mm not supplied) in "open" position
- neutralizing remote control

■ Ti24 interface for direct link to PLC and Acti 9 Smartlink

ComReady

■ IP20 insulated terminals

■ Bistable operation:
does not change state in the event of electrical power outage

■ Operating state indicator lamp

■ Resetting handle

■ Pushbutton:

- manual control: opening/closing
- choice of operating "modes"

VisiSafe

- Positive contact indication
- Uimp: 6 kV
- Ui: 500 V
- Degree of pollution: level 3

- Longer product service life thanks to:
 - good overvoltage withstand capacity: products designed to provide a high industrial performance level (degree of pollution, rated impulse withstand voltage and insulation voltage),
 - high limitation performances,
 - fast closure independent of the speed of resetting of the operating handle.

Legend

Ti24 interface	
+24VDC	V DC power supply
Y3	Remote control by latched order
auto/OFF	Circuit-breaker state information
O/C	Control circuit state information (open/closed)
0 V	V DC power supply

Y1	Latched order control
Y2	Control by impulse-type
N	230 V AC power supply
P	
O/C	Control circuit state indication contact
auto/OFF	Circuit-breaker tripping indication contact

Control, remote control

Integrated control circuit breakers

Reflex iC60N, iC60H (curves B, C, D)

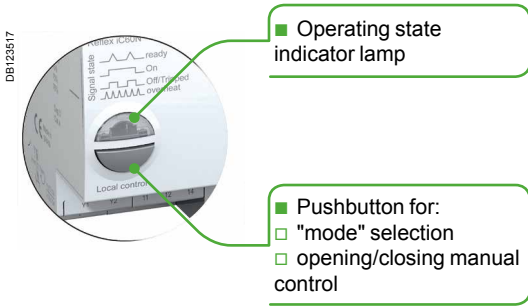

Remote control is possible by 3 operating modes to be set using the pushbutton on the front panel.

Three types of control: Y1, Y2, Y3

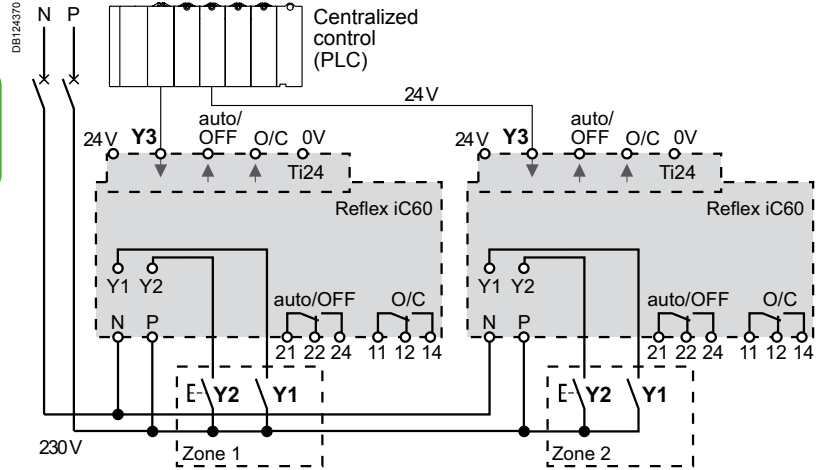

Operating modes

Mode 1: Reflex iC60 opening/closing, locally or centrally controlled

- The opening/closing orders come from various control points, and they are taken into account in their order of arrival
- Y1: latched order local control
- Y2: impulse-type local control
- Y3: latched order centralized control

Mode 2: Reflex iC60 opening/closing, possible inhibition of local impulse-type control

- Y1 is used to inhibit Y2
- Y1: local opening/Y2 inhibition latched order control
- Y2: impulse-type local opening/closing control
- Y3: latched order centralized opening/closing control

Mode 3: Reflex iC60 opening/closing, possible inhibition of centralised latched order control

- Y1 is used to inhibit Y3
- Y3 inhibition local latched order control
- Y2: impulse-type local opening/closing control
- Y3: latched order centralized opening/closing control

Reflex iC60

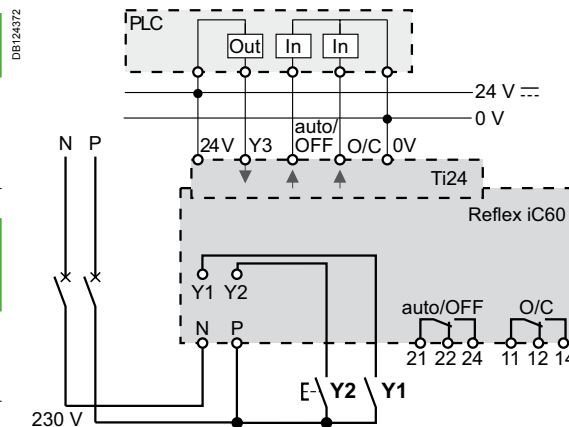

Table of modes

	Mode 1	Mode 2	Mode 3
Reflex iC60	■ Possible mode	■ Possible mode	■ Default mode

Control, remote control

Integrated control circuit breakers

Reflex iC60N, iC60H (curves B, C, D) (cont.)

Power connection

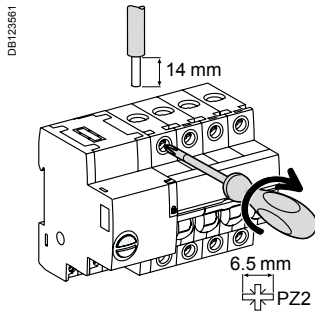

Terminal	Rating	Tightening torque	Without accessories		With accessories				
			Copper cables		Al terminal 50 mm ²	Screw-on connection for ring terminal	Multi-cable terminal		
			Rigid	Flexible or with ferrule			Rigid cables	Flexible cables	
Power	10 to 25 A 40 to 63 A	2 N.m 3.5 N.m	1 to 25 mm ² 1 to 35 mm ²	1 to 16 mm ² 1 to 25 mm ²	- 50 mm ²	Ø 5 mm	- 3 x 16 mm ²	- 3 x 10 mm ²	

Control connection

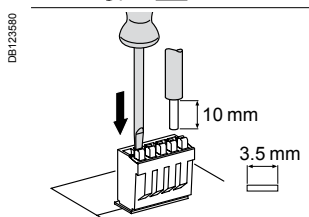
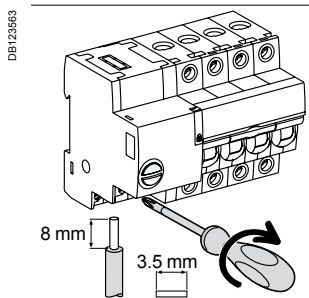
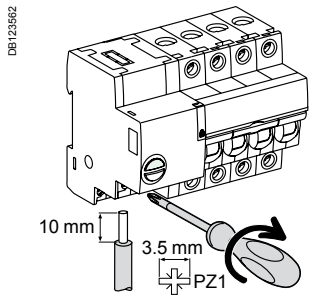

Terminal	Tightening torque	Without accessories		
		Copper cables		
		Rigid	Flexible	Flexible with ferrule
Power supply (N/P) Inputs (Y1/Y2)	1 N.m	1 to 10 mm ²	1 to 6 mm ²	1 to 4 mm ²
Outputs (O/C, auto/OFF)	0.7 N.m	1 to 2.5 mm ²	1 to 2.5 mm ²	1 to 1.5 mm ²
Ti24 interface	Spring-loaded terminals	0.5 to 1.5 mm ²	0.5 to 1.5 mm ²	0.5 to 1.5 mm ²

Control, remote control Integrated control circuit breakers

Reflex iC60N, iC60H (curves B, C, D)

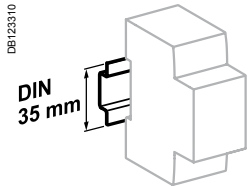

Clip on DIN rail 35 mm.

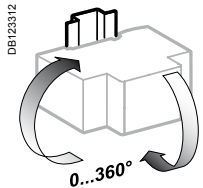

Indifferent position of installation.

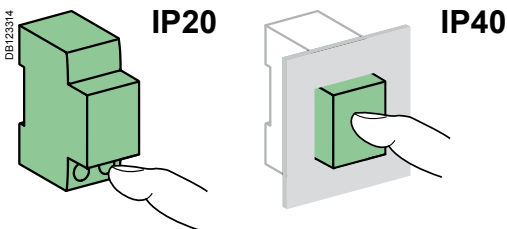

Weight (g)

Circuit breaker	
Type	Reflex iC60
2P	480
3P	620
4P	750

Dimensions (mm)

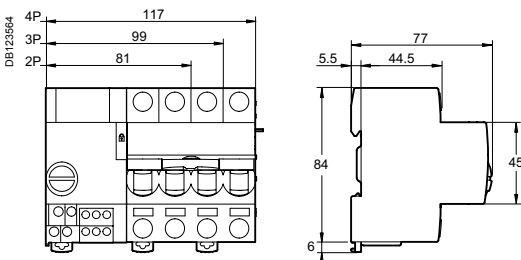

Technical data

Control circuit			
Supply voltage (Ue) (N/P)	230 V AC - 50/60 Hz		
Control voltage (Uc)	Inputs (Y1/Y2)	230 V AC - 23 mA (24...48 V AC/DC, with iMDU auxiliary)	
	Input (Y3)	24 V DC - 5.5 mA	
Min. duration of control impulse (Y2)	≥ 250 ms		
Response time (Y2)	≤ 250 ms		
Maximum continuous apparent power	Inputs (Y1/Y2)	5.3 VA	
	Input Y3	0.12 VA	
Length of control wires	Inputs (Y1/Y2/Y3)	500 m	
Inrush current at 230 V - 50/60 Hz		Measured peak current	Peak current duration
	2P	11.4 Å	11 ms
	3P	21.8 Å	11 ms
	4P	21.8 Å	11 ms
			Rms current measurement
			7.6 A
			14.5 A
			14.5 A

The inrush currents are added in the event of simultaneous control of several Reflex iC60. The controls should therefore be offset by 10 ms (by automaton or time-delay relays).

Power circuit		
Max. working voltage (Ue)	400 V AC	
Insulation voltage (Ui)	500 V	
Rated impulse withstand voltage (Uimp)	Set to disconnected	6 kV
	Set to Ready	4 kV
Thermal tripping	Reference temperature	50°C
Magnetic tripping	Curve B	4 In ± 20 %
	Curve C	8 In ± 20 %
	Curve D	12 In ± 20 %
Overvoltage category (IEC 60364)	IV	
Temperature derating	See module CA908007	

Indication / Remote control		
Potential-free changeover contact outputs (O/C, auto/OFF)	Min.	24 V DC - 100 mA
	Max	230 V AC - 1 A

Ti24 interface (as per IEC 61131)		
Outputs (O/C, auto/OFF)	Ti24 interface	24 V DC - 100 mA max

Endurance (O-C)		
Electrical	AC1 - AC7a	Up to 50,000 cycles
	AC5a - AC5b	Up to 15,000 cycles
	AC7c	Up to 20,000 cycles
Mechanical		50,000 cycles

Additional characteristics		
Degree of protection (IEC 60529)	Device only	IP20
	Device in a modular enclosure	IP40 Insulation class II
Degree of pollution	3	
Operating temperature	-25°C to +60°C	
Storage temperature	-40°C to +85°C	
Tropicalization	Treatment 2 (relative humidity of 93 % at 40°C)	
Immunity to voltage dips	IEC 61000-4-11 class III	
Immunity to power supply frequency variations	IEC 61000-4-28 and IACS E10	
Immunity to harmonics	IEC 61000-4-13 class 2	
Immunity to electrostatic discharges	Air	8 kV, IEC 61 000-4-2
	Contacts	4 kV, IEC 61 000-4-2
Immunity to stray magnetic fields	10 V/m up to 3 GHz, IEC 61000-4-3	
Immunity to fast transients	4 kV from 5 to 100 kHz, IEC 61000-4-4	
Immunity to shock waves	IEC 61000-4-5	
Immunity to power frequency magnetic fields	10 V from 150 kHz to 80 MHz, IEC 61000-4-6	
Immunité aux champs magnétiques à la fréquence du réseau	Level 4 30 A/m to IEC 61000-4-8 and IEC 61000-4-9	
Conducted emissions	CISPR 11/22	
Radiated emissions	CISPR 11/22	

Control Remote control Acti9 iCT contactors



Schneider Electric Acti9 iCT contactors range comprises various offers (A, B, C) to be as competitive as possible in each country, taking into account the specific features of each market:

- installation customs
- price
- approval by local organizations.

Variants

Offers	
Offer A	International with 3P+N contactor
Offer B	International with 4P contactor
Offer C	France

Common pages

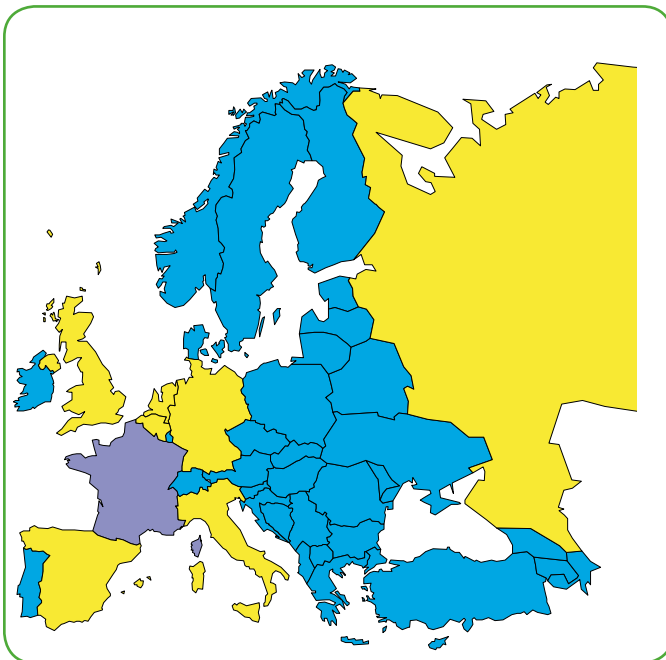

Only the product range to be marketed in your country and validated by the local product manager, in agreement with his Final Distribution (FD) partner should be retained. The others will be removed before publication.

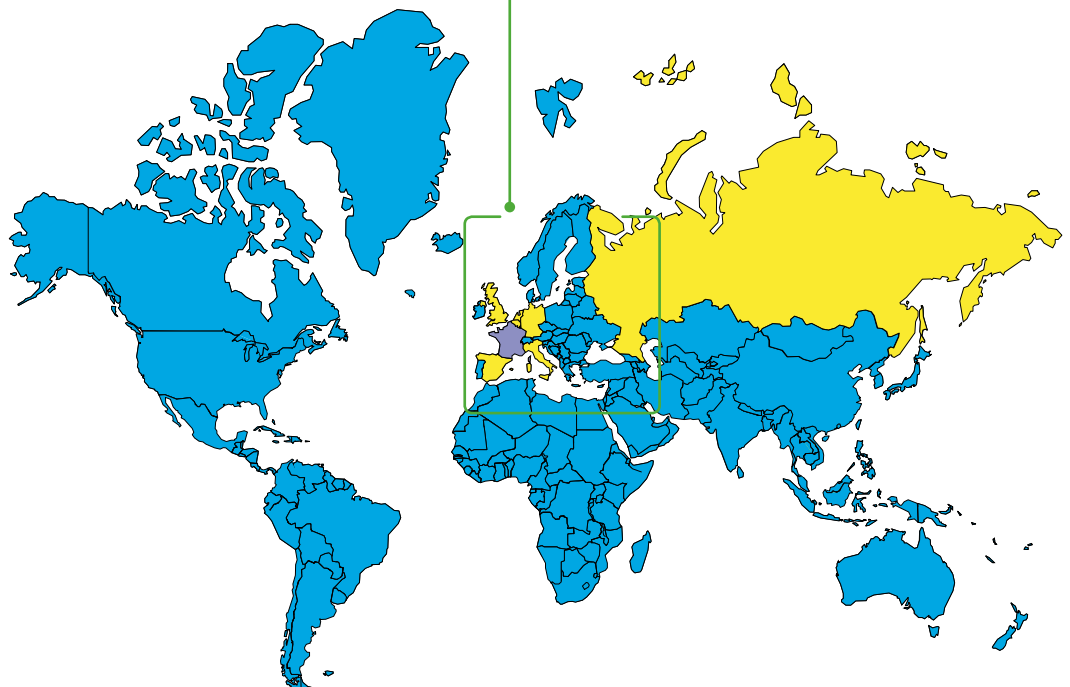

Control

Remote control

Acti9 iCT contactors

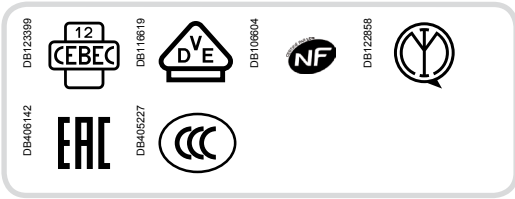

IEC/EN 61095

As per the above standards:

Acti9 iCT contactors are available in two versions:

- Contactors without manual operation
- Contactors with manual operation.

The breadth of the Acti9 iCT contactor range satisfies most application cases. Acti9 iCT contactors can be combined with auxiliary control, protection and indication functions.

- Acti9 iCT contactors can be used to remote control applications in alternating current:
 - lighting, heating, ventilation, roller blinds, sanitary hot water,
 - mechanical ventilation systems, etc,
 - load-shedding of non-priority circuits.
- The 3P+N Contactor comes with a reinforced neutral pole. It will bring robustness to control single-phase loads requiring group control.

> Contactors

> Contactor auxiliaries



Acti9 iCT 2P
manual control
PBI06115-35

Acti9 iCT 3P+N
AOC24763_Image-35

Acti9 iCT 4P
PBI06105-35

Indication Acti9 iACTs
■ This auxiliary allows indication of the "open" or "closed" position of the contactor power contacts
PBI06120-34

Interference filtering Acti9 iACTp
■ This auxiliary is an interference suppressor which limits overvoltages on the control circuit
PBI06124-34

Dual control Acti9 iACTc
■ Used to control a contactor in impulse-type mode or to combine latched or impulse-type control orders
PBI06123-34

Control and indication 24 V DC Acti9 iACT24
■ Allows control and indication of a 230 V AC contactor from the Acti9 Smartlink or by a PLC, by 24 V DC signals
■ Also allows control by a maintained signal
PBI07751-34

Time delay Acti9 iATeT
■ This auxiliary is used to time delay for Acti9 iCT and iTL. According to cabling, there are 5 possible time delay types:
□ 1 for iTL
□ 4 for iCT
PBI06125-34

Function type A: late closing
Delay energizing of contactor

Function type B: time delay
■ Energize the contactor by closing a push button
■ The time delay starts as soon as the control contacts are closed

Function type C: late opening
■ Energize the contactor by closing a push button
■ The time delay starts when the control contacts are opened

Function type H: fixed time operation
■ Operate the contactor for a pre-determined time from the moment of energizing

		Choice of 50 Hz contactors									
Type		Contactor						Manually-operated contactors			
Rating	A	16	20	25	40	63	100	16	25	40	63
Auxiliaries		Contactors that can be equipped with auxiliaries									
iACTs indication auxiliary		Yes	Yes	Yes				Yes			
iACTp protection auxiliary	By yellow clips	No	No	Yes				No	Yes		
iACTc, iATeT control auxiliary	By yellow clips	No	No	Yes				No	Yes		
iACT24 control auxiliary		No	No	Yes (for contactors 230 V - 50 Hz)				No	Yes (for contactors 230 V - 50 Hz)		

Control Remote control Acti9 iCT contactors (cont.)

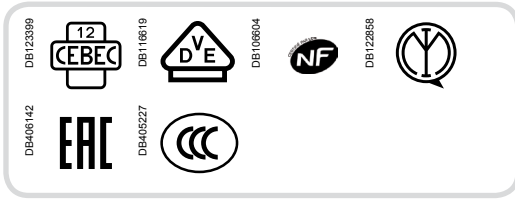

IEC/EN 61095

As per the above standards:
Acti9 iCT contactors are available in two versions:

- Contactors without manual operation
- Contactors with manual operation.

The breadth of the Acti9 iCT contactor range satisfies most application cases.
Acti9 iCT contactors can be combined with auxiliary control, protection and indication functions.

- Acti9 iCT contactors can be used to remote control applications in alternating current:
 - lighting, heating, ventilation, roller blinds, sanitary hot water,
 - mechanical ventilation systems, etc,
 - load-shedding of non-priority circuits.

> Contactors

> Contactor auxiliaries



Indication Acti9 iACTi
■ This auxiliary allows indication of the "open" or "closed" position of the contactor power contacts

Interference filtering Acti9 iACTp
■ This auxiliary is an interference suppressor which limits overvoltages on the control circuit

Dual control Acti9 iACTc
■ Used to control a contactor in impulse-type mode or to combine latched or impulse-type control orders

Control and indication 24 V DC Acti9 iACT24
■ Allows control and indication of a 230 V AC contactor from the Acti9 Smartlink or by a PLC, by 24 V DC signals
■ Also allows control by a maintained signal

Time delay Acti9 iATEt
■ This auxiliary is used to time delay for Acti9 iCT and iTL. According to cabling, there are 5 possible time delay types:
□ 0 for iTL
□ 4 for iCT

Function type A: late closing
Delay energizing of contactor

Function type B: time delay
■ Energize the contactor by closing a push button
■ The time delay starts as soon as the control contacts are closed

Function type C: late opening
■ Energize the contactor by closing a push button
■ The time delay starts when the control contacts are opened

Function type H: fixed time operation
■ Operate the contactor for a pre-determined time from the moment of energizing

Offer B

Offer selection see page 499

This sticker must be removed before publishing

		Choice of 50 Hz contactors									
Type		Contactor					Manually-operated contactors				
Rating	A	16	20	25	40	63	100	16	25	40	63
Auxiliaries		Contactors that can be equipped with auxiliaries									
iACTs indication auxiliary		Yes	Yes	Yes				Yes			
iACTp protection auxiliary	By yellow clips	No	No	Yes				No	Yes		
iACTc, iATEt control auxiliary	By yellow clips	No	No	Yes				No	Yes		
iACT24 control auxiliary		No	No	Yes (for contactors 230 V - 50 Hz)				No	Yes (for contactors 230 V - 50 Hz)		

Control

Remote control

Acti9 iCT contactors



IEC/EN 61095

As per the above standards:

Acti9 iCT contactors are available in two versions:

- Contactors without manual operation
- Contactors with manual operation.

The breadth of the Acti9 iCT contactor range satisfies most application cases.

Acti9 iCT contactors can be combined with auxiliary control, protection and indication functions.

- Acti9 iCT contactors can be used to remote control applications in alternating current:
 - lighting, heating, ventilation, roller blinds, sanitary hot water,
 - mechanical ventilation systems, etc,
 - load-shedding of non-priority circuits.
- The 3P+N Contactor comes with a reinforced neutral pole. It will bring robustness to control single-phase loads requiring group control.

> Contactors

> Contactor auxiliaries



Indication Acti9 iACTs
■ This auxiliary allows indication of the "open" or "closed" position of the contactor power

Interference filtering Acti9 iACTp
■ This auxiliary is an interference suppressor which limits overvoltages on the control circuit

Dual control Acti9 iACTc
■ Used to control a contactor in impulse-type mode or to combine latched or impulse-type control orders

Control and indication 24 V DC Acti9 iACT24
■ Allows control and indication of a 230 V AC contactor from the Acti9 Smartlink or by a PLC, by 24 V DC signals
■ Also allows control by a maintained signal

Time delay Acti9 iATEt
■ This auxiliary is used to time delay for Acti9 iCT and iTL. According to cabling, there are 5 possible time delay types:
□ 1 for iTL
□ 4 for iCT

Function type A: late closing
Delay energizing of contactor

Function type B: time delay
■ Energize the contactor by closing a push button
■ The time delay starts as soon as the control contacts are closed

Function type C: late opening
■ Energize the contactor by closing a push button
■ The time delay starts when the control contacts are opened

Function type H: fixed time operation
■ Operate the contactor for a pre-determined time from the moment of energizing

		Choice of 50 Hz contactors									
Type		Contactor						Manually-operated contactors			
Rating	A	16	20	25	40	63	100	16	25	40	63
Auxiliaries		Contactors that can be equipped with auxiliaries									
iACTs indication auxiliary		Yes	Yes	Yes				Yes			
iACTp protection auxiliary	By yellow clips	No	No	Yes				No	Yes		
iACTc, iATEt control auxiliary	By yellow clips	No	No	Yes				No	Yes		
iACT24 control auxiliary		No	No	Yes (for contactors 230 V - 50 Hz)				No	Yes (for contactors 230 V - 50 Hz)		

Control

Remote control

Acti9 iCT contactors (cont.)

PB106115-39

Yellow clip
 ■ Clip-on system for electrical and mechanical connections between contactors ≥ 25 A and their auxiliaries

■ Insulated terminals IP20

■ Large circuit labeling area

■ Low noise

■ Consistent with the entire Acti9 offer and with all types of lighting

■ Mechanical contact position indicator

■ Manually-operated contactors have a 4-position selector switch on their front face:

- automatic operating mode
- temporary "ON" override
- permanent "ON" override: used to lock the contactor in the ON position during installation maintenance
- shutdown

Offer selection see page 499

Offer A, B, C

This sticker must be removed before publishing

Choice of 60 Hz contactors				
Contactor				Manually-operated contactors
16	25	40	63	40
Contactors that can be equipped with auxiliaries				
Yes				Yes
No	Yes			Yes
No	Yes			Yes
No	Yes			No

Control

Remote control

Acti9 iCT contactors (cont.)

Catalog numbers

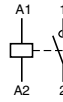
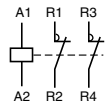
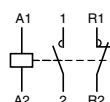
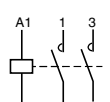
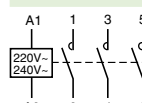
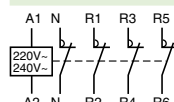
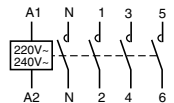
Acti9 iCT contactors - 50 Hz							
Type						Width in 9 mm modules	
1P	Rating (In)		Control voltage (V AC) (50 Hz)	Contact			
	AC7a	AC7b					
 DB103373-5	16 A	6 A	12	1NO	A9C22011	2	
			24	1NO	A9C22111	2	
			48	1NO	A9C22211	2	
			220	1NO	A9C22511	2	
			230...240	1NO	A9C22711	2	
	25 A	8.5 A	220	1NO	A9C20531	2	
230...240			1NO	A9C20731	2		
2P							
 DB122915	16 A	6 A	12	2NO	A9C22012	2	
			24	2NO	A9C22112	2	
			48	2NO	A9C22212	2	
			220	2NO	A9C22512	2	
			230...240	2NO	A9C22712	2	
 DB103377-11			12	1NO+1NC	A9C22015	2	
			24	1NO+1NC	A9C22115	2	
			220	1NO+1NC	A9C22515	2	
			230...240	1NO+1NC	A9C22715	2	
 DB103375-10	20 A	-	230...240	2NO	A9C22722	2	
	25 A	8.5 A	24	2NO	A9C20132	2	
			48	2NO	A9C20232	2	
			220	2NO	A9C20532	2	
			230...240	2NO	A9C20732	2	
			220	2NC	A9C20536	2	
				230...240	2NC	A9C20736	2
	40 A	15 A	220...240	2NO	A9C20842	4	
	63 A	20 A	24	2NO	A9C20162	4	
			220...240	2NO	A9C20862	4	
100 A (*)	-	220...240	2NO	A9C20882	6		
3P							
 DB423841	16 A	6 A	220...240	3NO	A9C22813	4	
	25 A	8.5 A	220...240	3NO	A9C20833	4	
	40 A	15 A	220...240	3NO	A9C20843	6	
	63 A	20 A	220...240	3NO	A9C20863	6	
3P+N							
 DB423880	40 A	15 A	220...240	4NO	A9C24740	6	
			220...240	4NC	A9C22740	6	
 DB423861	63 A	20 A	220...240	4NO	A9C24763	6	
			220...240	4NC	A9C22763	6	

(*) do not use for lighting applications

Offer selection see page 499

Offer A

This sticker must be removed before publishing

Control



Remote control

Acti9 iCT contactors (cont.)

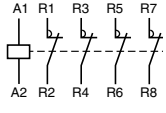
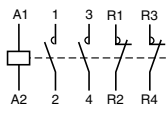
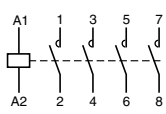
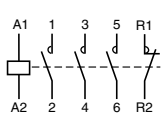
Catalog numbers

Acti9 iCT contactors - 50 Hz						Width in 9 mm modules		
Type	Rating (In)		Control voltage (V AC) (50 Hz)	Contact				
4P	AC7a	AC7b						
 DB122916	16 A	6 A	24	4NO	A9C22114	4		
			220...240	4NO	A9C22814	4		
			220...240	2NO+2NC	A9C22818	4		
 DB122917	20 A	-	220...240	4NO	A9C22824	4		
			25 A	8.5 A	24	4NO	A9C20134	4
					220...240	4NO	A9C20834	4
 DB103381-118	40 A	15 A	220...240	4NO	A9C20844	6		
			63 A	20 A	24	4NC	A9C20847	6
					220...240	4NO	A9C20164	6
 DB122918	20 A	-	24	4NO	A9C20864	6		
			100 A (*)	-	24	4NC	A9C20167	6
					220...240	4NC	A9C20867	6
			220...240	2NO+2NC	A9C20868	6		
			220...240	3NO+1NC	A9C20869	6		
			220...240	4NO	A9C20884	12		

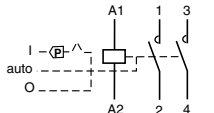
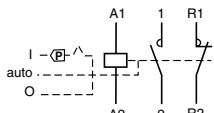
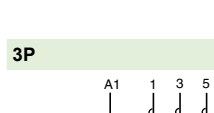
(*) do not use for lighting applications

Acti9 iCT manual control contactor 50 Hz						Width in 9 mm modules
Type	Rating (In)		Control voltage (V AC) (50 Hz)	Contact		
2P	AC7a	AC7b				
 DB106317-24	16 A	6 A	220	2NO	A9C23512	2
			230...240	2NO	A9C23712	2
			220	1NO+1NC	A9C23515	2
 DB106319-27	25 A	8,5 A	230...240	1NO+1NC	A9C23715	2
			24	2NO	A9C21132	2
			220	2NO	A9C21532	2
 DB106319-27	40 A	15 A	230...240	2NO	A9C21732	2
			24	2NO	A9C21142	2
			220...240	2NO	A9C21842	4
 DB106319-27	63 A	20 A	24	2NO	A9C21162	4
			220...240	2NO	A9C21862	4
			25 A	8,5 A	220...240	3NO
	40 A	15 A	220...240	3NO	A9C21843	6

Offer selection see page 499

Offer A

This sticker must be removed before publishing

Control

Remote control

Acti9 iCT contactors (cont.)

Catalog numbers

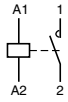
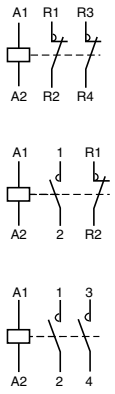
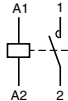
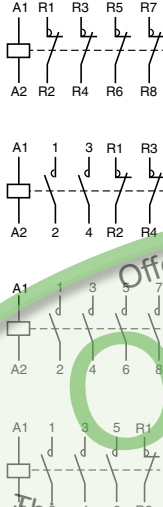
Acti9 iCT contactors - 50 Hz							
Type	Rating (In)		Control voltage (V AC) (50 Hz)	Contact		Width in 9 mm modules	
	AC7a	AC7b					
1P 	16 A	6 A	12	1NO	A9C22011	2	
			24	1NO	A9C22111	2	
			48	1NO	A9C22211	2	
			220	1NO	A9C22511	2	
			230...240	1NO	A9C22711	2	
	25 A	8.5 A	220	1NO	A9C20531	2	
			230...240	1NO	A9C20731	2	
2P 	16 A	6 A	12	2NO	A9C22012	2	
			24	2NO	A9C22112	2	
			48	2NO	A9C22212	2	
			220	2NO	A9C22512	2	
			230...240	2NO	A9C22712	2	
		20 A	-	12	1NO+1NC	A9C22015	2
				24	1NO+1NC	A9C22115	2
				220	1NO+1NC	A9C22515	2
				230...240	1NO+1NC	A9C22715	2
				230...240	2NO	A9C22722	2
		25 A	8.5 A	24	2NO	A9C20132	2
				48	2NO	A9C20232	2
				220	2NO	A9C20532	2
				230...240	2NO	A9C20732	2
				220	2NC	A9C20536	2
		230...240	2NC	A9C20736	2		
	40 A	15 A	220...240	2NO	A9C20842	4	
	63 A	20 A	24	2NO	A9C20162	4	
			220...240	2NO	A9C20862	4	
	100 A (*)	-	220...240	2NO	A9C20882	6	
3P 	16 A	6 A	220...240	3NO	A9C22813	4	
	25 A	8.5 A	220...240	3NO	A9C20833	4	
	40 A	15 A	220...240	3NO	A9C20843	6	
	63 A	20 A	220...240	3NO	A9C20863	6	
4P 	16 A	6 A	24	4NO	A9C22114	4	
			220...240	4NO	A9C22814	4	
			220...240	2NO+2NC	A9C22818	4	
		20 A	-	220...240	4NO	A9C22824	4
				24	4NO	A9C20134	4
				220...240	4NO	A9C20834	4
		25 A	8.5 A	24	4NC	A9C20137	4
				220...240	4NC	A9C20837	4
				220...240	2NO+2NC	A9C20838	4
		40 A	15 A	220...240	4NO	A9C20844	6
				220...240	4NC	A9C20847	6
				24	4NO	A9C20164	6
		63 A	20 A	220...240	4NO	A9C20864	6
				24	4NC	A9C20167	6
				220...240	4NC	A9C20867	6
	100 A (*)	-	220...240	2NO+2NC	A9C20868	6	
			220...240	3NO+1NC	A9C20869	6	
			220...240	4NO	A9C20884	12	

Offer selection see page 499

Offer B

This sticker must be removed before publishing

(*) do not use for lighting applications

Control

Remote control

Acti9 iCT contactors (cont.)

Catalog numbers

Acti9 iCT manual control contactor 50 Hz						Width in 9 mm modules
Type	Rating (In)		Control voltage (V AC) (50 Hz)	Contact		
	AC7a	AC7b				
<p>DB106317-24</p>	16 A	6 A	220	2NO	A9C23512	2
			230...240	2NO	A9C23712	2
	25 A	8,5 A	220	1NO+1NC	A9C23515	2
			230...240	1NO+1NC	A9C23715	2
			24	2NO	A9C21132	2
			220	2NO	A9C21532	2
40 A	15 A	230...240	2NO	A9C21732	2	
		24	2NO	A9C21142	2	
63 A	20 A	220...240	2NO	A9C21842	4	
		24	2NO	A9C21162	4	
<p>DB106318-27</p>			220...240	2NO	A9C21862	4
	3P					
<p>DB106319-27</p>	25 A	8,5 A	220...240	3NO	A9C21833	4
	40 A	15 A	220...240	3NO	A9C21843	6
<p>DB106320-31</p>	25 A	8,5 A	24	4NO	A9C21134	4
			220...240	4NO	A9C21834	4
	40 A	15 A	24	4NO	A9C21144	6
			220...240	4NO	A9C21844	6
	63 A	20 A	24	4NO	A9C21164	6
			220...240	4NO	A9C21864	6

Offer selection see page 499

Offer B

This sticker must be removed before publishing

Control

Remote control

Acti9 iCT contactors (cont.)

Catalog numbers

Acti9 iCT contactors - 50 Hz						
Type	Rating (In)		Control voltage (V AC) (50 Hz)	Contact		Width in 9 mm modules
	AC7a	AC7b				
1P 	16 A	6 A	12	1NO	A9C22011	2
			24	1NO	A9C22111	2
			48	1NO	A9C22211	2
			220	1NO	A9C22511	2
			230...240	1NO	A9C22711	2
			25 A	8.5 A	220	1NO
			230...240	1NO	A9C20731	2
2P 	16 A	6 A	12	2NO	A9C22012	2
			24	2NO	A9C22112	2
			48	2NO	A9C22212	2
			220	2NO	A9C22512	2
			230...240	2NO	A9C22712	2
			12	1NO+1NC	A9C22015	2
	24	1NO+1NC	A9C22115	2		
	220	1NO+1NC	A9C22515	2		
	230...240	1NO+1NC	A9C22715	2		
	20 A	-	230...240	2NO	A9C22722	2
	25 A	8.5 A	24	2NO	A9C20132	2
			48	2NO	A9C20232	2
			220	2NO	A9C20532	2
			230...240	2NO	A9C20732	2
			220	2NC	A9C20536	2
			230...240	2NC	A9C20736	2
	40 A	15 A	220...240	2NO	A9C20842	4
	63 A	20 A	24	2NO	A9C20162	4
		220...240	2NO	A9C20862	4	
100 A (*)	-	220...240	2NO	A9C20882	6	
3P 	16 A	6 A	220...240	3NO	A9C22813	4
	25 A	8.5 A	220...240	3NO	A9C20833	4
	40 A	15 A	220...240	3NO	A9C20843	6
	63 A	20 A	220...240	3NO	A9C20863	6
3P+N 	40 A	15 A	220...240	4NO	A9C24740	6
			220...240	4NC	A9C22740	6
	63 A	20 A	220...240	4NO	A9C24763	6
			220...240	4NC	A9C22763	6
4P 	16 A	6 A	24	4NO	A9C22114	4
			220...240	4NO	A9C22814	4
			220...240	2NO+2NC	A9C22818	4
			220...240	4NO	A9C22824	4
	20 A	8.5 A	24	4NO	A9C20134	4
			220...240	4NO	A9C24834	4
			24	4NC	A9C20137	4
			220...240	4NC	A9C20837	4
	40 A	15 A	220...240	2NO+2NC	A9C20838	4
			220...240	4NO	A9C20844	6
			220...240	4NC	A9C20847	6
			24	4NO	A9C20164	6
63 A	20 A	220...240	4NO	A9C20864	6	
		220...240	4NC	A9C20167	6	
		220...240	4NC	A9C20867	6	
		220...240	2NO+2NC	A9C20868	6	
100 A (*)	-	220...240	3NO+1NC	A9C20869	6	
		220...240	4NO	A9C20884	12	

(*) do not use for lighting applications

Control

Remote control

Acti9 iCT contactors (cont.)

Catalog numbers

Acti9 iCT manual control contactor 50 Hz						Width in 9 mm modules	
Type	Rating (In)		Control voltage (V AC) (50 Hz)	Contact			
	AC7a	AC7b					
	16 A	6 A	220	2NO	A9C23512	2	
			230...240	2NO	A9C23712	2	
			220	1NO+1NC	A9C23515	2	
			230...240	1NO+1NC	A9C23715	2	
	25 A	8,5 A	24	2NO	A9C21132	2	
			220	2NO	A9C21532	2	
			230...240	2NO	A9C25732	2	
			24	2NO	A9C21142	2	
40 A	15 A	220...240	2NO	A9C21842	4		
		24	2NO	A9C21162	4		
		220...240	2NO	A9C21862	4		
		24	2NO	A9C21862	4		
3P							
	25 A	8,5 A	220...240	3NO	A9C21833	4	
			40 A	15 A	220...240	3NO	A9C21843
		25 A	8,5 A	24	4NO	A9C21134	4
				220...240	4NO	A9C21834	4
40 A		15 A	24	4NO	A9C21144	6	
			220...240	4NO	A9C21844	6	
63 A	20 A	24	4NO	A9C21164	6		
		220...240	4NO	A9C21864	6		

Offer selection see page 499

Offer C

This sticker must be removed before publishing

Control

Remote control

Acti9 iCT contactors (cont.)

Catalog numbers

Acti9 iCT contactors - 60 Hz						
Type	Rating (In)		Control voltage (V AC) (60 Hz)	Contact		Width in 9 mm modules
1P	AC7a	AC7b				
	25 A	8.5 A	127	1NO	A9C20431	2
			220...240	1NO	A9C20631	2
	16 A	6 A	127	1NO+1NC	A9C22415	2
			220...240	1NO+1NC	A9C22615	2
	25 A	8.5 A	127	2NO	A9C20432	2
			220...240	2NO	A9C20632	2
	40 A	15 A	127	2NC	A9C20436	2
			220...240	2NC	A9C20636	2
40 A	15 A	127	2NO	A9C20442	4	
		220...240	2NO	A9C20642	4	
	25 A	8.5 A	127	3NO	A9C20433	4
			220...240	3NO	A9C20633	4
	40 A	15 A	127	3NO	A9C20443	6
			220...240	3NO	A9C20643	6
	63 A	20 A	127	3NO	A9C20463	6
			220...240	3NO	A9C20663	6

Acti9 iCT manual control contactor 60 Hz						
Type	Rating (In)		Control voltage (V AC) (60 Hz)	Contact		Width in 9 mm modules
2P	AC7a	AC7b				
	40 A	15 A	127	2NO	A9C21442	4
			220...240	2NO	A9C21642	4

Operation (Manual control contactor)

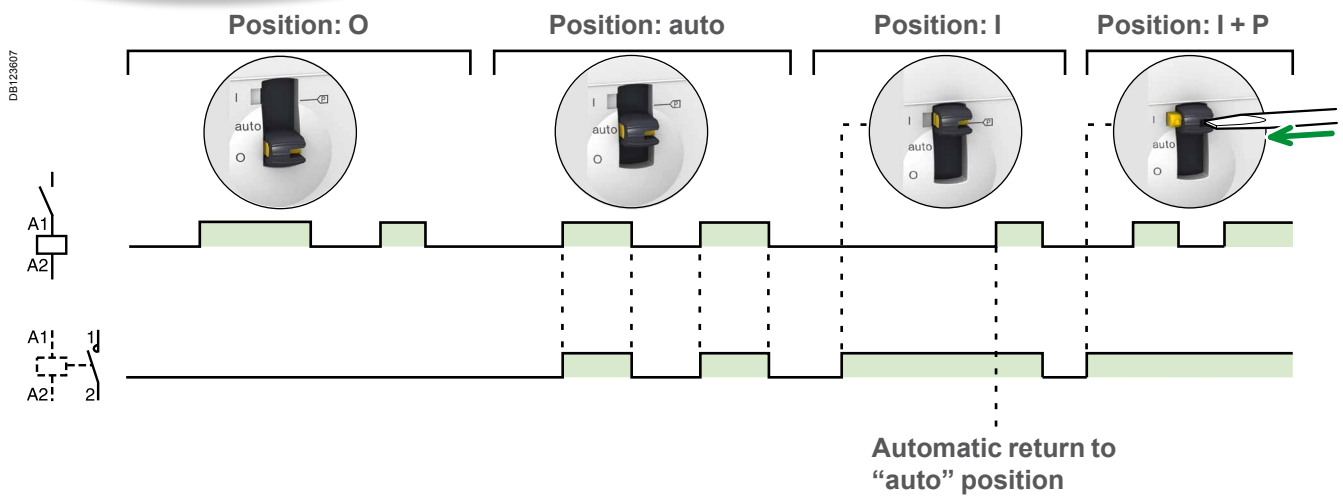

Control Remote control Acti9 iCT contactors (cont.)

Connection

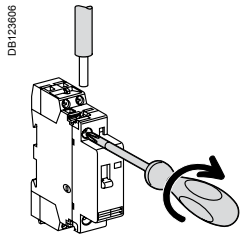

Type	Circuit	Rating	Length tripping	Tightening torque	Copper cables		
					Rigid	Flexible or with ferrule	
Acti9 iCT	PZ1: 4 mm	Control	16 - 100 A	9 mm	0.8 N.m		
		Power	16 and 25 A				
	PZ2: 6 mm	40 A - 63 A	14 mm	3.5 N.m			
iACTs, iACTp, iACTc, iATEt	PZ1: 4 mm	-	-	9 mm	0.8 N.m	1.5 to 2.5 mm: 2 x 1.5 mm ²	1.5 to 2.5 mm: 2 x 2.5 mm ²

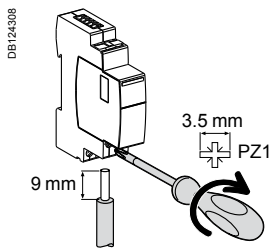

Type	Terminals	Tightening torque	Copper cables		
			Rigid	Flexible	Flexible or with ferrule
iACT24	Power supply (N/P) Input (Y1/Y2)	1 N.m	0.5 to 10 mm ² 2 x 0.5 to 2 x 2.5 mm ²	0.5 to 6 mm ² 2 x 0.5 to 2 x 2.5 mm ²	0.5 to 4 mm ² 2 x 0.5 to 2 x 2.5 mm ²

Ti24 connector connection

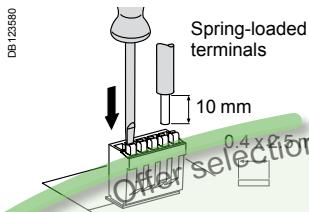

Type	Catalog numbers	Copper cables	
		Rigid	Flexible
Ti24 Interface	A9XC2412	1 x 0.5 to 1.5 mm ²	1 x 0.5 to 1.5 mm ²

Ti24 prefabricated cables connection

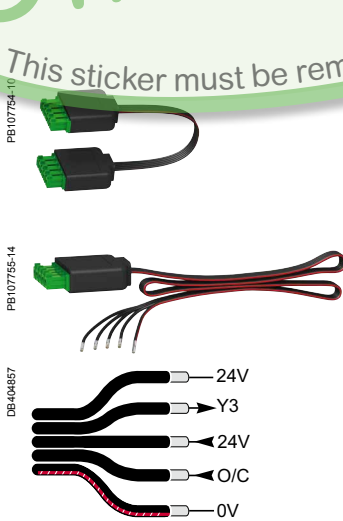

Type	Catalog numbers	Length
Connection for Acti9 Smartlink		
6 short prefabricated	A9XCAS06	100 mm
6 medium-sized prefabricated	A9XCAM06	160 mm
6 long prefabricated	A9XCAL06	870 mm
Connection for PLC type terminals		
6 long prefabricated on a single side	A9XCAU06	870 mm

Control

Remote control

Acti9 iCT contactors (cont.)

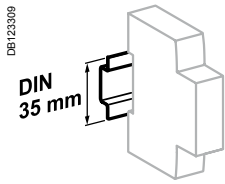

Clip on DIN rail 35 mm.

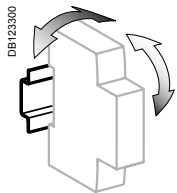

± 30° vertical.

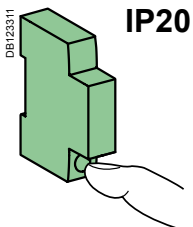

IP20

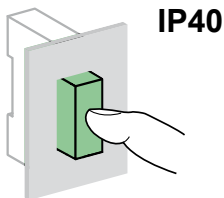

IP40

Technical data

Power circuit		
Voltage rating (Ue)	1P, 2P	250 V AC
	3P, 3P+N, 4P	400 V AC
Frequency	50 Hz or 60 Hz	
Type of load	See module CA908026	
Endurance (O-C)		
Electrical	100,000 cycles	
Maximum number of switching operations per day	100	
Additional characteristics		
Insulation voltage (Ui)	440 V AC	
Pollution degree	2	
Rated impulse withstand voltage (Uimp)	2.5 kV (4 kV for 12/24/48 V AC)	
Degree of protection (IEC 60529)	Device only	IP20
	Device in modular enclosure	IP40
Operating temperature	-5°C to +60°C	
Storage temperature	-40°C to +70°C	
Tropicalization (IEC 60068-2-30)	Treatment 2 (relative humidity 95 % at 55°C)	
ELSV compliance (Extra Low Safety Voltage) for 12/24/48 V AC versions		
The product control conforms to the SELV (safety extra low voltage) requirements		

Temperature derating table

Acti9 iCT Rating (A)	Ambient temperature (°C)		
	≤ 40	50	60
63	63	59.8	50
40	40	38	32
25	25	23.8	20
16	16	15.2	12.8

If multiple iCTs side by side: install spacer and apply 0.8 coefficient on upper current values.

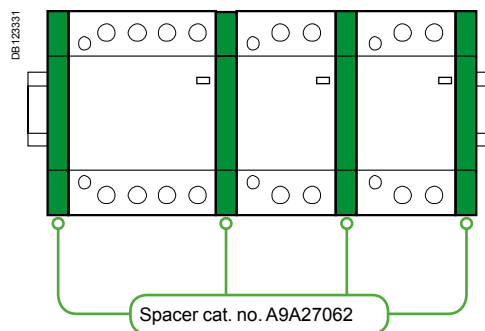

Offer selection see page 499

Offer A

This sticker must be removed before publishing

Control

Remote control

Acti9 iCT contactors (cont.)

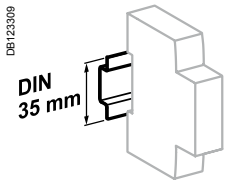

Clip on DIN rail 35 mm.

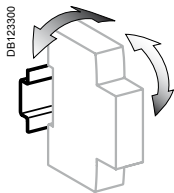

± 30° vertical.

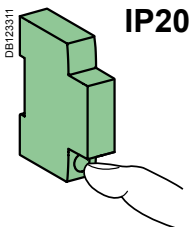

IP20

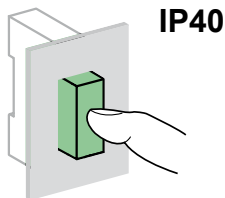

IP40

Technical data

Power circuit		
Voltage rating (Ue)	1P, 2P	250 V AC
	3P, 4P	400 V AC
Frequency	50 Hz or 60 Hz	
Type of load	See module CA908026	
Endurance (O-C)		
Electrical	100,000 cycles	
Maximum number of switching operations per day	100	
Additional characteristics		
Insulation voltage (Ui)	440 V AC	
Pollution degree	2	
Rated impulse withstand voltage (Uimp)	2.5 kV (4 kV for 12/24/48 V AC)	
Degree of protection (IEC 60529)	Device only	IP20
	Device in modular enclosure	IP40
Operating temperature	-5°C to +60°C	
Storage temperature	-40°C to +70°C	
Tropicalization (IEC 60068-2-30)	Treatment 2 (relative humidity 95 % at 55°C)	
ELSV compliance (Extra Low Safety Voltage) for 12/24/48 V AC versions		
The product control conforms to the SELV (safety extra low voltage) requirements		

Temperature derating table

Acti9 iCT	Ambient temperature (°C)		
Rating (A)	≤ 40	50	60
63	63	59.8	50
40	40	38	32
25	25	23.8	20
16	16	15.2	12.8

If multiple iCTs side by side: install spacer and apply 0.8 coefficient on upper current values.

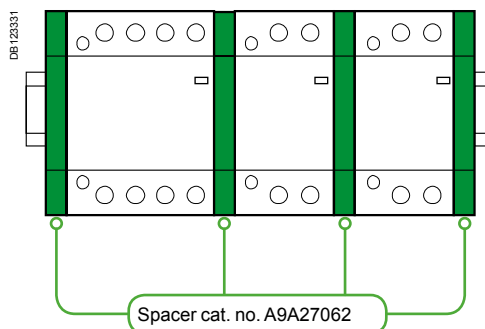

Offer selection see page 499

Offer B

This sticker must be removed before publishing

Acti9 iCT contactors (cont.)

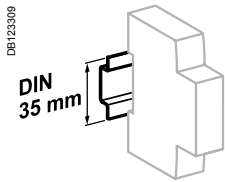

Clip on DIN rail 35 mm.

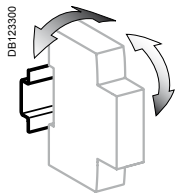

± 30° vertical.

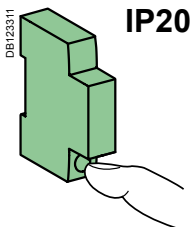

IP20

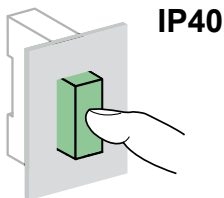

IP40

Technical data

Power circuit		
Voltage rating (Ue)	1P, 2P	250 V AC
	3P, 3P+N, 4P	400 V AC
Frequency	50 Hz or 60 Hz	
Type of load	See module CA908026	
Endurance (O-C)		
Electrical	100,000 cycles	
Maximum number of switching operations per day	100	
Additional characteristics		
Insulation voltage (Ui)	440 V AC	
Pollution degree	2	
Rated impulse withstand voltage (Uimp)	2.5 kV (4 kV for 12/24/48 V AC)	
Degree of protection (IEC 60529)	Device only	IP20
	Device in modular enclosure	IP40
Operating temperature	-5°C to +60°C	
Storage temperature	-40°C to +70°C	
Tropicalization (IEC 60068-2-30)	Treatment 2 (relative humidity 95 % at 55°C)	
ELSV compliance (Extra Low Safety Voltage) for 12/24/48 V AC versions		
The product control conforms to the SELV (safety extra low voltage) requirements		

Temperature derating table

Acti9 iCT Rating (A)	Ambient temperature (°C)		
	≤ 40	50	60
63	63	59.8	50
40	40	38	32
25	25	23.8	20
16	16	15.2	12.8

If multiple iCTs side by side: install spacer and apply 0.8 coefficient on upper current values.

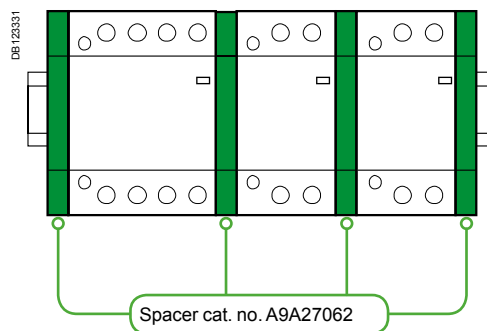

Offer selection see page 499

Offer C

This sticker must be removed before publishing

Control Remote control Acti9 iCT contactors (cont.)

Mounting accessories

7	Sealable screw shields for top and bottom	3P, 4P 25 A	A9A15921
		2P 40/63 A	A9A15922
		3P, 40/63 A	A9A15923
		3P+N, 4P	
8	9 mm spacer		A9A27062
9	Yellow clips		A9C15415
10	Clip-on terminal markers	see module	CA907001
11	Comb busbar	3P+N	A9XCT712

Auxiliaries

Indication			
2	Acti9 iACTs	1NO + 1NC	A9C15914
		1CO	A9C15915
		2NO	A9C15916
Double control inputs			
3	Acti9 iACTc	230 V AC	A9C18308
		24 V AC	A9C18309
Coil suppression blocs			
4	Acti9 iACTp	12...48 V AC	A9C15919
		48...127 V AC	A9C15918
		220...240 V AC	A9C15920
Time delay			
5	Acti9 iATEt	24...240 V AC	A9C15419
Control and indication			
6	Acti9 iACT24	230 V AC	A9C15924

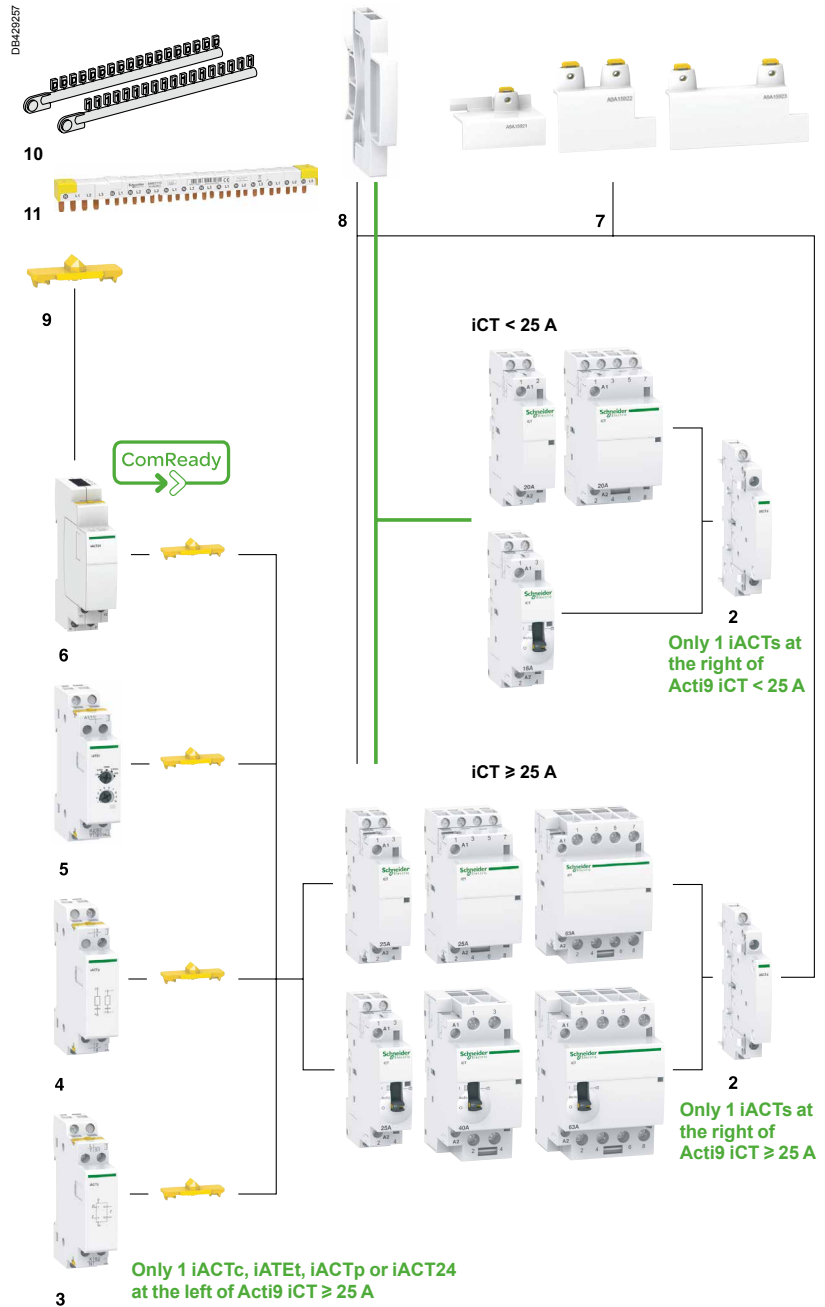

Offer selection see page 499

Offer A

This sticker must be removed before publishing

Control

Remote control

Acti9 iCT contactors (cont.)

Mounting accessories

7	Sealable screw shields for top and bottom	3P, 4P 25 A	A9A15921
		2P 40/63 A	A9A15922
		3P, 4P 40/63 A	A9A15923
8	9 mm spacer		A9A27062
9	Yellow clips		A9C15415
10	Clip-on terminal markers	see module	CA907001

Auxiliaries

Indication			
2	Acti9 iACTs	1NO + 1NC	A9C15914
		1CO	A9C15915
		2NO	A9C15916
Double control inputs			
3	Acti9 iACTc	230 V AC	A9C18308
		24 V AC	A9C18309
Coil suppression blocs			
4	Acti9 iACTp	12...48 V AC	A9C15919
		48...127 V AC	A9C15918
		220...240 V AC	A9C15920
Time delay			
5	Acti9 iATEt	24...240 V AC	A9C15419
Control and indication			
6	Acti9 iACT24	230 V AC	A9C15924

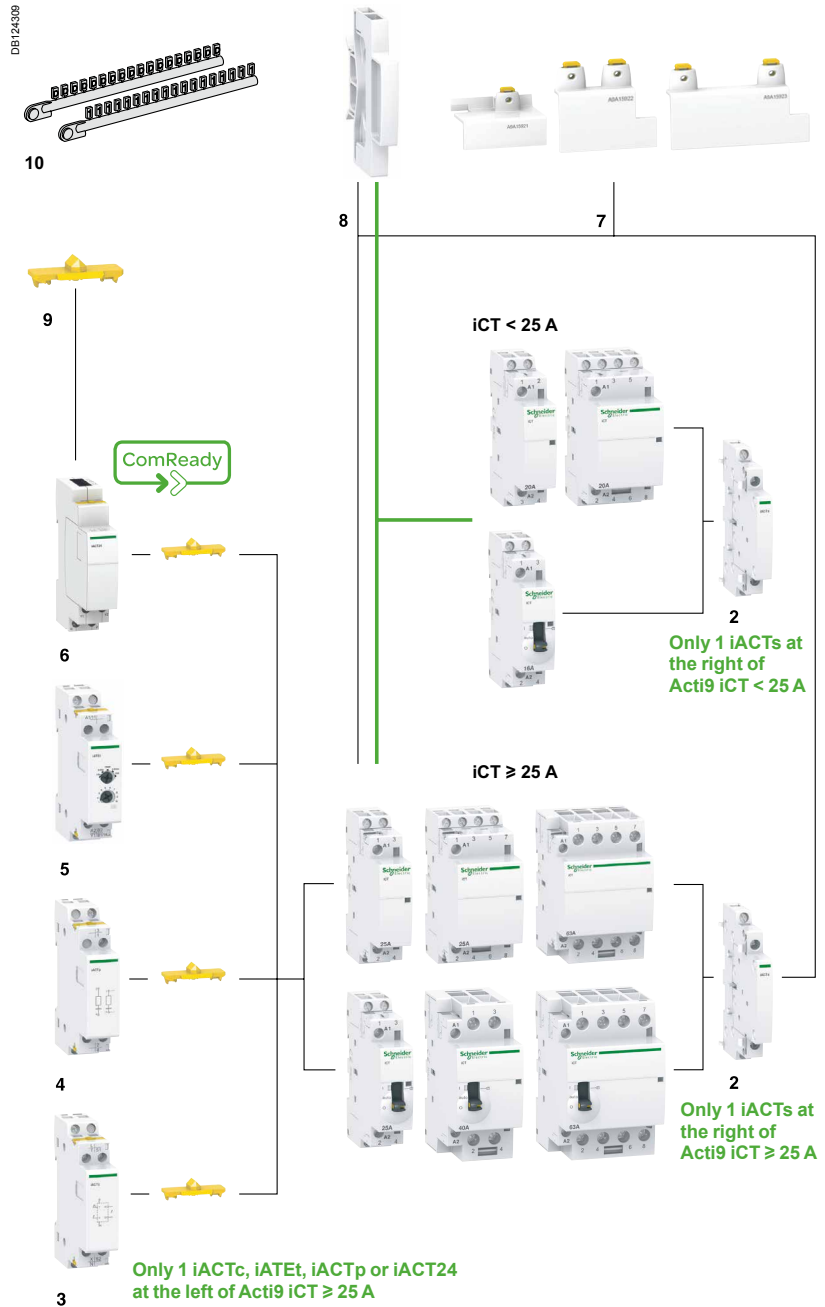

Offer selection see page 499

Offer B

This sticker must be removed before publishing

Control Remote control Acti9 iCT contactors (cont.)

Mounting accessories

7	Sealable screw shields for top and bottom	3P, 4P 25 A	A9A15921
		2P 40/63 A	A9A15922
		3P, 40/63 A	A9A15923
		3P+N, 4P	
8	9 mm spacer		A9A27062
9	Yellow clips		A9C15415
10	Clip-on terminal markers	see module	CA907001
11	Comb busbar	3P+N	A9XCT712

Auxiliaries

Indication			
2	Acti9 iACTs	1NO + 1NC	A9C15914
		1CO	A9C15915
		2NO	A9C15916

Double control inputs			
3	Acti9 iACTc	230 V AC	A9C18308
		24 V AC	A9C18309

Coil suppression blocs			
4	Acti9 iACTp	12...48 V AC	A9C15919
		48...127 V AC	A9C15918
		220...240 V AC	A9C15920

Time delay			
5	Acti9 iATEt	24...240 V AC	A9C15419

Control and indication			
6	Acti9 iACT24	230 V AC	A9C15924

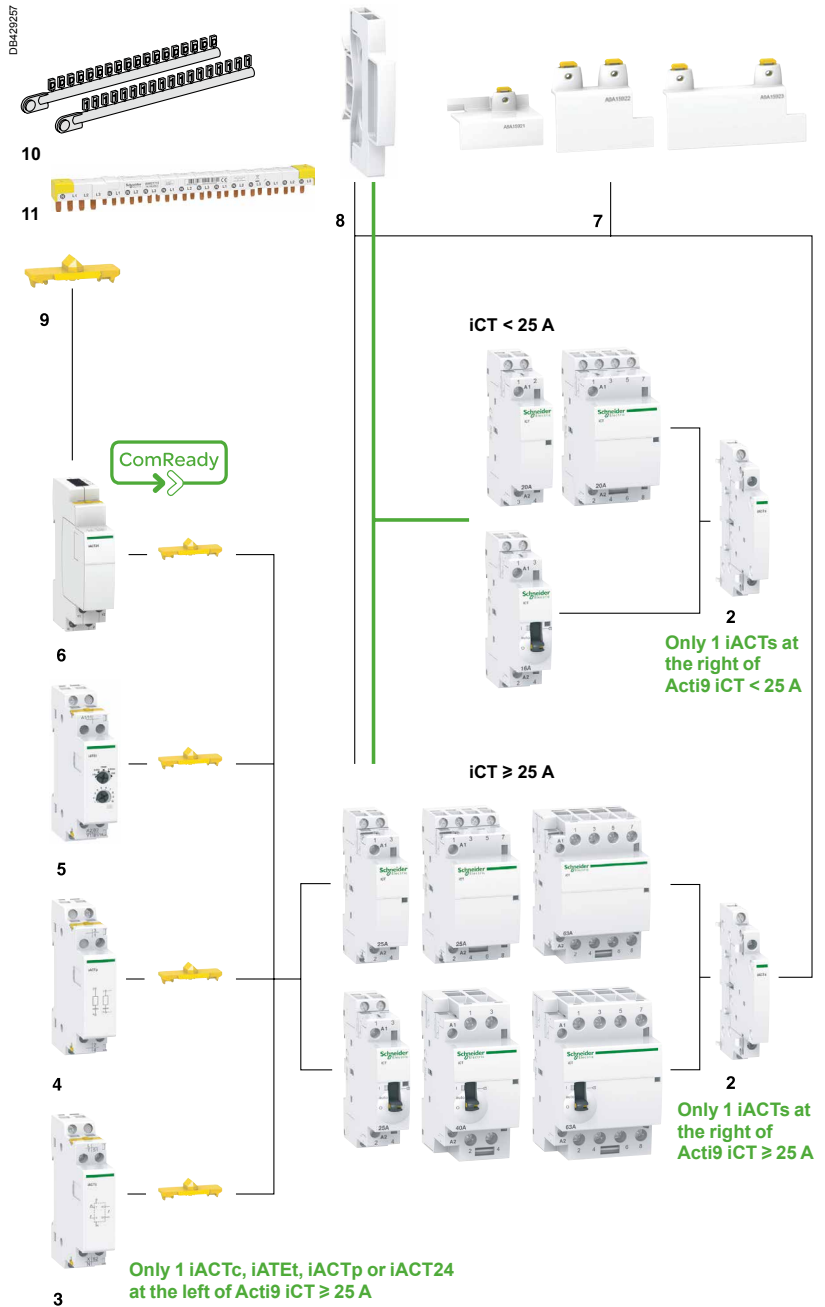



Offer selection see page 499

Offer C

This sticker must be removed before publishing

Acti9 iCT contactors

Electrical auxiliaries for Acti9 iCT

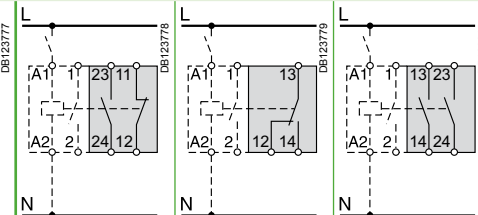
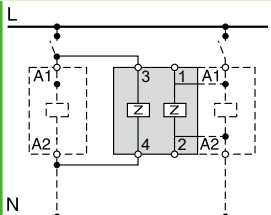
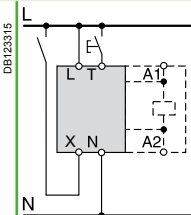
	Indication			Protection			Control	
Auxiliaries	Acti9 iACTs			Acti9 iACTp			Acti9 iACTc	
Type	Indication			Interference filtering			Impulse/latched control	
	With Open/Close auxiliary contact			2 protection circuits				
								
Function	<ul style="list-style-type: none"> This auxiliary allows indication of the "open" or "closed" position of the contactor power contacts 			<ul style="list-style-type: none"> This auxiliary is an interference suppressor which limits overvoltages on the control circuit 			<ul style="list-style-type: none"> This auxiliary, combined with contactors, enables them to be controlled by 2 order types: <ul style="list-style-type: none"> impulse order for local control (input T) latched order for centralised control (input X) the last order received takes priority 	
Wiring diagrams								
Mounting	<ul style="list-style-type: none"> Mounted to the right of Acti9 iCT 			<ul style="list-style-type: none"> Mounted to the left of Acti9 iCT by yellow clips⁽¹⁾ By wires 			<ul style="list-style-type: none"> Mounted to the left of Acti9 iCT by yellow clips⁽¹⁾ 	
				<ul style="list-style-type: none"> The iACTp has 2 separate and identical circuits, allowing it to be combined with 2 different one on the Acti9 iCT the other by wires 			<ul style="list-style-type: none"> Mains power outages: <ul style="list-style-type: none"> < 70 ms: keeps its initial status > 80 ms: reset put back into operation by manual operation on input X or T. Minimum impulse duration: 250 ms 	
Catalog numbers	A9C15914	A9C15915	A9C15916	A9C15918	A9C15919	A9C15920	A9C18308	A9C18309
Technical specifications								
Control voltage (Ue)	V AC	24...240		48...127	12...48	220...240	230...240	24...48
	V DC	24...130		-			-	
Control voltage frequency	Hz	50/60		50/60			50/60	
Width in 9 mm modules		1		2			2	
Auxiliary contact (breaking capacity)		<ul style="list-style-type: none"> Minimum: 10 mA at 24 V DC/AC Maximum: <ul style="list-style-type: none"> 5 A at 230 V AC, AC12 2 A at 230 V AC, AC15 1 A at 130 V DC, DC13 		-			-	
Number of contacts		1NO + 1NC	1CO	2NO	-			-
Operating temperature	°C	-5°C to +50°C		-			-	
Storage temperature	°C	-40°C to +70°C		-			-	
Consumption		-		-			OFF load: 3 VA Inrush ⁽²⁾ : 2 VA Holding ⁽²⁾ : 0.2 VA	

(1) Electrical and mechanical link.

(2) Maximum consumption of all contactors controlled.

Acti9 iCT contactors

Electrical auxiliaries for Acti9 iCT (cont.)

Control (cont.)

Acti9 iATEt

Time delay

PF106125-34



- This auxiliary is used to time delay for Acti9 iCT and iTL. According to cabling, there are 5 possible time delay types:
- 1 for iTL
- 4 for iCT.

Function type A: late closing

- Delay energizing of contactor.

Function type B: time delay

- Energize the contactor by closing a push button.
- The time delay starts as soon as the control contacts are closed.

Function type C: late opening

- Energize the contactor by closing a push button.
- The time delay starts when the control contacts are opened.

Function type H: fixed time operation

- Operate the contactor for a pre-determined time from the moment of energizing.

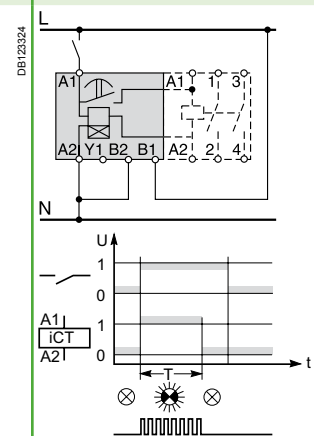
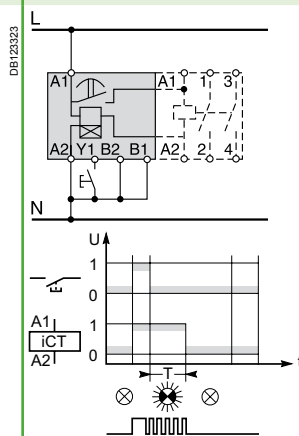
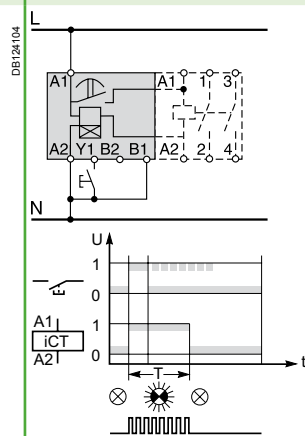
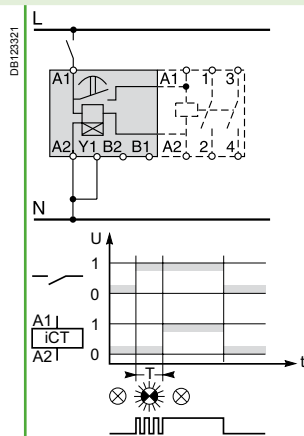

- Mounted to the left of Acti9 iCT by yellow clips⁽¹⁾

A9C15419

24...240

24...110

50/60

2

-20°C to +50°C

-40°C to +80°C

Off-load: 5 VA
Inrush⁽²⁾: 3 A
Holding⁽²⁾: 0.2 A

Offer selection see page 499

Offer A, B, C

This sticker must be removed before publishing

Acti9 iCT contactors

Electrical auxiliaries for Acti9 iCT (cont.)

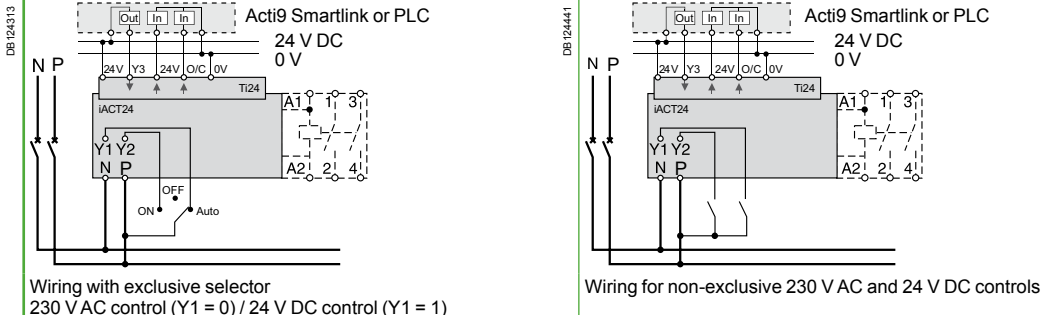

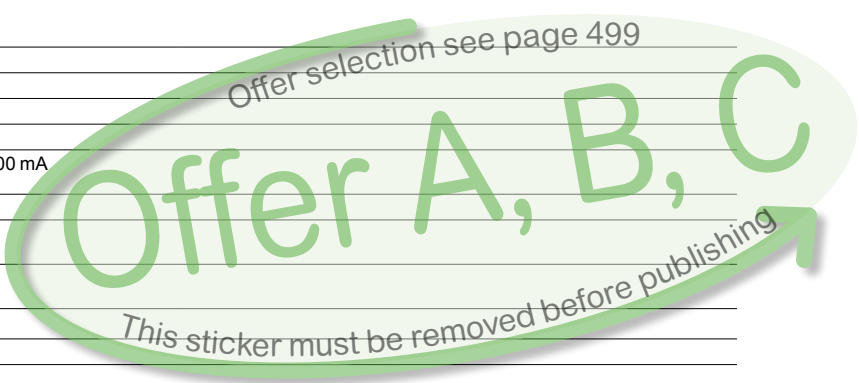

	Control and indication	
Auxiliary	Acti9 iACT24	
Type	Control and indication 24 V DC	
	With Ti24 connector	
		
Function	<ul style="list-style-type: none"> This auxiliary allows a contactor to be interfaced with the Acti9 Smartlink interface or a programmable logic controller (PLC) in 24 V DC (control, O/C indication) 230 V AC control 	
Wiring diagrams	 <p>Wiring with exclusive selector 230 V AC control (Y1 = 0) / 24 V DC control (Y1 = 1)</p> <p>Wiring for non-exclusive 230 V AC and 24 V DC controls</p>	
Mounting	<ul style="list-style-type: none"> To the left of the Acti9 iCT contactor using the yellow clips⁽¹⁾. When an iACT24 is used, the A1/A2 terminals of the contactors should not be wired. Only the yellow clips integral with the iACT24 should be used for connection to the coil. 	
Utilization	<ul style="list-style-type: none"> 230 V AC interface: <ul style="list-style-type: none"> Y1: enabling of 24 V DC control (Y1 = 1) or inhibition of 24 V DC control (Y1 = 0). Y2: 230 V pulse control "Ti24" 24 V DC interface: <ul style="list-style-type: none"> Y3: 24 V DC control of Acti9 iCT closing on rising edge and opening on falling edge reading of the contactor status (opened or closed) from the position of the integrated O/C auxiliary contact monitoring of connection of the "Ti24" terminal block by the upstream system (PLC, supervision system) via the 24 V terminal (in the centre of the Ti24 terminal block) 	
Catalog numbers	A9C15924	
Technical specifications		
Control voltage	V AC	230, +10 %, -15 % (Y2)
(Ue)	V DC	24, ± 20 % (Y3)
Control voltage frequency	Hz	50/60
Insulation voltage (Ui)	V AC	250
Rated impulse withstand voltage (Uimp)	kV	8 (OVC IV)
Pollution degree		3
Degree of protection		IP20B device only IP40 device in modular enclosure
Width in 9 mm modules		2
Auxiliary contact (O/C) Ti24		24 V DC protected output, min. 2 mA, max. 100 mA
Contact		1 O/C operating category AC 14
Operating temperature	°C	-25°C to +60°C
Storage temperature	°C	-40°C to +80°C
Consumption		<1 W
Standard		IEC/EN 60947-5-1

(1) Mechanical and electrical link.



Acti9 iCT contactors

Accessories for Acti9 iCT

Security									
Accessories	Sealable screw shields			Yellow clips	Spacer				
PE104485-15		PE104486-15		PE104487-15		PE104483-10		PE104483-40	
Function									
	<ul style="list-style-type: none"> Designed to cover terminals to avoid contact with device screws. Allow sealing 			<ul style="list-style-type: none"> Ensure the mechanical and/or electrical link between contactors and their auxiliaries. 		<ul style="list-style-type: none"> Required to reduce temperature rise of modular devices installed side by side. Recommended to separate electronic devices (thermostat, programmable clock, etc.) from electromechanical devices (relays, contactors). 			
	■ For Acti9 iCT: 3P, 4P - 25 A	■ For Acti9 iCT: 2P - 40/63 A	■ For Acti9 iCT: 3P, 3P+N, 4P - 40/63 A	■ For Acti9 iCT: ≥ 25 A					
Set of	10 upstream / 10 downstream			10	5				
Catalog numbers	A9A15921	A9A15922	A9A15923	A9C15415	A9A27062				
Technical specifications									
Width in 9 mm modules	4	4	6	–	1				
Number of poles	3P, 4P	2P	3P, 3P+N, 4P	–	–				





Offer selection see page 499

Offer A

This sticker must be removed before publishing

Acti9 iCT contactors

Accessories for Acti9 iCT

Security					
Accessories	Sealable screw shields			Yellow clips	Spacer
 PB104485-15	 PB104486-15	 PB104487-15	 PB108143-10	 PB104483-40	
Function					
<ul style="list-style-type: none"> Designed to cover terminals to avoid contact with device screws. Allow sealing 			<ul style="list-style-type: none"> Ensure the mechanical and/or electrical link between contactors and their auxiliaries. 		<ul style="list-style-type: none"> Required to reduce temperature rise of modular devices installed side by side. Recommended to separate electronic devices (thermostat, programmable clock, etc.) from electromechanical devices (relays, contactors).
<ul style="list-style-type: none"> For Acti9 iCT: 3P, 4P - 25 A 		<ul style="list-style-type: none"> For Acti9 iCT: 2P - 40/63 A 	<ul style="list-style-type: none"> For Acti9 iCT: 3P, 4P - 40/63 A 	<ul style="list-style-type: none"> For Acti9 iCT: ≥ 25 A 	
Set of	10 upstream / 10 downstream			10	5
Catalog numbers	A9A15921	A9A15922	A9A15923	A9C15415	A9A27062
Technical specifications					
Width in 9 mm modules	4	4	6	–	1
Number of poles	3P, 4P	2P	3P, 4P	–	–





Offer selection see page 499

Offer B

This sticker must be removed before publishing

Acti9 iCT contactors

Accessories for Acti9 iCT

Security									
Accessories	Sealable screw shields			Yellow clips	Spacer				
PE104485-15		PE104486-15		PE104487-15		PE104483-10		PE104483-40	
Function									
	<ul style="list-style-type: none"> Designed to cover terminals to avoid contact with device screws. Allow sealing 			<ul style="list-style-type: none"> Ensure the mechanical and/or electrical link between contactors and their auxiliaries. 		<ul style="list-style-type: none"> Required to reduce temperature rise of modular devices installed side by side. Recommended to separate electronic devices (thermostat, programmable clock, etc.) from electromechanical devices (relays, contactors). 			
	■ For Acti9 iCT: 3P, 4P - 25 A	■ For Acti9 iCT: 2P - 40/63 A	■ For Acti9 iCT: 3P, 3P+N, 4P - 40/63 A	■ For Acti9 iCT: ≥ 25 A					
Set of	10 upstream / 10 downstream			10	5				
Catalog numbers	A9A15921	A9A15922	A9A15923	A9C15415	A9A27062				
Technical specifications									
Width in 9 mm modules	4	4	6	–	1				
Number of poles	3P, 4P	2P	3P, 3P+N, 4P	–	–				

Offer selection see page 499

Offer C

This sticker must be removed before publishing

Control
Remote control

Acti9 iCT contactors

Technical advice for Acti9 iCT (cont.)



Operation of the iACT24

O/C 24 V DC output

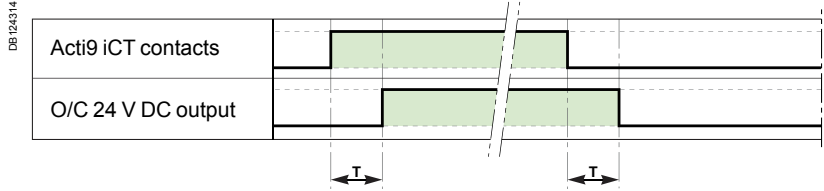

	Parameter	Min	Max
T	Time delay between iACT24 closing and indication	100 ms	200 ms

- Minimum duration of 230 V AC pulse (Y2): 200 ms.
- 30 iACT24 closing or opening actuations are authorized per minute: Minimum time delay between 2 actuations on the iACT24 via Y1, Y2, Y3 (closing or opening of the Acti9 iCT coil): 220 ms.
- 10 closing or opening actuations spaced 440 milliseconds apart are authorized following no loading of the iACT24 during a period of 20 seconds.

Wiring with exclusive selector 230 V AC control (Y1 = 0) / 24 V DC control (Y1 = 1)

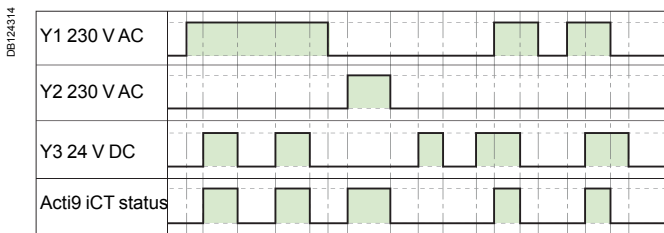
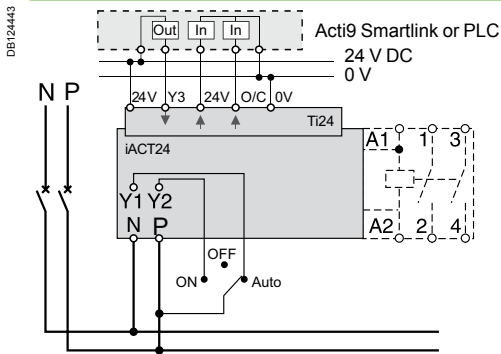

Wiring for non-exclusive 230 V AC and 24 V DC controls

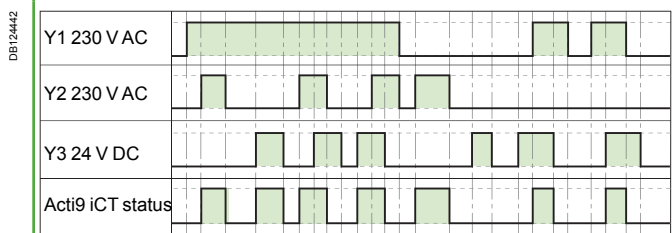
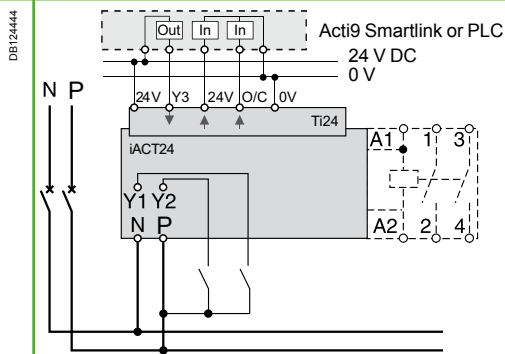

Offer selection see page 499

Offer A, B, C

This sticker must be removed before publishing

Acti9 iCT contactors

Technical advice for Acti9 iCT (cont.)

Consumption

Acti9 iCT contactors - 50 Hz									
Type									
1P	Rating (In)		Control voltage (V AC) (50 Hz)	Consumption		Max. power			
	AC7a	AC7b		Holding	Inrush				
16 A	5 A		12	3.8 VA	15 VA	1.3 W	A9C22011		
			24	3.8 VA	15 VA	1.3 W	A9C22111		
			48	3.8 VA	15 VA	1.3 W	A9C22211		
			220	3.8 VA	15 VA	1.3 W	A9C22511		
			230...240	2.7 VA	9.2 VA	1.2 W	A9C22711		
	25 A	8.5 A		220	3.8 VA	15 VA	1.3 W	A9C20531	
				230...240	2.7 VA	9.2 VA	1.2 W	A9C20731	
2P									
16 A	5 A		12	3.8 VA	15 VA	1.3 W	A9C22012		
			24	3.8 VA	15 VA	1.3 W	A9C22112		
			48	3.8 VA	15 VA	1.3 W	A9C22212		
			220	3.8 VA	15 VA	1.3 W	A9C22512		
			230...240	2.7 VA	9.2 VA	1.2 W	A9C22712		
			12	3.8 VA	15 VA	1.3 W	A9C22015		
			24	3.8 VA	15 VA	1.3 W	A9C22115		
			220	3.8 VA	15 VA	1.3 W	A9C22515		
			230...240	2.7 VA	9.2 VA	1.2 W	A9C22715		
			20 A	6.4 A	230...240	2.7 VA	9.2 VA	1.2 W	A9C22722
	25 A	8.5 A		24	3.8 VA	15 VA	1.3 W	A9C20132	
				48	3.8 VA	15 VA	1.3 W	A9C20232	
				220	3.8 VA	15 VA	1.3 W	A9C20532	
				230...240	2.7 VA	9.2 VA	1.2 W	A9C20732	
				230...240	2.7 VA	9.2 VA	1.2 W	A9C20736	
	40 A	15 A	220...240	4.6 VA	34 VA	1.6 W	A9C20842		
	63 A	20 A		24	4.6 VA	34 VA	1.6 W	A9C20162	
				220...240	4.6 VA	34 VA	1.6 W	A9C20862	
	100 A (*)	-	220...240	6.5 VA	53 VA	2.1 W	A9C20882		
	3P								
16 A	5 A	220...240	4.6 VA	34 VA	1.6 W	A9C22813			
25 A	8.5 A	220...240	4.6 VA	34 VA	1.6 W	A9C20833			
40 A	15 A	220...240	6.5 VA	53 VA	2.1 W	A9C20843			
63 A	20 A	220...240	6.5 VA	53 VA	2.1 W	A9C20863			
3P+N									
40 A	15 A		220...240	6.5 VA	53 VA	2.1 W	A9C24740		
			220...240	6.5 VA	53 VA	2.1 W	A9C22740		
63 A	20 A		220...240	6.5 VA	53 VA	2.1 W	A9C24763		
			220...240	6.5 VA	53 VA	2.1 W	A9C22763		
4P									
16 A	5 A		24	4.6 VA	34 VA	1.6 W	A9C22114		
			220...240	4.6 VA	34 VA	1.6 W	A9C22814		
			220...240	4.6 VA	34 VA	1.6 W	A9C22818		
20 A	6.4 A	220...240	4.6 VA	34 VA	1.6 W	A9C22824			
25 A	8.5 A		24	4.6 VA	34 VA	1.6 W	A9C20134		
			220...240	4.6 VA	34 VA	1.6 W	A9C20834		
			24	4.6 VA	34 VA	1.6 W	A9C20137		
			220...240	4.6 VA	34 VA	1.6 W	A9C20837		
			220...240	4.6 VA	34 VA	1.6 W	A9C20838		
			40 A	15 A	220...240	6.5 VA	53 VA	2.1 W	A9C20844
			220...240	6.5 VA	53 VA	2.1 W	A9C20847		
63 A	20 A		24	6.5 VA	53 VA	2.1 W	A9C20164		
			220...240	6.5 VA	53 VA	2.1 W	A9C20864		
			24	6.5 VA	53 VA	2.1 W	A9C20167		
			220...240	6.5 VA	53 VA	2.1 W	A9C20867		
			220...240	6.5 VA	53 VA	2.1 W	A9C20868		
			220...240	6.5 VA	53 VA	2.1 W	A9C20869		
			100 A (*)	-	220...240	13 VA	106 VA	4.2 W	A9C20884

(*) do not use for lighting applications

Offer selection see page 499

Offer A

This sticker must be removed before publishing

Acti9 iCT contactors

Technical advice for Acti9 iCT (cont.)

Consumption

Acti9 iCT contactors - 50 Hz

Type

1P	Rating (In)		Control voltage (V AC) (50 Hz)	Consumption		Max. power			
	AC7a	AC7b		Holding	Inrush				
1P	16 A	5 A	12	3.8 VA	15 VA	1.3 W	A9C22011		
			24	3.8 VA	15 VA	1.3 W	A9C22111		
			48	3.8 VA	15 VA	1.3 W	A9C22211		
			220	3.8 VA	15 VA	1.3 W	A9C22511		
			230...240	2.7 VA	9.2 VA	1.2 W	A9C22711		
	25 A	8.5 A	220	3.8 VA	15 VA	1.3 W	A9C20531		
			230...240	2.7 VA	9.2 VA	1.2 W	A9C20731		
			2P						
			16 A	5 A	12	3.8 VA	15 VA	1.3 W	A9C22012
					24	3.8 VA	15 VA	1.3 W	A9C22112
48	3.8 VA	15 VA			1.3 W	A9C22212			
220	3.8 VA	15 VA			1.3 W	A9C22512			
230...240	2.7 VA	9.2 VA			1.2 W	A9C22712			
12	3.8 VA	15 VA			1.3 W	A9C22015			
20 A	6.4 A	24	3.8 VA	15 VA	1.3 W	A9C22115			
		220	3.8 VA	15 VA	1.3 W	A9C22515			
		230...240	2.7 VA	9.2 VA	1.2 W	A9C22715			
25 A	8.5 A	230...240	2.7 VA	9.2 VA	1.2 W	A9C22722			
		24	3.8 VA	15 VA	1.3 W	A9C20132			
		48	3.8 VA	15 VA	1.3 W	A9C20232			
		220	3.8 VA	15 VA	1.3 W	A9C20532			
		230...240	2.7 VA	9.2 VA	1.2 W	A9C20732			
40 A	15 A	220	3.8 VA	15 VA	1.3 W	A9C20536			
		230...240	2.7 VA	9.2 VA	1.2 W	A9C20736			
		220...240	2.7 VA	9.2 VA	1.2 W	A9C20842			
63 A	20 A	24	4.6 VA	34 VA	1.6 W	A9C20162			
		220...240	4.6 VA	34 VA	1.6 W	A9C20862			
100 A (*)	-	220...240	6.5 VA	53 VA	2.1 W	A9C20882			
3P									
3P	16 A	5 A	220...240	4.6 VA	34 VA	1.6 W	A9C22813		
	25 A	8.5 A	220...240	4.6 VA	34 VA	1.6 W	A9C20833		
	40 A	15 A	220...240	6.5 VA	53 VA	2.1 W	A9C20843		
	63 A	20 A	220...240	6.5 VA	53 VA	2.1 W	A9C20863		
4P									
4P	16 A	5 A	24	4.6 VA	34 VA	1.6 W	A9C22114		
			220...240	4.6 VA	34 VA	1.6 W	A9C22814		
			220...240	4.6 VA	34 VA	1.6 W	A9C22818		
	20 A	6.4 A	220...240	4.6 VA	34 VA	1.6 W	A9C22824		
			25 A	8.5 A	24	4.6 VA	34 VA	1.6 W	A9C20134
	220...240	4.6 VA	34 VA		1.6 W	A9C20834			
	24	4.6 VA	34 VA		1.6 W	A9C20137			
	220...240	4.6 VA	34 VA		1.6 W	A9C20837			
	220...240	4.6 VA	34 VA		1.6 W	A9C20838			
	40 A	15 A	220...240	6.5 VA	53 VA	2.1 W	A9C20844		
220...240			6.5 VA	53 VA	2.1 W	A9C20847			
63 A	20 A	24	6.5 VA	53 VA	2.1 W	A9C20164			
		220...240	6.5 VA	53 VA	2.1 W	A9C20864			
		24	6.5 VA	53 VA	2.1 W	A9C20167			
		220...240	6.5 VA	53 VA	2.1 W	A9C20867			
		220...240	6.5 VA	53 VA	2.1 W	A9C20868			
100 A (*)	-	220...240	6.5 VA	53 VA	2.1 W	A9C20869			
		220...240	13 VA	106 VA	4.2 W	A9C20884			

(*) do not use for lighting applications

Offer selection see page 499

Offer B

This sticker must be removed before publishing

Acti9 iCT contactors

Technical advice for Acti9 iCT (cont.)

Consumption

Acti9 iCT contactors - 50 Hz											
Type											
1P	Rating (In)		Control voltage (V AC) (50 Hz)	Consumption		Max. power					
	AC7a	AC7b		Holding	Inrush						
16 A	5 A		12	3.8 VA	15 VA	1.3 W	A9C22011				
			24	3.8 VA	15 VA	1.3 W	A9C22111				
			48	3.8 VA	15 VA	1.3 W	A9C22211				
			220	3.8 VA	15 VA	1.3 W	A9C22511				
			230...240	2.7 VA	9.2 VA	1.2 W	A9C22711				
	25 A	8.5 A		220	3.8 VA	15 VA	1.3 W	A9C20531			
				230...240	2.7 VA	9.2 VA	1.2 W	A9C20731			
				2P							
				16 A	5 A		12	3.8 VA	15 VA	1.3 W	A9C22012
							24	3.8 VA	15 VA	1.3 W	A9C22112
48	3.8 VA	15 VA	1.3 W				A9C22212				
220	3.8 VA	15 VA	1.3 W				A9C22512				
230...240	2.7 VA	9.2 VA	1.2 W				A9C22712				
20 A	6.4 A		12	3.8 VA	15 VA	1.3 W	A9C22015				
			24	3.8 VA	15 VA	1.3 W	A9C22115				
			220	3.8 VA	15 VA	1.3 W	A9C22515				
			230...240	2.7 VA	9.2 VA	1.2 W	A9C22715				
			230...240	2.7 VA	9.2 VA	1.2 W	A9C22722				
25 A	8.5 A		24	3.8 VA	15 VA	1.3 W	A9C20132				
			48	3.8 VA	15 VA	1.3 W	A9C20232				
			220	3.8 VA	15 VA	1.3 W	A9C20532				
			230...240	2.7 VA	9.2 VA	1.2 W	A9C24732				
			230...240	2.7 VA	9.2 VA	1.2 W	A9C20536				
40 A	15 A		230...240	2.7 VA	9.2 VA	1.2 W	A9C20736				
			220...240	4.6 VA	34 VA	1.6 W	A9C20842				
			63 A	20 A	24	4.6 VA	34 VA	1.6 W	A9C20162		
					220...240	4.6 VA	34 VA	1.6 W	A9C20862		
			100 A (*)	-		220...240	6.5 VA	53 VA	2.1 W	A9C20882	
3P											
16 A	5 A		220...240	4.6 VA	34 VA	1.6 W	A9C22813				
25 A	8.5 A		220...240	4.6 VA	34 VA	1.6 W	A9C20833				
40 A	15 A		220...240	6.5 VA	53 VA	2.1 W	A9C20843				
63 A	20 A		220...240	6.5 VA	53 VA	2.1 W	A9C20863				
3P+N											
40 A	15 A		220...240	6.5 VA	53 VA	2.1 W	A9C24740				
			220...240	6.5 VA	53 VA	2.1 W	A9C22740				
63 A	20 A		220...240	6.5 VA	53 VA	2.1 W	A9C24763				
			220...240	6.5 VA	53 VA	2.1 W	A9C22763				
4P											
16 A	5 A		24	4.6 VA	34 VA	1.6 W	A9C22114				
			220...240	4.6 VA	34 VA	1.6 W	A9C22814				
			220...240	4.6 VA	34 VA	1.6 W	A9C22818				
20 A	6.4 A		220...240	4.6 VA	34 VA	1.6 W	A9C22824				
25 A	8.5 A		24	4.6 VA	34 VA	1.6 W	A9C20134				
			220...240	4.6 VA	34 VA	1.6 W	A9C24834				
			24	4.6 VA	34 VA	1.6 W	A9C20137				
			220...240	4.6 VA	34 VA	1.6 W	A9C20837				
			220...240	4.6 VA	34 VA	1.6 W	A9C20838				
			220...240	4.6 VA	34 VA	1.6 W	A9C20844				
40 A	15 A		220...240	6.5 VA	53 VA	2.1 W	A9C20847				
			220...240	6.5 VA	53 VA	2.1 W	A9C20847				
63 A	20 A		24	6.5 VA	53 VA	2.1 W	A9C20164				
			220...240	6.5 VA	53 VA	2.1 W	A9C20864				
			24	6.5 VA	53 VA	2.1 W	A9C20167				
			220...240	6.5 VA	53 VA	2.1 W	A9C20867				
			220...240	6.5 VA	53 VA	2.1 W	A9C20868				
			220...240	6.5 VA	53 VA	2.1 W	A9C20869				
			220...240	6.5 VA	53 VA	2.1 W	A9C20884				
100 A (*)	-		220...240	13 VA	106 VA	4.2 W	A9C20884				

(*) do not use for lighting applications

Offer selection see page 499

Offer C

This sticker must be removed before publishing

Acti9 iCT contactors

Technical advice for Acti9 iCT (cont.)

Consumption

Acti9 iCT manual control contactor 50 Hz

Type								
2P	Rating (In)		Control voltage (V AC) (50 Hz)	Consumption		Max. power		
	AC7a	AC7b		Holding	Inrush			
16 A	5 A		220	2.7 VA	9.2 VA	1.2 W	A9C23512	
			230...240	2.7 VA	9.2 VA	1.2 W	A9C23712	
			220	3.8 VA	15 VA	1.3 W	A9C23515	
			230...240	2.7 VA	9.2 VA	1.2 W	A9C23715	
	25 A	8.5 A		24	3.8 VA	15 VA	1.3 W	A9C21132
				220	2.7 VA	9.2 VA	1.2 W	A9C21532
				230...240	2.7 VA	9.2 VA	1.2 W	A9C21732
	40 A	15 A		24	4.6 VA	34 VA	1.6 W	A9C21142
220...240				4.6 VA	34 VA	1.6 W	A9C21842	
63 A	20 A		24	4.6 VA	34 VA	1.6 W	A9C21162	
			220...240	4.6 VA	34 VA	1.6 W	A9C21862	
3P								
25 A	8.5 A		220...240	4.6 VA	34 VA	1.6 W	A9C21833	
			40 A	15 A	220...240	6.5 VA	53 VA	2.1 W
4P								
25 A	8.5 A		24	4.6 VA	34 VA	1.6 W	A9C21134	
			220...240	4.6 VA	34 VA	1.6 W	A9C21834	
40 A	15 A		24	6.5 VA	53 VA	2.1 W	A9C21144	
			220...240	6.5 VA	53 VA	2.1 W	A9C21844	
63 A	20 A		24	6.5 VA	53 VA	2.1 W	A9C21164	
			220...240	6.5 VA	53 VA	2.1 W	A9C21864	

Acti9 iCT contactors - 60 Hz

Type							
1P	Rating (In)		Control voltage (V AC) (60 Hz)	Consumption		Max. power	
	AC7a	AC7b		Holding	Inrush		
25 A	8.5 A		127	3.8 VA	15 VA	1.3 W	A9C20431
			220 ...240	2.7 VA	9.2 VA	0.9 W	A9C20631
2P							
16 A	5 A		127	3.8 VA	15 VA	1.3 W	A9C22415
			220...240	2.7 VA	9.2 VA	0.9 W	A9C22615
25 A	8.5 A		127	3.8 VA	15 VA	1.3 W	A9C20432
			220...240	2.7 VA	9.2 VA	0.9 W	A9C20632
			127	3.8 VA	15 VA	1.3 W	A9C20436
			220...240	2.7 VA	9.2 VA	0.9 W	A9C20636
40 A	15 A		127	4.6 VA	34 VA	1.6 W	A9C20442
			220...240	4.6 VA	34 VA	1.6 W	A9C20642
3P							
25 A	8.5 A		127	4.6 VA	34 VA	1.6 W	A9C20433
			220...240	4.6 VA	34 VA	1.6 W	A9C20633
40 A	15 A		127	6.5 VA	53 VA	2.1 W	A9C20443
			220...240	6.5 VA	53 VA	2.1 W	A9C20643
63 A	20 A		127	6.5 VA	53 VA	2.1 W	A9C20463
			220...240	6.5 VA	53 VA	2.1 W	A9C20663

Offer selection see page 499

Offer A, B

This sticker must be removed before publishing

Acti9 iCT contactors

Technical advice for Acti9 iCT (cont.)

Consumption

Acti9 iCT manual control contactor 50 Hz								
Type								
2P	Rating (In)		Control voltage (V AC) (50 Hz)	Consumption		Max. power		
	AC7a	AC7b		Holding	Inrush			
16 A	5 A		220	2.7 VA	9.2 VA	1.2 W	A9C23512	
			230...240	2.7 VA	9.2 VA	1.2 W	A9C23712	
			220	3.8 VA	15 VA	1.3 W	A9C23515	
			230...240	2.7 VA	9.2 VA	1.2 W	A9C23715	
	25 A	8.5 A		24	3.8 VA	15 VA	1.3 W	A9C21132
				220	2.7 VA	9.2 VA	1.2 W	A9C21532
				230...240	2.7 VA	9.2 VA	1.2 W	A9C25732
	40 A	15 A		24	4.6 VA	34 VA	1.6 W	A9C21142
220...240				4.6 VA	34 VA	1.6 W	A9C21842	
63 A	20 A		24	4.6 VA	34 VA	1.6 W	A9C21162	
			220...240	4.6 VA	34 VA	1.6 W	A9C21862	
3P								
25 A	8.5 A		220...240	4.6 VA	34 VA	1.6 W	A9C21833	
			40 A	15 A	220...240	6.5 VA	53 VA	2.1 W
4P								
25 A	8.5 A		24	4.6 VA	34 VA	1.6 W	A9C21134	
			220...240	4.6 VA	34 VA	1.6 W	A9C21834	
40 A	15 A		24	6.5 VA	53 VA	2.1 W	A9C21144	
			220...240	6.5 VA	53 VA	2.1 W	A9C21844	
63 A	20 A		24	6.5 VA	53 VA	2.1 W	A9C21164	
			220...240	6.5 VA	53 VA	2.1 W	A9C21864	

Acti9 iCT contactors - 60 Hz							
Type							
1P	Rating (In)		Control voltage (V AC) (60 Hz)	Consumption		Max. power	
	AC7a	AC7b		Holding	Inrush		
25 A	8.5 A		127	3.8 VA	15 VA	1.3 W	A9C20431
			220 ...240	2.7 VA	9.2 VA	0.9 W	A9C20631
2P							
16 A	5 A		127	3.8 VA	15 VA	1.3 W	A9C22415
			220...240	2.7 VA	9.2 VA	0.9 W	A9C22615
25 A	8.5 A		127	3.8 VA	15 VA	1.3 W	A9C20432
			220...240	2.7 VA	9.2 VA	0.9 W	A9C20632
			127	3.8 VA	15 VA	1.3 W	A9C20436
			220...240	2.7 VA	9.2 VA	0.9 W	A9C20636
40 A	15 A		127	4.6 VA	34 VA	1.6 W	A9C20442
			220...240	4.6 VA	34 VA	1.6 W	A9C20642
3P							
25 A	8.5 A		127	4.6 VA	34 VA	1.6 W	A9C20433
			220...240	4.6 VA	34 VA	1.6 W	A9C20633
40 A	15 A		127	6.5 VA	53 VA	2.1 W	A9C20443
			220...240	6.5 VA	53 VA	2.1 W	A9C20643
63 A	20 A		127	6.5 VA	53 VA	2.1 W	A9C20463
			220...240	6.5 VA	53 VA	2.1 W	A9C20663

Offer selection see page 499

Offer C

This sticker must be removed before publishing

Control
Remote control

Acti9 iCT contactors

Dimensions for Acti9 iCT

Dimensions (mm)

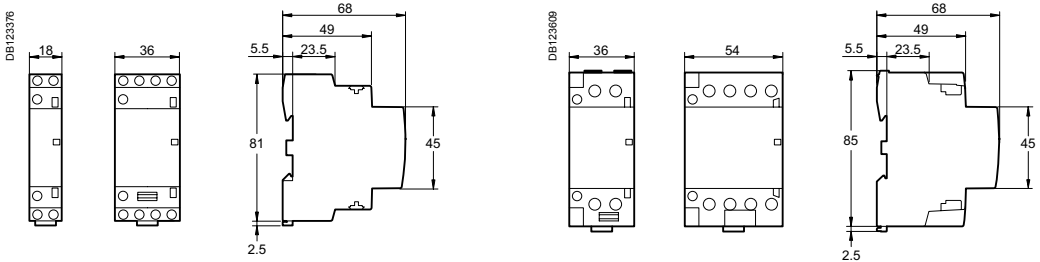

Acti9 iCT 16/25 A

Acti9 iCT 40/63 A

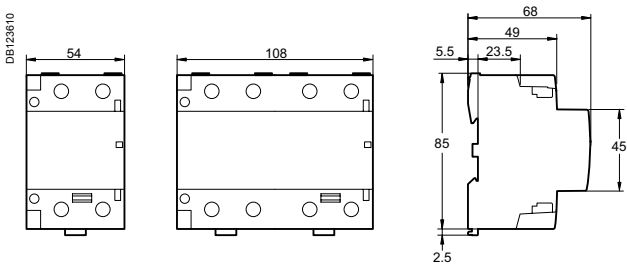

Acti9 iCT 100 A

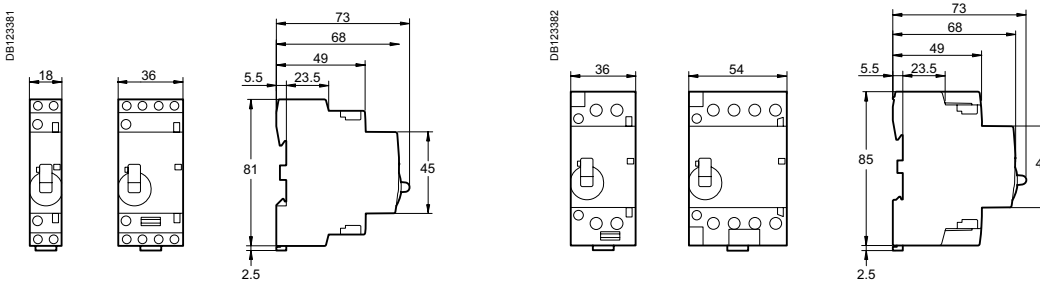

Acti9 iCT manual control contactor 16/25 A

Acti9 iCT manual control contactor 40/63 A

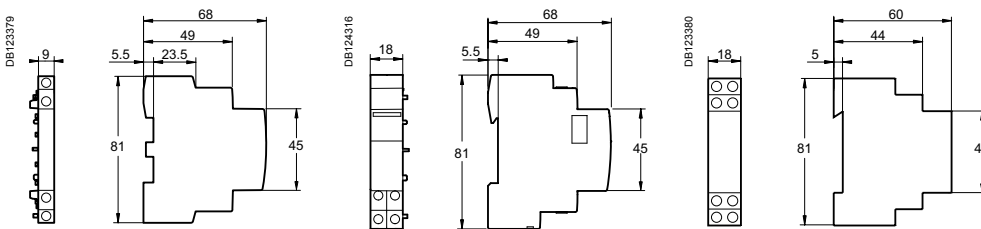

iACTs

iACT24

iATEt
iACTp
iACTc

Offer selection see page 499

Offer A, B, C

This sticker must be removed before publishing

Control Remote control iTL impulse relays

DB123399
CEBEC 12
DB110619
VDE
iTL, iTLI, iTLs, iTLc, iTLm
Country approval pictograms

IEC/EN 60669-2-2
iTLs: IEC/EN 60947-5-1

> Impulse relays



iTL
 ■ The impulse relays are used to control, by means of pushbuttons, lighting circuits consisting of:
 □ incandescent lamps, low-voltage halogen lamps, etc. (resistive loads)
 □ fluorescent lamps, discharge lamps, etc. (inductive loads)

> Remote indication



iTLs
 ■ Allows remote indication of its operating state (open/closed)



Indication iATLs
 ■ Allows remote indication of the associated impulse relay

> Centralised control



iTLc
 ■ Allows centralised control of a group of TLc impulse relays, whilst at the same time retaining local impulse-type control



Centralised control iATLc
 ■ Used for centralised control, thanks to a "pilot line", of a group of impulse relays controlling separate circuit, while at the same time maintaining local individual control of each impulse relay

> Latched control



iTLm
 ■ Operated by latched orders from a changeover contact (switch, time switch, thermostat). Manual control does not work



Latched control iATLm
 ■ Controls the associated impulse relay by latched orders from a changeover contact

Impulse relays

Control Remote control

iTL impulse relays (cont.)

Impulse relays are used:

- Closing of the impulse relay pole(s) is triggered by an impulse on the coil.
- Having two stable mechanical positions, the pole(s) will be opened by the next impulse. Each impulse received by the coil reverses the position of the pole(s).
- Can be controlled by an unlimited number of pushbuttons.
- Zero energy consumption.



Changeover contact iTLi

- This impulse relay has a changeover contact

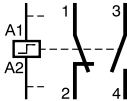

Extensions iETL

- Used to increase the number of impulse relay poles
- Can be installed on the iTL, iTLi, iTLc, iTLm and iTLs

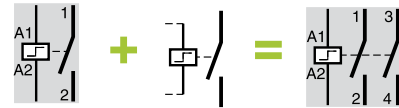

Centralised control + indication iATLc+s

- Used for centralised control, thanks to a "pilot line", of a group of impulse relays controlling separate circuit, while at the same time maintaining local individual control of each impulse relay
- Remote indication of the mechanical status of each relay



Multi-level centralised control iATLc+c

- Allows centralised control of a group of iTLc or "iTL + ATLc" impulse relays



Control and indication 24 V DC iATL24

- Allows control and indication of a 230 V AC impulse relay from the Acti 9 Smartlink or by a PLC, by 24 V DC signals
- Also allows control by a pulsed signal

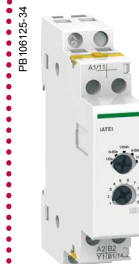

Time delay iATE

- Combined with an impulse relay, it automatically disconnects the circuit after a preset time



Control iATLz

- Must be used when installing several illuminated PBs in parallel to control an impulse relay (prevents operating malfunctions)



Step by step control iATL4

- Allows step-by-step control of two circuits via a single pushbutton

Impulse relays auxiliaries

Specific auxiliaries

Control

Remote control

iTL impulse relays (cont.)

Mounting accessories

11	Yellow clips	A9C15415
12	9 mm spacer	A9A27062
13	Clip-on terminal markers	see module CA907001

DB 123631

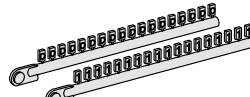

13



12



11

Auxiliaries

Centralised control	Control voltage	Cat. no.
2 iATLc ^{(1), (3)}	24...240 V AC	A9C15404
Indication		
3 iATLs ⁽¹⁾	-	A9C15405
Centralised control + indication		
4 iATLc+s ⁽³⁾	24...240 V AC	A9C15409
Multi-level centralised control		
5 iATLc+c ^{(2), (3)}	24...240 V AC	A9C15410
Step by step control		
6 iATL4	230 V AC	A9C15412
Control by illuminated push-buttons		
7 iATLz	230...240 V AC	A9C15413
Latched control		
8 iATLm ⁽¹⁾	12...240 V AC	A9C15414
Time delay control		
9 iATEt ⁽⁴⁾	24...240 V AC	A9C15419
Control and indication		
10 iATL24	230 V AC	A9C15424

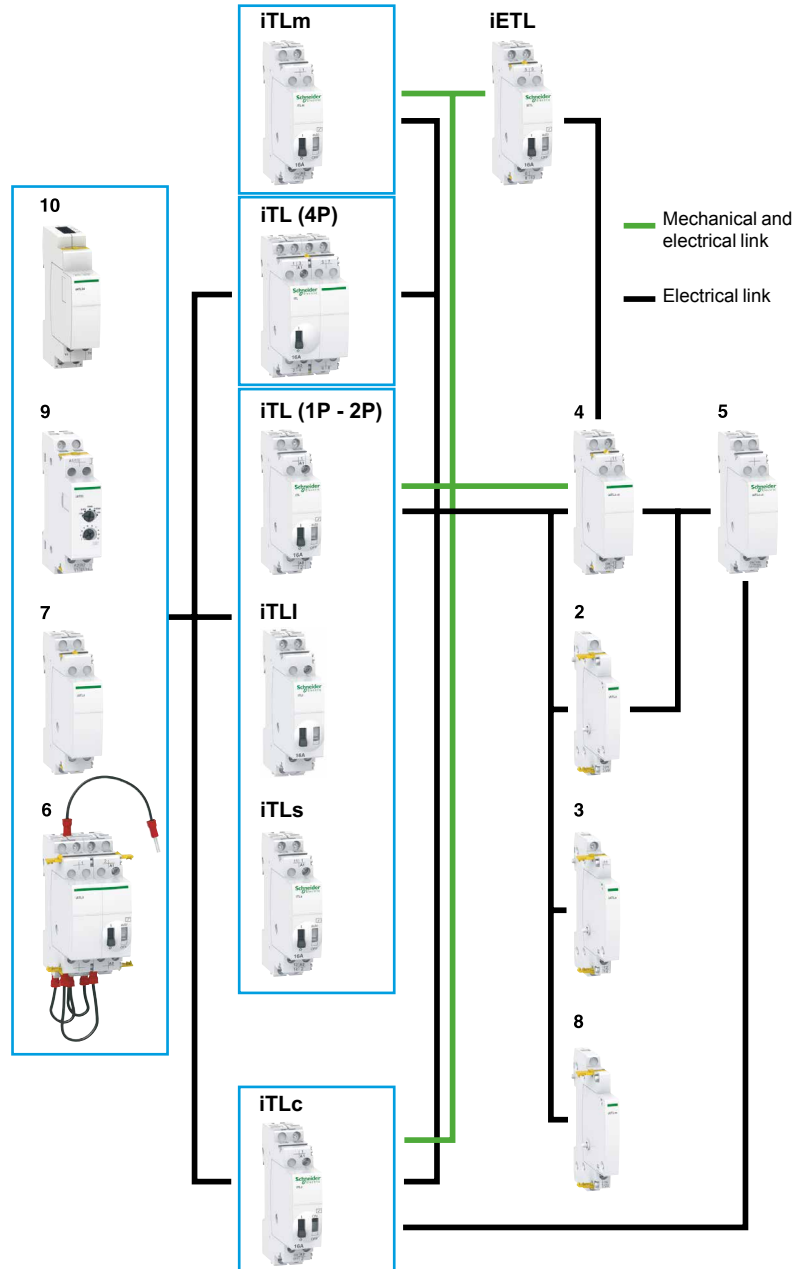

(1) The iATLc, iATLs and iATLm 9 mm auxiliaries must be mounted to the right of an impulse relay.

(2) Connection by traditional cabling.

The iATLc+c must be mounted to the right of an iATLc+s or an iATLc.

(3) The centralised control functions (iTLc, iATLc, iATLc+s, iATLc+c) only operate on AC voltage networks.

(4) iATEt: control voltage: 24...240 V AC, 24...110 V DC.

Control

Remote control

iTL impulse relays (cont.)

PE1010128-41

Yellow clip

- A simple clip-on system for flexible auxiliaries combination and improved robustness
- For electrical and mechanical connections

■ Insulated terminals IP20

■ Large circuit labeling area

■ Consistent with the entire Acti 9 offer and with all types of lighting

■ Manual controls on front face: direct and priority manual control by O-I toggle

■ Mechanical contact position indicator

■ Disconnection of remote control by selector switch (except for 4P single-piece iTL) for maintenance operation

■ Built-in or optional auxiliary function: state indication, centralised control, latched control, control for illuminated pushbutton, step-by-step control, time delay



Control

Remote control

iTL impulse relays (cont.)

Auxiliaries choice in V AC and V DC

V AC		Choice impulse relays auxiliaries																		
Type		Standard iTL					Changeover iTLI					iTLc centralised control			iTLm control on latched order		iTLs remote indication			
Rating	A	16					32					16			16		16			
Control voltage (Uc)	V AC	230/240	130	48	24	12	230/240	230/240	130	48	24	12	230/240	48	24	230/240	230/240	48	24	
Auxiliaries																				
Extension																				
iETL		■	■	■	■	■	■	■	■	■	■	■	■	■	■	■	■	■	■	■
Centralised control + indication																				
iATLc+s		■	■	■	■	-	■	■	■	-	-	-	-	-	-	-	-	■	■	■
Centralised control																				
iATLc		■	■	■	■	-	■	■	■	-	-	-	-	-	-	-	-	■	■	■
Indication																				
iATLs		■	■	■	■	-	■	■	■	■	■	■	■	■	■	■	■	■	■	■
Multi-level centralised control																				
iATLc+c		■	■	■	■	-	■	■	■	-	-	■	■	■	-	-	-	■	■	■
Latched control																				
iATLm		■	■	■	■	■	■	■	■	■	■	-	-	-	-	-	-	■	■	■
Control for illuminated Pushbutton																				
iATLz		■	-	-	-	-	■	■	-	-	-	■	-	-	-	-	-	■	-	-
Step by step control																				
iATL4		■	-	-	-	-	■	■	-	-	-	■	-	-	-	-	-	■	-	-
Time delay control																				
iATET		■	■	■	■	-	■	■	■	■	-	-	-	-	-	-	-	■	■	■
Control and indication																				
iATL24		■	-	-	-	-	■	■	-	-	-	■	-	-	-	-	-	■	-	-

V DC		Choice impulse relays auxiliaries																		
Type		Standard iTL					Changeover iTLI					iTLc centralised control			iTLm control on latched order		iTLs remote indication			
Rating	A	16					32					16			16		16			
Control voltage (Uc)	V DC	110	48	24	12	6	110	110	48	24	12	6	-	-	-	110	110	24	12	
Auxiliaries																				
Extension																				
iETL		■	■	■	■	■	■	■	■	■	■	-	-	-	-	-	-	■	■	■
Indication																				
iATLs		■	■	■	■	-	■	■	■	■	■	-	-	-	-	-	-	■	■	■
Time delay control																				
iATET		■	■	■	-	-	■	■	■	-	-	-	-	-	-	-	-	■	■	-

Control

Remote control

iTL impulse relays (cont.)

Catalogue numbers

iTL impulse relays				
Type	1P	2P	3P	4P
	1 NO	2 NO	1 NO + 1 NO/NC + 1 NO	4 NO
	2 NO + 1 NO/NC + 1 NO			2 NO + 1 NO/NC + 1 NO
Rating (In)	Control voltage (Uc)			
	(V AC)	(V DC)		
	(50/60 Hz)			
16 A	12	6	A9C30011	A9C30012
	24	12	A9C30111	A9C30112
	48	24	A9C30211	A9C30212
	130	48	A9C30311	A9C30312
	230...240	110	A9C30811	A9C30812
Width in 9 mm modules			2	2
	1 NO	1 NO + 1 NO	1 NO + 1 NO + 1 NO	1 NO + 1 NO + 1 NO + 1 NO
32 A	230...240	110	A9C30831	A9C30831 + A9C32836
Width in 9 mm modules			2	4
			6	8

iTLI impulse relays			
Type	2P		
	1 NO + 1 NC		
Rating (In)	Control voltage (Uc)		
	(V AC)	(V DC)	
	(50/60 Hz)		
16 A	12	6	A9C30015
	24	12	A9C30115
	48	24	A9C30215
	130	48	A9C30315
	230...240	110	A9C30815
Width in 9 mm modules			2

iETL extensions for iTL and iTLI			
Type	1P	2P	
	1 NO	1 NO/NC + 1 NO	
Rating (In)	Control voltage (Uc)		
	(V AC)	(V DC)	
	(50/60 Hz)		
16 A	12	6	-
	24	12	-
	48	24	-
	130	48	-
	230...240	110	-
32 A	230...240	110	A9C32836
Width in 9 mm modules			2

Control
Remote control

iTL impulse relays (cont.)

iTLc , iTLm, iTLs with built-in auxiliary function

Catalogue numbers (cont.)

		iTLc impulse relay with centralised control	
Type		1P	3P
		1NO	1 NO + 1 NO/NC + 1 NO
Rating (In)	Control voltage (Uc) (V AC) (50/60 Hz)		
16 A	24	A9C33111	A9C33111 + A9C32116
	48	A9C33211	A9C33211 + A9C32216
	230...240	A9C33811	A9C33811 + A9C32816
Width in 9 mm modules		2	4

		iTLm impulse relay with latched control	
Type		1P	3P
		1NO	1 NO + 1 NO/NC + 1 NO
Rating (In)	Control voltage (Uc) (V AC) (50/60 Hz)		
16 A	230...240	A9C34811	A9C34811 + A9C32816
	230...240	A9C34811	A9C34811 + A9C32816
Width in 9 mm modules		2	4





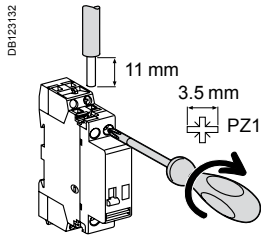

		iTLs impulse relay with remote indication*	
Type		1P	3P
		1NO	1 NO + 1 NO/NC + 1 NO
Rating (In)	Control voltage (Uc) (V AC) (50/60 Hz) (V DC)		
16 A	24	12	A9C32111
	48	24	A9C32211
	230...240	110	A9C32811
Width in 9 mm modules		2	4

(*) Short circuit protection device for indication contacts : 6 A gG fuse.



Control Remote control iTL impulse relays (cont.)

Connection



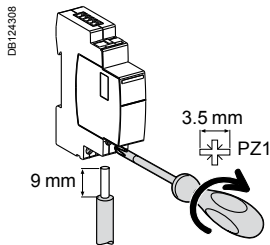

Type	Rating	Circuit	Tightening torque	Copper cables	
				Rigid or with ferrule	Flexible or with ferrule
iTL, iTLi, iTLc, iTLm, iTLs, iETL	16 A	Control	1 N.m		
		Power			
iTL, iETL	32 A	Control	1.2 N.m		
		Power			
iATLs, iATLc, iATLc+s, iATLc+c, iATLm, iATEt, iATL4, iATLz			1 N.m		

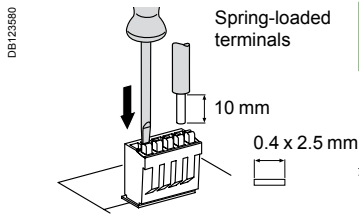

Type	Terminals	Tightening torque	Copper cables		
			Rigid	Flexible	Flexible or with ferrule
iATL24	Power supply (N/P) Input (Y1/Y2)	1 N.m	 0.5 to 10 mm ² 2 x 0.5 to 2 x 2.5 mm ²	 0.5 to 6 mm ² 2 x 0.5 to 2 x 2.5 mm ²	 0.5 to 4 mm ² 2 x 0.5 to 2 x 2.5 mm ²

Ti24 connector connection



Type	Catalogue numbers	Copper cables	
		Rigid	Flexible
Ti24 interface	A9XC2412	 1 x 0.5 to 1.5 mm ²	 1 x 0.5 to 1.5 mm ²

Ti24 prefabricated cables connection

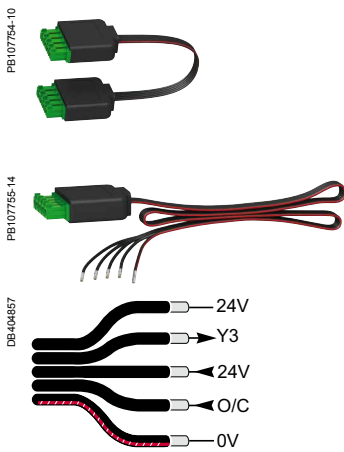

Type	Catalogue numbers	Length
Connection for Acti 9 Smartlink		
6 short prefabricated	A9XCAS06	100 mm
6 medium-sized prefabricated	A9XCAM06	160 mm
6 long prefabricated	A9XCAL06	870 mm
Connection for PLC type terminals		
6 long prefabricated on a single side	A9XCAU06	870 mm

Control Remote control iTL impulse relays (cont.)

Operation

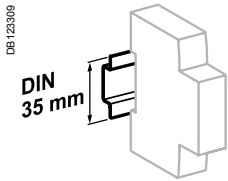
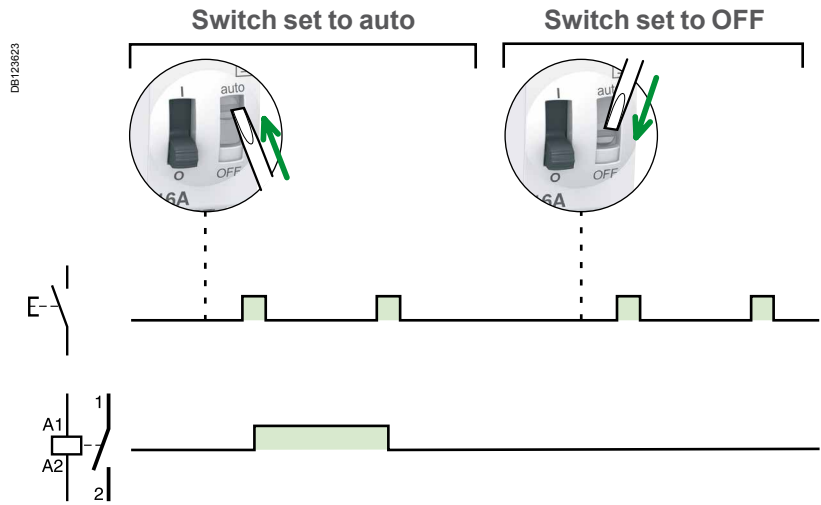

Clip on DIN rail 35 mm.

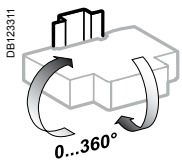

Indifferent position of installation.

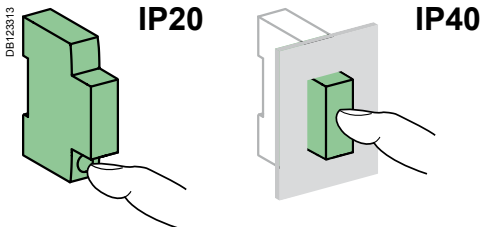

Technical data

Control circuit		iTL and iTLI 16 A iTLC, iTLm, iTLs, iETL 16 A	iTL 32 A, iETL 32 A
Control voltage (Uc)	Tolerance at 50 Hz	+6 %, -15 %	
	Tolerance at 60 Hz	±6 %	
	Tolerance V DC	+6 %, -10 %	
Dissipated power (during the impulse)	1, 2, 3P: 19 VA	19 VA	
	4P: 38 VA		
Illuminated PB control	Max. current 3 mA (if > use an ATLz)		
Operating threshold	Min. 85 % of Un in conformance with IEC/EN60669-2-2		
Duration of the control order	50 ms to 1 s (200 ms recommended)		
Response time	50 ms		
Power circuit			
Voltage rating (Ue)	1P, 2P	24 ...250 V AC	
	3P, 4P	24...415 V AC	
Frequency	50 Hz or 60 Hz		
Maximum number of operations per minute	5		
Maximum number of switching operation a day	100		
Additional characteristics			
Insulation voltage (Ui)	440 V AC		
Pollution degree	3		
Rated impulse withstand voltage (Uimp)	6 kV		
Overvoltage category	IV		
Endurance (O-C)			
Electrical	200,000 cycles (AC21)	50,000 cycles (AC21)	
	100,000 cycles (AC22)	20,000 cycles (AC22)	
Other characteristics			
Degree of protection (IEC 60529)	Device only	IP20	
	Device in modular enclosure	IP40 Insulation class II	
Operating temperature	-20°C to +50°C		
Storage temperature	-40°C to +70°C		
Tropicalization (IEC 60068-1)	Treatment 2 (relative humidity 95 % at 55°C)		





iTL impulse relays (cont.)

Electrical auxiliaries for iTL impulse relays

		Indication	Control		
Auxiliaries		iATLs	iATLc	iATLc+s	iATLc+c
Type		Indication	Centralised control	Centralised control + indication	Multi-level centralised control
Function		<ul style="list-style-type: none"> Allows remote indication of the associated impulse relay 	<ul style="list-style-type: none"> Used for centralised control, thanks to a "pilot line", of a group of impulse relays controlling separate networks, while at the same time maintaining local individual control of each impulse relay 	<ul style="list-style-type: none"> And for remote indication of the mechanical status of each relay 	<ul style="list-style-type: none"> Used to control the centralised controls of a number of impulse relay groups, while at the same time maintaining local individual control and centralised control by level
Wiring diagrams					
Mounting		<ul style="list-style-type: none"> Mounted to the right of iTL by yellow clips 	<ul style="list-style-type: none"> Mounted to the right of iTL by yellow clips 	<ul style="list-style-type: none"> Mounted to the right of iTL by yellow clips 	<ul style="list-style-type: none"> Without mechanical link with impulse relays and auxiliaries
Catalogue numbers		A9C15405	A9C15404	A9C15409	A9C15410
Technical specifications					
Control voltage (Uc)	V AC	—	24...240	24...240	24...240
	V DC	—	—	—	—
Control voltage frequency	Hz	—	50/60	50/60	50/60
Width in 9 mm modules		1	1	2	2
Auxiliary contact (breaking capacity)		<ul style="list-style-type: none"> Minimum: 10 mA at 24 V AC/DC Maximum (IEC 60947-5-1): <ul style="list-style-type: none"> 12...240 V AC 6 A 12...24 V DC 6 A 15...240 V AC 2 A 13...24 V DC 2 A 	—	<ul style="list-style-type: none"> Minimum: 10 mA at 24 V AC/DC Maximum (IEC 60947-5-1): <ul style="list-style-type: none"> 12...240 V AC 6 A 12...24 V DC 6 A 15...240 V AC 2 A 13...24 V DC 2 A 	—
Number of contacts		—	—	—	—
Operating temperature	°C	-20°C to +50°C			
Storage temperature	°C	-40°C to +70°C			

iTL impulse relays (cont.)

Electrical auxiliaries for iTL impulse relays (cont.)

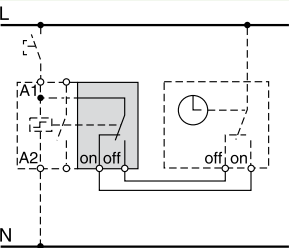
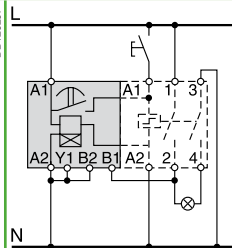
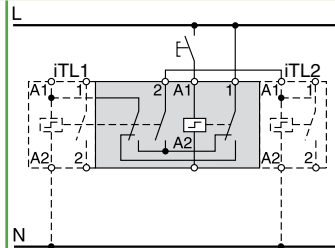
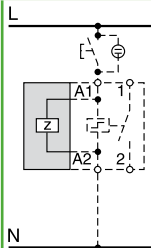
Control				
	iATLm	iATEt	iATL4	iATLz
	Latched control	Time delay	Step by step control	Control by illuminated push-buttons
				
	<ul style="list-style-type: none"> Combined with an impulse relay, it operates on latched orders 	<ul style="list-style-type: none"> Combined with an impulse relay, it automatically disconnects the circuit after a preset time 	<ul style="list-style-type: none"> Allows the step by step sequence over 2 circuits 	<ul style="list-style-type: none"> Used to control impulse relays by illuminated push-buttons, without operating risks
				
		<ul style="list-style-type: none"> 5 time setting ranges: <ul style="list-style-type: none"> 1 to 10 s 6 to 60 s 2 to 10 min 6 to 60 min 2 to 10 h 	<ul style="list-style-type: none"> The cycle is as follows: <ul style="list-style-type: none"> 1st impulse - iTL 1 closed, iTL 2 open 2nd impulse - iTL 1 open, iTL 2 closed 3rd impulse - iTL 1 and 2 closed 4th impulse - iTL 1 and 2 open 5th impulse - iTL 1 closed, iTL 2 open, etc 	<ul style="list-style-type: none"> Provide an iATLz when the current drawn up by the illuminated push-buttons is higher than 3 mA (this current is sufficient to keep the coils energised). Above this value, fit one extra iATLz per 3 mA. For example: for 7 mA, fit 2 iATLz
	<ul style="list-style-type: none"> Mounted to the right of iTL by yellow clips 	<ul style="list-style-type: none"> Mounted to the left of iTL by yellow clips 	<ul style="list-style-type: none"> Assembled between 2 impulse relays: according to the auxiliarisation table by yellow clips 	<ul style="list-style-type: none"> Mounted to the left of iTL by yellow clips
	A9C15414	A9C15419	A9C15412	A9C15413
	12...240	24...240	230	230...240
	—	24...110	—	—
	50/60	50/60	50/60	50/60
	1	2	4	2
	—	—	—	—
	—	—	—	—
	-20°C to +50°C	—	—	—
	-40°C to +70°C	—	—	—

iTL impulse relays (cont.)

Electrical auxiliaries for iTL impulse relays (cont.)

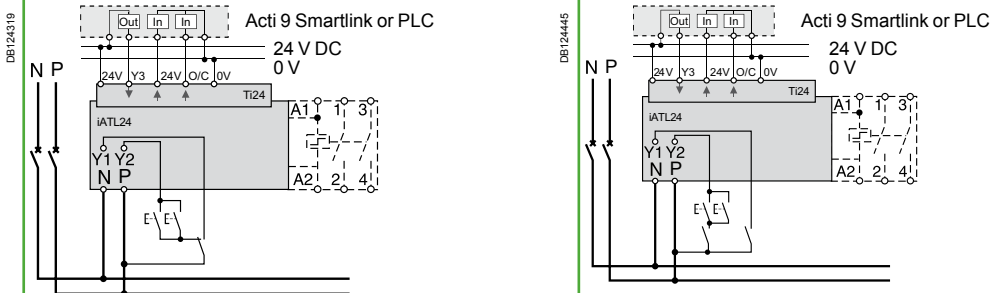
		Control and indication	
Auxiliaire		iATL24	
Type		Control and indication 24 V DC	
		With Ti24 connector	
			
Function		<ul style="list-style-type: none"> This auxiliary allows a impulse relay to be interfaced with the Acti 9 Smartlink interface or a programmable logic controller (PLC) in 24 V DC (control, O/C indication) 230 V AC control 	
Wiring diagrams			
Mounting		<ul style="list-style-type: none"> To the left of the iTL impulse relay using the yellow clips⁽¹⁾. When an iATL24 is used, the A1/A2 terminals of the impulse relay should not be wired. Only the yellow clips integral with the iATL24 should be used for connection to the coil. 	
Utilization		<ul style="list-style-type: none"> 230 V AC interface: <ul style="list-style-type: none"> Y1: enabling of 24 V DC control (Y1 = 1) or inhibition of 24 V DC control (Y1 = 0). Y2: 230 V pulse control "Ti24" 24 V DC interface: <ul style="list-style-type: none"> Y3: 24 V DC control of iTL closing on rising edge and opening on falling edge reading of the impulse relay status (opened or closed) from the position of the integrated O/C auxiliary contact monitoring of connection of the "Ti24" terminal block by the upstream system (PLC, supervision system) via the 24 V terminal (in the centre of the Ti24 terminal block) 	
Catalogue numbers		A9C15424	
Technical specifications			
Control voltage (Uc)	V AC	230, +10 %, -15 % (Y2)	
	V DC	24, ± 20 % (Y3)	
Control voltage frequency	Hz	50/60	
Insulation voltage (Ui)	V AC	250	
Rated impulse withstand voltage (Uimp)	kV	8 (OVC IV)	
Pollution degree		3	
Degree of protection		IP20B device only	
		IP40 device in modular enclosure	
Width in 9 mm modules		2	
Auxiliary contact (O/C) Ti24		24 V DC protected output, min. 2 mA, max. 100 mA	
Contact		1 O/C operating category AC 14	
Operating temperature	°C	-25°C to +60°C	
	°C	-40°C to +80°C	
Storage temperature	°C	-40°C to +80°C	
Consumption		<1 W	
Standard		IEC/EN 60947-5-1	

(1) Mechanical and electrical connection.

iTL impulse relays (cont.)

Electrical auxiliaries for iTL impulse relays (cont.)



Operation of the iATL24

O/C 24 V DC output

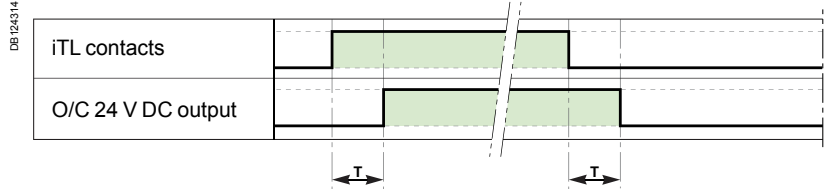

Parameter	Min	Max
T Time delay between iATL24 closing and indication	100 ms	200 ms

- Minimum duration of 230 V AC pulse (Y2): 200 ms.
- 30 iATL24 closing or opening actuations are authorized per minute: Minimum time delay between 2 actuations on the iATL24 via Y1, Y2, Y3 (closing or opening of the iTL coil): 440 ms.
- 10 closing or opening actuations spaced 440 milliseconds apart are authorized following no loading of the iATL24 during a period of 20 seconds.

Wiring with exclusive selector 230 V AC and 24 V DC controls

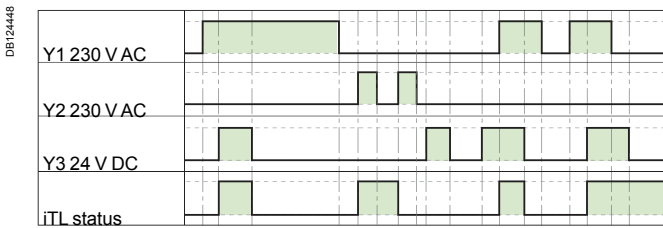
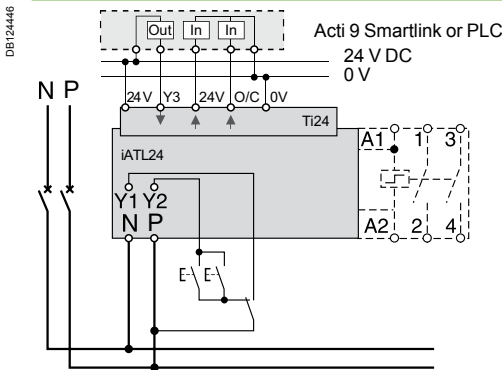

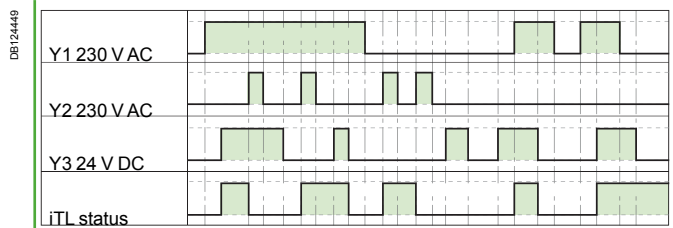
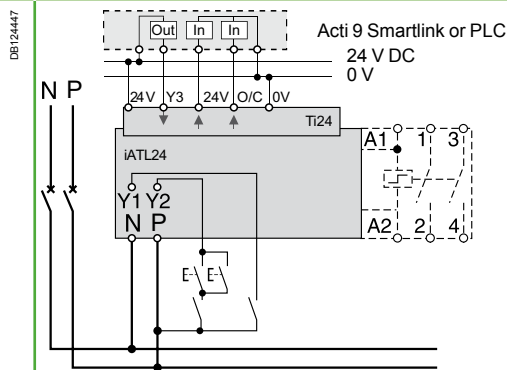

Wiring for non-exclusive 230 V AC and 24 V DC controls



Control
Remote control

iTL impulse relays (cont.)
Accessories for iTL impulse relays

		Security	
Accessories		Yellow clips	Spacer
		 <p>PB106143-10</p>	 <p>PB104483</p>
Function		<ul style="list-style-type: none"> Ensure the mechanical and/or electrical link between impulse relays and their auxiliaries (set of 10). 	<ul style="list-style-type: none"> Required to reduce temperature rise of modular devices installed side by side. Recommended to separate electronic devices (thermostat, programmable clock, etc.) from electromechanical devices (relays, contactors).
Catalogue numbers		A9C15415	A9A27062
Technical specifications			
Width in 9 mm modules		-	1

Dimensions (mm)

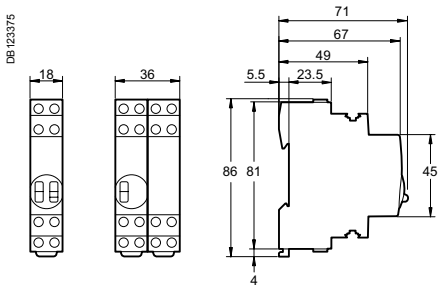

iTL 1P
iTLc
iTLm
iTLs
iTLi
iETL

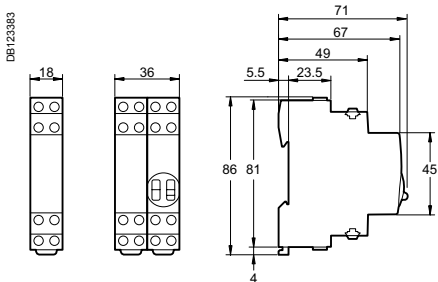

iATLc+s
iATLc+c
iATLz
iATL4

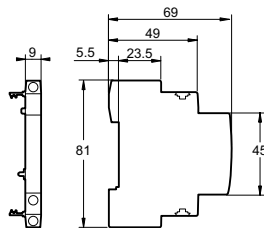

iATLc
iATLs
iATLm

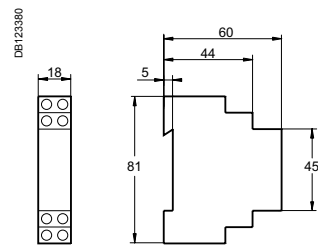

iATET

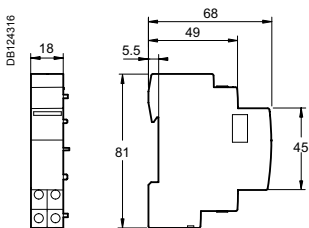

iATL24



Control / Remote control

TL impulse relays

Clario, Prodis, Libro

Contents

The Schneider Electric range of TL impulse relays comprises various offers (Clario, Prodis, Libro) so as to be as competitive as possible in each country, taking into account the specific features of each market:

- installation customs
- price
- approval by local organizations.

Variants

Offers		Pages
Clario	Catalogue numbers	548
Prodis	Catalogue numbers	549
Libro	Catalogue numbers	550
Common pages		551

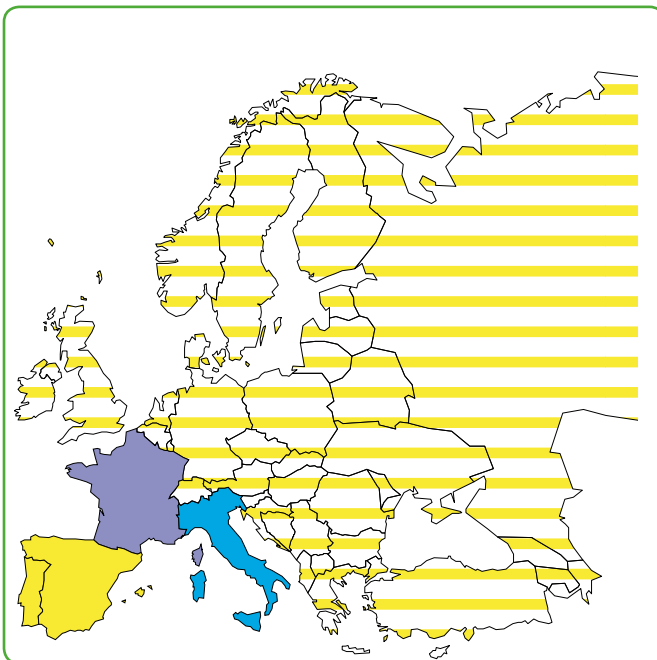

Only the product range to be marketed in your country and validated by the local product manager, in agreement with his Final Distribution (FD) partner should be retained. The others will be removed before publication.

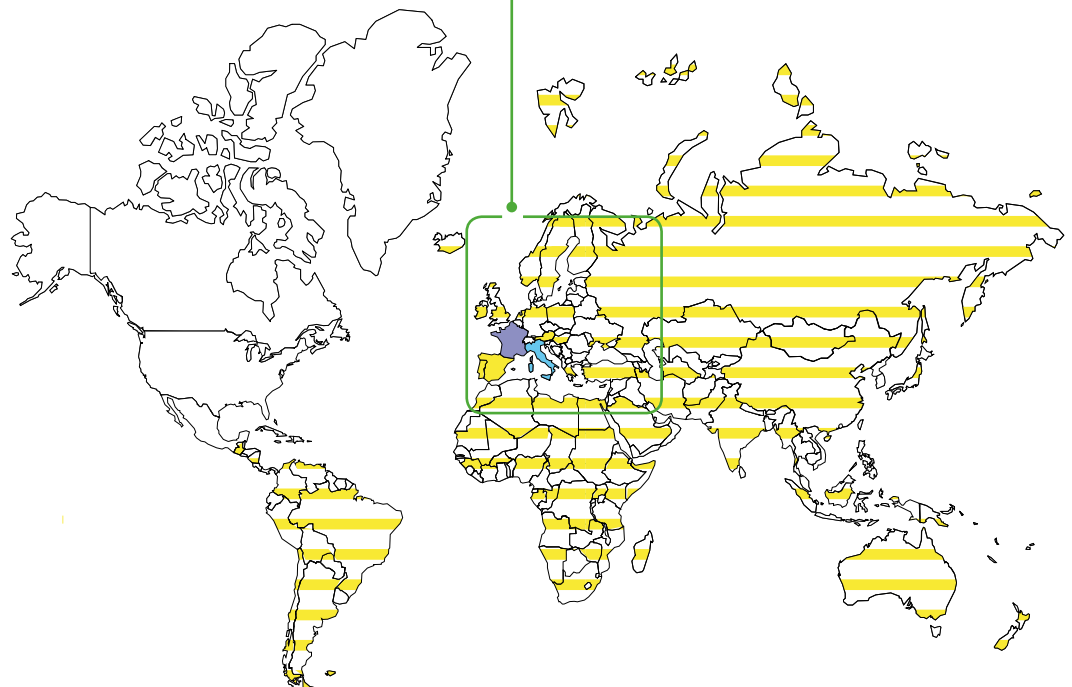

Control

Remote control

TL impulse relays

Clario

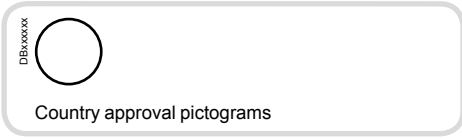

TL impulse relays allow remote control of single-phase circuits.

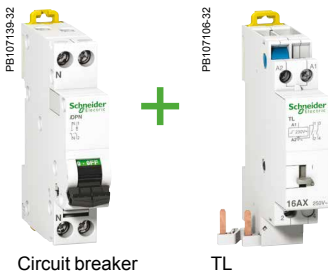

IEC 60669-1 and IEC 60669-2-2

TL impulse relays are combined with single-phase circuit breakers or residual current devices.

Operation

TL impulse relays:

- have normally open contacts
- are controlled by impulse type electrical orders. One or more control points are possible.

Catalogue numbers

TL impulse relays			
Type	Rating		Width in 9-mm modules
1P			
	16 A	A9C15488	2
2P			
	16 A	A9C15489	2



Control

Remote control

TL impulse relays

Prodis

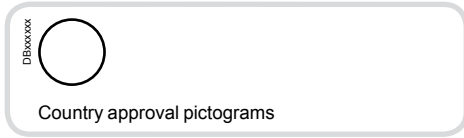

TL impulse relays allow remote control of single-phase circuits.

IEC 60669-1 and IEC 60669-2-2

TL impulse relays are combined with single-phase circuit breakers or residual current devices.

Operation

TL impulse relays:

- have normally open contacts
- are controlled by impulse type electrical orders. One or more control points are possible.

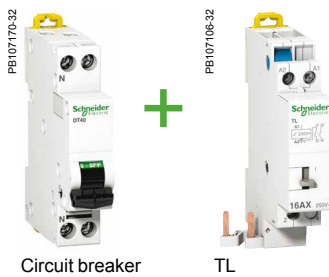

Circuit breaker

TL

Catalogue numbers

TL impulse relays			
Type	Rating		Width in 9-mm modules
1P			
	16 A	A9C15506	2
2P			
	16 A	A9C15507	2



Control

Remote control

TL impulse relays

Librio

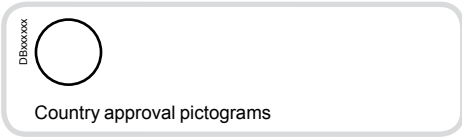

IEC 60669-1 and IEC 60669-2-2

TL impulse relays allow remote control of single-phase circuits.

TL impulse relays are combined with single-phase circuit breakers or residual current devices.

Operation

TL impulse relays:

- have normally open contacts
- are controlled by impulse type electrical orders. One or more control points are possible.

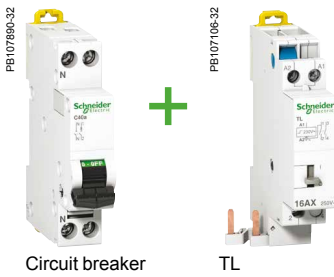

Catalogue numbers

TL impulse relays			
Type	Rating		Width in 9-mm modules
2P			
	16 A	A9C15485	2



Control

Remote control

TL impulse relays

Clario, Prodis, Libro

- Can be dismantled with the comb busbar in place
- A connector ensures a fast, reliable electrical connection with the line protection circuit breaker; a branch circuit remains possible at the circuit breaker outlet (e.g. safety lighting power supply). For cabling by wire, the connector can be dismantled
- The staggered terminals facilitate cable connection
- The operating handle on the front panel allows local manual control and indicates the status of the contacts

Connection

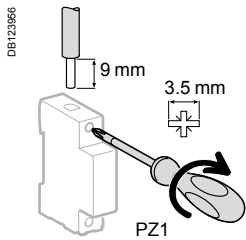

Circuit	Tightening torque	Copper cables	
		Rigid	Flexible or with ferrule
Power	1 N.m	1 x 1 to 4 mm ² 2 x 1 to 2,5 mm ²	1 x 1 to 4 mm ² 2 x 1 to 2,5 mm ²
Control	1 N.m	1 x 0,5 to 1,5 mm ²	1 x 0,5 to 1,5 mm ²

2 possible connections

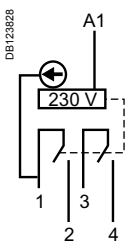

Figure 1:
Coil cabling with 1 wire

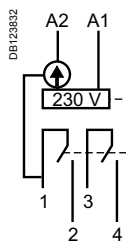
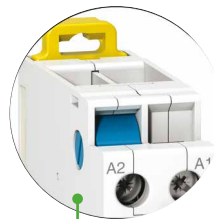
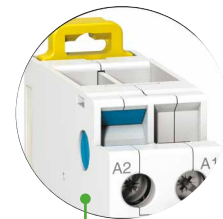

Figure 2:
Coil cabling with 2 wires



■ Cabling with a single wire



■ Standard cabling

Control

Remote control

TL impulse relays

Clario, Prodis, Libro (cont.)

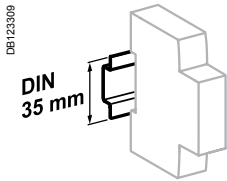

Clip on DIN rail 35 mm.

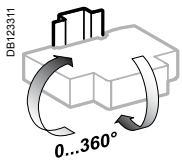

Indifferent position of installation.

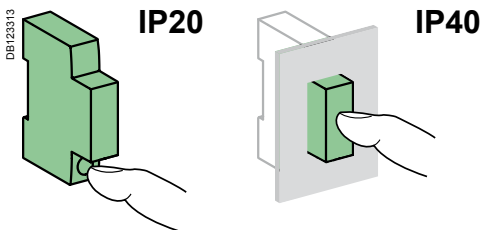

Technical data

Control circuit		
Coil voltage (Uc)	230/240 V AC	
Frequency	50 Hz	
Inrush power	19 VA	
Control by luminous push buttons	Max. current consumption = 3 mA	
Power circuit		
Voltage rating (Ue)	250 V AC	
Frequency	50 Hz	
Max. number of switching operations per minute	5	
Pulse duration	50 ms (recommended value for automatic control: 200 ms)	
Additional characteristics		
Insulation voltage (Ui)	500 V AC	
Noise level at activation	< 60 dBA (to 1 m)	
Pollution degree	3	
Rated impulse withstand voltage (Uimp)	2.5 kV	
Degree of protection (IEC 60529)	Device only	IP20
	Device in modular enclosure	IP40
Endurance (O-C)	Electrical	200 000 cycles (AC22)
Operating temperature		-20°C to +50°C
Storage temperature		-40°C to +80°C
Tropicalization		Treatment 2 (relative humidity of 95 % at 55°C)

Weight (g)

TL impulse relays	
1P	100
2P	105

Dimensions (mm)

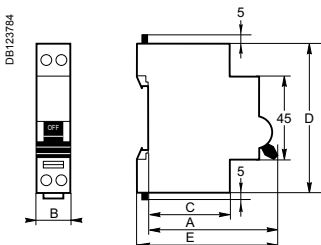

TL impulse relays					
Type	A	B	C	D	E
1P/2P	63	18	44	81	69

Control / Remote control

CT contactors

Clario, Prodis, Libro

Contents



The Schneider Electric range of CT contactors comprises various offers (Clario, Prodis, Libro) so as to be as competitive as possible in each country, taking into account the specific features of each market:

- installation customs
- price
- approval by local organizations.

Variants

Offers	Catalogue numbers	Pages
Clario	Catalogue numbers	554
Prodis	Catalogue numbers	555
Libro	Catalogue numbers	556
Common pages		557

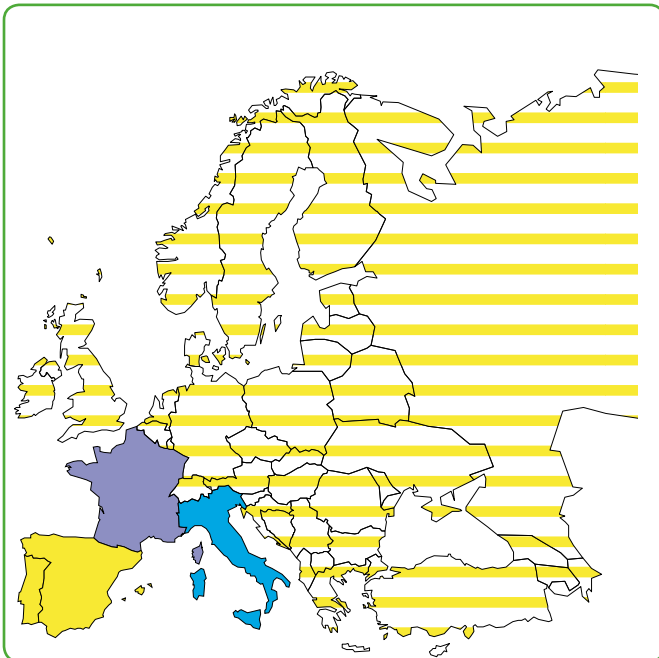

Only the product range to be marketed in your country and validated by the local product manager, in agreement with his Final Distribution (FD) partner should be retained. The others will be removed before publication.

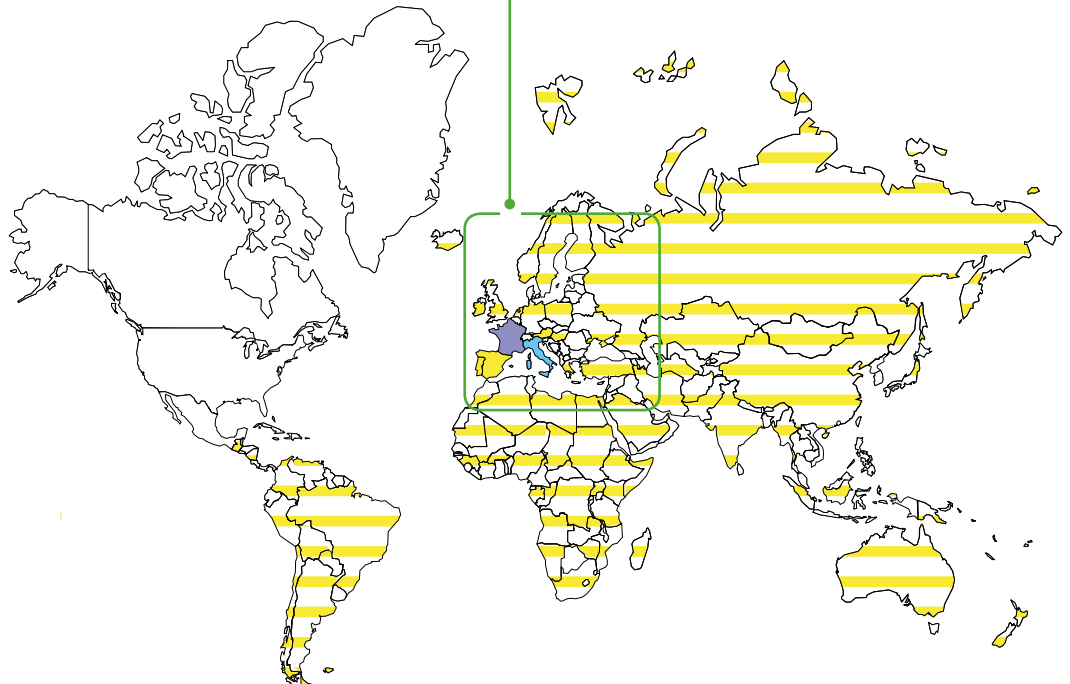

Control Remote control CT contactors Clario



IEC/EN 61095

CT contactors combined with single-phase circuit breakers or residual current devices, allow remote control of single-phase circuits.

Operation

CT contactors:

- have normally open contacts
- are controlled by latched type electrical orders.

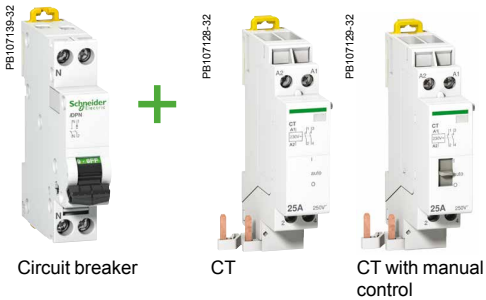

Catalogue numbers

CT contactors			
Type	Rating		Width in 9-mm modules
2P			
<p>DB123663</p>	25 A	A9C15180	2
2P with manual control			
<p>DB123664</p>	25 A	A9C15181	2



Control Remote control CT contactors Prodis



IEC/EN 61095

CT contactors combined with single-phase circuit breakers or residual current devices, allow remote control of single-phase circuits.

Operation

CT contactors:

- have normally open contacts
- are controlled by latched type electrical orders.

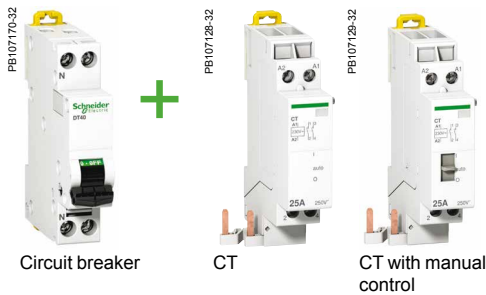

Catalogue numbers

CT contactors			
Type	Rating		Width in 9-mm modules
2P			
	25 A	A9C15185	2
2P with manual control			
	25 A	A9C15186	2



Control Remote control CT contactors Librio



IEC/EN 61095

CT contactors combined with single-phase circuit breakers or residual current devices, allow remote control of single-phase circuits.

Operation

CT contactors:

- have normally open contacts
- are controlled by latched type electrical orders.

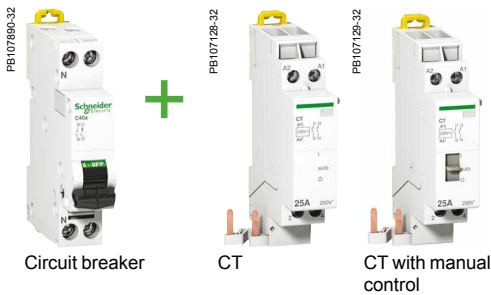

Catalogue numbers

CT contactors			
Type	Rating		Width in 9-mm modules
2P			
<p>DB123863</p>	25 A	A9C15182	2
2P with manual control			
<p>DB123864</p>	25 A	A9C15183	2



Control

Remote control

CT contactors

Clario, Prodis, Librio

■ The staggered terminals facilitate cable connection

■ A connector ensures a fast, reliable electrical connection with the line protection circuit breaker; a branch circuit remains possible at the circuit breaker outlet (e.g. safety lighting power supply). For cabling by wire, the connector can be dismantled

■ Every circuit breaker combined with a CT contactor remains compatible with the indication and tripping auxiliaries

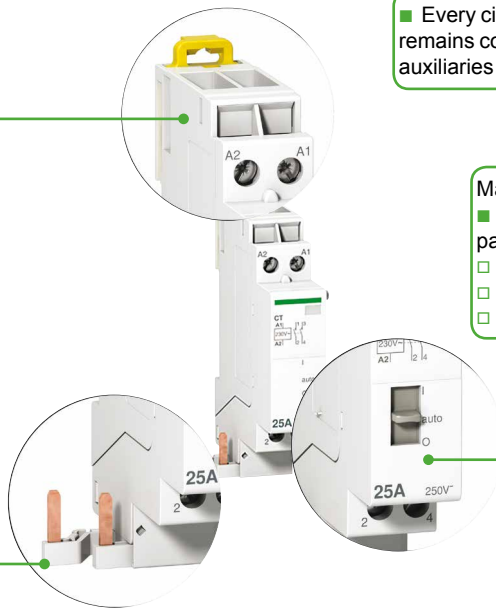

Manual-control CT contactors:

- Have a 3-position selector on the front panel:
 - automatic operation
 - temporary forced starting
 - permanent stoppage

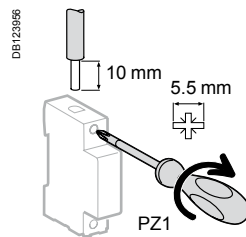

Connection



Rating	Tightening torque	Copper cables	
		Rigid	Flexible or with ferrule
25 A	0.8 N.m	 ≤ 6 mm ²	 ≤ 6 mm ²

Control

Remote control

CT contactors

Clario, Prodis, Libro (cont.)

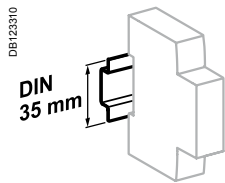

Clip on DIN rail 35 mm.

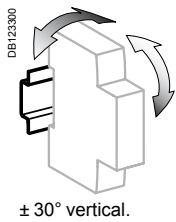

± 30° vertical.

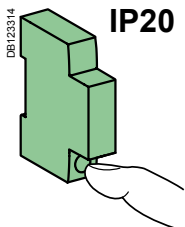

IP20

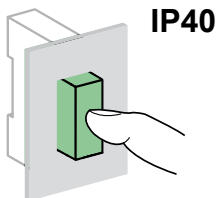

IP40

Technical data

Control circuit		
Coil voltage (Uc)	230 V AC	
Frequency	50 Hz	
Inrush power	15 VA	
Holding power	3.8 VA	
Voltage presence indicating system on front panel	Red indicator: coil energized	
Power circuit		
Voltage rating (Ue)	250 V AC	
Frequency	50 Hz	
Max. number of switching operations per minute	6	
Max. number of switching operations per day	100	
Additional characteristics		
Insulation voltage (Ui)	500 V AC	
Silent operation	< 20 dB	
Pollution degree	2	
Rated impulse withstand voltage (Uimp)	2.5 kV	
Degree of protection (IEC 60529)	Device only Device in modular enclosure	IP20 IP40 Insulation class II
Operating temperature	-5°C to +60°C	
Storage temperature	-40°C to +60°C	
Tropicalization	Treatment 2 (relative humidity 95 % to 55°C)	

Weight (g)

CT contactors	
Standard 2P	110
2P with manual control	120

Dimensions (mm)

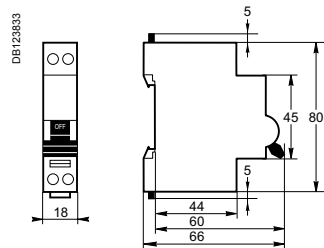

Control

Remote control

Acti9 TL40 impulse relays

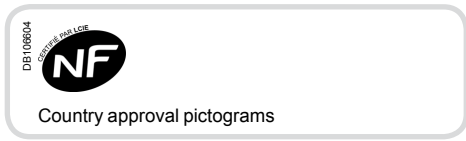

IEC 60669-1 and IEC 60669-2-2

Acti9 TL40 impulse relays allow remote control of single-phase circuits.

Acti9 TL40 impulse relays are combined with single-phase circuit breakers or residual current devices.

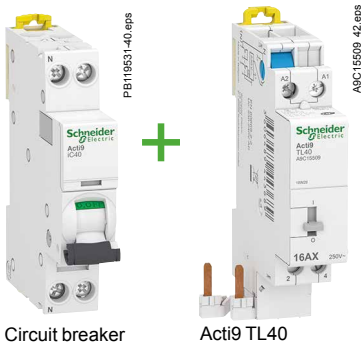

Circuit breaker

Acti9 TL40

Operation

Acti9 TL40 impulse relays:

- have normally open contacts
- are controlled by impulse type electrical orders. One or more control points are possible.

Catalogue numbers

Acti9 TL40 impulse relays			
Type	Rating		Width in 9-mm modules
1P			
	16 A	A9C15504	2
2P			
	16 A	A9C15509	2



A9C15504



A9C15509

Control



Remote control

Acti9 TL40 impulse relays (cont.)

- Can be dismantled with the comb busbar in place
- Clear space to allow comb busbar installation
- The staggered terminals facilitate cable connection
- A connector ensures a fast, reliable electrical connection with the line protection circuit breaker; a branch circuit remains possible at the circuit breaker outlet (e.g. safety lighting power supply). For cabling by wire, the connector can be dismantled
- The operating handle on the front panel allows local manual control and indicates the status of the contacts

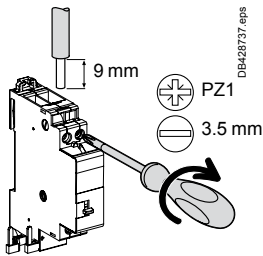
Connection



Circuit	Tightening torque	Copper cables	
		Rigid	Flexible or with ferrule
Power	1 N.m	 DB122845.eps 1 x 1 to 4 mm ² 2 x 1 to 2.5 mm ²	 DB122846.eps 1 x 1 to 4 mm ² 2 x 1 to 2.5 mm ²
Control	1 N.m	1 x 0.5 to 1.5 mm ²	1 x 0.5 to 1.5 mm ²

2 possible connections

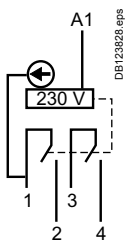

Figure 1: Coil cabling with 1 wire

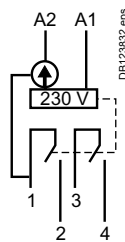
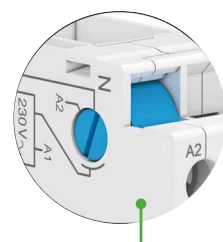
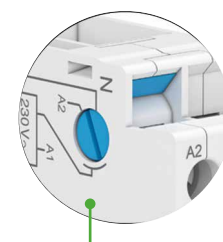

Figure 2: Coil cabling with 2 wires



■ Cabling with 1 wire



■ Cabling with 2 wires

Control Remote control Acti9 TL40 impulse relays (cont.)

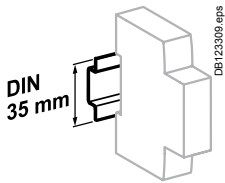

Clip on DIN rail 35 mm.

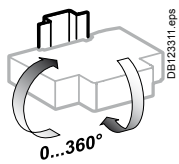

Indifferent position of installation.

IP20

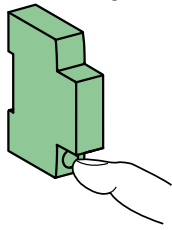

IP40

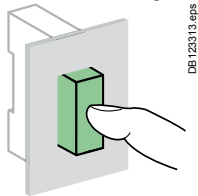

Dimensions (mm)

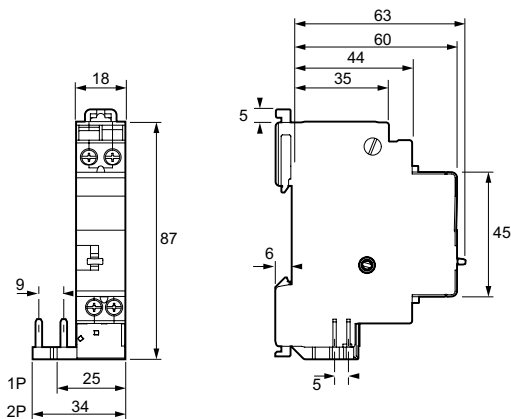

Weight (g)

Acti9 TL40 impulse relays	
1P	100
2P	105

Technical data

Control circuit		
Coil voltage (Uc)	230 V CA	
Frequency	50 Hz	
Inrush power	19 VA	
Control by luminous push buttons	Max. current consumption = 3 mA	
Power circuit		
Voltage rating (Ue)	250 V CA	
Frequency	50 Hz	
Max. number of switching operations per minute	5	
Pulse duration	50 ms (recommended value for automatic control: 200 ms)	
Additional characteristics		
Insulation voltage (Ui)	500 V CA	
Noise level at activation	< 60 dBA (to 1 m)	
Pollution degree	3	
Rated impulse withstand voltage (Uimp)	2.5 kV	
Degree of protection (IEC 60529)	Device only	IP20
	Device in modular enclosure	IP40
Endurance (O-C)	Electrical	200 000 cycles (AC-22)
Operating temperature	-20°C to +50°C	
Storage temperature	-40 °C to +80°C	
Tropicalization	Treatment 2 (relative humidity of 95 % at 55°C)	

Control

Remote control

Acti9 CT40 contactors



IEC/EN 61095

Acti9 CT40 contactors combined with single-phase circuit breakers or residual current devices, allow remote control of single-phase circuits.

Operation

Acti9 CT40 contactors:

- have normally open contacts
- are controlled by latched type electrical orders.

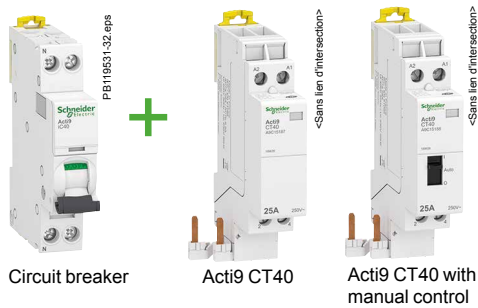

Catalogue numbers

Acti9 CT40 contactors			
Type	Rating		Width in 9-mm modules
2P			
	25 A	A9C15187	2
2P with manual control			
	25 A	A9C15188	2

Acti9 CT40 contactors (cont.)

■ Clear space to allow comb busbar installation

■ The staggered terminals facilitate cable connection

■ A connector ensures a fast, reliable electrical connection with the line protection circuit breaker; a branch circuit remains possible at the circuit breaker outlet (e.g. safety lighting power supply). For cabling by wire, the connector can be dismantled

Manual-control Acti9 CT40 contactors:
 ■ Have a 3-position selector on the front panel:
 automatic operation
 temporary forced starting
 permanent stoppage

DB428850.eps
A2 A1
A2 A1
A2 A1
DB428852.eps
DB428851.eps
25A 250V~
18W28
Auto
25A 250V~

Connection

10 mm
PZ1
5.5 mm
DB428728.eps

Rating	Tightening torque	Copper cables	
		Rigid	Flexible or with ferrule
25 A	0.8 N.m	DB172245.eps ≤ 6 mm ²	DB172246.eps ≤ 6 mm ²

Acti9 CT40 contactors (cont.)

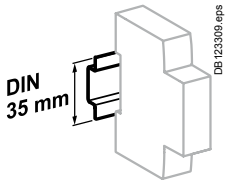

Clip on DIN rail 35 mm.

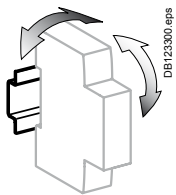

± 30° vertical.

IP20

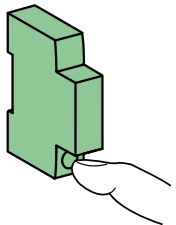

IP40

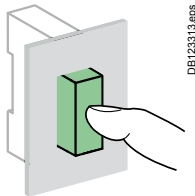

Technical data

Control circuit					
Coil voltage (Uc)	230 V CA				
Frequency	50 Hz				
Inrush power	15 VA				
Holding power	3.8 VA				
Voltage presence indicating system on front panel	Red indicator: coil energized				
Power circuit					
Voltage rating (Ue)	250 V CA				
Frequency	50 Hz				
Max. number of switching operations per minute	6				
Max. number of switching operations per day	100				
Additional characteristics					
Insulation voltage (Ui)	500 V CA				
Silent operation	< 20 dB				
Pollution degree	2				
Rated impulse withstand voltage (Uimp)	2.5 kV				
Degree of protection (IEC 60529)	<table border="1"> <tr> <td>Device only</td> <td>IP20</td> </tr> <tr> <td>Device in modular enclosure</td> <td>IP40</td> </tr> </table> Insulation class II	Device only	IP20	Device in modular enclosure	IP40
Device only	IP20				
Device in modular enclosure	IP40				
Operating temperature	-5°C to +60°C				
Storage temperature	-40°C to +60°C				
Tropicalization	Treatment 2 (relative humidity 95 % to 55°C)				

Weight (g)

Acti9 CT40 contactors	
Standard 2P	110
2P with manual control	120

Dimensions (mm)

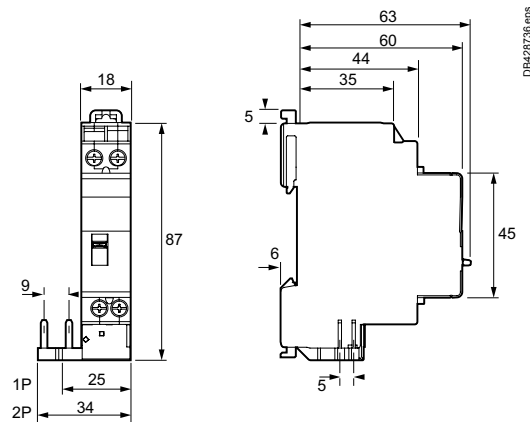

Control Remote control iTL+ high-performance impulse relays

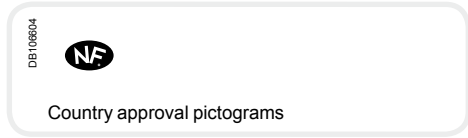

EN 60669-2-2

The iTL+ high-performance impulse relay allows remote control of single-phase circuits. It is designed for demanding applications.

The iTL+ high-performance impulse relay is used for push-button control of lighting circuits consisting of:

- incandescent lamps, low-voltage halogen lamps, etc. (resistive loads)
- fluorescent tubes, discharge lamps, etc. (inductive loads).

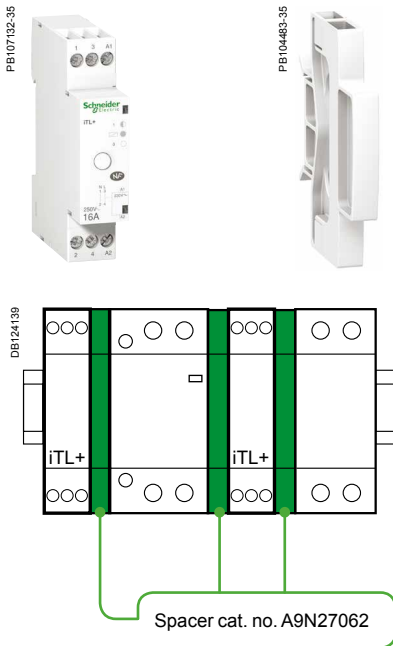

iTL+			
Type	Rating		Width in 9 mm modules
1P+N	16 A	A9C15032	2+1 ⁽¹⁾

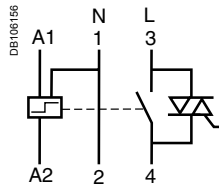

(1) Supplied with a 9 mm spacer (cat. no. A9N27062): to be used for mounting the iTL+ alongside a circuit breaker, contactor, impulse relay, etc., in order to maintain optimal operation.



- It is compulsory:**
- to connect the neutral
 - to keep the same control circuit connection "A1: phase", "A2: neutral"
 - to use the same phase for connection of the power and control functions.

Operation

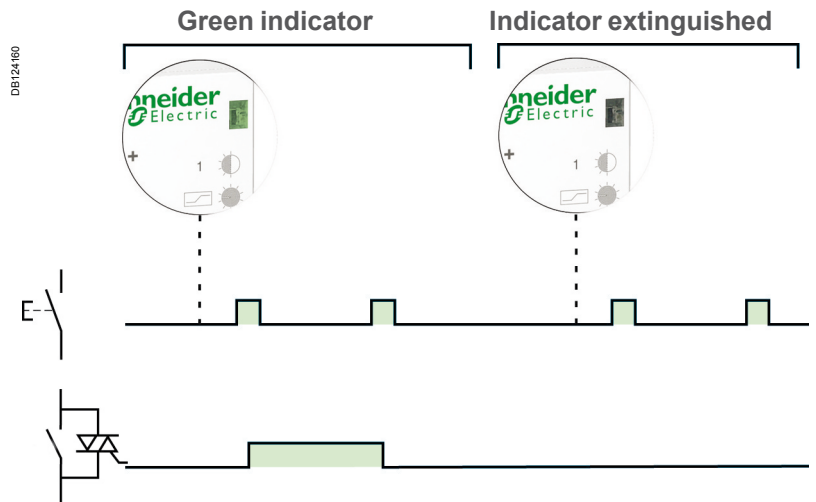

Connection

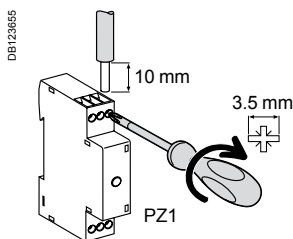

Type	Rating	Tightening torque	Copper cables	
			Rigid or flexible with ferrule	Rigid or flexible without ferrule
iTL+	16 A	1 N.m	 2 x 1.5 mm ²	 2 x 2.5 mm ² 1 x 4 mm ²

iTL+ high-performance impulse relays (cont.)

They combine the benefits of static switching and electromechanical technology: small size, little temperature rise.

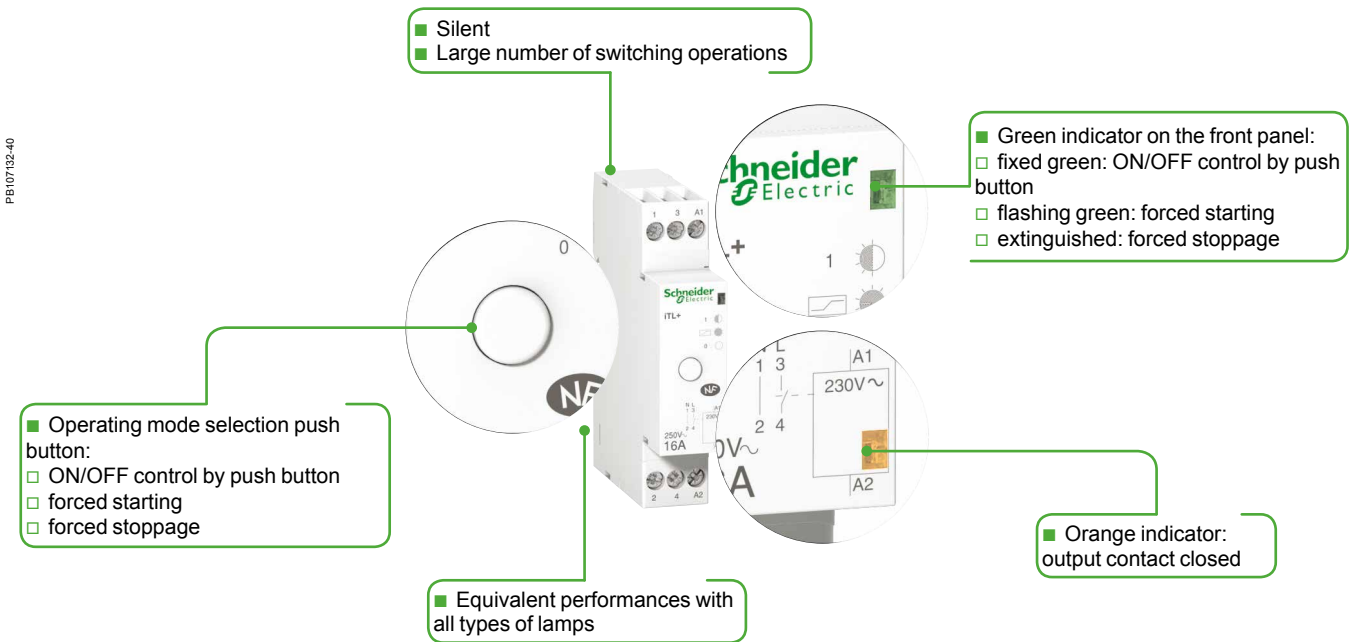

Following a mains failure, the iTL+ returns to 0 position (forced stoppage) irrespective of its initial state.

Technical data

Control circuit		
Coil voltage (Uc)		230 V AC
Frequency		50 Hz
Inrush power		11 VA
Holding power		1.1 VA
Control by luminous push button		Max. current 5 mA
Control order duration		50 ms to 1 s (recommended 200 ms)
Power circuit		
Voltage rating (Ue)		230 V AC
Frequency		50 Hz
Electrical load	Minimum	20 W
	Maximum	3600 W
Max. number of switching operations per minute		6
Other characteristics		
Degree of protection (IEC 60529)	Device only	IP20
	Device in modular enclosure	IP40 Insulation class II
Endurance (O-C)	Electrical	5.000.000 cycles (AC21 - AC22)
Noise level at activation		< 30 dBA
Operating temperature		-5°C to +55°C
Storage temperature		-40°C to +60°C
Tropicalization (IEC 60068-1)		Treatment 2 (relative humidity of 95 % at 55°C)

Weight (g)

High-performance impulse relays	
Type	iTL+
1P+N	70

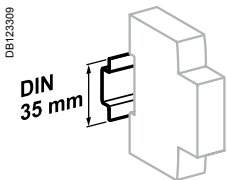

Clip on DIN rail 35 mm.

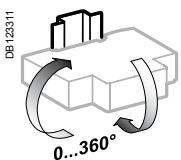

Indifferent position of installation.

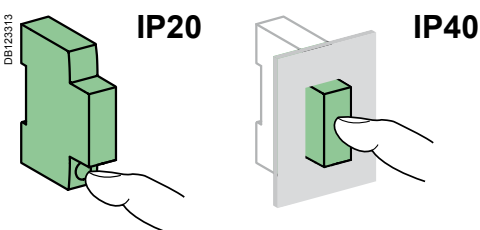

Control Remote control iCT+ high-performance contactors

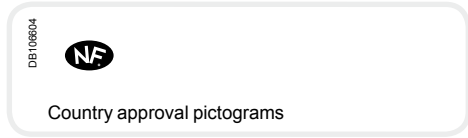

iCT+ high-performance contactors allow remote control of single-phase circuits. They are designed for demanding applications.

EN 60669-2-2

iCT+ high-performance contactors can be used for remote control of applications on AC networks:

- lighting, heating, ventilation, roller blinds, domestic hot water
- mechanical ventilation systems, etc.
- load shedding on non-priority circuits.



iCT+				
Type	Rating	Contact		Width in 9-mm modules
Standard 1P+N				
E57638 	20 A	1 NO	A9C15030	2+1 ⁽¹⁾
1P+N with manual control				
E57646 	20 A	1 NO	A9C15031	2+1 ⁽¹⁾

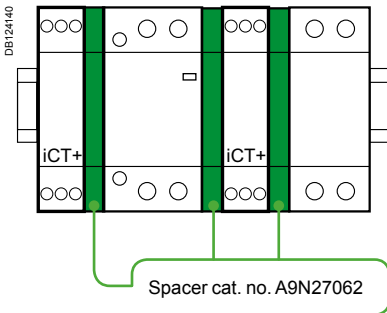

(1) Supplied with a 9 mm spacer (cat. no. A9N27062): to be used for mounting the iCT+ alongside a circuit breaker, contactor, impulse relay, etc., in order to maintain optimal operation.



- It is compulsory:**
- to connect the neutral
 - to keep the same control circuit connection "A1: phase", "A2: neutral"
 - to use the same phase for connection of the power and control functions.

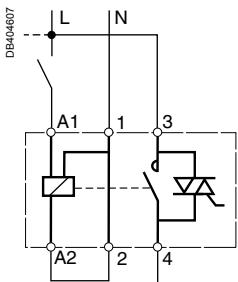

Operation (manual-control contactor)

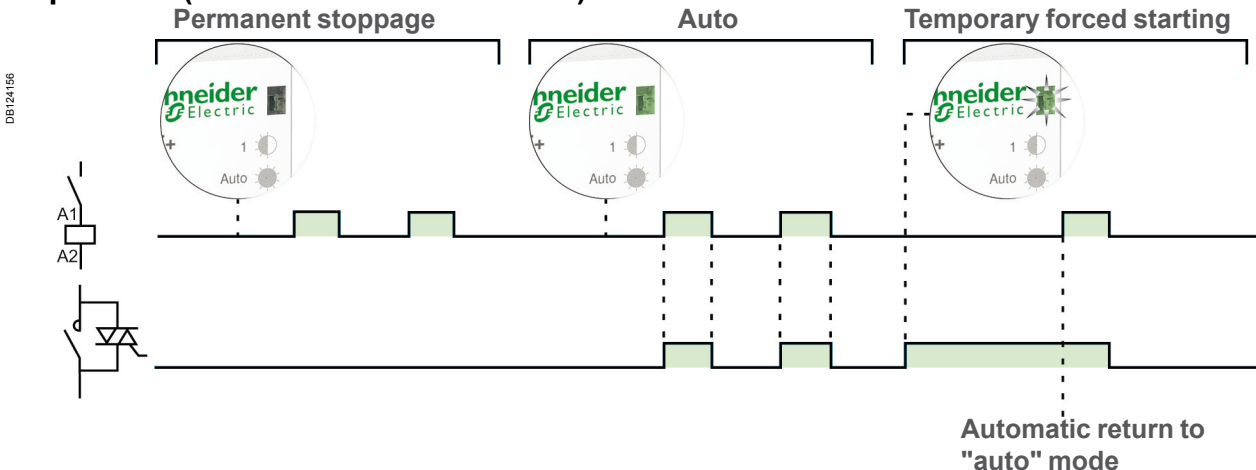

Control Remote control iCT+ high-performance contactors (cont.)

They combine the benefits of static switching and electromechanical technology: small size, little temperature rise.

- Silent
- Large number of switching operations
- Operating mode selection push button:
 - auto operation
 - temporary forced starting*
 - permanent stoppage
- Equivalent performances with all types of lamps
- No derating
- Green indicator on the front panel:
 - fixed green: auto operation
 - flashing green: temporary forced starting
 - extinguished: permanent stoppage
- Orange indicator: output contact closed

Following a mains failure, the iCT+ returns to "auto" operating mode irrespective of its initial state.

Connection

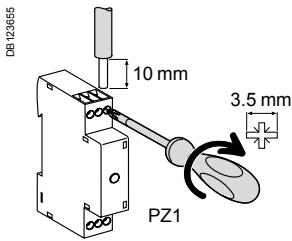

Type	Tightening torque	Copper cables	
		Rigid or flexible with ferrule	Rigid or flexible without ferrule
iCT+	1 N.m	2 x 1.5 mm ²	2 x 2.5 mm ² 1 x 4 mm ²

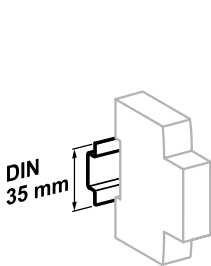

Clip on DIN rail 35 mm.

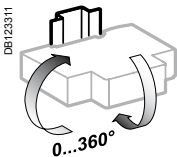

Indifferent position of installation.

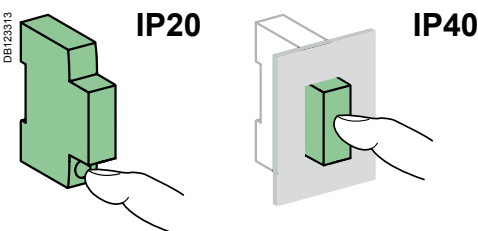

Technical data

Control circuit		
Coil voltage (Uc)		230 V AC (± 10 %)
Frequency		50 Hz
Inrush power		11 VA
Holding power		1.1 VA
Power circuit		
Voltage rating (Ue)		230 V AC (± 10 %)
Frequency		50 Hz
Electrical load	Minimum	20 W
	Maximum	3600 W
Max. number of switching operations per minute		6
Other characteristics		
Endurance (O-C)	Electrical	5.000.000 cycles
Pollution degree		3
Degree of protection (IEC 60529)	Device only	IP20
	Device in modular enclosure	IP40 Insulation class II
Operating temperature		-5°C to +55°C
Storage temperature		-40°C to +60°C
Tropicalization (IEC 60068-1)		2 (relative humidity of 95 % at 55°C)

Weight (g)





High-performance contactors	
Type	iCT+
Standard 1P+N	70
1P+N with manual control	70

Monitor Indication iLL indicator lights



IEC 60947-5-1

■ iLL indicator lights light up to indicate that a voltage is present.

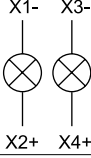
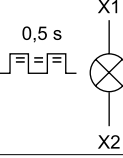
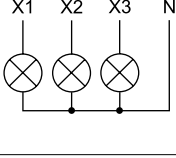
Catalogue numbers

iLL indicator lights										
Type	Single					Double		Flashing light	Three-phase voltage presence indicator light	
										
Diagram										
Colour	Red	Green	White	Blue	Yellow	Green/red	White/white	Red	Red/red/red	
Cat. no.										
12...48 V AC/DC	A9E18330	A9E18331	A9E18332	A9E18333	A9E18334	A9E18335	-	-	-	
110...230 V AC	A9E18320	A9E18321	A9E18322	A9E18323	A9E18324	A9E18325	A9E18328	-	-	
110...130 V DC										
110...230 V AC	-	-	-	-	-	-	-	A9E18326	-	
230...400 V AC (3 phases)	-	-	-	-	-	-	-	-	A9E18327	
Width in 9 mm modules	2					2		2	2	

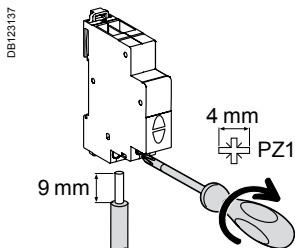
Connection

	Tightening torque	
	1 N.m	
	Copper cables	
	Rigid	Flexible or with ferrule
	 0.5 mm ² min. 2 x 2.5 mm ² max.	 0.5 mm ² min. 2 x 2.5 mm ² max.

- Phase-separated wall that can be divided to allow the teeth of all types of comb busbar to pass through.
- Staggered terminals to simplify connection.

Dimensions (mm)

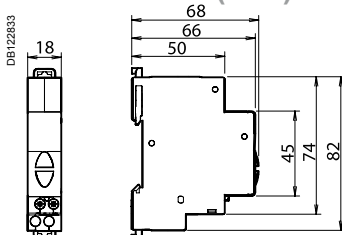

Technical data

Main characteristics	
Pollution degree	3
Power circuit	
Operating frequency	50...60 Hz
Flashing frequency	2 Hz
Additional characteristics	
Operating temperature	-35°C... +70°C
Storage temperature	-40°C... +80°C
Tropicalization	Treatment 2 (relative humidity 95 % at 55°C)
LED indicator light	Consumption per indicator light: 0.3 W Service life: 100,000 hours of constant lighting efficiency Maintenance-free indicator light (non-interchangeable LEDs)

Measurement and indication

iSO bells and iRO buzzers



iSO and iRO

Audible indication in housing and the tertiary sector.

Catalogue numbers

Bell and buzzer			
Type	Voltage (Ue)		Width in 9 mm modules
iSO bell DB123820	230 V AC	A9A15320	2
	8...12 V AC	A9A15321	2
iRO buzzer DB123821	230 V AC	A9A15322	2
	8...12 V AC	A9A15323	2
Operating frequency		50...60 Hz	

Connection

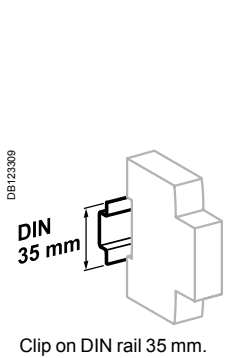

Clip on DIN rail 35 mm.

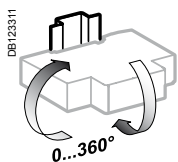

Indifferent position of installation.

Tightening torque	Copper cables	
	Rigid	Flexible or with ferrule
1.3 N.m	< 4 mm ²	< 4 mm ²

Technical data

Main characteristics	iSO	iRO
Consumption	8...12 V AC 220...240 V AC	3.6 VA 5 VA
Additional characteristics		
Degree of protection (IEC 60529)	Device only Device in modular enclosure	IP40 IP20
Operating temperature	-10°C to +40°C	
Storage temperature	-25°C to +60°C	
Sound level (at a distance of 60 cm)	80 dBA	70 dBA

Weight (g)

Bell and buzzer	
Type	Weight (g)
iSO	77
iRO	64

Dimensions (mm)

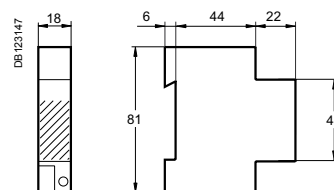

iSO bell and iRO buzzer

Measurement, indication iTR transformers



Country approval pictogram



Bell transformers: EN/IEC 61558-2-8.

Safety transformers: EN/IEC 61558-2-6.

Bell transformers and safety transformers allow for a very low voltage (ELV 8 V, 12 V or 24 V) to be obtained from a low voltage network (LV 230 V).

All Schneider Electric transformers are:

- Safe: primary and secondary circuits are perfectly insulated by each other
- Resistant to short-circuit currents thanks to the built-in device
- Class II with terminal shield (optional).

Catalogue numbers



Bell transformer				
Type	Power	Secondary voltage		Width in 9 mm modules
E56759 	4 VA	8 V AC	A9A15214	4
E56760 	4 VA	8-12 V AC	A9A15213	4
	8 VA	8-12 V AC	A9A15216	4
	16 VA	8-12 V AC	A9A15212	4
E56761 	25 VA	12-24 V AC	A9A15215	6

Safety transformer				
Type	Power	Secondary voltage		Width in 9 mm modules
DB124153 	16 VA	12-24 V AC	A9A15218	10
	25 VA	12-24 V AC	A9A15219	10
DB124154 	40 VA	12-24 V AC	A9A15220	10
	63 VA	12-24 V AC	A9A15222	10
DB124155 				
Operating frequency	50/60 Hz			

Terminal shield			
Type			Width in 9 mm modules
	15228		4
	15229		6

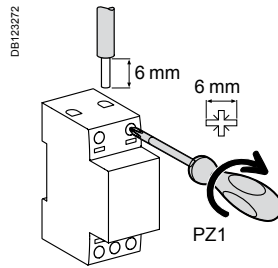
Connection



Tightening torque	Copper cables	
	Rigid	Flexible or with ferrule
0.5 N.m	 < 2.5 mm ²	 < 2.5 mm ²

Technical data

Main characteristics		
Primary voltage		230 V AC ±10 %
Secondary voltage on load	For bell transformers	8-12-24 V AC ±15 %
	For safety transformers	12-24 V AC ±5 %
Transformer catalogue numbers	Rated secondary voltage	Off load voltage
A9A15214	8 V	12 V
A9A15213	8 V	12 V
	12 V	16 V
A9A15216	8 V	13 V
	12 V	18 V
A9A15212	8 V	13 V
	12 V	18 V
A9A15215	12 V	16 V
	24 V	32 V
A9A15218	12 V	14 V
	24 V	28 V
A9A15219	12 V	14 V
	24 V	28 V
A9A15220	12 V	14 V
	24 V	28 V
A9A15222	12 V	14 V
	24 V	28 V
Additional characteristics		
Degree of protection	Device only (IEC 60529)	IP20 with terminal shield
Operating temperature		-20°C to +55°C
Storage temperature		-25°C to +80°C

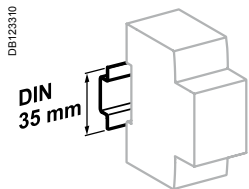

Clip on DIN rail 35 mm.

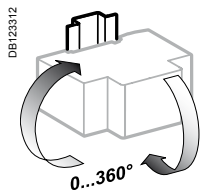

Bell transformer: indifferent position of installation.
Safety transformer: vertical position.

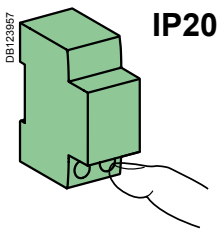

Note: Transformers have an off load operating voltage that is higher than the rated voltage. For loads that are sensitive to overloads (electro-magnetic circuits), the transformer must be made to operate at In. After operation of the protection device upon an overload, cut-off the power supply and let the transformer cool down before restart.

Weight (g)

iTR		
Type	Cat. no.	Weight
Bell	A9A15212	384
	A9A15213	240
	A9A15214	237
	A9A15215	633
	A9A15216	275
Safety	A9A15218	1082
	A9A15219	1125
	A9A15220	1190
	A9A15222	1309

Dimensions (mm)

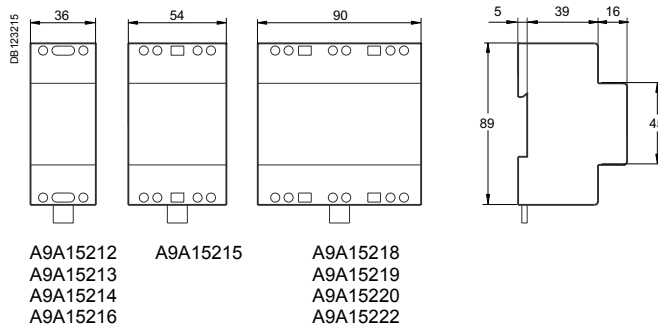

A9A15212 A9A15215 A9A15218
 A9A15213 A9A15219
 A9A15214 A9A15220
 A9A15216 A9A15222

Monitoring Control / Remote control Relays

Time delay relays are used in service sector and industrial buildings for small automatic control systems: ventilation, heating, animation, roller blind servo controls, escalators, pumps, lighting, signalling, monitoring, etc.

> Time delay relays



iRTA
■ Delays energizing of a load



iRTB
■ Delays de-energizing of a load upon closing of an auxiliary contact (push button)



iRTC
■ Delays de-energizing of a load upon opening of an auxiliary contact (push button)

^ Time delay

iRBN and iRTBT relays can interface automatic control system inputs/ outputs with low-voltage devices.

> Interface relays



iRBN
Low level relay
■ Actuation of low-amperage electronic circuits upon receiving an LV electrical order



iRTBT
Extra low voltage relay
■ Actuation of LV circuits based on an extra low voltage order

^ Control

Control relays monitor electrical parameters and indicate when they are exceeded

> Control relays



iRCP
Phase control
■ Monitors the order and asymmetry of phases and the presence of voltage on the 3 phases of a three-phase circuit (power supply of a motor, etc.)



iRCI
Current control
■ Monitors the current flowing in a circuit and indicates any crossing of the set threshold

^ Monitoring

Monitoring Control / Remote control Relays (cont.)



iRTH
■ Applies a time delay to de-energizing of a load



iRTL
■ Applies a time delay to energizing and de-energizing of a load during different times, repeatedly (flasher)



iRTMF
■ Allows one of the four types of time delay to be selected: A, B, C or H

iRLI and iERL relays are used to relay ON or OFF information to the auxiliary circuits and actuate low-power loads

> Changeover relays



iRLI Changeover
■ Relays ON or OFF information to the auxiliary circuits
■ Actuates low-power loads



iERL extension

^ Relaying and control





iRCU Voltage control
■ Monitors the potential difference of a circuit and indicates any crossing of the set threshold



iRCC Compressor control
■ Monitors the compressor power supply and prevents its immediate restarting upon detection of a power cut or voltage dip

Time delay relays

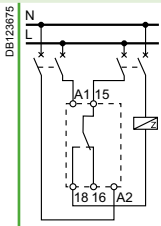
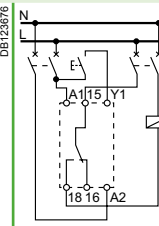
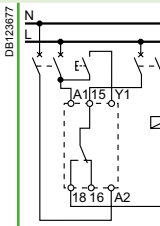
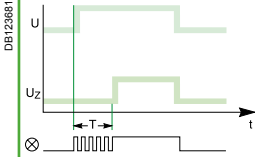
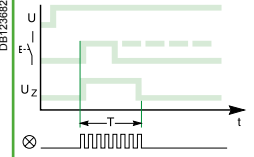
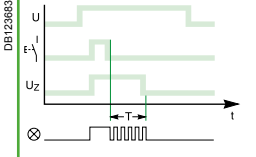

iRTA, iRTB, iRTC, iRTH, iRTL and iRTMF

		Time delay relays		
		iRTA	iRTB	iRTC
Type				
Function		■ Delays energizing of a load	■ Delays de-energizing of a load upon closing of an auxiliary contact (push button)	■ Delays de-energizing of a load upon opening of an auxiliary contact (push button)
Wiring diagrams				
Use		 <ul style="list-style-type: none"> ■ The single time delay cycle starts at switching on of the iRTA relay power supply ■ The load is energized at the end of time delay T 	 <ul style="list-style-type: none"> ■ The single time delay cycle starts at closing of an auxiliary contact (push button) ■ The load is de-energized at the end of time delay T 	 <ul style="list-style-type: none"> ■ The single time delay cycle starts only upon release of an auxiliary contact (push button) ■ The load is de-energized at the end of time delay T
Catalogue numbers		A9E16065	A9E16066	A9E16067
Technical specifications				
Control and power supply voltage (Uc)	V AC	24...240, ±10 %	24...240, ±10 %	24...240, ±10 %
	V DC	24, ±10 %	24, ±10 %	24, ±10 %
Operating frequency	Hz	50/60	50/60	50/60
Time delay range		0.1 s to 100 h	0.1 s to 100 h	0.1 s to 100 h
Precision		±10 % of full scale	±10 % of full scale	±10 % of full scale
Minimum duration of control impulse		100 ms	100 ms	100 ms
Insensitive to brownouts		≤ 20 ms	≤ 20 ms	≤ 20 ms
Max. resetting time per voltage interruption		100 ms	100 ms	100 ms
Accuracy of repetition		±0.5 % at constant parameters	±0.5 % at constant parameters	±0.5 % at constant parameters
Changeover contact (cadmium free)	Mini	Rating 10 mA/5 V DC	Rating 10 mA/5 V DC	Rating 10 mA/5 V DC
	Maxi	Rating 8 A/250 V AC/DC	Rating 8 A/250 V AC/DC	Rating 8 A/250 V AC/DC
Endurance	Mechanical	> 5 x 10 ⁶ switching operations	> 5 x 10 ⁶ switching operations	> 5 x 10 ⁶ switching operations
	Electrical	> 10 ⁵ switching operations (utilization category AC1)	> 10 ⁵ switching operations (utilization category AC1)	> 10 ⁵ switching operations (utilization category AC1)
Display of contact status by green indicator lamp		Flashing during time delay	Flashing during time delay	Flashing during time delay
Degree of protection	Device only	IP20	IP20	IP20
Connection by tunnel terminals	Without ferrule	2 x 2.5 mm ² single-strand	2 x 2.5 mm ² single-strand	2 x 2.5 mm ² single-strand
	With ferrule	2 x 1.5 mm ² multi-strand	2 x 1.5 mm ² multi-strand	2 x 1.5 mm ² multi-strand
Width in 9-mm modules		2	2	2
Operating temperature	°C	-5 ... +55	-5 ... +55	-5 ... +55
Storage temperature	°C	-40 ... +70	-40 ... +70	-40 ... +70



Monitoring Control / Remote control

Time delay relays

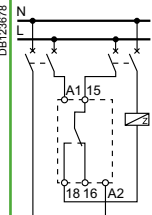
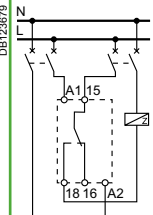
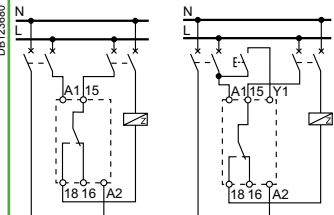
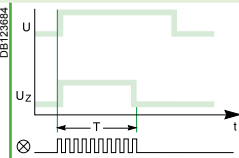
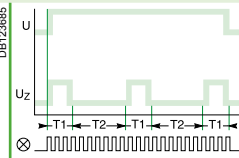

iRTA, iRTB, iRTC, iRTH, iRTL and iRTMF (cont.)

	iRTH	iRTL	iRTMF
			
	<ul style="list-style-type: none"> Applies a time delay to de-energizing of a load 	<ul style="list-style-type: none"> Applies a time delay to energizing and de-energizing of a load during different times, repeatedly (flasher) 	<ul style="list-style-type: none"> Allows one of the four types of time delay to be selected: A, B, C or H
			
			
	<ul style="list-style-type: none"> The single time delay cycle starts at switching on of the iRTH relay power supply The load is de-energized at the end of time delay T 	<ul style="list-style-type: none"> The time delay cycle starts at energizing The load is energized during an adjustable time T1 and then de-energized during an adjustable time T2. This cycle is reproduced until de-energizing of the iRTL relay power supply 	<ul style="list-style-type: none"> Depending on the choice, the iRTMF generates time delay cycles for the iRTA, iRTB, iRTC or iRTH relays
	A9E16068	A9E16069	A9E16070
	24...240, ±10 %	24...240, ±10 %	12...240, ±10 %
	24, ±10 %	24, ±10 %	12...240, ±10 %
	50/60	50/60	50/60
	0.1 s to 100 h	0.1 s to 100 h	0.1 s to 100 h
	±10 % of full scale	±10 % of full scale	±10 % of full scale
	100 ms	100 ms	100 ms
	≤ 20 ms	≤ 20 ms	≤ 20 ms
	100 ms	100 ms	100 ms
	±0.5 % at constant parameters	±0.5 % at constant parameters	±0.5 % at constant parameters
	Rating 10 mA/5 V DC	Rating 10 mA/5 V DC	Rating 10 mA/5 V DC
	Rating 8 A/250 V AC/DC	Rating 8 A/250 V AC/DC	Rating 8 A/250 V AC/DC
	> 5 x 10 ⁶ switching operations	> 5 x 10 ⁶ switching operations	> 5 x 10 ⁶ switching operations
	> 10 ⁵ switching operations (utilization category AC1)	> 10 ⁵ switching operations (utilization category AC1)	> 10 ⁵ switching operations (utilization category AC1)
	Flashing during time delay	Flashing during time delay	Flashing during time delay
	IP20	IP20	IP20
	2 x 2.5 mm ² single-strand	2 x 2.5 mm ² single-strand	2 x 2.5 mm ² single-strand
	2 x 1.5 mm ² multi-strand	2 x 1.5 mm ² multi-strand	2 x 1.5 mm ² multi-strand
	2	2	2
	-5 ... +55	-5 ... +55	-5 ... +55
	-40 ... +70	-40 ... +70	-40 ... +70

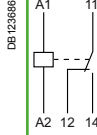
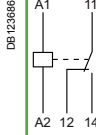
Monitoring Control / Remote control Interface relays iRBN, iRTBT

Interface relays			
Type	iRBN	iRTBT	
	Low level	Extra low voltage	
			
Standard	IEC/EN 61810-1	IEC/EN 61810-1	
Function	■ Actuation of low-amperage electronic circuits upon receiving an LV electrical order	■ Actuation of LV circuits based on an extra low voltage order	
Wiring diagrams			
Use	■ Inputs of programmable logic controllers, of measuring or supervision circuits, etc.	■ ELV orders can be issued by a programmable logic controller (24 V DC static outputs), a central fire detection unit, a regulation system, etc.	
Catalogue numbers	A9A15393	A9A15416	
Technical specifications			
Input control voltage (Uc)	V AC	230, ±10 %	12...24, -15 to +10 %
	V DC	-	12...24, ±20 %
Output contact rating	Mini	5 mA/5 V DC (DC12) 5 mA/5 V AC	10 mA/10 V DC (DC12) 10 mA/10 V AC
	Maxi	1 A/24 V DC (DC12) 5 A/250 V AC	1 A/24 V DC (DC12) 5 A/250 V AC
Operating frequency	Hz	50/60	0...60
Strengthened insulation between ELV/LV circuits		4 kV	4 kV
Consumption	At inrush	5 VA	0.22 W
	At holding	2.5 VA	0.11 W
Endurance	Electrical	100,000 switching operations	100,000 switching operations
Display of voltage presence on the control circuit		By green indicator lamp	By green indicator lamp
Degree of protection	Device only	IP20	IP20
Connection by tunnel terminals		0.5 x 6 mm ²	0.5 x 6 mm ²
Width in 9-mm modules		2	2
Operating temperature	°C	-5 ... +55	-5 ... +55
Storage temperature	°C	-40 ... +70	-40 ... +70

iRLI changeover and iERL extension relays

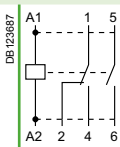
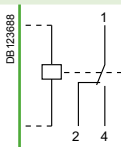







Changeover and extension relays									
	iRLI				iERL				
Type	Changeover relay				Extension for RLI				
									
Standard	IEC/EN 61810-1 and NF C 45-250				IEC/EN 61810-1 and NF C 45-250				
Function	<ul style="list-style-type: none"> Relaying of ON or OFF information to the auxiliary circuits and actuation of low-power loads 				<ul style="list-style-type: none"> Extension allowing additional contacts to be added to the iRLI changeover relays 				
Wiring diagrams									
Use	<ul style="list-style-type: none"> The iRLI relay contains 1 changeover contact (O-C) and 1 normally open contact (N/O) 				<ul style="list-style-type: none"> The iERL extension (max. 3 iERLs for 1 iRLI) contains 1 changeover contact (O-C) and 1 normally open contact (N/O) Can be mounted without any tool and without additional cabling using a yellow clip which performs mechanical assembly and electrical connection between the coils 				
Catalogue numbers	A9E15535	A9E15536	A9E15537	A9E15538	A9E15539	A9E15540	A9E15541	A9E15542	
Technical specifications									
Control voltage (Uc)	V AC	230...240	48	24	12	230...240	48	24	12
Voltage rating (Ue)	V AC	230							
Insulation voltage (Ui)	V AC	250							
Rating (In)	A	10, cos φ = 1				10, cos φ = 1			
Operating frequency	Hz	50/60				50/60			
Inrush and holding power		4 VA				iRLI + iERL : 8 VA			
Endurance	Electrical	100,000 cycles AC21 (cos φ = 1)				100,000 cycles AC21 (cos φ = 1)			
Direct front face control	Power	By push button				By push button			
	Coil	By selector switch (disconnection)				By selector switch (disconnection)			
Position indicator		Mechanical indicator				Mechanical indicator			
Marking		Clip-on markers on the front panel				Clip-on markers on the front panel			
Degree of protection	Device only	IP20				IP20			
Connection by tunnel terminals		0.5 x 6 mm ²				0.5 x 6 mm ²			
Width in 9-mm modules		2				2			
Operating temperature	°C	-5 ... +55				-5 ... +55			
Storage temperature	°C	-40 ... +70				-40 ... +70			

iRCP phase control, iRCI current control, iRCU voltage control and iRCC compressor control relays

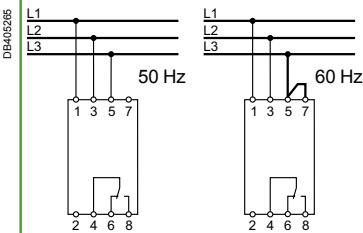
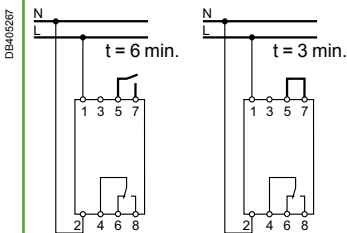
		Control relays	
		iRCI	iRCU
Type		Current control	Voltage control
Function		<ul style="list-style-type: none"> Monitors the current (I_r) flowing in an AC or DC circuit and indicates any crossing of the set threshold 	<ul style="list-style-type: none"> Monitors the voltage variation (U_r) of an AC or DC circuit and indicates any crossing of the set threshold
Wiring diagrams			
Catalogue numbers		A9E21181	A9E21182
Common technical specifications			
Supply voltage (U_c)	V AC	230, -15 % à +10 %	
Frequency	Hz	50/60	
Parameter setting		<ul style="list-style-type: none"> On the front panel, by direct scale, using a screwdriver 	
Precision of display		±10 % of full scale	
Output by changeover contact		8 A under 250 V AC ($\cos \phi = 1$)	
Indications by LED	Green	Voltage presence	
	Red	Fault	
Consumption	VA	3	
Dissipated power	W	2	
Degree of protection	Device only	IP20	
Connection by tunnel terminals	Rigid cable	1.5 x 6 mm ²	
Width in 9-mm modules		4	
Operating temperature	°C	-5 ... +55	
Storage temperature	°C	-40 ... +80	
Particular technical specifications			
		Threshold adjustable from 10 % to 100 % of I_r	Threshold adjustable from 10 % to 100 % of U_r
		Hysteresis adjustable from 5 % to 50 % of I_r	Hysteresis adjustable from 5 % to 50 % of U_r
		Monitoring of overcurrent and undercurrent (selection by selector switch)	
		Fail-safe contact	
		De-energized	
		Energized with fault	
		Energized without fault	
		Time delay on crossing threshold: 0.1 s to 10 s	
		Possibility of memorizing fault with resetting	
		Compatible with current transformers (CTs) of ratio X/5	<ul style="list-style-type: none"> Automatic recognition of AC voltage or DC voltage. 2 measuring ranges selected by cabling: <ul style="list-style-type: none"> 10 V to 50 V 50 V to 500 V
		<ul style="list-style-type: none"> Automatic recognition of alternating or direct current. 2 measuring ranges selected by cabling: <ul style="list-style-type: none"> 0.15 A to 1.5 A 1 A to 10 A 	

Monitoring Control / Remote control

iRCP phase control, iRCI current control, iRCU voltage control and iRCC compressor control relays (cont.)

iRCP		iRCC	
Phase control		Compressor control	
 <p>PE107124-35</p>	 <p>PE107127-35</p>		
<p>■ Monitors phases and the presence of voltage on the 3 phases of a three-phase circuit (power supply of a motor, etc.). It indicates any phase loss or inversion</p>		<p>■ Monitors the compressor's power supply and prevents its immediate restarting upon detection of a power cut or voltage dip</p>	
 <p>DB405266</p>		 <p>DB405267</p>	
A9E21180		A9E21183	
400, ±15 %		230, -15 % à +10 %	
50/60			
■ On the front panel, by direct scale, using a screwdriver			
±10 % of full scale			
8 A under 250 V AC (cos φ = 1)			
Voltage presence			
Fault			
3		2	
3 (total on the 3 phases)			
IP20			
1.5 x 6 mm ²			
4			
-5 ... +55			
-40 ... +80			
Setting of phase asymmetry threshold: 5 % to 2 5% of 400 V		Threshold setting: ±5 % to ±15 % of 230 V	
Hysteresis: fixed, 5 % of asymmetry threshold			
Monitoring of direction of phase rotation			
Monitoring of presence of the 3 phases			
Fail-safe contact		Fail-safe contact	
De-energized		De-energized	
Energized with fault		Energized with fault	
Energized without fault		Energized without fault	
Time delay on tripping: 0.3 s		Time delay on overshoot: 3 or 6 minutes (selection by cabling)	

Technical data

Weight (g)

Relays	
Type	Weight (g)
iRTA, iRTB, iRTC, iRTH, iRBN	65
iRTL	66
iRTMF	68
iRTBT	63
iRLI, iERL	112
iRCP, iRCC	210
iRCI, iRCU	215

Dimensions (mm)

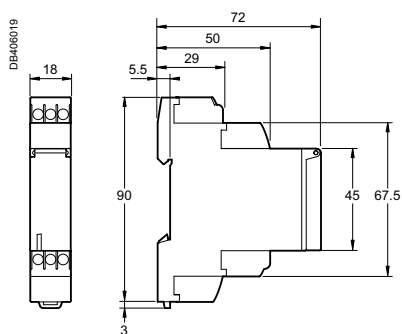

iRTA, iRTB, iRTC, iRTH, iRTL, iRTMF

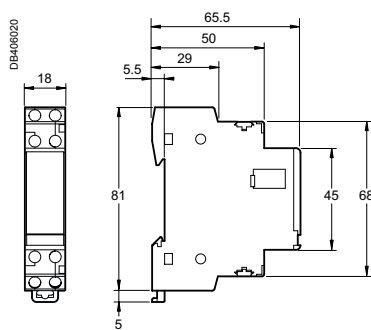

iRBN, iRTBT

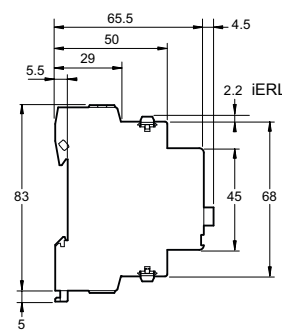

iRLI, iERL

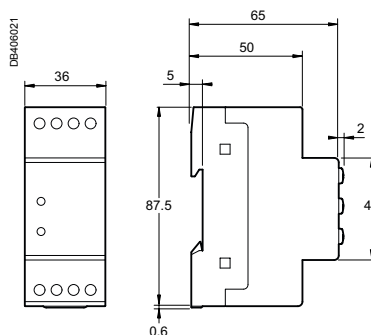

iRCP, iRCI, iRCU, iRCC

DSE1, CDS, CDSc load-shedders

CDS
DSE1



Country approval pictograms

DSE1: IEC 64-8

CDS, CDSc : NF C 61.750, EN 500 81.1

When consumption exceeds the selected threshold, the load-shedder temporarily cuts off the power supply to non-priority circuits.

Load-shedders are used to:

- increase the number of loads without modifying the installed power
- reduce the installed power
- prevent nuisance tripping of the upstream circuit breaker.

Load-shedders



Single-phase DSE1

- Load-shedding and restoration of 1 non-priority channel
- Tripping threshold adjustable from 0.8 kW to 7 kW (by default: 3.7 kW)
- Pre-alarm time before load-shedding (Ton) adjustable from 0 s to 9999 s (by default: 60 s)
- Load-shedding time (Toff) adjustable from 0 s to 9999 s (by default: 120 s)
- Buzzer operating time (Tbe) adjustable from 1 s to 9999 s (by default: 60 s)
- Backlit LCD display, 3 digits after the decimal point



Single-phase CDS

- Load-shedding and restoration in cascading configuration of 2 non-priority circuits via 2 relays with time-delayed action:
 - load-shedding of circuit 1 only: load restoration after 5 min
 - load-shedding of circuit 1 and circuit 2:
 - load restoration of circuit 2: after 10 min
 - load restoration of circuit 1: 5 min. after circuit 2



Three-phase CDS

- Load-shedding and restoration separately phase by phase
- 1 relay per phase
- Load-shedding time: 5 min. for each channel

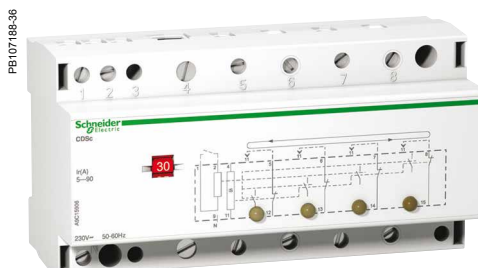

Single-phase CDSc

- Load-shedding and restoration in cascading configuration, then 1 to 4 non-priority circuits successively in turn
- Cyclic load-shedding: changing the order every 5 min.



DSE1, CDS, CDS_c load-shedders (cont.)



DSE1



CDS 1P



CDS 3P

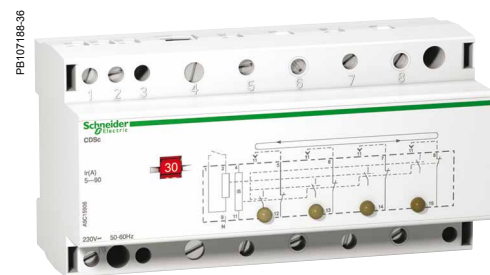

CDS_c

Catalogue numbers

DSE1		
Type		Width in 9-mm modules
Single-phase		
	A9C15907	4
CDS		
Type		Width in 9-mm modules
Single-phase		
	A9C15908	10
Three-phase		
	A9C15913	16
CDS _c		
Type		Width in 9-mm modules
Single-phase		
	A9C15906	16

DSE1, CDS, CDS_c load-shedders (cont.)

Connection

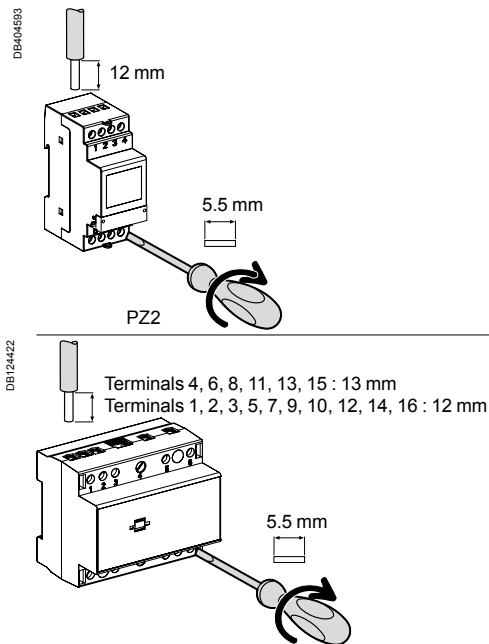

Type	Tightening torque	Copper cables	
		Rigid	Flexible or with ferrule
DSE1	1.2 N.m	6 mm ²	6 mm ²
CDS, CDS _c	Priority circuit	10 to 50 mm ²	10 to 35 mm ²
	Non-priority circuit	2.5 to 10 mm ²	2.5 to 10 mm ²

■ Connection via tunnel terminals (captive screws).

Technical data

Main characteristics		DSE1	CDS		CDS _c
		1P	1P	3P	1P
Insulation voltage (U _i)		230 V AC	230 V AC	230 V AC	230 V AC
Tension d'emploi (U _e)		230 V AC, -15 %, +10 %	230 V AC	415 V AC	230 V AC
Frequency		50/60 Hz	50/60 Hz		
Threshold		From 3.5 A to 32 A, accuracy ±1 %		5-10-15-20-25-30-40-45-50-60-75-90	
Rating	Priority circuit	32 A (cosφ = 1)		90 A (cosφ = 1)	
	Non-priority circuit	16 A, 250 V AC (cosφ = 1) >16 A relaying by contactor required		Relaying by contactor required	
Load-shedding indication		By red indicator By buzzer		By yellow indicators	
Power consumption		5 VA, backlit 3.5 VA, not backlit		12 VA	4 VA
Active power		40 W to 8 kW, 32 A maximum		20 kW maximum	
Control of current greater than 90 A		-		Use of an In/5 current transformer Threshold setting: 5 A	
Forced load-shedding input		-		■	■
1 A - 250 V make contact for remote indication		-		2	3
Additional characteristics					
Degree of protection (IEC 60529)	Device only	IP20	IP20		IP20
	Device in modular enclosure	IP40	IP40		IP40
Operating temperature		-5°C to +50°C		-5°C to +55°C	
Storage temperature		-40°C to +70°C		-40°C to +70°C	
Tropicalisation (IEC 60068-1)		Treatment 2 (relative humidity 95 % to 55°C)		Treatment 2 (relative humidity 95 % to 55°C)	

DSE1, CDS, CDS_c load-shedders (cont.)

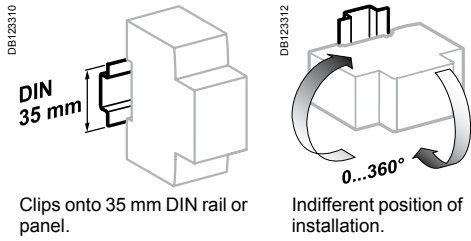

Technical data (cont.)

Weight (g)

Load-shedders			
Type	DSE1	CDS	CDS _c
1P	130	300	600
3P	-	500	-

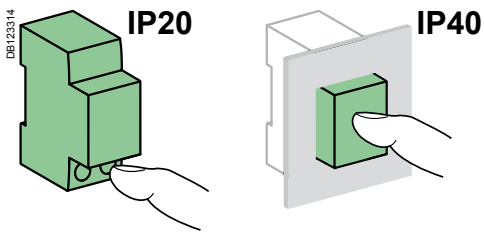

Dimensions (mm)

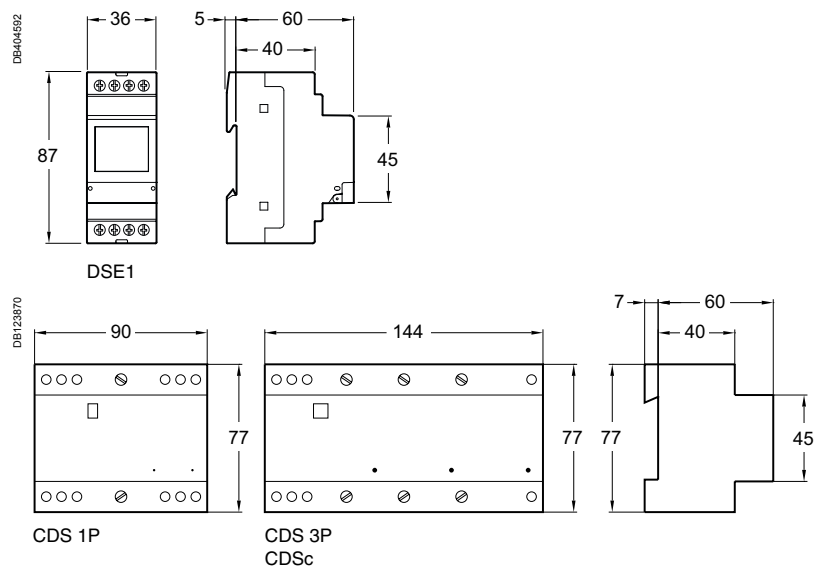

DSE1, CDS, CDSc load-shedders (cont.)

Installation

⚠ Use a contactor for any load-shedding above 16 A.
Designed for load-shedding household equipment circuits, except lighting circuits.
The load is restored without pre-indication.

DSE1

DB4048Z1

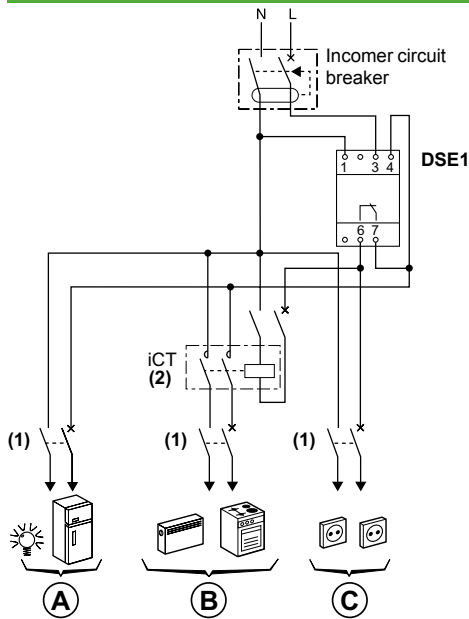

- (1) Determine the circuit-breaker rating according to the cable cross-section.
- (2) Calculate the contactor rating according to the load power.

- A** Non load-sheddable priority loads.
- B** Load-sheddable non-priority loads >16 A (relaying by contactor).
- C** Load-sheddable non-priority loads < 16 A.

DSE1, CDS, CDS_c load-shedders (cont.)

Installation (cont.)

⚠ Non-priority outputs must not be connected directly: they must be relayed by means of contactors.
Do not shed circuit loads that include machine and lighting type applications.

CDS_c

DB124424

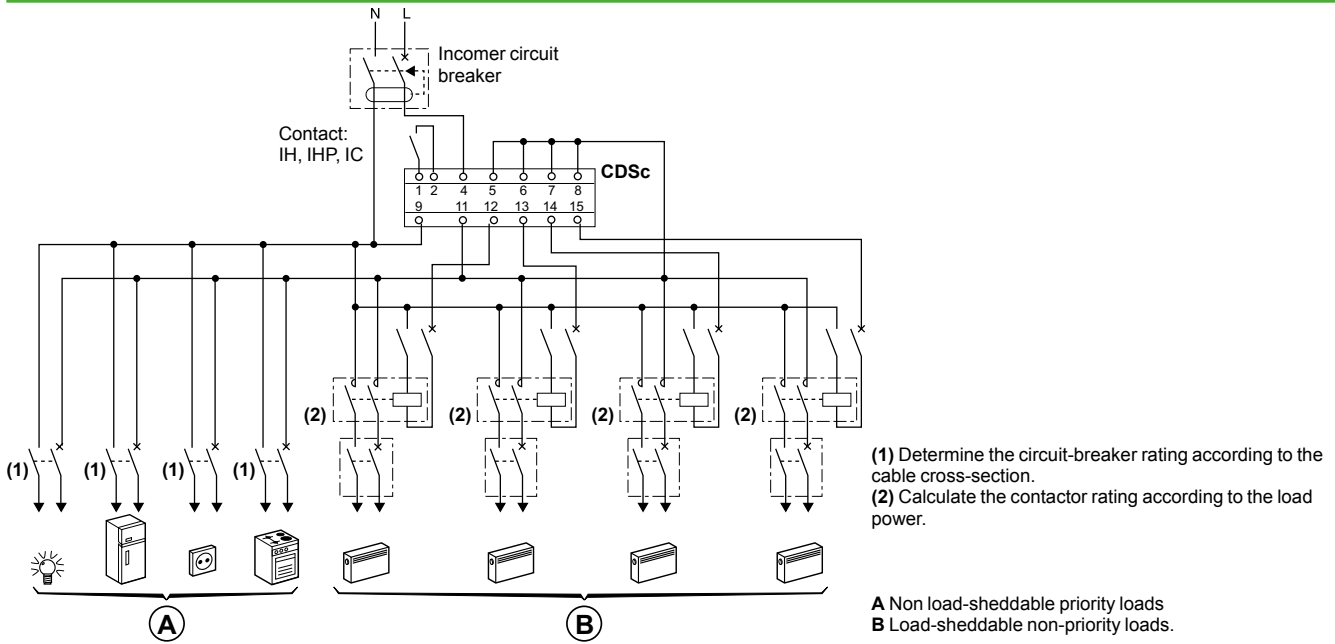

CDS

DB124423

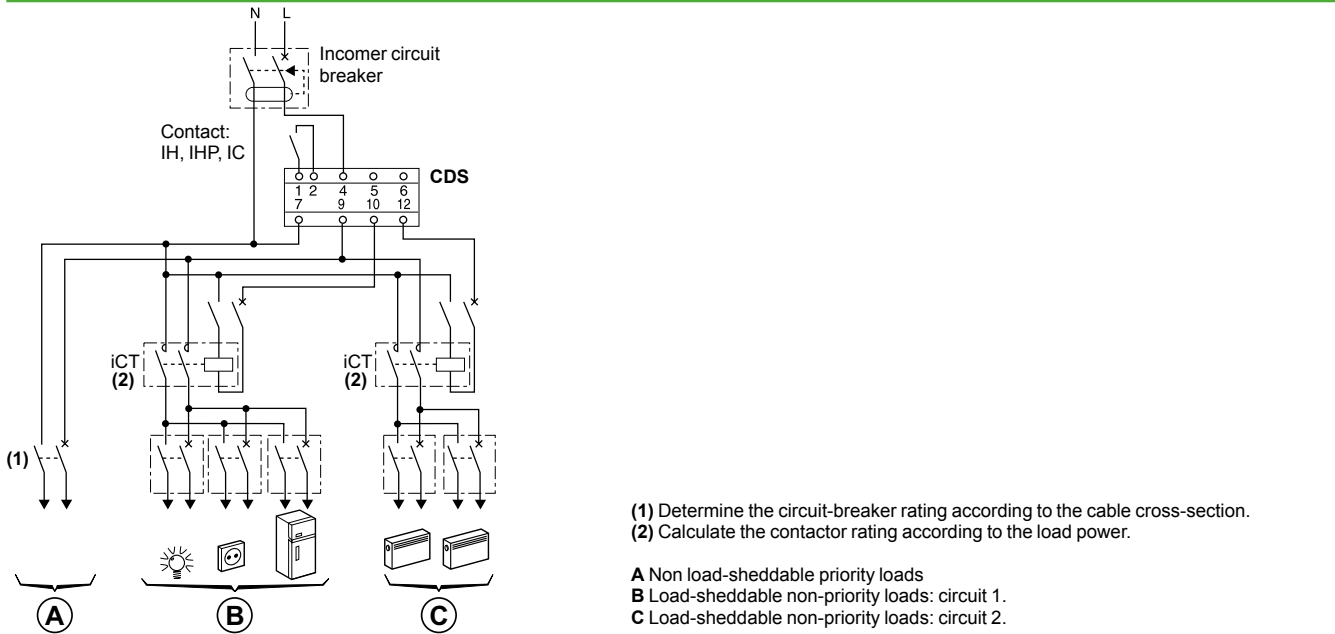

Control

Local control

Modular iPC power sockets

These power sockets allow low-voltage devices to be connected to the electrical network.
The differentiated socket is designed for specific applications (backed-up networks, sockets powered by a UPS, etc.), when it is wanted to highlight specialized power sockets. Its yellow colour allows users to locate and identify it easily.

IEC 60884

Catalogue numbers

iPC 16 A power sockets							
Diagram							
Approval pictogram							
Type	Standard	With indicator	Differentiated	Standard	With indicator	Differentiated	Standard
Color	White	White	Yellow	White	White	Yellow	White
Cover	With	With	With	Without	Without	With	With
Cat. no.	A9A15306	A9A15307	15324	A9A15310	A9A15035	15033	A9A15303
Standard	NF C 61314, NBN C 61112		NF C 61314	VDE 0620, NEN 1020	VDE 0620		IMQ as per CEI 2350
Width in 9-mm modules	5						

Connection

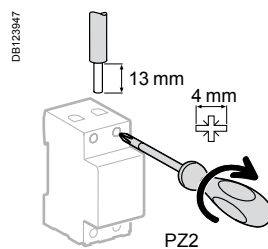

Type	Tightening torque	Copper cables	
		Rigid	Flexible or with ferrule
iPC 16 A	1.2 N.m		
		10 mm ²	6 mm ²

Modular iPC power sockets (cont.)

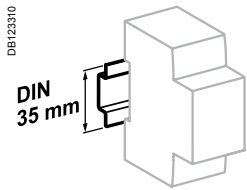

Clip on DIN rail 35 mm.

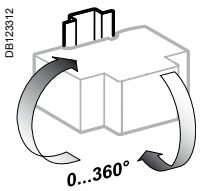

Indifferent position of installation.

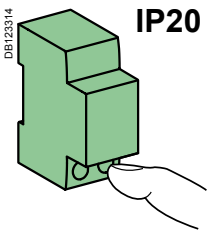

IP20

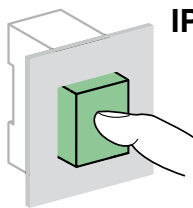

IP40

Technical data

Main characteristics		iPC 16 A
Voltage rating (Ue)		250 V AC
Power on indicator		LED technology long service life: 100,000 hours
Additional characteristics		
Degree of protection (IEC 60529)	Device only	IP20
	Device in modular enclosure	IP40
Operating temperature		-25°C to +70°C
Storage temperature		-40°C to +80°C
Tropicalization (IEC 60068-1)		Treatment 2 (relative humidity of 95 % at 55°C)

Dimensions (mm)

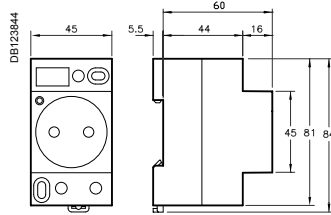

iPC 16 A NF standard

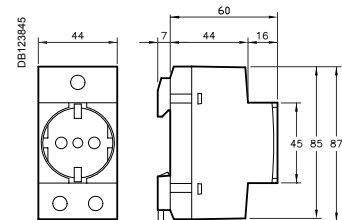

iPC 16 A Italian standard

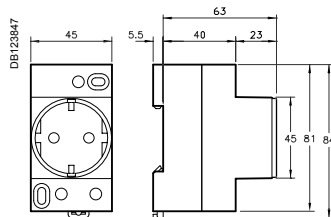

iPC 16 A German standard

Weight (g)

iPC power sockets	
Type	Weight (g)
iPC 16 A	98

> Twilight switches

IC100
Adjustable from 2 to 100 lux.
It comes with a wall-mounted cell.



IC2000
Adjustable from 2 to 2000 lux. It comes with a standard wall-mounted or switchboard cell.

IC2000P+
It has 3 customisable pre-set programs and 3 setting ranges from 2 to 2100 lux. Its 4 keys and large screen facilitate its programming.
It comes with a wall-mounted cell.

IC Astro
It operates without photoelectric cell and calculates sunrise and sunset times according to its geographic position.
It can be customised by using its programming function.

IC100kp+
Adjustable from 1 to 99000 lux.
Its 4 keys and large screen facilitate its programming.
It comes with a digital wall-mounted and a memory key.

Selection table

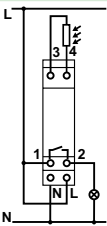
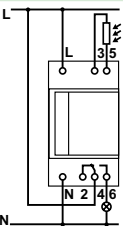
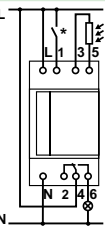
	IC100	IC2000	IC2000P+	
	 <p>P111637 + P83237</p>	 <p>P111639 + P116858 + P106856</p>	 <p>P111640 + P83237</p>	
Function	The IC100 controls closing of a contact when brightness decreases and drops below the selected threshold. It controls opening of a contact when brightness increases and rises above the selected threshold	The IC2000 control closing of a contact when brightness decreases and drops below the selected threshold. They control opening of a contact when brightness increases and rises above the selected threshold	The IC2000P+ controls lighting according to brightness and time. If brightness drops below the set threshold (twilight function: IC) and if the time program allows relay closing (time switch function), then the lighting circuit is activated	
Wiring diagrams	 <p>P106857</p>	 <p>P106858</p>	 <p>P106859</p>	
Catalogue numbers	15482	CCT15284	CCT15368	
			15483 (1)	
Technical specifications				
Delivered with	Wall-mounted cell	Switchboard cell (15281)	Wall-mounted cell (CCT15268)	Wall-mounted cell
Optional accessories	Wall-mounted cell (CCT15268)	Switchboard cell (15281) Wall-mounted cell (CCT15268)	Wall-mounted cell (CCT15268) Switchboard cell (15281)	Wall-mounted cell (CCT15268)
Adjustable brightness threshold	2 to 100 lx	2 to 2000 lx		Range 1: 2 to 50 lx Range 2: 60 to 300 lx Range 3: 350 to 2100 lx
Voltage rating (Ue) (+10 %, -15 %)	230 V AC, 50/60 Hz	230 V AC, 50/60 Hz		230 V AC, 50/60 Hz
Consumption	6 VA	6 VA		3 VA
Operating temperature	-20°C to +50°C	-25°C to +50°C		-20°C to +50°C
Width (9 mm modules)	2	5		5
Insulation class	Class II	Class II		Class II
Degree of protection	IP20B	IP20B		IP20B
Output contact rating $\cos \varphi = 1$ (under 250 VAC)	16 A	16 A		16 A
$\cos \varphi = 0.6$	10 A	10 A		10 A
Time delays (On and Off)	20 s (On) 80 s (Off)	≥ 60 s		Adjustable from 20 to 140 s (80 s by default)
Operating accuracy	–	–		$\leq \pm 1$ s / day at 20°C.
Monitoring indicator light, not time delayed, lit when brightness is less than the threshold	Red	Red		–
Contact switching indicator light	Green	Green		–
LCD liquid crystal display	–	–		Back-lit
Program saving by lithium battery	–	–		■
Operating reserve	–	–		5-6 years
Location for instruction manual on front face	–	■		■
Cabling test function with a push-button on front face	–	■		–
Number of channels	1	1		1
Control by brightness detection	■	■		■
Coupling with weekly programming	–	–		42 switching times Minimum switching: 1 min Switching accuracy: 1 s
Control by calculation of sunrise/sunset times	–	–		–

Languages: (1) English, french, spanish, italian, german, portuguese, swedish, dutch, finnish, norwegian/danish. (2) English, french, spanish, portuguese, hungarian, polish, romanian, turkish.



The IC100kp+ 1C/2C control lighting according to brightness and time. If brightness drops below the set threshold (twilight function: IC) and if the time program allows relay closing (time switch function), then the lighting circuit is activated

The IC Astro astronomic programmable twilight switch is used to start and stop an electric load (e.g. lighting) according to sunrise and sunset times, without a brightness detector. Sunrise and sunset times are calculated automatically by the IC Astro according to the geographic parameters configured by the user

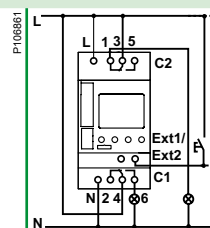
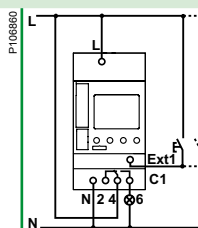
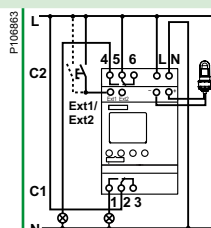
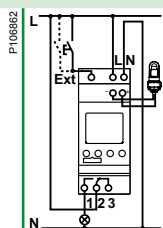

CCT15490 (2)
CCT15491 (3)

CCT15492 (2)
CCT15493 (3)

CCT15223 (2)
CCT15224 (3)

CCT15243 (2)
CCT15244 (3)

Digital wall-mounted cell (**CCT15260**)
Memory key (alone) (**CCT15861**)

–
Programming kit for PC (**CCT15860**)
Memory key (alone) (**CCT15861**)

Memory key (alone) (**CCT15861**)

1 to 99000 lx

According to sunrise/sunset times

230 V AC, 50/60 Hz
3 VA

100-240 V AC, 50/60 Hz

230 V AC, 50/60 Hz
3 VA

6 VA

-30°C to +50°C

-25°C to +45°C

4

6

5

Class II

Class II

IP20C

IP20B

16 A

16 A

10 A

10 A

Adjustable from 0 to 59.59 min.

Difference in sunset and/or sunrise times adjustable separately by ±120 min.

Back-lit

Back-lit

10 years

6 years

1

2







1

2

84 switching times
Operating accuracy: < ±1 s / day at 20°C
Minimum switching: 1 min
Switching accuracy: 1 s

84 switching times (not including sunrise/sunset)
Minimum time between 2 switching operations: 1 min.
Switching accuracy: 1 s
Time accuracy: ±1 s / day

Accessories selection table

	Wall-mounted cell	Switchboard cell	Programming kit for PC	Memory key	Digital wall-mounted cell	Digital switchboard cell	
							
Function	Wall-mounted photoelectric cell	Switchboard photoelectric cell	Consists of a programming device, a memory key, a CDROM and a 2 m USB cable	Saving and duplicating programs	Digital wall-mounted photoelectric cell	Digital wall-mounted photoelectric cell	
Mounting	<ul style="list-style-type: none"> Delivered with its fixing device for IC100 and IC200P+ Replaced by CCT15268 for spare part use Cell connection: by double insulation 2-conductor cable, not to be laid next to mains cables or water ducts, maximum length: 25 m 	Delivered with 1 m cable and its fixing device	<ul style="list-style-type: none"> Delivered with its fixing device Cell connection: by double insulation 2-conductor cable, not to be laid next to mains cables or water ducts, maximum length: 100 m 	–	–	<ul style="list-style-type: none"> Delivered with its fixing device. Cell connection: <ul style="list-style-type: none"> by double insulation 2-conductor cable: <ul style="list-style-type: none"> - 0.5 - 2.5 mm² for CCT15260 - 0.25 - 1.5 mm² for CCT15261 Not to be laid next to mains cables or water ducts, maximum length: <ul style="list-style-type: none"> - 100 m (2 x 1.5 mm²) - 50 m (2 x 0.75 mm²) 	
Catalogue no.	–	CCT15268	15281	CCT15860	CCT15861	CCT15260	CCT15261

Technical specifications

	IP54	IP55	IP65	–	–	IP55	IP66
Degree of protection	IK05	–	IK05	–	–	–	–
Operating temperature	-40°C to +70°C	-40°C to +70°C	-40°C to +70°C	–	–	-40°C to +70°C	-40°C to +70°C
Horizontally orientable	–	–	90°	–	–	90°	90°

Load table

Type of lighting (230 V AC)	Max. power (for higher power, relay with a contactor)				
	IC100	IC2000	IC2000P+	IC Astro	IC100kp+
Incandescent and halogen lamps	2300 W	2300 W	2300 W	2600 W	2600 W
LED lamps	Power for one lamp < 2 W	20 W	20 W	20 W	30 W
	Power for one lamp from 2 to 8 W	55 W	55 W	55 W	100 W
Non-corrected / serial-corrected / dual mounted fluorescent tubes with conventional ballast	2300 VA	2300 VA	26 x 36 W, 20 x 58 W, 10 x 100 W	26 x 36 W, 20 x 58 W, 10 x 100 W	26 x 36 W, 20 x 58 W, 10 x 100 W
Parallel corrected fluorescent tubes with conventional ballast	400 VA	400 VA	10 x 36 W, 6 x 58 W, 2 x 100 W	10 x 36 W, 6 x 58 W, 2 x 100 W	10 x 36 W, 6 x 58 W, 2 x 100 W
Fluorescent tubes with electronic ballast	–	–	9 x 36 W, 6 x 58 W	9 x 36 W, 6 x 58 W	650 VA max.
Dual-mounted fluorescent tubes with electronic ballast	300 VA	300 VA	5 x (2 x 36 W), 3 x (2 x 58 W)	5 x (2 x 36 W), 3 x (2 x 58 W)	–
Fluocompact lamps with electronic ballast	9 x 7 W, 7 x 11 W, 7 x 15 W, 7 x 20 W, 7 x 23 W	9 x 7 W, 7 x 11 W, 7 x 15 W, 7 x 20 W, 7 x 23 W	9 x 7 W, 7 x 11 W, 7 x 15 W, 7 x 20 W	9 x 7 W, 7 x 11 W, 7 x 15 W, 7 x 20 W	22 x 7 W, 18 x 11 W, 16 x 15 W, 16 x 20 W, 14 x 23 W
Fluocompact lamps with conventional ballast	1500 VA	1500 VA	–	–	–
Parallel-corrected mercury and sodium vapour lamps	400 VA	400 VA	250 VA	250 VA	800 VA max. (80 µF)
Non-corrected/ serial-corrected mercury and sodium vapour lamps	1000 VA	1000 VA	–	–	–
Motor	–	–	–	–	2300 VA max.

Specific technical data

IC2000P+

External input

Voltage rating (Ue)	230 V AC, +10 %, -15 %
Frequency	50/60 Hz
Input current	≤ 2.5 mA
Consumption	≤ 0.4 mW
Cable length	≤ 100 m

IC Astro

Programming longitude	-180° (East) to +180° (West) in steps of 1°
Programming latitude	-90° (South) to +90° (North) in steps of 1°

IC100kp+, IC Astro

Programming accessories	<ul style="list-style-type: none"> ■ Programming kit for PC consists of a programming device, a memory key, a CDROM and a 2 m USB cable ■ Memory key for saving and duplicating programs, delivered on front face
-------------------------	---

External inputs

External inputs for external control with a standard switch or a push-button	<ul style="list-style-type: none"> ■ 1 input "Ext" for 1 channel versions ■ 2 inputs "Ext1" and "Ext2" for 2 channels versions
Voltage rating (Ue)	<ul style="list-style-type: none"> ■ 230 V AC, +10 %, -15 % for 1 channel versions ■ 100-240 V AC +10 %, -15 % for 2 channels versions
Frequency	50/60 Hz
Input current	≤ 0.5 mA
Consumption	≤ 130 mW
Cable length	≤ 100 m

IC2000P+

The IC 2000P+ uses its time programming to define lighting On and Off periods:

- According to three pre-set time programs:
 - "DAYPROG": On time programming from 7 am to 8 pm a validation of the IC function from 7 am to 8 pm,
 - "NIGHTPROG": On time programming from 5 am to 8 am and from 6 pm to 11 pm a validation of the IC function on these two operating periods,
 - "EMPTYPROG": Off time programming throughout the day a no validation of the IC function. These programs can be modified if necessary.
- According to a customised operating period, with possibility of copying to the other days. It is equipped with the following functions:
 - consideration of periods of absence (holidays),
 - temporary or permanent On or Off override,
 - remote control of lighting override by NO external contact,
 - consideration of change to "summer/winter" time, automatic or manual,
 - permanent liquid crystal display: of time and minutes, of day of the week, of the contact output status and current program.

Example

Lighting of a shop window, in the evening, at a time variable according to brightness and switch-off at a set time (e.g. 11 pm). Then in the morning, lighting at a set time (e.g. 4 am) and switch-off at a time variable according to brightness (see Fig. 1).

Configuration

This consists of recording in the memory:

- The language.
- The year, month, day and time.
- One of the 3 pre-set programs:
 - "DAYPROG": "On" time programming from 7 am to 8 pm → validation of the IC function from 7 am to 8 pm,
 - "NIGHTPROG": "On" time programming from 5 am to 8 am and from 6 pm to 11 pm → validation of the IC function on these two operating periods,
 - "EMPTYPROG": "Off" time programming throughout the day → no validation of the IC function. These programs can be modified.
- The brightness threshold. Once this phase is over, your IC 2000P+ operates in AUTO mode according to the items you have chosen.

Programming

The IC2000P+ is used to manage time programs. It allows:

- Creation of a new program with the possibility of copying to the other days.
- Viewing programs in memory.
- Modification of a program in memory, of the time, date, summer/winter time.
- Partial or total deletion of the program (date, time and language are kept).
- Modification of the brightness threshold.
- Separate setting of the time delay on switch-on and switch-off.

Move to On/Off override

- Press briefly (< 2 s) and simultaneously the 2 keys "-", "+" (value setting and navigation keys) on the front face to move to "MAN ON" or "MAN OFF".
- Press the keys for more than 2 s to move to "PERM ON" or "PERM OFF".
- Supply of terminal 1 overrides the IC 2000P+ output to the "On" position.

This external override takes priority over the product On/Off override function (see Fig. 2, 3).

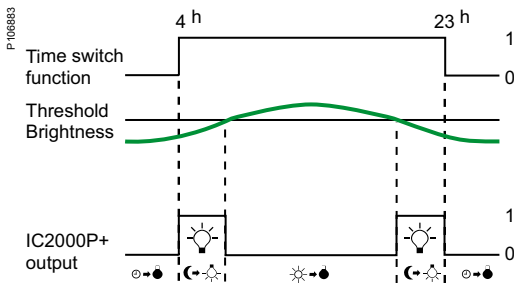

Fig. 1.

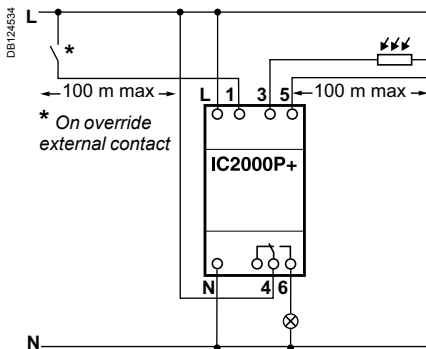

Fig. 2.

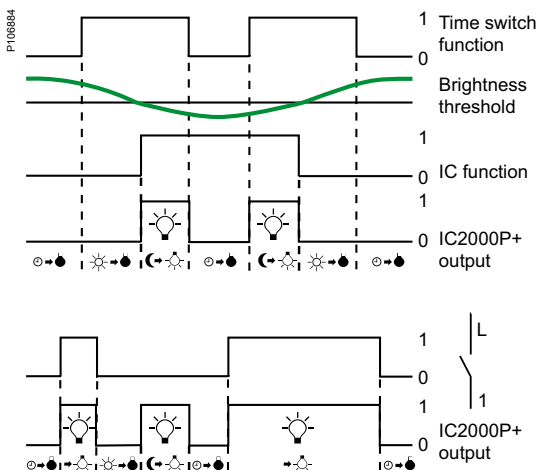

Fig. 3.

IC Astro

The IC Astro is configured according to the place of installation.

- The place of installation of the IC Astro can be configured:
 - either by selecting a country and a town,
 - or by its geographic coordinates (latitude, longitude).
- The IC Astro allows:
 - addition or deletion of a switch-off/switch-on switching operation (Off-On) between the sunset and sunrise times,
 - different programmes each day,
 - difference in sunset and/or sunrise times, adjustable separately by ± 120 min. according to local constraints (mountains, buildings, etc.),
 - consideration of periods of absence (holidays),
 - remote control of lighting override by external standard switch or push-button via the external input (1 external input per channel),
 - re-initialisation of programmes,
 - automatic switching to "summer-winter" time,
 - permanent display by liquid crystals: hours and minutes, day of the week, contact output status, and current programme,
 - manual waiver of the lighting On/Off programme, permanently or temporarily (up to the next switching operation).
 - back-lighting of the screen.



Fig. 3.



Fig. 4.

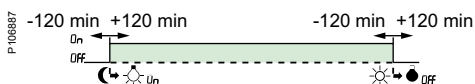

Fig. 5.

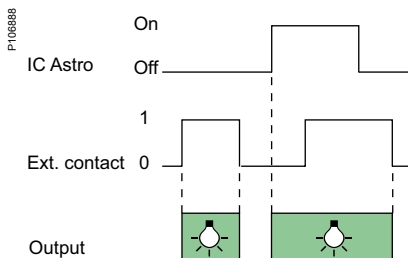

Fig. 6.

Example

Automatically lighting On and Off a shop window in Paris according to sunset and sunrise, example the 20th June.

- At night (10 pm) the lighting switch-on.
- At the morning (6 am) the lighting switch-off.

Configuration

This consists of writing in the memory:

- The language.
- The place of installation, either:
 - by its position (Argentina, China, etc.) and by the closest town,
 - by its geographic coordinates (latitude, longitude, time difference with respect to GMT) (a map is provided with the product).
- The year, month, day and time.
- Once this phase is complete, IC Astro will calculate the sunrise and sunset times and propose a default programme (operation from sunset to sunrise) (see Fig. 3).

Programming an Off period

The IC Astro offers the possibility of adding an "Off" period (programmed switch-off and switch-on) inside the programme, between the sunrise and sunset times (by default it is proposed from 11 pm to 5 am) (see Fig. 4).

Modifying programming and configuration

The twilight switch allows:

- Creation of a new customised programme with possibility of copying onto the other days.
- Display of programmes in memory.
- Deletion, modification or addition of an automatic or programmed switching operation.
- Partial or total deletion of the programme (date, time and language are kept).
- Modification of time, date, summer/winter time.
- Temporary cancellation of the "On" periods by configuring start and end dates and Times of absence (holidays).
- Adjustment of difference in sunset and/or sunrise times by ± 120 min. according to local constraints (mountains, buildings, etc.) (see Fig. 5).

Move to On/Off override

- Briefly press (<2 s) at the same time on the 2 keys "-", "+": (value setting and navigation keys) on the front face to move to "ON TEMP" or "OFF TEMP".
- Hold down (>2 s) the keys to move to "ON PERM" or "OFF PERM".
- The supply of input 5 forces the IC Astro output to the "ON" position. This override takes priority over the product On/Off override function (see Fig. 6).

Connection

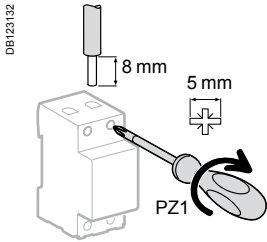

Type	Tightening torque	Copper cables	
		Rigid	Flexible or with ferrule
IC100, IC2000P+	1.2 N.m	DB1223M45 ≤ 6 mm ²	DB1235E3 ≤ 6 mm ²
IC2000, IC Astro, IC100kp+	2 screwless / pole	2 x 2.5 mm ²	2 x 2.5 mm ²

IC100, IC Astro are mechanical compatible with electrical distribution comb busbar.

Weight (g)

Twilight switches	1C	2C
IC100	173	
IC2000	280	
IC2000P+	323	
IC Astro	132	
IC100kp+	183	352

Dimensions (mm)

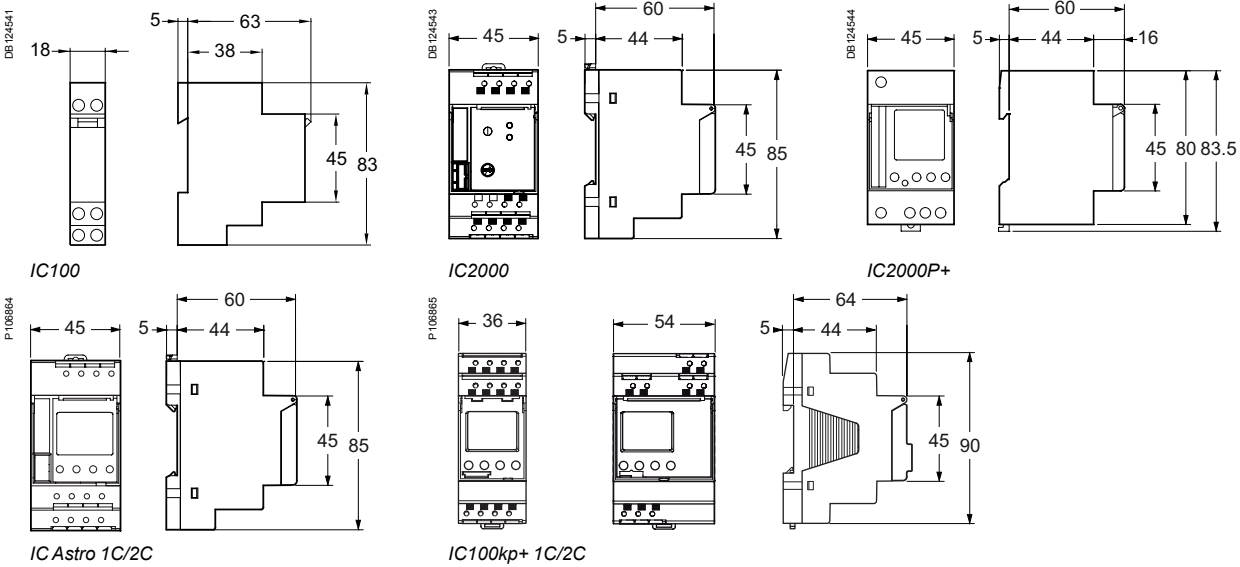

Cells

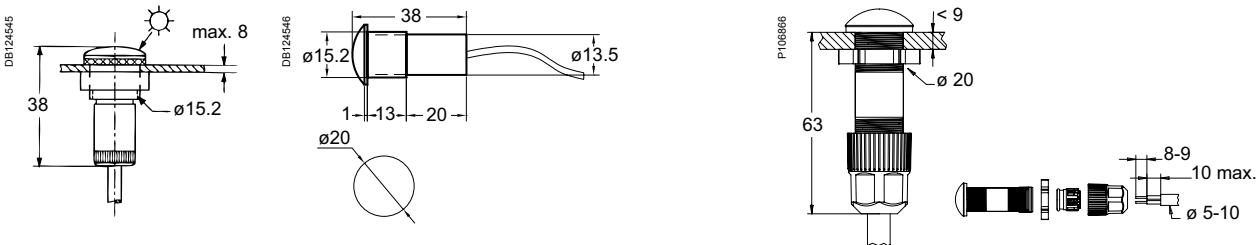

Standard switchboard cell (15281) Fixed externally in vertical position by 2 ø 4 mm screws

Digital switchboard cell (CCT15261)

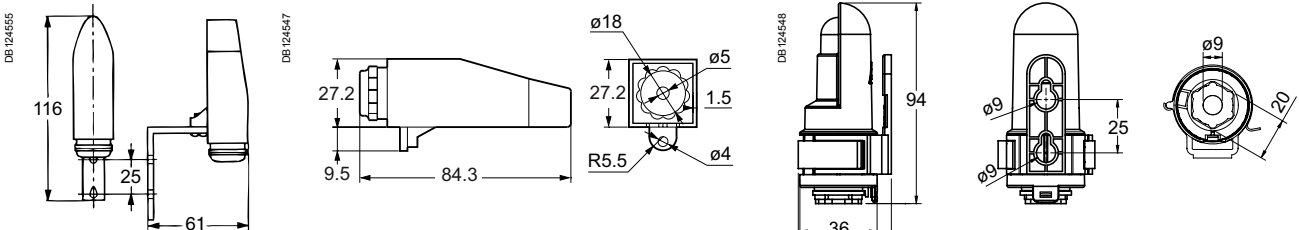

Wall-mounted cell (delivered with IC100, IC2000P+)

Standard and digital wall-mounted cell (CCT15268, CCT15260)

> Time switches

> The 36 and 45 mm digital time switches

IHP 1c **IHP 2c** **IHP+1c** **IHP+2c**

Automatically switch On and Off loads according to the program entered by the user with 4 keys and a display, they operate on a weekly cycle: the same program is repeated week after week.

IHP+ DCF 1c + DCF77 antenna

Synchronised on the frankfort transmitter via the DCF77 antenna.

> The 18 mm digital time switches

IHP 1c/+ 1c

Automatically switch On and Off loads according to the program entered by the user with 4 keys and a display, they operate on a weekly cycle: the same program is repeated week after week.

➤ The 54 mm mechanical time switches

IH 60mn 1c SRM **IH 24h 1c SRM/ARM** **IH 24h 2c ARM**

IH 24h + 7j 1c ARM **IH 7j 1c ARM**

Automatically switch On and Off loads according to the program entered by the user they operate on an hourly, daily or weekly cycle: the same program is repeated hour after hour (IH 60mn), day after day (IH 24h) or week after week (IH 7j).

➤ The 18 mm mechanical time switches

IH 24h 1c SRM/ARM **IHH 7j 1c ARM**

Automatically switch On and Off loads according to the program entered by the user they operate daily on a weekly cycle.

➤ The digital yearly time switches

ITA 1C **ITA 4C**

They operate on an daily, weekly or yearly program (ITA 1c: 1 channel, ITA 4c: 1, 2, 3 or 4 channels - 2 external inputs).

Selection table

The time switches control opening and closing of one or more separate circuits according to a programming pre-set by the user:

- by memorisation of On and Off switching operations for the IHP and ITA digital time switches
- by positioning of jumpers or captive segments on a programming dial for the IH mechanical time switches.

An IHP, IH or ITA time switch is chosen according to the following criteria:

Designation	Number of channels	Cycle period (d: day)	Minimum time between 2 switching operations	Number of switching operations	Saving on mains cut off	Width (modules of 9 mm)	Override controls On / Off	Output contact changeover switch (cos φ =1)	Time changeover (summer / winter)
The 36 or 45 mm digital time switches									
IHP 1c	1	24 h and/or 7 d	1 min.	56	6 years	5	On / Off	16 A	Auto
IHP + 1c	1	24 h and/or 7 d	1 s	84	6 years	5	On / Off	16 A	Auto
IHP 2c	2	24 h and/or 7 d	1 min.	56	6 years	5	On / Off	16 A	Auto
IHP + 2c	2	24 h and/or 7 d	1 s	84	6 years	5	On / Off	16 A	Auto
IHP+ DCF 1c ⁽¹⁾	1	24 h and/or 7 d	1 s	84	10 years	4	On / Off	16 A	Auto
The 18 mm digital time switches									
IHP 1c 18 mm	1	24 h and/or 7 d	1 min.	56	10 years	2	On / Off	16 A	Auto
IHP + 1c 18 mm	1	24 h and/or 7 d	1 s.	84	10 years	2	On / Off	16 A	Auto
The 36 or 72 mm digital yearly time switches									
ITA 1c ⁽²⁾	1	24 h, 7 d, year	1 s	300	10 years	4	On/Off	16 A	Manual / Auto ⁽³⁾
ITA 4c ⁽²⁾	4	24 h, 7 d, year	1 s	300	10 years	8	On/Off	16 A	Manual / Auto ⁽³⁾
The 54 mm mechanical time switches									
IH 60mn 1c SRM	1	60 min.	37.5 s	48 On - 48 Off	none	6	On / Off	10 A	Manual
IH 24h 1c SRM	1	24 h	15 min.	48 On - 48 Off	none	6	On / Off	16 A	Manual
IH 24h 1c ARM	1	24 h	15 min.	48 On - 48 Off	200 h ⁽⁴⁾	6	On / Off	16 A	Manual
IH 24h 2c ARM	2	24 h	30 min.	24 On - 24 Off	150 h	6	On	16 A	Manual
IH 7j 1c ARM	1	7 days	2 h	42 On - 42 Off	200 h ⁽⁴⁾	6	On / Off	16 A	Manual
IH 24h + 7j 1+1c ARM	1+1	24 h + 7 days	45 min. + 12 h	16 On -16 Off + 7 On -7 Off	150 h	6	On	16 A	Manual
The 18 mm mechanical time switches									
IHH 7j 1c ARM	1	7 days	2 h	42 On - 42 Off	100 h	2	On / Off	16 A	Manual
IH 24h 1c ARM	1	24 h	15 min.	48 On - 48 Off	100 h	2	On / Off	16 A	Manual
IH 24h 1c SRM	1	24 h	15 min.	48 On - 48 Off	none	2	On / Off	16 A	Manual

⁽¹⁾ The IHP+ DCF 1c can be synchronised on the Frankfurt's DCF77 radio station via the DCF77 antenna.

⁽²⁾ The ITA 1c and ITA 4c can be synchronised on the Frankfurt's DCF77 radio station via the DCF antenna for ITA or GPS antenna for ITA.

⁽³⁾ Summer/Winter-Time can be set to auto without any antenna.

⁽⁴⁾ 110 h for 100 V AC supply voltage.

Back-lit display, random function and pulse programming	"Absence for holidays" function	Screwless connection	Mechanical compatibility with electrical distribution comb busbars	Input for external control	Instruction manual holder on front face	Memory key supplied with the product	Cat. no.
	■	■	■		■		CCT15400 ⁽⁶⁾ , CCT15420 ⁽⁷⁾ , CCT15450 ⁽⁸⁾ , CCT15720 ⁽⁹⁾ , CCT15850 ⁽¹⁰⁾
■ + Cycle programming	■	■	■	1 input	■	■	CCT15401 ⁽⁶⁾ , CCT15451 ⁽⁸⁾ , CCT15721 ⁽⁹⁾ , CCT15851 ⁽¹⁰⁾
	■	■	■		■		CCT15402 ⁽⁶⁾ , CCT15422 ⁽⁷⁾ , CCT15452 ⁽⁸⁾ , CCT15722 ⁽⁹⁾ , CCT15852 ⁽¹⁰⁾
■ + Cycle programming	■	■	■	2 inputs	■	■	CCT15423 ⁽⁷⁾ , CCT15723 ⁽⁹⁾ , CCT15853 ⁽¹⁰⁾
■ + Cycle programming	■	■		1 input		■	CCT15857
	■	■				(12)	CCT15854 ⁽¹¹⁾
■ + Cycle programming	■	■		1 input		■	CCT15838 ⁽¹¹⁾
Back-lit display, pulse and cycle programming	■ ⁽⁵⁾					(13)	CCT15910
Back-lit display, pulse and cycle programming	■ ⁽⁵⁾			2 inputs		(13)	CCT15940
		■					CCT15338
		■					CCT16364
		■					CCT15365
							15337
		■					CCT15367
							15366
							15331
							15336
							15335

(5) Function included and can be realized through special program entry.

(6) English, Russian, Ukrainian, Latvian, Lituani, Estonian languages.

(7) English, Bulgarian, Greek, Slovene, Serbian, Croatian languages.

(8) English, Hungarian, Polish, Romanian, Czech, Slovak languages.

(9) French, English, Italian, Spanish, German, Portuguese languages.



(10) French, English, Swedish, Dutch, Finnish, Norwegian/Danish languages.

(11) French, English, Italian, Spanish, German, Portuguese, Dutch languages.

(12) Memory key (CCT15861) is not supplied with IHP 1c 18 mm (CCT15854) but this memory key and the programming kit (CCT15860) can be used and operate on IHP 1c 18 mm (see "Accessories selection table").

(13) Memory key (CCT15955) is not supplied with ITA 1c/4c but this memory key and the programming kit (CCT15950) can be used and operate on ITA 1c/4c (see "Accessories selection table").

Selection table Programmable time switches

	IHP 1c	IHP2c	IHP+1c	IHP+2c
	P140626 	P140627 	P111624 	P111626 

Function

- These time switches automatically switch on and off loads according to the program entered by the user
 - They operate on weekly cycle: the same program is repeated week after week
 - They offer automatic summer/winter time change and allow to adjust it according to where you are located
 - The program can be overridden temporary or permanently by pressing 2 keys on the product
 - They also offer holidays program, by configuring the starting and ending dates of the absence.
- A memory key and a programming kit can be used to duplicate on another IHP+ or to save the program created by the contractor (see "Accessories selection table")
 - Override control with switch or push-button via external input (1 external input for IHP+1c and 2 external inputs for IHP+ 2c)

Wiring diagrams

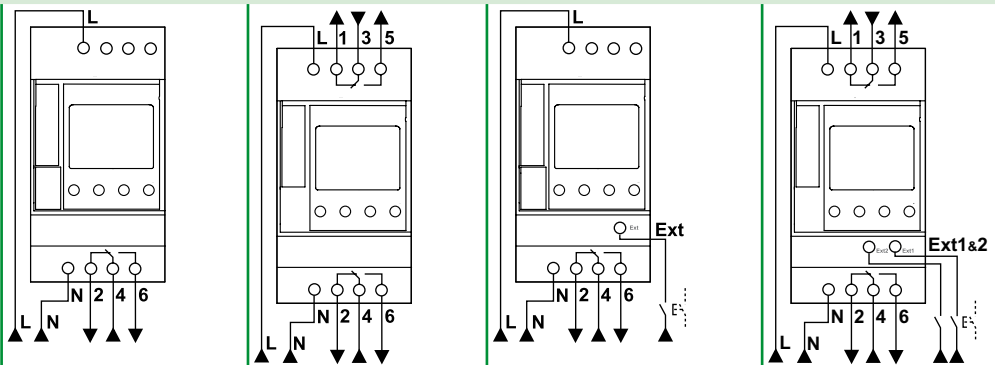





Catalogue numbers	CCT15400 ⁽¹⁾ CCT15420 ⁽²⁾ CCT15450 ⁽³⁾ CCT15720 ⁽⁴⁾ CCT15850 ⁽⁵⁾	CCT15402 ⁽¹⁾ CCT15422 ⁽²⁾ CCT15452 ⁽³⁾ CCT15722 ⁽⁴⁾ CCT15852 ⁽⁵⁾	CCT15401 ⁽¹⁾ CCT15451 ⁽³⁾ CCT15721 ⁽⁴⁾ CCT15851 ⁽⁵⁾	CCT15423 ⁽²⁾ CCT15723 ⁽⁴⁾ CCT15853 ⁽⁵⁾
-------------------	---	---	--	--

Technical specifications

Voltage rating (Ue)	230 V AC, ±10 %, 50/60 Hz	230 V AC, ±10 %, 50/60 Hz	230 V AC, ±10 %, 50/60 Hz	230 V AC, ±10 %, 50/60 Hz
Consumption	0.8 W	0.8 W	0.8 W	0.8 W
Output contact current (250 V AC)	Cos φ = 1 16 A Cos φ = 0.6 10 A	16 A 10 A	16 A 10 A	16 A 10 A
Degree of protection	IP20B	IP20B	IP20B	IP20B
Operating temperature	-10°C to +50°C	-10°C to +50°C	-10°C to +50°C	-10°C to +50°C
Time accuracy	± 1 s per day at 20°C	± 1 s per day at 20°C	± 1 s per day at 20°C	± 1 s per day at 20°C
Program saving and time by lithium battery	Lifetime	6 years	6 years	6 years
	Back-up time, cumulated mains cut off	6 years	6 years	6 years



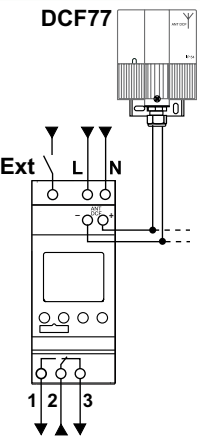
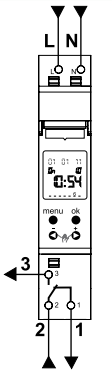
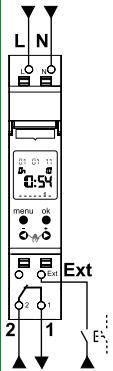
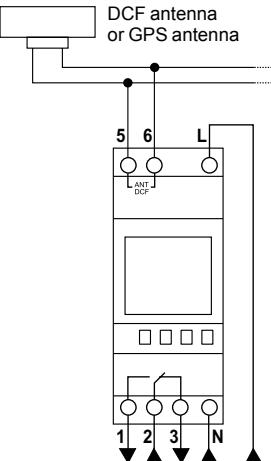
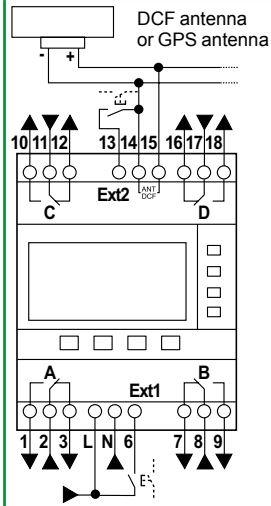

(1) English, russian, ukrainian, latvian, lituanien, estonian. (2) English, bulgarian, greek, slovene, serbian, croatian. (3) English, hungarian, polish, romanian, czech, slovak. (4) French, english, italian, spanish, german, portuguese. (5) French, english, swedish, dutch, finnish, norwegian/danish.

Yearly programmable time switches

	IHP+ DCF 1c	IHP 1c 18 mm	IHP+1c 18 mm	ITA 1c	ITA 4c
					
				<ul style="list-style-type: none"> Weekly or yearly time programming to be distributed over 1 channel 	<ul style="list-style-type: none"> Weekly or yearly time programming to be distributed over 1, 2, 3 or 4 channels Override control with switch or push-button via external inputs
	<ul style="list-style-type: none"> A memory key and a programming kit can be used to duplicate on another IHP or to save the program created by the contractor (see "Accessories selection table") 100% time precision enabled via optional DCF77 antenna (to be ordered separately - see "Accessories selection table") 	<ul style="list-style-type: none"> A memory key and a programming kit can be used to duplicate on another IHP or to save the program created by the contractor (see "Accessories selection table") 		<ul style="list-style-type: none"> A memory key and a programming kit can be used to duplicate on another ITA or to save the program created by the user (see "Accessories selection table"). 	
					
	CCT15857	CCT15854 (6)	CCT15838 (6)	CCT15910	CCT15940
	230 V AC, ±10 %, 50/60 Hz	230 V AC, +10 %, -15 %, 50/60 Hz	230 V AC, +10 %, -15 %, 50/60 Hz	230 V AC, 50/60 Hz	230 V AC, 50/60 Hz
	1.4 W	0.4 W	0.4 W	1.4 - 1.9 W (depending on the switching status)	1.2 - 3.2 W (depending on the switching status)
	16 A	16 A	16 A	16 A	16 A
	10 A	4 A	4 A	6 A	6 A
	IP20B	IP20B	IP20B	IP20	IP20
	-30°C to +55°C	-25°C to +55°C	-25°C to +55°C	-30°C to +55°C	-30°C to +55°C
	Without antenna: ± 0.25 s per day at 25°C With antenna: 1 s on 1 million years (7)	± 0.25 s per day at 25°C	± 0.25 s per day at 25°C	Without antenna: ± 0.5 s per day at 20°C With antenna: 1 s on 1 million years (7)	Without antenna: ± 0.5 s per day at 20°C With antenna: 1 s on 1 million years (7)
	10 years	10 years	10 years	10 years	10 years
	10 years	10 years	10 years	10 years	10 years

(6) French, english, italian, spanish, german, portuguese, dutch. (7) Thanks to the synchronisation on the DCF Frankfurt's DCF77 radio station via the DCF antenna or GPS antenna.

Selection table Mechanical time switches

	IH 60mn 1c SRM	IH 24h 1c SRM	IH 24h 1c ARM	IH 24h 2c ARM
P116860		P116861		P116892
				P116816
				

Function

- They operate on hourly, daily or weekly cycle: the same program is repeated hour after hour (IH 60mn), day after day (IH 24h) or week after week (IH 7), (IHH 7)
- The program can be overridden On

Wiring diagrams

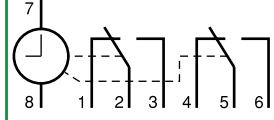
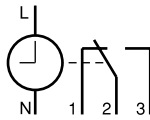
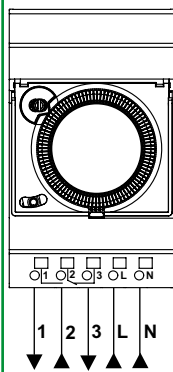



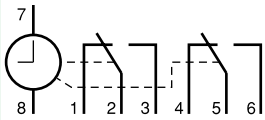
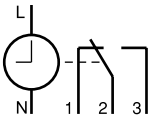
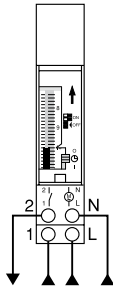

Catalogue numbers		CCT15338	CCT16364	CCT15365	15337
Technical specifications					
Voltage rating (Ue)		230 V AC +10 %, -15%, 50 Hz	230 V AC +10 %, -15%, 50/60 Hz	110-230 V AC +10 %, -15%, 50/60 Hz	230 V AC +10 %, -15%, 50/60 Hz
Consumption		1 VA	2.5 VA	2.5 VA	2.5 VA
Output contact current under 250 VAC	Cos φ = 1	10 A	16 A	16 A	16 A
	Cos φ = 0.6	4 A	4 A	4 A	4 A
Degree of protection		IP20B	IP20B	IP20B	IP20B
Operating temperature		-20°C to +55°C	-20°C to +55°C	-20°C to +55°C	-20°C to +55°C
Time accuracy		±1 s per day at 20°C	±1 s per day at 20°C	±1 s per day at 20°C	±1 s per day at 20°C
Saving of program and time by lithium battery	Lifetime	-	-	6 years	6 years
	Back-up time, cumulated mains cut off	-	-	200 h with 230 V AC 100 h with 100 V AC	150 h
Programming by:	Jumpers (supplied)	-	-	-	4 red + 4 green + 2 white
	Captive segments	96	96	96	-

	IH 24h + 7j 1+1c ARM	IH 7j 1c ARM	IH24h 1c SRM 18 mm	IH 24h 1c ARM 18 mm	IHH 7j 1c ARM 18 mm
P111619		P111663	P111614	P111615	P111613

				
---	---	--	--	--

	15366	CCT15367	15335	15336	15331
	230 V AC +10 %, -15%, 50 Hz	110-230 V AC +10 %, -15%, 50/60 Hz	230 V AC, ±10 %, 50/60 Hz	230 V AC, ±10 %, 50/60 Hz	230 V AC, ±10 %, 50/60 Hz
	2.5 VA	2.5 VA	2.5 VA	2.5 VA	2.5 VA
	16 A	16 A	16 A	16 A	16 A
	4 A	4 A	4 A	4 A	4 A
	IP20B	IP20B	IP20B	IP20B	IP20B
	-20°C to +55°C	-20°C to +55°C	-10°C to +50°C	-10°C to +50°C	-10°C to +50°C
	±1 s per day at 20°C	±1 s per day at 20°C	±1 s per day at 20°C	±1 s per day at 20°C	±1 s per day at 20°C
	6 years	6 years	10 years	10 years Exchangeable battery	10 years Exchangeable battery
	150 h	200 h with 230 V AC 100 h with 110 V AC	–	100 h	100 h
	6 yellow (24 h), 12 blue + 2 red (7 days)	–	–	–	–
	–	84	96	96	84



Accessories selection table	Programming kits for PC		Memory keys	
	IHP+	ITA	IHP+	ITA
				
Function	Consists of a programming device, a memory key, a CDROM and a 2 m USB cable For IHP+ 1c/2c, IHP 1c 18 mm, IHP+ 1c 18 mm	Consists of a programming device, a CDROM and a 1.5 m USB cable For ITA 1c and ITA 4c	Saving and duplicating programs For IHP+ 1c/2c, IHP 1c 18 mm, IHP+ 1c 18 mm, IHP+ DCF 1c	
Mounting	–		Located on front face	
Catalogue numbers	CCT15860	CCT15950	CCT15861	CCT15955
Technical specifications				
Degree of protection	–		–	–
Operating temperature	–		–	–

Specific technical data

IHP+ 1c, IHP+ 2c, IHP+ DCF 1c	
Manual functions	Temporary cancellation of programming for holidays, public holidays, etc. by configuration of the 2 dates - start and end of absence Simulation of presence thanks to random operation during On periods
Pulse functions	Programming of pulses adjustable from 1 to 59 s (pulse takes priority over switching)
Back-lighting of the screen	
External input (only for IHP+ 1c, IHP+ 2c)	
External inputs for external control with a standard switch or a push-button	1 input for IHP+ 1c 2 inputs for IHP+ 2c
Voltage rating (Ue)	230 V AC, +10 %, -15 %
Frequency	50/60 Hz
Input current	≤ 1.2 mA
Consumption	≤ 0.3 mW
Cable length	≤ 100 m
(2) The ITA 1c and ITA 4c can be synchronised on the Frankfurt 's DCF77 radio station via the DCF or GPS antenna	
Automatic on commissioning, then at 1 am, 2 am, 3 am and 4 am every day	
Manual by pressing the IHP or ITA keys or after a "reset"	
Displayed on the screen by the letters RC	
Programming of pulses adjustable from 1 to 59 s (pulse takes priority over switching)	

Antennas

Additional jumpers

	DCF77 antenna for IHP+ DCF	DCF antenna for ITA	GPS antenna for ITA	IH jumpers		
P135728		P140482		P140481		
	Antenna for IHP+ DCF 1c	Antenna for ITA 1c and ITA 4c	Antenna for ITA 1c and ITA 4c	They are used to program a larger number of sequences for: <ul style="list-style-type: none"> ■ IH 24h 2c ARM (15337) ■ IH 24h + 7j 1+1c ARM (15366) 		
	<ul style="list-style-type: none"> ■ 10 IHP+ DCF 1c maximum per antenna, maximum distance between the IHP+ DCF 1c and the antenna: 100 m ■ Outside the electrical switchboard, outdoors, under shelter 	<ul style="list-style-type: none"> ■ 10 ITA maximum per antenna, maximum distance between the ITA and the antenna: 200 m ■ Outside the electrical switchboard, outdoors, under shelter 	<ul style="list-style-type: none"> ■ 10 ITA maximum per antenna, maximum distance between the ITA and the antenna: 200 m ■ Outside the electrical switchboard, outdoors, under shelter 	1 bag containing: <ul style="list-style-type: none"> ■ 5 red ■ 5 green ■ 5 white ■ 5 yellow 		
	MTN6606-0070	CCT15960	CCT15970 ⁽¹⁾	15341		
	IP54	IP54	IP54	–		
	-20 °C to +70 °C	-20 °C to +50 °C	-30 °C to +55 °C	–		

⁽¹⁾ external 12-30 V DC power supply needed

ITA 1c, ITA 4c

Switching functions	On, Off, pulse, cycle, yearly program	
Pulse lenght pulse function (switching time)	1 s to 59 min 59s	
Pulse lenght timer (manual switching)	1 s to 9 h 59 min 59 s	
Pulse/pause length cycle	1 s to 9 h 59 min 59 s	
Minimum interval	1 min	
External inputs (only for ITA 4c)		
External inputs for external control with a standard switch or a push-button	2 inputs : <ul style="list-style-type: none"> ■ Ext1 input: supplied with 230 V AC, ±10%- 50/60 Hz ■ Ext2 input Ext2: potential free 	
Antennas	DCF- ITA	GPS- ITA
Power supply	Via time switch (without battery)	External 12 - 30 V DC
Output	Protocole DCF	DCF time telegraph (no weather data)
Receiver	Narrowband-heterodyne receiver	–
Operation indicator	Flashing LED on receiving	Flashing LED on receiving

IHP, IH, IHH, ITA (cont.)

Praticle advices

Programming principle

- For the digital time switches, this consists of memorising the days and times of the required switching operations.
- For the mechanical time switches, this is performed by positioning captive segments or jumpers on a switching dial.

Example

- Controlling an air conditioner in a hairdressing salon:

	Monday ⁽¹⁾	Tuesday	Wednesday	Thursday ⁽²⁾	Etc.	
On n° 1		08 h 30	08 h 30	08 h 30		Switch on
Off n° 1		12 h 00	12 h 00			Switch off
On n° 2		13 h 30	13 h 30			Switch on
Off n° 2		20 h 00	20 h 00	20 h 00		Switch off

⁽¹⁾ Closed on Mondays

⁽²⁾ Non-stop

Programming by copying or blocks

Whenever identical switching operations are found at the same times, several days in the week, this function lets you program these operations once only. In this case a single switching operation is used. If this function is used wisely, the number of possible switching operations can be greatly increased.

Example

	Monday	Tuesday	Wednesday	Thursday	Friday	
On n°1	10 h 00			10 h 00		Switch on
Off n°1		18 h 00	18 h 00		18 h 00	Switch off

Number of switching operations

Designation	Number of switching operations
IHP 1c	56
IHP + 1c	84
IHP+ DCF 1c	84
IHP 2c	56
IHP + 2c	84
IHP 1c 18 mm	56
IHP + 1c 18 mm	84
ITA 1c, ITA 4c	300
IH 24h 1c ARM	48 On - 48 Off
IH 24h 1c SRM	48 On - 48 Off
IH 60mn 1c SRM	48 On - 48 Off
IH 24h 1c SRM	48 On - 48 Off
IH 24h 1c ARM	48 On - 48 Off
IH 24h 2c ARM	24 On - 24 Off
IH 7j 1c ARM	42 On - 42 Off
IH 24 h + 7j 1+1c ARM	16 On - 16 Off + 7 On - 7 Off

Saving on mains cut off

For digital switches equipped with this function, a lithium battery is used for saving. The program, date and time are preserved. Switching operations are not performed.

Lets you control starting and stopping of a group of loads according to a cycle that is repeated every 60 minutes.

60 min. time programming

Example

Controlling automatic watering	
On n° 1	2 min. 30 s
Off n° 1	5 min.
On n° 2	25 min.
Off n° 2	37 min. 30 s

Relevant time switches

IH 60mn 1c SRM.

Lets you control starting and stopping of one or two groups of loads according to a daily cycle that is repeated, in identical manner, every day of the week.

24 h daily programming

Example

- Controlling a door of a block of flats:
 - from 8 am to 7.30 pm: contact on "On", free access,
 - from 7.30 pm to 8 am the next day: contact on "Off", access by confidential code every day of the week:

From Monday to Sunday	
On n° 1	8 am
Off n° 1	7.30 pm

Relevant time switches

- IH 24h 1c SRM/ARM.
- IH 24h 2c ARM.
- IHP 1c 18 mm.
- IHP + 1c 18 mm.
- IHP+ DCF 1c.
- IHP 1c, IHP + 1c.
- IHP 2c, IHP + 2c.
- ITA 1c, ITA 4c.

Lets you control starting and stopping of one to 4 groups of loads according to a weekly cycle, that can be different each day, repeated each week.

7 days weekly programming

Example

- Controlling an air conditioner in a hairdressing salon:

	Monday	Tuesday	Wednesday	Thursday	Friday	Saturday	Sunday
On n° 1			09 h 00	09 h 00	09 h 00		
Off n° 1			12 h 00	12 h 00			
On n° 2			14 h 00	14 h 00			
Off n° 2			20 h 00	20 h 00	20 h 00		
On n° 3						8 h 30	8 h 30
Off n° 3						12 h 30	12 h 30
On n° 4						14 h 30	14 h 30
Off n° 4						21 h 00	21 h 00

Relevant time switches

- IH 7j 1c ARM.
- IHP 1c, IHP + 1c.
- IHP 2c, IHP + 2c.
- IHP 1c 18 mm.
- IHP + 1c 18 mm.
- IHP+ DCF 1c.
- ITA 1c, ITA 4c.

Lets you control by pulses (adjustable from 1 to 59 s) one to four groups of loads (pulse relays, bells, etc.).

Pulse programming

Example

■ Automatic controlling of bells, lighting and distribution of food: bells sounding the resumption and finish of work (channel 1), lighting of premises (channel 2), feeding fish in the aquarium (channel 3):

	Monday	Tuesday	Wednesday	Thursday	Friday	Saturday	Sunday
Channel 1: bell (20 s pulse order)							
On	08 h 00	08 h 00	08 h 00	08 h 00	07 h 00	09 h 00	–
Duration	20 s	20 s	20 s	20 s	20 s	20 s	–
On	12 h 00	12 h 00	12 h 00	12 h 00	11 h 00	13 h 00	–
Duration	20 s	20 s	20 s	20 s	20 s	20 s	–
On	14 h 00	14 h 00	14 h 00	14 h 00	13 h 00	–	–
Duration	20 s	20 s	20 s	20 s	20 s	–	–
On	18 h 00	18 h 00	18 h 00	18 h 00	16 h 00	–	–
Duration	20 s	20 s	20 s	20 s	20 s	–	–
Channel 2: lighting (latched order)							
On	07 h 30	07 h 30	07 h 30	07 h 30	06 h 30	08 h 30	–
Off	18 h 30	18 h 30	18 h 30	18 h 30	17 h 00	13 h 30	–
Channel 3: aquarium (15 s pulse order)							
On	10 h 00	–	10 h 00	–	10 h 00	–	10 h 00
Duration	15 s	–	15 s	–	15 s	–	15 s

Programming

- Programming of a pulse takes up 2 memory spaces.
- Combination of the two order types (pulse and latched) is possible on the same channel.

Relevant time switches

- IHP + 1c.
- IHP + 1c 18 mm.
- IHP+ DCF 1c.
- IHP + 2c.
- ITA 1c, ITA 4c.

Lets you create special programs for dated days.

Programming special days.

Example

- Controlling lighting and heating in a school:
- basic programming: program lighting (channel 1) and heating (channel 2):

	Monday	Tuesday	Wednesday	Thursday	Friday	Saturday	Sunday
Channel 1: lighting							
On	07 h 00	07 h 00	07 h 00	07 h 00	07 h 00	–	–
Off	20 h 00	20 h 00	16 h 00	20 h 00	16 h 00	–	–
Channel 2: heating							
On	06 h 00	06 h 00	06 h 00	06 h 00	06 h 00	–	–
Off	18 h 00	18 h 00	12 h 00	18 h 00	12 h 00	–	–

- dated programming: periods of non-operation, school holidays, etc. Just memorise an Off at the start and another Off at the end of each period of absence:

		Holidays				
		Winter	Spring	Summer	Autumn	End of year
Channel 1: lighting						
Off	Date	20 feb.	17-apr	07-july	23 oct.	18 dec.
	Time	12 h 00	17 h 00	12 h 00	17 h 00	12 h 00
Off	Date	08-march	03-may	9 sept.	2 nov.	4 jan.
	Time	01 h 00	01 h 00	01 h 00	01 h 00	01 h 00
Channel 2: heating						
Off	Date	20 feb.	17-apr		23 oct.	18 dec.
	Time	12 h 00	17 h 00		17 h 00	12 h 00
Off	Date	08-march	03-may		2 nov.	4 jan.
	Time	01 h 00	01 h 00		01 h 00	01 h 00

Relevant time switches

- ITA 1c, ITA 4c.

Load table

Type of lighting (230 V AC)	Max. power (for higher power, relay with a contactor)						
	IHP 45 mm	IHP 18 mm	IHP+ 18 mm	IHP+ DCF 36 mm	IH 18 mm	IH 54 mm	ITA
Incandescent and halogen lamps	2600 W	1000 W	2000 W	2600 W	1000 W	1000 W	2000 W
LED lamps	Power for one lamp < 2 W	30 W	6 W	55 W	30 W	15 W	5 W
	Power for one lamp from 2 to 8 W	100 W	20 W	180 W	100 W	50 W	15 W
Non-corrected / serial-corrected / dual mounted fluorescent tubes with conventional ballast	2300 VA	1000 VA	2000 VA	1000 VA	700 VA	600 VA	1000 VA
Parallel corrected fluorescent tubes with conventional ballast	730 W (80 µF)	80 W (14 µF) 2 x 40 W (4.7 µF) 2 x 58 W (7 µF)	1300 W (140 µF)	730 VA (80 µF)	400 W (37 µF)	80 W (12 µF)	550 VA
Fluocompact lamps with electronic ballast	170 W	30 W	300 W	22 x 7 W, 18 x 11 W, 16 x 15 W, 16 x 20 W, 14 x 23 W	80 W	25 W	200 W

Connection

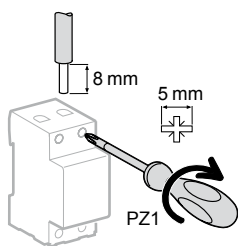

Type	Tightening torque	Copper cables	
		Rigid	Flexible or with ferrule
IHP 1c, 2c, +1c, +2c	2 screwless / pole	2 x 2.5 mm ²	2 x 2.5 mm ²
IHP 18 mm 1c, +1c	2 screwless / pole	2 x 2.5 mm ²	2 x 2.5 mm ²
IHP+ DCF 1c	2 screwless / pole	2 x 2.5 mm ²	2 x 2.5 mm ²
IH 60mn 1c SRM	2 screwless / pole	2 x 2.5 mm ²	2 x 2.5 mm ²
	24h 1c SRM, ARM	2 screwless / pole	2 x 2.5 mm ²
	24h 2c ARM	1.2 N.m	≤ 6 mm ²
	7j 1c ARM	2 screwless / pole	2 x 2.5 mm ²
24h + 7j 1+1c ARM	1.2 N.m	≤ 6 mm ²	≤ 6 mm ²
IH 18 mm 24h 1c SRM / ARM	1.2 N.m	≤ 6 mm ²	≤ 6 mm ²
IHH 18 mm 7j 1c ARM	1.2 N.m	≤ 6 mm ²	≤ 6 mm ²
ITA 1c, ITA 4c	1.2 N.m	≤ 6 mm ²	≤ 6 mm ²

IHP 1c/2c, IHP+ 1c/2c are mechanical compatible with electrical distribution comb busbar.

Weight (g)

Time switches		
IHP	1c / 2c	170 / 205
IHP+	1c / 2c	190 / 211
IHP 18 mm	1c / +1c	90
IHP+ DCF	1c	244
IH 54 mm	60mn 1c SRM	208
	24h 1c SRM/ARM	212 / 119
	24h 2c ARM	216
	7j 1c ARM	119
	24h + 7j 1+1c ARM	223
IH 18 mm	24h 1c SRM / ARM	97
IHH 18 mm	7j 1c ARM	101
ITA 1c		152
ITA 4c		303

Dimensions (mm)

IHP time switches

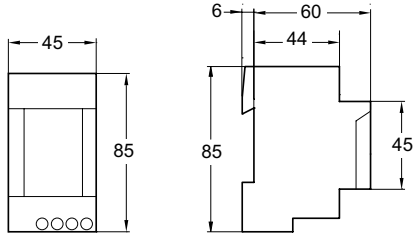

5P (45 mm)
IHP1c, IHP2c, IHP+1c, IHP+2c

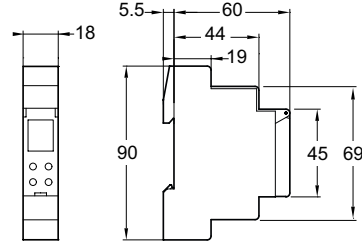

2P (18 mm)
IHP1c, IHP+1c

IHP+ DCF 1c

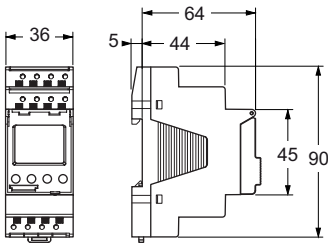

4P (36 mm)
IHP+ DCF 1c

DCF77 antenna for IHP+ DCF 1c

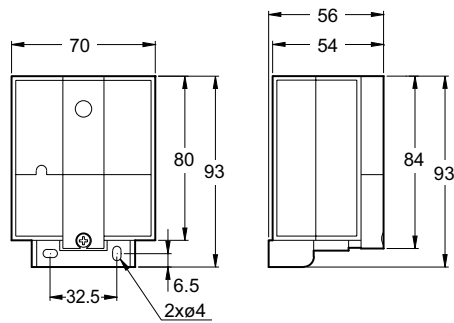

IH, IHH time switches

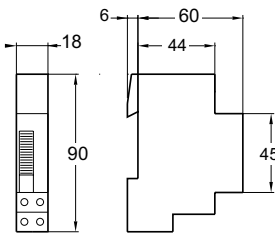

2P (18 mm)
IH 24h 1c SRM/ARM
IHH 7j1c ARM

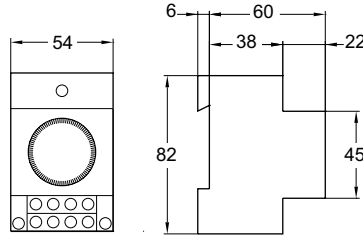

6P (54 mm)
IH 24h 2c ARM,
IH 24h +7j 1+1c ARM

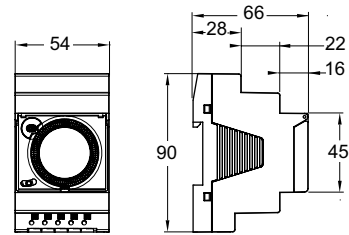

6P (54 mm)
IH 60mn 1c SRM, IH 24h 1c SRM/ARM
IH 7j 1c ARM

ITA yearly time switches

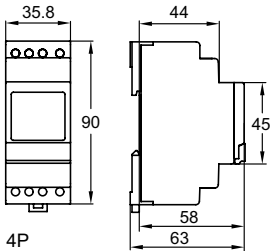

4P

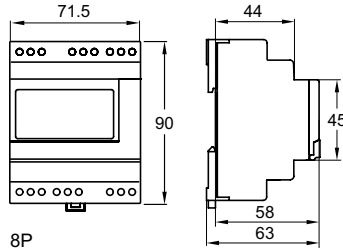

8P

DCF antenna and GPS antenna for ITA

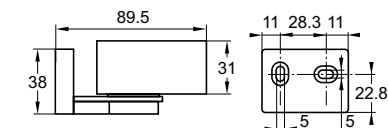
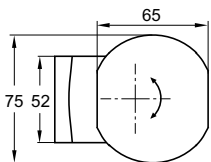

> Timers

> Electromechanical timer

MIN
Adjustable time delay from 1 to 7 min.



> Silent electronic timers



MINs
Adjustable time delay from 0.5 to 20 min.

MINp
Adjustable time delay from 0.5 to 20 min. with switch-off warning.

MINT
Adjustable time delay from 0.5 to 20 min. with switch-off warning and impulse relay function.

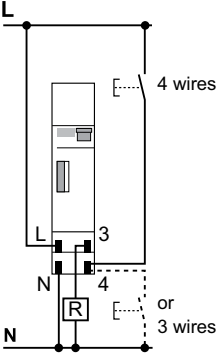
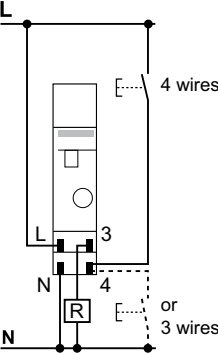
Selection table

	MIN	MINs
Type	Electromechanical timer 	Silent electronic timer 
Function	These timers allow closing and then opening of a contact in a determined time Control circuit: connected standard or luminous push-buttons. Timer inoperative via self-protection if consumption above 50 mA maximum	
Wiring diagrams		
Mounting	Two operating modes triggered by switch on front face: <ul style="list-style-type: none"> ■ Automatic mode: <ul style="list-style-type: none"> □ operation in timing mode □ time delay adjustable from 1 to 7 min. □ setting in steps of 15 s using knob □ pressing a push-button renews the time delay ■ Manual override mode: constant lighting 	Two operating modes triggered by switch on front face: <ul style="list-style-type: none"> ■ Timer mode: time delay adjustable from 0.5 to 20 min. ■ Permanent mode: constant lighting
Catalogue numbers	15363	CCT15232
Technical specifications		
Voltage rating (Ue) (+10 %, -15 %)	230 V AC, 50 Hz	230 V AC, 50/60 Hz
Consumption	1 VA	< 6 VA
Output contact current $\cos \varphi = 1$	16 A	16 A
Degree of protection	IP20B	IP20B
Operating temperature	-10°C to +50°C	-10°C to +50°C
Width (9 mm modules)	2	2
Consumption of connected luminous push-buttons	50 mA maxi	150 mA maxi
Adjustable time delay	1 to 7 min.	0.5 to 20 min.
Long time delay	–	–
Insulation class	–	Class II
1 screw connection per pole for cables up to 6 mm ²	■	■
Selection of the type of connection (3 or 4 wires)	Selector switch	Automatic
Mechanical compatibility with electrical distribution comb busbar	–	■
Switch-off warning function	–	–
Impulse relay function	–	–

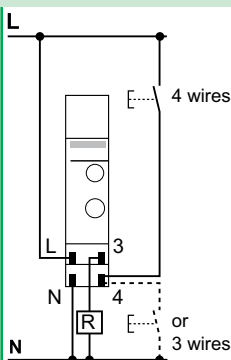
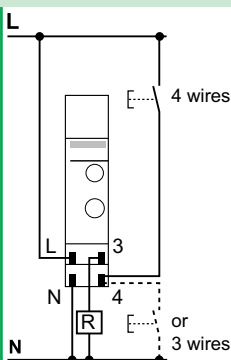
MINp	MINt	Accessory
Silent electronic timer 		Wall mount accessory 
<p>The MINp timer allows closing and then opening of a contact in a determined time, and it also provides warning that the lighting is about to be switched off by flickering of the lamplight (switch-off warning)</p>	<p>The MINt timer is the same as MINp with an "impulse relay" additional function</p>	<p>The MIN timers can be mounted on a wall by using 15359 reference. The protection cover is sealable.</p>
		<p>The 15359 accessory can be also used to mount others 18 mm DIN rail devices (for example: time switches, circuit breakers...).</p>
<ul style="list-style-type: none"> ■ Time delay adjustable from 0.5 to 20 min. ■ Three operating modes triggered by switch on front face: <ul style="list-style-type: none"> <input type="checkbox"/> timer mode with "switch-off warning" function built into the device. The lamp blinks 40 and 30 s before the end of the time delay <input type="checkbox"/> timer mode without "switch-off warning" function <input type="checkbox"/> permanent mode : constant lighting 	<ul style="list-style-type: none"> ■ Timer mode operation: <ul style="list-style-type: none"> <input type="checkbox"/> pressing a push-button for longer than 2 s: lighting will last for 1 h. Pressing again a push-button for less than 2 s relaunch the time delay of 1 h and pressing again a push-button for more than 2 s switches off the light <input type="checkbox"/> pressing a push-button for less than 2 s launch the pre-set time delay, pressing again a push-button for less than 2 s relaunch the pre-set time delay 	<ul style="list-style-type: none"> ■ Timer mode operation: <ul style="list-style-type: none"> <input type="checkbox"/> pressing a push-button for longer than 2 s: lighting will last for 1 h. Pressing again a push-button for less than 2 s relaunch the time delay of 1 h and pressing again a push-button for more than 2 s switches off the light <input type="checkbox"/> pressing a push-button for less than 2 s launch the pre-set time delay, pressing again a push-button for less than 2 s, switches off the light (impulse relay mode)
CCT15233	CCT15234	15359
230 V AC, 50/60 Hz	230 V AC, 50/60 Hz	
< 6 VA	< 6 VA	
16 A	16 A	
IP20B	IP20B	
-25°C to +50°C	-25°C to +50°C	
2	2	See § dimensions
150 mA maxi	150 mA maxi	
0.5 to 20 min.	0.5 to 20 min.	
1 h	1 h	
Class II	Class II	
■ Automatic	■ Automatic	
■	■	
■	■	
-	-	

Load table

Products	MIN	MINs	MINp, MINT
Type of lighting	Maximum power		
230 V incandescent and halogen lamps	2300 W	2300 W	3600 W
LED lamps	Power for one lamp < 2 W	30 W	55 W
	Power for one lamp from 2 to 8 W	90 W	150 W
Non-corrected / serial-corrected / dual mounted fluorescent tubes with conventional ballast	2300 VA	2300 VA	3600 VA ⁽¹⁾
Fluocompact lamps with conventional ballast	2000 VA	1500 VA	1500 VA ⁽¹⁾
Parallel-corrected fluorescent tubes with conventional ballast	1300 VA (70 F)	400 VA (42 µF)	1200 VA (120 µF) ⁽¹⁾
Fluorescent tubes with electronic ballast	300 VA	300 VA	1000 VA
Fluocompact lamps with electronic ballast	9 x 7 W, 6 x 11 W, 5 x 15 W, 5 x 20 W	9 x 7 W, 7 x 11 W, 7 x 15 W, 7 x 20 W, 7 x 23 W	34 x 7 W, 27 x 11 W, 24 x 15 W, 22 x 23 W

⁽¹⁾ The "switch-off warning" function is not available for these types of loads.

Connection

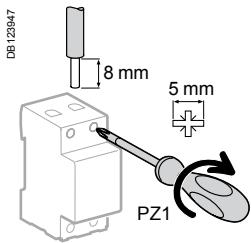

Type	Tightening torque	Copper cables	
		Rigid	Flexible or with ferrule
MIN, MINs, MINp, MINT	1.2 N.m	 ≤ 6 mm ²	 ≤ 6 mm ²

Weight (g)

Time switches	
MIN	84
MINs	75
MINp	103
MINT	76

Dimensions (mm)

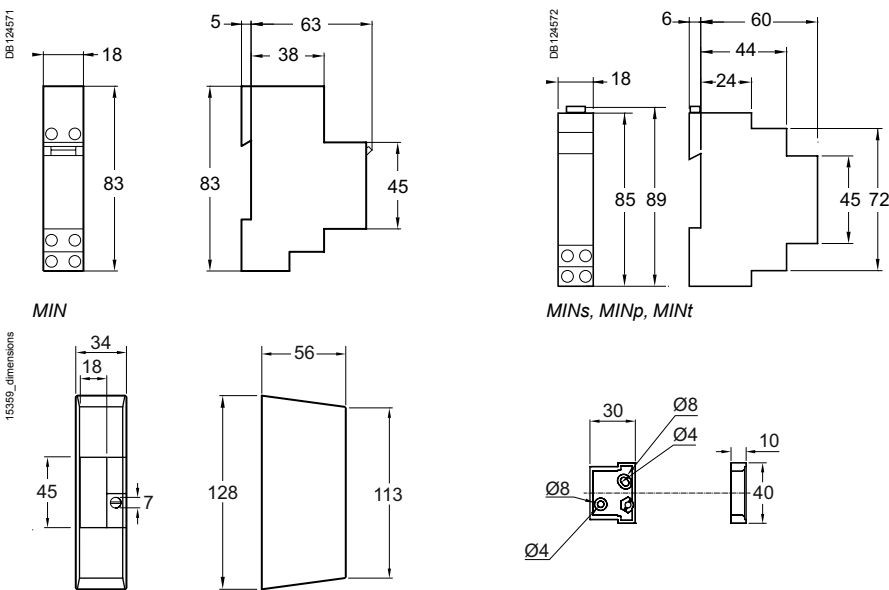

Wall mount accessory

STD and SCU range

STD400RC/RL-DIN & SAE

STD400LED, STD400LED+

STD1000RL-DIN & SAE

SCU10-DIN & SAE

STD



STD

- The STD dimmers modulate incandescent halogen, lighting brightness and motors for unit powers from 40 to 1000 W from one or more switch-on points.
- They can be controlled either with the local control push-button placed on front panel or with auxiliary push-buttons.
- They have soft-On / soft-Off, light level memory and minimum level setting features.
- They are available in 2 different types:
 - DIN type (STD400RC/RL-DIN, STD1000RL-DIN) supplied without digital inputs,
 - SAE type (STD400RC/RL-SAE, STD1000RL-SAE) supplied with 4 digital inputs.



STD LED

- The STD LED dimmers switch and dim the lighting brightness of:
 - incandescent lamps, halogen lamps, (conventional or with electronic transformer),
 - dimmable lamps: fluocompact and LED 230 V.
- The brightness is set via the push buttons connected to the dimmer.
- They have soft-On / soft-Off, light level memory and minimum level setting features.
- The STD LED+ could be used with a movement detector, a presence detector or a programmable time switch. It also provides a staircase function incl. pre-warning.

SCU



SCU





- The SCU dimmers modulate fluorescent lighting brightness for unit powers from 40 to 1500 W from one or more switch-on points.
- They can be controlled either with the local control push-button placed on front panel or with auxiliary push-buttons.
- They have soft-On / soft-Off, light level memory and minimum level setting features.
- They are available in 2 different types:
 - DIN type (SCU10-DIN) supplied without digital inputs,
 - SAE type (SCU10-SAE) supplied with 4 digital inputs.

STD and SCU range (cont.)

STD400RC/RL-DIN & SAE
 STD400LED, STD400LED+
 STD1000RL-DIN & SAE
 SCU10-DIN & SAE

Selection table

STD

	STD400RC/RL-DIN	STD400RC/RL-SAE	STD1000RL-DIN	STD1000RL-SAE
Type	400 W		1000 W	
				

Wiring diagrams

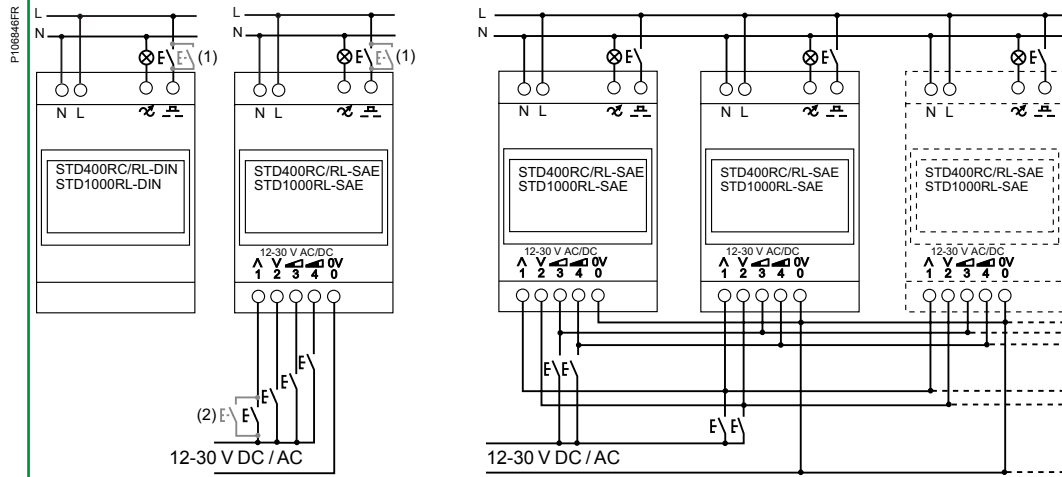

Mounting

With SAE types, it is possible to control a maximum of 20 dimmers combining STD400RC/RL-SAE and STD1000RL-SAE, with only one push-button via the 4 digital inputs

Catalogue numbers	CCTDD20001	CCTDD20002	CCTDD20003	CCTDD20004
--------------------------	-------------------	-------------------	-------------------	-------------------

Technical specifications

Voltage rating (Ue)	230 V AC \pm 10 %, 50 Hz			
Control voltage	230 V AC \pm 10 %, 50 Hz			
Consumption	0.8 VA			
Power loss	3 W			
Local push-button	Short push for On/Off control, long push for dimming			
Auxiliary push-button input	Short push for On/Off control, long push for dimming: <ul style="list-style-type: none"> ■ up to 25 parallel connected auxiliary push-buttons without indication lamps ■ up to 5 parallel connected auxiliary push-buttons with indication lamps ■ max wire length 50 m 			
The minimum light level setting is adjustable	■			
Indication blue LED (built in the local push-button)	Illuminates during the on-state. The LED is blinking in error mode			
Protection class	-			
Degree of protection	IP20			
Operating temperature	0°C to +40°C, 40°C to +70°C with -6 W / °C de-rating			
Storage temperature	0°C to +60°C			
Width (module of 9 mm)	4	4	8	8
Protections, fuses	<ul style="list-style-type: none"> ■ Electronic overload, overvoltage and over temperature protection ■ Single shot thermal fuse 			
Standards	According to EN 60669-2-1			
Directives	According to CE, EMC 89/336/EEC and LVD 73/73/23/EEC			

(1) Use of maximum 25 push-buttons without indication lamp and 5 push-buttons with indication lamp, connected in parallel.

(2) Use of maximum 25 push-buttons without indication lamp, connected in parallel, only for STD400RC/RL-SAE and STD1000RL-SAE.

STD400LED

400 W



STD400LED+

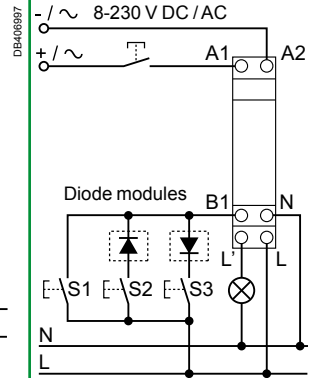
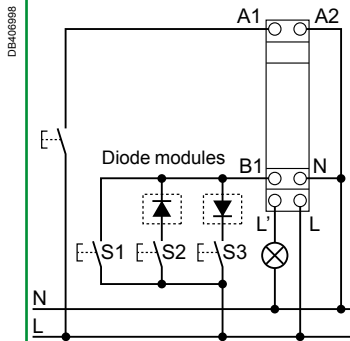
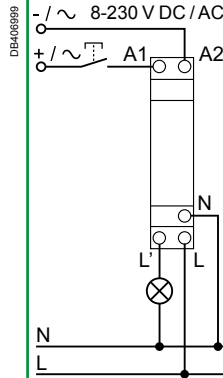
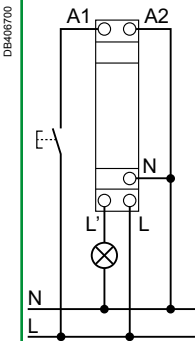

-

The 2 diode modules (supplied) could be used to implement 2 push-buttons, for example (push-button 1 = Switch on/Dim up, push-button 2 = Switch off/dim down) or to manage until 3 scenarios of lighting

CCTDD20016

CCTDD20017

230 V AC +10 %, -15 %, 50 Hz

8...230 V AC/DC

0.3 W

0.2 W

-

Short push for On/Off control, long push for dimming:
 ■ up to 10 parallel connected auxiliary push-buttons without indication lamps
 ■ max wire length 100 m

■

-

II

IP20

-30°C to +50°C

-20°C to +70°C

2

Electronic overload, overvoltage and over temperature protection

According to EN 60669-1, EN 60669-2-1

According to CE, 2004/108/EC, 2006/95/EC, 2011/65/EC

0.2 W

-

Short push for On/Off control, long push for dimming:
 ■ up to 10 parallel connected auxiliary push-buttons without indication lamps
 ■ max wire length 100 m

-

-20°C to +70°C

STD and SCU range (cont.)

STD400RC/RL-DIN & SAE
 STD400LED, STD400LED+
 STD1000RL-DIN & SAE
 SCU10-DIN & SAE

Selection table

SCU

Type	SCU10-DIN	SCU10-SAE
	1 - 10 V	
		

Wiring diagrams

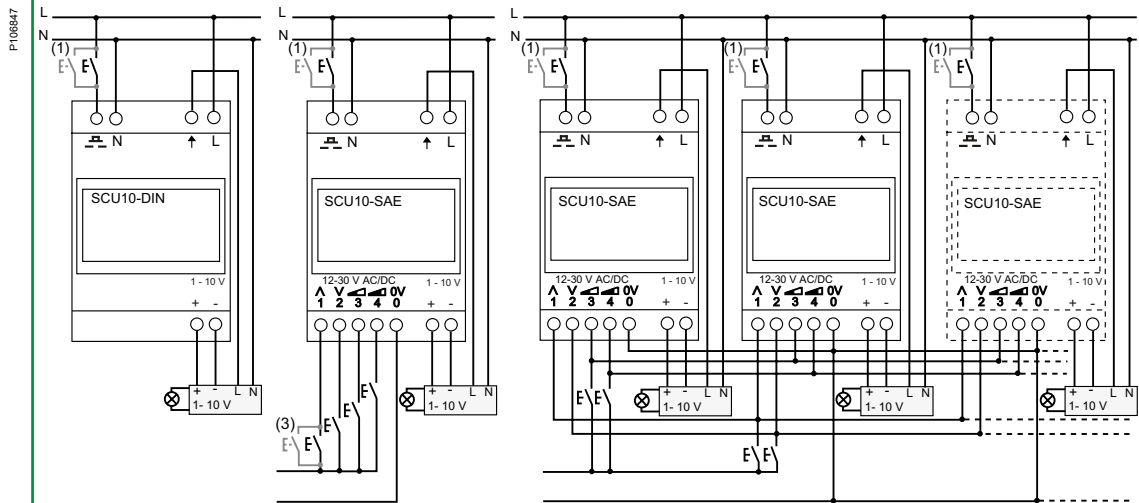

Mounting

With SAE types, it is possible to control a maximum of 20 dimmers combining STD400RC/RL-SAE, STD1000RL-SAE and SCU10-SAE with only one push-button via the 4 digital inputs

Catalogue numbers	CCTDD20011	CCTDD20012
-------------------	------------	------------

Technical specifications

Voltage rating (Ue)	230 V AC ± 10 %, 50 Hz	
Consumption	0.8 VA	
Power loss	3 W	
Current sink for 1-10 V output	0.2- 100 mA	
Local push-button	Short push for On/Off control, long push for dimming	
Auxiliary push-button input	Short push for On/Off control, long push for dimming: ■ up to 25 parallel connected auxiliary push-buttons without indication lamps ■ up to 5 parallel connected auxiliary push-buttons with indication lamps ■ max wire length 50 m	
The minimum light level setting is adjustable	■	
Indication blue LED (built in the local push-button)	Illuminates during the on-state. The LED is blinking in error mode	
Degree of protection	IP20	
Operating temperature	0°C to +40°C, 40°C to +70°C with - 6 W /°C de-rating	
Storage temperature	0°C to +60°C	
Width (module of 9 mm)	8	8
Protections, fuses	■ Electronic overload, overvoltage and over temperature protection ■ Single shot thermal fuse	
Standards	According to EN 60669-2-1	
Directives	According to CE, EMC 89/336/EEC and LVD 73/73/23/EEC	

(1) Use of maximum 25 push-buttons without indication lamp and 5 push-buttons with indication lamp, connected in parallel.
 (3) Use of maximum 25 push-buttons without indication lamp, connected in parallel, only for SCU10-SAE

STD and SCU range (cont.)

STD400RC/RL-DIN & SAE
 STD400LED, STD400LED+
 STD1000RL-DIN & SAE
 SCU10-DIN & SAE

Specific technical data

SAE types									
Input voltage	12- 30 V AC/DC								
The STD400RC/RL-SAE , STD1000RL-SAE and SCU10-SAE dimmers are supplied with 4 digital inputs	<table border="1"> <tr> <td>Input 1</td> <td>On/Off and dimming up/down or only On and dimming up (depends on function mode)</td> </tr> <tr> <td>Input 2</td> <td>Off and dimming down or only Off (depends on function mode)</td> </tr> <tr> <td>Input 3</td> <td>Adjustable lighting level memory 1 (50 % default)</td> </tr> <tr> <td>Input 4</td> <td>Adjustable lighting level memory 2 (100 % default)</td> </tr> </table>	Input 1	On/Off and dimming up/down or only On and dimming up (depends on function mode)	Input 2	Off and dimming down or only Off (depends on function mode)	Input 3	Adjustable lighting level memory 1 (50 % default)	Input 4	Adjustable lighting level memory 2 (100 % default)
Input 1	On/Off and dimming up/down or only On and dimming up (depends on function mode)								
Input 2	Off and dimming down or only Off (depends on function mode)								
Input 3	Adjustable lighting level memory 1 (50 % default)								
Input 4	Adjustable lighting level memory 2 (100 % default)								
Max wire length	50 m								
Up to 25 push-buttons per input. No push-button with indication lamp									
STD400RC/RL-DIN and STD400RC/RL-SAE dimmers are power regulators designed for all dimmable load types. Dimmers have automatic load type detection and the load regulation method is adjusted to fit the load									

Operation modes for SAE types

- **STD400RC/RL-SAE**, **STD1000RL-SAE** and **SCU10-SAE** dimmers have 2 different operation modes (**A** and **B**) using auxiliary push-buttons connected on digital inputs (1, 2, 3 and 4 terminals).
- Modes **A** and **B** can be changed by pushing the digital inputs 3 and 4 simultaneously for 10 s. After the mode is changed the load and the LED start to blink as long as the inputs are pushed.
- In the mode **A**, the input 1 dims the lights on with a short push and up with a long push and turns light off with a short push and dims the light down with a long push. The direction is changed every time the input 1 is released. The input 2 dims the lights always off.
- In the mode **B**, the input 1 dims lights only up with a long push and turns lights on with a short push. The input 2 dims the lights only down with a long push and turns lights off with a short push.
- Inputs 3 and 4 are for memory places for light levels. The light level is called with a short push and set into the memory with a long push of 3 s.

Common technical data



Common operation mode for SAE & DIN types

- The dimmer is turned On/Off by shortly pushing the front panel push-button. This push-button lights blue when the dimmer is On.
- The light level is controlled by keeping the front panel push-button pushed until wanted level has been reached.
- The direction of dimming (up/down) is changed every time the front panel push-button is released.
- The dimmer has memory function which stores the light level before Off-command. When the dimmer is turned back On, the light level is the same as it was before Off-command.
- Auxiliary push-buttons connected on  terminal have the same functionality as the push-button on the front panel of the dimmer.

STD and SCU range (cont.)

STD400RC/RL-DIN & SAE
 STD400LED, STD400LED+
 STD1000RL-DIN & SAE
 SCU10-DIN & SAE

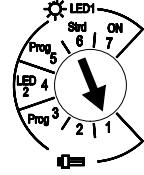
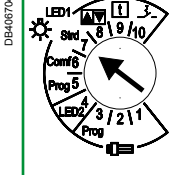
STD400LED specific technical data

Lamp	Function	Product
		<div style="display: flex; justify-content: space-between;"> <div style="width: 48%;"> <p>STD400LED</p>  <p>DB400703</p> </div> <div style="width: 48%;"> <p>STD400LED+</p>  <p>DB400704</p> </div> </div>
		<div style="display: flex; justify-content: space-between;"> <div style="width: 48%;"> <p>Switch for setting the functions</p> </div> <div style="width: 48%;"> <p>Switch for setting the functions</p> </div> </div>
		<div style="display: flex; justify-content: space-between;"> <div style="width: 48%;"> <p>-</p> </div> <div style="width: 48%;">  <p>DE-400705</p> <p>Potentiometer for setting the dimming time</p> </div> </div>
Dimmable compact fluorescent lamps (CFL)	1	<p>Automatic load detection Start with 100 % Dimming down not possible till after 3 s</p>
	2	<p>No automatic load detection (always with phase section) Start with 50 % Dimming down not possible till after 2 s</p>
	Prog 3	<p>Programming the minimum brightness</p>
Dimmable LED	4	No automatic load (always with phase section) to used if dimming problems with the LEDs
Standard: Incandescent, Halogen, Transformer, Dimmable LEDs ...	Prog 5	Programming the minimum brightness
	6	<p>Standard function: Adjustable switch-on brightness (preset 100 %) Light brightness dimming switch-on after 2 s</p>
	7	Dimmer is always on
	8	-
	9	-
	10	-

STD and SCU range (cont.)

STD400RC/RL-DIN & SAE
 STD400LED, STD400LED+
 STD1000RL-DIN & SAE
 SCU10-DIN & SAE

Load table**STD400RC/RL-DIN, STD400RC/RL-SAE**

230 V incandescent and halogen lamps	40 - 400 W
Low voltage halogen lamps with electronic transformer	40 - 400 W
Low voltage halogen lamps with conventional transformer	40 - 400 W
Low voltage halogen lamps with toroidal transformer	40 - 300 W
Motors (fans, ventilators...)	40 - 200 W

STD400LED, STD400LED+

230 V incandescent and halogen lamps	0 - 400 W *
Low voltage halogen lamps with electronic transformer	0 - 300 W
Low voltage halogen lamps with conventional transformer	0 - 400 W *
Low voltage halogen lamps with toroidal transformer	0 - 400 W *
Dimmable fluocompact lamps (CFL)	0 - 80 W
Dimmable LED lamps	0 - 60 W

* In the case of a load of >300 W keep an 8 mm ventilation distance to the right and left.

STD1000RL-DIN, STD1000RL-SAE

230 V incandescent and halogen lamps	60 - 1000 W
Low voltage halogen lamps with conventional transformer	60 - 1000 W
Motors (fans, ventilators...)	60 - 600 W

SCU10-DIN, SCU10-SAE

Mono fluorescent tubes with electronic ballast (dia.26 mm)	50 x 18 W, 40 x 36 W, 25 x 58 W
Duo fluorescent tubes with electronic ballast (dia.26 mm)	40 x 18 W, 20 x 36 W, 12 x 58 W
Fluocompact lamps with electronic ballast	50 max. up to 1500 W

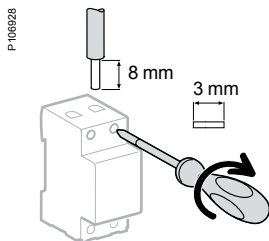
Connection

Type	Tightening torque	Copper cables	
		Rigid	Flexible or with ferrule
STD and SCU (top connection)	0.5 N.m	< 4 mm ²	< 4 mm ²
STD and SCU (bottom connection)	0.5 N.m	< 2.5 mm ²	< 2.5 mm ²
STD400LED, STD400LED+	0.5 N.m	< 2.5 mm ²	< 2.5 mm ²

Weight (g)**Dimmers**

STD400RC/RL-DIN	80
STD400RC/RL-SAE	90
STD1000RL-DIN	120
STD1000RL-SAE, SCU10	130
STD400LED	65
STD400LED+	70

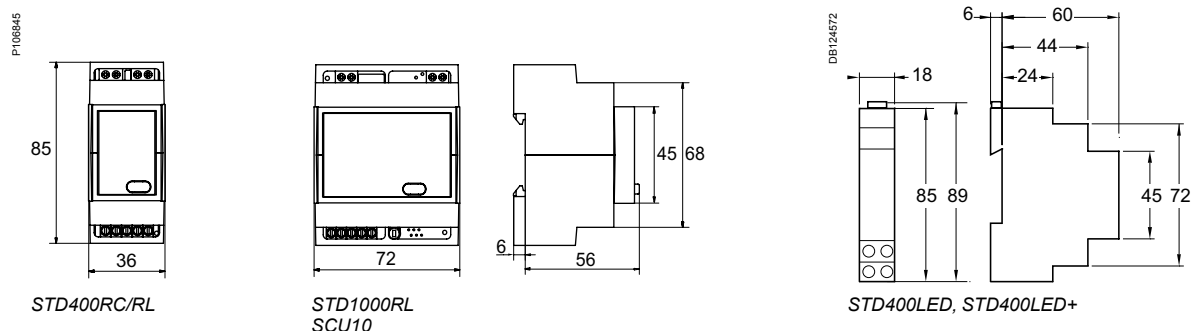
Dimensions (mm)



> **Thermostats**

P123732



P123731



TH4

For individual and multifamily housing, tertiary premises, TH4 thermostat monitors and regulates ambient temperature from +8°C to +26°C according to 3 temperature set points:

- comfort: while the premises are occupied
- reduced: while the premises are unoccupied
- above freezing: for a prolonged period of non-occupancy.

TH7

For industrial premises stretching from cold storage to ovens, TH7 thermostat monitors and regulates temperature from -40°C to +80°C with a wide setting range. It can also be used for frost protections at home.

> **Programmable thermostat**

DB40875





THP1+ 1C

Programmable thermostat control the operating periods of all heating types by monitoring and regulating ambient temperature between 10°C and 30°C, using a programme pre-set by the user.

Selection table

Thermostats

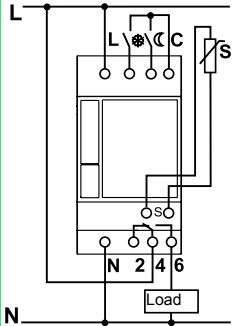
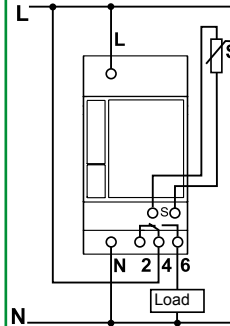
		TH4	TH7
Type		<p>P123732</p> 	<p>P123731</p> 
Function		<p>For individual and multifamily housing, tertiary premises, TH4 thermostat monitors and regulates ambient temperature from +8°C to +26°C according to 3 temperature set points:</p> <ul style="list-style-type: none"> ■ comfort: while the premises are occupied ■ reduced: while the premises are unoccupied ■ above freezing: for a prolonged period of non-occupancy 	<ul style="list-style-type: none"> ■ For industrial premises stretching from cold storage to ovens, TH7 thermostat monitors and regulates temperature from -40°C to +80°C with a wide setting range ■ It can also be used for frost protections at home
Wiring diagrams		<p>P106772</p> 	<p>P106773</p> 
Mounting		Delivered with CCT15846 ambient temperature probe	Delivered without probe
Catalogue numbers		CCT15841	CCT15840
Technical specifications			
Voltage rating (Ue)		230 V AC ± 10 %, 50/60 Hz	
Consumption		< 4 VA	
Output contact current (250 V AC)	Max.	Cos φ = 1	16 A
		Cos φ = 0.6	3 A
	Min.		—
Power reserve		—	
Time base		—	
Difference between tripping and activation		± 0.2°C	
Degree of protection		IP20	
Operating temperature		-10°C to +55°C	
Storage temperature		-20°C to +60°C	
Set Point accuracy		1°C	
Humidity		15-95 % RH (no condensation)	
Width (module of 9 mm)		5	
Color		White RAL 9003	
Protections, fuses		Internal over voltage protection against surges, internal over temperature protection	
Compliance with Community Directives	Isolating requirements, E.M.C. guidelines and Safety guidelines	EN 60730-2-9	
	RoHS and environmental issues	EU-directive 2002/95/EC (RoHS)	
		WEEE-directive 2002/96/EC (recycling)	
		REACH Regulation (EC) No 1907/2006	

Programmable thermostat

THP1+ 1C

DB-406875



- The THP1+ 1C programmable thermostat controls the operating periods of all heating types by monitoring and regulating ambient temperature between 10°C and 30°C, using a programme pre-set by the user and memorised
- The THP1+ 1C monitors and regulates temperature in a room by comparing the value of the temperature measured by the ambient temperature probe with the value of the setpoint displayed on its front face according to 3 operating modes:
 - comfort: 10°C to 30°C while the premises are occupied
 - reduced: 10°C to 26°C while the premises are unoccupied
 - above freezing: the temperature in the premises is maintained at approximately 10°C
- The THP1+ 1C, can control the following loads:
 - convectors
 - a burner
 - a "hot air" heating system
 - heating valves: hydraulic, electromagnetic or electrothermal

DB-406879

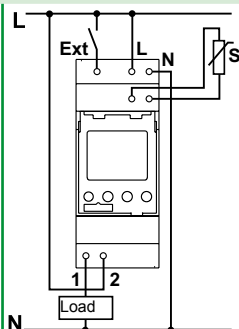

An ambient temperature probe needs to be ordered separately (see next page ref. 15835 or 15836)

CCT15833

230-240 V AC $\pm 10\%$, 50-60 Hz

1.36 VA

10 A

2 A

10 mA (230 V AC, 100 mA (12 V AC/DC)

10 years at 20°C

Quartz

$\pm 0.2^\circ\text{C}$

IP20

0°C to +50°C

-20°C to +70°C

0.1°C

-

4

White RAL 9003

Internal short circuit protection

EN 60730-2-9



2006/95/EC - low voltage directive

2011/65/EU - RoHS directive

2004/108/EC - electromagnetic compatibility

Selection table TH4, TH7

Temperature probes

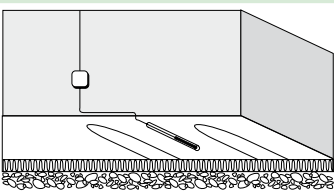
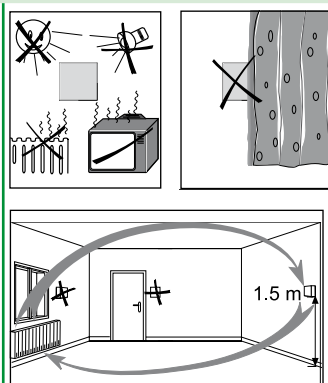
Accessories	Floor temperature probe (with 1.5 m cable)	Ambient temperature probe (with 1.5 m cable)
Type	<p>P123733</p> 	<p>P123734</p> 
Installation	<p>P108853</p> 	<p>P108854</p> 
Mounting	<p>This probe must be placed:</p> <ul style="list-style-type: none"> ■ in a Ø 9 mm tube, embedded in the slab in the middle of a turn ■ one of the ends must run out of a distribution box sealed in the nearest wall (to simplify probe installation or replacement) 	<p>This probe must be fixed 1.50 m above the floor, away from drafts and sources of heat (sun's rays, radiators, machines, etc.)</p>
Catalogue numbers	CCT15845	CCT15846

Note: for all probes, do not run connecting cables alongside power cables.
 TH4 and TH7 probes cables can be extended up to 70 m by using 6/10th telephone cable or up to 150 m by using shielded copper cable.
 THP1+ 1C probes cables can be extended up to 50 m by using 6/10th telephone cable or shielded copper cable.

Specific technical data





TH4		
Settings	Comfort	From +8°C to +26°C
	Reduced	From 0°C to 10°C below the selected "comfort" temperature set point: control (manual or automatic) by external dry contact
	Above freezing	Maintains room temperature according to a factory adjusted temperature set point of +5°C: control (manual or automatic) by external dry contact
Three indicator lights visualise	Green	Above freezing operation
	Yellow	Reduced operation
	Red	Relay: ON
Delivered with ambient temperature probe (CCT15846)		NTC 10 kΩ (25°C) can be extended up to 150 m with shielded copper cable and up to 70 m with telephone cable
<p>Note: however, the set point selected never can't be less than +8°C. Eg. If the reduced set point is selected with a 12°C set point temperature and a 10°C reduction temperature, the operative set point will not be +2°C (12-10) but rather +8°C (+5°C only if the "above freezing" input is closed/active).</p>		
TH7		
Temperature set point settings ⁽¹⁾	Range	6 fixed positions: -40°C, -20°C, 0°C, +20°C, +40°C and +60°C
	Adjustements	From 0°C to 20°C above the selected fixed position
Indicator light	Red	Relay: ON
Delivered without probe		

(1) For example: if "range" is on -40°C, setting is possible between -40°C and -20°C.

THP1+ 1C

Temperature probes

Ambient temperature probes

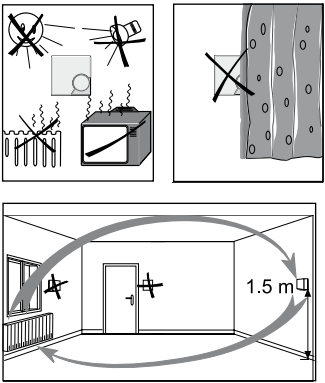
Outside temperature probe (with 2 m cable)		Collar temperature probe (with 1.5 m cable)		Non-adjustable probe		± 3 °C adjustable probe	
P123735		P123736		P126320		049540r	
				<p style="text-align: center;">P106855</p> 			
<p>This probe must be fixed away from:</p> <ul style="list-style-type: none"> ■ the sun preferably facing north ■ all heat sources (chimney, etc.) 		<p>This probe must be fixed on the hot water outgoing pipe (min. ø 21 mm, max. ø 90 mm) approximately 1.50 m from the boiler.</p>		<p>These probes must be fixed 1.50 m above the floor, away from drafts and sources of heat (sun's rays, radiators, machines, etc.)</p>			
CCT15847		CCT15848		15835		15836	

Memory key (optional)

P93581-8_13



Saving and duplicating programs

Catalogue number

CCT15861

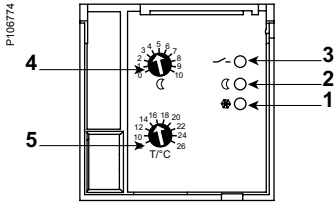

Fig. 1.

TH4

Front face (see Fig. 1)

- 1 Above freezing mode indicator.
- 2 Reduced mode indicator.
- 3 Relay.
- 4 Reduced threshold adjustment (reduction of temperature with respect to the setpoint).
- 5 Temperature threshold adjustment.

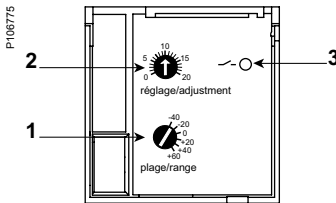

Fig. 2.

TH7

Front face (see Fig. 2)

- 1 Temperature range setting (6 ranges).
- 2 Temperature fine adjustment.
- 3 Relay indicator.

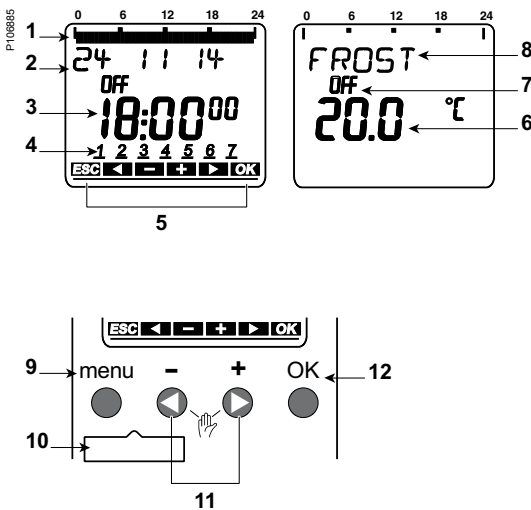

Fig. 3.

THP1+ 1C

Front face (see Fig. 3)

- 1 Programmed switching times
- 2 Date display
- 3 Time display
- 4 Days of the week from 1 to 7
- 5 Display of the active buttons with the relevant function
- 6 Actual temperature: 20°C
- 7 Channel status: ON = On, OFF = Off
- 8 Operating mode: Frost, Comfort, Reduce
- 9 menu: Activate display, Open menu, Cancel menu, ESC (leave menu)
- 10 Memory card interface
- 11 Options are displayed
- 12 OK: Save selection, Confirm selection

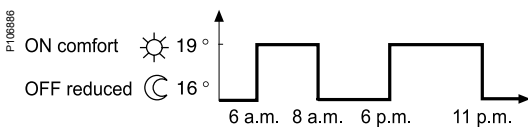

Fig. 4.

THP1+ 1C programming

A programmable clock, built into the THP1+ 1C, is used for programming (see Fig. 4).

- The various operations for updating time and day.
- Programming possibilities:
 - 24 hours and 7 days: a separate programme for each day of the week,
 - up to 42 switching operations memorised,
 - the same switching operation used over several days only counts as one switching operation,
 - Power reserve: 10 years.

Example

- Programming:
 - temperature thresholds: "comfort" 19°C and "reduced" 16°C,
 - presence from 6 a.m. to 8 a.m. and from 6 p.m. to 11 p.m.: "comfort" heating, temperature of 19°C,
 - absence (from 8 a.m. to 6 p.m.) and nighttime (from 11 p.m. to 6 a.m.): "reduced" heating, temperature of 16°C.

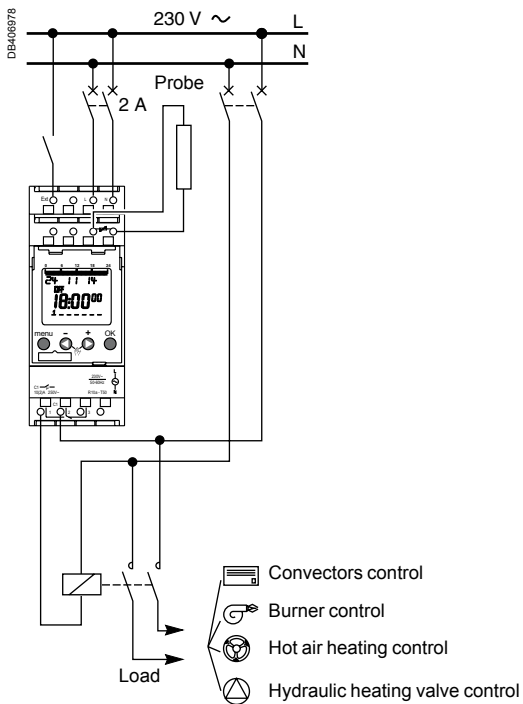

Fig. 5. THP1+ 1C connection example.

Local control

The configuration interface of the THP1+ 1C programmable thermostat consists of a screen and four configuration buttons.

The THP1+ 1C programmable thermostat has a built-in clock and its main menu is used to:

- set the temperatures: "comfort", "reduced" or "frost protection",
- assign these temperatures to a maximum of 42 hourly switching operations over 7 days,
- set the date and time format, the transition to summer or winter time,
- manually override the temperature without changing the hourly switching operations if the premises are not used during holidays, etc.

The option menu can be accessed to set:

- the external input (deactivated, "comfort", "reduced" or "frost protection" temperature),
- the type of heating:
 - heater, convector (NORMAL),
 - inertia heating (UNDERFLOOR),
 - pulsed-air heating (AIR HEATING),
- the temperature compensation to correct the measurement obtained by the temperature probe in the event of an unfavourable location,
- the screen lighting mode:
 - constantly on,
 - off after 1 minute,
- the language used,
- and to reset the parameters (return to factory settings).

Connection

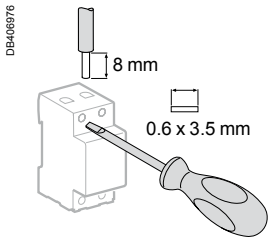

Type	Tightening torque	Copper cables	
		Rigid	Flexible or with ferrule
TH4, TH7, THP1+ 1C	2 screwless / pole	2 x 2.5 mm ²	2 x 2.5 mm ²

Weight (g)

Thermostats	
TH4, TH7	125
TH4 with probe	205
Programmable thermostat	
THP1+ 1C	184

Dimensions (mm)

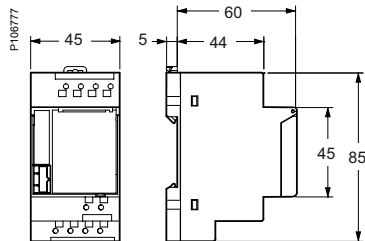

TH4 and TH7 thermostats

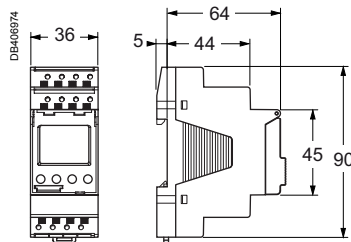

THP1+ 1C programmable thermostat

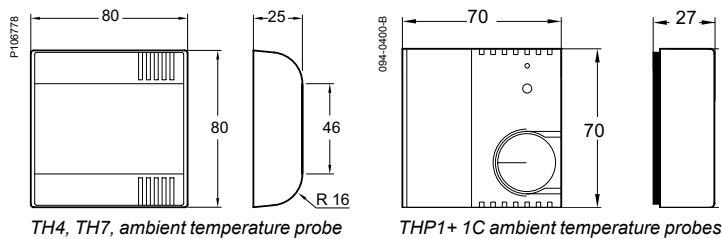

TH4, TH7, ambient temperature probe

THP1+ 1C ambient temperature probes

	16330	287, 288	18632	90, 91	18729	95	18806	100, 101
	16331	287, 288	18633	90, 91	18730	95	18807	100, 101
Symbols	16332	287, 288	18634	90, 91	18731	95	18810	101
*	16360	287, 288	18635	90, 91	18732	95	18811	101
+ : AB1-R12	16361	287, 288	18636	90, 91	18733	95	18812	101
- : AB1-R13	16362	287, 288	18637	91	18734	95	18813	101
0 : AB1-R0	16363	287, 288	18638	90, 91	18735	95	18814	101
1 : AB1-R1	16643	287, 288	18639	90, 91	18736	95	18815	101
2 : AB1-R2	16644	287, 288	18640	91	18737	95	18816	101
3 : AB1-R3	16645	287, 288	18641	90	18738	95	18817	101
4 : AB1-R4	16646	288	18642	91	18739	95	18818	101
5 : AB1-R5	16649	287, 288	18643	90	18740	95	18821	100
6 : AB1-R6	16763	194	18644	91	18741	100, 101	18822	100
7 : AB1-R7	16764	194	18645	90	18742	100, 101	18823	100
8 : AB1-R8	16765	194	18646	90, 91	18743	100, 101	18824	100
9 : AB1-R9	16766	194	18647	90, 91	18744	100, 101	18825	100
01202	16905	194	18648	90, 91	18745	100, 101	18826	100
04000	16906	194	18649	90, 91	18746	100, 101	18827	100
04004	16907	194	18650	90, 91	18747	100, 101	18828	100
04008	16908	194	18651	90, 91	18748	100, 101	18829	100
04012	16920	194	18652	90, 91	18749	100, 101	18830	100, 101
04013	16921	194	18653	90, 91	18750	100, 101	18831	100, 101
04014	16922	194	18654	90, 91	18751	100, 101	18832	100, 101
04018	16924	194	18655	90, 91	18752	100, 101	18833	100, 101
04021	16925	194	18656	90, 91	18753	100, 101	18834	100, 101
04024	16926	194	18657	90	18754	100, 101	18835	100, 101
04026	16927	194	18658	91	18755	100, 101	18836	100, 101
04029	16938	195	18659	90	18756	100, 101	18837	100, 101
04030	16939	195	18659	90	18757	100, 101	18838	100, 101
04031	16940	195	18660	91	18758	100, 101	18839	100, 101
04037	16966	194	18661	90	18759	100, 101	18840	100, 101
04040	16967	194	18662	91	18760	100, 101	18841	100, 101
04041	16970	194	18663	90, 91	18761	100, 101	18842	100, 101
04045	16971	194	18664	90, 91	18762	100, 101	18843	100, 101
04046	16972	194	18665	90, 91	18763	100, 101	18844	100, 101
04047	16973	194	18666	90, 91	18764	100, 101	18845	100, 101
14811	17400	355, 356, 358,	18667	90, 91	18765	100, 101	18846	100, 101
14812	389, 401	359, 368, 372	18668	90, 91	18766	100, 101	18847	100, 101
14813	389, 401	18264	18669	90, 91	18767	100, 101	18848	100, 101
14814	389, 401	18265	18670	90, 91	18768	100, 101	18849	100, 101
14818	389, 408	18266	18671	90, 91	18769	100, 101	18850	100, 101
14900	378	18267	18672	91	18770	100, 101	18851	100, 101
14901	378	18268	18673	90, 91	18771	100, 101	18852	100, 101
14909	378	18269	18674	90, 91	18772	100, 101	18853	100, 101
14910	378	18270	18687	267	18773	100, 101	18854	100, 101
14911	378	18280	18688	267	18774	100, 101	18855	100, 101
15033	589	18281	18689	267	18775	100, 101	18856	100, 101
15125	491	18526	18690	267	18776	100, 101	18857	100, 101
15126	491	18527	18691	267	18777	100, 101	18858	100, 101
15228	571	18528	18692	267	18778	100, 101	18859	100, 101
15229	571	18603	18705	95	18779	100, 101	18860	100, 101
15281	594	18604	18706	95	18780	100, 101	18861	100, 101
15284	593	18605	18707	95	18781	100, 101	18862	100, 101
15324	589	18607	18708	95	18782	100, 101	18863	100, 101
15331	606	18608	18709	95	18783	100, 101	18864	100, 101
15335	606	18609	18710	95	18784	100, 101	18865	100, 101
15336	606	18610	18711	95	18785	100, 101	18868	132
15337	606	18611	18712	95	18788	100, 101	18869	132
15341	609	18612	18713	95	18789	100, 101	18870	132
15359	362	18613	18714	95	18790	100, 101	18871	132
15363	617	18614	18715	95	18791	100, 101	18872	132
15366	606	18615	18716	95	18792	100, 101	18873	132
15482	593	18616	18717	95	18793	100, 101	18874	132
15483	593	18617	18718	95	18794	100, 101	18875	132
15668	137	18618	18719	95	18795	100, 101	18876	132
15669	137	18621	18720	95	18796	100, 101	18879	132
15835	631	18622	18721	95	18799	100, 101	18880	132
15836	631	18623	18722	95	18800	100, 101	18881	132
16314	288	18624	18723	95	18801	100, 101	18882	132
16315	288	18625	18724	95	18802	100, 101	18883	132
16316	288	18626	18725	95	18803	100, 101	18884	132
16317	288	18627	18726	95	18804	100, 101	18885	132
16318	288	18628	18727	95	18805	100, 101	18886	132
16329	287, 288	18629	18728	95				

18887	132	19082	361, 374	27053	137, 342, 343,	A9A26975	346, 348,	A9C15918	515, 516,		
18889	337, 338	19083	361, 374	344, 346, 348, 349, 350,	A9A26976	349, 351, 364	A9C15919	515, 516,	517, 518			
18890	337, 338	19084	361, 374	351, 352, 353, 354, 355,	349, 351, 364	A9A26981	346, 348,	517, 518	A9C15920	515, 516,		
18891	337, 338	19085	361, 374	356, 357, 358, 359, 360,	A9A26982	174, 175, 351, 364	A9C15924	515, 516,	517, 518			
18892	337, 338	19086	361, 374	365, 372	A9A27001	A9A27003	346, 348,	517, 520	A9C18195	346, 348,	
18893	338	19087	361, 374	27060	349, 351, 364	A9A27005	346, 349,	465	A9C18308	515, 516,	
18894	338	19088	361, 374	349, 351, 353, 354, 355,	A9A15035	A9A27005	346, 349	517, 518	A9C18309	515, 516,	
18895	338	19089	361, 374	356, 358, 359, 360, 365,	A9A15096	A9A27005	362	517, 518	A9C20132	504, 506,	
18896	338	19090	361, 374	372	A9A15151	A9A27006	346, 349,	508, 525, 526, 527	A9C20134	505, 506,	
18897	337	19091	346, 348, 349,	27145	A9A15152	362	362	508, 525, 526, 527	A9C20137	505, 506,	
18898	337	351, 353, 354, 355, 356,	A9A15212	571, 572	A9A15213	A9A27008	346, 349,	508, 525, 526, 527	A9C20162	504, 506,	
18899	337	358, 359, 360, 361, 374,	A9A15213	571, 572	A9A15214	A9A27049	352	508, 525, 526, 527	A9C20167	505, 506,	
18900	337	365, 372	A9A15214	571, 572	A9A15216	A9A27052	342, 343,	508, 525, 526, 527	A9C20232	504, 506,	
19000	236, 239	19092	361, 374	A9A15218	A9A15218	344, 362	A9C20167	505, 506,	508, 525, 526, 527		
19001	236, 239	19093	361, 374	A9A15219	A9A15219	546, 515, 516, 517, 521,	A9C20232	504, 506,	508, 525, 526, 527		
19002	236, 239	19094	361, 374	A9A15220	A9A15220	522, 364	A9C20431	510, 528,	529		
19003	236, 239	19095	361, 374	A9A15222	A9A15222	A9A27063	351, 352	A9C20432	510, 528,	
19004	236, 239	19096	346, 348, 349,	A9A15303	A9A15303	A9A27108	461	A9C20433	510, 528,	
19005	236, 239	351, 353, 354, 355, 356,	A9A15306	589	A9A15306	A9C15030	567	529	A9C20436	510, 528,	
19008	237, 240	358, 359, 360, 361, 374,	A9A15307	589	A9A15307	A9C15031	567	529	A9C20442	510, 528,	
19009	237, 240	365, 372	A9A15310	589	A9A15310	A9C15032	565	529	A9C20443	510, 528,	
19010	240	19097	361, 374	A9A15310	A9A15310	A9C15032	565	529	A9C20443	510, 528,
19011	237	19099	361, 374	A9A15320	A9A15320	A9C15120	491	A9C20433	510, 528,	
19012	237, 240	19100	238, 241	A9A15320	A9A15320	A9C15121	491	529	A9C20436	510, 528,
19013	237, 240	19101	238, 241	A9A15321	A9A15321	A9C15122	491	529	A9C20436	510, 528,
19014	237, 240	19106	238, 241	A9A15322	A9A15322	A9C15123	491	529	A9C20442	510, 528,
19015	240	19107	238, 241	A9A15322	A9A15322	A9C15180	554	529	A9C20442	510, 528,
19016	240	21100	124	A9A15323	A9A15323	A9C15181	554	529	A9C20442	510, 528,
19017	237	21101	124	A9A15323	A9A15323	A9C15182	556	529	A9C20443	510, 528,
19018	237	21102	124	A9A15323	A9A15323	A9C15183	556	529	A9C20443	510, 528,
19030	237, 240	21103	124	A9A15323	A9A15323	A9C15185	555	529	A9C20463	510, 528,
19031	237, 240	21104	124	A9A15323	A9A15323	A9C15186	555	529	A9C20463	510, 528,
19032	237, 240	21105	124	A9A15323	A9A15323	A9C15187	562	529	A9C20531	504, 506,
19033	237, 240	21106	124	A9A15323	A9A15323	A9C15188	562	529	508, 525, 526, 527		
19034	237, 240	21107	124	A9A15323	A9A15323	A9C15404	543	529	A9C20532	504, 506,
19035	237, 240	21108	124	A9A15323	A9A15323	A9C15405	543	529	508, 525, 526, 527		
19036	237, 240	21109	124	A9A15323	A9A15323	A9C15409	543	529	A9C20536	504, 506,
19037	237, 240	21110	124	A9A15323	A9A15323	A9C15410	543	529	508, 525, 526, 527		
19039	237, 240	21111	124	A9A15323	A9A15323	A9C15412	543	529	A9C20631	510, 528,
19041	237, 240	21112	124	A9A15323	A9A15323	A9C15413	543	529	A9C20632	510, 528,
19042	237, 240	21113	124	A9A15323	A9A15323	A9C15414	543	529	A9C20632	510, 528,
19044	237, 240	21115	124	A9A15323	A9A15323	A9C15415	515, 516,	517, 521, 522, 523, 546	A9C20633	510, 528,
19045	237	21116	126	A9A15323	A9A15323	A9C15419	515, 516,	517, 518, 543	A9C20636	510, 528,
19046	240	21117	126	A9A15323	A9A15323	A9C15424	544	529	A9C20636	510, 528,
19047	237, 240	21118	126	A9A15323	A9A15323	A9C15485	550	529	A9C20642	510, 528,
19048	237	21119	126	A9A15323	A9A15323	A9C15488	548	529	529		
19049	240	21120	126	A9A15323	A9A15323	A9C15489	548	529	A9C20643	510, 528,
19050	237	21121	126	A9A15323	A9A15323	A9C15504	559	529	529		
19051	237	21122	126	A9A15323	A9A15323	A9C15506	549	529	A9C20663	510, 528,
19053	237, 240	21127	126	A9A15323	A9A15323	A9C15507	549	529	529		
19054	237, 240	21128	126	A9A15323	A9A15323	A9C15509	559	529	A9C20731	504, 506,
19055	237, 240	21129	126	A9A15323	A9A15323	A9C15906	584	529	508, 525, 526, 527		
19056	237, 240	21130	126	A9A15323	A9A15323	A9C15907	584	529	A9C20732	504, 506,
19058	476	21133	127	A9A15323	A9A15323	A9C15908	584	529	525, 526		
19059	476	26970	355, 356, 357,	A9A15323	A9A15323	A9C15913	584	529	A9C20736	504, 506,
19060	476	358, 359, 360, 368, 370	A9A15323	342, 343, 344, 346, 349,	A9A15323	A9C15914	515, 516,	529	529	508, 525, 526, 527		
19061	475	26975	370	350, 351, 352, 462	A9A15323	A9C15915	517, 518,	529	529	A9C20833	504, 506,
19063	475	26976	370	A9A26927	A9A26927	A9C15916	515, 516,	529	525, 526		
19063	475	26978	368	344, 346, 350, 351, 352,	A9A26927	A9C15916	517, 518	529	529	A9C20834	505, 506,
19064	475	26978	368	462	A9A26929	A9C15916	517, 518	529	529	525, 526		
19065	475	26981	355, 356, 360,	A9A26929	A9A26929	A9C15916	517, 518	529	525, 526		
19065	475	368, 370	A9A26946	461	A9A26946	A9C15916	517, 518	529	529	525, 526		
19066	475	26996	355, 356, 358,	A9A26947	A9A26947	A9C15916	517, 518	529	525, 526		
19067	475	359, 370	A9A26948	461	A9A26948	A9C15916	517, 518	529	529	525, 526		
19069	475	26997	353, 370	A9A26949	A9A26949	A9C15916	517, 518	529	525, 526		
19070	475	27001	353, 354, 355,	A9A26959	A9A26959	A9C15916	517, 518	529	525, 526		
19071	361, 475	356, 358, 359, 360, 368,	A9A26960	461	A9A26960	A9C15916	517, 518	529	529	525, 526		
19072	361, 475	370	A9A26961	461	A9A26961	A9C15916	517, 518	529	529	525, 526		
19074	361, 374	27046	353, 354, 355,	A9A26963	A9A26963	A9C15916	517, 518	529	525, 526		
19075	361, 374	357, 358, 359, 368, 370	A9A26969	461	A9A26969	A9C15916	517, 518	529	529	525, 526		
19076	361, 374	27047	353, 354, 355,	A9A26970	A9A26970	A9C15916	517, 518	529	525, 526		
19077	361, 374	357, 358, 359, 368, 370	A9A26970	342, 343,	A9A26970	A9C15916	517, 518	529	529	525, 526		
19078	361, 374	27048	353, 354, 355,	344, 346, 348, 349, 350,	A9A26971	A9C15916	517, 518	529	529	525, 526		
19080	361, 374	357, 358, 359, 368, 370	A9A26972	351, 362	A9A26971	A9C15916	517, 518	529	529	525, 526		
19081	361, 374	357, 358, 359, 368, 370	A9A26972	351	A9A26972	A9C15916	517, 518	529	529	525, 526		

A9C20837 505, 506, 508, 525, 526, 527	A9C22115 504, 506, 508, 525, 526, 527	A9C32216 537	A9C66216 494	A9D32716 265
A9C20838 505, 506, 508, 525, 526, 527	A9C22211 504, 506, 508, 525, 526, 527	A9C32316 537	A9C66225 494	A9D32720 265
A9C20842 504, 506, 508, 525, 526, 527	A9C22212 504, 506, 508, 525, 526, 527	A9C32811 538	A9C66310 494	A9D32725 265
A9C20843 504, 506, 508, 525, 526, 527	A9C22415 510, 528, 529	A9C32816 537	A9C66316 494	A9D32732 265
A9C20844 505, 506, 508, 525, 526, 527	A9C22511 504, 506, 508, 525, 526, 527	A9C32836 537	A9C66325 494	A9D32740 265
A9C20847 505, 506, 508, 525, 526, 527	A9C22512 504, 506, 508, 525, 526, 527	A9C33111 538	A9C66410 494	A9D33606 247
A9C20862 504, 506, 508, 525, 526, 527	A9C22415 510, 528, 529	A9C33211 538	A9C66416 494	A9D33610 247
A9C20863 504, 506, 508, 525, 526, 527	A9C22515 504, 506, 508, 525, 526, 527	A9C33811 538	A9C66425 494	A9D33613 247
A9C20864 505, 506, 508, 525, 526, 527	A9C22615 510, 528, 529	A9C34811 538	A9C70112 477	A9D33616 247
A9C20867 505, 506, 508, 525, 526, 527	A9C22711 504, 506, 508, 525, 526, 527	A9C61210 494	A9C70114 477	A9D33620 247
A9C20868 505, 506, 508, 525, 526, 527	A9C22712 504, 506, 508, 525, 526, 527	A9C61216 494	A9C70122 477	A9D33625 247
A9C20869 505, 506, 508, 525, 526, 527	A9C22715 504, 506, 508, 525, 526, 527	A9C61225 494	A9C70124 477	A9D33632 247
A9C20882 504, 506, 508, 525, 526, 527	A9C22722 504, 506, 508, 525, 526, 527	A9C61240 494	A9C70132 482	A9D33640 247
A9C20884 505, 506, 508, 525, 526, 527	A9C22740 504, 508, 525, 527	A9C61263 494	A9C70134 482	A9D33710 265
A9C21132 505, 507, 509, 528, 529	A9C22763 504, 508, 525, 527	A9C61310 494	A9C70342 482	A9D33713 265
A9C21134 507, 509, 528, 529	A9C22813 504, 506, 508, 525, 526, 527	A9C61316 494	A9C70344 482	A9D33716 265
A9C21142 505, 507, 509, 528, 529	A9C22814 505, 506, 508, 525, 526, 527	A9C61325 494	A9D01610 247	A9D33720 265
A9C21144 507, 509, 528, 529	A9C22818 505, 506, 508, 525, 526, 527	A9C61340 494	A9D01616 247	A9D33725 265
A9C21162 505, 507, 509, 528, 529	A9C22824 505, 506, 508, 525, 526, 527	A9C61363 494	A9D01620 247	A9D33732 265
A9C21164 507, 509, 528, 529	A9C23512 505, 507, 509, 528, 529	A9C61410 494	A9D02610 247	A9D33740 265
A9C21442 510	A9C23515 505, 507, 509, 528, 529	A9C61416 494	A9D02616 247	A9D34606 246
A9C21532 505, 507, 509, 528, 529	A9C23712 505, 507, 509, 528, 529	A9C61425 494	A9D05610 246	A9D34610 246
A9C21642 510	A9C23715 505, 507, 509, 528, 529	A9C61440 494	A9D05616 246	A9D34616 246
A9C21732 505, 507, 528	A9C24732 508, 527	A9C61463 494	A9D06610 246	A9D34620 246
A9C21833 505, 507, 509, 528, 529	A9C24740 504, 508, 525, 527	A9C62210 494	A9D06616 247	A9D34625 246
A9C21834 507, 509, 528, 529	A9C24763 504, 508, 525, 527	A9C62216 494	A9D06620 247	A9D34632 246
A9C21842 505, 507, 509, 528, 529	A9C24834 508, 527	A9C62225 494	A9D07606 248	A9D34640 246
A9C21843 505, 507, 509, 528, 529	A9C25732 509, 529	A9C62240 494	A9D07610 248	A9D34606 246
A9C21844 507, 509, 528, 529	A9C30011 537	A9C62263 494	A9D07616 248	A9D35610 246
A9C21864 507, 509, 528, 529	A9C30012 537	A9C62310 494	A9D07620 248	A9D35613 246
A9C22011 504, 506, 508, 525, 526, 527	A9C30015 537	A9C62316 494	A9D07625 248	A9D35616 246
A9C22012 504, 506, 508, 525, 526, 527	A9C30111 537	A9C62325 494	A9D07632 248	A9D35620 246
A9C22015 504, 506, 508, 525, 526, 527	A9C30112 537	A9C62340 494	A9D07713 249	A9D35625 246
A9C22111 504, 506, 508, 525, 526, 527	A9C30114 537	A9C62363 494	A9D07716 249	A9D35632 246
A9C22112 504, 506, 508, 525, 526, 527	A9C30115 537	A9C62410 494	A9D08610 247	A9D35640 246
A9C22112 504, 506, 508, 525, 526, 527	A9C30211 537	A9C62416 494	A9D08616 247	A9D37606 248
A9C22114 505, 506, 508, 525, 526, 527	A9C30212 537	A9C62425 494	A9D20610 263	A9D37610 248
A9C22116 505, 506, 508, 525, 526, 527	A9C30215 537	A9C62440 494	A9D20616 263	A9D37616 248
A9C22116 505, 506, 508, 525, 526, 527	A9C30311 537	A9C62463 494	A9D20620 263	A9D37620 248
A9C22116 505, 506, 508, 525, 526, 527	A9C30312 537	A9C63210 494	A9D21610 263	A9D37625 248
A9C22116 505, 506, 508, 525, 526, 527	A9C30315 537	A9C63216 494	A9D21616 263	A9D37632 248
A9C22116 505, 506, 508, 525, 526, 527	A9C30811 5377	A9C63225 494	A9D21620 263	A9D37713 249
A9C22116 505, 506, 508, 525, 526, 527	A9C30812 537	A9C63310 494	A9D22610 263	A9D37716 249
A9C22116 505, 506, 508, 525, 526, 527	A9C30814 537	A9C63316 494	A9D22616 263	A9D38606 248
A9C22116 505, 506, 508, 525, 526, 527	A9C30815 537	A9C63325 494	A9D22620 263	A9D38610 248
A9C22116 505, 506, 508, 525, 526, 527	A9C30815 537	A9C63410 494	A9D23610 263	A9D38616 248
A9C22116 505, 506, 508, 525, 526, 527	A9C30831 537	A9C63416 494	A9D23616 263	A9D38620 248
A9C22116 505, 506, 508, 525, 526, 527	A9C32016 537	A9C63425 494	A9D23620 263	A9D38625 248
A9C22116 505, 506, 508, 525, 526, 527	A9C32111 538	A9C64210 494	A9D31606 247	A9D38632 248
A9C22116 505, 506, 508, 525, 526, 527	A9C32116 537	A9C64216 494	A9D31610 247	A9D41606 247
A9C22116 505, 506, 508, 525, 526, 527	A9C32211 538	A9C64225 494	A9D31616 247	A9D41610 247
A9C22116 505, 506, 508, 525, 526, 527	A9C66210 494	A9C64240 494	A9D31620 247	A9D41616 247
A9C22116 505, 506, 508, 525, 526, 527	A9C66216 494	A9C64310 494	A9D31625 247	A9D41620 247
A9C22116 505, 506, 508, 525, 526, 527	A9C66225 494	A9C64316 494	A9D31632 247	A9D41625 247
A9C22116 505, 506, 508, 525, 526, 527	A9C66310 494	A9C64325 494	A9D31640 247	A9D41632 247
A9C22116 505, 506, 508, 525, 526, 527	A9C66316 494	A9C64340 494	A9D31706 265	A9D41640 247
A9C22116 505, 506, 508, 525, 526, 527	A9C66325 494	A9C64410 494	A9D31710 265	A9D41710 265
A9C22116 505, 506, 508, 525, 526, 527	A9C66410 494	A9C64416 494	A9D31716 265	A9D41716 265
A9C22116 505, 506, 508, 525, 526, 527	A9C66416 494	A9C64425 494	A9D31720 265	A9D41720 265
A9C22116 505, 506, 508, 525, 526, 527	A9C66425 494	A9C64440 494	A9D31725 265	A9D41725 265
A9C22116 505, 506, 508, 525, 526, 527	A9C70112 477	A9C65210 494	A9D31732 265	A9D41732 265
A9C22116 505, 506, 508, 525, 526, 527	A9C70114 477	A9C65216 494	A9D31740 265	A9D41740 265
A9C22116 505, 506, 508, 525, 526, 527	A9C70122 477	A9C65225 494	A9D32606 247	A9D42606 247
A9C22116 505, 506, 508, 525, 526, 527	A9C70124 477	A9C65240 494	A9D32610 247	A9D42610 247
A9C22116 505, 506, 508, 525, 526, 527	A9C70132 482	A9C65310 494	A9D32613 247	A9D42613 247
A9C22116 505, 506, 508, 525, 526, 527	A9C70134 482	A9C65316 494	A9D32616 247	A9D42616 247
A9C22116 505, 506, 508, 525, 526, 527	A9C70342 482	A9C65325 494	A9D32620 247	A9D42620 247
A9C22116 505, 506, 508, 525, 526, 527	A9C70344 482	A9C65340 494	A9D32625 247	A9D42625 247
A9C22116 505, 506, 508, 525, 526, 527	A9D01610 247	A9C65410 494	A9D32632 247	A9D42632 247
A9C22116 505, 506, 508, 525, 526, 527	A9D01616 247	A9C65416 494	A9D32640 247	A9D42640 247
A9C22116 505, 506, 508, 525, 526, 527	A9D01620 247	A9C65425 494	A9D32706 265	A9D42710 265
A9C22116 505, 506, 508, 525, 526, 527	A9D02610 247	A9C65440 494	A9D32710 265	A9D42716 265
A9C22116 505, 506, 508, 525, 526, 527	A9D02616 247	A9C66210 494	A9D32713 265	A9D42720 265

A9D42725	265	A9D55725	265	A9DC3725	254	A9DE7640	254	A9DH3640	254
A9D42732	265	A9D55732	265	A9DC3732	254	A9DE7710	254	A9DH3710	254
A9D42740	265	A9D55740	265	A9DC3740	254	A9DE7716	254	A9DH3716	254
A9D43606	247	A9D56604	247	A9DC4606	256	A9DE7720	254	A9DH7606	254
A9D43610	247	A9D56606	247	A9DC4610	256	A9DE7725	254	A9DH7610	254
A9D43613	247	A9D56610	247	A9DC4616	256	A9DE7732	254	A9DH7616	254
A9D43616	247	A9D56613	247	A9DC4620	256	A9DE7740	254	A9DH7620	254
A9D43620	247	A9D56616	247	A9DC4625	256	A9DE8606	256	A9DH7625	254
A9D43625	247	A9D56620	247	A9DC4632	256	A9DE8610	256	A9DH7632	254
A9D43632	247	A9D56625	247	A9DC4706	256	A9DE8616	256	A9DH7640	254
A9D43640	247	A9D56632	247	A9DC4710	256	A9DE8620	256	A9E15535	579
A9D44606	246	A9D56640	247	A9DC4713	256	A9DE8625	256	A9E15536	579
A9D44610	246	A9D56706	265	A9DC4716	256	A9DE8632	256	A9E15537	579
A9D44616	246	A9D56710	265	A9DC4720	256	A9DF3606	254	A9E15538	579
A9D44620	246	A9D56713	265	A9DC4725	256	A9DF3610	254	A9E15539	579
A9D44625	246	A9D56716	265	A9DC4732	256	A9DF3613	254	A9E15540	579
A9D44632	246	A9D56720	265	A9DC7610	254	A9DF3616	254	A9E15541	579
A9D44640	246	A9D56725	265	A9DC7613	254	A9DF3620	254	A9E15542	579
A9D47606	248	A9D56732	265	A9DC7616	254	A9DF3625	254	A9E16065	576
A9D47610	248	A9D56740	265	A9DC7710	254	A9DF3632	254	A9E16066	576
A9D47616	248	A9D60604	247	A9DC7716	254	A9DF3640	254	A9E16067	576
A9D47620	248	A9D60606	247	A9DC8606	256	A9DF3710	254	A9E16068	576
A9D47625	248	A9D60610	247	A9DC8610	256	A9DF3713	254	A9E16069	576
A9D47632	248	A9D60613	247	A9DC8616	256	A9DF3716	254	A9E16070	576
A9D48606	248	A9D60616	247	A9DC8620	256	A9DF3720	254	A9E18030	487
A9D48610	248	A9D60620	247	A9DC8625	256	A9DF3725	254	A9E18031	487
A9D48616	248	A9D60625	247	A9DC8632	256	A9DF3732	254	A9E18032	487
A9D48620	248	A9D60632	247	A9DC9610	252	A9DF3740	254	A9E18033	487
A9D48625	248	A9D60640	247	A9DC9616	252	A9DF4606	256	A9E18034	487
A9D48632	248	A9D61606	250	A9DCA610	254	A9DF4610	256	A9E18035	487
A9D51606	246	A9D61610	250	A9DCA616	254	A9DF4616	256	A9E18036	487
A9D51610	246	A9D61616	250	A9DCB632	254	A9DF4620	256	A9E18037	487
A9D51616	246	A9D61620	250	A9DCB640	254	A9DF4625	256	A9E18038	487
A9D51620	246	A9D61625	250	A9DCG613	254	A9DF4632	256	A9E18039	487
A9D51625	246	A9D61632	250	A9DE2606	252	A9DF7606	254	A9E18070	488
A9D51632	246	A9D61640	250	A9DE2610	252	A9DF7610	254	A9E18071	488
A9D51640	246	A9D62606	249	A9DE2616	252	A9DF7616	254	A9E18072	488
A9D52606	247	A9D62610	249	A9DE2620	252	A9DF7620	254	A9E18073	488
A9D52610	247	A9D62613	249	A9DE2625	252	A9DF7625	254	A9E18074	488
A9D52613	247	A9D62616	249	A9DE2632	252	A9DF7632	254	A9E18320	569
A9D52616	247	A9D68604	247	A9DE2640	252	A9DF7640	254	A9E18321	569
A9D52620	247	A9D68606	247	A9DE3606	254	A9DF8606	256	A9E18322	569
A9D52625	247	A9D68610	247	A9DE3610	254	A9DF8610	256	A9E18323	569
A9D52632	247	A9D68616	247	A9DE3616	254	A9DF8616	256	A9E18324	569
A9D52640	247	A9D68620	247	A9DE3620	254	A9DF8620	256	A9E18325	569
A9D53606	247	A9D68625	247	A9DE3625	254	A9DF8625	256	A9E18326	569
A9D53610	247	A9D68632	247	A9DE3632	254	A9DF8632	256	A9E18327	569
A9D53613	247	A9D68640	247	A9DE3640	254	A9DG2606	252	A9E18328	569
A9D53616	247	A9D69604	247	A9DE3710	254	A9DG2610	252	A9E18330	569
A9D53620	247	A9D69606	247	A9DE3716	254	A9DG2616	252	A9E18331	569
A9D53625	247	A9D69610	247	A9DE3720	254	A9DG3606	254	A9E18332	569
A9D53632	247	A9D69613	247	A9DE3725	254	A9DG3610	254	A9E18333	569
A9D53640	247	A9D69616	247	A9DE3732	254	A9DG3613	254	A9E18334	569
A9D54606	246	A9D69620	247	A9DE3740	254	A9DG3616	254	A9E18335	569
A9D54610	246	A9D69625	247	A9DE4606	256	A9DG3710	254	A9E21180	580
A9D54613	246	A9D69632	247	A9DE4610	256	A9DG3713	254	A9E21181	580
A9D54616	246	A9D69640	247	A9DE4616	256	A9DG3716	254	A9E21182	580
A9D54620	246	A9DC2606	252	A9DE4620	256	A9DG4606	256	A9E21183	580
A9D54625	246	A9DC2610	252	A9DE4625	256	A9DG4610	256	A9F03101	30
A9D54632	246	A9DC2613	252	A9DE4632	256	A9DG4616	256	A9F03102	30
A9D54640	246	A9DC2616	252	A9DE6606	252	A9DG4620	256	A9F03104	30
A9D55604	247	A9DC3606	254	A9DE6610	252	A9DG4625	256	A9F03106	30
A9D55606	247	A9DC3610	254	A9DE6616	252	A9DG4632	256	A9F03110	30
A9D55610	247	A9DC3613	254	A9DE6620	252	A9DGA610	254	A9F03113	30
A9D55616	247	A9DC3616	254	A9DE6625	252	A9DGA616	254	A9F03116	30
A9D55620	247	A9DC3620	254	A9DE6632	252	A9DGB632	254	A9F03120	30
A9D55625	247	A9DC3625	254	A9DE6640	252	A9DGB640	254	A9F03125	30
A9D55632	247	A9DC3632	254	A9DE7606	254	A9DH3606	254	A9F03132	30
A9D55640	247	A9DC3640	254	A9DE7610	254	A9DH3610	254	A9F03140	30
A9D55706	265	A9DC3710	254	A9DE7616	254	A9DH3616	254	A9F03150	30
A9D55710	265	A9DC3713	254	A9DE7620	254	A9DH3620	254	A9F03163	30
A9D55716	265	A9DC3716	254	A9DE7625	254	A9DH3625	254	A9F03202	30
A9D55720	265	A9DC3720	254	A9DE7632	254	A9DH3632	254	A9F03204	30

A9F03206	30	A9F04213	30	A9F05104	30	A9F06225	44	A9F07316	44
A9F03210	30	A9F04216	30	A9F05106	30	A9F06232	44	A9F07320	44
A9F03213	30	A9F04220	30	A9F05110	30	A9F06240	44	A9F07325	44
A9F03216	30	A9F04225	30	A9F05113	30	A9F06250	44	A9F07332	44
A9F03220	30	A9F04232	30	A9F05116	30	A9F06263	44	A9F07340	44
A9F03225	30	A9F04240	30	A9F05120	30	A9F06306	44	A9F07350	44
A9F03232	30	A9F04250	30	A9F05125	30	A9F06310	44	A9F07363	44
A9F03240	30	A9F04263	30	A9F05132	30	A9F06313	44	A9F07370	44
A9F03250	30	A9F04270	30	A9F05140	30	A9F06316	44	A9F07401	44
A9F03263	30	A9F04301	30	A9F05150	30	A9F06320	44	A9F07402	44
A9F03302	30	A9F04302	30	A9F05163	30	A9F06325	44	A9F07403	44
A9F03306	30	A9F04303	30	A9F05170	30	A9F06332	44	A9F07404	44
A9F03310	30	A9F04304	30	A9F05201	30	A9F06340	44	A9F07406	44
A9F03313	30	A9F04306	30	A9F05202	30	A9F06350	44	A9F07410	44
A9F03316	30	A9F04310	30	A9F05203	30	A9F06363	44	A9F07413	44
A9F03320	30	A9F04313	30	A9F05204	30	A9F06406	44	A9F07416	44
A9F03325	30	A9F04316	30	A9F05206	30	A9F06410	44	A9F07420	44
A9F03332	30	A9F04320	30	A9F05210	30	A9F06413	44	A9F07425	44
A9F03340	30	A9F04325	30	A9F05213	30	A9F06416	44	A9F07432	44
A9F03350	30	A9F04332	30	A9F05216	30	A9F06420	44	A9F07440	44
A9F03363	30	A9F04340	30	A9F05220	30	A9F06425	44	A9F07450	44
A9F03406	30	A9F04350	30	A9F05225	30	A9F06432	44	A9F07463	44
A9F03410	30	A9F04363	30	A9F05232	30	A9F06440	44	A9F07470	44
A9F03413	30	A9F04370	30	A9F05240	30	A9F06450	44	A9F07601	44
A9F03416	30	A9F04401	30	A9F05250	30	A9F06463	44	A9F07602	44
A9F03420	30	A9F04402	30	A9F05263	30	A9F06606	44	A9F07603	44
A9F03425	30	A9F04403	30	A9F05270	30	A9F06610	44	A9F07604	44
A9F03432	30	A9F04404	30	A9F05301	30	A9F06613	44	A9F07606	44
A9F03440	30	A9F04406	30	A9F05302	30	A9F06616	44	A9F07610	44
A9F03450	30	A9F04410	30	A9F05303	30	A9F06620	44	A9F07613	44
A9F03463	30	A9F04413	30	A9F05304	30	A9F06625	44	A9F07616	44
A9F03606	30	A9F04416	30	A9F05306	30	A9F06632	44	A9F07620	44
A9F03610	30	A9F04420	30	A9F05310	30	A9F06640	44	A9F07625	44
A9F03613	30	A9F04425	30	A9F05313	30	A9F06650	44	A9F07632	44
A9F03616	30	A9F04432	30	A9F05316	30	A9F06663	44	A9F07640	44
A9F03620	30	A9F04440	30	A9F05320	30	A9F07101	44	A9F07650	44
A9F03625	30	A9F04450	30	A9F05325	30	A9F07102	44	A9F07663	44
A9F03632	30	A9F04463	30	A9F05332	30	A9F07103	44	A9F07670	44
A9F03640	30	A9F04470	30	A9F05340	30	A9F07104	44	A9F08101	44
A9F03650	30	A9F04601	30	A9F05350	30	A9F07106	44	A9F08102	44
A9F03663	30	A9F04602	30	A9F05363	30	A9F07110	44	A9F08103	44
A9F03706	30	A9F04603	30	A9F05370	30	A9F07113	44	A9F08104	44
A9F03710	30	A9F04604	30	A9F05401	30	A9F07116	44	A9F08106	44
A9F03713	30	A9F04606	30	A9F05402	30	A9F07120	44	A9F08110	44
A9F03716	30	A9F04610	30	A9F05403	30	A9F07125	44	A9F08113	44
A9F03720	30	A9F04613	30	A9F05404	30	A9F07132	44	A9F08116	44
A9F03725	30	A9F04616	30	A9F05406	30	A9F07140	44	A9F08120	44
A9F03732	30	A9F04620	30	A9F05410	30	A9F07150	44	A9F08125	44
A9F03740	30	A9F04625	30	A9F05413	30	A9F07163	44	A9F08132	44
A9F03750	30	A9F04632	30	A9F05416	30	A9F07170	44	A9F08140	44
A9F03763	30	A9F04640	30	A9F05420	30	A9F07201	44	A9F08150	44
A9F04101	30	A9F04650	30	A9F05425	30	A9F07202	44	A9F08163	44
A9F04102	30	A9F04663	30	A9F05432	30	A9F07203	44	A9F08170	44
A9F04103	30	A9F04670	30	A9F05440	30	A9F07204	44	A9F08201	44
A9F04104	30	A9F04701	30	A9F05450	30	A9F07206	44	A9F08202	44
A9F04106	30	A9F04702	30	A9F05463	30	A9F07210	44	A9F08203	44
A9F04110	30	A9F04703	30	A9F05470	30	A9F07213	44	A9F08204	44
A9F04113	30	A9F04704	30	A9F06106	44	A9F07216	44	A9F08206	44
A9F04116	30	A9F04706	30	A9F06110	44	A9F07220	44	A9F08210	44
A9F04120	30	A9F04710	30	A9F06113	44	A9F07225	44	A9F08213	44
A9F04125	30	A9F04713	30	A9F06116	44	A9F07232	44	A9F08216	44
A9F04132	30	A9F04716	30	A9F06120	44	A9F07240	44	A9F08220	44
A9F04140	30	A9F04720	30	A9F06125	44	A9F07250	44	A9F08225	44
A9F04150	30	A9F04725	30	A9F06132	44	A9F07263	44	A9F08232	44
A9F04163	30	A9F04732	30	A9F06140	44	A9F07270	44	A9F08240	44
A9F04170	30	A9F04740	30	A9F06150	44	A9F07301	44	A9F08250	44
A9F04201	30	A9F04750	30	A9F06163	44	A9F07302	44	A9F08263	44
A9F04202	30	A9F04763	30	A9F06206	44	A9F07303	44	A9F08270	44
A9F04203	30	A9F04770	30	A9F06210	44	A9F07304	44	A9F08301	44
A9F04204	30	A9F05101	30	A9F06213	44	A9F07306	44	A9F08302	44
A9F04206	30	A9F05102	30	A9F06216	44	A9F07310	44	A9F08303	44
A9F04210	30	A9F05103	30	A9F06220	44	A9F07313	44	A9F08304	44

A9F08306	44	A9F64406	16	A9F73603	22, 24, 26	A9F74470	22, 24, 26	A9F75440	22, 24, 26
A9F08310	44	A9F64410	16	A9F73604	22, 24, 26	A9F74601	22, 24, 26	A9F75450	22, 24, 26
A9F08313	44	A9F64413	16	A9F73606	26	A9F74602	22, 24, 26	A9F75463	22, 24, 26
A9F08316	44	A9F64416	16	A9F73610	26	A9F74603	22, 24, 26	A9F75470	22, 24, 26
A9F08320	44	A9F64420	16	A9F73613	22, 24, 26	A9F74604	22, 24, 26	A9F75601	22, 24, 26
A9F08325	44	A9F64425	16	A9F73616	26	A9F74606	26	A9F75602	22, 24, 26
A9F08332	44	A9F64432	16	A9F73620	26	A9F74610	26	A9F75603	22, 24, 26
A9F08340	44	A9F64440	16	A9F73625	26	A9F74613	22, 24, 26	A9F75604	22, 24, 26
A9F08350	44	A9F64450	16	A9F73632	26	A9F74616	26	A9F75606	22, 24, 26
A9F08363	44	A9F64463	16	A9F73640	26	A9F74620	26	A9F75610	22, 24, 26
A9F08370	44	A9F73101	22, 24, 26	A9F73650	26	A9F74625	26	A9F75613	22, 24, 26
A9F08401	44	A9F73102	22, 24, 26	A9F73663	26	A9F74632	26	A9F75616	22, 24, 26
A9F08402	44	A9F73103	22, 24, 26	A9F73670	22, 24, 26	A9F74640	26	A9F75620	22, 24, 26
A9F08403	44	A9F73104	22, 24, 26	A9F74101	22, 24, 26	A9F74650	26	A9F75625	22, 24, 26
A9F08404	44	A9F73106	26	A9F74102	22, 24, 26	A9F74663	26	A9F75632	22, 24, 26
A9F08406	44	A9F73110	26	A9F74103	22, 24, 26	A9F74670	22, 24, 26	A9F75640	22, 24, 26
A9F08410	44	A9F73113	22, 24, 26	A9F74104	22, 24, 26	A9F75101	22, 24, 26	A9F75650	22, 24, 26
A9F08413	44	A9F73116	26	A9F74106	26	A9F75102	22, 24, 26	A9F75663	22, 24, 26
A9F08416	44	A9F73120	26	A9F74110	26	A9F75103	22, 24, 26	A9F75670	22, 24, 26
A9F08420	44	A9F73125	26	A9F74113	22, 24, 26	A9F75104	22, 24, 26	A9F76106	22
A9F08425	44	A9F73132	26	A9F74116	26	A9F75106	22, 24, 26	A9F76110	22
A9F08432	44	A9F73140	26	A9F74120	26	A9F75110	22, 24, 26	A9F76116	22
A9F08440	44	A9F73150	26	A9F74125	26	A9F75113	22, 24, 26	A9F76120	22
A9F08450	44	A9F73163	26	A9F74132	26	A9F75116	22, 24, 26	A9F76125	22
A9F08463	44	A9F73170	22, 24, 26	A9F74140	26	A9F75120	22, 24, 26	A9F76132	22
A9F08470	44	A9F73201	22, 24, 26	A9F74150	26	A9F75125	22, 24, 26	A9F76140	22
A9F64101	16	A9F73202	22, 24, 26	A9F74163	26	A9F75132	22, 24, 26	A9F76150	22
A9F64102	16	A9F73203	22, 24, 26	A9F74170	22, 24, 26	A9F75140	22, 24, 26	A9F76163	22
A9F64103	16	A9F73204	22, 24, 26	A9F74201	22, 24, 26	A9F75150	22, 24, 26	A9F76206	22
A9F64104	16	A9F73206	26	A9F74202	22, 24, 26	A9F75163	22, 24, 26	A9F76210	22
A9F64106	16	A9F73210	26	A9F74203	22, 24, 26	A9F75170	22, 24, 26	A9F76216	22
A9F64110	16	A9F73213	22, 24, 26	A9F74204	22, 24, 26	A9F75201	22, 24, 26	A9F76220	22
A9F64113	16	A9F73216	26	A9F74206	26	A9F75202	22, 24, 26	A9F76225	22
A9F64116	16	A9F73220	26	A9F74210	26	A9F75203	22, 24, 26	A9F76232	22
A9F64120	16	A9F73225	26	A9F74213	22, 24, 26	A9F75204	22, 24, 26	A9F76240	22
A9F64125	16	A9F73232	26	A9F74216	26	A9F75206	22, 24, 26	A9F76250	22
A9F64132	16	A9F73240	26	A9F74220	26	A9F75210	22, 24, 26	A9F76263	22
A9F64140	16	A9F73250	26	A9F74225	26	A9F75213	22, 24, 26	A9F76306	22
A9F64150	16	A9F73263	26	A9F74232	26	A9F75216	22, 24, 26	A9F76310	22
A9F64163	16	A9F73270	22, 24, 26	A9F74240	26	A9F75220	22, 24, 26	A9F76316	22
A9F64201	16	A9F73301	22, 24, 26	A9F74250	26	A9F75225	22, 24, 26	A9F76320	22
A9F64202	16	A9F73302	22, 24, 26	A9F74263	26	A9F75232	22, 24, 26	A9F76325	22
A9F64203	16	A9F73303	22, 24, 26	A9F74270	22, 24, 26	A9F75240	22, 24, 26	A9F76332	22
A9F64204	16	A9F73304	22, 24, 26	A9F74301	22, 24, 26	A9F75250	22, 24, 26	A9F76340	22
A9F64206	16	A9F73306	26	A9F74302	22, 24, 26	A9F75263	22, 24, 26	A9F76350	22
A9F64210	16	A9F73310	26	A9F74303	22, 24, 26	A9F75270	22, 24, 26	A9F76363	22
A9F64213	16	A9F73313	22, 24, 26	A9F74304	22, 24, 26	A9F75301	22, 24, 26	A9F76406	22
A9F64216	16	A9F73316	26	A9F74306	26	A9F75302	22, 24, 26	A9F76410	22
A9F64220	16	A9F73320	26	A9F74310	26	A9F75303	22, 24, 26	A9F76416	22
A9F64225	16	A9F73325	26	A9F74313	22, 24, 26	A9F75304	22, 24, 26	A9F76420	22
A9F64232	16	A9F73332	26	A9F74316	26	A9F75306	22, 24, 26	A9F76425	22
A9F64240	16	A9F73340	26	A9F74320	26	A9F75310	22, 24, 26	A9F76432	22
A9F64250	16	A9F73350	26	A9F74325	26	A9F75313	22, 24, 26	A9F76440	22
A9F64263	16	A9F73363	26	A9F74332	26	A9F75316	22, 24, 26	A9F76450	22
A9F64301	16	A9F73370	22, 24, 26	A9F74340	26	A9F75320	22, 24, 26	A9F76463	22
A9F64302	16	A9F73401	22, 24, 26	A9F74350	26	A9F75325	22, 24, 26	A9F76606	22
A9F64303	16	A9F73402	22, 24, 26	A9F74363	26	A9F75332	22, 24, 26	A9F76610	22
A9F64304	16	A9F73403	22, 24, 26	A9F74370	22, 24, 26	A9F75340	22, 24, 26	A9F76616	22
A9F64306	16	A9F73404	22, 24, 26	A9F74401	22, 24, 26	A9F75350	22, 24, 26	A9F76620	22
A9F64310	16	A9F73406	26	A9F74402	22, 24, 26	A9F75363	22, 24, 26	A9F76625	22
A9F64313	16	A9F73410	26	A9F74403	22, 24, 26	A9F75370	22, 24, 26	A9F76632	22
A9F64316	16	A9F73413	22, 24, 26	A9F74404	22, 24, 26	A9F75401	22, 24, 26	A9F76640	22
A9F64320	16	A9F73416	26	A9F74406	26	A9F75402	22, 24, 26	A9F76650	22
A9F64325	16	A9F73420	26	A9F74410	26	A9F75403	22, 24, 26	A9F76663	22
A9F64332	16	A9F73425	26	A9F74413	22, 24, 26	A9F75404	22, 24, 26	A9F77106	22
A9F64340	16	A9F73432	26	A9F74416	26	A9F75406	22, 24, 26	A9F77110	22
A9F64350	16	A9F73440	26	A9F74420	26	A9F75410	22, 24, 26	A9F77116	22
A9F64363	16	A9F73450	26	A9F74425	26	A9F75413	22, 24, 26	A9F77120	22
A9F64401	16	A9F73463	26	A9F74432	26	A9F75416	22, 24, 26	A9F77125	22
A9F64402	16	A9F73470	22, 24, 26	A9F74440	26	A9F75420	22, 24, 26	A9F77132	22
A9F64403	16	A9F73601	22, 24, 26	A9F74450	26	A9F75425	22, 24, 26	A9F77140	22
A9F64404	16	A9F73602	22, 24, 26	A9F74463	26	A9F75432	22, 24, 26	A9F77150	22

A9F77163	22	A9F78463	24	A9F83203	36, 38, 40	A9F84170	36, 38, 40	A9F85140	36, 38, 40
A9F77206	22	A9F78606	24	A9F83204	36, 38, 40	A9F84201	36, 38, 40	A9F85150	36, 38, 40
A9F77210	22	A9F78610	24	A9F83206	40	A9F84202	36, 38, 40	A9F85163	36, 38, 40
A9F77216	22	A9F78616	24	A9F83210	40	A9F84203	36, 38, 40	A9F85170	36, 38, 40
A9F77220	22	A9F78620	24	A9F83213	36, 38, 40	A9F84204	36, 38, 40	A9F85201	36, 38, 40
A9F77225	22	A9F78625	24	A9F83216	40	A9F84206	40	A9F85202	36, 38, 40
A9F77232	22	A9F78632	24	A9F83220	40	A9F84210	40	A9F85203	36, 38, 40
A9F77240	22	A9F78640	24	A9F83225	40	A9F84213	36, 38, 40	A9F85204	36, 38, 40
A9F77250	22	A9F78650	24	A9F83232	40	A9F84216	40	A9F85206	36, 38, 40
A9F77263	22	A9F78663	24	A9F83240	40	A9F84220	40	A9F85210	36, 38, 40
A9F77306	22	A9F79106	24	A9F83250	40	A9F84225	40	A9F85213	36, 38, 40
A9F77310	22	A9F79110	24	A9F83263	40	A9F84232	40	A9F85216	36, 38, 40
A9F77316	22	A9F79116	24	A9F83270	36, 38, 40	A9F84240	40	A9F85220	36, 38, 40
A9F77320	22	A9F79120	24	A9F83301	36, 38, 40	A9F84250	40	A9F85225	36, 38, 40
A9F77325	22	A9F79125	24	A9F83302	36, 38, 40	A9F84263	40	A9F85232	36, 38, 40
A9F77332	22	A9F79132	24	A9F83303	36, 38, 40	A9F84270	36, 38, 40	A9F85240	36, 38, 40
A9F77340	22	A9F79140	24	A9F83304	36, 38, 40	A9F84301	36, 38, 40	A9F85250	36, 38, 40
A9F77350	22	A9F79150	24	A9F83306	40	A9F84302	36, 38, 40	A9F85263	36, 38, 40
A9F77363	22	A9F79163	24	A9F83310	40	A9F84303	36, 38, 40	A9F85270	36, 38, 40
A9F77406	22	A9F79206	24	A9F83313	36, 38, 40	A9F84304	36, 38, 40	A9F85301	36, 38, 40
A9F77410	22	A9F79210	24	A9F83316	40	A9F84306	40	A9F85302	36, 38, 40
A9F77416	22	A9F79216	24	A9F83320	40	A9F84310	40	A9F85303	36, 38, 40
A9F77420	22	A9F79220	24	A9F83325	40	A9F84313	36, 38, 40	A9F85304	36, 38, 40
A9F77425	22	A9F79225	24	A9F83332	40	A9F84316	40	A9F85306	36, 38, 40
A9F77432	22	A9F79232	24	A9F83340	40	A9F84320	40	A9F85310	36, 38, 40
A9F77440	22	A9F79240	24	A9F83350	40	A9F84325	40	A9F85313	36, 38, 40
A9F77450	22	A9F79250	24	A9F83363	40	A9F84332	40	A9F85316	36, 38, 40
A9F77463	22	A9F79263	24	A9F83370	36, 38, 40	A9F84340	40	A9F85320	36, 38, 40
A9F77606	22	A9F79306	24	A9F83401	36, 38, 40	A9F84350	40	A9F85325	36, 38, 40
A9F77610	22	A9F79310	24	A9F83402	36, 38, 40	A9F84363	40	A9F85332	36, 38, 40
A9F77616	22	A9F79316	24	A9F83403	36, 38, 40	A9F84370	36, 38, 40	A9F85340	36, 38, 40
A9F77620	22	A9F79320	24	A9F83404	36, 38, 40	A9F84401	36, 38, 40	A9F85350	36, 38, 40
A9F77625	22	A9F79325	24	A9F83406	40	A9F84402	36, 38, 40	A9F85363	36, 38, 40
A9F77632	22	A9F79332	24	A9F83410	40	A9F84403	36, 38, 40	A9F85370	36, 38, 40
A9F77640	22	A9F79340	24	A9F83413	36, 38, 40	A9F84404	36, 38, 40	A9F85401	36, 38, 40
A9F77650	22	A9F79350	24	A9F83416	40	A9F84406	40	A9F85402	36, 38, 40
A9F77663	22	A9F79363	24	A9F83420	40	A9F84410	40	A9F85403	36, 38, 40
A9F78106	24	A9F79406	24	A9F83425	40	A9F84413	36, 38, 40	A9F85404	36, 38, 40
A9F78110	24	A9F79410	24	A9F83432	40	A9F84416	40	A9F85406	36, 38, 40
A9F78116	24	A9F79416	24	A9F83440	40	A9F84420	40	A9F85410	36, 38, 40
A9F78120	24	A9F79420	24	A9F83450	40	A9F84425	40	A9F85413	36, 38, 40
A9F78125	24	A9F79425	24	A9F83463	40	A9F84432	40	A9F85416	36, 38, 40
A9F78132	24	A9F79432	24	A9F83470	36, 38, 40	A9F84440	40	A9F85420	36, 38, 40
A9F78140	24	A9F79440	24	A9F83601	36, 38, 40	A9F84450	40	A9F85425	36, 38, 40
A9F78150	24	A9F79450	24	A9F83602	36, 38, 40	A9F84463	40	A9F85432	36, 38, 40
A9F78163	24	A9F79463	24	A9F83603	36, 38, 40	A9F84470	36, 38, 40	A9F85440	36, 38, 40
A9F78206	24	A9F79606	24	A9F83604	36, 38, 40	A9F84601	36, 38, 40	A9F85450	36, 38, 40
A9F78210	24	A9F79610	24	A9F83606	40	A9F84602	36, 38, 40	A9F85463	36, 38, 40
A9F78216	24	A9F79616	24	A9F83610	40	A9F84603	36, 38, 40	A9F85470	36, 38, 40
A9F78220	24	A9F79620	24	A9F83613	36, 38, 40	A9F84604	36, 38, 40	A9F85601	36, 38, 40
A9F78225	24	A9F79625	24	A9F83616	40	A9F84606	40	A9F85602	36, 38, 40
A9F78232	24	A9F79632	24	A9F83620	40	A9F84610	40	A9F85603	36, 38, 40
A9F78240	24	A9F79640	24	A9F83625	40	A9F84613	36, 38, 40	A9F85604	36, 38, 40
A9F78250	24	A9F79650	24	A9F83632	40	A9F84616	40	A9F85606	36, 38, 40
A9F78263	24	A9F79663	24	A9F83640	40	A9F84620	40	A9F85610	36, 38, 40
A9F78306	24	A9F83101	36, 38, 40	A9F83650	40	A9F84625	40	A9F85613	36, 38, 40
A9F78310	24	A9F83102	36, 38, 40	A9F83663	40	A9F84632	40	A9F85616	36, 38, 40
A9F78316	24	A9F83103	36, 38, 40	A9F83670	36, 38, 40	A9F84640	40	A9F85620	36, 38, 40
A9F78320	24	A9F83104	36, 38, 40	A9F84101	36, 38, 40	A9F84650	40	A9F85625	36, 38, 40
A9F78325	24	A9F83106	40	A9F84102	36, 38, 40	A9F84663	40	A9F85632	36, 38, 40
A9F78332	24	A9F83110	40	A9F84103	36, 38, 40	A9F84670	36, 38, 40	A9F85640	36, 38, 40
A9F78340	24	A9F83113	36, 38, 40	A9F84104	36, 38, 40	A9F85101	36, 38, 40	A9F85650	36, 38, 40
A9F78350	24	A9F83116	40	A9F84106	40	A9F85102	36, 38, 40	A9F85663	36, 38, 40
A9F78363	24	A9F83120	40	A9F84110	40	A9F85103	36, 38, 40	A9F85670	36, 38, 40
A9F78406	24	A9F83125	40	A9F84113	36, 38, 40	A9F85104	36, 38, 40	A9F86106	36
A9F78410	24	A9F83132	40	A9F84116	40	A9F85106	36, 38, 40	A9F86110	36
A9F78416	24	A9F83140	40	A9F84120	40	A9F85110	36, 38, 40	A9F86116	36
A9F78420	24	A9F83150	40	A9F84125	40	A9F85113	36, 38, 40	A9F86120	36
A9F78425	24	A9F83163	40	A9F84132	40	A9F85116	36, 38, 40	A9F86125	36
A9F78432	24	A9F83170	36, 38, 40	A9F84140	40	A9F85120	36, 38, 40	A9F86132	36
A9F78440	24	A9F83201	36, 38, 40	A9F84150	40	A9F85125	36, 38, 40	A9F86140	36
A9F78450	24	A9F83202	36, 38, 40	A9F84163	40	A9F85132	36, 38, 40	A9F86150	36

A9F86163	36	A9F87463	36	A9F89263	38	A9F92250	48	A9F93340	48
A9F86206	36	A9F87606	36	A9F89306	38	A9F92263	48	A9F93350	48
A9F86210	36	A9F87610	36	A9F89310	38	A9F92270	48	A9F93363	48
A9F86216	36	A9F87616	36	A9F89316	38	A9F92272	48	A9F93370	48
A9F86220	36	A9F87620	36	A9F89320	38	A9F92301	48	A9F93401	48
A9F86225	36	A9F87625	36	A9F89325	38	A9F92302	48	A9F93402	48
A9F86232	36	A9F87632	36	A9F89332	38	A9F92303	48	A9F93403	48
A9F86240	36	A9F87640	36	A9F89340	38	A9F92304	48	A9F93404	48
A9F86250	36	A9F87650	36	A9F89350	38	A9F92306	48	A9F93406	48
A9F86263	36	A9F87663	36	A9F89363	38	A9F92310	48	A9F93410	48
A9F86306	36	A9F88106	38	A9F89406	38	A9F92316	48	A9F93416	48
A9F86310	36	A9F88110	38	A9F89410	38	A9F92320	48	A9F93420	48
A9F86316	36	A9F88116	38	A9F89416	38	A9F92325	48	A9F93425	48
A9F86320	36	A9F88120	38	A9F89420	38	A9F92332	48	A9F93432	48
A9F86325	36	A9F88125	38	A9F89425	38	A9F92340	48	A9F93440	48
A9F86332	36	A9F88132	38	A9F89432	38	A9F92350	48	A9F93450	48
A9F86340	36	A9F88140	38	A9F89440	38	A9F92363	48	A9F93463	48
A9F86350	36	A9F88150	38	A9F89450	38	A9F92370	48	A9F93470	48
A9F86363	36	A9F88163	38	A9F89463	38	A9F92372	48	A9F94101	48
A9F86406	36	A9F88206	38	A9F89606	38	A9F92401	48	A9F94102	48
A9F86410	36	A9F88210	38	A9F89610	38	A9F92402	48	A9F94103	48
A9F86416	36	A9F88216	38	A9F89616	38	A9F92403	48	A9F94104	48
A9F86420	36	A9F88220	38	A9F89620	38	A9F92404	48	A9F94106	48
A9F86425	36	A9F88225	38	A9F89625	38	A9F92406	48	A9F94110	48
A9F86432	36	A9F88232	38	A9F89632	38	A9F92410	48	A9F94116	48
A9F86440	36	A9F88240	38	A9F89640	38	A9F92416	48	A9F94120	48
A9F86450	36	A9F88250	38	A9F89650	38	A9F92420	48	A9F94125	48
A9F86463	36	A9F88263	38	A9F89663	38	A9F92425	48	A9F94132	48
A9F86606	36	A9F88306	38	A9F90204	129	A9F92432	48	A9F94140	48
A9F86610	36	A9F88310	38	A9F90210	129	A9F92440	48	A9F94150	48
A9F86616	36	A9F88316	38	A9F90216	129	A9F92450	48	A9F94163	48
A9F86620	36	A9F88320	38	A9F90225	129	A9F92463	48	A9F94170	48
A9F86625	36	A9F88325	38	A9F90240	129	A9F92470	48	A9F94201	48
A9F86632	36	A9F88332	38	A9F90272	129	A9F92472	48	A9F94202	48
A9F86640	36	A9F88340	38	A9F90273	129	A9F93101	48	A9F94203	48
A9F86650	36	A9F88350	38	A9F90276	129	A9F93102	48	A9F94204	48
A9F86663	36	A9F88363	38	A9F90282	129	A9F93103	48	A9F94206	48
A9F87106	36	A9F88406	38	A9F90304	129	A9F93104	48	A9F94210	48
A9F87110	36	A9F88410	38	A9F90310	129	A9F93106	48	A9F94216	48
A9F87116	36	A9F88416	38	A9F90316	129	A9F93110	48	A9F94220	48
A9F87120	36	A9F88420	38	A9F90325	129	A9F93116	48	A9F94225	48
A9F87125	36	A9F88425	38	A9F90340	129	A9F93120	48	A9F94232	48
A9F87132	36	A9F88432	38	A9F90372	129	A9F93125	48	A9F94240	48
A9F87140	36	A9F88440	38	A9F90373	129	A9F93132	48	A9F94250	48
A9F87150	36	A9F88450	38	A9F90376	129	A9F93140	48	A9F94263	48
A9F87163	36	A9F88463	38	A9F90382	129	A9F93150	48	A9F94270	48
A9F87206	36	A9F88606	38	A9F92101	48	A9F93163	48	A9F94301	48
A9F87210	36	A9F88610	38	A9F92102	48	A9F93170	48	A9F94302	48
A9F87216	36	A9F88616	38	A9F92103	48	A9F93201	48	A9F94303	48
A9F87220	36	A9F88620	38	A9F92104	48	A9F93202	48	A9F94304	48
A9F87225	36	A9F88625	38	A9F92106	48	A9F93203	48	A9F94306	48
A9F87232	36	A9F88632	38	A9F92110	48	A9F93204	48	A9F94310	48
A9F87240	36	A9F88640	38	A9F92116	48	A9F93206	48	A9F94316	48
A9F87250	36	A9F88650	38	A9F92120	48	A9F93210	48	A9F94320	48
A9F87263	36	A9F88663	38	A9F92125	48	A9F93216	48	A9F94325	48
A9F87306	36	A9F89106	38	A9F92132	48	A9F93220	48	A9F94332	48
A9F87310	36	A9F89110	38	A9F92140	48	A9F93225	48	A9F94340	48
A9F87316	36	A9F89116	38	A9F92150	48	A9F93232	48	A9F94350	48
A9F87320	36	A9F89120	38	A9F92163	48	A9F93240	48	A9F94363	48
A9F87325	36	A9F89125	38	A9F92170	48	A9F93250	48	A9F94370	48
A9F87332	36	A9F89132	38	A9F92172	48	A9F93263	48	A9F94401	48
A9F87340	36	A9F89140	38	A9F92201	48	A9F93270	48	A9F94402	48
A9F87350	36	A9F89150	38	A9F92202	48	A9F93301	48	A9F94403	48
A9F87363	36	A9F89163	38	A9F92203	48	A9F93302	48	A9F94404	48
A9F87406	36	A9F89206	38	A9F92204	48	A9F93303	48	A9F94406	48
A9F87410	36	A9F89210	38	A9F92206	48	A9F93304	48	A9F94410	48
A9F87416	36	A9F89216	38	A9F92210	48	A9F93306	48	A9F94416	48
A9F87420	36	A9F89220	38	A9F92216	48	A9F93310	48	A9F94420	48
A9F87425	36	A9F89225	38	A9F92220	48	A9F93316	48	A9F94425	48
A9F87432	36	A9F89232	38	A9F92225	48	A9F93320	48	A9F94432	48
A9F87440	36	A9F89240	38	A9F92232	48	A9F93325	48	A9F94440	48
A9F87450	36	A9F89250	38	A9F92240	48	A9F93332	48	A9F94450	48

A9F94463	48	A9FDN610	282	A9K02410	68	A9K12440	69	A9K23425	51
A9F94470	48	A9FDN616	282	A9K02416	68	A9K12450	69	A9K23432	51
A9F95101	48	A9FDN620	282	A9K02420	68	A9K12463	69	A9K23440	51
A9F95102	48	A9FDN625	282	A9K02432	68	A9K17106	55	A9K23450	51
A9F95103	48	A9K01106	62, 68	A9K02440	68	A9K17110	55	A9K23463	51
A9F95104	48	A9K01110	62, 68	A9K02450	68	A9K17116	55	A9K23601	51
A9F95106	48	A9K01113	62	A9K02463	68	A9K17120	55	A9K23602	51
A9F95110	48	A9K01116	62, 68	A9K02613	62	A9K17125	55	A9K23603	51
A9F95116	48	A9K01120	62, 68	A9K02616	62	A9K17132	55	A9K23604	51
A9F95120	48	A9K01125	62	A9K02713	62	A9K17206	55	A9K23606	51
A9F95125	48	A9K01132	62, 68	A9K02716	62	A9K17210	55	A9K23610	51
A9F95132	48	A9K01140	62, 68	A9K11106	69	A9K17216	55	A9K23616	51
A9F95140	48	A9K01150	68	A9K11110	69	A9K17220	55	A9K23620	51
A9F95150(3)	48	A9K01163	68	A9K11116	69	A9K17225	55	A9K23625	51
A9F95163(3)	48	A9K01206	68	A9K11120	69	A9K17232	55	A9K23632	51
A9F95170	48	A9K01210	68	A9K11132	69	A9K17306	55	A9K23640	51
A9F95172	48	A9K01216	68	A9K11140	69	A9K17310	55	A9K23650	51
A9F95201	48	A9K01220	68	A9K11150	69	A9K17316	55	A9K23663	51
A9F95202	48	A9K01232	68	A9K11163	69	A9K17320	55	A9K24101	55, 56, 57
A9F95203	48	A9K01240	68	A9K11206	69	A9K17325	55	A9K24102	55, 56, 57
A9F95204	48	A9K01250	68	A9K11210	69	A9K17332	55	A9K24103	55, 56, 57
A9F95206	48	A9K01263	68	A9K11216	69	A9K17406	55	A9K24104	55, 56, 57
A9F95210	48	A9K01306	62, 68	A9K11220	69	A9K17410	55	A9K24106	56
A9F95216	48	A9K01310	62, 68	A9K11232	69	A9K17416	55	A9K24110	56
A9F95220	48	A9K01316	62, 68	A9K11240	69	A9K17420	55	A9K24113	56
A9F95225	48	A9K01320	62, 68	A9K11250	69	A9K17425	55	A9K24116	56
A9F95232	48	A9K01325	62	A9K11263	69	A9K17432	55	A9K24120	56
A9F95240	48	A9K01332	62, 68	A9K11306	69	A9K17606	55	A9K24125	56
A9F95250	48	A9K01340	62, 68	A9K11310	69	A9K17610	55	A9K24132	56
A9F95263	48	A9K01350	68	A9K11316	69	A9K17616	55	A9K24140	55, 56, 57, 58
A9F95270	48	A9K01363	68	A9K11320	69	A9K17620	55	A9K24150	55, 56
A9F95272	48	A9K01406	68	A9K11332	69	A9K17625	55	A9K24163	55, 56
A9F95301	48	A9K01410	68	A9K11340	69	A9K17632	55	A9K24201	55, 56
A9F95302	48	A9K01416	68	A9K11350	69	A9K23101	51	A9K24202	55, 56
A9F95303	48	A9K01420	68	A9K11363	69	A9K23102	51	A9K24203	55, 56
A9F95304	48	A9K01432	68	A9K11406	69	A9K23103	51	A9K24204	55, 56
A9F95306	48	A9K01440	68	A9K11410	69	A9K23104	51	A9K24206	56
A9F95310	48	A9K01450	68	A9K11416	69	A9K23106	51	A9K24210	56
A9F95316	48	A9K01463	68	A9K11420	69	A9K23110	51	A9K24213	56
A9F95320	48	A9K01613	62	A9K11432	69	A9K23116	51	A9K24216	56
A9F95325	48	A9K01616	62	A9K11440	69	A9K23120	51	A9K24220	56
A9F95332	48	A9K02102	62	A9K11450	69	A9K23125	51	A9K24225	56
A9F95340	48	A9K02104	62	A9K11463	69	A9K23132	51	A9K24232	56
A9F95350	48	A9K02106	62, 68	A9K12106	69	A9K23140	51	A9K24240	55, 56, 57, 58
A9F95363	48	A9K02110	62, 68	A9K12110	69	A9K23150	51	A9K24250	55, 56
A9F95370	48	A9K02113	62	A9K12116	69	A9K23163	51	A9K24263	55, 56
A9F95372	48	A9K02116	62, 68	A9K12120	69	A9K23201	51	A9K24306	56, 57, 58
A9F95401	48	A9K02120	62, 68	A9K12132	69	A9K23202	51	A9K24310	56, 57, 58
A9F95402	48	A9K02125	62	A9K12140	69	A9K23203	51	A9K24313	56
A9F95403	48	A9K02132	62, 68	A9K12150	69	A9K23204	51	A9K24316	56, 57, 58
A9F95404	48	A9K02140	62, 68	A9K12163	69	A9K23206	51	A9K24320	56, 57, 58
A9F95406	48	A9K02150	68	A9K12206	69	A9K23210	51	A9K24325	56, 57, 58
A9F95410	48	A9K02163	68	A9K12210	69	A9K23216	51	A9K24332	56, 57, 58
A9F95416	48	A9K02206	68	A9K12216	69	A9K23220	51	A9K24340	55, 56, 57, 58
A9F95420	48	A9K02210	68	A9K12220	69	A9K23225	51	A9K24350	55, 56
A9F95425	48	A9K02216	68	A9K12232	69	A9K23232	51	A9K24363	55, 56
A9F95432	48	A9K02220	68	A9K12240	69	A9K23240	51	A9K24406	56, 57, 58
A9F95440	48	A9K02232	68	A9K12250	69	A9K23250	51	A9K24410	56, 57, 58
A9F95450	48	A9K02240	68	A9K12263	69	A9K23263	51	A9K24413	56
A9F95463	48	A9K02250	68	A9K12306	69	A9K23306	51	A9K24416	56, 57, 58
A9F95470	48	A9K02263	68	A9K12310	69	A9K23310	51	A9K24425	56, 57, 58
A9F95472	48	A9K02306	62, 68	A9K12316	69	A9K23316	51	A9K24432	56, 57, 58
A9FDB606	278	A9K02310	62, 68	A9K12320	69	A9K23320	51	A9K24440	55, 56, 57, 58
A9FDB610	278	A9K02313	62	A9K12332	69	A9K23325	51	A9K24450	55, 56
A9FDB613	278	A9K02316	62, 68	A9K12340	69	A9K23332	51	A9K24463	55, 56
A9FDB616	278	A9K02320	62, 68	A9K12350	69	A9K23340	51	A9K24601	55, 56
A9FDB620	278	A9K02325	62	A9K12363	69	A9K23350	51	A9K24602	55, 56
A9FDB625	278	A9K02332	62, 68	A9K12406	69	A9K23363	51		
A9FDB7610	278	A9K02340	62, 68	A9K12410	69	A9K23406	51		
A9FDB7613	278	A9K02350	68	A9K12416	69	A9K23410	51		
A9FDB7616	278	A9K02363	68	A9K12420	69	A9K23416	51		
A9FDD225	274	A9K02406	68	A9K12432	69	A9K23420	51		

A9K24603	55, 56	A9KF71302	65	A9L08300	300	A9L16568	305	A9L40601	301
A9K24604	55, 56	A9KF71303	65	A9L08321	300	A9L16569	305	A9L65101	301
A9K24606	56	A9KF71304	65	A9L08400	300	A9L16571	305	A9L65102	301
A9K24610	56	A9KF71306	65	A9L08421	300	A9L16572	305	A9L65121	301
A9K24613	56	A9KF71310	65	A9L08500	300	A9L16573	305	A9L65122	301
A9K24616	56	A9KF71316	65	A9L08501	300	A9L16574	305	A9L65201	301
A9K24620	56	A9KF71320	65	A9L08600	300	A9L16576	305	A9L65301	301
A9K24625	56	A9KF71325	65	A9L08601	300	A9L16577	305	A9L65321	301
A9K24632	56	A9KF71332	65	A9L15581	293	A9L16578	305	A9L65401	301
A9K24640	55, 56	A9KF71340	65	A9L15582	293, 297	A9L16579	305	A9L65501	301
A9K24650	55, 56	A9KF71350	65	A9L15584	293	A9L16597	305	A9L65601	301
A9K24663	55, 56	A9KF71363	65	A9L15585	293	A9L16599	305	A9MEM1520	441, 451
A9K24706	55	A9KF71401	65	A9L15586	293, 297	A9L16617BA	311	A9MEM1520	419
A9K24710	55	A9KF71402	65	A9L15587	293	A9L16618AA	311	A9MEM1521	419
A9K24716	55	A9KF71403	65	A9L15588	293	A9L16619	311	A9MEM1522	419
A9K24720	55	A9KF71404	65	A9L15590	293	A9L16632	287, 288	A9MEM1540	441
A9K24725	55	A9KF71406	65	A9L15592	293	A9L16633	287, 288	A9MEM1541	419
A9K24732	55	A9KF71410	65	A9L15593	293	A9L16634	287, 288	A9MEM1542	419
A9K24740	55	A9KF71416	65	A9L15595	292	A9L16659	305	A9MEM1543	441
A9K24750	55	A9KF71420	65	A9L15596	292	A9L16664	305	A9MEM1560	419
A9K24763	55	A9KF71425	65	A9L15597	293, 297	A9L16667	305	A9MEM1561	419
A9K27106	57, 58	A9KF71432	65	A9L15598	292	A9L16669	305	A9MEM1562	419
A9K27110	57, 58	A9KF71440	65	A9L15683	293	A9L16672	305	A9MEM1563	419
A9K27116	57, 58	A9KF71450	65	A9L15684	293	A9L16673	305	A9MEM1570	419, 441
A9K27120	57, 58	A9KF71463	65	A9L15685	293	A9L16674	305	A9MEM1571	419
A9K27125	57, 58	A9KR11225	188	A9L15686	293, 297	A9L16677	305	A9MEM1572	419
A9K27132	57, 58	A9KR11240	188	A9L15687	293, 297	A9L16678	305	A9N15635	136
A9K27206	57, 58	A9KR11263	188	A9L15688	297	A9L16679	305	A9N15636	136
A9K27210	57, 58	A9KR11425	188	A9L15690	293	A9L16680	305	A9N15645	136
A9K27216	57, 58	A9KR11440	188	A9L15691	293, 297	A9L16681	304	A9N15646	136
A9K27220	57, 58	A9KR11463	188	A9L15692	293, 297	A9L16682	304	A9N15650	136
A9K27225	57, 58	A9KR12225	188	A9L15693	297	A9L16683	316	A9N15651	136
A9K27232	57, 58	A9KR12240	188	A9L15694	292	A9L16684	304	A9N15655	136
A9KF21106	65	A9KR12263	188	A9L15695	292	A9L16685	304	A9N15656	136
A9KF21110	65	A9KR12425	188	A9L15696	292	A9L16686	304	A9N15657	136
A9KF21116	65	A9KR12440	188	A9L16292	309	A9L16687	304	A9N15658	136
A9KF21120	65	A9KR12463	188	A9L16293	309	A9L16688	304	A9N18340	78
A9KF21125	65	A9KR13225	189	A9L16294	309	A9L16689	304	A9N18341	78
A9KF21132	65	A9KR13240	189	A9L16295	309	A9L16690	316	A9N18342	78
A9KF21206	65	A9KR13263	189	A9L16296	309	A9L16691	304	A9N18343	78
A9KF21210	65	A9KR13440	189	A9L16297	309	A9L16692	316	A9N18344	78
A9KF21216	65	A9KR13463	189	A9L16298	309	A9L20100	301	A9N18345	78
A9KF21220	65	A9KR14225	188	A9L16299	309	A9L20102	301	A9N18346	78
A9KF21225	65	A9KR14240	188	A9L16300	309	A9L20122	301	A9N18347	78
A9KF21232	65	A9KR14263	188	A9L16310	308	A9L20200	301	A9N18348	78
A9KF71101	65	A9KR14425	188	A9L16311	308	A9L20300	301	A9N18349	78
A9KF71102	65	A9KR14440	188	A9L16312	308	A9L20321	301	A9N18350	78
A9KF71103	65	A9KR14463	188	A9L16313	308	A9L20400	301	A9N18351	78
A9KF71104	65	A9KR15240	189	A9L16337	313	A9L20421	301	A9N18352	78
A9KF71106	65	A9KR15263	189	A9L16339	313	A9L20500	301	A9N18353	78
A9KF71110	65	A9KR15440	189	A9L16434	316	A9L20501	301	A9N18354	78
A9KF71116	65	A9KR15463	189	A9L16436	316	A9L20600	301	A9N18355	78
A9KF71120	65	A9KR16225	189	A9L16441	315	A9L20601	301	A9N18356	78
A9KF71125	65	A9KR16240	189	A9L16442	305	A9L40100	301	A9N18357	78
A9KF71132	65	A9KR16263	189	A9L16443	305	A9L40101	301	A9N18358	78
A9KF71140	65	A9KR16440	189	A9L16444	305	A9L40102	301	A9N18359	78
A9KF71150	65	A9KR16463	189	A9L16445	305	A9L40122	301	A9N18360	78
A9KF71163	65	A9KS15140	332	A9L16446	305	A9L40172	319	A9N18361	78
A9KF71201	65	A9KS15163	332	A9L16447	305	A9L40182	319	A9N18362	78
A9KF71202	65	A9KS15240	332	A9L16448	305	A9L40200	301	A9N18363	78
A9KF71203	65	A9KS15263	332	A9L16449	305	A9L40201	301	A9N18364	78
A9KF71204	65	A9KS15280	332	A9L16555	305	A9L40271	319	A9N18365	78
A9KF71206	65	A9KS15340	332	A9L16556	305	A9L40281	319	A9N18367	78
A9KF71210	65	A9KS15363	332	A9L16557	305	A9L40300	301	A9N18369	78
A9KF71216	65	A9KS15440	332	A9L16558	305	A9L40301	301	A9N18371	78
A9KF71220	65	A9KS15463	332	A9L16559	305	A9L40321	301	A9N18372	78
A9KF71225	65	A9KS15480	332	A9L16561	305	A9L40400	301	A9N18373	78
A9KF71232	65	A9L00002	301	A9L16562	305	A9L40401	301	A9N18374	78
A9KF71240	65	A9L08100	300	A9L16563	305	A9L40421	301	A9N18375	78
A9KF71250	65	A9L08102	301	A9L16564	305	A9L40500	301	A9N18376	78
A9KF71263	65	A9L08122	301	A9L16566	305	A9L40501	301	A9N18377	78
A9KF71301	65	A9L08200	300	A9L16567	305	A9L40600	301	A9N18378	78

A9N18379	78	A9N18556	232	A9N19675	260	A9N60734	73	A9P42610	1
A9N18380	78	A9N18557	232	A9N19676	260	A9N60737	73	A9P42613	1
A9N18381	78	A9N18558	232	A9N19677	260	A9N60738	73	A9P42616	1
A9N18382	78	A9N18559	232	A9N19678	260	A9N60741	73	A9P42620	1
A9N18383	78	A9N18560	232	A9N19679	260	A9N60742	73	A9P42625	1
A9N18384	78	A9N18561	232	A9N19681	260	A9N60745	73	A9P42632	1
A9N18385	78	A9N18563	230	A9N19683	260	A9N60746	73	A9P42640	1
A9N18386	78	A9N18564	230	A9N19685	260	A9N60749	73	A9P42706	1
A9N18387	78	A9N18565	230	A9N19686	260	A9N60750	73	A9P42710	1
A9N18388	78	A9N18566	230	A9N19687	260	A9N60753	73	A9P42716	1
A9N18389	78	A9N18567	230	A9N19688	260	A9N60754	73	A9P42720	1
A9N18390	78	A9N18568	230	A9N19689	260	A9N60757	73	A9P42725	1
A9N18391	78	A9N18569	230	A9N19753	261	A9N60758	73	A9P42732	1
A9N18392	78	A9N18570	230	A9N19754	261	A9N60777	74	A9P42740	1
A9N18393	78	A9N18571	230	A9N19755	261	A9N60778	74	A9P44606	5
A9N18401	82	A9N18572	231	A9N19756	261	A9N60781	74	A9P44610	5
A9N18402	82	A9N18573	231	A9N19757	261	A9N60782	74	A9P44613	5
A9N18403	82	A9N18574	231	A9N19758	261	A9N60785	74	A9P44616	5
A9N18404	82	A9N18575	231	A9N19759	261	A9N60786	74	A9P44620	5
A9N18412	82	A9N18576	231	A9N19760	261	A9N60789	74	A9P44625	5
A9N18413	82	A9N18577	231	A9N19771	261	A9N60790	74	A9P44632	5
A9N18414	82	A9N18578	231	A9N19772	261	A9N61500	105	A9P44640	5
A9N18415	82	A9N18579	231	A9N19773	261	A9N61501	105	A9P44706	5
A9N18423	82	A9N18580	231	A9N19774	261	A9N61502	105	A9P44710	5
A9N18424	82	A9N18587	231	A9N19775	261	A9N61503	105	A9P44713	5
A9N18425	82	A9N18588	231	A9N19777	261	A9N61504	105	A9P44716	5
A9N18426	82	A9N18589	231	A9N19778	261	A9N61505	105	A9P44720	5
A9N18434	82	A9N18591	232	A9N19780	261	A9N61506	105	A9P44725	5
A9N18435	82	A9N18592	232	A9N26476	468	A9N61508	105	A9P44732	5
A9N18436	82	A9N18594	232	A9N26477	468	A9N61509	105	A9P44740	5
A9N18437	82	A9N18595	232	A9N26478	468	A9N61510	105	A9P52306	1
A9N18445	82	A9N18597	232	A9N26500	468	A9N61511	105	A9P52310	1
A9N18446	82	A9N18598	232	A9N26899	353, 354,	A9N61512	105	A9P52316	1
A9N18447	82	A9N18599	232	355, 356, 357, 358, 360,		A9N61513	105	A9P52320	1
A9N18448	82	A9N19304	260	470		A9N61514	105	A9P52325	1
A9N18456	82	A9N19305	260	A9N26923	356, 470	A9N61515	105	A9P52332	1
A9N18457	82	A9N19532	261	A9N26924	353, 354,	A9N61517	105	A9P52340	1
A9N18458	82	A9N19533	261	355, 356, 357, 358, 360,		A9N61518	105	A9P52602	1
A9N18459	82	A9N19534	261	470		A9N61519	105	A9P52604	1
A9N18467	82	A9N19631	260	A9N26927	353, 354,	A9N61520	105	A9P52606	1
A9N18468	82	A9N19632	260	355, 356, 357, 358, 360,		A9N61521	105	A9P52610	1
A9N18469	82	A9N19633	260	470		A9N61522	105	A9P52613	1
A9N18470	82	A9N19634	260	A9N26929	353, 354,	A9N61523	105	A9P52616	1
A9N18478	82	A9N19635	260	355, 356, 357, 358, 360,		A9N61524	105	A9P52620	1
A9N18479	82	A9N19636	260	470		A9N61525	105	A9P52625	1
A9N18480	82	A9N19637	260	A9N26946	468	A9N61526	105	A9P52632	1
A9N18481	82	A9N19638	260	A9N26947	468	A9N61528	105	A9P52640	1
A9N18489	82	A9N19641	260	A9N26948	468	A9N61529	105	A9P52706	1
A9N18490	82	A9N19642	260	A9N26959	468	A9N61530	105	A9P52710	1
A9N18491	82	A9N19643	260	A9N26960	468	A9N61531	105	A9P52716	1
A9N18492	82	A9N19644	260	A9N26961	468	A9N61532	105	A9P52720	1
A9N18500	82	A9N19645	260	A9N26963	468	A9N61533	105	A9P52725	1
A9N18501	82	A9N19646	260	A9N26969	468	A9N61534	105	A9P52732	1
A9N18502	82	A9N19647	260	A9N26971	468	A9N61535	105	A9P52740	1
A9N18503	82	A9N19648	260	A9N27062	353, 354,	A9N61537	105	A9P53602	3
A9N18511	82	A9N19650	260	355, 356, 357, 358, 359,		A9N61538	105	A9P53606	3
A9N18512	82	A9N19651	260	360, 368, 370		A9N61539	105	A9P53610	3
A9N18513	82	A9N19653	260	A9N60708	72	A9N61650	108	A9P53616	3
A9N18514	82	A9N19655	260	A9N60709	72	A9N61651	108	A9P53620	3
A9N18522	82	A9N19656	260	A9N60711	72	A9N61652	108	A9P53625	3
A9N18523	82	A9N19657	260	A9N60712	72	A9N61653	108	A9P53632	3
A9N18524	82	A9N19658	260	A9N60714	72	A9N61654	108	A9P53640	3
A9N18525	82	A9N19659	260	A9N60715	72	A9N61655	108	A9P54306	5
A9N18542	230	A9N19661	260	A9N60717	72	A9N61656	108	A9P54310	5
A9N18543	230	A9N19663	260	A9N60718	72	A9N61657	108	A9P54313	5
A9N18544	230	A9N19665	260	A9N60720	72	A9N61658	108	A9P54316	5
A9N18545	230	A9N19666	260	A9N60721	72	A9N61659	108	A9P54320	5
A9N18546	230	A9N19667	260	A9N60723	72	A9N61660	108	A9P54325	5
A9N18547	230	A9N19668	260	A9N60724	72	A9N61690	112	A9P54332	5
A9N18548	230	A9N19669	260	A9N60729	73	A9N61699	116	A9P54340	5
A9N18549	230	A9N19671	260	A9N60730	73	A9N61701	121	A9P54602	5
A9N18554	232	A9N19673	260	A9N60733	73	A9P42606	1	A9P54604	5

A9P54606	5	A9PS2625	10	A9Q31440	216	A9R12240	150, 153,	A9R21425	154, 160
A9P54610	5	A9PS2632	10	A9Q41225	217	156, 159		A9R21440	154, 160
A9P54613	5	A9PS2640	10	A9Q41240	217	A9R12263	150, 153,	A9R21463	154, 160
A9P54616	5	A9PS2706	10	A9Q41325	217	156, 159		A9R21480	151, 154,
A9P54620	5	A9PS2710	10	A9Q41340	217	A9R12280	150, 153,	157, 160	
A9P54625	5	A9PS2716	10	A9Q41425	217	156, 159		A9R21491	154, 157,
A9P54632	5	A9PS2720	10	A9Q41440	217	A9R12291	150, 153,	160	
A9P54640	5	A9PS2725	10	A9Q44225	217	156, 159		A9R22440	151, 154,
A9P54706	5	A9PS2732	10	A9Q44240	217	A9R12440	150, 153,	157, 160	
A9P54710	5	A9PS2740	10	A9Q44325	217	156, 159		A9R22463	151, 154,
A9P54713	5	A9PS4606	12	A9Q44340	217	A9R12463	150, 153,	157, 160	
A9P54716	5	A9PS4610	12	A9Q44425	217	156, 159		A9R24225	154, 160
A9P54720	5	A9PS4613	12	A9Q44440	217	A9R12480	150, 153,	A9R24240	154, 160
A9P54725	5	A9PS4616	12	A9Q51225	219	156, 159		A9R24263	154, 160
A9P54732	5	A9PS4620	12	A9Q51325	219	A9R12491	150, 153,	A9R24291	154, 157,
A9P54740	5	A9PS4625	12	A9Q51425	219	156, 159		160	
A9P55606	7	A9PS4632	12	A9Q54225	219	A9R14225	150	A9R24425	154, 160
A9P55610	7	A9PS4640	12	A9Q54325	219	A9R14240	150	A9R24440	154, 160
A9P55613	7	A9PS4706	12	A9Q54425	219	A9R14263	150	A9R24463	154, 160
A9P55616	7	A9PS4710	12	A9Q61225	220	A9R14280	150, 153,	A9R24480	151, 154,
A9P55625	7	A9PS4713	12	A9Q61240	220	156, 159		157, 160	
A9P55632	7	A9PS4716	12	A9Q61325	220	A9R14291	150, 153,	A9R24491	154, 157,
A9P55706	7	A9PS4720	12	A9Q61340	220	156, 159		160	
A9P55710	7	A9PS4725	12	A9Q61425	220	A9R14425	150	A9R25240	154, 157,
A9P55713	7	A9PS4732	12	A9Q61440	220	A9R14440	150	160	
A9P55716	7	A9PS4740	12	A9Q81325	214, 218	A9R14463	150	A9R25263	154, 157,
A9P55725	7	A9Q01225	218	A9Q81425	214, 218	A9R14480	150, 153,	160	
A9P55732	7	A9Q01225	214	A9R01225	151	156, 159		A9R25291	154, 157,
A9P62306	1	A9Q01240	214, 218	A9R01240	151	A9R14491	150, 153,	160	
A9P62310	1	A9Q01263	218	A9R01263	151	156, 159		A9R25440	154, 157,
A9P62316	1	A9Q04225	214, 218	A9R01291	151	A9R15263	150, 153,	160	
A9P62320	1	A9Q04240	214, 218	A9R01425	151	156, 159		A9R25463	154, 157,
A9P62325	1	A9Q04263	218	A9R01440	151	A9R15280	150, 153,	160	
A9P62332	1	A9Q10225	213, 217	A9R01463	151	156, 159		A9R25480	151, 154,
A9P62340	1	A9Q11225	213	A9R01491	151	A9R15291	150, 153,	157, 160	
A9P62706	1	A9Q11240	213	A9R04225	151	156, 159		A9R25491	154, 157,
A9P62710	1	A9Q11325	213	A9R04240	151	A9R15440	150, 153,	160	
A9P62716	1	A9Q11340	213	A9R04263	151	156, 159		A9R26440	151, 154,
A9P62720	1	A9Q11425	213	A9R04291	151	A9R15463	150, 153,	157, 160	
A9P62725	1	A9Q11440	213	A9R04425	151	156, 159		A9R26463	151, 154,
A9P62732	1	A9Q12225	213, 217	A9R04440	151	A9R15480	150, 153,	157, 160	
A9P62740	1	A9Q12425	213, 217	A9R04463	151	156, 159		A9R26491	151, 154,
A9P64306	5	A9Q14225	213	A9R04491	151	A9R15491	150, 153,	157, 160	
A9P64310	5	A9Q14240	213	A9R05240	151	156, 159		A9R30225	152, 155,
A9P64313	5	A9Q14325	213	A9R05263	151	A9R16225	150, 153,	158, 161	
A9P64316	5	A9Q14340	213	A9R05291	151	156, 159		A9R31225	152
A9P64320	5	A9Q14425	213	A9R05440	151	A9R16240	150, 153,	A9R31240	152
A9P64325	5	A9Q14440	213	A9R05463	151	156, 159		A9R31263	152
A9P64332	5	A9Q16225	213, 217	A9R05491	151	A9R16263	150, 153,	A9R31425	152
A9P64340	5	A9Q16240	213, 217	A9R08263	151, 154,	156, 159		A9R31440	152
A9P64602	5	A9Q16325	213, 217	157, 160		A9R16425	150, 153,	A9R31463	152
A9P64606	5	A9Q16340	213, 217	A9R08463	151, 154,	156, 159		A9R31480	152, 155,
A9P64610	5	A9Q16425	213, 217	157, 160		A9R16440	150, 153,	158, 161	
A9P64613	5	A9Q16440	213, 217	A9R10216	150, 153,	156, 159		A9R31491	152, 155,
A9P64616	5	A9Q21225	215	156, 159		A9R16463	150, 153,	158, 161	
A9P64620	5	A9Q21325	215	A9R10225	150, 153,	156, 159		A9R34463	152, 155,
A9P64625	5	A9Q21425	215	156, 159		A9R16480	150, 153,	158, 161	
A9P64632	5	A9Q22225	215, 219	A9R11225	150	156, 159		A9R34491	152, 155,
A9P64640	5	A9Q22325	215, 219	A9R11240	150	A9R17440	150, 153,	158, 161	
A9P64706	5	A9Q22425	215, 219	A9R11263	150	156, 159		A9R35240	152, 155,
A9P64710	5	A9Q24225	215	A9R11280	150, 153,	A9R17463	150, 153,	158, 161	
A9P64713	5	A9Q24325	215	156, 159		156, 159		A9R35263	152, 155,
A9P64716	5	A9Q24425	215	A9R11291	150, 153,	A9R17480	150, 153,	158, 161	
A9P64720	5	A9Q26225	215, 219	156, 159		156, 159		A9R35291	152, 155,
A9P64725	5	A9Q26325	215, 219	A9R11425	150	A9R20216	151, 154,	158, 161	
A9P64732	5	A9Q26425	215, 219	A9R11440	150	157, 160		A9R35440	152, 155,
A9P64740	5	A9Q30225	216, 220	A9R11463	150	A9R20225	151, 154,	158, 161	
A9PS2606	10	A9Q31225	216	A9R11480	150, 153,	157, 160		A9R35463	152, 155,
A9PS2610	10	A9Q31240	216	156, 159		A9R21225	154, 160	158, 161	
A9PS2613	10	A9Q31325	216	A9R11491	150, 153,	A9R21240	154, 160	A9R35480	152, 155,
A9PS2616	10	A9Q31340	216	156, 159		A9R21263	154, 160	158, 161	
A9PS2620	10	A9Q31425	216			A9R21291	154, 157,	A9R35491	152, 155,
						160		158, 161	

A9W10225	224	A9XCATM1	433	A9XPH457	380, 397,	A9Y82640	197	A9Z14491	164
A9W11225	224	A9XCAU06	433, 539,	397	A9Y82725	197	A9Z15240	164	
A9W11263	224	425, 463, 471		A9XPH512	380, 395	A9Y82740	197	A9Z15263	164
A9W11325	224	A9XCT712	387, 515,	A9XPH518	380, 395	A9Y83325	197	A9Z15280	164
A9W11363	224	517		A9XPH524	380, 395	A9Y83340	197	A9Z15291	164
A9W11425	224	A9XELC08	425	A9XPH557	380, 395	A9Y83625	197	A9Z15440	164
A9W11463	224	A9XELC10	439, 446,	A9XPH612	407	A9Y83640	197	A9Z15463	164
A9W12225	224	419		A9XPH624	407	A9Y83725	197	A9Z15480	164
A9W12263	224	A9XM2B04	433	A9XPH708	407	A9Y83740	197	A9Z15491	164
A9W12425	224	A9XMBP02	425	A9XPH712	407	A9Y84325	197	A9Z20216	165
A9W12463	224	A9XMC1D3	447	A9XPH716	407	A9Y84340	197	A9Z20225	165
A9W14225	224	A9XMC2D3	447	A9XPH720	407	A9Y84625	197	A9Z21225	165
A9W14263	224	A9XMFA04	425	A9XPH724	407	A9Y84640	197	A9Z21240	165
A9W14325	224	A9XMLA02	433	A9XPH810	395	A9Y84725	197	A9Z21263	165
A9W14363	224	A9XMSB11	433	A9XPH812	395	A9Y84740	197	A9Z21280	165
A9W14425	224	A9XMVA01	425	A9XPH814	395	A9Y85325	197	A9Z21291	165
A9W14463	224	A9XMWD20	417, 446	A9XPH816	395	A9Y85340	197	A9Z21425	165
A9W21225	225	A9XMWD100	417, 446	A9XPH822	406	A9Y85625	197	A9Z21440	165
A9W21263	225	A9XMZA08	433, 439,	A9XPK707	376	A9Y85640	197	A9Z21463	165
A9W21325	225	441		A9XPK714	376	A9Y85725	197	A9Z21480	165
A9W21363	225	A9XPA648	383, 400	A9XPKL10	376	A9Y85740	197	A9Z21491	165
A9W21425	225	A9XPA748	383, 400	A9XPKV04	376	A9Y87625	197	A9Z22240	165
A9W21463	225	A9XPC604	407	A9XPP606	385	A9Z01225	185	A9Z22263	165
A9W22225	225	A9XPC612	383, 398,	A9XPP612	385	A9Z01240	185	A9Z22280	165
A9W22263	225	399		A9XPP624	385	A9Z01425	185	A9Z22291	165
A9W22425	225	A9XPC624	383, 398,	A9XPP712	385	A9Z01440	185	A9Z22440	165
A9W22463	225	399		A9XPP724	385	A9Z01463	185	A9Z22463	165
A9W24225	225	A9XPC648	383, 398,	A9XPT620	407	A9Z02240	186	A9Z22480	165
A9W24263	225	399		A9XPT920	381, 382,	A9Z02263	186	A9Z22491	165
A9W24325	225	A9XPC712	383, 398,	404, 406		A9Z02440	186	A9Z24225	165
A9W24363	225	399		A9XPV648	383, 400	A9Z02463	186	A9Z24240	165
A9W24425	225	A9XPC724	383, 398,	A9XPV748	383, 400	A9Z03240	186	A9Z24263	165
A9W24463	225	399		A9Y70625	200	A9Z03263	186	A9Z24280	165
A9W25263	225	A9XPC748	383, 398,	A9Y70640	200	A9Z03440	186	A9Z24291	165
A9W25363	225	399		A9Y70725	200	A9Z03463	186	A9Z24425	165
A9W25463	225	A9XPCD04	404	A9Y70740	200	A9Z04440	185	A9Z24440	165
A9W26225	225	A9XPCM04	381, 382,	A9Y71625	200	A9Z04463	185	A9Z24463	165
A9W26263	225	384, 407		A9Y71640	200	A9Z05225	185	A9Z24480	165
A9W26325	225	A9XPE110	381, 404	A9Y71725	200	A9Z05240	185	A9Z24491	165
A9W26363	225	A9XPE210	381, 404,	A9Y71740	200	A9Z05425	185	A9Z25240	165
A9W26425	225	407		A9Y72625	200	A9Z05440	185	A9Z25263	165
A9W26463	225	A9XPE310	381, 404	A9Y72640	200	A9Z05463	185	A9Z25280	165
A9W30225	226	A9XPE410	381, 382,	A9Y72725	200	A9Z06440	185	A9Z25291	165
A9W31225	226	404, 406, 407		A9Y72740	200	A9Z06463	185	A9Z25440	165
A9W31263	226	A9XPF521	382, 396	A9Y73625	200	A9Z09440	185	A9Z25463	165
A9W31325	226	A9XPF524	382, 396	A9Y73640	200	A9Z10225	164	A9Z25480	165
A9W31363	226	A9XPH106	380, 393	A9Y73725	200	A9Z11225	164	A9Z25491	165
A9W31425	226	A9XPH112	380, 393	A9Y73740	200	A9Z11240	164	A9Z26425	165
A9W31463	226	A9XPH124	380, 393	A9Y74625	200	A9Z11263	164	A9Z26440	165
A9W35263	226	A9XPH157	380, 393	A9Y74640	200	A9Z11280	164	A9Z26463	165
A9W35363	226	A9XPH206	380, 395	A9Y74725	200	A9Z11291	164	A9Z26480	165
A9W35463	226	A9XPH208	380, 395	A9Y74740	200	A9Z11425	164	A9Z26491	165
A9X21094	384, 386	A9XPH210	380, 395	A9Y75625	200	A9Z11440	164	A9Z30225	166
A9X21095	386, 388	A9XPH212	380, 395	A9Y75640	200	A9Z11463	164	A9Z31225	166
A9X21096	386, 388	A9XPH218	380, 395	A9Y75725	200	A9Z11480	164	A9Z31240	166
A9XAH157	380, 393	A9XPH224	380, 395	A9Y75740	200	A9Z11491	164	A9Z31263	166
A9XAH257	380, 395	A9XPH257	380, 395	A9Y76640	200	A9Z12240	164	A9Z31280	166
A9XAH357	380, 394	A9XPH306	380, 393	A9Y76740	200	A9Z12263	164	A9Z31291	166
A9XAH457	380, 397	A9XPH309	380, 393	A9Y80325	197	A9Z12280	164	A9Z31425	166
A9XAH557	380, 396	A9XPH311	404	A9Y80340	197	A9Z12291	164	A9Z31440	166
A9XAH657	380, 393	A9XPH312	380, 393	A9Y80625	197	A9Z12440	164	A9Z31463	166
A9XC2412	471, 539,	A9XPH316	380, 393	A9Y80640	197	A9Z12463	164	A9Z31480	166
463, 425, 463, 471		A9XPH318	380, 393	A9Y80725	197	A9Z12480	164	A9Z31491	166
A9XCAC01	425, 463,	A9XPH320	380, 393	A9Y80740	197	A9Z12491	164	A9Z32240	166
471		A9XPH324	380, 393	A9Y81325	197	A9Z14225	164	A9Z32263	166
A9XCAH06	425, 463,	A9XPH357	380, 393	A9Y81340	197	A9Z14240	164	A9Z32280	166
471		A9XPH408	380, 397	A9Y81625	197	A9Z14263	164	A9Z32291	166
A9XCAL06	433, 539,	A9XPH412	380, 397,	A9Y81640	197	A9Z14280	164	A9Z32440	166
425, 463, 471		397		A9Y81725	197	A9Z14291	164	A9Z32463	166
A9XCAM06	433, 539,	A9XPH416	380, 397	A9Y81740	197	A9Z14425	164	A9Z32480	166
425, 463, 471		A9XPH424	380, 397,	A9Y82325	197	A9Z14440	164	A9Z32491	166
A9XCAS06	433, 539,	397		A9Y82340	197	A9Z14463	164	A9Z35240	166
425, 463, 471				A9Y82625	197	A9Z14480	164	A9Z35263	166

A9Z35280	166	A9Z93440	166	CCT15402, CCT1542,	DF2EN32	141	MGN09120	139
A9Z35291	166	A9Z93463	166	CCT15452, CCT15722,	DF2EN40	141	MGN09125	139
A9Z35440	166	A9Z95440	166	CCT15852	DF2EN50	141	MGN09135	139
A9Z35463	166	A9Z95463	166	CCT15423, CCT15723,	DF2FA32	141	MGN09150	139
A9Z35480	166	A : AB1-GA	365	CCT15853,	DF2FA40	141	MTN6606-0070	609
A9Z35491	166	AB1-GA	369, 372	CCT15490	DF2FA50	141	N	
A9Z51216	172, 175	AB1-GB	369, 372	CCT15491	DF2FA63	141	N : AB1-GN	365
A9Z51225	172, 175	AB1-GC	369, 372	CCT15493	DF2FA80	141	O	
A9Z51240	172, 175	AB1-GD	369, 372	CCT15833	DF2FA100	141	O : AB1-GO	365
A9Z51440	172, 175	AB1-GE	369, 372	CCT15838	DF2FA125	141	P	
A9Z51463	172, 175	AB1-GF	369, 372	CCT15840	DF2FN32	141	P : AB1-GP	365
A9Z52225	175	AB1-GG	369, 372	CCT15841	DF2FN40	141	PRA90046	309
A9Z61225	171, 174	AB1-GH	369, 372	CCT15845	DF2FN50	141	PRA90053	309
A9Z61240	171, 174	AB1-GI	369, 372	CCT15846	DF2FN63	141	Q	
A9Z61263	171, 174	AB1-GJ	369, 372	CCT15847	DF2FN80	141	Q : AB1-GQ	365
A9Z61425	171, 174	AB1-GK	369, 372	CCT15848	DF2FN100	141	R	
A9Z61440	171, 174	AB1-GL	369, 372	CCT15854			R9XE110	403
A9Z61463	171, 174	AB1-GM	369, 372	CCT15857			R9XE210	403
A9Z61480	171, 174	AB1-GN	369, 372	CCT15860	594, 609	EER31710	R9XE310	403
A9Z63440	174	AB1-GO	369, 372	CCT15861	594, 609,	EER31800	R9XE410	403
A9Z63463	174	AB1-GP	369, 372	631			R9XFH112	402
A9Z64225	171, 174	AB1-GQ	369, 372	CCT15910	604	F : AB1-GF	R9XFH118	402
A9Z64240	171, 174	AB1-GR	369, 372	CCT15940	604		R9XFH157	402
A9Z64263	171, 174	AB1-GS	369, 372	CCT15950	609	G : AB1-GG	R9XFH212	402
A9Z64425	171, 174	AB1-GT	369, 372	CCT15955	609	GV2G05+LA9E07	R9XFH218	402
A9Z64440	171, 174	AB1-GU	369, 372	CCT15960	609	GV2G09	R9XFH257	402
A9Z64463	171, 174	AB1-GV	369, 372	CCT15970	609	GV2G10	R9XFH306	402
A9Z64480	171, 174	AB1-GW	369, 372	CCT16364	606	GV2G254	R9XFH309	402
A9Z65440	171, 174	AB1-GX	369, 372	CCTDD20001	620	GV2G454	R9XFH311	402
A9Z65463	171, 174	AB1-GY	369, 372	CCTDD20002	620	GV2SN23	R9XFH312	402
A9Z65480	171, 174	AB1-GZ	369, 372	CCTDD20003	620	GV2SN24	R9XFH318	402
A9Z66440	171, 174	AB1-R0	369, 372	CCTDD20004	620	GV2SN33	R9XFH357	402
A9Z66463	171, 174	AB1-R1	369, 372	CCTDD20011	622	GV2SN34	R9XFH412	402
A9Z66480	171, 174	AB1-R2	369, 372	CCTDD20012	622	GVAPL01	R9XFH418	402
A9Z71440	164	AB1-R3	369, 372	CCTDD20016	620	H	R9XFH457	402
A9Z71463	164	AB1-R4	369, 372	CCTDD20017	620	H : AB1-GH	R9XFH512	402
A9Z72440	164	AB1-R5	369, 372	D		I : AB1-GI	R9XFH518	402
A9Z72463	164	AB1-R6	369, 372	D : AB1-GD	365	J : AB1-GJ	R9XFH518G	402
A9Z73440	164	AB1-R7	369, 372	DF2BA0200	136	J	R9XFH557	402
A9Z73463	164	AB1-R8	369, 372	DF2BA0400	136	K : AB1-GK	R9XT20	403
A9Z74440	164	AB1-R9	369, 372	DF2BA0600	136	L	R : AB1-GR	365
A9Z74463	164	AB1-R12	369, 372	DF2BA0800	136	L : AB1-GL	S	
A9Z75440	164	AB1-R13	369, 372	DF2BA1000	136	LGY112510	S : AB1-GS	365
A9Z75463	164	AB1-RV	369, 372	DF2BN0200	136	LGY116013	T	
A9Z76240	164	ABL8MEM24003	425	DF2BN0400	136	LGY125014	T : AB1-GT	365
A9Z76263	164	ABL8MEM24012	425	DF2BN0600	136	LGY410028	TCSEGWB13FA0	425
A9Z76480	164	B		DF2BN0800	136	LGY412548	U	
A9Z76491	164	B : AB1-GB	365	DF2BN1000	136	LGY412560	U : AB1-GU	365
A9Z77240	164	C		DF2CA02	136	LGY416048	V	
A9Z77263	164	CA907001	515, 516,	DF2CA04	136	LGYN1007	V : AB1-GV	365
A9Z77480	164	517		DF2CA10	136	LGYN12512	Vierge : AB1-RV	365
A9Z77491	164	C : AB1-GC	365	DF2CA16	136	LGYN12515	W	
A9Z78440	164	CCT15223	593	DF2CN02	136	LV434020	W : AB1-GW	365
A9Z78463	164	CCT15224	593	DF2CN04	136	LV434021	X	
A9Z79440	164	CCT15232	617	DF2CN06	136	LV434022	X : AB1-GX	365
A9Z79463	164	CCT15233	617	DF2CN10	136	LV434023	Y	
A9Z81240	165	CCT15234	617	DF2CN16	136	M	Y : AB1-GY	365
A9Z81263	165	CCT15243	593	DF2CN20	136	M : AB1-GM	Z : AB1-GZ	365
A9Z81440	165	CCT15244	593	DF2CN25	136	MGN01316		
A9Z81463	165	CCT15260	594	DF2EA10	141	MGN01610		
A9Z81480	165	CCT15261	594	DF2EA12	141	MGN01613		
A9Z81491	165	CCT15268	594	DF2EA16	141	MGN01616		
A9Z82240	165	CCT15338	606	DF2EA20	141	MGN01710		
A9Z82440	165	CCT15365	606	DF2EA25	141	MGN01713		
A9Z82463	165	CCT15367	606	DF2EA32	141	MGN01716		
A9Z82491	165	CCT15368	593	DF2EA40	141	MGN02163		
A9Z83440	165	CCT15400, CCT15420,		DF2EA50	141	MGN02263		
A9Z83463	165	CCT15450, CCT15720,		DF2EA10	141	MGN02363		
A9Z91440	165	CCT15850	604	DF2EN10	141	MGN02663		
A9Z91463	165	CCT15401, CCT15451,		DF2EN16	141	MGN02763		
A9Z92440	165	CCT15721, CCT15851		DF2EN20	141			
A9Z92463	165	604		DF2EN25	141			

Life Is On



Schneider Electric Industries SAS

35, rue Joseph Monier
CS 30323
92506 Rueil Malmaison Cedex
France

RCS Nanterre 954 503 439
Capital social 896 313 776 €
www.se.com

07-2019
CA909006E

© 2019 - Schneider Electric. All Rights Reserved.
All trademarks are owned by Schneider Electric Industries SAS or its affiliated companies.

This document has been
printed on recycled paper

