

Low voltage

Acti 9

the efficiency you deserve

Gulf Catalogue
2014 / 2015



5 generations

of industry experience and 21 new patents
make Acti 9 the new reference in low-voltage
modular systems

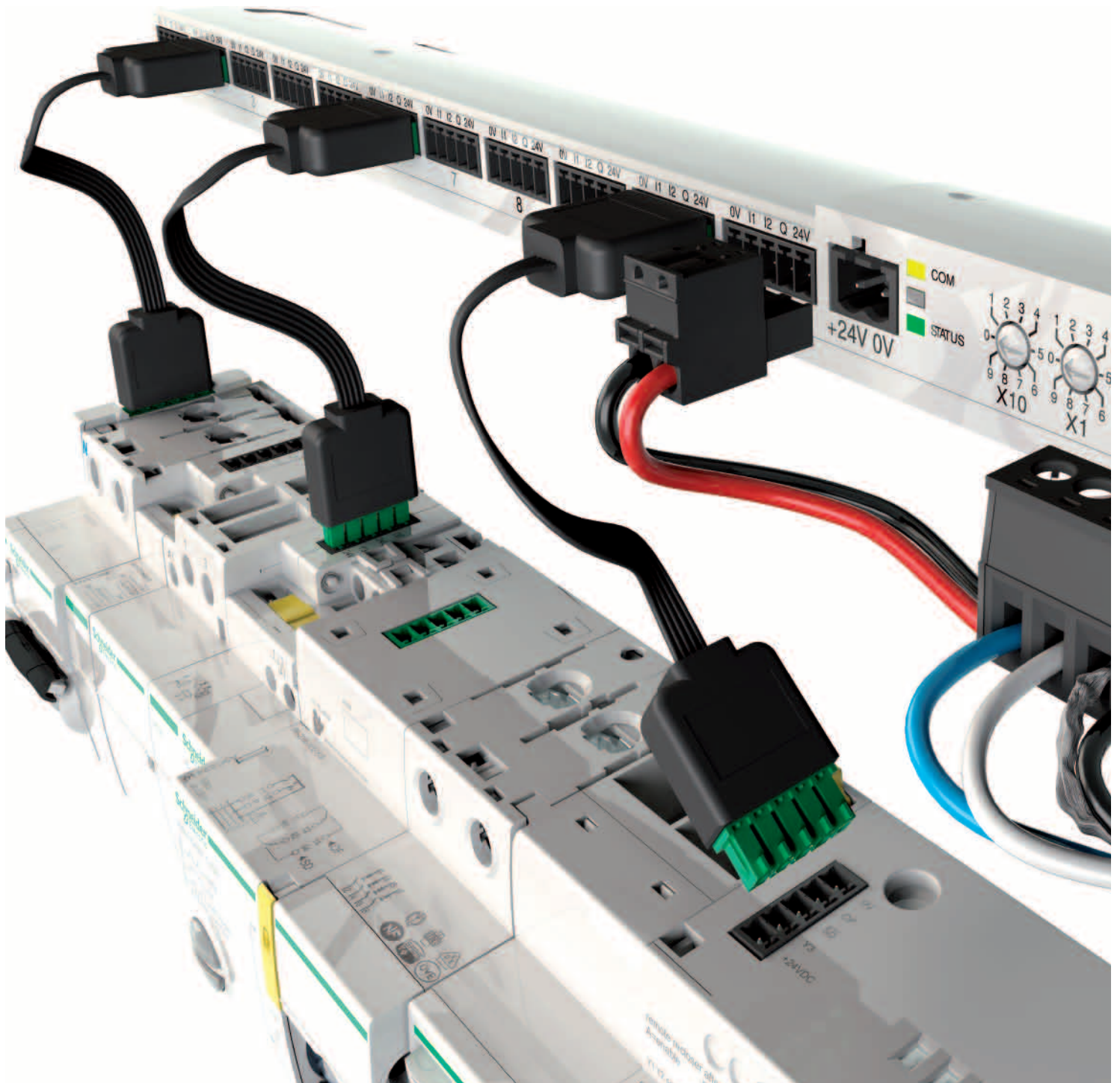

		Page
General	Principle of catalogue numbers, protection (Acti 9)	7
Circuit protection	Choice of circuit protective devices	8
	Circuit breaker panorama	10
	Neutral breaking circuit breakers	
	iDPN and iDPN N	A-2
	Circuit breakers up to 63 A	
	iK60 (B curve)	A-4
	iK60 (C curve)	A-7
	iC60N	A-9
	iC60H	A-12
	iC60L	A-16
	Circuit breakers up to 125 A	
	C120N	A-20
	C120H	A-23
	High performance circuit breakers	
	NG125a	A-27
	NG125N	A-29
	NG125H	A-31
	NG125L	A-33
	Direct current circuit breakers	
	C60H-DC	A-35
	Motor protection circuit breakers	
	i60CLMA	A-38
	NG125LMA	A-41
Residual current devices	Choice of earth leakage protection devices	B-2
	Overview of the earth leakage protection product range	B-4
	Residual current circuit breakers	
	iID	B-6
	iID K	B-11
	RCCB-ID 125 A	B-13
	RCCB-ID type B	B-15
	Add-on residual current devices for circuit breakers	
	Vigi iC60	B-17
	Vigi C120	B-22
	Vigi NG125	B-27
	Vigi modules and residual current devices i DPN	B-33
	Residual current devices	
	iDPN Vigi	B-35
	iC60 RCBO	B-38
Load protection (surge arrester)	LV surge arresters	
	iPF	C-2
	iPRD	C-5
	iQuick PRD	C-8
	iQuick PF	C-11
	Surge arresters for telephon and informatic networks	
	iPRC/IPRI	C-13
	Surge arresters for photovoltaic installations	
	iPRD-DC PV (white product)	C-15
Disconnection	Switch-disconnectors	
	iSW (white product)	D-2
	Trip switch-disconnectors	
	NG125NA	D-7



Install, connection, power distribution	Accessorisation/Auxiliarisation	
	Accessories/ Auxiliarisation iC60, iID, iSW-NA, iDPN Vigi, Reflex iC60, RCA, ARA	E-2
	Accessories and Auxiliaries for C120 and Vigi C120 devices	E-7
	Accessories and Auxiliaries for C60H-DC device	E-8
	Accessories and Auxiliaries for iSW 40 and NG125 devices	E-9
	Circuit breakers and residual current devices accessories	
	Accessories for iC60, iID, iSW-NA, Reflex iC60, RCA, ARA	E-10
	Accessories for C120, iSW and C60H-DC devices	E-15
	Acti 9 comb busbars	E-18
	Distribloc 63 A	E-22
	Multiclip 80 A	E-24
	Accessories for NG125 devices	E-26
	Connection comb busbars for C120 and NG125	E-28
	iDPN Comb busbar	E-29
Accessories and Auxiliaries for iDPN	E-31	
Supervision and switchboard control	Acti 9 control system	
	Smartlink Acti 9	E-33
Monitoring and control of protections	Indication and tripping	
	Electrical auxiliaries for iC60, iID, iSW-NA, RCA, ARA	F-2
	Electrical auxiliaries for C120, DPN Vigi, ID, C60H-DC devices	F-9
	Electrical auxiliaries for NG125 devices	F-14
	Remote control	
	RCA remote controls for iC60 circuit breakers	F-18
	Automatic reclosers	
	ARA automatic reclosers for iC60 and iID	F-23
Electrical circuit control	Electrical control	
	Reflex iC60 integrated control circuit breakers	G-3
	iMDU for Reflex iC60	G-9
	iCT contactors	G-10
	iTL impulse relays	G-26
	TL+ impulse relays	G-39
	CT+ contactors	G-41
	Manual control	
	iPB pushbuttons	G-43
	iSSW linear switches	G-44
	DIN rail selector switches iCMB, iCMD, iCME, iCMC, iCMV and iCMA	G-45
Indication	Indicators	
	iIL indicator lights	H-2
	SO bells and iRO buzzers	H-3
	iTR transformers	H-4
Lighting, time and energy management	IC twilight switches	I-2
	IHP, IH, IHH, ITM	I-11
	MIN timers	I-24
	STD and SCU range	I-28
	TH4, TH7 and THP1, THP2	I-33
	Relays iRTA, iRTB, iRTC, iRTH, iRTL, iRTMF, iRBN, iRTBT, iRLI, iERL, iRCP, iRCI, iRCU, iRCC	I-42

Index

Reference	Description	Page	Reference	Description	Page	Reference	Description	Page
A9N21535	_L_DPN 1P+N 6A B	A-2	A9N21595	_L_DPN N 3P+N 6A C	A-3	A9K23332	iK60N 3P 32A B	A-5
A9N21536	_L_DPN 1P+N 10A B	A-2	A9N21596	_L_DPN N 3P+N 10A C	A-3	A9K23340	iK60N 3P 40A B	A-5
A9N21537	_L_DPN 1P+N 16A B	A-2	A9N21597	_L_DPN N 3P+N 16A C	A-3	A9K23350	iK60N 3P 50A B	A-5
A9N21538	_L_DPN 1P+N 20A B	A-2	A9N21598	_L_DPN N 3P+N 20A C	A-3	A9K23363	iK60N 3P 63A B	A-5
A9N21539	_L_DPN 1P+N 25A B	A-2	A9N21599	_L_DPN N 3P+N 25A C	A-3	A9K23406	iK60N 4P 6A B	A-5
A9N21540	_L_DPN 1P+N 32A B	A-2	A9N21600	_L_DPN N 3P+N 32A C	A-3	A9K23410	iK60N 4P 10A B	A-5
A9N21541	_L_DPN 1P+N 40A B	A-2	A9N21601	_L_DPN N 3P+N 40A C	A-3	A9K23416	iK60N 4P 16A B	A-5
A9N21542	_L_DPN 1P+N 1A C	A-2	A9N21605	_L_DPN N 3P+N 6A D	A-3	A9K23420	iK60N 4P 20A B	A-5
A9N21543	_L_DPN 1P+N 2A C	A-2	A9N21606	_L_DPN N 3P+N 10A D	A-3	A9K23425	iK60N 4P 25A B	A-5
A9N21544	_L_DPN 1P+N 3A C	A-2	A9N21607	_L_DPN N 3P+N 16A D	A-3	A9K23432	iK60N 4P 32A B	A-5
A9N21545	_L_DPN 1P+N 6A C	A-2	A9N21608	_L_DPN N 3P+N 20A D	A-3	A9K23440	iK60N 4P 40A B	A-5
A9N21546	_L_DPN 1P+N 10A C	A-2	A9N21609	_L_DPN N 3P+N 25A D	A-3	A9K23450	iK60N 4P 50A B	A-5
A9N21547	_L_DPN 1P+N 16A C	A-2	A9N21610	_L_DPN N 3P+N 32A D	A-3	A9K23463	iK60N 4P 63A B	A-5
A9N21548	_L_DPN 1P+N 20A C	A-2	A9N21611	_L_DPN N 3P+N 40A D	A-3	A9K23601	iK60N 1P+N 1A B	A-5
A9N21549	_L_DPN 1P+N 25A C	A-2	A9N21638	IDPN F 1P+N C 1A	A-3	A9K23602	iK60N 1P+N 2A B	A-5
A9N21550	_L_DPN 1P+N 32A C	A-2	A9N21641	IDPN F 1P+N C 2A	A-3	A9K23603	iK60N 1P+N 3A B	A-5
A9N21551	_L_DPN 1P+N 40A C	A-2	A9N21642	IDPN F 1P+N C 3A	A-3	A9K23604	iK60N 1P+N 4A B	A-5
A9N21723	13A B 1P+N	A-2	A9N21643	IDPN F 1P+N C 6A	A-3	A9K23606	iK60N 1P+N 6A B	A-5
A9N21724	13A C 1P+N	A-2	A9N21644	IDPN F 1P+N C 10A	A-3	A9K23610	iK60N 1P+N 10A B	A-5
A9N21731	13A B 3P+N	A-2	A9N21645	IDPN F 1P+N C 16A	A-3	A9K23616	iK60N 1P+N 16A B	A-5
A9N21732	13A C 3P+N	A-2	A9N21646	IDPN F 1P+N C 20A	A-3	A9K23620	iK60N 1P+N 20A B	A-5
A9N17515	IDPN N 1P+N B 4A	A-3	A9N21647	IDPN F 1P+N C 25A	A-3	A9K23625	iK60N 1P+N 25A B	A-5
A9N17516	IDPN N 1P+N B 6A	A-3	A9N21648	IDPN F 1P+N C 32A	A-3	A9K23632	iK60N 1P+N 32A B	A-5
A9N17517	IDPN N 1P+N B 10A	A-3	A9N21649	IDPN F 1P+N C 40A	A-3	A9K23640	iK60N 1P+N 40A B	A-5
A9N17518	IDPN N 1P+N B 13A	A-3	A9N21722	IDPN N 1P+N C 4A	A-3	A9K23650	iK60N 1P+N 50A B	A-5
A9N17519	IDPN N 1P+N B 16A	A-3	A9N21725	IDPN N 1P+N C 13A	A-3	A9K23663	iK60N 1P+N 63A B	A-5
A9N17520	IDPN N 1P+N B 20A	A-3	A9N21726	IDPN N 1P+N D 13A	A-3	A9K24101	iK60N 1P 1A C	A-7
A9N17521	IDPN N 1P+N B 25A	A-3	A9N21727	IDPN N 3P C 13A	A-3	A9K24102	iK60N 1P 2A C	A-7
A9N17522	IDPN N 1P+N B 32A	A-3	A9N21728	IDPN N 3P D 13A	A-3	A9K24103	iK60N 1P 3A C	A-7
A9N17523	IDPN N 1P+N B 40A	A-3	A9N21729	IDPN N 3P+N C 13A	A-3	A9K24104	iK60N 1P 4A C	A-7
A9N17581	IDPN N 3P+N B 13A	A-3	A9N21730	IDPN N 3P+N D 13A	A-3	A9K24106	iK60N 1P 6A C	A-7
A9N21552	_L_DPN N 1P+N 1A C	A-3	A9K23101	iK60N 1P 1A B	A-5	A9K24110	iK60N 1P 10A C	A-7
A9N21553	_L_DPN N 1P+N 2A C	A-3	A9K23102	iK60N 1P 2A B	A-5	A9K24116	iK60N 1P 16A C	A-7
A9N21554	_L_DPN N 1P+N 3A C	A-3	A9K23103	iK60N 1P 3A B	A-5	A9K24120	iK60N 1P 20A C	A-7
A9N21555	_L_DPN N 1P+N 6A C	A-3	A9K23104	iK60N 1P 4A B	A-5	A9K24125	iK60N 1P 25A C	A-7
A9N21556	_L_DPN N 1P+N 10A C	A-3	A9K23106	iK60N 1P 6A B	A-5	A9K24132	iK60N 1P 32A C	A-7
A9N21557	_L_DPN N 1P+N 16A C	A-3	A9K23110	iK60N 1P 10A B	A-5	A9K24140	iK60N 1P 40A C	A-7
A9N21558	_L_DPN N 1P+N 20A C	A-3	A9K23116	iK60N 1P 16A B	A-5	A9K24150	iK60N 1P 50A C	A-7
A9N21559	_L_DPN N 1P+N 25A C	A-3	A9K23120	iK60N 1P 20A B	A-5	A9K24163	iK60N 1P 63A C	A-7
A9N21560	_L_DPN N 1P+N 32A C	A-3	A9K23125	iK60N 1P 25A B	A-5	A9K24201	iK60N 2P 1A C	A-7
A9N21561	_L_DPN N 1P+N 40A C	A-3	A9K23132	iK60N 1P 32A B	A-5	A9K24202	iK60N 2P 2A C	A-7
A9N21565	_L_DPN N 1P+N 6A D	A-3	A9K23140	iK60N 1P 40A B	A-5	A9K24203	iK60N 2P 3A C	A-7
A9N21566	_L_DPN N 1P+N 10A D	A-3	A9K23150	iK60N 1P 50A B	A-5	A9K24204	iK60N 2P 4A C	A-7
A9N21567	_L_DPN N 1P+N 16A D	A-3	A9K23163	iK60N 1P 63A B	A-5	A9K24206	iK60N 2P 6A C	A-7
A9N21568	_L_DPN N 1P+N 20A D	A-3	A9K23201	iK60N 2P 1A B	A-5	A9K24210	iK60N 2P 10A C	A-7
A9N21569	_L_DPN N 1P+N 25A D	A-3	A9K23202	iK60N 2P 2A B	A-5	A9K24216	iK60N 2P 16A C	A-7
A9N21570	_L_DPN N 1P+N 32A D	A-3	A9K23203	iK60N 2P 3A B	A-5	A9K24220	iK60N 2P 20A C	A-7
A9N21571	_L_DPN N 1P+N 40A D	A-3	A9K23204	iK60N 2P 4A B	A-5	A9K24225	iK60N 2P 25A C	A-7
A9N21575	_L_DPN N 3P 6A C	A-3	A9K23206	iK60N 2P 6A B	A-5	A9K24232	iK60N 2P 32A C	A-7
A9N21576	_L_DPN N 3P 10A C	A-3	A9K23210	iK60N 2P 10A B	A-5	A9K24240	iK60N 2P 40A C	A-7
A9N21577	_L_DPN N 3P 16A C	A-3	A9K23216	iK60N 2P 16A B	A-5	A9K24250	iK60N 2P 50A C	A-7
A9N21578	_L_DPN N 3P 20A C	A-3	A9K23220	iK60N 2P 20A B	A-5	A9K24263	iK60N 2P 63A C	A-7
A9N21579	_L_DPN N 3P 25A C	A-3	A9K23225	iK60N 2P 25A B	A-5	A9K24306	iK60N 3P 6A C	A-7
A9N21580	_L_DPN N 3P 32A C	A-3	A9K23232	iK60N 2P 32A B	A-5	A9K24310	iK60N 3P 10A C	A-7
A9N21581	_L_DPN N 3P 40A C	A-3	A9K23240	iK60N 2P 40A B	A-5	A9K24316	iK60N 3P 16A C	A-7
A9N21585	_L_DPN N 3P 6A D	A-3	A9K23250	iK60N 2P 50A B	A-5	A9K24320	iK60N 3P 20A C	A-7
A9N21586	_L_DPN N 3P 10A D	A-3	A9K23263	iK60N 2P 63A B	A-5	A9K24325	iK60N 3P 25A C	A-7
A9N21587	_L_DPN N 3P 16A D	A-3	A9K23306	iK60N 3P 6A B	A-5	A9K24332	iK60N 3P 32A C	A-7
A9N21588	_L_DPN N 3P 20A D	A-3	A9K23310	iK60N 3P 10A B	A-5	A9K24340	iK60N 3P 40A C	A-7
A9N21589	_L_DPN N 3P 25A D	A-3	A9K23316	iK60N 3P 16A B	A-5	A9K24350	iK60N 3P 50A C	A-7
A9N21590	_L_DPN N 3P 32A D	A-3	A9K23320	iK60N 3P 20A B	A-5	A9K24363	iK60N 3P 63A C	A-7
A9N21591	_L_DPN N 3P 40A D	A-3	A9K23325	iK60N 3P 25A B	A-5	A9K24406	iK60N 4P 6A C	A-7

Index

Reference	Description	Page
A9K24410	ik60N 4P 10A C	A-7
A9K24416	ik60N 4P 16A C	A-7
A9K24420	ik60N 4P 20A C	A-7
A9K24425	ik60N 4P 25A C	A-7
A9K24432	ik60N 4P 32A C	A-7
A9K24440	ik60N 4P 40A C	A-7
A9K24450	ik60N 4P 50A C	A-7
A9K24463	ik60N 4P 63A C	A-7
A9K24601	ik60N 1P+N 1A C	A-7
A9K24602	ik60N 1P+N 2A C	A-7
A9K24603	ik60N 1P+N 3A C	A-7
A9K24604	ik60N 1P+N 4A C	A-7
A9K24606	ik60N 1P+N 6A C	A-7
A9K24610	ik60N 1P+N 10A C	A-7
A9K24616	ik60N 1P+N 16A C	A-7
A9K24620	ik60N 1P+N 20A C	A-7
A9K24625	ik60N 1P+N 25A C	A-7
A9K24632	ik60N 1P+N 32A C	A-7
A9K24640	ik60N 1P+N 40A C	A-7
A9K24650	ik60N 1P+N 50A C	A-7
A9K24663	ik60N 1P+N 63A C	A-7
A9F43101	IC60N 1P 1A B	A-9
A9F43102	IC60N 1P 2A B	A-9
A9F43103	IC60N 1P 3A B	A-9
A9F43104	IC60N 1P 4A B	A-9
A9F43106	IC60N 1P 6A B	A-9
A9F43110	IC60N 1P 10A B	A-9
A9F43116	IC60N 1P 16A B	A-9
A9F43120	IC60N 1P 20A B	A-9
A9F43125	IC60N 1P 25A B	A-9
A9F43132	IC60N 1P 32A B	A-9
A9F43140	IC60N 1P 40A B	A-9
A9F43150	IC60N 1P 50A B	A-9
A9F43163	IC60N 1P 63A B	A-9
A9F43170	IC60N 1P 0.5A B	A-9
A9F43201	IC60N 2P 1A B	A-9
A9F43202	IC60N 2P 2A B	A-9
A9F43203	IC60N 2P 3A B	A-9
A9F43204	IC60N 2P 4A B	A-9
A9F43206	IC60N 2P 6A B	A-9
A9F43210	IC60N 2P 10A B	A-9
A9F43216	IC60N 2P 16A B	A-9
A9F43220	IC60N 2P 20A B	A-9
A9F43225	IC60N 2P 25A B	A-9
A9F43232	IC60N 2P 32A B	A-9
A9F43240	IC60N 2P 40A B	A-9
A9F43250	IC60N 2P 50A B	A-9
A9F43263	IC60N 2P 63A B	A-9
A9F43270	IC60N 2P 0.5A B	A-9
A9F44101	IC60N 1P 1A C	A-9
A9F44102	IC60N 1P 2A C	A-9
A9F44103	IC60N 1P 3A C	A-9
A9F44104	IC60N 1P 4A C	A-9
A9F44106	IC60N 1P 6A C	A-9
A9F44110	IC60N 1P 10A C	A-9
A9F44116	IC60N 1P 16A C	A-9
A9F44120	IC60N 1P 20A C	A-9
A9F44125	IC60N 1P 25A C	A-9
A9F44132	IC60N 1P 32A C	A-9
A9F44140	IC60N 1P 40A C	A-9
A9F44150	IC60N 1P 50A C	A-9
A9F44163	IC60N 1P 63A C	A-9

Reference	Description	Page
A9F44170	IC60N 1P 0.5A C	A-9
A9F44201	IC60N 2P 1A C	A-9
A9F44202	IC60N 2P 2A C	A-9
A9F44203	IC60N 2P 3A C	A-9
A9F44204	IC60N 2P 4A C	A-9
A9F44206	IC60N 2P 6A C	A-9
A9F44210	IC60N 2P 10A C	A-9
A9F44216	IC60N 2P 16A C	A-9
A9F44220	IC60N 2P 20A C	A-9
A9F44225	IC60N 2P 25A C	A-9
A9F44232	IC60N 2P 32A C	A-9
A9F44240	IC60N 2P 40A C	A-9
A9F44250	IC60N 2P 50A C	A-9
A9F44263	IC60N 2P 63A C	A-9
A9F44270	IC60N 2P 0.5A C	A-9
A9F45101	IC60N 1P 1A D	A-9
A9F45102	IC60N 1P 2A D	A-9
A9F45103	IC60N 1P 3A D	A-9
A9F45104	IC60N 1P 4A D	A-9
A9F45106	IC60N 1P 6A D	A-9
A9F45110	IC60N 1P 10A D	A-9
A9F45116	IC60N 1P 16A D	A-9
A9F45120	IC60N 1P 20A D	A-9
A9F45125	IC60N 1P 25A D	A-9
A9F45132	IC60N 1P 32A D	A-9
A9F45140	IC60N 1P 40A D	A-9
A9F45150	IC60N 1P 50A D	A-9
A9F45163	IC60N 1P 63A D	A-9
A9F45170	IC60N 1P 0.5A D	A-9
A9F45201	IC60N 2P 1A D	A-9
A9F45202	IC60N 2P 2A D	A-9
A9F45203	IC60N 2P 3A D	A-9
A9F45204	IC60N 2P 4A D	A-9
A9F45206	IC60N 2P 6A D	A-9
A9F45210	IC60N 2P 10A D	A-9
A9F45216	IC60N 2P 16A D	A-9
A9F45220	IC60N 2P 20A D	A-9
A9F45225	IC60N 2P 25A D	A-9
A9F45232	IC60N 2P 32A D	A-9
A9F45240	IC60N 2P 40A D	A-9
A9F45250	IC60N 2P 50A D	A-9
A9F45263	IC60N 2P 63A D	A-9
A9F45270	IC60N 2P 0.5A D	A-9
A9F43301	IC60N 3P 1A B	A-10
A9F43302	IC60N 3P 2A B	A-10
A9F43303	IC60N 3P 3P 3A B	A-10
A9F43304	IC60N 3P 4A B	A-10
A9F43306	IC60N 3P 6A B	A-10
A9F43310	IC60N 3P 10A B	A-10
A9F43316	IC60N 3P 16A B	A-10
A9F43320	IC60N 3P 20A B	A-10
A9F43325	IC60N 3P 25A B	A-10
A9F43332	IC60N 3P 32A B	A-10
A9F43340	IC60N 3P 40A B	A-10
A9F43350	IC60N 3P 50A B	A-10
A9F43363	IC60N 3P 63A B	A-10
A9F43370	IC60N 4P 0.5A B	A-10
A9F43401	IC60N 4P 1A B	A-10
A9F43402	IC60N 4P 2A B	A-10
A9F43403	IC60N 4P 3A B	A-10
A9F43404	IC60N 4P 4A B	A-10
A9F43406	IC60N 4P 6A B	A-10

Reference	Description	Page
A9F43410	IC60N 4P 10A B	A-10
A9F43416	IC60N 4P 16A B	A-10
A9F43420	IC60N 4P 20A B	A-10
A9F43425	IC60N 4P 25A B	A-10
A9F43432	IC60N 4P 32A B	A-10
A9F43440	IC60N 4P 40A B	A-10
A9F43450	IC60N 4P 50A B	A-10
A9F43463	IC60N 4P 63A B	A-10
A9F43470	IC60N 3P 0.5A C	A-10
A9F44301	IC60N 3P 1A C	A-10
A9F44302	IC60N 3P 2A C	A-10
A9F44303	IC60N 3P 3A C	A-10
A9F44304	IC60N 3P 4A C	A-10
A9F44306	IC60N 3P 6A C	A-10
A9F44310	IC60N 3P 10A C	A-10
A9F44316	IC60N 3P 16A C	A-10
A9F44320	IC60N 3P 20A C	A-10
A9F44325	IC60N 3P 25A C	A-10
A9F44332	IC60N 3P 32A C	A-10
A9F44340	IC60N 3P 40A C	A-10
A9F44350	IC60N 3P 50A C	A-10
A9F44363	IC60N 3P 63A C	A-10
A9F44370	IC60N 4P 0.5A C	A-10
A9F44401	IC60N 4P 1A C	A-10
A9F44402	IC60N 4P 2A C	A-10
A9F44403	IC 60 N 4P 3A C	A-10
A9F44404	IC60N 4P 4A C	A-10
A9F44406	IC60N 4P 6A C	A-10
A9F44410	IC60N 4P 10A C	A-10
A9F44416	IC60N 4P 16A C	A-10
A9F44420	IC60N 4P 20A C	A-10
A9F44425	IC60N 4P 25A C	A-10
A9F44432	IC60N 4P 32A C	A-10
A9F44440	IC60N 4P 40A C	A-10
A9F44450	IC60N 4P 50A C	A-10
A9F44463	IC60N 4P 63A C	A-10
A9F44470	IC60N 4P 0.5A D	A-10
A9F45301	IC60N 3P 1A D	A-10
A9F45302	IC60N 3P 2A D	A-10
A9F45303	IC 60 N 3P 3A D	A-10
A9F45304	IC60N 3P 4A D	A-10
A9F45306	IC60N 3P 6A D	A-10
A9F45310	IC60N 3P 10A D	A-10
A9F45316	IC60N 3P 16A D	A-10
A9F45320	IC60N 3P 20A D	A-10
A9F45325	IC60N 3P 25A D	A-10
A9F45332	IC60N 3P 32A D	A-10
A9F45340	IC60N 3P 40A D	A-10
A9F45350	IC60N 3P 50A D	A-10
A9F45363	IC60N 3P 63A D	A-10
A9F45370	IC 60N 3P 0.5A D	A-10
A9F45401	IC60N 4P 1A D	A-10
A9F45402	IC60N 4P 2A D	A-10
A9F45403	IC60N 4P 3A D	A-10
A9F45404	IC60N 4P 4A D	A-10
A9F45406	IC60N 4P 6A D	A-10
A9F45410	IC60N 4P 10A D	A-10
A9F45416	IC60N 4P 16A D	A-10
A9F45420	IC60N 4P 20A D	A-12
A9F45425	IC60N 4P 25A D	A-12
A9F45432	IC60N 4P 32A D	A-12
A9F45440	IC60N 4P 40A D	A-12

Index

Reference	Description	Page	Reference	Description	Page	Reference	Description	Page
A9F45450	IC60N 4P 50A D	A-12	A9F55150	IC60H 1P 50A D	A-12	A9F55301	IC60H 3P 1A D	A-13
A9F45463	IC60N 4P 63A D	A-12	A9F55163	IC60H 1P 63A D	A-12	A9F55302	IC60H 3P 2A D	A-13
A9F45470	IC60N 4P 0.5 A B	A-12	A9F55201	IC60H 2P 1A D	A-12	A9F55304	IC60H 3P 4A D	A-13
A9F53101	IC60H 1P 1A B	A-12	A9F55202	IC60H 2P 2A D	A-12	A9F55306	IC60H 3P 6A D	A-13
A9F53102	IC60H 1P 2A B	A-12	A9F55204	IC60H 2P 4A D	A-12	A9F55310	IC60H 3P 10A D	A-13
A9F53103	IC60H 1P 3A B	A-12	A9F55206	IC60H 2P 6A D	A-12	A9F55316	IC60H 3P 16A D	A-13
A9F53104	IC60H 1P 4A B	A-12	A9F55210	IC60H 2P 10A D	A-12	A9F55320	IC60H 3P 20A D	A-13
A9F53106	IC60H 1P 6A B	A-12	A9F55216	IC60H 2P 16A D	A-12	A9F55325	IC60H 3P 25A D	A-13
A9F53110	IC60H 1P 10A B	A-12	A9F55220	IC60H 2P 20A D	A-12	A9F55332	IC60H 3P 32A D	A-13
A9F53116	IC60H 1P 16A B	A-12	A9F55225	IC60H 2P 25A D	A-12	A9F55340	IC60H 3P 40A D	A-13
A9F53120	IC60H 1P 20A B	A-12	A9F55232	IC60H 2P 32A D	A-12	A9F55350	IC60H 3P 50A D	A-13
A9F53125	IC60H 1P 25A B	A-12	A9F55240	IC60H 2P 40A D	A-12	A9F55363	IC60H 3P 63A D	A-13
A9F53132	IC60H 1P 32A B	A-12	A9F55250	IC60H 2P 50A D	A-12	A9F55401	IC60H 4P 1A D	A-13
A9F53140	IC60H 1P 40A B	A-12	A9F55263	IC60H 2P 63A D	A-12	A9F55402	IC60H 4P 2A D	A-13
A9F53150	IC60H 1P 50A B	A-12	A9F53301	IC60H 3P 1A B	A-13	A9F55404	IC60H 4P 4A D	A-13
A9F53163	IC60H 1P 63A B	A-12	A9F53302	IC60H 3P 2A B	A-13	A9F55406	IC60H 4P 6A D	A-13
A9F53201	IC60H 2P 1A B	A-12	A9F53304	IC60H 3P 4A B	A-13	A9F55410	IC60H 4P 10A D	A-13
A9F53202	IC60H 2P 2A B	A-12	A9F53306	IC60H 3P 6A B	A-13	A9F55416	IC60H 4P 16A D	A-13
A9F53204	IC60H 2P 4A B	A-12	A9F53310	IC60H 3P 10A B	A-13	A9F55420	IC60H 4P 20A D	A-13
A9F53206	IC60H 2P 6A B	A-12	A9F53316	IC60H 3P 16A B	A-13	A9F55425	IC60H 4P 25A D	A-13
A9F53210	IC60H 2P 10A B	A-12	A9F53320	IC60H 3P 20A B	A-13	A9F55432	IC60H 4P 32A D	A-13
A9F53216	IC60H 2P 16A B	A-12	A9F53325	IC60H 3P 25A B	A-13	A9F55440	IC60H 4P 40A D	A-13
A9F53220	IC60H 2P 20A B	A-12	A9F53332	IC60H 3P 32A B	A-13	A9F55450	IC60H 4P 50A D	A-13
A9F53225	IC60H 2P 25A B	A-12	A9F53340	IC60H 3P 40A B	A-13	A9F55463	IC60H 4P 63A D	A-13
A9F53232	IC60H 2P 32A B	A-12	A9F53350	IC60H 3P 50A B	A-13	A9F93101	IC60L 1P 1A B	A-16
A9F53240	IC60H 2P 40A B	A-12	A9F53363	IC60H 3P 63A B	A-13	A9F93102	IC60L 1P 2A B	A-16
A9F53250	IC60H 2P 50A B	A-12	A9F53401	IC60H 4P 1A B	A-13	A9F93103	IC60L 1P 3A B	A-16
A9F53263	IC60H 2P 63A B	A-12	A9F53402	IC60H 4P 2A B	A-13	A9F93104	IC60L 1P 4A B	A-16
A9F54101	IC60H 1P 1A C	A-12	A9F53406	IC60H 4P 4A B	A-13	A9F93110	IC60L 1P 6A B	A-16
A9F54102	IC60H 1P 2A C	A-12	A9F53410	IC60H 4P 6A B	A-13	A9F93116	IC60L 1P 16A B	A-16
A9F54104	IC60H 1P 4A C	A-12	A9F53416	IC60H 4P 16A B	A-13	A9F93120	IC60L 1P 20A B	A-16
A9F54106	IC60H 1P 6A C	A-12	A9F53420	IC60H 4P 20A B	A-13	A9F93125	IC60L 1P 25A B	A-16
A9F54110	IC60H 1P 10A C	A-12	A9F53425	IC60H 4P 25A B	A-13	A9F93132	IC60L 1P 32A B	A-16
A9F54116	IC60H 1P 16A C	A-12	A9F53432	IC60H 4P 32A B	A-13	A9F93140	IC60L 1P 40A B	A-16
A9F54120	IC60H 1P 20A C	A-12	A9F53440	IC60H 4P 40A B	A-13	A9F93150	IC60L 1P 50A B	A-16
A9F54125	IC60H 1P 25A C	A-12	A9F53450	IC60H 4P 50A B	A-13	A9F93163	IC60L 1P 63A B	A-16
A9F54132	IC60H 1P 32A C	A-12	A9F53463	IC60H 4P 63A B	A-13	A9F93170	IC60L 1P 0.5A B	A-16
A9F54140	IC60H 1P 40A C	A-12	A9F54301	IC60H 3P 1A C	A-13	A9F93201	IC60L 2P 1A B	A-16
A9F54150	IC60H 1P 50A C	A-12	A9F54302	IC60H 3P 2A C	A-13	A9F93202	IC60L 2P 2A B	A-16
A9F54163	IC60H 1P 63A C	A-12	A9F54304	IC60H 3P 4A C	A-13	A9F93203	IC60L 2P 3A B	A-16
A9F54201	IC60H 2P 1A C	A-12	A9F54306	IC60H 3P 6A C	A-13	A9F93204	IC60L 2P 4A B	A-16
A9F54202	IC60H 2P 2A C	A-12	A9F54310	IC60H 3P 10A C	A-13	A9F93206	IC60L 2P 6A B	A-16
A9F54204	IC60H 2P 4A C	A-12	A9F54316	IC60H 3P 16A C	A-13	A9F93210	IC60L 2P 10A B	A-16
A9F54206	IC60H 2P 6A C	A-12	A9F54320	IC60H 3P 20A C	A-13	A9F93216	IC60L 2P 16A B	A-16
A9F54210	IC60H 2P 10A C	A-12	A9F54325	IC60H 3P 25A C	A-13	A9F93220	IC60L 2P 20A B	A-16
A9F54216	IC60H 2P 16A C	A-12	A9F54332	IC60H 3P 32A C	A-13	A9F93225	IC60L 2P 25A B	A-16
A9F54220	IC60H 2P 20A C	A-12	A9F54340	IC60H 3P 40A C	A-13	A9F93232	IC60L 2P 32A B	A-16
A9F54225	IC60H 2P 25A C	A-12	A9F54350	IC60H 3P 50A C	A-13	A9F93240	IC60L 2P 40A B	A-16
A9F54232	IC60H 2P 32A C	A-12	A9F54363	IC60H 3P 63A C	A-13	A9F93250	IC60L 2P 50A B	A-16
A9F54240	IC60H 2P 40A C	A-12	A9F54401	IC60H 4P 1A C	A-13	A9F93263	IC60L 2P 63A B	A-16
A9F54250	IC60H 2P 50A C	A-12	A9F54402	IC60H 4P 2A C	A-13	A9F93270	IC60L 2P 0.5A C	A-16
A9F54263	IC60H 2P 63A C	A-12	A9F54404	IC60H 4P 4A C	A-13	A9F94101	IC60L 1P 1A C	A-16
A9F55101	IC60H 1P 1A D	A-12	A9F54406	IC60H 4P 6A C	A-13	A9F94102	IC60L 1P 2A C	A-16
A9F55102	IC60H 1P 2A D	A-12	A9F54410	IC60H 4P 10A C	A-13	A9F94103	IC60L 1P 3A C	A-16
A9F55104	IC60H 1P 4A D	A-12	A9F54416	IC60H 4P 16A C	A-13	A9F94104	IC60L 1P 4A C	A-16
A9F55106	IC60H 1P 6A D	A-12	A9F54420	IC60H 4P 20A C	A-13	A9F94106	IC60L 1P 6A C	A-16
A9F55110	IC60H 1P 10A D	A-12	A9F54425	IC60H 4P 25A C	A-13	A9F94110	IC60L 1P 10A C	A-16
A9F55116	IC60H 1P 16A D	A-12	A9F54432	IC60H 4P 32A C	A-13	A9F94116	IC60L 1P 16A C	A-16
A9F55120	IC60H 1P 20A D	A-12	A9F54440	IC60H 4P 40A C	A-13	A9F94120	IC60L 1P 20A C	A-16
A9F55125	IC60H 1P 25A D	A-12	A9F54450	IC60H 4P 50A C	A-13	A9F94125	IC60L 1P 25A C	A-16
A9F55132	IC60H 1P 32A D	A-12	A9F54463	IC60H 4P 63A C	A-13	A9F94132	IC60L 1P 32A C	A-16
A9F55140	IC60H 1P 40A D	A-12						

Index

Reference	Description	Page	Reference	Description	Page	Reference	Description	Page
A9F94140	IC60L 1P 40A C	A-16	A9F92172	IC60L 1P 1,6A Z	A-16	A9F94406	IC60L 4P 6A C	A-17
A9F94150	IC60L 1P 50A C	A-16	A9F92201	IC60L 2P 1A Z	A-16	A9F94410	IC60L 4P 10A C	A-17
A9F94163	IC60L 1P 63A C	A-16	A9F92202	IC60L 2P 2A Z	A-16	A9F94416	IC60L 4P 16A C	A-17
A9F94170	IC60L 1P 0.5A C	A-16	A9F92203	IC60L 2P 3A Z	A-16	A9F94420	IC60L 4P 20A C	A-17
A9F94201	IC60L 2P 1A C	A-16	A9F92204	IC60L 2P 4A Z	A-16	A9F94425	IC60L 4P 25A C	A-17
A9F94202	IC60L 2P 2A C	A-16	A9F92206	IC60L 2P 6A Z	A-16	A9F94432	IC60L 4P 32A C	A-17
A9F94203	IC60L 3P 3A C	A-16	A9F92210	IC60L 2P 10A Z	A-16	A9F94440	IC60L 4P 40A C	A-17
A9F94204	IC60L 2P 4A C	A-16	A9F92216	IC60L 2P 16A Z	A-16	A9F94450	IC60L 4P 50A C	A-17
A9F94206	IC60L 2P 6A C	A-16	A9F92220	IC60L 2P 20A Z	A-16	A9F94463	IC60L 4P 63A C	A-17
A9F94210	IC60L 2P 10A C	A-16	A9F92225	IC60L 2P 25A Z	A-16	A9F94470	IC60L 4P 0.5A C	A-17
A9F94216	IC60L 2P 16A C	A-16	A9F92232	IC60L 2P 32A Z	A-16	A9F95301	IC60L 3P 1A K	A-17
A9F94220	IC60L 2P 20A C	A-16	A9F92240	IC60L 2P 40A Z	A-16	A9F95302	IC60L 3P 2A K	A-17
A9F94225	IC60L 2P 25A C	A-16	A9F92250	IC60L 2P 50A Z	A-16	A9F95303	IC60L 3P 3A K	A-17
A9F94232	IC60L 2P 32A C	A-16	A9F92263	IC60L 2P 63A Z	A-16	A9F95304	IC60L 3P 4A K	A-17
A9F94240	IC60L 2P 40A C	A-16	A9F92270	IC60L 2P 0.5AZ	A-16	A9F95306	IC60L 3P 6A K	A-17
A9F94250	IC60L 2P 50A C	A-16	A9F92272	IC60L 2P 1,6A Z	A-16	A9F95310	IC60L 3P 10A K	A-17
A9F94263	IC60L 2P 63A C	A-16	A9F93301	IC60L 3P 1A B	A-17	A9F95316	IC60L 3P 16A K	A-17
A9F94270	IC60L 2P 0.5A K	A-16	A9F93302	IC60L 3P 2A B	A-17	A9F95320	IC60L 3P 20A K	A-17
A9F95101	IC60L 1P 1A K	A-16	A9F93303	IC60L 3P 3A B	A-17	A9F95325	IC60L 3P 25A K	A-17
A9F95102	IC60L 1P 2A K	A-16	A9F93304	IC60L 3P 4A B	A-17	A9F95332	IC60L 3P 32A K	A-17
A9F95103	IC60L 1P 3A K	A-16	A9F93306	IC60L 3P 6A B	A-17	A9F95340	IC60L 3P 40A K	A-17
A9F95104	IC60L 1P 4A K	A-16	A9F93310	IC60L 3P 10A B	A-17	A9F95350	IC60L 3P 50A K	A-17
A9F95106	IC60L 1P 6A K	A-16	A9F93316	IC60L 3P 16A B	A-17	A9F95363	IC60L 3P 63A K	A-17
A9F95110	IC60L 1P 10A K	A-16	A9F93320	IC60L 3P 20A B	A-17	A9F95370	IC60L 3P 0.5A K	A-17
A9F95116	IC60L 1P 16A K	A-16	A9F93325	IC60L 3P 25A B	A-17	A9F95372	IC60L 3P 1,6A K	A-17
A9F95120	IC60L 1P 20A K	A-16	A9F93332	IC60L 3P 32A B	A-17	A9F95401	IC60L 4P 1A K	A-17
A9F95125	IC60L 1P 25A K	A-16	A9F93340	IC60L 3P 40A B	A-17	A9F95402	IC60L 4P 2A K	A-17
A9F95132	IC60L 1P 32A K	A-16	A9F93350	IC60L 3P 50A B	A-17	A9F95403	IC60L 4P 3A K	A-17
A9F95140	IC60L 1P 40A K	A-16	A9F93363	IC60L 3P 63A B	A-17	A9F95404	IC60L 4P 4A K	A-17
A9F95150	IC60L 1P 50A K	A-16	A9F93370	IC60L 3P 0.5A B	A-17	A9F95406	IC60L 4P 6A K	A-17
A9F95163	IC60L 1P 63A K	A-16	A9F93401	IC60L 4P 1A B	A-17	A9F95410	IC60L 4P 10A K	A-17
A9F95170	IC60L 1P 0.5A K	A-16	A9F93402	IC60L 4P 2A B	A-17	A9F95416	IC60L 4P 16A K	A-17
A9F95172	IC60L 1P 1,6A K	A-16	A9F93403	IC60L 4P 3A B	A-17	A9F95420	IC60L 4P 20A K	A-17
A9F95201	IC60L 2P 1A K	A-16	A9F93404	IC60L 4P 4A B	A-17	A9F95425	IC60L 4P 25A K	A-17
A9F95202	IC60L 2P 2A K	A-16	A9F93406	IC60L 4P 6A B	A-17	A9F95432	IC60L 4P 32A K	A-17
A9F95203	IC60L 2P 3A K	A-16	A9F93410	IC60L 4P 10A B	A-17	A9F95440	IC60L 4P 40A K	A-17
A9F95204	IC60L 2P 4A K	A-16	A9F93416	IC60L 4P 16A B	A-17	A9F95450	IC60L 4P 50A K	A-17
A9F95206	IC60L 2P 6A K	A-16	A9F93420	IC60L 4P 20A B	A-17	A9F95463	IC60L 4P 63A K	A-17
A9F95210	IC60L 2P 10A K	A-16	A9F93425	IC60L 4P 25A B	A-17	A9F95470	IC60L 4P 0.5A K	A-17
A9F95216	IC60L 2P 16A K	A-16	A9F93432	IC60L 4P 32A B	A-17	A9F95472	IC60L 4P 1,6A K	A-17
A9F95220	IC60L 2P 20A K	A-16	A9F93440	IC60L 4P 40A B	A-17	A9F92301	IC60L 3P 1A Z	A-17
A9F95225	IC60L 2P 25A K	A-16	A9F93450	IC60L 4P 50A B	A-17	A9F92302	IC60L 3P 2A Z	A-17
A9F95232	IC60L 2P 32A K	A-16	A9F93463	IC60L 4P 63A B	A-17	A9F92303	IC60L 3P 3A Z	A-17
A9F95240	IC60L 2P 40A K	A-16	A9F93470	IC60L 4P 0.5A B	A-17	A9F92304	IC60L 3P 4A Z	A-17
A9F95250	IC60L 2P 50A K	A-16	A9F94301	IC60L 3P 1A C	A-17	A9F92306	IC60L 3P 6A Z	A-17
A9F95263	IC60L 2P 63A K	A-16	A9F94302	IC60L 3P 2A C	A-17	A9F92310	IC60L 3P 10A Z	A-17
A9F95270	IC60L 2P 0.5A K	A-16	A9F94303	IC60L 3P 3A C	A-17	A9F92316	IC60L 3P 16A Z	A-17
A9F95272	IC60L 2P 1,6A K	A-16	A9F94304	IC60L 3P 4A C	A-17	A9F92320	IC60L 3P 20A Z	A-17
A9F92101	IC60L 1P 1A Z	A-16	A9F94306	IC60L 3P 6A C	A-17	A9F92325	IC60L 3P 25A Z	A-17
A9F92102	IC60L 1P 2A Z	A-16	A9F94310	IC60L 3P 10A C	A-17	A9F92332	IC60L 3P 32A Z	A-17
A9F92103	IC60L 1P 3A Z	A-16	A9F94316	IC60L 3P 16A C	A-17	A9F92340	IC60L 3P 40A Z	A-17
A9F92104	IC60L 1P 4A Z	A-16	A9F94320	IC60L 3P 20A C	A-17	A9F92350	IC60L 3P 50A Z	A-17
A9F92106	IC60L 1P 6A Z	A-16	A9F94325	IC60L 3P 25A C	A-17	A9F92363	IC60L 3P 63A Z	A-17
A9F92110	IC60L 1P 10A Z	A-16	A9F94332	IC60L 3P 32A C	A-17	A9F92370	IC60L 3P 0.5A Z	A-17
A9F92116	IC60L 1P 16A Z	A-16	A9F94340	IC60L 3P 40A C	A-17	A9F92372	IC60L 3P 1,6A Z	A-17
A9F92120	IC60L 1P 20A Z	A-16	A9F94350	IC60L 3P 50A C	A-17	A9F92401	IC60L 4P 1A Z	A-17
A9F92125	IC60L 1P 25A Z	A-16	A9F94363	IC60L 3P 63A C	A-17	A9F92402	IC60L 4P 2A Z	A-17
A9F92132	IC60L 1P 32A Z	A-16	A9F94370	IC60L 0.5A 3P C	A-17	A9F92403	IC60L 4P 3A Z	A-17
A9F92140	IC60L 1P 40A Z	A-16	A9F94401	IC60L 4P 1A C	A-17	A9F92404	IC60L 4P 4A Z	A-17
A9F92150	IC60L 1P 50A Z	A-16	A9F94402	IC60L 4P 2A C	A-17	A9F92406	IC60L 4P 6A Z	A-17
A9F92163	IC60L 1P 63A Z	A-16	A9F94403	IC60L 4P 3A C	A-17	A9F92410	IC60L 4P 10A Z	A-17
A9F92170	IC60L 1P 0.5A Z	A-16	A9F94404	IC60L 4P 4A C	A-17	A9F92416	IC60L 4P 16A Z	A-17

Index

Reference	Description	Page	Reference	Description	Page	Reference	Description	Page
A9F92420	IC60L 4P 20A Z	A-17	A9N18404	C120H 1P 125A B	A-23	18623	NG125N 2P 20A C	A-29
A9F92425	IC60L 4P 25A Z	A-17	A9N18412	C120H 2P 63A B	A-23	18624	NG125N 2P 25A C	A-29
A9F92432	IC60L 4P 32A Z	A-17	A9N18413	C120H 2P 80A B	A-23	18625	NG125N 2P 32A C	A-29
A9F92440	IC60L 4P 40A Z	A-17	A9N18414	C120H 2P 100A B	A-23	18626	NG125N 2P 40A C	A-29
A9F92450	IC60L 4P 50A Z	A-17	A9N18415	C120H 2P 125A B	A-23	18627	NG125N 2P 50A C	A-29
A9F92463	IC60L 4P 63A Z	A-17	A9N18445	C120H 1P 63A C	A-23	18628	NG125N 2P 63A C	A-29
A9F92470	IC60L 4P 0.5A Z	A-17	A9N18446	C120H 1P 80A C	A-23	18629	NG125N 2P 80A C	A-29
A9F92472	IC60L 4P 1.6A Z	A-17	A9N18447	C120H 1P 100A C	A-23	18632	NG125N 3P 10A C	A-29
A9N18340	C120N 1P 63A B	A-20	A9N18448	C120H 1P 125A C	A-23	18633	NG125N 3P 16A C	A-29
A9N18341	C120N 1P 80A B	A-20	A9N18456	C120H 2P 63A C	A-23	18634	NG125N 3P 20A C	A-29
A9N18342	C120N 1P 100A B	A-20	A9N18457	C120H 2P 80A C	A-23	18635	NG125N 3P 25A C	A-29
A9N18343	C120N 1P 125A B	A-20	A9N18458	C120H 2P 100A C	A-23	18636	NG125N 3P 32A C	A-29
A9N18344	C120N 2P 63A B	A-20	A9N18459	C120H 2P 125A C	A-23	18637	NG125N 3P 40A C	A-29
A9N18345	C120N 2P 80A B	A-20	A9N18489	C120H 1P 63A D	A-23	18638	NG125N 3P 50A C	A-29
A9N18346	C120N 2P 100A B	A-20	A9N18490	C120H 1P 80A D	A-23	18639	NG125N 3P 63A C	A-29
A9N18347	C120N 2P 125A B	A-20	A9N18491	C120H 1P 100A D	A-23	18640	NG125N 3P 80A C	A-29
A9N18356	C120N 1P 63A C	A-20	A9N18492	C120H 1P 125A D	A-23	18642	NG125N 3P 100A C	A-29
A9N18357	C120N 1P 80A C	A-20	A9N18500	C120H 2P 63A D	A-23	18644	NG125N 3P 125A C	A-29
A9N18358	C120N 1P 100A C	A-20	A9N18501	C120H 2P 80A D	A-23	18646	NG125N 3P AND N 80A C	A-29
A9N18359	C120N 1P 125A C	A-20	A9N18502	C120H 2P 100A D	A-23	18647	NG125N 3P AND N 100A C	A-29
A9N18360	C120N 2P 63A C	A-20	A9N18503	C120H 2P 125A D	A-23	18648	NG125N 3P AND N 125A C	A-29
A9N18361	C120N 2P 80A C	A-20	A9N18423	C120H 3P 63A B	A-24	18649	NG125N 4P 10A C	A-29
A9N18362	C120N 2P 100A C	A-20	A9N18424	C120H 3P 80A B	A-24	18650	NG125N 4P 16A C	A-29
A9N18363	C120N 2P 125A C	A-20	A9N18425	C120H 3P 100A B	A-24	18651	NG125N 4P 20A C	A-29
A9N18378	C120N 1P 63A D	A-20	A9N18426	C120H 3P 125A B	A-24	18652	NG125N 4P 25A C	A-29
A9N18379	C120N 1P 80A D	A-20	A9N18434	C120H 4P 63A B	A-24	18653	NG125N 4P 32A C	A-29
A9N18380	C120N 1P 100A D	A-20	A9N18435	C120H 4P 80A B	A-24	18654	NG125N 4P 40A C	A-29
A9N18381	C120N 1P 125A D	A-20	A9N18436	C120H 4P 100A B	A-24	18655	NG125N 4P 50A C	A-29
A9N18382	C120N 2P 63A D	A-20	A9N18437	C120H 4P 125A B	A-24	18656	NG125N 4P 63A C	A-29
A9N18383	C120N 2P 80A D	A-20	A9N18467	C120H 3P 63A C	A-24	18658	NG125N 4P 80A C	A-29
A9N18384	C120N 2P 100A D	A-20	A9N18468	C120H 3P 80A C	A-24	18660	NG125N 4P 100A C	A-29
A9N18385	C120N 2P 125A D	A-20	A9N18469	C120H 3P 100A C	A-24	18662	NG125N 4P 125A C	A-29
A9N18348	C120N 3P 63A B	A-21	A9N18470	C120H 3P 125A C	A-24	18663	NG125N 3P 80A B	A-29
A9N18349	C120N 3P 80A B	A-21	A9N18478	C120H 4P 63A C	A-24	18664	NG125N 3P 100A B	A-29
A9N18350	C120N 3P 100A B	A-21	A9N18479	C120H 4P 80A C	A-24	18665	NG125N 3P 125A B	A-29
A9N18351	C120N 3P 125A B	A-21	A9N18480	C120H 4P 100A C	A-24	18666	NG125N 4P 80A B	A-29
A9N18352	C120N 4P 63A B	A-21	A9N18481	C120H 4P 125A C	A-24	18667	NG125N 4P 100A B	A-29
A9N18353	C120N 4P 80A B	A-21	A9N18511	C120H 3P 63A D	A-24	18668	NG125N 4P 125A B	A-29
A9N18354	C120N 4P 100A B	A-21	A9N18512	C120H 3P 80A D	A-24	18669	NG125N 3P 80A D	A-29
A9N18355	C120N 4P 125A B	A-21	A9N18513	C120H 3P 100A D	A-24	18670	NG125N 3P 100A D	A-29
A9N18364	C120N 3P 63A C	A-21	A9N18514	C120H 3P 125A D	A-24	18671	NG125N 3P 125A D	A-29
A9N18365	C120N 3P 80A C	A-21	A9N18522	C120H 4P 63A D	A-24	18672	NG125N 4P 80A D	A-29
A9N18367	C120N 3P 100A C	A-21	A9N18523	C120H 4P 80A D	A-24	18673	NG125N 4P 100A D	A-29
A9N18369	C120N 3P 125A C	A-21	A9N18524	C120H 4P 100A D	A-24	18674	NG125N 4P 125A D	A-29
A9N18371	C120N 4P 63A C	A-21	A9N18525	C120H 4P 125A D	A-24	18705	NG125H 1P 10A C	A-31
A9N18372	C120N 4P 80A C	A-21	18603	NG125Na 3P 80A C	A-27	18706	NG125H 1P 16A C	A-31
A9N18373	C120N 4P 80A C	A-21	18604	NG125Na 3P 100A C	A-27	18707	NG125H 1P 20A C	A-31
A9N18374	C120N 4P 100A C	A-21	18605	NG125Na 3P 125A C	A-27	18708	NG125H 1P 25A C	A-31
A9N18375	C120N 4P 100A C	A-21	18607	NG125Na 4P 80A C	A-27	18709	NG125H 1P 32A C	A-31
A9N18376	C120N 4P 125A C	A-21	18608	NG125Na 4P 100A C	A-27	18710	NG125H 1P 40A C	A-31
A9N18377	C120N 4P 125A C	A-21	18609	NG125Na 4P 125A C	A-27	18711	NG125H 1P 50A C	A-31
A9N18386	C120N 3P 63A D	A-21	18610	NG125N 1P 10A C	A-29	18712	NG125H 1P 63A C	A-31
A9N18387	C120N 3P 80A D	A-21	18611	NG125N 1P 16A C	A-29	18713	NG125H 1P 80A C	A-31
A9N18388	C120N 3P 100A D	A-21	18612	NG125N 1P 20A C	A-29	18714	NG125H 2P 10A C	A-31
A9N18389	C120N 3P 125A D	A-21	18613	NG125N 1P 25A C	A-29	18715	NG125H 2P 16A C	A-31
A9N18390	C120N 4P 63A D	A-21	18614	NG125N 1P 32A C	A-29	18716	NG125H 2P 20A C	A-31
A9N18391	C120N 4P 80A D	A-21	18615	NG125N 1P 40A C	A-29	18717	NG125H 2P 25A C	A-31
A9N18392	C120N 4P 100A D	A-21	18616	NG125N 1P 50A C	A-29	18718	NG125H 2P 32A C	A-31
A9N18393	C120N 4P 125A D	A-21	18617	NG125N 1P 63A C	A-29	18719	NG125H 2P 40A C	A-31
A9N18401	C120H 1P 63A B	A-23	18618	NG125N 1P 80A C	A-29	18720	NG125H 2P 50A C	A-31
A9N18402	C120H 1P 80A B	A-23	18621	NG125N 2P 10A C	A-29	18721	NG125H 2P 63A C	A-31
A9N18403	C120H 1P 100A B	A-23	18622	NG125N 2P 16A C	A-29	18722	NG125H 2P 80A C	A-31

Index

Reference	Description	Page
18723	NG125H 3P 10A C	A-31
18724	NG125H 3P 16A C	A-31
18725	NG125H 3P 20A C	A-31
18726	NG125H 3P 25A C	A-31
18727	NG125H 3P 32A C	A-31
18728	NG125H 3P 40A C	A-31
18729	NG125H 3P 50A C	A-31
18730	NG125H 3P 63A C	A-31
18731	NG125H 3P 80A C	A-31
18732	NG125H 4P 10A C	A-31
18733	NG125H 4P 16A C	A-31
18734	NG125H 4P 20A C	A-31
18735	NG125H 4P 25A C	A-31
18736	NG125H 4P 32A C	A-31
18737	NG125H 4P 40A C	A-31
18738	NG125H 4P 50A C	A-31
18739	NG125H 4P 63A C	A-31
18740	NG125H 4P 80A C	A-31
18741	NG125L 1P 10A B	A-33
18742	NG125L 1P 16A B	A-33
18743	NG125L 1P 20A B	A-33
18744	NG125L 1P 25A B	A-33
18745	NG125L 1P 32A B	A-33
18746	NG125L 1P 40A B	A-33
18747	NG125L 1P 50A B	A-33
18748	NG125L 1P 63A B	A-33
18749	NG125L 1P 80A B	A-33
18750	NG125L 2P 10A B	A-33
18751	NG125L 2P 16A B	A-33
18752	NG125L 2P 20A B	A-33
18753	NG125L 2P 25A B	A-33
18754	NG125L 2P 32A B	A-33
18755	NG125L 2P 40A B	A-33
18756	NG125L 2P 50A B	A-33
18757	NG125L 2P 63A B	A-33
18758	NG125L 2P 80A B	A-33
18759	NG125L 3P 10A B	A-33
18760	NG125L 3P 16A B	A-33
18761	NG125L 3P 20A B	A-33
18762	NG125L 3P 25A B	A-33
18763	NG125L 3P 32A B	A-33
18764	NG125L 3P 40A B	A-33
18765	NG125L 3P 50A B	A-33
18766	NG125L 3P 63A B	A-33
18767	NG125L 3P 80A B	A-33
18768	NG125L 4P 10A B	A-33
18769	NG125L 4P 16A B	A-33
18770	NG125L 4P 20A B	A-33
18771	NG125L 4P 25A B	A-33
18772	NG125L 4P 32A B	A-33
18773	NG125L 4P 40A B	A-33
18774	NG125L 4P 50A B	A-33
18775	NG125L 4P 63A B	A-33
18776	NG125L 4P 80A B	A-33
18777	NG125L 1P 10A C	A-33
18778	NG125L 1P 16A C	A-33
18779	NG125L 1P 20A C	A-33
18780	NG125L 1P 25A C	A-33
18781	NG125L 1P 32A C	A-33
18782	NG125L 1P 40A C	A-33
18783	NG125L 1P 50A C	A-33
18784	NG125L 1P 63A C	A-33

Reference	Description	Page
18785	NG125L 1P 80A C	A-33
18788	NG125L 2P 10A C	A-33
18789	NG125L 2P 16A C	A-33
18790	NG125L 2P 20A C	A-33
18791	NG125L 2P 25A C	A-33
18792	NG125L 2P 32A C	A-33
18793	NG125L 2P 40A C	A-33
18794	NG125L 2P 50A C	A-33
18795	NG125L 2P 63A C	A-33
18796	NG125L 2P 80A C	A-33
18799	NG125L 3P 10A C	A-33
18800	NG125L 3P 16A C	A-33
18801	NG125L 3P 20A C	A-33
18802	NG125L 3P 25A C	A-33
18803	NG125L 3P 32A C	A-33
18804	NG125L 3P 40A C	A-33
18805	NG125L 3P 50A C	A-33
18806	NG125L 3P 63A C	A-33
18807	NG125L 3P 80A C	A-33
18821	NG125L 4P 10A C	A-33
18822	NG125L 4P 16A C	A-33
18823	NG125L 4P 20A C	A-33
18824	NG125L 4P 25A C	A-33
18825	NG125L 4P 32A C	A-33
18826	NG125L 4P 40A C	A-33
18827	NG125L 4P 50A C	A-33
18828	NG125L 4P 63A C	A-33
18829	NG125L 4P 80A C	A-33
18830	NG125L 1P 10A D	A-33
18831	NG125L 1P 16A D	A-33
18832	NG125L 1P 20A D	A-33
18833	NG125L 1P 25A D	A-33
18834	NG125L 1P 32A D	A-33
18835	NG125L 1P 40A D	A-33
18836	NG125L 1P 50A D	A-33
18837	NG125L 1P 63A D	A-33
18838	NG125L 1P 80A D	A-33
18839	NG125L 2P 10A D	A-33
18840	NG125L 2P 16A D	A-33
18841	NG125L 2P 20A D	A-33
18842	NG125L 2P 25A D	A-33
18843	NG125L 2P 32A D	A-33
18844	NG125L 2P 40A D	A-33
18845	NG125L 2P 50A D	A-33
18846	NG125L 2P 63A D	A-33
18847	NG125L 2P 80A D	A-33
18848	NG125L 3P 10A D	A-33
18849	NG125L 3P 16A D	A-33
18850	NG125L 3P 20A D	A-33
18851	NG125L 3P 25A D	A-33
18852	NG125L 3P 32A D	A-33
18853	NG125L 3P 40A D	A-33
18854	NG125L 3P 50A D	A-33
18855	NG125L 3P 63A D	A-33
18856	NG125L 3P 80A D	A-33
18857	NG125L 4P 10A D	A-33
18858	NG125L 4P 16A D	A-33
18859	NG125L 4P 20A D	A-33
18860	NG125L 4P 25A D	A-33
18861	NG125L 4P 32A D	A-33
18862	NG125L 4P 40A D	A-33
18863	NG125L 4P 50A D	A-33

Reference	Description	Page
18864	NG125L 4P 63A D	A-33
18865	NG125L 4P 80A D	A-33
A9N61500	C60H-DC 1P 0,5A C 250Vdc	A-35
A9N61501	C60H-DC 1P 1A C 250Vdc	A-35
A9N61502	C60H-DC 1P 2A C 250Vdc	A-35
A9N61503	C60H-DC 1P 3A C 250Vdc	A-35
A9N61504	C60H-DC 1P 4A C 250Vdc	A-35
A9N61505	C60H-DC 1P 5A C 250Vdc	A-35
A9N61506	C60H-DC 1P 6A C 250Vdc	A-35
A9N61508	C60H-DC 1P 10A C 250Vdc	A-35
A9N61509	C60H-DC 1P 13A C 250Vdc	A-35
A9N61510	C60H-DC 1P 15A C 250Vdc	A-35
A9N61511	C60H-DC 1P 16A C 250Vdc	A-35
A9N61512	C60H-DC 1P 20A C 250Vdc	A-35
A9N61513	C60H-DC 1P 25A C 250Vdc	A-35
A9N61514	C60H-DC 1P 30A C 250Vdc	A-35
A9N61515	C60H-DC 1P 32A C 250Vdc	A-35
A9N61517	C60H-DC 1P 40A C 250Vdc	A-35
A9N61518	C60H-DC 1P 50A C 250Vdc	A-35
A9N61519	C60H-DC 1P 63A C 250Vdc	A-35
A9N61520	C60H-DC 2P 0,5A C 500Vdc	A-35
A9N61521	C60H-DC 2P 1A C 500Vdc	A-35
A9N61522	C60H-DC 2P 2A C 500Vdc	A-35
A9N61523	C60H-DC 2P 3A C 500Vdc	A-35
A9N61524	C60H-DC 2P 4A C 500Vdc	A-35
A9N61525	C60H-DC 2P 5A C 500Vdc	A-35
A9N61526	C60H-DC 2P 6A C 500Vdc	A-35
A9N61528	C60H-DC 2P 10A C 500Vdc	A-35
A9N61529	C60H-DC 2P 13A C 500Vdc	A-35
A9N61530	C60H-DC 2P 15A C 500Vdc	A-35
A9N61531	C60H-DC 2P 16A C 500Vdc	A-35
A9N61532	C60H-DC 2P 20A C 500Vdc	A-35
A9N61533	C60H-DC 2P 25A C 500Vdc	A-35
A9N61534	C60H-DC 2P 30A C 500Vdc	A-35
A9N61535	C60H-DC 2P 32A C 500Vdc	A-35
A9N61537	C60H-DC 2P 40A C 500Vdc	A-35
A9N61538	C60H-DC 2P 50A C 500Vdc	A-35
A9N61539	C60H-DC 2P 63A C 500Vdc	A-35
A9F90204	IC60L MA 2P 4A	A-39
A9F90210	IC60L MA 2P 10A	A-39
A9F90216	IC60L MA 2P 16A	A-39
A9F90225	IC60L MA 2P 25A	A-39
A9F90240	IC60L MA 2P 40A	A-39
A9F90272	IC60L MA 2P 1.6A	A-39
A9F90273	IC60L MA 2P 2.5A	A-39
A9F90276	IC60L MA 2P 6.3A	A-39
A9F90282	IC60L MA 2P 12.5A	A-39
A9F90304	IC60L MA 3P 4A	A-39
A9F90310	IC60L MA 3P 10A	A-39
A9F90316	IC60L MA 3P 16A	A-39
A9F90325	IC60L MA 3P 25A	A-39
A9F90340	IC60L MA 3P 40A	A-39
A9F90372	IC60L MA 3P 1.6A	A-39
A9F90373	IC60L MA 3P 2.5A	A-39
A9F90376	IC60L MA 3P 6.3A	A-39
A9F90382	IC60L MA 3P 12.5A	A-39
18868	NG125L 2P 4A MA	A-42
18869	NG125L 2P 6.3A MA	A-42
18870	NG125L 2P 10A MA	A-42
18871	NG125L 2P 12.5A MA	A-42
18872	NG125L 2P 16A MA	A-42
18873	NG125L 2P 25A MA	A-42

Index

Reference	Description	Page	Reference	Description	Page	Reference	Description	Page
18874	NG125L 2P 40A MA	A-42	A9R71463	iID 4P 63A 30mA AC-type	B-7	A9R50425	ILD K AC 30MA25A 4P	B-11
18875	NG125L 2P 63A MA	A-42	A9R74225	iID 2P 25A 300mA AC-type	B-7	A9R50440	ILD K AC 30MA50A 4P	B-11
18876	NG125L 2P 80A MA	A-42	A9R74240	iID 2P 40A 300mA AC-type	B-7	A9R70463	ILD K AC 30MA63A 4P	B-11
18879	NG125L 3P 4A MA	A-42	A9R74263	iID 2P 63A 300mA AC-type	B-7	A9R75225	ILD K AC 300MA25A 2P	B-11
18880	NG125L 3P 6.3A MA	A-42	A9R74425	iID 4P 25A 300mA AC-type	B-7	A9R75240	ILD K AC 300MA40A 2P	B-11
18881	NG125L 3P 10A MA	A-42	A9R74440	iID 4P 40A 300mA AC-type	B-7	A9R75425	ILD K AC 300MA 25A 4P	B-11
18882	NG125L 3P 12,5A MA	A-42	A9R74463	iID 4P 63A 300mA AC-type	B-7	A9R75440	ILD K AC 300MA40A 4P	B-11
18883	NG125L 3P 16A MA	A-42	A9R20216	iID 2P 16A 10mA A-type	B-8	A9R75463	ILD K AC 300MA63A 4P	B-11
18884	NG125L 3P 25A MA	A-42	A9R20225	iID 2P 25A 10mA A-type	B-8	16905	RCCB 4P 125A 30MA 72MM	B-13
18885	NG125L 3P 40A MA	A-42	A9R21291	iID 2P 100A 30mA A-type	B-8	16906	RCCB 4P 125A 100MA 72MM	B-13
18886	NG125L 3P 63A MA	A-42	A9R21480	iID 4P 80A 30mA A-type	B-8	16907	RCCB 4P 125A 300MA 72MM	B-13
18887	NG125L 3P 80A MA	A-44	A9R21491	iID 4P 100A 30mA A-type	B-8	16908	RCCB 4P 125A 500MA 72MM	B-13
A9N15635	Acti-9 STI 1P 8,5X31,5 400V	A-44	A9R22440	iID 4P 40A 100mA A-type	B-8	16920	RCCB SI 4P 125A 30MA 72MM	B-13
A9N15636	Acti-9 STI 1P 10,3X38 500V	A-44	A9R22463	iID 4P 63A 100mA A-type	B-8	16921	RCCB SI 4P 125A 300MA A	B-13
A9N15645	Acti-9 STI 1P N 8,5X31,5 400V	A-44	A9R24291	iID 2P 100A 300mA A-type	B-8	16924	RCCB 4P 125A 30MA A 72MM	B-13
A9N15646	Acti-9 STI 1P N 10,3X38 500V	A-44	A9R24480	iID 4P 80A 300mA A-type	B-8	16925	RCCB 4P 125A 300MA A S	B-13
A9N15650	Acti-9 STI 2P 8,5X31,5 400V	A-44	A9R24491	iID 4P 100A 300mA A-type	B-8	16926	RCCB 4P 125A 300MA A 72MM	B-13
A9N15651	Acti-9 STI 2P 10,3X38 500V	A-44	A9R25240	iID 2P 40A 300mA-S A-type	B-8	16927	RCCB 4P 125A 500MA A 72MM	B-13
A9N15655	Acti-9 STI 3P 8,5X31,5 400V	A-44	A9R25263	iID 2P 63A 300mA-S A-type	B-8	16938	10 TERM.SCREW SHIELD 2P	B-13
A9N15656	Acti-9 STI 3P 10,3X38 500V	A-44	A9R25291	iID 2P 100A 300mA-S A-type	B-8	16939	10 TERM.SCREW SHIELD 4P	B-13
A9N15657	Acti-9 STI 3P N 8,5X31,5 400V	A-44	A9R25440	iID 4P 40A 300mA-S A-type	B-8	16940	AUXILIARY OFSP FOR RCCB	B-13
A9N15658	Acti-9 STI 3P N 10,3X38 500V	A-44	A9R25463	iID 4P 63A 300mA-S A-type	B-8	16966	RCCB 2P 125A 30MA IEC1008	B-13
A9R10216	iID 2P 16A 10mA AC-type	B-7	A9R25480	iID 4P 80A 300mA-S A-type	B-8	16967	RCCB 2P 125A 300MA IEC1008	B-13
A9R10225	iID 2P 25A 10mA AC-type	B-7	A9R25491	iID 4P 100A 300mA-S A-type	B-8	16970	RCCB 2P 125A 300MA 72MM	B-13
A9R11280	iID 2P 80A 30mA AC-type	B-7	A9R26440	iID 4P 40A 500mA A-type	B-8	16971	RCCB 2P 125A 300MA	B-13
A9R11291	iID 2P 100A 30mA AC-type	B-7	A9R26463	iID 4P 63A 500mA A-type	B-8	16972	RCCB 2P 125A 30MA A SI	B-13
A9R11480	iID 4P 80A 30mA AC-type	B-7	A9R26491	iID 4P 100A 500mA A-type	B-8	16973	RCCB 2P 125A 300MA SI	B-13
A9R11491	iID 4P 100A 30mA AC-type	B-7	A9R21225	iID 2P 25A 30mA A-type	B-8	16750	ID 4P 25A 30MA B	B-15
A9R12240	iID 2P 40A 100mA AC-type	B-7	A9R21240	iID 2P 40A 30mA A-type	B-8	16751	ID 4P 25A 300MA B	B-15
A9R12263	iID 2P 63A 100mA AC-type	B-7	A9R21263	iID 2P 63A 30mA A-type	B-8	16752	RCCB 4P 40A 30mA B type	B-15
A9R12280	iID 2P 80A 100mA AC-type	B-7	A9R21425	iID 4P 25A 30mA A-type	B-8	16753	ID 4P 40A 300MA B	B-15
A9R12291	iID 2P 100A 100mA AC-type	B-7	A9R21440	iID 4P 40A 30mA A-type	B-8	16754	ID 4P 40A 300MA S B	B-15
A9R12440	iID 4P 40A 100mA AC-type	B-7	A9R21463	iID 4P 63A 30mA A-type	B-8	16755	ID 4P 40A 500MA B	B-15
A9R12463	iID 4P 63A 100mA AC-type	B-7	A9R24225	iID 2P 25A 300mA A-type	B-8	16756	ID 4P 63A 30MA B	B-15
A9R12480	iID 4P 80A 100mA AC-type	B-7	A9R24240	iID 2P 40A 300mA A-type	B-8	16757	ID 4P 63A 300MA B	B-15
A9R12491	iID 4P 100A 100mA AC-type	B-7	A9R24263	iID 2P 63A 300mA A-type	B-8	16758	ID 4P 63A 300MA S B	B-15
A9R14280	iID 2P 80A 300mA AC-type	B-7	A9R24425	iID 4P 25A 300mA A-type	B-8	16759	RCCB 4P 63A 500MA B	B-15
A9R14291	iID 2P 100A 300mA AC-type	B-7	A9R24440	iID 4P 40A 300mA A-type	B-8	16760	ID 4P 80A 30MA B	B-15
A9R14480	iID 4P 80A 300mA AC-type	B-7	A9R24463	iID 4P 63A 300mA A-type	B-8	16761	ID 4P 80A 300MA B	B-15
A9R14491	iID 4P 100A 300mA AC-type	B-7	A9R30225	iID 2P 25A 10mA ASI-type	B-9	16762	ID 4P 80A 300MA S B	B-15
A9R15263	iID 2P 63A 300mA-S AC-type	B-7	A9R31480	iID 4P 80A 30mA ASI-type	B-9	16763	ID 4P 125A 30MA B	B-15
A9R15280	iID 2P 80A 300mA-S AC-type	B-7	A9R31491	iID 4P 100A 30mA ASI-type	B-9	16764	ID 4P 125A 300MA B	B-15
A9R15291	iID 2P 100A 300mA-S AC-type	B-7	A9R34463	iID 4P 63A 300mA ASI-type	B-9	16765	RCCB 4P 125A 300MA S B	B-15
A9R15440	iID 4P 40A 300mA-S AC-type	B-7	A9R34491	iID 4P 100A 300mA ASI-type	B-9	16766	ID 4P 125A 500MA B	B-15
A9R15463	iID 4P 63A 300mA-S AC-type	B-7	A9R35240	iID 2P 40A 300mA-S ASI-type	B-9	A9V10225	Vigi iC60 2P 25A 10mA AC-type	B-17
A9R15480	iID 4P 80A 300mA-S AC-type	B-7	A9R35263	iID 2P 63A 300mA-S ASI-type	B-9	A9V12225	Vigi iC60 2P 25A 100mA AC-type	B-17
A9R15491	iID 4P 100A 300mA-S AC-type	B-7	A9R35291	iID 2P 100A 300mA-S ASI-type	B-9	A9V12263	Vigi iC60 2P 63A 100mA AC-type	B-17
A9R16225	iID 2P 25A 500mA AC-type	B-7	A9R35440	iID 4P 40A 300mA-S ASI-type	B-9	A9V12425	Vigi iC60 4P 25A 100mA AC-type	B-17
A9R16240	iID 2P 40A 500mA AC-type	B-7	A9R35463	iID 4P 63A 300mA-S ASI-type	B-9	A9V12463	Vigi iC60 4P 63A 100mA AC-type	B-17
A9R16263	iID 2P 63A 500mA AC-type	B-7	A9R35480	iID 4P 80A 300mA-S ASI-type	B-9	A9V15263	Vigi iC60 2P 63A 300mA-S AC-type	B-17
A9R16425	iID 4P 25A 500mA AC-type	B-7	A9R35491	iID 4P 100A 300mA-S ASI-type	B-9	A9V15363	Vigi iC60 3P 63A 300mA-S AC-type	B-17
A9R16440	iID 4P 40A 500mA AC-type	B-7	A9R37440	iID 4P 40A 500mA-S ASI-type	B-9	A9V15463	Vigi iC60 4P 63A 300mA-S AC-type	B-17
A9R16463	iID 4P 63A 500mA AC-type	B-7	A9R37463	iID 4P 63A 500mA-S ASI-type	B-9	A9V16225	Vigi iC60 2P 25A 500mA AC-type	B-17
A9R16480	iID 4P 80A 500mA AC-type	B-7	A9R37480	iID 4P 80A 500mA-S ASI-type	B-9	A9V16240	Vigi iC60 2P 40A 500mA AC-type	B-17
A9R17440	iID 4P 40A 500mA-S AC-type	B-7	A9R61225	iID 2P 25A 30mA ASI-type	B-9	A9V16263	Vigi iC60 2P 63A 500mA AC-type	B-17
A9R17463	iID 4P 63A 500mA-S AC-type	B-7	A9R61240	iID 2P 40A 30mA ASI-type	B-9	A9V16325	Vigi iC60 3P 25A 500mA AC-type	B-17
A9R17480	iID 4P 80A 500mA-S AC-type	B-7	A9R61263	iID 2P 63A 30mA ASI-type	B-9	A9V16340	Vigi iC60 3P 40A 500mA AC-type	B-17
A9R71225	iID 2P 25A 30mA AC-type	B-7	A9R61425	iID 4P 25A 30mA ASI-type	B-9	A9V16363	Vigi iC60 3P 63A 500mA AC-type	B-17
A9R71240	iID 2P 40A 30mA AC-type	B-7	A9R61440	iID 4P 40A 30mA ASI-type	B-9	A9V16425	Vigi iC60 4P 25A 500mA AC-type	B-17
A9R71263	iID 2P 63A 30mA AC-type	B-7	A9R61463	iID 4P 63A 30mA ASI-type	B-9	A9V16440	Vigi iC60 4P 40A 500mA AC-type	B-17
A9R71425	iID 4P 25A 30mA AC-type	B-7	A9R50225	ILD K AC 30MA 25A 2P	B-11	A9V16463	Vigi iC60 4P 63A 500mA AC-type	B-17
A9R71440	iID 4P 40A 30mA AC-type	B-7	A9R50240	ILD K AC 30MA40A 2P	B-11	A9V19263	Vigi iC60 2P 63A 100mA-S AC-type	B-17

Index

Reference	Description	Page
15336	IH 18mm 24h arm	I-13
15366	IH 45mm 2C 24h+7d arm	I-13
15857	IHP 7D 1C WITH RADIO-CONTROLLED-TIME ON	I-13
15858	RADIO ANTENNA FOR IHP 15857	I-13
CCT15338	IH 45mm 60m srm	I-13
CCT15365	IH 45mm 24h arm	I-13
CCT15367	IH 7j arm	I-13
CCT15850	IHP 45mm 1C 7d	I-13
CCT15851	IHP+ 45mm 1C 7d	I-13
CCT15852	IHP 45mm 2C 7d	I-13
CCT15853	IHP+ 45mm 2C 7d	I-13
CCT15854	IHP 1C 18mm	I-13
CCT16364	IH 24h srm	I-13
15337	IH 45mm 2C 24h arm	I-13
CCT15837	IHP+ 1C 18mm	I-13
15341	SET 20 RIDERS FOR TIME SW	I-18
15359	TERMINAL SHIELDS FOR TIME	I-18
15363	MIN	I-25
CCT15232	MINs	I-25
CCT15233	MINp	I-26
CCT15234	MINt	I-26
CCTDD20001	STD 400W RL/RC	I-29
CCTDD20002	STD 400W RL/RC - 4 dig. inputs	I-29
CCTDD20003	STD 1000W RL	I-29
CCTDD20004	STD 1000W RL - 4 dig. inputs	I-29
CCTDD20011	SCU 1-10V (controller)	I-30
CCTDD20012	SCU 1-10V (controller) - 4 dig. inputs	I-30
CCT15840	TH7 - Thermostat DIN	I-34
CCT15841	TH4 - Thermostat DIN	I-34
15833	THP1 - Thermostat DIN	I-35
15834	THP2 - Thermostat DIN	I-35
CCT15845	Floor temperature probe with 1.5 m cable	I-36
CCT15846	Ambient temperature probe	I-36
15835	sensor	I-37
15836	Adjustable ambient sensor	I-37
16358	SPARE PARTS BATTERY FOR THP 1/2	I-37
CCT15847	Outside temperature probe with 2 m cable	I-37
CCT15848	Collar temperature probe with 1.5 m cable	I-37
A9E16065	RTA TIME RELAY DELAY	I-44
A9E16066	RTB TIME RELAY DELAY	I-44
A9E16067	RTC TIME RELAY DELAY	I-44
A9E16068	RTH TIME RELAY DELAY	I-45
A9E16069	RTL TIME RELAY DELAY	I-45
A9E16070	RTMF TIME RELAY DELAY	I-45
A9A15393	IRBN LOW LEVEL	I-46
A9A15416	IRBTB EXTRA LOW LEVEL	I-46
A9E15535	IRLI CHANGEOVER RELAY	I-47
A9E15536	IRLI CHANGEOVER RELAY	I-47
A9E15537	IRLI CHANGEOVER RELAY	I-47
A9E15538	IRLI CHANGEOVER RELAY	I-47
A9E15539	IERL EXTENSION FOR RLI	I-47
A9E15540	IERL EXTENSION FOR RLI	I-47
A9E15541	IERL EXTENSION FOR RLI	I-47
A9E15542	IERL EXTENSION FOR RLI	I-47
A9E21181	IRCI CURRENT CONTROL	I-48
A9E21182	IRCU VOLTAGE CONTROL	I-48
A9E21180	IRCP PHASE CONTROL	I-49
A9E21183	IRCC COMPRESSOR CONTROL	I-49

iID, iC60, Vigi iC60, Reflex iC60, switches

A9 R 15 2 63

Range	Family	Code	Internal code	Poles	Code	Rating (A)	Code
Acti 9 (A9)	iID	R		0	0	0	00
	Vigi iC60	V		1P	1	0.5	70
	iC60	F		2P	2	0.75	71
	iK60	K		3P	3	1	01
	Auxiliaries and accessories	A		4P	4	1.6	72
	Switches	S		1N	5	2	02
	Reflex iC60	C		1P+N	6	2.5	73
	iC60 RCBO	D		3P+N	7	3	03
						4	04
						6	06
						6.3	76
						8	08
						10	10
						12.5	82
						13	13
						16	16
						20	20
						25	25
						32	32
						40	40
						50	50
						63	63
						80	80
						100	91
						125	92

Comb busbar and comb busbar accessories

A9 X P H 4 12

Range	Family	Code	Type	Type of installation	Number of poles	Dimensioning			
Acti 9 (A9)	Comb busbar	X	Comb busbar		1P	1	Comb busbar		
			Fork	F	Horizontal	H		Number of 18 mm modules (approximately)	
			Tooth	P			2P	2	Accessories
			Auxiliarisable	A			3P	3	
			Accessories				4P	4	
			End-piece	E	Double terminals	D	4P balanced, with neutral	5	
			Tooth cover	T	Single terminal	M	3P balanced for single-poles	6	
			Connector	C					

- Circuit breakers can:
 - guard against fires that might be caused by a faulty electric circuit (short-circuit, overload, insulation fault),
 - protect people against electric shock in the event of indirect contact.
- The choice of circuit breakers must be optimised to provide absolute protection while ensuring continuity of service.
- Although circuit breakers are sometimes used as control units, it is recommended to install separate control devices which are more suitable for frequent switching operations (switch, contactor, impulse relay).

Choice of protective circuit breakers

This depends on several criteria:

- breaking capacity
- max. voltage rating
- planned amperage for the circuit to be protected
- nature and cross section of cables
- ambient temperature (possible derating)
- the loads, which determine the number of poles of the protective circuit breaker installed on their power supply circuit and the tripping curve.

Choice of breaking capacity

- The breaking capacity must be greater than or equal to the prospective short-circuit current (I_{sc}) upstream of the circuit-breaker (I_{sc} depends on the length and cross section of the cable and the power of the source).
- However, in the event of use in combination with an upstream circuit-breaker limiting the current, this breaking capacity can possibly be reduced.

Choice of rating

- The rating (I_n) is chosen above all to protect the electrical connections:
 - for cables: it is chosen according to the cross section,
 - for Canalis prefabricated busbar trunking: it must be simply less than or equal to the rating of the busbar trunking.
- Generally, the rating should be greater than the nominal current of the circuits.
- The rating of the upstream circuit breaker must always be less than or equal to the sum of the ratings of the downstream circuit breakers.

Choice of tripping curve

The tripping curve makes the protection more or less sensitive to:

- the inrush current at power up
- the overload current.



Protection of electrical connections against magnetic short circuits and thermal overloads



Protection of loads against overloads



Protection of control devices



Protection for people against indirect contacts in IT and TN earthing systems

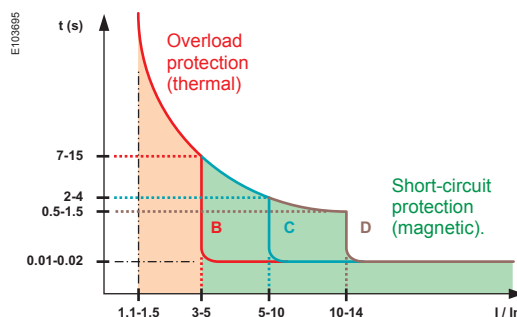

Tripping thresholds ($\times I_n$)

Curves	EN 60898	IEC 60947-2
B	Between 3 I_n and 5 I_n	Between 3.2 I_n and 4.8 I_n
C	Between 5 I_n and 10 I_n	Between 7 I_n and 10 I_n
D or K	-	Between 10 I_n and 14 I_n
MA	-	12 I_n
Z	-	Between 2.4 I_n and 3.6 I_n

- To prevent nuisance tripping, it may be advisable to choose a less sensitive curve, e.g. change from B to C.

Continuity of service

- Nuisance tripping can be generated by:
 - the inrush current at circuit closure,
 - the overload current, and sometimes the harmonic current flowing through the neutral of three-phase circuits ⁽¹⁾.

Solutions

- **Choose a circuit breaker with a less sensitive curve:** change from B curve to C curve or from C curve to D curve ⁽²⁾.
- **Reduce the number of loads per circuit.**
- **Energize the circuits in succession,** using time delay auxiliaries on the control devices.
- **Under no circumstances may the circuit breaker rating be increased, as the electrical connections would then no longer be protected.**
- **Ensure discrimination of the protective devices**

Discrimination is the coordination of automatic breaking devices in such a way that a fault occurring at any point on the network is eliminated by the circuit breaker located immediately upstream of the fault, and by it alone.

Total discrimination

For all values of the fault, from overload to non-resistive short circuit, distribution is fully discriminating if D2 opens and if D1 remains closed.

Partial discrimination

Discrimination is partial if the above condition is not complied with up to full short-circuit current, but only up to a lower value. This value is called the discrimination limit.

In the event of a fault exceeding this value, circuit breakers D1 and D2 open.

- (1) In the specific case of three-phase circuits supplying discharge lamps with electronic ballasts, harmonic currents of the third order and multiples of three are generated. The neutral cable must be sized to prevent it from overheating. However, the current flowing through the neutral conductor may become greater than the current of each phase and cause nuisance tripping.
- (2) In the case of installations with very long cables in a TN or IT system, it may be necessary to add an earth leakage protection device to protect human life..

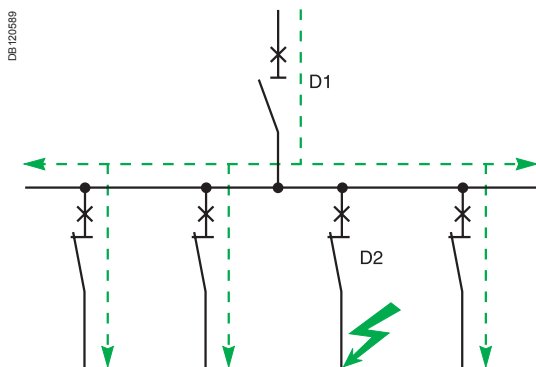

Circuit isolation



Motor protection

Disconnection

The purpose of disconnection is to separate and isolate a circuit or a device from the rest of the electrical installation in order to ensure the safety of personnel having to work on the electrical installation for maintenance or repair.

- The circuit breaking must be omnipolar, i.e. the live conductors, including neutral ⁽¹⁾, must be cut off.
- It must be lockable or padlockable in "open" position in order to prevent any unintentional reclosing, at least in industrial environments.
- It must be in compliance with a standard ensuring its suitability for isolation.

(1) With the exception of the PEN conductor which should never be cut off.



Motor protection

Protection of motors against risks of overheating due, for example, to an extended overload, rotor blocking or single-phase operation. Given the specific characteristics of motors:

- overload detection is entrusted to a thermal relay specially designed for their protection. This relay may possibly provide overload protection for busbar trunking
- in this case short-circuit protection is provided by a circuit breaker without a thermal release (MA type).

Selection guide

Circuit breakers

Type		iDPN	iDPN N	
				
Standard		IEC/EN 60898-1	IEC/EN 60898-1	
Number of poles		1P+N	1P+N, 3P, 3P+N	
Add-on residual current devices (Vigi)		■	■	
Auxiliaries for remote tripping and indication		■	■	
Electrical characteristics				
Curves		B, C	C, D	
Ratings (A)	In	1 to 40	1 to 40	
Maximum operational voltage (V)	Ue AC (50/60 Hz)	230	230/400	
	max DC	–	–	
Minimum operational voltage (V)	Ue AC (50/60 Hz)	–	–	
	min DC	–	–	
Insulation voltage (V AC)	Ui	440	440	
Rated impulse withstand voltage (kV)	Uimp	4	4	
Limitation class up to 40 A (EN 60898)		3	3	
Breaking capacity				
AC-Breaking capacity		Ue (50/60 Hz)		
IEC 60947-2 (kA)	Icu	12...60 V	–	
		12...133 V	–	
		100...133 V	–	
		220...240 V	6	10
		380...415 V	2 ⁽¹⁾	2 ⁽¹⁾
		440 V	–	–
	Ics	–	–	
IEC/EN 60898 (A)	Icn	240/415 V - 230/400 V	4500	6000
DC-Breaking capacity		Ue DC		
IEC 60947-2 (kA)	Icu	12...48 V (1P)	–	
		72 V (1P)	–	
		100...133 V (2P)	–	
		100...133 V (3P)	–	
		220...250 V (4P)	–	
	Ics	–	–	
Other characteristics				
Suitable for industrial isolation according to IEC/EN 60947-2		–	–	
Reference temperature IEC/EN 60947-2		–	–	
Fault tripping indication		–	–	
Positive contact indication		■	■	
Fast closing		■	■	
Degree of protection	IP	Device only	IP20	IP20
		Device in modular enclosure	IP40 Insulation class II	IP40 Insulation class II
For more detail, see page		A-2	A-3	
Accessories		E-29	E-29	
Auxiliaries		E-31	E-31	
Add-on residual current devices (Vigi)		B-33	B-33	



(1) Breaking capacity under 1 pole with IT isolated neutral system (case of double fault).

iK60N		iC60N		iC60H		iC60L	
							
IEC/EN 60898-1		IEC/EN 60947-2, 60898-1		IEC/EN 60947-2, 60898-1		IEC/EN 60947-2, 60898-1	
1P, 1P+N	2, 3, 4P	1P, 1P+N	2, 3, 4P	1P, 1P+N	2, 3, 4P	1P	2, 3, 4P
-	-	■	■	■	■	■	■
B, C	B, C, D	B, C, D	B, C, D	B, C, D	B, C, K, Z	B, C, K, Z	B, C, K, Z
1 to 63	0.5 to 63 (1 to 63 in DC)	0.5 to 63 (1 to 63 in DC)	0.5 to 63 (1 to 63 in DC)	0.5 to 63 (1 to 63 in DC)	0.5 to 63 (1 to 63 in DC)	0.5 to 63 (1 to 63 in DC)	0.5 to 63 (1 to 63 in DC)
230/400	240/415, 440	240/415, 440	240/415, 440	240/415, 440	240/415, 440	240/415, 440	240/415, 440
-	250	250	250	250	250	250	250
-	12	12	12	12	12	12	12
-	12	12	12	12	12	12	12
400	500	500	500	500	500	500	500
4	6	6	6	6	6	6	6
3	-	-	-	-	-	-	-
Ph / N	Ph / Ph	Ph / N	Ph / Ph	Ph / N	Ph / Ph	Ph / N	Ph / Ph
-	-	50 (0.5 to 4 A) 36 (6 to 63 A)	-	70 (0.5 to 4 A) 42 (6 to 63 A)	-	100 (0.5 to 4 A) 70 (6 to 63 A)	100 (0.5 to 4 A) 80 (6 to 63 A)
-	-	-	50 (0.5 to 4 A) 36 (6 to 63 A)	-	70 (0.5 to 4 A) 42 (6 to 63 A)	-	-
-	-	50 (0.5 to 4 A) 20 (6 to 63 A)	-	70 (0.5 to 4 A) 30 (6 to 63 A)	-	100 (0.5 to 4 A) 50 (6 to 25 A) 36 (32/40 A) 30 (50/63 A)	100 (0.5 to 4 A) 70 (6 to 63 A)
-	-	50 (0.5 to 4 A) 10 (6 to 63 A)	50 (0.5 to 4 A) 20 (6 to 63 A)	70 (0.5 to 4 A) 15 (6 to 63 A)	70 (0.5 to 4 A) 30 (6 to 63 A)	100 (0.5 to 4 A) 25 (6 to 25 A) 20 (32/40 A) 15 (50/63 A)	100 (0.5 to 4 A) 50 (6 to 25 A) 36 (32/40 A) 30 (50/63 A)
-	-	-	50 (0.5 to 4 A) 10 (6 to 63 A)	-	70 (0.5 to 4 A) 15 (6 to 63 A)	-	100 (0.5 to 4 A) 25 (6 to 25 A) 20 (32/40 A) 15 (50/63 A)
-	-	-	25 (0.5 to 4 A) 6 (6 to 63 A)	-	50 (0.5 to 4 A) 10 (6 to 63 A)	-	70 (0.5 to 4 A) 20 (6 to 25 A) 15 (32/40 A) 10 (50/63 A)
-	-	100 % of Icu (0.5 to 4 A) 75 % of Icu (6 to 63 A)	-	100 % of Icu (0.5 to 4 A) 50 % of Icu (6 to 63 A)	-	100 % of Icu (0.5 to 4 A) 50 % of Icu (6 to 63 A) ⁽¹⁾	-
6000	6000	6000	6000	10000	10000	15000	15000
-	-	15	-	20	-	25	-
-	-	6	-	10	-	15	-
-	-	-	6	-	10	-	15
-	-	-	15	-	20	-	25
-	-	-	6	-	10	-	15
-	-	100 % of Icu	-	100 % of Icu	-	100 % of Icu	-
-	-	■	-	■	-	■	-
-	-	50°C	-	50°C	-	50°C	-
-	-	Visi-trip window	-	Visi-trip window	-	Visi-trip window	-
-	-	■	-	■	-	■	-
-	-	■	-	■	-	■	-
IP20	IP20	IP20	IP20	IP20	IP20	IP20	IP20
IP40	IP40	IP40	IP40	IP40	IP40	IP40	IP40
Insulation class II	Insulation class II	Insulation class II	Insulation class II	Insulation class II	Insulation class II	Insulation class II	Insulation class II
A-4	A-9	A-9	A-12	A-12	A-16	A-16	A-16
-	E-2 and E-10	E-2 and E-10	E-2 and E-10	E-2 and E-10	E-2 and E-10	E-2 and E-10	E-2 and E-10
-	E-2 and F-2	E-2 and F-2	E-2 and F-2	E-2 and F-2	E-2 and F-2	E-2 and F-2	E-2 and F-2
-	B-17	B-17	B-17	B-17	B-17	B-17	B-17

(1) 100 % of Icu for ratings 6 to 25 A under Ue 100 to 133 V AC Ph/Ph and Ue 12 to 60 V AC Ph/N.

Selection guide (cont.)

Circuit breakers



Type		C120N		C120H		
						
Standard		IEC/EN 60898-1		IEC/EN 60898-1		
Number of poles		1P	2, 3, 4P	1P	2, 3, 4P	
Add-on residual current devices (Vigi)		■		■		
Auxiliaries for remote tripping and indication		■		■		
Electrical characteristics						
Curves		B, C		B, C		
Ratings (A)		In 10 to 125		63, 80, 100, 125		
Maximum operational voltage (V)		Ue AC (50/60 Hz) 240/415, 440 DC 125 per pole		240/415, 440 125 per pole		
Minimum operational voltage (V)		Ue AC (50/60 Hz) 12 DC 12		12 12		
Insulation voltage (V AC)		Ui 500		500		
Rated impulse withstand voltage (kV)		Uimp 6		6		
Breaking capacity						
AC-Breaking capacity		Ue (50/60 Hz)	Ph / N	Ph / Ph	Ph / N	Ph / Ph
IEC 60947-2 (kA)	Icu	110...130 V	–	–	–	–
		130 V	20	–	30	–
		220...240 V	10	20	15	30
		380...415 V	3 ⁽¹⁾	10	4.5 ⁽¹⁾	15
		440 V	–	6	–	10
		500 V	–	–	–	–
Ics	75 % of Icu		50 % of Icu			
IEC/EN 60898 (A)	Icn	230/400 V	10000	10000	15000	15000
DC-Breaking capacity		Ue DC				
IEC 60947-2 (kA)	Icu	60 V (1P)	10	–	15	–
		125 V (1P)	10	–	15	–
		250 V (2P)	–	10	–	15
		500 V (4P)	–	–	–	–
		Ics	100 % of Icu		100 % of Icu	
Other characteristics						
Suitable for industrial isolation according to IEC/EN 60947-2		■		■		
Reference temperature IEC/EN 60947-2		50°C		50°C		
Fault tripping indication		–		–		
Positive contact indication		■		■		
Fast closing		■		■		
Dismounting with comb busbar in place		Special comb busbar		Special comb busbar		
Degree of protection		IP	Device only IP20 Device in modular enclosure IP40	IP20 IP40		
For more detail, see page		A-20		A-23		
Accessories		E-7, E-15 and E-28		E-7, E-15 and E-28		
Auxiliaries		E-7 and F-9		E-7 and F-9		
Earth leakage see page (Vigi)		B-22		B-22		

(1) Breaking capacity under 1 pole with IT isolated neutral system (case of double fault).

NG125a		NG125N		NG125H		NG125L	
							
IEC/EN 60947-2		IEC/EN 60947-2		IEC/EN 60947-2		IEC/EN 60947-2	
3, 4P		1P	2, 3, 4P	1P	2, 3, 4P	1P	2, 3, 4P
■		■		■		■	
■		■		■		■	
C		B, C, D		C		B, C, D	
80 to 125		10 to 125		10 to 80		10 to 80	
240/415, 500		240/415, 500		240/415, 500		240/415, 500	
–		125 per pole		125 per pole		125 per pole	
12		12		12		12	
–		12		12		12	
690		690		690		690	
8		8		8		8	
Ph / Ph		Ph / N		Ph / Ph		Ph / N	
–		50		–		100	
–		–		–		–	
–		25		50		50	
16		6		25		12.5⁽¹⁾	
–		–		20		–	
6		–		10		–	
75 % of Icu		75 % of Icu		75 % of Icu		75 % of Icu	
–		–		–		–	
–		25		36		50	
–		25		36		50	
–		–		25		–	
20		–		25		–	
100 % of Icu		100 % of Icu		100 % of Icu		100 % of Icu	
■		■		■		■	
40°C		40°C		40°C		40°C	
■ Toggle position ■ Red mechanical indicator		■ Toggle position ■ Red mechanical indicator		■ Toggle position ■ Red mechanical indicator		■ Toggle position ■ Red mechanical indicator	
■		■		■		■	
■		■		■		■	
–		–		–		–	
IP20		IP20		IP20		IP20	
IP40		IP40		IP40		IP40	
A-27		A-29		A-31		A-33	
E-26		E-26		E-26		E-26	
F-14		F-14		F-14		F-14	
B-27		B-27		B-27		B-27	

(1) Breaking capacity under 1 pole with IT isolated neutral system (case of double fault).

Selection guide (cont.)

Instantaneous circuit breakers (ICB)				
Type		iC60LMA	NG125LMA	
				
Standard		IEC/EN 60947-2	IEC/EN 60947-2	
Quality label		Country approval pictogram	Country approval pictogram	
Number of poles		2, 3P	2, 3P	
Add-on residual current devices (Vigi)		■	■	
Auxiliaries for remote tripping and indication		■	■	
Electrical characteristics				
Curves		MA (li = 12 In)	MA (li = 12 In)	
Ratings (A)	In	1.6 to 40	4 to 80	
Maximum operational voltage (V)	Ue AC (50/60 Hz)	440	500	
	max DC	250	–	
Minimum operational voltage (V)	Ue AC (50/60 Hz)	12	12	
	min DC	12	–	
Insulation voltage (V AC)	Ui	500	690	
Rated impulse withstand voltage (kV)	Uimp	6	8	
Breaking capacity				
AC-Breaking capacity		Ue (50/60 Hz)		
IEC 60947-2 (kA)	Icu	12...60 V	–	
		12...133 V	–	
		100...133 V	–	
		110...130 V	–	
		130 V	–	
		220...240 V	40 (1.6 to 16 A) 30 (25 to 40 A)	100
		230/400 V	–	–
		380...415 V	20 (1.6 to 16 A) 15 (25 to 40 A)	50
		400/415 V	–	–
		440 V	15 (1.6 to 16 A) 10 (25 to 40 A)	40
		500 V	–	15
		Ics	50 % of Icu (1.6 to 40 A)	75 % of Icu
		IEC/EN 60898 (A)	Icn	230/400 V
Other characteristics				
Suitable for industrial isolation according to IEC/EN 60947-2		■	■	
Reference temperature IEC/EN 60947-2		50°C	40°C	
Fault tripping indication		Visi-trip window	■ Toggle position ■ Red mechanical indicator	
Positive contact indication		■	■	
Fast closing		■	■	
Dismounting with comb busbar in place		Upstream connection	–	
Degree of protection	IP	Device only	IP20	
		Device in modular enclosure	IP40	
		Insulation class II	IP40	
For more detail, see page		A-38	A-41	
Accessories		E-2 and E-10	E-26	
Auxiliaries		E-2 and F-2	F-14	
Add-on residual current devices (Vigi)		B-17	B-27	

Circuit Protection

A close-up photograph of a man with short brown hair and a slight smile, wearing a blue button-down shirt. He is leaning over a workbench, focused on a task. His hands are visible, holding a blue tool or component. The background is a blurred workshop or laboratory setting with various equipment and shelves.

The protection of property and people against direct or indirect contacts, insulation faults and fire hazards is implemented by residual current devices obtained by the combination of a circuit breaker and an earth leakage module.

EN 60898

The circuit breakers are designed for protection against short-circuit and overload currents, for the control and disconnection of final distribution circuits in service sector, agricultural and industrial applications, in TT earthing system or with multiple earthed neutral (TN-S) requiring neutral cutoff without its protective device.

Catalogue numbers

iDPN circuit breakers				
4500				
Type	1P+N		3P+N	
Auxiliaries	See page F-9		See page F-9	
Vigi	Module B-33		Module B-33	
Rating (In)	B curve	C curve	B curve	C curve
1 A	-	A9N21542	-	-
2 A	-	A9N21543	-	-
3 A	-	A9N21544	-	-
6 A	A9N21535	A9N21545	-	-
10 A	A9N21536	A9N21546	-	-
13 A	A9N21723	A9N21724	A9N21731	A9N21732
16 A	A9N21537	A9N21547	-	-
20 A	A9N21538	A9N21548	-	-
25 A	A9N21539	A9N21549	-	-
32 A	A9N21540	A9N21550	-	-
40 A	A9N21541	A9N21551	-	-
Width in 9-mm modules	2		6	
Accessories	See page E-29 and E-31			

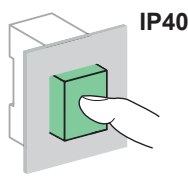
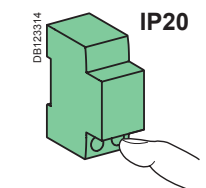
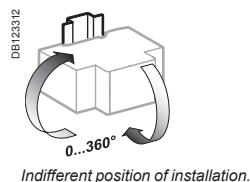
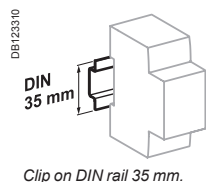

Technical data

Main characteristics		iDPN	iDPN F	iDPN N
Insulation voltage (Ui)	Phase-to-phase	440 V AC	-	440 V AC
Voltage rating (Ue)	Phase-to-neutral	230 V AC	230 V AC	230 V AC
	Phase-to-phase	400 V AC	-	400 V AC
Magnetic tripping	B curve	3 to 5 In	-	■
	C curve	5 to 10 In	■	■
	D curve	10 to 14 In	-	■
According to EN 60898-1				
Limitation class		3	3	3
Rated breaking capacity (Icn)		4500 A	6000 A	6000 A
Service breaking capacity (Ics)		100 % Icn	100 % Icn	100 % Icn
Rated breaking and making capacity on a single pole (Icn1)		Icn1 = Icn	Icn1 = Icn	Icn1 = Icn
According to IEC 60947-2				
Rated impulse withstand voltage (Uimp)		-	4 kV	4 kV
Breaking capacity (Icu)		-	6 kA	10 kA
Pollution degree		-	3 as per IEC 60947-1 (for installation in industrial environment)	-
Additional characteristics				
Degree of protection (IEC 60529)	Device only	IP20		
	Device in modular enclosure	IP40 Insulation class II		
Endurance (O-C)	Electrical	≤ 20 A	20000 cycles	20000 cycles
		≥ 25 A	10000 cycles	10000 cycles
	Mechanical	20000 cycles	20000 cycles	20000 cycles
Operating temperature		-25°C to +70°C	-25°C to +70°C	-25°C to +70°C
Storage temperature		-40°C to +70°C	-40°C to +70°C	-40°C to +70°C
Tropicalization (IEC 60068-1)		Treatment 2 (relative humidity of 95 % at 55°C)		
Neutral opening and closing shifted relative to phases		No surge upon operation of the device		



Catalogue numbers

iDPN F circuit breakers	
6000	
Type	1P+N
Auxiliaries	See pages F-9 and E-31
Vigi	See page B-33
Rating (In)	C curve
1 A	A9N21638
2 A	A9N21641
3 A	A9N21642
6 A	A9N21643
10 A	A9N21644
16 A	A9N21645
20 A	A9N21646
25 A	A9N21647
32 A	A9N21648
40 A	A9N21649
Width in 9-mm modules	2
Accessories	See page E-29 and E-31



iDPN N circuit breakers

6000								
Type	1P+N			3P		3P+N		
Auxiliaries	See pages F-9 and E-31			See pages F-9 and E-31		See pages F-9 and E-31		
Vigi	See page B-33			See page B-33		See page B-33		
Rating (In)	B curve	C curve	D curve	C curve	D curve	B curve	C curve	D curve
1 A	-	A9N21552	-	-	-	-	-	-
2 A	-	A9N21553	-	-	-	-	-	-
3 A	-	A9N21554	-	-	-	-	-	-
4 A	A9N17515	A9N21722	-	-	-	-	-	-
6 A	A9N17516	A9N21555	A9N21565	A9N21575	A9N21585	-	A9N21595	A9N21605
10 A	A9N17517	A9N21556	A9N21566	A9N21576	A9N21586	-	A9N21596	A9N21606
13 A	A9N17518	A9N21725	A9N21726	A9N21727	A9N21728	A9N17581	A9N21729	A9N21730
16 A	A9N17519	A9N21557	A9N21567	A9N21577	A9N21587	-	A9N21597	A9N21607
20 A	A9N17520	A9N21558	A9N21568	A9N21578	A9N21588	-	A9N21598	A9N21608
25 A	A9N17521	A9N21559	A9N21569	A9N21579	A9N21589	-	A9N21599	A9N21609
32 A	A9N17522	A9N21560	A9N21570	A9N21580	A9N21590	-	A9N21600	A9N21610
40 A	A9N17523	A9N21561	A9N21571	A9N21581	A9N21591	-	A9N21601	A9N21611
Width in 9-mm modules	2			6		6		
Accessories	See page E-29 and E-31							

Dimensions (mm)

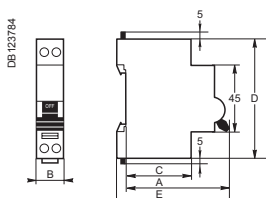

Weight (g)

Circuit breakers	
Type	iDPN, iDPN F, iDPN N
1P+N	115
3P	310
3P+N	322

Circuit breakers						
Type	Number of poles	A	B	C	D	E
iDPN, iDPN F, iDPN N	1P+N	70	18	44	80	76
	3P	70	54	44	80	76
	3P+N	70	54	44	80	76

iK60N circuit breakers (curve B)

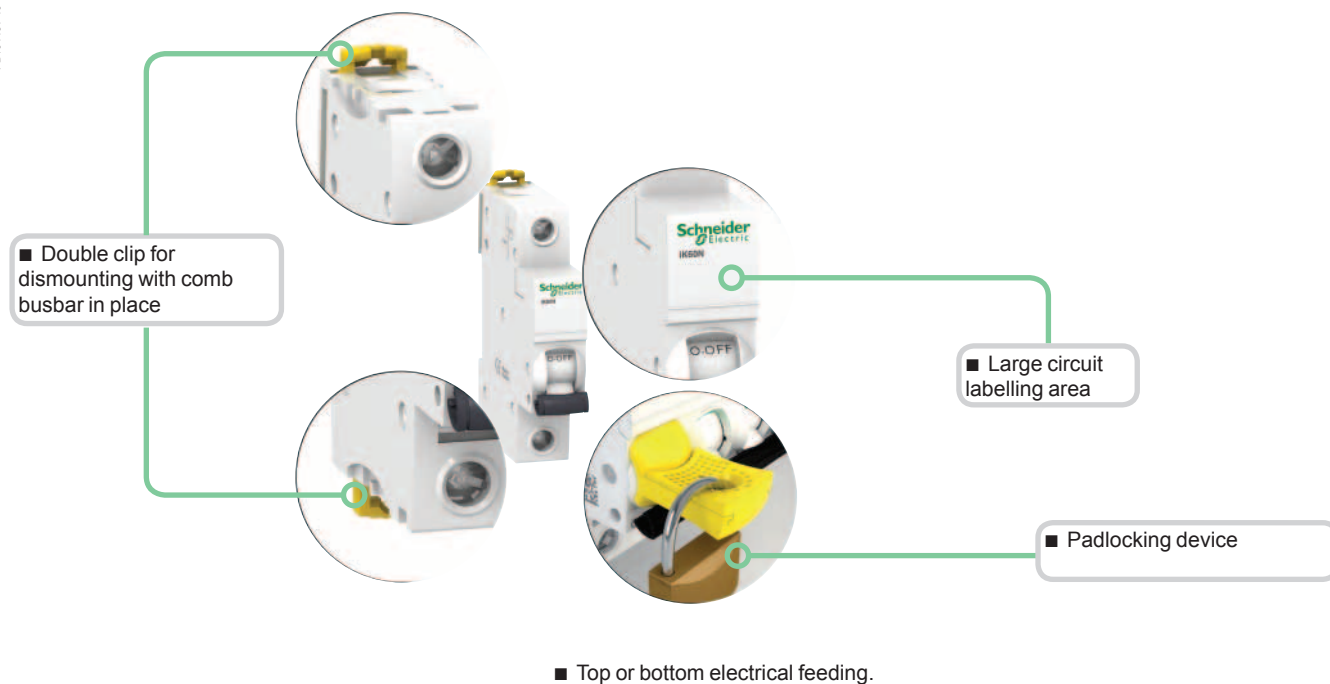

PB104434-40

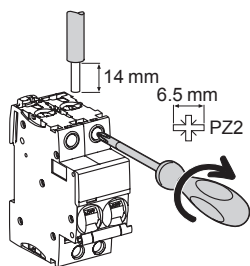

Connection

DB123060



Type	Rating	Tightening torque	Without accessory	
			Copper cables	
			Rigid	Flexible or ferrule
B curve	1 to 25 A	2 N.m		
	32 to 63 A	3.5 N.m		

iK60N circuit breakers (curve B) (cont.)



IEC/EN 60898-1

PB104469-40



PB104463-40



- iK60N circuit breakers are circuit breakers which combine the following functions:
 - circuit protection against short-circuit currents,
 - circuit protection against overload currents,
 - disconnection, opening and closing.



iK60N circuit breaker 50/60 Hz

Breaking capacity in short circuit (I _{cn}) as per IEC/EN 60898-1		Service breaking capacity (I _{cs}) 100 % of I _{cn}
Ph/Ph	400 V	
Ph/N	230 V	
Rating (I _n) 1 to 63 A	6000 A	

Catalogue numbers

iK60N circuit breaker						
Type	1P	1P+N	2P	3P	4P	
Auxiliaries	Without auxiliaries	Without auxiliaries	Without auxiliaries	Without auxiliaries	Without auxiliaries	
Vigi iC60	Without Vigi iC60	Without Vigi iC60	Without Vigi iC60	Without Vigi iC60	Without Vigi iC60	
Rating (I _n)	Curve B	Curve B	Curve B	Curve B	Curve B	
1 A	A9K23101	A9K23601	A9K23201	-	-	
2 A	A9K23102	A9K23602	A9K23202	-	-	
3 A	A9K23103	A9K23603	A9K23203	-	-	
4 A	A9K23104	A9K23604	A9K23204	-	-	
6 A	A9K23106	A9K23606	A9K23206	A9K23306	A9K23406	
10 A	A9K23110	A9K23610	A9K23210	A9K23310	A9K23410	
16 A	A9K23116	A9K23616	A9K23216	A9K23316	A9K23416	
20 A	A9K23120	A9K23620	A9K23220	A9K23320	A9K23420	
25 A	A9K23125	A9K23625	A9K23225	A9K23325	A9K23425	
32 A	A9K23132	A9K23632	A9K23232	A9K23332	A9K23432	
40 A	A9K23140	A9K23640	A9K23240	A9K23340	A9K23440	
50 A	A9K23150	A9K23650	A9K23250	A9K23350	A9K23450	
63 A	A9K23163	A9K23663	A9K23263	A9K23363	A9K23463	
Operating frequency	50/60 Hz	50/60 Hz	50/60 Hz	50/60 Hz	50/60 Hz	
Width in 9-mm modules	2	4	4	6	8	

iK60N circuit breakers (curve B) (cont.)

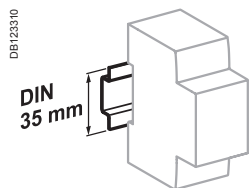

Clip on DIN rail 35 mm.

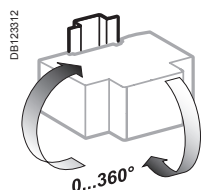

Indifferent position of installation.

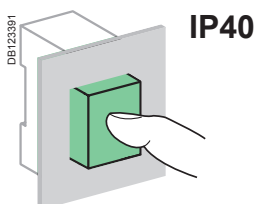

Technical data

Main characteristics		
According to IEC/EN 60898-1		
Insulation voltage (Ui)		440 V AC
Pollution degree		2
Rated impulse withstand voltage (Uimp)		4 kV
Thermal tripping	Reference temperature	30°C
	Temperature derating	See the Technical Guide
Magnetic tripping	B curve	3 to 5 In
Limitation class		3
Rated making and breaking capacity of an individual pole (Icn1)		Icn1 = Icn
Additional characteristics		
Degree of protection (IEC 60529)	Device in modular enclosure	IP40 Insulation classe II
Endurance (O-C)	Electrical	10,000 cycles
	Mechanical	20,000 cycles
Overvoltage category (IEC 60364)		III
Operating temperature		-25°C to +60°C
Storage temperature		-40°C to +85°C

Weight (g)

Circuit-breaker	
Type	iK60N
1P	100
2P	200
3P	300
4P	400

Dimensions (mm)

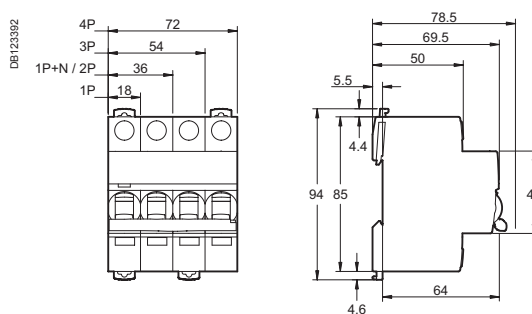

iK60N circuit breakers (curve C)



IEC/EN 60898-1

PB10469-40



PB10463-40



- iK60N circuit breakers are circuit breakers which combine the following functions:
 - circuit protection against short-circuit currents,
 - circuit protection against overload currents,
 - disconnection, opening and closing.

A

iK60N circuit breaker 50/60 Hz

Breaking capacity in short circuit (I _{cn}) as per IEC/EN 60898-1		Service breaking capacity (I _{cs}) 100 % of I _{cn}
Ph/Ph	400 V	
Ph/N	230 V	
Rating (I _n) 1 to 63 A	6000 A	

Catalogue numbers

iK60N circuit breakers					
Type	1P	1P+N	2P	3P	4P
Auxiliaries	Without auxiliaries	Without auxiliaries	Without auxiliaries	Without auxiliaries	Without auxiliaries
Vigi iC60	Without Vigi iC60	Without Vigi iC60	Without Vigi iC60	Without Vigi iC60	Without Vigi iC60
Rating (I _n)	Curve C	Curve C	Curve C	Curve C	Curve C
1 A	A9K24101	A9K24601	A9K24201	-	-
2 A	A9K24102	A9K24602	A9K24202	-	-
3 A	A9K24103	A9K24603	A9K24203	-	-
4 A	A9K24104	A9K24604	A9K24204	-	-
6 A	A9K24106	A9K24606	A9K24206	A9K24306	A9K24406
10 A	A9K24110	A9K24610	A9K24210	A9K24310	A9K24410
16 A	A9K24116	A9K24616	A9K24216	A9K24316	A9K24416
20 A	A9K24120	A9K24620	A9K24220	A9K24320	A9K24420
25 A	A9K24125	A9K24625	A9K24225	A9K24325	A9K24425
32 A	A9K24132	A9K24632	A9K24232	A9K24332	A9K24432
40 A	A9K24140	A9K24640	A9K24240	A9K24340	A9K24440
50 A	A9K24150	A9K24650	A9K24250	A9K24350	A9K24450
63 A	A9K24163	A9K24663	A9K24263	A9K24363	A9K24463
Operating frequency	50/60 Hz	50/60 Hz	50/60 Hz	50/60 Hz	50/60 Hz
Width in 9-mm modules	2	4	4	6	8

iK60N circuit breakers (curve C) (cont.)

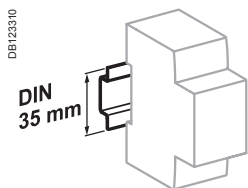

Clip on DIN rail 35 mm.

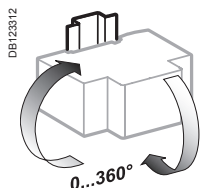

Position d'installation indifférente.

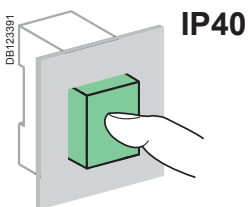

Technical data

Main characteristics

According to IEC/EN 60898-1

Insulation voltage (Ui)	440 V AC	
Pollution degree	2	
Rated impulse withstand voltage (Uimp)	4 kV	
Thermal tripping	Reference temperature	30°C
	Temperature derating	See the Technical Guide
Magnetic tripping	C curve	5 to 10 In
Limitation class		3
Rated making and breaking capacity of an individual pole (Icn1)		Icn1 = Icn

Additional characteristics

Degree of protection (IEC 60529)	Device in modular enclosure	IP40 Insulation classe II
Endurance (O-C)	Electrical	10,000 cycles
	Mechanical	20,000 cycles
Overvoltage category (IEC 60364)		III
Operating temperature		-25°C to +60°C
Storage temperature		-40°C to +85°C

Weight (g)

Circuit-breaker

Type	iK60N
1P	100
2P	200
3P	300
4P	400

Dimensions (mm)

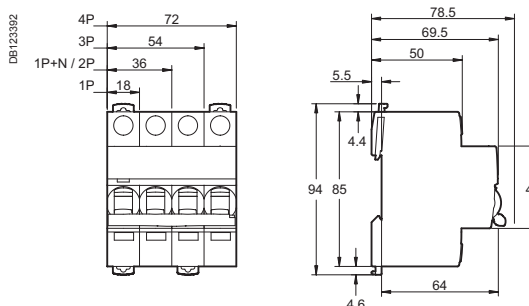

iC60N circuit breakers (curve B, C, D)



CEI/EN 60947-2 BS/EN 60898-1

- Disbo iC60N circuit breakers are multi-standard circuit breakers which combine the following functions:
 - circuit protection against short-circuit currents,
 - circuit protection against overload currents,
 - suitable for industrial isolation according to IEC/EN 60947-2, standard.
 - fault tripping indication by a red mechanical indicator in circuit breaker front face.

Alternating current (AC) 50/60 Hz

Breaking capacity (Icu) according to IEC/EN 60947-2	Voltage (Ue)				Service breaking capacity (Ics)
	12 to 133 V	220 to 240 V	380 to 415 V	440 V	
Ph/Ph (2P, 3P, 4P)	12 to 133 V	220 to 240 V	380 to 415 V	440 V	100 % of Icu
Ph/N (1P, 1P+N)	12 to 60 V	100 to 133 V	220 to 240 V	-	
Rating (In)	0.5 to 4 A	50 kA	50 kA	50 kA	25 kA
	6 to 63 A	36 kA	20 kA	10 kA	6 kA

Breaking capacity (Icn) according to IEC/EN 60898-1



Breaking capacity (Icn) according to IEC/EN 60898-1	Voltage (Ue)	
	Ph/Ph	Ph/N
	400 V	230 V
Rating (In)	0.5 to 63 A	6000 A

Direct current (DC)

Breaking capacity (Icu) according to IEC/EN 60947-2	Voltage (Ue)				Service breaking capacity (Ics)
	12 to 48 V	72 V	100 to 133 V	220 to 250 V	
Between +/-	12 to 48 V	72 V	100 to 133 V	220 to 250 V	100 % of Icu
Number of poles	1P	2P (in series)	3P (in series)	4P (in series)	
Rating (In)	1 to 63 A	15 kA	6 kA	6 kA	6 kA

Catalogue numbers

Disbo iC60N circuit breaker

Type	1P			2P		
						
Auxiliaries	See page E-2 and F-22			See page E-2 and F-22		
Rating (In)	Curve			Curve		
	B	C	D	B	C	D
0.5 A	A9F43170	A9F44170	A9F45170	A9F43270	A9F44270	A9F45270
1 A	A9F43101	A9F44101	A9F45101	A9F43201	A9F44201	A9F45201
2 A	A9F43102	A9F44102	A9F45102	A9F43202	A9F44202	A9F45202
3 A	A9F43103	A9F44103	A9F45103	A9F43203	A9F44203	A9F45203
4 A	A9F43104	A9F44104	A9F45104	A9F43204	A9F44204	A9F45204
6 A	A9F43106	A9F44106	A9F45106	A9F43206	A9F44206	A9F45206
10 A	A9F43110	A9F44110	A9F45110	A9F43210	A9F44210	A9F45210
16 A	A9F43116	A9F44116	A9F45116	A9F43216	A9F44216	A9F45216
20 A	A9F43120	A9F44120	A9F45120	A9F43320	A9F44220	A9F45220
25 A	A9F43125	A9F44125	A9F45125	A9F43325	A9F44225	A9F45225
32 A	A9F43132	A9F44132	A9F45132	A9F43232	A9F44232	A9F45232
40 A	A9F43140	A9F44140	A9F45140	A9F43240	A9F44240	A9F45240
50 A	A9F43150	A9F44150	A9F45150	A9F43250	A9F44250	A9F45250
63 A	A9F43163	A9F44163	A9F45163	A9F43263	A9F44263	A9F45263
Width in 9-mm modules	2			4		
Accessories	See page E-2 and E-10			See page E-2 and E-10		

iC60N circuit breakers (curve B, C, D) (cont.)

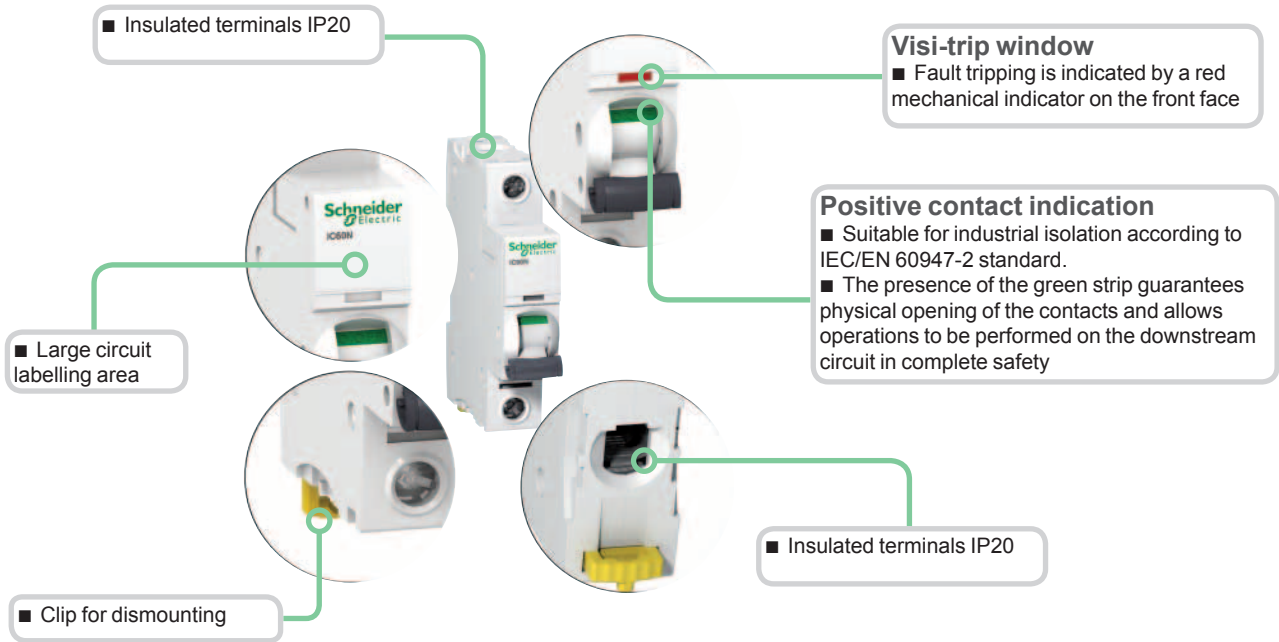

- Increased product service life thanks to:
 - overvoltage resistance by high level of industrial performances conception (pollution degree, rated impulse withstand voltage and insulation voltage),
 - high performance limitation (see limitation curves),
 - fast closing independent of the speed of actuation of the toggle.
- Remote indication, open/closed/tripped, by optional auxiliary contacts.
- Top or bottom electrical feeding.

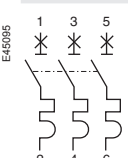
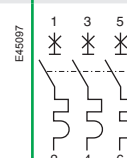
3P			4P		
					
See page E-2 and F-22			See page E-2 and F-22		
Curve			Curve		
B	C	D	B	C	D
A9F43370	A9F44370	A9F45370	A9F43470	A9F44470	A9F45470
A9F43301	A9F44301	A9F45301	A9F43401	A9F44401	A9F45401
A9F43302	A9F44302	A9F45302	A9F43402	A9F44402	A9F45402
A9F43303	A9F44303	A9F45303	A9F43403	A9F44403	A9F45403
A9F43304	A9F44304	A9F45304	A9F43404	A9F44404	A9F45404
A9F43306	A9F44306	A9F45306	A9F43406	A9F44406	A9F45406
A9F43310	A9F44310	A9F45310	A9F43410	A9F44410	A9F45410
A9F43316	A9F44316	A9F45316	A9F43416	A9F44416	A9F45416
A9F43220	A9F44320	A9F45320	A9F43420	A9F44420	A9F45420
A9F43225	A9F44325	A9F45325	A9F43425	A9F44425	A9F45425
A9F43332	A9F44332	A9F45332	A9F43432	A9F44432	A9F45432
A9F43340	A9F44340	A9F45340	A9F43440	A9F44440	A9F45440
A9F43350	A9F44350	A9F45350	A9F43450	A9F44450	A9F45450
A9F43363	A9F44363	A9F45363	A9F43463	A9F44463	A9F45463
6			8		
See page E-2 and E-10			See page E-2 and E-10		

iC60N circuit breakers (curve B, C, D) (cont.)

Connection

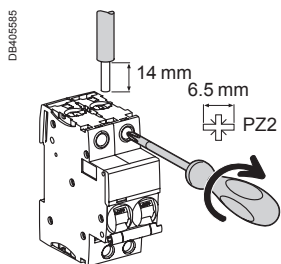

Rating	Tightening torque	Without accessory		With accessories		
		Rigid	Flexible or ferrule	50 mm ² Al terminal	Screw-on connection for ring terminal	Multi-cables terminal
0.5 to 25 A	2 N.m	DB1122945	DB1122946	DB1122935	DB118789	DB118787
32 to 63 A	3.5 N.m	1 to 25 mm ²	1 to 16 mm ²	-	∅ 5 mm	-
		1 to 35 mm ²	1 to 25 mm ²	50 mm ²		3 x 16 mm ²
						3 x 10 mm ²

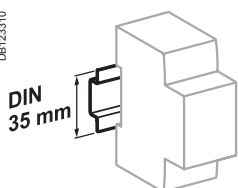

Clip on DIN rail 35 mm.

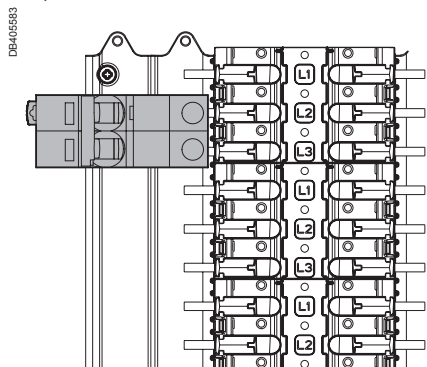

Installation on Fishbone.

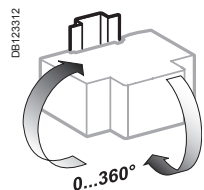

Indifferent position of installation.

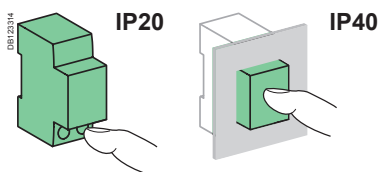

Technical data

Main characteristics

According to IEC/EN 60947-2

Insulation voltage (U _i)	500 V AC	
Pollution degree	3	
Rated impulse withstand voltage (U _{imp})	6 kV	
Thermal tripping	Reference temperature	
	Temperature derating	
	50 °C	
Magnetic tripping	B curve	4 I _n ± 20 %
	C curve	8 I _n ± 20 %
	D curve	12 I _n ± 20 %
Utilization category	A	

According to IEC/EN 60898-1

Limitation class	3
Rated making and breaking capacity of an individual pole (I _{cn1})	I _{cn1} = I _{cn}

Additional characteristics

Breaking capacity under 1 pole with IT 380-415 V isolated neutral system (case of double fault)	40 A	4 kA
	50/63 A	3 kA
Degree of protection (IEC 60529)	Device only	IP20
	Device in modular enclosure	IP40
Endurance (O-C)	Electrical	10,000 cycles
	Mechanical	20,000 cycles
Overvoltage category (IEC 60364)		IV
Operating temperature		-35°C to +70°C
Storage temperature		-40°C to +85°C
Tropicalization (IEC 60068-1)		Treatment 2 (relative humidity 95 % to 55°C)

Dimensions (mm)

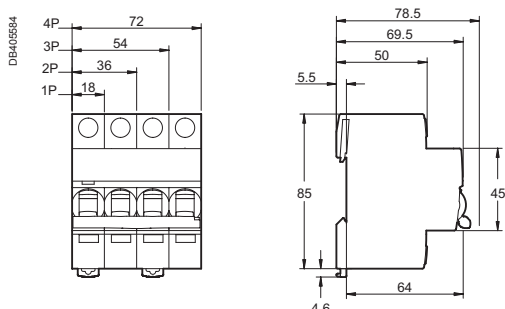

Weight (g)

Circuit-breaker

Type	Disbo iC60N
1P	125
2P	250
3P	375
4P	500

iC60H circuit breakers (curve B, C, D)



CEI/EN 60947-2 BS/EN 60898-1

■ Disbo iC60H circuit breakers are multi-standard circuit breakers which combine the following functions:

- circuit protection against short-circuit currents,
- circuit protection against overload currents,
- suitable for industrial isolation according to IEC/EN 60947-2, standard.
- fault tripping indication by a red mechanical indicator in circuit breaker front face.

Alternating current (AC) 50/60 Hz

Breaking capacity (Icu) according to IEC/EN 60947-2	Voltage (Ue)				Service breaking capacity (Ics)	
	12 to 133 V	220 to 240 V	380 to 415 V	440 V		
Ph/Ph (2P, 3P, 4P)	12 to 133 V	220 to 240 V	380 to 415 V	440 V		
Ph/N (1P, 1P+N)	12 to 60 V	100 to 133 V	220 to 240 V	-		
Rating (In)	1 to 4 A	70 kA	70 kA	70 kA	50 kA	100 % of Icu
	6 to 40 A	42 kA	30 kA	15 kA	10 kA	50 % of Icu
	50/63 A	42 kA	-	15 kA	10 kA	50 % of Icu

Breaking capacity (Icn) according to IEC/EN 60898-1

Breaking capacity (Icn) according to IEC/EN 60898-1	Voltage (Ue)	
	Ph/Ph	Ph/N
	400 V	230 V
Rating (In) 1 to 63 A	10000 A	

Direct current (DC)

Breaking capacity (Icu) according to IEC/EN 60947-2	Voltage (Ue)				Service breaking capacity (Ics)	
	Between +/-	12 to 48 V	72 V	100 to 133 V		220 to 250 V
Number of poles	1P	2P (in series)	3P (in series)	4P (in series)		
Rating (In) 1 to 63 A	20 kA	10 kA	10 kA	20 kA	10 kA	100 % of Icu

Catalogue numbers

Disbo iC60H circuit breaker

Type	1P			2P		
Auxiliaries	See page E-2 and F-2			See page E-2 and F-2		
Rating (In)	Curve			Curve		
	B	C	D	B	C	D
1 A	A9F53101	A9F54101	A9F55101	A9F53201	A9F54201	A9F55201
2 A	A9F53102	A9F54102	A9F55102	A9F53202	A9F54202	A9F55202
3 A	A9F53103	-	-	-	-	-
4 A	A9F53104	A9F54104	A9F55104	A9F53204	A9F54204	A9F55204
6 A	A9F53106	A9F54106	A9F55106	A9F53206	A9F54206	A9F55206
10 A	A9F53110	A9F54110	A9F55110	A9F53210	A9F54210	A9F55210
16 A	A9F53116	A9F54116	A9F55116	A9F53216	A9F54216	A9F55216
20 A	A9F53120	A9F54120	A9F55120	A9F53220	A9F54220	A9F55220
25 A	A9F53125	A9F54125	A9F55125	A9F53225	A9F54225	A9F55225
32 A	A9F53132	A9F54132	A9F55132	A9F53232	A9F54232	A9F55232
40 A	A9F53140	A9F54140	A9F55140	A9F53240	A9F54240	A9F55240
50 A	A9F53150	A9F54150	A9F55150	A9F53250	A9F54250	A9F55250
63 A	A9F53163	A9F54163	A9F55163	A9F53263	A9F54263	A9F55263
Width in 9-mm modules	2			4		
Accessories	See page E-2 and E-10			See page E-2 and E-10		

iC60H circuit breakers (curve B, C, D) (cont.)

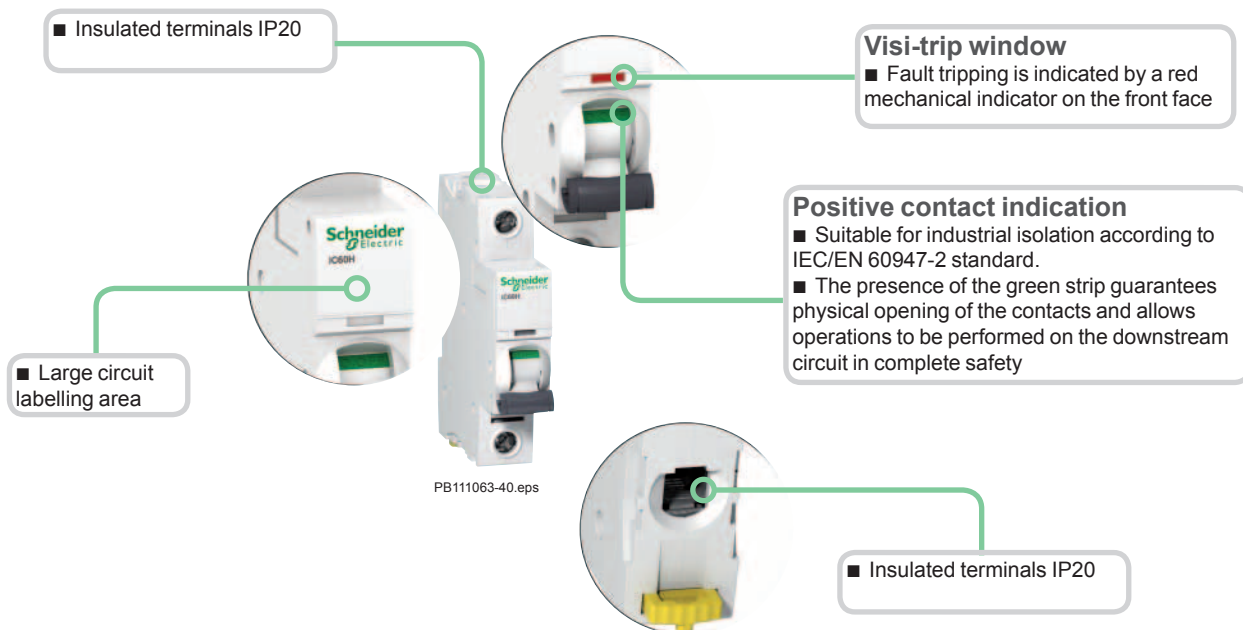

- Increased product service life thanks to:
 - overvoltage resistance by high level of industrial performances conception (pollution degree, rated impulse withstand voltage and insulation voltage),
 - high performance limitation (see limitation curves),
 - fast closing independent of the speed of actuation of the toggle.
- Remote indication, open/closed/tripped, by optional auxiliary contacts.
- Top or bottom electrical feeding.

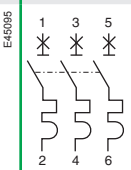
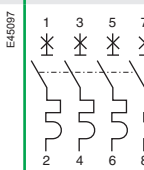
3P				4P							
											
See page E-2 and F-2				See page E-2 and F-2							
Curve				Curve							
B		C		D		B		C		D	
A9F53301	A9F53302	A9F54301	A9F54302	A9F55301	A9F55302	A9F53401	A9F53402	A9F54401	A9F54402	A9F55401	A9F55402
-	-	-	-	-	-	-	-	-	-	-	-
A9F53304	A9F53306	A9F54304	A9F54306	A9F55304	A9F55306	A9F53404	A9F53406	A9F54404	A9F54406	A9F55404	A9F55406
A9F53310	A9F53316	A9F54310	A9F54316	A9F55310	A9F55316	A9F53410	A9F53416	A9F54410	A9F54416	A9F55410	A9F55416
A9F53320	A9F53325	A9F54320	A9F54325	A9F55320	A9F55325	A9F53420	A9F53425	A9F54420	A9F54425	A9F55420	A9F55425
A9F53332	A9F53340	A9F54332	A9F54340	A9F55332	A9F55340	A9F53432	A9F53440	A9F54432	A9F54440	A9F55432	A9F55440
A9F53350	A9F53363	A9F54350	A9F54363	A9F55350	A9F55363	A9F53450	A9F53463	A9F54450	A9F54463	A9F55450	A9F55463
6						8					
See page E-2 and E-10						See page E-2 and E-10					

iC60H circuit breakers (curve B, C, D) (cont.)

Connection

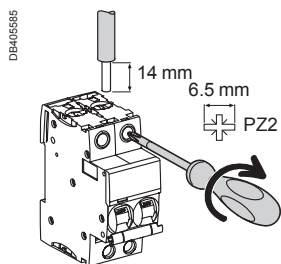

Rating	Tightening torque	Without accessory		With accessories				
		Copper cables		50 mm ² Al terminal	Screw-on connection for ring terminal		Multi-cables terminal	
		Rigid	Flexible or ferrule		Rigid cables	Flexible cables		
1 to 25 A	2 N.m	DB1122945	DB1122946	DB1122945	DB118789	DB118787	-	-
32 to 63 A	3.5 N.m	1 to 25 mm ²	1 to 16 mm ²	-	Ø 5 mm	-	-	-
		1 to 35 mm ²	1 to 25 mm ²	50 mm ²		3 x 16 mm ²	3 x 10 mm ²	

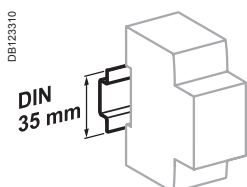

Clip on DIN rail 35 mm.

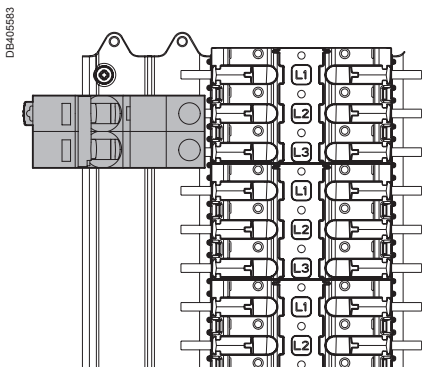

Installation on Fishbone.

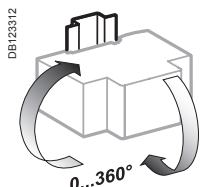

Indifferent position of installation.

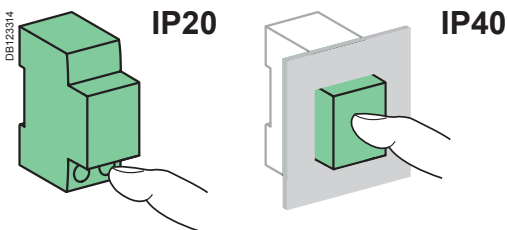

Technical data

Main characteristics

According to IEC/EN 60947-2

Insulation voltage (U _i)	500 V AC	
Pollution degree	3	
Rated impulse withstand voltage (U _{imp})	6 kV	
Thermal tripping	Reference temperature	50 °C
	Temperature derating	See the Technical Guide
Magnetic tripping	B curve	4 I _n ± 20 %
	C curve	8 I _n ± 20 %
	D curve	12 I _n ± 20 %
Utilization category	A	

According to IEC/EN 60898-1

Limitation class	3
Rated making and breaking capacity of an individual pole (I _{cn1})	I _{cn1} = I _{cn}

Additional characteristics

Breaking capacity under 1 pole with IT 380-415 V isolated neutral system (case of double fault)	40 A	4 kA
	50/63 A	3 kA
Degree of protection (IEC 60529)	Device only	IP20
	Device in modular enclosure	IP40
Endurance (O-C)	Electrical	10,000 cycles
	Mechanical	20,000 cycles
Overvoltage category (IEC 60364)	IV	
Operating temperature	-35°C to +70°C	
Storage temperature	-40°C to +85°C	
Tropicalization (IEC 60068-1)	Treatment 2 (relative humidity 95 % to 55°C)	

iC60H circuit breakers (curve B, C, D) (cont.)

Weight (g)

Circuit-breaker	
Type	Disbo iC60H
1P	125
2P	250
3P	375
4P	500

A

Dimensions (mm)

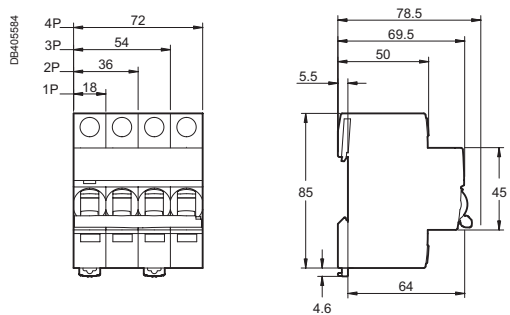

iC60L circuit breakers (curve B, C, K, Z)



IEC/EN 60947-2 IEC/EN 60898-1 up to 40 A

- iC60L circuit breakers are multi-standard circuit breakers which combine the following functions:
 - circuit protection against short-circuit currents,
 - circuit protection against overload currents,
 - suitable for industrial isolation according to IEC/EN 60947-2, standard.
 - fault tripping indication by a red mechanical indicator in circuit breaker front face.

Alternating current (AC) 50/60 Hz

Breaking capacity (Icu) according to IEC/EN 60947-2

	Voltage (Ue)				Service breaking capacity (Ics)
	12 to 133 V	220 to 240 V	380 to 415 V	440 V	
Ph/Ph (2P, 3P, 4P)	12 to 60 V	100 to 133 V	220 to 240 V	-	100 % of Icu
Ph/N (1P)	100 to 133 V	220 to 240 V	-	-	
Rating (In)	0.5 to 4 A	100 kA	100 kA	70 kA	
	6 to 25 A	70 kA	25 kA	20 kA	
	32 / 40 A	70 kA	20 kA	15 kA	50 % of Icu
	50 / 63 A	70 kA	15 kA	10 kA	50 % of Icu

Breaking capacity (Icn) according to IEC/EN 60898-1

	Voltage (Ue)
Ph/Ph	400 V
Ph/N	230 V
Rating (In)	0.5 to 40 A
	15000 A

Direct current (DC)

Breaking capacity (Icu) according to IEC/EN 60947-2

	Voltage (Ue)				Service breaking capacity (Ics)
	12 to 48 V	72 V	100 to 144 V	220 to 250 V	
Between +/-	1P	2P (in series)	3P (in series)	4P (in series)	100 % of Icu
Number of poles	1P	2P (in series)	3P (in series)	4P (in series)	
Rating (In)	1 to 63 A	25 kA	15 kA	15 kA	

Catalogue numbers

iC60L circuit breaker

Type	1P	2P						
Auxiliaries	See pages E-2 and F-2	See pages E-2 and F-2						
Vigi iC60	See page B-17	See page B-17						
Rating (In)	Curve				Curve			
	B	C	K	Z	B	C	K	Z
0.5 A	A9F93170	A9F94170	A9F95170	A9F92170	A9F93270	A9F94270	A9F95270	A9F92270
1 A	A9F93101	A9F94101	A9F95101	A9F92101	A9F93201	A9F94201	A9F95201	A9F92201
1.6 A	-	-	A9F95172	A9F92172	-	-	A9F95272	A9F92272
2 A	A9F93102	A9F94102	A9F95102	A9F92102	A9F93202	A9F94202	A9F95202	A9F92202
3 A	A9F93103	A9F94103	A9F95103	A9F92103	A9F93203	A9F94203	A9F95203	A9F92203
4 A	A9F93104	A9F94104	A9F95104	A9F92104	A9F93204	A9F94204	A9F95204	A9F92204
6 A	A9F93106	A9F94106	A9F95106	A9F92106	A9F93206	A9F94206	A9F95206	A9F92206
10 A	A9F93110	A9F94110	A9F95110	A9F92110	A9F93210	A9F94210	A9F95210	A9F92210
16 A	A9F93116	A9F94116	A9F95116	A9F92116	A9F93216	A9F94216	A9F95216	A9F92216
20 A	A9F93120	A9F94120	A9F95120	A9F92120	A9F93220	A9F94220	A9F95220	A9F92220
25 A	A9F93125	A9F94125	A9F95125	A9F92125	A9F93225	A9F94225	A9F95225	A9F92225
32 A	A9F93132	A9F94132	A9F95132	A9F92132	A9F93232	A9F94232	A9F95232	A9F92232
40 A	A9F93140	A9F94140	A9F95140	A9F92140	A9F93240	A9F94240	A9F95240	A9F92240
50 A	A9F93150	A9F94150	A9F95150 ⁽³⁾	A9F92150	A9F93250	A9F94250	A9F95250	A9F92250
63 A	A9F93163	A9F94163	A9F95163 ⁽³⁾	A9F92163	A9F93263	A9F94263	A9F95263	A9F92263
Width in 9-mm modules	2				4			
Accessories	See pages E-2 and E-10				See pages E-2 and E-10			

(1) 100 % of Icu for ratings 6 to 25 A under Ue 100 to 133 V AC Ph/Ph and Ue 12 to 60 V AC Ph/N.

(2) Information to be provided by the country.

(3) Without approval.

iC60L circuit breakers (curve B, C, K, Z) (cont.)

PB 104436-40

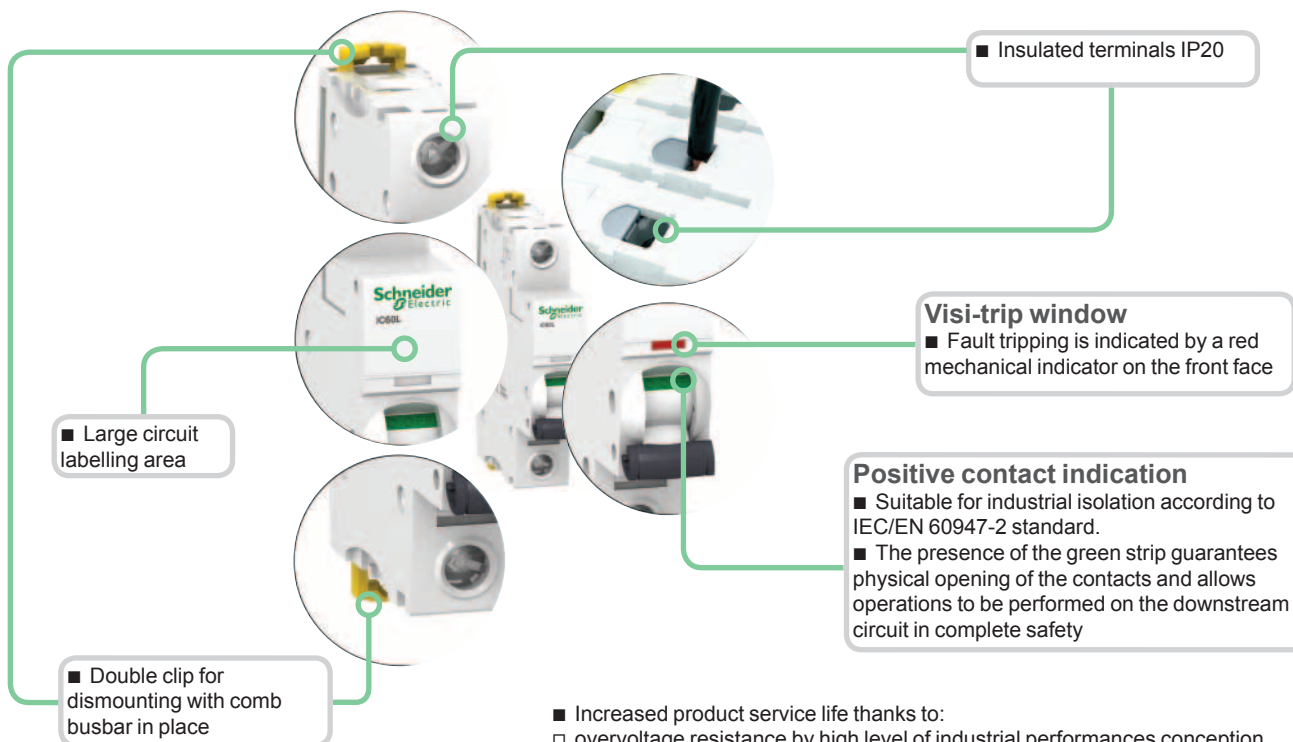

- Increased product service life thanks to:
 - overvoltage resistance by high level of industrial performances conception (pollution degree, rated impulse withstand voltage and insulation voltage),
 - high performance limitation (see limitation curves),
 - fast closing independent of the speed of actuation of the toggle.
- Remote indication, open/closed/tripped, by optional auxiliary contacts.
- Top or bottom electrical feeding.

3P				4P			
See pages E-2 and F-2				See pages E-2 and F-2			
See page B-17				See page B-17			
Curve				Curve			
B	C	K	Z	B	C	K	Z
A9F93370	A9F94370	A9F95370	A9F92370	A9F93470	A9F94470	A9F95470	A9F92470
A9F93301	A9F94301	A9F95301	A9F92301	A9F93401	A9F94401	A9F95401	A9F92401
-	-	A9F95372	A9F92372	-	-	A9F95472	A9F92472
A9F93302	A9F94302	A9F95302	A9F92302	A9F93402	A9F94402	A9F95402	A9F92402
A9F93303	A9F94303	A9F95303	A9F92303	A9F93403	A9F94403	A9F95403	A9F92403
A9F93304	A9F94304	A9F95304	A9F92304	A9F93404	A9F94404	A9F95404	A9F92404
A9F93306	A9F94306	A9F95306	A9F92306	A9F93406	A9F94406	A9F95406	A9F92406
A9F93310	A9F94310	A9F95310	A9F92310	A9F93410	A9F94410	A9F95410	A9F92410
A9F93316	A9F94316	A9F95316	A9F92316	A9F93416	A9F94416	A9F95416	A9F92416
A9F93320	A9F94320	A9F95320	A9F92320	A9F93420	A9F94420	A9F95420	A9F92420
A9F93325	A9F94325	A9F95325	A9F92325	A9F93425	A9F94425	A9F95425	A9F92425
A9F93332	A9F94332	A9F95332	A9F92332	A9F93432	A9F94432	A9F95432	A9F92432
A9F93340	A9F94340	A9F95340	A9F92340	A9F93440	A9F94440	A9F95440	A9F92440
A9F93350	A9F94350	A9F95350	A9F92350	A9F93450	A9F94450	A9F95450	A9F92450
A9F93363	A9F94363	A9F95363	A9F92363	A9F93463	A9F94463	A9F95463	A9F92463
4				6			
See pages E-2 and E-10				See pages E-2 and E-10			

iC60L circuit breakers (curve B, C, K, Z) (cont.)

Connection

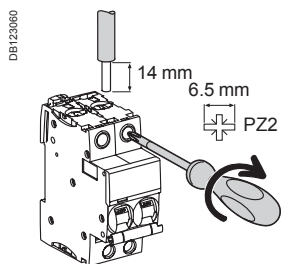

Rating	Tightening torque	Without accessory		With accessories		
		Rigid	Flexible or ferrule	50 mm ² Al terminal	Screw-on connection for ring terminal	Multi-cables terminal
		DB122945	DB122946	DB122935	DB118789	DB118787
0.5 to 25 A	2 N.m	1 to 25 mm ²	1 to 16 mm ²	-	Ø 5 mm	-
32 to 63 A	3.5 N.m	1 to 35 mm ²	1 to 25 mm ²	50 mm ²	-	3 x 16 mm ² / 3 x 10 mm ²

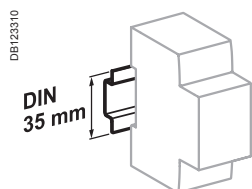

Clip on DIN rail 35 mm.

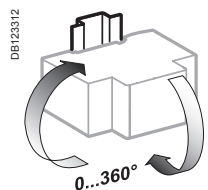

Indifferent position of installation.

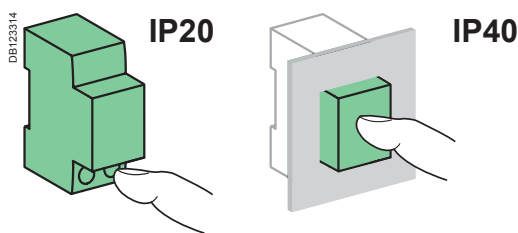

Technical data

Main characteristics

According to IEC/EN 60947-2

Insulation voltage (U _i)	500 V AC
Pollution degree	3
Rated impulse withstand voltage (U _{imp})	6 kV
Thermal tripping	Reference temperature 50 °C
	Temperature derating See the Technical Guide
Magnetic tripping	B curve 4 I _n ± 20 %
	C curve 8 I _n ± 20 %
	K curve 12 I _n ± 20 %
	Z curve 3 I _n ± 20 %

Utilization category

A

According to IEC/EN 60898-1

Limitation class	3
Rated making and breaking capacity of an individual pole (I _{cn1})	I _{cn1} = I _{cn}

Additional characteristics

Breaking capacity under 1 pole with IT 380-415 V isolated neutral system (case of double fault)	40 A	4 kA
	50/63 A	3 kA
Degree of protection (IEC 60529)	Device only	IP20
	Device in modular enclosure	IP40
		Insulation classe II
Endurance (O-C)	Electrical	10,000 cycles
	Mechanical	20,000 cycles
Overvoltage category (IEC 60364)		IV
Operating temperature		-35°C to +70°C
Storage temperature		-40°C to +85°C
Tropicalization (IEC 60068-1)		Treatment 2 (relative humidity 95 % to 55°C)

iC60L circuit breakers (curve B, C, K, Z) (cont.)

Weight (g)

Circuit-breaker	
Type	iC60L
1P	125
2P	250
3P	375
4P	500

A

Dimensions (mm)

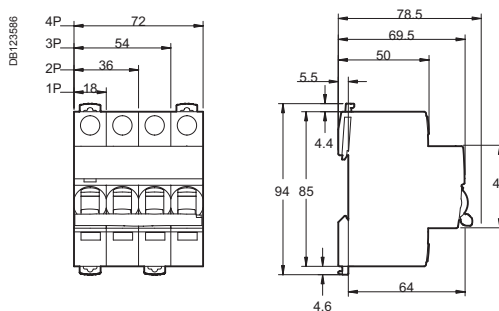

C120N circuit breakers (curves B, C, D)

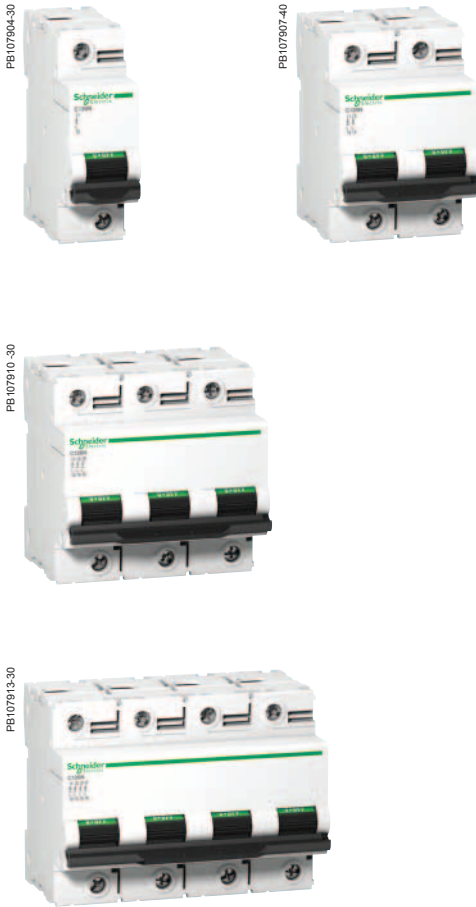

IEC/EN 60898-1, IEC 60947-2

C120N circuit breakers are multistandard circuit breakers that combine the following functions:

- circuit protection against short-circuit currents,
- circuit protection against overload currents,
- suitability for isolation in the industrial sector to IEC/EN 60947-2,
- fault tripping and indication by adding auxiliaries.

Alternating current (AC) 50/60 Hz

Breaking capacity (Icu) to IEC/EN 60947-2						Service breaking capacity (Ics)
Type	Voltage (V)					
1P	130 V	220 to 240 V	380 to 415 V	440 V		
Rating (In)	63 to 125 A	20 kA	10 kA	3 kA ⁽¹⁾	-	75 % Icu
2P/3P/4P	130 V	220 to 240 V	380 to 415 V	440 V		
	63 to 125 A	-	20 kA	10 kA	6 kA	75 % Icu

Breaking capacity (Icn) to IEC/EN 60898-1		
Type	Voltage (V)	
1P, 2P, 3P, 4P	230 to 400 V	
Rating (In)	63 to 125 A	10000 A
		75 % Icn



⁽¹⁾ One-pole breaking capacity in IT isolated neutral system (double fault).

Direct current (DC)

Breaking capacity (Icu) to IEC/EN 60947-2					Service breaking capacity (Ics)
Type	Voltage (V)				
1P	24/48 V	125 V	250 V		
Rating (In)	63 to 125 A	10 kA	10 kA	-	100 % Icu
2P (in series)	24/48 V	125 V	250 V		
	63 to 125 A	-	-	10 kA	100 % Icu

Catalogue numbers

C120N circuit breaker

Type	1P			2P		
						
Auxiliaries	See pages E-7 and F-9			See pages E-7 and F-9		
Vigi C120	See page B-22			See page B-22		
Rating (In)	Curve			Curve		
	B	C	D	B	C	D
63 A	A9N18340	A9N18356	A9N18378	A9N18344	A9N18360	A9N18382
80 A	A9N18341	A9N18357	A9N18379	A9N18345	A9N18361	A9N18383
100 A	A9N18342	A9N18358	A9N18380	A9N18346	A9N18362	A9N18384
125 A	A9N18343	A9N18359	A9N18381	A9N18347	A9N18363	A9N18385
Width in 9-mm modules	3			6		
Accessories	See pages E-7 and E-15			See pages E-7 and E-15		

⁽¹⁾ Country France only

C120N circuit breakers (curves B, C, D) (cont.)

PB107907-40

■ Terminals insulated to IP20

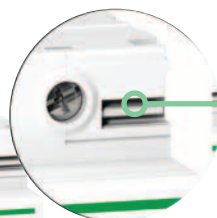
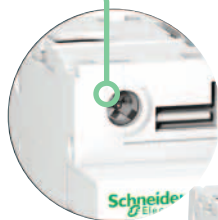

■ Location for 4 clip-on terminal markers



Positive contact indication

- Suitability for isolation in the industrial sector to IEC/EN 60947-2.
- The presence of the green strip guarantees that the contacts open physically and allows work to be carried out safely on the downstream circuit.

- Longer product service life thanks to:
 - good overvoltage withstand capacity: products designed to offer a high industrial performance level (degree of pollution, rated impulse withstand voltage and insulation voltage).
 - high limitation performances (see limitation curves).
 - fast closure independent of toggle operating speed.
- Remote indication of the open/closed/tripped state by auxiliary contacts (optional).
- Power supply from above or below.

A

3P			4P		
See pages E-7 and F-9			See pages E-7 and F-9		
See page B-22			See page B-22		
Curve			Curve		
B	C	D	B	C	D
A9N18348	A9N18364	A9N18386	A9N18352	A9N18371	A9N18390
A9N18349	A9N18365	A9N18387	A9N18353	A9N18372	A9N18391
A9N18350	A9N18367	A9N18388	A9N18354	A9N18373(1)	A9N18392
A9N18351	A9N18369	A9N18389	A9N18355	A9N18374	A9N18393
				A9N18375(1)	
				A9N18376	
				A9N18377(1)	
9			12		
See pages E-7 and E-15			See pages E-7 and E-15		

C120N circuit breakers (curves B, C, D) (cont.)

Connection

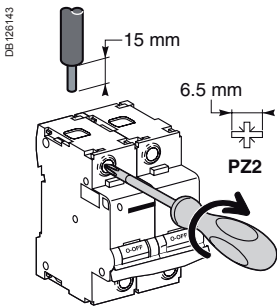

Rating	Tightening torque	Without access.		With accessories			
		Copper cables Rigid/ semi-rigid	Flexible or with ferrule	50 mm ² Al Terminal	Screw-on connection for ring terminal ⁽¹⁾	Multi-cable terminal Rigid cables	Flexible cables
63 to 125 A	3.5 N.m	1 to 50 mm ²	1.5 to 35 mm ²	16 to 50 mm ²	Ø 5 mm	3 x 16 mm ²	3 x 10 mm ²

(1) For lugs up to 63 A, front or rear access.

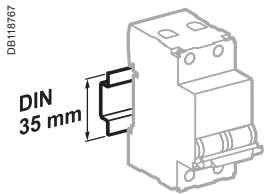

Clips onto 35 mm DIN rail.

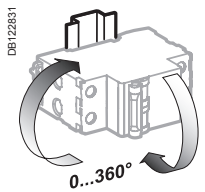

Any installation position.

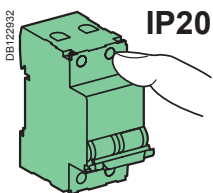

IP20

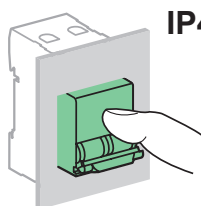

IP40

Technical data

Main characteristics		
To IEC/EN 60947-2		
Insulation voltage (U _i)		500 V AC
Degree of pollution		3
Rated impulse withstand voltage (U _{imp})		6 kV
Thermal tripping	Reference temperature	50°C
To IEC/EN 60898-1		
Magnetic tripping	Curve B	3 and 5 In
	Curve C	5 and 10 In
	Curve D	10 and 14 In
Limitation class		3
Additional characteristics		
Degree of protection (IEC 60529)	Device only	IP20
	Device in a modular enclosure	IP40
Endurance (O-C)	Electrical	63 A
		80...125 A
	Mechanical	20000 cycles
Operating temperature		-30°C to +70°C
Storage temperature		-40°C to +80°C
Tropicalisation (IEC 60068-1)		Treatment 2 (relative humidity 95 % at 55°C)

Weight (g)

Circuit breaker	
Type	C120N
1P	205
2P	410
3P	615
4P	820

Dimensions (mm)

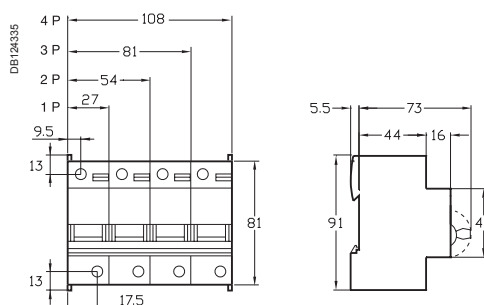

C120H circuit breakers (curves B, C, D)



IEC/EN 60898-1, IEC 60947-2

C120H circuit breakers are multistandard circuit breakers that combine the following functions:

- circuit protection against short-circuit currents
- circuit protection against overload currents
- suitability for isolation in the industrial sector to IEC/EN 60947-2
- fault tripping and indication by adding auxiliaries.

Alternating current (AC) 50/60 Hz

Breaking capacity (Icu) to IEC/EN 60947-2					Service breaking capacity (Ics)
Type	Voltage (V)				
1P	130 V	220 to 240 V	380 to 415 V	440 V	50 % Icu
Rating (In) 63 to 125 A	30 kA	15 kA	4,5 kA ⁽¹⁾	-	
2P, 3P, 4P	130 V	220 to 240 V	380 to 415 V	440 V	50 % Icu
63 to 125 A	-	30 kA	15 kA	10 kA	

Breaking capacity (Icn) to IEC/EN 60898-1

Type	Voltage (V)		Service breaking capacity (Ics)
1P, 2P, 3P, 4P	230 to 400 V		
Rating (In) 63 to 125 A	15000 A		

⁽¹⁾ One-pole breaking capacity in IT isolated neutral system (double fault).

Direct current (DC)

Breaking capacity (Icu) to IEC/EN 60947-2				Service breaking capacity (Ics)
Type	Voltage (V)			
1P	24/48 V	125 V	250 V	100 % Icu
Rating (In) 63 to 125 A	15 kA	15 kA	-	
2P (in series)	24/48 V	125 V	250 V	100 % Icu
63 to 125 A	-	-	15 kA	

Catalogue numbers

C120H circuit breaker

Type	1P	2P
Auxiliaries	See pages E-7 and F-9	See pages E-7 and F-9
Vigi C120	See page B-22	See page B-22
Rating (In)	Curve	Curve
	B C D	B C D
63 A	A9N18401 A9N18445 A9N18489	A9N18412 A9N18456 A9N18500
80 A	A9N18402 A9N18446 A9N18490	A9N18413 A9N18457 A9N18501
100 A	A9N18403 A9N18447 A9N18491	A9N18414 A9N18458 A9N18502
125 A	A9N18404 A9N18448 A9N18492	A9N18415 A9N18459 A9N18503
Width in 9 mm modules	3	6
Accessories	See pages E-7 and E-15	See pages E-7 and E-15

C120H circuit breakers (curves B, C, D) (cont.)

FB107806-40

■ Terminals insulated to IP20



■ Location for 4 clip-on terminal markers

Positive contact indication

- Suitability for isolation in the industrial sector to IEC/EN 60947-2.
- The presence of the green strip guarantees that the contacts open physically and allows work to be carried out safely on the downstream circuit.

- Longer product service life thanks to:
 - good overvoltage withstand capacity: products designed to provide a high industrial performance level (degree of pollution, rated impulse withstand voltage and insulation voltage).
 - high limitation performances (see limitation curves).
 - fast closure independent of toggle operating speed.
- Remote indication of the open/closed/tripped state by auxiliary contacts (optional).
- Power supply from above or below.

3P			4P		
See pages E-7 and F-9			See pages E-7 and F-9		
See page B-22			See page B-22		
Curve			Curve		
B	C	D	B	C	D
A9N18423	A9N18467	A9N18511	A9N18434	A9N18478	A9N18522
A9N18424	A9N18468	A9N18512	A9N18435	A9N18479	A9N18523
A9N18425	A9N18469	A9N18513	A9N18436	A9N18480	A9N18524
A9N18426	A9N18470	A9N18514	A9N18437	A9N18481	A9N18525
9			12		
See pages E-7 and E-15			See pages E-7 and E-15		

C120H circuit breakers (curves B, C, D) (cont.)

Connection

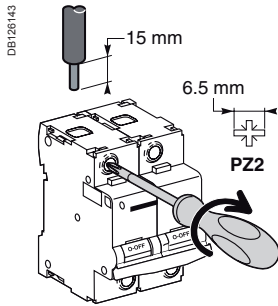

Rating	Tightening torque	Without access.		With accessories			
		Rigid	Flexible or with ferrule	50 mm ² Al term.	Screw-on connection for ring terminal ⁽¹⁾	Multi-cable terminal	
		DB122945	DB122946	Al	DB122935 DB118789	DB118787	
63 to 125 A	3.5 N.m	1 to 50 mm ²	1.5 to 35 mm ²	16 to 50 mm ²	Ø 5 mm	3 x 16 mm ²	3 x 10 mm ²

(1) For lugs up to 63 A, front or rear accessories.

A

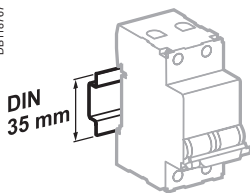

Clips onto 35 mm DIN rail.

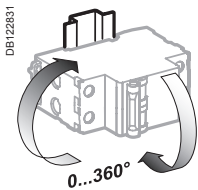

Any installation position.

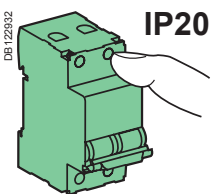

IP20

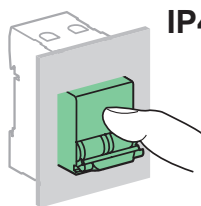

IP40

Technical data

Main characteristics

To IEC/EN 60947-2

Insulation voltage (U _i)	500 V AC
Degree of pollution	3
Rated impulse withstand voltage (U _{imp})	6 kV
Thermal tripping	Reference temperature
	50°C

To IEC/EN 60898-1

Magnetic tripping	Curve B	3 and 5 I _n
	Curve C	5 and 10 I _n
	Curve D	10 and 14 I _n
Limitation class		3

Additional characteristics

Degree of protection (IEC 60529)	Device only	IP20	
	Device in a modular enclosure	IP40 (IPXXD)	
Endurance (O-C)	Electrical	63 A	10000 cycles (O-C)
		80...125 A	5000 cycles (O-C)
	Mechanical		20000 cycles
Operating temperature		-30°C to +70°C	
Storage temperature		-40°C to +80°C	
Tropicalisation (IEC 60068-1)		Treatment 2 (relative humidity 95% at 55°C)	

Weight (g)

Circuit breaker

Type	C120H
1P	205
2P	410
3P	615
4P	820

Dimensions (mm)

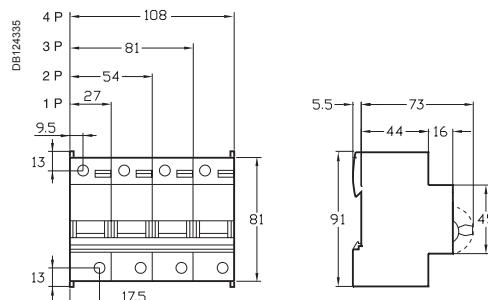

NG125 circuit breakers (curves B, C, D)

3P, 3P+N, 4P ≥ 80 A

- Voltage taps:
 - auxiliaries power supply
 - measurement
 - emergency stop
 - remote reporting

1P, 2P

- Padlocking in position:
 - O or I, manual control is inhibited, tripping is enabled

3P, 3P+N, 4P

- Integrated padlocking device

Central manual control, 3 positions:

- ON
- tripped on fault
- open

3P, 3P+N, 4P ≥ 80 A

- Cable strength:
 - ribbed cage
 - terminal depth
 - tightening by Allen hex key (NG125 ≥ 80 A)

Test button to check satisfactory operation of the tripping mechanism

Pull-out strength

- metallic lock

Impact and vibration resistance:

- high-strength enclosure
- IK 05

Electric power supply through the top or bottom

Positive contact indication:

- suitability for isolation in the industrial sector to IEC/EN 60947-2
- the presence of the green strip guarantees that the contacts open physically and allows work to be carried out safely on the downstream circuit

Longer product service life due to:

- good overvoltage withstand capacity,
- high limitation performances,
- fast closure independent of the speed of actuation of the toggle.

Circuit breaker tripped indicator

NG125

Schneider Electric

NG125

In = 63 A

In = 85 A

U = 690V

Uimp 8kV

Ue(V)	Icu(kA)
220/240 ~	70
380/415 ~	36
440 ~	30
500 ~	12

EC 947.2

18739

066618N_SE_80

DB123493

NG125a circuit breakers (curve C)



IEC/EN 60947-2

■ NG125a circuit breakers are circuit breakers which combine the following functions:

- circuit protection against short-circuit currents,
- circuit protection against overload currents,
- suitability for isolation in the industrial sector to IEC/EN 60947-2,
- tripping upon fault is indicated by a red mechanical state indicator light on the front face of the circuit breaker.



NG125a 3P



NG125a 4P

Alternating current (AC) 50/60 Hz			
Breaking capacity (I _{cu}) to IEC/EN 60947-2			Service breaking capacity (I _{cs})
Ph/Ph (3P, 4P)	Voltage (U _e)		
	380 to 415 V	500 V	75 % of I _{cu}
Rating (I _n)	80 to 125 A	16 kA / 8 kA	

Direct current (DC)			
Breaking capacity (I _{cu}) to IEC/EN 60947-2			Service breaking capacity (I _{cs})
Ph/Ph	Voltage (U _e)		
	375 V	500 V	100 % of I _{cu}
Number of poles	3P	4P	
Rating (I _n)	80 to 125 A	20 kA / 20 kA	

Catalogue numbers

NG125a circuit breaker			
Type	3P		4P
Auxiliaries	See page B-27 and F-14		
Rating (I _n)	Quality label ⁽¹⁾	Curve C	Curve C
80 A		18603	18607
100 A		18604	18608
125 A		18605	18609
Width in 9 mm modules		9	12
Accessories	see page E-26		

(1) Information to be supplied by the country concerned.

NG125a circuit breakers (curve C) (cont.)

Connection

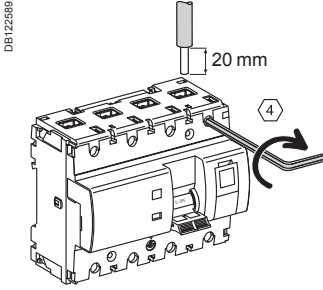

Rating	Tightening torque	Without accessories		With accessories				
		Copper cables		70 mm ² Al terminal	Screw-on connection for ring terminal	Small ring terminal	Multi-cable terminal	
		Rigid	Flexible or with ferrule				Rigid cables	Flexible cables
80 to 125 A	6 N.m	DB122945 	DB122946 	DB123410 	DB123488 	DB118789 	DB118787 	
		16 to 70 mm ²	10 to 50 mm ²	25 to 70 mm ²	2 x 35 mm ² 1 x 50 mm ²	1 x 70 mm ²	3 x 16 mm ²	3 x 10 mm ²

■ Upstream voltage taps for each pole, by 6.35 mm Fast-on terminal.

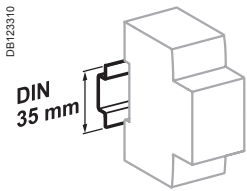

Clips on to 35 mm DIN rail.

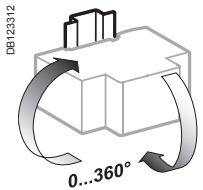

Any installation position.

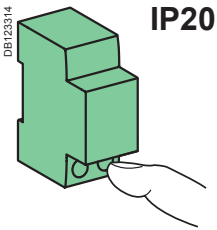

IP20

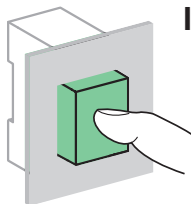

IP40

Technical data

Main characteristics

According to IEC/EN 60947-2

Insulation voltage (U _i)	690 V AC	
Degree of pollution	3	
Rated impulse withstand voltage (U _{imp})	8 kV	
Thermal tripping	Reference temperature	40°C
Magnetic tripping (I _i)	Curve C	8 I _n ± 20 %
Utilization category		A

Additional characteristics

Degree of protection (IEC 60529)	Device only	IP20
	Device in modular enclosure	IP40
Endurance (O-C)	Electrical	5000 cycles
	Mechanical	20,000 cycles
Operating temperature		-30°C to +70°C
Storage temperature		-40°C to +70°C
Tropicalization (IEC 60068-1)		Treatment 2 (relative humidity of 95 % at 55°C)

Weight (g)

Circuit breaker

Type	NG125a
3P	720
4P	960

Dimensions (mm)

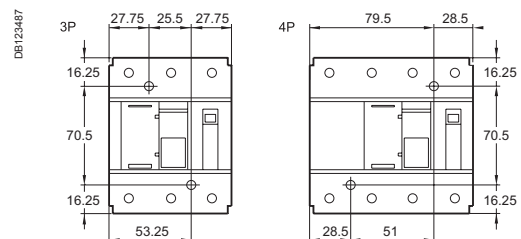
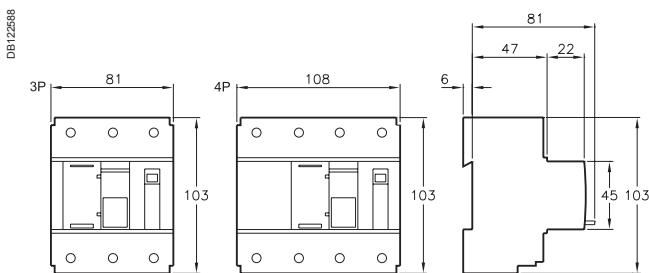

Spacing for mounting on panel

NG125N circuit breakers (curves B, C, D) (cont.)



IEC/EN 60947-2

■ NG125N circuit breakers are circuit breakers which combine the following functions:

- circuit protection against short-circuit currents,
- circuit protection against overload currents,
- suitability for isolation in the industrial sector to IEC/EN 60947-2,
- tripping upon fault is indicated by a red mechanical state indicator light on the front face of the circuit breaker.

A



NG125N 1P



NG125N 2P



NG125N 3P



NG125N 4P

Alternating current (AC) 50/60 Hz										
Breaking capacity (Icu) to IEC/EN 60947-2										
Voltage (Ue)										
Ph/Ph (2P, 3P, 3P+N, 4P)	-	-	220 to 240 V	-	380 to 415 V	440 V	500 V	Service breaking capacity (Ics)		
Ph/N (1P)	110 to 130 V	220 to 240 V	-	380 to 415 V	-	-	-			
Rating (In)	10 to 125 A	50 kA	25 kA	50 kA	6 kA ⁽²⁾	25 kA	20 kA			10 kA
75 % of Icu										

Direct current (DC)					
Breaking capacity (Icu) to IEC/EN 60947-2					
Voltage (Ue)					
Ph/Ph (2P, 3P, 3P+N, 4P)	-	-	250 V	500 V	Service breaking capacity (Ics)
Ph/N (1P)	60 V	125 V	-	-	
Number of poles	1P	1P	2P	4P	
Rating (In)	10 to 125 A	25 kA	25 kA	25 kA	
100 % of Icu					

Catalogue numbers

NG125N circuit breaker										
Type	1P	2P	3P	3P+N	4P					
	E449002 	E449004 	E449005 	DB122692 	E449097 					
Auxiliaries	See page F-14 – Vigi NG125 add-on residual current device, see page B-27									
Rating (In)	Quality label ⁽¹⁾	Curve C	Curve C	Curve B	Curve C	Curve D	Curve C	Curve B	Curve C	Curve D
10 A		18610	18621	-	18632	-	-	-	18649	-
16 A		18611	18622	-	18633	-	-	-	18650	-
20 A		18612	18623	-	18634	-	-	-	18651	-
25 A		18613	18624	-	18635	-	-	-	18652	-
32 A		18614	18625	-	18636	-	-	-	18653	-
40 A		18615	18626	-	18637	-	-	-	18654	-
50 A		18616	18627	-	18638	-	-	-	18655	-
63 A		18617	18628	-	18639	-	-	-	18656	-
80 A		18618	18629	18663	18640	18669	18646	18666	18658	18672
100 A		-	-	18664	18642	18670	18647	18667	18660	18673
125 A		-	-	18665	18644	18671	18648	18668	18662	18674
Width in 9 mm modules	3	6	9				12	12		
Accessories	See page E-26									

(1) Information to be supplied by the country concerned.

(2) Breaking capacity under 1 pole in IT isolated neutral system (case of a double fault).

NG125N circuit breakers (curves B, C, D) (cont.)

Connection

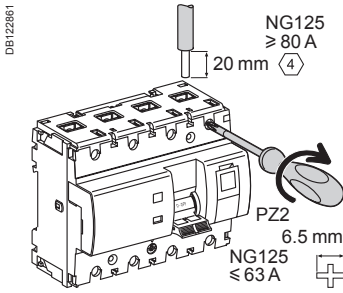

Rating	Tightening torque	Without accessories		With accessories				
		Copper cables		70 mm ² Al terminal	Screw-on connection for ring terminal	Small ring terminal	Multi-cable terminal	
		Rigid	Flexible or with ferrule				Rigid cables	Flexible cables
10 to 63 A 80 to 125 A	3.5 N.m	DB122945 1.5 to 50 mm ²	DB122946 1 to 35 mm ²	DB123410 -	DB123488 -	DB118789 -	3 x 16 mm ²	3 x 10 mm ²
	6 N.m	16 to 70 mm ²	10 to 50 mm ²	25 to 70 mm ²	2 x 35 mm ² 1 x 50 mm ²	1 x 70 mm ²		

■ On 3P, 3P+N and 4P ≥ 80 A: upstream voltage taps for each pole, by 6.35 mm Fast-on terminal.

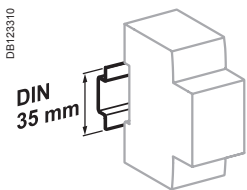

Clips on to 35 mm DIN rail.

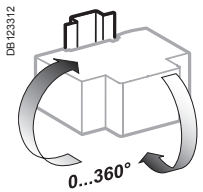

Any installation position.

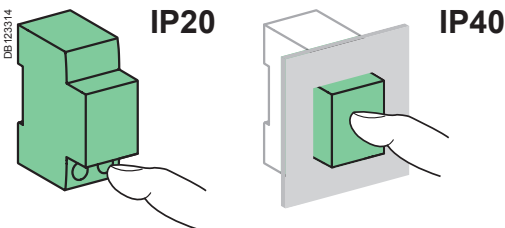

Technical data

Main characteristics		
According to IEC/EN 60947-2		
Insulation voltage (U _i)		690 V AC
Degree of pollution		3
Rated impulse withstand voltage (U _{imp})		8 kV
Thermal tripping	Reference temperature	40°C
Magnetic tripping (I _i)	Curve B	4 I _n ± 20 %
	Curve C	8 I _n ± 20 %
	Curve D	12 I _n ± 20 %
Utilization category		A
Additional characteristics		
Degree of protection (IEC 60529)	Device only	IP20
	Device in modular enclosure	IP40
Endurance (O-C)	Electrical	≤ 63 A: 10,000 cycles ≥ 63 A: 5000 cycles
	Mechanical	20,000 cycles
Operating temperature		-30°C to +70°C
Storage temperature		-40°C to +70°C
Tropicalization (IEC 60068-1)		Treatment 2 (relative humidity of 95 % at 55°C)

Dimensions (mm)

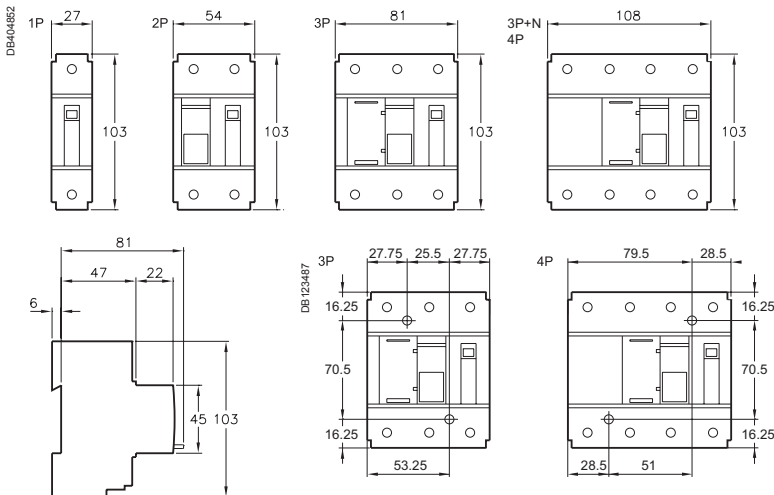

Spacing for mounting on panel

Weight (g)

Circuit breaker	
Type	NG125N
1P	240
2P	480
3P	720
3P+N	960
4P	960

NG125H circuit breakers (curve C)



IEC/EN 60947-2

■ NG125H circuit breakers are circuit breakers which combine the following functions:

- circuit protection against short circuit currents,
- circuit protection against overload currents,
- suitability for isolation in the industrial sector to IEC/EN 60947-2,
- tripping upon fault is indicated by a red mechanical state indicator light on the front face of the circuit breaker.



NG125H 1P



NG125H 2P



NG125H 3P



NG125H 4P

Alternating current (AC) 50/60 Hz							
Breaking capacity (Icu) to IEC/EN 60947-2							Service breaking capacity (Ics)
Ph/Ph (2P, 3P, 4P)	Voltage (Ue)						
	-	-	220 to 240 V	-	380 to 415 V	440 V	500 V
Ph/N (1P)	110 to 130 V	220 to 240 V	-	380 to 415 V	-	-	-
Rating (In)	10 to 80 A	70 kA	36 kA	70 kA	9 kA ⁽²⁾	36 kA	30 kA
						12 kA	75 % of Icu

Direct current (DC)				
Breaking capacity (Icu) to IEC/EN 60947-2				Service breaking capacity (Ics)
Ph/Ph (2P, 3P, 3P+N, 4P)	Voltage (Ue)			
	-	-	250 V	500 V
Ph/N (1P)	60 V	125 V	-	-
Number of poles	1P	1P	2P	4P
Rating (In)	10 to 80 A	36 kA	36 kA	36 kA
				100 % of Icu

Catalogue numbers

NG125H circuit breaker				
Type	1P	2P	3P	4P
	E46902 1 * 2	E46904 1 3 * * 2 4	E46905 1 3 5 * * * 2 4 6	E46907 1 3 5 7 * * * * 2 4 6 8
Auxiliaries	See page F-14 – Vigi NG125 add-on residual current device, see page B-27			
Rating (In)	Quality label ⁽¹⁾	Curve C	Curve C	Curve C
10 A		18705	18714	18723
16 A		18706	18715	18724
20 A		18707	18716	18725
25 A		18708	18717	18726
32 A		18709	18718	18727
40 A		18710	18719	18728
50 A		18711	18720	18729
63 A		18712	18721	18730
80 A		18713	18722	18731
Width in 9 mm modules		3	6	9
Accessories	See page E-26			

(1) Information to be supplied by the country concerned.

(2) Breaking capacity under 1 pole in IT isolated neutral system (case of a double fault).

NG125H circuit breakers (curve C) (cont.)

Connection

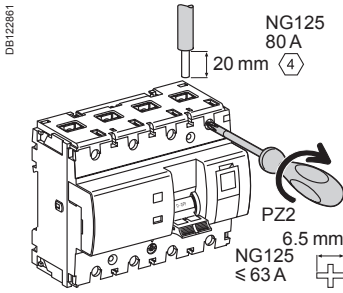

Rating	Tightening torque	Without accessories		With accessories			Multi-cable terminal	
		Copper cables		70 mm ² Al terminal	Screw-on connection for ring terminal	Small ring terminal	Rigid cables	Flexible cables
		Rigid	Flexible or with ferrule					
		DB122945	DB122946	DB123410	DB123488	DB118789	DB118787	
		1.5 to 50 mm ²	1 to 35 mm ²	-	-	-	3 x 16 mm ²	3 x 10 mm ²
10 to 63 A	3.5 N.m							
80 A	6 N.m	16 to 70 mm ²	10 to 50 mm ²	25 to 70 mm ²	2 x 35 mm ² 1 x 50 mm ²	1 x 70 mm ²		

■ On 3P and 4P 80 A: upstream voltage taps for each pole, by 6.35 mm Fast-on terminal.

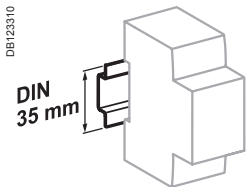

Clips on to 35 mm DIN rail.

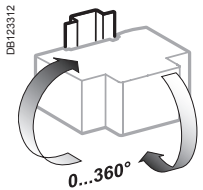

Any installation position.

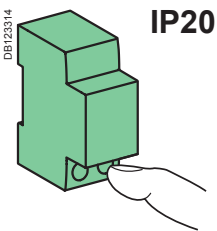

IP20

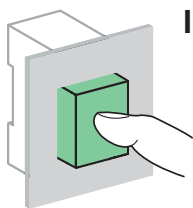

IP40

Technical data

Main characteristics

According to IEC/EN 60947-2

Insulation voltage (U _i)	690 V AC
Degree of pollution	3
Rated impulse withstand voltage (U _{imp})	8 kV
Thermal tripping	Reference temperature
	40°C
Magnetic tripping (I _i)	Curve C
	8 I _n ± 20 %
Utilization category	A

Additional characteristics

Degree of protection (IEC 60529)	Device only	IP20
	Device in modular enclosure	IP40 Insulation class II
Endurance (O-C)	Electrical	≤ 63 A: 10,000 cycles ≥ 63 A: 5000 cycles
	Mechanical	20,000 cycles
Operating temperature		-30°C to +70°C
Storage temperature		-40°C to +70°C
Tropicalization (IEC 60068-1)		Treatment 2 (relative humidity of 95 % at 55°C)

Dimensions (mm)

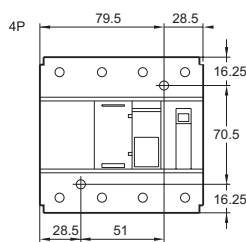
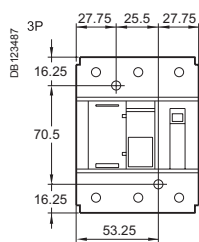
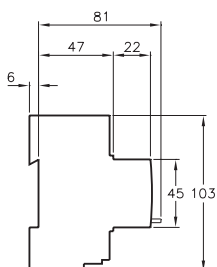
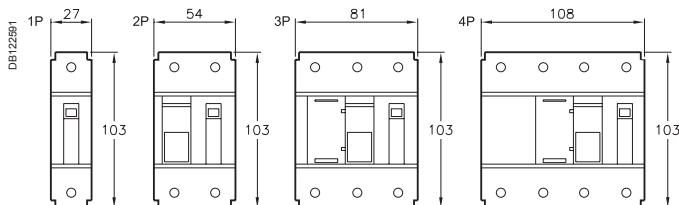

Spacing for mounting on panel

Weight (g)

Circuit breaker	
Type	NG125H
1P	240
2P	480
3P	720
4P	960

NG125L circuit breakers (curves B, C, D)



IEC/EN 60947-2

■ NG125L circuit breakers are circuit breakers which combine the following functions:

- circuit protection against short-circuit currents;
- circuit protection against overload currents;
- suitability for isolation in the industrial sector to IEC/EN 60947-2;
- tripping upon fault is indicated by a red mechanical state indicator light on the front face of the circuit breaker.



NG125L 1P



NG125L 2P



NG125L 3P



NG125L 4P

Alternating current (AC) 50/60 Hz							
Breaking capacity (I _{cu}) to IEC/EN 60947-2							
Ph/Ph (2P, 3P, 4P)	Voltage (U _e)						Service breaking capacity (I _{cs})
	-	-	220 to 240 V	-	380 to 415 V	440 V 500 V	
Ph/N (1P)	110 to 130 V	220 to 240 V	-	380 to 415 V	-	-	-
Rating (In)	10 to 80 A	100 kA 50 kA	100 kA	12.5 kA ⁽²⁾ 50 kA	40 kA	15 kA	75 % of I _{cu}

Direct current (DC)							
Breaking capacity (I _{cu}) to IEC/EN 60947-2							
Ph/Ph (2P, 3P, 3P+N, 4P)	Voltage (U _e)				Service breaking capacity (I _{cs})		
	-	-	250 V	500 V			
Ph/N (1P)	60 V	125 V	-	-	-		
Number of poles	1P	1P	2P	4P	-		
Rating (In)	10 to 80 A	50 kA	50 kA	50 kA	50 kA	100 % of I _{cu}	

Catalogue numbers

NG125L circuit breaker														
Type	1P			2P			3P			4P				
Auxiliaries	See page F-14 – Vigi NG125 add-on residual current device, see page B-27													
Rating (In)	Quality label (1)	Curve			Curve			Curve			Curve			
		B	C	D	B	C	D	B	C	D	B	C	D	
10 A		18741	18777	18830	18750	18788	18839	18759	18799	18848	18768	18821	18857	
16 A		18742	18778	18831	18751	18789	18840	18760	18800	18849	18769	18822	18858	
20 A		18743	18779	18832	18752	18790	18841	18761	18801	18850	18770	18823	18859	
25 A		18744	18780	18833	18753	18791	18842	18762	18802	18851	18771	18824	18860	
32 A		18745	18781	18834	18754	18792	18843	18763	18803	18852	18772	18825	18861	
40 A		18746	18782	18835	18755	18793	18844	18764	18804	18853	18773	18826	18862	
50 A		18747	18783	18836	18756	18794	18845	18765	18805	18854	18774	18827	18863	
63 A		18748	18784	18837	18757	18795	18846	18766	18806	18855	18775	18828	18864	
80 A		18749	18785	18838	18758	18796	18847	18767	18807	18856	18776	18829	18865	
Width in 9 mm modules		3			6			9			12			
Accessories	See page E-26													

(1) Information to be supplied by the country concerned.

(2) Breaking capacity under 1 pole in IT isolated neutral system (case of a double fault).

NG125L circuit breakers (curves B, C, D) (cont.)

Connection

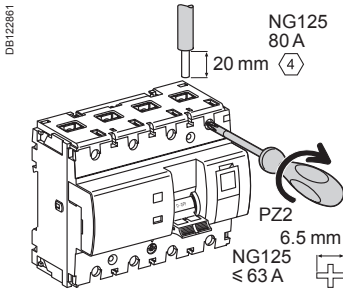

Rating	Tightening torque	Without accessories		With accessories			Multi-cable terminal	
		Copper cables		70 mm ² Al terminal	Screw-on connection for ring terminal	Small ring terminal	Rigid cables	Flexible cables
		Rigid	Flexible or with ferrule					
10 to 63 A 80 A	3.5 N.m	DB122945 1.5 to 50 mm ²	DB122946 1 to 35 mm ²	-	-	-	3 x 16 mm ²	3 x 10 mm ²
	6 N.m	16 to 70 mm ²	10 to 50 mm ²	25 to 70 mm ²	2 x 35 mm ² 1 x 50 mm ²	1 x 70 mm ²		

■ On 3P and 4P 80 A: upstream voltage taps for each pole, by 6.35 mm Fast-on terminal.

Technical data

Main characteristics		
According to IEC/EN 60947-2		
Insulation voltage (U _i)		690 V AC
Degree of pollution		3
Rated impulse withstand voltage (U _{imp})		8 kV
Thermal tripping	Reference temperature	40°C
Magnetic tripping (I _i)	Curve B	4 I _n ± 20 %
	Curve C	8 I _n ± 20 %
	Curve D	12 I _n ± 20 %
Utilization category		A
Additional characteristics		
Degree of protection (IEC 60529)	Device only	IP20
	Device in modular enclosure	IP40
Endurance (O-C)	Electrical	≤ 63 A: 10,000 cycles
		≥ 63 A: 5000 cycles
	Mechanical	20,000 cycles
Operating temperature		-30°C to +70°C
Storage temperature		-40°C to +70°C
Tropicalization (IEC 60068-1)		Treatment 2 (relative humidity of 95 % at 55°C)

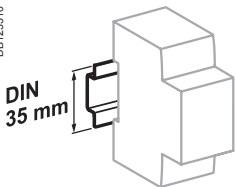

Clips on to 35 mm DIN rail.

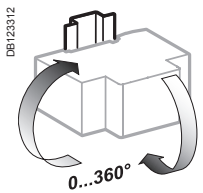

Any installation position.

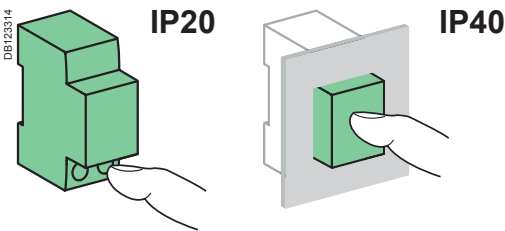

Dimensions (mm)

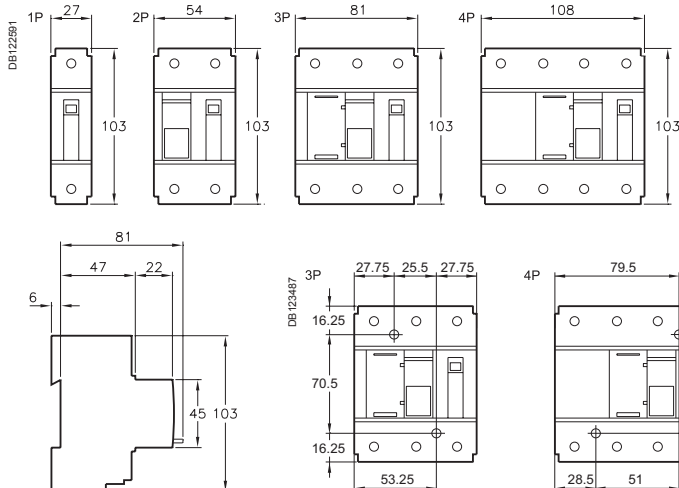

Spacing for mounting on panel

Weight (g)

Circuit breaker	
Type	NG125L
1P	240
2P	480
3P	720
4P	960



PB107193-34-eps



PB107194-34-eps



IEC/EN 60947-2

The C60H-DC supplementary protectors are used in direct current circuits (Industrial control and automations, transport, renewable energy...). They combine the following functions of circuit protection against short-circuit and overload currents, control and isolation.



Direct current (DC)						
Breaking capacity (Icu) according to IEC/EN 60947-2						Rated service breaking capacity (Ics)
Type	110 V	220 V	250 V	440 V	500 V	
1P	20 kA	10 kA	6 kA	-	-	75 % Icu
Rating (In)	0.5 to 63 A					
2P (in series)	20 kA	10 kA	6 kA	-	-	75 % Icu
Rating (In)	0.5 to 63 A					

Catalogue numbers

C60H-DC		
Type	1P	2P
	<p>Supply from above or below, observing the polarity</p>	<p>Supply from above</p> <p>Supply from below</p>
Auxiliaries	See page F-9	
Rating (In)	Courbe C	Courbe C
0.5 A	A9N61500	A9N61520
1 A	A9N61501	A9N61521
2 A	A9N61502	A9N61522
3 A	A9N61503	A9N61523
4 A	A9N61504	A9N61524
5 A	A9N61505	A9N61525
6 A	A9N61506	A9N61526
10 A	A9N61508	A9N61528
13 A	A9N61509	A9N61529
15 A	A9N61510	A9N61530
16 A	A9N61511	A9N61531
20 A	A9N61512	A9N61532
25 A	A9N61513	A9N61533
30 A	A9N61514	A9N61534
32 A	A9N61515	A9N61535
40 A	A9N61517	A9N61537
50 A	A9N61518	A9N61538
63 A	A9N61519	A9N61539
Number of modules of 9 mm	2	4
Accessories	See pages E-8 and E-15	

Connection

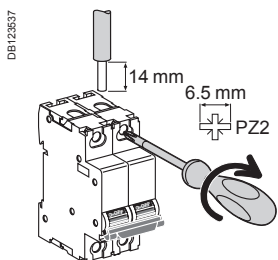

Rating	Tightening torque	Without accessory		With accessories				
		Copper cables		50 mm ² Al terminal	Screw-on connection for ring terminal	Multi-cables terminal		
		Rigid / Stranded	Flexible or ferrule			Rigid cables	Flexible cables	
≤ 25 A	2.5 N.m	DBI122945 	DBI122946 	DBI122935 	DBI116789 	DBI116787 		
> 25 A	3.5 N.m /	1 to 25 mm ²	1 to 16 mm ²	50 mm ²	Ø 5 mm		3 x 16 mm ²	3 x 10 mm ²
		1 to 35 mm ²	1 to 25 mm ²	-				

Multi-cables connection

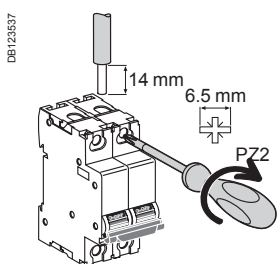

Rating	Tightening torque	Without accessory			
		2 Copper cables		3 Multi-cables / Different wires	
		Rigid / Stranded	Flexible or ferrule	Flexible / Stranded	Flexible / Stranded / Rigid
≤ 25 A	2.5 N.m	DBI122945 	DBI122946 	DBI118787 	
> 25 A	3.5 N.m	2 x 1 mm ² to 2 x 10 mm ²	2 x 1 mm ² to 2 x 16 mm ²	3 x 1 mm ²	2 x 2.5 mm ² + 1 x 1.5 mm ²
		2 x 1 mm ² to 2 x 16 mm ²		3 x 4 mm ²	2 x 10 mm ² + 1 x 6 mm ²

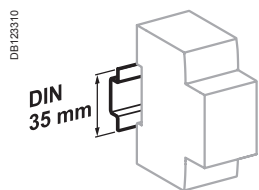

Clip on DIN rail 35 mm.

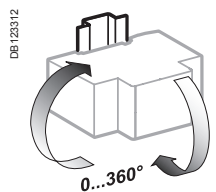

Indifferent position of installation.

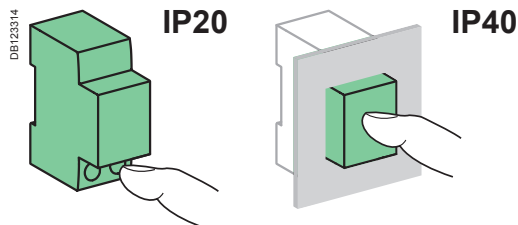

Technical data

- Tripping curves: C curve - Overcurrent protection for any type of application.
- Positive break indication - the green strip indicates that all the poles are open and allows work to be carried out on the downstream circuit in complete safety.
- Suitable for isolation as defined in IEC / EN 60947-2.
- Increase in the service life of the product: thanks to fast closure independent of the speed of action on the handle.
- Current limitation in the event of a fault: fast opening of the contacts prevents the loads from being destroyed in the event of a short-circuit.

Main characteristics		
According to IEC/EN 60947-2		
Insulation voltage (U _i)		500 V DC
Rated voltage (U _n)	1P	250 V DC
	2P	500 V DC
Pollution degree		3
Rated impulse withstand voltage (U _{imp}) under frame		6 kV
Magnetic tripping (I _i)		8.5 I _n (± 20 %) (compatible with curve C)
Additional characteristics		
Degree of protection (IEC 60529)	Device only	IP20
	Device in modular enclosure	IP40
Utilization category		A (no delay in accordance with IEC/EN 60947-2 standards)
Endurance (O-C)	Electrical	3,000 cycles (where L/R=2 ms)
	Mechanical	6,000 cycles where the circuit is resistive 20,000 cycles
Tropicalization (IEC 60068-2)		Treatment 2 (relative humidity 95 % at 55°C)
Operating temperature		-25°C to 70°C
Storage temperature		-40°C to 85°C



Failure to match polarity during connection may lead to a fire hazard and/or serious injury.

- The connection polarity must be observed (marked on the front panel).
- Use only with direct current.

Weight (g)

Circuit-breaker	
Type	C60H-DC
1P	128 g
2P	256 g

Dimensions (mm)

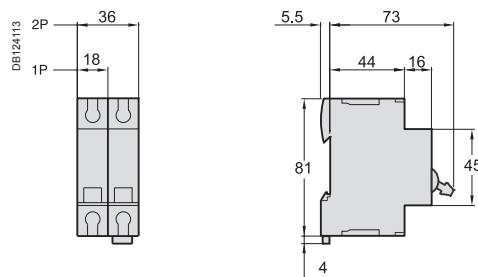

C60H-DC

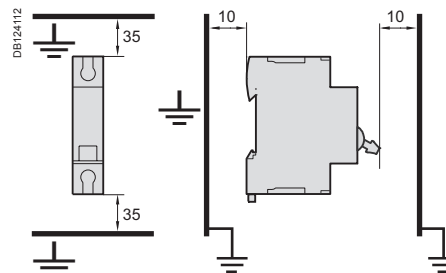

Details of minimum distance between circuit-breaker and earthed metal parts for circuit-breaker intended for use without enclosure.



iC60L circuit breakers instantaneous circuit breakers (ICB) (curve MA)

PB10434-40

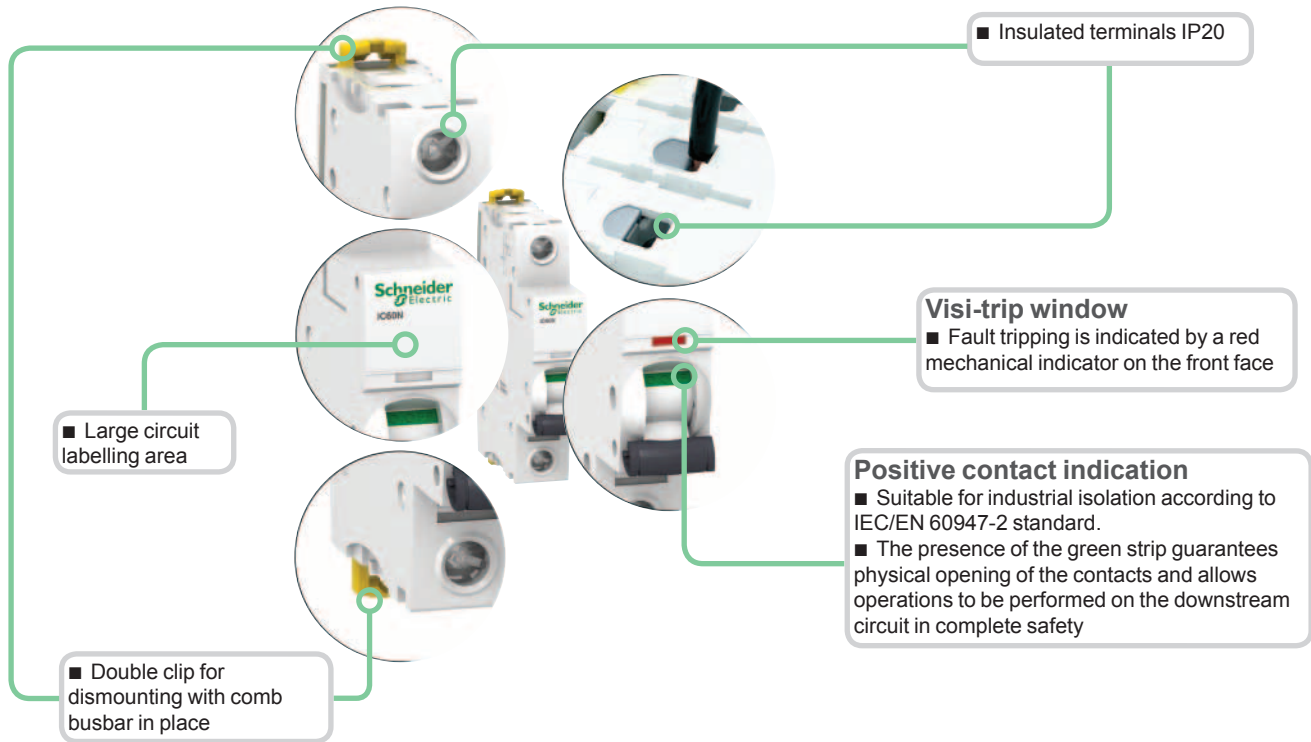

- Increased product service life thanks to:
 - overvoltage resistance by high level of industrial performances conception (pollution degree, rated impulse withstand voltage and insulation voltage),
 - high performance limitation (see limitation curves),
 - fast closing independent of the speed of actuation of the toggle.
- Remote indication, open/closed/tripped, by optional auxiliary contacts.
- Top or bottom electrical feeding.

(1) Information to be provided by the country.

iC60L circuit breakers instantaneous circuit breakers (ICB) (curve MA) (cont.)



IEC/EN 60947-2



- iC60L curve MA circuit breakers combine the following functions:
 - circuit protection against short-circuit currents,
 - suitability for industrial isolation according to IEC/EN 60947-2, standard,
 - fault tripping indication by a red mechanical indicator in circuit breaker front face,
 - to be associated with overload protection for motor.



Alternating current (AC) 50/60 Hz				
Breaking capacity (Icu) according to IEC/EN 60947-2				Service breaking capacity (Ics)
Ph/Ph (2P, 3P)	Voltage (Ue)			
	220 to 240 V	380 to 415 V	440 V	
Rating (In)	1.6 to 16 A	40 kA	20 kA	15 kA
	25 à 40 A	30 kA	15 kA	10 kA
				50 % of Icu
				50 % of Icu

Catalogue numbers

iC60L instantaneous trip circuit breaker				
Type	2P		3P	
Auxiliaries	see pages E-2 and F-2		see pages E-2 and F-2	
Vigi iC60	see page B-17		see page B-17	
Rating (In)	Quality label ⁽¹⁾	Curve MA	Curve MA	
1.6 A		A9F90272	A9F90372	
2.5 A		A9F90273	A9F90373	
4 A		A9F90204	A9F90304	
6.3 A		A9F90276	A9F90376	
10 A		A9F90210	A9F90310	
12.5 A		A9F90282	A9F90382	
16 A		A9F90216	A9F90316	
25 A		A9F90225	A9F90325	
40 A		A9F90240	A9F90340	
Width in 9-mm modules	4		6	
Accessories	See pages E-2 and E-10		See pages E-2 and E-10	

iC60L circuit breakers instantaneous circuit breakers (ICB) (curve MA) (cont.)

Connection

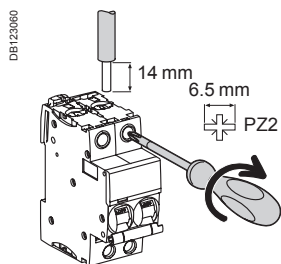

Rating	Tightening torque	Without accessory		With accessories		
		Rigid	Flexible or ferrule	50 mm ² Al terminal	Screw-on connection for ring terminal	Multi-cables terminal
1.6 to 16 A	2 N.m	DB1122945	DB1122946	DB1122945	DB1187789	DB118787
25 to 40 A	3.5 N.m	1 to 25 mm ²	1 to 16 mm ²	-	Ø 5 mm	-
		1 to 35 mm ²	1 to 25 mm ²	50 mm ²		3 x 16 mm ² / 3 x 10 mm ²

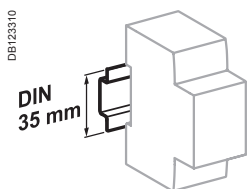

Clip on DIN rail 35 mm.

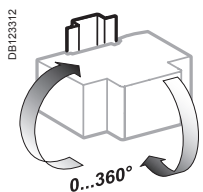

Indifferent position of installation.

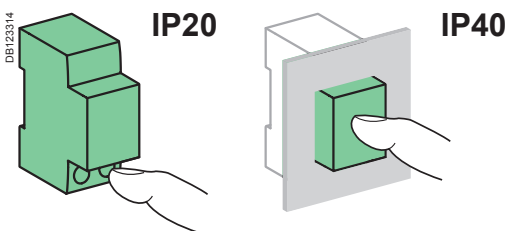

Technical data

Main characteristics

According to IEC/EN 60947-2

Insulation voltage (U _i)	500 V AC	
Pollution degree	3	
Rated impulse withstand voltage (U _{imp})	6 kV	
Thermal tripping	Reference temperature	50 °C
	Temperature derating	See the Technical Guide
Magnetic tripping	MA curve	12 I _n ± 20 %
Utilization category		A

Additional characteristics

Degree of protection (IEC 60529)	Device only	IP20
	Device in modular enclosure	IP40 Insulation classe II
Endurance (O-C)	Electrical	10,000 cycles
	Mechanical	20,000 cycles
Overvoltage category (IEC 60364)		IV
Operating temperature		-35°C to +70°C
Storage temperature		-40°C to +85°C
Tropicalization (IEC 60068-1)		Treatment 2 (relative humidity 95 % to 55°C)

Dimensions (mm)

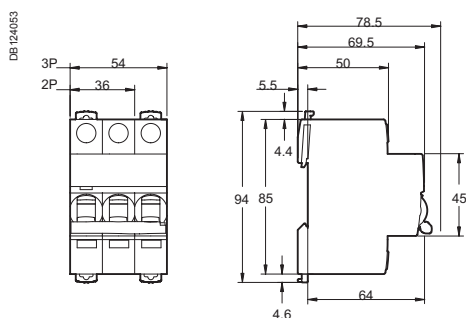

Weight (g)

Circuit-breaker

Type	iC60L
2P	250
3P	375

NG125LMA circuit breakers (curve MA)

A

056916N_SE-90

DB124483

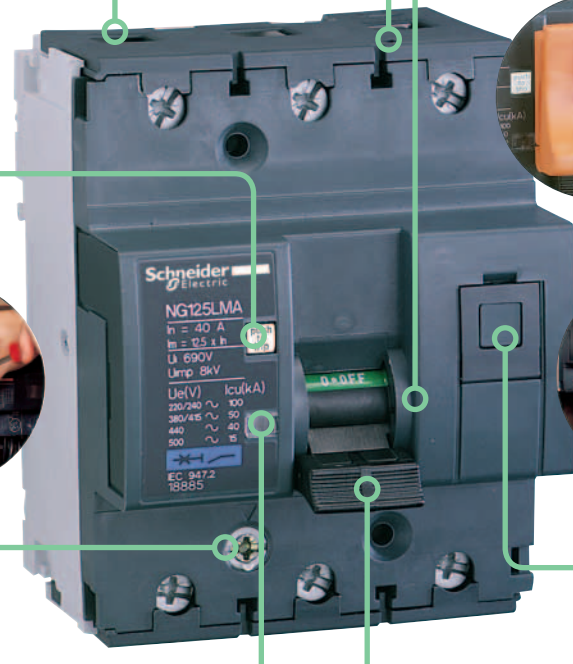

3P 80 A
 ■ Voltage taps:
 auxiliaries power supply
 measurement
 emergency stop
 remote reporting

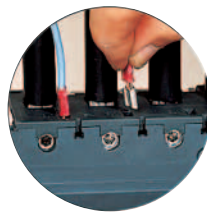

■ Cable strength:
 ribbed cage
 terminal depth
 tightening by Allen hex key (NG125 80 A)

■ Padlocking in position:
 O or I, manual control is inhibited, tripping is enabled

■ Test button to check satisfactory operation of the tripping mechanism



3P
 ■ Pull-out strength:
 metallic lock

3P
 ■ Integrated padlocking device

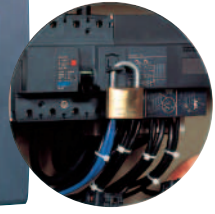

■ Impact and vibration resistance:
 high-strength enclosure
 IK 05

■ Central manual control, 3 positions:
 ON
 tripped on fault
 open

■ Circuit breaker tripped indicator

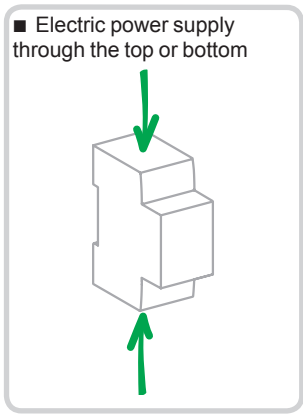

■ Positive contact indication:
 suitability for isolation in the industrial sector to IEC/EN 60947-2
 the presence of the green strip guarantees that the contacts open physically and allows work to be carried out safely on the downstream circuit

■ Longer product service life due to:
 good overvoltage withstand capacity,
 high limitation performances,
 fast closure independent of the speed of actuation of the toggle.

NG125LMA circuit breakers (curve MA) (cont.)



IEC/EN 60947-2

■ NG125LMA circuit breakers are circuit breakers which combine the following functions:

- circuit protection against short-circuit currents,
- circuit protection against overload currents,
- suitability for isolation in the industrial sector to IEC/EN 60947-2,
- tripping upon fault is indicated by a red mechanical state indicator light on the front face of the circuit breaker.



NG125LMA 2P



NG125LMA 3P

Alternating current (AC) 50/60 Hz					
Breaking capacity (Icu) to IEC/EN 60947-2					Service breaking capacity (Ics)
Ph/Ph (2P, 3P)	Voltage (Ue)				
	220 to 240 V	380 to 415 V	440 V	500 V	75 % of Icu
Rating (In) 4 to 80 A (trip units)	100 kA	50 kA	40 kA	15 kA	

Catalogue numbers

NG125LMA circuit breaker					
Type	2P		3P		
Auxiliaries		see page F-14 – Vigi NG125 add-on residual current device, see page B-27			
Rating (In)	Quality label (1)	Magn. I (A)	Curve MA	Curve MA	
4 A		50	18868	18879	
6.3 A		75	18869	18880	
10 A		120	18870	18881	
12.5 A		150	18871	18882	
16 A		190	18872	18883	
25 A		300	18873	18884	
40 A		480	18874	18885	
63 A		750	18875	18886	
80 A		960	18876	18887	
Width in 9 mm modules			6	9	
Accessories			See page E-26		

(1) Information to be supplied by the country concerned.

NG125LMA circuit breakers (curve MA) (cont.)

Connection

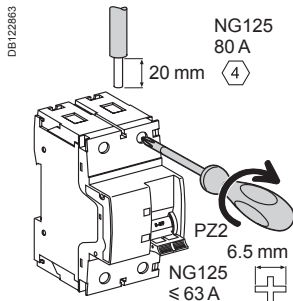

Rating	Tightening torque	Without accessories		With accessories			
		Copper cables	70 mm ² Al terminal	Screw-on connection for ring terminal	Small ring terminal	Multi-cable terminal	
		Rigid	Flexible or with ferrule			Rigid cables	Flexible cables
4 to 63 A 80 A	3.5 N.m 6 N.m	1.5 to 50 mm ² 16 to 70 mm ²	1 to 35 mm ² 10 to 50 mm ²	- 25 to 70 mm ²	- 2 x 35 mm ² 1 x 50 mm ²	1 x 70 mm ²	3 x 16 mm ² 3 x 10 mm ²

■ On 3P 80 A: upstream voltage taps for each pole, by 6.35 mm Fast-on terminal.

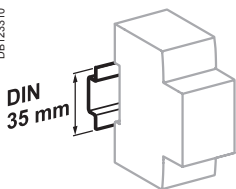

Clips on to 35 mm DIN rail.

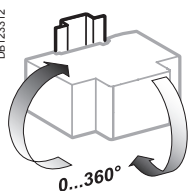

Any installation position.

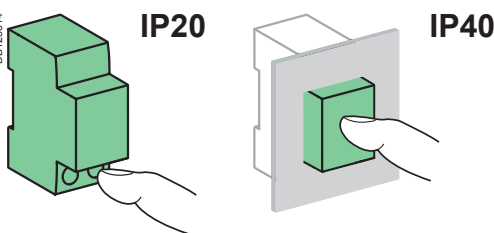

Technical data

Main characteristics		
According to IEC/EN 60947-2		
Insulation voltage (U _i)		690 V AC
Degree of pollution		3
Rated impulse withstand voltage (U _{imp})		8 kV
Thermal tripping	Reference temperature	40°C
Magnetic tripping (I _i)	MA curve	12 I _n ± 20 %
Utilization category		A
Additional characteristics		
Degree of protection (IEC 60529)	Device only	IP20
	Device in modular enclosure	IP40
Endurance (O-C)	Electrical	10,000 cycles
	Mechanical	20,000 cycles
Operating temperature		-30°C to +70°C
Storage temperature		-40°C to +70°C
Tropicalization (IEC 60068-1)		Treatment 2 (relative humidity of 95 % at 55°C)

Weight (g)

Circuit breaker	
Type	NG125LMA
2P	480
3P	720

Dimensions (mm)

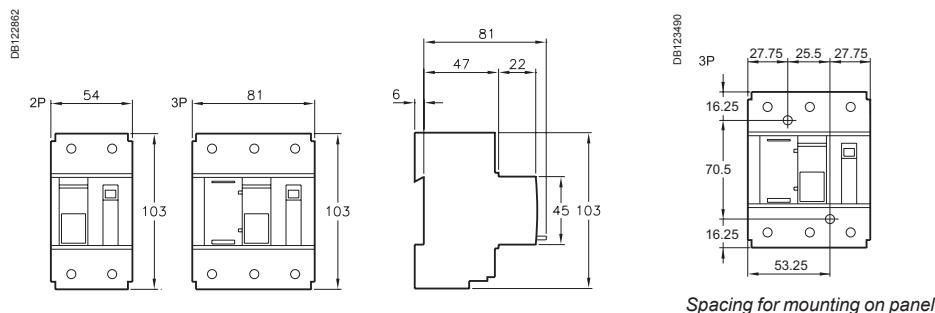













STI	Cartridges
IEC/EN 60947-3, IEC/EN 60269-2	IEC 60269-1, IEC 60269-2, NF C 60-200-2

- The STI isolatable fuse-carriers provide overload and short-circuit protection.
 - They are used for industrial applications requiring a high breaking capacity.
 - They perform the isolation function and must not be used as switches.
 - To be equipped with aM or gG (gL - gl) type fuse cartridge without striker, with or without fuse blowing indicator.
 - Isolation of all poles is guaranteed for the 2P, 3P, and 3P+N versions during factory assembly.
- The general purpose fuse (**gG fuse**) provides overload and short-circuit protection. The fuse for motor application (**aM fuse**) only provides short-circuit protection. It is used for protection of loads with a high peak current (motors, transformer primaries, etc.).

Catalogue numbers

Fuse cartridge (Type F)					STI fuse holder						
Type	Rating	Voltage rating (Ue)	Short-circuit current (Isc)		Network type						
			aM	gG	aM	gG	1P	1P+N ⁽¹⁾	2P	3P	3P+N ⁽¹⁾
 PB102086-20 8.5 x 31.5 mm	2 A	400 V AC	20 kA	20 kA	DF2BA0200	DF2BN0200					
	4 A	400 V AC	20 kA	20 kA	DF2BA0400	DF2BN0400					
	6 A	400 V AC	20 kA	20 kA	DF2BA0600	DF2BN0600					
	8 A	400 V AC	20 kA	20 kA	DF2BA0800	DF2BN0800					
	10 A	400 V AC	20 kA	20 kA	DF2BA1000	DF2BN1000					
PB102086-20 10.3 x 38 mm	2 A	500 V AC	120 kA	120 kA	DF2CA02	DF2CN02					
	4 A	500 V AC	120 kA	120 kA	DF2CA04	DF2CN04					
	6 A	500 V AC	120 kA	120 kA	DF2CA06	DF2CN06					
	10 A	500 V AC	120 kA	120 kA	DF2CA10	DF2CN10					
	16 A	500 V AC	120 kA	120 kA	DF2CA16	DF2CN16					
	20 A	500 V AC	120 kA	120 kA	DF2CA20	DF2CN20					
	25 A	400 V AC	120 kA	120 kA	DF2CA25	DF2CN25					

(1) The neutral pole comes equipped with a locked tube.

STI isolatable fuse-carriers (cont.)

230 V neon indicator light (Option)

- Indicates fuse blowing (off in normal operation and lit red after fuse blowing)
- 400 V maxi

Padlocking device

- Locks the toggle in the "open" or "closed" position. Used with an 8 mm max. diameter padlock (not supplied):
 - only one padlock for 1P, 1P+N and 2P products (on the left pole)
 - and two padlock on the 3P and 3P+N products (on every extremity)

1P+N, 3P+N

- Phase opening causes compulsory opening of the neutral
- The phase opens before the neutral on isolation and closes after the neutral on circuit closing
- Small dimensions
 - 1P+N in 18 mm
 - 3P+N in 54 mm

Clip-on markers

- Used to identify:
 - either on the front face
 - or on the downstream terminals

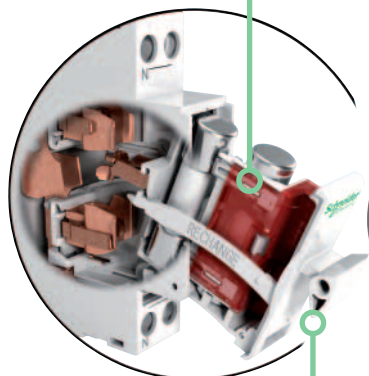





Fuse-carrier

- Captive
- Additional housing is provided for a spare fuse

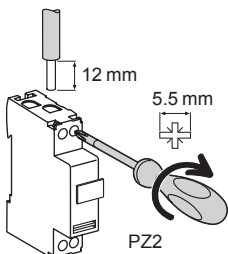
Connection

DB1123241



Type	Rating	Tightening torque	Without accessory		With accessories
			Copper cables		Screw-on connection for ring terminal
			Rigid	Flexible or ferrule	
STI	All	2 N.m	DB1122945 	DB1122946 	DB1118789 
			0.75 to 10 mm ² 2 x 0.75 mm ² to 2 x 4 mm ²	0.5 to 6 mm ² 2 x 0.5 mm ² to 2 x 4 mm ²	Ø 5 mm

1 Screw-on connection for ring terminal 27053

DB1123225

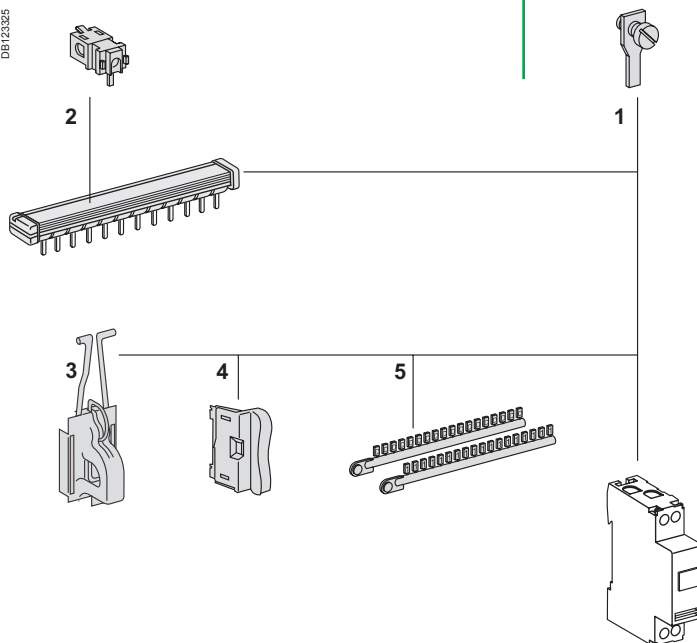

Mounting accessories

2	Comb busbar	See module	LIN001
3	Padlocking device		15669
4	Neon indicator light	1 piece blister	15668
5	Clip-on terminal markers	See module	CA907012

STI isolatable fuse-carriers (cont.)

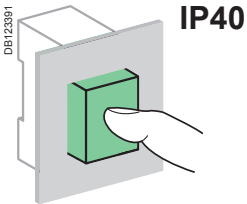
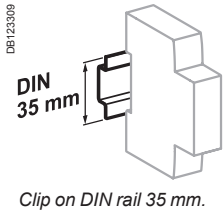

Technical data

Main characteristics

Insulation voltage (Ui)	500 V
Breaking capacity according to IEC 60269-2 ≤ 400 V	50 kA
Pollution degree	3
Operating frequency (Hz)	50/60

Additional characteristics

Degree of protection	Device in modular enclosure	IP40 Insulation classe II
Operating temperature		-20°C to +60°C
Storage temperature		-40°C to +80°C

Maximum dissipated power per pole of STI isolatable fuse-carriers

Fuse cartridge type	I _{th}	P _{max}	
8.5 x 31 mm	aM	10 A	2.5 W
	gG	20 A	2.5 W
10.3 x 38 mm	aM	16 A	3 W
	gG	25 A	3 W

Maximum dissipated power per fuse cartridges

Fuse cartridge type	I _{th}	P _{max}	
8.5 x 31 mm	aM	2 to 10 A	0.9 W
	gG	2 to 10 A	2.5 W
10.3 x 38 mm	aM	2 to 25 A	1.2 W
	gG	2 to 25 A	3 W

Dimensions (mm)

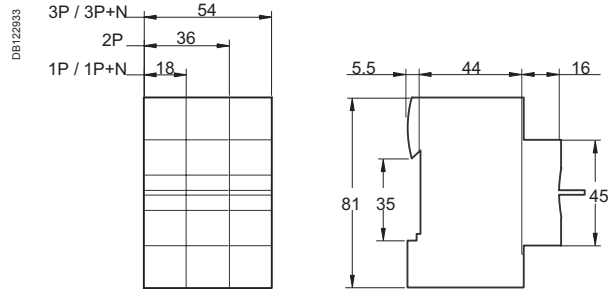

STI

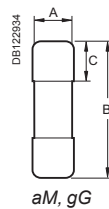

aM, gG fuse cartridge

Type	A	B	C
8.5 x 31.5 mm	8.5	31.5	10.3
10.3 x 38 mm	10.3	38	10.5

Residual Current Devices



B





Choice of sensitivity

The sensitivity of an earth leakage protection device depends mainly on the function it has to perform:

- Protection from electric shock by direct contact.
- Protection from electric shock by indirect contact.
- Protection from fire due to current leakage.

The following table gives a reminder of:





- The circuits that must be protected against these various risks (obligation or recommendation).
- The type of earth leakage protection device to be used in each case, its sensitivity, and its location in the distribution diagram.

Type of protection	Obligations	Recommended by Schneider Electric	Sensitivity (I Δ n)		
			30 mA (*)	100 mA to 3000 mA (depending on the earthing system)	300 mA (or 500 mA)
Protection from electric shock by direct contact					
 <small>DB123167</small>	Power supply for <ul style="list-style-type: none"> ■ General-purpose power sockets, up to 20 A ■ Appliances in the vicinity of a bathtub, shower, pond or swimming pool ■ Portable appliances for outdoor use, up to 32 A ■ Lighting for exhibition stands and shows ■ Outdoor lighting <i>To be modified according to national obligations (above)</i>	<ul style="list-style-type: none"> ■ Lighting in the home 	Setup in final distribution switchboard <ul style="list-style-type: none"> ■ Residual current device protecting a circuit ■ Residual current circuit breaker protecting a group of circuits 		
Protection from electric shock by indirect contact					
 <small>DB123168</small>	The entire power distribution system, except for devices: <ul style="list-style-type: none"> ■ With class II insulation ■ Operating at Safety Extra Low Voltage (class III) <i>To be modified according to national obligations (above)</i>	–		Setup in final distribution switchboard <ul style="list-style-type: none"> ■ Residual current circuit breaker or device, on incoming feeder Setup in subdistribution board or main switchboard <ul style="list-style-type: none"> ■ Residual current device protecting a circuit ■ Residual current device or circuit breaker protecting a group of circuits ■ On incoming feeder: residual current circuit breaker or device 	
Protection from fire due to current leakage					
 <small>DB123169</small>	<ul style="list-style-type: none"> ■ High-risk premises: <ul style="list-style-type: none"> □ explosion (BE3) □ fire (BE2) ■ Agricultural and horticultural buildings ■ Equipment for fairs, exhibitions and shows ■ Temporary outdoor recreational installations <i>To be modified according to national obligations (above)</i>	<ul style="list-style-type: none"> ■ Dilapidated buildings or electrical installations ■ Humid atmospheres: agricultural buildings, public swimming pools ■ Presence of chemical agents 			Setup in final distribution switchboard <ul style="list-style-type: none"> ■ Residual current circuit breaker or device, on incoming feeder Setup in subdistribution board or main switchboard <ul style="list-style-type: none"> ■ Residual current device protecting each circuit to a high-risk zone ■ Residual current device or circuit breaker protecting a group of circuits ■ On incoming feeder: residual current circuit breaker or device

(*) The 10 mA sensitivity is useful for certain very specific applications, where there is a risk that someone could sustain a non-dangerous current (10 to 30 mA) without being able to get free. Example: healthcare equipment for hospital beds. Generally, devices with this very high sensitivity are liable to cause frequent tripping, due to the natural leakage currents of the installation.

Interference immunity

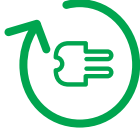
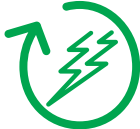
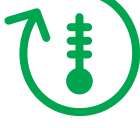

Schneider Electric provides various equipment technologies capable of overcoming the consequences of interference of all kinds.

Operating conditions		Examples	Types				
			AC	A	SI	B	
Loads						   	
	With no special characteristics	<ul style="list-style-type: none"> General-purpose power sockets Incandescent lighting Household appliances: microwave oven, dishwasher, clothes dryer Electric heating, water heater 	■	■	■	■	
	Including a rectifier	Single phase	<ul style="list-style-type: none"> Household appliances: induction cooking appliances, washing machines (variable speed) Single-phase variable speed drives 	-	■	■	-
		Three phase	<ul style="list-style-type: none"> Three-phase variable speed industrial drives Three-phase uninterruptible power supplies 	-	-	-	■
	Generating high-frequency interference (current peaks, harmonics)	<ul style="list-style-type: none"> Fluorescent lighting powered by extra low voltage transformer, by electronic ballast Variable luminosity lighting Powerful IT equipment Single-phase variable speed industrial drives Air conditioning Telecommunications equipment Capacitor banks 	-	-	■	■	
	Including an anti-harmonic filter in the power supply	<ul style="list-style-type: none"> Microcomputer systems Computer peripherals (printers, scanners, etc.) 	-	-	■	■	
Electrical environment							
	Vicinity of equipment generating transient overvoltages	<ul style="list-style-type: none"> High-powered switching devices Reactive energy compensation banks 	-	-	■	■	
	Circuits powered by an uninterruptible power supply "Isolated neutral" (IT) earthing system	<ul style="list-style-type: none"> Backed-up networks 	-	-	■	■	
	Major risk of lightning strokes	<ul style="list-style-type: none"> Buildings protected by a lightning protection system Mountainous or humid regions Regions with high keraunic level 	-	-	■	■	
Atmosphere							
	Ambient temperature which could be less than -5°C	-	-	■	■	■	
	Presence of corrosive agents (AF2 to AF4) or dust	<ul style="list-style-type: none"> Indoor swimming pools Yacht harbours, marinas, camping grounds Water treatment Chemical industries, heavy industries, paper mills Mines and cellars, road tunnels Markets, stock raising, food processing industries 	-	-	■ (1)	-	





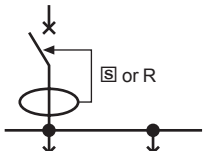
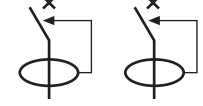



(1) SiE for C120 and NG125 circuit-breakers

Discrimination

Residual current devices of average sensitivity (100 mA and more) are available in a selective (S) and delayed (R) version. This option ensures that, in the event of an earth fault downstream of the installation, only the defective part is switched off. The table below shows (in green) which upstream/downstream equipment combinations provide this discrimination.

Sensitivity (mA) - Downstream		Sensitivity (mA) - Upstream												
		Instantaneous						Selective S			Delayed R			
		30	100	300	500	1000	3000	100	300	500	1000	3000	1000	3000
	Instantaneous	30	-	-	-	-	-	-	-	-	-	-	-	-
		100	-	-	-	-	-	-	-	-	-	-	-	-
		300	-	-	-	-	-	-	-	-	-	-	-	-
		500	-	-	-	-	-	-	-	-	-	-	-	-
		1000	-	-	-	-	-	-	-	-	-	-	-	-
		3000	-	-	-	-	-	-	-	-	-	-	-	-
	Selective S	100	-	-	-	-	-	-	-	-	-	-	-	-
		300	-	-	-	-	-	-	-	-	-	-	-	-
		500	-	-	-	-	-	-	-	-	-	-	-	-
		1000	-	-	-	-	-	-	-	-	-	-	-	-
		3000	-	-	-	-	-	-	-	-	-	-	-	-
		Delayed R	1000	-	-	-	-	-	-	-	-	-	-	-
		3000	-	-	-	-	-	-	-	-	-	-	-	-

Selection guide

Type		Residual current circuit breakers			
		iID K	iID	RCCB-ID 125 A	RCCB-ID type B
					
Standards		IEC/EN 61008	IEC/EN 61008	IEC/EN 61008-1 and VDE 0664	IEC/EN 61008 and VDE 0664
Number of poles	1P+N	–	–	–	–
	2P	■	■	■	–
	3P	–	–	–	–
	4P	■	■	■	■
Type	AC	■	■	■	–
	A	–	–	■	–
	S/I	–	■	■	–
	B	–	–	–	■
Voltage (V)	Ue	230/400	230/400	230/400	230/400
Impulse voltage (kV)	Uimp	4	6	4	4
Insulation voltage (V)	Ui	440	500	400	400
Current rating (A)	In	25 - 40 - 63	16 to 100	125	25 to 125
Frequency (Hz)		50/60	50	50	50
Rated breaking capacity (A)	Icn	–	–	10000	–
Rated conditional short-circuit current	Icn	4500	10000	10000	10000
Rated residual breaking and making capacity (A)	(IΔm)	10 In (500 A min.)	1500	1250	10 In (500 A min.)
Curve		–	–	–	–
Sensitivity (mA)	(IΔn)				
	10	–	■	–	–
	30	■	■	■	■
	100	–	■	■	–
	300	■	■	■	■
	500	–	■	■	■
	1000	–	–	–	–
	3000	–	–	–	–
	300 	–	■	■	■
	500 	–	■	–	–
1000 	–	–	–	–	
3000 	–	–	–	–	
Electrical characteristics					
Curves	B	–	–	–	–
	C	–	–	–	–
	D	–	–	–	–
	L	–	–	–	–
	K	–	–	–	–
	MA	–	–	–	–
For more details, see page		B-11	B-6	B-13	B-15
Accessories		–	E-2, E-10	B-13	B-15
Auxiliaries		–	E-2, F-2	B-13	B-15



I_{nc}: rated conditional short-circuit current

Value of the alternating component of the prospective current that a residual current circuit breaker protected by an appropriate short-circuit protective device (SCP) mounted in series can withstand in specified conditions of use.

I_{Δc}: rated residual short-circuit current

Value of the alternating component of the prospective residual current that a residual current circuit breaker protected by an appropriate short-circuit protective device (SCP) mounted in series can withstand in specified conditions of use.

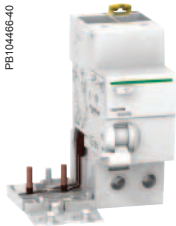
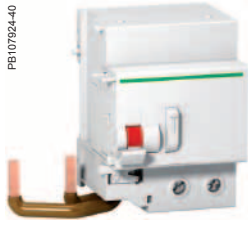
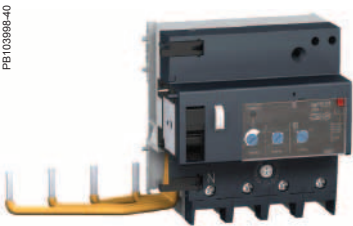
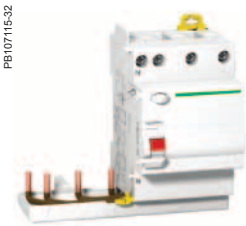
Overview of the earth leakage protection product range (cont.)

Add-on residual current devices				Residual current devices RCBO	
Vigi iC60	Vigi C120	Vigi NG125	Vigi iDPN	iDPNa Vigi	iDPN N/H Vigi
					
IEC/EN 61009	IEC/EN 61009	IEC/EN 61009	IEC/EN 61009	IEC/EN 61009	IEC/EN 61009
-	-	-	■	■	■
■	■	■	-	-	-
■	■	■	■	-	-
■	■	■	■	■	■
■	■	■	■	-	■
■	■	■	■	-	■
-	-	-	-	-	-
230/400	230/400	230/400	230/400	230	230
6	6	8	6	4	4
500	500	690	500	400	400
25 - 40 - 63	10 - 125	63 - 125	25 - 63	6 to 40	N= 4 to 40 H= 6 to 32
50/60	50/60	50/60	50/60	50/60	50/60
-	-	-	-	4500	6000/10000
-	-	-	-	-	-
-	-	-	-	4500	6000
-	-	-	-	B, C	B, C
■	-	-	-	■	-
■	■	■	■	■	■
■	-	-	■	-	-
■	■	■	■	■	■
■	■	■	-	-	-
-	-	■	-	-	-
-	-	■	-	-	-
■	■	■	-	-	-
■	■	■	-	-	-
-	-	■	-	-	-
-	-	■	-	-	-
Depending on circuit breaker used	Depending on circuit breaker used	Depending on circuit breaker used	Depending on circuit breaker used	-	■
-	-	-	-	■	■
-	-	-	-	-	-
-	-	-	-	-	-
-	-	-	-	-	-
B-17	B-22	B-27	B-33	B-35	B-36
E-2	E-7 and E-15	E-26	E-29	E-6, E-10 & E-29	E-6, E-10 & E-29
E-2	E-7 and F-9	F-14	E-31	F-2	F-2

B

***I_m*: rated making and breaking capacity**

Value of the alternating component of the prospective current that a residual current circuit breaker is capable of establishing or interrupting in specified conditions of use.

***I_{Δm}*: rated making and breaking capacity**

Value of the alternating component of the prospective residual current that a residual current circuit breaker is capable of establishing and withstanding during its opening time and interrupting in specified conditions of use and behaviour.

SCPD

Short-circuit protective device (a fuse in the case of our markings): this is the max. fuse that can be used to resist the value $I_{nc} = I_{Δc}$.

iLD residual current circuit breakers (AC, A, S/I types) (cont.)

PB104548-40

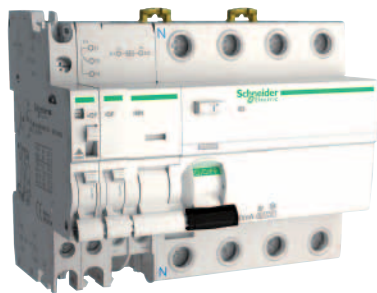

PB104472-40

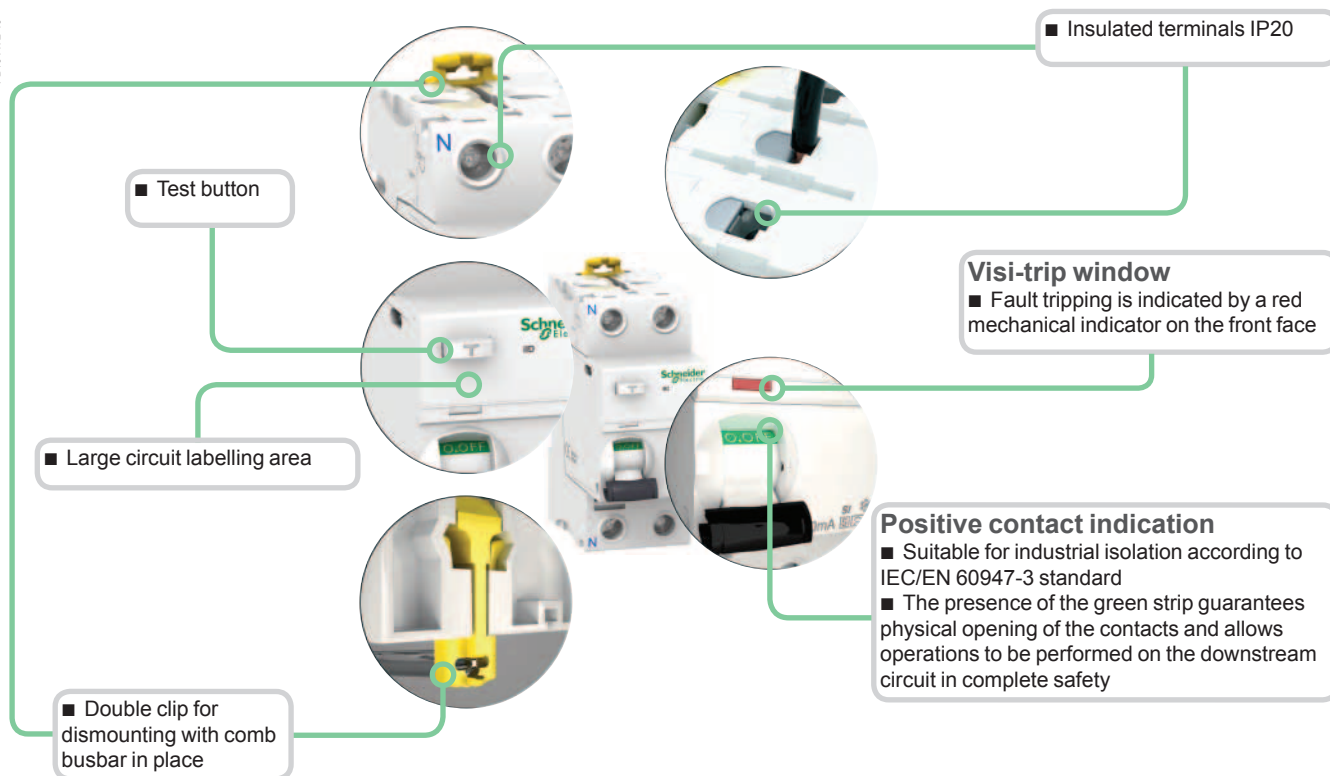

S/I type

The *S/I* type provides increased immunity from electrical interference and polluted or corrosive environments.



IEC/EN 61008-1

PB104472-40



PB104473-40



- The iID residual current circuit breakers provide:
 - protection of persons against electric shock by direct contact (≤ 30 mA),
 - protection of persons against electric shock by indirect contact (≥ 100 mA),
 - protection of installations against the risk of fire (300 mA or 500 mA).

Catalogue numbers

iID residual current circuit breakers										
Type	AC								Width in 9 mm module	
Product	iID									
Auxiliaries	See page E-2 and F-2									
2P	Sensitivity	10 mA	30 mA	100 mA	300 mA	500 mA	300 mA	500 mA		
	Rating	16 A	A9R10216	-	-	-	-	-	4	
		25 A	A9R10225	A9R71225	-	A9R74225	A9R16225	-		
		40 A	-	A9R71240	A9R12240	A9R74240	A9R16240	-		
		63 A	-	A9R71263	A9R12263	A9R74263	A9R16263	A9R15263	-	
		80 A	-	A9R11280	A9R12280	A9R14280	-	A9R15280	-	
		100 A	-	A9R11291	A9R12291	A9R14291	-	A9R15291	-	
	Rating	25 A	-	A9R71425	-	A9R74425	A9R16425	-	8	
		40 A	-	A9R71440	A9R12440	A9R74440	A9R16440	A9R15440	A9R17440	
		63 A	-	A9R71463	A9R12463	A9R74463	A9R16463	A9R15463	A9R17463	
		80 A	-	A9R11480	A9R12480	A9R14480	A9R16480	A9R15480	A9R17480	
		100 A	-	A9R11491	A9R12491	A9R14491	-	A9R15491	-	
Voltage rating (Ue)	2P	230 - 240 V								
	4P	400 - 415 V								
Operating frequency	50/60 Hz									
Accessories	See pages E-2 and E-10									

B



IEC/EN 61008-1

PB104472-40



PB104473-40



- The iID residual current circuit breakers provide:
 - protection of persons against electric shock by direct contact (≤ 30 mA),
 - protection of persons against electric shock by indirect contact (≥ 100 mA),
 - protection of installations against the risk of fire (300 mA or 500 mA).

Catalogue numbers

iID residual current circuit breakers									
Type	A							Width in 9 mm module	
Product	iID								
Auxiliaries	See page E-2 and F-2								
2P	Sensitivity	10 mA	30 mA	100 mA	300 mA	500 mA	300 mA 		
<p>DB122476</p>	Rating	16 A	A9R20216	-	-	-	-	4	
		25 A	A9R20225	A9R21225	-	A9R24225	-		
		40 A	-	A9R21240	-	A9R24240	-		A9R25240
		63 A	-	A9R21263	-	A9R24263	-		A9R25263
		100 A	-	A9R21291	-	A9R24291	-		A9R25291
4P	Sensitivity	10 mA	30 mA	100 mA	300 mA	500 mA	300 mA 		
<p>DB122477</p>	Rating	25 A	-	A9R21425	-	A9R24425	-	8	
		40 A	-	A9R21440	A9R22440	A9R24440	A9R26440		A9R25440
		63 A	-	A9R21463	A9R22463	A9R24463	A9R26463		A9R25463
		80 A	-	A9R21480	-	A9R24480	-		A9R25480
		100 A	-	A9R21491	-	A9R24491	A9R26491		A9R25491
Voltage rating (Ue)	2P	230 - 240 V							
	4P	400 - 415 V							
Operating frequency	50/60 Hz								
Accessories	See pages E-2 and E-10								



IEC/EN 61008-1

PB104472-40



PB104473-40



- The iID residual current circuit breakers provide:
 - protection of persons against electric shock by direct contact (≤ 30 mA),
 - protection of persons against electric shock by indirect contact (≥ 300 mA),
 - protection of installations against the risk of fire (300 mA or 500 mA).

The **SI** type provides increased immunity from electrical interference and polluted or corrosive environments.

Catalogue numbers

iID residual current circuit breakers							
Type	SI						Width in 9 mm module
Product	iID						
Auxiliaries	See page E-2 and F-2						
<p>DB122476</p>	2P Rating	Sensitivity	10 mA	30 mA	300 mA	300 mA 	500 mA
		16 A	-	-	-	-	4
		25 A	A9R30225	A9R61225	-	-	-
		40 A	-	A9R61240	-	A9R35240	-
		63 A	-	A9R61263	-	A9R35263	-
		100 A	-	-	-	A9R35291	-
<p>DB122477</p>	4P Rating	Sensitivity	10 mA	30 mA	300 mA	300 mA 	500 mA
		25 A	-	A9R61425	-	-	8
		40 A	-	A9R61440	-	A9R35440	A9R37440
		63 A	-	A9R61463	A9R34463	A9R35463	A9R37463
		80 A	-	A9R31480	-	A9R35480	A9R37480
		100 A	-	A9R31491	A9R34491	A9R35491	-
Voltage rating (Ue)	2P	230 - 240 V					
	4P	400 - 415 V					
Operating frequency	50/60 Hz						
Accessories	See pages E-2 and E-10						



iID residual current circuit breakers (AC, A, S/I types)

Connection

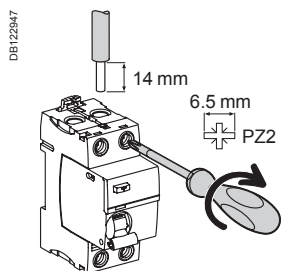

Type	Tightening torque	Without accessory		With accessories*			
		Copper cables		50 mm ² Al terminal	Screw-on connection for ring terminal	Multi-cables terminal	
		Rigid	Flexible or ferrule			Rigid cables	Flexible cables
iID	3.5 N.m	1 to 35 mm ²	1 to 25 mm ²	50 mm ²	Ø 5 mm	3 x 16 mm ² 3 x 10 mm ²	

* See page E-2

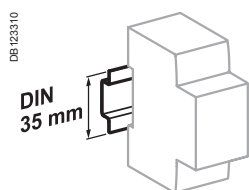

Clip on DIN rail 35 mm.

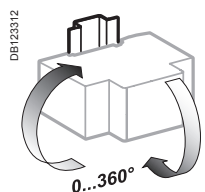

Indifferent position of installation.

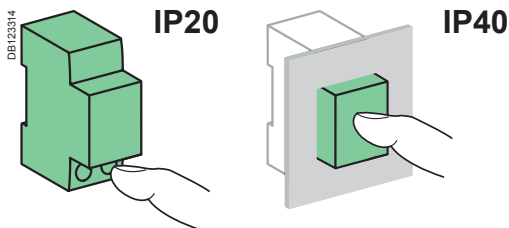

Technical data

Main characteristics

Insulation voltage (U _i)	500 V
Pollution degree	3
Rated impulse withstand voltage (U _{imp})	6 kV

According to IEC/EN 61008-1

Making and breaking capacity (I _m /I _{Δm})	1500 A	
Surge current withstand (8/20 μs) without tripping	AC and A types (no selective \square)	250 Å
	AC, A types (selective \square)	3 kÅ
	S/I type	3 kÅ
Conditional rated short circuit current (I _{nc} /I _{Δc})	With iC60N/H/L	Equal to breaking capacity of iC60
	With fuse	10,000 A

Additional characteristics

Degree of protection	Device only	IP20
	Device in modular enclosure	IP40 Insulation classe II
Endurance (O-C)	Electrical (AC1) 16 to 63 A	15,000 cycles
	80 to 100 A	10,000 cycles
	Mechanical	20,000 cycles
Operating temperature	AC type	-5°C to +60°C
	A and S/I types	-25°C to +60°C
Storage temperature		-40°C to +85°C

Weight (g)

Residual current circuit breakers

Type	iID
2P	210
4P	370

Dimensions (mm)

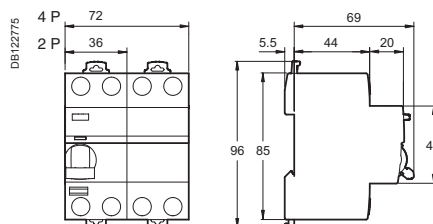



IEC/EN 61008-1

- The iID K residual current circuit breakers provide:
 - protection of persons against electric shock by direct contact (30 mA),
 - protection of persons against electric shock by indirect contact (300 mA)
 - protection of installations against the risk of fire (300 mA).



Catalogue numbers

iID K residual current circuit breakers				
Type	AC	Width in 9-mm modules		
Product	iID K			
Auxiliaries	Without auxiliaries			
		Sensitivity	30 mA	300 mA
2P 	Rating	25 A	A9R50225	A9R75225
		40 A	A9R50240	A9R75240
4P 	Rating	25 A	A9R50425	A9R75425
		40 A	A9R50440	A9R75440
		63 A	A9R70463	A9R75463
Voltage rating (Ue)	2P	230 - 240 V		
	4P	400 - 415 V		
Operating frequency	50/60 Hz			

B

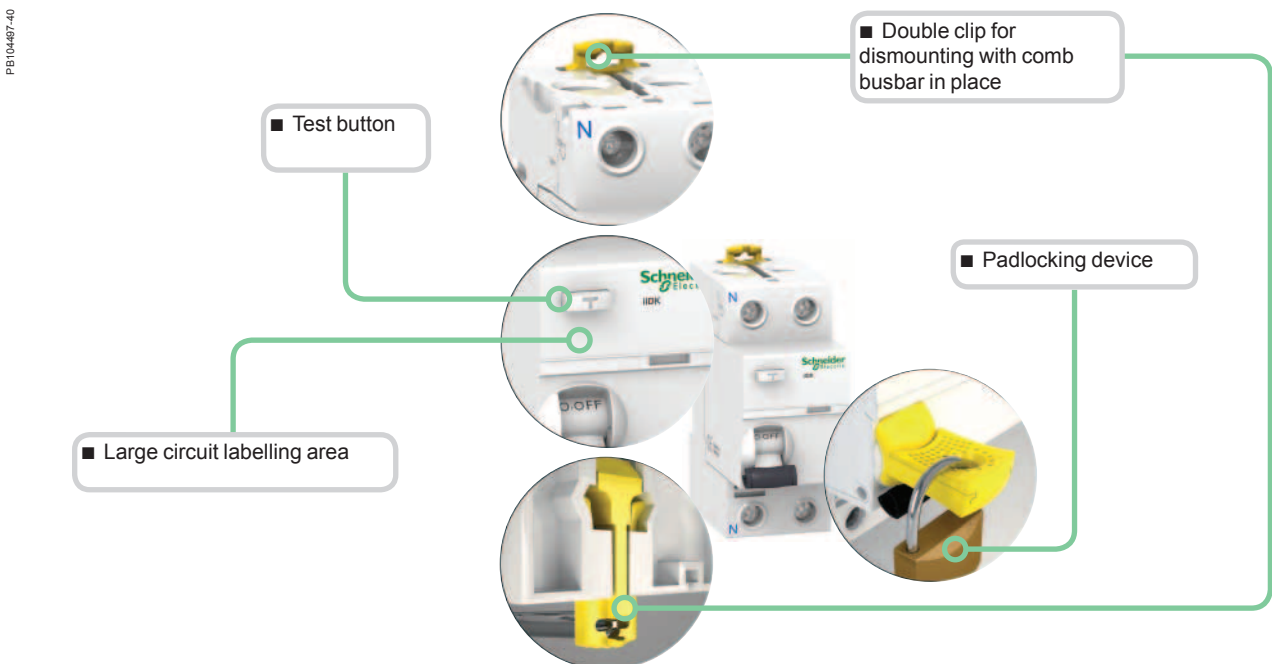

iID K residual current circuit breakers (cont.)

Connection

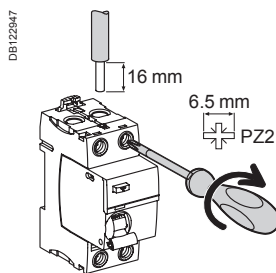

Type	Tightening torque	Without accessory	
		Copper cables Rigid	Flexible or ferrule
iID K	3.5 N.m	1 to 35 mm ²	1 to 25 mm ²

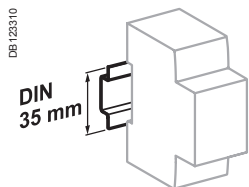

Clip on DIN rail 35 mm.

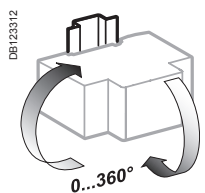

Indifferent position of installation.

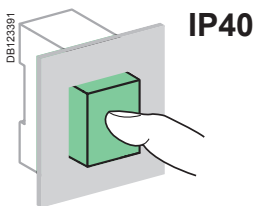

Technical data

Main characteristics

According to IEC/EN 61008-1

Insulation voltage (U _i)		440 V
Pollution degree		2
Rated impulse withstand voltage (U _{imp})		4 kV
Making and breaking capacity (I _m /I _{Δm})	25 to 40 A	500 A
	63 A	630 A
Surge current withstand (8/20 μs) without tripping		Up to 200 Å
Conditional rated short circuit current (I _{nc} /I _{Δc})	With iC60N/H/L, iK60N	6000 A
	With fuse	4500 A

Additional characteristics

Degree of protection	Device in modular enclosure	IP40
Endurance (O-C)	Electrical	2000 cycles (AC1)
	Mechanical	5000 cycles
Operating temperature		-5°C to +60°C
Storage temperature		-40°C to +85°C

Weight (g)

Residual current circuit breakers

Type	iID K
2P	210
4P	370

Dimensions (mm)

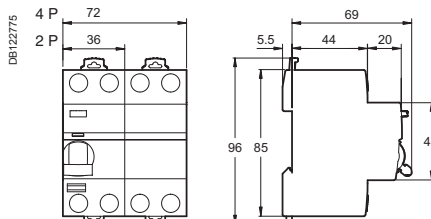

RCCB-ID 125 A residual current circuit breaker (AC, A, SI types)

IEC/EN 61008-1, VDE 0664

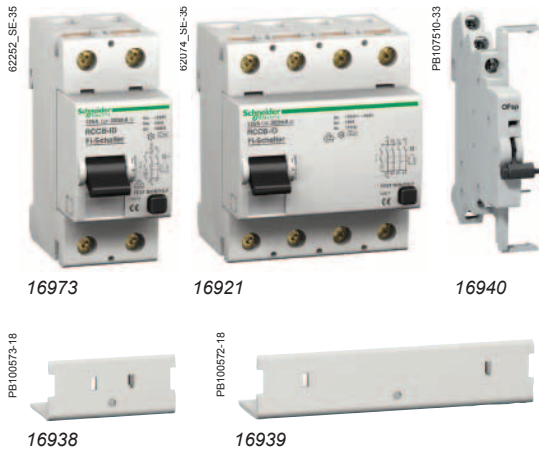

- The RCCB-ID 125 A residual current circuit breakers provide:
 - protection of persons against electric shock by direct contact (30 mA),
 - protection of persons against electric shock by indirect contact (≥ 100 mA),
 - protection of installations against the risk of fire (300 mA or 500 mA).

The *SI* type provides increased immunity from electrical interference and polluted or corrosive environments.

OFsp auxiliary

- Electrical indication: by OFsp auxiliary mounted to the left, it has a double changeover switch indicating the "open" or "closed" position of the RCCB-ID 125 A.

Accessories

- 2P and 4P sealable screw shield.

Catalogue numbers

RCCB-ID 125 A residual current circuit breakers													
Type		AC				A				SI		Width in 9 mm module	
2P	Sensitivity	30 mA	100 mA	300 mA	500 mA	30 mA	300 mA	300 mA	500 mA	30 mA	300 mA		
	Rating	125 A	16966	-	16967	-	16970	16971	-	-	16972	16973	4
	Rating	125 A	16905	16906	16907	16908	16924	16926	16925	16927	16920	16921	8
Voltage rating (Ue)	2P	230 V											
	4P	400 V											
Operating frequency	50 Hz												

Auxiliary				
Type	Contact	Voltage		Width in 9 mm module
	1 A	110 V DC	16940	1
	6 A	230 V AC (AC15)		

Accessory		
Type	Number of pole	
Screw shield (set of 10) for upstream or downstream	2P	16938
	4P	16939

RCCB-ID 125 A residual current circuit breaker (AC, A, S/I types) (cont.)

Connection

■ By tunnel terminals for:

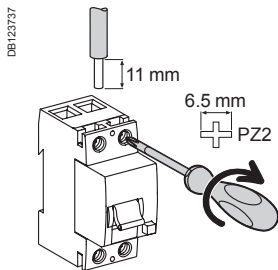

Type	Tightening torque	Copper cables	
		Rigid	Flexible or ferrule
RCCB-ID	3 N.m	1 x 1.5 to 50 mm ² 2 x 1.5 to 16 mm ²	1 x 1.5 to 35 mm ² 2 x 1.5 to 16 mm ²
OFsp	0.8 N.m	1 to 1.5 mm ²	1 to 1.5 mm ²

OFsp contact status, depending on the position of the residual current circuit breaker

Type				
RCCB-ID 125 A	Closed	■	-	-
	Open	-	■	-
	Tripped on fault	-	-	■
Contact OFsp	22/21	Open	Closed	Closed
	12/11			
	14/11	Closed	Open	Open

Technical data

Electrical characteristics		
Insulation voltage (U _i)	400 V	
Pollution degree	3	
Rated impulse withstand voltage (U _{imp})	4 kV	
According to IEC/EN 61008-1		
Making and breaking capacity (I _m /I _{Δm})	1250 A	
Surge current withstand (8/20 μs) without tripping	AC and A types (no selective ☐)	250 A
	S/I type (no selective ☐)	3 kA
	AC, A and S/I types (selective ☐)	3 kA
Conditional rated short circuit current (I _{nc} /I _{Δc})	With FU 125 A gG fuse	10,000 A
Additional characteristics		
Degree of protection	Device only	IP20 IP40 with screw shield
	Device in modular enclosure	IP40 Insulation classe II
Endurance (O-C)	Electrical	> 2 000 cycles
	Mechanical	> 5 000 cycles
Operating temperature		-25°C to +40°C
Storage temperature		-40°C to +85°C



Indication of the status of the RCCB-ID via the 3-position toggle and front panel indicator

- Closed (red indicator)
- Tripped on fault (green indicator)
- Open (green indicator)

Weight (g)

Residual current circuit breakers and auxiliary		
Type	RCCB-ID 125 A	OFsp
2P	230	40
4P	420	

Dimensions (mm)

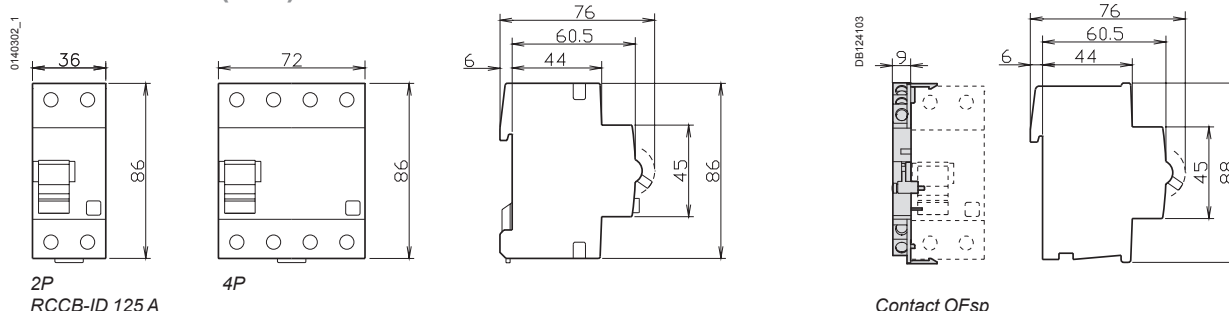

IEC/EN 61008, VDE 0664



16766



16940



16939

- The RCCB-ID 125 A residual current circuit breakers provide:
 - protection of persons against electric shock by direct contact (30 mA),
 - protection of persons against electric shock by indirect contact (≥ 300 mA),
 - protection of installations against the risk of fire (300 mA or 500 mA).

B type

The RCCB-ID B type residual current circuit breakers provide:

- protection in the event of a continuous fault current on three-phase networks generated by:
 - controllers and variable speed drives,
 - battery chargers and inverters,
 - backed-up power supplies.

- They include and also guarantee protection against fault currents:

- sinusoidal AC residual currents (AC type),
- pulsed DC residual currents (A type).

They can be adapted to all the application cases defined in standards IEC 60364 and EN 50178.

- Schneider Electric guarantees that the type B RCCB-ID works correctly in combination with the variable speed drives manufactured by Schneider Electric.

OFsp auxiliary

- Electrical indication: by OFsp auxiliary mounted to the left. It has a double changeover switch indicating the "open" or "closed" position of the RCCB-ID B type.

Accessories

- 4P sealable screw shield.

Catalogue numbers

RCCB-ID B type residual current circuit breakers

Type	B				Width in 9 mm module						
	Sensitivity		30 mA	300 mA		300 mA	500 mA				
4P	Rating	25 A	40 A	63 A	80 A	125 A	16750	16751	-	-	8
							16752	16753	16754	16755	
							16756	16757	16758	16759	
							16760	16761	16762	-	
							16763	16764	16765	16766	
Voltage rating (Ue)							230/400 V				
Operating frequency							50 Hz				

Auxiliary

Type				Width in 9 mm module
Contact OFsp	Contact	Voltage		16940
	1 A	110 V DC		
	6 A	230 V AC (AC15)		

Accessory

Type	Number of pole	
Screw shield (set of 10) for upstream or downstream	4P	16939

Connection

■ By tunnel terminals for:

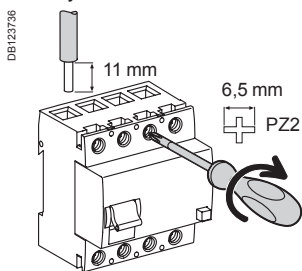

Type	Tightening torque	Copper cables	
		Rigid	Flexible or ferrule
RCCB-ID B type	3 N.m	1 x 1.5 to 50 mm ² 2 x 1.5 to 16 mm ²	1 x 1.5 to 35 mm ² 2 x 1.5 to 16 mm ²
OFsp	0.8 N.m	1 to 1.5 mm ²	1 to 1.5 mm ²

Technical data

OFsp contact status, depending on the position of the residual current circuit breaker

Type				
RCCB-ID B type	Closed	■	-	-
	Open	-	■	-
	Tripped on fault	-	-	■
Contact OFsp	22/21	Open	Closed	Closed
	12/11	Open	Closed	Closed
	14/11	Closed	Open	Open

Electrical characteristics

Insulation voltage (U _i)	400 V
Pollution degree	3
Rated impulse withstand voltage (U _{imp})	4 kV

According to IEC/EN 61008-1

Making and breaking capacity (I _m /I _{Δm})	25/40 A	500 A
	63/80 A	800 A
	125 A	1250 A
Surge current withstand (8/20 μs) without tripping	No selective ☒	250 Å
	Selective ☑	3 kÅ
Conditional rated short circuit current (I _{nc} /I _{Δc})	25/40 A with FU 80 A gG fuse	10,000 A
	63 A with FU 100 A gG fuse	10,000 A
	80/125 A with FU 125 A gG fuse	10,000 A

Additional characteristics

Degree of protection	Device only	IP20
	Device in modular enclosure	IP40 with screw shield
Endurance (O-C)	Electrical	> 2 000 cycles
	Mechanical	> 5 000 cycles
Operating temperature		-25°C to +40°C
Storage temperature		-40°C to +85°C

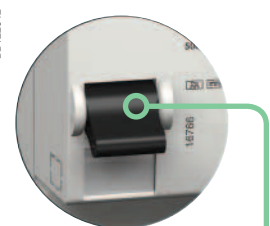

Indication of the status of the RCCB-ID B type via the 3-position toggle and front panel indicator

- Closed (red indicator)
- Tripped on fault (green indicator)
- Open (green indicator)

Weight (g)

Residual current circuit breakers and auxiliary

Type	RCCB-ID B type	OFsp
4P	450	40

Dimensions (mm)

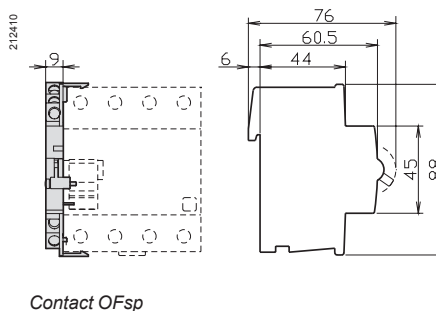
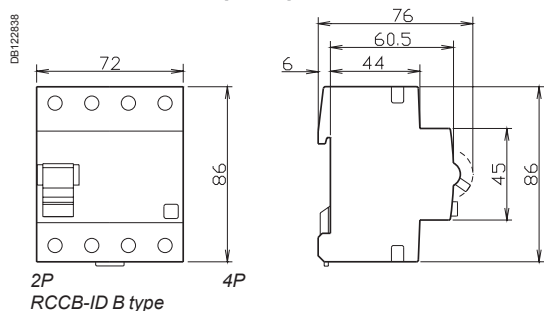



IEC/EN 61009-1

PB104466-35



PB104471-35

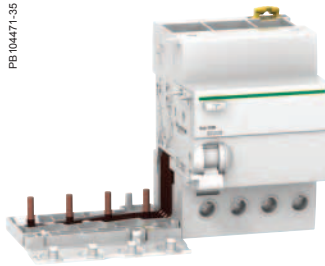

- Combined with iC60 circuit breaker, the Vigi iC60 provide:
 - protection of persons against electric shock by direct contact (≤ 30 mA),
 - protection of persons against electric shock by indirect contact (≥ 100 mA),
 - protection of installations against the risk of fire (300 mA or 500 mA).

Catalogue numbers

Vigi iC60 add-on residual current devices											
Type	AC									Width in 9 mm modules	
Product	Vigi iC60										
Auxiliaries	Without auxiliaries										
2P	Sensitivity	10 mA	30 mA	100 mA	300 mA	500 mA	300 mA	1000 mA			
<p>DB122482</p>	Rating	25 A	A9V41225	A9V41225 A9V01225*	A9V12225	A9V44225 A9V04225*	A9V16225	-	-	3	
		40 A	-	A9V41240 A9V01240*	-	A9V44240 A9V04240*	A9V16240	-	-	4	
		63 A	-	A9V41263 A9V01263*	A9V12263	A9V44263 A9V04263*	A9V16263	A9V15263	A9V19263	4	
<p>DB122483</p>	Rating	25 A	-	A9V41325	-	A9V44325	A9V16325	-	-	6	
		40 A	-	A9V41340	-	A9V44340	A9V16340	-	-	7	
		63 A	-	A9V41363	-	A9V44363	A9V16363	A9V15363	A9V19363	7	
<p>DB122484</p>	Rating	25 A	-	A9V41425	A9V12425	A9V44425	A9V16425	-	-	6	
		40 A	-	A9V41440	-	A9V44440	A9V16440	-	-	7	
		63 A	-	A9V41463	A9V12463	A9V44463	A9V16463	A9V15463	A9V19463	7	
Voltage rating (Ue)		230 - 240 V, 400 - 415 V Except * 130 V									
Operating frequency		50/60 Hz									
Accessories		See page E-2									

B



IEC/EN 61009-1

PB 104466-35



PB 104471-35

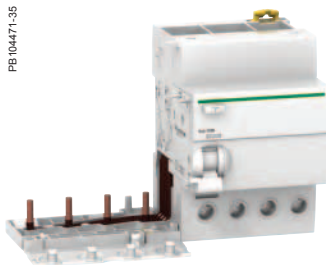

- Combined with iC60 circuit breaker, the Vigi iC60 provide:
 - protection of persons against electric shock by direct contact (30 mA),
 - protection of persons against electric shock by indirect contact (≥ 100 mA),
 - protection of installations against the risk of fire (300 mA or 500 mA).

Catalogue numbers

Vigi iC60 add-on residual current devices									
Type	A							Width in 9 mm modules	
Product	Vigi iC60								
Auxiliaries	Without auxiliaries								
2P	Sensitivity	30 mA	100 mA	300 mA	500 mA	300 mA	1000 mA		
	Rating	25 A	A9V51225	A9V22225	A9V54225	A9V26225	-	-	3
		63 A	A9V51263	A9V22263	A9V54263	A9V26263	A9V25263	A9V29263	4
	Rating	25 A	A9V51325	A9V22325	A9V54325	A9V26325	-	-	6
		63 A	A9V51363	-	A9V54363	A9V26363	A9V25363	A9V29363	7
	Rating	25 A	A9V51425	A9V22425	A9V54425	A9V26425	-	-	6
		63 A	A9V51463	A9V22463	A9V54463	A9V26463	A9V25463	A9V29463	7
Voltage rating (Ue)		230 - 240 V, 400 - 415 V							
Operating frequency		50/60 Hz							
Accessories		See page E-2							



IEC/EN 61009-1

PB 004466-35



PB 004471-35

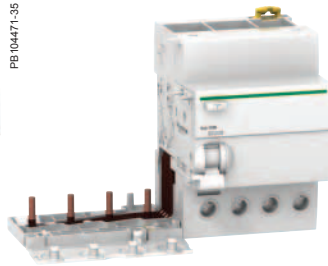

- Combined with iC60 circuit breaker, the Vigi iC60 provide:
 - protection of persons against electric shock by direct contact (≤ 30 mA),
 - protection of persons against electric shock by indirect contact (≥ 300 mA),
 - protection of installations against the risk of fire (300 mA).

The *SI* type provides increased immunity from electrical interference and polluted or corrosive environments.

Catalogue numbers

Vigi iC60 add-on residual current devices						
Type	SI					Width in 9 mm modules
Product	Vigi iC60					
Auxiliaries	Without auxiliaries					
2P	Sensitivity	10 mA	30 mA	300 mA	1000 mA	
	Rating	25 A	A9V30225	A9V61225	-	3
		40 A	-	A9V61240	-	4
		63 A	-	A9V61263	A9V65263	A9V39263
3P	Sensitivity	10 mA	30 mA	300 mA	1000 mA	
	Rating	25 A	-	A9V61325	-	6
		40 A	-	A9V61340	-	7
		63 A	-	A9V61363	A9V65363	A9V39363
4P	Sensitivity	10 mA	30 mA	300 mA	1000 mA	
	Rating	25 A	-	A9V61425	-	6
		40 A	-	A9V61440	-	7
		63 A	-	A9V61463	A9V65463	A9V39463
Voltage rating (Ue)		230 - 240 V, 400 - 415 V				
Operating frequency		50/60 Hz				
Accessories		See page E-2				



Vigi iC60 add-on residual current devices (AC, A, SI types)

Connection

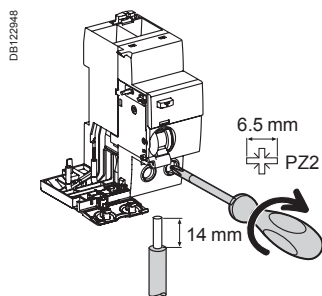

Type	Rating	Tightening torque	Copper cables	
			Rigid	Flexible or ferrule
Vigi iC60	25 A	2 N.m	1 to 25 mm ²	1 to 16 mm ²
	40 to 63 A	3.5 N.m	1 to 35 mm ²	1 to 25 mm ²

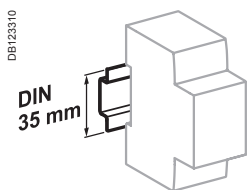

Clip on DIN rail 35 mm.

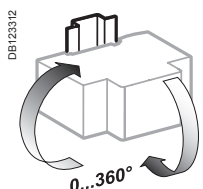

Indifferent position of installation.

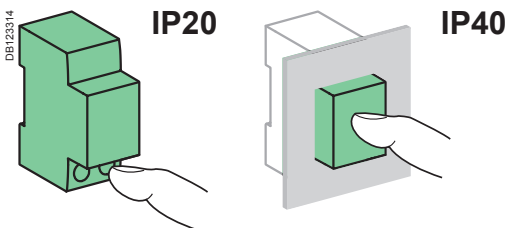

Technical data

Main characteristics

Insulation voltage (U _i)	500 V
Pollution degree	3
Rated impulse withstand voltage (U _{imp})	6 kV

According to IEC/EN 61009-1

Surge current withstand (8/20 μs) without tripping	AC and A types (no selective \square)	250 Å
	AC, A types (selective \square)	3 kÅ
	SI type	3 kÅ

Additional characteristics

Degree of protection	Device only	IP20
	Device in modular enclosure	IP40 Insulation classe II
Operating temperature	AC type	-5°C to +60°C
	A and SI types	-25°C to +60°C
Storage temperature		-40°C to +85°C

Weight (g)

Add-on residual current devices

Type	Vigi iC60
2P	165
3P	210
4P	245

Dimensions (mm)

Vigi iC60 25 A

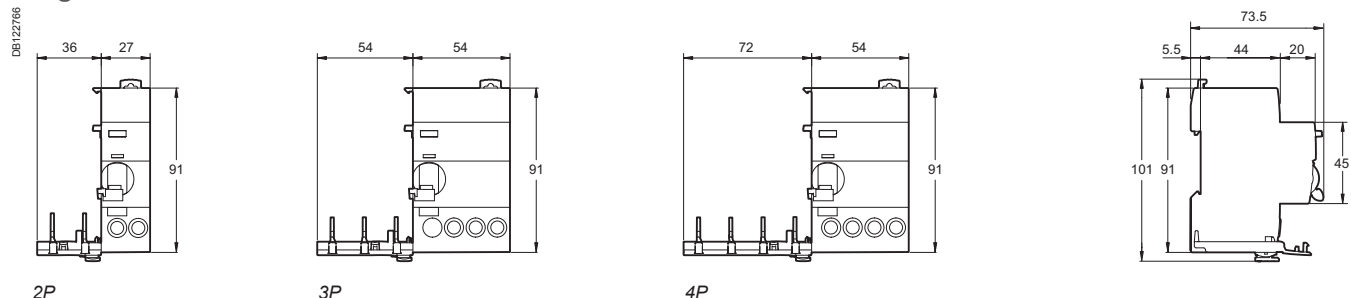

Vigi iC60 40 and 63 A

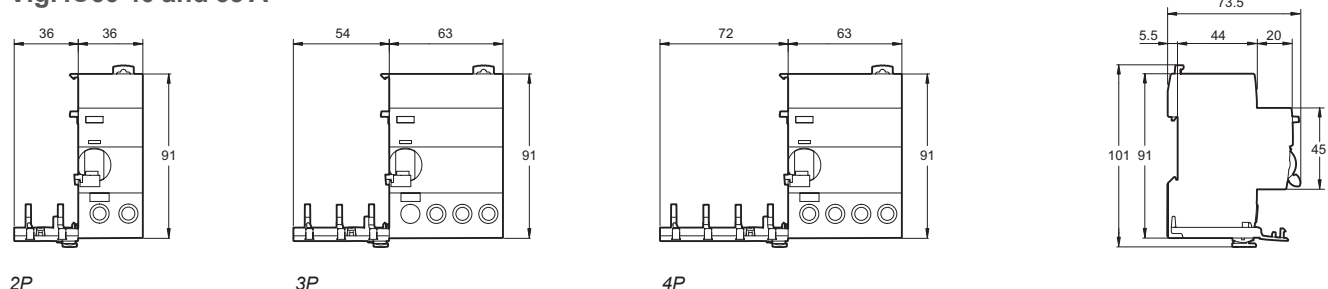

Vigi iC60 add-on residual current devices (AC, A, S/ types) (cont.)

PE104656-51

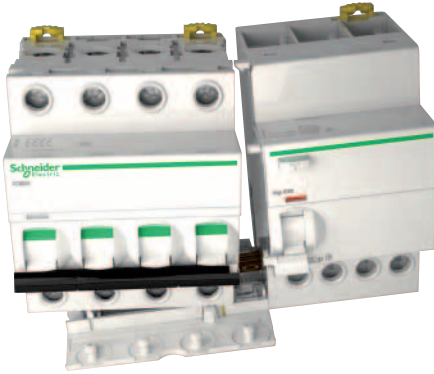

Association iC60a, N, H, L + Vigi iC60

iC60	Vigi iC60 25 A	Vigi iC60 40 A	Vigi iC60 63 A
$\square\square\text{L}\uparrow\pm\text{mm}\sqrt{2}\text{L}\uparrow$	■	■	■
$\sqrt{3}\sqrt{2}\uparrow\square\square\uparrow$	NO	■	■
$\text{L}\uparrow\square\text{L}\sqrt{3}\uparrow$	NO	NO	■

Association iC60L-MA + Vigi iC60

iC60	Vigi iC60 25 A	Vigi iC60 40 A	Vigi iC60 63 A
$\pm\text{L}\uparrow\pm\text{mm}\pm\text{L}\uparrow$	■	■	■
$\sqrt{2}\text{L}\uparrow$	NO	■	■
$\text{L}\uparrow$	NO	NO	■



Combining iC60 L-MA units with Vigi modules of higher rating.

PE104466-40

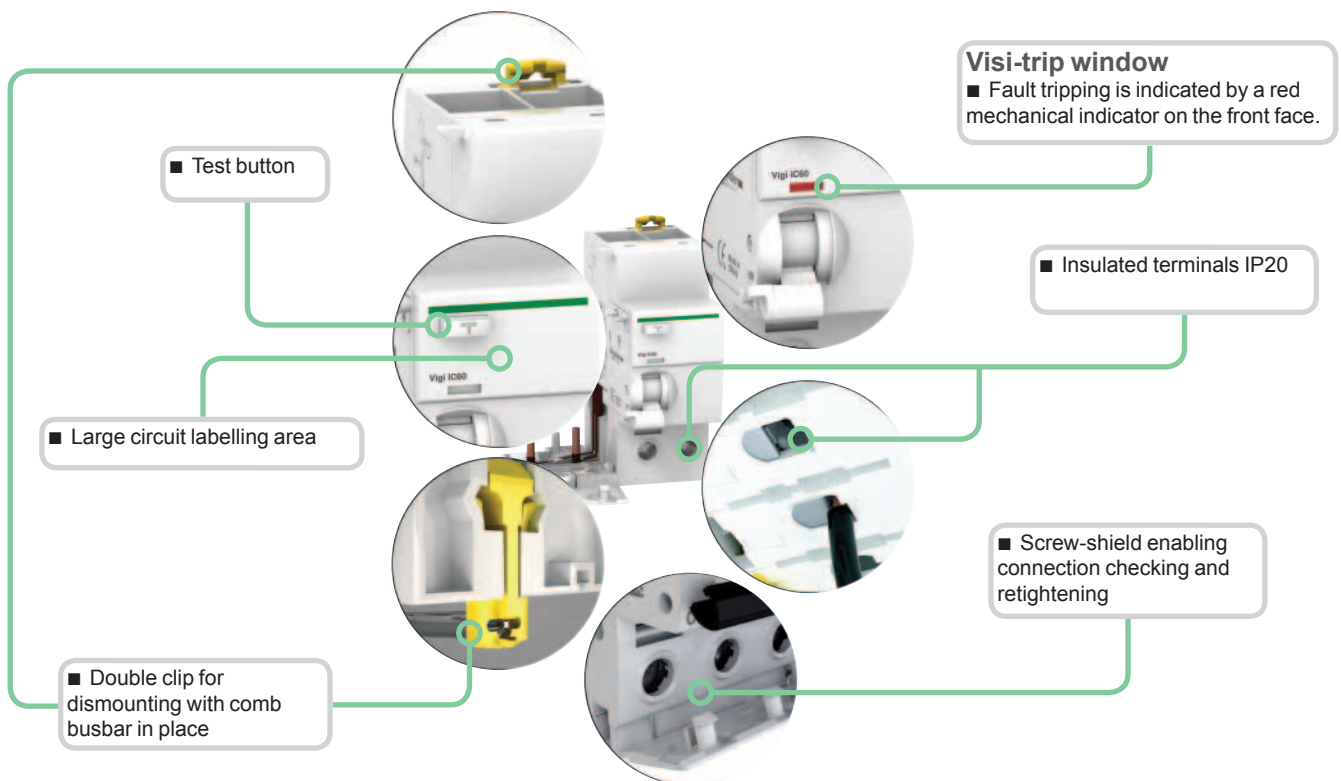

B

S/ type

The S/ type provides increased immunity from electrical interference and polluted or corrosive environments.

Vigi C120 add-on residual current devices (types AC, A and SI) (cont.)

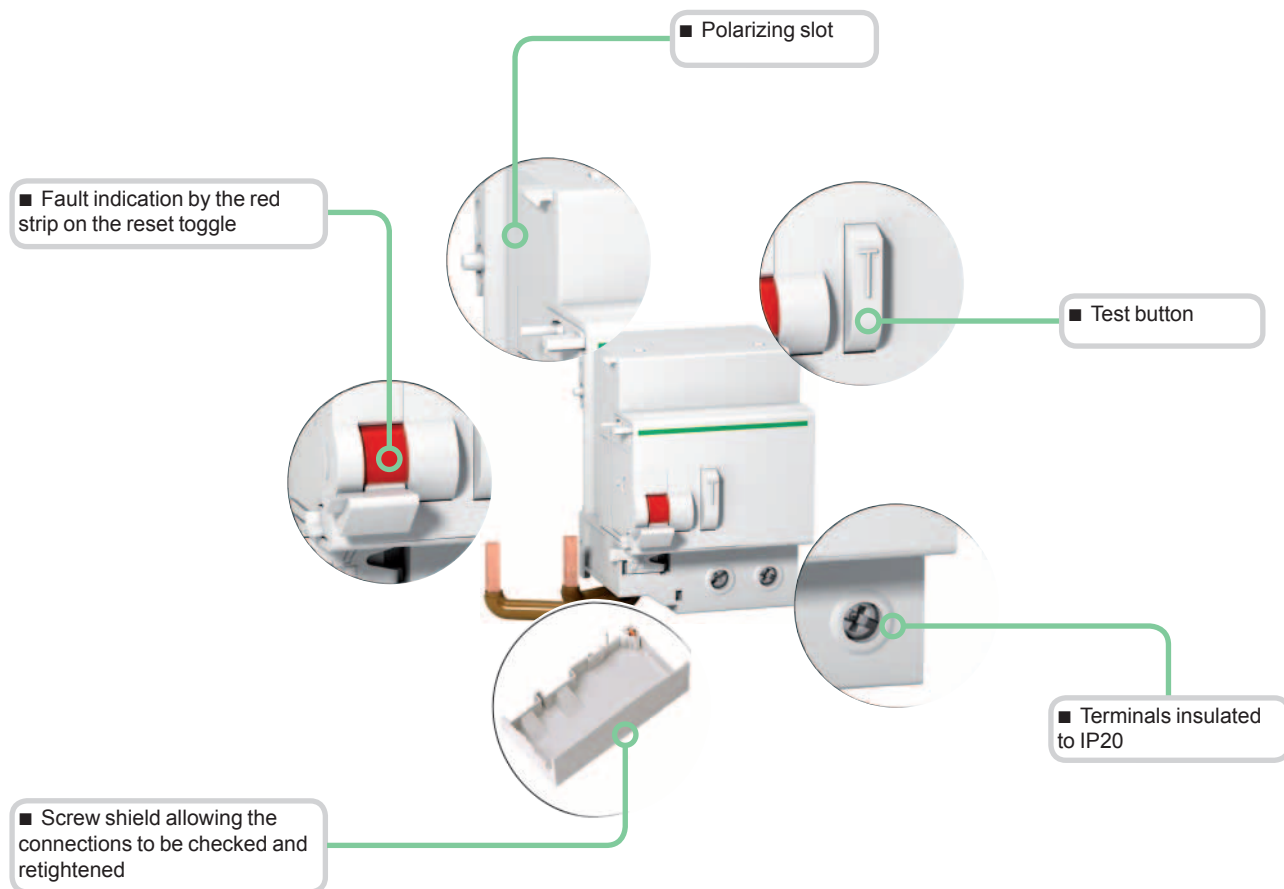

Type SI

The *SI* type provides increased immunity from electrical interference and polluted or corrosive environments.

EN 61009



2P



3P



4P

When a Vigi C120 device is combined with a C120 circuit breaker, it provides the following functions:

- protection of persons against electric shock by direct contact (30 mA),
- protection of persons against electric shock by indirect contact (≥ 300 mA),
- protection of installations against fire hazards (300 mA to 1000 mA).

Catalogue numbers

Vigi C120 add-on residual current devices							
Type	AC	Vigi C120					Width in 9 mm modules
Product	Without auxiliary						
Auxiliaries	Without auxiliary						
2P	Sensitivity	30 mA	300 mA	500 mA	300 mA 	1000 mA 	
		A9N18563	A9N18564	A9N18565	A9N18544	A9N18545	7
3P	Sensitivity	30 mA	300 mA	500 mA	300 mA 	1000 mA 	
		A9N18566	A9N18567	A9N18568	A9N18546	A9N18547	10
4P	Sensitivity	30 mA	300 mA	500 mA	300 mA 	1000 mA 	
		A9N18569 A9N18542 ⁽¹⁾	A9N18570 A9N18543 ⁽¹⁾	A9N18571	A9N18548	A9N18549	10
Operating voltage (Ue)	230...415 V						
Operating frequency	50/60 Hz						
Accessories	See page E-7 and E-15						

(1) specific offer for France

B

Vigi C120 add-on residual current devices (type A)

EN 61009

When a Vigi C120 device is combined with a C120 circuit breaker, it provides the following functions:

- protection of persons against electric shock by direct contact (30 mA),
- protection of persons against electric shock by indirect contact (≥ 300 mA),
- protection of installations against fire hazards (300 mA to 1000 mA).



2P













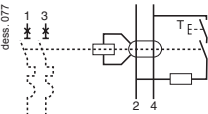

3P

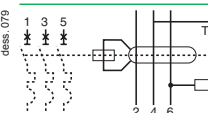

4P

Catalogue numbers

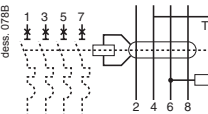
Vigi C120 add-on residual current devices								
Type	A 							Width in 9 mm modules
Product	Vigi C120							
Auxiliaries	Without auxiliary							
2P	Sensitivity	30 mA	300 mA	500 mA	300 mA 	500 mA 	1000 mA 	
		A9N18572	A9N18573	A9N18574	A9N18581	A9N18582	A9N18583	7
3P	Sensitivity	30 mA	300 mA	500 mA	300 mA 	500 mA 	1000 mA 	
		A9N18575	A9N18576	A9N18577	A9N18584	A9N18585	A9N18586	10
4P	Sensitivity	30 mA	300 mA	500 mA	300 mA 	500 mA 	1000 mA 	
		A9N18578	A9N18579	A9N18580	A9N18587	A9N18588	A9N18589	10
Operating voltage (Ue)	230...415 V							
Operating frequency	50/60 Hz							
Accessories	See page E-15 and E-7							

EN 61009

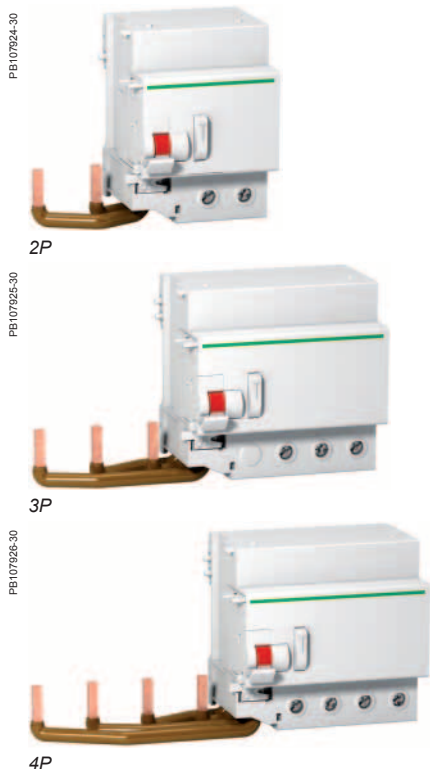

When a Vigi C120 device is combined with a C120 circuit breaker, it provides the following functions:

- protection of persons against electric shock by direct contact (30 mA),
- protection of persons against electric shock by indirect contact (≥ 300 mA),
- protection of installations against fire hazards (300 mA to 1000 mA).

Special feature of type SI :

They are appropriate for operating in environments with:

- high risk of nuisance tripping: frequent lightning strikes, IT system, presence of electronic ballasts, frequency converters, presence of switchgear incorporating lighting type interference filters, computer system, etc.
- blind sources:
 - presence of harmonics or high frequency rejections
 - presence of DC components: diodes, diode bridges, switch-mode power supplies, etc.
- protected against nuisance tripping caused by transient voltage surges (lightning strike, operation of switchgear on the network, etc.)

Catalogue numbers

Vigi C120 add-on residual current devices							
Type	SI					Width in 9 mm modules	
Product	Vigi C120						
Auxiliaries	Without auxiliary						
2P	Sensitivity	30 mA	300 mA	500 mA	300 mA 	1000 mA 	
 dess. 078		A9N18591	A9N18592	A9N18593	A9N18556	A9N18557	7
3P	Sensitivity	30 mA	300 mA	500 mA	300 mA 	1000 mA 	
 dess. 079		A9N18594	A9N18595	A9N18596	A9N18558	A9N18559	10
4P	Sensitivity	30 mA	300 mA	500 mA	300 mA 	1000 mA 	
 dess. 078B		A9N18597 A9N18554 ⁽¹⁾	A9N18598 A9N18555 ⁽¹⁾	A9N18599	A9N18560	A9N18561	10
Operating voltage (Ue)	230...415 V						
Operating frequency	50 Hz						
Accessories	See page E-7 and E-15						

(1) specific offer for France

B

Vigi C120 add-on residual current devices (types AC, A and SI)

Connection

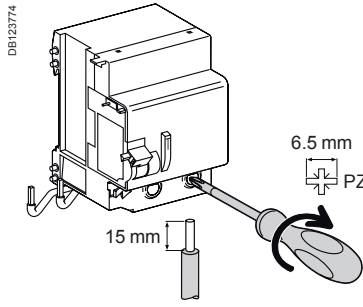

Type	Sensitivity	Tightening torque	Copper cables	
			Rigid	Flexible or with ferrule
Vigi C120	30...1000 mA	3.5 N.m	1 to 50 mm ²	1 to 35 mm ²

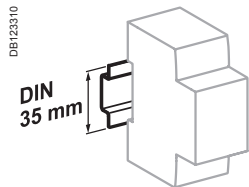

Clips onto 35 mm DIN rail.

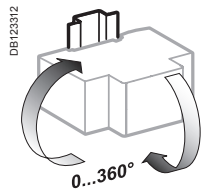

Any installation position.

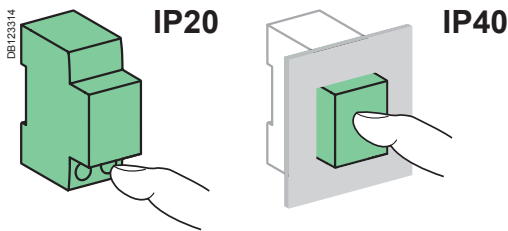

Technical data

Main characteristics

To IEC 60947-2

Insulation voltage (U _i)	500 V AC
Degree of pollution	3
Rated impulse withstand voltage (U _{imp})	6 kV

To EN 61009

Impulse current withstand (8/20 μs) without tripping	Types AC and A (non-selective Ⓜ)	250 Å
	Types AC and A (selective Ⓜ)	3 kÅ
	Types SI (non-selective Ⓜ)	3 kÅ
	Types SI (selective Ⓜ)	5 kÅ

Additional characteristics

Degree of protection	Device only	IP20
	Device in a modular enclosure	IP40
Operating temperature	Type AC	-5 °C to +60 °C
	Types A and SI	-25 °C to +60 °C
Storage temperature		-40 °C to +85 °C

Weight (g)

Add-on residual current devices

Type	Vigi C120
2P	325
3P	500
4P	580

Dimensions (mm)

C120 + Vigi C120

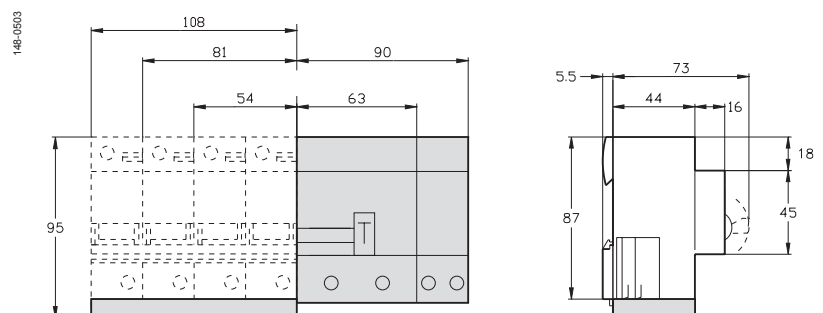

Vigi NG125 add-on residual current devices (AC, A, S/I types)

068341_SE-90



Association NG125 + Vigi NG125

	Vigi NG125 63 A	Vigi NG125 125 A
NG125 ≤ 63 A	■	NO
NG125 80...125 A*	NO	■

(*) No Vigi add-on residual current device for 2P circuit breakers of rating 80 A.

PB104468-40

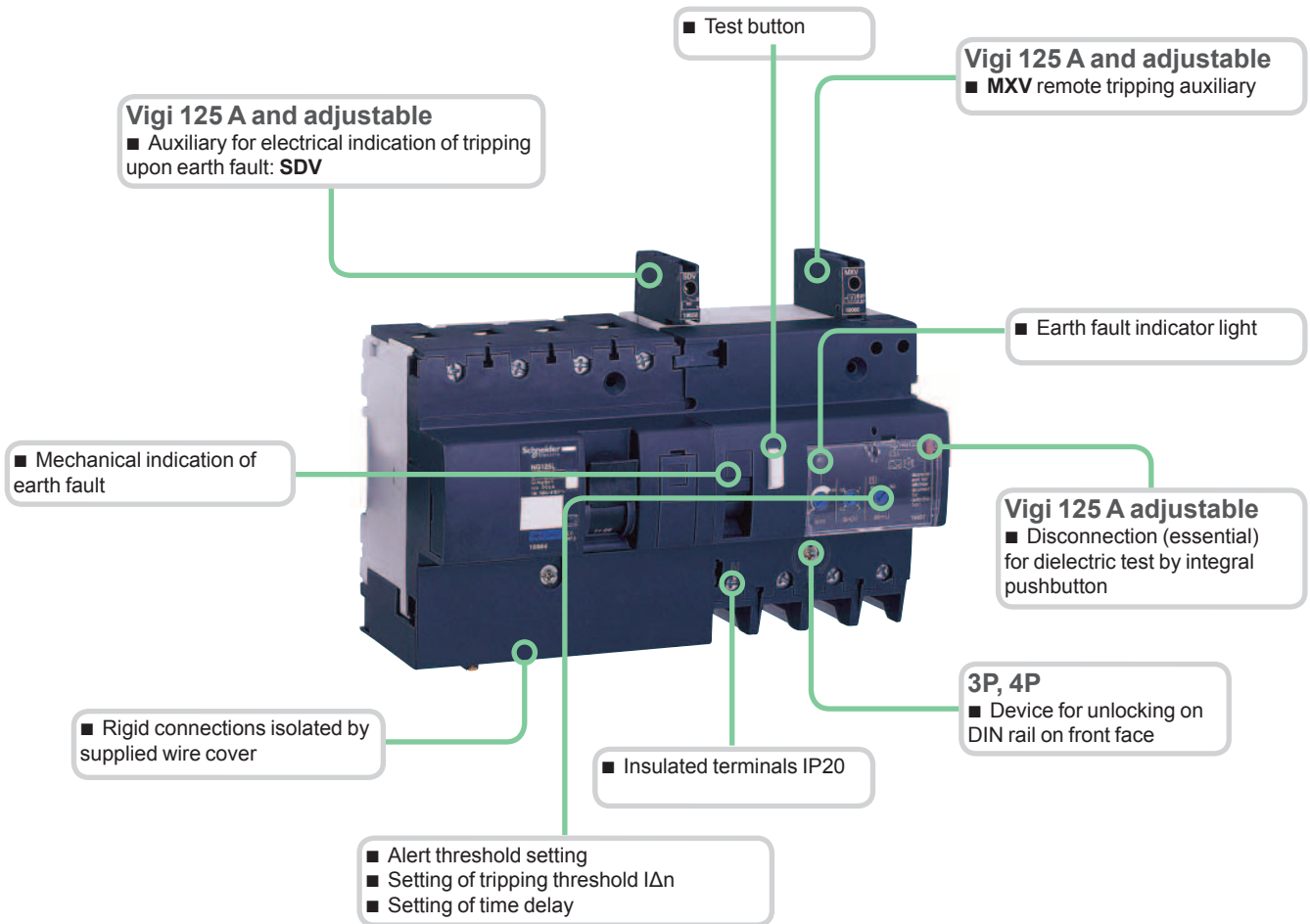

S/I type

S/I types are appropriate for operating in environments with:

- High risk of nuisance tripping: frequent lightning strikes, IT system, presence of electronic ballasts, frequency converters, presence of switchgear incorporating lighting type interference filters, computer system, etc.
- Blind sources
 - presence of harmonics or high frequency rejections,
 - presence of DC components: diodes, diode bridges, switch-mode power supplies, etc.
- Protected against nuisance tripping caused by transient voltage surges (lightning strike, operation of switchgear on the network, etc.).

Vigi NG125 add-on residual current devices (AC type)



IEC/EN 60947-2



- When it is combined with an NG125 circuit breaker, the Vigi NG125 add-on residual current device offers the following functions:
 - protection of persons against electric shocks by direct contact (30 mA),
 - protection of persons against electric shocks by indirect contact (300 mA),
 - protection of installations against fire risks (300 mA).

Catalogue numbers

Vigi NG125 add-on residual current devices					
Type	AC			Width in 9 mm modules	
Product	Vigi NG125				
Auxiliaries	Without auxiliaries				
2P DB1122462	Rating	63 A			
	Sensitivity		30 mA	300 mA	
			19000	19001	5
3P DB1122463	Rating	63 A			
	Sensitivity		30 mA	300 mA	
			19002	19003	9
4P DB1122464	Rating	63 A			
	Sensitivity		30 mA	300 mA	
			19004	19005	9
Voltage rating (Ue)			230 - 240 V, 400 - 415 V		
Operating frequency			50/60 Hz		
Accessories			See page E-26		



IEC/EN 60947-2

054383M-40

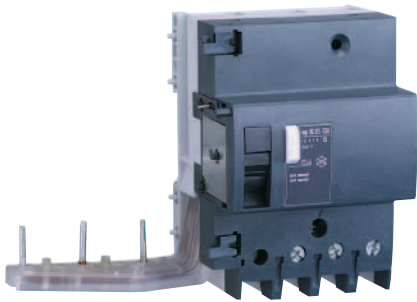

PB 10398-40

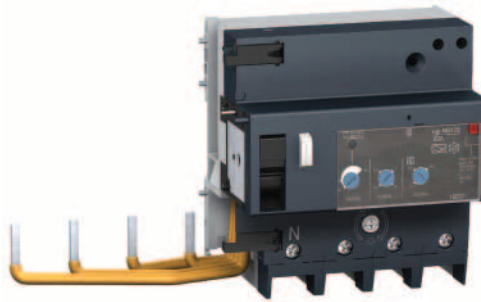

- When it is combined with an NG125 circuit breaker, the Vigi NG125 add-on residual current device offers the following functions:
 - protection of persons against electric shocks by direct contact (30 mA),
 - protection of persons against electric shocks by indirect contact (≥ 300 mA),
 - protection of installations against fire risks (300 mA or 500 mA).

Catalogue numbers

Vigi NG125 add-on residual current devices								
Type	A							Width in 9 mm modules
Product	Vigi NG125							
Auxiliaries	See page F-14							
2P	Sensitivity	30 mA	300 mA	300 mA 	1000 mA 	300...1000 I/S	300...3000 I/S/R	
 DB122462	Rating	63 A	19010 19008 (1)	19012 19009 (1)	19030	19031	-	5
3P	Sensitivity	30 mA	300 mA	300 mA 	1000 mA 	300...1000 I/S	300...3000 I/S/R	
 DB122463	Rating	63 A	19013	19014	19032	19033	-	9
			-	-	-	-	19036 19053 (2)	11
		125 A	19039	-	-	-	19044 19047 19055 (2)	11
4P	Sensitivity	30 mA	300 mA	300 mA 	1000 mA 	300...1000 I/S	300...3000 I/S/R	
 DB122464	Rating	63 A	19015	19016	19034	19035	-	9
			-	-	-	-	19037 19054 (2)	11
		125 A	19041	19042	-	-	19046 19049 19056 (2)	11
Voltage rating (Ue)	230 - 240 V, 400 - 415 V Except: (1) 110...220 V and (2) 440...500 V							
Operating frequency	50/60 Hz							
Accessories	See page E-26							

B

Vigi NG125 add-on residual current devices (SI type)



IEC/EN 60947-2

067484-40

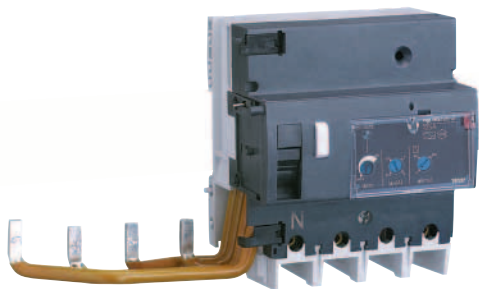

- When it is combined with an NG125 circuit breaker, the Vigi NG125 add-on residual current device offers the following functions:
 - protection of persons against electric shocks by direct contact (30 mA),
 - protection of persons against electric shocks by indirect contact (≥ 300 mA),
 - protection of installations against fire risks (300 mA or 500 mA).

SI types are appropriate for operating in environments with:

- High risk of nuisance tripping: frequent lightning strikes, IT system, presence of electronic ballasts, frequency converters, presence of switchgear incorporating lighting type interference filters, computer system, etc.
- Blind sources
 - presence of harmonics or high frequency rejections,
 - presence of DC components: diodes, diode bridges, switch-mode power supplies, etc.
- Protected against nuisance tripping caused by transient voltage surges (lightning strike, operation of switchgear on the network, etc.).

Catalogue numbers

Vigi NG125 add-on residual current devices						
Type	SI		Vigi NG125		Width in 9 mm modules	
Product	See page F-14					
Auxiliaries	Sensitivity		30 mA	300...3000 I/S/R		
3P 	Rating	125 A	19100	19106	11	
4P 	Rating	125 A	19101	19107	11	
Voltage rating (Ue)			230 - 240 V, 400 - 415 V			
Operating frequency			50/60 Hz			
Accessories			See page E-26			

Vigi NG125 add-on residual current devices (AC, A, S/I types)

Connection

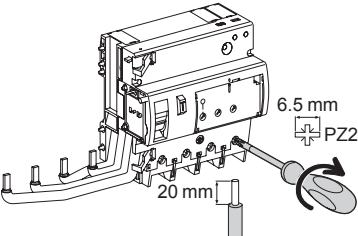
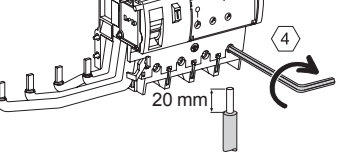
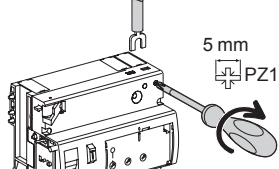
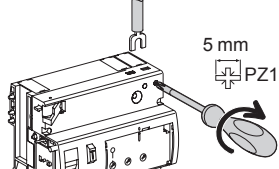
DB123404		Without accessories		With accessories				
		Rating	Tightening torque	Copper cables			70 mm ² Al terminal	Screw-on connection for ring terminal
				Rigid	Flexible or ferrule	Screw clamp terminal		
DB123405		63 A	3.5 N.m	1.5 to 50 mm ²	1 to 35 mm ²	-	-	
DB123408		125 A	6 N.m	16 to 70 mm ²	10 to 50 mm ²	25 to 70 mm ²	2 x 35 mm ² 1 x 50 mm ²	
DB123408		Pre-alarm	1 N.m	2 x 2.5 mm ²	2 x 1.5 mm ²	2 x 1.5 mm ²	-	

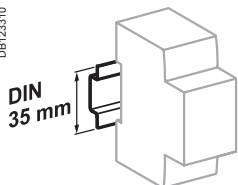

Clip on DIN rail 35 mm.

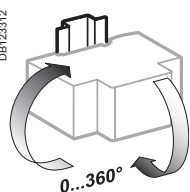

Indifferent position of installation.

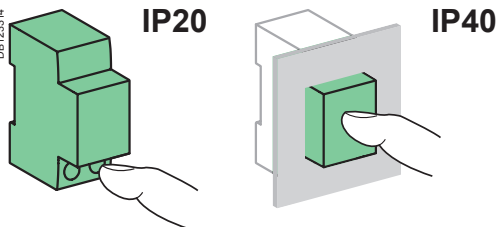

Technical data

Main characteristics		
Insulation voltage (U _i)		690 V
Pollution degree		3
Rated impulse withstand voltage (U _{imp})		8 kV
According to IEC/EN 61009-1		
Surge current withstand (8/20 μs) without tripping	Selective <input type="checkbox"/> or R	5 kA
	Instantaneous	3 kA
Additional characteristics		
Degree of protection	Device only	IP20
	Device in modular enclosure	IP40
Operating temperature	AC type	-5°C to +60°C
	A and S/I types	-25°C to +60°C
Storage temperature		-40°C to +85°C
Additional characteristics		
Vigi 125 A and adjustable		
Plug-in auxiliaries	MXV	Remote tripping
	SDV	Indication of tripping upon earth fault
Adjustable Vigi		
Sensitivity adjustable by notch (I _{Δn})		300, 500, 1000, 3000 mA
Tripping time	Instantaneous	
	Selective <input type="checkbox"/>	60 ms
	Time-delayed	150 ms
Leakage current indication on 3P and 4P 300...3000 I/S/R (pre-alarm)		On front face by LED Remote, by potential-free normally-open contact 250 V - 1 A (low level) Threshold setting by potentiometer from 10 % to 50 % of I _{Δn}
Disconnection essential for dielectric test		By integral pushbutton

B

Vigi NG125 add-on residual current devices (AC, A, S/ types) (cont.)

Weight (g)

Add-on residual current devices			
Number of 9 mm modules	2P	3P	4P
5 modules	250	-	-
9 modules	-	410	450
11 modules	-	750	800

Dimensions (mm)

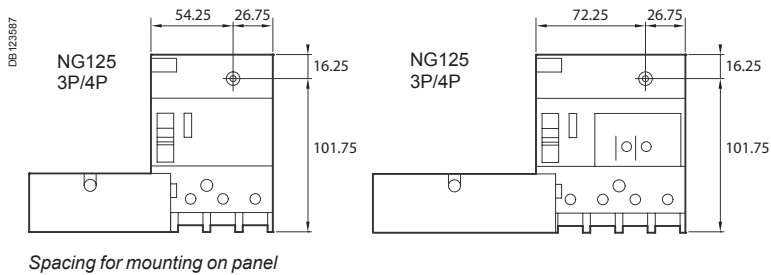
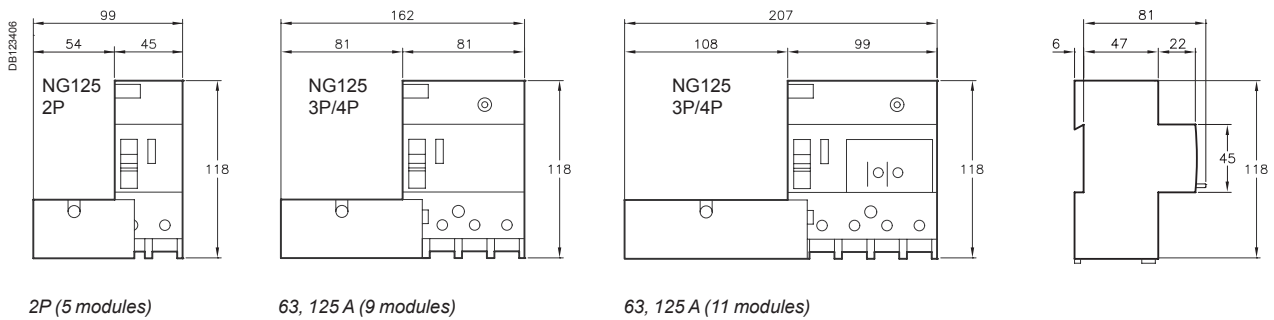

Earth leakage protection for "Group Feeders" is performed:

IEC/EN 61009-1 and 61009-2-1

- either by a monobloc residual current device
- or by a circuit breaker combined with a Vigi module.



Catalogue numbers

iDPN Vigi residual current devices 4500 EN 61009 - C curve						
Type	AC				Width in 9-mm modules	
Auxiliaries	See page E-31					
	Sensitivity Rating	25 A	A9N21771	A9N21775	A9N21772	12
		40 A	A9N21773	A9N21776	A9N21774	

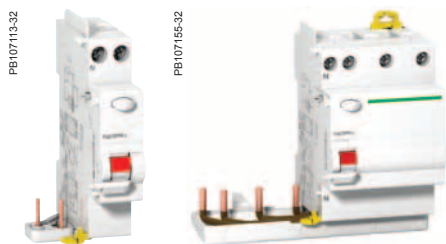

Catalogue numbers

"Group Feeder" iDPN Vigi modules											
Type	AC			A		SI			Width in 9-mm modules		
Auxiliaries	Without auxiliary			Without auxiliary		Without auxiliary					
	Sensitivity Rating	25 A	A9N21741	A9N21742	-	A9N21745	A9N21746	A9N21749	A9N21750	-	2
		40 A	A9N21743	A9N21744	-	A9N21747	A9N21748	A9N21751	A9N21752	A9N21753	
	Sensitivity Rating	25 A	A9N21755	A9N21756	-	A9N21759	A9N21760	A9N21763	A9N21764	-	6
		40 A	A9N21757	A9N21758	-	A9N21761	A9N21762	A9N21765	A9N21766	A9N21767	
		63 A	A9N26846	A9N26847	A9N26848	-	-	A9N26849	-	-	



IEC/EN 61009-1 and 61009-2-1

For the earth leakage protection of "outgoers", a residual current device is built by combining a circuit breaker and a Vigi module. "Outgoer" residual current devices are also available in monobloc version.



Catalogue numbers

<i>i</i> DPN Vigi residual current devices 4500 EN 61009 - C curve					
Type	AC		Width in 9-mm modules		
Auxiliaries	Add-on auxiliaries: see modules F-9 and E-31				
1P+N	Sensitivity	30 mA	300 mA		
	Rating	6 A	A9N21614	A9N21624	4
		10 A	A9N21615	A9N21625	
		16 A	A9N21616	A9N21626	
		20 A	A9N21617	A9N21627	
		25 A	A9N21618	A9N21628	
		32 A	A9N21619	A9N21629	
	40 A	A9N21620	A9N21630		

Catalogue numbers

"Outgoer" <i>i</i> DPN Vigi modules										
Type	AC			A		SI		Width in 9-mm modules		
1P+N	Sensitivity	30 mA	100 mA	300 mA	30 mA	300 mA	30 mA	300 mA		
	Rating	25 A	A9N21681	A9N21678	A9N21682	A9N21685	A9N21686	A9N21689	A9N21690	2
			A9N21680	A9N21679						
		40 A	A9N21683	-	A9N21684	A9N21687	A9N21688	A9N21691	A9N21692	
	Rating	25 A	A9N21695	-	A9N26696	A9N21699	A9N21700	A9N21703	A9N21704	4
		40 A	A9N21697	-	A9N26698	A9N21701	A9N21702	A9N21705	A9N21706	
	Rating	25 A	A9N21709	-	A9N21710	A9N21713	A9N21714	A9N21717	A9N21718	4
		40 A	A9N21711	-	A9N21712	A9N21715	A9N21716	A9N21719	A9N21720	



IEC/EN 61009



iDPN a Vigi

iDPN H Vigi

■ The iDPN Vigi residual current device provide complete protection for final circuits (against overcurrents and insulation faults):

- protection for users against electric shocks by direct contacts (≤ 30 mA),
- protection for users against electric shocks by indirect contacts (300 mA),
- protection of the installations against fire risks (300 mA).

■ The **SI** range has been designed to maintain a network with optimum safety and continuity of service in installations disturbed by:

- extreme atmospheric conditions,
- harmonic generating loads,
- transient operating currents.

Catalogue numbers

iDPN a Vigi 4500		AC				A		Width in 9 mm modules
Type		Remote tripping and indication, see pages E-2 and F-2						
Auxiliaries		Remote tripping and indication, see pages E-2 and F-2						
1P+N	Curve B	Sensitivity	30 mA	300 mA	10 mA	30 mA		
	Rating (In)	6 A	A9D51606	-	-	A9D54606	4	
		10 A	A9D51610	-	-	A9D54610		
		13 A	-	-	-	A9D54613		
		16 A	A9D51616	-	-	A9D54616		
		20 A	A9D51620	-	-	A9D54620		
		25 A	A9D51625	-	-	A9D54625		
		32 A	A9D51632	-	-	A9D54632		
		40 A	A9D51640	-	-	A9D54640		
Voltage rating (Ue)		230 V AC						
Operating frequency		50 Hz						
Accessories		See pages E-6 , E-10 and E-29						





iDPN N Vigi



iDPN N Vigi G Type 6000		AC		A		Width in 9 mm modules
Type		Remote tripping and indication, see pages E-2 and F-2				
Auxiliaries		Remote tripping and indication, see pages E-2 and F-2				
1P+N	Curve C	Sensitivity	30 mA	100 mA		
	Rating (In)	6 A	A9D62606	A9D72606	4	
		10 A	A9D62610	A9D72610		
		13 A	A9D62613	A9D72613		
		16 A	A9D62616	A9D72616		
Voltage rating (Ue)		230 V AC				
Operating frequency		50 Hz				
Accessories		See pages E-6 , E-10 and E-29				

B

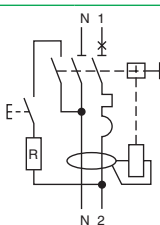
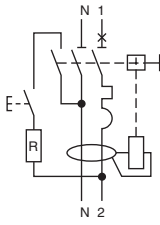
iDPN N Vigi 6000

Type		AC 	A 						SI 			Width in 9 mm modules
Auxiliaries		Remote tripping and indication, see pages E-2 and F-2										
1P+N	Curve B	Sensitivity	30 mA	300 mA	10 mA	30 mA	100 mA	300 mA	30 mA	100 mA	300 mA	
	Rating (In)	4 A	A9D55604	A9D68604	-	A9D56604	A9D60604	A9D69604	-	-	-	4
		6 A	A9D55606	A9D68606	-	A9D56606	A9D60606	A9D69606	-	-	-	
		10 A	A9D55610	A9D68610	A9D08610	A9D56610	A9D60610	A9D69610	-	-	-	
		13 A	-	-	-	A9D56613	A9D60613	A9D69613	-	-	-	
		16 A	A9D55616	A9D68616	A9D08616	A9D56616	A9D60616	A9D69616	-	-	-	
		20 A	A9D55620	A9D68620	-	A9D56620	A9D60620	A9D69620	-	-	-	
		25 A	A9D55625	A9D68625	-	A9D56625	A9D60625	A9D69625	-	-	-	
		32 A	A9D55632	A9D68632	-	A9D56632	A9D60632	A9D69632	-	-	-	
40 A	A9D55640	A9D68640	-	A9D56640	A9D60640	A9D69640	-	-	-			
1P+N	Curve C	Sensitivity	30 mA	300 mA	10 mA	30 mA	100 mA	300 mA	30 mA	100 mA	300 mA	
	Rating (In)	6 A	A9D31606	A9D41606	-	A9D32606	A9D52606	A9D42606	A9D33606	A9D53606	A9D43606	4
		10 A	A9D31610	A9D41610	A9D02610	A9D32610	A9D52610	A9D42610	A9D33610	A9D53610	A9D43610	
		13 A	-	-	-	A9D32613	A9D52613	A9D42613	A9D33613	A9D53613	A9D43613	
		16 A	A9D31616	A9D41616	A9D02616	A9D32616	A9D52616	A9D42616	A9D33616	A9D53616	A9D43616	
		20 A	A9D31620	A9D41620	-	A9D32620	A9D52620	A9D42620	A9D33620	A9D53620	A9D43620	
		25 A	A9D31625	A9D41625	-	A9D32625	A9D52625	A9D42625	A9D33625	A9D53625	A9D43625	
		32 A	A9D31632	A9D41632	-	A9D32632	A9D52632	A9D42632	A9D33632	A9D53632	A9D43632	
		40 A	A9D31640	A9D41640	-	A9D32640	A9D52640	A9D42640	A9D33640	A9D53640	A9D43640	
Voltage rating (Ue)		230 V AC										
Operating frequency		50 Hz										
Accessories		See pages E-6 , E-10 and E-29										

iDPN H Vigi 10000

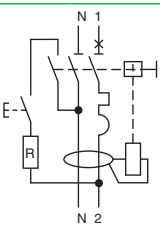
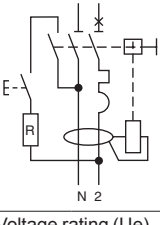
Type		A 	SI 				Width in 9 mm modules
Auxiliaries		Remote tripping and indication, see pages E-2 and F-2					
1P+N	Curve B	Sensitivity	30 mA	300 mA	30 mA	300 mA	
	Rating (In)	6 A	A9D07606	-	-	-	4
		10 A	A9D07610	-	-	-	
		16 A	A9D07616	-	-	-	
		20 A	A9D07620	-	-	-	
		25 A	A9D07625	-	-	-	
		32 A	A9D07632	-	-	-	
1P+N	Curve C	Sensitivity	30 mA	300 mA	30 mA	300 mA	
	Rating (In)	6 A	A9D37606	A9D47606	A9D38606	A9D48606	4
		10 A	A9D37610	A9D47610	A9D38610	A9D48610	
		16 A	A9D37616	A9D47616	A9D38616	A9D48616	
		20 A	A9D37620	A9D47620	A9D38620	A9D48620	
		25 A	A9D37625	A9D47625	A9D38625	A9D48625	
		32 A	A9D37632	A9D47632	A9D38632	A9D48632	
Voltage rating (Ue)		230 V AC					
Operating frequency		50 Hz					
Accessories		See pages E-6 , E-10 and E-29					

Residual current devices iDPN Vigi (cont.)

■ Fast contact closure

■ Insulated terminals IP20

Visi-trip double window

- Fault tripping circuit breaker is indicated by a red mechanical indicator on the front face.
- Earth fault is indicated by a red mechanical indicator on the front face

■ Test button

Positive contact indication

- A green strip on the toggle guarantees opening of all the poles in safety conditions (padlocking possible) for work to be carried out on live parts

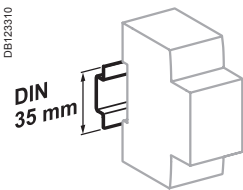

Clip on DIN rail 35 mm.

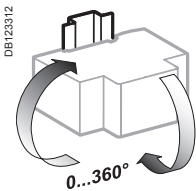

Indifferent position of installation.

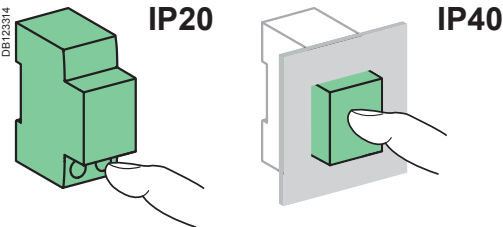

Connection

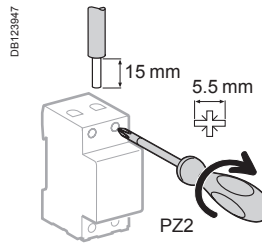

Rating	Tightening torque	Copper cables	
		Rigid	Flexible or ferrule
4 to 40 A	3.5 N.m	1 to 16 mm ²	1 to 10 mm ²

Technical data

Main characteristics

Type	iDPNa Vigi	iDPN N Vigi	iDPN H Vigi
Insulation voltage (Ui)	400 V AC		
Pollution degree	3		
Rated impulse withstand voltage (Uimp)	4 kV		
Setting temperature for ratings	30°C		
Magnetic tripping	Curve B	Between 3 and 5 In	
	Curve C	Between 5 and 10 In	

According to EN 61009

Limitation class	3			
Rated breaking capacity (Icn)	4500 A	6000 A	10,000 A	
Rated residual breaking and making capacity (IΔm)	4500 A	6000 A	10,000 A	
8/20 μs impulse withstand	Type AC	250 Å	250 Å	250 Å
	Type A	250 Å	250 Å	250 Å
	Type SI	-	3 kÅ	3 kÅ

Additional characteristics

Earth leakage protection with instantaneous tripping	10, 30, 300 mA	10, 30, 100, 300 mA	30, 300 mA
Degree of protection (IEC 60529)	Device only	IP20	
	Device in modular enclosure	IP40 Insulation classe II	
Endurance (O-C)	Electrical	≤ 20 A	20,000 cycles
		≥ 25 A	10,000 cycles
	Mechanical		20,000 cycles
Overvoltage category (IEC 60364)	III		
Operating temperature	Type AC	-5°C to +60°C	
	Type A, SI	-25°C to +60°C	
Storage temperature	-40°C to +85°C		
Tropicalization (IEC 60068-1)	Treatment 2 (relative humidity 95 % to 55°C)		

Weight (g)

Residual current device	
Type	iDPN Vigi
1P+N	125

Dimensions (mm)

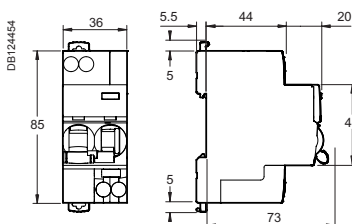

B

■ Insulated terminals IP20

■ Test push-button

Visi-trip window
■ Fault tripping is indicated by a red mechanical indicator on the front face

Positive contact indication
■ The presence of the green strip guarantees physical opening of the contacts and allows operations to be performed on the downstream circuit in complete safety

■ Insulated terminals IP20

■ Clip for dismounting

- Increased product service life thanks to fast closing independent of the speed of actuation of the toggle.
- Remote indication, open/closed/tripped, by optional auxiliary contacts.

Connection

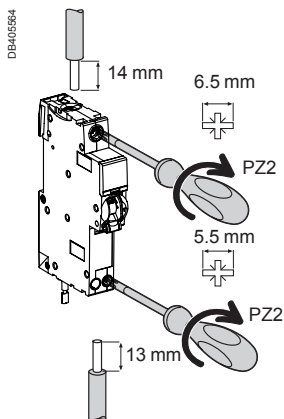

Type	Rating	Tightening torque	Copper cables	
			Rigid	Flexible
			DB122945	DB122946
N in and L in L out and N out	6 to 45 A	3.5 N.m 2 N.m	1 to 25 mm ² 1 to 16 mm ²	1 to 16 mm ² 1 to 10 mm ²



IEC 61009-1, IEC 61009-2-2

- The single-phase iC60N RCBO's self-contained residual current device carries out complete protection of final circuits:
 - protection against short-circuits and cable overloads,
 - protection against electrocution by direct contact.
- The neutral is not interrupted when the device is tripped. Hence iC60N RCBO can be used on most circuits, except for the ones operating under TT or IT earthing systems.

Alternating current (AC) 50/60 Hz

Breaking capacity (Icn) according to IEC 61009-1

Ph/N	Rating (In)	Voltage (Ue)
	6 to 45 A	240 V
		6000 A

Accessory

Padlocking device

- Used to lock the toggle in the "open" or "closed" position by 4 mm diameter padlock (not supplied).

Catalogue numbers

iC60N RCBO 6000

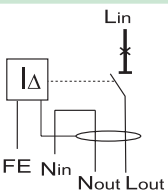
1P+N		A 		Width in 9-mm modules	
C curve	Voltage rating (V)	Sensitivity (IΔn)	30 mA	2	
	240	Rating (In)	6 A		A9D64806
			10 A		A9D64810
			16 A		A9D64816
			20 A		A9D64820
			25 A		A9D64825
			32 A		A9D64832
			40 A		A9D64840
			45 A	A9D64845	
Operating frequency			50...60 Hz		
Auxiliaries			See pages E-2 and F-2		

Accessory

Type	
Padlocking device (bag of 10 pieces)	A9A27049

IEC 61009-1, IEC 61009-2-2



- The single-phase iC60H RCBO's self-contained residual current device carries out complete protection of final circuits:
 - protection against short-circuits and cable overloads
 - protection of persons against electric shock by direct contact (30 mA sensitivities),
 - protection of persons against electric shock by indirect contact (100 mA sensitivity),
 - protection of equipment against fires set by leakage currents (100 mA sensitivity).
- The neutral is not interrupted when the device is tripped. Hence iC60H RCBO can be used on most circuits, except for the ones operating under TT or IT earthing systems.

Alternating current (AC) 50/60 Hz

Breaking capacity (Icn) according to IEC 61009-1

		Voltage (Ue)	
		110 V	240 V
Ph/N			
Rating (In)	6 to 45 A	10000 A	10000 A

Accessory

Padlocking device

- Used to lock the toggle in the "open" or "closed" position by 4 mm diameter padlock (not supplied).

Catalogue numbers

iC60H RCBO 10000							Width in 9-mm modules
1P+N			A				
B curve	Voltage rating (V)		Sensitivity (IΔn)	10 mA*	30 mA	100 mA	
	240	Rating (In)	6 A	A9D10806	A9D34806	-	2
			10 A	A9D10810	A9D34810	-	
			16 A	A9D10816	A9D34816	-	
			20 A	A9D10820	A9D34820	-	
			25 A	A9D10832	A9D34825	-	
			32 A		A9D34832	-	
			40 A		A9D34840	-	
			45 A		A9D34845	-	
C curve	Voltage rating (V)		Sensitivity (IΔn)				
	240	Rating (In)	6 A	A9D10806	A9D14806	A9D15806	2
			10 A	A9D10810	A9D14810	A9D15810	
			16 A	A9D10816	A9D14816	A9D15816	
			20 A	A9D10820	A9D14820	A9D15820	
			25 A	A9D10832	A9D14825	A9D15825	
			32 A		A9D14832	A9D15832	
			40 A		A9D14840	A9D15840	
			45 A		A9D14845	A9D15845	
Operating frequency				50...60 Hz			
Auxiliaries				See pages E-2 and F-2			

* Note: 10 mA available only in blue neutral.

Accessory

Type	
Padlocking device (bag of 10 pieces)	A9A27049

PB111076-70



IEC 61009-1, IEC 61009-2-2, AS/NZS 61009.1

- The 2-poles iC60H2 RCBO's self-contained residual current device carries out complete protection of final circuits:
 - protection against short-circuits and cable overloads,
 - protection of persons against electric shock by direct contact (30 mA sensitivities),
 - protection of equipment against fires set by leakage currents (300 mA sensitivity).
- iC60H2 RCBO switches neutral, together with phase. It is therefore suitable for all circuits, whatever the earthing system (except for TN-C).

Alternating current (AC) 50/60 Hz

Breaking capacity (Icn) according to IEC 61009-1

		Voltage (Ue)	
Ph/N, Ph/Ph		110 V	240 V
Rating (In)	10 to 32 A	10000 A	10000 A

Catalogue numbers

iC60H2 RCBO 10000

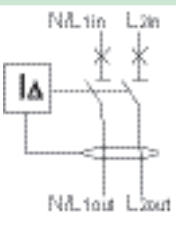
2P			A 		Width in 9-mm modules	
C curve	Voltage rating (V)	Sensitivity (IΔn)	30 mA	300 mA		
	240	Rating (In)	10 A	A9D11210	A9D51210	4
			16 A	A9D11216	A9D51216	
			20 A	A9D11220	A9D51220	
			25 A	A9D11225	A9D51225	
			32 A	A9D11232	A9D51232	
Operating frequency						
Auxiliaries			Refer to Page E-2 and F-2 of the Acti 9 catalogue			
Accessories padlocking device (bag of 10 pcs.)			A9A27049			

Technical data

Main characteristics		iC60N RCBO	iC60H RCBO	iC60H2 RCBO
Insulation voltage (Ui)		400 V AC		
Rated impulse withstand voltage (Uimp)		4 kV		
Rated residual operating current (IΔn)		30 mA	10, 30, 100 mA	30 mA, 300 mA
Thermal tripping	Reference temperature	50°C		
Temperature derating		See the Technical Guide		
Limitation class		3		
Surge current withstand (8/20 μs) without tripping		250 Å		
Rated nominal breaking capacity (Icn)		6,000 A	10,000 A	10,000 A
Phase/earth rated residual breaking and making capacity (IΔm)		6,000 A	7,500 A	7,500 A
Additional characteristics				
Degree of protection	Device only	IP20		
	Device in modular enclosure	IP40		
Endurance (O-C)	Electrical	5,000 cycles		
	Mechanical	20,000 cycles		
Operating temperature		-15°C to +60°C		
Storage temperature		-40°C to +85°C		
Tropicalization		Treatment 2 (relative humidity: 95 % at 55°C)		

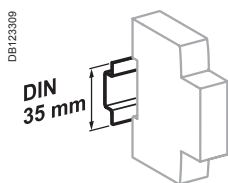

Clip on DIN rail 35 mm.

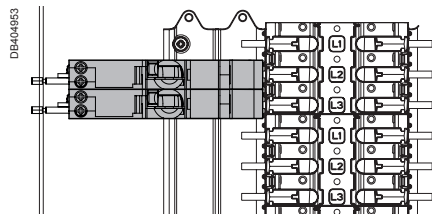

Installation on Fishbone.

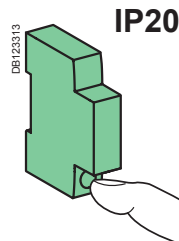

IP20

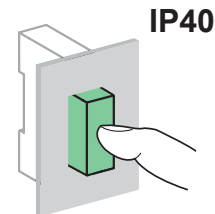

IP40

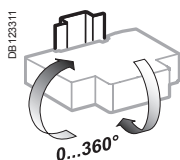

Indifferent position of installation.

Weight (g)

iC60 RCBO	
iC60N RCBO	205
iC60H RCBO	205
iC60H2 RCBO	332

Dimensions (mm)

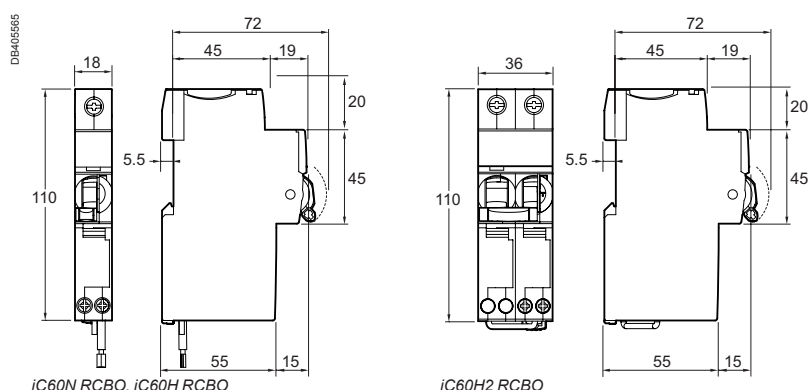

Load Protection (Surge arrester)



C



iPF surge arresters

Type 2 or 3 LV surge arresters

The iPF multi-pole single-piece surge arrester range is adapted for earthing systems: TT, TN-S, TN-C.

Type 2 surge arresters are tested with a 8/20 μ s current wave.

Type 3 surge arresters are tested with a 12/50 μ s and 8/20 μ s combined wave.

Each surge arrester in the range has a specific application:

■ **incoming protection (type 2):**

- the iPF65(r) is recommended for a very high risk level (strongly exposed site)
- the iPF40(r) is recommended for a high risk level
- the iPF20 is recommended for a medium risk level

■ **secondary protection (type 2 or 3):**

- the iPF8 ensures secondary protection of loads to be protected and is placed in cascade with the incoming surge arresters. This surge arrester is required when the loads to be protected are at a distance of more than 30 m from the incoming surge arrester.

The iPF surge arresters with “r” indication have remote transfer of the information: “surge arrester to be replaced”.

Rated discharge current (I _{max}) / Nominal discharge current (I _n)	Type of protection		Network							
	Incoming	Secondary (type 2 or 3)	1P+N	3P+N	1P	2P	3P	4P		
65 kA / 20 kA										
	iPF65				A9L15683					
			A9L15684			A9L15584				
							A9L15581			
			A9L15685							
			A9L15586						A9L15585	
40 kA / 15 kA										
High risk level	iPF40				A9L15686					
			A9L15687			A9L15587				
							A9L15582			
			A9L15690						A9L15590	
			A9L15688						A9L15588	
20 kA / 5 kA										
Medium risk level	iPF20				A9L15691					
			A9L15692			A9L15592				
							A9L15597			
			A9L15693						A9L15593	
8 kA / 2.5 kA										
Secondary protection: placed near the loads to be protected when they are at a distance of more than 30 m from the incoming surge arrester		iPF8			A9L15694					
			A9L15695			A9L15595				
							A9L15598			
			A9L15696					A9L15596		



1P+N.



3P+N.

Surge arrester/circuit breaker association

Type of surge arrester	Associated circuit breaker
iPF65	Curve C 50 A
iPF40	Curve C 40 A
iPF20	Curve C 25 A
iPF8	Curve C 20 A

	Earthing system	Transfer	Surge arrester name	Width in mod. of 9 mm	Up - (kV) Voltage protection level			Un - (V) Rated voltage network	Uc - (V) Maximum continuous operating voltage		
					CM*		DM*		CM*		DM*
					L/±	N/±	L/N		L/±	N/±	L/N
iPF65											
	TT & TN		iPF65 1P	2	≤ 1.5	-	-	230	340	-	-
	TT & TN-S		iPF65 1P+N	4	-	≤ 1.5	≤ 1.5		-	260	340
	TN-C		iPF65 2P		≤ 1.5	≤ 1.5	-		340	340	-
	TN-C		iPF65 3P	8	≤ 1.5	-	-	230/400	340	-	-
	TT & TN-S	■	iPF65r 3P+N		-	≤ 1.5	≤ 1.5		-	260	340
	TT & TN-S		iPF65 3P+N		-	≤ 1.5	≤ 1.5		-	260	340
	TN-C	■	iPF65r 4P		≤ 1.5	≤ 1.5	-		340	340	-
iPF40											
	TT & TN		iPF40 1P	2	≤ 1.5	-	-	230	340	-	-
	TT & TN-S		iPF40 1P+N	4	-	≤ 1.5	≤ 1.5		-	260	340
	TN-C		iPF40 2P		≤ 1.5	≤ 1.5	-		340	340	-
	TN-C		iPF40 3P	8	≤ 1.5	-	-	230/400	340	-	-
	TT & TN-S	■	iPF40r 3P+N		-	≤ 1.5	≤ 1.5		-	260	340
	TT & TN-S		iPF40 3P+N		-	≤ 1.5	≤ 1.5		-	260	340
	TN-C	■	iPF40r 4P		≤ 1.5	≤ 1.5	-		340	340	-
	TN-C		iPF40 4P		≤ 1.5	≤ 1.5	-		340	340	-
iPF20											
	TT & TN		iPF20 1P	2	≤ 1.1	-	-	230	340	-	-
	TT & TN-S		iPF20 1P+N	4	-	≤ 1.5	≤ 1.1		-	260	340
	TN-C		iPF20 2P		≤ 1.1	≤ 1.1	-		340	340	-
	TN-C		iPF20 3P	8	≤ 1.1	-	-	230/400	340	-	-
	TT & TN-S		iPF20 3P+N		-	≤ 1.5	≤ 1.1		-	260	340
	TN-C		iPF20 4P		≤ 1.1	≤ 1.1	-		340	340	-
iPF8 (1) Type 2 / Type 3											
	TT & TN		iPF8 1P	2	≤ 1 / ≤ 1.1	-	-	230	340	-	-
	TT & TN-S		iPF8 1P+N	4	-	≤ 1.5 / ≤ 1.2	≤ 1 / ≤ 1.1		-	260	340
	TN-C		iPF8 2P		≤ 1 / ≤ 1.1	≤ 1 / ≤ 1.1	-		340	340	-
	TN-C		iPF8 3P	8	≤ 1 / ≤ 1.1	-	-	230/400	340	-	-
	TT & TN-S		iPF8 3P+N		-	≤ 1.5 / ≤ 1.2	≤ 1 / ≤ 1.1		-	260	340
	TN-C		iPF8 4P		≤ 1 / ≤ 1.1	≤ 1 / ≤ 1.1	-		340	340	-

* **CM**: common mode (phase to earth and neutral to earth). * **DM**: differential mode (phase to neutral). (1) **Uoc**: combined waveform voltage: 10 kV.



iPF surge arresters

Type 2 or 3 LV surge arresters (cont.)

Connection

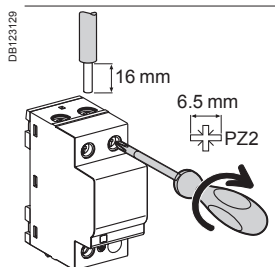
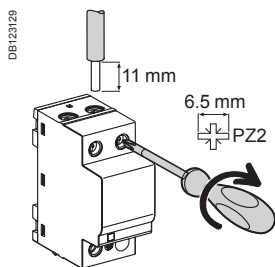

Type	Tightening torque	Copper cables		
		Rigid	Flexible or ferrule	
iPF8 / 20	Ph / N	1.2 N.m	16 mm ² max.	10 mm ² max.
	⊕			
iPF40 / 65	Ph / N	2 N.m	25 mm ² max.	16 mm ² max.
	⊕			

Technical data

Main characteristics		
Operating frequency	50/60 Hz	
Operating voltage (Ue)	230/400 V AC	
Permanent operating current (Ic)	< 1 mA	
Response time	< 25 ns	
End of life indication: by green/red mechanical indicator	Green	In operation
	Red	At end of life
End of life remote indication	By contact NO, NC 250 V / 0.25 A	
Additional characteristics		
Operating temperature	-25°C to +60°C	
Type of connection terminals	Tunnel terminals, 2.5 to 35 mm ²	
Standards	IEC 61643-1 [T2] and EN 61643-11 Type 2	

Weight (g)

Surge arrester	
Type	iPF
1P	125
2P	210
3P	335
4P	420

Dimensions (mm)

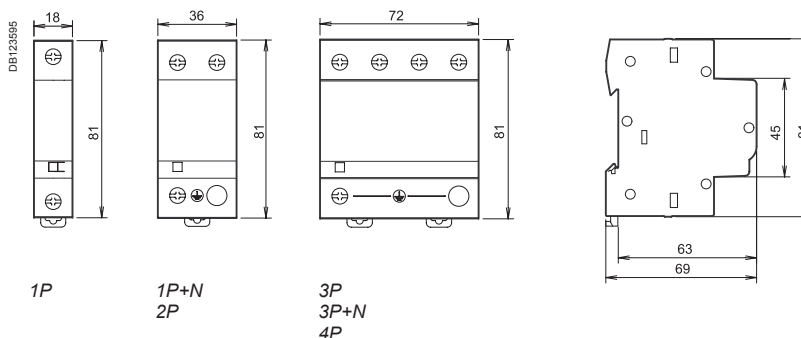

iPRD surge arresters

Type 2 or 3 LV withdrawable surge arresters

iPRD withdrawable surge arresters allow quick replacement of damaged cartridges.



1P+N



3P



3P+N



Cartridge

Rated discharge current (Imax) / Nominal discharge current (In)	Type of protection	Network							
				N L1 L2 L3		N L1 L2 L3			
	Incoming	Secondary	1P+N	3P+N	1P	2P	3P	4P	
65 kA / 20 kA									
Very high risk level (strongly exposed site)	iPRD65				A9L16555				
					A9L16556				
			A9L16557			A9L16442			
							A9L16558		
							A9L16443		
				A9L16559					
							A9L16659		
40 kA / 15 kA									
High risk level	iPRD40				A9L16561				
					A9L16566				
			A9L16562						
			A9L16567			A9L16444			
						A9L16667			
							A9L16445		
							A9L16568		
							A9L16563		
				A9L16564					
				A9L16569					
						A9L16597			
						A9L16664			
						A9L16669			
20 kA / 5 kA									
Medium risk level	iPRD20				A9L16571				
			A9L16672						
			A9L16572			A9L16446			
							A9L16447		
							A9L16573		
				A9L16674					
				A9L16574					
						A9L16599			
						A9L16673			
8 kA / 2.5 kA									
Secondary protection: placed near the loads to be protected when they are at a distance of more than 30 m from the incoming surge arrester	iPRD8				A9L16576				
			A9L16677						
			A9L16577						
						A9L16448			
							A9L16449		
							A9L16578		
				A9L16679					
				A9L16579					
						A9L16678			
						A9L16680			

Spare cartridges		
Type	Spare cartridges for	Cat. no
C 65-460	iPRD65r IT	A9L16682
C 65-340	iPRD65r	A9L16681
C 40-460	iPRD40r IT	A9L16684
C 40-340	iPRD40, iPRD40r	A9L16685
C 20-460	iPRD20r IT	A9L16686
C 20-340	iPRD20, iPRD20r	A9L16687
C 8-460	iPRD8r IT	A9L16688
C 8-340	iPRD8, iPRD8r	A9L16689
C neutral	All products	A9L16691

Surge arrester/circuit breaker association	
Type of surge arrester	Associated circuit breaker
iPRD65	Curve C 50 A
iPRD40	Curve C 40 A
iPRD20	Curve C 25 A
iPRD8	Curve C 20 A



iPRD surge arresters

Type 2 or 3 LV withdrawable surge arresters (cont.)

Earthing system	Transfer	Surge arrester name	Width in mod. of 9 mm	Up - (kV) Voltage protection level			Un - (V) Rated voltage network	Uc - (V) Maximum continuous operating voltage		
				CM*		DM*		CM*		DM*
				L/±	N/±	L/N				
				L/±	N/±	L/N	L/±	N/±	L/N	
iPRD65										
IT	■	iPRD65r 1P IT	2	≤ 2	-	-	230	460	-	-
TT & TN	■	iPRD65r 1P		≤ 1.5	-	-	-	340	-	-
TT & TN-S	■	iPRD65r 1P+N	4	-	≤ 1.5	≤ 1.5	-	-	260	340
TN-C	■	iPRD65r 2P		≤ 1.5	≤ 1.5	-	-	340	340	-
IT	■	iPRD65r 3P IT	6	≤ 2	-	-	230/400	460	-	-
TN-C	■	iPRD65r 3P		≤ 1.5	-	-	-	340	-	-
TT & TN-S	■	iPRD65r 3P+N	8	-	≤ 1.5	≤ 1.5	-	-	260	340
TN-C	■	iPRD65r 4P		≤ 1.5	≤ 1.5	-	-	340	340	-
iPRD40										
TT & TN	■	iPRD40r 1P	2	≤ 1.4	-	-	230	340	-	-
TT & TN		iPRD40 1P		≤ 1.4	-	-	-	340	-	-
TT & TN-S	■	iPRD40r 1P+N	4	-	≤ 1.4	≤ 1.4	-	-	260	340
TT & TN-S		iPRD40 1P+N		-	≤ 1.4	≤ 1.4	-	-	260	340
TN-C	■	iPRD40r 2P		≤ 1.4	≤ 1.4	-	-	340	340	-
TN-C		iPRD40 2P		≤ 1.4	≤ 1.4	-	-	340	340	-
TN-C	■	iPRD40r 3P	6	≤ 1.4	-	-	230/400	340	-	-
TN-C		iPRD40 3P		≤ 1.4	-	-	-	340	-	-
IT	■	iPRD40r 3P IT		≤ 2	-	-	-	460	-	-
TT & TN-S	■	iPRD40r 3P+N	8	-	≤ 1.4	≤ 1.4	-	-	260	340
TT & TN-S		iPRD40 3P+N		-	≤ 1.4	≤ 1.4	-	-	260	340
IT	■	iPRD40r 4P IT		≤ 2	≤ 2	-	-	460	460	-
TN-C	■	iPRD40r 4P		≤ 1.4	≤ 1.4	-	-	340	340	-
TN-C		iPRD40 4P		≤ 1.4	≤ 1.4	-	-	340	340	-
iPRD20										
TT & TN		iPRD20 1P	2	≤ 1.1	-	-	230	340	-	-
TT & TN-S	■	iPRD20r 1P+N	4	-	≤ 1.4	≤ 1.1	-	-	260	340
TT & TN-S		iPRD20 1P+N		-	≤ 1.4	≤ 1.1	-	-	260	340
TN-C		iPRD20 2P		≤ 1.1	≤ 1.1	-	-	340	340	-
TN-C		iPRD20 3P	6	≤ 1.1	-	-	230/400	340	-	-
IT	■	iPRD20r 3P IT		≤ 1.6	-	-	-	460	-	-
TT & TN-S	■	iPRD20r 3P+N	8	-	≤ 1.4	≤ 1.1	-	-	260	340
TT & TN-S		iPRD20 3P+N		-	≤ 1.4	≤ 1.1	-	-	260	340
IT	■	iPRD20r 4P IT		≤ 1.6	≤ 1.6	-	-	460	460	-
TN-C		iPRD20 4P		≤ 1.1	≤ 1.1	-	-	340	340	-
iPRD8 (1) Type 2 / Type 3										
TT & TN		iPRD8 1P	2	≤ 1 / ≤ 1	-	-	230	340	-	-
TT & TN-S	■	iPRD8r 1P+N	4	-	≤ 1.4 / ≤ 1	≤ 1 / ≤ 1.1	-	-	260	340
TT & TN-S		iPRD8 1P+N		-	≤ 1.4 / ≤ 1	≤ 1 / ≤ 1.1	-	-	260	340
TN-C		iPRD8 2P		≤ 1 / ≤ 1	≤ 1 / ≤ 1	-	-	340	340	-
TN-C		iPRD8 3P	6	≤ 1 / ≤ 1	-	-	230/400	340	-	-
IT	■	iPRD8r 3P IT		≤ 1.4 / ≤ 1.6	-	-	-	460	-	-
TT & TN-S	■	iPRD8r 3P+N	8	-	≤ 1.4 / ≤ 1	≤ 1 / ≤ 1.1	-	-	260	340
TT & TN-S		iPRD8 3P+N		-	≤ 1.4 / ≤ 1	≤ 1 / ≤ 1.1	-	-	260	340
IT	■	iPRD8r 4P IT		≤ 1.4 / ≤ 1.6	≤ 1.4 / ≤ 1.6	-	-	460	460	-
TN-C		iPRD8 4P		≤ 1 / ≤ 1	≤ 1 / ≤ 1	-	-	340	340	-

* **CM**: common mode (phase to earth and neutral to earth). * **DM**: differential mode (phase to neutral). (1) **Uoc**: combined waveform voltage: 10 kV.

iPRD surge arresters

Type 2 or 3 LV withdrawable surge arresters (cont.)

Connection

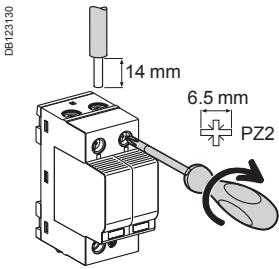

Type	Tightening torque	Copper cables	
		Rigid	Flexible or ferrule
iPRD	2 N.m	2.5 to 25 mm ²	2.5 to 16 mm ²

Technical data

Main characteristics	
Operating frequency	50/60 Hz
Operating voltage (Ue)	230/400 V AC
Permanent operating current (Ic)	< 1 mA
Response time	< 25 ns
End of life indication: by mechanical indicator	White Red
End of life remote indication	In operation At end of life By contact NO, NC 250 V / 0.25 A
Additional characteristics	
Operating temperature	-25°C to +60°C
Type of connection terminals	Tunnel terminals, 2.5 to 35 mm ²
Standards	IEC 61643-1 [T2] and EN 61643-11 Type 2

Weight (g)

Surge arrester	
Type	iPRD
1P	115
2P	220
3P	340
4P	450

Dimensions (mm)

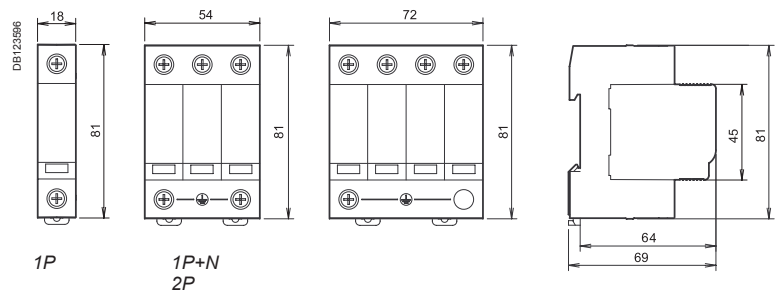

3P

3P+N
4P

Withdrawable surge arrester iQuick PRD Type 2 or Type 3

Withdrawable surge arrester iQuick PRD allow damaged cartridges to be replaced quickly. They offer remote reporting of the "cartridge must be changed" message.



Replacement cartridges.

IEC 61643-1 **T2**, EN 61643-11 Type 2

They protect electrical and electronic equipment against lightning-induced surges. Withdrawable surge arrester iQuick PRD surge arresters are prewired, incorporating their end-of-life disconnecter.

Each surge arrester in the range has a specific use:

■ **incoming protection (type 2):**

- iQuick PRD40r is recommended for a high risk level
- iQuick PRD20r is recommended for a moderate risk level

■ **secondary protection (type 2 or 3):**

- iQuick PRD8r provides secondary protection for the loads to be protected and is cascade-mounted with the incoming surge arresters. This surge arrester is required as close as possible to the loads to be protected when they are located more than 30 metres away from the incoming surge arrester.

Maximum discharge current (I _{max}) / Nominal discharge current (I _n)	Type of protection		Network		
	Incoming protection	Secondary protection	1P+N	3P+N	3P
40 kA / 20 kA					
High risk level	iQuick PRD40r		A9L16292	A9L16294	A9L16293
20 kA / 5 kA					
Moderate risk level	iQuick PRD20r		A9L16295	A9L16297	A9L16296
8 kA / 2 kA					
Secondary protection: placed near the loads to be protected when they are at a distance of more than 30 m from the incoming surge arrester		iQuick PRD8r	A9L16298	A9L16300	A9L16299

Replacement cartridges

Type	Replacement cartridges for	Cat. no.
C 40-350	iQuick PRD40r	A9L16310
C 20-350	iQuick PRD20r	A9L16311
C 8-350	iQuick PRD8r	A9L16312
C neutral-350	All products	A9L16313

Withdrawable surge arrester iQuick PRD Type 2 or Type 3

Connection

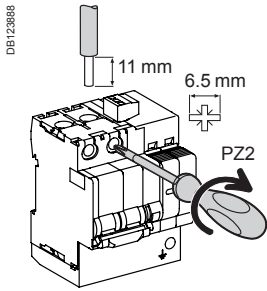

Type	Tightening torque	Copper cables		
		Rigid	Flexible or ferrule	
iQuick PRD	2.5 N.m			
		Ph / N 8r/20r	2.5 to 25 mm ²	2.5 to 25 mm ²
		Ph / N 40r	2.5 to 35 mm ²	2.5 to 35 mm ²
		25 mm ² max.	25 mm ² max.	

Earthing system	Transfert	Name of surge arrester	Width in 9 mm modules	Up – (kV) Voltage protection level			Un – (V) Nominal mains voltage	Uc – (V) Maximum continuous operating voltage		
				CM*	DM*			CM*	DM*	
				L/⊕	N/⊕	L/N		L/⊕	N/⊕	L/N
iQuick PRD40r										
TT & TN-S	■	1P+N	8	1.5	1.5	2.5	230	-	264	350
TN-C & IT 230 V	■	3P	13	2	-	-	230/400	350	-	-
TT & TN-S	■	3P+N	15	1.5	1.5	2.5		-	264	350
iQuick PRD20r										
TT & TN-S	■	1P+N	8	1.5	1.5	1.5	230	-	264	350
TN-C & IT 230 V	■	3P	13	1.5	-	-	230/400	350	-	-
TT & TN-S	■	3P+N	15	1.5	1.5	1.5		-	264	350
iQuick PRD8r (2) Type 2 / Type 3										
TT & TN-S	■	1P+N	8	1.5/1.4	1.5/1.5	1.2/1.4	230	-	264	350
TN-C & IT 230 V	■	3P	13	1.2/1.4	-	-	230/400	350	-	-
TT & TN-S	■	3P+N	15	1.5/1.4	1.5/1.5	1.2/1.4		-	264	350

* **CM** common mode (between phase/earth and neutral/earth). * **DM**: differential mode (between phase and neutral).

(1) Up (MCB + SPD): total value measured between Modular Circuit Breaker (MCB) terminal block and PE surge arrester device terminal block (SPD).

(2) Uoc: open-circuit voltage in combined wave: 10 kV.

Accessories

Earth terminal block support

Type		
Support kit		L = 4 blocks Batch of 1
25 mm ² terminal block kit		L = 1 block Batch of 5

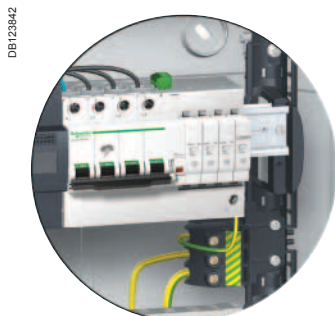

Pragma: the earth terminal block needs 1 support kit and 1 terminal block kit.

Withdrawable surge arrester iQuick PRD Type 2 or Type 3 (cont.)

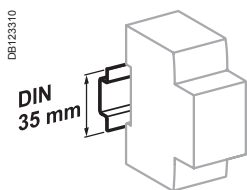

Clip on DIN rail 35 mm.

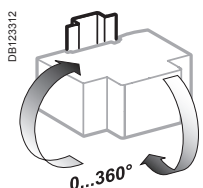

Indifferent position of installation.

Technical data

Main characteristics			
Operating frequency	50/60 Hz		
Operating voltage (Ue)	230/400 V AC		
Disconnecter short-circuit withstand (Isc)	25 kA (50 Hz)		
Permanent operating current (Ic)	<1 mA		
Response time	<25 ns		
Status indication	By the cartridges	White Red	Operational At end of life
	By white mechanical indicator/ handle ON		Operational
	By red mechanical indicator/ handle OFF		At end of life
Remote indication end of life	By the NO/NC remote indication contact 250 V AC / 2 A		
Additional characteristics			
Degree of protection	Device only	IP20, IK05	
	Device in modular enclosure	IP40	
Operating temperature	-25°C to +70°C		
Storage temperature	-40°C to +80°C		
Certifications	NF, KEMA KEUR (iQuick PRD 8r, 20r)		

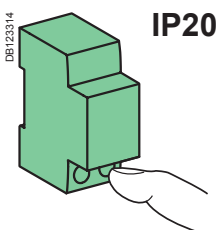

IP20

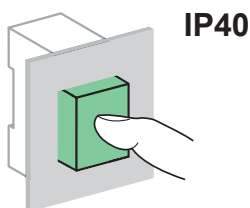

IP40

Weight (g)

Surge arresters		
Type	iQuick PRD8r/20r	iQuick PRD40r
1P+N	435	445
3P	665	700
3P+N	810	850

Dimensions (mm)

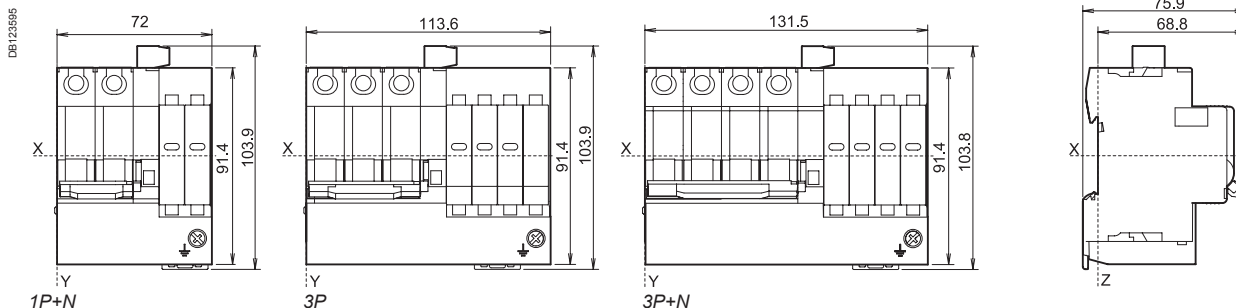

EN 61643-11 Type 2, IEC 61643-1 **T2**,
IEC 60364-4-443, IEC 60364-5-534

The iQuick PF multi-pole single-piece surge arrester range is adapted for earthing systems: TT, TN-S.
Type 2 surge arresters are tested with a 8/20 μ s current wave.

Protects electrical and electronic equipment against indirect overvoltage due to the lightning effect.
Coordination with selective version "si" and **S** types.

The iQuick PF is precabled. It incorporates its end of life safety disconnecter and an earthing terminal block.

Accessories supplied

- Terminal and 16 mm² cable for connection to the earth bar of the enclosure (supplied mounted)
- 1 lug to crimp for 16 mm² earthing cable
- iQuick PF 1P+N: 2 connection accessories for the electrical link between the surge arrester and the incoming residual current circuit breaker:
 - 1 mounted, centre distance between axes: 9 mm,
 - 1 supplied, centre distance between axes: 18 mm.



Maximum discharge current (I _{max}) / Nominal discharge current (I _n)	Network		Earthing system	Width in 9 mm modules	U _p – (kV) Voltage protection level (*)	U _n – (V) Nominal mains voltage	U _c – (V) Maximum continuous operating voltage
10 kA / 5 kA							
	1P+N	3P+N					
iQuick PF	A9L16617	A9L16618	TT & TN-S	4	1.5	230	275
			TT & TN-S	10	1.5	230/400	275

(*) common mode of protection (between phase/earth and neutral/earth) and differential mode of protection (between phase and neutral).

Remote auxiliary IEC 60947-5-1

The remote auxiliary iSR allows to remote the iQuick PF operating status.

Auxiliary			
Type			Width in mod. of 9 mm
iSR	Contact	Voltage (U _e)	A9L16619
	3 A	415 V CA	

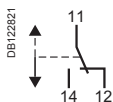

Connection

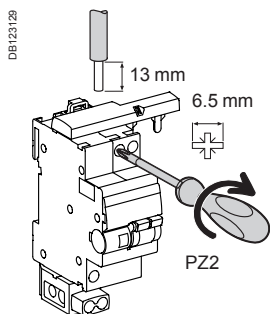

Type	Tightening torque	Copper cables	
		Rigid	Flexible or ferrule
iQuick PF	2 N.m		
		1 to 16 mm ²	1 to 16 mm ²
iSR	1.2 N.m	10 to 25 mm ²	10 to 25 mm ²
		16 mm ² max.	16 mm ² max.

Surge arrester iQuick PF Type 2 (cont.)

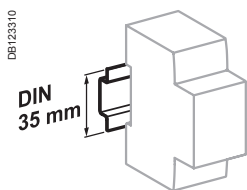

Clip on DIN rail 35 mm.

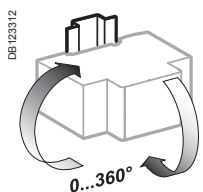

Indifferent position of installation.

Technical data

Main characteristics

Operating frequency	50 Hz
Operating voltage (Ue)	230/400 V AC
Integrated breaking capacity (Isc at 50 Hz)	6 kA
Status indication:	Mechanical indicator white/ handle ON
	Mechanical indicator red/ handle OFF
	Operational
	At end of life
Remote indication end of life	By iSR auxiliary

Additional characteristics

Degree of protection	Device only	IP20
	Device in modular enclosure	IP40
Operating temperature	-25°C to +70°C	
Storage temperature	-40°C to +80°C	

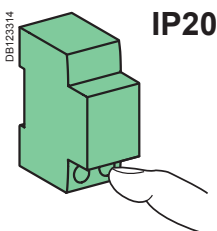

IP20

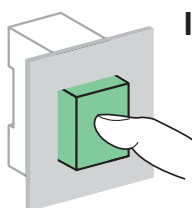

IP40

Weight (g)

Surge arresters

Type	iQuick PF
1P+N	370
3P+N	640

Dimensions (mm)

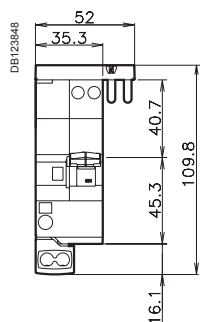

1P+N

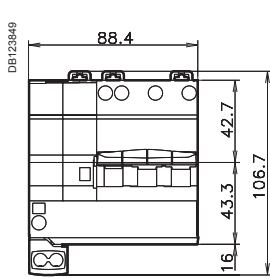
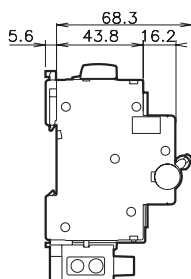

3P+N

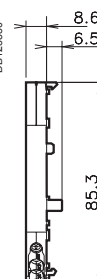
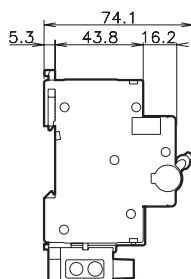

iSR

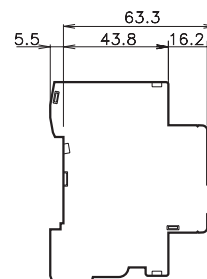



Protection against overvoltages related to lightning strikes.



A9L16337



A9L16339



Analogue telephone line protection: the iPRC surge arrester wired in series to the private installation input protects the telephones, the PABX, the modems (including ADSL), etc.

Protection for 2 low-current lines without common potential or 4 lines with common reference potential: the iPRI protects the measuring instrument and PLC "sensor" inputs and the DC power supply inputs up to 53 V and AC power supply inputs up to 37 V.
The input current must not exceed 300 mA.

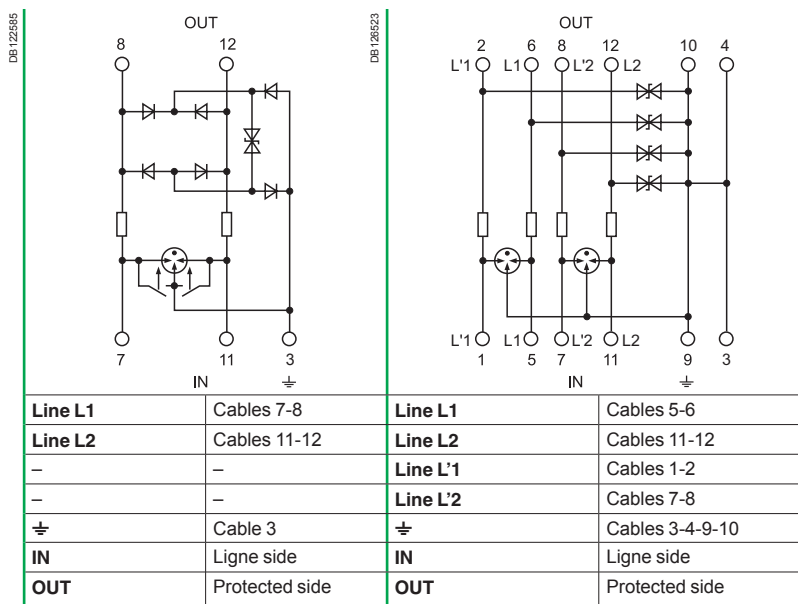

Catalogue numbers

Surge arresters	iPRC	iPRI
Mains voltage (Un)	<130 V AC	48 V DC
Analogue telephone system	■	—
Telephone transmitter	■	—
Digital telephone system	—	■
Automation network	—	■
VLV load power supply (12...48 V)	—	■
xDSL compatibility	■	—
Cat. no..	A9L16337	A9L16339
Width in 9 mm modules	2	2

Diagrams

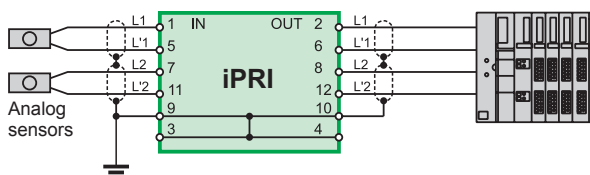
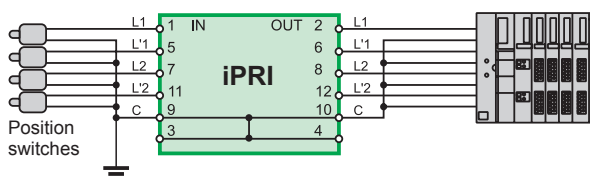
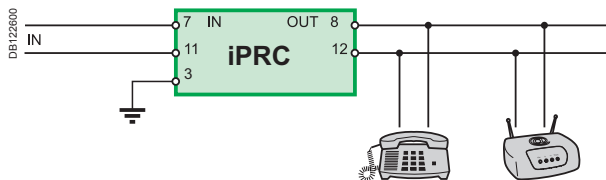

iPRC, iPRI surge arresters (cont.)

Connection

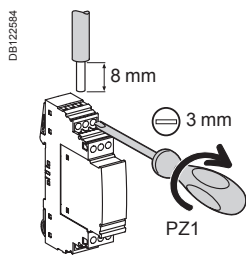

Tightening torque	Copper cables	
	Rigid	Flexible or ferrule
0.8 N.m	0.2 to 4 mm ²	0.2 to 2,5 mm ²

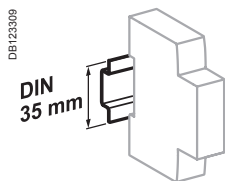

Clip on DIN rail 35 mm.

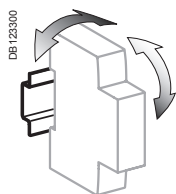

± 30° vertical.

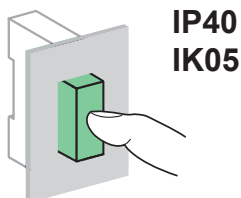
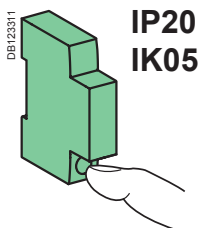

Technical data

Main characteristics		
	iPRC	iPRI
Number of protected lines	2	2
Test category	IEC/VDE	C1, C2, C3, D1, B2
Maximum continuous voltage (Uc)	180 V DC, 130 V AC	53 V DC, 37 V AC
Limitation voltage (Up)	300 V	70 V
Rated discharge current (8/20) (In)	10 kA	10 kA
Maximum discharge current (8/20) (Imax)	18 kA	10 kA
Response time	< 500 ns	≤ 1 ns
Nominal impulse current	100 A	70 A
Rated current (I _N)	450 mA (up to 45°C)	300 mA (up to 45°C)
Series resistor	2.2 Ω	4.7 Ω
End-of-life information by	Loss of dialling tone	Loss of transmission
Additional characteristics		
Degree of protection	Device only	IP20
	Device in modular enclosure	IP40
	IK	05
Operating temperature	-25°C to +60°C	-25°C to +60°C
Storage temperature	-40°C to +85°C	-40°C to +85°C

Weight (g)

Surge arresters		
Type	iPRC	iPRI
	25	65

Dimensions (mm)

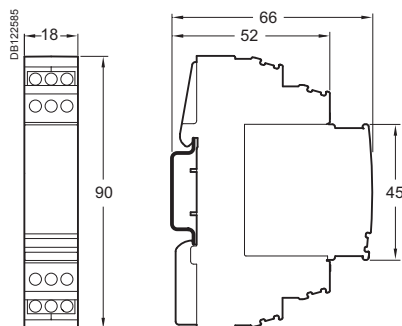

iPRD-DC surge arresters

Withdrawable surge arresters type 2 for photovoltaic applications



IEC 61643-1 **T2**
 EN 61643-11 Type 2
 UTE C 61740-51 **T2**
 prEN 50539-11 **T2**



iPRD-DC40r 600PV

iPRD-DC direct current surge arresters are designed to protect against overvoltages due to a lightning strike: of the "DC" input to the inverter and of photovoltaic panels.

It should be installed in a switchboard inside the building. If the switchboard is located outside, it must be weatherproof.

Withdrawable iPRD-DC surge arresters allow damaged cartridges to be replaced quickly. They offer remote reporting of the "cartridge must be changed" message.

Catalogue numbers

Internal diagram	Imax (kA) Maximum discharge current	In (kA) Nominal discharge current	Up (kV) Protection level			U _{CPV} (V) ⁽¹⁾ Maximum steady state voltage			Width in module of 9 mm	Cat. no.
			L+/ \neq	L-/ \neq	L+/L-	L+/ \neq	L-/ \neq	L+/L-		
iPRD-DC40r 600PV										
	40	15	1.6	1.6	2.8	600	600	840	6	A9L16434
iPRD-DC40r 1000PV										
	40	15	3.9	3.9	3.9	1000	1000	1000	6	A9L16436

(1) $U_{cpv} \geq 1.2 \times U_{oc\ stc}$ ($U_{oc\ stc}$: maximum no-load voltage of the photovoltaic generator "photovoltaic module manufacturer's data")



Replacement cartridges

Replacement cartridges		
Type	Replacement cartridges for	Cat. no.
C 40-600PV	iPRD-DC40r 600PV	A9L16683
C 40-1000PV	iPRD-DC40r 1000PV	A9L16692
C neutral PV	iPRD-DC40r 600PV	A9L16690



iPRD-DC surge arresters

Withdrawable surge arresters type 2 for photovoltaic applications (cont.)

Connection

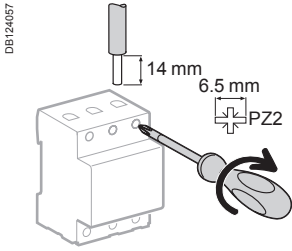

Type	Tightening torque	Copper cables	
		Rigid	Flexible or ferrule
iPRD-DC	2 N.m	2.5 to 25 mm ²	2.5 to 16 mm ²

Depending on the distance between the "generator" part and the "conversion" part, it may be necessary to install two surge arresters or more, to ensure protection of each of the two parts.

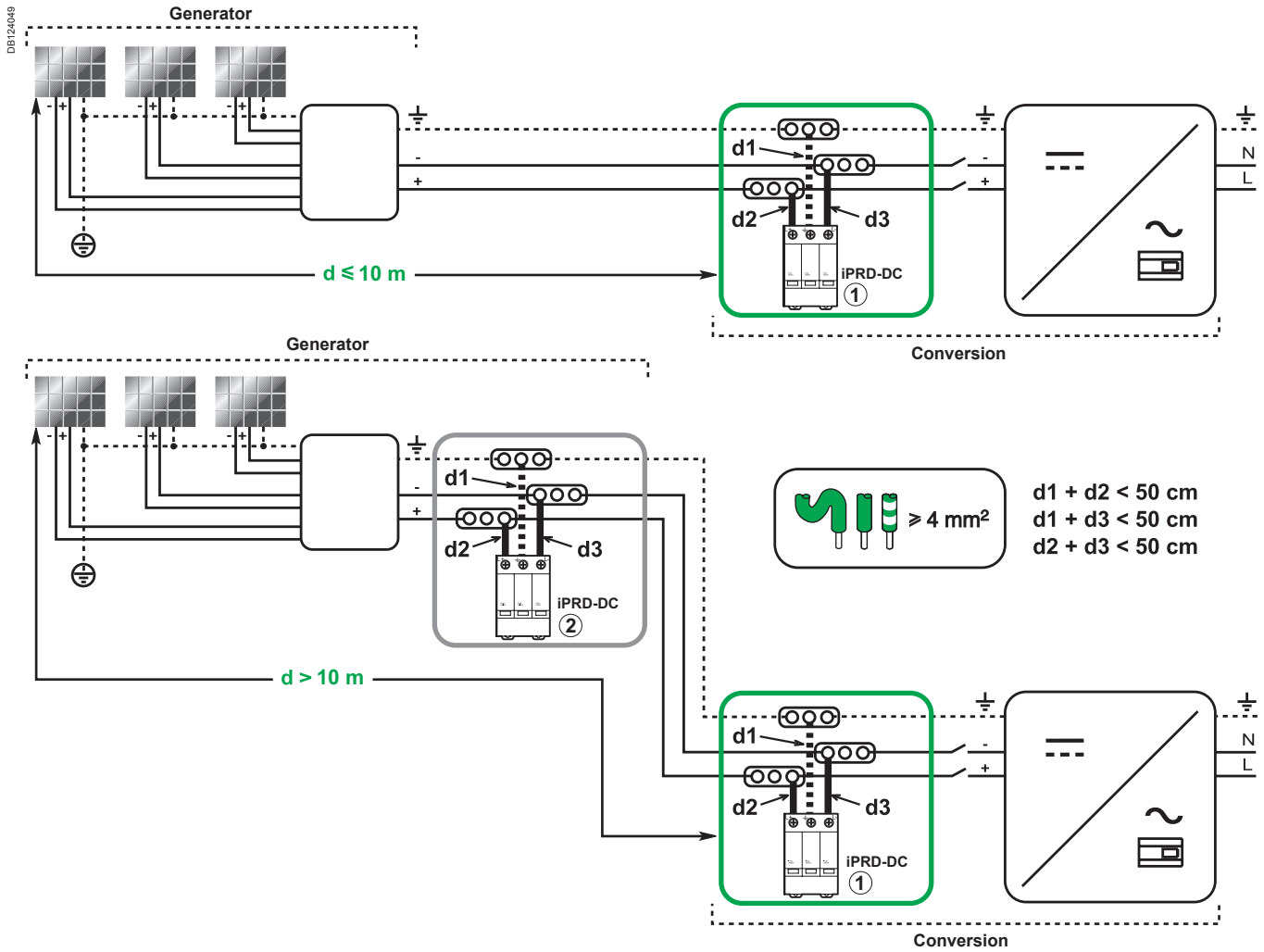

iPRD-DC surge arresters

Withdrawable surge arresters type 2 for photovoltaic applications (cont.)

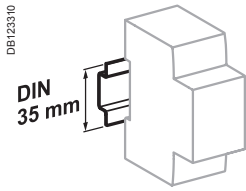

Clip on DIN rail 35 mm.

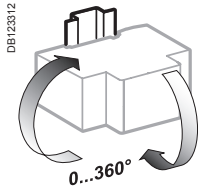

Indifferent position of installation.

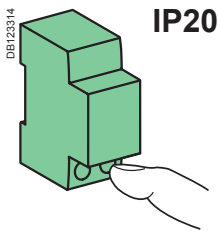

IP20

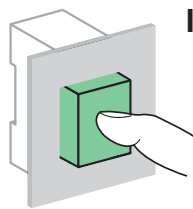

IP40

Technical data

Main characteristics			
Type of network	Isolated direct current		
Temps de réponse	< 25 ns		
Short circuit current (I_{SCP})	30 A		
Type of surge arresters	Type 2		
End-of-life indication mode	Circuit opened by integrated thermal disconnecter		
Additional characteristics			
Degree of protection (IEC 60529)	Device only	IP20	
	Device in modular enclosure	IP40	
	Chocs	IK03	
End-of-life indication	By the cartridges	White	Operational
		Red	At end of life
		By the NO/NC remote indication contact 250 V AC / 0.25 A	
Operating temperature	-25°C to +60°C		
Storage temperature	-40°C to +85°C		
Tropicalization (IEC 60068-1)	Treatment 2 (relative humidity of 95 % at 55°C)		

Weight (g)

Surge arresters	
Type	
iPRD-DC40r 600PV	400
iPRD-DC40r 1000PV	400

Dimensions (mm)

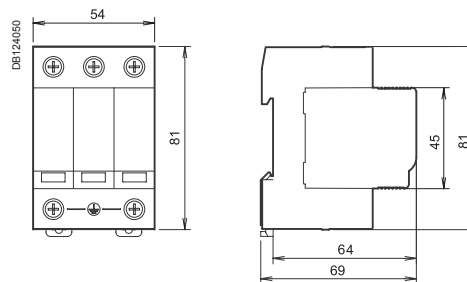

Disconnection



iSW switches

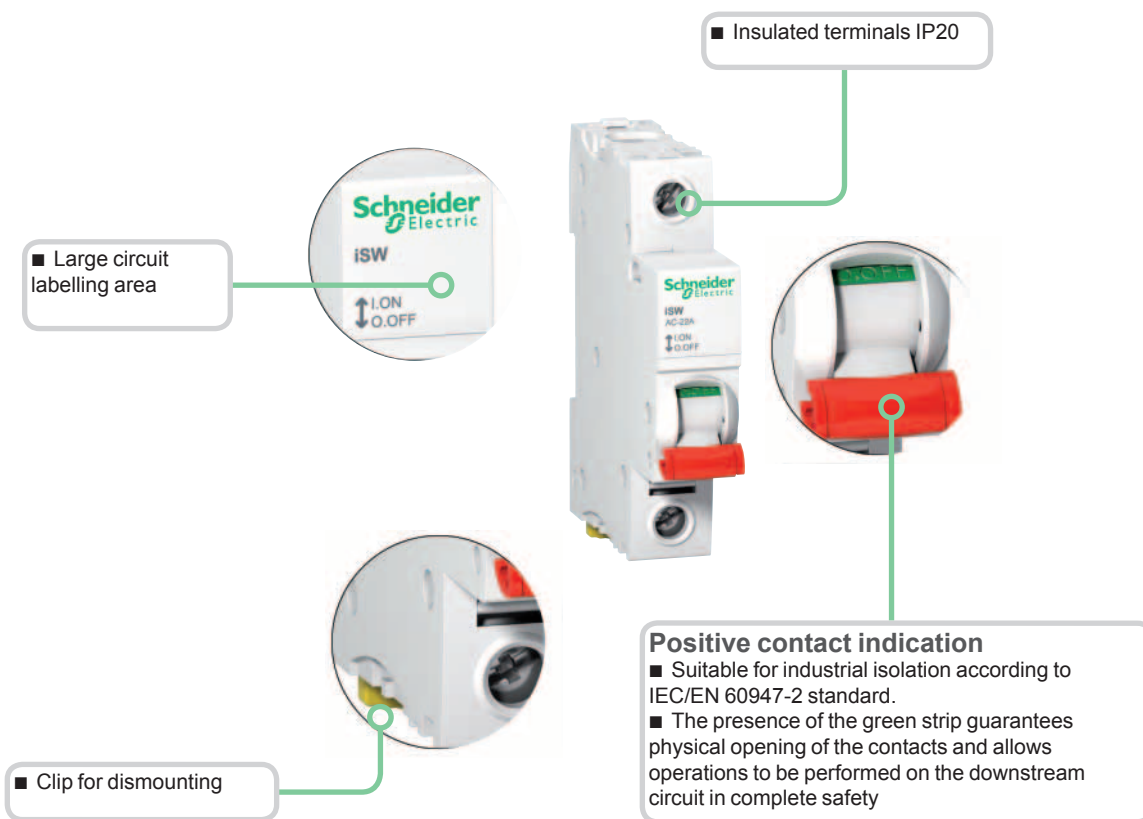

Position contact indication

- Suitable for industrial isolation according to IEC/EN 60947-3 standard.
- The presence of the green strip guarantees physical opening of the contacts and allows operations to be performed on the downstream circuit in complete safety.

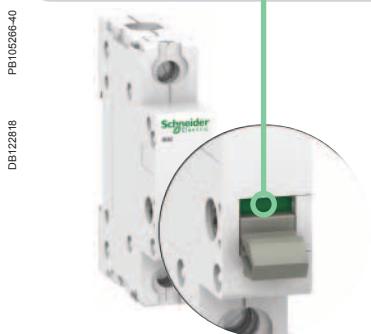

PB106286-40

DB1122818

iSW control switches (20, 32 A)

- IEC/EN 60669-1, iSW switch with indicator light.
- IEC/EN 60669-2-4, iSW switch without indicator light.

These switches are used for:

- Control (opening and closing of circuits under load).
- The 1P and 2P switches are available with or without indicator light.
- Disconnection, for switches without indicator light IEC/EN 60669-2-4.

iSW switch-disconnectors (40 to 125 A)

IEC 60947-3

The switch-disconnectors combine the following functions:

- Control (opening and closing of circuits under load).

OF iSW auxiliary

- Mounted on the left, it indicates the "open" or "closed" position of the switch and has a normally open (NO) or normally closed (NC) contact.



Control switches

PB106284-40



PB106285-40

Catalogue numbers

20, 32 A iSW control switches				
Type	Rating	Voltage (Ue)		Width in 9 mm modules
1P DB118998	20 A	250 V AC	A9S60120	2
	32 A	250 V AC	A9S60132	
2P DB118989	20 A	250 V AC	-	2
		415 V AC	A9S60220	
	32 A	250 V AC	-	
		415 V AC	A9S60232	
3P DB119000	20 A	415 V AC	A9S60320	4
	32 A	415 V AC	A9S60332	
4P DB119001	20 A	415 V AC	A9S60420	4
	32 A	415 V AC	A9S60432	
Operating frequency			50/60 Hz	
Accessories			See page E-15	



FB105264-40



Control switches with indicator light

Catalogue numbers (cont.)

20, 32 A iSW control switches with indicator light			
Type	Rating	230 V indicator light	Width in 9 mm modules
1P DB122819 	20 A	A9S61120	2
	32 A	A9S61132	
2P DB122820 	20 A	A9S61220	2
	32 A	A9S61232	
Operating frequency		50/60 Hz	
Accessories		See page E-15	

Spare indicator lights for 20, 32 A iSW switches		
Type	Voltage (Ue)	
Neon	230 V AC	15111
Supplied with a red diffuser (Pack of 10)		
Incandescent bulb (P=1.2 W)		
Supplied with a red diffuser (Pack of 10)	12 V DC/AC	15112
	24 V DC/AC	15113
	48 V DC/AC	15114

Catalogue numbers (cont.)

Auxiliary				
Type	Rating	Voltage (Ue)		Width in 9 mm modules
OF iSW DB122821 	3 A	415 V AC	A9A15096	2
	6 A	250 V AC		

FB105264-40



OF iSW

Technical data

Main characteristics	20, 32 A iSW		40 to 125 A iSW	
Insulation voltage (Ui)	Without indicator light	With indicator light	1P: 250 V AC 2P, 3P, 4P: 500 V AC	
	■ 1P: 250 V AC	■ 250 V AC		
	■ 2P, 3P, 4P: 500 V AC			
Pollution degree	2		3	
Power circuit				
Rated impulse withstand voltage (Uimp)	4 kV		6 kV	
Operating category	AC - 22 A		AC - 22 A	
Permissible rated short-time withstand current (Icw)	-		40 A, 63 A: 1260 A 100 A, 125 A: 2500 A	
Conditional rated short-circuit current (Isc)	3 kA to IEC/EN 60669-2-4		6 kA to IEC 60947-3	
Rated short-circuit closing current (Icm)	-		40 A, 63 A: 4.2 kA 100 A, 125 A: 5 kA	
Using direct current	48 V (110 V with 2 poles in series)			
Additional characteristics				
Degree of protection	IP40 on the front panel			
Endurance (O-C)	Mechanical	300,000 cycles		50,000 cycles
		Electrical	30,000 cycles	
			20,000 cycles	
			100 A iSW	
				10,000 cycles
				125 A iSW
				2 500 cycles
Operating temperature	-20°C to +50°C			
Storage temperature	-40°C to +70°C			
Tropicalization	Treatment 2 (relative humidity 95% at 55°C)			

DB123597

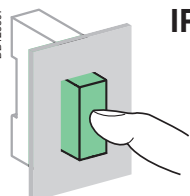

IP40

Connection

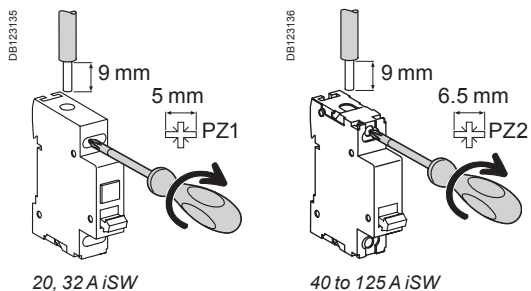

Type	Rating	Tightening torque	Copper cables	
			Rigid	Flexible or ferrule
iSW	20, 32 A	1.2 N.m	10 mm ²	10 mm ²
OF iSW	40 to 125 A	3.5 N.m	≤ 50 mm ²	≤ 35 mm ²
	-	1.2 N.m	10 mm ²	10 mm ²

Dimensions (mm)

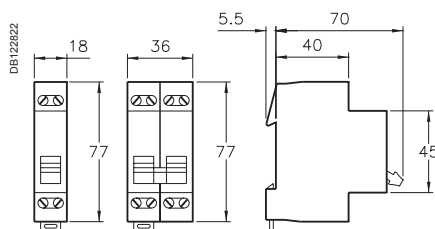

1P, 2P 3P, 4P
20, 32 A iSW

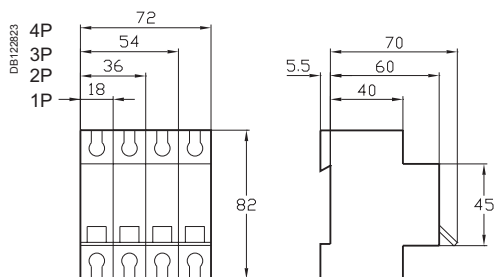

40 to 125 A iSW

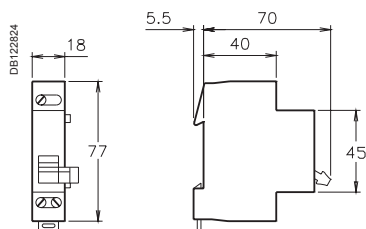

OF iSW



IEC/EN 60947-3
BSEN 60947-3
AS/NZS 60947-3

The switch-disconnectors combine the following functions:

- Control (opening and closing of circuits under load).

iOF auxiliary

- Mounted on the left, it indicates the "open" or "closed" position of the switch and has a normally open (NO) or normally closed (NC) contact.

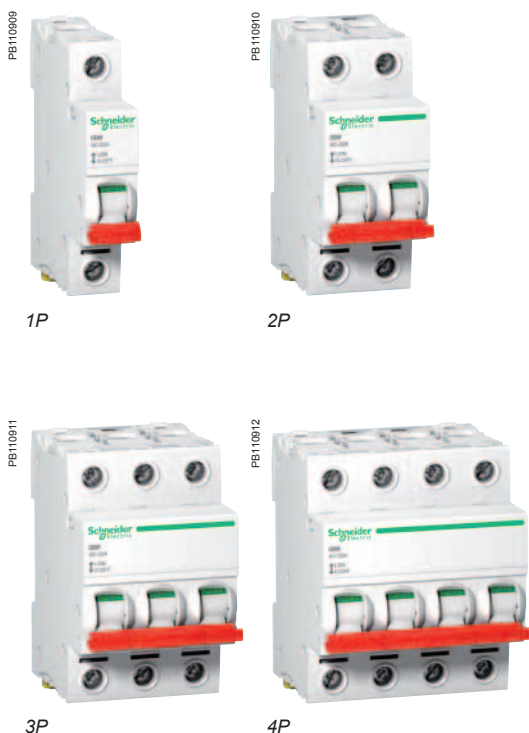

Catalogue numbers

40 to 125 A iSW switch-disconnectors				
Type				Width in 9 mm modules
1P				
	Rating	Voltage (Ue)		
DB118989 	40 A	240 V AC	A9S66140	2
	63 A	240 V AC	A9S66163	
	100 A	240 V AC	A9S66191	
	125 A	240 V AC	A9S66192	
2P				
DB118989 	40 A	415 V AC	A9S66240	4
	63 A	415 V AC	A9S66263	
	100 A	415 V AC	A9S66291	
	125 A	415 V AC	A9S66292	
3P				
DB119000 	40 A	415 V AC	A9S66340	6
	63 A	415 V AC	A9S66363	
	100 A	415 V AC	A9S66391	
	125 A	415 V AC	A9S66392	
3P+N				
DB404953 	125 A	415 V AC	A9S66792	8
4P				
DB119001 	40 A	415 V AC	A9S66440	8
	63 A	415 V AC	A9S66463	
	100 A	415 V AC	A9S66491	
	125 A	415 V AC	A9S66492	
Operating frequency		50/60 Hz		
Accessories		See pages E-2 and E-10		



Auxiliary			
Type			Width in 9 mm modules
iOF			
DB118810 	Voltage (Ue)		A9A26924
	240...415 V AC		
		24...130 V DC	1

056909N_SE-1011-90

- For rating ≥ 80 A**
- Voltage taps:
 - auxiliaries power supply
 - measurement
 - emergency stop
 - remote reporting

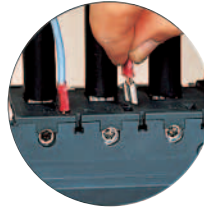

- Cable strength:
 - ribbed cage
 - terminal depth
 - tightening by Allen hex key (NG125 ≥ 80 A)

- Integrated padlocking device

- Test button to check satisfactory operation of the tripping mechanism



- Pull-out strength:
 - metallic lock

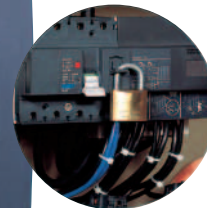

- Impact and vibration resistance:
 - high-strength enclosure
 - IK 05

- Central manual control, 3 positions:
 - ON
 - tripped on fault
 - open

- Circuit breaker tripped indicator

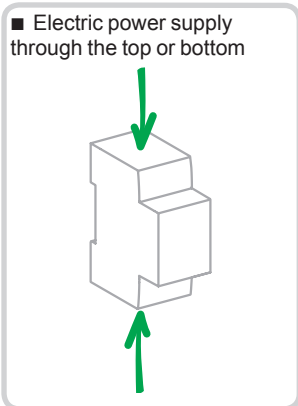

DB123493

- Positive contact indication:
 - suitability for isolation in the industrial sector to IEC/EN 60947-3;
 - the presence of the green strip guarantees that the contacts open physically and allows work to be carried out safely on the downstream circuit.

- Longer product service life due to:
 - good overvoltage withstand capacity;
 - high limitation performances;
 - fast closure independent of the speed of actuation of the toggle.





IEC/EN 60947-3

- The NG125NA is a switch-disconnector with free tripping for making and breaking under load.
- It is especially suitable for the modular enclosure incoming feeder with remote breaking (e.g. emergency cutoff).

056908N_SE:1811-35



NG125NA 3P

056909N_SE:1811-35



NG125NA 4P

Catalogue numbers

NG125NA switch			
Type		3P	3P+N
Auxiliaries		Remote indication and tripping, see page F-14	
Rating (In)	Quality label (1)		
63 A		18889	18893
80 A		18890	18894
100 A		18891	18895
125 A		18892	18896
Width in 9 mm modules		9	12
Accessories		See page E-26	

(1) Information to be supplied by the country concerned.

Connection

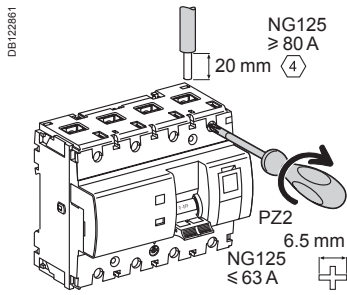

Rating	Tightening torque	Without accessories		With accessories				
		Copper cables		70 mm ² Al terminal	Screw-on connection for ring terminal	Small ring terminal	Multi-cable terminal	
		Rigid	Flexible or with ferrule				Rigid cables	Flexible cables
63 A	3.5 N.m	1.5 to 50 mm ²	1 to 35 mm ²	-	-	-	3 x 16 mm ²	3 x 10 mm ²
80 to 125 A	6 N.m	16 to 70 mm ²	10 to 50 mm ²	25 to 70 mm ²	2 x 35 mm ² 1 x 50 mm ²	1 x 70 mm ²		

■ For rating ≥ 80 A: upstream voltage taps for each pole, by 6.35 mm Fast-on terminal.

Technical data

Main characteristics			
According to IEC/EN 60947-3			
Max. voltage rating (Ue)	500 V AC		
Insulation voltage (Ui)	690 V AC		
Degree of pollution	3		
Rated impulse withstand voltage (Uimp)	8 kV		
Short time withstand current (50 ms) Icw	1.5 kA		
Rated short-circuit closing current (Icm)	2 kA		
Utilization category	AC22A/B - AC23B		
Additional characteristics			
Degree of protection	Device only	IP20	
	Device in modular enclosure	IP40	
Endurance (O-C)		Category A	Category B
Electrical (except AC20 and DC20)	≤ 100 A	1500 cycles	300 cycles
	125 A	1000 cycles	200 cycles
Mechanical		20,000 cycles	
Operating temperature		-30°C to +70°C	
Storage temperature		-40°C to +70°C	
Tropicalization (IEC 60068-1)		Treatment 2 (relative humidity of 95% at 55°C)	

Weight (g)

Switch	
Type	NG125NA
3P	720
4P	960

Dimensions (mm)

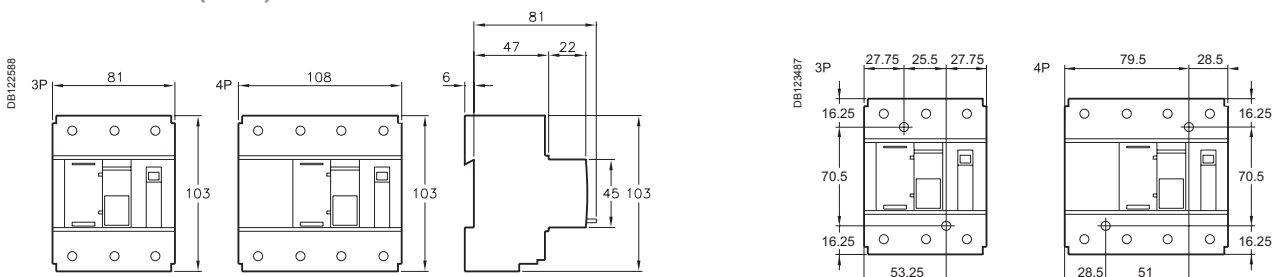

Spacing for mounting on panel



Install, Connection and Power Distribution

E



Connection accessories

See page E-10

8	Splitter blocks	Multiclip	See page	E-24
		Distribloc	See page	E-22
9	50 mm ² Al terminal			27060
10	Screw-on connection for ring terminal			27053
11	Multi-cables terminal	4 parts		19091
		3 parts		19096
12	Comb busbar		See page	E-18

Mounting accessories

See page E-10

13	Sealable terminal shields for top and bottom connection	1P (set of 2)	A9A26975
		2P (set of 2)	A9A26976
		3P	1P + 2P
		4P	2P + 2P
14	Interpole barrier	(set of 10)	A9A27001
15	Screw shields	4P (set of 20)	A9A26981
15"	Screw shields	Vigi iC60 (set of 12)	A9A26982
16	Clip-on terminal markers		See page E-10
17	9 mm spacer		A9A27062
18	Padlocking device	(set of 10)	A9A26970
19	Plug-in base		A9A27003
20	Rotary handle	Black handle	A9A27005
		Red handle	A9A27006
		No handle	A9A27008

Electrical auxiliaries

See page F-2

Indication			
4	iOF/SD+OF auxiliary contact (OF+SD or OF+OF combination switch)		A9A26929
5	iSD fault indicating contact		A9A26927
6	iOF open/close auxiliary contact		A9A26924
7	iOF+SD24 auxiliary contact		A9A26897

Tripping devices

2	iMN undervoltage release or iMNs undervoltage release delayed or iMNx undervoltage release with external feeding	See page	F-2
3	Shunt release iMX, iMX+OF overvoltage release iMSU	See page	F-2

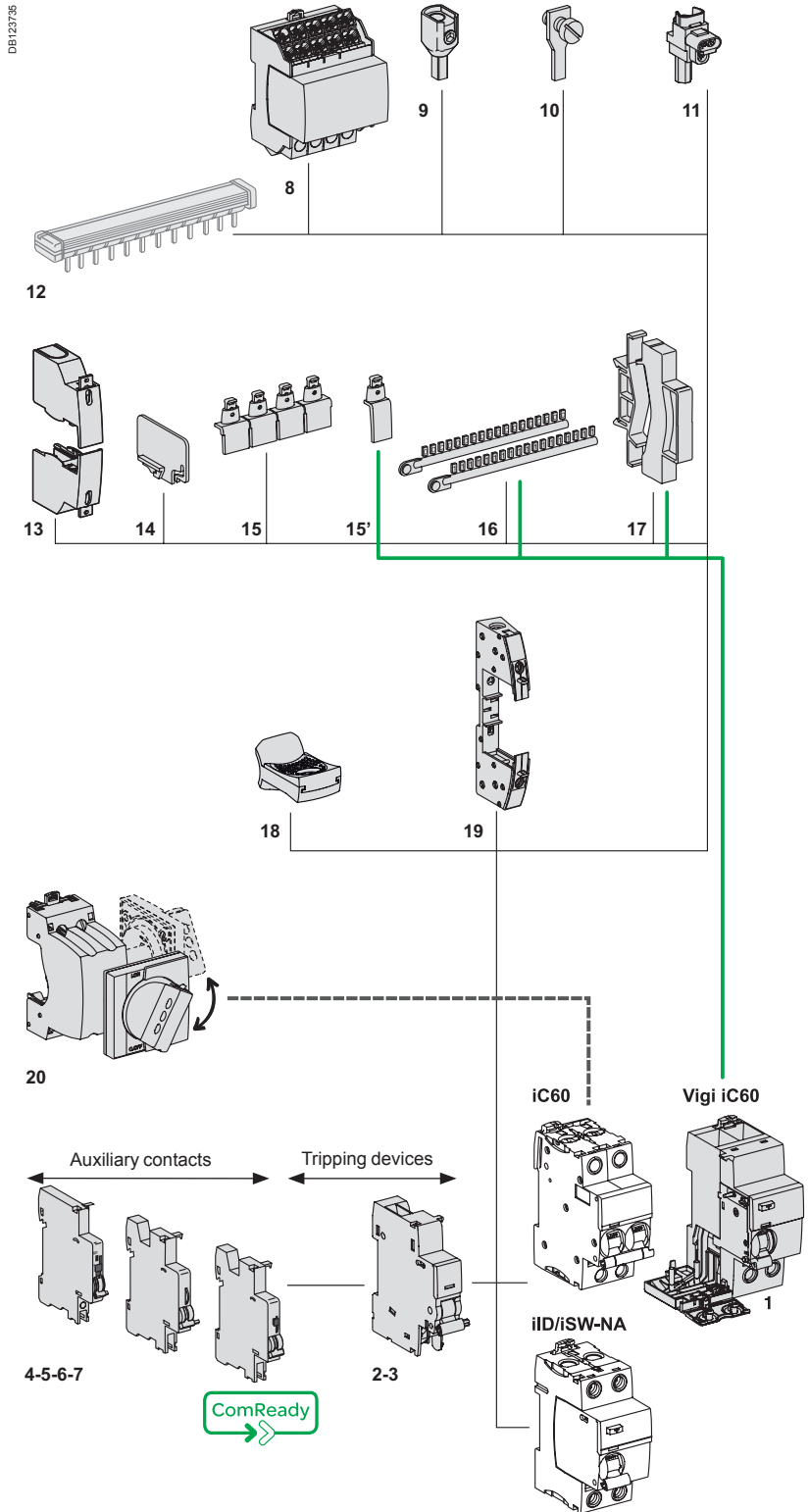

Vigi iC60

See page F-9

1	Vigi iC60 add-on residual current device	See page	B-17
---	--	----------	------



Tripping devices must be mounted first.
Respect specified position for SD functions.

Connection accessories

See page E-10

3	Splitter blocks	Multiclip	See page	E-24
		Distribloc	See page	E-22
4	50 mm ² Al terminal			27060
5	Screw-on connection for ring terminal			27053
6	Multi-cables terminal	4 parts		19091
		3 parts		19096
7	Comb busbar		See page	E-18

DB44783

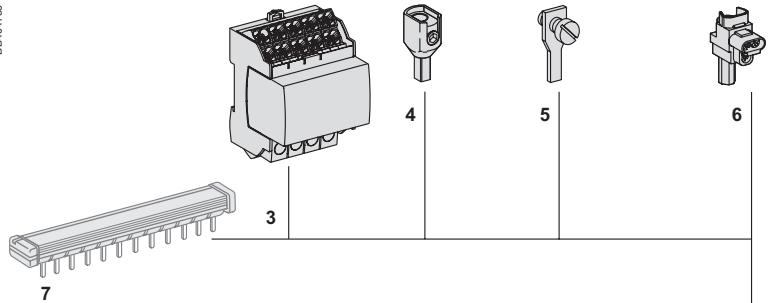

Mounting accessories

See page E-10

8	Sealable terminal shields for top and bottom connection	1P (set of 2)	A9A26975
		2P (set of 2)	A9A26976
		3P	1P + 2P
		4P	2P + 2P
9	Interpole barrier	(set of 10)	A9A27001
10	Screw shields	4P (set of 20)	A9A26981
11	Clip-on terminal markers		See page E-10
12	9 mm spacer		A9A27062
13	Padlocking device	(set of 10)	A9A26970

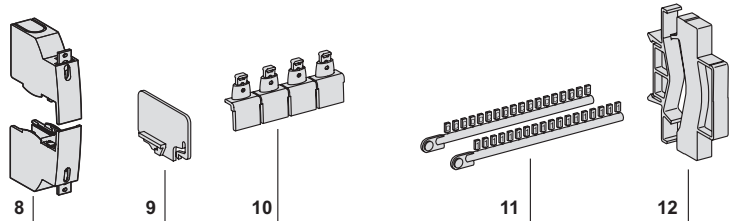

13

Electrical auxiliary

See page F-2

Control

2	iMDU voltage matching auxiliary	A9C18195
---	---------------------------------	----------

Vigi iC60

See page F-9

1	Vigi iC60 add-on residual current device	See page	B-17
---	--	----------	------

iMDU

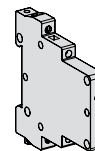

2

Reflex iC60

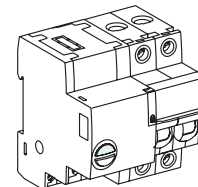

Vigi iC60

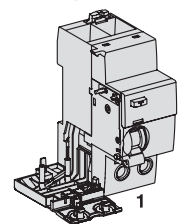

1

Electrical auxiliaries

See page F-2

Indication		
2	iOF/SD+OF auxiliary contact (OF+SD or OF+OF combination switch)	A9A26929
3	iSD fault indicating contact	A9A26927
4	iOF open/close auxiliary contact	A9A26924
5	iOF+SD24 auxiliary contact	A9A26897

Tripping devices		
6+	iMN undervoltage release or iMNs undervoltage release delayed or iMNx undervoltage release with external feeding	See page F-2
7	Shunt release iMX, iMX+OF overvoltage release iMSU	See page F-2

Control	
8	iMDU voltage matching auxiliary

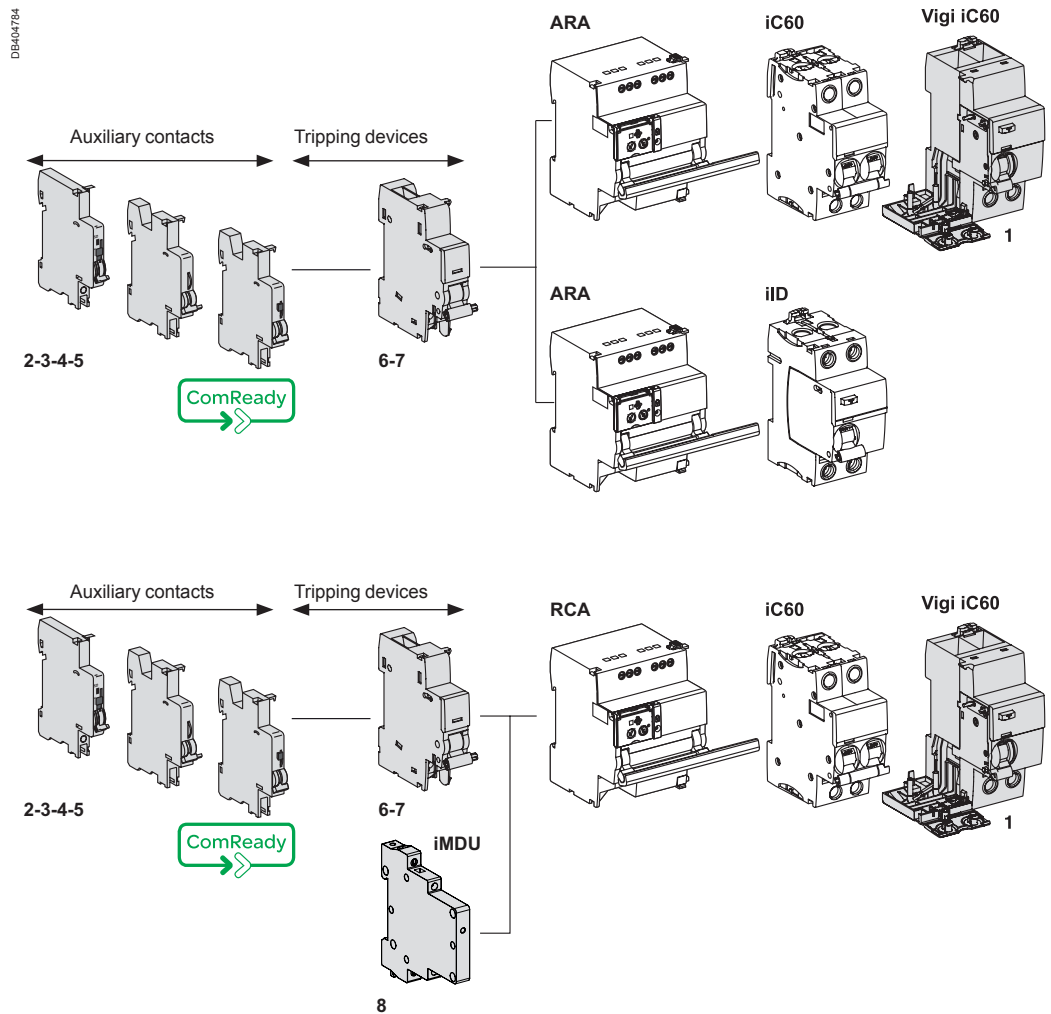

Vigi iC60

See page F-9

1	Vigi iC60 add-on residual current device	See page B-17
---	--	---------------



Tripping devices must be mounted first.
 Respect specified position for SD functions.

Connection accessories

See page E-10

2	Splitter blocks	Multiclip	See page	E-24
		Distribloc	See page	E-22
3	50 mm ² Al terminal			27060
4	Screw-on connection for ring terminal			27053
5	Multi-cables terminal	4 parts		19091
		3 parts		19096
6	Comb busbar		See page	E-18

DB44785

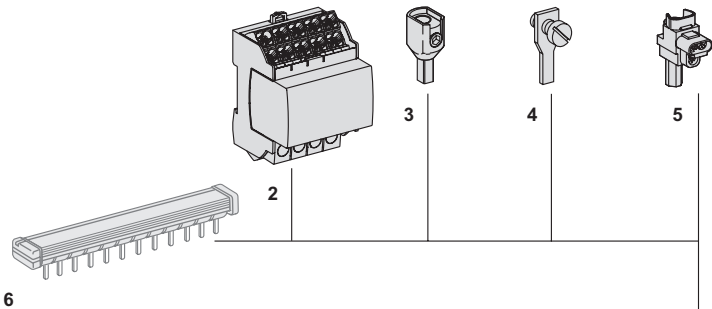

Mounting accessories

See page E-10

7	Sealable terminal shields for top and bottom connection	1P (set of 2)	A9A26975
		2P (set of 2)	A9A26976
		3P	1P + 2P
		4P	2P + 2P
8	Interpole barrier	(set of 10)	A9A27001
9	Clip-on terminal markers		See page E-10
10	9 mm spacer		A9A27062
11	Padlocking device	(set of 10)	A9A26970
12	Plug-in base		A9A27003
13	Rotary handle	Black handle	A9A27005
		Red handle	A9A27006
		No handle	A9A27008

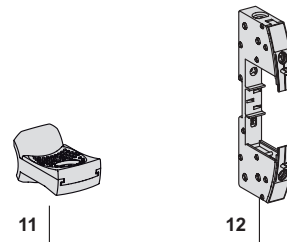
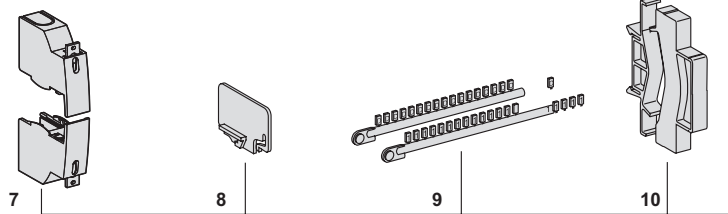

Electrical auxiliaries

See page F-2

Indication		
1	iOF open/close auxiliary contact	A9A26924

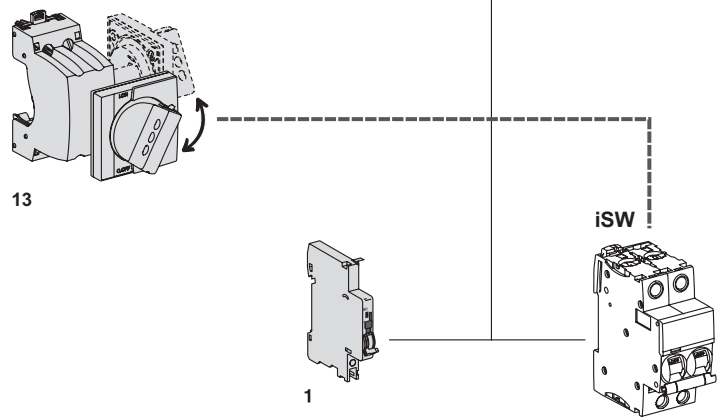

Connection accessories

See page E-10

6	Screw-on connection for ring terminal	27053
7	Comb busbar	See page E-29

Mounting accessories

See page E-10

8	Padlocking device (set of 10)	A9A26970
9	Clip-on terminal markers	See page E-10
10	9 mm spacer	A9A27062

Electrical auxiliaries

See page F-2

Indication

2	iOF/SD+OF auxiliary contact (OF+SD or OF+OF combination switch)	A9A26929
3	iSD fault indicating contact	A9A26927
4	iOF open/close auxiliary contact	A9A26924
5	iOF+SD24 auxiliary contact	A9A26897

Tripping devices

1	iMN undervoltage release or iMNx undervoltage release delayed or iMNx undervoltage release with external feeding or shunt release iMX, iMX+OF overvoltage release iMSU	See page F-2
---	--	--------------

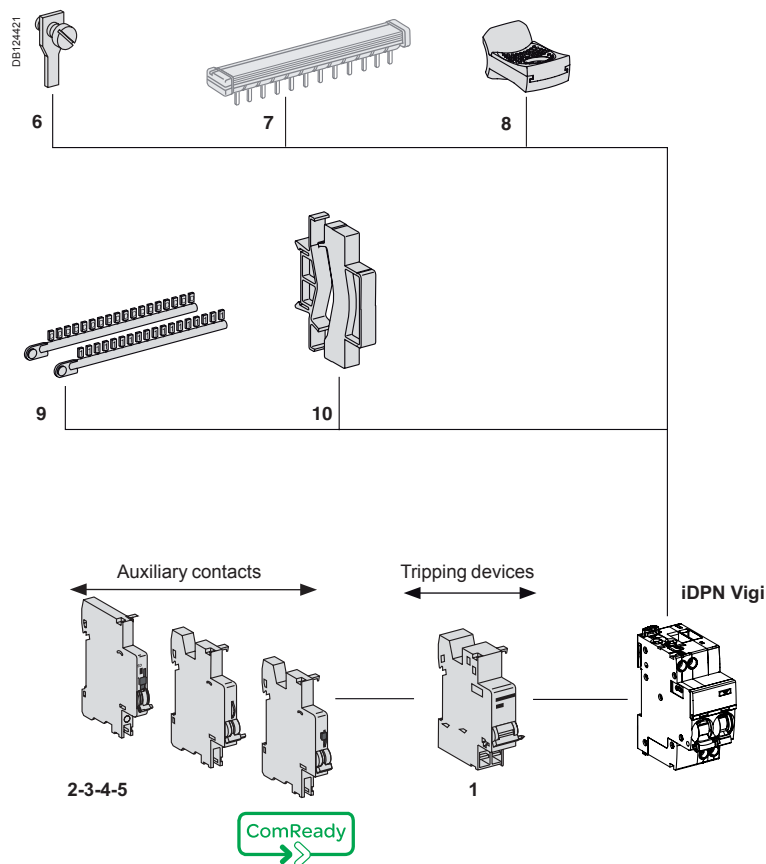

Tripping devices must be mounted first.
Respect specified position for SD functions.

Connection accessories

See page E-15

7	Multi-cable terminal	4 parts	19091
		3 parts	19096
8	Screw-on connection for ring terminal	8 parts	27053
9	Terminal for rear connector		18528
10	50 mm ² Al terminal		27060
11	Comb busbar	See page	E-28

Mounting accessories

See page E-15

12	Sealable terminal shields for top and bottom connection	1P (set of 2)	18526
13	Interpole barrier	(set of 10)	27001
14	Screw shields	4P (set of 2)	18527
15	Clip-on terminal markers	See page	E-15
16	9 mm spacer		A9N27062
17	Padlocking device		27145
18	Plug-in base ⁽¹⁾		26997
19	Rotary handle		
	Removable extended handle		27047
	Fixed handle		27048
	Operating sub-assembly ⁽²⁾		27046

(1) For 1P, centreline between two rows: 200 mm
(2) A complete rotary handle consists of a circuit-breaker operating sub-assembly, cat. no. 27046, a handle cat. no. 27047 or a handle cat. no. 27048.

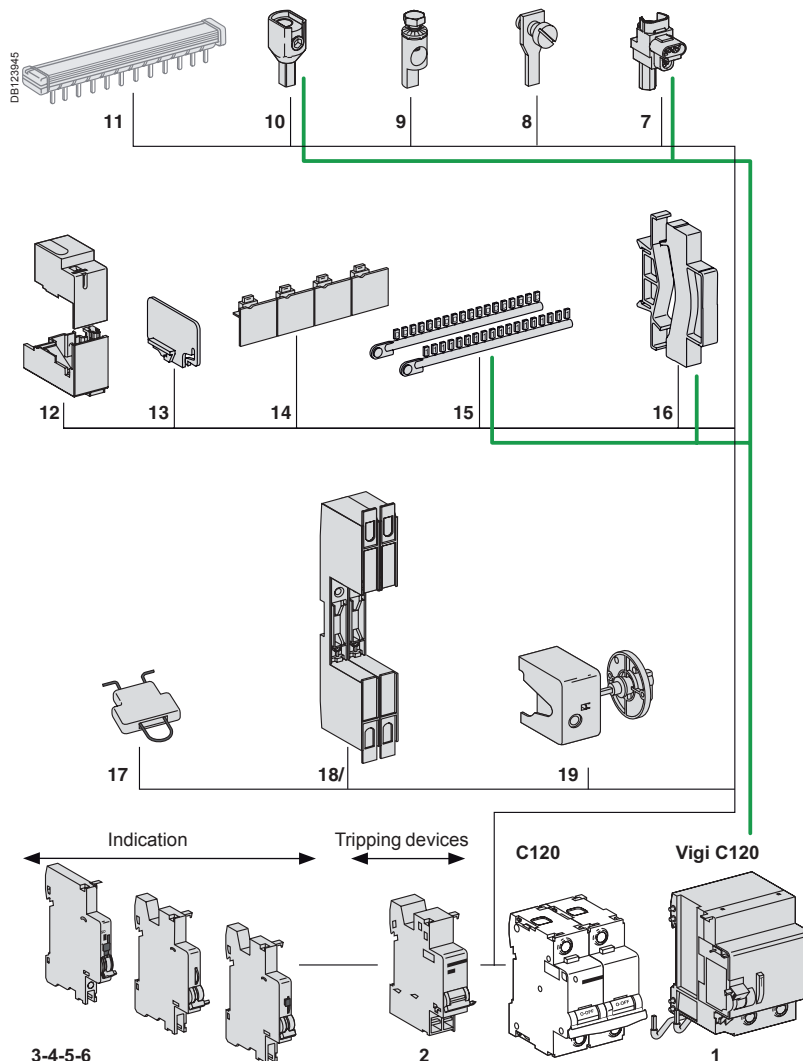

Electrical auxiliaries

See page F-9

Indication		
3	SD fault indicating contact	A9N26927
4	OF+SD24 auxiliary contact	A9N26899
5	OF open/close auxiliary contact	A9N26924
6	OF/SD+OF auxiliary contact (OF+SD or OF+OF combination switch)	A9N26929

Tripping		
2	MN, MNx, MN [⊗] undervoltage release, MSU overvoltage release or MX, MX + OF shunt release	See page F-9

Vigi C120

See page B-22

1	Vigi C120 add-on residual current device	See page	B-22
---	--	----------	------

Tripping devices must be mounted first.

Connection accessories

See page E-15

7	Insulated connector	See page	E-15
8	Comb busbar	See page	E-18
9	Terminal 50 mm ² Al / Cu		27060
10	Ring tongue terminal screw connection		27053
11	Ring tongue terminal connections kit Ø 5 mm, (upstream/downstream)		17400
12	Insulated distribution terminal	4 pieces	19091
		3 pieces	19096

Mounting accessories

See page E-15

13	Sealable terminal shield	See page	E-15
14	Inter-pole barrier		27001
15	Rotary handle		
	Switching sub-assembly		27046
	Disconnectable handle		27047
	Fixed handle		27048
16	Screw shield	See page	E-15
17	Padlocking accessory (to be locked in the "open" position)		26970
18	Spacer		A9N27062
19	Dividable mounting plate		26996
20	Marker strip	See page	E-15

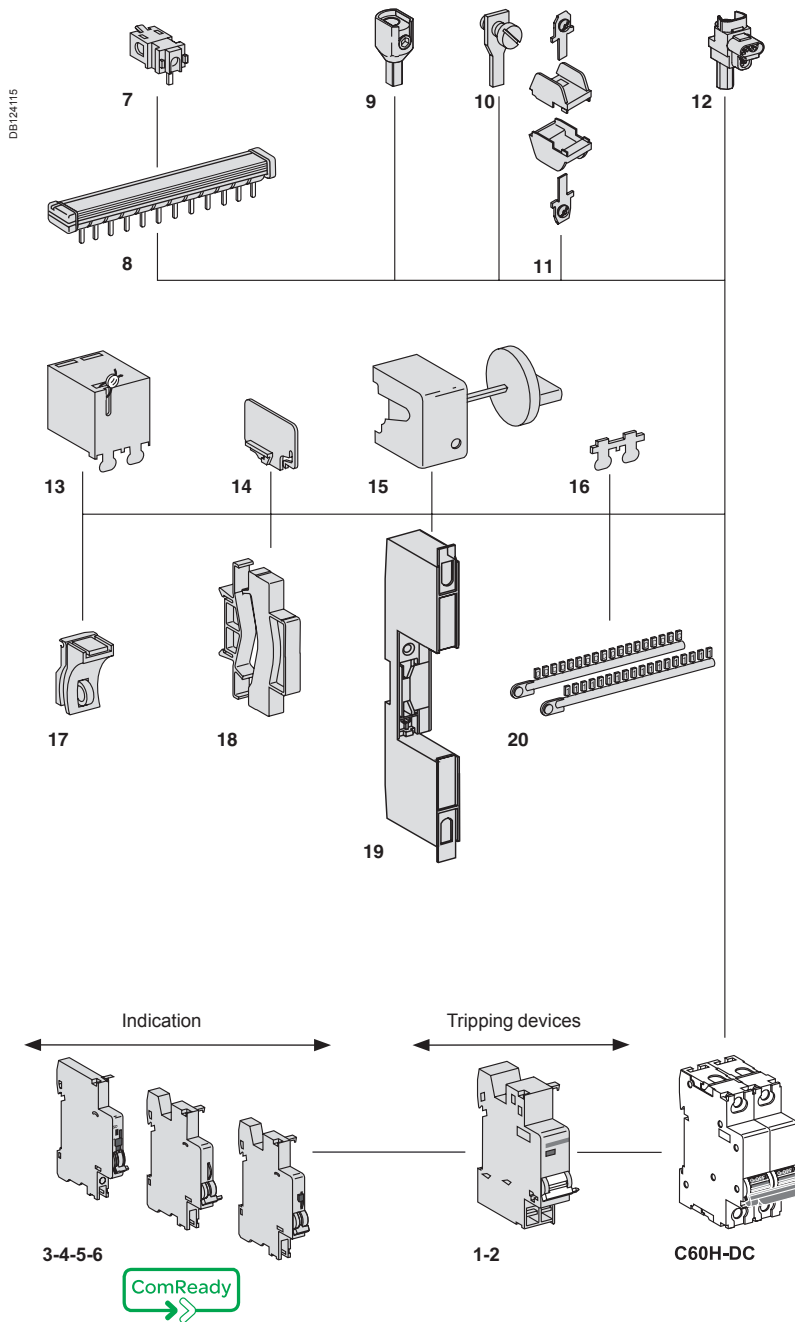

Electrical auxiliaries

See page F-9

Indication		
3	SD fault indicating switch	A9N26927
4	OF+SD24 auxiliary contact	A9N26899
5	OF open/closed contact	A9N26924
6	OF/SD+OF auxiliary contact (OF+SD or OF+OF combination switch)	A9N26929

Tripping		
1	MN, MNx, MN \square undervoltage release	See page F-9
2	MX, MX + OF shunt release	See page F-9

■ The electrical auxiliaries must be installed to the left of the circuit breaker.
■ If the auxiliary SD contacts are associated with the tripping auxiliaries (MN, MX, etc.), they must be installed to the left of these auxiliaries.

Connection accessories

See page E-15

1	Insulated connector	See page	E-15
2	Comb busbar	See page	E-18
3	Terminal 50 mm ² Al / Cu		27060
4	Ring tongue terminal screw connection		27053
5	Ring tongue terminal connections kit Ø 5 mm, (upstream/downstream)		17400
6	Insulated distribution terminal	4 pieces	19091
		3 pieces	19096

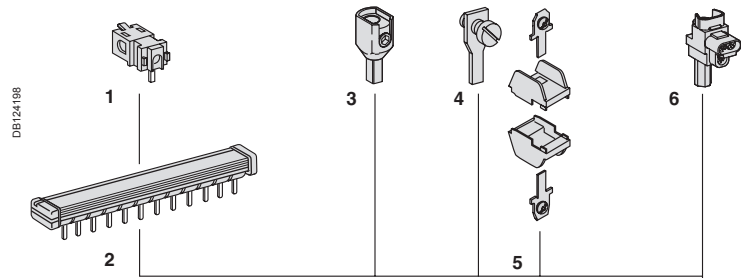

Mounting accessories

See page E-15

7	Sealable terminal shield	See page	E-15
8	Inter-pole barrier		27001
9	Rotary handle	Switching sub-assembly	27046
		Disconnectable handle	27047
		Fixed handle	27048
10	Screw shield	See page	E-15
11	Padlocking accessory (to be locked in the "open" position)		26970
12	Spacer		A9N27062
13	Dividable mounting plate		26996

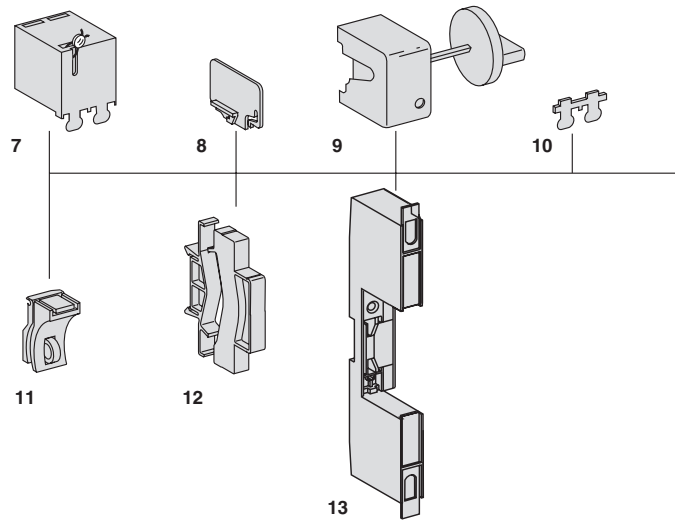





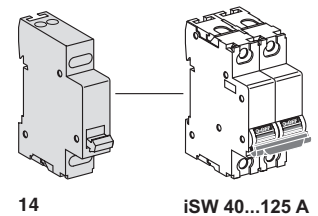

Electrical auxiliaries

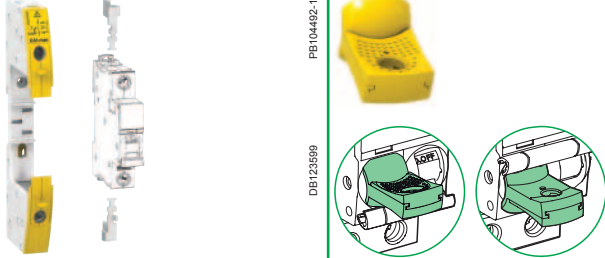
Indication





14	OF iSW open/closed contact	A9A15096
----	----------------------------	-----------------

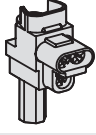
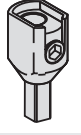

Mounting							
Accessories	Rotary handle			Plug-in base	Padlocking device		
PB104509-35				PB104509-35			
	PB106297_10				DB123599		
Function	<p>Front or side-mounted control</p> <ul style="list-style-type: none"> ■ Degree of protection: IP55 rotary handle ■ Installation: <ul style="list-style-type: none"> <input type="checkbox"/> the control mechanism is mounted on the device <input type="checkbox"/> the rotary handle is fixed to the front or side of the enclosure ■ Front-mounted (on door or faceplate) ■ Prevents the door from opening when the device is in the ON position (can be deactivated) ■ Can be padlocked when the device is in the "open" position (can be padlocked with the device in the "closed" position subject to adaptation) ■ Can be locked by padlock of (dia. 5 to 8 mm), not supplied with the device ■ Pushbutton: iID test available in the front face of the rotary handle 			<ul style="list-style-type: none"> ■ The Laser Square tool brings the accuracy to align the circuit breaker and the rotary handle 	<p>Allows a breaker to be removed or replaced quickly, without handling the connections</p> <ul style="list-style-type: none"> ■ Degree of protection: IP20 ■ Consists of: <ul style="list-style-type: none"> <input type="checkbox"/> a base to be fastened on a rail (or panel) <input type="checkbox"/> 2 "blades" to be fastened in the device's terminals ■ Connection: tunnel terminals for cable up to 35 mm² rigid, 25 mm² flexible, ■ Installation: <ul style="list-style-type: none"> <input type="checkbox"/> in universal enclosure <input type="checkbox"/> on horizontal rail ■ Height: 178 mm ■ Not compatible with Vigi iC60 and auxiliaries ■ Can be locked by padlock of (dia. 6 mm), not supplied with the device 	<p>Used to padlock breaker in open or closed position</p> <ul style="list-style-type: none"> ■ Padlock diameter: 3 to 6 mm ■ Sealable (max. diameter: 1.2 mm) ■ Locking in ON position does not prevent tripping of the breaker in the event of faults ■ Suitable for IEC/EN 60947-2 compliant disconnection 	
Catalogue numbers	A9A27005	A9A27006	A9A27008	GVP01	A9A27003 (1 per pole)	A9A26970	
	Operating sub-assembly						
	+	+					
	Black handle	Red handle	No handle				
Set of	1	1	1	1	1	10	
Suitability							
iC60	■ 2P, 3P, 4P						
iSW	■ 2P, 3P, 4P						
iC60 + Vigi iC60	■ 2P, 3P, 4P						
iID	■				■ ≤ 63 A		
iDPN Vigi	-						
Reflex iC60 or RCA+iC60 or ARA+iC60	-						
ARA+iID	-						
iSW-NA	■						

		Security					
Accessories		Screw shield		Terminal shield		Inter-pole barrier	Spacer
							
Function		Prevents any contact with the connecting screws <ul style="list-style-type: none"> Upgrades degree of protection to IP20D Sealable, max. diameter 1.2 mm 		Prevents any contact with the terminals <ul style="list-style-type: none"> Upgrades degree of protection to IP20D Sealable, max. diameter 1.2 mm Set of two, for upstream and downstream terminals For 3 poles: A9A26975 + A9A26976 For 4 poles: 2 X A9A26976 		Enhances insulation between connections: cables, terminals, lugs, etc	<ul style="list-style-type: none"> Used to: <ul style="list-style-type: none"> complete rows. separate devices. Width: 1 x 9 mm module Allows cable routing from one row to another, (above and below), up to 6 mm²
Catalogue numbers		A9A26982	A9A26981	A9A26975	A9A26976	A9A27001	A9A27062
Set of		12 x 1 pole	20 x 4 poles (splittable)	2 x 1 pole	2 x 2 poles	10	5
Suitability							
iC60		–	■	■	■	■	■
iSW		–	–	■	■	■	■
Vigi iC60		■	–	–	–	–	■
iID		–	■	–	■	■	■
iDPN Vigi		–	–	–	–	–	■
Reflex iC60 or RCA+iC60 or ARA+iC60		–	■	■	■	■	■
ARA+iID		–	■	–	■	■	■
iSW-NA		–	■	–	■	■	■

Accessories for iC60, iID, iDPN Vigi, iSW-NA, Reflex iC60, RCA, ARA, iSW (cont.)

		Connection		
Accessories	Multi-cable terminal	50 mm ² terminal Al	Screw-on connection for ring terminal	
				
Function				
	For 3 copper cables: ■ Rigid up to 16 mm ² ■ Flexible up to 10 mm ²	For aluminium cables from 16 to 50 mm ²	For lug tipped cables, front or rear mounting	
				
Catalogue numbers	19091	19096	27060	27053
Set of	4	3	1	8
iC60 ≤ 25 A Reflex iC60 ≤ 25 A	–	–	–	■
iC60 >25 A Reflex iC60 40 A, iSW	■	■	■	■
Vigi iC60	–	–	–	–
iID	■	■	■	■
iDPN Vigi	–	–	–	■
iSW-NA	■	■	■	■
Tightening torque	2 N.m		10 N.m	2 N.m
Length stripping	11 mm		13 mm	–
Tools to use	Dia. 5 mm or PZ2		Hc 1/5" or 5 mm	Dia. 5mm

		Marking				
Accessories	Marker strip					
						
Used for connection identification						
Catalogue numbers	0: AB1-R0 1: AB1-R1 2: AB1-R2 3: AB1-R3 4: AB1-R4	5: AB1-R5 6: AB1-R6 7: AB1-R7 8: AB1-R8 9: AB1-R9	A: AB1-GA B: AB1-GB C: AB1-GC D: AB1-GD E: AB1-GE F: AB1-GF G: AB1-GG H: AB1-GH I: AB1-GI	J: AB1-GJ K: AB1-GK L: AB1-GL M: AB1-GM N: AB1-GN O: AB1-GO P: AB1-GP Q: AB1-GQ R: AB1-GR	S: AB1-GS T: AB1-GT U: AB1-GU V: AB1-GV W: AB1-GW X: AB1-GX Y: AB1-GY Z: AB1-GZ	+ : AB1-R12 - : AB1-R13 blank: AB1-RV
Set of	250					
iC60, Reflex iC60, iSW	■ 4 markers max. per pole					
Vigi iC60	■ 4 markers max. per device					
iID	■ 4 markers max. per device					
iDPN Vigi	■ 4 markers max. per device					
iSW-NA	■ 4 markers max. per device					



Dimensions (mm)

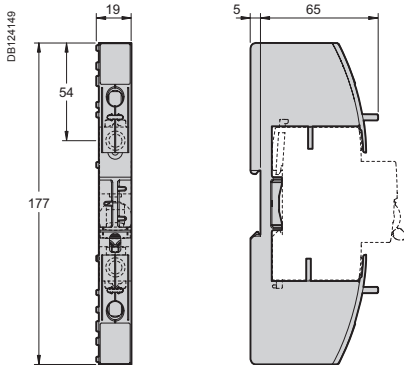

Plug-in base

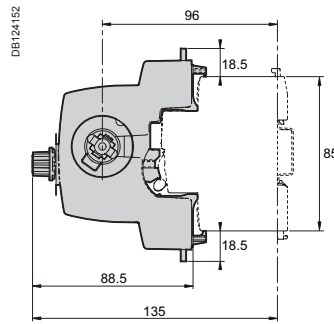

Adapter mechanism

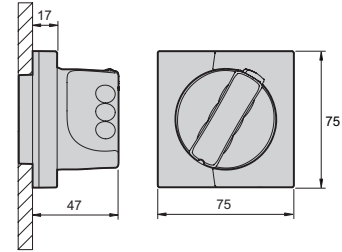

Handle

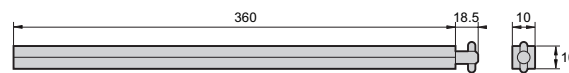

Rotary handle

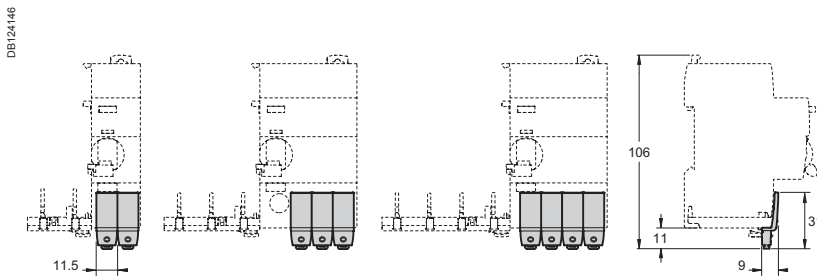

Screw shield 1P (A9A26982)

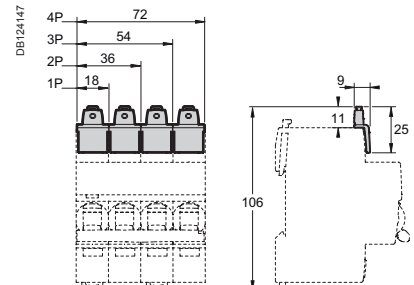

Screw shield 4P (A9A26981)

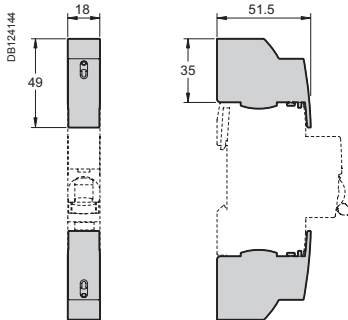

Terminal shield 1P

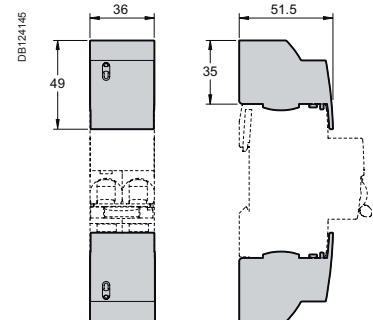

Terminal shield 2P

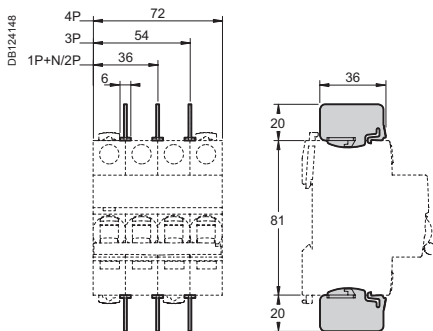

Inter-pole barrier

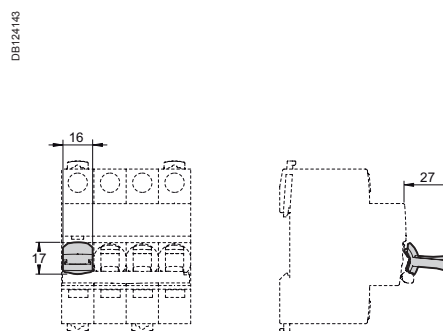

Padlocking device

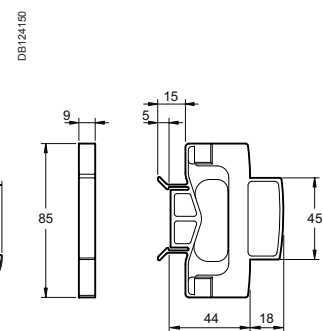

Spacer

Rotary handle installation

Dimensions (mm)

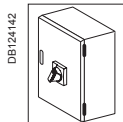

iC60	Z (mm)
2P	25.3
2P + Vigi	25.3
3P	25.3
3P + Vigi	43
4P	43
4P + Vigi	43

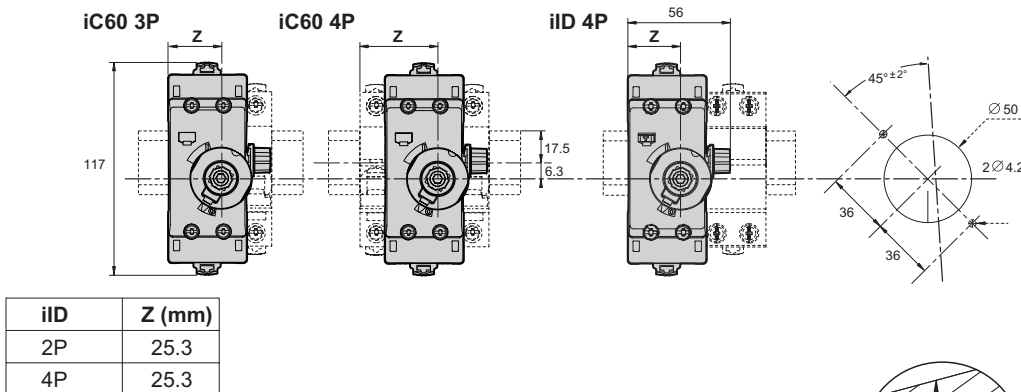

iID	Z (mm)
2P	25.3
4P	25.3

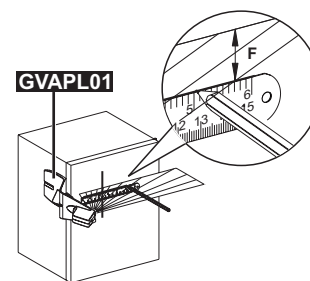
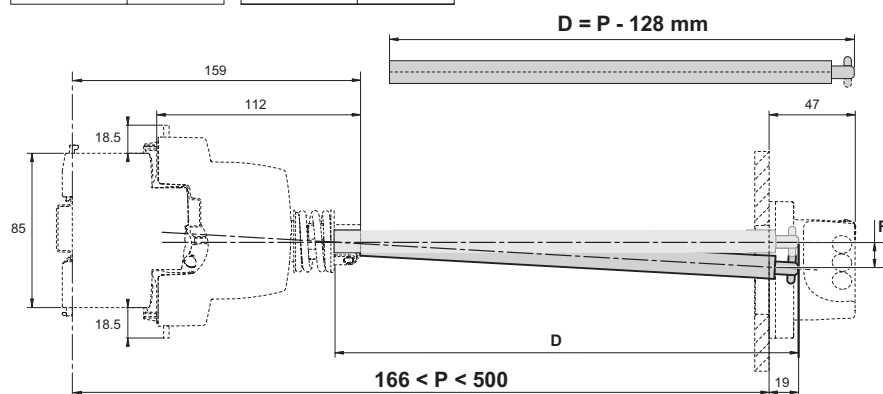

P (mm)	F (mm)
300	5
500	11

Rotary handle: front mounted control

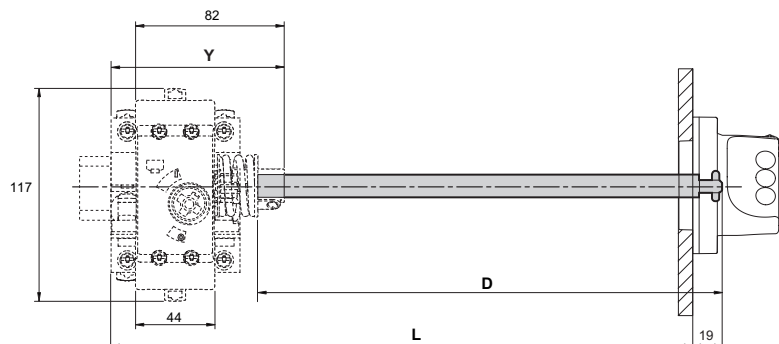
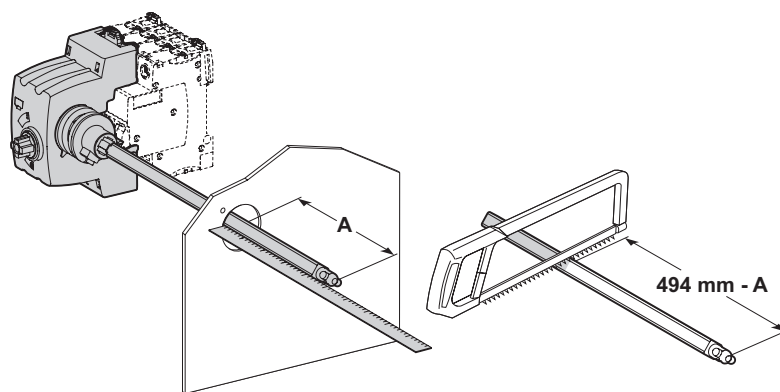
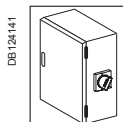









iC60	X (mm)	Y (mm)
2P	44.5	76.8
2P + Vigi	44.5	76.8
3P	44.5	76.8
3P + Vigi	62	94.5
4P	62	94.5
4P + Vigi	62	94.5







iID/iSW-NA	X (mm)	Y (mm)
2P	44.5	76.8
4P	44.5	76.8



Rotary handle: side mounted control

		Installation						
Accessories		Rotary handle		Plug-in base		Padlocking device		
								
Function		<p>Front or side control of 2, 3 and 4-pole circuit breakers</p> <ul style="list-style-type: none"> ■ Degree of protection: IP40 ■ A complete rotary handle consists of: <ul style="list-style-type: none"> <input type="checkbox"/> a circuit-breaker operating sub-assembly, cat. no. 27046, <input type="checkbox"/> a handle cat. no. 27047 or a handle cat. no. 27048 ■ Installation: <ul style="list-style-type: none"> <input type="checkbox"/> the circuit-breaker operating sub-assembly cat. no. 27046 is fixed to the circuit breaker <input type="checkbox"/> the removable handle cat. no. 27047 is mounted on the removable front panel or on the enclosure door <input type="checkbox"/> the fixed handle cat. no. 27048 is fixed to the front or side panel of the enclosure 		<p>Allows a circuit breaker to be quickly removed or replaced, without touching the connections</p> <ul style="list-style-type: none"> ■ Degree of protection: IP20 ■ It consists of: <ul style="list-style-type: none"> <input type="checkbox"/> a base to be fixed to a rail (or panel) <input type="checkbox"/> 2 "blades" to be fixed in the device terminals ■ Connection: tunnel terminals for cables up to 50 mm² (rigid) or 35 mm² (flexible) ■ Installation: <ul style="list-style-type: none"> <input type="checkbox"/> on backplate <input type="checkbox"/> on a horizontal rail ■ Centreline between two rows: 200 mm ■ Only on the circuit breaker, without a Vigi device or auxiliary ■ Padlocking option (8 mm dia. padlock not supplied) 		<p>Used to padlock a circuit breaker in the "open" or "closed" position</p> <ul style="list-style-type: none"> ■ Diameter of the padlock: 8 mm max. ■ Locking in the ON position does not prevent the circuit breaker from tripping in the event of a fault ■ Isolation: in conformity with IEC/EN 60947-2. 		
Cat. numbers		27047 Removable extended handle	27048 Fixed handle	27046 Operating sub-assembly	26996 (1 per pole)	26997 (1 per pole)	27145	26970
Set of		1	1	1	1	1	4	2
Suitable for the following devices:								
C120		■ 2P, 3P, 4P			–	■	■	–
C120 + Vigi C120		■ 2P, 3P, 4P			–	–	■	–
DPN, DPN Vigi		■ 3P, 4P			–	–	–	■
C60H-DC		■ 2P			■	–	–	■
SW60-DC, C60NA-DC, C60PV-DC		–			–	–	–	■
iSW		■ iSW ≥ at 4 modules of 9 mm			■ iSW 40 to 63 A	–	–	■

Safety							
Accessories	Screw shield		Terminal shield			Interpole barrier	Spacer
056870_SE-33 	PB124114 		056889_SE-33 	DB123898 		PB104463-3S 	
Function	Prevents all contact with the fixing screws <ul style="list-style-type: none"> ■ The degree of protection becomes IP40 ■ Sealable, max. diameter 1.2 mm ■ Dividable 		Prevents all contact with the terminals <ul style="list-style-type: none"> ■ Degree of protection becomes IP40 ■ Sealable, max. diameter 1.2 mm <ul style="list-style-type: none"> ■ 1P ■ 1P ■ 2P ■ 3P: 1 x 26975 + 1 x 26976 ■ 4P: 2 x 26976 			Improves the insulation between the connections: cables, terminals, lugs, etc. <ul style="list-style-type: none"> ■ Used to: <ul style="list-style-type: none"> □ complete the rows □ separate the devices ■ Width: 1 x 9 mm module ■ Allows that 2 cables are routed from one row to another (above and below), up to 6 mm² 	
Cat. numbers	18527	26981	18526	26975	26976	27001	A9N27062
Set of	2 (4P dividable)		2 (for upstream/downstream terminal)			10	1
Suitable for the following devices:							
C120	■	–	■	–	–	■	■
Vigi C120	–	–	–	–	–	–	■
DPN, DPN Vigi	–	–	–	–	–	–	■
C60H-DC	–	■	–	■	■	■	■
SW60-DC, C60NA-DC, C60PV-DC	–	■	–	–	–	■	■
iSW	–	■ iSW 40 to 125 A	–	■ iSW 40 to 125 A	–	■ iSW 40 to 125 A	■

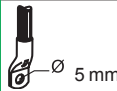
		Connection				
Accessories	Multi-cable terminal	50 mm ² Al terminal	Screw-on connection for ring terminal	Connection kit for ring terminals	Terminal for rear connector	
						
	DB118780	DB118782	DB118787	058987N-23	DB118784	
Function						
	For 3 copper cables: ■ Rigid up to 16 mm ² ■ Flexible up to 10 mm ²	For 16 to 50 mm ² aluminium cables	For lug tipped cables, front or rear mounting	For terminal up to 63 A, front or rear access (screw ⌀ 5 mm) ■ It incorporates a "conductive" part and an "insulating" part which ensures the phase-to-phase clearance	For cable up to 50 mm ² or by terminal ■ Supplied with a 1P terminal shield	
						
	DB118787	DB122835	DB118789			
Cat. numbers	19091	19096	27060	27053	17400	18528
Set of	4	3	1	8	2	2
C120	■	■	■	■	-	■
Vigi C120	■	■	■	-	-	-
DPN, DPN Vigi	-	-	-	■	-	-
C60H-DC, iSW 40 to 125 A	■	■	■	■	■	-
SW60-DC, C60NA-DC	■	■	■	■	-	-
C60PV-DC	-	-	■	■	-	-
Tightening torque	2 N.m		10 N.m	2 N.m	-	-
Stripping length	11 mm		13 mm	-	-	-
Tools to be used	Diameter 5 mm or PZ2		Hc 1/5" or 5 mm	Diameter 5 mm	Diameter 5 mm	-

		Identification			
Accessories	Clip-on terminal marker strip				
					
	031294D_SE-23				
Function		For connection identification			
Cat. numbers	0: AB1-R0 1: AB1-R1 2: AB1-R2 3: AB1-R3 4: AB1-R4 5: AB1-R5 6: AB1-R6 7: AB1-R7 8: AB1-R8 9: AB1-R9	A: AB1-GA B: AB1-GB C: AB1-GC D: AB1-GD E: AB1-GE F: AB1-GF G: AB1-GG H: AB1-GH I: AB1-GI J: AB1-GJ	K: AB1-GK L: AB1-GL M: AB1-GM N: AB1-GN O: AB1-GO P: AB1-GP Q: AB1-GQ R: AB1-GR S: AB1-GS T: AB1-GT	U: AB1-GU V: AB1-GV W: AB1-GW X: AB1-GX Y: AB1-GY Z: AB1-GZ +: AB1-R12 -: AB1-R13 Blank : AB1-RV	
Set of	250				
C120	■ 4 markers max. per pole				
Vigi C120	■ 4 markers max. per device				
DPN, DPN Vigi	■ 4 markers max. per pole				
C60H-DC, SW60-DC, C60NA-DC, C60PV-DC	■ 4 markers max. per pole				

Comb busbars

Acti 9

Not cuttable

PE110231-15

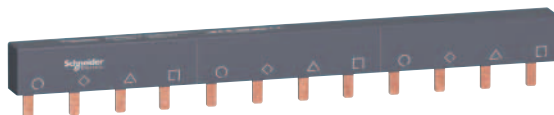

Function

Comb busbars make it easier to implement Schneider Electric products

- The phases are identified by symbols on each side of the comb busbar
- The spare teeth can be insulated with tooth covers
- They must not be cut

PE110290-40 + PE110793-40

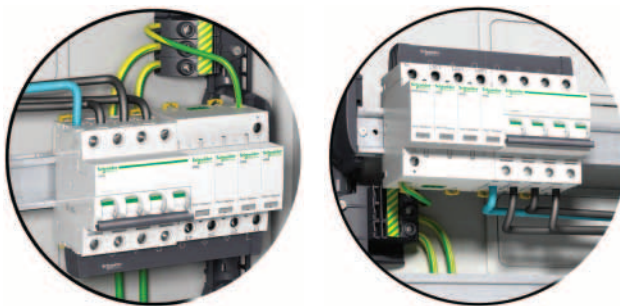



Use

- Power supply by connector recommended

Number of poles		1P	2P	3P	4P	3 (N+P)
Type		L1...	L1L2...	L1L2L3...	NL1L2L3...	NL1NL2NL3...
Catalogue numbers	12 modules of 18 mm	A9XPM112	A9XPM212	A9XPM312	A9XPM412	A9XPM512
	Accessories	–	–	–	–	–
Set of		1	1	1	1	1

Technical specifications

Rated voltage (Ue)	415 V
Insulation voltage (Ui)	500 V
Permissible current at 40°C	100 A
Short-circuit current withstand	Compatible with the breaking capacity of Schneider Electric modular circuit breakers
Fire resistance to IEC 695-2-1	Self-extinguishing 960°C 30 s
Standards	IEC 60947-7-1, IEC 61439-2
Colour	RAL 7016 (anthracite grey)

Accessories	
Tooth covers	Connectors Monoconnect
<p>PE110257-10</p> 	<p>PE110259-15</p> 
<ul style="list-style-type: none"> ■ Insulate teeth that have been left free 	<ul style="list-style-type: none"> ■ Comb busbar power supply
	<p>PE108139-25 + PE108134-38</p> 
	<ul style="list-style-type: none"> ■ Horizontal in-cable on each side ■ For 35 mm² cable ■ Tightening torque 4 N.m
-	-
-	-
A9XPT920	A9XPCM04
20	4

Acti 9 Comb busbars

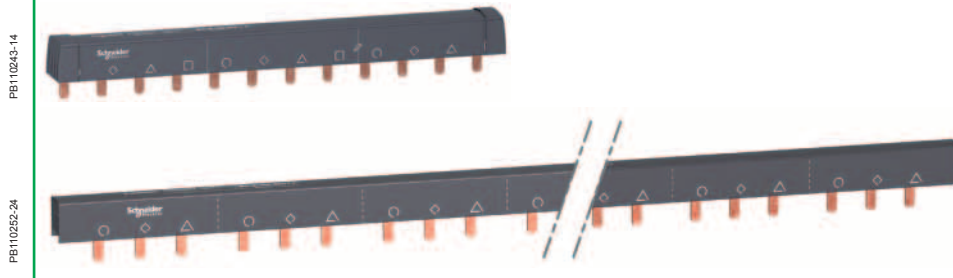

PB110243-14

PB110252-24

Function

- Comb busbars make it easier to implement Schneider Electric products
- Can be sawn and cut in a single pass, using busbar chocks
 - Supplied with two IP20 lateral end-pieces except for 57 module references
 - The end-pieces are compulsory during cutting
 - The phases are identified by symbols on each side of the comb busbar
 - Cutting marks on the insulating material
 - The spare teeth can be insulated with tooth covers
 - The special comb busbars for circuit breakers with 9 mm auxiliaries have a 9 mm gap for inserting iOF and iSD

Strengths: the marking is clear, whether the supply comes from above or below



PB110290-40 + PB110793-40



Use

- Power supply by connector recommended

Number of poles	1P	2P	3P	4P	3 (N+P)	Aux+1P	Aux+2P	Aux+3P	Aux+4P
Type	L1...	L1L2...	L1L2L3...	NL1L2L3...	NL1NL2NL3...	AuxL1...	AuxL1L2...	AuxL1L2L3...	AuxNL1L2L3 ...
Catalogue numbers	6 modules of 18 mm	A9XPH106	-	-	-	-	-	-	-
	12 modules of 18 mm	A9XPH112	A9XPH212	A9XPH312	A9XPH412	A9XPH512	-	-	-
	18 modules of 18 mm	-	-	-	-	A9XPH518	-	-	-
	24 modules of 18 mm	A9XPH124	A9XPH224	A9XPH324	A9XPH424	A9XPH524	-	-	-
	57 modules of 18 mm (end-pieces to be ordered separately)	A9XPH157	A9XPH257	A9XPH357	A9XPH457	A9XPH557	A9XAH157	A9XAH257	A9XAH357
Accessories (optional)	-	-	-	-	-	-	-	-	-
Set of	1	1	1	1	1	1	1	1	1

Technical specifications

Rated voltage (Ue)	415 V
Insulation voltage (Ui)	500 V
Permissible current at 40°C	100 A
Short-circuit current withstand	Compatible with the breaking capacity of Schneider Electric modular circuit breakers
Fire resistance to IEC 695-2-1	Self-extinguishing 960°C 30 s
Standards	IEC 60947-7-1, IEC 61439-2
Colour	RAL 7016 (anthracite grey)

		Accessories						
		End-piece		Tooth covers		Connectors Monoconnect		
								
		<ul style="list-style-type: none"> ■ Lateral end-pieces providing IP20 protection 		<ul style="list-style-type: none"> ■ Insulate teeth that have been left free 		<ul style="list-style-type: none"> ■ Comb busbar power supply 		
						<ul style="list-style-type: none"> ■ Horizontal in comer on each side ■ For 35 mm² cable ■ Tightening torque 4 N.m 		
	3 (Aux+1P)	3 (Aux+N+1P)	1P	2P	3P	4P	-	
	AuxL1AuxL2AuxL3...	AuxNL1AuxNL2AuxNL3...					-	
	-	-	-	-	-	-	-	
	-	-	-	-	-	-	-	
	-	-	-	-	-	-	-	
	-	-	-	-	-	-	-	
	A9XAH657	A9XAH557	-	-	-	-	-	
	-	-	A9XPE110	A9XPE210	A9XPE310	A9XPE410	A9XPT920	
	1	1	10	10	10	10	20	
							A9XPCM04	
							4	

Distribloc 63 A splitter block

IEC/EN 60947-7-1.
IEC/EN 61439-2.

Description

- Distribloc 63 A is a four pole splitter block installable on a standard DIN rail.
- Outgoing feeders are connected at the front, without screws, in spring terminals. The contact pressure of the cable is independent of the operator.
- The spring contact pressure adapts automatically to the cross section of the conductor. It is independent of the operator.

Advantages

- Very fast connection.
- Very simple phase rebalancing.
- In the event of an extension to or modification of the switchboard, connection is very easy.
- The appearance of its front panel (45 mm front tip) enables it to fit in on a row perfectly, alongside modular devices.

Technical data

Main characteristics

Cat. no	Distribution through the top	04040
	Distribution through the bottom	04041
According to IEC/EN 60947-7-1		
Degree of protection	IP20	
Rated insulation voltage (Ui)	500 V AC	
Voltage rating (Ue)	440 V AC	
Rated impulse withstand voltage (Uimp)	6 kV	
Short-circuit current withstand	Up to breaking capacity of Schneider Electric outgoing circuit breakers, even when reinforced by cascading implementation	
Reference temperature	40°C	
Rated current at 40°C (In)	63 A	
Operating frequency	50/60 Hz	
Width in 9-mm modules	8	

PE104409-40



DB122626

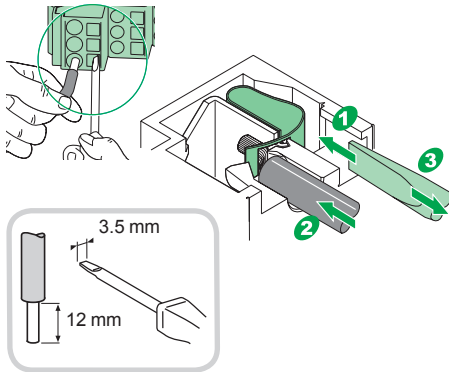

PB104500-80

Power supply

- Four-pole tunnel terminals with screw clamping.
- The tunnel terminals are located to facilitate the insertion of cables and clamping by screws.
- A single cable per connection point:
 - flexible from 4 to 16 mm²
 - rigid from 6 to 25 mm².

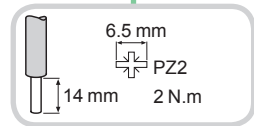

Installation

- Clip-on mounting on modular rail.
- Width occupied: 8x9-mm modules.

Distribution

- 3 outgoing feeders connected by flexible or rigid cables of cross section 1 to 6 mm².
- 2 rows of terminals:
 - 12 connection points for phases (L1, L2, L3)
 - 12 connection points for neutral.
- A single cable per connection point: flexible (without ferrule) or rigid from 1 to 6 mm².
- Reliable, maintenance-free (tightness guaranteed over time).
- Insensitive to vibrations and thermal variations.

Distribloc 63 A splitter block (cont.)



Additional characteristics	
According to IEC/EN 60947-7-1	
Rated cross section	16 mm ²
Rated connecting capacity	10-16-25 mm ²
Pollution degree	3
Storage temperature	-40°C to +85°C
According to IEC/EN 61439-2	
Operating temperature	-25°C to +60°C
Colour	RAL 7016, RAL 9003

Installation

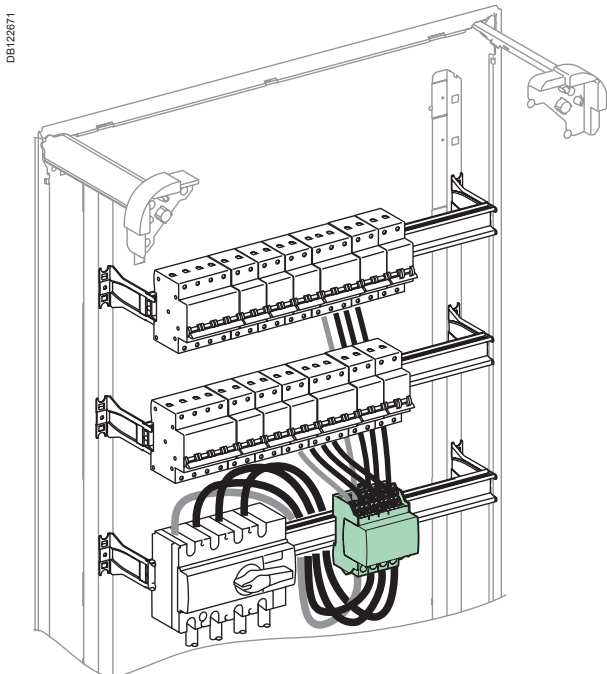

Distribution through the bottom.

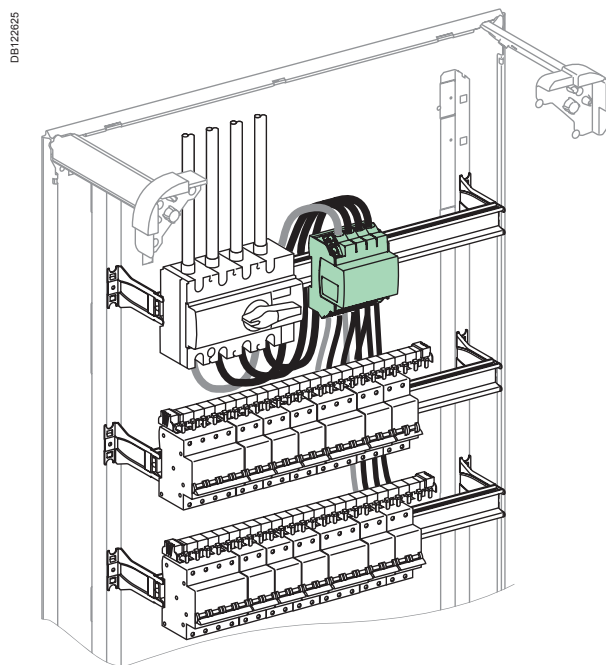

Distribution through the top.

Weight (g)

Splitter block	
Type	
Distribloc	290

Dimensions (mm)

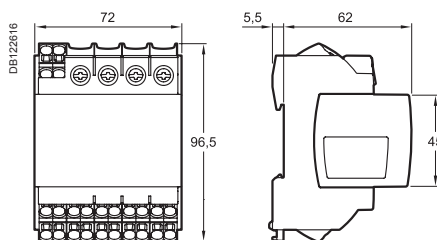

Multiclip 80 A splitter block

PB 044507-35

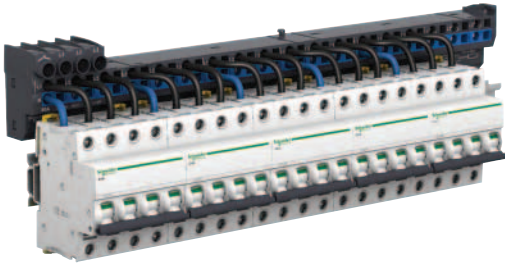

IEC/EN 60947-7-1.
IEC/EN 61439-2.

Description

- Multiclip 80 A is a four-pole splitter block 24 modules wide installable on a standard DIN rail.
- Outgoing feeders are connected at the front, without screws, in spring terminals.
- The spring contact pressure adapts automatically to the cross section of the conductor. It is independent of the operator.
- Supplied with 12 black and 12 blue pre-stripped 6 mm² cables.

DE12826

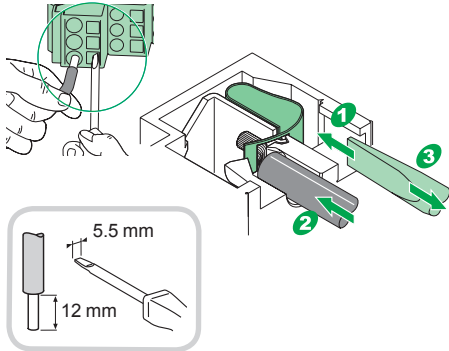

Advantages

- Very fast connection.
- Very simple phase rebalancing.
- In the event of an extension to or modification of the switchboard, connection is very easy.
- Compatible with inter-rows of 150 mm.

Technical data

Main characteristics	
Cat. no	04000
According to IEC/EN 60947-7-1	
Rated current at 40°C (I _n)	80 A
Maximum operated voltage (U _e)	440 V AC
Operating frequency	50/60 Hz
Rated insulation voltage (U _i)	500 V AC
Pollution degree	3
Rated impulse withstand voltage (U _{imp})	6 kV
Degree of protection	IP20
Short-circuit current withstand	Up to breaking capacity of Schneider Electric outgoing circuit breakers, even when reinforced by cascading implementation
Width in 9-mm modules	48

Power supply

- Four-pole tunnel terminals with screw clamping.
- The tunnel terminals are located to facilitate the insertion of cables and clamping by screws.
- One cable per connection point:
 - flexible from 6 to 25 mm²
 - rigid from 10 to 35 mm².

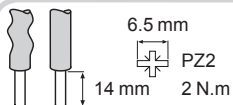

PB 044501-45

Installation

- Clip-on mounted Pragma and Prisma DIN rails.
- Screwed on all other symmetric rail.



Distribution

- Connection to spring terminals through the front.
- 2 rows of terminals:
 - 18 connection points for phases (L1, L2, L3)
 - 18 connection points for neutral.
- A single cable per connection point: flexible (without ferrule) or rigid from 1 to 6 mm².
- Maintenance-free (tightness guaranteed over time). Insensitive to vibrations and thermal variations.

Multiclip 80 A splitter block (cont.)

PB 104505-80



Additional characteristics

According to IEC/EN 61439-2

Operating temperature	-25°C to +60°C
Storage temperature	-40°C to +85°C
Colour	RAL 7016



Installation

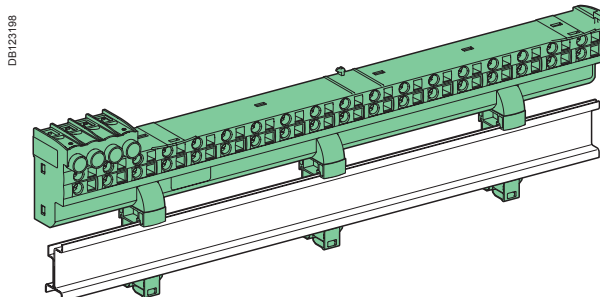

DB123198

On Pragma and Prisma rails

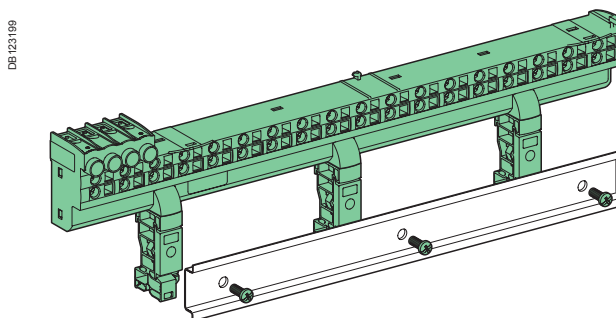

DB123199

On other symmetric rails

Weight (g)

Splitter block

Type

Multiclip	640
-----------	-----

Dimensions (mm)

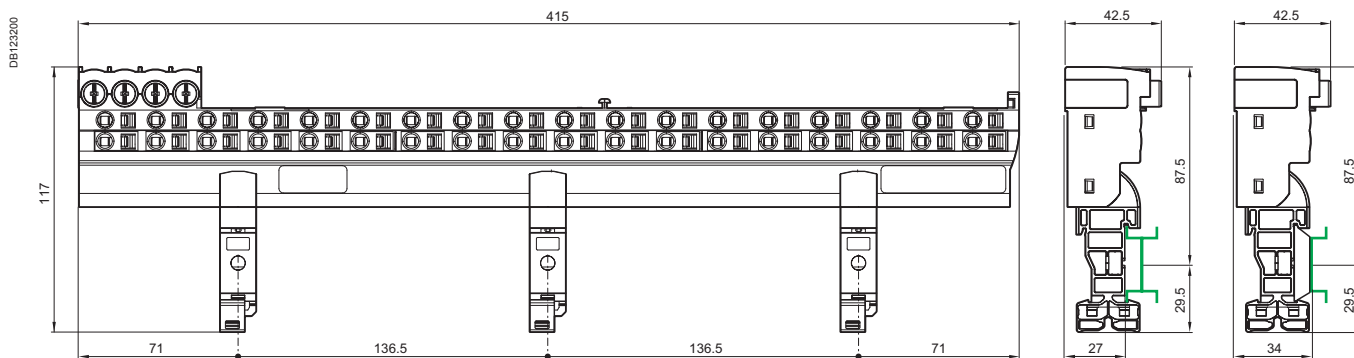

		Mounting			
Accessories	Rotary handle		Toggle	Padlocking device	
Function					
Extended rotary handle <ul style="list-style-type: none"> Degree of protection: rotary button IP55 Front installation: Prevents door opening when the circuit breaker is in position O Keeps disconnection Padlocking possible when the device is in position O Padlock diameter: 3 to 6 mm 		Direct rotary handle <ul style="list-style-type: none"> Front installation Keeps disconnection Padlocking possible when the device is in position O Padlock diameter: 3 to 6 mm 		White toggle <ul style="list-style-type: none"> Allows visual distinction of a switchboard incoming device 	
		<ul style="list-style-type: none"> Two versions: <ul style="list-style-type: none"> standard black red handle and yellow front plate for machine tool control 		Allows padlocking: <ul style="list-style-type: none"> In position I or O of NG125 1P or 2P circuit breakers In position I of NG125 3P or 4P circuit breakers or switches Padlock: dia. 5 to 8 mm (not supplied) <p><i>Note: NG125 3P/4P circuit breakers and switches are provided with padlocking in position O (disconnected) as original equipment.</i></p>	
Catalogue numbers	19088 Extended standard black	19089 Extended safety	19092 Direct standard black	19097 Direct safety red handle yellow background	19099 White toggle
Pack of	1		1	1	10
Suitable for the following devices:					
NG125	■ 3P, 4P		■	■ 3P, 4P	
Vigi NG125	-		-	-	



		Connection				
Accessories	Multi-cable terminal	70 mm ² Al terminal	Screw-on connection for ring terminal	Small ring terminal		
Function						
For 3 copper cables: <ul style="list-style-type: none"> Rigid up to 16 mm² Flexible up to 10 mm² 		For aluminium cables from 25 to 70 mm²	Installation: <ul style="list-style-type: none"> Upstream or downstream Connection ratings 80 to 125 A: <ul style="list-style-type: none"> copper terminal: <ul style="list-style-type: none"> flexible cable up to 35 mm² rigid cable up to 50 mm² bars: 16 x 3 mm, 15 x 4 mm, 16 x 4 mm small ring terminal Phase-to-phase insulation voltage: U_i = 1000 V 		Connection ratings 80 to 125 A: <ul style="list-style-type: none"> Flexible copper cable: 50 mm² Rigid copper cable: 70 mm² 	
Cat. nos.	19091	19096	19095	19093	19094	
Pack of	4	3	4	4	4	
NG125	■	■	■ 80, 100, 125 A	■ 80, 100, 125 A	■ 80, 100, 125 A	
Vigi NG125	-	-	■ 125 A	■ 125 A	■ 125 A	
Tightening torque	2 N.m		6 N.m	6 N.m	6 N.m	
Stripping length	11 mm		-	-	-	
Tools to be used	Diameter 5 mm or PZ2		Hc 4 mm	Hc 4 mm	-	

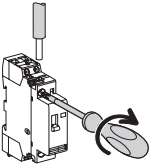
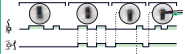
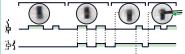

Safety

Accessories	Screw shield				Circuit breaker terminal shield				RCD terminal shield						
	 <p>DB123806</p>				 <p>DB123807</p>				 <p>DB123807</p>						
Function	<ul style="list-style-type: none"> ■ Prevents any contact with the connection screws ■ Protection against direct contact: <ul style="list-style-type: none"> □ IP40: on front panel □ IP20: at the connection level ■ Class II in steel or plastic enclosures ■ Sealing possible (max. diameter: 1.2 mm). 				<ul style="list-style-type: none"> ■ Prevents any contact with the terminals ■ Installation: mounted upstream and downstream of circuit breaker ■ Phase-to-phase insulation voltage $U_i = 1000\text{ V}$ ■ Protection against direct contact IP40 ■ Class II in steel or plastic enclosures (up to 440 V) ■ Sealing possible (max. diameter: 1.2 mm) 				<ul style="list-style-type: none"> ■ Installation: is mounted upstream of the circuit breaker and downstream of the Vigi device ■ Phase-to-phase insulation voltage $U_i = 1000\text{ V}$ ■ Protection against direct contact: IP40 ■ Class II in steel or plastic enclosures (up to 440 V) ■ Sealing possible (max. diameter: 1.2 mm) 						
	1P	2P	3P	4P	1P	2P	3P	4P	63 A			125 A			
									2P	3P	3P adjustable	4P	4P adjustable	3P	4P
Catalogue numbers	19084	19085	19086	19087	19080	19081	19082	19083	19074	19075	19077	19076	19078	19077	19078
Pack of	10				Set of 1 upstream / 1 downstream				Set of 1 upstream / 1 downstream						
Suitable for the following devices:															
NG125	■				■				■						
Vigi NG125	-				-				■						

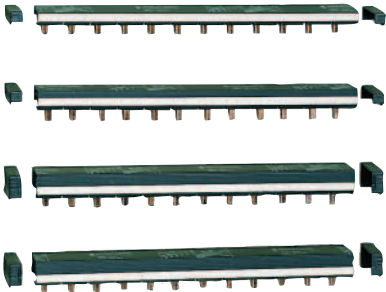
Connection comb busbars for C120 and NG125

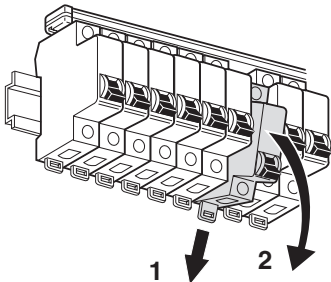
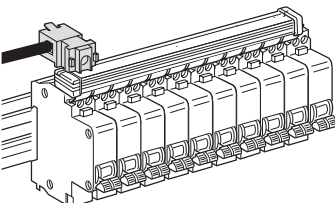
	Comb busbars				Accessories
Accessories	1P, 2P, 3P, 4P comb busbar				Insulated connector
					
Function	<p>The comb busbars make it easier to install Schneider Electric products.</p> <ul style="list-style-type: none"> ■ Supplied with 2 side plates, IP 2 ■ Outgoing feeders can be marked ■ Cutting markings on the copper bars and the insulating material ■ Self-extinguishing insulating material, colour RAL 7016 ■ The teeth left on standby can be isolated by tooth cover end-pieces 				<ul style="list-style-type: none"> ■ Compatible with all Schneider Electric comb busbars ■ Clip onto the comb busbar's insulating material, which gives them very great stability ■ Receive clip-on markers allowing circuit identification
Wiring diagram					
Use	<p>Direct power supply on the circuit-breaker terminal: maximum 50 mm² rigid</p>				<ul style="list-style-type: none"> ■ For 25 mm² semi-rigid cable
Catalogue numbers	14811	14812	14813	14814	14885
Number of 9 mm modules	L = 430 mm, 16 poles of 27 mm	L = 430 mm, 16 poles of 27 mm	L = 405 mm, 15 poles of 27 mm	L = 430 mm, 16 poles of 27 mm	
Set of	1				4
Suitable for the following devices:					
C120	■	■	■	■	–
NG125 ≤ 63 A	■	■	■	■	–
Technical specifications					
Voltage rating (Ue)	500 V				
Acceptable current at 40°C	125 A				
Max. current per feeder	63 A				
Resistance to short-circuit currents	Compatible with the breaking capacity of modular circuit breakers				

These comb busbars are a key part of the distribution system.

IEC 60947-7 concerning cable strength.

Combined with Schneider Electric distribution systems and switchgear, comb busbars allow the construction of switchboards tested in compliance with the IEC 60439-1 standard.

Comb busbars are available in several lengths for two types of distribution:

- single-phase 1P+N distribution
- three-phase 3P+N distribution (3P+N and 1P+N outgoing feeders can be combined under the same comb busbar).

The comb busbars ensure:

- easy, reliable mounting of 1P+N and 3P+N, TL, CT, ID, V, BP and CM switchgear: tooth positioning opposite the devices' terminals is ensured by indexing of copper parts.

- C60/ID Group Feeder comb busbars contain two different parts:

- connection of Group Feeder switchgear: C60 (3P+N) or ID (3P+N) circuit breaker in 18-mm modules, powered by cables, through the bottom, directly by the terminals,
- connection of Clario, Prodis and Libro switchgear in 9-mm modules.

- The special comb busbars for circuit breakers have a gap of 9 mm for inserting OF, SD, OF+SD/OF auxiliaries.

Catalogue numbers

Standard comb busbars

Complete comb busbars (supplied with 4 side plates and 1 tooth cover)		Number of 18-mm modules		
		Comb busbar	Tooth cover	
1P+N	12	3		21501
	18	3		19512
	24	6		21503
3P+N	12	3		21505
	18	3		19516
	24	6		21507
Comb busbars alone				
1P+N	48	-		21089
3P+N	48	-		21093
C60/ID Group Feeder comb busbars alone		Number of 18-mm modules	Power supply	
3P+N	12		Through left-side	10545
	48		Through left-side	10546
	48		Through right-side	10547
Accessories				
Set of 40 side plates		1P+N		21094
		3P+N		21095
Set of 12 tooth covers (3 x 18-mm modules)				21096
Set of 10 tooth cover end-pieces (1 x 18-mm module)				10405
Set of 4 connectors (4 grey)				21098

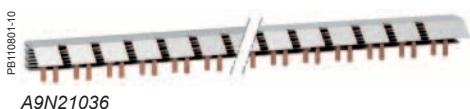
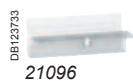
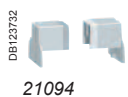

Comb busbars for circuit breaker with 9-mm auxiliaries

Comb busbars alone		Number of 18-mm modules		
Comb busbars	1P+N	56		A9N21035
	3P+N	56		A9N21036
Comb busbars DPN Vigi	1P+N	56		A9N21037
	3P+N	56		A9N21038
Accessories				
Set of 20 side plates		1P+N		A9N21039
		3P+N		A9N21040
Set of 10 phase connectors (grey)				A9N21041
Set of 10 neutral connectors (blue)				A9N21042
Set of 10 tooth cover (1 x 18-mm module)				A9N21050

Technical data

Main characteristics		
According to IEC 60439-1	Peignes standards	Peignes pour auxiliaires
Insulation voltage (Ui)	440 V AC	500 V AC
Pollution degree	3	3
Rated impulse withstand voltage (Uimp)	6 kV	6 kV
Acceptable current at 40°C (Ie)	80 A	63 A
Voltage rating (Ue)	Phase-to-neutral	230 V AC
	Phase-to-phase	400 V AC
Additional characteristics		
Degree of protection (IEC 60529)	IP20	
Fire resistance	Self-extinguishability 960°C, 30 s/30 s	
Dielectric strength (preserved after cutting)	2500 V AC	
Colour	RAL 7035 (the same color as device)	
Resistance to short-circuit currents	Compatible with the breaking capacity of the circuit breakers in the range	

Power supply

- Direct by Group Feeder earth leakage protection device.
- In the devices' terminals with comb busbar in place:
 - 16 mm² semi-rigid cable,
 - 25 mm² flexible cable.
- By insulated connector, horizontal inlet:
 - 25 mm² semi-rigid cable
 - 16 mm² flexible cable.

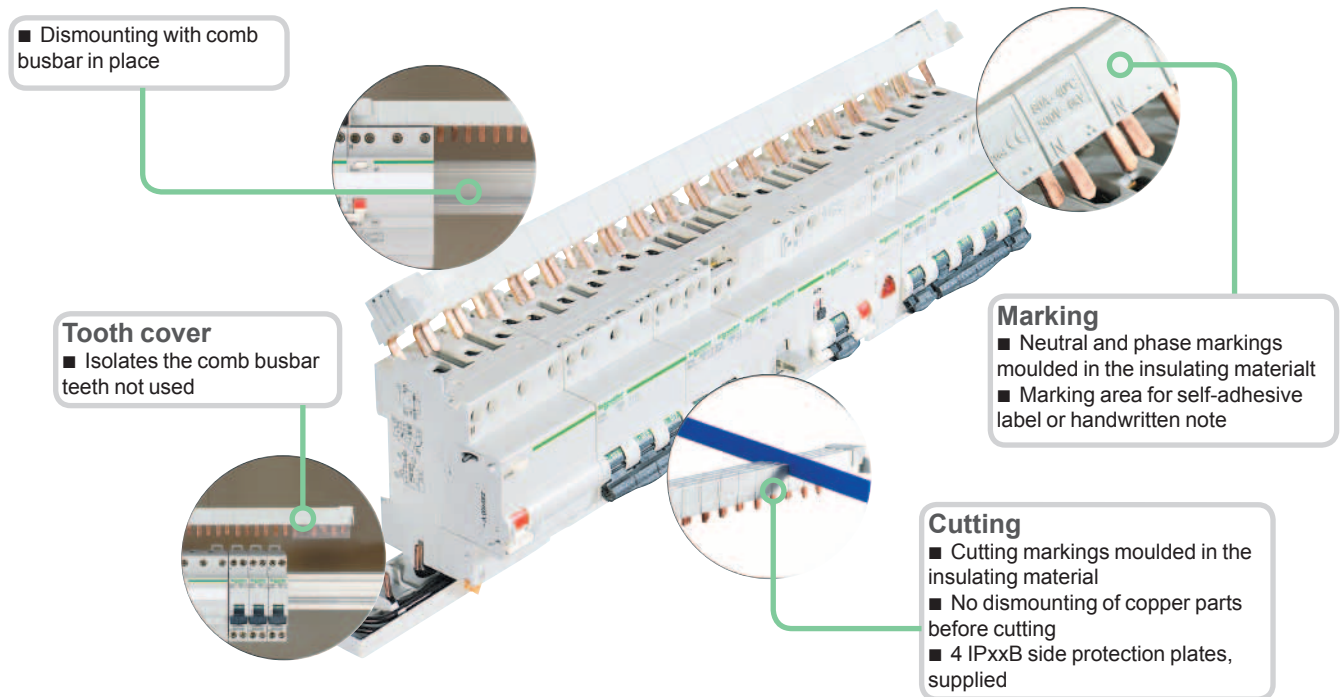

> Accessories and auxiliaries

> Mounting accessories

Comb busbars	See page	E-29
Padlocking		26970
9 mm spacer		A9N27062
Clip-on terminal markers		

> Auxiliaries

Auxiliary contacts		
Open/closed auxiliary contact OF.S for ID		A9N26923
Open/closed auxiliary contact OF		A9N26924
Fault indicating switch SD		A9N26927
Auxiliary contact OF/SD+OF (OF+SD or OF+OF combination)		A9N26929
Tripping devices		
Undervoltage release MN or delayed undervoltage release MNs or undervoltage release with external power supply MNx	See page	F-9
Shunt release MX, MX+OF or voltage threshold release MSU	See page	F-9

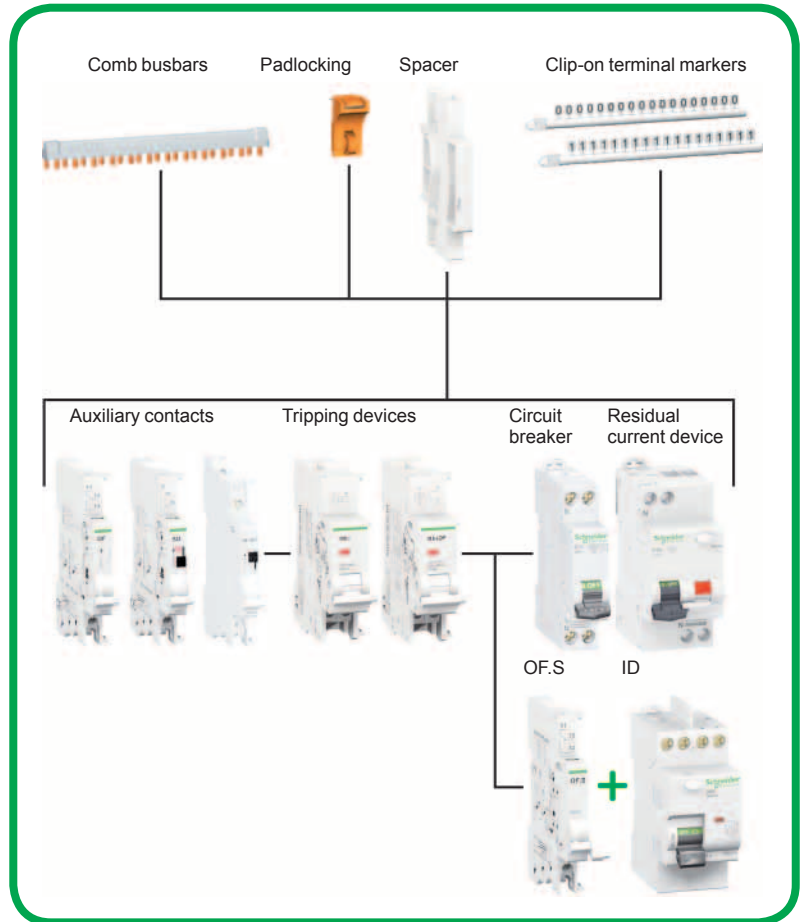

Supervision and switchboard control



PB 107797-47



IEC/EN 61131-2

The Acti 9 Smartlink transmits data from Acti 9 devices to a PLC or a supervision system via the Modbus serial line communication network.

Functions

Data transmission between the Modbus network and Acti 9 devices

- Circuit breakers, residual current circuit breakers, residual current devices:
 - open/closed state
 - tripped state
 - number of opening/closing cycles
 - number of tripping actions.
- Contactors, impulse relays:
 - opening control
 - closing control
 - open/closed state
 - number of cycles
 - total period of operation of the load (device closed).
- Remote controlled circuit breaker/Reflex iC60:
 - opening control
 - closing control
 - open/closed state
 - tripped state
 - number of cycles
 - total period of operation of the load.
- Power meters:
 - number of pulses recorded
 - pulse value setting (e.g. kWh)
 - total consumption recorded
 - estimate of power consumption.

All the data are stored in memory: number of cycles, consumption, period of operation, even in the event of a power failure.

The Acti 9 Smartlink can also exchange data with any device having 24 V DC digital inputs/outputs.

No configuration of the connected products is required.

When the Acti 9 Smartlink is switched on, communication automatically adjusts to the Modbus Master (PLC, control station) communication parameters.

PB 107753-68



A9XMSB11

Catalogue numbers

Acti 9 Smartlink			
Type		Set of	
Acti 9 Smartlink		1	A9XMSB11
Supplied with	Modbus connector	1	
	24 V DC power supply connector	1	
	Locking clips for mounting on Multiclip 80	2	
Accessories			
Link USB / Modbus for Acti 9 Smartlink test		1	A9XCATM1
Prefabricated cables			
With 2 connectors	Short: 100 mm	6	A9XCAS06
	Medium-sized: 160 mm	6	A9XCAM06
	Long: 870 mm	6	A9XCAL06
With 1 connector	Long: 870 mm	6	A9XCAU06
Connectors	5-pin connectors (Ti24)	12	A9XC2412
Mounting kit	DIN rail (4 feet, 4 straps, 4 adapters)	1	A9XMFA04
	Multiclip 200 A (4 adapters)	1	A9XM2B04
Spare parts	Lock for Multiclip 80 A (2 clips)	1	A9XMLA02

DB404941

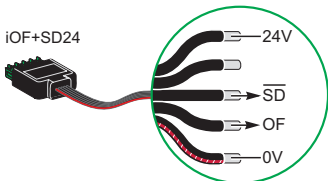

PB107754-12

PB107755-5

PB107756-7

The Acti 9 communication system

Acti 9 Smart Test software

- Electrical continuity test
- Functional testing of the devices
- Report printing
- Printing of a simplified diagram
- Project archiving
- Compatible with Windows XP, Seven
- To be download on: Schneider Electric web sites:
□ schneider-electric.com or
□ schneider-electric country web site)



11 input/output channels

- Standard connectors
- In accordance with the IEC 61131-2 standard

- Communication adapts automatically to the communication parameters of the Modbus master (PLC, supervisor).
- Up to 32 slaves connected

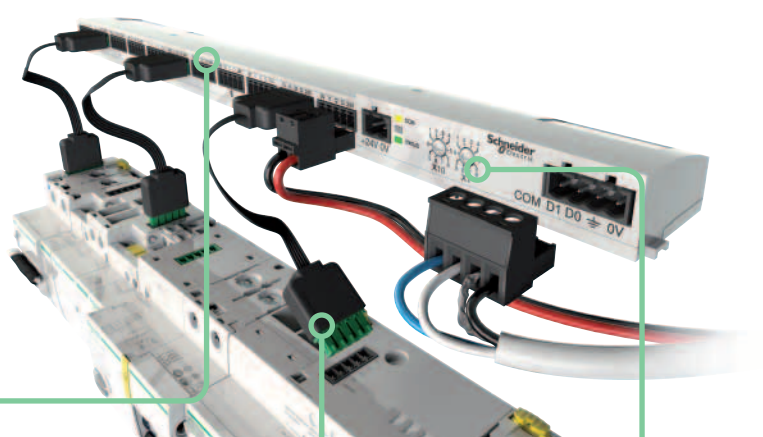

Prefabricated cables

- Simplified cabling
- Fast and safe

Modbus Communication

Connectable devices

With Ti24 interface

Type	Reference	Description
iACT24	A9C15924	Low-level control and indication auxiliary for iCT contactors
iATL24	A9C15424	Low-level control and indication auxiliary for iTL impulse relays
iOF+SD24	A9A26897	Low-level indication auxiliary for iC60, iID, ARA, RCA, iSW-NA
OF+SD24	A9N26899	Low-level indication auxiliary for C60, C120, DPN, RCCB/iD, C60H-DC
RCA	See page F-18	Remote control with Ti24 interface
Reflex iC60	See page G-3	Reflex iC60 with Ti24 interface

Without Ti24 interface

- Power meters with pulse output, e.g. IEM2000T
- Meters complying with the IEC 62053-21 standard
- 24 V DC indicator lamp, Harmony XVL range
- All loads not exceeding 100 mA, 24 V DC
- IC2000 light sensitive switches
- Timers, thermostats, time switches, load shedding devices
- All 24 V DC auxiliary contacts, IEC 61131-2 type 1

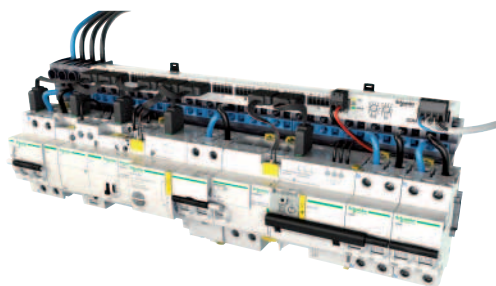

Installation

- Mounting in switchboards:
 - width 24 modules per row;
 - minimum spacing between rails 150 mm.

E

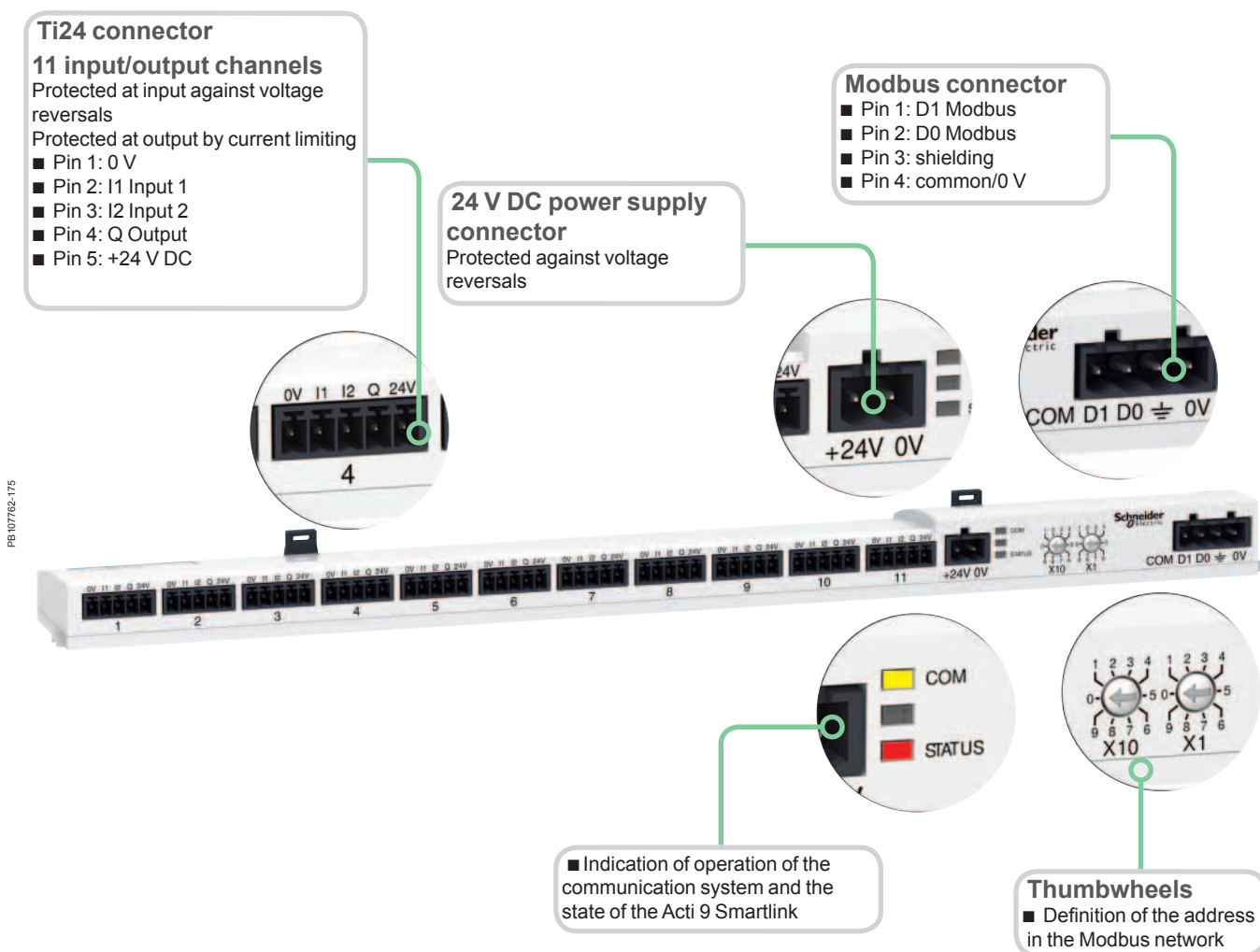

Connection

DB123660

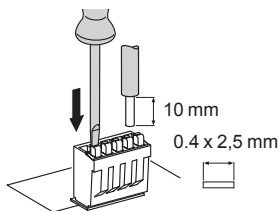

Connector cat. no: A9XC2412

DB124331

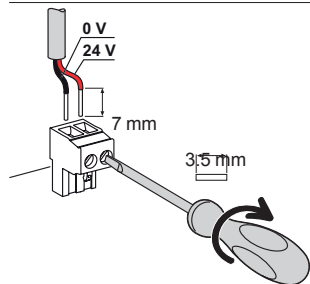

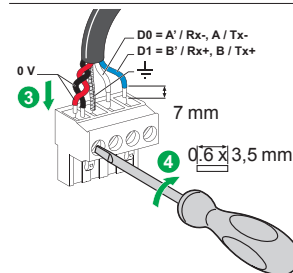

DB405141

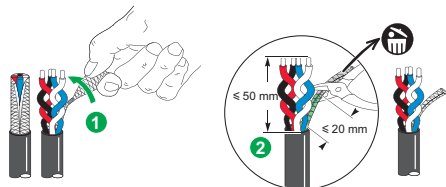

DB405142



Terminal	Tightening torque	Copper cables		
		Rigid	Flexible	Flexible with ferrule
Ti24 interface	Spring loaded terminal DB122945	0.5 to 1.5 mm ² 	0.5 to 1.5 mm ² 	- 
Power supply connector	0.8 N.m	0.2 to 1.5 mm ²	0.2 to 1.5 mm ²	0.2 to 1.5 mm ²
Modbus connector	0.8 N.m	0.25 mm ²	0.25 mm ²	0.25 mm ²

Weight (g)

Acti 9 Smartlink

Type

Acti 9 Smartlink	195
------------------	-----

Dimensions (mm)

DB124330

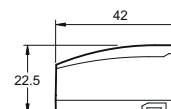
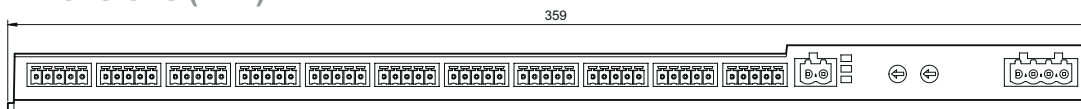

Technical characteristics

Characteristics of the Modbus link		
Link		Modbus, RTU, RS485 serial connection
Transmission	Transfer rate	9600 baud ... 19200 baud, self-adaptable
	Medium	Shielded cable, double twisted pair
Structure	Type	Modbus.org
	Method	Master/Slave
Type of device		Slave
Configuration	Modbus addressing range of the Acti 9 Smartlink	99
	Maximum number of slaves for a Modbus master	
	Maximum length of the bus	1000 m
Type of bus connector		4-pin connector
Power supply		
Rated		24 V DC \pm 20 %
Maximum input current		1.5 A
Maximum inrush current		3 A
Meter		
Capacity		2 ³² pulses per input
Input characteristics		
Type of input		Current collector Type 1 IEC 61131-2
Number of channels		11 2-input channels
Maximum cable length		20 m
Rated voltage		24 V DC
Voltage limits		24 V DC \pm 20 %
Rated current		2.5 mA
Maximum current		5 mA
Filtering time	In state 1	1 ms
	In state 0	1 ms
Isolation		No isolation between ports
Negative sequence voltage protection		Yes
Output characteristics		
Number of output channels		11
Type of output		24 V DC 0.1 A current source
Rated voltage	Voltage	24 V DC
	Maximum current	100 mA
Filtering time	In state 1	1 ms
	In state 0	1 ms
Voltage drop (voltage in state 1)		1 V max
Maximum inrush current		500 mA
Leakage current		0.1 mA
Overvoltage protection		33 V DC
Environmental characteristics		
Temperature	Operating	-25°C ... +60°C if vertical mounting, limited to 50°C
	Storage	-40°C ... +80°C
Tropicalization		Treatment 2 (relative humidity of 93% at 40°C)
Resistance to voltage dips		10 ms, class 3 as per IEC 61000-4-29
Degree of protection		IP20
Pollution degree		3
Altitude	Operating	0 ... 2000 m
Vibration resistance	As per IEC 60068.2.6	1 g / \pm 3.5 mm - 5 Hz to 300 Hz - 10 cycles
Shock resistance	As per IEC 60068.2.2.7	15 g / 11 ms
Immunity to electrostatic discharge	As per IEC 61000-4-2	Air: 8 kV Contact: 4 kV
Immunity to radiated magnetic fields	As per IEC 61000-4-3	10 V/m - 80 MHz to 3 GHz
Immunity to fast transients	As per IEC 61000-4-4	1 kV for inputs/outputs and Modbus communication. 2 kV for 24 DC power supply - 5 kHz - 100 kHz
Immunity to conducted magnetic fields	As per IEC 61000-4-6	10 V from 150 kHz to 80 MHz
Immunity to magnetic fields at mains frequency	As per IEC 61000-4-8	30 A/m
Resistance to corrosive atmospheres	As per IEC 60721-3-3	Level 3C2 on H ₂ S / SO ₂ / NO ₂ / Cl ₂
Fire resistance	For live parts	At 960°C 30 s / 30 s as per IEC 60 695-2-10 and IEC 60 695-2-11
	For other parts	At 650°C 30 s / 30 s as per IEC 60 695-2-10 and IEC 60 695-2-11
Salt spray test	As per IEC 60068.2.52	Severity 2
Environment		In compliance with the RoHS directive
Additional characteristics		
Mean time between failure (MTBF) = MTTF at 70°C		1,851,818 h
Duration of saving memory		10 years
Prefabricated cables characteristics		
Dielectric resistance		1 kV / 5 min
Minimum draw-out resistance		20 N



Monitoring and control of protections



Electrical auxiliaries for iC60, iID, iDPN Vigi, iSW-NA, RCA and ARA

- The electrical auxiliaries are combined with iC60 circuit breakers, iID residual current circuit breakers, remote tripping switch disconnectors iSW-NA, RCA remote controls and ARA automatic reclosers; they enable tripping or remote indication of their position (open/closed/tripped) upon a fault.
- They are fastened by clips (without tools) to the left side of the breaker.
- The iOF/SD+OF auxiliary is a 2-in-1 product: via a mechanical selector switch, it provides two contacts, OF+SD or OF+OF.
- The iOF+SD24 auxiliary can report open/closed (OF) status information and intentional or fault tripping of the associated device (SD) to the Acti 9 Smartlink or a programmable logic controller via the TI24 interface (24 V DC).

Tripping auxiliaries:

IEC/EN 60947-1

- iMN: undervoltage release
- iMNx: delayed undervoltage release
- iMNx: undervoltage release, independent from supply voltage
- iMX: shunt release
- iMX+OF: shunt release with open/close contact.

EN 50550

- iMSU: overvoltage release

Indication auxiliaries:







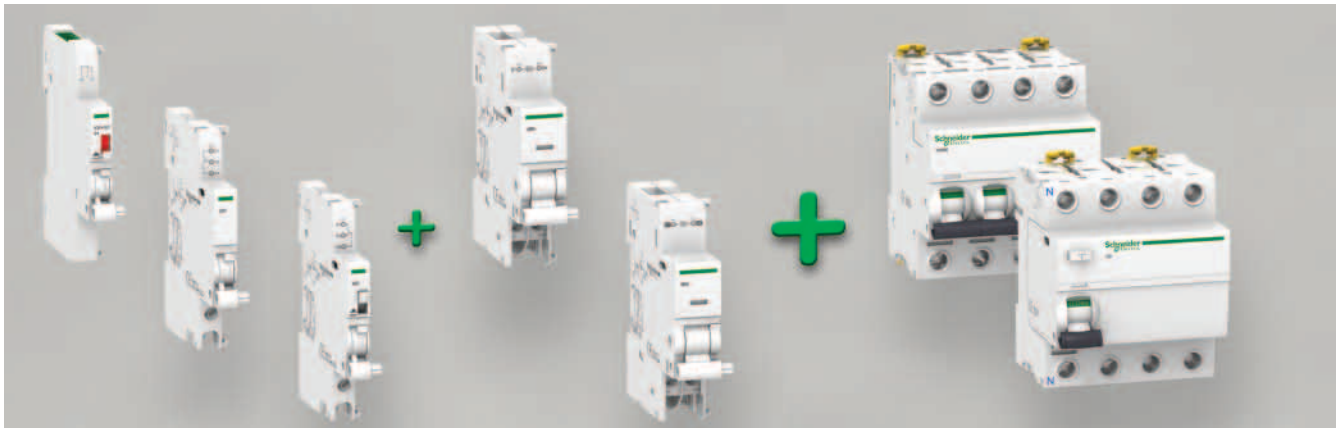



IEC/EN 60947-5-4

- iOF: open/close contact
- iSD: fault indicating contact
- iOF/SD+OF: open/close contact and switchable OF or SD contact.
- iOF+SD24: open/close contact OF and default indicating contact SD with TI24 interface.

DE404939



Combination table

Electrical auxiliaries			Remote control	Devices	
Indication auxiliaries		Tripping auxiliaries	ARA automatic recloser or RCA remote control	iC60/iID/iDPN Vigi/iSW-NA*	
Position		Max quantity		Vigi	
Left	Right				
1 (iOF/SD+OF or iOF+SD24)	+ 1 iOF/SD+OF	+ 1 (iMN, iMNs, iMNx or iMX, iMX+OF)	–	 PBI0440-25 iC60	 PBI0446-25 Vigi iC60
Or 1 iOF	+ 1 (iSD or iOF or iOF/SD+OF)	+ 2 (iMN, iMNs, iMNx or iMX, iMX+OF)			
Or None	+ 1 iOF+SD24	+ 2 (iMN, iMNs, iMNx or iMX, iMX+OF)			
Or None	+ None	+ 3 x iMSU			
None	+ 1 (iSD or iOF or iOF/SD+OF or iOF+SD24)	+ 1 (iMN, iMNs, iMNx or iMX, iMX+OF or iMSU)		 PBI0447-25 iID	–
Or 1 iOF	+ 1 (iSD or iOF or iOF/SD+OF)	+ None	 PBI0625-25 ARA	 PBI0440-25 iC60	 PBI0446-25 Vigi iC60
None	+ 1 (iSD or iOF or iOF/SD+OF or iOF+SD24)	+ 1 (iMN, iMNs, iMNx or iMX, iMX+OF or iMSU)		 PBI0447-25 iID	–
Or 1 iOF	+ 1 (iSD or iOF or iOF/SD+OF)	+ None	 PBI0625-25 RCA	 PBI0440-25 iC60	 PBI0446-25 Vigi iC60

Other possible associations: see technical pages





Tripping devices must be mounted first. Comply with the position of the SD function.

*iSW-NA: the iSD auxiliary contact must be associated with an auxiliary (iMN, iMX, iMX+OF); it indicates that the remote tripping switch disconnector has been tripped open.

F

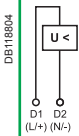
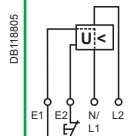

Electrical auxiliaries for iC60, iID, iDPN Vigi, iSW-NA, RCA and ARA (cont.)

		Tripping					
Auxiliaries		iMN		iMNs		iMNx	
Type		Undervoltage release					
		Instantaneous	Delayed		Independent of the supply voltage		
PB104477-35				PB104475-35			
PB104480-35							
Function		<ul style="list-style-type: none"> Trips the device with which it is combined when its input voltage decreases (between 70 % and 35 % U_n). Prevents device closing again until its input voltage is restored 				<ul style="list-style-type: none"> Tripping of the associated device by opening of the control circuit (e.g. push-button, dry contact) 	
				<ul style="list-style-type: none"> Not tripping on transient voltage dip (up to 0.2 s) 		<ul style="list-style-type: none"> A drop in the supply voltage does not trip the associated device A locking push-button control allows the circuit protected (e.g. machine control) to be placed in safety configuration 	
Wiring diagrams							
Use		<ul style="list-style-type: none"> Emergency stoppage by normally closed push button Ensures the safety of power supply circuits for several machines by preventing "uncontrolled" restarting 				<ul style="list-style-type: none"> Emergency stoppage with fail-safe principle Insensitive to control circuit voltage variation to increase service continuity Important: Before any servicing operation switch off the mains power supply (voltage presence at terminals E1/E2) 	
Catalogue numbers		A9A26960	A9A26961	A9A26959	A9A26963	A9A26969	A9A26971
iC60, iID, iDPN Vigi, iSW-NA, RCA et ARA		■	■	■	■	■	■
iC60, iID double terminals		■	■	■	■	■	■
Technical specifications							
Rated voltage (U_e)	V AC	220...240	48	115	220...240	220...240	380...415
	V DC	–	48	–	–	–	–
Standardised operating and non-response to voltage times (U_a)*		–	–	–	–	–	–
Maximum operating time		–	–	–	–	–	–
Minimum non-response time		–	–	–	–	–	–
Operating frequency	Hz	50/60		400	50/60	50/60	
Red mechanical indicator		On front face			On front face	On front face	
Test function		–			–	–	
Width in 9 mm modules		2			2	2	
Operating current		–			–	–	
Number of contacts		–			–	–	
Operating temperature	°C	-35...+70			-35...+70	-35...+70	
Storage temperature	°C	-40...+85			-40...+85	-40...+85	



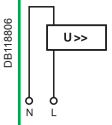
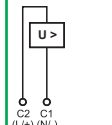
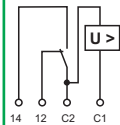

*(U_a)

Voltages measured between the phase and the neutral conductor, at which the IMSU device must control the associated protective device.

Electrical auxiliaries for iC60, iID, iDPN Vigi, iSW-NA, RCA and ARA (cont.)

iMSU					iMX			iMX+OF			
Overvoltage release					Shunt release			With Open/Close auxiliary contact			
											
<ul style="list-style-type: none"> Switches off the power supply by opening the breaker with which it is combined, in the event that the phase/neutral voltage is exceeded (loss of neutral). For a four-phase network, use three iMSU tripping auxiliaries 					<ul style="list-style-type: none"> Trips the breaker when powered 			<ul style="list-style-type: none"> Includes an open/close contact (OF) to indicate the "open" or "closed" position of the breaker 			
											
<ul style="list-style-type: none"> Protection of equipment against overvoltages on the electrical network (neutral conductor break) Voltage monitoring between phase and neutral conductors 					<ul style="list-style-type: none"> Emergency stoppage by normally open push button 			<ul style="list-style-type: none"> Emergency stoppage by normally open push button Remote indication of the position of the associated breaker 			
A9A26500	A9A26479	A9A26979			A9A26476	A9A26477	A9A26478	A9A26946	A9A26947	A9A26948	
■					■	■	■	■	■	■	
■					■	■	■	■	■	■	
230					100...415	48	12...24	100...415	48	12...24	
-					110...130	48	12...24	110...130	48	12...24	
255 V AC	275 V AC	300 V AC	350 V AC	400 V AC	-	-	-	-	-	-	
No tripping	15 s	5 s	0.75 s	0.20 s	-	-	-	-	-	-	
	3 s	1 s	0.25 s	0.07 s	-	-	-	-	-	-	
50/60					50/60				50/60		
On front face					On front face				On front face		
-					-				-		
2					2				2		
-					-				≤ 24 V DC	6 A	
-					-				48 V DC	2 A	
-					-				≤ 130 V DC	1 A	
-					-				≤ 240 V AC	6 A	
-					-				415 V AC	3 A	
-					-				1 NO/NC		
-35...+70					-35...+70				-35...+70		
-40...+85					-40...+85				-40...+85		

Electrical auxiliaries for iC60, iLD, iDPN Vigi, iSW-NA, RCA and ARA (cont.)

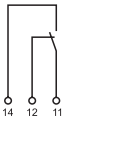
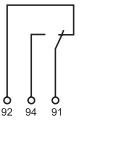
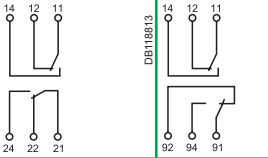
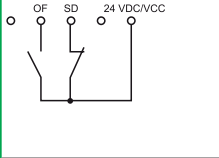
		Indication				
Auxiliaries		iOF	iSD	iOF/SD+OF	iOF+SD24	
Type		Open/close auxiliary contact	Fault indicating contact	Double open/close or fault indicating contact	Double open/close and fault indicating contact	
						
Function		<ul style="list-style-type: none"> Changeover contact indicates "open" or "closed" position of the breaker 	<ul style="list-style-type: none"> Changeover contact indicates position of the breaker; upon: <ul style="list-style-type: none"> electrical fault action on tripping auxiliary Same indication as VISI-TRIP 	<ul style="list-style-type: none"> The iOF/SD+OF auxiliary is a 2-in-1 product: via a mechanical selector switch, it provides two contacts, OF+SD or OF+OF 	<ul style="list-style-type: none"> Double changeover contact which can report the signalling information of the associated device to the Acti 9 Smartlink or a programmable logic controller: <ul style="list-style-type: none"> electrical fault actuation of the tripping auxiliary "Open" or "Closed" position of the associated device 	
Wiring diagrams						
Use		<ul style="list-style-type: none"> Remote indication of the position of the associated breaker 	<ul style="list-style-type: none"> Remote indication of tripping upon a fault of the associated breaker 	<ul style="list-style-type: none"> Remote indication of position and/or tripping upon a fault of the associated breaker 	<ul style="list-style-type: none"> Remote indication of position and tripping upon a fault of the associated breaker 	
Catalogue numbers		A9A26924	A9A26869	A9A26927 A9A26855	A9A26929	A9A26997
iC60, iLD, iDPN Vigi, iSW-NA, RCA et ARA		■	—	■	—	■
iC60, iLD double terminals		—	■	—	■	■
Technical specifications						
Rated voltage (Ue)	V AC	240...415	240...415	240...415	-	
	V DC	24...130	24...130	24...130	24	24
Operating frequency	Hz	50/60	50/60	50/60	-	
Red mechanical indicator		—	On front face	On front face	On front face	
Test function		On toggle	On toggle	On toggle	On toggle	
Width in 9 mm modules		1	1	1	1	
Operating current	24 V DC	6 A			2 mA mini, 50 mA maxi	
	48 V DC	2 A			-	
	60 V DC	1.5 A			-	
	130 V DC	1 A			-	
	240 V AC	6 A			-	
	415 V AC	3 A			-	
Number of contacts		1 NO/NC	1 NO/NC	1 NO/NC + 1 NO/NC	1 NO/NC	
Operating temperature	°C	-35...+70	-35...+70	-35...+70	-25...+70	
Storage temperature	°C	-40...+85	-40...+85	-40...+85	-40...+85	

Connection

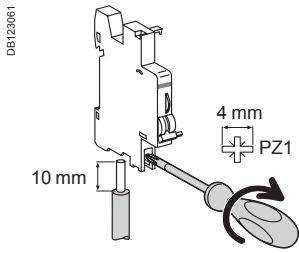

Type	Tightening torque	Copper cables		Multi-cables terminal	
		Rigid	Flexible	Rigid cables	Cables with ferrule
		DB122945	DB123007	DB123011	DB123008
Indication auxiliaries	1 N.m	1 to 4 mm ²	0.5 to 2.5 mm ²	2 x 2.5 mm ²	2 x 1.5 mm ²
Tripping auxiliaries	1 N.m	1 to 6 mm ²	0.5 to 4 mm ²	2 x 2.5 mm ²	2 x 2.5 mm ²

Ti24 connector connection

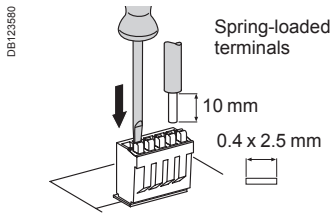

Type	Catalogue numbers	Copper cables	
		Rigid	Flexible
		DB122945	DB123553
Ti24 interface	A9XC2412	2 x 1.5 mm ²	2 x 1.5 mm ²

Ti24 prefabricated cables connection

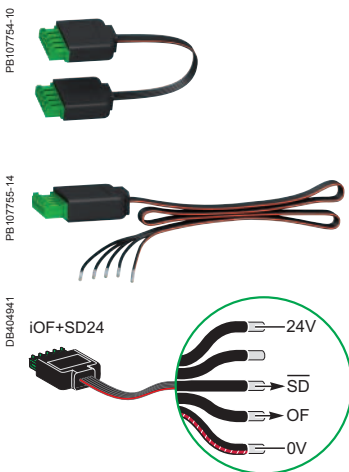

Type	Catalogue numbers	Length
Connection for Acti 9 Smartlink		
6 short prefabricated	A9XCAS06	100 mm
6 medium-sized prefabricated	A9XCAM06	160 mm
6 long prefabricated	A9XCAL06	870 mm
Connection for PLC type terminals		
6 long prefabricated on a single side	A9XCAU06	870 mm

F

Electrical auxiliaries for iC60, iID, iDPN Vigi, iSW-NA, RCA and ARA (cont.)

Technical data

Weight (g)

Electrical auxiliaries	
Type	
iMN	69
iMNs	72
iMNx	79
iMSU	68
iMX	64
iMX+OF	68
iOF	32
iSD	33
iOF/SD+OF	43
iOF+SD24	25

Dimensions (mm)

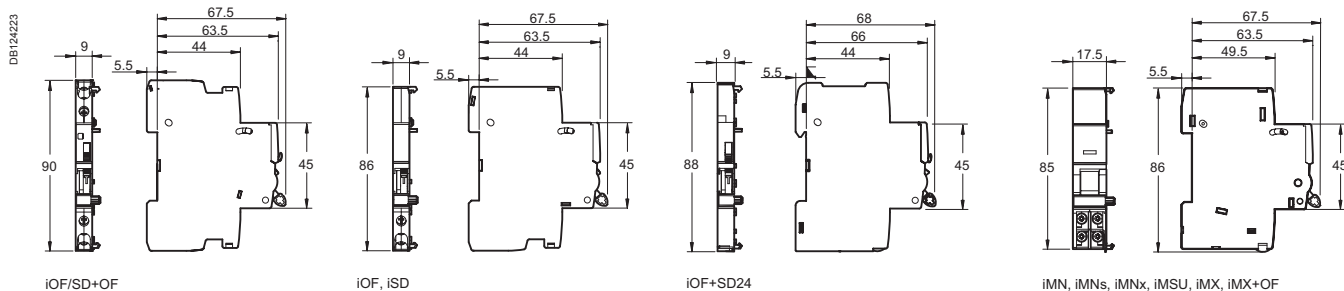

- The electrical auxiliaries provide the remote tripping or position (open/closed/tripped) indication functions of these devices in the event of a fault.
- They clip on (no tool required) to the left-hand side of the associated device.
- The OF+SD/OF auxiliary is a two-in-one product: a mechanical selector switch is used to select one of two contacts: OF+SD or OF+OF.
- The OF+SD24 auxiliary can report open/closed (OF) status information and intentional or fault tripping of the associated device (SD) to the Acti 9 Smartlink or a programmable logic controller via the Ti24 interface (24 V DC).



- The electrical auxiliaries are not compatible with ID residual current circuit breakers of type B.

Tripping auxiliaries:

IEC/EN 60947-1

- MN: undervoltage release
- MNs: delayed undervoltage release
- MNx: undervoltage release, independent of the supply voltage
- MX: shunt release
- MX+OF: shunt release with open/closed contact.

EN 50550

- MSU: overvoltage release

Indication auxiliaries:

IEC/EN 60947-5-4

- OF.S: open/closed contact for ID
- OF: open/closed contact
- SD: fault indicating contact
- OF+SD/OF: choice of open/closed contact and OF or SD contact via the selector switch
- OF/SD+OF: open/close contact and switchable OF or SD contact.
- OF+SD24: pen/close contact OF and cfault indicating contact SD with Ti24 interface.

DB124453







F



Tripping devices must be installed first.
If two tripping devices are used: the MN undervoltage release must be installed first
Indication auxiliaries: install the SD auxiliary first

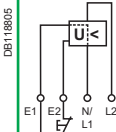

(1) MSU is not used in direct current

		Tripping					
Auxiliaries		MN		MNs		MNx	
Type		Undervoltage release					
		Instantaneous		Delayed		Independent of the supply voltage	
							
Function		<ul style="list-style-type: none"> Causes the device with which it is associated to trip when its input voltage decreases (between 70 % and 35 % of U_n). Prevents the device from closing until its input voltage has been restored 		<ul style="list-style-type: none"> No tripping in the event of transient voltage dips (up to 0.2 s) 		<ul style="list-style-type: none"> Tripping of the associated device by opening of the control circuit (e.g. push-button, dry contact) A drop in the supply voltage does not trip the associated device A locking push-button control allows the circuit protected (e.g. machine control) to be placed in safety configuration 	
Wiring diagrams							
Utilization		<ul style="list-style-type: none"> Emergency stop via a normally-closed pushbutton Ensures the safety of the power supply circuits of several machines by preventing accidental startups 				<ul style="list-style-type: none"> Fail-safe emergency stop Insensitive to the variation in the control circuit voltage to improve continuity of service Important: Before any servicing operation switch off the mains power supply (voltage presence at terminals E1/E2) 	
Catalogue numbers		A9N26960	A9N26961	A9N26959	A9N26963	A9N26969	A9N26971
C120, DPN, DPN Vigi, ID		■	■	■	■	■	■
C60H-DC, SW60-DC, C60PV-DC, C60NA-DC		■	■	■	■	■	■
Technical specifications							
Rated voltage (U_e)	V AC	220...240	48	115	220...240	230	400
	V DC	–	48	–	–	–	–
Standardised operating and non-response to voltage times (U_a)*		–	–	–	–	–	–
Maximum operating time		–	–	–	–	–	–
Minimum non-response time		–	–	–	–	–	–
Operating frequency	Hz	50/60		400	50/60	50/60	
Mechanical state indicator light, red		On front face			On front face		On front face
Test function		–			–		–
Width in 9 mm modules		2			2		2
Operating current		–			–		–
Number of contacts		–			–		–
Operating temperature	°C	-25...+50			-25...+50		-25...+50
Storage temperature	°C	-40...+85			-40...+85		-40...+85
Standards							
IEC/EN 60947-1		■		■		■	
IEC/EN 60947-5-1		–		–		–	
EN 60947-2		■		■		–	
EN 62019-2 ⁽¹⁾		–		–		–	

(1) For C120, DPN.

*(U_a)

Voltages measured between the phase and the neutral conductor, at which the MSU device must control the associated protective device.

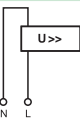
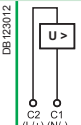
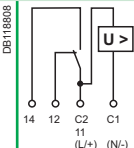

MSU					MX			MX+OF							
Voltage threshold release					Shunt release					With Open/Close auxiliary contact					
															
<ul style="list-style-type: none"> Cuts off the power supply by opening the device with which it is associated when the phase/neutral voltage is exceeded (loss of neutral). For a four-phase network, use three MSU tripping auxiliaries 					<ul style="list-style-type: none"> Trips the associated device when it is powered on 					<ul style="list-style-type: none"> Includes an open/close contact (OF) to indicate the "open" or "closed" position of the breaker 					
															
<ul style="list-style-type: none"> Protection of the devices against overvoltages on the electrical network (break in the neutral conductor) Monitoring the voltage between the phase conductor and the neutral conductor 					<ul style="list-style-type: none"> Emergency stop via a normally-open pushbutton. 					<ul style="list-style-type: none"> Emergency stop via a normally-open pushbutton Remote indication of the position of the associated device 					
A9N26500					A9N26476			A9N26477	A9N26478	A9N26946	A9N26947	A9N26948			
■					■			■	■	■	■	■			
-					-			-	-	-	-	-			
230					100...415			48	12...24	100...415	48	12...24			
-					110...130			48	12...24	110...130	48	12...24			
255 V AC					275 V AC			300 V AC	350 V AC	400 V AC					
No tripping					15 s			5 s	0.75 s	0.20 s					
					3 s			1 s	0.25 s	0.07 s					
50/60					50/60			50/60	50/60	50/60					
On front face					On front face			On front face	On front face	On front face					
-					-			-	-	-					
2					2			2	2	2					
-					-			-	-	3 A / 415 V AC					
-					-			-	-	6 A / ≤ 240 V AC					
-					-			-	-	1 NO/NC					
-25...+50					-25...+50			-25...+50	-25...+50	-25...+50					
-40...+85					-40...+85			-40...+85	-40...+85	-40...+85					
■					■			■	■	■					
-					-			-	-	-					
-					-			-	-	-					
-					-			-	-	-					

		Indication				
Auxiliaries		OF.S	OF	SD	OF+SD/OF	OF+SD24
Type		Open/closed auxiliary contact	Open/closed auxiliary contact	Fault indicating contact	Double open/closed or fault indicating contact	Double open/close and fault indicating contact
	 PB100620_SE-28-b	 PB107145-30	 PB107146-30	 PB100625_SE-28-b	 PB107160-35	
Function		<ul style="list-style-type: none"> Changeover contact indicating the "open" or "closed" position of the associated device <p>⚠ Compulsory for the addition of tripping or indication auxiliaries on a residual current circuit breaker ID</p>	<ul style="list-style-type: none"> Changeover contact indicating the "open" or "closed" position of the associated device 	<ul style="list-style-type: none"> Changeover contact indicating the position of the associated device in the event of: <ul style="list-style-type: none"> electrical fault action on the tripping auxiliary <p>⚠ Not compatible with a ID residual current circuit breaker, use an OF+SD/OF in the SD position</p>	<ul style="list-style-type: none"> The OF+SD/OF auxiliary is a two-in-one product: choice of OF + SD or OF + OF contact via the selector switch 	<ul style="list-style-type: none"> Double changeover contact which can report the signalling information of the associated device to the Acti 9 Smartlink or a programmable logic controller: <ul style="list-style-type: none"> electrical fault actuation of the tripping auxiliary "Open" or "Closed" position of the associated device
Wiring diagrams		 DB118810	 DB118811	 DB118812	 DB118813	 DB124318
Utilization		<ul style="list-style-type: none"> Remote indication of the position of the associated device 	<ul style="list-style-type: none"> Remote indication of the position of the associated device 	<ul style="list-style-type: none"> Remote fault tripping indication of the associated device 	<ul style="list-style-type: none"> Remote position and/or fault tripping indication of the associated device 	<ul style="list-style-type: none"> Remote indication of position and tripping upon a fault of the associated breaker
Catalogue numbers		A9N26923	A9N26924	A9N26927	A9N26929	A9N26899
ID		■	■	■	■	■
C120, DPN, DPN Vigi, C60H-DC, C60H-DC, SW60-DC, C60PV-DC, C60NA-DC		–	■	■	■	■
Technical specifications						
Rated voltage (Ue)	V AC	24...415	24...415	24...415	24...415	–
	V DC	24...130	24...130	24...130	24...130	24
Operating frequency	Hz	50/60	50/60	50/60	50/60	–
Mechanical state indicator		–	–	On front face	On front face	On front face
Test function		–	On front face	On front face	On front face	On toggle
Width in 9 mm modules		1	1	1	1	1
Operating current		3 A/415 V AC 6 A/≤ 240 V AC				2 mA mini, 50 mA maxi
Number of contacts		1 NO/NC	1 NO/NC	1 NO/NC	1 NO/NC + 1 NO/NC	1 NO + 1 NC
Operating temperature	°C	-25...+50	-25...+50	-25...+50	-25...+50	-25...+70
Storage temperature	°C	-40...+85	-40...+85	-40...+85	-40...+85	-40...+85
Standards						
IEC/EN 60947-1		–	–	–	–	–
IEC/EN 60947-5-1		■	■	■	■	■ IEC 60947-5-4
EN 60947-2		–	–	–	–	–
EN 62019-2 ⁽¹⁾		■	■	■	■	–

(1) For C120, DPN.

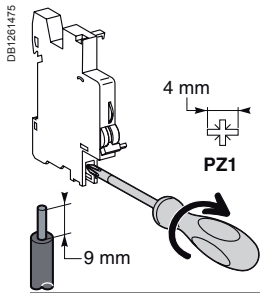

Connection

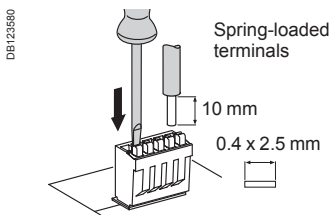

Type	Tightening torque	Copper cables	
		Rigid	Flexible or with ferrule
Indication and tripping auxiliaries	1 N.m	DB122845 	DB122846 
		0.5 to 2.5 mm ²	2 x 1.5 mm ²

Ti24 connector connection



Type	Catalogue numbers	Copper cables	
		Rigid	Flexible
Ti24 interface	A9XC2412	DB122845 	DB122853 
		1 x 0.5 to 1.5 mm ²	1 x 0.5 to 1.5 mm ²

Ti24 prefabricated cables connection

Type	Catalogue numbers	Length
Connection for Acti 9 Smartlink		
6 short prefabricated	A9XCAS06	100 mm
6 medium-sized prefabricated	A9XCAM06	160 mm
6 long prefabricated	A9XCAL06	870 mm
Connection for PLC type terminals		
6 long prefabricated on a single side	A9XCAU06	870 mm

DB107754-10

DB107755-14

DB404941

iOF+SD24

F

Electrical auxiliaries for NG125 devices

- The electrical auxiliaries are combined with NG125 circuit breakers and NG125 switch-disconnectors; they provide the remote tripping or position (open/closed/tripped) indication functions of these devices in the event of a fault.
- They clip on (no tool required) to the left-hand side of the associated device.

IEC/EN 60947-2

- Tripping auxiliaries:
 - MN: undervoltage release
 - MNx: undervoltage release, independent of the supply voltage
 - **MX+OF**: shunt release with open/closed contact
 - MXV: shunt release for Vigi add-on residual current device.

IEC/EN 60947-5-1

- Indication contacts:
 - OF+OF: open/closed contact
 - OF+SD: fault indicating contact
 - **MX+OF**: shunt release with open/closed contact
 - SDV: fault indicating contact for Vigi add-on residual current device.

DB123424







Combination table

Electrical auxiliaries		Device
Indication auxiliaries	Tripping auxiliaries	 08902N_SE-28 NG125
2 (OF+OF or OF+SD)	Max. quantity + 1 (MX+OF or MN or MNx)	

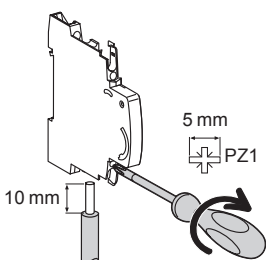

Connection

DB123413



Type	Tightening torque	Copper cables		Multi-cable terminal	
		Rigid	Flexible or with ferrule	Flexible or rigid cables	Cables with ferrule
Indication contacts	1 N.m	DB122945 	DB123411 		DB123412 
Tripping auxiliaries	1 N.m	0.5 to 2.5 mm ²	0.5 to 1.5 mm ²	2 x 2.5 mm ²	2 x 1.5 mm ²

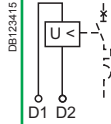
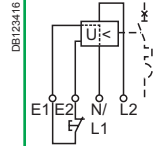
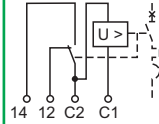

Electrical auxiliaries for NG125 devices and for Vigi NG125 add-on residual current devices (cont.)

		Tripping							
Auxiliaries		MN			MNx		MX+OF		
Type		Undervoltage release						Shunt release	
		Instantaneous			Independent of the supply voltage			With open/closed auxiliary contact	
									
Function									
		<ul style="list-style-type: none"> Causes tripping of the device with which it is combined when its input voltage decreases (between 70% and 35% of Un). Prevents closing of the device until its input voltage has been restored 			<ul style="list-style-type: none"> Tripping of the associated device by opening of the control circuit (e.g. push-button, dry contact) 		<ul style="list-style-type: none"> Causes tripping of the associated device when powered 		
					<ul style="list-style-type: none"> A drop in the supply voltage does not trip the associated device A locking push-button control allows the circuit protected (e.g. machine control) to be placed in safety configuration 		<ul style="list-style-type: none"> Includes an open/closed contact (OF) to indicate the "open" or "closed" position of the associated device 		
Wiring diagrams									
									
Utilization									
		<ul style="list-style-type: none"> Emergency stop by normally-closed pushbutton Ensures safety of the power supply circuits for several machines by preventing untimely restarting 			<ul style="list-style-type: none"> Fail-safe emergency stop Insensitive to variations in the control circuit voltage for improved continuity of service <p>Important: Before any servicing operation switch off the mains power supply (voltage presence at terminals E1/E2)</p>		<ul style="list-style-type: none"> Provided with a self-interrupting contact 		
Catalogue numbers		19067	19069	19070	19061	19064	19065	19066	19063
Technical specifications									
Rated voltage (Ue)	V AC	230...240	48	–	220...240	230...415	48...130	24	12
	V DC	–	–	48	–	110...130	48	24	12
Operating frequency	Hz	50/60			50/60	50/60			
Mechanical state indicator light, red		On front face			On front face	On front face			
Width in 9 mm modules		2			4	2			
Current rating		–			–	≥ 240 V AC	3 A		
		–			–	< 240 V AC	6 A		
		–			–	130 V CC	1 A		
		–			–	≤ 48 V CC	2 A		
		–			–	≤ 24 V CC	6 A		
Number of contacts		–			–	–			
Operating temperature	°C	-25...+60			-25...+60	-25...+60			
Storage temperature	°C	-40...+85			-40...+85	-40...+85			



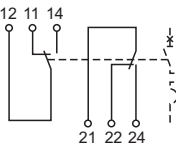
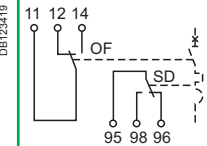

F

Electrical auxiliaries for NG125 devices and for Vigi NG125 add-on residual current devices (cont.)

Signalisation

OF+OF	OF+SD
Auxiliary contact	Fault indicating contact
	
<p>■ Double changeover contact indicating "open" or "closed" position of the associated device</p>	<p>■ Double changeover contact indicating:</p> <ul style="list-style-type: none"> <input type="checkbox"/> the position of the associated device in the event of: <ul style="list-style-type: none"> - electrical fault - actuation of the tripping auxiliary <input type="checkbox"/> the "open" or "closed" position of the associated device
	
<p>■ Remote indication of the position of the associated device</p>	<p>■ Remote indication of tripping upon a fault of the associated device</p>
19071	19072
220...240	220...240
-	-
50/60	50/60
-	-
1	1
240 V AC 6 A	240 V AC 6 A
415 V AC 3 A	415 V AC 3 A
2 NO/NC	2 NO/NC
-25...+60	-25...+60
-40...+85	-40...+85

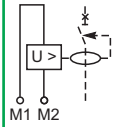
Electrical auxiliaries for NG125 devices and for Vigi NG125 add-on residual current devices (cont.)

		Indication	
Auxiliaries		MXV	SDV
Type		Shunt release	Vigi fault indicating contact
			
Function		<ul style="list-style-type: none"> At power up, actuates tripping of a circuit breaker or residual current circuit breaker It is provided with a self-interrupting contact 	<ul style="list-style-type: none"> Normally-closed or normally-open contact indicating tripping upon an earth fault (including tripped by MXV)
Wiring diagrams			
Utilization		<ul style="list-style-type: none"> Adaptable to 125 A Vigi add-on residual current device, all types, and to 63 A Vigi add-on residual current device, adjustable Impulse withstand voltage: 6 kV High-impedance input: use an iACTp if the leakage current in the control unit exceeds 1 mA (e.g. illuminated pushbutton) 	
Catalogue numbers		19060	19058 19059
Suitable for the following devices:			
NG125		–	–
Vigi NG125		■	■
Technical specifications			
Rated voltage (U _e)	V AC	110...240	250
	V DC	110	–
Operating frequency	Hz	50/60	50/60
Number of contacts		–	1 NO 1 NC
Current rating		–	0.1 to 1 A (AC14)
Operating temperature	°C	-25...+60	-25...+60
Storage temperature	°C	-40...+85	-40...+85

F

RCA remote controls

For iC60 circuit breakers

DB123576

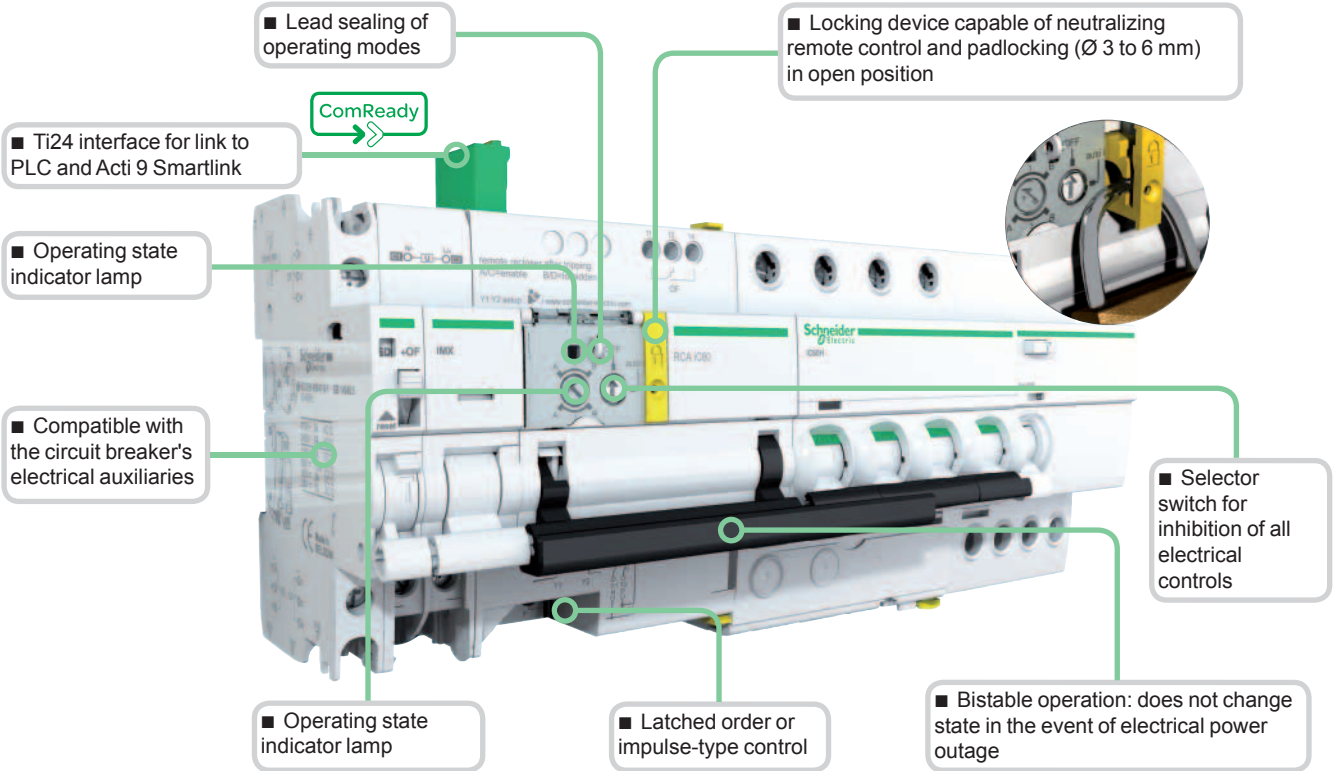

DB123763

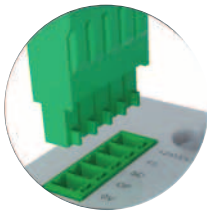

DB123578



DB123579



Legend

Type	Application
+24VDC	V DC power supply
Y3	Latched order centralized control
SD	Circuit-breaker tripping information
OF	Control circuit state information (open/closed)
0 V	V DC power supply
Y1	Latched order local control
Y2	Impulse-type or latched order local control (depending on mode)
N	230 V AC, 50 Hz power supply
P	
OF	Circuit-breaker state indication contact (open/closed)



Indication auxiliaries	Tripping auxiliaries	RCA remote control	iC60 circuit breaker	Vigi iC60 add-on RCD
------------------------	----------------------	--------------------	----------------------	----------------------

PB104474-25



PB104475-25

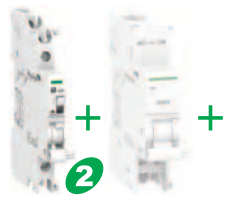

PB104468-25

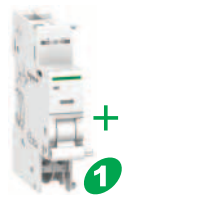

No	1 (iSD or iOF or iOF/SD+OF or iOF+SD24)	1 (iMX or iMN) max.		
1 iOF	1 (iSD or iOF or iOF/SD+OF)	No		

PB106253-25



RCA

PB104437-25



iC60

PB104437-25



Vigi iC60



The RCA remote control system allows:

- Remote electrical control (opening and closing) of circuit breakers with or without Vigi add-on RCD, with or without auxiliary.
- Circuit-breaker resetting after tripping, in accordance with safety principles and the regulations in force.
- Local control by operating handle.
- Circuit placing in safety configuration by padlocking.

2 choices of operation after tripping:

- A: Enabling of remote circuit-breaker resetting;
- B: Inhibition of remote resetting.

The version with Ti24 interface allows:

- Direct interfacing of remote control with a programmable logic controller (PLC), a supervision system and any other communication device, having inputs/outputs in 24 V DC (control, OF and SD indications).
- Fast, reliable connection of the remote control to the Acti 9 Smartlink thanks to the prefabricated cables.
- Remote indication by "OF" potential-free contact.
- Provision of 2 operating modes, "1 and 3".

The iMDU auxiliary allows RCA control in 24/48 V AC/DC.

Catalogue numbers

RCA remote control			
Type			Width in 9 mm modules
For circuit breakers	Voltage		
1P, 1P+N, 2P			
Without Ti24 interface	230 V AC, 50 Hz	A9C70112	7
With Ti24 interface	230 V AC, 50 Hz	A9C70122	7
For 3P, 4P circuit breakers			
Without Ti24 interface	230 V AC, 50 Hz	A9C70114	7
With Ti24 interface	230 V AC, 50 Hz	A9C70124	7
Auxiliaries	See page E-10 and F-2		



Without Ti24 interface

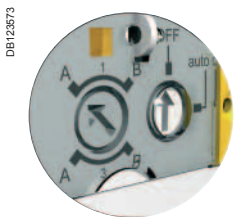
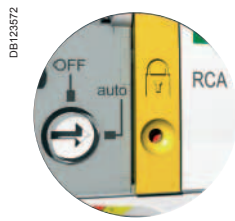

With Ti24 interface

Legend	
Type	Application
OFF	All remote control inhibited
auto	Circuit breaker remote reclosing after tripping allowed
A	Circuit breaker remote reclosing after tripping allowed
B	Circuit breaker remote reclosing after tripping inhibited
Green indicator lamp	Remote control possible
Orange indicator lamp	Remote control impossible
1 (Ti24)	Mode 1
3 (Ti24)	Mode 3
Y1	Latched order local control
Y2	Impulse-type or latched order local control (depending on mode)
Y3	Latched order centralized control

Standard RCA

■ The orders received on terminals Y1 and Y2 are taken into account progressively in their order of arrival.

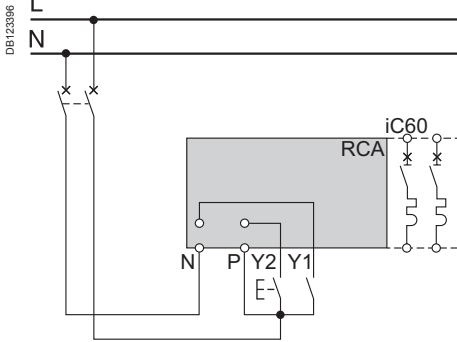

RCA Ti24

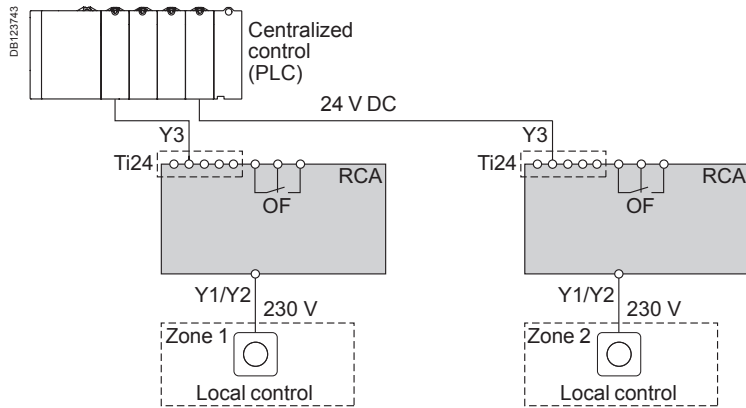

Mode 1: Locally or centrally controlled circuit-breaker opening/closing

■ The orders come from various control points, and they are taken into account in their order of arrival

- Y1: Latched order local control
- Y2: Impulse-type local control
- Y3: Latched order centralized control

RCA Ti24 mode 1

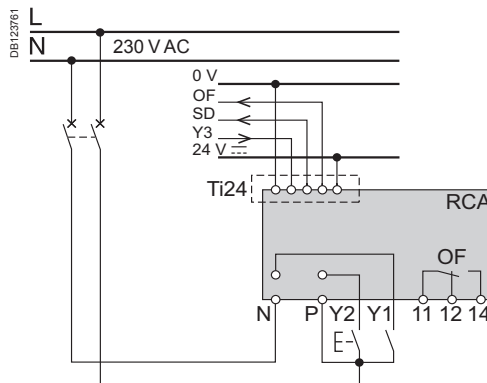

Mode 3: Centrally controlled opening/closing + local override

■ 3 positions allowing a choice between override and centralized control:

- Y1: Latched order local control
- Y2: Latched order local control
- Y3: Latched order centralized control

RCA Ti24 mode 3

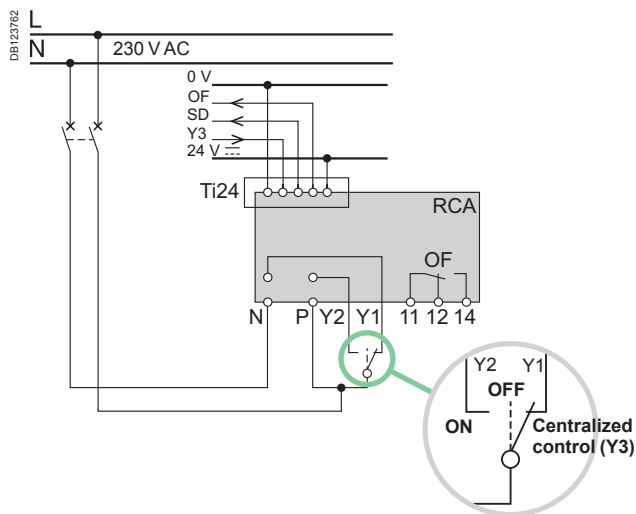

Connection

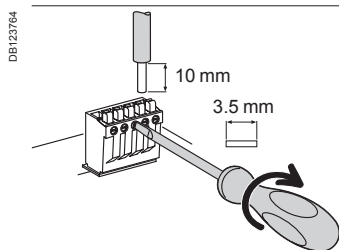
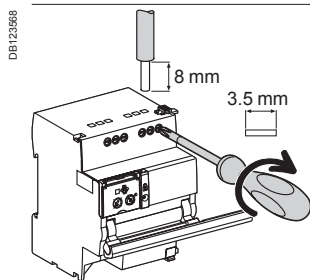
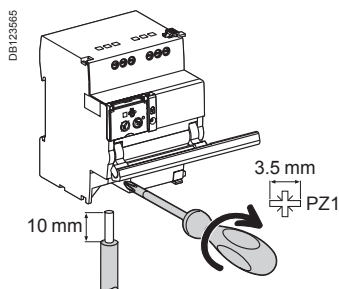

Terminal	Tightening torque	Without accessories		
		Copper cables		
		Rigid	Flexible	Flexible with ferrule
Power supply (N/P) Inputs (Y1/Y2)	1 N.m	0.5 to 10 mm ² 2 x 0.5 to 2 x 2.5 mm ²	0.5 to 6 mm ² 2 x 0.5 to 2 x 2.5 mm ²	0.5 to 4 mm ² 2 x 0.5 to 2 x 2.5 mm ²
Outputs (OF)	0.7 N.m	0.5 to 2.5 mm ² 2 x 0.5 to 2 x 1.5 mm ²	0.5 to 2.5 mm ² 2 x 0.5 to 2 x 1.5 mm ²	0.5 to 1.5 mm ² 2 x 0.5 to 2 x 1.5 mm ²
Ti24 interface	Spring-loaded terminals	0.5 to 1.5 mm ²	0.5 to 1.5 mm ²	-

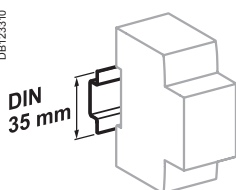

Clip on DIN rail 35 mm.

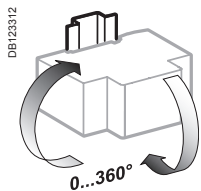

Indifferent position of installation.

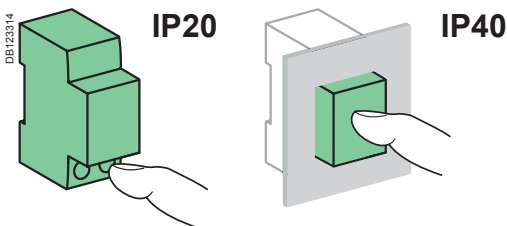

Technical data

Control circuit		
Supply voltage (Ue) (N/P)		230 V AC, 50 Hz
Control voltage (Uc)	Type 1 inputs (Y1/Y2)	230 V AC (as per IEC 61131-2)
Min. duration of control order (Y2)		≥ 200 ms
Response time (Y2)		< 500 ms
Consumption		≤ 1 W
Thermal self-protection with automatic Reset against overheating of the control circuit due to an abnormal number of operations		
Endurance (O-C) (RCA combined with a circuit breaker)		
Electrical/Mechanical		10,000 cycles
Indication / Remote control		
Potential free changeover contact output (OF)	Min.	24 V AC/DC, 10 mA
	Max.	230 V AC, 1 A
Input (Y1/Y2)	230 V AC	5 mA
Ti24 interface (as per IEC 61131)		
Type 1 input (Y3)	24 V DC	5.5 mA
Output (OF and SD)	24 V DC	In max.: 100 mA
Additional characteristics		
Degree of protection (IEC 60529)	Device only	IP20
	Device in a modular enclosure	IP40
		Insulation class II
Insulation voltage (Ui)		400 V
Degree of pollution (IEC 60947)		3
Rated impulse withstand voltage (Uimp)		6 kV
Operating temperature		-25°C to +60°C
Storage temperature		-40°C to +70°C
Tropicalization		Treatment 2 (relative humidity of 93 % at +40°C)

RCA remote controls (cont.)

For iC60 circuit breakers

Weight (g)

Remote controls	
Type	RCA
For 1P, 1P+N, 2P circuit breakers	400
For 3P, 3P+N, 4P circuit breakers	430

Dimensions (mm)

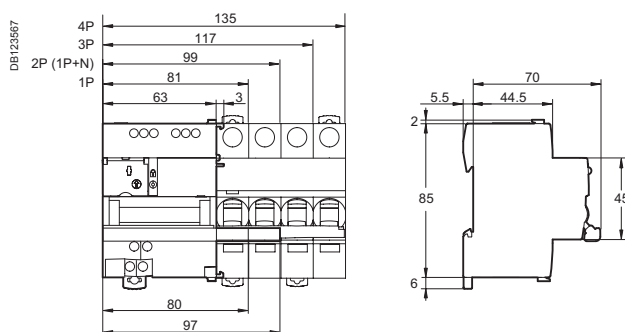

ARA automatic reclosers (cont.)

For iC60 circuit breakers
and iID residual current circuit breakers

PB10060-78

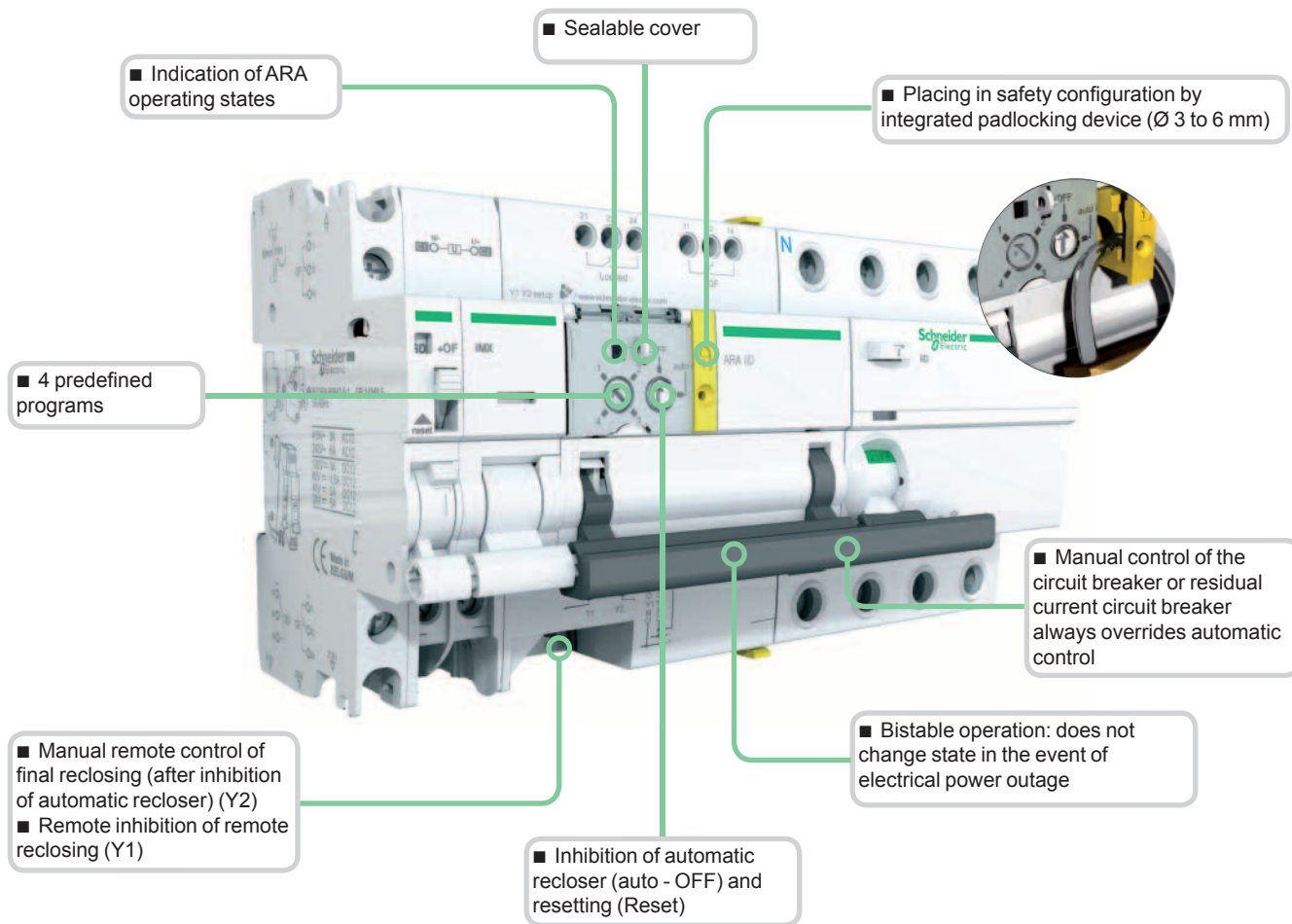

F

Indication auxiliaries		Tripping auxiliaries	ARA remote control	iC60 or iID device	Vigi iC60 add-on RCD
No	1 (iSD or iOF or iOF/SD+OF or iOF+SD24)	1 (iMX or iMN) max.	<p>ARA</p>	<p>iC60</p>	<p>Vigi iC60</p>
1 iOF	1 (iSD or iOF or iOF/SD+OF)	No		<p>iID</p>	-

PB104474-25

PB104475-25

PB104496-25

PB106256-25

PB104437-25

PB104437-25

PB104472-25

ARA automatic reclosers

For iC60 circuit breakers
and iID residual current circuit breakers



The ARA reclosing auxiliary can:

- Perform automatic reclosing of the associated protection device, after tripping.
- Increase the availability of installations without supervision, isolated, hard of access and demanding very great availability (mobile telephony systems, motorways, pumping stations, airports, railways, meteorological stations, service stations, automatic teller machines, public lighting, tunnels, etc.), by restoring them to operation without intervention by personnel in the event of a transient fault (atmospheric disturbances, industrial overvoltages, etc.).
- The operator can choose predefined reclosing program which allows the safety and availability of facilities to be reconciled taking into account the facility's environment.
- The circuit is placed in safety configuration by the padlocking device.

Catalogue numbers

ARA iC60				
For circuit breaker				Width in 9 mm modules
1P, 1P+N, 2P	Number of programs	Voltage		
	4	230 V AC, 50 Hz	A9C70132	7
3P, 4P	Number of programs	Voltage		
	4	230 V AC, 50 Hz	A9C70134	7

ARA iID				
For residual current circuit breaker				Width in 9 mm modules
2P	Number of programs	Voltage		
	1	230 V AC, 50 Hz	A9C70342	7
4P	Number of programs	Voltage		
	4	230 V AC, 50 Hz	A9C70332	7
4P	Number of programs	Voltage		
	4	230 V AC, 50 Hz	A9C70334	7

Diagram

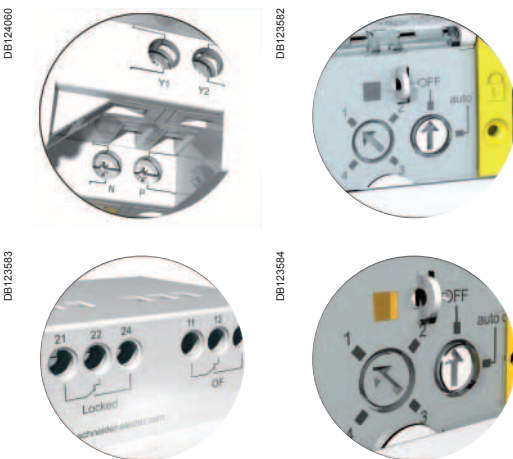
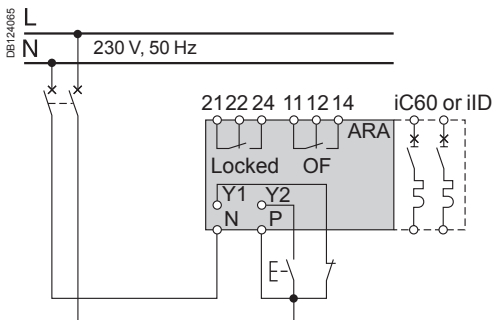

Legend		
Type	Application	
1 2 4 3	Choice of program	
Y1	"Remote" inhibition of automatic reclosing	
Y2	Remote control of final reclosing	
N	230 V power supply	
P		
Locked	Automatic recloser inhibition indication contact	
OF	Indicates the state of the circuit breaker or residual current circuit breaker (opened or closed)	
Indicator lamp	Flashing green	▲▲▲▲ ARA automatic recloser operational
	Flashing red	▲▲▲▲ Reclosing cycle in progress
	Fixed red	■ ARA automatic recloser locked at end of reclosing cycle: circuit breaker or residual current circuit breaker tripped (open)
	Flashing orange	▲▲▲▲ ARA automatic recloser not operational

ARA automatic reclosers (cont.)

For iC60 circuit breakers

and iID residual current circuit breakers

Operating principle

The ARA automatic recloser makes a number of attempts at reclosing depending on the program chosen by the user.

The program includes the following settings:

- A time delay before reclosing (TA).
- A reinitialization time delay (TB).
- A maximum number of reclosing attempts.

If, following these attempts, the fault is still present, the device places itself in waiting for manual reclosing, or final remote reclosing (Y2).

	iC60	iID		Number of reclosing attempts	Delay before reclosing	Check time		Final reclosing Y2	
		2P: A9C70342	2P: A9C70332 4P: A9C70334			TA	TB		
	1P, 1P+N, 2P: A9C70132 3P, 4P: A9C70134	2P: A9C70342	2P: A9C70332 4P: A9C70334						
Program	–	1 program	4 programs						
DB124061 	■	–	■	1	60 s	6 min.		Once after inhibition	
DB124062 	■	–	■	3	60 s 3 min. 3 min.	2 min. 6 min. 6 min.			
DB124063 	■	–	–	5	60 s 3 min. 3 min. 3 min. 3 min.	2 min. 6 min. 6 min. 6 min. 6 min.			
DB124064 	■	–	–	5	60 s 3 min. 4 min. 5 min. 6 min.	2 min. 6 min. 8 min. 10 min. 12 min.			
DB124063 	–	–	■	5	60 s 4 min. 10 min. 1 h 6 h	2 min. 3 min. 6 min. 10 min. 10 min.			Once per cycle
DB124064 	–	–	■	15	20 s 40 s 3 min. 3 min. ...	30 min. 30 min. ...			
Only 1 program available	–	■	–						



ARA automatic reclosers (cont.)

For iC60 circuit breakers
and iID residual current circuit breakers

Permanent fault ARA iC60

DB404539

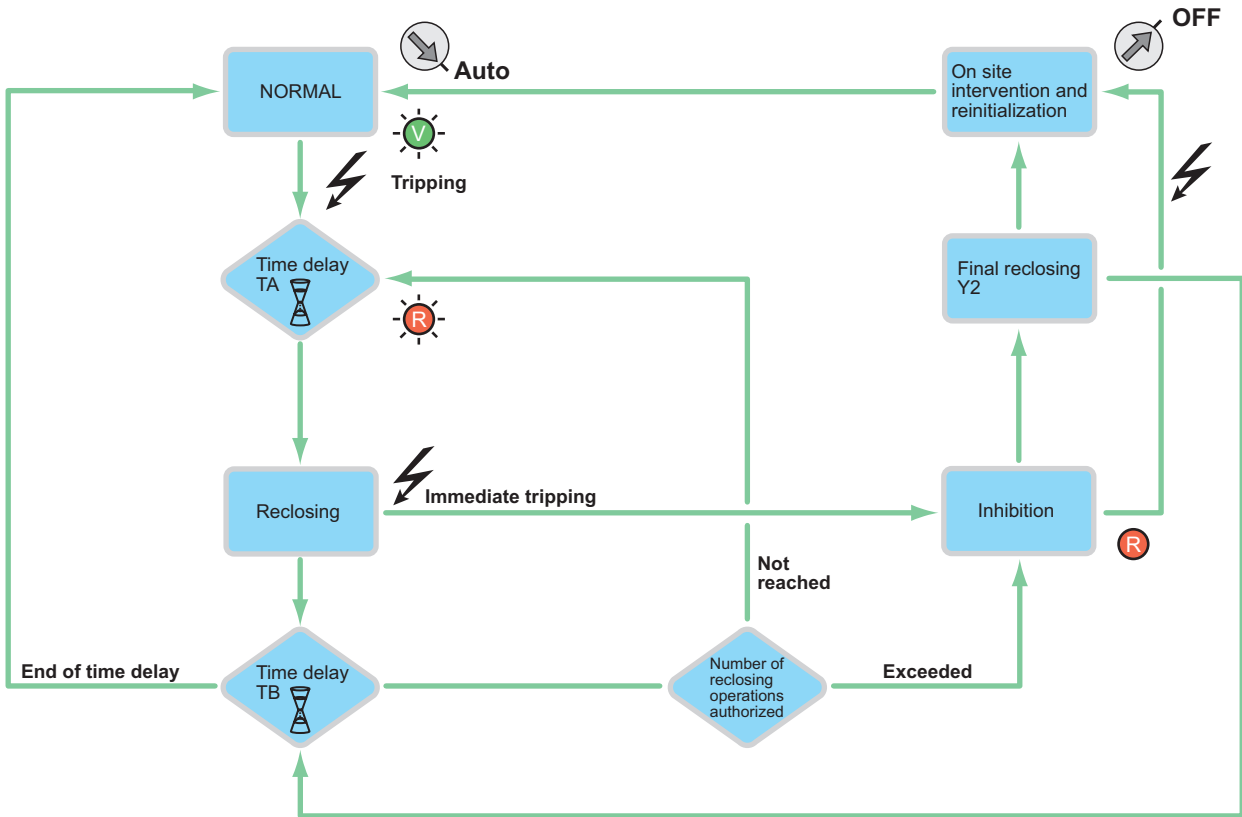

Permanent fault ARA iID

DB404538

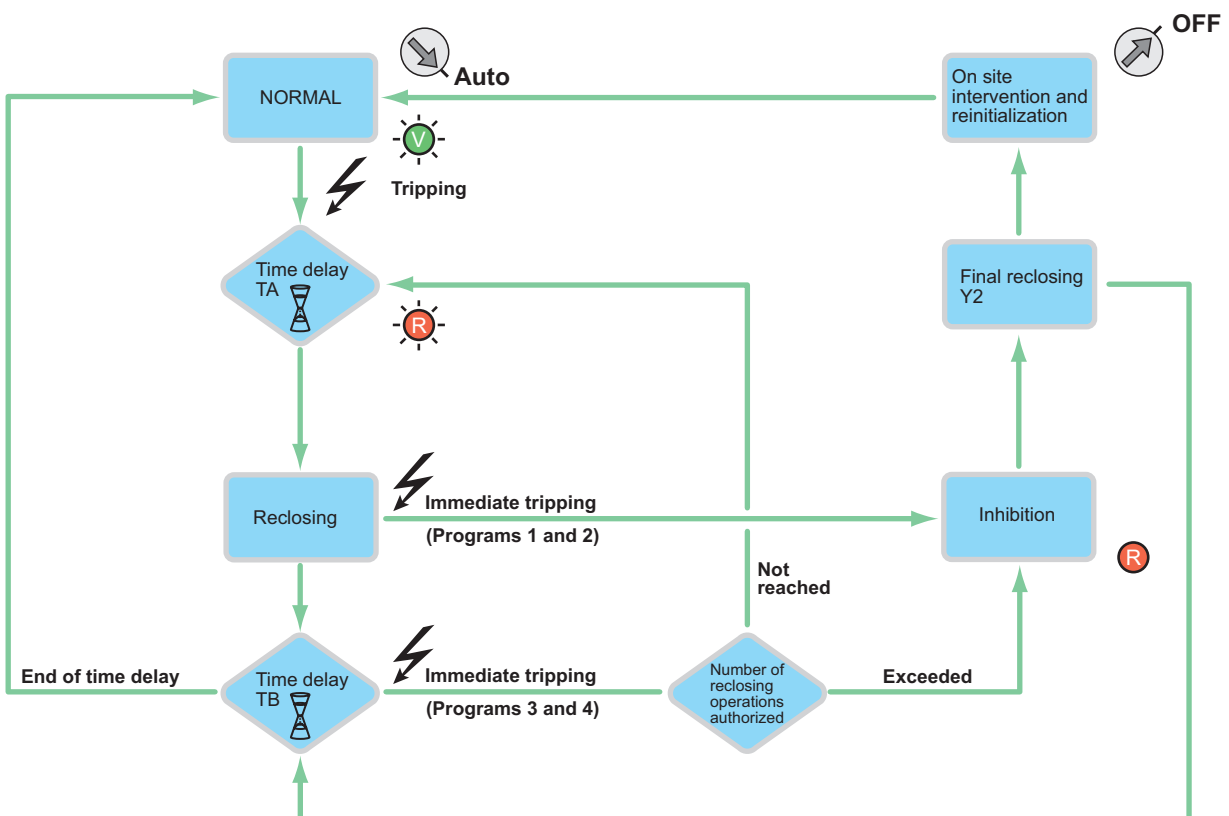

ARA automatic reclosers (cont.)

For iC60 circuit breakers
and iLD residual current circuit breakers

Connection

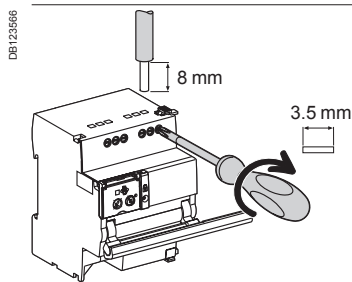
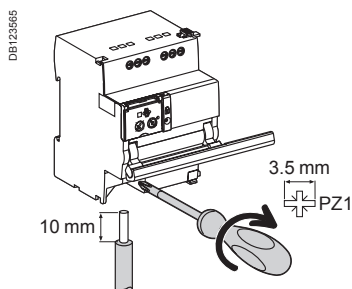

Terminal	Tightening torque	Without accessories		
		Copper cables Rigid	Flexible	Flexible with ferrule
Power supply (N/P) Inputs (Y1/Y2)	1 N.m	0.5 to 10 mm ² 2 x 0.5 to 2 x 2.5 mm ²	0.5 to 6 mm ² 2 x 0.5 to 2 x 2.5 mm ²	0.5 to 4 mm ² 2 x 0.5 to 2 x 2.5 mm ²
Outputs (OF/Locked)	0.7 N.m	0.5 to 2.5 mm ² 2 x 0.5 to 2 x 1.5 mm ²	0.5 to 2.5 mm ² 2 x 0.5 to 2 x 1.5 mm ²	0.5 to 1.5 mm ² 2 x 0.5 to 2 x 1.5 mm ²

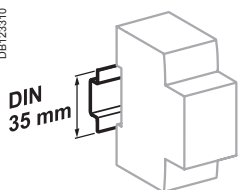

Clip on DIN rail 35 mm.

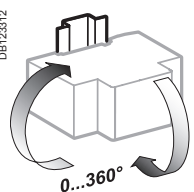

Indifferent position of installation.

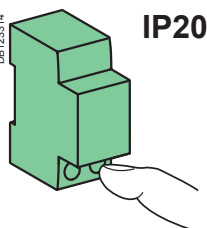

IP20

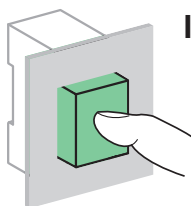

IP40

Dimensions (mm)

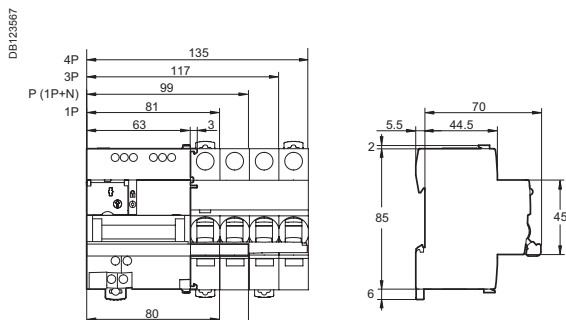

Technical data

Control circuit		
Supply voltage (Ue) (N/P)		230 V AC, 50 Hz
Control voltage (Uc)	Type 1 inputs (Y1/Y2)	230 V AC (as per IEC 61131-2)
Min. duration of control order (Y2)		≥ 200 ms
Response time (Y2)		< 500ms
Consumption		≤ 1 W
Endurance (O-C) (ARA combined with a circuit breaker)		
Electrical		5000 cycles
Indication / Remote control		
Potential-free changeover contact output (OF/Locked)	Min.	24 V AC/DC, 10 mA
	Max.	230 V AC, 1 A
Input (Y1/Y2)	230 V AC	5 mA
Additional characteristics		
Degree of protection (IEC 60529)	Device only	IP20
	Device in a modular enclosure	IP40
Insulation voltage (Ui)		Insulation class II 400 V
Degree of pollution (IEC 60947)		3
Rated impulse withstand voltage (Uimp)		6 kV
Operating temperature		-25°C to +60°C
Storage temperature		-40°C to +70°C
Tropicalization		Treatment 2 (relative humidity of 93 % at +40°C)

Weight (g)

Automatic reclosers	
Type	ARA
For 1P, 1P+N, 2P circuit breakers or iLD 2P residual current circuit breaker	440v
For 3P, 4P circuit breakers or iLD 4P residual current circuit breaker	470

Electrical circuit control

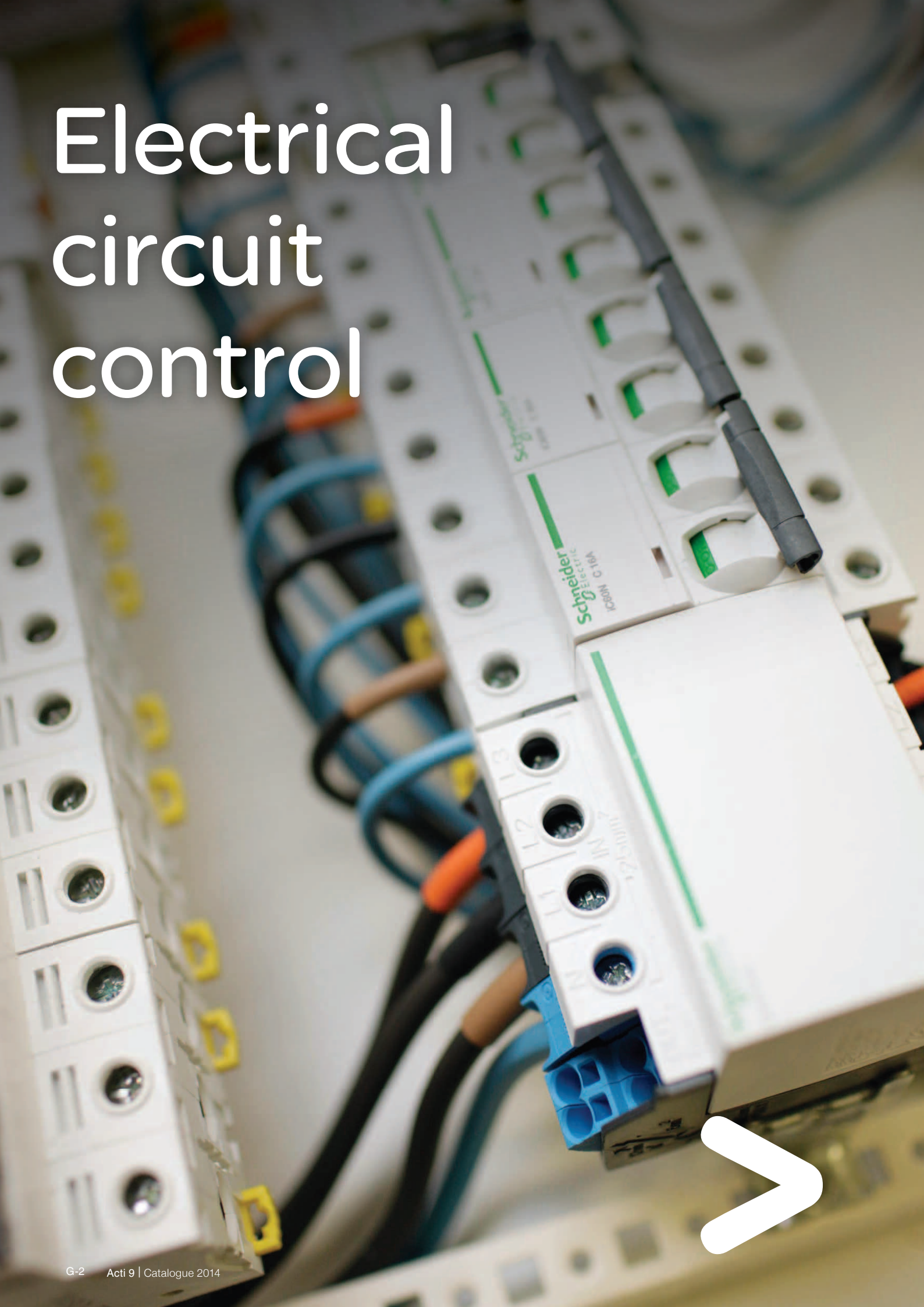

Reflex iC60N, iC60H (curves B, C, D)

PE1059946-70

ComReady

- Tripping and disconnection device capable of:
 - disconnecting and padlocking (Ø 3 to 6 mm not supplied) in "open" position
 - neutralizing remote control
- Ti24 interface for direct link to PLC and Acti 9 Smartlink
- IP20 insulated terminals
- Bistable operation: does not change state in the event of electrical power outage
- Resetting handle
- Operating state indicator lamp
- Pushbutton:
 - manual control: opening/closing
 - choice of operating "modes"
- VisiSafe
 - Positive contact indication
 - Uimp: 6 kV
 - Ui: 500 V
 - Degree of pollution: level 3

- Longer product service life thanks to:
 - good overvoltage withstand capacity: products designed to provide a high industrial performance level (degree of pollution, rated impulse withstand voltage and insulation voltage),
 - high limitation performances,
 - fast closure independent of the speed of resetting of the operating handle.

DB123765

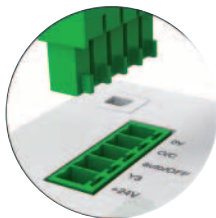

DB123516



Legend

Ti24 interface

+24VDC	V DC power supply
Y3	Remote control by latched order
auto/OFF	Circuit-breaker state information
O/C	Control circuit state information (open/closed)
0 V	V DC power supply
Y1	Latched order control
Y2	Control by impulse-type
N	230 V AC power supply
P	
O/C	Control circuit state indication contact
auto/OFF	Circuit-breaker tripping indication contact

IEC/EN 60947-2

The Reflex iC60 devices are integrated control circuit breakers which combine the following main functions in a single device:

- Remote control by latched and/or impulse-type order according to the 3 operating modes to be chosen by the user.
- Circuit breaker, to provide:
 - circuit protection against short-circuit currents,
 - circuit protection against overload currents,
 - disconnection in the industrial sector.

Resetting after a fault is performed manually, by the resetting handle.

The version with Ti24 allows direct interfacing of the Reflex iC60 with a PLC, to:

- Execute remote control (Y3).
- Indicate the state of the control circuit (O/C) and circuit-breaker state information (auto/OFF).

The Ti24 interface also allows fast, reliable connection of the Reflex iC60 to the Acti 9 Smartlink thanks to the prefabricated cables.

The IMDU auxiliary allows the Reflex iC60 to be controlled in 24/48 V AC/DC.

PB106239-40



PB106238-40



Alternating current (AC) 50 Hz				
Ultimate breaking capacity (Icu) as per IEC/EN 60947-2				Service breaking capacity (Ics)
		Voltage (Ue)		
Ph/Ph (2P, 3P, 4P)	220 to 240 V		380 to 415 V	
Reflex iC60N				
Rating (In)	10 to 40 A	20 kA	10 kA	75 % of Icu
	63 A	20 kA	10 kA	50 % of Icu
Reflex iC60H				
Rating (In)	10 to 40 A	30 kA	15 kA	50 % of Icu

Catalogue numbers

Reflex iC60 circuit breaker									
Type	2P			3P			4P		
	Curve			Curve			Curve		
Rating (In)	B	C	D	B	C	D	B	C	D
Reflex iC60N									
With Ti24 interface									
10 A	A9C61210	A9C62210	A9C63210	A9C61310	A9C62310	A9C63310	A9C61410	A9C62410	A9C63410
16 A	A9C61216	A9C62216	A9C63216	A9C61316	A9C62316	A9C63316	A9C61416	A9C62416	A9C63416
25 A	A9C61225	A9C62225	A9C63225	A9C61325	A9C62325	A9C63325	A9C61425	A9C62425	A9C63425
40 A	A9C61240	A9C62240	-	A9C61340	A9C62340	-	A9C61440	A9C62440	-
63 A	A9C61263	A9C62263	-	A9C61363	A9C62363	-	A9C61463	A9C62463	-
Without Ti24 interface									
10 A	-	A9C52210	-	-	A9C52310	-	-	A9C52410	-
16 A	-	A9C52216	-	-	A9C52316	-	-	A9C52416	-
25 A	-	A9C52225	-	-	A9C52325	-	-	A9C52425	-
40 A	-	A9C52240	-	-	A9C52340	-	-	A9C52440	-
63 A	-	A9C52263	-	-	A9C52363	-	-	A9C52463	-
Reflex iC60H									
With Ti24 interface									
10 A	A9C64210	A9C65210	A9C66210	A9C64310	A9C65310	A9C66310	A9C64410	A9C65410	A9C66410
16 A	A9C64216	A9C65216	A9C66216	A9C64316	A9C65316	A9C66316	A9C64416	A9C65416	A9C66416
25 A	A9C64225	A9C65225	A9C66225	A9C64325	A9C65325	A9C66325	A9C64425	A9C65425	A9C66425
40 A	A9C64240	A9C65240	-	A9C64340	A9C65340	-	A9C64440	A9C65440	-
Width in 9 mm modules	9			11			13		
Vigi iC60	See page B-17			See page B-17			See page B-17		
iMDU auxiliary	See page E-2 and F-2			See page E-2 and F-2			See page E-2 and F-2		
Accessories	See page E-2 and E-10			See page E-2 and E-10			See page E-2 and E-10		

DB123517

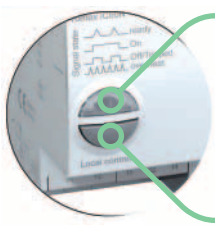

■ Operating state indicator lamp

■ Pushbutton for:
□ "mode" selection
□ opening/closing manual control

Remote control is possible by 3 operating modes to be set using the pushbutton on the front panel.

Three types of control: Y1, Y2, Y3

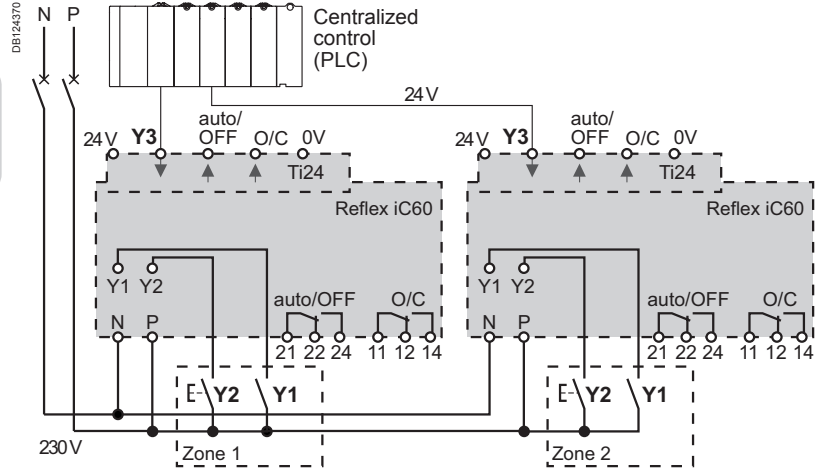

Operating modes

Mode 1: Reflex iC60 opening/closing, locally or centrally controlled

- The opening/closing orders come from various control points, and they are taken into account in their order of arrival
- Y1: latched order local control
- Y2: impulse-type local control
- Y3: latched order centralized control

Mode 2: Reflex iC60 opening/closing, possible inhibition of local impulse-type control

- Y1 is used to inhibit Y2
- Y1: local opening/Y2 inhibition latched order control
- Y2: impulse-type local opening/closing control
- Y3: latched order centralized opening/closing control

Mode 3: Reflex iC60 opening/closing, possible inhibition of centralised latched order control

- Y1 is used to inhibit Y3
- Y3 inhibition local latched order control
- Y2: impulse-type local opening/closing control
- Y3: latched order centralized opening/closing control

Reflex iC60 without Ti24 interface

Mode 1
Mode 2

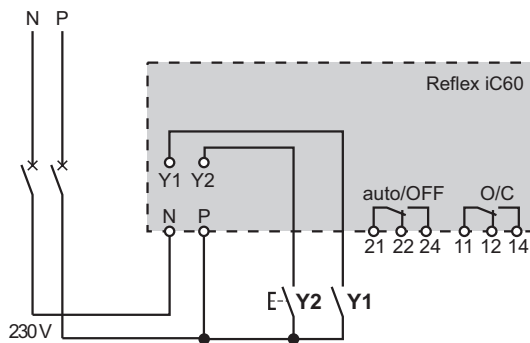

Reflex iC60 with Ti24 interface

Mode 1
Mode 2
Mode 3

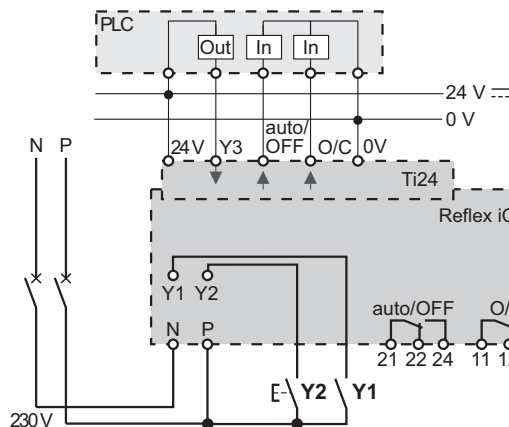
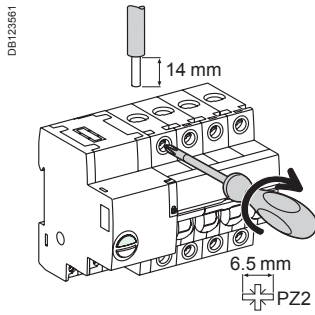

Table of modes

	Mode 1	Mode 2	Mode 3
Reflex iC60 without interface Ti24	■ Default mode	■ Possible mode	–
Reflex iC60 with interface Ti24	■ Possible mode	■ Possible mode	■ Default mode

Power connection



Terminal	Rating	Tightening torque	Without accessories		With accessories			
			Copper cables		Al terminal 50 mm ²	Screw-on connection for ring terminal	Multi-cable terminal	
			Rigid	Flexible or with ferrule			Rigid cables	Flexible cables
Power	10 to 25 A 40 to 63 A	2 N.m 3.5 N.m	DB1122945 1 to 25 mm ² 1 to 35 mm ²	DB1122946 1 to 16 mm ² 1 to 25 mm ²	DB1122935 AI 50 mm ²	DB118789 Ø 5 mm	DB118787 - 3 x 16 mm ²	- 3 x 10 mm ²

Control connection

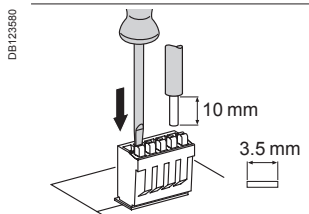
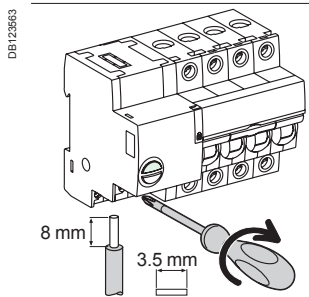
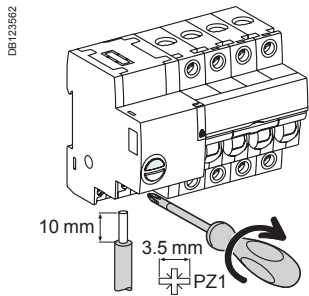

Terminal	Tightening torque	Without accessories		
		Copper cables		
		Rigid	Flexible	Flexible with ferrule
Power supply (N/P) Inputs (Y1/Y2)	1 N.m	DB1122945 1 to 10 mm ²	DB1122953 1 to 6 mm ²	DB1122954 1 to 4 mm ²
Outputs (O/C, auto/OFF)	0.7 N.m	1 to 2.5 mm ²	1 to 2.5 mm ²	1 to 1.5 mm ²
Ti24 interface	Spring-loaded terminals	0.5 to 1.5 mm ²	0.5 to 1.5 mm ²	0.5 to 1.5 mm ²

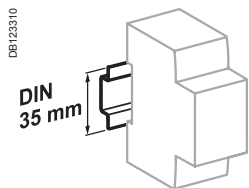

Clip on DIN rail 35 mm.

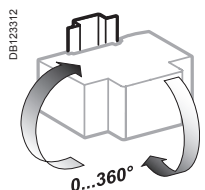

Indifferent position of installation.

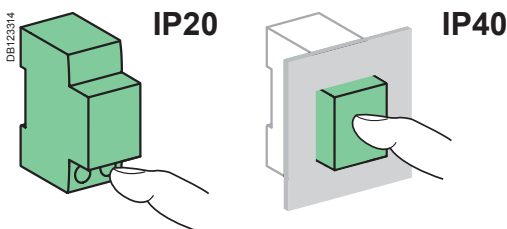

Technical data

Control circuit

Supply voltage (Ue) (N/P)		230 V AC - 50 Hz
Control voltage (Uc)	Inputs (Y1/Y2)	230 V AC - 5 mA (24...48 V AC/DC, with iMDU auxiliary)
	Input (Y3)	24 V DC - 5.5 mA
Min. duration of control impulse (Y2)		≥ 250 ms
Response time (Y2)		≤ 200 ms
Consumption		≤ 1 W
Inrush consumption		< 1000 VA
Length of control wires	Inputs (Y1/Y2)	Cable: 100 m Wires in a sheath: 500 m
	Input (Y3)	500 m
Inrush current at 230 V - 50 Hz	2P	4.2 Å
	3P	8.2 Å
	4P	16.2 Å

Power circuit

Max. working voltage (Ue)		400 V AC
Insulation voltage (Ui)		500 V
Rated impulse withstand voltage (Uimp)	Set to Disconnected	6 kV
	Set to Ready	4 kV
Thermal tripping	Reference temperature	50°C
Magnetic tripping	Curve B	4 In ± 20 %
	Curve C	8 In ± 20 %
	Curve D	12 In ± 20 %
Overvoltage category (IEC 60364)		IV
Temperature derating		See page CA908007

Indication / Remote control

Potential-free changeover contact outputs (O/C, auto/OFF)	Min.	24 V DC - 100 mA
	Max	230 V AC - 1 A

Ti24 interface (as per IEC 61131)

Outputs (O/C, auto/OFF)	Ti24 interface	24 V DC - 100 mA max
-------------------------	----------------	----------------------

Endurance (O-C)

Electrical	AC1 - AC7a	Up to 50,000 cycles ⁽¹⁾
	AC5a - AC5b	Up to 15,000 cycles ⁽¹⁾
	AC7c	Up to 20,000 cycles ⁽¹⁾
Mechanical		50,000 cycles

Additional characteristics

Degree of protection (IEC 60529)	Device only	IP20
	Device in a modular enclosure	IP40 Insulation class II
Degree of pollution		3
Operating temperature		-25°C to +60°C
Storage temperature		-40°C to +85°C
Tropicalization		Treatment 2 (relative humidity of 93 % at 40°C)
Immunity to voltage dips		IEC 61000-4-11 class III
Immunity to power supply frequency variations		IEC 61000-4-28 and IACS E10
Immunity to harmonics		IEC 61000-4-13 class 2
Immunity to electrostatic discharges	Air	8 kV, IEC 61 000-4-2
	Contacts	4 kV, IEC 61 000-4-2
Immunity to stray magnetic fields		10 V/m up to 3 GHz, IEC 61000-4-3
Immunity to fast transients		4 kV from 5 to 100 kHz, IEC 61000-4-4
Immunity to shock waves		IEC 61000-4-5
Immunity to power frequency magnetic fields		10 V from 150 kHz to 80 MHz, IEC 61000-4-6
Immunité aux champs magnétiques à la fréquence du réseau		Level 4 30 A/m to IEC 61000-4-8 and IEC 61000-4-9
Conducted emissions		CISPR 11/22
Radiated emissions		CISPR 11/22

(1) See the derating table according to the load types and ratings

Reflex iC60N, iC60H (curves B, C, D) (cont.)

Weight (g)

Circuit breaker	
Type	Reflex iC60
2P	480
3P	620
4P	750

Dimensions (mm)

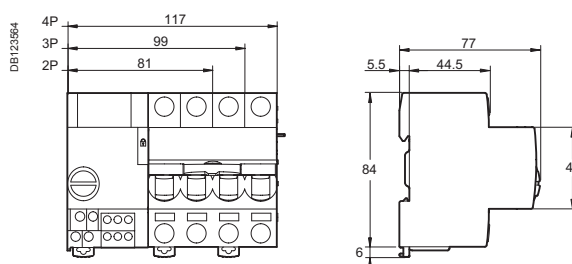

iMDU electrical auxiliary for Reflex iC60



A9C18195

The voltage matching module allows safety voltages of 24 and 48 V AC/DC to be used on the control inputs.

- Only connects to the Reflex iC60 circuit breakers remote controlled by a 220-240 V control voltage
- Galvanic isolation 6000 V
- Maximum combined power between terminals P and Y1/Y2: 100 mA at 230 V and 25°C.

Catalogue numbers

Electrical auxiliary for Reflex iC60		
Type		Width in 9 mm modules
iMDU	A9C18195	1

Diagram

An iMDU electrical auxiliary allows up to a maximum of five Reflex iC60 to be controlled simultaneously at the same input.

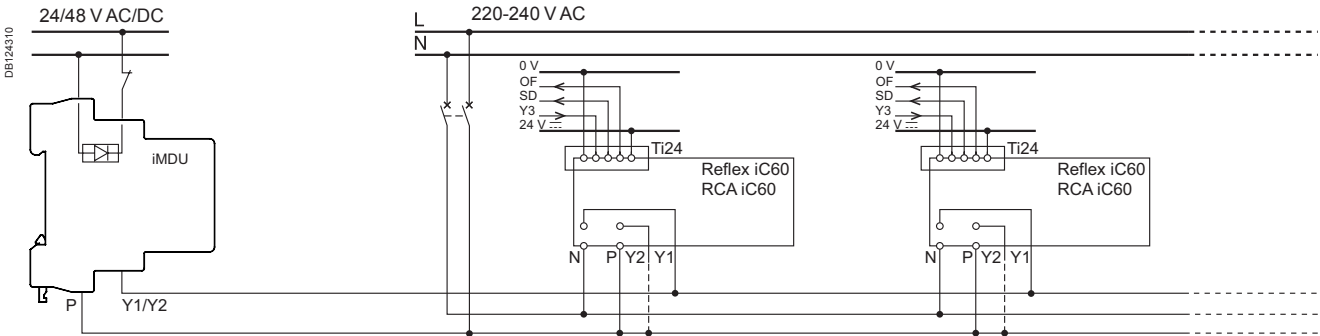

Dimensions (mm)

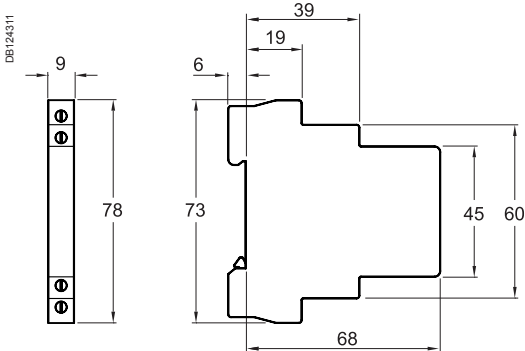

Connection

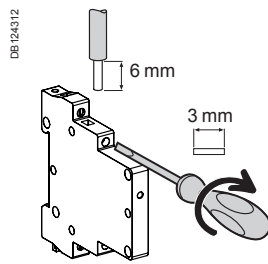

Type	Tightening torque	Copper cables	
		Rigid	Flexible or with ferrule
iMDU	1 N.m	1.5 mm ²	1.5 mm ²

Technical data

Main characteristics		
Control circuit voltage		24...48 V AC/DC
Insulation voltage (Ui)		500 V
Additional characteristics		
Degree of protection (IEC 60529)	Device only	IP20
	Device in modular enclosure	IP40 Insulation class II
Operating temperature		-20°C to +60°C
Storage temperature		-40°C to +80°C
Tropicalisation		Treatment 2 (relative humidity 95 % at 55°C)
Weight		53 g



EN 61095, IEC 1095

iCT contactors are available in two versions:

- Contactors without manually-operated
- Contactors with manually-operated.

The breadth of the iCT contactor range satisfies most application cases.
iCT contactors can be combined with auxiliary control, protection and indication functions.

Contactors

iCT 2P



manual control

iCT 4P



- iCT contactors can be used to remote control applications in alternative networks:
 - lighting, heating, ventilation, roller blinds, sanitary hot water
 - mechanical ventilation systems, etc
 - load-shedding of non-priority circuits

Indication iACTs
■ This auxiliary allows indication or control of the "open" or "closed" position of the contactor power contacts

Interference filtering iACTp
■ This auxiliary is an interference suppressor which limits overvoltages on the control circuit

Dual control iACTc
■ Used to control a contactor in impulse-type mode or to combine latched or impulse-type control orders

Control and indication 24 V DC iACT24
■ Allows control and indication of a 230 Vac contactor from the Acti 9 Smartlink or by a PLC, by 24 V DC signals
■ Also allows control by a maintained signal

Time delay iATEt
■ This auxiliary is used to time delay for iCT and iTL. According to cabling, there are 5 possible time delay types:
□ 1 for iTL
□ 4 for iCT

Function type A: late closing
Delay energizing of contactor

Function type B: time delay
■ Energize the contactor by closing a push button
■ The time delay starts as soon as the control contacts are closed

Function type C: late opening
■ Energize the contactor by closing a push button
■ The time delay starts when the control contacts are opened

Function type H: fixed time operation
■ Operate the contactor for a pre-determined time from the moment of energizing

Contactors

Contactors auxiliaries

Choice of 50 Hz contactors															
Type		Contactor						Manually-operated contactors							
Rating	A	16	20	25	40	63	100	16	25	40	63				
Auxiliaries															
iACTs indication auxiliary		Yes	Yes	Yes							Contactors that can be equipped with auxiliaries				
iACTp protection auxiliary		By yellow clips	No	No	Yes							No	Yes		
iACTc, iATEt control auxiliary		By yellow clips	No	No	Yes							No	Yes		
iACT24 control auxiliary		Non	No	Yes (for contactors 230 V - 50 Hz)								No	Yes (for contactors 230 V - 50 Hz)		

PB100115-39

Yellow clip
 ■ Clip-on system for electrical and mechanical connections between contactors ≥ 25 A and their auxiliaries

■ Insulated terminals IP20

■ Minimum noise

■ Large circuit labeling area

■ Mechanical contact position indicator

■ Consistent with the entire Acti 9 offer and with all types of lighting

■ Manually-operated contactors have a 4-position selector switch on their front face:
 automatic operating mode
 temporary "ON" override
 permanent "ON" override: used to lock the contactor in the ON position during installation maintenance
 shutdown



Choice of 60 Hz contactors				
Contactor				Manually-operated contactors
16	25	40	63	40
Contactors that can be equipped with auxiliaries				
Yes				
No	Yes			
No	Yes			
No				

Catalogue numbers

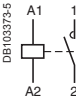
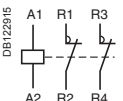
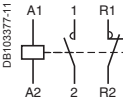
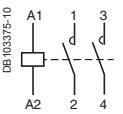
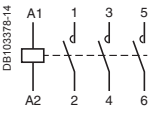
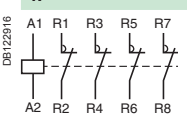
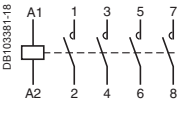
iCT contactors - 50 Hz							
Type						Width in 9 mm modules	
1P	Rating (In)		Control voltage (V AC) (50 Hz)	Contact	Catalogue number		
	AC7a	AC7b					
	16 A	6 A	12	1NO	A9C22011	2	
			24	1NO	A9C22111	2	
			48	1NO	A9C22211	2	
			220	1NO	A9C22511	2	
			230...240	1NO	A9C22711	2	
	25 A	8.5 A	220	1NO	A9C20531	2	
			230...240	1NO	A9C20731	2	
2P							
	16 A	6 A	12	2NO	A9C22012	2	
			24	2NO	A9C22112	2	
			48	2NO	A9C22212	2	
			220	2NO	A9C22512	2	
			230...240	2NO	A9C22712	2	
			12	1NO+1NC	A9C22015	2	
			24	1NO+1NC	A9C22115	2	
			220	1NO+1NC	A9C22515	2	
			230...240	1NO+1NC	A9C22715	2	
	20 A	6 A	230...240	2NO	A9C22722	2	
	25 A	8.5 A	24	2NO	A9C20132	2	
			48	2NO	A9C20232	2	
			220	2NO	A9C20532	2	
				230...240	2NO	A9C20732	2
				220	2NC	A9C20536	2
				230...240	2NC	A9C20736	2
	40 A	15 A	220...240	2NO	A9C20842	4	
	63 A	20 A	24	2NO	A9C20162	4	
				220...240	2NO	A9C20862	4
220...240				2NO	A9C20882	6	
3P							
	16 A	6 A	220...240	3NO	A9C22813	4	
	25 A	8.5 A	220...240	3NO	A9C20833	4	
	40 A	15 A	220...240	3NO	A9C20843	6	
	63 A	20 A	220...240	3NO	A9C20863	6	
4P							
	16 A	6 A	24	4NO	A9C22114	4	
			220...240	4NO	A9C22814	4	
			220...240	2NO+2NC	A9C22818	4	
	20 A	6 A	220...240	4NO	A9C22824	4	
	25 A	8.5 A	24	4NO	A9C20134	4	
220...240			4NO	A9C20834	4		
24			4NC	A9C20137	4		
220...240			4NC	A9C20837	4		
	40 A	15 A	220...240	2NO+2NC	A9C20838	4	
			220...240	4NO	A9C20844	6	
	63 A	20 A	220...240	4NC	A9C20847	6	
			24	4NO	A9C20164	6	
			220...240	4NO	A9C20864	6	
			24	4NC	A9C20167	6	
			220...240	4NC	A9C20867	6	
			220...240	2NO+2NC	A9C20868	6	
			220...240	3NO+1NC	A9C20869	6	
			220...240	4NO	A9C20884	12	

Catalogue numbers

ICT manual control contactor 50 Hz							
Type	Rating (In)		Control voltage (V AC) (50 Hz)	Contact		Width in 9 mm modules	
	AC7a	AC7b					
<p>DB106317-24</p>	16 A	6 A	220	2NO	A9C23512	2	
			230...240	2NO	A9C23712	2	
			220	1NO+1NC	A9C23515	2	
			230...240	1NO+1NC	A9C23715	2	
	<p>DB106318-27</p>	25 A	8,5 A	24	2NO	A9C21132	2
				220	2NO	A9C21532	2
		40 A	15 A	24	2NO	A9C21732	2
				220...240	2NO	A9C21732	2
		63 A	20 A	24	2NO	A9C21842	4
				220...240	2NO	A9C21842	4
<p>DB106319-27</p>	25 A	8,5 A	220...240	3NO	A9C21833	4	
	40 A	15 A	220...240	3NO	A9C21843	6	
	<p>DB106320-31</p>	25 A	8,5 A	24	4NO	A9C21134	4
		220...240	4NO	A9C21834	4		
40 A	15 A	24	4NO	A9C21144	6		
		220...240	4NO	A9C21844	6		
63 A	20 A	24	4NO	A9C21164	6		
		220...240	4NO	A9C21864	6		

Catalogue numbers

iCT contactors - 60 Hz							
Type						Width in 9 mm modules	
1P							
		Rating (In)		Control voltage (V AC) (60 Hz)	Contact		
		AC7a	AC7b				
		25 A	8.5 A	127	1NO	A9C20431	2
				220...240	1NO	A9C20631	2
2P							
		16 A	6 A	127	1NO+1NC	A9C22415	2
				220...240	1NO+1NC	A9C22615	2
		25 A	8.5 A	127	2NO	A9C20432	2
				220...240	2NO	A9C20632	2
				127	2NC	A9C20436	2
				220...240	2NC	A9C20636	2
		40 A	15 A	127	2NO	A9C20442	4
				220...240	2NO	A9C20642	4
3P							
		25 A	8.5 A	127	3NO	A9C20433	4
				220...240	3NO	A9C20633	4
		40 A	15 A	127	3NO	A9C20443	6
				220...240	3NO	A9C20643	6
63 A	20 A	127	3NO	A9C20463	6		
		220...240	3NO	A9C20663	6		

iCT manual control contactor 60 Hz							
Type						Width in 9 mm modules	
2P							
		Rating (In)		Control voltage (V AC) (60 Hz)	Contact		
		AC7a	AC7b				
		40 A	15 A	127	2NO	A9C21442	4
				220...240	2NO	A9C21642	4

Operation (Manual control contactor)

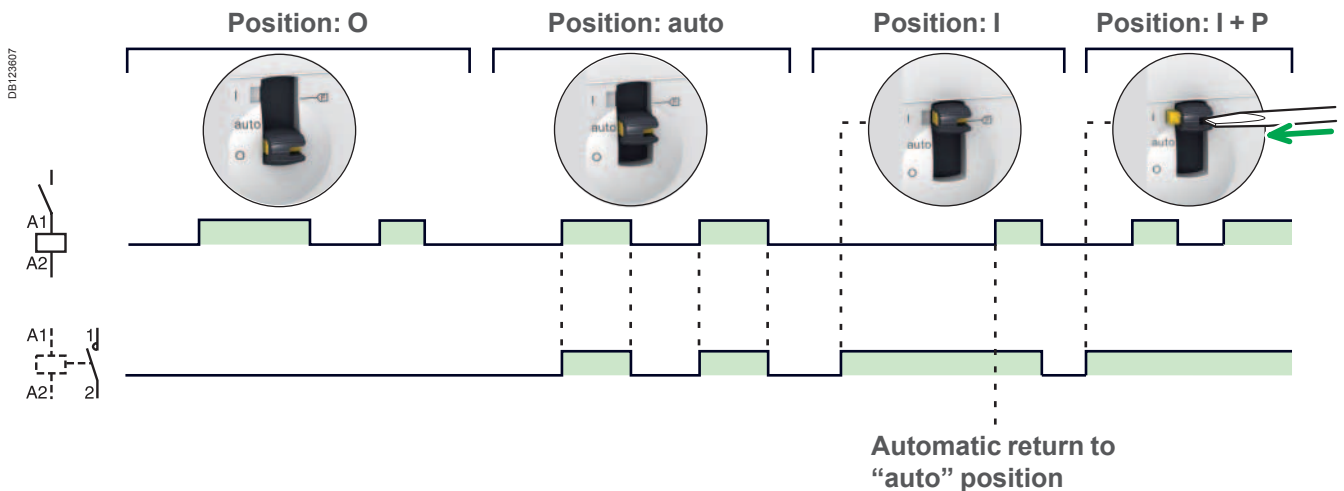

Connection

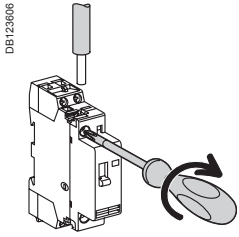

Type	Rating	Length tripping	Circuit	Tightening torque	Copper cables		
					Rigid	Flexible or ferrule	
iCT	PZ1: 4 mm	16 - 100 A	9 mm	Control	0.8 N.m		
	PZ2: 6 mm	40 A - 63 A	14 mm	3.5 N.m	6 to 25 mm ²	6 to 16 mm ²	
	100 A				6 to 35 mm ²	6 to 35 mm ²	
iACTs, iACTp, iACTc, iATet	PZ1: 4 mm	-	9 mm	-	0.8 N.m	1.5 to 2.5 mm: 2 x 1.5 mm ²	1.5 to 2.5 mm: 2 x 2.5 mm ²

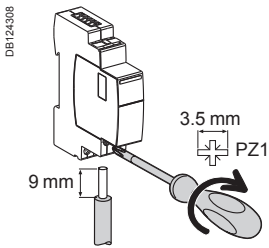

Type	Terminals	Tightening torque	Copper cables		
			Rigid	Flexible	Flexible or ferrule
iACT24	Power supply (N/P) Input (Y1/Y2)	1 N.m			
			0.5 to 10 mm ² 2 x 0.5 to 2 x 2.5 mm ²	0.5 to 6 mm ² 2 x 0.5 to 2 x 2.5 mm ²	0.5 to 4 mm ² 2 x 0.5 to 2 x 2.5 mm ²

Ti24 connector connection

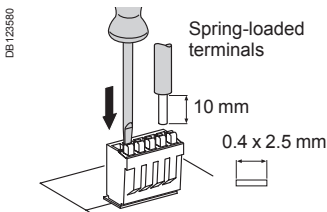

Type	Catalogue numbers	Copper cables	
		Rigid	Flexible
Ti24 Interface	A9XC2412		
		1 x 0.5 to 1.5 mm ²	1 x 0.5 to 1.5 mm ²

Ti24 prefabricated cables connection

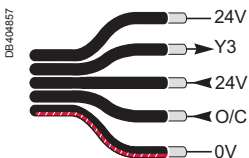

Type	Catalogue numbers	Length
Connection for Acti 9 Smartlink		
6 short prefabricated	A9XCAS06	100 mm
6 medium-sized prefabricated	A9XCAM06	160 mm
6 long prefabricated	A9XCAL06	870 mm
Connection for PLC type terminals		
6 long prefabricated on a single side	A9XCAU06	870 mm

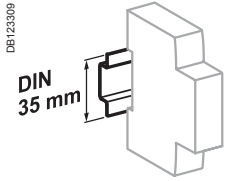

Clip on DIN rail 35 mm.

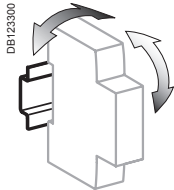

± 30° vertical.

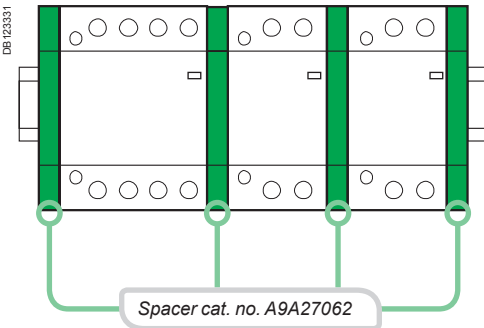
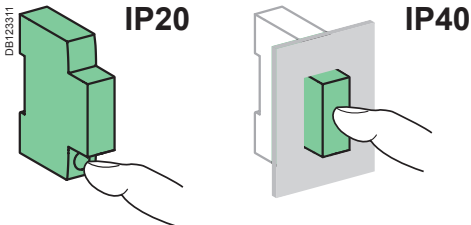

Technical data

Power circuit		
Voltage rating (Ue)	1P, 2P	250 VAC
	3P, 4P	400 VAC
Frequency	50 Hz or 60 Hz	
Type of load	See page the Technical Guide	
Endurance (O-C)		
Electrical	100,000 cycles	
Maximum number of switching operation a day	100	
Additional characteristics		
Insulation voltage (Ui)	500 VAC	
Pollution degree	2	
Rated impulse withstand voltage (Uimp)	2.5 kV (4 kV for 12/24/48 V AC)	
Degree of protection (IEC 60529)	Device only	IP20
	Device in modular enclosure	IP40
Operating temperature	-5°C to +60°C ⁽¹⁾	
Storage temperature	-40°C to +70°C	
Tropicalization (IEC 60068-1)	Treatment 2 (relative humidity 95 % at 55°C)	
ELSV compliance (Extra Low Safety Voltage) for 12/24/48 V AC versions		
The product control conforms to the SELV (safety extra low voltage) requirements		

(1) In the case of contactor mounting in a enclosure for which the interior temperature is in range between 50°C and 60°C, it is necessary to use a spacer, cat. no. A9A27062, between each contactor

Mounting accessories

7	Sealable screw shields for top and bottom	3P, 4P 25 A	A9A15921
		2P 40/63 A	A9A15922
		3P, 4P 40/63 A	A9A15923
8	9 mm spacer		A9A27062
9	Yellow clips		A9C15415
10	Clip-on terminal markers	see page	E-10

DB124309

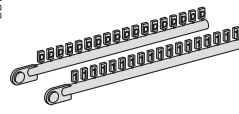

10



9

Auxiliaries

Indication

2	iACTs	1NO + 1NC	A9C15914
		1CO	A9C15915
		2NO	A9C15916

Double control inputs

3	iACTc	230 V AC	A9C18308
		24 V AC	A9C18309

Coil suppression blocs

4	iACTp	12...48 V AC	A9C15919
		48...127 V AC	A9C15918
		220...240 V AC	A9C15920

Time delay

5	iATEt	24...240 V AC	A9C15419
---	-------	---------------	-----------------

Control and indication

6	iACT24	230 V AC	A9C15924
---	--------	----------	-----------------

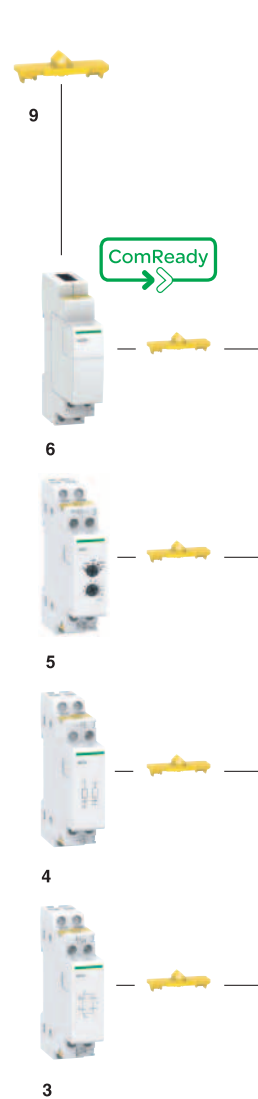

8

7

iCT < 25 A

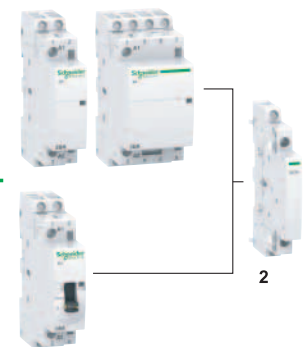

2

iCT ≥ 25 A

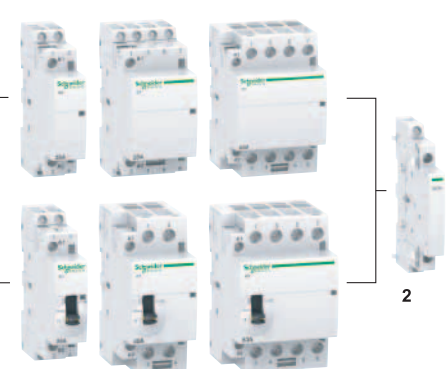



2



iCT contactors

Electrical auxiliaries for iCT

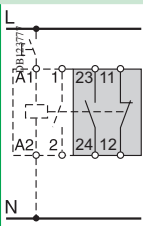
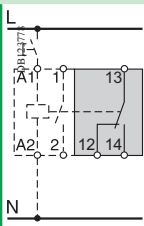
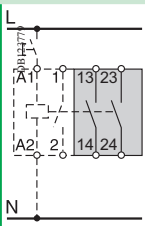
	Indication			Protection			Control																																																																																
Auxiliaries	iACTs			iACTp			iACTc																																																																																
Type	Indication			Interference filtering			Impulse/latched control																																																																																
	With Open/Close auxiliary contact			2 protection circuits																																																																																			
																																																																																							
Function	<ul style="list-style-type: none"> This auxiliary allows indication of the "open" or "closed" position of the contactor power contacts 			<ul style="list-style-type: none"> This auxiliary is an interference suppressor which limits overvoltages on the control circuit 			<ul style="list-style-type: none"> This auxiliary, combined with contactors, enables them to be controlled by 2 order types: <ul style="list-style-type: none"> impulse order for local control (input T) latched order for centralised control (input X) the last order received takes priority 																																																																																
Wiring diagrams																																																																																							
Mounting	<ul style="list-style-type: none"> Mounted to the right of iCT 			<ul style="list-style-type: none"> Mounted to the left of iCT by yellow clips⁽¹⁾ By wires 			<ul style="list-style-type: none"> Mounted to the left of iCT by yellow clips⁽¹⁾ 																																																																																
Use	-			<ul style="list-style-type: none"> The iACTp has 2 separate and identical circuits, allowing it to be combined with 2 different ones on the iCT the other by wires 			<ul style="list-style-type: none"> Mains power outages: <ul style="list-style-type: none"> < 1 s: keeps its initial status ≥ 5 s: reset put back into operation by manual operation on input X or T. Minimum impulse duration: 250 ms 																																																																																
Catalogue numbers	A9C15914	A9C15915	A9C15916	A9C15918	A9C15919	A9C15920	A9C18308	A9C18309																																																																															
Technical specifications	<table border="1"> <tr> <td rowspan="2">Control voltage (Ue)</td> <td>V AC</td> <td colspan="2">24...240</td> <td>48...127</td> <td>12...48</td> <td>220...240</td> <td>230...240</td> <td>24...48</td> </tr> <tr> <td>V DC</td> <td colspan="2">24...130</td> <td colspan="2">-</td> <td colspan="3">-</td> </tr> <tr> <td rowspan="2">Operating frequency</td> <td>Hz</td> <td colspan="2">50/60</td> <td colspan="2">50/60</td> <td colspan="3">50/60</td> </tr> <tr> <td>Width in 9 mm modules</td> <td colspan="2">1</td> <td colspan="2">2</td> <td colspan="3">2</td> </tr> <tr> <td rowspan="3">Auxiliary contact (breaking capacity)</td> <td colspan="8"> <ul style="list-style-type: none"> Minimum: 10 mA at 24 V DC/AC - cos φ = 1 Maximum: <ul style="list-style-type: none"> 5 A at 240 V AC - cos φ = 1 1 A at 130 V DC </td> </tr> <tr> <td>Number of contacts</td> <td>1NO + 1NC</td> <td>1CO</td> <td colspan="2">2NO</td> <td colspan="3">-</td> </tr> <tr> <td>Operating temperature</td> <td>°C</td> <td colspan="7">-5°C to +50°C</td> </tr> <tr> <td>Storage temperature</td> <td>°C</td> <td colspan="7">-40°C to +70°C</td> </tr> <tr> <td>Consumption</td> <td></td> <td colspan="5">-</td> <td colspan="3"> OFF load: 3 VA Inrush⁽²⁾: 2 VA Holding⁽²⁾: 0.2 VA </td> </tr> </table>								Control voltage (Ue)	V AC	24...240		48...127	12...48	220...240	230...240	24...48	V DC	24...130		-		-			Operating frequency	Hz	50/60		50/60		50/60			Width in 9 mm modules	1		2		2			Auxiliary contact (breaking capacity)	<ul style="list-style-type: none"> Minimum: 10 mA at 24 V DC/AC - cos φ = 1 Maximum: <ul style="list-style-type: none"> 5 A at 240 V AC - cos φ = 1 1 A at 130 V DC 								Number of contacts	1NO + 1NC	1CO	2NO		-			Operating temperature	°C	-5°C to +50°C							Storage temperature	°C	-40°C to +70°C							Consumption		-					OFF load: 3 VA Inrush ⁽²⁾ : 2 VA Holding ⁽²⁾ : 0.2 VA		
Control voltage (Ue)	V AC	24...240		48...127	12...48	220...240	230...240	24...48																																																																															
	V DC	24...130		-		-																																																																																	
Operating frequency	Hz	50/60		50/60		50/60																																																																																	
	Width in 9 mm modules	1		2		2																																																																																	
Auxiliary contact (breaking capacity)	<ul style="list-style-type: none"> Minimum: 10 mA at 24 V DC/AC - cos φ = 1 Maximum: <ul style="list-style-type: none"> 5 A at 240 V AC - cos φ = 1 1 A at 130 V DC 																																																																																						
	Number of contacts	1NO + 1NC	1CO	2NO		-																																																																																	
	Operating temperature	°C	-5°C to +50°C																																																																																				
Storage temperature	°C	-40°C to +70°C																																																																																					
Consumption		-					OFF load: 3 VA Inrush ⁽²⁾ : 2 VA Holding ⁽²⁾ : 0.2 VA																																																																																
<p>(1) Electrical and mechanical link. (2) Maximum consumption of all contactors controlled.</p>																																																																																							

iCT contactors

Electrical auxiliaries for iCT (cont.)

Control (cont.)

iATEt

Time delay

PB106125-34



- This auxiliary is used to time delay for iCT and iTL. According to cabling, there are 5 possible time delay types:
 - 1 for iTL
 - 4 for iCT.

Function type A: late closing

- Delay energizing of contactor.

Function type B: time delay

- Energize the contactor by closing a push button.
- The time delay starts as soon as the control contacts are closed.

Function type C: late opening

- Energize the contactor by closing a push button.
- The time delay starts when the control contacts are opened.

Function type H: fixed time operation

- Operate the contactor for a pre-determined time from the moment of energizing.

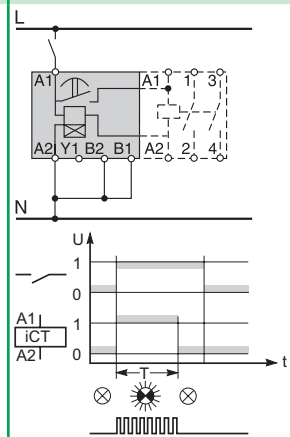
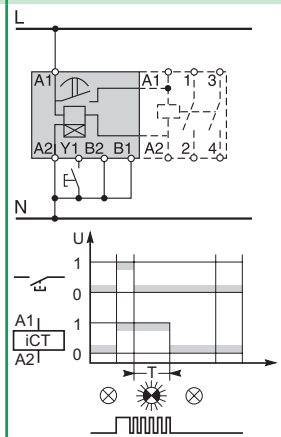
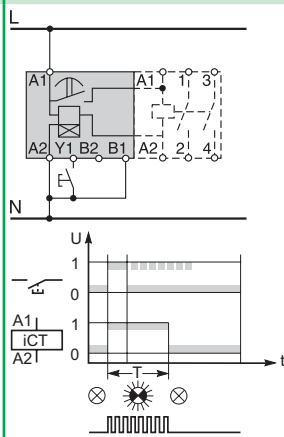
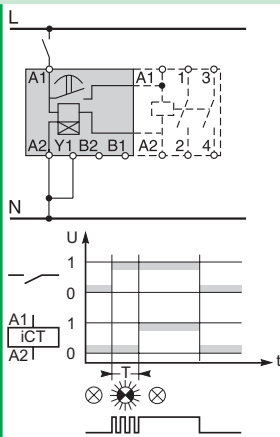

- Mounted to the left of iCT by yellow clips⁽¹⁾

A9C15419

24...240

24...110

50/60

2

-20°C to +50°C

-40°C to +80°C

Off-load: 5 VA
Inrush⁽²⁾: 3 A
Holding⁽²⁾: 0.2 A







iCT contactors

Electrical auxiliaries for iCT (cont.)

Control and indication		
Auxiliary	iACT24	
Type	Control and indication 24 V DC	
	With Ti24 connector	
		
Function	<ul style="list-style-type: none"> ■ This auxiliary allows a contactor to be interfaced with the Acti 9 Smartlink interface or a programmable logic controller (PLC) in 24 V DC (control, O/C indication) ■ 230 V AC control 	
Wiring diagrams	<p>Wiring with exclusive selector 230 V AC control (Y1 = 0) / 24 V DC control (Y1 = 1)</p> <p>Wiring for non-exclusive 230 V AC and 24 V DC controls</p>	
Mounting	<ul style="list-style-type: none"> ■ To the left of the iCT contactor using the yellow clips ⁽¹⁾. ■ When an iACT24 is used, the A1/A2 terminals of the contactors should not be wired. Only the yellow clips integral with the iACT24 should be used for connection to the coil. 	
Utilization	<ul style="list-style-type: none"> ■ 230 V AC interface: <ul style="list-style-type: none"> □ Y1: enabling of 24 V DC control (Y1 = 1) or inhibition of 24 V DC control (Y1 = 0). □ Y2: 230 V pulse control ■ "Ti24" 24 V DC interface: <ul style="list-style-type: none"> □ Y3: 24 V DC control of iCT closing on rising edge and opening on falling edge □ reading of the contactor status (opened or closed) from the position of the integrated O/C auxiliary contact □ monitoring of connection of the "Ti24" terminal block by the upstream system (PLC, supervision system) via the 24 V terminal (in the centre of the Ti24 terminal block) 	
Catalogue numbers	A9C15924	
Technical specifications		
Control voltage (Ue)	V AC	230, +10 %, -15 % (Y2)
	V DC	24, ± 20 % (Y3)
Operating frequency	Hz	50
Insulation voltage (Ui)	V AC	250
Rated impulse withstand voltage (Uimp)	kV	8
Pollution degree		3
Degree of protection		IP20B device only
		IP40 device in modular enclosure
Width in 9 mm modules		2
Auxiliary contact (O/C) Ti24		24 V DC protected output, min. 2 mA, max. 100 mA
Contact		1 O/C operating category AC 14
Operating temperature	°C	-25°C to +60°C
Storage temperature	°C	-40°C to +80°C
Consumption		<1 W
Standard		IEC/EN 60947-5-1

(1) Mechanical and electrical link.

iCT contactors Accessories for iCT

Security					
Accessories	Sealable screw shields			Yellow clips	Spacer
	 PB10A485-15	 PB10A486-15	 PB10A487-15	 PB10B153-10	 PB10A483-40
Function	<ul style="list-style-type: none"> ■ Designed to cover terminals to avoid contact with device screws. ■ Allow sealing 			<ul style="list-style-type: none"> ■ Ensure the mechanical and/or electrical link between contactors and their auxiliaries. 	<ul style="list-style-type: none"> ■ Required to reduce temperature rise of modular devices installed side by side. ■ Recommended to separate electronic devices (thermostat, programmable clock, etc.) from electromechanical devices (relays, contactors).
	■ For iCT: 3P, 4P - 25 A	■ For iCT: 2P - 40/63 A	■ For iCT: 3P, 4P - 40/63 A	■ For iCT: ≥ 25 A	
Use	■ Bag of 10 upstream/10 downstream			■ Bag of 10	■ Bag of 5
Catalogue numbers	A9A15921	A9A15922	A9A15923	A9C15415	A9A27062
Technical specifications					
Width in 9 mm modules	4	4	6	–	1
Number of poles	3P, 4P	2P	3P	–	–



Operation of the iACT24

O/C 24 V DC output

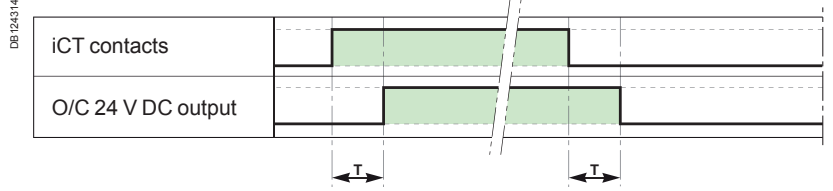

Parameter	Min	Max
T	100 ms	200 ms

- Minimum duration of 230 V AC pulse (Y2): 200 ms.
- 30 iACT24 closing or opening actuations are authorized per minute: Minimum time delay between 2 actuations on the iACT4 via Y1, Y2, Y3 (closing or opening of the iCT coil): 220 ms.
- 10 closing or opening actuations spaced 440 milliseconds apart are authorized following no loading of the iACT24 during a period of 20 seconds.

Wiring with exclusive selector 230 V AC control (Y1 = 0) / 24 V DC control (Y1 = 1)

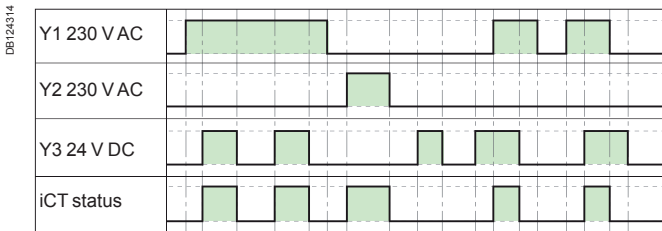
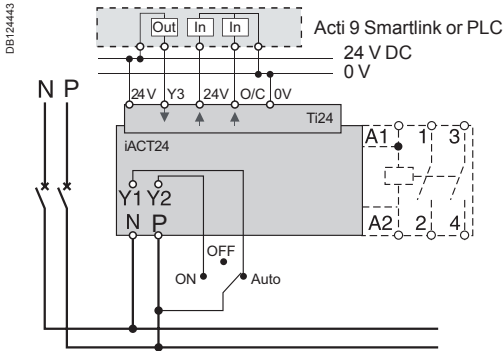

Wiring for non-exclusive 230 V AC and 24 V DC controls

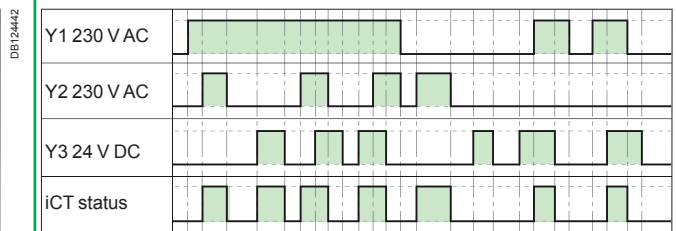
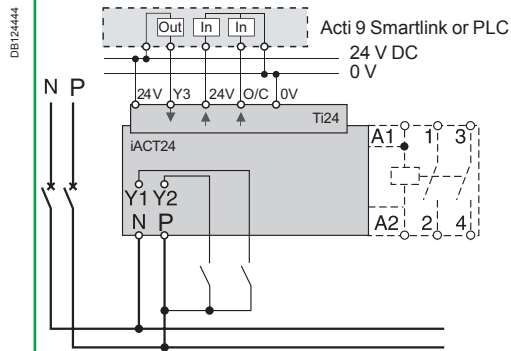

iCT contactors

Technical advice for iCT

Consumption

iCT contactors - 50 Hz										
Type										
1P	Rating (In)		Control voltage (V AC) (50 Hz)	Consumption		Max. power				
	AC7a	AC7b		Holding	Inrush					
16 A	5 A		12	3.8 VA	15 VA	1.3 W	A9C22011			
			24	3.8 VA	15 VA	1.3 W	A9C22111			
			48	3.8 VA	15 VA	1.3 W	A9C22211			
			220	3.8 VA	15 VA	1.3 W	A9C22511			
			230...240	2.7 VA	9.2 VA	1.2 W	A9C22711			
			25 A	8.5 A		220	3.8 VA	15 VA	1.3 W	A9C20531
						230...240	2.7 VA	9.2 VA	1.2 W	A9C20731
			2P							
16 A	5 A		12	3.8 VA	15 VA	1.3 W	A9C22012			
			24	3.8 VA	15 VA	1.3 W	A9C22112			
			48	3.8 VA	15 VA	1.3 W	A9C22212			
			220	3.8 VA	15 VA	1.3 W	A9C22512			
			230...240	2.7 VA	9.2 VA	1.2 W	A9C22712			
			12	3.8 VA	15 VA	1.3 W	A9C22015			
			24	3.8 VA	15 VA	1.3 W	A9C22115			
			220	3.8 VA	15 VA	1.3 W	A9C22515			
			230...240	2.7 VA	9.2 VA	1.2 W	A9C22715			
			20 A	6.4 A	230...240	2.7 VA	9.2 VA	1.2 W	A9C22722	
			25 A	8.5 A		24	3.8 VA	15 VA	1.3 W	A9C20132
						48	3.8 VA	15 VA	1.3 W	A9C20232
220	3.8 VA	15 VA				1.3 W	A9C20532			
230...240	2.7 VA	9.2 VA				1.2 W	A9C24732			
220	3.8 VA	15 VA				1.3 W	A9C20536			
		230...240	2.7 VA	9.2 VA	1.2 W	A9C20736				
40 A	15 A	220...240	4.6 VA	34 VA	1.6 W	A9C20842				
63 A	20 A		24	4.6 VA	34 VA	1.6 W	A9C20162			
			220...240	4.6 VA	34 VA	1.6 W	A9C20862			
100 A	-	220...240	6.5 VA	53 VA	2.1 W	A9C20882				
3P										
16 A	5 A	220...240	4.6 VA	34 VA	1.6 W	A9C22813				
25 A	8.5 A	220...240	4.6 VA	34 VA	1.6 W	A9C20833				
40 A	15 A	220...240	6.5 VA	53 VA	2.1 W	A9C20843				
63 A	20 A	220...240	6.5 VA	53 VA	2.1 W	A9C20863				
4P										
16 A	5 A		24	4.6 VA	34 VA	1.6 W	A9C22114			
			220...240	4.6 VA	34 VA	1.6 W	A9C22814			
			220...240	4.6 VA	34 VA	1.6 W	A9C22818			
20 A	6.4 A	220...240	4.6 VA	34 VA	1.6 W	A9C22824				
25 A	8.5 A		24	4.6 VA	34 VA	1.6 W	A9C20134			
			220...240	4.6 VA	34 VA	1.6 W	A9C24834			
			24	4.6 VA	34 VA	1.6 W	A9C20137			
			220...240	4.6 VA	34 VA	1.6 W	A9C20837			
			220...240	4.6 VA	34 VA	1.6 W	A9C20838			
40 A	15 A		220...240	6.5 VA	53 VA	2.1 W	A9C20844			
			220...240	6.5 VA	53 VA	2.1 W	A9C20847			
63 A	20 A		24	6.5 VA	53 VA	2.1 W	A9C20164			
			220...240	6.5 VA	53 VA	2.1 W	A9C20864			
			24	6.5 VA	53 VA	2.1 W	A9C20167			
			220...240	6.5 VA	53 VA	2.1 W	A9C20867			
			220...240	6.5 VA	53 VA	2.1 W	A9C20868			
			220...240	6.5 VA	53 VA	2.1 W	A9C20869			
100 A	-	220...240	13 VA	106 VA	4.2 W	A9C20884				

iCT contactors

Technical advice for iCT (cont.)

Consumption (cont.)

iCT manual control contactor 50 Hz							
Type							
2P	Rating (In)		Control voltage (V AC) (50 Hz)	Consumption		Max. power	
	AC7a	AC7b		Holding	Inrush		
16 A	5 A		220	2.7 VA	9.2 VA	1.2 W	A9C23512
			230...240	2.7 VA	9.2 VA	1.2 W	A9C23712
			220	3.8 VA	15 VA	1.3 W	A9C23515
			230...240	2.7 VA	9.2 VA	1.2 W	A9C23715
25 A	8.5 A		24	3.8 VA	15 VA	1.3 W	A9C21132
			220	2.7 VA	9.2 VA	1.2 W	A9C21532
			230...240	2.7 VA	9.2 VA	1.2 W	A9C25732
40 A	15 A		24	4.6 VA	34 VA	1.6 W	A9C21142
			220...240	4.6 VA	34 VA	1.6 W	A9C21842
63 A	20 A		24	4.6 VA	34 VA	1.6 W	A9C21162
			220...240	4.6 VA	34 VA	1.6 W	A9C21862
3P							
25 A	8.5 A		220...240	4.6 VA	34 VA	1.6 W	A9C21833
40 A	15 A		220...240	6.5 VA	53 VA	2.1 W	A9C21843
4P							
25 A	8.5 A		24	4.6 VA	34 VA	1.6 W	A9C21134
			220...240	4.6 VA	34 VA	1.6 W	A9C21834
40 A	15 A		24	6.5 VA	53 VA	2.1 W	A9C21144
			220...240	6.5 VA	53 VA	2.1 W	A9C21844
63 A	20 A		24	6.5 VA	53 VA	2.1 W	A9C21164
			220...240	6.5 VA	53 VA	2.1 W	A9C21864

iCT contactors - 60 Hz							
Type							
1P	Rating (In)		Control voltage (V AC) (60 Hz)	Consumption		Max. power	
	AC7a	AC7b		Holding	Inrush		
25 A	8.5 A		127	3.8 VA	15 VA	1.3 W	A9C20431
			220 ...240	2.7 VA	9.2 VA	0.9 W	A9C20631
2P							
16 A	5 A		127	3.8 VA	15 VA	1.3 W	A9C22415
			220...240	2.7 VA	9.2 VA	0.9 W	A9C22615
25 A	8.5 A		127	3.8 VA	15 VA	1.3 W	A9C20432
			220...240	2.7 VA	9.2 VA	0.9 W	A9C20632
			127	3.8 VA	15 VA	1.3 W	A9C20436
			220...240	2.7 VA	9.2 VA	0.9 W	A9C20636
40 A	15 A		127	4.6 VA	34 VA	1.6 W	A9C20442
			220...240	4.6 VA	34 VA	1.6 W	A9C20642
3P							
25 A	8.5 A		127	4.6 VA	34 VA	1.6 W	A9C20433
			220...240	4.6 VA	34 VA	1.6 W	A9C20633
40 A	15 A		127	6.5 VA	53 VA	2.1 W	A9C20443
			220...240	6.5 VA	53 VA	2.1 W	A9C20643
63 A	20 A		127	6.5 VA	53 VA	2.1 W	A9C20463
			220...240	6.5 VA	53 VA	2.1 W	A9C20663

Dimensions (mm)

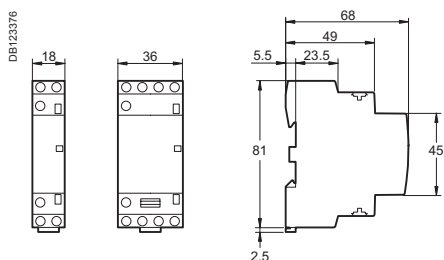

iCT 16/25 A

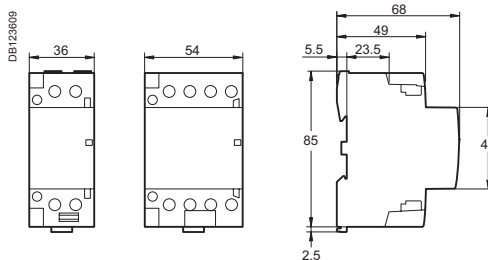

iCT 40/63 A

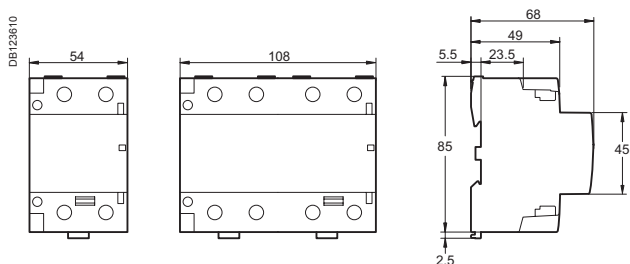

iCT 100 A

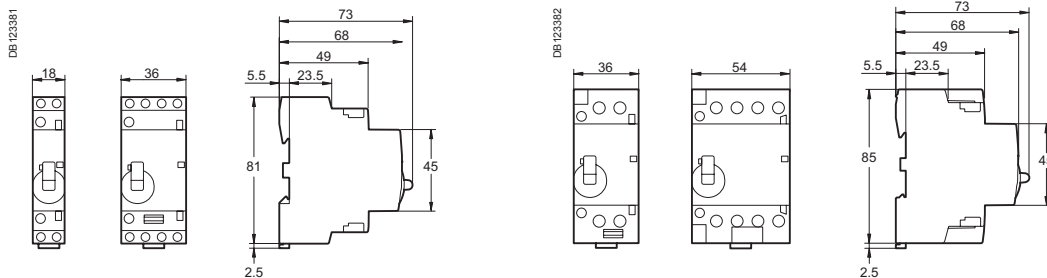

iCT manual control contactor 16/25 A

iCT manual control contactor 40/63 A

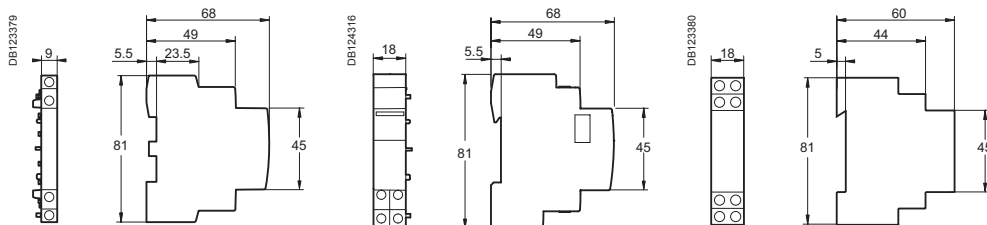

iACTs

iACT24

iATEt
iACTp
iACTc



DB110619



**iTL, iTLI,
iTLs, iTLc,
iTLm**

IEC/EN 60669-2-2
iTLs: IEC/EN 60947-5-1

Impulse relays



iTL

- The impulse relays are used to control, by means of pushbuttons, lighting circuits consisting of:
 - incandescent lamps, low-voltage halogen lamps, etc. (resistive loads)
 - fluorescent lamps, discharge lamps, etc. (inductive loads)

Remote indication



iTLs

- Allows remote indication of its operating state (open/closed)



Indication iATLs

- Allows remote indication of the associated impulse relay

Centralised control



iTLc

- Allows centralised control of a group of TLC impulse relays, whilst at the same time retaining local impulse-type control



Centralised control iATLc

- Used for centralised control, thanks to a "pilot line", of a group of impulse relays controlling separate circuit, while at the same time maintaining local individual control of each impulse relay

Latched control



iTLm

- Operated by latched orders from a changeover contact (switch, time switch, thermostat). Manual control does not work



Latched control iATLm

- Controls the associated impulse relay by latched orders from a changeover contact

 Impulse relays

Impulse relays are used:

- Closing of the impulse relay pole(s) is triggered by an impulse on the coil.
- Having two stable mechanical positions, the pole(s) will be opened by the next impulse. Each impulse received by the coil reverses the position of the pole(s).
- Can be controlled by an unlimited number of pushbuttons.
- Zero energy consumption.



Changeover contact iTLi

- This impulse relay has a changeover contact

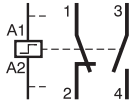

Extensions iTEL

- Used to increase the number of impulse relay poles
- Can be installed on the iTL, iTLi, iTLc, iTLm and iTLs



Centralised control + indication iATLc+s

- Used for centralised control, thanks to a "pilot line", of a group of impulse relays controlling separate circuit, while at the same time maintaining local individual control of each impulse relay
- Remote indication of the mechanical status of each relay



Multi-level centralised control iATLc+c

- Allows centralised control of a group of iTLc or "iTL + ATLc" impulse relays



Control and indication 24 V DC iATL24

- Allows control and indication of a 230 V AC impulse relay from the Acti 9 Smartlink or by a PLC, by 24 V DC signals
- Also allows control by a pulsed signal



Time delay iATEt

- Combined with an impulse relay, it automatically disconnects the circuit after a preset time



Control iATLz

- Must be used when installing several illuminated PBs in parallel to control an impulse relay (prevents operating malfunctions)



Step by step control iATL4

- Allows step-by-step control of two circuits via a single pushbutton

Mounting accessories

11	Yellow clips	A9C15415
12	9 mm spacer	A9A27062
13	Clip-on terminal markers	see page E-10

DB123831



Auxiliaries

Centralised control			
2	iATLc ^{(1), (3)}	24...240 V AC	A9C15404
Indication			
3	iATLs ⁽¹⁾	24...240 V AC	A9C15405
Centralised control + indication			
4	iATLc+s ⁽³⁾	24...240 V AC	A9C15409
Multi-level centralised control			
5	iATLc+c ^{(2), (3)}	24...240 V AC	A9C15410
Step by step control			
6	iATL4	230 V AC	A9C15412
Control by illuminated push-buttons			
7	iATLz	130...240 V AC	A9C15413
Latched control			
8	iATLm ⁽¹⁾	12...240 V AC	A9C15414
Time delay control			
9	iATEt ⁽⁴⁾	24...240 V AC	A9C15419
Control and indication			
10	iATL24	230 V AC	A9C15424

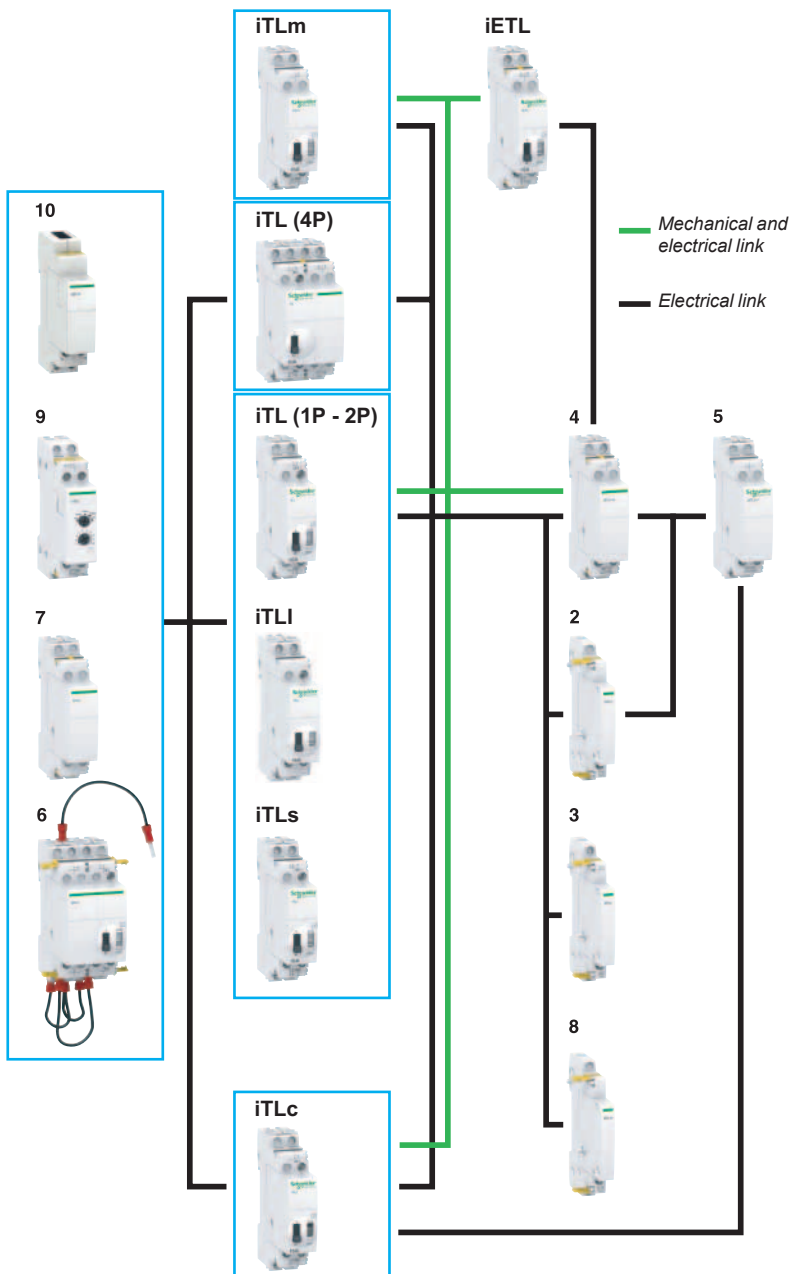

(1) The iATLc, iATLs and iATLm 9 mm auxiliaries are used by themselves to the right of an impulse relay.

(2) Connection by traditional cabling. The iATLc+c must be mounted to the right of an iATLc+s or an iATLc.

(3) The centralised control functions (iTLc, iATLc, iATLc+s, iATLc+c) only operate on AC voltage networks.

(4) iATEt: control voltage: 24...240 V AC, 24...110 V DC.

PB106126-41

Yellow clip
 ■ A simple clip-on system for flexible auxiliaries combination and improved robustness
 ■ For electrical and mechanical connections

■ Large circuit labeling area

■ Consistent with the entire Acti 9 offer and with all types of lighting



■ Insulated terminals IP20

■ Built-in or optional auxiliary function: state indication, centralised control, latched control, control for illuminated pushbutton, step-by-step control, time delay

■ Disconnection of remote control by selector switch (except for 4P single-piece iTL) for maintenance operation

■ Manual controls on front face: direct and priority manual control by O-I toggle
 ■ Mechanical contact position indicator

		Choice impulse relays auxiliaries																
Type		Standard iTL					Changeover iTLI					iTLc centralised control		iTLm control on latched order		iTLs remote indication		
Rating	A	16	32	16	16	16	16	16	16	16	16	16	16	16	16	16	16	16
Control voltage	V AC	230/240	130	48	24	12	230/240	130	48	24	12	230/240	48	24	230/240	230/240	48	24
	V DC	110	48	24	12	6	110	110	48	24	12	6	-	110	110	24	12	12
Auxiliaries																		
Extension																		
iETL		■	■	■	■	■	■	■	■	■	■	■	■	■	■			
Centralised control + indication																		
iATLc+s		■	■	■	■	-	■	■	■	-	-	-	-	-	-			
Centralised control																		
iATLc		■	■	■	■	-	■	■	■	-	-	-	-	-	-			
Indication																		
iATLs		■	■	■	■	-	■	■	■	■	■	■	■	■	■			
Multi-level centralised control																		
iATLc+c		■	■	■	■	-	■	■	■	-	-	■	■	■	-			
Latched control																		
iATLm		■	■	■	■	■	■	■	■	■	■	-	-	-	-			
Control for illuminated Pushbutton																		
iATLz		■	■	-	-	-	■	■	-	-	-	■	■	-	-			
Step by step control																		
iATL4		■	-	-	-	-	■	■	-	-	-	■	-	-	-			
Time delay control																		
iATEt		■	■	■	(*)	■	■	■	■	■	(*)	-	■	■	■	-		
Control and indication																		
iATL24		■	-	-	-	-	■	■	-	-	-	■	-	-	-			

(*) iATEt : does not operate on 12 V DC.



Catalogue numbers

iTL impulse relays						
Type	1P		2P	3P	4P	
Rating (In)	Control voltage (Uc)					
	(V AC)	(V DC)				
16 A	12	6	A9C30011	A9C30012	A9C30011 + A9C32016	A9C30012 + A9C32016
	24	12	A9C30111	A9C30112	A9C30111 + A9C32116	A9C30114
	48	24	A9C30211	A9C30212	A9C30211 + A9C32216	A9C30212 + A9C32216
	130	48	A9C30311	A9C30312	A9C30311 + A9C32316	A9C30312 + A9C32316
	230...240	110	A9C30811	A9C30812	A9C30811 + A9C32816	A9C30814
32 A	230...240	110	A9C30831	A9C30831 + A9C32836	A9C30831 + 2 x A9C32836	A9C30831 + 3 x A9C32836
Width in 9 mm modules			2	2	4	4

iTLI impulse relays				
Type	1P			
Rating (In)	Control voltage (Uc)			
	(V AC)	(V DC)		
16 A	12	6	A9C30015	
	24	12	A9C30115	
	48	24	A9C30215	
	130	48	A9C30315	
	230...240	110	A9C30815	
Width in 9 mm modules			2	

iETL extensions for iTL and iTLI						
Type	Rating (In)			Control voltage (Uc)		Width in 9 mm modules
		(V AC)	(V DC)			
	32 A	230...240	110	A9C32836		2
	16 A	12	6	A9C32016		2
		24	12	A9C32116		2
		48	24	A9C32216		2
		130	48	A9C32316		2
		230...240	110	A9C32816		2

iTLc, iTLm, iTLs with built-in auxiliary function

Catalogue numbers (cont.)

		iTLc impulse relay with centralised control	
Type		1P	3P
		1NO	3P
Rating (In)	Control voltage (Uc) (V AC)		
16 A	24	A9C33111	A9C33111 + A9C32116
	48	A9C33211	A9C33211 + A9C32216
	230...240	A9C33811	A9C33811 + A9C32816
Width in 9 mm modules		2	4





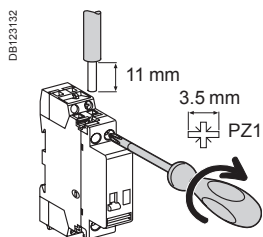

		iTLm impulse relay with latched control	
Type		1P	3P
		1NO	3P
Rating (In)	Control voltage (Uc) (V AC)		
16 A	230...240	A9C34811	A9C34811 + A9C32116
Width in 9 mm modules		2	4

		iTLs impulse relay with remote indication*	
Type		1P	3P
		1NO	3P
Rating (In)	Control voltage (Uc) (V AC) (V DC)		
16 A	24 12	A9C32111	A9C32111 + A9C32116
	48 24	A9C32211	A9C32211 + A9C32216
	230...240 110	A9C32811	A9C32811 + A9C32816
Width in 9 mm modules		2	4



(*) Short circuit protection device for indication contacts : 6 A gG fuse.

Connection



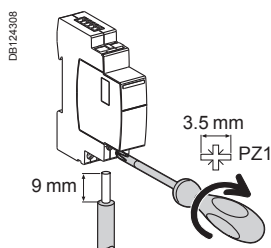

Type	Rating	Circuit	Tightening torque	Copper cables	
				Rigid or ferrule	Flexible or ferrule
iTL, iTLi, iTLc, iTLm, iTLs, iETL	16 A	Control	1 N.m		
		Power			
iTL, iETL	32 A	Control	1.2 N.m		
		Power			
iATLs, iATLc, iATLc+s, iATLc+c, iATLm, iATEt, iATL4, iATLz			1 N.m		

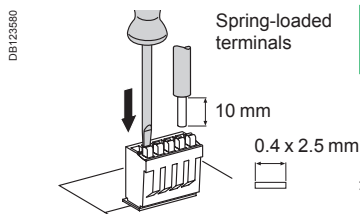

Type	Terminals	Tightening torque	Copper cables		
			Rigid	Flexible	Flexible or ferrule
iATL24	Power supply (N/P) Input (Y1/Y2)	1 N.m	 0.5 to 10 mm ² 2 x 0.5 to 2 x 2.5 mm ²	 0.5 to 6 mm ² 2 x 0.5 to 2 x 2.5 mm ²	 0.5 to 4 mm ² 2 x 0.5 to 2 x 2.5 mm ²

Ti24 connector connection



Type	Catalogue numbers	Copper cables	
		Rigid	Flexible
Ti24 interface	A9XC2412	 1 x 0.5 to 1.5 mm ²	 1 x 0.5 to 1.5 mm ²

Ti24 prefabricated cables connection

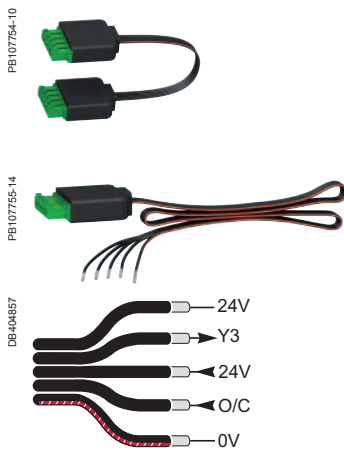

Type	Catalogue numbers	Length
Connection for Acti 9 Smartlink		
6 short prefabricated	A9XCAS06	100 mm
6 medium-sized prefabricated	A9XCAM06	160 mm
6 long prefabricated	A9XCAL06	870 mm
Connection for PLC type terminals		
6 long prefabricated on a single side	A9XCAU06	870 mm

Operation

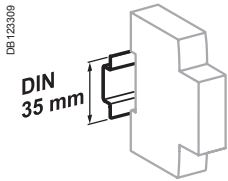
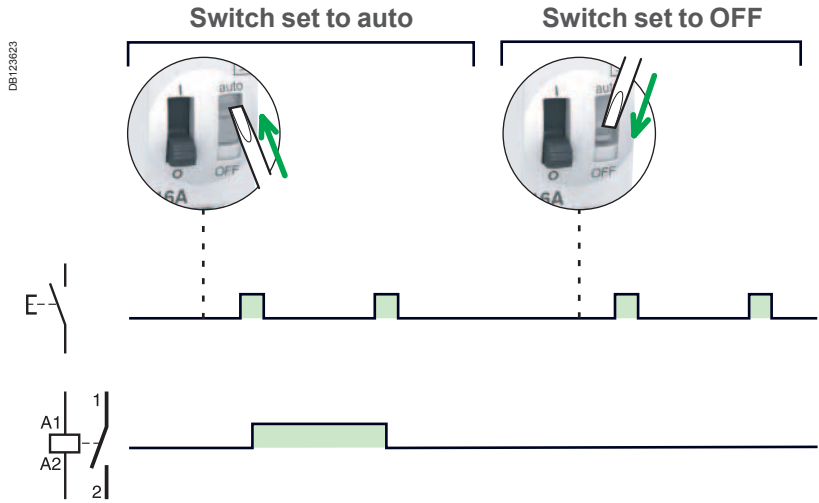

Clip on DIN rail 35 mm.

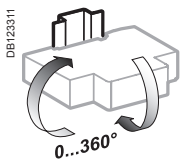

Indifferent position of installation.

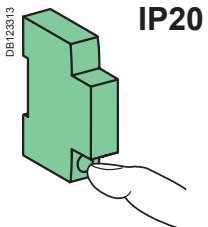

IP20

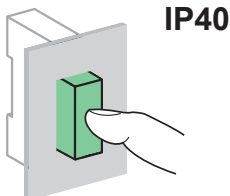





IP40

Technical data

Control circuit		
	iTL and iTLI 16 A iTLc, iTLm, iTLs, iETL 16 A	iTL 32 A, iETL 32 A
Dissipated power (during the impulse)	1, 2, 3P: 19 VA 4P: 38 VA	19 VA
Illuminated PB control	Max. current 3 mA (if > use an ATLz)	
Operating threshold	Min. 85 % of Un in conformance with IEC/EN60669-2-2	
Duration of the control order	50 ms to 1 s (200 ms recommended)	
Response time	50 ms	
Power circuit		
Voltage rating (Ue)	1P, 2P	24 ...250 V AC
	3P, 4P	24...415 V AC
Frequency	50 Hz or 60 Hz	
Maximum number of operations per minute	5	
Maximum number of switching operation a day	100	
Additional characteristics to IEC/EN 60947-3		
Insulation voltage (Ui)	440 V AC	
Pollution degree	3	
Rated impulse withstand voltage (Uimp)	6 kV	
Endurance (O-C)		
Electrical to IEC/EN 60947-3	200,000 cycles (AC21)	50,000 cycles (AC21)
	100,000 cycles (AC22)	20,000 cycles (AC22)
Overvoltage category	IV	
Other characteristics		
Degree of protection (IEC 60529)	Device only	IP20
	Device in modular enclosure	IP40 Insulation class II
Operating temperature	-20°C to +50°C	
Storage temperature	-40°C to +70°C	
Tropicalization (IEC 60068-1)	Treatment 2 (relative humidity 95 % at 55°C)	



iTL impulse relays Electrical auxiliaries for iTL impulse relays

Auxiliaries	Indication	Control		
Type	iATLs	iATLc	iATLc+s	iATLc+c
				
	Indication	Centralised control	Centralised control + indication	Multi-level centralised control

Function	iATLs	iATLc	iATLc+s	iATLc+c
	<ul style="list-style-type: none"> Allows remote indication of the associated impulse relay 	<ul style="list-style-type: none"> Used for centralised control, thanks to a "pilot line", of a group of impulse relays controlling separate networks, while at the same time maintaining local individual control of each impulse relay 	<ul style="list-style-type: none"> And for remote indication of the mechanical status of each relay 	<ul style="list-style-type: none"> Used to control the centralised controls of a number of impulse relay groups, while at the same time maintaining local individual control and centralised control by level

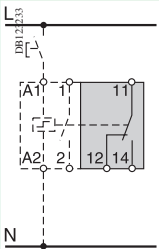
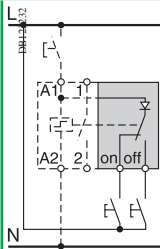
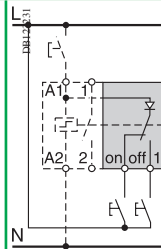
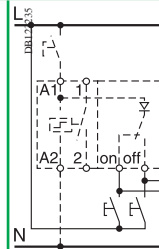
Wiring diagrams	iATLs	iATLc	iATLc+s	iATLc+c
				



Mounting	iATLs	iATLc	iATLc+s	iATLc+c
	<ul style="list-style-type: none"> Mounted to the right of iTL by yellow clips 	<ul style="list-style-type: none"> Mounted to the right of iTL by yellow clips 	<ul style="list-style-type: none"> Mounted to the right of iTL by yellow clips 	<ul style="list-style-type: none"> Without mechanical link with impulse relays and auxiliaries

Catalogue numbers	A9C15405	A9C15404	A9C15409	A9C15410

Technical specifications					
Control voltage (Ue)	V AC	24...240	24...240	24...240	24...240
	V DC	24...240	-	-	-
Width in 9 mm modules		1	1	2	2
Auxiliary contact (breaking capacity)		<ul style="list-style-type: none"> Minimum: 10 mA at 24 V AC/DC Maximum (IEC 60947-5-1): □ 12...240 V AC 6 A □ 12...24 V DC 6 A □ 15...240 V AC 2 A □ 13...24 V DC 2 A 		<ul style="list-style-type: none"> Minimum: 10 mA at 24 V AC/DC Maximum (IEC 60947-5-1): □ 12...240 V AC 6 A □ 12...24 V DC 6 A □ 15...240 V AC 2 A □ 13...24 V DC 2 A 	
Number of contacts		-	-	-	-
Operating temperature	°C	-20°C to +50°C			
Storage temperature	°C	-40°C to +70°C			

iTL impulse relays Electrical auxiliaries for iTL impulse relays (cont.)

Control

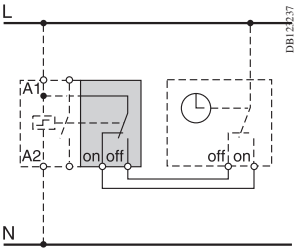
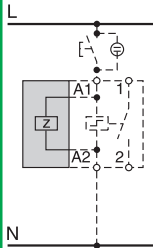
	iATLm	iATEt	iATL4	iATLz	
	Latched control	Time delay	Step by step control	Control by illuminated push-buttons	
PB106138-34		PB106125-34		PB106141-34	
	<ul style="list-style-type: none"> Combined with an impulse relay, it operates on latched orders 	<ul style="list-style-type: none"> Combined with an impulse relay, it automatically disconnects the circuit after a preset time 	<ul style="list-style-type: none"> Allows the step by step sequence over 2 circuits 	<ul style="list-style-type: none"> Used to control impulse relays by illuminated push-buttons, without operating risks 	
DB123234		DB123237	DB123552	DB123230	
		<ul style="list-style-type: none"> 5 time setting ranges: <ul style="list-style-type: none"> 1 to 10 s 6 to 60 s 2 to 10 min 6 to 60 min 2 to 10 h 	<ul style="list-style-type: none"> The cycle is as follows: <ul style="list-style-type: none"> 1st impulse - iTL 1 closed, iTL 2 open 2nd impulse - iTL 1 open, iTL 2 closed 3rd impulse - iTL 1 and 2 closed 4th impulse - iTL 1 and 2 open 5th impulse - iTL 1 closed, iTL 2 open, etc 	<ul style="list-style-type: none"> Provide an iATLz when the current drawn up by the illuminated push-buttons is higher than 3 mA (this current is sufficient to keep the coils energised). Above this value, fit one extra iATLz per 3 mA. For example: for 7 mA, fit 2 iATLz 	
	<ul style="list-style-type: none"> Mounted to the right of iTL by yellow clips 	<ul style="list-style-type: none"> Mounted to the left of iTL by yellow clips 	<ul style="list-style-type: none"> Assembled between 2 impulse relays: according to the auxiliarisation table by yellow clips 	<ul style="list-style-type: none"> Mounted to the left of iTL by yellow clips 	
	A9C15414	A9C15419	A9C15412	A9C15413	
	12...240	24...240	230	130...240	
	6...110	24...110	-	-	
	1	2	4	2	
	-	-	-	-	
	-	-	-	-	
	-20°C to +50°C				
	-40°C to +70°C				

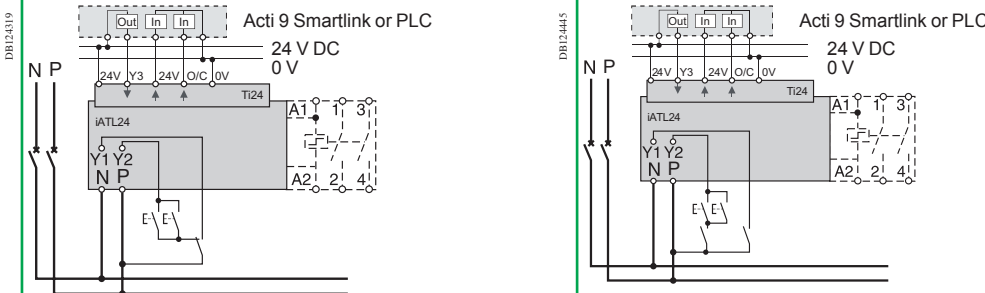

iTL impulse relays Electrical auxiliaries for iTL impulse relays (cont.)

		Control and indication
Auxiliaire	iATL24	
Type	Control and indication 24 V DC	
	With Ti24 connector	
		
Function	<ul style="list-style-type: none"> ■ This auxiliary allows a impulse relay to be interfaced with the Acti 9 Smartlink interface or a programmable logic controller (PLC) in 24 V DC (control, O/C indication) ■ 230 V AC control 	
Wiring diagrams		
Mounting	<ul style="list-style-type: none"> ■ To the left of the iTL impulse relay using the yellow clips⁽¹⁾. ■ When an iATL24 is used, the A1/A2 terminals of the impulse relay should not be wired. Only the yellow clips integral with the iATL24 should be used for connection to the coil. 	
Utilization	<ul style="list-style-type: none"> ■ 230 V AC interface: <ul style="list-style-type: none"> □ Y1: enabling of 24 V DC control (Y1 = 1) or inhibition of 24 V DC control (Y1 = 0). □ Y2: 230 V pulse control ■ "Ti24" 24 V DC interface: <ul style="list-style-type: none"> □ Y3: 24 V DC control of iTL closing on rising edge and opening on falling edge □ reading of the impulse relay status (opened or closed) from the position of the integrated O/C auxiliary contact □ monitoring of connection of the "Ti24" terminal block by the upstream system (PLC, supervision system) via the 24 V terminal (in the centre of the Ti24 terminal block) 	
Catalogue numbers	A9C15424	
Technical specifications		
Control voltage (Ue)	V AC	230, +10 %, -15 % (Y2)
	V DC	24, ± 20 % (Y3)
Operating frequency	Hz	50
Insulation voltage (Ui)	V AC	250
Rated impulse withstand voltage (Uimp)	kV	8
Pollution degree		3
Degree of protection		IP20B device only IP40 device in modular enclosure
Width in 9 mm modules		2
Auxiliary contact (O/C) Ti24		24 V DC protected output, min. 2 mA, max. 100 mA
Contact		1 O/C operating category AC 14
Operating temperature	°C	-25°C to +60°C
Storage temperature	°C	-40°C to +80°C
Consumption		<1 W
Standard		IEC/EN 60947-5-1

(1) Mechanical and electrical connection.

iTL impulse relays Electrical auxiliaries for iTL impulse relays (cont.)



Operation of the iATL24

O/C 24 V DC output

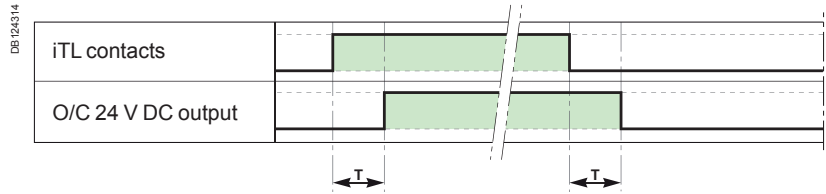

Parameter	Min	Max
T Time delay between iATL24 closing and indication	100 ms	200 ms

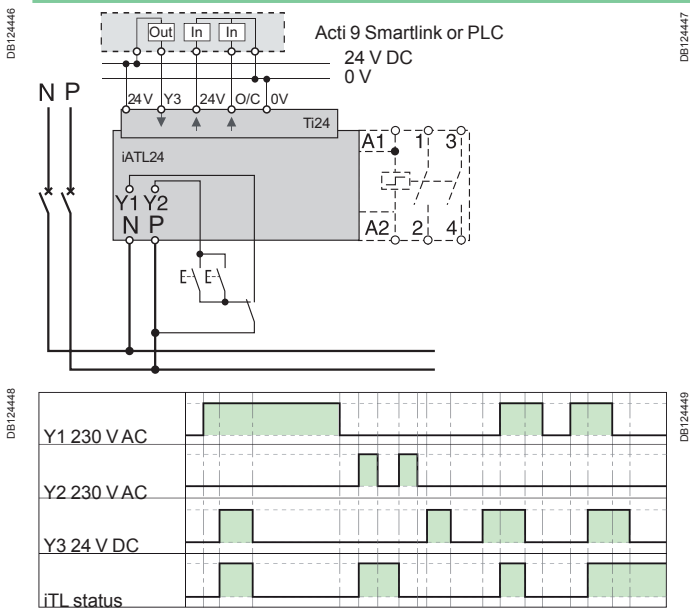

- Minimum duration of 230 V AC pulse (Y2): 200 ms.
- 30 iATL24 closing or opening actuations are authorized per minute: Minimum time delay between 2 actuations on the iATL24 via Y1, Y2, Y3 (closing or opening of the iTL coil): 440 ms.
- 10 closing or opening actuations spaced 440 milliseconds apart are authorized following no loading of the iATL24 during a period of 20 seconds.

Wiring with exclusive selector 230 V AC and 24 V DC controls

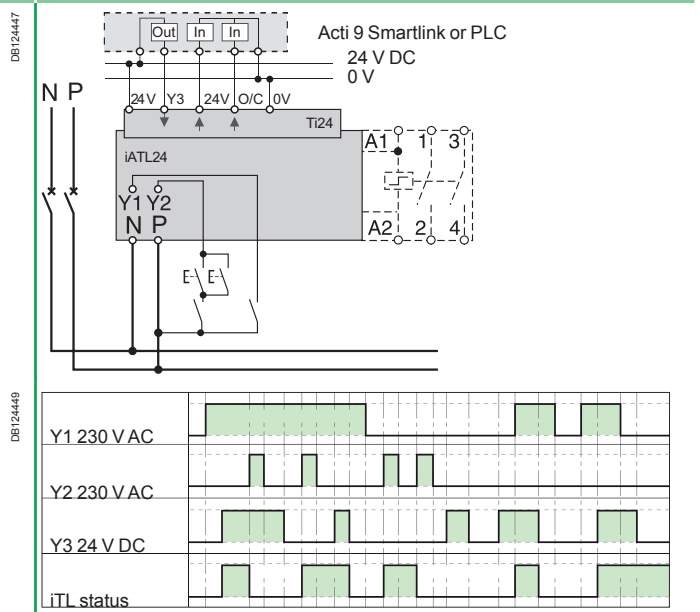

Wiring for non-exclusive 230 V AC and 24 V DC controls



		Security	
Accessories	Yellow clips	Spacer	
			
	PBI06143-10	PBI04483	
Function			
	<ul style="list-style-type: none"> ■ Ensure the mechanical and/or electrical link between impulse relays and their auxiliaries (set of 10). 		<ul style="list-style-type: none"> ■ Required to reduce temperature rise of modular devices installed side by side. ■ Recommended to separate electronic devices (thermostat, programmable clock, etc.) from electromechanical devices (relays, contactors).
Catalogue numbers			
	A9C15415		A9A27062
Technical specifications			
Width in 9 mm modules	-		1

Dimensions (mm)

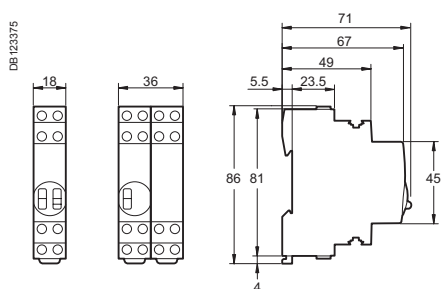

iTL 1P
iTLc
iTLm
iTLs
iTLi
iETL

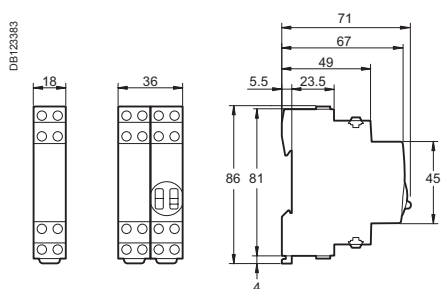

iATLc+s
iATLc+c
iATLz
iATL4

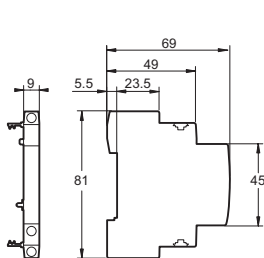

iATLc
iATLs
iATLm

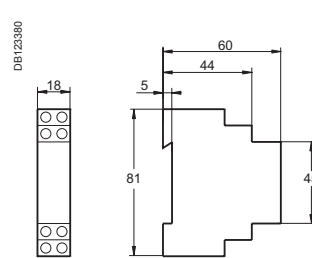

iATEt

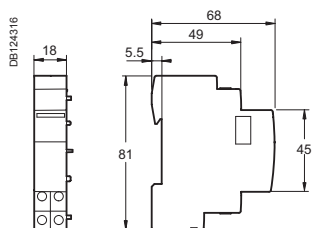

iATL24

iTL+ high-performance impulse relays

EN 60669-2-2

The iTL+ high-performance impulse relay allows remote control of single-phase circuits. It is designed for demanding applications.

The iTL+ high-performance impulse relay is used for push-button control of lighting circuits consisting of:

- incandescent lamps, low-voltage halogen lamps, etc. (resistive loads)
- fluorescent tubes, discharge lamps, etc. (inductive loads).

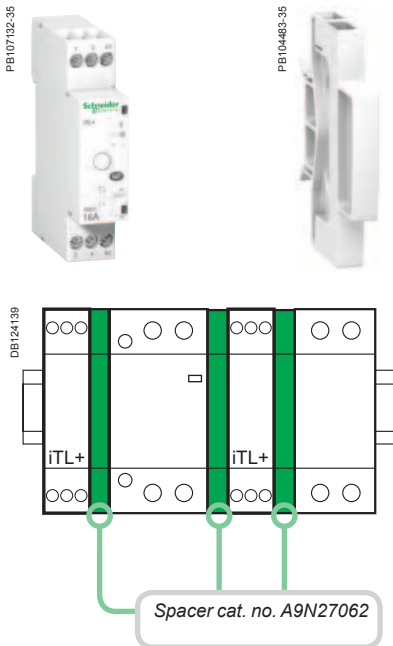

iTL+			
Type	Rating		Width in 9 mm modules
1P+N			
	16 A	A9C15032	2+1 ⁽¹⁾

(1) Supplied with a 9 mm spacer (cat. no. A9N27062): to be used for mounting the iTL+ alongside a circuit breaker, contactor, impulse relay, etc., in order to maintain optimal operation.



It is compulsory:

- to connect the neutral
- to keep the same control circuit connection "A1: phase", "A2: neutral"
- to use the same phase for connection of the power and control functions.

Operation

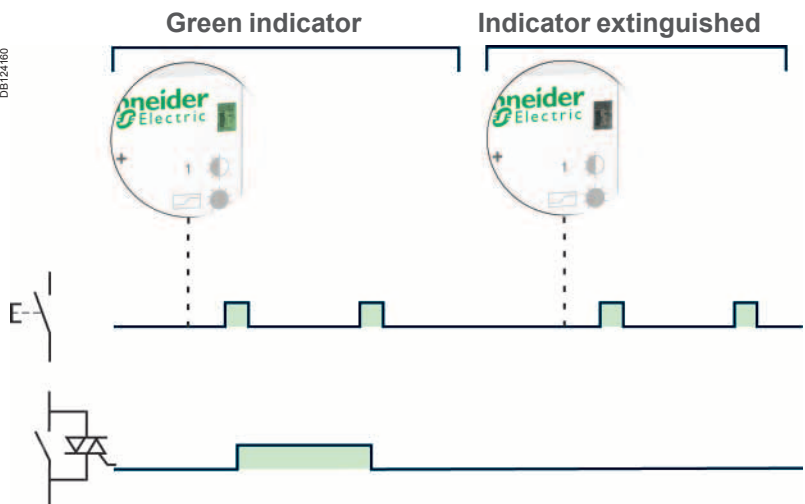
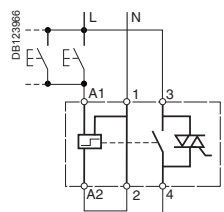

Connection

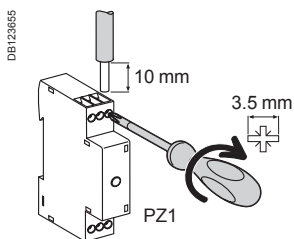

Type	Rating	Tightening torque	Copper cables	
			Rigid or flexible with ferrule	Rigid or flexible without ferrule
iTL+	16 A	1 N.m		

iTL+ high-performance impulse relays (cont.)

They combine the benefits of static switching and electromechanical technology: small size, little temperature rise.

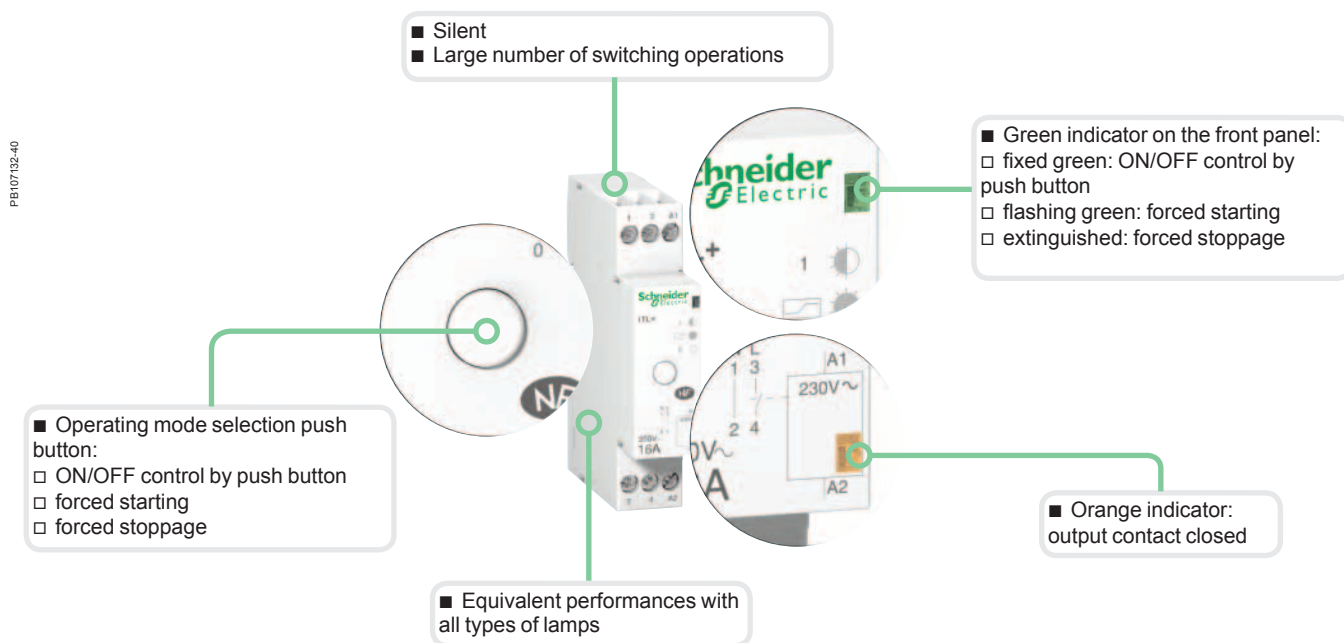

Following a mains failure, the iTL+ returns to 0 position (forced stoppage) irrespective of its initial state.

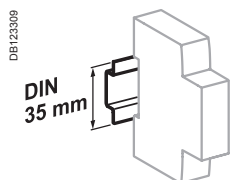

Clip on DIN rail 35 mm.

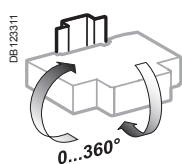

Indifferent position of installation.

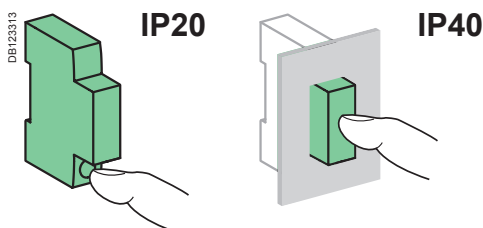

Technical data

Control circuit		
Coil voltage (Uc)		230 V AC
Frequency		50 Hz
Inrush power		11 VA
Holding power		1.1 VA
Control by luminous push button		Max. current 5 mA
Control order duration		50 ms to 1 s (recommended 200 ms)
Power circuit		
Voltage rating (Ue)		230 V AC
Frequency		50 Hz
Electrical load	Minimum	20 W
	Maximum	3600 W
Max. number of switching operations per minute		6
Other characteristics		
Degree of protection (IEC 60529)	Device only	IP20
	Device in modular enclosure	IP40 Insulation class II
Endurance (O-C)	Electrical	5.000.000 cycles (AC21 - AC22)
Noise level at activation		< 30 dBA
Operating temperature		-5°C to +55°C
Storage temperature		-40°C to +60°C
Tropicalization (IEC 60068-1)		Treatment 2 (relative humidity of 95 % at 55°C)

Weight (g)

High-performance impulse relays	
Type	iTL+
1P+N	70

EN 60669-2-2

iCT+ high-performance contactors allow remote control of single-phase circuits. They are designed for demanding applications.

iCT+ high-performance contactors can be used for remote control of applications on AC networks:

- lighting, heating, ventilation, roller blinds, domestic hot water
- mechanical ventilation systems, etc.
- load shedding on non-priority circuits.

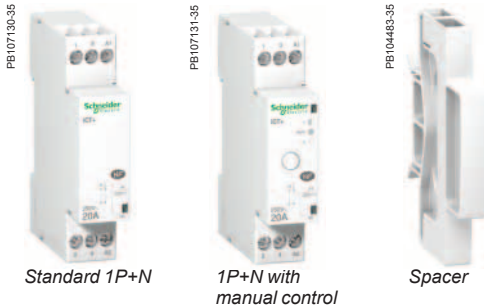

Standard 1P+N

1P+N with manual control

Spacer

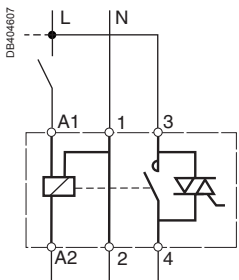
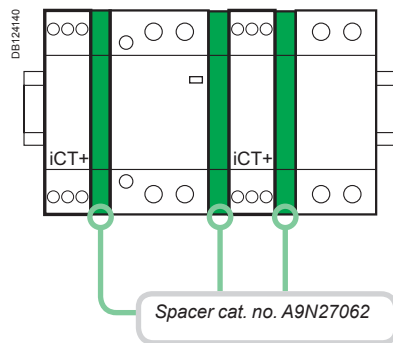

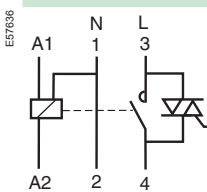
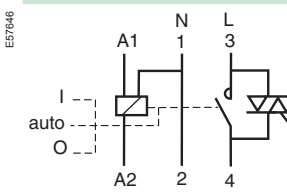
iCT+				
Type	Rating	Contact		Width in 9-mm modules
Standard 1P+N				
	20 A	1 NO	A9C15030	2+1 ⁽¹⁾
1P+N with manual control				
	20 A	1 NO	A9C15031	2+1 ⁽¹⁾

(1) Supplied with a 9 mm spacer (cat. no. A9N27062): to be used for mounting the iCT+ alongside a circuit breaker, contactor, impulse relay, etc., in order to maintain optimal operation.



It is compulsory:

- to connect the neutral
- to keep the same control circuit connection "A1: phase", "A2: neutral"
- to use the same phase for connection of the power and control functions.

Operation (manual-control contactor)

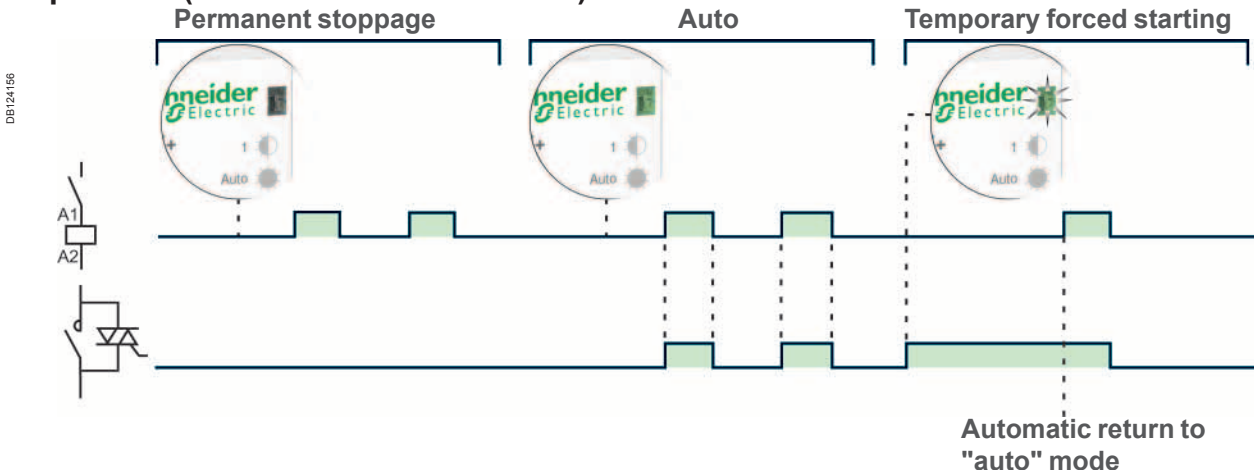

iCT+ high-performance contactors (cont.)

They combine the benefits of static switching and electromechanical technology: small size, little temperature rise.

■ Silent
■ Large number of switching operations

■ Green indicator on the front panel:
□ fixed green: auto operation
□ flashing green: temporary forced starting
□ extinguished: permanent stoppage

■ Operating mode selection push button:
□ auto operation
□ temporary forced starting*
□ permanent stoppage

■ Orange indicator: output contact closed

■ Equivalent performances with all types of lamps
■ No derating

Following a mains failure, the iCT+ returns to "auto" operating mode irrespective of its initial state.

Connection

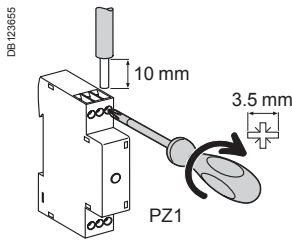

Type	Tightening torque	Copper cables	
		Rigid or flexible with ferrule	Rigid or flexible without ferrule
iCT+	1 N.m	2 x 1.5 mm ²	2 x 2.5 mm ² 1 x 4 mm ²

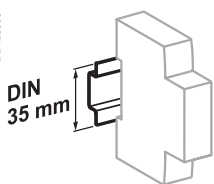

Clip on DIN rail 35 mm.

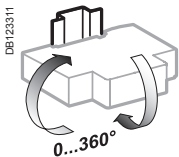

Indifferent position of installation.

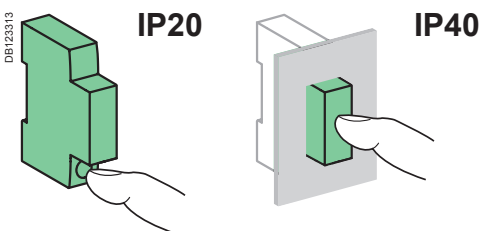

Technical data

Control circuit		
Coil voltage (U _c)		230 V AC (± 10 %)
Frequency		50 Hz
Inrush power		11 VA
Holding power		1.1 VA
Power circuit		
Voltage rating (U _e)		230 V AC (± 10 %)
Frequency		50 Hz
Electrical load	Minimum	20 W
	Maximum	3600 W
Max. number of switching operations per minute		6
Other characteristics		
Endurance (O-C)	Electrical	5.000.000 cycles
Pollution degree		3
Degree of protection (IEC 60529)	Device only	IP20
	Device in modular enclosure	IP40
Operating temperature		-5°C to +55°C
Storage temperature		-40°C to +60°C
Tropicalization (IEC 60068-1)		2 (relative humidity of 95 % at 55°C)

Weight (g)

High-performance contactors	
Type	iCT+
Standard 1P+N	70
1P+N with manual control	70

IEC 60669-1 and IEC 60947-5-1

■ iPB pushbuttons are used to control electric circuits by means of pulses.

Catalogue numbers

iPB pushbuttons														
Type	Single				Double		Single + indicator light							
Diagram														
Pushbutton Colour	Grey	Red	Grey	Grey	Green/red	Grey/grey	Grey	Grey	Grey	Grey	Grey	Grey	Grey	
Indicator light	Power supply	-	-	-	-	-	110...230 V AC		12...48 V AC/DC					
	Colour	-	-	-	-	-	Green	Red	Green	Red	Green	Red	Red	
Cat. no.	A9E18030	A9E18031	A9E18032	A9E18033	A9E18034	A9E18035	A9E18036	A9E18037	A9E18038	A9E18039	A9E18039	A9E18039	A9E18039	
Width in 9 mm modules	2				2		2							

Connection

Tightening torque	Copper cables	
	Rigid	Flexible or ferrule
1 N.m		
	0.5 mm ² min. 2 x 2.5 mm ² max.	0.5 mm ² min. 2 x 2.5 mm ² max.

- Phase-separated wall that can be divided to allow the teeth of all types of comb busbar to pass through.
- Staggered terminals to simplify connection.

Dimensions (mm)

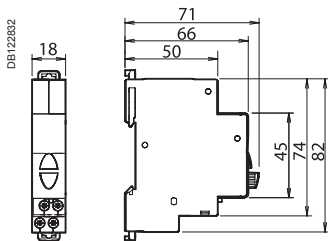



Technical data

Main characteristics	
Pollution degree	3
Power circuit	
Voltage rating (Ue)	250 V AC
Current rating (Ie)	20 A
Additional characteristics	
Endurance (O-C)	30,000 operations AC22 (cos φ = 0.8)
Operating temperature	-35°C... +70°C
Storage temperature	-40°C... +80°C
Tropicalization	Treatment 2 (relative humidity 95 % at 55°C)
LED indicator light	Consumption: 0.3 W Service life: 100,000 hours of constant lighting efficiency Maintenance-free indicator light (non-interchangeable LEDs)



IEC 60669-1 and IEC 60947-5-1

■ iSSW linear switches are used for the manual control of electric circuits.

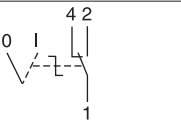
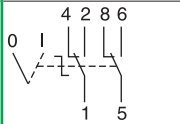
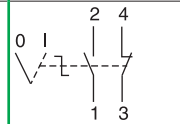
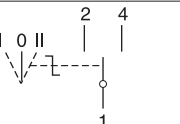
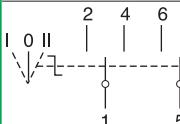
Catalogue numbers

iSSW linear switches					
Type	2 positions			3 positions	
					
Contact	1 changeover switch	2 changeover switches	1 NO + 1NC	1 changeover switch	2 changeover switches
Diagram					
Cat. no.	A9E18070	A9E18071	A9E18072	A9E18073	A9E18074
Width in 9 mm modules	2	4	2	2	4

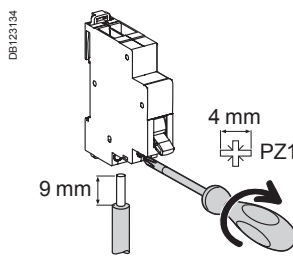
Connection

	Tightening torque		Copper cables	
	Rigid	Flexible or ferrule	Rigid	Flexible or ferrule
1 N.m	0.5 mm ² min. 2 x 2.5 mm ² max.	0.5 mm ² min. 2 x 2.5 mm ² max.		

- Phase-separated wall that can be divided to allow the teeth of all types of comb busbar to pass through.
- Staggered terminals to simplify connection.

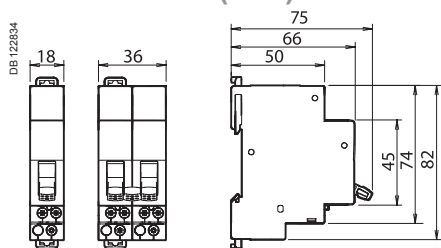

Dimensions (mm)



Technical data

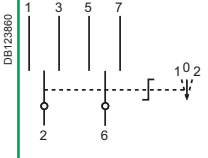
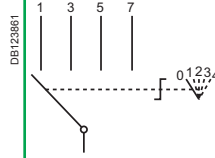
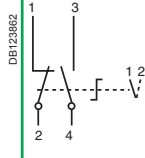

Main characteristics	
Pollution degree	3
Power circuit	
Voltage rating (Ue)	250 V AC
Current rating (Ie)	20 A
Additional characteristics	
Endurance (O-C)	30,000 cycles AC22 (cos φ = 0.8)
Operating temperature	-20°C... +50°C
Storage temperature	-40°C... +70°C
Tropicalization	Treatment 2 (relative humidity 95 % at 55°C)

DIN rail selector switches iCMB, iCMD, iCME, iCMC, iCMV and iCMA

		Control																													
Selector switches		iCMB	iCMD	iCME																											
Type		Two-pole with zero setting	4-way	2-way for electronic circuits																											
In compliance with standards		IEC 60947-3 (EN 60947-3) VDE 0660 part. 107 UL	IEC 60947-3 (EN 60947-3) VDE 0660 part. 107 UL	IEC 60947-3 (EN 60947-3) VDE 0660 part. 107 UL																											
																															
Function		<ul style="list-style-type: none"> This two-pole selector switch with zero setting allows manual control of a circuit with 2-way operation with a stop position 	<ul style="list-style-type: none"> This 4-way selector switch allows control of a circuit with operating priorities 	<ul style="list-style-type: none"> This 2-way selector switch is used specially for the control of electronic circuits of low voltage and current level 																											
Wiring diagrams																															
Use		Example: electrically controlled metal screen: <ul style="list-style-type: none"> position 1 = raising position 0 = stop position 2 = lowering 	Example: fan control: <ul style="list-style-type: none"> position 0 = stop position 1 = override operation, slow speed position 2 = override operation, high speed position 3 = remote control position 4 = automatic operation 	<ul style="list-style-type: none"> Voltage range from 30 mV to 600 V AC 																											
Catalogue numbers		A9E15120	A9E15121	A9E15122																											
Technical specifications																															
Rated voltage (Ue)	V AC	415	415	See following table																											
Maximum operating voltage	V	440	440	440																											
Rating	A	10	10	See following table																											
Operating frequency	Hz	50/60	50/60	50/60																											
Width in 9-mm modules		4	4	4																											
Breaking capacity (resistive load)		–	–	<table border="1"> <thead> <tr> <th></th> <th>V AC</th> <th>V DC</th> </tr> </thead> <tbody> <tr> <td>1 V</td> <td>5 A</td> <td>3 A</td> </tr> <tr> <td>12 V</td> <td>1.2 A</td> <td>0.7 A</td> </tr> <tr> <td>24 V</td> <td>0.7 A</td> <td>0.4 A</td> </tr> <tr> <td>48 V</td> <td>0.45 A</td> <td>0.25 A</td> </tr> <tr> <td>110 V</td> <td>0.25 A</td> <td>0.13 A</td> </tr> <tr> <td>240 V</td> <td>0.15 A</td> <td>0.08 A</td> </tr> <tr> <td>300 V</td> <td>0.13 A</td> <td>0.07 A</td> </tr> <tr> <td>440 V</td> <td>0.1 A</td> <td>0.05 A</td> </tr> </tbody> </table>		V AC	V DC	1 V	5 A	3 A	12 V	1.2 A	0.7 A	24 V	0.7 A	0.4 A	48 V	0.45 A	0.25 A	110 V	0.25 A	0.13 A	240 V	0.15 A	0.08 A	300 V	0.13 A	0.07 A	440 V	0.1 A	0.05 A
	V AC	V DC																													
1 V	5 A	3 A																													
12 V	1.2 A	0.7 A																													
24 V	0.7 A	0.4 A																													
48 V	0.45 A	0.25 A																													
110 V	0.25 A	0.13 A																													
240 V	0.15 A	0.08 A																													
300 V	0.13 A	0.07 A																													
440 V	0.1 A	0.05 A																													
Operating temperature	°C	-20...+55	-20...+55	-20...+55																											
Storage temperature	°C	-25...+80	-25...+80	-25...+80																											

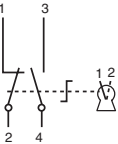
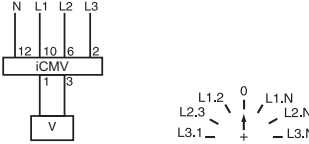
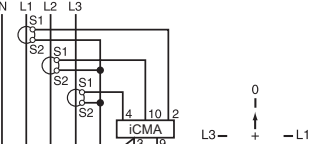

DIN rail selector switches iCMB, iCMD, iCME, iCMC, iCMV and iCMA (cont.)

iCMC	iCMV	iCMA
2-way key-actuated	7-position voltmeter	4-position ammeter
IEC 60947-3 (EN 60947-3) VDE 0660 part. 107 UL	IEC 60947-3 (EN 60947-3) VDE 0660 part. 107 UL	IEC 60947-3 (EN 60947-3) VDE 0660 part. 107 UL
		
<p>■ 2-way key-actuated selector switch with locking in one or the other position</p>	<p>■ This 7-position voltmeter selector switch makes it possible, with a single voltmeter, to measure in succession the voltages (phase-to-phase and phase-to-neutral) of a three-phase circuit</p>	<p>■ This 4-position ammeter selector switch makes it possible, with a single ammeter (using current transformers), to measure in succession the currents of a three-phase circuit</p>
		
-	-	-
A9E15123	15125	15126
415	415	415
440	440	440
10	10	10
50/60	50/60	
4	4	4
-	-	-
-20...+55	-20...+55	-20...+55
-25...+80	-25...+80	-25...+80

DIN rail selector switches iCMB, iCMD, iCME, iCMC, iCMV and iCMA (cont.)

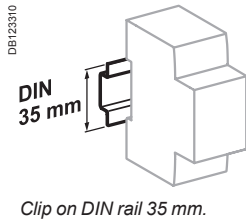

Connection

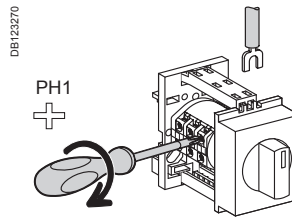

Tightening torque	Copper cables
0.35 N.m	Flexible or rigid with ferrule
	
	< 1.5 mm ²

■ Connection by jumper terminals with captive screws.

Technical data

Additional characteristics		
Degree of protection	Device only	IP20
Endurance (O-C)	Electrical	1,000,000 switching operations
	Mechanical	2,000,000 switching operations (AC21A-3 x 440 V)

Weight (g)

Selector switches	
Type	Weight (g)
iCMA	58
iCMB	58
iCMC	70
iCMD	58
iCME	44
iCMV	58

Dimensions (mm)

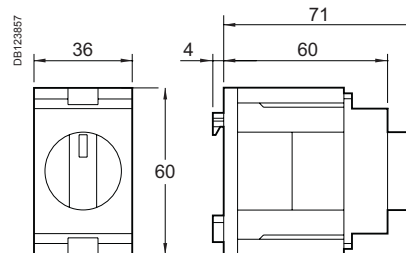

Indication





H



IEC 60947-5-1

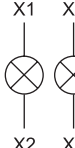
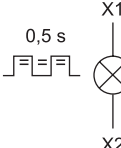
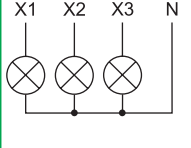

■ iIL indicator lights light up to indicate that a voltage is present.

Catalogue numbers

iIL indicator lights										
Type	Single					Double		Flashing light	Three-phase voltage presence indicator light	
										
Diagram	 X1- X2+					 X1 X3 X2 X4		 0,5 s X1 X2	 X1 X2 X3 N	
Colour	Red	Green	White	Blue	Yellow	Green/red	White/white	Red	Red/red/red	
Cat. no.										
12...48 V AC/DC	A9E18330	A9E18331	A9E18332	A9E18333	A9E18334	A9E18335	-	-	-	
110...230 V AC	A9E18320	A9E18321	A9E18322	A9E18323	A9E18324	A9E18325	A9E18328	A9E18326	-	
230...400 V AC (3 phases)	-	-	-	-	-	-	-	-	A9E18327	
Width in 9 mm modules	2					2		2	2	

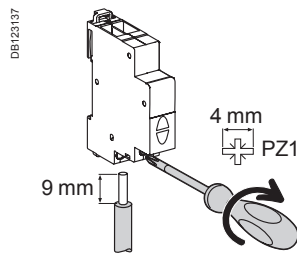
Connection



Tightening torque	Copper cables	
	Rigid	Flexible or ferrule
1 N.m	 0.5 mm ² min. 2 x 2.5 mm ² max.	 0.5 mm ² min. 2 x 2.5 mm ² max.

- Phase-separated wall that can be divided to allow the teeth of all types of comb busbar to pass through.
- Staggered terminals to simplify connection.

Dimensions (mm)

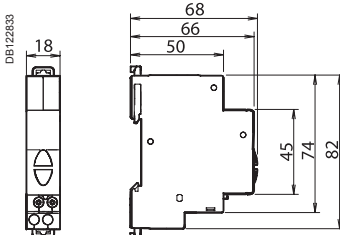

Technical data

Main characteristics	
Pollution degree	3
Power circuit	
Operating frequency	50...60 Hz
Flashing frequency	2 Hz
Additional characteristics	
Operating temperature	-35°C... +70°C
Storage temperature	-40°C... +80°C
Tropicalization	Treatment 2 (relative humidity 95 % at 55°C)
LED indicator light	Consumption per indicator light: 0.3 W
	Service life: 100,000 hours of constant lighting efficiency
	Maintenance-free indicator light (non-interchangeable LEDs)



SO and iRO

Audible indication in housing and the tertiary sector.

Catalogue numbers

Bell and buzzer			
Type	Voltage (Ue)		Width in 9 mm modules
SO bell DB123820	230 V AC	15320	2
	8...12 V AC	15321	2
iRO buzzer DB123821	230 V AC	A9A15322	2
	8...12 V AC	A9A15323	2
Operating frequency		50...60 Hz	

Connection

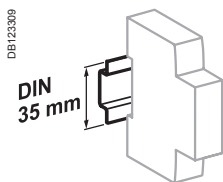

Clip on DIN rail 35 mm.

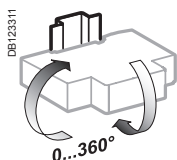

Indifferent position of installation.

Tightening torque	Copper cables	
	Rigid	Flexible or ferrule
1.3 N.m	< 4 mm ²	< 4 mm ²

Technical data

Main characteristics		SO	iRO
Consumption	8...12 V AC	3.6 VA	
	220...240 V AC	5 VA	
Additional characteristics			
Degree of protection (IEC 60529)	Device only	IP40	
	Device in modular enclosure	IP20	
Operating temperature		-10°C to +40°C	
Storage temperature		-25°C to +60°C	
Sound level (at a distance of 60 cm)		80 dBA	70 dBA

Weight (g)

Bell and buzzer	
Type	Weight (g)
SO	77
iRO	64

Dimensions (mm)

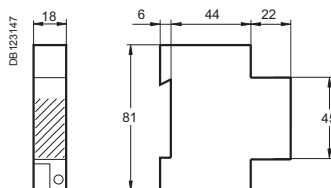

SO bell and iRO buzzer

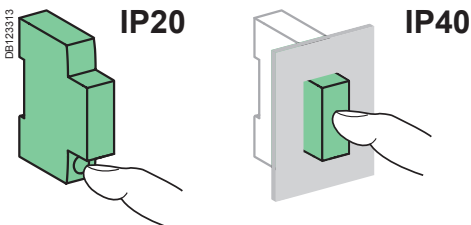

NF EN 60742, EN and IEC 61558-2-6, Approval NF USE

Bell transformers and safety transformers allow for a very low voltage (ELV 8 V, 12 V or 24 V) to be obtained from a low voltage network (LV 230 V).

All Schneider Electric transformers are:

- Safe: primary and secondary circuits are perfectly insulated by each other
- Resistant to short-circuit currents thanks to the built-in device
- Class II with terminal shield (optional).

PE107156-35



PE107156-35



Catalogue numbers



Bell transformer				
Type	Power	Secondary voltage		Width in 9 mm modules
E56759 	4 VA	8 V AC	A9A15214	4
	4 VA	8-12 V AC	A9A15213	4
E56760 	8 VA	8-12 V AC	A9A15216	4
	16 VA	8-12 V AC	A9A15212	4
E56761 	25 VA	12-24 V AC	A9A15215	6

Safety transformer				
Type	Power	Secondary voltage		Width in 9 mm modules
DB124153 	16 VA	12-24 V AC	A9A15218	10
	25 VA	12-24 V AC	A9A15219	10
DB124154 	40 VA	12-24 V AC	A9A15220	10
	63 VA	12-24 V AC	A9A15222	10
DB124155 				
Operating frequency	50/60 Hz			

Terminal shield	
Type	Width in 9 mm modules
15228	4
15229	6
15230	10

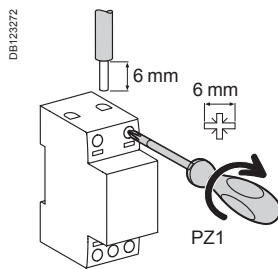
Connection



Tightening torque	Copper cables	
	Rigid	Flexible or with ferrule
0.5 N.m	 < 2.5 mm ²	 < 2.5 mm ²

Technical data

Main characteristics

Primary voltage	230 V AC ±10 %
Secondary voltage on load	For bell transformers: 8-12-24 V AC ±15 % For safety transformers: 12-24 V AC ±5 %

Transformer catalogue numbers	Rated secondary voltage	Off load voltage
A9A15214	8 V	12 V
A9A15213	8 V	12 V
	12 V	16 V
A9A15216	8 V	13 V
	12 V	18 V
A9A15212	8 V	13 V
	12 V	18 V
A9A15215	12 V	16 V
	24 V	32 V
A9A15218	12 V	14 V
	24 V	28 V
A9A15219	12 V	14 V
	24 V	28 V
A9A15220	12 V	14 V
	24 V	28 V
A9A15222	12 V	14 V
	24 V	28 V

Additional characteristics

Degree of protection (IEC 60529)	Device only	IP20 with terminal shield
Operating temperature		-20°C to +55°C
Storage temperature		-25°C to +80°C

Note: Transformers have an off load operating voltage that is higher than the rated voltage. For loads that are sensitive to overloads (electro-magnetic circuits), the transformer must be made to operate at I_n . After operation of the protection device upon an overload, cut-off the power supply and let the transformer cool down before restart.

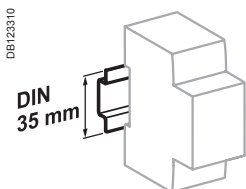

Clip on DIN rail 35 mm.

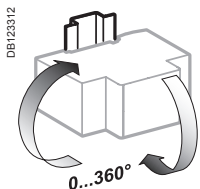

Bell transformer: indifferent position of installation.
Safety transformer: vertical position.

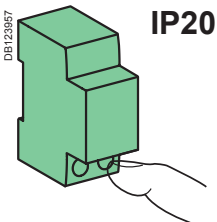

Weight (g)

iTR		
Type	Cat. no.	Weight
Bell	A9A15212	384
	A9A15213	240
	A9A15214	237
	A9A15215	633
	A9A15216	275
Safety	A9A15218	1082
	A9A15219	1125
	A9A15220	1190
	A9A15222	1309

Dimensions (mm)

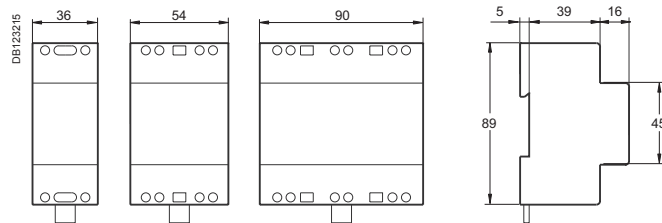

A9A15212
A9A15213
A9A15214
A9A15216

A9A15215

A9A15218
A9A15219
A9A15220
A9A15222

Lighting, time and energy management

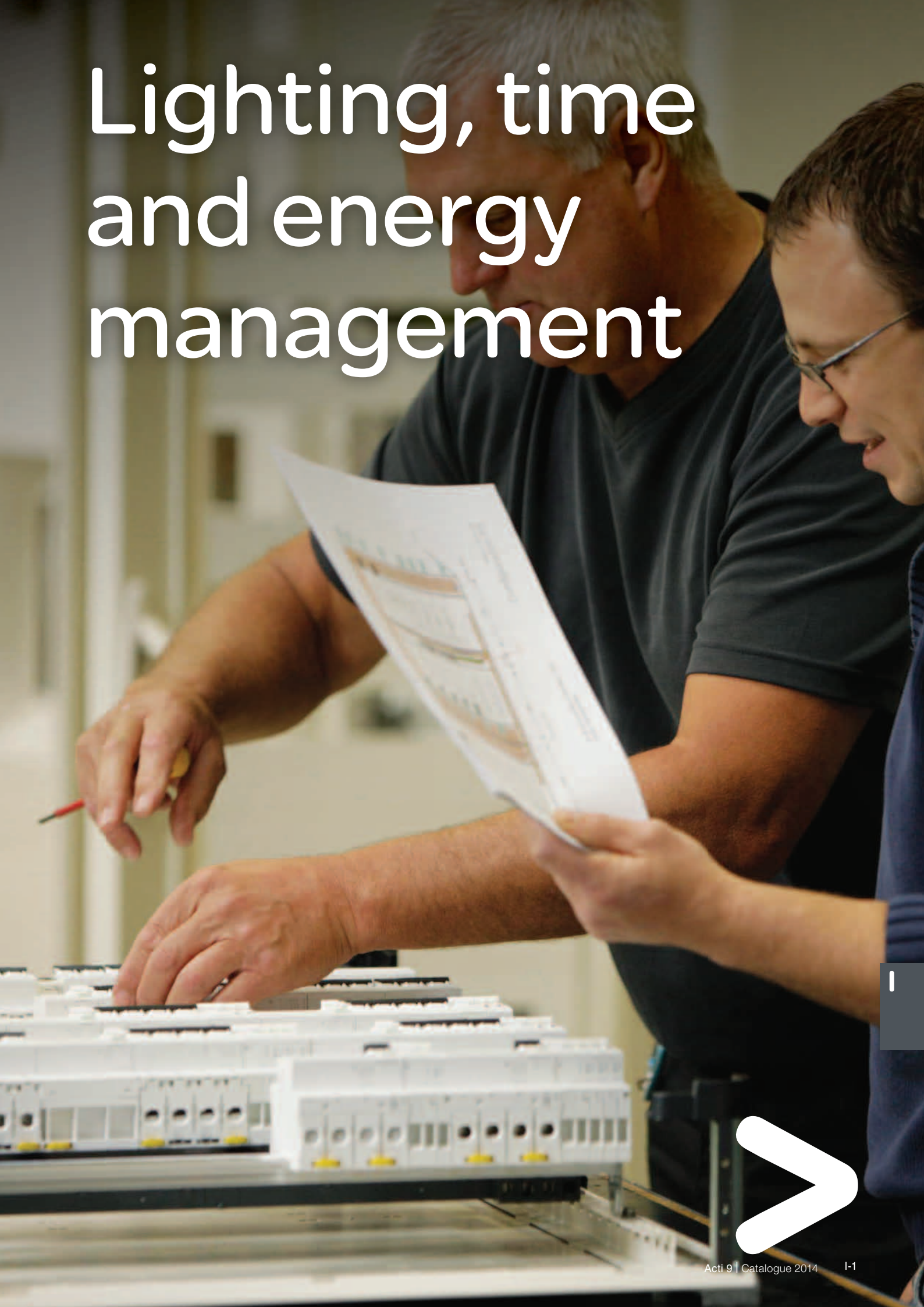

IC100, IC2000, IC2000P+, IC 100k, IC Astro

> Twilight switches

IC100
Adjustable from 2 to 100 lux.
It comes with a wall-mounted cell.



IC2000
Adjustable from 2 to 2000 lux. It comes with a standard wall-mounted or switchboard cell.

IC2000P+
It has 3 customisable pre-set programs and 3 setting ranges from 2 to 2100 lux. Its 4 keys and large screen facilitate its programming.
It comes with a wall-mounted cell.

IC Astro
It operates without photoelectric cell and calculates sunrise and sunset times according to its geographic position.
It can be customised by using its programming function.

IC 100k
Adjustable from 2 to 99000 lux.
Its 4 keys and large screen facilitate its programming.
It comes with a digital wall-mounted or a switchboard cell.

Selection table

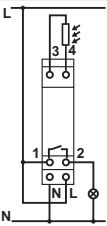
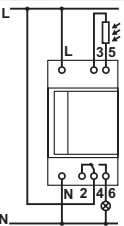
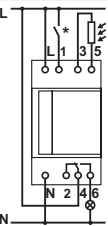
	IC100	IC2000	IC2000P+	
	 P111637 + P106237	 P111639 + P110656 + P106856	 P111640 + P106237	
Function	The IC100 controls closing of a contact when brightness decreases and drops below the selected threshold. It controls opening of a contact when brightness increases and rises above the selected threshold	The IC2000 control closing of a contact when brightness decreases and drops below the selected threshold. They control opening of a contact when brightness increases and rises above the selected threshold	The IC2000P+ controls lighting according to brightness and time. If brightness drops below the set threshold (twilight function: IC) and if the time program allows relay closing (time switch function), then the lighting circuit is activated	
Wiring diagrams	 P1106857	 P1106858	 P1106859	
Catalogue numbers	15482	CCT15284	CCT15368	
			15483 ⁽¹⁾	
Technical specifications				
Delivered with	Wall-mounted cell	Switchboard cell (15281)	Wall-mounted cell (CCT15268)	Wall-mounted cell
Optional accessories	Wall-mounted cell (CCT15268)	Switchboard cell (15281) Wall-mounted cell (CCT15268)	Wall-mounted cell (CCT15268) Switchboard cell (CCT15281)	Wall-mounted cell (CCT15268)
Adjustable brightness threshold	2 to 100 lx	2 to 2000 lx		Range 1: 2 to 50 lx Range 2: 60 to 300 lx Range 3: 350 to 2100 lx
Voltage rating (Ue) (+10 %, -15 %)	230 V AC, 50/60 Hz	230 V AC, 50/60 Hz		230 V AC, 50/60 Hz
Consumption	6 VA	6 VA		3 VA
Operating temperature	-20°C to +50°C	-25°C to +50°C		-20°C to +50°C
Width (9 mm modules)	2	5		5
Insulation class	Class II	Class II		Class II
Degree of protection	IP20B	IP20B		IP20B
Output contact rating $\cos \varphi = 1$ (under 250 VAC) $\cos \varphi = 0.6$	16 A 10 A	16 A 10 A		16 A 10 A
Time delays (On and Off)	20 s (On) 80 s (Off)	≥ 60 s		Adjustable from 20 to 140 s (80 s by default)
Operating accuracy	–	–		< ±1 s / day at 20 °C.
Monitoring indicator light, not time delayed, lit when brightness is less than the threshold	Red	Red		–
Contact switching indicator light	Green	Green		–
LCD liquid crystal display	–	–		Back-lit
Program saving by lithium battery	–	–		■
Operating reserve	–	–		5-6 years
Location for instruction manual on front face	–	■		■
Cabling test function with a push-button on front face	–	■		–
Number of channels	1	1		1
Control by brightness detection	■	■		■
Coupling with weekly programming	–	–		42 switching times Minimum switching: 1 min Switching accuracy: 1 s
Control by calculation of sunrise/sunset times	–	–		–

Languages: (1) English, french, spanish, italian, german, portuguese, swedish, dutch, finnish, norwegian/danish. (2) English, french, spanish, portuguese, hungarian, p

IC100, IC2000, IC2000P+, IC 100k, IC Astro (cont.)

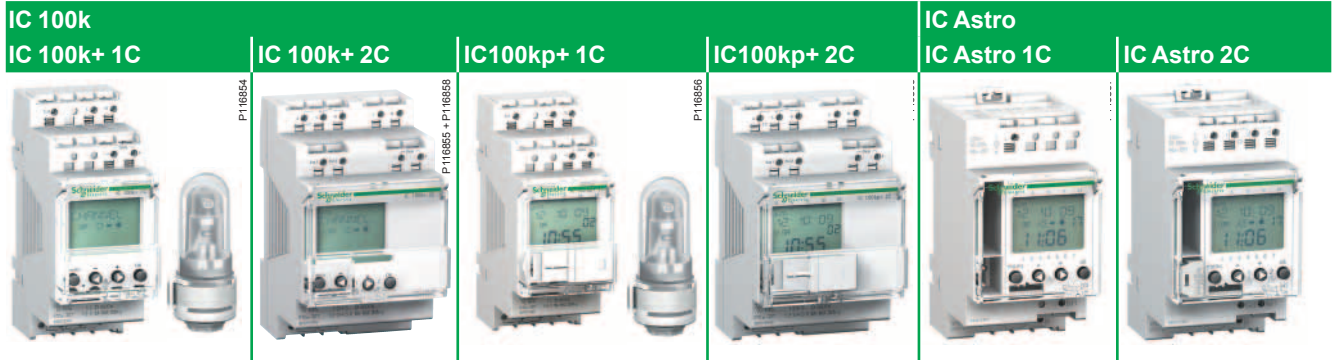

The IC 100k+ 1C/2C control closing of a contact when brightness decreases and drops below the selected threshold. It controls opening of a contact when brightness increases and rises above the selected threshold

The IC100kp+ 1C/2C control lighting according to brightness and time. If brightness drops below the set threshold (twilight function: IC) and if the time program allows relay closing (time switch function), then the lighting circuit is activated

The IC Astro astronomic programmable twilight switch is used to start and stop an electric load (e.g. lighting) according to sunrise and sunset times, without a brightness detector. Sunrise and sunset times are calculated automatically by the IC Astro according to the geographic parameters configured by the user

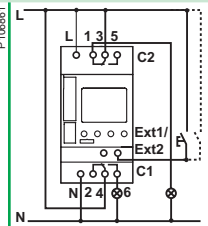
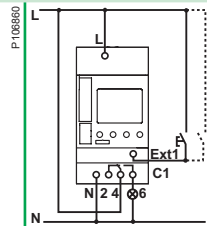
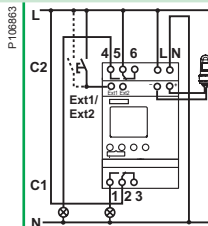
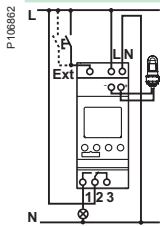

CCT15250 (2)
CCT15251 (3)

CCT15252 (2)
CCT15253 (3)

CCT15490 (2)
CCT15491 (3)

CCT15492 (2)
CCT15493 (3)







CCT15223 (2)
CCT15224 (3)

CCT15243 (2)
CCT15244 (3)

Digital wall-mounted cell (CCT15260)		Digital wall-mounted cell (CCT15260) Memory key (alone) (CCT15861)		– Memory key (alone) (CCT15861)	
Digital wall-mounted cell (CCT15260) Digital switchboard cell (CCT15261) Programming kit for PC (CCT15860)		Digital wall-mounted cell (CCT15260) Digital switchboard cell (CCT15261) Programming kit for PC (CCT15860) Memory key (alone) (CCT15861)		Programming kit for PC (CCT15860) Memory key (alone) (CCT15861)	
1 to 99000 lx		1 to 99000 lx		According to sunrise/sunset times	
230 V AC, 50/60 Hz	100-240 V AC, 50/60 Hz	230 V AC, 50/60 Hz	100-240 V AC, 50/60 Hz	230 V AC, 50/60 Hz	
3 VA		3 VA		3 VA	6 VA
-30°C to +50°C		-30°C to +50°C		-25°C to +45°C	
4	6	4	6	5	
Class II		Class II		Class II	
IP20C		IP20C		IP20B	
16 A		16 A		16 A	
10 A		10 A		10 A	
Adjustable from 0 to 59.59 min.				Difference in sunset and/or sunrise times adjustable separately by ±120 min.	
–		–		–	
–		–		–	
–		–		–	
Back-lit		Back-lit		Back-lit	
■		■		■	
10 years		10 years		6 years	
–		–		–	
–		–		–	
1	2	1	2	1	2
–		–		–	
–		84 switching times Operating accuracy: < ±1 s / day at 20°C Minimum switching: 1 min Switching accuracy: 1 s		84 switching times (not including sunrise/sunset) Minimum time between 2 switching operations: 1 min. Switching accuracy: 1 s Time accuracy: ±1 s /day	
–		–		■	

bulgarian, greek, slovene, serbian, croatian. (3) English, french, italian, german, swedish, dutch, finnish, danish, russian, ukrainian, latvian, lituanien, estonian, turkis

Accessories selection table

	Wall-mounted cell	Switchboard cell	Programming kit for PC	Memory key	Digital wall-mounted cell	Digital switchboard cell	
							
Function	Wall-mounted photoelectric cell	Switchboard photoelectric cell	Consists of a programming device, a memory key, a CDROM and a 2 m USB cable	Saving and duplicating programs	Digital wall-mounted photoelectric cell	Digital wall-mounted photoelectric cell	
Mounting	<ul style="list-style-type: none"> Delivered with its fixing device for IC100 and IC200P+ Replaced by CCT15268 for spare part use Cell connection: by double insulation 2-conductor cable, not to be laid next to mains cables or water ducts, maximum length: 25 m 	Delivered with 1 m cable and its fixing device	<ul style="list-style-type: none"> Delivered with its fixing device Cell connection: by double insulation 2-conductor cable, not to be laid next to mains cables or water ducts, maximum length: 100 m 	–	–	<ul style="list-style-type: none"> Delivered with its fixing device. Cell connection: <ul style="list-style-type: none"> by double insulation 2-conductor cable: <ul style="list-style-type: none"> - 0.5 - 2.5 mm² for CCT15260 - 0.25 - 1.5 mm² for CCT15261 Not to be laid next to mains cables or water ducts, maximum length: <ul style="list-style-type: none"> - 100 m (2 x 1.5 mm²) - 50 m (2 x 0.75 mm²) 	
Catalogue no.	–	CCT15268	15281	CCT15860	CCT15861	CCT15260	CCT15261

Technical specifications

	IP54	IP65	IP54	–	–	IP55	IP66
Degree of protection	IK05	–	IK05	–	–	–	–
Operating temperature	-40°C to +70°C	-40°C to +70°C	-40°C to +70°C	–	–	-40°C to +70°C	-40°C to +70°C
Horizontally orientable	–	–	90°	–	–	90°	90°

Load table

Type of lighting (230 V AC)	Max. power (for higher power, relay with a contactor)				
	IC100	IC2000	IC2000P+	IC Astro	IC 100k
Incandescent and halogen lamps	2300 W	2300 W	2300 W	2300 W	2600 W
Non-corrected / serial-corrected / dual mounted fluorescent tubes with conventional ballast	2300 VA	2300 VA	26 x 36 W, 20 x 58 W, 10 x 100 W	26 x 36 W, 20 x 58 W, 10 x 100 W	26 x 36 W, 20 x 58 W, 10 x 100 W
Parallel corrected fluorescent tubes with conventional ballast	400 VA	400 VA	10 x 36 W, 6 x 58 W, 2 x 100 W	10 x 36 W, 6 x 58 W, 2 x 100 W	10 x 36 W, 6 x 58 W, 2 x 100 W
Fluorescent tubes with electronic ballast	–	–	9 x 36 W, 6 x 58 W	9 x 36 W, 6 x 58 W	650 VA max.
Dual-mounted fluorescent tubes with electronic ballast	300 VA	300 VA	5 x (2 x 36 W), 3 x (2 x 58 W)	5 x (2 x 36 W), 3 x (2 x 58 W)	–
Fuocompact lamps with electronic ballast	9 x 7 W, 7 x 11 W, 7 x 15 W, 7 x 20 W, 7 x 23 W	9 x 7 W, 7 x 11 W, 7 x 15 W, 7 x 20 W, 7 x 23 W	9 x 7 W, 7 x 11 W, 7 x 15 W, 7 x 20 W	9 x 7 W, 7 x 11 W, 7 x 15 W, 7 x 20 W	22 x 7 W, 18 x 11 W, 16 x 15 W, 16 x 20 W, 14 x 23 W
Fuocompact lamps with conventional ballast	1500 VA	1500 VA	–	–	–
Parallel-corrected mercury and sodium vapour lamps	400 VA	400 VA	250 VA	250 VA	800 VA max. (80uF)
Non-corrected/ serial-corrected mercury and sodium vapour lamps	1000 VA	1000 VA	–	–	–
Motor	–	–	–	–	2300 VA max.

Specific technical data

IC2000P+	
External input	
Voltage rating (Ue)	230 V AC, +10 %, -15 %
Frequency	50/60 Hz
Input current	≤ 2.5 mA
Consumption	≤ 0.4 mW
Cable length	≤ 100 m
IC Astro	
Programming longitude	-180° (East) to +180° (West) in steps of 1°
Programming latitude	-90° (South) to +90° (North) in steps of 1°
External inputs for external control with a standard switch or a push-button	<ul style="list-style-type: none"> ■ 1 input "Ext1" for IC Astro 1C ■ 2 inputs "Ext1" and "Ext2" for IC Astro 2C □ consumption: < 0.5 mA □ cable length: ≤ 100 m
Programming accessories	<ul style="list-style-type: none"> ■ Programming kit for PC consists of a programming device, a memory key, a CDROM and a 2 m USB cable ■ Memory key for saving and duplicating programs
IC 100k, IC Astro	
Programming accessories	<ul style="list-style-type: none"> ■ Programming kit for PC consists of a programming device, a memory key, a CDROM and a 2 m USB cable ■ Memory key for saving and duplicating programs
Memory key delivered on front face for IC100kp+ 1C, IC100kp+ 2C and IC Astro	
External inputs	
External inputs for external control with a standard switch or a push-button	<ul style="list-style-type: none"> ■ 1 input "Ext" for 1 channel versions ■ 2 inputs "Ext1" and "Ext2" for 2 channels versions
Voltage rating (Ue)	<ul style="list-style-type: none"> ■ 230 V AC, +10 %, -15 % for 1 channel versions ■ 100-240 V AC +10 %, -15 % for 2 channels versions
Frequency	50/60 Hz
Input current	≤ 0.5 mA
Consumption	≤ 130 mW
Cable length	≤ 100 m

IC2000P+

The IC 2000P+ uses its time programming to define lighting On and Off periods:

- According to three pre-set time programs:
 - "DAYPROG": On time programming from 7 am to 8 pm a validation of the IC function from 7 am to 8 pm,
 - "NIGHTPROG": On time programming from 5 am to 8 am and from 6 pm to 11 pm a validation of the IC function on these two operating periods,
 - "EMPTYPROG": Off time programming throughout the day a no validation of the IC function. These programs can be modified if necessary.
- According to a customised operating period, with possibility of copying to the other days. It is equipped with the following functions:
 - consideration of periods of absence (holidays),
 - temporary or permanent On or Off override,
 - remote control of lighting override by NO external contact,
 - consideration of change to "summer/winter" time, automatic or manual,
 - permanent liquid crystal display: of time and minutes, of day of the week, of the contact output status and current program.

Example

Lighting of a shop window, in the evening, at a time variable according to brightness and switch-off at a set time (e.g. 11 pm). Then in the morning, lighting at a set time (e.g. 4 am) and switch-off at a time variable according to brightness (see Fig. 1).

Configuration

This consists of recording in the memory:

- The language.
- The year, month, day and time.
- One of the 3 pre-set programs:
 - "DAYPROG": "On" time programming from 7 am to 8 pm → validation of the IC function from 7 am to 8 pm,
 - "NIGHTPROG": "On" time programming from 5 am to 8 am and from 6 pm to 11 pm → validation of the IC function on these two operating periods,
 - "EMPTYPROG": "Off" time programming throughout the day → no validation of the IC function. These programs can be modified.
- The brightness threshold. Once this phase is over, your IC 2000P+ operates in AUTO mode according to the items you have chosen.

Programming

The IC2000P+ is used to manage time programs. It allows:

- Creation of a new program with the possibility of copying to the other days.
- Viewing programs in memory.
- Modification of a program in memory, of the time, date, summer/winter time.
- Partial or total deletion of the program (date, time and language are kept).
- Modification of the brightness threshold.
- Separate setting of the time delay on switch-on and switch-off.

Move to On/Off override

- Press briefly (< 2 s) and simultaneously the 2 keys "-", "+" (value setting and navigation keys) on the front face to move to "MAN ON" or "MAN OFF".
- Press the keys for more than 2 s to move to "PERM ON" or "PERM OFF".
- Supply of terminal 1 overrides the IC 2000P+ output to the "On" position.

This external override takes priority over the product On/Off override function (see Fig. 2, 3).

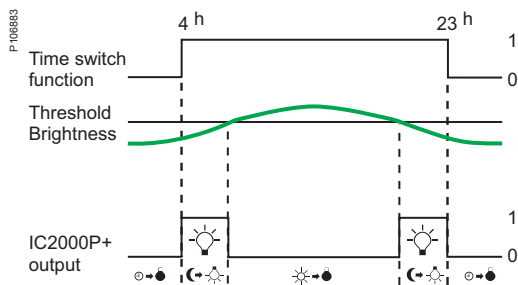

Fig. 1.

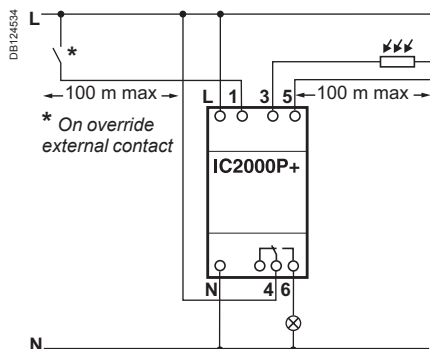

Fig. 2.

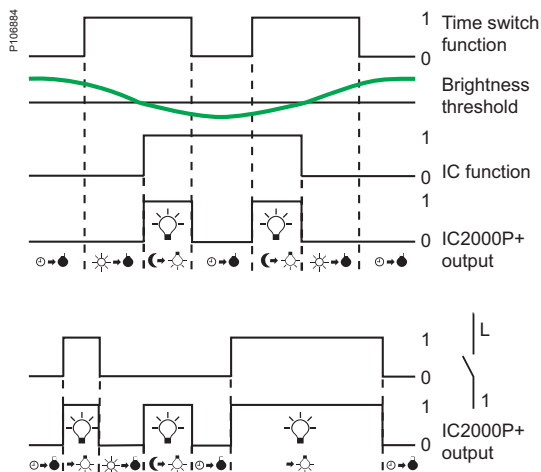

Fig. 3.

IC Astro

The IC Astro is configured according to the place of installation.

- The place of installation of the IC Astro can be configured:
 - either by selecting a country and a town,
 - or by its geographic coordinates (latitude, longitude).
- The IC Astro allows:
 - addition or deletion of a switch-off/switch-on switching operation (Off-On) between the sunset and sunrise times,
 - different programmes each day,
 - difference in sunset and/or sunrise times, adjustable separately by ± 120 min. according to local constraints (mountains, buildings, etc.),
 - consideration of periods of absence (holidays),
 - remote control of lighting override by external standard switch or push-button via the external input (1 external input per channel),
 - re-initialisation of programmes,
 - automatic switching to "summer-winter" time,
 - permanent display by liquid crystals: hours and minutes, day of the week, contact output status, and current programme,
 - manual waiver of the lighting On/Off programme, permanently or temporarily (up to the next switching operation).
 - back-lighting of the screen.



Fig. 3.



Fig. 4.



Fig. 5.

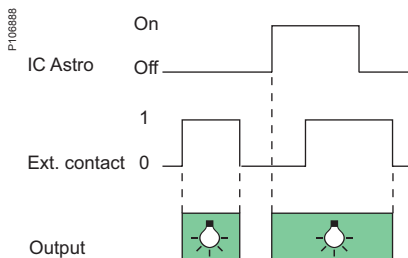

Fig. 6.

Example

Automatically lighting On and Off a shop window in Paris according to sunset and sunrise, example the 20th June.

- At night (10 pm) the lighting switch-on.
- At the morning (6 am) the lighting switch-off.

Configuration

This consists of writing in the memory:

- The language.
- The place of installation, either:
 - by its position (Argentina, China, etc.) and by the closest town,
 - by its geographic coordinates (latitude, longitude, time difference with respect to GMT) (a map is provided with the product).
- The year, month, day and time.
- Once this phase is complete, IC Astro will calculate the sunrise and sunset times and propose a default programme (operation from sunset to sunrise) (see Fig. 3).

Programming an Off period

The IC Astro offers the possibility of adding an "Off" period (programmed switch-off and switch-on) inside the programme, between the sunrise and sunset times (by default it is proposed from 11 pm to 5 am) (see Fig. 4).

Modifying programming and configuration

The twilight switch allows:

- Creation of a new customised programme with possibility of copying onto the other days.
- Display of programmes in memory.
- Deletion, modification or addition of an automatic or programmed switching operation.
- Partial or total deletion of the programme (date, time and language are kept).
- Modification of time, date, summer/winter time.
- Temporary cancellation of the "On" periods by configuring start and end dates and Times of absence (holidays).
- Adjustment of difference in sunset and/or sunrise times by ± 120 min. according to local constraints (mountains, buildings, etc.) (see Fig. 5).

Move to On/Off override

■ Briefly press (<2 s) at the same time on the 2 keys "-", "+": (value setting and navigation keys) on the front face to move to "ON TEMP" or "OFF TEMP".



■ Hold down (>2 s) the keys to move to "ON PERM" or "OFF PERM".

■ The supply of input 5 forces the IC Astro output to the "ON" position.

This override takes priority over the product On/Off override function (see Fig. 6).

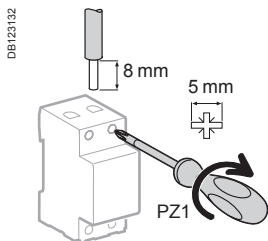
Connection



Type	Tightening torque	Copper cables	
		Rigid	Flexible or with ferrule
IC100, IC2000P+	1.2 N.m		
IC2000, IC Astro, IC 100k	2 screwless / pole	≤ 6 mm ²	≤ 6 mm ²
		2 x 2.5 mm ²	2 x 2.5 mm ²

IC100, IC Astro are mechanical compatible with electrical distribution comb busbar.

Weight (g)

Twilight switches	
IC100	173
IC2000	280
IC2000P+	323
IC Astro	132
IC 100k+/kp+ 1C / IC 100k+/kp+ 2C	183/ 352

Dimensions (mm)

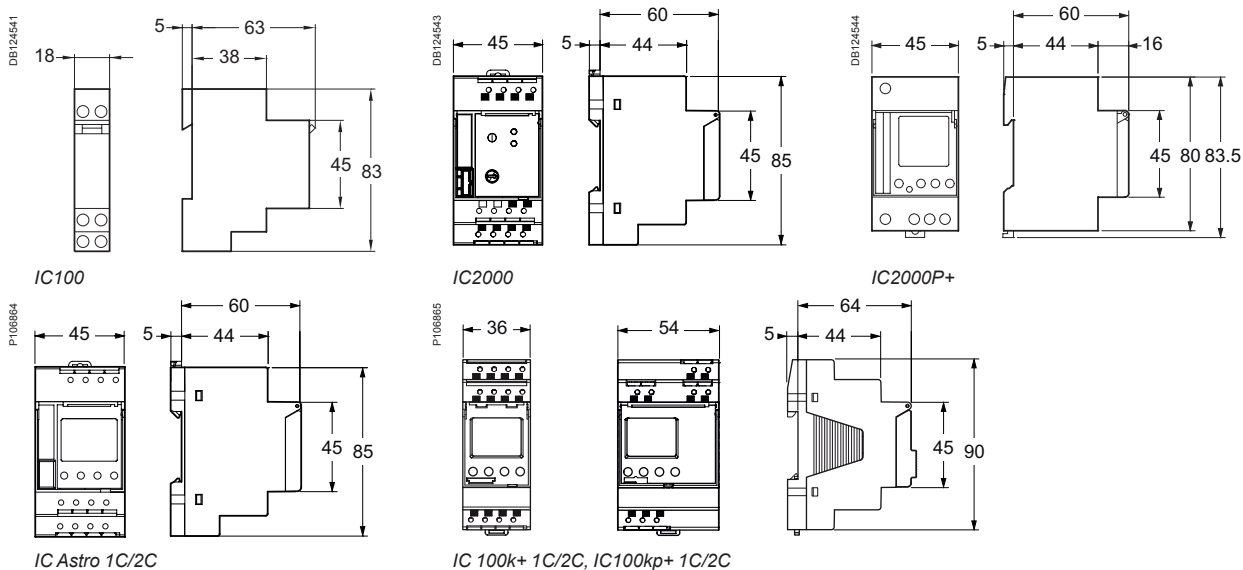

Cells

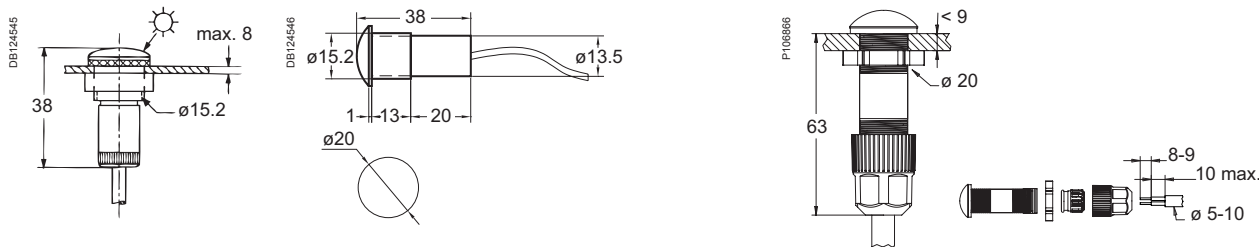

Standard switchboard cell (15281) Fixed externally in vertical position by 2 ø 4 mm screws

Digital switchboard cell (CCT15261)

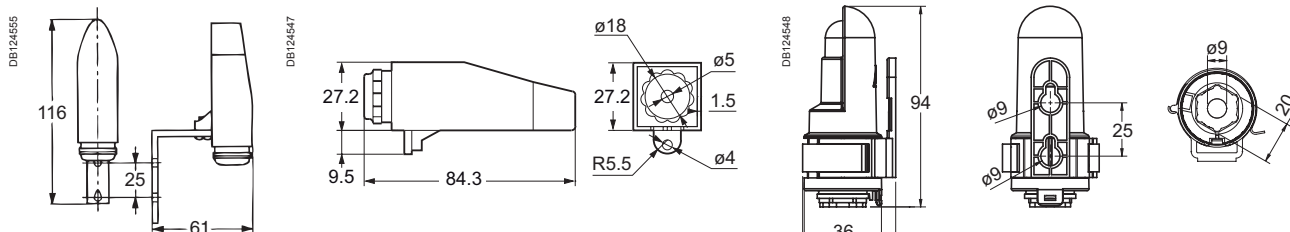

Wall-mounted cell (delivered with IC100, IC2000P+)

Standard and digital wall-mounted cell (CCT15268, CCT15260)

> Time switches

> The 45 mm intuitive switches

IHP 1c **IHP 2c** **IHP+1c** **IHP+2c**

Automatically switch On and Off loads according to the program entered by the user with 4 keys and a display, they operate on a weekly cycle: the same program is repeated week after week.

IHP DCF 1c + ANT DCF
Synchronised on the frankfort transmitter via the ANT DCF antenna.

> The 18 mm intuitive switches

IHP 1c/+ 1c

Automatically switch On and Off loads according to the program entered by the user with 4 keys and a display, they operate on a weekly cycle: the same program is repeated week after week.

> The 54 mm mechanical switches

IH 60mn 1c SRM **IH 24h 1c SRM/ARM** **IH 24h 2c ARM**

IH 24h + 7j 1+1c ARM **IH 7j 1c ARM**

Automatically switch On and Off loads according to the program entered by the user they operate on an hourly, daily or weekly cycle: the same program is repeated hour after hour (IH 60mn), day after day (IH 24h) or week after week (IH 7j).

> The 18 mm mechanical switches

IH 24h 1c SRM/ARM **IHH 7j 1c ARM**

Automatically switch On and Off loads according to the program entered by the user they operate daily on a weekly cycle.

> The multifunctional switch

ITM 4c-6E

They operate with weekly or annual time programming distributed across 1, 2, 3 or 4 channels, 6 inputs to condition the functions.

Selection table

The time switches control opening and closing of one or more separate circuits according to a programming pre-set by the user:

- by memorisation of On and Off switching operations for the IHP switches
- by positioning of jumpers or captive segments on a programming dial for the mechanical IH switches.

An IHP or IH time switch is chosen according to the following criteria:

Designation	Number of channels	Cycle period (d: day)	Minimum time between 2 switching operations	Number of switching operations	Saving on mains cut off	Width (modules of 9 mm)	Override controls On / Off	Output contact changeover switch (cos φ =1)	Time changeover (summer / winter)
The 45 mm intuitive switches									
IHP 1c	1	24 h and/or 7 d	1 min.	56	6 years	5	On / Off	16 A	Auto
IHP + 1c	1	24 h and/or 7 d	1 s	84	6 years	5	On / Off	16 A	Auto
IHP 2c	2	24 h and/or 7 d	1 min.	56	6 years	5	On / Off	16 A	Auto
IHP + 2c	2	24 h and/or 7 d	1 s	84	6 years	5	On / Off	16 A	Auto
IHP DCF 1c ⁽¹⁾	1	24 h and/or 7 d	1 s	42	4 years	5	On / Off	16 A	Auto
The 18 mm intuitive switches									
IHP 1c 18 mm	1	24 h and/or 7 d	1 min.	56	10 years	2	On / Off	16 A	Auto
IHP + 1c 18 mm	1	24 h and/or 7 d	1 min.	84	10 years	2	On / Off	16 A	Auto
The multifunctional switch									
ITM 4C-6E ⁽²⁾	4	60 min., 24 h, 7 d, 7 d + dated d	1 s	⁽³⁾	5 years	10	On/Off ⁽⁵⁾	10 A	Auto
The 54 mm mechanical switches									
IH 60mn 1c SRM	1	60 min.	37.5 s	48 On - 48 Off	none	6	On	10 A	Manual
IH 24h 1c SRM	1	24 h	15 min.	48 On - 48 Off	none	6	On	16 A	Manual
IH 24h 1c ARM	1	24 h	15 min.	48 On - 48 Off	200 h ⁽⁴⁾	6	On	16 A	Manual
IH 24h 2c ARM	2	24 h	30 min.	24 On - 24 Off	150 h	6	On	16 A	Manual
IH 7j 1c ARM	1	7 days	2 h	42 On - 42 Off	200 h ⁽⁴⁾	6	On	16 A	Manual
IH 24h + 7j 1+1c ARM	1+1	24 h + 7 days	45 min. + 12 h	16 On - 16 Off + 7 On - 7 Off	150 h	6	On	16 A	Manual
The 18 mm mechanical switches									
IHH 7j 1c ARM	1	7 days	2 h	42 On - 42 Off	100 h	2	On / Off	16 A	Manual
IH 24h 1c ARM	1	24 h	15 min.	48 On - 48 Off	100 h	2	On / Off	16 A	Manual
IH 24h 1c SRM	1	24 h	15 min.	48 On - 48 Off	none	2	On / Off	16 A	Manual
Accessories									
Programming kit ⁽⁶⁾									
Memory key ⁽⁶⁾									
Memory cartridge ⁽⁷⁾									
ANT DCF antenna									

⁽¹⁾ The IHP DCF is synchronised on the Frankfurt 's DCF77 radio station via the ANT DCF antenna.

⁽²⁾ 4 output channels and 6 condition inputs.

⁽³⁾ 45 time brackets in weekly time programming, 15 time brackets in annual time programming, 20 different pulses in pulse programming.

⁽⁴⁾ 110 h for 100 V CA supply voltage.

⁽⁵⁾ On/Off via an override input or a condition input.

⁽⁶⁾ For IHP + 1c and IHP+ 2c.

⁽⁷⁾ For ITM 4c-6E.

Back-lit display, random function and pulse programming ⁽⁸⁾	"Absence for holidays" function	Screwless connection	Mechanical compatibility with electrical distribution comb busbars	Input for external control	Instruction manual holder on front face	Memory key supplied with the product	Cat. no.
	■	■	■		■		CCT15850 ⁽¹³⁾
■	■	■	■	1 input	■	■	CCT15851 ⁽¹³⁾
	■	■	■		■		CCT15852 ⁽¹³⁾
■	■	■	■	2 inputs	■	■	CCT15853 ⁽¹³⁾
Random function	■				■		15857
	■	■					CCT15854 ⁽¹⁴⁾
Random and pulse function	■	■		■		■	CCT15837 ⁽¹⁴⁾
Pulse function		■			■	■	15270
		■					CCT15338
		■					CCT16364
		■					CCT15365
							15337
		■					CCT15367
							15366
							15331
							15336
							15335
							CCT15860
							CCT15861
							15280
							15858

⁽⁸⁾ Pulse programming allows switching operations of a duration less than one minute (adjustable from 1 to 59 s); a pulse control always has priority.

⁽⁹⁾ English, Russian, Ukrainian, Latvian, Lituanien, Estonian languages.

⁽¹⁰⁾ English, Bulgarian, Greek, Slovene, Serbian, Croatian languages.



⁽¹¹⁾ English, Hungarian, Polish, Romanian, Czech, Slovak languages.

⁽¹²⁾ French, English, Italian, Spanish, German, Portuguese languages.

⁽¹³⁾ French, English, Swedish, Dutch, Finnish, Norwegian/Danish languages.

⁽¹⁴⁾ French, English, Italian, Spanish, German, Portuguese, Dutch languages.

Selection table Programmable time switches

	IHP 1c	IHP2c	IHP+1c	IHP+2c
				

Function

- These time switches automatically switch on and off loads according to the program entered by the user
 - They operate on weekly cycle: the same program is repeated week after week
 - They offer automatic summer/winter time change and allow to adjust it according to where you are located
 - The program can be overridden temporary or permanently by pressing 2 keys on the product
 - They also offer holidays program, by configuring the starting and ending dates of the absence.
- A memory key (CT15861) and a programming kit (CT15860) can be used to duplicate on another IHP+ 1C/2c or to save the program created by the contractor (see "Accessories selection table")

Wiring diagrams

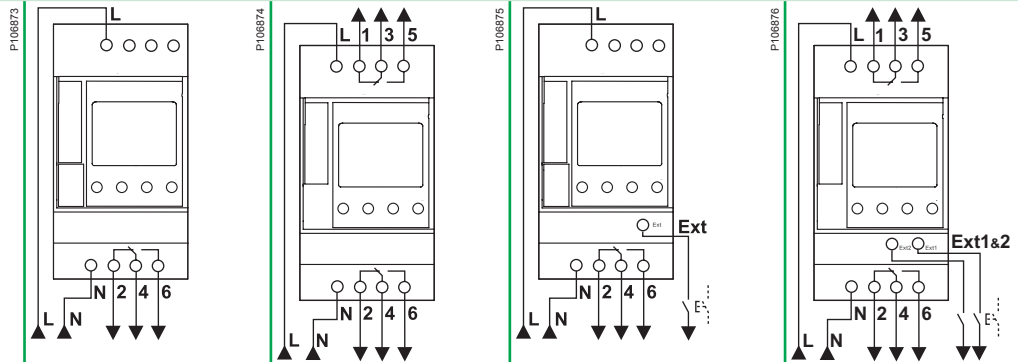

Catalogue Number	CCT15850 ⁽⁵⁾	CCT15852 ⁽⁵⁾	CCT15851 ⁽⁵⁾	CCT15853 ⁽⁵⁾
------------------	-------------------------	-------------------------	-------------------------	-------------------------

Technical specifications

Voltage rating (Ue)		230 V AC, ±10 %, 50/60 Hz	230 V AC, ±10 %, 50/60 Hz	230 V AC, ±10 %, 50/60 Hz	230 V AC, ±10 %, 50/60 Hz
Consumption		4 VA	7 VA	4 VA	7 VA
Output contact current (250 V AC)	Cos φ = 1	16 A	16 A	16 A	16 A
	Cos φ = 0.6	10 A	10 A	10 A	10 A
Degree of protection		IP20B	IP20B	IP20B	IP20B
Operating temperature		-10°C to +50°C	-10°C to +50°C	-10°C to +50°C	-10°C to +50°C
Time accuracy		± 1 s per day at 20°C	± 1 s per day at 20°C	± 1 s per day at 20°C	± 1 s per day at 20°C
Saving of program and time by lithium battery	Lifetime	6 years	6 years	6 years	6 years
	Back-up time, cumulated mains cut off	6 years	6 years	6 years	6 years

(1) English, russian, ukrainian, latvian, lituanien, estonian.
 (2) English, bulgarian, greek, slovene, serbian, croatian.
 (3) English, hungarian, polish, romanian, czech, slovak.
 (4) French, english, italian, spanish, german, portuguese.
 (5) French, english, swedish, dutch, finnish, norwegian/danish.
 (6) French, english, italian, spanish, german, portuguese, dutch.

Multifunctional time switch

IHP DCF 1c



P111633

IHP 1c
18 mm



P111630

IHP+1c
18 mm



P131635

P131636

ITM 4c-6E



- A memory key (CT15861) and a programming kit (CCT15860) can be used to duplicate on another IHP

- Weekly or annual time programming to be distributed over 1, 2, 3 or 4 channels.
- 6 inputs to condition these functions
- A memory cartridge can be used to duplicate on another ITM or to save the program created by the contractor

P106877

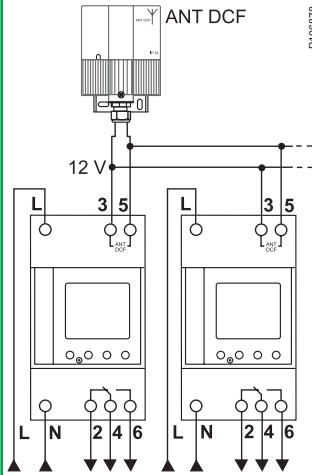

15857

P106878

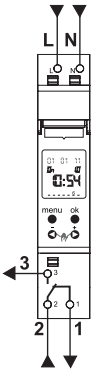

CCT15854⁽⁶⁾

P107021



CCT15837⁽⁶⁾

P107022

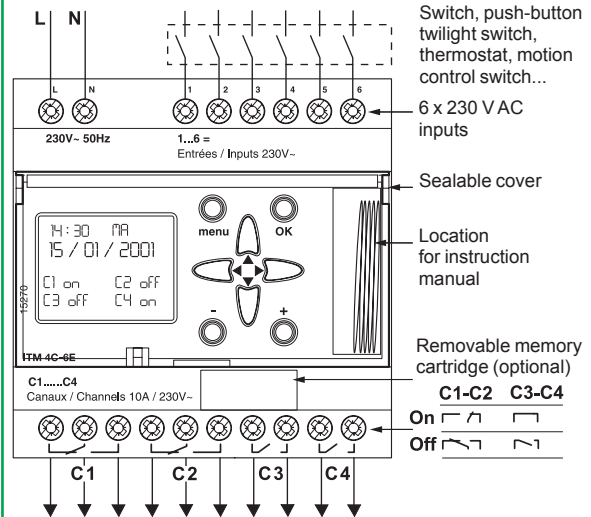

15270

230 V AC, ±10 %, 50/60 Hz

2 VA

16 A

10 A

IP20B

-10°C to +50°C

1 s on 1 million years thanks to the synchronisation on the DCF Frankfurt's DCF77 radio station via the ANT DCF

12 years

4 years

230 V AC, +10 %, -15 %, 50/60 Hz

2.3 VA

16 A

4 A

IP20B

-25°C to +55°C

± 0.5 s per day at 25°C

10 years

10 years

230 V AC, +10 %, -15 %, 50/60 Hz

2.3 VA

16 A

4 A

IP20B

-25°C to +55°C

± 0.5 s per day at 25°C

10 years

10 years

230 V AC, ±10 %, 50 Hz

4.5 VA

10 A

6 A

IP20B

-5°C to +50°C





± 1 s per day at 20°C

10 years

5 years

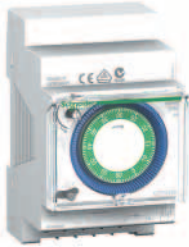
(1) English, russian, ukrainian, latvian, lituanien, estonian.
 (2) English, bulgarian, greek, slovene, serbian, croatian.
 (3) English, hungarian, polish, romanian, czech, slovak.
 (4) French, english, italian, spanish, german, portuguese.
 (5) French, english, swedish, dutch, finnish, norwegian/danish.
 (6) French, english, italian, spanish, german, portuguese, dutch.

Selection table Mechanical time switches

	IH 60mn 1c SRM	IH 24h 1c SRM	IH 24h 1c ARM	IH 24h 2c ARM
P116860		P116861 	P116862 	P116816 

Function

- They operate on hourly, daily or weekly cycle: the same program is repeated hour after hour (IH 60mn), day after day (IH 24h) or week after week (IH 7), (IHH 7)
- The program can be overridden On

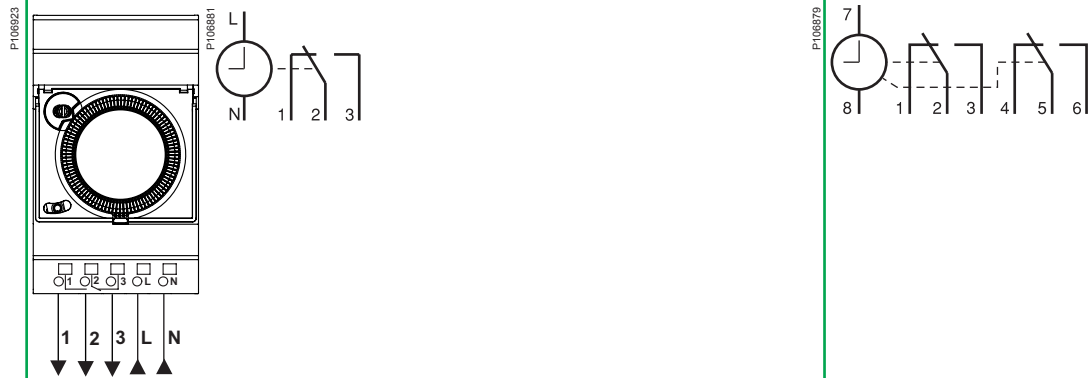

Wiring diagrams



Catalogue numbers	CCT15338	CCT16364	CCT15365	15337
--------------------------	-----------------	-----------------	-----------------	--------------



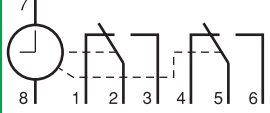
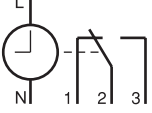
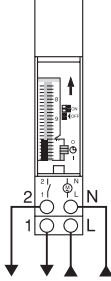

Technical specifications

Voltage rating (Ue)	230 V AC +10 %, -15%, 50/60 Hz	230 V AC +10 %, -15%, 50/60 Hz	110-230 V AC +10 %, -15%, 50/60 Hz	230 V AC +10 %, -15%, 50/60 Hz
Consumption	1 VA	2.5 VA	2.5 VA	2.5 VA
Output contact current under 250 VAC	Cos φ = 1	10 A	16 A	16 A
	Cos φ = 0.6	4 A	4 A	4 A
Degree of protection	IP20B	IP20B	IP20B	IP20B
Operating temperature	-20°C to +55°C	-20°C to +55°C	-20°C to +55°C	-20°C to +55°C
Time accuracy	±1 s per day at 20°C	±1 s per day at 20°C	±1 s per day at 20°C	±1 s per day at 20°C
Saving of program and time by lithium battery	Lifetime	-	6 years	6 years
	Back-up time, cumulated mains cut off	-	200 h with 230 V AC 100 h with 100 V AC	150 h
Programming by:	Jumpers (supplied)	-	-	4 red + 4 green + 2 white
	Captive segments	96	96	-

	IH 24h + 7j 1+1c ARM	IH 7j 1c ARM	IH24h 1c SRM 18 mm	IH 24h 1c ARM 18 mm	IHH 7j 1c ARM 18 mm
P111619		P111663 	P111614 	P111615 	P111613 

P1108979 	P1108881 	P1108882 			
15366	CCT15367	15335	15336	15331	

230 V AC +10 %, -15%, 50 Hz	110-230 V AC +10 %, -15%, 50/60 Hz	230 V AC, ±10 %, 50/60 Hz	230 V AC, ±10 %, 50/60 Hz	230 V AC, ±10 %, 50/60 Hz
2.5 VA	2.5 VA	2.5 VA	2.5 VA	2.5 VA
16 A	16 A	16 A	16 A	16 A
4 A	4 A	4 A	4 A	4 A
IP20B	IP20B	IP20B	IP20B	IP20B
-20°C to +55°C	-20°C to +55°C	-10°C to +50°C	-10°C to +50°C	-10°C to +50°C
±1 s per day at 20°C	±1 s per day at 20°C	±1 s per day at 20°C	±1 s per day at 20°C	±1 s per day at 20°C
6 years	6 years	–	10 years	10 years
150 h	200 h with 230 V AC 100 h with 110 V AC	–	100 h	100 h
6 yellow (24 h), 12 blue + 2 red (7 days)	–	–	–	–
–	84	96	96	84

Accessories selection table	Program	Memory		Antenna	Additional jumpers	Wall mount accessory
	IHP+ programming kit for PC	IHP+ key	Cartridge	IHP ANT DCF	IH jumpers	
						
Function	Consists of a programming device, a memory key, a CDROM and a 2 m USB cable	Saving and duplicating programs For IHP+ 1c/2c, ICAStro 1c/2c, IC100kp+ 1c/2c, IHP 1c 18 mm, IHP+ 1c 18 mm		Antenna for IHP DCF	They are used to program a larger number of sequences for: ■ IH 24h 2c ARM (15337) ■ IH 24h + 7j 1+1c ARM (15366)	The 18 mm time switches can be mounted on a wall by using 15359 reference. The protection cover is sealable.
Mounting	—	Located on front face		■ 5 IHP DCF maximum per antenna, maximum distance between the IHP DCF and the antenna: 200 m ■ Outside the electrical switchboard, outdoors, under shelter	1 bag containing: ■ 5 red ■ 5 green ■ 5 white ■ 5 yellow	The 15359 accessory can be also used to mount others 18 mm DIN rail devices (for example: timers, circuit breakers...).
Catalogue numbers	CCT15860	CCT15861	15280	15858	15341	15359
Technical specifications						
Degree of protection	—	—	—	IP54	—	—
Operating temperature	—	—	—	-20°C to +70°C	—	—
Overall dimensions L x W x H (mm)	—	—	—	70 x 57 x 92	—	See § dimensions

Specific technical data

IHP+ 1c, IHP+ 2c, IHP DCF	
Manual functions	Temporary cancellation of programming for holidays, public holidays, etc. by configuration of the 2 dates - start and end of absence Simulation of presence thanks to random operation during On periods
Pulse functions	Programming of pulses adjustable from 1 to 59 s (pulse takes priority over switching)
Back-lighting of the screen	
External input (only for IHP+ 1c, IHP+ 2c)	
External inputs for external control with a standard switch or a push-button	1 input for IHP+ 1c 2 inputs for IHP+ 2c
Voltage rating (Ue)	230 V AC, +10 %, -15 %
Frequency	50/60 Hz
Input current	≤ 1.2 mA
Consumption	≤ 0.3 mW
Cable length	≤ 100 m
Synchronisation on the Frankfurt's DCF 77 radio station signal (only for IHP DCF)	
Automatic on commissioning, then at 1 am, 2 am, 3 am and 4 am every day	
Manual by pressing the IHP keys or after a "reset"	
Displayed on the screen by the letters RC	
Programming of pulses adjustable from 1 to 59 s (pulse takes priority over switching)	

Programming principle

- For the IHP switches, this consists of memorising the days and times of the required switching operations.
- For the IH - IHH switches, this is performed by positioning captive segments or jumpers on a switching dial.

Example

- Controlling an air conditioner in a hairdressing salon:

	Monday	Tuesday	Wednesday	Thursday	Etc.	
On n° 1		08 h 30	08 h 30	08 h 30		Switch on
Off n° 1		12 h 00	12 h 00			Switch off
On n° 2		13 h 30	13 h 30			Switch on
Off n° 2		20 h 00	20 h 00	20 h 00		Switch off

(1) Closed on Mondays

(2) Non-stop

Programming by copying or blocks

Whenever identical switching operations are found at the same times, several days in the week, this function lets you program these operations once only. In this case a single switching operation is used. If this function is used wisely, the number of possible switching operations can be greatly increased.

Example

	Monday	Tuesday	Wednesday	Thursday	Friday	
On n°1	10 h 00			10 h 00		Switch on
Off n°1		18 h 00	18 h 00		18 h 00	Switch off

Number of switching operations

Designation	Number of switching operations
IHP 1c	56
IHP + 1c	84
IHP DCF 1c	42
IHP 2c	56
IHP + 2c	84
IHP 1c 18 mm	56
IHP + 1c 18 mm	84
ITM 4C-6E	45 time brackets in weekly time programming, 15 time brackets in annual time programming and 20 different pulses in pulse programming
IH 24h 1c ARM	48 On - 48 Off
IH 24h 1c SRM	48 On - 48 Off
IH 60mn 1c SRM	48 On - 48 Off
IH 24h 1c SRM	48 On - 48 Off
IH 24h 1c ARM	48 On - 48 Off
IH 24h 2c ARM	24 On - 24 Off
IH 7j 1c ARM	42 On - 42 Off
IH 24 h + 7j 1+1c ARM	16 On - 16 Off + 7 On - 7 Off

Saving on mains cut off

For IHP switches equipped with this function, a lithium battery is used for saving. The program, date and time are preserved. Switching operations are not performed.

Lets you control starting and stopping of a group of loads according to a cycle that is repeated every 60 minutes.

60 min. time programming

Example

Controlling automatic watering	
On n° 1	2 min. 30 s
Off n° 1	5 min.
On n° 2	25 min.
Off n° 2	37 min. 30 s

Relevant time switches

IH 60mn 1c SRM.

Lets you control starting and stopping of one or two groups of loads according to a daily cycle that is repeated, in identical manner, every day of the week.

24 h daily programming

Example

- Controlling a door of a block of flats:
 - from 8 am to 7.30 pm: contact on "On", free access,
 - from 7.30 pm to 8 am the next day: contact on "Off", access by confidential code every day of the week:

	From Monday to Sunday
On n° 1	8 am
Off n° 1	7.30 pm

Relevant time switches

- IH 24h 1c SRM/ARM.
- IH 24h 2c ARM.
- IHP 1c 18 mm.
- IHP + 1c 18 mm.
- IHP DCF 1c.
- IHP 1c, IHP + 1c.
- IHP 2c, IHP + 2c.
- ITM 4C-6E.

Lets you control starting and stopping of one to 4 groups of loads according to a weekly cycle, that can be different each day, repeated each week.

7 days weekly programming

Example

- Controlling an air conditionner in a hairdressing salon:

	Monday	Tuesday	Wednesday	Thursday	Friday	Saturday	Sunday
On n° 1			09 h 00	09 h 00	09 h 00		
Off n° 1			12 h 00	12 h 00			
On n° 2			14 h 00	14 h 00			
Off n° 2			20 h 00	20 h 00	20 h 00		
On n° 3						8 h 30	8 h 30
Off n° 3						12 h 30	12 h 30
On n° 4						14 h 30	14 h 30
Off n° 4						21 h 00	21 h 00

Relevant time switches

- IH 7j 1c ARM.
- IHP 1c, IHP + 1c.
- IHP 2c, IHP + 2c.
- IHP 1c 18 mm.
- IHP + 1c 18 mm.
- IHP DCF 1c.
- ITM 4C-6E.

Lets you control by pulses (adjustable from 1 to 59 s) one to four groups of loads (pulse relays, bells, etc.).

Pulse programming

Example

■ Automatic controlling of bells, lighting and distribution of food: bells sounding the resumption and finish of work (channel 1), lighting of premises (channel 2), feeding fish in the aquarium (channel 3):

	Monday	Tuesday	Wednesday	Thursday	Friday	Saturday	Sunday
Channel 1: bell (20 s pulse order)							
On	08 h 00	08 h 00	08 h 00	08 h 00	07 h 00	09 h 00	–
Duration	20 s	20 s	20 s	20 s	20 s	20 s	–
On	12 h 00	12 h 00	12 h 00	12 h 00	11 h 00	13 h 00	–
Duration	20 s	20 s	20 s	20 s	20 s	20 s	–
On	14 h 00	14 h 00	14 h 00	14 h 00	13 h 00	–	–
Duration	20 s	20 s	20 s	20 s	20 s	–	–
On	18 h 00	18 h 00	18 h 00	18 h 00	16 h 00	–	–
Duration	20 s	20 s	20 s	20 s	20 s	–	–
Channel 2: lighting (latched order)							
On	07 h 30	07 h 30	07 h 30	07 h 30	06 h 30	08 h 30	–
Off	18 h 30	18 h 30	18 h 30	18 h 30	17 h 00	13 h 30	–
Channel 3: aquarium (15 s pulse order)							
On	10 h 00	–	10 h 00	–	10 h 00	–	10 h 00
Duration	15 s	–	15 s	–	15 s	–	15 s

Programming

- Programming of a pulse takes up 2 memory spaces.
- Combination of the two order types (pulse and latched) is possible on the same channel.

Relevant time switches

- IHP + 1c.
- IHP + 1c 18 mm.
- IHP DCF 1c.
- IHP + 2c.
- ITM 4C-6E.

Lets you create special programs for dated days.

Programming special days.

Example

- Controlling lighting and heating in a school:
- basic programming: program lighting (channel 1) and heating (channel 2):

	Monday	Tuesday	Wednesday	Thursday	Friday	Saturday	Sunday
Channel 1: lighting							
On	07 h 00	07 h 00	07 h 00	07 h 00	07 h 00	–	–
Off	20 h 00	20 h 00	16 h 00	20 h 00	16 h 00	–	–
Channel 2: heating							
On	06 h 00	06 h 00	06 h 00	06 h 00	06 h 00	–	–
Off	18 h 00	18 h 00	12 h 00	18 h 00	12 h 00	–	–

- dated programming: periods of non-operation, school holidays, etc.
- Just memorise an Off at the start and another Off at the end of each period of absence:



		Holidays				
		Winter	Spring	Summer	Autumn	End of year
Channel 1: lighting						
Off	Date	20 feb.	17-apr	07-july	23 oct.	18 dec.
	Time	12 h 00	17 h 00	12 h 00	17 h 00	12 h 00
Off	Date	08-march	03-may	9 sept.	2 nov.	4 jan.
	Time	01 h 00	01 h 00	01 h 00	01 h 00	01 h 00
Channel 2: heating						
Off	Date	20 feb.	17-apr		23 oct.	18 dec.
	Time	12 h 00	17 h 00		17 h 00	12 h 00
Off	Date	08-march	03-may		2 nov.	4 jan.
	Time	01 h 00	01 h 00		01 h 00	01 h 00

Relevant time switches

- ITM 4C-6E.

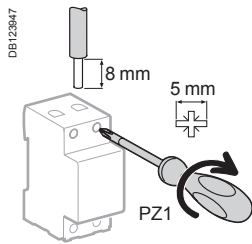
Connection



Type	Tightening torque	Copper cables	
		Rigid	Flexible or with ferrule
		DB112345 	DB112346 
IHP	1c, 2c, +1c, +2c	2 screwless / pole	2 x 2.5 mm ²
IHP 18 mm	1c, +1c	2 screwless / pole	2 x 2.5 mm ²
IHP	DCF	1.2 N.m	≤ 6 mm ²
IH	60mn 1c SRM	2 screwless / pole	2 x 2.5 mm ²
	24h 1c SRM, ARM	2 screwless / pole	2 x 2.5 mm ²
	24h 2c ARM	1.2 N.m	≤ 6 mm ²
	7j 1c ARM	2 screwless / pole	2 x 2.5 mm ²
	24h + 7j 1+1c ARM	1.2 N.m	≤ 6 mm ²
IH 18 mm	24h 1c SRM / ARM	1.2 N.m	≤ 6 mm ²
IHH 18 mm	7j 1c ARM	1.2 N.m	≤ 6 mm ²
ITM 4c-6E		1.2 N.m	≤ 6 mm ²

IHP 1c/2c, IHP+ 1c/2c are mechanical compatible with electrical distribution comb busbar.

Weight (g)

Time switches		
IHP	1c / 2c	170 / 205
IHP+	1c / 2c	190 / 211
IHP 18 mm	1c / +1c	90
IHP DCF		244
IH 54 mm	60mn 1c SRM	208
	24h 1c SRM/ARM	212 / 119
	24h 2c ARM	216
	7j 1c ARM	119
	24h + 7j 1+1c ARM	223
IH 18 mm	24h 1c SRM / ARM	97
IHH 18 mm	7j 1c ARM	101
ITM 4c-6E		415
Accessories		
Programming kit for PC		150
ANT DCF		168

Dimensions (mm)

IHP programmable time switches

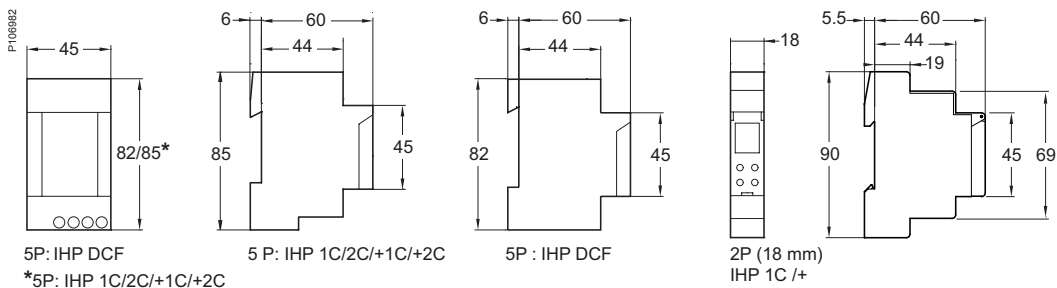

IH, IHH time switches

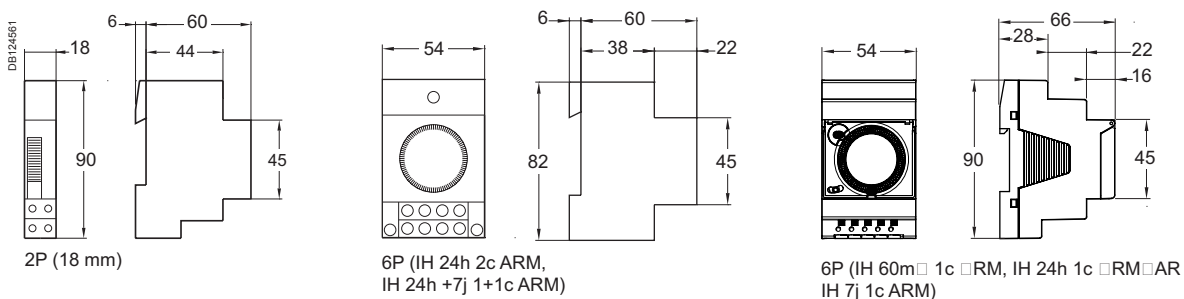

ANT DCF antenna

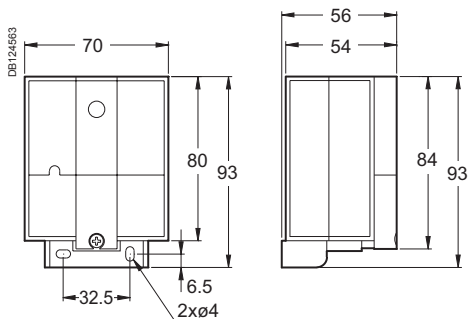

ITM 4C-6E

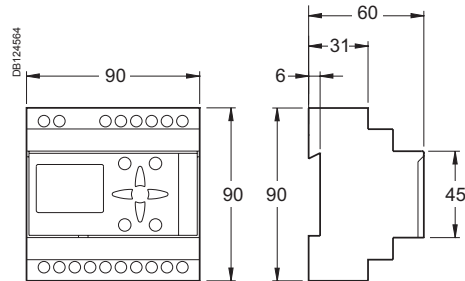

Wall mount accessory

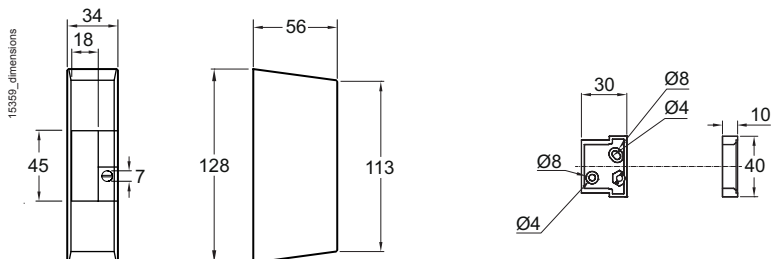

> Timers

> Electromechanical timer

P111648

MIN
Adjustable time delay from 1 to 7 min.

> Silent electronic timers

P111642

MINs
Adjustable time delay from 0.5 to 20 min.



P111643

MINp
Adjustable time delay from 0.5 to 20 min. with switch-off warning.

P111644

MINt
Adjustable time delay from 0.5 to 20 min. with switch-off warning and impulse relay function.

Selection table

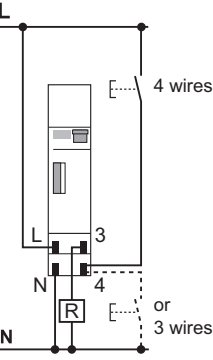
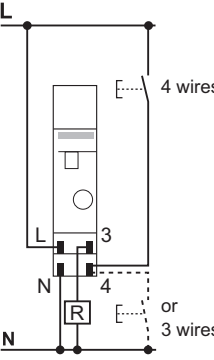
	MIN	MINs
Type	Electromechanical timer	Silent electronic timer
		
Function	These timers allow closing and then opening of a contact in a determined time Control circuit: connected standard or luminous push-buttons. Timer inoperative via self-protection if consumption above 50 mA maximum	
Wiring diagrams		
Mounting	Two operating modes triggered by switch on front face: <ul style="list-style-type: none"> ■ Automatic mode: <ul style="list-style-type: none"> □ operation in timing mode □ time delay adjustable from 1 to 7 min. □ setting in steps of 15 s using knob □ pressing a push-button renews the time delay ■ Manual override mode: constant lighting ■ Specific shield for terminal blocks insulation (Cat. no. 15359) 	Two operating modes triggered by switch on front face: <ul style="list-style-type: none"> ■ Timer mode: time delay adjustable from 0.5 to 20 min ■ Permanent mode: constant lighting
Catalogue numbers	15363	CCT15232
Technical specifications		
Voltage rating (Ue) (+10 %, -15 %)	230 V AC, 50 Hz	230 V AC, 50/60 Hz
Consumption	1 VA	< 6 VA
Output contact current Cos φ = 1	16 A	16 A
Degree of protection	IP20B	IP20B
Operating temperature	-10°C to +50°C	-10°C to +50°C
Width (9 mm modules)	2	2
Consumption of connected luminous push-buttons	50 mA maxi	150 mA maxi
Adjustable time delay	1 to 7 min.	0.5 to 20 min.
Long time delay	–	–
Insulation class	–	Class II
1 screw connection per pole for cables up to 6 mm ²	■	■
Selection of the type of connection (3 or 4 wires)	Selector switch	Automatic
Mechanical compatibility with electrical distribution comb busbar	–	■
Switch-off warning function	–	–
Impulse relay function	–	–

MINp	MINt
------	------

Silent electronic timer	
--------------------------------	--



The MINp timer allows closing and then opening of a contact in a determined time, and it also provides warning that the lighting is about to be switched off by flickering of the lamplight (switch-off warning)

The MINt timer is the same as MINp with an "impulse relay" additional function

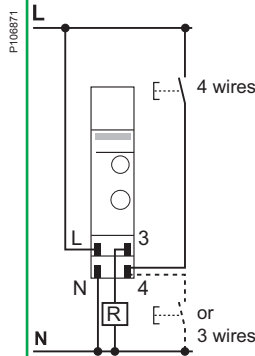
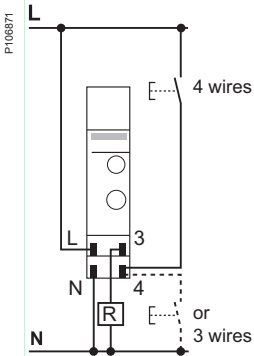

- Time delay adjustable from 0.5 to 20 min
- Three operating modes triggered by switch on front face:
 - timer mode with "switch-off warning" function built into the device. The lamp blinks 40 and 30 s before the end of the time delay
 - timer mode without "switch-off warning" function
 - permanent mode : constant lighting

- Timer mode operation:
 - pressing a push-button for longer than 2 s: lighting will last for 1h. Pressing again a push-button for less than 2 s relaunch the time delay of 1h and pressing again a push-button for more than 2 s switches off the light
 - pressing a push-button for less than 2 s launch the pre-set time delay, pressing again a push-button for less than 2 s relaunch the pre-set time delay

- Timer mode operation:
 - pressing a push-button for longer than 2 s: lighting will last for 1h. Pressing again a push-button for less than 2 s relaunch the time delay of 1h and pressing again a push-button for more than 2 s switches off the light
 - pressing a push-button for less than 2 s launch the pre-set time delay, pressing again a push-button for less than 2 s, switches off the light (impulse relay mode)

CCT15233

CCT15234

230 V AC, 50/60 Hz	230 V AC, 50/60 Hz
< 6 VA	< 6 VA
16 A	16 A
IP20B	IP20B
-25°C to +50°C	-25°C to +50°C
2	2
150 mA maxi	150 mA maxi
0.5 to 20 min.	0.5 to 20 min.
1 h	1 h
Class II	Class II
■	■
Automatic	Automatic
■	■
■	■
-	■

Load table

Products	MIN	MINs	MINp, MINt
Type of lighting	Maximum power		
230 V incandescent and halogen lamps	2300 W	2300 W	3600 W
Non-corrected / serial-corrected / dual mounted fluorescent tubes with conventional ballast	2300 VA	2300 VA	3600 VA ⁽¹⁾
Fuocompact lamps with conventional ballast	2000 VA	1500 VA	1500 VA ⁽¹⁾
Parallel-corrected fluorescent tubes with conventional ballast	1300 VA (70 F)	400 VA (42 µF)	1200 VA (120 µF) ⁽¹⁾
Fluorescent tubes with electronic ballast	300 VA	300 VA	1000 VA
Fuocompact lamps with electronic ballast	9 x 7 W, 6 x 11 W, 5 x 15 W, 5 x 20 W	9 x 7 W, 7 x 11 W, 7 x 15 W, 7 x 20 W, 7 x 23 W	34 x 7 W, 27 x 11 W, 24 x 15 W, 22 x 23 W

⁽¹⁾ The "switch-off warning" function is not available for these types of loads.

Connection

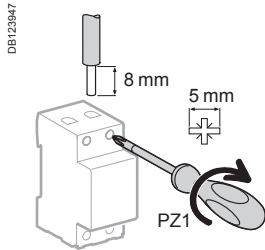

Type	Tightening torque	Copper cables	
		Rigid	Flexible or with ferrule
MIN, MINs, MINp, MINt	1.2 N.m	≤ 6 mm ²	≤ 6 mm ²

Weight (g)

Time switches	
MIN	84
MINs	75
MINp	103
MINt	76

Dimensions (mm)

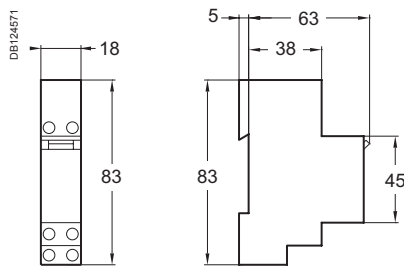

MIN

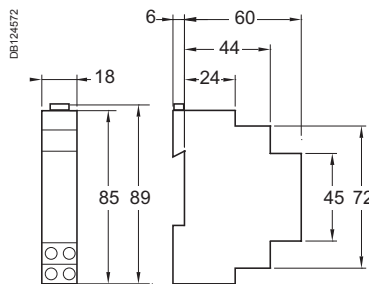

MINs, MINp, MINt

STD and SCU range

STD400RC/RL-DIN & SAE

STD1000RL-DIN & SAE

SCU10-DIN & SAE

> STD



STD

- The STD dimmers modulate incandescent halogen, lighting brightness and motors for unit powers from 40 to 1000 W from one or more switch-on points.
- They can be controlled either with the local control push-button placed on front panel or with auxiliary push-buttons.
- They have soft-On / soft-Off, light level memory and minimum level setting features.
- They are available in 2 different types:
 - DIN type (STD400RC/RL-DIN, STD1000RL-DIN) supplied without digital inputs,
 - SAE type (STD400RC/RL-SAE, STD1000RL-SAE) supplied with 4 digital inputs.

> SCU

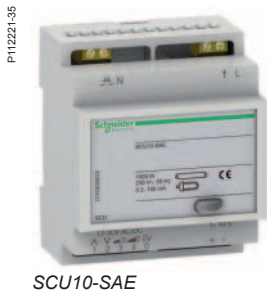

SCU

- The SCU dimmers modulate fluorescent lighting brightness for unit powers from 40 to 1500 W from one or more switch-on points.
- They can be controlled either with the local control push-button placed on front panel or with auxiliary push-buttons.
- They have soft-On / soft-Off, light level memory and minimum level setting features.
- They are available in 2 different types:
 - DIN type (SCU10-DIN) supplied without digital inputs,
 - SAE type (SCU10-SAE) supplied with 4 digital inputs.

STD and SCU range (cont.)





STD400RC/RL-DIN & SAE

STD1000RL-DIN & SAE

SCU10-DIN & SAE

Selection table

STD

Type	STD400RC/RL-DIN	STD400RC/RL-SAE	STD1000RL-DIN	STD1000RL-SAE
	400 W		1000 W	
				

Wiring diagrams

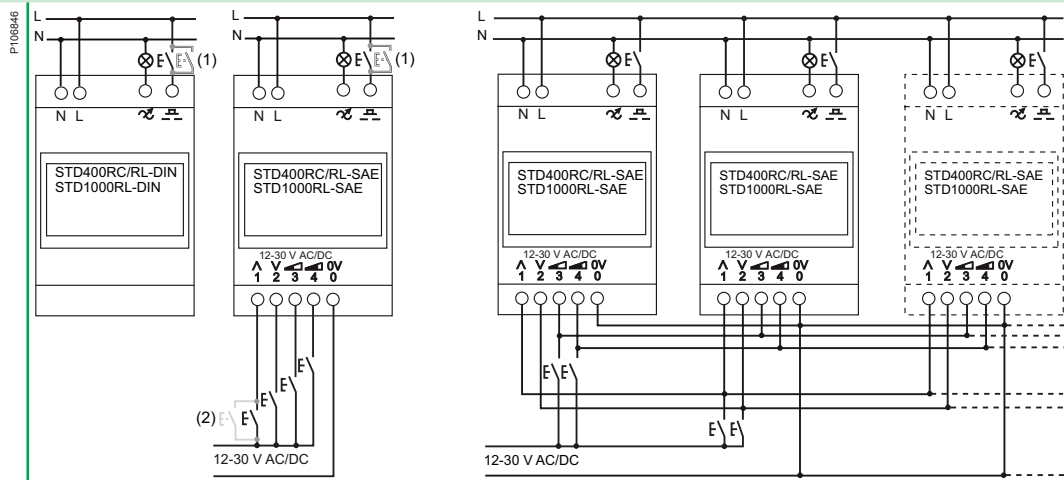

Mounting

With SAE types, it is possible to control a maximum of 20 dimmers combining STD400RC/RL-SAE and STD1000RL-SAE, with only one push-button via the 4 digital inputs

Catalogue numbers	CCTDD20001	CCTDD20002	CCTDD20003	CCTDD20004
-------------------	------------	------------	------------	------------

Technical specifications

Voltage rating (Ue)	230 V AC \pm 10 %, 50 Hz			
Consumption	0.8 VA			
Power loss	3 W			
Current sink for 1-10 V output	-			
Local push-button	Short push for On/Off control, long push for dimming			
Auxiliary push-button input	Short push for On/Off control, long push for dimming: ■ up to 25 parallel connected auxiliary push-buttons without indication lamps ■ up to 5 parallel connected auxiliary push-buttons with indication lamps ■ max wire length 50 m			
The minimum light level setting is adjustable	■			
Indication blue LED (built in the local push-button)	Illuminates during the on-state. The LED is blinking in error mode			
Degree of protection	IP20			
Operating temperature	0°C to +40°C, 40°C to +70°C with - 6 W /°C de-rating			
Storage temperature	0°C to +60°C			
Width (module of 9 mm)	4	4	8	8
Protections, fuses	■ Electronic overload, overvoltage and over temperature protection ■ Single shot thermal fuse			
Standards	According to EN 60669-2-1			
Directives	According to CE, EMC 89/336/EEC and LVD 73/73/23/EEC			

(1) Use of maximum 25 push-buttons without indication lamp and 5 push-buttons with indication lamp, connected in parallel.

(2) Use of maximum 25 push-buttons without indication lamp, connected in parallel, only for STD400RC/RL-SAE and STD1000RL-SAE.

STD and SCU range (cont.)

STD400RC/RL-DIN & SAE

STD1000RL-DIN & SAE

SCU10-DIN & SAE

SCU

SCU10-DIN

SCU10-SAE

1 - 10 V

P112250



P112221



P106847

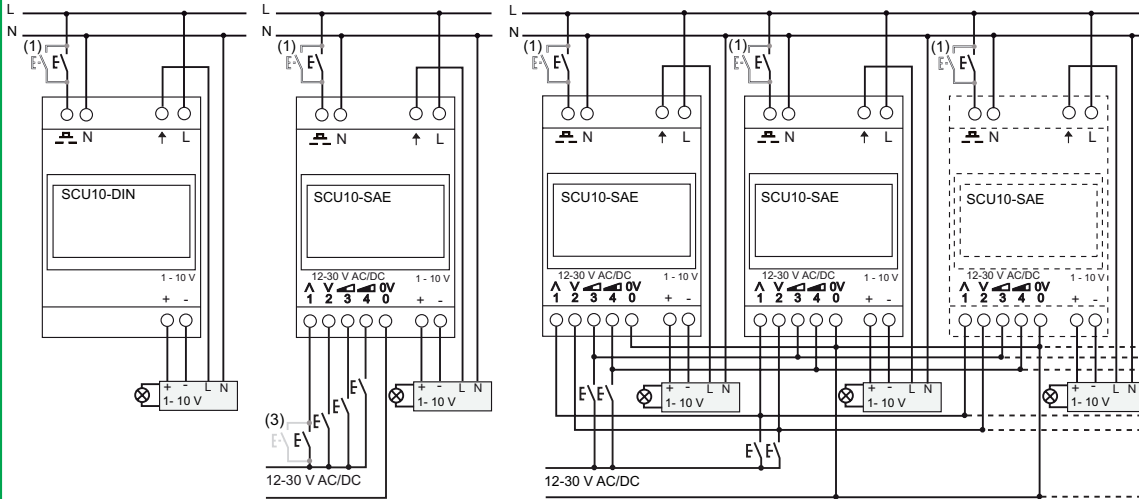

With SAE types, it is possible to control a maximum of 20 dimmers combining STD400RC/RL-SAE, STD1000RL-SAE and SCU10-SAE with only one push-button via the 4 digital inputs

CCTDD20011

CCTDD20012

230 V AC \pm 10 %, 50 Hz

0.8 VA

3 W

0.2- 100 mA

Short push for On/Off control, long push for dimming

Short push for On/Off control, long push for dimming:

- up to 25 parallel connected auxiliary push-buttons without indication lamps
- up to 5 parallel connected auxiliary push-buttons with indication lamps
- max wire length 50 m

Illuminates during the on-state. The LED is blinking in error mode

IP20

0°C to +40°C, 40°C to +70°C with - 6 W /°C de-rating

0°C to +60°C

8

8

- Electronic overload, overvoltage and over temperature protection
- Single shot thermal fuse

According to EN 60669-2-1

According to CE, EMC 89/336/EEC and LVD 73/73/23/EEC

(3) Use of maximum 25 push-buttons without indication lamp, connected in parallel, only for SCU10-SAE

STD and SCU range (cont.)

STD400RC/RL-DIN & SAE

STD1000RL-DIN & SAE

SCU10-DIN & SAE

Specific technical data

SAE types		
Input voltage	12- 30 V AC/DC	
The STD400RC/RL-SAE , STD1000RL-SAE and SCU10-SAE dimmers are supplied with 4 digital inputs	Input 1	On/Off and dimming up/down or only On and dimming up (depends on function mode)
	Input 2	Off and dimming down or only Off (depends on function mode)
	Input 3	Adjustable lighting level memory 1 (50 % default)
	Input 4	Adjustable lighting level memory 2 (100 % default)
Max wire length	50 m	
Up to 25 push-buttons per input. No push-button with indication lamp		
STD400RC/RL-DIN and STD400RC/RL-SAE dimmers are power regulators designed for all dimmable load types. Dimmers have automatic load type detection and the load regulation method is adjusted to fit the load		

Operation modes for SAE types

- **STD400RC/RL-SAE**, **STD1000RL-SAE** and **SCU10-SAE** dimmers have 2 different operation modes (**A** and **B**) using auxiliary push-buttons connected on digital inputs (1, 2, 3 and 4 terminals).
- Modes **A** and **B** can be changed by pushing the digital inputs 3 and 4 simultaneously for 10 s. After the mode is changed the load and the LED start to blink as long as the inputs are pushed.
- In the mode **A**, the input 1 dims the lights on with a short push and up with a long push and turns light off with a short push and dims the light down with a long push. The direction is changed every time the input 1 is released. The input 2 dims the lights always off.
- In the mode **B**, the input 1 dims lights only up with a long push and turns lights on with a short push. The input 2 dims the lights only down with a long push and turns lights off with a short push.
- Inputs 3 and 4 are for memory places for light levels. The light level is called with a short push and set into the memory with a long push of 3 s.

Common technical data

Common operation mode for SAE & DIN types

- The dimmer is turned On/Off by shortly pushing the front panel push-button. This push-button lights blue when the dimmer is On.
- The light level is controlled by keeping the front panel push-button pushed until wanted level has been reached.
- The direction of dimming (up/down) is changed every time the front panel push-button is released.
- The dimmer has memory function which stores the light level before Off-command. When the dimmer is turned back On, the light level is the same as it was before Off-command.
- Auxiliary push-buttons connected on  terminal have the same functionality as the push-button on the front panel of the dimmer.

Load table

STD400RC/RL-DIN, STD400RC/RL-SAE	
230 V incandescent and halogen lamps	40 - 400 W
Low voltage halogen lamps with electronic transformer	40 - 400 W
Low voltage halogen lamps with conventional transformer	40 - 300 W
Motors (fans, ventilators...)	40 - 200 W
STD1000RL-DIN, STD1000RL-SAE	
230 V incandescent and halogen lamps	60 - 1000 W
Low voltage halogen lamps with electronic transformer	60 - 1000 W
Low voltage halogen lamps with conventional transformer	60 - 1000 W
Motors (fans, ventilators...)	60 - 600 W
SCU10-DIN, SCU10-SAE	
Mono fluorescent tubes with electronic ballast (dia.26 mm)	50 x 18 W, 40 x 36 W, 25 x 58 W
Duo fluorescent tubes with electronic ballast (dia.26 mm)	40 x 18 W, 20 x 36 W, 12 x 58 W
Fluocompact lamps with electronic ballast	50 max. up to 1500 W

STD and SCU range (cont.)



STD400RC/RL-DIN & SAE

STD1000RL-DIN & SAE

SCU10-DIN & SAE

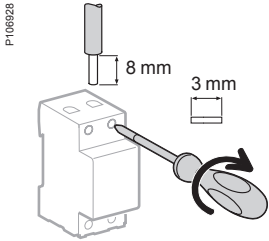
Connection



Type	Tightening torque	Copper cables	
		Rigid	Flexible or with ferrule
		DB122545 	DB123453 
STD and SCU (top connection)	0.5 N.m	< 4mm ²	< 4 mm ²
STD and SCU (bottom connection)	0.5 N.m	< 2.5 mm ²	< 2.5 mm ²

Weight (g)

Dimmers	
STD400RC/RL-DIN	80
STD400RC/RL-SAE	90
STD1000RL-DIN	120
STD1000RL-SAE, SCU10	130

Dimensions (mm)

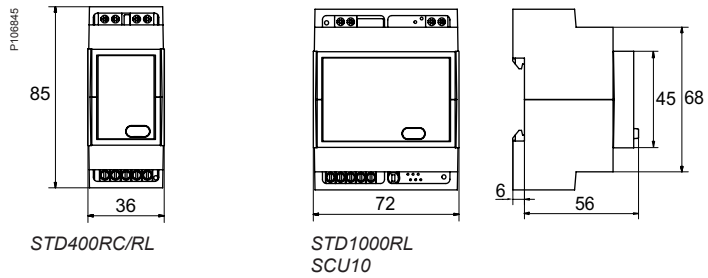



Thermostats

P123732



TH4

For individual and multifamily housing, tertiary premises, TH4 thermostat monitors and regulates ambient temperature from +8°C to +26°C according to 3 temperature set points:

- comfort: while the premises are occupied
- reduced: while the premises are unoccupied
- above freezing: for a prolonged period of non-occupancy.

P123731



TH7

For industrial premises stretching from cold storage to ovens, TH7 thermostat monitors and regulates temperature from -40°C to +80°C with a wide setting range.

It can also be used for frost protections at home.



Programmable thermostats

P126317



THP1 and THP2

Programmable thermostats control the operating periods of all heating types by monitoring and regulating ambient temperature between 5°C and 30°C, using a programme pre-set by the user and memorised:

- THP1: 1 zone,
- THP2: 2 zones.

P126318



TH4, TH7 and THP1, THP2 (cont.)

Selection table

Thermostats

Type	TH4	TH7
		

Function	TH4	TH7
	<p>For individual and multifamily housing, tertiary premises, TH4 thermostat monitors and regulates ambient temperature from +8°C to +26°C according to 3 temperature set points:</p> <ul style="list-style-type: none"> ■ comfort: while the premises are occupied ■ reduced: while the premises are unoccupied ■ above freezing: for a prolonged period of non-occupancy 	<ul style="list-style-type: none"> ■ For industrial premises stretching from cold storage to ovens, TH7 thermostat monitors and regulates temperature from -40°C to +80°C with a wide setting range ■ It can also be used for frost protections at home

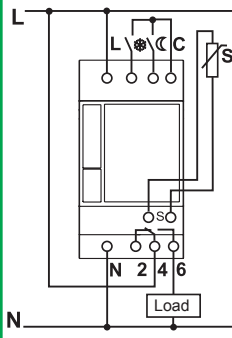
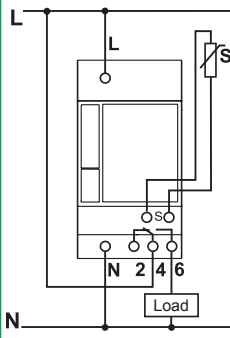
Wiring diagrams	TH4	TH7
		

Mounting	TH4	TH7
	Delivered with CCT15846 ambient temperature probe	Delivered without probe
Catalogue numbers	CCT15841	CCT15840

Technical specifications					
Voltage rating (Ue)	230 V AC, ± 10 %, 50/60 Hz				
Consumption	< 4 VA				
Output contact current (250 V AC)	<table border="0"> <tr> <td>Cos φ = 1</td> <td>16 A</td> </tr> <tr> <td>Cos φ = 0.6</td> <td>3 A</td> </tr> </table>	Cos φ = 1	16 A	Cos φ = 0.6	3 A
Cos φ = 1	16 A				
Cos φ = 0.6	3 A				
Power reserve	–				
Time base	–				
Difference between tripping and activation	±0.2°C				
Degree of protection	IP20				
Operating temperature	-10°C to +55°C				
Storage temperature	-20°C to +60°C				
Set Point accuracy	1°C				
Humidity	15-95 % RH (no condensation)				
Width (module of 9 mm)	5				
Color	White RAL 9003				
Protections, fuses	Internal over voltage protection against surges, internal over temperature protection				
Compliance with Community Directives	<table border="0"> <tr> <td>Isolating requirements, E.M.C. guidelines and Safety guidelines</td> <td>EN 60730-2-9</td> </tr> <tr> <td>RoHS and environmental issues</td> <td> EU-directive 2002/95/EC (RoHS) WEEE-directive 2002/96/EC (recycling) REACH Regulation (EC) No 1907/2006 </td> </tr> </table>	Isolating requirements, E.M.C. guidelines and Safety guidelines	EN 60730-2-9	RoHS and environmental issues	EU-directive 2002/95/EC (RoHS) WEEE-directive 2002/96/EC (recycling) REACH Regulation (EC) No 1907/2006
Isolating requirements, E.M.C. guidelines and Safety guidelines	EN 60730-2-9				
RoHS and environmental issues	EU-directive 2002/95/EC (RoHS) WEEE-directive 2002/96/EC (recycling) REACH Regulation (EC) No 1907/2006				

Programmable thermostats

THP1

P126317



THP2

P126318



- The THP1 and THP2 programmable thermostats control the operating periods of all heating types by monitoring and regulating ambient temperature between 5°C and 30°C, using a programme pre-set by the user and memorised
- The THP1 and THP2 monitors and regulates temperature in a room by comparing the value of the temperature measured by the ambient temperature probe with the value of the setpoint displayed on its front face according to 3 operating modes:
 - comfort: 5°C to 30°C while the premises are occupied
 - reduced: 5°C to 26°C while the premises are unoccupied
 - above freezing: the temperature in the premises is maintained at approximately 6°C
- The THP1 and THP2, can control the following loads:
 - convectors
 - a burner
 - a "hot air" heating system
 - heating valves: hydraulic, electromagnetic or electrothermal

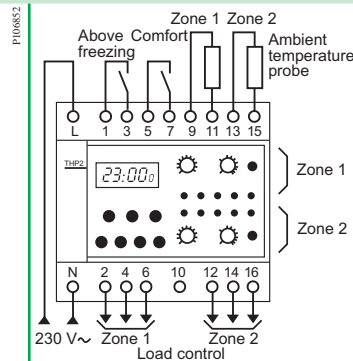
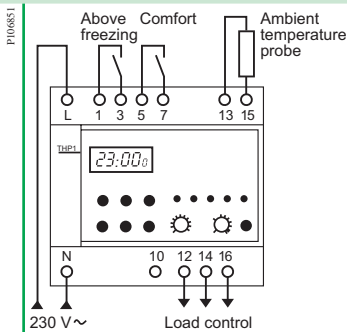

Delivered with 1 non-adjustable ambient temperature probe

15833

Delivered with -2 non-adjustable ambient temperature probes

15834

230 V AC

-

1 VA

5 A

1 A

6 years

Quartz

±0.2°C

IP20.1

-5°C to +55°C

-25°C to +70 °C

-

30-50 % RH (no condensation)

10

White RAL 9003

-

NF C 47-121

EN 60730-1: 1991



-

-

-

TH4, TH7 and THP1, THP2 (cont.)

Selection table TH4, TH7 temperature probes

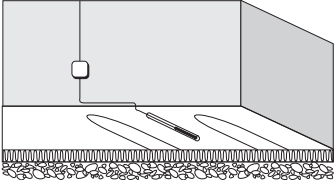
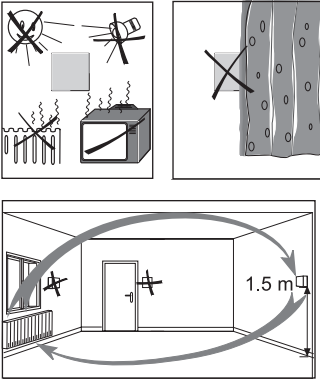
Accessories	Floor temperature probe (with 1.5 m cable)	Ambient temperature probe (with 1.5 m cable)
Type	<p>P123733</p> 	<p>P123734</p> 
Installation	<p>P106863</p> 	<p>P106864</p> 
Mounting	<p>This probe must be placed:</p> <ul style="list-style-type: none"> ■ in a Ø 9 mm tube, embedded in the slab in the middle of a turn ■ one of the ends must run out of a distribution box sealed in the nearest wall (to simplify probe installation or replacement) 	<p>This probe must be fixed 1.50 m above the floor, away from drafts and sources of heat (sun's rays, radiators, machines, etc.)</p>
Catalogue numbers	CCT15845	CCT15846

Note: for all probes, do not run connecting cables alongside power cables.
 TH4 and TH7 probes cables can be extended up to 70 m by using 6/10th telephone cable or up to 150 m by using shielded copper cable.
 THP1 and THP2 probes cables can be extended up to 50 m by using 6/10th telephone cable or shielded copper cable.

Specific technical data





TH4		
Settings	Comfort	From +8°C to +26°C
	Reduced	From 0°C to 10°C below the selected "comfort" temperature set point: control (manual or automatic) by external dry contact
	Above freezing	Maintains room temperature according to a factory adjusted temperature set point of +5°C: control (manual or automatic) by external dry contact
Three indicator lights visualise	Green	Above freezing operation
	Yellow	Reduced operation
	Red	Relay: ON
Delivered with ambient temperature probe (CCT15846)		NTC 10 kΩ (25°C) can be extended up to 150 m with shielded copper cable and up to 70 m with telephone cable

Note: however, the set point selected never can't be less than +8°C. Eg. If the reduced set point is selected with a 12°C set point temperature and a 10°C reduction temperature, the operative set point will not be +2°C (12-10) but rather +8°C (+5°C only if the "above freezing" input is closed/active).

TH7		
Temperature set point settings ⁽¹⁾	Range	6 fixed positions: -40°C, -20°C, 0°C, +20°C, +40°C and +60°C
	Adjustments	From 0°C to 20°C above the selected fixed position
Indicator light	Red	Relay: ON
Delivered without probe		

(1) For example: if "range" is on -40°C, setting is possible between -40°C and -20°C.

THP1, THP2 temperature probes

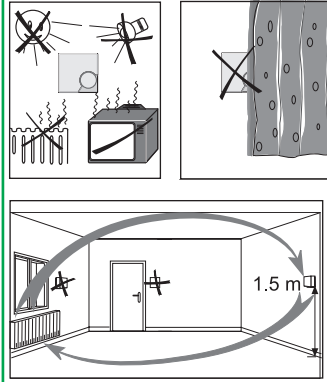
Outside temperature probe (with 2 m cable)		Collar temperature probe (with 1.5 m cable)		Ambient temperature probes				
				Non-adjustable probe	± 3 °C adjustable probe	Spare battery		
P122735		P122736		P126320			P126321	
								
This probe must be fixed away from: <ul style="list-style-type: none"> ■ the sun preferably facing north ■ all heat sources (chimney, etc.) 		This probe must be fixed on the hot water outgoing pipe (min. ø 21 mm, max. ø 90 mm) approximately 1.50 m from the boiler.		These probes must be fixed 1.50 m above the floor, away from drafts and sources of heat (sun's rays, radiators, machines, etc.)				
CCT15847		CCT15848		15835	15836	16358		

THP1, THP2

Display	<ul style="list-style-type: none"> By liquid crystal display of hour, minutes, day of the week and of contact status Indicator lights: 5 LEDs for 1 zone and 10 for 2 zones displaying: <ul style="list-style-type: none"> ■ the automatic, comfort and reduced operating modes (yellow) ■ the above freezing operating mode (green) ■ the ON position of the output contact(s) (red)
Choosing the operating mode	<ul style="list-style-type: none"> By local pushbutton: automatic, reduced, comfort, above freezing By external remote contact overriding the local push-button The comfort operating mode overrides the above freezing mode
Programming	<ul style="list-style-type: none"> Minimum programming time between 2 switching operations: 1 minute Memory: <ul style="list-style-type: none"> ■ THP1: up to 42 switching operations ■ THP2: up to 168 switching operations Programming 24 h / 7 days with: <ul style="list-style-type: none"> ■ possible anticipation of switching ■ deletion of a switching operation in order to modify or cancel a sequence Changeover to "summer-winter" time in a single operation

TH4, TH7 and THP1, THP2 (cont.) Practical advice

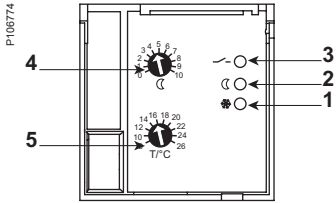

Fig. 1.

TH4

Front face (see Fig. 1)

- ☐ Above freezing mode indicator.
- √2 Reduced mode indicator.
- √3 Relay.
- ☐ Reduced threshold adjustment (reduction of temperature with respect to the setpoint).
- ☐ Temperature threshold adjustment.

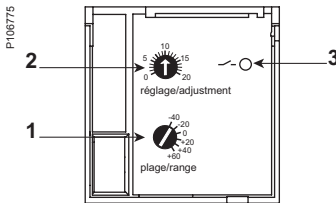

Fig. 2.

TH7

Front face (see Fig. 2)

- ☐ Temperature range setting (6 ranges).
- √2 Temperature fine adjustment.
- √3 Relay indicator.

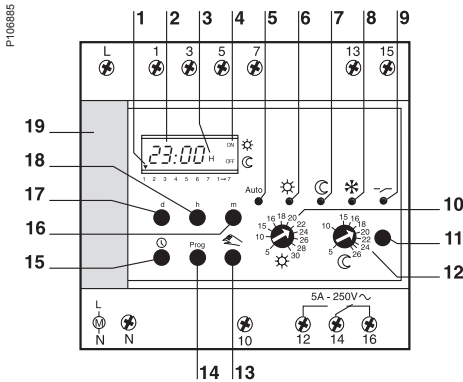

Fig. 3.

THP1

Front face (see Fig. 3)

- ☐ Days indication: cursor on 1 = Monday, on 2 = Tuesday, etc.
- √2 Hours and minutes indication.
- √3 Stopping during holiday periods (holiday override mode).
- ☐ Visualisation of switching status:
 - ON: comfort ☀
 - OFF: reduced ☾
- ☐ Yellow indicator light: "Auto" position.
- ☐ Yellow indicator light: "comfort" position.
- ☐ Yellow indicator light: "reduced" position.
- ☐ Green indicator light: "above freezing" position.
- ☐ Red indicator light: output contact status.
- ☐ Button for setting the "comfort" operating mode.
- ☐ Pushbutton for selecting the operating mode for zone 1.
- ☐ Button for setting the "reduced" operating mode.
- ☐ Key for anticipation of switching and programming over 7 days.
- ☐ Key for scrolling the switching and memorisation operations.
- ☐ Function key for time and day updating and return to the time display.
- ☐ Minutes setting key.
- ☐ Days setting key.
- ☐ Hours setting key.
- ☐ Manual slot.

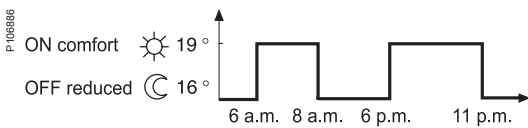

Fig. 4.

THP1 programming

A programmable clock, built into the THP1, is used for programming (see Fig. 4).

- The various operations for:
 - ☐ updating time and day,
 - ☐ introduction of the programme, are the same as those used to programme the IHP 24 hours and 7 days.
- Programming possibilities:
 - ☐ 24 hours and 7 days: a separate programme for each day of the week,
 - ☐ up to 42 switching operations memorised,
 - ☐ the same switching operation used over several days only counts as one switching operation,
 - ☐ power reserve: 6 years.

Example

- Programming:
 - ☐ temperature thresholds: "comfort" 19°C and "reduced" 16°C,
 - ☐ presence from 6 a.m. to 8 a.m. and from 6 p.m. to 11 p.m.: "comfort" heating, temperature of 19°C,
 - ☐ absence (from 8 a.m. to 6 p.m.) and nighttime (from 11 p.m. to 6 a.m.): "reduced" heating, temperature of 16°C.

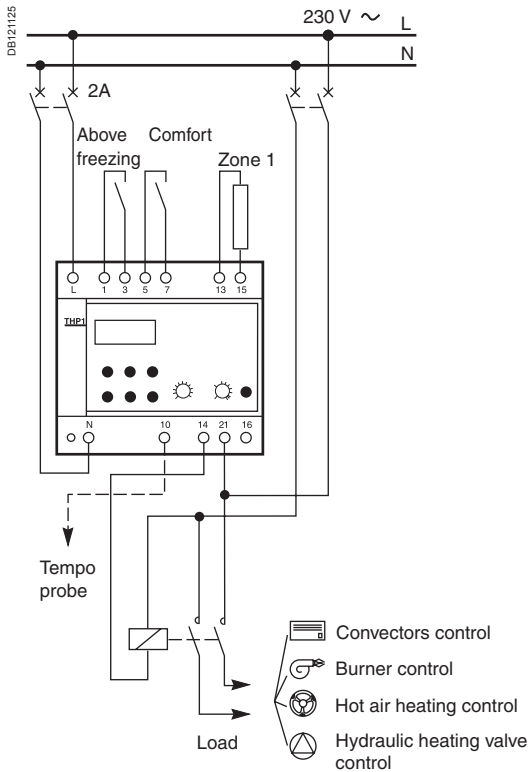

Fig. 5. THP1 connection example.

Local control

The operating mode pushbutton (11) is used to select the operating mode and to light up the relevant indicator lights in turn:

Auto (indicator light 5)

Operation takes place according to a pre-set programme (see § on "programming").

- Temperature is regulated with respect to the following temperature thresholds:
 - comfort (ON symbol visible) which is set using the button (10),
 - reduced (OFF symbol visible) which is set using the button (12).

Comfort (indicator light 6)

The ON symbol is visible.

- Indicator light ON: temperature is regulated only with respect to the "comfort" temperature threshold (setting button 10).
- Flashing indicator light (see § on "remote control").

Reduced (indicator light 7)

Temperature is regulated only with respect to the "reduced" temperature threshold (setting button 12). The OFF symbol is visible.

Above freezing (indicator light 8)

- Indicator light ON: temperature is regulated only with respect to the 6.5°C temperature threshold pre-set in the factory.
- Flashing indicator light (see § on "remote control").

Remote control

This operating mode corresponds to the closing of a contact external to the THP (e.g. switch or TRC).

Closing a comfort operation contact

(Red indicator light (6) flashing on the THP). Once closed, temperature is only regulated with respect to the "comfort" temperature threshold.

This external contact (terminals 5 and 7) takes priority over:

- The local controls ("Auto", "comfort", "reduced", "above freezing").
- The external "above freezing" contact.

Closing an above freezing operation contact

(Green indicator light (8) flashing on the THP). Once closed, temperature is only regulated with respect to the "above freezing" temperature threshold.

This external contact (terminals 1 and 3) takes priority over local controls ("Auto", "comfort", "reduced", "above freezing").

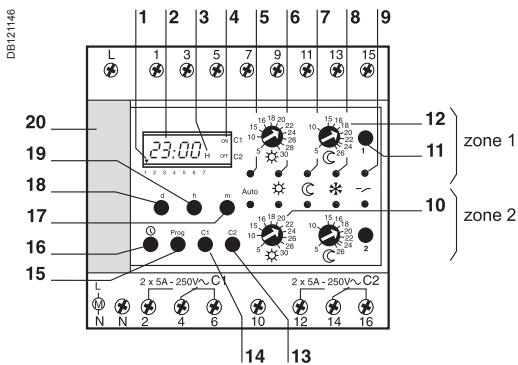

Fig. 6.

THP2

Front face (see Fig. 6)

- 2.5 Days indication: cursor on 1 = Monday, on 2 = Tuesday, etc.
- √2 Hours and minutes indication.
- √3 Stopping during holiday periods (holiday override).
- Visualisation of switching status.

		Comfort ☀	Reduced ☾
Zone 1	C1	ON	OFF
Zone 2	C2	ON	OFF

- Yellow indicator light: "Auto" position.
- Yellow indicator light: "comfort" position.
- Yellow indicator light: "reduced" position.
- √ Green indicator light: "above freezing" position.
- Red indicator light: output contact status.
- 2.5 □ Button for setting the "comfort" operating mode.
- 2.5 2.5 Pushbutton for selecting the operating mode for the zone.
- 2.5 √2 Button for setting the "reduced" operating mode.
- 2.5 √3 Zone 2 selection key.
- 2.5 □ Zone 1 selection key.
- 2.5 □ Key for scrolling switching and memorisation operations.
- 2.5 □ Function key for updating time and day and return to the time display.
- 2.5 □ Minutes setting key.
- 2.5 √ Days setting key.
- 2.5 □ Hours setting key.
- √2 □ Manual slot.

TH4, TH7 and THP1, THP2 (cont.) Practical advice

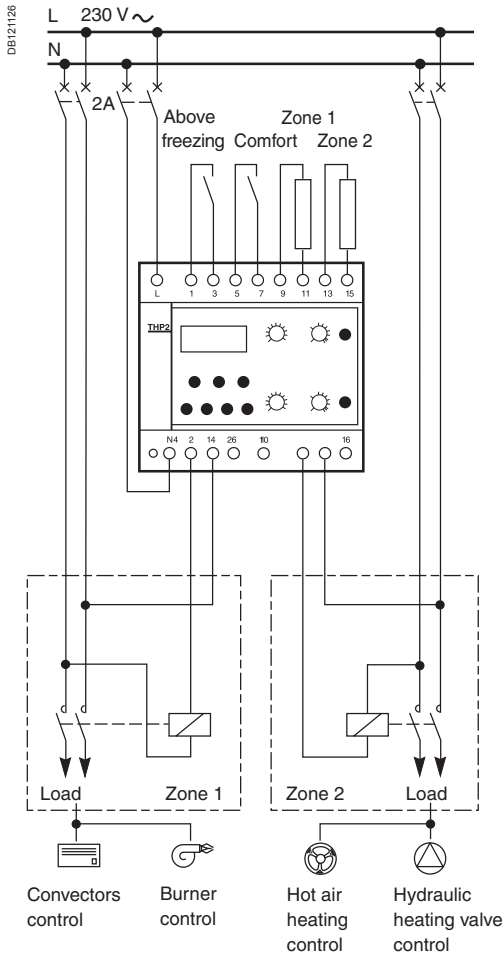
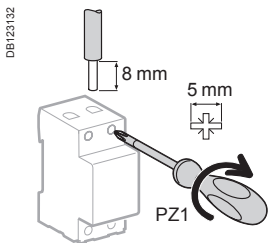





Fig. 7. THP2 connection example.

THP2 programming

- Programming is carried out by a 2 channel, IHP 24 hours and 7 days programmable time switch, built into the THP2.
- Programming possibilities:
 - 24 hours and 7 days: a separate programme for each day of the week,
 - 24 switching operations memorised, to be divided up over the 2 zones,
 - the same switching operation, used over several days, only counts for the same operation,
 - power reserve: 6 years.

Connection



Type	Tightening torque	Copper cables	
		Rigid	Flexible or with ferrule
THP1, THP2	1.2 N.m		
TH4, TH7	2 screwless / pole		

Weight (g)

Thermostats	
TH4, TH7	125
TH4 with probe	205
Programmable thermostats	
THP1	489
THP2	570

Dimensions (mm)

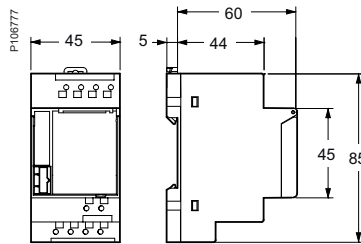

TH4 and TH7 thermostats

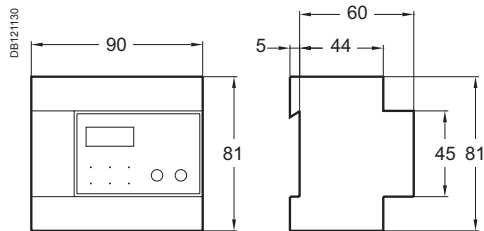

THP1 and THP2 programmable thermostats

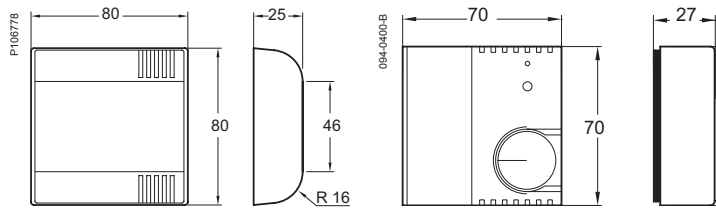

TH4, TH7, ambient temperature probe

THP1, THP2, ambient temperature probes

Relays

Time delay relays are used in service sector and industrial buildings for small automatic control systems: ventilation, heating, animation, roller blind servo controls, escalators, pumps, lighting, signalling, monitoring, etc.

> Time delay relays



iRTA
■ Delays energizing of a load



iRTB
■ Applies a time delay to energizing of a load upon closing of an auxiliary contact (push button)



iRTC
■ Delays de-energizing of a load upon closing of an auxiliary contact (push button)

^ Time delay

iRBN and iRTBT relays can interface automatic control system inputs/outputs with low-voltage devices.

> Interface relays



iRBN
Low level relay
■ Actuation of low-amperage electronic circuits upon receiving an LV electrical order



iRTBT
Extra low voltage relay
■ Actuation of LV circuits based on an extra low voltage order

^ Control

Control relays monitor electrical parameters and indicate when they are exceeded

> Control relays



iRCP
Phase control
■ Monitors the order and asymmetry of phases and the presence of voltage on the 3 phases of a three-phase circuit (power supply of a motor, etc.)



iRCI
Current control
■ Monitors the current flowing in a circuit and indicates any crossing of the set threshold

^ Monitoring



iRTH

- Applies a time delay to energizing of a load



iRTL

- Applies a time delay to energizing and de-energizing of a load during different times, repeatedly (flasher)



iRTMF

- Allows one of the four types of time delay to be selected: A, B, C or H

iRLI and iERL relays are used to relay ON or OFF information to the auxiliary circuits and actuate low-power loads

> Changeover relays



iRLI Changeover

- Relays ON or OFF information to the auxiliary circuits
- Actuates low-power loads



iERL extension

^ Relaying and control



iRCU Voltage control



- Monitors the potential difference of a circuit and indicates any crossing of the set threshold





iRCC Compressor control

- Monitors the compressor power supply and prevents its immediate restarting upon detection of a power cut or voltage dip

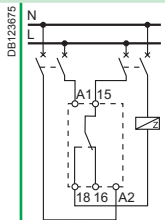
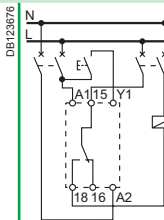
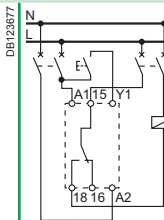
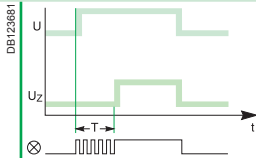
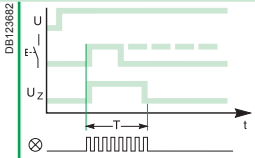
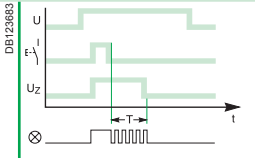

Time delay relays iRTA, iRTB, iRTC, iRTH, iRTL and iRTMF

		Time delay relays		
		iRTA	iRTB	iRTC
Type				
Function		<ul style="list-style-type: none"> ■ Delays energizing of a load 	<ul style="list-style-type: none"> ■ Applies a time delay to energizing of a load upon closing of an auxiliary contact (push button) 	<ul style="list-style-type: none"> ■ Delays de-energizing of a load upon closing of an auxiliary contact (push button)
Wiring diagrams				
Use		 <ul style="list-style-type: none"> ■ The single time delay cycle starts at switching on of the iRTA relay power supply ■ The load is energized at the end of time delay T 	 <ul style="list-style-type: none"> ■ The single time delay cycle starts at closing of an auxiliary contact (push button) ■ The load is de-energized at the end of time delay T 	 <ul style="list-style-type: none"> ■ The single time delay cycle starts only upon release of an auxiliary contact (push button) ■ The load is de-energized at the end of time delay T
Catalogue numbers		A9E16065	A9E16066	A9E16067
Technical specifications				
Control and power supply voltage (Uc)	V AC	24...240, ±10 %	24...240, ±10 %	24...240, ±10 %
	V DC	24, ±10 %	24, ±10 %	24, ±10 %
Operating frequency	Hz	50/60	50/60	50/60
Time delay range		0.1 s to 100 h	0.1 s to 100 h	0.1 s to 100 h
Precision		±10 % of full scale	±10 % of full scale	±10 % of full scale
Minimum duration of control impulse		100 ms	100 ms	100 ms
Insensitive to brownouts		≤ 20 ms	≤ 20 ms	≤ 20 ms
Max. resetting time per voltage interruption		100 ms	100 ms	100 ms
Accuracy of repetition		±0.5 % at constant parameters	±0.5 % at constant parameters	±0.5 % at constant parameters
Changeover contact (cadmium free)	Mini	Rating 10 mA/5 V DC	Rating 10 mA/5 V DC	Rating 10 mA/5 V DC
	Maxi	Rating 8 A/250 V AC/DC	Rating 8 A/250 V AC/DC	Rating 8 A/250 V AC/DC
Endurance	Mechanical	> 5 x 10 ⁶ switching operations	> 5 x 10 ⁶ switching operations	> 5 x 10 ⁶ switching operations
	Electrical	> 10 ⁵ switching operations (utilization category AC1)	> 10 ⁵ switching operations (utilization category AC1)	> 10 ⁵ switching operations (utilization category AC1)
Display of contact status by green indicator lamp		Flashing during time delay	Flashing during time delay	Flashing during time delay
Degree of protection	Device only	IP20	IP20	IP20
Connection by tunnel terminals	Without ferrule	2 x 2.5 mm ² single-strand	2 x 2.5 mm ² single-strand	2 x 2.5 mm ² single-strand
	With ferrule	2 x 1.5 mm ² multi-strand	2 x 1.5 mm ² multi-strand	2 x 1.5 mm ² multi-strand
Width in 9-mm modules		2	2	2
Operating temperature	°C	-5 ... +55	-5 ... +55	-5 ... +55
Storage temperature	°C	-40 ... +70	-40 ... +70	-40 ... +70

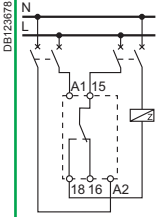
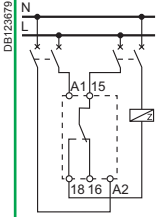
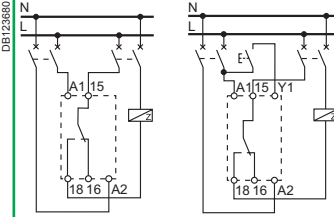
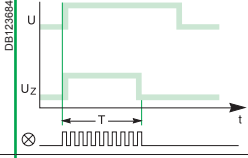
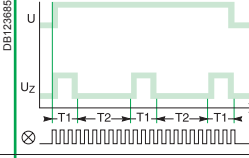

Time delay relays iRTA, iRTB, iRTC, iRTH, iRTL and iRTMF (cont.)

	iRTH	iRTL	iRTMF
			
	<ul style="list-style-type: none"> Applies a time delay to energizing of a load 	<ul style="list-style-type: none"> Applies a time delay to energizing and de-energizing of a load during different times, repeatedly (flasher) 	<ul style="list-style-type: none"> Allows one of the four types of time delay to be selected: A, B, C or H
			
			
	<ul style="list-style-type: none"> The single time delay cycle starts at switching on of the iRTH relay power supply The load is de-energized at the end of time delay T 	<ul style="list-style-type: none"> The time delay cycle starts at energizing The load is energized during an adjustable time T1 and then de-energized during an adjustable time T2. This cycle is reproduced until de-energizing of the iRTL relay power supply 	<ul style="list-style-type: none"> Depending on the choice, the iRTMF generates time delay cycles for the iRTA, iRTB, iRTC or iRTH relays
	A9E16068	A9E16069	A9E16070
	24...240, ±10 %	24...240, ±10 %	12...240, ±10 %
	24, ±10 %	24, ±10 %	12...240, ±10 %
	50/60	50/60	50/60
	0.1 s to 100 h	0.1 s to 100 h	0.1 s to 100 h
	±10 % of full scale	±10 % of full scale	±10 % of full scale
	100 ms	100 ms	100 ms
	≤ 20 ms	≤ 20 ms	≤ 20 ms
	100 ms	100 ms	100 ms
	±0.5 % at constant parameters	±0.5 % at constant parameters	±0.5 % at constant parameters
	Rating 10 mA/5 V DC	Rating 10 mA/5 V DC	Rating 10 mA/5 V DC
	Rating 8 A/250 V AC/DC	Rating 8 A/250 V AC/DC	Rating 8 A/250 V AC/DC
	> 5 x 10 ⁶ switching operations	> 5 x 10 ⁶ switching operations	> 5 x 10 ⁶ switching operations
	> 10 ⁵ switching operations (utilization category AC1)	> 10 ⁵ switching operations (utilization category AC1)	> 10 ⁵ switching operations (utilization category AC1)
	Flashing during time delay	Flashing during time delay	Flashing during time delay
	IP20	IP20	IP20
	2 x 2.5 mm ² single-strand	2 x 2.5 mm ² single-strand	2 x 2.5 mm ² single-strand
	2 x 1.5 mm ² multi-strand	2 x 1.5 mm ² multi-strand	2 x 1.5 mm ² multi-strand
	2	2	2
	-5 ... +55	-5 ... +55	-5 ... +55
	-40 ... +70	-40 ... +70	-40 ... +70

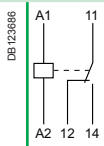
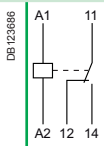

Interface relays iRBN, iRTBT

Interface relays			
	iRBN	iRTBT	
Type	Low level	Extra low voltage	
			
Standard	IEC 255 100 and IEC 529	IEC 255 100 and IEC 529	
Function	<ul style="list-style-type: none"> Actuation of low-amperage electronic circuits upon receiving an LV electrical order 	<ul style="list-style-type: none"> Actuation of LV circuits based on an extra low voltage order 	
Wiring diagrams			
Use	<ul style="list-style-type: none"> Inputs of programmable logic controllers, of measuring or supervision circuits, etc. 	<ul style="list-style-type: none"> ELV orders can be issued by a programmable logic controller (24 V DC static outputs), a central fire detection unit, a regulation system, etc. 	
Catalogue numbers	A9A15393	A9A15416	
Technical specifications			
Input control voltage (Uc)	V AC	230, ±10 %	12...24, -15 to +10 %
	V DC	-	12...24, ±20 %
Output contact rating	Mini	5 mA/5 V DC (DC12) 5 mA/5 V AC	10 mA/10 V DC (DC12) 10 mA/10 V AC
	Maxi	1 A/24 V DC (DC12) 5 A/250 V AC	1 A/24 V DC (DC12) 5 A/250 V AC
Operating frequency	Hz	50/60	0...60
Strengthened insulation between ELV/LV circuits		4 kV	4 kV
Consumption	At inrush	5 VA	0.22 W
	At holding	2.5 VA	0.11 W
Endurance	Electrical	100,000 switching operations	100,000 switching operations
Display of voltage presence on the control circuit		By green indicator lamp	By green indicator lamp
Degree of protection	Device only	IP20	IP20
Connection by tunnel terminals		0.5 x 6 mm ²	0.5 x 6 mm ²
Width in 9-mm modules		2	2
Operating temperature	°C	-5 ... +55	-5 ... +55
Storage temperature	°C	-40 ... +70	-40 ... +70

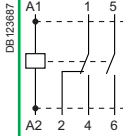
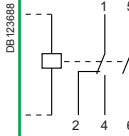

iRLI changeover and iERL extension relays

Changeover and extension relays										
	iRLI				iERL					
Type	Changeover relay				Extension for RLI					
										
Standard	IEC 255 and NF C 45-250				IEC 255 and NF C 45-250					
Function	<ul style="list-style-type: none"> Relaying of ON or OFF information to the auxiliary circuits and actuation of low-power loads 				<ul style="list-style-type: none"> Extension allowing additional contacts to be added to the iRLI changeover relays 					
Wiring diagrams										
Use	<ul style="list-style-type: none"> The iRLI relay contains 1 changeover contact (O-C) and 1 normally open contact (N/O) 				<ul style="list-style-type: none"> The iERL extension (max. 3 iERLs for 1 iRLI) contains 1 changeover contact (O-C) and 1 normally open contact (N/O) Can be mounted without any tool and without additional cabling using a yellow clip which performs mechanical assembly and electrical connection between the coils 					
Catalogue numbers	A9E15535	A9E15536	A9E15537	A9E15538	A9E15539	A9E15540	A9E15541	A9E15542		
Technical specifications										
Control voltage (Uc)	V AC	230...240	48	24	12	230...240	48	24	12	
Voltage rating (Ue)	V AC	230								
Insulation voltage (Ui)	V AC	250								
Rating (In)	A	10, cos φ = 1								
Operating frequency	Hz	50/60								
Inrush and holding power		4 VA				iRLI + iERL : 8 VA				
Endurance	Electrical	100,000 cycles AC21 (cos φ = 1)								
Commande directe en face avant	Power	By push button								
	Coil	By selector switch (disconnection)								
Position indicator		Mechanical indicator				Mechanical indicator				
Marking		Clip-on markers on the front panel				Clip-on markers on the front panel				
Degree of protection	Device only	IP20								
Connection by tunnel terminals		0.5 x 6 mm ²				0.5 x 6 mm ²				
Width in 9-mm modules		2								
Operating temperature	°C	-5 ... +55								
Storage temperature	°C	-40 ... +70								

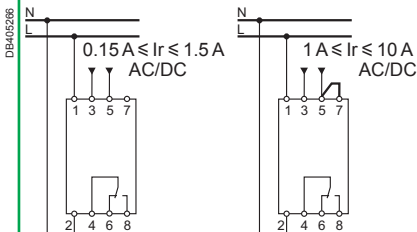
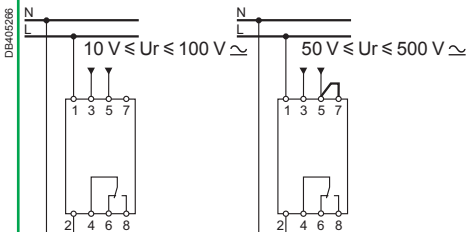

iRCP phase control, iRCI current control, iRCU voltage control and iRCC compressor control relays

Control relays		
Type	iRCI Current control	iRCU Voltage control
		
Function	<ul style="list-style-type: none"> Monitors the current (I_r) flowing in an AC or DC circuit and indicates any crossing of the set threshold 	<ul style="list-style-type: none"> Monitors the voltage variation (U_r) of an AC or DC circuit and indicates any crossing of the set threshold
Wiring diagrams		
Catalogue numbers	A9E21181	A9E21182

Common technical specifications		
Supply voltage (U_c)	V AC	230, -15 % à +10 %
Frequency	Hz	50/60
Parameter setting		<ul style="list-style-type: none"> On the front panel, by direct scale, using a screwdriver
Precision of display		±10 % of full scale
Output by changeover contact		8 A under 250 V AC ($\cos \varphi = 1$)
Indications by LED	Green	Voltage presence
	Red	Fault
Consumption	VA	3
Dissipated power	W	2
Degree of protection	Device only	IP20
Connection by tunnel terminals	Rigid cable	1.5 x 6 mm ²
Width in 9-mm modules		4
Operating temperature	°C	-5 ... +55
Storage temperature	°C	-40 ... +80

Particular technical specifications		
	Threshold adjustable from 10 % to 100 % of I_r	Threshold adjustable from 10 % to 100 % of U_r
	Hysteresis adjustable from 5 % to 50 % of I_r	Hysteresis adjustable from 5 % to 50 % of U_r
	Monitoring of overcurrent and undercurrent (selection by selector switch)	
	Fail-safe contact	
	De-energized	
	Energized with fault	
	Energized without fault	
	Time delay on crossing threshold: 0.1 s to 10 s	
	Possibility of memorizing fault with resetting	
	Compatible with current transformers (CTs) of ratio X/5	<ul style="list-style-type: none"> Automatic recognition of AC voltage or DC voltage. 2 measuring ranges selected by cabling: <ul style="list-style-type: none"> 10 V to 50 V 50 V to 500 V
	<ul style="list-style-type: none"> Automatic recognition of alternating or direct current. 2 measuring ranges selected by cabling: <ul style="list-style-type: none"> 0.15 A to 1.5 A 1 A to 10 A 	

iRCP phase control, iRCI current control, iRCU voltage control and iRCC compressor control relays (cont.)

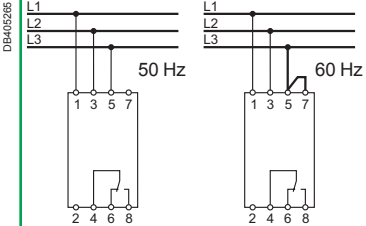
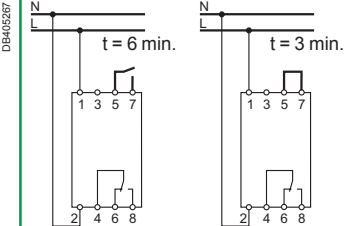
iRCP		iRCC	
Phase control		Compressor control	
			
<p>■ Monitors phases and the presence of voltage on the 3 phases of a three-phase circuit (power supply of a motor, etc.). It indicates any phase loss or inversion</p>		<p>■ Monitors the compressor's power supply and prevents its immediate restarting upon detection of a power cut or voltage dip</p>	
			
A9E21180		A9E21183	
400, ±15 %		230, -15 % à +10 %	
50/60			
■ On the front panel, by direct scale, using a screwdriver			
±10 % of full scale			
8 A under 250 V AC (cos φ = 1)			
Voltage presence			
Fault			
3			
3 (total on the 3 phases)		2	
IP20			
1.5 x 6 mm ²			
4			
-5 ... +55			
-40 ... +80			
Setting of phase asymmetry threshold: 5 % to 25 % of 400 V		Threshold setting: ±5 % to ±15 % of 230 V	
Hysteresis: fixed, 5 % of asymmetry threshold			
Monitoring of direction of phase rotation			
Monitoring of presence of the 3 phases			
Fail-safe contact		Fail-safe contact	
De-energized		De-energized	
Energized with fault		Energized with fault	
Energized without fault		Energized without fault	
Time delay on tripping: 0.3 s		Time delay on overshoot: 3 or 6 minutes (selection by cabling)	



Bigger energy savings start with the best energy efficiency education

Become an Energy Champion with FREE courses from Energy University

Businesses everywhere are dealing with rising energy costs as well as growing sustainability and regulatory concerns. Fortunately, there are practical, inexpensive solutions you can implement today to reduce energy use and increase savings. Energy University™ by Schneider Electric™ can help.

A free, online educational resource, Energy University offers more than 200 timely courses on energy efficiency and data centre topics to help you identify, implement, and monitor efficiency improvements within your organization. Courses are self-paced and available on demand, so you can create a learning schedule that meets your specific needs.

Help your company achieve real energy savings with an efficiency education from Energy University.

Energy University™
by Schneider Electric

Earn continuing education credits at your convenience

Complete courses and you can earn continuing education credits or receive recognition from leading industry associations, such as:

- > USGBC
- > IEEE
- > BOMI
- > And many more!



Begin your efficiency education!
Register for **FREE** courses today.

Visit www.MyEnergyUniversity.com
or call +971 4 7099333

Schneider Electric™

Become an energy champion today!

Because saving energy is everyone's business

- > Free Energy Efficiency courses for you and your staff
- > On-demand training takes less than an hour
- > More than 50,000 courses completed to date
- > Courses now available in multiple languages: Arabic, English, Chinese, Spanish, Italian, Russian, Brazilian Portuguese, German, Dutch, French, Japanese, Korean and Turkish.
- > More than 30,000 registered users from 120 plus countries



Enroll TODAY!

Classes are **FREE**, for a limited time only!
Visit www.MyEnergyUniversity.com
and enter the key code **32323P**

Stay connected all the time. Join us!

★ "Like" and "Follow" **Schneider Electric** on     
or visit www.schneider-electric.com/ae

Make the most of your energySM

Schneider Electric FZE

E Wing, Level 4, Dubai Silicon Oasis Headquarters,
P.O. Box 341057, Dubai, United Arab Emirates
Phone: + 971 (4) 709 91 00
Fax: + 971 (4) 709 91 01
www.schneider-electric.com/ae



Schneider Electric
Customer Care Center

UAE/Pakistan/Yemen	+971 4 7099333
Bahrain	+973 17 213277
Kuwait	+965 22494604
Oman	800 73666
Qatar	+974 44553010
Saudi Arabia	920 011101
Fax	+971 4 7099399

E-mail: ae-ccc-gulf@ae.schneider-electric.com
www.schneider-electric.ae

Due to evolution of standards and equipment, the characteristics indicated in texts and images of this document do not constitute a commitment on our part without confirmation.

Designed by: Dax Gaudiol, Marketing Communications,
Schneider Electric Gulf