



# EcoStruxure™ Power for single and multi-site commercial and industrial buildings

Grow your business with advanced digital solutions and services

Life Is On

**Schneider**  
Electric

# Contents

- > Challenges and business opportunities
- > EcoStruxure Power: a complete solution approach
- > Facilitating building design, construction, and operation
- > Grow your business with EcoStruxure Power
- > Case studies

# New challenges for your customers

Amid rising costs and increased regulation, digitization is transforming the way buildings operate today – and that's presenting new challenges to owners and managers of midsize buildings.

## Building types

Targeted Buildings: 500 to 15,000m<sup>2</sup>  
More than 65% of building market



Public  
Buildings



Retail



Small  
Industry



Small  
Healthcare

**Building investors** want to develop high-quality buildings that comply with the latest standards to maximize the value of their investments.

**Business owners** want to improve operational efficiency, avoid downtime, and ensure occupant comfort and safety.

**Building managers** want to know about an issue before it leads to unnecessary damage or downtime; whether managing their systems internally or outsourcing to an external company, they want to stay informed.

## Operating cost details

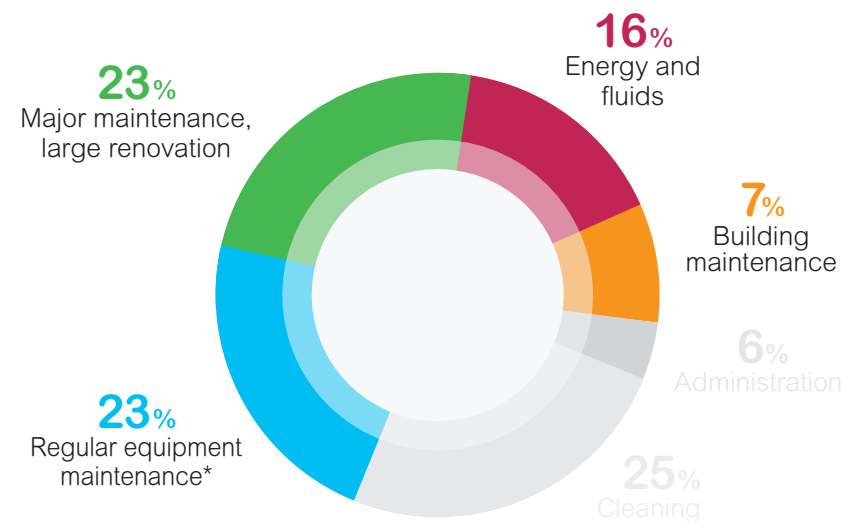

\*Sources: global cost analysis, using ISO 15686-5, [coutglobal.developpement-durable.gouv.fr](http://coutglobal.developpement-durable.gouv.fr)

Average amount of operation cost: 250k€ per year for a 5,000m<sup>2</sup> office building

# New challenges for your customers

Amid rising costs and increased regulation, digitization is transforming the way buildings operate today – and that's presenting new challenges to owners and managers of midsize buildings.

## Building types

Targeted Buildings: 500 to 15,000m<sup>2</sup>  
More than 65% of building market



Public  
Buildings



Retail



Small  
Industry



Small  
Healthcare



## Building Investors

### Reach superior ROI

- Higher revenues and occupancy rate
- Sustainable and efficient buildings

### Reduce time-to-market

- Shorter project cycles



# New challenges for your customers

Amid rising costs and increased regulation, digitization is transforming the way buildings operate today – and that's presenting new challenges to owners and managers of midsize buildings.

## Building types

Targeted Buildings: 500 to 15,000m<sup>2</sup>  
More than 65% of building market



Public  
Buildings



Retail



Small  
Industry



Small  
Healthcare

## Business Owner

### Reach business objectives

- Reliable power and building systems
- Lower operating expenses

### Increase safety and comfort

- Safer workplace
- Healthy and productive environment
- Regulations compliance



# New challenges for your customers

Amid rising costs and increased regulation, digitization is transforming the way buildings operate today – and that's presenting new challenges to owners and managers of midsize buildings.

## Building types

Targeted Buildings: 500 to 15,000m<sup>2</sup>  
More than 65% of building market



Public  
Buildings



Retail



Small  
Industry



Small  
Healthcare

## Building Managers

### Run efficiently

- Minimize downtime
- Optimize operational and energy costs

### Cope with limited workforces

- Remedy experience falloff
- New activities and new competencies



# Turn the new power paradigm into new business opportunities

As the world becomes more electric, more digitized, more decarbonized, and more decentralized, your customers do not have the time, skills, or tools to react effectively to these trends. That's where you come in.

With EcoStruxure™ Power, you can offer the cutting-edge digital solutions and support that they are looking for and take your share of those rising operating costs.

## Construction solutions

- Propose and deliver energy management and maintenance solutions that are digital, cost-effective, and scalable
- Good design is an opportunity to reduce operating costs

## Operation solutions

- Provide high-quality, energy-saving operational and maintenance services based on data-driven decisions and collaborative teams

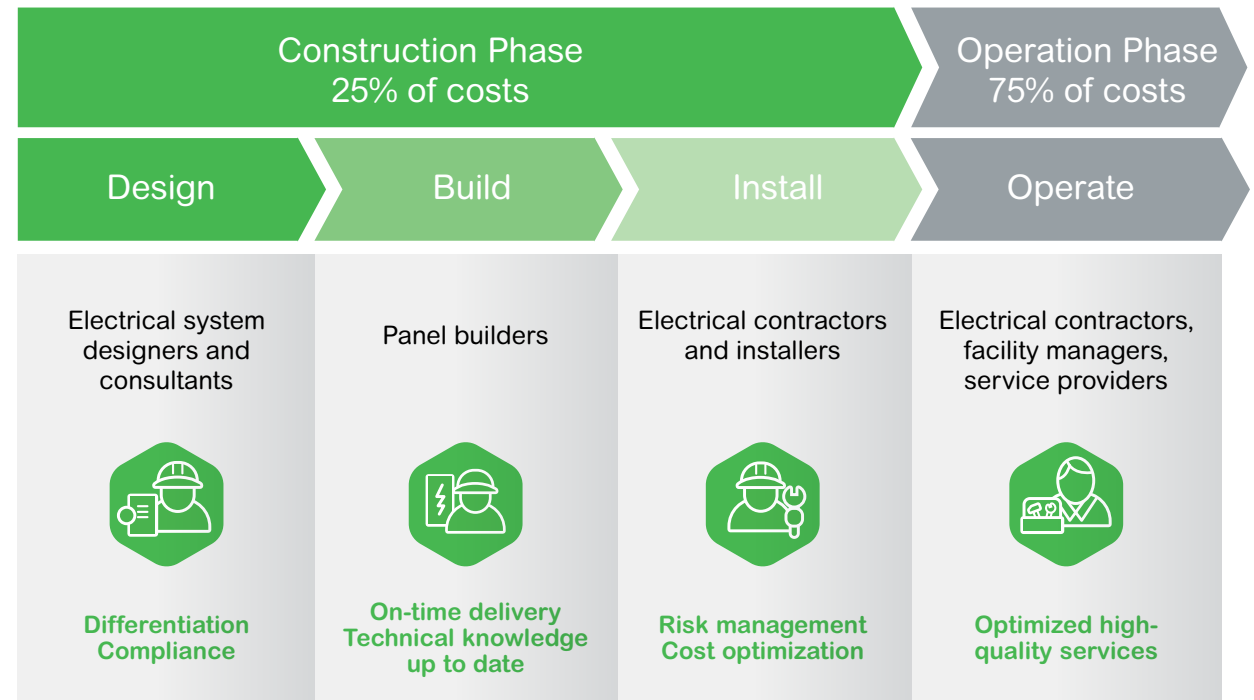

# Thrive in the new power paradigm

With EcoStruxure Power, we have redefined power distribution to elevate building **reliability, safety, efficiency, sustainability,** and **connectivity** to new levels.

## Construction phase benefits

### Standards compliance

- Construction and installation standard
- Electrical certifications
- Green certifications

### Shorter delivery time

- Reference designs
- Proven and tested architectures
- Design and commissioning tools

### Higher-value investment

- IoT technology
- Big data ready
- Green and energy efficient
- Higher tenant revenue



## Operation phase benefits

### Gain control on energy costs

- Clear view of energy consumption
- Benchmark building performance
- Demonstrate regulatory compliance

### Keep key assets up and running

- Monitor status of key assets to avoid power outage, assets breakdown
- Quickly implement corrective actions
- Switch to preventive maintenance

### Improve maintenance efficiency

- Simplify maintenance operations in the field
- Access maintenance operation history
- Schedule preventive maintenance tasks



# EcoStruxure Power gives you a complete solution approach to:

- Deliver safer, more reliable, and more efficient power
- Provide tailored, future-ready solutions that “simply work”
- Enable new services in energy and operation management
- Create new business opportunities for your company



# EcoStruxure Power: Innovation At Every Level

These three levels communicate continuously within a cyber-secure environment.

## Apps, Analytics & Services

Apps, analytics, and services let you make timely, informed decisions to reduce costs and boost efficiency.

## Edge Control

Operation monitoring and information sharing, supported by a suite of Schneider Electric software, allows 24/7 control on-site and remotely.

## Connected Products

Connected products collect and send information to the second level.



Apps, Analytics  
& Services

Edge Control

Connected  
Products

# Best-in-class connected products

EcoStruxure Power turns an electrical panel into a connected object, able to gather information from meters, circuit breakers, transformers, and other smart products.

## Make informed decisions

- Diagnostics for operations and maintenance
- Embedded and wireless metering

## Make future-ready systems

- Reference designs per application
- Scalable

## Make implementation simple

- Plug-and-play, with self-discovery
- Single commissioning tool

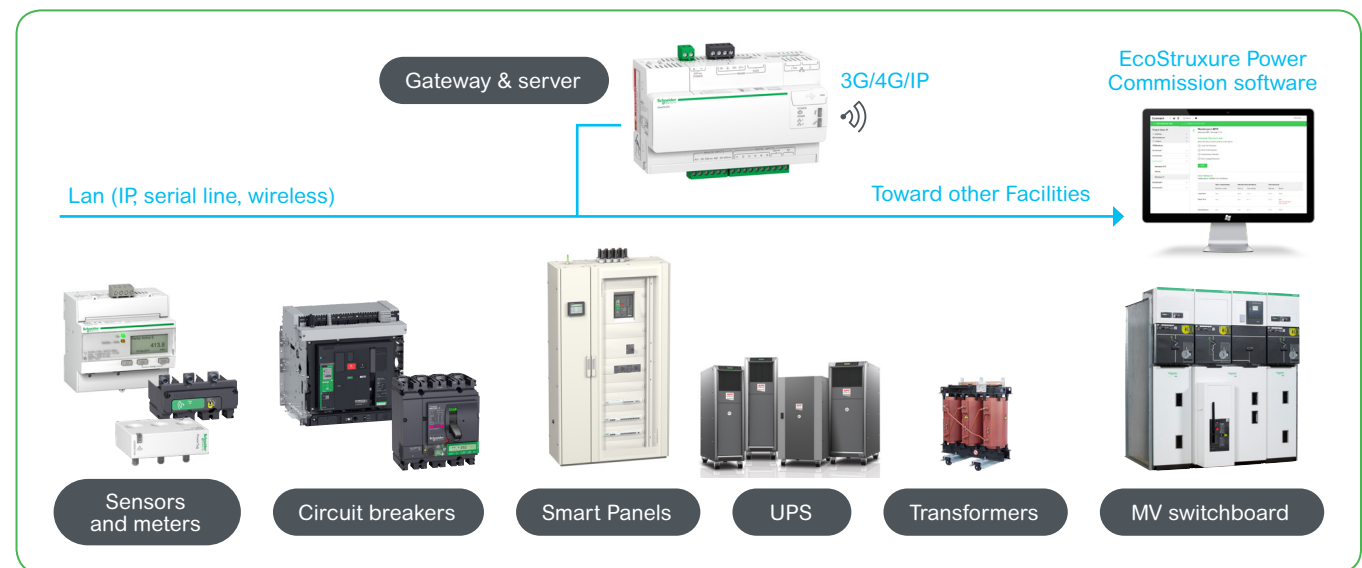

Connected products make critical information available on-site or remotely.

Apps, Analytics  
& Services  
↕  
Edge Control  
↕  
Connected  
Products

# Edge control cloud software

Schneider Electric software applications allow operation monitoring and information sharing, ensuring business continuity while reducing energy and maintenance costs.

## Keep key assets up and running

- Alerts with root cause and recommendation
- Asset condition monitoring

## Control energy costs

- Building performance assessment
- Multi-site benchmarking
- Energy cost allocation

## Improve operation and maintenance efficiency

- Proactive maintenance plan with technical documentation
- Task manager and repair logs
- Intervention and activity reports
- Cloud-based team collaboration

EcoStruxure Facility Expert software lets you ensure reliable and efficient operations.

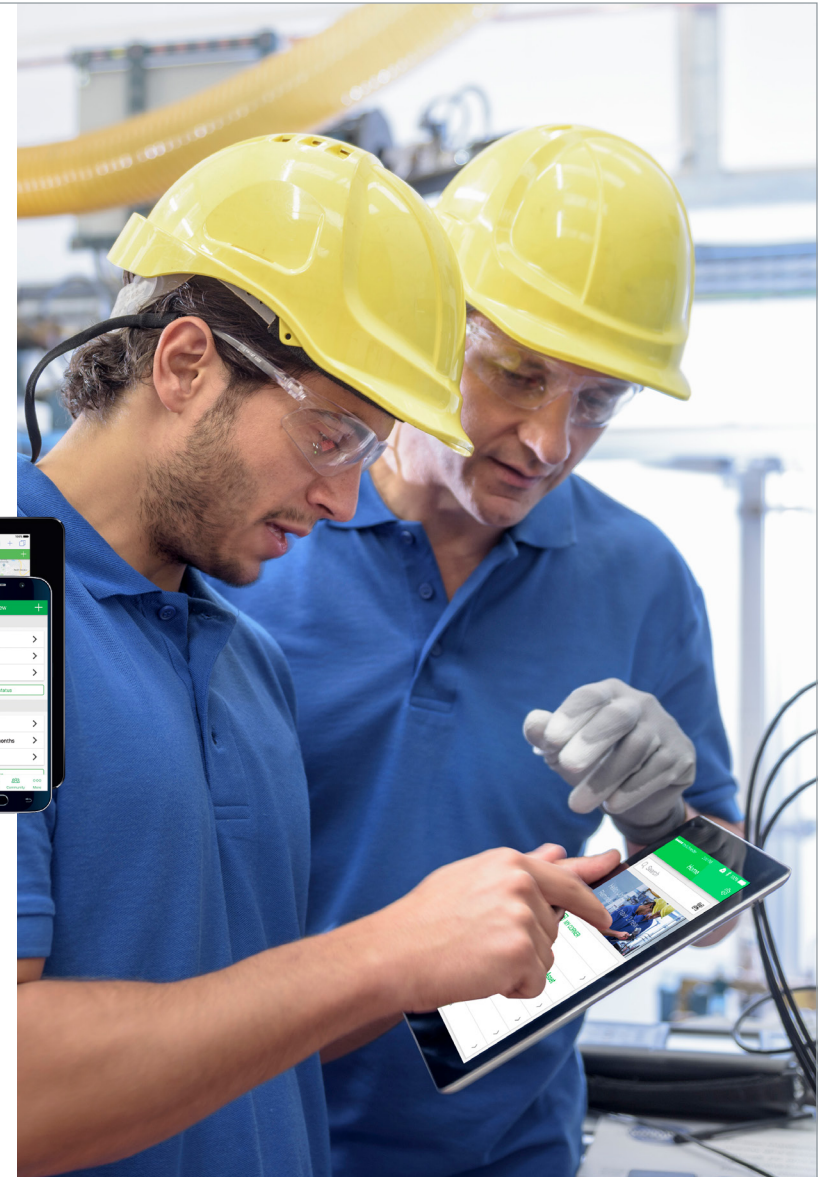
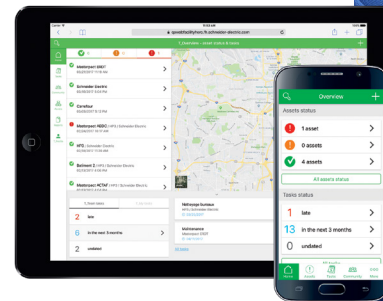

Apps, Analytics  
& Services

Edge Control

Connected  
Products

# Apps, analytics, and services

Enable your customers to make timely and informed decisions to reduce costs and boost their building performance.

## Generate greater savings

- Predictive analytics reveal invisible inefficiencies
- Proactive responses correct without delays

## Make data-driven decisions

- Analytics-powered alerts
- In-depth analysis of energy use and assets performance

## Secure your contract with your customer

- Performance reports with recommendations and action plan
- Expert support and partnership with Schneider Electric

Facility Advisor services allow you to reach unparalleled building performance and operational efficiency.

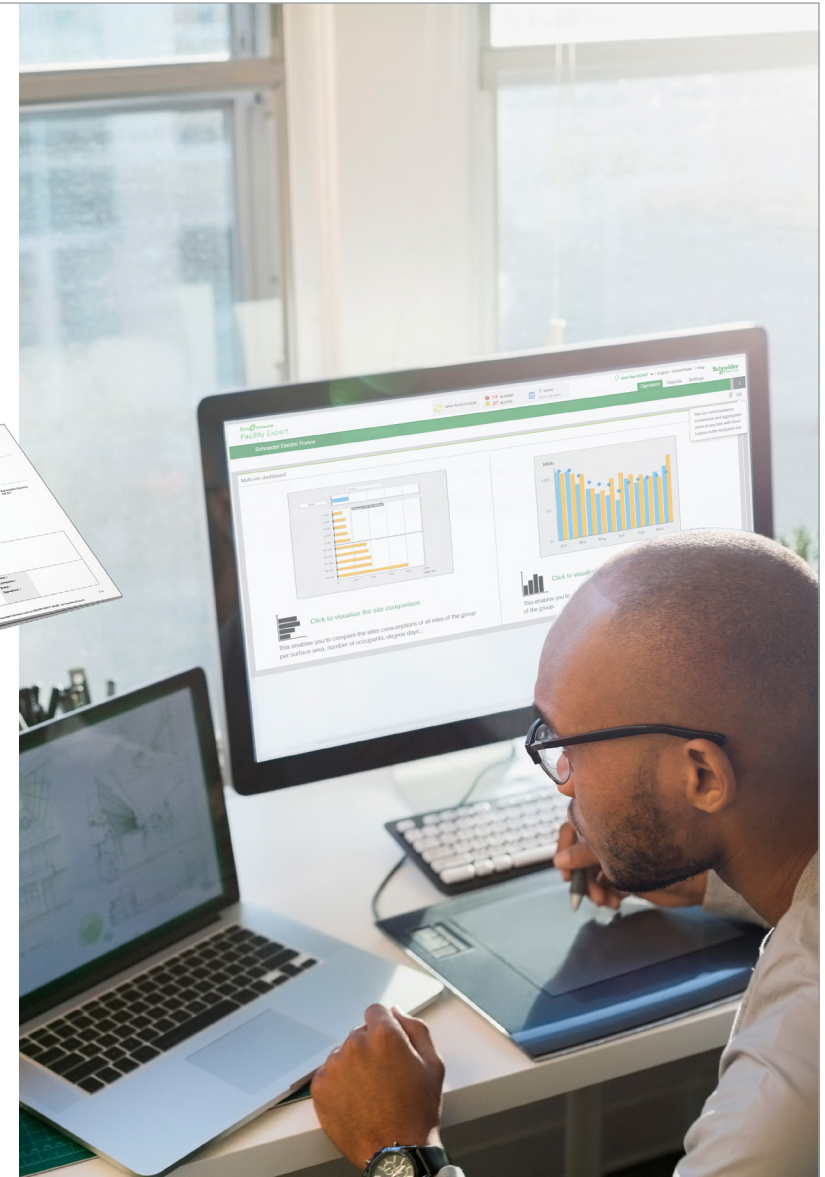

# New opportunities for your business

At every stage of a building's life cycle

Construction Phase

Operation Phase

Electrical system designers and consultants

Panel builders

Electrical contractors and installers

Electrical contractors, facility managers, service providers

# New opportunities for your business

At every stage of a building's life cycle

Construction Phase

Operation Phase

Design



## Electrical system designers and consultants

In the **DESIGN PHASE**, specifiers need to deliver state-of-the-art configurations that fit project, budget, and time specifications.

# New opportunities for your business

At every stage of a building's life cycle

Construction Phase

Operation Phase

Build



## Panel builders

In the **BUILD PHASE**, panel builders need to construct quality switchboards, incorporating new technology and delivered on time.



# New opportunities for your business

At every stage of a building's life cycle

Construction Phase

Operation Phase

Install



## Electrical contractors and installers

In the **INSTALLATION PHASE**, electrical contractors need to complete work on schedule, on budget, and to specification, with no surprises.

# New opportunities

At every stage of a building's life cycle

Operation Phase

Operate



## Electrical contractors, facility managers, service providers

In the **OPERATION PHASE**, service providers such as maintenance or facility managers need to maximize uptime and optimize operational and energy costs to offer new, high-quality services and competencies.

# Helping specifiers to win higher-value projects

In the **DESIGN** phase, EcoStruxure Power gives **specifiers** a competitive edge, allowing them to ensure compliance and differentiate their offer.

Construction Phase » Design



## Electrical system designers and consultants

EcoStruxure Power Benefits ▾

- Reduce design time
- Ensure standard compliance
- Gain recognition as a cutting-edge provider proposing cost-effective and scalable solutions for energy and maintenance management

# Helping specifiers to win higher-value projects

In the **DESIGN** phase, EcoStruxure Power gives **specifiers** a competitive edge, allowing them to ensure compliance and differentiate their offer.

Construction Phase » Design



## Electrical system designers and consultants

EcoStruxure Power Offer ▾

- Latest scalable technological solutions
- Trusted and complete system architectures
- Dedicated software and tools for efficient design and specification

### Reference Design & ID-Spec Software



# Helping specifiers to win higher-value projects

In the **DESIGN** phase, EcoStruxure Power gives **specifiers** a competitive edge, allowing them to ensure compliance and differentiate their offer.

Construction Phase >> Design



## Electrical system designers and consultants

Business Opportunity ▾



Win higher-value projects

# Ensuring on-time delivery for panel builders

In the **BUILD** phase, EcoStruxure Power helps **panel builders** increase volume and profitability by producing higher-value panel boards.

Construction Phase » Build



## Panel builders

### EcoStruxure Power Benefits ▾

- Increase project mean value by 5 percent\*
- Reduce mounting and cabling time
- Simplify panel operation with metering and communication
- Provide added value to your customers

\* Source: Navigant Research publication

# Ensuring on-time delivery for panel builders

In the **BUILD** phase, EcoStruxure Power helps **panel builders** increase volume and profitability by producing higher-value panel boards.

Construction Phase » Build



## Panel builders

EcoStruxure Power Offer ▾

- Tested and proven panel board architecture
- Tools that simplify selection, configuration, and assembly of smart electrical panels
- Test reports to ease administration
- Document repository for Factory Acceptance Test report and single-line diagram of the panel

### EcoStruxure Power Commission software

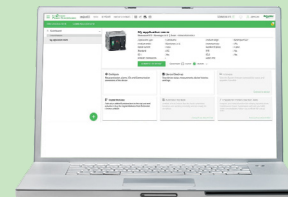

### Installation guide (Prisma and Blokset)



# Ensuring on-time delivery for panel builders

In the **BUILD** phase, EcoStruxure Power helps **panel builders** increase volume and profitability by producing higher-value panel boards.

Construction Phase » Build



Panel builders

Business Opportunity ▾



Increase turnover and profitability by selling higher value panelboards



# Helping contractors commission, maintain, and monitor energy-efficient installations

EcoStruxure Power helps contractors in the **INSTALLATION** phase win projects requiring digital skills, and in the **OPERATION** phase, offer new maintenance services and increase profitability.

Construction Phase >> Install



## Electrical contractors and installers

### EcoStruxure Power Benefits

- Install a secure system while reducing configuration time
- Enhance customer relationships by reducing energy costs by 5 percent\* and decreasing downtime by 10 percent\*\*
- Differentiate service offering by providing maintenance and energy management solutions

Sources: \*Navigant Research publication \*\*The Service Council publication

# Helping contractors commission, maintain, and monitor energy-efficient installations

EcoStruxure Power helps contractors in the **INSTALLATION** phase win projects requiring digital skills, and in the **OPERATION** phase, offer new maintenance services and increase profitability.

Construction Phase » Install



## Electrical contractors and installers

EcoStruxure Power Offer ▾

- A tested and proven architecture
- Documentation and tools that ease commissioning
- Web portal and smart phone app to manage maintenance activities, get alerts when issues arise, and monitor energy consumption

### EcoStruxure Power Commission software



### EcoStruxure Facility Expert



### Connected products

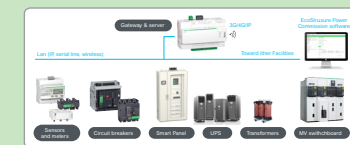

# Helping contractors commission, maintain, and monitor energy-efficient installations

EcoStruxure Power helps contractors in the **INSTALLATION** phase win projects requiring digital skills, and in the **OPERATION** phase, offer new maintenance services and increase profitability.

Construction Phase >> Install



## Electrical contractors and installers

Business Opportunity ▾



- Win projects requiring digital skills
- Increase profitability
- Start a new maintenance service business

# Enabling service providers to grow their business with new offerings

In the **OPERATION** phase, EcoStruxure Power helps **service providers** retain customers, increase profits, and extend their business to new energy management and equipment performance contracting offers.

Operation Phase » Operate



## Electrical contractors, facility managers, service providers

### EcoStruxure Power Benefits ▾

- Increase revenues
  - Propose new energy management services
  - Differentiate from standard maintenance service
- Decrease operating expenses
  - Improve operation and maintenance team efficiency by 12 percent\*
  - Have the right tool with the right information at the right time
- Improve customer loyalty
  - Prove job is complete
  - Perform faster repairs
  - Enhance customer relationships by reducing energy costs by 25 percent\*\* and decreasing downtime by 10 percent\*\*\*

Sources: \*Manufacturer publication CIAT & Trane \*\*Navigant Research publication \*\*\*The Service Council publication

# Enabling service providers to grow their business with new offerings

In the **OPERATION** phase, EcoStruxure Power helps **service providers** retain customers, increase profits, and extend their business to new energy management and equipment performance contracting offers.

Operation Phase » Operate



## Electrical contractors, facility managers, service providers

EcoStruxure Power Offer ▾

- Partnership with training and certification
- Web portal and app to manage maintenance activities, be alerted to issues, and monitor energy consumption
- In-depth energy and asset analysis to reveal inefficiencies
- Recommendations and action plans from Schneider Electric experts

### EcoStruxure Facility Advisor



### EcoStruxure Facility Expert



# Enabling service providers to grow their business with new offerings

In the **OPERATION** phase, EcoStruxure Power helps **service providers** retain customers, increase profits, and extend their business to new energy management and equipment performance contracting offers.

Operation Phase >> Operate



## Electrical contractors, facility managers, service providers

Business Opportunity ▾



Retain your customers to increase profits

Extend business with energy management services or equipment performance contracting

# Start a new business with EcoStruxure Power.



As an electrical contractor, embark on a progressive journey with Schneider Electric.

# Start a new business with EcoStruxure Power.



As an electrical contractor, embark on a progressive journey with Schneider Electric.



# Start a new business with EcoStruxure Power.



As an electrical contractor, embark on a progressive journey with Schneider Electric.

# Start a new business with EcoStruxure Power.



As an electrical contractor, embark on a progressive journey with Schneider Electric.

# Start a new business with EcoStruxure Power.



As an electrical contractor, embark on a progressive journey with Schneider Electric.

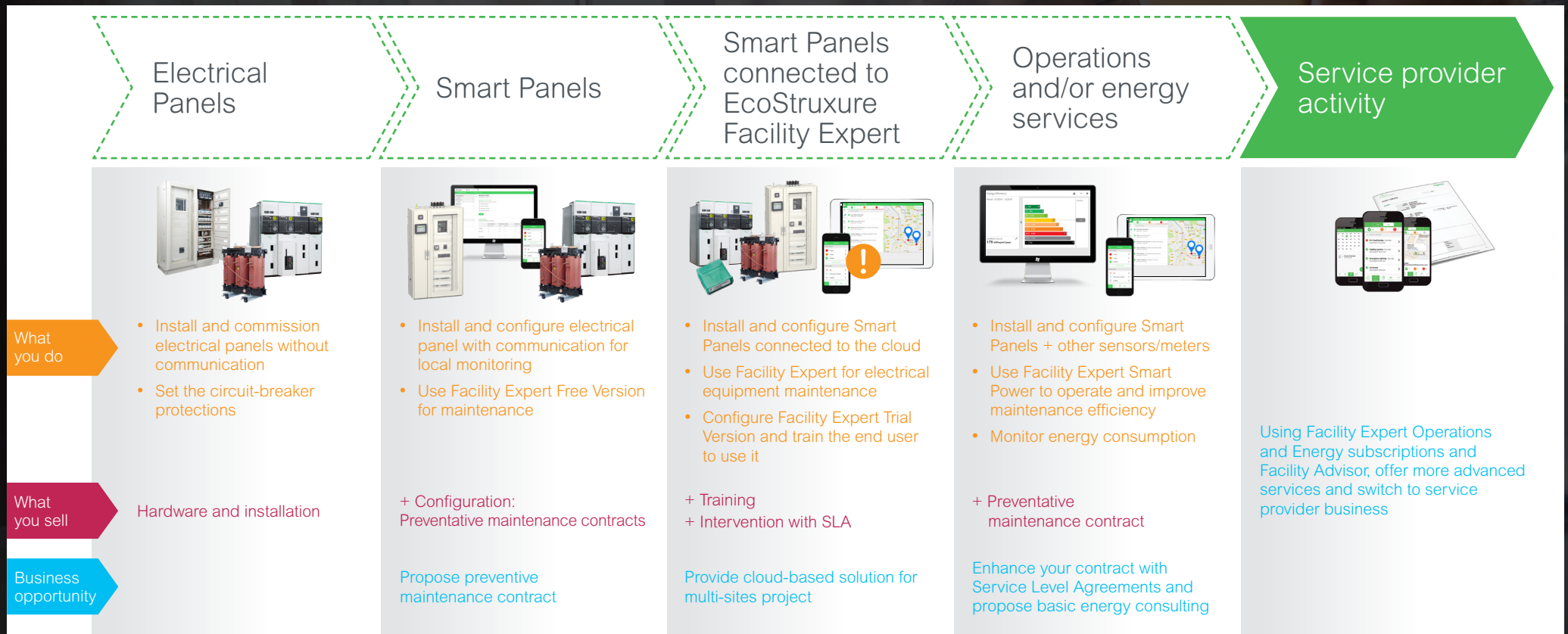

# Grow your business with EcoStruxure Power.



As a service provider, embark on a progressive journey with Schneider Electric.

# Grow your business with EcoStruxure Power.



As a service provider, embark on a progressive journey with Schneider Electric.

# Grow your business with EcoStruxure Power.



As a service provider, embark on a progressive journey with Schneider Electric.

# Grow your business with EcoStruxure Power.



As a service provider, embark on a progressive journey with Schneider Electric.

# Grow your business with EcoStruxure Power.



As a service provider, embark on a progressive journey with Schneider Electric.







# Case Study #1: City Hall, France

A complete solution with detailed dashboards, energy analysis, and access to the EcoStruxure Facility Expert web portal allows City Hall to identify potential issues based on analysis.

## Customer Needs

- Replace old switchboard
- Improve energy consumption traceability

## Customer Solution

- Smart Panels
  - ComPact NS and ComPact NSX circuit breakers with communication
  - MicroLogic modules to access energy data
- EcoStruxure Facility Expert
  - Allows monitoring and assessment of site energy performance
  - Access to Facility Expert web portal, with tracking consumption alerts

## Customer Outcomes

- Reduced time for installation and commissioning
- Continuous alerts available right after commissioning
- Reports to track potential issues
- Accurate evaluation of energy savings and building performance possible within one month of operation

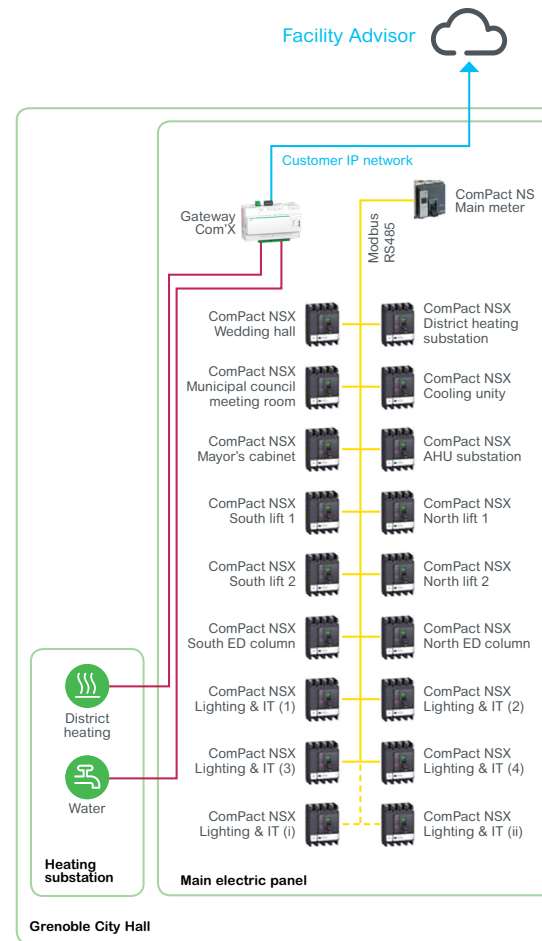



# Case Study #2: Public Buildings – Local Authority France

## Customer Needs

- Reduce building operations cost
- Improve energy consumption traceability
- Promote renewable energies and demonstrate commitment to sustainability to citizens

## Partner Needs

- Facility Manager partner needed to provide additional value beyond maintenance services to win the energy performance contract

## Customer Solution

Two EcoStruxure Facility Expert services deployed

- Facility Expert Energy
  - To monitor multiple energy consumptions, including gas, fuel, electricity, and district heating
- Facility Expert Operations
  - To monitor indoor temperatures and evaluate the impact of ECM
  - To alert technicians in the event of boiler failure

## Customer Outcomes

- Reduced design and configuration time
- Significant energy savings and improvement in building operation efficiencies with an ROI less than two years

## Partner Outcome

- Facility Manager partner won the energy performance and operation contract

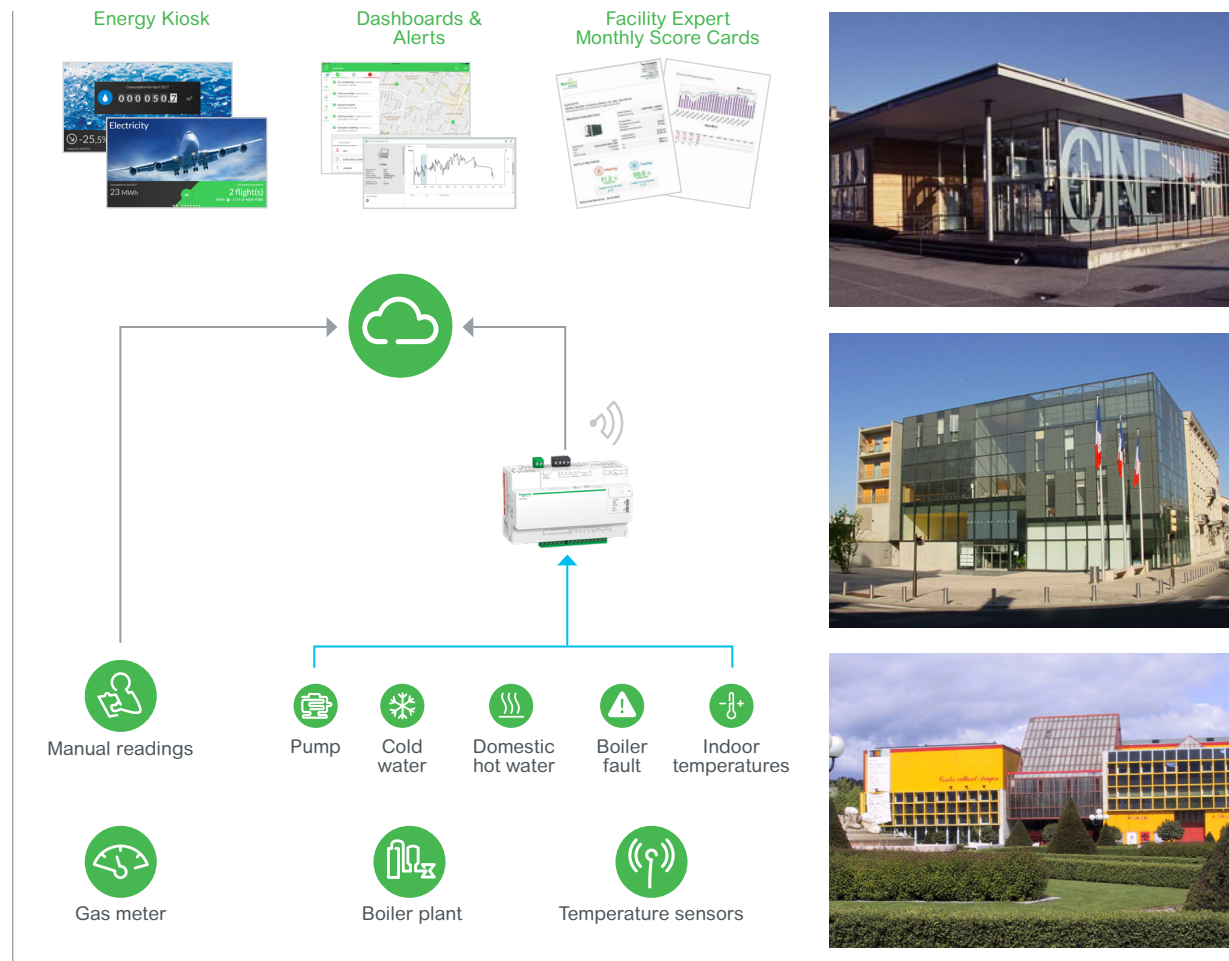



# Case Study #3: Child Care Center, France

Detailed analysis reports and access to the Schneider Electric web-based troubleshooting platform allowed our partner to identify issues for the Child Care Center and apply remedies based on real performance data.

## Customer Needs

- Occupant complaints due to discomfort
- Risk of non-compliance with child care building regulations
- Concern with undersized heat pump used for heating and cooling
- No data to identify issues and confirm assumptions

## Customer Solution

Two EcoStruxure Facility Advisor services deployed

- Facility Advisor Energy
  - To monitor and accurately assess the building's energy performance
- Facility Advisor HVAC
  - To monitor heat pump performance and status

## Customer Outcomes

- 40k€ saved over a two-year period
- Right level of comfort achieved, eliminating occupant complaints
- 33 percent potential energy savings identified
- Heat pump energy consumption reduced 40 percent; life expectancy extended
- Better management of air handling unit



### Running mode and energies

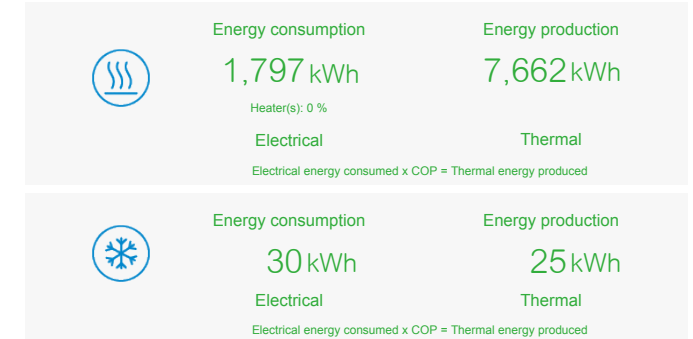

### Daily COP average

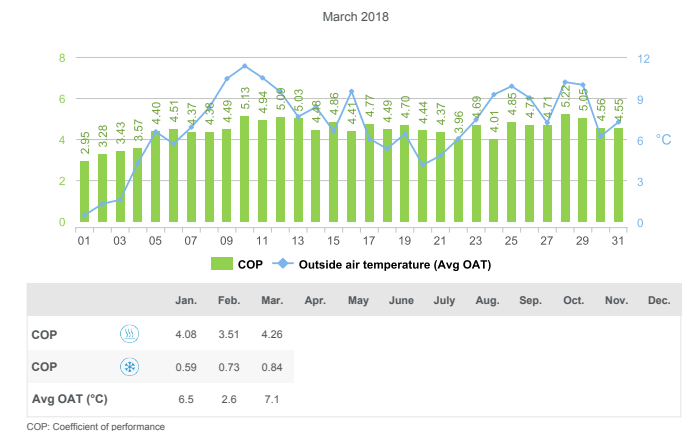

# Learn more



There's a lot more to EcoStruxure Power – learn the latest.



Give your electrical system a voice with Smart Panels – learn more today.



Monitor energy, optimize your operations, and more with Facility Expert – get started today.



Join our network of trained and certified partners by becoming an EcoXpert – find out how.

This document presents general, non-binding information regarding the potential value that digitized power distribution products and solutions can bring to the user. Due to varying user situations and goals, Schneider Electric does not warranty or guarantee that the same or similar results represented in this document can be achieved. Please refer to Schneider Electric product and solution catalogs for actual specifications and performance.



©2019 Schneider Electric. All Rights Reserved. Schneider Electric | Life Is On are trademarks and the property of Schneider Electric SE, its subsidiaries, and affiliated companies. All other trademarks are the property of their respective owners. 998-20267520 \_GMA-US

Life Is On

**Schneider**  
Electric