



TeSys® DF IEC-Type Fuseholders

Catalog
9080CT0801

08



Contents	Page
Characteristics.....	2
Fuseholders.....	3–4
Accessories.....	4
Dimensions.....	5
Wiring diagrams.....	5
Fuses.....	6–7

Fuseholder type	DF8	DF10	DF14	DF22	DFCC				
Environment characteristics									
Conforming to standards	IEC 60947-3, UL 512, CSA 22-2 n° 39								
Protective treatment	"TH," treatment for hot and humid environments								
Degree of protection	Conforming to IEC 60529	IP 20							
Ambient air temperature	Storage	°C (°F) - 40...+ 80 (- 40...+ 176)							
	For operation, with derating (1)	°C (°F) - 20...+ 60 (- 4...+ 140)							
Flame resistance	Conforming to IEC 60695-2-1	°C (°F) 960 (1760)							
Pole characteristics									
Fuse size	mm (inch)	8.5 x 31.5 (0.3 x 1.2)	10 x 38 (0.4 x 1.5)	14 x 51 (0.6 x 51)	22 x 58 (0.9 x 2.3)	10 x 38 (0.4 x 1.5) CC fuse			
Utilization category	AC20B								
Rated insulation voltage (Ui) with tubular links, a.c. supply	V	500	690	690	690	600			
Rated operational	Hz	50/60							
Rated impulse withstand voltage (Uimp)	kV	6	6	8	8	6			
Conventional thermal current (Ith) for ambient air temperature ≤ 40 °C (1)									
	With tubular links	A	25	32	50	125	30		
	With aM cartridge fuses	A	25	32	50	125	30		
	With gG cartridge fuses	A	25	32	50	100	30		
Short-circuit characteristics (with tubular links)									
	Permissible short-time rating (low) (rms value Cos φ = 0.35) Conforming to IEC 60947-3	A	300	385	800	1200	300		
	Maximum permissible peak value (dynamic stress) Conforming to IEC 60269-1	kA	11	15	15	19	11		
Certifications	 File E310269 CCN IZLT2 File E310269 CCN IZLT8					 E310269 CCN IZLT			
Wire sizes (number of conductors x c.s.a.)		Min.	Max.	Min.	Max.	Min.	Max.	Min.	Max.
	Solid wire	mm ² (AWG)	1 x 1.5 (1 x 16) 1 x 6 (1 x 16) 2 x 6 (2 x 10)	1 x 1.5 (1 x 16) 1 x 6 (1 x 16) 2 x 6 (2 x 10)	1 x 1.5 (1 x 16) 1 x 6 (1 x 16) 2 x 6 (2 x 10)	1 x 2.5 (1 x 14) 1 x 6 (1 x 16) 2 x 6 (2 x 10)	1 x 2.5 (1 x 14) 1 x 25 (1 x 4) 2 x 10 (2 x 8)	1 x 2.5 (1 x 14) 1 x 35 (1 x 2) 2 x 25 (2 x 4)	1 x 1.5 (1 x 16) 1 x 16 (1 x 6) 2 x 6 (2 x 10)
	Flexible wire without cable end	mm ² (AWG)	1 x 1.5 (1 x 16) 1 x 6 (1 x 16) 2 x 6 (2 x 10)	1 x 1.5 (1 x 16) 1 x 6 (1 x 16) 2 x 6 (2 x 10)	1 x 1.5 (1 x 16) 1 x 6 (1 x 16) 2 x 6 (2 x 10)	1 x 2.5 (1 x 14) 1 x 6 (1 x 16) 2 x 6 (2 x 10)	1 x 2.5 (1 x 14) 1 x 25 (1 x 4) 2 x 10 (2 x 8)	1 x 2.5 (1 x 14) 1 x 35 (1 x 2) 2 x 25 (2 x 4)	1 x 1.5 (1 x 16) 1 x 16 (1 x 6) 2 x 6 (2 x 10)
	Flexible wire with cable end	mm ² (AWG)	1 x 1.5 (1 x 16) 1 x 6 (1 x 16) 2 x 6 (2 x 10)	1 x 1.5 (1 x 16) 1 x 6 (1 x 16) 2 x 6 (2 x 10)	1 x 1.5 (1 x 16) 1 x 6 (1 x 16) 2 x 6 (2 x 10)	1 x 2.5 (1 x 14) 1 x 6 (1 x 16) 2 x 6 (2 x 10)	1 x 2.5 (1 x 14) 1 x 25 (1 x 4) 2 x 10 (2 x 8)	1 x 2.5 (1 x 14) 1 x 35 (1 x 2) 2 x 25 (2 x 4)	1 x 1.5 (1 x 16) 1 x 16 (1 x 6) 2 x 6 (2 x 10)
Tightening torque	Nm (lb-in)	2.2 (19)		3.5 (31)		4 (35)		2.2 (19)	
Characteristics of early break and signalling contacts DF14AM and DF22AM									
Rated insulation voltage (Ui) a.c. supply	V	250							
Conventional thermal current (Ith) for ambient air temperature ≤ 40 °C (1)	A	5							
Rated operational current		24 V		48 V		127 V		240 V	
	Category AC-15	A	4	4	3	2.5			
	Category DC-13	A	3	1	0.2	0.1			
Definition of rated characteristics	Conforming to IEC 60947-5-1	B300							
Low load operating characteristics	Minimum voltage	V	10						
	Minimum current	mA	30						
Cabling	Faston connectors								

(1) For use in an installation with ambient temp. > 20 °C (68 °F), apply a derating coefficient:

Max temperature °C (°F)	20 (68)	30 (86)	40 (104)	50 (122)	60 (140)
Max. relative humidity	95 %	90 %	80 %	50 %	50 %
Current derating coefficient	1	0.95	0.9	0.8	0.7

106786



DF101

106788



DF103N

106793



DF141

106795



DF143NC

106823



DF221

106825



DF223NC

106791



DF101NV

106792



DF103V

106834



DF141NV

106822



DF143VC

106834



DF221NV

106835



DF223VC

Fuseholders (1)

Conventional thermal current (Ith)	Size of cartridge fuse or link	Composition P = Poles(s) N = Neutral	Sold in lots of	Catalog numbers	Weight
A	mm (inch)				kg (oz)
25	8.5 x 31.5 (0.3 x 1.2)	1 P	12	DF81	0.061 (2.15)
		N	12	DF10N	0.071 (2.50)
		1 P + N (2)	6	DF81N	0.132 (4.66)
		2 P	6	DF82	0.122 (4.30)
		3 P	4	DF83	0.183 (6.46)
		3 P + N (2)	3	DF83N	0.254 (8.96)
32	10 x 38 (0.4 x 1.5)	1 P	12	DF101	0.061 (2.15)
		N	12	DF10N	0.071 (2.50)
		1 P + N (2)	6	DF101N	0.132 (4.66)
		2 P	6	DF102	0.122 (4.30)
		3 P	4	DF103	0.183 (6.46)
		3 P + N (2)	3	DF103N	0.254 (8.96)
50	14 x 51 (0.6 x 2.0)	1 P	6	DF141	0.140 (4.94)
		N	6	DF14N	0.150 (5.29)
		1 P + N (2)	3	DF141N	0.290 (10.23)
		2 P	3	DF142	0.280 (9.88)
		3 P	2	DF143C (3)	0.420 (14.82)
		3 P + N (2)	1	DF143NC (3)	0.570 (20.11)
125	22 x 58 (0.9 x 2.3)	1 P	6	DF221	0.218 (7.69)
		N	6	DF22N	0.238 (8.40)
		1 P + N (2)	3	DF221N	0.456 (16.09)
		2 P	3	DF222	0.436 (15.38)
		3 P	2	DF223C (3)	0.654 (23.07)
		3 P + N (2)	1	DF223NC (3)	0.892 (31.46)

Fuseholders with "blown fuse" indicators (neon) (1) (4)

Conventional thermal current (Ith)	Size of cartridge fuse or link	Composition P = Pole(s) N = Neutral	Sold in lots of	Catalog numbers	Weight
A	mm (inch)				kg (oz)
25	8.5 x 31.5 (0.3 x 1.2)	1 P	12	DF81V	0.064 (2.26)
		1 P + N (2)	6	DF81NV	0.135 (4.76)
		2 P	6	DF82V	0.125 (4.41)
		3 P	4	DF83V	0.186 (6.56)
		3 P + N (2)	3	DF83NV	0.257 (9.07)
		32	10 x 38 (0.4 x 1.5)	1 P	12
1 P + N (2)	6			DF101NV	0.135 (4.76)
2 P	6			DF102V	0.125 (4.41)
3 P	4			DF103V	0.186 (6.56)
3 P + N (2)	3			DF103NV	0.257 (9.07)
50	14 x 51 (0.6 x 2.0)			1 P	6
		1 P + N (2)	3	DF141NV	0.293 (10.34)
		2 P	3	DF142V	0.283 (9.98)
		3 P	2	DF143VC (3)	0.423 (14.92)
		3 P + N (2)	1	DF143NVC (3)	0.573 (20.21)
		125	22 x 58 (0.9 x 2.3)	1 P	6
1 P + N (2)	3			DF221NV	0.459 (16.19)
2 P	3			DF222V	0.439 (15.49)
3 P	2			DF223VC (3)	0.657 (23.18)
3 P + N (2)	1			DF223NVC (3)	0.895 (31.57)

(1) Each pole can be marked. A clip-in marker holder is provided for this purpose. Clip-in markers type AB1 R● or AB1 G● can also be used.

(2) N: neutral pole fitted with a locked tubular link as standard.

(3) A letter "C" in the catalog number indicates that the fuseholder can be fitted with auxiliary early break, "blown fuse" signalling and "fuse present" signalling contacts.

(4) Operational voltage of the blown fuse indicator: 110 V...690 V.

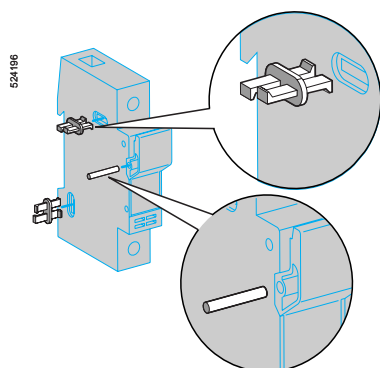

Detail of assembly clip and pin mounting

Fuseholders (1)

Conventional thermal current (Ith)	Size of cartridge fuse or link	Composition P = Poles	Sold in lots of	Catalog numbers	Weight kg (oz)
30	Class CC	1 P	12	DFCC1	0.061 (2.15)
		2 P	6	DFCC2	0.122 (4.30)
		3 P	4	DFCC3	0.183 (6.46)

Fuseholders with “blown fuse” indicators (neon) (1)

Conventional thermal current (Ith)	Size of cartridge fuse or link	P = Poles	Sold in lots of	Catalog numbers	Weight kg (oz)
30	Class CC	1 P	12	DFCC1V	0.064 (2.26)
		2 P	6	DFCC2V	0.125 (4.41)
		3 P	4	DFCC3V	0.186 (6.56)

Accessories

Auxiliary early break and “blown fuse” signalling contacts (2)

	Size of cartridge fuse or link mm (inch)	Number of contacts	Sold in lots of	Catalog numbers	Weight kg (oz)
DF14	14 x 51 (0.6 x 2.0)	1	1	DF14AM1	0.025 (0.88)
		2	1	DF14AM2	0.029 (1.02)
DF22	22 X 58 (0.9 x 2.3)	1	1	DF22AM1	0.032 (1.13)
		2	1	DF22AM2	0.035 (1.23)

Fuseholder assembly kits (3)

Fuseholders to be assembled	Size of cartridge fuse or link mm (inch)	Composition	Sold in lots of	Catalog numbers	Weight kg (oz)
DF8	8.5 x 31.5 (0.3 x 1.2)	12 pins, 24 clips	12	DF10AP	0.007 (0.25)
DF10	10 x 38 (0.4 x 1.5)				
DF14	14 x 51 (0.6 x 2.0)	10 pins, 30 clips	10	DF14AP	0.025 (0.88)
DF22	22 x 58 (0.9 x 2.3)	10 pins, 30 clips	10	DF22AP	0.028 (0.99)

Marking accessories

Description	Composition	Marking	Sold in lots of	Catalog numbers	Weight kg (oz)
Clip-in markers	Strip of 10 identical numbers or letters	0...9	25	AB1R● (4)	0.002 (0.07)
		A...Z	25	AB1G● (4)	0.002 (0.07)

(1) Each pole can be marked. A clip-in marker holder is provided for this purpose. Clip-in markers type AB1 R● or AB1 G● can also be used.

(2) These auxiliary contacts provide the following functions: early break, “blown fuse” signalling (if the Fuseholder is fitted with striker fuses) and “fuse present” signalling.

(3) 1 pin and 2 clips are required to assemble two DF8 or DF10 fuseholders together. 1 pin and 3 clips are required to assemble two DF14 or DF22 fuseholders together.

(4) When ordering, replace the ● in the catalog number with the number or letter required. Example: AB1-R1 or AB1-GA.

Note:

DF10 and DFCC fuseholders have been subjected to a current withstand of $I_p = 9$ kA and $12T = 38$ kA2s at 800 V ac maximum, 200 kA.

DF14 fuseholders have been subjected to a current withstand of $I_p = 24.2$ kA and $12T = 130$ kA2s at 750 V ac maximum, 200 kA.

DF22 fuseholders have been subjected to a current withstand of $I_p = 20.4$ kA and $12T = 141$ kA2s at 750 V ac maximum, 200 kA.

DF10, DF14, and DF22 devices accept fuses which provide supplementary protection and have not been evaluated by UL for use where branch circuit protection is needed.

Dimensions: mm (inch)

Modular fuseholders 25 A and 32 A

Mounting on 35 mm L rail

DF81 and DF81V
DF101 and DF101V
DF10N
DFCC1 and DFCC1V

DF81N and DF81NV
DF82 and DF82V
DF101N and DF101NV
DF102 and DF102V
DFCC2 and DFCC2V

DF83 and DF83V
DF103 and DF103V
DFCC3 and DFCC3V

DF83N and DF83NV
DF103N and DF103NV

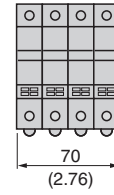
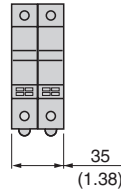
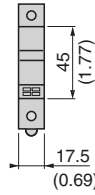
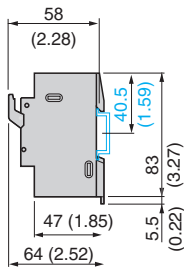

Modular fuseholders 50 A

Mounting on 35 mm L rail

DF141 and DF141V
DF14N

DF141N and DF141NV
DF142 and DF142V

DF143C and DF143VC

DF143NC and DF143NVC

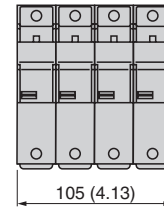
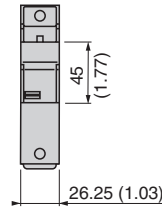
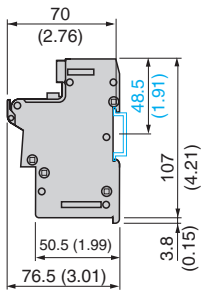

Modular fuseholders 125 A

Mounting on 35 mm L rail

DF221 and DF221V
DF22N

DF221N and DF221NV
DF222 and DF222V

DF223C and DF223VC

DF223NC and DF223NVC

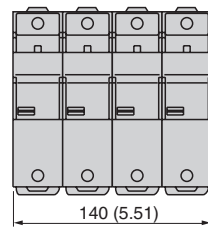
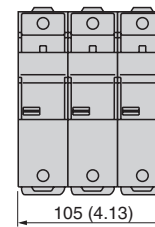
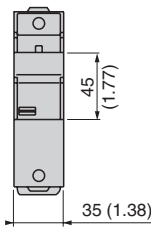
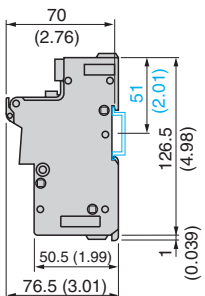

Wiring diagrams

Modular fuseholders

DF• 1P



DF• N



DF• 1P + N

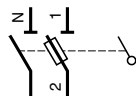

DF• 2P

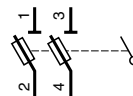

DF• 3P

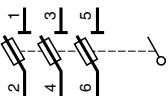

DF• 3P + N

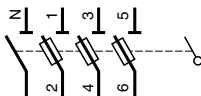

Cartridge fuses without striker, Type aM						
Cartridge fuse type	Maximum rated voltage	Rating	Sold in lots of	Catalog numbers	Weight	
mm (inch)	Vac	A			g (oz)	
Cylindrical 8.5 x 31.5 (0.3 x 1.2)	400	1	10	DF2BA0100	10 (0.35)	
		2	10	DF2BA0200	10 (0.35)	
		4	10	DF2BA0400	10 (0.35)	
		6	10	DF2BA0600	10 (0.35)	
		8	10	DF2BA0800	10 (0.35)	
		10	10	DF2BA1000	10 (0.35)	
Cylindrical 10 x 38 (0.4 x 1.5)	500	0.16	10	DF2CA001	10 (0.35)	
		0.25	10	DF2CA002	10 (0.35)	
		0.50	10	DF2CA005	10 (0.35)	
		1	10	DF2CA01	10 (0.35)	
		2	10	DF2CA02	10 (0.35)	
		4	10	DF2CA04	10 (0.35)	
		6	10	DF2CA06	10 (0.35)	
		8	10	DF2CA08	10 (0.35)	
		10	10	DF2CA10	10 (0.35)	
		12	10	DF2CA12	10 (0.35)	
		16	10	DF2CA16	10 (0.35)	
		400	20	10	DF2CA20	10 (0.35)
			25	10	DF2CA25	10 (0.35)
Cylindrical 14 x 51 (0.6 x 2.0)	500	0.25	10	DF2EA002	20 (0.71)	
		0.50	10	DF2EA005	20 (0.71)	
		1	10	DF2EA01	20 (0.71)	
		2	10	DF2EA02	20 (0.71)	
		4	10	DF2EA04	20 (0.71)	
		6	10	DF2EA06	20 (0.71)	
		8	10	DF2EA08	20 (0.71)	
		10	10	DF2EA10	20 (0.71)	
		12	10	DF2EA12	20 (0.71)	
		16	10	DF2EA16	20 (0.71)	
		20	10	DF2EA20	20 (0.71)	
		25	10	DF2EA25	20 (0.71)	
		32	10	DF2EA32	20 (0.71)	
		40	10	DF2EA40	20 (0.71)	
		400	50	10	DF2EA50	20 (0.71)
Cylindrical 22 x 58 (0.9 x 2.3)	690	4	10	DF2FA04	45 (1.59)	
		6	10	DF2FA06	45 (1.59)	
		8	10	DF2FA08	45 (1.59)	
		10	10	DF2FA10	45 (1.59)	
		16	10	DF2FA16	45 (1.59)	
		20	10	DF2FA20	45 (1.59)	
		25	10	DF2FA25	45 (1.59)	
		32	10	DF2FA32	45 (1.59)	
		40	10	DF2FA40	45 (1.59)	
		50	10	DF2FA50	45 (1.59)	
		500	63	10	DF2FA63	45 (1.59)
			80	10	DF2FA80	45 (1.59)
			100	10	DF2FA100	45 (1.59)
400	125	10	DF2FA125	45 (1.59)		



DF2CA***

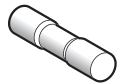

DF2EA***

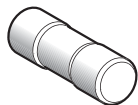

DF2FA**

Cartridge fuses with striker, Type aM

Cartridge fuse type	Maximum rated voltage	Rating	Sold in lots of	Catalog numbers	Weight
mm (inch)	Vac	A			g (oz)
Cylindrical 14 x 51 (0.6 x 2.0)	500	2	10	DF3EA02	20 (0.71)
		4	10	DF3EA04	20 (0.71)
		6	10	DF3EA06	20 (0.71)
		8	10	DF3EA08	20 (0.71)
		10	10	DF3EA10	20 (0.71)
		12	10	DF3EA12	20 (0.71)
		16	10	DF3EA16	20 (0.71)
		20	10	DF3EA20	20 (0.71)
		25	10	DF3EA25	20 (0.71)
		32	10	DF3EA32	20 (0.71)
		40	10	DF3EA40	20 (0.71)
		50	10	DF3EA50	20 (0.71)
		Cylindrical 22 x 58 (0.9 x 2.3)	690	4	10
6	10			DF3FA06	45 (1.59)
8	10			DF3FA08	45 (1.59)
10	10			DF3FA10	45 (1.59)
16	10			DF3FA16	45 (1.59)
20	10			DF3FA20	45 (1.59)
25	10			DF3FA25	45 (1.59)
32	10			DF3FA32	45 (1.59)
40	10			DF3FA40	45 (1.59)
50	10			DF3FA50	45 (1.59)
500	63			10	DF3FA63
	80	10	DF3FA80	45 (1.59)	
	100	10	DF3FA100	45 (1.59)	
400	125	10	DF3FA125	45 (1.59)	



DF3EA**



DF3FA**

The efficiency of Schneider Electric® brand *solutions*

Used in combination, Schneider Electric products provide quality solutions, meeting all your **Automation & Control** application requirements.



A worldwide presence

Constantly available

- More than 5,000 points of sale in 130 countries.
- A range of products that are right for you and comply with the standards in the country where they are used.

Technical assistance wherever you are

- Our technicians are at your disposal to assist you in finding the optimum solution for your particular needs.
- Schneider Electric provides you with all necessary technical assistance, throughout the world.

www.schneider-electric.us



Schneider Electric USA

8001 Knightdale Blvd.
Knightdale, NC 27545 USA
1-888-SquareD (1-888-778-2733)
www.schneider-electric.us

Electrical equipment should be installed, operated, serviced, and maintained only by qualified personnel. No responsibility is assumed by Schneider Electric for any consequences arising out of the use of this material.

© 2008 Schneider Electric. All Rights Reserved.

9080CT0801