

Vigilohm IFL12H

Insulation Fault Locator

User manual

7EN02-0407-04
06/2021



Legal Information

The Schneider Electric brand and any trademarks of Schneider Electric SE and its subsidiaries referred to in this guide are the property of Schneider Electric SE or its subsidiaries. All other brands may be trademarks of their respective owners.

This guide and its content are protected under applicable copyright laws and furnished for informational use only. No part of this guide may be reproduced or transmitted in any form or by any means (electronic, mechanical, photocopying, recording, or otherwise), for any purpose, without the prior written permission of Schneider Electric.

Schneider Electric does not grant any right or license for commercial use of the guide or its content, except for a non-exclusive and personal license to consult it on an "as is" basis. Schneider Electric products and equipment should be installed, operated, serviced, and maintained only by qualified personnel.

As standards, specifications, and designs change from time to time, information contained in this guide may be subject to change without notice.

To the extent permitted by applicable law, no responsibility or liability is assumed by Schneider Electric and its subsidiaries for any errors or omissions in the informational content of this material or consequences arising out of or resulting from the use of the information contained herein.

Safety information

Important information

Read these instructions carefully and look at the equipment to become familiar with the device before trying to install, operate, service, or maintain it. The following special messages may appear throughout this manual or on the equipment to warn of potential hazards or to call attention to information that clarifies or simplifies a procedure.



The addition of either symbol to a “Danger” or “Warning” safety label indicates that an electrical hazard exists which will result in personal injury if the instructions are not followed.



This is the safety alert symbol. It is used to alert you to potential personal injury hazards. Obey all safety messages that accompany this symbol to avoid possible injury or death.

DANGER

DANGER indicates a hazardous situation which, if not avoided, **will result in death or serious injury**.

Failure to follow these instructions will result in death or serious injury.

WARNING

WARNING indicates a hazardous situation which, if not avoided, **could result in death or serious injury**.

CAUTION

CAUTION indicates a hazardous situation which, if not avoided, **could result in minor or moderate injury**.

NOTICE

NOTICE is used to address practices not related to physical injury.

Please note

Electrical equipment should be installed, operated, serviced and maintained only by qualified personnel. No responsibility is assumed by Schneider Electric for any consequences arising out of the use of this material. A qualified person is one who has skills and knowledge related to the construction, installation, and operation of electrical equipment and has received safety training to recognize and avoid the hazards involved.

Notice

FCC

This equipment has been tested and found to comply with the limits for a Class A digital device, pursuant to Part 15 of the FCC rules. These limits are designed to provide reasonable protection against harmful interference when the equipment is operated in a commercial environment. This equipment generates, uses, and can radiate radio frequency energy and, if not installed and used in accordance with the instruction manual, may cause harmful interference to radio communications. Operation of this equipment in a residential area is likely to cause harmful interference in which case the user will be required to correct the interference at his own expense.

The user is cautioned that any changes or modifications not expressly approved by Schneider Electric could void the user's authority to operate the equipment.

This digital apparatus complies with CAN ICES-3 (A) /NMB-3(A).

About this manual

This manual discusses features of the Vigilohm IFL12H insulation fault locator and provides installation, commissioning, and configuration instructions.

This manual is intended for use by designers, panel builders, installers, system integrators, and maintenance technicians who are related with ungrounded electrical distribution systems featuring insulation monitoring devices (IMDs) with fault locating devices for medical applications.

Throughout the manual, the term “device” refers to IFL12H. Throughout the manual, the term “IMD” refers to IM20-H.

This manual assumes you have an understanding of insulation monitoring and locating and are familiar with the equipment and power system in which your device is installed.

This manual does not provide instructions on how to incorporate device data or perform device configuration using energy management systems or software.

Please contact your local Schneider Electric representative to learn what additional training opportunities are available for your devices.

Make sure you are using the most up-to-date version of your device’s firmware in order to access the latest features.

The most up-to-date documentation about your device is available for download from www.se.com.

Related documents

Document	Number
Instruction Sheet: Vigilohm IFL12H Insulation Fault Locator	QGH34270
Commissioning Guide: Vigilohm IFL12H Insulation Fault Locator	7EN02-0420
Vigilohm Catalog	PLSED310020EN
The IT earthing system: a solution to improve industrial electrical network availability - Application guide	PLSED110006EN
System earthings in LV (The schematics of earth links in LV (neutral modes) Cahier technique n° 172)	CT172
The IT system earthing (unearthed neutral) in LV (The IT scheme (in isolated neutral) of the links to the earth in LV Cahier technique n° 178)	CT178
Secure power distribution and monitoring solution for operating theatres - Solution guide	DESWED109024EN

Table of Contents

Safety precautions	9
Introduction	10
Ungrounded power system overview	10
Insulation resistance (R) monitoring	10
Device overview	10
Supplemental information.....	11
Hardware overview	11
Accessories	12
Device configuration and analysis tools	13
Application	15
Example application: Locating the insulating alarm with IMD	15
Example application: Locating the insulating alarm with IMD, where device and IMD are connected to an external network	15
Example application: Locating the insulating alarm with IMD, where device and IMD are connected to communication network	16
Human Machine Interface (HMI)	18
Device menu	18
Display interface.....	18
Navigation buttons and icons.....	19
Information icons.....	19
Status screens	20
Parameter modification using the display.....	22
Function.....	24
Commissioning	24
Automatic commissioning	25
Manual commissioning.....	25
Checking wiring connection	26
General configuration.....	27
Date/Time	27
Password.....	27
Language.....	27
Identification.....	28
Display.....	28
Network configuration	28
Channel Name	28
Alarm configuration.....	30
Insulation alarm (Ins. Alarm) thresholds	30
I/O configuration.....	31
Insulation alarm relay (Ins. AI. Relay)	32
R measurement.....	32
Insulation measurements	32
Monitoring power system insulation	32
Log.....	33
Reset.....	34
Auto-test.....	35
Communication	36
Communication parameters	36

Modbus functions	36
Modbus register table format	37
Modbus registers table	37
Alarm event records	44
Date and time (TI081 format)	46
Maintenance	48
Safety precautions	48
Product status light indicator	48
Troubleshooting	48
Specifications	50
China Standard Compliance	52

Safety precautions

Installation, wiring, testing and service must be performed in accordance with all local and national electrical codes.

Safety measures

⚡⚡ DANGER

HAZARD OF ELECTRIC SHOCK, EXPLOSION, OR ARC FLASH

- Apply appropriate Personal Protective Equipment (PPE) and follow safe electrical work practices. See NFPA 70E, CSA Z462 or other local standards.
- Turn off all power supplying this device and the equipment in which it is installed before working on or in the equipment.
- Always use a properly rated voltage sensing device to confirm that all power is off.
- Assume communications and I/O wiring are hazardous live until determined otherwise.
- Do not exceed the maximum ratings of this device.
- Disconnect all the device's input and output wires before performing dielectric (hi-pot) or Megger testing.
- Never shunt an external fuse or circuit breaker.
- Ensure that your ungrounded system has a compatible insulation monitoring device.

Failure to follow these instructions will result in death or serious injury.

NOTE: See IEC 60950-1:2005, Annex W for more information on communications and I/O wiring connected to multiple devices. See IEC 60364-4-41 for more information on protection against electrical shock.

⚠ WARNING

UNINTENDED OPERATION

Do not use this device for critical control or protection of persons, animals, property or equipment.

Failure to follow these instructions can result in death, serious injury, or equipment damage.

NOTICE

EQUIPMENT DAMAGE

- Do not open the device case.
- Do not attempt to repair any components of the device.

Failure to follow these instructions can result in equipment damage.

Introduction

Ungrounded power system overview

Ungrounded power system is an earthing system, which increases continuity of service of power systems and protection of people and property.

This system varies from country to country, including some applications where this system is mandated, such as hospital and the naval applications. This system is typically used in instances where the unavailability of power could result in lost production or incur significant downtime costs. Other potential applications are when there is a need to minimize the risk of fire and explosion. Lastly, this system is chosen in certain cases because it can facilitate preventive and corrective maintenance operations.

The system transformer's neutral is isolated from earth, or there is a high impedance between the neutral and earth, while the electrical load frames are earthed. This isolates the transformer and the load such that if the first fault occurs there is no loop for shorting current to flow, allowing the system to continue to operate normally without hazard to people and equipment. This system must have very low network capacitance to ensure that the first fault current cannot generate significant voltage. However, the faulty circuit must be detected and repaired before a second fault occurs. Because this system can tolerate an initial fault, maintenance operations can be improved and carried out in a safe and convenient manner.

Insulation resistance (R) monitoring

Ungrounded power system require insulation monitoring to identify when the first insulation fault has occurred.

In ungrounded power system, the installation must either be ungrounded or must be grounded using a sufficiently high level of impedance.

In the event of only one ground or earth fault, the fault current is very low and interruption is unnecessary. However, given that a second fault could potentially cause the circuit breaker to trip, an IMD has to be installed to indicate an initial fault. The device installed along with IMD detects the initial fault on the particular channel where the fault occurred. This device triggers an audible and/or a visual signal.

By constantly monitoring the insulation resistance, you can keep track of the system quality, which is a form of preventive maintenance. Further, monitoring the insulation resistance of individual channels, you can keep track of the individual channel quality.

Device overview

The device is a digital insulation fault locator (IFL) for low-voltage ungrounded power systems. An insulation monitoring device (IMD) must be connected to the ungrounded system where the device is connected. The device along with IMD locates the first fault and signals fault as alarm.

IMD monitors the insulation resistance of the system by injecting a signal. This technique is used for all power system types - AC, DC, combined, rectified, with a variable speed drive, etc. The device is connected to the channels of the system using Toroid. The device uses the injected signal from the IMD to monitor the individual channel circuits' insulation resistance. The device alerts when one or more of the monitored channels resistance is lower than the defined threshold and identifies the faulty channels. The device also provides local channel resistance values, which is used for more precise monitoring of individual channels within the system for the purposes of preventative maintenance.

The device offers the following features:

- Fault location up to 12 channels
- Fast fault location (time < 5 s)
- Dedicated commissioning mode for quick installation verification
- Auto-detects and configures compatible toroids in commissioning mode
- Detection of insulation faults in accordance to the configured threshold
- Relay for fault indication
- Communication via Modbus RS-485 protocol
- Configurable channel name
- Configurable insulation threshold per channel
- Insulation resistance display (R)
- Insulation fault log

Supplemental information

This document is intended to be used in conjunction with the installation sheet that ships in the box with your device and accessories.

See your device's installation sheet for information related to installation.

See your product's catalog pages at www.se.com for information about your device, its options and accessories.

You can download updated documentation from www.se.com or contact your local Schneider Electric representative for the latest information about your product.

Hardware overview

Vigilohm IFL12H feature 5 terminal blocks.

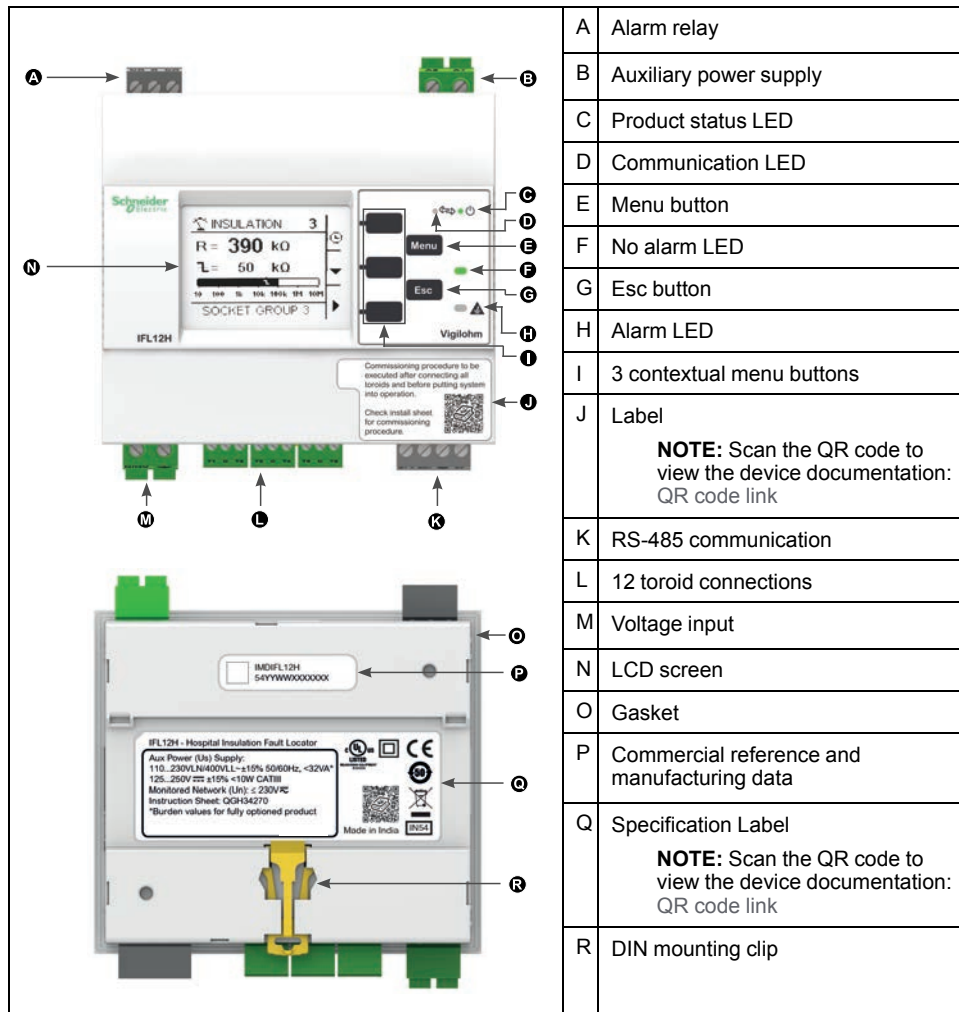

Device commercial reference

Model	Commercial reference
IFL12H	IMDIFL12H

Accessories

Accessories are required depending on the type of installation on which the device is installed.

Accessories list

Accessory	Catalog number
Toroid	Refer Vigilohm catalog

Toroids

The toroids are used to connect the device to the channels of the system, which can be monitored. The compatible toroids are:

- TA30

NOTE: This toroid is advised for IFL12H.

- PA50
- IA80

- MA120
- SA200
- GA300
- TOA80
- TOA120

Refer to the VigiloHM catalog for the most up to date listing of compatible devices. Refer to the toroid user guide for specifications.

Device configuration and analysis tools

ION Setup

ION Setup is a device configuration and verification tool.

ION Setup communicates with the device on the network and provides the basic configuration, which can be done via HMI and also advanced configuration, such as firmware upgrade and other features.

See [ION Setup](#) for latest version and instruction to install the tool and to add your device.

Ecoreach

Ecoreach is a software solution to configure and commission the smart device.

Ecoreach communicates with the device on the network and provides the following features:

- Automatic device discovery
- Device Check up & Control
- Firmware upgrade

See [Ecoreach](#) for instruction to install the solution and to add your device.

Power Monitoring Expert

EcoStruxure™ Power Monitoring Expert is a complete supervisory software package for power management applications.

The software collects and organizes data gathered from your facility's electrical network and presents it as meaningful, actionable information via an intuitive web interface.

Power Monitoring Expert communicates with devices on the network to provide:

- Real-time monitoring through a multi-user web portal
- Trend graphing and aggregation
- Power quality analysis and compliance monitoring
- Preconfigured and custom reporting

See the [EcoStruxure™ Power Monitoring Expert online help](#) for instructions on how to add your device into its system for data collection and analysis.

Power SCADA Operation

EcoStruxure™ Power SCADA Operation is a complete real-time monitoring and control solution for large facility and critical infrastructure operations.

It communicates with your device for data acquisition and real-time control. You can use Power SCADA Operation for:

- System supervision

- Real-time and historical trending, event logging
- PC-based custom alarms

See the EcoStruxure™ Power SCADA Operation online help for instructions on how to add your device into its system for data collection and analysis.

Gateways and supervision

The device is compatible with the gateways and supervision products.

The compatible gateway products are:

- Com'X510

See [Com'X510 Product Information](#) for more information..

- Link150

See [Link150 Product Information](#) for more information.

The compatible supervision product is spaceLYnk. See [spaceLYnk Product Information](#) for more information.

Application

This section explains the following examples of the insulation fault location application for ungrounded power system:

- Locating the insulating alarm with IMD
- Locating the insulating alarm with IMD, where device and IMD are connected to an external network
- Locating the insulating alarm with IMD, where device and IMD are connected to communication network

Example application: Locating the insulating alarm with IMD

You can use the device to locate the insulating alarm of an ungrounded power system with IMD.

IMD is powered by the ungrounded power system that it monitors. IMD is connected to neutral (or to one phase) and ground. The device is connected to the toroids. Toroids are connected to the channels of the system.

IMD monitors the insulation of the system. The device locates the channel where the insulation fault occurs. The device has a single relay output to control a light or a buzzer.

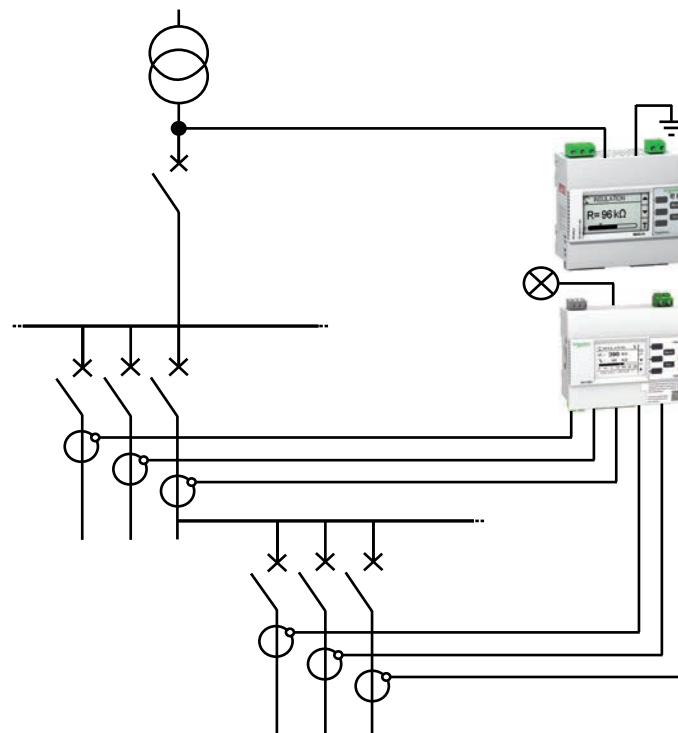

Example application: Locating the insulating alarm with IMD, where device and IMD are connected to an external network

You can use the device to locate the insulating alarm of an ungrounded power system with IMD connected to an external network.

IMD is powered by the ungrounded power system that it monitors. IMD is connected to neutral (or to one phase) and ground. The device is connected to the toroids. Toroids are connected to the channels of the system.

IMD monitors the insulation of the system. The device locates the channel where the insulation fault occurs. IMD insulation alarm output and the device alarm output are connected to an available input on a networked device (Power Meter or

PLC, for example). The networked device is connected to a supervisor via a communication network.

NOTE: In this example, only the fault information is available to the supervisor.

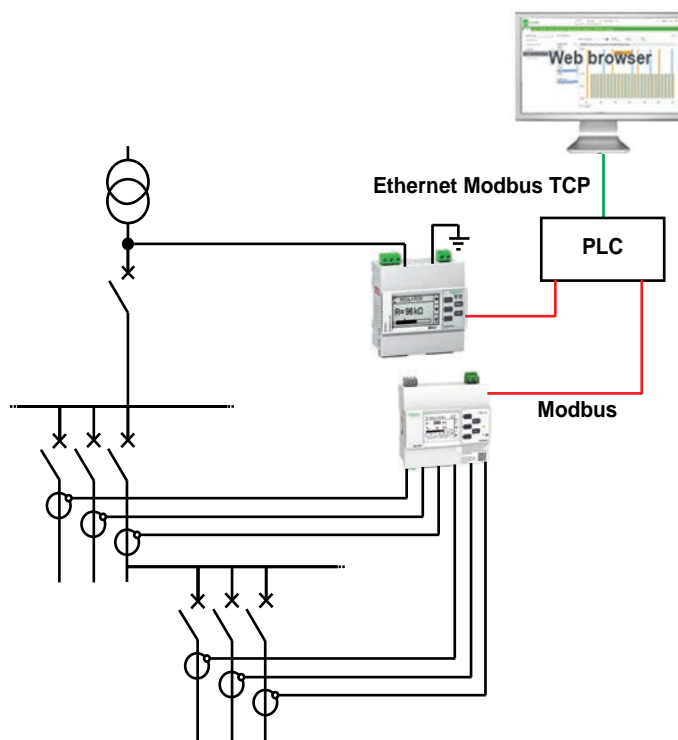

Example application: Locating the insulating alarm with IMD, where device and IMD are connected to communication network

You can use the device to locate the insulating alarm of an ungrounded power system with IMD connected to communication network.

IMD is powered by the ungrounded power system that it monitors. IMD is connected to neutral (or to one phase) and ground. The device is connected to the toroids. Toroids are connected to the channels of the system.

IMD monitors the insulation of the system. The device locates the channel where the insulation fault occurs. IMD and the device are connected to a supervisor via Modbus communication. This application can support the following actions from the supervisor level:

- Display:
 - Product status
 - All the channels insulation alarm (active and acknowledged)
- Configuring the product remotely: all the settings can be accessed remotely

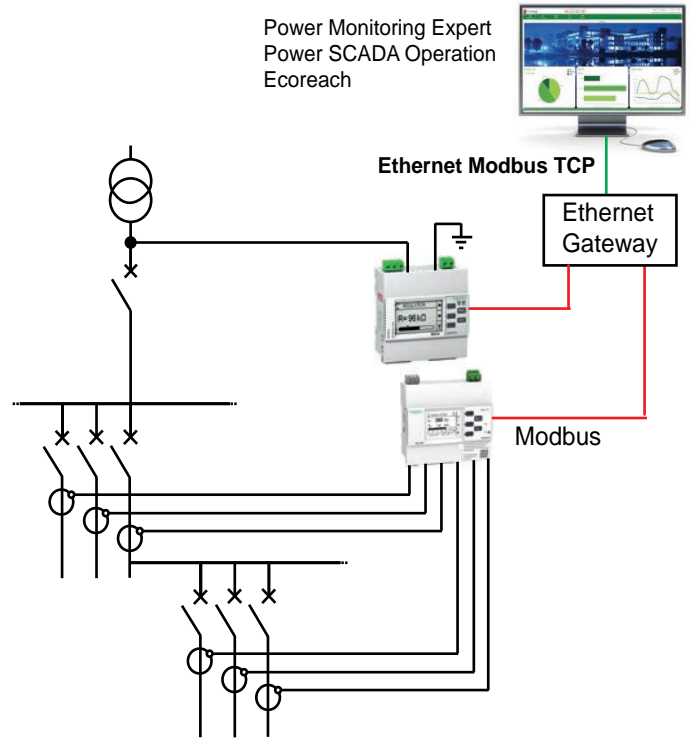

Human Machine Interface (HMI)

Device menu

Using the device’s display, you can navigate through the different menus to perform basic setup on your device.

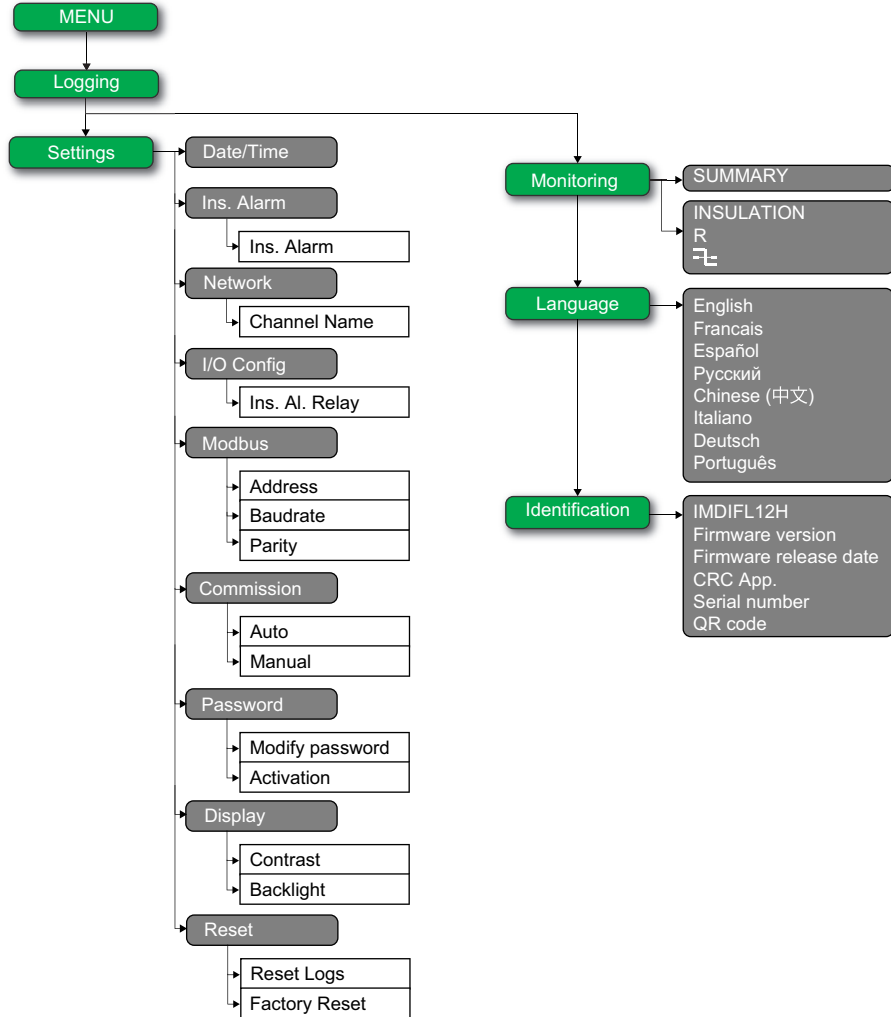

Display interface

Use the device display to perform various tasks such as configuring the device, displaying status screens, acknowledging alarms, or viewing events.

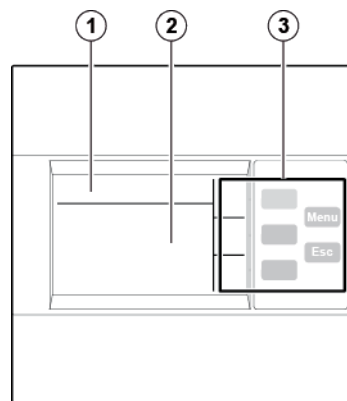

1	Screen identification area containing a menu icon, and the name of the menu or the parameter
2	Information area displaying information specific to the screen (measurement, insulation alarm, settings)
3	Navigation buttons

Navigation buttons and icons



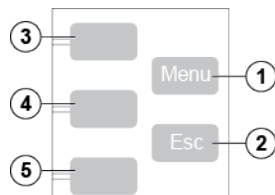















Use the display buttons to navigate through menus and perform actions.



Legend	Button	Icon	Description
1	Menu	–	Display the level 1 menu (Menu).
2	Esc	–	Go back to the previous level.
3	Contextual menu button 3		Scroll up the display or move to the previous item in a list.
			Access the date and time setting. If the clock icon flashes, it means that the Date/Time parameter needs to be set.
			Increase a numerical value. Modify the selected character
			Select all channels to set same value of insulation alarm threshold. Select all channels to perform manual commissioning.
			Select each channel to set value of insulation alarm threshold. Select each channel to perform manual commissioning.
4	Contextual menu button 2		Scroll down the display or move to the next item in a list.
			Move one digit to the left within a numerical value. If the digit on the far left is already selected, pressing the button loops you back to the digit on the right.
			Move from one character to the right of the one that is currently selected, or to loop back to the character on the left. Move from one channel to another channel to set value of insulation alarm threshold and to select channel for manual commissioning.
5	Contextual menu button 1		Validate the selected item.
			Run the auto-test manually.
			Go to a menu or submenu, or edit a parameter.
			Acknowledge the insulation alarm.
			Exit automatic commissioning mode.

Information icons

Icons in the information area of the LCD display provide information such as what menu is selected and the insulation alarm status.

Icon	Description
	Main menu
	<ul style="list-style-type: none"> System resistance (in the absence of an insulation fault) Measurement parameters menu Monitoring menu System resistance as primary record in Logging page
	Fault log menu
	Setting parameters menu and submenu
	Display language selection menu
	Product identification
	<ul style="list-style-type: none"> Indication of an insulation alarm Indication of product status Indication of channel status
	Summary
	No alarm
	Alarm
	Toroid disconnect
	Date/Time parameters menu
	Insulation alarm parameters menu
	I/O configuration parameters menu
	Modbus parameters menu
	Commission parameters menu
	Password parameters menu
	Display parameters menu
	Reset parameters menu

Status screens

Summary

The default screen shows the summary screen. This screen displays uncommissioned channels, commissioned channels, and insulation status of the commissioned channels.

An example of all 12 commissioned channels is as follows:

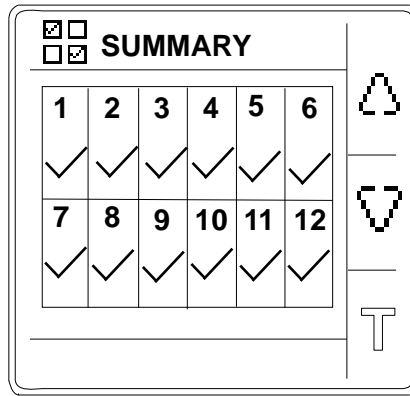

An example of 12 commissioned channel and 3 channels (channel number : 2, 6, and 10) displaying insulation alarm is as follows:

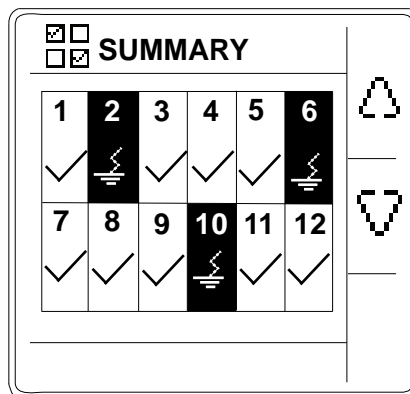

An example of 12 commissioned channel and 3 channels (channel number : 2, 6, and 10) displaying acknowledged insulation alarm is as follows:

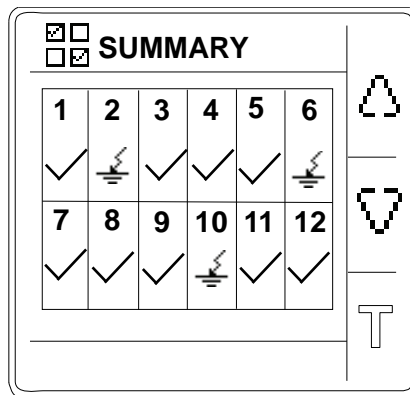

Insulation resistance measurement (R)

The device displays the insulation resistance measurement of each individual channel. An example measurement of channel 4 is as follows:

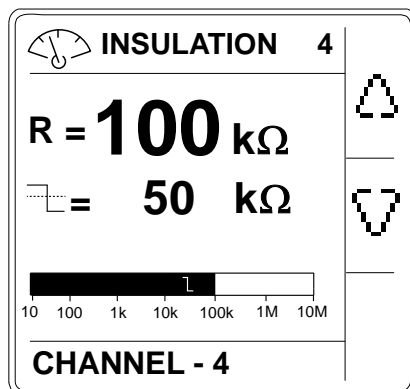

Insulation alarm detected: insulation fault

The device displays the insulation fault screen when the insulation value falls below the insulation alarm threshold. An example of insulation alarm of channel 4 is as follows:

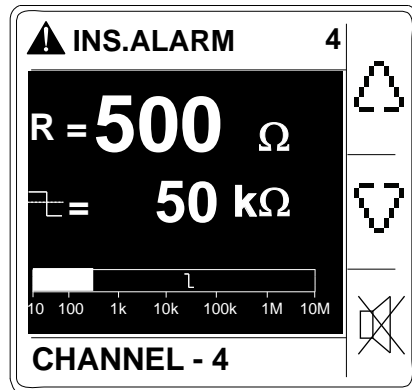

Acknowledge the insulation alarm by pressing the  button.

Insulation alarm acknowledged

This screen is displayed when you have acknowledged the insulation alarm. An example of insulation alarm acknowledged of channel 4 is as follows:

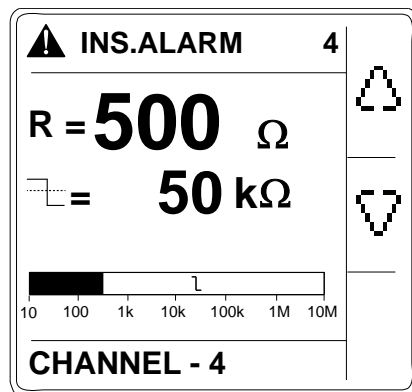

Parameter modification using the display

To modify the values, you must be thoroughly familiar with the interface menu structure and general navigation principles.

For more information about how the menus are structured, see [Device menu](#), page 18.

To modify the value of a parameter, follow either of these two methods:

- Select an item (value plus unit) in a list.
- Modify a numerical value, digit by digit and character value.

For the following parameters, the numerical value can be modified:

- Date
- Time
- Password
- Modbus address
- Toroid turns



For **Channel Name** parameter, the character value can be modified.

Selecting a value in a list

To select a value in a list, use the up and down menu buttons to scroll through the parameter values until you reach the desired value, then press  to confirm the new parameter value.



Modifying a numerical value

The numerical value of a parameter is made up of digits and the one on the far right is selected by default. To modify a numerical value, use the menu buttons as follows:

-  to modify the selected digit.
-  to select the digit to the left of the one that is currently selected, or to loop back to the digit on the right.
-  to confirm the new parameter value.

Modifying a character value

The character value of a parameter is made up of character and the one on the far left is selected by default. To modify a character value, use the menu buttons as follows:

-  to modify the selected character.
-  to select the character to the right of the one that is currently selected, or to loop back to the character on the left.
-  to confirm the new parameter value.

Saving a parameter

After you have confirmed the modified parameter, one of following two actions occur:

- If the parameter has been saved correctly, the screen displays **Saved** and then returns to the previous display.
- If the parameter has not been saved correctly, the screen displays **Error** and the editing screen remains active. A value is deemed to be out of range when it is classed as forbidden or when there are several interdependent parameters.

Canceling an entry

To cancel the current parameter entry, press the **Esc** button. The previous screen is displayed.

Function

Commissioning

The device must be commissioned so that the device can detect toroids and identify the insulation fault in the respective toroids.

Performing commissioning is mandatory when you:

- Install a new device
- Install one or more toroid to an installed device
- Remove one or more toroid from an installed device
- Replace the toroid with a different type. (Example: Replace TA30 type by PA50 type)
- Replace the device

Performing commissioning is not required when you reconnect or replace a toroid with the same type of toroid.

The device offers the following commissioning modes:



- Automatic
- Manual

Automatic commissioning

- At first power up or factory reset, the device displays **Detecting Toroid** message with a percentage progress bar.

NOTE: At first power up or factory reset, the device performs automatic commissioning.

- If toroid is detected, the **Commissioning** screen displays. This screen shows the status of commissioning. The following table provides the information of the various displays of commissioning grid.

HMI Display	Information
	Commissioned channel 4
	Non-commissioned channel 4
	Commissioned channel 4 with insulation fault

NOTE: Channel 4 is provided as an example. The displays are applicable for all 12 channels.

NOTE: If you have connected a toroid which is not one of the recommended toroids, then the device should be manually commissioned. See *Manual commissioning*, page 25. Refer to the Vigilohm catalog for the most up to date listing of compatible toroids.

- If toroid is not detected, the **No toroid** message displays. Perform one of the following action:
 - Check if the toroid is properly connected and navigate to **Menu > Settings > Commission > Auto**. The device performs automatic commissioning.
 - The connected toroid is not one of the recommended toroids. The device should be manually commissioned. See *Manual commissioning*, page 25.

NOTE: Refer to the Vigilohm catalog for the most up to date listing of compatible toroids.

- You can check the wiring of the system. To check, see *Checking wiring connection*, page 26. If you do not want to check, ignore this step and continue to next step.

- Press  button to exit the commissioning mode.

NOTE: The device automatically exits commissioning mode after one hour if manual exit is not performed.

The device displays **Summary** screen and the clock icon flashes to show that date and time needs to be set.

NOTE: If you have connected a new toroid or replaced a toroid, navigate to **Menu > Settings > Commission > Auto**. The device performs automatic commissioning.

Manual commissioning





The device must be manually commissioned if the connected toroid is not one of the recommended toroids.

NOTE: Refer to the Vigilohm catalog for the most up to date listing of compatible toroids.

1. Navigate to **Menu > Settings > Commissioning > Manual**.

The **Manual** screen displays with the channel grid and a flashing dot on the channel 1 grid. This indicates the channel 1 is selected.

2. Perform any one of the following:

- To commission channel 1, press  button.
- To commission other channels, press  button to navigate to the desired channel and press  button.
- To commission all channels, press  button and press  button.

The **Toroid Turns** screen displays.

3. Set the toroid turns (Allowed values: 300 to 3000) and press the  button. To set the toroid turns, see *Parameter modification using the display*, page 22.

- If the turn ratio is valid, the **Saved** message displays.
- If the turn ratio is not valid, the **Error** message displays. Select the correct turn ratio.

4. Press **Esc** button.

The **Manual** screen displays with the channel grid and a flashing dot on the channel 1 grid. This indicates the channel 1 is selected.

5. Perform Step 2 and Step 4 for other non commissioned channels.

Checking wiring connection

You can check the wiring of the system once the toroid has been commissioned. Performing this check successfully confirms that the wiring of the device is proper and the device is ready to use.

You can perform any of the following checks:

- You can induce one dummy fault on one channel. You can perform this check for all channels sequentially.
 1. Induce a dummy fault on one of the channel.

The device displays the insulation alarm on the detected channel, the **alarm LED** turns **ON**, and the **no alarm LED** turns **OFF**.
 2. Recover the dummy fault on the channel.

The device returns to toroid detected state, the **alarm LED** turns **OFF**, and the **no alarm LED** turns **ON**.
- You can induce two dummy faults simultaneously on two channels.
 1. Induce a dummy fault on one of the channel.

The device displays the insulation alarm on the detected channel, the **alarm LED** turns **ON**, and the **no alarm LED** turns **OFF**.
 2. Induce a dummy fault on the other channel.

The device displays the insulation alarm on both the detected channels, the **alarm LED** remains **ON**, and the **no alarm LED** remains **OFF**.

NOTE: If both the induced dummy faults are zero-impedance fault, then the device displays the insulation alarm on any one of the channel.
 3. Recover the dummy fault on one of the channel.

The insulation alarm on this channel is recovered. Because the dummy fault still exist on other channel, the device displays the insulation alarm on the other channel, the **alarm LED** remains **ON**, and the **no alarm LED** remains **OFF**.
 4. Recover the dummy fault on other channel.

The device returns to toroid detected state, the **alarm LED** turns **OFF**, and the **no alarm LED** turns **ON**.

NOTE: You are strongly advised not to induce more than one zero-impedance dummy fault.

General configuration

Date/Time

The date/time must be set:

- On first power up.
- Whenever factory reset is performed.
- Whenever the power supply is interrupted.
- When switching between summer and winter time and vice versa.

If the auxiliary power supply is interrupted, the device retains the date and time setting from immediately before the interruption. The device uses the date and time parameter to time-tag the system insulation faults recorded. The date is displayed in the format: dd/mm/yyyy. The time is displayed using the 24-hour clock in the format: hh/mm

After commissioning, the clock icon flashes on the **Summary** screen to indicate that the clock needs to be set. To set the date and time, see [Parameter modification using the display, page 22](#).

Password

You can set a password to limit access to configuration of the device parameters to authorized personnel only.

When a password is set, the information displayed on the device can be viewed but the parameter values cannot be edited. By default, the password protection is not activated. The default password is **0000**. You can set a 4-digit password from **0000** to **9999**.

To activate the password, navigate to **Menu > Settings > Password > Activation** and select **ON**.

To modify the password, navigate to **Menu > Settings > Password > Modify Password** and edit the new password. To modify the parameter value, see [Parameter modification using the display, page 22](#).

Language

The device supports 8 languages for HMI display.

The list of languages supported by the device HMI are as follows:

- English (Default)
- French
- Spanish
- Russian
- Chinese
- Italian
- German
- Portuguese

To set the language, navigate to **Menu > Language**. To modify the parameter value, see [Parameter modification using the display, page 22](#).

Identification

You can view the information about the device on the **Identification** screen.

The **Identification** screen displays the following information:

- Commercial reference
- Firmware version
- Firmware release date
- CRC App
- Serial number
- QR code

NOTE: Scan the QR code to view the VigiloHM products webpage.

To view the **Identification** screen, navigate to **Menu > Identification**.

Display

You can set the contrast and backlight for the display.

You can access the device display parameters by selecting **Menu > Settings > Display**.

The display parameters and its allowed and default values are as follows:

Parameter	Default value	Allowed values
Contrast	50 %	10 % to 100 %
Backlight	100 %	10 % to 100 %

To modify the parameter value, see [Parameter modification using the display](#), page 22.

Network configuration

You can configure the electrical network parameters to suit to the electrical applications you want to monitor.

You can access the device network parameters by selecting **Menu > Settings > Network**.

The network parameter is **Channel Name**.

To modify the parameter value, see [Parameter modification using the display](#), page 22.

Channel Name



You can set the channel name of your preference for all 12 channels.

The channel name can be set only in English. The allowed characters are:

- A to Z
- a to z
- 0 to 9
- Special characters (Hyphen-minus (-), Slash (/), Percent(%), Full stop (.), (blank))

The length of the channel name is automatically adjusted depending on the character selection. For example, if the channel name contains only the character “W”, then the maximum length is 8 characters and if the channel name contains only the character “I”, then the maximum length is 18 characters.

Use the following contextual buttons for editing:





-  to modify the selected character.
-  to select the character to the right of the one that is currently selected, or to loop back to the character on the left.
-  to confirm the channel name.

Changing the channel name

1. Navigate to **Menu > Settings > Network > Channel Name**.

The **CHANNEL NAME** screen displays with the channel grid and a flashing dot on the channel 1 grid. This indicates the channel 1 is selected.

2. Perform any one of the following:

- To modify the name for channel 1, press  button.
- To modify the name for other channels, press  button to navigate to the desired channel and press  button.
- To modify the name for all channels, press  button and press  button.

The **CHANNEL NAME** screen displays with the default name **CHANNEL – 1** and the character C highlighted.

3. Press the  button.

The **CHANNEL NAME** screen displays and the default name is deleted and the screen is blank.

- To delete the channel name, see [Deleting the channel name](#), page 30.
- To modify the channel name, press the  button.

The **CHANNEL NAME** screen displays and the highlighted character displays blank character.

Use the  button to navigate to the desired character.

NOTE: On each press of  button, the characters are looped in the following sequence:

1. A to Z
2. a to z
3. 0 to 9
4. Special characters (Minus (-), Slash (/), Percent(%), Full stop (.), (blank))

4. Press the  button and navigate to the next character.

5. Perform Step 3 to update the selected character.

6. Perform Step 4 and Step 5 for other characters.

7. Press the  button to confirm the channel name.

A **Saved** message displays.

8. Press the **Esc** button.

The **CHANNEL NAME** screen displays with the channel grid and a flashing dot on the channel 1 grid. This indicates the channel 1 is selected.





9. Perform Step 2 to Step 7 to change other channel names.

Deleting the channel name

1. Navigate to **Menu > Settings > Network > Channel Name**.

The **CHANNEL NAME** screen displays with the channel grid and a flashing dot on the channel 1 grid. This indicates the channel 1 is selected.

2. Perform any one of the following:

- To delete the name for channel 1, press  button.
- To delete the name for other channels, press  button to navigate to the desired channel and press  button.
- To delete the name for all channels, press  button and press  button.

The **CHANNEL NAME** screen displays with the default name **CHANNEL – 1** and the character C highlighted.

3. Press the  button.

The **CHANNEL NAME** screen displays and the default name is deleted and the screen is blank.

4. Press the  button to confirm the channel name deletion.

A **Saved** message displays.

5. Press the **Esc** button.

The **CHANNEL NAME** screen displays with the channel grid and a flashing dot on the channel 1 grid. This indicates the channel 1 is selected.

6. Perform Step 3 to Step 5 to delete other channel names.

Alarm configuration

You can configure the insulation alarm threshold to suit to the electrical applications you want to monitor.

You can access the device alarm parameters by selecting **Menu > Settings > Ins. Alarm**.

The alarm parameter is **Ins. Alarm**.

You can set the parameter values for all commissioned or uncommissioned channels

To modify the parameter value, see [Parameter modification using the display](#), page 22.

Insulation alarm (Ins. Alarm) thresholds

You can set the threshold value as per the level of insulation of the application you monitor.

The allowed values for this parameter are from **50 kΩ** to **200 kΩ**. The default value is **50 kΩ**. This value can be set for 12 channels individually or together.

When the device is powered up, it retrieves the last insulation alarm threshold values recorded.

An insulation alarm is cleared when the insulation level reaches 20% above the threshold.

Insulation alarm threshold hysteresis

A hysteresis is applied to limit the error in the insulation alarm due to fluctuations in the measurement when approaching threshold value.

A hysteresis principle is applied:

- When the insulation value measured decreases and falls below the setting threshold, the insulation alarm is triggered or the countdown is started if an insulation alarm time delay has been set.
- When the insulation value measured increases and exceeds 1.2 times the set threshold (i.e. the setting threshold +20%), the insulation alarm is deactivated.

The following diagrams show the behaviors:

- Without hysteresis:

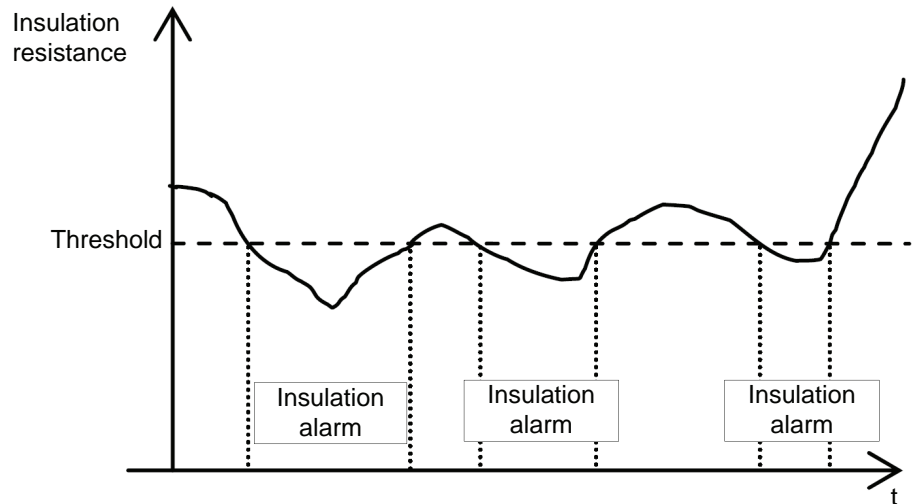

- With hysteresis:

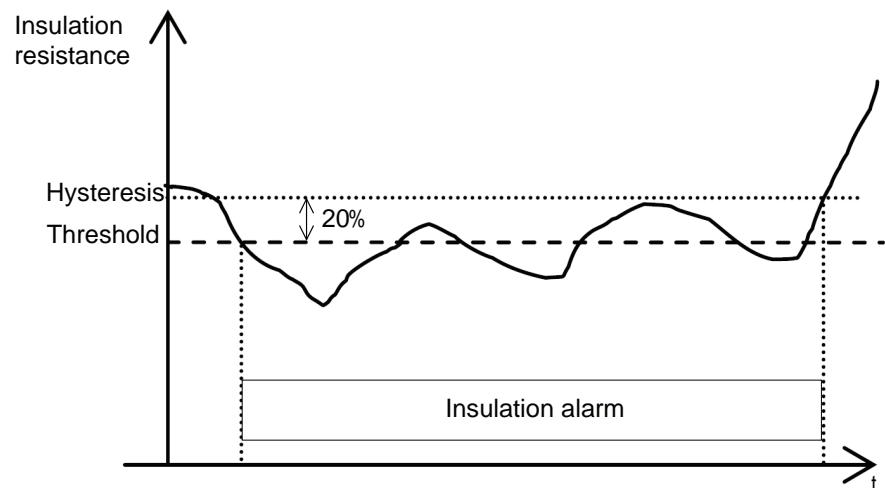

I/O configuration

You can configure the relay parameters to suit the type of relay output information.

You can access the device I/O parameters by selecting **Menu > Settings > I/O Config**.

The I/O parameter is **Ins. Al. Relay**.

To modify the parameter value, see Parameter modification using the display, page 22.

Insulation alarm relay (Ins. Al. Relay)

You can set the insulation alarm relay mode depending on the status of insulation.

The allowed values for this parameter are **FS** and **Std.**. The default value is **FS**.

When the insulation alarm relay is configured in failsafe (**FS**) mode:

- The insulation alarm relay is activated, that is, energized, in the following case:
 - No insulation fault is detected.
- The insulation alarm relay is deactivated, that is, de-energized, in the following cases:
 - Insulation fault is detected.
 - On first measurement after power cycle and on toroid disconnect.
 - The product is inoperative (detected by auto-test).
 - The auxiliary power supply is lost.
 - When the voltage signal is unavailable
 - Channel failure

When the insulation alarm relay is configured in standard (**Std.**) mode:

- The insulation alarm relay is activated, that is, energized, in the following cases:
 - Insulation fault is detected.
 - The product is inoperative (detected by auto-test).
 - Toroid disconnect
 - When the voltage signal is unavailable
 - Channel failure
- The insulation alarm relay is deactivated, that is, de-energized, in the following cases:
 - No insulation fault is detected.
 - On first measurement after power cycle
 - The auxiliary power supply is lost.

R measurement

Insulation measurements

The device monitors the insulation per connected channel of ungrounded power system.

The device measures and displays the insulation resistance R (Ω) continuously for 12 channels.

To view these values, navigate to **Menu > Monitoring**. To view each channel measurements, use the contextual menu buttons.

Monitoring power system insulation

The device monitors the ungrounded power system insulation in resistance in accordance with the following timing diagram which represents the default settings:

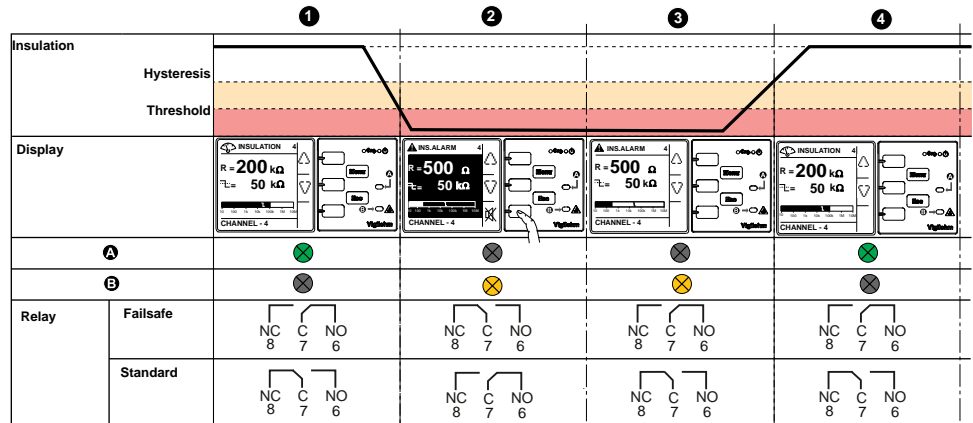

1	Network insulation is normal and no alarm on any channel.
2	An insulation fault occurred on channel 4. Active alarm is displayed on channel 4. Press button to acknowledge the alarm. See Relay Mode, page 32 for more information on relay modes.
3	An insulation fault occurred on channel 4. Active alarm acknowledged.
4	The insulation fault is corrected. The alarm LED turns off. The device reverts to normal status.

Log

The device records the details of the 240 most recent fault events. You can access all the 240 logs through HMI and communication. The fault events are triggered by insulation fault status.

Event 1 is the event that was recorded most recently and event 240 is the oldest recorded event.

The oldest event is deleted when a new event occurs (the table is not reset).





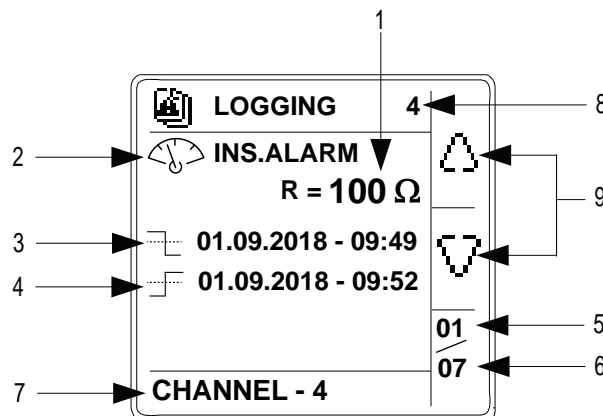

By referring to this information, the performance of the distribution system can be improved and maintenance work is facilitated.

Insulation fault log display screen

You can view the details of an insulation fault event by navigating to **Menu > Logging**.



1	Insulation fault value recorded
2	Type of fault recorded: Insulation fault NOTE: Only insulation fault is recorded as primary record.

3	Date and time when the fault appeared NOTE: This information is stored as primary record.
4	Date and time when the fault disappeared due to any one of the following event: <ul style="list-style-type: none"> •  Insulation fault acknowledgement •  Power failure while on active alarm. •  Toroid disconnect while on active alarm. •  Voltage signal unavailable while on active alarm. •  Product or channel error while on active alarm. •  Automatic commissioning initiated while on active alarm. NOTE: This information is stored as secondary record.
5	Number of the event displayed
6	Total number of events recorded
7	Name of the channel, where the log is recorded
8	Number of the channel, where the log is recorded
9	Up and down arrows: Use to view recorded events

Reset

You can reset logs. Further, you can perform factory reset.

You can access the device reset parameters by selecting **Menu > Settings > Reset**.

The reset parameters are **Reset Logs** and **Factory Reset**.

On performing reset of logs, the existing logs information is erased but the settings parameter value remains unchanged. On performing factory reset, the device restarts and automatic commissioning is initiated. Also, settings parameter values are reset to default.

The complete list of settings parameters, its default value, and allowed values are:

Parameter	Default Value	Allowed Values
Ins. Alarm	50 kΩ	50...200 kΩ
Channel Name	CHANNEL – 1 to CHANNEL – 12 for 12 channels	<ul style="list-style-type: none"> • A to Z • a to z • 0 to 9 • Special characters (Hyphen-minus (-), Slash (/), Percent(%), Full stop (.), (blank)) The length of the channel name is automatically adjusted depending on the character selection. For example, if the channel name contains only the character "W", then the maximum length is 8 characters and if the channel name contains only the character "I", then the maximum length is 18 characters.
Ins. Al. Relay	FS	<ul style="list-style-type: none"> • FS • Std.
Address	1	1...247
Baudrate	19200	<ul style="list-style-type: none"> • 4800 • 9600 • 19200 • 38400
Parity	Even	<ul style="list-style-type: none"> • None • Even • Odd

Parameter	Default Value	Allowed Values
Modify Password	0000	0000...9999
Activation (Password)	OFF	<ul style="list-style-type: none"> • ON • OFF
Contrast	50%	10...100%
Backlight	100%	10...100%

Auto-test

Auto test overview

The device performs auto-test in background to detect any potential faults in its internal and external circuits.

The device's auto test function tests:

- The product: indicator lights, internal electronics.
- The measuring chain and the insulation alarm relay.

You can initiate auto test by pressing the **T** contextual menu button on the **Summary** screen. Auto test is disabled during insulation fault, product error, or system error.

Auto test sequence

During auto test, the device's indicator lights illuminate and information is shown on the display.

The following LEDs turn ON in sequence and turn OFF after the predefined time:

1. Alarm Orange
2. No Alarm Green
3. Product Status Red
4. Product Status Green
5. Communication Orange

The relay toggles.

- If the auto test is successful, the following screen appears for 3 seconds and a status screen is displayed:

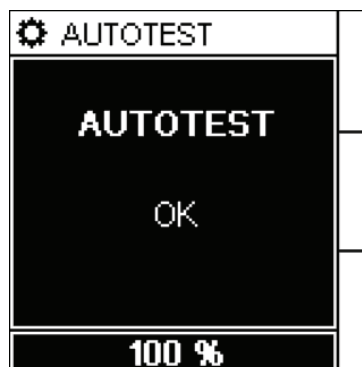

- If the auto test fails, the **Product Status** LED turns ON and a message is displayed to indicate that the product is malfunctioning. Disconnect the auxiliary power supply of device and reconnect. If the fault persists, contact technical support.

Communication

Communication parameters

Before initiating any communication with the device, you must configure the Modbus communication port. You can configure communication parameters by selecting (**Menu > Settings > Modbus**).

The communication parameters and its allowed and default values are as follows:

Parameter	Default value	Allowed values
Address	1	1...247
Baud rate	19200	<ul style="list-style-type: none"> • 4800 • 9600 • 19200 • 38400
Parity	Even	<ul style="list-style-type: none"> • None • Even • Odd

To modify the parameter value, see *Parameter modification using the display*, page 22.

In point-to-point mode, when the device is directly connected to a computer, the reserved address 248 can be used to communicate with the device irrespective of the device internal address.

Modbus functions

The device supports Modbus function codes.

Function Code		Function Name
Decimal	Hexadecimal	
3	0x03	Read Holding Registers ¹
4	0x04	Read Input Registers ¹
6	0x06	Write Single Register
8	0x08	Diagnostic Modbus
16	0x10	Write Multiple Registers
43 / 14	0x2B / 0E	Read Device Identification
43 / 15	0x2B / 0F	Get Date/Time
43 / 16	0x2B / 10	Set Date/Time

Read Device Identification request

Number	Type	Value
0	VendorName	Schneider Electric
1	ProductCode	IMDIFL12H
2	MajorMinorRevision	XXX.YYY.ZZZ
3	VendorURL	www.se.com
4	ProductName	Insulation Fault Locator
5	ModelName	IFL12H

1. The Read Holding and Read Input registers are identical.

The device answers any type of requests (basic, regular, extended).

Modbus register table format

Register tables have the following columns.

Column heading	Description
Address	The address of the Modbus, in decimal (dec) and hexadecimal (hex) formats.
Register	The register of the Modbus, in decimal (dec) and hexadecimal (hex) formats.
R/W	Read only (R) or read/write (R/W) register.
Unit	The unit in which the information is expressed.
Type	The coding data type. NOTE: For the Float32 data type, the byte order follows the Big Endian format.
Range	Permitted values for this variable, usually a subset of what the format allows.
Description	Provides information about the register and the values applied.

Modbus registers table

The following table lists the Modbus registers that apply to your device.

System status registers

Address		Register		R/W	Unit	Type	Range	Description
dec	hex	dec	hex					
100	64	101	65	R	–	Uint16	–	Product identifier 17032 - IFL12H
114..115	72...73	115...116	73...74	R	–	Uint32	–	Product state <ul style="list-style-type: none"> • Bit1 - Reserved • Bit2 - Auto test • Bit3 - Commissioning • Bit4 - Safe state • Bit5 - Monitoring • Bit6 - Channel error • Bit7 - Product error • Bit8 - System error • Bit9 - Reserved • Bit10 - Reserved
116	74	11722	75	R	–	Uint16	–	Product error codes <ul style="list-style-type: none"> • 0XFFFF - No error • 0x0000 - Unknown error • 0x0DEF - Undefined model • 0xAF00 - Auto-test failure • 0xBE00 - Metering • 0xC0F1 - Configuration error • 0x5EFA - Sensor call problem • 0xD1A1 - Glued IO • 0xD1A2 - RAM • 0xD1A3 - EEPROM • 0xD1A4 - Relay

System status registers (Continued)

Address		Register		R/ W	Unit	Type	Range	Description
dec	hex	dec	hex					
								<ul style="list-style-type: none"> 0xD1A5 - Status input 0xD1A6 - Flash 0xD1A7 - SIL 0xE000 - NMI interrupt 0xE001 - Hard fault exception 0xE002 - Memory fault exception 0xE003 - Bus fault exception 0xE004 - Usage fault exception 0xE005 - Unexpected interrupt 0xFAF5 - Unexpected interrupt
120...1-39	78...8B	121...140	79...8C	R	–	UTF8	–	Product family
140...1-59	8C...9F	141...160	8D...A0	R/ W	–	UTF8	–	Product name (User application name)
160...1-79	A0...B3	161...180	A1...B4	R	–	UTF8	–	Product code IMDIFL12H
180...1-99	B4...C7	181...200	B5...C8	R	–	UF8	–	Manufacturer: Schneider Electric
208...2-19	D0...DB	209...220	D1...DC	R	–	UF8	–	ASCII serial number
220	DC	221	DD	R	–	Uint16	–	Manufacturing unit identifier
227...2-46	E3...F6	228...247	E4...F7	R	–	UTF8	–	Product capability
247...2-66	F7...10-A	248...267	F8...10B	R	–	UTF8	–	Product model IFL12H
300...3-06	12C...-132	301...307	12D...133	R	–	Uint16	–	Date and time in 7 register format The following parameters correspond to each register: <ul style="list-style-type: none"> 300 - Year 301 - Month 302 - Day 303 - Hour 304 - Minute 305 - Second 306 - Millisecond
307...3-10	133...1-36	308...311	134...137	R/ W	–	Uint16	–	Date and time in TI081 format. See Date and time (TI081 format), page 46.
320...3-24	140...1-49	321...325	141...145	R	–	Uint16	–	Present firmware version <ul style="list-style-type: none"> X represents the primary revision number, which is encoded in register 321 Y represents the secondary revision number, which is encoded in register 322 Z represents the quality revision number, which is encoded in register 323
325...3-29	145...1-49	326...330	146...14A	R	–	Uint16	–	Previous firmware version <ul style="list-style-type: none"> X represents the primary revision number, which is encoded in register 326

System status registers (Continued)

Address		Register		R/W	Unit	Type	Range	Description
dec	hex	dec	hex					
								<ul style="list-style-type: none"> Y represents the secondary revision number, which is encoded in register 327 Z represents the quality revision number, which is encoded in register 328
340...3-44	154...1-58	341...345	155...159	R	–	Uint16	–	Boot firmware version <ul style="list-style-type: none"> X represents the primary revision number, which is encoded in register 341 Y represents the secondary revision number, which is encoded in register 342 Z represents the quality revision number, which is encoded in register 343
500...5-05	1F4...1-F9	501...506	1F5...1FA	R	–	UTF8	–	Hardware revision
550...5-55	226...2-2B	551...556	227...22C	R	–	UTF8	–	Existing OS version
556...5-61	22C...-231	557...562	22D...232	R	–	UTF8	–	Previous OS version
562...5-67	232...2-37	563...572	233...23C	R	–	UTF8	–	Existing RS/Boot version
586...5-91	24A...-24F	587...592	24B...250	R	–	UTF8	–	Existing SIL OS version

Modbus

Address		Register		R/W	Unit	Type	Range	Description
dec	hex	dec	hex					
750	2EE	751	2EF	R/W	–	Uint16	1...247	Device address Default value: 1
751	2EF	752	2F0	R/W	–	Uint16	<ul style="list-style-type: none"> 0 = 4800 1 = 9600 2 = 19200 3 = 38400 	Baud rate Default value: 2 (19200)
752	2F0	753	2F1	R/W	–	Uint16	<ul style="list-style-type: none"> 0 = Even 1 = Odd 2 = None 	Parity Default value: 0 (Even)

Insulation alarm

Address		Register		R/W	Unit	Type	Range	Description
dec	hex	dec	hex					
1102	44E	1103	44F	R	–	Uint16	–	Product alarm status <ul style="list-style-type: none"> • Bit 1...12 - Channel status for channel 1 to 12 respectively This bit is set for the corresponding channel for any of the following states: <ul style="list-style-type: none"> ◦ Active alarm ◦ Alarm acknowledged ◦ Toroid disconnect ◦ First measurement ◦ Channel error • Bit 13 - System error This bit is set for the following states: <ul style="list-style-type: none"> ◦ Voltage signal unavailable ◦ Toroid disconnect ◦ No toroid • Bit 14 - Product error This bit is set for Product failure state.
1103	44F	1104	450	R	–	Uint16	–	Compliment for product alarm status
1104...-1105	450...45-1	1105...1-106	451...452	R	–	Uint32	0...0xFFFFFFFF	Status counter

Insulation alarm (Continued)

Address		Register		R/W	Unit	Type	Range	Description
dec	hex	dec	hex					
1110...1-111	456...45-7	1111...1-112	457...458	R	–	Uint32	–	Product status <ul style="list-style-type: none"> • 0 - No alarm • Bit 1 - Active alarm • Bit 2 - Reserved • Bit 3 - Reserved • Bit 4 - Alarm acknowledged • Bit 5 - Reserved • Bit 6 - Reserved • Bit 7 - Reserved • Bit 8 - Reserved • Bit 9 - First measurement • Bit 10 - Reserved • Bit 11 - Reserved • Bit 12 - Reserved • Bit 13 - Auto test • Bit 14 - Commissioning • Bit 15 - Reserved • Bit 16 - Uncommissioned • Bit 17 - Locating signal unavailable • Bit 18 - Reserved • Bit 19 - Reserved • Bit 20 - Reserved • Bit 21 - Reserved • Bit 22 - Toroid disconnect • Bit 23 - Reserved • Bit 24 - Reserved • Bit 25 - Product error • Bit 26 - Channel error • Bit 27 - Reserved • Bit 28 - Reserved • Bit 29 - Reserved • Bit 30 - Reserved • Bit 31 - Reserved • Bit 32 - Power Down
1112...1-134	458...46-E	1113...1-135	459...46F	R	–	Uint32	–	Channel (1 to 12) status. Each channel represents 2 registers. <ul style="list-style-type: none"> • 0 - No alarm • Bit 1 - Active alarm • Bit 2 - Reserved • Bit 3 - Reserved • Bit 4 - Alarm acknowledged • Bit 5 - Reserved • Bit 6 - Reserved • Bit 7 - Reserved • Bit 8 - Reserved • Bit 9 - First measurement • Bit 10 - Reserved • Bit 11 - Reserved • Bit 12 - Reserved • Bit 13 - Auto test • Bit 14 - Commissioning • Bit 15 - Reserved • Bit 16 - Uncommissioned • Bit 17 - Locating signal unavailable

Insulation alarm (Continued)

Address		Register		R/W	Unit	Type	Range	Description
dec	hex	dec	hex					
								<ul style="list-style-type: none"> • Bit 18 - Reserved • Bit 19 - Reserved • Bit 20 - Reserved • Bit 21 - Reserved • Bit 22 - Toroid disconnect • Bit 23 - Reserved • Bit 24 - Reserved • Bit 25 - Product error • Bit 26 - Channel error • Bit 27 - Reserved • Bit 28 - Reserved • Bit 29 - Reserved • Bit 30 - Reserved • Bit 31 - Reserved • Bit 32 - Power Down

Diagnostics

Address		Register		R/W	Unit	Type	Range	Description
dec	hex	dec	hex					
2001...-2004	7D1...7-D4	2002...2-005	7D2...7D5	R	–	Date/Time	–	Total uptime since first power up of product. Registers correspond to (result - 01/01/2000) = total uptime. TI081 date format (See Date and time (TI081 format), page 46)
2005...-2006	7D5...7-D6	2006...2-007	7D6...7D7	R	–	Uint32	–	Total number of power cycles since first power-up of the product
2050	802	2051	803	W	–	Uint16	–	Write 0x1919 to reset factory settings (default factory settings)
2051	803	2052	804	W	–	Uint16	–	Write 0xF0A1 to reset all logs

CRC

Address		Register		R/W	Unit	Type	Range	Description
dec	hex	dec	hex					
2500...-2501	9C4...9-C5	2501...2-502	9C5...9C6	R	–	Uint32	–	Application CRC value.
2502...-2503	9C6...9-C7	2503...2-504	9C7...9C8	R	–	Uint32	–	Boot CRC value

Settings

Address		Register		R/W	Unit	Type	Range	Description
dec	hex	dec	hex					
2997...-2998	BB5...BB6	2998...2-999	BB6...BB7	R	–	Uint16	–	Total number of settings changed since first power-up. Incremented by 1 for each change of one or several parameters.
3001	BB9	3002	BBA	R/W	–	Uint16	<ul style="list-style-type: none"> • 1= Standard • 2 = Failsafe 	Insulation alarm relay logic command Default value: 2 (Failsafe)
3014	BC6	3015	BC7	R/W	–	Uint16	0000...9999	Password Default value: 0000

Settings (Continued)

Address		Register		R/W	Unit	Type	Range	Description
dec	hex	dec	hex					
3015	BC7	3016	BC8	R/W	–	Uint16	<ul style="list-style-type: none"> 0 = OFF 1 = ON 	Password protection Default value: 0 (password protection deactivated)
3016	BC8	3017	BC9	R/W	–	Uint16	<ul style="list-style-type: none"> 0 = English 1 = French 2 = Spanish 3 = Russian 4 = Chinese 5 = Italian 6 = German 7 = Portuguese 	Interface language Default value: 0 (English)
3017	BC9	3018	BCA	R/W	%	Uint16	10...100%	Screen contrast Default value: 50%
3018	BCA	3019	BCB	R/W	%	Uint16	10...100%	Screen brightness. Default value: 100%
3042	BE2	3043	BE3	W	–	Uint16	–	Commissioning mode Write 0xAABB to enter commissioning Write 0xBBAA to exit commissioning

Monitoring

Address		Register		R/W	Unit	Type	Range	Description
dec	hex	dec	hex					
10000...10023	2710...2727	10001...10024	2711...2728	R	Ohm	Float32	–	Resistance for 12 channels. Each channel represents 2 registers.
10072...10083	2758...2763	10073...10084	2759...2764	R	–	Uint16	<ul style="list-style-type: none"> 0 = Equal 1 = Under 2 = Over 3 = UnderStrict 4 = OverStrict 	R equality for 12 channels. Each channel represents 1 register.

NOTE: The following registers is applicable for channel 1. For channel 2 register, add “30” value to channel 1 register. For channel 3 register, add “30” value to channel 2 register and so on.

Settings – For individual channels

Address		Register		R/W	Unit	Type	Range	Description
dec	hex	dec	hex					
11000...11008	2AF8...2AFB	11001...11009	2AF9...2AFB	R/W	–	UTF8	Allowed length : 18 characters	Name of the channel. The most significant byte of the first register contains first character. The last significant byte of last register contains last character. Default value: CHANNEL - 1
11009...11010	2B01...2B02	11010...11011	2B02...2B03	R/W	Ohm	Uint32	50...200 kΩ	Insulation alarm threshold Default value: 50 kΩ
11016	2B08	11017	2B09	R/W	turns	Uint16	<ul style="list-style-type: none"> 0 = Uncommissioned 470, 1000 = Auto 300...3000 = Manual 	Number of toroid turns Default value: 0

Logging

Address		Register		R/W	Unit	Type	Range	Description
dec	hex	dec	hex					
19996...19997	4E1C...4E1D	19997...19998	4E1D...4E1E	R	–	UInt32	–	Roll over counter
19998...19999	4E1E...4E1F	19999...20000	4E1F...4E20	R	–	UInt32	1...240	Number of event records
20001	4E21	20002	4E22	R	–	UInt16	–	Most recent record number
20002...20013	4E22...4E2D	20003...20014	4E23...4E2E	R	–	Record	–	Record 1
20014...20025	4E2E...4E39	20015...20026	4E2F...4E3A	R	–	Record	–	Record 2
...								
20710...20721	50E6...50F1	20711...20722	50E7...50F2	R	–	Record	–	Record 60
22870...22881	5956...5961	22871...22882	5957...5962	R	–	Record	–	Record 240

Alarm event records

Each event is stored using two records:

- A "primary" record, which is created when the insulation alarm occurs. This contains the insulation value.
- A "secondary" record, which is created for the following type of events:
 - Acknowledged insulation alarm
 - Power failure or power cycle
 - Toroid disconnect
 - Locating signal unavailable
 - Product or channel error
 - Automatic commission initiation

Description of an Event Record in the Log

Register	Unit	Type	Range	Description
Word 1	–	UInt16	1...65535	Event record number
Word 2 Word 3 Word 4 Word 5	–	UInt64	–	Time tagging of event (using the same code as for the product date/time)
Word 6 Word 7	–	UInt32	<ul style="list-style-type: none"> • 0...1 • 0x40, 0x20 • 10000...10023, 1110...1134 	Record identifier: <ul style="list-style-type: none"> • Word 6, most significant byte: information for primary/secondary record. This field takes the value 1 for the primary record and value 0 for the secondary record. • Word 6, least significant byte: type of data stored in the Value field. • Word 7: address of the Modbus register that is the source of the data in the Value field.

Description of an Event Record in the Log (Continued)

Register	Unit	Type	Range	Description
Word 8 Word 9 Word 10 Word 11	–	Uint64	–	Depending on the type of record (primary or secondary): <ul style="list-style-type: none"> Primary record (when the event occurs): Insulation resistance value (in Ohm) when the event occurred (encoded in Float32 in the last 2 registers). Secondary record (for the earlier list of events) (encoded in Uint32 in the last 2 registers)
Word 12	–	Uint16	1..65534	Primary/secondary record identifier for the event: <ul style="list-style-type: none"> In the case of a primary record for an event, this identifier is an odd integer; numbering starts at 1 and the number is incremented by 2 for each new event. In the case of a secondary record for an event, this identifier is equal to the primary record identifier plus 1.

Example of an event

The next 2 records relate to an example insulation alarm that occurred on October 1, 2010 at 12:00 pm and was acknowledged at 12:29 pm.

Record number: 1

Address		Register		Unit	Type	Value	Description
dec	hex	dec	hex				
20002	4E22	20003	4E23	–	Uint16	1	Record number
20003	4E23	20004	4E24	–	Uint64	<ul style="list-style-type: none"> 10 0 10 1 12 0 0 	Date when insulation alarm occurred (October 1, 2010, 12:00 pm)
20007	4E27	20008	4E28	–	Uint32	<ul style="list-style-type: none"> 1 0x40 100-00 	Record identifier: <ul style="list-style-type: none"> Primary record plus secondary record Float32 value (insulation resistance) Value of register 10000 (register for insulation resistance monitoring)
20009	4E29	20010	4E2A	Ohm	Uint64	10000	Insulation resistance value at the time of the insulation alarm
20013	4E2D	20014	4E2E	–	Uint16	1	Secondary record identifier for the event

Record number: 2

Address		Register		Unit	Type	Value	Description
dec	hex	dec	hex				
20014	4E2E	20015	4E2F	–	Uint16	2	Record number
20015	4E2F	20016	4E30	–	Uint64	<ul style="list-style-type: none"> 10 0 10 1 12 29 0 	Date when insulation alarm acknowledged (October 1, 2010, 12:29 pm)

Record number: 2 (Continued)

Address		Register		Unit	Type	Value	Description
dec	hex	dec	hex				
20019	4E33	20020	4E34	–	Uint32	<ul style="list-style-type: none"> • 1 • 0x20 • 1112 	Record identifier: <ul style="list-style-type: none"> • Secondary record • Uint32 value (alarm acknowledged) • 1112 register value (channel status).
20021	4E35	20022	4E36	–	Uint64	8	Value of insulation alarm register at the time of insulation alarm acknowledgement
20025	4E39	20026	4E3A	–	Uint16	2	Secondary record identifier for the event

Date and time (TI081 format)

The following structure is used for date-time information exchange using Modbus protocol.

The date/time are encoded in 8 bytes as follows:

b15	b14	b13	b12	b11	b10	b09	b08	b07	b06	b05	b04	b03	b02	b01	b00	Word
0	0	0	0	0	0	0	0	R4	Y	Y	Y	Y	Y	Y	Y	Word 1
0	0	0	0	M	M	M	M	WD	WD	WD	D	D	D	D	D	Word 2
SU	0	0	H	H	H	H	H	iv	0	mn	mn	mn	mn	mn	mn	Word 3
ms	ms	ms	ms	ms	ms	ms	ms	ms	ms	ms	ms	ms	ms	ms	ms	Word 4

- R4: Reserved bit (reserved by IEC870-5-4), set to 0
- Y - Years
 - 1 byte
 - Value from 0...127 (1/1/2000 to 31/12/2127)
- M - Months
 - 1 byte
 - Value from 1...12
- D - Days
 - 1 byte
 - Value from 1...31
- H - Hours
 - 1 byte
 - Value from 0...23
- mn - Minutes
 - 1 byte
 - Value from 0...59
- ms - Milliseconds
 - 2 byte
 - Value from 0...59999

The following fields are in CP56Time2a standard and are considered as optional:

- WD - Week Day
 - If not used, set to 0 (1 = Sunday, 2 = Monday...)
 - Value from 1...7

- SU - Summertime
 - If not used, set to 0 (0 = standard time, 1 = summertime)
 - Value from 0...1
- iV - Validity of the information contained in the structure
 - If not used, set to 0 (0 = valid, 1 = not valid or not synchronized in system)
 - Value from 0...1

This information is encoded in binary form.

Maintenance

Safety precautions

The following safety precautions must be thoroughly implemented before attempting to commission the system, repair electrical equipment or carry out maintenance.

Carefully read and follow the safety precautions described below.

DANGER

HAZARD OF ELECTRIC SHOCK, EXPLOSION, OR ARC FLASH

- Apply appropriate Personal Protective Equipment (PPE) and follow safe electrical work practices. See NFPA 70E, CSA Z462 or other local standards.
- Turn off all power supplying this device and the equipment in which it is installed before working on or in the equipment.
- Always use a properly rated voltage sensing device to confirm that all power is off.

Failure to follow these instructions will result in death or serious injury.

NOTICE

EQUIPMENT DAMAGE

- Do not open this unit.
- Do not attempt to repair any components of this product or any of its accessory products.

Failure to follow these instructions can result in equipment damage.

Product status light indicator

If the **Product status** light indicator is red, there is an error in the power system or your device.

The error is one of the following cases:

- Auto test not OK
- Product error
- System error
- No toroid
- Toroid disconnect
- Locating signal unavailable

Troubleshooting

There are some checks you can perform to try to identify potential issues with the device's operation.

The following table describes potential problems, their possible causes, checks you can perform and possible solutions for each. After referring to this table, if you cannot resolve the problem, contact your local Schneider Electric sales representative for assistance.

Potential problem	Possible cause	Possible solution
The device displays nothing when switched on.	No power supply to the device.	Check that the auxiliary power supply is present.
	The auxiliary power supply is not compliant.	Check the auxiliary voltage.
The device notified an insulation fault, but your system shows no signs of abnormal behavior.	The insulation alarm threshold is not appropriate.	Check the value of the insulation alarm threshold. Modify the insulation alarm threshold as appropriate.
You deliberately created an insulation fault, but the device failed to detect it.	The resistance value used to simulate the fault is greater than the value of the insulation alarm threshold.	Use a resistance value that is lower than the insulation alarm threshold or modify the insulation alarm threshold.
	The fault is not detected between neutral and ground.	Start again ensuring you are between neutral and ground.
IMD detecting fault, the device is not	The insulation alarm threshold is not appropriate.	Check the value of the insulation alarm threshold. Modify the insulation alarm threshold as appropriate.
	There are faults on the same phase on several feeders and insufficient signal to locate fault with the selected device threshold.	
	Fault is on an ungrounded system location not monitored by the device, such as the bus between the branches	Check for insulation fault upstream of the device with the mobile fault location kit.
Device alarming but IMD not detecting fault	The insulation alarm threshold is not appropriate.	Check the value of the insulation alarm threshold. Modify the insulation alarm threshold as appropriate.
	Ungrounded system insulation may have changed over time or under different conditions.	Review insulation resistance history on the IMD and identify if its threshold needs changes.
Alarm relay behaviour inverted (off when should be on, or vice versa)	Incorrect relay wiring	Change relay wiring to provide the expected relay behaviour.
Alarm still on even after fault fixed	Second fault exists on indicated branch circuit (same live conductor, same feeder)	Check and correct the second fault.
The product status LED is red and the display indicates that an error occurred during the auto-test.	Internal error	Briefly disconnect the auxiliary power supply to the device.
Although the device is being supplied with power, the product status LED does not light up.	Faulty indicator light.	Restart the auto-test and check that the product status LED lights up briefly.
The alarm LED does not light up in the event of a fault.	Faulty indicator light.	Restart the auto-test and check that the alarm LED lights up briefly.

Specifications

This section provides specifications for the device.

Auxiliary power

AC	110...230 V LN / 400 V LL \pm 15% 50/60 Hz <ul style="list-style-type: none"> • < 22 VA at 440 V • < 8 VA at 230 V
DC	125...250 V \pm 15% < 10 W

Monitored network

AC	230 V
DC	230 V
Maximum leakage capacitance	5 μ F

Electrical

Insulation resistance range	100 Ω ...250 k Ω
Response time	5 s
Accuracy	As per IEC61557-9
Threshold	50...200 k Ω
Hysteresis	\pm 20%
Relay configuration	<ul style="list-style-type: none"> • Standard • Failsafe
Relay maximum AC voltage / current	250 V / 6 A
Relay maximum AC load	1500 VA
Relay maximum DC voltage / current	48 V / 1 A

Mechanical

Weight	0.55 kg (1.12 lb)
Mounting position	Vertical orientation only
IP degree of protection	<ul style="list-style-type: none"> • IP20 : Other sides • IP54 : Front
Installation category	<ul style="list-style-type: none"> • 300 V, CAT III, Pollution degree 2 • 600 V, CAT II, Pollution degree 2

Environment

Operating temperature	-25...70 $^{\circ}$ C (-13...158 $^{\circ}$ F)
RH non-condensing	5...95%
Maximum dewpoint	37 $^{\circ}$ C (99 $^{\circ}$ F)
Storage temperature	-40...85 $^{\circ}$ C (-40...185 $^{\circ}$ F)
Operating altitude	\leq 3000 m (9843 ft)
Usage	<ul style="list-style-type: none"> • For indoor use only • Not suitable for wet locations

Standards

Product	IEC 61557-9
Safety	IEC/UL 61010-1

Standards (Continued)

EMC	<ul style="list-style-type: none">• IEC 61326-2-4• IEC 61326-3-1• IEC 61000-6-2• IEC 61000-6-4
Installation	IEC 60364-7-710

China Standard Compliance

This product complies with the following standard(s) in China:

IEC 61557-9:2014 Electrical safety in low voltage distribution systems up to 1 000 V a.c. and 1 500 V d.c. - Equipment for testing, measuring or monitoring of protective measures - Part 9: Equipment for insulation fault location in IT systems

Schneider Electric
35 rue Joseph Monier
92500 Rueil Malmaison
France

+ 33 (0) 1 41 29 70 00

www.se.com

As standards, specifications, and design change from time to time,
please ask for confirmation of the information given in this publication.

© 2019 – 2021 Schneider Electric. All rights reserved.

7EN02-0407-04