

CATALOG NUMBER	PRIMARY VOLTAGE	SECONDARY VOLTAGE	50/60 Hz 1 PHASE		APPROXIMATE WEIGHT (Lbs/Kg)
			UL/cUL/CSA/NOM RATINGS (VA)	CE RATINGS (VA)	
9070TF150D20	208/230/460	115	150	150	5.5 / 2.4

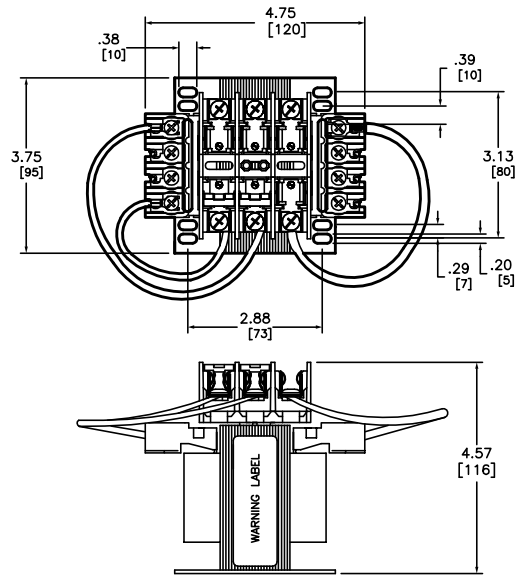

FILES/STANDARDS:  
 UL/cUL FILE: E61239  
 CSA FILE: LR37055  
 CE: TUV CERTIFIED TO 61558  
 NOM 117

150VA-CONTROL POWER TRANSFORMER  
 9070 TYPE TF  
 CATALOG NUMBERS: FROM CHART



DWG# 5923  
 NO.