

# PL7 JUNIOR/PRO

## Operate modes manual

07/2008

eng

---

## Document Set

---

### At a Glance

This manual consists of 3 sections:

- Part 1: General points on operate modes.
  - Part 2: Configuration and programming.
  - Part 3: Debugging, adjustment, documentation and appendices.
-



---

# Table of Contents



---

<b>About the Book</b> .....	<b>13</b>
<b>Part I Operating modes, general points</b> .....	<b>15</b>
Presentation .....	15
<b>Chapter 1 Setting up</b> .....	<b>17</b>
Presentation .....	17
General points on PL7 software .....	18
Connections .....	20
Software installation .....	21
<b>Chapter 2 Presentation of PL7 functions</b> .....	<b>23</b>
Presentation .....	23
Configuration editor .....	24
Variables editor .....	26
Editing in ladder language .....	28
Instruction list language editing .....	31
Structured text language editor .....	32
Grafcet language editor .....	33
Animation tables .....	35
Debugging .....	36
Diagnostics .....	38
Operating screens .....	41
Structure of the documentation file .....	42
General software ergonomics .....	43
<b>Chapter 3 Managing applications</b> .....	<b>47</b>
Presentation .....	47
PL7 access security management .....	48
Accessing PL7 software .....	50
Launch Options .....	52
Creating an application .....	54
Opening an application .....	55
Protecting an Application on a PLC .....	56
Saving an application .....	59

	Saving/restoring %MWi data on TSX 37 PLCs . . . . .	60
	Offline/online operation . . . . .	65
	Program Transfer Between the PC and PLC . . . . .	67
	Program Transfer Between the PLC and PC . . . . .	68
	Transferring data from file to PLC and vice versa . . . . .	70
	Comparing applications . . . . .	71
	Backing up in the internal Eprom Flash memory . . . . .	72
	Backing up on a TSX MFP BAK 032P memory card . . . . .	73
	Accessing a PL7 through a network . . . . .	75
	Memory Usage . . . . .	76
	Sending a command to the PL7 . . . . .	78
<b>Part II</b>	<b>Configuration and Programming . . . . .</b>	<b>79</b>
	Introduction . . . . .	79
<b>Chapter 4</b>	<b>Micro and Premium: Configuring . . . . .</b>	<b>81</b>
	At a Glance . . . . .	81
4.1	Micro . . . . .	82
	At a glance . . . . .	82
	Accessing the application configuration . . . . .	83
	Choosing/Changing the processor . . . . .	85
	Configuring the processor . . . . .	88
	Configuring the module positions . . . . .	91
	Configuration of each input/output module . . . . .	93
	Software configuration of the application . . . . .	95
	Configuring Grafcet objects . . . . .	96
4.2	Premium . . . . .	98
	At a glance . . . . .	98
	Accessing the application configuration . . . . .	99
	Rack Configuration . . . . .	101
	Configuring the supply modules . . . . .	104
	Select/Change processor . . . . .	105
	Configuration of the processor . . . . .	108
	Configuring the module positions . . . . .	111
	Configuring inputs/outputs for each module . . . . .	113
	Software configuration of the application . . . . .	116
	Configuring Grafcet objects . . . . .	117
<b>Chapter 5</b>	<b>Program access . . . . .</b>	<b>119</b>
	Introduction . . . . .	119
	Introducing the application browser . . . . .	120
	Creating or importing an LD, IL, ST section . . . . .	123
	Creating or importing a Grafcet section . . . . .	125
	Creating or importing a subroutine (SR) . . . . .	127
	Creating or importing an event . . . . .	128
	Editing/emptying/suppressing a section, an event or a sub-program . . . . .	129

---

	Modifying the section execution order . . . . .	130
	Accessing the runtime screens editor . . . . .	131
<b>Chapter 6</b>	<b>Programming in LD rung language . . . . .</b>	<b>135</b>
	Introduction . . . . .	135
	Structure of a program in Ladder language . . . . .	136
	Creating a Ladder program . . . . .	137
	Specific input . . . . .	139
	Modifying a network of contacts . . . . .	140
	Displaying variables as symbols or addresses . . . . .	144
	Information box . . . . .	146
	Online symbolization . . . . .	147
	Input of a predefined function block (Ladder editor) . . . . .	148
	Function library . . . . .	151
	Operate block entry . . . . .	153
	Horizontal and vertical block entry . . . . .	155
	Assisted entry of a library function or of an instance of DFB type (Ladder editor) . . . . .	156
	Direct access to a subroutine . . . . .	160
	Replacing a variable in the application . . . . .	161
	Cross Referencing a variable in an application . . . . .	163
	Animation of the Ladder program elements . . . . .	167
	Printing of a program . . . . .	168
	Export/Import of source files . . . . .	169
<b>Chapter 7</b>	<b>Programming instruction list in LIST language . . . . .</b>	<b>171</b>
	Introduction . . . . .	171
	Structure of an Instruction List program . . . . .	172
	Creating a program in Instruction List . . . . .	173
	Accessing a statement or instruction (Instruction List) . . . . .	174
	Displaying variables as symbols or addresses . . . . .	177
	Information box . . . . .	178
	Online symbolization . . . . .	179
	Input of a predefined function block (List editor) . . . . .	180
	Assisted entry of a library function (List editor) . . . . .	181
	Direct access to a subroutine . . . . .	183
	Replacing a variable in the application . . . . .	184
	Cross Referencing a variable in an application . . . . .	186
	Animation of List program elements . . . . .	189
	Printing of a program . . . . .	190
	Export/Import of source files . . . . .	191
<b>Chapter 8</b>	<b>Programming in Structured Text ST language . . . . .</b>	<b>193</b>
	Introduction . . . . .	193
	Structure of a program in Structured Text language . . . . .	194
	Creating a program in Structured Text (ST) . . . . .	195

---

	Modifying a Structured Text program . . . . .	196
	Displaying variables as symbols or addresses . . . . .	199
	Information box . . . . .	201
	Online symbolization . . . . .	202
	Input of a predefined function block (ST editor) . . . . .	203
	Assisted entry of a library function (ST editor) . . . . .	204
	Direct access to a subroutine. . . . .	206
	Replacing a variable in the application . . . . .	207
	Cross Referencing a variable in an application . . . . .	209
	Animation of Structured text program elements. . . . .	212
	Printing of a program . . . . .	213
	Export/Import of source files . . . . .	214
<b>Chapter 9</b>	<b>Programming in Grafcet language . . . . .</b>	<b>215</b>
	Introduction . . . . .	215
	Designing a program in Grafcet language . . . . .	216
	Structure of a Grafcet page . . . . .	217
	Grafcet graphic objects . . . . .	218
	Creating a Grafcet module. . . . .	222
	Modifying a Grafcet program . . . . .	235
	Replacing a variable in the application . . . . .	238
	Cross Referencing a variable in an application . . . . .	240
	Animation of Grafcet program elements . . . . .	243
	Printing of a program . . . . .	244
	Export/Import of source files . . . . .	245
<b>Chapter 10</b>	<b>Editing variables . . . . .</b>	<b>247</b>
	Introduction . . . . .	247
	Accessing the variables editor. . . . .	248
	Input/Modification/Suppression of symbols and comments. . . . .	249
	Objects associated with a variable. . . . .	251
	Presymbolization . . . . .	252
	Sorting variables by symbols or addresses . . . . .	254
	Displaying variables in the editor. . . . .	255
	Cutting/Copying/Pasting variables in a variables editor. . . . .	257
	Entering/Modifying constants. . . . .	258
	Parametrizing predefined function blocks (FB) . . . . .	259
	Printing variables . . . . .	263
	Exporting/Importing variables . . . . .	264
<b>Chapter 11</b>	<b>Function modules . . . . .</b>	<b>265</b>
	Presentation. . . . .	265
	Function modules. . . . .	266
	Properties of a function module . . . . .	267
	Creating a functional module . . . . .	268
	Programming a functional module. . . . .	269



	Debugging a functional module . . . . .	270
	Detaching/Deleting a functional module . . . . .	271
	Export of a functional module . . . . .	274
	Importing a functional module . . . . .	275
	Creating, deleting, moving, dragging and dropping an animation table in a functional module . . . . .	276
<b>Chapter 12</b>	<b>DFB function blocks . . . . .</b>	<b>279</b>
	Presentation . . . . .	279
	DFB types . . . . .	280
	Creating a DFB type . . . . .	282
	Programming a DFB type . . . . .	283
	DFB type instance . . . . .	287
	Running a DFB instance . . . . .	289
	Entering a DFB instance . . . . .	290
	How to protect a DFB . . . . .	291
	How to Import/Export a DFB type or an application containing DFB types . . . . .	293
<b>Part III</b>	<b>Debugging, adjustment, documentation and appendices . . . . .</b>	<b>295</b>
	Introduction . . . . .	295
<b>Chapter 13</b>	<b>Debugging . . . . .</b>	<b>297</b>
	Introduction . . . . .	297
	Introduction to the PLC debugging screen . . . . .	299
	CPU screen designation zone . . . . .	300
	Information zone . . . . .	301
	Task Zones . . . . .	302
	Operating mode zone . . . . .	304
	Event zone . . . . .	305
	Last stop zone . . . . .	306
	Realtime clock zone . . . . .	307
	Modification of the program in Run mode . . . . .	308
	Animating program elements . . . . .	309
	Grafcet debugging . . . . .	312
	Executing the programme . . . . .	315
	Task properties . . . . .	316
	Executing the MAST task . . . . .	317
	Executing the FAST task . . . . .	318
	Execution of a program with breakpoint . . . . .	319
	Executing a program in step by step mode . . . . .	322
	Forcing TOR input . . . . .	324
	Forcing analog inputs, Micro . . . . .	325
	Forcing analog inputs, Premium . . . . .	326
	Adjustment of the application specific functions . . . . .	327

---

	Debugging a functional module . . . . .	328
	Debugging DFBs . . . . .	330
<b>Chapter 14</b>	<b>Adjustment of variables . . . . .</b>	<b>331</b>
	Introduction . . . . .	331
	Animation of variables: creating Animation tables . . . . .	332
	Working with animation tables . . . . .	334
	Animation and modification of the variables: DFBs . . . . .	337
	Modification of the variables: . . . . .	339
	List of forced bits . . . . .	340
<b>Chapter 15</b>	<b>Diagnostic functions . . . . .</b>	<b>343</b>
	Introduction . . . . .	343
	Diagnostic of the PLC's last stop . . . . .	344
	Module/channel diagnostics . . . . .	345
	Program diagnostics . . . . .	346
	Module call stacks . . . . .	348
	Diagnostics DFBs . . . . .	349
	Implementation of diagnostics DFB . . . . .	351
	DFB diagnostics error messages . . . . .	352
<b>Chapter 16</b>	<b>Documentation . . . . .</b>	<b>357</b>
	Presentation . . . . .	357
	Contents of documentation file . . . . .	358
	Documentation: application documentation file . . . . .	361
<b>Chapter 17</b>	<b>Import/Export . . . . .</b>	<b>365</b>
	Introduction . . . . .	365
	General points on import/export . . . . .	367
	Import/Export source files . . . . .	368
	Exporting a Section, a Subroutine, an Event . . . . .	375
	Importing a Grafcet/Ladder/List/Structured text section . . . . .	377
	Exporting an LD, IL, ST, Grafcet source file . . . . .	378
	Importing an LD, IL, ST, Grafcet source file . . . . .	379
	Exporting variables . . . . .	381
	Importing variables . . . . .	382
	Importing/Exporting variables in EXCEL format . . . . .	384
	Exporting a functional module . . . . .	386
	Importing a functional module . . . . .	388
	Importing a functional module using the wizard . . . . .	390
	Exporting animation table(s) . . . . .	394
	Importing animation table(s) . . . . .	396
	Export of runtime screens . . . . .	398
	Import of runtime screens . . . . .	401
	Export of a DFB type . . . . .	404
	Importing a DFB type . . . . .	406

---

	Exporting an application . . . . .	408
	Importing an application . . . . .	410
	Exporting an application in FNES format (Input/Output Neutral File) . . . . .	413
	Importing an application in FNES format. . . . .	414
<b>Chapter 18</b>	<b>Configuring the Uni-telway link. . . . .</b>	<b>417</b>
	Introduction . . . . .	417
	General . . . . .	418
	Configuration of the terminal/PLC link. . . . .	421
	Advanced configuration . . . . .	428
<b>Chapter 19</b>	<b>Configuring the FIPWAY link. . . . .</b>	<b>431</b>
	Presentation . . . . .	431
	General . . . . .	432
	Configuring the terminal/FIPWAY link. . . . .	434
	Advanced Configuration . . . . .	437
<b>Chapter 20</b>	<b>OS Loader . . . . .</b>	<b>441</b>
	Introduction . . . . .	441
	The OS Loader: At a Glance. . . . .	442
	Displaying the PLC OS version. . . . .	444
	Downloading an OS . . . . .	445
	Communication error during downloading. . . . .	446
	Limitations of the OS Loader. . . . .	447
<b>Chapter 21</b>	<b>Windows . . . . .</b>	<b>449</b>
	Presentation . . . . .	449
	PL7 online help . . . . .	450
	Help Topics Browser . . . . .	451
	PL7 contextual Help . . . . .	453
	General points relating to Windows. . . . .	454
	Equivalent Windows keyboard: Basic principle . . . . .	455
	The menu keys . . . . .	456
	Windows dialogue box keys . . . . .	457
	Keys for modifying text . . . . .	459
	Text selection keys . . . . .	460
	Work station and Windows Explorer keys. . . . .	461
	Print management in Windows . . . . .	462
<b>Glossary</b>	<b>. . . . .</b>	<b>463</b>
<b>Index</b>	<b>. . . . .</b>	<b>473</b>



---

## About the Book

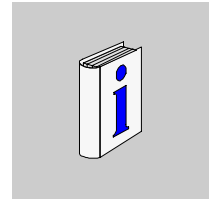

---

### At a Glance

<b>Document Scope</b>	This manual describes the installation of software for Micro and Premium PLCs
<b>Validity Note</b>	The update of this documentation takes into account the functions of PL7 V4.5. Nevertheless, it can be used to set up previous versions of PL7.
<b>User Comments</b>	We welcome your comments about this document. You can reach us by e-mail at <a href="mailto:techpub@schneider-electric.com">techpub@schneider-electric.com</a>

---



---

# Operating modes, general points

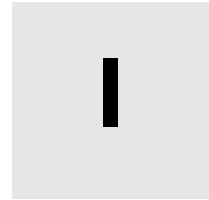

---

## Presentation

### Subject of this part

This part describes how to set up the software tool and gives general points on managing applications.

### What's in this Part?

This part contains the following chapters:

Chapter	Chapter Name	Page
1	Setting up	17
2	Presentation of PL7 functions	23
3	Managing applications	47





---

# Setting up



---

## Presentation

### Subject of this chapter

This chapter describes the software set up for the programming software.

### What's in this Chapter?

This chapter contains the following topics:

Topic	Page
General points on PL7 software	18
Connections	20
Software installation	21

## General points on PL7 software

---

### At a Glance

PL7 Micro/Junior/Pro are programming and debugging tools for Micro and Premium PLCs.

There are three software variants:

- the software suite that is used to install PL7 software,
- the software update suite that is used to update a previous version to a new version (P17 Micro V1.0 to P17 Micro V4.5),
- the software upgrade suite that is used to upgrade a previous version to a new version with a higher level of functionality (PL7 Micro V1.0 to P17 Junior V4.5, or PL7 Junior V1.0 to PL7 Pro V4.5).

A PL7 software suite comprises:

- a PL7 software installation CD-ROM,
  - a CD-ROM containing the previous version of the TSX37 and TSX57 processor operating systems,
  - a TSX07/37/57 PC UNI-TE terminal port cable (reference TSX PCX 1031 or TSX PCX 3030, not supplied with updates or upgrades),
  - an installation and start up guide for PL7,
  - a product identification number. A record of this number should be kept because it is needed each time the corresponding software is installed,
  - a CD containing documentation in French/English/German/Italian/Spanish.
-

**Functions**

The functions of PL7 software are as follows:

	<b>PI7-Micro</b>	<b>PI7-Junior</b>	<b>PI7-Pro</b>
<b>Programming</b>	Micro	Micro\Premium	Micro\Premium
<b>Grafcet Chart</b>	yes	yes	yes
<b>Grafcet Macro</b>	no	Premium	Premium
<b>Ladder</b>	yes	yes	yes
<b>List</b>	yes	yes	yes
<b>Structured text</b>	yes	yes	yes
<b>Sections</b>	yes	yes	yes
<b>Functional modules</b>	no	no	yes
<b>Debugging</b>	yes	yes	yes
<b>Adjustments</b>	yes	yes	yes
<b>Diagnostics</b>	yes	yes	yes
<b>Runtime screens</b>	no	no	creation/use
<b>DFB types</b>	no	use	creation/use
<b>DFB diagnostics</b>	no	no	TSX/PCX/PMX57
<b>Storage of PLC symbols</b>		Premium	Premium
<b>Application documentation file</b>	yes	yes	yes

## Connections

### Introduction

This module deals with the connection of the terminal to the PLC via a cable. A description of how to make other specific connections to the terminal (monitor, keyboard, mouse, printer, mains) is provided in the manufacturer documentation. Other modes of connections are possible, such as connections via UNITELWAY bus or Modem (via the telephone network).

### Connection of PC <-> PLC

To connect a PC you will require the 2.5m TSX PCX 1031 or TSX PCX 3030 link cable, supplied with new software packages (not supplied with update and upgrade variants).

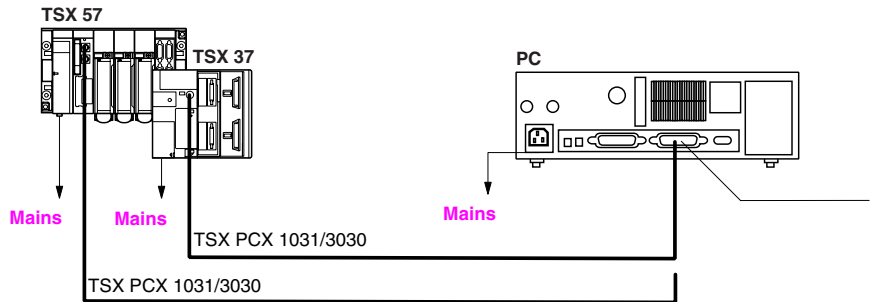

### Connection of FTX517/FT2000 <-> PLC

To connect a FTX 517 terminal you will require a 2.5m T FTX CBF 020 link cable. To connect an FT 2000 terminal you will require the 2.5m TSX PCX 1031 or TSX PCX 3030 link cable, supplied with new software package variants (not supplied with update and upgrade variants).

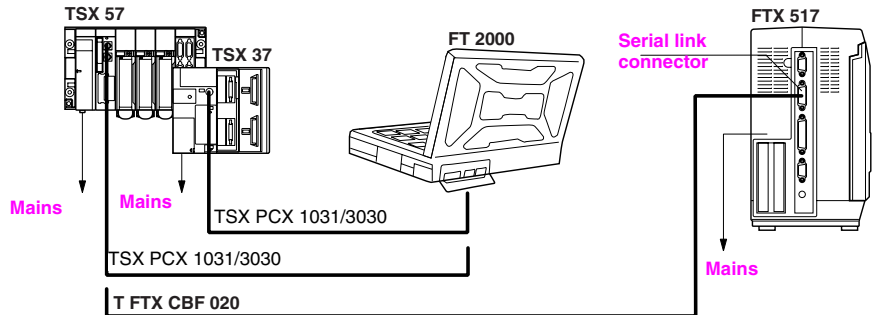

## Software installation

**Contents of PL7** You can choose which components of the PL7 software you wish to install. The standard installation is the most straightforward, but a customized installation allows you to optimize the space taken up by the software.  
Contents of a standard installation (in bold):

Software	Contents
PL7-Micro	<b>Core, function library, Uni-Telway driver.</b> <b>Servers (security management).</b> <b>Demonstration application.</b> FIP drivers PL7-2 converter
PL7-Junior	<b>Core, function library, Uni-Telway driver.</b> <b>Servers (security management).</b> <b>Demonstration application.</b> FIP drivers PL7-2 converter PL7-3 converter S1000 converter
PL7-Pro	<b>Core, function library, Uni-Telway driver.</b> <b>Servers (security management).</b> <b>Demonstration application.</b> FIP drivers FNES Import/Export function PL7-2 converter PL7-3 converter S1000 converter

**PL7 directories and files**

Directories created on C:

C:\PL7USER\	directory containing client and demonstration applications,
C:\PL7TEMP\	directory used as temporary space,
C:\CONGIG.SYS	modified file incorporating the UNITELWAY and FIPWAY drivers
C:\CONFIG.001	Old configuration file

Directories created on a path defined by the user (e.g.: D:\SOFTWARE\

\OFLIB32\	directory containing the functions
\PL7Micro33\	directory containing the module descriptions and executables for PL7 Micro
\PL7Junior33\	directory containing the module descriptions and executables for PL7 Junior
\PL7Pro33\	directory containing the module descriptions and executables for PL7 Pro
\PL7SYS\	directory containing shared PL7 files
\XWAYDRV\	directory containing COM drivers

Directories created in C:\WINDOWS\

\PL7SYS\	directory containing history
\PL7SYS\HISTO.REF	file containing installation history
\PL7SYS.INI	initialization file
\START MENU\PROGRAMS\M ODICON TELEMECANIQUE	directory containing the startup icons

**Execution**Carry out the following steps from the **Start** menu:

Step	Action
1	Select <b>Programs</b> from the <b>Start</b> menu.
2	Select the <b>Modicon Telemecanique</b> program group.
3	Select the software icon.

---

# Presentation of PL7 functions

# 2

---

## Presentation

### Subject of this chapter

This chapter describes very generally the various components of the software product.

### What's in this Chapter?

This chapter contains the following topics:

Topic	Page
Configuration editor	24
Variables editor	26
Editing in ladder language	28
Instruction list language editing	31
Structured text language editor.	32
Grafcet language editor	33
Animation tables	35
Debugging	36
Diagnostics	38
Operating screens	41
Structure of the documentation file	42
General software ergonomics	43

---

## Configuration editor

### Hardware configuration

The configuration editor is used intuitively and graphically to declare and configure the various constituent parts of the PL7.

- rack,
- supply,
- processor,
- application specific modules.

Editor:

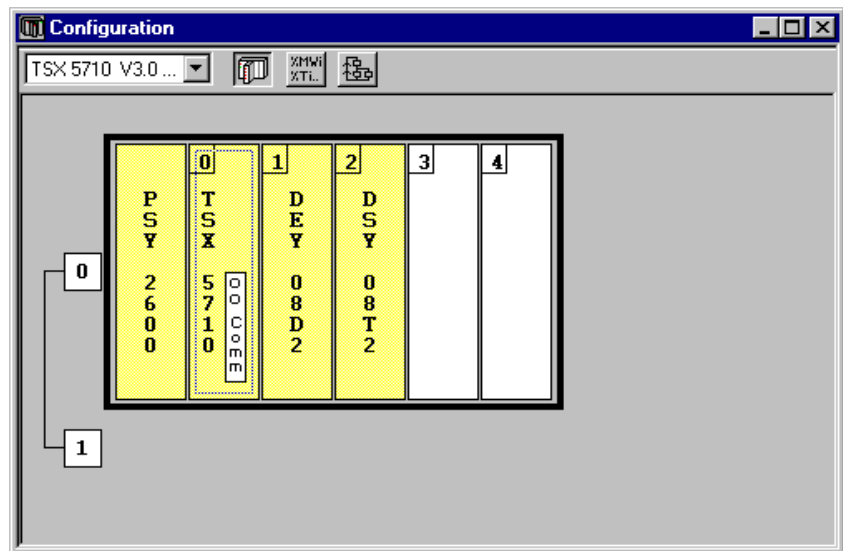

### Software configuration

The configuration editor also ensures the software parametrizing of the application by informing on the number of function blocks, registers and the size of the global variable fields.

### Configuring Grafcet objects

If the Grafcet programming language has been used, the configuration editor is used to define the Grafcet objects (steps, macro steps,...) and the execution parameters (number of steps and active transitions).



**Note**

In on-line mode the configuration editor also provides the debugging, adjustment and diagnostic functions.

---

## **Variables editor**

---

**Presentation**

The variables editor is used:

- to symbolize the various application objects,
- to parametrize the predefined function blocks,
- to enter the constant values and choose the display base,
- to parametrize the DFB user function blocks.

Access to variables is gained by:

- classifying by family and type,
- sorting functions (symbols or addresses),
- being able to pre-symbolize objects in certain applications,
- being able to launch a search with a joker on the symbol or comment,
- being able to filter the I/Os,
- being able to Copy/Paste by variables block,
- being able to remove pre-symbolization,
- displaying the variables used in the program in bold.

Editor:

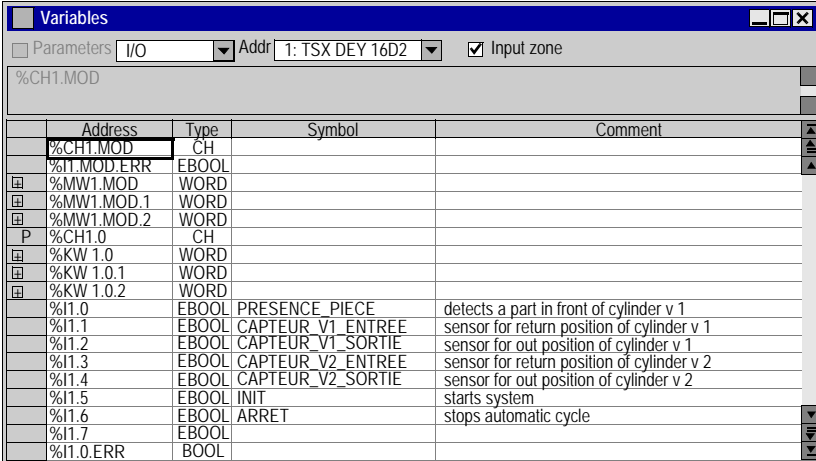

The screenshot shows a window titled "Variables" with a table of variables. The table has four columns: Address, Type, Symbol, and Comment. The variables listed include %CH1.MOD, %I1.MOD.ERR, %MW1.MOD, %MW1.MOD.1, %MW1.MOD.2, %CH1.0, %KW 1.0, %KW 1.0.1, %KW 1.0.2, %I1.0, %I1.1, %I1.2, %I1.3, %I1.4, %I1.5, %I1.6, %I1.7, and %I1.0.ERR. The symbols for %I1.0 through %I1.7 are pre-symbolized with their respective names and comments.

Address	Type	Symbol	Comment
%CH1.MOD	CH		
%I1.MOD.ERR	EBOOL		
%MW1.MOD	WORD		
%MW1.MOD.1	WORD		
%MW1.MOD.2	WORD		
%CH1.0	CH		
%KW 1.0	WORD		
%KW 1.0.1	WORD		
%KW 1.0.2	WORD		
%I1.0	EBOOL	PRESENCE_PIECE	detects a part in front of cylinder v 1
%I1.1	EBOOL	CAPTEUR_V1_ENTREE	sensor for return position of cylinder v 1
%I1.2	EBOOL	CAPTEUR_V1_SORTIE	sensor for out position of cylinder v 1
%I1.3	EBOOL	CAPTEUR_V2_ENTREE	sensor for return position of cylinder v 2
%I1.4	EBOOL	CAPTEUR_V2_SORTIE	sensor for out position of cylinder v 2
%I1.5	EBOOL	INIT	starts system
%I1.6	EBOOL	ARRET	stops automatic cycle
%I1.7	EBOOL		
%I1.0.ERR	BOOL		

## **Editing in ladder language**

---

**At a Glance**

The Ladder editor offers a number of tools to help build a ladder in a user-friendly way:

- a graphics palette,
- the language objects can be entered at random and displayed in the form of addresses, symbols or both at the same time,
- a collapsed view.

Editor:

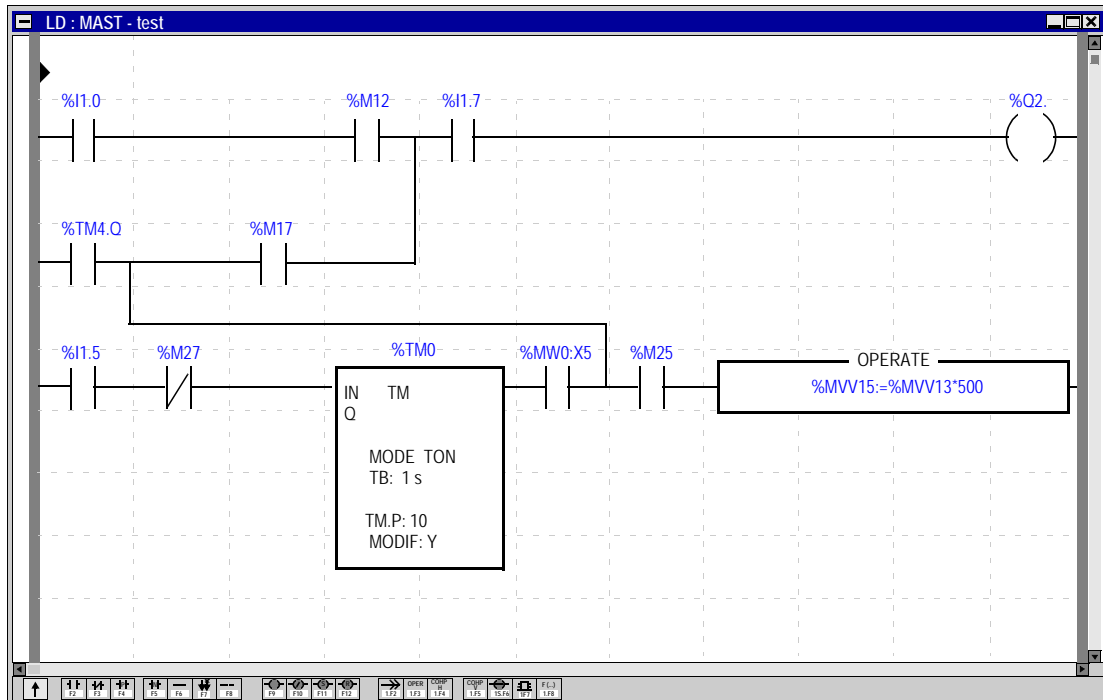

The editor is used to immediately call up assisted entry functions:

- to access function libraries,
- to enter variables in the form of symbols or addresses.

When displayed, the ladders are shown in contracted form. It is thus possible to view several ladders in the same window and to access them using the scroll bar or their label.

A subroutine can be accessed directly from the call program.

---

---

## Instruction list language editing

---

### Introduction

The Listeditor is used to input language instructions and operands via the keyboard, they are formatted automatically.

The operands can be input and viewed either as addresses or symbols.

To make program reading easier, key words of the language and comments are displayed in color.

Instruction list editor.

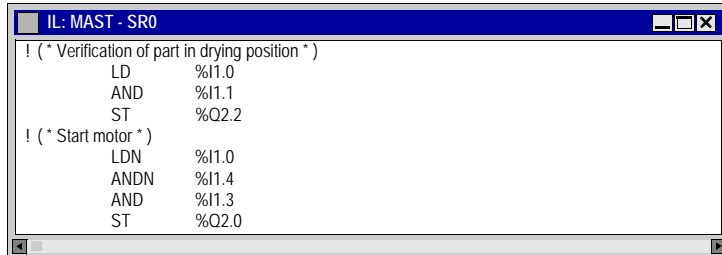

The Instruction list language editor offers input help options :

- for function block instructions ((%TMi, %Ci,...),
  - for functions, via the functions library.
-

## Structured text language editor.

### Introduction

The editor is used to input program lines via the keyboard, using alphanumeric characters.

The operands can be input and viewed either as addresses or symbols.

The editor provides a help option for function input via the functions library.

To make program reading easier, key words of the language and comments are displayed in color.

### Structured text editor

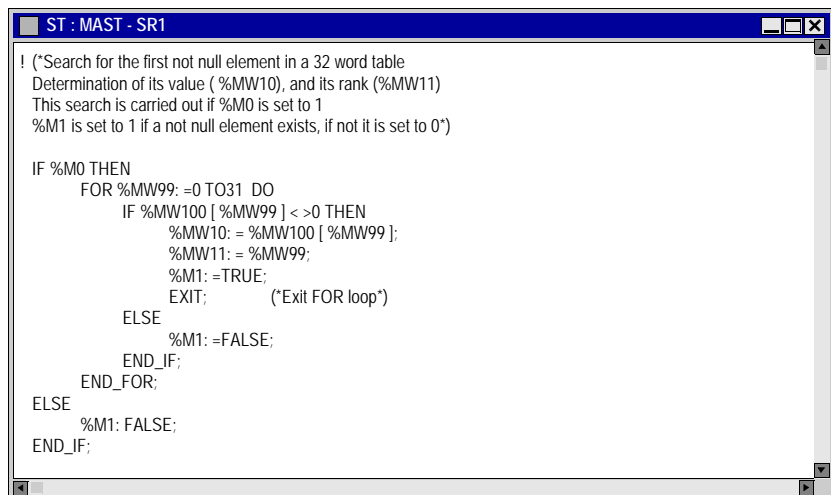

```
ST : MAST - SR1
! (*Search for the first not null element in a 32 word table
Determination of its value (%MW10), and its rank (%MW11)
This search is carried out if %M0 is set to 1
%M1 is set to 1 if a not null element exists, if not it is set to 0*)

IF %M0 THEN
  FOR %MW99: =0 TO31 DO
    IF %MW100 [%MW99 ] < >0 THEN
      %MW10: = %MW100 [%MW99 ];
      %MW11: = %MW99;
      %M1: =TRUE;
      EXIT;      (*Exit FOR loop*)
    ELSE
      %M1: =FALSE;
    END_IF;
  END_FOR;
ELSE
  %M1: FALSE;
END_IF;
```



## Grafcet language editor

---

### **Presentation**

The editor has a number of tools which are used to enter the chart in a user-friendly manner:

- a range of graphic objects,
- access to the actions or receptivity programs,
- automatic numbering of steps,
- a display of each Grafcet page with step and transition lines,
- simplified entering of remarks,
- a reduced view.

The graph is constructed by selecting the desired object from the graphics palette and putting it into the Grafcet page.

The graphics (fine lines) appear which ensures that the programmed graphic objects are displayed immediately.

---

**Illustration**

Grafcet editor

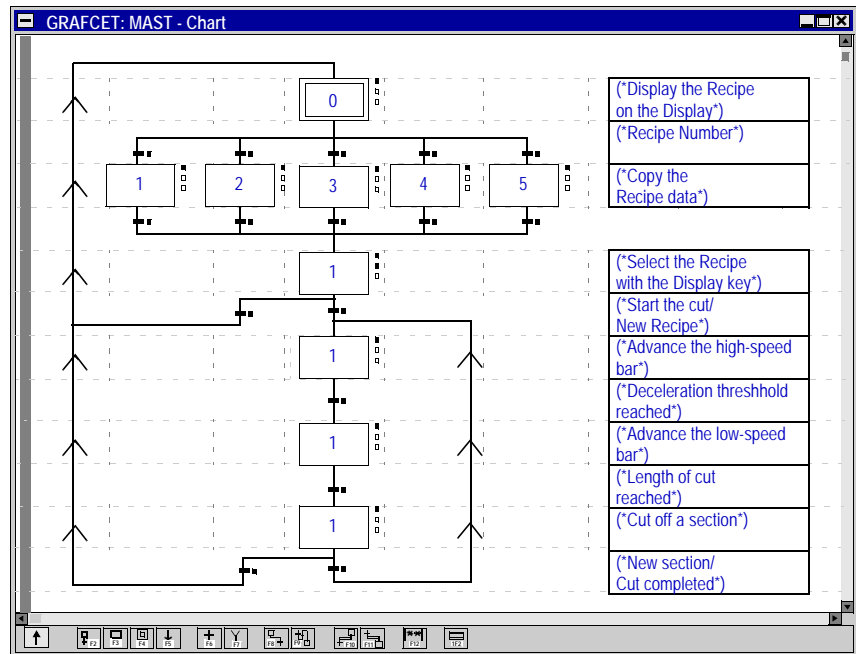

The Grafcet editor behaves like an editing field by shifting onto a complete module of 8 Grafcet pages.

# Animation tables

## At a Glance

Animation tables can be created by entering them or automatically initializing them from the rungs, selected sequences, or animated objects in the runtime screens.

The variables can then be:

- modified,
- forced to 0 or to 1 for the bit objects.

For each numerical variable it is possible to select the display base (decimal, binary, hexadecimal, floating, ASCII message).

Animation table:

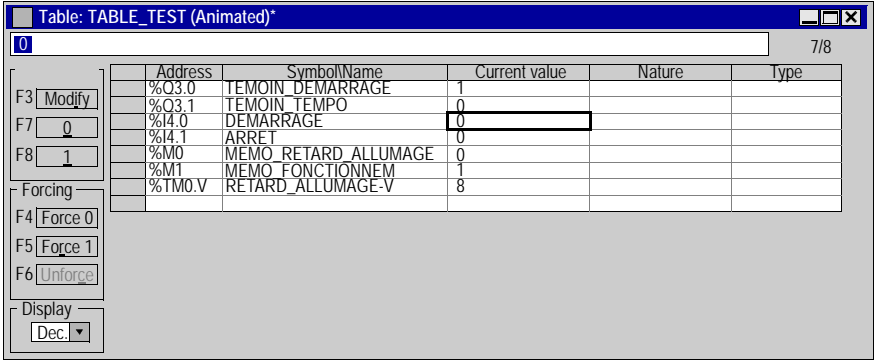

## Debugging

**Debugging tools** The PL7 software offers a complete range of tools for debugging applications.

A range of tools is used to access the main functions directly:

- setting the break point,
- running the program from step to step,
- independent running of the MAST master task and the FAST rapid task.

Debugging bar



### CU debugging screen

This CU debugging screen has the following functions:

- information on the application status,
- controlling the running of the program,
- access to the diagnostic module specific programs,
- access to updating and display of the real time clock.

Diagnostic tool:

Task	Period Set	Minimum Duration	Current Duration	Maximum Duration	Cycle time FIPIO Network	Watch dog	Operating Mode	State	Cmd	Activate task	Error	Init duration	Reset Fault
MAST	CYCLIC	2	6	12	Not pres	250	RUN	a	Stop	Deactivate	Fault	Init	Reset
FAST		0	1	2	Not pres	100	RUN	a	Stop	Deactivate	Fault	Init	Reset

**Grafcet debugging screen**

This Grafcet debugging screen is used to give a hierarchical display of the graph with overlays of the CHART module and the macro steps.

This view is animated on line. The animation is represented by the absence and presence of flags.

Debugging browser

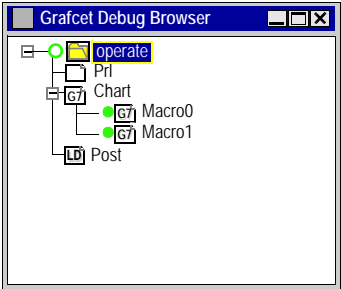

The debugging bar is used to display the status of the graph, to modify the status of the graph, to inform on the status of the master task.

Debugging bar



**Debugging function modules**

Organizing a function module, distributing the sections, events and Grafcet modules to the various modules has no effect on the running of the program. This is carried out according to the order shown in the structure view.

To debug a function module, the user has basic debugging functions and additional functions used for incremental debugging of the application, function module by function module.

These functions are:

- deactivating all sections attached to a function module,
- activating all sections attached to a function module,
- cancelling the forcing of all sections attached to a function module.

## Diagnostics

---

**Diagnostics tool** The software provides various diagnostics tools. To access the tools you need to be in online mode.

These tools are:

- diagnostics for the PLC's last operational stop,
  - module/channel diagnostics,
  - program diagnostics,
  - system diagnostics (See "Diagnostics functions installation manual",)
  - Diagnostics DFBs (See "Diagnostics functions installation manual")
-

## Diagnostics DFBs

Can be used with PL7 PRO. The diagnostics DFBs are composed of:

- Application diagnostics DFBs, which are used to set up process monitoring via the application program:
  - PL7 equation monitoring,
  - monitoring the reaction time of the process to a command,
  - monitoring safety conditions,
  - monitoring inputs, outputs and the ASI bus.
- Working part control and diagnostics DFBs which are used to control and monitor elements of the working part (EPOs):
  - monitoring sensor information,
  - monitoring actuator control requests,
  - monitoring the duration of a movement,
  - storing minimum and maximum movement durations,
  - learning the duration times of a movement,
  - controlling an actuator.

The library breaks down into the following DFBs:

<b>EV_DIA</b>	Monitoring the status of 2 bits without taking a time factor into account.
<b>MV_DIA</b>	Monitoring the status of two bits without taking a time factor into account, with the option of monitoring a movement's changes (change of bit status within a given time period).
<b>NEPO_DIA</b> <b>TEPO_DIA</b>	Monitoring, checking and diagnostics for a working part element.
<b>IO_DIA</b>	Diagnostics for all the I/O modules.
<b>ASI_DIA</b>	Diagnostics for an Asi input/output module.
<b>ALRM_DIA</b>	Interface with a diagnostics buffer (storage of errors).

### Error message:

Each DFB has its own standard error message, which may be customized according to the type of DFB.

Error messages are displayed on a **Viewer** integrated into PL7 Pro. A Diagnostics Viewer is also available with the CCX17 V2.5

Viewer:

Ack	Fault	Application	Appearance	Disappearance	Error Message	Status
<input type="checkbox"/>	ALARM	0	10/03/1998...	10/03/1998...	Silo empty or weighing ho	0.2
<input checked="" type="checkbox"/>	EV_DIA	0	11/03/1998...	11/03/1998...	def_1_faults island api 1 ho...	0.2

**Note:** the size of message type variables that are displayed in an alarm viewer should have 40 characters.

---



## Operating screens

### Presentation

The operating screens editor is a tool integrated into the PRO PL7 program from version V3.0 onwards.

It is used to make running an automated process easier.

From the **screen tab** you can:

- create operating screens, screen families,
- manage importing and exporting screens and screen families,
- manage the link between the screen number and the screen browser object,
- list all the variables used in a screen,
- parametrize the screen (size, elevator, full screen, mouse position....),
- copy/paste one or more objects,
- display the errors found by the diagnostic DFBs in the program.

From the **message tab** you can:

- Create the messages used in the screens.

From the **screen tab** you can:

- Create a library of graphics objects.

Operating screen:

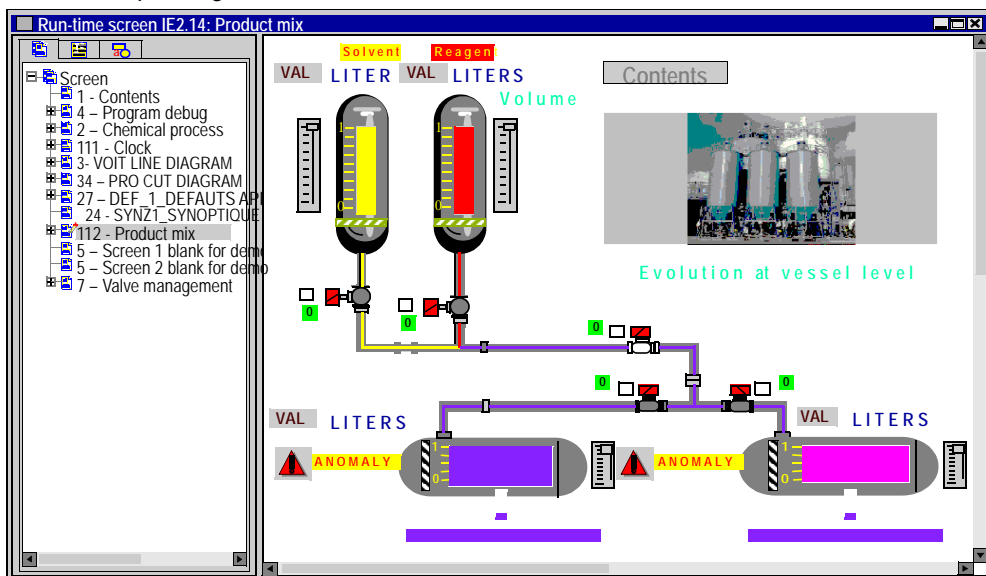

## Structure of the documentation file

### At a Glance

The documentation editor is linked to the **Documentation** browser which shows the documentation file structure in tree diagram format.

The documentation editor is used to define:

- a title page containing the name of the project and the designer,
- general information pages,
- a cartridge.

The documentation editor automatically generates:

- the contents table,
- the application documentation file (hardware/software configurations and program),
- the list of variables sorted by address or by symbol.

The documentation editor is also used:

- to print all or part of the application documentation file,
- to display documentation file pages before printing.

Documentation browser:

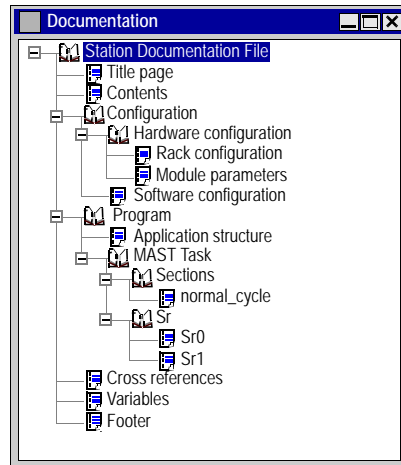

### For functional modules

When the documentation tool is launched, it detects whether there is at least one functional module referencing either program modules which are not empty (Section, Evt, Grafcet modules, Srs), or animation tables.

If this is the case, an additional node "Function view" is added to the directory tree.

## General software ergonomics

---

### General points

The PL7 software uses all the standard working tools for Windows:

- mouse or keyboard,
  - drop-down menus,
  - browsers,
  - tool bars and palettes with icons,
  - several tools in parallel,
  - on-line help and tool tips.
- 

### Standard elements

PL7 software uses Windows ergonomics and looks like this:

Example of a window:

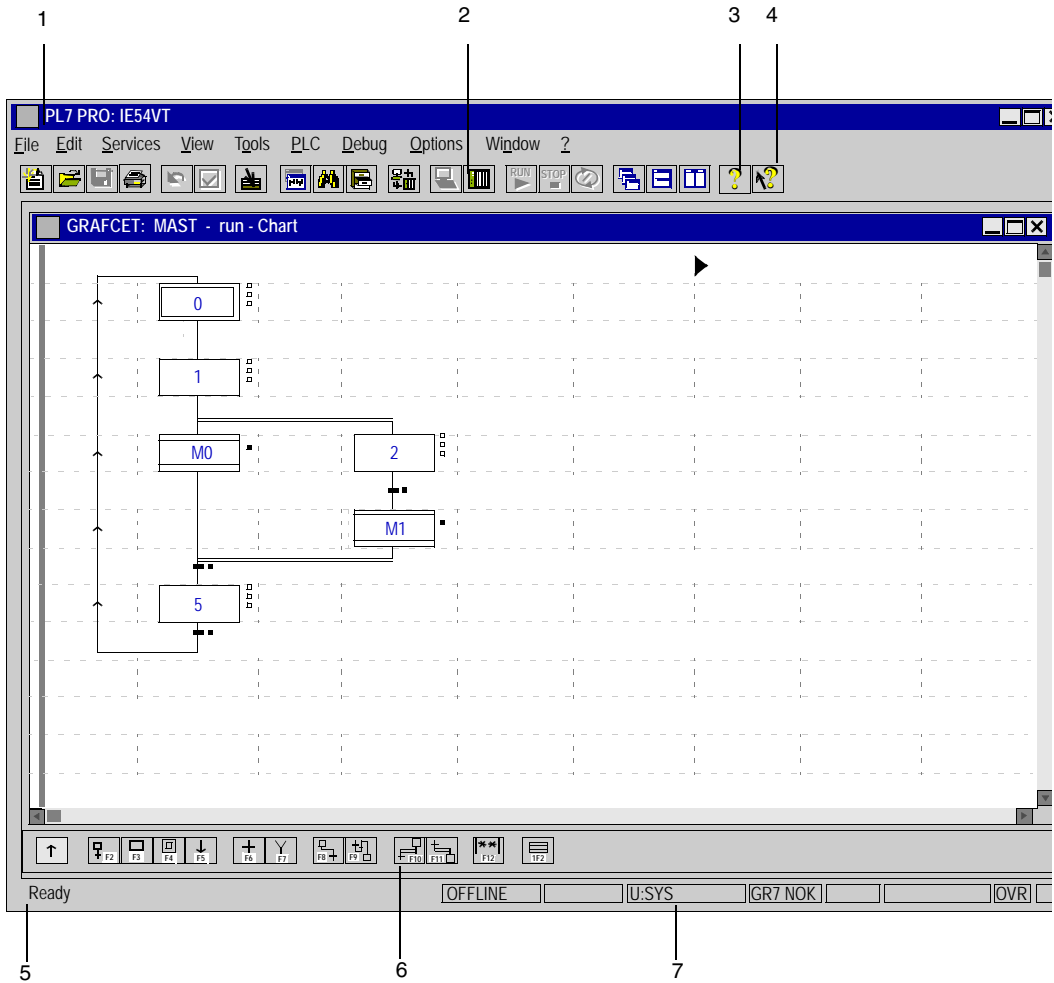

This table describes the different zones:

Number	Description
1	Menu bar, which is used to access all the software functions.
2	Tool bar for rapid access to all basic functions using the mouse.
3	On-line help on how to use the software.
4	Context sensitive help for the software.
5	Comments zone.
6	Palette of graphics elements.
7	Work context.

## Tool bar

The tool bar provides a rapid means of access to the standard software functions:



This table shows what each element of the tool bar is for:

Element	Function	Element	Function
	New application		Offline mode
	Open an application		Online mode
	Save the application		Switch PLC to RUN mode
	Print all or part of the application		Switch the PLC to STOP mode
	Undo		Start / Stop animation
	Confirm modifications		Arrange the windows in a cascade
	Go to		Tile Horizontally
	Application browser		Tile Vertically
	Cross references		Help
	Function library		What's This?
	PLC transfer<-> terminal		

**Status bar**

The PL7 status bar looks like this:

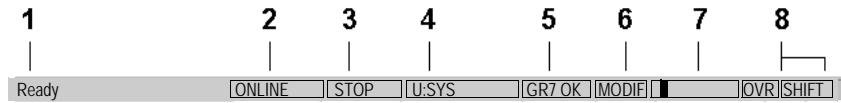

This table describes the different zones that make up the status bar:

Number	Zone	Function
1	Mini on-line help	Provides help linked to the menu commands or tool bar icons when these are selected.
2	Operating mode	Shows the current operating mode (offline, online).
3	PLC status	Shows the PLC status (Run, Stop, faulty, etc.).
4	Network address	Provides details of the PLC's network address.
5	Grafcet mode	Shows whether Grafcet mode is used in the application.
6	Modification in progress	Shows that the current application is not backed up or is different from the back up.
7	Animation flag	Symbol for online mode.
8	Keyboard functions	Shows the status of the <b>Insert</b> and <b>Caps</b> functions of the keyboard.

---

# Managing applications

# 3

---

## Presentation

### Subject of this chapter

This chapter shows the different tools used to manage an application.

### What's in this Chapter?

This chapter contains the following topics:

Topic	Page
PL7 access security management	48
Accessing PL7 software	50
Launch Options	52
Creating an application	54
Opening an application	55
Protecting an Application on a PLC	56
Saving an application	59
Saving/restoring %MWi data on TSX 37 PLCs	60
Offline/online operation	65
Program Transfer Between the PC and PLC	67
Program Transfer Between the PLC and PC	68
Transferring data from file to PLC and vice versa	70
Comparing applications	71
Backing up in the internal Eprom Flash memory	72
Backing up on a TSX MFP BAK 032P memory card	73
Accessing a PL7 through a network	75
Memory Usage	76
Sending a command to the PL7	78

## PL7 access security management

---

### At a Glance

PL7 access security management, administered by the super user, limits and controls access to the various PL7 functions.

It is applied to the terminal where the PL7 software is installed, not the application.

PL7 software provides 5 user profiles:

- Read Only,
- Operate,
- Adjust,
- Debug,
- Program.

---

### User information

The **User information** box displays information on the current user.

When the PL7 **Access security management** option has not been implemented or is inactive, this information is as follows:

- indication that PL7 access control is inactive,
- the **PL7.INI** file path.

When PL7 Access security management is active, this information is as follows:

- indication that PL7 access control is active,
  - user name,
  - user profile,
  - the "**User**".INI file name and path.
  - the start options file name and path.
-



**PL7 software  
access  
management**

The super user is the only one with the rights to manage PL7 access security.

From the "PL7 Access Security Management" dialog box the super user can:

- create/ modify a list of users,
- import a list of users,
- export a list of users,
- activate the "PL7 Access Security Management" function,
- modify his/her password.

<b>Note:</b> The name reserved for the super user is <b>Supervisor</b> .
--

---

## Accessing PL7 software

---

### At a Glance

It is possible to run several PL7 operations simultaneously (multi-instance) from the same station.

PL7 software also offers the possibility of setting the launch parameters for PL7 using a launch options (see *Launch Options, p. 52*) file. This is used, for example, to automatically launch an application in a given work environment using a customized short cut icon.

---

### Access without launch option

Carry out the following operations:

Step	Action
1	Select the PL7 icon required (Micro, Junior or Pro) from the Modicon Telemecanique program group.
2	If <b>PL7 Access Security Management is active</b> (see <i>PL7 access security management, p. 48</i> ), a dialog box is used to identify the user. Enter a user name.
3	Enter a password, where applicable.
4	Confirm with <b>OK</b> or press <b>Enter</b> .

---

**Access with  
launch option**

Carry out the following operations:

Step	Action
1	Select the icon for the launch option command line.
2	If PL7 Access Security Management is active, an information box warns that the program cannot be launched unless access rights have been granted. Click on <b>OK</b> .
3	A dialog box is then used to identify the user. Enter a password.
4	Confirm with <b>OK</b> or press <b>ENTER</b> .

**Notes:**

The operating mode described above can vary slightly depending on the launch options.

Depending on the launch options declared in the options file, different dialog boxes may appear.

When the user is not known (name and/or password incorrect), only the minimum PL7 profile (read only) is available.

## Launch Options

---

### At a Glance

The launch options make it possible to launch PL7 within the appropriate operating context. This operating context is defined using parameters that are entered in a text file with a user-definable file name suffix. All these parameters are optional. Their presence or absence affects the behavior of the software when it is opened.

---

### Description of the Parameters in the File

The table below provides a description of the parameters in the file:

Designation	Comment
Name	User name. The Name parameter makes it possible to determine the associated user profile and use a specific user option file.
Password	The user's password.
AutoOpenStx	Automatically opens an application. The full path to the application file's location must be entered in this field.
Address	Address of the target PLC. The PLC's address can be accessed in PL7 by selecting PLC/Define PLC address.
Driver	Driver used for communications between the terminal and the PLC. The driver used for communications can be accessed in PL7 by selecting PLC/Define PLC address.
AutoConnect	Attempts to open the application in online mode: <ul style="list-style-type: none"> <li>● TRUE: opens in online mode,</li> <li>● FALSE: opens in offline mode.</li> </ul>
AutoOpenTool	Automatically opens tools (see <i>PL7 Tools, p. 53</i> ) (e.g.: variables editor).Syntax: Tool'a', Tool'b',...
ShowIOModule	Automatically opens modules in the mode: <ul style="list-style-type: none"> <li>● configuration in the case of offline mode,</li> <li>● debugging in the case of online mode.</li> </ul> Enter the rack number followed by the module number. Syntax: Rack'x',Module'x1';Rack'y',Module'y1';...

---

**Example Launch Option File**     **[common]**  
 User name  
 Name=Fabien  
 Password=Joker  
 AutoOpenStx=c:\pl7user\Count.stx  
 Address=SYS  
 Driver=UNTLW01  
 AutoConnect=FALSE  
 AutoOpenTool=12,15  
 ShowIOModule=0,2;0,3;1,1

**PL7 Tools**

Description of PL7 tools:

Number	Designation
5	Opens the LD editor
6	Opens the Grafcet editor
7	Opens the IL editor
8	Opens the ST editor
10	Opens the configuration editor
12	Opens the variables editor
13	Opens the cross-reference browser
14	Creates an animation table
15	Opens the documentation editor
188	Opens the application import tool
189	Opens the text editor
207	Opens the runtime screen
210	Opens the DFB type editor
212	Opens the application browser
214	Opens the Grafcet debug browser
215	Opens the DFB code editor in ST

## Creating an application

---

### Procedure

Carry out the following actions:

Step	Action
1	Select the command <b>File/New</b> .
2	Select the hardware base.
3	Select the processor type:
4	Depending on which processor it is, select the type of memory card. The type of memory card can always be modified subsequently when configuring the processor.
5	Depending on the processor version, the Grafcet option must be selected before being used in the application.

---

### Suggestion for setting up an application

Define the structure of the program to be used:

- single task,
- multi task,
- fast task,
- events,
- function view.

Define the structuring of the variables in:

- bits,
- words,
- tables,
- chains,
- symbols.

Define the PL7 configuration and the module parameters.

---

## Opening an application

---

### Procedure

This function is applied from a PL7 product that is already open.

Carry out the following actions:

Step	Action
1	Select the command <b>File/ Open</b> .
2	Select the file for the application (*.STX).
3	Click on <b>Open</b> .

### Note:

The applications are saved by default in the directory defined when it was installed. This can be looked up and modified using the command **Option/Personalize**.

The modifications will take effect after the next PL7 session.

---

## Protecting an Application on a PLC

---

### At a Glance

The application's **Protection** function can be accessed in offline mode from the **Application properties** screen.

This function provides:

- Global application protection,
- Protection of the sections, for which the type of protection can be defined:
  - individually by section,
  - for all sections of an application or task.

**Note:** Protecting the sections does not work with PL7 Micro.

### Global Application Protection

Carry out the following actions:

Step	Action
1	From the <b>Station</b> directory select <b>Properties</b> via the contextual menu
2	Select the <b>Protection</b> tab.
3	In the <b>Application</b> zone, check the <b>Global application protection</b> box.

This function is used after transferring the application to the PLC to provide read and write protection.

Only the **Run**, **Stop** and **Init** functions, accessible via **PLC/PLC command**, are authorized in a protected PLC application.

	<p><b>WARNING</b></p> <p>Protection cannot be removed once applied. A protected application cannot be modified. The only option is to load a new application onto the PLC.</p> <p><b>Failure to follow this instruction can result in death, serious injury, or equipment damage.</b></p>
---	---



### Global Protection of all Sections

This is for sections included in either:

- the program,
- or a task.

Carry out the following actions:

Step	Action
1	Select the Programs, Tasks or Section directory.
2	Using the contextual menu select <b>Protection of Included Sections</b> .
3	Select the following from the drop-down menu: <b>Write Protect</b> , or <b>Read and Write Protect</b> .

### Individual Protection of Sections

Carry out the following actions:

Step	Action
1	Select the section to be protected.
2	Using the contextual menu select <b>Properties</b> .
3	From the drop-down menu, select <b>Protection: Write or Read and Write</b>

### Activating Section Protection

Step	Action
1	From the <b>Station</b> directory select <b>Properties</b> via the contextual menu.
2	Select the <b>Protection</b> tab.
3	Check the box <b>protection activated</b> , and enter the password. A padlock by the section shows that it is protected.

#### Notes:

The first time the application is used, the password must be confirmed.

The **Clear** button is used to delete the password.

The password is stored in the PLC when the application is transferred.

**Deactivating Protection**

Carry out the following actions:

Step	Action
1	From the <b>Station</b> directory select <b>Properties</b> via the contextual menu.
2	Select the <b>Protection</b> tab.
3	Check the <b>Protection deactivated</b> box, and enter password. An open padlock by the section shows that protection has been deactivated.

---

**Note**

It is not possible to modify a section if partial or total protection is activated.

A padlock shows that a type of protection has been activated:

- open: protected section - protection deactivated,
  - closed: protected section - protection activated.
-

---

## Saving an application

---

### Saving a new application

Carry out the following actions:

Step	Action
1	Select the command <b>File/Save</b> or <b>File/Save as</b> .
2	If necessary, select the application's disk and/or save directory using the pull-down menu " <b>In</b> ".
3	Enter the name of the file in the " <b>Name</b> " field (maximum of 215 characters). <b>Caution:</b> The characters given below cannot be used in naming a : \ / file: * ? " < >  .
4	Confirm using <b>Save</b> .

**Note:** When saving an application, which exceeds the capacity of one disk, dialog boxes will appear on the screen asking you to insert the disks one after another. This will continue until the save of the application is complete. You are advised to prepare several empty, formatted discs in advance, and to number them in the order in which you insert them.

### Saving an existing application

Select the command **File/Save**.

---

## Saving/restoring %MWi data on TSX 37 PLCs

---

### At a Glance

In order to meet the need to save configuration data in case a fault occurs with the processor battery or where no such battery is installed, TSX 37 PLCs provide the option of programmable copying of the first 1000 %MW words to internal FLASH EPROM.

**Note:** An %MW internal word backup is always accompanied by an application program backup when the application is stored in internal RAM.

**Note:** The save function cannot be performed once a TSX MFP BAK 032P Backup card with the WP switch set to OFF has been inserted into the PLC.

### Configuration of save mode

There are two save modes:

- by using the %I1.9 input as a condition for "Save program and first %MWi" (to be defined in the processor configuration screen),
- from an adjustment terminal by setting the bit 0 of the system word %SW96 to 1.

**Note:** The bit 0 of the %SW96 system word is always active while %I1.9 is only active when it has been configured. Furthermore, the "%MWi Reset on cold start" box in the processor configuration screen must not be checked.

## Saving

The save function is triggered either:

- on the rising edge of the discrete input %I1.9,
- on the rising edge of bit 0 of %SW96.

**Note:** This function requires the PLC to be in Stop.

The number of words to be transferred shall be initialized in advance in the system word %SW97:

- %SW97 = n (n = 1 to 1000): the application program in the internal RAM and the first n %MW words are transferred to internal FLASH EPROM.
- %SW97 = 0: only the application program contained in the internal RAM is transferred to internal FLASH EPROM. This action is equivalent to the performing an application backup using PL7 software. **In this case, the %MW backup is erased.**

**Note:** If the application program is executed from the PCMCIA card (TSX 37 2\*), performing the %MW backup (internal RAM -> internal FLASH EPROM) erases any program saved in the internal FLASH EPROM.

**Note:** In contrast, transferring a program stored in a TSX MFP BAK 032P Backup memory card with the WP switch set to ON to the internal memory of the PLC does not erase any %MW backup in internal FLASH EPROM.

**Note:** When the input %I1.9 is configured as a save input, you are advised to configure the %I1.8 input as a RUN/STOP input to be able to switch the PLC to STOP without having to use the terminal.

When saving is complete, the bit in position 2 of the word %MW96 provides the backup report (can also be viewed on the central display of the PLC by indicating that the backup was **OK** or **NOK** depending on the situation:

- 0 = backup completed without errors (OK),
- 1 = backup completed with errors (NOK).

The OK or NOK message is cleared when the PLC changes to Run or by simply pressing the button on the central display.

**Note:** If a power outage occurs during the backup, the system performs a warm restart upon power return and completes the backup in full transparency.

**Note:** If a cold start is caused by pressing the RESET button or by moving the TSX 37 2• handle and the backup is not yet complete, the application program and data saved in internal FLASH EPROM may be lost.

## Restoring

The saved %MWi internal words are transferred from internal FLASH EPROM memory to the internal RAM memory on a cold start.

- following an internal RAM failure, in which case the application program is transferred to RAM if the application backup is valid (TSX 37 05/08/10 or TSX 37 2• PLC without PCMCIA memory card),
- by pressing the RESET button on the front of the PLC,
- by setting the system bit %S0 to 1 in adjust mode,
- by clicking on the "cold start" button in the processor debugging screen,
- as a result of the program being transferred to the PLC,
- as a result of inserting a PCMCIA application memory card.

**Note:** In order for the saved %MW words to be restored to internal RAM, the "%MWi Reset on cold start" must not be checked in the processor configuration screen.

## Operating mode without PCMCIA card

The flow diagram below shows the operating modes of the PLC on power up

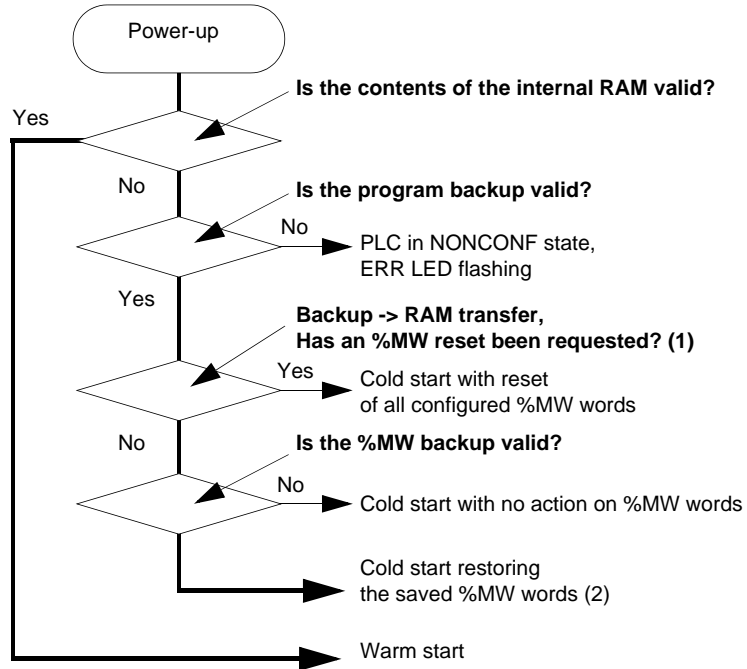

(1) this corresponds to checking the “%MWi Reset on cold start” checkbox in the processor configuration screen

(2) The %MWi internal words that have not been saved are left in the same state they were in before the power outage. If necessary, they must be reset by the application.

**Operating mode with PCMCIA**

The flow diagram below shows the operating modes of the PLC on power up

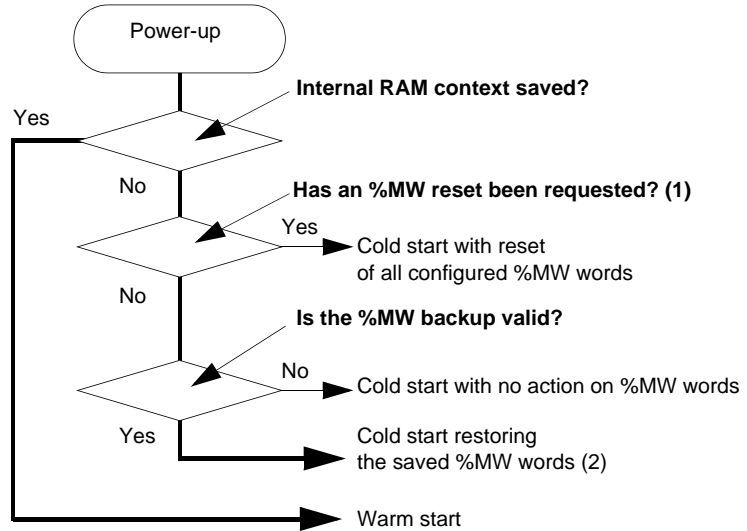

(1) this corresponds to checking the “%MWi Reset on cold start” checkbox in the processor configuration screen

(2) The %MWi internal words that have not been saved are left in the same state they were in before the power outage. If necessary, they must be reset by the application.



## Offline/online operation

---

**Offline mode** Offline mode (no PLC connection) is used to **Create/Modify** an application on the terminal. The application being edited is stored on disk in the working directory.

The **File/Save** command or the icon must be used to save to disk in the applications



directory.

---

## Online mode

Online mode (connected to the PLC) is used to **Create/Modify** an application in the PLC.

### The following functions are available:

- create/modify LD, IL, ST or Grafcet programs,
- modify task period,
- modify predefined function block parameters (apart from register size),
- modify number of internal words,
- modify module data and parameters,
- import/export a source file or variables, PLC in Stop mode,
- export an application, PLC in Stop mode,
- debug, adjustment.

### The following functions are not available:

- add or remove a module,
- modify the I/O channel association<->application-specific function,
- add predefined function blocks,
- modify register size,
- modify number of bits and internal constants,
- import an application
- open an application.

### Notes:

When being modified in online mode, the application is updated on the PLC and on the disk in the working directory:

- the save to the PLC is automatic.
- The **File/Save** command or the icon  must be used to save to disk in the

applications directory.

---

## For functional modules

A functional module can be created, modified, and removed in offline or online mode, with the PLC in Stop or Run mode.

---

## Commands

Switching to online mode: Select **PLC/Connect** command.

Switching to offline mode: Select the **PLC/Disconnect** command.

## Program Transfer Between the PC and PLC

### PC -> PLC Transfer

Carry out the following actions:

Step	Action
1	Select the command <b>AP/Transfer Program</b> or click . 
2	Select the transfer <b>PC-&gt;PLC</b> and confirm with OK.
3	If a cartridge enabling the storage of symbols and comments is declared in the configuration, the symbols box is available: you can choose to transfer now or postpone the symbols transfer until a later transfer phase.

Elements not transferred in the PLC:

- Functional Module description sheets,
- comments linked to DFB types (in the absence of a memory storage cartridge),
- comments linked to DFB instances (in the absence of a memory storage cartridge),
- animation tables,
- operator screens,
- symbols and comments of variables (in the absence of a memory storage cartridge).

	<b>WARNING</b>
	<p><b>Unexpected application behavior</b></p> <p>To load a TSXP57•M processor application to a TSXP57•AM processor (and vice versa), you <b>MUST</b> follow the instructions below:</p> <ul style="list-style-type: none"> <li>• Adjust the tasks period if you are programming in periodic mode,</li> <li>• Check the consequences on the operative part if you are programming in cyclic mode,</li> <li>• Advise users of the PCMCIA card of the specific choice of processor for the new application.</li> </ul> <p>The new TSXP57•AM processors have similar functionality to TSXP57•M processors, with the exception of the CPU scan time, which may differ in some instances. Refer to the relevant technical documentation for more information.</p> <p><b>Failure to follow this instruction can result in death, serious injury, or equipment damage.</b></p>

## Program Transfer Between the PLC and PC

### PLC -> PC Transfer

Carry out the following actions:

Step	Action
1	Select the command <b>AP/Transfer Program</b> or click .  
2	Select the transfer <b>PLC-&gt;PC</b> and confirm with <b>OK</b> .

### Notes for PLC -> PC Transfer

#### Note 1:

The program can only be transferred when no application is open on the terminal (PC). If the symbols/comments base is present on the PLC, this is then transferred. Otherwise the local base is initialized (empty).

#### Note 2:

If an application is open on the PC when you launch a PLC -> PC transfer request, and changes have been made since the first save, the software will ask you if you want to save the changes before continuing.

The software keeps the folder relating to the application, animation tables and operator screens present on the terminal (PC). For all other components, i.e. data (symbols) and comments of DFB instances, the software opens a dialog box and proposes that you either:

- keep the components of the PC,
- or replace the components of the PC with those of the PLC,
- or delete the components of the PC.

This dialog box also displays information comparing:

- the results of the comparison: application **Identical** or **Different**,
- the date and time of the last application modification in the PLC,
- the date and time of the last application modification in the PC.

	<b>WARNING</b>
	<p><b>Inconsistency</b></p> <p>In both cases where you can keep or replace the components (symbols and comments of DFB instances), there may be inconsistency between these components and the application.</p> <p><b>Failure to follow this instruction can result in death, serious injury, or equipment damage.</b></p>

	<b>WARNING</b>
	<b>Case of comments of DFB instances:</b> Comments of DFB instances are not kept in the variable editor, even when the user selects the option " <b>Use DFB info from PC</b> " To remedy this problem, you must: <ul style="list-style-type: none"><li>• either use a PCMCIA memory card enabling you to store symbols and comments,</li><li>• or Export the symbols and comments from the old application, unload the new application, and Import the symbols and comments into the new application.</li></ul> <b>Failure to follow this instruction can result in death, serious injury, or equipment damage.</b>

### Results of the Transfer

The results of the transfer are indicated in the status bar (at the bottom of the window).

The **ESC** key lets you interrupt the transfer at any time.

## Transferring data from file to PLC and vice versa

---

### File -> PLC data transfer

Carry out the following actions:

Step	Action
1	Select the <b>PLC/Transfer Data</b> command.
2	Select transfer direction, <b>File -&gt; PLC</b> .
3	Enter the name of the file to be transferred then click on <b>OK</b> .

The range of values contained in the file can be displayed by clicking on the icon



The ">" command displays a dialog box which is used to choose a data file from the existing ones on the disk.

---

### PLC -> File data transfer

Carry out the following actions:

Step	Action
1	Select the <b>PLC/Transfer Data</b> command.
2	Select transfer direction, <b>PLC -&gt; File</b> .
3	Set the transfer parameters: <ul style="list-style-type: none"> <li>● the range of %MW values to be transferred,</li> <li>● the name of the file in which the data will be stored.</li> </ul>
4	Click on <b>OK</b> .

The ">" command displays a dialog box which is used to choose the destination file.

	<b>WARNING</b>
	<p>A transfer in progress can only be interrupted if there is a fault of some kind (PLC fault, break in the PLC/PC link, etc.).</p> <p><b>Failure to follow this instruction can result in death, serious injury, or equipment damage.</b></p>

---

## Comparing applications

---

### Presentation

Comparing applications is used to identify any differences between:

- the application in the PL7 and the one in the terminal,
  - the application in the PL7's RAM and the one in the EPROM FLASH memory.
  - the PC and PL7 symbol base.
- 

### Procedure

Carry out the following actions:

Step	Action
1	Select the command <b>AP/Comparet</b> .
2	Select the type of comparison: <ul style="list-style-type: none"> <li>● PC program&lt;-&gt;PL7 program,</li> <li>● RAM &lt;-&gt;BACKUP field,,</li> <li>● PC symbol&lt;-&gt; PL7 symbol.</li> </ul>
3	Click on <b>OK</b> .

---

### Result

The result is shown in a dialogue box with:

- the date and the time of the last modification of the application run,
- the version number,
- the application name,
- the comments.

With the symbol base the dialogue box shows:

- the date and time of the last modification,
  - the signature,
  - the number of symbols,
  - the space occupied,
  - the total compressed size
-

## Backing up in the internal Eprom Flash memory

---

### Presentation

**TSX 37-10 PL7s** and **TSX 37-20 PL7s** can save the application (program and constants) in the internal PL7 EPROM FLASH memory if this is in the RAM and is not more than 15 associated symbol addresses.

This is used:

- to reload the PL7 RAM manually (transferring BACK UP -> RAM field) using the contents of the EPROM FLASH,
- to reload the RAM automatically using the contents of the EPROM FLASH, when the application in RAM is invalid.

This function must be carried out in **offline** mode.

---

### Transferring Ram -> Back up field

Carry out the following steps:

Step	Action
1	Select the command <b>AP/Backup</b> .
2	Select the RAM->BACK UP field <b>transfer and click on OK</b>

	<b>WARNING</b>
	<p>If the %SW97 system word is initialized at 0, only the application program contained in the internal RAM is transferred to the Eprom Flash (equivalent to a program back up). Any saving of %MWi is deleted.</p> <p><b>Failure to follow this instruction can result in death, serious injury, or equipment damage.</b></p>

---

### Transferring Back up -> Ram field

Carry out the following steps:

Step	Action
1	Select the command <b>AP/Backup</b> .
2	Select the BACK UP->RAM field <b>transfer and click on OK</b> .

The results of the transfer are shown on the status bar.

---



## Backing up on a TSX MFP BAK 032P memory card

### At a Glance

Micro and Premium PLCs provide the option of backing up the application (program and constants) on a TSX MFP BAK 032P memory card.

The internal RAM memory can thus be reloaded using the contents of the Backup card without having to use a terminal.

This Backup function is not available if the application is already running on a RAM or EPROM memory card.

### Ram -> Backup memory card transfer

Perform the following actions in **offline mode**:

Step	Action
1	Save (1) the application held in the PLC's internal RAM on the programming terminal.
2	Insert the <b>TSX MFP BAK 032P</b> memory card into the PLC (the write protection lock must be set to OFF).
3	Transfer (2) the application from the terminal to the PLC's internal RAM memory. To do this, select <b>PLC → Transfer Program → PC -&gt; PLC</b> then click <b>OK</b> .
4	Declare the memory card in the configuration editor.
5	Select <b>PLC → Backup → RAM -&gt; BACKUP Zone</b> then click <b>OK</b> .
6	When the transfer is complete, remove the Backup card and set the <b>WP</b> switch to <b>ON</b>
(1)	<b>For version V1.0 and V1.1 TSX 37 PLCs, it is essential that you ensure that the application in the PLC has been saved to the programming terminal before inserting the Backup PCMCIA card (lock set to OFF). Inserting the card completely clears the PLC's internal RAM.</b>
(2)	<b>For version V1.0 and V1.1 TSX 37 PLCs or when the application in the PLC is protected.</b>

**Note:** For a RAM->Backup transfer on TSX 3720 PLCs with an external memory card, priority is given to transferring the application to the memory card.

**Backup memory card -> Ram transfer**

Carry out the following actions:

Step	Action
1	As the transfer renders the backup of the %MW words in the internal FLASH EPROM invalid (%S97 = %SW96:x7 = 0), you are advised to back up these words prior to making the transfer (1).
2	Insert the TSX MFP BAK 032P memory card into the PLC (the write protection lock must be set to <b>ON</b> ). Note: Inserting the memory card automatically transfers its contents into internal RAM and into FLASH EPROM.
(1)	see <i>Saving/restoring %MWi data on TSX 37 PLCs, p. 60</i>

**Notes on the PLC's operating modes**

At the end of transfer, with the Backup card in the processor, the PLC is forced to STOP even if the AUTO RUN option has been configured. The PLC can be set to RUN from the terminal.

As long as the Backup card is in the PLC, a power outage followed by a power return will systematically cause a start in forced STOP.

Removing the Backup memory card causes a cold start in RUN or STOP mode depending on the AUTO RUN configuration.

If internal word initialization on cold restart is not configured, the transfer from the Backup memory card into RAM retains the internal word values.

---

---

## Accessing a PL7 through a network

---

**Procedure**

Carry out the following actions:

Step	Action
1	Select the command <b>AP/Enter PL7 address.</b>
2	Select the type of drivers (e.g. UNTLW01).
3	Enter the network address

---

**Network address syntax**

The network address syntax is as follows:

- **(network no. station no) module track no. PL7 address**
- **(network no. station no.)SYS**

**{network no. station no.}** = network address and destination station on FIPWAY (this part is omitted if the PL7 to be accessed is not on the FIPWAY network).

**PL7 module.track address** = UNI-TELWAY address (module = 0 or 254, track no. = 0 terminal point or 1 for the communication card, PL7 address = 0 to 98).

**SYS** = access to the system gate (or UNI-TE server) of the destination PL7.

---

**Note**

Using the number 254 as a position when communicating between slaves allows it to stay on the same UNITELWAY bus by optimizing exchange routing.

---

**Example**

**{0.2}0.1.3** = PL7 having 3 for an address on the Unitelway link of the module 0 communication card, track 1 of station 2 on network 0.

**SYS** = default address of the PL7 physically linked to the terminal.

---

## Memory Usage

---

### At a Glance

The memory usage function can be accessed via the **PLC/Memory usage** command or from the **Application properties** screen.

It provides information on:

- PLC memory used (data, program, configuration and system),
- memory mapping for an application (internal memory and memory card).

---

### "User data" zone

This zone groups together the objects linked to software configuration data:

- **Bits and I/O bits:**

- %Mi bits,
- %Si bits,
- Input/output bits,
- Bits associated with Grafcet, %Xi, %Xi,j,...

**TSX37xx**: zone set at 2560 bits and I/O bits outside the internal memory.

**TSX57xx**: zone in the internal memory that can be configured.

- **Words:**

- %MWi words,
- %SWi system words,
- Words linked to configured function blocks (%Ci:V, etc),
- Words associated with Grafcet, %Xi, T, %Xi,j,T,...

- **I/O data:**

- Data used for managing I/O modules and I/O words (%IW, %QW, %MW).

- **DFB:**

- data for DFB type instances,
  - PL7 internal management.
-

**"User program" zone**

This zone gives user program consumption details.

- **Constants:**
    - constants %Kwi + display base (binary, etc.).
  - **Executable code:**
    - code linked to the user program,
    - application EF code,
    - DFB type code + initialization value.
  - **Comments and graphic information:**
    - user program decompilation information,
    - information linked to EFs,
    - information linked to DFBs.
- 

**"Other" zone**

This zone summarizes consumption linked to the application configuration and application structure.

The total of the values declared is equal to the total amount of memory available in the various memory spaces.

Mapping by memory type is displayed by positioning the mouse over the bars of the chart.

- **Configuration.**
    - hardware configuration (I/O, FIP),
    - software configuration (Timers, Registers, etc.),
  - **System:**
    - Stack of tasks, catalogs, etc.
- 

**"Optimize" command**

The **Optimize** command is used to reorganize the memory structure where possible.

It is also used to remove EFs which are not used in the application from the memory.

---

## Sending a command to the PL7

---

**Presentation** The **Command to a PL7** function is used to run (**Run**), stop (**Stop**) or initialize (**Init**) a PL7 application from the terminal in offline mode.

---

**Procedure** Carry out the following actions:

Step	Action
1	Enter the communication driver type between the terminal and the PL7.
2	Enter the PL7's network address.
3	Select the command <b>Identify</b> in order to establish communication with the target PL7. The following parameters are supplied: <ul style="list-style-type: none"> <li>● the type of processor,</li> <li>● the current status of the PL7 (Run, Stop or Init),</li> <li>● the name and version of the PL7 application,</li> <li>● the date of the last modification,</li> <li>● any comments.</li> </ul>
4	Select the type of command (Run, Stop or Init).
5	Select the <b>Send</b> command.

---

---

# Configuration and Programming

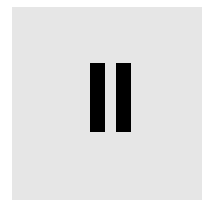

---

## Introduction

### Subject of this part

This part describes how to configure the hardware devices Micro/Premium and how to program an application.

### What's in this Part?

This part contains the following chapters:

Chapter	Chapter Name	Page
4	Micro and Premium: Configuring	81
5	Program access	119
6	Programming in LD rung language	135
7	Programming instruction list in LIST language	171
8	Programming in Structured Text ST language	193
9	Programming in Grafcet language	215
10	Editing variables	247
11	Function modules	265
12	DFB function blocks	279

---





---

# Micro and Premium: Configuring

# 4

---

## At a Glance

### Subject of this chapter

This chapter describes:

- How to configure the software application.
- How to configure the hardware application.

### What's in this Chapter?

This chapter contains the following sections:

Section	Topic	Page
4.1	Micro	82
4.2	Premium	98

## 4.1 Micro

---

### At a glance

---

#### Subject of this section

This section describes:

- How to configure the software application with a Micro.
  - How to configure the hardware application with a Micro.
- 

#### What's in this Section?

This section contains the following topics:

Topic	Page
Accessing the application configuration	83
Choosing/Changing the processor	85
Configuring the processor	88
Configuring the module positions	91
Configuration of each input/output module	93
Software configuration of the application	95
Configuring Grafcet objects	96

---

## Accessing the application configuration

---

### Principles

The configuration software displays the processor selected when the application was created.

The aim of this function is to:

- replace the processor (if the one selected at the time of creation is not suitable),
- configure the processor,
- declare/parametrize the various input/output modules and integrated modules,
- enter the software configuration,
- enter the Grafcet configuration.

In online mode this function is used to:

- diagnose module faults,
  - debug modules.
-

**Procedure**

Carry out the following actions:

Step	Action
1	From the <b>Application Browser</b> , double left click on the " <b>Configuration</b> " directory or position the cursor over it using the arrow keys and press right arrow.
2	Select: <ul style="list-style-type: none"><li>● <b>Hardware configuration</b> to access the module racks,</li><li>● <b>Software configuration</b> to define the application software parameters,</li><li>● <b>Grafcet object configuration</b> to define the grafcet parameters specific to the application.</li></ul>
3	The configuration entered is confirmed by the <b>Edit/Confirm</b> command, the <b>Confirm</b> command from the contextual menu, or the icon 

**Note:**The **Edit/Cancel modifications (CTRL+Z)** command or the icon cancels allmodifications made since the last confirmation.

---

## Choosing/Changing the processor

---

### Choosing the processor

Choosing the processor is the first stage in setting up an application. This choice is reversible.

Carry out the following actions:

Step	Action
1	Select the command <b>File/ New</b> from the PL7 home screen.
2	Select the PLC type > <b>Micro</b> .
3	Select the processor type -> <b>TSX37xx Vyy</b> .
4	If necessary, select a memory extension card (PCMCIA - if the processor supports it).
5	Specify whether or not your application contains Grafcet.
6	Click on <b>OK</b> .

---

## Changing the processor

The configuration editor provides assistance when attempting to change the processor. A message is sent out if the change is not authorized.

	<b>WARNING</b>
	<p><b>When changing to a version V3.x processor</b></p> <p>Using a <b>V3.x</b> processor in an application that has previously been configured with a lower processor version leads to an <b>irreversible change</b> in the application structure.</p> <p>This conversion involves:</p> <ul style="list-style-type: none"><li>• the creation of program structure in sections,</li><li>• the automatic creation of the Grafcet section when the initial program module is written in Grafcet language,</li><li>• an increase in the size of the application by approximately 100 bytes.</li></ul> <p><b>Failure to follow these instructions can result in death, serious injury, or equipment damage.</b></p>

Carry out the following actions:

<b>Step</b>	<b>Action</b>
1	Select the <b>Edit/Change processor</b> command.
2	Select the required processor.
3	Select a memory card if necessary.
4	Confirm and then click on <b>OK</b> or press <b>ENTER</b> .

**Note:**

It is possible to change the processor using the drop-down menu in the configuration editor.

---

## Configuring the processor

### Procedure

Carry out the following operations:

Step	Action
1	From the application configurator select <b>position 0</b> .
2	Select <b>Open module</b> using the contextual menu or double click on the processor.
3	According to the application, enable the <b>RUN/STOP input</b> (see <i>RUN/STOP input</i> , p. 89).
4	According to the application, enable the <b>Alarm</b> (see <i>Alarm output</i> , p. 89) output.
5	According to the application, enable the <b>Save program and first %MWi</b> (see <i>Saving/Restoring %MWi internal words</i> , p. 89) input.
6	According to the application, enable <b>Automatic start in RUN</b> (see <i>Automatic start in RUN</i> , p. 90).
7	According to the application, enable the initialization of %MWi internal words on <b>Cold restart</b> .
8	Select the type of memory card for processors which have this option.
9	Select the type of MAST task execution: <ul style="list-style-type: none"> <li>● Cyclical</li> <li>● Periodic: 1 to 255 ms (20 ms, default value). If the value is 0 execution will be cyclical.</li> </ul>
10	Enter the MAST task <b>watchdog</b> (see <i>WatchDog</i> , p. 90) value: 10 to 500 ms maximum (250ms, default value).
11	According to the application, enter the FAST task period value: 1 to 255 ms maximum (5ms, default value).
12	According to the application, enter the FAST task watchdog value: 10 to 500 ms maximum (100 ms, default value).
13	Confirm using the <b>Edit/ Confirm (CTRL + W)</b> command or using the icon .  



**RUN/STOP input** The %I1.8 input parameters can be set to switch the PLC between **RUN/STOP** as follows:

- %I1.8 to 1 -> the PLC switches to RUN (program running),
- %I1.8 to 0 -> the PLC switches to STOP (program stops running).

This is taken into account on rising edge.

A STOP command by the %I1.8 input takes priority over a RUN command from a terminal or a network command.

A fault on the RUN/STOP input causes the machine to STOP.

---

**Alarm output** An alarm function can be assigned to the %Q2.0 output.

After setting the PLC in RUN mode, if no blocking faults are detected (PLC in STOP mode or output in fallback mode, %S9=1), the safety output is set to 1.

This output can be used in safety circuits external to the PLC. For example:

- to pace the supply of output pre-actuators,
- to pace the PLC supply.

As soon as a blocking fault appears, the safety output is set to 0.

---

**Saving/  
Restoring %MWi  
internal words**

This function is only available on version V2.0 PL7s or later:

- **Saving**

To save internal words in Flash EPROM the application must be in STOP. Saving %MWi internal words is always linked to an application program save. It is triggered according to the selection made during configuration:

- by setting the discrete %I1.9 input to 1,
- by setting the bit 0 of %SW96 to 1.

- **Restoring**

The saved %MWi's are transferred from internal flash EPROM memory to RAM memory on a cold restart.

To restore the %MWi internal words to internal RAM you need to deactivate the Reset %MWi on cold restart box in the processor configuration screen .

---

**Automatic start  
in RUN**

If this option is checked, the PLC will automatically switch to RUN on a cold start.  
If there is no memory card, the PLC will start up using the contents of the processor's internal RAM.  
If a memory card is inserted, its contents determine the start up.

---

**WatchDog**

The duration of the master task operation when in **cyclic** or **periodic** mode, is controlled by the PLC (watchdog) and must not exceed the value set out in the T max configuration (250ms default, 500ms maximum, rollover 10ms).

If this value is exceeded, an error is declared in the application, which stops the PLC immediately:

- **Micro**: setting the %Q2.0 alarm output to 0 if it has been configured.

**Execution monitoring:**

- **%S11**: indicates that the watchdog has been exceeded. It is set to 1 by the system when the cycle time exceeds the watchdog value.
  - **%SW11**: contains the watchdog value (in ms).
  - **%S19 (periodic operation)**: indicates that the period has been exceeded. The system sets it to 1 when the cycle time exceeds the task period.
  - **%SW0 (periodic operation)**: this word contains the period value (in ms). It is initialized on cold restart by the value set during configuration. It can be modified by the user.
-

## Configuring the module positions

### Introduction

Editor:

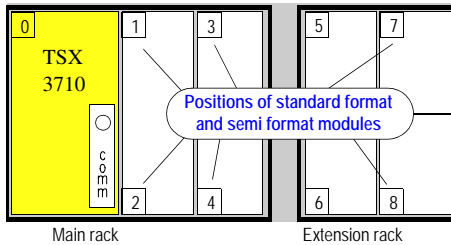

**A standard format module** takes up two positions.

**A half format module** takes up one position.

**The 0 position** is allocated to the processor and to integrated modules (such as the TSX 37-22).

**Procedure**

Carry out the following operations:

<b>Step</b>	<b>Action</b>
1	Select the position of the module to be configured (using the mouse or arrow keys).
2	Select the <b>Edit/Add module</b> command or double click on the position selected. A dialogue box is displayed showing a list by family of the modules that can be configured for the selected position (standard format module or half format).
3	Select the family (using the mouse or arrow keys), the module (the TAB key is used to move between the different zones) and choose <b>OK</b> to confirm.

**Notes:**

If the module takes up 2 positions (as with all standard format modules), the software automatically updates the position configuration.

If no input/output modules are declared in the configuration, or if there are any format modules, the PL7 software gives access to the %Ix.0 to %Ix.15 bits and to the %Qx.0 to %Qx.15 outputs for each position (even if the half format module concerned has less inputs/outputs).

If there are any standard format modules, the PL7 software gives access to the %Ix.0 to %Ix.31 input bits for odd positions and to the %Qx+1.0 to %Qx+1.31 output bits for even positions (even if the standard format module concerned has less inputs/outputs).

---

## Configuration of each input/output module

### Procedure

Carry out the following actions:

Step	Action
1	Select the module to be configured (using the mouse or arrow keys).
2	Select the <b>Utilities/Open Module</b> command or double click on the selected module. For built-in modules, a window indicates: <ul style="list-style-type: none"> <li>• the reference and the position of the module,</li> <li>• the current configuration context (see <i>Configuration context</i>, p. 94).</li> </ul>
3	Enter the parameters and confirm with <b>Edit/Confirm (CTRL + W)</b> . To enter the various parameters, please refer to the sections on the specific applications concerned. Depending on whether or not the command <b>View/Module Zone</b> is selected, the display will be different.
4	Close the window using the keys <b>(CTRL+F4)</b> and set the parameters for the next module.

### Channel management

When no input/output module is declared in a position in configuration mode, PL7 functions as if there was a 1/2 format 16 input / 16 output module present. PL7 thus gives access to input bits %Ix.0 to %Ix.15 and to output bits %Qx.0 to %Qx.15 for each position.

When modules in 1/2 format are declared, PL7 gives access to input bits %Ix.0 to %Ix.15 and to output bits %Qx.0 to %Qx.15 for each position (even if the half-format module has less inputs/outputs).

When mixed standard format modules are declared, PL7 gives access to input bits %Ix.0 to %Ix.31 for odd positions and to output bits %Q(x+1).0 to %Q(x+1).31 for even positions (even if the half-format module has less inputs/outputs).

Standard format input or output modules are managed as two modules in half-format occupying two overlapping positions.

**Configuration context**

Select **Configuration** to set the parameters for the module.

The **Adjust** option can be selected for counting, movement and weighing modules in order to:

- define the initial values of parameters in offline mode,
- modify these parameters in online mode.

The **Debug** option (only accessible in online mode) can, depending on the module, be used to:

- view the state of inputs,
  - display diagnostics for the module and channels,
  - write to outputs.
-

## Software configuration of the application

### Procedure

Carry out the following operations:

Step	Action
1	Double left click on the <b>Configuration</b> directory or select it using the arrow keys, then press right arrow.
2	Select the <b>Software configuration</b> directory. Software configuration is used to set the following for the application: <ul style="list-style-type: none"> <li>● the number of different types of function blocks,</li> <li>● the number of register words,</li> <li>● the number of %M internal bits,</li> <li>● the number of %M internal words,</li> <li>● the number of %KW constants.</li> </ul>
3	For each of the fields to be modified, select the field and then enter the required value (entry is controlled to prevent values greater than the maximum authorized number (see <i>Maximum number of authorized objects, p. 95</i> ) from being entered.
4	Confirm the configuration with the <b>Edit/Confirm (Ctrl + W)</b> command

### Maximum number of authorized objects

For each of the objects this number is:

Objects	Maximum value
%TMi timers	64
%Ti Series 7 timers	64
%MNi monostables	8
%Ci counters	32
%Ri registers	4
%DRi drums	8
Number of words per register	255
%Mi internal bits	depends on the size of memory available
%MWi internal words	depends on the size of memory available
%KWi constants	depends on the size of memory available

## Configuring Grafcet objects

### Introduction

Before configuring Grafcet objects the following action must be taken:

- when setting up the application you must specify that it will contain a Grafcet section, otherwise you will not be able to access the Grafcet configuration editor,
- the processor version (see *Processor version, p. 97*) used must support Grafcet language.

Grafcet object configuration is used to set the following for the application:

- the number of steps,
- the number of active steps,
- the number of valid transitions.

### Procedure

Carry out the following actions:

Step	Action
1	Double left click on the <b>Configuration</b> directory or select it using the arrow keys, then press right arrow.
2	Select the Configure Grafcet Objects directory.
3	For each of the fields to be modified, select the field and then enter the required value (entry is controlled to prevent values greater than the maximum authorized number (see <i>Maximum number of authorized objects, p. 96</i> ) from being entered).
4	Confirm the configuration with the command <b>Edit/ Confirm (Ctrl + W)</b> .

### Maximum number of authorized objects

For each of the objects this number is:

Objects	Maximum values
Number of steps	<b>TSX3705/08/10:</b> 1 to 96. <b>TSX3721/22:</b> 1 to 128.
Number of active steps	<b>TSX3705/08/10:</b> 1 to 96. <b>TSX3721/22:</b> 1 to 128.
Number of valid transitions	<b>TSX3705/08/10:</b> 1 to 192. <b>TSX3721/22:</b> 1 to 256.



**Processor  
version**

## Compatibility table

**V1.1 processor**

This generation of processors does not support Grafcet.

**V1.5, V2.0, V3.x, and V4.0 processors**

If you are using Grafcet it must be declared when the application is set up.  
It is not possible to change this option subsequently.

## 4.2 Premium

---

### At a glance

---

#### Subject of this section

This section describes:

- How to configure the software application with a TSX-Micro.
  - How to configure the hardware application with a TSX-Premium.
- 

#### What's in this Section?

This section contains the following topics:

Topic	Page
Accessing the application configuration	99
Rack Configuration	101
Configuring the supply modules	104
Select/Change processor	105
Configuration of the processor	108
Configuring the module positions	111
Configuring inputs/outputs for each module	113
Software configuration of the application	116
Configuring Grafcet objects	117

---

## Accessing the application configuration

---

### Principle

The configuration software displays a supply module and the processor selected when the application was set up.

The object of this function is to:

- replace the processor (if the one chosen at the beginning is not right),
- configure the processor,
- declare/parametrize the various input/output modules and integrated modules,
- enter the software configuration,
- enter the Grafcet configuration.

In on-line mode this function is used to:

- diagnose module faults,
  - debug modules.
-

**Procedure**

Carry out the following actions:

Step	Action
1	From the Application browser, double left click on the repertoire " <b>Configuration</b> " or position the arrow keys on this and press the right arrow.
2	Select: <ul style="list-style-type: none"><li>● <b>Hardware configuration</b> to access the module racks,</li><li>● <b>Software configuration</b> to define the software application parameters,</li><li>● <b>Grafcet objects configuration</b> to define the specific grafcet parameters for the application.</li></ul>
3	To confirm the configuration entered use the command <b>Edit/Confirm</b> or in the contextual menu <b>Confirm</b> or use the icon 

**Note:**The command **Edit/ Cancel modifications (CTRL+Z)** or the icon cancels allmodifications made since the last confirmation.

---

---

## Rack Configuration

---

### Introduction

A rack with a 0 address is compulsory, as it contains the station processor.

Number of racks managed by the different processor types:



Processor type	Number of racks managed
TSX/PCX/PMX 57-1x	Up to 2 racks
TSX/PCX/PMX 57-2x/3x	Up to 16 racks

For a station configured using **TSX/PCX/PMX 57-2x/3x** processors, it is not necessary to use successive addresses. It is possible to configure one station with a rack at address 0 and one rack at address 7.

Configuration with several racks must contain one rack that can be extended to address 0.

---

**Extension Racks** The following possibilities exist:

<b>You want</b>	<b>then</b>	<b>and</b>
<b>to add a rack</b>	select an empty address or the  symbol (rack EX) then the  command <b>Edit/Add a rack</b>	select the desired rack from the dialogue box displayed.
<b>to select a rack</b>	click on the white rectangle containing the address of the rack or on the white rectangle associated with the EX rack. A dotted frame will surround the selected rack.	
<b>to replace a rack</b>	double click on the white rectangle containing the address of the rack or on the white rectangle associated with the EX rack	select from the dialogue box displayed an extendible or non-extendible rack.
<b>to delete a rack</b>	select the rack	press the Del key or select the command <b>Edit/Delete rack</b> (impossible to delete rack 0).

**Note:**

The button only appears for processors of a version higher than or equal to **V3.3** and



for extendible racks.

Changing a **V3.3** -> **V3.0** processor can be refused if there are extension racks.

---

**Use of  
TSX REY 200**

This module allows the extension of two bus segments from the rack supporting the processor, up to a maximum distance of 250 meters. Each extended segment is able to support racks distributed along the X Bus to a maximum length of 100 meters.

**Note:** A configuration can only support one Bus X extension suite comprising a maximum of one master and two slaves:

- 1 TSX REY 200 in rack 0 (except slots 0 and 1), it will automatically configure itself as master,
- 1 or 2 TSX REY 200 in any racks, except rack 0, they will automatically configure themselves as slaves.

## Configuring the supply modules

---

### Introduction

The supply does not necessarily occupy the first position in a rack (the position furthest to the left). This position has no address.

Double format supplies occupy not only the first position but the 0 address position. In this case the processor is configured in the 1 address position.

---

### Configuration

There are the following possibilities:

<b>You want.....</b>	<b>then.....</b>	<b>and.....</b>
<b>select a module</b>	click on the module.	
<b>adding a module</b>	select the extreme left position of the rack then the command <b>Edit/ Add a module</b>	select a module from the dialogue box displayed.
<b>replacing a module</b>	select the module	select a module from the dialogue box displayed (it is not possible to configure a double format supply if the position is already occupied).
<b>suppressing a module</b>	select the module	press the Suppr key or select the command <b>Edit/Suppress the module.</b>
<b>moving a module</b>	select the module	move the module without releasing the mouse button (this action is possible if the furthest left position in another rack is free).
<b>copying a module</b>	select the module	press the <b>Ctrl</b> key and move the module without releasing the mouse button (this action is possible if the furthest left position in another rack is free).

---



---

## Select/Change processor

---

**Select processor** The selection of a processor is the first stage to create an application, and is not irreversible.

Carry out the following actions:

Stage	Action
1	From the PL7 welcome screen, select the command <b>File/New</b> .
2	Select the automation type -> <b>Premium</b> .
3	Select the automation type -> <b>TSX57xx Vyy</b> .
4	Possibly select an extension memory card (PCMCIA). The memory available depends on the card and the processor used
5	Specify (depending on the processor configured) whether your application houses a Grafset or not.
6	Validate by pressing <b>OK</b> .

---

**Change processor**

The configuration editor will assist you when you attempt to change the processor, a message is transmitted if the change is unauthorized.

	<b>WARNING</b>
	<p><b>Case of changing to a version V3.x processor.</b></p> <p>The use of a <b>V3.x</b> processor in a previously configured application using a processor of an inferior version involves an <b>irreversible</b> development in the structure of this application.</p> <p>This conversion is translated by:</p> <ul style="list-style-type: none"> <li>● the creation of a sectioned program structure,</li> <li>● the automatic creation of the Grafcet lsection when the initial program module is written in the Grafcet language,</li> <li>● the automatic replacement of the TSX SCY 21600 modules by the TSX SCY 21601 modules when occurring in the configuration.</li> <li>● the application size increases by around 10%, which may cause the conversion to fail.</li> </ul> <p><b>Failure to follow these instructions can result in death, serious injury, or equipment damage.</b></p>

Carry out the following actions:

Stage	Action
1	Select the command <b>Edit/Change the processor.</b>
2	Select the desired processor.
3	Possibly select a memory card.
4	Validate then confirm by pressing <b>OK</b> or by pressing <b>ENTER.</b>

**Comments:**

It is possible to change the processor by using the drop-down menu located in the configuration editor.

	<b>WARNING</b>
	<p><b>Unexpected behavior of the application</b></p> <p>To convert an application from a TSXP57 processor •M to an TSXP57 application •AM (and vice versa), it is imperative to observe the following settings :</p> <ul style="list-style-type: none"><li>• adjust the task period if you are programming in the periodic mode,</li><li>• check the effects on the operative section if you are programming in the cyclic mode,</li><li>• warn those using the PCMCIA card of the processor selection, which is retained for this new application.</li></ul> <p>The new TSXP57 processors •AM have functionalities similar to TSXP57 processors •M with the exception of the CPU cycle time, which may be different in some cases. Please consult the technical documentation related to these new processors for more specifications.</p> <p><b>Failure to follow these instructions can result in death, serious injury, or equipment damage.</b></p>

## Configuration of the processor

### Procedure

Carry out the following actions:

Step	Action
1	From the application configurator, select <b>position 0 or 1</b> from rack 0.
2	Select <b>Open module</b> from the context menu or double click on the processor.
3	Confirm, depending on the application, the <b>RUN/STOP input</b> (see <i>RUN/STOP input, p. 109</i> ).
4	Confirm, depending on the application, the <b>Automatic startup in RUN</b> (see <i>Automatic startup in RUN, p. 109</i> ).
5	Confirm, depending on the application, the memory protection, then, if need be, enter the input dedicated to this function.
6	Confirm, depending on the application, the initialization of internal words %MWi on <b>Cold restart</b> .
7	Select the type of memory card for processors with this option.
8	Select the type of MAST task execution: <ul style="list-style-type: none"> <li>● Cyclic</li> <li>● Periodic: 3 to 255 ms (20 ms, default value). If the value is 0, execution will be cyclic.</li> </ul>
9	Enter the value of the <b>watchdog</b> (see <i>Watchdog, p. 110</i> ) of the MAST task: 10 to 500 ms maximum (250ms, default value).
10	Enter, depending on the application, the value of the period of the FAST task: 2 to 255 ms maximum (5ms, default value).
11	Enter, depending on the application, the value of the FAST task watchdog: 10 to 500 ms maximum (100 ms, default value).
12	If necessary, select type of Fipio (see <i>Fipio, p. 110</i> ) mode for the MAST task: <ul style="list-style-type: none"> <li>● <b>Controlled mode</b>: the task is timed by a period (MAST in periodic execution).</li> <li>● <b>Free mode</b>: the task controlled variables are scanned in "<b>Optimal</b>" mode, but the scanning period may be greater than the period of the task, while still less than the task watchdog.</li> </ul>
13	If necessary, select type of <b>Fipio</b> mode for the FAST task (Controlled mode, Free mode).
14	Confirm using the command <b>Edit/Confirm (CTRL + W)</b> or using the icon . 

**RUN/STOP input**    The input %I1.8 can be parameterized to control the PLC's switching between **RUN/STOP** in the following way:

- %I1.8 = 1 -> the PLC switches to RUN (program executes),
- %I1.8 = 0 -> the PLC switches to STOP (program stops executing).

Retrieval is rising edge.

A STOP command via %I1.8 input has priority over a RUN command via terminal or network command.

An error on the RUN/STOP input causes a switch to STOP.

---

**Automatic startup in RUN**    If this option is checked, the PLC will automatically switch to RUN during a cold start. If there is no memory card, the PLC starts up according to the contents of the processor's internal RAM.

ee

If a memory card is inserted, it is the contents of the card which defines the startup.

---

**Memory protection**    This option enables the application contained in the PLC to be protected against any attempt to alter it.

The protection is activated by setting the PLC input dedicated to this function to 1.

---

## Watchdog

The period of master task execution, in **cyclic** or **periodic** operation, is controlled by the PLC (watchdog) and must not exceed the value defined in Tmax configuration (250ms by default, 500ms maximum, modulo 10ms).

If overflow should occur, the application is declared in error, which causes the PLC to stop immediately:

- **Premium:** supply alarm relay set to 0

### Execution monitoring:

- **%S11:** indicates a watchdog overflow, it is positioned to 1 by the system, when the cycle time becomes greater than the watchdog.
- **%SW11:** contains the value of the watchdog (in ms).
- **%S19 (periodic operation):** indicates a period overflow, it is positioned to 1 by the system, when the cycle time becomes greater than the task period.
- **%SW0 (periodic operation):** this word contains the value of the period (in ms), it is initialized on cold restart by the value defined at configuration, it can be changed by the user.

---

## Fipio

The **FIPIO** bus allows 127 devices to be connected to the connection point which is built into the processor.

The software **PL7-Junior** or **PL7-PRO** and the processors, **TSX P 5725x / 35x / 45x, TPCX 57351x, and TPMX 57352 /452** are used to configure and monitor the connected devices.

These devices can be any of the following:

- FIPIO agent PLCs,
  - TBX TOR or ANA,
  - Momentum TOR or ANA,
  - CCX-17,
  - ATV16/58/66,
  - AS-i gateway TBX SAP10,
  - devices which comply with FIPIO standard profiles,
  - PCs.
-

---

## Configuring the module positions

---

### Positioning a module

Carry out the following actions:

Step	Action
1	Select the position of the module to be configured (using the mouse or arrow keys). (The PgUp, PgDn, TAB and SHIFT+TAB keys are used to select a different rack).
2	Select the <b>Edit/Add module</b> command or double click on the position selected ( <b>ENTER</b> key). A dialogue box is displayed showing a list by family of modules that can be configured for the selected position
3	Select the family (using the mouse or arrow keys), the module (the TAB key is used to move between the different fields) and confirm by <b>OK</b> .

#### Notes:

Double format modules (for example the TSX CAY41 movement module) only appear in the module list when both the position selected, and the position before or after it (depending on type) are not occupied.

Position 0 can only be occupied by a double format supply module or processor.

---

**Moving a module** Carry out the following actions:

Step	Action
1	Select the required module.
2	Move it to the new position while keeping the mouse button held down or select the <b>Edit/Move a module</b> command.
3	Select the <b>Edit/Confirm</b> command for the modifications to be taken into account.

**Notes:**

Objects linked to the module at the former address are:

- deleted then recreated automatically at the new address,
- replaced in the program and variables editor (except for animation tables and runtime screens) by objects at the new address.

**Symbols** associated with objects from the moved module are reattached to the objects at the new address.

The module that has been moved keeps all its parameters.

The processor can only be moved into positions 0 and 1 of rack 0.

If you move a discrete module whose channel has been configured in RUN/STOP mode, the address of the RUN/STOP bit is not modified. You must ensure that the RUN/STOP input corresponds to an valid address for a discrete input.

When the module addresses are used in an EF (e.g. SEND\_REQ, READ\_VAR, etc.), they are not updated automatically.

---



**Copying a module**

Carry out the following actions:

Step	Action
1	Select the required module.
2	hold down <b>Ctrl</b> and drag the copy to the new position or select the <b>Edit/Copy Module</b> command.
3	Select the <b>Edit/Confirm</b> command for the modifications to be taken into account.

**Notes:**

The objects associated with a module with the old address are copied to the new address.

The module that has been copied keeps all its parameters.

Duplicating a module associated with an event (at least one module channel is associated with one event) is impossible. One event cannot be associated with several channels/modules at the same time.

**Deleting a module**

Carry out the following actions:

Step	Action
1	Select the required module.
2	Select <b>Edit/Delete</b> or press the <b>Del</b> key.
3	Select the <b>Edit/Confirm</b> command for the modifications to be taken into account.

**Notes**

If no input/output modules are declared in the configuration, or if there are any format modules, the PL7 software gives access to the %Ix.0 to %Ix.15 bits and to the %Qx.0 to %Qx.15 outputs for each position (even if the half format module concerned has less inputs/outputs).

If there are any standard format modules, the PL7 software gives access to the %Ix.0 to %Ix.31 input bits for odd positions and to the %Qx+1.0 to %Qx+1.31 output bits for even positions (even if the standard format module concerned has less inputs/outputs).

**Configuring inputs/outputs for each module****Procedure**

Carry out the following actions:

Step	Action
1	Select the module to be configured (using mouse or arrow keys).

Step	Action
2	Select the command <b>Services/Open the module</b> or double click on the module selected. A window is displayed indicating: <ul style="list-style-type: none"> <li>● the module reference and position,</li> <li>● the configuration context (see <i>Configuration context in progress</i> , p. 114) in progress.</li> </ul>
3	Enter the parameters and confirm with the command <b>Edit/Confirm (CTRL + W)</b> . To find out about the various parameters, refer to the job headings concerned. Depending on whether the command <b>View/ Module Zone</b> is selected or not, the display is different.
4	Close the window by pressing <b>(CTRL+F4)</b> and parametrize the next module.

---

**Special case for PCMCIA communication modules**

Carry out the following actions:

Step	Action
1	Select the " <b>Comm</b> " position.
2	Double click or move the up/down arrows and press the <b>ENTER</b> key.

---

**Special case for FIPIO communication modules**

Carry out the following actions:

Step	Action
1	Select the " <b>FIPIO</b> " position.
2	Double click or move the up/down arrows and press the <b>ENTER</b> key.

---

**Special case for integrated Adjustment modules (PMX 57102)**

Carry out the following actions:

Step	Action
1	Select the " <b>Loops</b> " position.
2	Double click or move the up/down arrows and press the <b>ENTER</b> key.

---

**Configuration context in progress**

The **Configuration** selection is used to set the module's parameters.

**Adjust** can be selected for counting, movement and weighing modules and is used to:

- set initial parameter values offline,
- modify these parameters on-line.

The **Debugging** selection (only accessible in on-line mode) is used, depending on the module to:

- display the status of the inputs,
  - display the module diagnostics and the channels,
  - perform output writing.
-

## Software configuration of the application

### Procedure

Carry out the following operations:

Step	Action
1	Double left click on the <b>Configuration</b> directory or select it using the arrow keys, then press right arrow.
2	Select the <b>Software configuration</b> directory. Software configuration is used to set the following for the application: <ul style="list-style-type: none"> <li>● the number of different types of function blocks,</li> <li>● the number of register words,</li> <li>● the number of %M internal bits,</li> <li>● the number of %M internal words,</li> <li>● the number of %KW constants.</li> </ul>
3	For each of the fields to be modified, select the field and then enter the required value (entry is controlled to prevent values greater than the maximum authorized number (see <i>Maximum number of authorized objects, p. 116</i> ) from being entered.
4	Confirm the configuration with the <b>Edit/Confirm (Ctrl + W)</b> command

### Maximum number of authorized objects

For each of the objects this number is:

Objects	Maximum value
%T <sub>Mi</sub> timers	255
%T <sub>i</sub> Series 7 timers	255
%M <sub>Ni</sub> monostables	255
%C <sub>i</sub> counters	255
%R <sub>i</sub> registers	255
%D <sub>Ri</sub> drums	255
Number of words per register	255
%M <sub>i</sub> internal bits	depends on the processor
%M <sub>Wi</sub> internal words	depends on the size of memory available
%K <sub>Wi</sub> constants	depends on the size of memory available

## Configuring Grafcet objects

### Introduction

Before configuring Grafcet objects the following action must be taken:

- the processor version (see *Processor version, p. 118*) used must support Grafcet language,
- creation of the Grafcet section for  $\geq$  V3.x processors.

Grafcet object configuration is used to set the following for the application:

- the number of macro steps,
- the number of (**Chart + Macro steps**),
- the number of active steps,
- the number of valid transitions.

### Procedure

Carry out the following actions:

Step	Action
1	Double left click on the <b>Configuration</b> directory or select it using the arrow keys, then press right arrow.
2	Select the Configure Grafcet Objects directory.
3	For each of the fields to be modified, select the field and then enter the required value (a check is made so that entries higher than the maximum authorized number (see <i>Maximum number of authorized objects, p. 117</i> ) cannot be made).
4	Confirm the configuration with the command <b>Edit/ Confirm (Ctrl + W)</b>

### Maximum number of authorized objects

For each of the objects this number is:

Objects	Maximum values
Number of steps (Chart)	250
Number of Macro steps	64
Number of steps in Macro steps	250 per Macro step
Number of steps (Chart + Macro step)	1024
Number of active steps	250
Number of valid transitions	400

**Processor  
version**

Compatibility table:

<b>V1.5 and V2.0 processors</b>
If you are using Grafcet it must be declared when the application is set up. This option cannot subsequently be changed.
<b>V3.x and V4.0 processors</b>
The choice of whether to use Grafcet is made when creating the Grafcet section.

---

---

# Program access



---

## Introduction

### Subject of this chapter

This chapter describes how to:

- Creating a program module.
- Access to a program module.
- Modifying a module program's execution order.

### What's in this Chapter?

This chapter contains the following topics:

---

Topic	Page
Introducing the application browser	120
Creating or importing an LD, IL, ST section	123
Creating or importing a Grafcet section	125
Creating or importing a subroutine (SR)	127
Creating or importing an event	128
Editing/emptying/suppressing a section, an event or a sub-program	129
Modifying the section execution order	130
Accessing the runtime screens editor	131

---

## Introducing the application browser

---

- General points**
- The application browser shows the contents of a **PL7** application in two forms:
- **the structure view,**
  - **the function view.**
- 

**Description**

### The structure view

The structure view shows the contents of a **PL7** application. It is used to navigate within an application and provides direct access:

- to configurations,
- to the program,
- to the DFBs contained in the application,
- to the data,
- to the animation tables,
- to certain parts of the documentation file (general information, title pages),
- to tools such as runtime screens.

Section execution order corresponds to display order, and this order can be modified.

**Note:** the default **PL7** application directory is called STATION. This name can be modified in the **Application properties** dialog box.

### The function view

The function view is a representation of the application split up into functional modules.



This split does not take the order of their execution by the PLC into account.

	<p><b>WARNING</b></p> <p>Only PL7 PRO can be used to set up functional modules on TSX/PMX/PCS57 PLCs.</p> <p><b>Failure to follow this precaution can result in death, serious injury, or equipment damage.</b></p>
---	---

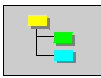
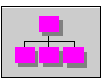

## Navigation between function view and structure view

### The different browser application icons

	Is used to display the application structure view.
	Is used to display the application function view.
	Is used to display the structure and function views in series.
	Is used to display the structure and function views in parallel.

## Application properties

The **Properties** function (which can be accessed from the **Functional View** of the **Application Browser** by right clicking on the application directory) at application level is used to:

- provide the user with information on the current application,
- manage certain application parameters.

### General tab

- application name (the application's default name is STATION),
- type of processor used (cannot be modified),
- version number (0 to 127) and revision number (0 to 255) manually managed by the user or automatically managed by the system on each save when a modification has been made
- comments,
- save.

### Protection tab

- application protection.

### Identification tab

- creation date,
- date of last update,
- application ID.

### Diagnostics tab

If the box is checked, the alarms generated by the diagnostics DFBs are saved in the diagnostics buffer and can be viewed with the runtime screen viewer.

**Identification,  
application IDs**

This information can be accessed via the **identification tab**.

The application is identified by a series of 8 numbers between 0 and 65535. Each of these represents the signature of an application segment.

These signatures, which are automatically generated by the system, are used to authenticate a given status of the application.

Each development of the application results in the modification of one or more signatures.

Numbers and designations:

<b>Number</b>	<b>Designation</b>
0	Station ID (global application).
1	Local I/O configuration ID.
2	Remote I/O configuration ID.
3	PL7 application ID (code).
4	Reserved.
5	ID of constants.
6	Reserved.
7	Reserved.

---

---

## Creating or importing an LD, IL, ST section

---

### At a Glance

Creating a section is authorized in offline and online mode with the PLC in Run or Stop mode.

Importing a section is authorized in offline and online mode with the PLC in Stop mode.

---

### Section properties

A section's properties are as follows:

- section name,
- associated task (only the MAST task supports Grafcet language),
- programming language used,
- execution condition (modifiable),
- comments,
- name of any associated functional module for PL7 Pro.

**Note:**

- the language can be modified if the section is not programmed,
  - the language for a Grafcet section cannot be modified.
- 

### Display or modify a section's properties

Carry out the following steps:

Step	Action
1	go to the section (in the <b>Application Browser</b> of the <b>Structure view</b> ) and select the <b>Properties</b> contextual menu (right click).
2	Carry out any necessary modifications.
3	Click on <b>OK</b> .

---

**Creating a section**

Carry out the following actions:

Step	Action
1	Left click on the <b>Section</b> directory for the required task or position the cursor over it using the arrow keys.
2	Via the contextual menu or using the <b>Shift+F10</b> keys select <b>Create</b> .
3	Fill in the name: maximum 16 characters.
4	Select the language you would like to use to program the section.
5	Specify the <b>Type of Protection</b> : <ul style="list-style-type: none"><li>● no protection,</li><li>● write protection,</li><li>● read/write protection.</li></ul>
6	Establish or if applicable modify the execution condition.
7	Where applicable select the functional module to be associated.
8	Where applicable enter the comment (250 characters max.). This comment can be modified from a section's " <b>Properties</b> " dialog box.
9	Click on <b>OK</b> .

---

**Importing a section**

Carry out the following actions:

Step	Action
1	Left click on the <b>Section</b> directory of the required task or position the cursor over it using the arrow keys.
2	Via the <b>Context</b> menu, the <b>File</b> menu or <b>Shift+F10</b> , select <b>Import</b> .
3	Select the file relating to the section to be imported.
4	Confirm with <b>Open</b> .

---

---

## Creating or importing a Grafcet section

---

### At a Glance

A Grafcet section can be created in offline and online mode with the PLC in Run or Stop mode.

Importing a section is authorized in offline and online mode with the PLC in Stop mode.

By default the creation of a Grafcet section generates three directories. These correspond to:

- preliminary processing (Prl),
- sequential processing (Chart),
- posterior processing (Post).

The creation of a macro-step generates an additional directory.

---

### PRL, POST Properties

The properties are as follows:

- name,
  - associated task,
  - associated section,
  - name of any associated functional module for PL7 Pro,
  - programming language used (the language can be modified if the module is not programmed),
  - programmed attribute.
- 

### CHART, XM Properties

The properties of a Grafcet module or macro-step are as follows:

- module or macro-step name,
- number of steps configured (during software configuration),
- programmed status (if the graph or macro-step are programmed),
- called status if the macro-step is called in the Chart,
- name of any associated functional module for PL7 Pro,
- a comment (max. 250 characters) visible while editing the documentation file.

For a macro-step:

- macro-step address and symbol,
  - a comment associated with the macro-step (defined using the variable editor).
-

**Creating a section**

Carry out the following actions:

Step	Action
1	Position the cursor over the section directory for the <b>MAST</b> , or <b>FAST</b> task using a left mouse click or the arrow keys.
2	Using the contextual menu or the <b>Shift+F10</b> keys select <b>Create</b> .
3	Enter the <b>Name</b> , 16 characters maximum.
4	Select the language <b>Grafcet</b> (non modifiable).
5	Specify the type of <b>protection</b> : <ul style="list-style-type: none"> <li>● no protection,</li> <li>● write protection,</li> <li>● read/write protection.</li> </ul>
6	Establish or if applicable modify the execution condition.
7	Where applicable select the functional module to be associated.
8	Where applicable enter a comment (250 characters max.). This comment can be modified from the <b>Properties</b> dialog box of a section.
9	Click on <b>OK</b> .

**Notes:**

A Grafcet section may not be created if the configuration is in the process of being modified.

A Grafcet section may not be deleted:

- if a section module is in the process of being edited,
- or if the configuration is in the process of being modified.

**Importing a section**

Carry out the following actions:

Step	Action
1	Position the cursor over the section directory for the <b>MAST</b> , or <b>FAST</b> task using a left mouse click or the arrow keys.
2	Using the <b>File</b> menu, the contextual menu or the <b>Shift+F10</b> keys, select <b>Import</b> .
3	Select the file relating to the section to be imported.
4	Confirm with <b>Open</b> .

## Creating or importing a subroutine (SR)

### At a Glance

Creating a subroutine is authorized in offline and online mode with the PLC in Run or Stop mode.

Importing a subroutine is authorized in offline and online mode with the PLC in Stop mode.

### SR properties

The properties are as follows:

- name,
- associated task,
- programming language used (the language can be modified if the module is not programmed),
- programmed attribute,
- called or non-called attribute in the task,
- a comment associated with the subroutine (defined using the variable editor).

### Creating a subroutine

Carry out the following actions:

Step	Action
1	Left click on the <b>SR</b> directory of the required task or position the cursor over it using the arrow keys.
2	Using the contextual menu or the <b>Shift+F10</b> keys select <b>Create</b> .
3	Select the language in which the SR is to be programmed.
4	Click on <b>OK</b> .

### Importing a subroutine

Carry out the following actions:

Step	Action
1	Left click on the <b>SR</b> directory of the required task or position the cursor over it using the arrow keys.
2	Using the contextual menu, the <b>File</b> menu or the <b>Shift+F10</b> keys select <b>Import</b> .
3	Select the file relating to the SR to be imported.
4	Confirm with <b>Open</b> .
5	Enter the SR number.
6	Click on <b>OK</b> .

### Note

A subroutine can be called from any section of its associated task, or from other subroutines of that task.

## Creating or importing an event

---

### At a Glance

Event creation is authorized in offline and online mode, with the PLC in Stop mode.

Importing an event is only authorized in offline mode.

---

### Event Properties

The properties are as follows:

- name,
  - associated task,
  - name of any associated functional module for PL7 Pro,
  - programming language used (the language can be modified if the module is not programmed),
  - programmed attribute,
  - called or non-called attribute in the task.
- 

### Creating an event

Carry out the following actions:

Step	Action
1	Left click on the <b>Event</b> directory or position the cursor over it using the arrow keys.
2	Using the contextual menu select <b>Create</b> .
3	Select the language in which the event is to be programmed.
4	Where applicable select the functional module to be associated.
5	Click on <b>OK</b> .

---

### Importing an event

Carry out the following actions:

Step	Action
1	Left click on the <b>Event</b> directory or position the cursor over it using the arrow keys.
2	Using the contextual menu or the <b>File</b> menu, select <b>Import</b> .
3	Select the file relating to the event to be imported.
4	Confirm with <b>Open</b> .
5	Enter the event number.
6	Where applicable select the functional module to be associated.
7	Click on <b>OK</b> .

---



---

## Editing/emptying/suppressing a section, an event or a sub-program

---

### Editing

Carry out the following:

Step	Action
1	Select the module (section, sub-program, event) required using the mouse or the arrow keys.
2	Edit the module using the command contextual menu <b>Open</b> or double click or key <b>ENTER</b> .

---

### Emptying

Carry out the following:

Step	Action
1	Select the module (section, sub-program, event task) required using the mouse or the arrow keys.
2	Select <b>Edit/Empty</b> , or use the command contextual menu <b>Empty</b> , or <b>(Shift+F10) Empty</b> .
3	Confirm with <b>YES</b> .

---

### Suppressing

Carry out the following:

Step	Action
1	Select the module (section, sub-program) required using the mouse or the arrow keys.
2	Select <b>Edit/Suppress</b> , or on the command contextual menu key <b>Suppress</b> , or <b>(Shift+F10) Suppress</b> .
3	Confirm with <b>YES</b> .

**Note:**

It is not possible to perform a suppression operation on an event task.

---

## Modifying the section execution order

---

### Principles

This action can be carried out from within the same task from the structure view.

It is done in offline or online mode with the PLC in Stop mode.

---

### Procedure

Carry out the following actions:

Step	Action
1	Left click (keeping the button held down) on the icon of the section to be moved.
2	Move the section to the desired place.

	<p><b>WARNING</b></p>
	<p><b>Running the program.</b></p> <p>The program runs in the order shown in structure view.</p> <p>The distribution of the sections, events and Grafcet modules in the various functional modules has no impact on the running of the program.</p> <p><b>Failure to follow this precaution can result in death, serious injury, or equipment damage.</b></p>

---

## Accessing the runtime screens editor

---

### At a Glance

Using PL7 you can access the runtime screens editor.

---

**How to access the runtime screens editor**

There are two potential scenarios:

- The application does not contain runtime screens:

Do the following:

Step	Action
1	Open the <b>Application Browser</b> .
2	Double click on the <b>Runtime screens</b> directory from the <b>structure</b> view: <b>Result:</b> The Runtime screens editor opens on a blank page, ready for the creation of a new screen or message.

- The application already contains runtime screens:

First scenario:

Step	Action
1	Open the <b>Application Browser</b> .
2	Double click on the <b>Runtime screens</b> directory from the <b>structure</b> view. <b>Result:</b> the editor appears, displaying the last screen open before the previous save:

The screenshot displays the 'Runtime Screens: BLEND\_PRODUCTS - Product - Blend - Titration' editor. On the left, a tree view shows the following structure:

- Screen
  - WELCOME!
    - 3 - Read\_me
    - 1 - Welcome\_screen
  - SYSTEM INFORMATION
    - 7 - System bit
    - 6 - Grafacet
  - TITRATION\_PRODUCTS
    - 2 - Screen\_monitoring
    - 0 - Product\_Blend\_Titration
  - DIAGNOSTICS\_APPLICATION
    - 8 - Monitoring\_mixer
  - DFB BEHAVIOR
    - 4 - DFB\_Screen - behavior
    - 5 - Information\_on\_DFB\_Debug

The main area on the right shows a process diagram with two vertical tanks labeled 'ie\_1' and 'Tré', connected by pipes. A central mixer unit is positioned between the tanks. The diagram includes various components like valves and sensors, with labels 'eur' and 'Tré'.

Second scenario:

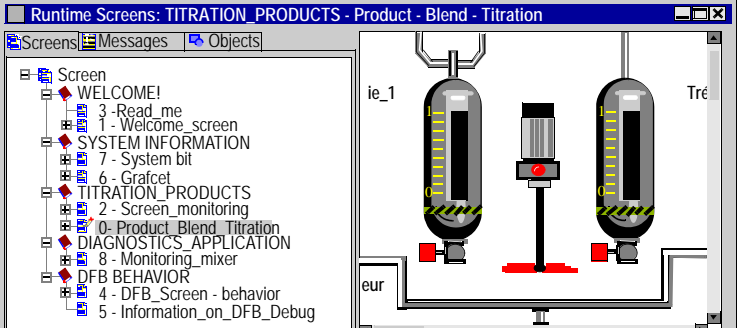
Step	Action
1	Open the <b>Application Browser</b> .
2	<p>Double click on the <b>desired screen or message</b> from the <b>structure</b> or <b>function</b> view.</p> <p><b>Result:</b> the editor displays the desired element immediately:</p> 



---

# Programming in LD rung language

# 6

---

## Introduction

### Subject of this chapter

This chapter reminds you of the structure of a program in rung language. It describes:

- How to create a program.
- How to use the different functions offered by the editor.
- How to manage the different modules making up the application.

### What's in this Chapter?

This chapter contains the following topics:

Topic	Page
Structure of a program in Ladder language	136
Creating a Ladder program	137
Specific input	139
Modifying a network of contacts	140
Displaying variables as symbols or addresses	144
Information box	146
Online symbolization	147
Input of a predefined function block (Ladder editor)	148
Function library	151
Operate block entry	153
Horizontal and vertical block entry	155
Assisted entry of a library function or of an instance of DFB type (Ladder editor)	156
Direct access to a subroutine	160
Replacing a variable in the application	161
Cross Referencing a variable in an application	163
Animation of the Ladder program elements	167
Printing of a program	168
Export/Import of source files	169

## Structure of a program in Ladder language

### Principal

A program written in ladder language is composed of a series of networks executed sequentially by the PLC.

Laid out between two potential bars, a network is a group of graphical elements linked to each other by horizontal and vertical links. These elements represent:

- The PLC's inputs/outputs (push-buttons, sensors, relays, indicators...).
- Automation functions (timers, counters...).
- Arithmetic and logical operations and transfer operations.
- The PLC's internal variables.

Each network (known as a **Rung**) is made up of:

- A **label** input area (cell situated in the top left of the rung).
- A **comment** input area (first line to the right of the label).
- A **(Test and Action)** input area for graphical elements:
  - 7 lines and 11 columns (maximum size) for a level L1 application.
  - 16 lines and 11 columns (maximum size) for a level L2 application

The Test area (columns 1 to 10) accommodates:

- Contacts.
- Function blocks.
- Comparison blocks.

The Action (column 11) accommodates:

- Coils.
- Operate blocks.

### Example

Network (Rung).

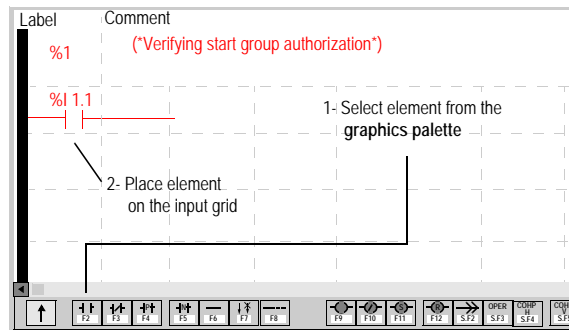





## Creating a Ladder program

### Procedure

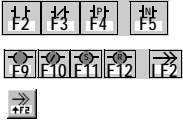
Carry out the following actions:

Step	Action
1	<i>Creating or importing an LD, IL, ST section, p. 123.</i>
2	Enter the label %Li (optional). Double click on the label area, or put the cursor in the area and press the <b>Space bar</b> , then confirm using <b>Enter</b> .
3	Enter the comment (optional). Double click on the comment area, or put the cursor in the area and press the <b>Space bar</b> , then confirm using <b>Enter</b> .
4	<p>Enter the graphical elements:</p>  <p><b>Using the mouse:</b></p> <ol style="list-style-type: none"> <li>1. Click on the graphical element situated in the graphical palette.</li> <li>2. Click on the grid at the required place.</li> <li>3. Enter the corresponding variable (by default enter with comment mode is active) and confirm using <b>ENTER</b>.</li> </ol> <p><b>Using the keyboard:</b></p> <ol style="list-style-type: none"> <li>1. Move the cursor over the grid to the required place.</li> <li>2. Press the function key corresponding to the graphical element situated in the graphical palette to be inserted.</li> <li>3. Enter the corresponding variable (by default enter with comment mode is active) and confirm using <b>ENTER</b>.</li> <li>4. Confirm the networks of contacts using the <b>ENTER</b> key, or using the command <b>Edit/Confirm</b> or using the icon  .</li> </ol>

### Moving within the editor

The possible moves are:

- From cell to cell: arrow keys.
- To the first column of the Rung: Home key.
- To the last column of the Rung: End key.
- To the next page: Page Down key.
- To the previous page: Page Up key.
- To the start of the module: Ctrl+Home keys.
- To the end of the module: Ctrl+End keys.

**Notes**

The software offers 2 input modes for a network of contacts:



- **Without comments:** allows you as a first step to build the network of contacts without commenting the graphical elements and to comment them once the graphics are completed.
- **With comments:** menu **Edit/Enter with comments**.

If an **error** is detected during validation, the rung stays **red**, if none are detected, the variables associated to the graphical elements are **blue**.

---

## Specific input



### Input/Deletion of the vertical links.

Select the cell situated at the top and to the right of the connection then click on the key **F7** or click on the icon   and position the cursor in the created cell

### Input/Deletion of horizontal connections

#### Input:

Select the cell where the link must be positioned and then click on the key **F6** or **F8**



or click on the icons ,  and position the cursor in the created cell.

#### Deletion:

select the required cell or cells then press the key **Del** or on the Contextual menu choose the command **Delete**.

### Inputting the codes: **HALT**, **RETURN** and **CALL**

Inputting instructions **HALT** (end of program), **RETURN** (return to the calling program), **CALL** (subroutine call) operates following the procedure:

Step	Action
1	Click on the icon  positioned in the graphic palette, the choice window  appears.
2	Select the required code and confirm with <b>ENTER</b> .
3	Place the cursor symbolizing the chosen code in the zone <b>Action</b> and click (in the case of a keyboard entry, the cursor should be positioned in the Action zone beforehand).
4	With codes, confirmation is direct <b>HALT</b> and <b>RETURN</b> . For the call, input the SR number (sub-routine created beforehand) and confirm with <b>ENTER</b> .

## Modifying a network of contacts

### Accessing a network (Rung)

The program module being displayed, select the command **Edit/Go to/Rung** (Ctrl+A) or the icon .

The possible choices are as follows:

Select in the label field...	position...
TOP	at the beginning of the program module.
BOTTOM	at the end of the program module.
%Li	at the corresponding label number.

The **Move** zone allows a movement relative to TOP/BOTTOM/%Li.

### Selecting one or several networks (Rung)

The possible choices are as follows:

Select...	by...	or...
one network	positioning the cursor over the Rung and selecting the command <b>Edit/Rung selection mode</b> .	by clicking to the left of the gray vertical bar.
several networks	1. positioning the cursor on the first or the last Rung to be selected and by selecting the command <b>Edit/Rung selection mode</b> .  2. then by moving the mouse while keeping the left button down to select the other rungs.	by clicking to the left of the gray vertical bar.  by pressing the SHIFT key and the arrow, Page Up or Page Down keys.

**Note:**

The display of each selected rung is implemented by means of a rectangle equipped with 8 handles.

### Selecting one or several graphical elements

This function supports operations on elements such as cut, copy, paste, move, delete, initialize an animation table or initialize a table of cross references.

The possible choices are as follows:

Select...	by...	or...
an element	left mouse click on the element	positioning the cursor over it using the arrow keys.
a group of elements	a left mouse click on the start cell (keep the mouse button down) then move the cursor towards the end cell,	

**Note:**

Acknowledgement of an element is shown by a rectangle equipped with 8 handles.

**Modifying a network (Rung)****Modifying a variable:**

Step	Action
1	Position the cursor over the variable to be modified then press the <b>Space bar</b> or double click on the variable to be modified (except for SRs and DFB types).
2	Enter the modification (Escape cancels the current modification) and confirm the entry using <b>ENTER</b> .
3	Confirm the modification using the keys ( <b>CTRL+W</b> ) or click on the icon  .

**Modifying a contact in a network:**

Step	Action
1	<p><b>Using the keyboard:</b> Position the cursor over the cell containing the element to be modified.</p> <p><b>Using the mouse:</b> Select the graphical element in the graphical palette by clicking on the required element.</p>
2	<p><b>Using the keyboard:</b> Select the graphical element in the graphical palette using the keys <b>F2 to F12</b> and <b>SHIFT+F2 to F8</b> and confirm the entry using <b>ENTER</b>.</p> <p><b>Using the mouse:</b> Position the cursor over the cell containing the element to be modified and confirm using <b>ENTER</b>.</p>
3	Confirm using <b>ENTER</b> or select the command <b>Edit/Confirm (CTRL+W)</b> or click on the icon  .

**Canceling a modification:**

To cancel a current modification on a network of contacts, select the command **Edit/Cancel modifications** or click on the icon .

**Deleting an element from a rung:**

The command **Edit/Delete** or the **Delete** key deletes the element and/or rung selected.

**Moving to a current modification which is not visible on the screen:**

Select the command **Edit/ Go to current modification** .

**Moving an element in a network (Rung)**

Carry out the following actions:

Step	Action
1	<p><b>Using the keyboard:</b> Position the cursor over the cell containing the element to be moved.</p> <p><b>Using the mouse:</b> Select the element to be moved, and maintain the selection.</p>
2	<p><b>Using the keyboard:</b> Select <b>Move using keyboard</b> from the Edit menu or <b>CTRL+L</b> then move the cursor by means of the arrow keys towards the destination cell(s) and confirm using <b>ENTER</b>.</p> <p><b>Using the mouse:</b> Move the element's ghost to the required cell.</p>
3	Confirm using <b>ENTER</b> or select the command <b>Edit/Confirm (CTRL+W)</b> or click on the icon  .

**Cutting/Copying/ Pasting one or several graphical elements**

Carry out the following operations:

To...	you must...	the selection...
copy one or several consecutive objects	select the element(s) to be copied and select the command <b>Edit/Copy (CTRL+C)</b>	is placed on the Windows clipboard.
paste one or several consecutive elements contained on the clipboard	select the cell which is the start point from which the element(s) contained on the clipboard are to be pasted and select the command <b>Edit/Paste (CTRL+V)</b>	is kept on the Windows clipboard.
cut one or several consecutive elements and place them on the clipboard	select the element(s) to be cut and select the command <b>Edit/Cut (CTRL+X)</b>	is placed on the Windows clipboard.

### Cutting/Copying/ Pasting one or several consecutive networks (Rungs)

Carry out the following operations:

To...	you must...	the selection...
copy one or several consecutive Rungs	select the Rung(s) to be copied and select the command <b>Edit/Copy (CTRL+C)</b>	is placed on the Windows clipboard.
paste one or several consecutive Rungs contained on the clipboard	select the Rung which is the start point from which the Rung(s) contained on the clipboard are to be pasted and select the command <b>Edit/Paste (CTRL+V)</b>	is kept on the Windows clipboard.
cut one or several consecutive Rungs and place them on the clipboard	select the Rung(s) to be cut and select the command <b>Edit/Cut (CTRL+X)</b>	is placed on the Windows clipboard.

#### Note:

The **Cut/Copy/Paste** function works in the same way for a selection of multi-Rungs and between program modules.

### Inserting a network (Rung)

To insert a rung between two networks of contacts (the inserted network is placed on top) or to place a rung at the top of the program module (TOP), after displaying the program module carry out the following actions:

Step	Action
1	Select the command <b>Edit/Select rung</b> or point directly to an element of the rung using the mouse.
2	Select the command <b>Edit/Insert rung (CTRL+I)</b> .
3	Enter the rung and confirm using <b>CTRL+W</b> or click on the icon  .

## Displaying variables as symbols or addresses

### Procedure

Carry out the following actions:

Step	Action
1	Open the program module with <b>right click + Open</b> or with a <b>double click</b> .
2	Select the command: <ul style="list-style-type: none"> <li>● <b>View/Addresses</b> to display the variables as addresses.</li> <li>● <b>View/Symbols</b> to display the variables as symbols.</li> <li>● <b>View/Symbols&amp;addresses</b> to display the variables as symbols/addresses (<b>Ladder editor only</b>).</li> </ul>

### Note:

It is possible to run the language editor from the Options menu in:

- addresses view,
- symbols view,
- symbols&addresses view (for the Ladder editor only).

### Example of display

Ladder editor used with the 3 views.

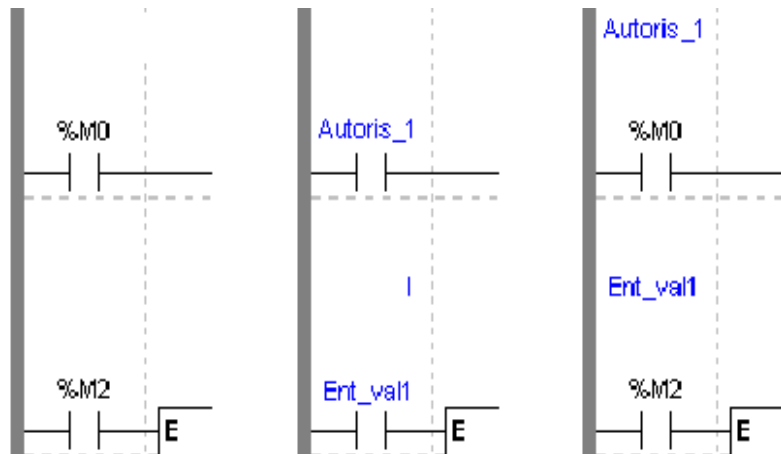



**Note**

If a symbol or address has more than 8 characters, the display can be truncated. Select the element, which is then displayed in full in the status bar. You can also use the **Information box**.

The **View/Collapsed** command is used to reduce the size of the window whilst maintaining the same level of information.

The **View/Normal** command allows you to return to the normal sized window.

---

## Information box

---

### Functions

This box, which can be accessed from all language objects, displays the symbols, address and comments for the selected object (except for the operate blocks and horizontal comparison) in an integrated format.

Display table according to object:

Single object	Complex object (operate block, comparison and horizon block)
<ul style="list-style-type: none"> <li>● symbolic format in blue</li> <li>● constructor name in black,</li> <li>● associated comments in green.</li> </ul>	<ul style="list-style-type: none"> <li>● symbolic format in blue</li> <li>● constructor address in black,</li> </ul>

### How to access the object information box

Carry out the following steps:

Step	Action
1	In the LD language editor, select the object.
2	Click on the right mouse button (contextual menu) and then select <b>Information</b> , or select the <b>View → Information</b> command.

### Note

The information box remains visible when it is not explicitly closed by the user. The contents of the **Information** box is updated according to the current selection.

---

---

## Online symbolization

---

### Principal

Online symbolization allows you, at the time of input of a Ladder, List, Structured Text program, to immediately (without opening the data editor) associate:

- an address to a new symbol,
- a symbol to a non symbolized address.

---

### Procedure

With the **Ladder** editor, start at **Step 1**, with the **Structured Text** or **List** editors, go straight to **step 2**.

Step	Action
1	Select the cell where the variable is situated.
2	Select the variable (highlight it).
3	Right mouse click on the variable and select <b>Associate Symbol&amp;Address</b> .
4	Enter the address or symbol and the comment.

---

## Input of a predefined function block (Ladder editor)

---

### Procedure

From within the language editor, carry out the following actions:

Step	Action
1	<p><b>Using the mouse:</b></p> <p>From the graphical palette, select the element .</p> <p><b>Using the keyboard:</b></p> <p>Select the destination cell with the help of the arrow keys, and press the keys <b>(Shift+F7)</b>.</p>
2	<p><b>Using the mouse:</b></p> <p>Select the item <b>SFB</b> (only Premium), and select the required function block, then click in the destination cell (Test zone) to position the function block.</p> <p><b>Using the keyboard:</b></p> <p>Select the item <b>SFB</b> with the help of the arrow keys and accept with <b>ENTER</b> (only Premium), then select the function block using the arrow keys and accept with <b>ENTER</b>.</p>
3	<p>Input the number of the function block and confirm with <b>ENTER</b> .</p>

---

**Function blocks** The different function blocks are:

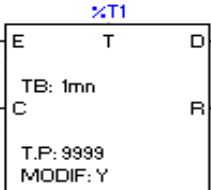
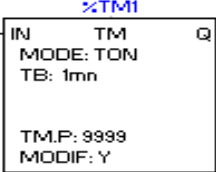
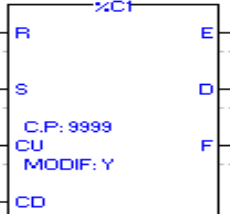
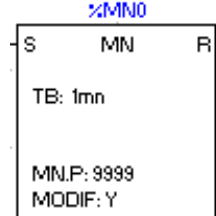
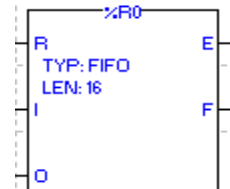
Function blocks	Syntax
PL7-3 timer (%Ti)	Timer block: 
TP/TON/TOF timer (%Tmi)	Timer block: 
Up/Down counter (%Ci)	Block Up/down counter 
Monostable (%Mni)	Monostable block: 
Register of FIFO/LIFO words (%Ri)	Register block: 

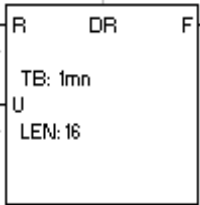
Function blocks	Syntax
Drum-DRUM (%Dri)	Drum controller block: 

---

---

## Function library

---

### Introduction

The functions library brings together all the associated information and utilities concerning functional elements (**EF**tab) and DFB function blocks (DFB tab).

Two access modes exist:

- in consult mode,
  - by calling a function from the editor.
- 

### Consulting an EF

To access the library, select **Library** from the **Tools menu** then choose the **EF tab** (default selection).

The functions library screen presents:

- **The list of available families** defined by:
  - family name,
  - the library version **Lib.V**,
  - the version of families used in the current application **App V** (open station only).
- **The list of functions associated with each family** defined by:
  - function **name**,
  - **comments**.

**Note:** In order to display an entire set of truncated comments (>>symbol at the end of the line), double click on the function or place the cursor above and use the Space bar.

- **The parameters of the selected function**, defined by:
  - **name**,
  - **type** (eg: DWORD),
  - **kind**,
  - **comments**,
  - the **result of a function** (if there is one).

**Note:** In order to display the parameters of a function and its possible result, select **Parameters** in the **Function Information** field.

---

## Consulting a DFB

**Note:** It is only possible to consult a DFB with Premiums.

To access the library, select **Library** from the **Tools menu** then choose the **DFB tab**.

For each DFB instance, the library screen presents:

- **The list of DFBs in the application** and defined by:
  - the DFB name,
  - the version (which is automatically incremented with the confirmation of each modification),
  - comments.
- **The list of the instance for a given DFB**(Select the instance),
- **The DFB parameters selected** defined by:
  - the **name**of the parameters,
  - **type** (eg: DWORD),
  - **kind**,
  - **comments**.

**Note:** A new instance can be created from the screen for The list of the instance for a given DFB.

---



---

## Operate block entry

---

### Introduction

There are various ways of selecting an operate block:

- using the mouse,
- using the keyboard,

With PL7 there is also help to enter the contents of an operate block.

---

### Select an operate block with the mouse

Carry out the following steps:

Step	Action
1	Click on the graphics element which corresponds to the operate block in the graphics palette at the bottom of the editor.
2	Click in the target cell ( <b>Action</b> zone) to position the operate block.
3	Enter the instruction string and confirm with <b>Enter</b> .

---

### Select an operate block using the keyboard

Carry out the following steps:

Step	Action
1	Select the target cell with the arrow keys.
2	Press the key combination <b>Shift+F3</b> .
3	Enter the instruction string and confirm with <b>Enter</b> .

---

**Operate block entry help**

The principles described below are illustrated using an example:  
 %MWO:=ABS(%MW1).

To enter a function call, carry out the following steps:

Step	Action
1	Enter the instruction as far as the function call (example %MWO=).
2	Select the contextual menu <b>Enter a function call</b> (right click or <b>SHIFT+F8</b> ). The "Parameters" option must be selected from the Function Information heading.
3	Select the <b>EF group</b> using the mouse or Tab and arrow keys (example: Single length integer).
4	Select the <b>function name</b> (example: ABS).
5	Enter the function variables and the entered function is displayed in the <b>Call Display</b> field.

**Note:**

- some functions have additional entry screens which are accessed using the **Detail** button,
- when the function syntax is known, enter the syntax directly into the editor,
- it is possible to directly enable assisted entry on a given function by selecting the function name and then selecting the **Service** → **Enter the function call** command or right click,
- Tabulation and line feed characters are represented by \$T and \$N respectively, they must be entered in \$\$T and \$\$N format.

**Modifying the function call**

Carry out the following steps:

Step	Action
1	Place the cursor on the function (example ABS).
2	Select the context menu (right click) <b>Modify the call</b> .

---

---

## Horizontal and vertical block entry

---

### Introduction

There is the option of entering the comparison blocks in different ways:

- using the mouse,
  - using the keyboard,
- 

### Entering a comparison block with the mouse

Carry out the following steps:

Step	Action
1	Click on the required graphic element in the graphics palette.
2	Click on the target cell ( <b>Test</b> zone) in order to position the selected comparison block.
3	Enter the comparison instruction and then confirm with <b>Enter</b> .

---

### Entering a comparison block using the keyboard

Carry out the following steps:

Step	Action
1	Select the target cell with the arrow keys.
2	Press the key combination <b>Shift+F4</b> or <b>Shift+F5</b> .
3	Enter the comparison instruction and then confirm with <b>Enter</b> .

---

## **Assisted entry of a library function or of an instance of DFB type (Ladder editor)**

---

### Entry procedure for a library function

The instruction to be entered is:

Example below:

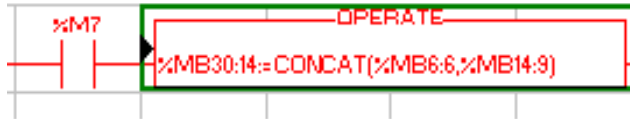

Perform the following actions to make an entry:

Step	Action
1	<p><b>Using the mouse:</b> Select the command <b>SHIFT+F8</b>.</p> <p><b>Using the keyboard:</b> Select the destination cell with the arrow keys (Action zone).</p>
2	<p><b>Using the mouse:</b> Click in the destination cell (Action zone) to position the text function block.</p> <p><b>Using the keyboard:</b> Press <b>SHIFT+F8</b>.</p>
3	Select the tab <b>EF</b> (selection by default). The " <b>Parameters</b> " option must be selected under the heading <b>Function Information</b> .
4	Select <b>the (EF) function family</b> required (e.g.: Character string).
5	Select <b>the (EF) function name</b> (e.g. CONCAT).
6	Enter <b>the (EF) function variables</b> (%MB4:6; %MB14:9). The function entered can be viewed in the <b>Display the call</b> field.
7	<p><b>Using the mouse:</b> Confirm the selection with <b>OK</b> or <b>ENTER</b> .</p> <p><b>Using the keyboard:</b> Select <b>OK</b> then confirm the selection with <b>ENTER</b></p>
8	With EFs, enter the variable to be associated with the function.%MB30:14:=
9	Click on <b>ENTER</b> .

### Notes:

Certain functions offer extra screens for parameter entry (e.g.: human-machine interface functions). These parameters are accessed with the **Detail** button that then appears at the bottom of the screen.

When the function syntax is known, enter syntax directly into the editor.

It is possible to directly enable assisted entry on a given function by selecting the function name then selecting the command **Service/Enter function call (SHIFT+F8)**.

**Procedure for an instance of DFB type**

Perform the following actions to make an entry:

Step	Action
1	<p><b>Using the mouse:</b> In the graphics palette click on the element </p> <p><b>Using the keyboard:</b> Select the destination cell (<b>Test Zone</b>) with the arrow keys.</p>
2	<p><b>Using the mouse:</b> Select DFB.</p> <p><b>Using the keyboard:</b> Press on the key combination, (<b>SHIFT+F7</b>).</p>
3	<p><b>Using the mouse:</b> Select the DFB type required.</p> <p><b>Using the keyboard:</b> Select DFB using the arrow keys then enable with <b>ENTER</b>.</p>
4	<p><b>Using the mouse:</b> Select the required instance from <b>Choice of instance</b> or create a new instance (name + possible comment) and confirm with <b>Create</b>.</p> <p><b>Using the keyboard:</b> Using the Tab or arrow keys, select the required function block.</p>
5	<p><b>Using the mouse:</b> Click on <b>OK</b>.</p> <p><b>Using the keyboard:</b> Select the required instance in <b>Choice of instance</b> or create a new instance (name + possible comment), select <b>Create</b> then confirm with <b>ENTER</b>.</p>
6	<p><b>Using the mouse:</b> Click in the destination cell (<b>Test zone</b>) to position the DFB type.</p> <p><b>Using the keyboard:</b> Select <b>OK</b> then confirm with <b>ENTER</b>.</p>

**Note:**

Two instances of the DFB type connected in series must be separated by at least 2 columns.

---

	<b>WARNING</b>
	<b>For EFs displayed in red:</b> EFs which are displayed in red in the function entry help screen cannot be used in the application. This limitation is encountered in the following instances: <ul style="list-style-type: none"><li>• when an earlier version of the EF is already used in the application,</li><li>• when the EF name is used as a variable linked symbol, and only concerns the EF ROUND (family of single precision reals).</li></ul> <b>Failure to follow this precaution can result in death, serious injury, or equipment damage.</b>

---

## Direct access to a subroutine

### Procedure

To access the **input/display** window of a **sub-routine** during the input/display of a sub-routine call, carry out the following.

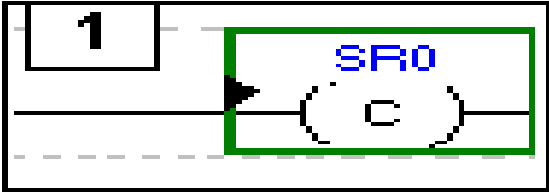
Step	Action
1	Select the sub-routine call coil: <b>SRI</b> . 
2	Select the command <b>Facility/Open</b> or select in the Contextual menu <b>Open</b> .



## Replacing a variable in the application

---

### Introduction

Finding and replacing an application variable as an address or a symbol (excluding variables used in operating screens). The replacement in the application may be total or partial, automatic or manual.

Replacement affects the indicated variable and its dependent objects as well (word extract bits...).



Exception: for Grafcet steps bits the associated activity times (e.g. %Xi.T) are not replaced.

Replacement is carried out at the following levels:

- Application (in all tasks).
  - Tasks (MAST, FAST, Evti).
  - Complete section.
  - Partial section (from address i to address j).
  - Replacement is also carried out at functional module level (complete functional module, sub-modules included).
-

**Procedure**

Carry out the following actions:

Step	Action
1	Select the command <b>Tools/Replace variables</b> or position the cursor over the <b>Station</b> directory and select <b>Replace variables</b> from the contextual menu.
2	Put the variable to be replaced (as an address or a symbol) in the <b>Findfield</b> and confirm with <b>ENTER</b> or <b>TAB</b> .
3	Put the variable to be replaced (as an address or a symbol) in the <b>Replacefield</b> and confirm with <b>ENTER</b> .
4	Select the view: <ul style="list-style-type: none"> <li>● Structure view </li> <li>● Function view </li> </ul>
5	Select one or more modules: <ul style="list-style-type: none"> <li>● if replacing in all the application, go to point 8,</li> <li>● if replacing in some of the modules, deselect the whole and select the modules, go to point 6,</li> <li>● if replacing in one of the modules, deselect the whole and select the module, go to point 6.</li> </ul>
6	Select the label (if LD, ST, IL) or the page (if G7) at the beginning of the replacement by positioning the pointer on the list <b>From</b> . If more precision is required, use the up and down arrow keys.
7	Select the label (if LD, ST, IL) or the page (if G7) at the end of the replacement by positioning the pointer on the list <b>To</b> . If more precision is required, use the up and down arrow keys.
8	Select the type of replacement: <ul style="list-style-type: none"> <li>● if <b>Replace</b>, the replacement is carried out occurrence by occurrence,</li> <li>● if <b>Replace All</b>, the replacement is carried out on all occurrences.</li> </ul> <b>Notes:</b> <ul style="list-style-type: none"> <li>● The status bar indicates the number of replacements carried out, and a report on the replacements not carried out.</li> <li>● The <b>ESC</b> key allows you to abort the function <b>Replace</b>, but the replacements already carried out are kept.</li> </ul>

## Cross Referencing a variable in an application

---

### Introduction

This function allows you to locate in the application:

- variables in the form of labels or symbols (except those used in operating screens),
  - DFB types (only on Premium with PI7 Junior and Pro),
  - DFB instances (only on Premium with PI7 Junior and Pro),
  - and to open modules/tasks/DFB types.
- 

### Principals of using debugging

The user realizes that the variable X is not the right value. To identify the cause he must therefore:

- find the places where this variable is used,
- obtain a list of statements, rungs and expressions,
- to display and verify the activation conditions of the variable.

**Note:**

In order to record the path of this search, the list elements thus visited are marked with an asterisk (\*).

---

### Operational mode for objects

A variable can be a read variable (**R**), a write variable (**W**) or a read/write variable (**R/W**).

- "**R**" groups together the read operational modes, indexed read, indexed word, input or input/output parameter of a indexed or non-indexed function.

- "**W**" groups together the write operational modes, indexed write, output or input/output parameter of indexed or non-indexed function and execution of Block Functions (SFB and DFB).

---

**Search source  
variables**

Table of variables:

<b>Bit</b>	%Ixi; %QXi; %Mi; %Si
<b>Word</b>	%MWi; %MDi; %MFi; %KBi; %KW; %KDi; KFi; %MBi; %SWi; %QWi; %QDi; %IW; %IDi; %NWi
<b>Instruction</b>	SRI; HALT

Other retrievable variables:

Byte variables
Word extract bits
Bit table
Grafcet bit table
Character string
Table of words and constants
Table of double words and constants
Constant character string
Standard Block Function
Standard Block Function element
Step status
Step activity time
NANET variables

## Search options

For an indexed variable, the variable and the index are taken into account in the list.

Table of options:

<b>Extract Bit</b>	This option is for variables of types %MW, %KW, %IW, %NW, %QW. It adds to the list the variable and the referenced bits.
<b>Table Object</b>	This option is for bit tables, word tables and immediate indexed variables. It adds to the list the immediate indexed table variables whose first element is the input variable.
<b>Channel Object</b>	This option is for channel objects. It adds to the list all the objects of the same referenced channel, including the tables and the extract bits.
<b>Network Objects</b>	This option is for the network variables. It allows you to obtain all the variables from the same remote module (NANET object).
<b>FB Object</b>	This option allows you to expand the list of SFB block function elements and the DFB type elements.
<b>FB Instance</b>	Only on Premium with PL7 Junior and Pro. This option is for DFB types. It allows you to obtain from the name of a DFB type the sections using its instances.

**Searching for cross references**

Carry out the following actions:

Step	Action
1	Select <b>the icon</b> 
2	Enter the search <b>source variable</b> as an address or a symbol (E.g. %M10) and the possible <b>options</b> then confirm via <b>Search</b> .
3	To display a module, select the module, via the <b>Contextual</b> menu, select <b>Open</b> or double click on the module.

**Selecting a variable from the list:**

- Select the variable from the list, the list of tasks, modules, labels is updated.

**Deleting a variable from the list:**

- Select the variable, enable the contextual menu (right click) then click on **Delete**.

**Displaying in structural view or in functional view:**

- Use the **View** menu or the **Function** button.
-

## Animation of the Ladder program elements

---

### At a Glance

Refer to the "**Debugging**" Chapter of the Part "**Debugging, Adjustment, Documentation and Appendices**"-> (see *Animating program elements*, p. 309).

---

## Printing of a program

---

### Procedure

Carry out the following steps:

Step	Action
1	Open the module with <b>right click + Open</b> or a <b>double click</b> .
2	Select the command <b>File/Print (Ctrl+P)</b> or click on the icon 
3	Select a print range: <ul style="list-style-type: none"><li>● if for the entire module, go to step 6.</li><li>● if for part of a module, go to step 4.</li></ul>
4	Select %Li/TOP/BOTTOM (if LD, ST, IL) or <b>start</b> page (if G7). If more precision is required, use the up and down arrow keys.
5	Select %Li/TOP/BOTTOM (if LD, ST, IL) or <b>endpage</b> (if G7). If more precision is required, use the up and down arrow keys.
6	Confirm with <b>OK</b> or <b>ENTER</b> .

### Notes

The print type depends on the type of display selected in the **View** menu.

- **Addresses:** prints variables with addresses,
  - **Symbols:** prints variables with symbols,
  - **Symbols&Addresses:** prints variables with symbols/addresses.
-



## Export/Import of source files

---

Refer to the "**Import/Export**" (See *Import/Export*, p. 365) Chapter of the Part "**Debugging, Adjustment, Documentation and Appendices**".

---



---

# Programming instruction list in LIST language

# 7

---

## Introduction

### Subject of this chapter

This chapter reminds you of the structure of a program in instruction list language.

It describes:

- How to create a program.
- How to use the different functions offered by the editor.
- How to manage the different modules making up the application.

### What's in this Chapter?

This chapter contains the following topics:

Topic	Page
Structure of an Instruction List program	172
Creating a program in Instruction List	173
Accessing a statement or instruction (Instruction List)	174
Displaying variables as symbols or addresses	177
Information box	178
Online symbolization	179
Input of a predefined function block (List editor)	180
Assisted entry of a library function (List editor)	181
Direct access to a subroutine	183
Replacing a variable in the application	184
Cross Referencing a variable in an application	186
Animation of List program elements	189
Printing of a program	190
Export/Import of source files	191

---

## Structure of an Instruction List program

---

### Principal

A program written in instruction list language is composed of a series of instructions executed sequentially by the PLC.

- An instruction takes up a maximum of one line.
- The instructions are organized into instruction statements (equivalent to a contacts network). Each instruction statement is made up of one or several instructions.
- Each instruction statement begins with an exclamation mark (generated automatically), it can include a **comment** and can be labeled with a **label**.
- A statement contains a maximum of **128 lines** (instruction, comment, label).
- In the editor a statement being input is displayed **in red**.
- A selected statement is surrounded by a **green frame**.
- The current statement is surrounded by a **black frame**.
- The number of the current instruction (instruction line or label) as well as the total number of instructions in the module are indicated in the bottom panel of the window (status bar).

### Example

```
! (*Drying wait*)
%L2:      ->Label
LD  %I1.0 ->Start of statement
AND %M10  ->Instruction
ST  %Q2.5 ->End of statement
```

#### Notes:

Key-words (LD, AND, ST...) are colored **blue**.

Comments are colored **green**.

The remainder is colored **black**.

---

## Creating a program in Instruction List

### Procedure

Carry out the following actions:

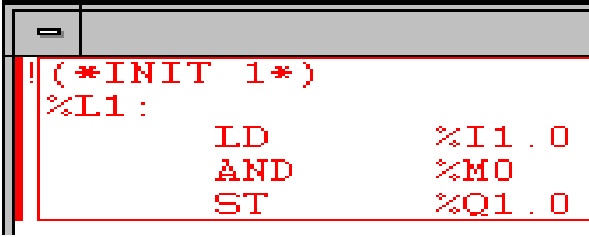
Step	Action
1	Create a List section (See <i>Creating or importing an LD, IL, ST section, p. 123</i> ).
2	<p>1. Enter the first statement. As input begins, the statement is displayed in red.</p>  <p>2. Accept each line with ENTER.  3. Use the TAB key to separate the code from the operand.  4. On line symbolization (See <i>Online symbolization, p. 179</i>).</p>
3	Confirm the input of the statement with the command <b>Edit/Confirm</b> ( <b>CTRL+W</b> )/ <b>SHIFT+ENTER</b> ) or via the icon <input checked="" type="checkbox"/> .

### Rules

They are:

- At the time of confirmation, the input text is formatted giving you automatically indented source code.
- If an **error** is detected at confirmation, the cursor is positioned over the first error detected, the error message is displayed at the bottom of the window.
- In the editor, a statement is displayed in **red** while being entered.
- A selected statement is surrounded by a **green frame**.
- The current statement is surrounded by a **black frame**.

## Accessing a statement or instruction (Instruction List)

### Accessing a statement or an instruction

When the program module is displayed, select the Edit/Go to (Ctrl+A) command or the icon  .

Access by label -> select "Label":

In the label zone, select...	position...
TOP	at the start of program module.
BOTTOM	at the end of program module.
%Li	at the corresponding label number.

The **Move** zone is used to make a movement relative to TOP/BOTTOM/%Li.

Access by instruction -> select "instruction":

In the instruction zone, select...	position...
instruction number	on the corresponding instruction.

The **Edit/Go to current modification** command allows you to position the cursor on the current modification.

### Selecting one or several statements

The possible choices are as follows:

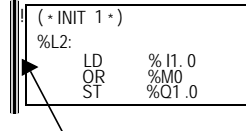
Select...	by...	or...
one statement	positioning the cursor over the statement and selecting the <b>Edit/Select</b> statement from the menu	by clicking in this zone, it is framed in green. Example: 
several statements	by selecting the different statements while holding down the left mouse button	using the keys (Shift+Arrow).
part of a statement	by moving the cursor over the text to be selected while holding down the left mouse button (Shift+Arrow)	

**Modifying a statement**

Carry out the following actions:

Step	Action
1	Position the cursor over the point where the modification is to be made.
2	Make the modification.
3	Confirm the modification with the keys (Ctrl+W) or (Shift+Enter) or the Icon  .

The deletion possibilities are as follows:

Delete...	by...	then by...
one statement	selecting the statement to be deleted	pressing the <b>Delete</b> key.
part of a statement	selecting the part of the statement to be deleted	pressing the <b>Delete</b> key.
a piece of text and place it on the clipboard	selecting the text to be cut	selecting the <b>Edit/Cut (Ctrl+X)</b> command.

**Inserting a statement before the current statement**

Carry out the following actions:

Step	Action
1	Position the cursor on the statement before which the insertion must be made.
2	Select the <b>Edit/Insert Statement</b> command or <b>(Ctrl+I)</b> .

**Cut/Copy/Paste part of a program module**

Carry out the following operations:

To.....	you must...	the text...
copy part of a statement	select the text to be copied and select the command <b>Edit/Copy (Ctrl+C)</b>	is placed on the Windows Clipboard.
paste the contents of the Clipboard into a document	select the point from where the text must be pasted and select the <b>Edit/Paste (Ctrl+V)</b> command	is kept on the Windows Clipboard.
cut a piece of text and place it on the clipboard	select the text to be cut and select the command <b>Edit/Cut (Ctrl+X)</b>	is placed on the Windows Clipboard.

**Note:**

The **Cut/Copy/Paste** function works in the same way for a selection of statement(s) and between program modules.

**Canceling a modification**

To cancel a modification carried out on an unconfirmed statement, select the **Edit/Undo** changes command or the icon  . This command allows you to return the sequence to its last confirmed state.



## Displaying variables as symbols or addresses

### Procedure

Carry out the following actions:

Step	Action
1	Open the program module with <b>right click + Open</b> or with a <b>double click</b> .
2	Select the command: <ul style="list-style-type: none"> <li>● <b>View/Addresses</b> to display the variables as addresses.</li> <li>● <b>View/Symbols</b> to display the variables as symbols.</li> <li>● <b>View/Symbols&amp;addresses</b> to display the variables as symbols/addresses (<b>Ladder editor only</b>).</li> </ul>

### Note:

It is possible to run the language editor from the Options menu in:

- addresses view,
- symbols view,
- symbols&addresses view (for the Ladder editor only).

### Example of display

Ladder editor used with the 3 views.

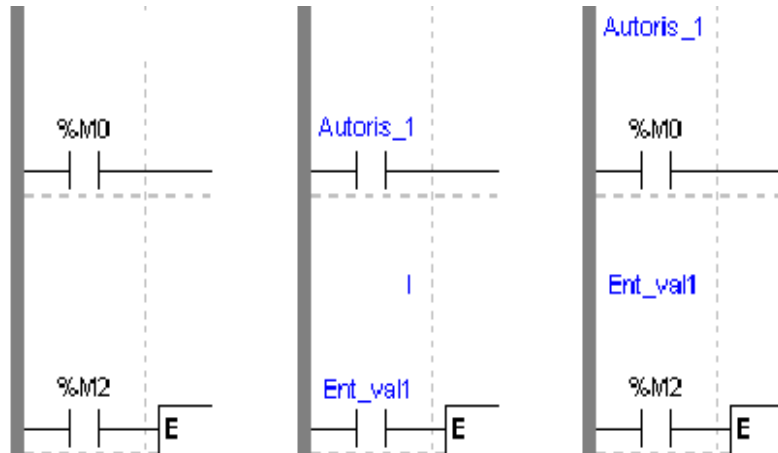

### Note

If a symbol or address has more than 8 characters, the display can be truncated. Select the element, which is then displayed in full in the status bar. You can also use the **Information box**.

The **View/Collapsed** command is used to reduce the size of the window whilst maintaining the same level of information.

The **View/Normal** command allows you to return to the normal sized window.

## Information box

---

### Functions

This box, which can be accessed from all language objects, displays the symbols, address and comments for the selected object (except for the operate and horizontal comparison blocks) in an integrated format.

Display table according to object:

Single object	Complex object (operate block, horizon comparison block)
<ul style="list-style-type: none"> <li>● symbol format in blue</li> <li>● constructor name in black,</li> <li>● associated comments in green.</li> </ul>	<ul style="list-style-type: none"> <li>● symbol format in blue</li> <li>● constructor address in black.</li> </ul>

---

### How to access the object information box

Carry out the following steps:

Step	Action
1	In the LIST language editor, select the object.
2	Click on the right mouse button (contextual menu) and then select <b>Information</b> , or select the <b>View → Information</b> command.

---

### Note

The information box remains visible if the user does not specifically close it. The contents of the **Information** box is updated according to the current selection.

---

---

## Online symbolization

---

### Principal

Online symbolization allows you, at the time of input of a Ladder, List, Structured Text program, to immediately (without opening the data editor) associate:

- an address to a new symbol,
  - a symbol to a non symbolized address.
- 

### Procedure

With the **Ladder** editor, start at **Step 1**, with the **Structured Text** or **List** editors, go straight to **step 2**.

Step	Action
1	Select the cell where the variable is situated.
2	Select the variable (highlight it).
3	Right mouse click on the variable and select <b>Associate Symbol&amp;Address</b> .
4	Enter the address or symbol and the comment.

---

## Input of a predefined function block (List editor)

---

### Procedure

From within the language editor, carry out the following actions:

Step	Action
1	From the <b>Contextual</b> or the <b>Service</b> menu, select the command <b>Input a block function call (Shift+F7)</b> .
2	Select the SFB type (counter, monostable...) using a <b>double click</b> (selection via the keyboard is done using the Arrow keys and ENTER). The input mask is displayed.

### Function blocks

The different **function blocks** and their **instructions** are:

Function blocks	Instruction	Syntax
TP/TON/TOF timer (%T <sub>Mi</sub> )	Start Initialize	<b>IN</b> %T <sub>Mi</sub> (Rising edge) <b>IN</b> %T <sub>Mi</sub> (Falling edge)
Up/Down counter (%C <sub>i</sub> )	Reset to 0 Set to Preset value Increment by 1 Decrement by 1	<b>R</b> %C <sub>i</sub> <b>S</b> %C <sub>i</sub> <b>CU</b> %C <sub>i</sub> <b>CD</b> %C <sub>i</sub>
Monostable (%M <sub>Ni</sub> )	Start	<b>S</b> %M <sub>Ni</sub>
Register of FIFO/LIFO words (%R <sub>i</sub> )	Reset contents Saving in %R <sub>i</sub> ;I Removing from %R <sub>i</sub> ;O	<b>R</b> %R <sub>i</sub> <b>I</b> %R <sub>i</sub> <b>O</b> %R <sub>i</sub>
Drum-DRUM (%D <sub>Ri</sub> )	Position at step 0 Change step	<b>R</b> %D <sub>Ri</sub> <b>U</b> %D <sub>Ri</sub>

---

## Assisted entry of a library function (List editor)

### Entry procedure for a library function

The instruction to be entered is:

```
[%MW5:=%MW30 + 100 + ROL(%MW8,2)]
```

To enter a function, perform the following actions

Step	Action
1	Enter the instruction as far as the <b>ROL</b> function call.
2	Via the <b>Contextual</b> or <b>Service</b> menu, select the <b>Enter call for a function</b> command.
3	Select the required tab (default selection). For an elementary function ( <b>EF</b> ) the <b>"Parameters"</b> option must be selected in the <b>Function Information</b> menu.
4	Select the <b>(EF) function family</b> (e.g.: Single length integer), or the required <b>DFB block</b> (only on Premium with PL7 Junior and Pro).
5	Select the <b>(EF) function name</b> (e.g. ROL), or the name of the <b>DFB</b> instance. An instance can be created for a DFB: <ol style="list-style-type: none"> <li>1. Select <b>Create</b>.</li> <li>2. Enter the <b>name</b>.</li> <li>3. Enter a <b>comment</b>.</li> <li>4. Confirm using <b>Create</b>.</li> </ol>
6	Enter the <b>(EF) function variables</b> or <b>DFB type parameters</b> in the parameter entry field. The function entered can be viewed in the <b>Display the call</b> field.
7	Confirm the selection with <b>OK</b> .
8	End the instruction entry (end character <b>]</b> ).
9	Confirm the entry with <b>ENTER</b> .

**Notes**

Certain functions offer extra screens for parameter entry (e.g.: human-machine interface functions). These parameters are accessed with the **Detail** button that then appears at the bottom of the screen.

When the function syntax is known, enter syntax directly into the editor.

It is possible to directly enable assisted entry on a given function by selecting the name of the function then selecting the **Service/Enter call for a function** command or performing a **RIGHT MOUSE CLICK**.

	<b>WARNING</b>
	<p><b>For EFs displayed in red:</b></p> <p>EFs which are displayed in red in the function entry help screen cannot be used in the application. This limitation is encountered in the following instances:</p> <ul style="list-style-type: none"><li>• When an earlier version of the EF is already used in the application,</li><li>• when the EF name is used as a variable linked symbol, and only concerns the EF ROUND (family of single precision reals).</li></ul> <p><b>Failure to follow this precaution can result in death, serious injury, or equipment damage.</b></p>

---

## Direct access to a subroutine

---

### Procedure

To access **the subroutine's** input/viewing window during the input/viewing of a subroutine call, **carry out** the following actions:

Step	Action
1	Select the subroutine call object: <b>SRI</b> %L1: LD%M0 <b>SR1</b>
2	Select the command <b>Facility/Open</b> or in the Contextual menu select <b>Open</b> .

---

## Replacing a variable in the application

---

### Introduction

Finding and replacing an application variable as an address or a symbol (excluding variables used in operating screens). The replacement in the application may be total or partial, automatic or manual.

Replacement affects the indicated variable and its dependent objects as well (word extract bits...).

Exception: for Grafcet steps bits the associated activity times (e.g. %Xi.T) are not replaced.



Replacement is carried out at the following levels:

- Application (in all tasks).
  - Tasks (MAST, FAST, Evti).
  - Complete section.
  - Partial section (from address i to address j).
  - Replacement is also carried out at functional module level (complete functional module, sub-modules included).
-



**Procedure**

Carry out the following actions:

<b>Step</b>	<b>Action</b>
1	Select the command <b>Tools/Replace variables</b> or position the cursor over the <b>Station</b> directory and select <b>Replace variables</b> from the contextual menu.
2	Put the variable to be replaced (as an address or a symbol) in the <b>Find</b> field and confirm with <b>ENTER</b> or <b>TAB</b> .
3	Put the variable to be replaced (as an address or a symbol) in the <b>Replace</b> field and confirm with <b>ENTER</b> .
4	Select the view: <ul style="list-style-type: none"> <li>● Structure view  ,</li> <li>● Function view  .</li> </ul>
5	Select one or more modules: <ul style="list-style-type: none"> <li>● if replacing in all the application, go to point 8,</li> <li>● if replacing in some of the modules, deselect the whole and select the modules, go to point 6,</li> <li>● if replacing in one of the modules, deselect the whole and select the module, go to point 6.</li> </ul>
6	Select the label (if LD, ST, IL) or the page (if G7) at the beginning of the replacement by positioning the pointer on the list <b>From</b> . If more precision is required, use the up and down arrow keys.
7	Select the label (if LD, ST, IL) or the page (if G7) at the end of the replacement by positioning the pointer on the list <b>To</b> . If more precision is required, use the up and down arrow keys.
8	Select the type of replacement: <ul style="list-style-type: none"> <li>● if <b>Replace</b>, the replacement is carried out occurrence by occurrence,</li> <li>● if <b>Replace All</b>, the replacement is carried out on all occurrences.</li> </ul> <b>Notes:</b> <ul style="list-style-type: none"> <li>● The status bar indicates the number of replacements carried out, and a report on the replacements not carried out.</li> <li>● The <b>ESC</b> key allows you to abort the function <b>Replace</b>, but the replacements already carried out are kept.</li> </ul>

## Cross Referencing a variable in an application

---

### Introduction

This function allows you to locate in the application:

- variables in the form of labels or symbols (except those used in operating screens),
- DFB types (only on Premium with PI7 Junior and Pro),
- DFB instances (only on Premium with PI7 Junior and Pro),
- and to open modules/tasks/DFB types.

### Principals of using debugging

The user realizes that the variable X is not the right value. To identify the cause he must therefore:

- find the places where this variable is used,
- obtain a list of statements, rungs and expressions,
- to display and verify the activation conditions of the variable.

**Note:**

In order to record the path of this search, the list elements thus visited are marked with an asterisk (\*).

### Operational mode for objects

A variable can be a read variable (**R**), a write variable (**W**) or a read/write variable (**R/W**).

- "**R**" groups together the read operational modes, indexed read, indexed word, input or input/output parameter of a indexed or non-indexed function.

- "**W**" groups together the write operational modes, indexed write, output or input/output parameter of indexed or non-indexed function and execution of Block Functions (SFB and DFB).

---

**Search source variables**

Table of variables:

<b>Bit</b>	%Ixi; %QXi; %Mi; %Si
<b>Word</b>	% MWi; %MDi; %MFi; %KBi; %KW; %KDi; KFi; %MBi; %SWi; %QWi; %QDi; %IWi; %IDi; %NWi
<b>Instruction</b>	SRI; HALT

Other retrievable variables:

Byte variables
Word extract bits
Bit table
Grafcet bit table
Character string
Table of words and constants
Table of double words and constants
Constant character string
Standard Block Function
Standard Block Function element
Step status
Step activity time
Manet variables

**Search options** For an indexed variable, the variable and the index are taken into account in the list.

Table of options:

<b>Extract Bit</b>	This option is for variables of types %MW, %KW, %IW, %NW, %QW. It adds to the list the variable and the referenced bits.
<b>Table Object</b>	This option is for bit tables, word tables and immediate indexed variables. It adds to the list the immediate indexed table variables whose first element is the input variable.
<b>Channel Object</b>	This option is for channel objects. It adds to the list all the objects of the same referenced channel, including the tables and the extract bits.
<b>Network Objects</b>	This option is for the network variables. It allows you to obtain all the variables from the same remote module (nanet object).
<b>FB Object</b>	This option allows you to expand the list of SFB block function elements and the DFB type elements.
<b>FB Instance</b>	Only on Premium with PL7 Junior and Pro. This option is for DFB types. It allows you to obtain from the name of a DFB type the sections using its instances.

**Searching for cross references**

Carry out the following actions:

Step	Action
1	Select the icon 
2	Enter the search <b>source variable</b> as an address or a symbol (E.g. %M10) and the possible <b>options</b> then confirm via <b>Search</b> .
3	To display a module, select the module, via the <b>Contextual</b> menu, select <b>Open</b> or double click on the module.

**Selecting a variable from the list:**

- Select the variable from the list, the list of tasks, modules, labels is updated.

**Deleting a variable from the list:**

- Select the variable, enable the contextual menu (right click) then click on **Delete**.

**Displaying in structural view or in functional view:**

- Use the **View** menu or the **Function** button.

## Animation of List program elements

---

### At a Glance

Refer to the "**Debugging**" Chapter of the Part "**Debugging, Adjustment, Documentation and Appendices**"-> (see *Animating program elements*, p. 309).

---

## Printing of a program

---

### Procedure

Carry out the following steps:

Step	Action
1	Open the module with <b>right click + Open</b> or a <b>double click</b> .
2	Select the command <b>File/Print (Ctrl+P)</b> or click on the icon 
3	Select a print range: <ul style="list-style-type: none"> <li>● if for the entire module, go to step 6.</li> <li>● if for part of a module, go to step 4.</li> </ul>
4	Select %Li/TOP/BOTTOM (if LD, ST, IL) or <b>start</b> page (if G7). If more precision is required, use the up and down arrow keys.
5	Select %Li/TOP/BOTTOM (if LD, ST, IL) or <b>end</b> page (if G7). If more precision is required, use the up and down arrow keys.
6	Confirm with <b>OK</b> or <b>ENTER</b> .

---

### Notes

The print type depends on the type of display selected in the **View** menu.

- **Addresses:** prints variables with addresses,
  - **Symbols:** prints variables with symbols,
  - **Symbols&Addresses:** prints variables with symbols/addresses.
-

## Export/Import of source files

---

Refer to the "**Import/Export**" (See *Import/Export*, p. 365) Chapter of the Part "**Debugging, Adjustment, Documentation and Appendices**".

---





---

# Programming in Structured Text ST language

# 8

---

## Introduction

### Subject of this chapter

This chapter reminds you of the structure of a program in Structured Text language.

It describes:

- How to create a program.
- How to use the different functions offered by the editor.
- How to manage the different modules making up the application.

### What's in this Chapter?

This chapter contains the following topics:

Topic	Page
Structure of a program in Structured Text language.	194
Creating a program in Structured Text (ST)	195
Modifying a Structured Text program	196
Displaying variables as symbols or addresses	199
Information box	201
Online symbolization	202
Input of a predefined function block (ST editor)	203
Assisted entry of a library function (ST editor)	204
Direct access to a subroutine	206
Replacing a variable in the application	207
Cross Referencing a variable in an application	209
Animation of Structured text program elements	212
Printing of a program	213
Export/Import of source files	214

---

## Structure of a program in Structured Text language.

---

<b>Introduction</b>	Structured Text (ST) can be used on PLCs Premium (V>=V1.0) and on the Micro (V>=V1.5).
<b>Principal</b>	<p>A module written in Structured Text language is composed of a series of statements executed sequentially by the PLC.</p> <ul style="list-style-type: none"> <li>● Each statement begins with an exclamation mark (generated automatically), it can include one or several <b>comments</b>, one or several <b>instructions</b> and can be marked with a <b>label</b>.</li> <li>● A statement contains a <b>maximum of 128 lines of 300 characters</b> (instructions, comments, label).</li> <li>● In the editor a statement being input is displayed <b>in red</b>.</li> <li>● A selected statement is surrounded by a <b>green frame</b>.</li> <li>● The current statement is surrounded by a <b>black frame</b>.</li> <li>● The line number and the column number as well as the number of the current statement are written in the bottom panel of the window (status bar).</li> </ul>
<b>Example</b>	<pre>! (*Initialisation*) %L2: (*Label*) %MW0:=0; (* Init Index *) %MW2:=%MW99:2; (* length of table *) <b>IF</b> (%MW2 REM 2=0) <b>THEN</b> DEC %MW0; <b>END_IF</b>; (* while the index is &lt; the length of the table    carry out shift *) <b>WHILE</b>(%MW0&lt;%MW2)<b>DO</b>     %MW100[%MW0]:=(SHR(%MW100[%MW0],8))OR(SHL(%MW101[%MW0],8));     INC %MW0; <b>END_WHILE</b>;</pre> <p><b>Notes :</b>  Key-words (example AND, OR, IF...) are colored <b>blue</b>.  Comments are colored <b>green</b>.  The rest is colored <b>black</b>.</p>

---



## Creating a program in Structured Text (ST)

### Introduction

Structured Text can be used on PLCs Premium ( $V \geq V1.0$ ) and on the Micro ( $V \geq V1.5$ ).

### Procedure

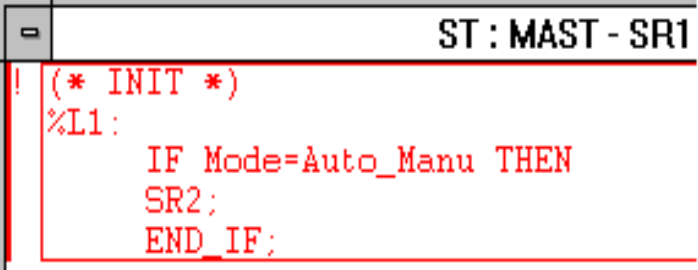
Carry out the following actions:

Step	Action
1	<i>Creating or importing an LD, IL, ST section, p. 123</i>
2	<p>1. Enter the first statement. As input begins, the statement is displayed in red.</p>  <p>2. Accept each line with ENTER.</p> <p>3. Use the TAB key to indent the code.</p> <p>4. <i>Online symbolization, p. 179</i></p>
3	<p>Confirm the input of the statement with the command <b>Edit/Confirm</b> (<b>CTRL+W</b>)/(<b>SHIFT+ENTER</b>) or via the icon .</p>

### Rules

They are:

- When confirming the statement, superfluous spaces are ignored.
- If an **error** is detected at confirmation, the cursor is positioned over the first error detected, the error message is displayed at the bottom of the window.
- In the editor, a statement is displayed in **red** while being entered.
- A selected statement is surrounded by a **green frame**.
- The current statement is surrounded by a **black frame**.

## Modifying a Structured Text program

### Accessing a statement or instruction

The program module being displayed, select the command **Edit/Go to (Ctrl+A)** or the icon .

The possible choices are as follows:

Select in the label field...	position...
TOP	at the beginning of the program module.
BOTTOM	at the end of the program module.
%Li	at the corresponding label number.

The **Move** zone allows a movement relative to TOP/BOTTOM/%Li.

The command **Edit/ Go to current modification** allows you to position the cursor on the statement which is currently being modified.

### Selecting one or several statements

The possible choices are as follows:

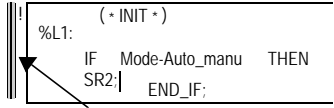
Select...	by...	or...
one statement	positioning the cursor over the statement and selecting the menu <b>Edit/Select statement</b> .	by clicking in this area, the latter is framed in green. 
several statements	move the mouse over the different statements while keeping the left button down.	by using the keys <b>(SHIFT+Arrow)</b> .
a part of a statement	by moving the cursor over the text to be selected while keeping the left mouse button down <b>(SHIFT+Arrow)</b> .	

**Modifying one statement**

Carry out the following actions:

Step	Action
1	Position the cursor over the point to be modified.
2	Carry out the modification
3	Confirm the modification with the keys <b>CTRL + W</b> or <b>SHIFT+ ENTER</b> or the icon  .

The deletion possibilities are as follows:

Delete...	by...	then by...
one statement	selecting the statement to delete	pressing the key <b>Delete</b> .
a part of a statement	selecting the part of the statement to delete	pressing the key <b>Delete</b> .
a piece of text and place it on the clipboard	selecting the text to be cut	selecting the command <b>Edit/Cut (CTRL+X)</b> .

**Inserting a statement before the current statement**

Carry out the following actions:

Step	Action
1	Position the cursor on the statement before which the insertion must be carried out.
2	Select the command <b>Edit/Insert statement</b> or <b>(Ctrl+I)</b> .

**Cut/Copy/Paste a part of a program module**

Carry out the following operations:

To...	you must...	the text...
Copy a part of a statement	select the text to be copied and select the command <b>Edit/Copy (Ctrl+C)</b>	is placed on the Windows clipboard.
Paste the contents of the clipboard into a document	select the start point from which the text must be pasted and select the command <b>Edit/Paste (CTRL+V)</b>	is kept on the Windows clipboard.
Cut a piece of text and place it on the clipboard	select the text to be cut and select the command <b>Edit/Cut (CTRL+X)</b>	is placed on the Windows clipboard.

**Note:**

The **Cut/Copy/Paste** function works in the same way for a selection of statement(s) and between program modules.

**Canceling a modification**

To cancel a modification carried out on an unconfirmed statement, select the command **Edit/Undo changes** or **the icon**  . This command allows you to return the statement to its last confirmed state.

---

## Displaying variables as symbols or addresses

### Procedure

Carry out the following actions:

Step	Action
1	Open the program module by <b>right mouse click + Open</b> or <b>double mouse click</b> .
2	Select the command: <ul style="list-style-type: none"> <li>● <b>View/Addresses</b> to display the variables as addresses.</li> <li>● <b>View/Symbols</b> to display the variables as symbols.</li> <li>● <b>View/Symbols&amp;Addresses</b> to display the variables as symbols/addresses (<b>only Ladder editor</b>).</li> </ul>

### Note:

It is possible to run the language editor from the Options menu in:

- addresses view,
- symbols view,
- symbols&addresses view (only for the Ladder editor).

### Example display

Ladder editor used with the 3 views.

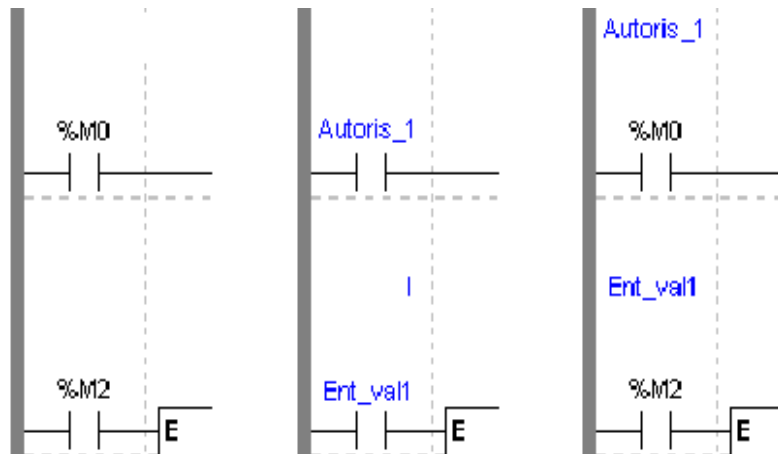

**Note**

If a symbol or an address has more than 8 characters, the display can be truncated. Select the element displayed in this way in the status bar. You can also use the **Information box**.

The command **View/Reduced** allows you to reduce the size of the window while keeping the same level of information.

The command **View/Normal** allows you to return to the normal sized window.

---



## Information box

---

### Functions

This box, which can be accessed from all language objects, displays the symbols, address and comments for the selected object (with the exception of the operate and horizontal comparison blocks) in an integrated format.

Display table according to object:

Single object	Complex object (operate block, horizon comparison block)
<ul style="list-style-type: none"> <li>● symbol format in blue</li> <li>● constructor name in black,</li> <li>● associated comments in green.</li> </ul>	<ul style="list-style-type: none"> <li>● symbol format in blue,</li> <li>● constructor address in black,</li> </ul>

### How to access the object information box

Carry out the following steps:

Step	Action
1	In the ST language editor, select the object.
2	Click on the right mouse button (contextual menu) and then select <b>Information</b> , or select the <b>View</b> → <b>Information</b> command.

### Note

The information box remains visible if the user does not specifically close it. The contents of the **Information** box is updated according to the current selection.

---

## Online symbolization

---

### Principal

Online symbolization allows you, at the time of input of a Ladder, List, Structured Text program, to immediately (without opening the data editor) associate:

- an address to a new symbol,
- a symbol to a non symbolized address.

### Procedure

With the **Ladder** editor, start at **Step 1**, with the **Structured Text** or **List** editors, go straight to **step 2**.

Step	Action
1	Select the cell where the variable is situated.
2	Select the variable (highlight it).
3	Right mouse click on the variable and select <b>Associate Symbol&amp;Address</b> .
4	Enter the address or symbol and the comment.

---

## Input of a predefined function block (ST editor)

### Procedure

From within the language editor, input at the cursor position one of the instructions presented below corresponding to the desired function block.

### Function blocks

The different **function blocks** and their **instructions** are:

Function blocks	Instruction	Syntax
PL7-3 timer(%Ti)	Start Stop Reinitialize	<b>START</b> %Ti; <b>STOP</b> %Ti; <b>PRESET</b> %Ti;
TP/TON/TOF timer (%Tmi)	Start Initialize	<b>START</b> %Tmi; <b>DOWN</b> %Tmi;
Up/Down counter (%Ci)	Reset to 0 Set to Preset value Increment by 1 Decrement by 1	<b>RESET</b> %Ci; <b>PRESET</b> %Ci; <b>UP</b> %Ci; <b>DOWN</b> %Ci;
Monostable (%Mni)	Start	<b>START</b> %Mni;
Register of FIFO/LIFO words (%Ri)	Reset contents Saving in %Ri,I Removing from %Ri,O	<b>RESET</b> %Ri; <b>PUT</b> %Ri; <b>GET</b> %Ri;
Drum-DRUM (%DRi)	Position at step 0 Change step	<b>RESET</b> %DRi; <b>UP</b> %DRi;

## Assisted entry of a library function (ST editor)

---

### Procedure

The instruction to be entered is:

```
%MD5:=%MD30 AND 100 AND ROL(%MD8,2);
```

Perform the following actions to make an entry:

Step	Action
1	Enter the instruction as far as the <b>ROL</b> function call.
2	Via the <b>Contextual</b> or <b>Service</b> menu, select the <b>Enter call for a function</b> command.
3	Select the required tab (default selection). For an elementary function ( <b>EF</b> ) the <b>"Parameters"</b> option must be selected in the <b>Function Information</b> menu.
4	Select the <b>(EF) function family</b> (e.g.: Double length integer, or the required <b>DFB block</b> (only on Premium with PL7 Junior and Pro)).
5	Select the <b>(EF) function name</b> (e.g. ROL), or the name of the <b>DFB</b> instance. An instance can be created for a DFB: 1. Select <b>Create</b> . 2. Enter the <b>name</b> . 3. Enter a <b>comment</b> . 4. Confirm using <b>Create</b> .
6	Enter the <b>(EF) function variables</b> or <b>DFB type parameters</b> in the parameter entry field. The function entered can be viewed in the <b>Display the call</b> field.
7	Confirm the selection with <b>OK</b> .
8	End the instruction input (end character ;).
9	Confirm the entry with <b>ENTER</b> .

---

**Notes**

Certain functions offer extra screens for parameter entry (e.g.: human-machine interface functions). These parameters are accessed with the **Detail** button that then appears at the bottom of the screen.

When the function syntax is known, enter syntax directly into the editor.

It is possible to directly enable assisted entry on a given function by selecting the name of the function then selecting the **Service/Enter call for a function** command or performing a **RIGHT MOUSE CLICK**.

Tabulation and Line Feed characters are represented by **\$T** and **\$N** respectively. They must be entered in **\$\$T** and **\$\$N** format.

	<b>WARNING</b>
	<p><b>For EFs displayed in red:</b></p> <p>EFs which are displayed in red in the function entry help screen cannot be used in the application. This limitation is encountered in the following instances:</p> <ul style="list-style-type: none"><li>• when an earlier version of the EF is already used in the application,</li><li>• the EF name is used as a variable linked symbol, and concerns the EF ROUND (family of single precision reals).</li></ul> <p><b>Failure to follow this precaution can result in death, serious injury, or equipment damage.</b></p>

## Direct access to a subroutine

---

### Procedure

To access the **input/display** window of a sub-routine during the **input/display** of a sub-routine call, carry out the following actions:

Step	Action
1	Select the subroutine call object: <b>SRI</b> %L1: IF %M0 THEN <b>SR1</b> ; END_IF;
2	Select the command <b>Service/Open</b> or select <b>Open</b> from the contextual menu.

---

## Replacing a variable in the application

---

### Introduction

Finding and replacing an application variable as an address or a symbol (excluding variables used in operating screens). The replacement in the application may be total or partial, automatic or manual.

Replacement affects the indicated variable and its dependent objects as well (word extract bits...).

Exception: for Grafcet steps bits the associated activity times (e.g. %Xi.T) are not replaced.

Replacement is carried out at the following levels:

- Application (in all tasks).
  - Tasks (MAST, FAST, Evti).
  - Complete section.
  - Partial section (from address i to address j).
  - Replacement is also carried out at functional module level (complete functional module, sub-modules included).
-

**Procedure**

Carry out the following actions:

Step	Action
1	Select the command <b>Tools/Replace variables</b> or position the cursor over the <b>Station</b> directory and select <b>Replace variables</b> from the contextual menu.
2	Put the variable to be replaced (as an address or a symbol) in the <b>Find</b> field and confirm with <b>ENTER</b> or <b>TAB</b> .
3	Put the variable to be replaced (as an address or a symbol) in the <b>Replace</b> field and confirm with <b>ENTER</b> .
4	Select the view: <ul style="list-style-type: none"> <li>● Structure view</li> <li>● Function view</li> </ul>
5	Select one or more modules: <ul style="list-style-type: none"> <li>● if replacing in all the application, go to point 8,</li> <li>● if replacing in some of the modules, deselect the whole and select the modules, go to point 6,</li> <li>● if replacing in one of the modules, deselect the whole and select the module, go to point 6.</li> </ul>
6	Select the label (if LD, ST, IL) or the page (if G7) at the beginning of the replacement by positioning the pointer on the list <b>From</b> . If more precision is required, use the up and down arrow keys.
7	Select the label (if LD, ST, IL) or the page (if G7) at the end of the replacement by positioning the pointer on the list <b>To</b> . If more precision is required, use the up and down arrow keys.
8	Select the type of replacement: <ul style="list-style-type: none"> <li>● if <b>Replace</b>, the replacement is carried out occurrence by occurrence,</li> <li>● if <b>Replace All</b>, the replacement is carried out on all occurrences.</li> </ul> <b>Notes:</b> <ul style="list-style-type: none"> <li>● The status bar indicates the number of replacements carried out, and a report on the replacements not carried out.</li> <li>● The <b>ESC</b> key allows you to abort the function <b>Replace</b>, but the replacements already carried out are kept.</li> </ul>



## Cross Referencing a variable in an application

---

### Introduction

This function allows you to locate in the application:

- variables in the form of labels or symbols (except those used in operating screens),
  - DFB types (only on Premium with PI7 Junior and Pro),
  - DFB instances (only on Premium with PI7 Junior and Pro),
  - and to open modules/tasks/DFB types.
- 

### Principals of using debugging

The user realizes that the variable X is not the right value. To identify the cause he must therefore:

- find the places where this variable is used,
- obtain a list of statements, rungs and expressions,
- to display and verify the activation conditions of the variable.

**Note:**

In order to record the path of this search, the list elements thus visited are marked with an asterisk (\*).

---

### Operational mode for objects

A variable can be a read variable (**R**), a write variable (**W**) or a read/write variable (**R/W**).

- "**R**" groups together the read operational modes, indexed read, indexed word, input or input/output parameter of a indexed or non-indexed function.

- "**W**" groups together the write operational modes, indexed write, output or input/output parameter of indexed or non-indexed function and execution of Block Functions (SFB and DFB).

---

**Search source variables**

Table of variables:

<b>Bit</b>	%Ixi; %QXi; %Mi; %Si
<b>Word</b>	% MWi; %MDi; %MFi; %KBi; %KW; %KDi; KFi; %MBi; %SWi; %QWi; %QDi; %IW; %ID; %NWi
<b>Instruction</b>	SRI; HALT

Other retrievable variables:

Byte variables
Word extract bits
Bit table
Grafcet bit table
Character string
Table of words and constants
Table of double words and constants
Constant character string
Standard Block Function
Standard Block Function element
Step status
Step activity time
Manet variables

---

**Search options** For an indexed variable, the variable and the index are taken into account in the list.

Table of options:

<b>Extract Bit</b>	This option is for variables of types %MW, %KW, %IW, %NW, %QW. It adds to the list the variable and the referenced bits.
<b>Table Object</b>	This option is for bit tables, word tables and immediate indexed variables. It adds to the list the immediate indexed table variables whose first element is the input variable.
<b>Channel Object</b>	This option is for channel objects. It adds to the list all the objects of the same referenced channel, including the tables and the extract bits.
<b>Network Objects</b>	This option is for the network variables. It allows you to obtain all the variables from the same remote module (nanet object).
<b>FB Object</b>	This option allows you to expand the list of SFB block function elements and the DFB type elements.
<b>FB Instance</b>	Only on Premium with PL7 Junior and Pro. This option is for DFB types. It allows you to obtain from the name of a DFB type the sections using its instances.

### Searching for cross references

Carry out the following actions:

Step	Action
1	Select the icon 
2	Enter the search <b>source variable</b> as an address or a symbol (E.g. %M10) and the possible <b>options</b> then confirm via <b>Search</b> .
3	To display a module, select the module, via the <b>Contextual</b> menu, select <b>Open</b> or double click on the module.

#### Selecting a variable from the list:

- Select the variable from the list, the list of tasks, modules, labels is updated.

#### Deleting a variable from the list:

- Select the variable, enable the contextual menu (right click) then click on **Delete**.

#### Displaying in structural view or in functional view:

- Use the **View** menu or the **Function** button.

## Animation of Structured text program elements

---

### At a Glance

Refer to the "**Debugging**" Chapter of the Part "**Debugging, Adjustment, Documentation and Appendices**"-> (see *Animating program elements*, p. 309) .

---

## Printing of a program

### Procedure

Carry out the following steps:

Step	Action
1	Open the module with <b>right click + Open</b> or a <b>double click</b> .
2	Select the command <b>File/Print (Ctrl+P)</b> or click on the icon 
3	Select a print range: <ul style="list-style-type: none"> <li>● if for the entire module, go to step 6.</li> <li>● if for part of a module, go to step 4.</li> </ul>
4	Select %Li/TOP/BOTTOM (if LD, ST, IL) or <b>start</b> page (if G7). If more precision is required, use the up and down arrow keys.
5	Select %Li/TOP/BOTTOM (if LD, ST, IL) or <b>end</b> page (if G7). If more precision is required, use the up and down arrow keys.
6	Confirm with <b>OK</b> or <b>ENTER</b> .

### Notes

The print type depends on the type of display selected in the **View** menu.

- **Addresses:** prints variables with addresses,
- **Symbols:** prints variables with symbols,
- **Symbols&Addresses:** prints variables with symbols/addresses.

## Export/Import of source files

---

Refer to the "**Import/Export**" (See *Import/Export*, p. 365) Chapter of the Part "**Debugging, Adjustment, Documentation and Appendices**".

---

---

# Programming in Grafcet language

# 9

---

## Introduction

### Subject of this chapter

This chapter reminds you of the structure of a program in grafcet language.

It describes:

- how to create a program;
- how to use the different functions offered by the editor;
- how to manage the different modules making up the application.

### What's in this Chapter?

This chapter contains the following topics:

Topic	Page
Designing a program in Grafcet language	216
Structure of a Grafcet page	217
Grafcet graphic objects	218
Creating a Grafcet module	222
Modifying a Grafcet program	235
Replacing a variable in the application	238
Cross Referencing a variable in an application	240
Animation of Grafcet program elements	243
Printing of a program	244
Export/Import of source files	245

---

## Designing a program in Grafcet language

---

### Principal

Grafcet language (GR7) allows the sequential operation of automation to be represented graphically and in a structured way.

This description is carried out with help from single graphical objects (See *Grafcet graphic objects, p. 218*) representing:

- the **steps** with which the actions can be associated (except the OUT step),
- the **macro-steps**, (onlyTSX/PCX/PMX57)
- the **transitions** with which the receptivity **is associated**,
- the **positioned links** connecting a step to a transition or a transition to a step.

The graph is input by Grafcet pages (See *Structure of a Grafcet page, p. 217*) addressed from 0 to 7 in the status bar.

---

### Example

Grafcet editor:

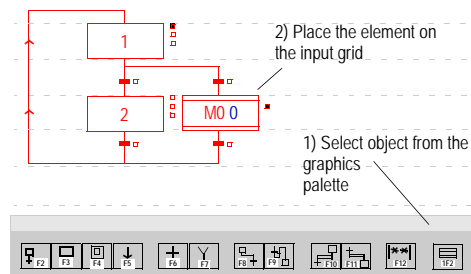



## Structure of a Grafcet page

### Principles

The Grafcet page is displayed in the form of a matrix made up of 14 lines and 11 columns defining 154 cells.

Each cell can receive a graphic object (See *Grafcet graphic objects*, p. 218).

There are two types of line:

- step lines where steps, macro steps and connectors are entered,
- transition lines where the transitions and source connectors are entered.

Comments can be entered. These are independent graphic objects, which are not attached to steps or transitions.

A program module is made up of 8 Grafcet pages, and a Grafcet page is accessed

via the **Edit/Go to** command, or the icon .

There are two Grafcet page viewing modes offered, which can be accessed from the View menu:

- normal view (default display),
- collapsed view.

### Example

Grafcet page:

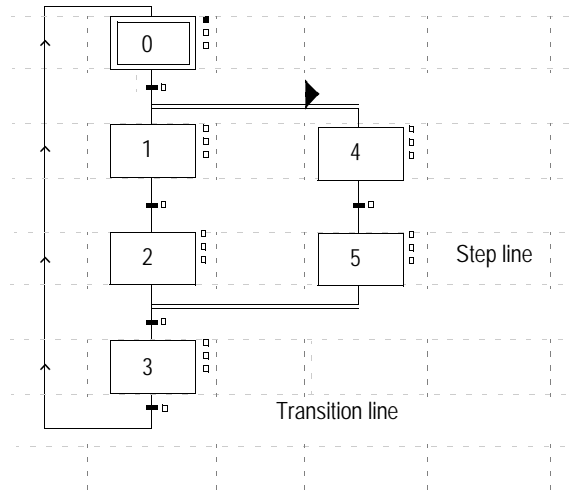

## Grafcet graphic objects



---

### Steps

Number of possible steps by PLC type:

- TSX37-10 Max: 96,
- TSX37-20 Max: 128,
- TSX/PCX/PMX57 Max: 250.

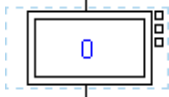
Type of steps:

Can be accessed from the graphics palette using the <b>F3</b> and <b>F4</b> keys or the icons		
		
<b>Initial</b>	Example: 	Defines the initial situation of the PLC, i = 0 to 63.
<b>Standard</b>	Example: 	Defines the stable PLC state.

### Macro-steps





Only enabled on TSX/PCX/PMX57, Max: 64.



Can be accessed from the graphics palette using the **(Shift+F2)** keys or

the icon  .

**Macro-Step steps**

Only enabled on TSX/PCX/PMX57, Max: 250 per Macro-Step plus IN and OUT step.  
Types of Macro-step steps:

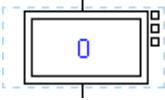
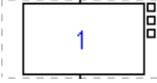
Can be accessed from the graphics palette using the keys **F3**, **F4**, **(Shift+F2)**, **(Shift+F3)**, **(Shift+F4)** or the icons      .

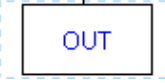
<b>Initial</b>	Example: 	Defines the initial situation of the PLC, i= 0 to 63.
<b>Standard</b>	Example: 	Defines the stable PLC state.
<b>IN</b>	Example: 	Macro-Step input step.
<b>OUT</b>	Example: 	Macro-Step output step.

**Step + Transition**

Step/Transition:

Can be accessed from the graphics palette using the **(F2)** key or the icon  .

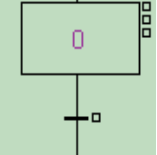
<b>Step + Transition</b>	Example: 	Simultaneously lays down a step with a number and transition.
--------------------------	---	---

**Transitions**

Number of possible transitions by PLC type:

- TSX37-10 Max: 192,
- TSX37-20 Max: 256,
- TSX/PCX/PMX57 Max: 1024.

Type of transition:

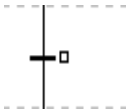
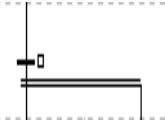
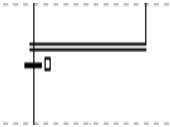
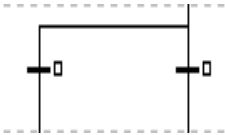
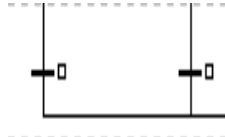
Can be accessed from the graphics palette using the keys <b>F6</b> , <b>F8</b> , <b>F9</b> , <b>F10</b> and <b>F11</b> or the icons  .		
<b>Standard</b>	Example: 	Allows the transition from one step to another.
<b>AND divergence</b>	Example: 	Allows the simultaneous activation of a maximum of 11 steps.
<b>AND convergence</b>	Example: 	Allows the simultaneous deactivation of a maximum of 11 steps.
<b>OR divergence</b>	Example: 	Allows you to create a branch to a maximum of 11 steps.
<b>OR convergence</b>	Example: 	Allows you to close a branch from a maximum of 11 steps.

**Connectors**

Connector types:

Can be accessed from the graphics palette via the **F5**, and **F7** keys or the icons



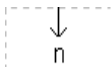
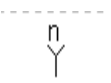

<b>Destination</b>	Example: 	n = destination step number.
<b>Origin</b>	Example: 	n = origin step number.

**Oriented links**

Link types:

Can be accessed via the graphics palette via the **F9** key, or the icon

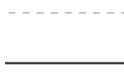

<b>Up</b>	Example: 	Allows the loop iteration of a chart (arrow keys).
<b>Down</b>	Example: 	
<b>Left or right</b>	Example: 	

**Comments**

Can be accessed from the graphics palette via the **F12** key or the icon



## Creating a Grafcet module

---

### Procedure

Carry out the following actions:

Step	Action
1	Create a Grafcet section (See <i>Creating or importing a Grafcet section</i> , p. 125).
2	Open the Grafcet module (chart). (See <i>Open the Grafcet module (chart)</i> , p. 222)
3	Enter the following graphical elements: <ul style="list-style-type: none"> <li>● entering a step, a transition, a connector. (See <i>Entering a step, an action, a connector</i>, p. 223)</li> <li>● entering a macro-step (See <i>Entering a Macro-Step</i>, p. 224) (only TSX 57).</li> <li>● carrying out an AND divergence (See <i>Carrying out an AND divergence</i>, p. 225).</li> <li>● carrying out an AND convergence (See <i>Carrying out an AND convergence</i>, p. 227).</li> <li>● carrying out a Step -&gt; Transition link (See <i>Carrying out a Step -&gt; Transition link</i>, p. 228).</li> <li>● carrying out a Transition -&gt; Step link. (See <i>Carrying out a Transition -&gt; Step link.</i>, p. 229)</li> <li>● carrying out loop iteration. (See <i>Carrying out a loop iteration</i>, p. 230)</li> </ul>
4	Program actions. (See <i>Programming actions</i> , p. 232)
5	Program the transition conditions. (See <i>Programming the transition conditions</i> , p. 233)
6	Enter comments. (See <i>Entering comments</i> , p. 234)

### Open the Grafcet module (chart)

Carry out the following actions from the Grafcet section previously created.

Step	Action
1	Put the cursor on the Chart module in the Grafcet section.
2	Open the Chart module using the command <b>Services/Open</b> or using the contextual menu <b>Open</b> .

---

**Entering a step,  
an action, a  
connector**

Carry out the following actions:

Step	Action
1	<p><b>Using the mouse:</b> Click on the graphical object situated in the graphical palette.</p> <p><b>Using the keyboard:</b> Position the cursor on the grid at the required place (using the arrow keys).</p>
2	<p><b>Using the mouse:</b> Click on the grid at the required place, for:</p> <ul style="list-style-type: none"> <li>● a step, a number is offered by default, modify it if applicable, then confirm it using <b>ENTER</b>.</li> <li>● a step+transition, a number is fixed by default.</li> </ul> <p><b>Using the keyboard:</b> Press the function key corresponding to the graphical object situated in the graphical palette to be inserted, for:</p> <ul style="list-style-type: none"> <li>● a step, a number is proposed by default, modify it if applicable.</li> <li>● a step+transition, a number is fixed by default.</li> </ul>
3	<p><b>Using the mouse or the keyboard:</b> Proceed in the same way for the other graphical objects.</p>
4	<p><b>Using the mouse:</b> Confirm the chart by clicking on the icon  or by using the command <b>Edit/Confirm</b>.</p> <p><b>Using the keyboard:</b> Confirm the chart using the <b>ENTER</b> key, or using the command <b>Edit/Confirm</b>.</p>

**Entering a Macro-Step**

A macro-step must be:

- defined in order to be inserted in a Grafcet module (chart or macro-step),
- created (using the application browser) in order to be entered in a Grafcet module (chart + macro-step),
- completed (number of the corresponding macro-step) in order to be validated.

Carry out the following actions:

Step	Action
1	<b>Using the mouse:</b> Click on the graphical object situated in the graphical palette. <b>Using the keyboard:</b> Position the cursor on the grid at the required place (using the arrow keys).
2	<b>Using the mouse:</b> Click on the grid at the required place. <b>Using the keyboard:</b> Press the function key corresponding to the Macro-step object ( <b>Shift +F2</b> )
3	<b>Using the mouse or the keyboard:</b> Enter a macro-step number, then confirm with <b>ENTER</b> .
4	<b>Using the keyboard:</b> Confirm the chart using the <b>ENTER</b> key, or using the command <b>Edit/Confirm</b> .

**Note:**

When a chart is confirmed, the display changes:

- the graphical objects change from red to black,
  - the page border becomes gray.
-



### Carrying out an AND divergence

An AND divergence starts with a transition and goes to a step.

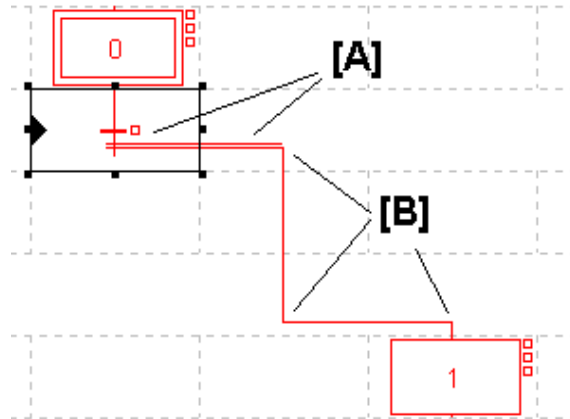

Carry out the following actions:

Step	Action
1	<p><b>Using the mouse:</b> Click on the graphical object situated in the graphical palette (<b>F11</b>).</p> <p><b>Using the keyboard:</b> Put the cursor on the start transition or on the pre-existing divergence segment <b>[A]</b> (in the case of multiple divergence) using the arrows.</p>
2	<p><b>Using the mouse:</b> Click on the start transition or on the pre-existing divergence segment <b>[A]</b> (in the case of a multiple divergence).</p> <p><b>Using the keyboard:</b> Press (<b>F11</b>).</p>
3	<p><b>Using the mouse:</b> Draw the link by clicking on the break points of the line <b>[B]</b> (change of direction) in the transition lines.</p> <p><b>Using the keyboard:</b> Draw the link using the arrow keys.</p>
4	<p><b>Using the mouse:</b> Double click on the last break point or click again on the graphical object situated in the graphical palette (<b>F11</b>).</p> <p><b>Using the keyboard:</b> Press <b>F11</b> again on the last break point. If the destination cell is empty, a step is automatically created.</p>
5	<p><b>Using the mouse or the keyboard:</b> Modify the step number if applicable, then confirm using <b>ENTER</b>.</p>

**Note:**

An AND divergence is always represented from left to right, the segment represented by a double line cannot be cut by another link.

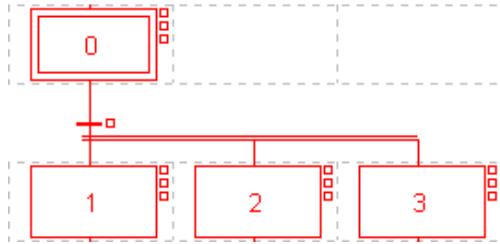

## Carrying out an AND convergence

An AND convergence starts with a step and goes to a transition.

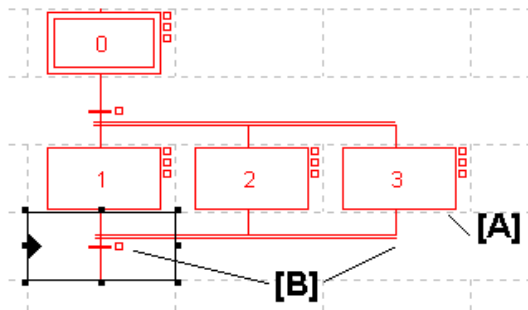

Carry out the following actions:

Step	Action
1	<p><b>Using the mouse:</b> Click on the graphical object situated in the graphical palette (<b>F10</b>).</p> <p><b>Using the keyboard:</b> Put the cursor on the start step using the arrow keys.</p>
2	<p><b>Using the mouse:</b> Click on the start step [A].</p> <p><b>Using the keyboard:</b> Press (<b>F10</b>).</p>
3	<p><b>Using the mouse:</b> Draw the link by clicking on the break points of the line [B] (change of direction) in the transition lines.</p> <p><b>Using the keyboard:</b> Draw the link using the arrow keys.</p>
4	<p><b>Using the mouse:</b> If the destination cell is empty, double click on the last break point or click again on the graphical object situated in the graphical palette to create the transition.</p> <p><b>Using the keyboard:</b> If the destination cell is empty, press (<b>F10</b>) again on the last break point to create the transition.</p>

### Notes:

The segment represented by a double line cannot be cut by another link.  
An AND convergence can only be entered from right to left.

**Carrying out a Step -> Transition link**

A step -> transition link starts with a step and goes to a transition.

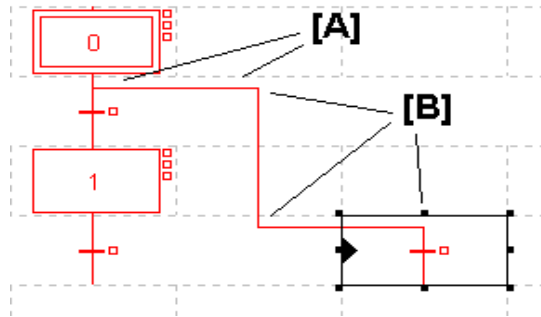

Carry out the following actions:

Step	Action
1	<p><b>Using the mouse:</b> Click on the graphical object situated in the graphical palette (<b>F8</b>).</p> <p><b>Using the keyboard:</b> Put the cursor on the start step or on the pre-existing step -&gt; transition link segment [A] (in the case of multiple link) using the arrows.</p>
2	<p><b>Using the mouse:</b> Click on the start step or on the pre-existing step -&gt; transition link segment [A] (in the case of a multiple link).</p> <p><b>Using the keyboard:</b> Press (<b>F8</b>).</p>
3	<p><b>Using the mouse:</b> Draw the link by clicking on the break points of the line [B] (change of direction) in the transition lines.</p> <p><b>Using the keyboard:</b> Draw the line using the arrow keys.</p>
4	<p><b>Using the mouse:</b> If the cell is empty, double click on the break point or click again on the graphical object situated in the graphical palette to create the transition.</p> <p><b>Using the keyboard:</b> If the destination cell is empty, press (<b>F8</b>) again on the last break point to create the transition.</p>

### Carrying out a Transition -> Step link.

A transition -> step link starts with a transition and goes to a step.

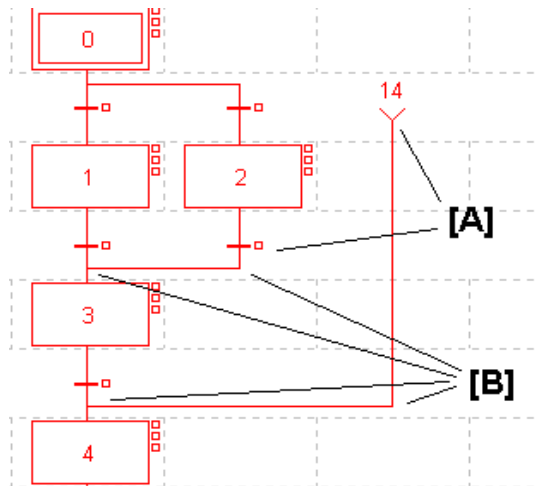

Carry out the following actions:

Step	Action
1	<p><b>Using the mouse:</b> Click on the graphical object situated in the graphical palette (F9).</p> <p><b>Using the keyboard:</b> Put the cursor on the start transition or the source connector using the arrow keys.</p>
2	<p><b>Using the mouse:</b> Click on the start transition or the source connector [A]</p> <p><b>Using the keyboard:</b> Press (F9).</p>
3	<p><b>Using the mouse:</b> Draw the link by clicking on the break points of the line [B] (change of direction) in the transition lines.</p> <p><b>Using the keyboard:</b> Draw the link using the arrow keys as far as the step or the destination connector.</p>
4	<p><b>Using the mouse:</b> If the destination cell is empty, double click on the last break point or click again on the graphical object situated in the graphical palette to create the step.</p> <p><b>Using the keyboard:</b> If the destination cell is empty, press (F9) again on the last break point to create the step.</p>
5	<p><b>Using the mouse or the keyboard:</b> Modify the step number if applicable, then confirm using ENTER.</p>

**Carrying out a loop iteration**

Two types of loop iteration are available to complete a chart:

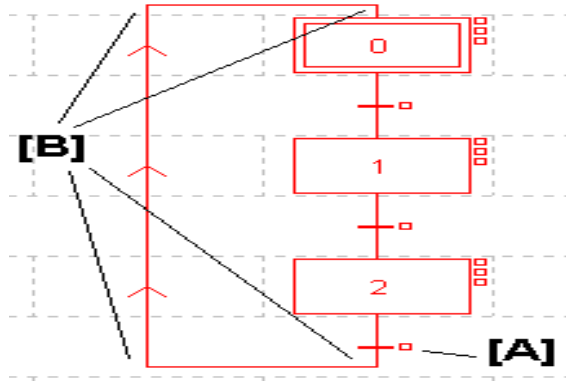

Using directed links:

Step	Action
1	<p><b>Using the mouse:</b> Click on the graphical object situated in the graphical palette (<b>F9</b>).</p> <p><b>Using the keyboard:</b> Put the cursor on the start transition <b>[A]</b> using the arrow keys.</p>
2	<p><b>Using the mouse:</b> Click on the end of chart transition <b>[A]</b>.</p> <p><b>Using the keyboard:</b> Press (<b>F9</b>).</p>
3	<p><b>Using the mouse:</b> Draw the link by clicking on the break points of the line <b>[B]</b> (change of direction) in the transition lines.</p> <p><b>Using the keyboard:</b> Draw the link using the arrow keys as far as the step or the destination connector.</p>
4	<p><b>Using the mouse:</b> Double click on the step to be linked or click again on the graphical object situated in the graphical palette to validate the object.</p>

Using connectors:

Step	Action
1	<p><b>Using the mouse:</b> Click on the graphical object situated in the graphical palette (<b>F5 or F7</b>)</p> <p><b>Using the keyboard:</b> Place the cursor in the required place.</p>
2	<p><b>Using the mouse:</b> Click on the grid at the required place.</p> <p><b>Using the keyboard:</b> Select the required graphical object by pressing (<b>F5 or F7</b>).</p>
3	<p><b>Using the mouse:</b> Complete the source or destination step number, then confirm using <b>ENTER</b>.</p> <p><b>Using the keyboard:</b> Complete the source or destination step number, then confirm using <b>ENTER</b></p>

Example of loop iteration using connectors:

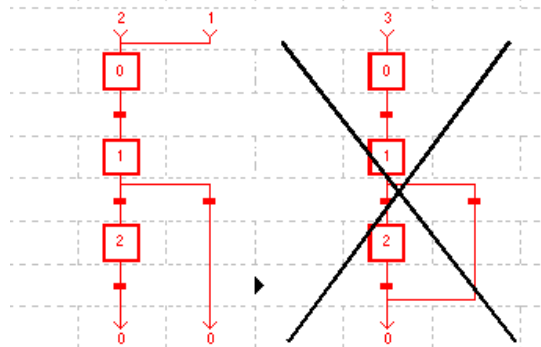

**Programming actions**

Carry out the following actions:

Step	Action
1	<p><b>Using the mouse:</b> Select the step with a right click.</p> <p><b>Using the keyboard:</b> Put the cursor on the step using the arrow keys, then confirm the selection by using the command (<b>Shift+F10</b>).</p>
2	<p><b>Using the mouse:</b> Select the type of action associated with the step (activation action, continuous action or deactivation action).</p> <p><b>Using the keyboard:</b> Use the arrow keys to select the type of action associated to the step that is to be modified, then confirm with <b>ENTER</b>.</p>
3	<p><b>Using the mouse:</b> Select the type of language:</p> <ul style="list-style-type: none"> <li>● ladder language <b>LD</b>,</li> <li>● instruction list language <b>IL</b>,</li> <li>● structured text language <b>ST</b>,</li> </ul> <p>and confirm with <b>OK</b></p> <p><b>Using the keyboard:</b> Select the type of language using the arrow keys:</p> <ul style="list-style-type: none"> <li>● ladder language <b>LD</b>,</li> <li>● instruction list language <b>IL</b>,</li> <li>● structured text language <b>ST</b></li> </ul> <p>and confirm with <b>OK</b>.</p>
4	Complete the programming.

---



## Programming the transition conditions

Carry out the following operations:

step	Action
1	<p><b>Using the mouse:</b> Select the transition with a right click.</p> <p><b>Using the keyboard:</b> Put the cursor on the transition using the arrow keys, then confirm the selection by using the <b>Service/Open</b> command.</p>
2	<p><b>Using the mouse:</b> Select <b>Open</b></p> <p><b>Using the keyboard:</b> Select the type of language using the arrow keys:</p> <ul style="list-style-type: none"> <li>● ladder language <b>LD</b>,</li> <li>● instruction list language <b>IL</b>,</li> <li>● structured text language <b>ST</b>,</li> </ul> <p>and confirm with <b>ENTER</b>.</p>
3	<p><b>Using the mouse:</b> Select the type of language:</p> <ul style="list-style-type: none"> <li>● ladder language <b>LD</b>,</li> <li>● instruction list language <b>IL</b>,</li> <li>● structured text language <b>ST</b></li> </ul> <p>and confirm with <b>OK</b></p> <p><b>Using the keyboard:</b> Complete the programming.</p>
4	<p><b>Using the mouse:</b> Complete the programming.</p>

### Limitations:

- in ladder language (**LD**) only the follow elements can be used:
  - test graphical elements: contacts (Bi, I/O, Ti, D...), comparison blocks,
  - action graphical elements: only "transition condition" coils (other coils not being relevant in this case).
- in instruction list language (**IL**) the following objects are prohibited:
  - no labels (%L),
  - no action instructions (bit objects, words or function blocks),
  - no jumps, sub-routine calls.
- in structured text language (ST) the following objects are prohibited:
  - no labels (%L),
  - no action statements, conditional statements or iterative statements,
  - no actions on bit objects,
  - no jumps, sub-routine calls,
  - no transfers, no action instructions on blocks.

**Entering comments**

Carry out the following actions:

Step	Action
1	<p><b>Using the mouse:</b> Click on the graphical object situated in the graphical palette .</p> <p><b>Using the keyboard:</b> Position the cursor on the grid at the required place (using the arrow keys).</p>
2	<p><b>Using the mouse:</b> Click on the grid at the required place.</p> <p><b>Using the keyboard:</b> Press the function key (<b>F12</b>).</p>
3	Enter the comment (access the second line using <b>(CTRL+ENTER)</b> ).
4	Confirm with <b>ENTER</b> .

**Notes:**

Comments are not mandatory.

They are stored on the PLC, as a consequence they take up memory.

---

## Modifying a Grafcet program

---

### Introduction

A Grafcet module (Graphic object, Step number, Macro-step (TSX 57 only), Comment), is modified in the same way as it is created.

Actions and transition conditions are modified in the same way as they are created.

---

### Rules for modifying a chart

A modification is authorized on any Grafcet page if:

- no other modification is in progress in the editor,
- no language editor is open on a transition condition or action module.

Modifications can only be entered on the page in the process of being modified (chart displayed in **red**).

Modifications can be only made in Offline or Online mode, with the PLC in STOP mode.

Modifications cannot be made:

- in step by step program,
  - when a breakpoint is set in the program.
-

**Modifying a graphic object, comment, step number or connector**

Carry out the following actions:

Step	Action
1	Put the cursor on the required Grafcet page (See <i>Structure of a Grafcet page, p. 217</i> ).
2	<b>Using the mouse:</b> Left double click on the element to be modified (the chart goes into modification mode, and is displayed in red). <b>Using the keyboard:</b> Put the cursor on the element to be modified.
3	<b>Using the mouse:</b> Make the modification. <b>Using the keyboard:</b> Press the space bar (the chart goes into modification mode, and is displayed in red).
4	<b>Using the mouse:</b> Confirm with <b>ENTER</b> . <b>Using the keyboard:</b> Make the modification.
5	<b>Using the keyboard:</b> Click on <b>ENTER</b> .

**Modifying a Macro-Step**

The procedure for modifying a macro-step or a macro-step number is the same as the procedure for modifying a step or a step number.

A macro-step can be accessed by selecting the macro-step in the application browser or by selecting the macro-step object in the Grafcet page.

---

**Modifying an action**

Carry out the following actions:

Step	Action
1	Put the cursor on the required Grafcet page (See <i>Structure of a Grafcet page, p. 217</i> ).
2	<b>Using the mouse:</b> Select the action to be modified by right clicking on the associated step. <b>Using the keyboard:</b> Using the arrow keys, put the cursor on the associated step then confirm the selection by using the <b>Service/Open</b> command.
3	<b>Using the mouse:</b> Select the type of action associated to the step that is to be modified. <b>Using the keyboard:</b> Use the arrow keys to select the type of action associated to the step that is to be modified, then confirm with <b>ENTER</b> .
4	Make the modification.

**Modifying a transition condition**

Carry out the following actions:

Step	Action
1	Put the cursor on the required Grafcet page (See <i>Structure of a Grafcet page</i> , p. 217).
2	<b>Using the mouse:</b> Select the transition condition to be modified by right clicking on the associated step. <b>Using the keyboard:</b> Using the arrow keys, put the cursor on the associated step then confirm the selection by using the <b>Service/Open</b> command.
3	<b>Using the mouse:</b> Select <b>Open</b> . <b>Using the keyboard:</b> Make the modification.
4	<b>Using the mouse:</b> Make the modification.

**Cut/Copy/Paste/Move one or more consecutive objects.**

These actions can be performed on graphic objects and any programs associated with them. They can be made in offline and online mode, with the PLC in Stop mode. Carry out the following actions:

To.....	you must...
<b>copy</b> one object or several consecutive objects	<ul style="list-style-type: none"> <li>1. Select the object or objects to be copied.</li> <li>2. Select <b>Copy</b> from the Edit menu or press <b>CTRL+C</b> (keyboard shortcut) and the Grafcet objects are placed on the Windows clipboard.</li> </ul>
<b>paste</b> one object or several consecutive objects from the clipboard	<ul style="list-style-type: none"> <li>1. Select the cell where the object or objects on the clipboard are going to be pasted.</li> <li>2. Select <b>Paste</b> from the Edit menu or press <b>CTRL+V</b> (keyboard shortcut) and the ghosted selection appears.</li> <li>3. Click on the ghost or press <b>ENTER</b> to make the pasted objects appear.</li> </ul>
<b>cut</b> (delete) one object or several consecutive objects and place them on the clipboard	<ul style="list-style-type: none"> <li>1. Select the object or objects to be cut.</li> <li>2. Select <b>Cut</b> from the Edit menu or press <b>CTRL+X</b> (keyboard shortcut) and the Grafcet objects are placed on the Windows clipboard.</li> </ul>
<b>move</b> one object or several consecutive objects	<ul style="list-style-type: none"> <li>1. Select the object or objects to be moved.</li> <li>2. According to your choice: <ul style="list-style-type: none"> <li>Left click (keeping the button held down) on the selected cell or cells then move the cursor towards the destination cell or cells.</li> <li>Select <b>Move</b> from the Edit menu or <b>CTRL+L</b> (keyboard shortcut) then using the arrow keys move the cursor towards the destination cell(s).</li> </ul> </li> </ul>

## Replacing a variable in the application

---

### At a Glance

Finding and replacing an application variable in the form of an address or a symbol (excluding variables used in runtime screens). Replacement in the application may be total or partial, automatic or manual.

Replacement concerns the variable indicated and its dependent objects (word extract bits etc.).



Exception: for Grafcet step bits the associated activity times (e.g. %Xi.T) are not replaced.

Replacement is carried out at the following levels:

- Application (in all tasks).
  - Tasks (MAST, FAST, Evti).
  - Complete section.
  - Partial section (from address i to address j).
  - Replacement is also carried out at functional module level (complete functional module, sub-modules included).
-

**Procedure**

Carry out the following actions:

Step	Action
1	Select the command <b>Tools/Replace variables</b> or position the cursor over the <b>Station</b> directory and select <b>Replace variables</b> from the contextual menu.
2	Indicate the variable to be replaced (as an address or a symbol) in the <b>Find</b> zone and confirm with <b>ENTER</b> or <b>TAB</b> .
3	Indicate the replacement variable (as an address or a symbol) in the <b>Replace</b> field and confirm with <b>ENTER</b> .
4	Select the view: <ul style="list-style-type: none"> <li>• Structure view </li> <li>• Function view </li> </ul>
5	Select one or more modules: <ul style="list-style-type: none"> <li>• if replacing throughout application, go to point 8,</li> <li>• if replacing in some of the modules, deselect all, select the modules, and go to point 6,</li> <li>• if replacing in one of the modules, deselect all and select the module, and go to point 6.</li> </ul>
6	Select the label (if LD, ST, IL) or the page (if G7) at the beginning of the replacement by positioning the pointer on the list <b>From</b> . If more precision is required, use the up and down arrow keys.
7	Select the label (if LD, ST, IL) or the page (if G7) at the end of the replacement by positioning the pointer on the list <b>To</b> . If more precision is required, use the up and down arrow keys.
8	Select the type of replacement: <ul style="list-style-type: none"> <li>• if <b>Next</b>, the replacement is carried out occurrence by occurrence,</li> <li>• if <b>Replace All</b>, the replacement is carried out on all occurrences.</li> </ul> <b>Notes:</b> <ul style="list-style-type: none"> <li>• The status bar indicates the number of replacements carried out, and a report on the replacements not carried out.</li> <li>• The <b>ESC</b> key is used to abort the function <b>Replace</b>, but the replacements already carried out are retained.</li> </ul>

## Cross Referencing a variable in an application

---

### Introduction

This function allows you to locate in the application:

- variables in the form of labels or symbols (except those used in operating screens),
- DFB types (only on Premium with PI7 Junior and Pro),
- DFB instances (only on Premium with PI7 Junior and Pro),
- and to open modules/tasks/DFB types.

### Principals of using debugging

The user realizes that the variable X is not the right value. To identify the cause he must therefore:

- find the places where this variable is used,
- obtain a list of statements, rungs and expressions,
- to display and verify the activation conditions of the variable.

**Note:**

In order to record the path of this search, the list elements thus visited are marked with an asterisk (\*).

### Operational mode for objects

A variable can be a read variable (**R**), a write variable (**W**) or a read/write variable (**R/W**).

- "**R**" groups together the read operational modes, indexed read, indexed word, input or input/output parameter of a indexed or non-indexed function.

- "**W**" groups together the write operational modes, indexed write, output or input/output parameter of indexed or non-indexed function and execution of Block Functions (SFB and DFB).

---



**Search source variables**

Table of variables:

<b>Bit</b>	%Ixi; %QXi; %Mi; %Si
<b>Word</b>	% MWi; %MDi; %MFi; %KBi; %KWi; %KDi; KFi; %MBi; %SWi; %QWi; %QDi; %IW; %IDi; %NWi
<b>Instruction</b>	SRI; HALT

Other retrievable variables:

Byte variables
Word extract bits
Bit table
Grafcet bit table
Character string
Table of words and constants
Table of double words and constants
Constant character string
Standard Block Function
Standard Block Function element
Step status
Step activity time
Manet variables

**Search options** For an indexed variable, the variable and the index are taken into account in the list.

Table of options:

<b>Extract Bit</b>	This option is for variables of types %MW, %KW, %IW, %NW, %QW. It adds to the list the variable and the referenced bits.
<b>Table Object</b>	This option is for bit tables, word tables and immediate indexed variables. It adds to the list the immediate indexed table variables whose first element is the input variable.
<b>Channel Object</b>	This option is for channel objects. It adds to the list all the objects of the same referenced channel, including the tables and the extract bits.
<b>Network Objects</b>	This option is for the network variables. It allows you to obtain all the variables from the same remote module (nanet object).
<b>FB Object</b>	This option allows you to expand the list of SFB block function elements and the DFB type elements.
<b>FB Instance</b>	Only on Premium with PL7 Junior and Pro. This option is for DFB types. It allows you to obtain from the name of a DFB type the sections using its instances.

**Searching for cross references**

Carry out the following actions:

Step	Action
1	Select the icon 
2	Enter the search <b>source variable</b> as an address or a symbol (E.g. %M10) and the possible <b>options</b> then confirm via <b>Search</b> .
3	To display a module, select the module, via the <b>Contextual</b> menu, select <b>Open</b> or double click on the module.

**Selecting a variable from the list:**

- Select the variable from the list, the list of tasks, modules, labels is updated.

**Deleting a variable from the list:**

- Select the variable, enable the contextual menu (right click) then click on **Delete**.

**Displaying in structural view or in functional view:**

- Use the **View** menu or the **Function** button.

## Animation of Grafcet program elements

---

### At a Glance

Refer to the "**Debugging**" Chapter of the Part "**Debugging, Adjustment, Documentation and Appendices**"-> (see *Animating program elements*, p. 309).

---

## Printing of a program

---

### Procedure

Carry out the following steps:

Step	Action
1	Open the module with <b>right click + Open</b> or a <b>double click</b> .
2	Select the command <b>File/Print (Ctrl+P)</b> or click on the icon 
3	Select a print range: <ul style="list-style-type: none"><li>• if, the whole module, then go to step 6.</li><li>• if for part of a module, go to step 4.</li></ul>
4	Select %Li/TOP/BOTTOM (if LD, ST, IL) or <b>start</b> page (if G7). If more precision is required, use the up and down arrow keys.
5	Select %Li/TOP/BOTTOM (if LD, ST, IL) or <b>end</b> page (if G7). If more precision is required, use the up and down arrow keys.
6	Confirm with <b>OK</b> or <b>ENTER</b> .

### Notes

The print type depends on the type of display selected in the **View** menu.

- **Addresses:** prints variables with addresses,
  - **Symbols:** prints variables with symbols,
  - **Symbols&Addresses:** prints variables with symbols/addresses.
-

## Export/Import of source files

---

Refer to the "**Import/Export**" (See *Import/Export*, p. 365) chapter within "**Debugging, Adjustment, Documentation and Appendices**".

---



---

# Editing variables

# 10

---

## Introduction

### Subject of this chapter

This chapter describes how to use the variables editor.

### What's in this Chapter?

This chapter contains the following topics:

Topic	Page
Accessing the variables editor	248
Input/Modification/Suppression of symbols and comments	249
Objects associated with a variable	251
Presymbolization	252
Sorting variables by symbols or addresses	254
Displaying variables in the editor	255
Cutting/Copying/Pasting variables in a variables editor	257
Entering/Modifying constants	258
Parametrizing predefined function blocks (FB)	259
Printing variables	263
Exporting/Importing variables	264

---

## Accessing the variables editor

---

### Introduction

The editor allows the input/modification/display of all the variables with their parameters and attributes.

---

### Accessing the editor

Carry out the following:

Step	Action
1	Open the application browser and on the repertoire select <b>Variables</b> menu <b>Edit/Select</b> .
2	Left click on the directory <b>Variables</b> .
3	Open the editor on the type of variables required with a double left click or via the <b>Open contextual menu</b> or by pressing <b>ENTER</b> .

---



## Input/Modification/Suppression of symbols and comments

### Introduction

The variables editor allows the **input/modification/display/suppression** of all the variables with their parameters and attributes.

### Input/ Modification procedure

Carry out the following:

Step	Action
1	Open the application browser.
2	Double left click on the <b>Variables directory</b> or select this and then press the <b>right arrow</b> .
3	Select the variable type: <ul style="list-style-type: none"> <li>● MEMORY OBJECTS,</li> <li>● SYSTEM OBJECTS,</li> <li>● CONSTANTS,</li> <li>● GRAFCET OBJECTS,</li> <li>● PRE-DEFINED FB,</li> <li>● I/O,</li> <li>● DFB INSTANCES (only on Premium TSX with Junior and Pro PL7)</li> </ul>
4	Select the variable format: <ul style="list-style-type: none"> <li>● EBOOL (bit): example %M1,</li> <li>● BYTE (octet): example %MB25,</li> <li>● WORD (16 bit word): example %MW0,</li> <li>● DWORD (32 bit word): example %MD2,</li> <li>● REAL (real 32 bit word): example %MF14,</li> <li>● CHART: example: %X0,</li> <li>● Macro module: example %XM0 (only Premium TSX with Junior and Pro PL7,</li> <li>● FB: example %TM0,</li> <li>● DFB type: example: Day_counter (only Premium TSX with Junior and Pro PL7).</li> </ul> With inputs/outputs select the module position: <ul style="list-style-type: none"> <li>● I/O: 0...710,</li> <li>● FIP: \adrUC.channel no. Point of connection no.\ module no.</li> </ul>
5	Select the variable to be informed and make the entry: <ul style="list-style-type: none"> <li>● either directly into the symbol and comments field,</li> <li>● or in an entry field (accessed by clicking on the entry field option).</li> </ul>
6	Enter the symbol and press <b>ENTER</b> .
7	Enter the comment and press <b>ENTER</b> .

**Select the whole line**

Click on the rectangle to the left of the variable address or press the keys **(SHIFT+SPACE)**.

---

**Suppression procedure**

Carry out the following actions:

Step	Action
1	Select the symbol, the comment or the whole line with the <b>(Shift+Space) keys</b> or left click on the line.
2	Select the command <b>Edit/Suppress</b> or press the <b>Del</b> key.

---

---

## Objects associated with a variable

---

### Procedure

In the variables editor, if the variable is preceded by the symbol "+", in order to know which objects are associated with the variable you must:

Step	Action
1	In the variables editor select the type of variables you require.
2	Select the command <b>View/Variables sorted by address</b> if the display is in symbols.
3	Select the variable.
4	Select the command <b>Edit/Expand</b> or double click on the "+", the list of all the objects (bits, words..) associated with the variable is displayed.
5	To close the list of objects associated with the variable, select the command <b>Edit/Contract</b> or double click on the "-" associated with the variable.

---

## Presymbolization

---

### Introduction

Presymbolization allows automatic association of **constructive suffixes** for a channel level (%Chxy.i) module language object with **prefixes** defined by the user.

The **prefix** defined by the user is the generic symbol given to the %Chxy.i channel (12 characters maximum).

The constructive **suffix** is the part of the symbol which corresponds to the bit object or %Chxy.i channel word (20 characters maximum).

The presymbolization function automatically generates a constructive comment. This succinctly reminds you of the role of the object.

---

### Setting up

Carry out the following actions:

Step	Action
1	Open the variables editor (See <i>Accessing the variables editor, p. 248</i> ). In the I/O variable <b>type</b> .
2	Double left click on the "T" associated with the channel object that is to be symbolized or position yourself on the channel object and select the <b>Edit/Presymbolize command</b> .
3	<p>Three illustrations can be displayed:</p> <ul style="list-style-type: none"> <li>● <b>The channel object is not symbolized.</b> <ul style="list-style-type: none"> <li>● Enter the prefix.</li> </ul> </li> <li>● <b>The channel object is already symbolized (symbol of less than 12 characters).</b> <ul style="list-style-type: none"> <li>● If necessary modify the prefix.</li> </ul> </li> <li>● <b>The channel object is already symbolized (symbol of more than 12 characters).</b> <p>A dialogue box shows:</p> <ul style="list-style-type: none"> <li>● the actual channel symbol.</li> <li>● the prefix used (limited to 12 characters).</li> </ul> <p>If necessary modify the prefix.</p> </li> </ul>

---

**Suppressing  
presym-  
bolization**

Cancelling presymbolization for a given logic channel is done to suppress all the object symbols described in the presymbolization file.  
Carry out the following actions:

Actions	Step
1	Double left click on the "T" associated with the channel object that is to be symbolized or position yourself on the channel object and select the <b>Edit/Presymbolize command</b> .
2	Only two options are suggested: <ul style="list-style-type: none"><li data-bbox="456 423 1221 508">● <b>Erase all presymbols.</b> No prefix is chosen, all the symbols are erased (including those which the user would have modified directly in the editor).</li><li data-bbox="456 508 1221 594">● <b>Erase the prefixed presymbols.</b> The user indicates the prefix (example ANA) of the symbols to be erased: in this case only the symbols of objects with the entered prefix are erased.</li></ul>

## Sorting variables by symbols or addresses

---

### Procedure

To classify variables in:

- ascending order of address numbers, select the command **View/Variables sorted by addresses**.  
In the case of I/Os, the variables are classified according to the type of module configured.
  - alphanumeric order of symbols, select the command **View/Variables sorted by symbols**.
-

## Displaying variables in the editor

### Displaying variables used in the application

The variables used in the application (sections, subroutines, sequential tasks) are viewed in **bold characters** in the variables editor.

For this, input the **Options\Variables editor\Usage in the application** command before opening the variables editor.

#### Example:

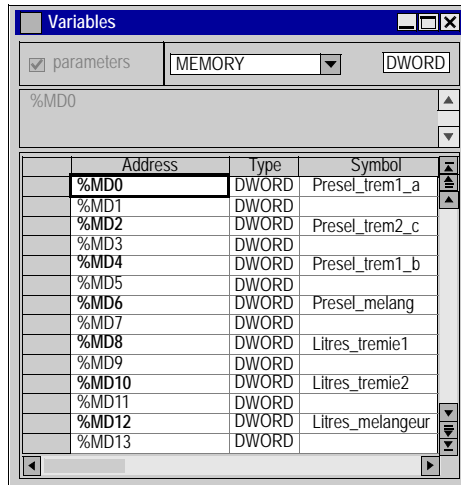

### Display of variables with overlapping

Overlapping is possible on the following variables:

- %MB,
- %MW,
- %MD,
- %MF,
- %KB,
- %KW,
- %KD,
- %MF.

#### Example:

If %MW1 is used in the application, the overlapping is effective for:

- %MD1,
- %MF1,
- %MB2,
- %MB3.

The overlapping is represented by displaying the variables in **red characters** and it is managed providing that:

- the variables are used in the application program (Sections, subroutines, events),
- the **Options\Variables editor\Overlapping** command has been selected before opening the variables editor.

**Example:**

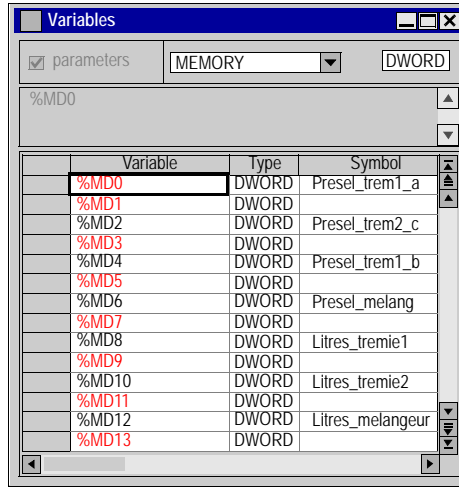

Simultaneous display of the variables used in the application with overlapping is possible by selecting the commands:

- **Options\Variables editor\Overlapping,**
- **Options\Variables editor\Usage in the application.**

**Example:**

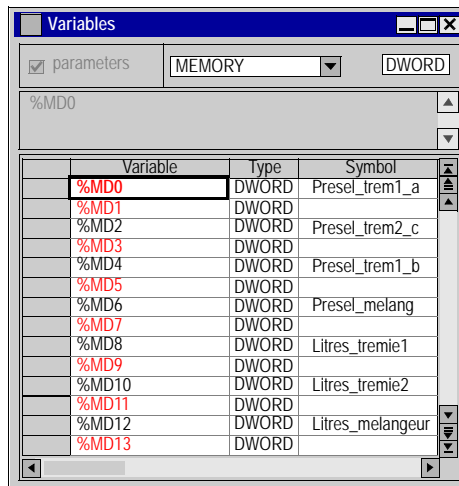



## Cutting/Copying/Pasting variables in a variables editor

### Introduction

PL7 gives the option of **Cutting** or **Pasting** a selection of variables, within the variables editor.

### How to Copy/ Paste a block of variables in a variables editor

Carry out the following steps:

Step	Action
1	Select a block of variables by clicking and dragging from the first variable of the block through the whole block, keeping the <b>Shift</b> key held down, in the far left hand column of the variables editor.
2	Right click on the selection (contextual menu) and select <b>Copy</b> .
3	Place the cursor on the first variable in the block where the copied variables are to be pasted.
4	Right click (contextual menu) and select <b>Paste</b> . <b>Result:</b> the following window appears.

Please modify all symbols before confirming

Address	Symbol	Comment
%M56	Trig_sect_remp	Validation condition
%M57	Trig_sect_vidan_mix_a	Validation condition

All the variables duplicated in this way should be renamed before you **Paste** them.

### How to Cut/Paste a block of variables in a variables editor

Carry out the following steps:

Step	Action
1	Select a block of variables by clicking and dragging from the first variable of the block through the whole block, keeping the <b>SHIFT</b> key held down, in the far left hand column of the variables editor.
2	Right click (contextual menu) on the selection and select <b>Cut</b> .
3	Place the cursor on the first variable in the block where you want to paste the copied variables.
4	Right click (contextual menu) and select <b>Paste</b> .

## Entering/Modifying constants

---

### Introduction

The variables editor is used to **enter/modify/display** all the variables with their parameters and attributes.

---

### Procedure

Carry out the following operations:

Step	Action
1	Open the application browser.
2	Double left click on the <b>Variables repertoire</b> or select this with the arrows and then press the right arrow.
3	Select the " <b>CONSTANTS</b> " variable type.
4	Select the variable format: <ul style="list-style-type: none"> <li>● BYTE (octet): example %KB26,</li> <li>● WORD (16 bit constant): example %KW0,</li> <li>● DWORD (32 bit constant): example %KD2,</li> <li>● REAL (real 32 bit word): example %KF14.</li> </ul>
5	Select the variable to be informed: example: %KW0.
6	Enter the symbol and press ENTER.
7	Enter the comment and press ENTER.
8	Select the <b>Parameters</b> option.
9	Select the <b>entry/display</b> base (optional):
10	Enter the value and press <b>ENTER</b> . The syntax of the value automatically updates the associated base (e.g.: if 16#AA is entered -> the base goes to hexadecimal). <b>In the case of %KB messages:</b> <ul style="list-style-type: none"> <li>● enter the chain of characters in quotes then press ENTER (e.g.: "Number of parts"),</li> <li>● To modify a message, select the %KB byte with the base '<b>Begin Mess.</b>'.</li> </ul>
11	Deselect the parameter option to close the parameter entry window.

---

## Parametrizing predefined function blocks (FB)

### Introduction

The predefined function blocks are:

- %TMI timer FB,
- %Ti Series 7 timer FB,
- %MNI Monostable FB.
- %Ci Counter/down counter FB,
- %Ri Register FB,
- %DRi Drum FB.

The %Ti, %MNI and %DRi FBs must be declared in advance in software configuration.

The editor is used to **enter/modify/display** all the variables with their parameters and attributes.

### Procedure

Carry out the following actions:

Step	Action
1	Open the application browser.
2	Double left click on the <b>Variables</b> repertoire or select this with the arrows and then press the right arrow.
3	Select the type: <b>PRE-DEFINED FB</b> .
4	Select the type of FB to be parametrized: <ul style="list-style-type: none"> <li>● Parametrizing %TMI (See <i>Parametrizing %TMI</i>, p. 260),</li> <li>● Parametrizing %Ti (See <i>Parametrizing the %Ti</i>, p. 260),</li> <li>● Parametrizing %MNI (See <i>Parametrizing the %MNI</i>, p. 260),</li> <li>● Parametrizing %Ci (See <i>Parametrizing the %Ci</i>, p. 261),</li> <li>● Parametrizing %Ri (See <i>Parametrizing the %Ri</i>, p. 261),</li> <li>● Parametrizing %DRi (See <i>Parametrizing the %DRi</i>, p. 261),</li> </ul>

**Parametrizing  
%TMi**

Carry out the following actions:

Step	Action
1	Select the variable to be informed (e.g.: %TM0).
2	Enter the symbol and press ENTER.
3	Enter the comment and press ENTER.
4	Select the " <b>parameters</b> " option.
5	Enter the <b>PRESET</b> value (%Tmi.P: 0 to 999) and press ENTER.
6	Select the operating mode of the block: <b>TP,TON,TOF</b> .
7	Select the value of the time base <b>TB</b> .
8	Select the <b>Reg</b> option depending on the case (Adjusting by terminal).

---

**Parametrizing  
the %Ti**

Carry out the following actions:

Step	Action
1	Select the variable to be informed (e.g.: %T0).
2	Enter the symbol and press ENTER.
3	Enter the comment and press ENTER.
4	Select the " <b>parameters</b> " option.
5	Enter the <b>PRESET</b> value (%Ti.P) and press ENTER.
6	Select the value of the time base <b>TB</b> .
7	Select the <b>Reg</b> option depending on the case (Adjusting by terminal).

---

**Parametrizing  
the %Mni**

Carry out the following actions:

Step	Action
1	Select the variable to be informed (e.g.: %MN0).
2	Enter the symbol and press ENTER.
3	Enter the comment and press ENTER.
4	Select the " <b>parameters</b> " option.
5	Enter the <b>PRESET</b> value (%Mni.P) and press ENTER.
6	Select the value of the time base <b>TB</b> .
7	Select the <b>Reg</b> option depending on the case (Adjusting by terminal).

---

**Parametrizing  
the %Ci**

Carry out the following actions:

Step	Action
1	Select the variable to be informed (e.g.: %C0).
2	Enter the symbol and press ENTER.
3	Enter the comment and press ENTER.
4	Select the " <b>parameters</b> " option.
5	Enter the <b>PRESET</b> value (%Ci.P) and press ENTER.
6	Select the <b>Reg</b> option depending on the case (Adjusting by terminal).

**Parametrizing  
the %Ri**

Carry out the following actions:

Step	Action
1	Select the variable to be informed (e.g.: %R0).
2	Enter the symbol and press ENTER.
3	Enter the comment and press ENTER.
4	Select the " <b>parameters</b> " option.
5	The length (1<LEN<255) of the registers can be modified in the software configuration.
6	Select the operating mode of the block: <b>LIFO,FIFO</b> .

**Parametrizing  
the %DRi**

Carry out the following actions:

Step	Action
1	Select the variable to be informed (e.g.: %DR0).
2	Enter the symbol and press ENTER.
3	Enter the comment and press ENTER.
4	Select the " <b>parameters</b> " option.
5	Select the number of steps <b>NB (1 to16)</b> .
6	Select the value of the time base <b>TB</b> .
7	Select the <b>STEPS field</b> to define the bit status for each step. 1. Allocate a variable %Qi.j or %Mi to each bit. 2. Show the value of variable for each step by clicking on the value 0 or 1 (flip flop).

**Cop/Paste the pre-defined function block parameters**

This function is used to **Copy/Paste** the parameters of one function block into one or more other function blocks of the same family to avoid tiresome entering.

Carry out the following actions:

Step	Actions
1	From the variables editor select the <b>PRE-DEFINED FB</b> type.
2	Select the desired FB family.
3	Select the FB to be copied by clicking to the left of the name (the line goes to reverse video).
4	Select the <b>Edit\Copy SFB parameters</b> command or, using the contextual menu <b>Copy SFB parameters</b> .
5	Select the target FB(s) by: <ul style="list-style-type: none"> <li>● clicking to the left of the name (for one FB),</li> <li>● clicking to the left of the name + pressing the Shift key, and move the mouse up or down (for several FBs).</li> </ul>
6	Select the <b>Edit\Paste SFB parameters</b> command or, using the contextual menu <b>Paste SFB parameters</b> .

Note:

The **Paste** function can only be done with consecutive objects.

---

---

## Printing variables

---

**Introduction** This heading is use to print the list(s) of variables with their parameters.

---

**Procedure** Carry out the following actions:

Step	Action
1	In the variables editor select the type of variables you require.
2	Select the ascending order of printing with the command <b>View</b> → <b>Variables sorted by address</b> or <b>View</b> → <b>Variables sorted by symbols</b> .
3	Configure printing using the command <b>File</b> → <b>Configuring printing</b> .
4	Select the command <b>File</b> → <b>Print</b> .
4	Select: <ul style="list-style-type: none"><li>● <b>"All"</b> to print all the variables configured in the application with the various parameters.</li><li>● <b>"Current type"</b> to print the variables of the selected type.</li></ul>
5	Confirm printing with <b>OK</b> .

---

## Exporting/Importing variables

---

Refer to the "**Debugging, adjusting, documentation and appendix**" part chapter heading "**Importing and exporting**":

- See: *Exporting variables*, p. 381.
  - See: *Importing variables*, p. 382.
-



---

# Function modules

# 11

---

## Presentation

### Subject of this chapter

This chapter describes the function modules.

### What's in this Chapter?

This chapter contains the following topics:

Topic	Page
Function modules	266
Properties of a function module	267
Creating a functional module	268
Programming a functional module	269
Debugging a functional module	270
Detaching/Deleting a functional module	271
Export of a functional module	274
Importing a functional module	275
Creating, deleting, moving, dragging and dropping an animation table in a functional module	276

---

## Function modules

---

### Definition

- A function module is a group of program elements (sections, sub-programs, macro steps, animation tables, operating screens...) used to carry out a PL7 function.
  - A function module can itself be broken down into lower level function modules. In relation to the principle function these modules assume one or more PL7 sub-functions.
- 

### Attributes of a function module

A function module is composed of:

- **a short name** : 8 characters (e.g.: TR371), this name must be unique in the application,
  - **a long name** : 16 characters (e.g.: Continue/Withdraw for BT371),
  - **function sub-modules** : these are lower level function modules,
  - **associated program code modules**. sections, events, grafcet module (PrI, Chart, macro steps Xm, Post),
  - **a descriptive form** (with no maximum number of characters), stored in the PL7,
  - **associated animation tables,**
  - **operating screens.**
-

---

## Properties of a function module

---

### Properties to be defined

List of different properties to be defined:

- the short name: composed of 8 characters (e.g.: TR371), this name must be unique in the application,
  - the optional long name composed of 16 characters (e.g.: Continue/Withdraw for BT371),
  - the optional descriptive form stored in the PL7.
- 

### How to display or modify the properties

Carry out the following steps:

Step	Action
1	Right click on the function module, in the <b>Function view</b> of the <b>Application browser</b> .
2	Click on <b>Properties</b> .
2	Carry out the modifications.
3	Click on <b>OK</b> .

**Note:** The **Apply** button confirms the modifications without closing the window.

---

## Creating a functional module

---

### At a Glance

A functional module can be created offline, with the PLC in **Stop** or in **Run**.

It can be created at Station level or at the level of each existing functional module.

---

### How to create a functional module

Carry out the following actions:

Step	Action
1	From the functional view, right click on the <b>Station</b> directory, or on the directory of an existing functional module, or place the cursor on this directory and then press <b>Shift+F10</b> .
2	Select <b>Create</b> .
3	Fill in the short name, the long name, the comment and confirm with <b>OK</b> .

---

### How to create a lower level functional module

Carry out the following actions:

Step	Action
1	Right click on the "higher level" module or position the cursor on it and press Shift + F10.
2	Select <b>Create</b> .
3	Fill in the short name, the long name, the comment and confirm with <b>OK</b> .

---

### Moving a functional module

A functional module can be moved offline, with the PLC in **Stop** or in **Run** (this has no effect on the execution of the application). The movement only corresponds to a modification in the functional architecture of the application (a module is linked directly to the **Station** directory level or to another functional module).

To move a functional module:

Step	Action
1	Left click (keeping the button held down) on the module to be moved,
2	Move the module to the desired position.

---

## Programming a functional module

### Introduction to programming a functional module

A functional module has **aprogram** directory which may contain:

- LD, ST, or IL sections,
- events,
- of a Chart, Prl, Post, Macro-Steps module.

Several scenarios are possible during functional module programming:

- **1st scenario:** the section, event and graph already exist in structure view (See *Introducing the application browser, p. 120*),
- **2nd scenario:** the section, event, and graph are created from function view (See *Introducing the application browser, p. 120*),
- **3rd scenario:** the section, event and graph must be created from structure view.

### 1st scenario: the section, event and graph already exist in structure view,

The section has already been created in structure view;

Step	Action
1	Select the section.
2	Move the section to the functional module.

### 2nd scenario: creating the section, event, or graph from function view

The principle is the same as for creating a section from structure view:

Step	Action
1	Right click on the <b>Program directory</b> or place the cursor on the Program directory and then press <b>Shift+F10</b> ,
2	Select Create,
3	Select the Section, Event or Macro step tab,
4	Fill in the various headings in the same way as for creating a section from the structure view. The name of the function module is stored at the structure view level.

### Rules

Take the following rules into account:

1	A Grafcet section can only be created offline and only in the <b>Mast</b> task.
2	A macro step or an event can only be created offline.
3	The other actions can be carried out offline, with the PLC in <b>Stop</b> or in <b>Run</b> .
4	Module protection applies to all sections linked to the functional module.

## Debugging a functional module

---

### At a Glance

The organization of a functional module and the distribution of sections events and Grafcet modules in the different modules has no effect on the execution of the program. The program is executed in the order shown in the structure view. To debug a functional module there are:

- standard debugging functions,
  - additional functions allowing incremental debugging of the application, functional module by functional module.
- 

### Deactivating all sections linked to a functional module

This function is used to **force to 0** all the execution conditions of the module sections.

Step	Action
1	Select the functional module.
2	From the contextual menu, select the <b>Activation condition for the included sections -&gt; Force to 0</b> command.

---

### Activating all sections linked to a functional module

This action is used to **force to 1** all the execution conditions of the module sections.

Step	Action
1	Select the functional module.
2	From the contextual menu, select the <b>Activation condition for the included sections -&gt; Force to 1</b> command.

---

### Canceling the forcing of all sections linked to a functional module

This action is used to **unforce** all the execution conditions of the module sections.

Step	Action
1	Select the functional module.
2	From the contextual menu, select the <b>Activation condition for the included sections -&gt; Unforce</b> command.

---

## Detaching/Deleting a functional module

### Detaching one or more functional module(s)

Detaching a functional module involves severing the links between a functional module and the associated objects (code modules and animation tables),

- the sections contained in the module are not deleted, only detached,
- the animation tables associated with the modules are not deleted but only detached from the module.

To detach one or more of the functional modules, carry out the following steps:

Step	Action
1	Select the corresponding Station, Functional module, Program, Section, Event, or Animation Table directory in the <b>Function View</b> of the <b>Application Browser</b> .
2	Select the <b>Detach</b> or <b>Detach All Included Elements</b> contextual menu.
3	Confirm with <b>Yes</b> .

**Note:** this action is allowed in offline and in online mode, with the PLC in **Stop** or in **Run**.

### Introduction to deleting a functional module

There are several different ways of deleting:

- deleting one or more functional modules without deleting the code modules and the animation tables,
- deleting a functional module and deleting the code modules and animation tables,
- deleting all the functional modules and deleting the code modules and animation tables,
- deleting a section, a macro-step or an event in a functional module.

### Deleting one or more functional modules without deleting the code modules and animation tables

To delete a functional module without deleting the code modules and animation tables, you must:

Step	Action
1	Detach the module and its sub-modules.
2	Delete the module or modules by right clicking (contextual menu) and selecting <b>Delete</b> .
	<b>Note:</b> you must be in <b>offline</b> mode.

**Deleting a functional module and deleting the modules and animation tables**

	<b>CAUTION</b>
	<p>Deleting the module entails deleting the submodules.</p> <ul style="list-style-type: none"> <li>- the sections contained in the module are deleted,</li> <li>- the animation tables associated with the module are deleted.</li> </ul> <p>Failure to follow this precaution can result in injury or equipment damage.</p>

Carry out the following actions:

Step	Action
1	Select the module.
2	Select <b>Delete</b> .
3	Confirm with <b>Yes</b> .

**Note:** this action is authorized in offline mode, with the PLC in **Stop** and is not authorized in **Run**.

**Deleting all the functional modules and deleting the code modules and animation tables**

	<b>CAUTION</b>
	<p>Deleting the module entails deleting the submodules.</p> <ul style="list-style-type: none"> <li>- the sections contained in the modules are deleted,</li> <li>- the animation tables associated with the modules are deleted.</li> </ul> <p>Failure to follow this precaution can result in injury or equipment damage.</p>

Carry out the following actions:

Step	Action
1	Select the Station directory.
2	Select <b>Delete All Functional Modules</b> .
3	Confirm with <b>Yes</b> .

**Note:** this action is authorized in offline mode, with the PLC in **Stop** and is not authorized in **Run**.



### Deleting a section, a macro-step or an event in a functional module

	<b>CAUTION</b>
	<p>A section or a macro-step can be deleted in a functional module. They are then deleted in the module and in the associated task. Deleting an event only results in it being detached from the functional module because an event cannot be deleted from the application.</p> <p><b>Failure to follow this precaution can result in injury or equipment damage.</b></p>

Carry out the following actions:

Step	Action
1	Select the desired section.
2	Select <b>Delete</b> .
3	Confirm with <b>Yes</b> .

### Rules

Please observe the following rules

1	Deletion is authorized in offline mode with the PLC in <b>Stop</b> , but it is not authorized in <b>Run</b> .
2	A Grafcet section or a macro-step can only be deleted in offline mode.
3	A <b>PRL</b> , <b>Chart</b> or <b>POST</b> module cannot be deleted, only detached.

## Export of a functional module

---

### Exporting a functional module

See *Exporting a functional module*, p. 386 from the section "**Debugging, Documentation and Annexes**" chapter "**Import/Export**"

---

## Importing a functional module

---

### Importing a functional module

See *Importing a functional module*, p. 388 from the section "**Debugging, Adjustment, Documentation and Annexes**" chapter "**Import/Export**".

---

## Creating, deleting, moving, dragging and dropping an animation table in a functional module

### Introduction

In a functional module, you can create, delete, move and drag and drop the animation table.

### Creating an animation table

Steps to follow:

If the table...	Then...
already exists	<ul style="list-style-type: none"> <li>select the animation table,</li> <li>move the animation table to a functional module on the <b>Animation table</b> directory's level.</li> </ul>
is to be created via the function view	<ul style="list-style-type: none"> <li>right mouse click on the module's <b>Animation table</b> directory or put the cursor on this and press Shift+F10,</li> <li>select <b>Create</b>.</li> </ul>
is to be created via the structure view	it is also necessary that you specify the functional module it is to be associated with.

### Deleting an animation table

Carry out the following actions:

Step	Action
1	Select the table.
2	Select the <b>Delete</b> contextual menu.

### Moving an animation table

Steps to follow:

If using...	Then...
the drag and drop function	<ul style="list-style-type: none"> <li>left mouse click (and hold the mouse button down) on the table to be moved,</li> <li>move the table to the desired place.</li> </ul>
the Properties contextual menu	<ul style="list-style-type: none"> <li>select the table,</li> <li>select the <b>Properties</b> contextual menu.</li> <li>select the module's name in the localization zone.</li> </ul>

**Detaching an animation table**

Steps to follow:

If using the...	Then...
Detach contextual menu	<ul style="list-style-type: none"><li>● select the animation table,</li><li>● select the contextual menu,</li><li>● confirm with <b>Yes</b>.</li></ul>
Properties contextual menu	<ul style="list-style-type: none"><li>● select the table,</li><li>● select the <b>Properties</b> contextual menu.</li><li>● select "none" in the localization zone.</li></ul>



---

# DFB function blocks

12

---

## Presentation

### Subject of this chapter

This chapter describes how to set up DFB function blocks.

### What's in this Chapter?

This chapter contains the following topics:

Topic	Page
DFB types	280
Creating a DFB type	282
Programming a DFB type	283
DFB type instance	287
Running a DFB instance	289
Entering a DFB instance	290
How to protect a DFB	291
How to Import/Export a DFB type or an application containing DFB types	293

## DFB types

---

### At a Glance

DFB types (Derived Function Block) are function blocks which can be programmed by the user in Structured Text or Ladder language.

These DFBs are used in an application to:

- simplify program design and entry,
- improve program readability,
- facilitate debugging (all variables manipulated by the DFB type are identified on its interface),
- reduce the volume of code generated (the code corresponding to the DFB is only loaded once, regardless of the number of calls to the DFB).

**PL7 Pro** software is needed to create a DFB type.

A DFB type can be used with **PL7 Pro** or **PL7 Junior** on a **TSX/PCX/PMX 57** type PLC.

A DFB type is called in an editor (LD, IL or ST) via an **Instance** of the DFB type that is the image of the DFB type.

A DFB type instance can be used several times in a single application.

---



---

## How to gain access to the DFB types' properties

Carry out the following actions:

Step	Action
1	Select the <b>DFB Type</b> directory in the application browser.
2	From the contextual menu select the <b>Properties</b> command.

The properties of a DFB type can be accessed by two tabs:

- The "**General**" tab which gives the following information:
    - version,
    - date of last modification,
    - programming language used,
    - protection.
  
  - The "**Information**" tab which gives the following information:
    - number of elements (Inputs, Outputs, Inputs/Outputs, etc.),
    - size of data,
    - number of instances used in the application.
-

## Creating a DFB type

---

- Presentation** A DFB type can be made up in several steps:
- creating the DFB type (empty structure),
  - DFB type parameters,
  - DFB type programming (Code).
- 

**Creating the DFB type** Carry out the following actions:

Step	Action
1	<b>Open the application browser.</b>
2	Right click with the mouse on the <b>DFB type</b> directory and select <b>Create</b> from the context-sensitive menu.
3	Enter the name of the new <b>DFB</b> type.
4	Select the language: Ladder or Structured text.
5	Click on <b>OK</b> .

**Note:**

The choice of language **Ladder** or **Structured text** for the DFB code can be modified as long as the code is not entered.

---

**Setting the parameters for the DFB type**

This is done using the DFB type editor. It consists of declaring:

- the input, input/output and output interfaces,
- the public variables,
- the private variables,
- and documenting the description file.

**Note:** the size of message type variables that are displayed in an alarm viewer should have 40 characters.

---

**DFB type programming**

Programming a DFB is done using the **DFB code** editor which can be accessed from the DFB editor.

---

## Programming a DFB type

---

### Principles

The code defines the processing that the DFB type must carry out depending on the declared interfaces.

#### **All language instructions are permitted except for:**

- calling up standard function blocks,
- calling up other DFB types,
- jumping to a label (JUMP),
- calling up a subroutine,
- instructions using input/output module variables (e.g. READ\_STS, SMOVE etc.).

#### **The code of the DFB type may only use:**

- input/output objects (%I, %Q..),
- global application objects (%MW,%KW...) excluding %S and %SW bits and system words.

#### **There are functions specific to development of a DFB type such as:**

- the timer functions, FTON, FTOF, FTP, FPULSOR, which can be used instead of timer function blocks,
  - the instructions, LW, HW, COCATW which are used to handle double words,
  - the instructions, LENGTH\_ARW, LENGTH\_ARD, LENGTH\_ARR, which are used to calculate table lengths.
-

**Programming rules**

DFB instances can be used in various parts of the application, which use the languages LD, IL or ST (apart from in event tasks).

- sections,
- subroutines.

The programming rules are as follows:

- All table type input parameters and input/output parameters must be entered.
  - Unconnected input parameters keep the value of the previous call or the initialization value if the block has never been called with this entered or connected input.
  - All the objects assigned to input, output and input/output parameters must be of the same type as those entered at the time DFB Type creation,
  - Only BOOL and EBOOL types can be mixed for input or output parameters.
- 

**Entering and modifying code**

Carry out the following steps:

Step	Action
1	Click on <b>Code</b> in the DFB editor or select <b>Utilities/Open</b> then click on <b>ENTER</b> to open the DFB code editor.
2	Enter the code.
3	Confirm the code. Any confirmation made at DFB editor level is global.

**Note:**

DFB type code can only be entered or modified on an unprotected DFB type.

Code that has not been confirmed (in the process of being created or modified) is indicated by a red dash in the left hand margin of the editor.

---

**Search/Replace:  
to find or replace  
an object in the  
code**

This function is used to search for and/or replace an object (interface or variable) in the DFB code.

**Searching for an object:**

Step	Action
1	Select <b>Search/Replace...</b> from the Edit menu
2	In the <b>Search</b> zone indicate the object to be searched for (e.g.: Input0).
3	Select <b>Next</b> to go to the different occurrences in the order in which they appear.



**Search/Replace: to find/replace an object:**

Step	Action
1	Select <b>Search/Replace...</b> from the edit menu.
2	In the <b>Search</b> zone indicate the object to be searched for (e.g.: Input0).
3	In the <b>Replace</b> zone indicate the object to be replaced (e.g.: Input1).
4	Select: <ul style="list-style-type: none"><li>● <b>Next</b> to go to the first occurrence,</li><li>● <b>Replace</b> to replace only the current occurrence,</li><li>● <b>Replace All</b> to replace all occurrences.</li></ul>

## Confirming a DFB type

Confirming a DFB type is a global operation which can be used to confirm the interfaces, the variables, descriptive form and the code.

Carry out the following actions:

To confirm a DFB from...	you must...
DFB editor	click on the icon  or select <b>Edit/Confirm</b> then press <b>ENTER</b> .
DFB code editor	click on the icon  or select <b>Edit/Confirm DFB type</b> then press <b>ENTER</b> .

### Note:

To confirm a DFB type, it must have at least one **Boolean input**.

The DFB editor cannot be closed until the DFB type has been confirmed or canceled.

## How to access a line of code

This function is used to go to a line of code within the code of a given DFB type by entering its numeric position.

Carry out the following steps to access a line of code:

Step	Action
1	When the code is displayed, select the <b>Edit</b> → <b>Go to</b> command.
2	Enter the line number then click <b>OK</b> .

## Errors

If there is an interface, variable or code error, the DFB type cannot be confirmed, and the system then positions itself at the first error.

You must:

1. Correct the error(s).
2. Reconfirm.

## DFB type instance

---

**Presentation** A DFB type instance is a named copy of a **validated DFB type**.

The **same instance** can be used several times in an application.

One DFB type can have **several instances**, in this case the Input/Output interfaces, the public variables and the private variables are duplicated (one duplication per instance). The DFB code is not duplicated.

The name given to an instance cannot be:

- a PL7 reserved word,
- a symbol,
- an EF (elementary function),
- the name of a DFB type.

### Creating an instance from an application browser

Carry out the following actions:

Step	Action
1	From the application browser, right click on the sub-directory <b>DFB Variables/Instances DFB</b> .
2	Select the command <b>Open</b> .
3	Select the DFB type to be instanced using the mouse or the Tab and arrow keys.
4	Enter the name of the new instance in the last line of the <b>Name field</b> (32 characters maximum).
5	Enter a comment in the <b>Comments field</b> (80 characters maximum).
6	Click on <b>ENTER</b> .

---

**Creating an instance from the function library**

Carry out the following actions:

Step	Action
1	Select <b>Library</b> from the <b>Tools</b> menu then select the DFB tab.
2	Select the type of DFB to be instanced in a line of the <b>Name field</b> .
3	Click on the button <b>Create</b> .
4	Enter the name of the new instance (32 characters maximum).
5	Enter any comments.
6	Click on <b>Create</b> .

---

**Modifying an instance**

An instance is modified if its name and/or comments are modified.

Modifying the name of an instance:

- leads to the automatic updating of its sub-objects,
  - can only be carried out if it is not referenced.
- 

**Deleting an instance**

Carry out the following actions:

Step	Action
1	From the application browser, right click on the sub-directory <b>DFB Variables/Instances DFB</b> .
2	Select the command <b>Open</b> .
1	<b>If the instance is not referenced in the application:</b> Select the instance to be deleted in the <b>Name</b> column and delete it. <b>If the instance is referenced in the application:</b> 1. Delete it in the corresponding language editor. 2. Select the instance to be deleted in the <b>Name</b> column and delete it.

---



## Running a DFB instance

---

### Rules

Running a DFB instance is done in the following order:

**1.**

Loading the input and input/output parameters using the actual parameters.

Any input left free takes on the initialization value defined in the DFB type when being initialized or starting from cold, then the current value of the parameter.

The input parameters (except for table types) are sent by value, the input/output parameters are sent by address.

**2.**

Running the text code, or ladder.

**3.**

Writing the output parameters.

---

## Entering a DFB instance

### Presentation

Entering a DFB instance is done from:

- the ladder editor,
- the list editor,
- the structured text editor.

### From the ladder editor

Carry out the following actions

Step	Action
1	Click on the graphic element in the graphics palette. 
2	Select <b>DFB</b> .
3	Select the type <b>of DFB</b> required.
4	Select an instance required in <b>Choice of instance</b> or create a new instance (name and any comments then click on <b>Create</b> ).
5	Click on <b>OK</b> .
6	Click on the destination cell (Test zone) to set the type of <b>DFB</b> .

### From the list or structured text editor.

Carry out the following actions:

Step	Action
1	Select the command <b>Service/Enter function call</b> or <b>SHIFT+F8</b> .
2	Select the DFB tab.
3	Select the required DFB block.
4	Select the required instance or create a new instance (any name + comments) then click on <b>Create</b> .
5	Enter the DFB type parameters in the entry field parameters.
5	Confirm your selection by <b>OK</b> .
6	Confirm your selection by <b>ENTER</b> .

---

## How to protect a DFB

---

### Presentation

There are two protection levels for a DFB type:

- modification protection which limits access to the DFB type editor to read only,
- expertise protection which prevents access to the DFB type code and to its private variables.

Protection is only applicable on a validated DFB type. It is managed by a password.

---

### Protecting a DFB type

Carry out the following actions:

Step	Action
1	Open the DFB type editor.
2	Select <b>Edit/Properties</b> of the type.
3	Select the protection type.
4	Enter a password (8 characters maximum).
5	Confirm by entering the password again.
6	Click twice on <b>OK</b> .

---

### Modifying protection type for a DFB type

Carry out the following actions:

Step	Action
1	Open the DFB type editor.
2	Select <b>Edit/Properties</b> of the type.
3	Select the new protection type.
4	Enter the password.
5	Click on <b>OK</b> .

---

**Modifying the password**

Carry out the following actions:

<b>Step</b>	<b>Action</b>
1	Open the DFB type editor.
2	Select <b>Edit/Properties</b> of the type.
3	Select <b>Change</b> .
4	Enter the current password.
5	Enter the new password (8 characters maximum).
6	Confirm by entering the password again.
7	Click on <b>OK</b> .

---

## How to Import/Export a DFB type or an application containing DFB types

---

### **Exporting/ Importing a DFB type**

Refer to the **"Import/Export"** Chapter of the Part **"Debugging, Adjustment, Documentation and Appendices"**.

See *Exporting a standard format DFB type*, p. 405.

See *Export of a binary format DFB type*, p. 405.

See *Importing a DFB type in binary format*, p. 406.

See *Importing a DFB type in binary format*, p. 406.

---

### **Exporting/ Importing an application containing DFB types.**

Refer to the **"Import/Export"** Chapter of the Part **"Debugging, Adjustment, Documentation and Appendices"**.

See *Exporting an application with DFB*, p. 408.

See *Importing an application with DFBs*, p. 411.

---



---

# Debugging, adjustment, documentation and appendices

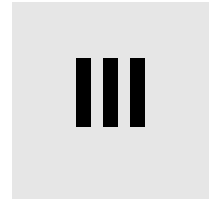

---

## Introduction

### Subject of this part

This part gives information about the application context and describes how to:

- Debug an application.
- Diagnose an application.
- Export/Import application modules.

### What's in this Part?

This part contains the following chapters:

Chapter	Chapter Name	Page
13	Debugging	297
14	Adjustment of variables	331
15	Diagnostic functions	343
16	Documentation	357
17	Import/Export	365
18	Configuring the Uni-telway link	417
19	Configuring the FIPWAY link	431
20	OS Loader	441
21	Windows	449





---

## Introduction

### Subject of this chapter

This chapter describes the PL7 debugging functions.

### What's in this Chapter?

This chapter contains the following topics:

Topic	Page
Introduction to the PLC debugging screen	299
CPU screen designation zone	300
Information zone	301
Task Zones	302
Operating mode zone	304
Event zone	305
Last stop zone	306
Realtime clock zone	307
Modification of the program in Run mode	308
Animating program elements	309
Grafcet debugging	312
Executing the programme	315
Task properties	316
Executing the MAST task	317
Executing the FAST task	318
Execution of a program with breakpoint	319
Executing a program in step by step mode.	322
Forcing TOR input	324
Forcing analog inputs, Micro	325
Forcing analog inputs, Premium	326

<b>Topic</b>	<b>Page</b>
Adjustment of the application specific functions	327
Debugging a functional module	328
Debugging DFBs	330

---

## Introduction to the PLC debugging screen

### How to access the PLC debugging screen

Carry out the following steps:

Step	Action
1	Click on the <b>Debug</b> menu on the <b>PL7</b> task bar.
2	Click on the <b>Access PLC debugging screen</b> sub-menu.

### PLC Debugging screen

The **PLC debugging screen** offers different functions and information, which are divided up into zones:

PLC debugging screen :

TSX 57352 [RACK 0 POSITION 0]

Debugging  
Designation: PROCESSOR TSX P 57352  
 RUN  IO  ERR  DIAG...

Information  
Processor present: TSX 57352 Processor version: 3.7(88)  
Network address: SYS Number of forced bits: 0

Task	Period Set	Min. Duration	Current Duration	Max. Duration	Cycle time Fpio network	Watch Dog	Operating	Status	Cmd	Enable task	Error	Init duration	Reset Def
MAST	CYCLIC	2	6	6	0	250	STOP	a	Run	Deactivate	Def	Init	Reset
FAST	0	0	0	0	0	0	Not						

Operating mode  
 Output fallback   
 Outputs in fallback mode

Last stop  
Cause  
Wednesday  
Date: 23/02/2000 Time: 10:16:33

Events  
Status:     
Number of events: 0

Realtimeclock  
Wednesday  
23/02/2000   
10:27:08

- Designation (See *CPU screen designation zone*, p. 300) zone,
- Information (See *Information zone*, p. 301) zone,
- Task (See *Task Zones*, p. 302) zone,
- Operating mode (See *Operating mode zone*, p. 304) zone,
- Event (See *Event zone*, p. 305) zone,
- Last stop (See *Last stop zone*, p. 306) zone,
- Real time clock (See *Realtime clock zone*, p. 307) zone.

**Note:** To access the debugging functions you need to be in online mode (PLC → Connect).

---

## CPU screen designation zone

---

### At a Glance

This zone allows you to find out the execution status of an application in the PLC. Designation Zone:

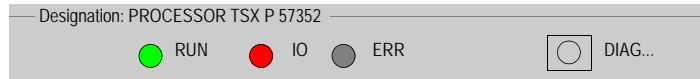

---

### Description

Elements and their functions:

Element	Function
The <b>RUN</b> indicator	This indicates the state of the PLC: <ul style="list-style-type: none"><li>• it is constant when the PLC is in RUN,</li><li>• it blinks when the PLC is in STOP.</li></ul>
The <b>I/O</b> indicator	Red light indicating the errors on another module in the station or a configuration error.
The <b>ERR</b> indicator	Red light indicating the errors relating to the processor and its on-board devices (PCMCIA memory card and PCMCIA communication card).
The <b>DIAG</b> button	It gives access to diagnostics information.

---

---

## Information zone

---

### At a Glance

This zone provides miscellaneous information:  
Information zone:

Information			
Processor present:	TSX 57352	Processor Version:	3.7(88)
Network address:	SYS	Number of forced bits:	0

### Description

Fields and their function:

Field	Function
<b>Processor present</b>	Provides information about the type of processor in the PLC.
<b>Network Address</b>	Provides information about the PLC network address.
<b>Processor version</b>	Gives the version of the processor which is in the PLC.
<b>Number of forced bits</b>	Indicates the number of forced bits.

---

## Task Zones

### At a Glance

This zone gives access to the various **FAST** task and **MAST** task execution commands:

- **RUN/STOP** commands,
- **Activate/Deactivate** Task commands,
- setting periods,
- Period Initialization command,
- Error Management commands.

Task Zone:

Tasks													
	Period Set	Minimum Duration	Current Duration	Maximum Duration	Cycle time Fipio network	Watch Dog	Operating Mode	Status	Cmd	Enable task	Fault	Init duration	Reset Fault
MAST	40	4	10	55	4	250	RUN	a	Stop	Deactivate	Fault	Init	Reset
FAST	5	1	1	3	0	100	RUN	a	Stop	Deactivate	Fault	Init	Reset

### MAST or FAST task RUN/STOP command

The **RUN/STOP** buttons associated with the **MAST** and **FAST** tasks are used to switch to RUN or STOP mode.

In **RUN** mode the inputs are read, the program is executed and the outputs are refreshed.

In **STOP** mode the inputs are read, the program is not executed and the outputs are not refreshed.

**Note:** These functions are also accessible via the **Debug** menu.

### MAST or FAST task Activate/Deactivate command

The **Activate/Deactivate** buttons associated with the **MAST** and **FAST** tasks are used to activate or deactivate a task.

When a task is **activated**, the code is scanned and executed. The inputs/outputs are refreshed.

When a task is **deactivated**, the code is neither scanned nor executed. The inputs/outputs are still refreshed.

**Note:** The **Status** field informs you of the status of a task:

- a: for active (the system bits %S30 and %S31 are set at 1),
- i: for inactive (the system bits %S30 and %S31 are set at 0).

**Setting periods**

In periodic operation, the "Period set" column is used to set the task period. This setting is lost on cold start. The value entered in the configuration is then taken into account. It is possible to save the period set using the **Utility** → **Save task periods** command.

**Note:** The **Utility** → **Restore task periods** command replaces the period set with the period defined in the configuration.

**Error initialization command**

The minimum, current and maximum durations are provided by the PLC. The **Init** button in the Init column restores these values in order to carry out new measurements (except the current duration).

**Error management commands**

Buttons and functions:

Button	Function
<b>Fault bit</b>	Enables any errors in the corresponding task to be viewed.
<b>Reset</b>	Is used to reset the system bits associated with the task errors to zero, in order to be sure that the error(s) is/are still valid.

## Operating mode zone

---

### At a Glance

This zone gives access to various modeling buttons:

- **Warm restart,**
- **Cold start,**
- **Output fallback.**

Operating Mode Zone:

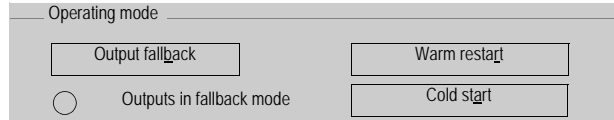

### Description

Buttons and functions:

Button	Function
<b>Warm Restart</b>	Click on this button to simulate a warm PLC restart. This sets the %S1 bit to 1, which for example is used to command a partial initialization program.
<b>Cold start</b>	Click on this button to simulate a cold PLC start. This initializes the data, the system, and sets the %S0 bit to 1 which (in this case) is used for example to command a specific initialization program.
<b>Output fallback</b>	Is used to switch the outputs into fallback mode. When the outputs are in fallback, the <b>Output fallback</b> button becomes Maintain outputs. It is therefore used to exit the fallback mode.

---



## Event zone

### At a Glance

Event processing can be globally enabled or inhibited by the application program by means of the %S8 system bit or a terminal command (program debugging function). If one or several events occur whilst they are inhibited, the associated processing is lost.

The **Event** zone gives access to different functions.

Event Zone:

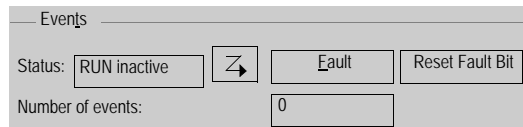

### Description

Elements and functions:

Element	Function
<b>Number of events</b>	Indicates the number of events executed.
<b>Default button</b>	Is used to view the default bits and to access the events diagnostics program.
<b>Reset fault bit button</b>	Is used to reset the fault bits associated with the execution of events to zero.
<b>Status field</b>	Informs about the status of an event (active/inactive, <b>RUN/STOP</b> ).
Icon 	Is used to activate/deactivate events.

## Last stop zone

---

### At a Glance

This zone gives the diagnostics on the last stop of the PLC.

#### Last stop zone:

Last stop

Cause:

Tuesday,

Date:  Time:

### Description

Fields and functions:

Field	Function
<b>Cause</b> field	Gives the causes for the last stop of the PLC.
<b>Date</b> field	Gives the date of the last stop of the PLC.
<b>Time</b> field	Gives the time of the last stop of the PLC.

---

---

## Realtime clock zone

---

### At a Glance

This zone gives access to the realtime clock settings.

**Realtime clock zone:**

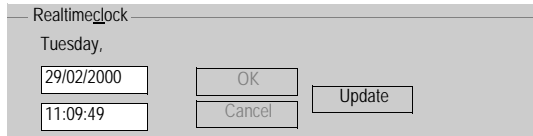

The screenshot shows a dialog box titled "Realtimeclock". It displays the day "Tuesday," followed by two input fields: the date "29/02/2000" and the time "11:09:49". To the right of the date field are two buttons: "OK" and "Cancel". To the right of the time field is one button: "Update".

### Description

Buttons and functions:

Button	Function
<b>OK</b> button	Is used to confirm once the date and the time have been set using the double arrows.
<b>Update</b> button	Updates the realtime clock according to the date and time of the terminal.
<b>Cancel</b> button	Cancels all modifications if the PLC update has not been confirmed.

---

## Modification of the program in Run mode

---

### Introduction

The program editor authorizes the modification of the application in RUN mode, except for the **Grafcet** structure part.

---

### Principals

Modification of program elements LD, IL, ST PLC in RUN, is possible at the level of a LD rung, of an IL statement or of an ST instruction, except if the contents are contained in an event processing (EVTi).

**The situation with Grafcet:** only the processing linked to steps and transitions can be modified, Grafcet can not be modified.

	<b>CAUTION</b>
	<p>For security reasons, you are advised to start the PLC programming at the stop<b>STOP</b>. Modification in <b>RUNmode</b> must be used for program modifications which do not require the application to be stopped and are under the responsibility of the user.</p> <p><b>Failure to follow this precaution can result in injury or equipment damage.</b></p>

### The operate modes

The operate modes are the same as for modification in PLC local mode or connected mode in **STOP** mode. However some modifications are applied:

- no jump on an undefined label,
  - not to be in step by step mode or have set a breakpoint,
  - the PLC must not be at default,
  - the multi-rung functions are not authorized,
  - it is impossible to add a function block which is not already represented in the application.
-

## Animating program elements

### At a Glance

The animation of the parts of the program when the PLC is in RUN (rungs Ladder, instruction LIST sequence, Structured text sequence, Grafcet) is carried out directly in the language editors by activating the animation function when PL7 is connected to a PLC.

### Ladder rung animation

The editor animates the following elements:

- the rungs are highlighted when they are running,

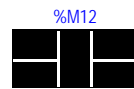

- the coils are highlighted when the associated bit is set to 1,



- the FB outputs are highlighted when they are set to 1. Some internal parameters are animated by the display of their numerical value inside the block.

**Note:** A forced variable is indicated by **F**.

### Animation of List sequences

The editor carries out animation in the following way:

- a variable at 1 is indicated by a black rectangle,
- a variable set at 0 is indicated by a white rectangle,
- a forced variable is indicated by an **F**.

Example:

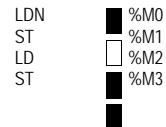

**Animation of Structured text sequences (PL7 Junior, PL7 Pro)**

The editor animates by linking itself to the Animation tables tool in the following way:

Select the **Option** → **Animation by tables**, command after having started the Structured Text sequence editor, and the tool is then placed next to the editor.

Each language element displayed on the editor screen is entered in the table, keeping to the limit of 40 possible variables.

**Note:** For a table type variable, only the first element in the table is taken into account. It is therefore possible to add other elements from the table which may be important in the context of the application.

---

**Animation of the Grafcet steps**

The editor carries out animation in the following way:

- an active step is indicated by a black rectangle,
- an inactive step is indicated by a white rectangle,

Example:

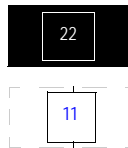

---

**Animation of macro-steps**

A macro-step is animated (highlighted) if at least one of these steps is active.

---

**Animation of DFB code**

If the DFB type has not been code protected, it is possible to view the code dynamically using animation tables.

Select a call interface in a section then select the **Open** contextual menu.

---

**Animation  
commands**

Commands and functions:

Command	Function
<b>Utility → Stop Animation</b>	Suspends animation.
<b>Utility → Animate</b>	Restarts animation.
<b>Utility → Freeze</b>	The animation is frozen, the variables change but the display is no longer refreshed.

**Note:**

- the animation is synchronous with the end of the MAST task cycle.
- for all indexed objects, if index overflow occurs, there may be inconsistency in the animation.

Example:

LD %M[%MW10] animation = status of indexed object even in the case of index overflow.

ST %M1 animation = status of %M0 if there is index overflow.

## Grafcet debugging

### At a Glance

Grafcet debugging allows you to:



- control charts in order to facilitate debugging,
- perform maintenance actions.

This makes it possible to check that the synchronization of operating modes and the coordination of tasks is being carried out correctly (forcing command).

When an installation is switched to manual mode, either for adjustment or because of an error, the context of the graph is saved (freeze command) and it is then possible to resume the cycle at the same place once the adjustment is finished or the fault has been acknowledged.

### How to gain access to the Grafcet debugging bar

Carry out the following steps:

Step	Action
1	Click on the <b>debugging bar</b> icon  .
2	The following bar appears: 



## Grafcet debugging bar

The following illustration shows the arrangement of the command buttons in the debugging bar.

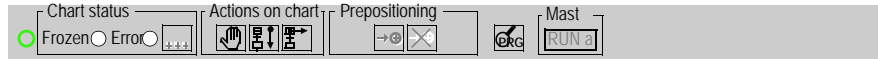

Zone	Functions
Chart status	<p>Provides information about the chart status:</p> <ul style="list-style-type: none"> <li>● <b>Frozen</b>: indicates whether or not the chart is frozen,</li> <li>● <b>Error</b>: indicates whether there is an error in the chart,</li> <li>● <b>Button</b>: can be activated when there is an error, is used to create an information box with the list of active errors.</li> </ul>
Actions on chart	<p>Contains buttons which are used to:</p> <ul style="list-style-type: none"> <li>● <b>Freeze/Unfreeze</b> the chart. On <b>Freeze</b>, the active steps remain active and continuous actions only are executed. On <b>Unfreeze</b>, the operating cycle resumes from the same place.</li> <li>● <b>Initialize</b> the chart on these initial steps. It develops from these steps and continues in its current operating mode.</li> <li>● <b>Position</b> the chart in an empty location with no step on the chart being active.</li> </ul>
Prepositioning	<p>Contains buttons which are used to:</p> <ul style="list-style-type: none"> <li>● <b>Position</b> the chart on the steps to be prepositioned that are selected from the grafcet editor. Prepositioning is indicated by a full stop to the left of the step.</li> <li>● <b>Delete</b> configured prepositions. To delete the prepositioning of a step, select the step from the editor and the <b>Delete prepositioning</b> command from the contextual menu.</li> </ul>
Mast	<p>Provides information on the task status:</p> <ul style="list-style-type: none"> <li>● RUN a: Mast task active in Run,</li> <li>● STOP a: Mast task active in Stop,</li> <li>● RUN i: Mast task inactive in Run,</li> <li>● STOP i: Mast task inactive in Stop,</li> <li>● STEP: Step by Step program in progress,</li> <li>● ERR: execution error.</li> </ul>

The animation of the Grafcet section's activity condition is displayed on the far left of the debugging bar.



The  button is used to switch from the Grafcet debugging bar to the program debugging bar.

**How to gain access to the Grafcet debugging screen**

Carry out the following steps:

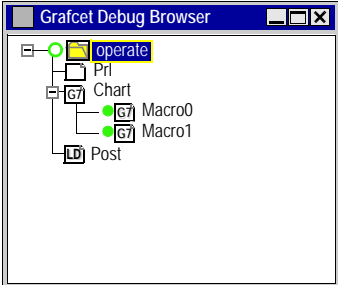
Step	Action
1	In the <b>Application browser</b> in the <b>Structure view</b> , look at the <b>Program</b> directory and right click (contextual menu) on the <b>G7</b> icon.
2	The following screen appears: 

**The Grafcet debug browser**

The Grafcet debug browser can be accessed from the Grafcet editor or from the application browser's Grafcet section using the contextual menu.

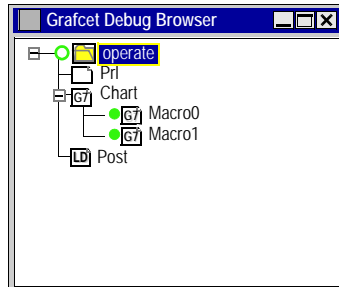

This screen gives a hierarchical view of the chart with the nesting of the CHART module and macro-steps.

This view is animated in online mode with the animation indicated by the absence or presence of a token (an active macro-step is shown by the presence of a green circle).

A certain number of operations are possible via:

- the contextual menu at the bottom of the screen,
- the contextual menu on an item describing a macro-step:
  - deactivating a macro-step,
  - activating a macro-step,
  - editing a macro-step.

## Executing the programme

### At a glance

Executing an application on a PLC can be controlled using the functions:

- RUN, STOP, INIT PLC,
- RUN, STOP at the level of a task (MAST or FAST),
- breakpoint and step by step,
- Grafcet debugging.

### Finding out the confirmation conditions of a section

Carry out the following steps:

Step	Action
1	In the <b>Application Browser</b> of the <b>structure view</b> , choose the section.
2	Right click (contextual menu) and select <b>Properties</b> .

### Accessing the contents of a section

Carry out the following steps:

Step	Action
1	Go to the <b>Application Browser</b> of the <b>Structure View</b> .
2	Double click on the section icon.

### Operating the programme

In runtime:

- a **green** circle indicates that the section is confirmed,
- a **red** circle indicates that the section is not confirmed (confirmation bit at zero).

### Forcing the confirmation values of the section

Carry out the following steps:

Step	Action
1	In the <b>Application Browser</b> in the <b>structure view</b> , choose the section.
2	Select the contextual menu (right click) <b>Force the activation condition to 0</b> or <b>Force the activation condition to 1</b> , this is indicated by a <b>F</b> on the green circle.

## Task properties

---

### Task configuration

The MAST task may feature:

- cyclical execution (default selection),
- periodic execution.

In cyclic operation, the task executions follow on directly from one another. In periodic operation, the task executions are sequenced at a period set by the user.

Whatever the operating mode: whether periodic or cyclic, the task is controlled by a watch dog device which is used to detect an abnormal period in the application program. If overrun occurs, the **S%** system bit is positioned at t 1 and the application is declared in blocking fault mode for the PLC.

### Task debugging

The Operating mode zone indicates the status of the task execution. The Duration zone indicates the execution time of the **MAST** and **FAST** tasks.

---

## Executing the MAST task

### Introduction

In this procedure, only the MAST task is executed.

### How to put the MAST task into RUN

There are several ways in which the MAST task can be put into RUN:

- select the **Debug** → **Run Mast** command,
- select the **Debug** → **Access the PLC debugging screen** command and click on the RUN button associated with the MAST task.

### How to put the MAST task into STOP

There are several ways in which the MAST task can be put into STOP:

- select the **Debug** → **Stop Mast** command,
- select the **Debug** → **Access the PLC debugging screen** command and click on the STOP button associated with the MAST task.
- click on the **STOP** icon on the general panel.

**Note:** The execution status of the task is shown in the debugging bar:

- STOP, RUN,
- a: the task is active (the %S30 system bit is at 1),
- i: the task is inactive (the %S30 system bit is at 0),
- Non Pr: the task is not programmed,
- STEP: step by step function in progress,
- ERR: execution error.

### Duration adjustment

In periodic operation, the "Adjusted Period" column is used to adjust the task period. This adjustment is lost on cold start, it is the value entered in the configuration which is taken into account in this case, it is possible to save the adjusted period using the **Services** → **Save the Set Period** command.

**Note:** The **Service** → **Restore periods** command replaces the period set with the period defined in the configuration.

The minimum, current, maximum durations are provided by the PLC, the duration button **Init** in the column **Init** resets these values in order to carry out new process values.

### Task activation-Fault management

The **Activation/Deactivation** button on the **UC debugging screen** is used to activate the MAST task when the latter is in RUN.

The **Err** button on the **UC debugging screen** displays the MAST task errors and the **Reset** button is used to reset the system bits associated with task errors to zero to ensure that the error(s) is/are still valid.

## Executing the FAST task

### Introduction

In this procedure, only the FAST task is executed.

### How to put the FAST task into RUN

There are several options for putting the FAST task into RUN:

- select the **Debug** → **Run Fast** command,
- select the **Debug** → **Access the UC debugging screen** command and click on the RUN button associated with the FAST task.

### How to put the FAST task into STOP

There are several options for putting the FAST task into STOP:

- select the **Debug** → **Stop Fast** command,
- select the **Debug** → **Access the UC debugging screen** command and click on the STOP button associated with the FAST task.
- click on the **STOP** icon on the general panel.

**Note:** The execution status of the task is shown in the debugging bar:

- STOP, RUN,
- a: the task is active (the %S30 system bit is at 1),
- i: the task is inactive (the %S30 system bit is at 0),
- Non Pr: the task is not programmed,
- STEP: step by step function in progress,
- ERR: execution error.

### Duration adjustment

In periodic operation, the "Adjusted Period" column is used to adjust the task period. This adjustment is lost on cold start, it is the value entered in the configuration which is taken into account in this case, it is possible to save the adjusted period using the **Services** → **Save the Set Period** command.

**Note:** The **Service** → **Restore periods** command replaces the period set with the period defined in the configuration.

The minimum, current, maximum durations are provided by the PLC, the duration button **Init** in the column **Init** resets these values in order to carry out new process values.

### Task activation-Fault management

The **Activation/Deactivation** button on the **UC debugging screen** is used to activate the MAST task when the latter is in RUN.

The **Err** button on the **UC debugging screen** displays the FAST task errors and the **Reset** button is used to reset the system bits associated to task errors to zero in order to ensure that the error(s) present are still correct.

## Execution of a program with breakpoint

### At a Glance

The software manages a single breakpoint which can be set in on-line mode on any program element (LD rung or IL, ST, DFB sequence) that is contained in the MAST, FAST, or SR tasks.

Setting these breakpoints is one of the functions of the debug bar.

### How to access the debug bar

Carry out the following steps:

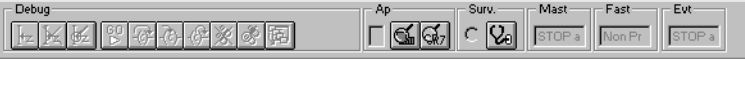

Step	Action
1	Click on the <b>Debug</b> menu on the <b>PL7</b> task bar.
2	Click on the <b>Debug bar</b> sub-menu. <b>Result:</b> the following bar appears at the bottom of your <b>PL7</b> screen



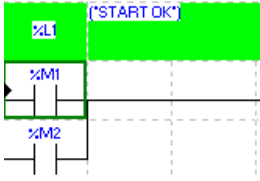

The screenshot shows a horizontal toolbar with the following elements from left to right: a 'Debug' label, a set of icons for program control (stop, play, pause, etc.), a 'Ap' section with a checkbox and a 'PL7' label, a 'Surv.' section with a circular arrow icon, a 'Mast' section with a 'STOP' button, a 'Fast' section with a 'Mon Pr' button, and an 'Evt' section with a 'STOP' button.

**Setting a breakpoint**

Breakpoint are positioned directly from the languages editors.  
 Carry out the following actions:

Step:	Action:
1	Place the cursor on the program element (LD rung or IL, ST statement) that is to be the breakpoint. Example: 
2	Select the <b>Debug/Set the breakpoint</b> command or click on the button  on the debug bar.

With Structured Text:

Step:	Action:
1	Select the <b>Debug/Line mode</b> command or click on the button  on the debug bar.
2	Place the cursor at the position on the instruction line at which the breakpoint is to be set,
3	Select the <b>Debug/Set breakpoint</b> command or click on the button  on the debug bar.

**Note:**

Setting a new breakpoint deletes any existing breakpoint.



---

**Executing the program**

Execute the **PLC/Run, Debug/Run Mast, Debug/Run Fast** program if the PLC is not already in Run.

The program is executed until the rung, the statement or the instruction line (with Structured Text in line mode) associated with the point is reached. The statement, instruction line or the rung is not executed.

The breakpoint is displayed in yellow (step in progress), so it is possible to execute the program in step by step mode.

---

**Accessing the breakpoint**

To place the cursor directly on the breakpoint set in the application (without first accessing the program module), select the **Debug/Show Breakpoint Inserted**

command or click on the button  .

---

**Accessing the step in progress**

To place the cursor directly on the step in progress in the application (without first accessing the program module), select the **Debug/Show Current Step** command

or click on the  button on the debug bar.

---

**Deleting the breakpoint**

Select the **Debug/Remove breakpoint** command or click on the button  on the debug bar.

---

**With DFBs**

A breakpoint cannot be directly inserted into the code of a DFB type (accessible in read mode).

It is recommended that you set the breakpoint directly on the calling code element, then enter the instance code via the **Call Module** menu.

---

**Module Call Stack**

For an error diagnosed in a SR or in a DFB, the **Debug/Set up module call stack** command is used to recognize the chronological sequence of calls that have led to the faulty module being executed.

The dialog box contains the following information:

- the current task name,
- the module call list as well as the line/statement number which have led to the execution of the faulty module (the first in the list is the top of the stack).

The **View** button is used to view the module selected in the stack. This function is also accessible by double clicking on the List Box.

---

## Executing a program in step by step mode.

---

### At a Glance

The program is executed rung by rung, sequence by sequence or instruction line by instruction line (in line mode with ST). All the active tasks are executed, the inputs are acknowledged and the outputs are set.

One of the functions of the debug bar is to execute the program in step by step mode.

---

### How to access the debug bar

Carry out the following steps:

Step	Action
1	Click on the <b>Debug</b> menu on the <b>PL7</b> task bar.
2	Click on the <b>Debug bar</b> sub-menu. <b>Result:</b> the following bar appears at the bottom of your <b>PL7</b> screen

The screenshot shows a horizontal toolbar with the following elements from left to right: a 'Debug' label, a set of icons for Stop, Run, Step, and other controls, a 'PLC' label, a 'Monit.' label with a refresh icon, a 'Mast' label with a refresh icon, a 'Fast' label with a refresh icon, and an 'Evt' label with a refresh icon. Below these labels are several buttons: a 'RUN a' button, another 'RUN a' button, and a third 'RUN a' button.

---

### Step by step program execution







Carry out the following actions:

Step:	Action:
1	Insert a breakpoint in a module through which the program will pass when it is executed in step by step mode.
2	Give the <b>AP/Run</b> , <b>Debug/Run Mast</b> and <b>Debug/Run Fast</b> commands in program execution mode.

---

**Commands**

The commands are accessible via the debug bar or the Debug menu:

Debug bar	Debug menu
Button: 	<b>Menu/Start task</b> (in step by step mode).
Button: 	<b>Debug/Go to next rung/next sequence/next instruction line</b> (execute the program element at the position at which it stopped and stop at the beginning of the following program element). With a SR call, this function does not enter the SR body and executes all of it.
Button: 	<b>Debug/Call module</b> (access SR module).
Button: 	<b>Debug/Exit module</b> (return to calling module).
Button: 	<b>Debug/Abort Step by Step</b> (the breakpoint is deleted and the task restarts).
Button: 	<b>Debug/Show Current Step</b> (move directly onto the current application step, without accessing the program module beforehand).

	<b>WARNING</b>
	<p><b>With alarm relay:</b></p> <p>At each step the alarm relay (or safety output) controlled by the PLC momentarily changes its status. At the end of the cycle, the outputs are refreshed for approximately 1 ms. To avoid these effects on the alarm relay and the physical outputs, the %S9 bit can be set at 1, which will force the physical outputs into fallback.</p> <p><b>Failure to follow this precaution can result in death, serious injury, or equipment damage.</b></p>

---

## Forcing TOR input

---

### Introduction

You must be in connected mode to access the forcing of TOR input .

---

### How to force TOR inputs

Carry out the following steps:

Step	Action
1	Select the command <b>AP</b> → <b>Connect</b> .
2	In <b>Application Browser</b> in the structure view, click on the <b>Configuration</b> directory, then double click (or contextual menu) on the <b>Hardware configuration directory</b> .
3	Select the module and then double click (or contextual menu). Each channel is viewed: <ul style="list-style-type: none"><li>● <b>channel</b>: input or output channel number,</li><li>● <b>symbol</b>: symbol set by the user linked to the channel,</li><li>● <b>parametering</b>: memory, event...</li></ul>
4	Next select the channel and right click, then click on <b>Command</b> .
5	Select the command <b>Force to 0</b> (state F0) or <b>Force to 1</b> (state F1).

To delete the forcing of a channel click on **Unforce** (select the channel then the contextual menu **Command**).

To delete the forcing of all of the module's channels, click on the **Global unforcing** button.

---

## Forcing analog inputs, Micro

### Introduction

You must be in connected mode to access the forcing tools.

### How to force analog inputs

Carry out the following steps:

Step	Action
1	Select the command <b>AP</b> → <b>Connect</b> .
2	In <b>Application Browser</b> in the structure view, left mouse click on the <b>Configuration</b> directory then double click on the <b>Hardware configuration</b> directory.
3	Select the position of the module then double click on it.
4	Select the channel.
5	Select the forcing value.
6	Click on the <b>Force</b> button.

**Note:** When a channel is forced, the information **F** appears in the value's display zone.

### Forcing an input

When an analog input is forced, the value present in the module's input is not available. The forced value is indicated in the **Value** and **Forcing** fields on the screen. The forcing of inputs is active whether the PLC is in RUN or in STOP mode.

### Forcing an output

When an analog output is forced, the value present in the module's output is indicated in the **Forcing field on the screen**. The value calculated by the application remains displayed in the **screen's Value** field .

### Deleting forcings

To delete the forcing of a channel, select it and then press the **Unforce** button.

To delete the forcing of all of the module's channels, click on the **Global unforcing** button.

## Forcing analog inputs, Premium

### Introduction

You must be in connected mode to access the forcing tools.

### How to force analog inputs

Carry out the following steps:

Step	Action
1	Select the command <b>AP</b> → <b>Connect</b> .
2	In <b>Application Browser</b> in the structure view, left mouse click on the <b>Configuration</b> directory then double click on the <b>Hardware configuration</b> directory.
3	Select the position of the module then double click on it.
4	Select the channel.
5	Select the forcing value.
6	Click on the <b>Force</b> button.

**Note:** When a channel is forced, the information **F** appears in the value's display zone.

### Forcing an input

When an analog input is forced, the value present in the module's input is not available. The forced value is indicated in the **Value** and **Forcing** fields on the screen. The forcing of inputs is active whether the PLC is in **RUN** or in **STOP** mode.

### Forcing an output

The forcing is only possible if the task associated to the output is in **RUN** mode. If the task is in **STOP** mode the output is put into fallback/maintain. When an analog output is forced, the value present in the module's output is indicated in the **Forcing** field on the screen. The value calculated by the application remains displayed in the **Forcing on the screen** field. The value calculated by the application remains displayed in the Value field on the screen.

### Deleting forcings

To delete the forcing of a channel, select it and then press the **Unforce** button.

To delete the forcing of all of the module's channels, click on the **Global unforcing** button.

## Adjustment of the application specific functions

### Introduction

You must be in connected mode to access the adjustment of the application specific functions.

### How to adjust the application specific functions

Carry out the following steps:

Step	Action
1	Select the command <b>AP</b> → <b>Connect</b> .
2	In the structural view's <b>Application browser</b> select <b>Configuration</b> → <b>Hardware configuration</b> .
3	Select the module position to be debugged then select the contextual menu (right click) <b>Open the module</b> or double click on the module. The attainable functions are: <ul style="list-style-type: none"> <li>● viewing the parameters,</li> <li>● adjusting the selected channel.</li> </ul>
4	Select the adjustment option to start the adjustment functions.

**In local:** the input parameters correspond to the initial parameters (value of the parameters during the first start or during a cold re-start).

**In connected:** the input parameters correspond to the current parameters (they are lost during a cold re-start if they have not been saved beforehand).

### The commands

Commands and functions:

Command	Function
<b>Service</b> → <b>Save parameters</b>	Allows you to save the current parameters (replacing the initial values with the current values) if the application is in RAM memory.
<b>Service</b> → <b>Restore parameters</b>	Allows you to replace the current values with the initial values.

**Note:** the functions and the commands which are available depend upon the application specific module which you are using.

## Debugging a functional module

---

### At a Glance

The organization of a functional module and the distribution of Grafcet sections, events and modules in the different modules has no effect on the execution of the program.

The program runs in the order shown in structure view.

In order to debug a functional module, the user can use of the following functions:

- standard debugging functions. Refer to the "**Access to debugging functions**" heading of the "**Debugging**" Chapter of the Part "**Debugging, Adjustment, Documentation and Annexes**".
  - additional functions allowing incremental debugging of the application, functional module by functional module.
- 

### Execution condition of the sections

The execution condition is used to validate or inhibit a section by program.

The section is active if the condition is at 1 and it is inhibited if it is at 0 (on cold start, the execution conditions are at 0).

A section can be activated or deactivated by the user insofar as the condition is forcable.

Types of objects accepted as conditions:

Objects	Forcable
%Si	
%Mi	X
Grafcet Objects	
%MW:Xj	X
%SW:Xj	
%KW:Xj	
%Mi[%MWj]	
%Mi[%SWj]	
%Mi[%KWj]	

---



**Deactivation of all sections linked to a functional module**

Action used to **force to 0** all the execution conditions of the module sections.

Step	Action
1	Select the desired functional module.
2	From the contextual menu, select the <b>Activation condition for the included sections</b> command.
3	Select the <b>Force to 0</b> command.

**Activation of all sections linked to a functional module**

Action used to **force to 1** all the execution conditions of the module sections.

Step	Action
1	Select the desired functional module.
2	From the contextual menu, select the <b>Activation condition for the included sections</b> command.
3	Select the <b>Force to 1</b> command.

**Cancellation of the forcing of all sections which are linked to a functional model**

Action used to **unforce** all the execution conditions of the module sections.

Step	Action
1	Select the desired functional module.
2	From the contextual menu, select the <b>Activation condition for the included sections</b> command.
3	Select the <b>Unforce</b> command.

## Debugging DFBs

---

### Procedure

Refer to the section "**Debugging, Adjustment, Documentation and Annexes**" Chapter "**Debugging**" headings:

- see : *Animating program elements, p. 309,*
  - see : *Execution of a program with breakpoint, p. 319,*
  - see : *Executing a program in step by step mode., p. 322,*
  - see : *Animation and modification of the variables: DFBs, p. 337.*
-

---

# Adjustment of variables

# 14

---

## Introduction

### Subject of this chapter

This chapter describes how to adjust variables.

### What's in this Chapter?

This chapter contains the following topics:

Topic	Page
Animation of variables: creating Animation tables	332
Working with animation tables	334
Animation and modification of the variables: DFBS	337
Modification of the variables:	339
List of forced bits	340

## Animation of variables: creating Animation tables

---

### At a Glance

The software is used to create animation tables containing lists of variables and is used to ascertain the value of the variables using various display types and to force the bit variables. The variables tables can be created in offline or in online mode.

It is possible:

- to create an animation table automatically,
  - to create an animation table manually,
  - to enter a table of variables of the same type.
- 

### Automatically creating an animation table

The software is used to automatically create animation tables by selecting one or more rungs LD (Ladder), statements IL (Instruction List), instructions ST (Structured Text), or a DFB in the language editors and by activating a utility which initializes a new table with all the objects contained in the selected program element.

Procedure:

Step	Action
1	Access the program module of the structure or function views, on which the table is to be created.
2	Select the rung, the statement, the instruction and the DFB then select the <b>Initialize Animation Table</b> contextual menu. The tables which are automatically created in this way can then be modified by deleting or adding new variables.

---

### Manually creating an animation table

Procedure:

Step	Action
1	Select <b>Animation Table</b> in the application browser.
2	Select <b>Edit/Create</b> or use the contextual menu.
3	Enter the variables in address or symbol format and confirm with <b>ENTER</b> . The current value of the variables is displayed.
4	When the table is created, close the entry box.
5	Specify the name of the table, enter any comments and confirm with <b>ENTER</b> or <b>Confirm As</b> .

---

### Entering a table of variables of the same type

Procedure:

Step	Action
1	Enter the first variable.
2	Enter the separator - to increment the position or -.. to increment the channel.
3	Enter the length.
4	Confirm with <b>ENTER</b> .

### Accessing an existing animation table

Carry out the following steps:

Step	Action
1	In the <b>Application browser</b> go to <b>structure</b> view.
2	Double click on the <b>Animation table</b> directory.
3	Double click on the <b>Animation table</b> that you want to access. <b>Result:</b> the animation table editor appears.

### Animation table properties

Animation table properties are:

- **Table name:** it is possible to modify the name, if the table is not open.
- **Location:** this gives the name of any potential functional module associated with the animation table when using PL7 Pro. The animation table can be assigned to a different functional module or detached from the functional module (select "None").
- **Comment:** the comment can be entered and modified.

### How to display or modify the properties of an animation table

Carry out the following steps:

Step	Action
1	Select the animation table.
2	Select the <b>Properties</b> contextual menu.
3	Carry out the modifications.
4	Click on <b>OK</b> .

## Working with animation tables

---

### At a Glance

It is possible to perform several types of operation in an animation table:

- selecting and deleting one or more lines,
  - entering a value for N consecutive variables,
  - changing the format of N consecutive variables,
  - inserting one or more lines,
  - saving the animation table on the PC,
  - deleting the table,
  - changing the name of the table,
  - masking the "Modification, Forcing" zone.
- 

### Selecting and deleting one or more lines

#### Selecting

Click on the rectangle on the left of the variable address (**SHIFT+SPACE**) in order to select the line or click and drag to select more than one line (the selected lines are highlighted in black).

#### Deleting

Select the line or lines and press **Delete**.

---

### Entering a value for N consecutive variables

Carry out the following steps:

Step	Action
1	Click on the first of the consecutive values in the <b>Current value</b> field.
2	<b>SHIFT+Click</b> on the last of the consecutive variables in the <b>Current Value</b> field. <b>Result:</b> the selected variables are highlighted in black.
3	Enter your value in the animation table entry field and confirm with <b>Enter</b> . <b>Result:</b> the selected variables all have the same value.

---

### Changing the display format for N consecutive variables

Carry out the following steps:

Step	Action
1	Select N consecutive variables as explained above.
2	Press the <b>F9</b> key until the required format is obtained.

	<b>WARNING</b>
	<p><b>Displaying digital values:</b></p> <p>If numerical values of more than three figures are truncated, change the thousands separator value in the Windows Control Panel under Regional Settings, numbers section.</p> <p><b>Failure to follow this precaution can result in death, serious injury, or equipment damage.</b></p>

### Inserting one or more lines

Select the line before which the insertion is to be made and select the **Insert a line** contextual menu.

### Saving the animation table on the PC

Select the command **Edit** → **Confirm as** enter the name of the table and confirm with **OK**.

### Deleting an animation table

Procedure:

Step	Action
1	Select the table in question from the application browser.
2	Select <b>Edit</b> → <b>Delete</b> from the menu or press the <b>DELETE</b> key or use the <b>Delete</b> contextual menu.

### Changing the name of an animation table

Procedure:

Step	Action
1	Select the table.
2	Press the <b>F2</b> key or select the <b>Properties</b> contextual menu.
3	Enter the new name and confirm with <b>OK</b> .

**Masking the  
"Modification,  
Forcing" zone**

Select the **View** → **Command Zone** command.

---



## Animation and modification of the variables: DFBs

### Introduction

With DFBs, there are several possibilities for the animation and the modification of the variables:

- automatic creation via a DFB code,
- automatic creation via a DFB instance call,
- automatic creation via a DFB instance code,
- contraction and expansion,
- display and modification of a character string,
- the operate mode for the tables.

**Note:** You can only animate the instances used in the table.

### Automatic creation via a DFB code

It is possible to automatically create an animation table from a DFB code. Select the instance in the list and confirm with **OK**. All the accessible variables on the animation table level will automatically be input.

### Automatic creation via a DFB instance call

Proceed according to the following cases:

If the DFB type...	Then...
is not protected	the call interface and the public variables are viewed and are modifiable. These standard functions are available only for the <b>PL7 Pro</b> product to enable debugging of the DFB type. For the <b>PL7 Junior</b> product, the variables are not modifiable.
is protected	the call interface and the public variables are viewed in read-only. The instance variables are viewed in the table according to a <b>Contract/Expand</b> operate mode on the DFB types.

**Automatic creation via a DFB instance code**

It is possible to automatically create an animation table from a DFB instance code. The variables of the instances depend on the level of protection. Several levels of protection are possible:

If the DFB type...	Then...
is not protected	the parameters and the public and private variables used in the code are viewed and are modifiable. These standard functions are available only for the <b>PL7 Pro</b> product to enable debugging of the DFB type. For the <b>PL7 Junior</b> product, the variables are not modifiable and the private variables are not viewed.
is write-protected	the parameters and public variables used in the code are viewed in read-only.
is in know-how protection	no access is possible.

**Contract/Expand**

If the variable in the animation table is preceded by the + symbol, to know the objects associated to the variable:

- select the variable,
- select the **Edit** → **Expand** command or double click on the +, so the list of associated variables is displayed.

To contract the list of objects associated to the variable, select the **Edit** → **Contract** command or double click on the -.

**Displaying/Modifying a character string**

All the displayable ASCII characters (eg: 1,2,A,B,+,...) are displayed only in animation and the non-displayable ones are replaced by a vertical dash. The NULL character shows the end of the chain. It is not displayed. In **animation**, only the first 10 characters are displayed.

To **Display/Modify** a whole string, you can:

- double click on the concerned cell,
- select the **Display** → **Modify** menu (as a contextual menu or on the menu bar).

Modification: all the objects whose attributes are mandatory inputs (objects whose attributes are by reference) are not modifiable.

**The operate mode for the tables**

According to the type of table chosen in the DFB editor (static or dynamic), the **Animation tables** tool offers:

- static tables: **Contract/Expand** expand to the same level as the number of the element,
- dynamic tables: (in connected mode with the PLC in RUN) **Contract/Expand** expand when the instance is executed and the number of elements is known.

## Modification of the variable

### Introduction

The software allows you to create animation tables containing lists of variables, to know the value of the variables with different types of display and to force the bit variables.

The variables tables can be created in local or in connected mode.

### Viewing the state of the variables

In connected mode, you can activate (**Service** → **Animate** command) or deactivate a table's animation (**Service** → **Stop animation** command). The animation is carried out asynchronously: all the values of the objects are read in the processor at the end of the **MAST** task's cycle. You can view each value on the screen in different display modes. The available modes depend on the type of the object. It is also possible to individually modify the value of a variable and to force or unforce the value of a bit.

### Modifying a variable

Steps to follow:

Step	Action
1	Select the variable and put the cursor on the <b>Current value</b> zone.
2	Input the variable's value and confirm with <b>Modify</b> .

### Forcing a bit in an animation table

Steps to follow:

Step	Action
1	Select the variable to be forced and put the cursor on the <b>Current value</b> zone.
2	Select <b>Force 0</b> to force the bit to zero. The forcing is shown by the letter <b>F</b> . Select <b>Force 1</b> to force the bit to 1 and the forcing is again shown by the letter <b>F</b> .

### Unforcing a bit in an animation table

Steps to follow:

Step	Action
1	Select the variable to be unforced and put the cursor on the <b>Current value</b> zone.
2	Select <b>Unforce</b> .

## List of forced bits

---

### Introduction

PL7 features a tool which allows you to view the list of forced bits in the PLC at any given time without having to go into the animation table in the usual way.

---

### Principles

The forced bits display function is available from the **PLC** menu in online mode only. Launch the forced bits search and the resulting list is displayed in the animation tables editor. The entire man-machine interface is therefore sub-processed to the animation tables editor.

The "**Forced bits list**" tool can be broken down into 2 components:

- **A component in the PLC's OS environment, with the following functions:**
    - managing a forced bits trace table in order to optimize the search,
    - implementing a request to read the trace table.
  
  - **A component in the PL7 environment, with the following functions:**
    - searching for forced bits and creating a list of forced bits,
    - initializing an animation table from this list.
-

**"List of forced bits" tool**

You must be in online mode to access this tool.

Click on **PLC** → **List of forced bits**.

There are two possible scenarios:

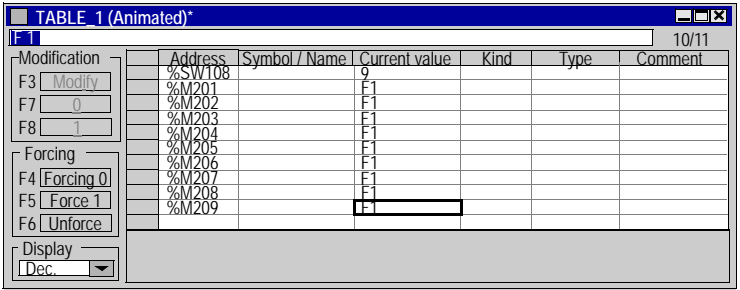
If...	Then...
the PLC contains no forced bits	the following message is displayed: <b>"No forced bits."</b>
there are forced bits.	a forced bits animation table appears: 

When the table is open, the **PLC** → **List of forced bits** command restarts the search creating another forced bits animation table.

**Note:** the **List of forced bits** table displays the forced bits at a given time **t** in the PLC and this table is not refreshed. In fact, we have a static image of the data read in the PLC at the time at which the **PLC** → **List of forced bits** is executed. To obtain the list of forced bits at any given moment **t+1** another **List of forced bits** table must be launched.

**Contents of the "List of forced bits" table**

The contents of a list is identical to the contents of an animation table except that the system word **%SW108** which gives information about the number of forced bits in the PLC, appears at the start of the list.

Review of table fields:

- address,
  - symbol,
  - current value,
  - kind,
  - type,
  - comments.
- 

**Limits and restrictions**

A **List of forced bits** table has a display capacity of 32 forced bits.

If the table is full, no further new forced variables are stored and the %S108 bit system switches to 1. In the case of additional forcing, an OS internal flag will indicate this overflow.

When the maximum number of forced bits is reached, the OS component saves no further forcing/unforcing actions in the table. However, these actions are still carried out and there is no change to the operating procedures at the user and PL7 end. In this context, there is inconsistency between the table contents and the PLC memory. An information message is displayed, which could be:

- **"Overflow of number of forced bits"**,
- **"Cold start necessary to reinitialize the forced bits table"**,
- **"OK"**.

The forced bits list will be displayed again following a cold start (reinitializing all the forced bits and the forced bits table).

---

---

# Diagnostic functions

# 15

---

## Introduction

### Subject of this chapter

This chapter describes the diagnostic functions available for diagnosing the hardware and the application.

### What's in this Chapter?

This chapter contains the following topics:

Topic	Page
Diagnostic of the PLC's last stop	344
Module/channel diagnostics	345
Program diagnostics	346
Module call stacks	348
Diagnostics DFBs	349
Implementation of diagnostics DFB	351
DFB diagnostics error messages	352

---

## Diagnostic of the PLC's last stop

---

### Introduction

To access the diagnostic of the PLC's last stop, you need to be in connected mode.

---

### How to access the diagnostic of the PLC's last stop

The **UC debugging screen** which is accessible through the **Debug** → **Access UC debugging screen** command, allows you to know the cause of the last stop and the date when this stop happened.

Refer to the debugging chapter, last stop zone (see *Last stop zone*, p. 306).

---



## Module/channel diagnostics

### Introduction

The software provides various diagnostics tools. You must be in online mode to access these tools.

**Note:** the diagnostics for the **Discrete** modules and for the **analog** modules are performed in the same way as those described below.

### How to access to module/channel diagnostics

Carry out the following steps:

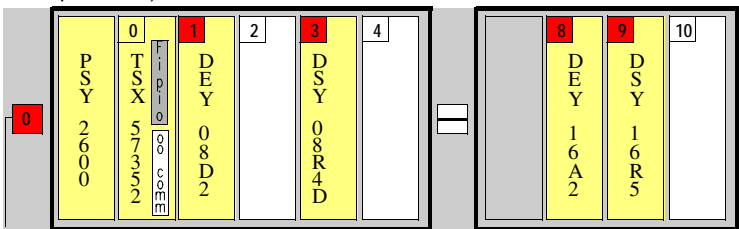
Step	Action
1	Select the command <b>PLC</b> → <b>Connect</b> .
2	In the <b>Application Browser</b> in the <b>structure</b> view, select the <b>Configuration</b> directory then double click on <b>Hardware configuration</b> . When a module is faulty, a red indicator appears on the module position (see example below).
	
3	Select the position of the faulty module, then right click and choose the <b>Open the module</b> command or double click on the selected position.
4	Click on the <b>Diag</b> button. The <b>Diagnostics module</b> screen displays the errors classified by category: internal errors, external errors or other errors. The <b>Channel Diagnostics</b> screen which is accessible by the <b>Diag</b> button in the command zone is used to refine the results.

## Program diagnostics

---

### Introduction

To access the diagnostics tools it is necessary to be in online mode. To connect, select the **PLC** → **Connect** command.

Program diagnostics is used to find out the cause and the source of the switch to error mode. Various types of error are signaled:

- blocking errors (which cause the execution to be stopped),
  - non-blocking errors (which become blocking when the application monitoring option is selected),
  - non-blocking errors.
- 

### Blocking errors (causing the execution to be stopped)

Blocking errors causing the execution to be stopped:

- HALT instruction,
  - incomplete JUMP instruction,
  - watchdog overflow,
  - Grafcet table overflow (active steps, valid transitions),
  - undefined downstream step (rerouting to one step).
- 

### Non-blocking errors (which become blocking when the application monitoring option is selected)

Non-blocking errors which become blocking when the application monitoring option is selected:

- index overflow,
  - division by zero,
  - capacity overflow of an unsigned arithmetic calculation,
  - character string error (the character string transfer zone is too small to accommodate this string),
  - floating point calculation error (division by zero, capacity overflow, incompatibility with the IEEE 754 format following the overlap of the memory zones etc.).
-

**Non-blocking errors**

the following are non-blocking errors:

- cycle time overflow,
- task inputs/output overflow,
- capacity overflow during an arithmetic calculation.

A blocking error is signaled on the status bar.

**Diagnostics procedure for blocking errors**

Carry out the following steps:

Step	Action
1	Access the debugging screen ( <b>Debug</b> → <b>Access the PLC debugging screen</b> ). The <b>ERR</b> indicator flashes.
2	Click on the <b>Diag</b> button or select the <b>PLC</b> → <b>Diagnostics</b> command.

A dialog box provides the diagnostics details:

- click on **Show source** to position the cursor on the faulty module,
- click on **Show Module call stack** to ascertain the chronological sequence of calls which led to the execution of the faulty module (from the most recent to the oldest).

**Diagnostics procedure for non-blocking errors**

These errors are indicated for each task.

Carry out the following steps:

Step	Action
1	In the PLC debugging screen, click on the <b>Fault</b> button which is associated with the task.
2	Click on the <b>Reset Fault Bit</b> button (reset bits systems to 0) to confirm the presence of the error on the different tasks ( <b>FAST</b> , <b>MAST</b> , <b>EVT</b> ).

**Application monitoring**

To refine the diagnostics, or in other words, to make this fault type blocking in order to isolate it, choose the monitoring option (**Mon.**) on the **debugging bar** or use the **Application monitoring** command from the **Debug** menu.

Then execute the diagnostics procedure for non-blocking errors.

## Module call stacks

---

### Introduction

The **Module call stack** display function lets you know the chronological chain of calls that have led to the execution of the faulty module (from the most recent to the oldest), for a diagnostics error in a **SR** or a **DFB** type.

---

### Accessing the Module call stack

This function is accessible in diagnostics and in step by step program.

Click on **Debug** → **Show module call stack**.

The dialog box contains:

- the current task's name. It is also possible to display the other tasks (only in diagnostics mode),
- the modules' call list as well as the line/phrase which have led to the execution of the faulty module (the first in the list is the top of the pile).

The **View** button allows you to view the module selected in the stack (or just double click on the module). This function is also accessible by double clicking on the **ListeBox**.

---

## Diagnostics DFBs

### Introduction

The diagnostics DFBs are accessible from **PL7-Pro**, and are used in the applications which run on **TSX57/PCX57/PMX57** processors.

Diagnostics DFBs consist of:

- diagnostics application DFBs which are used to set up process monitoring via the application program:
  - PL7 equation monitoring,
  - monitoring the reaction time of the process to a command,
  - monitoring the inputs/outputs and the ASI bus,
  - monitoring the safety conditions.
- working part control and diagnostics DFBs which are used to control and monitor elements of the working part (EPOs):
  - monitoring sensor information,
  - monitoring actuator control requests,
  - monitoring the duration of a movement,
  - memorizing the minimum and maximum durations of a movement,
  - learning the duration times of a movement,
  - controlling an actuator.

### At a Glance

The DFB diagnostics provided with PL7-Pro are:

DFB	Functions
EV_DIA	Monitoring the status of 2 bits without taking a time factor into account.
MV_DIA	Monitoring the status of two bits without taking a time factor into account, with the option of monitoring a movement's changes (change of bit status within a given time period).
NEPO_DIA TEPO_DIA	Monitoring, checking and diagnostics for a working part element.
IO_DIA	Diagnostics for all the I/O modules.
ASI_DIA	Diagnostics for an ASI inputs/output module.
ALRM_DIA	Interface with diagnostics buffer (error storage).

**Descriptive form** Every diagnostics DFB possesses a descriptive form describing the DFB function and its parameters (inputs, outputs and public variables).

This form is accessed by double clicking on a DFB type in the application browser, then by clicking on the **Descriptive form** tab in the DFB editor.

---

## Implementation of diagnostics DFB

### Configuration of the diagnostics buffer

To reserve a diagnostics buffer, carry out the following actions:

Step:	Action:
1	Open the application's <b>Properties</b> dialog box (Station directory in the application browser).
2	Choose the Diagnostics tab.
3	Tick the <b>Activate the diagnostics in the application</b> box.

### Registering diagnostic DFBs

Before using a DFB in the application, carry out the following actions:

Step:	Action:
1	Import the <b>binary DFB</b> file (*.UFB) using <b>Import binary</b> from the contextual menu within the PL7's installation directory (example <b>C:\PL7\PL7PRO33\DIAG</b> ).
2	Create a DFB instance (see <i>Creating an instance from an application browser</i> , p. 287) in the PL7's variables editor.

### Programming rule for diagnostics DFBs

A Diagnostic DFB:

- must be executed in the MAST task for managing operate modes. So that it is executed, it is necessary that:
  - the DFB is called (the program element to which it is assigned must be executed)
  - the ED input must be at 1.
- can be instanced in any program module (Section, SR) written in Ladder language (LD), Structured Text (ST) or Instruction list (IL). It is strongly recommended that you only program the instance once,
- imposes a Label on the rung or the phrase containing it.

### Information system

System words and bits acquire information relative to the diagnostics:

Object	Information
%S101=1	Configured diagnostics buffer.
%S102=1	Full diagnostics buffer. If the diagnostics buffer cannot save an error, this error is lost and the %S102 bit passes to 1.
%SW162	The number of errors in the diagnostics buffer.

## DFB diagnostics error messages

### Display window for error messages

All the error messages appear in a window in the lower part of the runtime screens tool.

The size of this window can be modified with the mouse, but its position is fixed. However, it can be hidden.

It consists of a list of messages and has:

- a vertical scroll bar allowing you to view any obscured messages in the list,
- a horizontal scroll bar used to view the entire contents of a line.

### Illustration of the Viewer

Integrated Viewer in PL7-Pro

Acknowledgement	Fault	Application	Appearance: 5	Disappearance: 5	Message	Status
✓	Without Ac...Ev_dia	0	01/03/2000 - 18:21:41	01/03/2000 - 18:21:46	Mixing time too short (< 5 s)	16#C
✓	Without Ac...Alrm_dia	0	01/03/2000 - 18:21:43	01/03/2000 - 18:22:16	Max mixer level reached: 25 liters	
✗	Not Ac... Alrm_dia	0	01/03/2000 - 18:22:16	01/03/2000 - 18:22:18	Max mixer level reached: 25 liters	
✓	Without Ac...Ev_dia	0	01/03/2000 - 18:22:25	01/03/2000 - 18:22:25	Mixing time too short (< 5 s)	16#C
✗	Not Ac... Alrm_dia	0	01/03/2000 - 18:23:05	01/03/2000 - 18:23:11	Max mixing level reached: 25 liters	

A Diagnostics viewer is also available with the CCX17 V2.5.

**Note:** the size of message type variables that are displayed in an alarm viewer should have 40 characters.



**Structure of error messages**

Every line displayed in the Viewer corresponds to an error and contains the following information:

- the message status which is indicated by an icon plus text (the message having to be acknowledged or not),
- the faulty DFB type,
- the geographical zone in which the source of the error is located,
- the time and date when the error appeared,
- the time and date when the error disappeared,
- the message associated with the error,
- the value of the word status at the time of the error.

The user can increase or decrease the size of the columns using the mouse. A column not displaying the information in its entirety ends in an ellipsis.

The width of each column is stored and retrieved while opening the runtime screens tool.

---

**Error message display**

The number of messages it is possible to display is limited only by the size of the memory buffer. When there is not enough memory, a message warns the user and any messages of errors that have disappeared or have been acknowledged (if necessary) are then deleted.

It is possible to modify the color of the messages and the blinking associated with an acknowledged message.

In the viewer, it is possible to show only those messages which come from one or more specific zones.

The list of messages can be sorted according to each field. To do this, simply click on the column header containing the data on the basis of which the sort is to be carried out.

A second click carries out the sort in opposite order.

By default, the error messages are inserted into the list in the chronological order in which they appear.

---

**Error message management**

Possible operations:

Operation	Implementation
Navigation	With the <b>Up, Down, Page-Up, Page-Down, Home, and End</b> keys.
Acknowledgment	By using the contextual menu having selected the corresponding item. Several messages can be acknowledged at the same time. After an acknowledgment, an order is sent to the PLC. The acknowledgment can come from another viewer, in which case the runtime screens tool is alerted and the message is displayed as acknowledged.
Deletion	By using the contextual menu having selected the corresponding item or by using the <b>Delete</b> key. Only messages that have disappeared and been acknowledged (if necessary) are deleted.
Properties	By using the contextual menu, or the <b>Enter</b> key. The following information is displayed: <ul style="list-style-type: none"> <li>● the name and type of the faulty DFB instance,</li> <li>● the program address containing the faulty DFB instance,</li> <li>● the associated text and status bits.</li> </ul>

**Error message archiving**

Archiving is used to create a log file. The activation and the location of this file are configured in a window that can be accessed using the **Service/Configure/Viewer tab** command.

It is possible to modify the directory in which the archive file is located. By default, it is kept in **C:\PL7USER\NameAppli.HIS**.

This file is in ASCII format, so it is easy to import it into a text editor or a spreadsheet.

To stop the file from becoming too large, it is renamed in NameAppli.BAK every 1000 saves and a new file is created with its source name.

	<b>WARNING</b>
	<p>If a NameAppli.BAK file already exists, it is deleted without warning.</p> <p><b>Failure to follow this instruction can result in death, serious injury, or equipment damage.</b></p>

**Error message customization**

Messages can be customized for every diagnostics DFB instance.

The modification is made via the **DFB** variable editor menu and the new message is entered into the comment zone.

**Note:**

The diagnostics DFBs that do not support error message customization are **IO\_IA** and **ASI\_DIA**.

---



---

# Documentation

# 16

---

## Presentation

### Subject of this chapter

This chapter describes how to create the documentation file for the application.

### What's in this Chapter?

This chapter contains the following topics:

Topic	Page
Contents of documentation file	358
Documentation: application documentation file	361

## Contents of documentation file

---

### At a Glance

The documentation file of an application contains the following different headings:

- title page,
  - contents,
  - configuration,
  - function view,
  - program,
  - DFB types,
  - cross references,
  - animation table,
  - variables,
  - cartridges.
- 

### Description of the title page and the contents

#### **Title page:**

this heading gives the name of the designer and the name of the project.

#### **Contents:**

the contents table is created automatically by the software according to the selected options.

---

### Description of the configuration heading

This heading has two sub-headings:

- hardware configuration,
- software configuration.

#### **Hardware configuration:**

rack configuration, module parameters.

This sub-heading allows you to print the PLC configuration as well as the different parameters of the input/output modules.

#### **Software configuration:**

this sub-heading allows you to print the application software configuration.

---

### Description of the Function View heading

This heading gives the function view contents list.

---

---

**Description of the program heading**

Choosing this heading automatically selects the existing modules in the application. For each language LD, IL and ST select printing in symbol or address format. The selected mode applies to all modules in the same language. The "With Variables Used" option allows you to print the list of the variables used after each rung or phrase.

Several sub-headings are available:

- application structure,
- **MAST** task,
- **FAST** task,
- event task.

**Application structure:**

this heading is used to print the application software structure as well as the tree structure subroutine calls.

**MAST Task :**

this sub-heading is itself built up of sections (as well as PRL/CHART/POST modules if there is a GR7 section) and subroutines.

**FAST Task :**

this sub-heading is also built up of sections and subroutines.

All of these headings are used to print the contents of the different sections that constitute the program.

---

**Description of the DFB Type heading**

The following details are given for each DFB type:

- the properties,
  - the descriptive form,
  - the interface and public variables,
  - the code (except for Schneider Automation diagnostics DFBs),
  - the private variables.
- 

**Description of the cross references, animation tables and variables headings****Cross references:**

this heading allows you to print the list or lists of variable cross references.

**Animation table:**

this heading allows you to print the different animation tables along with the addresses, the symbols, the types and the kind.

**List of variables :**

this heading is used to print the list or lists of variables and their parameters.

---

**Description of  
the footer  
heading**

Select this heading to create a footer at the bottom of the documentation page:

- the blank fields can be filled in by the user,
  - the shaded fields are filled in automatically.
-



## Documentation: application documentation file

### Accessing the application documentation file

To access a documentation file, double click on the **documentation file** icon in the structure view of the application browser, a **documentation** window then displays the various components of the application documentation file.

### Components of the application documentation file

Each element of the documentation file can be included or excluded by using the contextual menu: by right clicking.

The elements included in the documentation file are marked with a red square.

#### To build the file carry out the following actions:

Step	Action
1	Select each element to be included or excluded in the file using the <b>Include heading</b> or <b>Exclude heading</b> contextual menus or select <b>Edit</b> → <b>Exclude heading</b> from the menu.
2	Set the parameters for the various elements: Program, DFB type, Cross references, Variables, Footer.
3	Select the <b>Build</b> contextual menu via the general documentation file icon or select <b>Edit</b> → <b>Build</b> from the menu.

### Setting the documentation file parameters

Various parameter settings are available for the documentation file:

- setting the footer parameters,
- setting the variable sorting parameters,
- setting the cross reference sorting parameters,
- setting the program printing parameters,
- setting the DFB printing parameters.

#### Setting the footer parameters

Click on the footer icon in the **documentation** window and select the **Parameters** contextual menu.

- the blank fields can be filled in by the user,
- the shaded fields are filled in automatically.

### Setting the variable sorting parameters

Carry out the following actions:

Step	Action
1	Click on the variables icon in the <b>documentation</b> window and select the <b>Parameters</b> contextual menu.
2	Select the variable sorting order: ascending order of symbols, ascending order of addresses or both.

### Setting the cross reference sorting parameters

Carry out the following actions:

Step	Action
1	Click on the <b>Cross references</b> icon in the documentation window and select the Parameters contextual menu.
2	Select the variable sorting order: ascending order of symbols, ascending order of addresses or both.

### Setting the program printing parameters

Click on the Program icon in the **documentation** window and select the **Parameters** contextual menu to access the different tabs:

- Instruction List tab  
Select printing in either symbol or address format.  
Check the **With variables used** box to also print the variables of the program module.
- Structured Text tab  
Select printing in either symbol or address format.  
Check the **With variables used** box to also print the variables of the program module.
- Ladder Language tab  
Check the **Long Text** box to print all the symbols.  
Select printing in symbol and/or address format.  
Check the **With variables used** box to also print the variables of the program module.

### Setting the DFB printing parameters

Carry out the following actions:

Step	Action
1	Click on the <b>DFB type icon</b> in the <b>documentation</b> window and select the contextual <b>Parameters</b> menu.
2	Select the components to be printed.

## Printing the documentation file

### Documentation file print setup

Carry out the following actions:

Step	Action
1	Select the <b>File</b> → <b>Print Setup</b> menu. <ul style="list-style-type: none"> <li>• if a printer is already configured in the Windows Print Manager as a default printer, it is shown in the dialog box,</li> <li>• if several printers have been declared in the Windows Print Manager, select the required printer from the list.</li> </ul>
2	Configure the printer by clicking on <b>Configuration</b> .

**Note:** It is necessary to rebuild the documentation file if the printer is changed.

### Print Preview

Carry out the following actions:

Step	Action
1	Select the element to be displayed from the documentation file.
2	Select the <b>View</b> contextual menu (right click).

### Printing the documentation file

Two printing options:

- **printing the documentation file,**
- **printing a element of the documentation file.**

### Printing the documentation file

Step	Action
1	Click on the program icon in the <b>documentation</b> window.
2	Select <b>Print</b> from the contextual menu or click on the printer icon in the task bar.

### Printing an element of the documentation file

Step	Action
1	Click on icon of the element to be printed in the <b>documentation</b> window.
2	Select <b>Print</b> from the contextual menu or click on the printer icon in the task bar.

**Note:** It is possible to interrupt printing by clicking on **Cancel**.



---

## Introduction

### Subject of this chapter

This chapter describes :

- The application's source files.
- The export/import of the application's source files.

### What's in this Chapter?

This chapter contains the following topics:

Topic	Page
General points on import/export	367
Import/Export source files	368
Exporting a Section , a Subroutine, an Event	375
Importing a Grafcet/Ladder/List/Structured text section	377
Exporting an LD, IL, ST, Grafcet source file	378
Importing an LD, IL, ST, Grafcet source file.	379
Exporting variables	381
Importing variables	382
Importing/Exporting variables in EXCEL format	384
Exporting a functional module	386
Importing a functional module	388
Importing a functional module using the wizard	390
Exporting animation table(s)	394
Importing animation table(s)	396
Export of runtime screens	398
Import of runtime screens	401
Export of a DFB type	404
Importing a DFB type	406
Exporting an application	408

<b>Topic</b>	<b>Page</b>
Importing an application	410
Exporting an application in FNES format (Input/Output Neutral File)	413
Importing an application in FNES format	414

---

---

## General points on import/export

---

### Introduction

Import/Export functions for the PLC TSX 37 or TSX 57 applications allow you:

- to insert or to duplicate all or part of **IL, LD, ST, Grafcet** program module.
  - to insert an **IL, LD** or **ST** section into a task (MAST, FAST, EVT...).
  - to insert a **DFB** type into the list of DFBs.
  - to insert **symbolized variables** in the table of variables.
- 

### File types

The following file types can be imported or exported:

- LD source denoted by **\*.LD**.
- IL source denoted by **\*.IL**.
- ST source denoted by **\*.ST**.
- Grafcet source denoted by **\*.GR7**.
- Symbols source denoted by **\*.SCY**.
- DFB type source denoted by **\*.DFB**.
- DFB type binary denoted by: **\*.UFB**.
- Application source denoted by **\*.FEF**.

#### Notes:

File source code is 8 bit **ASCII** conforming to ISO standard 8859-1.

The input of code is possible directly using **WINDOWS compatible editors**, such as Word in text format (\*.TXT).

The code of a DFB type binary is not accessible (encrypted).

---

### Possible commands

**File/Export** supports the export of:

- All or part of a LD, IL, ST or Grafcet program module.
- All or part of the symbols table.
- A DFB type.

**File/Import** supports the import of:

- An LD, IL, ST, G7 file.
- A DFB type.
- A symbol source.

#### Notes:

In order to select the directory containing the application **source files**, use the command **Options/Customize**. (The file PL7.INI contains the pathname for the source files). The source directory becomes the **current** directory for import/export.

---

## Import/Export source files

---

### General points

A source file is composed of a minimum of **three blocks** of information structured in **lines** of a maximum 1024 characters, terminating in one or two end of entry characters.

A block is identified by its **name** between [ ].

The end of the source file is identified by the "[**EOF**]" (End Of File) character string.

---

### Description of the blocks

A file is made up of the following blocks:

- A [**HEADER**] block, containing general information (Date, Manufacturer's Name).
  - The [**APPLICATION**] block identifies:
    - The name of the source application.
    - Date of creation.
    - Version.
    - Comments.
  - The [**VENDOR**] block describes the configuration (number of timers, counters, internal bits, etc.).
  - The [**SOURCE UNIT**] block for the program modules contains:
    - **LD** code for \*.LD files.
    - **IL** code for \*.IL files.
    - **ST** code for \*.ST files.
    - **GR7** code for \*.GR7 files.
    - **Properties, parameters** and **code** for DFB files (\*.DFB).
  - The [**DATA UNIT**] block for the symbols files contains:
    - application variables (file denoted by "\*.SCY").
-



**LD source file****Header Block**

```
[HEADER]
DATE = date #1999-12-10
STANDARD = 'PLCopen v0.1 1993'
SENDER = 'Schneider Automation PL7 PRO V3.4'
```

**Application Block**

```
[APPLICATION]
NAME = 'MACHINE_DOSAGE'
DATE = date_and_time#1999-12-10-14:52:06
VERSION = '0.125'
```

**Source Unit Block**

```
[SOURCE_UNIT]
SU_TYPE = PROG
NAME = 'MAST_MAIN'
LANGUAGE = LD
BODY =
ADDRESS = MAST MAIN
PROGRAM
RUNG (*Mixing timer*)
P_CONTACT(%M17),BLOCK(%TM0),H_LINK(7),COIL(%M15);
EMPTY_LINE;EMPTY_LINE;
END_RUNG
RUNG
(*Management of mixer emptying*)
OPEN_CONTACT(%X1.0),H_LINK,P_CONTACT(%M200),
OPEN_CONTACT(%M16),H_LINK(3),OPERATE DEC %MD12 END_BLOCK;
END_RUNG
END_PROGRAM
[EOF]
```

**IL source file****Header Block**

```
[HEADER]
DATE = date #1999-10-10
STANDARD = 'PLCopen v0.1 1993'
SENDER = 'Schneider Automation PL7 PRO V3.4'
```

**Application Block**

```
[APPLICATION]
NAME = 'MOP5'
DATE = date_and_time#1999-10-10-14:52:06
VERSION = '0.125'
```

**Source Unit Block**

```
[SOURCE_UNIT]
SU_TYPE = PROG
NAME = 'MAST_SR1'
LANGUAGE = IL
BODY =
ADDRESS = MAST SR1
PROGRAM(*PHRASE*)(* *) LDN %M0 ST %M1
LD %M2 ST %M3
(*END_PHRASE*)
END_PROGRAM
[EOF]
```

---

**ST source file****Header Block**

```
[HEADER]
DATE = date #1999-08-10
STANDARD = 'PLCopen v0.1 1993'
SENDER = 'Schneider Automation PL7 PRO V3.4'
```

**Application Block**

```
[APPLICATION]
NAME = 'MOP6'
DATE = date_and_time#1999-08-10-14:52:06
VERSION = '0.125'
```

**Source Unit Block**

```
[SOURCE_UNIT]
SU_TYPE = PROG
NAME = 'FAST_MAIN'
LANGUAGE = ST
BODY =
ADDRESS = FAST MAIN
PROGRAM(*PHRASE*)(*INIT*)%L1:
  IF %MW0=%MWW1
    THEN %SR1;
  END_IF;
(*END_PHRASE*)
END_PROGRAM
[EOF]
```

## 7 source file

### Header Block

```
[HEADER]
DATE = date #1999-06-10
STANDARD = 'PLCopen v0.1 1993'
SENDER = 'Schneider Automation PL7 PRO V3.4'
```

### Application Block

```
[APPLICATION]
NAME = 'MOP7'
DATE = date_and_time#1999-06-10-14:52:06
VERSION = '0.125'
```

**Source Unit Block**

```
[SOURCE_UNIT]
SU_TYPE = PROG
NAME = 'Sequential'
LANGUAGE = OTHERS
BODY =
ADDRESS = MAST Chart
PROG_LANGAGE = GR7VAR_GLOBAL
END_VAR
PROGRAMMAST'Chart'
NB_PAGES = 8
PAGE 0
INITIAL_STEP 0 AT (C 4,L 3) :
ACTION (N1,LD) :
RUNG EMPTY_LINE;OPEN_CONTACT(%M8),H_LINK(9),
COIL(%M10);
END_RUNG
END_ACTION
END_STEP
TRANSITION (*TOP*) (LD) AT (C 4,L 4) :
RUNG OPEN_CONTACT(%M1),H_LINK(9),
HASH_COIL;
END_RUNG
END_TRANSITION
T_S_OR_LINK FROM (C 4,L 4) TO (C 4,L 3) := [H_LINK FROM (C 4,L 4)
TO (C 5,L 4), V_LINK FROM (C 5,L 4) TO (C 5,L 2),
H_LINK FROM (C 5,L 2) TO (C 4,L 2)]END_PAGEPAGE 1
END_PAGE
PAGE 2
END_PAGE
PAGE 3
END_PAGE
PAGE 4
END_PAGE
PAGE 5
END_PAGE
PAGE 6
END_PAGE
PAGE 7
END_PAGE
END_PROGRAM
[EOF]
```

**Symbols source  
file****Header Block**

```
[HEADER]
DATE = date #1999-12-10
STANDARD = 'PLCopen v0.1 1993'
SENDER = 'Schneider Automation PL7 PRO V3.4'
```

**Application Block**

```
[APPLICATION]
NAME = 'MOTOR'
DATE = date_and_time#1998-12-02-14:52:06
VERSION = '0.125'
```

**Data Unit Block**

```
[DATA_UNIT]
DA_TYPE =
LOCATION =
NAME =
BODY =
VAR_GLOBAL
Surv_niv_malax : Alrm_dia (*Maximum mixer level reached: 25 liters*);
Gest_prod_silo_a : Cpt_replissage;Gest_prod_silo_c :
Cpt_replissage;Gest_prod_silo_b : Cpt_replissage;
Gest_prod_melangeur : Cpt_replissage;Surv_malax :
Ev_dia (*Mixing time too short (<5secs)*);
Vidange_cuve : Simul_vidange;Dcy AT %M0 : EBOOL
(*Start cycle*);Evt_1 AT %M1 : EBOOL
(*Silo A valve (=0 closed =1 open)*); Evt_2 AT %M2 : EBOOL
(*Silo B valve (=0 closed =1 open)*); Evt_3 AT %M3 : EBOOL
(*Silo C valve (=0 closed =1 open)*); Evt_4 AT %M4 : EBOOL
(*Hopper B1 valve (=0 closed =1 open)*); Evt_5 AT %M5 : EBOOL
(*Hopper B2 valve (=0 closed =1 open)*); Evt_6 AT %M6 : EBOOL
(*Mixer valve (=0 closed =1 open)*);
END_VAR
[EOF]
```

## Exporting a Section , a Subroutine, an Event

### Introduction

The **Export** function can be accessed in local mode and in connected mode, with the PLC in Stop mode.

It supports export of:

- all or part of a program module from within a language editor (LD, IL, ST, Grafcet),
- a whole section, a program module from within the application browser.

### Exporting from within an editor

Carry out the following actions:

Step	Action
1	Open the section (LD, IL, ST or Grafcet).
2	Select the part of the program to be exported (if nothing is selected, the whole module is exported). For <b>Grafcet</b> , select either: <ul style="list-style-type: none"> <li>• the whole module (default),</li> <li>• the current page (the one where the cursor is),</li> <li>• from page x to page y inclusive, between values 0 and 7.</li> </ul>
3	Select the command <b>File/Export</b> .
4	Select the disk and/or the directory where the file is to be saved using the pull-down menu <b>In</b> .
5	Enter a file name in the field <b>Name</b> .
6	Confirm with <b>Save</b> .

### Exporting from within the application browser

Carry out the following actions:

Step	Action
1	Left mouse click on the <b>Section</b> or the <b>Module</b> to be exported or move the cursor using the arrow keys.
2	Using the contextual menu or the <b>File</b> menu or the keys <b>Shift+F10</b> select the command <b>Export</b>
3	Select the disk and/or the directory where the file is to be saved.
4	Enter a file name in the field <b>Name</b> .
5	Confirm with <b>Save</b> .

**Notes**

During export, the message "**Processing (Esc to cancel):1**" is displayed in the status bar.

Pressing **Esc** followed by confirmation stops the export and the source file is not created.

---

**Errors**

The only error that can arise is insufficient disk space available. If this happens, an error message is displayed.

The generation of the source file in progress is aborted.

---



## Importing a Grafcet/Ladder/List/Structured text section

---

### Importing a Grafcet section

See: *Creating or importing a Grafcet section, p. 125.*

---

### Importing a Ladder/List/ Structured text section

See: *Creating or importing an LD, IL, ST section, p. 123.*

---

## Exporting an LD, IL, ST, Grafcet source file

---

### Introduction

The Export function can be accessed off-line or on-line, PLC at Stop).

It is used to export:

- all or part of a program module from a language editor (LD, IL, ST, Grafcet),
  - a complete section or program module from the application browser.
- 

### Exporting from an editor

Carry out the following:

Step	Action
1	Open the (SR, EVT, PRL, POST) section or module.
2	Select the part of the program to be exported (if nothing is selected, all the module is exported). <b>With Grafcet:</b> Select either: <ul style="list-style-type: none"><li>● the whole module (by default),</li><li>● the current page (the one the cursor is on),</li><li>● from page x to page y with x, y between 0 and 7.</li></ul>
3	Select the command <b>File/Export</b> .
4	Select the disk and/or directory where the file is to be saved using the scrollable menu <b>In</b> .
5	Enter a filename in the field <b>Name</b> .
6	Confirm with <b>Save</b> .

---

### Exporting from an application browser

Carry out the following:

Step	Action
1	Right click on the section or module to be exported or select with the arrow keys and then press (Shift + F10).
2	Select the command <b>Export</b> .
3	Select the disk and/or directory where the file is to be saved.
4	Enter the filename in the field <b>Name</b> .
5	Confirm with <b>Save</b> .

---

### Errors

The only error that can occur with an **Export** is lack of available disk space; in this case an error message is displayed.

---

## Importing an LD, IL, ST, Grafcet source file.

### Introduction

The Import function can be accessed in local mode and in connected mode, with the PLC in Stop mode.

It supports import of:

- A source file into a section (empty or already programmed) from a language editor,
- A section or a module from the application browser.

### Importing from within an editor

Carry out the following actions:

Step	Action
1	Open the section, or the module (SR, EVT, PRL, POST).
2	Put the cursor in the editor in the position where you want to insert the code.
3	From the <b>File</b> menu select the command <b>Import</b> .
4	Select the source file relating to the section to be imported.
5	Carry out any necessary corrections (label %Li, Step number...).
6	Confirm the import with <b>Enter</b> or select the command <b>Edit/Accept (CTRL+W)</b> or click on the icon  .

### Importing from within the application browser

- Importing a Section (See *Creating or importing an LD, IL, ST section, p. 123*),
- Importing an SR (See *Creating or importing a subroutine (SR), p. 127*),
- Importing an event (See *Creating or importing an event, p. 128*),
- Importing a **Grafcet** source:
  - This applies to all or part of the chart (CHART module, Step-Macro).
  - It can be carried out from any page referenced by the position of the cursor. The imported pages replace the current pages.
  - If Grafcet objects (step activity bits, step time bits) are referenced in the application, a message informs the user.
  - At the end of the import, the cursor is positioned on the last defined return key symbol or on the page which follows the last imported page.
  - **Special cases:**
    - If eight pages are read, the cursor remains on page seven.
    - If the user aborts the import part way through, the cursor is positioned on the first page of the import.
    - If the contents of a page are incorrect, the editor displays the page in error with the correction functions for the page and the look-up functions for the pages already imported.
    - The contents of a Macro-Step cannot be imported into the CHART and vice versa.

**Notes**

During import, the message "**Processing (Esc to cancel): 1**" is displayed in the status bar.

Pressing **Esc** followed by confirmation deletes the code already inserted.

---

**Errors**

Two types of error are possible:

- Non blocking errors, in this case:
  - The corresponding editor is launched on the phrase, the contacts network or the chart containing the anomaly.
  - The user can correct or abort the import. If the correction is carried out the import continues.
- Blocking error (source file modified in the editor), in this case:
  - The user can only abort the import, the import is interrupted.
  - The user must remedy the cause and restart the import procedure.

**Note:**

If an object is not configured, accessing configuration to remedy the problem is possible, after validation the import can continue.

---

## Exporting variables

---

**Functionality** The Export variables function can be accessed in local mode and in connected mode, with the PLC in Stop mode.

---

**Procedure** Carry out the following actions:

Step	Action
1	Open the variables editor from the application browser by double clicking with the left mouse button on one of the data families or by using the keys <b>Shift+F10</b> or via the contextual menu command <b>Open</b> .
2	From the <b>File</b> menu select the command <b>Export</b> .
3	Select the disk and/or the directory where the file is to be saved using the pull-down menu <b>In</b> .
4	Enter a file name in the field <b>Name</b> .
5	Select the export mode. <ul style="list-style-type: none"> <li>● <b>All types</b>: all the database entries are exported,</li> <li>● <b>Current type</b>: only the data relating to the current display type is processed.</li> </ul>
6	Confirm with <b>Save</b> .

**Notes:**

During the processing period the message "**Processing object (Escape to cancel):xx**" (number of the element being processed) is displayed in the status bar.

Pressing **Esc** followed by confirmation stops the processing and no source file is created.

---

**Errors** The only error that can arise is insufficient disk space available. If this happens, an error message is displayed.

The generation of the source file in progress is aborted.

---

## Importing variables

---

### Introduction

The Import variables function can be accessed in local mode and in connected mode, with the PLC in Stop mode.

It supports insertion of a data file into the application (%M, %S, %K, %X, E/S, SFB, EFB, DFB) from the variables editor.

---

### Managing conflicts

There are three kinds of conflicts:

- Address conflict:
  - The symbol to be read already exists in the symbols database, but it represents a different address
- Symbol conflict:
  - The address to be read is already represented in the symbols database, but by a different symbol.
- Comments conflict:
  - The address to be read is already represented in the symbols database with the same symbol, but the 2 comments which are associated with them are different.

Three modes of operation allow you to manage these situations:

- Overwrite mode:
    - Priority is given to the contents of the source file.
  - Do not overwrite mode:
    - Priority is given to the contents of the symbols database.
  - Dialog mode:
    - The user chooses the priority in relation to the conflict displayed.
-

**Procedure**

Carry out the following actions:

Step	Action
1	Open the variables editor from the application browser by double clicking with the left mouse button on one of the data families, or via the <b>Contextual</b> menu select the command <b>Open</b> .
2	Select the command <b>File/Import</b> .
3	Select the file <b>.SCY</b> to be imported.
4	Select the operation mode: <ul style="list-style-type: none"><li>● Overwrite,</li><li>● Do not overwrite,</li><li>● Dialog.</li></ul>
5	Accept with <b>Open</b> .

**Notes:**

During the processing period the message "**Processing object (Escape to cancel):xx**" with xx the number of the element being processed is displayed in the status bar.

Pressing **Esc** causes the abort after restoring the current variable, the variables already restored are kept.

**Errors**

On detecting collisions in the database the user can either:

- Keep the contents of the database.
- Overwrite the variable with that from the file being restored.
- Abort the import.

## Importing/Exporting variables in EXCEL format

### Introduction

This function concerns the unitary import/export of variables.  
 It is possible to import/export application variables using a format which is compatible with **EXCEL**.  
 This makes it easier to work with and create source files, using **EXCEL**.

### General points

**TXT** is the chosen format, using tabs as separators. Provision is made for this save format in the **EXCEL** tool.  
 However, when reading these files in EXCEL, it must be indicated to EXCEL that the tabulation character is to be interpreted as a separator (standard principles of file import into **EXCEL**).

### How to export variables in EXCEL format

Carry out the following steps:

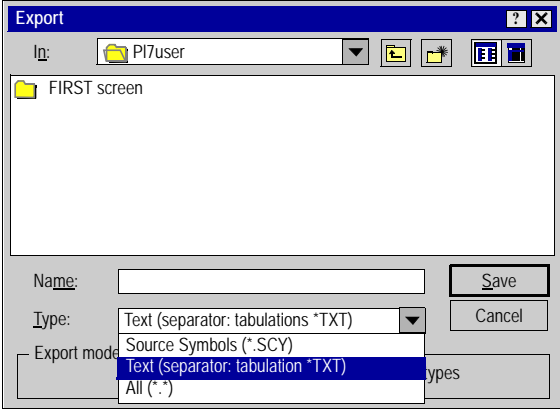
Step	Action
1	In the <b>Structure View</b> of the <b>Application Browser</b> double click on the <b>Variables</b> directory.
2	Right click (contextual menu) on one of the variable items.
3	Click on open. <b>Result:</b> a variables window appears.
4	Select <b>File</b> → <b>Export</b> . <b>Result:</b> the following window appears. 
5	Choose the export destination directory and in the <b>Type</b> field select: " <b>Text (separator: tabulations *TXT)</b> ".
6	Name the file and click on <b>Save</b> .



## How to import variables in EXCEL format

Carry out the following steps:

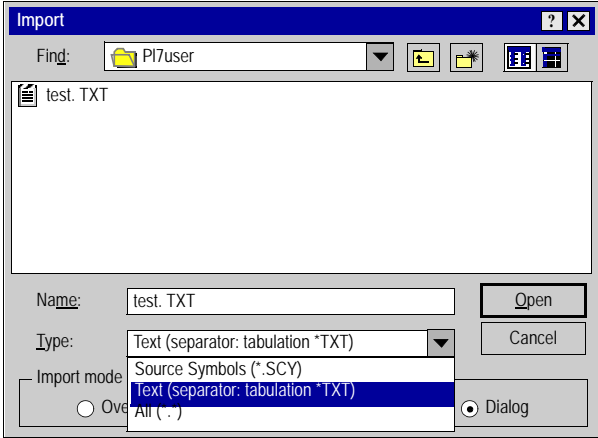
Step	Action
1	In the <b>Structure View</b> of the <b>Application Browser</b> double click on the <b>Variables</b> directory.
2	Right click (contextual menu) on one of the variable items.
3	Click on open. <b>Result:</b> a variables window appears.
4	Select <b>File</b> → <b>Import</b> . <b>Result:</b> the following window appears.
	
5	Choose the directory from which the import should be carried out and in the <b>Type</b> field select: " <b>Text (separator: tabulations *TXT)</b> ".
6	Select the file and click on <b>Save</b> .

## Exporting a functional module

---

### Introduction

Exporting a functional module carries out:

- the export of the sections, events and Grafcet modules which make up the functional module,
- the export of the functional sub-modules which make up the functional module.

The short name and the function name are exported and then restored at the time of import.

The function Export an application can be accessed in local mode and in connected mode, with the PLC in Stop mode.

**Note: When the functional module has one or more DFB instances:**  
The receiver application must contain the DFB type(s) corresponding to the functional module instances, in order to be able to subsequently import the functional module.

### Procedure

Carry out the following actions:

Step	Action
1	Left mouse click on the module to be exported or position the cursor over it using the arrow keys.
2	Using the contextual menu or the <b>File</b> menu or using the <b>Shift+F10</b> keys select the command <b>Export</b> .
3	Select the disk and/or the directory where the file is to be saved (default directory is PL7user).
4	Enter a file name in the field <b>Name</b> (the source file is of the type *.FM)
5	Confirm with <b>Save</b> .

### Notes:

It is forbidden to export a functional module if an associated section, event or Grafcet module is being modified.

---

**Exporting a functional module with operating screen(s)**

The export of a functional module leads to the creation of a directory NomRep.FM which contains:

- a source file NomMod.FM,
- a directory ECREXP in which the tree structure dedicated to the operating screens is located.

**The export procedure is identical to that described above.**

---

**Exporting a functional module with animation table(s)**

The source file NomMod.FM contains the source of each animation table contained in the functional module.

The export of the functional module is allowed if no animation table is being modified.

**The Export procedure is identical to that described above.**

---

## Importing a functional module

---

### At a Glance

The import of a functional module behaves like a creation with:

- the import of the sections, events and Grafcet modules which make up the functional module,
- the import of the functional sub-modules which make up the functional module.

The short name and the function name are exported and then restored at the time of import.

If a section, event, Grafcet module, a functional sub-module making up the imported functional module already exists with the same name, the software allows you to enter a new name.

The Import function can be accessed in local mode and in connected mode, with the PLC in Stop mode.

Two import procedures are available:

- import without reassignment,
- import with reassignment, which allows you to make changes before starting the import.

**Note: When the functional module has one or more DFB instances:**

The receiver application must contain the DFB type(s) corresponding to the functional module instances, in order to be able to import the functional module.

---

### Procedure for importing without reassignment

Carry out the following actions:

Step	Action
1	Left mouse click on the destination directory (station or functional module directory) or position the cursor over it using the arrow keys.
2	Using the <b>Contextual</b> menu, the <b>File</b> menu or the <b>Shift+F10</b> keys select the <b>Import</b> command.
3	Select the source file ( <b>*.FM</b> ) to be imported.
4	Accept with <b>Open</b>

**Note:**

As only one Grafcet section is allowed in the MAST task, importing a module containing a Grafcet section is forbidden if a Grafcet section already exists.

---

**Procedure for importing with reassignment**

Carry out the following actions:

Step	Action
1	Left mouse click on the destination directory (station or functional module directory) or position the cursor over it using the arrow keys.
2	Using the <b>Contextual</b> menu or the <b>File</b> menu or using the keys <b>Shift+F10</b> select the command <b>Import</b> .
3	Select the source file (*.FM) to be imported.
4	Check the box <b>Open with wizard</b> .
5	Accept with <b>Open</b> .

**Note:**

For more information on the wizard, see "Importing functional module using the wizard" (See *Importing a functional module using the wizard*, p. 390).

**Importing a functional module with animation table(s)**

The contents of the file NOM.FM containing the source of each animation table in addition to the information linked to the functional module is imported.

The possible conflicts are dealt with in the section *Importing animation table(s)*, p. 396.

If the procedure with reassignment is selected then:

- it is impossible to reassign a variable present uniquely in an animation table,
- reassigned variables are also reassigned at the level of the animation tables which contain them.

**Importing a functional module with operating screen(s)**

If the procedure with reassignment is selected then:

- it is impossible to reassign a variable present uniquely in an operating screen,
- reassigned variables are also reassigned at the level of the operating screens which contain them.

## Importing a functional module using the wizard

---

### Introduction

When **importing with reassignment**, if you want assistance check the box **Open with wizard**. This tool guides you through the reassignments.

Detailed below are the different **Tabs** in the tool.

---

---

**Directory Tree  
Tab**

Supports the modification of the different elements. The source name is quoted as a prefix to the new name: **Source Name => Target Name**.

The entry is **enabled** by a **double left click on the object**, **confirmed** by the **Enter** key, **cancelled** by the **Esc** key.

The different elements are:

- Functional Module:
    - The name is made up of a maximum of eight alphanumeric characters ('A'..'Z' and '0'..'9') and underscore ('\_'), the first character obligatorily being a letter.
    - The name must be unique.
    - The long name associated with a functional module can be displayed and modified in the Long name field.
  - Section, Task:
    - The name is made up of a maximum of sixteen alphanumeric characters ('A'..'Z' and '0'..'9') and underscore ('\_'), the first character obligatorily being a letter.
    - The name of a section must be unique.
    - The task associated with a section (not including the Grafcet section) can be displayed and modified with the help of the associated pull-down menu (MAST, FAST).
  - Grafcet and Macro-Steps:
    - When the Grafcet section is imported in its entirety, it appears in the graphical representation of the functional module, and can thus be modified.
    - When Grafcet modules are imported independently of their Grafcet section, the user can display and modify the name of the Grafcet section in the field "Grafcet Section". This field is visible as soon as a Grafcet module is highlighted in the tree directory.
    - The name of the Grafcet entities PRL, POST and CHART cannot be modified.
    - For the macro-steps Macro<i>, the new name entered must not be more than a maximum of 7 characters, only their number can be modified and this number must be between 0 and 63.
    - The new macro-step Macro<i> must be unique, that is no other macro-step must have the same number, or correspond to a macro-step Target call.
  - Events:
    - The name is made up of a maximum of five characters. Only the modification of their number (0..63) is allowed.
    - The new event Evt<i> must be unique.
-

**Addresses Tab**      Presents the symbols and addresses of the functional module and supports modification of the name of the different elements.

The entry is **enabled** by a **double left click on the object**, **confirmed** by the **Enter** key, **cancelled** by the **Esc** key.

The family field supports the selection of the different imported objects:

- Standard objects are taken into account.
- Derived objects are not taken into account:
  - Indexed object.
  - Extract bits from indexed object.
  - Indexed extract bit.
  - Table.
  - Indexed table.

---

**DFB Tab**              Presents the DFB instances which are declared in the functional module.

The entry is **enabled** by a **double left click on the object**, **confirmed** by the **Enter** key, **cancelled** by the **Esc** key.

The different elements are:

- Comment:
  - The comment associated with a DFB instance in the table can be displayed and modified in the Comments field.
  - The comment is written on a single scrollable line. It can contain a maximum of 508 characters.
- Type, Source Name, Target Name:
  - Type: indicates the type of a DFB.
  - Source Name: indicates the source name of the instance.
  - Target Name: supports the modification of the target name of every instance.
    1. The name is made up of a maximum of thirty-two alphanumeric characters ('A'..'Z' and '0'..'9') and underscore ('\_'), the first character obligatorily being a letter.
    2. The Target name of the new instance must be unique, that is, no Target symbol nor other instance of Target DFB, nor any DFB type can have the same name.
- Ordering DFBs:
  - In alphabetical order by the DFB type.
  - In alphabetical order by the Source name of the instances.



## External Calls Tab

Presents the calls to the SRs from the functional module, and the calls to the Macro-steps not imported with the functional module (see directory tree).

The entry is **enabled** by a **double left click on the object**, **confirmed** by the **Enter** key, **cancelled** by the **Esc** key.

The different calls are:

- Source Call:
  - Presents the source SRs and Macro steps.
- Target Call:
  - Supports the modification of the target SRs and Macro steps.
  - Only the modification of the SR<i> number is allowed. This number must be between 0 and 254. The new Target call SR<i> must be unique.
  - Only the modification of the M<i> number is allowed. This number must be between 0 and 63. The new Target call must be unique.
- Ordering SRs and Macro-Steps
  - First the calls to SRs then the calls to Macros-steps.
  - In alphabetical order by the number of the Source call.

## Correspondence File Zone

This file in text format contains all the information concerning the reassignments carried out in the different tabs described above.

This information is that defined in the tabs:

- Directory Tree.
- Addresses.
- DFB.
- External Calls.

	<p><b>WARNING</b></p> <p>The correspondence information is specific to the functional module analyzed. It is strongly recommended that you save your work to disk before exiting the "IMF" function, as once it is closed, all the work carried out on the functional module is lost.</p> <p><b>Failure to follow this precaution can result in death, serious injury, or equipment damage.</b></p>
---	---

The commands available in the "**Correspondence Files**" zone are:

- Save:
  - Allows you to store in a file the reassignments carried out up to that time.
- Retrieve:
  - Allows you to automatically execute the reassignments previously stored in a file.

## Exporting animation table(s)

---

### Introduction

The Export function can be accessed in local mode and in connected mode, with the PLC in Run or Stop mode.

It supports export of:

- a single animation table via:
    - the application browser,
    - the animation table editor.
  - a set of animation tables via:
    - the application browser,
- 

### Rules

Exporting an animation table via the animation table editor or via the application browser is only possible if the table is not being modified.

Exporting a set of animation tables via the application browser is only possible if no animation table editor is open in modification mode.

The export can be interrupted at any moment by pressing the Escape key. After confirming this, the export is stopped and no source file (\*.TAB) is created.

---

### Exporting via the animation table editor

Carry out the following steps:

Step	Action
1	Select the <b>File/Export</b> command, then the Export window is displayed on the screen.
2	Via the Export window choose: <ul style="list-style-type: none"><li>● in the <b>In</b> zone the path where the source file containing the animation table (by default \PL7USER) is stored,</li><li>● in the <b>Name</b> zone the name of the source file (Nom.TAB).</li></ul>
3	Confirm with <b>Save</b> .

---

### Exporting a set of animation tables via the application browser

Carry out the following steps:

Step	Action
1	Select the <b>Animation tables</b> directory.
2	Select the <b>File/Export</b> command, or from the contextual menu the <b>Export</b> command, then the Export window is displayed on the screen.
3	Via the Export window choose: <ul style="list-style-type: none"> <li>● in the <b>In</b> zone the path where the source file containing the animation tables (by default \PL7USER) is stored,</li> <li>● in the <b>Name</b> zone the name of the source file (Nom.TAB).</li> </ul>
4	Confirm with <b>Save</b> .

### Exporting one animation table via the application browser

Carry out the following steps:

Step	Action
1	Double click on the <b>Animation tables</b> directory.
2	Select the animation table to be exported.
3	Select the <b>File/Export</b> command, or from the contextual menu the <b>Export</b> command, then the Export window is displayed on the screen.
4	Via the Export window choose: <ul style="list-style-type: none"> <li>● in the <b>In</b> zone the path where the source file containing the animation table (by default \PL7USER) is stored,</li> <li>● in the <b>Name</b> zone the name of the source file (Nom.TAB).</li> </ul>
5	Confirm with <b>Save</b> .

### Errors

The only error that can arise when processing an **Export** is insufficient disk space available. If this happens, an error message is displayed.

## Importing animation table(s)

---

### At a Glance

The Import function can be accessed in offline mode and in online mode, with the PLC in Run or Stop mode.

It is used to import the following via the application browser:

- a single animation table,
  - a set of animation tables.
- 

### Rules

When importing, if there is an identity problem between the name of the imported table and a table already existing in the application, a dialog box appears offering the option of renaming the table being imported.

When importing, only the addresses are imported but not the symbols. Therefore, the imported animation table is slaved the application's existing symbols database.

The import can be aborted at any moment by pressing the Escape button and after confirming this, the import is stopped and the animation table being imported is not imported.

For a source file containing several animation tables, the imported tables are not deleted.

---

### Importing a table or a set of animation tables via the application browser

Carry out the following actions:

Step	Action
1	Select the <b>Animation tables</b> directory.
2	Select the <b>File/Import</b> command, or from the contextual menu the select the <b>Import</b> command. The Import window is displayed on the screen.
3	From the <b>Import</b> window choose: <ul style="list-style-type: none"><li>● in the <b>Search</b> zone the path of the location from which the source file containing the animation table(s) (by default \PL7USER) is to be read,</li><li>● in the <b>Name</b> zone the name of the source file (NAME.TAB).</li></ul>
4	Confirm with <b>Open</b> .

---

**Errors**

When importing, if the animation table contains a variable that is not configured in the application, a dialog box indicating the problem is displayed, giving the option:

- of either ignoring the variable and continuing the import,
- or of interrupting the import so that the table being imported is not imported, but the tables already imported are not deleted.

If, when importing, the source file contains:

- a reference to a DFB type that does not exist in the application, then a dialog box is displayed indicating the conflict, giving the option:
    - of either ignoring the variable and continuing the import,
    - or of interrupting the import so that the table being imported is not imported, but the tables already imported are not deleted.
  - a reference that does not exist in the application, but whose DFB type does exist, then a dialog box is displayed indicating the conflict, and giving the option:
    - of either ignoring the variable and continuing the import,
    - or of interrupting the import so that the table being imported is not imported, but the tables already imported are not deleted.
-

## **Export of runtime screens**

---

### **Introduction**

PL7 is used to export runtime screens or families of runtime screens.

The Export function can be accessed in offline mode and in online mode, with the PLC in Run or Stop mode.

---

## How to export a runtime screen (or a family)

Carry out the following steps:

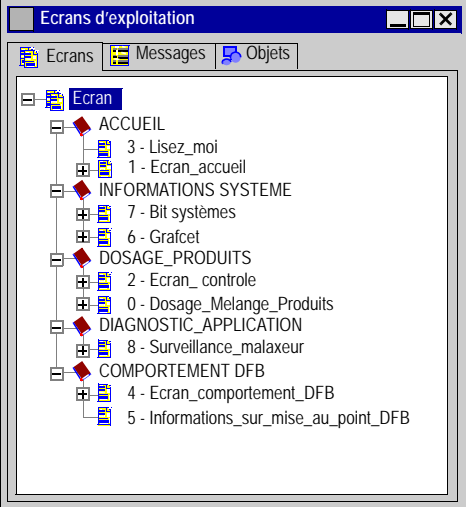
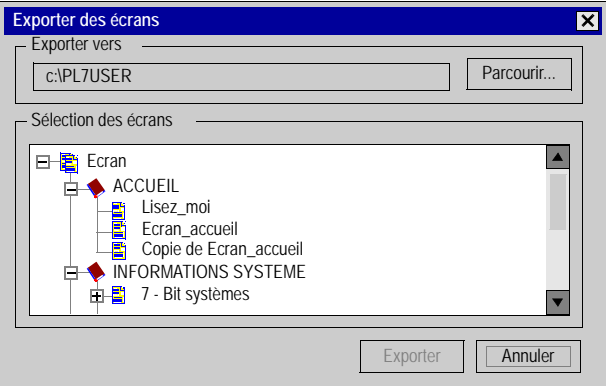
Step	Action
1	<p>In the <b>Application Browser</b> in the <b>structure view</b> double click on the <b>Runtime screens</b> directory.</p> <p><b>Result:</b></p> 
2	<p>Right click on one of the runtime screen items or on a family directory (example here: Home, Information system...).</p>
3	<p>Select the <b>Export</b> command.</p> <p><b>Result:</b></p> 
4	<p>Choose the directory from which you wish to import the screen or the family of screens.</p>
5	<p>Select the screen and click on <b>Export</b>.</p>





## Import of runtime screens

---

### Introduction

PL7 can be used to import runtime screens or runtime screen families into your applications.

The Import function can be accessed in offline mode and in online mode, with the PLC in Run or Stop mode.

---

## How to import a runtime screen (or a family)

Carry out the following steps:

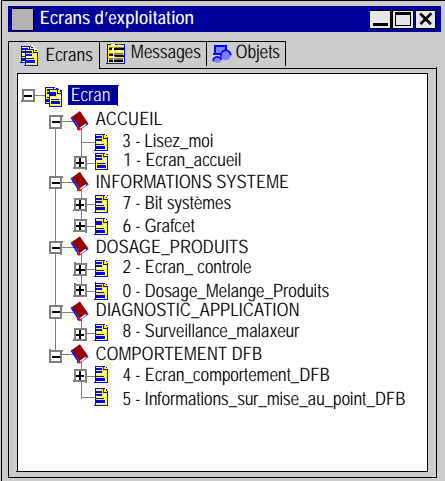
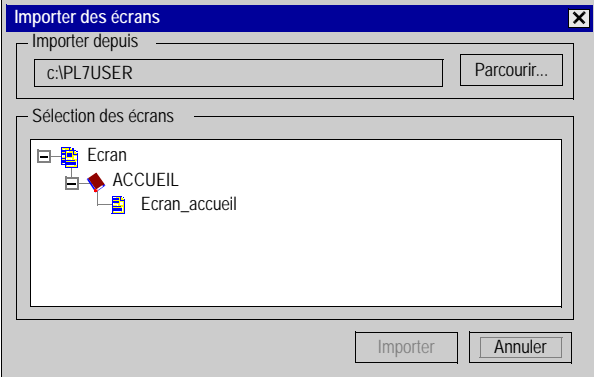
Step	Action
1	<p>In the <b>Application Browser</b> in the <b>structure view</b> double click on the <b>Runtime screens</b> directory.</p> <p><b>Result:</b></p> 
2	<p>Right click on one of the runtime screen items or on a family directory (example here: Home, Information system...).</p>
3	<p>Select the <b>import</b> command.</p> <p><b>Result:</b></p> 
4	<p>Choose the directory from which you wish to import the screen or the family of screens.</p>
5	<p>Select the screen(s) and click on <b>import</b>.</p>



## Export of a DFB type

---

### At a Glance

Export of a DFB type is global and includes:

- the properties of the DFB type,
- the descriptive form,
- the description of public interfaces (inputs, inputs/outputs, outputs) and public variables,
- the description of private variables,
- the code.

A DFB type can be exported from the **application browser** or **the DFB type editor**.

Two export formats are offered:

- standard (unprotected DFB types ),
  - binary (protected (See *How to protect a DFB*, p. 291) or unprotected DFB types).
-

### Exporting a standard format DFB type

The Export function can be accessed in local mode and in online mode, the PLC in Stop.

Carry out the following actions:

Step	Action
1	<ul style="list-style-type: none"> <li>● <b>Export from the application browser:</b> <ol style="list-style-type: none"> <li>1. Left mouse click on the DFB type or put the cursor over it using the arrow keys.</li> <li>2. From the context menu or the <b>File</b> menu or using the keys <b>Shift+F10</b>, select the <b>Export</b> command.</li> </ol> </li> <li>● <b>Exporting from the DFB type editor:</b> <ol style="list-style-type: none"> <li>1. Left mouse click on the DFB type or put the cursor over it using the arrow keys.</li> <li>2. Edit the DFB type <b>right mouse click + Open key</b>.</li> <li>3. From the <b>File</b> menu, select the <b>Export</b> command.</li> </ol> </li> </ul>
2	Select the disk and/or directory where the file must be saved using the pull-down menu <b>In</b> .
3	Enter a file name in the <b>Name</b> field.
4	Confirm using <b>Save</b> .

#### Comments:

Export from the DFB type editor is authorized whether DFB type is enabled or not.

Only an enabled DFB type can be exported from the application browser.

### Export of a binary format DFB type

The **Export binary** function can be accessed in local mode and in online mode, the PLC in Stop.

Carry out the following actions:

Step	Action
1	Left mouse click on the DFB type or put the cursor over it using the arrow keys.
2	From the context menu or using the keys <b>Shift+F10</b> select <b>Export binary</b> .
3	Select the disk and/or directory where the file must be saved using the pull-down menu <b>In</b> .
4	Enter a file name in the <b>Name</b> field.
5	Confirm using <b>Save</b> .

#### Comment:

Export is possible if the DFB type is enabled.

## Importing a DFB type

---

### Introduction

The Import function is only accessible in local mode.

The DFB type is imported from within the application browser.

The import of a DFB type is global and includes:

- the properties of the DFB type,
  - the descriptive form,
  - the description of the public interfaces (inputs, inputs/outputs, outputs) and public variables,
  - the description of the private variables,
  - the code.
- 

### Importing a DFB type in binary format

Carry out the following actions:

Step	Action
1	Left mouse click on the directory DFB Type or position the cursor over it using the arrow keys.
2	Using the Contextual menu or the File menu or the keys Shift+F10 select the command <b>Import</b> .
3	Select the source file <b>*.DFB</b> relating to the type to be imported.
4	Confirm with <b>Import</b> .

---

### Importing a DFB type in binary format

carry out the following actions:

Step	Action
1	Left mouse click on the directory DFB Type or position the cursor over it using the arrow keys.
2	Using the Contextual menu select the command <b>Import binary</b> .
3	Select the source file <b>*.UFB</b> relating to the type to be imported.
4	Confirm with <b>Import</b> .

---

**Specific cases**

It is possible that the DFB type to be imported is already present in the application.

Three cases are possible:

- The DFB type present in the application is protected:
    - In this case the import is impossible.
  - The DFB type present in the application is not protected and not instanced:
    - A dialog box offers to replace, rename, cancel the import of the DFB type.
  - The DFB type present in the application is not protected but instanced:
    - If the interfaces are identical, a dialog box offers to replace, rename or cancel the import of the DFB type.
    - If the interfaces are different, the import is impossible. It is then necessary to delete the instances first.
-

## Exporting an application

---

### Introduction

The Export an application function can be accessed in local mode and in connected mode, with the PLC in Stop mode.

---

### Exporting an application without DFB

Carry out the following actions:

Step	Action
1	Open the application to be exported.
2	On the File menu select the command <b>Export an application</b> , or from the directory <b>Station</b> using the <b>Contextual</b> menu or using the keys <b>Shift+F10</b> select <b>Export an application</b> .
3	Select the disk and/or the directory where the file is to be saved using the pull-down menu <b>In</b> .
4	Enter a file name in the field <b>Name</b> .
5	Confirm with <b>Save</b> .

---

### Exporting an application with DFB

Exporting an application only takes into account the enabled DFB types.

Two cases are possible:

- Non protected DFB(s):
  - All the contents of the DFB(s) are saved in the resulting export file \*.FEF.
- Protected DFB(s) or DFB(s) exported from PL7-Junior:
  - Only the names of the DFB type are saved in the resulting file \*.FEF.
  - The binary format of the DFB(s) (**\*.UFB**) must also be exported (see Exporting a DFB type (See *Export of a DFB type, p. 404*)).

In the two cases, **the Export procedure is identical to that described above.**

---

### Exporting an application with animation tables

Exporting the application includes all the animation tables contained in the directory **Animation tables** in the application browser.

The source file of the application (NomAppli.FEF) contains the source of the animation tables.

**The Export procedure is identical to that described above.**

---



**Exporting an application with operating screens**

The export of the application leads to the creation of a directory.

This directory NomRep.FEF contains:

- the source file NonAppli.FEF,
- a directory ECREXP in which the tree structure dedicated to the operating screens is located.

**The Export procedure is identical to that described above.**

---

## Importing an application

---

### At a Glance

The Import application function can be accessed in offline and online mode, with the PLC in Stop mode.

The Import application function involves:

- redefining the inputs/outputs,
  - finding and replacing modified objects,
  - initializing the station with the new application obtained.
- 

### Importing an application without DFBs

Carry out the following actions:

Step	Action
1	Create an empty application.
2	Using the <b>Contextual</b> menu, the <b>File</b> menu or the keys <b>Shift+F10</b> select the command <b>Import an application</b> .
3	Select the *.FEF file to be imported.
4	Confirm with <b>Open</b> .
5	If applicable correct any non configured objects.
6	Click on <b>OK</b> .

---

**Importing an application with DFBs**

The function Import an application with DFB is only accessible in offline mode.

There are two possible scenarios:

- Non protected DFB(s):
  - Their contents which are saved in the \*.FEF are imported in the same way as the rest of the application.
  - The Import procedure is the same as that described above.
- Protected DFB(s):
  - When Importing, a dialog box asks for the pathname of the binary file(s) (**\*.UFB**) in order to import them.

Carry out the following actions:

Step	Action
1	Create an empty application.
2	Using the <b>Contextual</b> menu, the <b>File</b> menu or the keys <b>Shift+F10</b> select the command <b>Import an application</b> .
3	Select the <b>*.FEF</b> file to be imported.
4	Confirm with <b>Open</b> .
5	If applicable correct any non configured objects.
6	Click on <b>OK</b> .
7	Using the <b>Find</b> drop-down menu, enter the name of the disk and/or directory where the first type of DFB in the ( <b>*.UFB</b> ) list is located.
8	Confirm with <b>Import</b> .

---

### Importing an application with animation tables

The application import incorporates all the animation tables contained in the file NAME.FEF.

If any non configured variables are present in the application, a list appears allowing the user to modify the current configuration and continue with the import.

The Import procedure is identical to those described above.

---

### Errors

Three possible scenarios:

- Importing an application without DFBs:
    - An error message is displayed.
  
  - Importing an application with DFBs:
    - An error can appear if:
      - The source file has been modified with a text editor.
      - The DFB type is not present on the station onto which the application is imported.
      - The DFB type is of a different application identification and is incompatible.
    - An error message is displayed, and the station is reinitialized to the application by default.
  
  - Importing an application with animation tables.
-

---

## Exporting an application in FNES format (Input/Output Neutral File)

---

### Introduction

The FNES file (Input/Output Neutral File) generated by an export can only be used with a single PLC.

It contains the description of all the symbolized Inputs/Outputs, except for discrete Inputs/Outputs when all the Inputs/Outputs are described (symbolized or not).

This functionality is only accessible in local mode.

This functionality is not accessible (menu grayed out) if a modification is being carried out in the editor and vice versa, during the execution of an Export, no other action is possible in the editor.

Only the software PL7 Pro allows access to the Export/Import FNES functionality.

---

### Procedure

Carry out the following actions:

Step	Action
1	From the <b>Station</b> directory on the <b>Contextual</b> menu or using the <b>File</b> menu or the keys <b>Shift+F10</b> , select <b>Export/Import FNES+Export FNE</b> .
2	Select the destination directory and indicate the name of the file (*.FNE),
3	Click on <b>Save</b> .

#### Notes:

The export can be interrupted by the user using the Escape key, in this case, no FNE file is exported.

The default directory offered is that on the **Customize Options/Source directory** menu, subsequently, the offered directory will always be the last entered (for the current PL7 session).

---

### Errors

The errors that can arise when processing an Export are insufficient disk space available or a problem retrieving data.

An error message is displayed and the process is interrupted. If this happens, no file is generated.

---

## Importing an application in FNES format

---

### At a Glance

Importing a FNES file (Input/Output Neutral File) allows you to increment the application's symbols database, but does not modify its configuration data in any way.

Inserting symbols into an existing symbols database involves managing the following conflicts:

- Address conflict:
  - The symbol to be read already exists in the symbols database, but represents a different address.
- Symbol conflict:
  - The address to be read is already represented in the symbols database, but by a different symbol.
- Comment conflict:
  - The address to be read is represented in the symbols database already, by the same symbol, but the 2 comments associated with them are different.

To deal with this, 3 import modes are offered:

- Overwrite mode (to overwrite symbol database):
  - Priority is given to the contents of the FNES file.
- Do not overwrite mode (does not overwrite symbols database):
  - Priority is given to the contents of the symbols database.
- Dialog mode (default mode):
  - The user chooses the priority depending on the conflict displayed.

This function can only be accessed in offline mode.

This function cannot be accessed (menu grayed out) if a modification is in progress in the editor and conversely, during Import execution, no other actions are possible in the editor.

Only PL7 Pro software provides access to the Import/Export FNES function.

---

**Procedure**

Carry out the following actions:

Step	Action
1	From the Station directory using the Contextual menu, the File menu or the Shift+F10 keys, select <b>Import/Export FNES + Import FNE</b> .
2	Select the source directory and give the file name (*.FNE).
3	Select import mode: <ul style="list-style-type: none"> <li>● overwrite mode,</li> <li>● do not overwrite mode,</li> <li>● dialog mode.</li> </ul>
4	Confirm with <b>Open</b> .

**Notes:**

The import can be aborted by pressing the Escape key.

The import is aborted after restoring the current object, but the objects that have already been imported remain.

The directory proposed by default is that specified in the **Options/Customize/Source directory** menu. Subsequently, the proposed directory will always be the last entered (for the current PL7 session).

If several PLCs are present in the file, a message is displayed giving the user the possibility of consulting the list of PLCs or of canceling the import.

If the user chooses to continue the import, the list of associated applications and processors is displayed.

**Errors**

There are two possible scenarios:

- Blocking error:
  - These errors interrupt the import. They can only occur if the FNE file was generated outside of PL7 Pro (e.g.: bad syntax in the FNE file).  
You must abort the import, correct the error (fix the FNE file), then restart the desired Import.
- Non blocking error:
  - Example: error caused by a collision or bad configuration.  
You must replace the symbol or symbols already configured or cancel the import.





---

# Configuring the Uni-telway link

18

---

## Introduction

### Subject of this chapter

This chapter describes how to configure the Uni-telway driver.

### What's in this Chapter?

This chapter contains the following topics:

Topic	Page
General	418
Configuration of the terminal/PLC link	421
Advanced configuration	428

## General

---

### At a Glance

The Uni-telway tool is used to configure the operating parameters of the Uni-Telway driver depending on the PLC's terminal port characteristics.

---

## How to configure the UNITELWAY driver

The following table describes the procedure for configuring the UNITELWAY driver.

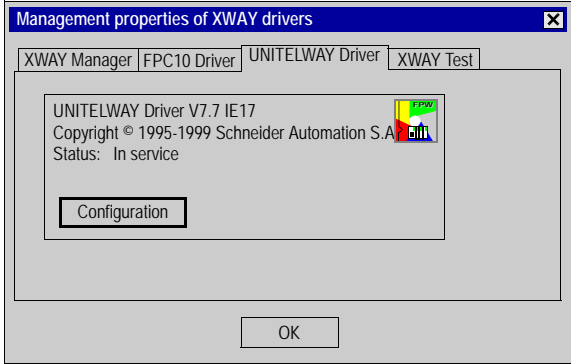
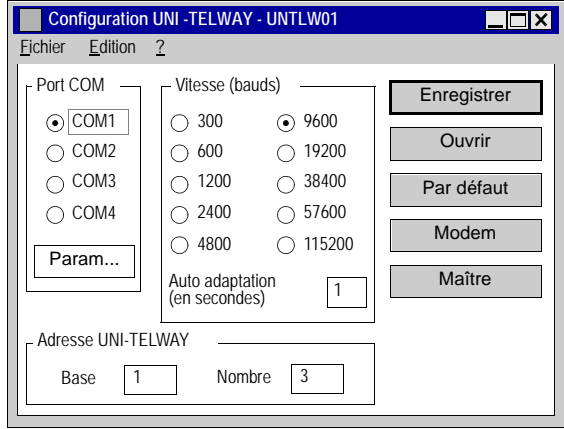
Step	Action
1	From the <b>Start</b> menu select the <b>Program</b> group.
2	Select the <b>Modicon Telemecanique</b> program group.
3	Select <b>XWAY Driver Manager</b> .
4	Click on the <b>UNITELWAY</b> tab. <b>Result:</b> the following window appears:
	
5	Click on the <b>Configuration</b> button. <b>Result:</b> The dialog box below appears:
	
6	Configure: <ul style="list-style-type: none"> <li>• the communication port,</li> <li>• the transmission speed,</li> <li>• the UNITELWAY address.</li> </ul>
7	Click on <b>Save</b> .



## Configuration of the terminal/PLC link

### At a Glance

Various configuration parameters are available for the **Uni-telway** driver. Main configuration screen.

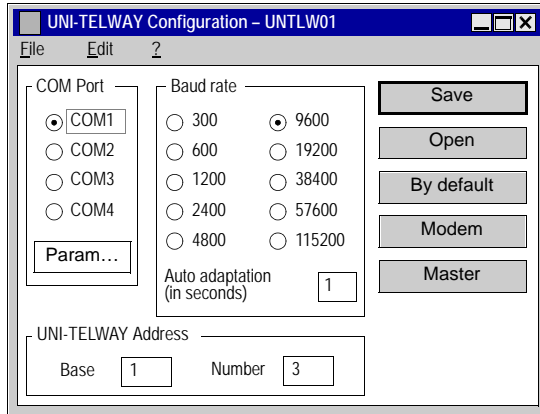

**Description of the COM Port zone**

This zone allows you to select the terminal serial port (COM1 to COM4), to be used for Uni-telway communication. The default value is COM1 (COM2 on TELEMECANIQUE FTX or CCX terminals).

Use the other COMs according to the availability on your hardware.

The **Param.** button makes the following dialog box appear:

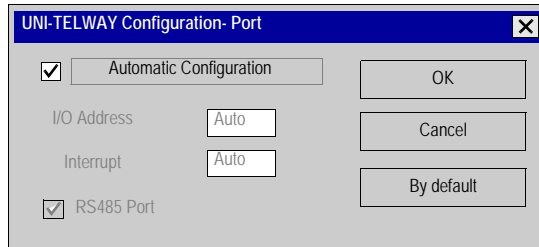

This allows you to force the hardware configuration of the selected serial port. By default, the configuration is determined automatically by the driver at start up.

**Note:** apart from with the generally marginal use of serial link cards or internal modems which do not comply with the normal values used for the serial port's hardware configuration, it is advisable to select **Automatic configuration**. When this box is ticked, you no longer have access to I/O address, Interrupt and RS 485 Port.

**Using the COM 2 port in RS 232 C**

The FTX 417-40 terminal allows the use of the COM 2 port in serial link RS 232C. This type of use necessitates the deselection of the **Automatic configuration** and **RS485 Port** boxes.

---

### Description of the speed zone and the address zone

#### Speed Zone (bauds):

This zone is used to select the standard speed of the serial link, from 300 to 115200 bauds. If the actual link speed is different from the selected speed, the auto driver adapts its speed. The **Auto adaptation** field defines the auto adaptation mechanism time in seconds. The driver automatically changes its speed after n seconds if the connection is not established at the current speed. Auto adaptation is disabled for a value of 0. The values by default are 9600 bauds for the speed and 1 second for the auto adaptation.

#### Uni-telway address zone:

This zone is used to select the standard link address as well as the number of addresses to which the Uni-telway driver responds. The default values are 1 for the standard address and 3 for the number of addresses that respond to the following configuration: Ad0=1, Ad1=2, Ad2=3 (Ad0 corresponding to the server address, Ad1 to the client application address and Ad2 to the listening application address).

### Description of the Save button

#### Save button:

is used to save the Uni-telway driver configuration. The **Save** button appears in the following dialog box:

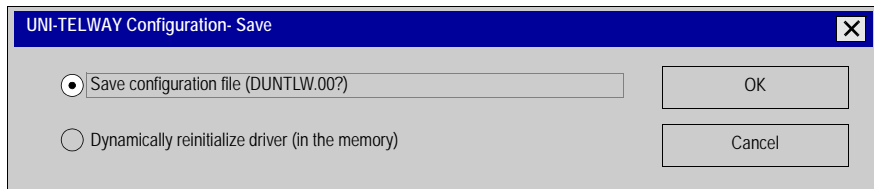

#### Elements and their functions:

Element	Function
Saving a configuration file (DUNTLW.00?)	The configuration of the Uni-telway driver is saved in a configuration file on disk (usually DUNTLW.001 in the <b>xwaydrv</b> directory). This file is read by the driver when the computer boots up. The modifications will therefore be acknowledged the next time the computer is started.
Dynamically reinitialize the driver (in memory)	The configuration is directly described in the driver memory. Modifications are acknowledged immediately by the driver. Dynamic reinitialization is impossible: <ul style="list-style-type: none"> <li>• if the driver is not loaded into the memory (at installation, for example),</li> <li>• if the modifications relate to parameters that cannot be dynamically modified (the COM port, for example),</li> <li>• if the driver is being used (if the PL7 is connected, for example).</li> </ul>

**Description of the Open button**

**The Open button:**

is used to read the Uni-telway driver configuration.

The **Open** button appears in the following dialog box:

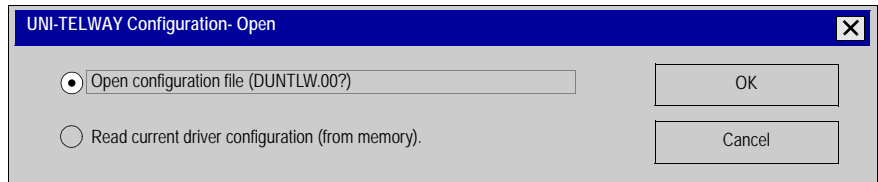

Elements and their functions:

Element	Function
Open a configuration file (DUNTLW.00?)	The configuration of the Uni-telway driver is read in a configuration file on disk (usually DUNTLW.001). From this, you can view and modify the driver's initial configuration (read upon start-up).
Read current driver configuration (in memory)	The configuration is read directly in the driver memory. From this you can view and modify the driver's real time configuration. This selection is deactivated if the driver is not loaded into the memory (at installation, for example).



**Description of the Default button and the Modem button**

**The Default button:**

is used to reset the values of the COM Port, Speed (bauds) and Uni-telway groups to their default values, to port COM1 (COM2 for FTX or CCX terminals), speed 9600 bauds, auto adaptation 1 second, standard address 1 and number of addresses 3.

**The Modem button:**

is used to select the use of a MODEM and the associated parameters.

The Modem button makes the following dialog box appear:

Elements and their functions:

Element	Function
Connection by MODEM	Is used to select the management of the MODEM by the driver.
Telephone number	Is used to enter the telephone number of the remote MODEM to be called.
HAYES Initialization	Is used to define the HAYES command string emitted by the driver in order to initialize the MODEM each time it connects.

**Note:** Consult the documentation of your MODEM to ensure that it is initialized correctly. By default the MODEM connection is disabled.

**Description of the Master button**

**The Master button:**

is used to activate the Uni-telway protocol in master mode on the PC. The Master button makes the following dialog box appear:

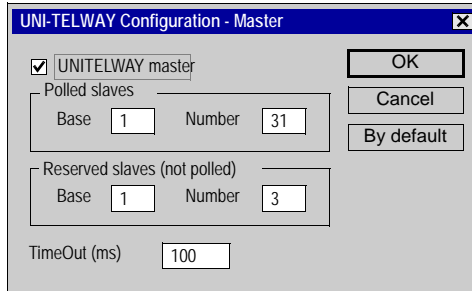

The **Uni-telway master** check box is used to select the protocol management in master mode on the PC.

The **Base** and **Number** fields respectively are used to input the first slave and the number of slaves on the PC which may or may not need to be scanned. The default values are base 1 and number 31.

With **Polled Slaves** the **Base** will inform the master of the slave address from which it will start to scan and the **Number** will be the number of slave addresses to scan.

With **Reserved Slaves (not polled)**, these are the addresses that the PC reserves for applications using the Uni-telway driver which transmit to the slaves. The **Base** will therefore be the first address and the **Number** will depend on the application using the driver (with PL7, Number=3). These addresses must not be used by a slave.

The Time Out field gives the polling response time in milliseconds.

**Note:** it is not advisable to enter a value lower than the 100ms default value, because of the PC's timing constraints (high CPU consumption for low timeouts). By default, master mode is disabled.

The following diagram shows a configuration example:

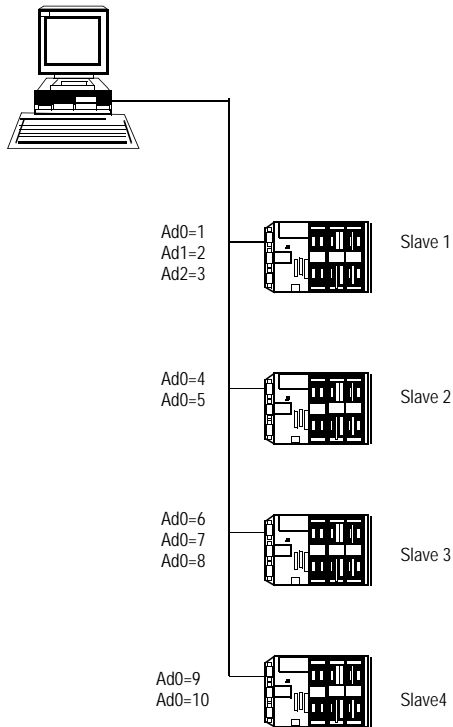

In this case the configuration will be Uni-telway-Master:

**Polled slaves**

Base=1 and Number=10

**Reserved slaves (not polled)**

Base=11 and Number=3 (if the PL7 is using the Uni-telway driver).

## Advanced configuration

---

### At a Glance

An advanced configuration is also available for the **Uni-telway** driver.

---

**How to access advanced configuration for the Uni-telway driver**

The following table describes how to access advanced configuration:

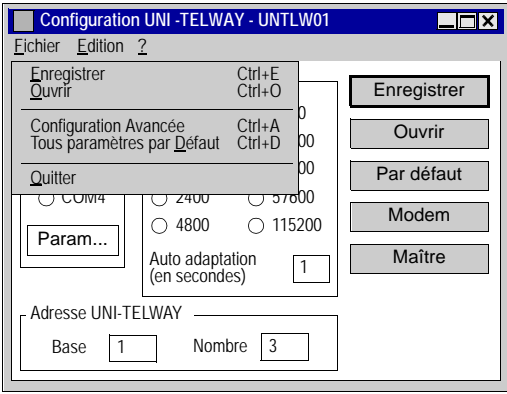
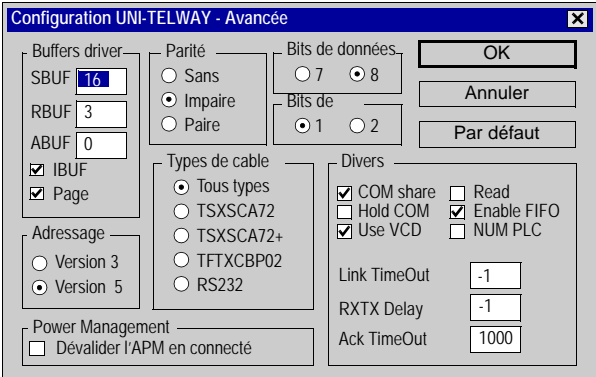
Step	Action
1	<p>From the configuration window click on <b>File</b> then select <b>Advanced configuration</b>, as shown in the following window:</p> 
2	<p>Click on advanced configuration. <b>Result:</b> the following window appears:</p> 

	<b>CAUTION</b>
	<p>Advanced parameters may only be modified by special instruction from the software using the Uni-telway driver or under the supervision of the technical support department of <b>Schneider Automation S.A.S.</b></p> <p><b>Failure to follow this precaution can result in injury or equipment damage.</b></p>



---

# Configuring the FIPWAY link

19

---

## Presentation

### Subject of this chapter

This chapter describes configuration operations for the FIPWAY driver.

### What's in this Chapter?

This chapter contains the following topics:

Topic	Page
General	432
Configuring the terminal/FIPWAY link	434
Advanced Configuration	437

## General

---

### At a Glance

The FIPWAY tool is used to configure the operating parameters of the terminal's FIPWAY driver.

---



## How to configure the FIPWAY driver

The following table describes the procedure for configuring the FIPWAY driver.

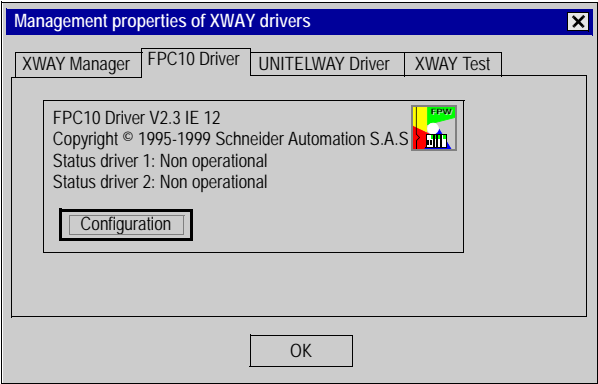
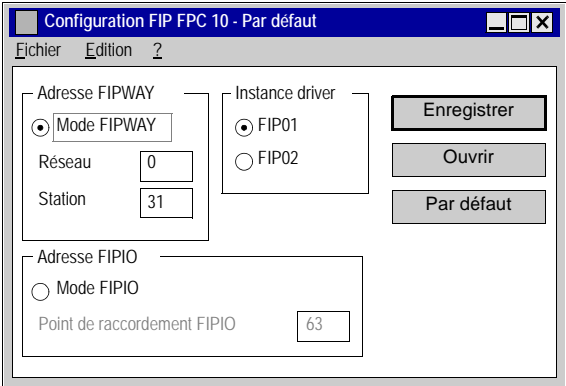
Step	Action
1	From the <b>Start</b> menu select the <b>Program</b> group.
2	Select the <b>Modicon Telemecanique</b> program group.
3	Select <b>XWAY Driver Manager</b> .
4	Click on the <b>FPC10 Driver</b> tab. <b>Result:</b> the following window appears:
	
5	Click on the <b>Configuration</b> button. <b>Result:</b> The dialog box below appears:
	
6	Configure: <ul style="list-style-type: none"> <li>the FIPWAY operating mode and address,</li> <li>the driver instance,</li> <li>the FIPIO operating mode and connection point.</li> </ul>
7	Click on <b>Save</b> .

## Configuring the terminal/FIPWAY link

---

### At a Glance

Various configuration parameters are available for the **Fipway** driver. Main configuration screen:

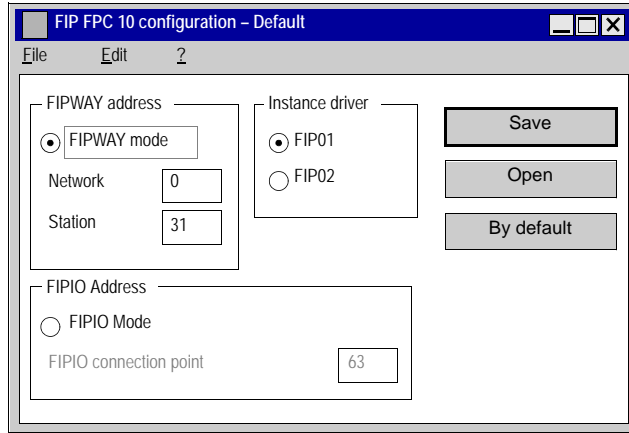

### Description of the FIPWAY Address zone

This zone is used to select the FIPWAY operating mode (the driver is selected on the FIPWAY network), as well as the network parameters and associated stations. **Network** gives the network number and **Station** gives the station number. The default values are **Network: 0** and **Station: 31**.

### Description of the FIPIO Address zone

This zone is used to select the FIPIO operating mode (the driver is selected on a FIPIO bus) for the driver, as well as the associated **Connection point**. The default connection point is 63.

### Description of the Driver instance zone

This zone is used to select the driver instance to be modified. In most cases only one FPC10 card is installed on the computer for FIP communication. Thus, only the **FIP01** driver instance will be used. However, if a second FPC10 card is installed, a second driver instance **FIP02** is necessary.

---

**Description of the Save button****Save button:**

is used to save the FIP FPC10 driver configuration.

The save button makes the following dialog box appear:

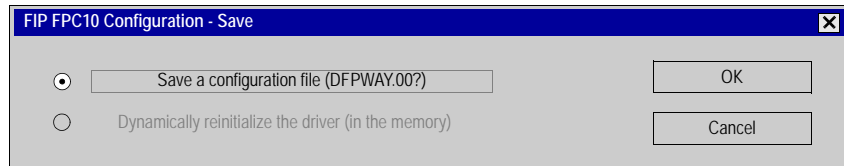
**Elements and their functions:**

Element	Function
Save in a configuration file (DFPWAY.00?)	The FIP FPC10 driver configuration is saved on disk in a configuration file (usually DFPWAY.001). This file is read by the driver when the computer boots up. Modifications are taken into account the next time the computer is booted up.
Dynamically reinitialize the driver (in memory)	The configuration is written directly to the driver memory. Modifications are acknowledged immediately by the driver. Dynamic reinitialization is impossible: <ul style="list-style-type: none"> <li>• if the driver is not loaded into the memory (at installation, for example),</li> <li>• if the modifications apply to parameters which cannot be dynamically modified (for some advanced parameters for example).</li> <li>• if the driver is being used (if the PL7 is connected, for example).</li> </ul>

**Description of the Open button**

**The Open button:**

is used to read the FIP FPC10 driver configuration.

The **Open** button causes the following dialog box to appear:

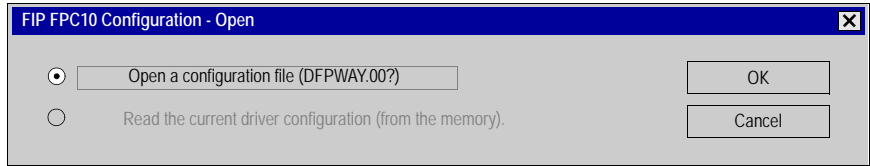

**Elements and their functions:**

Element	Function
Open a configuration file (DFPWAY.00?)	The FIP FPC10 driver configuration is read in a configuration file on disk (usually DFPWAY.001). From this, you can view and modify the driver's initial configuration (read upon start-up).
Read current driver configuration (in memory).	The configuration is read directly in the driver memory. From this you can view and modify the driver's real time configuration. This selection is deactivated if the driver is not loaded into the memory (at installation, for example).

**Description of the Default Button**

**The Default button:**

is used to reinitialize the FIPWAY Address group values, FIPIO Address group values and Driver instance group values to their default values, either:

- **FIPWAY** mode,
  - **Network 0** and **Station 31**,
  - **FIPIO connection point 63**,
  - **FIP01 Instance**.
-

## Advanced Configuration

---

### At a Glance

An advanced configuration is also available for the **FIPWAY** driver.

---

**How to access advanced configuration for the FIPWAY driver**

The following table describes how to access advanced configuration:

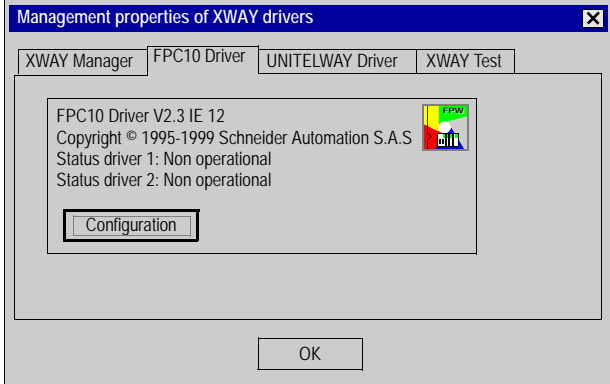
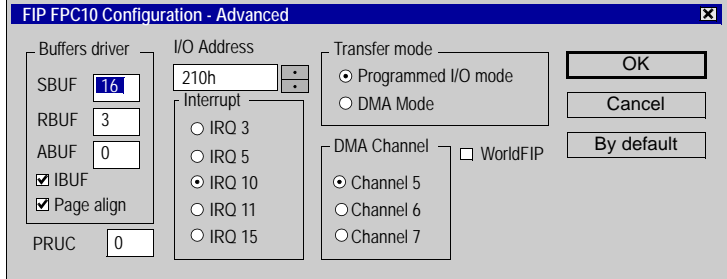
Step	Action
1	<p>From the configuration window click on <b>File</b> then select <b>Advanced configuration</b>, as shown in the following window:</p> 
2	<p>Click on Advanced Configuration.  <b>Result:</b> the following window appears:</p>  <p>The I/O Address fields, the Interrupt, Transfer Mode and DNA Channel zones are used to adapt the driver configuration to the FPC10 card hardware configuration. Modify these values if you modify the hardware configuration of your FPC10 card in relation to the factory configuration.</p>

	<b>CAUTION</b>
	<b>Significant risks</b> The other advanced parameters may only be modified by special instruction from the software using the FIP FPC10 driver or under the supervision of the technical support department of <b>Schneider Automation S.A.S.</b> <b>Failure to follow this precaution can result in injury or equipment damage.</b>





---

## Introduction

### Subject of this chapter

This chapter presents the standard functions of the **OS Loader**.

### What's in this Chapter?

This chapter contains the following topics:

Topic	Page
The OS Loader: At a Glance	442
Displaying the PLC OS version	444
Downloading an OS	445
Communication error during downloading	446
Limitations of the OS Loader	447

---

## The OS Loader: At a Glance

---

### Introduction

This software is used to update the operating system on the Micro and Premium PLCs by a download via the terminal port.

It also gives the option of reinstalling a previous version of the OS.

---

### The functions of the OS Loader

The OS Loader is used:

- to display the OS version installed on the PLC,
- to download the operating system into a PLC memory system.

	<b>CAUTION</b>
	<p>The download operation includes a delicate phase during which any PLC power outage is likely to render it unusable.</p> <p><b>Failure to follow this precaution can result in injury or equipment damage.</b></p>

---

## How to access the OS Loader

Carry out the following steps:

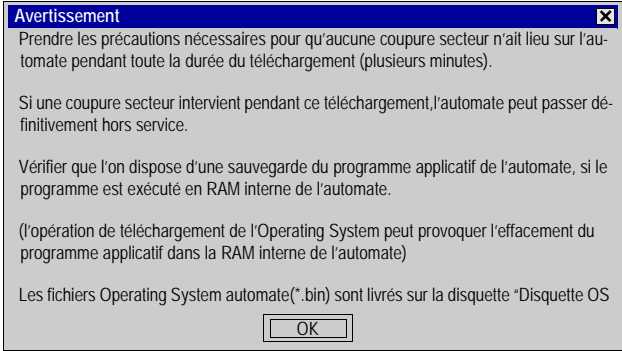
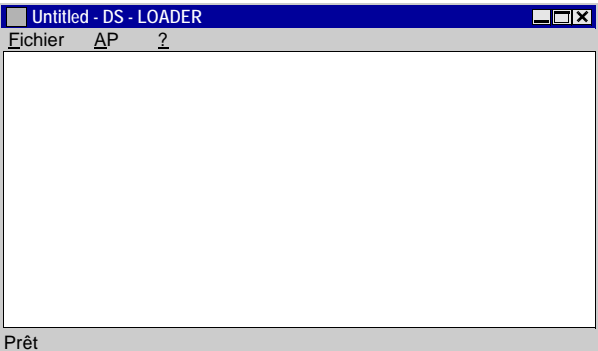
Step	Action
1	Click on <b>Start</b> → <b>Program</b> .
2	<p>Select the <b>Modicon Telemacanique</b> menu.</p> <p><b>Result:</b></p> 
3	<p>Next, click on <b>OK</b>.</p> <p><b>Result:</b></p> 

---

## Displaying the PLC OS version

---

### Introduction

The OS Loader is used to display various information on the OS version installed on the PLC:

- the product reference,
  - the specific-application type,
  - the hardware variant,
  - the software version (SV) of the operating system,
  - the development index (DI) of the operating system.
- 

### How to access the OS version display

Carry out the following steps:

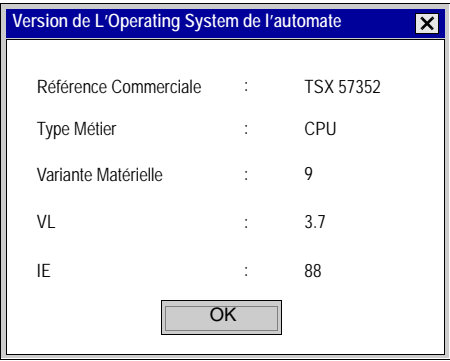
Step	Action
1	In the OS Loader window, click on the <b>PLC</b> menu.
2	Click on <b>Display version</b> . <b>Result:</b> 

---

## Downloading an OS

### Preliminary operations

Before installing the new operating system on the PLC, you are advised to:

- copy the contents of the CD-ROM containing the OS into a hard disk directory and work from this directory (downloading time optimized),
- consult the Readme.txt file document on the CD-ROM.

Disconnect the PLC from all networks before downloading.

The Uni-telway driver must be installed on the terminal and must be the only resident driver.

**Dedicated features of the Micro:** set the "Write Project" micro-switch (situated in the battery recess), into the **OFF** position. When the download is complete, put the micro-switch back into the **ON** position.

### How to select an OS

Carry out the following steps:

Step	Action
1	Select the <b>File</b> → <b>Select</b> command from the OS Loader window.
2	Select the drive containing the OS CD-ROM (or the hard disk directory to which it has been copied).
3	Select the file which relates to the type of processor in question.

### Downloading a new OS

Carry out the following steps:

Step	Action
1	Select the <b>PLC</b> → <b>Load Operating System</b> command. A dialog box displays the information concerning: <ul style="list-style-type: none"> <li>• the operating system on the PLC,</li> <li>• the new operating system to be installed.</li> </ul> A warning message indicates: <ul style="list-style-type: none"> <li>• the risks in the event of a power outage,</li> <li>• that the PLC has switched to <b>STOP</b> mode.</li> </ul>
2	Click on the <b>Load</b> button. Once the download has been completed, there are two possible scenarios: <ul style="list-style-type: none"> <li>• <b>PLC without application or in STOP mode prior to downloading:</b> close the dialog box by double clicking on the system box.</li> <li>• <b>PLC in RUN mode prior to downloading:</b> a dialog box offers to switch the application to RUN mode; confirm your choice by clicking on <b>YES</b> or <b>NO</b>.</li> </ul>
3	Close the dialog box by double clicking on the system box.

## Communication error during downloading

---

### Introduction

Communication errors are caused by certain events (loss of connection, power outage...).

These errors can be classified into two types:

- **minor**,
  - **fatal**.
- 

### Minor errors

Example: disconnection of the terminal port.

A dialog box offers whether to continue or to stop the download :

- select the **Repeat** command after having fixed whatever was causing the download to be interrupted or,
  - select the **Abort load** command : the PLC passes into "loading" mode, so you will have to restart a new download of the operating system in order to use the PLC,
  - click on **OK** to return to the main window.
- 

### Fatal errors

Example: power outage.

The PLC then becomes unusable. The leds **RUN**, **I/O** and **ERR** are constantly lit and the terminal/PLC dialog is impossible.

---

## Limitations of the OS Loader

### The limitations of the OS Loader

An operating system cannot be downloaded in the following cases :  
Carry out these actions in the event of these cases:

Case	Action
the PLC is out of service or does not respond any more	<b>Impossible to establish the connection!</b> Check that the PLC has not suffered a power outage, that it is always connected to console and that no other tool is connected to the terminal port.
The PLC is still reserved by another tool	<b>Cannot load</b> Disconnect the unit which is reserving the PLC.
the binary file to be loaded is incompatible with the target processor	<b>Cannot load</b> Check the type of PLC then select the adapted binary file.
The selected file is not (*.Bin) type	Use a (*.Bin) type file.
the binary file to be loaded is incompatible with the application in the PLC	<b>Warning :</b> the application will be lost when the OS is loaded.





---

## Presentation

### Subject of this chapter

This chapter deals specifically with Windows.

### What's in this Chapter?

This chapter contains the following topics:

Topic	Page
PL7 online help	450
Help Topics Browser	451
PL7 contextual Help	453
General points relating to Windows	454
Equivalent Windows keyboard: Basic principle	455
The menu keys	456
Windows dialogue box keys	457
Keys for modifying text	459
Text selection keys	460
Work station and Windows Explorer keys	461
Print management in Windows	462

---

## PL7 online help

---

### At a glance

PL7 online help describes the set up of various software editors in a sequential fashion. It provides detailed information on:

- users access rights,
  - PL7 general information (setting up an application, addressing bit objects and words, memory management, etc.)
  - PL7 language instructions (functions, syntaxes, operands),
  - using PL7 (programming, debugging, diagnostics),
  - Micro and Premium application-specific functions (Process control, Upcounting, Weighing, etc.).
- 

### Access mode using PLC

There are two access modes:

- from a **help** browser,
  - directly from a **context sensitive Help** PL7 screen.
-

---

## Help Topics Browser

---

### At a Glance

The **Help Topics** browser provides for three types of search:

- from the **Contents**, which displays a view of the all the different chapters of the Help system,
- using the **Index**, which displays an alphabetical list of key words,
- using the **Find** mode, which displays all the words used in the on-line Help in alphabetical order.

### Illustration of the browser

The following illustration shows the browser open at **Contents**

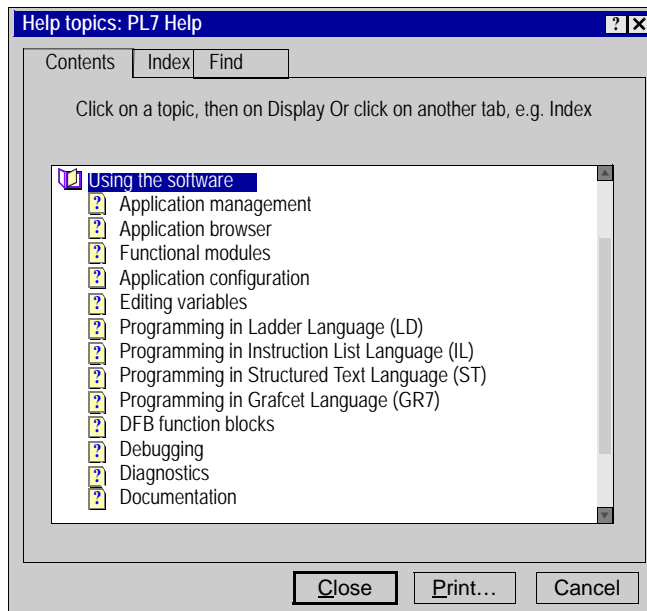

**Accessing the browser****Contents tab**

Step	Action
1	Select the <b>Index</b> command from the ? menu or click on the icon  .
2	Select then open the required directory.

**Index tab**

Step	Action
1	Select the <b>Find ...</b> command from the ? menu or click on the  icon then select the <b>Index</b> tab.
2	Enter the key word.
3	Select then open the required topic.

**Find tab**

Step	Action
1	Click on the  icon then select the <b>Find</b> tab.
2	Enter the word to be found.
3	Select then open the required topic.

---

---

## PL7 contextual Help

---

### At a Glance

Contextual Help is used to directly access information from the selected element.

---

### Accessing the Contextual Help

Two exclusive modes of access are used to access Contextual Help.

Standard screens

Step	Action
1	Select the <b>What's this?</b> command from the <b>?</b> menu or click on the  icon,
2	Select the element for which you require technical information (menu, screen, toolbar, etc.).

Modal dialog boxes

Step	Action
1	Click on the  icon of the current element.

---

## General points relating to Windows

---

### Introduction

Some general points relating to Windows are explained below:

- organization of workspace windows,
  - modification of the applications directory and the working directory.
- 

### Organization of workspace windows

You can open several windows at the same time on your PC.

Example: Configuration editor, MAST task section, FAST task section, etc.

In order to quickly reorganize all the open windows on the screen, select the **PL7 Window** menu and click on the appropriate sub-menu.

The following table shows you the different sub-menus and their functions:

Sub-menu	Function
Cascade	Arranges the open windows so that the title bar of each of them is visible.
Tile Horizontally	Tiles the open windows side by side so that they are all visible horizontally.
Tile Vertically	Tiles the windows side by side so that they are all visible vertically.
Arrange Icons	Aligns all the window icons.

**Note:** To quickly access one of the open windows, select its name at the bottom of the **Window** menu.

---

### Modification of the applications directory and the working directory

When PL7 opens an existing application, it copies it into the working directory; all modifications are made on this copy which must be saved using the **File** → **Save** command in the application archive directory.

The working directory disk and the application directory are defined at installation and can be modified with the **Option** → **Custom** command. The modifications will take effect after the next PL7 session.

---

---

## Equivalent Windows keyboard: Basic principle

---

**Presentation**      Combination of keys producing the same effect as a command using the mouse.  
The screen displays the keys to press to activate the required function from the keyboard: you just need to type **ALT + the underlined letter** for the menus and the buttons and only the underlined letter for the sub-menus.

---

**Illustration**      The following window is an example:

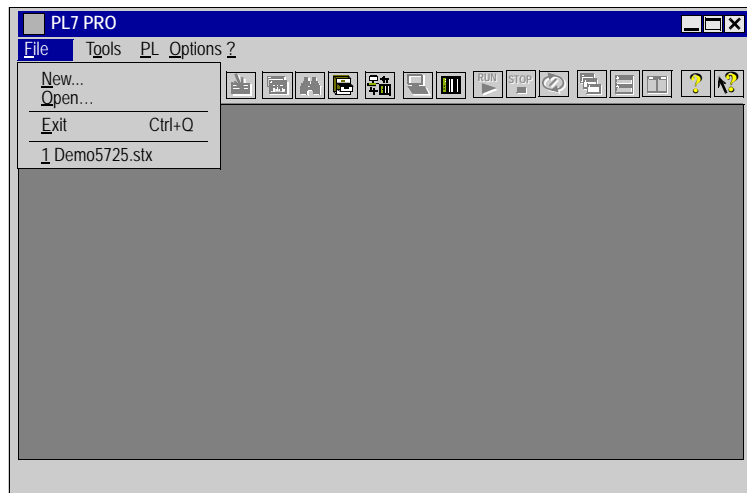

To open the **File** menu you must type **ALT+F**, and to open the sub-menu **New...** type **N**.

---

## The menu keys

---

### Introduction

The following keys or combination of keys can be used to select the menus and the commands.

---

### The keys and their functions

This table shows the keys or combinations of keys and their functions:

Press...	to.....
ALT or F10	Select the first menu from the menu bar or cancel the selection.
ALT + character key	Choose the menu whose number or underlined letter corresponds to the one that you are typing.
Right and left arrows	go from one menu to another
Up and down arrows	go from one command to another.
ENTER	Choose the menu name or the command selected.
A character key	Choose the command whose number or underlined letter corresponds to the one that you are typing.
ESC	<ul style="list-style-type: none"><li>● cancel the name of the menu selected,</li><li>● or close the open menu.</li></ul>

---



## Windows dialogue box keys

### Introduction

To work in a dialogue box you can use various keys or combinations of keys.

### The keys and their functions

The following table shows the keys or combinations of keys and their functions:

Press...	to.....
<b>TAB</b>	Go from one option to another (from left to right and from top to bottom).
SHIFT+TAB	Go from one option to another in the opposite direction.
CTRL+TAB	Go to the next tab.
CTRL+SHIFT+TAB	Go to the previous tab.
ALT + character key	Select the option or the group whose number or underlined letter corresponds to the one you are typing.
An arrow key	<ul style="list-style-type: none"> <li>● move the cursor from selecting one option (e.g.: button) to another in a group of options,</li> <li>● or move the cursor to the left, right, up or down in a list or text field.</li> </ul>
HOME	Select the first element or character in a list or text field.
END	Select the last element or character in a list or text field.
Page Up and Page Down	Scroll up or down a screen list.
ALT+Page Down	Open a list.
SPACE	<ul style="list-style-type: none"> <li>● select an element or cancel a selection in a list,</li> <li>● confirm the button in question,</li> <li>● activate or deactivate a box to be checked.</li> </ul>
CTRL+/ (forward slash)	Select all the elements in a list field.
CTRL+\ (back slash)	Cancel all the selections except the current selection.
SHIFT+ arrows	Delete or cancel the selection character by character in a text field.
SHIFT+HOME	Delete or cancel the selection up to the first character in a text field.
SHIFT+END	Delete or cancel the selection up to the last character in a text field.
ENTER	<ul style="list-style-type: none"> <li>● carry out a command,</li> <li>● choose the selected element from a list, then carry out the command,</li> <li>● click on the button with the bold border.</li> </ul>

<b>Press...</b>	<b>to.....</b>
ESC or CTRL+F4	Close a dialogue box without carrying out the command.
Arrow keys	Moving the cursor or insert point into the text fields or entry fields.

---

---

## Keys for modifying text

---

### Introduction

You can modify text with keys or a combination of keys.

---

### The keys and their functions

The following table shows the keys or combinations of keys and their functions:

Press...	to.....
Go back	<ul style="list-style-type: none"><li>• delete the character to the left of the insert point,</li><li>• or delete the selected text.</li></ul>
DEL	<ul style="list-style-type: none"><li>• delete the character to the right of the insert point,</li><li>• or delete the selected text.</li></ul>
SHIFT+DEL	Delete the selected text and put it in the clipboard.
SHIFT+INS	Paste the text from the clipboard into the active window.
CTRL+INS	Copy the selected text and put it in the clipboard.
SHIFT+Z	Cancel the last modification.

---

## Text selection keys

---

### Introduction

The following keys can be used in most Windows applications, but they do not necessarily work everywhere you can select text or in all applications. All the following selections start at the insert point. If a text is already selected, the keys cancel the selection.

---

### The keys and their functions

The following table shows the keys or combinations of keys and their functions:

Press...	To select or deselect.....
SHIFT+ left and right arrow	One character at a time to the left or right.
SHIFT+ up and down arrow	A text line up or down.
SHIFT+Page Up	All the text from the previous screen.
SHIFT+Page Down	All the text from the following screen.
SHIFT+HOME	The text up to the beginning of the line.
SHIFT+END	The text up to the end of the line.
CTRL+SHIFT+ left arrow	The word before.
CTRL+SHIFT+ right arrow	The word after.
CTRL+SHIFT+HOME	The text up to the beginning of the document.
CTRL+SHIFT+END	The text up to the end of the document.

---

---

## Work station and Windows Explorer keys

---

### Introduction

To work in the windows or the **Program management group**, you can use various keys and combinations of keys.

---

### The keys and their functions

The table below shows the keys or combinations of keys and their functions:

Press...	to.....
F2	Rename an element.
F3	Search for a file or data set.
CAP + DEL	Delete the element directly without putting it in the recycle bin.
ALT+Enter	Display the properties of the selected element.
CTRL+A	Select all.
F5	Update the information in a window.
CAP while clicking on the Close button	Close the selected file and all its parent files.

---

## Print management in Windows

---

### Introduction

Print management is a Windows application that manages print works.

When you print a document from a Windows application this transmits to the print manager all the information on the printing, the fonts and the document file.

---

### Description

Print management:

- takes care of printing the document while you continue to work on other Windows applications,
- indicates problems if an error occurs,
- prints the documents on a local or network printer.

<p><b>Note:</b> It is possible to print several documents at a time or one document after the other. The documents are then placed in a queue which is used to verify printing information.</p>
---

---

### How to install a printer

Carry out the following steps:

Step	Action
1	Click on <b>Run</b> .
2	Click on <b>Parameters</b> .
3	Click on <b>Printers</b> .
4	Click on <b>add a printer</b> and follow the instructions of the <b>Add printer assistant</b> .

---

---

# Glossary

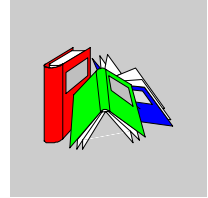

---

## A

**Animation table** Table created by the user or created contextually from within a language editor or an operating screen.  
In connected mode allows you to view the development of the PLC's variables and to force the values when debugging.

**ASCII** **American Standard Code for Information Interchange.**  
Is pronounced "aski". This is an American code (but has become an international standard) which allows by means of 7 bits the definition of all the alphanumeric characters used in English, punctuation marks, certain graphical characters as well as various commands.

**Auto Run** Function which allows you to automatically execute the application program on the PLC at initialization.

---

## B

**BIT** Contraction of the English words Binary Digit.  
This is the binary unit of information which can represent two distinct values (or states): 0 or 1. A field of 8 bits makes up what we call 1 **Byte** or 1 **octet**.

- Block functions**      Blocks contained in the PL7 product (defined by Schneider Automation).  
The user has only to parameterize these blocs in the variables editor heading "Pre-defined FB".  
These blocks are:
- Timer,
  - Monostable,
  - Up/down counter,
  - Drum,
  - Register.
- Breakpoint**            Used in "debug" mode in the application.  
It is unique (only one at a time) and once reached, signals to the processor to stop the execution of the program.  
Used in connected mode, it can be positioned in one of the following program elements:
- Ladder rung,
  - Structured Text or Instruction List statement,
  - Structured Text line (line mode).

---

**C**

- Comment**                A comment of 127 characters can be associated to each address even if the latter does not have a symbol, from within the variables editor.
- Comment for ST language**      The comment (optional) can be integrated anywhere in a statement. It is separated at both ends by the characters (\*and \*) and can occupy a **maximum of 128 lines**. Its size is limited to **256 characters** (new lines are included in the count). The comments are stored in the PLC and can be accessed at any time by the user. They therefore use up program memory.
- Constants**                Memory unit (Bit, Word, Dword, etc.) whose contents cannot be modified by the program being executed.



---

<b>CPU</b>	<b>Central Processing Unit</b> This is the microprocessor. It is made up of the control unit and the arithmetic logic unit. The purpose of the control unit is to extract from the central memory the instruction to be executed as well as the data necessary for the execution of this instruction, to establish the electric connections in the arithmetic logic unit and to start the data processing in this unit. You can sometimes find <b>ROM</b> or <b>RAM</b> memories included on the same chip, or even I/O interfaces or buffers.
<b>CU</b>	Central Unit: generic name for Schneider Electric processors.

---

**D**

<b>DFB</b>	The DFB types (Derived Function Blocks) are function blocks which can be programmed by the user in ST or LD language. Using these DFB types in an application: <ul style="list-style-type: none"><li>● simplifies the design and input of the program,</li><li>● improves the readability of the program,</li><li>● facilitates its debugging,</li><li>● decreases the amount of code generated.</li></ul> PL7 Pro software is needed to create a DFB type.
<b>DFB instance</b>	This regards a copy of a DFB type when the latter is called from within a language editor. The instance has a name. Input/output interfaces, public and private variables are duplicated (one duplication per instance, the code is not duplicated) A DFB type can have several instances.
<b>Documentation</b>	Contains all the information on the application, the documentation is printed after being put together and is used for maintenance purposes. It contains information regarding: <ul style="list-style-type: none"><li>● hardware and software configuration,</li><li>● the program,</li><li>● the DFB types,</li><li>● the variables and the animation tables,</li><li>● the cross-references.</li></ul> When putting the documentation together, it is possible to include only certain headings, if the user so wishes.

**Driver** Program which informs the operating system of the presence and characteristics of a peripheral. Also called the peripheral device driver.

---

**E**

**Events** Software or hardware initiated modules (module operation).  
Events have priority over MAST or FAST tasks; they are executed as soon as they are detected.  
Event EVT0 has the highest priority; the others have the same level of priority.

---

**F**

**FAST task** Task activated periodically (the period controlled in the configuration of the processor) used to execute a part of an application with superior priority to a MAST (master) task.

**Flash EPROM** PCMCIA memory cards:

- internal (TSX37) containing program, constants, memory %MW,
- external (TSX37-57) containing program and constants.

**FNES** Fichiers Neutres d'Entrées Sorties (Input/Output Neutral Files). The FNES format describes the PLCs in terms of rack, cards and channels using a tree structure. It is based on the CNOMO standard (Comité de Normalisation des Outillages de Machines Outils).

**Function** Functions delivered with PL7 and accessed from the **Tools/Library** menu. The user has only to parameterize these functions. He can develop others with the help of a development kit SDKC which is an option of PL7.

**Function view** View allowing you to see the program part of the application by means of functional modules created by the user (see definition Functional module).

**Functional module** A functional module is a grouping together of program elements (sections, subroutines, macro-steps, animation tables, operating screens) intended to carry out an automation function.  
A functional module can itself be broken up into functional modules of a lower level, these modules taking on, in relation to the main function, one or several automation sub-functions.

---

**G****Grafcet****Grafcet language.**

Grafcet language conforms to "Sequential Function Chart" language (SFC) of the IEC 1131-3 standard.

Grafcet allows the operation of sequential automation to be represented graphically and in a structured manner. This graphical description of the automated sequential performance and the different situations which arise is carried out with the help of simple graphical symbols.

---

**I****Instructions for ST language**

An instruction can be either **simple** (Assign, Increment, Call SR) or **control structure** (IF, WHILE, FOR, REPEAT...). The character ; is obligatory at the end of each instruction.

---

**L****Label**

A label (optional) allows you to find a statement or a rung in a program module and is required to allow a jump after a GOTO instruction. The following syntax **%Li**: with *i* between 0 and 999.

The label is positioned at the beginning of the statement or rung and can only be assigned to a single statement or rung within the same program module. The order of label address is not important; it is the input order of the statements or rungs which is taken into account by the system at scanning.

**Ladder****Rung language.**

A program written in rung language is composed of a series of rungs executed sequentially by the PLC.

**LIST****Instruction list language.**

A program written in instruction list language is composed of a series of instructions executed sequentially by the PLC. Each instruction is composed of an instruction code and an operand.

---

**M**

- Macro-step** A macro-step is the symbolic representation of a unique set of steps and transitions, which starts with an input step (IN) and terminates with an output step (OUT). A macro-step can call another macro-step (nesting).
- Mono task** Application made up of a single task, has to be a MAST task (master task).
- Multi task** Application made up of several tasks (MAST, FAST, event). An order of priority for task execution is defined by the PLC's operating system.
- 

**O**

- Operating screen** This is a tool integrated into software applications PL7-PRO and PL7-PRODYN from version 3.0 onwards. It is intended to facilitate the operation of an automated process. The end-user controls and monitors the operation of the installation and in case of a problem, he can act quickly and easily.
- 

**P**

- Protection** Function preventing the reading of the contents of a program module (read protection), or the reading and modifying of the contents of a program module (read/write protection). Protection is confirmed by a password.
-

---

**R**

- RS 232C** Communication series standard which defines among others the following service voltage:
- a signal of +12 V indicates a digital 0,
  - a signal of -12 V indicates a digital 1.
- However detection to thresholds of +3 V and -3 V is allowed in case of a weakened signal.
- Between these two bounds, the signal will be considered invalid.
- RS 232 links are quite sensitive to interference. The standard recommends not exceeding 15 meters in distance and 9,600 bauds (bits/sec) maximum.
- RS 485** Communication series standard which works differentially at 10 V/+5 V. It uses 2 wires for sending and receiving. Its "3-state" output allows it to go into listening mode, when the transmission has finished.
- Run** Function which allows you to execute the application program on the PLC.
- Rung** A rung is entered between two potential bars in a Ladder editor and is composed of a group of graphical elements joined to each other by horizontal or vertical links. The maximum dimensions of a rung are 16 lines and 11 columns (for PLCs TSX/PMX/PCX 57), or 7 lines and 11 columns (for PLCs TSX 37) split into two zones: the test zone and the editing zone.
- 

**S**

- Section** Program module belonging to a task (MAST, FAST) which can be written in a language chosen by the programmer (Structured Text, Ladder, List, Grafcet). A task can be made up of several sections; the order of execution of the sections within the task corresponds to the order in which they were created. This order can be modified.
- ST** **Structured text language.**
- Structured text language allows you to create programs by writing lines of code composed of alphanumeric characters. This language can only be used for the software **PL7 Junior** and **PL7 Pro** on PLCs TSX/PMX/PCX 57. In the version PL7 Pro, this language allows the creation of user function blocks DFB.

<b>Statement</b>	Basic unit of List language or Structured Text language. A statement is made up of lines, which are themselves made up of instructions. It begins with an exclamation mark, can include a comment and can be marked with a label.
<b>Step</b>	A Grafcet step designates a state of sequential operation of automation. <b>Initial step</b> defines the initial automation situation. <b>Single step</b> defines a stable automation situation. Actions can be associated. These can be expressed in Ladder, Structured Text or List language.
<b>Stop</b>	Function which allows you to stop the execution of the application program on the PLC.
<b>Subroutine</b>	Program module belonging to a task (MAST, FAST) which can be written in a language chosen by the programmer (Structured Text, Ladder, List). A subroutine can only be called by a section or another subroutine (nesting) belonging to the task in which it is registered.
<b>Symbol</b>	A symbol is a string of a maximum of 32 alphanumeric characters, of which the first character is alphabetic. It allows you to personalize a PLC object in such a way as to facilitate the maintainability of the application; it is used on the PLC if the user wants to.

---

**T**

<b>Task</b>	Group of sections and subroutines, executed cyclically or periodically for the MAST task or periodically for the FAST task. A task has a level of priority which is linked to the input and output.
<b>Time Out</b>	<b>Exceeding delay.</b> Stopping of the application or disconnection following a too-long period of inactivity.

**Transition**

A transition indicates the possibility of development between several steps.

A transition condition called **Receptivity** is associated with it.

The transition is valid if:

- the upstream steps (directly linked to this step) are active,
- the associated receptivity is true.

The releasing of a transition provokes the change of status for the steps which are linked to it.

The receptivities are expressed in Ladder, Structured Text or List language.

---

**V****Variable**

Memory unit of a type (Bit, Word, Dword, etc.) whose contents cannot be modified by the program being executed.

---





---

# Index

---

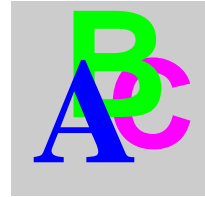

## A

Access to a subroutine, 183  
Access to PL7, 50  
Accessing a statement or instruction list, 174  
Accessing a subroutine, 206  
Accessing the configuration, 99  
Adjustment of the application specific functions, 327  
Animating the program, 309  
Animating variables, 337  
Animation of variables, 332  
Application browser, 120  
Application opening, 55  
Assisted entry of a function in List, 181

## B

Backing up, 73  
Breakpoint, 319

## C

Comments, 249  
Comparing applications, 71  
Configuration editor, 24  
Connections, 20  
Counter/ down counter, 261  
Create section, 123  
Creating a DFB instance, 287  
Creating a DFB type, 282  
Creating a functional module, 268  
Creating a Grafcet module, 222

Creating a Grafcet section, 125  
Creating a Ladder program, 137  
Creating a Structured Test program, 195  
Creating a Subroutine, 127  
Creating an animation table, 276  
Creating an application, 54  
Creating an event, 128  
Cross Referencing, 163, 186, 209, 240  
Cutting/Copying/Pasting variables, 257

## D

Debugging, 36  
Debugging functional modules, 328  
Designing a Grafcet program, 216  
Detaching/Deleting functional modules, 271  
DFB debugging, 330  
DFB Diag error messages, 352  
Display variables, 255  
Displaying variables, 144, 177, 199  
Documentation, 358, 361  
Downloading an OS, 445, 446  
Drum, 261

## E

Editing a section, 129  
Editing a sub-program, 129  
Editing an event, 129  
Entering a DFB instance, 290  
Eprom Flash Back up, 72  
Event, 128

- Export an application with DFB types, 293
- Export of runtime screens, 398
- Export Section/SR/EVT, 375
- Exporting a DFB type, 293
- Exporting a functional module, 386
- Exporting a source file, 378
- Exporting an application, 408
- Exporting an application in FNES format (Input/Output Neutral File), 413
- Exporting animation table(s), 394
- Exporting variables, 381

## F

- FIPWAY Configuration, 432, 437
- Forcing analog inputs
  - Micro, 325
  - Premium, 326
- Function block, 203
- Function blocks and DFB instances in Ladder, 156
- Function modules, 266
- Functional module debugging, 270

## G

- Grafcet configuration
  - TSX 37, 96
  - TSX 57, 117
- Grafcet debugging, 312
- Grafcet graphic objects, 218

## H

- Hardware configuration
  - TSX 37, 101

## I

- Implementation of diagnostics DFB, 351
- Import of runtime screens, 401
- Import section, 123
- Import/Export source file, 368
- Importing a DFB type, 293
- Importing a functional module, 388, 390

- Importing a Grafcet section, 125
- Importing a Subroutine, 127
- Importing an application, 410, 414
- Importing an application with DFB types, 293
- Importing an event, 128
- Importing animation table, 396
- Importing DFB, 406
- Importing LD, IL, ST, 379
- Importing variables, 382
- Input of a function block, 148
- Input of a predefined block, 180

## L

- Ladder Editing, 28
- Library function (ST editor), 204
- Limitation of the OS Loader, 447
- Link configuration, 421, 434
- List Editing, 31
- List of forced bits, 340

## M

- Memory Usage, 76
- Modification of the program in Run mode, 308
- Modifying a network of contacts, 140
- Modifying a Structured Test program, 196
- Modifying Grafcet programs, 235
- Modifying section order, 130
- Modifying variables, 339
- Module call stack, 348
- Module configuration
  - TSX 37, 91, 93
  - TSX 57, 111
- Module/channel diagnostics, 345
- Monostable, 260

## O

- Online symbolization, 147, 179, 202
- Operating screen, 41

**P**

Parametrizing the function blocks, 259  
PC PLC Program Transfer, 67  
PL7 address, 75  
PL7 Security, 48  
PLC PC Program Transfer, 68  
Presymbolization of variables, 252  
Print management in Windows, 462  
Printing variables, 263  
Processor  
    TSX 37, 85, 88  
    TSX 57, 105, 108  
Program diagnostics, 346  
Program printing, 168, 190, 213, 244  
Programming a DFB type, 283  
Programming a functional Module, 269  
Properties of a function module, 267  
Protecting a DFB type, 291  
Protecting an application, 56

**R**

Register, 261  
Replacing a variable, 161, 184, 207, 238  
Restoring %MWi words, 60  
Runtime screens, 131

**S**

Saving %MWi words, 60  
Saving an application, 59  
Sending a command to the PL7, 78  
Series 7 timer, 260  
Short cut keyboard, 459, 460  
Software configuration  
    TSX 37, 95  
    TSX 57, 116  
Software installation, 21  
Sorting variables, 254  
Specific Ladder input, 139  
Step by step mode, 322  
Structure of a List program, 172  
Structure of an ST program, 194  
Structured language editor (ST), 32  
Symbols, 249

**T**

Timer, 260  
Transferring data, 70  
TSX 37  
    supply configuration, 104  
TSX 57  
    module configuration, 113

**U**

Uni-telway Configuration, 418  
Uni-telway configuration, 428

**V**

Variables editor, 26  
Variables in EXCEL format, 384

**W**

Windows  
    short cut keyboard, 461  
    short cut keyboards, 456, 457  
Working with animation tables, 334

