



Panorama tertiair tot 250A

flipbook.se.com

Bekijk nu onze
volledig digitale
Algemene Catalogus

eDesign:

De snelste en eenvoudigste tool voor het ontwerpen
van elektrische verdeelkasten.

Log in om te profiteren van de volgende voordelen:
Automatische opslag van uw projecten en laatste wijzigingen.
Toegang tot al uw favoriete producten. Opslag van: foto's enz.
Vertrouwelijkheid van gegevens in overeenstemming met de GDPR.

edesign.se.com

Schneider Electric nv/sa
Dieweg 3
B-1180 Brussel
NL : +32 (0)2 620 80 85
FR : +32 (0)2 620 80 81
customer-service.be@schneider-electric.com

BTW: BE 0451.362.180
RPR Brussel
ING: 310-1110264-88
IBAN: BE 56 3101 1102 6488
SWIFT BIC: BBRU BE BB

Schneider
Electric

> Acti9 Diff. <63A

Ref.	Omschrijving
Type A	
A9R01240	iID 2P 40A 30mA Onmiddellijk
A9R01263	iID 2P 63A 30mA Onmiddellijk
A9R01440	iID 4P 40A 30mA Onmiddellijk
A9R01463	iID 4P 63A 30mA Onmiddellijk
A9R01491	iID 2P 40A 300mA Onmiddellijk
A9R21480	iID 2P 63A 300mA Onmiddellijk
A9R04240	iID 4P 40A 300mA Onmiddellijk
A9R04263	iID 4P 63A 300mA Onmiddellijk
A9R04463	iID 4P 63A 300mA Onmiddellijk
A9R05440	iID 4P 40A 300mA Selectief
A9R05463	iID 4P 63A 300mA Selectief
A9R24480	iID 4P 40A 300mA Selectief
A9R04440	iID 4P 63A 300mA Selectief
Type A-SI Supergeïmmuniseerd	
A9R31240	iID 2P 40A 30mA Onmiddellijk
A9R31263	iID 2P 63A 30mA Onmiddellijk
A9R31440	iID 4P 40A 30mA Onmiddellijk
A9R31463	iID 4P 63A 30mA Onmiddellijk
A9R31480	iID 4P 63A 300mA Onmiddellijk
A9R31491	iID 2P 40A 300mA Selectief
A9R34463	iID 2P 63A 300mA Selectief
A9R34491	iID 4P 40A 300mA Selectief
A9R35240	iID 4P 63A 300mA Selectief
A9R35263	iID 4P 40A 500mA Selectief
A9R35440	iID 4P 63A 500mA Selectief
A9R35463	iID 4P 63A 300mA Selectief
A9R37440	iID 4P 40A 500mA Selectief
A9R37463	iID 4P 63A 500mA Selectief
Type B	
A9Z51240	iID 2P 40A 30mA Type B-EV Onmiddellijk
A9Z51440	iID 4P 40A 30mA Type B-EV Onmiddellijk
A9Z61240	iID 2P 40A 30mA Type B-SI Onmiddellijk
A9Z61440	iID 4P 40A 30mA Type B-SI Onmiddellijk
A9Z61463	iID 4P 63A 30mA Type B-SI Onmiddellijk
A9Z64240	iID 2P 40A 300mA Type B-SI Onmiddellijk
A9Z64263	iID 2P 63A 300mA Type B-SI Onmiddellijk
A9Z64440	iID 4P 40A 300mA Type B-SI Onmiddellijk
A9Z64463	iID 4P 63A 300mA Type B-SI Onmiddellijk
A9Z65440	iID 4P 40A 300mA Type B-SI Selectief
A9Z65463	iID 4P 63A 300mA Type B-SI Selectief

> Acti9 Differentieelblok Vigi 125A

Ref.	Omschrijving
A9N18578	Vigi C120 4P 30mA Type A Onmiddellijk
A9N18579	Vigi C120 4P 300mA Type A Onmiddellijk
A9N18587	Vigi C120 4P 300mA Type A Selectief
A9N18589	Vigi C120 4P 1000mA Type A Selectief
A9N18554	Vigi C120 4P 30mA Type A-SI Onmiddellijk
A9N18560	Vigi C120 4P 30mA Type A-SI Selectief
A9N18555	Vigi C120 4P 300mA Type A-SI Onmiddellijk
A9N18561	Vigi C120 4P 1000mA Type A-SI Selectief

> Acti9 Diff. >63A

Ref.	Omschrijving
Type A	
A9R01491	iID 4P 100A 30mA Onmiddellijk
A9R21480	iID 4P 80A 30mA Onmiddellijk
A9R24480	iID 4P 80A 300mA Onmiddellijk
A9R04491	iID 4P 100A 300mA Onmiddellijk
A9R05491	iID 4P 100A 300mA Selectief
A9R25480	iID 4P 80A 300mA Selectief
A9R21492	iID 4P 125A 30mA Onmiddellijk
A9R24492	iID 4P 125A 300mA Onmiddellijk
A9R25492	iID 4P 125A 300mA Selectief
Type A-SI Supergeïmmuniseerd	
A9R31480	iID 4P 80A 30mA Onmiddellijk
A9R31491	iID 4P 100A 30mA Onmiddellijk
A9R34491	iID 4P 100A 300mA Onmiddellijk
A9R35480	iID 4P 80A 300mA Selectief
A9R35491	iID 4P 100A 300mA Selectief
A9R37480	iID 4P 80A 500mA Selectief
A9R31492	iID 4P 125A 30mA Onmiddellijk
Type B	
A9Z61480	iID 4P 80A 30mA Type B-SI Onmiddellijk
A9Z64480	iID 4P 80A 300mA Type B-SI Onmiddellijk
A9Z65480	iID 4P 80A 300mA Type B-SI Selectief
A9R44492	iID 4P 125A 300mA Type B Onmiddellijk
A9R45492	iID 4P 125A 300mA Type B Selectief
Toebehorens	
A9A26981	Acti9 Klemmenafdekkap voor iC60 iID, 20x
16939	Acti9 Klemmenafdekkap voor iC60 iID, 10x

> Acti9 Differentieelblok Vigi 63A

Ref.	Omschrijving
A9V21263	Vigi iC60 2P 30mA Type A Onmiddellijk
A9V21463	Vigi iC60 4P 30mA Type A Onmiddellijk
A9V24263	Vigi iC60 2P 300mA Type A Onmiddellijk
A9V24463	Vigi iC60 4P 300mA Type A Onmiddellijk
A9V25263	Vigi iC60 2P 300mA Type A Selectief
A9V25463	Vigi iC60 4P 300mA Type A Selectief
A9V29463	Vigi iC60 4P 1000mA Type A Onmiddellijk
A9V31263	Vigi iC60 2P 30mA Type A-SI Onmiddellijk
A9V31463	Vigi iC60 4P 30mA Type A-SI Onmiddellijk
A9V35263	Vigi iC60 2P 300mA Type A-SI Selectief
A9V35463	Vigi iC60 4P 300mA Type A-SI Selectief

> Acti9 iC60 RCBO

Ref.	Omschrijving
A9D17216	RCBO 2P 16A 30mA Type A
A9D67432	RCBO 4P 32A 30mA Type A
A9D54216	RCBO 2P 16A 300mA Type A
A9D67416	RCBO 4P 16A 30mA Type A
A9D17220	RCBO 2P 20A 30mA Type A

> Acti9 Automaat 63A-125A

Ref.	Omschrijving
10 kA Icu bev 380...415 VCA volgens EN/IEC 60947-2	
A9N18365	C120N 3P 80A curve C
A9N18367	C120N 3P 100A curve C
A9N18369	C120N 3P 125A curve C
A9N18371	C120N 4P 63A curve C
A9N18372	C120N 4P 80A curve C
A9N18374	C120N 4P 100A curve C
A9N18376	C120N 4P 125A curve C
A9N18391	C120N 4P 80A curve D
A9N18392	C120N 4P 100A curve D
15 kA Icu bev 380...415 VCA volgens EN/IEC 60947-2	
A9N18479	C120H 4P 80A curve C
A9N18480	C120H 4P 100A curve C
A9N18481	C120H 4P 125A curve C



> Acti9 Automaat ≤63A

Ref.	Omschrijving
4500 A bev 400 VCA volgens IEC60898-1 6 kA Icu bev 380...415 VCA volgens IEC60947-2	
A9F64202	iC60a 2P 2A curve C
A9F64204	iC60a 2P 4A curve C
A9F64206	iC60a 2P 6A curve C
A9F64210	iC60a 2P 10A curve C
A9F64216	iC60a 2P 16A curve C
A9F64220	iC60a 2P 20A curve C
A9F64225	iC60a 2P 25A curve C
A9F64232	iC60a 2P 32A curve C
A9F64240	iC60a 2P 40A curve C
A9F64250	iC60a 2P 50A curve C
A9F64263	iC60a 2P 63A curve C
A9F64316	iC60a 3P 16A curve C
A9F64363	iC60a 3P 63A curve C
A9F64406	iC60a 4P 6A curve C
A9F64410	iC60a 4P 10A curve C
A9F64416	iC60a 4P 16A curve C
A9F64420	iC60a 4P 20A curve C
A9F64425	iC60a 4P 25A curve C
A9F64432	iC60a 4P 32A curve C
A9F64440	iC60a 4P 40A curve C
A9F64450	iC60a 4P 50A curve C
A9F64463	iC60a 4P 63A curve C



*Gelieve pagina's L270-L271 in onze algemene catalogus te raadplegen voor de uitschakelcurves

> Acti9 Automaat ≤63A (vervolg)

Ref.	Omschrijving
6000 A Icn bev 400 VCA volgens IEC60898-1* 10 kA Icu bev 380...415 VCA volgens IEC60947-2*	
A9F79206	iC60N 2P 6A curve C
A9F79210	iC60N 2P 10A curve C
A9F79216	iC60N 2P 16A curve C
A9F79220	iC60N 2P 20A curve C
A9F79225	iC60N 2P 25A curve C
A9F79232	iC60N 2P 32A curve C
A9F79240	iC60N 2P 40A curve C
A9F79250	iC60N 2P 50A curve C
A9F79263	iC60N 2P 63A curve C
A9F79406	iC60N 4P 6A curve C
A9F79410	iC60N 4P 10A curve C
A9F79416	iC60N 4P 16A curve C
A9F79420	iC60N 4P 20A curve C
A9F79425	iC60N 4P 25A curve C
A9F79432	iC60N 4P 32A curve C
A9F79440	iC60N 4P 40A curve C
A9F79450	iC60N 4P 50A curve C
A9F79463	iC60N 4P 63A curve C
10000 A Icn bev 400 VCA volgens IEC60898-1 15 kA Icu bev 380...415 VCA volgens IEC60947-2	
A9F89206	iC60H 2P 6A curve C
A9F89210	iC60H 2P 10A curve C
A9F89216	iC60H 2P 16A curve C
A9F89220	iC60H 2P 20A curve C
A9F89225	iC60H 2P 25A curve C
A9F89232	iC60H 2P 32A curve C
A9F89240	iC60H 2P 40A curve C
A9F89250	iC60H 2P 50A curve C
A9F89263	iC60H 2P 63A curve C
A9F89406	iC60H 4P 6A curve C
A9F89410	iC60H 4P 10A curve C
A9F89416	iC60H 4P 16A curve C
A9F89420	iC60H 4P 20A curve C
A9F89425	iC60H 4P 25A curve C
A9F89432	iC60H 4P 32A curve C
A9F89440	iC60H 4P 40A curve C
A9F89450	iC60H 4P 50A curve C
A9F89463	iC60H 4P 63A curve C

> NSXm

Ref.	Omschrijving
C11E4TM063L	ComPacT NSXm E 4P4d TM63D EverLink
C11E4TM080L	ComPacT NSXm E 4P4d TM80D EverLink
C11E4TM100L	ComPacT NSXm E 4P4d TM100D EverLink
C12E4TM125L	ComPacT NSXm E 4P4d TM125D EverLink
C12E4TM160L	ComPacT NSXm E 4P4d TM160D EverLink
C11E44V100L	ComPacT NSXm MicroLogic 4.1 E 4P 100A EverLink
C12E44V160L	ComPacT NSXm MicroLogic 4.1 E 4P 160A EverLink

> PrismaSeT S opbouw

Metalen / kunststof kasten Klasse II* tot 160A

Ref.	Omschrijving
LVSS424	4x24M - zonder deur
LVSS524	5x24M - zonder deur
LVSS624	6x24M - zonder deur
LVSS724	7x24M - zonder deur
LVSS824	8x24M - zonder deur
LVSSD624	6x24M - zonder deur - met koker
LVSSD724	7x24M - zonder deur - met koker
LVSSD824	8x24M - zonder deur - met koker



Deuren

LVSSDD6	voor koker - 6 rijen - wit
LVSSDD7	voor koker - 7 rijen - wit
LVSSDD8	voor koker - 8 rijen - wit
LVSSDP424	4 rijen 24M - wit
LVSSDP524	5 rijen 24M - wit
LVSSDP624	6 rijen 24M - wit
LVSSDP724	7 rijen 24M - wit
LVSSDP824	8 rijen 24M - wit
LVSSDT424	Transparant - 4 rijen 24M
LVSSDT524	Transparant - 5 rijen 24M
LVSSDT624	Transparant - 6 rijen 24M
LVSSDT724	Transparant - 7 rijen 24M
LVSSDT824	Transparant - 8 rijen 24M

Toebehorens

LVSSY801	Montagekit voor NSXm 160A in de kast
LVSSY802	Montagekit voor NSXm 160A - in de koker
A9XPK707	VDIS 3P - 125A - 250/440V - 33 connecties
A9XPK714	VDIS 3P - 125A - 250/440V - 33 connecties
A9XPK715	VDIS 3PN - 160A - 250/440V - 66 connect. - met voedingskabels
A9XPKL10	Vergrendelingsclips - montage in PrismaSeT XS/S - set van 10
A9XPKV04	Montage accessoire voor PrismaSet G - set van 4



*Kast met dubbele isolatie die beschermt tegen indirect contact zonder nood aan een beschermingsgeleider (aarding)

> Mureva kasten

Waterdicht, dubbel geïsoleerd - IP65

Ref.	Omschrijving
13962M	12 modulen - 1 rij
13964M	12 modulen - 2 rijen
13966M	12 modulen - 3 rijen
13963M	18 modulen - 1 rij
13965M	18 modulen - 2 rijen
13967M	18 modulen - 3 rijen
13968M	18 modulen - 4 rijen



> PrismaSeT G functionele kasten tot 630A













Wandmontage Kasten met een breedte van 600

		Kast B600			Koker B300	
	Hoogte	Behuizing	Volle deur	Tranparente deur	Koker	Volle deur
Wandmontage (B600)						
6M	330 mm	LVS08102	LVS08122	LVS08132	LVS08172	LVS08182
9M	480 mm	LVS08103	LVS08123	LVS08133	LVS08173	LVS08183
12M	630 mm	LVS08104	LVS08124	LVS08134	LVS08174	LVS08184
15M	780 mm	LVS08105	LVS08125	LVS08135	LVS08175	LVS08185
18M	930 mm	LVS08106	LVS08126	LVS08136	LVS08176	LVS08186
21M	1080 mm	LVS08107	LVS08127	LVS08137	LVS08177	LVS08187
24M	1230 mm	LVS08108	LVS08128	LVS08138	LVS08178	LVS08188
27M	1380 mm	LVS08109	LVS08222	LVS08232	LVS08179	LVS08282

Vloermontage Kasten met een breedte van 600

		Bord 600			Koker B300	
	Hoogte	Behuizing	Volle deur	Tranparente deur	Koker	Volle deur
Vloerstaand (B600)						
27M	1530 mm	LVS08202	LVS08222	LVS08232	LVS08272	LVS08282
30M	1680 mm	LVS08203	LVS08223	LVS08233	LVS08273	LVS08283
33M	1830 mm	LVS08204	LVS08224	LVS08234	LVS08274	LVS08284
36M	1980 mm	LVS08205	LVS08225	LVS08235	LVS08275	LVS08285

Toebehoren voor PrismaSeT G

		B600		B300			
DIN-rail	Vast	LVS03001		LVS03010			
	Instelbaar	LVS03002		LVS03011			
	Verzonken	LVS03003		/			
	Achter Rail	LVS03004		/			
Modulaire afdekplaat	3M hoog	LVS03203		LVS03213			
	4M hoog	LVS03204		LVS03214			
	5M hoog	LVS03205					
Volle afdekplaat/	1M hoog	LVS03801		LVS03811			
	2M hoog	LVS03802		LVS03812			
	3M hoog	LVS03803		LVS03813			
	4M hoog	LVS03804		LVS03814			
	5M hoog	LVS03805		LVS03815			
	6M hoog	LVS03806		LVS03816			
Beugels	HZ bev (12 st)	LVS04239					
	HZ Bev band	LVS04243					
	V bev (12 st)	LVS04264					
	V Bev band	LVS04263					
Geperforeerde plaat		LVS03170		LVS03175			
		LVS03171		LVS03176			
		LVS03172		LVS03177			
		LVS03173		LVS03178			
Groene Bar		LVS08893		LVS08886			
Verlichting		LVS08964		/			
Algemeen	LVS08867	BEV.ST. IN KAST (1 ST=2)					
	LVS04200	KOPEREN GEAARDEBAR + 40 KLEMMEN					
	LVS08963	TEKENINGHOUDER RAL9003					
	LVS03220	BLINDSTROOK L1000					

> PrismaSeT G functionele kasten tot 630A

Kasten met een breedte van 850

	Hoogte	Bord B850			Koker B300	
		Behuizing	Volle deur	Tranparente deur	Koker	Volle deur
Vloerstaand (B850)						
27M	1530 mm	LVS08242	LVS08252	LVS08262	LVS08272	LVS08282
30M	1680 mm	LVS08243	LVS08253	LVS08263	LVS08273	LVS08283
33M	1830 mm	LVS08244	LVS08254	LVS08264	LVS08274	LVS08284
36M	1980 mm	LVS08245	LVS08255	LVS08265	LVS08275	LVS08285

Toebehoren voor PrismaSeT G (B850)

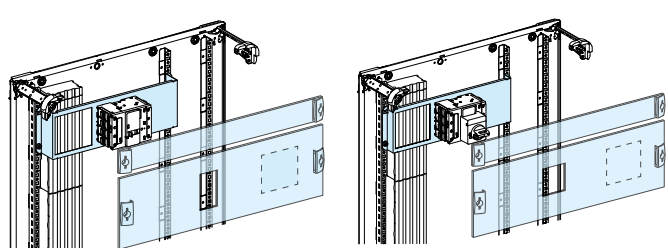
		Ref.	
DIN-rail	Vast	LVS03006	
	Instelbaar	LVS03007	
Modulaire afdekplaat	3M hoog	LVS03216	
	4M hoog	LVS03217	
	5M hoog	LVS03218	
Volle afdekplaat/	1M hoog	LVS03851	
	3M hoog	LVS03853	
	4M hoog	LVS03854	
	6M hoog	LVS03856	

Montage in PrismaSeT kast

	 Zone A - kast B600	 Zone B - Koker	
Modulair <40A	LVS03001	Montageplaat NS_INS250	LVS03050
	LVS03203	Afdekplaat INS-INV250 (9M)	LVS03251
Modulair <= 63A (1 rij)	LVS03001	Montageplaat NSX160/250A	LVS03050
	LVS03204	Afdekplaat NSX160/250 (9M)	LVS03253
Volle afdekplaat voor rijgklemmen	LVS03805	Verbinding NSX-Barenstel 630A	LVS04075
	LVS03002	Trapvormige verdeler 160A 4P	LVS04052
INS40-160 / NG125 / C120 / modulaire apparaten	LVS03260	Trapvormige verdeler 250A 4P	LVS04053
NSXm + modulaire apparaten	LVS03261	Trapvormige verdeler 400A 4P	LVS04054
ComPacT INS/ INV250 (hor)	LVS03264	Trapvormige verdeler 630A 4P	LVS04055
ComPacT NSX 100/250 (hor)	LVS03030	POLYBLOC 250A 4P	LVS04034
	LVS03232	Bijkomend blok 35mm ² 4P	LVS04156
	LVS03802	Instelbaar rail L250	LVS03011

*Voor meer details en de montagevoorschriften verwijzen wij u naar pagina's F26 tot F88 van de digitale catalogus

> Beheer van verlichting, tijd & energie

Nieuwe multifunctionele schakelaar Acti9 iC+!

Ref. Omschrijving

[A9C1B120](#) Bluetooth iC+ 20A contactor met astro+tijdschakelaarfuncties



Schakelklokken

Ref. Omschrijving

[15331](#) Acti9 IHH 7d 1 kanaal ARM*

[15335](#) Acti9 IH 24u 1 kanaal SRM**

[15336](#) Acti9 IH 24u 1 kanaal ARM*

[CCT15365](#) Acti9 IH 24u 1 kanaal ARM*

[CCT15367](#) Acti9 IH 7d 1 kanaal ARM*

[CCT15441](#) Acti9 IHP 1 kanaal

[CCT15551](#) Acti9 IHP+ 1 kanaal - smart

[CCT15443](#) Acti9 IHP 2 kanalen

[CCT15553](#) Acti9 IHP+ 2 kanalen - smart

[CCT15854](#) Acti9 IHP 1 kanaal - 24u

[CCT16364](#) Acti9 IH 24u 1 kanaal SRM**

* Met gangreserve

** Zonder gangreserve



Schemerschakelaars

Ref. Omschrijving

[CCT15482](#) IC100

[CCT15483](#) IC2000p+ 1 kanaal

[CCT15225](#) IC Astro - 1 kanaal - smart

[CCT15245](#) IC Astro - 2 kanalen - smart

[CCT15369](#) IC2000 met lichtsensor voor buiten (18 mm)



Beltransformatoren -



Ref. Omschrijving

[A9A15212](#) iTR 16VA 8-12V AC

[R9C15408](#) iTR 4VA 8V AC

[A9A15215](#) iTR 25VA 12-24V AC

[A9A15216](#) iTR 8VA 8-12V AC

Modulaire veiligheidstransformatoren



Ref. Omschrijving

[A9A15218](#) iTR 16VA 12-24V AC

[A9A15219](#) iTR 25VA 12-24V AC

[A9A15220](#) iTR 40VA 12-24V AC

[A9A15222](#) iTR 63VA 12-24V AC

Tijdsrelais

Ref. Omschrijving

[A9E16065](#) iRTA relais - 1C/O - Uc 24-240 V CA/24V CC

[A9E16066](#) iRTB relais - 1C/O-Uc 24-240VCA/24V CC

[A9E16067](#) iRTC relais - 1O/C-Uc 24-240V CA / 24V CC





[A9E16068](#) iRTH relais - 1C/O-Uc 24-240V CA / 24V CC

[A9E16069](#) Knipperrelais iRTL - 1C/O - Uc 24 - 240 VAC/24VDC

[A9E16070](#) iRTMF relais - 4 types vertraging - Uc 12 - 240 VAC/VDC

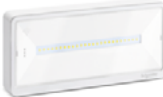

> Exiway Noodverlichting

Ref.	Omschrijving	
Exiway Trend		
OVA47028	LED - Standaard - IP42/110lm - 1/1,5/2/3 u - P/NP	
OVA47029	LED - Standaard - IP65/110lm - 1/1,5/2/3 u - P/NP	
OVA47030	LED - Standaard - IP42/250lm - 1/1,5/2/3 u - P/NP	
OVA47031	LED - Standaard - IP65/250lm - 1/1,5/2/3 u - P/NP	
OVA47131	LED - Activa -IP65/250lm - 1/1,5/2/3 u - P/NP	
OVA47133	LED - Activa - IP65/500lm - 1/1,5/2/3 u - P/NP	
Exiway Smartduo		
OVA48020	LED - Activa - iP65/2400lm - 1u - NP/N	
Exiway Smartled		
OVA48524	LED - Activa - IP65/250lm - 1/1,5/2/3 u - P/NP	
OVA48525	LED - Activa - IP65/500lm - 1/1,5/2/3 u - P/NP	
OVA48526	LED - Activa - IP65/800lm - 1/1,5/2/3 u - P/NP - -25°C	
OVA48527	LED - Activa - IP65/800lm - 1/1,5/2/3 u - P/NP	
OVA48528	LED - Activa - IP65/1250lm - 1/1,5/2/3 u - P/NP	
OVA48529	LED - Activa - IP65/1400lm - 1/1,5/2/3 u - P/NP	
Exiway Light		
OVA44016	LED - Standaard - IP42 -110lm - 1/1,5/2/3 u	
OVA44018	LED - Standaard - IP42 -250lm - 1/1,5/2/3 u	
Exiway Smartbeam		
OVA48952	LED - Inbouw - Vluchtroute - IP42 - 1,5u	
OVA48953	LED - Inbouw - Antipaniek - IP42 - 1,5u	
OVA48956	LED - Inbouw - 5lux -220lm - IP42 - wit - 3u	
OVA48985	LED - Opbouw - Antipaniek - IP65 - 3u	
OVA48984	LED - Opbouw - Vluchtroute - IP65 - 3u	

Raadpleeg het [Panorama Emergency Lighting](#) voor een beter overzicht van onze noodverlichtingsoplossingen.

> SpaceLogic KNX

Ref.	Omschrijving
MTN6513-1202	KNX Voeding KNX 640 mA
MTN6705-0008S	Actuator Master 8 kanalen 10AX/16AC1
MTN6805-0008	Actuator Extension. 8 kanalen 10AX/16AC1
MTN6710-0102S	Universele dimmer master 2 kanalen
MTN6710-0102	Universele dimmer extension 2 kanalen
MTN644492	Binaire ingang REG-K 4x10V
MTN644592	Binaire ingang REG-K 8x10V
MTN6725-0101	DALI Gateway KNX/DALI Pro 1 kanaal DALI-2
MTN6500-0103	Router IP KNX SpaceLogic voor DIN-rail 1M (18mm)
MTN6303-0019	Mini-aanwezigheidsdetector, IP20, wit
MTN630919	Aanwezigheidsmelder, met lichtregeling en IR-ontv
MTN6215-0410S	KNX Touchscreen 4", 24VDC, Zwart
MTN6194-6010S	KNX Drukknop met dynamische labeling
MTN6191-6034	1 toets voor drukknoop met dyn. labeling, antraciet
MTN6191-6035	1 toets voor drukknoop met dyn. labeling, wit
MTN6192-6034	2 toetsen voor drukknoop met dyn. labeling, antraciet
MTN6192-6035	2 toetsen voor drukknoop met dyn. labeling, wit
MTN6193-6034	3 toetsen voor drukknoop met dyn. labeling, antraciet
MTN6193-6035	3 toetsen voor drukknoop met dyn. labeling, wit
MTN6194-6034	4 toetsen voor drukknoop met dyn. labeling, antraciet

> SpaceLogic KNX

Ref.	Omschrijving
MTN6194-6035	4 toetsen voor drukknop met dyn. labeling, wit
MTN6185-6034	KNX Drukknop Pro T antraciet
MTN6185-6035	KNX Drukknop Pro T wit
MEG4010-6534	Afwerkingsplaat antraciet (eenvoudig)
MEG4010-6535	Afwerkingsplaat wit (eenvoudig)
MTN6002-0002S	Drukknopinterface 2-voudig
MTN6002-0004S	Drukknopinterface 4-voudig
MTN6002-0008S	Drukknopinterface 8-voudig
MTN6002-0108S	Drukknopinterface 8-voudig Pro

> EcoStruxure voor klein tertiair

Panelserver en softwarelicenties

Ref.	Omschrijving
PAS400	ESX Panel Server Entry - draadloze concentrator - 100..277 VAC/DC
PSWEOESSPLT12A	Abonnement Essential voor EcoStruxure Energy Hub - licentie 1 apparaat - 1j
PSWEOESSPLT36A	Abonnement Essential voor EcoStruxure Energy Hub - licentie 1 apparaat - 3j
PSWEOECCALT12A	Abonnement Advanced EcoStruxure Energy Hub - licentie -1 apparaat - 1j
PSWEOADVPLT36A	Abonnement Advanced EcoStruxure Energy Hub - licentie -1 apparaat - 3j

Compatibel met

Ref.	Omschrijving
A9MEM1521	Acti 9 - PowerTag - 1P+N - Boven - Energiesensor - Max. 63A
A9MEM1522	Acti 9 - PowerTag - 1P+N - Beneden - Energiesensor - Max. 63A
A9MEM1541	Acti 9 - PowerTag - 3P+N - Boven - Energiesensor - Max. 63A
A9MEM1542	Acti 9 - PowerTag - 3P+N - Beneden - Energiesensor - Max. 63A
A9MEM1543	PowerTag 3P (230V) 63A
A9MEM1560	Acti9 PowerTag FLEX 1P+N Boven/Onder
A9MEM1570	Acti9 PowerTag FLEX 3P+N Boven/Onder
A9MEM1580	PowerTag Energy F160 3P/3P+N
A9MEM1590	PowerTag Energy R200 3P/3P+N
A9MEM1591	PowerTag Energy R600 3P/3P+N
A9MEM1592	PowerTag Energy R1000 3P/3P+N
A9MEM1593	PowerTag Energy R2000 3P/3P+N
LV434020	PowerTag NSX 3P - 250A
LV434021	PowerTag NSX 3P+N 250 A
LV434022	PowerTag NSX 3P - 630A
LV434023	PowerTag NSX 3P+N - 630A
A9XMC1D3	PowerTag C Controle Module I/O
A9XST114	4 Powertag A (4 T° Sensoren)

Noodverlichting draadloze communicatie

Ref.	Omschrijving
OVA47211	Exiway Trend - Activa link - IP65/110lm - 1/1,5/2/3 u - P/NP - Geconnecteerd
OVA47213	Exiway Trend - Activa link - IP65/250lm - 1/1,5/2/3 u - P/NP - Geconnecteerd
OVA47215	Exiway Trend - Activa link - IP65/500lm - 1/1,5/2/3 u - P/NP - Geconnecteerd
OVA44211	Exiway Light - Activa Link - IP65/110lm - 1/1,5/2/3 u - P/NP - Geconnecteerd
OVA44213	Exiway Light - Activa Link - IP65/250lm - 1/1,5/2/3 u - P/NP - Geconnecteerd
OVA44215	Exiway Light - Activa Link - IP65/500lm - 1/1,5/2/3 u - P/NP - Geconnecteerd



> Energiemetering



Ref.	Omschrijving
A9MEM2455	iEM2155 1P 63A met Modbus MID communicatie.
A9MEM3110	iEM3110 3P 63A, met pulsuitgang, MID
A9MEM3155	iEM3155 3P 63A

> Overspanningsbegrenzers



Ref.	Omschrijving
A9L1F625	Acti9 iPRD1 25kA 3P+N T1+2 Zelfbeveiligend
A9L1F325	Acti9 iPRD1 25kA 3P T1+2 Zelfbeveiligend
A9L2F640	Acti9 iPRD 40kA 3P+N T2+3 Zelfbeveiligend
A9L2F340	Acti9 iPRD 40kA 3P T2+3 Zelfbeveiligend
A9L16294	Acti9 iQuick PRD 40kA 3P+N T2 Zelfbeveiligend
A9L16297	Acti9 iQuick PRD 20kA 3P+N T2 Zelfbeveiligend
A9L1C625	Acti9 iPRD1 25kA 3P+N T1+2 Compact formaat
A9L1C325	Acti9 iPRD1 25kA 3P T1+2 Compact formaat
A9L1H625	Acti9 iPRD1 25kA 3P+N T1+2
A9L1H325	Acti9 iPRD1 25kA 3P T1+2
A9L20601	Acti9 iPRD 20kA 3P+N T2
A9L16482	Acti9 iPRD1 12.5kA 3P+N T1+2

> Ontdek mySchneider



Ontdek **mySchneider**, het elektriciensprogramma van Schneider Electric! Krijg toegang tot productinformatie, software en trainingen. Blijf op de hoogte van de laatste ontwikkelingen en vind oplossingen voor de uitdagingen die je in de praktijk tegenkomt. Schrijf je in als Premier Partner en geniet van de voordelen van ons loyaliteitsprogramma.



> Laadpalen

Ref.	Omschrijving
Schneider Charge Pro	
EVB4S22N40	Schneider Charge Pro 1P-3P, 1xT2S, 7.4-11-22kW 16-32A, zonder kabel
EVB4S22N40M	Schneider Charge Pro 1P-3P, 1xT2S, 7.4-11-22kW 16-32A, met MID, zonder kabel
EVB4S22NC0M	Schneider Charge Pro 1P-3P, 7.4-11-22kW, 16-32A, met MID, met kabel
EVB4S22N40MG	Schneider Charge Pro 1P-3P, 1xT2S, 7.4-11-22kW, 16-32A, met MID en 4G modem, zonder kabel
EVB4S22NC0MG	Schneider Charge Pro 1P-3P, 7.4-11-22kW, 16-32A, met MID en 4G modem, met kabel
EVA2PBS1	Sokkel voor 1 Schneider Charge Pro
EVA2PBS2	Sokkel voor 2 Schneider Charge Pro
EVA2HPC3	Schneider Charge Peek-Controller 3P
Schneider StarCharge Fast DC	
EVD2S120TBB	120kW 2x CCS2, kabel 3.8m met kabelbeheersysteem
EVD2S150TBB	150kW 2x CCS2, kabel 3.8m met kabelbeheersysteem
EVD2S180TBB	180kW 2x CCS2, kabel 3.8m met kabelbeheersysteem
EVD2S180TBBC7	180kW 2x CCS2, kabel 7.5m zonder kabelbeheersysteem
EVD2S180TBBC	180kW 2x CCS2, kabel 3.8m met kabelbeheersysteem en creditcardlezer
EVD2S240TBB	240kW 2x CCS2, kabel 3.8m met kabelbeheersysteem
EVD2S320TBB	320kW 2x CCS2, kabel 3.8m met kabelbeheersysteem
EVD2S320TBBC7	320kW 2x CCS2, kabel 7.5m zonder kabelbeheersysteem
EVD2S320TBBC	320kW 2x CCS2, kabel 3.8m met kabelbeheersysteem en creditcardlezer
Load Management System	
HMIBX1A0NEVB-100SCP	EcoStruxure™ EV Charging Expert, 250 laadstations, dynamisch laadbeheer



[Bekijk ons Panorama Canalis om ook de installatie van uw laadpalen te vereenvoudigen.](#)