

Altivar® 61/71

Adjustable Speed Drives

Spare Parts Kits

Instruction Bulletin

30072-452-80

Retain for future use.



For Frame Size 13:

**ATV61HC25N4, ATV61HC31N4, ATV71HC20N4,
ATV71HC25N4, ATV71HC28N4**

Contents



Hazard Categories and Special Symbols	4
Product Support	4
Before You Begin	5
Introduction	7
Related Documentation	8
Receiving, Handling, and Storage	9
Electrostatic Precautions	9
Inspecting the Spare Part Kits	9
Preliminary Recommendations	10
Qualified Personnel	10
Working Procedures	10
Tools Required	11
Power Removal and Bus Voltage Measurement	12
Discharging Stored Energy in Capacitors	13
Parts Locations	14
Level 1 Parts	14
Level 2 Parts	16
Installation Procedures for Level 1 Parts	20
Removing and Replacing the Front Cover VY1A1214	20
Replacing the Plastic Parts Kit VY1A1403	21
Replacing the Internal Fans VZ3V1213	24
Replacing the Soft Charge Board VX5A1300	25
Replacing the SCR Snubber Board VX4A1200	26
Replacing the Fan Control Board VX5A1400	27
Replacing the Filter Board (VX4A1115) and Motor Current Sensors (VY1A1108)	29
Installation Procedures for Level 2 Parts	45
Disassembly Steps for Accessing Level 2 Parts	45
Replacing the Power Board VX5A1HC2025, VX5A1HC2531, VX5A71HC28N4	59
Replacing the Gate Driver Boards VX5A1201 and VX5A1202	64
Replacing the Temperature Sensors, VZ3G1104	70
Replacing the Power IGBT Modules VZ3IM1602M1271, and VZ3IM1402M1271	72
Replacing the Capacitors VY1ADC1112 and VY1ADC1114	75
Replacing the SCR Modules (VZ3TM1425M1671, VZ3TM1600M1671) and Diode Modules (VZ3DM1600M1671)	77
Reassembly Steps for Level 2 Parts	91
Wiring	104

Hazard Categories and Special Symbols

The following symbols and special messages may appear in this document or on the equipment to warn of potential hazards or to call attention to information that clarifies or simplifies a procedure.

A lightning bolt or ANSI man symbol in a “Danger” or “Warning” safety label on the equipment indicates an electrical hazard which, as indicated below, can or will result in personal injury if the instructions are not followed.

The exclamation point symbol in a safety message in a manual indicates potential personal injury hazards. Obey all safety messages introduced by this symbol to avoid possible injury or death.

Symbol	Name
	Lightning Bolt
	ANSI Man
	Exclamation Point

⚠ DANGER
DANGER indicates an imminently hazardous situation which, if not avoided, will result in death or serious injury.

⚠ WARNING
WARNING indicates a potentially hazardous situation which, if not avoided, can result in death or serious injury.

⚠ CAUTION
CAUTION indicates a potentially hazardous situation which, if not avoided, can result in minor or moderate injury.

CAUTION
CAUTION , used without the safety alert symbol, indicates a potentially hazardous situation which, if not avoided, can result in property damage.

Product Support

For support and assistance, contact the Product Support Group. The Product Support Group is staffed from Monday through Friday, 8:00 am until 6:00 pm Eastern time, to assist with product selection, start-up, and diagnosis of product or application problems. Emergency phone support is available 24 hours a day, 365 days a year.

Toll free: 888-SquareD (888-778-2733)
 E-Mail: drive.products.support@us.schneider-electric.com
 Fax: 919-217-6508

Before You Begin

Read and follow these precautions before performing any procedure with this drive.

The word “drive” as used in this bulletin refers to the controller portion of the adjustable speed drive as defined in the National Electrical Code (NEC).

⚠ DANGER

HAZARD OF ELECTRIC SHOCK, EXPLOSION, OR ARC FLASH

- Read and understand this manual before installing or operating the Altivar 61 or 71 drive. Installation, adjustment, repair, and maintenance must be performed by qualified personnel.
- The user is responsible for compliance with all international and national electrical code requirements with respect to grounding of all equipment.
- Many parts of this drive, including the printed circuit boards, operate at the line voltage. **DO NOT TOUCH.** Use only electrically insulated tools.
- **DO NOT** touch unshielded components or terminal strip screw connections with voltage present.
- **DO NOT** short across terminals PA/+ and PC/- or across the DC bus capacitors.
- Before servicing the drive:
 - Disconnect all power, including external control power that may be present.
 - Place a “DO NOT TURN ON” label on all power disconnects.
 - Lock all power disconnects in the open position.
 - **WAIT 15 MINUTES** to allow the DC bus capacitors to discharge. Then follow the “Bus Voltage Measurement Procedure” on page 12 to verify that the DC voltage is less than 42 V. The drive LED is not an indicator of the absence of DC bus voltage.
- Install and close all covers before applying power or starting and stopping the drive.

Failure to follow these instructions will result in death or serious injury.

Introduction

This instruction bulletin contains replacement procedures for the Altivar[®] 61 and 71 spare parts kits identified in Table 1. Read and understand the instructions in this document and other referenced documents before installing the kits.

Table 1: Altivar[®] 61 and 71 Spare Parts Kits¹

Kit Catalog No.	Description	For Use On Drive:	For Location of Parts, See:
VY1A1214	Front Cover Assembly	ATV61HC25N4, ATV61HC31N4, ATV71HC20N4, ATV71HC25N4, ATV71HC28N4	page 20
VY1A1403	Plastic Parts Kit	ATV61HC25N4, ATV61HC31N4, ATV71HC20N4, ATV71HC25N4, ATV71HC28N4	pages 14, 15, and 16
VZ3V1213	Internal Fan	ATV61HC25N4, ATV61HC31N4, ATV71HC20N4, ATV71HC25N4, ATV71HC28N4	page 14
VX5A1300	Soft Charge Board	ATV61HC25N4, ATV61HC31N4, ATV71HC20N4, ATV71HC25N4, ATV71HC28N4	page 14
VX5A1400	Fan Control Board	ATV61HC25N4, ATV61HC31N4, ATV71HC20N4, ATV71HC25N4, ATV71HC28N4	page 15
VX4A1115	Filter Board	ATV61HC25N4, ATV61HC31N4, ATV71HC20N4, ATV71HC25N4, ATV71HC28N4	page 15
VX5A1HC2025	Power Board	ATV61HC25N4, ATV71HC20N4	page 16
VX5A1HC2531	Power Board	ATV71HC25N4, ATV61HC31N4	
VX5A71HC28N4	Power Board	ATV71HC28N4	
VY1A1108	Motor Current Sensor	ATV61HC25N4, ATV61HC31N4, ATV71HC20N4, ATV71HC25N4, ATV71HC28N4	page 15
VX5A1201	Gate Driver Board	ATV61HC25N4, ATV71HC20N4	page 17
VX5A1202	Gate Driver Board	ATV61HC31N4, ATV71HC25N4, ATV71HC28N4	
VZ3G1104	Temperature Sensors	ATV61HC25N4, ATV61HC31N4, ATV71HC20N4, ATV71HC25N4, ATV71HC28N4	page 18
VZ3IM1402M1271	Power IGBT ² Module	ATV61HC25N4, ATV71HC20N4	page 18
VZ3IM1602M1271	Power IGBT ² Module	ATV61HC31N4, ATV71HC25N4, ATV71HC28N4	
VY1ADV1109	Screw Kit	ATV61HC25N4, ATV61HC31N4, ATV71HC20N4, ATV71HC25N4, ATV71HC28N4	—
VY1ADC1112	Capacitors	ATV61HC31N4, ATV71HC25N4, ATV71HC28N4	page 18
VY1ADC1114	Capacitors	ATV61HC25N4, ATV71HC20N4	
VX4A1200	SCR Snubber Board	ATV61HC25N4, ATV61HC31N4, ATV71HC20N4, ATV71HC25N4, ATV71HC28N4	page 15
VZ3TM1425M1671	SCR ³ Module	ATV61HC25N4, ATV71HC20N4	page 19
VZ3TM1600M1671	SCR ³ Module	ATV61HC31N4, ATV71HC25N4, ATV71HC28N4	

Table 1: Altivar® 61 and 71 Spare Parts Kits¹ (continued)

Kit Catalog No.	Description	For Use On Drive:	For Location of Parts, See:
VZ3DM1600M1671	Diode Module	ATV61HC25N4, ATV61HC31N4, ATV71HC20N4, ATV71HC25N4, ATV71HC28N4	page 19
VZ3N1318	Wire Kit	ATV61HC25N4, ATV61HC31N4, ATV71HC20N4, ATV71HC25N4, ATV71HC28N4	—

¹ For kit contents, refer to document 30072-452-44.

² IGBT: Insulated-gate bipolar transistor

³ SCR: Silicon controlled rectifier

Related Documentation

For drive installation instructions, refer to the following documents:

- *Altivar® 61 Installation Manual 0.5 to 100 HP*, module no. 1760643
- *Supplementary Instructions to ATV61 Variable Speed Drives Installation Manual—Low Horsepower*, document no. 30072-451-50
- *Altivar® 61 Installation Manual 75 to 800 HP*, module no. 1760655
- *Addendum to ATV61 Variable Speed Drives Installation Manual—High Horsepower*, document no. 30072-451-57
- *Altivar® 71 Installation Manual 0.5 to 100 HP*, module no. 1755843
- *Altivar® 71 Installation Manual 75 to 700 HP*, module no. 1755849

All documentation referenced in this bulletin is provided with the drive or on the CD-ROM included with the spare parts kits. You can also download the documentation from the Technical Library at www.schneider-electric.us.

Receiving, Handling, and Storage

Electrostatic Precautions

⚠ CAUTION

STATIC SENSITIVE COMPONENTS

Circuit boards and option cards can be damaged by static electricity. Observe the electrostatic precautions below when handling controller circuit boards or testing components.

Failure to follow these instructions can result in injury or equipment damage.

Observe the following precautions for handling static-sensitive components:

- Keep static-producing material such as plastic, upholstery, and carpeting out of the immediate work area.
- Store static-sensitive components in protective packaging when they are not installed in the drive.
- When handling a static-sensitive component, wear a conductive wrist strap connected to the component or drive through a minimum of 1 megohm resistance.
- Avoid touching exposed conductors and component leads with skin or clothing.

Inspecting the Spare Part Kits

After receiving the ATV61/ATV71 spare parts kit:

- Ensure that the catalog number printed on the kit label is the same as that on the packing slip and corresponding purchase order. Contact your Schneider Electric representative if there are any errors.
- Remove the kit from its packaging and inspect it for damage. If any damage is found, notify the carrier and your Schneider Electric representative.
- To store the kit, replace any static-sensitive parts in their protective packaging and store them at -25 to +70 °C (-13 to +158 °F).

⚠ WARNING

DAMAGED EQUIPMENT

Do not install or operate any equipment that appears damaged.

Failure to follow these instructions can result in death, serious injury, or equipment damage.

Preliminary Recommendations

Before beginning the installation procedures, read and understand all the information in this section.

Qualified Personnel

For the protection of personnel and equipment, a qualified person must perform the procedures detailed in this instruction bulletin.

A qualified person is one who has skills and knowledge related to the construction and operation of this electrical equipment and the installation, and has received safety training to recognize and avoid the hazards involved. Refer to the most current release of NFPA 70E[®], "Standard for Electrical Safety in the Workplace," for safety training requirements.

In addition, the person must be:

- Able to read, interpret, and follow the instructions and precautions in this instruction bulletin and the other documentation referenced.
- Able to use the required tools listed in this instruction bulletin in a safe and correct manner.

Working Procedures

Observe the following working procedures:

- Use only the components provided with the kits listed in Table 1 beginning on page 7. Do not attempt to repair the drive with other spare parts or equipment.
- If the part being replaced includes labels, ensure that the labels are applied to the replacement part. If the labels are not available in the kit, contact your Schneider Electric representative.
- Mount the spare parts only in the locations specified in the installation procedures.
- Route and position the wires as shown in the instructions. Use the wires and cables provided with the spare parts kits or with the drive. Do not modify the wires and cables. Do not route wires and cables outside of the drive enclosure.
- Install the power terminal shield as specified on pages 21–22, the filter board shield as specified on pages 41–42, and the SCR assembly shield as specified on page 99 of the installation procedures.
- Observe the hardware and torque requirements specified in the installation procedures. Do not substitute hardware. Carefully segregate and label all removed hardware and parts for use in reassembly of the drive.
- Mount all panels and covers as specified in the installation procedures.

Tools Required

- Needle-nose pliers
- Torque wrench, 0–45 N•m (0–398 lb-in)
- Voltmeter, 1–1000 Vdc
- Driver bits:
 - T-10 Torx[®] driver
 - T-20 Torx[®] driver
 - T-30 Torx[®] driver
 - T-30 Torx[®] right-angle driver
 - Size 2 magnetic tip Phillips[®] driver
 - Size 3 magnetic tip Phillips[®] driver
- Socket wrenches:
 - 7 mm
 - 10 mm
 - 13 mm
 - 16 mm
- Open-end wrenches:
 - 18 mm
 - 21 mm

Power Removal and Bus Voltage Measurement

⚠ DANGER

HAZARD OF ELECTRIC SHOCK, EXPLOSION, OR ARC FLASH

Read and understand the precautions in "Before You Begin" starting on page 5 before performing this procedure.

Failure to follow these instructions will result in death or serious injury.

The DC bus voltage can exceed 1,000 Vdc. Use a properly rated voltage-sensing device when performing this procedure. To measure the DC bus voltage:

1. Disconnect all power.
2. Wait 15 minutes to allow the DC bus to discharge.
3. Measure the voltage of the DC bus between the PA/+ and PC/- terminals to ensure that the voltage is less than 42 Vdc. These terminals are clearly labeled on each drive.
4. If the DC bus capacitors do not discharge completely, contact your local Schneider Electric representative. Do not repair or operate the drive.

⚠ CAUTION

IMPROPER DRIVE OPERATION

- If no power is applied to the drive for a long period, the performance of its electrolytic capacitors will be reduced.
- If the drive is not in active service, apply power to the drive every two years using the following procedure. Do not initially connect the drive directly to full line voltage. Without a motor connected to the drive, gradually increase the voltage using an adjustable AC source connected between drive terminals L1 and L2:
 - 25% of rated voltage for 30 minutes
 - 50% of rated voltage for 30 minutes
 - 75% of rated voltage for 30 minutes
 - 100% of rated voltage for at least 5 hours
- Check drive operation before placing the drive into service.

Failure to follow these instructions can result in injury or equipment damage.

Discharging Stored Energy in Capacitors

⚠ DANGER

HAZARD OF ELECTRIC SHOCK, EXPLOSION, OR ARC FLASH

- When the controller is damaged, voltage may remain on certain energy storage capacitors after de-energization of the controller and discharge of the main capacitor bank.
- Before working on or near assemblies containing energy storage capacitors, verify that the capacitor voltages are less than 42 Vdc.
- The following assemblies have energy-storing capacitors:
 - Filter board
 - SCR snubber board
- Always check for the presence of voltage using a voltmeter set to the 1000 Vdc scale. When voltage is present, allow the voltmeter to discharge the capacitor's stored charge.

Failure to follow these instructions will result in death or serious injury.

Capacitors are used throughout the drive as energy storage devices. Some of the capacitors can store potentially lethal amounts of energy during normal controller operation.

When power is removed from an undamaged controller, the stored energy in these capacitors is automatically discharged to nonhazardous levels. However, the discharge mechanisms in a damaged controller may not be operating properly, and stored energy may be present on printed circuit boards.

Do not touch traces on printed circuit boards, such as the line filter board and SCR snubber board, unless you have first checked for voltage with a voltmeter!

To discharge the filter board and SCR snubber board capacitors, use a voltmeter set to the 1000 Vdc scale. It will take approximately 6.6 minutes for a 10 megohm input impedance voltmeter to discharge a 10 microfarad capacitor from 700 V to less than 42 V. It will take approximately 40 seconds for a 1 megohm input impedance voltmeter to discharge a 10 microfarad capacitor from 700 V to less than 50 V.

⚠ DANGER

HAZARD OF ELECTRIC SHOCK, EXPLOSION, OR ARC FLASH

- Do not use a voltmeter to discharge stored energy on the DC bus capacitors.
- If the energy on the DC bus capacitors remains greater than 42 Vdc after 15 minutes, contact Product Support.

Failure to follow these instructions will result in death or serious injury.

Parts Locations

Refer to the figures in this section to familiarize yourself with the layout of the drive and the location of the parts before performing the installation procedures.

Level 1 Parts

Figure 1: Level 1 Parts

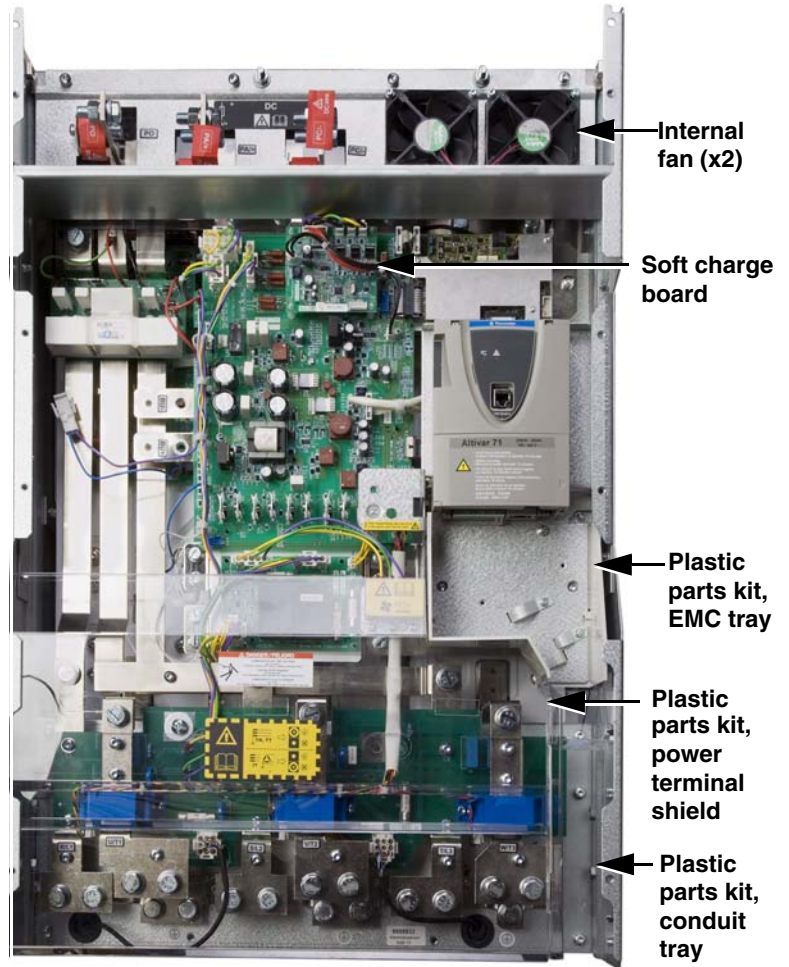
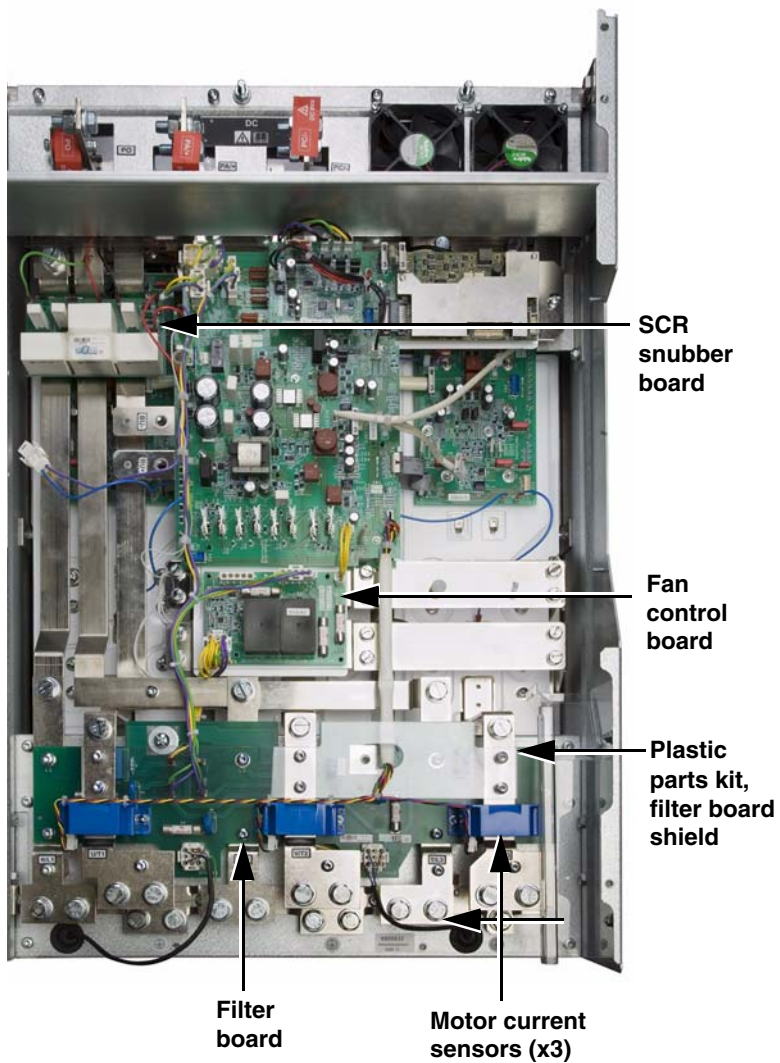

Figure 2: Level 1 Parts (continued)



Level 2 Parts

Figure 3: SCR Assembly Shield and Power Board

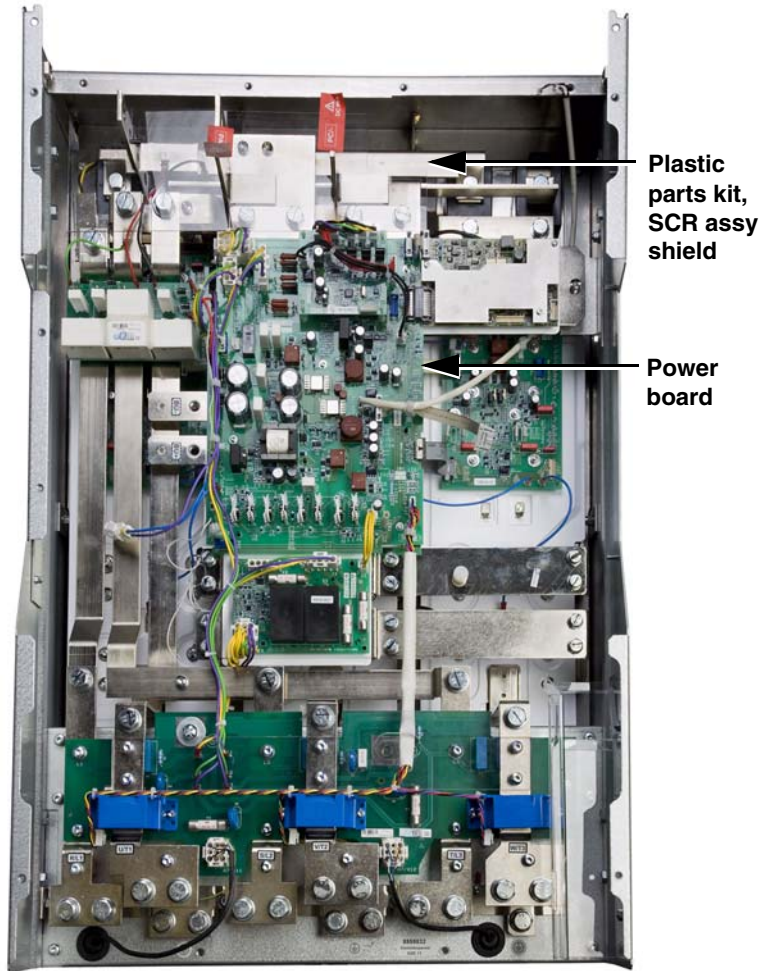

Figure 4: Gate Driver Boards

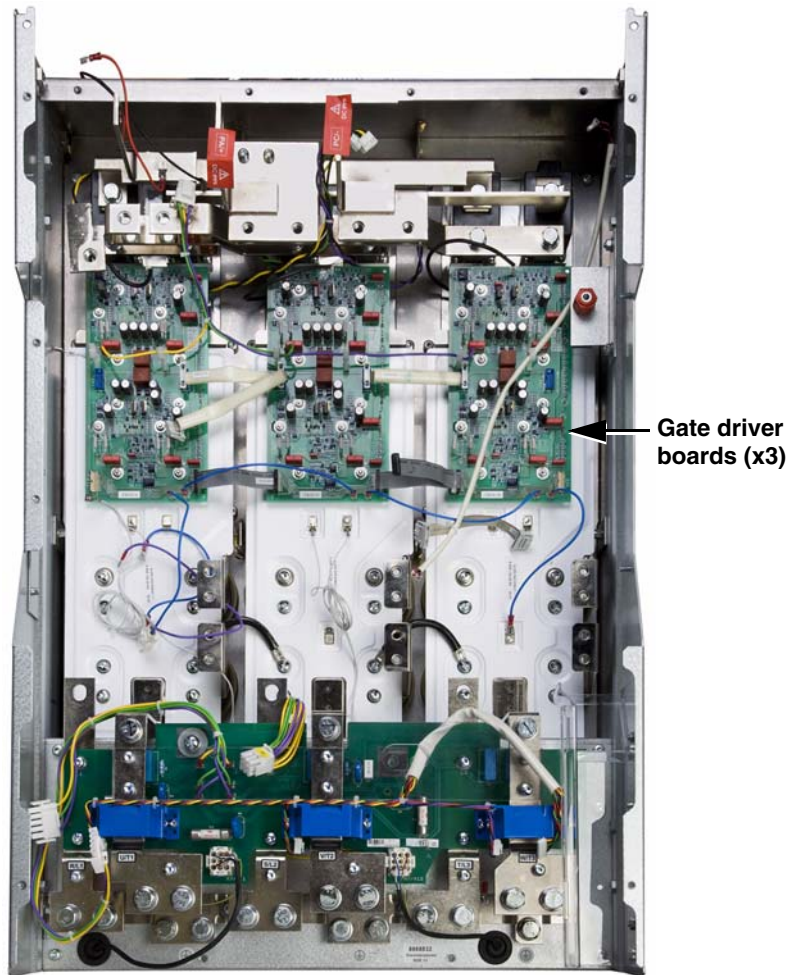

Figure 5: Temperature Sensors, Power IGBT Modules, and Capacitors

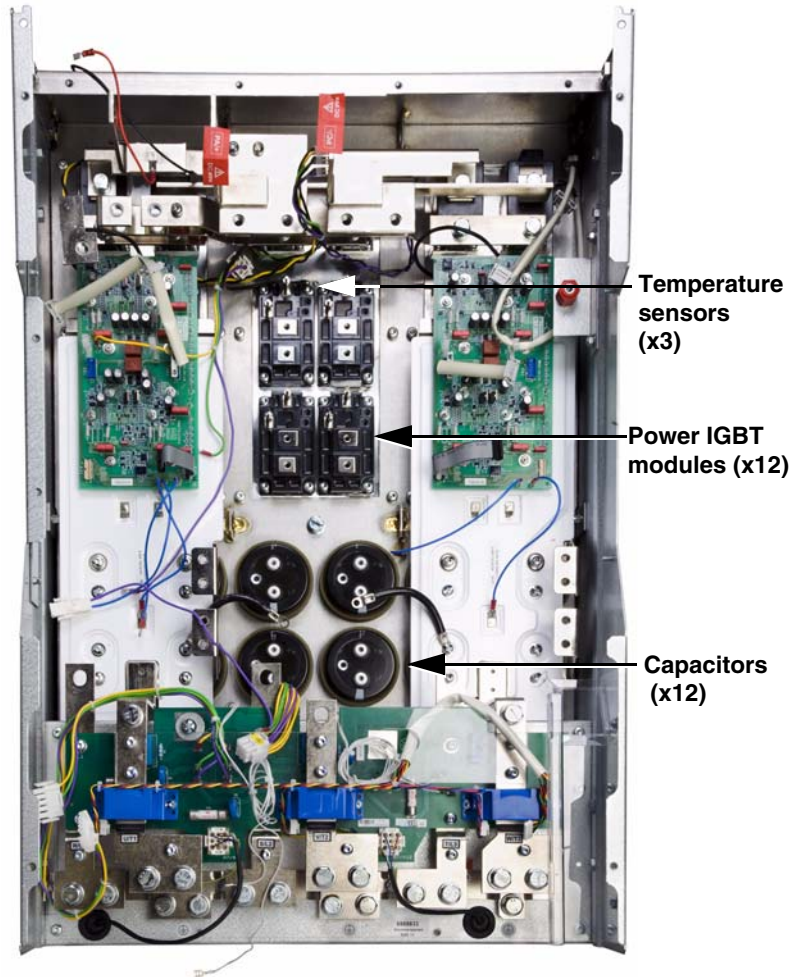
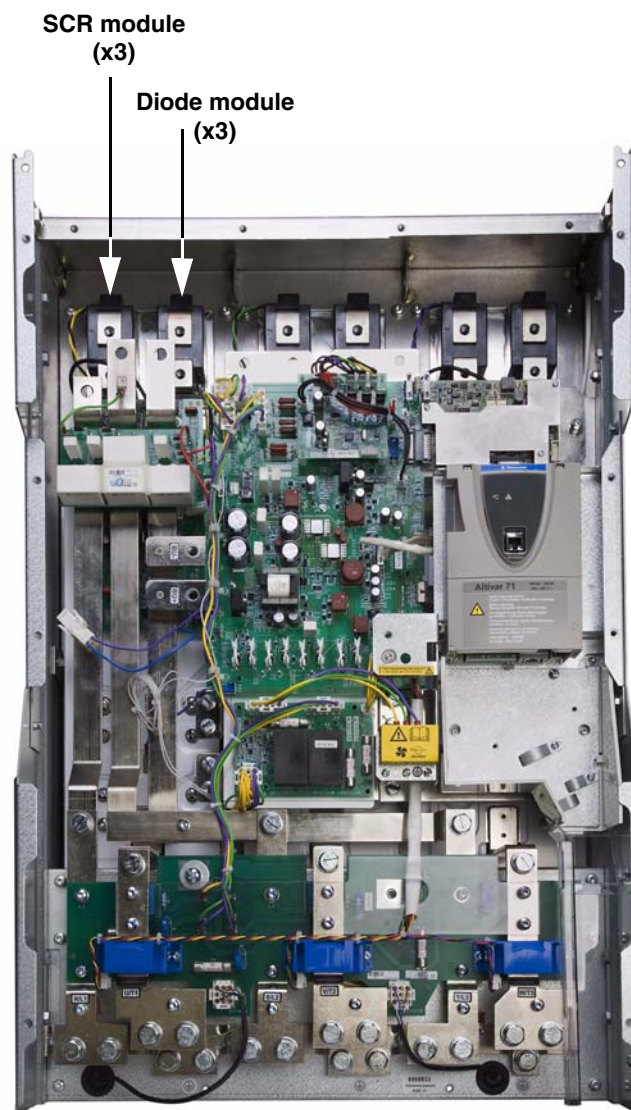

Figure 6: SCR Modules and Diode Modules



Installation Procedures for Level 1 Parts

Level 1 parts consist of the front cover and parts that are accessible directly under the front cover. They are:

Front cover	Fan control board
Power terminal shield (plastic kit)	Motor current sensors
Conduit tray (plastic kit)	Filter board
EMC tray (plastic kit)	Filter board shield (plastic kit)
Internal fans	SCR snubber board
Soft charge board	

Removing and Replacing the Front Cover VY1A1214

IMPORTANT: Label and retain all removed hardware and cables for use in reassembly.

⚠ DANGER

HAZARD OF ELECTRIC SHOCK, EXPLOSION, OR ARC FLASH

- Read and understand the precautions in “Before You Begin” starting on page 5 before performing this procedure.
- Before working on this equipment, turn off all power supplying it and perform the DC bus voltage measurement procedure on page 12.

Failure to follow these instructions will result in death or serious injury.

All of the procedures in this manual require removal and replacement of the front cover. See Figure 7.

- To remove the front cover, using a size 2 Phillips driver, remove nine screws and take the front cover off the drive.
- To replace the front cover, using a size 2 Phillips driver secure the front cover with nine screws. Tighten the screws to 5.5 N•m (48.7 lb-in).

Figure 7: Front Cover

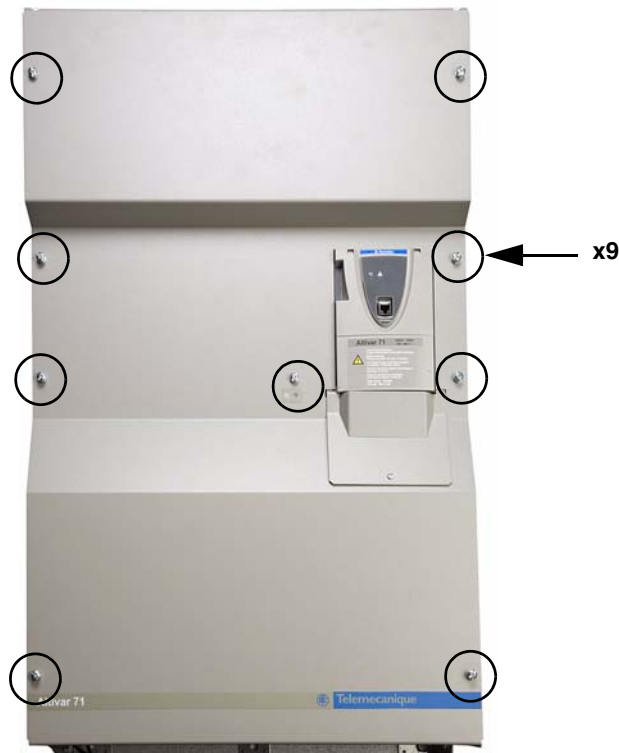

Replacing the Plastic Parts Kit VY1A1403

IMPORTANT: Label and retain all removed hardware and cables for use in reassembly.

⚠ DANGER

HAZARD OF ELECTRIC SHOCK, EXPLOSION, OR ARC FLASH

- Read and understand the precautions in “Before You Begin” starting on page 5 before performing this procedure.
- Before working on this equipment, turn off all power supplying it and perform the DC bus voltage measurement procedure on page 12.

Failure to follow these instructions will result in death or serious injury.

The replacement steps for some parts of the plastic kit are covered in other procedures. See Table 2.

Table 2: Plastic Kit Contents

Description	For replacement steps, see
Power terminal shield	“Replacing the Power Terminal Shield” beginning on page 21
Conduit tray	“Replacing the Filter Board (VX4A1115) and Motor Current Sensors (VY1A1108)” beginning on page 29
EMC tray	“Replacing the EMC Tray” beginning on page 23
Filter board shield	“Replacing the Filter Board (VX4A1115) and Motor Current Sensors (VY1A1108)” beginning on page 29
SCR assembly shield	“Replacing the SCR Modules (VZ3TM1425M1671, VZ3TM1600M1671) and Diode Modules (VZ3DM1600M1671)” beginning on page 77

Remove the Front Cover

Using a size 2 Phillips driver, remove nine screws and take the front cover off the drive. See Figure 7 on page 20.

Replacing the Power Terminal Shield

If the transparent power terminal shield is cracked, broken, or damaged, replace it as follows.

1. The power terminal shield has two retaining tabs (**A**, Figure 8 on page 22) on the right that fit into slots on the conduit tray, and three mounting holes (**B**, Figure 8 on page 22) on the left that fit over posts on the side panel of the drive. Disengage the shield from the retaining tabs and mounting slots and remove it from the drive.

NEXT STEP: If you are also replacing the EMC tray, perform the steps in “Replacing the EMC Tray” beginning on page 23 before installing the new power terminal shield.

2. If you are only replacing the power terminal shield, install the new shield as shown in Figures 8 and 9 on page 22.
Labels for the new shield are included in the plastic kit. Add the new labels in the same positions as on the old shield.
3. Replace the front cover. Using a size 2 Phillips driver, secure the front cover with nine screws. See Figure 7 on page 20. Tighten the screws to 5.5 N•m (48.7 lb-in).

⚠ DANGER

HAZARD OF ELECTRIC SHOCK, EXPLOSION, OR ARC FLASH

- Install the power terminal shield as shown in Figures 8 and 9.
- Before installing the shield, ensure that it has no tears or cracks. If the shield is damaged, install a new piece from the plastic kit. See page 21.
- Do not install a damaged shield.

Failure to follow these instructions will result in death or serious injury.

Figure 8: Power Terminal Shield

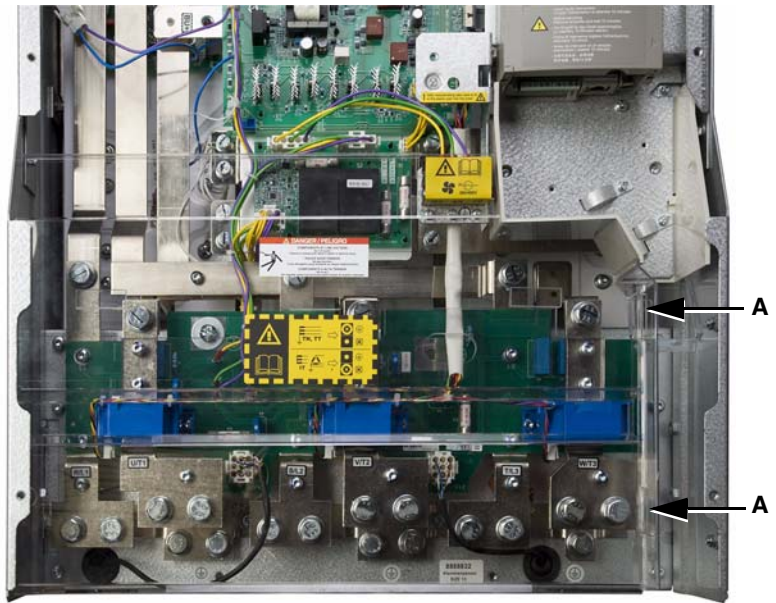

Figure 9: Power Terminal Shield Retaining Posts



Replacing the EMC Tray

Replace the EMC tray as follows.

1. Using a T-20 Torx driver, remove three screws (**A**) securing the EMC tray to the control module mounting plate and remove the tray from the drive. See Figure 10.

Figure 10: EMC Tray

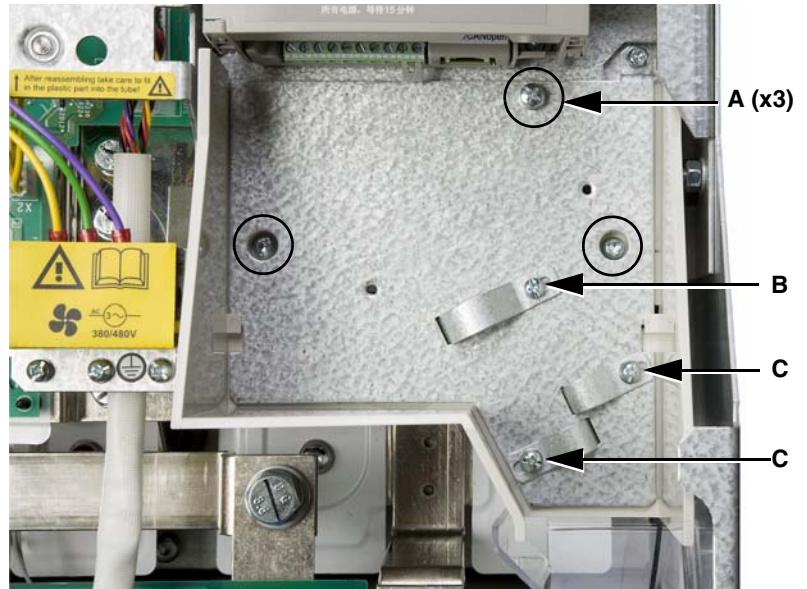

Table 3: EMC Tray Hardware Torque Values

Item	Description	Torque Range	
		N•m	lb-in
A	(3) T-20 screws	0.4–0.6	3.5–5.3
B	(1) Size 2 Phillips screw (20 mm length)	0.4–0.6	3.5–5.3
C	(2) Size 2 Phillips screws (10 mm length)	0.4–0.6	3.5–5.3

2. Using a size 2 Phillips driver, remove three screws (**B** and **C**) securing the cable clamps to the metal EMC plate, and remove the clamps from the plate. See Figure 10.

NOTE: Note the differences in the cable clamps and screws. The screw (**B**) in the large clamp is longer than the screws (**C**) in the two shorter clamps.

3. Remove the metal EMC plate from the plastic tray and discard the plastic tray.
4. Place the metal EMC plate into the new plastic tray.
5. Using a size 2 Phillips driver, install the cable clamps on the EMC plate with three screws (**B** and **C**). See Figure 10.
6. Using a T-20 Torx driver, secure the plastic EMC tray to the control module mounting plate with mounting three screws (**A**). See Figure 10.
7. Tighten the hardware to the torque values listed in Table 3.

Replace the Power Terminal Shield

Replace the power terminal shield as illustrated in Step 2 of “Replacing the Power Terminal Shield” on page 21.

Replace the Front Cover

Replace the front cover. Using a size 2 Phillips driver, secure the front cover with nine screws. See Figure 7 on page 20. Tighten the screws to 5.5 N•m (48.7 lb-in).

Replacing the Internal Fans VZ3V1213

IMPORTANT: Label and retain all removed hardware and cables for use in reassembly.

Remove the Front Cover

Replace the Internal Fan

⚠ DANGER

HAZARD OF ELECTRIC SHOCK, EXPLOSION, OR ARC FLASH

- Read and understand the precautions in “Before You Begin” starting on page 5 before performing this procedure.
- Before working on this equipment, turn off all power supplying it and perform the DC bus voltage measurement procedure on page 12.

Failure to follow these instructions will result in death or serious injury.

1. Using a size 2 Phillips driver, remove nine screws and take the front cover off the drive. See Figure 7 on page 20.
2. Remove the internal fan you are replacing as follows. See Figure 11.
 - Using needle-nose pliers, carefully unplug the fan’s 2-pin connector (**A**) from the top bracket.
 - Using a T-20 Torx driver, remove four screws (**B**) securing the fan to the top bracket and remove the fan from the drive.

Figure 11: Internal Fans

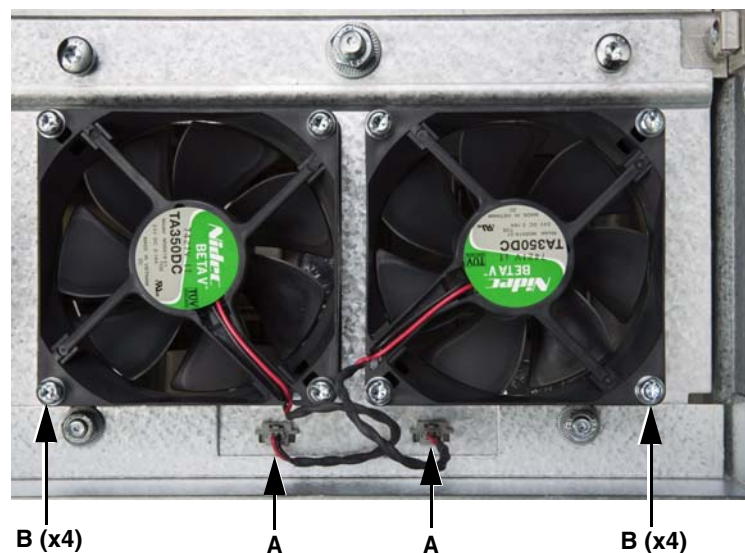

3. Install the new fan as follows. See Figure 11.
 - Using a T-20 Torx driver, secure the fan to the top bracket with four screws (**B**). Tighten the screws to 1.1–1.7 N•m (9.7–15 lb-in).
 - Plug the fan’s 2-pin connector (**A**) into the terminal on the top bracket.
4. Replace the front cover. Using a size 2 Phillips driver, secure the front cover with nine screws. See Figure 7 on page 20. Tighten the screws to 5.5 N•m (48.7 lb-in).

Replace the Front Cover

Replacing the Soft Charge Board VX5A1300

IMPORTANT: Label and retain all removed hardware and cables for use in reassembly.

Table 4: Soft Charge Board Wiring

Wire No. ¹	Terminal No.	Description	To:
E110	CN2A	9-pin, red	PB ² X30 (9-pin)
E109	CNL3G	2-pin, violet/black	SCR ³ 3 Terms. 4 & 5
E108	CNL2G	2-pin, green/black	SCR 2 Terms. 4 & 5
E107	CNL1G	2-pin, yellow/black	SCR 1 Terms. 4 & 5
E111	CN7A	2-pin, black	PB X31

¹ See the schematic on page 106 for complete drive wiring. Wire numbers are given for cross referencing the wires with the wiring table and the schematic. The numbers do not appear on the wires.

² PB: Power board

³ SCR: Silicon controlled rectifier

⚠ DANGER

HAZARD OF ELECTRIC SHOCK, EXPLOSION, OR ARC FLASH

- Read and understand the precautions in “Before You Begin” starting on page 5 before performing this procedure.
- Before working on this equipment, turn off all power supplying it and perform the DC bus voltage measurement procedure on page 12.

Failure to follow these instructions will result in death or serious injury.

1. Using a size 2 Phillips driver, remove nine screws and take the front cover off the drive. See Figure 7 on page 20.
2. Using needle-nose pliers, carefully remove the following connections. See Table 4 and Figure 12 for connector locations.
 - At the top of the soft charge board, from left to right remove: the 9-pin connector from terminal CN2A, the 2-pin connector from terminal CNL3G, the 2-pin connector from terminal CNL2G, and the 2-pin connector from terminal CNL1G.
 - At the left side of the board, remove the 2-pin connector from terminal CN7A.

Figure 12: Soft Charge Board

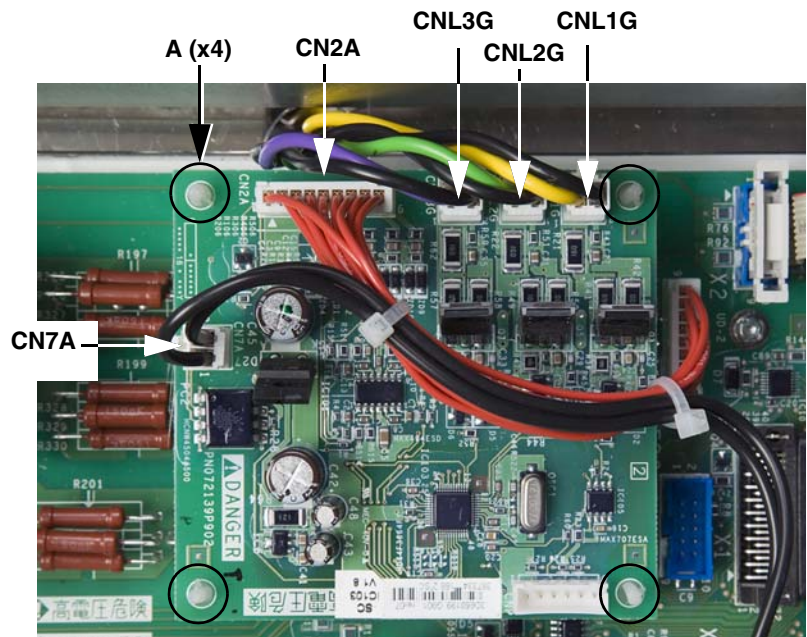

3. Using needle-nose pliers, compress the four plastic mounting posts (A, Figure 12), one at a time, while lifting the soft charge board off the posts. Remove the soft charge board from the drive.
4. Press the new soft charge board down over the four mounting posts (A, Figure 12) until it is securely seated.
5. Install five connections on the new soft charge board. See Table 4 and Figure 12 for connector locations.
6. Replace the front cover. Using a size 2 Phillips driver, secure the front cover with nine screws. See Figure 7 on page 20. Tighten the screws to 5.5 N•m (48.7 lb-in).

Replacing the SCR Snubber Board VX4A1200

IMPORTANT: Label and retain all removed hardware and cables for use in reassembly.

⚠ DANGER

HAZARD OF ELECTRIC SHOCK, EXPLOSION, OR ARC FLASH

- Read and understand the precautions in “Before You Begin” starting on page 5 before performing this procedure.
- Before working on this equipment, turn off all power supplying it and perform the DC bus voltage measurement procedure on page 12.

Failure to follow these instructions will result in death or serious injury.

⚠ DANGER

HAZARD OF ELECTRIC SHOCK, EXPLOSION, OR ARC FLASH

- When the controller is damaged, voltage may remain on certain energy storage capacitors after de-energization of the controller and discharge of the main capacitor bank.
- Before working on or near assemblies containing energy storage capacitors, verify that the capacitor voltages are less than 42 Vdc.
- The following assemblies have energy-storing capacitors:
 - SCR snubber board. See Figure 14 on page 27.
- Always check for the presence of voltage using a voltmeter set to the 1000 Vdc scale. When voltage is present, allow the voltmeter to discharge the capacitor’s stored charge. Refer to “Discharging Stored Energy in Capacitors” on page 13.

Failure to follow these instructions will result in death or serious injury.

Table 5: SCR Snubber Board Wiring

Wire No. ¹	Terminal No.	Description	To:
E131	X1	Green	L1 bus bar
E130	X4	Red	PO/+ bus bar
E133	X5	Black	PC/- bus bar
E126	X10	Red, 0.25 in., 1-pin	PB ² RFS+X10
E171	X11	Red, 0.19 in., 1-pin	PB RFS+X11

¹ See the schematic on page 106 for complete drive wiring. Wire numbers are given for cross referencing the wires with the wiring table and the schematic. The numbers do not appear on the wires.

² PB: Power board

1. Using a size 2 Phillips driver, remove nine screws and take the front cover off the drive. See Figure 7 on page 20.
2. Using needle-nose pliers, carefully remove all connections from the SCR snubber board. See Table 5 and Figure 13 for the connection locations.

Figure 13: SCR Snubber Board Layout

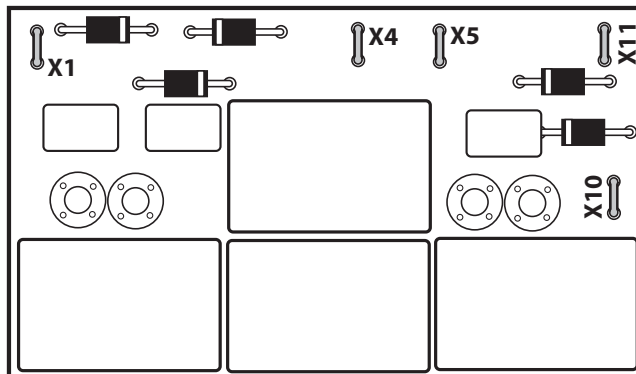

- Using a 7 mm socket wrench, remove two nuts (**A**, Figure 14) securing the SCR snubber board to the standoffs on the SCR L2 and L3 bus bars and remove the snubber board from the drive.

Figure 14: SCR Snubber Board

Table 6: SCR Snubber Board Hardware Torque Values

Item	Description	Torque Range	
		N•m	lb-in
A	(2) 7 mm nuts	1.1–1.7	9.7–15

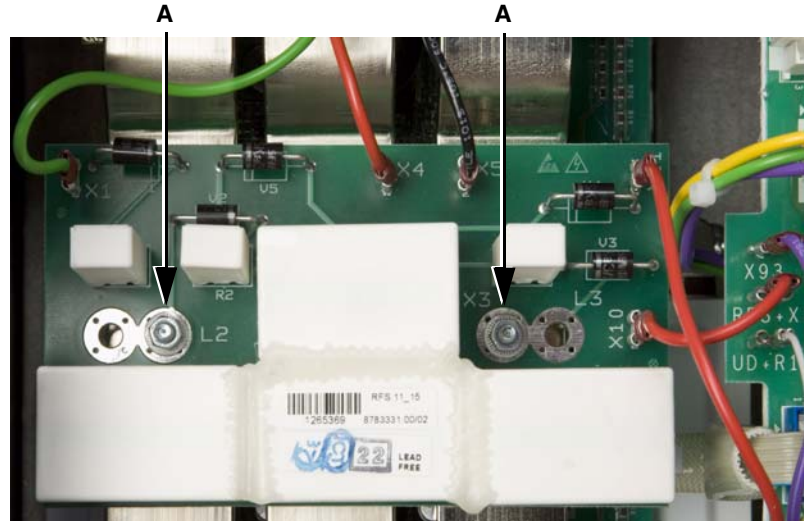

- Using a 7 mm socket wrench, secure the new SCR snubber board to the standoffs on the SCR L2 and L3 bus bars with two nuts (**A**, Figure 14). Tighten the nuts to the torque values shown in Table 6.
- Replace all connections to the SCR snubber board. See Table 5 and Figure 13 on page 26 for the connection locations.
- Replace the front cover. Using a size 2 Phillips driver, secure the front cover with nine screws. See Figure 7 on page 20. Tighten the screws to 5.5 N•m (48.7 lb-in).

Replacing the Fan Control Board VX5A1400

IMPORTANT: Label and retain all removed hardware and cables for use in reassembly.

⚠ DANGER

HAZARD OF ELECTRIC SHOCK, EXPLOSION, OR ARC FLASH

- Read and understand the precautions in “Before You Begin” starting on page 5 before performing this procedure.
- Before working on this equipment, turn off all power supplying it and perform the DC bus voltage measurement procedure on page 12.

Failure to follow these instructions will result in death or serious injury.

- Using a size 2 Phillips driver, remove nine screws and take off the front cover of the drive. See Figure 7 on page 20.
- Remove the power terminal shield as described in Step 1 of “Replacing the Power Terminal Shield” on page 21.

Table 7: Fan Control Board Wiring

Wire No. ¹	Terminal No.	Description	To:
E124	X4	5-pin, violet/green/yellow	Fan control terminal block TB1
E118	X1	5-pin, violet/green/yellow	FB ² X1
			FB X2
			FB X3
E105	X2	3-pin, yellow	PB ³ X14
E114	X3	9-pin, black/white/brown/blue with yellow and green ground wire	FB X11 & X12
—	X6	Not used	—

¹ See the schematic on page 105 for complete drive wiring. Wire numbers are given for cross referencing the wires with the wiring table and the schematic. The numbers do not appear on the wires.

² FB: Filter board

³ PB: Power board

3. Remove the following connections from the fan control board. See Table 7 and Figure 15 for connector locations.
 - From the top of the board, remove from left to right: the 5-pin connector from terminal X4, the 5-pin connector from terminal X1, and the 3-pin connector from terminal X2.
 - From the bottom left of the board, remove the 9-pin connector from terminal X3.
4. Using a T-10 Torx driver, remove 1 screw (**A**, Figure 15) from the board between connectors X1 and X4.
5. Using needle-nose pliers, compress the four plastic mounting posts (**B**, Figure 15), one at a time, while lifting the board off the posts. Remove the board from the drive.

Figure 15: Fan Control Board

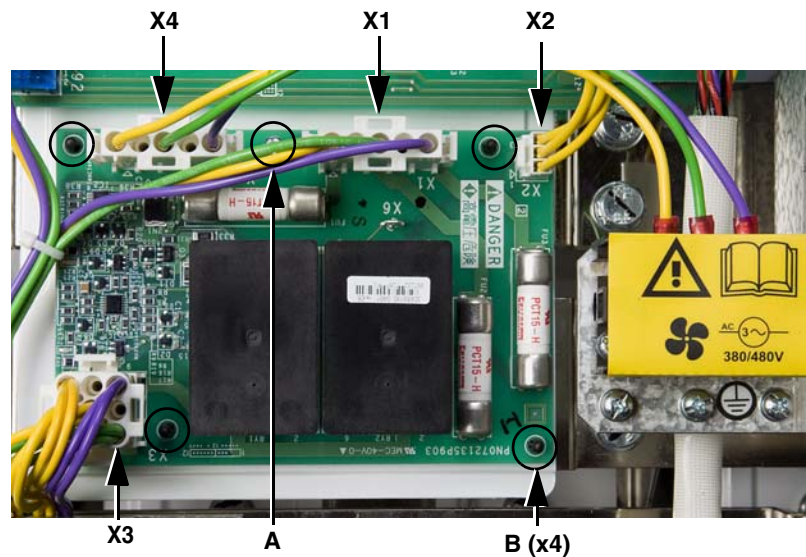

6. Press the new fan control board down over the four mounting posts until it is securely seated.
7. Using a T-10 Torx driver secure the board with one screw (**A**, Figure 15). Tighten the screw to 0.8 N•m (7.1 lb-in).
8. Install the four connections on the new fan control board. See Table 7 and Figure 15 for connector locations.
9. Replace the power terminal shield as illustrated in Step 2 on page 27.
10. Replace the front cover. Using a size 2 Phillips driver, secure the front cover with nine screws. See Figure 7 on page 20. Tighten the screws to 5.5 N•m (48.7 lb-in).

Replacing the Filter Board (VX4A1115) and Motor Current Sensors (VY1A1108)

IMPORTANT: Label and retain all removed hardware and cables for use in reassembly.

⚠ DANGER

HAZARD OF ELECTRIC SHOCK, EXPLOSION, OR ARC FLASH

- Read and understand the precautions in “Before You Begin” starting on page 5 before performing this procedure.
- Before working on this equipment, turn off all power supplying it and perform the DC bus voltage measurement procedure on page 12.

Failure to follow these instructions will result in death or serious injury.

⚠ DANGER

HAZARD OF ELECTRIC SHOCK, EXPLOSION, OR ARC FLASH

- When the controller is damaged, voltage may remain on certain energy storage capacitors after de-energization of the controller and discharge of the main capacitor bank.
- Before working on or near assemblies containing energy storage capacitors, verify that the capacitor voltages are less than 42 Vdc.
- The following assemblies have energy-storing capacitors:
 - Filter board. See Figure 19 on page 31.
- Always check for the presence of voltage using a voltmeter set to the 1000 Vdc scale. When voltage is present, allow the voltmeter to discharge the capacitor’s stored charge. Refer to “Discharging Stored Energy in Capacitors” on page 13.

Failure to follow these instructions will result in death or serious injury.

Remove the Front Cover

1. Using a size 2 Phillips driver, remove nine screws and take the front cover off the drive. See Figure 7 on page 20.

Remove the Power Terminal Shield

2. The power terminal shield has two retaining tabs (**A**, Figure 16) on the right that fit into slots on the conduit tray, and three mounting holes (**B**, Figure 17) on the left that fit over posts on the side panel of the drive. Disengage the shield from the retaining tabs and mounting slots and remove it from the drive.

Figure 16: Power Terminal Shield

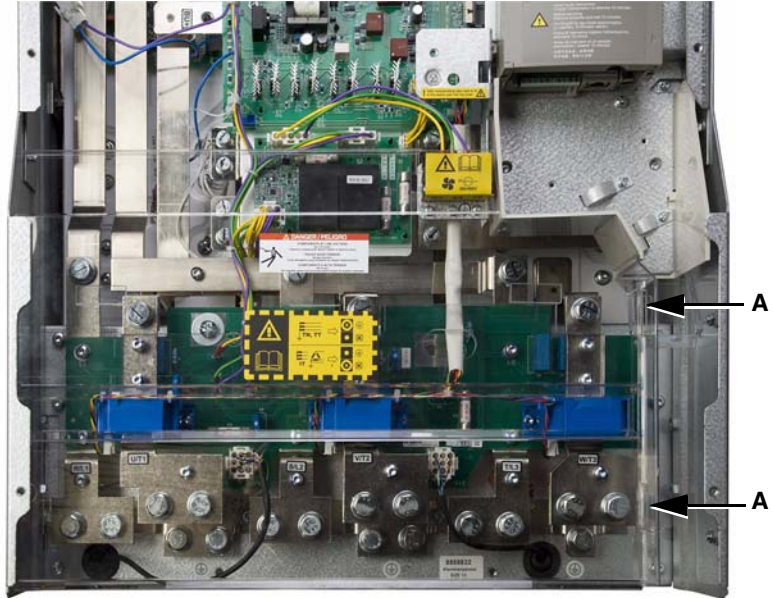

Figure 17: Power Terminal Shield Retaining Posts



Remove the EMC Tray

- Using a T-20 Torx driver, remove three screws (A) securing the EMC tray to the control module mounting plate and remove the tray from the drive. See Figure 18.

Figure 18: EMC Tray



Remove the Filter Board Shield

- Remove the filter board shield as follows.
 - Using a T-30 Torx driver, remove six screws (A, Figure 19) securing the filter board shield to the output bus bars.

Figure 19: Filter Board Shield

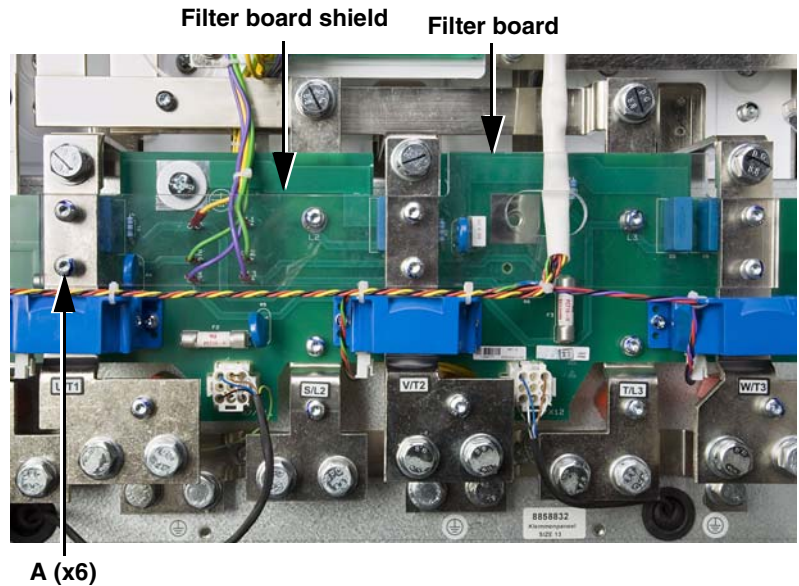

- Disconnect the cable (wire E103) from terminal X11 of the power board, remove it from the cable clamp, and route it under the TB1 bracket and through the hole in the filter board shield. See Figures 20 and 21.
- Remove the filter board shield from the drive.

Figure 20: Power Board Connection X11

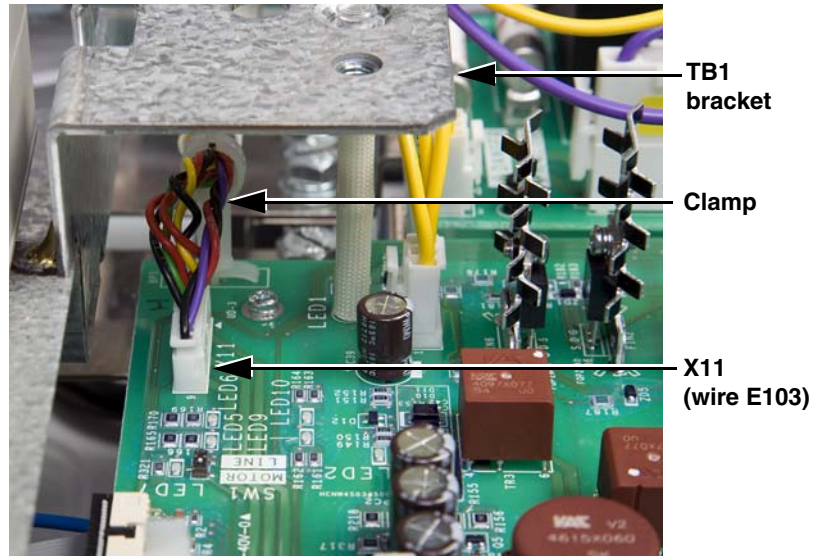
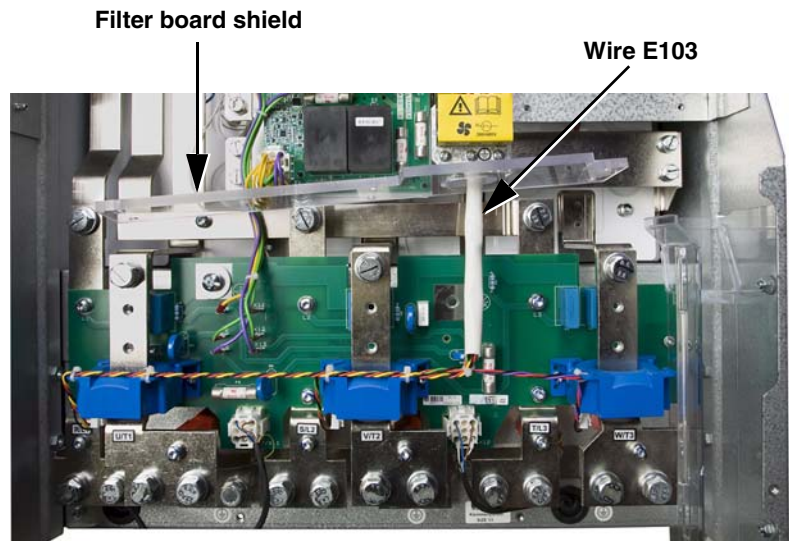

Figure 21: Filter Board Shield



Loosen the Output Bus Bars

5. Loosen the output bus bars as follows.
 - Using a T-30 Torx driver, remove three screws and washers (**A**, Figure 22) securing the output bus bars to the red insulators at terminals U/T1, V/T2, and W/T3.
 - Using an 18 mm socket wrench, remove three bolts with two washers each (**B**, Figure 22) securing the output bus bars to the DC bus plates.

Figure 22: Output Bus Bars

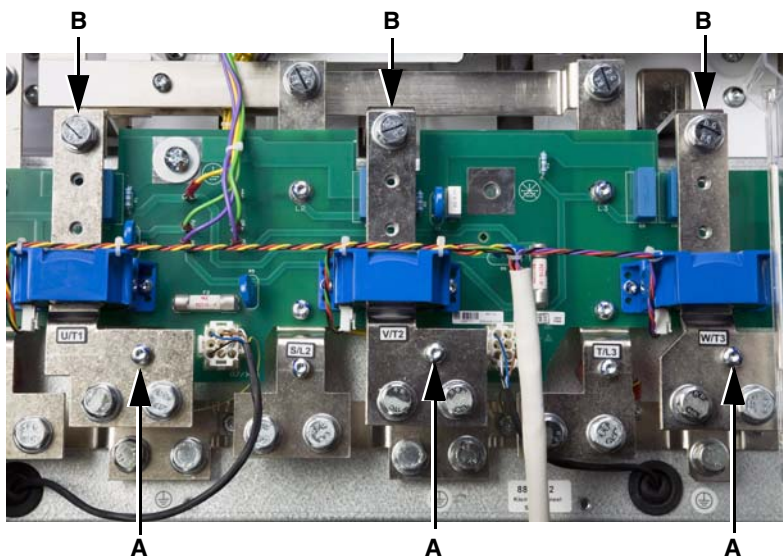

Remove the Conduit Tray

6. Remove the conduit tray as follows. See Figure 23.
 - Rotate the T3 bus bar to the right as shown in Figure 23.
 - Using a 10 mm socket wrench, remove two nuts securing the conduit tray to the drive frame and remove the tray.

Figure 23: Conduit Tray

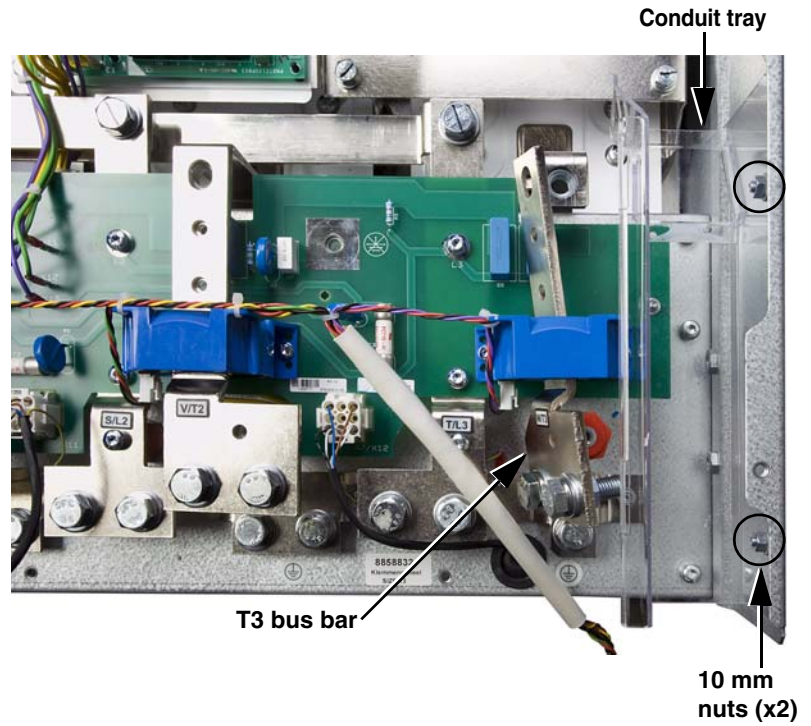

Remove the Filter Board and Fan Connections

Table 8: Filter Board Wiring

Wire No. ¹	Terminal No.	Description	To:
E118	X1	Yellow, 0.25 in. connector	FCB ² X1
	X2	Green, 0.25 in. connector	
	X3	Violet, 0.25 in. connector	
E120	X11	Yellow, 0.19 in. connector	PB ³ X7
	X12	Green, 0.19 in. connector	
	X13	Violet, 0.19 in. connector	
E115	A7/X11	Black sleeve, 9-pin	Heatsink fan 1
E125	A7/X12	Black sleeve, 9-pin	Heatsink fan 2

¹ See the schematic on page 105 for complete drive wiring. Wire numbers are given for cross referencing the wires with the wiring table and the schematic. The numbers do not appear on the wires.

² FCB: Fan control board

³ PB: Power board

7. Using needle-nose pliers, remove the six 1-pin connections from the filter board. See Table 8 and Figure 24 for connector locations.

Figure 24: Filter Board Connections

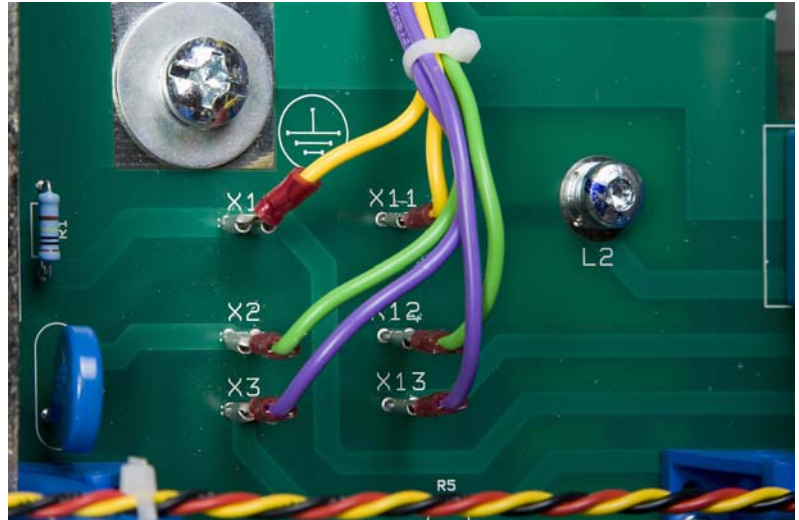

8. Disconnect the 9-pin fan connectors from terminals A7/X11 and A7/X12. See Figure 25.

Figure 25: Filter Board Fan Connections

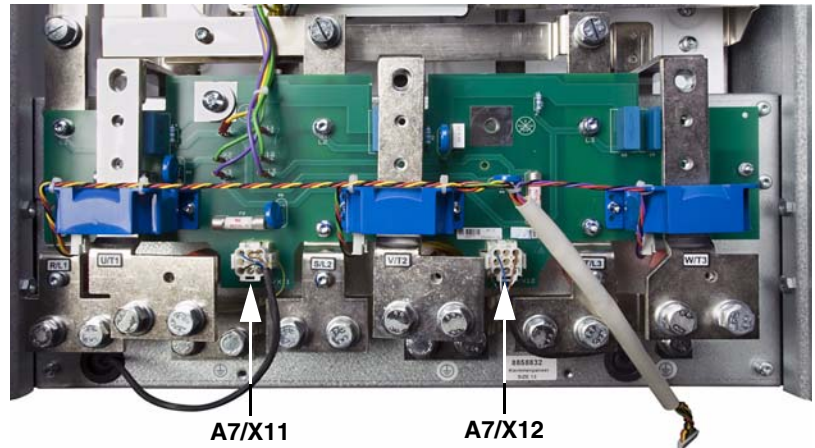

Remove the Filter Board

9. Remove the filter board as follows.
 - Using a T-30 Torx driver, remove six screws (**A**, Figure 26) securing the filter board to the input bus bars.
 - Using a 7 mm socket wrench, remove one nut (**B**, Figure 26) securing the filter board to the bracket on the drive frame.
 - Using a size 3 Phillips driver, remove the grounding screw and washer (**C**, Figure 26) securing the filter board to the drive frame.

NOTE: Note whether the screw is installed in the grounded or non-grounded position for reinstallation. Figure 26 shows the screw in the grounded position.

- Gently press in on the tabs at the top and bottom of the fan connectors at terminals A7/X11 and A7/X12 and push the connectors down through the cutouts in the board. See Figure 27.
- Remove the filter board from the drive. The output bus bar segments come out with the board.

Figure 26: Filter Board Mounting Hardware

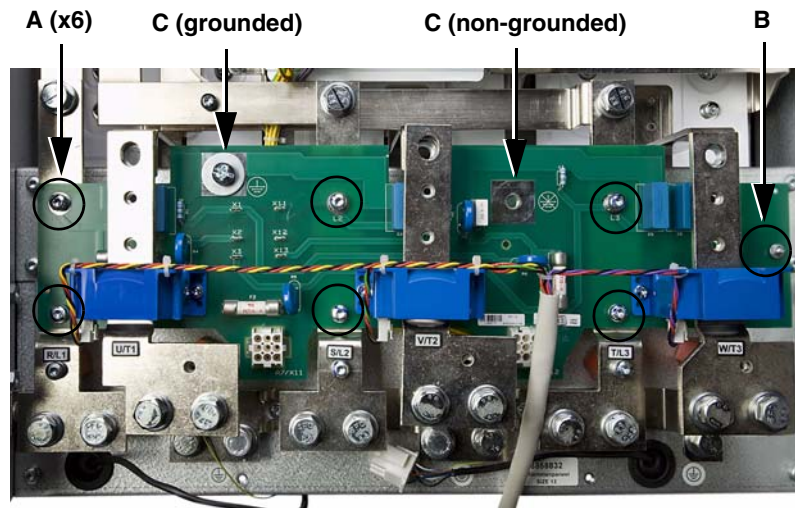
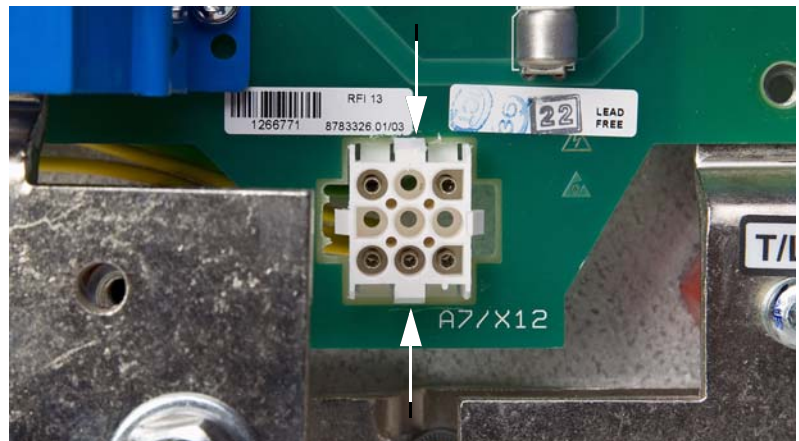

Figure 27: Fan Connector Detail



Remove the Motor Current Sensors

10. Remove the motor current sensors from the filter board as follows:
 - Remove the E103 cable connections from the motor current sensors. See Figure 28.
 - Slide the output bus bars out of the motor current sensors.
 - Using a T-20 Torx driver, remove six screws (**E**, Figure 28) securing the motor current sensors to the filter board, and using a 7 mm socket wrench, remove six nuts (**F**, Figure 29) from the back of the filter board.

Table 9: Motor Current Sensor Hardware Torque Values

Item	Description	Torque Range	
		N•m	lb-in
E	(6) T-20 screws	1.2	10.6
F	(6) 7 mm nuts	1.2	10.6

Figure 28: Filter Board Front

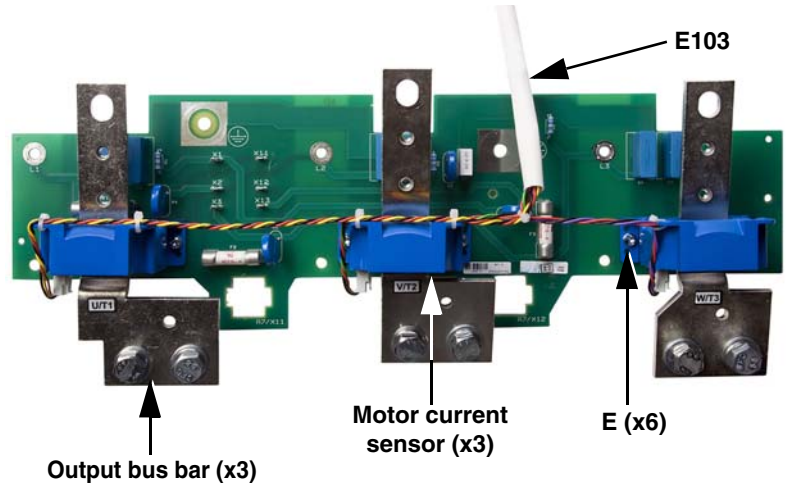
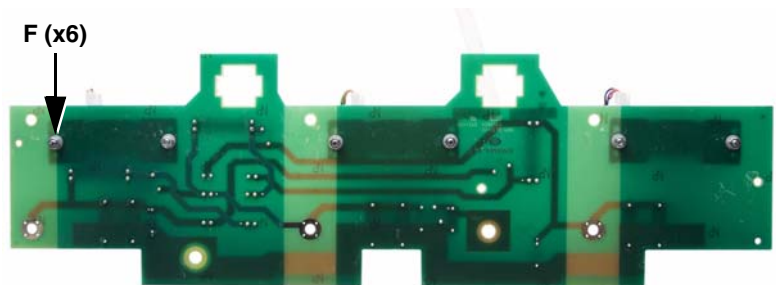

Figure 29: Filter Board Back



NEXT STEP: In the next steps you can install a new filter board, install new motor current sensors, or both. If you are installing new motor current sensors, you must replace all three current sensors.

Install the Motor Current Sensors

11. Install the motor current sensors as follows.
 - Install the motor current sensors on the filter board and secure them with six T-20 Torx screws (**E**, Figure 28) and six 7 mm nuts (**F**, Figure 29) each. Tighten the hardware to the values specified in Table 9.
 - Slide the output bus bars through the motor current sensors as illustrated in Figure 28.

NOTE: Note the markings on the output bus bars and install them in the positions shown in Figure 28. U/T1 (left), V/T2 (center), W/T3 (right).

- Connect cable E103 to the motor current sensors. See Figure 28 on page 37.

NOTE: Note the position of the wires. T1: yellow/red/black; T2: green/red/black; T3: violet/red/black.

Install the Filter Board

12. Install the filter board as follows:

- Position the filter board and output bus bars in the drive as shown in Figure 30. Gently press the top and bottom tabs on the fan connectors (Figure 31 on page 39) and push them up through the cutouts on the filter board.
- Using a T-30 Torx driver, secure the filter board to the input bus bars with six screws (**A**, Figure 30).
- Using a 7 mm socket wrench, secure the right edge of the filter board to the bracket on the drive frame with one nut (**B**, Figure 30).
- Using a size 3 Phillips driver, install the grounding screw and washer (**C**, Figure 30).

NOTE: Be sure to install the size 3 Phillips screw and washer (**C**) in the original position. Figure 30 shows the screw in the grounded position.

- Tighten the hardware to the torque values specified in Table 10.

Table 10: Filter Board Hardware Torque Values

Item	Description	Torque Range	
		N•m	lb-in
A	(6) T-30 screws	5.5	48.7
B	(1) 7 mm nut	1.2	10.6
C	(1) Size 3 Phillips screw	5.5	48.7

Figure 30: Filter Board Mounting Hardware

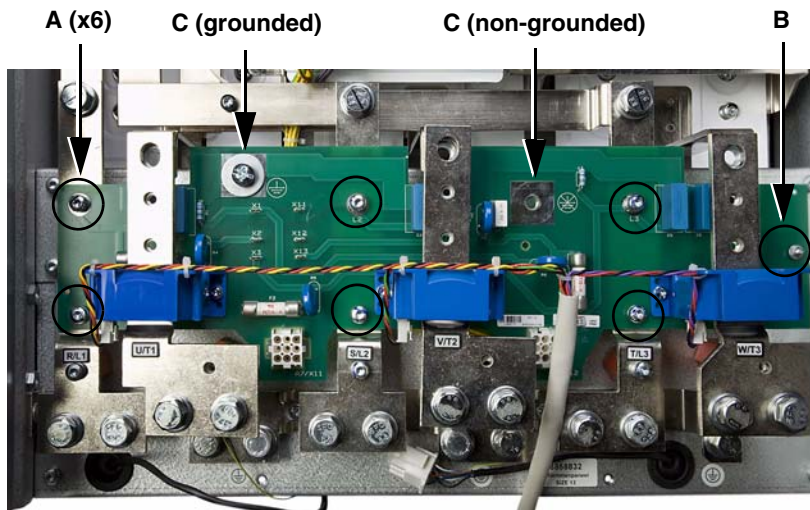
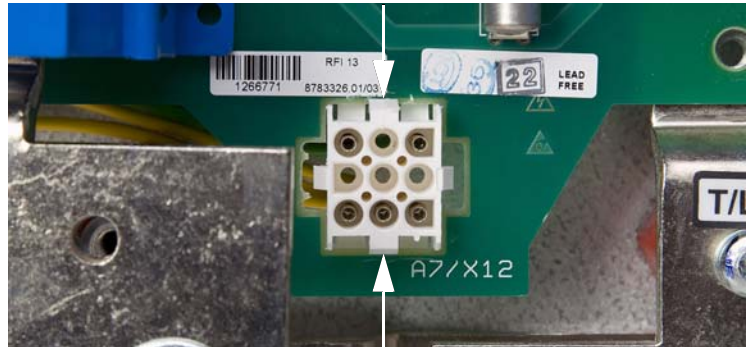

Figure 31: Fan Connector Detail



Replace the Filter Board and Fan Connections

13. Replace the fan and filter board connections as follows.

- Connect the 9-pin fan connectors at terminals A7/X11 and A7/X12. See Figure 32.
- Replace the six 1-pin connections on the filter board. See Table 11 and Figure 33 for connector locations.

Table 11: Filter Board Wiring

Wire No. ¹	Terminal No.	Description	To:
E118	X1	Yellow, 0.25 in. connector	FCB ² X1
	X2	Green, 0.25 in. connector	
	X3	Violet, 0.25 in. connector	
E120	X11	Yellow, 0.19 in. connector	PB ³ X7
	X12	Green, 0.19 in. connector	
	X13	Violet, 0.19 in. connector	
E115	A7/X11	Black sleeve, 9-pin	Heatsink fan 1
E125	A7/X12	Black sleeve, 9-pin	Heatsink fan 2

¹ See the schematic on page 105 for complete drive wiring. Wire numbers are given for cross referencing the wires with the wiring table and the schematic. The numbers do not appear on the wires.

² FCB: Fan control board

³ PB: Power board

Figure 32: Filter Board Fan Connections

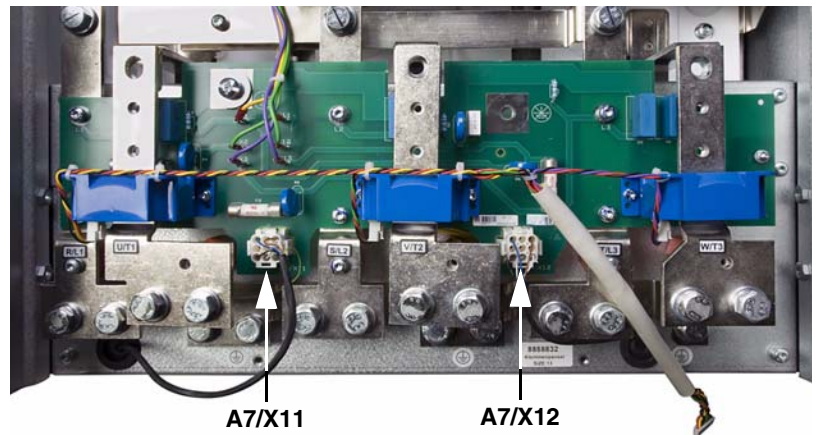
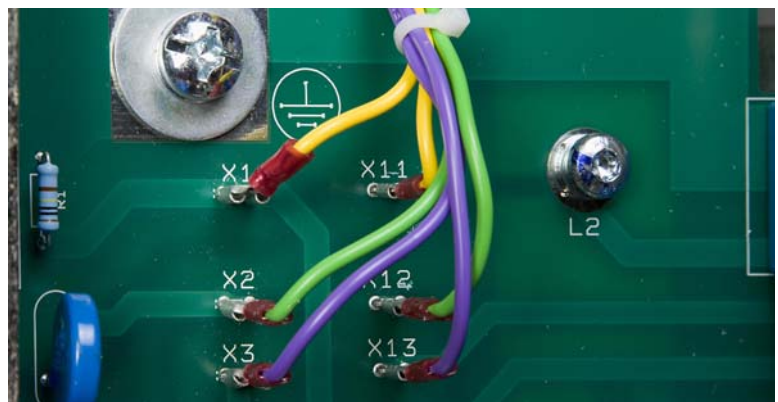

Figure 33: Filter Board Connections



Replace the Conduit Tray

14. Replace the conduit tray as follows. If the tray is cracked, broken, or damaged, replace it with a new piece from the plastic kit. See page 20.
 - Turn the T3 bus bar to the right as shown in Figure 34.
 - Using a 10 mm socket wrench, secure the conduit tray to the drive frame with two nuts. See Figure 34. Tighten the nuts to 5.5 N•m (48.7 lb-in).
 - Straighten the T3 bus bar to its correct position.

Figure 34: Conduit Tray

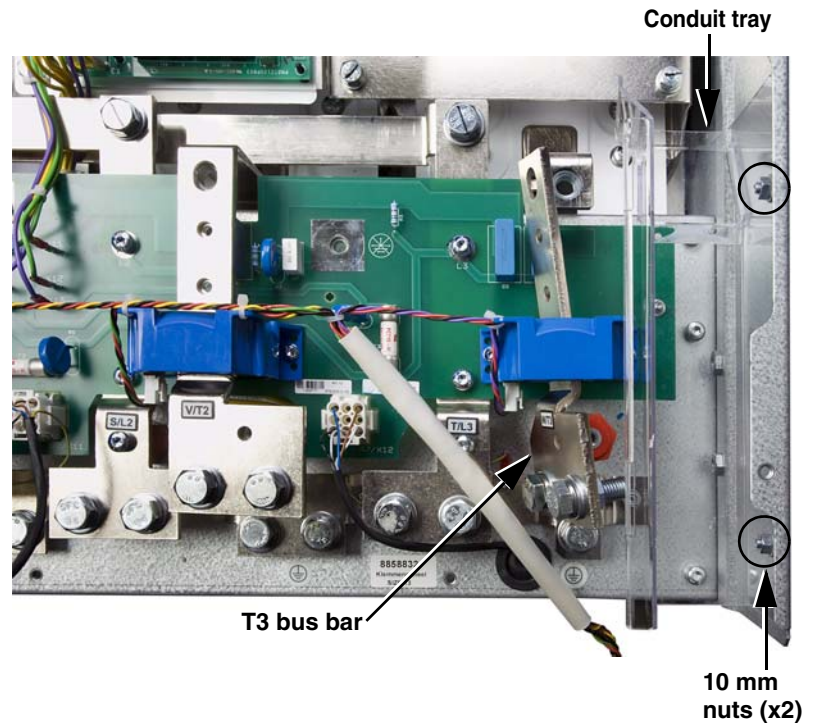

Secure the Output Bus Bars

Table 12: Output Bus Bar Hardware Torque Values

Item	Description	Torque Range	
		N•m	lb-in
A	(3) T-30 screws and washers	5.5	48.7
B	(3) 18 mm bolts	45	398

15. Secure the output bus bars as follows.
 - Using a 18 mm socket wrench, secure the output bus bars to the DC bus plates with three bolts (B, Figure 35).
 - Using a Torx T-30 driver, secure the output bus bars to the red insulators at terminals U/T1, V/T2, and W/T3 with three screws (A, Figure 35).
 - Tighten the hardware to the torque values specified in Table 12.

Figure 35: Output Bus Bars

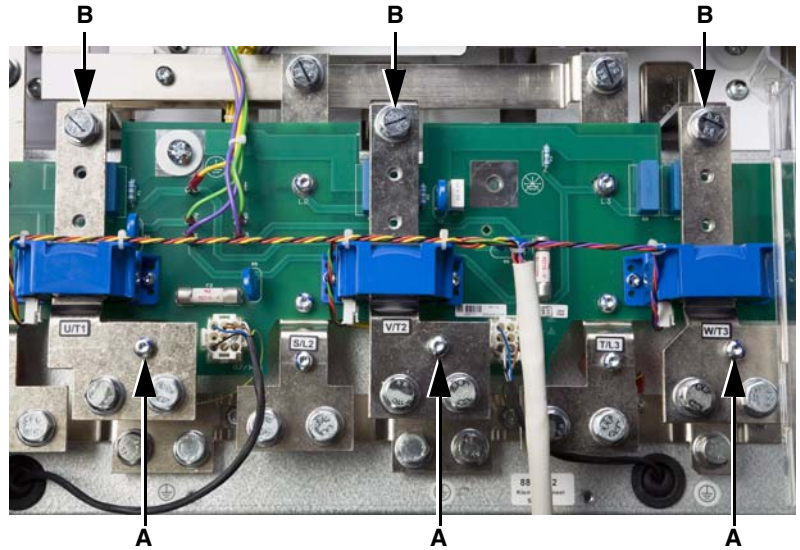

Replace the Filter Board Shield

⚠ DANGER

HAZARD OF ELECTRIC SHOCK, EXPLOSION, OR ARC FLASH

- Install the filter board shield as shown in Figure 37 on page 42.
- Before installing the shield, ensure that it has no tears or cracks. If the shield is damaged, install a new piece from the plastic kit. See page 21.
- Do not install a damaged shield.

Failure to follow these instructions will result in death or serious injury.

16. Replace the filter Board shield as follows.
 - If the shield is cracked, broken, or damaged, replace it with a new piece from the plastic kit. See page 20.
 - Route the cable from the motor current sensors (wire E103) through the hole in the filter board shield and under the TB1 bracket. See Figure 36 and Figure 38 on page 42.

Figure 36: Filter Board Shield

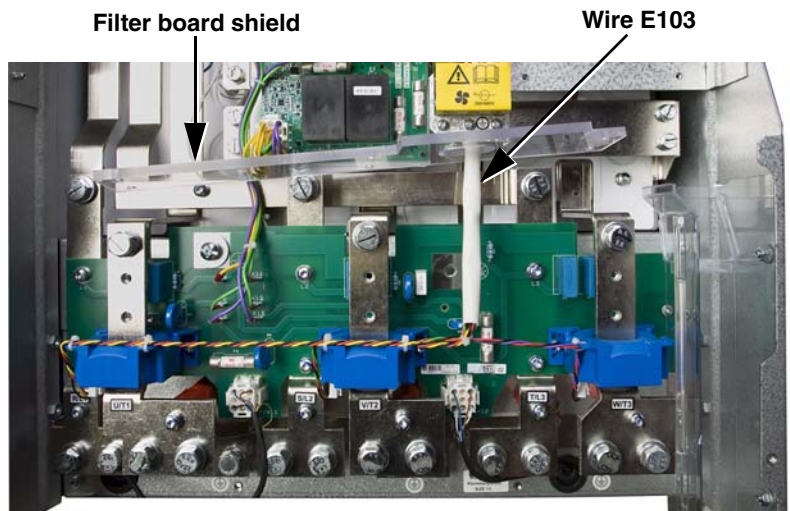

- Using a T-30 Torx driver, secure the filter board shield to the output bus bars with six screws (A, Figure 37). Tighten the screws to the torque values specified in Table 13.

Figure 37: Filter Board Shield

Table 13: Filter Board Shield Hardware Torque Values

Item	Description	Torque Range	
		N•m	lb-in
A	(6) T-30 screws	5.5	48.7

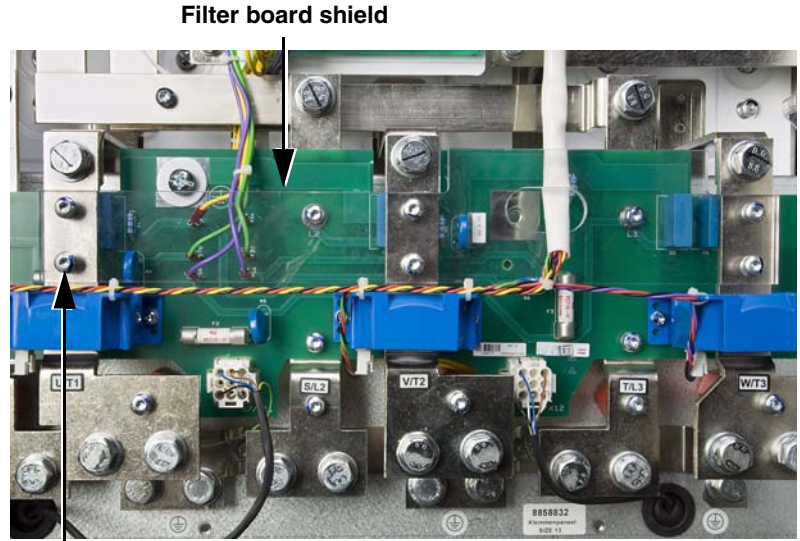

A (x6)

- Route the cable from the motor current sensors (wire E103) through the hole in the filter board, connect it to terminal X11 of the power board, and secure it in the cable clamp on the power board. See Figures 37 and 38.

Figure 38: Power Board Connection X11

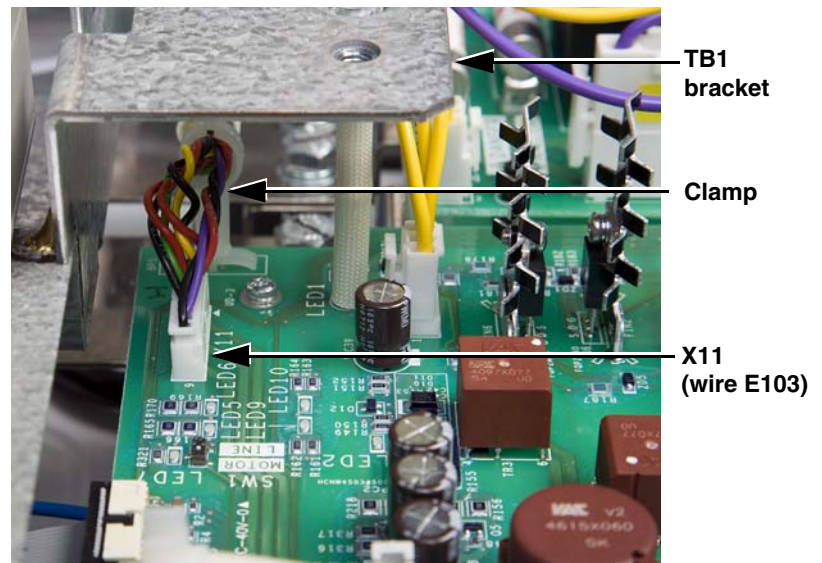

Replace the EMC Tray

- Using a T-20 Torx driver, securing the EMC tray to the control module plate with three screws. See Figure 39. Tighten the screws to 1.1–1.7 N•m (9.7–15.0 lb-in).

Figure 39: EMC Tray



Replace the Power Terminal Shield

18. Replace the power terminal shield as follows.

⚠ DANGER

HAZARD OF ELECTRIC SHOCK, EXPLOSION, OR ARC FLASH

- Install the power terminal shield as shown in Figures 40 and 41.
- Before installing the shield, ensure that it has no tears or cracks. If the shield is damaged, install a new piece from the plastic kit. See page 21.
- Do not install a damaged shield.

Failure to follow these instructions will result in death or serious injury.

- Hook the mounting holes on the left side of the shield over the posts on the side panel of the drive (**B**, Figure 40).
- Insert the retaining tabs on the right side of the shield in the slots on the conduit tray (**A**, Figure 41).

Figure 40: Power Terminal Shield Retaining Posts



Figure 41: Power Terminal Shield

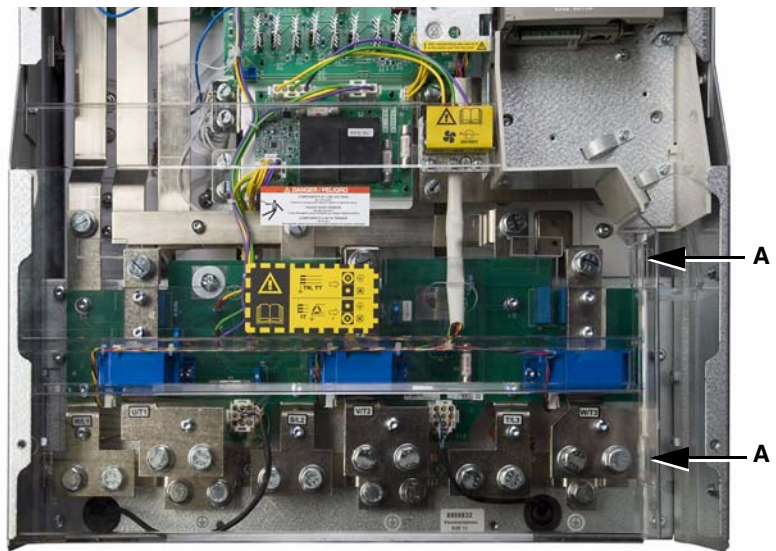

Replace the Front Cover

19. Replace the front cover. Using a size 2 Phillips driver, secure the front cover with nine screws. See Figure 7 on page 20. Tighten the screws to 5.5 N•m (48.7 lb-in).

Installation Procedures for Level 2 Parts

The level 2 parts are under the control module assembly, the bus assembly, or the fan plate. They are:

Power board	Capacitors
Gate driver boards	SCR assembly shield (plastic kit)
Temperature sensors	SCR modules
Power IGBT modules	Diode modules

You must remove equipment from the drive as described in the following section to access the level 2 parts.

Disassembly Steps for Accessing Level 2 Parts

IMPORTANT: Label and retain all removed hardware and cables for use in reassembly.

DANGER

HAZARD OF ELECTRIC SHOCK, EXPLOSION, OR ARC FLASH

- Read and understand the precautions in “Before You Begin” starting on page 5 before performing this procedure.
- Before working on this equipment, turn off all power supplying it and perform the DC bus voltage measurement procedure on page 12.

Failure to follow these instructions will result in death or serious injury.

This section contains instructions for removing the following parts from the drive:

- | | |
|--|--|
| <input type="checkbox"/> Front cover | <input type="checkbox"/> Power board connections |
| <input type="checkbox"/> Power terminal shield | <input type="checkbox"/> Soft charge board connections |
| <input type="checkbox"/> EMC tray | <input type="checkbox"/> Fan control board connections |
| <input type="checkbox"/> Control module assembly | <input type="checkbox"/> Bus plate assembly |
| <input type="checkbox"/> Top crossbrace | <input type="checkbox"/> Gate driver boards |
| <input type="checkbox"/> Fan plate | <input type="checkbox"/> DC bus plate |
| <input type="checkbox"/> SCR assembly shield | |

You must perform some or all of the steps in this section to access the level 2 parts. Consult Table 14 for the disassembly steps that must be performed to access the spare parts you are replacing.

Table 14: Disassembly Steps

If you are replacing:	Perform disassembly steps:	Then follow procedure:
Power boards VX5A1HC2025 VX5A1HC2531 VX5A71HC28N4	Steps 1–6	“Replacing the Power Board VX5A1HC2025, VX5A1HC2531, VX5A71HC28N4” beginning on page 59
Gate driver boards VX5A1201 and VX5A1202	Steps 1–16	“Replacing the Gate Driver Boards VX5A1201 and VX5A1202” beginning on page 64
Temperature sensors VZ3G1104	Steps 1–19	“Replacing the Temperature Sensors, VZ3G1104” beginning on page 70
Power IGBT modules VZ3IM1602M1271 VZ3IM1402M1271	Steps 1–20	“Replacing the Power IGBT Modules VZ3IM1602M1271, and VZ3IM1402M1271” beginning on page 72
Capacitors VY1ADC1112 VY1ADC1114	Steps 1–20	“Replacing the Capacitors VY1ADC1112 and VY1ADC1114” beginning on page 75
SCR modules VZ3TM1425M1671 VZ3TM1600M1671 Diode modules VZ3DM1600M1671	Steps 1–12	“Replacing the SCR Modules (VZ3TM1425M1671, VZ3TM1600M1671) and Diode Modules (VZ3DM1600M1671)” beginning on page 77

Remove the Front Cover

1. Using a size 2 Phillips driver, remove nine screws and take the front cover off the drive. See Figure 7 on page 20.

Remove the Power Terminal Shield

2. The power terminal shield has two retaining tabs (**A**, Figure 42) on the right that fit into slots on the conduit tray, and three mounting holes (**B**, Figure 43) on the left that fit over posts on the side panel of the drive. Disengage the shield from the retaining tabs and mounting slots and remove it from the drive.

Figure 42: Power Terminal Shield

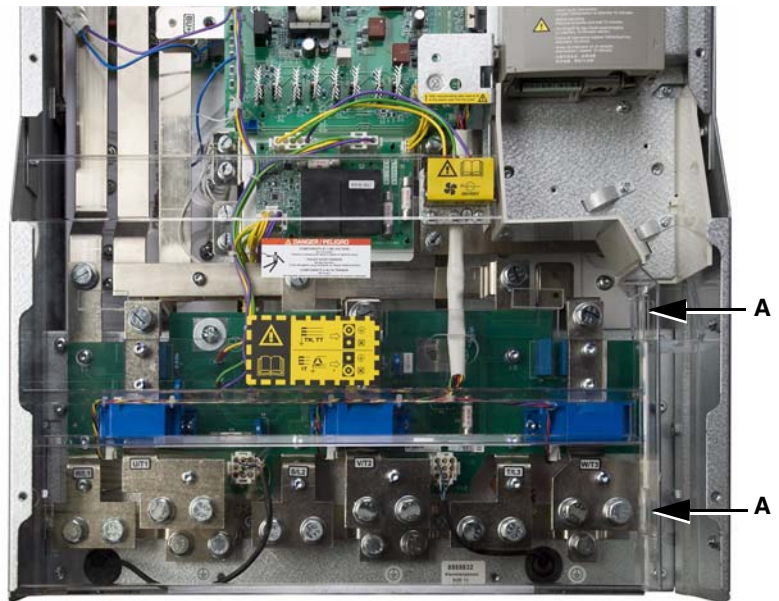

Figure 43: Power Terminal Shield Retaining Posts



Remove the EMC Tray

- Using a T-20 Torx driver, remove three screws (A) securing the EMC tray to the control module mounting plate and remove the tray from the drive. See Figure 44.

Figure 44: EMC Tray

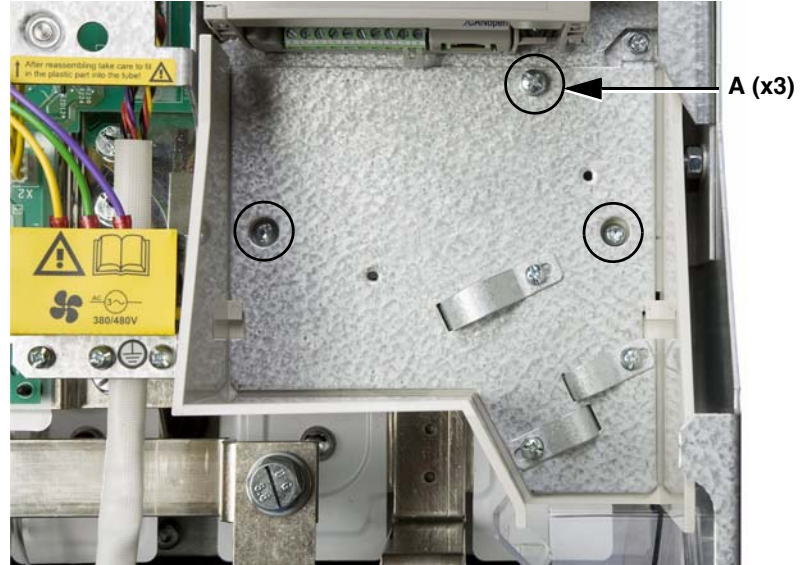

Remove the Control Module Assembly

- Remove the following connections.
 - Remove the 5-pin connector from fan control board terminal X4. See Figure 45.
 - Remove the 26-pin ribbon cable from motor control board terminal X3. See Figure 46 on page 49.

Figure 45: Fan Control Board Terminal X4

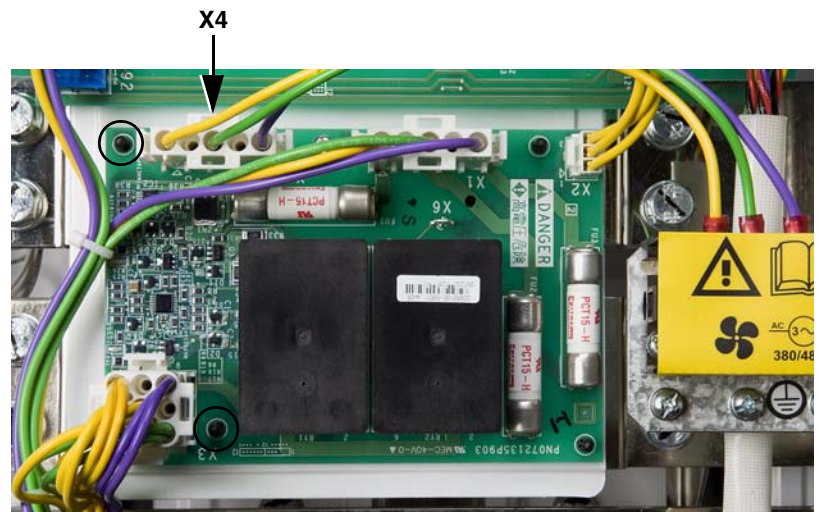
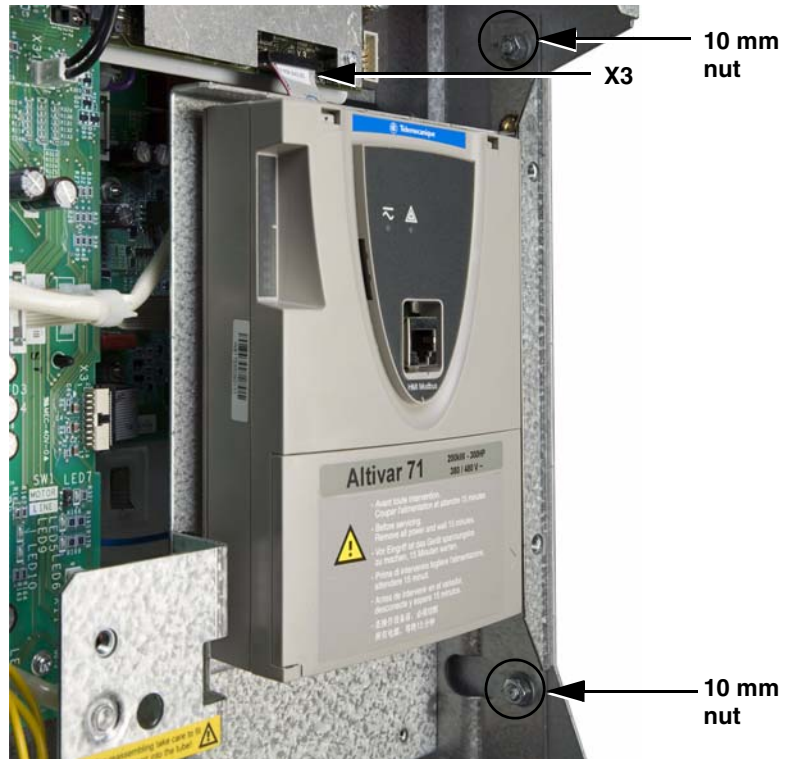
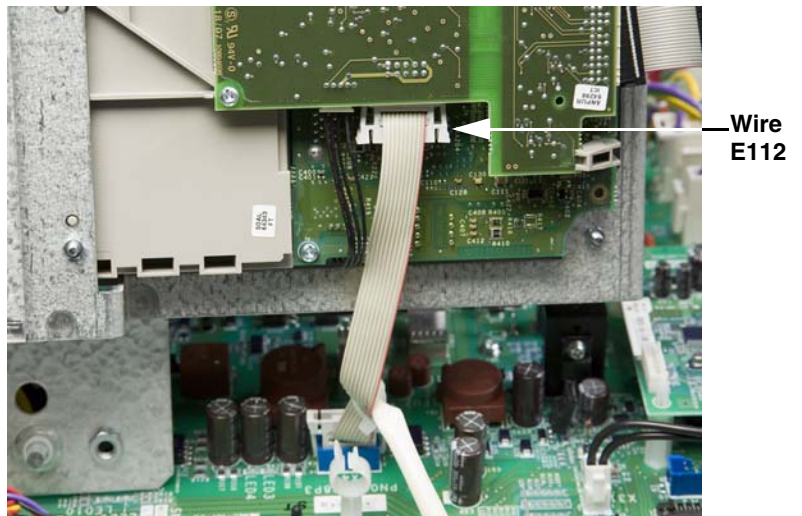

Figure 46: Control Module Assembly Front



5. Using a 10 mm socket wrench, remove two nuts securing the control module assembly to the drive frame. See Figure 46.
6. Turn the assembly over, disconnect the ribbon cable from the back (wire E112, Figure 47), and remove the assembly from the drive.

Figure 47: Control Module Assembly Back



NEXT STEP: If you are replacing the power board, skip to “Replacing the Power Board VX5A1HC2025, VX5A1HC2531, VX5A71HC28N4” beginning on page 59.

Remove the Top Crossbrace

- Using a 10 mm socket wrench, remove six nuts (**A**, Figure 48) securing the top crossbrace to the fan plate and the drive frame, and remove the crossbrace.

Figure 48: Fan Plate and Crossbrace

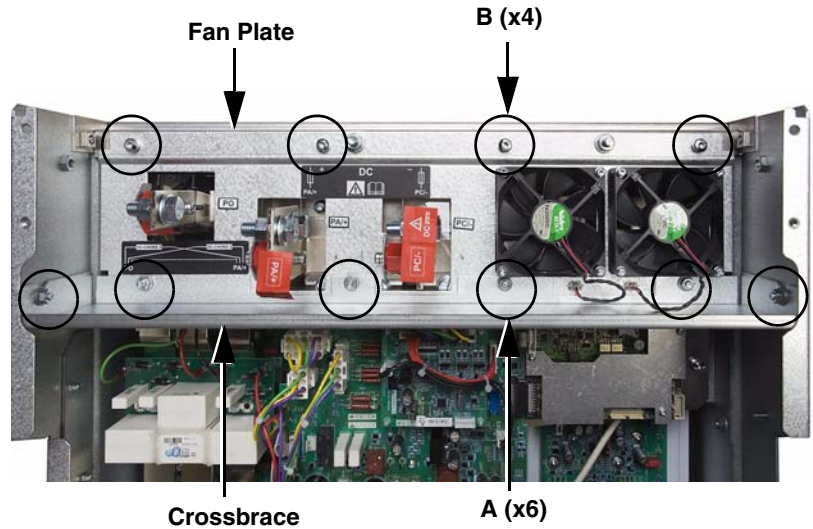

Remove the Fan Plate

- Using a T-30 Torx driver, remove four screws (**B**, Figure 48) securing the fan plate to the drive frame.
- Using a T-30 Torx right-angle driver, remove three screws (**C**, Figure 49) from the right sides of the three red insulators at the PO, PA+, and PC/- terminals.
- Using an 18 mm socket wrench, remove five nuts and bolts from the PO, PA+, and PC bus bars (**D**, Figure 49). Each bolt has two flat washers and one lock washer.
- Remove the internal fan connections from the back of the fan plate, and remove the fan plate from the drive. See Figure 50 on page 51.

Figure 49: Fan Plate with Bus Bar Detail

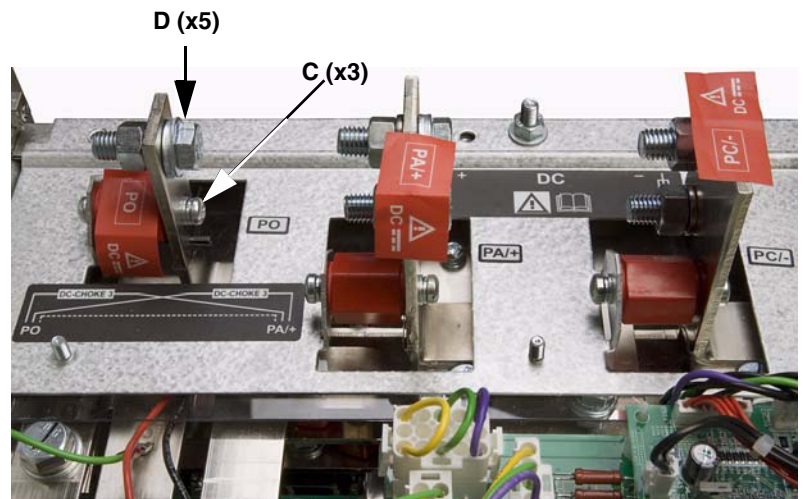
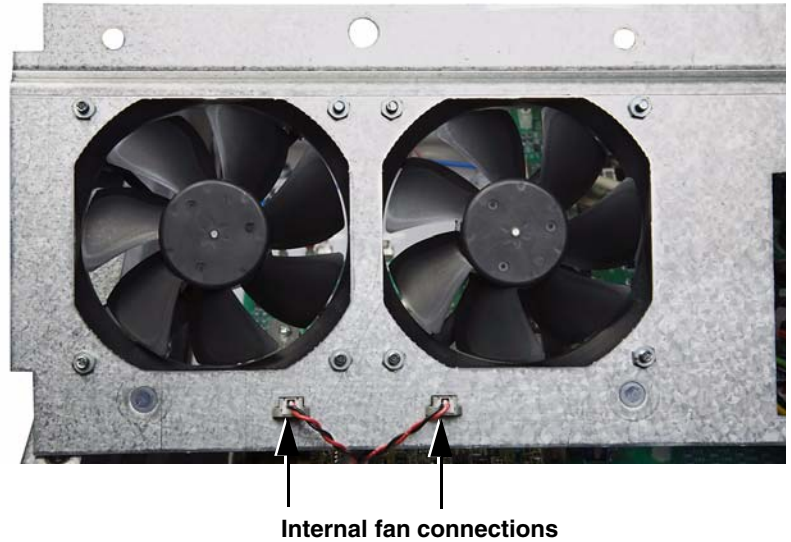

Figure 50: Internal Fan Connections



Remove the SCR Assembly Shield

12. Remove the transparent shield over the SCR assembly. See Figure 51.

Figure 51: SCR Assembly Shield

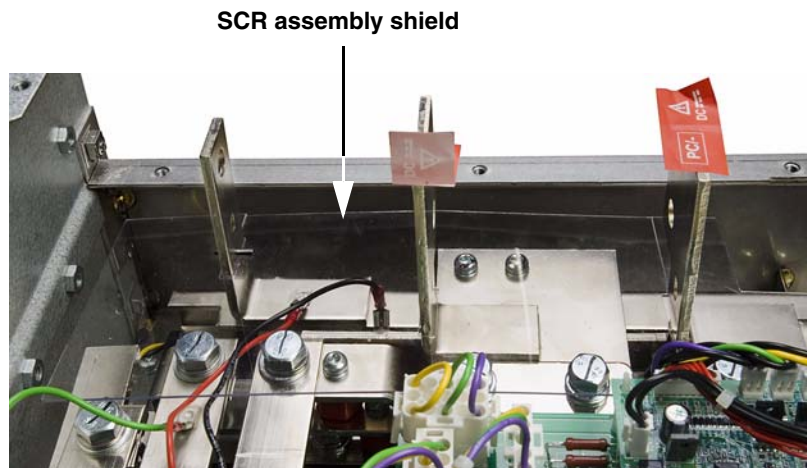

NEXT STEP: If you are replacing the SCR modules or Diode modules, skip to “Replacing the SCR Modules (VZ3TM1425M1671, VZ3TM1600M1671) and Diode Modules (VZ3DM1600M1671)” beginning on page 77.

Remove the Power Board Connections

NOTE: Take care not to damage the LED (see Figure 52) when removing, handling, or installing the power board.

13. Using needle-nose pliers, carefully remove the power board connections listed in Table 15. See Figure 52 for the connection locations.

Table 15: Power Board Wiring

Wire No. ¹	Terminal No.	Description	To:
E103	X11	9-pin, multi color	Motor current sensors
E105	X14	3-pin, yellow	FCB ² X2
E136	UD0	1-pin, blue	Phase U DC bus plate
E141	UD -R1	1-pin, white	Bleeder resistor
E139	UD +R1	1-pin, white	Bleeder resistor
E171	RFS +X11	1-pin, red	SCR ³ snubber board X11
E126	RFS +X10	1-pin, red	SCR snubber board X10
E143	X5	6-pin, yellow/green/violet	GDB ⁴ U X2, GDB V X2, GDB W X2
E120	X7	6-pin, yellow/green/violet	Filter board X11, X12, X13
—	X2	10-pin, gray	Motor control board X2
E129	X93	1-pin, violet	Dynamic braking board X20 ⁵
E142	X3	18-pin, gray	GDB W X31
E100	X8	10-pin, white	GDB V X81
E106	X21	2-pin, red/black	Internal fan
E106	X22	2-pin, red/black	Internal fan
E112	X4	10-pin, gray	Control module
—	X16	Not used	—
—	X91	Not used	—
—	X92	Not used	—

Figure 52: Power Board Connections

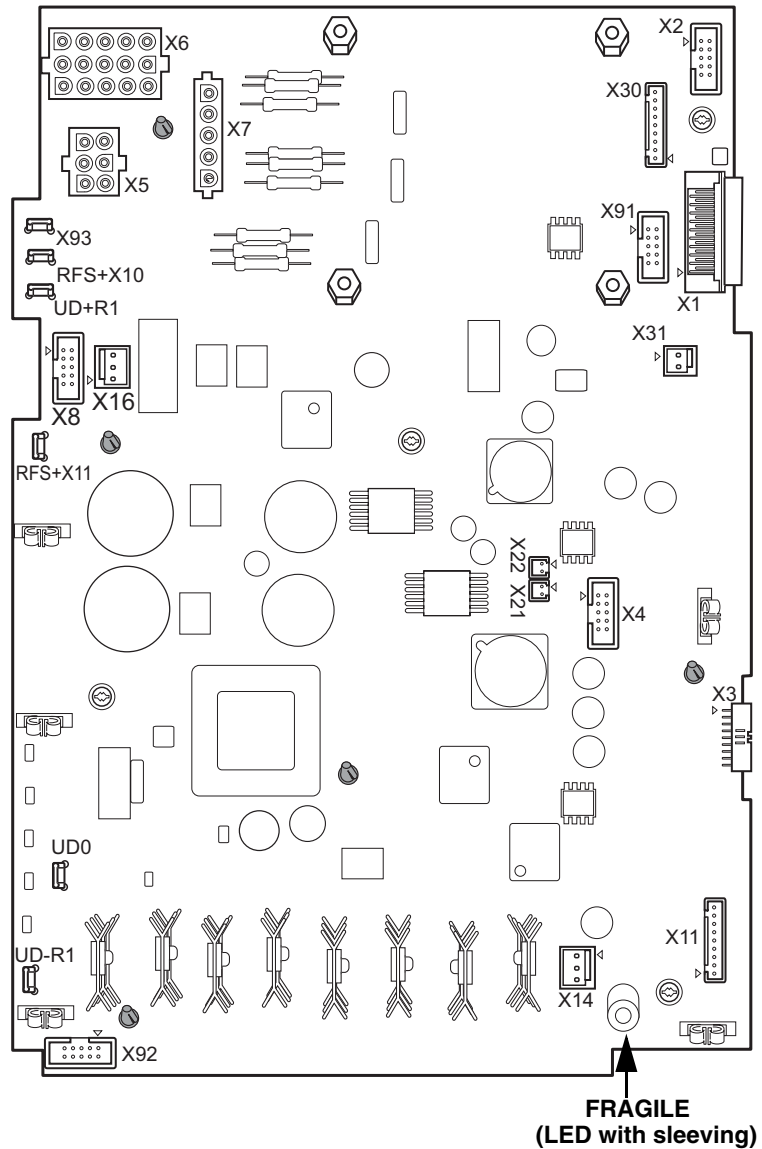

¹ See the schematic on page 106 for complete drive wiring. Wire numbers are given for cross referencing the wires with the wiring table and the schematic. The numbers do not appear on the wires.
² FCB: Fan control board
³ SCR: Silicon controlled rectifier
⁴ GDB: Gate driver board
⁵ The optional dynamic braking board may not be present in the drive.

Remove the Soft Charge Board Connections

- Using needle-nose pliers, remove soft charge board connections CNL1G, CNL2G, and CNL3G. See Figure 53 for terminal locations.

Figure 53: Soft Charge Board Connections

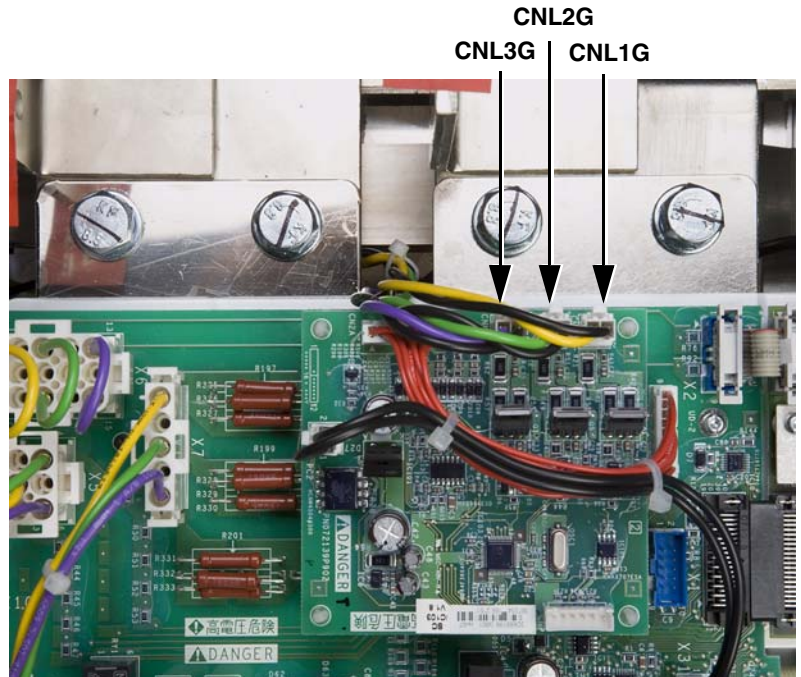

Remove the Fan Control Board Connections

- Remove the connections from terminals X1 and X3 of the fan control board. See Figure 54 for terminal locations.

Figure 54: Fan Control Board Connections X1 and X3

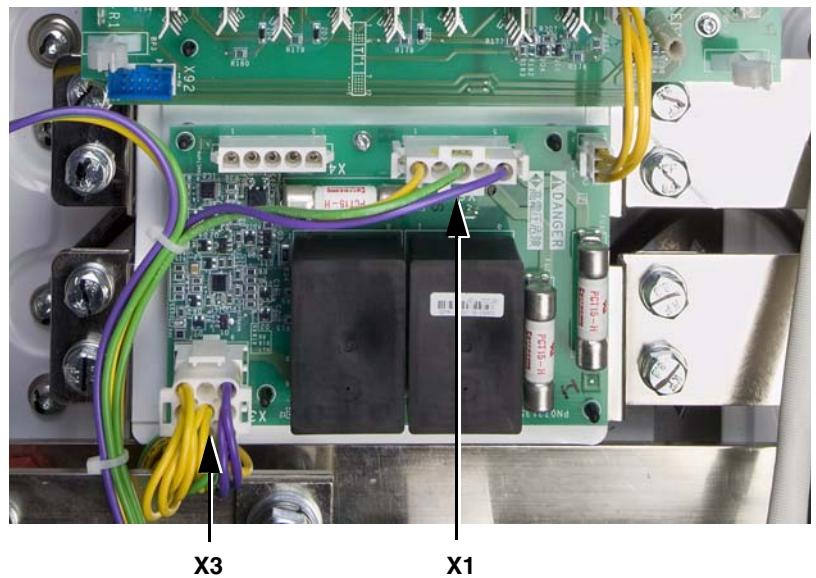

Remove the Bus Plate Assembly

16. Remove the bus plate assembly as follows. See Figure 55.

- Using a T-30 Torx driver, remove one screw and washer (A) securing the bus plate assembly to the red insulator on the drive frame.
- Using a 16 mm socket wrench, remove two bolts (B) securing the bus plate assembly to the PC/- bus.
- Using a 16 mm socket wrench, remove two bolts (C) securing the bus plate assembly to the PA/+ bus.
- Using a 13 mm socket wrench, remove four screws (D) securing the bus plate assembly to the phase W positive and negative buses.
- Using a 13 mm socket wrench, remove four screws (E) securing the bus plate assembly to the phase V positive and negative buses.
- Using a 13 mm socket wrench, remove four screws (F) securing the bus plate assembly to the phase U positive and negative buses.
- Remove the bus plate assembly from the drive.

Figure 55: Bus Plate Assembly

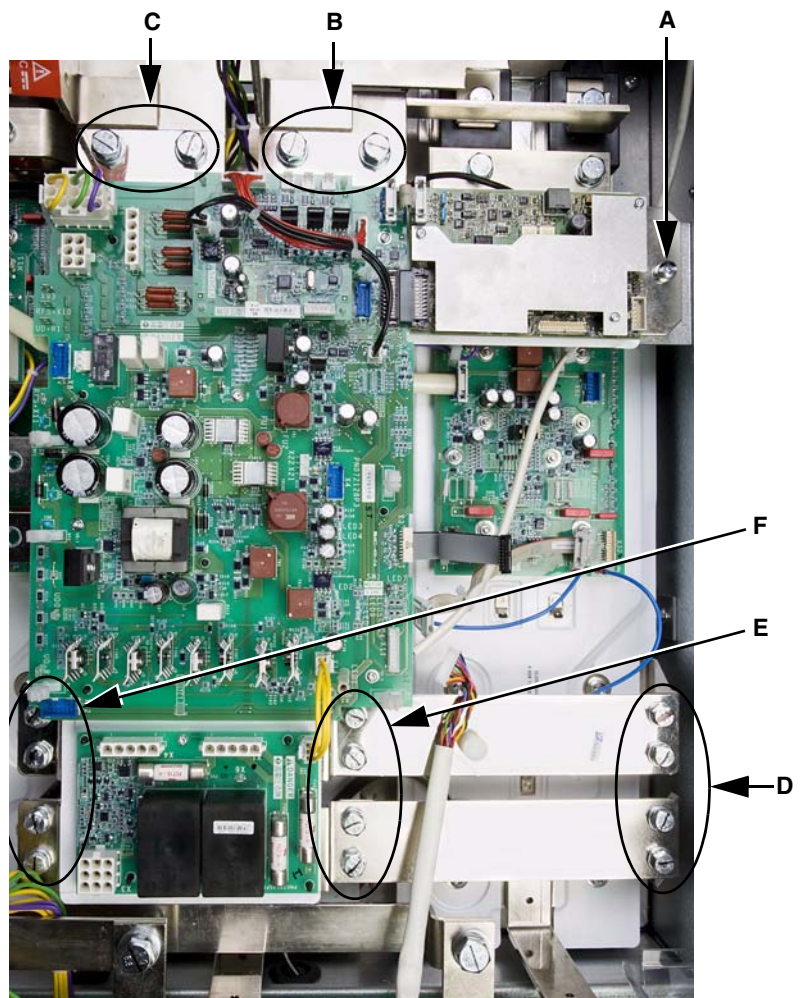

NEXT STEP: If you are replacing a gate driver board, skip to “Replacing the Gate Driver Boards VX5A1201 and VX5A1202” on page 64.

Remove the Gate Driver Board

NOTE: Perform the steps in this section only if you are removing a gate driver board to access parts under the DC bus plate.

If you are replacing a gate driver board, skip to “Replacing the Gate Driver Boards VX5A1201 and VX5A1202” on page 64.

If you are removing equipment to make repairs in **phase U**, remove the left gate driver board. Begin with Step 17 on this page.

If you are removing equipment to make repairs in **phase V**, remove the center gate driver board. Begin with Step 18 on page 56.

If you are removing equipment to make repairs in **phase W**, remove the right gate driver board. Begin with Step 18 on page 56.

17. If you are removing gate driver board U, perform these steps to remove the L1, L2, and L3 bus bars. If you removing gate driver boards V or W, skip to Step 18 on page 56.

- Remove the connections from terminals X4 and X5 on the SCR snubber board. See Figure 56.
- Using an 18 mm socket wrench, remove three bolts (**A**, Figure 57) joining the L1, L2, and L3 bus bars to the lower bus segments.
- Using an 18 mm socket wrench, remove three bolts (**B**, Figure 57) joining the L1, L2, and L3 bus bars to the SCR bus segments and remove the bus bars. See Figure 57.

Figure 56: SCR Snubber Board



Figure 57: L1, L2, L3 Bus Bars

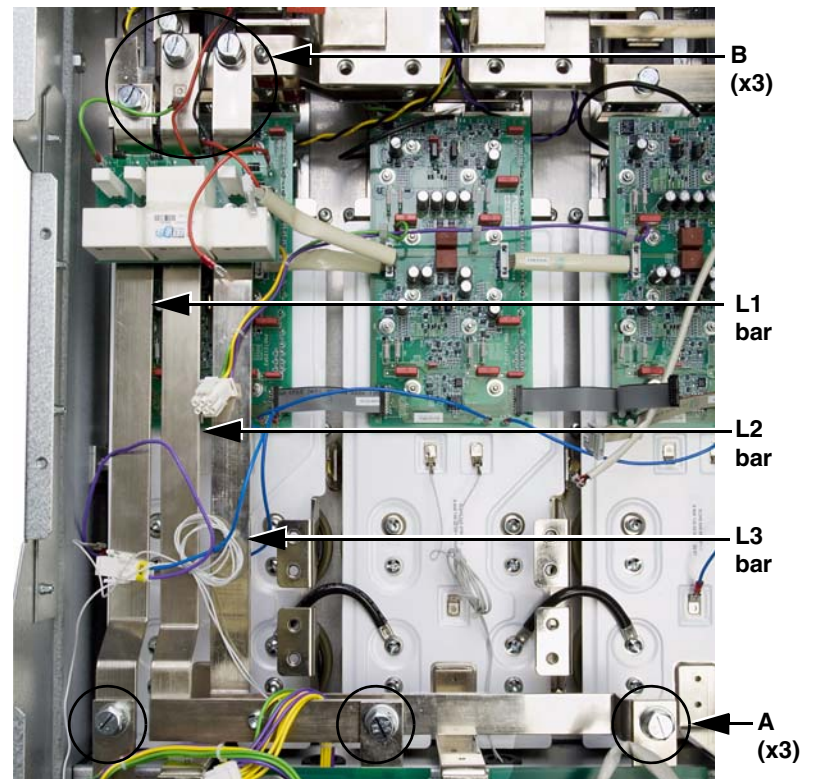

18. Remove the connections from the gate driver board that you are removing. See Table 16 and Figure 58 on page 57.
19. Using a 7 mm socket wrench, remove 12 nuts securing the gate driver board you are removing to the DC bus plate, and remove the gate driver board from the drive. See Figure 58 on page 57.

NEXT STEP: If you are replacing a temperature sensor, skip to “Replacing the Temperature Sensors, VZ3G1104” beginning on page 70.

Table 16: Gate Driver Board Wiring

Wire No. ¹	Terminal No.	Description	To:
Gate Driver Board U (Left)			
E143	X2	1-pin, yellow	Power board X5
E144	X4	2-pin, black	Temperature sensor U
E138	X32	18-pin, gray	GDB ² V X31
E129	X51	1-pin, blue	DBB X20 ³
E127	X52	1-pin, blue	GDB V, X51
E100	X82	10-pin, white	GDB V X81
—	X31	Not used	—
—	X81	Not used	—
Gate Driver Board V (Center)			
E143	X2	1-pin, green	Power board X5
E127	X51	1-pin, blue	GDB U, X52
E123	X52	1-pin, blue	GDB W, X51
E100	X81	10-pin, white	GDB U, X82, PB-X8
E102	X82	10-pin, white	GDB W, X81
E138	X31	18-pin, gray	GDB U, X32
E142	X32	18-pin, gray	GDB W, X31
E128	X4	2-pin, black	Temperature sensor V
Gate Driver Board W (Right)			
E143	X2	1-pin, violet	Power board X5
E145	X4	2-pin, black	Temperature sensor W
E123	X51	1-pin, blue	GDB V, X52
E132	X52	1-pin, blue	Neutral on W power bus
E102	X81	10-pin, white	GDB V, X82
E142	X31	18-pin, gray	GDB V, X32 & PB X3
—	X32	Not used	—
—	X82	Not used	—

¹ See the schematic on page 106 for complete drive wiring. Wire numbers are given for cross referencing the wires with the wiring table and the schematic. The numbers do not appear on the wires.

² GDB: Gate driver board

³ DBB: Dynamic braking board. This option may not be present in the drive.

Figure 58: Gate Driver Boards

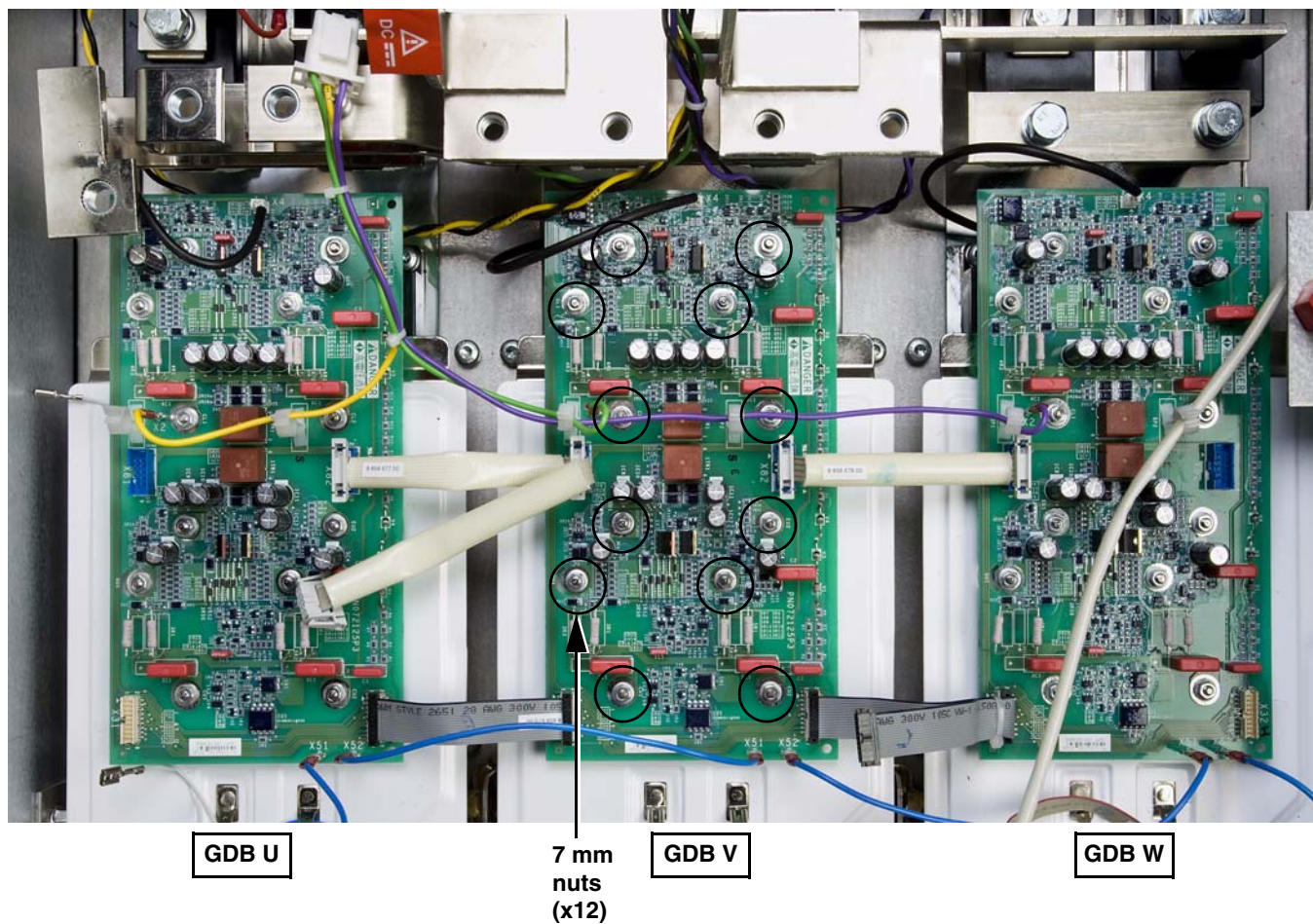

Remove the DC Bus Plate

NOTE: If you are removing equipment to make repairs in **phase U**, remove the left DC bus plate.

If you are removing equipment to make repairs in **phase V**, remove the center DC bus plate.

If you are removing equipment to make repairs in **phase W**, remove the right DC bus plate.

20. Remove the DC bus plate as follows. See Figure 59.

- Using an 18 mm socket wrench, remove one bolt (A) securing the DC bus plate to the output bus bar.
- Using a size 2 Phillips driver, remove two screws securing the DC bus plate to the IGBT modules (B) and four screws securing the bus plate to the capacitors (C).
- Using a T-30 Torx driver, remove two 20 mm screws securing the DC bus plate to the IGBT modules (D) and four 14 mm screws securing the bus plate to the capacitors (E).
- Using a 10 mm socket wrench, remove two 6 mm standoffs (F) and two 11 mm standoffs (G).
- Remove the DC bus plate from the drive.

NEXT STEP: If you are replacing the power IGBT modules, skip to “Replacing the Power IGBT Modules VZ3IM1602M1271, and VZ3IM1402M1271” beginning on page 72.

If you are replacing the capacitors, skip to “Replacing the Capacitors VY1ADC1112 and VY1ADC1114” beginning on page 75.

Figure 59: DC Bus Plate (Phase V Shown)

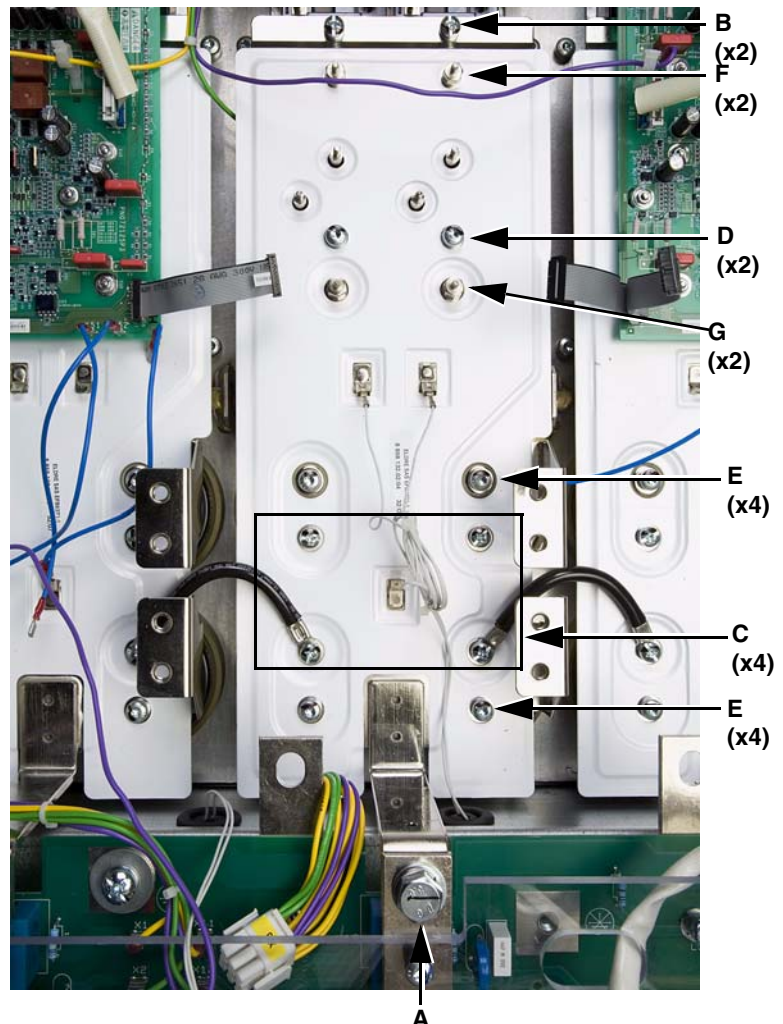

Replacing the Power Board VX5A1HC2025, VX5A1HC2531, VX5A71HC28N4

IMPORTANT: Label and retain all removed hardware and cables for use in reassembly.

DANGER

HAZARD OF ELECTRIC SHOCK, EXPLOSION, OR ARC FLASH

- Read and understand the precautions in “Before You Begin” starting on page 5 before performing this procedure.
- Before working on this equipment, turn off all power supplying it and perform the DC bus voltage measurement procedure on page 12.

Failure to follow these instructions will result in death or serious injury.

Before performing the steps in this procedure, perform Steps 1–6 of “Disassembly Steps for Accessing Level 2 Parts” beginning on page 45 to remove the following parts from the drive:

- The front cover
- The power terminal shield
- The EMC tray
- The control module assembly

Remove the Soft Charge Board

Table 17: Soft Charge Board Wiring

Wire No. ¹	Terminal No.	Description	To:
E110	CN2A	9-pin, red	PB ² X30 (9-pin)
E109	CNL3G	2-pin, violet/black	SCR ³ 3 Terms. 4 & 5
E108	CNL2G	2-pin, green/black	SCR 2 Terms. 4 & 5
E107	CNL1G	2-pin, yellow/black	SCR 1 Terms. 4 & 5
E111	CN7A	2-pin, black	PB X31

¹ See the schematic on page 106 for complete drive wiring. Wire numbers are given for cross referencing the wires with the wiring table and the schematic. The numbers do not appear on the wires.

² PB: Power board

³ SCR: Silicon controlled rectifier

- Using needle-nose pliers, carefully remove the following connections from the soft charge board. See Table 17 and Figure 60 for connector locations.
 - At the top of the board, from left to right remove: the 9-pin connector from terminal CN2A, the 2-pin connector from terminal CNL3G, the 2-pin connector from terminal CNL2G, and the 2-pin connector from terminal CNL1G.
 - At the left side of the board, remove the 2-pin connector from terminal CN7A.

Figure 60: Soft Charge Board

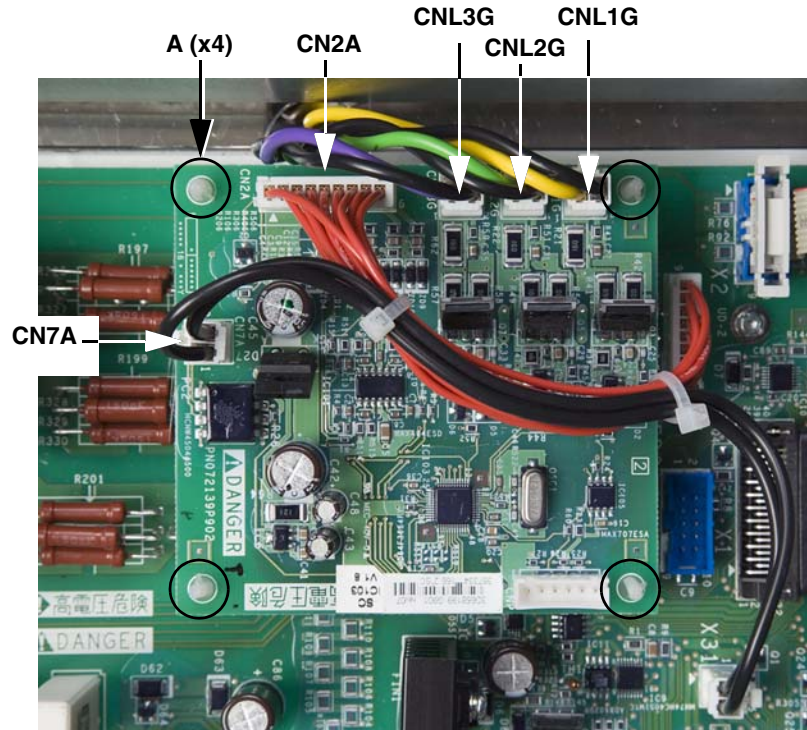

- Using needle-nose pliers, compress the four plastic mounting posts (**A**, Figure 60), one at a time, while lifting the soft charge board off the posts. Remove the soft charge board from the drive.

Remove the Power Board Connections

NOTE: Take care not to damage the LED (see Figure 61) when removing, handling, or installing the power board.

- Using needle-nose pliers, carefully remove all connections from the power board **except** the connections at terminals X6, X30, and X31. See Table 18 and Figure 61 for the connections.

Table 18: Power Board Wiring

Wire No. ¹	Terminal No.	Description	To:
E103	X11	9-pin, multi color	Motor current sensors
E105	X14	3-pin, yellow	FCB ² X2
E136	UD0	1-pin, blue	Phase U DC bus plate
E141	UD -R1	1-pin, white	Bleeder resistor
E139	UD +R1	1-pin, white	Bleeder resistor
E171	RFS +X11	1-pin, red	SCR ³ snubber board X11
E126	RFS +X10	1-pin, red	SCR snubber board X10
E129	X93	1-pin, violet	Dynamic braking board X2 ⁴
E143	X5	6-pin, yellow/green/violet	GDB ⁵ U X2, GDB V X2, GDB W X2
E120	X7	6-pin, yellow/green/violet	Filter board X11, X12, X13
—	X2	10-pin, gray	Motor control board X2
E142	X3	18-pin, gray	GDB W X31
E100	X8	10-pin, white	GDB V X81
E106	X21	2-pin, red/black	Internal fan
E106	X22	2-pin, red/black	Internal fan
E112	X4	10-pin, gray	Control module
—	X16	Not used	—
—	X91	Not used	—
—	X92	Not used	—

Figure 61: Power Board Connections

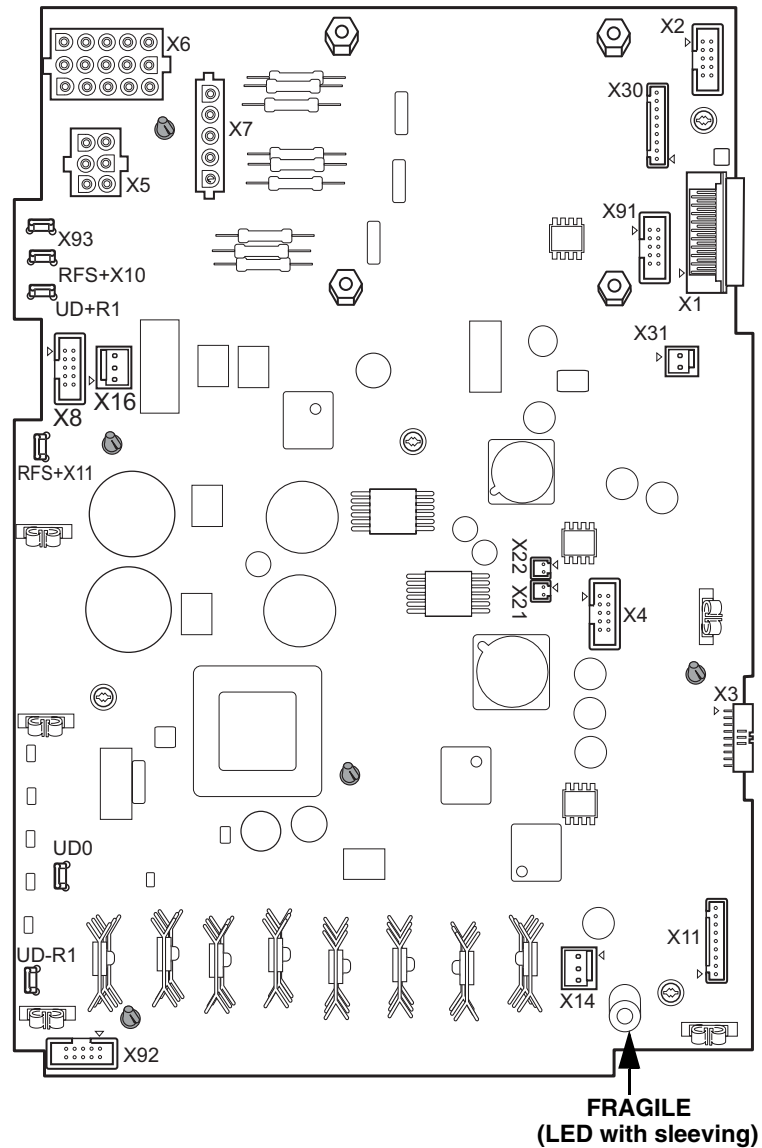

¹ See the schematic on page 106 for complete drive wiring. Wire numbers are given for cross referencing the wires with the wiring table and the schematic. The numbers do not appear on the wires.
² FCB: Fan control board
³ SCR: Silicon controlled rectifier
⁴ The optional dynamic braking board may not be present in the drive.
⁵ GDB: Gate driver board

Remove the Power Board

NOTE: Take care not to damage the LED (see Figure 62) when removing, handling, or installing the power board.

4. Remove the old power board as follows. See Figure 62.
 - Using a T-10 Torx driver, remove four screws (A) securing the power board to the laminated bus assembly.
 - Using needle-nose pliers, gently compress the five plastic mounting posts (B), one at a time, while lifting the power board off the posts. Carefully disconnect the connection between the power board and the motor control board (C) as you remove the power board.

Figure 62: Power Board

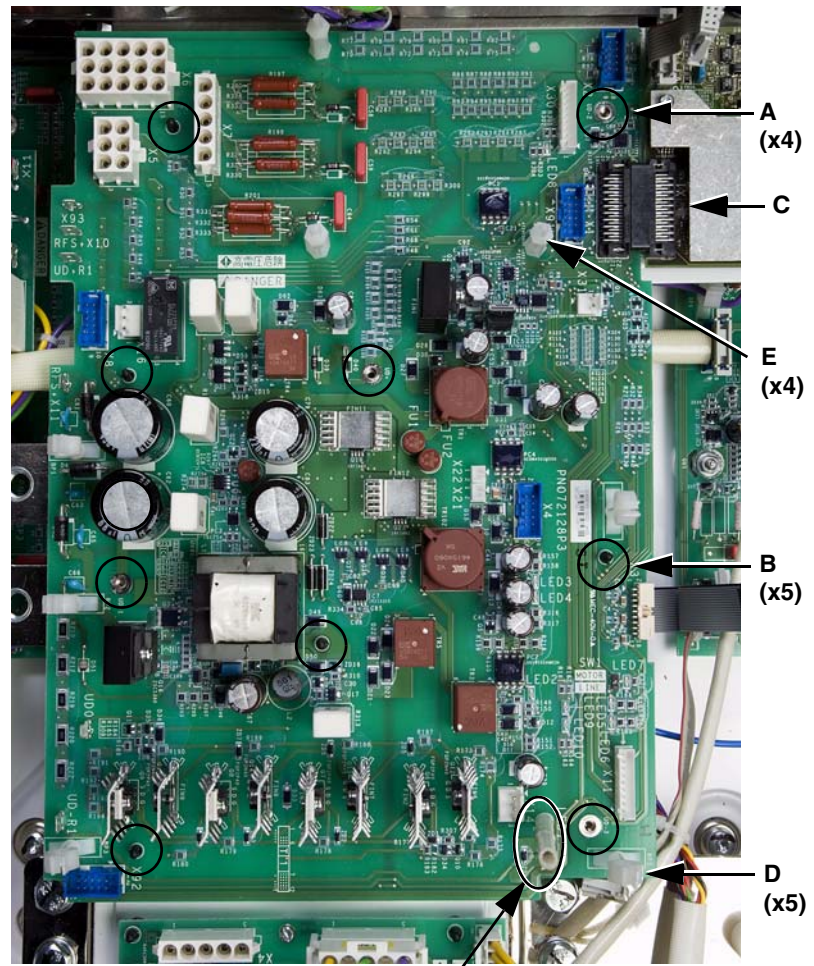

**FRAGILE
(LED with sleeving)**

Install the New Power Board

5. Transfer the connections from terminals X6, X30, and X31 of the old power board to the corresponding terminals on the new board. See Figure 61 on page 61 for terminal locations.
6. Transfer the five plastic cable clamps (D, Figure 62) from the old power board onto the new one as follows.
 - To remove a clamp, pinch the clamp on the bottom side of the board and push it up through the mounting hole.

- Snap the cable clamps into the mounting holes on the new board.
- 7. Transfer the four soft charge board mounting posts (**E**, Figure 62 on page 62) from from the old power board onto the new one as follows:
 - Using a 7 mm socket wrench, remove the plastic nuts securing the soft charge board mounting posts to the power board. The nuts are on the back of the board.
 - Push the posts into the corresponding mounting holes from the front of the new power board and secure them at the back with the 7 mm nuts. Tighten the nuts to 0.4–0.6 N•m (3.5–5.3 lb-in).
- 8. Gently push the new power board down over the five plastic mounting posts (**B**, Figure 62 on page 62) until it is securely seated.
- 9. Using a T-10 Torx driver, secure the power board to the laminated bus assembly with four screws (**A**, Figure 62 on page 62). Tighten the screws to 0.5–0.7 N•m (4.4–6.2 lb-in).
- 10. Replace the power board wiring. See Table 18 and Figure 61 on page 61 for the connection locations.
- 11. Replace the soft charge board as follows.
 - Press the new soft charge board down over the four mounting posts (**A**, Figure 63) until it is securely seated.
 - Install five connections to the new soft charge board. See Table 19 and Figure 63 for connector locations.

Replace the Soft Charge Board

Table 19: Soft Charge Board Wiring

Wire No. ¹	Terminal No.	Description	To:
E110	CN2A	9-pin, red	PB ² X30
E109	CNL3G	2-pin, violet/black	SCR ³ 3 Terms. 4 & 5
E108	CNL2G	2-pin, green/black	SCR 2 Terms. 4 & 5
E107	CNL1G	2-pin, yellow/black	SCR 1 Terms. 4 & 5
E111	CN7A	2-pin, black	PB X31

¹ See the schematic on page 106 for complete drive wiring. Wire numbers are given for cross referencing the wires with the wiring table and the schematic. The numbers do not appear on the wires.

² PB: Power board

³ SCR: Silicon controlled rectifier

Figure 63: Soft Charge Board

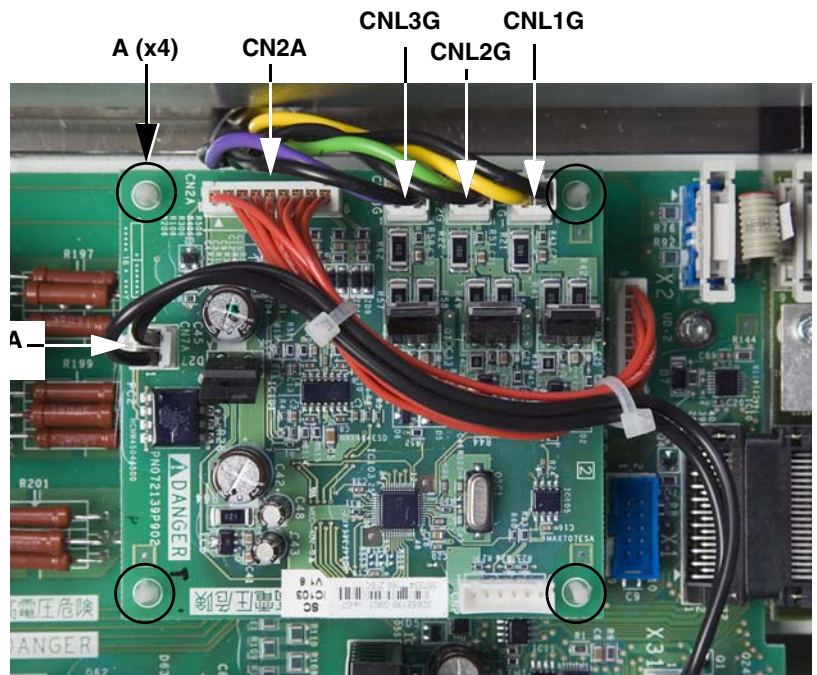

Replace the Front Cover

- 12. Replace the front cover. Using a size 2 Phillips driver, secure the front cover with nine screws. See Figure 7 on page 20. Tighten the screws to 5.5 N•m (48.7 lb-in).

Reassemble the Drive

If you are only replacing the power board, perform Steps 12–17 of “Reassembly Steps for Level 2 Parts” beginning on page 91 to replace the following parts:

- The control module assembly
- The EMC tray
- The power terminal shield
- The front cover

Replacing the Gate Driver Boards VX5A1201 and VX5A1202

IMPORTANT: Label and retain all removed hardware and cables for use in reassembly.

⚠ DANGER

HAZARD OF ELECTRIC SHOCK, EXPLOSION, OR ARC FLASH

- Read and understand the precautions in “Before You Begin” starting on page 5 before performing this procedure.
- Before working on this equipment, turn off all power supplying it and perform the DC bus voltage measurement procedure on page 12.

Failure to follow these instructions will result in death or serious injury.

Before performing the steps in this procedure, perform Steps 1–16 of “Disassembly Steps for Accessing Level 2 Parts” beginning on page 45 to remove the following parts from the drive:

- Front cover
- Power terminal shield
- EMC tray
- Control module assembly
- Top crossbrace
- Fan plate
- SCR assembly shield
- Power board connections
- Soft charge board connections
- Fan control board connections
- Bus plate assembly

Remove the Gate Driver Board

1. If you are replacing gate driver board U, perform these steps to remove the L1, L2, and L3 bus bars. If you replacing gate driver boards V or W, skip to Step 2 on page 66.
 - Remove the connections from terminals X4 and X5 on the SCR snubber board. See Figure 64.
 - Using an 18 mm socket wrench, remove three bolts joining the L1, L2, and L3 bus bars to the lower bus segments. See Figure 65.
 - Using an 18 mm socket wrench, remove three bolts joining the L1, L2, and L3 bus bars to the SCR bus segments and remove the bus bars. See Figure 65.

Figure 64: SCR Snubber Board

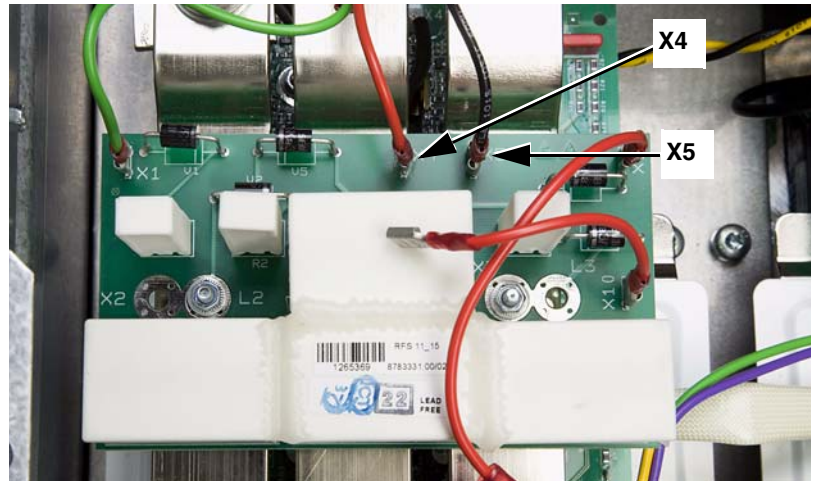
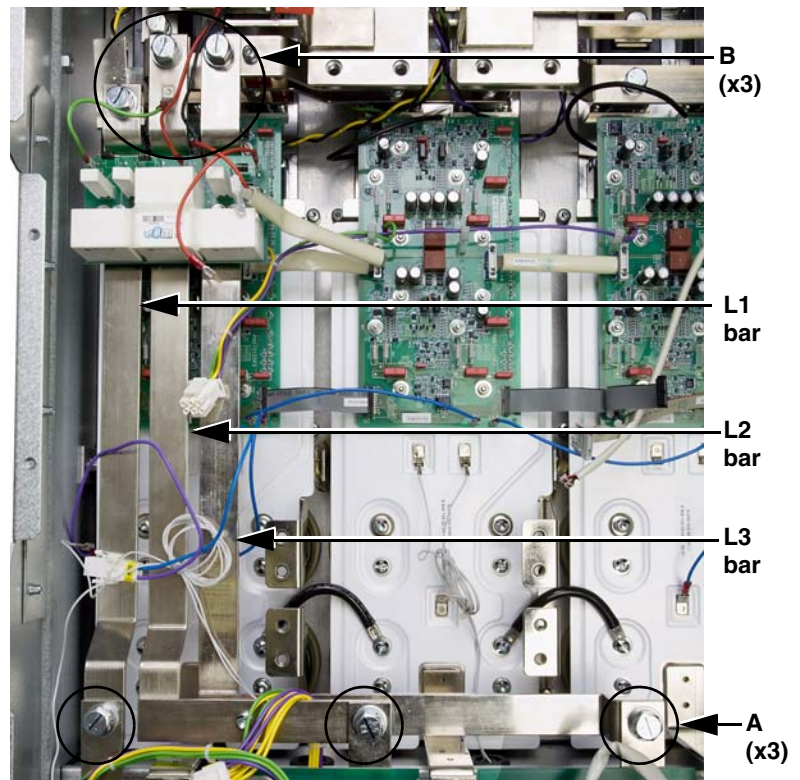

Figure 65: L1, L2, L3 Bus Bars



2. Remove the connections from the gate driver board that you are replacing. See Table 20 and Figure 66 on page 67.
3. Using a 7 mm socket wrench, remove 12 nuts securing the gate driver board to the power bus, and remove the board from the drive. See Figure 66 on page 67.

Table 20: Gate Driver Board Wiring

Wire No. ¹	Terminal No.	Description	To:
Gate Driver Board U (Left)			
E143	X2	1-pin, yellow	Power board X5
E144	X4	2-pin, black	Temperature sensor U
E138	X32	18-pin, gray	GDB ² V X31
E129	X51	1-pin, blue	DBB X20 ³
E127	X52	1-pin, blue	GDB V, X51
E100	X82	10-pin, white	GDB V X81
—	X31	Not used	—
—	X81	Not used	—
Gate Driver Board V (Center)			
E143	X2	1-pin, green	Power board X5
E127	X51	1-pin, blue	GDB U, X52
E123	X52	1-pin, blue	GDB W, X51
E100	X81	10-pin, white	GDB U, X82, PB-X8
E102	X82	10-pin, white	GDB W, X81
E138	X31	18-pin, gray	GDB U, X32
E142	X32	18-pin, gray	GDB W, X31
E128	X4	2-pin, black	Temperature sensor V
Gate Driver Board W (Right)			
E143	X2	1-pin, violet	Power board X5
E145	X4	2-pin, black	Temperature sensor W
E123	X51	1-pin, blue	GDB V, X52
E132	X52	1-pin, blue	Neutral on W power bus
E102	X81	10-pin, white	GDB V, X82
E142	X31	18-pin, gray	GDB V, X32 & PB X3
—	X32	Not used	—
—	X82	Not used	—

¹ See the schematic on page 106 for complete drive wiring. Wire numbers are given for cross referencing the wires with the wiring table and the schematic. The numbers do not appear on the wires.

² GDB: Gate driver board

³ DBB: Dynamic braking board. This option may not be present in the drive.

Figure 66: Gate Driver Boards

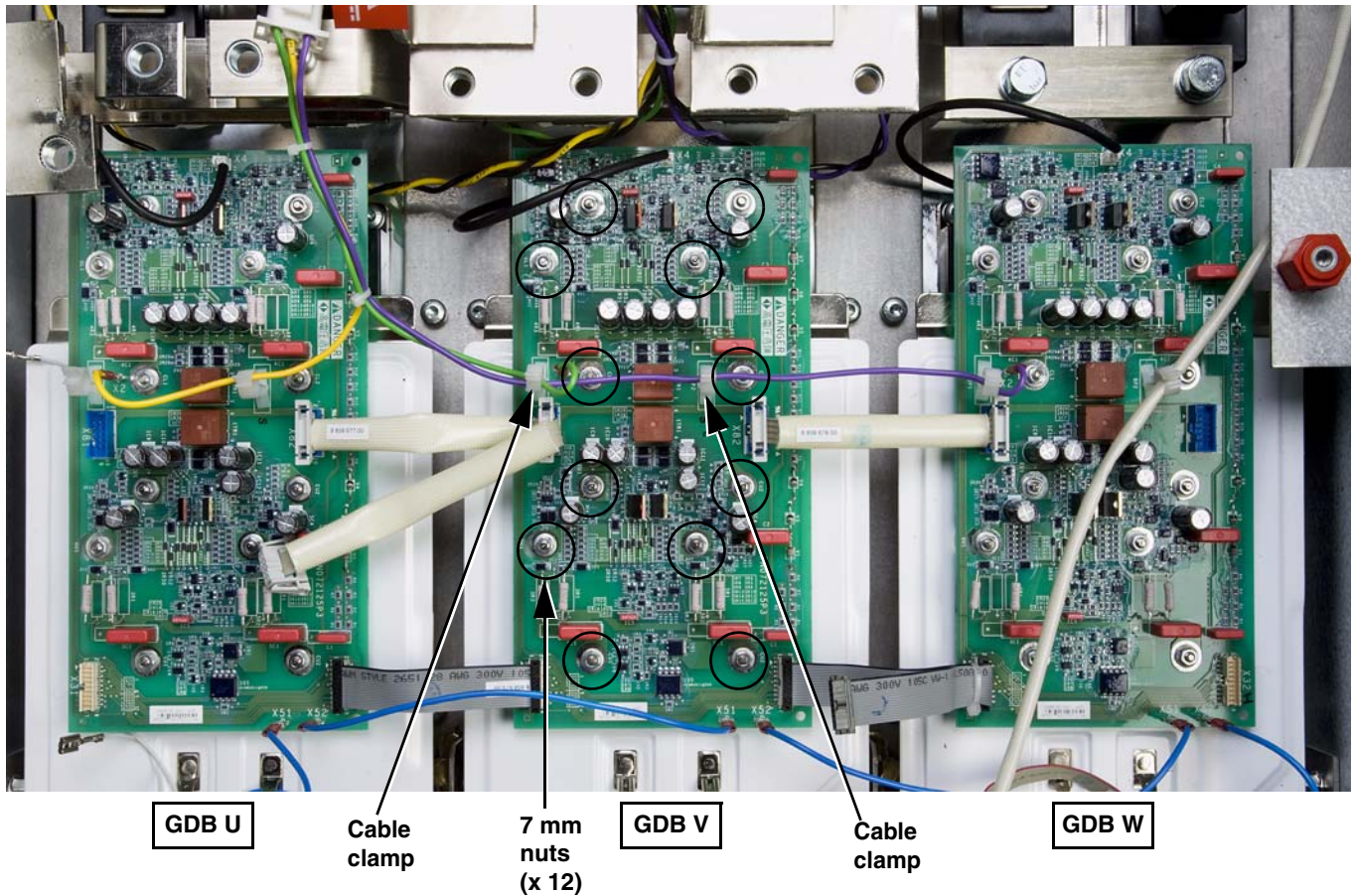

Install the New Gate Driver Board

4. Transfer the two plastic cable clamps (see Figure 66) from the old gate driver board onto the new one as follows.
 - To remove a clamp, pinch the clamp on the bottom side of the board and push it up through the mounting hole.
 - Snap the cable clamps into the mounting holes on the new board.
5. Seat the Gate driver board on the DC bus plate standoffs.
6. Using a 7 mm socket wrench, secure the board with 12 nuts. See Figure 66. Tighten the nuts to 1.2 N•m (10.6 lb-in).
7. Replace the gate driver board wiring. See Table 20 on page 66 and Figure 66 for the connections.

8. If you are replacing gate driver board U (right board), replace the L1, L2, and L3 bus bars as follows.
 - Using an 18 mm socket wrench, secure the L1, L2, and L3 bus bars to the SCR bus segments with three bolts (B, Figure 67).
 - Using an 18 mm socket wrench, secure the L1, L2, and L3 bus bars to the lower bus segments with three bolts (A, Figure 67).
 - Tighten the hardware to the torque values specified in Table 21.
 - Replace the connections to terminals X4 and X5 on the SCR snubber board. See Figure 68.

Figure 67: L1, L2, L3 Bus Bars

Table 21: L1, L2, L3 Bus Bar Hardware Torque Values

Item	Description	Torque Range	
		N•m	lb-in
A	(3) 18 mm bolts	45	398
B	(3) 18 mm bolts	45	398

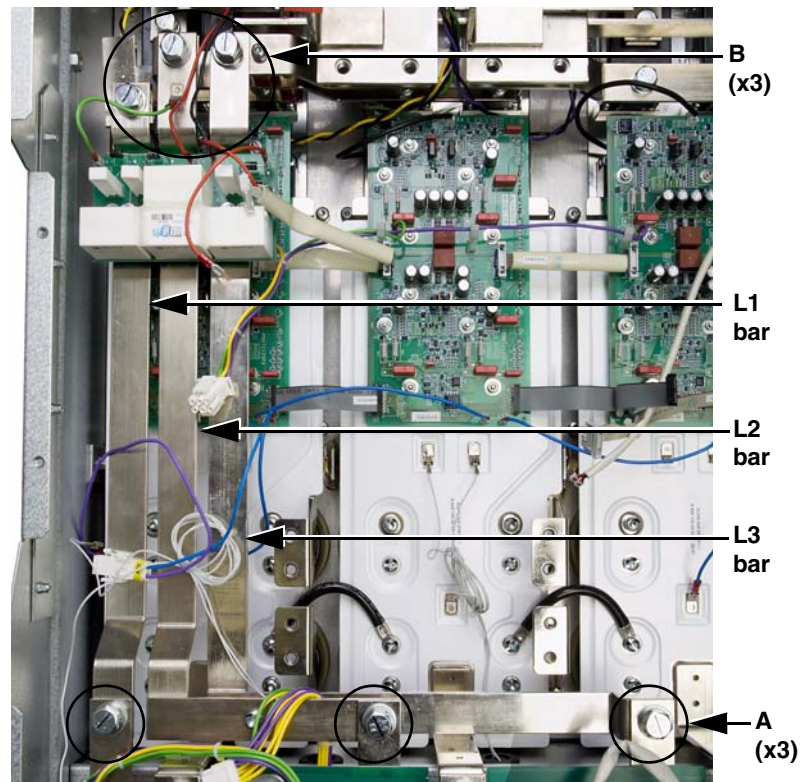
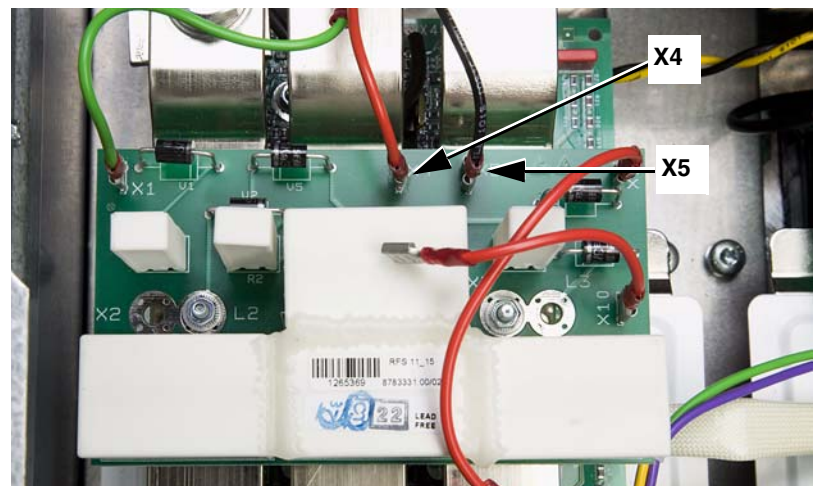

Figure 68: SCR Snubber Board



Reassemble the Drive

If you are only replacing a gate driver board, perform Steps 5–17 of “Reassembly Steps for Level 2 Parts” beginning on page 91 to replace the following parts:

- Bus plate assembly
- Fan control board connections
- Soft charge board connections
- Power board connections
- SCR assembly shield
- Fan plate
- Top crossbrace
- Control module assembly
- EMC tray
- Power terminal shield
- Front cover

Replacing the Temperature Sensors, VZ3G1104

IMPORTANT: Label and retain all removed hardware and cables for use in reassembly.

⚠ DANGER

HAZARD OF ELECTRIC SHOCK, EXPLOSION, OR ARC FLASH

- Read and understand the precautions in “Before You Begin” starting on page 5 before performing this procedure.
- Before working on this equipment, turn off all power supplying it and perform the DC bus voltage measurement procedure on page 12.

Failure to follow these instructions will result in death or serious injury.

There is one temperature sensor for each phase in the drive. The sensors are located under the gate driver boards on the DC bus plate.

Before performing the steps in this procedure, perform Steps 1–19 of “Disassembly Steps for Accessing Level 2 Parts” beginning on page 45 to remove the following parts from the drive:

- | | |
|--|--|
| <input type="checkbox"/> Front cover | <input type="checkbox"/> SCR assembly shield |
| <input type="checkbox"/> Power terminal shield | <input type="checkbox"/> Power board connections |
| <input type="checkbox"/> EMC tray | <input type="checkbox"/> Soft charge board connections |
| <input type="checkbox"/> Control module assembly | <input type="checkbox"/> Fan control board connections |
| <input type="checkbox"/> Top crossbrace | <input type="checkbox"/> Bus plate assembly |
| <input type="checkbox"/> Fan plate | <input type="checkbox"/> Gate driver board |

1. Using a T-10 Torx driver, remove one screw securing the temperature sensor to the DC bus plate. See Figure 69.
2. Replace the temperature sensor and secure it with the T-10 screw. Tighten the screw to 0.4–0.6 Nm (3.5–5.3 lb-in).

Figure 69: Temperature Sensor

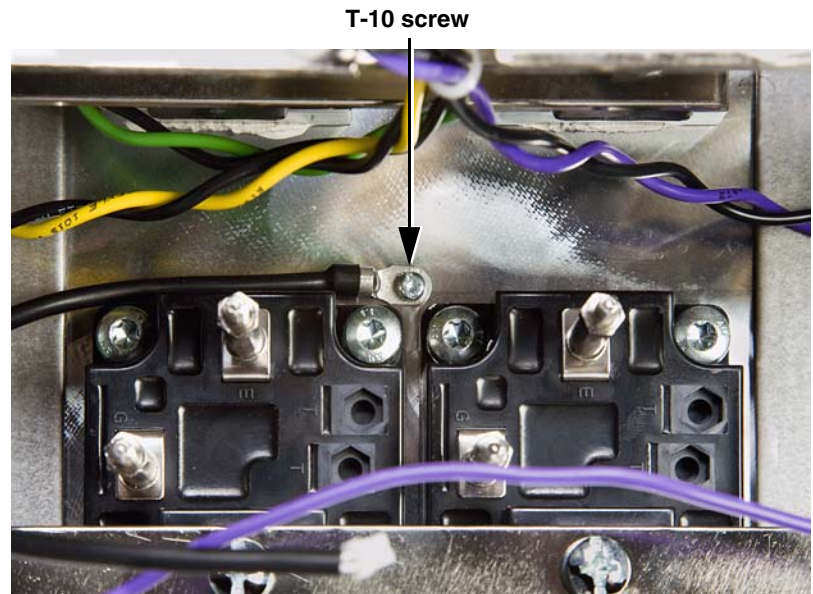

Reassemble the Drive

If you are only replacing a temperature sensor, perform Steps 2–17 of “Reassembly Steps for Level 2 Parts” beginning on page 91 to replace the following parts:

- Gate driver board
- Bus plate assembly
- Fan control board connections
- Soft charge board connections
- Power board connections
- SCR assembly shield
- Fan plate
- Top crossbrace
- Control module assembly
- EMC tray
- Power terminal shield
- Front cover

Replacing the Power IGBT Modules VZ3IM1602M1271, and VZ3IM1402M1271

IMPORTANT: Label and retain all removed hardware and cables for use in reassembly.

⚠ DANGER

HAZARD OF ELECTRIC SHOCK, EXPLOSION, OR ARC FLASH

- Read and understand the precautions in “Before You Begin” starting on page 5 before performing this procedure.
- Before working on this equipment, turn off all power supplying it and perform the DC bus voltage measurement procedure on page 12.

Failure to follow these instructions will result in death or serious injury.

Before performing the steps in this procedure, perform Steps 1–20 of “Disassembly Steps for Accessing Level 2 Parts” beginning on page 45 to remove the following parts from the drive:

- | | |
|--|--|
| <input type="checkbox"/> Front cover | <input type="checkbox"/> Power board connections |
| <input type="checkbox"/> Power terminal shield | <input type="checkbox"/> Soft charge board connections |
| <input type="checkbox"/> EMC tray | <input type="checkbox"/> Fan control board connections |
| <input type="checkbox"/> Control module assembly | <input type="checkbox"/> Bus plate assembly |
| <input type="checkbox"/> Top crossbrace | <input type="checkbox"/> Gate driver board |
| <input type="checkbox"/> Fan plate | <input type="checkbox"/> DC bus plate |
| <input type="checkbox"/> SCR assembly shield | |

You must replace the power IGBT modules in pairs as follows. See Figure 71 on page 73.

- Replace modules 1 and 2 together.
- Replace modules 3 and 4 together.

Figure 70: Torque Sequence

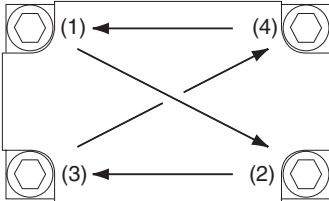

1. Using a T-30 Torx driver, remove four screws (**A**) securing the module to the heatsink and remove the module from the drive.
2. Using a 7 mm socket wrench, remove two standoffs (**B**) from the old IGBT module, and install them on terminals E and G of the new module. Tighten the standoffs to 1.2 N•m (10.6 lb-in).
3. Clean the portion of the heatsink that makes contact with the power IGBT module.
4. Evenly coat the bottom of the new power IGBT module with a thin layer of thermal compound, included in the kit, and position the module on the heatsink.
5. Using a T-30 Torx driver, secure the module to the heatsink with four screws (**A**). Initially tighten the screws, in the sequence shown in Figure 70, to 0.7–1.0 N•m (6.2–8.9 lb-in), and then to a final torque of 3.3–4.4 N•m (29.2–38.9 lb-in).

NEXT STEP: If you are also replacing the capacitors, skip to “Replacing the Capacitors VY1ADC1112 and VY1ADC1114” beginning on page 75.

If you are only replacing the power IGBT modules, continue with “Reassemble the Drive” on page 74.

Figure 71: Power IGBT Modules

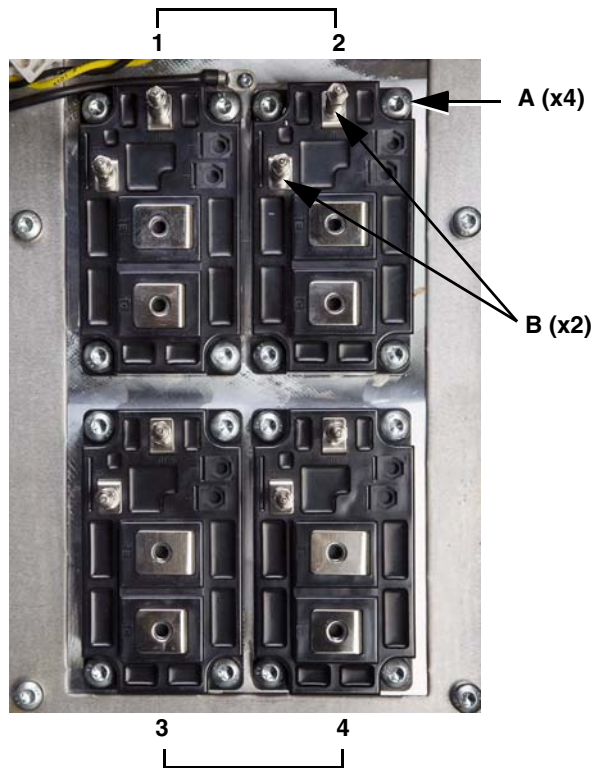

Reassemble the Drive

If you are only replacing the IGBT modules, perform Steps 1–17 of “Reassembly Steps for Level 2 Parts” beginning on page 91 to replace the following parts:

- DC bus plate assembly
- Gate driver board
- Bus plate assembly
- Fan control board connections
- Soft charge board connections
- Power board connections
- SCR assembly shield
- Fan plate
- Top crossbrace
- Control module assembly
- EMC tray
- Power terminal shield
- Front cover

Replacing the Capacitors VY1ADC1112 and VY1ADC1114

IMPORTANT: Label and retain all removed hardware and cables for use in reassembly.

⚠ DANGER

HAZARD OF ELECTRIC SHOCK, EXPLOSION, OR ARC FLASH

- Read and understand the precautions in “Before You Begin” starting on page 5 before performing this procedure.
- Before working on this equipment, turn off all power supplying it and perform the DC bus voltage measurement procedure on page 12.

Failure to follow these instructions will result in death or serious injury.

This kit contains six capacitors. If a capacitor has shorted, you must replace **all** of the capacitors in the drive.

Before performing the steps in this procedure, perform Steps 1–20 of “Disassembly Steps for Accessing Level 2 Parts” beginning on page 45 to remove the following parts from the drive:

- | | |
|--|--|
| <input type="checkbox"/> Front cover | <input type="checkbox"/> Power board connections |
| <input type="checkbox"/> Power terminal shield | <input type="checkbox"/> Soft charge board connections |
| <input type="checkbox"/> EMC tray | <input type="checkbox"/> Fan control board connections |
| <input type="checkbox"/> Control module assembly | <input type="checkbox"/> Bus plate assembly |
| <input type="checkbox"/> Top crossbrace | <input type="checkbox"/> Gate driver board |
| <input type="checkbox"/> Fan plate | <input type="checkbox"/> DC bus plate |
| <input type="checkbox"/> SCR assembly shield | |

1. Replace a capacitor as follows. See Figure 72.

- Unlock the capacitor by turning it counterclockwise, and remove it from the drive.
- Install the new capacitor and lock it into place.

NOTE: Ensure that the positive terminal (+) is oriented toward the top of the drive and negative terminal (-) toward the bottom.

Figure 72: Capacitors, Phase V Shown



Reassemble the Drive

If you are only replacing the capacitors, perform Steps 1–17 of “Reassembly Steps for Level 2 Parts” beginning on page 91 to replace the following parts:

- DC bus plate assembly
- Gate driver board
- Bus plate assembly
- Fan control board connections
- Soft charge board connections
- Power board connections
- SCR assembly shield
- Fan plate
- Top crossbrace
- Control module assembly
- EMC tray
- Power terminal shield
- Front cover

Replacing the SCR Modules (VZ3TM1425M1671, VZ3TM1600M1671) and Diode Modules (VZ3DM1600M1671)

IMPORTANT: Label and retain all removed hardware and cables for use in reassembly.

⚠ DANGER

HAZARD OF ELECTRIC SHOCK, EXPLOSION, OR ARC FLASH

- Read and understand the precautions in “Before You Begin” starting on page 5 before performing this procedure.
- Before working on this equipment, turn off all power supplying it and perform the DC bus voltage measurement procedure on page 12.

Failure to follow these instructions will result in death or serious injury.

⚠ DANGER

HAZARD OF ELECTRIC SHOCK, EXPLOSION, OR ARC FLASH

- When the controller is damaged, voltage may remain on certain energy storage capacitors after de-energization of the controller and discharge of the main capacitor bank.
- Before working on or near assemblies containing energy storage capacitors, verify that the capacitor voltages are less than 42 Vdc.
- The following assemblies have energy-storing capacitors:
 - SCR snubber board. See Figure 73 on page 78.
- Always check for the presence of voltage using a voltmeter set to the 1000 Vdc scale. When voltage is present, allow the voltmeter to discharge the capacitor’s stored charge. Refer to “Discharging Stored Energy in Capacitors” on page 13.

Failure to follow these instructions will result in death or serious injury.

Before performing the steps in this procedure, perform Steps 1–12 of “Disassembly Steps for Accessing Level 2 Parts” beginning on page 45 to remove the following parts from the drive:

- Front cover
- Power terminal shield
- EMC tray
- Control module assembly
- Top crossbrace
- Fan plate
- SCR assembly shield

Remove the Top Crossbrace

1. Using a 10 mm socket wrench, remove six nuts (A, Figure 48) securing the top crossbrace to the fan plate and the drive frame, and remove the crossbrace.

Figure 73: Fan Plate and Crossbrace

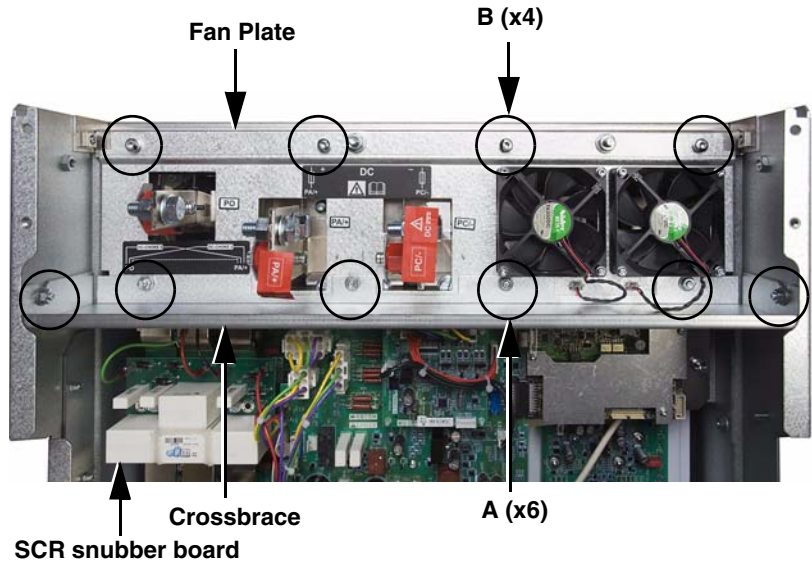

Remove the Fan Plate

2. Using a T-30 Torx driver, remove four screws (B, Figure 73) securing the fan plate to the drive frame.
3. Using a T-30 Torx right-angle driver, remove three screws (C, Figure 74) from the right sides of the red insulators at the PO, PA/+, and PC/- terminals.
4. Using an 18 mm socket wrench, remove five nuts and bolts from the PO, PA/+, and PC bus bars (D, Figure 74).
5. Remove the internal fan connections from the back of the fan plate, and remove the fan plate from the drive. See Figure 75 on page 79.

Figure 74: Fan Plate with Bus Bar Detail

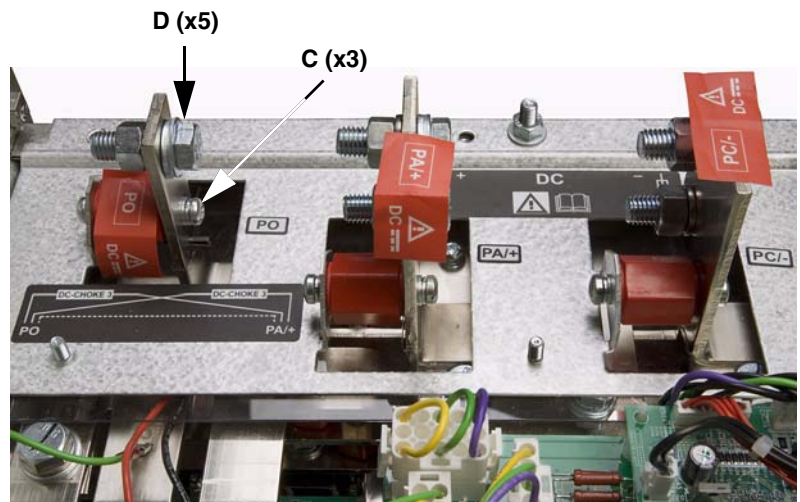
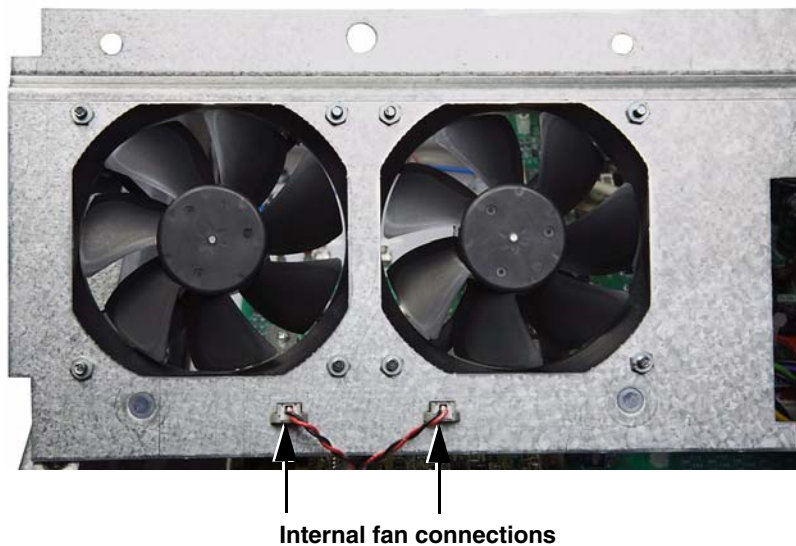

Figure 75: Internal Fan Connections



Remove the SCR Assembly Shield

6. Remove the transparent shield over the SCR assembly. See Figure 76.

Figure 76: SCR Assembly Shield

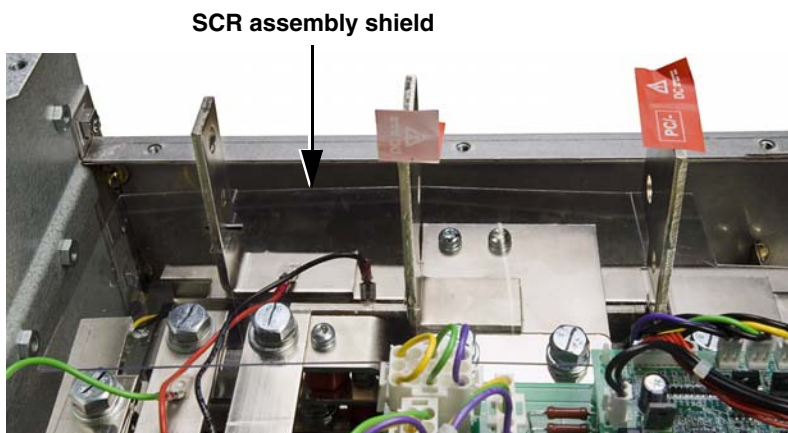

Remove the PA/+ Bus Assembly

7. Remove the PA/+ bus assembly as follows.
 - Using a 16 mm socket wrench, remove two bolts (**A**, Figure 77) securing the positive bus plate assembly to the underlying bus bar.
 - Using a 16 mm socket wrench, remove two bolts (**B**, Figure 77) securing the negative bus plate assembly to the underlying bus bar.
 - Using a 18 mm socket wrench, remove three bolts and washers (**C**, Figure 77) securing the L1, L2, and L3 bus bars to the underlying bus bar.
 - Using a T-30 Torx driver, remove two screws (**D**, Figure 77) securing the PA/+ bus assembly to the red insulators on the PO bus bar and remove the PA/+ bus assembly.

Figure 77: PA/+ Bus Assembly

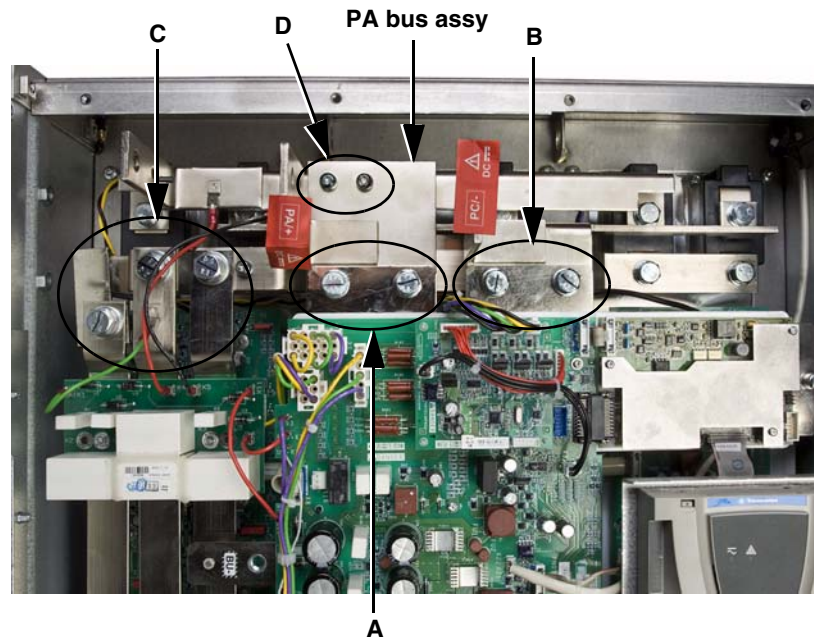

Remove the PO Bus Bar

8. Remove the PO bus bar as follows.
 - Remove the connections from terminals X4 (red wire) and X5 (black wire) of the SCR snubber board. See Figure 78.
 - Using a 16 mm socket wrench, remove three bolts (A, Figure 78) securing the PO bus bar to terminal 2 the SCR modules and remove the bus bar. The red wire from SCR snubber board terminal X4 comes out with the bar.

Figure 78: PO Bus Bar

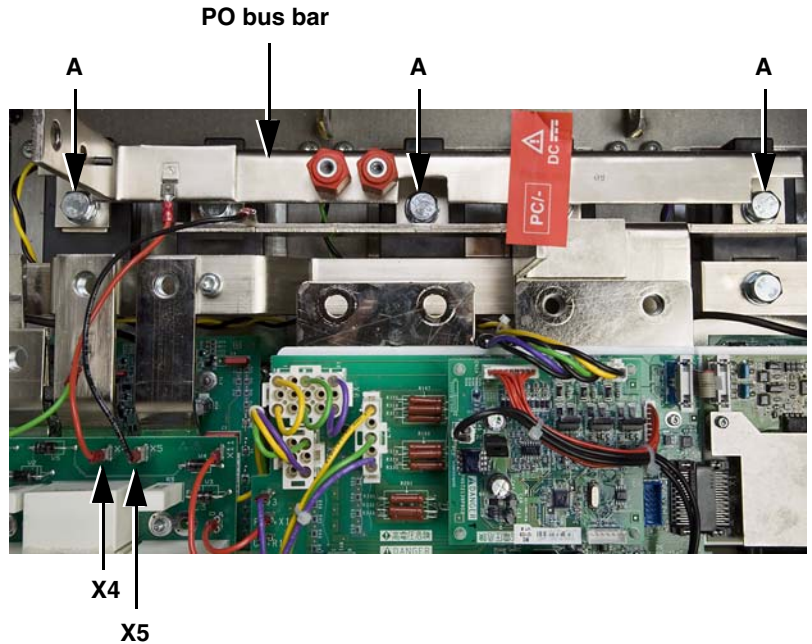

Remove the PC/- Bus Bar

9. Using a 16 mm socket wrench, remove three bolts and washers (B, Figure 79) securing the PC/- bus bar to the terminal 2 of the diode modules and remove the bus bar. The black wire from SCR snubber board terminal X5 comes out with the bar.

Figure 79: PC/- Bus Bar

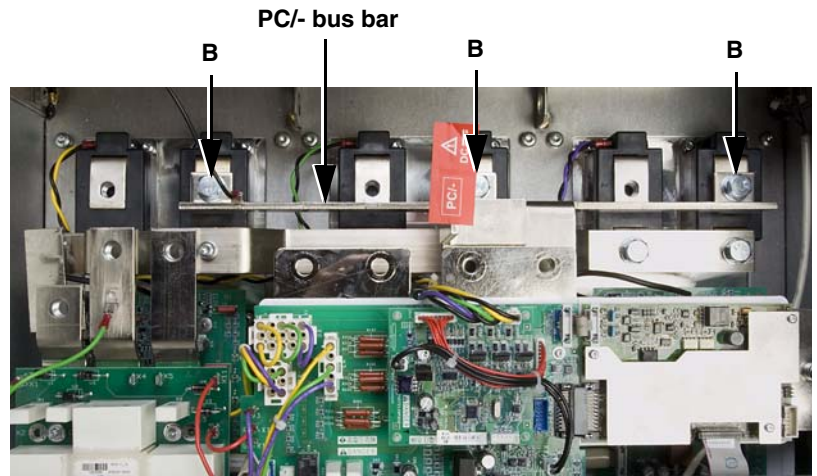

Remove the Phase W SCR Buswork

10. Remove the phase W SCR buswork as follows.

- Using a 16 mm socket wrench, remove two bolts and washers (A, Figure 80) connecting bus bar X to terminal 1 of the SCR module and diode module in phase W.
- Using a T-30 Torx driver, remove one screw (B, Figure 80) securing bus bar X to the red insulator on bus bar Y (see Figure 81 on page 83) and remove bus bar X.

Figure 80: SCR Buswork, Phase W

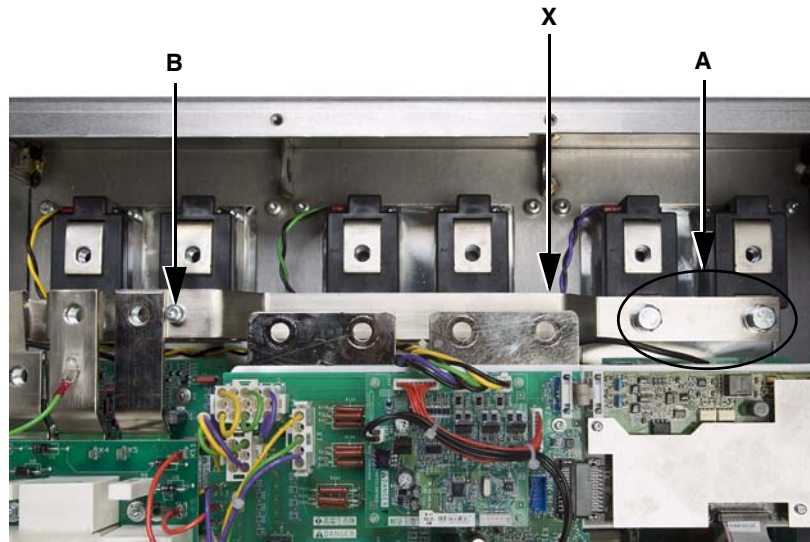

NEXT STEP: If you are only replacing an SCR or diode module in phase W, skip to Step 13 on page 84 to replace the module.

If you are also replacing an SCR or diode module in phases V or U, continue with Step 11 below.

Remove the Phase V SCR Buswork

11. Remove the phase V SCR buswork as follows.
 - Using a 16 mm socket wrench, remove two bolts and washers (C, Figure 81) connecting bus bar Y to terminal 1 of the SCR module and diode module in phase V.
 - Using a T-30 Torx driver, remove one screw (D, Figure 81) securing bus bar Y to the red insulator on bus bar Z (see Figure 82 on page 83) and remove bus bar Y.

Figure 81: SCR Buswork, Phase V

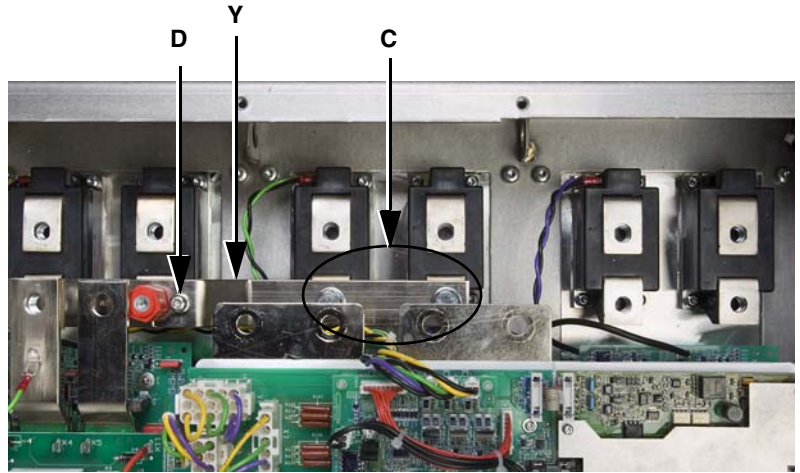

NEXT STEP: If you are only replacing an SCR or diode module in phase V, skip to Step 13 on page 84 to replace the module.
If you are also replacing an SCR or diode module in phase U, continue with Step 12 below.

Removing the Phase U SCR Buswork

12. Using a 16 mm socket wrench, remove two bolts and washers (E, Figure 82) connecting bus bar Z to terminal 1 of the SCR module and diode modules in phase U and remove bus bar Z.

Figure 82: SCR Buswork, Phase U

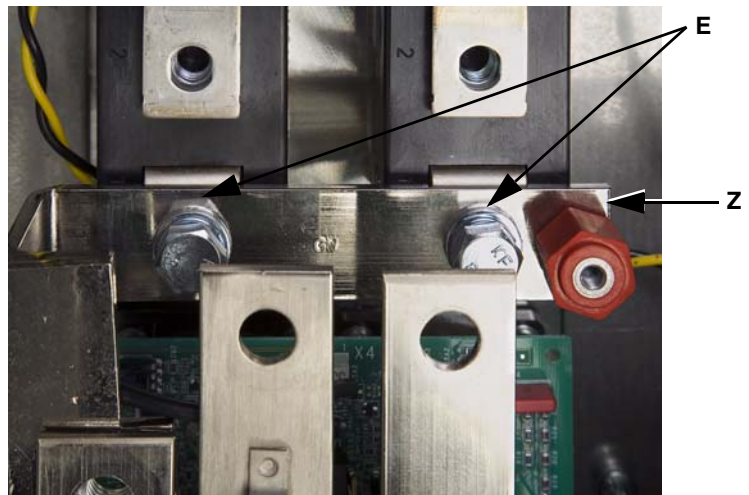

Replace the SCR Module

Figure 83: Torque Sequence

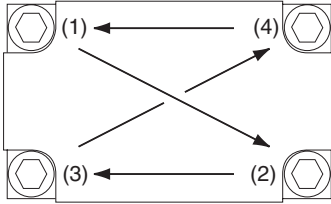

13. Replace an SCR module or diode module as follows.

- If you are replacing an SCR module, remove the connections from terminals 4 and 5. See Figure 84.
- Using a T-20 Torx driver, remove four screws (**A**) securing the SCR or diode module to the heatsink and remove the module from the drive. See Figure 84.
- Clean the portion of the heatsink that makes contact with the SCR or diode module.
- Evenly coat the bottom of the new module with a thin layer of thermal compound included in the kit.
- Position the new SCR or diode module on the heatsink under the input bus bar.
- Using a T-20 Torx driver, secure the module with four screws (**A**). See Figure 84. Initially tighten the screws, in the sequence shown in Figure 83, to 0.7–1.0 N•m (6.2–8.9 lb-in), and then to a final torque of 3.3–4.4 N•m (29.2–38.9 lb-in).
- If you are replacing an SCR module, replace the connections to terminals 4 and 5. See Figure 84.

NOTE: Note the cable positions. The yellow and black twisted cable goes to SCR module 1, the green and black cable goes to SCR module 2, and the violet and black cable goes to SCR module 3. The black wire goes on the top terminal of each SCR module.

Figure 84: SCR and Diode Modules

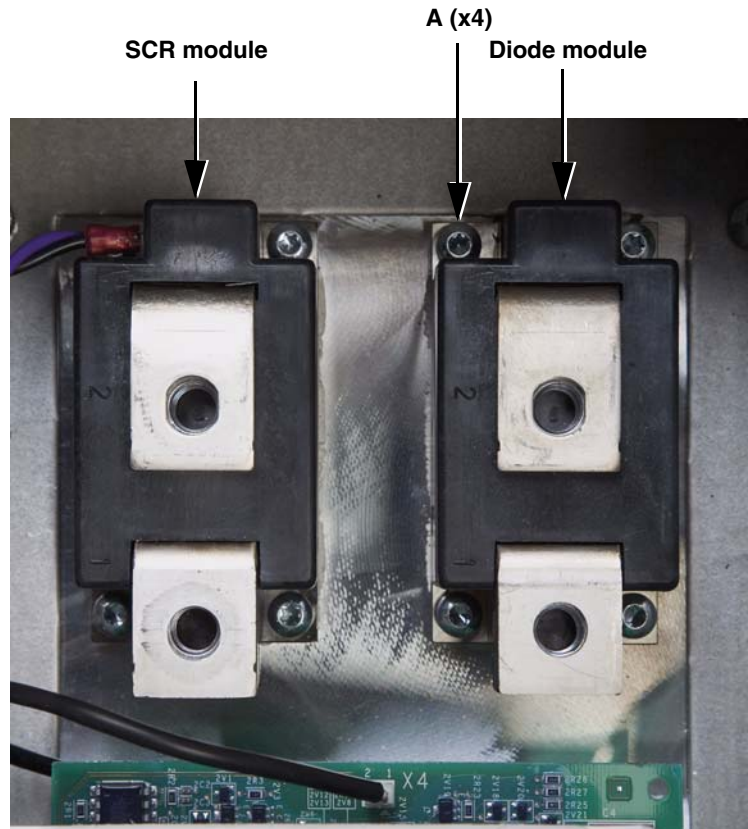

Replacing the Phase U SCR Buswork

Table 22: SCR Buswork Hardware Torque Values

Item	Description	Torque Range	
		N•m	lb-in
A	(2) 16 mm bolts and washers	27	239
B	(1) T-30 screw	5.5	48.6
C	(2) 16 mm bolts and washers	27	239
D	(1) T-30 screw	5.5	48.6
E	(2) 16 mm bolts and washers	27	239

14. Replace the phase U SCR buswork as follows. See Figure 85.

- Using a 16 mm socket wrench, secure bus bar **Z** to terminal 1 of the SCR module and diode module with two bolts and washers (**E**, Figure 85).
- Tighten the hardware to the torque values specified in Table 22 on page 85.

Figure 85: SCR Buswork, Phase U

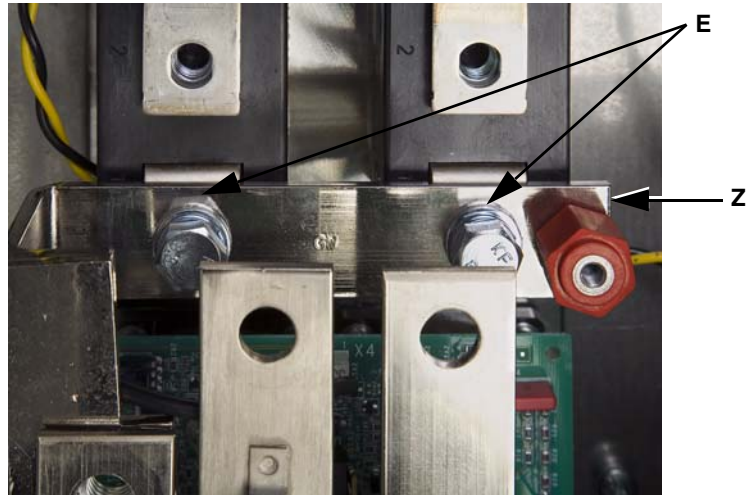

Replacing the Phase V SCR Buswork

15. Replace the phase V SCR buswork as follows. See Figure 86.

- Using a T-30 Torx driver, secure bus bar **Y** (Figure 86) to the red insulator on bus bar **Z** (Figure 85) with one screw (**D**, Figure 86).
- Using a 16 mm socket wrench, secure bus bar **Y** to terminal 1 of the SCR module and diode module in phase V with two bolts and washers (**C**, Figure 86).
- Tighten the hardware to the torque values specified in Table 22.

Figure 86: SCR Buswork, Phase V

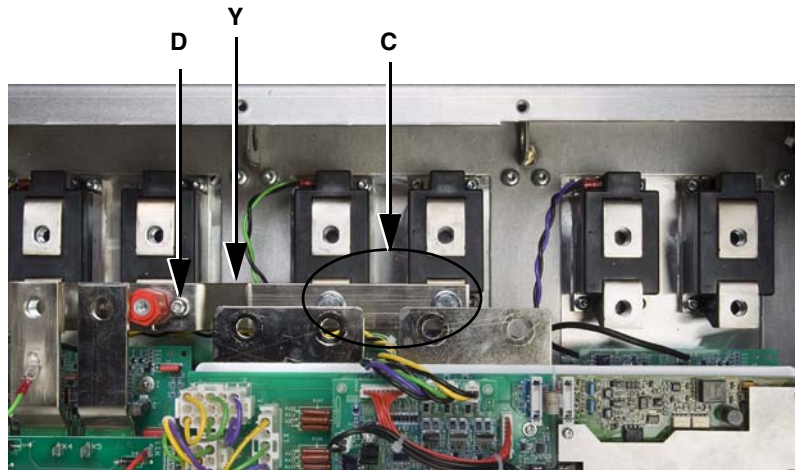

Replacing the Phase W SCR Buswork

16. Replace the phase W SCR buswork as follows. See Figure 87.

- Using a T-30 Torx driver, secure bus bar **X** to the red insulator on bus bar **Y** (Figure 86) with one screw (**B**, Figure 87).
- Using a 16 mm socket wrench, secure bus bar **X** to terminal 1 of the SCR module and diode module in phase W with two bolts and washers (**A**, Figure 87).
- Tighten the hardware to the torque values specified in Table 22 on page 85.

Figure 87: SCR Buswork, Phase W

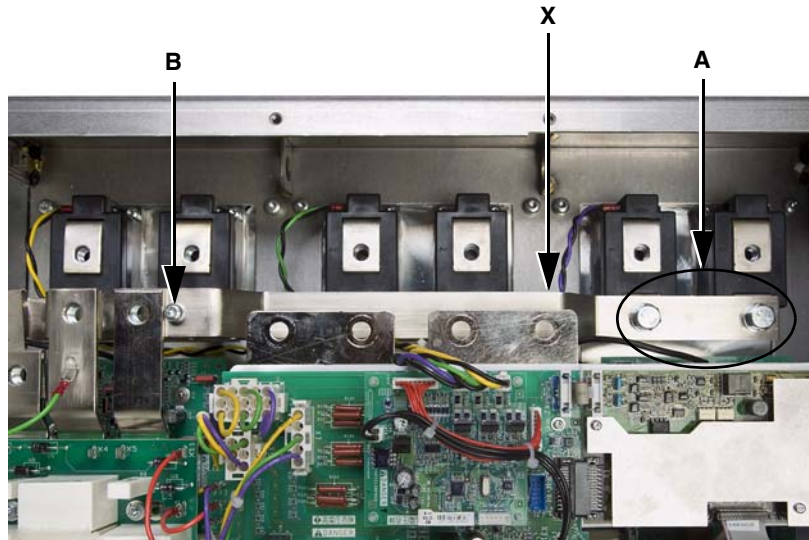

Replace the PC/- Bus Bar

17. Using a 16 mm socket wrench, secure the PC/- bus bar to the terminal 2 of the diode modules with three bolts and washers (**B**, Figure 88). Tighten the bolts to the torque values specified in Table 23.

Figure 88: PC/- Bus Bar

Table 23: PC/- and PO Bus Bar Hardware Torque Values

Item	Description	Torque Range	
		N•m	lb-in
A	(3) 16 mm bolts	27	239
B	(3) 16 mm bolts	27	239

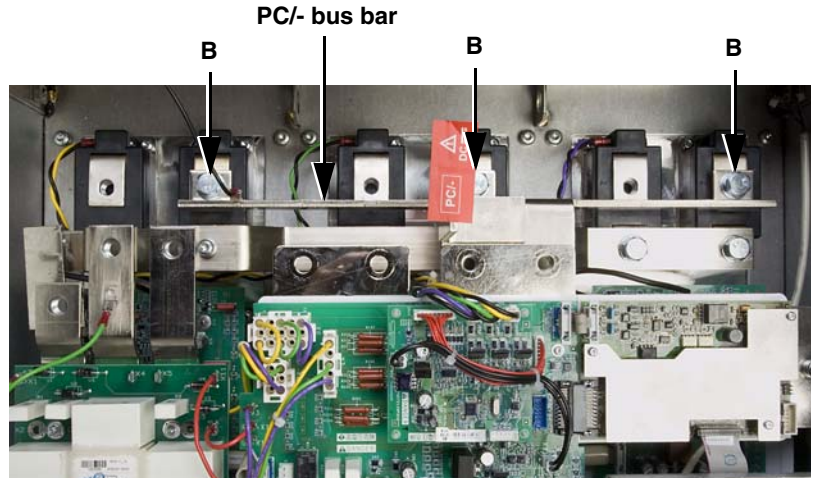

Replace the PO Bus Bar

18. Replace the PO bus bar as follows.
 - Using a 16 mm socket wrench, secure the PO bus bar to terminal 2 of the SCR modules with three bolts (**A**, Figure 89).
 - Tighten the bolts to the torque values specified in Table 23.
 - Replace the connections to terminals X4 (red wire) and X5 (black wire) of the SCR snubber board. See Figure 89.

Figure 89: PO Bus Bar

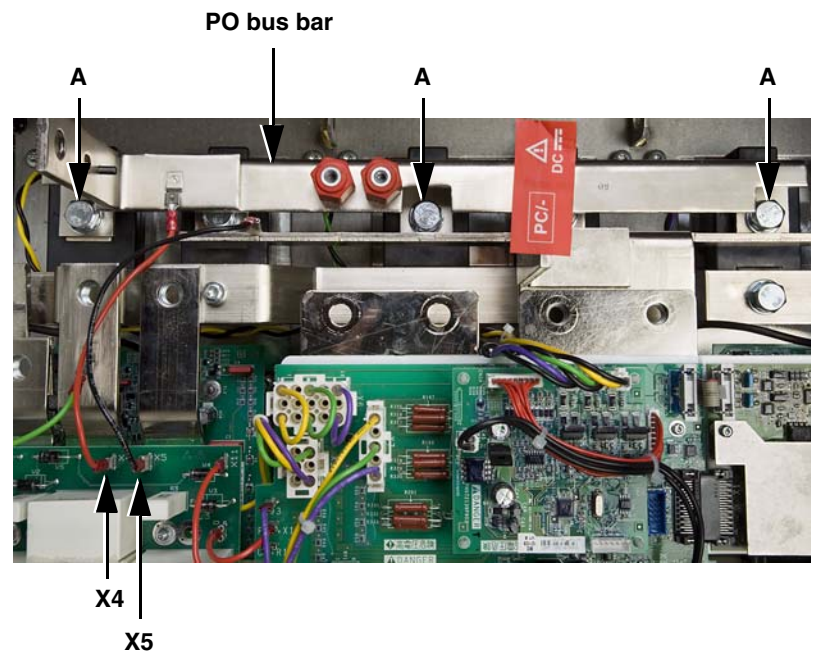

Replace the PA/+ Bus Assembly

19. Replace the PA/+ bus assembly as follows.

- Using a T-30 Torx driver, secure the PA/+ bus assembly to the red insulators on the PO bus bar with two screws (**D**, Figure 90).
- Using a 18 mm socket wrench, secure the L1, L2, and L3 bus bars to the SCR/diode line bus bar with three bolts and washers (**C**, Figure 90).
- Using a 16 mm socket wrench, secure the negative bus plate assembly to the DC negative bus bar with two bolts (**B**, Figure 90).
- Using a 16 mm socket wrench, secure the positive bus plate assembly to the DC positive bus bar with two bolts (**A**, Figure 90).
- Tighten the hardware to the torque values shown in Table 24.

Figure 90: PA/+ Bus Assembly

Table 24: PA/+ Bus Assembly Hardware Torque Values

Item	Description	Torque Range	
		N•m	lb-in
A	(2) 16 mm bolts	27	239
B	(2) 16 mm bolts	27	239
C	(3) 18 mm bolts and washers	45	398
D	(2) T-30 screws	5.5	48.6

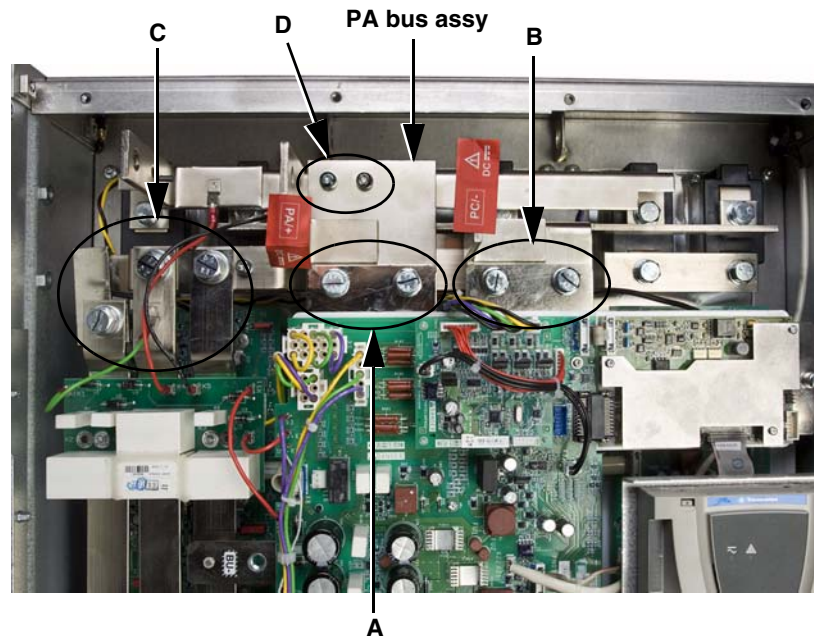

Replace the SCR Assembly Shield

20. Replace the transparent shield over the SCR assembly. See Figure 91.

Figure 91: SCR Assembly Shield

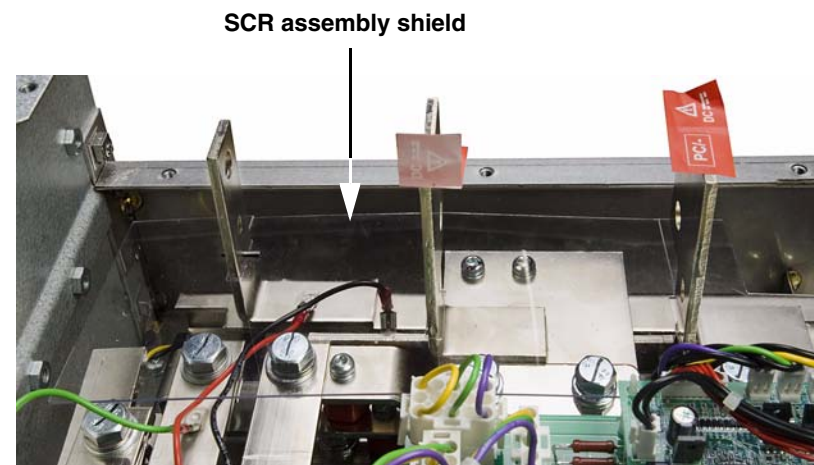

⚠ DANGER

HAZARD OF ELECTRIC SHOCK, EXPLOSION, OR ARC FLASH

- Install the SCR assembly shield as shown in Figure 91.
- Before installing the shield, ensure that it has no tears or cracks. If the shield is damaged, install a new piece from the plastic kit. See page 21.
- Do not install a damaged shield.

Failure to follow these instructions will result in death or serious injury.

Replace the Fan Plate

21. Replace the fan plate as follows.

- Replace the internal fan connections on the back of the fan plate, and position the fan plate in the drive. See Figure 92.
- Using an 18 mm socket wrench, replace five nuts and bolts on the PO, PA/+, and PC bus bars (D, Figure 93).
- Using a T-30 Torx right-angle driver, secure the PO, PA/+, and PC/- bus bars to the red insulators on fan plate with three screws (C, Figure 93).
- Using a T-30 Torx driver, secure the fan plate to the drive frame with four screws (B, Figure 94 on page 90).
- Tighten the hardware to the torque values specified in Table 25.

Figure 92: Internal Fan Connections

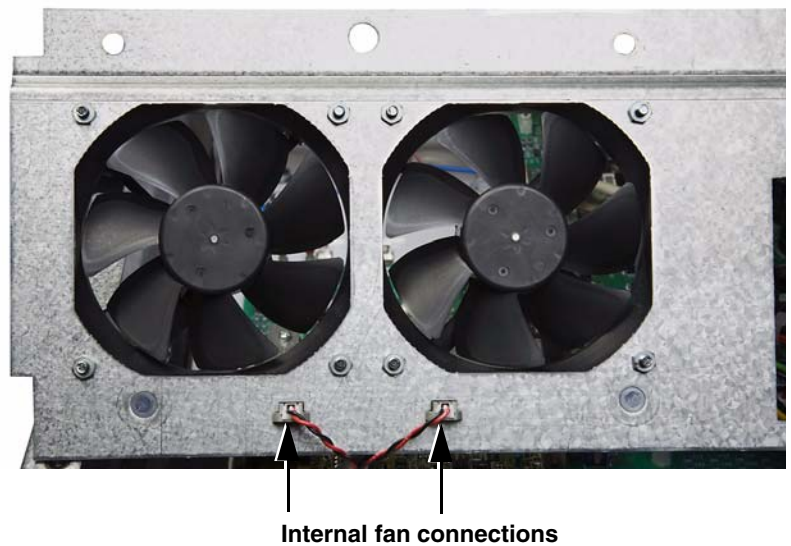
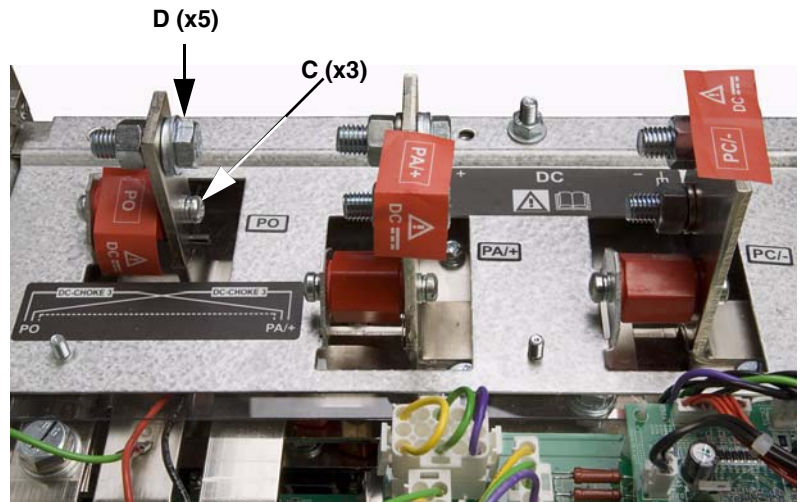

Figure 93: Fan Plate with Bus Bar Detail

Table 25: Fan Plate Hardware Torque Values

Item	Description	Torque Range	
		N•m	lb-in
A	(6) 10 mm nuts	5.5	48.6
B	(4) T-30 screws	5.5	48.6
C	(3) T-30 screws	5.5	48.6
D	(5) 18 mm bolts	45	398



Replace the Top Crossbrace

22. Using a 10 mm socket wrench, secure the top crossbrace to the fan plate and drive frame with six nuts (A, Figure 94). Tighten the nuts to the torque values specified in Table 25 on page 89.

Figure 94: Fan Plate and Crossbrace

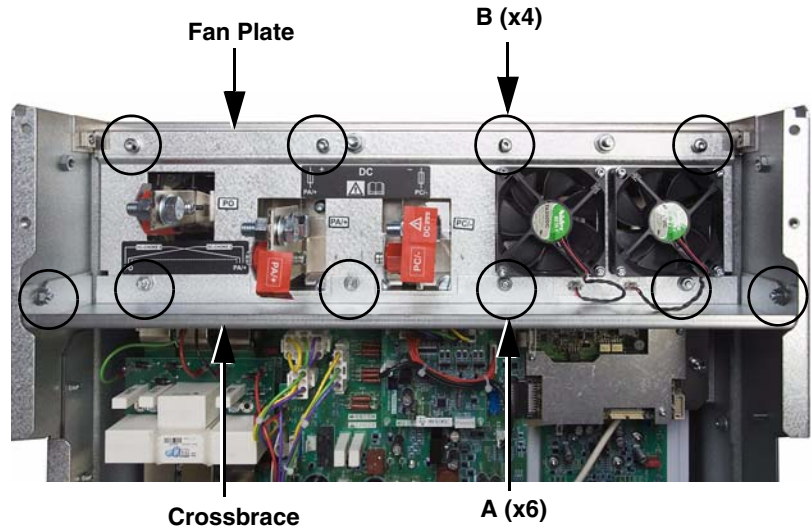

Reassemble the Drive

If you are only replacing the SCR snubber board or the SCR modules, perform Steps 15–17 of “Reassembly Steps for Level 2 Parts” beginning on page 91 to replace the following parts:

- SCR assembly shield
- Fan plate
- Top crossbrace
- Control module assembly
- EMC tray
- Power terminal shield
- Front cover

Reassembly Steps for Level 2 Parts

IMPORTANT: Label and retain all removed hardware and cables for use in reassembly.

⚠ DANGER

HAZARD OF ELECTRIC SHOCK, EXPLOSION, OR ARC FLASH

- Read and understand the precautions in “Before You Begin” starting on page 5 before performing this procedure.
- Before working on this equipment, turn off all power supplying it and perform the DC bus voltage measurement procedure on page 12.

Failure to follow these instructions will result in death or serious injury.

This section contains instructions for replacing the following parts in the drive:

- | | |
|--|--|
| <input type="checkbox"/> DC bus plate | <input type="checkbox"/> Fan plate |
| <input type="checkbox"/> Gate driver boards | <input type="checkbox"/> Top crossbrace |
| <input type="checkbox"/> Bus plate assembly | <input type="checkbox"/> Control module assembly |
| <input type="checkbox"/> Fan control board connections | <input type="checkbox"/> EMC tray |
| <input type="checkbox"/> Soft charge board connections | <input type="checkbox"/> Power terminal shield |
| <input type="checkbox"/> Power board connections | <input type="checkbox"/> Front cover |
| <input type="checkbox"/> SCR assembly shield | |

You must perform some or all of the procedures in this section after replacing the spare parts identified in Table 26. Consult Table 26 for the reassembly steps that must be performed for the corresponding spare parts.

Table 26: Reassembly Steps

If you replaced	Perform reassembly steps:
Power board VX5A1HC2025 VX5A1HC2531 VX5A71HC28N4	Steps 12–17
Gate driver board VX5A1201 or VX5A1202	Steps 5–17
Temperature sensors VZ3G1104	Steps 2–17
Power IGBT modules VZ3IM1600M1271 VZ3IM1602M1271 VZ3IM1402M1271	Steps 1–17
Capacitors VY1ADC1112 VY1ADC1114	Steps 1–17
SCR modules VZ3TM1425M1671 VZ3TM1600M1671	Steps 15–17
Diode modules VZ3DM1600M1671	Steps 15–17

Replace the DC Bus Plate

1. Replace the DC bus plate as follows. See Figure 95.
 - Position the DC bus plate in the drive as illustrated in Figure 95.
 - Using an 18 mm socket wrench, securing the DC bus plate to the output bus bar with one bolt (A).
 - Using a size 2 Phillips driver, secure the DC bus plate to the IGBT modules with two screws (B) and secure the plate to the capacitors with four screws (C).
 - Using a T-30 Torx driver, secure the DC bus plate to the IGBT modules with two 20 mm screws (D) and secure the plate to the capacitors with four 14 mm screws (E).
 - Using a 10 mm socket wrench, install two 6 mm standoffs (F) and two 11 mm standoffs (G).
 - Tighten the hardware to the torque values specified in Table 27.

Figure 95: DC Bus Plate (Phase V Shown)

Table 27: DC Bus Plate Hardware Torque Values

Item	Description	Torque Range	
		N•m	lb-in
A	(1) 18 mm bolts	45	398
B	(2) Size 2 Phillips screws	3.3	29.2
C	(4) Size 2 Phillips screws	3.3	29.2
D	(2) Long T-30 screws (20 mm length)	3.3	29.2
E	(4) Short T-30 screws (14 mm length)	3.3	29.2
F	(2) Short 10-mm standoffs (6 mm length)	3.3	29.2
G	(2) Long 10 mm standoffs (11 mm length)	3.3	29.2

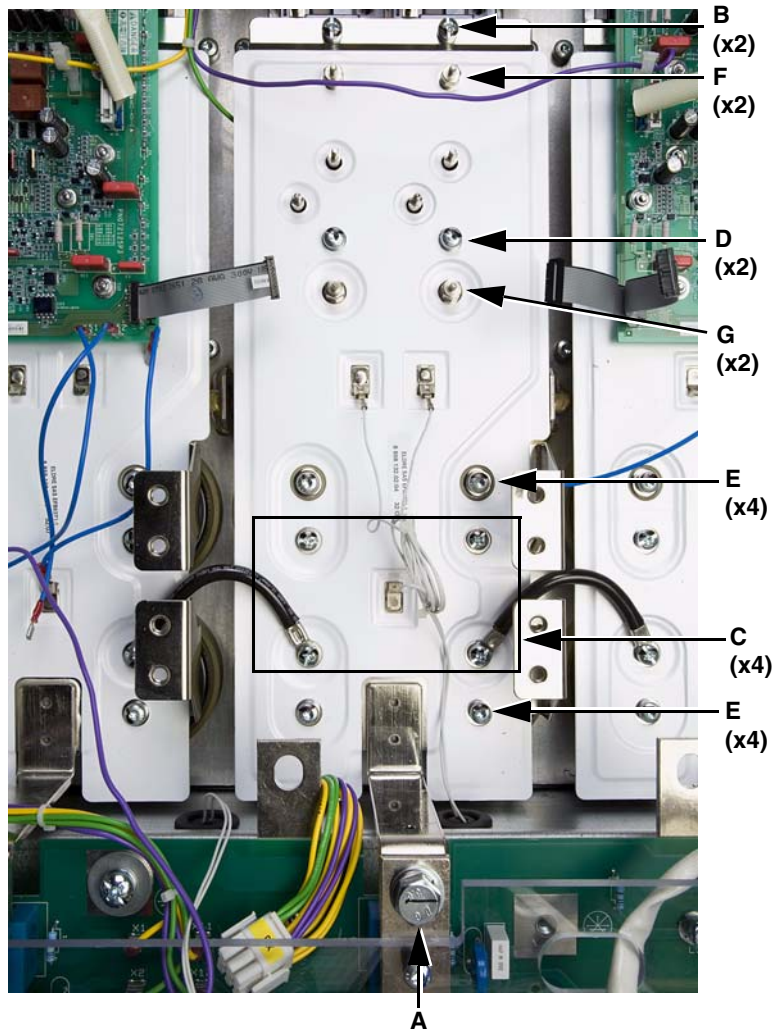

Replace the Gate Driver Boards

2. Replace the gate driver board(s) as follows.
 - Using a 7 mm socket wrench, secure the gate driver boards to the DC bus plate with 12 nuts each. See Figure 96 on page 94. Tighten the nuts to 1.2 N•m (10.6 lb-in).
3. Replace the gate driver board connections. See Table 28 and Figure 96 on page 94.

Table 28: Gate Driver Board Wiring

Wire No. ¹	Terminal No.	Description	To:
Gate Driver Board U (Left)			
E143	X2	1-pin, yellow	Power board X5
E144	X4	2-pin, black	Temperature sensor U
E138	X32	18-pin, gray	GDB ² V X31
E129	X51	1-pin, blue	DBB X20 ³
E127	X52	1-pin, blue	GDB V, X51
E100	X82	10-pin, white	GDB V X81
—	X31	Not used	—
—	X81	Not used	—
Gate Driver Board V (Center)			
E143	X2	1-pin, green	Power board X5
E127	X51	1-pin, blue	GDB U, X52
E123	X52	1-pin, blue	GDB W, X51
E100	X81	10-pin, white	GDB U, X82, PB-X8
E102	X82	10-pin, white	GDB W, X81
E138	X31	18-pin, gray	GDB U, X32
E142	X32	18-pin, gray	GDB W, X31
E128	X4	2-pin, black	Temperature sensor V
Gate Driver Board W (Right)			
E143	X2	1-pin, violet	Power board X5
E145	X4	2-pin, black	Temperature sensor W
E123	X51	1-pin, blue	GDB V, X52
E132	X52	1-pin, blue	Neutral on W power bus
E102	X81	10-pin, white	GDB V, X82
E142	X31	18-pin, gray	GDB V, X32 & PB X3
—	X32	Not used	—
—	X82	Not used	—

¹ See the schematic on page 106 for complete drive wiring. Wire numbers are given for cross referencing the wires with the wiring table and the schematic. The numbers do not appear on the wires.

² GDB: Gate driver board

³ DBB: Dynamic braking board. This option may not be present in the drive.

Figure 96: Gate Driver Boards

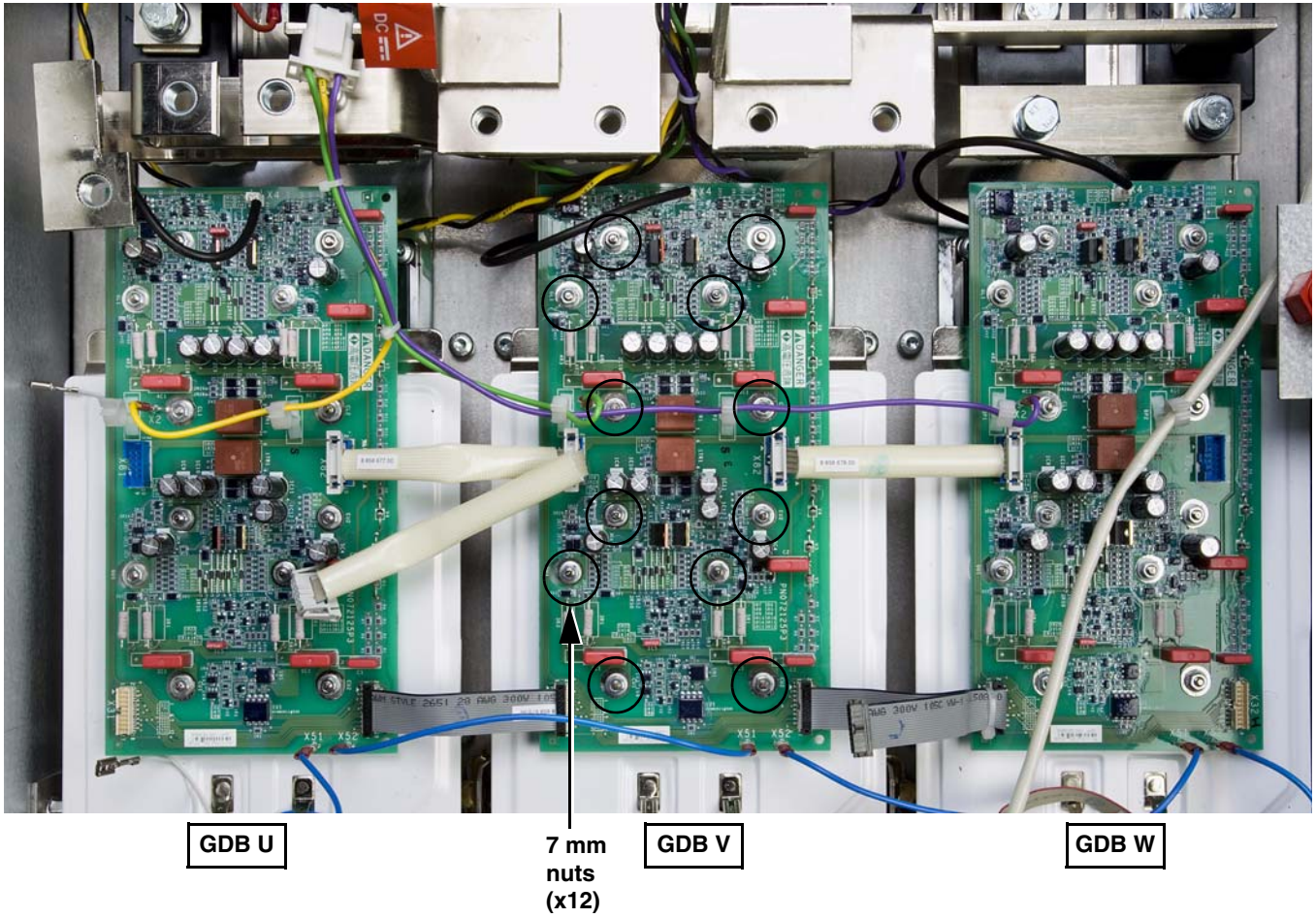

4. If you are replacing gate driver board U (right board), replace the L1, L2, and L3 bus bars as follows.
 - Using an 18 mm socket wrench, secure the L1, L2, and L3 bus bars to the SCR bus segments with three bolts (**B**, Figure 97).
 - Using an 18 mm socket wrench, secure the L1, L2, and L3 bus bars to the lower bus segments with three bolts (**A**, Figure 97).
 - Tighten the hardware to the torque values specified in Table 29.
 - Replace the connections to terminals X4 and X5 on the SCR snubber board. See Figure 98.

Figure 97: L1, L2, L3 Bus Bars

Table 29: L1, L2, L3 Bus Bar Hardware Torque Values

Item	Description	Torque Range	
		N•m	lb-in
A	(3) 18 mm bolts	45	398
B	(3) 18 mm bolts	45	398

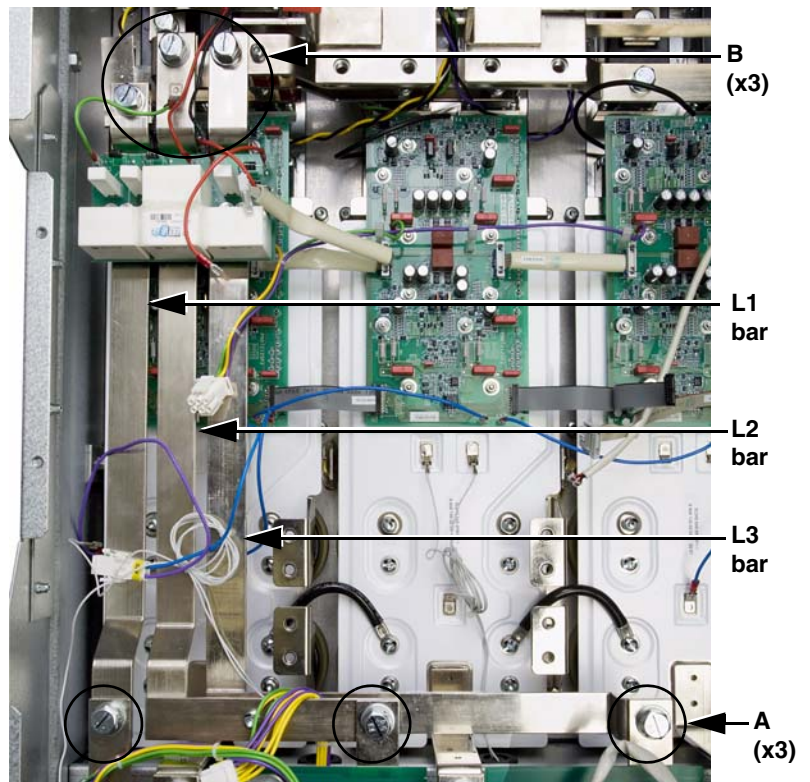
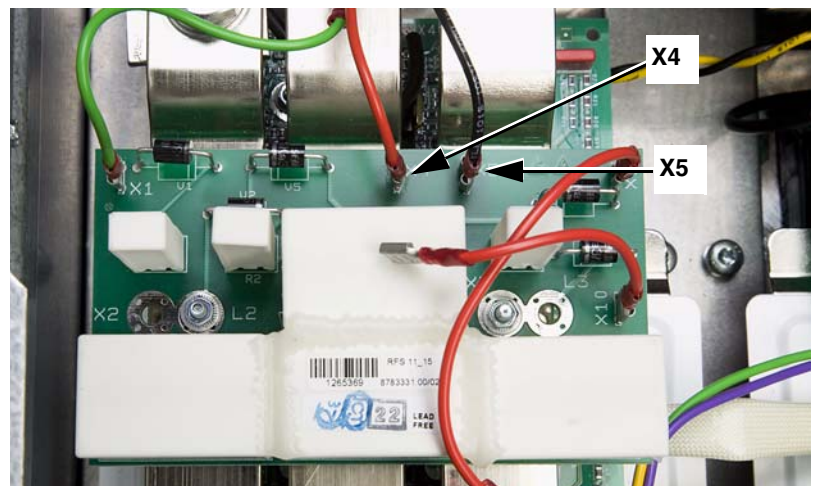

Figure 98: SCR Snubber Board



Replace the Bus Plate Assembly

5. Replace the bus plate assembly as follows.
 - Position the bus plate assembly in the drive as illustrated in Figure 99.
 - Using a 13 mm socket wrench, secure the bus plate assembly to the phase U positive and negative buses with four screws (F).
 - Using a 13 mm socket wrench, secure the bus plate assembly to the phase V positive and negative buses with four screws (E).
 - Using a 13 mm socket wrench, secure the bus plate assembly to the phase W positive and negative buses with four screws (D).
 - Using a 16 mm socket wrench, secure the bus plate assembly to the PA/+ bus with two bolts (C).
 - Using a 16 mm socket wrench, secure the bus plate assembly to the PC/- bus with two bolts (B).
 - Using a T-30 Torx driver, secure the bus plate assembly to the red insulator on the drive frame with one screw and washer (A).
 - Tighten the hardware to the torque values specified in Table 30.

Figure 99: Bus Plate Assembly

Table 30: Bus Plate Assembly Hardware Torque Values

Item	Description	Torque Range	
		N•m	lb-in
A	(2) T-30 screws	5.5	48.7
B	(2) 16 mm bolts	27	239
C	(2) 16 mm bolts	27	239
D	(4) 13 mm bolts	13.5	119
E	(4) 13 mm bolts	13.5	119
F	(4) 13 mm bolts	13.5	119

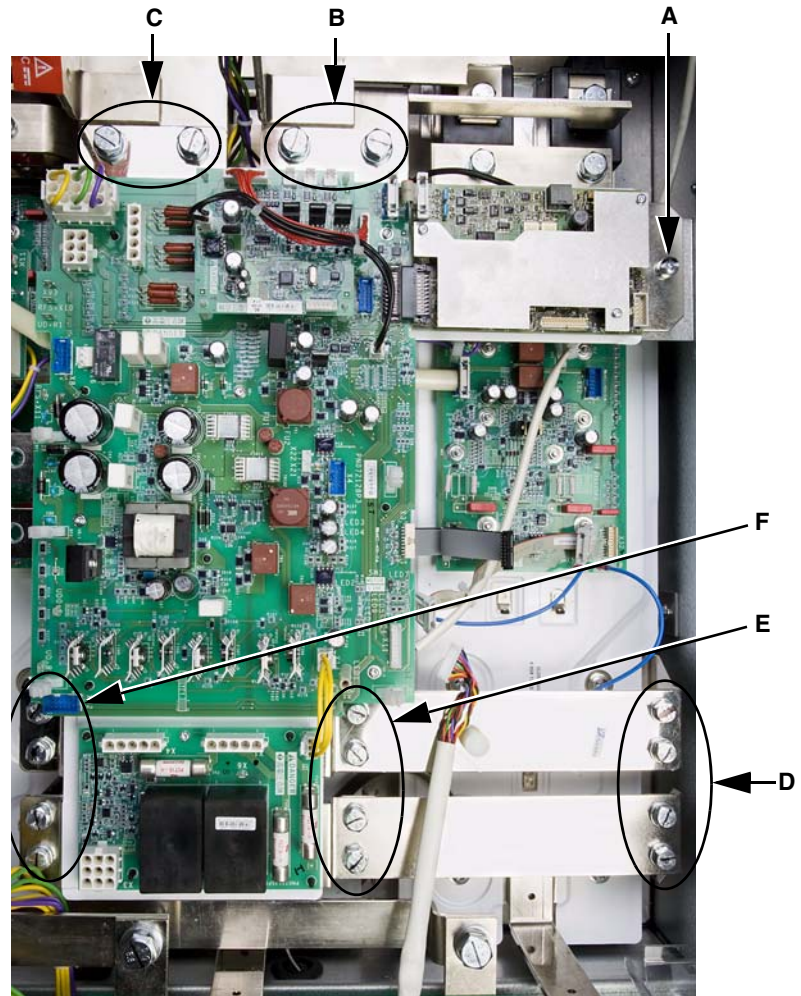

Replace the Fan Control Board Connections

6. Replace the connections on terminals X1 and X3 of the fan control board. See Figure 100 for terminal locations.

Figure 100: Fan Control Board Connections X1 and X3

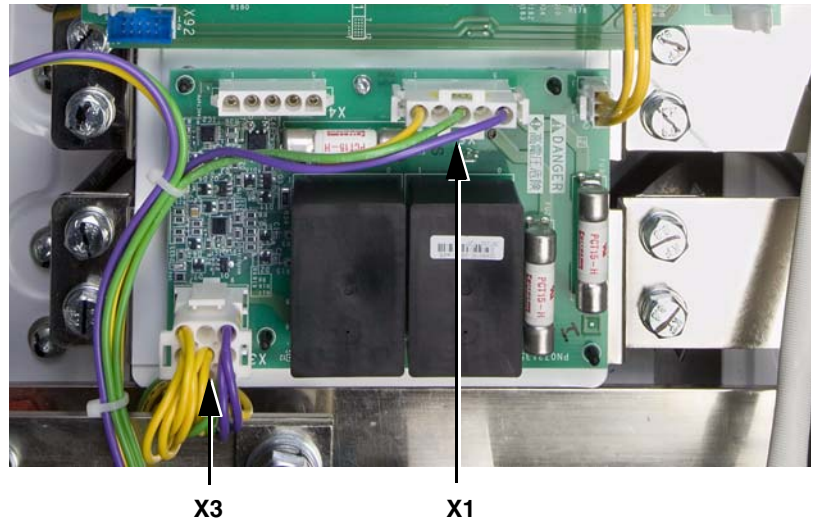

Replace the Soft Charge Board Connections

7. Replace soft charge board connections CNL1G, CNL2G, and CNL3G. See Figure 101 for terminal locations.

Figure 101: Soft Charge Board Connections

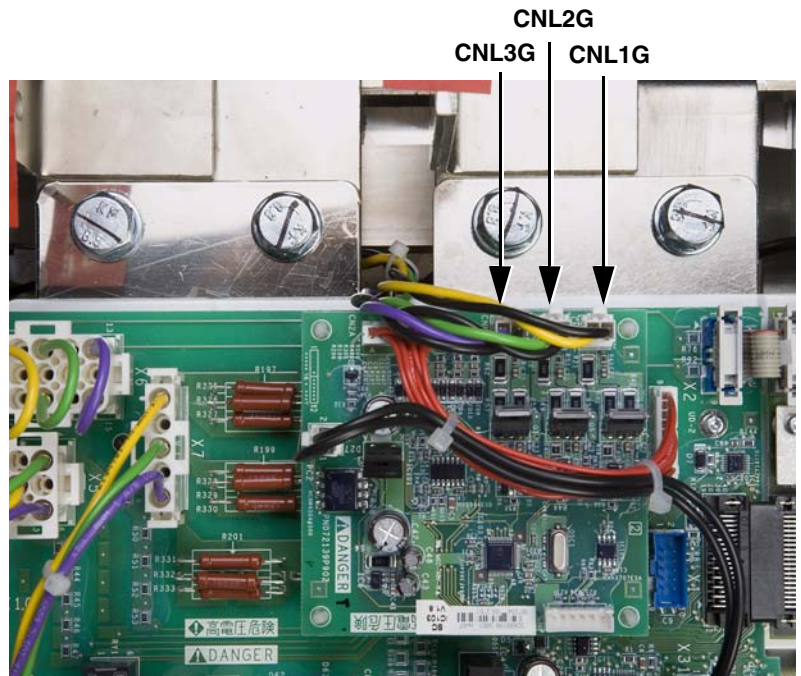

Replace the Power Board Connections

NOTE: Take care not to damage the LED (see Figure 102) when removing, handling, or installing the power board.

8. Replace the power board connections listed in Table 31. See Figure 102 for the connection locations.

Table 31: Power Board Wiring

Wire No. ¹	Terminal No.	Description	To:
E103	X11	9-pin, multi color	Motor current sensors
E105	X14	3-pin, yellow	FCB ² X2
E136	UD0	1-pin, blue	Phase U DC bus plate
E141	UD -R1	1-pin, white	Bleeder resistor
E139	UD +R1	1-pin, white	Bleeder resistor
E171	RFS +X11	1-pin, red	SCR ³ snubber board X11
E126	RFS +X10	1-pin, red	SCR snubber board X10
E143	X5	6-pin, yellow/green/violet	GDB ⁴ U X2, GDB V X2, GDB W X2
E120	X7	6-pin, yellow/green/violet	Filter board X11, X12, X13
—	X2	10-pin, gray	Motor control board X2
E129	X93	1-pin, violet	Dynamic braking board X20 ⁵
E142	X3	18-pin, gray	GDB W X31
E100	X8	10-pin, white	GDB V X81
E106	X21	2-pin, red/black	Internal fan
E106	X22	2-pin, red/black	Internal fan
E112	X4	10-pin, gray	Control module
—	X16	Not used	—
—	X91	Not used	—
—	X92	Not used	—

Figure 102: Power Board Connections

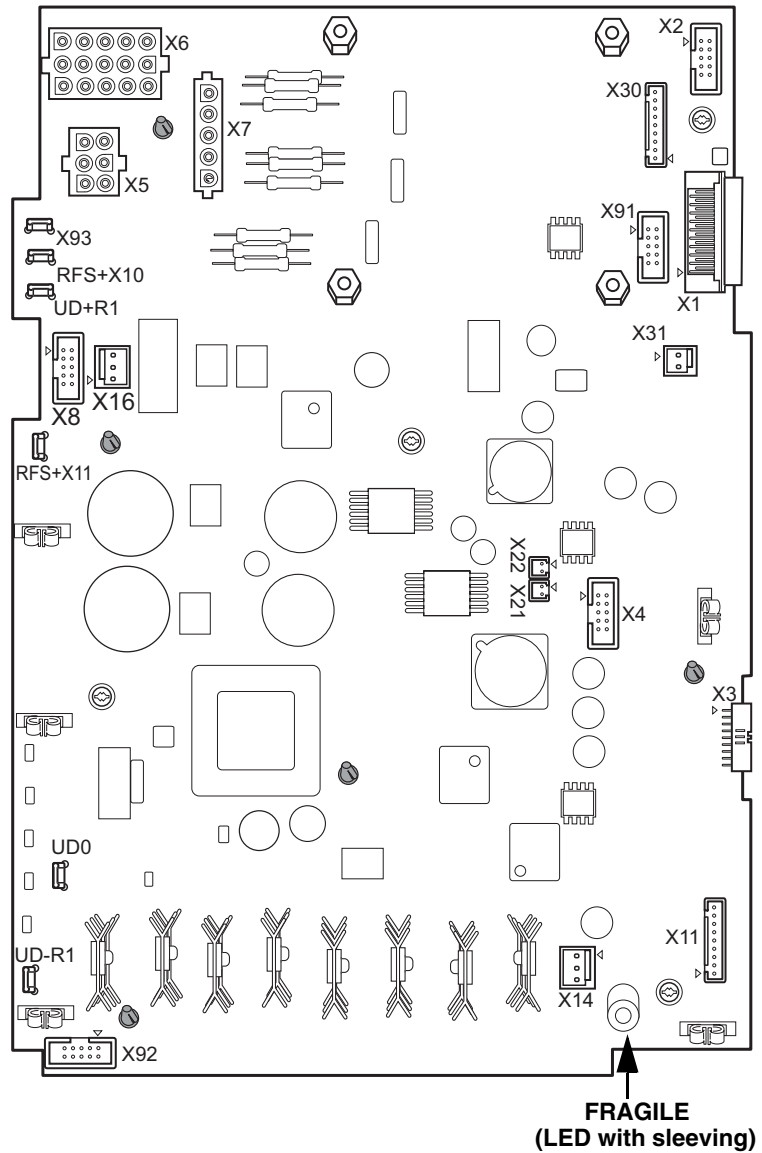

¹ See the schematic on page 106 for complete drive wiring. Wire numbers are given for cross referencing the wires with the wiring table and the schematic. The numbers do not appear on the wires.
² FCB: Fan control board
³ SCR: Silicon controlled rectifier
⁴ GDB: Gate driver board
⁵ The optional dynamic braking board may not be present in the drive.

Replace the SCR Assembly Shield

⚠ DANGER

HAZARD OF ELECTRIC SHOCK, EXPLOSION, OR ARC FLASH

- Install the SCR assembly shield as shown in Figure 103.
- Before installing the shield, ensure that it has no tears or cracks. If the shield is damaged, install a new piece from the plastic kit. See page 21.
- Do not install a damaged shield.

Failure to follow these instructions will result in death or serious injury.

9. Replace the transparent shield over the SCR assembly. See Figure 103.

Figure 103: SCR Assembly Shield

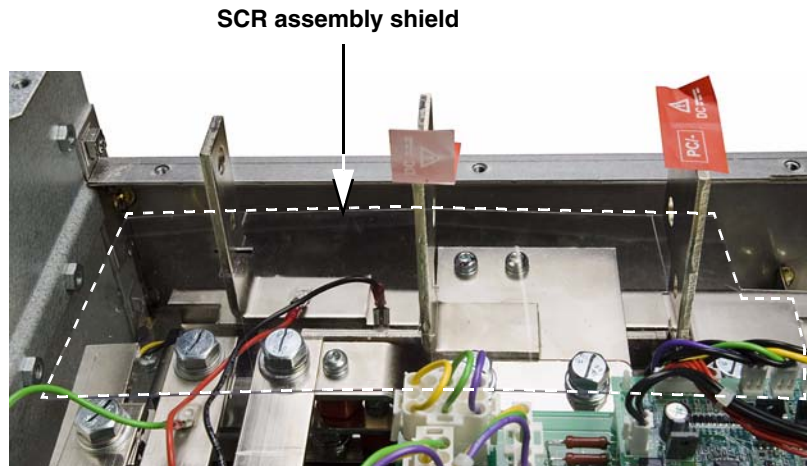

Replace the Fan Plate

10. Replace the fan plate as follows.

- Replace the internal fan connections on the back of the fan plate, and position the fan plate in the drive. See Figure 104.
- Using an 18 mm socket wrench, replace five nuts and bolts on the PO, PA+, and PC bus bars (**D**, Figure 105 on page 100).
- Using a T-30 Torx right-angle driver, secure the PO, PA+, and PC/-bus bars to the red insulators on fan plate with three screws (**C**, Figure 105 on page 100).
- Using a T-30 Torx driver, secure the fan plate to the drive frame with four screws (**B**, Figure 106 on page 100).
- Tighten the hardware to the torque values specified in Table 32 on page 100.

Figure 104: Internal Fan Connections

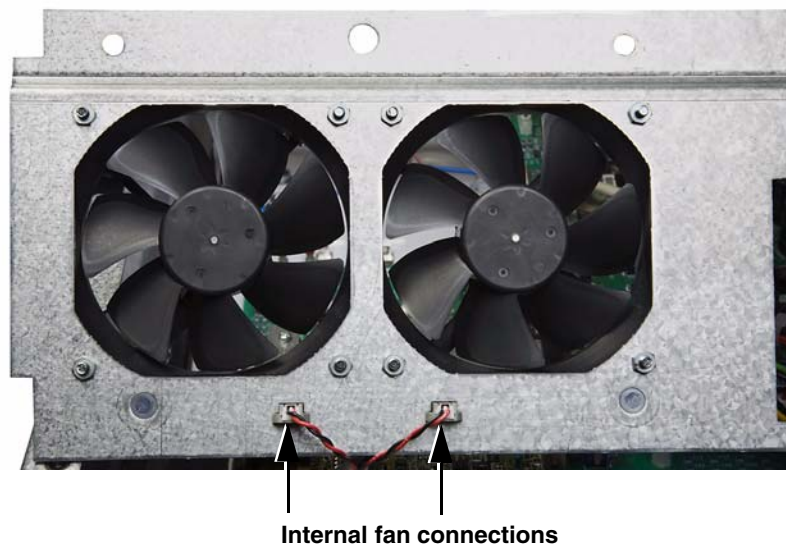
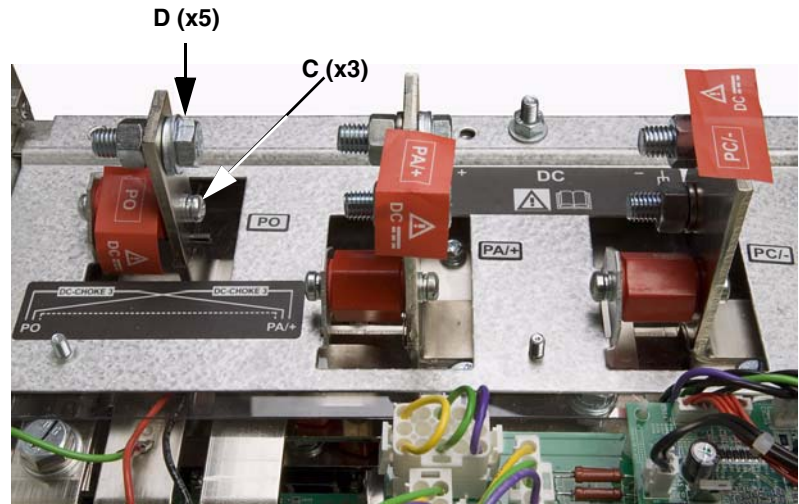

Figure 105: Fan Plate with Bus Bar Detail

Table 32: Fan Plate Hardware Torque Values

Item	Description	Torque Range	
		N•m	lb-in
A	(6) 10 mm nuts	5.5	48.7
B	(4) T-30 screws	5.5	48.7
C	(3) T-30 screws	5.5	48.7
D	(5) 18 mm bolts	45	398



Replace the Top Crossbrace

11. Using a 10 mm socket wrench, secure the top crossbrace to the fan plate and drive frame with six nuts (A, Figure 106). Tighten the nuts to the torque values specified in Table 32.

Figure 106: Fan Plate and Crossbrace

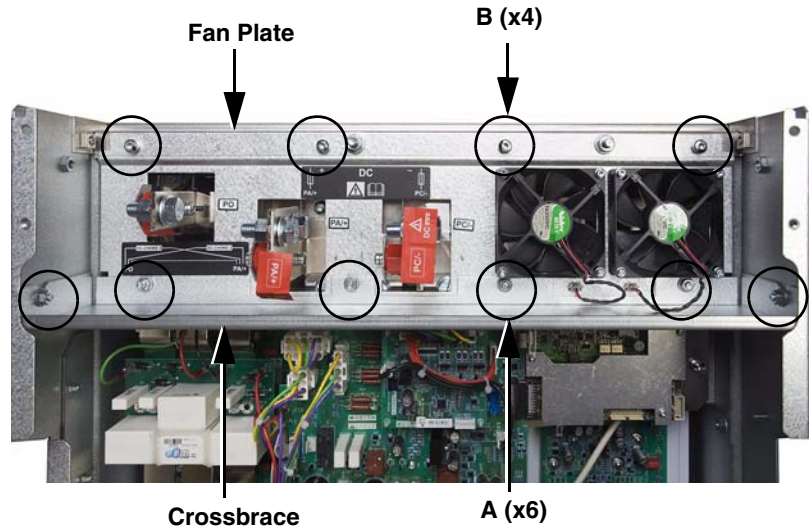

Replace the Control Module Assembly

12. Connect the ribbon cable (wire **E112**, Figure 107) from power board terminal X11 to the back of the control module assembly.

Figure 107: Control Module Assembly Back

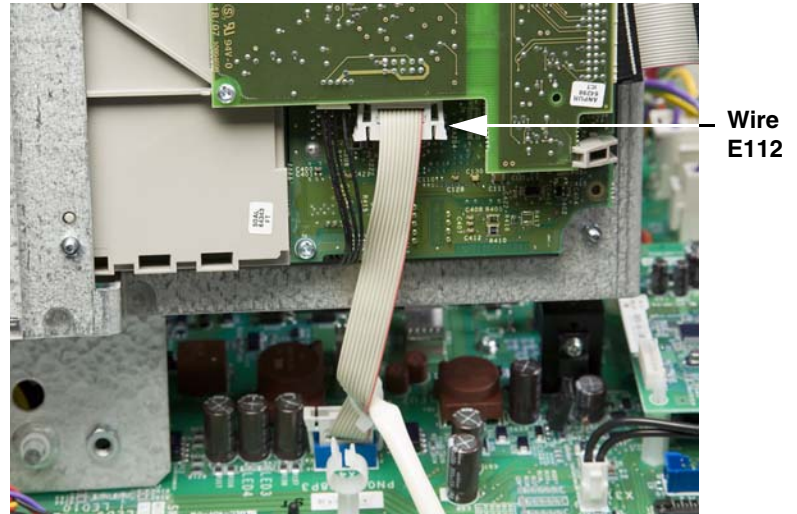

13. Using a 10 mm socket wrench, secure the control module assembly to the drive frame with two nuts (Figure 108). Tighten the nuts to 5.5 N•m (48.7 lb-in).

Figure 108: Control Module Assembly Front

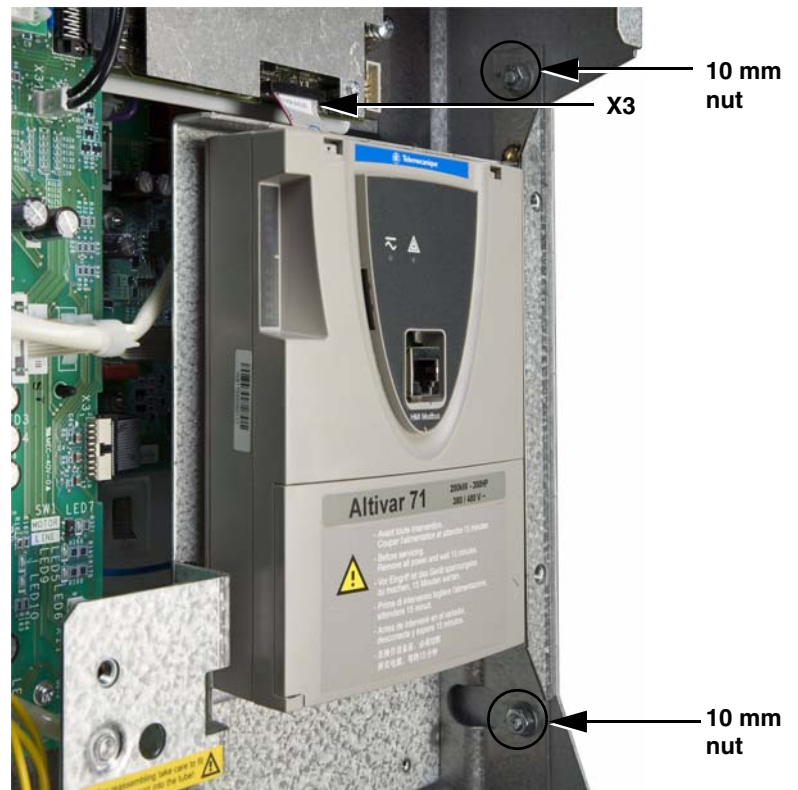

14. Replace the following connections.

- Install the 26-pin ribbon cable from the control module assembly to motor control board terminal X3. See Figure 108 on page 101.
- Install the 5-pin connector from the TB1 bracket to fan control board terminal X4. See Figure 109.

Figure 109: Fan Control Board Terminal X4

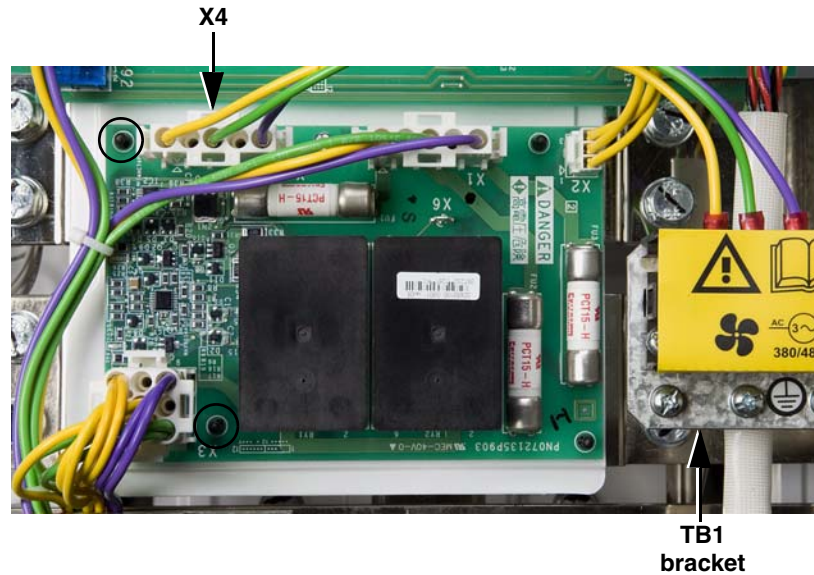

Replace the EMC Tray

15. Using a T-20 Torx driver, secure the EMC tray to the control module plate with three screws. See Figure 110. Tighten the screws to 1.1–1.7 N•m (9.7–15.0 lb-in).

Figure 110: EMC Tray



Replace the Power Terminal Shield

16. Replace the power terminal shield as follows.

⚠ DANGER

HAZARD OF ELECTRIC SHOCK, EXPLOSION, OR ARC FLASH

- Install the power terminal shield as shown in Figures 111 and 112.
- Before installing the shield, ensure that it has no tears or cracks. If the shield is damaged, install a new piece from the plastic kit. See page 21.
- Do not install a damaged shield.

Failure to follow these instructions will result in death or serious injury.

- Hook the mounting holes on the left side of the shield over the posts on the side panel of the drive (**B**, Figure 111).
- Insert the retaining tabs on the right side of the shield in the slots on the conduit tray (**A**, Figure 112).

Figure 111: Power Terminal Shield Retaining Posts



Figure 112: Power Terminal Shield

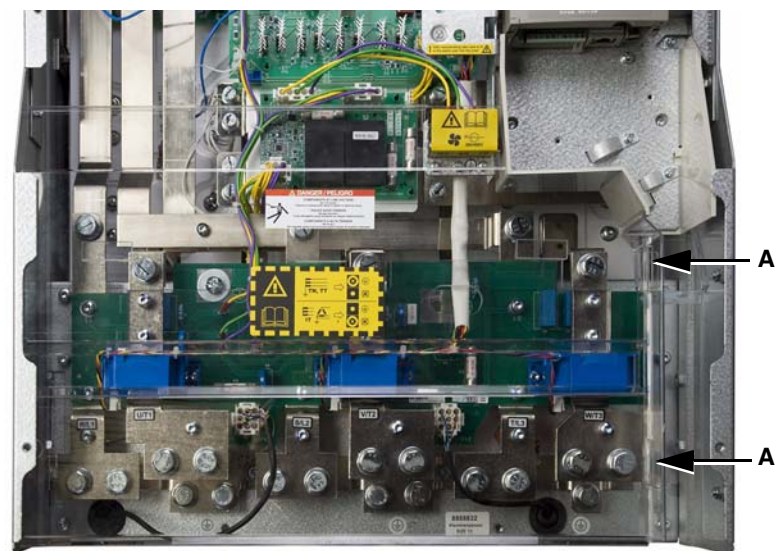

Replace the Front Cover

17. Replace the front cover. Using a size 2 Phillips driver, secure the front cover with nine screws. See Figure 7 on page 20. Tighten the screws to 5.5 N•m (48.7 lb-in).

Wiring

Table 33: Wiring Table

Wire No. ¹	Description	From:		To:	
		Component	Terminal No.	Component	Terminal No.
E100	10-pin, white	Power board	X8	Gate driver board V	X81
		Gate driver board V	X81	Gate driver board U	X82
E102	10-pin, white	Gate driver board V	X82	Gate driver board W	X81
E103	9-pin, multi color	Power board	X11	Motor current sensors	—
E105	3-pin, yellow	Fan control board	X2	Power board	X14
E106	2-pin, red/black	Power board	X21, X22	Internal fan	—
E107	2-pin, Yellow/black	Soft charge board	CNL1G	SCR 1	4, 5
E108	2-pin, green/black	Soft charge board	CNL2G	SCR 2	4, 5
E109	2-pin, violet/black	Soft charge board	CNL3G	SCR 3	4, 5
E110	9-pin, red	Soft charge board	CN2A	Power board	X30
E111	2-pin, black	Soft charge board	CN7A	Power board	X31
E112	10-pin, gray	Power board	X4	Control module	—
E114	9-pin, black/white/brown/blue with yellow & green ground wire	Fan control board	X3	Filter board	X11, X12
E115	9-pin, black sleeve	Filter board	A7/X11	Heatsink fan 1	—
E118	5-pin, violet/green/yellow	Fan control board	X1	Filter board	X1
					X2
					X3
E120	6-pin, yellow/green/violet	Power board	X7	Filter board	X11
					X12
					X13
E123	1-pin, blue	Gate driver board V	X52	Gate driver board W	X51
E124	5-pin, violet/green/yellow	Fan control board	X4	Fan control terminal block TB1	—
E125	9-pin, black sleeve	Filter board	A7/X12	Heatsink fan 2	—
E126	1-pin, red	SCR snubber board	X10	Power board	RFS +X10
E127	1-pin, blue	Gate driver board U	X52	Gate driver board V	X51
E128	2-pin, black	Gate driver board V	X4	Temperature sensor V	—

Table 33: Wiring Table (continued)

Wire No. ¹	Description	From:		To:	
		Component	Terminal No.	Component	Terminal No.
E129	1-pin, violet	Power board	X93	Dynamic braking board ²	X20
	1-pin, blue	Dynamic braking board	X20	Gate driver board U	X51
E130	1-pin, red	SCR snubber board	X4	PO/+ bus bar	—
E131	1-pin, green	SCR snubber board	X1	L1 bus bar	—
E132	1-pin, blue	Gate driver board W	X52	Neutral on W DC power bus plate	—
E133	1-pin, black	SCR snubber board	X5	PC/- bus bar	—
E136	1-pin, blue	Power board	UD0	U DC bus plate	—
E138	18-pin, gray	Gate driver board U	X32	Gate driver board V	X31
E139	1-pin, white	Power board	UD +R1	Bleeder resistor	—
E141	1-pin, white	Power board	UD -R1	Bleeder resistor	—
E142	18-pin, gray	Gate driver board V	X32	Gate driver board W	X31
		Gate driver board W	X31	Power board	X3
E143	6-pin, yellow/green/violet	Power board	X5	Gate driver board U	X2
				Gate driver board V	X2
				Gate driver board W	X2
E144	2-pin, black	Gate driver board U	X4	Temperature sensor U	—
E145	2-pin, black	Gate driver board W	X4	Temperature sensor W	—
E161	1-pin, white	R2	—	Bus V	UD+
E162	1-pin, white	R2	—	Bus V	UD-
E171	1-pin, red	SCR snubber board	X11	Power board	RFS +X11
—	10-pin, gray	Power board	X2	Motor control board	X2

¹ Wire numbers are given for cross referencing the wires with the schematic on page 106. The numbers do not appear on the wires.

² The optional dynamic braking board may not be present in the drive.

Figure 113: Wiring Schematic

NOTE: The wiring schematic illustrates connections between the components in the drive. It does not illustrate the layout of the various boards or the connector locations on them.

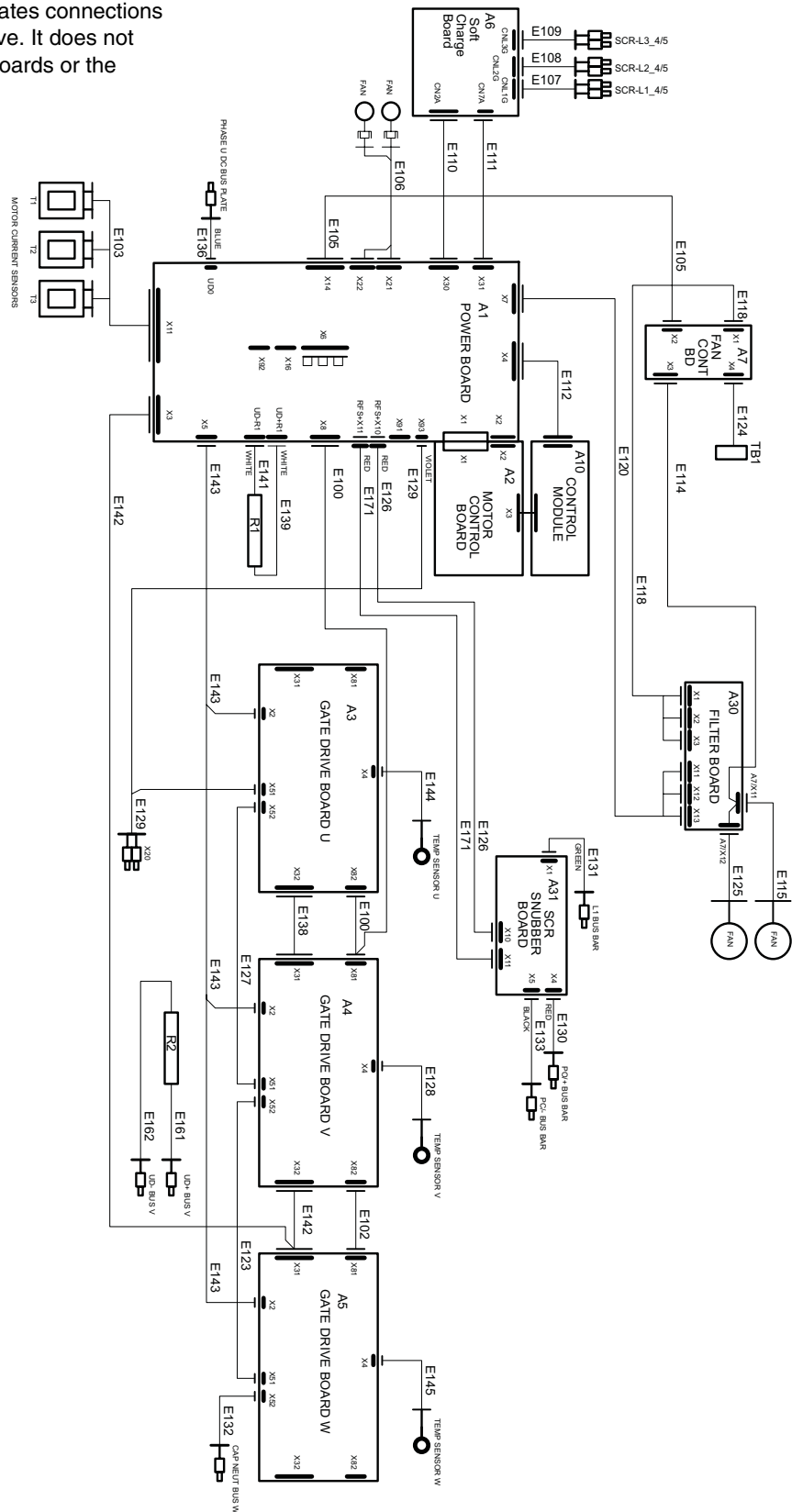

**Spare Parts Kits for Altivar® 61/71 Drives, Frame Size 13
Instruction Bulletin**

Schneider Electric USA

8001 Knightdale Blvd.
Raleigh, NC 27545 USA
1-888-SquareD
(1-888-778-2733)
www.schneider-electric.us

Altivar® is a registered trademark of Schneider Electric. Other trademarks used herein are the property of their respective owners.

Electrical equipment should be installed, operated, serviced, and maintained only by qualified personnel. No responsibility is assumed by Schneider Electric for any consequences arising out of the use of this material.

30072-452-80 © 2009 Schneider Electric All Rights Reserved