

Low voltage

Acti 9

the efficiency you deserve

Catalogue | 03/2016



General

Principle of catalogue numbers, protection (Acti 9)

CA901009E 1

Circuit protection

Choice of circuit protective devices

CA901011E 2

Circuit breaker panorama

CA901000E 4

Neutral breaking circuit breakers

i DPN, DT40, DT60, C40 (Clario, Libro, Prodis)

CA901012E 14

Circuit breakers up to 63 A

iC60a

CA901010E 28

iC60N

CA901002E 33

iC60N double terminals

CA901019E 42

iC60H

CA901003E 47

iC60H double terminals

CA901020E 56

iC60L

CA901004E 60

iK60 (B curve)

CA901006E 63

iK60 (C curve)

CA901007E 66

iK60 Biconnect

CA901027E 72

Circuit breakers up to 125 A

C120a, N, H (RSA)

CA901017E 83

C120N

CA901015E 88

C120H

CA901016E 92

High performance circuit breakers

NG125a

CM901027E 95

NG125N

CM901028E 99

NG125H

CM901029E 105

NG125L

CM901030E 109

Direct current circuit breakers

C60H-DC

CA901024E 115

C60PV-DC

CA901031E 118

C60NA-DC

CA901032E 122

SW60-DC

CA901030E 126

C120NA-DC

CA901043E 130

Motor protection circuit breakers

P25M

CM901026E 134

iC60LMA

CA901005E 139

NG125LMA

CM901031E 142

Fuses

STI

CM901033E 146

DO fuse disconnectors switches (projet Dido)

CA901035E 149

Fuse holder with indicator light SBI

CM901034E 151

Residual current protection

Choice of earth leakage protection devices

CA902000E 154

Overview of the earth leakage protection product range

CA902011E 156

Residual current circuit breakers

iID

CA902002E 159

iID double terminals

CA902018E 174

iID K

CA902007E 180

iID K biconnect

CA902027E 185

IDc, ITG40, ID C40 (Clario, Libro, Prodis)

CA902012E 191

RCCB-ID 125 A

CM902001E 196

RCCB-ID type B

CM902002E 198

Add-on residual current devices for circuit breakers

Vigi iC60

CA902005E 200

Vigi iC60 double terminals

CA902019E 218

Vigi C120

CA902016E 224

Vigi NG125

CM902008E 229

Residual current devices

iDPN Vigi

CA902026E 239

i DPN Vigi, Vigi i DPN, Vigi TG40, Vigi TG60, DT40 Vigi, Vigi DT40, Vigi C40, C40 Vigi (Clario, Libro, Prodis)

CA902013E 245

DPNa Vigi, DPN N Vigi

CA902014E 258

DPN Vigi K

CA902032E 262

SPN N Vigi

CA902017E 264

DPN N Vigi

CA902037E 266

REDS, REDtest

CM902017E 268

Fire protection

Fire prevention unit by arc monitoring

iARC

CA901040E 275

iDPN arc

CA901048E 277

Load protection (surge arrester)

LV surge arresters

iPRF1 - PRF1 - PRD1

CA903005E 280

iPF

CA903001E 286

iPFK

CA903011E 290

iPRD Acti 9

CA903008E 294

iPRD (white product)

CA903002E 298

iQuick PRD

CA903003E 302

iQuick PF

CA903004E 305

Surge arresters for telephon and informatic networks

iPRC/iPRI

CA903006E 307

Surge arresters for photovoltaic installations

iPRD-DC PV (white product)

CA903007E 309

iPRD-PV-DC

CA903009E 312

Disconnection

Switch-disconnectors

iSW Acti 9

CA904027E 316

SW Biconnect switches

CA904030E 322

Trip switch-disconnectors

iSW-NA

CA904013E 327

NG125NA

CM901035E 329

Install, connection, power distribution

Accessorisation/Auxiliarisation

Accessories / Auxiliarisation iC60, iID, iSW-NA, Reflex iC60, RCA, ARA

CA907000E 336

Accessories and auxiliaries for C120, Vigi C120, DPN, C60H-DC devices

CA907013E 343

Accessories and auxiliaries for NG125 devices

CM907004E 351

Circuit breakers and residual current devices accessories

Accessories for iC60, iID, iSW-NA, Reflex iC60, RCA, ARA

CA907001E 352

Accessories for DT60

CA907011E 358

Accessories for C120, DPN, DPN Vigi, C60H-DC devices

CA907012E 360

Accessories for NG125 devices

CM907006E 364

Comb busbar and devices feeders		
Vertical comb busbars	CA907018E	366
Comb busbars selection guide connection to the top	CA907026E	367
Comb busbars selection guide connection to the bottom	CA907027E	377
Lineryg DX : Quick distribution blocks	LIN003	386
Lineryg FM: Quick device feeders	LIN022	388
Lineryg DS: Devices feeders	CA907023E	390
Supervision and switchboard control		
Acti 9 control system		
Smartlink Acti 9	CA907019E	393
Monitoring and control of protections		
Indication and tripping		
Electrical auxiliaries for iC60, iID, iSW-NA, RCA, ARA	CA907002E	401
Electrical auxiliaries for C120, DPN, DPN Vigi, ID, C60H-DC devices	CA907008E	409
Electrical auxiliaries for NG125 devices	CM907005E	415
Remote control		
RCA remote controls for iC60 circuit breakers	CA904011E	419
Automatic reclosers		
ARA automatic reclosers for iC60 and iID	CA904010E	424
Electrical circuit control		
Manual control		
iPB pushbuttons	CA904003E	429
iSSW linear switches	CA904004E	430
DIN rail selector switches iCMB, iCMD, iCME, iCMC, iCMV and iCMA	CA904024E	432
Button holders	CA907007E	435
Electrical control		
Reflex iC60 integrated control circuit breakers	CA904012E	436
ICT contactors	CA904007E	441
iTL impulse relays	CA904008E	458
TL impulse relays (Clario, Libro, Prodis)	CA904020E	473
CT contactors (Clario, Libro, Prodis)	CA904021E	479
TL+ impulse relays	CA904018E	485
CT+ contactors	CA904019E	487
Indication		
Indicators		
iLL indicator lights	CA904006E	489
iSO bells and iRO buzzers	CA904014E	490
iTR transformers	CA904015E	491
Lighting, time and energy management		
Relays iRTA, iRTB, iRTC, iRTH, iRTL, iRTMF, iRBN, iRTBT, iRLI, iERL, iRCP, iRCI, iRCU, iRCC	CA904022E	494
CDS load-shedding	CA904023E	503
Modular iPC power sockets	CA904017E	509
Twilight and time switches, timers, thermostats		
IC twilight switches	LSB02323EN	511
IHP, ITM time switches	LSB02322EN	520
MIN timers	LSB02321EN	535
STD, STU dimmers	LSB02325EN	539
TH4, TH7, THP1, THP2 thermostats	LSB02324EN	547
Complementary technical information		
400 Hz network	CA908005E	555
Influence of ambient temperature	CA908007E	557
Dissipated power, Impedance and Voltage drop	CA908009E	565
Resistance to environmental conditions	CA908027E	568
Connection «Cable-to-cable» iC60, iID double terminals	CA908038E	570
Surface mounting iC60, iK60, iID, iID K, iSW, iSW-NA	CA908042E	571
Circuit protections		
Tripping curves circuit breakers	CA908024E	572
Short-circuit current limiting	CA908025E	581
Cascading	557E4200	599
Protection discrimination	557E4300	638
	557E4305	644
	557E4310	678
	557E4330	685
	CA908036E	705
	CA908032E	708
	CA908006E	725
	CA908022E	751
	CA908035E	752
	CA908040E	757
Acti 9 Smartlink		
Acti 9 Smartlink installation	CA908033E	762
Earth leakage protections		
Routine operating checks	CA908012E	765
Response time of high-sensitivity residual current devices	CA908013E	768
Response time of medium-sensitivity residual current devices	CA908018E	769
Electrical and electromagnetic interference	CA908015E	773
Co-ordination	CA908023E	776
Co-ordination RCBO	CA908039E	783
Surge arrester		
Co-ordination of Surge protection devices	CA903014E	785
Fuses		
SBI/STI curves	CM908003E	795
Impulse relays, contactors		
iTL impulse relays and ICT contactors, choice of rating according to load type	CA908026E	799
Auxiliaries		
Auxiliary indicating contacts for Acti 9 protective devices	CA908028E	805
Auxiliary trip units for Acti 9 protective devices	CA908029E	808
Combination electrical auxiliaries for iC60, iID, iSW-NA, ARA and RCA	CA908030E	814

iID, iC60, Vigi iC60, Reflex iC60, switches

A9 R 15 2 63

Range	Family	Code	Internal code	Poles	Code	Rating (A)	Code
Acti 9 (A9)	iID	R		0	0	0	00
	Vigi iC60	V		1P	1	0.5	70
	iC60	F		2P	2	0.75	71
	iK60	K		3P	3	1	01
	Auxiliaries and accessories	A		4P	4	1.6	72
	Switches	S		1N	5	2	02
	Reflex iC60	C		1P+N	6	2.5	73
				3P+N	7	3	03
						4	04
						6	06
						6.3	76
						8	08
						10	10
						12.5	82
						13	13
						16	16
						20	20
						25	25
						32	32
						40	40
						50	50
						63	63
						80	80
						100	91
						125	92

Comb busbar and comb busbar accessories

A9 X P H 4 12

Range	Family	Code	Type	Type of installation	Number of poles	Dimensioning			
Acti 9 (A9)	Comb busbar	X	Comb busbar		1P	1	Comb busbar		
			Fork teeth	F	Horizontal		H	Number of 18 mm modules (approximately)	
			Pin teeth	P			2P	2	Accessories
			Auxiliarisable	A			3P		Number of pieces per cat. no.
			Accessories				4P		4
			End-piece	E	Double terminals	D	4P balanced, with neutral	5	
			Tooth cover	T	Single terminal	M	3P balanced for single-poles	6	
			Connector	C					

DB123788



Protection of electrical connections against short circuits and overloads

DB123789



Protection of loads against overloads

DB123790



Protection of control devices

DB123792



Protection for people against indirect contacts in IT and TN earthing systems

- Circuit breakers can:
 - break a faulty electrical circuit (short-circuit, overload, insulation fault), to prevent fires,
 - protect control devices,
 - increase the service life of the installation, thanks to its ability to limit the short-circuit current (see module CA908025),
 - in IT and TN systems, they ensure personal protection against electrocution in the event of indirect contacts.
- The choice of circuit breakers must be optimised to provide absolute protection while ensuring continuity of service.
- Although circuit breakers are sometimes used as control units, it is recommended to install separate control devices which are more suitable for frequent switching operations (switch, contactor, impulse relay).

Choice of protective circuit breakers

This depends on several criteria:

- prospective short-circuit current
- max. voltage rating
- planned amperage for the circuit to be protected
- nature and cross section of cables
- ambient temperature (possible derating)
- the network and neutral system, which determine the number of poles of the protective circuit breaker installed on their power supply circuit and the tripping curve
- coordination with the other electrical devices (protection, discrimination, cascading).

Choice of breaking capacity

- The breaking capacity must be greater than or equal to the prospective short-circuit current (Isc) upstream of the circuit-breaker (Isc depends on the length, type of conductor and cross section of the cable and the power of the source).
- However, in the event of use in combination with an upstream circuit-breaker limiting the current, this breaking capacity can possibly be reduced (cascading, see module 557E4200).

Choice of rating

- The rating (In) is chosen above all to protect the electrical connections:
 - for cables: it is chosen according to the cross section and type of conductor,
 - for Canalis prefabricated busbar trunking: it must be simply less than or equal to the rating of the busbar trunking.
- The rating should be greater than the nominal current of the loads.

Choice of tripping curve

The tripping curve makes the protection more or less sensitive to:

- the inrush current at power up
- the overload current.

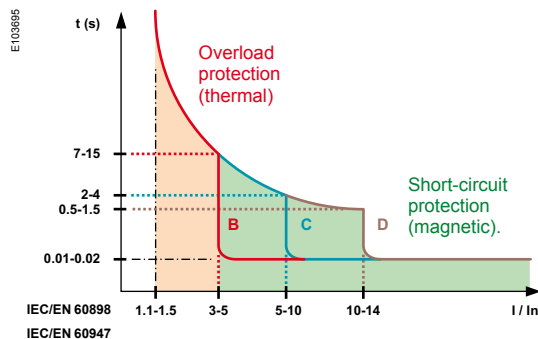

Tripping thresholds ($\times I_n$)

Curves	IEC /EN 60898	IEC/EN 60947-2
B	Between 3 I_n and 5 I_n	4 $\pm 20\%$
C	Between 5 I_n and 10 I_n	8 $\pm 20\%$
D or K	Between 10 I_n and 14 I_n	12 $\pm 20\%$
MA	-	12 $\pm 20\%$
Z	-	3 $\pm 20\%$

- To prevent nuisance tripping, it may be advisable to choose a less sensitive curve, e.g. change from B to C (tripping curves, see module CA908024).

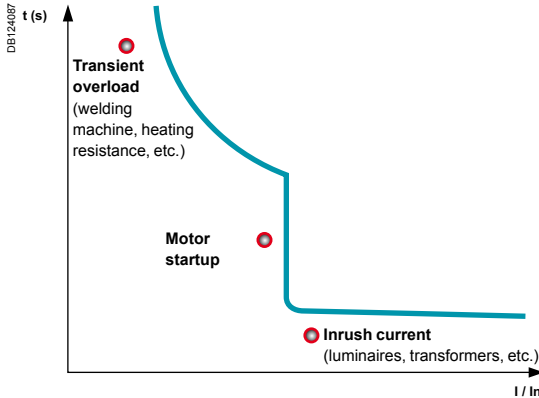

Continuity of service

- Nuisance tripping can be generated by:
 - the inrush current at circuit closure,
 - the overload current, and sometimes the harmonic current flowing through the neutral of three-phase circuits ⁽¹⁾,
 - motor startup currents.

Solutions

- **Choose a circuit breaker with a less sensitive curve:** change from B curve to C curve or from C curve to D curve ⁽²⁾.
- **Reduce the number of loads per circuit.**
- **Energize the circuits in succession,** using time delay auxiliaries on the control devices.
- **Under no circumstances may the circuit breaker rating be increased beyond the maximum constraints permitted by the cable as the electrical connections will no longer be protected.**

Ensure discrimination of the protective devices

(see modules **557E4300**).

Discrimination is the coordination of automatic breaking devices in such a way that a fault occurring at any point on the network is eliminated by the circuit breaker located immediately upstream of the fault, and by it alone.

Total discrimination

For all values of the fault, from overload to non-resistive short circuit, distribution is fully discriminating if D2 opens and if D1 remains closed.

Partial discrimination

Discrimination is partial if the above condition is not complied with up to full short-circuit current, but only up to a lower value. This value is called the discrimination limit.

In the event of a fault exceeding this value, circuit breakers D1 and D2 open.

(1) In the case of three-phase circuits, third-order harmonic currents and harmonic currents that are multiples of three are generated by loads (discharge lamps with electronic ballast, etc.). The neutral cable must be sized to prevent it from overheating. The current flowing through the neutral conductor may become greater than the current of each phase and cause nuisance tripping.

(2) In the case of installations with very long cables in a TN or IT system, it may be necessary to add an earth leakage protection device to protect human life..

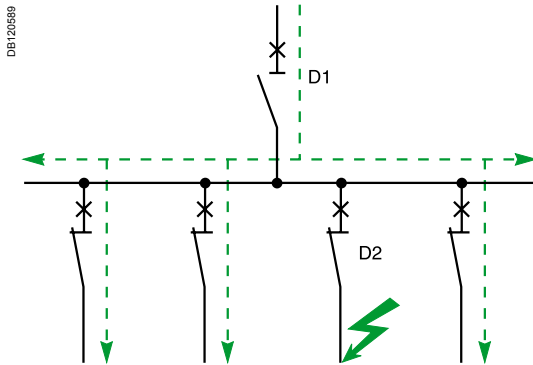

Circuit disconnection

Disconnection

The purpose of disconnection is to separate and isolate a circuit or a device from the rest of the electrical installation in order to ensure the safety of personnel having to work on the electrical installation for maintenance or repair.

- The circuit breaking must be omnipolar, i.e. the live conductors, including neutral ⁽³⁾, must be cut off (depending on country regulations).
- It must be lockable or padlockable in "open" position in order to prevent any unintentional reclosing, at least in industrial environments.
- It must be in compliance with a standard ensuring its suitability for isolation.

(3) With the exception of the PEN conductor which should never be cut off.

Selection guide



Circuit breakers

Type	<i>i</i> DPN		
			
Standard	IEC/EN 60898-1		
Quality label	Country approval pictogram		
Number of poles	1P+N, 3P+N		
Add-on residual current devices (Vigi)	■		
Auxiliaries for remote tripping and indication	■		
Electrical characteristics			
Curves	B, C		
Ratings (A)	In	1 to 40	
Maximum operational voltage (V)	Ue	AC (50/60 Hz)	230/400
	max	DC	–
Minimum operational voltage (V)	Ue	AC (50/60 Hz)	–
	min	DC	–
Insulation voltage (V AC)	Ui	440	
Rated impulse withstand voltage (kV)	Uimp	4	
Limitation class 40 A (EN 60898)	3		
Breaking capacity			
IEC/EN 60898 (A)	Icn	240/415 V - 230/400 V	4500
AC-Breaking capacity		Ue (50/60 Hz)	1P+N, 3P+N
Ratings (A)	In	1 to 40	
IEC 60947-2 (kA)	Icu	12...60 V	–
		12...133 V	–
		100...133 V	–
		220...240 V	6
		380...415 V	–
		440 V	–
	Ics	75 % of Icu	
DC-Breaking capacity		Ue	DC
IEC 60947-2 (kA)	Icu	12...60 V (1P)	–
		≤ 72 V (1P)	–
		≤ 125 V (2P)	–
		≤ 180 V (3P)	–
		≤ 250 V (4P)	–
			Ics
Other characteristics			
Suitable for industrial isolation according to IEC/EN 60947-2	–		
Reference temperature IEC/EN 60947-2	–		
Fault tripping indication	–		
Positive contact indication	■		
Fast closing	■		
Degree of protection	IP	Device only	IP20
		Device in modular enclosure	IP40 Insulation class II
For more detail, see module			CA901012
Accessories			CA907010
Auxiliaries			CA907008 and CA907010
Add-on residual current devices (Vigi)			CA902013

iDPN N	
	
IEC/EN 60898-1	
Country approval pictogram	
1P+N, 3P, 3P+N	
■	
■	
B, C, D	
1 to 40	
AC (50/60 Hz)	230/400
DC	–
AC (50/60 Hz)	–
DC	–
440	
4	
3	
240/415 V - 230/400 V	6000
	1P+N
	3P, 3P+N
	1 to 40
12...60 V	–
12...133 V	–
100...133 V	–
220...240 V	10
380...415 V	15
440 V	10
	–
	75 % of Icu
	75 % of Icu
12...60 V (1P)	–
≤ 72 V (1P)	–
≤ 125 V (2P)	–
≤ 180 V (3P)	–
≤ 250 V (4P)	–
	–
	–
	–
	■
	■
	IP20
	IP40
	Insulation class II
	CA901012
	CA907010
	CA907008 and CA907010
	CA902013

Selection guide

Circuit breakers



Type	iK60N		iC60N					
								
Standard	IEC/EN 60898-1		IEC/EN 60947-2, 60898-1					
Quality label	Country approval pictogram		Country approval pictogram					
Number of poles	1P, 1P+N	2, 3, 4P	1P, 1P+N	2, 3, 4P				
Add-on residual current devices (Vigi)	-		■					
Auxiliaries for remote tripping and indication	-		■					
Electrical characteristics								
Curves	B, C		B, C, D					
Ratings (A)	In	1 to 63	0.5 to 63					
Maximum operational voltage (V)	Ue	AC (50/60 Hz)	230/400		240/415, 440			
	max	DC	-		250			
Minimum operational voltage (V)	Ue	AC (50/60 Hz)	-		12			
	min	DC	-		12			
Insulation voltage (V AC)	Ui	400	500					
Rated impulse withstand voltage (kV)	Uimp	4	6					
Limitation class 40 A (EN 60898)		3	3					
Breaking capacity								
IEC/EN 60898 (A)	Icn	240/415 V - 230/400 V	6000	6000	6000	6000		
AC-Breaking capacity	Ue	(50/60 Hz)	1P, 1P+N	2, 3, 4P	1P, 1P+N	2, 3, 4P		
Ratings (A)	In		1 to 63		0.5 to 4 A	6 to 63 A	0.5 to 4 A	6 to 63 A
IEC 60947-2 (kA)	Icu	12...60 V	-	-	50	36	-	-
		12...133 V	-	-	-	-	50	36
		100...133 V	-	-	50	20	-	-
		220...240 V	-	-	50	10	50	20
		380...415 V	-	-	-	-	50	10
440 V	-	-	-	-	-	25	6	
Ics		-	-	-	100 % of Icu	75 % of Icu	100 % of Icu	75 % of Icu
DC-Breaking capacity	Ue	DC						
IEC 60947-2 (kA)	Icu	12...60 V (1P)	-	-	15		-	-
		≤ 72 V (1P)	-	-	10		-	-
		≤ 125 V (2P)	-	-	10		-	-
		≤ 180 V (3P)	-	-	10		-	-
		≤ 250 V (4P)	-	-	10		-	-
Ics		-	-	-	100 % of Icu		-	-
Other characteristics								
Suitable for industrial isolation according to IEC/EN 60947-2	-		■					
Reference temperature IEC/EN 60947-2	-		50°C					
Fault tripping indication	-		Visi-trip window					
Positive contact indication	-		■					
Fast closing	-		■					
Degree of protection	IP	Device only	IP20	IP20				
		Device in modular enclosure	IP40	IP40				
			Insulation class II	Insulation class II				
For more detail, see module			CA901006 and CA901007		CA901002			
Accessories			-		CA907000 and CA907001			
Auxiliaries			-		CA907000 and CA907002			
Add-on residual current devices (Vigi)			-		CA902005			

iC60H					iC60L											
																
IEC/EN 60947-2, 60898-1					IEC/EN 60947-2, 60898-1											
Country approval pictogram					Country approval pictogram											
1P, 1P+N		2, 3, 4P			1P				2, 3, 4P							
■					■											
■					■											
B, C, D					B, C, K, Z											
0.5 to 63					0.5 to 63											
AC (50/60 Hz)	240/415, 440				240/415, 440											
DC	250				250											
AC (50/60 Hz)	12				12											
DC	12				12											
500					500											
6					6											
3					-											
240/415 V - 230/400 V	10000				10000				15000				15000			
1P, 1P+N		2, 3, 4P			1P				2, 3, 4P							
	0.5 to 4 A	6 to 63 A	0.5 to 4 A	6 to 63 A	0.5 to 4 A	6 to 25 A	32/40 A	50/63 A	0.5 to 4 A	6 to 25 A	32/40 A	50/63 A				
12...60 V	70	42	-	-	100	70	70	70	-	-	-	-				
12...133 V	-	-	70	42	-	-	-	-	100	70	70	70				
100...133 V	70	30	-	-	100	50	36	30	-	-	-	-				
220...240 V	70	15	70	30	100	25	20	15	100	50	36	30				
380...415 V	-	-	70	15	-	-	-	-	100	25	20	15				
440 V	-	-	50	10	-	-	-	-	70	20	15	10				
	100 % of Icu	50 % of Icu	100 % of Icu	50 % of Icu	100 % of Icu	50 % of Icu (1)	50 % of Icu	50 % of Icu	50 % of Icu	50 % of Icu (1)	50 % of Icu	50 % of Icu				
12...60 V (1P)	20				25											
≤ 72 V (1P)	15				20											
≤ 125 V (2P)	15				20											
≤ 180 V (3P)	15				20											
≤ 250 V (4P)	15				20											
	100 % of Icu				100 % of Icu											
■					■											
50°C					50°C											
Visi-trip window					Visi-trip window											
■					■											
■					■											
IP20					IP20											
IP40					IP40											
Insulation class II					Insulation class II											
CA901003					CA901004											
CA907000 and CA907001					CA907000 and CA907001											
CA907000 and CA907002					CA907000 and CA907002											
CA902005					CA902005											

(1) 100 % of Icu for ratings 6 to 25 A under Ue 100 to 133 V AC Ph/Ph and Ue 12 to 60 V AC Ph/N.

Selection guide (cont.)

Circuit breakers

Type	C120N		C120H			
						
Standard	IEC/EN 60898-1		IEC/EN 60898-1			
Quality label	Country approval pictogram		Country approval pictogram			
Number of poles	1P	2, 3, 4P	1P	2, 3, 4P		
Add-on residual current devices (Vigi)	■		■			
Auxiliaries for remote tripping and indication	■		■			
Electrical characteristics						
Curves	B, C, D		B, C, D			
Ratings (A)	In	63 to 125	63 to 125			
Maximum operational voltage (V)	Ue	AC (50/60 Hz)	240/415, 440			
		DC	125 per pole			
Minimum operational voltage (V)	Ue	AC (50/60 Hz)	12			
		DC	12			
Insulation voltage (V AC)	Ui	500	500			
Rated impulse withstand voltage (kV)	Uimp	6	6			
Breaking capacity						
IEC/EN 60898 (A)	Icn	230/400 V	10000	10000	15000	15000
AC-Breaking capacity	Ue	(50/60 Hz)	1P	2, 3, 4P	1P	2, 3, 4P
Ratings (A)	In		63 to 125		63 to 125	
IEC 60947-2 (kA)	Icu	110...130 V	–	–	–	–
		12...130 V	20	–	30	–
		220...240 V	10	20	15	30
		380...415 V	3⁽¹⁾	10	4.5⁽¹⁾	15
		440 V	–	6	–	10
		500 V	–	–	–	–
Ics		75 % of Icu		50 % of Icu		
DC-Breaking capacity						
IEC 60947-2 (kA)	Icu	12...125 V (1P)	15		20	
		≤ 144 V (1P)	10		15	
		≤ 250 V (2P)	10		15	
		≤ 375 V (3P)	10		15	
		≤ 500 V (4P)	10		15	
		Ics		100 % of Icu		100 % of Icu
Other characteristics						
Suitable for industrial isolation according to IEC/EN 60947-2	■		■			
Reference temperature IEC/EN 60947-2	50°C		50°C			
Fault tripping indication	–		–			
Positive contact indication	■		■			
Fast closing	■		■			
Degree of protection	IP	Device only	IP20	IP20		
		Device in modular enclosure	IP40	IP40		
For more detail, see module			CA901015	CA901016		
Accessories			CA907012 and CA907013	CA907012 and CA907013		
Auxiliaries			CA907008 and CA907013	CA907008 and CA907013		
Earth leakage module (Vigi)			CA902016	CA902016		

(1) Breaking capacity under 1 pole with IT isolated neutral system (case of double fault).

	NG125a	NG125N	NG125H	NG125L
				
	IEC/EN 60947-2	IEC/EN 60947-2	IEC/EN 60947-2	IEC/EN 60947-2
	Country approval pictogram	Country approval pictogram	Country approval pictogram	Country approval pictogram
	3, 4P	1P 2, 3P, 3P+N, 4P	1P 2, 3, 4P	1P 2, 3, 4P
	■	■	■	■
	■	■	■	■
	C	B, C, D	C	B, C, D
	80 to 125	10 to 125	10 to 80	10 to 80
AC (50/60 Hz)	240/415, 500	240/415, 500	240/415, 500	240/415, 500
DC	125 per pole	125 per pole	125 per pole	125 per pole
AC (50/60 Hz)	12	12	12	12
DC	12	12	12	12
	690	690	690	690
	8	8	8	8
230/400 V	–	–	–	–
	3, 4P	1P 2, 3P, 3P+N, 4P	1P 2, 3, 4P	1P 2, 3, 4P
	80 to 125	10 to 125	10 to 80	10 to 80
110...130 V	–	50	70	100
12...130 V	–	–	–	–
220...240 V	–	25	36	50
380...415 V	16	6⁽¹⁾	9⁽¹⁾	12.5⁽¹⁾
440 V	–	–	–	–
500 V	8	–	–	–
	75 % of Icu	75 % of Icu	75 % of Icu	75 % of Icu
12...125 V (1P)	–	25	36	50
≤ 144 V (1P)	–	20	25	36
≤ 250 V (2P)	–	20	25	36
≤ 375 V (3P)	20	20	25	36
≤ 500 V (4P)	20	20	25	36
	100 % of Icu	100 % of Icu	100 % of Icu	100 % of Icu
	■	■	■	■
	40°C	40°C	40°C	40°C
	■ Toggle position ■ Red mechanical indicator	■ Toggle position ■ Red mechanical indicator	■ Toggle position ■ Red mechanical indicator	■ Toggle position ■ Red mechanical indicator
	■	■	■	■
	■	■	■	■
	IP20	IP20	IP20	IP20
	IP40	IP40	IP40	IP40
	CM901027	CM901028	CM901029	CM901030
	CM907004 and CM907006	CM907004 and CM907006	CM907004 and CM907006	CM907004 and CM907006
	CM907004 and CM907005	CM907004 and CM907005	CM907004 and CM907005	CM907004 and CM907005
	CM902008	CM902008	CM902008	CM902008

(1) Breaking capacity under 1 pole with IT isolated neutral system (case of double fault).

Selection guide (cont.)

Circuit breakers			
Type	iC60a		
			
Standard	IEC/EN 60947-2, 60898-1		
Quality label	Country approval pictogram		
Number of poles	1P	2, 3, 4P	
Add-on residual current devices (Vigi)	■		
Auxiliaries for remote tripping and indication	■		
Electrical characteristics			
Curves	C		
Ratings (A)	In	1 to 63	
Maximum operational voltage (V)	Ue	AC (50/60 Hz)	240/415
	max	DC	–
Minimum operational voltage (V)	Ue	AC (50/60 Hz)	–
	min	DC	–
Insulation voltage (V AC)	Ui	500	
Rated impulse withstand voltage (kV)	Uimp	6	
Limitation class 40 A (EN 60898)	3		
Breaking capacity			
IEC/EN 60898 (A)	Icn	240/415 V - 230/400 V	4500
AC-Breaking capacity	Ue	(50/60 Hz)	1P 2, 3, 4P
Ratings (A)	In	1 to 63	
IEC 60947-2 (kA)	Icu	12...60 V	–
		12...133 V	–
		100...133 V	–
		220...240 V	6 10
		380...415 V	– 6
		440 V	–
Ics	100 % of Icu		
DC-Breaking capacity	Ue	DC	
IEC 60947-2 (kA)	Icu	12...48 V (1P)	–
		≤ 72 V (1P)	–
		≤ 125 V (2P)	–
		≤ 180 V (3P)	–
		≤ 250 V (4P)	–
		Ics	–
Other characteristics			
Suitable for industrial isolation according to IEC/EN 60947-2	■		
Reference temperature IEC/EN 60947-2	50°C		
Fault tripping indication	Visi-trip window		
Positive contact indication	■		
Fast closing	■		
Degree of protection	IP	Device only	IP20
		Device in modular enclosure	IP40 Insulation class II
For more detail, see module			CA901010
Accessories			CA907000 and CA907001
Auxiliaries			CA907000 and CA907002
Add-on residual current devices (Vigi)			CA902005

Selection guide (cont.)

Instantaneous circuit breakers (ICB)				
Type	iC60LMA		NG125LMA	
				
Standard	IEC/EN 60947-2		IEC/EN 60947-2	
Quality label	Country approval pictogram		Country approval pictogram	
Number of poles	2, 3P		2, 3P	
Add-on residual current devices (Vigi)	■		■	
Auxiliaries for remote tripping and indication	■		■	
Electrical characteristics				
Curves	MA (li = 12 In ± 20 %)		MA (li = 12 In ± 20 %)	
Ratings (A)	In	1.6 to 40	4 to 80	
Maximum operational voltage (V)	Ue AC (50/60 Hz)	440	500	
	max DC	–	–	
Minimum operational voltage (V)	Ue AC (50/60 Hz)	12	12	
	min DC	–	–	
Insulation voltage (V AC)	Ui	500	690	
Rated impulse withstand voltage (kV)	Uimp	6	8	
Breaking capacity				
IEC/EN 60898 (A)	Icn 230/400 V	–	–	
AC-Breaking capacity	Ue (50/60 Hz)	2, 3P	2, 3P	
Ratings (A)	In	1.6 to 16 A	25 to 40 A	
IEC 60947-2 (kA)	Icu	12...60 V	–	
		12...133 V	–	
		100...133 V	–	
		110...130 V	–	
		130 V	–	
		220...240 V	40	30
		230/400 V	–	–
		380...415 V	20	15
		400/415 V	–	–
		440 V	15	10
500 V	–	–		
	Ics	50 % of Icu	50 % of Icu	
75 % of Icu				
Other characteristics				
Suitable for industrial isolation according to IEC/EN 60947-2	■		■	
Reference temperature IEC/EN 60947-2	50°C		40°C	
Fault tripping indication	Visi-trip window		■ Toggle position ■ Red mechanical indicator	
Positive contact indication	■		■	
Fast closing	■		■	
Degree of protection	IP	Device only	IP20	
		Device in modular enclosure	IP40	
		Insulation class II		
For more detail, see module				
Accessories	CA901005		CM901031	
Auxiliaries	CA907000 and CA907001		CM907004 and CM907006	
Auxiliaries	CA907000 and CA907002		CM907004 and CM907005	
Add-on residual current devices (Vigi)	CA902005		CM902008	

Selection guide (cont.)

P25M circuit breakers													
Type			P25M										
													
Standard			IEC 60947-2 and IEC 60947-4-1										
Quality label			CEBEC, DEMCO, NEMKO, SEMKO, FI										
Number of poles			3P										
Add-on residual current devices (Vigi)			-										
Auxiliaries for remote tripping and indication			■										
Electrical characteristics													
Magnetic tripping			12 In ($\pm 20\%$)										
Ratings (A)			In 0.16 to 25 (63 A with limiter block)										
Maximum operational voltage (V)			Ue max		AC (50/60 Hz)			690					
					DC			-					
Minimum operational voltage (V)			Ue min		AC (50/60 Hz)			230					
					DC			-					
Insulation voltage (V AC)			Ui		690								
Rated impulse withstand voltage (kV)			Uimp		6								
Breaking capacity													
AC-Breaking capacity			Ue (50/60 Hz)		3P								
Ratings (A)			In		0.16 to 1.6	2.5	4	6.3	10	14	18	23	25
IEC 60947-2 (kA)			Icu 230...240 V		Unlimited						50	50	
			Ics		-						100 % of Icu		
			Icu 400...415 V		Unlimited						15	15	
			Ics		-						50 % of Icu		
			Icu 440 V		Unlimited		50	15	8	8	6	6	
			Ics		-						100 % of Icu		
			Icu 500 V		Unlimited		50	10	6	6	4	4	
			Ics		-						100 % of Icu		
			Icu 690 V		Unlimited	3	3	3	3	3	3	3	
			Ics		-						75 % of Icu		
Other characteristics													
Suitable for industrial isolation according to IEC/EN 60947-2			■										
Fault tripping indication			Toggle position										
Positive contact indication			-										
Fast closing			-										
Degree of protection			IP		Device only			IP20					
					Device in modular enclosure			IP40					
For more detail, see module			CM901026										
Accessories			CM901026										
Auxiliaries			CM901026										
Add-on residual current devices (Vigi)			-										

Selection guide (cont.)

Circuit breakers				
Type	xC60			
				
Standard	IEC/EN 60947-2, 60898-1			
Quality label	Country approval pictogram			
Number of poles	1P	2, 3, 4P		
Add-on residual current devices (Vigi)	■			
Auxiliaries for remote tripping and indication	■			
Electrical characteristics				
Curves	B, C, D			
Ratings (A)	In	B curve: 6 to 63 - C curve: 0.5 to 63 - D curve: 1 to 63		
Maximum operational voltage (V)	Ue max	AC (50/60 Hz) DC	240/415 -	
Minimum operational voltage (V)	Ue min	AC (50/60 Hz) DC	- -	
Insulation voltage (V AC)	Ui	500		
Rated impulse withstand voltage (kV)	Uimp	6		
Limitation class up to 40 A (EN 60898)	-			
Breaking capacity				
AC-Breaking capacity	Ue	(50/60 Hz)	1P 2, 3, 4P	
Ratings (A)	In	B curve: 6 to 63 - C curve: 0.5 to 63 - D curve: 1 to 63		
IEC 60947-2 (kA)	Icu	12...133 V	-	
		220...240 V	≤ 40 A Curves B, C, D	15
	50-63 A Curves B, C		10	
	50-63 A Curve D		6	
	380...415 V	≤ 40 A Curves B, C, D	-	15
		50-63 A Curves B, C	-	10
		50-63 A Curve D	-	6
	440 V	-		
	Ics	≤ 40 A Curves B, C, D 50-63 A Curves B, C 50-63 A Curve D	50 % Icu	
			75 % Icu	
100 % Icu				
IEC/EN 60898 (A)	Icn	240/415 V - 230/400 V	10,000	
DC-Breaking capacity				
IEC 60947-2 (kA)	Icu	12...48 V (1P)	15	
		60 V (1P)	6	
		100...125 V (2P in series) (3P in series)	6	
			15	
	220...250 V (4P in series)	6		
Ics	100 % Icu			
Other characteristics				
Suitable for industrial isolation according to IEC/EN 60947-2	■			
Reference temperature IEC/EN 60947-2	50°C			
Fault tripping indication	■			
Positive contact indication	■			
Fast closing	■			
Degree of protection	IP	Device only	IP20	
		Device in modular enclosure	IP40 Insulation class II	
For more detail, see module				
Accessories	CA901029			
Auxiliaries	CA907000 and CA907001			
Add-on residual current devices (Vigi)	CA907000 and CA907002			
	CA902029			



The Schneider Electric circuit breaker range comprises various offers (Clario, Prodis, Libro) so as to be as competitive as possible in each country, taking into account the specific features of each market:

- installation customs
- price
- approval by local organizations.

Variants

Offers		Pages
Clario	Catalogue numbers	15
Prodis	Catalogue numbers	19
Libro	Catalogue numbers	23
Common pages		26



Only the product range to be marketed in your country and validated by the local product manager, in agreement with his Final Distribution (FD) partner should be retained. The others will be removed before publication.

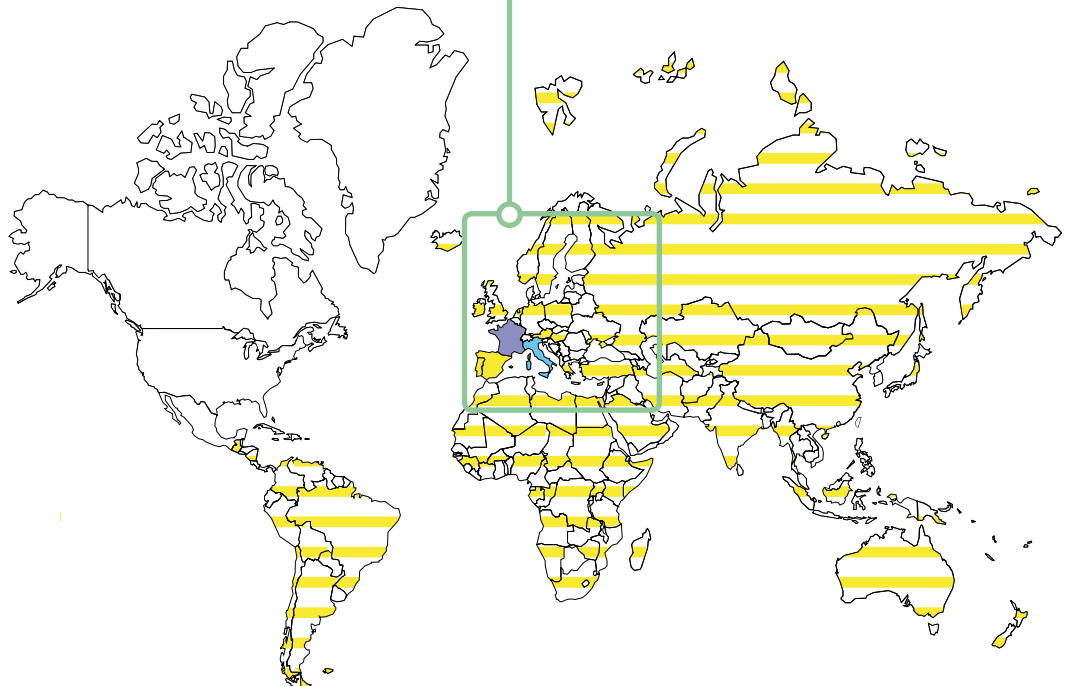



Country approval pictogram

IEC/EN 60898-1

- i DPN are circuit breakers which combine the following functions:
 - circuit protection against short-circuit currents,
 - circuit protection against overload currents,
 - suitable for isolation according to IEC/EN 60898-1 standard.

Offer selection see page 14

Clario

This sticker must be removed before publishing



Catalogue numbers

i DPN circuit breakers				
4500				
Type	1P+N		3P+N	
Auxiliaries	Modules CA907008 and CA907010		Modules CA907008 and CA907010	
Vigi	Module CA902013		Module CA902013	
Rating (In)	B curve	C curve	B curve	C curve
1 A	-	A9N21542	-	-
2 A	-	A9N21543	-	-
3 A	-	A9N21544	-	-
6 A	A9N21535	A9N21545	A9N17489*	A9N17525*
10 A	A9N21536	A9N21546	A9N17490*	A9N17526*
13 A	A9N21723	A9N21724	A9N21731	A9N21732
16 A	A9N21537	A9N21547	A9N17491*	A9N17527*
20 A	A9N21538	A9N21548	A9N17492*	A9N17528*
25 A	A9N21539	A9N21549	A9N17493*	A9N17529*
32 A	A9N21540	A9N21550	A9N17494	A9N17530*
40 A	A9N21541	A9N21551	A9N17495*	A9N17531*
Width in 9-mm modules	2		6	
Accessories	Module CA907010			

(*) Libro catalogue number, IMQ approval

DB123400



Country approval pictogram

IEC/EN 60947-2
IEC/EN 60898-1

- i DPN F are circuit breakers which combine the following functions:
 - circuit protection against short-circuit currents,
 - circuit protection against overload currents,
 - suitable for isolation according to IEC/EN 609898-1 standard.

Offer selection see page 14

Clario

This sticker must be removed before publishing

PB1107140-32



Catalogue numbers

i DPN F circuit breakers

	6000
Type	1P+N
Auxiliaries	Modules CA907008 and CA907010
Vigi	Module CA902013
Rating (In)	C curve
1 A	A9N21638
2 A	A9N21641
3 A	A9N21642
6 A	A9N21643
10 A	A9N21644
16 A	A9N21645
20 A	A9N21646
25 A	A9N21647
32 A	A9N21648
40 A	A9N21649
Width in 9-mm modules	2
Accessories	Module CA907010

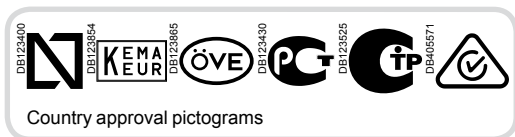

IEC/EN 60898-1
IEC/EN 60947-2 for 1P+N C curve products

- i DPN N are circuit breakers which combine the following functions:
 - circuit protection against short-circuit currents,
 - circuit protection against overload currents,
 - suitable for isolation according to IEC/EN 60898-1 standard.

Offer selection see page 14

Clario

This sticker must be removed before publishing



Catalogue numbers

i DPN N circuit breakers								
6000								
Type	1P+N			3P		3P+N		
Auxiliaries	Modules CA907008 and CA907010			Modules CA907008 and CA907010		Modules CA907008 and CA907010		
Vigi	Module CA902013			Module CA902013		Module CA902013		
Rating (In)	B curve	C curve	D curve	C curve	D curve	B curve	C curve	D curve
1 A	-	A9N21552	-	-	-	-	-	-
2 A	-	A9N21553	-	-	-	-	-	-
3 A	-	A9N21554	-	-	-	-	-	-
4 A	A9N17515	A9N21722	-	-	-	-	-	-
6 A	A9N17516	A9N21555	A9N21565	A9N21575	A9N21585	A9N17553*	A9N21595	A9N21605
10 A	A9N17517	A9N21556	A9N21566	A9N21576	A9N21586	A9N17554*	A9N21596	A9N21606
13 A	A9N17518	A9N21725	A9N21726	A9N21727	A9N21728	A9N17581	A9N21729	A9N21730
16 A	A9N17519	A9N21557	A9N21567	A9N21577	A9N21587	A9N17555*	A9N21597	A9N21607
20 A	A9N17520	A9N21558	A9N21568	A9N21578	A9N21588	A9N17556*	A9N21598	A9N21608
25 A	A9N17521	A9N21559	A9N21569	A9N21579	A9N21589	A9N17557*	A9N21599	A9N21609
32 A	A9N17522	A9N21560	A9N21570	A9N21580	A9N21590	A9N17558*	A9N21600	A9N21610
40 A	A9N17523	A9N21561	A9N21571	A9N21581	A9N21591	A9N17559*	A9N21601	A9N21611
Width in 9-mm modules	2			6		6		
Accessories	Module CA907010							

(*) Libro catalogue number, IMQ approval

Technical data

Main characteristics		i DPN	i DPN F	i DPN N
Insulation voltage (Ui)	Phase-to-neutral	400 V	400 V	400 V
	Phase-to-phase	440 V	-	440 V
Voltage rating (Ue)	Phase-to-neutral	230...240 V	230...240 V	230...240 V
	Phase-to-phase	400...415 V	-	400...415 V
Magnetic tripping	B curve	3 to 5 In	-	■
	C curve	5 to 10 In	■	■
	D curve	10 to 14 In	-	■
Operating frequency		50 Hz	50 Hz	50 Hz
According to IEC/EN 60898-1				
Limitation class		3	3	3
Rated breaking capacity (Icn)		4500 A	6000 A	6000 A
Service breaking capacity (Ics)		100 % Icn	100 % Icn	100 % Icn
Rated breaking and making capacity on a single pole (Icn1)		Icn1 = Icn	Icn1 = Icn	Icn1 = Icn
According to IEC 60947-2				
Rated impulse withstand voltage (Uimp)		-	4 kV	4 kV
Breaking capacity (Icu)		-	6 kA	10 kA
Service breaking capacity (Ics)		-	75 % Icu	75 % Icu
Pollution degree		-	3	3
Additional characteristics				
Degree of protection (IEC 60529)	Device only	IP20		
	Device in modular enclosure	IP40		
Endurance (O-C)	Electrical	≤ 20 A	20000 cycles	
		≥ 25 A	10000 cycles	
	Mechanical	20000 cycles		
Operating temperature		-25°C to +70°C		
Storage temperature		-40°C to +70°C		
Tropicalization (IEC 60068-1)		Treatment 2 (relative humidity of 95 % at 55°C)		
Neutral opening and closing shifted relative to phases		No surge upon operation of the device		

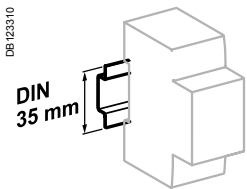

Clip on DIN rail 35 mm.

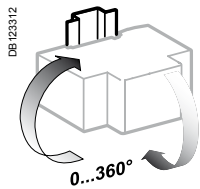

Indifferent position of installation.

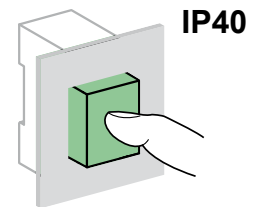
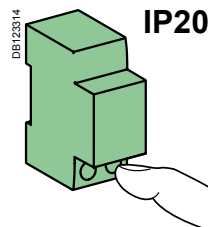

Dimensions (mm)

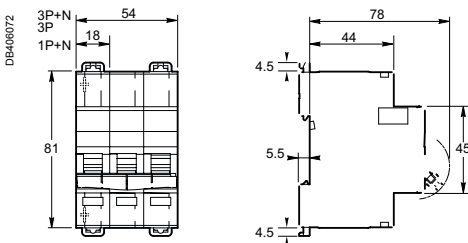

Weight (g)

Circuit breakers	
Type	i DPN, i DPN F, i DPN N
1P+N	115
3P	310
3P+N	322

Offer selection see page 14

Clario

This sticker must be removed before publishing

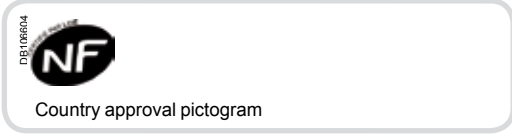

IEC/EN 60947-2
IEC/EN 60898-1

- DT40K are circuit breakers which combine the following functions:
 - circuit protection against short-circuit currents,
 - circuit protection against overload currents,
 - suitable for isolation according to IEC/EN 60898-1 standard.

Offer selection see page 14

Prodis

This sticker must be removed before publishing



Catalogue numbers

DT40K circuit breakers		
4500		
Type	1P+N	3P+N
	<p>DB40877</p>	<p>DB40879</p>
Auxiliaries	Without auxiliary	Without auxiliary
Vigi	Without Vigi	Without Vigi
Rating (In)	C curve	C curve
2 A	A9N21101	-
6 A	A9N21102	-
10 A	A9N21103	A9N21113
16 A	A9N21104	A9N21114
20 A	A9N21105	A9N21115
25 A	A9N21106	A9N21116
32 A	A9N21107	A9N21117
40 A	A9N21108	A9N21118
Width in 9-mm modules	2	6
Accessories	Module CA907010	

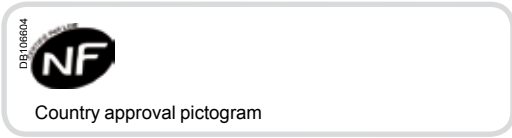

IEC/EN 60947-2
IEC/EN 60898-1

- DT40 and DT60 are circuit breakers which combine the following functions:
 - circuit protection against short-circuit currents,
 - circuit protection against overload currents,
 - suitable for isolation according to IEC/EN 609898-1 standard.

Prodis

Offer selection see page 14

This sticker must be removed before publishing



Catalogue numbers

DT40 circuit breakers						
4500						
Type	1P+N		3P		3P+N	
Auxiliaries	Modules CA907008 and CA907010		Modules CA907008 and CA907010		Modules CA907008 and CA907010	
Vigi	Module CA902013		Module CA902013		Module CA902013	
Rating (In)	B curve	C curve	C curve	D curve	C curve	D curve
1 A	-	A9N21019	-	-	-	-
2 A	-	A9N21020	-	-	-	-
3 A	-	A9N21021	-	-	-	-
4 A	-	A9N21022	-	-	-	-
6 A	A9N21009	A9N21023	A9N21043	A9N21053	A9N21063	A9N21073
10 A	A9N21010	A9N21024	A9N21044	A9N21054	A9N21064	A9N21074
16 A	A9N21011	A9N21025	A9N21045	A9N21055	A9N21065	A9N21075
20 A	A9N21012	A9N21026	A9N21046	A9N21056	A9N21066	A9N21076
25 A	A9N21013	A9N21027	A9N21047	A9N21057	A9N21067	A9N21077
32 A	A9N21014	A9N21028	A9N21048	A9N21058	A9N21068	A9N21078
40 A	A9N21015	A9N21029	A9N21049	A9N21059	A9N21069	A9N21079
Width in 9-mm modules	2		6		6	
Accessories	Module CA907010					

Catalogue numbers

DT40N circuit breakers						
6000						
Type	1P+N		3P		3P+N	
Auxiliaries	Modules CA907008 and CA907010		Modules CA907008 and CA907010		Modules CA907008 and CA907010	
Vigi	Module CA902013		Module CA902013		Module CA902013	
Rating (In)	C curve	D curve	C curve	D curve	C curve	D curve
1 A	A9N21360	A9N21371	-		-	-
2 A	A9N21361	A9N21372	-		-	-
3 A	A9N21362	-	-		-	-
4 A	A9N21363	A9N21373	-		-	-
6 A	A9N21364	A9N21374	A9N21384	A9N21394	A9N21404	A9N21414
10 A	A9N21365	A9N21375	A9N21385	A9N21395	A9N21405	A9N21415
16 A	A9N21366	A9N21376	A9N21386	A9N21396	A9N21406	A9N21416
20 A	A9N21367	A9N21377	A9N21387	A9N21397	A9N21407	A9N21417
25 A	A9N21368	A9N21378	A9N21388	A9N21398	A9N21408	A9N21418
32 A	A9N21369	A9N21379	A9N21389	A9N21399	A9N21409	A9N21419
40 A	A9N21370	A9N21380	A9N21390	A9N21400	A9N21410	A9N21420
Width in 9-mm modules	2		6		6	
Accessories	Module CA907010					

Offer selection see page 14

Prodis

This sticker must be removed before publishing



Catalogue numbers

DT60 circuit breakers		
Type	DT60N 6000	DT60H 10000
	3P+N	
Auxiliaries	Modules CA907008 and CA907010	Modules CA907008 and CA907010
Vigi	Module CA902013	Module CA902013
Rating (In)	C curve	C curve
40 A	A9N21030	A9N21032
63 A	A9N21031	-
Width in 9-mm modules	8	
Accessories	Module CA907010 and CA907011	

Technical data

Main characteristics		DT40K	DT40	DT40N	DT60N	DT60H
Insulation voltage (Ui)	Phase-to-neutral	400 V	400 V	400 V	500 V	500 V
	Phase-to-phase	440 V	440 V	440 V	500 V	500 V
Voltage rating (Ue)	Phase-to-neutral	230...240 V	230...240 V	230...240 V	230...240 V	230...240 V
	Phase-to-phase	400...415 V	400...415 V	400...415 V	400...415 V	400...415 V
Magnetic tripping	B curve	3 to 5 In	-	■	-	-
	C curve	5 to 10 In	■	■	■	■
	D curve	10 to 14 In	-	■	-	-
Operating frequency		50 Hz	50 Hz	50 Hz	50 Hz	50 Hz
According to IEC/EN 60898-1						
Limitation class		3	3	3		
Rated breaking capacity (Icn)		4500 A	4500 A	6000 A	6000 A	10000 A
Service breaking capacity (Ics)		100 % Icn	100 % Icn	100 % Icn	100 % Icn	75 % Icn
Rated breaking and making capacity on a single pole (Icn1)		Icn1 = Icn	Icn1 = Icn	Icn1 = Icn	Icn1 = Icn	Icn1 = Icn
According to IEC 60947-2						
Rated impulse withstand voltage (Uimp)		4 kV	4 kV	4 kV	6 kV	6 kV
Breaking capacity (Icu)		4.5 kA	6 kA	10 kA	10 kA	15 kA
Service breaking capacity (Ics)		75 % Icu	75 % Icu	75 % Icu	75 % Icu	50 % Icu
Pollution degree		3			3	
Additional characteristics						
Degree of protection (IEC 60529)	Device only	IP20			IP20	
	Device in modular enclosure	IP40 Insulation class II			IP40 Insulation class II	
Endurance (O-C)	Electrical	≤ 20 A	20000 cycles		-	-
		≥ 25 A	10000 cycles		10000 cycles	10000 cycles
	Mechanical		20000 cycles		20000 cycles	20000 cycles
Operating temperature		-25°C to +70°C		-25°C to +70°C		-25°C to +70°C
Storage temperature		-40°C to +70°C		-40°C to +70°C		-40°C to +70°C
Tropicalization (IEC 60068-1)		Treatment 2 (relative humidity of 95 % at 55°C)				
Neutral opening and closing shifted relative to phases		No surge upon operation of the device				

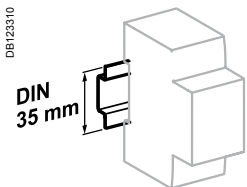

Clip on DIN rail 35 mm.

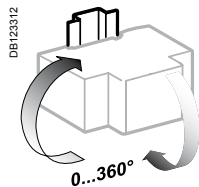

Indifferent position of installation.

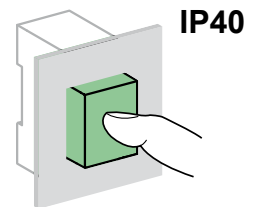
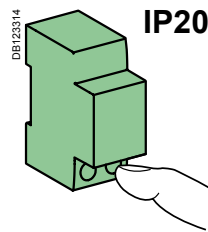

Dimensions (mm)

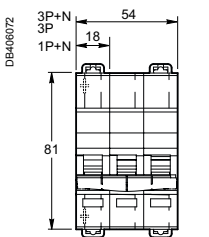

DT40K, DT40, DT40N

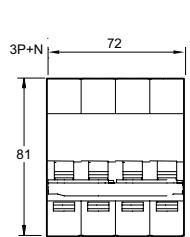
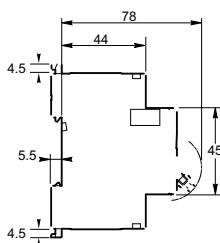

DT60N, DT60H

Weight (g)

Circuit breakers			
Type	DT40K	DT40, DT40N	DT60N, DT60H
1P+N	115	115	-
3P	-	310	-
3P+N	322	322	440

Offer selection see page 14

Prodis

This sticker must be removed before publishing

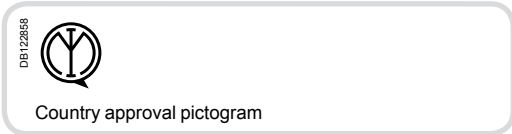

IEC/EN 60898-1

- C40a are circuit breakers which combine the following functions:
 - circuit protection against short-circuit currents,
 - circuit protection against overload currents,
 - suitable for isolation according to IEC/EN 60898-1 standard.



Catalogue numbers

C40a circuit breakers				
4500				
Type	1P+N		3P+N	
Auxiliaries	Modules CA907008 and CA907010		Modules CA907008 and CA907010	
Vigi	Module CA902013		Module CA902013	
Rating (In)	B curve	C curve	B curve	C curve
1 A	-	A9N17503	-	-
2 A	-	A9N17504	-	-
3 A	-	A9N17505	-	-
4 A	-	A9N17506	-	-
6 A	A9N17475	A9N17507	A9N17489	A9N17525
10 A	A9N17476	A9N17508	A9N17490	A9N17526
16 A	A9N17477	A9N17509	A9N17491	A9N17527
20 A	A9N17478	A9N17510	A9N17492	A9N17528
25 A	A9N17479	A9N17511	A9N17493	A9N17529
32 A	A9N17480	A9N17512	A9N17494	A9N17530
40 A	A9N17481	A9N17513	A9N17495	A9N17531
Width in 9-mm modules	2		6	
Accessories	Module CA907010			



IEC/EN 60898-1

- C40N are circuit breakers which combine the following functions:
 - circuit protection against short-circuit currents,
 - circuit protection against overload currents,
 - suitable for isolation according to IEC/EN 60898-1 standard.



Catalogue numbers

C40N circuit breakers				
6000				
Type	1P+N		3P+N	
	<p>DB12389</p>		<p>DB123861</p>	
Auxiliaries	Modules CA907008 and CA907010		Modules CA907008 and CA907010	
Vigi	Module CA902013		Module CA902013	
Rating (In)	B curve	C curve	B curve	C curve
1 A	-	A9N17567	-	-
2 A	-	A9N17568	-	-
3 A	-	A9N17569	-	-
4 A	-	A9N17570	-	-
6 A	A9N17539	A9N17571	A9N17553	A9N17589
10 A	A9N17540	A9N17572	A9N17554	A9N17590
16 A	A9N17541	A9N17573	A9N17555	A9N17591
20 A	A9N17542	A9N17574	A9N17556	A9N17592
25 A	A9N17543	A9N17575	A9N17557	A9N17593
32 A	A9N17544	A9N17576	A9N17558	A9N17594
40 A	A9N17545	A9N17577	A9N17559	A9N17595
Width in 9-mm modules	2		6	
Accessories	Module CA907010			

Technical data

Main characteristics		C40a	C40N
Insulation voltage (Ui)	Phase-to-neutral	400 V	400 V
	Phase-to-phase	440 V	440 V
Voltage rating (Ue)	Phase-to-neutral	230 V	230 V
	Phase-to-phase	400 V	400 V
Magnetic tripping	B curve	3 to 5 I _n	■
	C curve	5 to 10 I _n	■
Operating frequency		50 Hz	50 Hz
According to IEC/EN 60898-1			
Limitation class		3	3
Rated breaking capacity (I _{cn})		4500 A	6000 A
Service breaking capacity (I _{cs})		100 % I _{cn}	100 % I _{cn}
Rated breaking and making capacity on a single pole (I _{cn1})		I _{cn1} = I _{cn}	I _{cn1} = I _{cn}
Additional characteristics			
Degree of protection (IEC 60529)	Device only	IP20	
	Device in modular enclosure	IP40 Insulation class II	
Endurance (O-C)	Electrical	≤ 20 A	20000 cycles
		≥ 25 A	10000 cycles
	Mechanical	20000 cycles	
Operating temperature		-25°C to +70°C	
Storage temperature		-40°C to +70°C	
Tropicalization (IEC 60068-1)		Treatment 2 (relative humidity of 95 % at 55°C)	
Neutral opening and closing shifted relative to phases		No surge upon operation of the device	

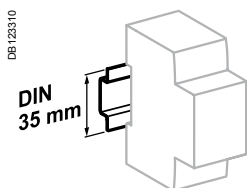

Clip on DIN rail 35 mm.

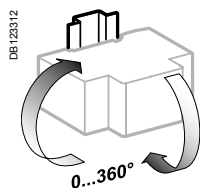

Indifferent position of installation.

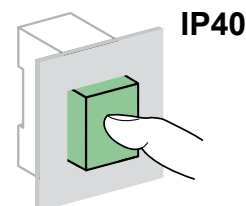
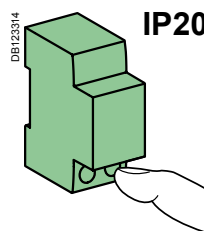

Offer selection see page 14

Librio

This sticker must be removed before publishing

Dimensions (mm)

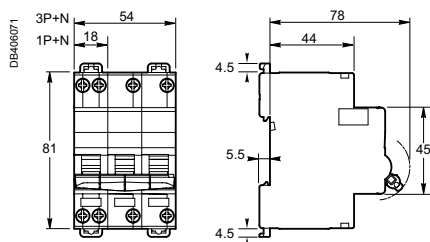

Weight (g)

Circuit breakers	
Type	C40a, C40N
1P+N	115
3P+N	322

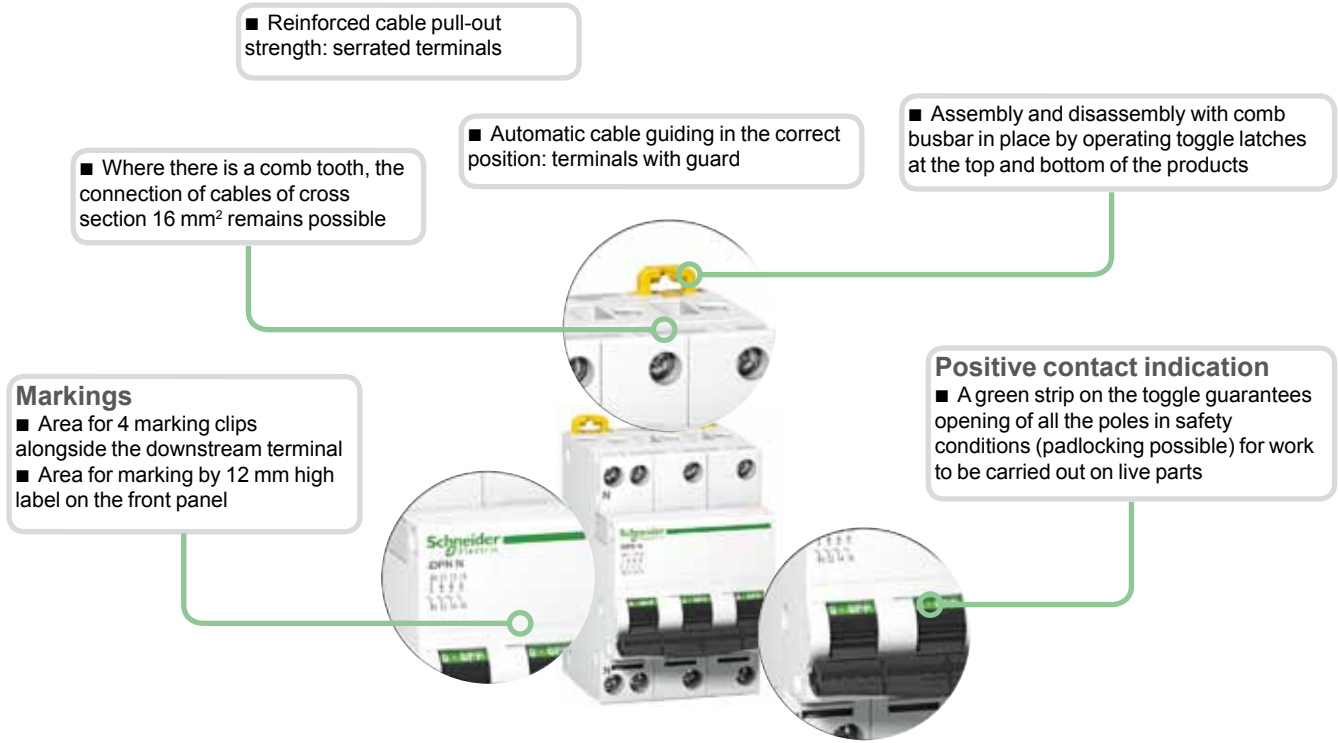

Connection

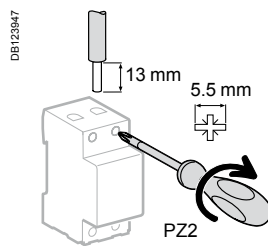

Rating	Tightening torque	Copper cables	
		Rigid	Flexible or with ferrule
DT40, i DPN, C40	2 N.m	DB122945 0.75 to 16 mm ²	DB122946 0.33 to 10 mm ²
DT60	3.5 N.m	0.5 to 35 mm ²	0.5 to 25 mm ²

■ Connection by comb busbar or cables (as per EN 50027).

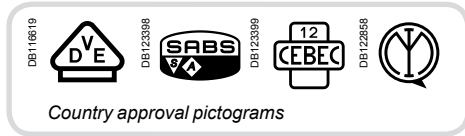

IEC/EN 60947-2
IEC/EN 60898-1



- iC60a circuit breakers are multi-standard circuit breakers which combine the following functions:
 - circuit protection against short-circuit currents,
 - circuit protection against overload currents,
 - suitable for industrial isolation according to IEC/EN 60947-2, standard.
 - fault tripping indication by a red mechanical indicator in circuit breaker front face.

Alternating current (AC) 50/60 Hz			
Breaking capacity (Icu) according to IEC/EN 60947-2			Service breaking capacity (Ics)
	Voltage (Ue)		
Ph/Ph (2P, 3P, 4P)	220 to 240 V	380 to 415 V	
Ph/N (1P)		220 to 240 V	
Rating (In) 1 to 63 A	10 kA	6 kA	100 % of Icu
Breaking capacity (Icn) according to IEC/EN 60898-1			
	Voltage (Ue)		
Ph/Ph	400 V		
Ph/N	230 V		
Rating (In) 1 to 63 A	4500 A		

Catalogue numbers

iC60a circuit breaker

Type		1P	2P
Auxiliaries		Remote tripping and indication, module CA907000 and CA907002	Remote tripping and indication, module CA907000 and CA907002
Vigi iC60		Vigi iC60 add-on residual current device, module CA902005	Vigi iC60 add-on residual current device, module CA902005
Rating (In)	Quality label (1)	Curve C	Curve C
1 A		A9F64101	A9F64201
2 A		A9F64102	A9F64202
3 A		A9F64103	A9F64203
4 A		A9F64104	A9F64204
6 A		A9F64106	A9F64206
10 A		A9F64110	A9F64210
13 A		A9F64113	A9F64213
16 A		A9F64116	A9F64216
20 A		A9F64120	A9F64220
25 A		A9F64125	A9F64225
32 A		A9F64132	A9F64232
40 A		A9F64140	A9F64240
50 A		A9F64150	A9F64250
63 A		A9F64163	A9F64263
Width in 9-mm modules		2	4
Accessories		Module CA907000 and CA907001	Module CA907000 and CA907001

(1) Information to be provided by the country.

iC60a circuit breakers (curve C) (cont.)

PB104433-40

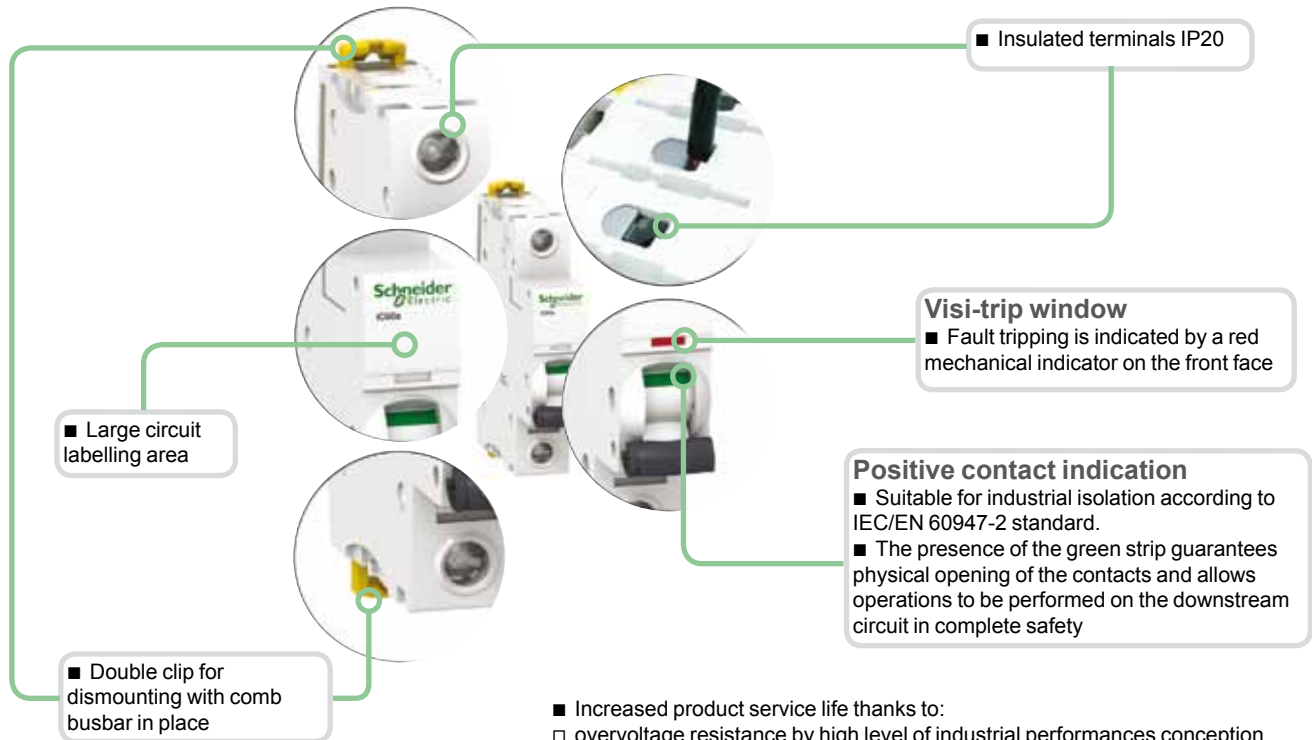

- Increased product service life thanks to:
 - overvoltage resistance by high level of industrial performances conception (pollution degree, rated impulse withstand voltage and insulation voltage),
 - high performance limitation (see limitation curves),
 - fast closing independent of the speed of actuation of the toggle.
- Remote indication, open/closed/tripped, by optional auxiliary contacts.
- Top or bottom electrical feeding.

3P	4P
Remote tripping and indication, module CA907000 and CA907002	Remote tripping and indication, module CA907000 and CA907002
Vigi iC60 add-on residual current device, module CA902005	Vigi iC60 add-on residual current device, module CA902005
Curve C	Curve C
A9F64301	A9F64401
A9F64302	A9F64402
A9F64303	A9F64403
A9F64304	A9F64404
A9F64306	A9F64406
A9F64310	A9F64410
A9F64313	A9F64413
A9F64316	A9F64416
A9F64320	A9F64420
A9F64325	A9F64425
A9F64332	A9F64432
A9F64340	A9F64440
A9F64350	A9F64450
A9F64363	A9F64463
6 Module CA907000 and CA907001	8 Module CA907000 and CA907001

iC60a circuit breakers (curve C) (cont.)

Connection

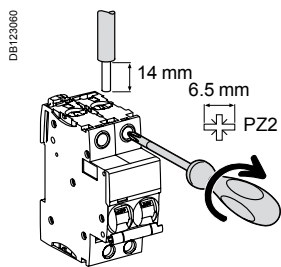

Rating	Tightening torque	Without accessory		With accessories			
		Copper cables	50 mm ² Al terminal	Screw-on connection for ring terminal	Multi-cables terminal		
		Rigid	Flexible or with ferrule			Rigid cables	Flexible cables
1 to 25 A	2 N.m	DBI122945	DBI122946	DBI122935	DBI118789	DBI118787	
32 to 63 A	3.5 N.m			50 mm ²	Ø 5 mm		
		1 to 25 mm ²	1 to 16 mm ²	-		-	-
		1 to 35 mm ²	1 to 25 mm ²	50 mm ²		3 x 16 mm ²	3 x 10 mm ²

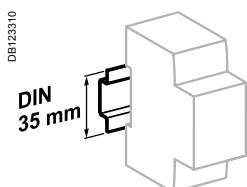

Clip on DIN rail 35 mm.

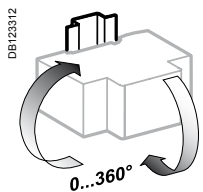

Indifferent position of installation.

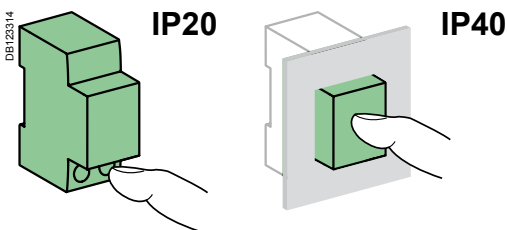

Technical data

Main characteristics

According to IEC/EN 60947-2

Insulation voltage (U _i)	500 V AC
Pollution degree	3
Rated impulse withstand voltage (U _{imp})	6 kV
Thermal tripping	Reference temperature
	Temperature derating
	50 °C
	See module CA908007
Magnetic tripping	C curve
	8 I _n ± 20 %
Utilization category	A

According to IEC/EN 60898-1

Limitation class	3
Rated making and breaking capacity of an individual pole (I _{cn1})	I _{cn1} = I _{cn}

Additional characteristics

Degree of protection (IEC 60529)	Device only	IP20
	Device in modular enclosure	IP40 Insulation class II
Endurance (O-C)	Electrical	10,000 cycles
	Mechanical	20,000 cycles
Overvoltage category (IEC 60364)		IV
Operating temperature		-35°C to +70°C
Storage temperature		-40°C to +85°C
Tropicalization (IEC 60068-1)		Treatment 2 (relative humidity 95 % to 55°C)

iC60a circuit breakers (curve C) (cont.)

Weight (g)

Circuit-breaker	
Type	iC60a
1P	125
2P	250
3P	375
4P	500

Dimensions (mm)

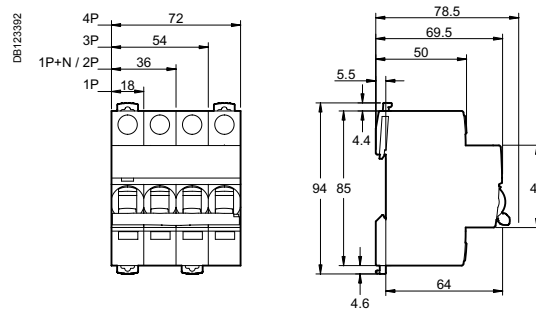





Schneider Electric's range of circuit breakers consists of different products (A, B, C) to enable it to be the most competitive range possible in each country, allowing for the special characteristics of each market:

- usual installation procedure
- price
- accreditations by local bodies.

Variants

Offers		Pages
Offer A	Catalogue numbers	34
Offer B	Catalogue numbers	36
Offer C	Catalogue numbers	38
Common pages		40

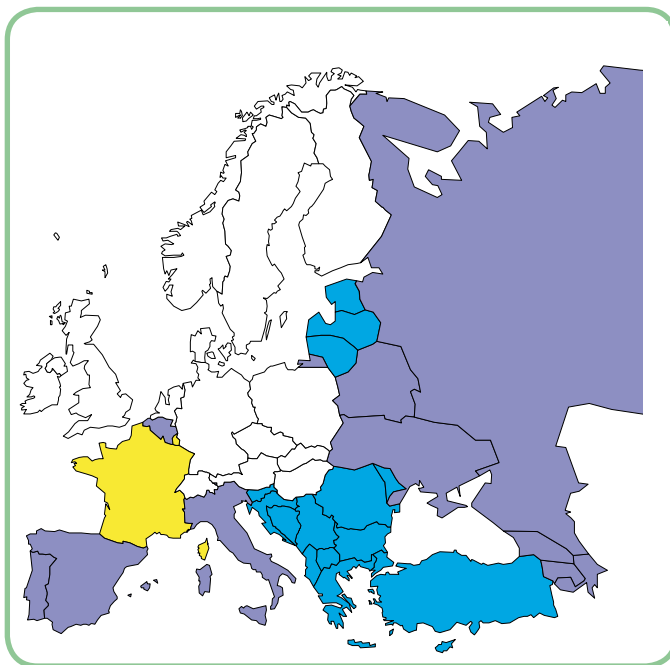

Only the product range to be marketed in your country and validated by the local product manager, in agreement with his Final Distribution (FD) partner should be retained. The others will be removed before publication.

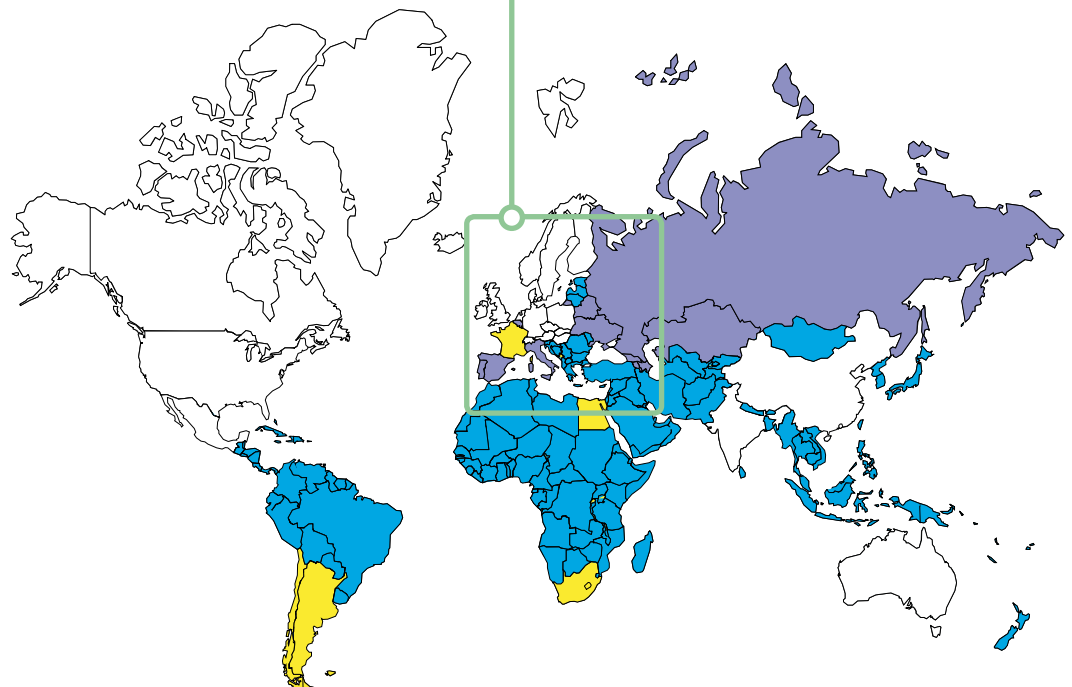

iC60N circuit breakers (curve B, C, D)



IEC/EN 60947-2 IEC/EN 60898-1

- iC60N circuit breakers are multi-standard circuit breakers which combine the following functions:
 - circuit protection against short-circuit currents,
 - circuit protection against overload currents,
 - suitable for industrial isolation according to IEC/EN 60947-2, standard.
 - fault tripping indication by a red mechanical indicator in circuit breaker front face.



Alternating current (AC) 50/60 Hz

Breaking capacity (Icu) according to IEC/EN 60947-2	Voltage (Ue)				Service breaking capacity (Ics)
	12 to 133 V	220 to 240 V	380 to 415 V	440 V	
Ph/Ph (2P, 3P, 4P)	12 to 133 V	220 to 240 V	380 to 415 V	440 V	100 % of Icu 75 % of Icu
Ph/N (1P, 1P+N)	12 to 60 V	100 to 133 V	220 to 240 V	-	
Rating (In)	0.5 to 4 A	50 kA	50 kA	50 kA	
	6 to 63 A	36 kA	20 kA	10 kA	6 kA

Breaking capacity (Icn) according to IEC/EN 60898-1	Voltage (Ue)	
	Ph/Ph	Ph/N
	400 V	230 V
Rating (In)	0.5 to 63 A	6000 A

Direct current (DC)

Breaking capacity (Icu) according to IEC/EN 60947-2	Voltage (Ue)					Service breaking capacity (Ics)
	Between +/-	≤ 72 V	≤ 125 V	≤ 180 V	≤ 250 V	
	1P	2P	3P	4P		
Rating (In)	0.5 to 63 A	15 kA	10 kA	10 kA	10 kA	100 % of Icu

Offer selection see page 33

Offer A

This sticker must be removed before publishing

Catalogue numbers

iC60N circuit breaker						
Type	1P			1P+N		
Auxiliaries	Remote tripping and indication, module CA907000 and CA907002			Remote tripping and indication, module CA907000 and CA907002		
Vigi iC60	Vigi iC60 add-on residual current device, module CA902005			Vigi iC60 add-on residual current device, module CA902005		
Rating (In)	Curve			Curve		
	B	C	D ⁽¹⁾	B	C	D ⁽¹⁾
0.5 A ⁽¹⁾	A9F73170	A9F74170	A9F75170	A9F73670	A9F74670	A9F75670
1 A ⁽¹⁾	A9F73101	A9F74101	A9F75101	A9F73601	A9F74601	A9F75601
2 A ⁽¹⁾	A9F73102	A9F74102	A9F75102	A9F73602	A9F74602	A9F75602
3 A ⁽¹⁾	A9F73103	A9F74103	A9F75103	A9F73603	A9F74603	A9F75603
4 A ⁽¹⁾	A9F73104	A9F74104	A9F75104	A9F73604	A9F74604	A9F75604
6 A	A9F76106	A9F77106	A9F75106	A9F76606	A9F77606	A9F75606
10 A	A9F76110	A9F77110	A9F75110	A9F76610	A9F77610	A9F75610
13 A ⁽¹⁾	A9F73113	A9F74113	A9F75113	A9F73613	A9F74613	A9F75613
16 A	A9F76116	A9F77116	A9F75116	A9F76616	A9F77616	A9F75616
20 A	A9F76120	A9F77120	A9F75120	A9F76620	A9F77620	A9F75620
25 A	A9F76125	A9F77125	A9F75125	A9F76625	A9F77625	A9F75625
32 A	A9F76132	A9F77132	A9F75132	A9F76632	A9F77632	A9F75632
40 A	A9F76140	A9F77140	A9F75140	A9F76640	A9F77640	A9F75640
50 A	A9F76150	A9F77150	A9F75150	A9F76650	A9F77650	A9F75650
63 A	A9F76163	A9F77163	A9F75163	A9F76663	A9F77663	A9F75663
Width in 9-mm modules	2			4		
Accessories	Module CA907000 and CA907001			Module CA907000 and CA907001		

(1) VDE approved only.

iC60N circuit breakers (curve B, C, D) (cont.)

PB10434-40

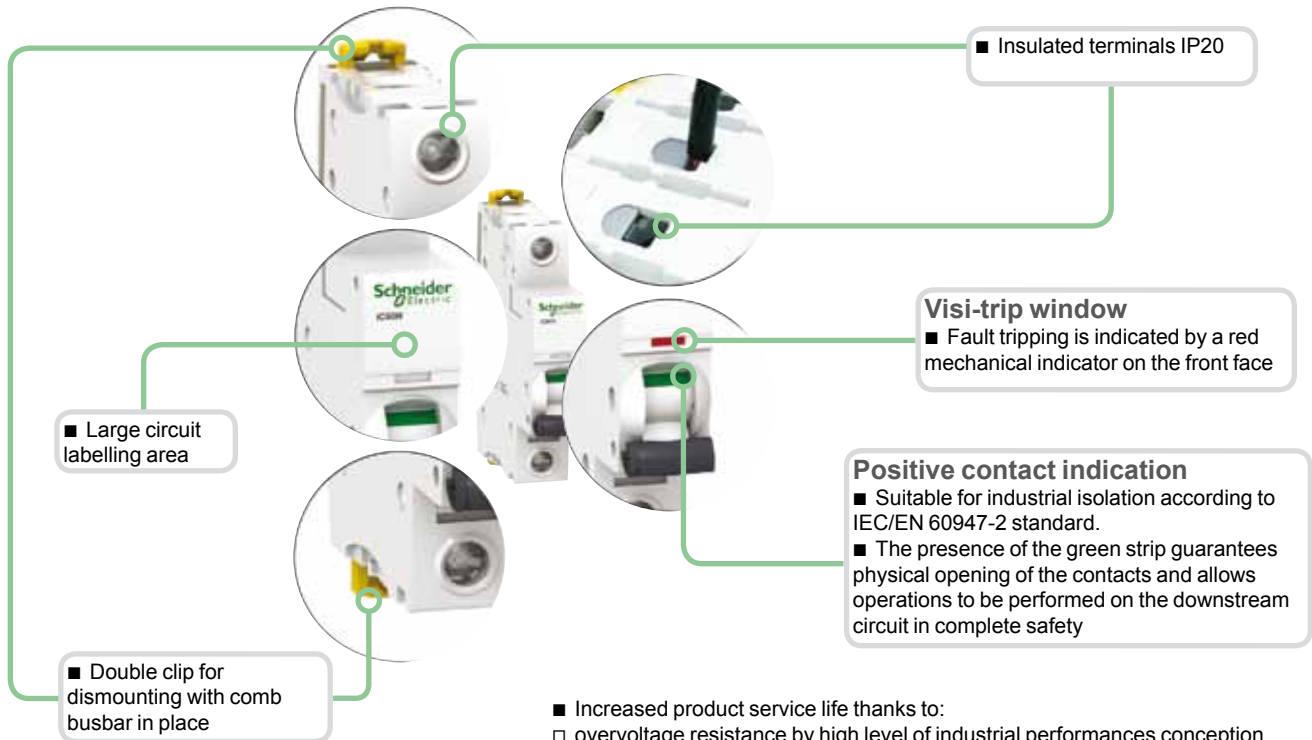

- Increased product service life thanks to:
 - overvoltage resistance by high level of industrial performances conception (pollution degree, rated impulse withstand voltage and insulation voltage),
 - high performance limitation (see limitation curves),
 - fast closing independent of the speed of actuation of the toggle.
- Remote indication, open/closed/tripped, by optional auxiliary contacts.
- Top or bottom electrical feeding.

	2P			3P			4P			
E45094				E46095			E46097			
	Remote tripping and indication, module CA907000 and CA907002			Remote tripping and indication, module CA907000 and CA907002			Remote tripping and indication, module CA907000 and CA907002			
	Vigi iC60 add-on residual current device, module CA902005			Vigi iC60 add-on residual current device, module CA902005			Vigi iC60 add-on residual current device, module CA902005			
	Curve			Curve			Curve			
	B	C	D ⁽¹⁾	B	C	D ⁽¹⁾	B	C	D ⁽¹⁾	
	A9F73270	A9F74270	A9F75270	A9F73370	A9F74370	A9F75370	A9F73470	A9F74470	A9F75470	
	A9F73201	A9F74201	A9F75201	A9F73301	A9F74301	A9F75301	A9F73401	A9F74401	A9F75401	
	A9F73202	A9F74202	A9F75202	A9F73302	A9F74302	A9F75302	A9F73402	A9F74402	A9F75402	
	A9F73203	A9F74203	A9F75203	A9F73303	A9F74303	A9F75303	A9F73403	A9F74403	A9F75403	
	A9F73204	A9F74204	A9F75204	A9F73304	A9F74304	A9F75304	A9F73404	A9F74404	A9F75404	
	A9F76206	A9F77206	A9F75206	A9F76306	A9F77306	A9F75306	A9F76406	A9F77406	A9F75406	
	A9F76210	A9F77210	A9F75210	A9F76310	A9F77310	A9F75310	A9F76410	A9F77410	A9F75410	
	A9F73213	A9F74213	A9F75213	A9F73313	A9F74313	A9F75313	A9F73413	A9F74413	A9F75413	
	A9F76216	A9F77216	A9F75216	A9F76316	A9F77316	A9F75316	A9F76416	A9F77416	A9F75416	
	A9F76220	A9F77220	A9F75220	A9F76320	A9F77320	A9F75320	A9F76420	A9F77420	A9F75420	
	A9F76225	A9F77225	A9F75225	A9F76325	A9F77325	A9F75325	A9F76425	A9F77425	A9F75425	
	A9F76232	A9F77232	A9F75232	A9F76332	A9F77332	A9F75332	A9F76432	A9F77432	A9F75432	
	A9F76240	A9F77240	A9F75240	A9F76340	A9F77340	A9F75340	A9F76440	A9F77440	A9F75440	
	A9F76250	A9F77250	A9F75250	A9F76350	A9F77350	A9F75350	A9F76450	A9F77450	A9F75450	
	A9F76263	A9F77263	A9F75263	A9F76363	A9F77363	A9F75363	A9F76463	A9F77463	A9F75463	
4	Module CA907000 and CA907001			6	Module CA907000 and CA907001			8	Module CA907000 and CA907001	

iC60N circuit breakers (curve B, C, D)

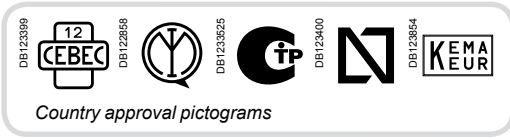

IEC/EN 60947-2 IEC/EN 60898-1

- iC60N circuit breakers are multi-standard circuit breakers which combine the following functions:
 - circuit protection against short-circuit currents,
 - circuit protection against overload currents,
 - suitable for industrial isolation according to IEC/EN 60947-2, standard.
 - fault tripping indication by a red mechanical indicator in circuit breaker front face.



Alternating current (AC) 50/60 Hz

Breaking capacity (Icu) according to IEC/EN 60947-2	Voltage (Ue)				Service breaking capacity (Ics)
	12 to 133 V	220 to 240 V	380 to 415 V	440 V	
Ph/Ph (2P, 3P, 4P)	12 to 133 V	220 to 240 V	380 to 415 V	440 V	100 % of Icu
Ph/N (1P, 1P+N)	12 to 60 V	100 to 133 V	220 to 240 V	-	
Rating (In)	0.5 to 4 A	50 kA	50 kA	50 kA	25 kA
	6 to 63 A	36 kA	20 kA	10 kA	6 kA
					75 % of Icu

Breaking capacity (Icn) according to IEC/EN 60898-1	Voltage (Ue)	
	Ph/Ph	Ph/N
	400 V	230 V
Rating (In)	0.5 to 63 A	6000 A

Direct current (DC)

Breaking capacity (Icu) according to IEC/EN 60947-2	Voltage (Ue)					Service breaking capacity (Ics)
	Between +/-	≤ 72 V	≤ 125 V	≤ 180 V	≤ 250 V	
						100 % of Icu
Number of poles	1P		2P	3P	4P	
Rating (In)	0.5 to 63 A	15 kA	10 kA	10 kA	10 kA	

Offer selection see page 33
Offer B

Catalogue numbers

iC60N circuit breaker

Type	1P	1P+N																																																																																																																																
Auxiliaries	Remote tripping and indication, module CA907000 and CA907002	Remote tripping and indication, module CA907000 and CA907002																																																																																																																																
Vigi iC60	Vigi iC60 add-on residual current device, module CA902005	Vigi iC60 add-on residual current device, module CA902005																																																																																																																																
Rating (In)	<table border="1"> <thead> <tr> <th>Curve</th> <th>B</th> <th>C</th> <th>D⁽¹⁾</th> </tr> </thead> <tbody> <tr><td>0.5 A⁽¹⁾</td><td>A9F73170</td><td>A9F74170</td><td>A9F75170</td></tr> <tr><td>1 A⁽¹⁾</td><td>A9F73101</td><td>A9F74101</td><td>A9F75101</td></tr> <tr><td>2 A⁽¹⁾</td><td>A9F73102</td><td>A9F74102</td><td>A9F75102</td></tr> <tr><td>3 A⁽¹⁾</td><td>A9F73103</td><td>A9F74103</td><td>A9F75103</td></tr> <tr><td>4 A⁽¹⁾</td><td>A9F73104</td><td>A9F74104</td><td>A9F75104</td></tr> <tr><td>6 A</td><td>A9F78106</td><td>A9F79106</td><td>A9F75106</td></tr> <tr><td>10 A</td><td>A9F78110</td><td>A9F79110</td><td>A9F75110</td></tr> <tr><td>13 A⁽¹⁾</td><td>A9F73113</td><td>A9F74113</td><td>A9F75113</td></tr> <tr><td>16 A</td><td>A9F78116</td><td>A9F79116</td><td>A9F75116</td></tr> <tr><td>20 A</td><td>A9F78120</td><td>A9F79120</td><td>A9F75120</td></tr> <tr><td>25 A</td><td>A9F78125</td><td>A9F79125</td><td>A9F75125</td></tr> <tr><td>32 A</td><td>A9F78132</td><td>A9F79132</td><td>A9F75132</td></tr> <tr><td>40 A</td><td>A9F78140</td><td>A9F79140</td><td>A9F75140</td></tr> <tr><td>50 A</td><td>A9F78150</td><td>A9F79150</td><td>A9F75150</td></tr> <tr><td>63 A</td><td>A9F78163</td><td>A9F79163</td><td>A9F75163</td></tr> </tbody> </table>	Curve	B	C	D ⁽¹⁾	0.5 A ⁽¹⁾	A9F73170	A9F74170	A9F75170	1 A ⁽¹⁾	A9F73101	A9F74101	A9F75101	2 A ⁽¹⁾	A9F73102	A9F74102	A9F75102	3 A ⁽¹⁾	A9F73103	A9F74103	A9F75103	4 A ⁽¹⁾	A9F73104	A9F74104	A9F75104	6 A	A9F78106	A9F79106	A9F75106	10 A	A9F78110	A9F79110	A9F75110	13 A ⁽¹⁾	A9F73113	A9F74113	A9F75113	16 A	A9F78116	A9F79116	A9F75116	20 A	A9F78120	A9F79120	A9F75120	25 A	A9F78125	A9F79125	A9F75125	32 A	A9F78132	A9F79132	A9F75132	40 A	A9F78140	A9F79140	A9F75140	50 A	A9F78150	A9F79150	A9F75150	63 A	A9F78163	A9F79163	A9F75163	<table border="1"> <thead> <tr> <th>Curve</th> <th>B</th> <th>C</th> <th>D⁽¹⁾</th> </tr> </thead> <tbody> <tr><td>0.5 A⁽¹⁾</td><td>A9F73670</td><td>A9F74670</td><td>A9F75670</td></tr> <tr><td>1 A⁽¹⁾</td><td>A9F73601</td><td>A9F74601</td><td>A9F75601</td></tr> <tr><td>2 A⁽¹⁾</td><td>A9F73602</td><td>A9F74602</td><td>A9F75602</td></tr> <tr><td>3 A⁽¹⁾</td><td>A9F73603</td><td>A9F74603</td><td>A9F75603</td></tr> <tr><td>4 A⁽¹⁾</td><td>A9F73604</td><td>A9F74604</td><td>A9F75604</td></tr> <tr><td>6 A</td><td>A9F78606</td><td>A9F79606</td><td>A9F75606</td></tr> <tr><td>10 A</td><td>A9F78610</td><td>A9F79610</td><td>A9F75610</td></tr> <tr><td>13 A⁽¹⁾</td><td>A9F73613</td><td>A9F74613</td><td>A9F75613</td></tr> <tr><td>16 A</td><td>A9F78616</td><td>A9F79616</td><td>A9F75616</td></tr> <tr><td>20 A</td><td>A9F78620</td><td>A9F79620</td><td>A9F75620</td></tr> <tr><td>25 A</td><td>A9F78625</td><td>A9F79625</td><td>A9F75625</td></tr> <tr><td>32 A</td><td>A9F78632</td><td>A9F79632</td><td>A9F75632</td></tr> <tr><td>40 A</td><td>A9F78640</td><td>A9F79640</td><td>A9F75640</td></tr> <tr><td>50 A</td><td>A9F78650</td><td>A9F79650</td><td>A9F75650</td></tr> <tr><td>63 A</td><td>A9F78663</td><td>A9F79663</td><td>A9F75663</td></tr> </tbody> </table>	Curve	B	C	D ⁽¹⁾	0.5 A ⁽¹⁾	A9F73670	A9F74670	A9F75670	1 A ⁽¹⁾	A9F73601	A9F74601	A9F75601	2 A ⁽¹⁾	A9F73602	A9F74602	A9F75602	3 A ⁽¹⁾	A9F73603	A9F74603	A9F75603	4 A ⁽¹⁾	A9F73604	A9F74604	A9F75604	6 A	A9F78606	A9F79606	A9F75606	10 A	A9F78610	A9F79610	A9F75610	13 A ⁽¹⁾	A9F73613	A9F74613	A9F75613	16 A	A9F78616	A9F79616	A9F75616	20 A	A9F78620	A9F79620	A9F75620	25 A	A9F78625	A9F79625	A9F75625	32 A	A9F78632	A9F79632	A9F75632	40 A	A9F78640	A9F79640	A9F75640	50 A	A9F78650	A9F79650	A9F75650	63 A	A9F78663	A9F79663	A9F75663
Curve	B	C	D ⁽¹⁾																																																																																																																															
0.5 A ⁽¹⁾	A9F73170	A9F74170	A9F75170																																																																																																																															
1 A ⁽¹⁾	A9F73101	A9F74101	A9F75101																																																																																																																															
2 A ⁽¹⁾	A9F73102	A9F74102	A9F75102																																																																																																																															
3 A ⁽¹⁾	A9F73103	A9F74103	A9F75103																																																																																																																															
4 A ⁽¹⁾	A9F73104	A9F74104	A9F75104																																																																																																																															
6 A	A9F78106	A9F79106	A9F75106																																																																																																																															
10 A	A9F78110	A9F79110	A9F75110																																																																																																																															
13 A ⁽¹⁾	A9F73113	A9F74113	A9F75113																																																																																																																															
16 A	A9F78116	A9F79116	A9F75116																																																																																																																															
20 A	A9F78120	A9F79120	A9F75120																																																																																																																															
25 A	A9F78125	A9F79125	A9F75125																																																																																																																															
32 A	A9F78132	A9F79132	A9F75132																																																																																																																															
40 A	A9F78140	A9F79140	A9F75140																																																																																																																															
50 A	A9F78150	A9F79150	A9F75150																																																																																																																															
63 A	A9F78163	A9F79163	A9F75163																																																																																																																															
Curve	B	C	D ⁽¹⁾																																																																																																																															
0.5 A ⁽¹⁾	A9F73670	A9F74670	A9F75670																																																																																																																															
1 A ⁽¹⁾	A9F73601	A9F74601	A9F75601																																																																																																																															
2 A ⁽¹⁾	A9F73602	A9F74602	A9F75602																																																																																																																															
3 A ⁽¹⁾	A9F73603	A9F74603	A9F75603																																																																																																																															
4 A ⁽¹⁾	A9F73604	A9F74604	A9F75604																																																																																																																															
6 A	A9F78606	A9F79606	A9F75606																																																																																																																															
10 A	A9F78610	A9F79610	A9F75610																																																																																																																															
13 A ⁽¹⁾	A9F73613	A9F74613	A9F75613																																																																																																																															
16 A	A9F78616	A9F79616	A9F75616																																																																																																																															
20 A	A9F78620	A9F79620	A9F75620																																																																																																																															
25 A	A9F78625	A9F79625	A9F75625																																																																																																																															
32 A	A9F78632	A9F79632	A9F75632																																																																																																																															
40 A	A9F78640	A9F79640	A9F75640																																																																																																																															
50 A	A9F78650	A9F79650	A9F75650																																																																																																																															
63 A	A9F78663	A9F79663	A9F75663																																																																																																																															
Width in 9-mm modules	2	4																																																																																																																																
Accessories	Module CA907000 and CA907001	Module CA907000 and CA907001																																																																																																																																

(1) VDE approved only.

iC60N circuit breakers (curve B, C, D) (cont.)

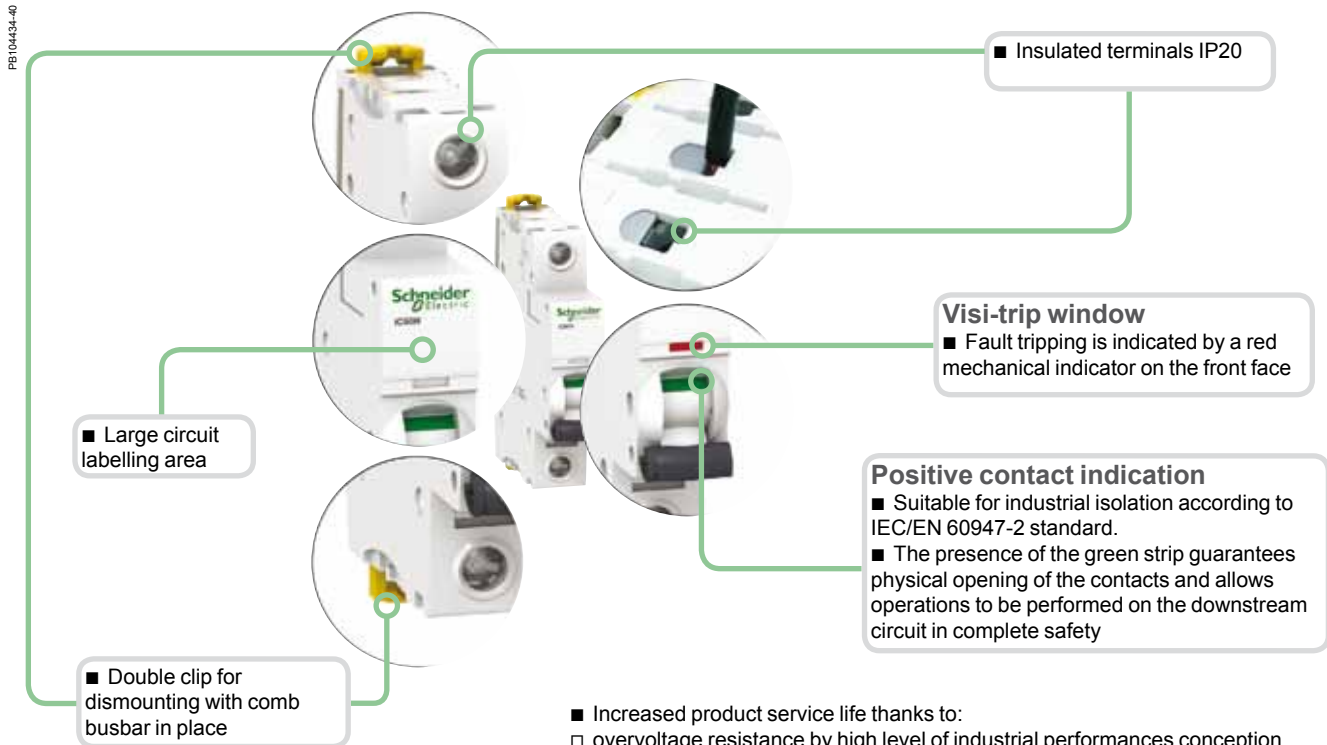

- Increased product service life thanks to:
 - overvoltage resistance by high level of industrial performances conception (pollution degree, rated impulse withstand voltage and insulation voltage),
 - high performance limitation (see limitation curves),
 - fast closing independent of the speed of actuation of the toggle.
- Remote indication, open/closed/tripped, by optional auxiliary contacts.
- Top or bottom electrical feeding.

2P				3P			4P			
E46094				E46095			E46097			
Remote tripping and indication, module CA907000 and CA907002				Remote tripping and indication, module CA907000 and CA907002			Remote tripping and indication, module CA907000 and CA907002			
Vigi iC60 add-on residual current device, module CA902005				Vigi iC60 add-on residual current device, module CA902005			Vigi iC60 add-on residual current device, module CA902005			
Curve				Curve			Curve			
B		C		D ⁽¹⁾		B		C		D ⁽¹⁾
A9F73270	A9F74270	A9F75270	A9F73370	A9F74370	A9F75370	A9F73470	A9F74470	A9F75470		
A9F73201	A9F74201	A9F75201	A9F73301	A9F74301	A9F75301	A9F73401	A9F74401	A9F75401		
A9F73202	A9F74202	A9F75202	A9F73302	A9F74302	A9F75302	A9F73402	A9F74402	A9F75402		
A9F73203	A9F74203	A9F75203	A9F73303	A9F74303	A9F75303	A9F73403	A9F74403	A9F75403		
A9F73204	A9F74204	A9F75204	A9F73304	A9F74304	A9F75304	A9F73404	A9F74404	A9F75404		
A9F78206	A9F79206	A9F75206	A9F78306	A9F79306	A9F75306	A9F78406	A9F79406	A9F75406		
A9F78210	A9F79210	A9F75210	A9F78310	A9F79310	A9F75310	A9F78410	A9F79410	A9F75410		
A9F73213	A9F74213	A9F75213	A9F73313	A9F74313	A9F75313	A9F73413	A9F74413	A9F75413		
A9F78216	A9F79216	A9F75216	A9F78316	A9F79316	A9F75316	A9F78416	A9F79416	A9F75416		
A9F78220	A9F79220	A9F75220	A9F78320	A9F79320	A9F75320	A9F78420	A9F79420	A9F75420		
A9F78225	A9F79225	A9F75225	A9F78325	A9F79325	A9F75325	A9F78425	A9F79425	A9F75425		
A9F78232	A9F79232	A9F75232	A9F78332	A9F79332	A9F75332	A9F78432	A9F79432	A9F75432		
A9F78240	A9F79240	A9F75240	A9F78340	A9F79340	A9F75340	A9F78440	A9F79440	A9F75440		
A9F78250	A9F79250	A9F75250	A9F78350	A9F79350	A9F75350	A9F78450	A9F79450	A9F75450		
A9F78263	A9F79263	A9F75263	A9F78363	A9F79363	A9F75363	A9F78463	A9F79463	A9F75463		
4				6			8			
Module CA907000 and CA907001				Module CA907000 and CA907001			Module CA907000 and CA907001			

iC60N circuit breakers (curve B, C, D)

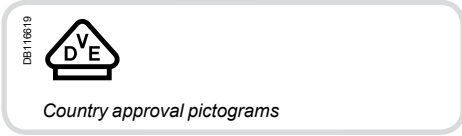

IEC/EN 60947-2 IEC/EN 60898-1

- iC60N circuit breakers are multi-standard circuit breakers which combine the following functions:
 - circuit protection against short-circuit currents,
 - circuit protection against overload currents,
 - suitable for industrial isolation according to IEC/EN 60947-2, standard.
 - fault tripping indication by a red mechanical indicator in circuit breaker front face.

Alternating current (AC) 50/60 Hz

Breaking capacity (Icu) according to IEC/EN 60947-2	Voltage (Ue)				Service breaking capacity (Ics)
	12 to 133 V	220 to 240 V	380 to 415 V	440 V	
Ph/Ph (2P, 3P, 4P)	12 to 133 V	220 to 240 V	380 to 415 V	440 V	100 % of Icu
Ph/N (1P, 1P+N)	12 to 60 V	100 to 133 V	220 to 240 V	-	
Rating (In)	0.5 to 4 A	50 kA	50 kA	50 kA	25 kA
	6 to 63 A	36 kA	20 kA	10 kA	6 kA

Breaking capacity (Icn) according to IEC/EN 60898-1	Voltage (Ue)	
	Ph/Ph	Ph/N
Ph/Ph	400 V	
Ph/N	230 V	
Rating (In)	0.5 to 63 A	6000 A

Direct current (DC)

Breaking capacity (Icu) according to IEC/EN 60947-2	Voltage (Ue)					Service breaking capacity (Ics)
	Between +/-	≤ 72 V	≤ 125 V	≤ 180 V	≤ 250 V	
Number of poles	1P		2P	3P	4P	100 % of Icu
Rating (In)	0.5 to 63 A	15 kA	10 kA	10 kA	10 kA	

Offer selection see page 33

offer

This sticker must be removed before publishing

Catalogue numbers

iC60N circuit breaker						
Type	1P			1P+N		
Auxiliaries	Remote tripping and indication, module CA907000 and CA907002			Remote tripping and indication, module CA907000 and CA907002		
Vigi iC60	Vigi iC60 add-on residual current device, module CA902005			Vigi iC60 add-on residual current device, module CA902005		
Rating (In)	Curve					
	B	C	D	B	C	D
0.5 A	A9F73170	A9F74170	A9F75170	A9F73670	A9F74670	A9F75670
1 A	A9F73101	A9F74101	A9F75101	A9F73601	A9F74601	A9F75601
2 A	A9F73102	A9F74102	A9F75102	A9F73602	A9F74602	A9F75602
3 A	A9F73103	A9F74103	A9F75103	A9F73603	A9F74603	A9F75603
4 A	A9F73104	A9F74104	A9F75104	A9F73604	A9F74604	A9F75604
6 A	A9F73106	A9F74106	A9F75106	A9F73606	A9F74606	A9F75606
10 A	A9F73110	A9F74110	A9F75110	A9F73610	A9F74610	A9F75610
13 A	A9F73113	A9F74113	A9F75113	A9F73613	A9F74613	A9F75613
16 A	A9F73116	A9F74116	A9F75116	A9F73616	A9F74616	A9F75616
20 A	A9F73120	A9F74120	A9F75120	A9F73620	A9F74620	A9F75620
25 A	A9F73125	A9F74125	A9F75125	A9F73625	A9F74625	A9F75625
32 A	A9F73132	A9F74132	A9F75132	A9F73632	A9F74632	A9F75632
40 A	A9F73140	A9F74140	A9F75140	A9F73640	A9F74640	A9F75640
50 A	A9F73150	A9F74150	A9F75150	A9F73650	A9F74650	A9F75650
63 A	A9F73163	A9F74163	A9F75163	A9F73663	A9F74663	A9F75663
Width in 9-mm modules	2			4		
Accessories	Module CA907000 and CA907001			Module CA907000 and CA907001		

iC60N circuit breakers (curve B, C, D) (cont.)

PB10434-40

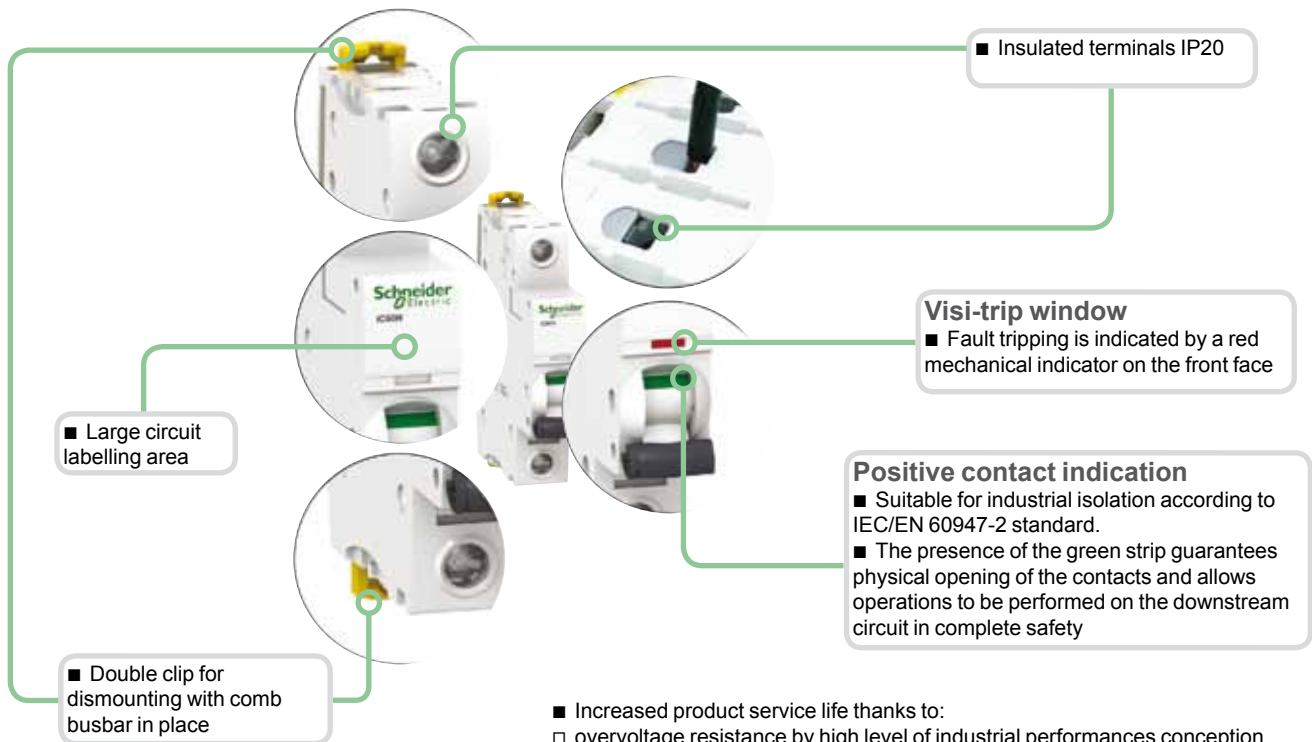

- Increased product service life thanks to:
 - overvoltage resistance by high level of industrial performances conception (pollution degree, rated impulse withstand voltage and insulation voltage),
 - high performance limitation (see limitation curves),
 - fast closing independent of the speed of actuation of the toggle.
- Remote indication, open/closed/tripped, by optional auxiliary contacts.
- Top or bottom electrical feeding.

2P				3P			4P			
E46094				E46095				E46097		
	Remote tripping and indication, module CA907000 and CA907002				Remote tripping and indication, module CA907000 and CA907002				Remote tripping and indication, module CA907000 and CA907002	
Vigi iC60 add-on residual current device, module CA902005				Vigi iC60 add-on residual current device, module CA902005				Vigi iC60 add-on residual current device, module CA902005		
Curve				Curve				Curve		
B		C		B		C		D		
A9F73270	A9F74270	A9F75270		A9F73370	A9F74370	A9F75370	A9F73470	A9F74470	A9F75470	
A9F73201	A9F74201	A9F75201		A9F73301	A9F74301	A9F75301	A9F73401	A9F74401	A9F75401	
A9F73202	A9F74202	A9F75202		A9F73302	A9F74302	A9F75302	A9F73402	A9F74402	A9F75402	
A9F73203	A9F74203	A9F75203		A9F73303	A9F74303	A9F75303	A9F73403	A9F74403	A9F75403	
A9F73204	A9F74204	A9F75204		A9F73304	A9F74304	A9F75304	A9F73404	A9F74404	A9F75404	
A9F73206	A9F74206	A9F75206		A9F73306	A9F74306	A9F75306	A9F73406	A9F74406	A9F75406	
A9F73210	A9F74210	A9F75210		A9F73310	A9F74310	A9F75310	A9F73410	A9F74410	A9F75410	
A9F73213	A9F74213	A9F75213		A9F73313	A9F74313	A9F75313	A9F73413	A9F74413	A9F75413	
A9F73216	A9F74216	A9F75216		A9F73316	A9F74316	A9F75316	A9F73416	A9F74416	A9F75416	
A9F73220	A9F74220	A9F75220		A9F73320	A9F74320	A9F75320	A9F73420	A9F74420	A9F75420	
A9F73225	A9F74225	A9F75225		A9F73325	A9F74325	A9F75325	A9F73425	A9F74425	A9F75425	
A9F73232	A9F74232	A9F75232		A9F73332	A9F74332	A9F75332	A9F73432	A9F74432	A9F75432	
A9F73240	A9F74240	A9F75240		A9F73340	A9F74340	A9F75340	A9F73440	A9F74440	A9F75440	
A9F73250	A9F74250	A9F75250		A9F73350	A9F74350	A9F75350	A9F73450	A9F74450	A9F75450	
A9F73263	A9F74263	A9F75263		A9F73363	A9F74363	A9F75363	A9F73463	A9F74463	A9F75463	
4				6				8		
Module CA907000 and CA907001				Module CA907000 and CA907001				Module CA907000 and CA907001		

iC60N circuit breakers (curve B, C, D) (cont.)

Connection

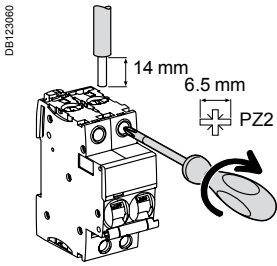

Rating	Tightening torque	Without accessory		With accessories		
		Rigid	Flexible or with ferrule	50 mm ² Al terminal	Screw-on connection for ring terminal	Multi-cables terminal
0.5 to 25 A	2 N.m	DB1122945	DB1122946	DB1122945	DB118789	DB118787
32 to 63 A	3.5 N.m	1 to 25 mm ²	1 to 16 mm ²	-	∅ 5 mm	-
		1 to 35 mm ²	1 to 25 mm ²	50 mm ²		3 x 16 mm ²
						3 x 10 mm ²

Technical data

Main characteristics

According to IEC/EN 60947-2

Insulation voltage (U _i)	500 V AC	
Pollution degree	3	
Rated impulse withstand voltage (U _{imp})	6 kV	
Thermal tripping	Reference temperature	50 °C
	Temperature derating	See module CA908007
Magnetic tripping	B curve	4 I _n ± 20 %
	C curve	8 I _n ± 20 %
	D curve	12 I _n ± 20 %
Utilization category	A	

According to IEC/EN 60898-1

Limitation class	3
Rated making and breaking capacity of an individual pole (I _{cn1})	I _{cn1} = I _{cn}

Additional characteristics

Breaking capacity under 1 pole with IT 380-415 V isolated neutral system (case of double fault)	40 A	4 kA
	50/63 A	3 kA
Degree of protection (IEC 60529)	Device only	IP20
	Device in modular enclosure	IP40
Endurance (O-C)	Electrical	10,000 cycles
	Mechanical	20,000 cycles
Overvoltage category (IEC 60364)	IV	
Operating temperature	-35°C to +70°C	
Storage temperature	-40°C to +85°C	
Tropicalization (IEC 60068-1)	Treatment 2 (relative humidity 95 % to 55°C)	

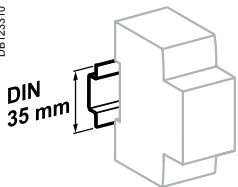

Clip on DIN rail 35 mm.

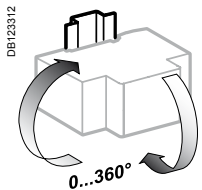

Indifferent position of installation.

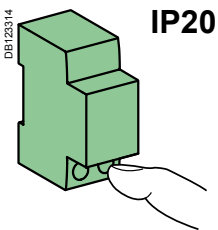

IP20

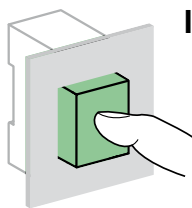

IP40

Weight (g)

Circuit-breaker	
Type	iC60N
1P	125
2P	250
3P	375
4P	500

Dimensions (mm)

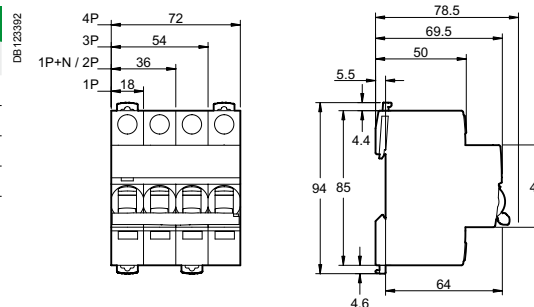

iC60N double terminals circuit breakers (curve B, C, D)

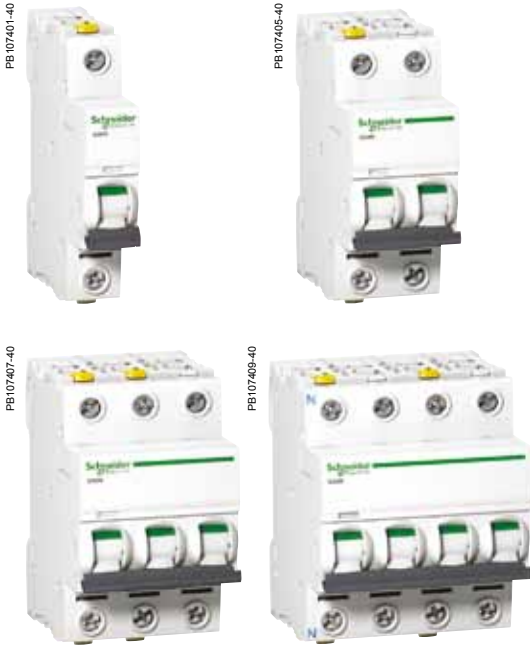
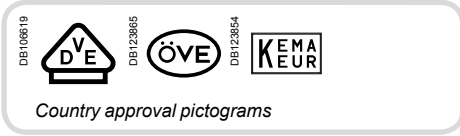

IEC/EN 60947-2 IEC/EN 60898-1

- iC60N double terminal terminals circuit breakers are multi-standard circuit breakers which combine the following functions:
 - circuit protection against short-circuit currents,
 - circuit protection against overload currents,
 - suitable for industrial isolation according to IEC/EN 60947-2, standard.
 - fault tripping indication by a red mechanical indicator in circuit breaker front face.

Alternating current (AC) 50/60 Hz

Breaking capacity (Icu) according to IEC/EN 60947-2	Voltage (Ue)				Service breaking capacity (Ics)
	12 to 133 V	220 to 240 V	380 to 415 V	440 V	
Ph/Ph (2P, 3P, 3P+N, 4P)					100 % of Icu 75 % of Icu
Ph/N (1P, 1P+N)	12 to 60 V	100 to 133 V	220 to 240 V	-	
Rating (In)	0.5 to 4 A 6 to 63 A	50 kA 36 kA	50 kA 20 kA	50 kA 10 kA	25 kA 6 kA

Breaking capacity (Icn) according to IEC/EN 60898-1

Breaking capacity (Icn) according to IEC/EN 60898-1	Voltage (Ue)	
	Ph/Ph	Ph/N
Rating (In)	0.5 to 63 A	6000 A

Direct current (DC)

Breaking capacity (Icu) according to IEC/EN 60947-2	Voltage (Ue)					Service breaking capacity (Ics)
	Between +/-	12 to 60 V	≤ 72 V	≤ 125 V	≤ 180 V	
Number of poles	1P		2P	3P	4P	100 % of Icu
Rating (In)	1 to 63 A	15 kA	10 kA	10 kA	10 kA	

Catalogue numbers

iC60N double terminals circuit breaker

Type	1P	1P+N	2P
Auxiliaries	Remote tripping and indication, module CA907000 and CA907002	Remote tripping and indication, module CA907000 and CA907002	Remote tripping and indication, module CA907000 and CA907002
Vigi iC60	Vigi iC60 add-on residual current device, module CA902005	Vigi iC60 add-on residual current device, module CA902005	Vigi iC60 add-on residual current device, module CA902005
Rating (In)	Curve B C D	Curve B C	Curve B C D
0.5 A	- A9F04170 A9F05170	- A9F04670	- A9F04270 A9F05270
1 A	A9F03101 A9F04101 A9F05101	- A9F04601	- A9F04201 A9F05201
2 A	A9F03102 A9F04102 A9F05102	- A9F04602	A9F03202 A9F04202 A9F05202
3 A	- A9F04103 A9F05103	- A9F04603	- A9F04203 A9F05203
4 A	A9F03104 A9F04104 A9F05104	- A9F04604	A9F03204 A9F04204 A9F05204
6 A	A9F03106 A9F04106 A9F05106	A9F03606 A9F04606	A9F03206 A9F04206 A9F05206
10 A	A9F03110 A9F04110 A9F05110	A9F03610 A9F04610	A9F03210 A9F04210 A9F05210
13 A	A9F03113 A9F04113 A9F05113	A9F03613 A9F04613	A9F03213 A9F04213 A9F05213
16 A	A9F03116 A9F04116 A9F05116	A9F03616 A9F04616	A9F03216 A9F04216 A9F05216
20 A	A9F03120 A9F04120 A9F05120	A9F03620 A9F04620	A9F03220 A9F04220 A9F05220
25 A	A9F03125 A9F04125 A9F05125	A9F03625 A9F04625	A9F03225 A9F04225 A9F05225
32 A	A9F03132 A9F04132 A9F05132	A9F03632 A9F04632	A9F03232 A9F04232 A9F05232
40 A	A9F03140 A9F04140 A9F05140	A9F03640 A9F04640	A9F03240 A9F04240 A9F05240
50 A	A9F03150 A9F04150 A9F05150	A9F03650 A9F04650	A9F03250 A9F04250 A9F05250
63 A	A9F03163 A9F04163 A9F05163	A9F03663 A9F04663	A9F03263 A9F04263 A9F05263
Width in 9-mm modules	2	4	4
Accessories	Modules CA907000 and CA907001	Modules CA907000 and CA907001	Modules CA907000 and CA907001

iC60N double terminals circuit breakers (curve B, C, D) (cont.)

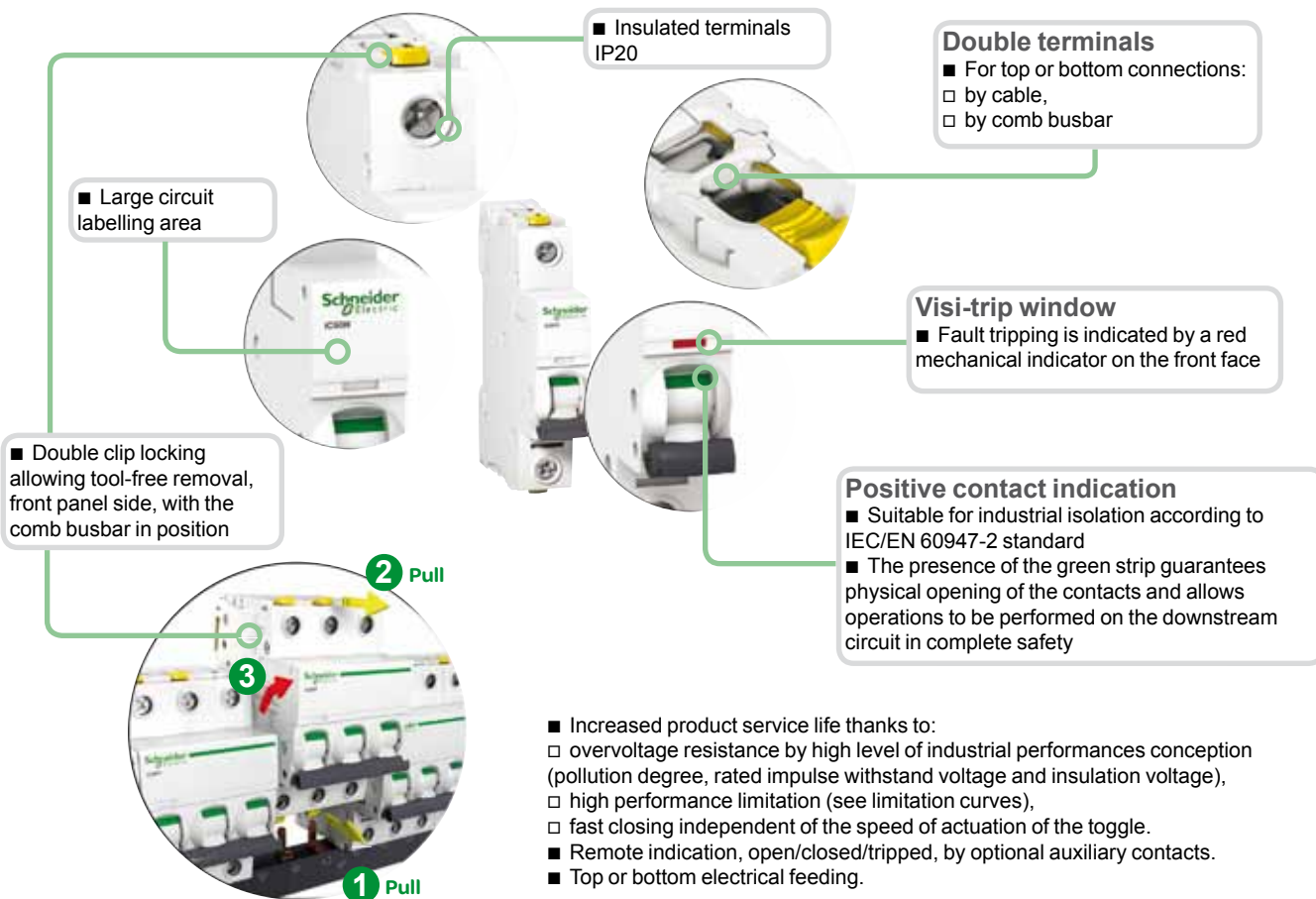

3P			3P+N			4P		
Remote tripping and indication, module CA907000 and CA907002			Remote tripping and indication, module CA907000 and CA907002			Remote tripping and indication, module CA907000 and CA907002		
Vigi iC60 add-on residual current device, module CA902005			Vigi iC60 add-on residual current device, module CA902005			Vigi iC60 add-on residual current device, module CA902005		
Curve			Curve			Curve		
B	C	D	B	C		B	C	D
-	A9F04370	A9F05370	-	A9F04770	-	-	A9F04470	A9F05470
-	A9F04301	A9F05301	-	A9F04701	-	-	A9F04401	A9F05401
A9F03302	A9F04302	A9F05302	-	A9F04702	-	-	A9F04402	A9F05402
-	A9F04303	A9F05303	-	A9F04703	-	-	A9F04403	A9F05403
-	A9F04304	A9F05304	-	A9F04704	-	-	A9F04404	A9F05404
A9F03306	A9F04306	A9F05306	A9F03706	A9F04706	A9F03406	A9F04406	A9F05406	
A9F03310	A9F04310	A9F05310	A9F03710	A9F04710	A9F03410	A9F04410	A9F05410	
A9F03313	A9F04313	A9F05313	A9F03713	A9F04713	A9F03413	A9F04413	A9F05413	
A9F03316	A9F04316	A9F05316	A9F03716	A9F04716	A9F03416	A9F04416	A9F05416	
A9F03320	A9F04320	A9F05320	A9F03720	A9F04720	A9F03420	A9F04420	A9F05420	
A9F03325	A9F04325	A9F05325	A9F03725	A9F04725	A9F03425	A9F04425	A9F05425	
A9F03332	A9F04332	A9F05332	A9F03732	A9F04732	A9F03432	A9F04432	A9F05432	
A9F03340	A9F04340	A9F05340	A9F03740	A9F04740	A9F03440	A9F04440	A9F05440	
A9F03350	A9F04350	A9F05350	A9F03750	A9F04750	A9F03450	A9F04450	A9F05450	
A9F03363	A9F04363	A9F05363	A9F03763	A9F04763	A9F03463	A9F04463	A9F05463	
6			8		8			
Modules CA907000 and CA907001			Modules CA907000 and CA907001			Modules CA907000 and CA907001		

iC60N double terminals circuit breakers (curve B, C, D) (cont.)

Connection between double terminal circuit breakers

With comb busbar at the back/cables at the front

Without comb busbar at the back/cables at the front

DBA04815



		Back	Front	
Rating	Tightening torque	Comb busbar	Copper cables	
		Thickness of the teeth	Rigid	Flexible or with ferrule
			DB122945	DB122946
0.5 to 25 A	2 N.m	1.5 mm	1 to 25 mm ²	1 to 16 mm ²
32 to 63 A	3.5 N.m	1.5 mm	1 to 25 mm ²	1 to 25 mm ²

Between double terminal circuit breakers and single-terminal circuit breakers

Cables at the back/comb busbar at the front

DBA04817



		Back	Front	
Rating	Tightening torque	Copper cables		Comb busbar
		Rigid	Flexible or with ferrule	Thickness of the teeth
		DB122945	DB122946	
0.5 to 25 A	2 N.m	1 to 16 mm ²	1 to 10 mm ²	1.5 mm
32 to 63 A	3.5 N.m	1 to 16 mm ²	1 to 10 mm ²	1.5 mm

- Connection by comb busbar or by cable (according to EN 50027).

Connection

DB123847

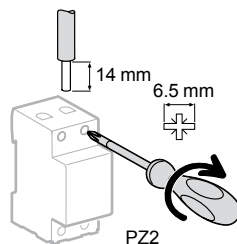

		With accessories		
Rating	50 mm ² Al terminal	Screw-on connection for ring terminal	Multi-cables terminal	
			Rigid cables	Flexible cables
		DB122935	DB118787	
0.5 to 25 A	-	Ø 5 mm	-	-
32 to 63 A	50 mm ²		3 x 16 mm ²	3 x 10 mm ²

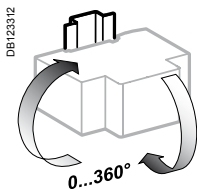

Indifferent position of installation.

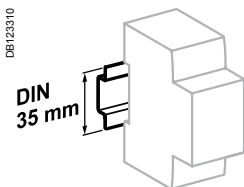
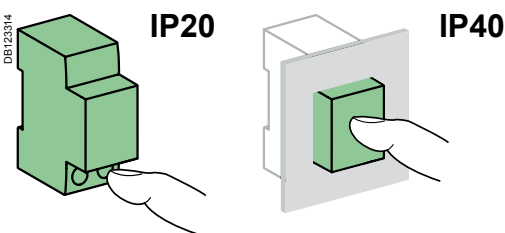

Clip on DIN rail 35 mm.

Technical data

Main characteristics		
According to IEC/EN 60947-2		
Insulation voltage (U _i)		500 V AC
Pollution degree		3
Rated impulse withstand voltage (U _{imp})		6 kV
Thermal tripping	Reference temperature	50°C
	Temperature derating	See module CA908007
Magnetic tripping	B curve	4 I _n ± 20 %
	C curve	8 I _n ± 20 %
	D curve	12 I _n ± 20 %
Utilization category		A
According to IEC/EN 60898-1		
Limitation class		3
Rated making and breaking capacity of an individual pole (I _{cn1})		I _{cn1} = I _{cn}
Additional characteristics		
Degree of protection (IEC 60529)	Device only	IP20
	Device in modular enclosure	IP40 Insulation class II
Endurance (O-C)	Electrical	10,000 cycles
	Mechanical	20,000 cycles
Overvoltage category (IEC 60364)		IV
Operating temperature		-35°C to +70°C
Storage temperature		-40°C to +85°C
Tropicalization (IEC 60068-1)		Treatment 2 (relative humidity 95 % to 55°C)

Disassembly double terminals iC60 circuit breaker with the comb busbar in position

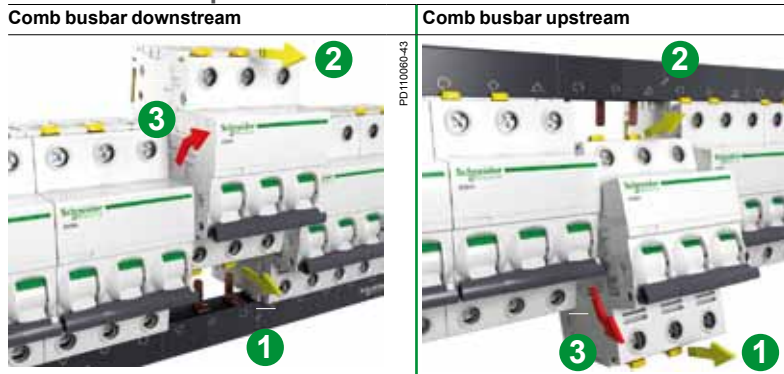

- 1- Pull lower "clip locking"
- 2- Pull upper "clip locking"
- 3- Remove the circuit breaker

Dimensions (mm)

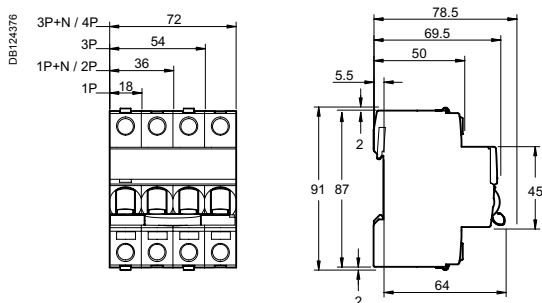

Weight (g)

Circuit-breaker	
Type	iC60N
1P	125
2P (1P+N)	250
3P	375
4P (3P+N)	500





Schneider Electric's range of circuit breakers consists of different products (A, B, C) to enable it to be the most competitive range possible in each country, allowing for the special characteristics of each market:

- usual installation procedure
- price
- accreditations by local bodies.

Variants

Offers		Pages
Offer A	Catalogue numbers	48
Offer B	Catalogue numbers	50
Offer C	Catalogue numbers	52
Common pages		54

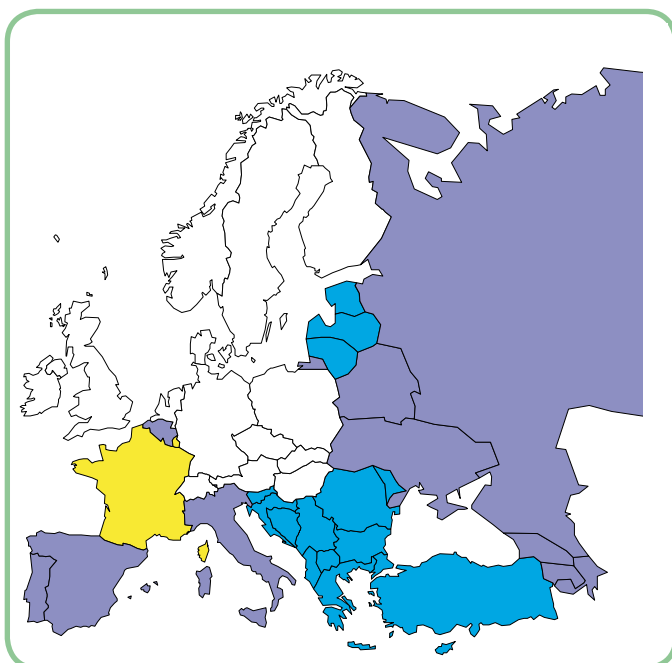

Only the product range to be marketed in your country and validated by the local product manager, in agreement with his Final Distribution (FD) partner should be retained. The others will be removed before publication.

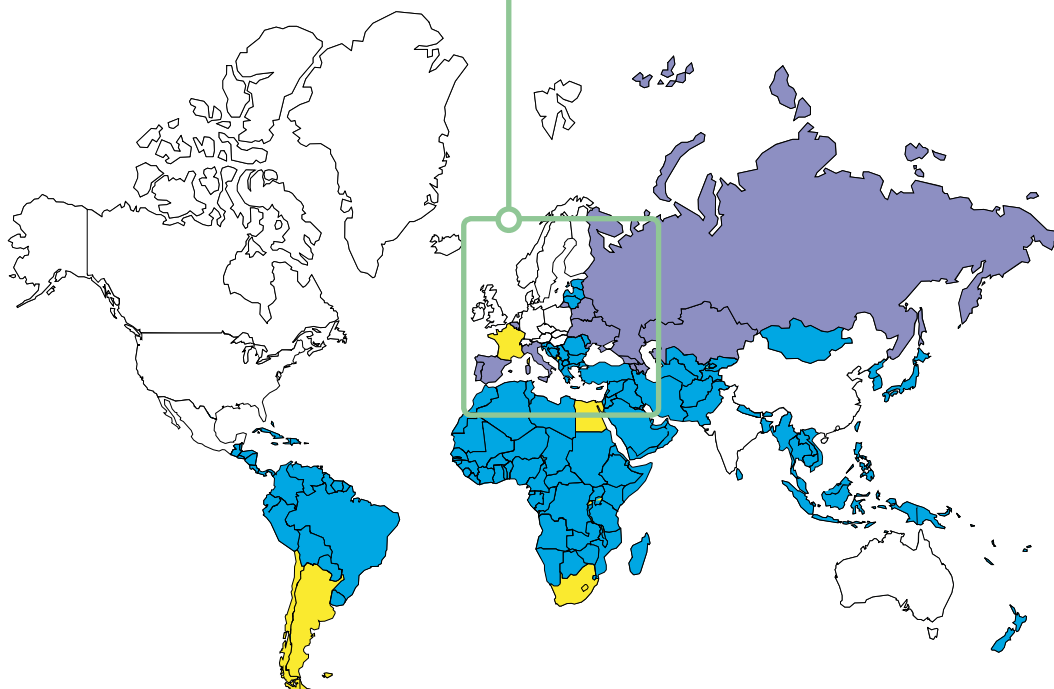

iC60H circuit breakers (curve B, C, D)



IEC/EN 60947-2 IEC/EN 60898-1

- iC60H circuit breakers are multi-standard circuit breakers which combine the following functions:
 - circuit protection against short-circuit currents,
 - circuit protection against overload currents,
 - suitable for industrial isolation according to IEC/EN 60947-2, standard.
 - fault tripping indication by a red mechanical indicator in circuit breaker front face.



Alternating current (AC) 50/60 Hz

Breaking capacity (Icu) according to IEC/EN 60947-2	Voltage (Ue)				Service breaking capacity (Ics)
	Ph/Ph (2P, 3P, 4P)	12 to 133 V	220 to 240 V	380 to 415 V	
Ph/N (1P, 1P+N)	12 to 60 V	100 to 133 V	220 to 240 V	-	
Rating (In)	0.5 to 4 A	70 kA	70 kA	50 kA	100 % of Icu
	6 to 63 A	42 kA	30 kA	15 kA	50 % of Icu

Breaking capacity (Icn) according to IEC/EN 60898-1	Voltage (Ue)	
	Ph/Ph	Ph/N
	400 V	230 V
Rating (In)	0.5 to 63 A	10000 A

Direct current (DC)

Breaking capacity (Icu) according to IEC/EN 60947-2	Voltage (Ue)					Service breaking capacity (Ics)
	Between +/-	12 to 60 V	≤ 72 V	≤ 125 V	≤ 180 V	
Number of poles	1P			2P	3P	4P
Rating (In)	0.5 to 63 A	20 kA	15 kA	15 kA	15 kA	15 kA

Offer selection see page 47
Offer A

Catalogue numbers

iC60H circuit breaker

Type	1P			1P+N		
Auxiliaries	Remote tripping and indication, module CA907000 and CA907002			Remote tripping and indication, module CA907000 and CA907002		
Vigi iC60	Vigi iC60 add-on residual current device, module CA902005			Vigi iC60 add-on residual current device, module CA902005		
Rating (In)	Curve			Curve		
	B	C	D ⁽¹⁾	B	C	D ⁽¹⁾
0.5 A ⁽¹⁾	A9F83170	A9F84170	A9F85170	A9F83670	A9F84670	A9F85670
1 A ⁽¹⁾	A9F83101	A9F84101	A9F85101	A9F83601	A9F84601	A9F85601
2 A ⁽¹⁾	A9F83102	A9F84102	A9F85102	A9F83602	A9F84602	A9F85602
3 A ⁽¹⁾	A9F83103	A9F84103	A9F85103	A9F83603	A9F84603	A9F85603
4 A ⁽¹⁾	A9F83104	A9F84104	A9F85104	A9F83604	A9F84604	A9F85604
6 A	A9F86106	A9F87106	A9F85106	A9F86606	A9F87606	A9F85606
10 A	A9F86110	A9F87110	A9F85110	A9F86610	A9F87610	A9F85610
13 A ⁽¹⁾	A9F83113	A9F84113	A9F85113	A9F83613	A9F84613	A9F85613
16 A	A9F86116	A9F87116	A9F85116	A9F86616	A9F87616	A9F85616
20 A	A9F86120	A9F87120	A9F85120	A9F86620	A9F87620	A9F85620
25 A	A9F86125	A9F87125	A9F85125	A9F86625	A9F87625	A9F85625
32 A	A9F86132	A9F87132	A9F85132	A9F86632	A9F87632	A9F85632
40 A	A9F86140	A9F87140	A9F85140	A9F86640	A9F87640	A9F85640
50 A	A9F86150	A9F87150	A9F85150	A9F86650	A9F87650	A9F85650
63 A	A9F86163	A9F87163	A9F85163	A9F86663	A9F87663	A9F85663
Width in 9-mm modules	2			4		
Accessories	Module CA907000 and CA907001			Module CA907000 and CA907001		

(1) VDE approved only.

iC60H circuit breakers (curve B, C, D) (cont.)

PB104495-40

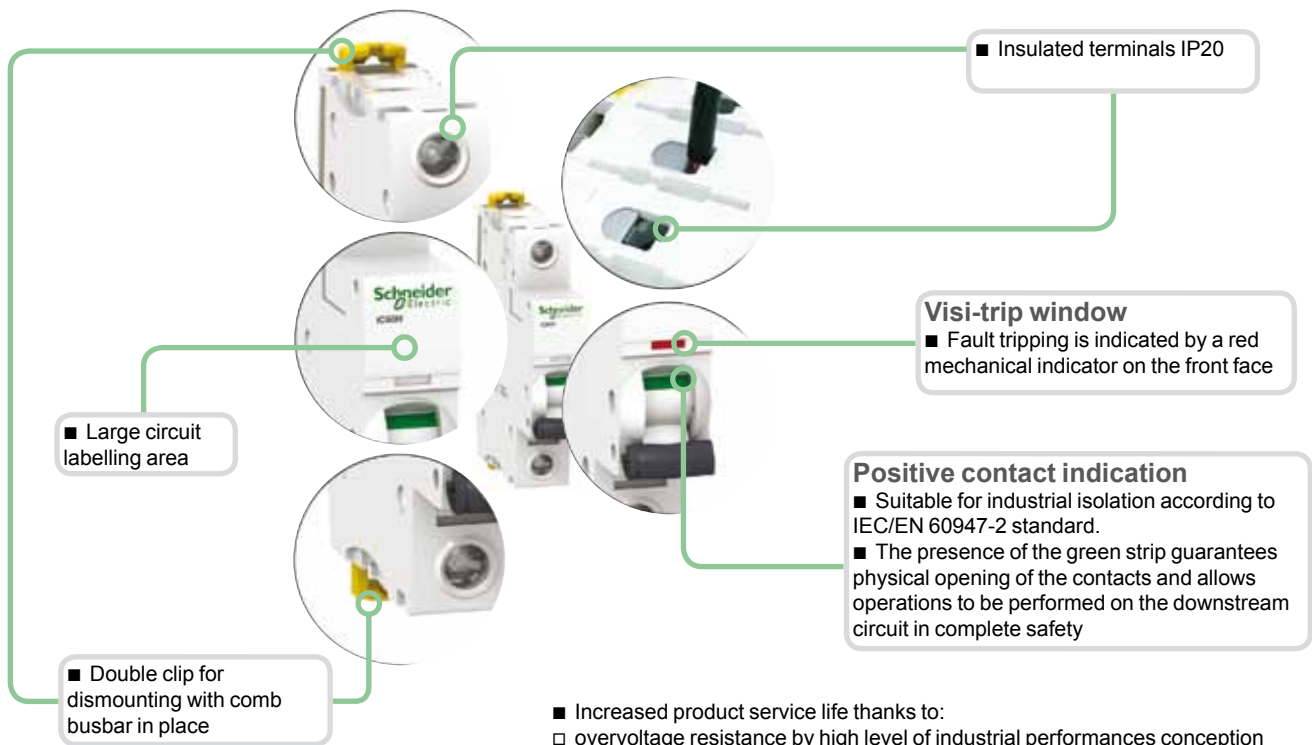

- Increased product service life thanks to:
 - overvoltage resistance by high level of industrial performances conception (pollution degree, rated impulse withstand voltage and insulation voltage),
 - high performance limitation (see limitation curves),
 - fast closing independent of the speed of actuation of the toggle.
- Remote indication, open/closed/tripped, by optional auxiliary contacts.
- Top or bottom electrical feeding.

2P			3P			4P		
E-6094 			E-6095 			E-6097 		
Remote tripping and indication, module CA907000 and CA907002			Remote tripping and indication, module CA907000 and CA907002			Remote tripping and indication, module CA907000 and CA907002		
Vigi iC60 add-on residual current device, module CA902005			Vigi iC60 add-on residual current device, module CA902005			Vigi iC60 add-on residual current device, module CA902005		
Curve			Curve			Curve		
B	C	D ⁽¹⁾	B	C	D ⁽¹⁾	B	C	D ⁽¹⁾
A9F83270	A9F84270	A9F85270	A9F83370	A9F84370	A9F85370	A9F83470	A9F84470	A9F85470
A9F83201	A9F84201	A9F85201	A9F83301	A9F84301	A9F85301	A9F83401	A9F84401	A9F85401
A9F83202	A9F84202	A9F85202	A9F83302	A9F84302	A9F85302	A9F83402	A9F84402	A9F85402
A9F83203	A9F84203	A9F85203	A9F83303	A9F84303	A9F85303	A9F83403	A9F84403	A9F85403
A9F83204	A9F84204	A9F85204	A9F83304	A9F84304	A9F85304	A9F83404	A9F84404	A9F85404
A9F86206	A9F87206	A9F85206	A9F86306	A9F87306	A9F85306	A9F86406	A9F87406	A9F85406
A9F86210	A9F87210	A9F85210	A9F86310	A9F87310	A9F85310	A9F86410	A9F87410	A9F85410
A9F83213	A9F84213	A9F85213	A9F83313	A9F84313	A9F85313	A9F83413	A9F84413	A9F85413
A9F86216	A9F87216	A9F85216	A9F86316	A9F87316	A9F85316	A9F86416	A9F87416	A9F85416
A9F86220	A9F87220	A9F85220	A9F86320	A9F87320	A9F85320	A9F86420	A9F87420	A9F85420
A9F86225	A9F87225	A9F85225	A9F86325	A9F87325	A9F85325	A9F86425	A9F87425	A9F85425
A9F86232	A9F87232	A9F85232	A9F86332	A9F87332	A9F85332	A9F86432	A9F87432	A9F85432
A9F86240	A9F87240	A9F85240	A9F86340	A9F87340	A9F85340	A9F86440	A9F87440	A9F85440
A9F86250	A9F87250	A9F85250	A9F86350	A9F87350	A9F85350	A9F86450	A9F87450	A9F85450
A9F86263	A9F87263	A9F85263	A9F86363	A9F87363	A9F85363	A9F86463	A9F87463	A9F85463
4			6			8		
Module CA907000 and CA907001			Module CA907000 and CA907001			Module CA907000 and CA907001		

iC60H circuit breakers (curve B, C, D)

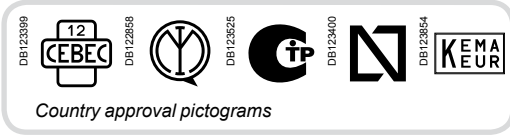

IEC/EN 60947-2 IEC/EN 60898-1

- iC60H circuit breakers are multi-standard circuit breakers which combine the following functions:
 - circuit protection against short-circuit currents,
 - circuit protection against overload currents,
 - suitable for industrial isolation according to IEC/EN 60947-2, standard.
 - fault tripping indication by a red mechanical indicator in circuit breaker front face.



Alternating current (AC) 50/60 Hz

Breaking capacity (Icu) according to IEC/EN 60947-2	Voltage (Ue)				Service breaking capacity (Ics)
	12 to 133 V	220 to 240 V	380 to 415 V	440 V	
Ph/Ph (2P, 3P, 4P)	12 to 133 V	220 to 240 V	380 to 415 V	440 V	100 % of Icu
Ph/N (1P, 1P+N)	12 to 60 V	100 to 133 V	220 to 240 V	-	
Rating (In)	0.5 to 4 A	70 kA	70 kA	70 kA	50 kA
	6 to 63 A	42 kA	30 kA	15 kA	10 kA

Breaking capacity (Icn) according to IEC/EN 60898-1	Voltage (Ue)	
	Ph/Ph	Ph/N
	400 V	230 V
Rating (In)	0.5 to 63 A	10000 A

Direct current (DC)

Breaking capacity (Icu) according to IEC/EN 60947-2	Voltage (Ue)					Service breaking capacity (Ics)
	Between +/-	12 to 60 V	≤ 72 V	≤ 125 V	≤ 180 V	
Number of poles	1P			2P	3P	4P
Rating (In)	0.5 to 63 A	20 kA	15 kA	15 kA	15 kA	15 kA

Offer selection see page 47

Offer B

This sticker must be removed before publishing

Catalogue numbers

iC60H circuit breaker

Type	1P			1P+N		
Auxiliaries	Remote tripping and indication, module CA907000 and CA907002			Remote tripping and indication, module CA907000 and CA907002		
Vigi iC60	Vigi iC60 add-on residual current device, module CA902005			Vigi iC60 add-on residual current device, module CA902005		
Rating (In)	Curve			Curve		
	B	C	D ⁽¹⁾	B	C	D ⁽¹⁾
0.5 A ⁽¹⁾	A9F83170	A9F84170	A9F85170	A9F83670	A9F84670	A9F85670
1 A ⁽¹⁾	A9F83101	A9F84101	A9F85101	A9F83601	A9F84601	A9F85601
2 A ⁽¹⁾	A9F83102	A9F84102	A9F85102	A9F83602	A9F84602	A9F85602
3 A ⁽¹⁾	A9F83103	A9F84103	A9F85103	A9F83603	A9F84603	A9F85603
4 A ⁽¹⁾	A9F83104	A9F84104	A9F85104	A9F83604	A9F84604	A9F85604
6 A	A9F88106	A9F89106	A9F85106	A9F88606	A9F89606	A9F85606
10 A	A9F88110	A9F89110	A9F85110	A9F88610	A9F89610	A9F85610
13 A ⁽¹⁾	A9F83113	A9F84113	A9F85113	A9F83613	A9F84613	A9F85613
16 A	A9F88116	A9F89116	A9F85116	A9F88616	A9F89616	A9F85616
20 A	A9F88120	A9F89120	A9F85120	A9F88620	A9F89620	A9F85620
25 A	A9F88125	A9F89125	A9F85125	A9F88625	A9F89625	A9F85625
32 A	A9F88132	A9F89132	A9F85132	A9F88632	A9F89632	A9F85632
40 A	A9F88140	A9F89140	A9F85140	A9F88640	A9F89640	A9F85640
50 A	A9F88150	A9F89150	A9F85150	A9F88650	A9F89650	A9F85650
63 A	A9F88163	A9F89163	A9F85163	A9F88663	A9F89663	A9F85663
Width in 9-mm modules	2			4		
Accessories	Module CA907000 and CA907001			Module CA907000 and CA907001		

(1) VDE approved only.

iC60H circuit breakers (curve B, C, D) (cont.)

PB104495-40

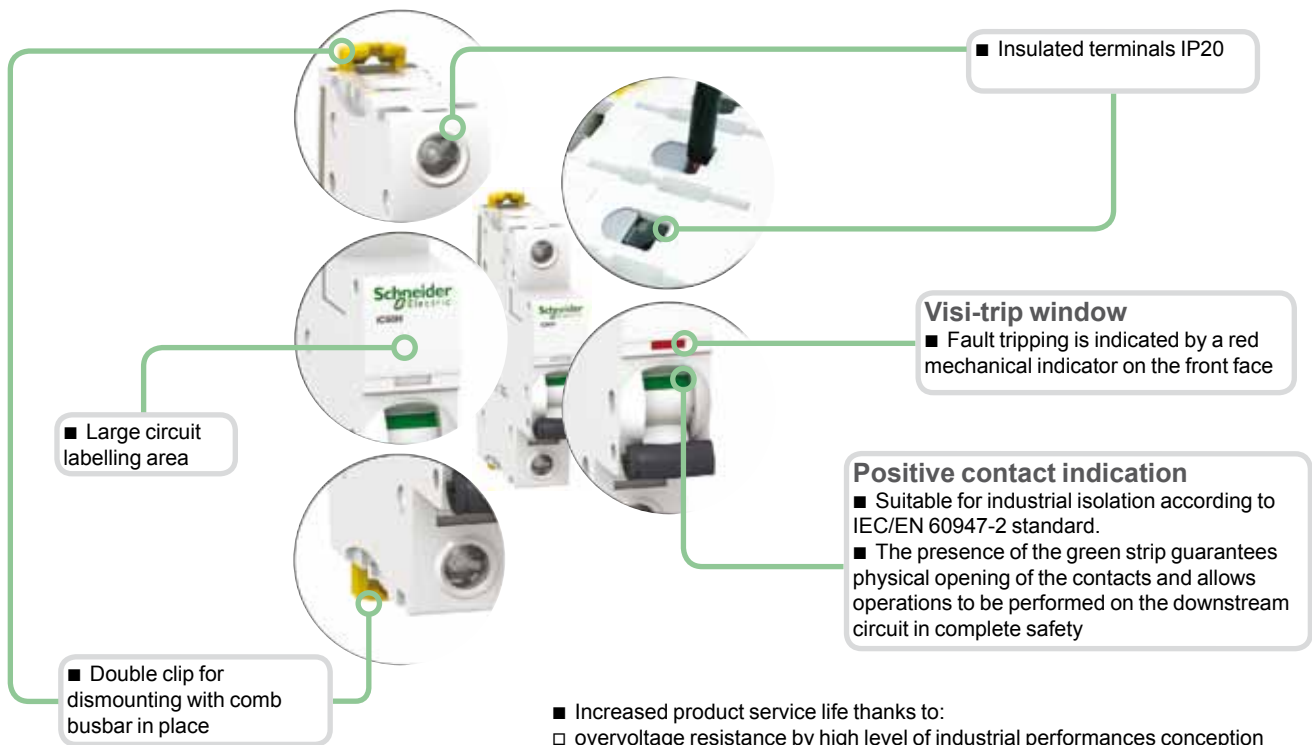

- Increased product service life thanks to:
 - overvoltage resistance by high level of industrial performances conception (pollution degree, rated impulse withstand voltage and insulation voltage),
 - high performance limitation (see limitation curves),
 - fast closing independent of the speed of actuation of the toggle.
- Remote indication, open/closed/tripped, by optional auxiliary contacts.
- Top or bottom electrical feeding.

2P			3P			4P		
E-46094			E-46095			E-46097		
Remote tripping and indication, module CA907000 and CA907002			Remote tripping and indication, module CA907000 and CA907002			Remote tripping and indication, module CA907000 and CA907002		
Vigi iC60 add-on residual current device, module CA902005			Vigi iC60 add-on residual current device, module CA902005			Vigi iC60 add-on residual current device, module CA902005		
Curve			Curve			Curve		
B	C	D ⁽¹⁾	B	C	D ⁽¹⁾	B	C	D ⁽¹⁾
A9F83270	A9F84270	A9F85270	A9F83370	A9F84370	A9F85370	A9F83470	A9F84470	A9F85470
A9F83201	A9F84201	A9F85201	A9F83301	A9F84301	A9F85301	A9F83401	A9F84401	A9F85401
A9F83202	A9F84202	A9F85202	A9F83302	A9F84302	A9F85302	A9F83402	A9F84402	A9F85402
A9F83203	A9F84203	A9F85203	A9F83303	A9F84303	A9F85303	A9F83403	A9F84403	A9F85403
A9F83204	A9F84204	A9F85204	A9F83304	A9F84304	A9F85304	A9F83404	A9F84404	A9F85404
A9F88206	A9F89206	A9F85206	A9F88306	A9F89306	A9F85306	A9F88406	A9F89406	A9F85406
A9F88210	A9F89210	A9F85210	A9F88310	A9F89310	A9F85310	A9F88410	A9F89410	A9F85410
A9F83213	A9F84213	A9F85213	A9F83313	A9F84313	A9F85313	A9F83413	A9F84413	A9F85413
A9F88216	A9F89216	A9F85216	A9F88316	A9F89316	A9F85316	A9F88416	A9F89416	A9F85416
A9F88220	A9F89220	A9F85220	A9F88320	A9F89320	A9F85320	A9F88420	A9F89420	A9F85420
A9F88225	A9F89225	A9F85225	A9F88325	A9F89325	A9F85325	A9F88425	A9F89425	A9F85425
A9F88232	A9F89232	A9F85232	A9F88332	A9F89332	A9F85332	A9F88432	A9F89432	A9F85432
A9F88240	A9F89240	A9F85240	A9F88340	A9F89340	A9F85340	A9F88440	A9F89440	A9F85440
A9F88250	A9F89250	A9F85250	A9F88350	A9F89350	A9F85350	A9F88450	A9F89450	A9F85450
A9F88263	A9F89263	A9F85263	A9F88363	A9F89363	A9F85363	A9F88463	A9F89463	A9F85463
4			6			8		
Module CA907000 and CA907001			Module CA907000 and CA907001			Module CA907000 and CA907001		

iC60H circuit breakers (curve B, C, D)



Country approval pictograms



IEC/EN 60947-2 IEC/EN 60898-1

- iC60H circuit breakers are multi-standard circuit breakers which combine the following functions:
 - circuit protection against short-circuit currents,
 - circuit protection against overload currents,
 - suitable for industrial isolation according to IEC/EN 60947-2, standard.
 - fault tripping indication by a red mechanical indicator in circuit breaker front face.

Alternating current (AC) 50/60 Hz

Breaking capacity (Icu) according to IEC/EN 60947-2	Voltage (Ue)				Service breaking capacity (Ics)
	12 to 133 V	220 to 240 V	380 to 415 V	440 V	
Ph/Ph (2P, 3P, 4P)	12 to 133 V	220 to 240 V	380 to 415 V	440 V	100 % of Icu 50 % of Ics
Ph/N (1P, 1P+N)	12 to 60 V	100 to 133 V	220 to 240 V	-	
Rating (In) 0.5 to 4 A	70 kA	70 kA	70 kA	50 kA	
6 to 63 A	42 kA	30 kA	15 kA	10 kA	

Breaking capacity (Icn) according to IEC/EN 60898-1

Breaking capacity (Icn) according to IEC/EN 60898-1	Voltage (Ue)	
	Ph/Ph	Ph/N
	400 V	230 V
Rating (In) 0.5 to 63 A	10000 A	

Direct current (DC)

Breaking capacity (Icu) according to IEC/EN 60947-2	Voltage (Ue)					Service breaking capacity (Ics)
	Between +/-	12 to 60 V	≤ 72 V	≤ 125 V	≤ 180 V	
Number of poles	1P			2P	3P	4P
Rating (In) 0.5 to 63 A	20 kA	15 kA	15 kA	15 kA	15 kA	100 % of Icu

Offer C

Offer selection see page 47

This sticker must be removed before publishing

Catalogue numbers

iC60H circuit breaker

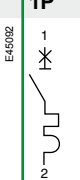
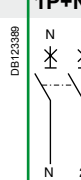
Type	1P			1P+N																																																																																																																																		
																																																																																																																																						
Auxiliaries	Remote tripping and indication, module CA907000 and CA907002			Remote tripping and indication, module CA907000 and CA907002																																																																																																																																		
Vigi iC60	Vigi iC60 add-on residual current device, module CA902005			Vigi iC60 add-on residual current device, module CA902005																																																																																																																																		
Rating (In)	<table border="1"> <thead> <tr> <th>Curve</th> <th>B</th> <th>C</th> <th>D</th> </tr> </thead> <tbody> <tr><td>0.5 A</td><td>A9F83170</td><td>A9F84170</td><td>A9F85170</td></tr> <tr><td>1 A</td><td>A9F83101</td><td>A9F84101</td><td>A9F85101</td></tr> <tr><td>2 A</td><td>A9F83102</td><td>A9F84102</td><td>A9F85102</td></tr> <tr><td>3 A</td><td>A9F83103</td><td>A9F84103</td><td>A9F85103</td></tr> <tr><td>4 A</td><td>A9F83104</td><td>A9F84104</td><td>A9F85104</td></tr> <tr><td>6 A</td><td>A9F83106</td><td>A9F84106</td><td>A9F85106</td></tr> <tr><td>10 A</td><td>A9F83110</td><td>A9F84110</td><td>A9F85110</td></tr> <tr><td>13 A</td><td>A9F83113</td><td>A9F84113</td><td>A9F85113</td></tr> <tr><td>16 A</td><td>A9F83116</td><td>A9F84116</td><td>A9F85116</td></tr> <tr><td>20 A</td><td>A9F83120</td><td>A9F84120</td><td>A9F85120</td></tr> <tr><td>25 A</td><td>A9F83125</td><td>A9F84125</td><td>A9F85125</td></tr> <tr><td>32 A</td><td>A9F83132</td><td>A9F84132</td><td>A9F85132</td></tr> <tr><td>40 A</td><td>A9F83140</td><td>A9F84140</td><td>A9F85140</td></tr> <tr><td>50 A</td><td>A9F83150</td><td>A9F84150</td><td>A9F85150</td></tr> <tr><td>63 A</td><td>A9F83163</td><td>A9F84163</td><td>A9F85163</td></tr> </tbody> </table>			Curve	B	C	D	0.5 A	A9F83170	A9F84170	A9F85170	1 A	A9F83101	A9F84101	A9F85101	2 A	A9F83102	A9F84102	A9F85102	3 A	A9F83103	A9F84103	A9F85103	4 A	A9F83104	A9F84104	A9F85104	6 A	A9F83106	A9F84106	A9F85106	10 A	A9F83110	A9F84110	A9F85110	13 A	A9F83113	A9F84113	A9F85113	16 A	A9F83116	A9F84116	A9F85116	20 A	A9F83120	A9F84120	A9F85120	25 A	A9F83125	A9F84125	A9F85125	32 A	A9F83132	A9F84132	A9F85132	40 A	A9F83140	A9F84140	A9F85140	50 A	A9F83150	A9F84150	A9F85150	63 A	A9F83163	A9F84163	A9F85163	<table border="1"> <thead> <tr> <th>Curve</th> <th>B</th> <th>C</th> <th>D</th> </tr> </thead> <tbody> <tr><td>0.5 A</td><td>A9F83670</td><td>A9F84670</td><td>A9F85670</td></tr> <tr><td>1 A</td><td>A9F83601</td><td>A9F84601</td><td>A9F85601</td></tr> <tr><td>2 A</td><td>A9F83602</td><td>A9F84602</td><td>A9F85602</td></tr> <tr><td>3 A</td><td>A9F83603</td><td>A9F84603</td><td>A9F85603</td></tr> <tr><td>4 A</td><td>A9F83604</td><td>A9F84604</td><td>A9F85604</td></tr> <tr><td>6 A</td><td>A9F83606</td><td>A9F84606</td><td>A9F85606</td></tr> <tr><td>10 A</td><td>A9F83610</td><td>A9F84610</td><td>A9F85610</td></tr> <tr><td>13 A</td><td>A9F83613</td><td>A9F84613</td><td>A9F85613</td></tr> <tr><td>16 A</td><td>A9F83616</td><td>A9F84616</td><td>A9F85616</td></tr> <tr><td>20 A</td><td>A9F83620</td><td>A9F84620</td><td>A9F85620</td></tr> <tr><td>25 A</td><td>A9F83625</td><td>A9F84625</td><td>A9F85625</td></tr> <tr><td>32 A</td><td>A9F83632</td><td>A9F84632</td><td>A9F85632</td></tr> <tr><td>40 A</td><td>A9F83640</td><td>A9F84640</td><td>A9F85640</td></tr> <tr><td>50 A</td><td>A9F83650</td><td>A9F84650</td><td>A9F85650</td></tr> <tr><td>63 A</td><td>A9F83663</td><td>A9F84663</td><td>A9F85663</td></tr> </tbody> </table>			Curve	B	C	D	0.5 A	A9F83670	A9F84670	A9F85670	1 A	A9F83601	A9F84601	A9F85601	2 A	A9F83602	A9F84602	A9F85602	3 A	A9F83603	A9F84603	A9F85603	4 A	A9F83604	A9F84604	A9F85604	6 A	A9F83606	A9F84606	A9F85606	10 A	A9F83610	A9F84610	A9F85610	13 A	A9F83613	A9F84613	A9F85613	16 A	A9F83616	A9F84616	A9F85616	20 A	A9F83620	A9F84620	A9F85620	25 A	A9F83625	A9F84625	A9F85625	32 A	A9F83632	A9F84632	A9F85632	40 A	A9F83640	A9F84640	A9F85640	50 A	A9F83650	A9F84650	A9F85650	63 A	A9F83663	A9F84663	A9F85663
Curve	B	C	D																																																																																																																																			
0.5 A	A9F83170	A9F84170	A9F85170																																																																																																																																			
1 A	A9F83101	A9F84101	A9F85101																																																																																																																																			
2 A	A9F83102	A9F84102	A9F85102																																																																																																																																			
3 A	A9F83103	A9F84103	A9F85103																																																																																																																																			
4 A	A9F83104	A9F84104	A9F85104																																																																																																																																			
6 A	A9F83106	A9F84106	A9F85106																																																																																																																																			
10 A	A9F83110	A9F84110	A9F85110																																																																																																																																			
13 A	A9F83113	A9F84113	A9F85113																																																																																																																																			
16 A	A9F83116	A9F84116	A9F85116																																																																																																																																			
20 A	A9F83120	A9F84120	A9F85120																																																																																																																																			
25 A	A9F83125	A9F84125	A9F85125																																																																																																																																			
32 A	A9F83132	A9F84132	A9F85132																																																																																																																																			
40 A	A9F83140	A9F84140	A9F85140																																																																																																																																			
50 A	A9F83150	A9F84150	A9F85150																																																																																																																																			
63 A	A9F83163	A9F84163	A9F85163																																																																																																																																			
Curve	B	C	D																																																																																																																																			
0.5 A	A9F83670	A9F84670	A9F85670																																																																																																																																			
1 A	A9F83601	A9F84601	A9F85601																																																																																																																																			
2 A	A9F83602	A9F84602	A9F85602																																																																																																																																			
3 A	A9F83603	A9F84603	A9F85603																																																																																																																																			
4 A	A9F83604	A9F84604	A9F85604																																																																																																																																			
6 A	A9F83606	A9F84606	A9F85606																																																																																																																																			
10 A	A9F83610	A9F84610	A9F85610																																																																																																																																			
13 A	A9F83613	A9F84613	A9F85613																																																																																																																																			
16 A	A9F83616	A9F84616	A9F85616																																																																																																																																			
20 A	A9F83620	A9F84620	A9F85620																																																																																																																																			
25 A	A9F83625	A9F84625	A9F85625																																																																																																																																			
32 A	A9F83632	A9F84632	A9F85632																																																																																																																																			
40 A	A9F83640	A9F84640	A9F85640																																																																																																																																			
50 A	A9F83650	A9F84650	A9F85650																																																																																																																																			
63 A	A9F83663	A9F84663	A9F85663																																																																																																																																			
Width in 9-mm modules	2			4																																																																																																																																		
Accessories	Module CA907000 and CA907001			Module CA907000 and CA907001																																																																																																																																		

iC60H circuit breakers (curve B, C, D) (cont.)

PB104495-40

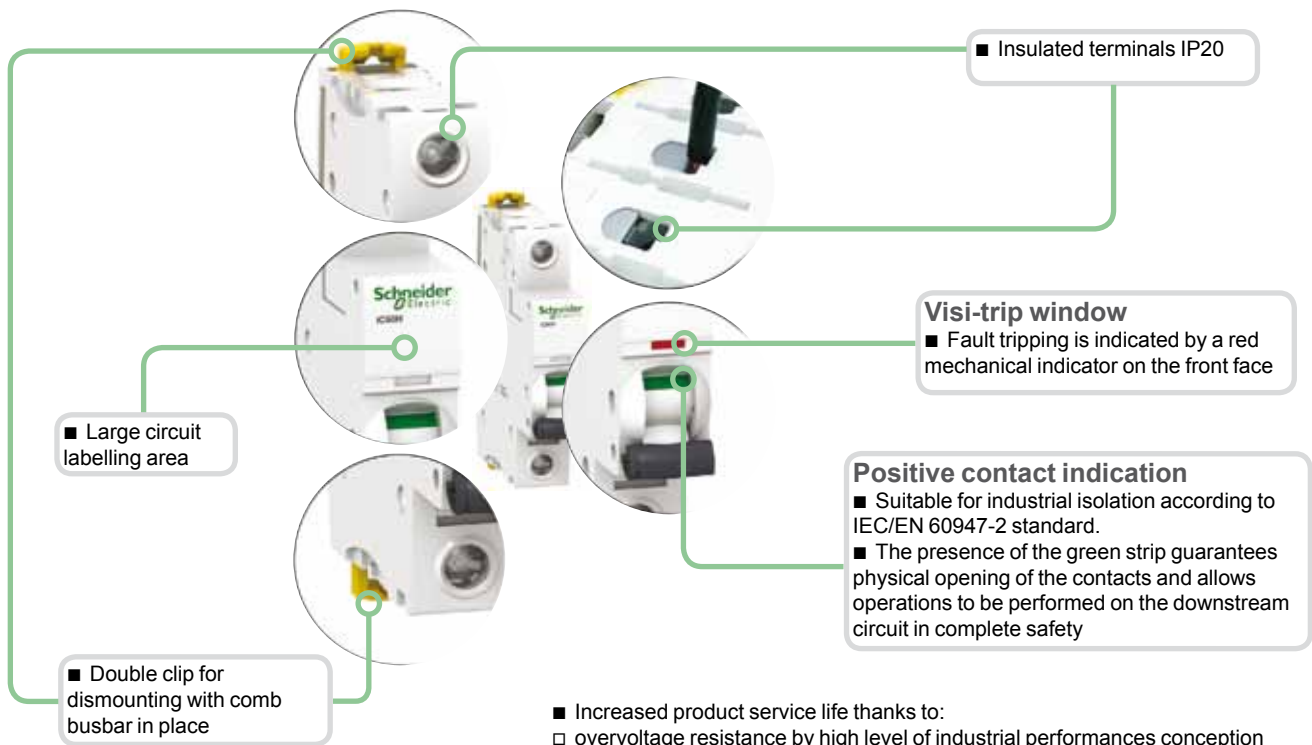

- Increased product service life thanks to:
 - overvoltage resistance by high level of industrial performances conception (pollution degree, rated impulse withstand voltage and insulation voltage),
 - high performance limitation (see limitation curves),
 - fast closing independent of the speed of actuation of the toggle.
- Remote indication, open/closed/tripped, by optional auxiliary contacts.
- Top or bottom electrical feeding.

2P				3P			4P			
E46004 1 3 2 4				E46006 1 3 5 2 4 6			E46007 1 3 5 7 2 4 6 8			
Remote tripping and indication, module CA907000 and CA907002				Remote tripping and indication, module CA907000 and CA907002			Remote tripping and indication, module CA907000 and CA907002			
Vigi iC60 add-on residual current device, module CA902005				Vigi iC60 add-on residual current device, module CA902005			Vigi iC60 add-on residual current device, module CA902005			
Curve				Curve			Curve			
B		C		D		B		C		D
A9F83270	A9F84270	A9F85270	A9F83370	A9F84370	A9F85370	A9F83470	A9F84470	A9F85470		
A9F83201	A9F84201	A9F85201	A9F83301	A9F84301	A9F85301	A9F83401	A9F84401	A9F85401		
A9F83202	A9F84202	A9F85202	A9F83302	A9F84302	A9F85302	A9F83402	A9F84402	A9F85402		
A9F83203	A9F84203	A9F85203	A9F83303	A9F84303	A9F85303	A9F83403	A9F84403	A9F85403		
A9F83204	A9F84204	A9F85204	A9F83304	A9F84304	A9F85304	A9F83404	A9F84404	A9F85404		
A9F83206	A9F84206	A9F85206	A9F83306	A9F84306	A9F85306	A9F83406	A9F84406	A9F85406		
A9F83210	A9F84210	A9F85210	A9F83310	A9F84310	A9F85310	A9F83410	A9F84410	A9F85410		
A9F83213	A9F84213	A9F85213	A9F83313	A9F84313	A9F85313	A9F83413	A9F84413	A9F85413		
A9F83216	A9F84216	A9F85216	A9F83316	A9F84316	A9F85316	A9F83416	A9F84416	A9F85416		
A9F83220	A9F84220	A9F85220	A9F83320	A9F84320	A9F85320	A9F83420	A9F84420	A9F85420		
A9F83225	A9F84225	A9F85225	A9F83325	A9F84325	A9F85325	A9F83425	A9F84425	A9F85425		
A9F83232	A9F84232	A9F85232	A9F83332	A9F84332	A9F85332	A9F83432	A9F84432	A9F85432		
A9F83240	A9F84240	A9F85240	A9F83340	A9F84340	A9F85340	A9F83440	A9F84440	A9F85440		
A9F83250	A9F84250	A9F85250	A9F83350	A9F84350	A9F85350	A9F83450	A9F84450	A9F85450		
A9F83263	A9F84263	A9F85263	A9F83363	A9F84363	A9F85363	A9F83463	A9F84463	A9F85463		
4				6			8			
Module CA907000 and CA907001				Module CA907000 and CA907001			Module CA907000 and CA907001			

iC60H circuit breakers (curve B, C, D) (cont.)

Connection

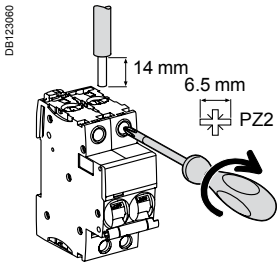

Rating	Tightening torque	Without accessory		With accessories			
		Copper cables Rigid	Copper cables Flexible or with ferrule	50 mm ² Al terminal	Screw-on connection for ring terminal	Multi-cables terminal Rigid cables	Multi-cables terminal Flexible cables
0.5 to 25 A	2 N.m	1 to 25 mm ²	1 to 16 mm ²	-	Ø 5 mm	-	-
32 to 63 A	3.5 N.m	1 to 35 mm ²	1 to 25 mm ²	50 mm ²	-	3 x 16 mm ²	3 x 10 mm ²

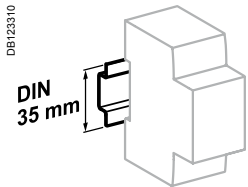

Clip on DIN rail 35 mm.

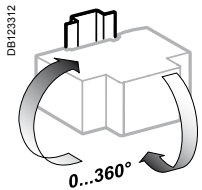

Indifferent position of installation.

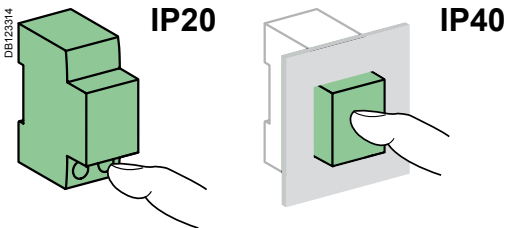

Technical data

Main characteristics		
According to IEC/EN 60947-2		
Insulation voltage (Ui)		500 V AC
Pollution degree		3
Rated impulse withstand voltage (Uimp)		6 kV
Thermal tripping	Reference temperature	50 °C
	Temperature derating	See module CA908007
Magnetic tripping	B curve	4 In ± 20 %
	C curve	8 In ± 20 %
	D curve	12 In ± 20 %
Utilization category		A
According to IEC/EN 60898-1		
Limitation class		3
Rated making and breaking capacity of an individual pole (Icn1)		Icn1 = Icn
Additional characteristics		
Breaking capacity under 1 pole with IT 380-415 V isolated neutral system (case of double fault)	40 A	4 kA
	50/63 A	3 kA
Degree of protection (IEC 60529)	Device only	IP20
	Device in modular enclosure	IP40
Endurance (O-C)	Electrical	10,000 cycles
	Mechanical	20,000 cycles
Overvoltage category (IEC 60364)		IV
Operating temperature		-35°C to +70°C
Storage temperature		-40°C to +85°C
Tropicalization (IEC 60068-1)		Treatment 2 (relative humidity 95 % to 55°C)

Weight (g)

Circuit-breaker	
Type	iC60H
1P	125
2P	250
3P	375
4P	500

Dimensions (mm)

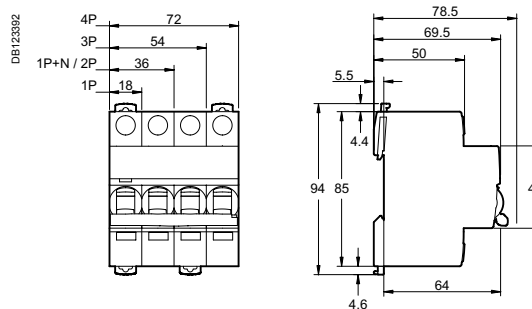

iC60H double terminals circuit breakers (curve B, C, D)

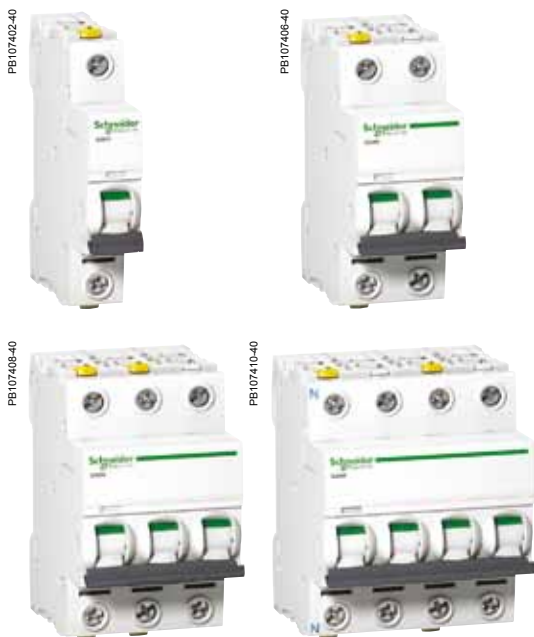
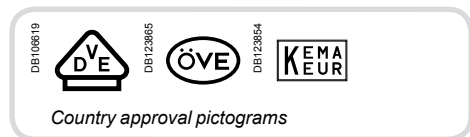

IEC/EN 60947-2 IEC/EN 60898-1

- iC60H double terminals circuit breakers are multi-standard circuit breakers which combine the following functions:
 - circuit protection against short-circuit currents,
 - circuit protection against overload currents,
 - suitable for industrial isolation according to IEC/EN 60947-2, standard.
 - fault tripping indication by a red mechanical indicator in circuit breaker front face.

Alternating current (AC) 50/60 Hz

Breaking capacity (Icu) according to IEC/EN 60947-2	Voltage (Ue)				Service breaking capacity (Ics)
	Ph/Ph (2P, 3P, 4P)	12 to 133 V	220 to 240 V	380 to 415 V 440 V	
Ph/N (1P, 1P+N)	12 to 60 V	100 to 133 V	220 to 240 V	-	
Rating (In)	0.5 to 4 A	70 kA	70 kA	70 kA	50 kA
	6 to 40 A	42 kA	30 kA	15 kA	10 kA
	50/63 A	42 kA	30 kA	15 kA	10 kA

Breaking capacity (Icn) according to IEC/EN 60898-1

Breaking capacity (Icn) according to IEC/EN 60898-1	Voltage (Ue)	
	Ph/Ph	400 V
Ph/N	230 V	
Rating (In)	0.5 to 63 A	10000 A

Direct current (DC)

Breaking capacity (Icu) according to IEC/EN 60947-2	Voltage (Ue)					Service breaking capacity (Ics)
	Between +/-	12 to 60 V	≤ 72 V	≤ 125 V	≤ 180 V ≤ 250 V	
Number of poles	1P			2P	3P	4P
Rating (In)	1 to 63 A	20 kA	15 kA	15 kA	15 kA	15 kA

Catalogue numbers

iC60H double terminals circuit breaker

Type	1P	1P+N	2P			
Auxiliaries	Remote tripping and indication, module CA907000 and CA907002	Remote tripping and indication, module CA907000 and CA907002	Remote tripping and indication, module CA907000 and CA907002			
Vigi iC60	Vigi iC60 add-on residual current device, module CA902005	Vigi iC60 add-on residual current device, module CA902005	Vigi iC60 add-on residual current device, module CA902005			
Rating (In)	Curve		Curve			
	B	C	D	B	C	D
0.5 A	-	A9F07170	A9F08170	-	A9F07670	A9F08270
1 A	-	A9F07101	A9F08101	-	A9F07601	A9F08201
2 A	-	A9F07102	A9F08102	-	A9F07602	A9F08202
3 A	-	A9F07103	A9F08103	-	A9F07603	A9F08203
4 A	-	A9F07104	A9F08104	-	A9F07604	A9F08204
6 A	A9F06106	A9F07106	A9F08106	A9F06606	A9F07606	A9F06206
10 A	A9F06110	A9F07110	A9F08110	A9F06610	A9F07610	A9F06210
13 A	A9F06113	A9F07113	A9F08113	A9F06613	A9F07613	A9F06213
16 A	A9F06116	A9F07116	A9F08116	A9F06616	A9F07616	A9F06216
20 A	A9F06120	A9F07120	A9F08120	A9F06620	A9F07620	A9F06220
25 A	A9F06125	A9F07125	A9F08125	A9F06625	A9F07625	A9F06225
32 A	A9F06132	A9F07132	A9F08132	A9F06632	A9F07632	A9F06232
40 A	A9F06140	A9F07140	A9F08140	A9F06640	A9F07640	A9F06240
50 A	A9F06150	A9F07150	A9F08150	A9F06650	A9F07650	A9F06250
63 A	A9F06163	A9F07163	A9F08163	A9F06663	A9F07663	A9F06263
Width in 9-mm modules	2		4		4	
Accessories	Modules CA907000 and CA907001		Modules CA907000 and CA907001		Modules CA907000 and CA907001	

iC60H double terminals circuit breakers (curve B, C, D) (cont.)

Insulated terminals IP20

Double terminals
 ■ For top or bottom connections:
 □ by cable,
 □ by comb busbar

Large circuit labelling area

Visi-trip window
 ■ Fault tripping is indicated by a red mechanical indicator on the front face

Double clip locking allowing tool-free removal, front panel side, with the comb busbar in position

Positive contact indication
 ■ Suitable for industrial isolation according to IEC/EN 60947-2 standard
 ■ The presence of the green strip guarantees physical opening of the contacts and allows operations to be performed on the downstream circuit in complete safety

1 Pull
2 Pull
3 Pull

- Increased product service life thanks to:
 - overvoltage resistance by high level of industrial performances conception (pollution degree, rated impulse withstand voltage and insulation voltage),
 - high performance limitation (see limitation curves),
 - fast closing independent of the speed of actuation of the toggle.
- Remote indication, open/closed/tripped, by optional auxiliary contacts.
- Top or bottom electrical feeding.

3P				4P			
Remote tripping and indication, module CA907000 and CA907002				Remote tripping and indication, module CA907000 and CA907002			
Vigi iC60 add-on residual current device, module CA902005				Vigi iC60 add-on residual current device, module CA902005			
Curve				Curve			
B	C	D		B	C	D	
-	A9F07370	A9F08370		-	A9F07470	A9F08470	
-	A9F07301	A9F08301		-	A9F07401	A9F08401	
-	A9F07302	A9F08302		-	A9F07402	A9F08402	
-	A9F07303	A9F08303		-	A9F07403	A9F08403	
-	A9F07304	A9F08304		-	A9F07404	A9F08404	
A9F06306	A9F07306	A9F08306		A9F06406	A9F07406	A9F08406	
A9F06310	A9F07310	A9F08310		A9F06410	A9F07410	A9F08410	
A9F06313	A9F07313	A9F08313		A9F06413	A9F07413	A9F08413	
A9F06316	A9F07316	A9F08316		A9F06416	A9F07416	A9F08416	
A9F06320	A9F07320	A9F08320		A9F06420	A9F07420	A9F08420	
A9F06325	A9F07325	A9F08325		A9F06425	A9F07425	A9F08425	
A9F06332	A9F07332	A9F08332		A9F06432	A9F07432	A9F08432	
A9F06340	A9F07340	A9F08340		A9F06440	A9F07440	A9F08440	
A9F06350	A9F07350	A9F08350		A9F06450	A9F07450	A9F08450	
A9F06363	A9F07363	A9F08363		A9F06463	A9F07463	A9F08463	
6				8			
Modules CA907000 and CA907001				Modules CA907000 and CA907001			

iC60H double terminals circuit breakers (curve B, C, D) (cont.)

Connection between double terminal circuit breakers

With comb busbar at the back/cables at the front

Without comb busbar at the back/cables at the front

DB404815



		Back	Front	
Rating	Tightening torque	Comb busbar	Copper cables	
		Thickness of the teeth	Rigid	Flexible or with ferrule
0.5 to 25 A	2 N.m	1.5 mm	DB122945	DB122946
32 to 63 A	3.5 N.m	1.5 mm	1 to 25 mm ²	1 to 16 mm ²
			1 to 25 mm ²	1 to 25 mm ²

Between double terminal circuit breakers and single-terminal circuit breakers

Cables at the back/comb busbar at the front

DB404817



		Back	Front	
Rating	Tightening torque	Copper cables		Thickness of the teeth
		Rigid	Flexible or with ferrule	
0.5 to 25 A	2 N.m	DB122945	DB122946	1.5 mm
32 to 63 A	3.5 N.m	1 to 16 mm ²	1 to 10 mm ²	1.5 mm
		1 to 16 mm ²	1 to 10 mm ²	1.5 mm

■ Connection by comb busbar or by cable (according to EN 50027).

Connection

DB123847

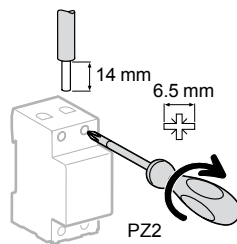

		With accessories		
Rating	50 mm ² Al terminal	Screw-on connection for ring terminal	Multi-cables terminal	
		DB118789	Rigid cables	Flexible cables
0.5 to 25 A	-	DB122935	DB118787	-
32 to 63 A	50 mm ²	Ø 5 mm	3 x 16 mm ²	3 x 10 mm ²

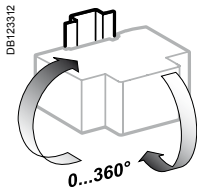

Indifferent position of installation.

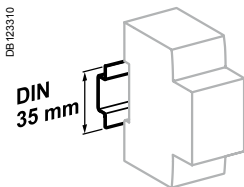
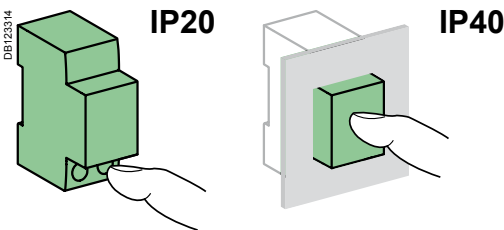

Clip on DIN rail 35 mm.

Technical data

Main characteristics		
According to IEC/EN 60947-2		
Insulation voltage (Ui)		500 V AC
Pollution degree		3
Rated impulse withstand voltage (Uimp)		6 kV
Thermal tripping	Reference temperature	50°C
	Temperature derating	See module CA908007
Magnetic tripping	B curve	4 In ± 20 %
	C curve	8 In ± 20 %
	D curve	12 In ± 20 %
Utilization category		A
According to IEC/EN 60898-1		
Limitation class		3
Rated making and breaking capacity of an individual pole (Icn1)		Icn1 = Icn
Additional characteristics		
Degree of protection (IEC 60529)	Device only	IP20
	Device in modular enclosure	IP40 Insulation class II
Endurance (O-C)	Electrical	10,000 cycles
	Mechanical	20,000 cycles
Overvoltage category (IEC 60364)		IV
Operating temperature		-35°C to +70°C
Storage temperature		-40°C to +85°C
Tropicalization (IEC 60068-1)		Treatment 2 (relative humidity 95 % to 55°C)

Disassembly double terminals iC60 circuit breaker with the comb busbar in position

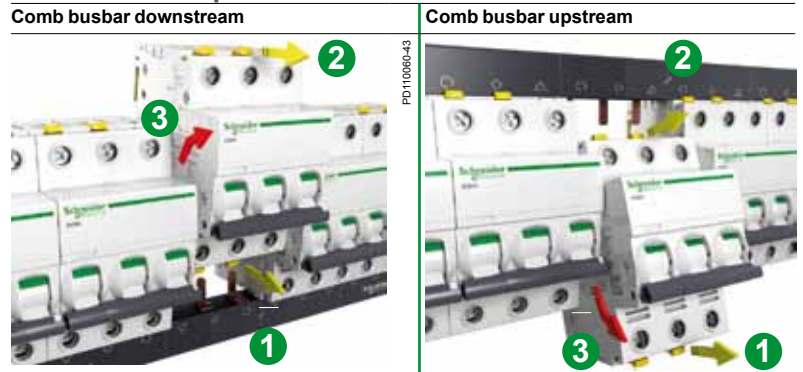

- 1- Pull lower "clip locking"
- 2- Pull upper "clip locking"
- 3- Remove the circuit breaker

Dimensions (mm)

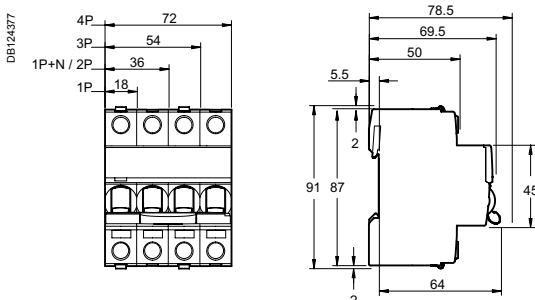

Weight (g)

Circuit-breaker	
Type	iC60H
1P	125
2P (1P+N)	250
3P	375
4P	500

iC60L circuit breakers (curve B, C, K, Z)



IEC/EN 60947-2 IEC/EN 60898-1 up to 40 A

- iC60L circuit breakers are multi-standard circuit breakers which combine the following functions:
 - circuit protection against short-circuit currents,
 - circuit protection against overload currents,
 - suitable for industrial isolation according to IEC/EN 60947-2, standard.
 - fault tripping indication by a red mechanical indicator in circuit breaker front face.

Alternating current (AC) 50/60 Hz

Breaking capacity (Icu) according to IEC/EN 60947-2						Service breaking capacity (Ics)
		Voltage (Ue)				
Ph/Ph (2P, 3P, 4P)		12 to 133 V	220 to 240 V	380 to 415 V	440 V	100 % of Icu
Ph/N (1P)		12 to 60 V	100 to 133 V	220 to 240 V	-	
Rating (In)	0.5 to 4 A	100 kA	100 kA	100 kA	70 kA	100 % of Icu
	6 to 25 A	70 kA	50 kA	25 kA	20 kA	50 % of Icu ⁽¹⁾
	32 / 40 A	70 kA	36 kA	20 kA	15 kA	50 % of Icu
	50 / 63 A	70 kA	30 kA	15 kA	10 kA	50 % of Icu

Breaking capacity (Icn) according to IEC/EN 60898-1	
Voltage (Ue)	
Ph/Ph	400 V
Ph/N	230 V
Rating (In)	0.5 to 40 A 15000 A

Direct current (DC)

Breaking capacity (Icu) according to IEC/EN 60947-2						Service breaking capacity (Ics)	
		Voltage (Ue)					
Between +/-		12 to 60 V	≤ 72 V	≤ 125 V	≤ 180 V	≤ 250 V	100 % of Icu
Number of poles		1P		2P	3P	4P	
Rating (In)		0.5 to 63 A	25 kA	20 kA	20 kA	20 kA	20 kA

Catalogue numbers

iC60L circuit breaker

Type	1P	2P						
Auxiliaries	Remote tripping and indication, module CA907000 and CA907002	Remote tripping and indication, module CA907000 and CA907002						
Vigi iC60	Vigi iC60 add-on residual current device, module CA902005	Vigi iC60 add-on residual current device, module CA902005						
Rating (In)	Curve				Curve			
Quality label (2)								
	B	C	K	Z	B	C	K	Z
0.5 A	A9F93170	A9F94170	A9F95170	A9F92170	A9F93270	A9F94270	A9F95270	A9F92270
1 A	A9F93101	A9F94101	A9F95101	A9F92101	A9F93201	A9F94201	A9F95201	A9F92201
1.6 A	-	-	A9F95172	A9F92172	-	-	A9F95272	A9F92272
2 A	A9F93102	A9F94102	A9F95102	A9F92102	A9F93202	A9F94202	A9F95202	A9F92202
3 A	A9F93103	A9F94103	A9F95103	A9F92103	A9F93203	A9F94203	A9F95203	A9F92203
4 A	A9F93104	A9F94104	A9F95104	A9F92104	A9F93204	A9F94204	A9F95204	A9F92204
6 A	A9F93106	A9F94106	A9F95106	A9F92106	A9F93206	A9F94206	A9F95206	A9F92206
10 A	A9F93110	A9F94110	A9F95110	A9F92110	A9F93210	A9F94210	A9F95210	A9F92210
16 A	A9F93116	A9F94116	A9F95116	A9F92116	A9F93216	A9F94216	A9F95216	A9F92216
20 A	A9F93120	A9F94120	A9F95120	A9F92120	A9F93220	A9F94220	A9F95220	A9F92220
25 A	A9F93125	A9F94125	A9F95125	A9F92125	A9F93225	A9F94225	A9F95225	A9F92225
32 A	A9F93132	A9F94132	A9F95132	A9F92132	A9F93232	A9F94232	A9F95232	A9F92232
40 A	A9F93140	A9F94140	A9F95140	A9F92140	A9F93240	A9F94240	A9F95240	A9F92240
50 A	A9F93150	A9F94150	A9F95150 ⁽³⁾	A9F92150	A9F93250	A9F94250	A9F95250	A9F92250
63 A	A9F93163	A9F94163	A9F95163 ⁽³⁾	A9F92163	A9F93263	A9F94263	A9F95263	A9F92263
Width in 9-mm modules	2				4			
Accessories	Module CA907000 and CA907001				Module CA907000 and CA907001			

(1) 100 % of Icu for ratings 6 to 25 A under Ue 100 to 133 V AC Ph/Ph and Ue 12 to 60 V AC Ph/N.
 (2) Information to be provided by the country.
 (3) Without approval.

iC60L circuit breakers (curve B, C, K, Z) (cont.)

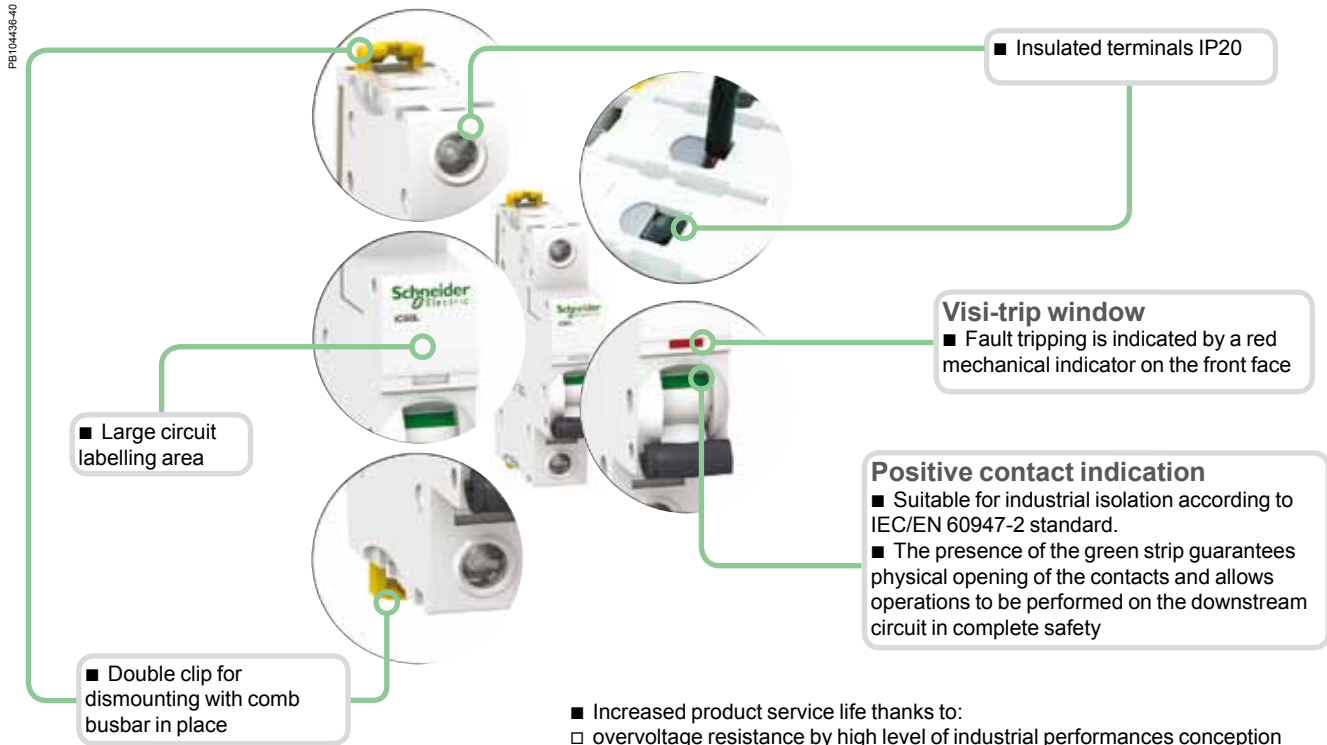

- Increased product service life thanks to:
 - overvoltage resistance by high level of industrial performances conception (pollution degree, rated impulse withstand voltage and insulation voltage),
 - high performance limitation (see limitation curves),
 - fast closing independent of the speed of actuation of the toggle.
- Remote indication, open/closed/tripped, by optional auxiliary contacts.
- Top or bottom electrical feeding.

3P				4P			
E-6095				E-6097			
Remote tripping and indication, module CA907000 and CA907002				Remote tripping and indication, module CA907000 and CA907002			
Vigi iC60 add-on residual current device, module CA902005				Vigi iC60 add-on residual current device, module CA902005			
Curve		Curve		Curve		Curve	
B	C	K	Z	B	C	K	Z
A9F93370	A9F94370	A9F95370	A9F92370	A9F93470	A9F94470	A9F95470	A9F92470
A9F93301	A9F94301	A9F95301	A9F92301	A9F93401	A9F94401	A9F95401	A9F92401
-	-	A9F95372	A9F92372	-	-	A9F95472	A9F92472
A9F93302	A9F94302	A9F95302	A9F92302	A9F93402	A9F94402	A9F95402	A9F92402
A9F93303	A9F94303	A9F95303	A9F92303	A9F93403	A9F94403	A9F95403	A9F92403
A9F93304	A9F94304	A9F95304	A9F92304	A9F93404	A9F94404	A9F95404	A9F92404
A9F93306	A9F94306	A9F95306	A9F92306	A9F93406	A9F94406	A9F95406	A9F92406
A9F93310	A9F94310	A9F95310	A9F92310	A9F93410	A9F94410	A9F95410	A9F92410
A9F93316	A9F94316	A9F95316	A9F92316	A9F93416	A9F94416	A9F95416	A9F92416
A9F93320	A9F94320	A9F95320	A9F92320	A9F93420	A9F94420	A9F95420	A9F92420
A9F93325	A9F94325	A9F95325	A9F92325	A9F93425	A9F94425	A9F95425	A9F92425
A9F93332	A9F94332	A9F95332	A9F92332	A9F93432	A9F94432	A9F95432	A9F92432
A9F93340	A9F94340	A9F95340	A9F92340	A9F93440	A9F94440	A9F95440	A9F92440
A9F93350	A9F94350	A9F95350	A9F92350	A9F93450	A9F94450	A9F95450	A9F92450
A9F93363	A9F94363	A9F95363	A9F92363	A9F93463	A9F94463	A9F95463	A9F92463
4				6			
Module CA907000 and CA907001				Module CA907000 and CA907001			

iC60L circuit breakers (curve B, C, K, Z) (cont.)

Connection

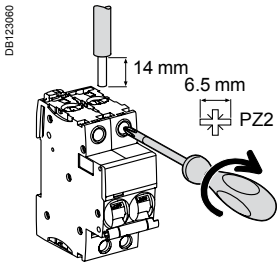

Rating	Tightening torque	Without accessory		With accessories		
		Rigid	Flexible or with ferrule	50 mm ² Al terminal	Screw-on connection for ring terminal	Multi-cables terminal
0.5 to 25 A	2 N.m	DB1122945	DB1122946	DB1122935	DB118789	DB118787
32 to 63 A	3.5 N.m	1 to 25 mm ²	1 to 16 mm ²	-	Ø 5 mm	-
		1 to 35 mm ²	1 to 25 mm ²	50 mm ²		3 x 16 mm ²
						3 x 10 mm ²

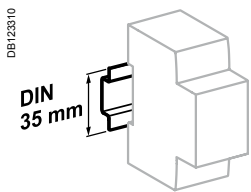

Clip on DIN rail 35 mm.

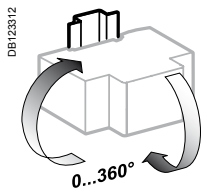

Indifferent position of installation.

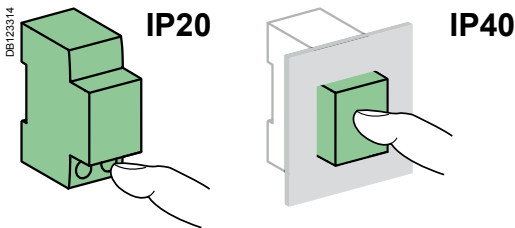

Technical data

Main characteristics

According to IEC/EN 60947-2

Insulation voltage (U _i)	500 V AC	
Pollution degree	3	
Rated impulse withstand voltage (U _{imp})	6 kV	
Thermal tripping	Reference temperature	50 °C
	Temperature derating	See module CA908007
Magnetic tripping	B curve	4 I _n ± 20 %
	C curve	8 I _n ± 20 %
	K curve	12 I _n ± 20 %
	Z curve	3 I _n ± 20 %
Utilization category	A	

According to IEC/EN 60898-1

Rated making and breaking capacity of an individual pole (I _{cn1})	I _{cn1} = I _{cn}	
--	------------------------------------	--

Additional characteristics

Breaking capacity under 1 pole with IT 380-415 V isolated neutral system (case of double fault)	40 A	4 kA
	50/63 A	3 kA
Degree of protection (IEC 60529)	Device only	IP20
	Device in modular enclosure	IP40
		Insulation class II
Endurance (O-C)	Electrical	10,000 cycles
	Mechanical	20,000 cycles
Overvoltage category (IEC 60364)	IV	
Operating temperature	-35°C to +70°C	
Storage temperature	-40°C to +85°C	
Tropicalization (IEC 60068-1)	Treatment 2 (relative humidity 95 % to 55°C)	

Weight (g)

Circuit-breaker	
Type	iC60L
1P	125
2P	250
3P	375
4P	500

Dimensions (mm)

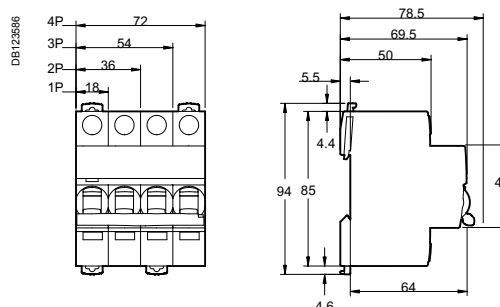

iK60N circuit breakers (curve B)

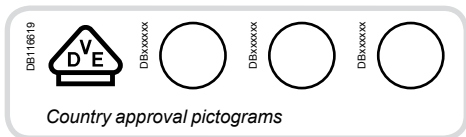

IEC/EN 60898-1



- iK60N circuit breakers are circuit breakers which combine the following functions:
 - circuit protection against short-circuit currents,
 - circuit protection against overload currents,
 - disconnection, opening and closing.

iK60N circuit breaker 50/60 Hz

Breaking capacity in short circuit (I _{cn}) as per IEC/EN 60898-1		Service breaking capacity (I _{cs}) 100 % of I _{cn}
Ph/Ph	400 V	
Ph/N	230 V	
Rating (I _n) 1 to 63 A	6000 A	

Catalogue numbers

iK60N circuit breaker					
Type	1P	1P+N	2P	3P	4P
	 E45092	 DB123389	 E45094	 E45095	 E45097
Auxiliaries	Without auxiliaries	Without auxiliaries	Without auxiliaries	Without auxiliaries	Without auxiliaries
Vigi iC60	Without Vigi iC60	Without Vigi iC60	Without Vigi iC60	Without Vigi iC60	Without Vigi iC60
Rating (I _n)	Curve B	Curve B	Curve B	Curve B	Curve B
1 A	A9K23101	A9K23601	A9K23201	-	-
2 A	A9K23102	A9K23602	A9K23202	-	-
3 A	A9K23103	A9K23603	A9K23203	-	-
4 A	A9K23104	A9K23604	A9K23204	-	-
6 A	A9K23106	A9K23606	A9K23206	A9K23306	A9K23406
10 A	A9K23110	A9K23610	A9K23210	A9K23310	A9K23410
16 A	A9K23116	A9K23616	A9K23216	A9K23316	A9K23416
20 A	A9K23120	A9K23620	A9K23220	A9K23320	A9K23420
25 A	A9K23125	A9K23625	A9K23225	A9K23325	A9K23425
32 A	A9K23132	A9K23632	A9K23232	A9K23332	A9K23432
40 A	A9K23140	A9K23640	A9K23240	A9K23340	A9K23440
50 A	A9K23150	A9K23650	A9K23250	A9K23350	A9K23450
63 A	A9K23163	A9K23663	A9K23263	A9K23363	A9K23463
Operating frequency	50/60 Hz	50/60 Hz	50/60 Hz	50/60 Hz	50/60 Hz
Width in 9-mm modules	2	4	4	6	8
Accessories	Padlocking device cat. no. A9A26970				

iK60N circuit breakers (curve B) (cont.)



PB10434-40

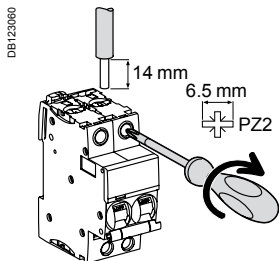

■ Top or bottom electrical feeding.

Connection



Type	Rating	Tightening torque	Copper cables	
			Rigid	Flexible or with ferrule
B curve	1 to 25 A	2 N.m	 DB1229M45	 DB1229M6
	32 to 63 A	3.5 N.m		
			1 to 35 mm ²	1 to 25 mm ²

iK60N circuit breakers (curve B) (cont.)

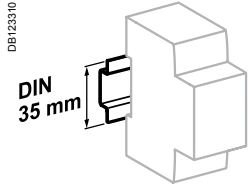

Clip on DIN rail 35 mm.

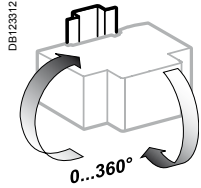

Indifferent position of installation.

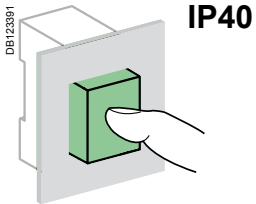

Technical data

Main characteristics

According to IEC/EN 60898-1

Insulation voltage (Ui)		440 V AC
Pollution degree		2
Rated impulse withstand voltage (Uimp)		4 kV
Thermal tripping	Reference temperature	30°C
	Temperature derating	See module CA908007
Magnetic tripping	B curve	3 to 5 In
Limitation class		3
Rated making and breaking capacity of an individual pole (Icn1)		Icn1 = Icn

Additional characteristics

Degree of protection (IEC 60529)	Device in modular enclosure	IP40 Insulation class II
Endurance (O-C)	Electrical	10,000 cycles
	Mechanical	20,000 cycles
Overvoltage category (IEC 60364)		III
Operating temperature		-25°C to +60°C
Storage temperature		-40°C to +85°C

Weight (g)

Circuit-breaker

Type	iK60N
1P	100
2P	200
3P	300
4P	400

Dimensions (mm)

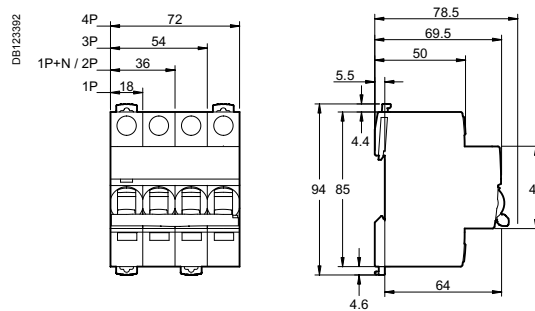



Schneider Electric's range of circuit breakers consists of different products (A, B, C) to enable it to be the most competitive range possible in each country, allowing for the special characteristics of each market:

- usual installation procedure
- price
- accreditations by local bodies.

Variants

Offers		Pages
Offer A	Catalogue numbers	67
Offer B	Catalogue numbers	68
Offer C	Catalogue numbers	69
Common pages		70

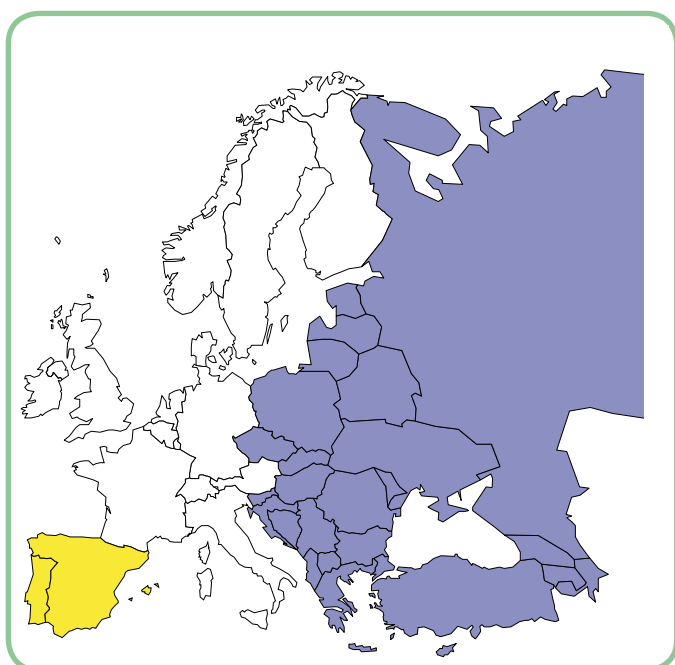

Only the product range to be marketed in your country and validated by the local product manager, in agreement with his Final Distribution (FD) partner should be retained. The others will be removed before publication.

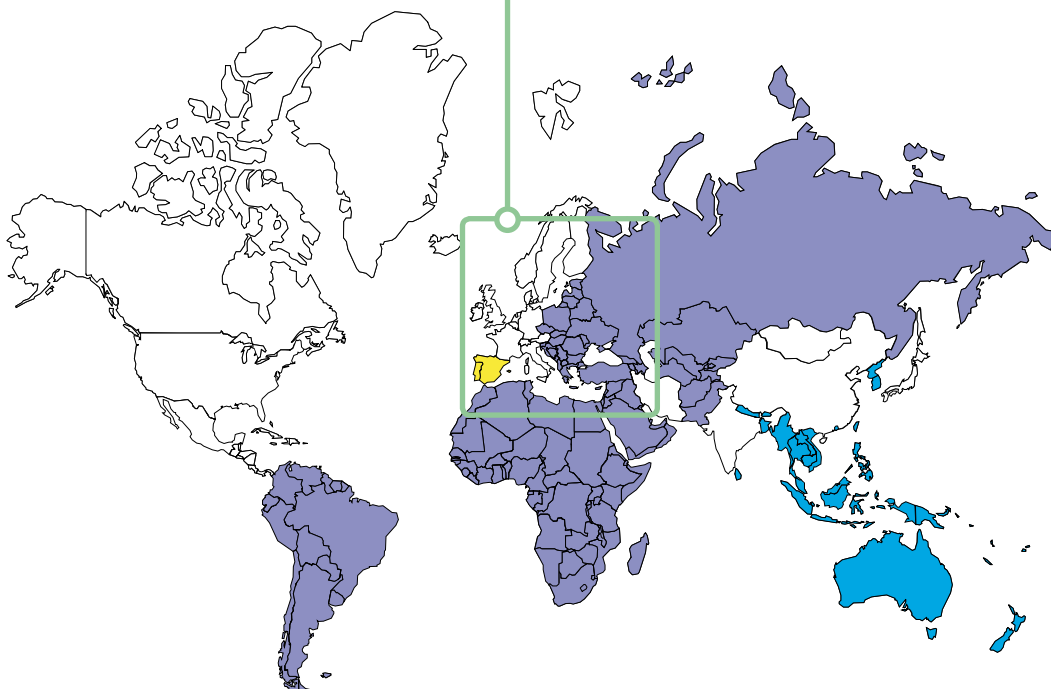



IEC/EN 60898-1

PB104459-40



- iK60N circuit breakers are circuit breakers which combine the following functions:
 - circuit protection against short-circuit currents,
 - circuit protection against overload currents,
 - disconnection, opening and closing.

iK60N circuit breaker 50/60 Hz		Service breaking capacity (Ics)
Breaking capacity in short circuit (Icn) as per IEC/EN 60898-1		
Ph/Ph	400 V	100 % of Icn
Ph/N	230 V	
Rating (In) 1 to 63 A	6000 A	

Catalogue numbers

iK60N circuit breakers						
Type	1P	1P+N	2P	3P	3P+N	4P
Auxiliaries	Without auxiliaries					
Vigi iC60	Without Vigi iC60					
Rating (In)	Curve C	Curve C	Curve C	Curve C	Curve C	Curve C
1 A ⁽¹⁾	A9K24101	A9K24601	A9K24201	-	-	-
2 A ⁽¹⁾	A9K24102	A9K24602	A9K24202	-	-	-
3 A ⁽¹⁾	A9K24103	A9K24603	A9K24203	-	-	-
4 A ⁽¹⁾	A9K24104	A9K24604	A9K24204	-	-	-
6 A	A9K17106	A9K17606	A9K17206	A9K17306	A9K24706	A9K17406
10 A	A9K17110	A9K17610	A9K17210	A9K17310	A9K24710	A9K17410
16 A	A9K17116	A9K17616	A9K17216	A9K17316	A9K24716	A9K17416
20 A	A9K17120	A9K17620	A9K17220	A9K17320	A9K24720	A9K17420
25 A	A9K17125	A9K17625	A9K17225	A9K17325	A9K24725	A9K17425
32 A	A9K17132	A9K17632	A9K17232	A9K17332	A9K24732	A9K17432
40 A ⁽¹⁾	A9K24140	A9K24640	A9K24240	A9K24340	A9K24740	A9K24440
50 A ⁽¹⁾	A9K24150	A9K24650	A9K24250	A9K24350	A9K24750	A9K24450
63 A ⁽¹⁾	A9K24163	A9K24663	A9K24263	A9K24363	A9K24763	A9K24463
Operating frequency	50/60 Hz	50/60 Hz	50/60 Hz	50/60 Hz	50/60 Hz	50/60 Hz
Width in 9-mm modules	2	4	4	6	8	8
Accessories	Padlocking device cat. no. A9A26970					

(1) VDE and RT approved, excepted 3P+N products.

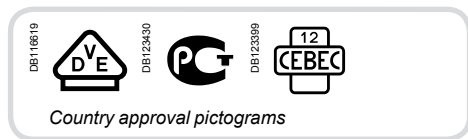

IEC/EN 60898-1

PE104459-40



- iK60N circuit breakers are circuit breakers which combine the following functions:
 - circuit protection against short-circuit currents,
 - circuit protection against overload currents,
 - disconnection, opening and closing.

iK60N circuit breaker 50/60 Hz

Breaking capacity in short circuit (I _{cn}) as per IEC/EN 60898-1		Service breaking capacity (I _{cs}) 100 % of I _{cn}
Ph/Ph	400 V	
Ph/N	230 V	
Rating (I _n) 1 to 63 A	6000 A	

Catalogue numbers

iK60N circuit breakers					
Type	1P	1P+N	2P	3P	4P
Auxiliaries	Without auxiliaries				
Vigi iC60	Without Vigi iC60				
Rating (I _n)	Curve C	Curve C	Curve C	Curve C	Curve C
1 A	A9K24101	A9K24601	A9K24201	-	-
2 A	A9K24102	A9K24602	A9K24202	-	-
3 A	A9K24103	A9K24603	A9K24203	-	-
4 A	A9K24104	A9K24604	A9K24204	-	-
6 A	A9K24106	A9K24606	A9K24206	A9K24306	A9K24406
10 A	A9K24110	A9K24610	A9K24210	A9K24310	A9K24410
13 A	A9K24113	A9K24613	A9K24213	A9K24313	A9K24413
16 A	A9K24116	A9K24616	A9K24216	A9K24316	A9K24416
20 A	A9K24120	A9K24620	A9K24220	A9K24320	A9K24420
25 A	A9K24125	A9K24625	A9K24225	A9K24325	A9K24425
32 A	A9K24132	A9K24632	A9K24232	A9K24332	A9K24432
40 A	A9K24140	A9K24640	A9K24240	A9K24340	A9K24440
50 A	A9K24150	A9K24650	A9K24250	A9K24350	A9K24450
63 A	A9K24163	A9K24663	A9K24263	A9K24363	A9K24463
Operating frequency	50/60 Hz	50/60 Hz	50/60 Hz	50/60 Hz	50/60 Hz
Width in 9-mm modules	2	4	4	6	8
Accessories	Padlocking device cat. no. A9A26970				

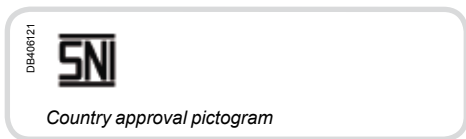

IEC/EN 60898-1

PE104459-40



- iK60N circuit breakers are circuit breakers which combine the following functions:
 - circuit protection against short-circuit currents,
 - circuit protection against overload currents,
 - disconnection, opening and closing.

iK60N circuit breaker 50/60 Hz		Service breaking capacity (Ics) 100 % of Icn
Breaking capacity in short circuit (Icn) as per IEC/EN 60898-1		
Ph/Ph	400 V	
Ph/N	230 V	
Rating (In) 6 to 63 A	6000 A	

Catalogue numbers

iK60N circuit breakers				
Type	1P	2P	3P	4P
	 E45692	 E45694	 E45695	 E45697
Auxiliaries	Without auxiliaries			
Vigi IC60	Without Vigi IC60			
Rating (In)	Curve C	Curve C	Curve C	Curve C
1 A	A9K24101	-	-	-
2 A	A9K24102	-	-	-
3 A	A9K24103	-	-	-
4 A	A9K24104	-	-	-
6 A	A9K27106	A9K27206	A9K24306	A9K24406
10 A	A9K27110	A9K27210	A9K24310	A9K24410
16 A	A9K27116	A9K27216	A9K24316	A9K24416
20 A	A9K27120	A9K27220	A9K24320	A9K24420
25 A	A9K27125	A9K27225	A9K24325	A9K24425
32 A	A9K27132	A9K27232	A9K24332	A9K24432
40 A	A9K24140	A9K24240	A9K24340	A9K24440
Operating frequency	50/60 Hz			
Width in 9-mm modules	2	4	6	8
Accessories	Padlocking device cat. no. A9A26970			



iK60N circuit breakers (curve C) (cont.)

PB10434-40

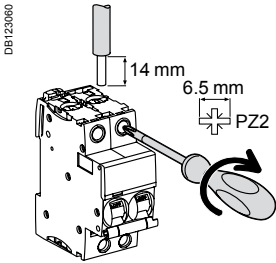

Connection



Type	Rating	Tightening torque	Copper cables	
			Rigid	Flexible or with ferrule
C curve	1 to 32 A	2 N.m		
	40 to 63 A	3.5 N.m		
			1 to 35 mm ²	1 to 25 mm ²

iK60N circuit breakers (curve C) (cont.)

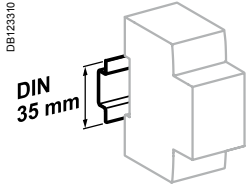

Clip on DIN rail 35 mm.

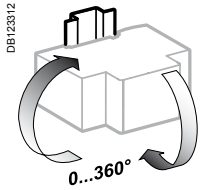

Position d'installation indifférente.

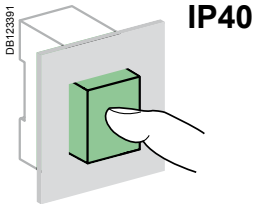

Technical data

Main characteristics

According to IEC/EN 60898-1

Insulation voltage (Ui)		440 V AC
Pollution degree		2
Rated impulse withstand voltage (Uimp)		4 kV
Thermal tripping	Reference temperature	30°C
	Temperature derating	See module CA908007
Magnetic tripping	C curve	5 to 10 In
Limitation class		3
Rated making and breaking capacity of an individual pole (Icn1)		Icn1 = Icn

Additional characteristics

Degree of protection (IEC 60529)	Device in modular enclosure	IP40 Insulation class II
Endurance (O-C)	Electrical	10,000 cycles
	Mechanical	20,000 cycles
Overvoltage category (IEC 60364)		III
Operating temperature		-25°C to +60°C
Storage temperature		-40°C to +85°C

Weight (g)

Circuit-breaker

Type	iK60N
1P	100
2P (1P+N)	200
3P	300
4P (3P+N)	400

Dimensions (mm)

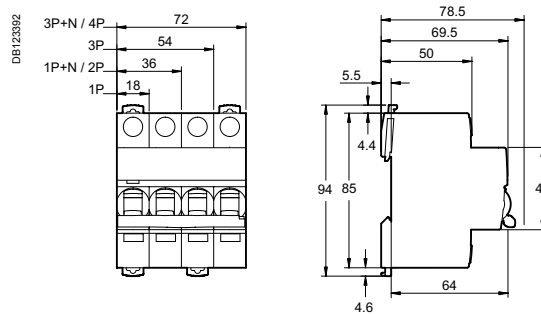



Schneider Electric's range of K60 Biconnect circuit breakers consists of different products (A, B, C) to enable it to be the most competitive range possible in each country, allowing for the special characteristics of each market:

- usual installation procedure
- price
- accreditations by local bodies.

Variants

Offers	Catalogue numbers	Pages
Offer A	Catalogue numbers	page 73
Offer B	Catalogue numbers	page 76
India		
Offer C	Catalogue numbers	page 79
Singapour		

DB407236

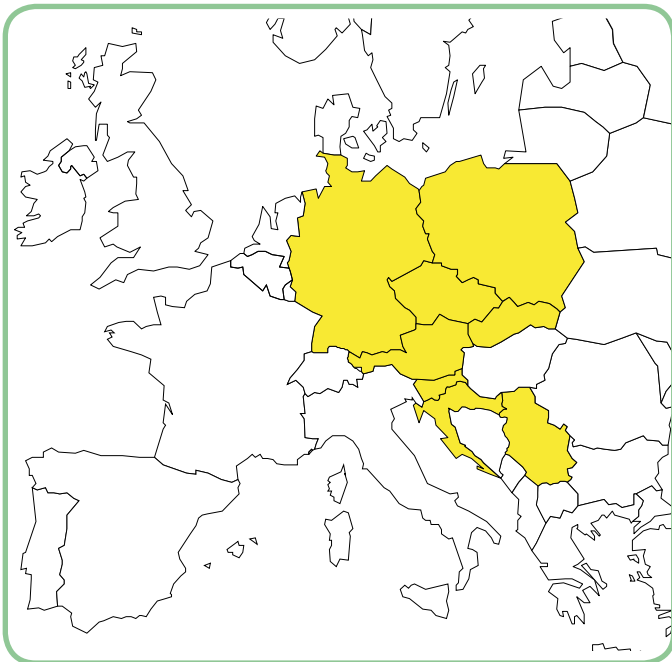

Only the product range to be marketed in your country and validated by the local product manager, in agreement with his Final Distribution (FD) partner should be retained. The others will be removed before publication.

DB407237

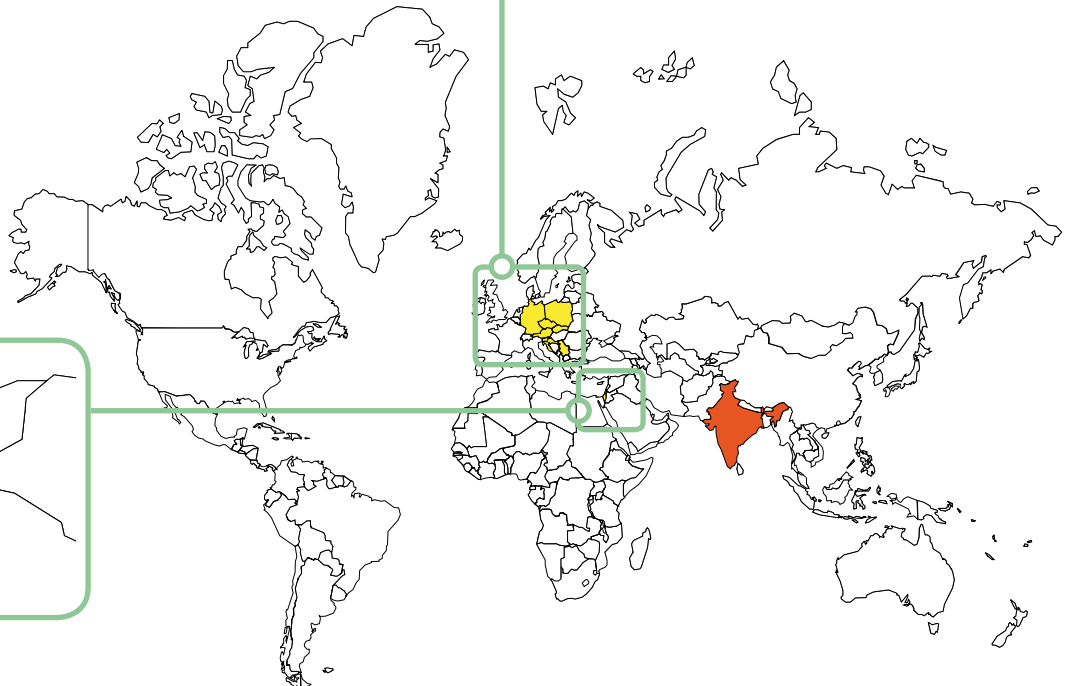

DB407240

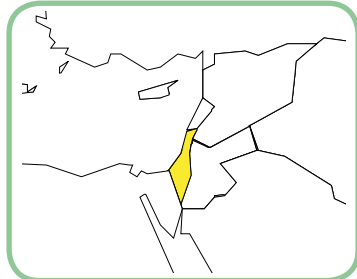



IEC/EN 60898-1



- K60N Biconnect circuit breakers are circuit breakers which combine the following functions:
 - circuit protection against short-circuit currents,
 - circuit protection against overload currents,
 - disconnection, opening and closing.

K60N Biconnect circuit breaker 50/60 Hz		
Breaking capacity in short circuit (I _{cn}) as per IEC/EN 60898-1		Service breaking capacity (I _{cs})
Ph/Ph	400 V	100 % of I _{cn}
Ph/N	230 V	
Rating (I _n)	2 to 40 A	



Catalogue numbers

K60N Biconnect circuit breaker								
Type	1P		1P+N		3P		3P+N	
Auxiliaries	Without auxiliaries		Without auxiliaries		Without auxiliaries		Without auxiliaries	
Rating (I _n)	Curve		Curve		Curve		Curve	
	B	C	B	C	B	C	C	
2 A	-	A9K02102	-	-	-	-	-	-
4 A	-	A9K02104	-	-	-	-	-	-
6 A	A9K01106	A9K02106	-	-	A9K01306	A9K02306	-	-
10 A	A9K01110	A9K02110	-	-	A9K01310	A9K02310	-	-
13 A	A9K01113	A9K02113	A9K01613	A9K02613	-	A9K02313	A9K02713	
16 A	A9K01116	A9K02116	A9K01616	A9K02616	A9K01316	A9K02316	A9K02716	
20 A	A9K01120	A9K02120	-	-	A9K01320	A9K02320	-	
25 A	A9K01125	A9K02125	-	-	A9K01325	A9K02325	-	
32 A	A9K01132	A9K02132	-	-	A9K01332	A9K02332	-	
40 A	A9K01140	A9K02140	-	-	A9K01340	A9K02340	-	
Width in 9-mm modules	2	2	4	4	6	6	8	
Accessories	Padlocking device cat. no. 26970							

K60N Biconnect circuit breakers (cont.)

PB110016-60

■ Reinforced cable pull-out strength: serrated terminals

■ Fast closing independent of the speed of actuation of the toggle.



057200L_SE-33



Padlocking device

■ Padlocking possible for work to be carried out on live parts

DB1404823



Connection

- Downstream by Biconnect comb busbar
- Upstream/downstream by tunnel terminals

DB1405041



Connection

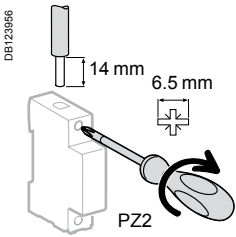

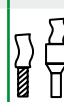
Type	Rating	Tightening torque	Copper cables	
			Rigid	Flexible or with ferrule
K60N Biconnect	2 to 25 A	2 N.m	DB122545 	DB122546 
	32 - 40 A	3.5 N.m	0.5 to 35 mm ²	0.5 to 25 mm ²

■ Connection by comb busbar or cables (conforms to EN 50027).

Offer selection see page 72

Offer A

This sticker must be removed before publishing

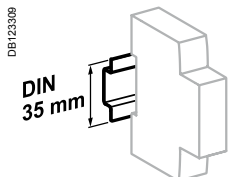

Clip on DIN rail 35 mm.

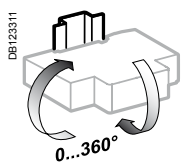

Indifferent position of installation.

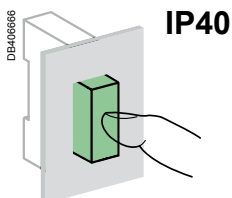

Technical data

Main characteristics

Insulation voltage (Ui)	Phase-to-phase	440 V AC
	Phase-to-neutral	230 V AC
	Phase-to-phase	400 V AC
Voltage rating (Ue)	B curve	3 to 5 In
	C curve	5 to 10 In

According to EN 60898-1

Limitation class	3
Rated breaking capacity (Icn)	6000 A
Service breaking capacity (Ics)	100 % Icn
Rated breaking and making capacity on a single pole (Icn1)	Icn1 = Icn

Additional characteristics

Degree of protection (IEC 60529)	Device in modular enclosure	IP40
Endurance (O-C)	Electrical	≤ 20 A ≥ 25 A
		20,000 cycles 10,000 cycles
	Mechanical	20,000 cycles
Operating temperature		-25°C to +70°C
Storage temperature		-40°C to +70°C
Tropicalization (IEC 60068-1)		Treatment 2 (relative humidity 95% at 55°C)

Weight (g)

Circuit-breaker

Type	K60N Biconnect
1P	120
1P+N	240
3P	360
3P+N	480

Offer selection see page 72

Offer A

This sticker must be removed before publishing

Dimensions (mm)

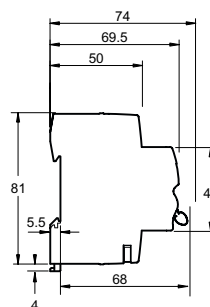
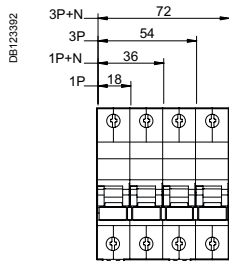

DB4C4807



Country approval pictogram

IS/IEC 60898-1
IEC/EN 60898-1

■ K60H Biconnect circuit breakers are circuit breakers which combine the following functions:

- circuit protection against short-circuit currents,
- circuit protection against overload currents,
- disconnection, opening and closing.

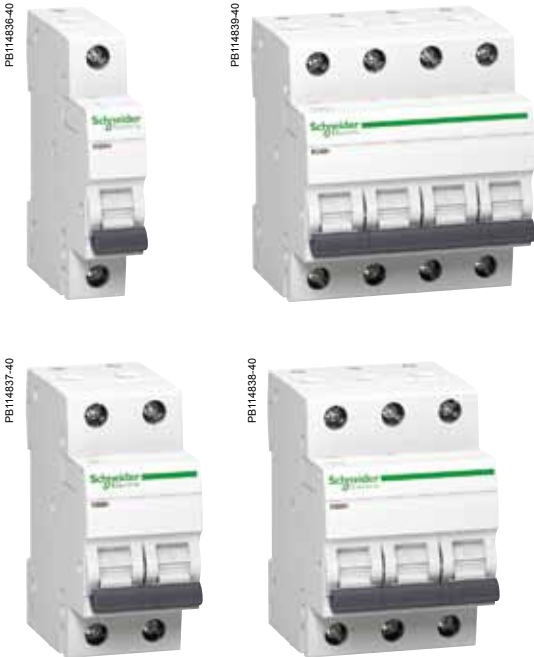

K60H Biconnect circuit breaker 50/60 Hz

Breaking capacity in short circuit (I_{cn}) as per IEC/EN 60898-1

Ph/Ph	415 V
Ph/N	240 V
Rating (I _n)	1 to 63 A

Service breaking capacity (I_{cs})

75 % of I_{cn}



Catalogue numbers

K60H Biconnect circuit breaker						
Type	1P		2P		3P	4P
Auxiliaries	Without auxiliaries					
Rating (I _n)	Curve		Curve		Curve	Curve
	B	C	B	C	C	C
1 A	-	A9KF71101	-	A9KF71201	A9KF71301	A9KF71401
2 A	-	A9KF71102	-	A9KF71202	A9KF71302	A9KF71402
3 A	-	A9KF71103	-	A9KF71203	A9KF71303	A9KF71403
4 A	-	A9KF71104	-	A9KF71204	A9KF71304	A9KF71404
6 A	A9KF21106	A9KF71106	A9KF21206	A9KF71206	A9KF71306	A9KF71406
10 A	A9KF21110	A9KF71110	A9KF21210	A9KF71210	A9KF71310	A9KF71410
16 A	A9KF21116	A9KF71116	A9KF21216	A9KF71216	A9KF71316	A9KF71416
20 A	A9KF21120	A9KF71120	A9KF21220	A9KF71220	A9KF71320	A9KF71420
25 A	A9KF21125	A9KF71125	A9KF21225	A9KF71225	A9KF71325	A9KF71425
32 A	A9KF21132	A9KF71132	A9KF21232	A9KF71232	A9KF71332	A9KF71432
40 A	-	A9KF71140	-	A9KF71240	A9KF71340	A9KF71440
50 A	-	A9KF71150	-	A9KF71250	A9KF71350	A9KF71450
63 A	-	A9KF71163	-	A9KF71263	A9KF71363	A9KF71463
Width in 9-mm modules	2		4		6	8
Accessories	Padlocking device cat. no. 26970					

PB114837-60

■ Reinforced cable pull-out strength: serrated terminals

■ Fast closing independent of the speed of actuation of the toggle.



Padlocking device

■ Padlocking possible for work to be carried out on live parts

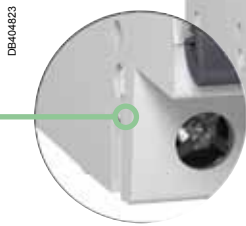

Connection

- Downstream by Biconnect comb busbar
- Upstream/downstream by tunnel terminals

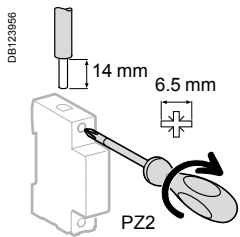

Connection



Type	Rating	Tightening torque	Copper cables	
			Rigid	Flexible or with ferrule
K60H Biconnect	1 to 25 A	2 N.m	DB122945 	DB122946 
	32 to 63 A	3.5 N.m	0.5 to 35 mm ²	0.5 to 25 mm ²

Offer selection see page 72

Offer B

This sticker must be removed before publishing

K60H Biconnect circuit breakers (cont.)

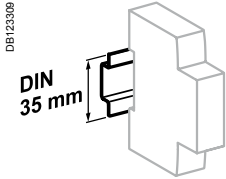

Clip on DIN rail 35 mm.

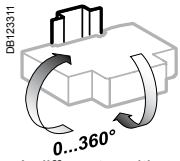

Indifferent position of installation.

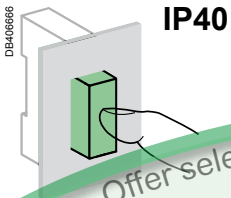

Offer selection see page 72

Offer B

This sticker must be removed before publishing

Technical data

Main characteristics

Insulation voltage (Ui)	Phase-to-phase	500 V AC	
Voltage rating (Ue)	Phase-to-neutral	240 V AC	
	Phase-to-phase	415 V AC	
Rated impulse withstand voltage (Uimp)		4 kV	
Magnetic tripping	B curve	3 to 5 I _n	■
	C curve	5 to 10 I _n	■

According to EN 60898-1

Limitation class	3
Rated breaking capacity (I _{cn})	10,000 A
Service breaking capacity (I _{cs})	75 % I _{cn}
Rated breaking and making capacity on a single pole (I _{cn1})	I _{cn1} = I _{cn}

Additional characteristics

Degree of protection (IEC 60529)	Device in modular enclosure	IP40	
Degree of pollution		Insulation class II	
Endurance (O-C)	Electrical	≤ 20 A	20,000 cycles
		≥ 25 A	10,000 cycles
	Mechanical	20,000 cycles	
Operating temperature		-5°C to +55°C	
Storage temperature		-25°C to +85°C	
Tropicalization (IEC 60068-1)		Treatment 2 (relative humidity 95% at 55°C)	

Circuit-breaker

Type	K60H Biconnect
1P	120
2P	240
3P	360
4P	480

Dimensions (mm)

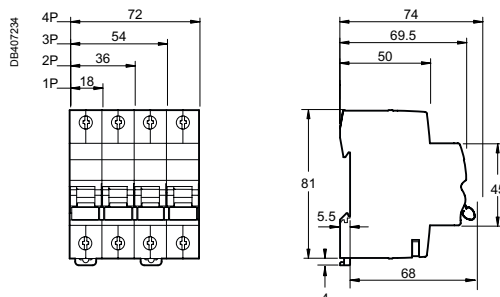

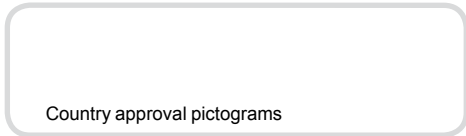

IEC/EN 60898-1



- K60N Biconnect circuit breakers are circuit breakers which combine the following functions:
 - circuit protection against short-circuit currents,
 - circuit protection against overload currents,
 - disconnection, opening and closing.

K60N Biconnect circuit breaker 50/60 Hz		
Breaking capacity in short circuit (Icn) as per IEC/EN 60898-1		Service breaking capacity (Ics) 100 % of Icn
Ph/Ph	400 V	
Ph/N	230 V	
Rating (In)	6 to 63 A	6000 A

Offer selection see page 72

Offer C

This sticker must be removed before publishing

Catalogue numbers

K60N Biconnect circuit breaker								
Type	1P		2P		3P		4P	
Auxiliaries	Without auxiliaries		Without auxiliaries		Without auxiliaries		Without auxiliaries	
Rating (In)	Curve		Curve		Curve		Curve	
	B	C	B	C	B	C	B	C
6 A	A9K01106	A9K02106	A9K01206	A9K02206	A9K01306	A9K02306	A9K01406	A9K02406
10 A	A9K01110	A9K02110	A9K01210	A9K02210	A9K01310	A9K02310	A9K01410	A9K02410
16 A	A9K01116	A9K02116	A9K01216	A9K02216	A9K01316	A9K02316	A9K01416	A9K02416
20 A	A9K01120	A9K02120	A9K01220	A9K02220	A9K01320	A9K02320	A9K01420	A9K02420
32 A	A9K01132	A9K02132	A9K01232	A9K02232	A9K01332	A9K02332	A9K01432	A9K02432
40 A	A9K01140	A9K02140	A9K01240	A9K02240	A9K01340	A9K02340	A9K01440	A9K02440
50 A	A9K01150	A9K02150	A9K01250	A9K02250	A9K01350	A9K02350	A9K01450	A9K02450
63 A	A9K01163	A9K02163	A9K01263	A9K02263	A9K01363	A9K02363	A9K01463	A9K02463
Width in 9-mm modules	2		4		6		8	
Accessories	Padlocking device cat. no. 26970							

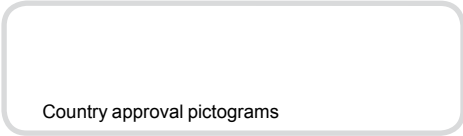

IEC/EN 60898-1



- K60H Biconnect circuit breakers are circuit breakers which combine the following functions:
 - circuit protection against short-circuit currents,
 - circuit protection against overload currents,
 - disconnection, opening and closing.

K60H Biconnect circuit breaker 50/60 Hz		
Breaking capacity in short circuit (I_{cn}) as per IEC/EN 60898-1		Service breaking capacity (I_{cs}) 75 % of I _{cn}
Ph/Ph	400 V	
Ph/N	230 V	
Rating (I_n)	6 to 63 A	10000 A

Offer selection see page 72

Offer C

This sticker must be removed before publishing

Catalogue numbers

K60H Biconnect circuit breaker								
Type	1P		2P		3P		4P	
Auxiliaries	Without auxiliaries		Without auxiliaries		Without auxiliaries		Without auxiliaries	
Rating (I_n)	Curve		Curve		Curve		Curve	
	B	C	B	C	B	C	B	C
6 A	A9K11106	A9K12106	A9K11206	A9K12206	A9K11306	A9K12306	A9K11406	A9K12406
10 A	A9K11110	A9K12110	A9K11210	A9K12210	A9K11310	A9K12310	A9K11410	A9K12410
16 A	A9K11116	A9K12116	A9K11216	A9K12216	A9K11316	A9K12316	A9K11416	A9K12416
20 A	A9K11120	A9K12120	A9K11220	A9K12220	A9K11320	A9K12320	A9K11420	A9K12420
32 A	A9K11132	A9K12132	A9K11232	A9K12232	A9K11332	A9K12332	A9K11432	A9K12432
40 A	A9K11140	A9K12140	A9K11240	A9K12240	A9K11340	A9K12340	A9K11440	A9K12440
50 A	A9K11150	A9K12150	A9K11250	A9K12250	A9K11350	A9K12350	A9K11450	A9K12450
63 A	A9K11163	A9K12163	A9K11263	A9K12263	A9K11363	A9K12363	A9K11463	A9K12463
Width in 9-mm modules	2		4		6		8	
Accessories	Padlocking device cat. no. 26970							

PB114837-60

■ Reinforced cable pull-out strength: serrated terminals

■ Fast closing independent of the speed of actuation of the toggle.



DB404823

05720BJ_BE33

Padlocking device

■ Padlocking possible for work to be carried out on live parts

Connection

- Downstream by Biconnect comb busbar
- Upstream/downstream by tunnel terminals

DB407861



Connection

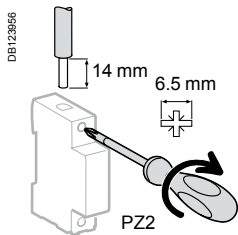

Type	Rating	Tightening torque	Copper cables	
			Rigid	Flexible or with ferrule
K60 Biconnect	6 to 20 A	2 N.m	DB122945	DB122946
	32 to 63 A	3.5 N.m	0.5 to 35 mm ²	0.5 to 25 mm ²

■ Connection by comb busbar or cables (conforms to EN 50027).

Offer selection see page 72

Offer C

This sticker must be removed before publishing

K60 Biconnect circuit breakers (cont.)

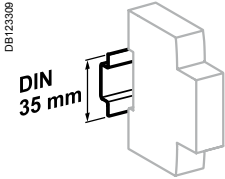

Clip on DIN rail 35 mm.

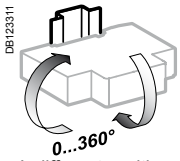

Indifferent position of installation.

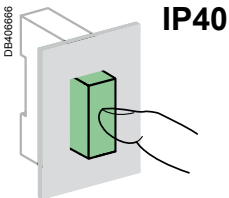

Offer selection see page 72

Offer C

This sticker must be removed before publishing

Technical data

Main characteristics		K60N	K60H
Insulation voltage (Ui)	Phase-to-phase	440 V AC	
Voltage rating (Ue)	Phase-to-neutral	230 V AC	
	Phase-to-phase	400 V AC	
Magnetic tripping	B curve	3 to 5 In	■
	C curve	5 to 10 In	■
According to EN 60898-1			
Limitation class		3	
Rated breaking capacity (Icn)		6000 A	10000 A
Service breaking capacity (Ics)		100 % of Icn	75 % of Icn
Rated breaking and making capacity on a single pole (Icn1)		Icn1 = Icn	
Additional characteristics			
Degree of protection (IEC 60529)	Device in modular enclosure	IP40 Insulation class II	
Endurance (O-C)	Electrical ≤ 20 A	20,000 cycles	
	≥ 32 A	10,000 cycles	
	Mechanical	20,000 cycles	
Operating temperature		-5°C to +55°C	
Storage temperature		-25°C to +85°C	
Tropicalization (IEC 60068-1)		Treatment 2 (relative humidity 95% at 55°C)	

Weight (g)

Circuit-breaker	K60 Biconnect
Type	
1P	120
2P	240
3P	360
4P	480

Dimensions (mm)

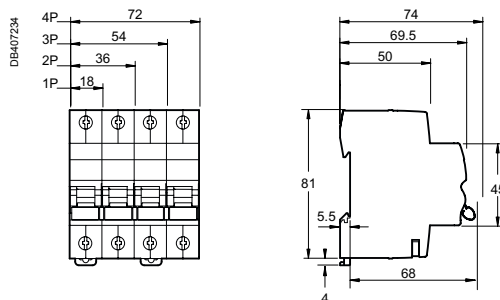

C120a circuit breakers (curves C, D)

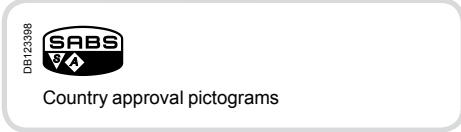

IEC/EN 60947-2

C120a circuit breakers are multistandard circuit breakers that combine the following functions:

- circuit protection against short-circuit currents,
- circuit protection against overload currents,
- suitability for isolation in the industrial sector to IEC/EN 60947-2,
- fault tripping and indication by adding auxiliaries.



Alternating current (AC) 50/60 Hz		
Breaking capacity (Icu) to IEC/EN 60947-2		Service breaking capacity (Ics)
Type	Voltage (V)	
1P, 2P, 3P, 4P	230 to 400 V	100 % of Icu
Rating (In)	80 and 100 A	

Catalogue numbers

C120a circuit breaker						
Type	1P	2P	3P	4P		
Auxiliaries	Remote indication and tripping, module CA907008 and CA907013		Remote indication and tripping, module CA907008 and CA907013		Remote indication and tripping, module CA907008 and CA907013	
Vigi C120	Vigi C120 add-on residual current device, module CA902016		Vigi C120 add-on residual current device, module CA902016		Vigi C120 add-on residual current device, module CA902016	
Rating (In)	Curve C D		Curve C D		Curve C	
80 A	A9N60708	A9N60720	A9N60711	A9N60714	A9N60723	A9N60717
100 A	A9N60709	A9N60721	A9N60712	A9N60715	A9N60724	A9N60718
Width in 9-mm modules	3		6		12	
Accessories	Module CA907012 and CA907013		Module CA907012 and CA907013		Module CA907012 and CA907013	

C120N circuit breakers (curves C, D)

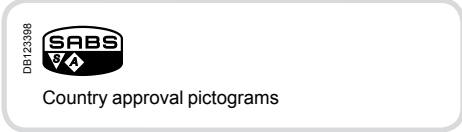

IEC/EN 60947-2

C120N circuit breakers are multistandard circuit breakers that combine the following functions:

- circuit protection against short-circuit currents,
- circuit protection against overload currents,
- suitability for isolation in the industrial sector to IEC/EN 60947-2,
- fault tripping and indication by adding auxiliaries.

Alternating current (AC) 50/60 Hz		
Breaking capacity (Icu) to IEC/EN 60947-2		Service breaking capacity (Ics)
Type	Voltage (V)	
1P, 2P, 3P, 4P	230 to 400 V	75 % of Icu
Rating (In)	80 and 100 A 10 kA	

Direct current (DC)						
Breaking capacity (Icu) according to IEC/EN 60947-2					Service breaking capacity (Ics)	
Between +/-	Voltage (Ue)					
	12 to 125 V	≤ 144 V	≤ 250 V	≤ 375 V	≤ 500 V	100 % of Icu
Number of poles	1P		2P	3P	4P	
Rating (In)	80 and 100 A	15 kA	10 kA	10 kA	10 kA	

Catalogue numbers

C120N circuit breaker									
Type	1P		2P		3P		4P		
Auxiliaries	Remote indication and tripping, module CA907008 and CA907013		Remote indication and tripping, module CA907008 and CA907013		Remote indication and tripping, module CA907008 and CA907013		Remote indication and tripping, module CA907008 and CA907013		
Vigi C120	Vigi C120 add-on residual current device, module CA902016		Vigi C120 add-on residual current device, module CA902016		Vigi C120 add-on residual current device, module CA902016		Vigi C120 add-on residual current device, module CA902016		
Rating (In)	Curve C D		Curve C D		Curve C D		Curve C D		
80 A	A9N60729	A9N60745	A9N60733	A9N60749	A9N60737	A9N60753	A9N60741	A9N60757	
100 A	A9N60730	A9N60746	A9N60734	A9N60750	A9N60738	A9N60754	A9N60742	A9N60758	
Width in 9-mm modules	3		6		9		12		
Accessories	Module CA907012 and CA907013		Module CA907012 and CA907013		Module CA907012 and CA907013		Module CA907012 and CA907013		

C120H circuit breakers (curve C)

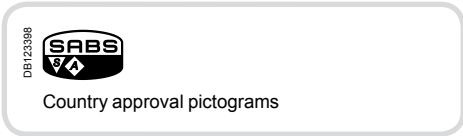

IEC/EN 60947-2

C120H circuit breakers are multistandard circuit breakers that combine the following functions:

- circuit protection against short-circuit currents,
- circuit protection against overload currents,
- suitability for isolation in the industrial sector to IEC/EN 60947-2,
- fault tripping and indication by adding auxiliaries.

Alternating current (AC) 50/60 Hz

Breaking capacity (Icu) to IEC/EN 60947-2		Service breaking capacity (Ics)
Type	Voltage (V)	
1P	230 to 400 V	50 % of Icu
Rating (In)	80 and 100 A	

Direct current (DC)

Between +/-	Voltage (Ue)				Service breaking capacity (Ics)
	12 to 125 V	≤ 144 V	≤ 250 V	≤ 375 V	
Number of poles	1P	2P	3P	4P	100 % of Icu
Rating (In)	80 and 100 A	20 kA	15 kA	15 kA	

Catalogue numbers

C120H circuit breaker

Type	1P	2P	3P	4P
Auxiliaries	Remote indication and tripping, module CA907008 and CA907013	Remote indication and tripping, module CA907008 and CA907013	Remote indication and tripping, module CA907008 and CA907013	Remote indication and tripping, module CA907008 and CA907013
Vigi C120	Vigi C120 add-on residual current device, module CA902016	Vigi C120 add-on residual current device, module CA902016	Vigi C120 add-on residual current device, module CA902016	Vigi C120 add-on residual current device, module CA902016
Rating (In)	Curve C	Curve C	Curve C	Curve C
80 A	A9N60777	A9N60781	A9N60785	A9N60789
100 A	A9N60778	A9N60782	A9N60786	A9N60790
Width in 9-mm modules	3	6	9	12
Accessories	Module CA907012 and CA907013	Module CA907012 and CA907013	Module CA907012 and CA907013	Module CA907012 and CA907013

PB107917-40

■ Terminals insulated to IP20



■ Location for 4 clip-on terminal markers



Positive contact indication

- Suitability for isolation in the industrial sector to IEC/EN 60947-2.
- The presence of the green strip guarantees that the contacts open physically and allows work to be carried out safely on the downstream circuit.

- Longer product service life thanks to:
 - good overvoltage withstand capacity: products designed to offer a high industrial performance level (degree of pollution, rated impulse withstand voltage and insulation voltage).
 - high limitation performances (see limitation curves).
 - fast closure independent of toggle operating speed.
- Remote indication of the open/closed/tripped state by auxiliary contacts (optional).
- Power supply from above or below.

Connection

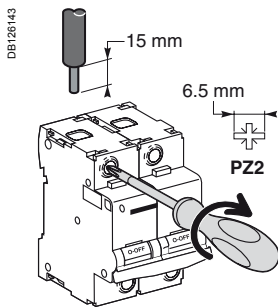

Rating	Tightening torque	Without access.		With accessories			
		Rigid/semi-rigid	Flexible or with ferrule	50 mm ² Al Terminal	Screw-on connection for ring terminal ⁽¹⁾	Rigid cables	Flexible cables
		DB122845	DB122846	DB122835	DB118789	DB118787	
80 and 100 A	3.5 N.m	1.5 to 50 mm ²	1.5 to 35 mm ²	16 to 50 mm ²	Ø 5 mm	3 x 16 mm ²	3 x 10 mm ²

(1) For lugs up to 63 A, front or rear access.

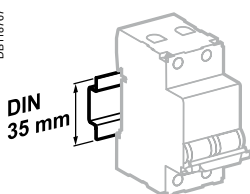

Clips onto 35 mm DIN rail.

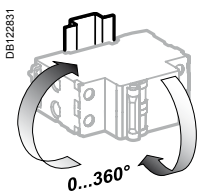

Any installation position.

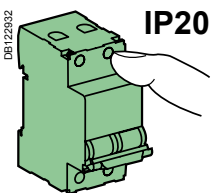

IP20

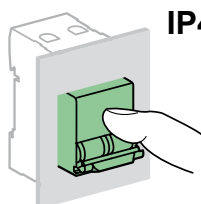

IP40

Technical data

Main characteristics

To IEC/EN 60947-2

Insulation voltage (U _i)	500 V AC	
Degree of pollution	3	
Rated impulse withstand voltage (U _{imp})	6 kV	
Thermal tripping	Reference temperature	50°C
Magnetic tripping	Curve C	8 I _n ± 20 %
	Curve D	12 I _n ± 20 %
Limitation class	3	

Additional characteristics

Degree of protection (IEC 60529)	Device only	IP20
	Device in a modular enclosure	IP40
Endurance (O-C)	Electrical	5000 cycles (O-C)
	Mechanical	20000 cycles
Operating temperature	-30°C to +70°C	
Storage temperature	-40°C to +80°C	
Tropicalisation (IEC 60068-1)	Treatment 2 (relative humidity 95 % at 55°C)	

Weight (g)

Circuit breaker

Type	C120
1P	205
2P	410
3P	615
4P	820

Dimensions (mm)

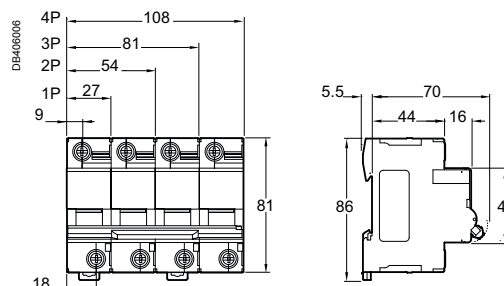

C120N circuit breakers (curves B, C, D)

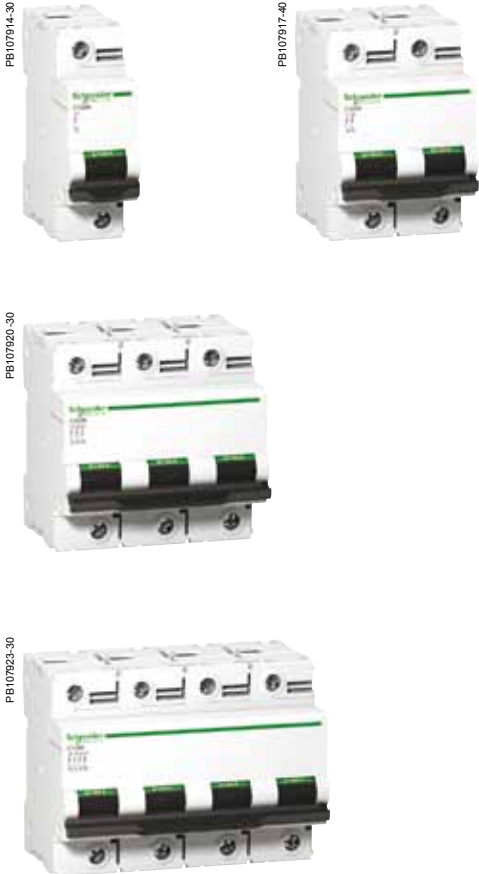

IEC/EN 60898-1

C120N circuit breakers are multistandard circuit breakers that combine the following functions:

- circuit protection against short-circuit currents,
- circuit protection against overload currents,
- suitability for isolation in the industrial sector to IEC/EN 60947-2,
- fault tripping and indication by adding auxiliaries.

Alternating current (AC) 50/60 Hz

Breaking capacity (Icu) to IEC/EN 60947-2						Service breaking capacity (Ics)
Type	Voltage (V)					
1P	12 to 130 V	220 to 240 V	380 to 415 V	440 V		75 % of Icu
Rating (In) 63 to 125 A	20 kA	10 kA	3 kA ⁽¹⁾	-		
2P/3P/4P	12 to 130 V	220 to 240 V	380 to 415 V	440 V		75 % of Icu
63 to 125 A	-	20 kA	10 kA	6 kA		

Breaking capacity (Icn) to IEC/EN 60898-1		
Type	Voltage (V)	
1P, 2P, 3P, 4P	230 to 400 V	
Rating (In) 63 to 125 A	10000 A	
	75 % of Icn	

⁽¹⁾ One-pole breaking capacity in IT isolated neutral system (double fault).

Direct current (DC)

Breaking capacity (Icu) according to IEC/EN 60947-2							Service breaking capacity (Ics)
Between +/-	Voltage (Ue)						
	12 to 125 V	≤ 144 V	≤ 250 V	≤ 375 V	≤ 500 V		
Number of poles	1P	2P	3P	4P			
Rating (In) 63 to 125 A	15 kA	10 kA	10 kA	10 kA	10 kA	100 % of Icu	

Catalogue numbers

C120N circuit breaker

Type	1P	2P
Auxiliaries	Remote indication and tripping, module CA907008 and CA907013	Remote indication and tripping, module CA907008 and CA907013
Vigi C120	Vigi C120 add-on residual current device, module CA902016	Vigi C120 add-on residual current device, module CA902016
Rating (In)	Curve	Curve
	B C D	B C D
63 A	A9N18340 A9N18356 A9N18378	A9N18344 A9N18360 A9N18382
80 A	A9N18341 A9N18357 A9N18379	A9N18345 A9N18361 A9N18383
100 A	A9N18342 A9N18358 A9N18380	A9N18346 A9N18362 A9N18384
125 A	A9N18343 A9N18359 A9N18381	A9N18347 A9N18363 A9N18385
Width in 9-mm modules	3	6
Accessories	Module CA907012 and CA907013	Module CA907012 and CA907013

⁽¹⁾ Country France only

C120N circuit breakers (curves B, C, D) (cont.)

PB107817-40

■ Terminals insulated to IP20



■ Location for 4 clip-on terminal markers

Positive contact indication

- Suitability for isolation in the industrial sector to IEC/EN 60947-2.
- The presence of the green strip guarantees that the contacts open physically and allows work to be carried out safely on the downstream circuit.

- Longer product service life thanks to:
 - good overvoltage withstand capacity: products designed to offer a high industrial performance level (degree of pollution, rated impulse withstand voltage and insulation voltage).
 - high limitation performances (see limitation curves).
 - fast closure independent of toggle operating speed.
- Remote indication of the open/closed/tripped state by auxiliary contacts (optional).
- Power supply from above or below.

3P				4P		
Remote indication and tripping, module CA907008 and CA907013				Remote indication and tripping, module CA907008 and CA907013		
Vigi C120 add-on residual current device, module CA902016				Vigi C120 add-on residual current device, module CA902016		
Curve				Curve		
B	C	D		B	C	D
A9N18348	A9N18364	A9N18386		A9N18352	A9N18371	A9N18390
A9N18349	A9N18365	A9N18387		A9N18353	A9N18372	A9N18391
A9N18350	A9N18367	A9N18388		A9N18354	A9N18373(1)	A9N18392
A9N18351	A9N18369	A9N18389		A9N18355	A9N18374	A9N18392
					A9N18375(1)	
					A9N18376	A9N18393
					A9N18377(1)	
9				12		
Module CA907012 and CA907013				Module CA907012 and CA907013		

C120N circuit breakers (curves B, C, D) (cont.)

Connection

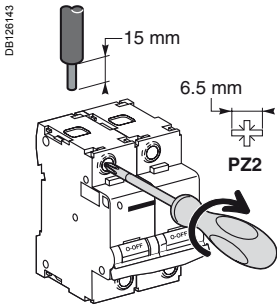

Rating	Tightening torque	Without access.		With accessories		
		Rigid/semi-rigid	Flexible or with ferrule	50 mm ² Al Terminal	Screw-on connection for ring terminal ⁽¹⁾	Multi-cable terminal
		DBI122845	DBI122846	DBI122835	DBI18789	DBI18787
63 to 125 A	3.5 N.m	1.5 to 50 mm ²	1.5 to 35 mm ²	16 to 50 mm ²	Ø 5 mm	3 x 16 mm ² / 3 x 10 mm ²

(1) For lugs up to 63 A, front or rear access.

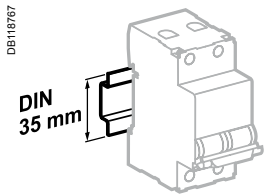

Clips onto 35 mm DIN rail.

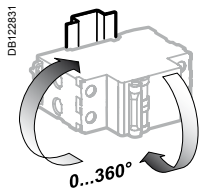

Any installation position.

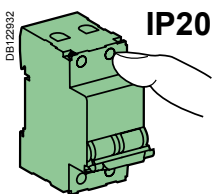

IP20

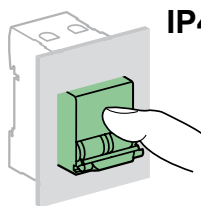

IP40

Technical data

Main characteristics

To IEC/EN 60947-2

Insulation voltage (U _i)	500 V AC
Degree of pollution	3
Rated impulse withstand voltage (U _{imp})	6 kV
Thermal tripping	Reference temperature
	50°C

To IEC/EN 60898-1

Magnetic tripping	Curve B	3 and 5 I _n
	Curve C	5 and 10 I _n
	Curve D	10 and 14 I _n
Limitation class		3

Additional characteristics

Degree of protection (IEC 60529)	Device only	IP20	
	Device in a modular enclosure	IP40	
Endurance (O-C)	Electrical	63 A	10000 cycles (O-C)
		80...125 A	5000 cycles (O-C)
	Mechanical		20000 cycles
Operating temperature		-30°C to +70°C	
Storage temperature		-40°C to +80°C	
Tropicalisation (IEC 60068-1)		Treatment 2 (relative humidity 95 % at 55°C)	

Weight (g)

Circuit breaker

Type	C120N
1P	205
2P	410
3P	615
4P	820

Dimensions (mm)

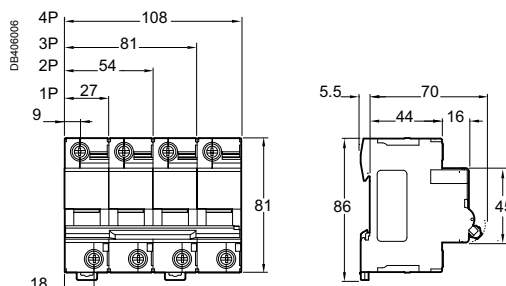

C120H circuit breakers (curves B, C, D)

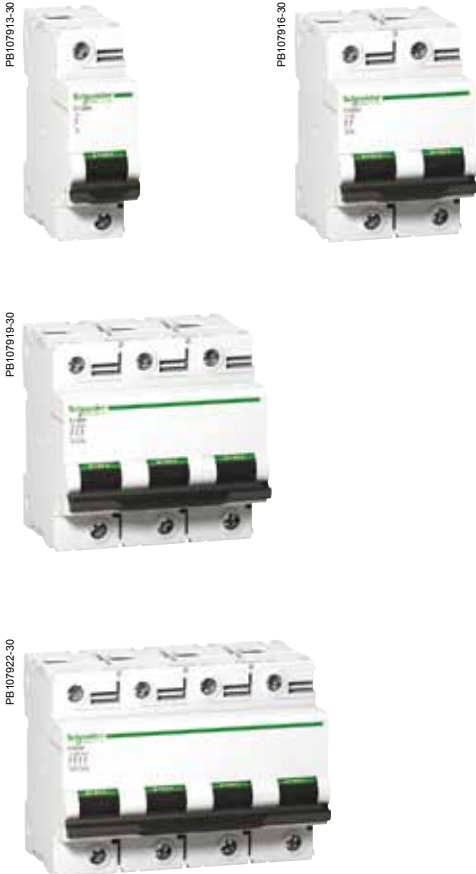

IEC/EN 60898-1

C120H circuit breakers are multistandard circuit breakers that combine the following functions:

- circuit protection against short-circuit currents
- circuit protection against overload currents
- suitability for isolation in the industrial sector to IEC/EN 60947-2
- fault tripping and indication by adding auxiliaries.

Alternating current (AC) 50/60 Hz

Breaking capacity (Icu) to IEC/EN 60947-2						Service breaking capacity (Ics)
Type	Voltage (V)					
1P	12 to 130 V	220 to 240 V	380 to 415 V	440 V		50 % of Icu
Rating (In) 63 to 125 A	30 kA	15 kA	4,5 kA ⁽¹⁾	-		
2P, 3P, 4P	12 to 130 V	220 to 240 V	380 to 415 V	440 V		50 % of Icu
63 to 125 A	-	30 kA	15 kA	10 kA		

Breaking capacity (Icn) to IEC/EN 60898-1		
Type	Voltage (V)	
1P, 2P, 3P, 4P	230 to 400 V	
Rating (In) 63 to 125 A	15000 A	
	50 % of Icn	

(1) One-pole breaking capacity in IT isolated neutral system (double fault).

Direct current (DC)

Breaking capacity (Icu) according to IEC/EN 60947-2							Service breaking capacity (Ics)
Between +/-	Voltage (Ue)						
	12 to 125 V	≤ 144 V	≤ 250 V	≤ 375 V	≤ 500 V		100 % of Icu
Number of poles	1P		2P	3P	4P		
Rating (In) 63 to 125 A	20 kA	15 kA	15 kA	15 kA	15 kA		

Catalogue numbers

C120H circuit breaker

Type	1P	2P
Auxiliaries	Remote indication and tripping, module CA907008 and CA907013	Remote indication and tripping, module CA907008 and CA907013
Vigi C120	Vigi C120 add-on residual current device, module CA902016	Vigi C120 add-on residual current device, module CA902016
Rating (In)	Curve	Curve
	B C D	B C D
63 A	A9N18401 A9N18445 A9N18489	A9N18412 A9N18456 A9N18500
80 A	A9N18402 A9N18446 A9N18490	A9N18413 A9N18457 A9N18501
100 A	A9N18403 A9N18447 A9N18491	A9N18414 A9N18458 A9N18502
125 A	A9N18404 A9N18448 A9N18492	A9N18415 A9N18459 A9N18503
Width in 9 mm modules	3	6
Accessories	Module CA907012 and CA907013	Module CA907012 and CA907013

C120H circuit breakers (curves B, C, D) (cont.)

PB107916-40

■ Terminals insulated to IP20



■ Location for 4 clip-on terminal markers

Positive contact indication

- Suitability for isolation in the industrial sector to IEC/EN 60947-2.
- The presence of the green strip guarantees that the contacts open physically and allows work to be carried out safely on the downstream circuit.

- Longer product service life thanks to:
 - good overvoltage withstand capacity: products designed to provide a high industrial performance level (degree of pollution, rated impulse withstand voltage and insulation voltage).
 - high limitation performances (see limitation curves).
 - fast closure independent of toggle operating speed.
- Remote indication of the open/closed/tripped state by auxiliary contacts (optional).
- Power supply from above or below.

3P				4P		
Remote indication and tripping, module CA907008 and CA907013				Remote indication and tripping, module CA907008 and CA907013		
Vigi C120 add-on residual current device, module CA902016				Vigi C120 add-on residual current device, module CA902016		
Curve				Curve		
B	C	D		B	C	D
A9N18423	A9N18467	A9N18511		A9N18434	A9N18478	A9N18522
A9N18424	A9N18468	A9N18512		A9N18435	A9N18479	A9N18523
A9N18425	A9N18469	A9N18513		A9N18436	A9N18480	A9N18524
A9N18426	A9N18470	A9N18514		A9N18437	A9N18481	A9N18525
9				12		
Module CA907012 and CA907013				Module CA907012 and CA907013		

C120H circuit breakers (curves B, C, D) (cont.)

Connection

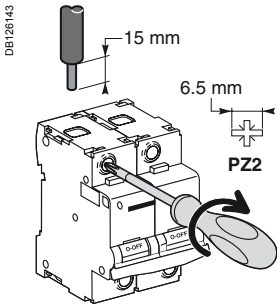

Rating	Tightening torque	Without access.		With accessories			
		Rigid	Flexible or with ferrule	50 mm ² Al term.	Screw-on connection for ring terminal ⁽¹⁾	Rigid cables	Flexible cables
63 to 125 A	3.5 N.m	DB122945	DB122946	DB122935	DB118769	DB118767	
		1.5 to 50 mm ²	1.5 to 35 mm ²	16 to 50 mm ²	Ø 5 mm	3 x 16 mm ²	3 x 10 mm ²

(1) For lugs up to 63 A, front or rear accessories.

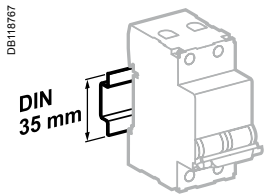

Clips onto 35 mm DIN rail.

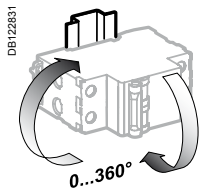

Any installation position.

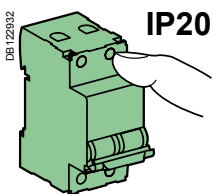

IP20

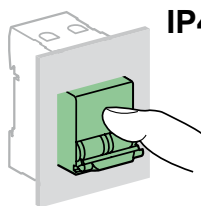

IP40

Technical data

Main characteristics

To IEC/EN 60947-2

Insulation voltage (U _i)	500 V AC
Degree of pollution	3
Rated impulse withstand voltage (U _{imp})	6 kV
Thermal tripping	Reference temperature
	50°C

To IEC/EN 60898-1

Magnetic tripping	Curve B	3 and 5 I _n
	Curve C	5 and 10 I _n
	Curve D	10 and 14 I _n
Limitation class		3

Additional characteristics

Degree of protection (IEC 60529)	Device only	IP20	
	Device in a modular enclosure	IP40 (IPXXD)	
Endurance (O-C)	Electrical	63 A	10000 cycles (O-C)
		80...125 A	5000 cycles (O-C)
	Mechanical		20000 cycles
Operating temperature		-30°C to +70°C	
Storage temperature		-40°C to +80°C	
Tropicalisation (IEC 60068-1)		Treatment 2 (relative humidity 95% at 55°C)	

Weight (g)

Circuit breaker

Type	C120H
1P	205
2P	410
3P	615
4P	820

Dimensions (mm)

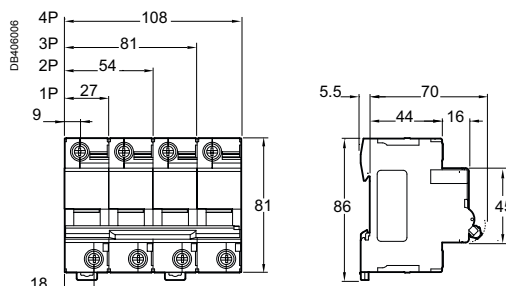

NG125a circuit breakers (curve C)

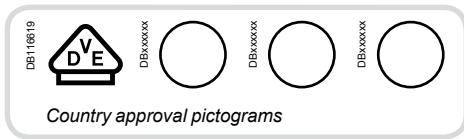

IEC/EN 60947-2

■ NG125a circuit breakers are circuit breakers which combine the following functions:

- circuit protection against short-circuit currents,
- circuit protection against overload currents,
- suitability for isolation in the industrial sector to IEC/EN 60947-2,
- tripping upon fault is indicated by a red mechanical state indicator light on the front face of the circuit breaker.



NG125a 3P



NG125a 4P

Alternating current (AC) 50/60 Hz			
Breaking capacity (Icu) to IEC/EN 60947-2			Service breaking capacity (Ics)
Ph/Ph (3P, 4P)	Voltage (Ue)		
Rating (In) 80 to 125 A	380 to 415 V	500 V	75 % of Icu
	16 kA	8 kA	

Direct current (DC)			
Breaking capacity (Icu) to IEC/EN 60947-2			Service breaking capacity (Ics)
	Voltage (Ue)		
	≤ 375 V	≤ 500 V	100 % of Icu
Number of poles	3P	4P	
Rating (In) 80 to 125 A	20 kA	20 kA	

Catalogue numbers

NG125a circuit breaker			
Type	3P		4P
	<p>E45095</p>		<p>E45097</p>
Auxiliaries	Remote indication and tripping, module CM907004 and CM907005		
Vigi NG125	Vigi NG125 add-on residual current device, module CM902008		
Rating (In)	Quality label ⁽¹⁾	Curve C	Curve C
80 A		18603	18607
100 A		18604	18608
125 A		18605	18609
Width in 9 mm modules		9	12
Accessories	Module CM907004 and CM907006		

(1) Information to be supplied by the country concerned.

NG125a circuit breakers (curve C) (cont.)

Connection

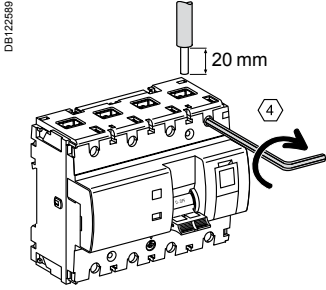

Rating	Tightening torque	Without accessories		With accessories					
		Copper cables		70 mm ² Al terminal	Screw-on connection for ring terminal	Small ring terminal	Multi-cable terminal		
		Rigid	Flexible or with ferrule				Rigid cables	Flexible cables	
80 to 125 A	6 N.m	DB1122945 	DB1122946 	DB1123410 	DB1123488 	DB1118789 	DB1118787 		

■ Upstream voltage taps for each pole, by 6.35 mm Fast-on terminal.

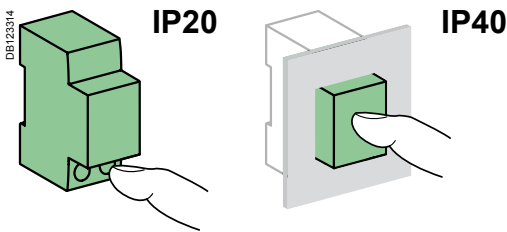
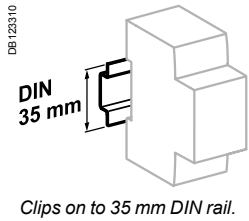

Technical data

Main characteristics		
According to IEC/EN 60947-2		
Insulation voltage (U _i)		690 V AC
Degree of pollution		3
Rated impulse withstand voltage (U _{imp})		8 kV
Thermal tripping	Reference temperature	40°C
Magnetic tripping (I _n)	Curve C	8 I _n ± 20 %
Utilization category		A
Additional characteristics		
Degree of protection (IEC 60529)	Device only	IP20
	Device in modular enclosure	IP40
Endurance (O-C)	Electrical	5000 cycles
	Mechanical	20,000 cycles
Operating temperature		-30°C to +70°C
Storage temperature		-40°C to +70°C
Tropicalization (IEC 60068-1)		Treatment 2 (relative humidity of 95 % at 55°C)

NG125a circuit breakers (curve C) (cont.)

Weight (g)

Circuit breaker	
Type	NG125a
3P	720
4P	960

Dimensions (mm)

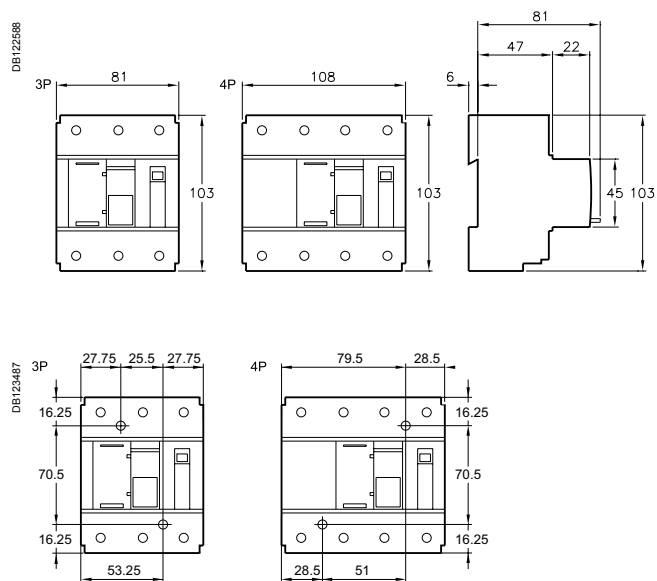

Spacing for mounting on panel

NG125a circuit breakers (curve C) (cont.)

068914N_SE-90

DB122493

- Voltage taps:
 - auxiliaries power supply
 - measurement
 - emergency stop
 - remote reporting



- Cable strength:
 - ribbed cage
 - terminal depth
 - tightening by Allen hex key

- Integrated padlocking device

- Test button to check satisfactory operation of the tripping mechanism



- Pull-out strength:
 - metallic lock



- Impact and vibration resistance:
 - high-strength enclosure
 - IK 05

- Central manual control, 3 positions:
 - ON
 - tripped on fault
 - open

- Circuit breaker tripped indicator

- Electric power supply through the top or bottom



- Positive contact indication:
 - suitability for isolation in the industrial sector to IEC/EN 60947-2
 - the presence of the green strip guarantees that the contacts open physically and allows work to be carried out safely on the downstream circuit

- Longer product service life due to:
 - good overvoltage withstand capacity,
 - high limitation performances,
 - fast closure independent of the speed of actuation of the toggle.



The Schneider Electric circuit breaker range comprises various offers (A, B) so as to be as competitive as possible in each country, taking into account the specific features of each market:

- Installation customs
- Price
- Approval by local organizations.

Variants

Offers		Pages
Offer A	Catalogue numbers	100
Offer B	Catalogue numbers	101
Common pages		102



Only the product range to be marketed in your country and validated by the local product manager, in agreement with his Final Distribution (FD) partner should be retained. The others will be removed before publication.

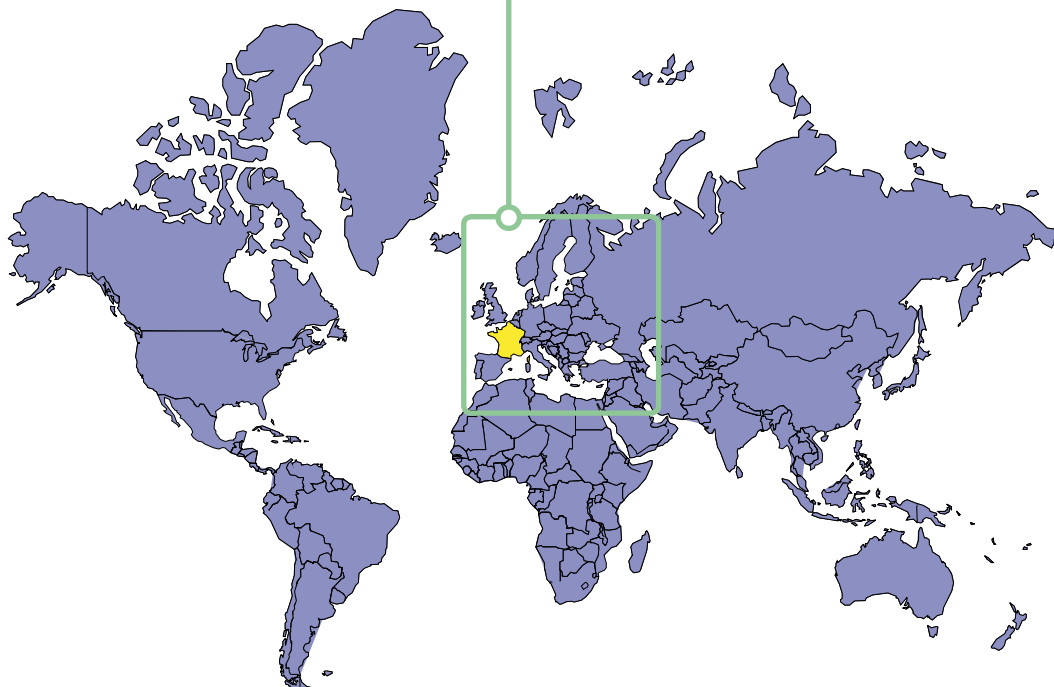

NG125N circuit breakers (curves B, C, D)

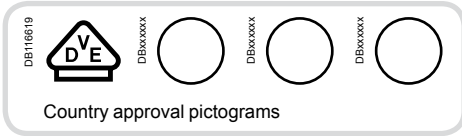

IEC/EN 60947-2

■ NG125N circuit breakers are circuit breakers which combine the following functions:

- circuit protection against short-circuit currents,
- circuit protection against overload currents,
- suitability for isolation in the industrial sector to IEC/EN 60947-2,
- tripping upon fault is indicated by a red mechanical state indicator light on the front face of the circuit breaker.



NG125N 1P

NG125N 2P



NG125N 3P





NG125N 4P

Alternating current (AC) 50/60 Hz							Service breaking capacity (Ics)
Breaking capacity (Icu) to IEC/EN 60947-2							
Ph/Ph (2P, 3P, 3P+N, 4P)	Voltage (Ue)					Rating (In)	75 % of Icu
(1P)	110 to 130 V	220 to 240 V	220 to 240 V	380 to 415 V	440 V to 500 V		
	50 kA	25 kA	50 kA	6 kA ⁽²⁾	25 kA	20 kA	10 kA

Direct current (DC)						Service breaking capacity (Ics)	
Breaking capacity (Icu) according to IEC/EN 60947-2							
Number of poles	Voltage (Ue)					Rating (In)	100 % of Icu
	12 to 125 V	≤ 144 V	≤ 250 V	≤ 375 V	≤ 500 V		
1P	25 kA	20 kA	20 kA	20 kA	20 kA	100 % of Icu	

Catalogue numbers

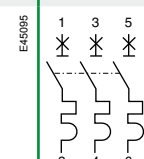
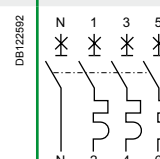
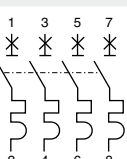
NG125N circuit breaker										
Type	1P	2P	3P			3P+N	4P			
										
Auxiliaries	Remote indication and tripping, module CM907004 and CM907005									
Vigi NG125	Vigi NG125 add-on residual current device, module CM902008									
Rating (In)	Quality label ⁽¹⁾	Curve C	Curve C	Curve B	Curve C	Curve D	Curve C	Curve B	Curve C	Curve D
10 A		18610	18621	-	18632	-	-	-	18649	-
16 A		18611	18622	-	18633	-	-	-	18650	-
20 A		18612	18623	-	18634	-	-	-	18651	-
25 A		18613	18624	-	18635	-	-	-	18652	-
32 A		18614	18625	-	18636	-	-	-	18653	-
40 A		18615	18626	-	18637	-	-	-	18654	-
50 A		18616	18627	-	18638	-	-	-	18655	-
63 A		18617	18628	-	18639	-	-	-	18656	-
80 A		18618	18629	18663	18641	18669	18646	18666	18657	18672
100 A		-	-	18664	18643	18670	18647	18667	18659	18673
125 A		-	-	18665	18645	18671	18648	18668	18661	18674
Width in 9 mm modules	3	6	9			12	12			
Accessories	Module CM907004 and CM907006									

(1) Information to be supplied by the country concerned.

(2) Breaking capacity under 1 pole in IT isolated neutral system (case of a double fault).

NG125N circuit breakers (curves B, C, D) (cont.)

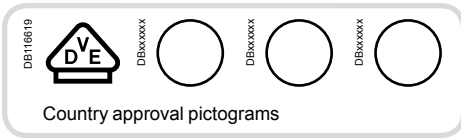

IEC/EN 60947-2

■ NG125N circuit breakers are circuit breakers which combine the following functions:

- circuit protection against short-circuit currents,
- circuit protection against overload currents,
- ability for isolation in the industrial sector to IEC/EN 60947-2,
- tripping upon fault is indicated by a red mechanical state indicator light on the front face of the circuit breaker.



NG125N 1P

NG125N 2P



NG125N 3P



NG125N 4P

Alternating current (AC) 50/60 Hz									
Breaking capacity (I _{cu}) to IEC/EN 60947-2									
Ph/Ph (2P, 3P, 3P+N, 4P)	Voltage (U _e)					Service breaking capacity (I _{cs})			
	110 to 130 V	220 to 240 V	220 to 240 V	380 to 415 V	440 V	500 V			
Rating (I _n)	10 to 125 A	50 kA	25 kA	50 kA	6 kA ⁽²⁾	25 kA	20 kA	10 kA	75 % of I _{cu}

Direct current (DC)							
Breaking capacity (I _{cu}) according to IEC/EN 60947-2							
	Voltage (U _e)					Service breaking capacity (I _{cs})	
	12 to 125 V	≤ 144 V	≤ 250 V	≤ 375 V	≤ 500 V		
Number of poles	1P	2P	3P	4P			
Rating (I _n)	10 to 125 A	25 kA	20 kA	20 kA	20 kA	20 kA	100 % of I _{cu}

Catalogue numbers

NG125N circuit breaker										
Type	1P	2P	3P	3P+N	4P					
Auxiliaries	Remote indication and tripping, module CM907004 and CM907005									
Vigi NG125	Vigi NG125 add-on residual current device, module CM902008									
Rating (I _n)	Quality label (1)	Curve C	Curve C	Curve B	Curve C	Curve D	Curve C	Curve B	Curve C	Curve D
10 A		18610	18621	-	18632	-	-	-	18649	-
16 A		18611	18622	-	18633	-	-	-	18650	-
20 A		18612	18623	-	18634	-	-	-	18651	-
25 A		18613	18624	-	18635	-	-	-	18652	-
32 A		18614	18625	-	18636	-	-	-	18653	-
40 A		18615	18626	-	18637	-	-	-	18654	-
50 A		18616	18627	-	18638	-	-	-	18655	-
63 A		18617	18628	-	18639	-	-	-	18656	-
80 A		18618	18629	18663	18640	18669	18646	18666	18658	18672
100 A		-	-	18664	18642	18670	18647	18667	18660	18673
125 A		-	-	18665	18644	18671	18648	18668	18662	18674
Width in 9 mm modules	3	6	9				12	12		
Accessories	Module CM907004 and CM907006									

(1) Information to be supplied by the country concerned.

(2) Breaking capacity under 1 pole in IT isolated neutral system (case of a double fault).

NG125N circuit breakers (curves B, C, D) (cont.)

Connection

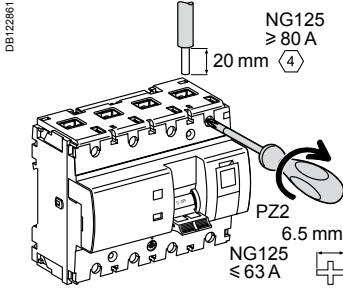

Rating	Tightening torque	Without accessories			With accessories				
		Copper cables			70 mm ² Al terminal	Screw-on connection for ring terminal	Small ring terminal	Multi-cable terminal	
		Rigid	Flexible or with ferrule					Rigid cables	Flexible cables
10 to 63 A 80 to 125 A	3.5 N.m 6 N.m	DBI122945 1.5 to 50 mm ²	DBI122946 1.5 to 35 mm ²	DBI123410 25 to 70 mm ²	DBI123488 2 x 35 mm ² 1 x 50 mm ²	DBI119789 1 x 70 mm ²	DBI119787 3 x 16 mm ²	3 x 10 mm ²	

■ On 3P, 3P+N and 4P ≥ 80 A: upstream voltage taps for each pole, by 6.35 mm Fast-on terminal.

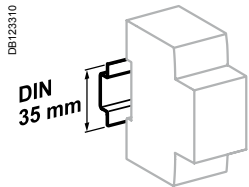

Clips on to 35 mm DIN rail.

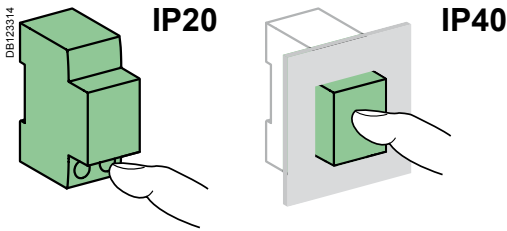

Technical data

Main characteristics

According to IEC/EN 60947-2

Insulation voltage (U _i)	690 V AC	
Degree of pollution	3	
Rated impulse withstand voltage (U _{imp})	8 kV	
Thermal tripping	Reference temperature	40°C
Magnetic tripping (I _t)	Curve B	4 I _n ± 20 %
	Curve C	8 I _n ± 20 %
	Curve D	12 I _n ± 20 %
Utilization category	A	

Additional characteristics

Degree of protection (IEC 60529)	Device only	IP20
	Device in modular enclosure	IP40
Endurance (O-C)	Electrical	≤ 63 A: 10,000 cycles ≥ 63 A: 5000 cycles
	Mechanical	20,000 cycles
Operating temperature		-30°C to +70°C
Storage temperature		-40°C to +70°C
Tropicalization (IEC 60068-1)		Treatment 2 (relative humidity of 95 % at 55°C)

NG125N circuit breakers (curves B, C, D) (cont.)

Weight (g)

Circuit breaker	
Type	NG125N
1P	240
2P	480
3P	720
3P+N	960
4P	960

Dimensions (mm)

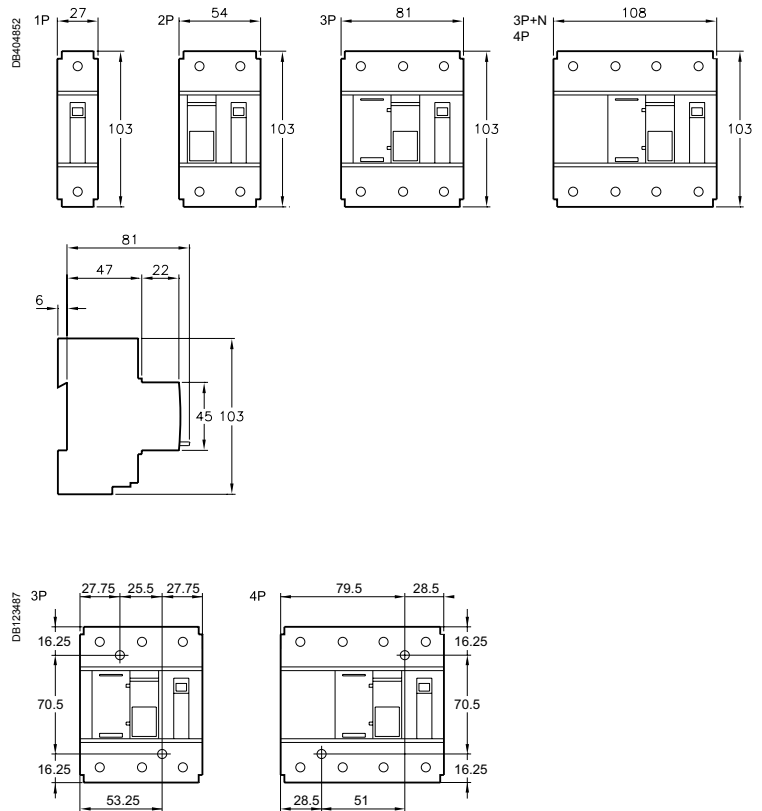

Spacing for mounting on panel

NG125N circuit breakers (curves B, C, D) (cont.)

056918N_SE-90

0612493

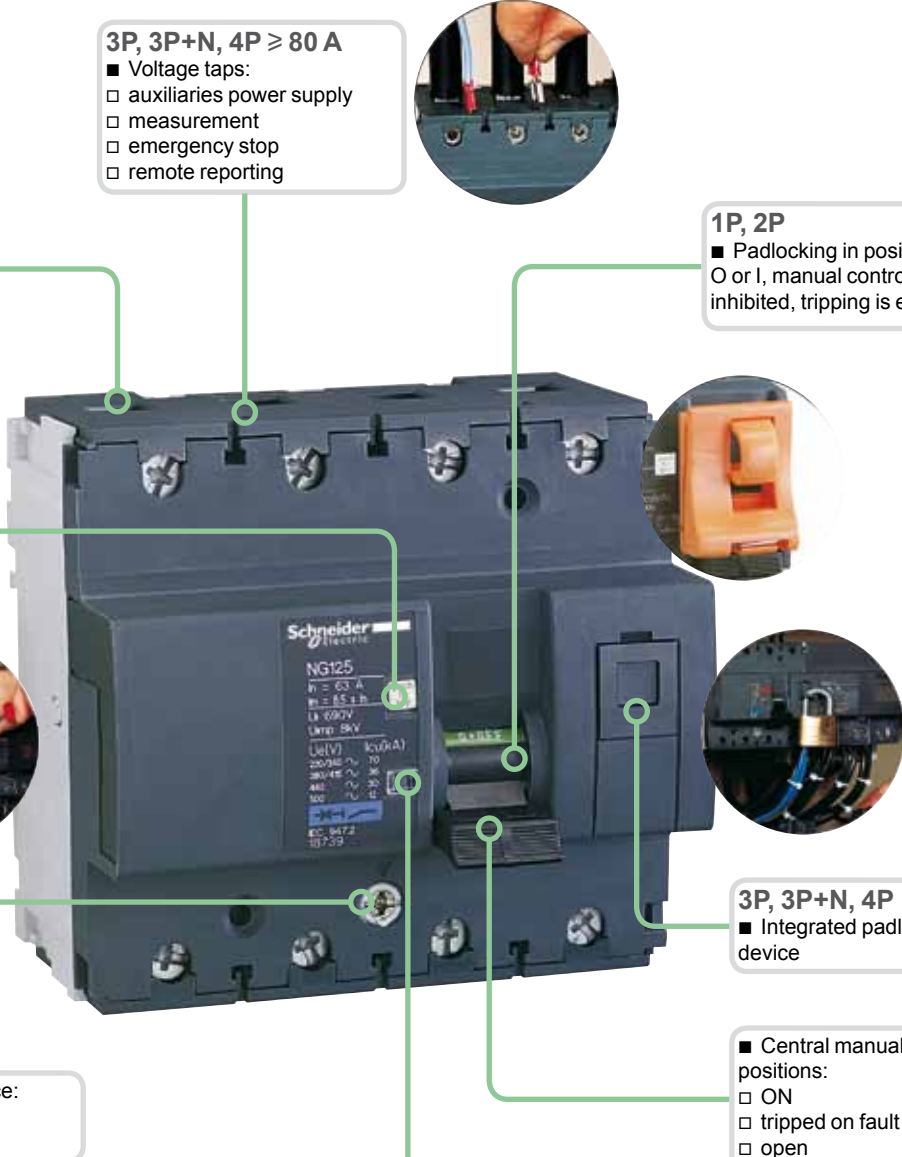

3P, 3P+N, 4P ≥ 80 A
 ■ Voltage taps:
 auxiliaries power supply
 measurement
 emergency stop
 remote reporting

■ Cable strength:
 ribbed cage
 terminal depth
 tightening by Allen hex key (NG125 ≥ 80 A)

1P, 2P
 ■ Padlocking in position:
 O or I, manual control is inhibited, tripping is enabled

■ Test button to check satisfactory operation of the tripping mechanism

■ Pull-out strength
 metallic lock

■ Impact and vibration resistance:
 high-strength enclosure
 IK 05

3P, 3P+N, 4P
 ■ Integrated padlocking device

■ Circuit breaker tripped indicator

■ Central manual control, 3 positions:
 ON
 tripped on fault
 open

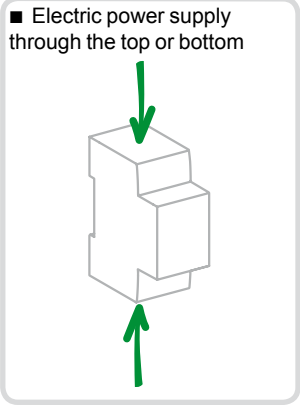

■ Positive contact indication:
 suitability for isolation in the industrial sector to IEC/EN 60947-2
 the presence of the green strip guarantees that the contacts open physically and allows work to be carried out safely on the downstream circuit

■ Longer product service life due to:
 good overvoltage withstand capacity,
 high limitation performances,
 fast closure independent of the speed of actuation of the toggle.

NG125H circuit breakers (curve C)

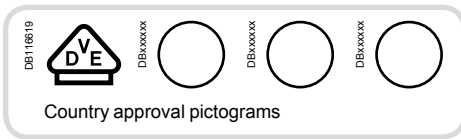

IEC/EN 60947-2

■ NG125H circuit breakers are circuit breakers which combine the following functions:

- circuit protection against short circuit currents,
- circuit protection against overload currents,
- suitability for isolation in the industrial sector to IEC/EN 60947-2,
- tripping upon fault is indicated by a red mechanical state indicator light on the front face of the circuit breaker.



NG125H 1P



NG125H 2P



NG125H 3P



NG125H 4P

Alternating current (AC) 50/60 Hz								
Breaking capacity (Icu) to IEC/EN 60947-2							Service breaking capacity (Ics)	
Ph/Ph (2P, 3P, 4P)	Voltage (Ue)							
	-	-	220 to 240 V	-	380 to 415 V	440 V	500 V	
Ph/N (1P)	110 to 130 V	220 to 240 V	-	380 to 415 V	-	-	-	
Rating (In)	10 to 80 A	70 kA	36 kA	70 kA	9 kA ⁽²⁾	36 kA	30 kA	12 kA
								75 % of Icu

Direct current (DC)					
Breaking capacity (Icu) according to IEC/EN 60947-2					Service breaking capacity (Ics)
Voltage (Ue)					
	12 to 125 V	≤ 144 V	≤ 250 V	≤ 375 V	≤ 500 V
Number of poles	1P		2P	3P	4P
Rating (In)	10 to 80 A	36 kA	25 kA	25 kA	25 kA
					100 % of Icu

Catalogue numbers

NG125H circuit breaker					
Type	1P	2P	3P	4P	
	E-46902 1 2	E-46904 1 3 2 4	E-46905 1 3 5 2 4 6	E-46907 1 3 5 7 2 4 6 8	
Auxiliaries	Remote indication and tripping, module CM907004 and CM907005				
Vigi NG125	Vigi NG125 add-on residual current device, module CM902008				
Rating (In)	Quality label ⁽¹⁾	Curve C	Curve C	Curve C	Curve C
10 A		18705	18714	18723	18732
16 A		18706	18715	18724	18733
20 A		18707	18716	18725	18734
25 A		18708	18717	18726	18735
32 A		18709	18718	18727	18736
40 A		18710	18719	18728	18737
50 A		18711	18720	18729	18738
63 A		18712	18721	18730	18739
80 A		18713	18722	18731	18740
Width in 9 mm modules		3	6	9	12
Accessories	Module CM907004 and CM907006				

(1) Information to be supplied by the country concerned.

(2) Breaking capacity under 1 pole in IT isolated neutral system (case of a double fault).

NG125H circuit breakers (curve C) (cont.)

Connection

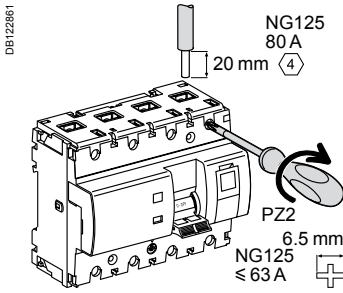

Rating	Tightening torque	Without accessories		With accessories				
		Copper cables		70 mm ² Al terminal	Screw-on connection for ring terminal	Small ring terminal	Multi-cable terminal	
		Rigid	Flexible or with ferrule				Rigid cables	Flexible cables
10 to 63 A 80 A	3.5 N.m 6 N.m	DBI122946 1.5 to 50 mm ²	DBI122946 1.5 to 35 mm ²	DBI123410 25 to 70 mm ²	DBI123488 2 x 35 mm ² 1 x 50 mm ²	DBI118789 1 x 70 mm ²	DBI118787 3 x 16 mm ²	3 x 10 mm ²

■ On 3P and 4P 80 A: upstream voltage taps for each pole, by 6.35 mm Fast-on terminal.

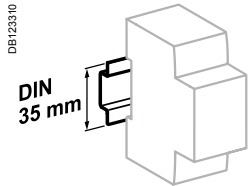

Clips on to 35 mm DIN rail.

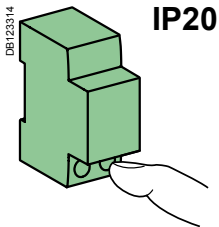

IP20

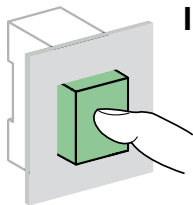

IP40

Technical data

Main characteristics

According to IEC/EN 60947-2

Insulation voltage (U _i)	690 V AC
Degree of pollution	3
Rated impulse withstand voltage (U _{imp})	8 kV
Thermal tripping	Reference temperature 40°C
Magnetic tripping (I _i)	Curve C 8 I _n ± 20 %
Utilization category	A

Additional characteristics

Degree of protection (IEC 60529)	Device only	IP20
	Device in modular enclosure	IP40 Insulation class II
Endurance (O-C)	Electrical	≤ 63 A: 10,000 cycles ≥ 63 A: 5000 cycles
	Mechanical	20,000 cycles
Operating temperature	-30°C to +70°C	
Storage temperature	-40°C to +70°C	
Tropicalization (IEC 60068-1)	Treatment 2 (relative humidity of 95 % at 55°C)	

NG125H circuit breakers (curve C) (cont.)

Weight (g)

Circuit breaker	
Type	NG125H
1P	240
2P	480
3P	720
4P	960

Dimensions (mm)

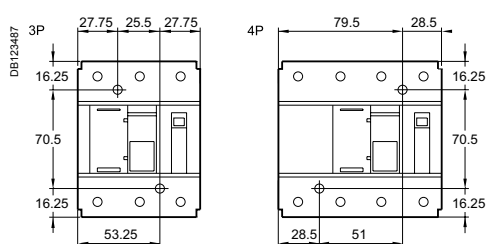
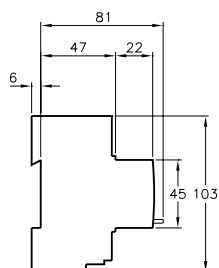
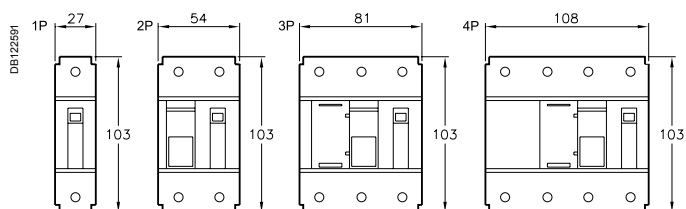

Spacing for mounting on panel

NG125H circuit breakers (curve C) (cont.)

056918N_SE-90

3P, 4P 80 A

- Voltage taps:
 - auxiliaries power supply
 - measurement
 - emergency stop
 - remote reporting



- Cable strength:
 - ribbed cage
 - terminal depth
 - tightening by Allen hex key (NG125 80 A)

1P, 2P

- Padlocking in position:
 - O or I, manual control is inhibited, tripping is enabled

- Test button to check satisfactory operation of the tripping mechanism



- Pull-out strength:
 - metallic lock



3P, 4P

- Integrated padlocking device

- Central manual control, 3 positions:
 - ON
 - tripped on fault
 - open



- Impact and vibration resistance:
 - high-strength enclosure
 - IK 05

- Circuit breaker tripped indicator

- Electric power supply through the top or bottom



- Positive contact indication:

- suitability for isolation in the industrial sector to IEC/EN 60947-2
- the presence of the green strip guarantees that the contacts open physically and allows work to be carried out safely on the downstream circuit

- Longer product service life due to:

- good overvoltage withstand capacity,
- high limitation performances,
- fast closure independent of the speed of actuation of the toggle.

DB 125483



The Schneider Electric circuit breaker range comprises various offers (A, B) so as to be as competitive as possible in each country, taking into account the specific features of each market:

- Installation customs
- Price
- Approval by local organizations.

Variants

Offers		Pages
Offer A	Catalogue numbers	110
Offer B	Catalogue numbers	111
Common pages		112



Only the product range to be marketed in your country and validated by the local product manager, in agreement with his Final Distribution (FD) partner should be retained. The others will be removed before publication.

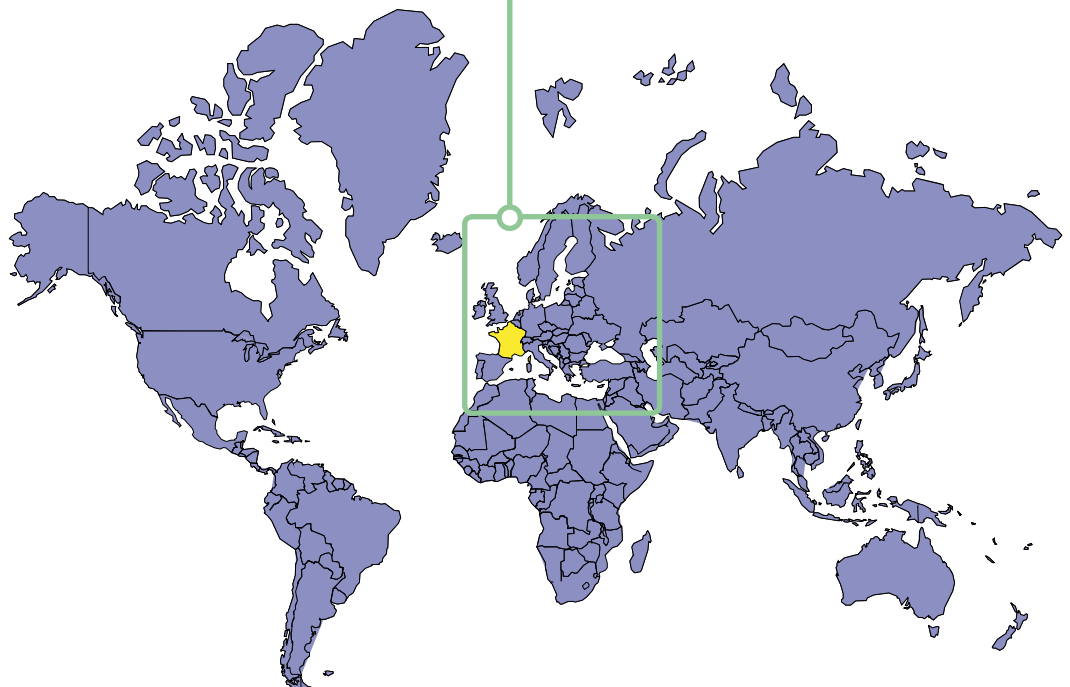

NG125L circuit breakers (curves B, C, D) (cont.)

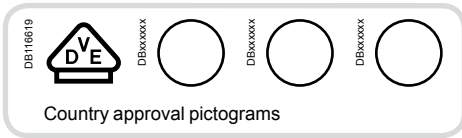

IEC/EN 60947-2

- NG125L circuit breakers are circuit breakers which combine the following functions:
 - circuit protection against short-circuit currents;
 - circuit protection against overload currents;
 - suitability for isolation in the industrial sector to IEC/EN 60947-2;
 - tripping upon fault is indicated by a red mechanical state indicator light on the front face of the circuit breaker.

Offer selection see page 109

Offer A

This sticker must be removed before publishing



NG125L 1P

NG125L 2P



NG125L 3P

NG125L 4P

Alternating current (AC) 50/60 Hz							Service breaking capacity (Ics)		
Breaking capacity (Icu) to IEC/EN 60947-2									
	Voltage (Ue)						Service breaking capacity (Ics)		
Ph/Ph (2P, 3P, 4P)	-	-	220 to 240 V	-	380 to 415 V	440 V		500 V	
Ph/N (1P)	110 to 130 V	220 to 240 V	-	380 to 415 V	-	-	-		
Rating (In)	10 to 80 A	100 kA	50 kA	100 kA	12.5 kA ⁽²⁾	50 kA	40 kA	15 kA	75 % of Icu

Direct current (DC)						Service breaking capacity (Ics)
Breaking capacity (Icu) according to IEC/EN 60947-2						
	Voltage (Ue)					Service breaking capacity (Ics)
	12 to 125 V	≤ 144 V	≤ 250 V	≤ 375 V	≤ 500 V	
Number of poles	1P	2P	3P	4P		
Rating (In)	10 to 80 A	50 kA	36 kA	36 kA	36 kA	

Catalogue numbers

NG125L circuit breaker													
Type	1P			2P			3P			4P			
Auxiliaries	Remote indication and tripping, module CM907004 and CM907005												
Vigi NG125	Vigi NG125 add-on residual current device, module CM902008												
Rating (In)	Quality label ⁽¹⁾	Curve			Curve			Curve			Curve		
		B	C	D	B	C	D	B	C	D	B	C	D
10 A		18741	18777	18830	18750	18788	18839	18759	18799	18848	18768	18821	18857
16 A		18742	18778	18831	18751	18789	18840	18760	18800	18849	18769	18822	18858
20 A		18743	18779	18832	18752	18790	18841	18761	18801	18850	18770	18823	18859
25 A		18744	18780	18833	18753	18791	18842	18762	18802	18851	18771	18824	18860
32 A		18745	18781	18834	18754	18792	18843	18763	18803	18852	18772	18825	18861
40 A		18746	18782	18835	18755	18793	18844	18764	18804	18853	18773	18826	18862
50 A		18747	18783	18836	18756	18794	18845	18765	18805	18854	18774	18827	18863
63 A		18748	18784	18837	18757	18795	18846	18766	18806	18855	18775	18828	18864
80 A		18749	18785	18838	18758	18796	18847	18767	18807	18856	18776	18829	18865
Width in 9 mm modules		3			6			9			12		
Accessories		Module CM907004 and CM907006											

(1) Information to be supplied by the country concerned.
(2) Breaking capacity under 1 pole in IT isolated neutral system (case of a double fault).

NG125L circuit breakers (curves B, C, D)

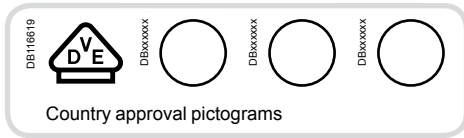

IEC/EN 60947-2

- NG125L circuit breakers are circuit breakers which combine the following functions:
 - circuit protection against short-circuit currents;
 - circuit protection against overload currents;
 - suitability for isolation in the industrial sector to IEC/EN 60947-2;
 - tripping upon fault is indicated by a red mechanical state indicator light on the front face of the circuit breaker.



NG125L 1P

NG125L 2P



NG125L 3P

NG125L 4P

Alternating current (AC) 50/60 Hz									
Breaking capacity (Icu) to IEC/EN 60947-2	Voltage (Ue)						Service breaking capacity (Ics)		
	110 to 130 V	220 to 240 V	220 to 240 V	380 to 415 V	440 V	500 V			
Ph/Ph (2P, 3P, 4P)	-	-	220 to 240 V	-	380 to 415 V	440 V	500 V		
Ph/N (1P)	110 to 130 V	220 to 240 V	-	380 to 415 V	-	-	-		
Rating (In)	10 to 80 A	100 kA	50 kA	100 kA	12.5 kA ⁽²⁾	50 kA	40 kA	15 kA	75 % of Icu

Direct current (DC)							
Breaking capacity (Icu) according to IEC/EN 60947-2	Voltage (Ue)					Service breaking capacity (Ics)	
	12 to 125 V	≤ 144 V	≤ 250 V	≤ 375 V	≤ 500 V		
Number of poles	1P	2P	3P	4P			
Rating (In)	10 to 80 A	50 kA	36 kA	36 kA	36 kA	36 kA	100 % of Icu

Catalogue numbers

NG125L circuit breaker													
Type	1P			2P			3P			4P			
Auxiliaries	Remote indication and tripping, module CM907004 and CM907005												
Vigi NG125	Vigi NG125 add-on residual current device, module CM902008												
Rating (In)	Quality label ⁽¹⁾	Curve			Curve			Curve			Curve		
		B	C	D	B	C	D	B	C	D	B	C	D
10 A		18741	18777	18830	18750	18788	18839	18759	18799	18848	18768	18810	18857
16 A		18742	18778	18831	18751	18789	18840	18760	18800	18849	18769	18811	18858
20 A		18743	18779	18832	18752	18790	18841	18761	18801	18850	18770	18812	18859
25 A		18744	18780	18833	18753	18791	18842	18762	18802	18851	18771	18813	18860
32 A		18745	18781	18834	18754	18792	18843	18763	18803	18852	18772	18814	18861
40 A		18746	18782	18835	18755	18793	18844	18764	18804	18853	18773	18815	18862
50 A		18747	18783	18836	18756	18794	18845	18765	18805	18854	18774	18816	18863
63 A		18748	18784	18837	18757	18795	18846	18766	18806	18855	18775	18817	18864
80 A		18749	18785	18838	18758	18796	18847	18767	18807	18856	18776	18818	18865
Width in 9 mm modules		3			6			9			12		
Accessories		Module CM907004 and CM907006											

(1) Information to be supplied by the country concerned.

(2) Breaking capacity under 1 pole in IT isolated neutral system (case of a double fault).

NG125L circuit breakers (curves B, C, D) (cont.)

Connection

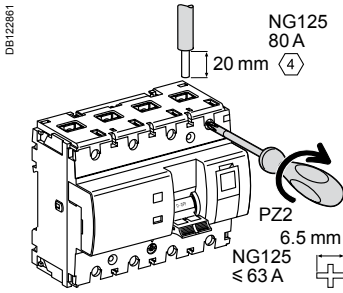

Rating	Tightening torque	Without accessories		With accessories				
		Copper cables		70 mm ² Al terminal	Screw-on connection for ring terminal	Small ring terminal	Multi-cable terminal	
		Rigid	Flexible or with ferrule				Rigid cables	Flexible cables
10 to 63 A 80 A	3.5 N.m 6 N.m	DB122945 1.5 to 50 mm ²	DB122946 1.5 to 35 mm ²	DB123410 25 to 70 mm ²	DB123488 2 x 35 mm ² 1 x 50 mm ²	DB119789 1 x 70 mm ²	DB119787 3 x 16 mm ²	3 x 10 mm ²

■ On 3P and 4P 80 A: upstream voltage taps for each pole, by 6.35 mm Fast-on terminal.

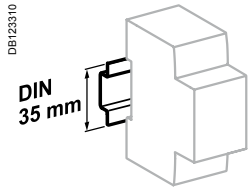

Clips on to 35 mm DIN rail.

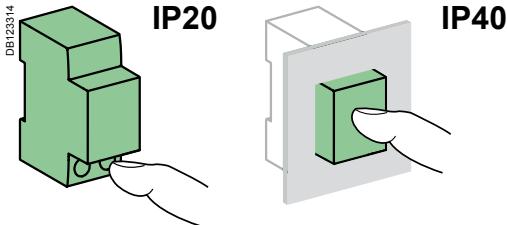

Technical data

Main characteristics		
According to IEC/EN 60947-2		
Insulation voltage (U _i)		690 V AC
Degree of pollution		3
Rated impulse withstand voltage (U _{imp})		8 kV
Thermal tripping	Reference temperature	40°C
Magnetic tripping (I _i)	Curve B	4 I _n ± 20 %
	Curve C	8 I _n ± 20 %
	Curve D	12 I _n ± 20 %
Utilization category		A
Additional characteristics		
Degree of protection (IEC 60529)	Device only	IP20
	Device in modular enclosure	IP40
Endurance (O-C)	Electrical	≤ 63 A: 10,000 cycles ≥ 63 A: 5000 cycles
	Mechanical	20,000 cycles
Operating temperature		-30°C to +70°C
Storage temperature		-40°C to +70°C
Tropicalization (IEC 60068-1)		Treatment 2 (relative humidity of 95 % at 55°C)

NG125L circuit breakers (curves B, C, D) (cont.)

Weight (g)

Circuit breaker	
Type	NG125L
1P	240
2P	480
3P	720
4P	960

Dimensions (mm)

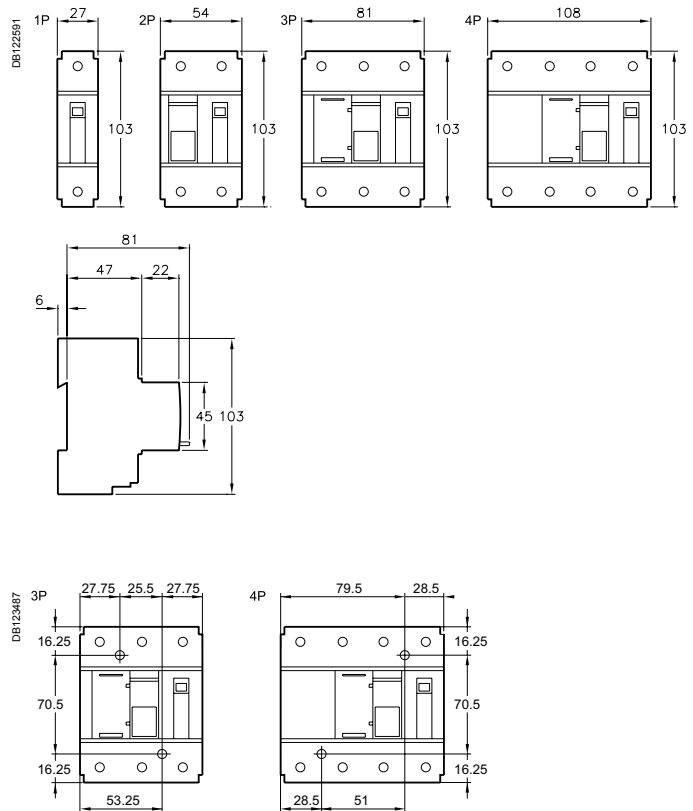

Spacing for mounting on panel

NG125L circuit breakers (curves B, C, D) (cont.)

06691BN_SE-90

DB123493

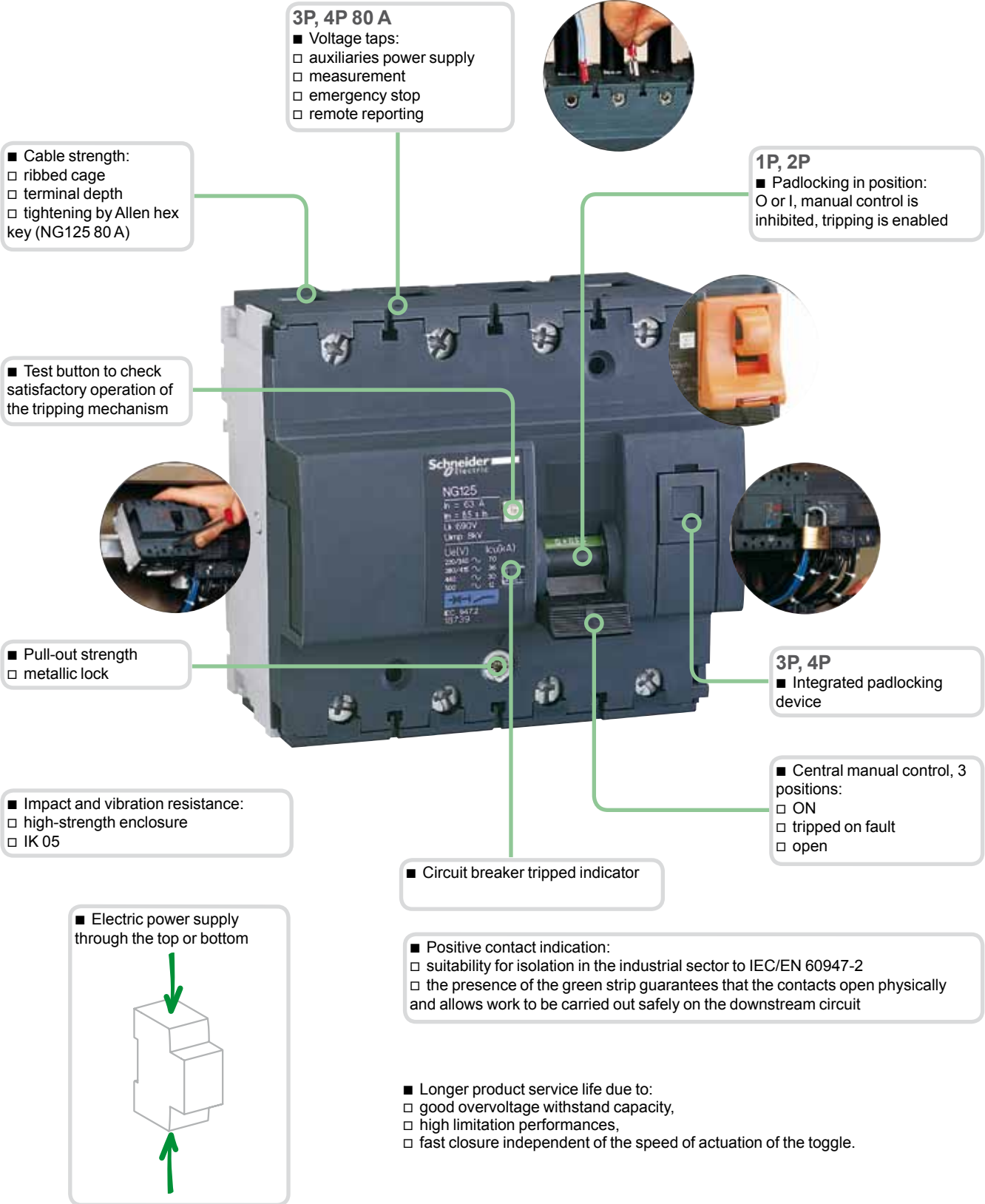



PB107193-34.eps



PB107194-34.eps



CE

IEC 60947-2

The C60H-DC supplementary protectors are used in direct current circuits (Industrial control and automations, transport, renewable energy...). They combine the following functions of circuit protection against short-circuit and overload currents, control and isolation.

Direct current (DC)						
Breaking capacity (Icu) according to IEC 60947-2						Rated service breaking capacity (Ics)
Type	110 V	220 V	250 V	440 V	500 V	
1P	20 kA	10 kA	6 kA	-	-	75 % Icu
Rating 0.5 to 63 A (In)						
2P (in series)	20 kA	10 kA	6 kA	-	-	75 % Icu
Rating 0.5 to 63 A						

Catalogue numbers

C60H-DC		
Type	1P	2P
	<p>DB116688</p> <p>Supply from above or below, observing the polarity</p>	<p>DB124110</p> <p>Supply from above</p> <p>DB124111</p> <p>Supply from below</p>
Auxiliaries	Remote signalisation and tripping, module CA907008	
Rating (In)	Curve C	Curve C
0.5 A	A9N61500	A9N61520
1 A	A9N61501	A9N61521
2 A	A9N61502	A9N61522
3 A	A9N61503	A9N61523
4 A	A9N61504	A9N61524
5 A	A9N61505	A9N61525
6 A	A9N61506	A9N61526
10 A	A9N61508	A9N61528
13 A	A9N61509	A9N61529
15 A	A9N61510	A9N61530
16 A	A9N61511	A9N61531
20 A	A9N61512	A9N61532
25 A	A9N61513	A9N61533
30 A	A9N61514	A9N61534
32 A	A9N61515	A9N61535
40 A	A9N61517	A9N61537
50 A	A9N61518	A9N61538
63 A	A9N61519	A9N61539
Number of modules of 9 mm	2	4
Accessories	Modules CA907013 and CA907012	

Connection

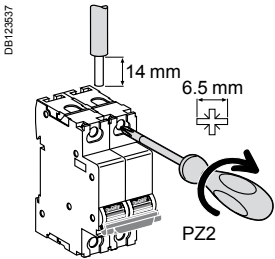

Rating	Tightening torque	Without accessory		With accessories			
		Copper cables		50 mm ² Al terminal	Screw-on connection for ring terminal	Multi-cables terminal	
		Rigid / Stranded	Flexible or with ferrule		Rigid cables	Flexible cables	
≤ 25 A	2.5 N.m	DB122945 1 to 25 mm ²	DB122946 1 to 16 mm ²	DB122935 - 50 mm ²	DB118789 Ø 5 mm	DB118787 - 3 x 16 mm ²	- 3 x 10 mm ²
> 25 A	3.5 N.m	1 to 35 mm ²	1 to 25 mm ²				

Multi-cables connection

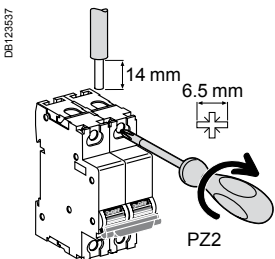

Rating	Tightening torque	Without accessory			
		2 Copper cables		3 Multi-cables / Different wires	
		Rigid / Stranded	Flexible or with ferrule	Flexible / Stranded	Flexible / Stranded / Rigid
≤ 25 A	2.5 N.m	DB122945 2 x 1 mm ² to 2 x 10 mm ²	DB122946 2 x 1 mm ² to 2 x 10 mm ²	DB118787 3 x 1 mm ²	2 x 2.5 mm ² + 1 x 1.5 mm ²
> 25 A	3.5 N.m	2 x 1 mm ² to 2 x 16 mm ²		3 x 4 mm ²	2 x 10 mm ² + 1 x 6 mm ²

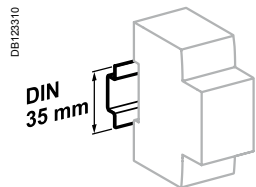

Clip on DIN rail 35 mm.

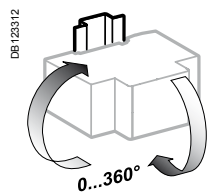

Indifferent position of installation.

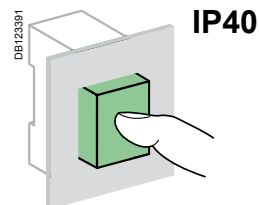

Technical data

- Tripping curves: C curve - Overcurrent protection for any type of application.
- Positive break indication - the green strip indicates that all the poles are open and allows work to be carried out on the downstream circuit in complete safety.
- Suitable for isolation as defined in IEC 60947-2.
- Increase in the service life of the product: thanks to fast closure independent of the speed of action on the handle.
- Current limitation in the event of a fault: fast opening of the contacts prevents the loads from being destroyed in the event of a short-circuit.

Main characteristics

According to IEC 60947-2

Insulation voltage (Ui)		500 V DC
Rated voltage (Un)	1P	250 V DC
	2P	500 V DC
Operating voltage (Ue)	1P	24...250 V DC
	2P	24...500 V DC
Pollution degree		3
Rated impulse withstand voltage (Uimp) under frame		6 kV
Magnetic tripping (Ii)		8.5 In (± 20 %) (compatible with curve C)

Additional characteristics

Degree of protection (IEC 60529)	Device in modular enclosure	IP40
Utilization category		A (no delay in accordance with IEC 60947-2 standards)
Endurance (O-C)	Electrical	3,000 cycles (where L/R=2 ms) 6,000 cycles where the circuit is resistive
	Mechanical	20,000 cycles
Tropicalization (IEC 60068-2)		Treatment 2 (relative humidity 95 % at 55°C)
Operating temperature		-25°C to 70°C
Storage temperature		-40°C to 85°C



Failure to match polarity during connection may lead to a fire hazard and/or serious injury.

- The connection polarity must be observed (marked on the front panel).
- Use only with direct current.

Weight (g)

Circuit-breaker	
Type	C60H-DC
1P	128 g
2P	256 g

Dimensions (mm)

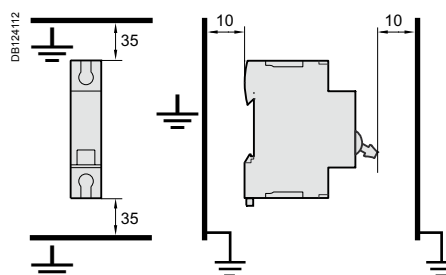
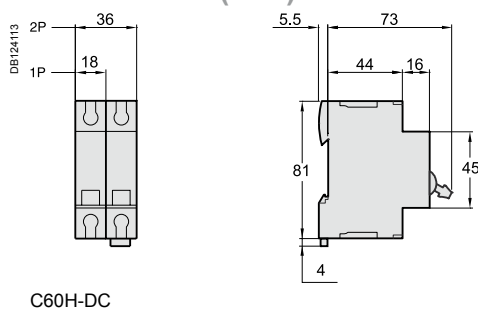

Details of minimum distance between circuit-breaker and earthed metal parts for circuit-breaker intended for use without enclosure.

PB109403-50



The C60PV-DC is a DC circuit breaker dedicated to multi string photovoltaic installations.

This circuit breaker is designed to protect the cables located between each string of photovoltaic modules and the photovoltaic inverter against overloads and short circuits (see application diagram).

Combined with a switch (of the C60NA-DC type, for example), the C60PV-DC will be installed in a string PV protection enclosure at the end of each string of photovoltaic modules.

It can be locked (by a padlocking device) in OFF position as a safety measure for removal of the PV inverter.

Since a fault current can flow in the reverse direction to the operating current, the C60PV-DC can detect and protect against any bidirectional current.

To ensure the safety of the installation, it is necessary, depending on the various types of application, to combine the C60PV-DC with:

- a residual current device at the AC end,
- a fault passage detector (insulation monitoring device) at the DC end
- an earth protection circuit breaker at the DC end (see Practical Advice CA908035).

In all cases, fast action on site will be required to clear the fault (protection not ensured in the event of a double fault).

C60PV-DC is not polarity sensitive: (+) and (-) wires can be inverted without any risk.

The C60PV-DC is delivered with three inter-pole barriers to provide increased isolation distance between two adjacent connectors.

IEC / EN 60947-2



DB404840



Main characteristics

Operating voltage (Ue)	800 V DC
Rated insulation voltage (Ui)	1,000 V DC
Breaking capacity (Icu)	1.5 kA
Impulse voltage (Uimp)	6 kV
Electrical connection	By the bottom for In and Out
Number of poles	2P
Number of modules of 9 mm	8

Diagrams

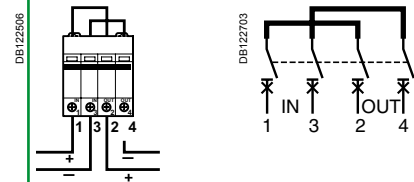

Standards	IEC 60947-2 EN 60947-2
-----------	---------------------------

Rating (A)	Catalogue numbers
1	A9N61653
2	A9N61654
3	A9N61655
5	A9N61656
8	A9N61657
10	A9N61650
13	A9N61658
15	A9N61659
16	A9N61651
20	A9N61652
25	A9N61660
Auxiliaries	See modules CA907008 and CA907013

Application diagram

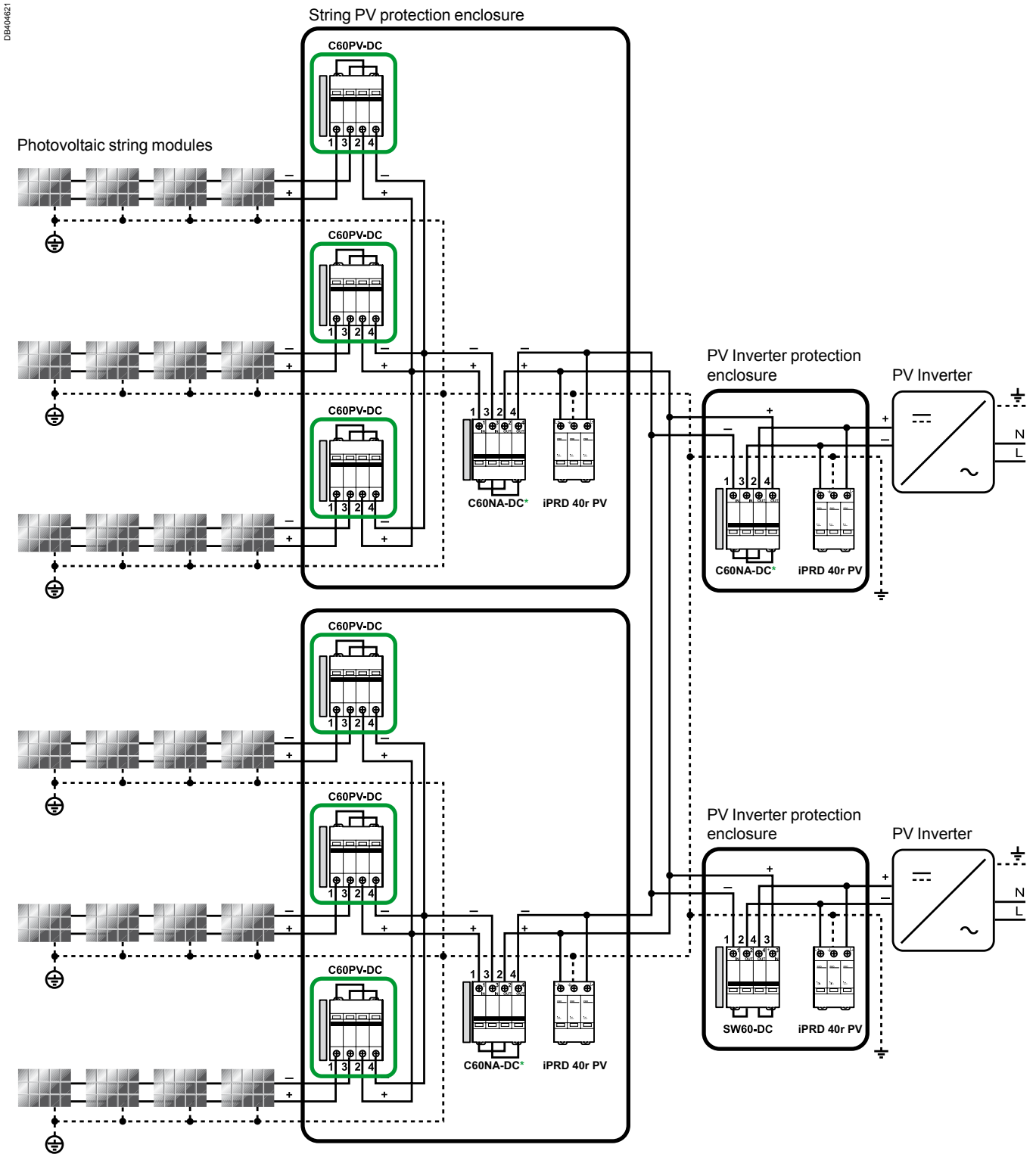

DB404621

MN, MX, MNx, MN \square , MX+OF, OF, SD, OF+SD/OF

*C60NA-DC:
20 A/1000 V DC or
32 A/800 V DC or
50 A/700 V DC

Technical data

- Position contact indication - suitability for isolation according to IEC/EN 60947-2 standard.
- The presence of the green strip guarantees physical opening of the contacts and allows operations to be performed on the downstream circuit in complete safety.
- Increased product service life thanks to fast closing independent of the speed of actuation of the toggle.
- Pre-wired product: Input / Output on the same side.

Main characteristics

Rated service breaking capacity (Ics)		100 % of the Icu
Endurance (O-C)	Electrical	1,500 cycles (where L/R=2 ms)
	Mechanical	20,000 cycles
Mechanical		20,000 cycles
Degree of pollution		2
Category		A (no delay in accordance with IEC / EN 60947-2 standards)
Degree of protection (IEC 60529)	Device in modular enclosure	IP40
Tropicalisation		Relative humidity: 95 % at 55°C in accordance with IEC 60068-2 and GB 14048.2 standards
Temperature	Operating	-25°C to 70 °C
	Storage	-40°C to 85°C

Additional characteristics

Rating (A)	Voltage drop (mV)	Impedance (mΩ)	Power loss (W)
1	9200	9200	9.2
2	5104	2552	10.2
3	2980	993.3	8.9
5	2000	400	10
8	1384	173	11.1
10	680	68	6.8
13	572	44	7.4
15	600	40	9
16	648	40.5	10.4
20	588	29.4	11.8
25	488	19.5	12.2

Derating table (A)

C60PV-DC Rating	Ambient temperature (°C)																				
	-30	-25	-20	-15	-10	-5	0	+5	+10	+15	+20	+25	+30	+35	+40	+45	+50	+55	+60	+65	+70
1 A	1.18	1.17	1.15	1.14	1.12	1.1	1.09	1.07	1.05	1.04	1.02	1	0.98	0.96	0.94	0.92	0.9	0.88	0.86	0.84	0.82
2 A	2.54	2.5	2.45	2.41	2.36	2.31	2.26	2.21	2.16	2.11	2.06	2	1.94	1.88	1.82	1.76	1.7	1.63	1.56	1.48	1.41
3 A	3.78	3.71	3.65	3.58	3.51	3.45	3.38	3.3	3.23	3.16	3.08	3	2.92	2.84	2.75	2.66	2.57	2.48	2.38	2.27	2.17
5 A	6	5.92	5.83	5.74	5.66	5.57	5.48	5.39	5.29	5.2	5.1	5	4.9	4.8	4.69	4.58	4.47	4.36	4.24	4.12	4
8 A	9.64	9.5	9.36	9.22	9.08	8.93	8.78	8.63	8.48	8.32	8.16	8	7.83	7.67	7.49	7.31	7.13	6.95	6.76	6.56	6.36
10 A	12.6	12.4	12.2	11.9	11.7	11.5	11.2	11	10.8	10.5	10.3	10	9.7	9.4	9.2	8.9	8.6	8.2	7.9	7.6	7.2
13 A	15.5	15.3	15.1	14.8	14.6	14.4	14.2	14	13.7	13.5	13.2	13	12.7	12.5	12.2	12	11.7	11.4	11.1	10.8	10.5
15 A	18.6	18.3	18	17.7	17.4	17.1	16.7	16.4	16.1	15.7	15.4	15	14.6	14.3	13.9	13.5	13.0	12.6	12.2	11.7	11.2
16 A	19.4	19.1	18.9	18.6	18.3	18.0	17.6	17.3	17.0	16.7	16.3	16	15.7	15.3	14.9	14.6	14.2	13.8	13.4	13.0	12.5
20 A	24.1	23.7	23.4	23.0	22.7	22.3	21.9	21.6	21.2	20.8	20.4	20	19.6	19.2	18.7	18.3	17.9	17.4	16.9	16.4	15.9
25 A	30.4	29.9	29.5	29.0	28.5	28.1	27.6	27.1	26.6	26.1	25.5	25	24.5	23.9	23.3	22.7	22.1	21.5	20.9	20.2	19.6

Technical data (cont.)

Moreover it is recommended to use:

- a terminal Screw Shield snaps onto the front of the C60PV-DC protective devices to provide greater insulation of the terminal screws
- a spacer clips 9 mm in each side to provide isolation.

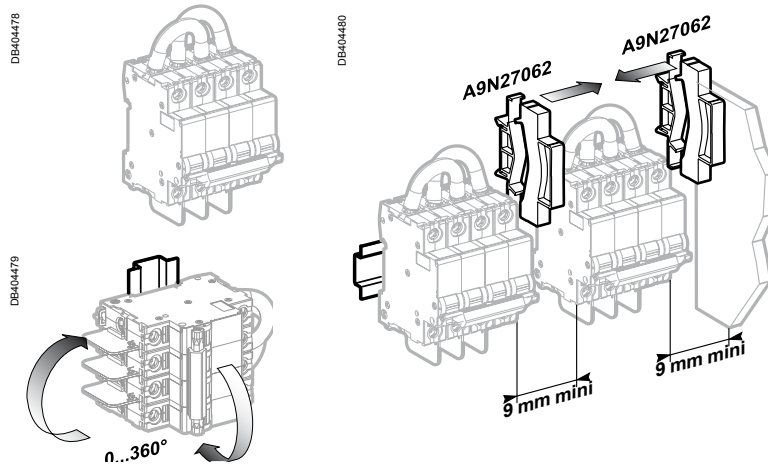

⚠ Required to have a 9 mm space isolation in each side"

Weight (g)

Circuit breaker	
Type	C60PV-DC
	545

Dimensions (mm)

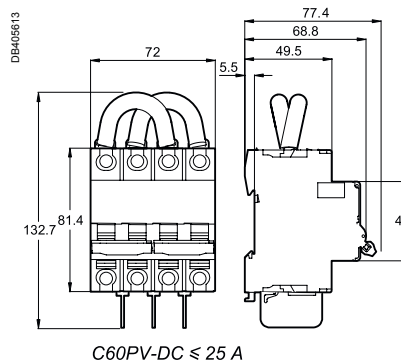

Connection

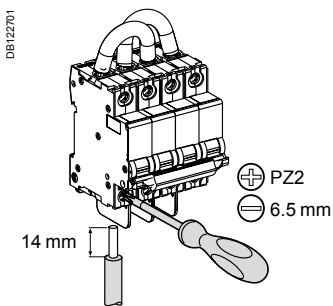

Rating	Tightening torque	Without accessory		With accessories	
		Copper cables UL 486A file no. #E216919		50 mm ² Cu/Al Terminal	Ring tongue terminal screw connection
		Rigids	Flexibles with ferrule		
≤ 25 A	2.5 N.m	DB112804 	DB112805 	DB118725 	DB118726
		1 to 25 mm ²	1 to 16 mm ²	50 mm ²	Ø 5 mm

PB109404-50



The C60NA-DC is a direct current switch-disconnector dedicated to disconnection of the string of photovoltaic modules and the PV inverter.

It is designed to isolate the string of photovoltaic modules and the inverter from the rest of the photovoltaic installation for maintenance operations in complete safety.

Combined with a circuit breaker (of the C60PV-DC type, for example), the C60NA-DC will be installed in a string PV protection enclosure close to the strings of photovoltaic modules. It can also be installed near the PV inverter.

It can be locked (by a padlocking device) in OFF position to ensure safety during maintenance operations.

Since a fault current can flow in the reverse direction to the normal operating current, the C60NA-DC can switch a multi-directional current.

C60NA-DC is not polarity sensitive: (+) and (-) wires can be inverted without any risk.

The C60NA-DC is delivered with three inter-pole barriers to provide increased isolation distance between two adjacent connectors.

IEC / EN 60947-3



DB6404841



Main characteristics

Operating voltage (Ue)	20 A: 1000 V CC
	32 A: 800 V CC
	50 A: 700 V CC
Rated insulation voltage (Ui)	1,000 V DC
Rated operational current (Ie)	50 A
Impulse voltage (Uimp)	6 kV
Permissible rated short-time withstand current (Icw)	600 A
Rated short-circuit closing current (Icm)	1 kA
Electrical connection	By the top for In and Out
Number of poles	2P
Number of modules of 9 mm	8
Diagrams	
Standards	IEC 60947-3 EN 60947-3
Catalogue number	A9N61690
Auxiliaries	See modules CA907008 and CA907013

Additional characteristics

Rating (A)	Voltage drop (mV)	Impedance (mΩ)	Power loss (W)
20 A	100	5.02	2
32 A	151	5.02	5.14
50 A	251	5.02	12.55

Application diagram

DB404622

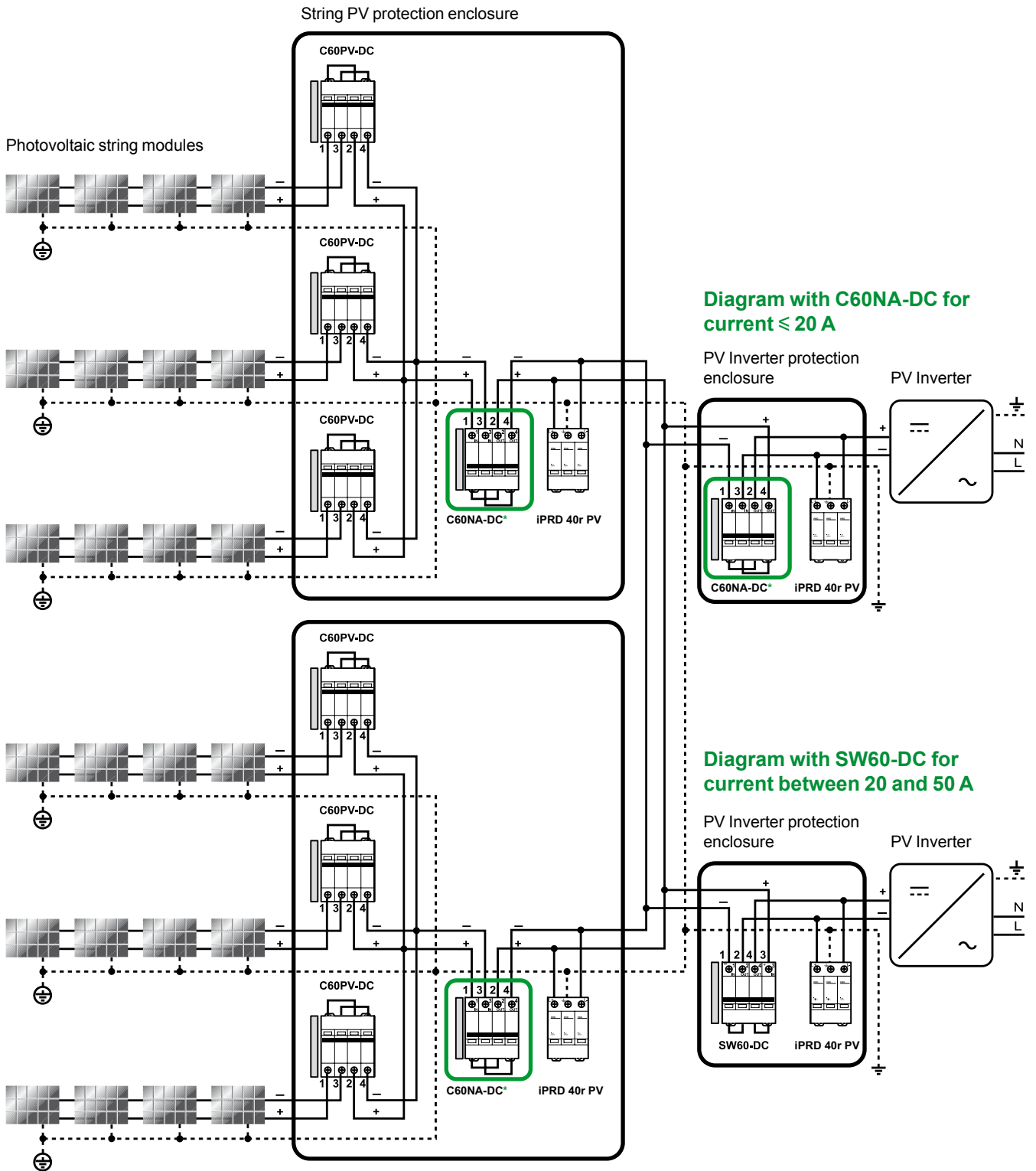

Diagram with C60NA-DC for current ≤ 20 A

Diagram with SW60-DC for current between 20 and 50 A

*C60NA-DC:
20 A/1000 V DC or
32 A/800 V DC or
50 A/700 V DC

MN, MX, MNx, MN \square , MX+OF,
OF, SD, OF+SD/OF, OF+SD24

Technical data

- Position contact indication - suitability for isolation according to IEC/EN 60947-3 standard.
- The presence of the green strip guarantees physical opening of the contacts and allows operations to be performed on the downstream circuit in complete safety.
- Increased product service life thanks to fast closing independent of the speed of actuation of the toggle.
- Pre-wired product: Input / Output on the same side.

Endurance (O-C)	Electrical	300 cycles
	Mechanical	20,000 cycles
Degree of pollution		2
Category		DC21B
Degree of protection (IEC 60529)	Device in modular enclosure	IP40
Tropicalisation		Relative humidity: 95 % at 55°C in accordance with IEC 60068-2 and GB 14048.2 standards
Temperature	Operating	-25°C to 70°C
	Storage	-40°C to 85°C

Derating table (A)

C60NA-DC Rating	Ambient temperature (°C)											
	+5	+10	+15	+20	+25	+30	+35	+40	+45	+50	+60	+70
50 A	63	61	60	58	56	54	52	50	48	46	41	35

Moreover it is recommended to use:

- a terminal Screw Shield snaps onto the front of the C60NA-DC protective devices to provide greater insulation of the terminal screws
- a Spacer clips 9 mm in each side to provide isolation.

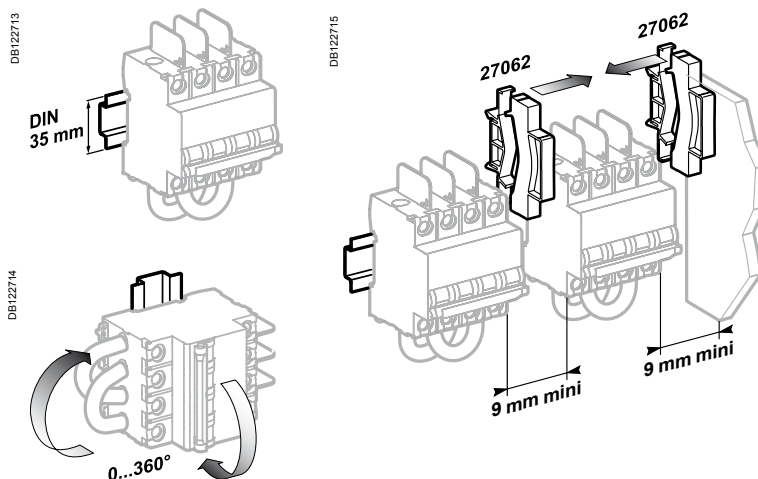

⚠ Required to have a 9 mm space isolation in each side"

Technical data (cont.)

Weight (g)

Switch disconnecter	
Type	C60NA-DC
	530

Dimensions (mm)

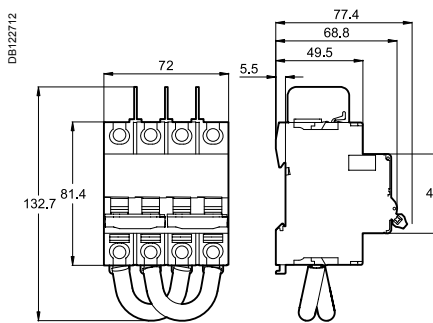

C60NA-DC

Connection

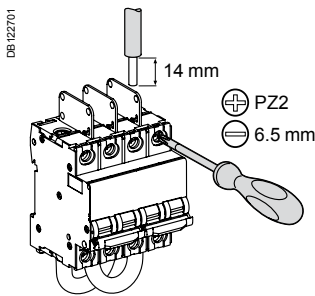

Rating	Tightening torque	Without accessory		With accessories				
		Copper cables UL 486A file no. #E216919		50 mm ² Cu/Al Terminal	Screw on connection for ring terminal	Multi-cables terminal		
		Rigids	Flexibles with ferrule			Rigid cables	Flexible cables	
50 A	3.5 N.m	DBI12804 	DBI12805 	DBI18755 	DBI18756 	DBI18757 	3 x 16 mm ²	3 x 10 mm ²

PB109406-50



The SW60-DC is a direct current switch-disconnector dedicated to disconnection of the string of photovoltaic modules and the PV inverter.

It is designed to isolate the inverter from the rest of the photovoltaic installation for maintenance operations in complete safety.

Combined with a circuit breaker (of the C60PV-DC type, for example) and a switch (of the C60NA-DC type, for example), the SW60-DC will be installed in the string PV protection enclosure close to the PV inverter (see application diagram).

It can be locked (by a padlocking device) in OFF position to ensure safety when removing the PV inverter.

SW60-DC is polarity sensitive: (+) and (-) has to be respected for connection.

The SW60-DC is delivered with three inter-pole barrier to provide increased isolation distance between two adjacent connectors.

IEC / EN 60947-3



DB404942

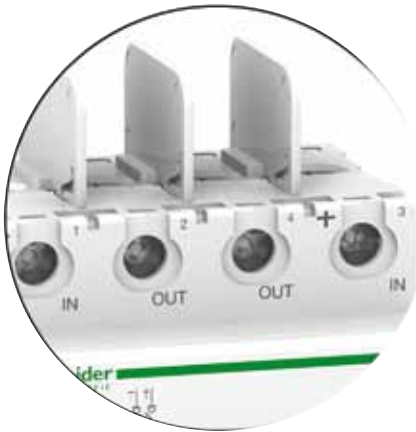

General technical data

Operating voltage (Ue)	1000 V DC
Rated insulation voltage (Ui)	1000 V DC
Rated operational current (Ie)	50 A
Impulse voltage (Uimp)	6 kV
Permissible rated short-time withstand current (Icw)	600 A
Rated short-circuit closing current (Icm)	1 kA
Electrical connection	By the top for In and Out
Number of poles	2P
Number of modules of 9 mm	8
Diagrams	
Standards	IEC 60947-3 EN 60947-3
Catalogue number	A9N61699

Applications

DE404639

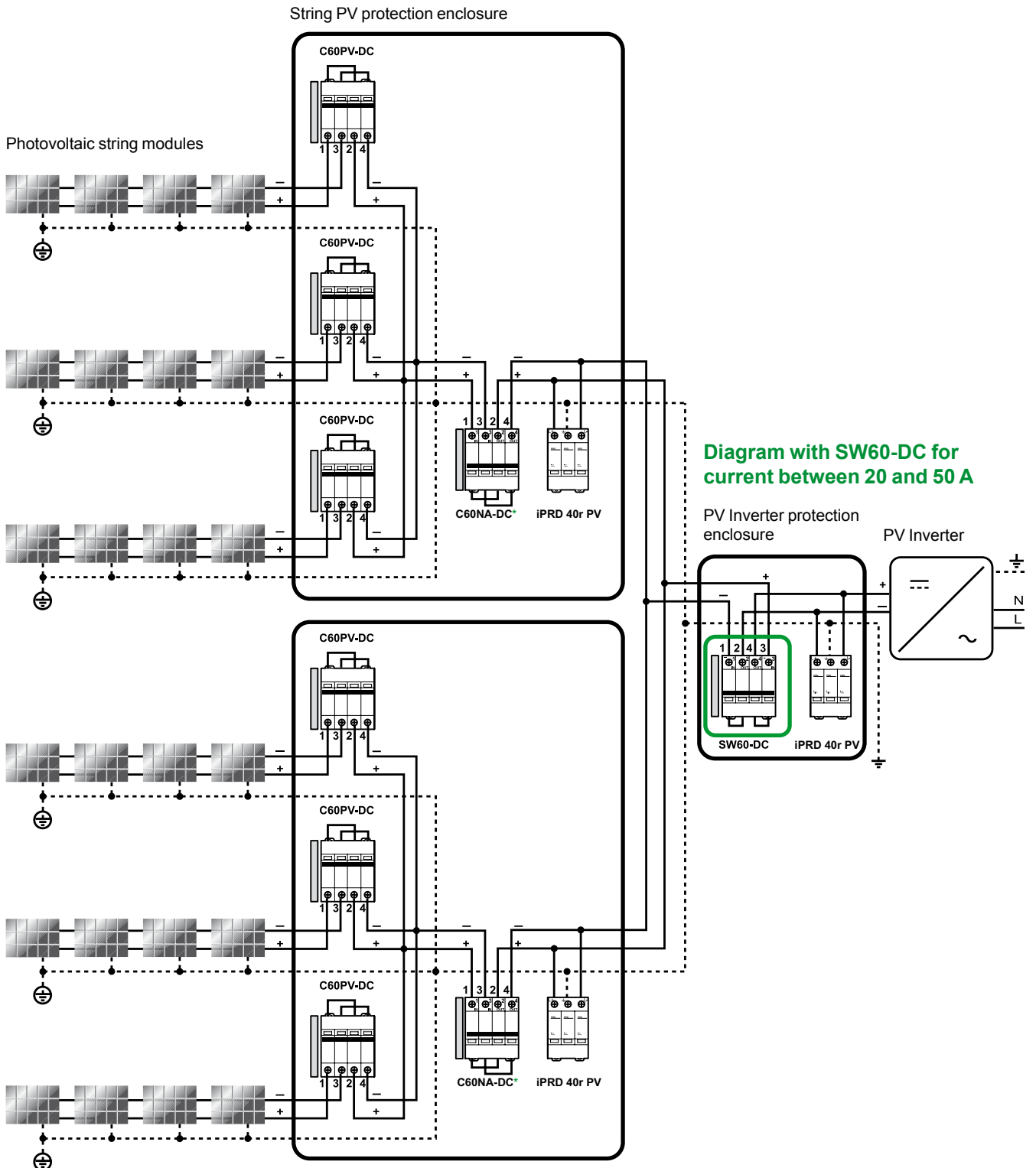

Diagram with SW60-DC for current between 20 and 50 A

*C60NA-DC:
20 A/1000 V DC or
32 A/800 V DC or
50 A/700 V DC

MN, MX, MNx, MN \square , MX+OF,
OF, SD, OF+SD/OF, OF+SD24

DC main switch for photovoltaic installations **Switch SW60-DC (cont.)**

Technical data

- Position contact indication - suitability for isolation according to IEC/EN 60947-3 standard.
- The presence of the green strip guarantees physical opening of the contacts and allows operations to be performed on the downstream circuit in complete safety.
- Increased product service life thanks to fast closing independent of the speed of actuation of the toggle.
- Pre-wired product: Input / Output on the same side.

Main characteristics

Endurance (O-C)	Electrical	1,500 cycles
	Mechanical	20,000 cycles
Degree of pollution		2
Category		DC21A
Degree of protection (IEC 60529)	Device in modular enclosure	IP40
Tropicalisation		Relative humidity: 95 % at 55°C in accordance with IEC 60068-2 and GB 14048.2 standards
Temperature	Operating	-25°C to 70°C
	Storage	-40°C to 85°C
Rating adjustment		40°C

Additional characteristics

Rating (A)	Voltage drop (mV)	Impedance (mΩ)	Power loss (W)
50 A	251	5.02	12.54

Derating table (A)

SW60PV-DC	Ambient temperature (°C)											
Rating	+5	+10	+15	+20	+25	+30	+35	+40	+45	+50	+60	+70
50 A	63	61	60	58	56	54	52	50	48	46	41	35

Moreover it is recommended to use:

- a terminal Screw Shield snaps onto the front of the SW60-DC protective devices to provide greater insulation of the terminal screws.
- a Spacer clips 9 mm in each side to provide isolation.

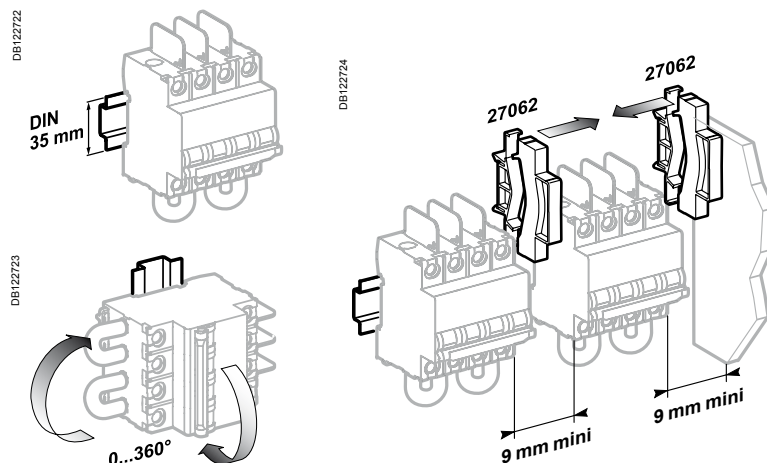

⚠ 9 mm spacers must be used on both sides of the device to create a local ventilation space around the product.

⚠ Failure to match polarity during connection may lead to a fire hazard and/or serious injury. The connection polarity must be observed (marked on the front panel). Use only with direct current.

Technical data (cont.)

Weight (g)

Switch disconnecter	
Type	SW60-DC 530

Dimensions (mm)

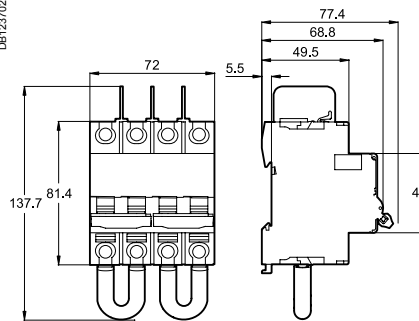

SW60-DC

Connection

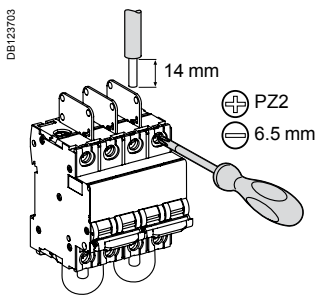

Rating	Tightening torque	Without accessory		With accessories			
		Copper cables UL 486A file no. #E216919		50 mm ² Cu/Al Terminal	screw on connection for ring terminal	Multi-cables terminal	
		Rigids	Flexibles with ferrule			Rigid cables	Flexible cables
50 A	3.5 N.m	DE112804 	DE112805 	DE119755 	DE119756 	DE119757 	
		1 to 35 mm ²	1 to 25 mm ²	50 mm ²	Ø 5 mm	3 x 16 mm ²	3 x 10 mm ²



Country approval pictograms

IEC / EN 60947-3

PB113148-50



The C120NA-DC is a direct current switch-disconnector dedicated to disconnection of the string of photovoltaic modules and the PV inverter.

It is designed to isolate the string of photovoltaic modules and the inverter from the rest of the photovoltaic installation for maintenance operations in complete safety.

The C120NA-DC will be installed in a string PV protection enclosure close to the strings of photovoltaic modules. It can also be installed near the PV inverter.

It can be locked (by a padlocking device) in OFF position to ensure safety during maintenance operations. Since a fault current can flow in the reverse direction to the normal operating current, the C120NA-DC can switch a multi-directional current.

Connection

- The C120NA-DC is not polarity sensitive: (+) and (-) wires can be inverted without any risk.

Isolation distance

- The C120NA-DC is delivered with three inter-pole barriers to provide increased isolation distance between two adjacent connectors

Prewired

- The cables cross-section is suitable
- The tightening torque is mastered



Main characteristics

Operating voltage (Ue)	1000 V DC
Rated insulation voltage (Ui)	1000 V DC
Rated operational current (Ie)	100 A
Impulse voltage (Uimp)	6 kV
Permissible rated short-time withstand current (Icw)	1.5 kA / 500 ms
Rated short-circuit closing current (Icm)	1 kA
Electrical connection	By the top for In and Out
Number of poles	2P
Number of modules of 9 mm	12
Diagrams	
Standards	IEC 60947-3 EN 60947-3
Catalogue number	A9N61701
Auxiliaries	See modules CA907008 and CA907013

Additional technical data

- Position contact indication - suitability for isolation according to IEC/EN 60947-3 standard.
- The presence of the green strip guarantees physical opening of the contacts and allows operations to be performed on the downstream circuit in complete safety.
- Increased product service life thanks to fast closing independent of the speed of actuation of the toggle.
- Prewired product: Input / Output on the same side.

Endurance (O-C)	Electrical	300 cycles
	Mechanical	20,000 cycles
Degree of pollution		2
Category		DC21B
Tropicalisation		Relative humidity: 95 % at 55°C in accordance with IEC 60068-2 and GB 14048.2 standards
Temperature	Operating	-25°C to 70 °C
	Storage	-40°C to 85°C

Derating table (A)

C120NA-DC	Ambient temperature (°C)											
Rating	+5	+10	+15	+20	+25	+30	+35	+40	+45	+50	+60	+70
100 A	113	111	110	108	106	104	102	100	98	96	91	85

Upstream connection

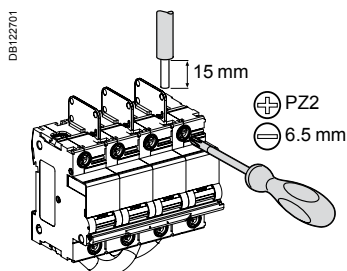

Tightening torque	Without accessory		With accessories			
	Copper cables		50 mm ² Cu/Al Terminal	Screw on connection for ring terminal	Multi-cables terminal	
	Rigids	Flexibles with ferrule			Rigid cables	Flexible cables
3.5 N.m	DB112845 	DB112846 	DB118755 	DB118756 	DB118757 	
	35 to 50 mm ²	25 to 35 mm ²	50 mm ²	Ø 5 mm	3 x 16 mm ²	3 x 10 mm ²

Downstream connection

Prewired delivered product: **Do not remove**

Moreover it is recommended to use:

- a terminal Screw Shield snaps onto the front of the C120NA-DC protective devices to provide greater insulation of the terminal screws
- a Spacer clips 9 mm in each side to provide isolation.

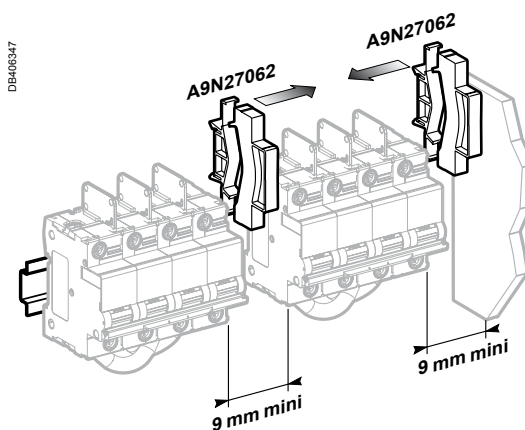
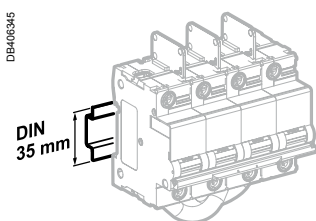

Required: to have a 9 mm space isolation in each side"

Weight (g)

Switch disconnector	
Type	C120NA-DC 910

Dimensions (mm)

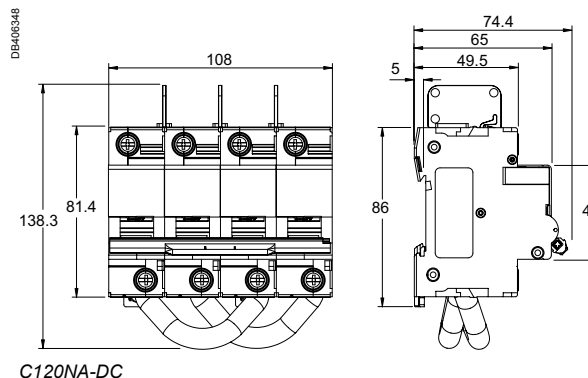

DC main switch for photovoltaic installations **C120NA-DC (cont.)**

Application diagram

DE940328

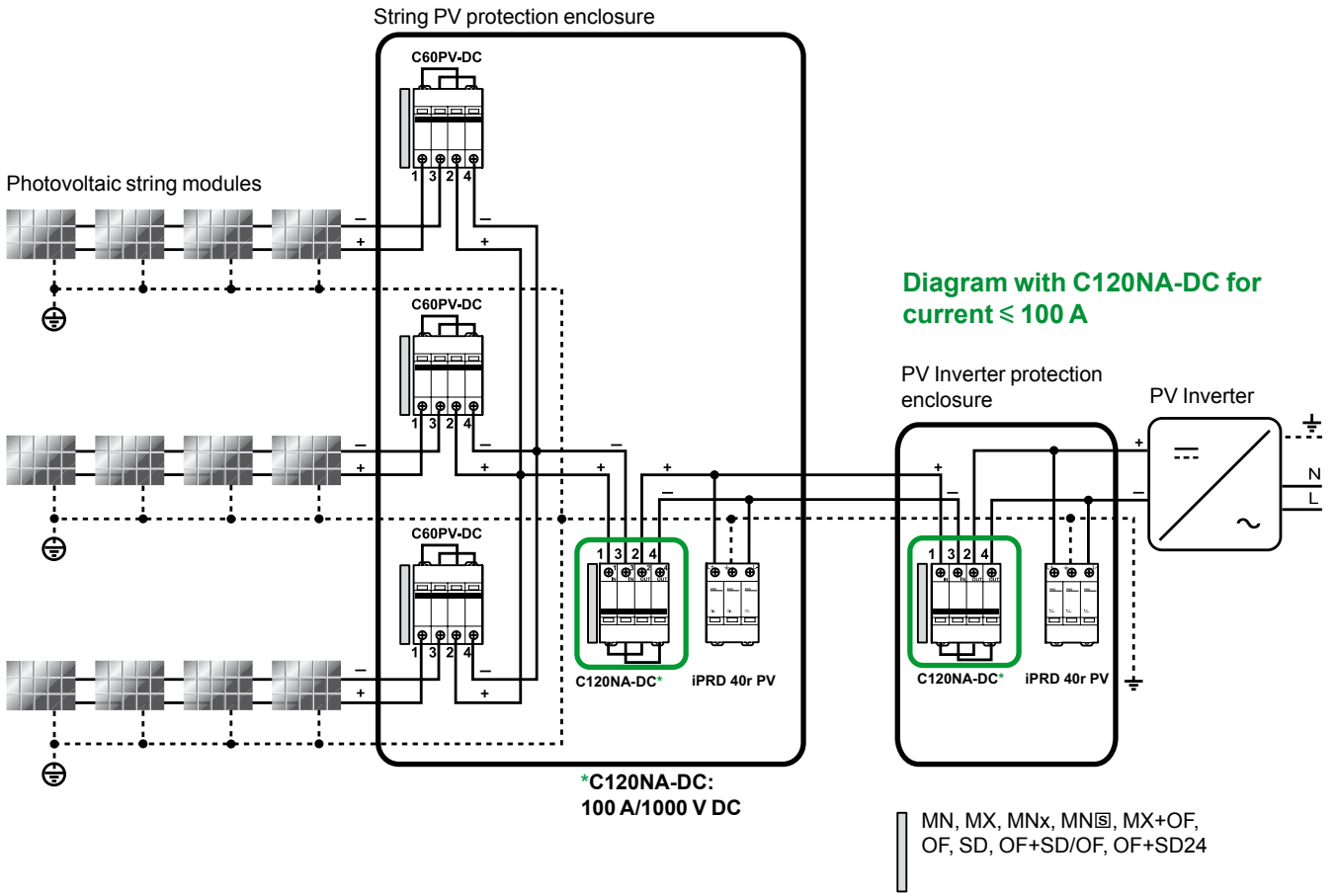

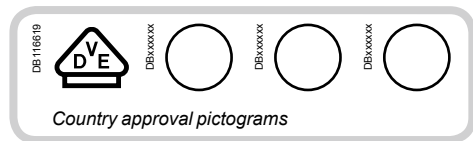

IEC 60947-2 and IEC 60947-4-1 (in combination)

They protect single-phase or three-phase motors with manual local control.
This protection includes:

- isolation
- manual or remote control
- short-circuit protection (magnetic)
- overload protection (thermal).

Breaking capacity to IEC 60947-2

Rating (A)	Voltage (V)																		
	230...240		400...415		440		500		690										
	Icu kA	Ics %	Icu kA	Ics %	Icu kA	Ics %	Icu kA	Ics %	Icu kA	Ics %									
0.16 to 1.6	Unlimited																		
2.5																		3	75
4																		3	75
6.3															50	100	50	100	3
10					15	100	10	100	3	75									
14			15	50	8	50	6	75	3	75									
18			15	50	8	50	6	75	3	75									
23	50	100	15	40	6	50	4	75	3	75									
25	50	100	15	40	6	50	4	75	3	75									

The limiting unit increases the breaking capacity up to 100 kA at 415 V.

Catalogue numbers

Motor characteristics							P25M circuit breaker			
Type	Standardised power (kW) of three-phase 50/60 Hz motors in category AC3						Rating In (A)	Setting	Cat. no.	Width in 9 mm modules
	Voltage (V AC)									
	230	400	415	440	500	690				
3P										
E12848C 	-	-	-	-	-	-	0.16	0.1-0.16	21100	5
	-	-	-	-	-	-	0.25	0.16-0.25	21101	5
	-	-	-	-	-	-	0.40	0.25-0.40	21102	5
	-	-	-	-	-	0.37	0.63	0.40-0.63	21103	5
	-	-	-	0.37	0.37	0.55	1.0	0.63-1	21104	5
	0.37	0.75	-	0.55	0.75	1.1	1.6	1-1.6	21105	5
	0.75	1.5	1.1	1.1	1.1	1.5	2.5	1.6-2.5	21106	5
	1.1	2.2	1.5	1.5	2.2	3	4.0	2.5-4	21107	5
	2.2	4	2.2	3	3.7	4	6.3	4-6.3	21108	5
	3	5.5	4	4	5;5	7.5	10	6-10	21109	5
	4	7.5	5.5	7.5	9	11	14	9-14	21110	5
	5.5	9	9	9	10	15	18	13-18	21111	5
5.5	11	11	11	11	18.5	23	17-23	21112	5	
5.5	11	11	11	15	22	25	20-25	21113	5	



Limiting unit

Type	Rating In (A)	Cat. no.	Width in 9 mm modules
3P	63	21115	5

Connection

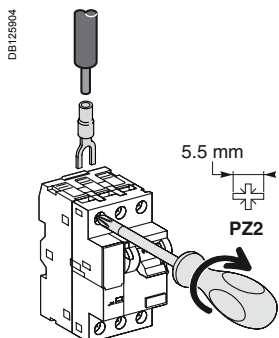

P25M			Limiting unit
Tightening torque	Terminal clamps		Tunnel terminals
	Rigid Cu	Flexible Cu	Flexible or rigid Cu
1.7 N.m.	2 x 1 ... 6 mm ²	2 x 1.5 ... 6 mm ²	1 x 25 mm ² or 2 x 10 mm ²

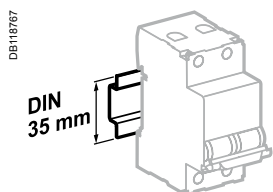

Mounted on 35 mm DIN rail.

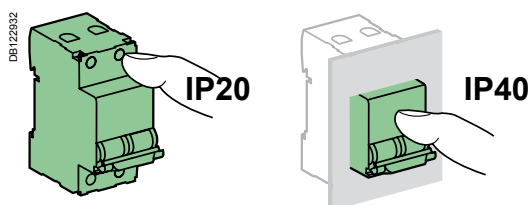
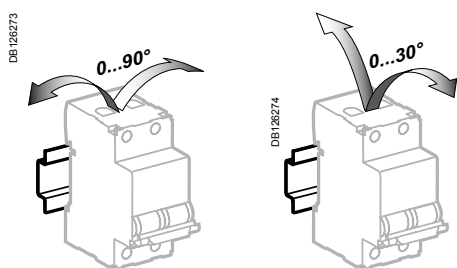

Weight (g)

P25M	260
Limiting unit	130

Technical data

Electrical characteristics	
Operating voltage (Ue)	690 V AC
Insulation voltage (Ui)	690 V
Rated impulse withstand voltage (Uimp)	6 kV
Endurance (O-C)	Electrical AC3
Thermal trip unit	100,000 cycles
Settings	Sensitive to missing phase
	Factory < settings range
	Simultaneously on the front face
	On current drawn in nominal operation
Ratings (In)	0.16 to 25 A adjustable
Temperature compensation	-20 °C to +40 °C in an enclosure
Magnetic trip unit	12 x the In rating (±20 %)

Other characteristics	
Padlocking device on the front face	
Tropicalisation	Treatment 2 (relative humidity 95 % at 55 °C)
Operating temperature	-20 ...+60 °C
Storage temperature	-40 ...+80 °C

Rated operating current (Ie) of auxiliary contacts under the rated operating voltage (Ue)					
Operating voltage (Ue)		Operating current			
(V AC)	(V DC)	Position contact		fault tripping contact	
		AC 15 (AAC)	DC 13 (A DC)	AC 14 (AAC)	DC 13 (A DC)
415	220	2.2	0.5	-	-
240	110	3.3	1.3	-	-
130	60	4.5	3	0.5	0.15
48	48	6	5	1	0.3
24	24	-	6	1.5	1

Dimensions (mm)

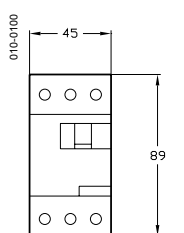

Circuit breaker

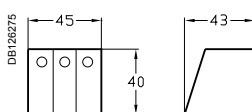
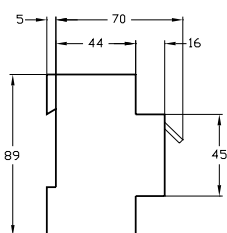

Limiting unit only

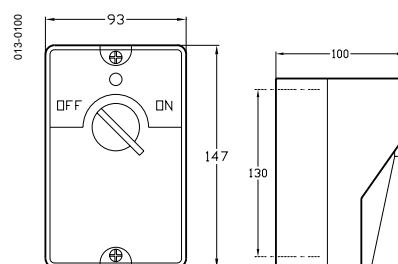

Insulating enclosure

Connection

Cables			
	Rigid	Flexible	Flexible with ferrule
Mini	1 x 1 to 2.5 mm ²	1 x 0.75 to 2.5 mm ²	1 x 0.75 to 1.5 mm ²
Maxi	2 x 1 to 2.5 mm ²	2 x 0.75 to 2.5 mm ²	2 x 0.75 to 1.5 mm ²
Tightening torque	1.4 N.m		

The electrical auxiliaries allow remote tripping or position or fault indication of the PM25 circuit breakers.

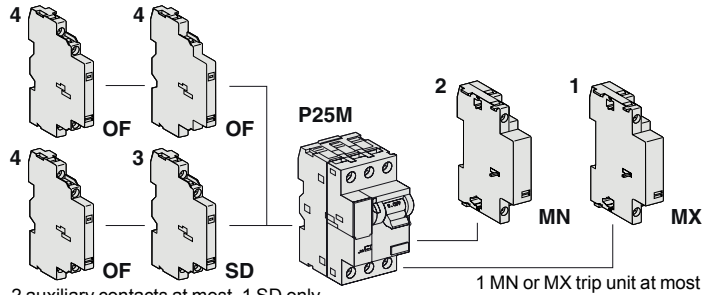

2 auxiliary contacts at most, 1 SD only.
SD is always mounted next to the P25M.

Catalogue numbers

Trip units

	Type	Control voltage (V AC)	Width in 9 mm modules	Cat. no.
1 MX shunt release				
■ Emergency stoppage by normally open push button		220...240	2	21127
■ Causes tripping of the associated device when powered		380...415	2	21128
2 MN undervoltage release				
■ Emergency stoppage by normally closed push button		220...240	2	21129
■ Ensures the safety of power supply circuits for several machines by preventing untimely restarting		380...415	2	21130
■ Causes tripping of the circuit breaker with which it is associated when its input voltage decreases (between 70% and 35% of Un)				
■ Prevents closing of the device until its input voltage has been restored				

Auxiliary contacts

	Type	Width in 9 mm modules	Cat. no.
3 Position and fault tripping indication contacts			
F + SD.F		1	21118
O + SD.F		1	21119
F + SD.O		1	21120
O + SD.O		1	21121
4 Position contacts			
O + F		1	21117
F + F		1	21116

"O": normally closed contact
 "F": normally open contact
 SD: contact indicating the position of the associated device in the event of an electrical fault
 SD.F: to indicate a closed contact fault
 SD.O: to indicate an open contact fault

Accessories make it easier to integrate the circuit breakers and extend their use.

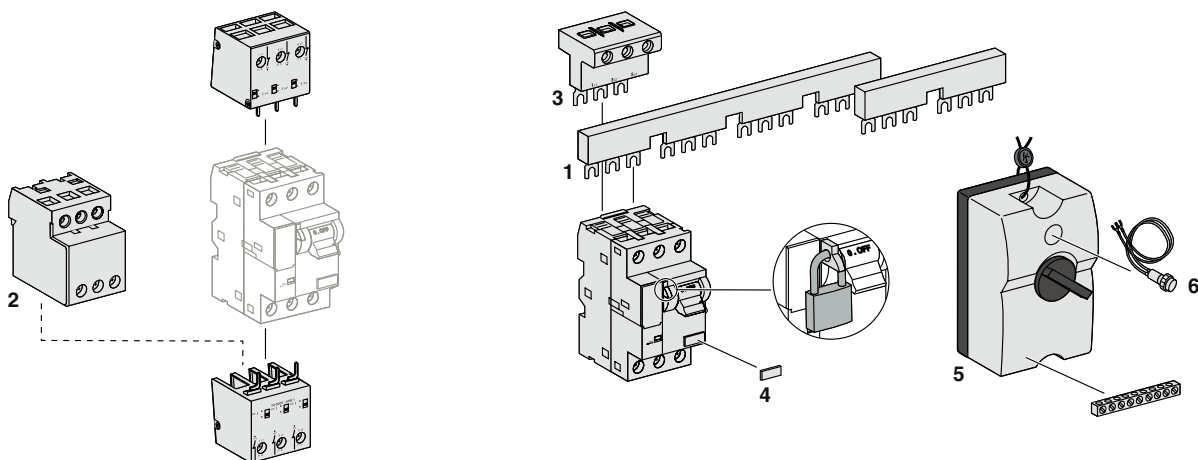

Catalogue numbers

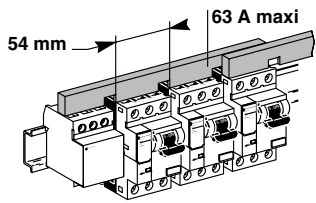
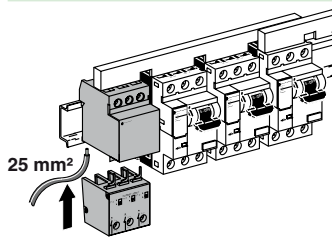
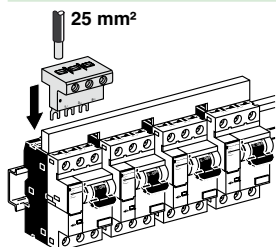
	Type	Cat. no.
1 Comb busbars 	2 P25M feeders	GV2G254
	4 P25M feeders	GV2G454
	Protection end-piece	GV2G10
2 Downstream terminal block 		GV2G05+LA9E07
	GV2G05: Downstream terminal block LA9E07: Cover for downstream terminal block	
3 Insulated connector 		GV2G09
4 Clip-on terminal markers	see module CM907003E	
5 Insulating enclosure Individual installation of a P25M circuit breaker with an auxiliary contact block and trip unit. Double insulation \square and sealed to IP55. L = 93, H = 147, P = 100 (mm)		21133
6 Neon indicator light 230-240 V AC 400-415 V AC	Green	GV2SN23
	Red	GV2SN24
	Green	GV2SN33
	Red	GV2SN34

Choice of motor supply cable cross-section

- The motor starting current and permissible voltage drop must be taken into account when choosing the cross-section.
- The cable must accept a current at least equal, when used continuously, to the sum of $I_n + I_d/3$ where:
 - I_n : rated current,
 - I_d : starting current (4 to 8 I_n), depending on the motors.

Voltage drop

- The voltage drop permitted between the source and the motor concerned is 5% for public distribution networks and 8% for subscriber or transformer substations.
- If the torque of the machine to be driven is low at startup, simply check the voltage drop for the rated current of the motor.
- If the startup torque is high (grain crushers, goods lift, etc.), check the voltage drop for the starting current.

Protection of the motor supply line

- All circuits and motors must be protected against overloads and short-circuits.

Connecting the circuit breaker for use with a single-phase motor

- Two circuit breaker poles must be connected in series.

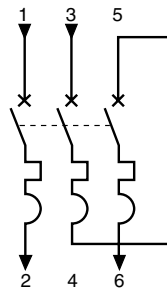

iC60L circuit breakers instantaneous circuit breakers (ICB) (curve MA)

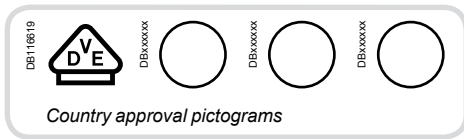

IEC/EN 60947-2



- iC60L curve MA circuit breakers combine the following functions:
 - circuit protection against short-circuit currents,
 - suitability for industrial isolation according to IEC/EN 60947-2, standard,
 - fault tripping indication by a red mechanical indicator in circuit breaker front face,
 - to be associated with overload protection for motor.

Alternating current (AC) 50/60 Hz					
Breaking capacity (Icu) according to IEC/EN 60947-2				Service breaking capacity (Ics)	
Ph/Ph (2P, 3P)	Voltage (Ue)				
Rating (In)	1.6 to 16 A	220 to 240 V	380 to 415 V	440 V	50 % of Icu
	25 à 40 A	30 kA	20 kA	15 kA	50 % of Icu

Catalogue numbers

iC60L instantaneous trip circuit breaker		
Type	2P	3P
Auxiliaries	Remote tripping and indication, module CA907000 and CA907002	Remote tripping and indication, module CA907000 and CA907002
Vigi iC60	Vigi iC60 add-on residual current device, module CA902005	Vigi iC60 add-on residual current device, module CA902005
Rating (In)	Curve MA	Curve MA
Quality label (1)		
1.6 A	A9F90272	A9F90372
2.5 A	A9F90273	A9F90373
4 A	A9F90204	A9F90304
6.3 A	A9F90276	A9F90376
10 A	A9F90210	A9F90310
12.5 A	A9F90282	A9F90382
16 A	A9F90216	A9F90316
25 A	A9F90225	A9F90325
40 A	A9F90240	A9F90340
Width in 9-mm modules	4	6
Accessories	Module CA907000 and CA907001	Module CA907000 and CA907001

(1) Information to be provided by the country.

iC60L circuit breakers instantaneous circuit breakers (ICB) (curve MA) (cont.)

PB10434-40

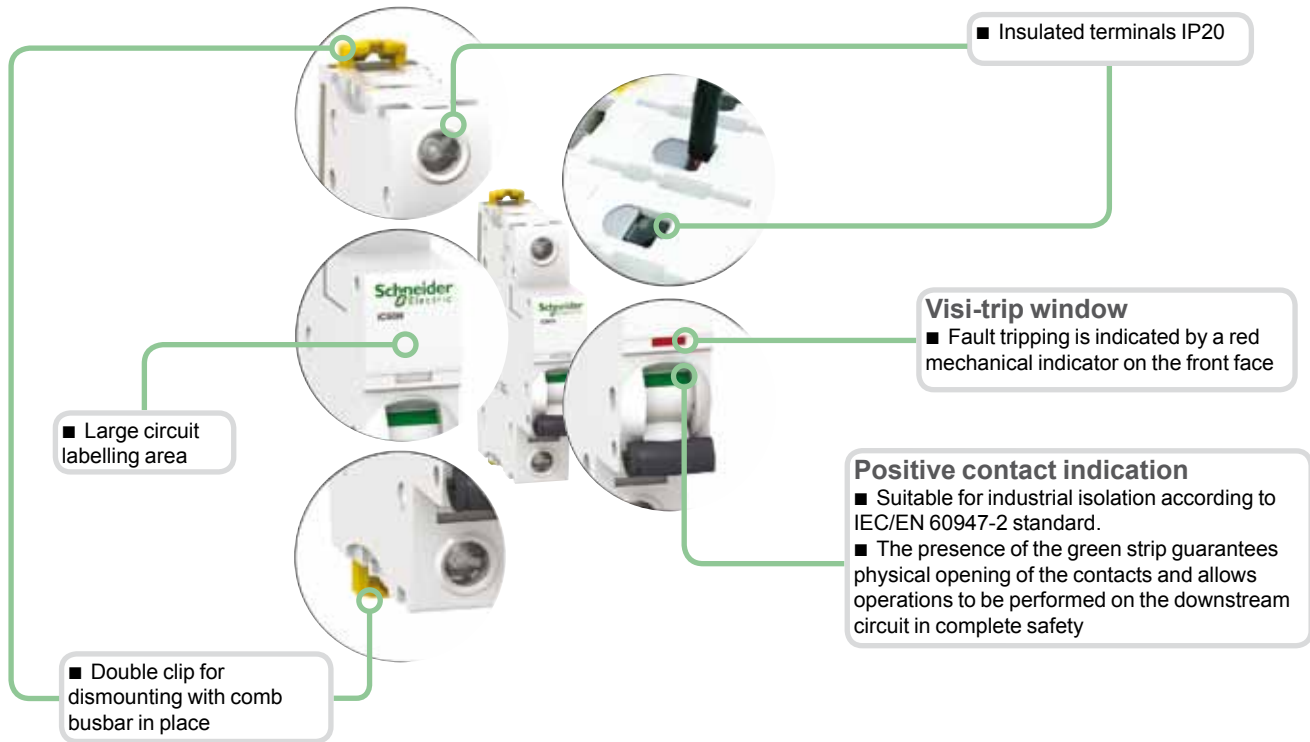

- Increased product service life thanks to:
 - overvoltage resistance by high level of industrial performances conception (pollution degree, rated impulse withstand voltage and insulation voltage),
 - high performance limitation (see limitation curves),
 - fast closing independent of the speed of actuation of the toggle.
- Remote indication, open/closed/tripped, by optional auxiliary contacts.
- Top or bottom electrical feeding.

iC60L circuit breakers instantaneous circuit breakers (ICB) (curve MA) (cont.)

Connection

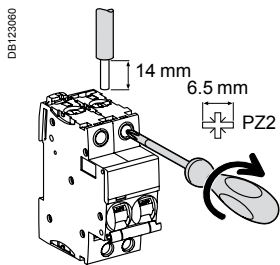

Rating	Tightening torque	Without accessory		With accessories		
		Rigid	Flexible or with ferrule	50 mm ² Al terminal	Screw-on connection for ring terminal	Multi-cables terminal
		DB122945	DB122946	DB122935	DB118789	DB118787
1.6 to 16 A	2 N.m	1 to 25 mm ²	1 to 16 mm ²	-	∅ 5 mm	-
25 to 40 A	3.5 N.m	1 to 35 mm ²	1 to 25 mm ²	50 mm ²	-	3 x 16 mm ² / 3 x 10 mm ²

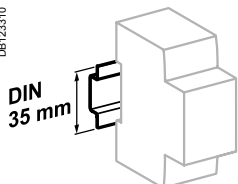

Clip on DIN rail 35 mm.

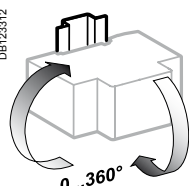

Indifferent position of installation.

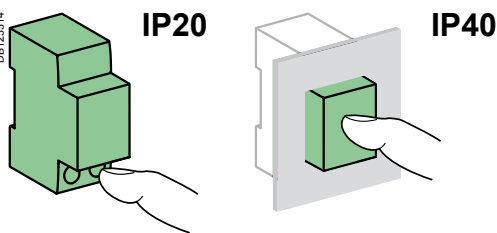

Technical data

Main characteristics		
According to IEC/EN 60947-2		
Insulation voltage (U _i)		500 V AC
Pollution degree		3
Rated impulse withstand voltage (U _{imp})		6 kV
Thermal tripping	Reference temperature	50 °C
	Temperature derating	See module CA908007
Magnetic tripping	MA curve	12 I _n ± 20 %
Utilization category		A
Additional characteristics		
Degree of protection (IEC 60529)	Device only	IP20
	Device in modular enclosure	IP40
Endurance (O-C)	Electrical	10,000 cycles
	Mechanical	20,000 cycles
Overvoltage category (IEC 60364)		IV
Operating temperature		-35°C to +70°C
Storage temperature		-40°C to +85°C
Tropicalization (IEC 60068-1)		Treatment 2 (relative humidity 95 % to 55°C)

Weight (g)

Circuit-breaker	
Type	iC60L
2P	250
3P	375

Dimensions (mm)

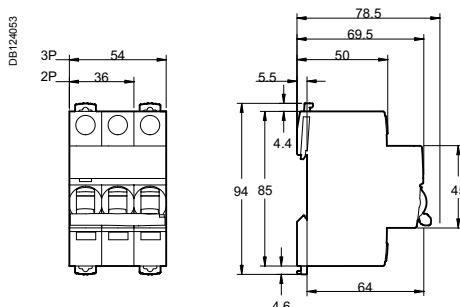

NG125LMA circuit breakers (curve MA)

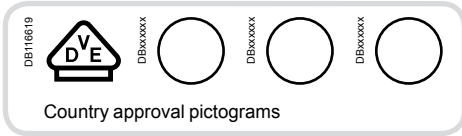

IEC/EN 60947-2

■ NG125LMA circuit breakers are circuit breakers which combine the following functions:

- circuit protection against short-circuit currents,
- circuit protection against overload currents,
- suitability for isolation in the industrial sector to IEC/EN 60947-2,
- tripping upon fault is indicated by a red mechanical state indicator light on the front face of the circuit breaker.



NG125LMA 2P



NG125LMA 3P

Alternating current (AC) 50/60 Hz					
Breaking capacity (Icu) to IEC/EN 60947-2					
Ph/Ph (2P, 3P)	Voltage (Ue)				Service breaking capacity (Ics)
	220 to 240 V	380 to 415 V	440 V	500 V	
Rating (In) 4 to 80 A (trip units)	100 kA	50 kA	40 kA	15 kA	75 % of Icu

Catalogue numbers

NG125LMA circuit breaker					
Type	2P		3P		
Auxiliaries	Remote indication and tripping, module CM907004 and CM907005				
Vigi NG125	Vigi NG125 add-on residual current device, module CM902008				
Rating (In)	Quality label ⁽¹⁾	Magn. I (A)	Curve MA	Curve MA	
4 A		50	18868	18879	
6.3 A		75	18869	18880	
10 A		120	18870	18881	
12.5 A		150	18871	18882	
16 A		190	18872	18883	
25 A		300	18873	18884	
40 A		480	18874	18885	
63 A		750	18875	18886	
80 A		960	18876	18887	
Width in 9 mm modules			6	9	
Accessories			Module CM907004 and CM907006		

(1) Information to be supplied by the country concerned.

NG125LMA circuit breakers (curve MA) (cont.)

Connection

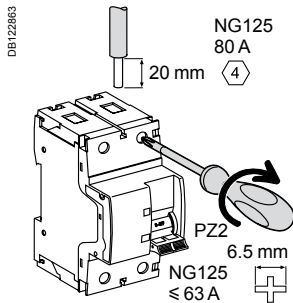

Rating	Tightening torque	Without accessories		With accessories				
		Copper cables		70 mm ² Al terminal	Screw-on connection for ring terminal	Small ring terminal	Multi-cable terminal	
		Rigid	Flexible or with ferrule				Rigid cables	Flexible cables
4 to 63 A	3.5 N.m	DB122945 	DB122946 	DB123410 	DB123488 	DB118769 	DB118787 	
80 A	6 N.m	1.5 to 50 mm ²	1.5 to 35 mm ²	-	-	-	3 x 16 mm ²	3 x 10 mm ²
		16 to 70 mm ²	10 to 50 mm ²	25 to 70 mm ²	2 x 35 mm ² 1 x 50 mm ²	1 x 70 mm ²		

■ On 3P 80 A: upstream voltage taps for each pole, by 6.35 mm Fast-on terminal.

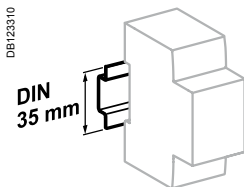

Clips on to 35 mm DIN rail.

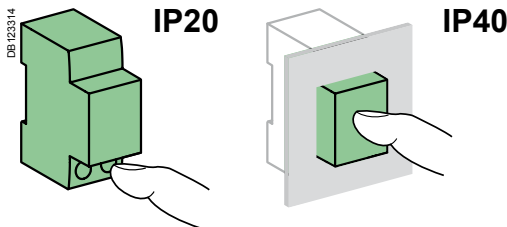

Technical data

Main characteristics

According to IEC/EN 60947-2

Insulation voltage (U _i)	690 V AC	
Degree of pollution	3	
Rated impulse withstand voltage (U _{imp})	8 kV	
Thermal tripping	Reference temperature	40°C
Magnetic tripping (I _n)	MA curve	12 I _n ± 20 %
Utilization category		A

Additional characteristics

Degree of protection (IEC 60529)	Device only	IP20
	Device in modular enclosure	IP40
Endurance (O-C)	Electrical	10,000 cycles
	Mechanical	20,000 cycles
Operating temperature		-30°C to +70°C
Storage temperature		-40°C to +70°C
Tropicalization (IEC 60068-1)		Treatment 2 (relative humidity of 95 % at 55°C)

NG125LMA circuit breakers (curve MA) (cont.)

Weight (g)

Circuit breaker	
Type	NG125LMA
2P	480
3P	720

Dimensions (mm)

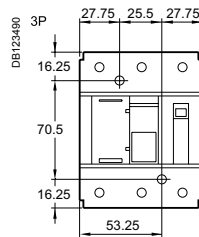
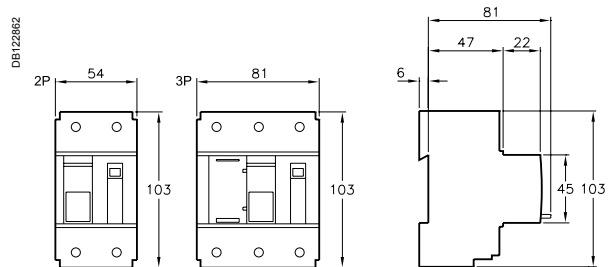

Spacing for mounting on panel

NG125LMA circuit breakers (curve MA) (cont.)

095918N_SE-90

DB123483



3P 80 A
 ■ Voltage taps:
 auxiliaries power supply
 measurement
 emergency stop
 remote reporting



■ Cable strength:
 ribbed cage
 terminal depth
 tightening by Allen hex key (NG125 80 A)

■ Padlocking in position:
 O or I, manual control is inhibited, tripping is enabled

■ Test button to check satisfactory operation of the tripping mechanism



3P
 ■ Pull-out strength:
 metallic lock

3P
 ■ Integrated padlocking device

■ Impact and vibration resistance:
 high-strength enclosure
 IK 05

■ Central manual control, 3 positions:
 ON
 tripped on fault
 open

■ Circuit breaker tripped indicator

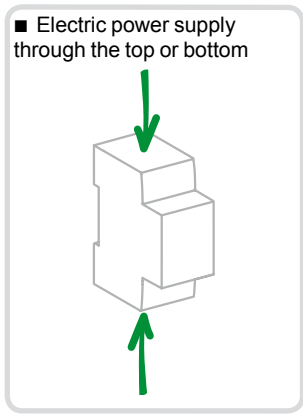

■ Positive contact indication:
 suitability for isolation in the industrial sector to IEC/EN 60947-2
 the presence of the green strip guarantees that the contacts open physically and allows work to be carried out safely on the downstream circuit

■ Longer product service life due to:
 good overvoltage withstand capacity,
 high limitation performances,
 fast closure independent of the speed of actuation of the toggle.



15646



15668

STI	Cartridges
IEC EN 60947-3	NF C 60-200, NF C 63-210 and IEC 60269-1/2

- The STI isolatable fuse-carriers provide overload and short-circuit protection.
 - They are used for industrial applications requiring a high breaking capacity.
 - They perform the isolation function and must not be used as switches.
 - They can be equipped with an indicator light indicating blowing of the fuse cartridge.
 - Isolation of all poles is guaranteed for the 2P, 3P, and 3P+N versions during factory assembly.
- The general purpose fuse (gG fuse) provides overload and short-circuit protection. The fuse for motor application (**aM fuse**) only provides short-circuit protection. It is used for protection of loads with a high peak current (motors, transformer primaries, etc.).

Accessories

Comb busbar

- Used to quickly bridge several STI of the same kind.

Busbar connectors

- Used to supply the busbar.
- For 25 mm² cable.

230 V neon indicator light

- Indicates fuse blowing (off in normal operation and lit red after fuse blowing).
- 400 V maxi.

Padlocking device

- Locks the toggle in the "open" or "closed" position. Used with an 8 mm max. diameter padlock (not supplied).

Clip-on markers (C60 type)

- Used to identify:
 - either on the front face of the device
 - or on the downstream terminals.

Catalogue numbers

Fuse cartridge (Type F)					STI fuse holder						
Type	Rating	Voltage rating (Ue)	Short-circuit current (Isc)				Network type				
			aM	gG	aM	gG	1P	1P+N ⁽¹⁾	2P	3P	3P+N ⁽¹⁾
8.5 x 31.5	2 A	400 V AC	20 kA	20 kA	DF2BA0200	DF2BN0200					
	4 A	400 V AC	20 kA	20 kA	DF2BA0400	DF2BN0400					
	6 A	400 V AC	20 kA	20 kA	DF2BA0600	DF2BN0600					
	8 A	400 V AC	20 kA	20 kA	DF2BA0800	DF2BN0800					
	10 A	400 V AC	20 kA	20 kA	DF2BA1000	DF2BN1000					
10.3 x 38	2 A	500 V AC	120 kA	120 kA	DF2CA02	DF2CN02					
	4 A	500 V AC	120 kA	120 kA	DF2CA04	DF2CN04					
	6 A	500 V AC	120 kA	120 kA	DF2CA06	DF2CN06					
	10 A	500 V AC	120 kA	120 kA	DF2CA10	DF2CN10					
	16 A	500 V AC	120 kA	120 kA	DF2CA16	DF2CN16					
	20 A	500 V AC	120 kA	120 kA	DF2CA20	DF2CN20					
25 A	400 V AC	120 kA	120 kA	DF2CA25	DF2CN25						
Operating frequency : 50/60 Hz											

(1) The neutral pole comes equipped with a locked tube.

Connection

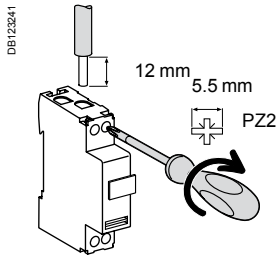

Type	Rating	Tightening torque	Without accessory		With accessories
			Copper cables		Screw-on connection for ring terminal
			Rigid	Flexible or with ferrule	
STI	All	2 N.m	0.75 to 10 mm ²	0.33 to 6 mm ²	Ø 5 mm

2	Screw-on connection for ring terminal		27053
3	Insulated connectors (set of 4)		14885
4	Comb busbar 24 pas 1P		14881
	26 pas 1P+N		14880
	24 pas 2P		14882
	24 pas 3P		14883
	24 pas 4P		14884
5	Flange for comb busbars (set of 40)	For 1P, 2P	14886
		For 3P, 4P	14887
6	Teeth shield (set of 40)		14888

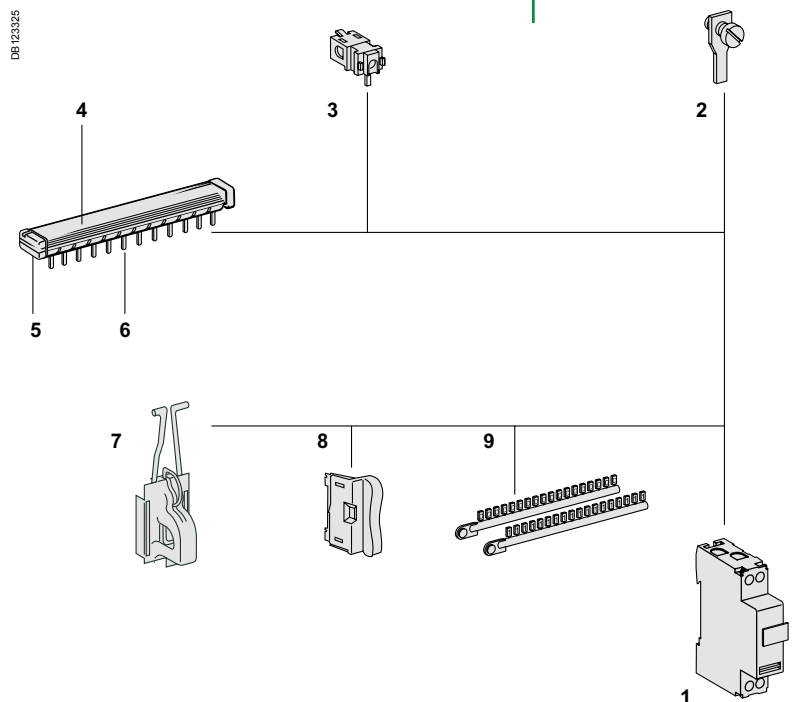

Mounting accessories

7	Padlocking device		15669
8	Neon indicator light	1 piece blister	15668
9	Clip-on terminal markers	See module	CA907001

STI isolatable fuse-carriers (cont.)

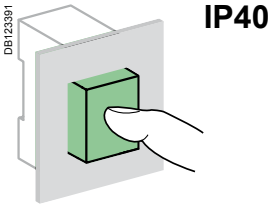
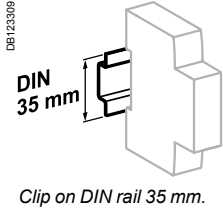

Technical data

Main characteristics	
Insulation voltage (Ui)	500 V
Pollution degree	3
Additional characteristics	
Degree of protection	Device in modular enclosure
Operating temperature	-20°C to +60°C
Storage temperature	-40°C to +80°C
Isolation with positive contact indication by tilting the fuse-carrier	Captive fuse-carrier Additional housing is provided for a spare fuse
Cartridge blowing signalling (option)	By indicator light ON after blowing
To be equipped with aM or gG (gL - gl) type fuse cartridge without striker, with or without fuse blowing indicator	

Maximum dissipated power per pole of STI isolatable fuse-carriers			
Fuse cartridge type		Ith	Pmax
8.5 x 31 mm	aM	10 A	2.5 W
	gG	20 A	2.5 W
10.3 x 38 mm	aM	16 A	3 W
	gG	25 A	3 W

Maximum dissipated power per fuse cartridges			
Fuse cartridge type		Ith	Pmax
8.5 x 31 mm	aM	2 to 10 A	0.9 W
	gG	2 to 10 A	2.5 W
10.3 x 38 mm	aM	2 to 25 A	1.2 W
	gG	2 to 25 A	3 W

Specific technical data STI 1P+N and 3P+N	
Disconnection of the phase and neutral in the normal dimensions of the phase (2 mod. of 9 mm)	
Phase opening causes compulsory opening of the neutral	
The phase opens before the neutral on isolation and closes after the neutral on circuit closing	

Dimensions (mm)

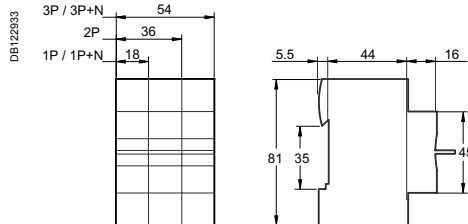

STI

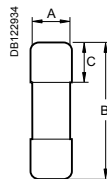

aM, gG fuse cartridge			
Type	A	B	C
8.5 x 31.5 mm	8.5	31.5	10.3
10.3 x 38 mm	10.3	38	10.5

aM, gG

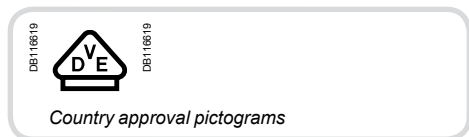

IEC/EN 60947-1, IEC/EN 60947-3, IEC 60269-1,
IEC 60269-3,
VDE 0660-100, VDE 0660-107



- The plug-in fuse switches disconnectors D01 and the switches disconnectors fuse D02 provide protection against overloads and short circuits.
- They are used for service sector and industrial applications.
- Depending on the versions, they should be provided with D01 or D02 type cartridges.

Accessories

- The D02 gauges allow you to limit the rating of the fuses, depending on the model used, from 20 A to 50 A.

Catalogue numbers

Fuse disconnectors switches										
Type	1P		1P+N		2P		3P		3P+N	
	D01	D01	D01	D02	D02	D01	D02	D01	D02	
D01 fuse switches disconnectors										
Rating (In)										
10 A	-	MGN01610	-	-	-	-	-	MGN01710	-	
13 A	-	MGN01613	-	-	-	-	-	MGN01713	-	
16 A	-	MGN01616	-	-	-	MGN01316	-	MGN01716	-	
Width in 9 mm modules	-	4	-	-	-	6	-	8	-	
D02 switches disconnectors fuse										
Rating (In)										
63 A	MGN02163	MGN02663	MGN02263	MGN02363	MGN02363	MGN02363	MGN02363	MGN02763	MGN02763	
Width in 9 mm modules	3	6	6	9	9	9	9	12	12	



Accessories for D02 switches disconnectors fuse

Type	Rating	Colour	
Fuse gauge	20 A	Blue	MGN09120
	25 A	Yellow	MGN09125
	32-35-40 A	Black	MGN09135
	50 A	White	MGN09150

D02 : Gauges

- These allow fitting of fuses from 20 A to 50 A

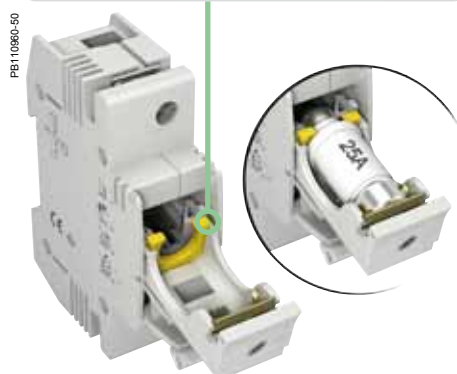

Connection

- Upstream/downstream by tunnel terminals
- For D01: by 18 mm forked comb busbar

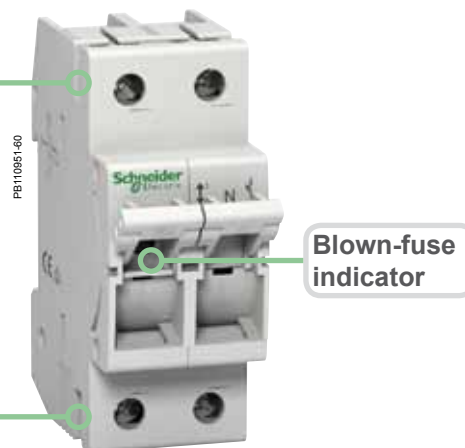

Blown-fuse indicator

D0 fuse disconnectors switches (cont.)

Connection

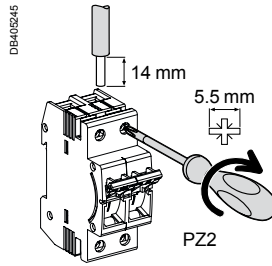

Type	Tightening torque	Copper cables	
		Rigid	Flexible or with ferrule
D01	2 N.m	1.5 to 25 mm ²	1.5 to 16 mm ²
D02	3 N.m	1.5 to 35 mm ²	1.5 to 25 mm ²

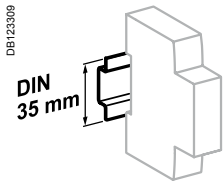

Clip on DIN rail 35 mm.

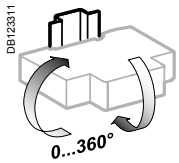

Indifferent position of installation.

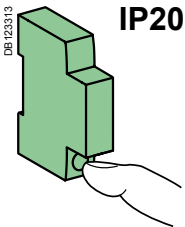

IP20

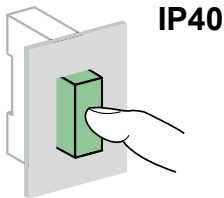

IP40

Technical data

Main characteristics		D01	D02
Operating voltage (Ue)		230/400 V AC	230/400 V AC 110 V DC (2P)
Operating frequency (Hz)		45-62 Hz	45-62 Hz
Service breaking capacity (Isc)		AC	50 kA
		DC	- 8 kA
Rated insulation voltage (Ui)		400 V	400 V
Rated impulse withstand voltage (Ui)		6000 V	6000 V
Utilization category (IEC 60947-3)		400 V AC	AC-22A
		110 V DC (2P)	- DC-22B (63 A)
		48 V DC (1P)	- DC-22A (63 A)
Endurance (O-C)		Electrical	1500 cycles
		Mechanical	10,000 cycles
Degree of protection		Device only	IP20
		Device in modular enclosure	IP40
Operating temperature		-5°C to +40°C	
Storage temperature		-25°C to +55°C	

Additional characteristics

Dimensions (mm)

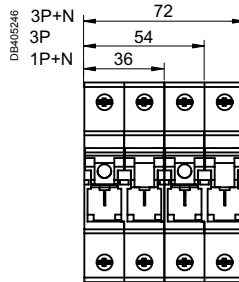

D01 fuse switches disconnectors

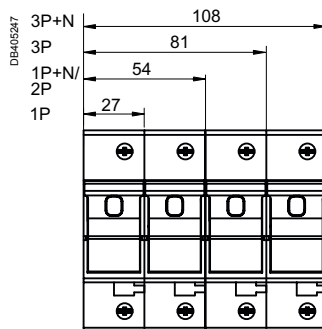
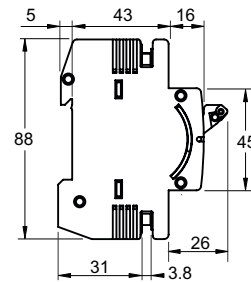

D02 switches disconnectors fuse

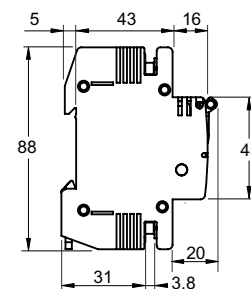

SBI fuse holder with indicator light

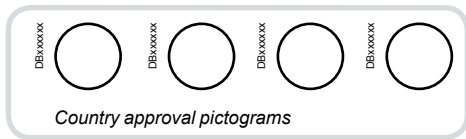

IEC EN 60947-3



MGN15707



MGN15712



MGN15714



MGN15718

- SBI fuse holders provide overload and short-circuit protection.
- They are used for industrial applications requiring a high breaking capacity.
- They perform the isolation function and must not be used as switches.
- They are equipped with an indicator light indicating blowing of the fuse cartridge: to be equipped with aM or gG (gL-gl) type fuse cartridge without striker. The general purpose fuse (gG fuse) provides overload and short-circuit protection. The fuse for motor application (**aM fuse**) only provides short-circuit protection. It is used for protection of loads with a high peak current (motors, transformer primaries, etc.).

Catalogue numbers

Fuse cartridge						SBI fuse holder						
Type	Rating	Voltage rating (Ue)	Short-circuit current (Isc)		Network type							
			aM	gG	aM	gG	N	1P	1P+N ⁽¹⁾	2P	3P	3P+N ⁽¹⁾
14 x 51 mm	10 A	690 V CA	120 kA	120 kA	DF2EA10	DF2EN10	MGN15708	MGN15707	MGN15709	MGN15710	MGN15711	MGN15712
	12 A	690 V CA	120 kA	-	DF2EA12	-						
	16 A	690 V CA	120 kA	120 kA	DF2EA16	DF2EN16						
	20 A	690 V CA	120 kA	120 kA	DF2EA20	DF2EN20						
	25 A	690 V CA	120 kA	120 kA	DF2EA25	DF2EN25						
	32 A	500 V CA	120 kA	120 kA	DF2EA32	DF2EN32						
	40 A	500 V CA	120 kA	120 kA	DF2EA40	DF2EN40						
	50 A	400 V CA	120 kA	120 kA	DF2EA50	DF2EN50						
22 x 58 mm	32 A	690 V CA	80 kA	80 kA	DF2FA32	DF2FN32	MGN15714	MGN15713	MGN15715	MGN15716	MGN15717	MGN15718
	40 A	690 V CA	80 kA	80 kA	DF2FA40	DF2FN40						
	50 A	690 V CA	80 kA	80 kA	DF2FA50	DF2FN50						
	63 A	690 V CA	80 kA	80 kA	DF2FA63	DF2FN63						
	80 A	690 V CA	80 kA	80 kA	DF2FA80	DF2FN80						
	100 A	400 V CA	120 kA	120 kA	DF2FA100	DF2FN100						
	125 A	400 V CA	120 kA	-	DF2FA125	-						



Operating frequency: 50/60 Hz

(1) The neutral pole comes equipped with a locked tube.

SBI fuse holder with indicator light (cont.)

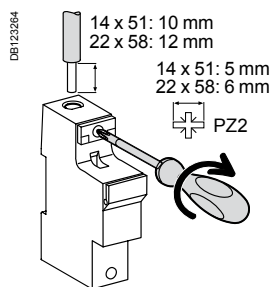
Connection



Type of fuse cartridge	Tightening torque	Copper cables		Multi-cables terminal	
		Rigid	Flexible or with ferrule	Rigid cables	Flexible cables
14 x 51 mm	3.5 N.m	 2.5 to 25 mm ²	 2.5 to 25 mm ²	 2.5 to 10 mm ²	2.5 to 10 mm ²
22 x 58 mm	3.5 N.m	2.5 to 35 mm ²	2.5 to 35 mm ²	2.5 to 25 mm ²	2.5 to 16 mm ²

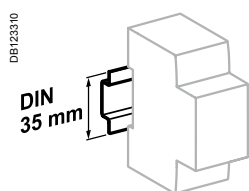

Clip on DIN rail 35 mm.

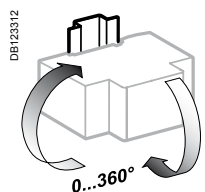

Indifferent position of installation.

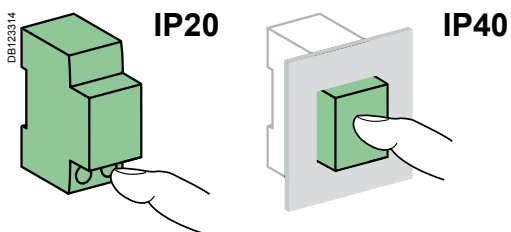

Technical data

Main characteristics	
Insulation voltage (U _i)	690 V
Utilization category	AC20B isolation by switching the drawer, must not be operated under load

Additional characteristics	
Degree of protection	Device only: IP20 Device in modular enclosure: IP40
Operating temperature	-20°C to +60°C
Storage temperature	-40°C to +80°C
Cartridge blowing signalling	By indicator light ON (neon)

Maximum permissible characteristics of the fuse cartridges:

Fuse cartridge type	I _{th}	P _{max} *
14 x 51 mm	aM	3 W
	gG	5 W
22 x 58 mm	aM	9.5 W
	gG	9.5 W

*P_{max}: maximum dissipated power per fuse cartridge.

SBI fuse holder with indicator light (cont.)

Dimensions (mm)

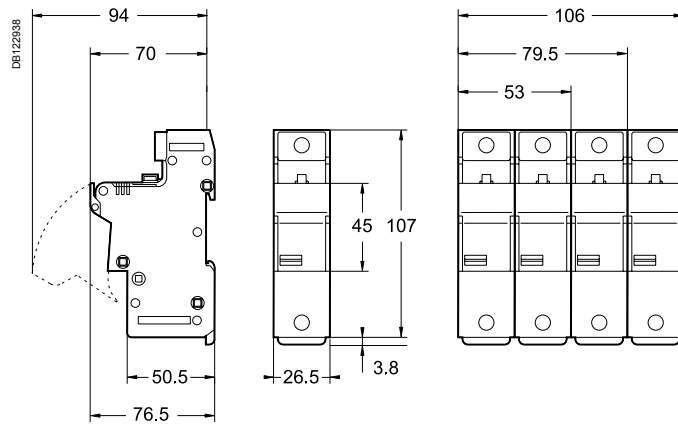

14 x 51 mm

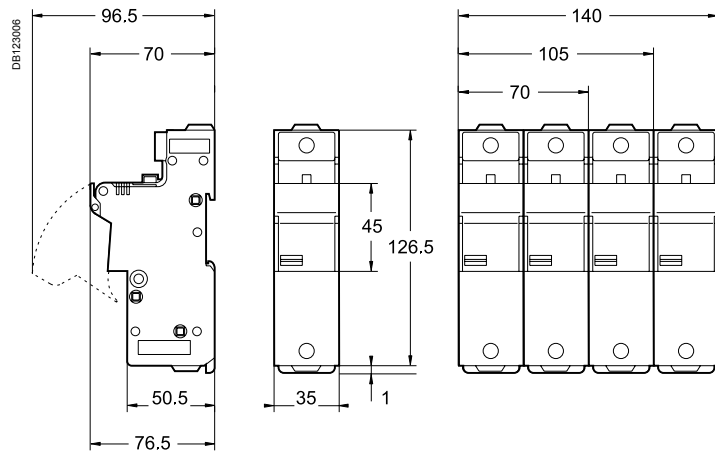

22 x 58 mm

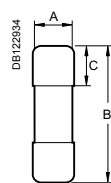

aM, gG fuse cartridge

Type	A	B	C
14 x 51 mm	14.3	51	13.8
22 x 58 mm	22.2	58	16.2

aM, gG



Choice of sensitivity

The sensitivity of an earth leakage protection device depends mainly on the function it has to perform:

- Protection from electric shock by direct contact.
- Protection from electric shock by indirect contact.
- Protection from fire due to current leakage.

The following table gives a reminder of:



- The circuits that must be protected against these various risks (obligation or recommendation).
- The type of earth leakage protection device to be used in each case, its sensitivity, and its location in the distribution diagram.

Type of protection	Obligations		Recommended by Schneider Electric	Sensitivity (I Δ n)		
	National standard <i>To be filled in according to the country standard</i>	International standard IEC 60364		30 mA (*)	100 mA to 3000 mA (depending on the earthing system)	300 mA (or 500 mA)
Protection from electric shock by direct contact						
 <small>DB123167</small>	<i>To be filled in according to the country standard</i>	Power supply for <ul style="list-style-type: none"> ■ General-purpose power sockets, up to 20 A ■ Appliances in the vicinity of a bathtub, shower, pond or swimming pool ■ Portable appliances for outdoor use, up to 32 A ■ Lighting for exhibition stands and shows ■ Outdoor lighting <i>To be modified according to national obligations (above)</i>	<ul style="list-style-type: none"> ■ Lighting in the home 	Setup in final distribution switchboard <ul style="list-style-type: none"> ■ Residual current device protecting a circuit ■ Residual current circuit breaker protecting a group of circuits 		
Protection from electric shock by indirect contact						
 <small>DB123168</small>	<i>To be filled in according to the country standard</i>	The entire power distribution system, except for devices: <ul style="list-style-type: none"> ■ With class II insulation ■ Operating at Safety Extra Low Voltage (class III) <i>To be modified according to national obligations (above)</i>	—	Setup in final distribution switchboard <ul style="list-style-type: none"> ■ Residual current circuit breaker or device, on incoming feeder Setup in subdistribution board or main switchboard <ul style="list-style-type: none"> ■ Residual current device protecting a circuit ■ Residual current device or circuit breaker protecting a group of circuits ■ On incoming feeder: residual current circuit breaker or device 		
Protection from fire due to current leakage						
 <small>DB123169</small>	<i>To be filled in according to the country standard</i>	<ul style="list-style-type: none"> ■ High-risk premises: <ul style="list-style-type: none"> □ explosion (BE3) □ fire (BE2) ■ Agricultural and horticultural buildings ■ Equipment for fairs, exhibitions and shows ■ Temporary outdoor recreational installations <i>To be modified according to national obligations (above)</i>	<ul style="list-style-type: none"> ■ Dilapidated buildings or electrical installations ■ Humid atmospheres: agricultural buildings, public swimming pools ■ Presence of chemical agents 			Setup in final distribution switchboard <ul style="list-style-type: none"> ■ Residual current circuit breaker or device, on incoming feeder Setup in subdistribution board or main switchboard <ul style="list-style-type: none"> ■ Residual current device protecting each circuit to a high-risk zone ■ Residual current device or circuit breaker protecting a group of circuits ■ On incoming feeder: residual current circuit breaker or device

(*) The 10 mA sensitivity is useful for certain very specific applications, where there is a risk that someone could sustain a non-dangerous current (10 to 30 mA) without being able to get free. Example: healthcare equipment for hospital beds. Generally, devices with this very high sensitivity are liable to cause frequent tripping, due to the natural leakage currents of the installation.

Interference immunity



Schneider Electric provides various equipment technologies capable of overcoming the consequences of interference of all kinds.

Operating conditions		Examples	Types				
			AC	A	SI	B	
Loads							
	With no special characteristics	<ul style="list-style-type: none"> General-purpose power sockets Incandescent lighting Household appliances: microwave oven, dishwasher, clothes dryer Electric heating, water heater 	■	■	■	■	
	Including a rectifier	Single phase	<ul style="list-style-type: none"> Household appliances: induction cooking appliances, washing machines (variable speed) Single-phase variable speed drives 	-	■	■	-
		Three phase	<ul style="list-style-type: none"> Three-phase variable speed industrial drives Three-phase uninterruptible power supplies 	-	-	-	■
	Generating high-frequency interference (current peaks, harmonics)		<ul style="list-style-type: none"> Fluorescent lighting powered by extra low voltage transformer, by electronic ballast Variable luminosity lighting Powerful IT equipment Single-phase variable speed industrial drives Air conditioning Telecommunications equipment Capacitor banks 	-	-	■	■
	Including an anti-harmonic filter in the power supply		<ul style="list-style-type: none"> Microcomputer systems Computer peripherals (printers, scanners, etc.) 	-	-	■	■
Electrical environment							
	Vicinity of equipment generating transient overvoltages	<ul style="list-style-type: none"> High-powered switching devices Reactive energy compensation banks 	-	-	■	■	
	Circuits powered by an uninterruptible power supply "Isolated neutral" (IT) earthing system	<ul style="list-style-type: none"> Backed-up networks 	-	-	■	■	
	Major risk of lightning strokes	<ul style="list-style-type: none"> Buildings protected by a lightning protection system Mountainous or humid regions Regions with high keraunic level 	-	-	■	■	
Atmosphere							
	Ambient temperature which could be less than -5°C	-	-	■	■	■	
	Presence of corrosive agents (AF2 to AF4) or dust	<ul style="list-style-type: none"> Indoor swimming pools Yacht harbours, marinas, camping grounds Water treatment Chemical industries, heavy industries, paper mills Mines and cellars, road tunnels Markets, stock raising, food processing industries 	-	-	■ (1)	-	



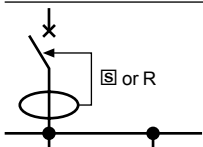
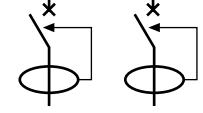

(1) SiE for C120 and NG125 circuit-breakers

Discrimination

Residual current devices of average sensitivity (100 mA and more) are available in a selective (S) and delayed (R) version. This option ensures that, in the event of an earth fault downstream of the installation, only the defective part is switched off. The table below shows (in green) which upstream/downstream equipment combinations provide this discrimination.

Sensitivity (mA) - Downstream		Sensitivity (mA) - Upstream												
		Instantaneous						Selective S			Delayed R			
		30	100	300	500	1000	3000	100	300	500	1000	3000	1000	3000
	Instantaneous	30	-	-	-	-	-	-	-	-	-	-	-	-
		100	-	-	-	-	-	-	-	-	-	-	-	-
		300	-	-	-	-	-	-	-	-	-	-	-	-
		500	-	-	-	-	-	-	-	-	-	-	-	-
		1000	-	-	-	-	-	-	-	-	-	-	-	-
		3000	-	-	-	-	-	-	-	-	-	-	-	-
	Selective S	100	-	-	-	-	-	-	-	-	-	-	-	-
		300	-	-	-	-	-	-	-	-	-	-	-	-
		500	-	-	-	-	-	-	-	-	-	-	-	-
		1000	-	-	-	-	-	-	-	-	-	-	-	-
		3000	-	-	-	-	-	-	-	-	-	-	-	-
		Delayed R	1000	-	-	-	-	-	-	-	-	-	-	-
		3000	-	-	-	-	-	-	-	-	-	-	-	-

Selection guide

Type		Residual current circuit breakers				
		iID K	iID	RCCB-ID 125 A		RCCB-ID type B
						
Standards		IEC/EN 61008	IEC/EN 61008	IEC/EN 61008-1 and VDE 0664		IEC/EN 61008 and VDE 0664
Voltage (V)	Ue	230/400	110/230 230/400	230/400		230/400
Number of poles	1P+N	–	–	–		–
	2P	■	■	■		–
	3P	–	–	–		–
	4P	■	■	■		■
Type	AC	■	–	■		–
	A	–	■	■		–
	S/I	–	–	■		–
	B	–	–	–		■
Impulse voltage (kV)	Uimp	4	6	6		4
Insulation voltage (V)	Ui	440	500	500		400
Current rating (A)	In	25 - 40 - 63	63	16 to 100		125
Frequency (Hz)		50/60	50	50		50
Rated breaking capacity (A)	Icn	–	–	–		–
Rated conditional short-circuit current	Icn	4500	10000	10000		10000
Rated residual breaking and making capacity (A)	(IΔm)	10 In (500 A min.)	1500	1500		1250
Sensitivity (mA)	(IΔn)					
	10	–	–	■		–
	30	■	■	■		■
	100	–	–	■		–
	300	■	–	■		■
	500	–	–	■		■
	1000	–	–	–		–
	3000	–	–	–		–
	300 \square	–	–	■		■
	500 \square	–	–	■		–
1000 \square	–	–	–		–	
3000 \square	–	–	–		–	
Electrical characteristics						
Curves	B	–	–	–		–
	C	–	–	–		–
	D	–	–	–		–
	L	–	–	–		–
	K	–	–	–		–
	MA	–	–	–		–
	For more details, see module		CA902007	CA902002	CM902001	
Accessories	–	–	CA907000, CA907001	CM902001		CM902002
Auxiliaries	–	–	CA907000, CA907002	CM902001		CM902002

I_{nc}: rated conditional short-circuit current

Value of the alternating component of the prospective current that a residual current circuit breaker protected by an appropriate short-circuit protective device (SCPD) mounted in series can withstand in specified conditions of use.

I_{Δc}: rated residual short-circuit current

Value of the alternating component of the prospective residual current that a residual current circuit breaker protected by an appropriate short-circuit protective device (SCPD) mounted in series can withstand in specified conditions of use.

I_m: rated making and breaking capacity

Value of the alternating component of the prospective current that a residual current circuit breaker is capable of establishing or interrupting in specified conditions of use.

I_{Δm}: rated making and breaking capacity







Value of the alternating component of the prospective residual current that a residual current circuit breaker is capable of establishing and withstanding during its opening time and interrupting in specified conditions of use and behaviour.

SCPD

Short-circuit protective device (a fuse in the case of our markings): this is the max. fuse that can be used to resist the value $I_{nc} = I_{Δc}$.

Add-on residual current devices				Residual current devices RCBO		
Vigi iC60			Vigi C120	Vigi NG125	DPNa Vigi	DPN N Vigi
						
IEC/EN 61009			IEC/EN 61009	IEC/EN 61009	IEC/EN 61009	IEC/EN 61009
110/230	230/400	400/415	230/400	230/400	230	230
-	-	-	-	-	■	■
■	■	■	■	■	-	-
-	■	-	■	■	-	-
■	■	-	■	■	■	■
■	■	■	■	■	■	-
-	■	-	■	■	-	■
-	-	-	-	-	-	-
6	6	6	6	8	4	4
500	500	500	500	690	400	400
25-40-63	25-40-63	63	10-125	63-125	10-16	4 to 40
50/60	50/60	50/60	50/60	50/60	50/60	50/60
-	-	-	-	-	4500	6000
-	-	-	-	-	-	-
-	-	-	-	-	4500	6000
-	■	-	-	-	■	-
■	■	■	■	■	-	■
-	■	-	-	-	-	-
■	■	-	■	■	-	■
-	■	-	■	■	-	-
-	-	-	-	■	-	-
-	-	-	-	■	-	-
-	■	-	■	■	-	-
-	■	-	■	■	-	-
-	-	-	-	■	-	-
-	-	-	-	■	-	-
Depending on circuit breaker used	Depending on circuit breaker used	Depending on circuit breaker used	-	■	■	-
-	-	-	-	-	-	-
-	-	-	-	-	-	-
-	-	-	-	-	-	-
CA902005	CA902016	CM902008	CA902014	CA902014		
CA907000, CA907001	CA907012, CA907013	CM907004, CM907006	CA907013, CA907012	CA907013, CA907012		
CA907000, CA907002	CA907008, CA907013	CM907004, CM907005	CA907013, CA907008	CA907013, CA907008		

Selection guide

Type		Residual current circuit breakers	Add-on residual current devices
		xID	Vigi xC60
			
		IEC/EN 61008	IEC/EN 61009
Standards			
Voltage (V)	Ue	230/400	230/400
Number of poles	1P+N	–	–
	2P	■	■
	3P	–	–
	4P	■	■
Type	AC	■	■
	A	–	–
	S/I	■	–
	B	–	–
Impulse voltage (kV)	Uimp	6	6
Insulation voltage (V)	Ui	440	500
Current rating (A)	In	25 - 40 - 63 - 80	25 - 63
Frequency (Hz)		50/60	50/60
Rated breaking capacity (A)	Icn	–	–
Rated conditional short-circuit current	Inc	10,000	–
Rated residual breaking and making capacity (A)	(IΔm)	10 In (500 A min.)	–
Curve		–	–
Sensitivity (mA)	(IΔn)	–	–
	10	–	–
	30	■	■
	100	■	■
	300	■	■
	500	–	–
	1000	–	–
	3000	–	–
	300 	■	–
	500 	–	–
	1000 	–	–
3000 	–	–	
Electrical characteristics			
Curves	B	–	Depending on circuit breaker used
	C	–	
	D	–	
	L	–	
	K	–	
	MA	–	
For more details, see module		CA902028	CA902029
Accessories		CA907012	CA907012
Auxiliaries		CA907008	CA907008

Schneider Electric's range of residual current circuit breakers consists of different products (A, B, C, D) to enable it to be the most competitive range possible in each country, allowing for the special characteristics of each market:

- usual installation procedure
- price
- accreditations by local bodies.

Variants

Offers		Pages
Offer A	Catalogue numbers	160
Offer B	Catalogue numbers	163
Offer C	Catalogue numbers	166
Offer D	Catalogue numbers	169
Common pages		172

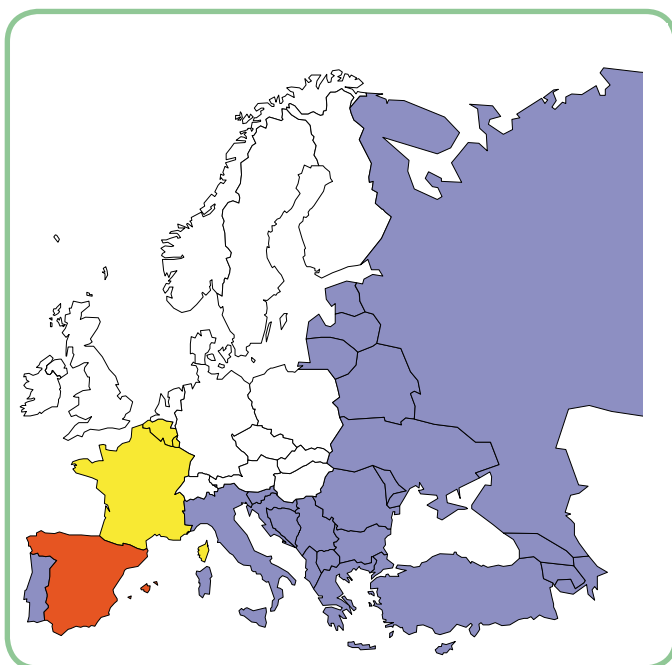

Only the product range to be marketed in your country and validated by the local product manager, in agreement with his Final Distribution (FD) partner should be retained. The others will be removed before publication.

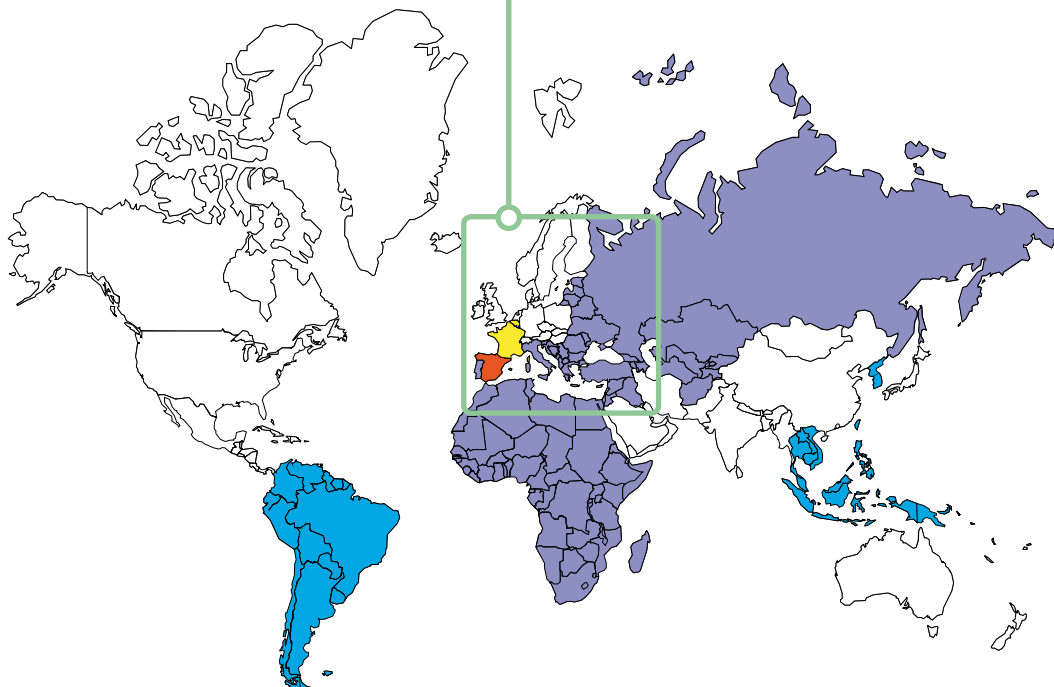

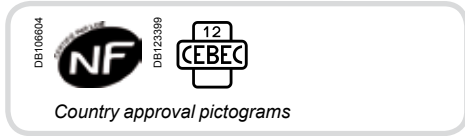

IEC/EN 61008-1



- The iID residual current circuit breakers provide:
 - protection of persons against electric shock by direct contact (≤ 30 mA),
 - protection of persons against electric shock by indirect contact (≥ 100 mA),
 - protection of installations against the risk of fire (300 mA or 500 mA).

Offer selection see page 159

Offer A

This sticker must be removed before publishing

Catalogue numbers

iID residual current circuit breakers for 230/400 V network

Type	AC								Width in 9 mm module	
Auxiliaries	Module CA907002									
2P	Sensitivity	10 mA	30 mA	100 mA	300 mA	500 mA	300 mA 	500 mA 		
	Rating	16 A	A9R10216	-	-	-	-	-	4	
		25 A	A9R10225	A9R11225	-	A9R14225	A9R16225	-		
		40 A	-	A9R11240	A9R12240	A9R14240	A9R16240	-		
		63 A	-	A9R11263	A9R12263	A9R14263	A9R16263	A9R15263		
		80 A	-	A9R11280	A9R12280	A9R14280	-	A9R15280		
		100 A	-	A9R11291	A9R12291	A9R14291	-	A9R15291		
4P	Sensitivity	10 mA	30 mA	100 mA	300 mA	500 mA	300 mA 	500 mA 		
	Rating	25 A	-	A9R11425	-	A9R14425	A9R16425	-	8	
		40 A	-	A9R11440	A9R12440	A9R14440	A9R16440	A9R15440		
		63 A	-	A9R11463	A9R12463	A9R14463	A9R16463	A9R15463		
		80 A	-	A9R11480	A9R12480	A9R14480	A9R16480	A9R15480		
		100 A	-	A9R11491	A9R12491	A9R14491	-	A9R15491		
Voltage rating (Ue)	2P	230 - 240 V								
	4P	400 - 415 V								
Operating frequency	50/60 Hz									
Accessories	Module CA907000 and CA907001									

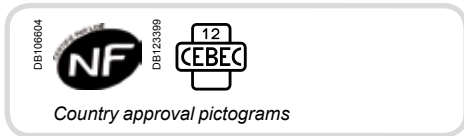

IEC/EN 61008-1

- The iID residual current circuit breakers provide:
 - protection of persons against electric shock by direct contact (≤ 30 mA),
 - protection of persons against electric shock by indirect contact (≥ 100 mA),
 - protection of installations against the risk of fire (300 mA or 500 mA).

Catalogue numbers

iID residual current circuit breakers for 230/400 V network

Type	A							Width in 9 mm module	
Auxiliaries	Module CA907002								
2P	Sensitivity	10 mA	30 mA	100 mA	300 mA	500 mA	300 mA		
	Rating	16 A	A9R02016	-	-	-	-	4	
		25 A	A9R02025	A9R01225	-	A9R04225	-		
		40 A	-	A9R01240	-	A9R04240	-		A9R05240
		63 A	-	A9R01263	-	A9R04263	-		A9R05263
		100 A	-	A9R01291	-	A9R04291	-		A9R05291
	Rating	25 A	-	A9R01425	-	A9R04425	-	8	
		40 A	-	A9R01440	A9R22440	A9R04440	A9R26440		A9R05440
		63 A	-	A9R01463	A9R22463	A9R04463	A9R26463		A9R05463
		80 A	-	A9R21480	-	A9R24480	-		A9R25480
		100 A	-	A9R01491	-	A9R04491	A9R26491		A9R05491
Voltage rating (Ue)	2P	230 - 240 V							
	4P	400 - 415 V							
Operating frequency	50/60 Hz								
Accessories	Module CA907000 and CA907001								

iID residual current circuit breakers for 110/230 V network

Type	A		Width in 9 mm module
Auxiliaries	Module CA907002		
2P	Sensitivity	30 mA	
	Rating	63 A	A9R08263
	Rating	63 A	A9R08463
Voltage rating (Ue)	2P	110 V	
	4P	230 V	
Operating frequency	50/60 Hz		
Accessories	Module CA907000 and CA907001		

Offer selection see page 159

Offer A

This sticker must be removed before publishing

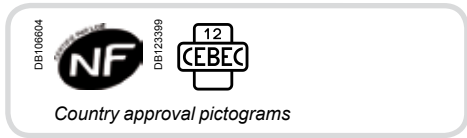

IEC/EN 61008-1



- The iID residual current circuit breakers provide:
 - protection of persons against electric shock by direct contact (≤ 30 mA),
 - protection of persons against electric shock by indirect contact (≥ 300 mA),
 - protection of installations against the risk of fire (300 mA or 500 mA).

The **SI** type provides increased immunity from electrical interference and polluted or corrosive environments.

Offer selection see page 159

Offer A

This sticker must be removed before publishing

Catalogue numbers

iID residual current circuit breakers for 230/400 V network								
Type	SI						Width in 9 mm module	
Auxiliaries		Module CA907002						
2P		Sensitivity	10 mA	30 mA	300 mA	300 mA	500 mA	
<p>DB122476</p>	Rating	16 A	-	-	-	-	4	
		25 A	A9R30225	A9R31225	-	-		-
		40 A	-	A9R31240	-	A9R35240		-
		63 A	-	A9R31263	-	A9R35263		-
		100 A	-	-	-	A9R35291		-
<p>DB122476</p>	Rating	25 A	-	A9R31425	-	-	8	
		40 A	-	A9R31440	-	A9R35440		A9R37440
		63 A	-	A9R31463	A9R34463	A9R35463		A9R37463
		80 A	-	A9R31480	-	A9R35480		A9R37480
		100 A	-	A9R31491	A9R34491	A9R35491		-
Voltage rating (Ue)		2P	230 - 240 V					
		4P	400 - 415 V					
Operating frequency		50/60 Hz						
Accessories		Module CA907000 and CA907001						

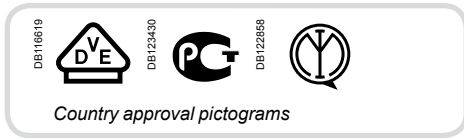

IEC/EN 61008-1



- The iID residual current circuit breakers provide:
 - protection of persons against electric shock by direct contact (≤ 30 mA),
 - protection of persons against electric shock by indirect contact (≥ 100 mA),
 - protection of installations against the risk of fire (300 mA or 500 mA).

Offer selection see page 159

Offer B

This sticker must be removed before publishing

Catalogue numbers

iID residual current circuit breakers for 230/400 V network									
Type	AC								Width in 9 mm module
Auxiliaries	Module CA907002								
2P	Sensitivity	10 mA	30 mA	100 mA	300 mA	500 mA	300 mA	500 mA	
	Rating	16 A	A9R10216	-	-	-	-	-	4
		25 A	A9R10225	A9R41225	-	A9R44225	A9R16225	-	
		40 A	-	A9R41240	A9R12240	A9R44240	A9R16240	-	
		63 A	-	A9R41263	A9R12263	A9R44263	A9R16263	A9R15263	
		80 A	-	A9R11280	A9R12280	A9R14280	-	A9R15280	
		100 A	-	A9R11291	A9R12291	A9R14291	-	A9R15291	
	Rating	25 A	-	A9R41425	-	A9R44425	A9R16425	-	8
		40 A	-	A9R41440	A9R12440	A9R44440	A9R16440	A9R15440	
		63 A	-	A9R41463	A9R12463	A9R44463	A9R16463	A9R15463	
		80 A	-	A9R11480	A9R12480	A9R14480	A9R16480	A9R15480	
		100 A	-	A9R11491	A9R12491	A9R14491	-	A9R15491	
Voltage rating (Ue)	2P	230 - 240 V							
	4P	400 - 415 V							
Operating frequency	50/60 Hz								
Accessories	Module CA907000 and CA907001								

iID residual current circuit breakers (A type)

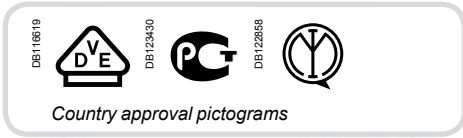

IEC/EN 61008-1

- The iID residual current circuit breakers provide:
 - protection of persons against electric shock by direct contact (≤ 30 mA),
 - protection of persons against electric shock by indirect contact (≥ 100 mA),
 - protection of installations against the risk of fire (300 mA or 500 mA).

Catalogue numbers

iID residual current circuit breakers for 230/400 V network

Type	A							Width in 9 mm module	
Auxiliaries	Module CA907002								
2P	Sensitivity	10 mA	30 mA	100 mA	300 mA	500 mA	300 mA		
<p>DB122476</p>	Rating	16 A	A9R20216	-	-	-	-	4	
		25 A	A9R20225	A9R21225	-	-	A9R24225		
		40 A	-	A9R21240	-	-	A9R24240		
		63 A	-	A9R21263	-	-	A9R24263		
		100 A	-	A9R21291	-	-	A9R24291		
<p>DB122477</p>	Rating	25 A	-	A9R21425	-	-	A9R24425	8	
		40 A	-	A9R21440	A9R22440	-	A9R24440		
		63 A	-	A9R21463	A9R22463	-	A9R24463		
		80 A	-	A9R21480	-	-	A9R24480		
		100 A	-	A9R21491	-	-	A9R24491		
Voltage rating (Ue)	2P	230 - 240 V							
	4P	400 - 415 V							
Operating frequency	50/60 Hz								
Accessories	Module CA907000 and CA907001								

iID residual current circuit breakers for 110/230 V network

Type	A		Width in 9 mm module
Auxiliaries	Module CA907002		
2P	Sensitivity	30 mA	
<p>DB122476</p>	Rating	63 A	A9R08263
<p>DB122477</p>	Rating	63 A	A9R08463
Voltage rating (Ue)	2P	110 V	
	4P	230 V	
Operating frequency	50/60 Hz		
Accessories	Module CA907000 and CA907001		

Offer selection see page 159

Offer B

This sticker must be removed before publishing

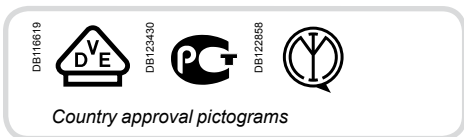

IEC/EN 61008-1



- The iID residual current circuit breakers provide:
 - protection of persons against electric shock by direct contact (≤ 30 mA),
 - protection of persons against electric shock by indirect contact (≥ 300 mA),
 - protection of installations against the risk of fire (300 mA or 500 mA).

The **SI** type provides increased immunity from electrical interference and polluted or corrosive environments.



Catalogue numbers

iID residual current circuit breakers for 230/400 V network								
Type	SI						Width in 9 mm module	
Auxiliaries	Module CA907002							
2P	Sensitivity	10 mA	30 mA	300 mA	300 mA 	500 mA 		
<p>DB122476</p>	Rating	16 A	-	-	-	-	4	
		25 A	A9R30225	A9R61225	-	-		-
		40 A	-	A9R61240	-	A9R35240		-
		63 A	-	A9R61263	-	A9R35263		-
		100 A	-	-	-	A9R35291		-
4P	Sensitivity	10 mA	30 mA	300 mA	300 mA 	500 mA 		
<p>DB122477</p>	Rating	25 A	-	A9R61425	-	-	8	
		40 A	-	A9R61440	-	A9R35440		A9R37440
		63 A	-	A9R61463	A9R34463	A9R35463		A9R37463
		80 A	-	A9R31480	-	A9R35480		A9R37480
		100 A	-	A9R31491	A9R34491	A9R35491		-
Voltage rating (Ue)	2P	230 - 240 V						
	4P	400 - 415 V						
Operating frequency	50/60 Hz							
Accessories	Module CA907000 and CA907001							



Country approval pictogram

IEC/EN 61008-1



- The iID residual current circuit breakers provide:
 - protection of persons against electric shock by direct contact (≤ 30 mA),
 - protection of persons against electric shock by indirect contact (≥ 100 mA),
 - protection of installations against the risk of fire (300 mA or 500 mA).

Offer selection see page 159

offer C

This sticker must be removed before publishing

Catalogue numbers

iID residual current circuit breakers for 230/400 V network

Type	AC								Width in 9 mm module	
Auxiliaries	Module CA907002									
2P	Sensitivity	10 mA	30 mA	100 mA	300 mA	500 mA	300 mA	500 mA		
	Rating	16 A	A9R10216	-	-	-	-	-	4	
		25 A	A9R10225	A9R71225	-	A9R74225	A9R16225	-		
		40 A	-	A9R71240	A9R12240	A9R74240	A9R16240	-		
		63 A	-	A9R71263	A9R12263	A9R74263	A9R16263	A9R15263	-	
		80 A	-	A9R11280	A9R12280	A9R14280	-	A9R15280	-	
		100 A	-	A9R11291	A9R12291	A9R14291	-	A9R15291	-	
	Rating	25 A	-	A9R71425	-	A9R74425	A9R16425	-	8	
		40 A	-	A9R71440	A9R12440	A9R74440	A9R16440	A9R15440	A9R17440	
		63 A	-	A9R71463	A9R12463	A9R74463	A9R16463	A9R15463	A9R17463	
		80 A	-	A9R11480	A9R12480	A9R14480	A9R16480	A9R15480	A9R17480	
		100 A	-	A9R11491	A9R12491	A9R14491	-	A9R15491	-	
Voltage rating (Ue)	2P	230 - 240 V								
	4P	400 - 415 V								
Operating frequency	50/60 Hz									
Accessories	Module CA907000 and CA907001									

iID residual current circuit breakers (A type)

IEC/EN 61008-1

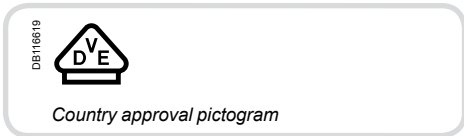

- The iID residual current circuit breakers provide:
 - protection of persons against electric shock by direct contact (≤ 30 mA),
 - protection of persons against electric shock by indirect contact (≥ 100 mA),
 - protection of installations against the risk of fire (300 mA or 500 mA).

Catalogue numbers

iID residual current circuit breakers for 230/400 V network									
Type	A							Width in 9 mm module	
Auxiliaries	Module CA907002								
2P	Sensitivity	10 mA	30 mA	100 mA	300 mA	500 mA	300 mA		
	Rating	16 A	A9R20216	-	-	-	-	4	
		25 A	A9R20225	A9R51225	-	A9R54225	-		
		40 A	-	A9R51240	-	A9R54240	-	A9R25240	
		63 A	-	A9R51263	-	A9R54263	-	A9R25263	
		100 A	-	A9R21291	-	A9R24291	-	A9R25291	
	Rating	25 A	-	A9R51425	-	A9R54425	-	8	
		40 A	-	A9R51440	A9R22440	A9R54440	A9R26440	A9R25440	
		63 A	-	A9R51463	A9R22463	A9R54463	A9R26463	A9R25463	
		80 A	-	A9R21480	-	A9R24480	-	A9R25480	
		100 A	-	A9R21491	-	A9R24491	A9R26491	A9R25491	
Voltage rating (Ue)	2P	230 - 240 V							
	4P	400 - 415 V							
Operating frequency	50/60 Hz								
Accessories	Module CA907000 and CA907001								

iID residual current circuit breakers for 110/230 V network									
Type	A							Width in 9 mm module	
Auxiliaries	Module CA907002								
2P	Sensitivity	30 mA							
	Rating	63 A	A9R08263						4
	Rating	63 A	A9R08463						8
Voltage rating (Ue)	2P	110 V							
	4P	230 V							
Operating frequency	50/60 Hz								
Accessories	Module CA907000 and CA907001								

Offer selection see page 159

Offer C

This sticker must be removed before publishing

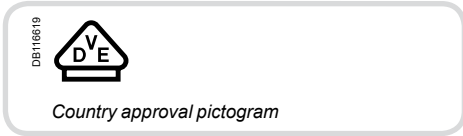

IEC/EN 61008-1



- The iID residual current circuit breakers provide:
 - protection of persons against electric shock by direct contact (≤ 30 mA),
 - protection of persons against electric shock by indirect contact (≥ 300 mA),
 - protection of installations against the risk of fire (300 mA or 500 mA).

The **SI** type provides increased immunity from electrical interference and polluted or corrosive environments.

Offer selection see page 159

Offer C

This sticker must be removed before publishing

Catalogue numbers

iID residual current circuit breakers for 230/400 V network

Type		SI					Width in 9 mm module	
Auxiliaries		Module CA907002						
2P		Sensitivity	10 mA	30 mA	300 mA	300 mA	500 mA	
	Rating	16 A	-	-	-	-	4	
		25 A	A9R30225	A9R91225	-	-	-	
		40 A	-	A9R91240	-	A9R35240	-	
		63 A	-	A9R91263	-	A9R35263	-	
		100 A	-	-	-	A9R35291	-	
4P		Sensitivity	10 mA	30 mA	300 mA	300 mA	500 mA	
	Rating	25 A	-	A9R91425	-	-	8	
		40 A	-	A9R91440	-	A9R35440	A9R37440	
		63 A	-	A9R91463	A9R34463	A9R35463	A9R37463	
		80 A	-	A9R31480	-	A9R35480	A9R37480	
		100 A	-	A9R31491	A9R34491	A9R35491	-	
Voltage rating (Ue)		2P	230 - 240 V					
		4P	400 - 415 V					
Operating frequency		50/60 Hz						
Accessories		Module CA907000 and CA907001						

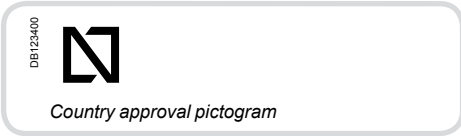

IEC/EN 61008-1



- The iID residual current circuit breakers provide:
 - protection of persons against electric shock by direct contact (≤ 30 mA),
 - protection of persons against electric shock by indirect contact (≥ 100 mA),
 - protection of installations against the risk of fire (300 mA or 500 mA).

Offer selection see page 159

Offer D

This sticker must be removed before publishing

Catalogue numbers

iID residual current circuit breakers for 230/400 V network

Type		AC							Width in 9 mm module	
Auxiliaries		Module CA907002								
2P		Sensitivity	10 mA	30 mA	100 mA	300 mA	500 mA	300 mA	500 mA	
	Rating	16 A	A9R10216	-	-	-	-	-	-	4
		25 A	A9R10225	A9R81225	-	A9R84225	A9R16225	-	-	
		40 A	-	A9R81240	A9R12240	A9R84240	A9R16240	-	-	
		63 A	-	A9R81263	A9R12263	A9R84263	A9R16263	A9R15263	-	
		80 A	-	A9R11280	A9R12280	A9R14280	-	A9R15280	-	
		100 A	-	A9R11291	A9R12291	A9R14291	-	A9R15291	-	
	Rating	25 A	-	A9R81425	-	A9R84425	A9R16425	-	-	8
		40 A	-	A9R81440	A9R12440	A9R84440	A9R16440	A9R15440	A9R17440	
		63 A	-	A9R81463	A9R12463	A9R84463	A9R16463	A9R15463	A9R17463	
		80 A	-	A9R11480	A9R12480	A9R14480	A9R16480	A9R15480	A9R17480	
		100 A	-	A9R11491	A9R12491	A9R14491	-	A9R15491	-	
Voltage rating (Ue)	2P	230 - 240 V								
	4P	400 - 415 V								
Operating frequency	50/60 Hz									
Accessories	Module CA907000 and CA907001									

iID residual current circuit breakers (A type)

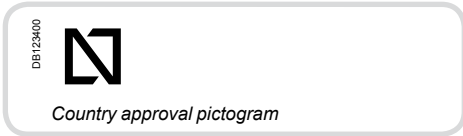

IEC/EN 61008-1

- The iID residual current circuit breakers provide:
 - protection of persons against electric shock by direct contact (≤ 30 mA),
 - protection of persons against electric shock by indirect contact (≥ 100 mA),
 - protection of installations against the risk of fire (300 mA or 500 mA).

Catalogue numbers

iID residual current circuit breakers for 230/400 V network

Type		A							Width in 9 mm module	
Auxiliaries		Module CA907002								
2P		Sensitivity	10 mA	30 mA	100 mA	300 mA	500 mA	300 mA		
	Rating	16 A	A9R20216	-	-	-	-	-	4	
		25 A	A9R20225	A9R21225	-	A9R24225	-	-		
		40 A	-	A9R21240	-	A9R24240	-	A9R25240		
		63 A	-	A9R21263	-	A9R24263	-	A9R25263		
		100 A	-	A9R21291	-	A9R24291	-	A9R25291		
4P		Sensitivity	10 mA	30 mA	100 mA	300 mA	500 mA	300 mA		
	Rating	25 A	-	A9R21425	-	A9R24425	-	-	8	
		40 A	-	A9R21440	A9R22440	A9R24440	A9R26440	A9R25440		
		63 A	-	A9R21463	A9R22463	A9R24463	A9R26463	A9R25463		
		80 A	-	A9R21480	-	A9R24480	-	A9R25480		
		100 A	-	A9R21491	-	A9R24491	A9R26491	A9R25491		
Voltage rating (Ue)		2P	230 - 240 V							
		4P	400 - 415 V							
Operating frequency		50/60 Hz								
Accessories		Module CA907000 and CA907001								

iID residual current circuit breakers for 110/230 V network

Type		A		Width in 9 mm module
Auxiliaries		Module CA907002		
2P		Sensitivity	30 mA	
	Rating	63 A	A9R08263	4
4P		Sensitivity	30 mA	
	Rating	63 A	A9R08463	8
Voltage rating (Ue)		2P	110 V	
		4P	230 V	
Operating frequency		50/60 Hz		
Accessories		Module CA907000 and CA907001		

Offer selection see page 159

Offer D

This sticker must be removed before publishing

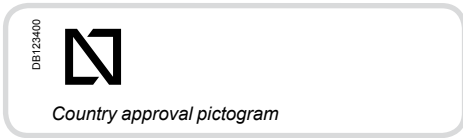

IEC/EN 61008-1



- The iID residual current circuit breakers provide:
 - protection of persons against electric shock by direct contact (≤ 30 mA),
 - protection of persons against electric shock by indirect contact (≥ 300 mA),
 - protection of installations against the risk of fire (300 mA or 500 mA).

The **SI** type provides increased immunity from electrical interference and polluted or corrosive environments.

Offer selection see page 159

Offer D

This sticker must be removed before publishing

Catalogue numbers

iID residual current circuit breakers for 230/400 V network

Type	SI						Width in 9 mm module	
Auxiliaries	Module CA907002							
2P	Sensitivity	10 mA	30 mA	300 mA	300 mA 	500 mA 		
	Rating	16 A	-	-	-	-	4	
		25 A	A9R30225	A9R61225	-	-		
		40 A	-	A9R61240	-	A9R35240		
		63 A	-	A9R61263	-	A9R35263		
		100 A	-	-	-	A9R35291		
4P	Sensitivity	10 mA	30 mA	300 mA	300 mA 	500 mA 		
	Rating	25 A	-	A9R61425	-	-	8	
		40 A	-	A9R61440	-	A9R35440		A9R37440
		63 A	-	A9R61463	A9R34463	A9R35463		A9R37463
		80 A	-	A9R31480	-	A9R35480		A9R37480
		100 A	-	A9R31491	A9R34491	A9R35491		-
Voltage rating (Ue)	2P	230 - 240 V						
	4P	400 - 415 V						
Operating frequency	50/60 Hz							
Accessories	Module CA907000 and CA907001							

iID residual current circuit breakers (AC, A, SI types)

Connection

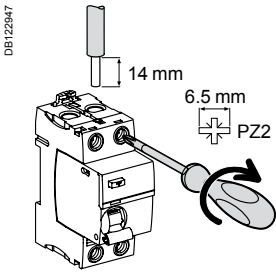

Type	Tightening torque	Without accessory		With accessories*			
		Copper cables		50 mm ²	Screw-on connection for ring terminal	Multi-cables terminal	
		Rigid	Flexible or with ferrule	Al terminal		Rigid cables	Flexible cables
iID	3.5 N.m	1 to 35 mm ²	1 to 25 mm ²	50 mm ²	∅ 5 mm	3 x 16 mm ²	3 x 10 mm ²

* See module CA907000

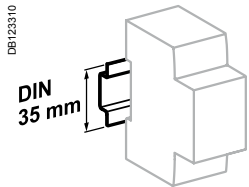

Clip on DIN rail 35 mm.

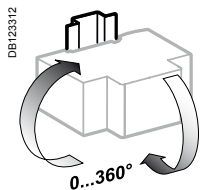

Indifferent position of installation.

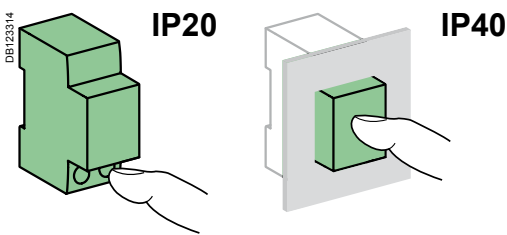

Technical data

Main characteristics

Insulation voltage (U _i)	500 V
Pollution degree	3
Rated impulse withstand voltage (U _{imp})	6 kV

According to IEC/EN 61008-1

Making and breaking capacity (I _m /I _{Δm})	1500 A	
Surge current withstand (8/20 μs) without tripping	AC and A types (no selective)	250 A
	AC, A types (selective)	3 kA
	SI type	3 kA
Conditional rated short circuit current (I _{nc} /I _{Δc})	With iC60N/H/L	Equal to breaking capacity of iC60
	With fuse	10,000 A
Behaviour in case of voltage drop		Residual current protection down to 0 V according to IEC/EN 61008-1 § 3.3.4

Additional characteristics

Degree of protection	Device only	IP20
	Device in modular enclosure	IP40
Endurance (O-C)	Electrical (AC1) 16 to 63 A	15,000 cycles
		80 to 100 A
	Mechanical	20,000 cycles
Operating temperature	AC type	-5°C to +60°C
	A and SI types	-25°C to +60°C
Storage temperature		-40°C to +85°C

Weight (g)

Residual current circuit breakers	
Type	iID
2P	210
4P	370

Dimensions (mm)

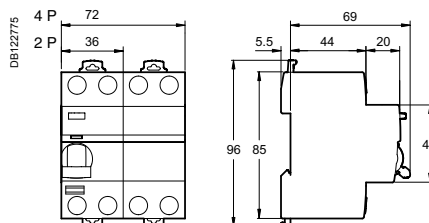

iLD residual current circuit breakers (AC, A, *SI* types) (cont.)



PB104548-40

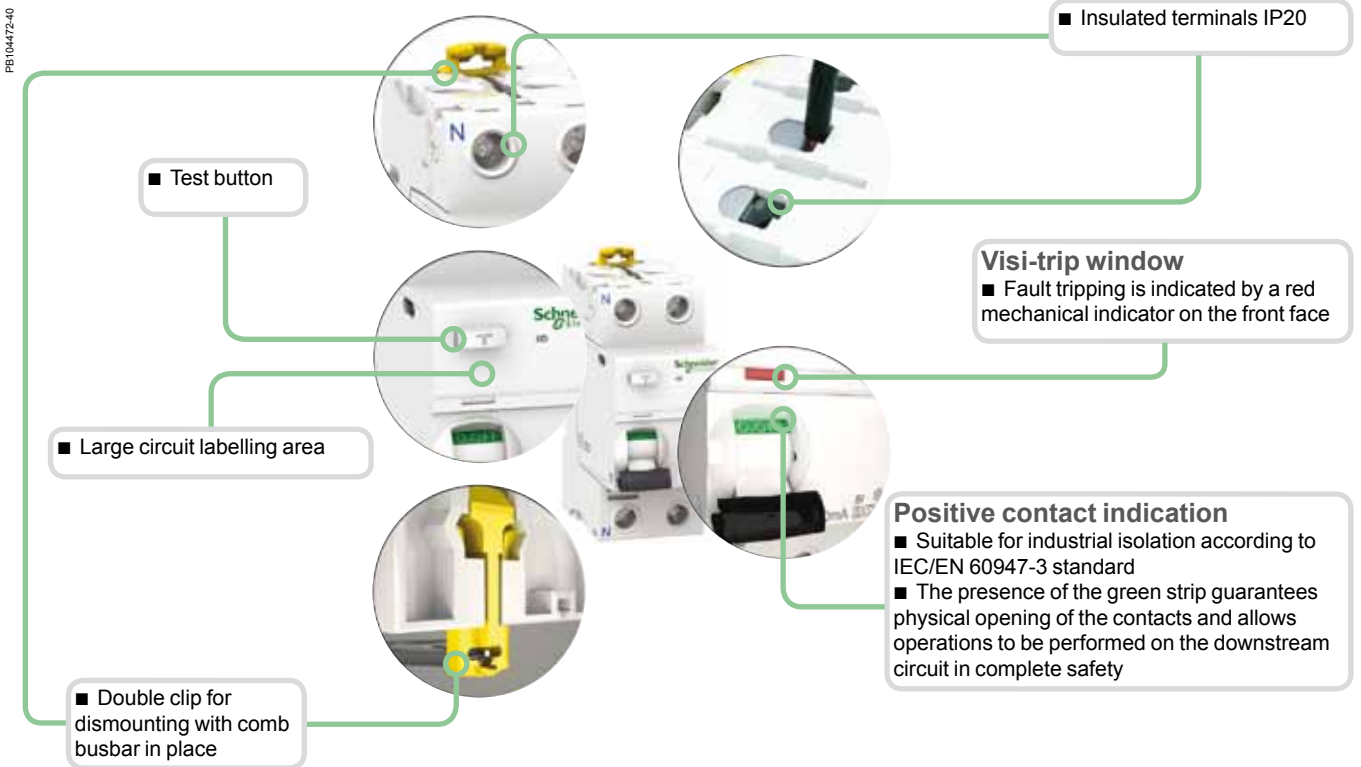

PB104472-40

SI type

The *SI* type provides increased immunity from electrical interference and polluted or corrosive environments.

iID double terminals residual current circuit breakers (AC type)



IEC/EN 61008-1

KEMA KEUR approval, only for 2P/4P 25 A to 63 A catalogue numbers.



- The iID double tunnel terminals residual current circuit breakers provide:
 - protection of persons against electric shock by direct contact (≤ 30 mA),
 - protection of persons against electric shock by indirect contact (≥ 100 mA),
 - protection of installations against the risk of fire (300 mA).

Catalogue numbers

iID double terminals residual current circuit breakers											
Type	AC									Width in 9 mm module	
Product	iID										
Auxiliaries	Can accept auxiliaries, module CA907002										
2P	Sensitivity	10 mA	30 mA	30 mA Type G	100 mA	100 mA	100 mA Type G	300 mA	300 mA		
	Rating	25 A	A9Z10225	A9Z11225	-	-	-	A9Z14225	-	4	
		40 A	-	A9Z11240	A9Z76240	A9Z12240	-	A9Z77240	A9Z14240	A9Z15240	
		63 A	-	A9Z11263	A9Z76263	A9Z12263	-	A9Z77263	A9Z14263	A9Z15263	
		80 A	-	A9Z11280	-	A9Z12280	-	-	A9Z14280	A9Z15280	
		100 A	-	A9Z11291	-	A9Z12291	-	-	A9Z14291	A9Z15291	
	Rating	25 A	-	A9Z11425	-	-	-	A9Z14425	-	8	
		40 A	-	A9Z11440	-	A9Z12440	-	-	A9Z14440	A9Z15440	
		63 A	-	A9Z11463	-	A9Z12463	-	-	A9Z14463	A9Z15463	
		80 A	-	A9Z11480	A9Z76480	A9Z12480	-	A9Z77480	A9Z14480	A9Z15480	
		100 A	-	A9Z11491	A9Z76491	A9Z12491	-	A9Z77491	A9Z14491	A9Z15491	
	Rating	40 A	-	A9Z71440	A9Z78440	A9Z72440	A9Z73440	A9Z79440	A9Z74440	A9Z75440	8
		63 A	-	A9Z71463	A9Z78463	A9Z72463	A9Z73463	A9Z79463	A9Z74463	A9Z75463	
Voltage rating (Ue)	2P	230 - 240 V									
	4P	400 - 415 V									
Operating frequency	50/60 Hz										
Accessories	Module CA907000 and CA907001										

iID double terminals residual current circuit breakers (A type)



Country approval pictograms

KEMA KEUR approval, only for 2P/4P 25 A to 63 A catalogue numbers.

IEC/EN 61008-1



- The iID double tunnel terminals residual current circuit breakers provide:
 - protection of persons against electric shock by direct contact (≤ 30 mA),
 - protection of persons against electric shock by indirect contact (≥ 100 mA),
 - protection of installations against the risk of fire (300 mA or 500 mA).

Catalogue numbers

iID double terminals residual current circuit breakers											
Type	A iID										Width in 9 mm module
Product	Can accept auxiliaries, module CA907002										
Auxiliaries											
2P	Sensitivity	10 mA	30 mA	30 mA Type G	100 mA	100 mA	100 mA Type G	300 mA	300 mA	500 mA	
	Rating	16 A	A9Z20216	-	-	-	-	-	-	-	4
		25 A	A9Z20225	A9Z21225	-	-	-	A9Z24225	-	-	
		40 A	-	A9Z21240	A9Z81240	A9Z22240	-	A9Z82240	A9Z24240	A9Z25240	-
		63 A	-	A9Z21263	A9Z81263	A9Z22263	-	-	A9Z24263	A9Z25263	-
		80 A	-	A9Z21280	-	A9Z22280	-	-	A9Z24280	A9Z25280	-
		100 A	-	A9Z21291	-	A9Z22291	-	-	A9Z24291	A9Z25291	-
	Rating	25 A	-	A9Z21425	-	-	-	A9Z24425	-	A9Z26425	8
		40 A	-	A9Z21440	-	A9Z22440	-	-	A9Z24440	A9Z25440	A9Z26440
		63 A	-	A9Z21463	-	A9Z22463	-	-	A9Z24463	A9Z25463	A9Z26463
		80 A	-	A9Z21480	A9Z81480	A9Z22480	-	-	A9Z24480	A9Z25480	A9Z26480
		100 A	-	A9Z21491	A9Z81491	A9Z22491	-	A9Z82491	A9Z24491	A9Z25491	A9Z26491
	Rating	40 A	-	A9Z81440	A9Z91440	A9Z82440	A9Z83440	A9Z92440	-	-	8
		63 A	-	A9Z81463	A9Z91463	A9Z82463	A9Z83463	A9Z92463	-	-	
Voltage rating (Ue)	2P	230 - 240 V									
	4P	400 - 415 V									
Operating frequency	50/60 Hz										
Accessories	Module CA907000 and CA907001										

iID double terminals residual current circuit breakers (SI type)

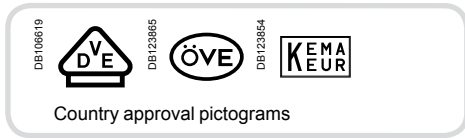

KEMA KEUR approval, only for 2P/4P 25 A to 63 A catalogue numbers.

IEC/EN 61008-1



- The iID double tunnel terminals residual current circuit breakers provide:
 - protection of persons against electric shock by direct contact (≤ 30 mA),
 - protection of persons against electric shock by indirect contact (≥ 100 mA),
 - protection of installations against the risk of fire (300 mA).

The SI type provides increased immunity from electrical interference and polluted or corrosive environments.

Catalogue numbers

iID double terminals residual current circuit breakers							
Type	SI						Width in 9 mm module
Product	iID						
Auxiliaries	Can accept auxiliaries, module CA907002						
2P	Sensitivity	10 mA	30 mA	100 mA	100 mA 	300 mA 	
	Rating 25 A	A9Z30225	A9Z31225	-	-	-	4
	40 A	-	A9Z31240	A9Z32240	-	A9Z35240	
	63 A	-	A9Z31263	A9Z32263	-	A9Z35263	
	80 A	-	A9Z31280	A9Z32280	-	A9Z35280	
	100 A	-	A9Z31291	A9Z32291	-	A9Z35291	
4P	Sensitivity	10 mA	30 mA	100 mA	100 mA 	300 mA 	
	Rating 25 A	-	A9Z31425	-	-	-	8
	40 A	-	A9Z31440	A9Z32440	-	A9Z35440	
	63 A	-	A9Z31463	A9Z32463	-	A9Z35463	
	80 A	-	A9Z31480	A9Z32480	-	A9Z35480	
	100 A	-	A9Z31491	A9Z32491	-	A9Z35491	
4P Type THV	Sensitivity	10 mA	30 mA	100 mA	100 mA 	300 mA 	
	Rating 40 A	-	-	-	A9Z93440	A9Z95440	8
	63 A	-	-	-	A9Z93463	A9Z95463	
Voltage rating (Ue)	2P	230 - 240 V					
	4P	400 - 415 V					
Operating frequency	50/60 Hz						
Accessoires	Module CA907000 and CA907001						

iLD double terminals residual current circuit breakers (AC, A, SI types) (cont.)

Connection between double-terminal protection devices

With comb busbar at the back/cables at the front

Without comb busbar at the back/cables at the front

DB404815



		Back	Front	
Rating	Tightening torque	Comb busbar	Copper cables	
		Thickness of the teeth	Rigid	Flexible or with ferrule
All	3.5 N.m	1.5 mm	DB122945 	DB122946
			1 to 35 mm ²	1 to 25 mm ²

Connection between double-terminal and single-terminal protection devices

Cables at the back/comb busbar at the front

DB404817



		Back	Front	
Rating	Tightening torque	Copper cables		Comb busbar
		Rigid	Flexible or with ferrule	Thickness of the teeth
All	3.5 N.m	DB122945 	DB122946 	1.5 mm
		1 to 25 mm ²	1 to 16 mm ²	

■ Connection by comb busbar or by cable (according to EN 50027).

Connection

DB123947

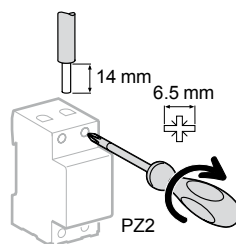

		With accessories		
Rating	50 mm ² AI terminal	Screw-on connection for ring terminal	Multi-cables terminal	
			Rigid cables	Flexible cables
All	DB122935 	DB118789 	DB118787 	
	50 mm ²	Ø 5 mm	3 x 16 mm ²	3 x 10 mm ²

iID double terminals residual current circuit breakers (AC, A, SI types)

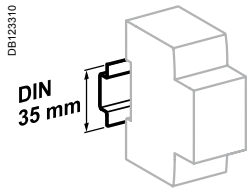

Clip on DIN rail 35 mm.

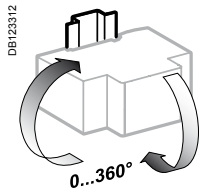

Indifferent position of installation.

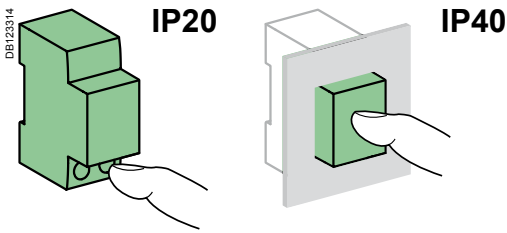

Dimensions (mm)

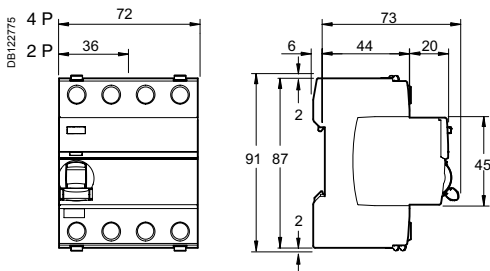

Technical data

Main characteristics			
Insulation voltage (U _i)		500 V	
Pollution degree		3	
Rated impulse withstand voltage (U _{imp})		6 kV	
According to IEC/EN 61008-1			
Making and breaking capacity (I _m /I _{Δm})		1500 A	
Surge current withstand (8/20 μs) without tripping	AC and A types (no selective ⓐ)	250 Å	
	AC, A types (selective ⓐ)	3 kÅ	
	SI type	3 kÅ	
Conditional rated short circuit current (I _{nc} /I _{Δc})	With iC60N/H/L	Equal to breaking capacity of iC60	
	With fuse 100 A	10,000 A	
Behaviour in case of voltage drop		Residual current protection down to 0 V according to IEC/EN 61008-1 § 3.3.4	
Additional characteristics			
Degree of protection	Device only	IP20	
	Device in modular enclosure	IP40 Insulation class II	
Endurance (O-C)	Electrical (AC1)	16 to 63 A	15,000 cycles
		80 to 100 A	10,000 cycles
	Mechanical	20,000 cycles	
Operating temperature	AC type	-5°C to +60°C	
	A and SI types	-25°C to +60°C	
Storage temperature		-40°C to +85°C	

Weight (g)

iID double terminals residual current circuit breakers	
Type	iID
2P	210
4P	370

iLD double terminals residual current circuit breakers (AC, A, SI types) (cont.)

PB107414-40



PB107413-60

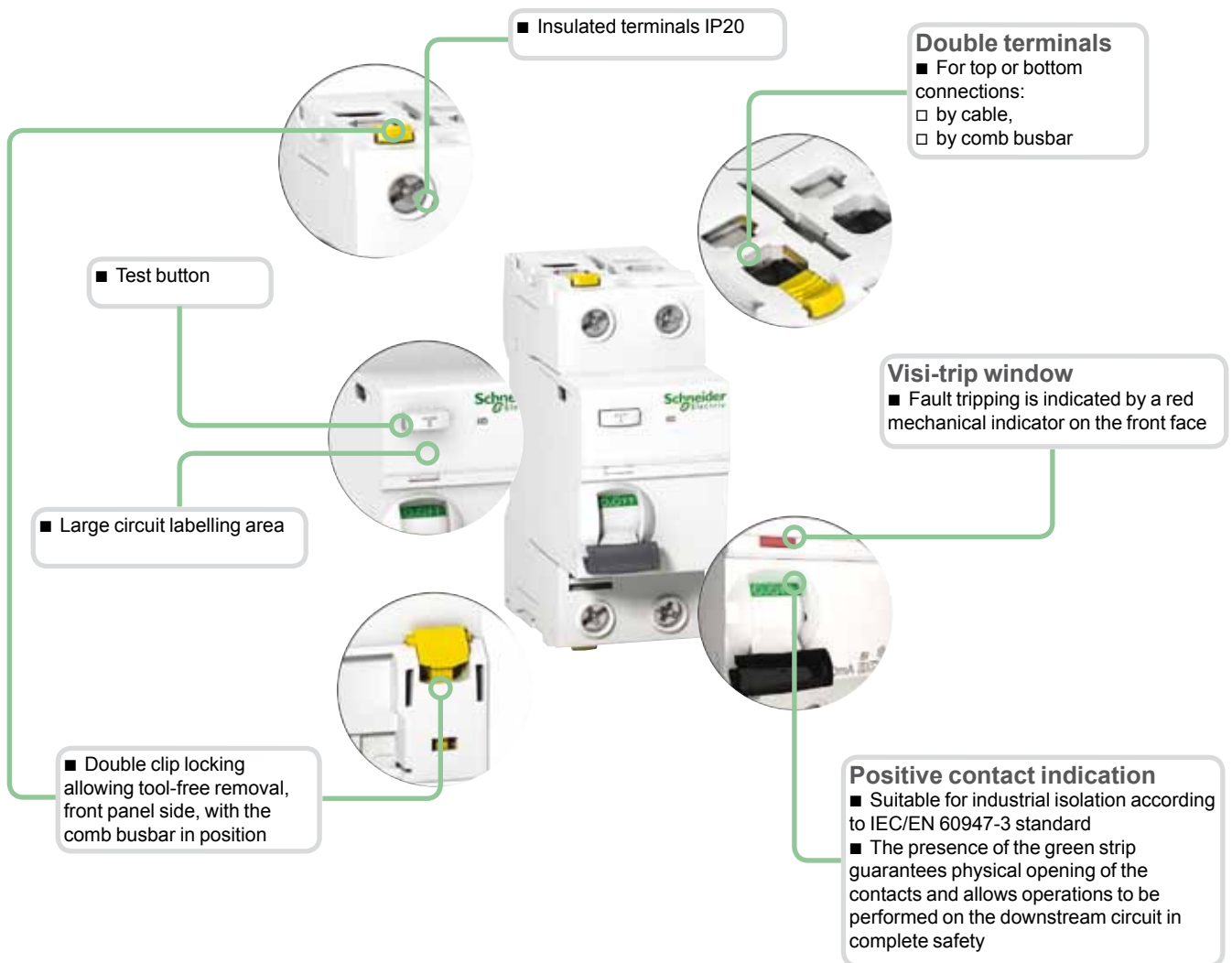

SI type

The SI type provides increased immunity from electrical interference and polluted or corrosive environments.



Schneider Electric's range of residual current circuit breakers consists of different products (A, B, C, D) to enable it to be the most competitive range possible in each country, allowing for the special characteristics of each market:

- usual installation procedure
- price
- accreditations by local bodies.

Variants

Offers		Pages
Offer A	Catalogue numbers	181
Offer B/C	Catalogue numbers	182
Offer D	Catalogue numbers	183
Common pages		184

DB400490

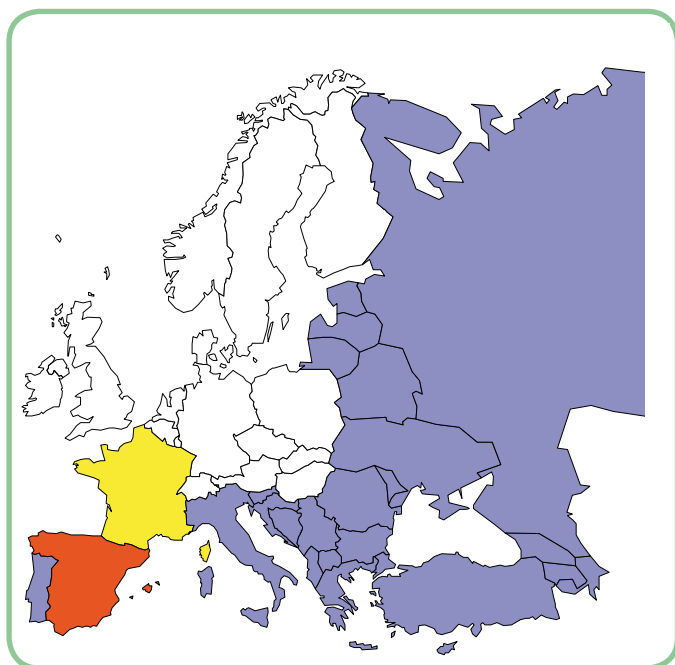

Only the product range to be marketed in your country and validated by the local product manager, in agreement with his Final Distribution (FD) partner should be retained. The others will be removed before publication.

DB400491



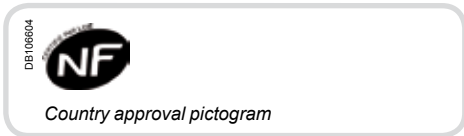

IEC/EN 61008-1

- The iID K residual current circuit breakers provide:
 - protection of persons against electric shock by direct contact (30 mA),
 - protection of persons against electric shock by indirect contact (300 mA),
 - protection of installations against the risk of fire (300 mA).



Catalogue numbers

iID K residual current circuit breakers					
Type	AC			Width in 9-mm modules	
Product	iID K				
Auxiliaries	Without auxiliaries				
	Sensitivity	30 mA	300 mA		
2P DB1122476	Rating	25 A	A9R55225	A9R56225	4
		40 A	A9R55240	A9R56240	
4P DB1122477	Rating	25 A	A9R55425	A9R56425	8
		40 A	A9R55440	A9R56440	
Voltage rating (Ue)	2P	230 - 240 V			
	4P	400 - 415 V			
Operating frequency	50/60 Hz				

Offer selection see page 180

Offer A

This sticker must be removed before publishing

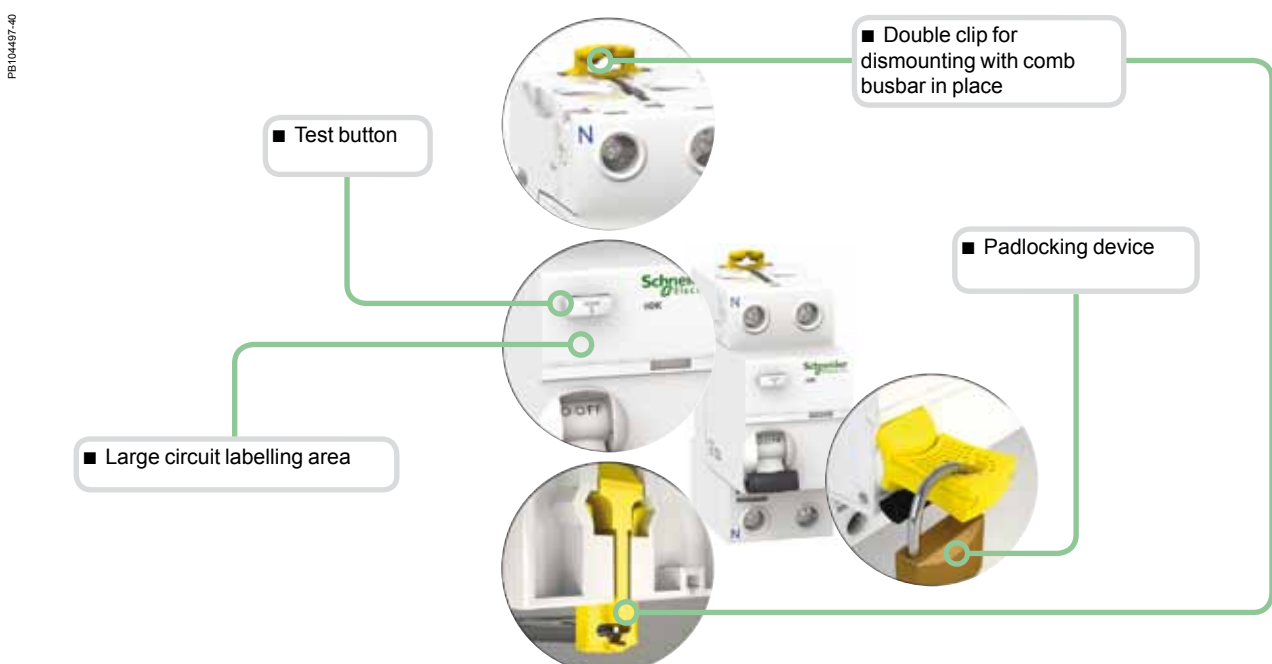



IEC/EN 61008-1

- The iID K residual current circuit breakers provide:
 - protection of persons against electric shock by direct contact (30 mA),
 - protection of persons against electric shock by indirect contact (300 mA),
 - protection of installations against the risk of fire (300 mA).



Catalogue numbers

iID K residual current circuit breakers					
Type		AC		Width in 9-mm modules	
Product		iID K			
Auxiliaries		Without auxiliaries			
2P	Sensitivity	30 mA	300 mA		
	Rating	25 A	A9R50225	A9R75225	4
		40 A	A9R50240	A9R75240	
	Sensitivity	30 mA	300 mA		8
	Rating	25 A	A9R50425	A9R75425	
		40 A	A9R50440	A9R75440	
		63 A	A9R70463	A9R75463	
Voltage rating (Ue)	2P	230 - 240 V			
	4P	400 - 415 V			
Operating frequency	50/60 Hz				

Offer selection see page 180

Offer B, C

This sticker must be removed before publishing

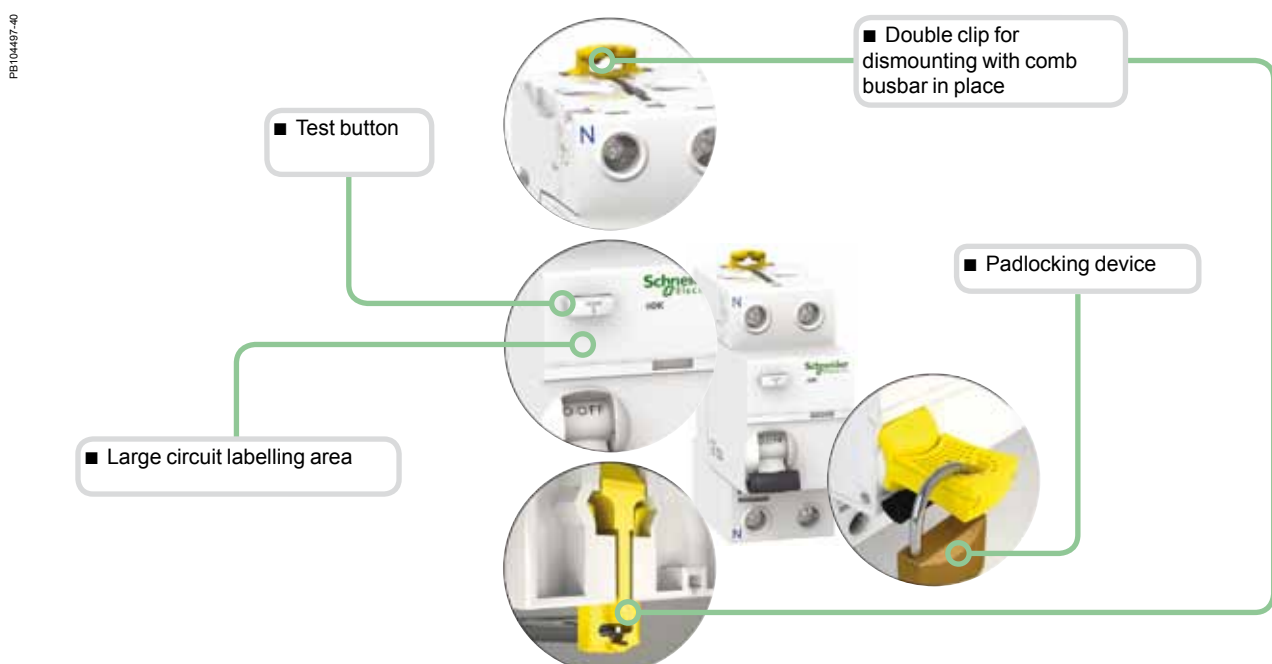

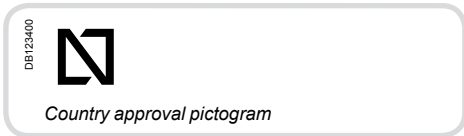

IEC/EN 61008-1

- The iID K residual current circuit breakers provide:
 - protection of persons against electric shock by direct contact (30 mA),
 - protection of persons against electric shock by indirect contact (300 mA),
 - protection of installations against the risk of fire (300 mA).



Catalogue numbers

iID K residual current circuit breakers					
Type	AC		Width in 9-mm modules		
Product	iID K				
Auxiliaries	Without auxiliaries				
	Sensitivity	30 mA	300 mA		
2P 	Rating	25 A	A9R60225	A9R75225	4
		40 A	A9R60240	A9R75240	
4P 	Rating	25 A	A9R50425	A9R75425	8
		40 A	A9R50440	A9R75440	
		63 A	A9R70463	A9R75463	
Voltage rating (Ue)	2P	230 - 240 V			
	4P	400 - 415 V			
Operating frequency	50/60 Hz				

Offer D

Offer selection see page 180

This sticker must be removed before publishing

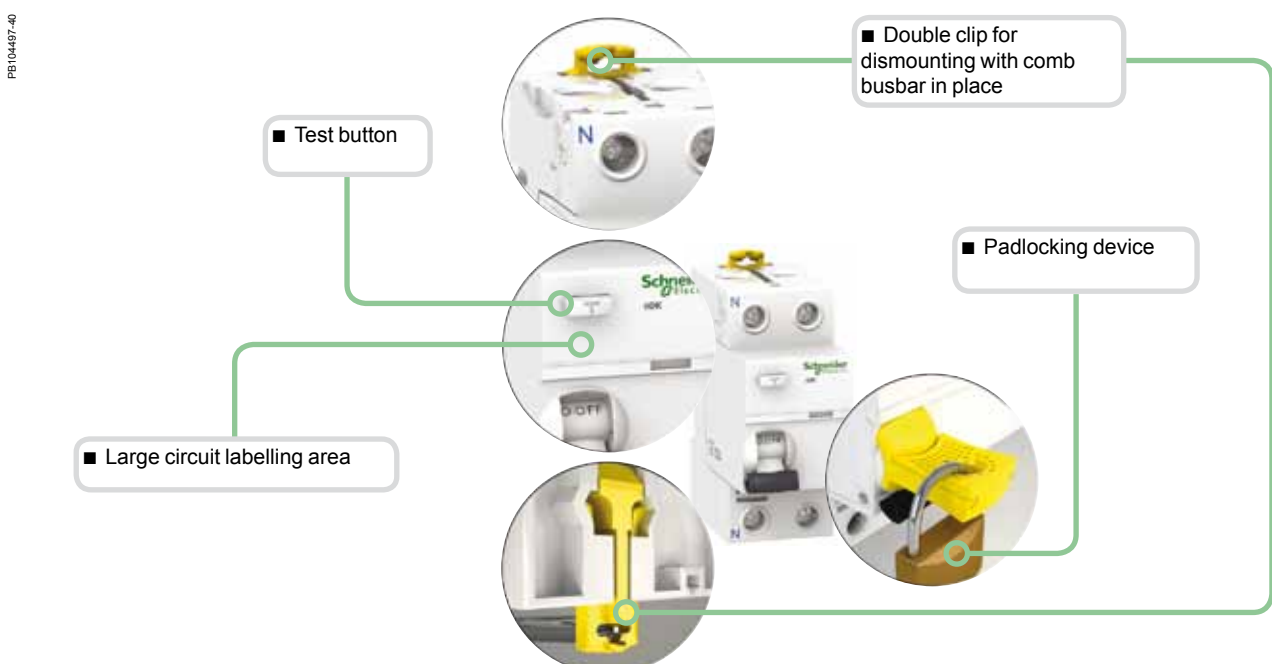

iID K residual current circuit breakers (cont.)

Connection

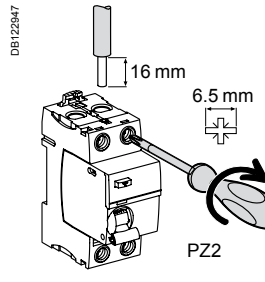

Type	Tightening torque	Copper cables	
		Rigid	Flexible or with ferrule
iID K	3.5 N.m	1 to 35 mm ²	1 to 25 mm ²

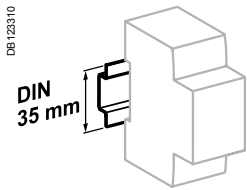

Clip on DIN rail 35 mm.

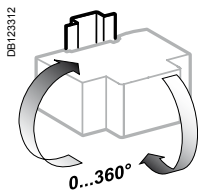

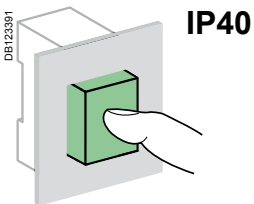

Indifferent position of installation.



Technical data

Main characteristics

According to IEC/EN 61008-1

Insulation voltage (U _i)	440 V
Pollution degree	2
Rated impulse withstand voltage (U _{imp})	4 kV
Making and breaking capacity (I _m /I _{Δm})	25 to 40 A 63 A
Surge current withstand (8/20 μs) without tripping	Up to 200 Å
Conditional rated short circuit current (I _{nc} /I _{Δc})	With iC60N/H/L, iK60N 6000 A
	With fuse 
Behaviour in case of voltage drop	 Residual current protection down to 0 V according to IEC/EN 61008-1 § 3.3.4

Additional characteristics

Degree of protection	Device in modular enclosure	IP40
Endurance (O-C)	Electrical	2000 cycles (AC1)
	Mechanical	5000 cycles
Operating temperature		-5°C to +60°C
Storage temperature		-40°C to +85°C

Weight (g)

Residual current circuit breakers

Type	iID K
2P	210
4P	370

Dimensions (mm)

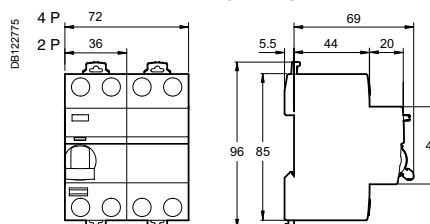



Schneider Electric's range of ID K Biconnect residual current circuit breakers consists of different products (A, B, C) to enable it to be the most competitive range possible in each country, allowing for the special characteristics of each market:

- usual installation procedure
- price
- accreditations by local bodies.

Variants

Offers	Pages
Offer A	Catalogue numbers page 186
Offer B	Catalogue numbers page 187
Common pages offers A and B	
	page 188
Offer C	Catalogue numbers page 189

DE408951

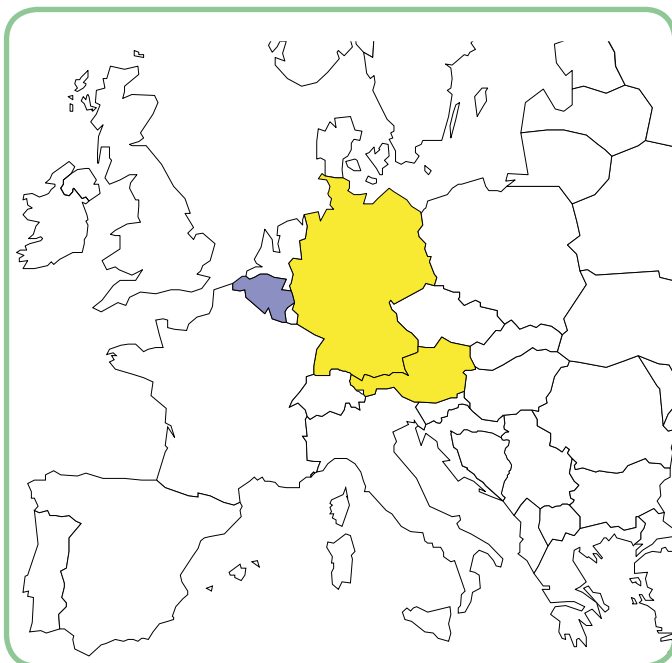

Only the product range to be marketed in your country and validated by the local product manager, in agreement with his Final Distribution (FD) partner should be retained. The others will be removed before publication.

DE408950

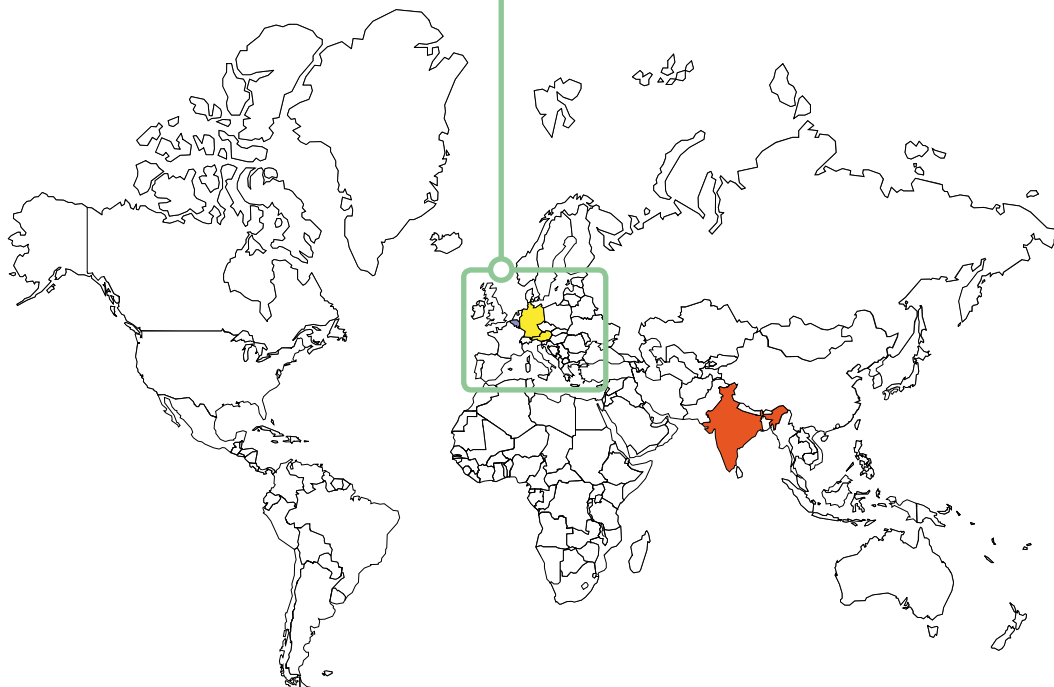



IEC/EN 61008-1



- The ID K Biconnect residual current circuit breakers offer the following functions:
 - protection of persons against electric shock by direct contact (30 mA),
 - protection of persons against electric shock by indirect contact (300 mA),
 - protection of installations against the risks of fire (300 mA).

Catalogue numbers

ID K Biconnect residual current circuit breakers						
Type		AC		A		Width in 9 mm modules
2P 	Sensitivity	30 mA	300 mA	30 mA	300 mA	4
	Rating	25 A A9Z05225	-	A9Z01225	-	
		40 A A9Z05240	-	A9Z01240	-	
4P 	Sensitivity	30 mA	300 mA	30 mA	300 mA	8
	Rating	25 A A9Z05425	-	A9Z01425	-	
		40 A A9Z05440	A9Z06440	A9Z01440	A9Z04440	
		63 A A9Z05463	A9Z06463	A9Z01463	A9Z04463	
Operating voltage (Ue)	2P	230 - 240 V				
	4P	400 - 415 V				
Operating frequency	50 Hz					

Offer selection see page 185

Offer A

Catalogue numbers

ID K Biconnect residual current circuit breakers Type G				
Type		AC	AC THV	Width in 9 mm modules
4P 	Sensitivity	30 mA Type G	30 mA Type G	8
	Rating	40 A A9Z07440	A9Z08440	
Operating voltage (Ue)	400 - 415 V			
Operating frequency	50 Hz			

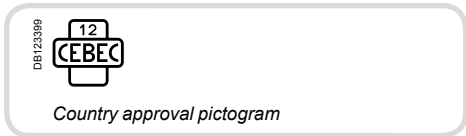

IEC/EN 61008-1

- The ID K Biconnect residual current circuit breakers offer the following functions:
 - protection of persons against electric shock by direct contact (30 mA),
 - protection of persons against electric shock by indirect contact (300 mA),
 - protection of installations against the risks of fire (300 mA).

- Delivered with sealable screw shield (lead sealing wire diameter: mini 1.5 mm, maxi 1.7 mm).



Catalogue numbers

ID K Biconnect residual current circuit breakers				
Type	A			Width in 9 mm modules
	Sensitivity	30 mA	300 mA	
2P 	Rating	40 A	A9Z02240	4
		63 A	A9Z02263	
4P 	Rating	40 A	A9Z02440	8
		63 A	A9Z02463	
Operating voltage (Ue)	2P	230 - 240 V		
	4P	400 - 415 V		
Operating frequency	50 Hz			

Offer selection see page 185

Offer B

This sticker must be removed before publishing

ID K Biconnect residual current circuit breakers (cont.)

PE110018-40

- Test button: used to check that the residual current device is operating correctly
- Large space for marking circuits
- Indication of the earth fault on the front panel by the position of the handle
- Terminals insulated to IP20
- Connection**
 - Downstream by Biconnect comb busbar
 - Upstream/downstream by tunnel terminals

Connection

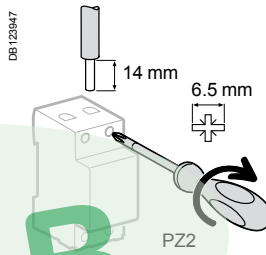

Type	Tightening torque	Copper cables	
		Rigid	Flexible or with ferrule
ID K Biconnect	3.5 N.m	DB122945 1 to 35 mm ²	DB122946 1 to 25 mm ²

■ Connection by comb busbar or cables (conforms to EN 50027).

Technical data

Main characteristics

Insulation voltage (U _i)	440 V	
Degree of pollution	2	
Rated impulse withstand voltage (U _{imp})	4 kV	
Making and breaking capacity (I _m /I _{Δm})	500 A	
Impulse current withstand (8/20 μs) without tripping	Up to 200 Å	
Conditional rated short-circuit current (I _{nc} /I _{Δc})	With circuit breaker	6000 A
	With fuse	4500 A
Behaviour in case of voltage drop	Residual current protection down to 0 V according to IEC/EN 61008-1 § 3.3.4	

Additional characteristics

Degree of protection	Device only	IP20
	Device in a modular enclosure	IP40
Endurance (O-C)	Electrical	2000 cycles (AC1)
	Mechanical	5000 cycles
Operating temperature	AC type	-5°C to +40°C
	A type	-25°C to +40°C
Storage temperature		-30°C to +70°C

Offer selection see page 185

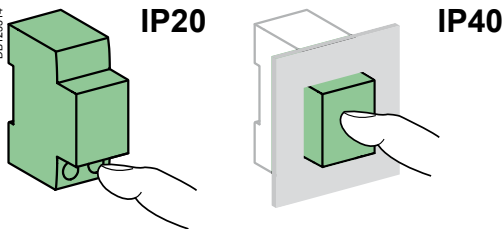
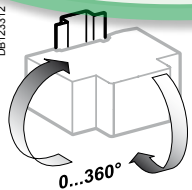

Weight (g)

Residual current circuit breakers	
Type	ID K Biconnect
2P	180
4P	350

Dimensions (mm)

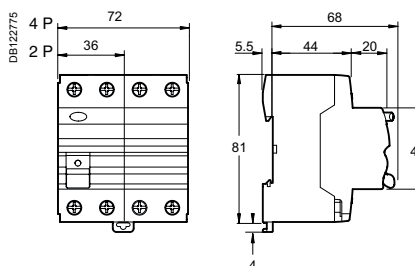

DB4C4807



Country approval pictogram

PE110016-40



PE110016-40



IS 12640 (Part 1) IEC/EN 61008-1

- The ID K Biconnect residual current circuit breakers offer the following functions:
 - protection of persons against electric shock by direct contact (30 mA),
 - protection of persons against electric shock by indirect contact (≥ 100 mA),
 - protection of installations against the risks of fire (300 mA).

Catalogue numbers

ID K Biconnect residual current circuit breakers						
Type	AC			Width in 9 mm modules		
	Sensitivity	30 mA	100 mA	300 mA		
2P DB122476	Rating	25 A	A9KR11225	A9KR12225	A9KR14225	4
		40 A	A9KR11240	A9KR12240	A9KR14240	
		63 A	A9KR11263	A9KR12263	A9KR14263	
4P DB122477	Rating	25 A	A9KR11425	A9KR12425	A9KR14425	8
		40 A	A9KR11440	A9KR12440	A9KR14440	
		63 A	A9KR11463	A9KR12463	A9KR14463	
Operating voltage (Ue)	2P	240 V				
	4P	415 V				
Operating frequency	50 Hz					

Offer selection see page 185

offer C

This sticker must be removed before publishing

Connection

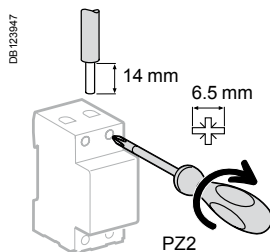

Type	Tightening torque	Copper cables	
		Rigid	Flexible or with ferrule
ID K Biconnect	3.5 N.m	 DB122845 1 to 35 mm ²	 DB122846 1 to 25 mm ²

PE110018-40

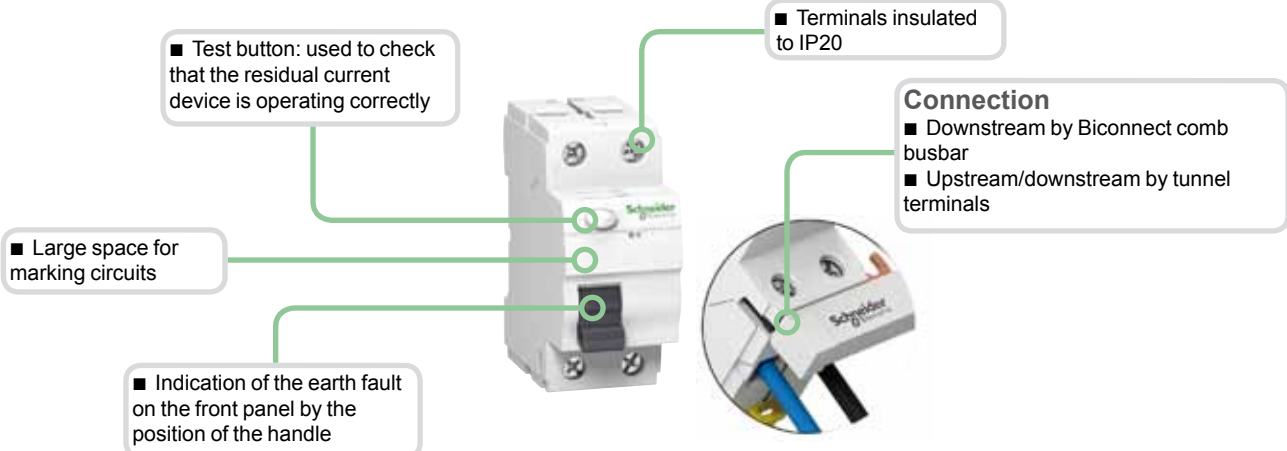

Offer selection see page 185

DB123310

DIN 35 mm

Offer C

This sticker must be removed before publishing

DB123312

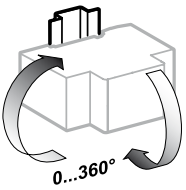

Indifferent position of installation.

DB123314

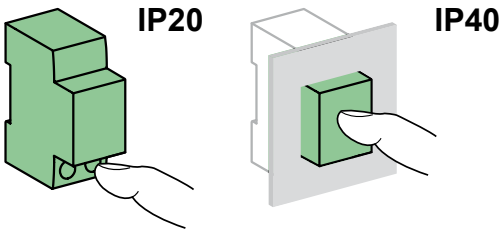

Technical data

Main characteristics		
Insulation voltage (U _i)		440 V
Degree of pollution		2
Rated impulse withstand voltage (U _{imp})		4 kV
Making and breaking capacity (I _m /I _{Δm})	25 - 40 A	500 A
	63 A	630 A
Impulse current withstand (8/20 μs) without tripping		Up to 200 Å
Conditional rated short-circuit current (I _{nc} /I _{Δc})	With circuit breaker	6000 A
	With fuse	4500 A
Behaviour in case of voltage drop		 Residual current protection down to 0 V according to IEC/EN 61008-1 § 3.3.4
Additional characteristics		
Degree of protection	Device only	IP20
	Device in a modular enclosure	IP40
		Insulation class II
Endurance (O-C)	Electrical	4000 cycles (AC1)
	Mechanical	5000 cycles
Operating temperature	AC type	-5°C to +55°C
Storage temperature		-25°C to +85°C
Tropicalization (IEC 60068-1)		Treatment 2 (relative humidity 95% at 55°C)

Weight (g)

Residual current circuit breakers	
Type	ID K Biconnect
2P	180
4P	350

Dimensions (mm)

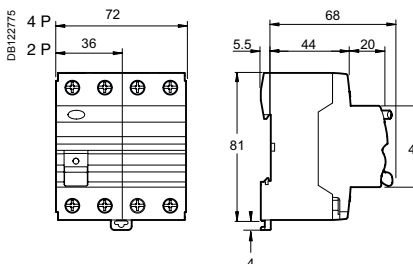



The Schneider Electric range of residual current circuit breakers comprises various offers (Clario, Prodis, Libro) so as to be as competitive as possible in each country, taking into account the specific features of each market:

- installation customs
- price
- approval by local organizations.

Variants

Offers		Pages
Clario	Catalogue numbers	192
Prodis	Catalogue numbers	193
Librio	Catalogue numbers	194
Common pages		195

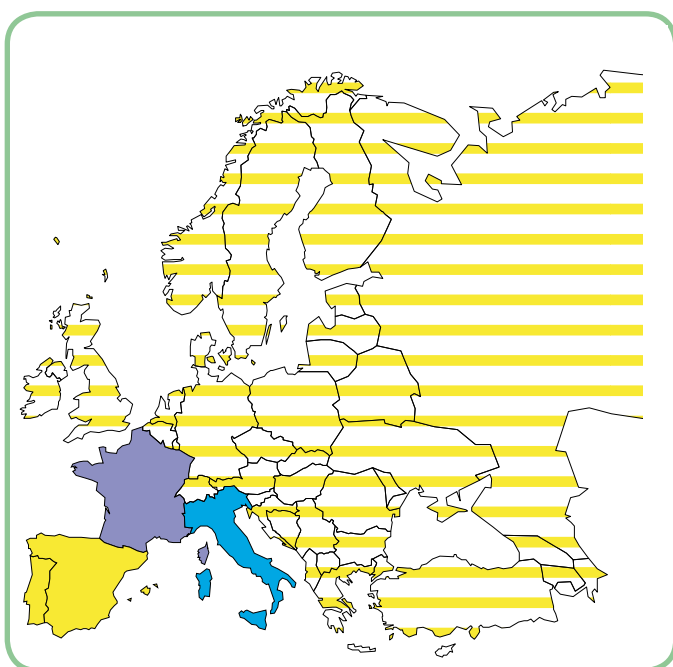

Only the product range to be marketed in your country and validated by the local product manager, in agreement with his Final Distribution (FD) partner should be retained. The others will be removed before publication.

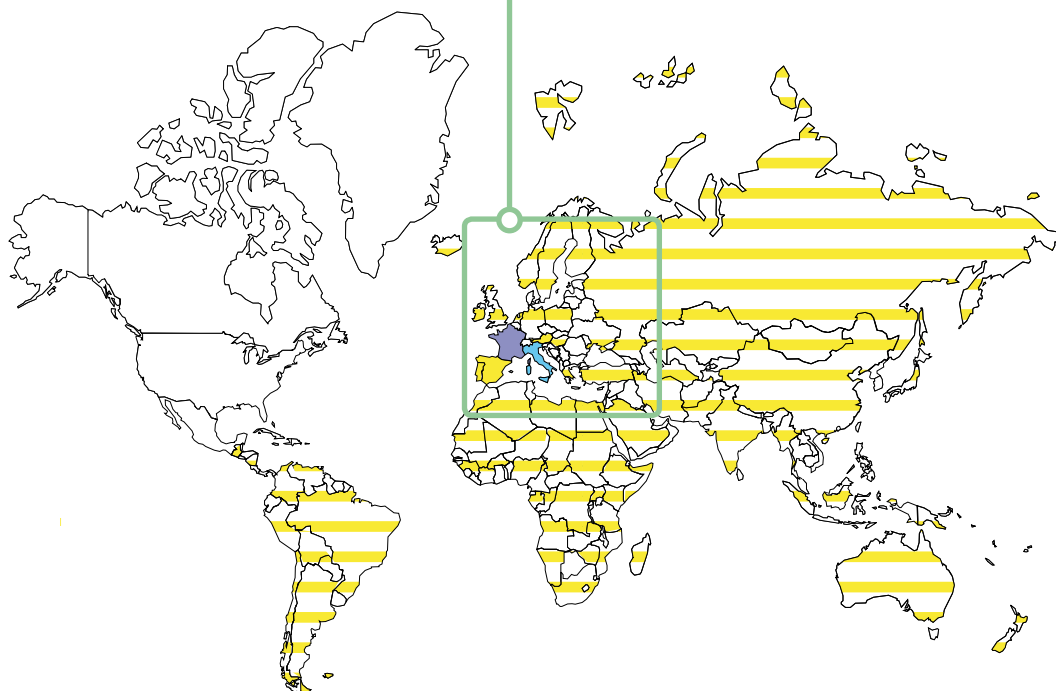



IEC/EN 61008-1

Adapted to the needs of service sector and industrial building installations, residual current circuit breakers ensure:

- earth leakage protection of final distribution circuits.
- disconnection.

In accordance with the IEC 61008 standard for residual current devices, a residual current circuit breaker also performs the function of disconnection of electrical circuits.

Residual current circuit breakers include in their enclosure the residual current relay and the toroid. The residual current tripping device is electromechanical and operates without an auxiliary source.

Operation

- When an earth fault occurs, the residual current circuit breaker uses the energy of the fault to perform tripping. Fault indication is performed on the front panel by a mechanical indicator.
- Resetting is performed using the reset handle.

PB107117-32



Offer selection see page 191

Clario

This sticker must be removed before publishing

Catalogue numbers

Residual current circuit breakers

Type	AC	SI	Width in 9-mm modules			
Auxiliaries	Modules CA907008 and CA907010	Modules CA907008 and CA907010				
1P+N	Sensitivity 30 mA	300 mA	30 mA	300 mA		
	Rating 25 A	A9N21780	A9N21781	A9N21784	-	4
	40 A	A9N21782	A9N21783	A9N21786	A9N21785	
Voltage rating (Ue)	230 V AC	230 V AC				
Operating frequency	50 Hz	50 Hz				
Accessories	Modules CA907010 and CA907012	Modules CA907010 and CA907012				

DB123685

"Group Feeder"

- Residual current circuit breakers are especially suitable for "Group Feeder" protection: the downstream terminals are located in the upper part of the device for direct connection to the comb busbar.



Terminals with guard

- Automatic cable guiding in the correct position

PB107117-40

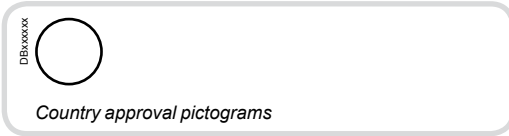

IEC/EN 61008-1

Adapted to the needs of service sector and industrial building installations, residual current circuit breakers ensure:

- earth leakage protection of final distribution circuits.
- disconnection.

In accordance with the IEC 61008 standard for residual current devices, a residual current circuit breaker also performs the function of disconnection of electrical circuits.

Residual current circuit breakers include in their enclosure the residual current relay and the toroid. The residual current tripping device is electromechanical and operates without an auxiliary source.

Operation

- When an earth fault occurs, the residual current circuit breaker uses the energy of the fault to perform tripping. Fault indication is performed on the front panel by a mechanical indicator.
- Resetting is performed using the reset handle.

PE107180-32

Offer selection see page 191

Prodis

This sticker must be removed before publishing

Catalogue numbers

Residual current circuit breakers						
Type		AC			SI	Width in 9-mm modules
Auxiliaries		Modules CA907008 and CA907010		Modules CA907008 and CA907010		
1P+N	Sensitivity	30 mA	300 mA	30 mA	300 mA	
	Rating	25 A	A9N21520	A9N21522	A9N21524	4
		40 A	A9N21521	A9N21523	A9N21526	
Voltage rating (Ue)		230 V AC		230 V AC		
Operating frequency		50 Hz		50 Hz		
Accessories		Modules CA907010 and CA907012		Modules CA907010 and CA907012		

DB123685

"Group Feeder"

- Residual current circuit breakers are especially suitable for "Group Feeder" protection: the downstream terminals are located in the upper part of the device for direct connection to the comb busbar



Terminals with guard

- Automatic cable guiding in the correct position

PE107180-40

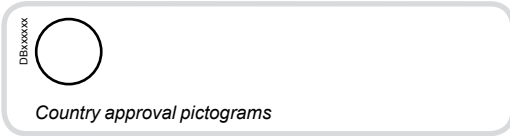

IEC/EN 61008-1

Adapted to the needs of service sector and industrial building installations, residual current circuit breakers ensure:

- earth leakage protection of final distribution circuits.
- disconnection.

In accordance with the IEC 61008 standard for residual current devices, a residual current circuit breaker also performs the function of disconnection of electrical circuits.

Residual current circuit breakers include in their enclosure the residual current relay and the toroid. The residual current tripping device is electromechanical and operates without an auxiliary source.

Operation

- When an earth fault occurs, the residual current circuit breaker uses the energy of the fault to perform tripping. Fault indication is performed on the front panel by a mechanical indicator.
- Resetting is performed using the reset handle.

PEI 07910-32



Offer selection see page 191

Librio

This sticker must be removed before publishing
Catalogue numbers

Residual current circuit breakers

Type	AC	A	S/	Width in 9-mm modules
Auxiliaries	Modules CA907008 and CA907010		Modules CA907008 and CA907010	Modules CA907008 and CA907010
1P+N	Sensitivity 30 mA 300 mA		30 mA 300 mA	30 mA 300 mA
Rating	25 A 40 A	A9N19410 A9N19411 A9N19412 A9N19413	A9N19414 A9N19415 A9N19416 A9N19417	A9N19418 - A9N19420 A9N19423
Voltage rating (Ue)	230 V AC		230 V AC	230 V AC
Operating frequency	50 Hz		50 Hz	50 Hz
Accessories	Modules CA907010 and CA907012		Modules CA907010 and CA907012	Modules CA907010 and CA907012

DB123685

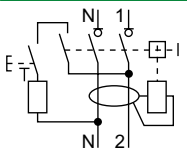

"Group Feeder"
■ Residual current circuit breakers are especially suitable for "Group Feeder" protection: the downstream terminals are located in the upper part of the device for direct connection to the comb busbar



Terminals with guard
■ Automatic cable guiding in the correct position

Connection

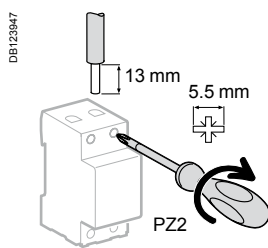

Rating	Tightening torque	Copper cables	
		Rigid	Flexible or with ferrule
25 and 40 A	2 N.m	1 to 16 mm ²	1 to 10 mm ²

- Where there is a comb busbar tooth, the connection of cables of cross section 16 mm² remains possible.
- Connection by comb busbar or cables (as per EN 50027).

“Group Feeder” connection:

- Upstream: by cables.
- Downstream: direct by comb busbar.

Technical data

Main characteristics

Insulation voltage (Ui)		440 V AC
Voltage rating (Ue)	Phase-to-neutral	230 V AC
	Phase-to-phase	400 V AC
Rated impulse withstand voltage (Uimp)		4 kV
Positive contact indication		A green strip on the operating handle guarantees opening of all the poles in safety conditions for work to be carried out on live parts

According to IEC/EN 61008-1

Rated residual breaking and making capacity (IΔm)		1 kA
Rated breaking and making capacity (Im)	Instantaneous	1 kA
	Selective	630 A
Rated conditional short-circuit current (Inc) identical to the rated residual short-circuit current (IΔc)	Instantaneous	6 kA
	Selective	630 A
Behaviour in case of voltage drop		Residual current protection down to 0 V according to IEC/EN 61008-1 § 3.3.4

Additional characteristics

Degree of protection (IEC 60529)	Device only	IP20
	Device in modular enclosure	IP40
Operating temperature	AC Types	-5°C to +40°C
	A, S/ types	-25°C to +40°C
Storage temperature		-40°C to +70°C
Tropicalization (IEC 60068-1)		Treatment 2 (relative humidity of 95 % at 55°C)

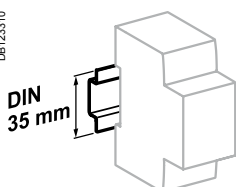

Clip on DIN rail 35 mm.

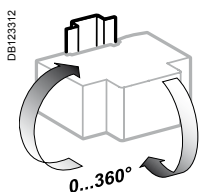

Indifferent position of installation.

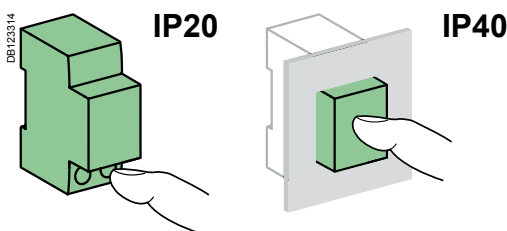

Dimensions (mm)

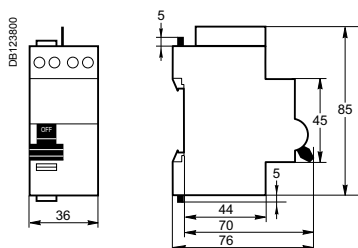

Weight (g)

Residual current circuit breakers

Type

1P+N	205
------	-----

RCCB-ID 125 A residual current circuit breaker (AC, A, SI types)

IEC/EN 61008-1
VDE 0664

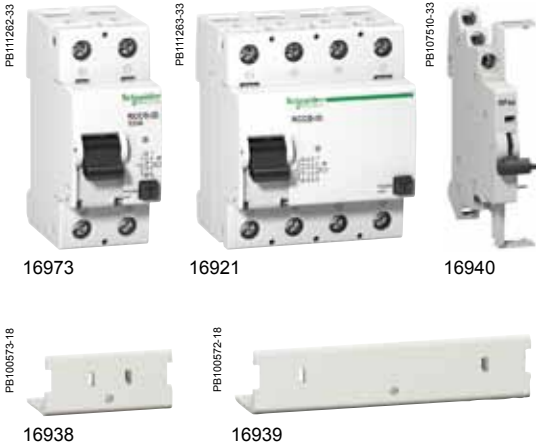

- The RCCB-ID 125 A residual current circuit breakers provide:
 - protection of persons against electric shock by direct contact (30 mA),
 - protection of persons against electric shock by indirect contact (≥ 100 mA),
 - protection of installations against the risk of fire (300 mA or 500 mA).

The **SI** type provides increased immunity from electrical interference and polluted or corrosive environments.

OFsp auxiliary

- Electrical indication: by OFsp auxiliary mounted to the left, it has a double changeover switch indicating the "open" or "closed" position of the RCCB-ID 125 A.

Accessories

- 2P and 4P sealable screw shield.

Catalogue numbers

RCCB-ID 125 A residual current circuit breakers													
Type		AC	A				SI				Width in 9 mm module		
2P	Sensitivity	30 mA	100 mA	300 mA	500 mA	30 mA	300 mA	300 mA	500 mA	30 mA	300 mA		
	Rating	125 A	16966	-	16967	-	16970	16971	-	-	16972	16973	4
4P	Sensitivity	30 mA	100 mA	300 mA	500 mA	30 mA	300 mA	300 mA	500 mA	30 mA	300 mA		
	Rating	125 A	16905	16906	16907	16908	16924	16926	16925	16927	16920	16921	8
Voltage rating (Ue)	2P	230 V											
	4P	400 V											
Operating frequency	50 Hz												

Auxiliary				
Type				Width in 9 mm module
Contact OFsp	Contact	Voltage		
	1 A	110 V DC		16940
	6 A	230 V AC (AC15)		

Accessory		
Type	Number of pole	
Screw shield (set of 10) for upstream or downstream	2P	16938
	4P	16939

RCCB-ID 125 A residual current circuit breaker (AC, A, SI types) (cont.)

Connection

■ By tunnel terminals for:

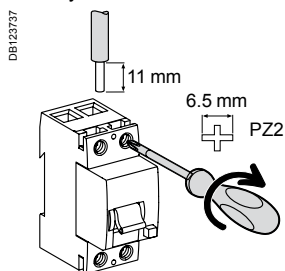

Type	Tightening torque	Copper cables	
		Rigid	Flexible or with ferrule
RCCB-ID	3 N.m	DB112804 	DB112805
		1 x 1.5 to 50 mm ² 2 x 1.5 to 16 mm ²	1 x 1.5 to 35 mm ² 2 x 1.5 to 16 mm ²
OFsp	0.8 N.m	1 to 1.5 mm ²	1 to 1.5 mm ²

OFsp contact status, depending on the position of the residual current circuit breaker

Type				
RCCB-ID 125 A	Closed	■	-	-
	Open	-	■	-
	Tripped on fault	-	-	■
Contact OFsp	22/21 12/11	Open	Closed	Closed
	14/11	Closed	Open	Open

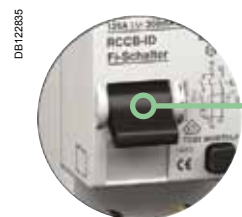

Indication of the status of the RCCB-ID via the 3-position toggle and front panel indicator

- Closed (red indicator)
- Tripped on fault (green indicator)
- Open (green indicator)

Technical data

Electrical characteristics	
Insulation voltage (U _i)	400 V
Pollution degree	3
Rated impulse withstand voltage (U _{imp})	4 kV

According to IEC/EN 61008-1		
Making and breaking capacity (I _m /I _{Δm})	1250 A	
Surge current withstand (8/20 μs) without tripping	AC and A types (no selective ☒)	250 Å
	SI type (no selective ☒)	3 kÅ
	AC, A and SI types (selective ☒)	3 kÅ
Conditional rated short circuit current (I _{nc} /I _{Δc})	With FU 125 A gG fuse	10,000 A
Behaviour in case of voltage drop		Residual current protection down to 0 V according to IEC/EN 61008-1 § 3.3.4

Additional characteristics			
Degree of protection	Device only	IP20 IP40 with screw shield	
	Device in modular enclosure	IP40 Insulation class II	
Endurance (O-C)	Electrical	> 2 000 cycles	
	Mechanical	> 5 000 cycles	
Operating temperature		-25°C to +40°C	
Storage temperature		-40°C to +85°C	
Range of test button operating voltage	30 mA	2P	160...250 V AC
		4P	250...440 V AC
	100, 300, 500 mA	2P	185...250 V AC
		4P	185...440 V AC

Weight (g)

Residual current circuit breakers and auxiliary		
Type	RCCB-ID 125 A	OFsp
2P	230	40
4P	420	

Dimensions (mm)

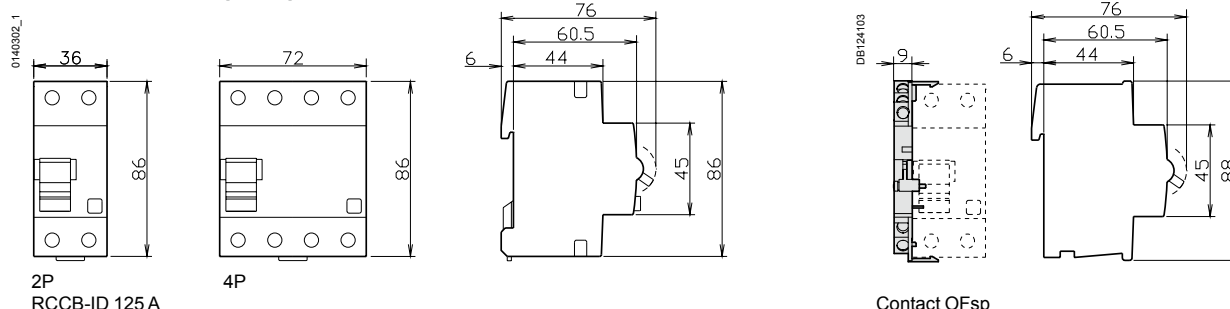

IEC/EN 61008-1 VDE 0664



16766



16940



16939

- The RCCB-ID 125 A residual current circuit breakers provide:
 - protection of persons against electric shock by direct contact (30 mA),
 - protection of persons against electric shock by indirect contact (≥ 300 mA),
 - protection of installations against the risk of fire (300 mA or 500 mA).

B type

The RCCB-ID B type residual current circuit breakers provide:

- protection in the event of a continuous fault current on three-phase networks generated by:
 - controllers and variable speed drives,
 - battery chargers and inverters,
 - backed-up power supplies.

- They include and also guarantee protection against fault currents:

- sinusoidal AC residual currents (AC type),
- pulsed DC residual currents (A type).

They can be adapted to all the application cases defined in standards IEC 60364 and EN 50178.

- Schneider Electric guarantees that the type B RCCB-ID works correctly in combination with the variable speed drives manufactured by Schneider Electric.

OFsp auxiliary



- Electrical indication: by OFsp auxiliary mounted to the left.
It has a double changeover switch indicating the "open" or "closed" position of the RCCB-ID B type.

Accessories

- 4P sealable screw shield.

Catalogue numbers

RCCB-ID B type residual current circuit breakers

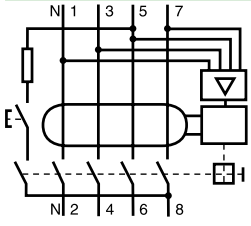
Type		B  				Width in 9 mm module
4P		Sensitivity	30 mA	300 mA	300 mA 	500 mA
	Rating	25 A	16750	16751	-	-
		40 A	16752	16753	16754	16755
		63 A	16756	16757	16758	16759
		80 A	16760	16761	16762	-
		125 A	16763	16764	16765	16766
Voltage rating (Ue)		230/400 V				
Operating frequency		50 Hz				

Auxiliary

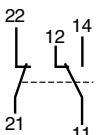
Type		Contact OFsp		Width in 9 mm module
Contact OFsp		Contact	Voltage	
		1 A	110 V DC	16940
		6 A	230 V AC (AC15)	

Accessory

Type	Number of pole	
Screw shield (set of 10) for upstream or downstream	4P	16939

Connection

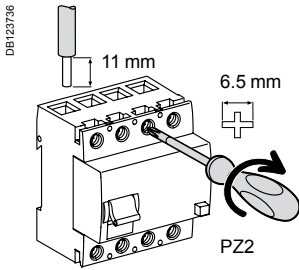

Type	Tightening torque	Copper cables	
		Rigid	Flexible or with ferrule
RCCB-ID B type	3 N.m	1 x 1.5 to 50 mm ² 2 x 1.5 to 16 mm ²	1 x 1.5 to 35 mm ² 2 x 1.5 to 16 mm ²
OFsp	0.8 N.m	1 to 1.5 mm ²	1 to 1.5 mm ²

OFsp contact status, depending on the position of the residual current circuit breaker

Type				
RCCB-ID B type	Closed	■	-	-
	Open	-	■	-
	Tripped on fault	-	-	■
Contact OFsp	22/21 12/11	Open	Closed	Closed
	14/11	Closed	Open	Open

Technical data

Electrical characteristics			
Insulation voltage (U _i)		400 V	
Pollution degree		3	
Rated impulse withstand voltage (U _{imp})		4 kV	
According to IEC/EN 61008-1			
Making and breaking capacity (I _m /I _{Δm})	25/40 A	500 A	
	63/80 A	800 A	
	125 A	1250 A	
Surge current withstand (8/20 μs) without tripping	No selective ☒	250 A	
	Selective ☑	3 kA	
Conditional rated short circuit current (I _{nc} /I _{Δc})	25/40 A with FU 80 A gG fuse	10,000 A	
	63 A with FU 100 A gG fuse	10,000 A	
	80/125 A with FU 125 A gG fuse	10,000 A	
Additional characteristics			
Degree of protection	Device only	IP20 IP40 with screw shield	
	Device in modular enclosure	IP40 Insulation class II	
Endurance (O-C)	Electrical	> 2 000 cycles	
	Mechanical	> 5 000 cycles	
Operating temperature		-25°C to +40°C	
Storage temperature		-40°C to +85°C	
Range of test button operating voltage	30 mA	2P	160...250 V AC
		4P	250...440 V AC
	100, 300, 500 mA	2P	185...250 V AC
		4P	185...440 V AC



Indication of the status of the RCCB-ID B type via the 3-position toggle and front panel indicator

- Closed (red indicator)
- Tripped on fault (green indicator)
- Open (green indicator)

Weight (g)

Type	RCCB-ID B type	OFsp
4P	450	40

Dielectric test

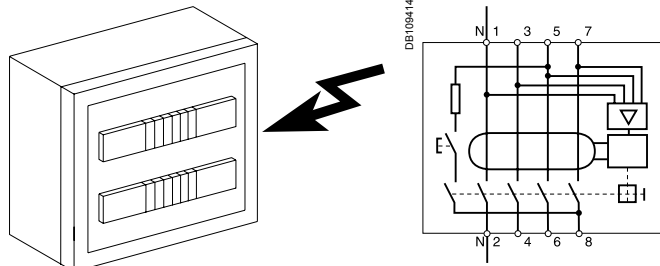

⚠ To perform the dielectric test, disconnect terminals 3, 5, 7 and 4, 6, 8.

Dimensions (mm)

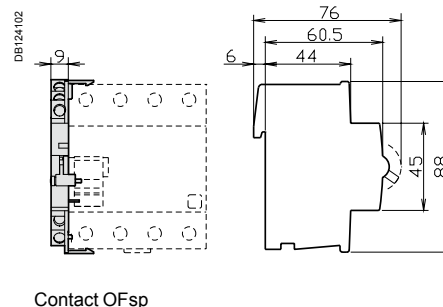
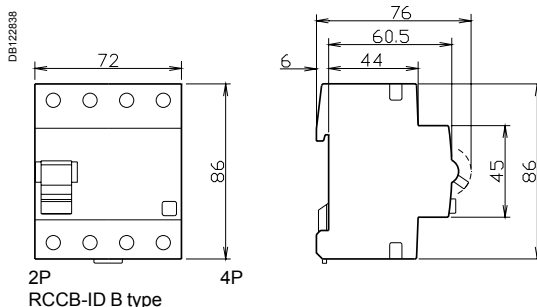



Schneider Electric's range of add-on residual current devices consists of different products (A, B, C, D, E) to enable it to be the most competitive range possible in each country, allowing for the special characteristics of each market:

- usual installation procedure
- price
- accreditations by local bodies.

Variants

Offers		Pages
Offer A	Catalogue numbers	201 and 208
Offer B	Catalogue numbers	204 and 208
Offer C	Catalogue numbers	207 and 208
Offer D Quick Vigi	Catalogue numbers	209 and 215
Offer E Quick Vigi	Catalogue numbers	212 and 215
Common pages		17



Only the product range to be marketed in your country and validated by the local product manager, in agreement with his Final Distribution (FD) partner should be retained. The others will be removed before publication.





IEC/EN 61009-1



- Combined with iC60 circuit breaker, the Vigi iC60 provide:
 - protection of persons against electric shock by direct contact (≤ 30 mA),
 - protection of persons against electric shock by indirect contact (≥ 100 mA),
 - protection of installations against the risk of fire (300 mA or 500 mA).

Catalogue numbers

Vigi iC60 add-on residual current devices for 230/400 V network										
Type	AC									Width in 9 mm modules
Auxiliaries	Without auxiliaries									
2P	Sensitivity	10 mA	30 mA	100 mA	300 mA	500 mA	300 mA	1000 mA		
 DB122462	Rating	25 A	A9V10225	A9V11225	A9V12225	A9V14225	A9V16225	-	-	3
		40 A	-	A9V11240	-	A9V14240	A9V16240	-	-	4
		63 A	-	A9V11263	A9V12263	A9V14263	A9V16263	A9V15263	A9V19263	4
 DB122463	Rating	25 A	-	A9V11325	-	A9V14325	A9V16325	-	-	6
		40 A	-	A9V11340	-	A9V14340	A9V16340	-	-	7
		63 A	-	A9V11363	-	A9V14363	A9V16363	A9V15363	A9V19363	7
 DB122464	Rating	25 A	-	A9V11425	A9V12425	A9V14425	A9V16425	-	-	6
		40 A	-	A9V11440	-	A9V14440	A9V16440	-	-	7
		63 A	-	A9V11463	A9V12463	A9V14463	A9V16463	A9V15463	A9V19463	7
Voltage rating (Ue)	2P	230 - 240 V								
	3P-4P	400 - 415 V								
Operating frequency	50/60 Hz									
Accessories	Module CA907000									

Offer selection see page 200

Offer A

This sticker must be removed before publishing

Vigi iC60 add-on residual current devices for 110 V network					
Type	AC				Width in 9 mm modules
Auxiliaries	Without auxiliaries				
2P	Sensitivity	30 mA	300 mA		
 DB122462	Rating	25 A	A9V01225	A9V04225	3
		40 A	A9V01240	A9V04240	4
		63 A	A9V01263	A9V04263	4
Voltage rating (Ue)	110 V				
Operating frequency	50/60 Hz				
Accessories	Module CA907000				

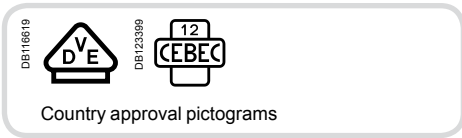

IEC/EN 61009-1

PB 104466-35

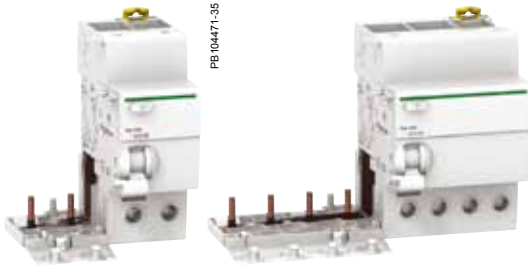

PB 104471-35

- Combined with iC60 circuit breaker, the Vigi iC60 provide:
 - protection of persons against electric shock by direct contact (30 mA),
 - protection of persons against electric shock by indirect contact (≥ 100 mA),
 - protection of installations against the risk of fire (300 mA or 500 mA).

Catalogue numbers

Vigi iC60 add-on residual current devices for 230/400 V network									
Type	A							Width in 9 mm modules	
Auxiliaries	Without auxiliaries								
2P	Sensitivity	30 mA	100 mA	300 mA	500 mA	300 mA	1000 mA		
 DB122462	Rating	25 A	A9V21225	A9V22225	A9V24225	A9V26225	-	3	
		63 A	A9V21263	A9V22263	A9V24263	A9V26263	A9V25263	A9V29263	4
 DB122463	Rating	25 A	A9V21325	A9V22325	A9V24325	A9V26325	-	6	
		63 A	A9V21363	-	A9V24363	A9V26363	A9V25363	A9V29363	7
 DB122464	Rating	25 A	A9V21425	A9V22425	A9V24425	A9V26425	-	6	
		63 A	A9V21463	A9V22463	A9V24463	A9V26463	A9V25463	A9V29463	7
Voltage rating (Ue)	2P	230 - 240 V							
	3P-4P	400 - 415 V							
Operating frequency	50/60 Hz								
Accessories	Module CA907000								

Offer selection see page 200

Offer A

This sticker must be removed before publishing

Vigi iC60 add-on residual current devices for 400 V network				
Type	A			Width in 9 mm modules
Auxiliaries	Without auxiliaries			
2P	Sensitivity	30 mA		
 DB122462	Rating	63 A		A9V07263
Voltage rating (Ue)	400 - 415 V			
Operating frequency	50/60 Hz			
Accessories	Module CA907000			



IEC/EN 61009-1



- Combined with iC60 circuit breaker, the Vigi iC60 provide:
 - protection of persons against electric shock by direct contact (≤ 30 mA),
 - protection of persons against electric shock by indirect contact (≥ 300 mA),
 - protection of installations against the risk of fire (300 mA).

The SI type provides increased immunity from electrical interference and polluted or corrosive environments.

Catalogue numbers

Vigi iC60 add-on residual current devices for 230/400 V network						
Type	SI					Width in 9 mm modules
Auxiliaries	Without auxiliaries					
2P	Sensitivity	10 mA	30 mA	300 mA	1000 mA	
 DB122462	Rating	25 A	A9V30225	A9V31225	-	3
		40 A	-	A9V31240	-	4
		63 A	-	A9V31263	A9V35263	A9V39263
 DB122463	Rating	25 A	-	A9V31325	-	6
		40 A	-	A9V31340	-	7
		63 A	-	A9V31363	A9V35363	A9V39363
 DB122464	Rating	25 A	-	A9V31425	-	6
		40 A	-	A9V31440	-	7
		63 A	-	A9V31463	A9V35463	A9V39463
Voltage rating (Ue)	2P	230 - 240 V				
	3P-4P	400 - 415 V				
Operating frequency	50/60 Hz					
Accessories	Module CA907000					

Offer selection see page 200

Offer A

This sticker must be removed before publishing



IEC/EN 61009-1

PB 104466-35

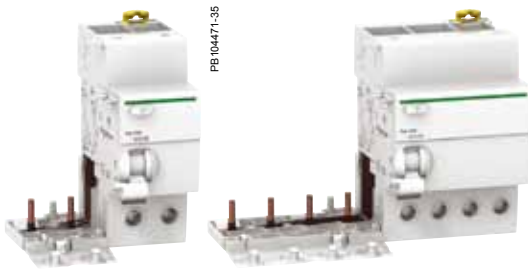

PB 104471-35

- Combined with iC60 circuit breaker, the Vigi iC60 provide:
 - protection of persons against electric shock by direct contact (≤ 30 mA),
 - protection of persons against electric shock by indirect contact (≥ 100 mA),
 - protection of installations against the risk of fire (300 mA or 500 mA).

Catalogue numbers

Vigi iC60 add-on residual current devices for 230/400 V network										
Type	AC								Width in 9 mm modules	
Auxiliaries	Without auxiliaries									
2P	Sensitivity	10 mA	30 mA	100 mA	300 mA	500 mA	300 mA	1000 mA		
 DB122462	Rating	25 A	A9V10225	A9V41225	A9V12225	A9V44225	A9V16225	-	3	
		40 A	-	A9V41240	-	A9V44240	A9V16240	-	4	
		63 A	-	A9V41263	A9V12263	A9V44263	A9V16263	A9V15263	A9V19263	4
 DB122463	Rating	25 A	-	A9V41325	-	A9V44325	A9V16325	-	6	
		40 A	-	A9V41340	-	A9V44340	A9V16340	-	7	
		63 A	-	A9V41363	-	A9V44363	A9V16363	A9V15363	A9V19363	7
 DB122464	Rating	25 A	-	A9V41425	A9V12425	A9V44425	A9V16425	-	6	
		40 A	-	A9V41440	-	A9V44440	A9V16440	-	7	
		63 A	-	A9V41463	A9V12463	A9V44463	A9V16463	A9V15463	A9V19463	7
Voltage rating (Ue)	2P	230 - 240 V								
	3P-4P	400 - 415 V								
Operating frequency	50/60 Hz									
Accessories	Module CA907000									

Vigi iC60 add-on residual current devices for 110 V network										
Type	AC								Width in 9 mm modules	
Auxiliaries	Without auxiliaries									
2P	Sensitivity	30 mA	300 mA							
 DB122462	Rating	25 A	A9V01225	A9V04225						3
		40 A	A9V01240	A9V04240						4
		63 A	A9V01263	A9V04263						4
Voltage rating (Ue)	110 V									
Operating frequency	50/60 Hz									
Accessories	Module CA907000									

Offer selection see page 200

Offer B

This sticker must be removed before publishing

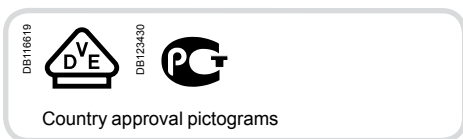

IEC/EN 61009-1



- Combined with iC60 circuit breaker, the Vigi iC60 provide:
 - protection of persons against electric shock by direct contact (30 mA),
 - protection of persons against electric shock by indirect contact (≥ 100 mA),
 - protection of installations against the risk of fire (300 mA or 500 mA).

Catalogue numbers

Vigi iC60 add-on residual current devices for 230/400 V network									
Type	A							Width in 9 mm modules	
Auxiliaries	Without auxiliaries								
2P	Sensitivity	30 mA	100 mA	300 mA	500 mA	300 mA	1000 mA		
 DB122462	Rating	25 A	A9V51225	A9V22225	A9V54225	A9V26225	-	3	
		63 A	A9V51263	A9V22263	A9V54263	A9V26263	A9V25263	A9V29263	4
 DB122463	Rating	25 A	A9V51325	A9V22325	A9V54325	A9V26325	-	6	
		63 A	A9V51363	-	A9V54363	A9V26363	A9V25363	A9V29363	7
 DB122464	Rating	25 A	A9V51425	A9V22425	A9V54425	A9V26425	-	6	
		63 A	A9V51463	A9V22463	A9V54463	A9V26463	A9V25463	A9V29463	7
Voltage rating (Ue)	2P	230 - 240 V							
	3P-4P	400 - 415 V							
Operating frequency	50/60 Hz								
Accessories	Module CA907000								

Offer selection see page 200

Offer B

This sticker must be removed before publishing

Vigi iC60 add-on residual current devices for 400 V network				
Type	A			Width in 9 mm modules
Auxiliaries	Without auxiliaries			
2P	Sensitivity	30 mA		
 DB122462	Rating	63 A		A9V07263
Voltage rating (Ue)	400 - 415 V			
Operating frequency	50/60 Hz			
Accessories	Module CA907000			



IEC/EN 61009-1

PB104466-35

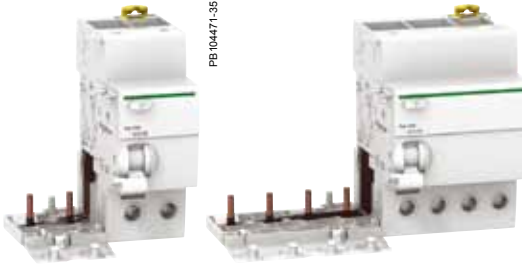

PB104471-35

- Combined with iC60 circuit breaker, the Vigi iC60 provide:
 - protection of persons against electric shock by direct contact (≤ 30 mA),
 - protection of persons against electric shock by indirect contact (≥ 300 mA),
 - protection of installations against the risk of fire (300 mA).

The SI type provides increased immunity from electrical interference and polluted or corrosive environments.

Catalogue numbers

Vigi iC60 add-on residual current devices for 230/400 V network						
Type	SI					Width in 9 mm modules
Auxiliaries	Without auxiliaries					
2P	Sensitivity	10 mA	30 mA	300 mA	1000 mA	
	Rating	25 A	A9V61225	A9V61225	-	3
		40 A	-	A9V61240	-	4
		63 A	-	A9V61263	A9V65263	A9V39263
	Rating	25 A	-	A9V61325	-	6
		40 A	-	A9V61340	-	7
		63 A	-	A9V61363	A9V65363	A9V39363
	Rating	25 A	-	A9V61425	-	6
		40 A	-	A9V61440	-	7
		63 A	-	A9V61463	A9V65463	A9V39463
Voltage rating (Ue)	2P	230 - 240 V				
	3P-4P	400 - 415 V				
Operating frequency	50/60 Hz					
Accessories	Module CA907000					

Offer selection see page 200

Offer B

This sticker must be removed before publishing

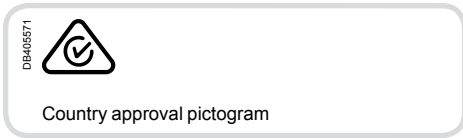

IEC/EN 61009-1

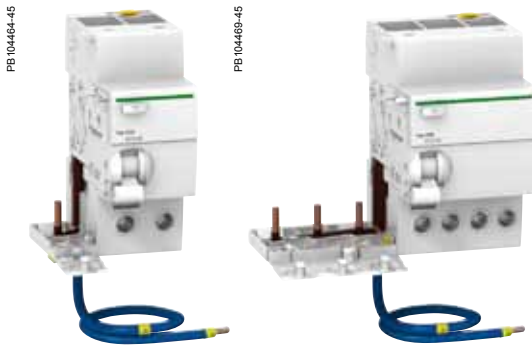

- Combined with iC60 circuit breaker, the Vigi iC60 provide:
 - protection of persons against electric shock by direct contact (30 mA),
 - protection of persons against electric shock by indirect contact (≥ 100 mA),
 - protection of installations against the risk of fire (300 mA).

Catalogue numbers

Vigi iC60 add-on residual current devices for 230/400 V network					
Type	A				Width in 9 mm modules
Auxiliaries	Without auxiliaries				
2P	Sensitivity	30 mA	100 mA	300 mA	
	Rating	25 A			3
		63 A	A9V02663	A9V03663	A9V06663
4P	Sensitivity	30 mA	100 mA	300 mA	
	Rating	63 A	-	A9V06763	7
Voltage rating (Ue)	2P	230 - 240 V			
	4P	400 - 415 V			
Operating frequency	50/60 Hz				
Accessories	Module CA907000				

Offer selection see page 200

Offer

This sticker must be removed before publishing

Vigi iC60 add-on residual current devices for 110 V network					
Type	A				Width in 9 mm modules
Auxiliaries	Without auxiliaries				
2P	Sensitivity	30 mA			
	Rating	63 A	A9V01663		4
Voltage rating (Ue)	110 V				
Operating frequency	50/60 Hz				
Accessories	Module CA907000				

Vigi iC60 add-on residual current devices (AC, A, SI types) (cont.)

PE104556-51



Offer selection see page 200

Association iC60a, N, H, L + Vigi iC60

iC60	Vigi iC60 25 A	Vigi iC60 40 A	Vigi iC60 63 A
0.5 A to 25 A	■	■	■
32 A - 40 A	NO	■	■
50 A - 63 A	NO	NO	■

Association iC60L-MA + Vigi iC60

iC60	Vigi iC60 25 A	Vigi iC60 40 A	Vigi iC60 63 A
1.6 A to 16 A	■	■	■
25 A	NO	■	■
40 A	NO	NO	■

Offer A, B, C
This sticker must be removed before publishing



Combining iC60 L-MA units with Vigi modules of higher rating.

PE104466-40

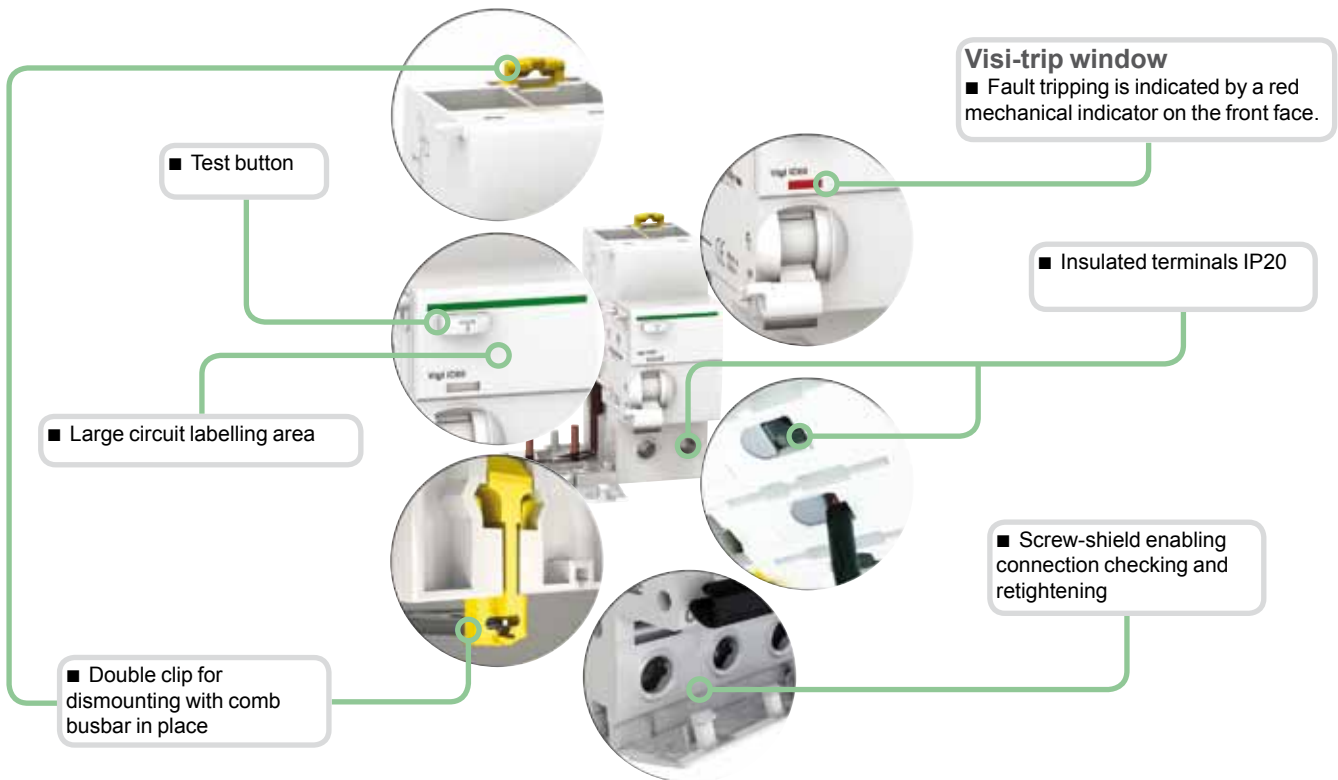

SI type

The SI type provides increased immunity from electrical interference and polluted or corrosive environments.



IEC/EN 61009-1

DB123811



- Combined with iC60 circuit breaker, the Vigi iC60 provide:
 - protection of persons against electric shock by direct contact (≤ 30 mA),
 - protection of persons against electric shock by indirect contact (≥ 100 mA),
 - protection of installations against the risk of fire (300 mA or 500 mA).

Catalogue numbers

Vigi iC60 add-on residual current devices for 230/400 V network									
Type	AC								Width in 9 mm modules
Auxiliaries		Without auxiliaries							
2P		Sensitivity	10 mA	30 mA	100 mA	300 mA	500 mA	300 mA	1000 mA
	Rating	25 A	A9Q10225	A9Q11225	A9Q12225	A9Q14225	A9Q16225	-	-
		40 A	-	A9Q11240	-	A9Q14240	A9Q16240	-	-
		63 A ⁽¹⁾	-	A9V11263	A9V12263	A9V14263	A9V16263	A9V15263	A9V19263
	Rating	25 A	-	A9Q11325	-	A9Q14325	A9Q16325	-	-
		40 A	-	A9Q11340	-	A9Q14340	A9Q16340	-	-
		63 A ⁽¹⁾	-	A9V11363	-	A9V14363	A9V16363	A9V15363	A9V19363
	Rating	25 A	-	A9Q11425	A9Q12425	A9Q14425	A9Q16425	-	-
		40 A	-	A9Q11440	-	A9Q14440	A9Q16440	-	-
		63 A ⁽¹⁾	-	A9V11463	A9V12463	A9V14463	A9V16463	A9V15463	A9V19463
Voltage rating (Ue)	2P	230 - 240 V							
	3P-4P	400 - 415 V							
Operating frequency	50/60 Hz								
Accessories	Module CA907000								

(1) Vigi iC60 add-on residual current devices rated at 63 A are VDE approved.

Offer D Quick

Offer selection see page 200

This sticker must be removed before publishing

Vigi iC60 add-on residual current devices for 110 V network									
Type	AC								Width in 9 mm modules
Auxiliaries		Without auxiliaries							
2P		Sensitivity	30 mA	300 mA					
	Rating	25 A	A9Q01225	A9Q04225					
		40 A	A9Q01240	A9Q04240					
		63 A ⁽¹⁾	A9V01263	A9V04263					
Voltage rating (Ue)	110 V								
Operating frequency	50/60 Hz								
Accessories	Module CA907000								

(1) Vigi iC60 add-on residual current devices rated at 63 A are VDE approved.



IEC/EN 61009-1

DB123811



- Combined with iC60 circuit breaker, the Vigi iC60 provide:
 - protection of persons against electric shock by direct contact (30 mA),
 - protection of persons against electric shock by indirect contact (≥ 100 mA),
 - protection of installations against the risk of fire (300 mA or 500 mA).

Catalogue numbers

Vigi iC60 add-on residual current devices for 230/400 V network								
Type	A							Width in 9 mm modules
Auxiliaries		Without auxiliaries						
Sensitivity		30 mA	100 mA	300 mA	500 mA	300 mA	1000 mA	
2P DB122462	Rating	25 A	A9Q21225	A9Q22225	A9Q24225	A9Q26225	-	3
		63 A ⁽¹⁾	A9V21263	A9V22263	A9V24263	A9V26263	A9V25263	A9V29263
3P DB122463	Rating	25 A	A9Q21325	A9Q22325	A9Q24325	A9Q26325	-	6
		63 A ⁽¹⁾	A9V21363	-	A9V24363	A9V26363	A9V25363	A9V29363
4P DB122464	Rating	25 A	A9Q21425	A9Q22425	A9Q24425	A9Q26425	-	6
		63 A ⁽¹⁾	A9V21463	A9V22463	A9V24463	A9V26463	A9V25463	A9V29463
Voltage rating (Ue)	2P	230 - 240 V						
	3P-4P	400 - 415 V						
Operating frequency	50/60 Hz							
Accessories	Module CA907000							

(1) Vigi iC60 add-on residual current devices rated at 63 A are VDE approved.

Offer selection see page 200

Offer D Quick

This sticker must be removed before publishing



IEC/EN 61009-1

DB123811



- Combined with iC60 circuit breaker, the Vigi iC60 provide:
 - protection of persons against electric shock by direct contact (≤ 30 mA),
 - protection of persons against electric shock by indirect contact (≥ 300 mA),
 - protection of installations against the risk of fire (300 mA).

The **SI** type provides increased immunity from electrical interference and polluted or corrosive environments.

Catalogue numbers

Vigi iC60 add-on residual current devices for 230/400 V network						
Type	SI					Width in 9 mm modules
Auxiliaries	Without auxiliaries					
2P	Sensitivity	10 mA	30 mA	300 mA	1000 mA	
	Rating	25 A	A9Q30225	A9Q31225	-	3
		40 A	-	A9Q31240	-	4
		63 A ⁽¹⁾	-	A9V31263	A9V35263	A9V39263
	Rating	25 A	-	A9Q31325	-	6
		40 A	-	A9Q31340	-	7
		63 A ⁽¹⁾	-	A9V31363	A9V35363	A9V39363
	Rating	25 A	-	A9Q31425	-	6
		40 A	-	A9Q31440	-	7
		63 A ⁽¹⁾	-	A9V31463	A9V35463	A9V39463
Voltage rating (Ue)	2P	230 - 240 V				
	3P-4P	400 - 415 V				
Operating frequency	50/60 Hz					
Accessories	Module CA907000					

(1) Vigi iC60 add-on residual current devices rated at 63 A are VDE approved.

Offer selection see page 200

Offer D Quick

This sticker must be removed before publishing



IEC/EN 61009-1

DB123611



- Combined with iC60 circuit breaker, the Vigi iC60 provide:
 - protection of persons against electric shock by direct contact (≤ 30 mA),
 - protection of persons against electric shock by indirect contact (≥ 100 mA),
 - protection of installations against the risk of fire (300 mA or 500 mA).

Catalogue numbers

Vigi iC60 add-on residual current devices for 230/400 V network										
Type	AC								Width in 9 mm modules	
Auxiliaries		Without auxiliaries								
2P	Sensitivity	10 mA	30 mA	100 mA	300 mA	500 mA	300 mA	1000 mA		
	Rating	25 A	A9Q10225	A9Q41225	A9Q12225	A9Q44225	A9Q16225	-	3	
		40 A	-	A9Q41240	-	A9Q44240	A9Q16240	-	4	
		63 A ⁽¹⁾	-	A9V41263	A9V12263	A9V44263	A9V16263	A9V15263	A9V19263	4
	Rating	25 A	-	A9Q41325	-	A9Q44325	A9Q16325	-	6	
		40 A	-	A9Q41340	-	A9Q44340	A9Q16340	-	7	
		63 A ⁽¹⁾	-	A9V41363	-	A9V44363	A9V16363	A9V15363	A9V19363	7
	Rating	25 A	-	A9Q41425	A9Q12425	A9Q44425	A9Q16425	-	6	
		40 A	-	A9Q41440	-	A9Q44440	A9Q16440	-	7	
		63 A ⁽¹⁾	-	A9V41463	A9V12463	A9V44463	A9V16463	A9V15463	A9V19463	7
Voltage rating (Ue)	2P	230 - 240 V								
	3P-4P	400 - 415 V								
Operating frequency	50/60 Hz									
Accessories	Module CA907000									

(1) Vigi iC60 add-on residual current devices rated at 63 A are VDE approved.

Vigi iC60 add-on residual current devices for 110 V network

Type	AC		Width in 9 mm modules		
Auxiliaries		Without auxiliaries			
2P	Sensitivity	30 mA	300 mA		
	Rating	25 A	A9Q01225	A9Q04225	3
		40 A	A9Q01240	A9Q04240	4
		63 A ⁽¹⁾	A9V01263	A9V04263	4
Voltage rating (Ue)	110 V				
Operating frequency	50/60 Hz				
Accessories	Module CA907000				

(1) Vigi iC60 add-on residual current devices rated at 63 A are VDE approved.

Offer selection see page 200

Offer E Quick

This sticker must be removed before publishing

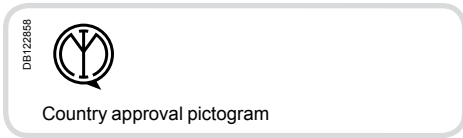

IEC/EN 61009-1

DB123811



- Combined with iC60 circuit breaker, the Vigi iC60 provide:
 - protection of persons against electric shock by direct contact (30 mA),
 - protection of persons against electric shock by indirect contact (≥ 100 mA),
 - protection of installations against the risk of fire (300 mA or 500 mA).

Offer selection see page 200

Offer E Quick

This sticker must be removed before publishing

Catalogue numbers

Vigi iC60 add-on residual current devices for 230/400 V network									
Type	A							Width in 9 mm modules	
Auxiliaries	Without auxiliaries								
2P	Sensitivity	30 mA	100 mA	300 mA	500 mA	300 mA	1000 mA		
	Rating	25 A	A9Q51225	A9Q22225	A9Q54225	A9Q26225	-	3	
		63 A ⁽¹⁾	A9V51263	A9V22263	A9V54263	A9V26263	A9V25263	A9V29263	4
	Rating	25 A	A9Q51325	A9Q22325	A9Q54325	A9Q26325	-	6	
		63 A ⁽¹⁾	A9V51363	-	A9V54363	A9V26363	A9V25363	A9V29363	7
	Rating	25 A	A9Q51425	A9Q22425	A9Q54425	A9Q26425	-	6	
		63 A ⁽¹⁾	A9V51463	A9V22463	A9V54463	A9V26463	A9V25463	A9V29463	7
Voltage rating (Ue)	2P	230 - 240 V,							
	3P-4P	400 - 415 V							
Operating frequency	50/60 Hz								
Accessories	Module CA907000								

(1) Vigi iC60 add-on residual current devices rated at 63 A are VDE approved.

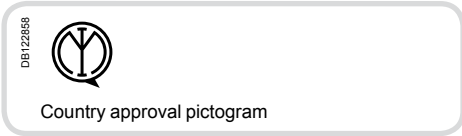

IEC/EN 61009-1

DB123811



- Combined with iC60 circuit breaker, the Vigi iC60 provide:
 - protection of persons against electric shock by direct contact (≤ 30 mA),
 - protection of persons against electric shock by indirect contact (≥ 300 mA),
 - protection of installations against the risk of fire (300 mA).

The **SI** type provides increased immunity from electrical interference and polluted or corrosive environments.

Offer selection see page 200

Offer E Quick

This sticker must be removed before publishing

Catalogue numbers

Vigi iC60 add-on residual current devices for 230/400 V network						
Type	SI					Width in 9 mm modules
Auxiliaries	Without auxiliaries					
2P	Sensitivity	10 mA	30 mA	300 mA	1000 mA	
	Rating	25 A	A9Q30225	A9Q61225	-	3
		40 A	-	A9Q61240	-	4
		63 A ⁽¹⁾	-	A9V61263	A9V65263	A9V39263
	Rating	25 A	-	A9Q61325	-	6
		40 A	-	A9Q61340	-	7
		63 A ⁽¹⁾	-	A9V61363	A9V65363	A9V39363
	Rating	25 A	-	A9Q61425	-	6
		40 A	-	A9Q61440	-	7
		63 A ⁽¹⁾	-	A9V61463	A9V65463	A9V39463
Voltage rating (Ue)	2P	230 - 240 V				
	3P-4P	400 - 415 V				
Operating frequency	50/60 Hz					
Accessories	Module CA907000					

(1) Vigi iC60 add-on residual current devices rated at 63 A are VDE approved.

Vigi iC60 add-on residual current devices (AC, A, SI types) (cont.)

DB128612



Offer selection see page 200

Association iC60a, N, H, L + Vigi iC60

iC60	Vigi iC60 25 A	Vigi iC60 40 A	Vigi iC60 63 A
0.5 A to 25 A	■	■	■
32 A - 40 A	NO	■	■
50 A - 63 A	NO	NO	■

Association iC60 L-MA + Vigi iC60

iC60	Vigi iC60 25 A	Vigi iC60 40 A	Vigi iC60 63 A
1.6 A to 16 A	■	■	■
25 A	NO	■	■
40 A	NO	NO	■



Combining iC60 L-MA units with Vigi modules of higher rating.

Offer D, E Quick

This sticker must be removed before publishing

DB128515

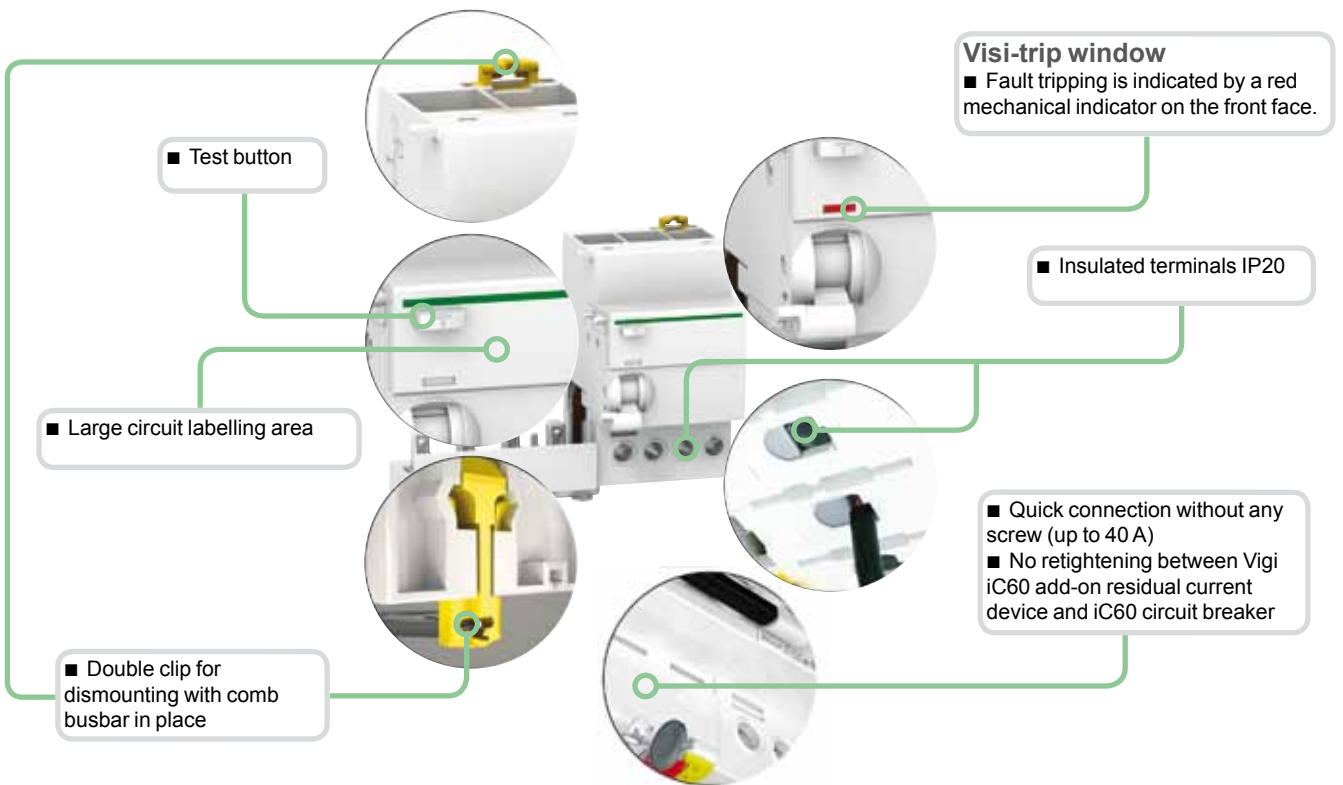

SI type

The SI type provides increased immunity from electrical interference and polluted or corrosive environments.

Vigi iC60 add-on residual current devices (AC, A, SI types) (cont.)

Connection

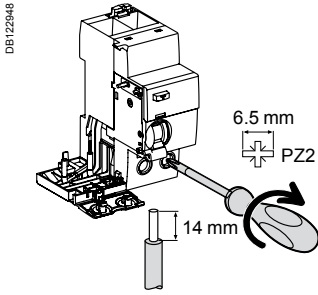

Type	Rating	Tightening torque	Copper cables	
			Rigid	Flexible or with ferrule
Vigi iC60	25 A	2 N.m	1 to 25 mm ²	1 to 16 mm ²
	40 to 63 A	3.5 N.m	1 to 35 mm ²	1 to 25 mm ²

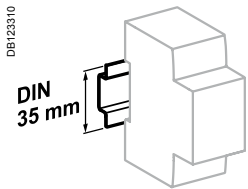



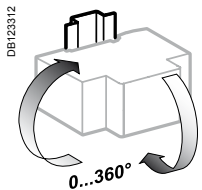

Clip on DIN rail 35 mm.

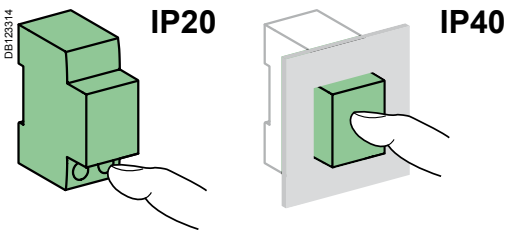

Indifferent position of installation.



Technical data

Main characteristics		
Insulation voltage (U _i)		500 V
Pollution degree		3
Rated impulse withstand voltage (U _{imp})		6 kV
According to IEC/EN 61009-1		
Surge current withstand (8/20 μs) without tripping	AC and A types (no selective )	250 Å
	AC, A types (selective )	3 kÅ
	SI type	3 kÅ
Behaviour in case of voltage drop		Residual current protection down to 0 V according to IEC/EN 61009-1 § 3.3.8
Additional characteristics		
Degree of protection	Device only	IP20
	Device in modular enclosure	IP40
Operating temperature	AC type	-5°C to +60°C
	A and SI types 	-25°C to +60°C
Storage temperature		-40°C to +85°C

Vigi iC60 add-on residual current devices (AC, A, SI types) (cont.)

Weight (g)

Add-on residual current devices	
Type	Vigi iC60
2P	165
3P	210
4P	245

Dimensions (mm)

Vigi iC60 25 A

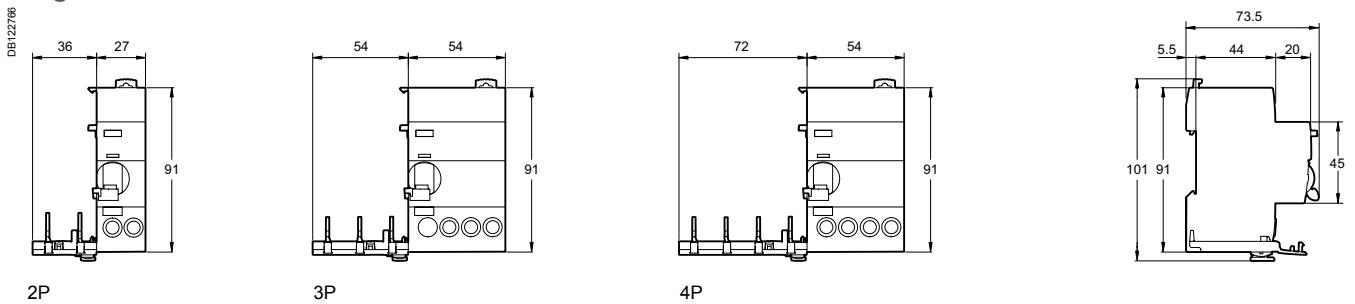

Vigi iC60 40 and 63 A

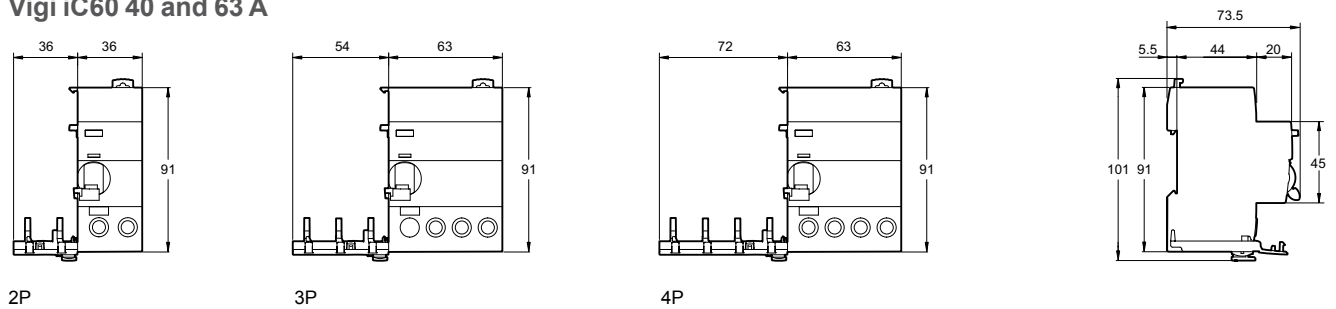

Vigi iC60 add-on residual current devices for iC60 double terminals (AC type)

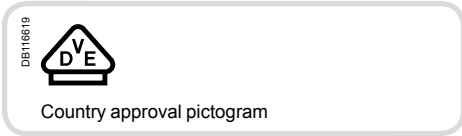

IEC/EN 61009-1

- Combined with iC60 double tunnel terminals circuit breaker, the Vigi iC60 provide:
 - protection of persons against electric shock by direct contact (≤ 30 mA),
 - protection of persons against electric shock by indirect contact (≥ 100 mA),
 - protection of installations against the risk of fire (300 mA).



Catalogue numbers

Vigi iC60 add-on residual current devices							
Type	AC					Width in 9 mm modules	
Product	Vigi iC60						
Auxiliaries	Without auxiliaries						
2P 	Sensitivity	10 mA	30 mA	100 mA	300 mA		
	Rating	25 A	A9W10225	A9W11225 A9W01225*	A9W12225	A9W14225	3
		63 A	-	A9W11263	A9W12263	A9W14263	4
3P 	Sensitivity	10 mA	30 mA	100 mA	300 mA		
	Rating	25 A	-	A9W11325	-	A9W14325	6
		63 A	-	A9W11363	-	A9W14363	7
4P 	Sensitivity	10 mA	30 mA	100 mA	300 mA		
	Rating	25 A	-	A9W11425	A9W12425	A9W14425	6
		63 A	-	A9W11463	A9W12463	A9W14463	7
Voltage rating (Ue)	2P	230 - 240 V Except * 130 V					
	3P-4P	400 - 415 V					
Operating frequency	50/60 Hz						
Accessories	Module CA907000						

Vigi iC60 add-on residual current devices for iC60 double terminals (A type)

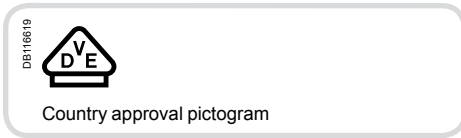

IEC/EN 61009-1

- Combined with iC60 double tunnel terminals circuit breaker, the Vigi iC60 provide:
 - protection of persons against electric shock by direct contact (30 mA),
 - protection of persons against electric shock by indirect contact (≥ 100 mA),
 - protection of installations against the risk of fire (300 mA or 500 mA).



Catalogue numbers

Vigi iC60 add-on residual current devices								
Type	A						Width in 9 mm modules	
Product	Vigi iC60							
Auxiliaries	Without auxiliaries							
	Sensitivity	30 mA	100 mA	300 mA	300 mA	500 mA		
DB110619 	Rating	25 A	A9W21225	A9W22225	A9W24225	-	A9W26225	3
		63 A	A9W21263	A9W22263	A9W24263	A9W25263	A9W26263	4
DB1224E3 	Rating	25 A	A9W21325	-	A9W24325	-	A9W26325	6
		63 A	A9W21363	-	A9W24363	A9W25363	A9W26363	7
DB124E511 	Rating	25 A	A9W21425	A9W22425	A9W24425	-	A9W26425	6
		63 A	A9W21463	A9W22463	A9W24463	A9W25463	A9W26463	7
Voltage rating (Ue)	2P	230 - 240 V						
	3P-4P	400 - 415 V						
Operating frequency	50/60 Hz							
Accessories	Module CA907000							

Vigi iC60 add-on residual current devices for iC60 double terminals (SI type)

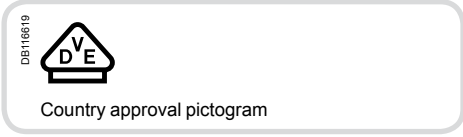

IEC/EN 61009-1

- Combined with iC60 double tunnel terminals circuit breaker, the Vigi iC60 provide:
 - protection of persons against electric shock by direct contact (≤ 30 mA),
 - protection of persons against electric shock by indirect contact (≥ 300 mA),
 - protection of installations against the risk of fire (300 mA).

The **SI** type provides increased immunity from electrical interference and polluted or corrosive environments.



Catalogue numbers

Vigi iC60 add-on residual current devices						
Type	SI					Width in 9 mm modules
Product	Vigi iC60					
Auxiliaries	Auxiliaries					
2P 	Sensitivity Rating	25 A	10 mA	30 mA	300 mA	3
		63 A	A9W30225	A9W31225	-	4
			-	A9W31263	A9W35263	
3P 	Sensitivity Rating	25 A	10 mA	30 mA	300 mA	6
		63 A	-	A9W31325	-	7
			-	A9W31363	A9W35363	
4P 	Sensitivity Rating	25 A	10 mA	30 mA	300 mA	6
		63 A	-	A9W31425	-	7
			-	A9W31463	A9W35463	
Voltage rating (Ue)	2P	230 - 240 V				
	3P-4P	400 - 415 V				
Operating frequency	50/60 Hz					
Accessories	Module CA907000					

Vigi iC60 add-on residual current devices for iC60 double terminals (AC, A, SI types)

Connection

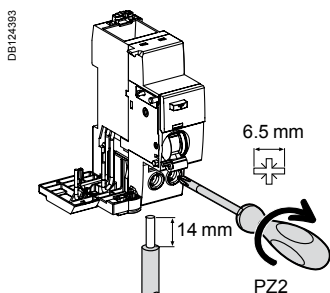

Type	Rating	Tightening torque	Copper cables	
			Rigid	Flexible or with ferrule
Vigi iC60	25 A	2 N.m	1 to 25 mm ²	1 to 16 mm ²
	63 A	3.5 N.m	1 to 35 mm ²	1 to 25 mm ²

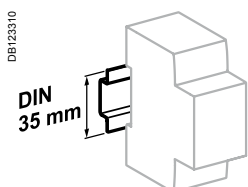

Clip on DIN rail 35 mm.

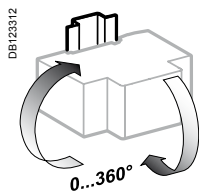

Indifferent position of installation.

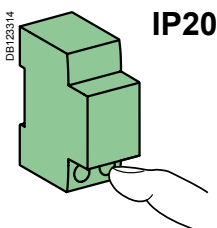

IP20

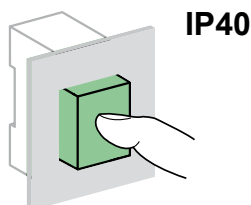

IP40

Technical data

Main characteristics

Insulation voltage (U _i)	500 V
Pollution degree	3
Rated impulse withstand voltage (U _{imp})	6 kV

According to IEC/EN 61009-1

Surge current withstand (8/20 μs) without tripping	AC and A types (no selective)	250 Å
	AC, A types (selective \square)	3 kÅ
	SI type	3 kÅ

Behaviour in case of voltage drop		Residual current protection down to 0 V according to IEC/EN 61009-1 § 3.3.8
-----------------------------------	---	---

Additional characteristics

Degree of protection	Device only	IP20
	Device in modular enclosure	IP40
Operating temperature	AC type	-5°C to +60°C
	A and SI types	-25°C to +60°C
Storage temperature		-40°C to +85°C

Vigi iC60 add-on residual current devices for iC60 double terminals (AC, A, SI types) (cont.)

Weight (g)

Add-on residual current devices	
Type	Vigi iC60
2P	165
3P	210
4P	245

Dimensions (mm)

Vigi iC60 25 A

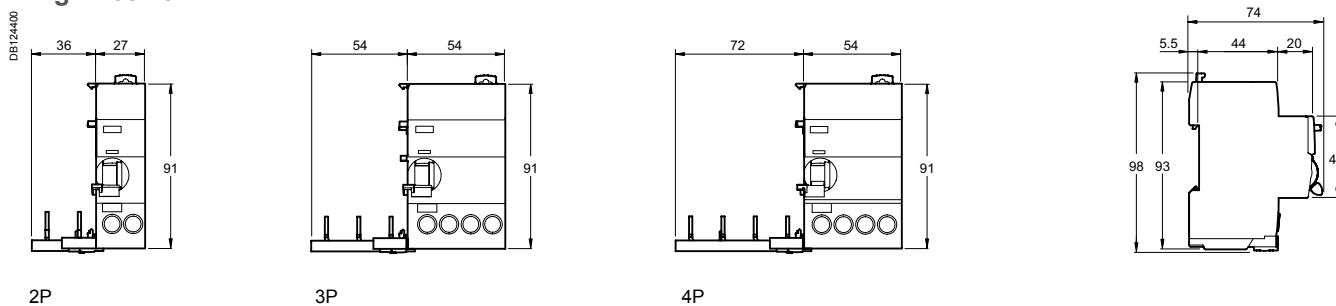

Vigi iC60 63 A

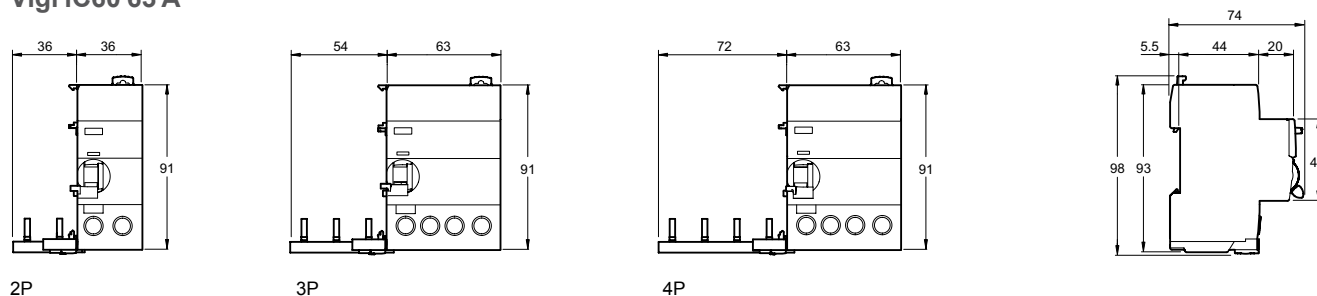

Vigi iC60 add-on residual current devices for iC60 double terminals (AC, A, SI types) (cont.)

DE124384



Association iC60N, H, L + Vigi iC60

iC60	Vigi iC60 25 A	Vigi iC60 63 A
0.5 A to 25 A	■	■
32 A - 40 A	NO	■
50 A - 63 A	NO	■

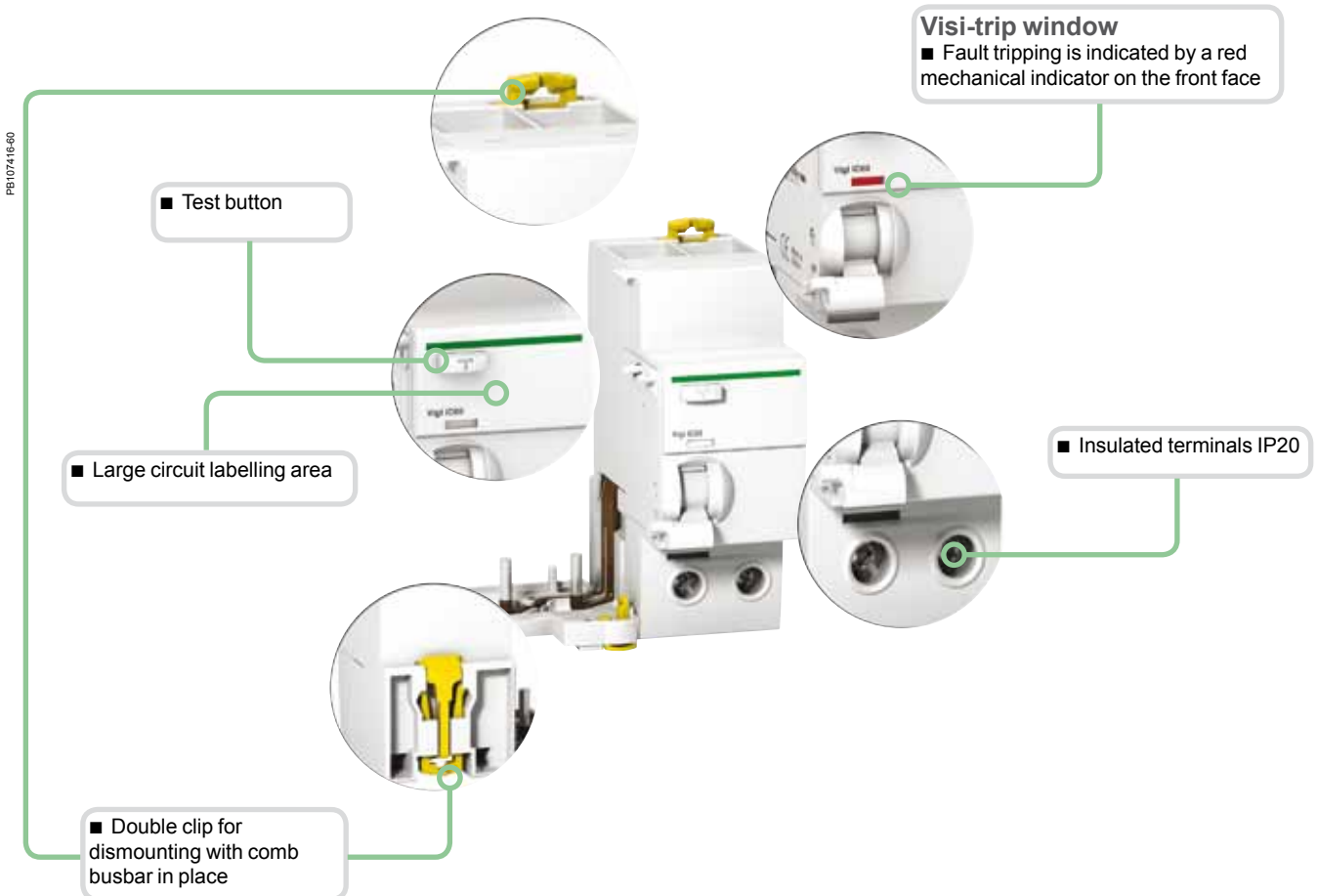

Type SI

The SI type provides increased immunity from electrical interference and polluted or corrosive environments.

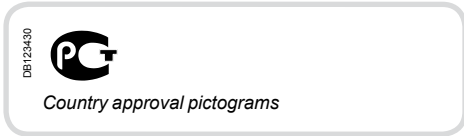

EN 61009

When a Vigi C120 device is combined with a C120 circuit breaker, it provides the following functions:

- protection of persons against electric shock by direct contact (30 mA),
- protection of persons against electric shock by indirect contact (≥ 300 mA),
- protection of installations against fire hazards (300 mA to 1000 mA).



2P



3P



4P

Catalogue numbers

Vigi C120 add-on residual current devices							
Type	AC					Width in 9 mm modules	
Product	Vigi C120						
Auxiliaries	Without auxiliary						
2P	Sensitivity	30 mA	300 mA	500 mA	300 mA	1000 mA	7
		A9N18563	A9N18564	A9N18565	A9N18544	A9N18545	
3P	Sensitivity	30 mA	300 mA	500 mA	300 mA	1000 mA	10
		A9N18566	A9N18567	A9N18568	A9N18546	A9N18547	
4P	Sensitivity	30 mA	300 mA	500 mA	300 mA	1000 mA	10
		A9N18569 A9N18542 ⁽¹⁾	A9N18570 A9N18543 ⁽¹⁾	A9N18571	A9N18548	A9N18549	
Operating voltage (Ue)	230...415 V						
Operating frequency	50/60 Hz						
Accessories	Module CA907012 and CA907013						

(1) specific offer for France

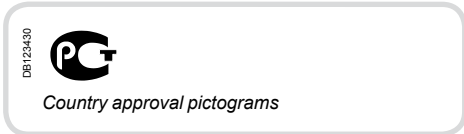

EN 61009

When a Vigi C120 device is combined with a C120 circuit breaker, it provides the following functions:

- protection of persons against electric shock by direct contact (30 mA),
- protection of persons against electric shock by indirect contact (≥ 300 mA),
- protection of installations against fire hazards (300 mA to 1000 mA).



2P



3P



4P

Catalogue numbers

Vigi C120 add-on residual current devices								
Type	A							Width in 9 mm modules
Product	Vigi C120							
Auxiliaries	Without auxiliary							
2P	Sensitivity	30 mA	300 mA	500 mA	300 mA 	500 mA 	1000 mA 	
		A9N18572	A9N18573	A9N18574	-	-	-	7
3P	Sensitivity	30 mA	300 mA	500 mA	300 mA 	500 mA 	1000 mA 	
		A9N18575	A9N18576	A9N18577	-	-	-	10
4P	Sensitivity	30 mA	300 mA	500 mA	300 mA 	500 mA 	1000 mA 	
		A9N18578	A9N18579	A9N18580	A9N18587	A9N18588	A9N18589	10
Operating voltage (Ue)	230...415 V							
Operating frequency	50/60 Hz							
Accessories	Module CA907012 and CA907013							

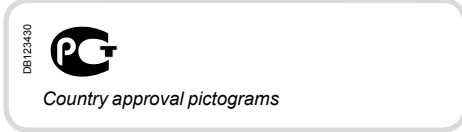

EN 61009

When a Vigi C120 device is combined with a C120 circuit breaker, it provides the following functions:

- protection of persons against electric shock by direct contact (30 mA),
- protection of persons against electric shock by indirect contact (≥ 300 mA),
- protection of installations against fire hazards (300 mA to 1000 mA).

Special feature of type SI

They are appropriate for operating in environments with:

- high risk of nuisance tripping: frequent lightning strikes, IT system, presence of electronic ballasts, frequency converters, presence of switchgear incorporating lighting type interference filters, computer system, etc.
- blind sources:
 - presence of harmonics or high frequency rejections
 - presence of DC components: diodes, diode bridges, switch-mode power supplies, etc.
- protected against nuisance tripping caused by transient voltage surges (lightning strike, operation of switchgear on the network, etc.)

PB107924-30



2P

PB107925-50



3P

PB107926-30



4P

Catalogue numbers

Vigi C120 add-on residual current devices							
Type	SI						Width in 9 mm modules
Product	Vigi C120						
Auxiliaries	Without auxiliary						
2P	Sensitivity	30 mA	300 mA	500 mA	300 mA 	1000 mA 	
		A9N18591	A9N18592	-	A9N18556	A9N18557	7
3P	Sensitivity	30 mA	300 mA	500 mA	300 mA 	1000 mA 	
		A9N18594	A9N18595	-	A9N18558	A9N18559	10
4P	Sensitivity	30 mA	300 mA	500 mA	300 mA 	1000 mA 	
		A9N18597 A9N18554 ⁽¹⁾	A9N18598 A9N18555 ⁽¹⁾	A9N18599	A9N18560	A9N18561	10
Operating voltage (Ue)	230...415 V						
Operating frequency	50 Hz						
Accessories	Module CA907012 and CA907013						

(1) specific offer for France

Vigi C120 add-on residual current devices (types AC, A and SI)

Connection

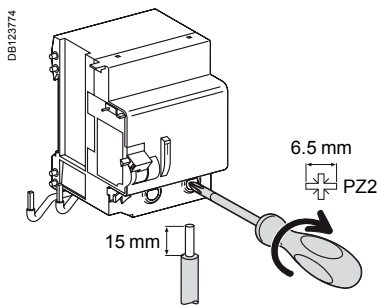

Type	Sensitivity	Tightening torque	Copper cables	
			Rigid	Flexible or with ferrule
Vigi C120	30...1000 mA	3.5 N.m	1 to 50 mm ²	1 to 35 mm ²

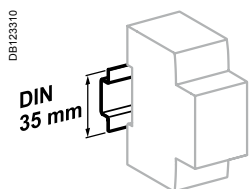

Clips onto 35 mm DIN rail.

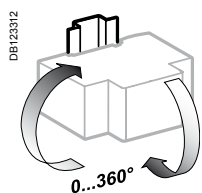

Any installation position.

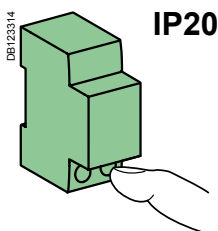

IP20

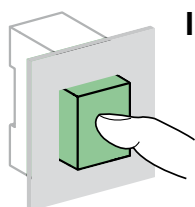

IP40

Technical data

Main characteristics

To IEC 60947-2

Insulation voltage (U _i)	500 V AC
Degree of pollution	3
Rated impulse withstand voltage (U _{imp})	6 kV

To EN 61009

Impulse current withstand (8/20 μs) without tripping	Types AC and A (non-selective ☒)	250 Å
	Types AC and A (selective ☒)	3 kÅ
	Types SI (non-selective ☒)	3 kÅ
	Types SI (selective ☒)	5 kÅ

Additional characteristics

Degree of protection	Device only	IP20
	Device in a modular enclosure	IP40
Operating temperature	Type AC	-5 °C to +60 °C
	Types A and SI	-25 °C to +60 °C
Storage temperature		-40 °C to +85 °C

Weight (g)

Add-on residual current devices

Type	Vigi C120
2P	325
3P	500
4P	580

Dimensions (mm)

C120 + Vigi C120

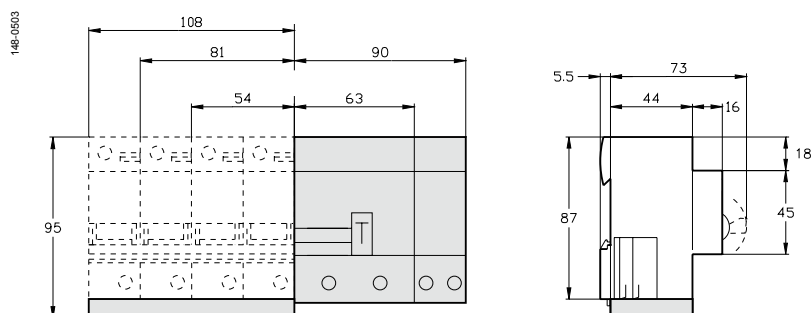

Vigi C120 add-on residual current devices (types AC, A and SI) (cont.)

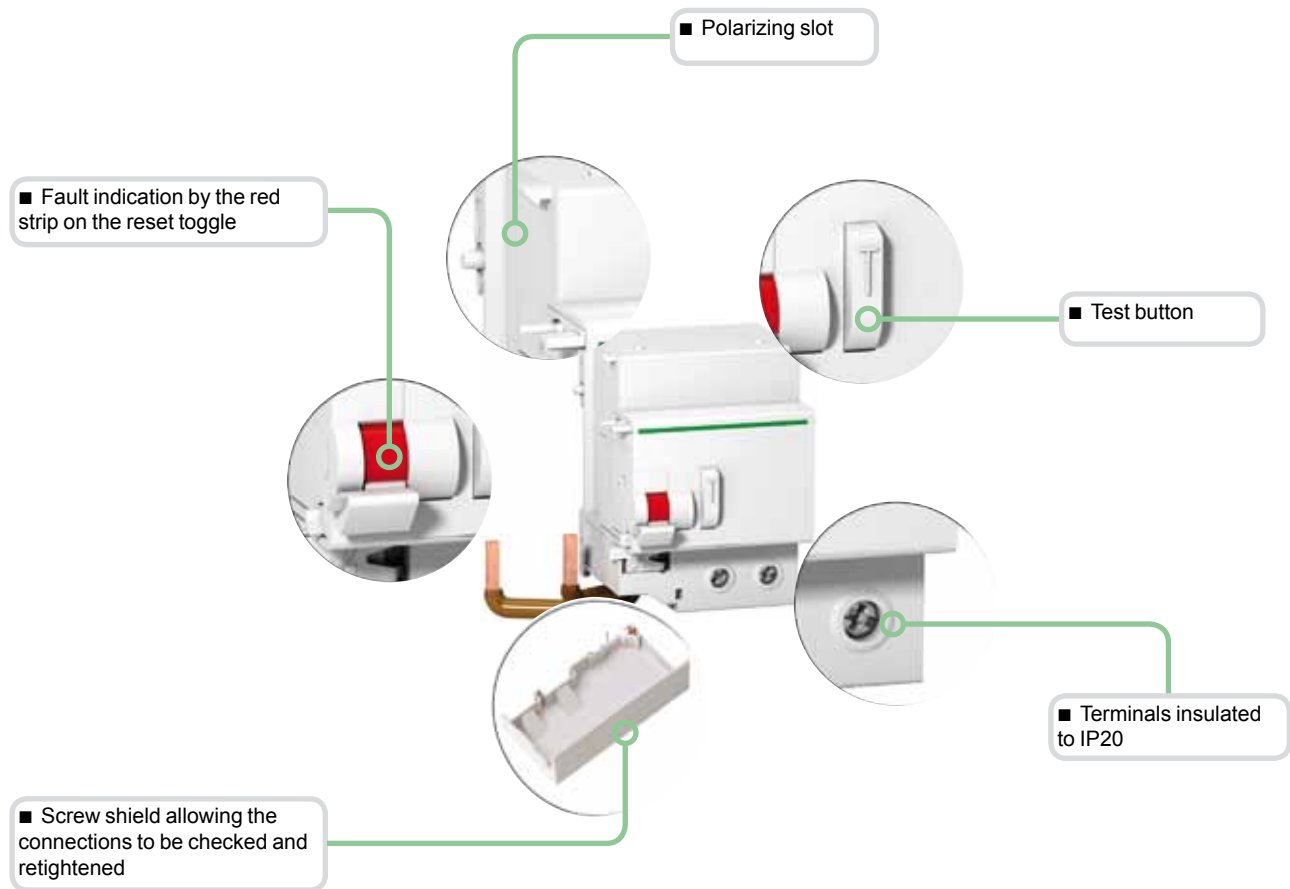

Type SI

The *SI* type provides increased immunity from electrical interference and polluted or corrosive environments.



Schneider Electric's range of add-on residual current devices consists of different products (A, B) to enable it to be the most competitive range possible in each country, allowing for the special characteristics of each market:

- usual installation procedure
- price
- accreditations by local bodies.

Variants

Offers		Pages
Offer A	Catalogue numbers	230
Offer B	Catalogue numbers	233
Common pages		236

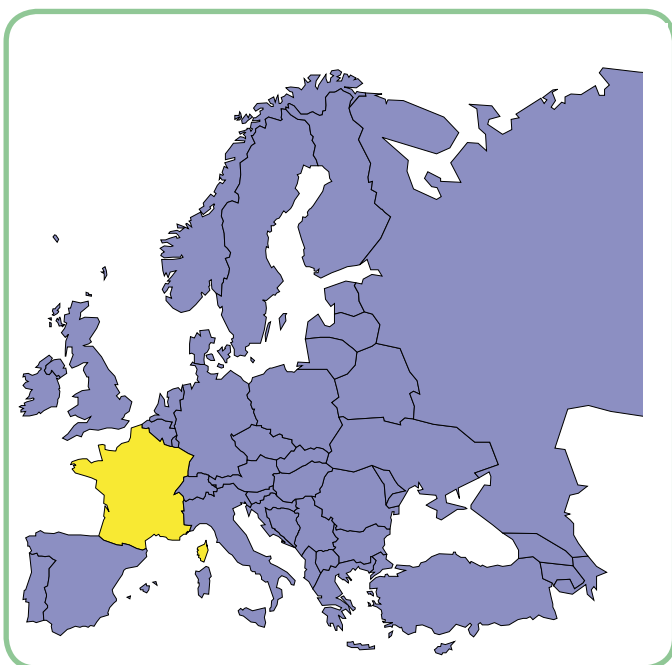

Only the product range to be marketed in your country and validated by the local product manager, in agreement with his Final Distribution (FD) partner should be retained. The others will be removed before publication.

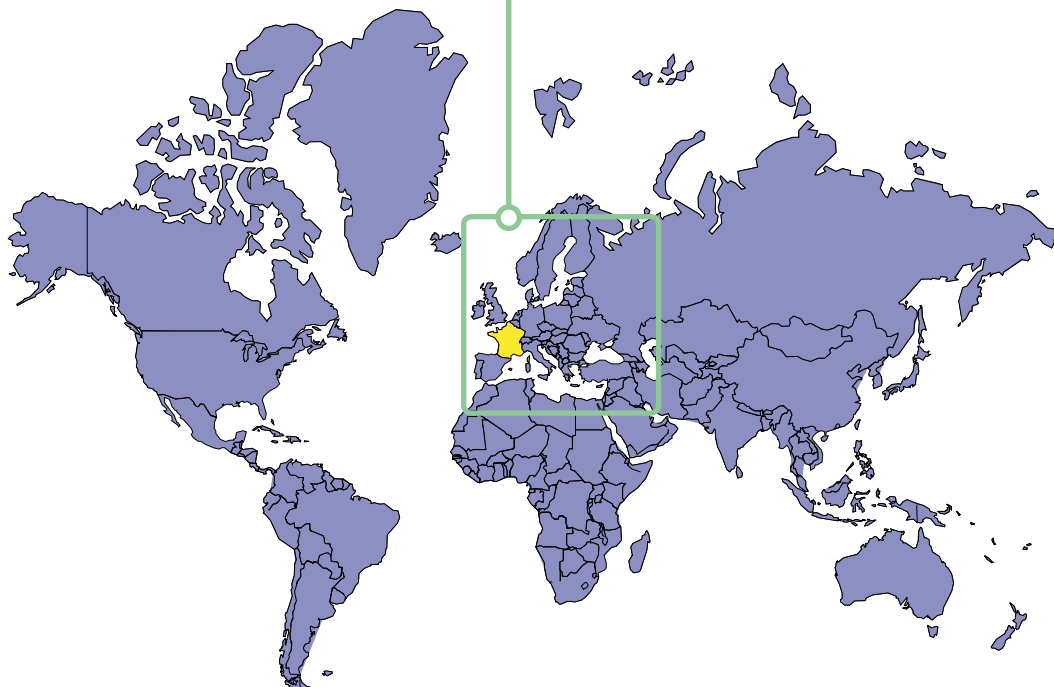

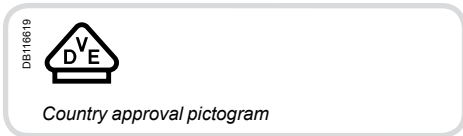

IEC/EN 61009-1

PB 103984-40

offer selection see page 229

PB 103984-40

PB 103986-40

offer A

This sticker must be removed before publishing

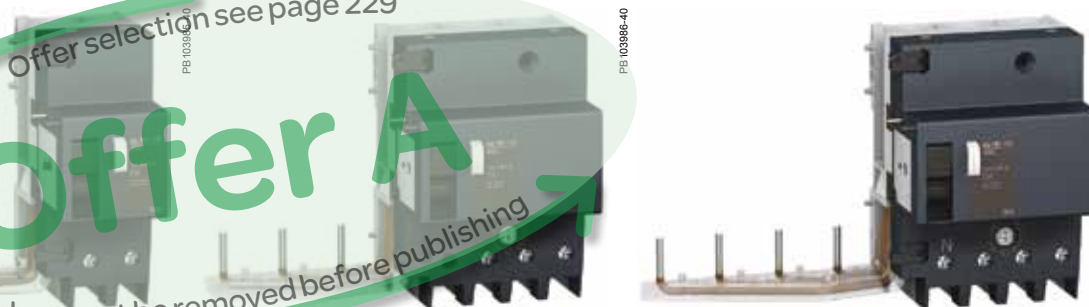

- When it is combined with an NG125 circuit breaker, the Vigi NG125 add-on residual current device offers the following functions:
 - protection of persons against electric shocks by direct contact (30 mA),
 - protection of persons against electric shocks by indirect contact (300 mA),
 - protection of installations against fire risks (300 mA).

Catalogue numbers

Vigi NG125 add-on residual current devices					
Type	AC		Width in 9 mm modules		
Product	Vigi NG125				
Auxiliaries	Without auxiliaries				
	Sensitivity		30 mA	300 mA	
DB122462 	Rating	63 A	19000	19001	5
DB122463 	Rating	63 A	19002	19003	9
DB122464 	Rating	63 A	19004	19005	9
Voltage rating (Ue)			230 - 240 V, 400 - 415 V		
Operating frequency			50/60 Hz		
Accessories			Module CM907006		

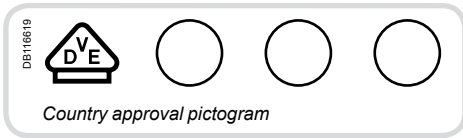

IEC/EN 61009-1

054383M-40

Offer selection see page 229

offer A

This sticker must be removed before publishing



- When it is combined with an NG125 circuit breaker, the Vigi NG125 add-on residual current device offers the following functions:
 - protection of persons against electric shocks by direct contact (30 mA),
 - protection of persons against electric shocks by indirect contact (≥ 300 mA),
 - protection of installations against fire risks (300 mA or 500 mA).

Catalogue numbers

Vigi NG125 add-on residual current devices									
Type	A							Width in 9 mm modules	
Product	Vigi NG125								
Auxiliaries	Module CM907005								
2P	Sensitivity	30 mA	300 mA	300 mA	1000 mA	300...1000 I/S	300...3000 I/S/R		
 DB122462	Rating	63 A	19011 19008 (1)	19012 19009 (1)	19030	19031	-	-	5
 DB122463	Rating	63 A	19013	19014	19032	19033	-	-	9
		125 A	19039 19050 (2)	-	-	-	19044	19036 19053 (2)	11
 DB122464	Rating	63 A	19017	19018	19034	19035	-	-	9
		125 A	19041 19051 (2)	19042	-	-	19045	19037 19054 (2)	11
Voltage rating (Ue)		230 - 240 V, 400 - 415 V Except: (1) 110...220 V and (2) 440...500 V							
Operating frequency		50/60 Hz							
Accessories		Module CM907006							

Vigi NG125 add-on residual current devices (SI type)

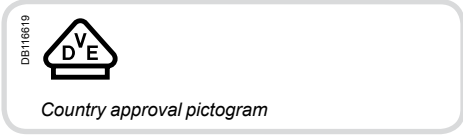

IEC/EN 61009-1

067484-40



■ When it is combined with an NG125 circuit breaker, the Vigi NG125 add-on residual current device offers the following functions:

- protection of persons against electric shocks by direct contact (30 mA),
- protection of persons against electric shocks by indirect contact (≥ 300 mA),
- protection of installations against fire risks (300 mA or 500 mA).

SI types are appropriate for operating in environments with:

- High risk of nuisance tripping: frequent lightning strikes, IT system, presence of electronic ballasts, frequency converters, presence of switchgear incorporating lighting type interference filters, computer system, etc.
- Blind sources
- presence of harmonics or high frequency rejections,
- presence of DC components: diodes, diode bridges, switch-mode power supplies, etc.
- Protected against nuisance tripping caused by transient voltage surges (lightning strike, operation of switchgear on the network, etc.).

Offer selection see page 229

Offer A

This sticker must be removed before publishing

Catalogue numbers

Vigi NG125 add-on residual current devices					
Type			SI	Width in 9 mm modules	
Product			Vigi NG125		
Auxiliaries			Module CM907005		
3P	Sensitivity		30 mA	300...3000 I/S/R	
	Rating	125 A	19100	19106	11
4P	Sensitivity		30 mA	300...3000 I/S/R	
	Rating	125 A	19101	19107	11
Voltage rating (Ue)			230 - 240 V, 400 - 415 V		
Operating frequency			50/60 Hz		
Accessories			Module CM907006		

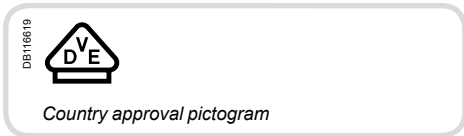

IEC/EN 61009-1



- When it is combined with an NG125 circuit breaker, the Vigi NG125 add-on residual current device offers the following functions:
 - protection of persons against electric shocks by direct contact (30 mA),
 - protection of persons against electric shocks by indirect contact (300 mA),
 - protection of installations against fire risks (300 mA).

Offer selection see page 229

Offer B

This sticker must be removed before publishing

Catalogue numbers

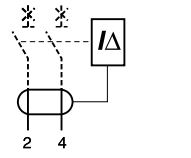
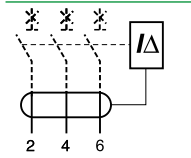
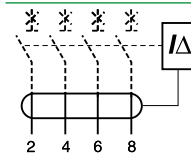
Vigi NG125 add-on residual current devices					
Type	AC		Width in 9 mm modules		
Product	Vigi NG125				
Auxiliaries	Without auxiliaries				
2P	Sensitivity	30 mA	300 mA		
	Rating 63 A	19000	19001	5	
3P	Sensitivity	30 mA	300 mA		
	Rating 63 A	19002	19003	9	
4P	Sensitivity	30 mA	300 mA		
	Rating 63 A	19004	19005	9	
Voltage rating (Ue)		230 - 240 V, 400 - 415 V			
Operating frequency		50/60 Hz			
Accessories		Module CM907006			

IEC/EN 61009-1

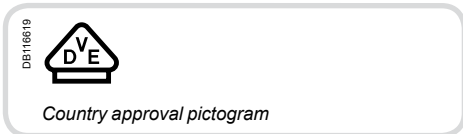

054383M-40

PE103988-40

Offer selection see page 229

Offer B

This sticker must be removed before publishing

- When it is combined with an NG125 circuit breaker, the Vigi NG125 add-on residual current device offers the following functions:
 - protection of persons against electric shocks by direct contact (30 mA),
 - protection of persons against electric shocks by indirect contact (≥ 300 mA),
 - protection of installations against fire risks (300 mA or 500 mA).

Catalogue numbers

Vigi NG125 add-on residual current devices									
Type	A							Width in 9 mm modules	
Product	Vigi NG125								
Auxiliaries	Module CM907005								
2P	Sensitivity	30 mA	300 mA	300 mA	1000 mA	300...1000 I/S	300...3000 I/S/R		
	Rating	63 A	19010 19008 (1)	19012 19009 (1)	19030	19031	-	-	5
	Rating	63 A	19013	19014	19032	19033	-	-	9
			-	-	-	-	-	19036 19053 (2)	11
	125 A	19039	-	-	-	19044	19047 19055 (2)	11	
	Rating	63 A	19015	19016	19034	19035	-	-	9
			-	-	-	-	-	19037 19054 (2)	11
	125 A	19041	19042	-	-	19046	19049 19056 (2)	11	
Voltage rating (Ue)		230 - 240 V, 400 - 415 V Except: (1) 110...220 V and (2) 440...500 V							
Operating frequency		50/60 Hz							
Accessories		Module CM907006							

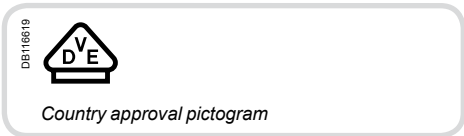

IEC/EN 61009-1

067484-10

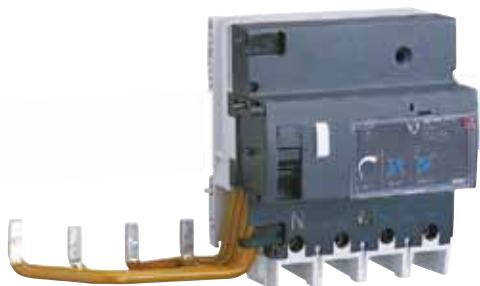

■ When it is combined with an NG125 circuit breaker, the Vigi NG125 add-on residual current device offers the following functions:

- protection of persons against electric shocks by direct contact (30 mA),
- protection of persons against electric shocks by indirect contact (≥ 300 mA),
- protection of installations against fire risks (300 mA or 500 mA).

SI types are appropriate for operating in environments with:

- High risk of nuisance tripping: frequent lightning strikes, IT system, presence of electronic ballasts, frequency converters, presence of switchgear incorporating lighting type interference filters, computer system, etc.
- Blind sources
- presence of harmonics or high frequency rejections,
- presence of DC components: diodes, diode bridges, switch-mode power supplies, etc.
- Protected against nuisance tripping caused by transient voltage surges (lightning strike, operation of switchgear on the network, etc.).

Offer selection see page 229

Offer B

This sticker must be removed before publishing

Catalogue numbers

Vigi NG125 add-on residual current devices					
Type			SI		Width in 9 mm modules
Product			Vigi NG125		
Auxiliaries			Module CM907005		
3P	Sensitivity		30 mA	300...3000 I/S/R	
<p>DB122463</p>	Rating	125 A	19100	19106	11
<p>DB122464</p>	Rating	125 A	19101	19107	11
Voltage rating (Ue)			230 - 240 V, 400 - 415 V		
Operating frequency			50/60 Hz		
Accessories			Module CM907006		

Vigi NG125 add-on residual current devices (AC, A, S/I types)

Connection

DB123404	Rating	Tightening torque	Without accessories			With accessories	
			Copper cables Rigid	Flexible or with ferrule	Screw clamp terminal	70 mm ² Al terminal	Screw-on connection for ring terminal
	63 A	3.5 N.m	1.5 to 50 mm ²	1 to 35 mm ²	-	-	-
	125 A	6 N.m	16 to 70 mm ²	10 to 50 mm ²	-	25 to 70 mm ²	2 x 35 mm ² 1 x 50 mm ²
	Pre-alarm	1 N.m	2 x 2.5 mm ²	2 x 1.5 mm ²	2 x 1.5 mm ²	-	-

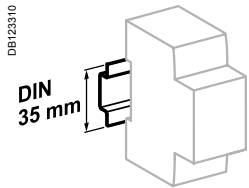

Clip on DIN rail 35 mm.

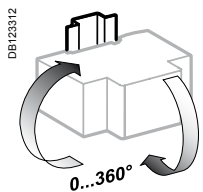

Indifferent position of installation.

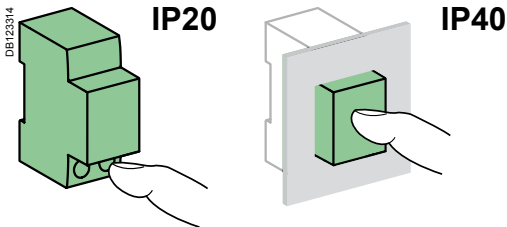

Technical data

Main characteristics		
Insulation voltage (U _i)		690 V
Pollution degree		3
Rated impulse withstand voltage (U _{imp})		8 kV
According to IEC/EN 61009-1		
Surge current withstand (8/20 μs) without tripping	Selective <input type="checkbox"/> or R	5 kA
	Instantaneous	3 kA
Behaviour in case of voltage drop		Residual current protection down to 0 V according to IEC/EN 61009-1 § 3.3.8
Additional characteristics		
Degree of protection	Device only	IP20
	Device in modular enclosure	IP40
Operating temperature	AC type	-5°C to +60°C
	A and S/I types	-25°C to +60°C
Storage temperature		-40°C to +85°C
Additional characteristics		
Vigi 125 A and adjustable		
Plug-in auxiliaries	MXV	Remote tripping
	SDV	Indication of tripping upon earth fault
Adjustable Vigi		
Sensitivity adjustable by notch (IΔn)		300, 500, 1000, 3000 mA
Tripping time	Instantaneous	
	Selective <input type="checkbox"/>	60 ms
	Time-delayed	150 ms
Leakage current indication on 3P and 4P 300...3000 I/S/R (pre-alarm)		On front face by LED Remote, by potential-free normally-open contact 250 V - 1 A (low level) Threshold setting by potentiometer from 10 % to 50 % of IΔn
Disconnection essential for dielectric test		By integral pushbutton

Vigi NG125 add-on residual current devices (AC, A, S/ types) (cont.)

Weight (g)

Add-on residual current devices			
Number of 9 mm modules	2P	3P	4P
5 modules	250	-	-
9 modules	-	410	450
11 modules	-	750	800

Dimensions (mm)

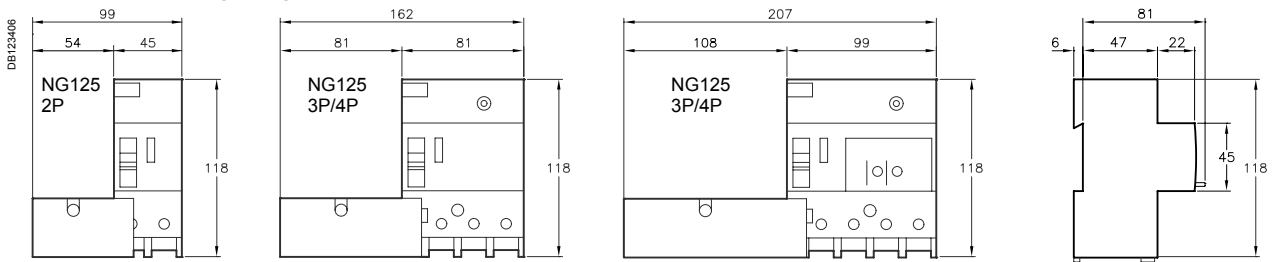

2P (5 modules)

63, 125 A (9 modules)

63, 125 A (11 modules)

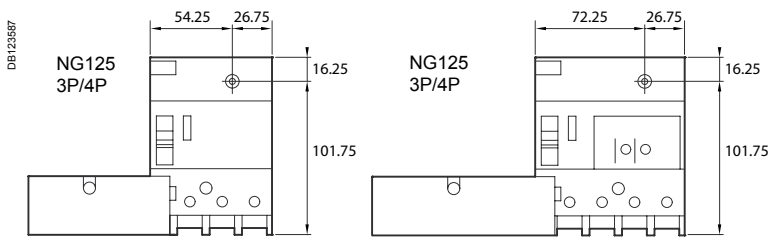

Spacing for mounting on panel

Vigi NG125 add-on residual current devices (AC, A, S/I types) (cont.)

058341_SE-50



Association NG125 + Vigi NG125

	Vigi NG125 63 A	Vigi NG125 125 A
NG125 ≤ 63 A	■	NO
NG125 80...125 A*	NO	■

(*) No Vigi add-on residual current device for 2P circuit breakers of rating 80 A.

FB104466-40

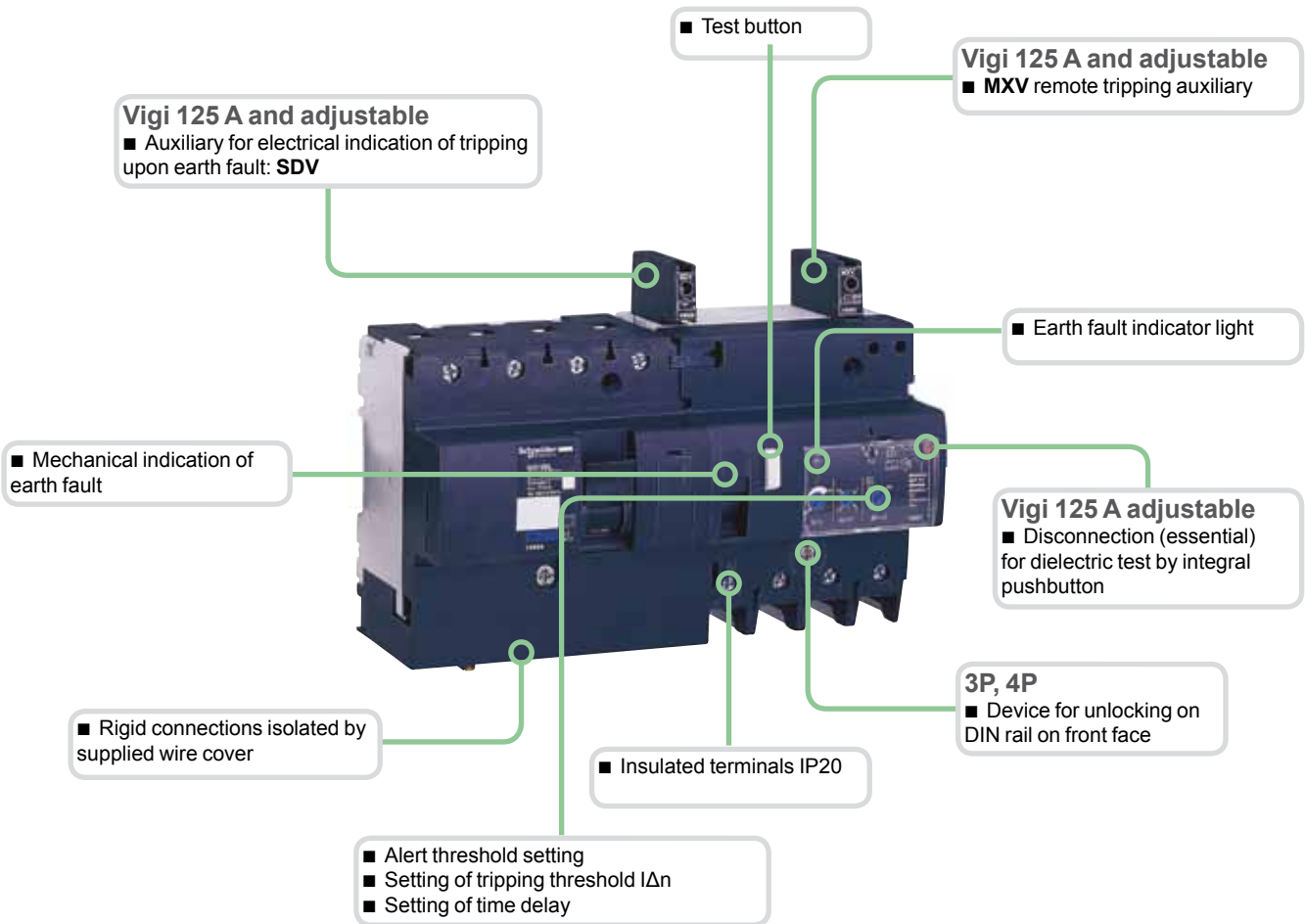

S/I type

S/I types are appropriate for operating in environments with:

- High risk of nuisance tripping: frequent lightning strikes, IT system, presence of electronic ballasts, frequency converters, presence of switchgear incorporating lighting type interference filters, computer system, etc.
- Blind sources
 - presence of harmonics or high frequency rejections,
 - presence of DC components: diodes, diode bridges, switch-mode power supplies, etc.
- Protected against nuisance tripping caused by transient voltage surges (lightning strike, operation of switchgear on the network, etc.).



Schneider Electric's range of residual current devices consists of different products (A, B) to enable it to be the most competitive range possible in each country, allowing for the special characteristics of each market:

- usual installation procedure
- price
- accreditations by local bodies.

Variants

Offers		Pages
Offer A	Catalogue numbers	241
Offer B	Catalogue numbers	243
Common pages		244

DE406602



Only the product range to be marketed in your country and validated by the local product manager, in agreement with his Final Distribution (FD) partner should be retained. The others will be removed before publication.

DE406601

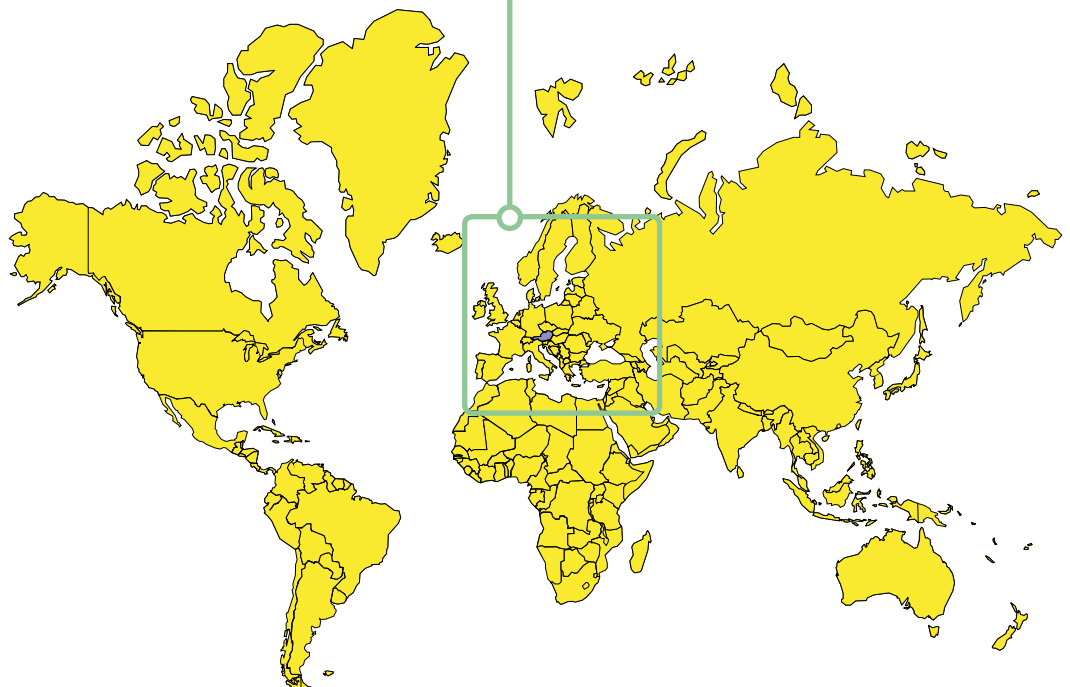



IEC/EN 61009-1



iDPNa Vigi



iDPN H Vigi



iDPN N Vigi

Offer selection see page 239

Offer A

This sticker must be removed before publishing

- The iDPN Vigi residual current device provide complete protection for final circuits (against overcurrents and insulation faults):
 - protection for users against electric shocks by direct contacts (≤ 30 mA),
 - protection for users against electric shocks by indirect contacts (300 mA),
 - protection of the installations against fire risks (300 mA).

- The **SI** range has been designed to maintain a network with optimum safety and continuity of service in installations disturbed by:
 - extreme atmospheric conditions,
 - harmonic generating loads,
 - transient operating currents.

Catalogue numbers

iDPNa Vigi 4500

Type	AC	A	Width in 9 mm modules
Auxiliaries	Module CA907000 and CA907013		
1P+N Curve B	Sensitivity	30 mA	300 mA
	Rating (In)	30 mA	300 mA
	6 A	A9D51606	-
	10 A	A9D51610	-
	13 A	-	-
	16 A	A9D51616	-
	20 A	A9D51620	-
	25 A	A9D51625	-
	32 A	A9D51632	-
40 A	A9D51640	-	
1P+N Curve C	Sensitivity	30 mA	300 mA
	Rating (In)	30 mA	300 mA
	6 A	A9D34606	A9D44606
	10 A	A9D34610	A9D44610
	13 A	-	-
	16 A	A9D34616	A9D44616
	20 A	A9D34620	A9D44620
	25 A	A9D34625	A9D44625
	32 A	A9D34632	A9D44632
40 A	A9D34640	A9D44640	
Voltage rating (Ue)	230...240 V AC		
Operating frequency	50 Hz		
Accessories	Module CA907000 and CA907001, comb busbars CA907013		

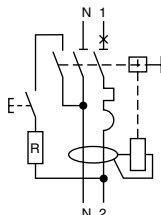
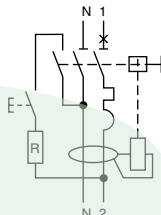

Catalogue numbers

iDPN N Vigi 6000				
Type	A 		Width in 9 mm modules	
Auxiliaries		Module CA907000 and CA907013		
1P+N Curve B	Sensitivity	30 mA	4	
	Rating (In)	10 A		A9D06610
		16 A		A9D06616
		20 A		A9D06620
1P+N Curve C	Sensitivity	30 mA	4	
	Rating (In)	10 A		A9D01610
		16 A		A9D01616
		20 A		A9D01620
Voltage rating (Ue)		110 V AC		
Operating frequency		50 Hz		
Accessories		Module CA907000 and CA907001, comb busbars CA907013		

Offer selection see page 239

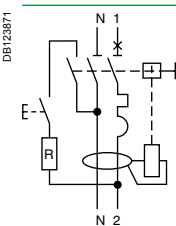
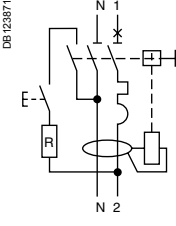

Offer A

This sticker must be removed before publishing

iDPN N Vigi 6000												
Type	AC 			A 				SI 			Width in 9 mm modules	
Auxiliaries		Module CA907000 and CA907013										
1P+N Curve B	Sensitivity	30 mA	300 mA	10 mA	30 mA	100 mA	300 mA	30 mA	100 mA	300 mA	4	
	Rating (In)	4 A	A9D55604	A9D68604	-	A9D56604	A9D60604	A9D69604	-	-		-
		6 A	A9D55606	A9D68606	-	A9D56606	A9D60606	A9D69606	-	-		-
		10 A	A9D55610	A9D68610	A9D08610	A9D56610	A9D60610	A9D69610	-	-		-
		13 A	-	-	-	A9D56613	A9D60613	A9D69613	-	-		-
		16 A	A9D55616	A9D68616	A9D08616	A9D56616	A9D60616	A9D69616	-	-		-
		20 A	A9D55620	A9D68620	-	A9D56620	A9D60620	A9D69620	-	-		-
		25 A	A9D55625	A9D68625	-	A9D56625	A9D60625	A9D69625	-	-		-
		32 A	A9D55632	A9D68632	-	A9D56632	A9D60632	A9D69632	-	-		-
		40 A	A9D55640	A9D68640	-	A9D56640	A9D60640	A9D69640	-	-	-	
1P+N Curve C	Sensitivity	30 mA	300 mA	10 mA	30 mA	100 mA	300 mA	30 mA	100 mA	300 mA	4	
	Rating (In)	6 A	A9D31606	A9D41606	-	A9D32606	A9D52606	A9D42606	A9D33606	A9D53606		A9D43606
		10 A	A9D31610	A9D41610	A9D02610	A9D32610	A9D52610	A9D42610	A9D33610	A9D53610		A9D43610
		13 A	-	-	-	A9D32613	A9D52613	A9D42613	A9D33613	A9D53613		A9D43613
		16 A	A9D31616	A9D41616	A9D02616	A9D32616	A9D52616	A9D42616	A9D33616	A9D53616		A9D43616
		20 A	A9D31620	A9D41620	-	A9D32620	A9D52620	A9D42620	A9D33620	A9D53620		A9D43620
		25 A	A9D31625	A9D41625	-	A9D32625	A9D52625	A9D42625	A9D33625	A9D53625		A9D43625
		32 A	A9D31632	A9D41632	-	A9D32632	A9D52632	A9D42632	A9D33632	A9D53632		A9D43632
		40 A	A9D31640	A9D41640	-	A9D32640	A9D52640	A9D42640	A9D33640	A9D53640		A9D43640
	Voltage rating (Ue)		230...240 V AC									
Operating frequency		50 Hz										
Accessories		Module CA907000 and CA907001, comb busbars CA907013										

Catalogue numbers

iDPN H Vigi 10000

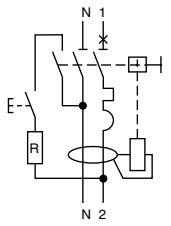
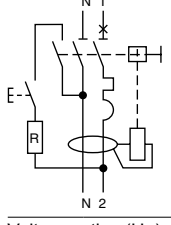
Type		A 	SI 				Width in 9 mm modules
Auxiliaries		Module CA907000 and CA907013					
1P+N	Curve B	Sensitivity	30 mA	300 mA	30 mA	300 mA	
	Rating (In)	6 A	A9D07606	-	-	-	4
		10 A	A9D07610	-	-	-	
		16 A	A9D07616	-	-	-	
		20 A	A9D07620	-	-	-	
		25 A	A9D07625	-	-	-	
		32 A	A9D07632	-	-	-	
1P+N	Curve C	Sensitivity	30 mA	300 mA	30 mA	300 mA	
	Rating (In)	6 A	A9D37606	A9D47606	A9D38606	A9D48606	4
		10 A	A9D37610	A9D47610	A9D38610	A9D48610	
		16 A	A9D37616	A9D47616	A9D38616	A9D48616	
		20 A	A9D37620	A9D47620	A9D38620	A9D48620	
		25 A	A9D37625	A9D47625	A9D38625	A9D48625	
		32 A	A9D37632	A9D47632	A9D38632	A9D48632	
Voltage rating (Ue)		230...240 V AC					
Operating frequency		50 Hz					
Accessories		Module CA907000 and CA907001, comb busbars CA907013					

Offer selection see page 239

offer A

This sticker must be removed before publishing



IEC/EN 61009-1



iDPN N Vigi

Offer selection see page 239

Offer B

This sticker must be removed before publishing

- The iDPN Vigi residual current device provide complete protection for final circuits (against overcurrents and insulation faults):
 - protection for users against electric shocks by direct contacts (30 mA),
 - protection for users against electric shocks by indirect contacts (100 mA),
 - protection of the installations against fire risks (100 mA).

Catalogue numbers

iDPN N Vigi G Type 6000					
Type		AC	A	Width in 9 mm modules	
Auxiliaries		Module CA907000 and CA907013			
1P+N	Curve C	Sensitivity		30 mA	100 mA
	Rating (In)	6 A	A9D62606	A9D72606	4
		10 A	A9D62610	A9D72610	
		13 A	A9D62613	A9D72613	
		16 A	A9D62616	A9D72616	
Voltage rating (Ue)		230...240 V AC			
Operating frequency		50 Hz			
Accessories		Module CA907000 and CA907001, comb busbars CA907013			

DB40596-40

■ Fast contact closure

■ Insulated terminals IP20

Visi-trip double window

- Fault tripping circuit breaker is indicated by a red mechanical indicator on the front face.
- Earth fault is indicated by a red mechanical indicator on the front face

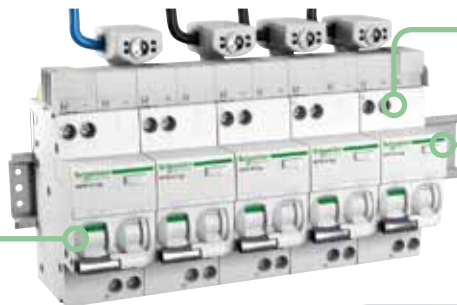

■ Test button

Positive contact indication

- A green strip on the toggle guarantees opening of all the poles in safety conditions (padlocking possible) for work to be carried out on live parts

DB123310

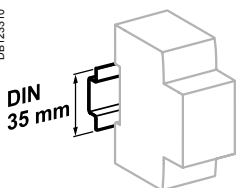

Clip on DIN rail 35 mm.

DB123312

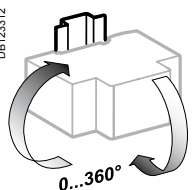

Indifferent position of installation.

DB123314

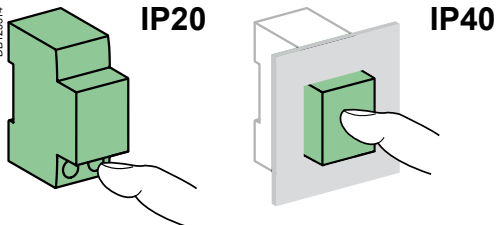

Weight (g)

Residual current device

Type	iDPN Vigi
1P+N	125

Dimensions (mm)

DB124454

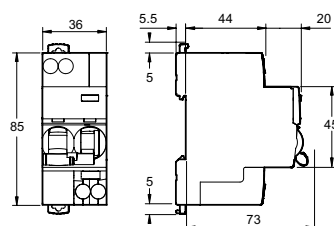

Connection

DB123347

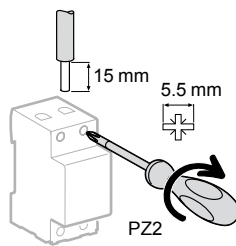

Rating	Tightening torque	Copper cables	
		Rigid	Flexible or with ferrule
4 to 40 A	2 N.m	1 to 16 mm ²	1 to 10 mm ²

Technical data

Main characteristics

Type	iDPNa Vigi	iDPN N Vigi	iDPN H Vigi
Insulation voltage (Ui)	400 V AC		
Pollution degree	3		
Rated impulse withstand voltage (Uimp)	4 kV		
Setting temperature for ratings	30°C		
Magnetic tripping	Curve B	Between 3 and 5 In	
	Curve C	Between 5 and 10 In	

According to IEC/EN 61009-1

Limitation class	3		
Rated breaking capacity (Icn)	4500 A	6000 A	10,000 A
Rated residual breaking and making capacity (IΔm)	4500 A	6000 A	10,000 A
8/20 μs impulse withstand	Type AC	250 Å	250 Å
	Type A	250 Å	250 Å
	Type S/	-	3 kÅ

Behaviour in case of voltage drop		Residual current protection down to 0 V according to IEC/EN 61009-1 § 3.3.8	
-----------------------------------	--	---	--

Additional characteristics

Earth leakage protection with instantaneous tripping		10, 30, 300 mA	10, 30, 100, 300 mA	30, 300 mA
Degree of protection (IEC 60529)	Device only	IP20		
	Device in modular enclosure	IP40		
Endurance (O-C)	Electrical	≤ 20 A	20,000 cycles	
		≥ 25 A	10,000 cycles	
	Mechanical	20,000 cycles		
Overvoltage category (IEC 60364)	III			
Operating temperature	Type AC	-5°C to +60°C		
	Type A, S/	-25°C to +60°C		
Storage temperature	-40°C to +85°C			
Tropicalization (IEC 60068-1)	Treatment 2 (relative humidity 95 % to 55°C)			



The Schneider Electric residual current device range comprises various offers (Clario, Prodis, Libro) so as to be as competitive as possible in each country, taking into account the specific features of each market:

- installation customs
- price
- approval by local organizations.

Variants

Offers		Pages
Common pages		246
Clario	Catalogue numbers	247
Prodis	Catalogue numbers	250
Librio	Catalogue numbers	254
Common pages		257

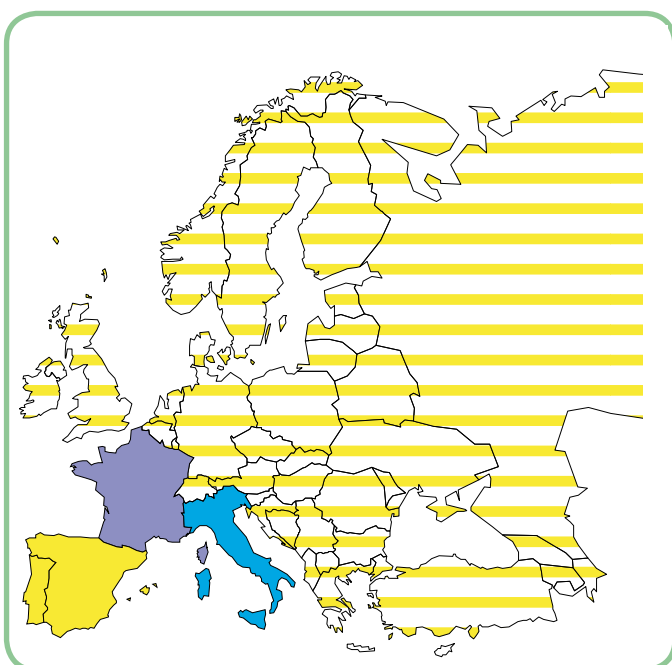

Only the product range to be marketed in your country and validated by the local product manager, in agreement with his Final Distribution (FD) partner should be retained. The others will be removed before publication.

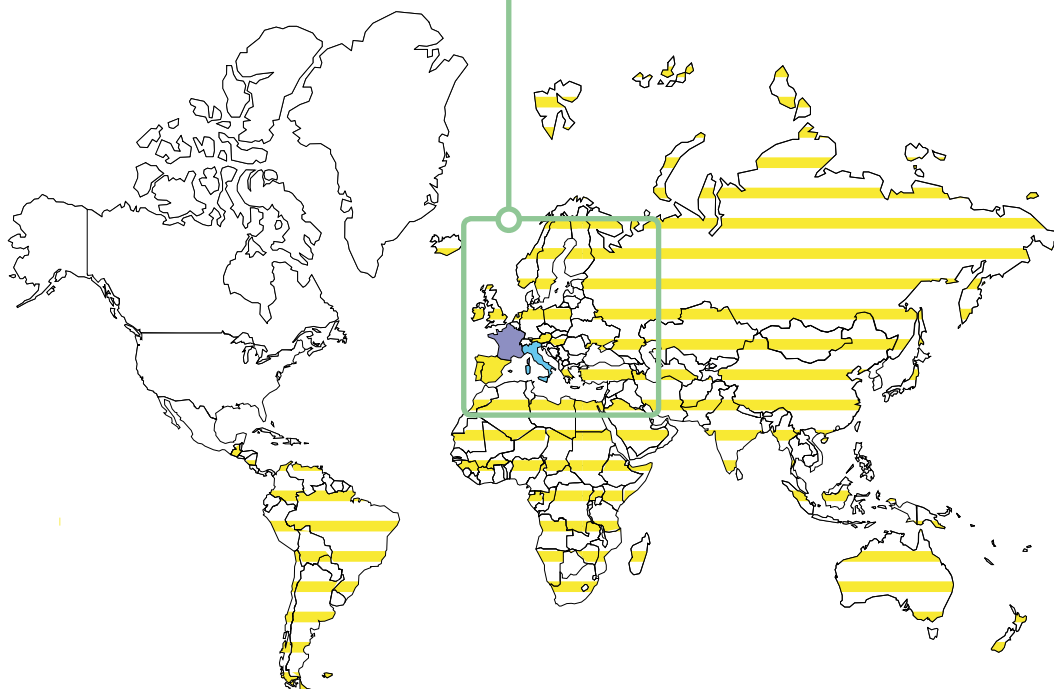

Vigi modules and residual current devices

Clario, Prodis, Libro

The Vigi module combined with a circuit breaker or the residual current device offers the following functions of earth leakage protection and circuit protection.

■ Earth leakage protection:

- protection of persons against electric shock by direct contact (30 mA),
- protection of persons against electric shock by indirect contact,
- protection of installations against the risk of fire.

■ Circuit protection:

- circuit protection against short-circuit currents,
- circuit protection against overload currents,
- disconnection.



Earth leakage protection

"Group Feeder"

PB107115-25



"Outgoers"

PB107169-25



 Monobloc

"Group Feeder"

PB107139-25



+

PB107113-25



PB107143-25



+

PB107155-25



"Outgoers"

PB107139-25



+

PB107111-25



PB107143-25



+

PB107114-25



 Add-on modules

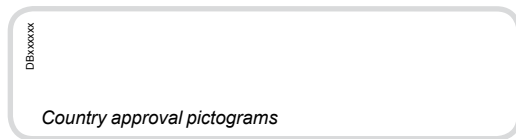

IEC/EN 61009-1

Earth leakage protection for "Group Feeders" is performed:
 ■ either by a monobloc residual current device
 ■ or by a circuit breaker combined with a Vigi module.



Catalogue numbers

DPN Vigi c residual current devices 6000 EN 61009 - C curve											
Type		AC									Width in 9-mm modules
Auxiliaries		Add-on auxiliaries: see modules CA907008 and CA907010									
3P+N		Sensitivity			30 mA	300 mA	300 mA				
	Rating	25 A	A9N21771	A9N21775	A9N21772				12		
		40 A	A9N21773	A9N21776	A9N21774						



Catalogue numbers

"Group Feeder" Vigi i DPN modules											
Type		AC			A		SI			Width in 9-mm modules	
1P+N		Sensitivity			30 mA	300 mA	300 mA	30 mA	300 mA	300 mA	
	Rating	25 A	A9N21741	A9N21742	-	A9N21745	A9N21746	A9N21749	A9N21750	-	2
		40 A	A9N21743	A9N21744	-	A9N21747	A9N21748	A9N21751	A9N21752	A9N21753	
3P+N		Sensitivity			30 mA	300 mA	300 mA	30 mA	300 mA	300 mA	
	Rating	25 A	A9N21755	A9N21756	-	A9N21759	A9N21760	A9N21763	A9N21764	-	6
		40 A	A9N21757	A9N21758	-	A9N21761	A9N21762	A9N21765	A9N21766	A9N21767	

Vigi modules and residual current devices *i*DPN "Outgoer"

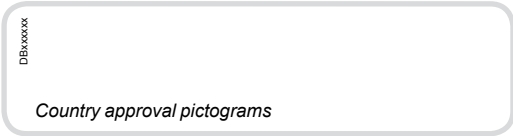

IEC/EN 61009-1

For the earth leakage protection of "outgoers", a residual current device is built by combining a circuit breaker and a Vigi module. "Outgoer" residual current devices are also available in monobloc version.

Catalogue numbers



<i>i</i> DPN Vigi residual current devices 4500 EN 61009 - C curve					
Type	AC			Width in 9-mm modules	
Auxiliaries	Add-on auxiliaries: see modules CA907008 and CA907010				
1P+N	Sensitivity	30 mA	300 mA		
<p>DB406480</p>	Rating	6 A	A9N21614	A9N21624	4
		10 A	A9N21615	A9N21625	
		16 A	A9N21616	A9N21626	
		20 A	A9N21617	A9N21627	
		25 A	A9N21618	A9N21628	
		32 A	A9N21619	A9N21629	
		40 A	A9N21620	A9N21630	

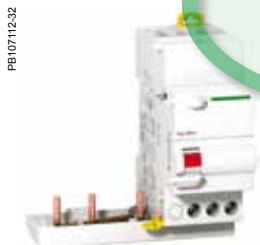

Catalogue numbers

"Outgoer" Vigi <i>i</i> DPN modules										
Type	AC			A		SI		Width in 9-mm modules		
1P+N	Sensitivity	30 mA	100 mA	300 mA	30 mA	300 mA	30 mA	300 mA		
<p>DB406483</p>	Rating	25 A	A9N21681 A9N21680 Type G	A9N21678 A9N21679 Type G	A9N21682	A9N21685	A9N21686	A9N21689	A9N21690	2
		40 A	A9N21683	-	A9N21684	A9N21687	A9N21688	A9N21691	A9N21692	
<p>DB406484</p>	Rating	25 A	A9N21695	-	A9N21696	A9N21699	A9N21700	A9N21703	A9N21704	4
		40 A	A9N21697	-	A9N21698	A9N21701	A9N21702	A9N21705	A9N21706	
<p>DB406485</p>	Rating	25 A	A9N21709	-	A9N21710	A9N21713	A9N21714	A9N21717	A9N21718	4
		40 A	A9N21711	-	A9N21712	A9N21715	A9N21716	A9N21719	A9N21720	

Dimensions (mm)

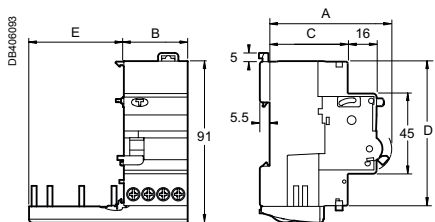

"Outgoer" Vigi modules

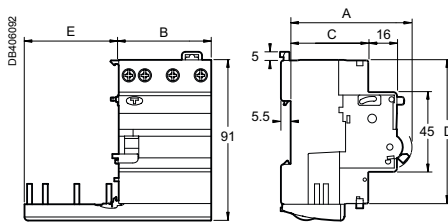

"Group Feeder" Vigi modules

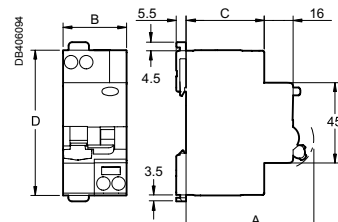

1P+N Residual current devices

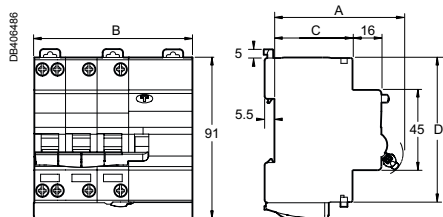

3P+N DPN Vigi c Residual current devices

Earth leakage protection

Type	Number of poles	A	B	C	D	E
"Outgoer" Vigi / DPN modules	1P+N	69	18	44	81	18
	3P	69	36	44	81	54
	3P+N	69	36	44	81	54
"Group Feeder" Vigi / DPN modules	1P+N	70	18	44	82	18
	3P+N	70	54	44	82	54
Residual current devices / DPN Vigi	1P+N	71	36	44	81	-
Residual current devices DPN Vigi c	3P+N	71	108	44	81	-

Offer selection see page 245

Clario

This sticker must be removed before publishing

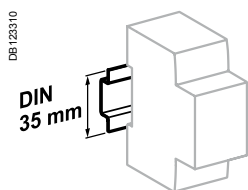

Clip on DIN rail 35 mm.

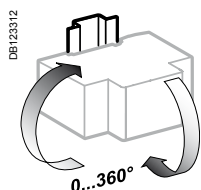

Indifferent position of installation.

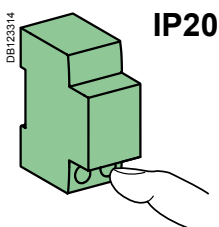

IP20

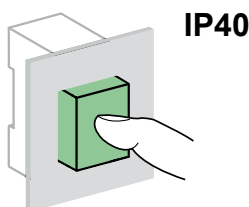

IP40

Technical data

Main characteristics

According to IEC/EN 61009-1

Insulation voltage (Ui)	Phase-to-phase	440 V AC
Voltage rating (Ue)	Phase-to-neutral	230 V AC
	Phase-to-phase	400 V AC
Operating frequency		50 Hz
Pollution degree		3 as per IEC 61009 (for installation in industrial environment)
Rated impulse withstand voltage (Uimp)		4 kV
Behaviour in the event of a phase-to-earth fault in TN-S earthing system		Residual breaking and making capacity (IΔm) identical to the rated breaking capacity (Icn)
Behaviour in case of voltage drop		Residual current protection down to 0 V according to IEC/EN 61009-1 § 3.3.8

Additional characteristics

Degree of protection	Device only	IP20
	Device in modular enclosure	IP40
Operating temperature	A and SI types	-25°C to +60°C
	AC type	-5°C... +60°C
Storage temperature		-40°C to +60°C
Tropicalization		Treatment 2 (relative humidity of 95 % at 55°C)
Reinforced cable pull-out strength		Serrated terminals
Automatic cable guiding in the correct position		Terminals with guard

EN 61009-1, EN 60947-2

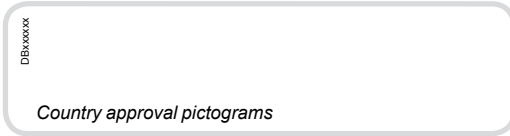

Earth leakage protection for "Group Feeders" is performed by a circuit breaker combined with a Vigi module.

Offer selection see page 245

Prodis

This sticker must be removed before publishing



Catalogue numbers

"Group Feeder" Vigi TG40 modules

Type		AC		SI			Width in 9-mm modules
 DB406483	Sensitivity	30 mA	300 mA	30 mA	300 mA	300 mA	2
	Rating	25 A 40 A	A9N21480 A9N21482	A9N21481 A9N21483	A9N21484 A9N21486	A9N21485 A9N21487	
 DB406484	Sensitivity	30 mA	300 mA	30 mA	300 mA	300 mA	6
	Rating	25 A 40 A	A9N21490 A9N21492	A9N21491 A9N21493	A9N21494 A9N21496	A9N21495 A9N21497	

"Group Feeder" Vigi TG60 modules

Type		AC		SI			Width in 9-mm modules
 DB406485	Sensitivity	30 mA	300 mA	30 mA	300 mA	300 mA	6
	Rating	40 A 63 A	A9N21511 A9N21562	A9N21512 A9N21563	A9N21513 A9N21564	A9N21514 A9N21572	

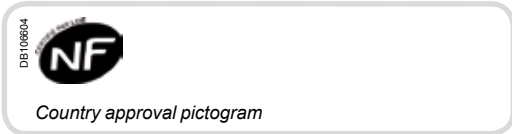

EN 61009-1, EN 60947-2

Earth leakage protection for "Outgoer" is performed by a monobloc residual current device.



Catalogue numbers

DT40 Vigi K residual current devices 4500 EN 61009 - C curve					
Type		AC		Width in 9-mm modules	
		Sensitivity	30 mA	300 mA	
1P+N 	Rating	10 A	A9N21201	A9N21207	4
		16 A	A9N21202	A9N21208	
		20 A	A9N21203	A9N21209	
		25 A	A9N21204	A9N21210	
		32 A	A9N21205	A9N21211	
		40 A	A9N21206	A9N21212	
		3P+N 	Rating	10 A	
16 A	A9N21222			A9N21228	
20 A	A9N21223			A9N21229	
25 A	A9N21224			A9N21230	
32 A	A9N21225			A9N21231	
40 A	A9N21226			A9N21232	



Vigi modules and residual current devices DT40 "Outgoer"



EN 61009-1
EN 60947-2, DT40 Vigi

For the earth leakage protection of "outgoers", a residual current device is built by combining a circuit breaker and a Vigi module. "Outgoer" residual current devices are also available in monobloc version.

Catalogue numbers

DT40 Vigi residual current devices 4500 EN 61009 - C curve						
Type		AC	SI		Width in 9-mm modules	
Auxiliaries		Add-on auxiliaries: see modules CA907008 and CA907010				
1P+N	Sensitivity	30 mA	300 mA	30 mA	300 mA	
	Rating	10 A	A9N21442	A9N21443	A9N21440	4
		16 A	A9N21444	A9N21445	A9N21441	
		20 A	A9N21446	A9N21447	A9N21448	



Catalogue numbers

"Outgoer" Vigi DT40 modules						
Type		AC	SI		Width in 9-mm modules	
1P+N	Sensitivity	30 mA	300 mA	30 mA	300 mA	
	Rating	25 A	A9N21450	A9N21451	A9N21454	2
		40 A	A9N21452	A9N21453	A9N21456	
					A9N21457	
3P	Sensitivity	30 mA	300 mA	30 mA	300 mA	
	Rating	25 A	A9N21460	A9N21461	A9N21464	4
		40 A	A9N21462	A9N21463	A9N21466	
					A9N21467	
3P+N	Sensitivity	30 mA	300 mA	30 mA	300 mA	
	Rating	25 A	A9N21470	A9N21471	A9N21474	4
		40 A	A9N21472	A9N21473	A9N21476	
					A9N21477	

Dimensions (mm)

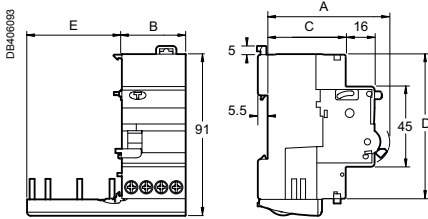

"Outgoer" Vigi modules

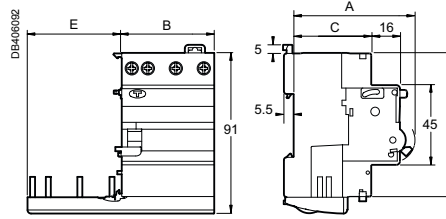

"Group Feeder" Vigi modules

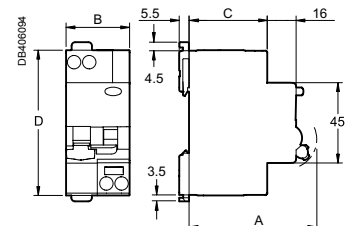

1P+N Residual current devices

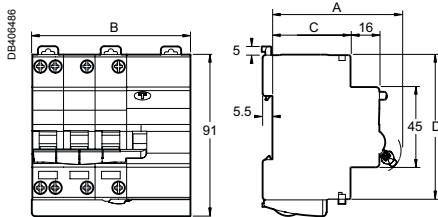

3P+N DT40 Vigi K Residual current devices

Earth leakage protection

Type	Number of poles	A	B	C	D	E
"Outgoer" Vigi DT40 modules	1P+N	69	18	44	81	18
	3P	69	36	44	81	54
	3P+N	69	36	44	81	54
"Group Feeder" Vigi TG40, Vigi TG60 modules	1P+N	70	18	44	82	18
	3P+N	70	54	44	82	54
	4P	70	54	44	82	72
Residual current devices DT40 Vigi, DT40 Vigi K	1P+N	71	36	44	81	-
	DT40 Vigi K	3P+N	73	90	44	81

Offer selection see page 245

Prodis

This sticker must be removed before publishing

Technical data

Main characteristics

According to EN 61009-1

Insulation voltage (Ui)	Phase-to-phase	440 V AC
Voltage rating (Ue)	Phase-to-neutral	230 V AC
	Phase-to-phase	400 V AC
Operating frequency		50 Hz
Pollution degree		3 as per IEC 61009 (for installation in industrial environment)
Rated impulse withstand voltage (Uimp)		4 kV
Behaviour in the event of a phase-to-earth fault in TN-S earthing system		Residual breaking and making capacity (I Δ m) identical to the rated breaking capacity (Icn)
Behaviour in case of voltage drop		Residual current protection down to 0 V according to NF EN 61009-1 § 3.3.8

Additional characteristics

Breaking capacity (Icu) according to EN 60947-2		4.5 kA
Degree of protection	Device only	IP20
	Device in modular enclosure	IP40
Operating temperature	A and SI types	-25°C to +60°C
	AC type	-5°C...+60°C
Storage temperature		-40°C to +60°C
Tropicalization		Treatment 2 (relative humidity of 95 % at 55°C)
Reinforced cable pull-out strength		Serrated terminals
Automatic cable guiding in the correct position		Terminals with guard

According to EN 60947-2

	DT40 Vigi	DT40 Vigi K
Rated impulse withstand voltage (Uimp)	4 kA	4 kA
Breaking capacity (Icu)	6 kA	4 kA
Service breaking capacity (Ics)	75 %	100 %

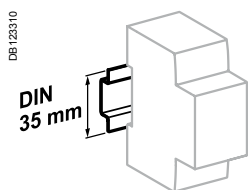

Clip on DIN rail 35 mm.

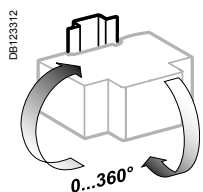

Indifferent position of installation.

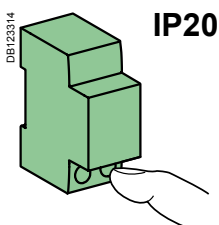

IP20

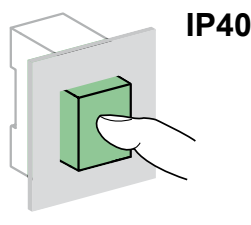

IP40

EN 61009-1

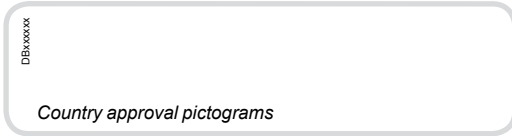

Earth leakage protection for "Group Feeders" is performed by a circuit breaker combined with a Vigi module.

Offer selection see page 245

Librio

This sticker must be removed before publishing

PE107904-32



PE107906-32



Catalogue numbers

"Group Feeder" Vigi C40 modules

Type		AC	A		SI	Width in 9-mm modules		
1P+N 	Sensitivity	30 mA	300 mA	30 mA	300 mA	30 mA	300 mA	2
	Rating	25 A 40 A	A9N19470 A9N19474	A9N19471 A9N19475	A9N19480 A9N19484	A9N19481 A9N19485	A9N19490 A9N19494	
3P+N 	Sensitivity	30 mA	300 mA	30 mA	300 mA	30 mA	300 mA	6
	Rating	25 A 40 A	A9N19472 A9N19476	A9N19473 A9N19477	A9N19482 A9N19486	A9N19483 A9N19487	A9N19492 A9N19496	

Vigi modules and residual current devices C40 "Outgoer"

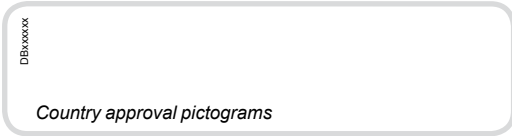

EN 61009-1

For the earth leakage protection of "outgoers", a residual current device is built by combining a circuit breaker and a Vigi module. "Outgoer" residual current devices are also available in monobloc version.

Catalogue numbers

C40a Vigi residual current devices 4500 EN 61009 - C curve

Type	AC	Width in 9-mm modules
Auxiliaries	Add-on auxiliaries: see modules CA907008 and CA907010	
1P+N	Sensitivity 30 mA	
	Rating 6 A	A9N19275
	10 A	A9N19276
	16 A	A9N19277
	20 A	A9N19278
	25 A	A9N19279
	32 A	A9N19280
	40 A	A9N19281

C40N Vigi residual current devices 6000 EN 61009 - C curve

Type	AC	Width in 9-mm modules
Auxiliaries	Add-on auxiliaries: see modules CA907008 and CA907010	
1P+N	Sensitivity 30 mA	
	Rating 6 A	A9N19285
	10 A	A9N19286
	16 A	A9N19287
	20 A	A9N19288
	25 A	A9N19289
	32 A	A9N19290
	40 A	A9N19291



Offer selection see page 245

Librio

This sticker must be removed before publishing



Catalogue numbers

"Outgoer" Vigi C40 modules

Type	AC	A	SI	Width in 9-mm modules
1P+N	Sensitivity 30 mA	300 mA	30 mA	
	Rating 25 A	A9N19440	A9N19441	A9N19450
	40 A	A9N19444	A9N19445	A9N19454
				A9N19451
				A9N19455
			A9N19460	
			A9N19464	
3P+N	Sensitivity 30 mA	300 mA	30 mA	
	Rating 25 A	A9N19442	A9N19443	A9N19452
	40 A	A9N19446	A9N19447	A9N19456
				A9N19453
				A9N19457
			A9N19462	
			A9N19466	

Vigi modules and residual current devices

Librio (cont.)

Dimensions (mm)

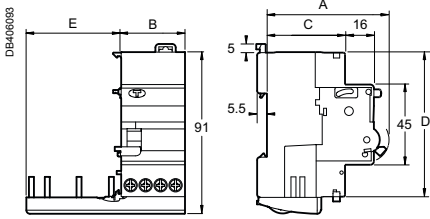

"Outgoer" Vigi modules

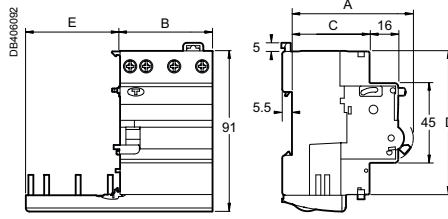

"Group Feeder" Vigi modules

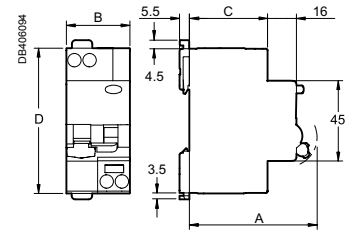

Residual current devices

Earth leakage protection

Type	Number of poles	A	B	C	D	E
"Outgoer" Vigi C40 modules	1P+N	69	18	44	81	18
	3P	69	36	44	81	54
	3P+N	69	36	44	81	54
"Group Feeder" Vigi C40 modules	1P+N	70	18	44	82	18
	3P+N	70	54	44	82	54
Residual current devices C40a Vigi, C40N vigi	1P+N	71	36	44	81	-

Offer selection see page 245

Librio

This sticker must be removed before publishing

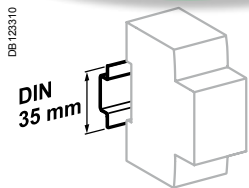

Clip on DIN rail 35 mm.

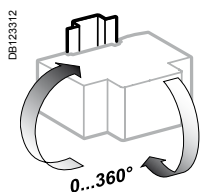

Indifferent position of installation.

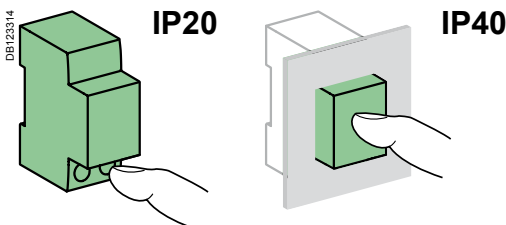

Technical data

Main characteristics

According to EN 61009-1

Insulation voltage (Ui)	Phase-to-phase	440 V AC
Voltage rating (Ue)	Phase-to-neutral	230 V AC
	Phase-to-phase	400 V AC
Operating frequency		50 Hz
Pollution degree		3 as per IEC 61009 (for installation in industrial environment)
Rated impulse withstand voltage (Uimp)		4 kV
Behaviour in the event of a phase-to-earth fault in TN-S earthing system		Residual breaking and making capacity (I _{Δm}) identical to the rated breaking capacity (I _{cn})
Behaviour in case of voltage drop		Residual current protection down to 0 V according to IEC/EN 61009-1 § 3.3.8

Additional characteristics

Degree of protection	Device only	IP20
	Device in modular enclosure	IP40
Operating temperature	A and SI types	-25°C to +60°C
	AC type	-5°C...+60°C
Storage temperature		-40°C to +60°C
Tropicalization		Treatment 2 (relative humidity of 95 % at 55°C)
Reinforced cable pull-out strength		Serrated terminals
Automatic cable guiding in the correct position		Terminals with guard

Vigi modules and residual current devices

Clario, Prodis, Libro

Connection

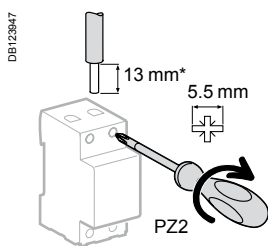

Tightening torque	Copper cables	
	Rigid	Flexible or with ferrule
2 N.m	DB123945 0.75 to 16 mm ²	DB123946 0.33 to 10 mm ²

(*) 15 mm for DT40 Vigi K 3P+N (Prodis)

- Where there is a comb busbar tooth, the connection of cables of cross section 16 mm² remains possible.
- Outgoer connection:
 - upstream: direct by comb busbar,
 - downstream: by cables.
- Group Feeder connection:
 - upstream: by cables,
 - downstream: direct by comb busbar.

■ All Vigi modules that can be combined with circuit breakers have a rating foolproofing element preventing any combination on an inappropriate circuit breaker: in accordance with Annex G of the EN 61009-1 standard

"Group Feeder" Vigi modules
 ■ The downstream terminals are located in the upper part of the device for direct connection to the comb busbar

"Outgoer" Vigi modules
 ■ The downstream terminals are located in the lower part of the device

■ Every circuit breaker combined with a Vigi module remains compatible with the indication and tripping auxiliaries



Weight (g)

Type	Vigi modules	Residual current devices
1P+N	90	210
3P	165	-
3P+N	210	520
3P+N DT40 Vigi K (Prodis)	-	498
4P	210	-



The Schneider Electric residual current device range comprises various offers (A, B) to enable it to be the most competitive range possible in each country, allowing for the special characteristics of each market:

- usual installation procedure
- price
- accreditations by local bodies.

Variants

Offers		Pages
Offer A	Catalogue numbers	259
Offer B	Catalogue numbers	260
Common pages		261



Only the product range to be marketed in your country and validated by the local product manager, in agreement with his Final Distribution (FD) partner should be retained. The others will be removed before publication.





Country approval pictograms



IEC/EN 61009-1

- The DPN Vigi residual current device provides complete protection for final circuits (against overcurrents and insulation faults):
 - protection for people against electric shocks by direct contacts (30 mA),
 - protection for people against electric shocks by indirect contacts (300 mA),
 - protection of installations against risk of fire (300 mA).
- The *SI* range has been designed to maintain a network with optimum safety and continuity of service in installations disturbed by:
 - extreme atmospheric conditions,
 - harmonic generating loads,
 - transient switching currents.

Catalogue numbers

DPNa Vigi 4500			
Type	A		Width in 9-mm modules
Auxiliaries	Module CA907013 and CA907008		
1P+N C curve	Sensitivity	10 mA	
	Rating (In)	10 A	A9N19304
		16 A	A9N19305
Voltage rating (Ue)		230 V AC	
Operating frequency		50/60 Hz	
Accessories		Module CA907013 and CA907012	

Catalogue numbers

DPN N Vigi 6000						
Type	AC	SI			Width in 9-mm modules	
Auxiliaries	Module CA907013 and CA907008					
1P+N B curve	Sensitivity	30 mA	300 mA	30 mA	300 mA	
	Rating (In)	4 A	A9N19650	-	-	
		6 A	A9N19651	A9N19671	-	
		10 A	A9N19653	A9N19673	-	
		13 A	-	-	-	
		16 A	A9N19655	A9N19675	-	
		20 A	A9N19656	A9N19676	-	
		25 A	A9N19657	A9N19677	-	
		32 A	A9N19658	A9N19678	-	
	40 A	A9N19659	A9N19679	-		
1P+N C curve	Sensitivity	30 mA	300 mA	30 mA	300 mA	
	Rating (In)	6 A	A9N19661	A9N19681	A9N19631	A9N19641
		10 A	A9N19663	A9N19683	A9N19632	A9N19642
		13 A	-	-	A9N19633	A9N19643
		16 A	A9N19665	A9N19685	A9N19634	A9N19644
		20 A	A9N19666	A9N19686	A9N19635	A9N19645
		25 A	A9N19667	A9N19687	A9N19636	A9N19646
		32 A	A9N19668	A9N19688	A9N19637	A9N19647
		40 A	A9N19669	A9N19689	A9N19638	A9N19648
Voltage rating (Ue)		230 V AC				
Operating frequency		50/60 Hz				
Accessories		Module CA907013 and CA907012				

Offer selection see page 258

Offer A

This sticker must be removed before publishing

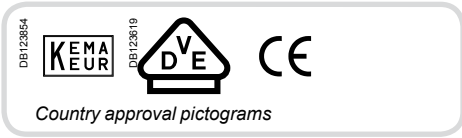

IEC/EN 61009-1

■ The DPN Vigi residual current device provides complete protection for final circuits (against overcurrents and insulation faults) it ensure the protection for people against electric shocks by direct contacts.

Catalogue numbers

DPNa Vigi 4500				
Type	A		Width in 9-mm modules	
Auxiliaries	Module CA907013 and CA907008			
1P+N C curve	Sensitivity	30 mA		
	Rating (In)	10 A	4	
		13 A		A9N19533
		16 A		A9N19534
Voltage rating (Ue)		230 V AC		
Operating frequency		50/60 Hz		
Auxiliaries	Module CA907013 and CA907012			

Offer selection see page 258

Offer B

This sticker must be removed before publishing

Catalogue numbers

DPN N Vigi 6000				
Type	A		Width in 9-mm modules	
Auxiliaries	Module CA907013 and CA907008			
1P+N B curve	Sensitivity	30 mA		
	Rating (In)	6 A	4	
		10 A		A9N19754
		13 A		A9N19755
		16 A		A9N19756
		20 A		A9N19757
		25 A		A9N19758
		32 A		A9N19759
		40 A		A9N19760
1P+N C curve	Sensitivity	30 mA		
	Rating (In)	6 A	4	
		10 A		A9N19772
		13 A		A9N19773
		16 A		A9N19774
		20 A		A9N19775
		25 A		A9N19780
		32 A		A9N19777
		40 A		A9N19778
Voltage rating (Ue)		230 V AC		
Operating frequency		50/60 Hz		
Auxiliaries	Module CA907013 and CA907012			

Positive contact indication

■ A green strip on the toggle guarantees opening of all the poles in safety conditions (padlocking possible) for work to be carried out on live parts



■ Fast closing

■ Display of earth fault on the front panel by position of toggle

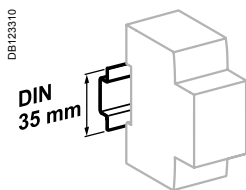

Clip on DIN rail 35 mm.

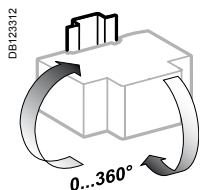

Indifferent position of installation.

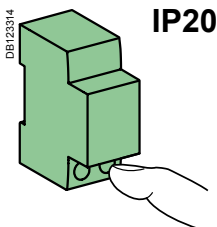

IP20

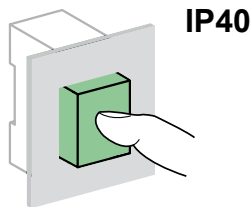

IP40

Connection

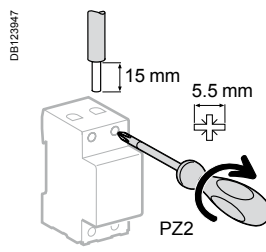

Rating	Tightening torque	Copper cables	
		Rigid	Flexible or with ferrule
4 to 40 A	2 N.m	1 to 16 mm ²	1 to 10 mm ²

Technical data

Main characteristics		
Type	DPNa Vigi	DPN N Vigi
Insulation voltage (U _i)	400 V AC	
Pollution degree	3	
Rated impulse withstand voltage (U _{imp})	4 kV	
Setting temperature for ratings	30°C	
Earth leakage protection with instantaneous tripping	10, 30 mA	30, 300 mA
Magnetic tripping	B curve	Between 3 and 5 I _n
	C curve	Between 5 and 10 I _n
Utilization category	A	
Insulation class	2	
8/20 μs impulse withstand current	AC type	250 Å
	A type	250 Å
	S/ type	3 kÅ

According to IEC/EN 61009-1		
Limitation class	3	
Rated breaking capacity (I _{cn})	4500 A	6000 A
Rated residual breaking and making capacity (I _{Δm})	4500 A	6000 A
Behaviour in case of voltage drop	Residual current protection down to 0 V according to IEC/EN 61009-1 § 3.3.8	

Additional characteristics		
Degree of protection (IEC 60529)	Device only	IP20
	Device in modular enclosure	IP40
		Insulation class II
Endurance (O-C)	Electrical	20,000 cycles
		10,000 cycles
	≤ 20 A	20,000 cycles
	≥ 25 A	20,000 cycles
Overvoltage category (IEC 60364)	IV	
Operating temperature	AC type	-5°C to +60°C
	A, S/ type	-25°C to +60°C
Storage temperature	-30°C to +70°C	
Tropicalization (IEC 60068-1)	Treatment 2 (relative humidity of 95% at 55°C)	

Weight (g)

Residual current device		
Type	DPNa Vigi	DPN N Vigi
1P+N	125	125

Dimensions (mm)

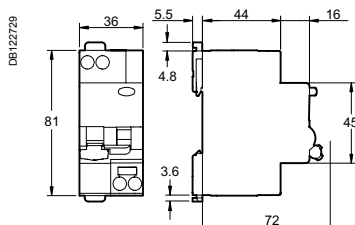

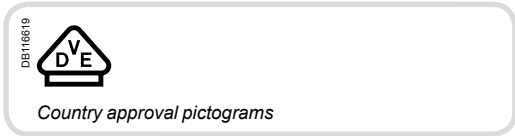

IEC/EN 61009-1



DPN Vigi K

■ The residual current devices DPN Vigi K provides complete protection of final circuits (overcurrents and insulation faults) and the protection of people against electric shocks by direct contacts (30 mA).

- Fast closing.
- Positive break indication.
- Display of earth fault on the front panel by position of toggle.

Catalogue numbers

DPN Vigi K		AC	A	Width in 9-mm modules
Type		30 mA	30 mA	
1P+N Curve B 	Rating	10 A	A9D22610	4
		16 A	A9D22616	
		20 A	A9D22620	
			A9D23610	
1P+N Curve C 	Rating	10 A	A9D20610	4
		16 A	A9D20616	
		20 A	A9D20620	
			A9D21610	
Voltage rating (Ue)		230 V AC		
Operating frequency		50 Hz		

Connection

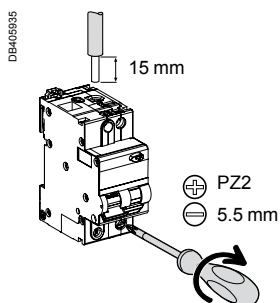

Type	Rating	Tightening torque	Copper cables		
			Rigid	Flexible or with ferrule	
DPN Vigi K	10 to 20 A	Phase	2 N.m	1 to 25 mm ²	1 to 16 mm ²
		Neutral	2 N.m	1 to 16 mm ²	1 to 10 mm ²

Residual current devices DPN Vigi K (cont.)

The DPN Vigi K residual current device can be installed in the middle of a line of K60 circuit breakers. The phase can be powered via the biconnect comb busbar, the neutral is powered via a cable.

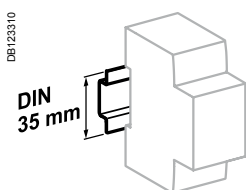
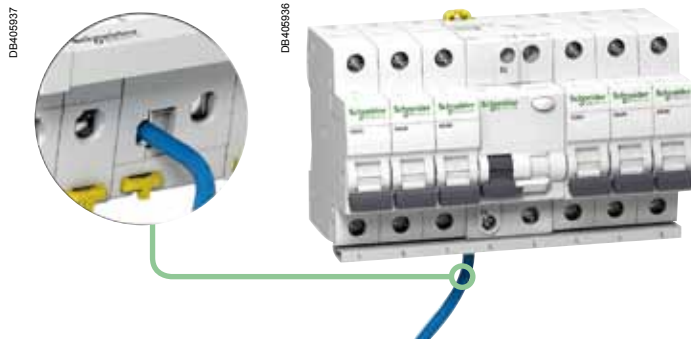

Clip on DIN rail 35 mm.

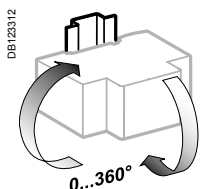

Indifferent position of installation.

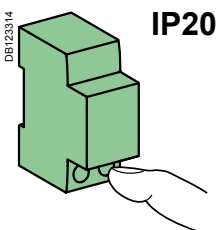

IP20

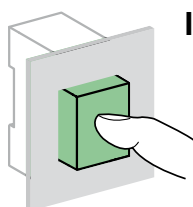

IP40

Technical data

Main characteristics

Insulation voltage (Ui)	400 V
Pollution degree	3
Rated impulse withstand voltage (Uimp)	4 kV
Setting temperature for ratings	30°C
Tripping curve	Curve B Curve C
	Between 3 and 5 In Between 5 and 10 In

According to IEC/EN 61009-1

Limitation class	3	
Rated breaking capacity (Icn)	6000 A	
Rated residual breaking and making capacity (IΔm)	4500 A	
8/20 μs impulse withstand without tripping	AC type A type	250 Å 250 Å
Behaviour in case of voltage drop		Residual current protection down to 0 V according to IEC/EN 61009-1 § 3.3.8

Additional characteristics

Degree of protection	Device only	IP20
	Device in modular enclosure	IP40 Insulation class II
Endurance (O-C)	Electrical Mechanical	20000 cycles 20000 cycles
Overvoltage category (O-C)		III
Service temperature	AC type A type	-5°C to +40°C -25°C to +40°C
		
Storage temperature		-30°C to +70°C
Tropicalization		Treatment 2 (relative humidity 95 % at 55°C)

Weight (g)

Residual current device

Type	DPN Vigi K
1P+N	125

Dimensions (mm)

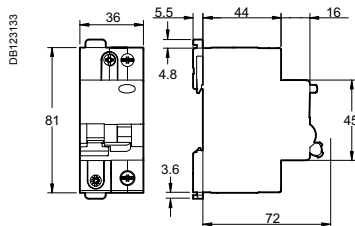

DPN Vigi K

SPN N Vigi

30 mA instantaneous, C curve
IEC 61009-2-2, AS/NZS 61009-1: 6000 A



Standards: IEC 61009-2-2, AS/NZS 61009-1.

- The single-phase SPN N Vigi self-contained residual current device carries out:
 - protection of persons against direct and indirect contacts (30 mA)
 - complete protection of final circuits (overcurrents and insulation faults)
 - safety device to switch both of active and neutral
- A class SPN N Vigi are sensitive to the pulsed type DC component.
- Overload, short circuit and earth fault currents are indicated by location of the handle in the OFF position.
- A push-test button "T" is positioned on the front of the device for testing that product is operational.

Accessories

Padlocking device

- Used to lock the toggle in the "open" or "closed" position by 8 mm diameter padlock (not supplied).

1P+N comb busbars

- The comb busbars make it easier to install Schneider Electric products.

Catalogue numbers

SPN N Vigi

Type	Voltage rating (V)	Rating (In)	Sensitivity (IΔn)	A	Width in 9-mm modules
C curve 	240	Rating (In)	10 A	30 mA	2
			16 A	19583	
			20 A	19584	
			25 A	19585	
				19586	
Operating frequency				50 Hz	

Accessories

Type	
Padlocking device (bag of 2 pieces)	26970
1P+N comb busbar 26 modules of 9-mm	14880
1P+N comb busbar 48 modules of 9-mm	14890
Side-plates (bag of 40 pieces)	14886
Tooth cover end-piece (bag of 40 pieces)	14888

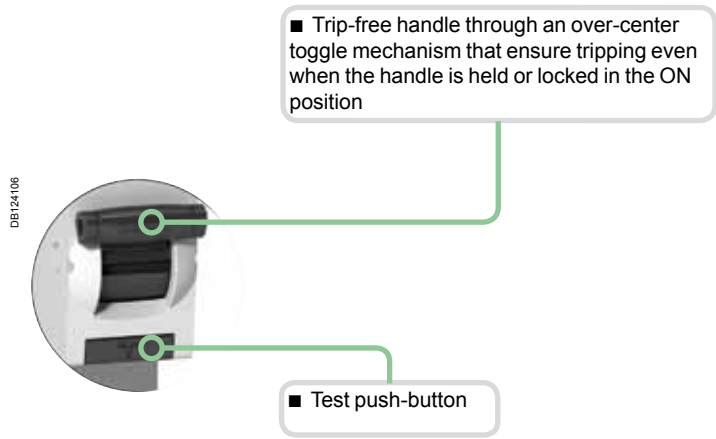

Connection

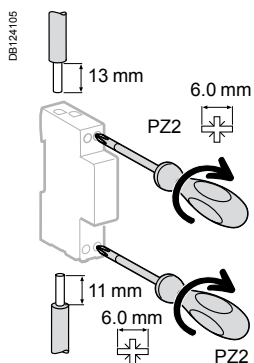

Type	Rating	Tightening torque	Copper cables	
			Rigid	Flexible
L and N upstream	10 to 25 A	2 N.m	1 to 16 mm ²	1 to 16 mm ²
L and N downstream		2 N.m	1 to 10 mm ²	1 to 10 mm ²

Note: for any case, isolate power before installation. Wire neutral prior to installing active.

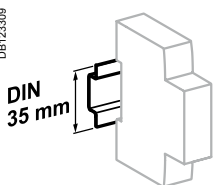

Clip on DIN rail 35 mm.

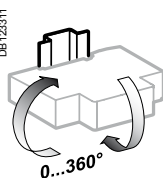

Indifferent position of installation.

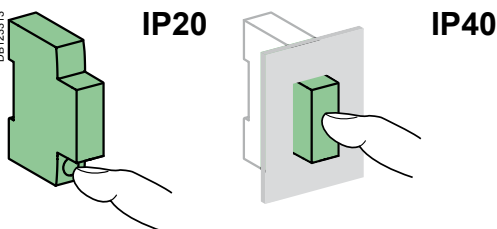

Technical data

Main characteristics		
Voltage rating (U _e)	240 V + 10 %, -15 %	
Insulation voltage (U _i)	400 V	
Rated impulse withstand voltage (U _{imp})	4 kV	
Rated residual operating current (I _{Δn})	30 mA	
Thermal tripping	Reference temperature	30°C
Magnetic tripping	C curve	Between 5 and 10 I _n
Limitation class	3	
Surge current withstand (8/20 μs) without tripping	3000 A	
Rated nominal breaking capacity (I _{cn})	6000 A	
Phase/earth rated residual breaking and making capacity (I _{Δm})	500 A	
Additional characteristics		
Degree of protection	Device only	IP20
	Device in modular enclosure	IP40
Endurance (O-C)	Electrical	10,000 cycles
	Mechanical	20,000 cycles
Operating temperature	-5°C to +40°C	
Storage temperature	-25°C to +70°C	
Tropicalization	Treatment 2 (relative humidity: 95 % at 55°C)	

Dimensions (mm)

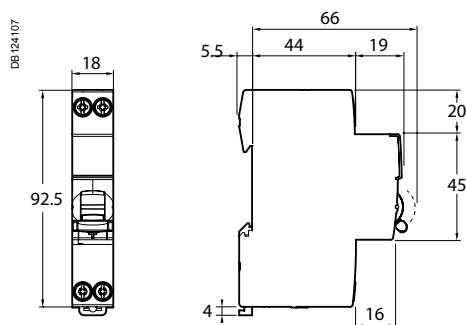

Weight (g)

Residual current device	
Type	SPN N Vigi
1P+N	136

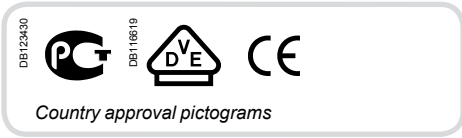

IEC/EN 61009-1



DPN N Vigi

- The DPN N Vigi residual current device provide complete protection for final circuits (against overcurrents and insulation faults):
 - protection for users against electric shocks by direct contacts (30 mA),
 - protection for users against electric shocks by indirect contacts (300 mA),
 - protection of the installations against fire risks (300 mA).

- The *SI* range has been designed to maintain a network with optimum safety and continuity of service in installations disturbed by:
 - extreme atmospheric conditions,
 - harmonic generating loads,
 - transient operating currents.

Catalogue numbers

DPN N Vigi 6000								
Type	AC	A		SI		Width in 9 mm modules		
Auxiliaries	Module CA907013 and CA907008							
3P+N Curve B	Sensitivity		30 mA	300 mA	30 mA	300 mA	30 mA	
	Rating (In)	6 A	A9D55706	-	A9D56706	-	-	10
		10 A	A9D55710	-	A9D56710	-	-	
		13 A	-	-	A9D56713	-	-	
		16 A	A9D55716	-	A9D56716	-	-	
		20 A	A9D55720	-	A9D56720	-	-	
		25 A	A9D55725	-	A9D56725	-	-	
		32 A	A9D55732	-	A9D56732	-	-	
		40 A	A9D55740	-	A9D56740	-	-	
	Rating (In)	6 A	A9D31706	-	A9D32706	-	-	10
		10 A	A9D31710	A9D41710	A9D32710	A9D42710	A9D33710	
		13 A	-	-	A9D32713	-	A9D33713	
		16 A	A9D31716	A9D41716	A9D32716	A9D42716	A9D33716	
		20 A	A9D31720	A9D41720	A9D32720	A9D42720	A9D33720	
		25 A	A9D31725	A9D41725	A9D32725	A9D42725	A9D33725	
		32 A	A9D31732	A9D41732	A9D32732	A9D42732	A9D33732	
		40 A	A9D31740	A9D41740	A9D32740	A9D42740	A9D33740	
Voltage rating (Ue)	400 V AC							
Operating frequency	50 Hz							
Accessories	Module CA907013							

- Fast contact closure
- Possibility of mixing iDPN Vigi 1P+N and DPN Vigi 3P+N devices on the same row and on the same comb busbar.
- Insulated terminals IP20
- Double clip for dismounting with comb busbar in place
- Test button
- Positive contact indication
 - A green strip on the toggle guarantees opening of all the poles in safety conditions (padlocking possible) for work to be carried out on live parts

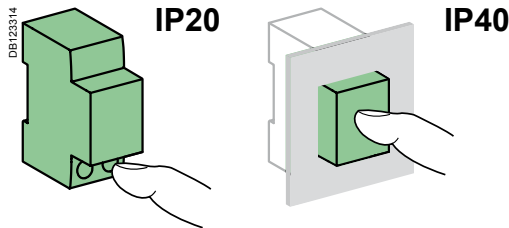
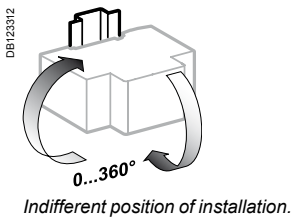
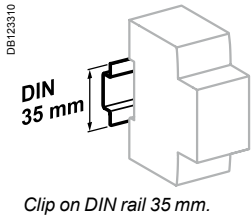

Connection

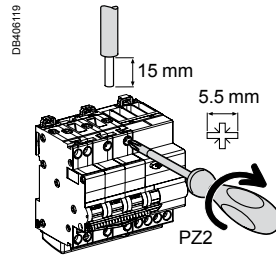

Rating	Tightening torque	Copper cables	
		Rigid	Flexible or with ferrule
6 to 40 A	2 N.m	DB 122546 0.75 to 16 mm ²	DB 122546 0.33 to 10 mm ²

Technical data

Main characteristics

Type	DPN N Vigi
Insulation voltage (U _i)	440 V AC
Pollution degree	3
Rated impulse withstand voltage (U _{imp})	4 kV
Setting temperature for ratings	30°C
Magnetic tripping	Curve B Curve C
	Between 3 and 5 In Between 5 and 10 In

According to IEC/EN 61009-1

Limitation class	3
Rated breaking capacity (I _{cn})	6000 A
Rated residual breaking and making capacity (I _{Δm})	6000 A
8/20 μs impulse withstand	Type AC: 250 Å Type A: 250 Å Type SI: -

Behaviour in case of voltage drop	 Residual current protection down to 0 V according to IEC/EN 61009-1 § 3.3.8
-----------------------------------	--

Additional characteristics

Earth leakage protection with instantaneous tripping	30, 300 mA
Degree of protection (IEC 60529)	Device only: IP20 Device in modular enclosure: IP40 Insulation class II
Endurance (O-C)	Electrical: ≤ 20 A: 20,000 cycles ≥ 25 A: 10,000 cycles Mechanical: 20,000 cycles
Overvoltage category (IEC 60364)	III
Operating temperature	Type AC: -5°C to +60°C Type A, SI: -25°C to +60°C
Storage temperature	-40°C to +70°C
Tropicalization (IEC 60068-1)	Treatment 2 (relative humidity 95 % to 55°C)

Weight (g)

Residual current device	
Type	DPN N Vigi
3P+N	498

Dimensions (mm)

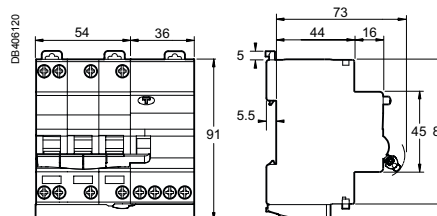



IMQ only for REDs,
cat. no. 18264, 18265, 18266, 18267,
18268, 18269, 18687 and 18689

Country approval pictogram

EN 50557

The REDs and the REDtest, **RE**sidual current **D**evice recloser, is made up of a residual current device and a recloser.

The **REDs** and **REDtest RESidual current Devices** offer the following functions:

- protection of people against direct and indirect contacts
- protection of installations against insulation faults
- disconnection of on-load electric circuits, already protected against overloads and short-circuits
- automatic restart after insulation monitoring of the downstream circuit.

REDtest provides the following additional functions:

- automatic and periodical test of the device, without breaking downstream circuit (REDtest).

Only used on TT and TN-S earthing grounding systems.

PB101780_SE-40



REDs 2P

PB104000_SE-40



REDs 4P

PB113821-40



REDtest

Residual current circuit breakers	2P	4P
Making and breaking capacity, rated residual current ($I_{\Delta m} = I_m$)	630 A	630 A
Breaking capacity in association with protection device	6000 A (gL 63 A)	10,000 A (gL 80 A)

Catalogue numbers

REDs residual current circuit breakers REDs					
A type				Width in mod. of 9 mm	
2P 	Sensitivity	30 mA	300 mA	8	
	Rating	25 A	18687		18688
		40 A	18689		18690
		63 A	18691		18692
Voltage rating (Ue)		230 V			
Frequency rating		50 Hz			
4P 	Sensitivity	30 mA	300 mA	14	
	Rating	25 A	18264		18265
		40 A	18266		18267
		63 A	18268		18269
		100 A	-		18270
Voltage rating (Ue)		400 V			
Frequency rating		50 Hz			

REDtest residual current circuit breakers				
A type				Width in mod. of 9 mm
2P 	Sensitivity	30 mA		10
	Rating	25 A	18280	
		40 A	18281	
Voltage rating (Ue)		230 V		
Frequency rating		50 Hz		

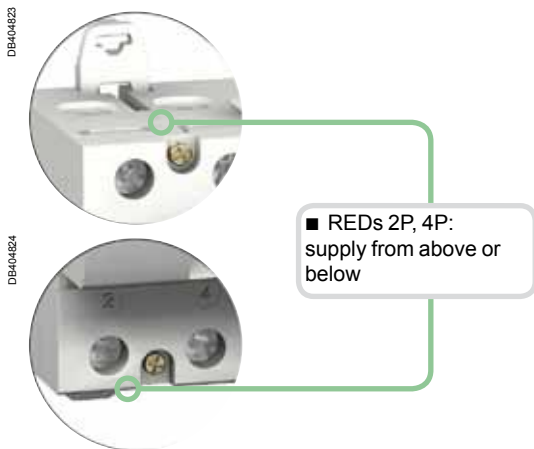

Coordination table, max short-circuit current (kA rms)

Circuit-breakers, fuse / A type REDs, REDtest coordination

		Circuit-breakers					Fuse		
		DPN	DPN N	iC60	C120	NG125	gL 63	gL 80	gL100
REDs A type 2P									
Network	25 A	6	6	10	10	10	6	-	-
230 V	40 A	6	6	10	10	10	6	-	-
L/N	63 A	-	-	10	10	10	6	-	-
REDs A type 4P									
Network	25 A	6	10	10	10	10	-	10	-
400 V	40 A	6	10	10	10	10	-	10	-
L/N	63 A	-	10	10	10	10	-	10	-
	100 A	-	10	10	10	10	-	-	10
REDtest A type 2P									
Network	25 A	6	6	6	6	6	6	-	-
230 V	40 A	6	6	6	6	6	6	-	-
L/N									

DB 1223983

		Circuit-breaker (MCB) or Fuse (FU)			
		≤ 25 A	≤ 40 A	≤ 63 A	≤ 100 A
REDs / REDtest	25 A	■	—	—	—
	40 A	■	■	—	—
REDs	63 A	■	■	■	—
	100 A	■	■	■	■

Operation

REDs

The REDs operates in the residual current device mode, without automatic restart, when the sliding cover is open, i.e. to the right in the Auto Off position (Fig. 1).

The automatic restart mode and the Autotest are activated, when the sliding cover is closed, i.e. to the left in the Auto On position (Fig. 2).

Test

⚠ This is only possible in manual mode, i.e. sliding cover open in the Auto Off position. You can then manually test the device by pressing the Test key. The downstream installation is then temporarily broken. You must then manually reclose the RED by activating the O-I lever to power supply the downstream circuit.

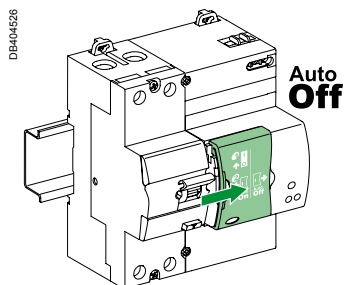

Fig. 1

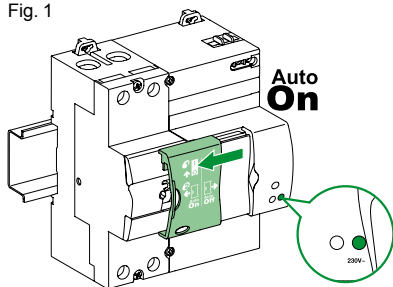

Fig. 2

REDtest

■ The REDtest carries out automatic testing of earth leakage protection every months.

The test consists in opening and reclosing the REDtest, during which time continuity of supply of the downstream installation is guaranteed.

Autotest: after checking installation insulation, the REDtest monitors its residual current device, without breaking the downstream power supply (bypass by bypass contact).

REDs, REDtest

Operation ON mode: temporary network fault REDs, REDtest

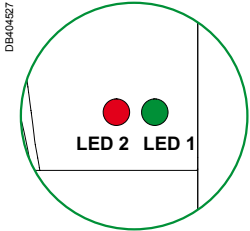

(*) Reclosing time:
 REDtest 2P: 10 s
 REDs 2P: 90 s
 REDs 4P: 10 s

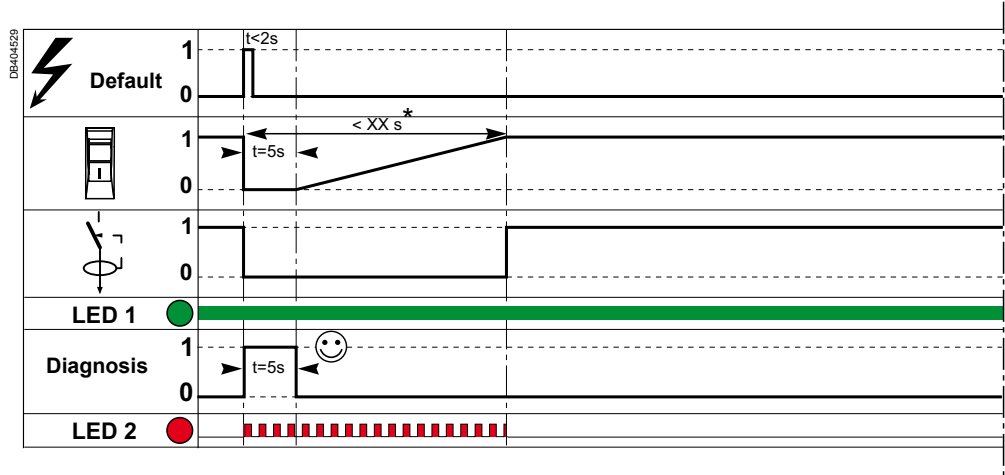

The built-in automatic recloser automatically recloses the residual current device after checking insulation of the downstream circuit.

Rd: lower level of insulation resistance, if $R < R_d$ = no reclose
 Rdo: higher level of insulation resistance, if $R_d > R_{do}$ = reclose

$I_{\Delta n}$	30 mA	300 mA
Rd	8 k Ω	2.5 k Ω
Rdo	16 k Ω	5 k Ω

Operation ON mode: long network fault

REDs

If the circuit is faulty, the switch is prohibited from reclosing. After a time delay of 2 minutes, the downstream circuit insulation is rechecked.

There are then two possibilities:

- the installation is still faulty (the resistance to earth is lower than Rd): in this case a new check will be carried out in 2 minutes.
- the fault was temporary and has disappeared (the resistance to earth is higher than Rdo): the recloser automatically recloses the REDs.

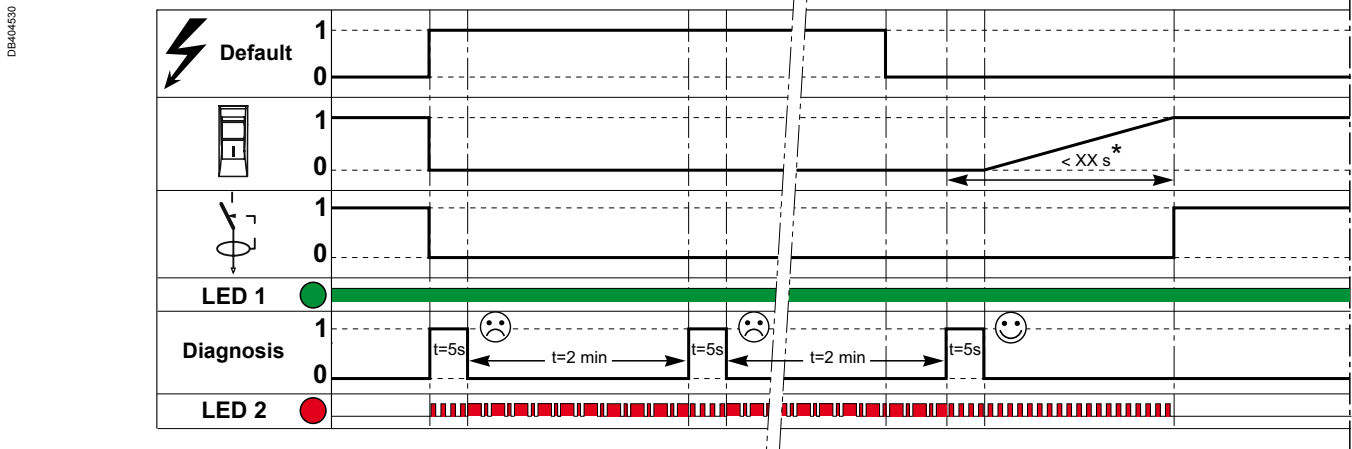

(*) Reclosing time:
 REDs 2P: 90 s
 REDs 4P: 10 s

IΔn	30 mA
Rd	20 k Ω
Rdo	70 k Ω

Operation ON mode: long network fault (cont.)

REDtest

If the circuit is faulty for a length of time "greater than 5 seconds", the switch is prohibited from reclosing.

- The installation is faulty: the earth resistance is lower than Rd.

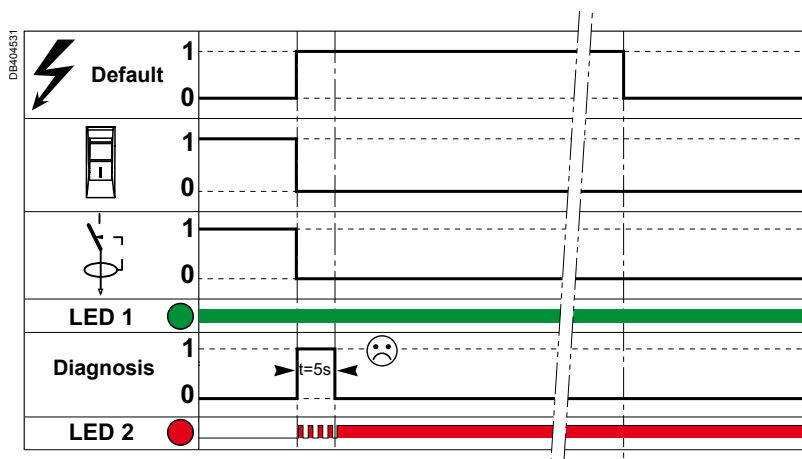

Connection

Type	Tightening torque	Copper cables	
		Rigid	Flexible or with ferrule
N, L	2 N.m	35 mm ²	35 mm ²
AUX REDs	0.4 N.m	2.5 mm ²	2.5 mm ²
AUX REDtest	0.4 N.m	2.5 mm ²	2.5 mm ²

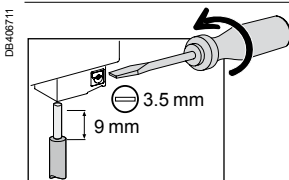
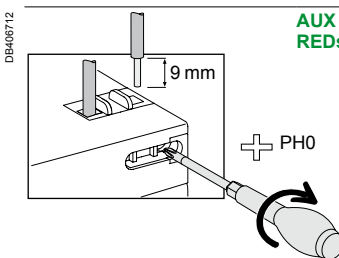
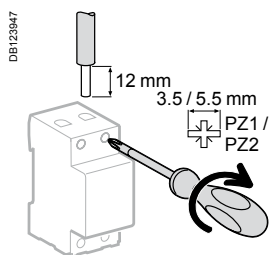

Connection by tunnel terminal with guard

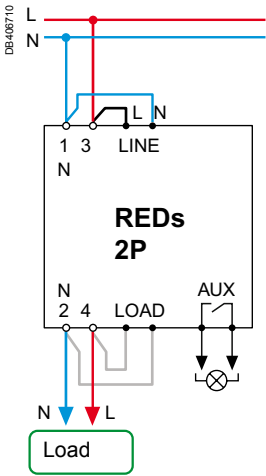

Wiring of non-polarized white wires

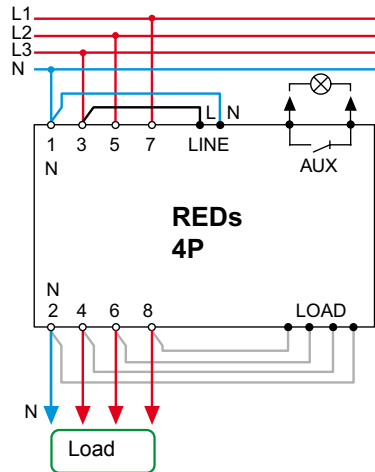

Wiring of non-polarized white wires

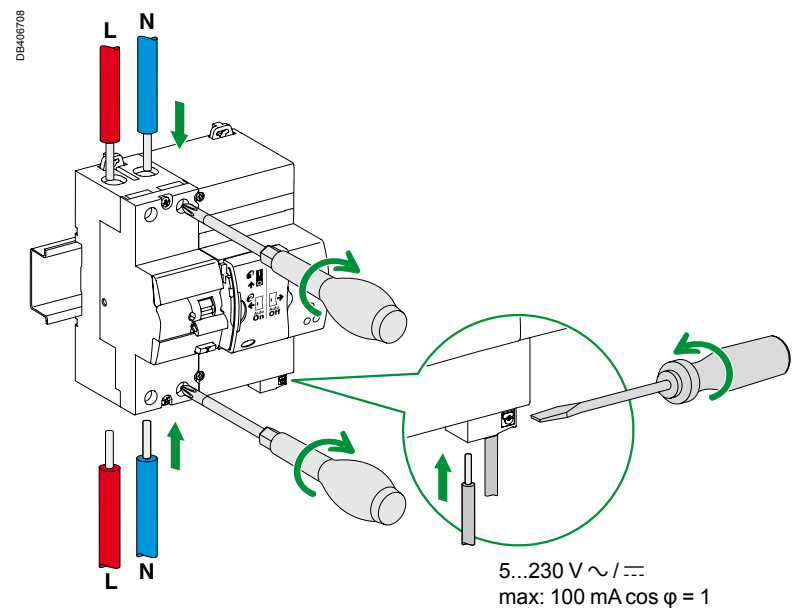
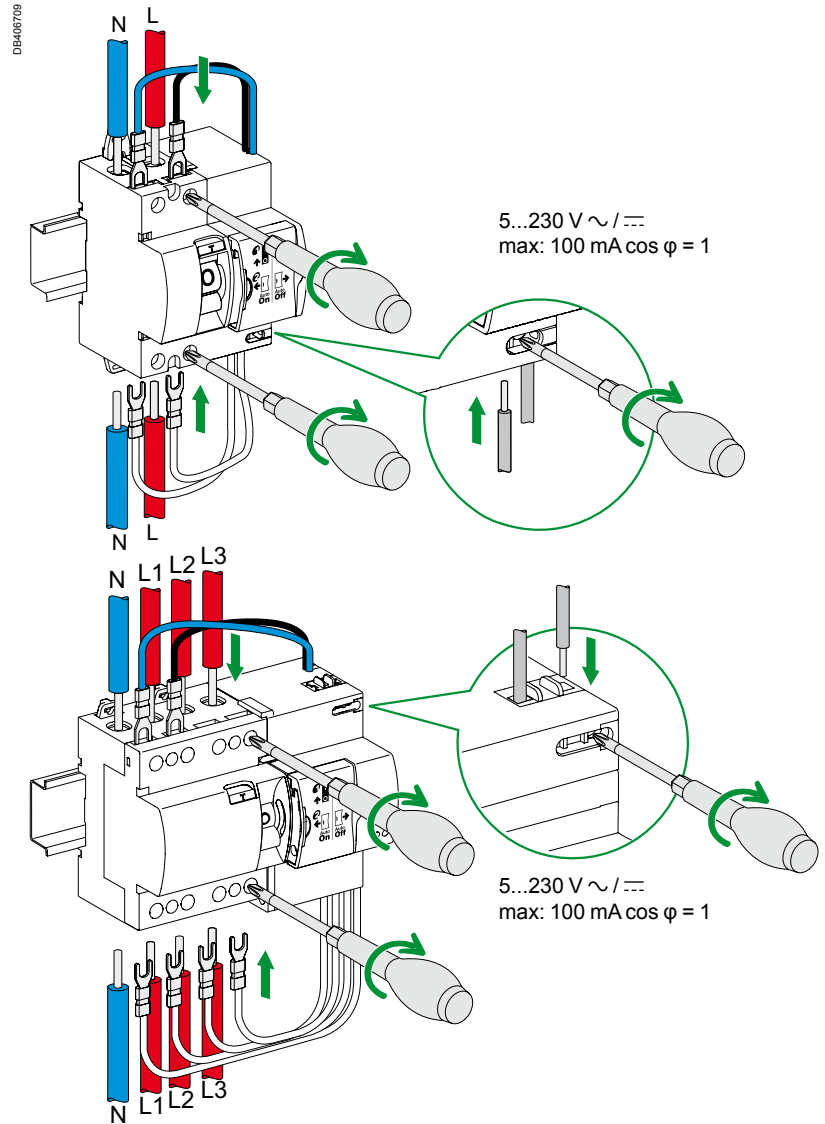
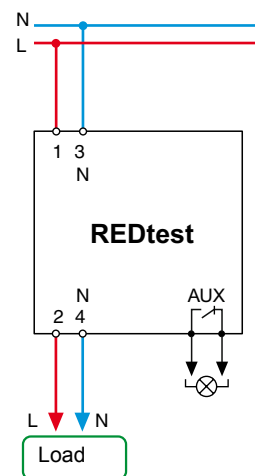

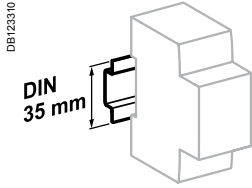

Clip on DIN rail 35 mm.

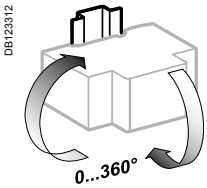

Indifferent position of installation.

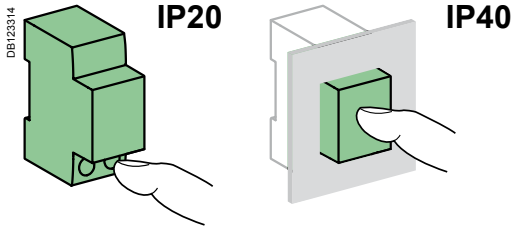

Technical data.

Main characteristics		2P	4P
Common technical data		REDtest	REDs
Earthing grounding systems	TT and TN-S only		
Impulse withstand voltage (U _{imp})	4 kV		
Insulation voltage (U _i)	500 V		
8/20 μs wave immunity level	250 Å		
Tropicalization	Treatment 2 (relative humidity: 95 % at 55°C)		
Operating temperature	-5°C to +40°C		
Storage temperature	-20°C to +60°C		
Protection class	IP20 at terminals		
Additional characteristics			
Residual current device			
Tripping time	IΔn: ≤ 300 ms		
	5 IΔn: ≤ 40 ms		
Number of cycles (O-C)	1 000		4 000
Fixed sensitivity releases for all ratings	Instantaneous release		
Test button min operating voltage	195 V	100 V	170 V
Recloser			
Max duration of a restart cycle	< 10 s	< 90 s	< 10 s
Maximum number of consecutive restart attempts (if no earth fault)	3		
Min interval between 2 closings	180 s		30 s
Insulation fault presence monitoring	Yes		
Insulation fault diagnosis	If fault: stopping of the restart cycle	If fault: diagnosis every 2 minutes with stopping of the restart cycle	
Stopping restart cycle if insulation fault present	Yes	Yes, during 15 minutes	
Not operating resistance to earth (R _d)	20 kΩ	8 kΩ (30 mA), 2.5 kΩ (300 mA)	
Operating resistance to earth (R _{do})	70 kΩ	16 kΩ (30 mA), 5 kΩ (300 mA)	
Power consumed by the electronics	8 VA	0 VA	
Indication			
Status indication	Mechanical: by O-I (open-closed) 2-position lever ■ Electrical: by 2 indicator lights on the front panel: □ left: red/yellow LED □ right: green LED Remote: by 1 built-in auxiliary contact		
Auxiliary contact			
Voltage rating (U _e)	5...230 V AC/DC		
Insulation voltage (U _i)	350 V		
Current rating (I _n)	Min: 0.6 mA Max: 100 mA, power factor = 1		
Type	Configurable	NO or NC	Intermittent 1 Hz or NO or NC
Connection by tunnel terminal	Flexible or rigid cable: max 2.5 mm ²		

REDs, REDtest

Weight (g)

Reclosers	2P	4P
REDs	360	<ul style="list-style-type: none"> ■ 25/40 A: 670 ■ 63 A: 720 □ 30 mA: 720 □ 300 mA: 680 ■ 100 A: 948
REDtest	370	-

Dimensions (mm)

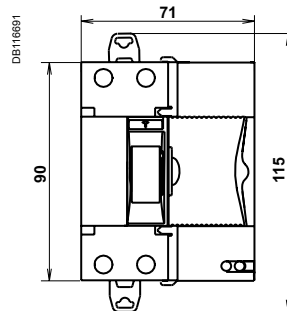

REDs 2P

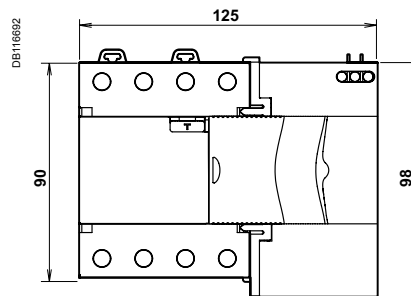
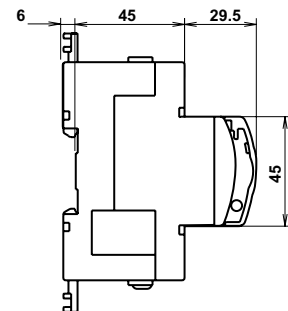

REDs 4P

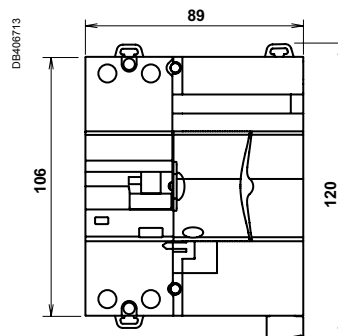
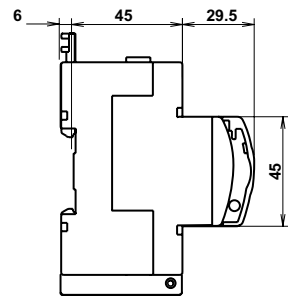

REDtest

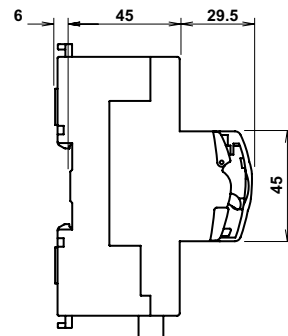



Country approval pictograms

iARC reduces the risk of electrical fires. By continuously analysing a large number of electrical parameters, it detects the appearance of electric arcs that are responsible for starting fires. It automatically isolates the circuit concerned before the first flame appears. In residential installations, iARC is particularly suitable for protecting circuits where the risk of fire is highest:

- bedroom and living room socket circuits that are live, unattended power outlets
- circuits susceptible to be damaged (surface-mounted, outdoor installation, etc.).

IEC 62606

General requirements for arc detection devices.

■ iARC monitors electric arcs that occur in cables and connections and cause a fire. These arcs are the result of localised cable deterioration or loose connections

■ It is used for three types of situations that can result in a fire:

- parallel arc detection: insulation problems between two live conductors that cause a resistive short-circuit, too weak to be detected by a circuit breaker and with no earth leakage that would be detected by an earth-leakage protection device,
- series arc detection: a damaged conductor or connection that causes part of the current to pass into its carbonised insulation due to a local rise in temperature,
- overheating of electronic components in loads, when exposed to an overvoltage for several seconds.

■ It combines the following functions:

- protection against fire hazards by detection of abnormal electric arcs,
- protection against load fire hazards due to slow overvoltages,
- circuit opening and positive break indication (green strip),
- fire hazard tripping indication via the front panel indicator,
- device self-diagnostics via the test button.

■ Installed in series with a circuit breaker or RCBO (DPN Vigi), max. 25 A, it protects Phase-Neutral or Phase-Phase circuits, in full coordination under short-circuit conditions up to a rated breaking capacity (Inc) of 10,000 A.



Catalogue numbers

iARC			
Arc Fault Detection Device (AFDD) to IEC 62606			Width in 9 mm modules
1P+N			
	Rating 25 A (In)	A9FDD225	4
Operating voltage	230 V AC		
Operating frequency	50 Hz		

Connection

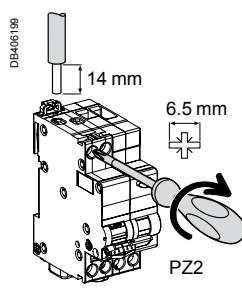

Tightening torque	Copper cables only	
	Rigid	Flexible or with ferrule
2 N.m	 1 x 1 to 16 mm ² 2 x 1 to 2.5 mm ²	 1 x 1 to 10 mm ² 2 x 1 to 2.5 mm ²



PB111222-50



Test button

■ For device self-diagnostic

Positive break indication

■ A green strip on the handle ensures that all the poles are open for insulation

Red square indicator

■ Fire hazard tripping indication via a "red" status indicator

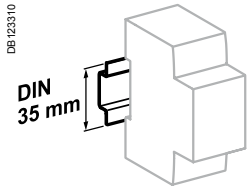

Clip on DIN rail 35 mm.

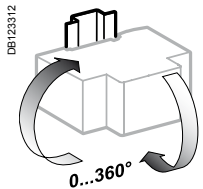

Indifferent position of installation.

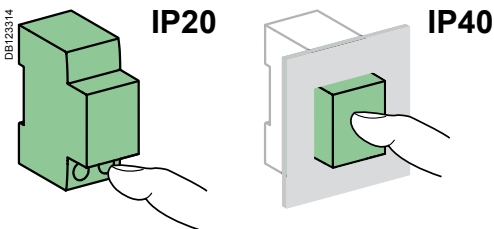

Technical data

Main characteristics

Tripping time/arc current value with $U_n = 230 \text{ V AC}$ (to IEC 62606)	Arc current	2.5 A	5 A	10 A	16 A	25 A
	Max. operating time	1 s	0.5 s	0.25 s	0.15 s	0.14 s
Overvoltage tripping time (neutral conductor break)		400 V AC, 200 ms				
Insulation voltage (U_i)		400 V AC				
Degree of pollution		2				
Rated impulse withstand voltage (U_{imp})		4 kV				
Rated making and breaking capacity (I_m)		500 A				
Overvoltage category		III				
Coordinated with an upstream circuit breaker	Max. rating	25 A				
	Curve	B or C				
	Rated breaking capacity (I_{nc})	Up to 10,000 A				

Additional characteristics

Degree of protection	Device alone	IP20
	Device in a modular enclosure	IP40 Insulation class II
Endurance (O-C)	Electrical $\leq 20 \text{ A}$	20,000 cycles
	25 A	10,000 cycles
	Mechanical	20,000 cycles
Operating temperature		-25°C to +60°C
Storage temperature		-40°C to +85°C
Tropicalization (to IEC 62606)		Severity B (to IEC 60068-2-30) during 28 days

Weight (g)

Arc detection device	
Type	iARC
1P+N	198

Dimensions (mm)

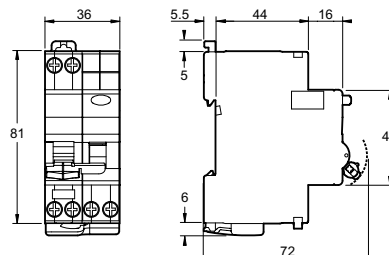



Fire prevention

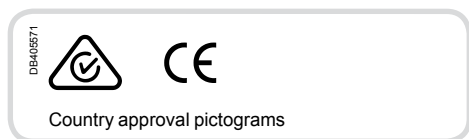

The iDPN N Arc circuit breaker reduces the risk of electrical fires. By continuously analysing a large number of electrical parameters, it detects the appearance of electric arcs that are responsible for starting fires. It automatically isolates the circuit concerned before the first flame appears. In residential installations, it is particularly suitable for protecting circuits where the risk of fire is highest:

- bedroom and living room socket circuits that are live, unattended power outlets
- circuits susceptible to be damaged (surface-mounted, outdoor installation, etc.).

IEC/EN 60898-1

Circuit breakers for the protection against the overload (residential and similar installations).

IEC 62606

General requirements for arc detection devices.

- In addition to protection against overloads and short-circuits, the iDPN N Arc monitors for electric arcs that occur in cables and connections, that may cause a fire. These arcs are the result of localised cable deterioration or loose connections.
- It is used for three types of situations that can result in a fire:
 - parallel arc detection: insulation problems between two live conductors that cause a resistive short-circuit, too weak to be detected by a circuit breaker and with no earth leakage to be detected by a residual current circuit breaker,
 - series arc detection: a damaged conductor or connection that causes part of the current to flow through its carbonised insulation due to a local rise in temperature,
 - overheating of electronic components in loads, when exposed to an overvoltage for several seconds.
- It combines the following functions:
 - circuit protection against overload and short-circuit currents (circuit breaker function),
 - protection against fire hazards by detection of abnormal electric arcs,
 - protection against load fire hazards due to slow overvoltages (network overvoltage),
 - fire hazard tripping indication via the front panel indicator,
 - device self-diagnostics via the test button,
 - positive contact indication (green strip).



Catalogue numbers

iDPN N Arc 6000			Width in 9 mm modules
Arc Fault Detection Devices (AFDD) to IEC 62606		C curve	
	Rating (In)	6 A	4
		10 A	
		16 A	
		20 A	
		25 A	
Operating voltage	230/240 V AC		
Operating frequency	50 Hz		

Connection

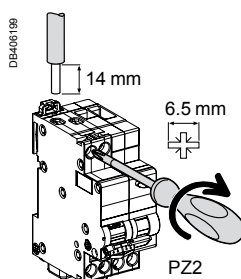

Tightening torque	Copper cables only	
	Rigid	Flexible or with ferrule
2 N.m	 1 x 1 to 16 mm ² 2 x 1 to 2.5 mm ²	 1 x 1 to 10 mm ² 2 x 1 to 2.5 mm ²



FB115631-50

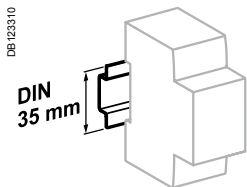

Clip on DIN rail 35 mm.

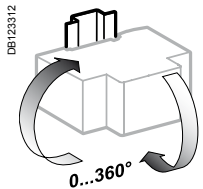

Indifferent position of installation.

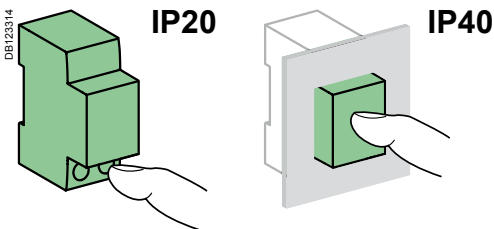

Technical data

Main characteristics

Tripping time/arc current value with $U_n = 230$ V AC (to IEC 62606)	Arc current	2.5 A	5 A	10 A	16 A	25 A
	Max. operating time	1 s	0.5 s	0.25 s	0.15 s	0.14 s
Overvoltage tripping time (neutral conductor break)		400 V AC, 200 ms				
Insulation voltage (U_i)		400 V AC				
Degree of pollution		2				
Rated impulse withstand voltage (U_{imp})		4 kV				
Overvoltage category		III				
Limitation class		3				
Thermal tripping	Reference temperature	30°C				
Magnetic tripping	Curve C	Between 5 and 10 I_n				
Rated breaking capacity (I_{nc})		6 000 A				

Additional characteristics

Degree of protection	Device alone	IP20
	Device in a modular enclosure	IP40 Insulation class II
Endurance (O-C)	Electrical ≤ 20 A	20,000 cycles
	25 A	10,000 cycles
	Mechanical	20,000 cycles
Operating temperature		-25°C to +60°C
Storage temperature		-40°C to +85°C
Tropicalization (to IEC 62606)		Severity B (to IEC 60068-2-30) during 28 days

Weight (g)

Arc fault detection circuit breaker	
Type	iDPN N Arc
1P+N	198

DB408187

Dimensions (mm)

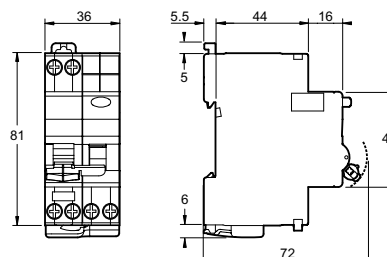

iPRF1 12.5r/PRD1 35r/ PRD1 25r/PRD1 Master Type 1 and 2 LV surge arresters

The Type 1 range of surge arresters meets the normative withstand capability of current wave type 10/350 μ s (8/20 μ s for Type 2 surge arresters).

It is suitable for use with TT, TN-S, TN-C and IT earthing connection systems (neutral point connection).

In addition, the PRD1 35r surge arrester covers the 400 V IT system.

iPRF1 12.5r and PRD1 surge arresters are fitted with a remote transfer contact to send "end-of-life indication" information.

PRD1 surge arresters are fitted with easy-to-replace withdrawable cartridges.

iPRF1 12.5r/PRD1 35r/PRD1 25r/PRD1 Master

The Type 1 surge arrester is recommended for electrical installations in the service sector and industrial buildings protected by a lightning conductor or by a meshed cage.

It protects electrical installations against direct lightning strikes.

It is used to conduct the direct lightning current, propagating from the earth conductor to the network conductors.

It must be installed with an upstream disconnection device, such as a fuse or circuit-breaker, whose breaking capacity must be at least equal to the maximum prospective short-circuit current at the installation point.

iPRF1 12.5r and PRD1 25r surge arresters also provide Type 2 protection and protect the electrical installation by finely clipping the lightning wave overvoltages.

PE104275-35-b



iPRF1 12.5r (3P+N)

DB408470



PRD1 35r (1P)

PE104260-35



PRD1 25r (3P+N)

PE104264-35



PRD1 Master (3P+N)

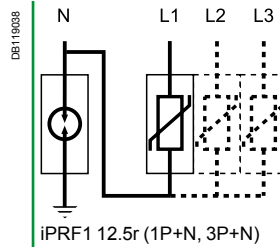

Type	Product solution	
Fixed surge arrester	1P+N	3P+N
	iPRF1 12.5r T1, T2	A9L16632 A9L16634
Cartridge surge arrester	1P+N	3P+N
	PRD1 25r T1 + T2	16330 16332
PRD1 Master T1	16361	16363
PRD1 35r T1		

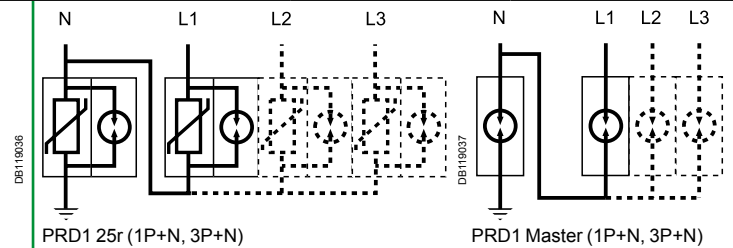

iPRF1 12.5r/PRD1 35r/ PRD1 25r/PRD1 Master

Type 1 and 2 LV surge arresters (cont.)

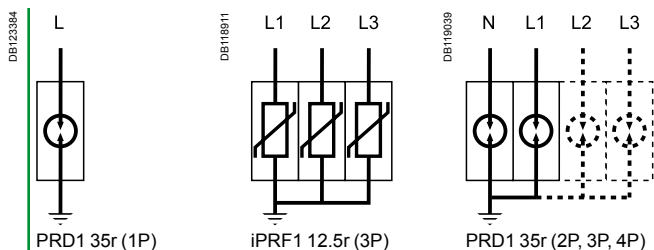

				Earthing system	Recommended accessory
1P	2P	3P	4P	TT, TN-S	
		A9L16633		TN-C	

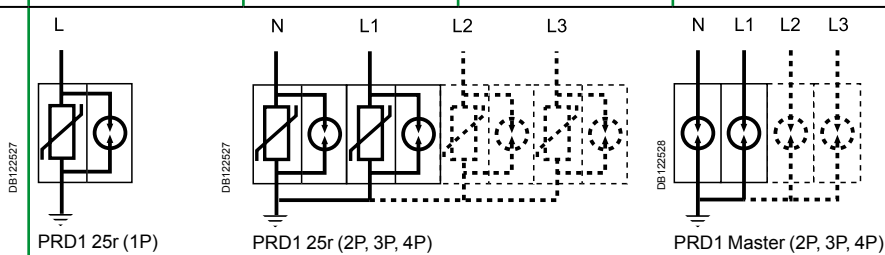

				Earthing system	Recommended accessory
1P	2P	3P	4P	TT, TN-S	
16329	2 x 16329	16331	4 x 16329	TT, TN-C	
		16360	4 x 16360	TN-C	
				TT, TN-S	
16360	2 x 16360	16362	4 x 16360	TT, TN-C	
	2 x 16649			TN-C	
16649		3 x 16649		IT distributed neutral, TT, TN-S	16643
			4 x 16649	IT non-distributed neutral, TN-C	16644
				IT distributed neutral	16645

iPRF1 12.5r/PRD1 35r/ PRD1 25r/PRD1 Master

Type 1 and 2 LV surge arresters (cont.)

Type	Nb. of poles	Width	I imp (kA) (10/350) Impulse current	I max (kA) (8/20) Maximum discharge current	In - kA Nominal discharge current	Up - kV Voltage protection level	Un - (V) Rated voltage network	Uc - V Maximum continuous operating voltage	Cat. no.
Fixed surge arrester		9 mm modules						(L-N)/(N-PE)	
iPRF1 12.5r	Type 1 + 2								
	1P+N	4	12.5 (L-N)/50 (N-PE)	50	25	≤ 1.5	230	350/255	A9L16632
	3P	8	12.5	50	25	≤ 1.5	230/400	350	A9L16633
	3P+N	8	12.5 (L-N)/50 (N-PE)	50	25	≤ 1.5	230/400	350/255	A9L16634
Withdrawable surge arrester									
PRD1 25r	Type 1 + 2								
	1P	4	25	40	25	≤ 1.5	230	350	16329
	1P+N	8	25 (L-N)/100 (N-PE)	40	25	≤ 1.5	230	350/350	16330
	3P	12	25	40	25	≤ 1.5	230/400	350	16331
	3P+N	16	25 (L-N)/100 (N-PE)	40	25	≤ 1.5	230/400	350/350	16332
PRD1 Master	Type 1								
	1P	4	25	50	25	≤ 1.5	230	350	16360
	1P+N	8	25 (L-N)/100 (N-PE)	50	25	≤ 1.5/2.5	230	350/350	16361
	3P	12	25	50	25	≤ 1.5	230/400	350	16362
	3P+N	16	25 (L-N)/100 (N-PE)	50	25	≤ 1.5/2.5	230/400	350/350	16363
PRD1 35r	Type 1								
	1P	4	35	50	35	≤ 2.5	230/400	440	16649
Spare cartridge									
C1 Master-350	-	4	-	-	25	≤ 1.5	-	350	16314
C1 25-350	-	23 mm	-	-	25	≤ 1.5	-	350	16315
C2 40-350	-	12 mm	-	-	20	≤ 1.5	-	350	16316
C1 Neutral-350	-	4	-	-	-	-	-	350	16317
C1 35-440	-	4	-	-	35	≤ 2.5	-	440	16318

PB10426E-30



C1 Neutral-350

DB12370



Surge arresters	Spare cartridge		Neutral
	Phase Type 1	Type 2	
PRD1 25r			
PRD1 25r 1P	16315	16316	-
PRD1 25r 1P+N	16315	16316	16317
PRD1 25r 3P	3 x 16315	3 x 16316	-
PRD1 25r 3P+N	3 x 16315	3 x 16316	16317
PRD1 Master			
PRD1 Master 1P	16314	-	-
PRD1 Master 1P+N	16314	-	16317
PRD1 Master 3P	3 x 16314	-	-
PRD1 Master 3P+N	3 x 16314	-	16317
PRD1 35r			
PRD1 35r 1P	1 x 16318	-	-
PRD1 35r 2P	2 x 16318	-	-
PRD1 35r 3P	3 x 16318	-	-
PRD1 35r 4P	4 x 16318	-	-

Accessories		
Type	Number of poles (18 mm)	
Wiring comb busbars for 2 x 1P	4	16643
Wiring comb busbars for 3 x 1P	6	16644
Wiring comb busbars for 4 x 1P	8	16645
200 mm flexible cable	-	16646

iPRF1 12.5r/PRD1 35r/ PRD1 25r/PRD1 Master

Type 1 and 2 LV surge arresters (cont.)

Technical data

		iPRF1 12.5r	PRD1 35r	PRD1 25r	PRD1 Master
Operating frequency		50 Hz	50/60 Hz	50 Hz	50 Hz
Degree of protection	Front panel	IP40	IP40	IP40	IP40
	Terminals	IP20	IP20	IP20	IP20
	Impacts	IK05	IK05	IK05	IK05
Response time		≤ 25 ns	≤ 100 ns	≤ 25 ns	≤ 100 ns
Short circuit withstand (I _{sc})		50 kA	50 kA	25 kA	50 kA
Temporary overvoltage withstand (U _T)	U _T (L-N)	335 V AC/5 s	580 V AC/5 s	415 V AC/5 s	415 V AC/5 s
	U _T (N-PE)	1200 V AC/200 ms	800 V AC/120 min	1200 V AC/200 ms	1200 V AC/200 ms
Temporary overvoltage Safe failure mode (U _T)	U _T (L-N)	440 V AC/120 min	1640 V AC/200 ms	440 V AC/120 min	440 V AC/120 min
Ground residual current (I _{PE})	I _{PE} (N-PE)	0.004 mA	≤ 0.005 mA	≤ 0.01 mA for 1P+N, 3P+N	≤ 0.01 mA for 1P+N, 3P+N
Follow current interrupting rating (I _f)	I _f (L-N)	-	50 kA	25 kA/264 V AC 3 kA/350 V AC	50 kA
	I _f (N-PE)	100 A	-	100 A	100 A
End-of-life indication		Green: correct operation Red: at end of life	White: correct operation Red: at end of life	White: correct operation Red: at end of life	White: correct operation Red: at end of life
	Remote notification	1.5 A/250 V AC	1 A/250 V AC ≤ 1 A/30 V DC	1 A/250 V AC ≤ 1 A/30 V DC	1 A/250 V AC ≤ 1 A/30 V DC
By tunnel terminal	Rigid cable	10...35 mm ²	16...35 mm ²	10...35 mm ²	10...35 mm ²
	Flexible cable	10...25 mm ²	10...25 mm ²	10...25 mm ²	10...25 mm ²
Operating temperature		-25°C to +60°C	-40°C to +80°C	-40°C to +80°C	-40°C to +80°C
Humidity range		5 % to 95 %	5 % to 95 %	5 % to 95 %	5 % to 95 %
Standards		IEC 61643-11: 2011 T1 , T2 EN 61643-11: 2012 Type 1 + Type 2	IEC 61643-11 T1 EN 61643-11 Type 1	IEC 61643-11: 2011 T1 , T2 EN 61643-11: 2012 Type 1 + Type 2	IEC 61643-11: 2011 T1 EN 61643-11: 2012 Type 1
Approvals		CE, EAC	CE	CE, KEMA-KEUR	CE, KEMA-KEUR

Choice of disconnector / surge arrester

Type	I _{imp} : impulse current	I _{sc} : prospective short-circuit current at the installation point				
		10 kA	15 kA	25 kA	36 kA	50 kA
iPRF1 12.5r	12.5 kA	C120N 80 A curve C or Compact NSX100B 100 A *	C120H 80 A curve C or Compact NSX100B 100 A *	NG125N 80 A curve C or Compact NSX100B 100 A *	NG125H 80 A curve C or Compact NSX100F 100 A *	NG125L 80 A curve C or Compact NSX100N 100 A *
PRD1 35r	35 kA	Compact NSX160B 160 A		Compact NSX160F 160 A	Compact NSX160N 160 A	
PRD1 25r	25 kA	Compact NSX100B 100 A		-	Compact NSX100N 100 A	
PRD1 Master	25 kA	Compact NSX100B 100 A		Compact NSX100F 100 A	Compact NSX100N 100 A	

(*) For lightning impulse current withstand

PR113736-90

PRD1 25r / PRD1 Master / PRD1 35r Reversible

■ The surge arrester base can be turned over to allow the phase/neutral/earth cables to enter through either the top or the bottom



iPRF1 12.5r/PRD1 35r/ PRD1 25r/PRD1 Master

Type 1 and 2 LV surge arresters (cont.)

Dimensions (mm)

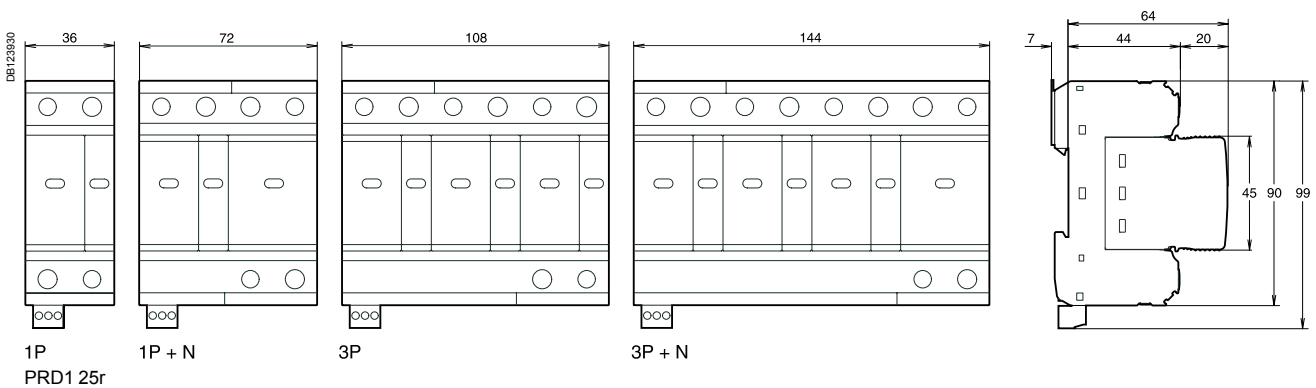
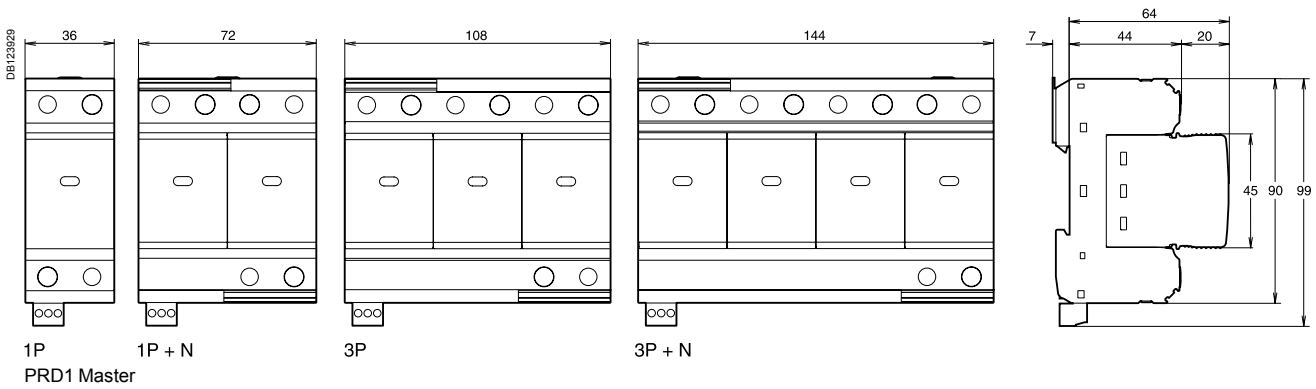
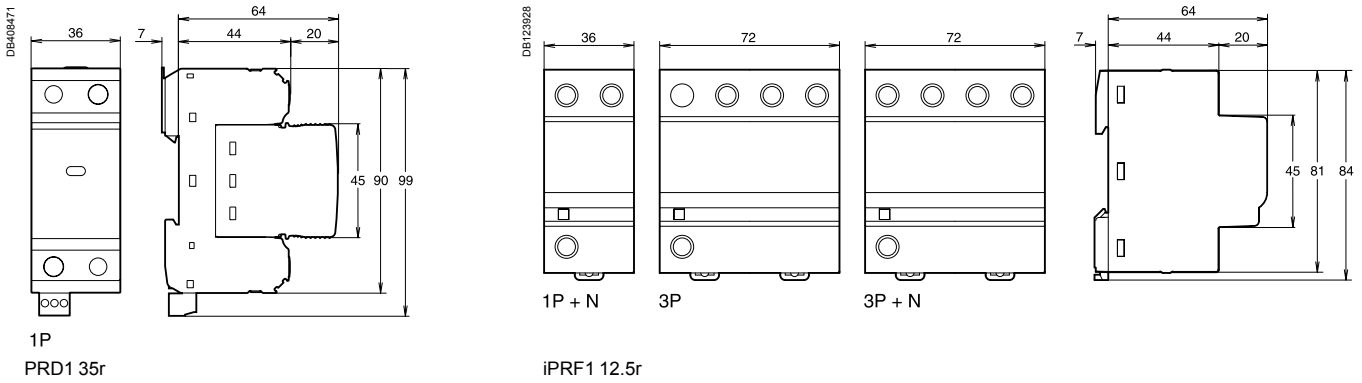

Weight (g)

Surge arresters				
Type	iPRF1 12,5r	PRD1 35r	PRD1 25r	PRD1 Master
1P	-	401	334	394
1P+N	290	-	725	774
3P	590	-	1010	1175
3P+N	590	-	1338	1535
Cartridge	Neutral	-	229	229
	Phase	-	-	242

The iPF multi-pole single-piece surge arrester range is adapted for earthing systems: TT, TN-S, TN-C.

Type 2 surge arresters are tested with a 8/20 μ s current wave.

Type 3 surge arresters are tested with a 12/50 μ s and 8/20 μ s combined wave.

Each surge arrester in the range has a specific application:

■ **incoming protection (type 2):**

- the iPF65(r) is recommended for a very high risk level (strongly exposed site)
- the iPF40(r) is recommended for a high risk level
- the iPF20 is recommended for a medium risk level

■ **secondary protection (type 2 or 3):**

- the iPF8 ensures secondary protection of loads to be protected and is placed in cascade with the incoming surge arresters. This surge arrester is required when the loads to be protected are at a distance of more than 30 m from the incoming surge arrester.

The iPF surge arresters with “r” indication have remote transfer of the information: “surge arrester to be replaced”.

Rated discharge current (I _{max}) / Nominal discharge current (I _n)	Type of protection		Network								
	Incoming	Secondary (type 2 or 3)	1P+N		3P+N		1P	2P	3P	4P	
65 kA / 20 kA											
Very high risk level	iPF65						A9L15683				
			A9L15684					A9L15584			
										A9L15581	
							A9L15685				
							A9L15586				
									A9L15585		
40 kA / 15 kA											
High risk level	iPF40						A9L15686				
			A9L15687						A9L15587		
											A9L15582
							A9L15690				
							A9L15688				
									A9L15590		
									A9L15588		
20 kA / 5 kA											
Medium risk level	iPF20						A9L15691				
			A9L15692						A9L15592		
											A9L15597
							A9L15693				
									A9L15593		
8 kA / 2.5 kA											
Secondary protection: placed near the loads to be protected when they are at a distance of more than 30 m from the incoming surge arrester	iPF8						A9L15694				
			A9L15695						A9L15595		
											A9L15598
							A9L15696				
									A9L15596		

PB1105278-35

1P+N.

PB1105280-35

3P+N.

Surge arrester/circuit breaker association



Type of surge arrester	Associated circuit breaker
iPF65	Curve C 50 A
iPF40	Curve C 40 A
iPF20	Curve C 25 A
iPF8	Curve C 20 A

	Earthing system	Transfer	Surge arrester name	Width in mod. of 9 mm	Up - (kV) Voltage protection level			Un - (V) Rated voltage network	Uc - (V) Maximum continuous operating voltage		
					CM*		DM*		CM*		DM*
					L/±	N/±	L/N		L/±	N/±	L/N
iPF65											
	TT & TN		iPF65 1P	2	≤ 1.5	-	-	230	340	-	-
	TT & TN-S		iPF65 1P+N	4	-	≤ 1.5	≤ 1.5		-	260	340
	TN-C		iPF65 2P		≤ 1.5	≤ 1.5	-		340	340	-
	TN-C		iPF65 3P	8	≤ 1.5	-	-	230/400	340	-	-
	TT & TN-S	■	iPF65r 3P+N		-	≤ 1.5	≤ 1.5		-	260	340
	TT & TN-S		iPF65 3P+N		-	≤ 1.5	≤ 1.5		-	260	340
	TN-C	■	iPF65r 4P		≤ 1.5	≤ 1.5	-		340	340	-
iPF40											
	TT & TN		iPF40 1P	2	≤ 1.5	-	-	230	340	-	-
	TT & TN-S		iPF40 1P+N	4	-	≤ 1.5	≤ 1.5		-	260	340
	TN-C		iPF40 2P		≤ 1.5	≤ 1.5	-		340	340	-
	TN-C		iPF40 3P	8	≤ 1.5	-	-	230/400	340	-	-
	TT & TN-S	■	iPF40r 3P+N		-	≤ 1.5	≤ 1.5		-	260	340
	TT & TN-S		iPF40 3P+N		-	≤ 1.5	≤ 1.5		-	260	340
	TN-C	■	iPF40r 4P		≤ 1.5	≤ 1.5	-		340	340	-
	TN-C		iPF40 4P		≤ 1.5	≤ 1.5	-		340	340	-
iPF20											
	TT & TN		iPF20 1P	2	≤ 1.1	-	-	230	340	-	-
	TT & TN-S		iPF20 1P+N	4	-	≤ 1.5	≤ 1.1		-	260	340
	TN-C		iPF20 2P		≤ 1.1	≤ 1.1	-		340	340	-
	TN-C		iPF20 3P	8	≤ 1.1	-	-	230/400	340	-	-
	TT & TN-S		iPF20 3P+N		-	≤ 1.5	≤ 1.1		-	260	340
	TN-C		iPF20 4P		≤ 1.1	≤ 1.1	-		340	340	-
iPF8 (1) Type 2 / Type 3											
	TT & TN		iPF8 1P	2	≤ 1 / ≤ 1.1	-	-	230	340	-	-
	TT & TN-S		iPF8 1P+N	4	-	≤ 1.5 / ≤ 1.2	≤ 1 / ≤ 1.1		-	260	340
	TN-C		iPF8 2P		≤ 1 / ≤ 1.1	≤ 1 / ≤ 1.1	-		340	340	-
	TN-C		iPF8 3P	8	≤ 1 / ≤ 1.1	-	-	230/400	340	-	-
	TT & TN-S		iPF8 3P+N		-	≤ 1.5 / ≤ 1.2	≤ 1 / ≤ 1.1		-	260	340
	TN-C		iPF8 4P		≤ 1 / ≤ 1.1	≤ 1 / ≤ 1.1	-		340	340	-

* **CM**: common mode (phase to earth and neutral to earth). * **DM**: differential mode (phase to neutral). (1) **Uoc**: combined waveform voltage: 10 kV.

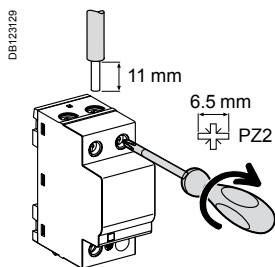
Connection



Type	Tightening torque	Copper cables	
		Rigid	Flexible or with ferrule
iPF	3.5 N.m	DBI122946  25 mm ² max.	DBI122946  16 mm ² max.

Technical data

Main characteristics		
Operating frequency	50/60 Hz	
Operating voltage (U _e)	230/400 V AC	
Permanent operating current (I _c)	< 1 mA	
Response time	< 25 ns	
End of life indication: by green/red mechanical indicator	Green	In operation
	Red	At end of life
End of life remote indication	By contact NO, NC 250 V / 0.25 A	
Additional characteristics		
Operating temperature	-25°C to +60°C	
Type of connection terminals	Tunnel terminals, 2.5 to 35 mm ²	
Standards	IEC 61643-1 T2 and EN 61643-11 Type 2	

Weight (g)

Surge arrester	
Type	iPF
1P	125
2P	210
3P	335
4P	420

Dimensions (mm)

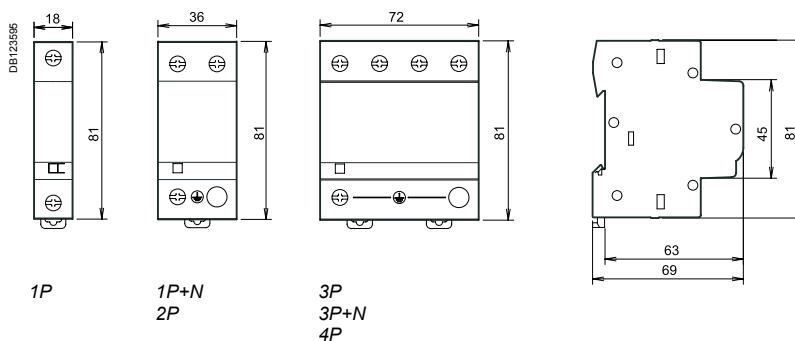



Each surge arrester in the range has a specific application:

■ **incoming protection (type 2):**

- the iPF K 65 is recommended for a very high risk level (strongly exposed site),
- the iPF K 40 is recommended for a high risk level,
- the iPF K 20 is recommended for a medium risk level.

The iPF K multi-pole single-piece surge arrester range is adapted for earthing systems: TT, TN-S, TN-C.

Type 2 surge arresters are tested with a 8/20 μ s current wave.



1P



1P+N



3P



3P+N

Rated discharge current (I _{max}) / Nominal discharge current (I _n)	Type of protection	Network				
		1P+N	3P+N	1P	3P	
65 kA / 20 kA	Incoming					
Very high risk level		iPF K 65		A9L15586		
40 kA / 15 kA	High risk level					
High risk level		iPF K 40	A9L15687		A9L15686	
						A9L15582
			A9L15688			
20 kA / 5 kA	Medium risk level					
Medium risk level		iPF K 20	A9L15692		A9L15691	
						A9L15597
			A9L15693			

Surge arrester/circuit breaker association



Type of surge arrester	Associated circuit breaker (1 to 4 poles protected) (I _{sc} ≤ 6 kA)
iPF K 65	iK60N Curve C 50 A
iPF K 40	iK60N Curve C 40 A
iPF K 20	iK60N Curve C 20 A

	Earthing system	Surge arrester name	Width in mod. of 9 mm	Up - (kV) Voltage protection level			Un - (V) Rated voltage network	Uc - (V) Maximum continuous operating voltage		
				CM*		DM*		CM*		DM*
				L/±	N/±	L/N		L/±	N/±	L/N
iPF K 65										
	TT & TN-S	iPF K 65 3P+N		-	≤ 1.5	≤ 1.5		-	260	340
iPF K 40										
	TN	iPF K 40 1P	2	≤ 1.5	-	-	230	340	-	-
	TT & TN-S	iPF K 40 1P+N	4	-	≤ 1.5	≤ 1.5		-	260	340
	TN-C	iPF K 40 3P	8	≤ 1.5	-	-	230/400	340	-	-
	TT & TN-S	iPF K 40 3P+N		-	≤ 1.5	≤ 1.5		-	260	340
iPF K 20										
	TN	iPF K 20 1P	2	≤ 1.1	-	-	230	340	-	-
	TT & TN-S	iPF K 20 1P+N	4	-	≤ 1.5	≤ 1.1		-	260	340
	TN-C	iPF K 20 3P	8	≤ 1.1	-	-	230/400	340	-	-
	TT & TN-S	iPF K 20 3P+N		-	≤ 1.5	≤ 1.1		-	260	340

* **CM**: common mode (phase to earth and neutral to earth). * **DM**: differential mode (phase to neutral). (1) **Uoc**: combined waveform voltage: 10 kV.

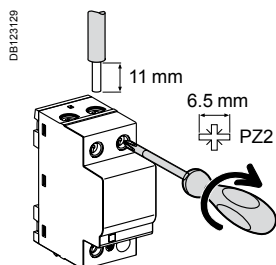
Connection



Type	Tightening torque	Copper cables	
		Rigid	Flexible or with ferrule
iPF K	3.5 N.m	 25 mm ² max.	 16 mm ² max.

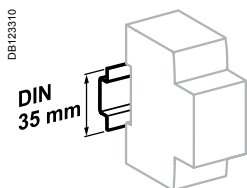

Clip on DIN rail 35 mm.

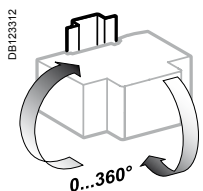

Indifferent position of installation.

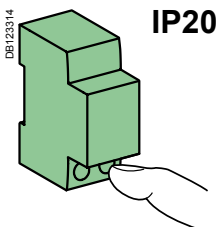

IP20

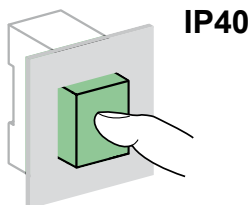

IP40

Technical data

Main characteristics		
Operating frequency		50/60 Hz
Rated voltage network (Un)		230/400 V AC ±10 %
Permanent operating current (Ic)		< 5 mA
Response time		< 25 ns
Short circuit withstand (I _{SCCR})		25 kA (50 Hz)
Temporary overvoltage withstand (U _T) LV network	U _T (L-N)	337 V AC / 5 s
	U _T (L-PE)	442 V AC / 120 min
Temporary overvoltage withstand (U _T) HV network	U _T (N-PE)	1200 V AC / 200 ms
	U _T (L-PE)	1453 V AC / 200 ms
Ground residual current (I _{PE})	I _{PE} (L-PE)	1P: ≤ 5 mA
		3P: ≤ 25 mA
	I _{PE} (N-PE)	3 μA for 1P+N, 3P+N
Operation indication by mechanical indicator	Green	In operation
	Red	At end of life
Additional characteristics		
Degree of protection (IEC 60529)	Device only	IP20 (built-in)
	Device in modular enclosure	IP40
Operating temperature		-25°C to +60°C
Humidity range		5 % to 95 %
Standards		IEC 61643-11: 2011 T2

Weight (g)

Surge arrester	
Type	iPF K
1P	125
1P+N	210
3P	335
3P+N	420

Dimensions (mm)

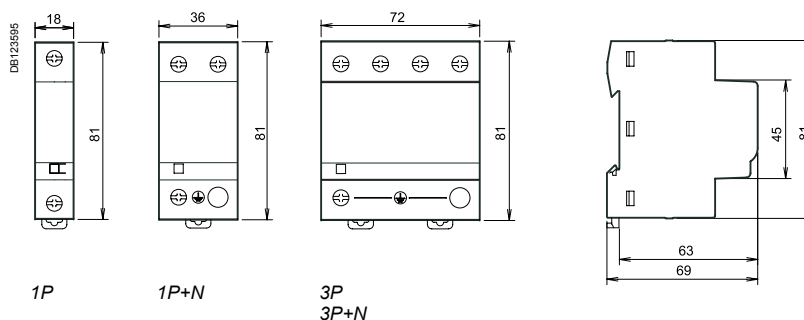



iPRD withdrawable surge arresters allow quick replacement of damaged cartridges.
Type 2 surge arresters are tested with a 8/20 μ s current wave.
Type 3 surge arresters are tested with a 1.2/50 μ s and 8/20 μ s combined wave.

Each surge arrester in the range has a specific application:

■ **incoming protection (type 2):**

- the iPRD65r is recommended for a very high risk level (strongly exposed site)
- the iPRD40(r) is recommended for a high risk level
- the iPRD20(r) is recommended for a medium risk level

■ **secondary protection (type 2 or 3):**

- the iPRD8(r) ensures secondary protection of loads to be protected and is placed in cascade with the incoming surge arresters. This surge arrester is required when the loads to be protected are at a distance of more than 10 m from the incoming surge arrester.

The iPRD surge arresters with “r” indication have remote transfer of the information: “cartridge to be replaced”.

Catalogue number iPRD surge arresters

Rated discharge current (Imax)	Nominal discharge current (In)	Type of protection		Network						
		Incoming	Secondary	1P+N	3P+N	1P	2P	3P	4P	
iPRD65 65 kA Very high risk level (strongly exposed site)	20 kA	iPRD65								
				A9L65501	A9L65101	A9L65121				
						A9L65201			A9L65301	
								A9L65321		
					A9L65601					A9L65401
iPRD40 40 kA High risk level	15 kA	iPRD40								
					A9L40101					
				A9L40501	A9L40100					
				A9L40500		A9L40201				
						A9L40200			A9L40301	
								A9L40321		
								A9L40300		
				A9L40601						A9L40401
A9L40600						A9L40421				
						A9L40400				
iPRD20 20 kA Medium risk level	5 kA	iPRD20								
				A9L20501	A9L20100					
				A9L20500						
						A9L20200				
								A9L20300		
								A9L20321		
iPRD8 8 kA Secondary protection: placed near the loads to be protected when they are at a distance of more than 10 m from the incoming surge arrester	2.5 kA	iPRD8								
				A9L08501	A9L08100					
				A9L08500						
						A9L08200			A9L08300	
								A9L08321		
				A9L08601						A9L08400
A9L08600						A9L08421				



iPRD surge arresters

Type 2 or 3 LV withdrawable surge arresters (cont.)



Cartridge

Spare cartridges iPRD

Type	Spare cartridges for	Cat. no
iPRD 65-350	iPRD65r	A9L65102
iPRD 40-350	iPRD40r, iPRD40r	A9L40102
iPRD 20-350	iPRD20r, iPRD20r	A9L20102
iPRD 8-350	iPRD8r, iPRD8r	A9L08102
iPRD Neutral	All products (1P+N, 3P+N)	A9L00002

Spare cartridges iPRD IT

Type	Spare cartridges for	Cat. no
C 65-460	iPRD65r IT	A9L65122
C 40-460	iPRD40r IT	A9L40122
C 20-460	iPRD20r IT	A9L20122
C 8-460	iPRD8r IT	A9L08122

	Earthing system	Transfer	Surge arrester name	Width in mod. of 9 mm	Up - (kV) Voltage protection level			Un - (V) Rated voltage network	Uc - (V) Maximum continuous operating voltage		
					CM*		DM*		CM*		DM*
					L/±	N/±			L/N	L/±	
iPRD65											
A9L65101	TT & TN	■	iPRD65r 1P	2	≤ 1.5	-	-	230	350	-	-
A9L65121	IT	■	iPRD65r 1P IT	2	≤ 2.3	-	-	230	460	-	-
A9L65501	TT & TN-S	■	iPRD65r 1P+N	4	-	≤ 1.4	≤ 1.5	230	-	260	350
A9L65201	TN-C-S	■	iPRD65r 2P	4	≤ 1.5	≤ 1.5	-	230/400	350	350	-
A9L65301	TN-C	■	iPRD65r 3P	6	≤ 1.5	-	-	230/400	350	-	-
A9L65321	IT	■	iPRD65r 3P IT	6	≤ 2.3	-	-	230/400	460	-	-
A9L65601	TT & TN-S	■	iPRD65r 3P+N	8	-	≤ 1.4	≤ 1.5	230	-	260	350
A9L65401	TN-C-S	■	iPRD65r 4P	8	≤ 1.5	≤ 1.5	-	230/400	350	350	-
iPRD40											
A9L40101	TT & TN	■	iPRD40r 1P	2	≤ 1.6	-	-	230	350	-	-
A9L40100	TT & TN	■	iPRD40 1P	2	≤ 1.6	-	-	230	350	-	-
A9L40501	TT & TN-S	■	iPRD40r 1P+N	4	-	≤ 1.4	≤ 1.6	230	-	260	350
A9L40500	TT & TN-S	■	iPRD40 1P+N	4	-	≤ 1.4	≤ 1.6	230	-	260	350
A9L40201	TN-C-S	■	iPRD40r 2P	4	≤ 1.6	≤ 1.6	-	230/400	350	350	-
A9L40200	TN-C-S	■	iPRD40 2P	4	≤ 1.6	≤ 1.6	-	230/400	350	350	-
A9L40301	TN-C	■	iPRD40r 3P	6	≤ 1.6	-	-	230/400	350	-	-
A9L40321	IT	■	iPRD40r 3P IT	6	≤ 2.2	-	-	230/400	460	-	-
A9L40300	TN-C	■	iPRD40 3P	6	≤ 1.6	-	-	230/400	350	-	-
A9L40601	TT & TN-S	■	iPRD40r 3P+N	8	-	≤ 1.4	≤ 1.6	230	-	260	350
A9L40600	TT & TN-S	■	iPRD40 3P+N	8	-	≤ 1.4	≤ 1.6	230	-	260	350
A9L40401	TN-C-S	■	iPRD40r 4P	8	≤ 1.6	≤ 1.6	-	230/400	350	350	-
A9L40421	IT	■	iPRD40r 4P IT	8	≤ 2.2	≤ 2.2	-	230/400	460	-	-
A9L40400	TN-C-S	■	iPRD40 4P	8	≤ 1.6	≤ 1.6	-	230/400	350	350	-
iPRD20											
A9L20100	TT & TN	■	iPRD20 1P	2	≤ 1.2	-	-	230	350	-	-
A9L20501	TT & TN-S	■	iPRD20r 1P+N	4	-	≤ 1.4	≤ 1.2	230	-	260	350
A9L20500	TT & TN-S	■	iPRD20 1P+N	4	-	≤ 1.4	≤ 1.2	230	-	260	350
A9L20200	TN-C-S	■	iPRD20 2P	4	≤ 1.2	≤ 1.2	-	230/400	350	350	-
A9L20300	TN-C	■	iPRD20 3P	6	≤ 1.2	-	-	230/400	350	-	-
A9L20321	IT	■	iPRD20r 3P IT	6	≤ 1.8	-	-	230/400	460	-	-
A9L20601	TT & TN-S	■	iPRD20r 3P+N	8	-	≤ 1.4	≤ 1.2	230	-	260	350
A9L20600	TT & TN-S	■	iPRD20 3P+N	8	-	≤ 1.4	≤ 1.2	230	-	260	350
A9L20400	TN-C-S	■	iPRD20 4P	8	≤ 1.2	≤ 1.2	-	230/400	350	350	-
A9L20421	IT	■	iPRD20r 4P IT	8	≤ 1.8	≤ 1.8	-	230/400	460	-	-
iPRD8 (1)											
Type 2 / Type 3 (1)											
A9L08100	TT & TN	■	iPRD8 1P	2	≤ 1.2	-	-	230	350	-	-
A9L08501	TT & TN-S	■	iPRD8r 1P+N	4	-	≤ 1.4	≤ 1.2	230	-	260	350
A9L08500	TT & TN-S	■	iPRD8 1P+N	4	-	≤ 1.4	≤ 1.2	230	-	260	350
A9L08200	TN-C-S	■	iPRD8 2P	4	≤ 1.2	≤ 1.2	-	230/400	350	350	-
A9L08300	TN-C	■	iPRD8 3P	6	≤ 1.2	-	-	230/400	350	-	-
A9L08321	IT	■	iPRD8r 3P IT	6	≤ 1.6 / ≤ 1.8	-	-	230/400	460	-	-
A9L08601	TT & TN-S	■	iPRD8r 3P+N	8	-	≤ 1.4	≤ 1.2	230	-	260	350
A9L08600	TT & TN-S	■	iPRD8 3P+N	8	-	≤ 1.4	≤ 1.2	230	-	260	350
A9L08400	TN-C-S	■	iPRD8 4P	8	≤ 1.2	≤ 1.2	-	230/400	350	350	-
A9L08421	IT	■	iPRD8r 4P IT	8	≤ 1.6 / ≤ 1.8	≤ 1.6 / ≤ 1.8	-	230/400	460	-	-

* CM: common mode (phase to earth and neutral to earth). * DM: differential mode (phase to neutral). (1) Uoc: combined waveform voltage: 10 kV.

iPRD surge arresters

Type 2 or 3 LV withdrawable surge arresters

Connection iPRD surge arresters

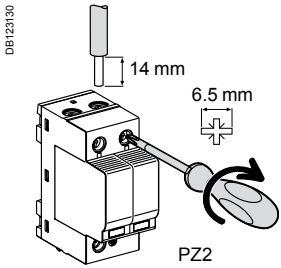

Type	Tightening torque	Copper cables	
		Rigid	Flexible or with ferrule
iPRD	3.5 N.m	2.5 to 25 mm ²	4 to 16 mm ²

Technical data iPRD surge arresters

Main characteristics	iPRD	iPRD IT
Operating frequency	50/60 Hz	
Operating voltage (U _e)	230/400 V AC ±10 %	
Permanent operating current (I _c)	< 1 mA	
Response time	< 25 ns	
Short circuit current rating (I _{scrr})	50 kA (50 Hz)	
Short circuit current rating (I _{scrr}), case of double fault	-	5 kA (50 Hz)
Temporary overvoltage withstand (U _T)	U _T (L-N)	337 V AC / 5 s
	U _T (L-PE)	442 V AC / 120 min
Temporary overvoltage	U _T (N-PE)	1200 V AC / 200 ms
Safe failure mode (U_T)	U _T (L-PE)	1455 V AC / 200 ms
Ground residual current (I _{PE})	I _{PE} (L-PE)	600 µA for 1P, 2P, 3P, 4P
	I _{PE} (N-PE)	3 µA for 1P+N, 3P+N
Satisfactory operation indication: by mechanical indicator	White	In operation
	Red	Cartridge must be replaced
Remote indication of satisfactory operation	By contact NO, NC 250 V / 0.25 A	

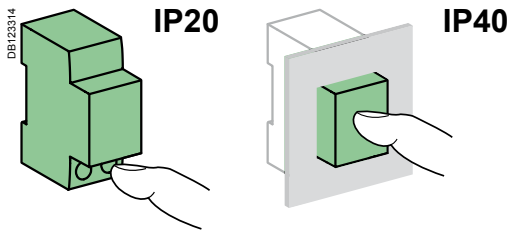

Additional characteristics		
Degree of protection (IEC 60529)	Device only	IP20 (built-in)
	Device in modular enclosure	IP40
Operating temperature	-25°C to +60°C	
Storage temperature	-40°C to +85°C	
Humidity range	5 % to 95 %	
Type of connection terminals	Tunnel terminals, 2.5 to 35 mm ²	
Standards	IEC 61643-11: 2011 [T2], [T3] and EN 61643-11: 2012 Type 2, Type 3	

Surge arrester/circuit breaker association

Type of surge arrester	Associated circuit breaker (1 to 4 poles protected)	
	iPRD	iPRD IT
iPRD65	Curve C 50 A	Curve C 25 A
iPRD40	Curve C 40 A	Curve C 20 A
iPRD20	Curve C 20 A	Curve C 10 A
iPRD8	Curve C 10 A	Curve C 10 A

iPRD dimensions (mm)

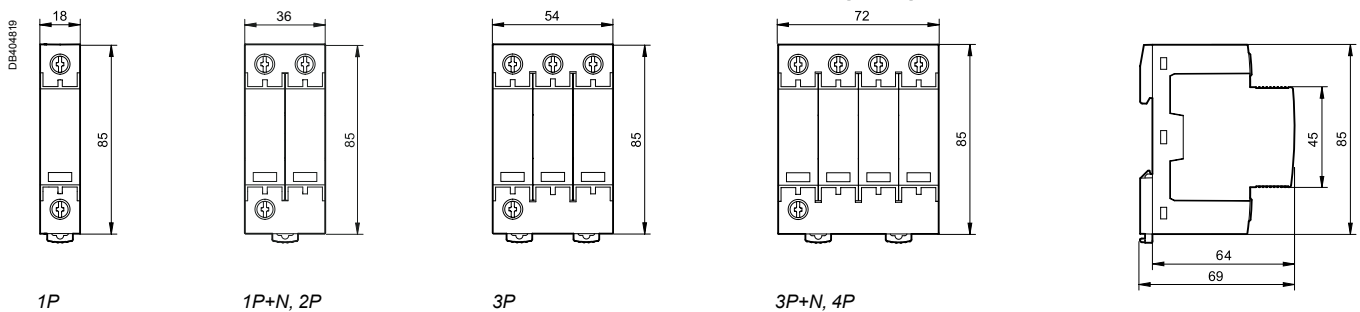

Weight (g)

Surge arrester	
Type	iPRD
1P	119
1P+N, 2P	220
3P	340
3P+N, 4P	450

iPRD surge arresters

Type 2 or 3 LV withdrawable surge arresters (cont.)

iPRD surge arresters

PB1102281-80

Satisfactory operation indication

- By mechanical indicator
- white: operating
- red: cartridge must be replaced



Connection iPRD surge arrester with its short circuit disconnecter

TT / TN-S

Power supply through the top
Connection with cables

PB1102289-50



Surge arrester iPRD 3P+N + iC60N 3P+N

Reversible

■ The surge arrester base can be turned over to allow the phase/neutral/earth cables to enter through either the top or the bottom

TT / TN-S

Power supply through the bottom
Connection with comb busbar

PB110783-50



Surge arrester iPRD 3P+N + iC60N 3P+N

IT/TNC-S with neutral

Power supply through the top
Connection with comb busbar

PB1102287-50



Surge arrester iPRD 4P + iC60N 4P

IT/TNC-S with neutral

Power supply through the bottom
Connection with comb busbar

PB110794-50



Surge arrester iPRD 4P + iC60N 4P

iPRD surge arresters

Type 2 or 3 LV withdrawable surge arresters

iPRD withdrawable surge arresters allow quick replacement of damaged cartridges.



1P+N



3P



3P+N



Cartridge

Rated discharge current (I _{max}) / Nominal discharge current (I _n)	Type of protection	Network							
		Incoming	Secondary	1P+N	3P+N	1P	2P	3P	4P
65 kA / 20 kA	iPRD65	Very high risk level (strongly exposed site)			A9L16555				
				A9L16557			A9L16442		
								A9L16558	
								A9L16443	
					A9L16559				
									A9L16659
40 kA / 15 kA	iPRD40	High risk level			A9L16561				
				A9L16562					
				A9L16567				A9L16444	
								A9L16667	
									A9L16445
									A9L16568
									A9L16563
					A9L16564				
					A9L16569				
									A9L16597
							A9L16664		
							A9L16669		
20 kA / 5 kA	iPRD20	Medium risk level			A9L16571				
				A9L16672					
				A9L16572					
								A9L16446	
									A9L16447
									A9L16573
							A9L16599		
							A9L16673		
8 kA / 2.5 kA	iPRD8	Secondary protection: placed near the loads to be protected when they are at a distance of more than 30 m from the incoming surge arrester			A9L16576				
				A9L16677					
				A9L16577					
								A9L16448	
									A9L16449
									A9L16578
							A9L16678		
							A9L16680		

Spare cartridges		
Type	Spare cartridges for	Cat. no
C 65-460	iPRD65r IT	A9L16682
C 65-340	iPRD65r	A9L16681
C 40-460	iPRD40r IT	A9L16684
C 40-340	iPRD40, iPRD40r	A9L16685
C 20-460	iPRD20r IT	A9L16686
C 20-340	iPRD20, iPRD20r	A9L16687
C 8-460	iPRD8r IT	A9L16688
C 8-340	iPRD8, iPRD8r	A9L16689
C neutral	All products	A9L16691

Surge arrester/circuit breaker association	
Type of surge arrester	Associated circuit breaker
iPRD65	Curve C 50 A
iPRD40	Curve C 40 A
iPRD20	Curve C 25 A
iPRD8	Curve C 20 A

iPRD surge arresters

Type 2 or 3 LV withdrawable surge arresters (cont.)

	Earthing system	Transfer	Surge arrester name	Width in mod. of 9 mm	Up - (kV) Voltage protection level			Un - (V) Rated voltage network	Uc - (V) Maximum continuous operating voltage		
					CM*		DM*		CM*		DM*
					L/±	N/±	L/N		L/±	N/±	L/N
iPRD65											
	IT	■	iPRD65r 1P IT	2	≤ 2	-	-	230	460	-	-
	TT & TN	■	iPRD65r 1P		≤ 1.5	-	-		340	-	-
	TT & TN-S	■	iPRD65r 1P+N	4	-	≤ 1.5	≤ 1.5		-	260	340
	TN-C	■	iPRD65r 2P		≤ 1.5	≤ 1.5	-	340	340	-	
	IT	■	iPRD65r 3P IT	6	≤ 2	-	-	230/400	460	-	-
	TN-C	■	iPRD65r 3P		≤ 1.5	-	-		340	-	-
	TT & TN-S	■	iPRD65r 3P+N	8	-	≤ 1.5	≤ 1.5		-	260	340
	TN-C	■	iPRD65r 4P		≤ 1.5	≤ 1.5	-	340	340	-	
iPRD40											
	TT & TN	■	iPRD40r 1P	2	≤ 1.4	-	-	230	340	-	-
	TT & TN		iPRD40 1P		≤ 1.4	-	-		340	-	-
	TT & TN-S	■	iPRD40r 1P+N	4	-	≤ 1.4	≤ 1.4		-	260	340
	TT & TN-S		iPRD40 1P+N		-	≤ 1.4	≤ 1.4	-	260	340	
	TN-C	■	iPRD40r 2P		≤ 1.4	≤ 1.4	-	340	340	-	
	TN-C		iPRD40 2P		≤ 1.4	≤ 1.4	-	340	340	-	
	TN-C	■	iPRD40r 3P	6	≤ 1.4	-	-	230/400	340	-	-
	TN-C		iPRD40 3P		≤ 1.4	-	-		340	-	-
	IT	■	iPRD40r 3P IT		≤ 2	-	-		460	-	-
	TT & TN-S	■	iPRD40r 3P+N	8	-	≤ 1.4	≤ 1.4	-	260	340	
	TT & TN-S		iPRD40 3P+N		-	≤ 1.4	≤ 1.4	-	260	340	
	IT	■	iPRD40r 4P IT		≤ 2	≤ 2	-	460	460	-	
	TN-C	■	iPRD40r 4P		≤ 1.4	≤ 1.4	-	340	340	-	
	TN-C		iPRD40 4P		≤ 1.4	≤ 1.4	-	340	340	-	
iPRD20											
	TT & TN		iPRD20 1P	2	≤ 1.1	-	-	230	340	-	-
	TT & TN-S	■	iPRD20r 1P+N	4	-	≤ 1.4	≤ 1.1		-	260	340
	TT & TN-S		iPRD20 1P+N		-	≤ 1.4	≤ 1.1		-	260	340
	TN-C		iPRD20 2P		≤ 1.1	≤ 1.1	-	340	340	-	
	TN-C		iPRD20 3P	6	≤ 1.1	-	-	230/400	340	-	-
	IT	■	iPRD20r 3P IT		≤ 1.6	-	-		460	-	-
	TT & TN-S	■	iPRD20r 3P+N	8	-	≤ 1.4	≤ 1.1		-	260	340
	TT & TN-S		iPRD20 3P+N		-	≤ 1.4	≤ 1.1	-	260	340	
	IT	■	iPRD20r 4P IT		≤ 1.6	≤ 1.6	-	460	460	-	
	TN-C		iPRD20 4P		≤ 1.1	≤ 1.1	-	340	340	-	
iPRD8 (1) Type 2 / Type 3											
	TT & TN		iPRD8 1P	2	≤ 1 / ≤ 1	-	-	230	340	-	-
	TT & TN-S	■	iPRD8r 1P+N	4	-	≤ 1.4 / ≤ 1	≤ 1 / ≤ 1.1		-	260	340
	TT & TN-S		iPRD8 1P+N		-	≤ 1.4 / ≤ 1	≤ 1 / ≤ 1.1		-	260	340
	TN-C		iPRD8 2P		≤ 1 / ≤ 1	≤ 1 / ≤ 1	-	340	340	-	
	TN-C		iPRD8 3P	6	≤ 1 / ≤ 1	-	-	230/400	340	-	-
	IT	■	iPRD8r 3P IT		≤ 1.4 / ≤ 1.6	-	-		460	-	-
	TT & TN-S	■	iPRD8r 3P+N	8	-	≤ 1.4 / ≤ 1	≤ 1 / ≤ 1.1		-	260	340
	TT & TN-S		iPRD8 3P+N		-	≤ 1.4 / ≤ 1	≤ 1 / ≤ 1.1	-	260	340	
	IT	■	iPRD8r 4P IT		≤ 1.4 / ≤ 1.6	≤ 1.4 / ≤ 1.6	-	460	460	-	
	TN-C		iPRD8 4P		≤ 1 / ≤ 1	≤ 1 / ≤ 1	-	340	340	-	

* **CM**: common mode (phase to earth and neutral to earth). * **DM**: differential mode (phase to neutral). (1) **Uoc**: combined waveform voltage: 10 kV.

iPRD surge arresters

Type 2 or 3 LV withdrawable surge arresters (cont.)

Connection

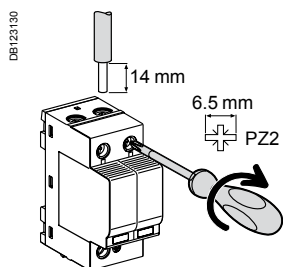

Type	Tightening torque	Copper cables	
		Rigid	Flexible or with ferrule
iPRD	2 N.m	2.5 to 25 mm ²	2.5 to 16 mm ²

Technical data

Main characteristics		
Operating frequency	50/60 Hz	
Operating voltage (Ue)	230/400 V AC	
Permanent operating current (Ic)	< 1 mA	
Response time	< 25 ns	
End of life indication: by mechanical indicator	White	In operation
	Red	At end of life
End of life remote indication	By contact NO, NC 250 V / 0.25 A	
Additional characteristics		
Operating temperature	-25°C to +60°C	
Type of connection terminals	Tunnel terminals, 2.5 to 35 mm ²	
Standards	IEC 61643-1 [T2] and EN 61643-11 Type 2	

Weight (g)

Surge arrester	
Type	iPRD
1P	115
2P	220
3P	340
4P	450

Dimensions (mm)

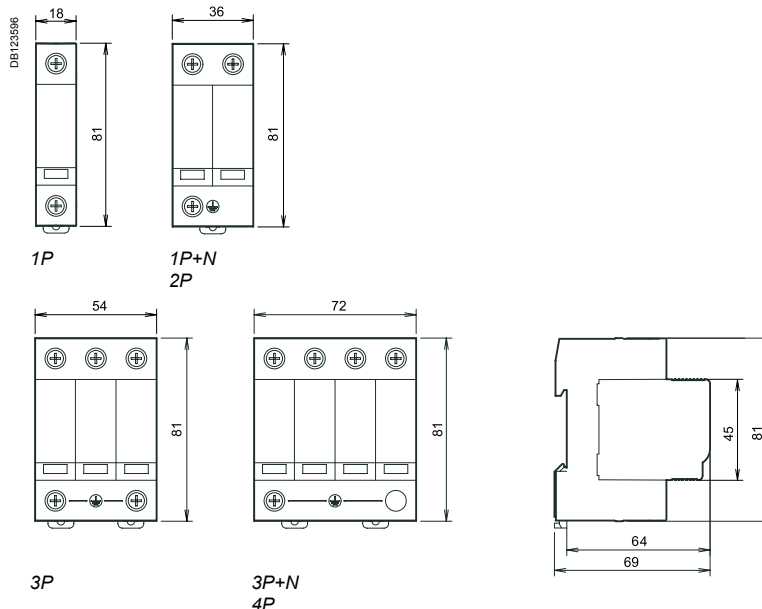

Withdrawable surge arrester iQuick PRD Type 2 or Type 3

Withdrawable surge arrester iQuick PRD allow damaged cartridges to be replaced quickly. They offer remote reporting of the "cartridge must be changed" message.



EN 61643-11: 2012 Type 2, IEC 61643-11: 2011 T2

They protect electrical and electronic equipment against lightning-induced surges. Withdrawable surge arrester iQuick PRD surge arresters are prewired, incorporating their end-of-life disconnecter.

Each surge arrester in the range has a specific use:

■ **incoming protection (type 2):**

- iQuick PRD40r is recommended for a high risk level
- iQuick PRD20r is recommended for a moderate risk level

■ **secondary protection (type 2 or 3):**

- iQuick PRD8r provides secondary protection for the loads to be protected and is cascade-mounted with the incoming surge arresters. This surge arrester is required as close as possible to the loads to be protected when they are located more than 30 metres away from the incoming surge arrester.



Replacement cartridges.

Maximum discharge current (Imax) / Nominal discharge current (In)	Type of protection		Network		
	Incoming protection	Secondary protection	1P+N	3P+N	3P
40 kA / 20 kA					
High risk level	iQuick PRD40r		A9L16292		A9L16293
				A9L16294	
20 kA / 5 kA					
Moderate risk level	iQuick PRD20r		A9L16295		A9L16296
				A9L16297	
8 kA / 2 kA					
Secondary protection: placed near the loads to be protected when they are at a distance of more than 30 m from the incoming surge arrester		iQuick PRD8r	A9L16298		A9L16299
				A9L16300	



Replacement cartridges

Type	Replacement cartridges for	Cat. no.
C 40-350	iQuick PRD40r	A9L16310
C 20-350	iQuick PRD20r	A9L16311
C 8-350	iQuick PRD8r	A9L16312
C neutral-350	All products	A9L16313

Withdrawable surge arrester iQuick PRD Type 2 or Type 3 (cont.)

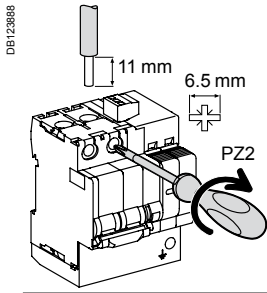
Connection



Type	Tightening torque	Copper cables	
		Rigid	Flexible or with ferrule
iQuick PRD Ph / N 8r/20r Ph / N 40r ⊕	2.5 N.m		
		2.5 to 25 mm ²	2.5 to 25 mm ²
		2.5 to 35 mm ² 25 mm ² max.	2.5 to 35 mm ² 25 mm ² max.

	Earthing system	Transfert	Name of surge arrester	Width in 9 mm modules	Up – (kV) Voltage protection level		Un - (V) Rated voltage network	Uc – (V) Maximum continuous operating voltage	
					CM*	DM*		CM*	DM*
					N/⊕	L/N		N/⊕	L/N
iQuick PRD40r									
	TT & TN-S	■	1P+N	8	≤ 1.7	≤ 2.5	230	264	350
	TN-C	■	3P	13	-	≤ 2.5	230/400	-	-
	TT & TN-S	■	3P+N	15	≤ 1.7	≤ 2.5		264	350
iQuick PRD20r									
	TT & TN-S	■	1P+N	8	≤ 1.7	≤ 1.7	230	264	350
	TN-C	■	3P	13	-	≤ 1.5	230/400	-	-
	TT & TN-S	■	3P+N	15	≤ 1.5	≤ 1.5		264	350
iQuick PRD8r (2)					Type 2 / Type 3				
	TT & TN-S	■	1P+N	8	≤ 1.7/1,5	≤ 1.2/1.4	230	264	350
	TN-C	■	3P	13	-	≤ 1.2/1.4	230/400	-	-
	TT & TN-S	■	3P+N	15	≤ 1.7/1,5	≤ 1.2/1.4		264	350



* **CM** common mode (between neutral and earth). * **DM**: differential mode (between phase and neutral).

(1) Up (MCB + SPD): total value measured between Modular Circuit Breaker (MCB) terminal block and PE surge arrester device terminal block (SPD).

(2) Uoc: open-circuit voltage in combined wave: 10 kV.

Accessories

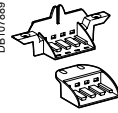
Earth terminal block support

Type			Cat. no.
Support kit	L = 4 blocks	Batch of 1	PRA90053
			
25 mm ² terminal block kit	L = 1 block	Batch of 5	PRA90046
			



Pragma: the earth terminal block needs 1 support kit and 1 terminal block kit.

Withdrawable surge arrester iQuick PRD Type 2 or Type 3 (cont.)

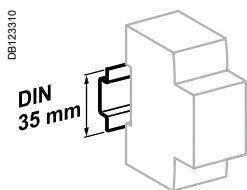

Clip on DIN rail 35 mm.

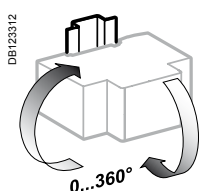

Indifferent position of installation.

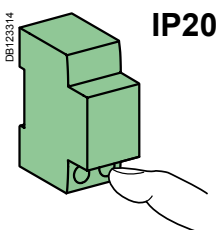

IP20

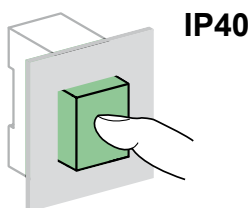

IP40

Technical data

Main characteristics		
Operating frequency	50/60 Hz	
Operating voltage (Ue)	230/400 V AC	
Disconnecter short-circuit withstand (Isc)	iQuick PRD 8r/20r	25 kA (50 Hz)
	iQuick PRD 40r	20 kA (50 Hz)
Temporary overvoltage withstand (U _r)	U _r (L-N)	415 V AC / 5 s
	U _r (N-PE)	1200 V AC / 200 ms
Temporary overvoltage withstand Safe failure mode (U _r)	U _r (L-N)	440 V AC / 120 min
Permanent operating current (Ic)	< 1 mA	
Response time	< 25 ns	
Status indication	By the cartridges	White Red
	By white mechanical indicator/handle ON	Operational
	By red mechanical indicator/handle OFF	At end of life
Remote indication end of life	By the NO/NC remote indication contact 250 V AC / 2 A	
Additional characteristics		
Degree of protection	Device only	IP20, IK05
	Device in modular enclosure	IP40
Operating temperature	-25°C to +60°C	
Storage temperature	-40°C to +80°C	
Humidity range	5 % to 95 %	
Certifications	NF, KEMA KEUR	

Weight (g)

Surge arresters		
Type	iQuick PRD8r/20r	iQuick PRD40r
1P+N	435	445
3P	665	700
3P+N	810	850

Dimensions (mm)

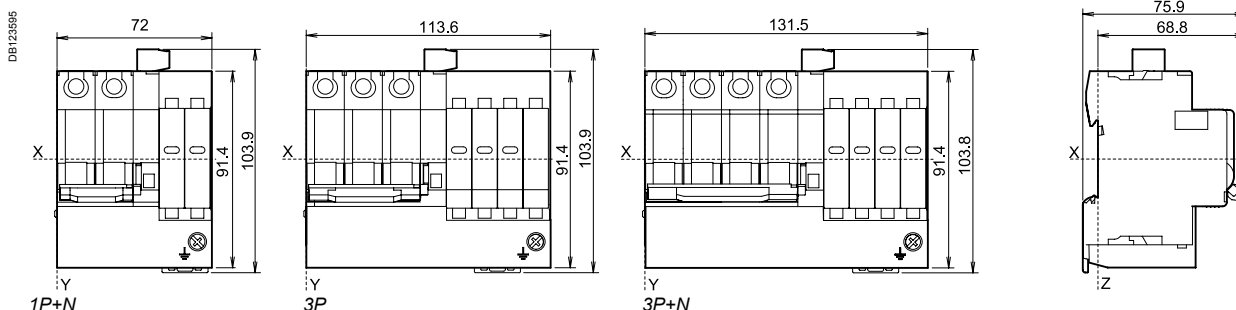



The iQuick PF multi-pole single-piece surge arrester range is adapted for earthing systems: TT, TN-S. Type 2 surge arresters are tested with a 8/20 μ s current wave.

EN 61643-11: 2012 Type 2, IEC 61643-11: 2011 **T2**

Protects electrical and electronic equipment against indirect overvoltage due to the lightning effect.

Coordination with selective version "SI" and **SI** types.

The iQuick PF is precabled. It incorporates its end of life safety disconnecter and an earthing terminal block.

Accessories supplied

- Terminal and 16 mm² cable for connection to the earth bar of the enclosure (supplied mounted).
- 1 lug to crimp for 16 mm² earthing cable.
- iQuick PF 1P+N: 2 connection accessories for the electrical link between the surge arrester and the incoming residual current circuit breaker:
 - 1 mounted, centre distance between axes: 9 mm,
 - 1 supplied, centre distance between axes: 18 mm.



Maximum discharge current (I _{max}) / Nominal discharge current (I _n)	Network		Earthing system	Width in 9 mm modules	U _p – (kV) Voltage protection level (*)	U _n - (V) Rated voltage network	U _c – (V) Maximum continuous operating voltage
	1P+N	3P+N					
10 kA / 5 kA							
iQuick PF	A9L16617	A9L16618	TT & TN-S	4	1.5	230	275
			TT & TN-S	10	1.5	230/400	275

(*) common mode of protection (between phase/earth and neutral/earth) and differential mode of protection (between phase and neutral).

Remote auxiliary IEC 60947-5-1

The remote auxiliary iSR allows to remote the iQuick PF operating status.



Auxiliary				Width in mod. of 9 mm
Type	Contact	Voltage (U _e)		
iSR	3A	415 V CA	A9L16619	1

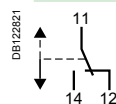

Connection

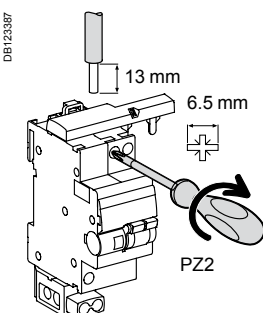

Type	Tightening torque	Copper cables	
		Rigid	Flexible or with ferrule
iQuick PF	Ph / N	1 to 16 mm ²	1 to 16 mm ²
	⊕	10 to 25 mm ²	10 to 25 mm ²
iSR	1.2 N.m	16 mm ² max.	16 mm ² max.

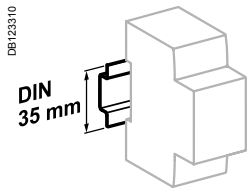

Clip on DIN rail 35 mm.

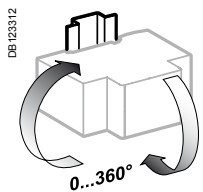

Indifferent position of installation.

Technical data

Main characteristics

Operating frequency	50 Hz	
Operating voltage (U _e)	230/400 V AC	
Integrated breaking capacity (I _{sc} at 50 Hz)	6 kA	
Temporary overvoltage withstand (U _T)	U _T (L-N)	337 V AC / 5 s
	U _T (L-PE)	442 V AC / 5 s
Temporary overvoltage withstand Safe failure mode (U _T)	U _T (N-PE)	1200 V AC / 200 ms
Ground residual current (I _{PE})	I _{PE} (N-PE)	30 µA
Status indication:	Mechanical indicator white/ handle ON	Operational
	Mechanical indicator red/ handle OFF	At end of life
Remote indication end of life	By iSR auxiliary	

Additional characteristics

Degree of protection	Device only	IP20
	Device in modular enclosure	IP40
Operating temperature	-25°C to +70°C	
Storage temperature	-40°C to +80°C	
Humidity range	5 % to 95 %	

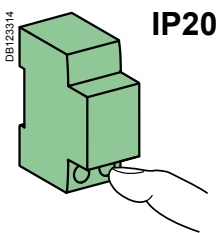

IP20

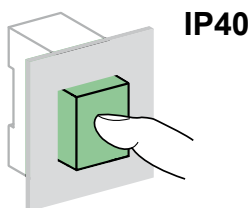

IP40

Weight (g)

Surge arresters

Type	iQuick PF
1P+N	370
3P+N	640

Dimensions (mm)

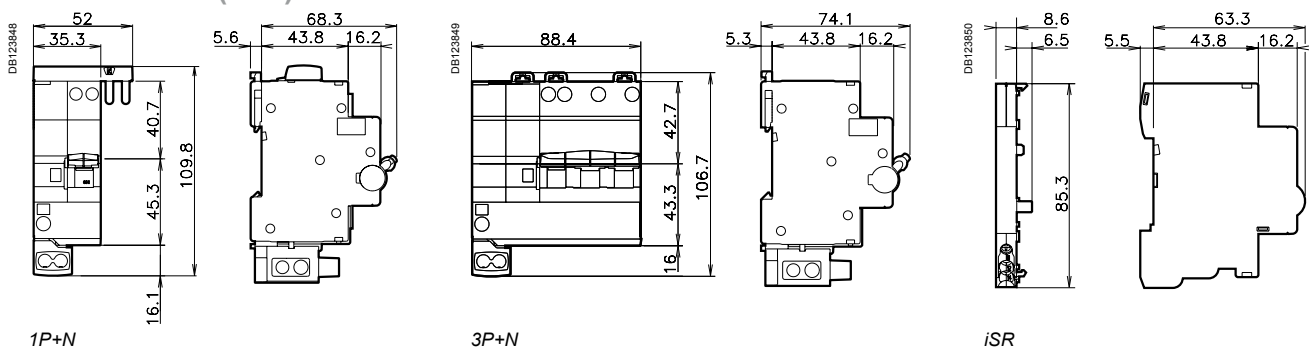

Country approval pictograms

Protection against overvoltages related to lightning strikes.



Analogue telephone line protection: the iPRC surge arrester wired in series to the private installation input protects the telephones, the PABX, the modems (including ADSL), etc.

Protection for 2 low-current lines without common potential or 4 lines with common reference potential: the iPRI protects the measuring instrument and PLC "sensor" inputs and the DC power supply inputs up to 53 V and AC power supply inputs up to 37 V. The input current must not exceed 300 mA.

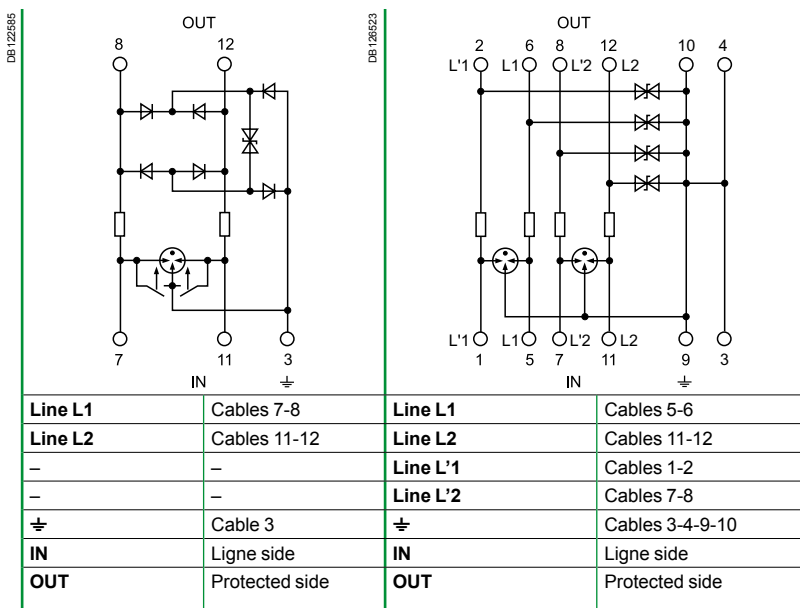

Catalogue numbers

Surge arresters	iPRC	iPRI
Mains voltage (Un)	<130 V AC	48 V DC
Analogue telephone system	■	–
Telephone transmitter	■	–
Digital telephone system	–	■
Automation network	–	■
VLV load power supply (12...48 V)	–	■
xDSL compatibility	■	–
Cat. no..	A9L16337	A9L16339
Width in 9 mm modules	2	2

Diagrams

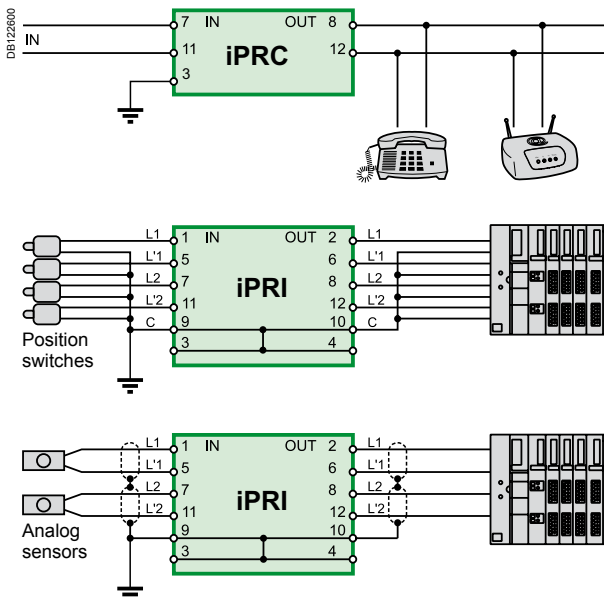

Connection

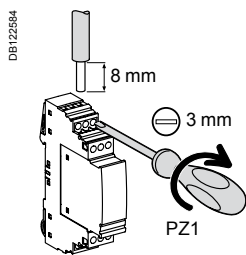

Tightening torque	Copper cables	
	Rigid	Flexible or with ferrule
0.8 N.m	DB122945 0.2 to 4 mm ²	DB122946 0.2 to 2,5 mm ²

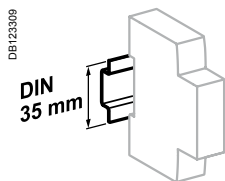

Clip on DIN rail 35 mm.

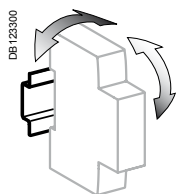

± 30° vertical.

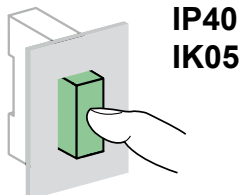
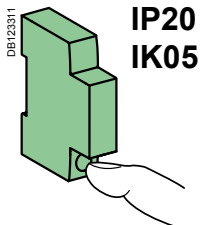

Technical data

Main characteristics			
		iPRC	iPRI
Number of protected lines		2	2
Test category	IEC/EN	C1, C2, C3, D1, B2	C1, C2, C3, D1, B2
Maximum continuous voltage (Uc)		180 V DC, 130 V AC	53 V DC, 37 V AC
Limitation voltage (Up)		300 V	70 V
Rated discharge current (8/20) (In)		10 kA	10 kA
Maximum discharge current (8/20) (Imax)		18 kA	10 kA
Response time		< 500 ns	≤ 1 ns
Nominal impulse current		100 A	70 A
Rated current (I _N)		450 mA (up to 45°C)	300 mA (up to 45°C)
Series resistor		2.2 Ω	4.7 Ω
End-of-life information by		Loss of dialling tone	Loss of transmission
Additional characteristics			
Degree of protection	Device only	IP20	IP20
	Device in modular enclosure	IP40	IP40
	IK	05	05
Operating temperature		-25°C to +60°C	-25°C to +60°C
Storage temperature		-40°C to +85°C	-40°C to +85°C

Weight (g)

Surge arresters		
Type	iPRC	iPRI
	25	65

Dimensions (mm)

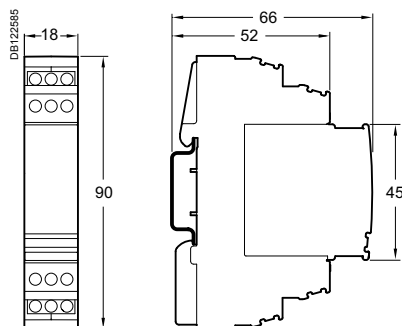

iPRD-DC surge arresters

Withdrawable surge arresters type 2 for photovoltaic applications



Country approval pictograms

IEC 61643-1 **T2**
EN 61643-11 Type 2
UTE C 61740-51 **T2**
prEN 50539-11 **T2**



iPRD-DC40r 600PV

iPRD-DC direct current surge arresters are designed to protect against overvoltages due to a lightning strike: of the "DC" input to the inverter and of photovoltaic panels.

It should be installed in a switchboard inside the building. If the switchboard is located outside, it must be weatherproof.

Withdrawable iPRD-DC surge arresters allow damaged cartridges to be replaced quickly. They offer remote reporting of the "cartridge must be changed" message.

Catalogue numbers

Internal diagram	Imax (kA) Maximum discharge current	In (kA) Nominal discharge current	Up (kV) Protection level			U _{CPV} (V) ⁽¹⁾ Maximum steady state voltage			Width in module of 9 mm	Cat. no.
			L+/ \neq	L-/ \neq	L+/L-	L+/ \neq	L-/ \neq	L+/L-		
iPRD-DC40r 600PV										
	40	15	1.6	1.6	2.8	600	600	840	6	A9L16434
iPRD-DC40r 1000PV										
	40	15	3.9	3.9	3.9	1000	1000	1000	6	A9L16436

(1) $U_{cpv} \geq 1.2 \times U_{oc\ stc}$ ($U_{oc\ stc}$: maximum no-load voltage of the photovoltaic generator "photovoltaic module manufacturer's data")



Replacement cartridges

Replacement cartridges

Type	Replacement cartridges for	Cat. no.
C 40-600PV	iPRD-DC40r 600PV	A9L16683
C 40-1000PV	iPRD-DC40r 1000PV	A9L16692
C neutral PV	iPRD-DC40r 600PV	A9L16690

iPRD-DC surge arresters

Withdrawable surge arresters type 2 for photovoltaic applications (cont.)

Connection

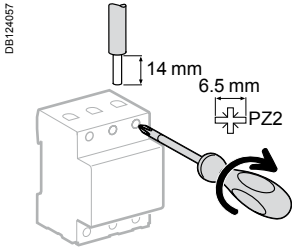

Type	Tightening torque	Copper cables	
		Rigid	Flexible or with ferrule
iPRD-DC	2 N.m	2.5 to 25 mm ²	2.5 to 16 mm ²

Depending on the distance between the "generator" part and the "conversion" part, it may be necessary to install two surge arresters or more, to ensure protection of each of the two parts.

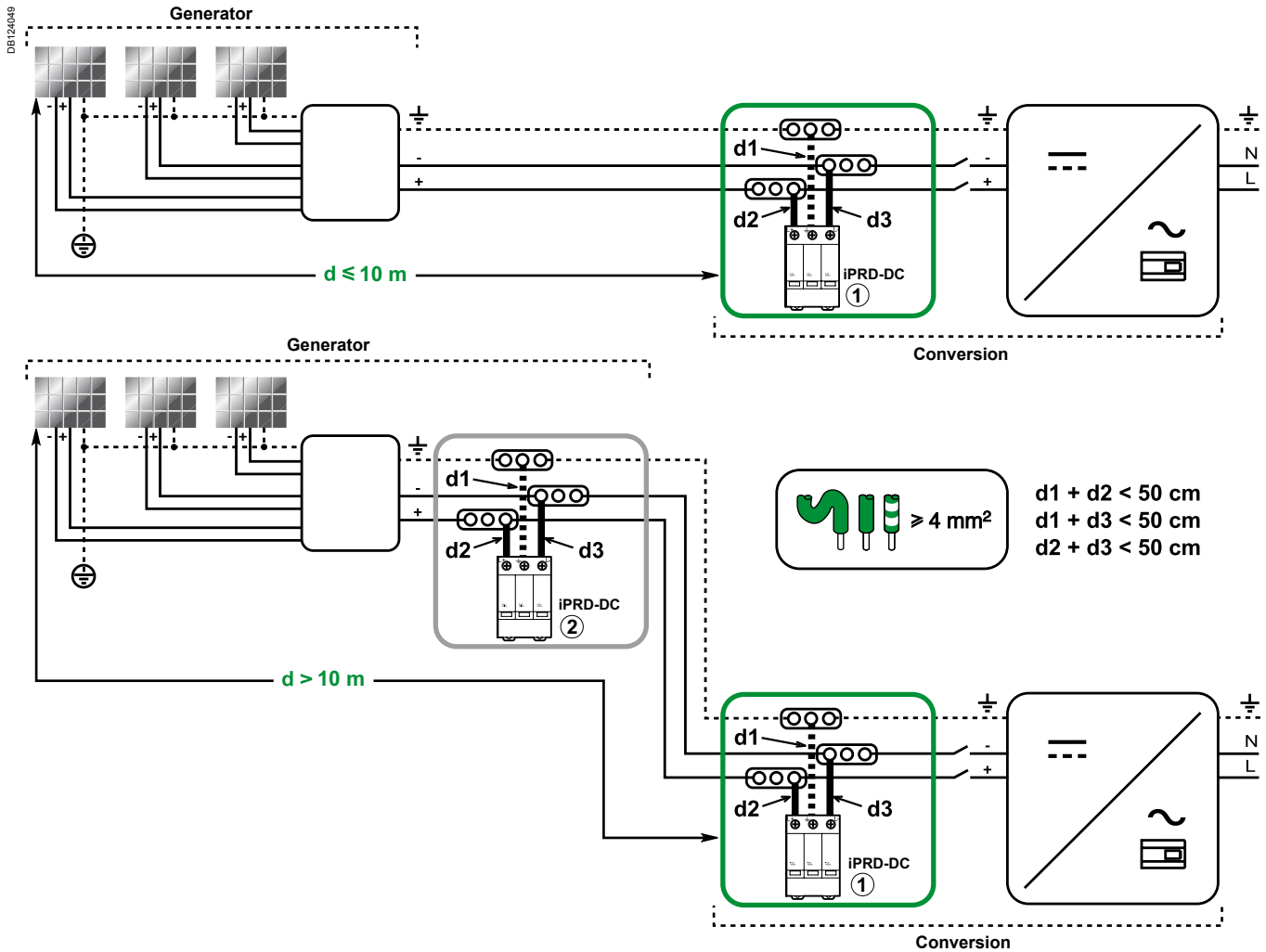

iPRD-DC surge arresters

Withdrawable surge arresters type 2 for photovoltaic applications (cont.)

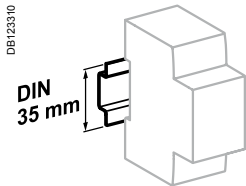

Clip on DIN rail 35 mm.

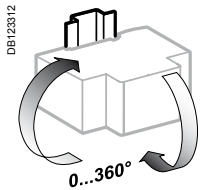

Indifferent position of installation.

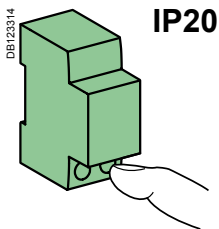

IP20

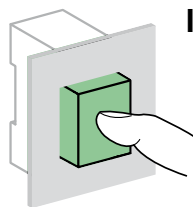

IP40

Technical data

Main characteristics

Type of network	Isolated direct current
Temps de réponse	< 25 ns
Short circuit current (I_{SCP})	30 A
Type of surge arresters	Type 2
End-of-life indication mode	Circuit opened by integrated thermal disconnecter

Additional characteristics

Degree of protection (IEC 60529)	Device only	IP20	
	Device in modular enclosure	IP40	
	Chocs	IK03	
End-of-life indication	By the cartridges	White	Operational
		Red	At end of life
		By the NO/NC remote indication contact 250 V AC / 0.25 A	
Operating temperature	-25°C to +60°C		
Storage temperature	-40°C to +85°C		
Tropicalization (IEC 60068-1)	Treatment 2 (relative humidity of 95 % at 55°C)		

Weight (g)

Surge arresters

Type

iPRD-DC40r 600PV	400
iPRD-DC40r 1000PV	400

Dimensions (mm)

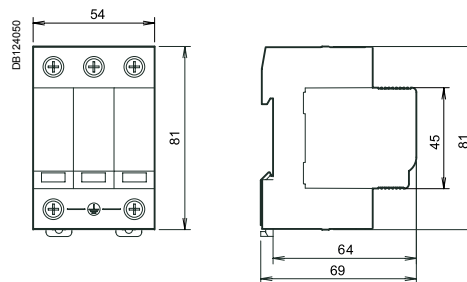

iPRD PV-DC surge arresters

Withdrawable surge arresters type 2 for photovoltaic applications



Country approval pictograms

UTE C 61740-51 T2
EN 50539-11: 2013 T2



iPRD 40r 800PV

iPRD PV-DC direct current surge arresters are designed to protect against overvoltages due to a lightning strike: of the "DC" input to the inverter and of photovoltaic panels.

It should be installed in a switchboard inside the building. If the switchboard is located outside, it must be weatherproof.

Withdrawable iPRD PV-DC surge arresters allow damaged cartridges to be replaced quickly.

The surge arrester base can be turned over to allow the phase/neutral/earth cables to enter through either the top or the bottom

They offer remote reporting of the "cartridge must be changed" message.

Catalogue numbers

Internal diagram	I_{Total} (kA) Total discharge current	I_n (kA) Nominal discharge current	U_p (kV) Protection level L+/-, L-/-, L+/L-	U_{CPV} (V) ⁽¹⁾ Maximum continuous operating voltage L+/-, L-/-, L+/L-	Width in module of 9 mm	Cat. no.
iPRD 40r 800PV						
	40	15	3	800	6	A9L40271
iPRD 40r 1000PV						
	40	15	3.9	1000	6	A9L40281

(1) $U_{cpv} \geq 1.2 \times U_{oc\ stc}$ ($U_{oc\ stc}$: maximum no-load voltage of the photovoltaic generator "photovoltaic module manufacturer's data")



Replacement cartridges

Replacement cartridges

Type	Replacement cartridges for	Cat. no.
C 40-800PV	iPRD 40r 800PV	A9L40172
C 40-1000PV	iPRD 40r 1000PV	A9L40182

iPRD PV-DC surge arresters

Withdrawable surge arresters type 2 for photovoltaic applications (cont.)

Connection

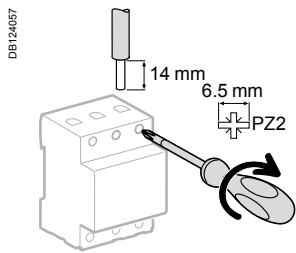

Type	Tightening torque	Copper cables	
		Rigid	Flexible or with ferrule
iPRD PV-DC	3.5 N.m	2.5 to 25 mm ²	2.5 to 16 mm ²

Depending on the distance between the "generator" part and the "conversion" part, it may be necessary to install two surge arresters or more, to ensure protection of each of the two parts.

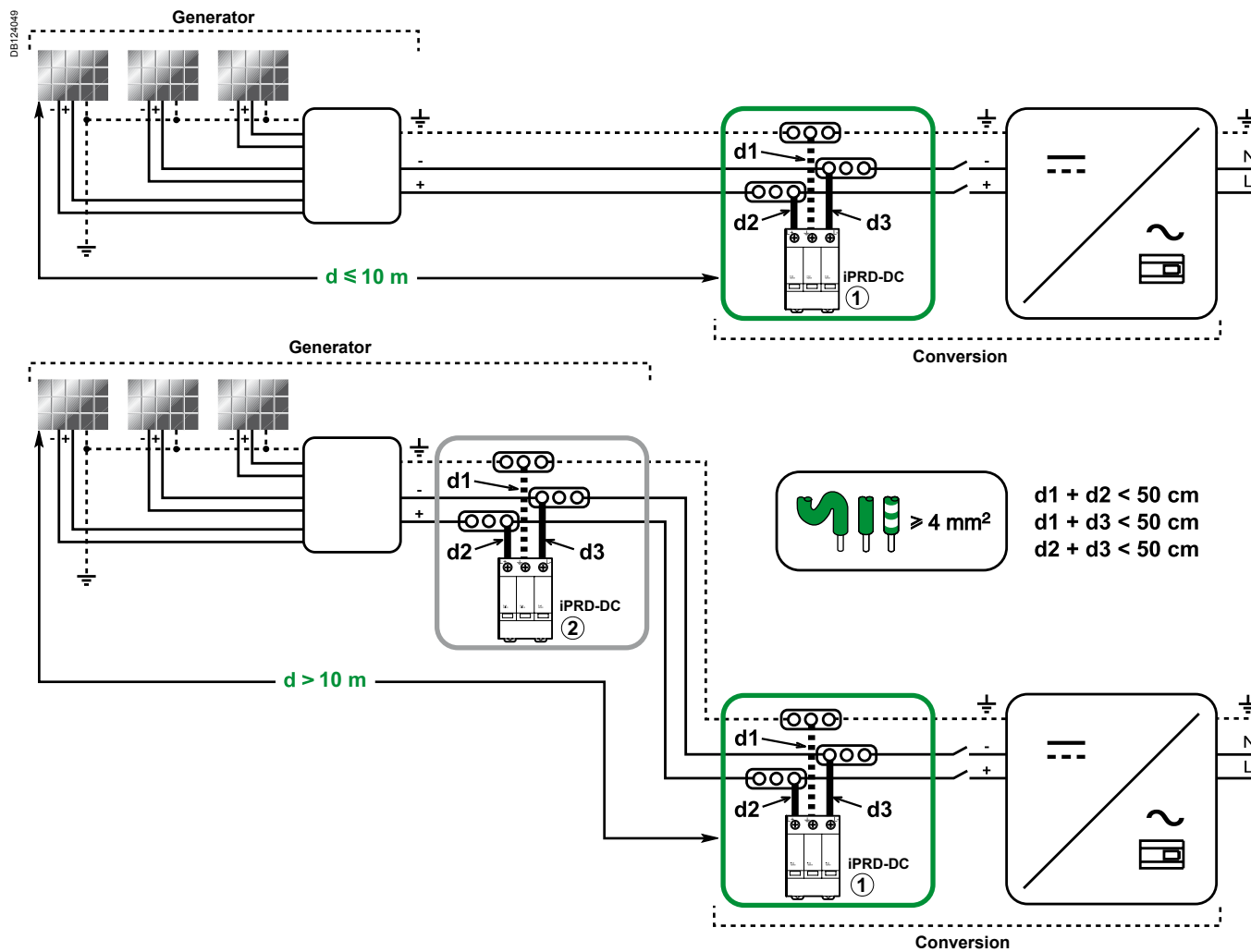

iPRD PV-DC surge arresters

Withdrawable surge arresters type 2 for photovoltaic applications

Application diagram

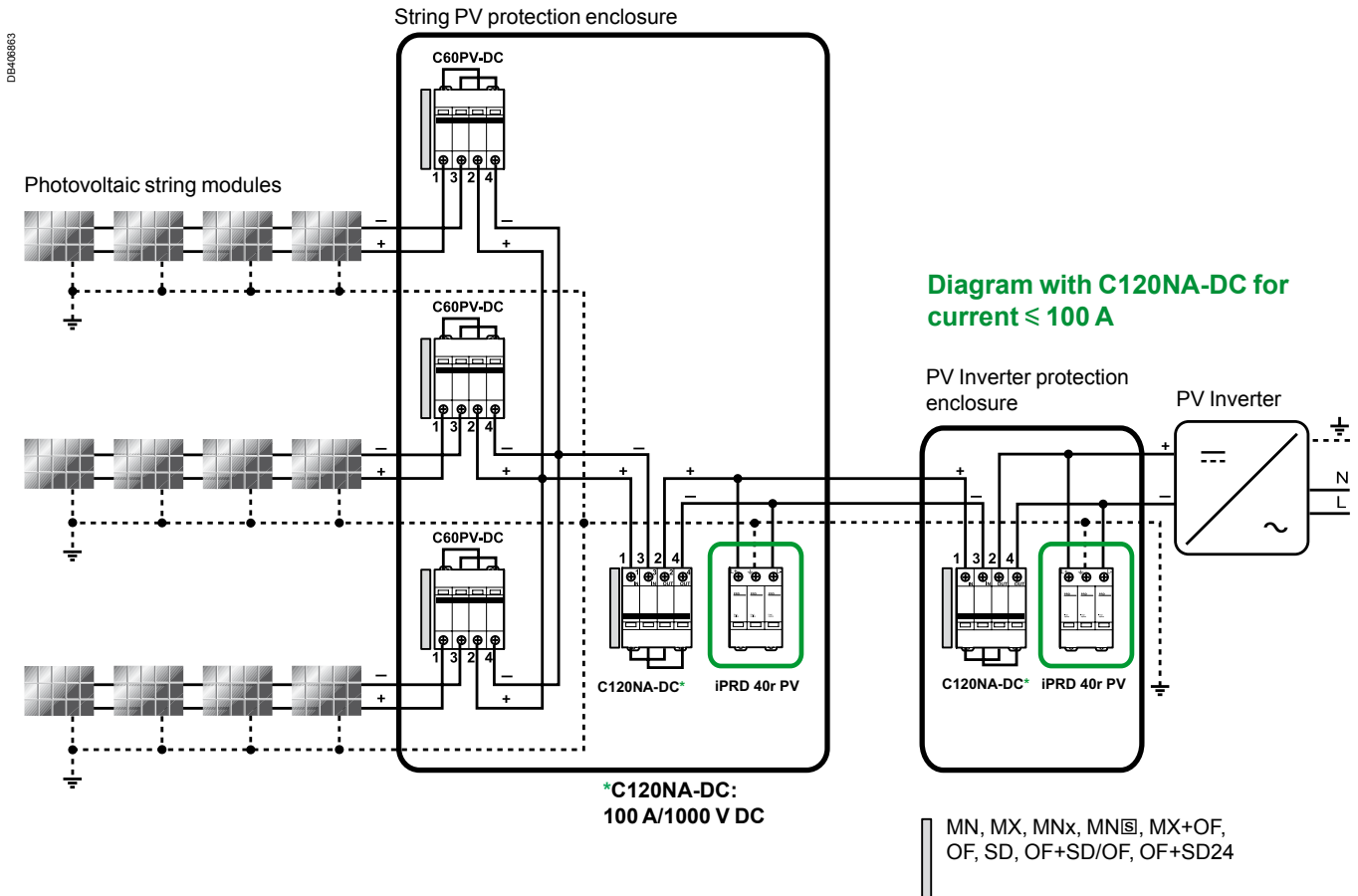

iPRD PV-DC surge arresters

Withdrawable surge arresters type 2 for photovoltaic applications (cont.)

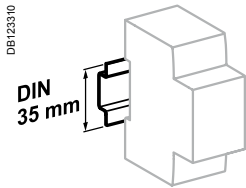

Clip on DIN rail 35 mm.

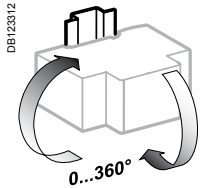

Indifferent position of installation.

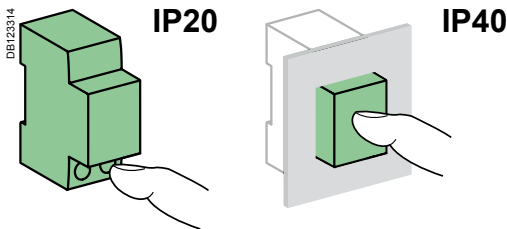

Technical data

Main characteristics			
Type of network	Isolated direct current		
Maximum continuous operating voltage (U_{OPV})	iPRD 40r 800PV	800 V	
	iPRD 40r 1000PV	1000 V	
Response time	< 25 ns		
Permanent operating current (I_c)	< 1 mA		
Short circuit current (I_{SCPV})	200 A		
Type of surge arresters	Type 2		
Ground residual current	I_{PE} (AC)	600 μ A	
	I_{PE} (DC)	60 μ A	
End-of-life indication mode	Circuit opened by integrated thermal disconnecter		
Additional characteristics			
Degree of protection (IEC 60529)	Device only	IP20	
	Device in modular enclosure	IP40	
	Chocs	IK03	
Satisfactory operation indication	By the cartridges	White	Operational
		Red	Cartridge must be replaced
		By the NO/NC remote indication contact 250 V AC / 0.25 A	
Operating temperature	-25°C to +60°C		
Storage temperature	-40°C to +85°C		
Humidity range	5 % to 95 %		
Standards	UTE C 61740-51 [T2] EN 50539-11: 2013 [T2]		

Weight (g)

Surge arresters	
Type	Weight (g)
iPRD 40r 800PV	400
iPRD 40r 1000PV	400

Dimensions (mm)

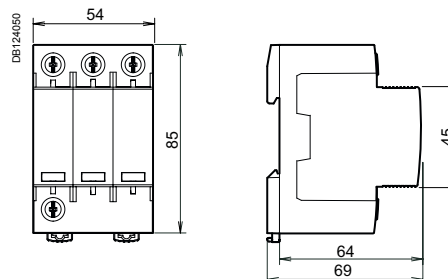



Schneider Electric's range of switches consists of different products (A, B) to enable it to be the most competitive range possible in each country, allowing for the special characteristics of each market:

- usual installation procedure
- price
- accreditations by local bodies.

Variants

Offers		Pages
Offer A	Catalogue numbers	317, 319
Offer B	Catalogue numbers	318, 320
Common pages		321

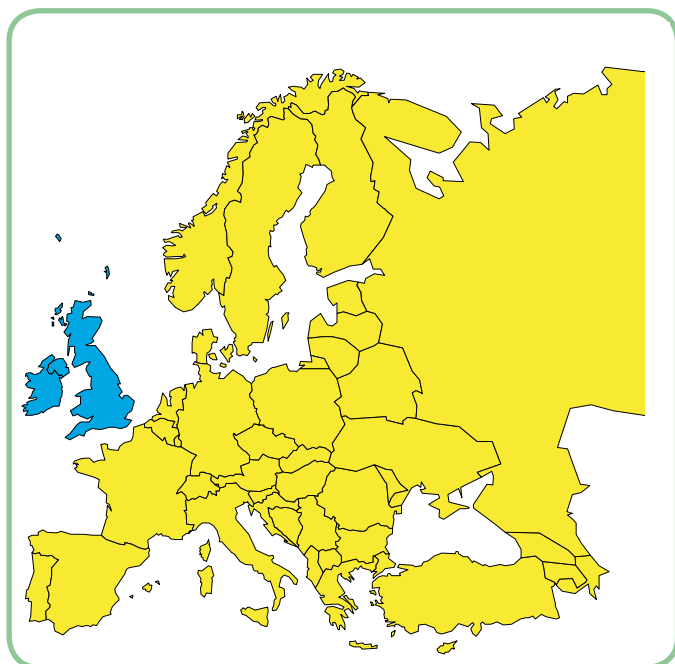

Only the product range to be marketed in your country and validated by the local product manager, in agreement with his Final Distribution (FD) partner should be retained. The others will be removed before publication.

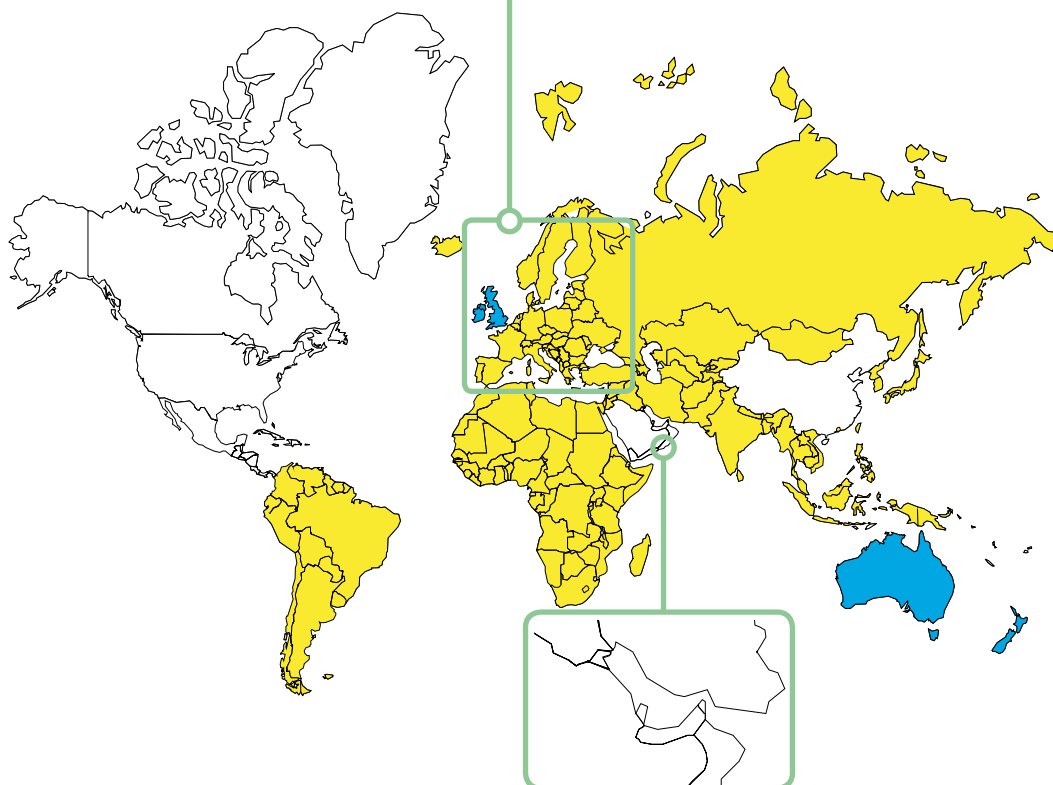

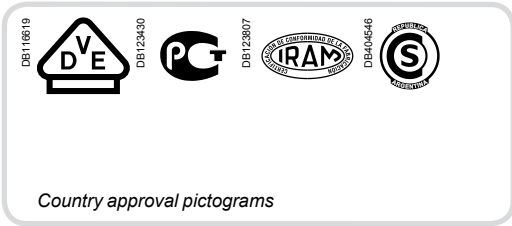

IEC/EN 60947-3

The switch-disconnectors combine the following functions:

- Control (opening and closing of circuits under load).

iOF auxiliary

- Mounted on the left, it indicates the "open" or "closed" position of the switch and has a normally open (NO) or normally closed (NC) contact.



Catalogue numbers

40 to 125 A iSW switch-disconnectors				
Type				Width in 9 mm modules
 DB110898	1P	Rating	Voltage (Ue)	
	1	40 A	240 V AC	A9S65140
		63 A	240 V AC	A9S65163
		100 A	240 V AC	A9S65191
	2	125 A	240 V AC	A9S65192
 DB110899	2P			
	1 3	40 A	415 V AC	A9S65240
		63 A	415 V AC	A9S65263
		100 A	415 V AC	A9S65291
	2 4	125 A	415 V AC	A9S65292
 DB119000	3P			
	1 3 5	40 A	415 V AC	A9S65340
		63 A	415 V AC	A9S65363
		100 A	415 V AC	A9S65391
	2 4 6	125 A	415 V AC	A9S65392
 DB119001	4P			
	1 3 5 7	40 A	415 V AC	A9S65440
		63 A	415 V AC	A9S65463
		100 A	415 V AC	A9S65491
	2 4 6 8	125 A	415 V AC	A9S65492
Operating frequency			50/60 Hz	
Accessories			Module CA907000 and CA907001	

Offer selection see page 316

Offer A

This sticker must be removed before publishing



Auxiliary			
Type			Width in 9 mm modules
 DB118810	iOF	Voltage (Ue)	
		240...415 V AC	A9A26924
		24...130 V DC	



IEC/EN 60947-3
BSEN 60947-3
AS/NZS 60947-3

The switch-disconnectors combine the following functions:
 ■ Control (opening and closing of circuits under load).

iOF auxiliary

■ Mounted on the left, it indicates the "open" or "closed" position of the switch and has a normally open (NO) or normally closed (NC) contact.



Catalogue numbers

40 to 125 A iSW switch-disconnectors				
Type				Width in 9 mm modules
1P				
DB118998 	Rating	Voltage (Ue)		2
	40 A	240 V AC	A9S66140	
	63 A	240 V AC	A9S66163	
	100 A	240 V AC	A9S66191	
125 A	240 V AC	A9S66192		
2P				
DB118999 	Rating	Voltage (Ue)		4
	40 A	415 V AC	A9S66240	
	63 A	415 V AC	A9S66263	
	100 A	415 V AC	A9S66291	
125 A	415 V AC	A9S66292		
3P				
DB119000 	Rating	Voltage (Ue)		6
	40 A	415 V AC	A9S66340	
	63 A	415 V AC	A9S66363	
	100 A	415 V AC	A9S66391	
125 A	415 V AC	A9S66392		
3P+N				
DB404563 	Rating	Voltage (Ue)		8
	125 A	415 V AC	A9S66792	
4P				
DB119001 	Rating	Voltage (Ue)		8
	40 A	415 V AC	A9S66440	
	63 A	415 V AC	A9S66463	
	100 A	415 V AC	A9S66491	
125 A	415 V AC	A9S66492		
Operating frequency		50/60 Hz		
Accessories		Module CA907000 and CA907001		

Auxiliary			
Type			Width in 9 mm modules
DB118810 	Voltage (Ue)		1
	240...415 V AC		
		A9A26924	
		24...130 V DC	

Offer selection see page 316

Offer B

This sticker must be removed before publishing

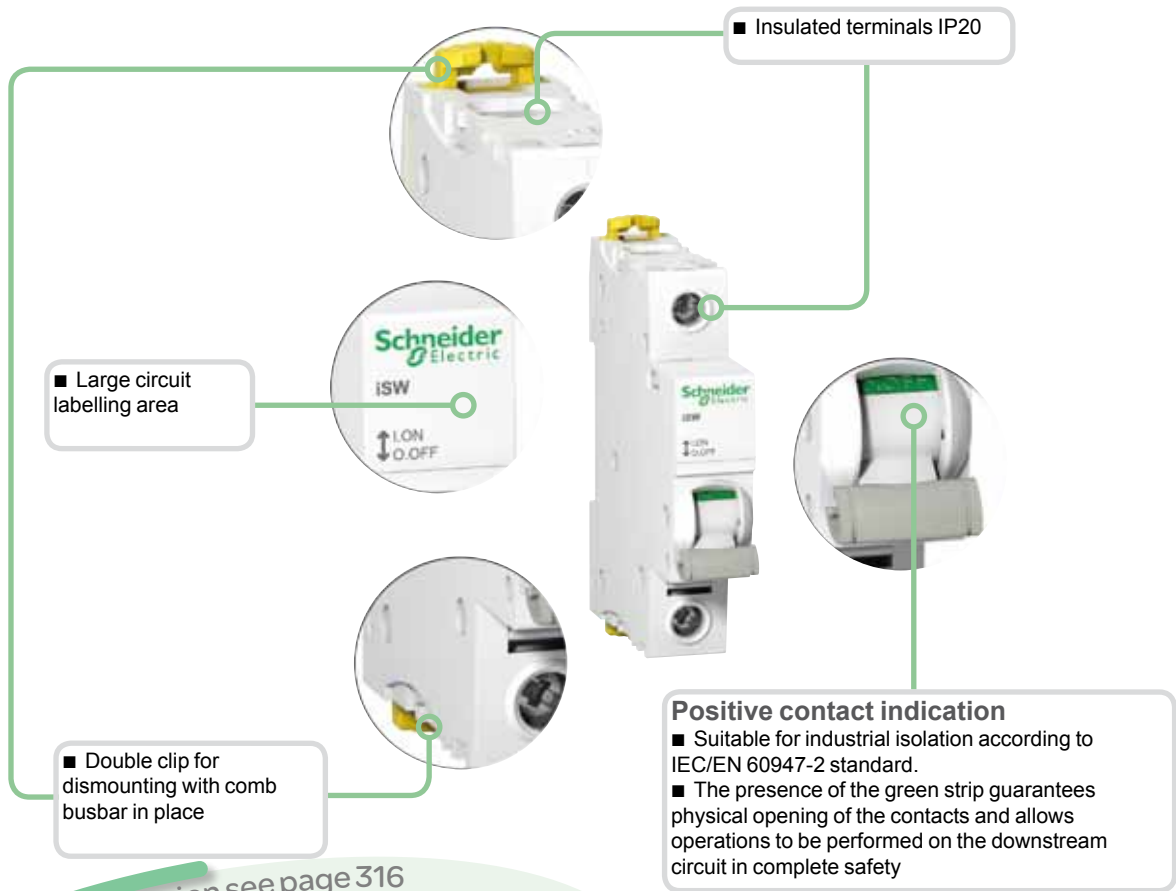

Offer selection see page 316

Offer A

This sticker must be removed before publishing

Dimensions (mm)

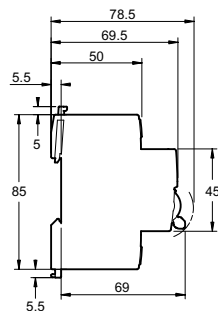
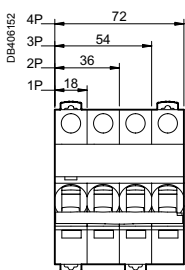

iSW

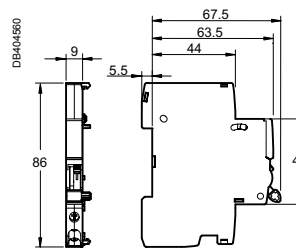

iOF

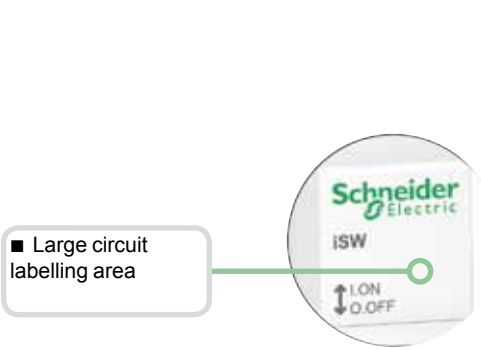

■ Insulated terminals IP20



■ Clip for dismounting

Positive contact indication

- Suitable for industrial isolation according to IEC/EN 60947-2 standard.
- The presence of the green strip guarantees physical opening of the contacts and allows operations to be performed on the downstream circuit in complete safety

Offer selection see page 316

Offer B

This sticker must be removed before publishing

Dimensions (mm)

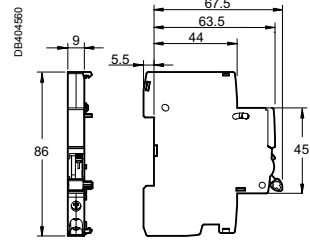
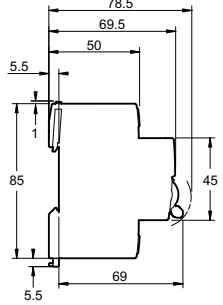
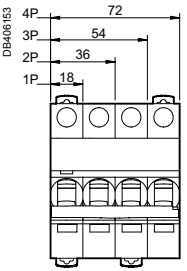



iSW



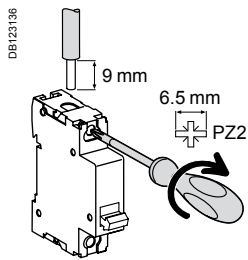

iOF

Connection

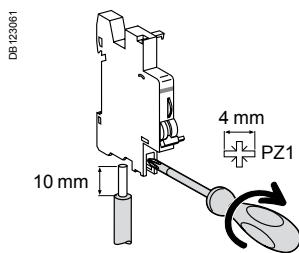

Type	Rating	Tightening torque	Copper cables	
			Rigid	Flexible or with ferrule
iSW	40 to 125 A	3.5 N.m	 $\leq 50 \text{ mm}^2$	 $\leq 35 \text{ mm}^2$



Type	Tightening torque	Copper cables		Multi-cables terminal	
		Rigid	Flexible	Rigid cables	Cables with ferrule
iOF	1 N.m	 1 to 4 mm ²	 0.5 to 2.5 mm ²	 2 x 2.5 mm ²	 2 x 1.5 mm ²

Technical data

Main characteristics

Insulation voltage (Ui)	1P: 250 V AC 2P, 3P, 4P: 500 V AC
Pollution degree	3
Power circuit	
Rated impulse withstand voltage (Uimp)	6 kV
Operating category	AC - 22A
Permissible rated short-time withstand current (Icw)	1500 A
Conditional rated short-circuit current (Inc)	10 kA according to IEC 60947-3
Rated short-circuit closing current (Icm)	5 kA

Additional characteristics

Degree of protection	Device only	IP20						
	Device in modular enclosure	IP40						
Endurance (O-C)	Mechanical	20,000 cycles						
		Electrical	<table border="1"> <tbody> <tr> <td>40 A - 63 A</td> <td>15,000 cycles</td> </tr> <tr> <td>80 A - 100 A</td> <td>10,000 cycles</td> </tr> <tr> <td>125 A</td> <td>2 500 cycles</td> </tr> </tbody> </table>	40 A - 63 A	15,000 cycles	80 A - 100 A	10,000 cycles	125 A
	40 A - 63 A	15,000 cycles						
	80 A - 100 A	10,000 cycles						
125 A	2 500 cycles							
Operating temperature	-25°C to +60°C							
Storage temperature	-40°C to +85°C							
Tropicalization	Treatment 2 (relative humidity 95% at 55°C)							

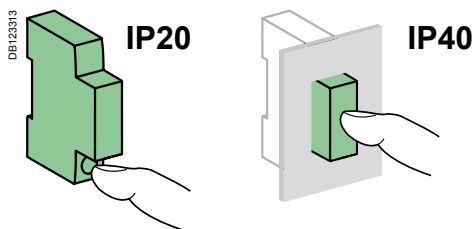

iOF characteristics

Rated voltage (Ue)	240...415 V AC	
	24...130 V DC	
Operating frequency	50/60 Hz	
Operating current	24 V DC	6 A
	48 V DC	2 A
	60 V DC	1.5 A
	130 V DC	1 A
	240 V AC	6 A
	415 V AC	3 A
Number of contacts	1 NO/NC	
Operating temperature	-35°C to +70°C	
Storage temperature	-40°C to +85°C	



Schneider Electric's range of SW Biconnect switches consists of different products (A, B) to enable it to be the most competitive range possible in each country, allowing for the special characteristics of each market:

- usual installation procedure
- price
- accreditations by local bodies.

Variants

Offers	Catalogue numbers	Pages
Offer A	Catalogue numbers	page 323
Offer B	Catalogue numbers	page 325
India		

DE407236

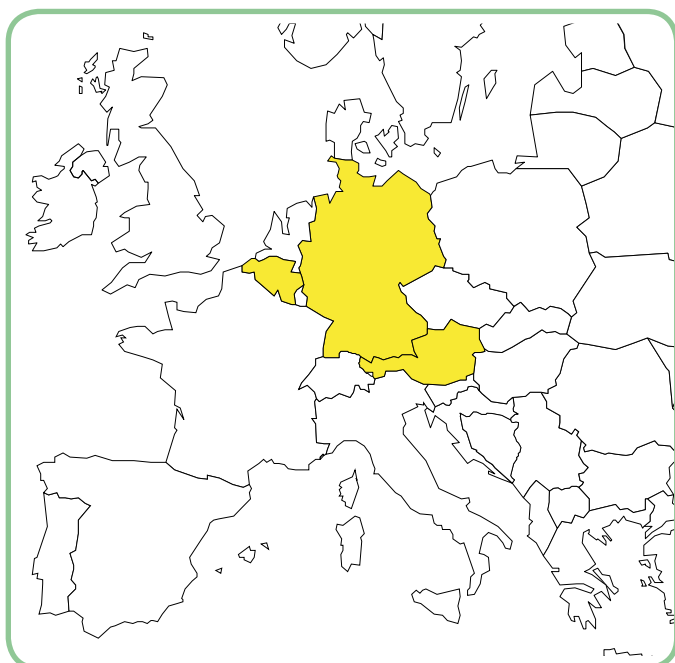

Only the product range to be marketed in your country and validated by the local product manager, in agreement with his Final Distribution (FD) partner should be retained. The others will be removed before publication.

DE407237

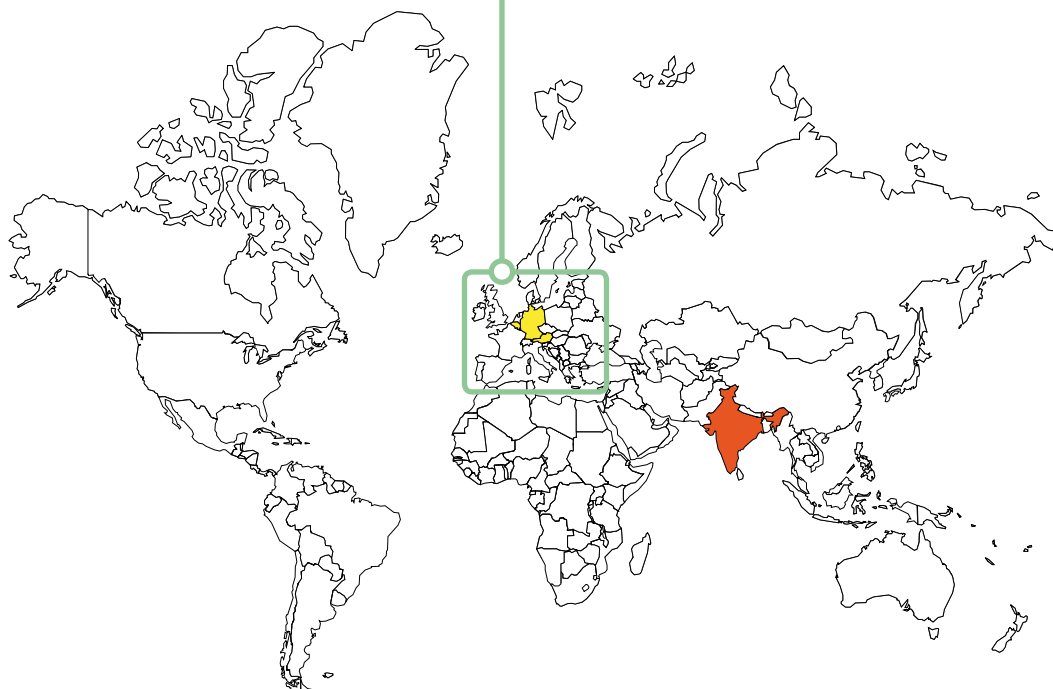

Country approval pictograms

IEC 60947-3

Control and disconnection of on-load electrical circuits already protected against overloads and short-circuits.

Catalogue numbers

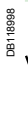
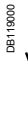
Biconnect switch-disconnectors				
Type	Rating	Voltage (Ue)		Width in 9 mm modules
1P 	63 A	240 V AC	A9S62163	2
3P 	63 A	415 V AC	A9S62363	6
Operating frequency			50/60 Hz	



1P



3P

Offer selection see page 322

Offer A

This sticker must be removed before publishing

- Cable automatically guided to the correct position: terminals with guard
- Insulated terminals IP20

- Manual control on front face by O-I lever

Connection

- Downstream by Biconnect comb busbar
- Upstream/downstream by tunnel terminals

Connection

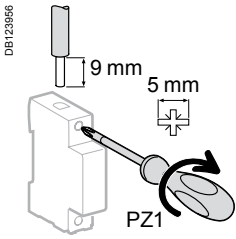

Type	Tightening torque	Copper cables	
		Rigid	Flexible or with ferrule
		DB122945	DB122946
SW Biconnect	3.5 N.m	≤ 50 mm ²	≤ 35 mm ²

■ Connection by comb busbar or cables (as per EN 50027).

Technical data

Main characteristics

Insulation voltage (U _i)	500 V AC
Pollution degree	3

Power circuit

Rated impulse withstand voltage (U _{imp})	6 kV
Operating category	AC-22 A
Permissible rated short-time withstand current (I _{cw})	1260 A
Conditional rated short-circuit current (I _{nc})	6 kA according to IEC 60947-3
Rated short-circuit closing current (I _{cm})	4.2 kA

Additional characteristics

Degree of protection	Device only	IP20
	Device in modular enclosure	IP40
Endurance (O-C)	Mechanical	50,000 cycles
	Electrical	20,000 cycles
Operating temperature		-20°C to +50°C
Storage temperature		-40°C to +70°C
Tropicalization		Treatment 2 (relative humidity 95% at 55°C)

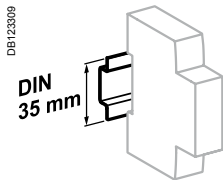

Clip on DIN rail 35 mm.

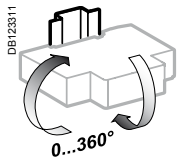

Indifferent position of installation.

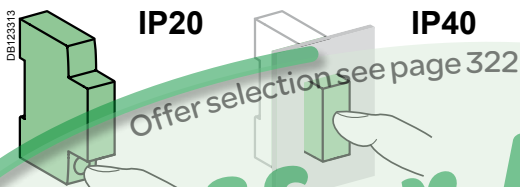

Offer A

This sticker must be removed before publishing

Weight (g)

Biconnect switch-disconnectors	
Type	SW Biconnect
1P	75
3P	230

Dimensions (mm)

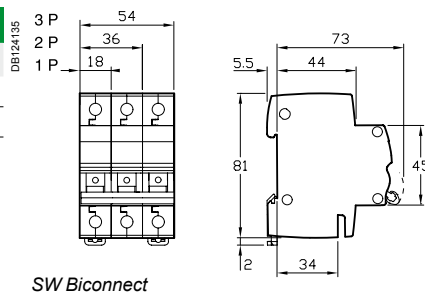

SW Biconnect

Country approval pictogram

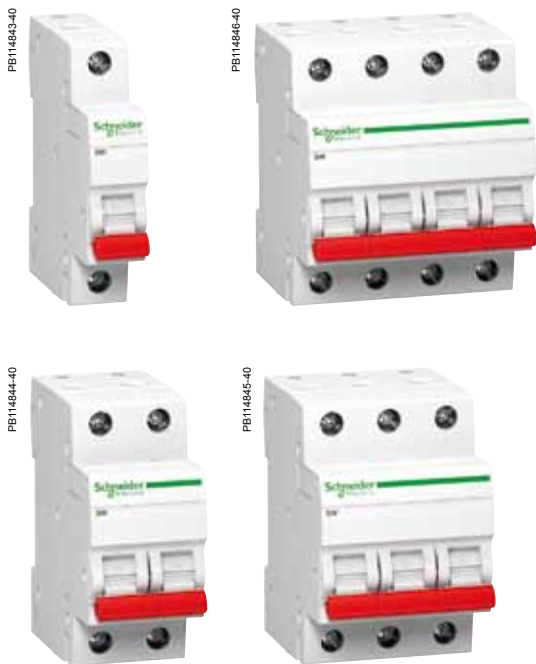

IS/IEC 60947-3

Control and disconnection of on-load electrical circuits already protected against overloads and short-circuits.

Catalogue numbers

Biconnect switch-disconnectors

Type	Rating (In)	Voltage (Ue)		Width in 9 mm modules
1P DB118998	40 A	240 V AC	A9KS15140	2
	63 A	240 V AC	A9KS15163	
2P DB118999	40 A	415 V AC	A9KS15240	4
	63 A	415 V AC	A9KS15263	
	80 A	415 V AC	A9KS15280	
3P DB119000	40 A	415 V AC	A9KS15340	6
	63 A	415 V AC	A9KS15363	
4P DB119001	40 A	415 V AC	A9KS15440	8
	63 A	415 V AC	A9KS15463	
	80 A	415 V AC	A9KS15480	
Operating frequency			50/60 Hz	

DB407251

Offer selection see page 322

Offer B

This sticker must be removed before publishing

- Cable automatically guided to the correct position: terminals with guard
- Insulated terminals IP20

DB407252

Connection

- Downstream by Biconnect comb busbar
- Upstream/downstream by tunnel terminals

- Manual control on front face by O-I lever



Connection

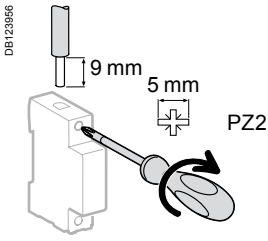

Type	Tightening torque	Copper cables	
		Rigid	Flexible or with ferrule
SW Biconnect	3.5 N.m	1 to 35 mm ²	1 to 25 mm ²

■ Connection by comb busbar or cables (as per EN 50027).

Technical data

Main characteristics		
Insulation voltage (Ui)	500 V AC	
Pollution degree	2	
Power circuit		
Rated impulse withstand voltage (Uimp)	4 kV	
Operating category	AC-22 A	
Permissible rated short-time withstand current (Icw)	12 In for 300 ms	
Rated short-circuit closing current (Icm)	40 - 63 A	15 In
	80 A	1 kA
Additional characteristics		
Degree of protection	Device only	IP20
	Device in modular enclosure	IP40
Endurance (O-C)	Mechanical	20,000 cycles
	Electrical	10,000 cycles
Operating temperature	-5°C to +55°C	
Storage temperature	-25°C to +85°C	
Tropicalization	Treatment 2 (relative humidity 95% at 55°C)	

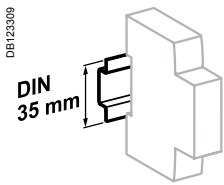

Clip on DIN rail 35 mm.

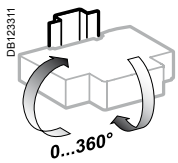

Indifferent position of installation.

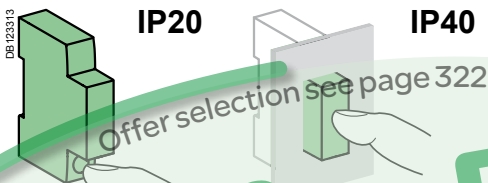

Offer B

This sticker must be removed before publishing

Weight (g)

Biconnect switch-disconnectors	
Type	SW Biconnect
1P	120
2P	240
3P	360
3P	480

Dimensions (mm)

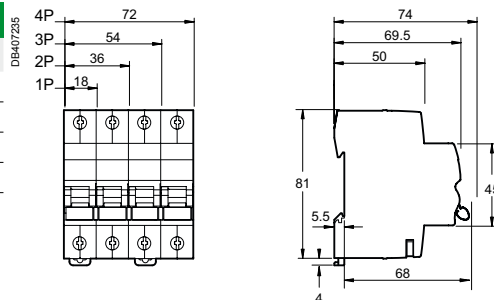

SW Biconnect

Switch-disconnectors remote tripping types iSW-NA

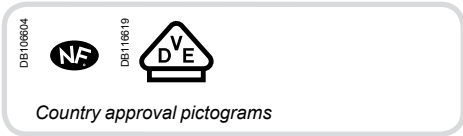

Positive break indication

- Suitability for isolation in the industrial sector to IEC/EN 60947-3.
- The presence of the green strip guarantees that the contacts open physically and allows work to be carried out safely on the downstream circuit.



IEC/EN 60947-3

The iSW-NA trip switch-disconnectors combine the following functions:

- control (opening and closing of circuits under load)
- isolation.

They are designed for switchboard or cubicle incoming units in the tertiary and industry sectors, with the possibility of remote tripping via a coil.

Catalogue numbers

iSW-NA			
Type			Width in 9 mm modules
1P+N 	Rating		
	40 A	A9S70640	4
	63 A	A9S70663	
	80 A	A9S70680	
	100 A	A9S70690	
3P+N 	40 A	A9S70740	8
	63 A	A9S70763	
	80 A	A9S70780	
	100 A	A9S70790	
	Voltage rating (Ue)	1P+N	230-240 V AC
	3P+N	400-415 V AC	
Operating frequency		50/60 Hz	
Auxiliaries*		Module CA907000 and CA907002	
Accessories		Module CA907000 and CA907001	

* Electrical auxiliaries must be installed to the left of the switch-disconnector. The iSD auxiliary contact must be combined with an auxiliary device (iMN, iMX, iMX+OF): it indicates that the switch-disconnector has been tripped open..

Switch-disconnectors remote tripping types iSW-NA (cont.)

Connection

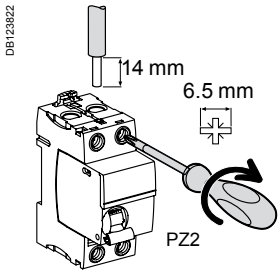

Type	Tightening torque	Without accessory		With accessories*			
		Copper cables		50 mm ² Al terminal	Screw-on connection for ring terminal	Multi-cables terminal	
		Rigid	Flexible or with ferrule			Rigid cables	Flexible cables
iSW-NA	3.5 N.m	DB122945 1 to 35 mm ²	DB122946 1 to 25 mm ²	DB122935 50 mm ²	DB118769 Ø 5 mm	DB118787 3 x 16 mm ²	3 x 10 mm ²

* See module CA907000

Technical data

Main characteristics	iSW-NA	
	40/63 A	80/100 A
According to IEC 60947-3		
Insulation voltage (Ui)	500 V AC	
Pollution degree	3	
Rated impulse withstand voltage (Uimp)	6 kV	
Operating category	AC22A	
Permissible rated short-time withstand current (Icw)	20 In/1s	15 In/1s
Rated short-circuit making (Icm)	5 kA	
Conditional rated short circuit current (Inc/IΔc)	With iC60N/H/L	Equal to breaking capacity of iC60
	With fuse	6000 A
Additional characteristics		
Degree of protection	Device only	IP20
	Device in modular enclosure	IP40 Insulation class II
Endurance (O-C)	Electrical	15,000 cycles
	Mechanical	20,000 cycles
Operating temperature	-35°C to +70°C	
Storage temperature	-40°C to +85°C	
Tropicalization	Treatment 2 (relative humidity 95 % at 55°C)	

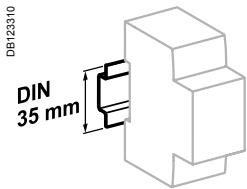

Clip on DIN rail 35 mm.

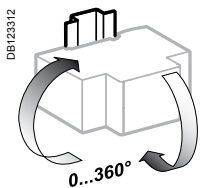

Indifferent position of installation.

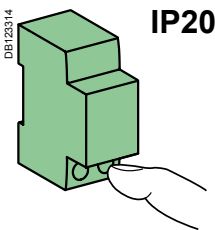

IP20

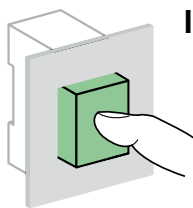

IP40

Dimensions (mm)

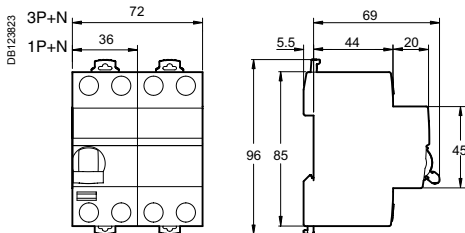

Weight (g)

Switch-disconnectors	
Type	iSW-NA
1P+N	170
3P+N	300



The Schneider Electric range of switches up to 125 A comprises various offers (A, B) so as to be as competitive as possible in each country, taking into account the specific features of each market:

- installation customs
- price
- approval by local organizations.

Variants

Offers		Pages
Offer A	Catalogue numbers	330
Offer B	Catalogue numbers	331
Common pages		332

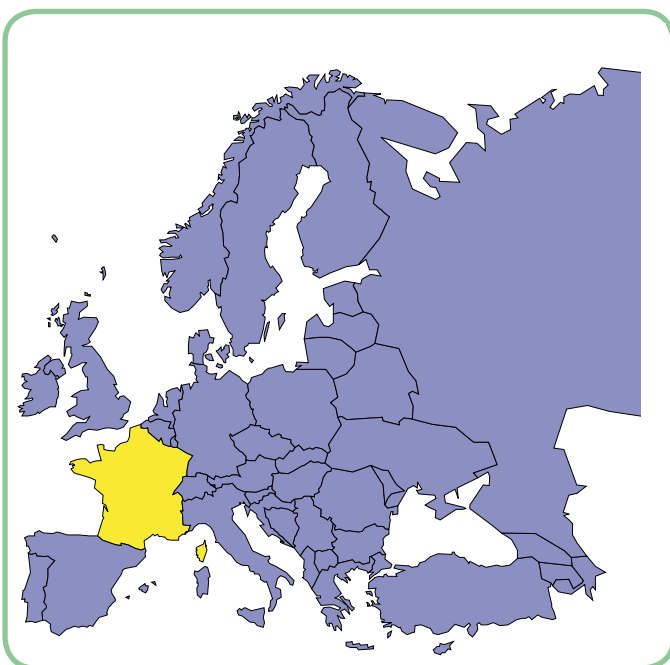

Only the product range to be marketed in your country and validated by the local product manager, in agreement with his Final Distribution (FD) partner should be retained. The others will be removed before publication.

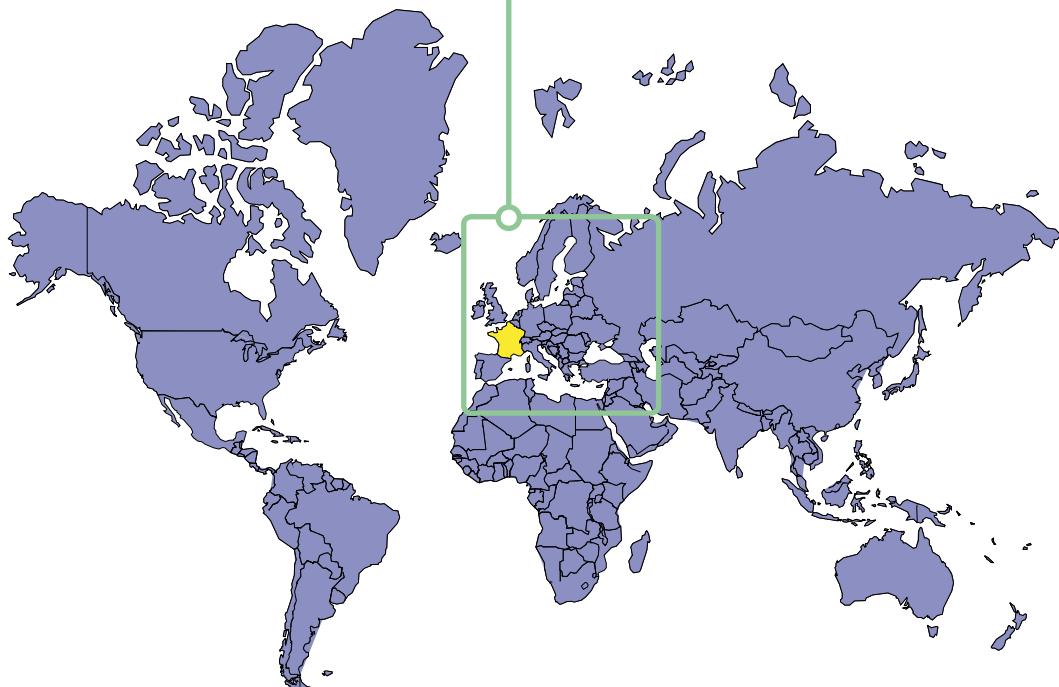

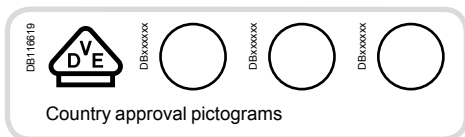

IEC/EN 60947-3

- The NG125NA is a switch-disconnector with free tripping for making and breaking under load.
- It is especially suitable for the modular enclosure incoming feeder with remote breaking (e.g. emergency cutoff).

066908N_SE-2011-35



NG125NA 3P

066909N_SE-2011-35



NG125NA 4P

Offer selection see page 329

Offer A

Catalogue numbers

NG125NA switches

Type

3P

3P+N

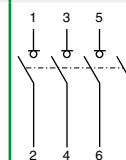
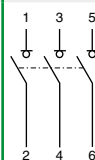

Auxiliaries

Remote indication and tripping, module CM907004 and CM907005

Rating (In)

Quality label (1)

Rating (In)	Quality label (1)	3P	3P+N
63 A		18889	18897
80 A		18890	18898
100 A		18891	18899
125 A		18892	18900
Width in 9 mm modules		9	12
Accessories		Module CM907004 and CM907006	

(1) Information to be supplied by the country concerned.

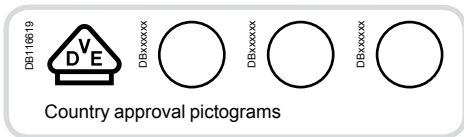

IEC/EN 60947-3

- The NG125NA is a switch-disconnector with free tripping for making and breaking under load.
- It is especially suitable for the modular enclosure incoming feeder with remote breaking (e.g. emergency cutoff).



NG125NA 3P



NG125NA 4P

Offer selection see page 329

Offer B

Catalogue numbers

NG125NA switches

Type	3P	3P+N
Auxiliaries	Remote indication and tripping, module CM907005	
Rating (In)	Quality label (1)	
63 A	18889	18893
80 A	18890	18894
100 A	18891	18895
125 A	18892	18896
Width in 9 mm modules	9	12
Accessories	Module CM907006	

(1) Information to be supplied by the country concerned.

Connection

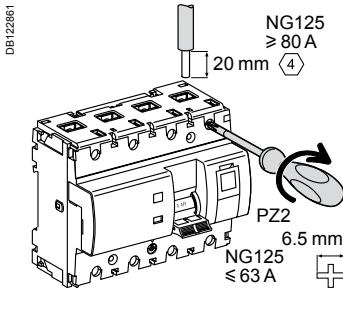

Rating	Tightening torque	Without accessories			With accessories			Multi-cable terminal	
		Copper cables			70 mm ² Al terminal	Screw-on connection for ring terminal	Small ring terminal	Rigid cables	Flexible cables
		Rigid	Flexible or with ferrule						
		DB122945	DB122946	DB123410					
63 A	3.5 N.m	1.5 to 50 mm ²	1.5 to 35 mm ²	-	-	-	3 x 16 mm ²	3 x 10 mm ²	
80 to 125 A	6 N.m	16 to 70 mm ²	10 to 50 mm ²	25 to 70 mm ²	2 x 35 mm ² 1 x 50 mm ²	1 x 70 mm ²			

■ For rating ≥ 80 A: upstream voltage taps for each pole, by 6.35 mm Fast-on terminal.

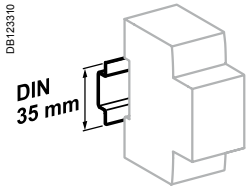

Clips onto 35 mm DIN rail.

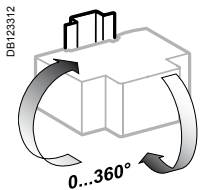

Any installation position.

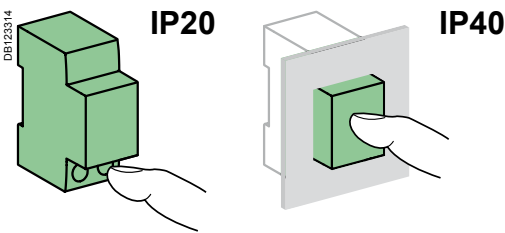

Technical data

Main characteristics

According to IEC/EN 60947-3

Max. voltage rating (U _e)	500 V AC
Insulation voltage (U _i)	690 V AC
Degree of pollution	3
Rated impulse withstand voltage (U _{imp})	8 kV
Short time withstand current (50 ms) I _{cw}	1.5 kA
Rated short-circuit closing current (I _{cm})	2 kA
Utilization category	AC22A/B - AC23B

Additional characteristics

Degree of protection (IEC 60529)	Device only	IP20
	Device in modular enclosure	IP40

Endurance (O-C)

		Category A	Category B
Electrical (except AC20 and DC20)	≤ 100 A	1500 cycles	300 cycles
	125 A	1000 cycles	200 cycles
Mechanical		20,000 cycles	

Operating temperature	-30°C to +70°C
Storage temperature	-40°C to +70°C
Tropicalization (IEC 60068-1)	Treatment 2 (relative humidity of 95% at 55°C)

Weight (g)

Switch	
Type	NG125NA
3P	720
4P	960

Dimensions (mm)

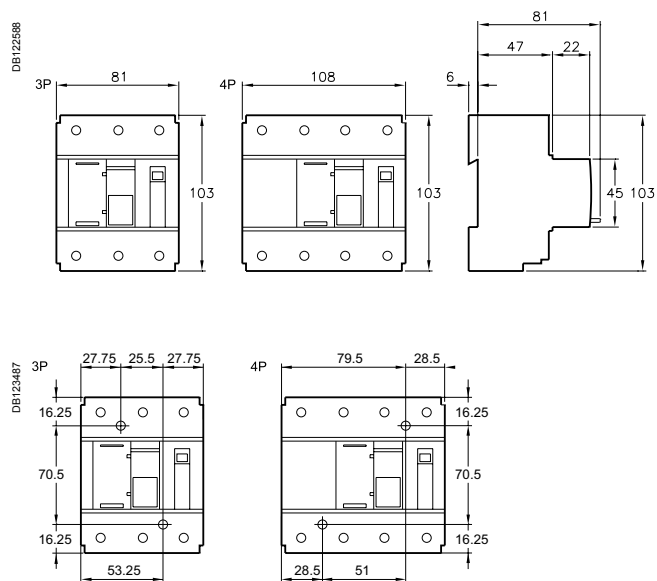

Spacing for mounting on panel

05909N_LSE-2011-90

DB123493



For rating ≥ 80 A

- Voltage taps:
 - auxiliaries power supply
 - measurement
 - emergency stop
 - remote reporting



■ Cable strength:

- ribbed cage
- terminal depth
- tightening by Allen hex key (NG125 ≥ 80 A)

■ Integrated padlocking device

■ Test button to check satisfactory operation of the tripping mechanism



■ Pull-out strength:

- metallic lock



■ Impact and vibration resistance:

- high-strength enclosure
- IK 05

■ Central manual control, 3 positions:

- ON
- tripped on fault
- open

■ Circuit breaker tripped indicator

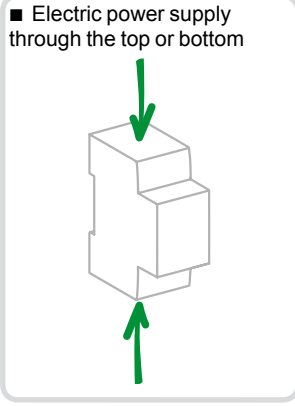

■ Positive contact indication:

- suitability for isolation in the industrial sector to IEC/EN 60947-3;
- the presence of the green strip guarantees that the contacts open physically and allows work to be carried out safely on the downstream circuit.

■ Longer product service life due to:

- good overvoltage withstand capacity;
- high limitation performances;
- fast closure independent of the speed of actuation of the toggle.

Connection accessories

See module CA907001

9	Splitter blocks	Linergy FM	See module	LIN022
		Linergy DX	See module	LIN003
10	50 mm ² Al terminal			27060
11	Screw-on connection for ring terminal			27053
12	Multi-cables terminal	4 parts		19091
		3 parts		19096
13	Comb busbar		See modules	CA907026, CA907027

Mounting accessories

See module CA907001

14	Sealable terminal shields for top and bottom connection	1P (set of 2)	A9A26975
		2P (set of 2)	A9A26976
		3P	1P + 2P
		4P	2P + 2P
15	Interpole barrier	(set of 10)	A9A27001
16	Screw shields	4P (set of 20)	A9A26981
16"	Screw shields	Vigi iC60 (set of 12)	A9A26982
17	Clip-on terminal markers		See module CA907001
18	9 mm spacer		A9A27062
19	Padlocking device	(set of 10)	A9A26970
20	Plug-in base		A9A27003
21	Rotary handle	Black handle	A9A27005
		Red handle	A9A27006
		No handle	A9A27008

Electrical auxiliaries

See module CA907002

Indication		
4	iOF/SD+OF auxiliary contact (OF+SD or OF+OF combination switch)	A9A26929
5	iSD fault indicating contact	A9A26927
6	iOF open/close auxiliary contact	A9A26924
7	iOF+SD24 auxiliary contact	A9A26897

Control		
8	iMDU voltage matching auxiliary	A9C18195

Tripping devices		
2	iMN undervoltage release or iMNs undervoltage release delayed or iMNx undervoltage release with external feeding	See module CA907002
3	Shunt release iMX, iMX+OF overvoltage release iMSU	See module CA907002

Vigi iC60

1	Vigi iC60 add-on residual current device	See module	CA902005
	Double terminals Vigi iC60 add-on residual current device	See module	CA902019

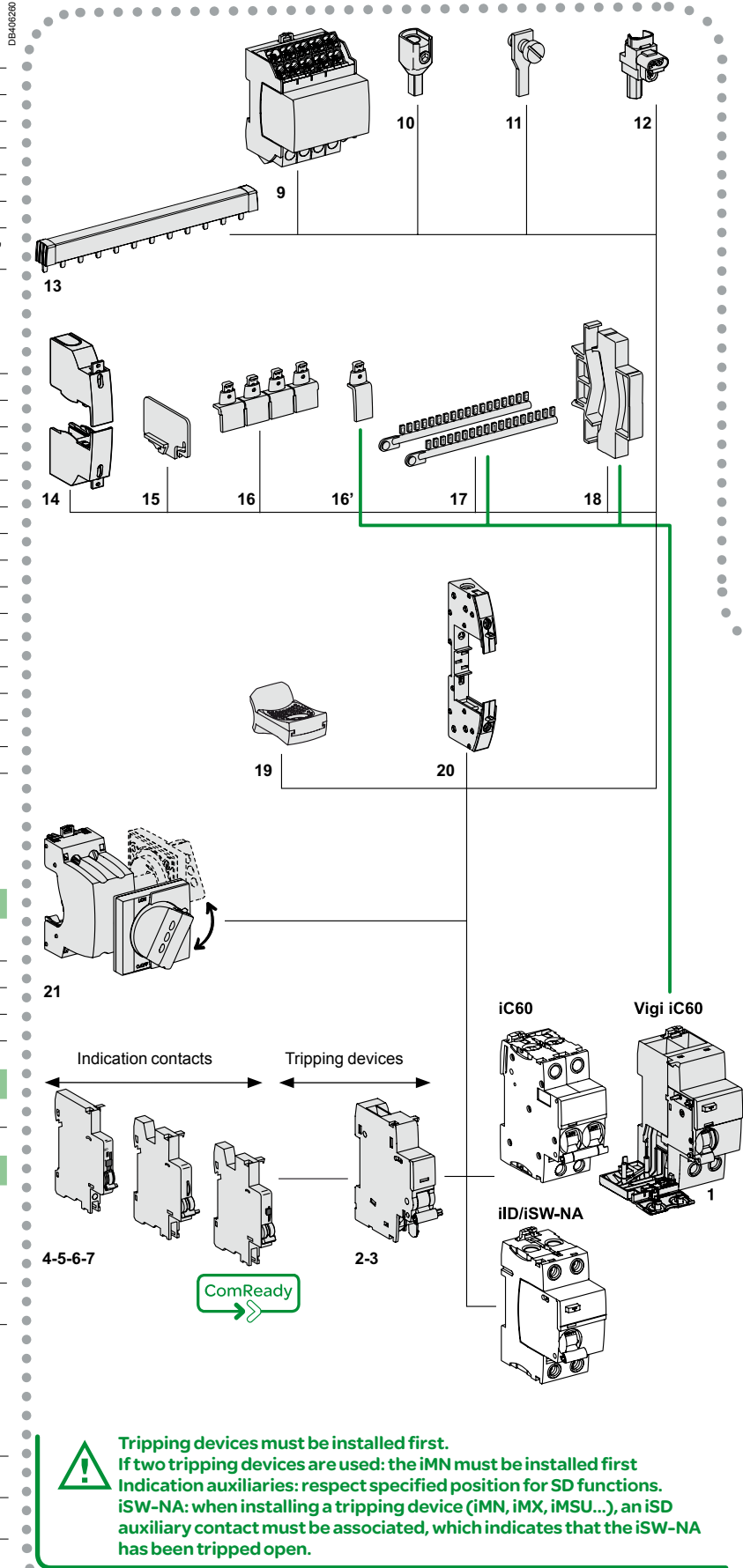

Tripping devices must be installed first.

If two tripping devices are used: the iMN must be installed first

Indication auxiliaries: respect specified position for SD functions.

iSW-NA: when installing a tripping device (iMN, iMX, iMSU...), an iSD

auxiliary contact must be associated, which indicates that the iSW-NA has been tripped open.

Assembly rule

The mounting order and the number for the various auxiliaries must be complied with.

The tripping auxiliaries (iMN, iMX, iMSU...) should be mounted first **1** as close as possible to the main device.

Then at the left, the indicating auxiliaries (iOF, iSD) should be mounted **2** then **3** complying with the following association table.

Indicating auxiliaries 3	+ 2	Tripping auxiliaries + 1	Remote control	Device	Vigi iC60
1 (iOF/SD+OF or iOF+SD24 or iSD)	1 iOF/SD+OF	1 (iMN, iMNs, iMNx or iMX, iMX+OF or iMSU)	–	iC60, iID, iSW-NA	<i>Vigi iC60</i>
1 iOF	1 (iSD or iOF or iOF/SD+OF)	2 (iMN, iMNs, iMNx or iMX, iMX+OF or iMSU)			
–	1 iOF+SD24	2 (iMN, iMNs, iMNx or iMX, iMX+OF or iMSU)			
–	–	3 iMSU			
1 iSD	1 iSD	1 (iMN, iMNs, iMNx or iMX, iMX+OF or iMSU)			
–	1 (iSD or iOF or iOF/SD+OF or iOF+SD24)	1 (iMN, iMNs, iMNx or iMX, iMX+OF or iMSU)	ARA, RCA	<i>iC60</i>	<i>Vigi iC60</i>
1 iOF	1 (iSD or iOF or iOF/SD+OF)	–			
–	1 (iSD or iOF or iOF/SD+OF or iOF+SD24)	1 (iMN, iMNs, iMNx or iMX, iMX+OF or iMSU) maxi	ARA	<i>iID</i>	–
1 iOF	1 (iSD or iOF or iOF/SD+OF)	–			

DB-04784

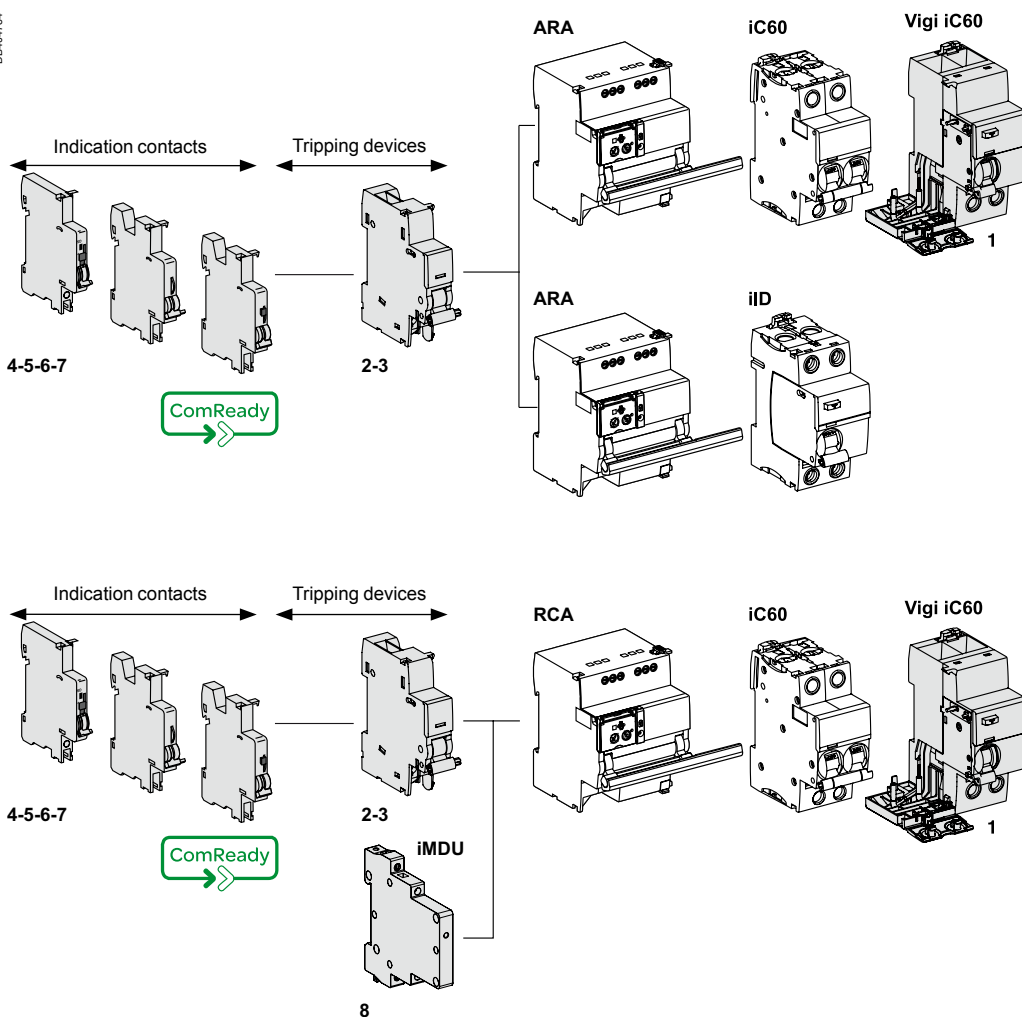

Connection accessories

See module CA907001

3	Splitter blocks	Linergy FM	See module	LIN022
		Linergy DX	See module	LIN003
4	50 mm ² Al terminal			27060
5	Screw-on connection for ring terminal			27053
6	Multi-cables terminal	4 parts		19091
		3 parts		19096
7	Comb busbar		See modules	CA907026, CA907027

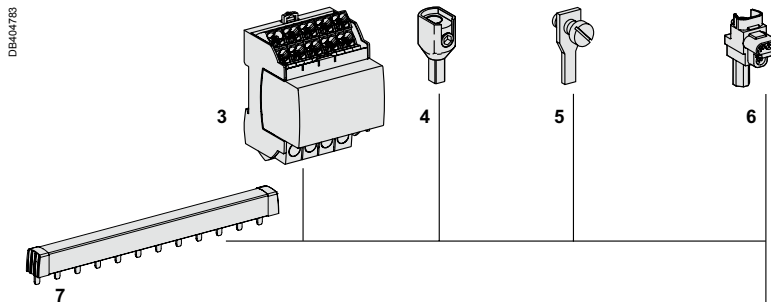

Mounting accessories

See module CA907001

8	Sealable terminal shields for top and bottom connection	1P (set of 2)	A9A26975
		2P (set of 2)	A9A26976
		3P	1P + 2P
		4P	2P + 2P
9	Interpole barrier	(set of 10)	A9A27001
10	Screw shields	4P (set of 20)	A9A26981
11	Clip-on terminal markers		See module CA907001
12	9 mm spacer		A9A27062
13	Padlocking device	(set of 10)	A9A26970

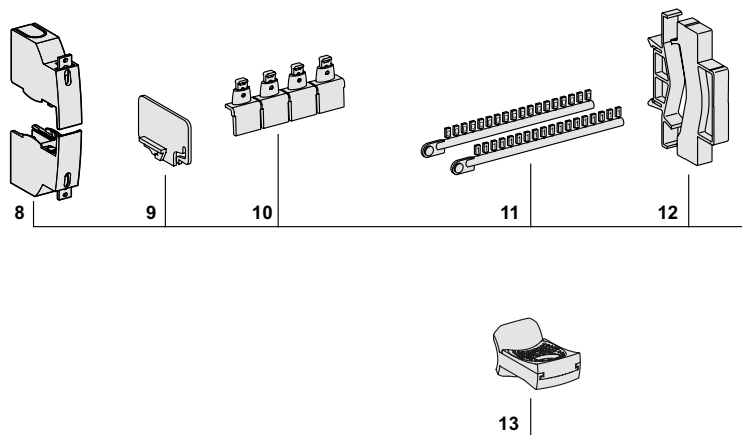

Electrical auxiliary

See module CA907002

Control		
2	iMDU voltage matching auxiliary	A9C18195

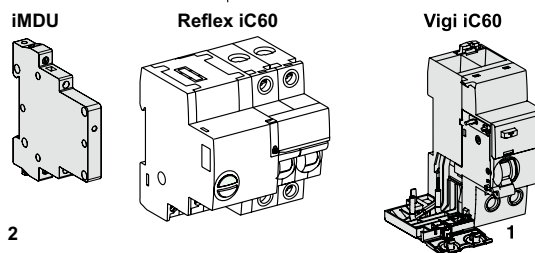

Vigi iC60

See module CA907005

1	Vigi iC60 add-on residual current device	See module CA902005
---	--	---------------------

Connection accessories

See module CA907001

2	Splitter blocks	Linergy FM	See module	LIN022
		Linergy DX	See module	LIN003
3	50 mm² Al terminal			27060
4	Screw-on connection for ring terminal			27053
5	Multi-cables terminal	4 parts		19091
		3 parts		19096
6	Comb busbar		See modules	CA907026, CA907027

DB44785

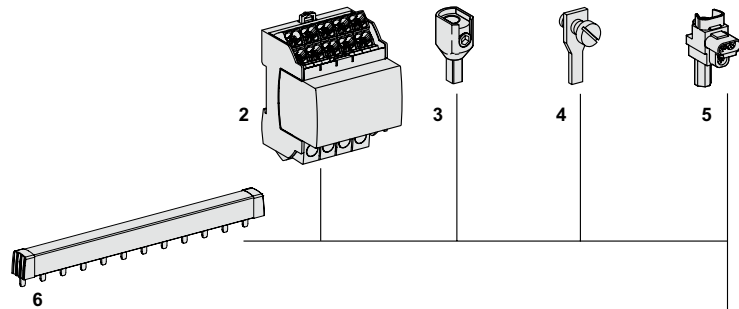

Mounting accessories

See module CA907001

7	Sealable terminal shields for top and bottom connection	1P (set of 2)	A9A26975
		2P (set of 2)	A9A26976
		3P	1P + 2P
		4P	2P + 2P
8	Interpole barrier	(set of 10)	A9A27001
9	Clip-on terminal markers		See module CA907001
10	9 mm spacer		A9A27062
11	Padlocking device	(set of 10)	A9A26970
12	Plug-in base		A9A27003
13	Rotary handle	Black handle	A9A27005
		Red handle	A9A27006
		No handle	A9A27008

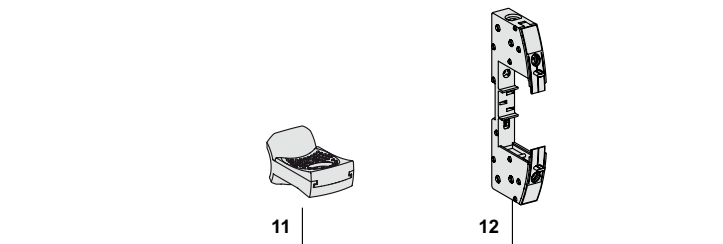
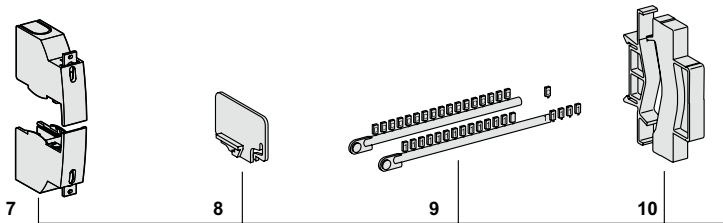

Electrical auxiliaries

See module CA907002

Indication

1	iOF open/close auxiliary contact	A9A26924
---	----------------------------------	----------

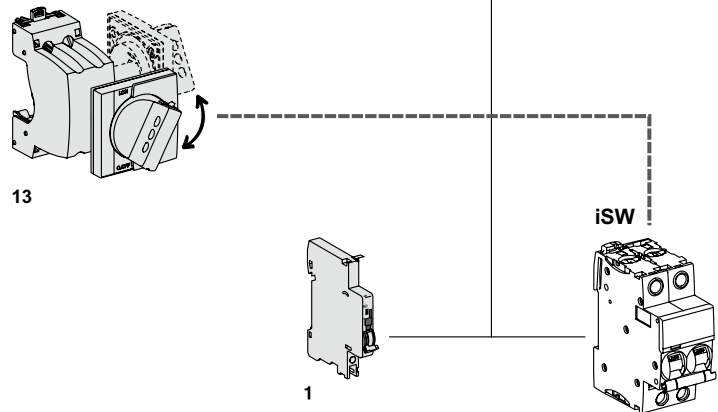

Connection accessories

See module CA907001

6	Screw-on connection for ring terminal	27053
7	Comb busbar	See modules CA907026, CA907027

Mounting accessories

See module CA907001

8	Padlocking device (set of 10)	A9A26970
9	Clip-on terminal markers	See module CA907001
10	9 mm spacer	A9A27062

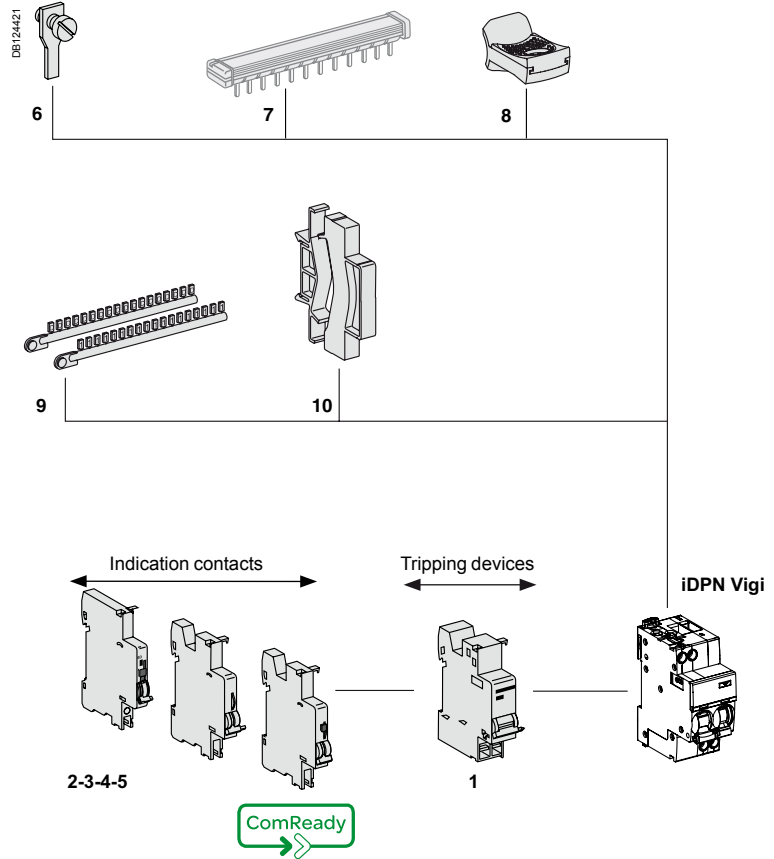

Electrical auxiliaries

See module CA907002

Indication

2	iOF/SD+OF auxiliary contact (OF+SD or OF+OF combination switch)	A9A26929
3	iSD fault indicating contact	A9A26927
4	iOF open/close auxiliary contact	A9A26924
5	iOF+SD24 auxiliary contact	A9A26897

Tripping devices

1	iMN undervoltage release or iMNs undervoltage release delayed or iMNx undervoltage release with external feeding or shunt release iMX, iMX+OF overvoltage release iMSU	See module CA907002
---	--	---------------------



Tripping devices must be installed first.
If two tripping devices are used: the iMN must be installed first
Indication auxiliaries: respect specified position for SD functions.

Assembly rule

The mounting order and the number for the various auxiliaries must be complied with.

The tripping auxiliaries iMN, iMX, iMSU... should be mounted first **1** as close as possible to the main device.

Then at the left, the indicating auxiliaries (iOF, iSD) should be mounted **2** then **3** complying with the following association table.

Indicating auxiliaries		Tripping auxiliaries		Device
3	+ 2	+ 1		
1 (iOF/SD+OF or iOF+SD24 or iSD)	1 iOF/SD+OF	1 (iMN, iMNs, iMNx or iMX, iMX+OF or iMSU)	iDPN Vigi	
1 iOF	1 (iSD or iOF or iOF/SD+OF)	2 (iMN, iMNs, iMNx or iMX, iMX+OF or iMSU)		
-	1 iOF+SD24	2 (iMN, iMNs, iMNx or iMX, iMX+OF or iMSU)		
-	-	3 iMSU		
1 iSD	1 iSD	1 (iMN, iMNs, iMNx or iMX, iMX+OF or iMSU)		

Connection accessories

See module CA907021

6	50 mm ² Al terminal	27060
7	Screw-on connection for ring terminal	27053
8	Multi-cables terminal	4 parts 19091
		3 parts 19096

Mounting accessories

See module CA907021

9	Sealable terminal shields for top and bottom connection	1P (set of 2) A9A26975
		2P (set of 2) A9A26976
		3P 1P + 2P
		4P 2P + 2P
10	Screw shields	4P (set of 20) A9A26981
10"	Screw shields Vigi iC60	(set of 12) A9A26982
11	Clip-on terminal markers	See module CA907021
12	9 mm spacer	A9A27063
13	Padlocking device	(set of 10) A9A26970
14	Padlocking device for Isobar enclosure	(set of 10) A9A26972
15	Interpole barrier	(set of 10) A9A27001

Electrical auxiliaries

See module CA907002

Indication

4	iSD fault indicating contact	A9A26927
5	iOF open/close auxiliary contact	A9A26924

Tripping devices

2	iMN undervoltage release or iMNs undervoltage release delayed or iMNx undervoltage release with external feeding	See module CA907002
3	Shunt release iMX, iMX+OF overvoltage release iMSU	See module CA907002

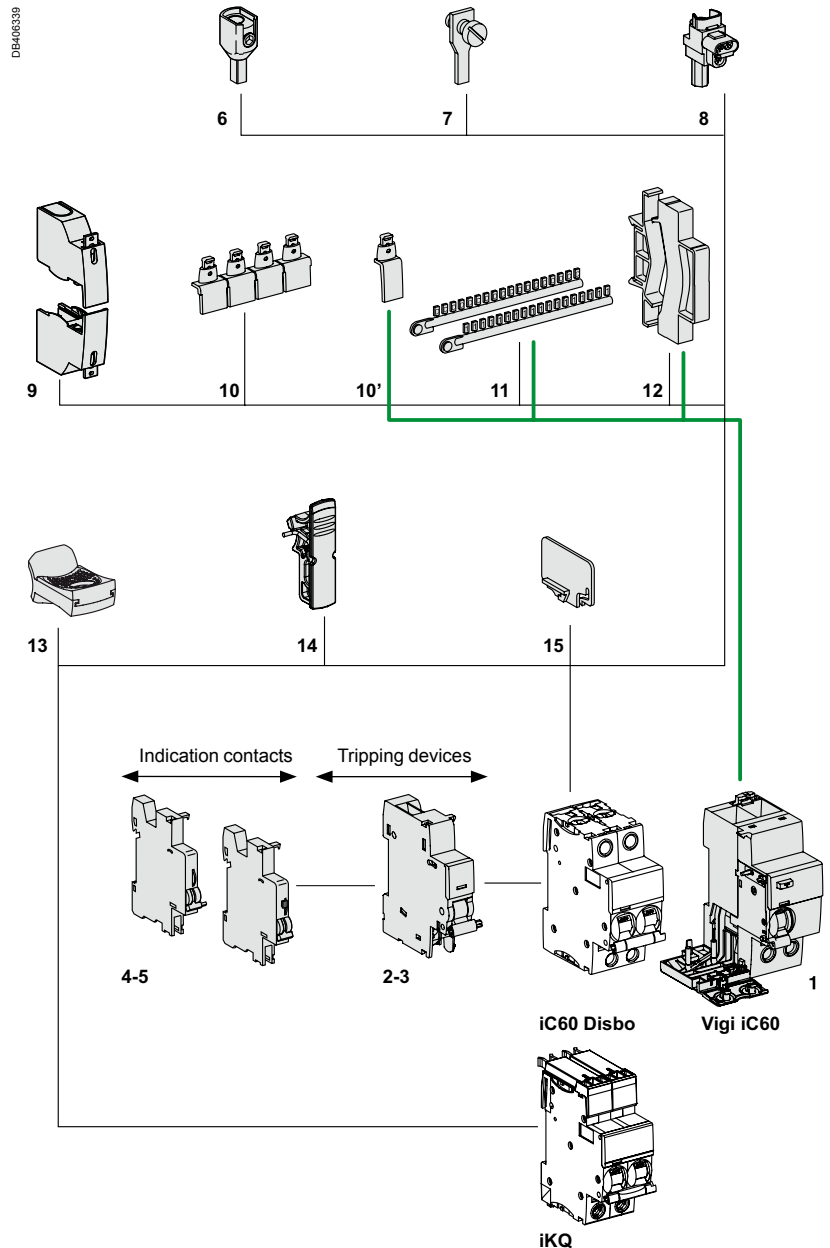

Vigi iC60

1	Vigi iC60 add-on residual current device	See module CA902005
---	--	---------------------



Tripping devices must be installed first.

If two tripping devices are used: the iMN must be installed first

Indication auxiliaries: respect specified position for SD functions.

Assembly rule

The mounting order and the number for the various auxiliaries must be complied with.

The tripping auxiliaries (iMN, iMX, iMSU...) should be mounted first **1** as close as possible to the main device.

Then at the left, the indicating auxiliaries (iOF, iSD) should be mounted **2** then **3** complying with the following association table.

Indicating auxiliaries		Tripping auxiliaries		Device	Vigi iC60
3	+ 2	+ 1			
1 iOF	1 (iSD or iOF)	2 (iMN, iMNs, iMNx or iMX, iMX+OF or iMSU)		iC60	Vigi iC60
-	-	3 iMSU		Disbo	

Connection accessories

See module CA907021

5	Screw-on connection for ring terminal	27053
---	---------------------------------------	-------

Mounting accessories

See module CA907021

6	Padlocking device (set of 10)	A9A27049
7	Clip-on terminal markers	See module CA907021
8	9 mm spacer	A9A27063

Electrical auxiliaries

See module CA907002

Indication

3	iSD fault indicating contact	A9A26927
4	iOF open/close auxiliary contact	A9A26924

Tripping devices

1	iMN undervoltage release or iMNs undervoltage release delayed or iMNx undervoltage release with external feeding	See module CA907002
2	Shunt release iMX, iMX+OF overvoltage release iMSU	See module CA907002

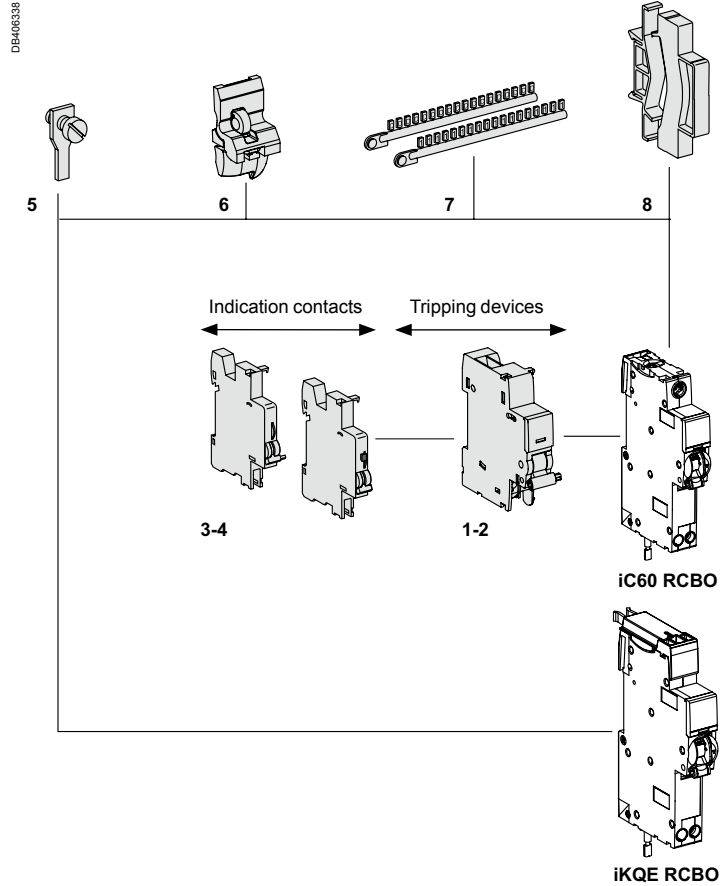

Tripping devices must be installed first.
If two tripping devices are used: the iMN must be installed first
Indication auxiliaries: respect specified position for SD functions.

Assembly rule

The mounting order and the number for the various auxiliaries must be complied with.

The tripping auxiliaries (iMN, iMX, iMSU...) should be mounted first **1** as close as possible to the main device.

Then at the left, the indicating auxiliaries (iOF, iSD) should be mounted **2** then **3** complying with the following association table.

Indicating auxiliaries		Tripping auxiliaries		Device
3	+ 2	+ 1		
1 iOF	1 (iSD or iOF)	2 (iMN, iMNs, iMNx or iMX, iMX+OF or iMSU)		iC60 Disbo
-	-	1 iMSU		

Connection accessories

See module CA907012

7	Multi-cable terminal	4 parts	19091
		3 parts	19096
8	Screw-on connection for ring terminal	8 parts	27053
9	Terminal for rear connector		18528
10	50 mm ² Al terminal		27060
11	Comb busbar	See module	LIN001

Mounting accessories

See module CA907012

12	Sealable terminal shields for top and bottom connection	1P (set of 2)	18526
13	Interpole barrier	(set of 10)	27001
14	Screw shields	4P (set of 2)	18527
15	Clip-on terminal markers	See module	CA907012
16	9 mm spacer		A9N27062
17	Padlocking device		27145
18	Plug-in base ⁽¹⁾		26997
19	Rotary handle	Removable extended handle	27047
		Fixed handle	27048
		Operating sub-assembly ⁽²⁾	27046

(1) For 1P, centreline between two rows: 200 mm

(2) A complete rotary handle consists of a circuit-breaker operating sub-assembly, cat. no. 27046, a handle cat. no. 27047 or a handle cat. no. 27048.

Electrical auxiliaries

See module CA907008

Indication

3	SD fault indicating contact	A9N26927
4	OF+SD24 auxiliary contact	A9N26899
5	OF open/close auxiliary contact	A9N26924
6	OF+SD/OF auxiliary contact (OF+SD or OF+OF combination switch)	A9N26929

Tripping

2	MN, MNx, MN \square undervoltage release, MSU overvoltage release or MX, MX + OF shunt release	See module CA907008
---	--	---------------------

Vigi C120

See module CA902016

1	Vigi C120 add-on residual current device	See module CA902016
---	--	---------------------

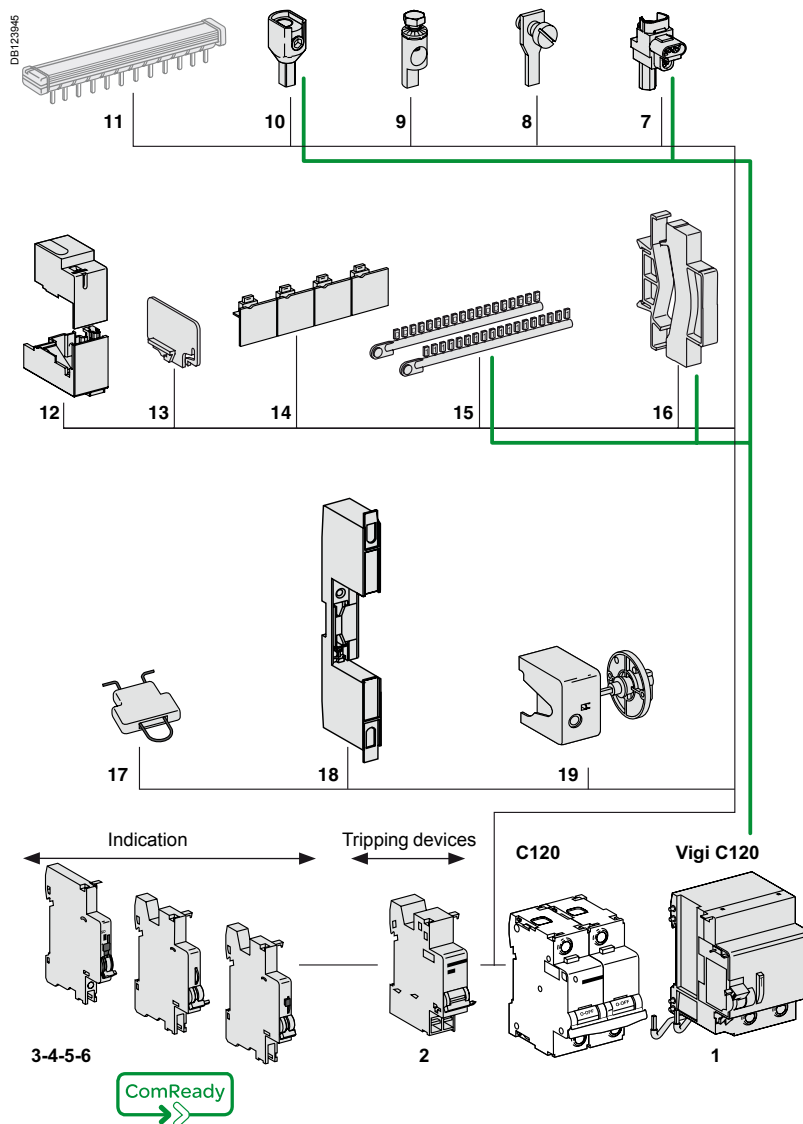

Tripping devices must be installed first.
If two tripping devices are used: the MN must be installed first
Indication auxiliaries: respect specified position for SD functions.

Assembly rule

The mounting order and the number for the various auxiliaries must be complied with.

The tripping auxiliaries MN, MX, MSU... should be mounted first **1** as close as possible to the main device.

Then at the left, the indicating auxiliaries (OF, SD) should be mounted **2** then **3** complying with the following association table.

Indicating auxiliaries		Tripping auxiliaries		Device	Vigi C120
3	+ 2	+ 1			
1 (OF+SD/OF or OF+SD24)	1 OF+SD/OF	1 (MN, MNx, MN \square or MX, MX+OF or MSU)	C120	Vigi C120	
1 OF	1 (OF+SD/OF or SD or OF)	2 (MN, MNx, MN \square or MX, MX+OF or MSU)			
-	1 OF+SD24	2 (MN, MNx, MN \square or MX, MX+OF or MSU)			
-	-	3 MSU			

Connection accessories

See module CA907012

6	50 mm ² Al terminal	27060
7	Terminal for rear connector	18528
8	Screw-on connection for ring terminal	8 parts 27053
9	Multi-cable terminal	4 parts 19091
		3 parts 19096

Mounting accessories

See module CA907012

10	Sealable terminal shields for top and bottom connection	1P (set of 2)	18526
11	Interpole barrier	(set of 10)	27001
12	Screw shields	4P (set of 2)	18527
13	Clip-on terminal markers	See module	CA907012
14	9 mm spacer		A9N27062
15	Padlocking device		27145
16	Rotary handle		
	Removable extended handle		27047
	Fixed handle		27048
	Operating sub-assembly ⁽¹⁾		27046

⁽¹⁾ A complete rotary handle consists of a circuit-breaker operating sub-assembly, cat. no. 27046, a handle cat. no. 27047 or a handle cat. no. 27048.

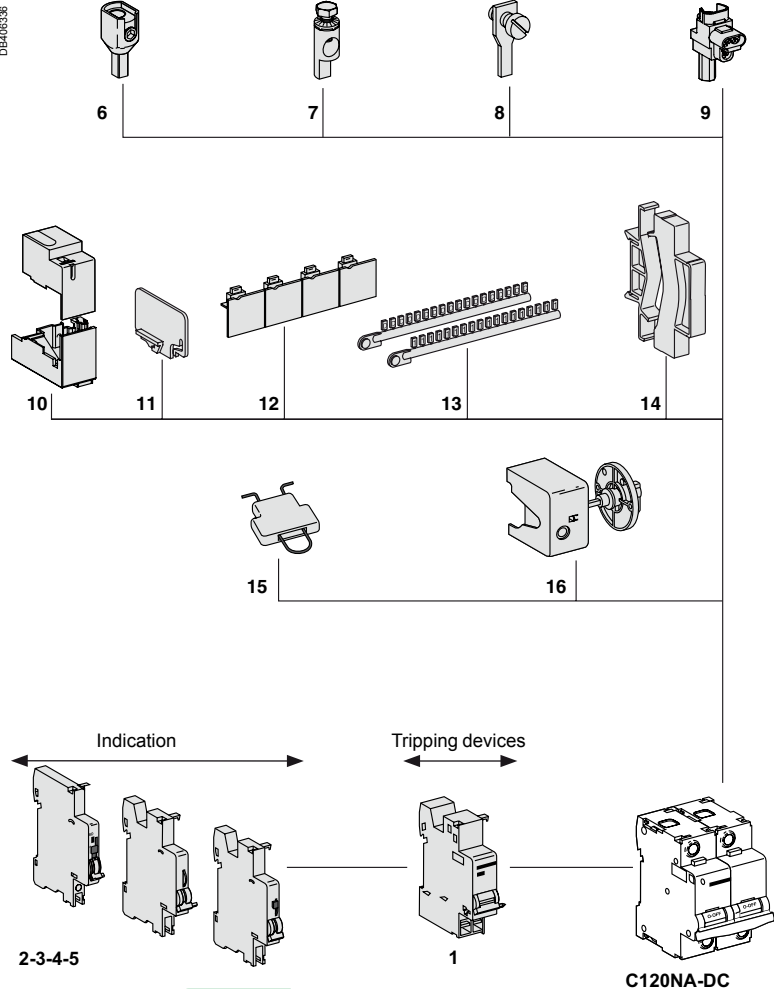

Electrical auxiliaries

See module CA907008

Indication		
2	SD fault indicating contact	A9N26927
3	OF+SD24 auxiliary contact	A9N26899
4	OF open/close auxiliary contact	A9N26924
5	OF+SD/OF auxiliary contact (OF+SD or OF+OF combination switch)	A9N26929

Tripping		
1	MN, MNx, MN \square undervoltage release or MX, MX + OF shunt release	See module CA907008



⚠ Tripping devices must be installed first.
If two tripping devices are used: the MN must be installed first
Indication auxiliaries: respect specified position for SD functions.

Assembly rule

The mounting order and the number for the various auxiliaries must be complied with.

The tripping auxiliaries (MN, MX...) should be mounted first **1** as close as possible to the main device.

Then at the left, the indicating auxiliaries (OF, SD) should be mounted **2** then **3** complying with the following association table.

Indicating auxiliaries 3		Indicating auxiliaries + 2		Indicating auxiliaries + 1		Device
1 (OF+SD/OF or OF+SD24)	1 OF+SD/OF	1 (MN, MNx, MN \square or MX, MX+OF)	C120NA-DC			
1 OF	1 (OF+SD/OF or SD or OF)	2 (MN, MNx, MN \square or MX, MX+OF)				
-	1 OF+SD24	2 (MN, MNx, MN \square or MX, MX+OF)				

Connection accessories

See module CA907012

6	Insulated connector	See module	LIN001
7	Comb busbar	See module	LIN001
8	50 mm ² Al terminal		27060
9	Ring tongue terminal screw connection		27053
10	Ring tongue terminal connections kit Ø 5 mm, (upstream/downstream)		17400
11	Insulated distribution terminal	4 parts	19091
		3 parts	19096

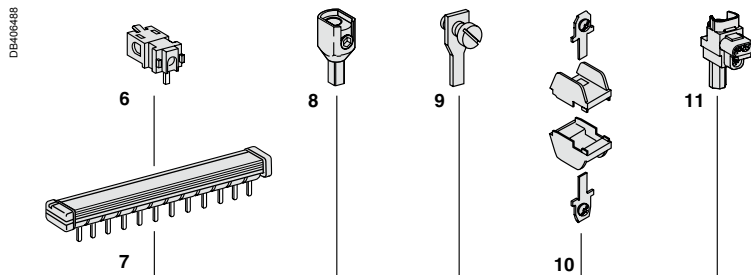

Mounting accessories

See module CA907012

12	Sealable terminal shield	See module	CA907012
13	Inter-pole barrier		27001
14	Rotary handle		
	Switching sub-assembly		27046
	Disconnectable handle		27047
	Fixed handle		27048
15	Screw shield	See module	26981
16	Padlocking accessory (to be locked in the "open" position)		26970
17	Spacer		A9N27062
18	Plug-in base		26996
19	Marker strip	See module	CA907012

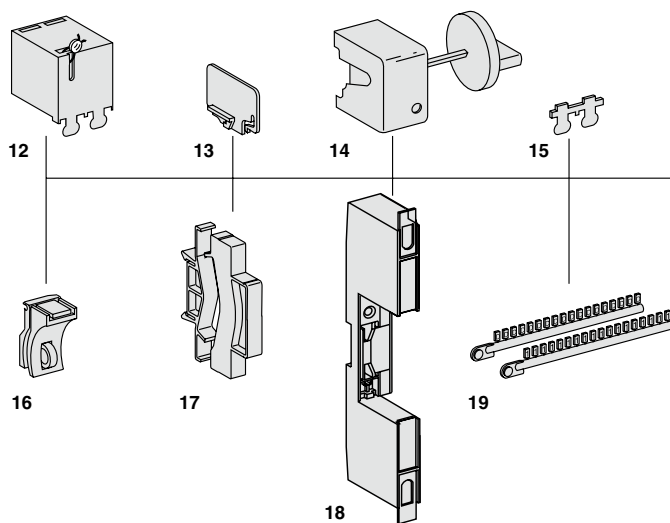

(1) A complete rotary handle consists of a circuit-breaker operating sub-assembly, cat. no. 27046, a handle cat. no. 27047 or a handle cat. no. 27048.

Electrical auxiliaries

See module CA907008

Indication

2	SD fault indicating contact		A9N26927
3	OF+SD24 auxiliary contact		A9N26899
4	OF open/close auxiliary contact		A9N26924
5	OF+SD/OF auxiliary contact (OF+SD or OF+OF combination switch)		A9N26929

Tripping

1	MN, MNx, MN [⊗] undervoltage release, MSU overvoltage release or MX, MX + OF shunt release	See module	CA907008
---	---	------------	----------

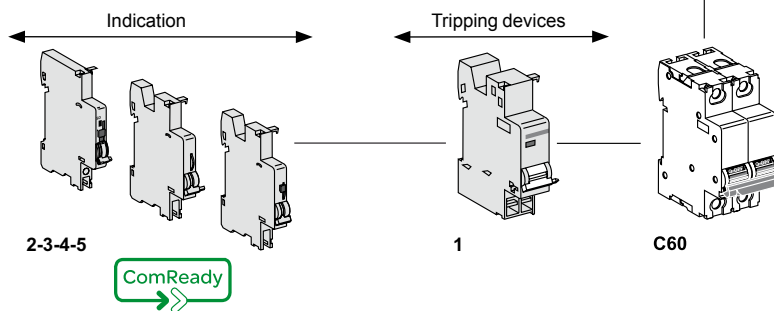

Tripping devices must be installed first.
If two tripping devices are used: the MN must be installed first
Indication auxiliaries: respect specified position for SD functions.

Assembly rule

The mounting order and the number for the various auxiliaries must be complied with.

The tripping auxiliaries (MN, MX...) should be mounted first **1** as close as possible to the main device.

Then at the left, the indicating auxiliaries (OF, SD) should be mounted **2** then **3** complying with the following association table.

Indicating auxiliaries 3		Indicating auxiliaries + 2		Indicating auxiliaries + 1		Device
1 (OF+SD/OF or OF+SD24)	1 OF+SD/OF	1 (MN, MNx, MN [⊗] or MX, MX+OF or MSU)				
1 OF	1 (OF+SD/OF or SD or OF)	2 (MN, MNx, MN [⊗] or MX, MX+OF or MSU)				
-	1 OF+SD24	2 (MN, MNx, MN [⊗] or MX, MX+OF or MSU)				
-	-	3 MSU				

Connection accessories

See module CA907012

7	Insulated connector	See module	LIN001
8	Comb busbar	See module	LIN001
9	50 mm ² Al terminal		27060
10	Ring tongue terminal screw connection		27053
11	Ring tongue terminal connections kit Ø 5 mm, (upstream/downstream)		17400
12	Insulated distribution terminal	4 parts	19091
		3 parts	19096

Mounting accessories

See module CA907012

13	Sealable terminal shield	See module	CA907012
14	Inter-pole barrier		27001
15	Screw shield		26981
16	Padlocking accessory (to be locked in the "open" position)		26970
17	Spacer		A9N27062
18	Plug-in base		26996
19	Marker strip	See module	CA907012

Electrical auxiliaries

See module CA907008

Indication		
1	OF.S auxiliary contact	A9N26923
3	SD fault indicating contact	A9N26927
4	OF+SD24 auxiliary contact	A9N26899
5	OF open/close auxiliary contact	A9N26924
6	OF+SD/OF auxiliary contact (OF+SD or OF+OF combination switch)	A9N26929

Tripping		
2	MN, MNx, MN [⊗] undervoltage release, MSU overvoltage release or MX, MX + OF shunt release	See module CA907008

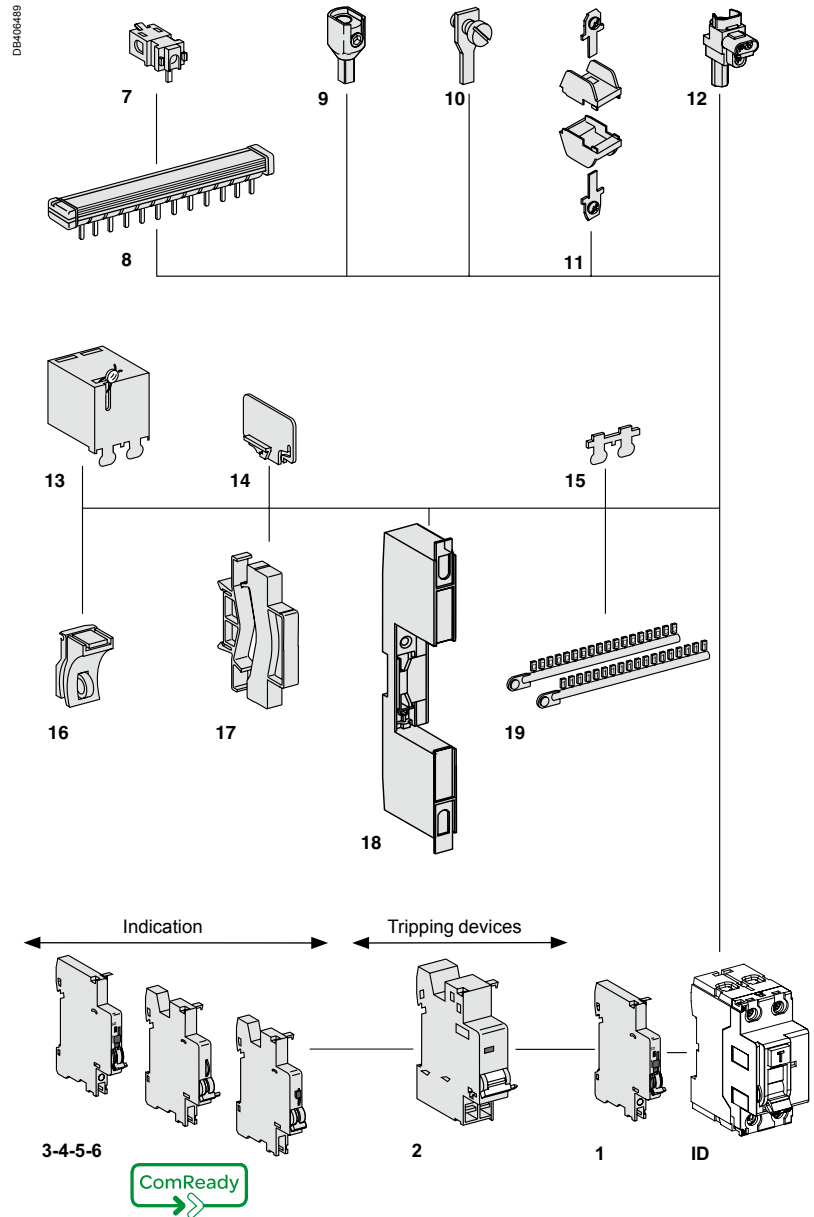

! Tripping devices must be installed first.
If two tripping devices are used: the MN must be installed first
Indication auxiliaries: respect specified position for SD functions.

Assembly rule

The mounting order and the number for the various auxiliaries must be complied with.

The tripping auxiliaries MN, MX...) should be mounted first **1** as close as possible to the main device.

Then at the left, the indicating auxiliaries (OF, SD) should be mounted **2** then **3** complying with the following association table.

Indicating auxiliaries 3		Indicating auxiliaries + 2		Indicating auxiliaries + 1		Device
-		1 (OF+SD/OF or OF or OF+SD24)		2 (MN, MNx, MN [⊗] or MX, MX+OF or MSU)		
1 OF		1 OF		1 (MN, MNx, MN [⊗] or MX, MX+OF or MSU)		

Connection accessories

See module CA907012

6	Screw-on connection for ring terminal	8 parts	27053
7	Comb busbar	See module	LIN001

Mounting accessories

See module CA907012

8	Padlocking device	26970
9	Clip-on terminal markers	See module CA907012
10	9 mm spacer	A9N27062
11	Rotary handle for DPN, DPN Vigi 3P, 4P	
	Removable extended handle	27047
	Fixed handle	27048
	Operating sub-assembly ⁽¹⁾	27046

(1) A complete rotary handle consists of a circuit-breaker operating sub-assembly, cat. no. 27046, a handle cat. no. 27047 or a handle cat. no. 27048.

Electrical auxiliaries

See module CA907008

Indication

2	SD fault indicating contact	A9N26927
3	OF+SD24 auxiliary contact	A9N26899
4	OF open/close auxiliary contact	A9N26924
5	OF+SD/OF auxiliary contact (OF+SD or OF+OF combination switch)	A9N26929

Tripping

1	MN, MNx, MN \square undervoltage release, MSU overvoltage release or MX, MX + OF shunt release	See module CA907008
---	--	---------------------

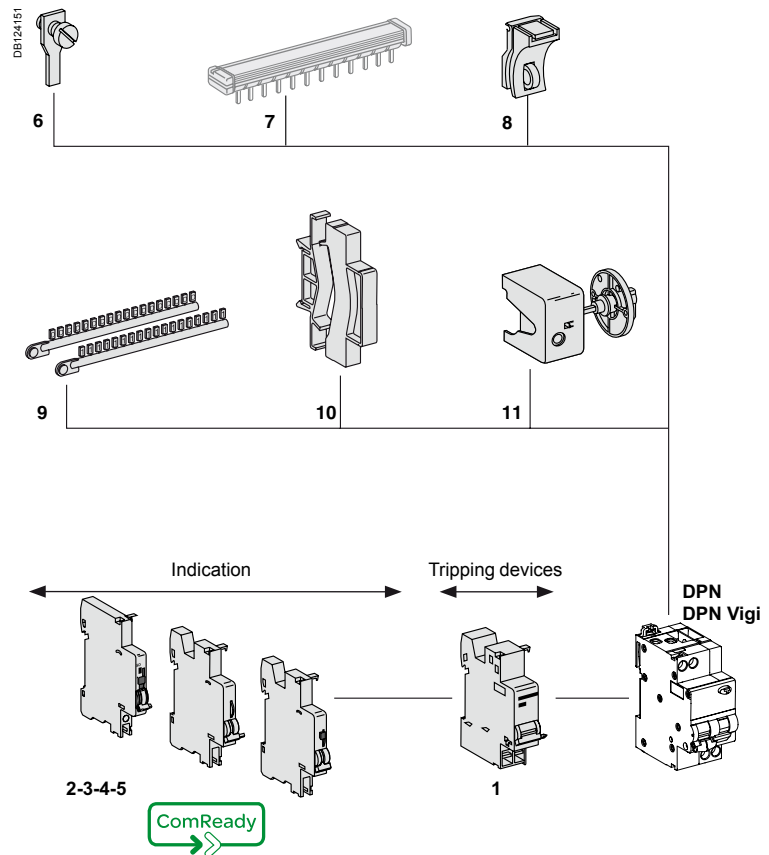

! Tripping devices must be installed first.
If two tripping devices are used: the MN must be installed first
Indication auxiliaries: respect specified position for SD functions.

Assembly rule

The mounting order and the number for the various auxiliaries must be complied with.

The tripping auxiliaries MN, MX, MSU...) should be mounted first **1** as close as possible to the main device.

Then at the left, the indicating auxiliaries (OF, SD) should be mounted **2** then **3** complying with the following association table.

Indicating auxiliaries 3		Indicating auxiliaries + 2		Indicating auxiliaries + 1		Device
1 (OF+SD/OF or OF+SD24)		1 OF+SD/OF		1 (MN, MNx, MN \square or MX, MX+OF or MSU)		
1 OF		1 (OF+SD/OF or SD or OF)		2 (MN, MNx, MN \square or MX, MX+OF or MSU)		
-		1 OF+SD24		2 (MN, MNx, MN \square or MX, MX+OF or MSU)		
-		-		3 MSU		

Connection accessories

See module CA907012

7	Insulated connector	See module LIN001
8	Comb busbar	See module LIN001
9	50 mm ² Al terminal	27060
10	Ring tongue terminal screw connection	27053
11	Ring tongue terminal connections kit Ø 5 mm, (upstream/downstream)	17400
12	Insulated distribution terminal	4 parts 19091 3 parts 19096

Mounting accessories

See module CA907012

13	Sealable terminal shield	See module CA907012
14	Inter-pole barrier	27001
15	Rotary handle	
	Switching sub-assembly	27046
	Disconnectable handle	27047
	Fixed handle	27048
16	Screw shield	See module CA907012
17	Padlocking accessory (to be locked in the "open" position)	26970
18	Spacer	A9N27062
19	Plug-in base	26996
20	Marker strip	See module CA907012

(1) A complete rotary handle consists of a circuit-breaker operating sub-assembly, cat. no. 27046, a handle cat. no. 27047 or a handle cat. no. 27048.

Electrical auxiliaries

See module CA907008

Indication		
3	SD fault indicating switch	A9N26927
4	OF+SD24 auxiliary contact	A9N26899
5	OF open/closed contact	A9N26924
6	OF+SD/OF auxiliary contact (OF+SD or OF+OF combination switch)	A9N26929

Tripping		
1	MN, MNx, MN \square undervoltage release	See module CA907008
2	MX, MX + OF shunt release	See module CA907008

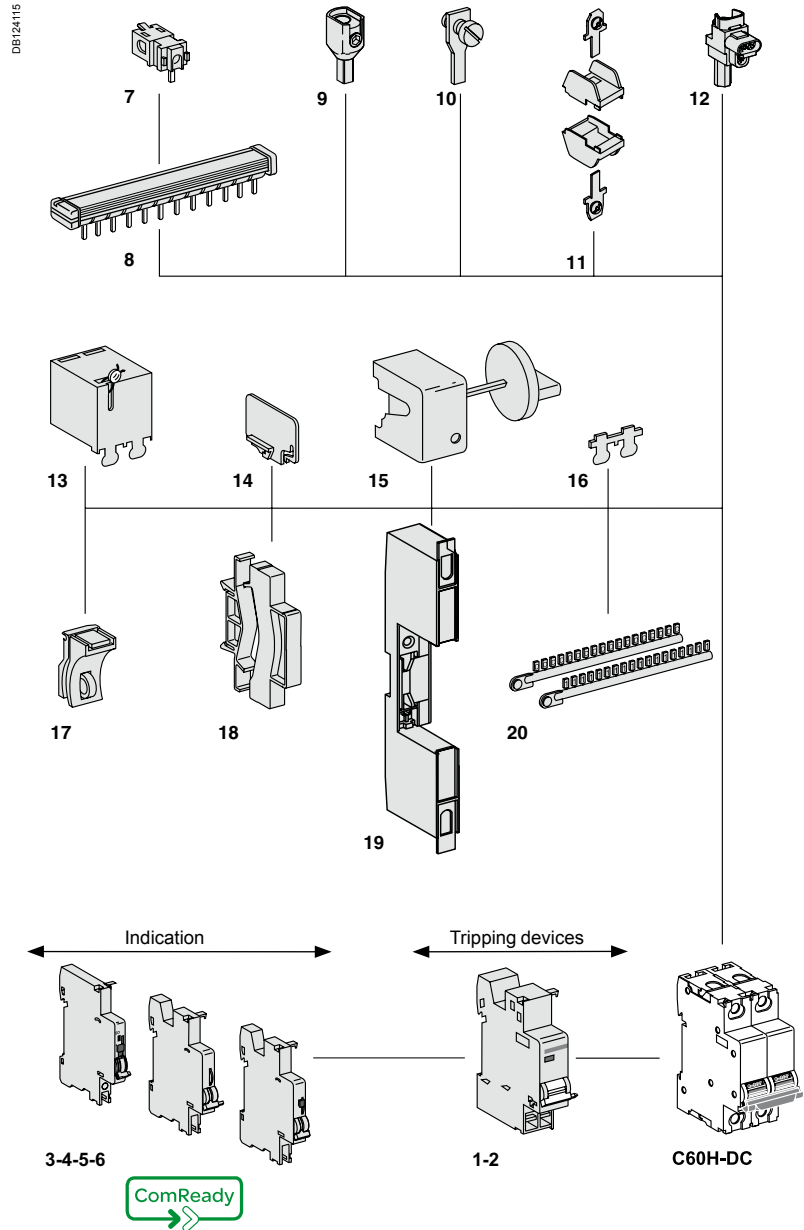

⚠ Tripping devices must be installed first.
If two tripping devices are used: the MN must be installed first
Indication auxiliaries: respect specified position for SD functions.

Assembly rule

The mounting order and the number for the various auxiliaries must be complied with.

The tripping auxiliaries MN, MX...) should be mounted first **1** as close as possible to the main device.

Then at the left, the indicating auxiliaries (OF, SD) should be mounted **2** then **3** complying with the following association table.

Indicating auxiliaries 3		Indicating auxiliaries + 2		Indicating auxiliaries + 1		Device
1 (OF+SD/OF or OF+SD24)		1 OF+SD/OF		1 (MN, MNx, MN \square or MX, MX+OF)		
1 OF		1 (OF+SD/OF or SD or OF)		2 (MN, MNx, MN \square or MX, MX+OF)		
-		1 OF+SD24		2 (MN, MNx, MN \square or MX, MX+OF)		

Connection accessories

See module CA907012

1	Insulated connector	See module LIN001
2	Comb busbar	See module LIN001
3	50 mm ² Al terminal	27060
4	Ring tongue terminal screw connection	27053
5	Ring tongue terminal connections kit Ø 5 mm, (upstream/downstream)	17400
6	Insulated distribution terminal	4 parts 19091 3 parts 19096

iSW 40...125 A

DB124188

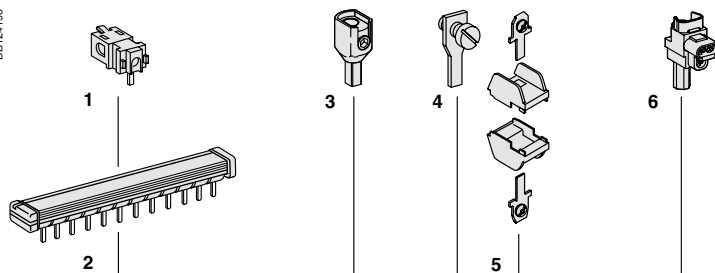

Mounting accessories

See module CA907012

7	Sealable terminal shield	See module CA907012
8	Inter-pole barrier	27001
9	Rotary handle	
	Switching sub-assembly	27046
	Disconnectable handle	27047
	Fixed handle	27048
10	Screw shield	See module CA907012
11	Padlocking accessory (to be locked in the "open" position)	26970
12	Spacer	A9N27062
13	Plug-in base	26996

(1) A complete rotary handle consists of a circuit-breaker operating sub-assembly, cat. no. 27046, a handle cat. no. 27047 or a handle cat. no. 27048.

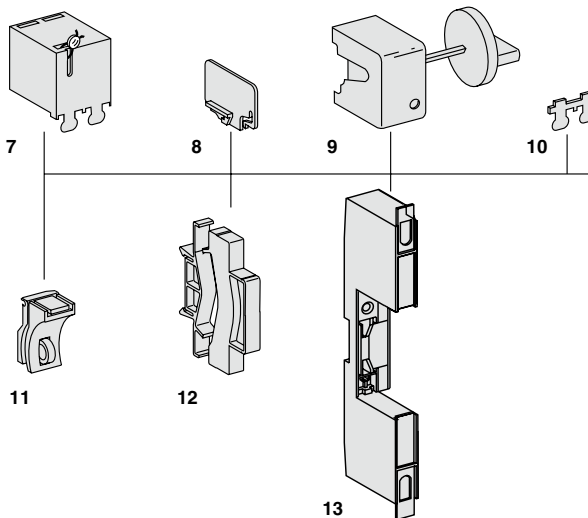

Electrical auxiliary

See module iSW CA904005

Indication

14	OF iSW open/closed contact	A9A15096
----	----------------------------	----------

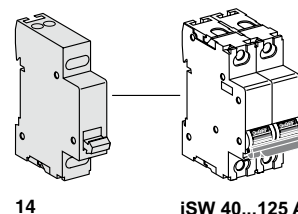

iSW 20...32 A

DB40267

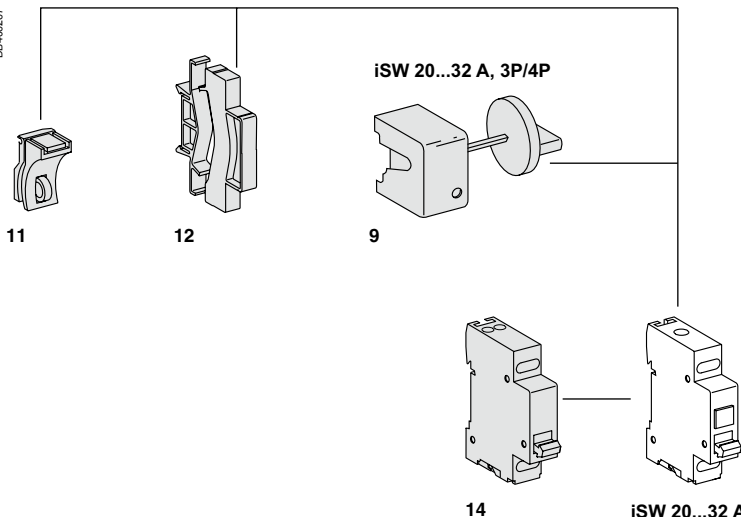

Accessories and Auxiliaries for SW60-DC, C60NA-DC, C60PV-DC devices

Connection accessories

See module CA907012

7	50 mm ² Al terminal	27060
8	Ring tongue terminal screw connection	27053
9	Insulated distribution terminal	19091
	3 parts	19096

Mounting accessories

See module CA907012

10	Inter-pole barrier	27001
11	Screw shield	26981
12	Padlocking accessory (to be locked in the "open" position)	26970
13	Spacer	A9N27062
14	Marker strip	See module CA907012

Electrical auxiliaries

See module CA907008

Indication		
3	SD fault indicating switch	A9N26927
4	OF+SD24 auxiliary contact	A9N26899
5	OF open/closed contact	A9N26924
6	OF+SD/OF auxiliary contact (OF+SD or OF+OF combination switch)	A9N26929

Tripping		
1	MN, MNx, MN \square undervoltage release	See module CA907008
2	MX, MX + OF shunt release	See module CA907008

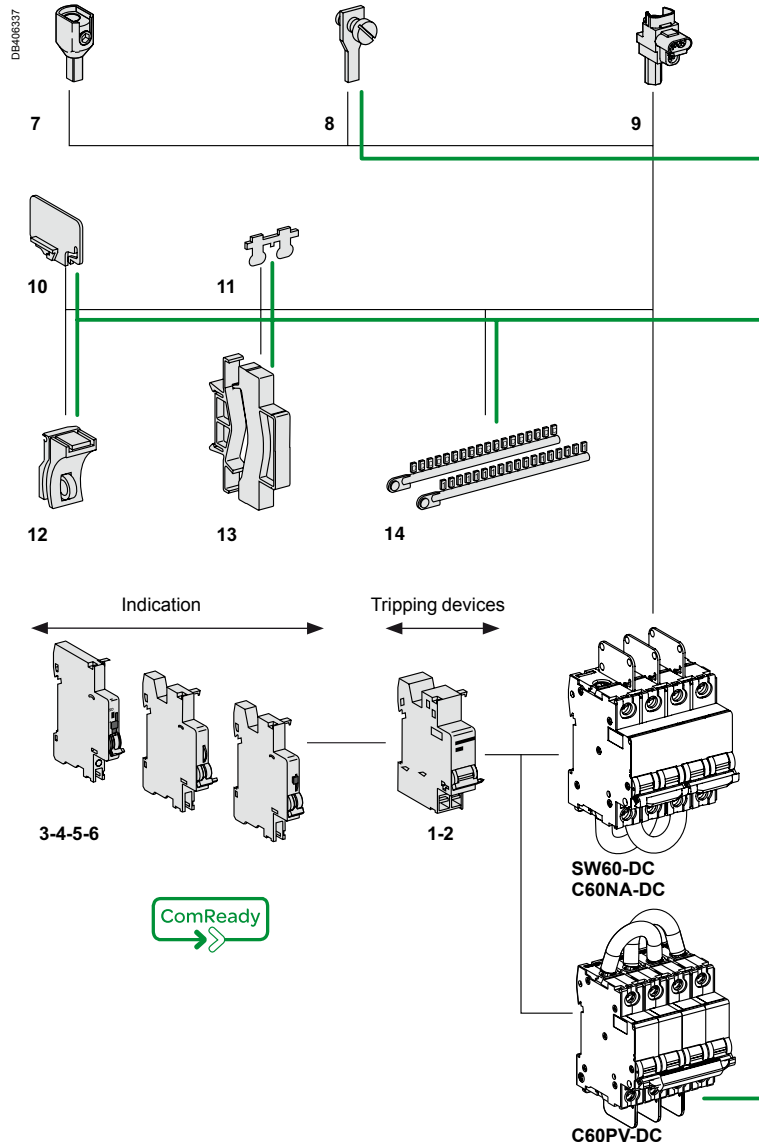

Tripping devices must be installed first.
If two tripping devices are used: the MN must be installed first
Indication auxiliaries: respect specified position for SD functions.

Assembly rule

The mounting order and the number for the various auxiliaries must be complied with.

The tripping auxiliaries MN, MX...) should be mounted first **1** as close as possible to the main device.

Then at the left, the indicating auxiliaries (OF, SD) should be mounted **2** then **3** complying with the following association table.

Indicating auxiliaries 3		Indicating auxiliaries + 2		Indicating auxiliaries + 1		Device
1 (OF+SD/OF or OF+SD24)		1 OF+SD/OF		1 (MN, MNx, MN \square or MX, MX+OF)		
1 OF		1 (OF+SD/OF or SD or OF)		2 (MN, MNx, MN \square or MX, MX+OF)		
-		1 OF+SD24		2 (MN, MNx, MN \square or MX, MX+OF)		

Connection

6	Comb busbar	see modules	CA907026, CA907027
7	Splitter blocks	Lineryg DX see module	LIN003
8	70 mm ² Al terminal		19095
9	Multi-cable terminal	4 parts	19091
		3 parts	19096
10	Screw-on connection for ring	125 A (pack of 4)	19093
11	Small ring terminal	(pack of 4)	19094

Mounting accessories

12	Sealable terminal shield (upstream/downstream)	1P	19080
		2P	19081
		3P	19082
		4P	19083
13	Residual current device terminal shield (upstream of circuit breaker / downstream of Vigi device)	63 A 2P	19074
		3P	19075
		3P adjustable	19077
		4P	19076
		4P adjustable	19078
14	Circuit breaker screw shield	125 A 3P	19077
		4P	19078
		1P (pack of 10)	19084
		2P	19085
15	Rotary handle	3P	19086
		4P	19087
		Extended standard Black	19088
		Extended safety Red handle, yellow	19089
16	Padlocking device	Direct standard Black	19092
		Direct safety Red handle, yellow background	19097
17	White toggle	(pack of 10)	19099

Electrical auxiliaries

Indication

3	Fault indicating auxiliary contact OF+SD	19071
	Open/closed auxiliary contact OF+OF	19072



Tripping devices



2	Undervoltage release MN or undervoltage release with external power supply MNx	see module	CM907005
	Shunt release MX+OF	see module	CM907005

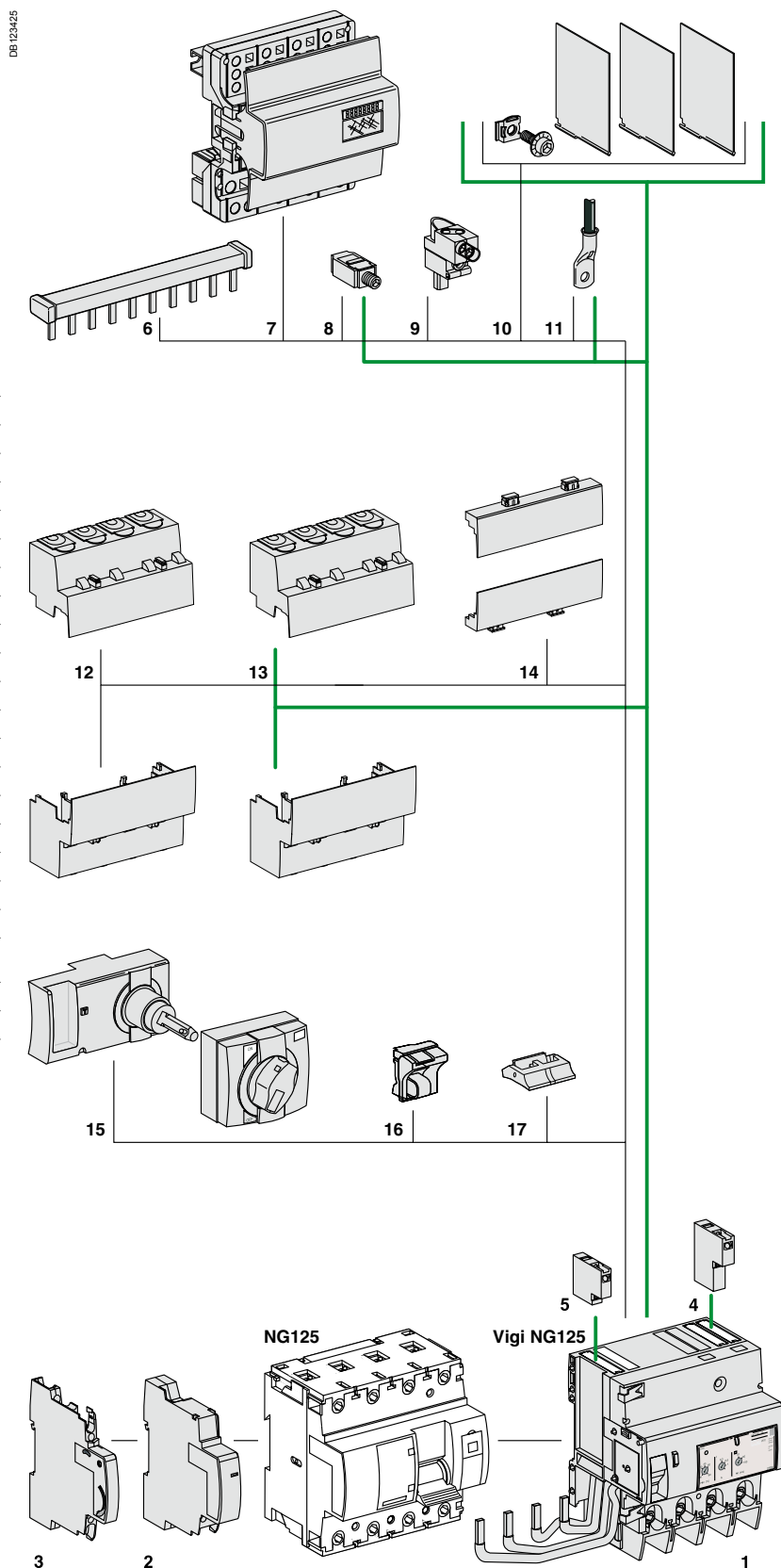



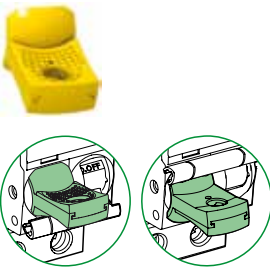
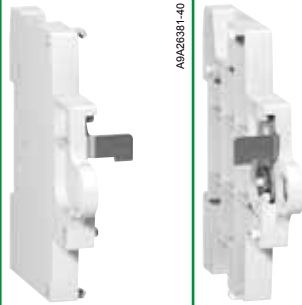

Vigi NG125







1	Vigi NG125 add-on residual current device ⁵	see module	CM902008
4	MXV	see module	CM907005
5	SDV	see module	CM907005

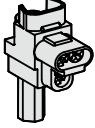

Mounting					
Accessories	Rotary handle			Plug-in base	
					
					
Function	<p>Front or side-mounted control</p> <ul style="list-style-type: none"> ■ Degree of protection: IP55 rotary handle ■ Installation: <ul style="list-style-type: none"> □ the control mechanism is mounted on the device □ the rotary handle is fixed to the front or side of the enclosure ■ Front-mounted (on door or faceplate) ■ Prevents the door from opening when the device is in the ON position (can be deactivated) ■ Can be padlocked when the device is in the "open" position (can be padlocked with the device in the "closed" position subject to adaptation) ■ Can be locked by padlock of (dia. 5 to 8 mm), not supplied with the device ■ Pushbutton: iID test available in the front face of the rotary handle 			<ul style="list-style-type: none"> ■ The Laser Square tool brings the accuracy to align the circuit breaker and the rotary handle 	<p>Allows a breaker to be removed or replaced quickly, without handling the connections</p> <ul style="list-style-type: none"> ■ Degree of protection: IP20 ■ Consists of: <ul style="list-style-type: none"> □ a base to be fastened on a rail (or panel) □ 2 "blades" to be fastened in the device's terminals ■ Connection: tunnel terminals for cable up to 35 mm² rigid, 25 mm² flexible, ■ Installation: <ul style="list-style-type: none"> □ in universal enclosure □ on horizontal rail ■ Height: 178 mm ■ Not compatible with Vigi iC60 and auxiliaries ■ Can be locked by padlock of (dia. 6 mm), not supplied with the device
Catalogue numbers	A9A27005	A9A27006	A9A27008	GVAPL01	A9A27003 (1 per pole)
	Operating sub-assembly				
	+	+			
	Black handle	Red handle	No handle		
Set of	1	1	1	1	1
Suitability					
iC60	■ 2P, 3P, 4P				
iSW	■ 2P, 3P, 4P				
iC60 + Vigi iC60	■ 2P, 3P, 4P				
iID	■				■ ≤ 63 A
iDPN Vigi	-				
Reflex iC60 or RCA+iC60 or ARA+iC60	-				
ARA+iID	-				
iSW-NA	■				

Padlocking device				Wall mounting	Spare part Locking clips	
Front		Side				
PB104492-15 DB123599						
<p>Used to padlock breaker in open or closed position</p> <ul style="list-style-type: none"> ■ Padlock diameter: 3 to 6 mm ■ Sealable (max. diameter: 1.2 mm) ■ Locking in ON position does not prevent tripping of the breaker in the event of faults ■ Suitable for IEC/EN 60947-2 compliant disconnection 		<p>Can be used to padlock a circuit breaker in open position</p> <ul style="list-style-type: none"> ■ Attached directly to the circuit breaker, it cannot be lost ■ Padlock diameter: 6 mm 		<p>Can be used for wall mounted installation of any 18 mm DIN rail devices</p> <ul style="list-style-type: none"> ■ Degree of protection: IP40 ■ Sealable: (max. diameter: 1.5 mm) 	<p>Top and bottom locking clips for monoconnect iC60</p>	
A9A26970		A9A26380 Left-hand mounting	A9A26381 Right-hand mounting	15359	A9A27052	
10		1	1	1	10	
■	■	■	■	<ul style="list-style-type: none"> ■ All products up to 18 mm ■ Except iCT 	■	
■	–	–	–		–	
■	–	–	–		–	
■	■	–	–		–	
■	–	–	–		–	
■	–	–	–		–	
■	–	–	–		–	
■	–	–	–		–	

Security						
Accessories	Screw shield		Terminal shield		Inter-pole barrier	Spacer
						
Function	Prevents any contact with the connecting screws <ul style="list-style-type: none"> Upgrades degree of protection to IP20D Sealable, max. diameter 1.2 mm 		Prevents any contact with the terminals <ul style="list-style-type: none"> Upgrades degree of protection to IP20D Sealable, max. diameter 1.2 mm Set of two, for upstream and downstream terminals For 3 poles: A9A26975 + A9A26976 For 4 poles: 2 X A9A26976 		Enhances insulation between connections: cables, terminals, lugs, etc	<ul style="list-style-type: none"> Used to: <ul style="list-style-type: none"> complete rows separate devices. Width: 1 x 9 mm module Allows cable routing from one row to another, (above and below), up to 6 mm²
Catalogue numbers	A9A26982	A9A26981	A9A26975	A9A26976	A9A27001	A9A27062
Set of	12 x 1 pole	20 x 4 poles (splittable)	2 x 1 pole	2 x 2 poles	10	5
Suitability						
iC60	-	■	■	■	■	■
iSW	-	-	■	■	■	■
Vigi iC60	■	-	-	-	-	■
iID	-	■	-	■	■	■
iDPN Vigi	-	-	-	-	-	■
Reflex iC60 or RCA+iC60 or ARA+iC60	-	■	■	■	■	■
ARA+iID	-	■	-	■	■	■
iSW-NA	-	■	-	■	■	■

		Connection		
Accessories	Multi-cable terminal	50 mm ² terminal Al	Screw-on connection for ring terminal	
				
Function				
	For 3 copper cables: ■ Rigid up to 16 mm ² ■ Flexible up to 10 mm ²	For aluminium cables from 16 to 50 mm ²	For lug tipped cables, front or rear mounting	
			 ∅ 5 mm	
Catalogue numbers	19091	19096	27060	27053
Set of	4	3	1	8
Suitability				
iC60 ≤ 25 A Reflex iC60 ≤ 25 A	–	–	–	■
iC60 > 25 A Reflex iC60 40 A, iSW	■	■	■	■
Vigi iC60	–	–	–	–
iID	■	■	■	■
iDPN Vigi	–	–	–	■
iSW-NA	■	■	■	■
Tightening torque	2 N.m		10 N.m	2 N.m
Length stripping	11 mm		13 mm	–
Tools to use	Dia. 5 mm or PZ2		Hc 1/5" or 5 mm	Dia. 5mm

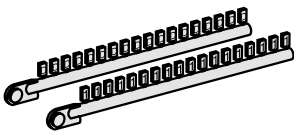
		Marking				
Accessories	Marker strip					
						
Used for connection identification						
Catalogue numbers	0: AB1-R0 1: AB1-R1 2: AB1-R2 3: AB1-R3 4: AB1-R4	5: AB1-R5 6: AB1-R6 7: AB1-R7 8: AB1-R8 9: AB1-R9	A: AB1-GA B: AB1-GB C: AB1-GC D: AB1-GD E: AB1-GE F: AB1-GF G: AB1-GG H: AB1-GH I: AB1-GI	J: AB1-GJ K: AB1-GK L: AB1-GL M: AB1-GM N: AB1-GN O: AB1-GO P: AB1-GP Q: AB1-GQ R: AB1-GR	S: AB1-GS T: AB1-GT U: AB1-GU V: AB1-GV W: AB1-GW X: AB1-GX Y: AB1-GY Z: AB1-GZ	+ : AB1-R12 - : AB1-R13 Blank: AB1-RV
Set of	250					
Suitability						
iC60, Reflex iC60, iSW	■ 4 markers max. per pole					
Vigi iC60	■ 4 markers max. per device					
iID	■ 4 markers max. per device					
iDPN Vigi	■ 4 markers max. per device					
iSW-NA	■ 4 markers max. per device					

Dimensions (mm)

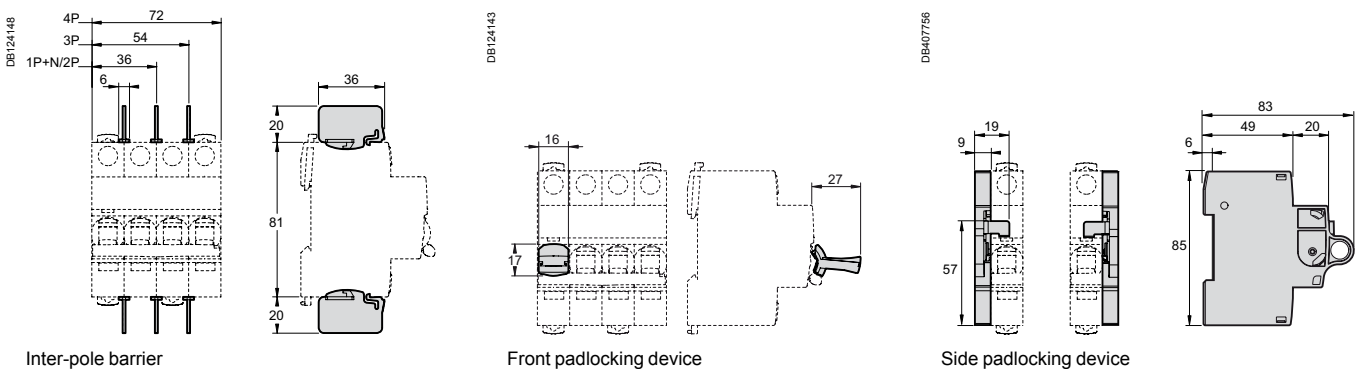
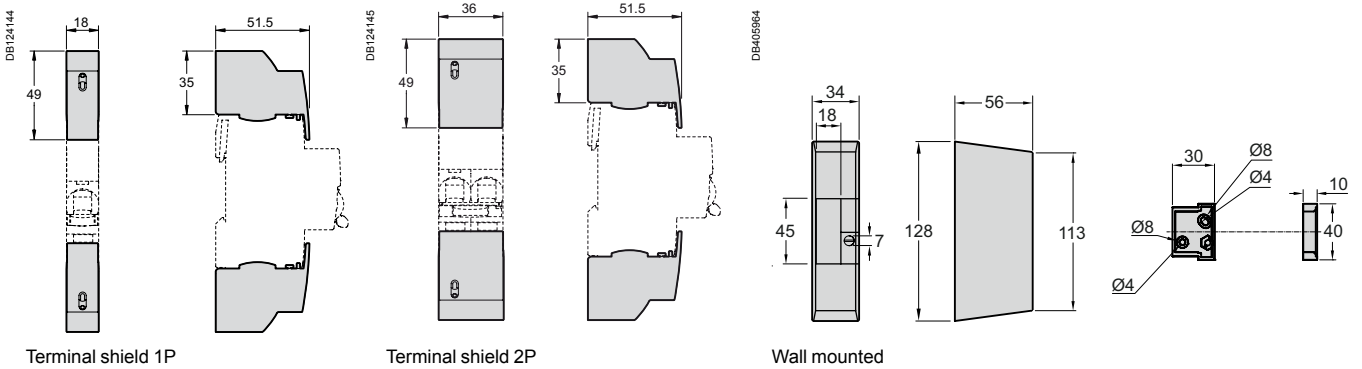
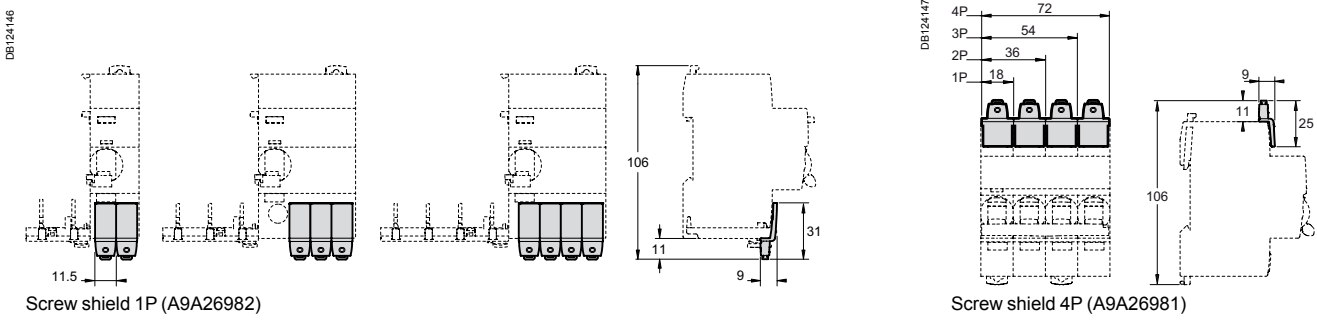
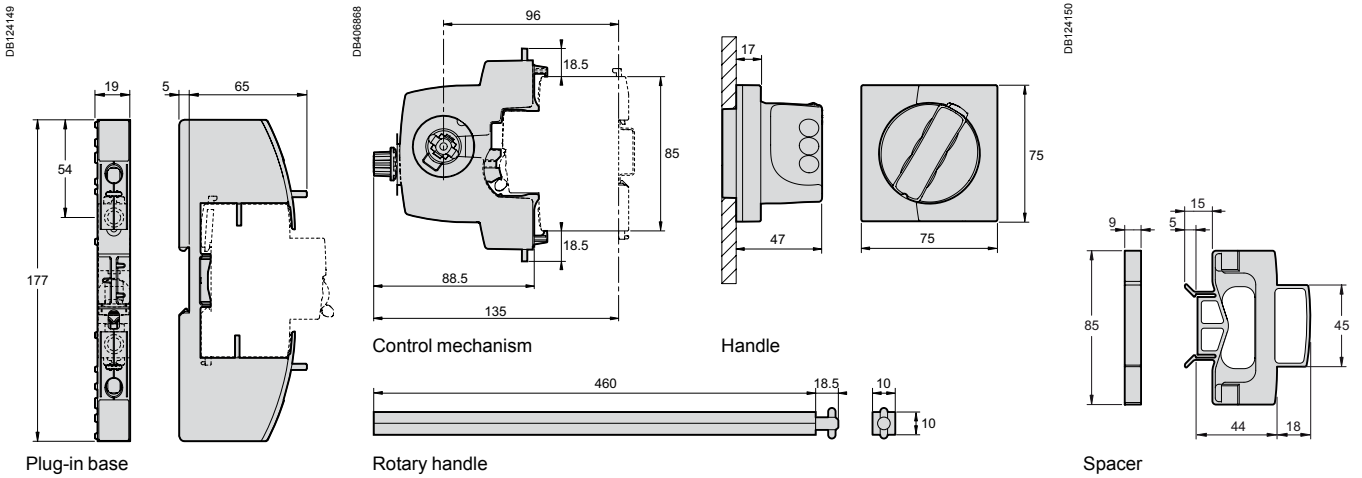

Rotary handle installation

Dimensions (mm)

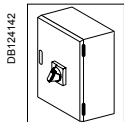

iC60	Z (mm)
2P	25.3
2P + Vigi	25.3
3P	25.3
3P + Vigi	43
4P	43
4P + Vigi	43

iID	Z (mm)
2P	25.3
4P	25.3

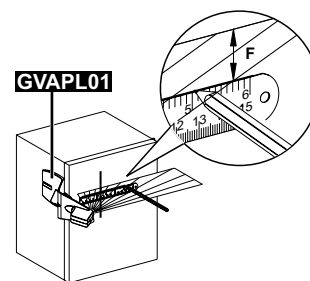
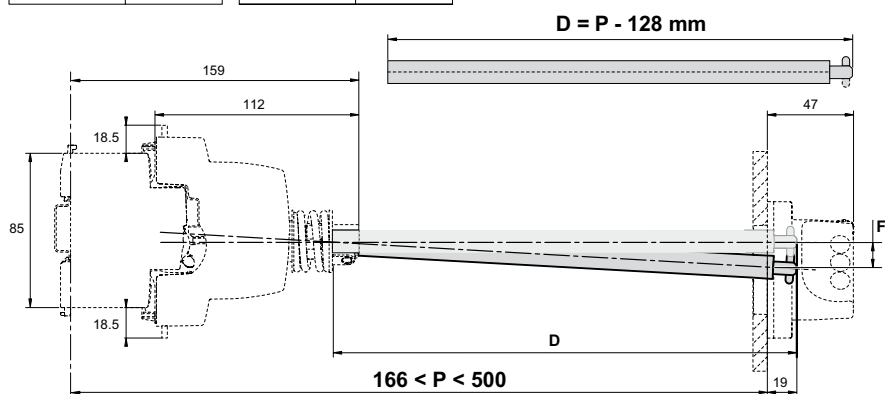
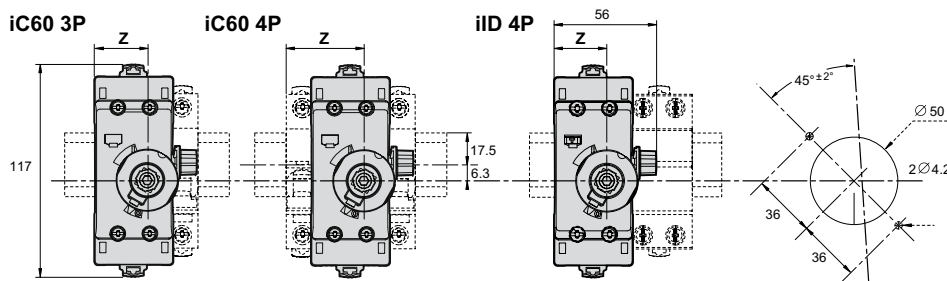

P (mm)	F (mm)
300	5
500	11

Rotary handle: front mounted control

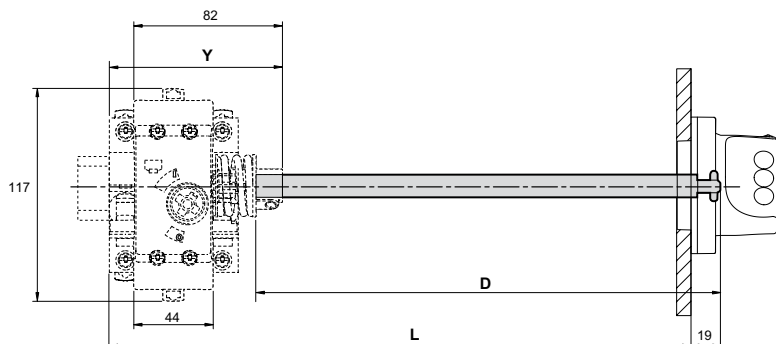
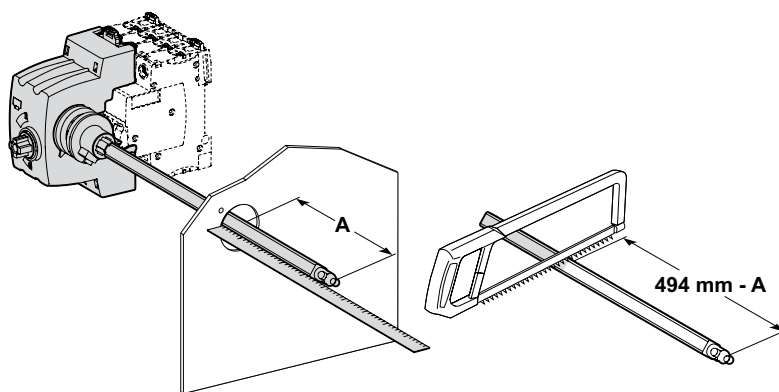
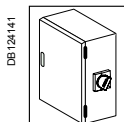





iC60	X (mm)	Y (mm)
2P	44.5	76.8
2P + Vigi	44.5	76.8
3P	44.5	76.8
3P + Vigi	62	94.5
4P	62	94.5
4P + Vigi	62	94.5

iID/iSW-NA	X (mm)	Y (mm)
2P	44.5	76.8
4P	44.5	76.8

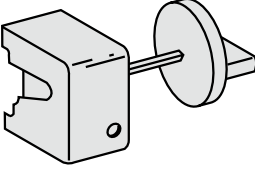
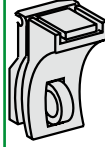

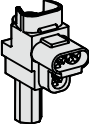
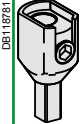
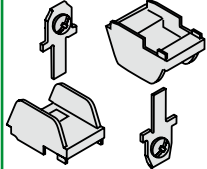

Rotary handle: side mounted control

Installation				
Accessories	Rotary handle			Padlocking device
				
Function				
	<p>Front or side control of circuit breakers</p> <ul style="list-style-type: none"> ■ Degree of protection: IP40, IK10 ■ A complete rotary handle consists of: <ul style="list-style-type: none"> □ a circuit-breaker operating sub-assembly, cat. no. 27046, □ a handle cat. no. 27047 or a handle cat. no. 27048 ■ Installation: <ul style="list-style-type: none"> □ the circuit-breaker operating sub-assembly cat. no. 27046 is fixed to the circuit breaker □ the removable handle cat. no. 27047 is mounted on the removable front panel or on the enclosure door □ the fixed handle cat. no. 27048 is fixed to the front or side panel of the enclosure 			<p>Used to padlock a circuit breaker in the "open" or "closed" position</p> <ul style="list-style-type: none"> ■ Diameter of the padlock: 8 mm max. ■ Locking in the ON position does not prevent the circuit breaker from tripping in the event of a fault ■ Isolation: in conformity with IEC/EN 60947-2
Cat. numbers	27046	27047	27048	26970
Set of	1	1	1	2
Number of pôle	-	-	-	-
DT60	■	■	■	■

Connection				
Accessories	Multi-cable terminal		50 mm ² Al terminal	Connection kit for ring terminals
				
Function				
	<p>For 3 copper cables:</p> <ul style="list-style-type: none"> ■ Rigid up to 16 mm² ■ Flexible up to 10 mm² 		<p>For 16 to 50 mm² aluminium cables</p>	<p>For terminal up to 63 A, front or rear access (screw Ø 5 mm)</p> <ul style="list-style-type: none"> ■ It incorporates a "conductive" part and an "insulating" part which ensures the phase-to-phase clearance
				 Ø 5 mm
Cat. numbers	19091	19096	27060	17400
Set of	4	3	1	2
DT60	■	■	■	■
Tightening torque	2 N.m		10 N.m	2 N.m
Stripping length	11 mm		13 mm	-
Tools to be used	Diameter 5 mm or PZ2		Hc 1/5" or 5 mm	Diameter 5 mm

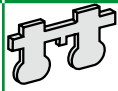
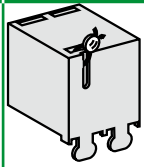

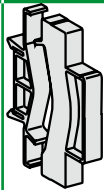
Safety

Screw shield	Terminal shield	Interpole barrier	Spacer
 <p>DB118776</p>	 <p>DB118777</p>	 <p>DB118728</p>	 <p>DB118779</p>
<p>Prevents all contact with the fixing screws</p> <ul style="list-style-type: none"> ■ The degree of protection becomes IP40 ■ Sealable ■ Dividable 	<p>Prevents all contact with the terminals</p> <ul style="list-style-type: none"> ■ Degree of protection IP40 ■ Sealable, max. diameter 1.2 mm 	<p>Improves the insulation between the connections: cables, terminals, lugs, etc.</p>	<ul style="list-style-type: none"> ■ Used to: <ul style="list-style-type: none"> □ complete the rows □ separate the devices ■ Width: 1 x 9 mm module ■ Allows cables to be routed from one row to another (above and below), up to 6 mm²
26981	26978	27001	A9N27062
2	2	10	1
4P	4P	-	-
■	■	■	■

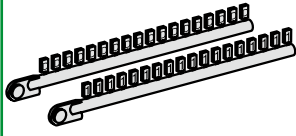



Identification

Accessories	Clip-on terminal marker strip																																																						
	 <p>DB118785</p>																																																						
Function	For connection identification																																																						
Cat. numbers	<table border="0"> <tr> <td>0: AB1-R0</td> <td>5: AB1-R5</td> <td>A: AB1-GA</td> <td>J: AB1-GJ</td> <td>S: AB1-GS</td> <td>+: AB1-R12</td> </tr> <tr> <td>1: AB1-R1</td> <td>6: AB1-R6</td> <td>B: AB1-GB</td> <td>K: AB1-GK</td> <td>T: AB1-GT</td> <td>-: AB1-R13</td> </tr> <tr> <td>2: AB1-R2</td> <td>7: AB1-R7</td> <td>C: AB1-GC</td> <td>L: AB1-GL</td> <td>U: AB1-GU</td> <td>Blank: AB1-RV</td> </tr> <tr> <td>3: AB1-R3</td> <td>8: AB1-R8</td> <td>D: AB1-GD</td> <td>M: AB1-GM</td> <td>V: AB1-GV</td> <td></td> </tr> <tr> <td>4: AB1-R4</td> <td>9: AB1-R9</td> <td>E: AB1-GE</td> <td>N: AB1-GN</td> <td>W: AB1-GW</td> <td></td> </tr> <tr> <td></td> <td></td> <td>F: AB1-GF</td> <td>O: AB1-GO</td> <td>X: AB1-GX</td> <td></td> </tr> <tr> <td></td> <td></td> <td>G: AB1-GG</td> <td>P: AB1-GP</td> <td>Y: AB1-GY</td> <td></td> </tr> <tr> <td></td> <td></td> <td>H: AB1-GH</td> <td>Q: AB1-GQ</td> <td>Z: AB1-GZ</td> <td></td> </tr> <tr> <td></td> <td></td> <td>I: AB1-GI</td> <td>R: AB1-GR</td> <td></td> <td></td> </tr> </table>	0: AB1-R0	5: AB1-R5	A: AB1-GA	J: AB1-GJ	S: AB1-GS	+: AB1-R12	1: AB1-R1	6: AB1-R6	B: AB1-GB	K: AB1-GK	T: AB1-GT	-: AB1-R13	2: AB1-R2	7: AB1-R7	C: AB1-GC	L: AB1-GL	U: AB1-GU	Blank: AB1-RV	3: AB1-R3	8: AB1-R8	D: AB1-GD	M: AB1-GM	V: AB1-GV		4: AB1-R4	9: AB1-R9	E: AB1-GE	N: AB1-GN	W: AB1-GW				F: AB1-GF	O: AB1-GO	X: AB1-GX				G: AB1-GG	P: AB1-GP	Y: AB1-GY				H: AB1-GH	Q: AB1-GQ	Z: AB1-GZ				I: AB1-GI	R: AB1-GR		
0: AB1-R0	5: AB1-R5	A: AB1-GA	J: AB1-GJ	S: AB1-GS	+: AB1-R12																																																		
1: AB1-R1	6: AB1-R6	B: AB1-GB	K: AB1-GK	T: AB1-GT	-: AB1-R13																																																		
2: AB1-R2	7: AB1-R7	C: AB1-GC	L: AB1-GL	U: AB1-GU	Blank: AB1-RV																																																		
3: AB1-R3	8: AB1-R8	D: AB1-GD	M: AB1-GM	V: AB1-GV																																																			
4: AB1-R4	9: AB1-R9	E: AB1-GE	N: AB1-GN	W: AB1-GW																																																			
		F: AB1-GF	O: AB1-GO	X: AB1-GX																																																			
		G: AB1-GG	P: AB1-GP	Y: AB1-GY																																																			
		H: AB1-GH	Q: AB1-GQ	Z: AB1-GZ																																																			
		I: AB1-GI	R: AB1-GR																																																				
Set of	250																																																						
DT60	■ 6 markers max. on front face																																																						









Accessories for C60, C120, DPN, DPN Vigi, C60H-DC, SW60-DC, C60NA-DC, C60PV-DC, ID, iSW devices

		Installation					
Accessories		Rotary handle		Plug-in base		Padlocking device	
							
Function		<p>Front or side control of 2, 3 and 4-pole circuit breakers</p> <ul style="list-style-type: none"> ■ Degree of protection: IP40 ■ A complete rotary handle consists of: <ul style="list-style-type: none"> □ a circuit-breaker operating sub-assembly, cat. no. 27046, □ a handle cat. no. 27047 or a handle cat. no. 27048 ■ Installation: <ul style="list-style-type: none"> □ the circuit-breaker operating sub-assembly cat. no. 27046 is fixed to the circuit breaker □ the removable handle cat. no. 27047 is mounted on the removable front panel or on the enclosure door □ the fixed handle cat. no. 27048 is fixed to the front or side panel of the enclosure 		<p>Allows a circuit breaker to be quickly removed or replaced, without touching the connections</p> <ul style="list-style-type: none"> ■ Degree of protection: IP20 ■ It consists of: <ul style="list-style-type: none"> □ a base to be fixed to a rail (or panel) □ 2 "blades" to be fixed in the device terminals ■ Connection: tunnel terminals for cables up to 50 mm² (rigid) or 35 mm² (flexible) ■ Installation: <ul style="list-style-type: none"> □ on backplate □ on a horizontal rail ■ Centreline between two rows: 200 mm ■ Only on the circuit breaker, without a Vigi device or auxiliary ■ Padlocking option (8 mm dia. padlock not supplied) 		<p>Used to padlock a circuit breaker in the "open" or "closed" position</p> <ul style="list-style-type: none"> ■ Diameter of the padlock: 8 mm max. ■ Locking in the ON position does not prevent the circuit breaker from tripping in the event of a fault ■ Isolation: in conformity with IEC/EN 60947-2. 	
Cat. numbers	27047 Removable extended handle	27048 Fixed handle	27046 Operating sub-assembly	26996 (1 per pole)	26997 (1 per pole)	27145	26970
Set of	1	1	1	1	1	4	2
Suitable for the following devices:							
C60	■ 2P, 3P, 4P			■	–	–	■
C120, C120NA-DC	■ 2P, 3P, 4P			–	■ ≤ 63 A	■	–
C120 + Vigi C120	■ 2P, 3P, 4P			–	–	■	–
DPN, DPN Vigi	■ 3P, 4P			–	–	–	■
C60H-DC	■ 2P			■	–	–	■
SW60-DC, C60NA-DC, C60PV-DC	–			–	–	–	■
ID	–			■ ≤ 63 A	–	–	■
iSW	■ iSW ≥ 4 modules of 9 mm			■ iSW 40 to 63 A	–	–	■

Accessories for C60, C120, DPN, DPN Vigi, C60H-DC, SW60-DC, C60NA-DC, C60PV-DC, ID, iSW devices (cont.)

Safety								
Accessories	Screw shield		Terminal shield			Interpole barrier	Spacer	
								
	056870_SE-33	PE124114	056889_SE-38		DE123898	PE104485-35		
Function	Prevents all contact with the fixing screws <ul style="list-style-type: none"> The degree of protection becomes IP40 Sealable, max. diameter 1.2 mm Dividable 		Prevents all contact with the terminals <ul style="list-style-type: none"> Degree of protection becomes IP40 Sealable, max. diameter 1.2 mm 			Improves the insulation between the connections: cables, terminals, lugs, etc.		<ul style="list-style-type: none"> Used to: <ul style="list-style-type: none"> complete the rows separate the devices Width: 1 x 9 mm module Allows that 2 cables are routed from one row to another (above and below), up to 6 mm²
			<ul style="list-style-type: none"> 1P 	<ul style="list-style-type: none"> 1P 	<ul style="list-style-type: none"> 2P 			
				<ul style="list-style-type: none"> 3P: 1 x 26975 + 1 x 26976 4P: 2 x 26976 				
Cat. numbers	18527	26981	18526	26975	26976	27001	A9N27062	
Set of	2 (4P dividable)		2 (for upstream/downstream terminal)			10	1	
Suitable for the following devices:								
C60	–	■	–	■	■	■	■	
C120, C120NA-DC	■	–	■	–	–	■	■	
Vigi C120	–	–	–	–	–	–	■	
DPN, DPN Vigi	–	–	–	–	–	–	■	
C60H-DC	–	■	–	■	■	■	■	
SW60-DC, C60NA-DC, C60PV-DC	–	■	–	–	–	■	■	
ID	–	■	–	■	■	■	■	
iSW	–	■ iSW 40 to 125 A	–	■ iSW 40 to 125 A	■ iSW 40 to 125 A	■ iSW 40 to 125 A	■	

Accessories for C60, C120, DPN, DPN Vigi, C60H-DC, SW60-DC, C60NA-DC, C60PV-DC, ID, iSW devices (cont.)

		Connection				
Accessories	Multi-cable terminal	50 mm ² Al terminal	Screw-on connection for ring terminal	Connection kit for ring terminals	Terminal for rear connector	
						
Function		For 3 copper cables: ■ Rigid up to 16 mm ² ■ Flexible up to 10 mm ²	For 16 to 50 mm ² aluminium cables	For lug tipped cables, front or rear mounting	For terminal up to 63 A, front or rear access (screw Ø 5 mm) ■ It incorporates a "conductive" part and an "insulating" part which ensures the phase-to-phase clearance	For cable up to 50 mm ² or by terminal ■ Supplied with a 1P terminal shield
						
Cat. numbers	19091	19096	27060	27053	17400	18528
Set of	4	3	1	8	2	2
Suitable for the following devices:						
C60 ≤ 25 A	–	–	–	■	■	–
C60 > 25 A	■	■	■	■	■	–
C120, C120NA-DC	■	■	■	■	–	■
Vigi C120	■	■	■	–	–	–
DPN, DPN Vigi	–	–	–	■	–	–
C60H-DC, ID	■	■	■	■	■	–
iSW 40 to 125 A	■	■	■	■	–	–
SW60-DC, C60NA-DC	■	■	■	■	–	–
C60PV-DC	–	–	–	■	–	–
Tightening torque	2 N.m		10 N.m	2 N.m	–	–
Stripping length	11 mm		13 mm	–	–	–
Tools to be used	Diameter 5 mm or PZ2		Hc 1/5" or 5 mm	Diameter 5 mm	Diameter 5 mm	13 mm spanner





		Identification	
Accessories	Clip-on terminal marker strip		
			
Function		For connection identification	
Cat. numbers		0: AB1-R0	A: AB1-GA
		1: AB1-R1	B: AB1-GB
		2: AB1-R2	C: AB1-GC
		3: AB1-R3	D: AB1-GD
		4: AB1-R4	E: AB1-GE
		5: AB1-R5	F: AB1-GF
		6: AB1-R6	G: AB1-GG
		7: AB1-R7	H: AB1-GH
		8: AB1-R8	I: AB1-GI
		9: AB1-R9	J: AB1-GJ
		K: AB1-GK	L: AB1-GL
		M: AB1-GM	N: AB1-GN
		O: AB1-GO	P: AB1-GP
		Q: AB1-GQ	R: AB1-GR
		S: AB1-GS	T: AB1-GT
		U: AB1-GU	V: AB1-GV
		W: AB1-GW	X: AB1-GX
		Y: AB1-GY	Z: AB1-GZ
		+: AB1-R12	–: AB1-R13
		Blank : AB1-RV	
Set of	250		
Suitable for the following devices:			
C60, ID	■ 4 markers max. per pole		
C120, C120NA-DC	■ 4 markers max. per pole		
Vigi C120	■ 4 markers max. per device		
DPN, DPN Vigi	■ 4 markers max. per pole		
C60H-DC, SW60-DC, C60NA-DC, C60PV-DC	■ 4 markers max. per pole		

		Mounting				
Accessories	Rotary handle		Toggle	Padlocking device		
Function						
	Extended rotary handle <ul style="list-style-type: none"> Degree of protection: rotary button IP55 Front installation: Prevents door opening when the circuit breaker is in position O Keeps disconnection Padlocking possible when the device is in position O Padlock diameter: 3 to 6 mm 		Direct rotary handle <ul style="list-style-type: none"> Front installation Keeps disconnection Padlocking possible when the device is in position O Padlock diameter: 3 to 6 mm 	White toggle <ul style="list-style-type: none"> Allows visual distinction of a switchboard incoming device 	Allows padlocking: <ul style="list-style-type: none"> In position I or O of NG125 1P or 2P circuit breakers In position I of NG125 3P or 4P circuit breakers or switches Padlock: dia. 5 to 8 mm (not supplied) <p><i>Note: NG125 3P/4P circuit breakers and switches are provided with padlocking in position O (disconnected) as original equipment.</i></p>	
			<ul style="list-style-type: none"> Two versions: standard black red handle and yellow front plate for machine tool control 			
Catalogue numbers	19088 Extended standard black	19089 Extended safety	19092 Direct standard black	19097 Direct safety red handle yellow background	19099 White toggle	19090
Pack of	1		1	1	10	1
Suitable for the following devices:						
NG125	<ul style="list-style-type: none"> 3P, 4P 				<ul style="list-style-type: none"> 3P, 4P 	
Vigi NG125	-		-	-	-	-

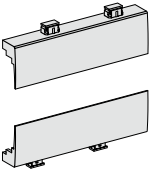
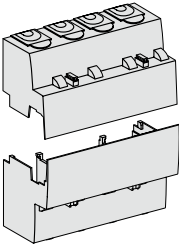
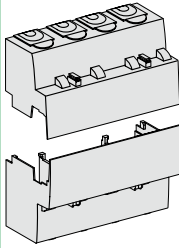
		Connection				
Accessories	Multi-cable terminal	70 mm ² Al terminal	Screw-on connection for ring terminal	Small ring terminal		
Function						
	For 3 copper cables: <ul style="list-style-type: none"> Rigid up to 16 mm² Flexible up to 10 mm² 	For aluminium cables from 25 to 70 mm²	Installation: <ul style="list-style-type: none"> Upstream or downstream Connection ratings 80 to 125 A: <ul style="list-style-type: none"> copper terminal: <ul style="list-style-type: none"> flexible cable up to 35 mm² rigid cable up to 50 mm² bars: 16 x 3 mm, 15 x 4 mm, 16 x 4 mm small ring terminal Phase-to-phase insulation voltage: U_i = 1000 V 	Connection ratings 80 to 125 A: <ul style="list-style-type: none"> Flexible copper cable: 50 mm² Rigid copper cable: 70 mm² 		
Cat. nos.	19091	19096	19095	19093	19094	
Pack of	4	3	4	4	4	
NG125	■	■	■ 80, 100, 125 A	■ 80, 100, 125 A	■ 80, 100, 125 A	
Vigi NG125	-	-	■ 125 A	■ 125 A	■ 125 A	
Tightening torque	2 N.m		6 N.m	6 N.m	6 N.m	
Stripping length	11 mm		-	-	-	
Tools to be used	Diameter 5 mm or PZ2		Hc 4 mm	Hc 4 mm	-	

Safety

Accessories	Screw shield				Circuit breaker terminal shield				RCD terminal shield						
															
Function	<ul style="list-style-type: none"> ■ Prevents any contact with the connection screws ■ Protection against direct contact: <ul style="list-style-type: none"> □ IP40: on front panel □ IP20: at the connection level ■ Class II in steel or plastic enclosures ■ Sealing possible (max. diameter: 1.2 mm). 				<ul style="list-style-type: none"> ■ Prevents any contact with the terminals ■ Installation: mounted upstream and downstream of circuit breaker ■ Phase-to-phase insulation voltage $U_i = 1000\text{ V}$ ■ Protection against direct contact IP40 ■ Class II in steel or plastic enclosures (up to 440 V) ■ Sealing possible (max. diameter: 1.2 mm) 				<ul style="list-style-type: none"> ■ Installation: is mounted upstream of the circuit breaker and downstream of the Vigi device ■ Phase-to-phase insulation voltage $U_i = 1000\text{ V}$ ■ Protection against direct contact: IP40 ■ Class II in steel or plastic enclosures (up to 440 V) ■ Sealing possible (max. diameter: 1.2 mm) 						
	1P	2P	3P	4P	1P	2P	3P	4P	63 A				125 A		
									2P	3P	3P adjustable	4P	4P adjustable	3P	4P
Catalogue numbers	19084	19085	19086	19087	19080	19081	19082	19083	19074	19075	19077	19076	19078	19077	19078
Pack of	10				Set of 1 upstream / 1 downstream				Set of 1 upstream / 1 downstream						
Suitable for the following devices:															
NG125	■				■				■						
Vigi NG125	-				-				■						

		Comb busbars				
Accessories		Vertical comb busbars				
		PB106071-40 	PB106073-40 	DB124263-40 	PB106072-40 	PB106074-40 
Function		Comb busbars make it easier to implement Schneider Electric products. <ul style="list-style-type: none"> ■ They provide a 2P supply to the main incomers from one row to the next: □ centreline between rows: 125 mm or 150 mm, depending on the model □ distances between terminals: 9 mm or 18 mm, depending on the model 				
Use		<ul style="list-style-type: none"> ■ Direct power supply to circuit breaker or residual current circuit breaker terminals 				
Catalogue numbers		14900	14901	14909	14910	14911
Distance between upstream terminals		9 mm		18 mm		
Distance between downstream terminals		9 mm		18 mm		
Centreline between rows		125 mm	150 mm	125 mm	125 mm	150 mm
Technical specifications						
Rated voltage (Ue)		415 V				
Insulation voltage (Ui)		500 V				
Permissible current at 40°C		80 A				
Short-circuit current withstand		Compatible with the breaking capacity of Schneider Electric modular circuit breakers				
Fire resistance to IEC 695-2-1		Self-extinguishing: 850°C 30 s				
Standards		IEC 60664-1				
Colour		RAL 7035 (light grey)	RAL 7016 (anthracite grey)	RAL 7035 (light grey)	RAL 7035 (light grey)	RAL 7016 (anthracite grey)

Acti 9 System

Connection to the top



Linergy DS :
Distribution blocks





Acti 9 Comb busbars

Linergy FM
+
Acti 9 Smartlink

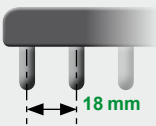
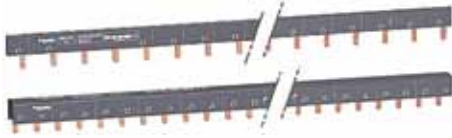
Selection guide

Acti 9 iC60, iK60



Number of poles	18 mm modules	Cat. no.	Distributed neutral	Number of poles	18 mm modules	Cat. no.
1P						
 L1	6	A9XPH106				
	12	A9XPH112				
	24	A9XPH124				
	57	A9XPH157				
2P						
 L1 L2	12	A9XPH212				
	24	A9XPH224				
	57	A9XPH257				
3P						
 L1 L2 L3	6	A9XPH306				
	12	A9XPH312				
	24	A9XPH324				
	57	A9XPH357				
3P+N			N, L1, N, L2, N, L3			
 N L1 L2 L3	12	A9XPH412	 N L1 N L2 N L3		12	A9XPH512
	24	A9XPH424			18	A9XPH518
	57	A9XPH457			24	A9XPH524
					57	A9XPH557

Comb busbar cat. no.: A9XPH1●●

Comb busbar cat. no.: A9XPH3●●

Comb busbar cat. no.: A9XPH4●●

Comb busbar cat. no.: A9XPH5●●



L1



L1 L2 L3

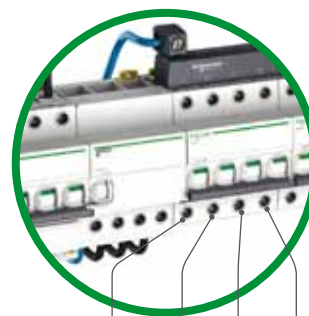

N L1 L2 L3

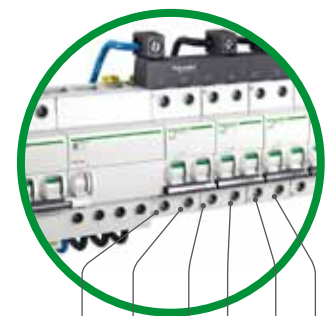





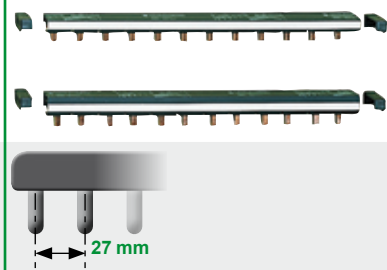



N L1 N L2 N L3

Acti 9 iC60	C120/NG125
-------------	------------

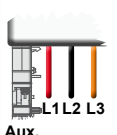

With 9 mm auxiliary

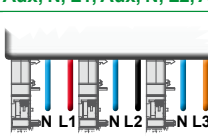
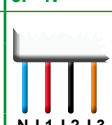
Number of poles	18 mm modules	Cat. no.	Distributed	18 mm modules	Cat. no.	Number of poles	27 mm modules	Cat. no.
Aux, L1						1P		
	57	A9XAH157					16	14811
Aux, L1, L2						2P		
	57	A9XAH257					16	14812
Aux, L1, L2, L3			Aux, L1, Aux, L2, Aux, L3			3P		
	57	A9XAH357		57	A9XAH657		15	14813
Aux, N, L1, L2, L3			Aux, N, L1, Aux, N, L2, Aux, N, L3			3P+N		
	57	A9XAH457		57	A9XAH557		16	14814

Comb busbar cat. no.: A9XAH257

Comb busbar cat. no.: A9XAH357

Comb busbar cat. no.: A9XAH657

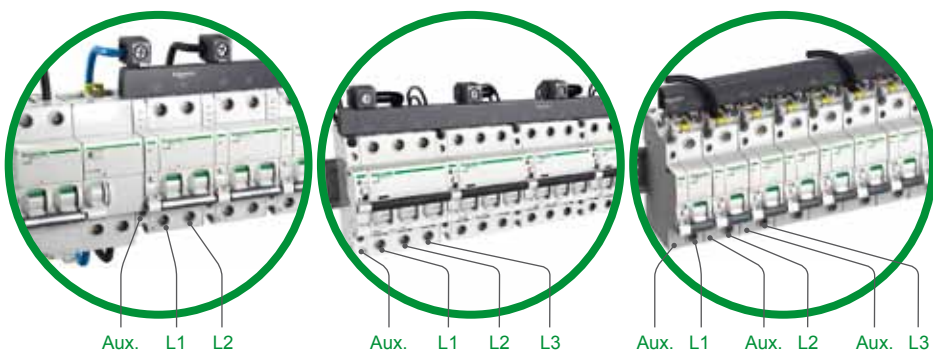

Selection guide

Acti 9 iDPN, iDPN Vigi

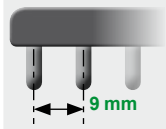

Number of poles	18 mm modules	Cat. no.
<p>1P+N</p>	12	21501
	18	19512
	24	21503
	48	21089
<p>3P+N</p>	12	21505
	18	19516
	24	21507
	48	21093

Comb busbar cat. no.: 19512

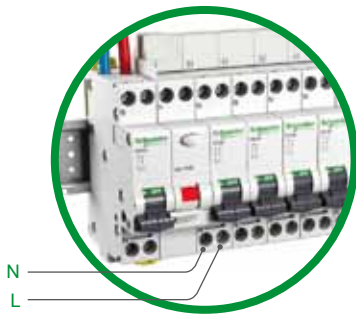



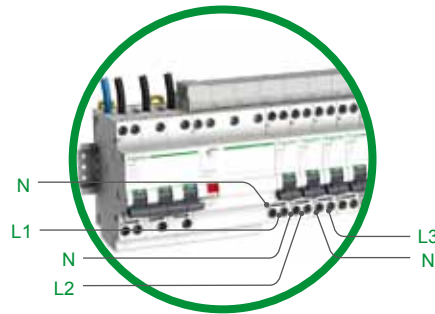

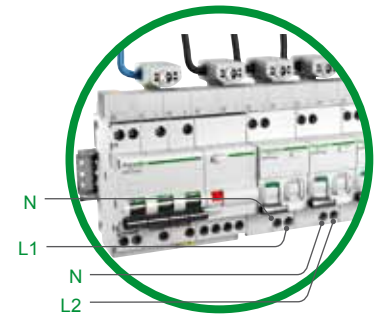

Comb busbar cat. no.: 19516



Comb busbar cat. no.: 21507

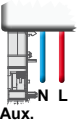
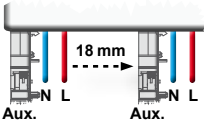

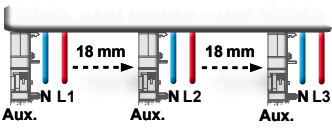
Acti 9 iDPN			Acti 9 iDPN Vigi		
					
					
With 9 mm auxiliary			With 9 mm auxiliary		
Number of poles	18 mm modules	Cat. no.	Number of poles	18 mm modules	Cat. no.
Aux, N, L			Aux, N, L		
	56	A9N21035		56	A9N21037
Aux, N, L1, Aux, N, L2, Aux, N, L3			Aux, N, L1-Aux, N, L2-Aux, N, L3		
	56	A9N21036		56	A9N21038

Comb busbar cat. no.: A9N21036

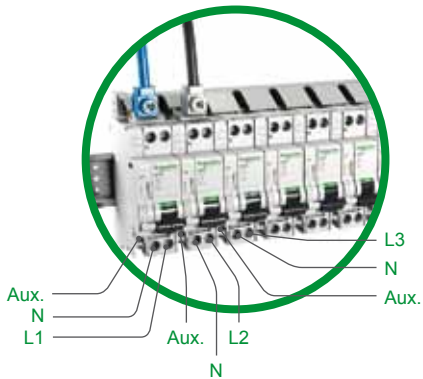

Comb busbar cat. no.: A9N21037

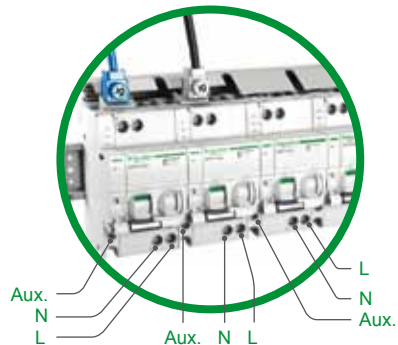



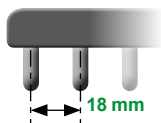

Horizontal comb busbars 18 mm modules for Acti 9: iC60, iK60

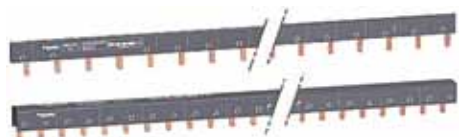

IEC 60947-7-1, IEC 61439-2



Acti 9 iC60, iK60	18 mm poles, cuttable				
Number of poles	1P	2P	3P	4P	3 (N+P)
	 L1	 L1 L2	 L1 L2 L3	 N L1 L2 L3	 N L1 NL2 N L3
Type	L1...	L1L2...	L1L2L3...	NL1L2L3...	NL1NL2NL3...
Set of	1	1	1	1	1
Catalogue numbers					
6 modules of 18 mm	A9XPH106	-	A9XPH306	-	-
12 modules of 18 mm	A9XPH112	A9XPH212	A9XPH312	A9XPH412	A9XPH512
18 modules of 18 mm	-	-	-	-	A9XPH518
24 modules of 18 mm	A9XPH124	A9XPH224	A9XPH324	A9XPH424	A9XPH524
57 modules of 18 mm	A9XPH157	A9XPH257	A9XPH357	A9XPH457	A9XPH557

Technical data

Operating current (Ie) at 40°C	100 A
Short circuit current (Isc)	Compatible with the breaking capacity of Schneider Electric circuit breakers
Rated insulation voltage (Ui)	500 V AC
Operating voltage (Ue)	415 V AC
Pollution degree	3
Fire resistance IEC 695-2-1	Self-extinguishing at 960°C 30 secondes
Color	RAL 7016 (anthracite grey)

End-pieces

- essential to ensure the correctly comb busbars insulation





Connectors

- facilitate comb busbar power supply

Tooth covers

- Insulate teeth that have been left free

Accessories

Number of poles	1P	2P	3P	4P	-	-
						
	End-pieces				Tooth covers	Connectors
	Lateral end-pieces providing IP20 protection				Insulate teeth that have been left free	Monoconnect Comb busbar power supply. Horizontal in comer on each side. For 35 mm ² cable. Tightening torque 4 N.m
Set of	10	10	10	10	20	4
Catalogue numbers	A9XPE110	A9XPE210	A9XPE310	A9XPE410	A9XPT920	A9XPCM04



Cuttable comb busbars, 18 mm modules, with 9 mm auxiliary

Aux+1P	Aux+2P	Aux+3P	Aux+4P	3 (Aux+1P)	3 (Aux+N+1P)
AuxL 1...	AuxL 1L2...	AuxL 1L2L3...	AuxNL 1L2L3...	AuxL 1AuxL2AuxL3...	AuxL 1AuxL2AuxL3...
1	1	1	1	1	1
-	-	-	-	-	-
-	-	-	-	-	-
-	-	-	-	-	-
-	-	-	-	-	-
A9XAH157	A9XAH257	A9XAH357	A9XAH457	A9XAH657	A9XAH557

Horizontal comb busbars 9 mm modules for Acti 9: iDPN, iDPN Vigi

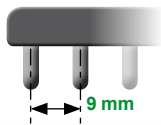

IEC 60439-1



Acti 9 iDPN, iDPN Vigi	9 mm poles, cuttable							
	1P + N				3P + N			
Number of poles	 N L				 N L1 N L2 N L3			
Number of 18 mm modules	12	18	24	48	12	18	24	48
Supplied accessories Tooth covers (for 3 modules of 18 mm)	1	1	2	-	1	1	2	-
End-pieces	4	4	4	-	4	4	4	-
Catalogue numbers	21501	19512	21503	21089	21505	19516	21507	21093

Technical data		
Operating current at 40°C	(Ie)	80 A
Short circuit current	(Isc)	Compatible with the breaking capacity of Schneider Electric circuit breakers
Rated insulation voltage	(Ui)	440 V AC
Operating voltage	(Ue)	230 V AC (P + N) - 400 V AC (3P + N)
Degree of protection		IP20
Pollution degree		3
Fire resistance IEC 695-2-1		Self-extinguishing at 960°C 30 secondes
Color		RAL 7035

Connectors

- facilitate comb busbar power supply

End-pieces

- essential to ensure the correctly comb busbars insulation

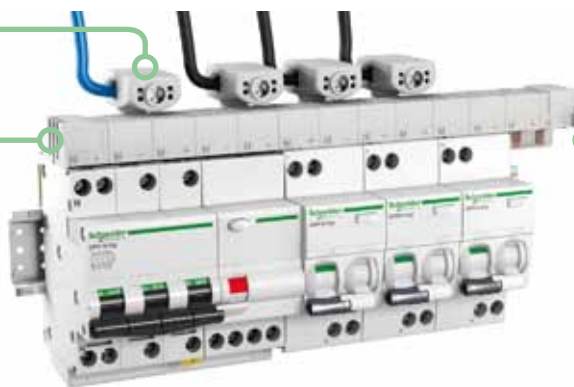

Tooth covers

- Insulate teeth that have been left free

Accessories				
Number of poles	1P + N	3P + N		
	End-pieces	Tooth covers (3 x 18 mm modules)	Tooth covers (1 x 18 mm module)	Connectors (grey)
Set of	40	12	10	4
Catalogue numbers	021094	021095	010405	021098

Horizontal comb busbars 9 mm modules for Acti 9: iDPN, iDPN Vigi

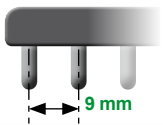

IEC 60439-1

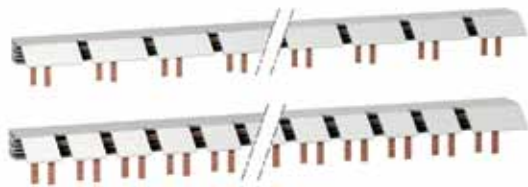

Comb busbar for 1P+N circuit breaker with 9 mm auxiliary iOF, iSD

Acti 9 iDPN, iDPN Vigi	9 mm poles, cuttable			
Number of poles	Aux., N, L	Aux. NL1, Aux. NL2, Aux. NL3	Aux., N, L1	Aux. NL1, Aux. NL2, Aux. NL3
	iDPN comb busbar		iDPN Vigi comb busbar	
Number of 18 mm modules	56	56	56	56
Catalogue numbers	A9N21035	A9N21036	A9N21037	A9N21038

Technical data		
Operating current at 40°C	(Ie)	63 A
Short circuit current	(Isc)	Compatible with the breaking capacity of Schneider Electric circuit breakers
Rated insulation voltage	(Ui)	500 V AC
Operating voltage	(Ue)	230 V AC (P + N) - 400 V AC (3P + N)
Degree of protection		IP20
Pollution degree		3
Fire resistance IEC 695-2-1		Self-extinguishing at 960°C 30 secondes
Color		RAL 7035

Connectors

- facilitate comb busbar power supply

End-pieces

- essential to ensure the correctly comb busbars insulation

Auxiliaries

- free space for 9 mm electrical auxiliary



Tooth covers

- Insulate teeth that have been left free



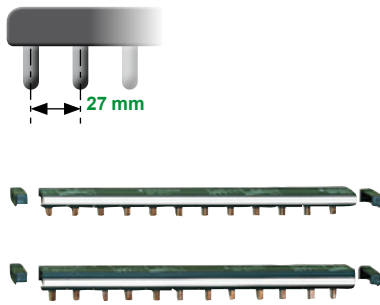

Accessories					
Number of poles	Aux., N, L	Aux. NL1, Aux. NL2, Aux. NL3			
Set of	End-pieces	Connectors (grey)	Neutral connectors (bleu)	Tooth covers (1 x 18 mm module)	
	20	10	10	10	
Catalogue numbers	A9N21039	A9N21040	A9N21041	A9N21042	A9N21050

Horizontal comb busbars 27 mm modules for C120, NG125



IEC 60664-1



C120, NG125		27 mm poles, cuttable			
Number of poles	1P	2P	3P	4P	
	 L1	 L1 L2	 L1 L2 L3	 N L1 L2 L3	
Number of 27 mm modules	16	16	15	16	
Set of	1				
Catalogue numbers	14811	14812	14813	14814	

Technical data		
Operating current at 40°C (Ie)	125 A	
Short circuit current (Isc)	Compatible with the breaking capacity of Schneider Electric circuit breakers	
Rated insulation voltage (Ui)	620 V AC	
Operating voltage (Ue)	500 V AC	
Pollution degree	3	
Fire resistance IEC 695-2-1	Self-extinguishing at 960°C 30 secondes	
Color	RAL 7016 (anthracite grey)	

Power supply
■ directly in the circuit breaker terminals



End-pieces
■ essential to ensure the correctly comb busbars insulation



Tooth covers
■ Insulate teeth that have been left free

Accessories	
Number of poles	1P, 2P, 3P, 4P
	
	Tooth covers Insulate teeth that have been left free
Set of	20
Catalogue numbers	14818

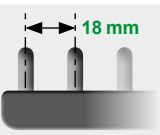
Selection guide

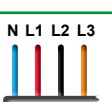
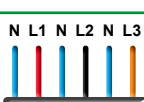

Acti 9 K60 biconnect			Acti 9 iC60					
								
								
								
Standard			Standard					
Number of poles	18 mm modules	Cat. no.	Number of poles	18 mm modules	Cat. no.	Distributed neutral		
						Number of poles	18 mm modules	Cat. no.
1P								
	12	R9XFH112		6	A9XPH106			
	18	R9XFH118		12	A9XPH112			
	57	R9XFH157		24	A9XPH124			
				57	A9XPH157			
2P								
	12	R9XFH212		12	A9XPH212			
	18	R9XFH218		24	A9XPH224			
	57	R9XFH257		57	A9XPH257			
3P								
	12	R9XFH312		6	A9XPH306			
	18	R9XFH318		12	A9XPH312			
	57	R9XFH357		24	A9XPH324			
				57	A9XPH357			
3P+N								
	12	R9XFH412		12	A9XPH412		12	A9XPH512
	18	R9XFH418		24	A9XPH424		18	A9XPH518
	57	R9XFH457		57	A9XPH457		24	A9XPH524
						57	A9XPH557	

Comb busbar cat. no.: R9XFH3●●

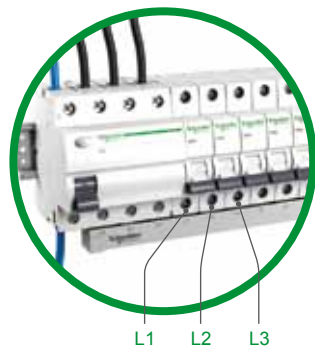
Comb busbar cat. no.: A9XPH3●●

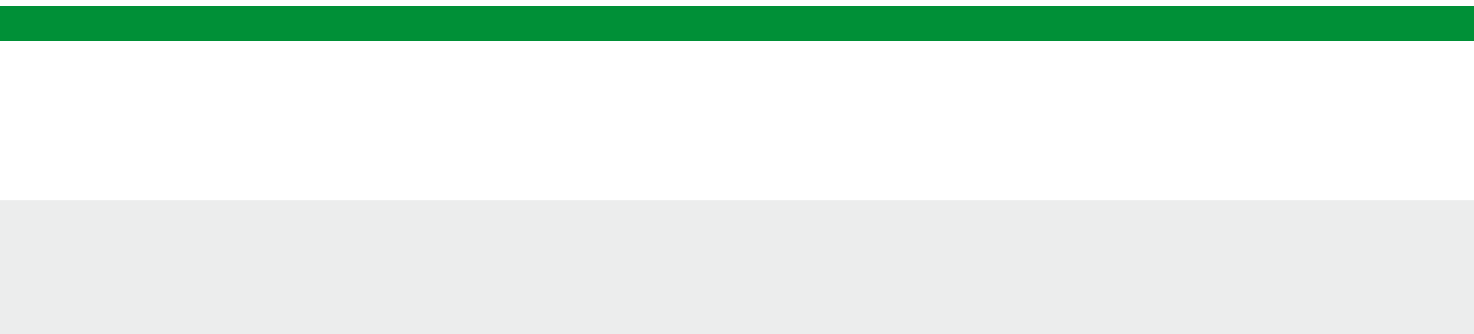

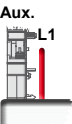

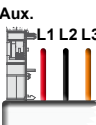
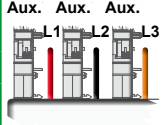
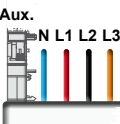
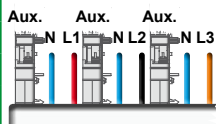



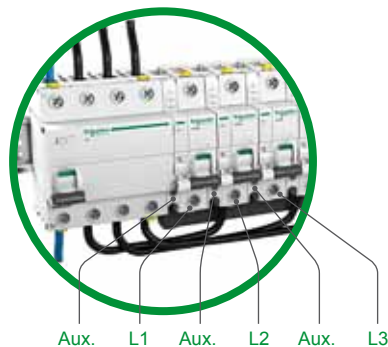

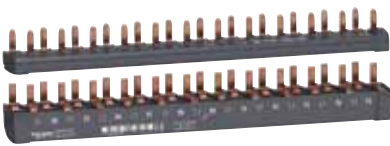
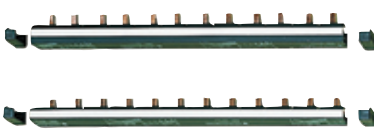
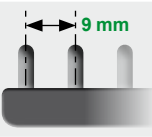
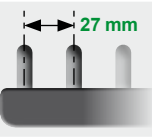

Auxiliarisables (9 mm auxiliaies)						
Number of poles			Distributed neutral			
18 mm modules	Cat. no.	Number of poles	18 mm modules	Cat. no.	18 mm modules	Cat. no.
Aux, L						
	57	A9XAH157				
Aux, L1, L2						
	57	A9XAH257				
Aux, L1, L2, L3			Aux, L1, Aux, L2, Aux, L3			
	57	A9XAH357		57	A9XAH657	
Aux, N, L1, L2, L3			Aux, N, L1, Aux, N, L2, Aux, N, L3			
	57	A9XAH457		57	A9XAH557	

Comb busbar cat. no.: A9XAH657



Selection guide

Acti 9 iDPN, iDPN Vigi			C120/NG125		
					
					
					
Standard			Standard		
Number of poles	18 mm modules	Cat. no.	Number of poles	27 mm modules	Cat. no.
1P			1P		
	-	-	 L1	16	14811
1P+N			2P		
 N L1	12	A9XPH612	 L1 L2	16	14812
	24	A9XPH624			
3P			3P		
	-	-	 L1 L2 L3	15	14813
3P+N			3P+N		
 N L1 N L2 N L3	12	A9XPH712	 N L1 L2 L3	16	14814
	20	A9XPH724			

Comb busbar cat. no.: A9XPH7●●



Comb busbar cat. no.: 14813



Biconnect horizontal comb busbars 18 mm modules for K60

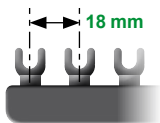

IEC 60664-1

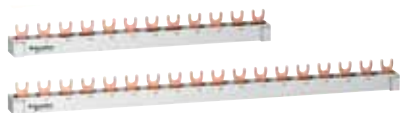

Acti 9 K60 biconnect	18 mm poles, cuttable											
Number of poles	1P L1			2P L1 L2			3P L1 L2 L3			4P N L1 L2 L3		
Type	L1			L1L2			L1L2L3			NL1L2L3		
Number of 18 mm modules	12	18	57	12	18	57	12	18	57	12	18	57
Set of	1	1	1	1	1	1	1	1	1	1	1	1
Catalogue numbers	R9XFH112	R9XFH118	R9XFH157	R9XFH212	R9XFH218	R9XFH257	R9XFH312	R9XFH318	R9XFH357	R9XFH412	R9XFH418	R9XFH457

Technical data		
Operating current at 40°C (Ie)	63 A	
Short circuit current (Isc)	Compatible with the breaking capacity of Schneider Electric circuit breakers	
Rated insulation voltage (Ui)	500 V AC	
Operating voltage (Ue) L/N	230 V AC	
	L/L	400 V AC
Pollution degree	3	
Fire resistance IEC 695-2-1	Self-extinguishing at 960°C 30 secondes	
Color	RAL 7035 (grey)	

End-pieces
■ essential to ensure the correctly comb busbars insulation



Tooth covers
■ Insulate teeth that have been left free

Accessories						
Number of poles	1P	2P	3P	4P		
	End-pieces			Tooth covers		Connectors
Set of	10			20		4
Catalogue numbers	R9XE110	R9XE210	R9XE310	R9XE410	R9XT20	R9XFC04

Horizontal comb busbars 18 mm modules for Acti 9: iC60

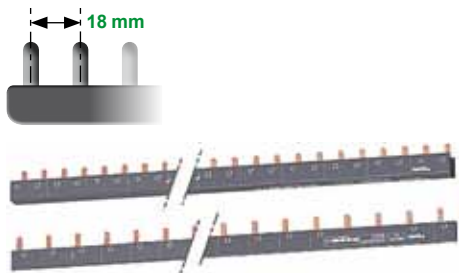

IEC 60947-7-1, IEC 61439-2



Acti 9 iC60	18 mm poles, cuttable				
Number of poles	1P	2P	3P	4P	3 (N+P)
	L1 	L1 L2 	L1 L2 L3 	N L1 L2 L3 	N L1 N L2 N L3
Type	L1...	L1L2...	L1L2L3...	NL1L2L3...	NL1NL2NL3...
Set of	1	1	1	1	1
Catalogue numbers					
6 modules of 18 mm	A9XPH106	-	A9XPH306	-	-
12 modules of 18 mm	A9XPH112	A9XPH212	A9XPH312	A9XPH412	A9XPH512
18 modules of 18 mm	-	-	-	-	A9XPH518
24 modules of 18 mm	A9XPH124	A9XPH224	A9XPH324	A9XPH424	A9XPH524
57 modules of 18 mm	A9XPH157	A9XPH257	A9XPH357	A9XPH457	A9XPH557

Technical data

Operating current (Ie) at 40°C	100 A
Short circuit current (Isc)	Compatible with the breaking capacity of Schneider Electric circuit breakers
Rated insulation voltage (Ui)	500 V AC
Operating voltage (Ue)	415 V AC
Pollution degree	3
Fire resistance IEC 695-2-1	Self-extinguishing at 960°C 30 secondes
Color	RAL 7016 (anthracite grey)

End-pieces

- essential to ensure the correctly comb busbars insulation



Tooth covers

- Insulate teeth that have been left free

Accessories

Number of poles	1P	2P	3P	4P		
	End-pieces				Tooth covers	
	Lateral end-pieces providing IP20 protection				Insulate teeth that have been left free	
					Connectors	
					Monoconnect	
					Comb busbar power supply. Horizontal in-comer on each side. For 35 mm ² cable. Tightening torque 4 N.m	
Set of	10	10	10	10	20	4
Catalogue numbers	A9XPE110	A9XPE210	A9XPE310	A9XPE410	A9XPT920	A9XPCD04



Cuttable comb busbars, 18 mm modules, with 9 mm auxiliary

Aux+1P	Aux+2P	Aux+3P	Aux+4P	3 (Aux+1P)	3 (Aux+N+1P)
Aux. L1	Aux. L1 L2	Aux. L1 L2 L3	Aux. N L1 L2 L3	Aux. Aux. Aux. L1 L2 L3	Aux. Aux. Aux. N L1 N L2 N L3
AuxL1...	AuxL1L2...	AuxL1L2L3...	AuxNL1L2L3...	AuxL1AuxL2AuxL3...	AuxNL1AuxNL2AuxNL3...
1	1	1	1	1	1
-	-	-	-	-	-
-	-	-	-	-	-
-	-	-	-	-	-
-	-	-	-	-	-
A9XAH157	A9XAH257	A9XAH357	A9XAH457	A9XAH657	A9XAH557

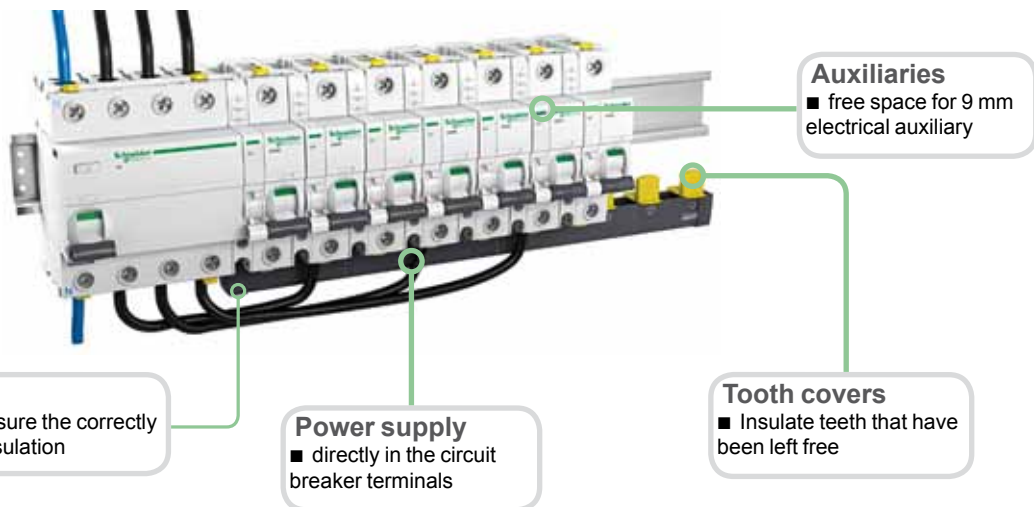

Horizontal comb busbars 9 mm modules for Acti 9 : iDPN, iDPN Vigi

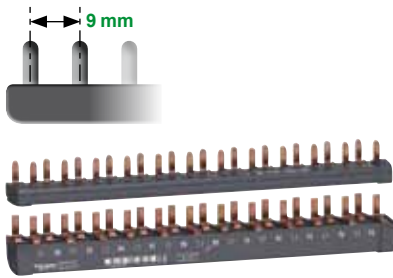

IEC 60947-7-1, IEC 61439-1



Acti 9 iDPN, iDPN Vigi		9 mm poles	
Number of poles	1P+N	3P+N	
	N L1 	N L1 N L2 N L3 	
Type	N, L1...	N, L1, N, L2, N, L3...	
Set of	1	1	
Number of 18 mm modules	12	24	24
Catalogue numbers	A9XPH612	A9XPH624	A9XPH712 A9XPH724

Technical data		
Operating current at 40°C (Ie)	80 A	
Short circuit current (Isc)	Compatible with the breaking capacity of Schneider Electric circuit breakers	
Rated insulation voltage (Ui)	500 V AC	
Operating voltage (Ue)	230 V AC	230 V AC (Ph/N) / 400 V AC (Ph/Ph)
Degree of protection IEC 60529	IP20	
Pollution degree	3	
Fire resistance IEC 695-2-1	Self-extinguishing at 960°C 30 secondes	
Color	RAL 7016 (anthracite grey)	

End-pieces

- essential to ensure the correctly comb busbars insulation

Connectors

- facilitate comb busbar power supply

Tooth covers

- Insulate teeth that have been left free

Accessories					
Number of poles	1P+N	3P+N	For 1P+N comb busbars	For 3P+N comb busbars	
	End-pieces		Connectors		Tooth covers
	Lateral end-pieces providing IP20 protection		Comb busbar power supply. Horizontal incomer on each side. For 35 mm ² cable. Tightening torque 4 N.m		Insulate teeth that have been left free
Color	RAL 7016 (anthracite grey)		RAL 7016 (anthracite grey)		Yellow
Set of	10		4		20
Catalogue numbers	A9XPE210	A9XPE410	A9XPC604	A9XPCM04	A9XPT620

Horizontal comb busbars 27 mm modules for C120, NG125

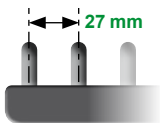

IEC 60664-1



C120, NG125		27 mm poles, cuttable			
Number of poles	1P	2P	3P	4P	
	L1	L1 L2	L1 L2 L3	N L1 L2 L3	
Number of 27 mm modules	16	16	15	16	
Set of	1				
Catalogue numbers	14811	14812	14813	14814	

Technical data	
Operating current at 40°C (Ie)	125 A
Short circuit current (Isc)	Compatible with the breaking capacity of Schneider Electric circuit breakers
Rated insulation voltage (Ui)	620 V AC
Operating voltage (Ue)	500 V AC
Degree of protection	3
Fire resistance IEC 695-2-1	Self-extinguishing at 960°C 30 secondes
Color	RAL 7016 (anthracite grey)

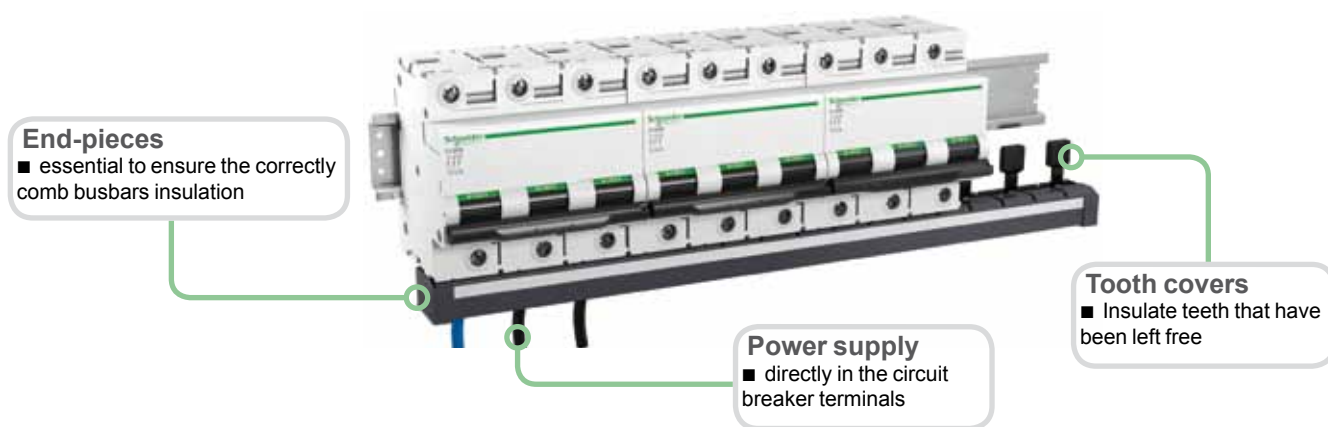

Accessories	
Number of poles	1P, 2P, 3P, 4P
	Tooth covers Insulate teeth that have been left free
Set of	20
Catalogue numbers	14818

IEC 60947-7-1, IEC 61439-2



Description

- Downstream circuits are connected from the front, to spring terminals.
- Contact pressure automatically adapts to the size of the conductor.
- Contacts are insensitive to vibrations and thermal variations.
- Only one cable (flexible or rigid) can be inserted per terminal.

Quick distribution blocks



Number of poles		4P, incomers from top	4P, incomers from bottom
Rated operational current at 40 °C	(Ie)	63 A	63 A
Rated conditional short-circuit current of an assembly	(Isc)	The reinforced breaking capacity due to cascading in circuit breaker combinations is maintained. The worst-case situations have been tested.	The reinforced breaking capacity due to cascading in circuit breaker combinations is maintained. The worst-case situations have been tested.
Rated insulation voltage	(Ui)	500 V AC	500 V AC
Rated operational voltage	(Ue)	440 V AC	440 V AC
Rated impulse withstand voltage	(Uimp)	6 kV	6 kV
Rated short-time withstand current	(Icw)	-	-
Rated operational frequency		50/60 Hz	50/60 Hz
Degree of protection		IPxxB	IPxxB
Incoming terminals		1 tunnel terminal 25 ² /phase	1 tunnel terminal 25 ² /phase
Total connection capacity, outgoing terminals		24 connections: 4 x 6 ² /phase 12 x 6 ² /neutral	24 connections: 4 x 6 ² /phase 12 x 6 ² /neutral
Dimensions (H x W x D)		96.5 x 72 x 62 8 x 9 mm pitch	96.5 x 72 x 62 8 x 9 mm pitch
Installation		Clipped onto a DIN rail	Clipped onto a DIN rail
Other			
Standard for installation inside Prisma		IEC 61439-2	IEC 61439-2
Glow-wire 60695-2-11		960 °C	960 °C
Degree of pollution		3	3
References		04040	04041

Accessories

References	-	-
-------------------	---	---

Advantages

- A reliable electrical connection, no maintenance required (tightness guaranteed over time).
- Quick connection.
- Easy phase balancing.
- Ease of rewiring if the switchboard is expanded or modified.

4P		1P
		
125 A	160 A	160 A
20 kA/60 ms max according to IEC 61439-1	20 kA/60 ms max according to IEC 61439-1	32 kA
750 V AC	750 V AC	750 V AC
690 V AC	690 V AC	690 V AC
8 kV	8 kV	8 kV
4.5 kA rms/1 s	4.5 kA rms/1 s	
50/60 Hz	50/60 Hz	50/60 Hz
IPxxB	IPxxB	IPxxB
1 tunnel terminal 35 ² /phase	1 tunnel terminal 35 ² /phase	1 tunnel terminal 70 ² /phase
52 connections: 7 x 4 ² /phase 3 x 6 ² /phase 2 x 10 ² /phase 1 x 16 ² /phase (screw terminal)	52 connections: 7 x 4 ² /phase 3 x 6 ² /phase 2 x 10 ² /phase 1 x 16 ² /phase (screw terminal)	6 connections: 6 x 16 ² /phase
127 x 108 x 48 8 x 9 mm pitch	127 x 108 x 48 8 x 9 mm pitch	95 x 36 x 70 4 x 9 mm pitch
Screwed to plain or slotted backplate or onto DIN rail	Screwed to plain or slotted backplate or onto DIN rail	Onto DIN rail
Possible to combine 2 terminal blocks (2 nd terminal block supplied from enclosed terminals in the 1 st , I _{max} of 2 nd terminal block: 80 A)	Possible to combine 2 terminal blocks (2 nd terminal block supplied from enclosed terminals in the 1 st , I _{max} of 2 nd terminal block: 80 A)	
IEC 61439-2	IEC 61439-2	IEC 61439-2
960 °C	960 °C	960 °C
3	3	3
04045	04046	04031

125 A flexible connectors (4)		Copper spacer (batch of 4)
04047	-	04037

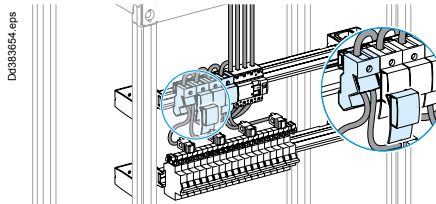
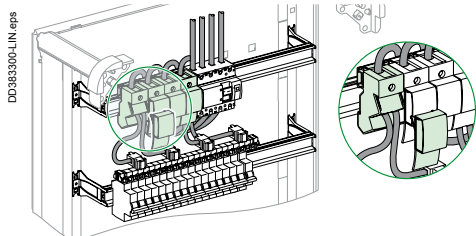
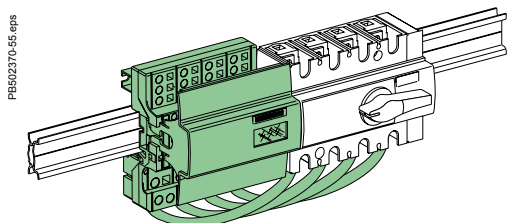

IEC 60947-7-1, IEC 61439-2



Description

- Distribution over full rows of modular devices.
- The distribution block is generally supplied by busbars in enclosures and cubicles.
- Easy phase balancing.
- Mix of devices and functions in the same row.
- Installation ≥ 160 A: clipped onto the back of a modular rail or screwed onto a solid or pre-slotted plate.

Distribution blocks

Number of poles		4P	4P
Rated peak withstand current (Ipk)		63 A	80 A
Rated conditional short-circuit current of an assembly (Isc)		15 kA	15 kA
Rated insulation voltage (Ui)		500 V AC	500 V AC
Rated operational voltage (Ue)		440 V AC	440 V AC
Rated impulse withstand voltage (Uimp)		6 kV	6 kV
Maximum current (Imax)		-	-
Rated operational frequency		50/60 Hz	
Degree of protection		IPxxB	IP20
Lenght			
In 9 mm modules		24	48
In 18 mm modules		12	24
Upstream connection capacity		Tunnel terminals for cables up to 25 mm ²	Tunnel terminals for cables up to 25 mm ²
Downstream connection capacity, cable to be used without ferrules	Max. 4 mm ²	Phase 2 Neutral 4	-
	Max. 6 mm ²	Phase 2 Neutral 4	-
	Max. 10 mm ²	Phasesw - Neutral 18	18
Accessories included	Pre-stripped copper connections Protective cover Screws and nuts	10 of 4 mm ² + 6 of 6 mm ² (L = 100 mm)	12 blue + 12 black
References		04008	04000

Installation

DD381664-LIN.eps

Clipped onto the back of a modular rail, or screw fixing





DB1241195-LIN.eps

Clipped onto the back of a modular rail, or screw fixing

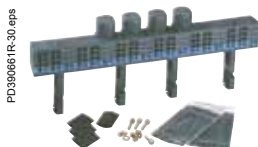
DB1241196-LIN.eps

Can be mounted in Pragma Evolution enclosures and in Prisma Pack 160



4P	2P	3P	4P	4P
				
160 A 27 kA	200 A 25 kA	200 A 25 kA	200 A 30 kA	200 A 27 kA
The cascading reinforced breaking capacity when combining circuit breakers is maintained. The worst-case scenarios have been tested.				
750 V AC	750 V AC	750 V AC	750 V AC	750 V AC
690 V AC	690 V AC	690 V AC	690 V AC	690 V AC
8 kV	8 kV	8 kV	8 kV	8 kV
50 A for feeder for 10 mm ² cable/63 A for feeder for 2 cables of 10 mm ²				
50/60 Hz				
IPxxB				
24	48			72
12	24			36
Direct on directing pads by 50 mm ² cables or by 20 x 3 flexible bar with a prefabricated connection from busbar				
-	-			
-	-			
6	12			
6	18			
20 of 4 mm ² + 6 of 6 mm ² (L = 100 mm)				
For pads (IPxxB)				
For pads				
04018	04012	04013	04014	04026

Connections to the distribution block

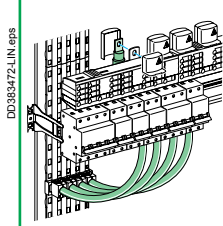
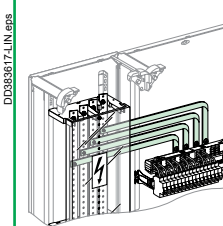
				
	4P 200 A connection (supplied with fixing accessories)	4P 200 A connection (supplied with fixing accessories)	4P 200 A connection (supplied with fixing accessories)	4P 160 A connection for Linergy FM 1/2 row
Allows power supply from	Linergy BW busbar	Linergy BS busbar	Linergy BS rear busbar	Switchgear
References	04021	04024	04029	04030

Spare parts

	
	4 covers for 160/200 A Linergy FM rows
Reference	01202

PB111254-30_1.eps



PB111253-30_1.eps



IEC/EN 60947-7-1, IEC/EN 61439-1 & 2



Description

- Single-pole or four-pole distribution block that can be installed on a standard DIN rail or on a mounting plate.
- Compatible with Prisma G and P, Pragma, Mini Pragma and Resbo series switchboards.
- Incomers and feeders are connected to screw terminals that accept rigid or flexible cables with ferrule.
- Optional: additional neutral terminal strip for four-pole distribution block.

Advantages

- Simplified power supply for main incomers.
- Easy phase balancing.
- Easy, effortless cabling due to excellent accessibility.
- Visible cabling.
- Insulation between phases.
- The single-pole distribution blocks are adjacent and bridgeable via the second incoming hole for parallel connection.

Screw distribution blocks

Number of poles	1P			4P
				
Rated operational current	125 A	160 A	250 A	100 A
Total connections capacity	10	13	14	4 x 7
Terminal capacity				
Diameter	2 x Ø 9.5 mm	2 x Ø 12 mm	1 x Ø 15.3 mm	2 x Ø 7.5 mm
	2 x Ø 7.5 mm	3 x Ø 7.5 mm	1 x Ø 10 mm	5 x Ø 5.5 mm
	6 x Ø 5.8 mm	8 x Ø 5.8 mm	4 x Ø 6 mm	-
	-	-	8 x Ø 7.5 mm	-
Rated peak withstand current (I _{pk} /60 ms)	25 kÅ	36 kÅ	60 kÅ	14 kÅ
	I _{pk} /6 ms	-	-	24 kÅ
Rated short-time withstand current (I _{cw}) (IEC/EN 60947-7-1)	4.2 kA rms/1 s	8.4 kA rms/1 s	14.4 kA rms/1 s	3 kA rms/1 s
Width (number of 9 mm pitches)	3	4	5	8
Dimension (H x W x D)	85 x 27 x 50.5	85 x 36 x 50.5	85 x 45 x 50.5	100 x 71 x 50.5
Weight (g)	125	163	239	210
Neutral terminal strip (optional)	-	-	-	LGYN1007
References	LGY112510	LGY116013	LGY125014	LGY410028

Technical data

Common characteristics

To IEC/EN 60947-7-1 and IEC/EN 61439-1 & 2

Rated insulation voltage (Ui)	500 V AC
Rated operational voltage (Ue)	230 V AC (Ph/N) 440 V AC (Ph/Ph)
Rated impulse withstand voltage (Uimp)	8 kV
Rated conditional short-circuit current of an assembly	Up to the breaking capacity of Schneider Electric feeder circuit breakers, even in cascading configuration
Network frequency	50/60 Hz
Pollution degree	3
Overvoltage category	III

Additional technical characteristics

Reference temperature	40 °C
Operating temperature	-25 °C to 55 °C
Dielectric withstand (IEC/EN 60947-1)	2500 V AC

DB408005_1.eps



On LGY412560 and LGY416048 references.
Input cabling facilitated by side terminals.

			Neutral terminal strip			
						
125 A		160 A	100 A	125 A		
4 x 12	4 x 15	4 x 12	7	12	15	
1 x Ø 9 mm	1 x Ø 9.5 mm	1 x Ø 12 mm	2 x Ø 7.5 mm	1 x Ø 9 mm	1 x Ø 9.5 mm	
7 x Ø 7.5 mm	3 x Ø 8.5 mm	3 x Ø 9 mm	5 x Ø 5.5 mm	7 x Ø 7.5 mm	3 x Ø 8.5 mm	
4 x Ø 6.5 mm	11 x Ø 6.5 mm	8 x Ø 7.5 mm	-	4 x Ø 6.5 mm	11 x Ø 6.5 mm	
-	-	-	-	-	-	
18 kA	18 kA	22 kA	-	-	-	
26 kA	28 kA	36 kA	-	-	-	
4.2 kA rms/1 s	4.2 kA rms/1 s	8.4 kA rms/1 s	-	-	-	
14	20	18	7	14	17	
100 x 126 x 50.5	100 x 162 x 50.5	100 x 174 x 50.5	20 x 70 x 35	20 x 125 x 35	20 x 155 x 35	
390	559	567	63	111	149	
LGYN12512	LGYN12515	LGYN12512	-	-	-	
LGY412548	LGY412560	LGY416048	LGYN1007	LGYN12512	LGYN12515	

Terminal technical data

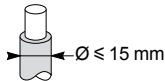
Type	PZ2 screw							
Diameter	Ø 5.5 mm	Ø 5.8 mm	Ø 6 mm	Ø 6.5 mm	Ø 7.5 mm	Ø 8.5 mm	Ø 9 mm	Ø 9.5 mm
Section rigid cable	1.5 to 16 mm ²	1.5 to 16 mm ²	1.5 to 16 mm ²	1.5 to 16 mm ²	2.5 to 25 mm ²	6 to 35 mm ²	10 to 35 mm ²	10 to 35 mm ²
Section flexible cable or with ferrule	1.5 to 10 mm ²	1.5 to 10 mm ²	1.5 to 10 mm ²	1.5 to 10 mm ²	1.5 to 16 mm ²	4 to 25 mm ²	4 to 25 mm ²	6 to 35 mm ²
Tightening torque	2 N.m	2 N.m	2 N.m	2 N.m	2 N.m	2 N.m	2.5 N.m	2.5 N.m
Type	Hc screw							
Diameter	Ø 9.5 mm	Ø 10 mm	Ø 12 mm		Ø 15.3 mm			
Section rigid cable	10 to 35 mm ²	1.5 to 50 mm ²	25 to 70 mm ²		35 to 120 mm ²			
								
Section flexible cable or with ferrule	6 to 35 mm ²	1.5 to 35 mm ²	16 to 50 mm ²		25 to 95 mm ²			
Tightening torque	8 N.m	4 N.m	1P: 9 N.m	4P: 5 N.m	14 N.m			

Dimensions (mm)

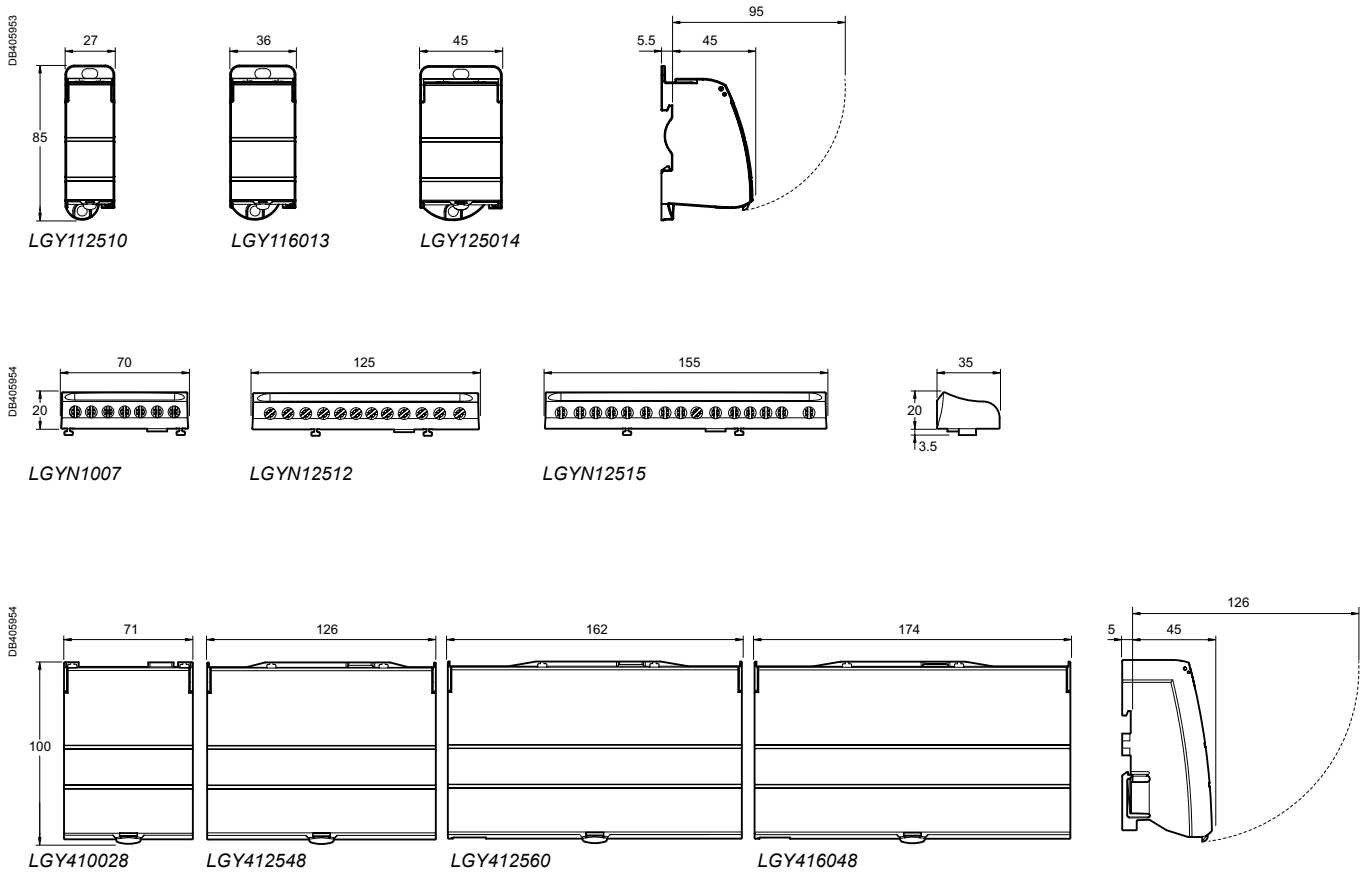



Country approval pictograms

IEC/EN 61131-2

Acti 9 Smartlink Modbus Slave and Acti 9 Smartlink Ethernet are used to transfer data from Acti 9 devices to a PLC or monitoring system via the communication system:

- Modbus serial line for Acti 9 Smartlink Modbus Slave
- Modbus Ethernet TCP/IP or http for Acti 9 Smartlink Ethernet.

Functions

Data transmission between the network and Acti 9 devices

- Circuit breakers, residual current circuit breakers, residual current devices:
 - open/closed state
 - tripped state
 - number of opening/closing cycles
 - number of tripping actions.
- Contactors, impulse relays:
 - opening control
 - closing control
 - open/closed state
 - number of opening/closing cycles
 - total period of operation of the load (device closed).
- Remote controlled circuit breaker/Reflex iC60:
 - opening control
 - closing control
 - open/closed state
 - tripped state
 - number of opening/closing cycles
 - total period of operation of the load.
- Power meters:
 - number of pulses recorded
 - pulse value setting (e.g. kWh)
 - total consumption recorded
 - estimate of power consumption.
- Analog sensors only for Acti 9 Smartlink Ethernet:
 - temperature sensor
 - humidity sensor,
 - CO₂ detector,
 - optical detector
 - ...

All the data are stored in memory: number of cycles, consumption, period of operation, even in the event of a power failure.

Acti 9 Smartlink can also exchange data with any device having 24 V DC digital inputs/outputs.

No configuration of the connected products is required.

When Acti 9 Smartlink is switched on, communication automatically adjusts to the Modbus Master or Ethernet (PLC, control station) communication parameters.

Installation

- Mounting in switchboards:
 - width 24 modules per row
 - minimum spacing between rails 150 mm.
- Mounting on
 - DIN rail, with mounting kit **A9XMFA04**
 - Linergy FM 80 A, with locking clips supplied
 - Linergy FM 200 A, with mounting kit **A9XM2B04**.

Test

- The communication and cabling test for the connected devices can be performed using Acti 9 Smart Test software

PB107197-47



DE404802



Acti 9 Smart Test software

- Electrical continuity test
- Functional testing of the devices
- Report printing
- Printing of a simplified diagram
- Project archiving
- Compatible with Windows XP, Windows 7, Windows 8
- To be download on: Schneider Electric web sites:
 - schneider-electric.com or
 - schneider-electric country web site



DE405140

DE406513





Acti 9 Smartlink Modbus Slave



Acti 9 Smartlink Ethernet

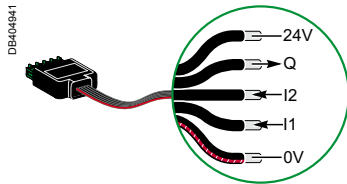

A9XCAU06



PB107804-43

Catalogue numbers

Acti 9 Smartlink			
Type		Set of	
Acti 9 Smartlink Modbus Slave		1	A9XMSB11
Supplied with	Modbus connector	1	
	24 V DC power supply connector	1	
	Locking clips for mounting on Linergy FM 80	2	
Acti 9 Smartlink Ethernet		1	A9XMEA08
Supplied with	Connector for 4-point analog output	1	
	Modbus connector	1	
	24 V DC power supply connector	1	
	Locking clips for mounting on Linergy FM 80	2	
Accessories			
USB cable link / Modbus for Acti 9 Smartlink test		1	A9XCATM1
Prefabricated cables			
With 2 connectors	100 mm	6	A9XCAS06
	160 mm	6	A9XCAM06
	450 mm	6	A9XCAH06
	870 mm	6	A9XCAL06
With 1 connector	870 mm	6	A9XCAU06
	4000 mm	1	A9XCAC01
Connectors	5-pin connectors (Ti24)	12	A9XC2412
Mounting kit	DIN rail (4 feet, 4 straps, 4 adapters)	1	A9XMFA04
	Linergy FM 200 A (4 adapters)	1	A9XM2B04
	Back panel (2 angle brackets)	1	A9XMBP02
Spare parts	Lock for Linergy FM 80 A (2 clips)	1	A9XMLA02

Connectable devices

With Ti24 interface		
Type	Reference	Description
iACT24	A9C15924	Low-level control and indication auxiliary for iCT contactors
iATL24	A9C15424	Low-level control and indication auxiliary for iTL impulse relays
iOF+SD24	A9A26897	Low-level indication auxiliary for iC60, iD, ARA, RCA, iSW-NA
OF+SD24	A9N26899	Low-level indication auxiliary for C60, C120, DPN, RCCB/iD, C60H-DC
RCA	See module CA904011	Remote control with Ti24 interface
Reflex iC60	See module CA904012	Reflex iC60 with Ti24 interface
Without Ti24 interface		
Power meters with pulse output, e.g. IEM2000T		
Impulse meters complying with the IEC 62053-21 standard		
24 V DC indicator lamps, Harmony XVL range		
All loads not exceeding 100 mA, 24 V DC		
Light sensitive switches: example IC2000		
Timers, thermostats, time switches, load shedding devices		
All 24 V DC auxiliary contacts, IEC 61131-2 type 1		
With analog outputs		
Temperature and humidity sensors, with a 0-10 V or 4-20 mA output		
CO ₂ and optical detectors, with a 0-10 V or 4-20 mA output		

Example of an installation

DB406505

Ethernet link
 ■ 10/100 MB Ethernet, Modbus TCP server

DB406544

1 analog input channel
 ■ Example: temperature sensor connection

DB406506

Modbus Communication
 ■ Up to 8 Acti 9 Smartlink Modbus Slave or others slaves Modbus connected

DB406508

Prefabricated cables
 ■ Simplified cabling
 ■ Fast and safe

DB406507

Connection to the Ethernet network

Acti 9 Smartlink Ethernet has an embedded web server that can be used to configure the connection to the Ethernet network

DB406473

Measurement Status	
Alarm & Sub-alarm	
Current Phase 1	95 A
Current Phase 2	97 A
Current Phase 3	95 A
Voltage	
Voltage Phase 1	230 V
Voltage Phase 2	230 V
Voltage Phase 3	230 V
Total energy consumption	300 A

■ Web Page available, to configure Acti 9 Smartlink Ethernet communication Ethernet parameter, to visualize or control data

Acti 9 Smartlink Ethernet

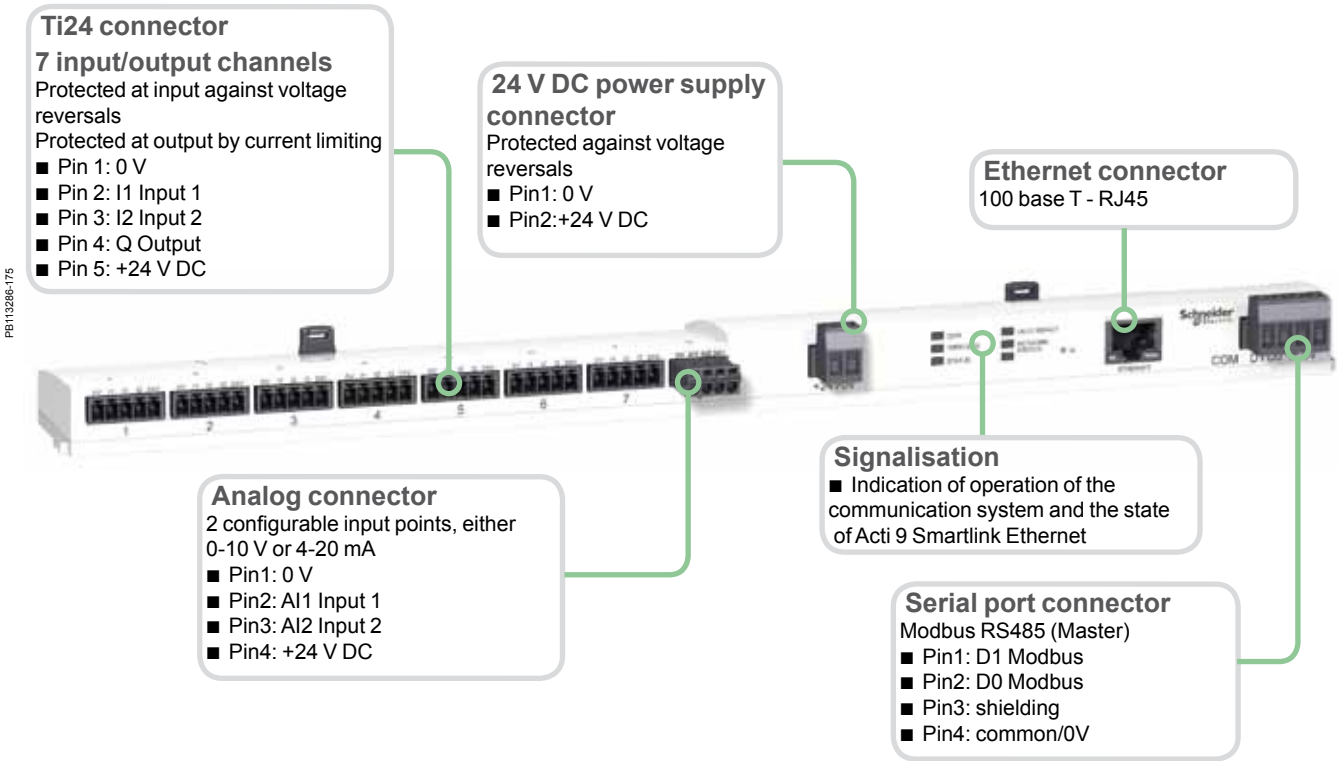

Acti 9 Smartlink Modbus Slave

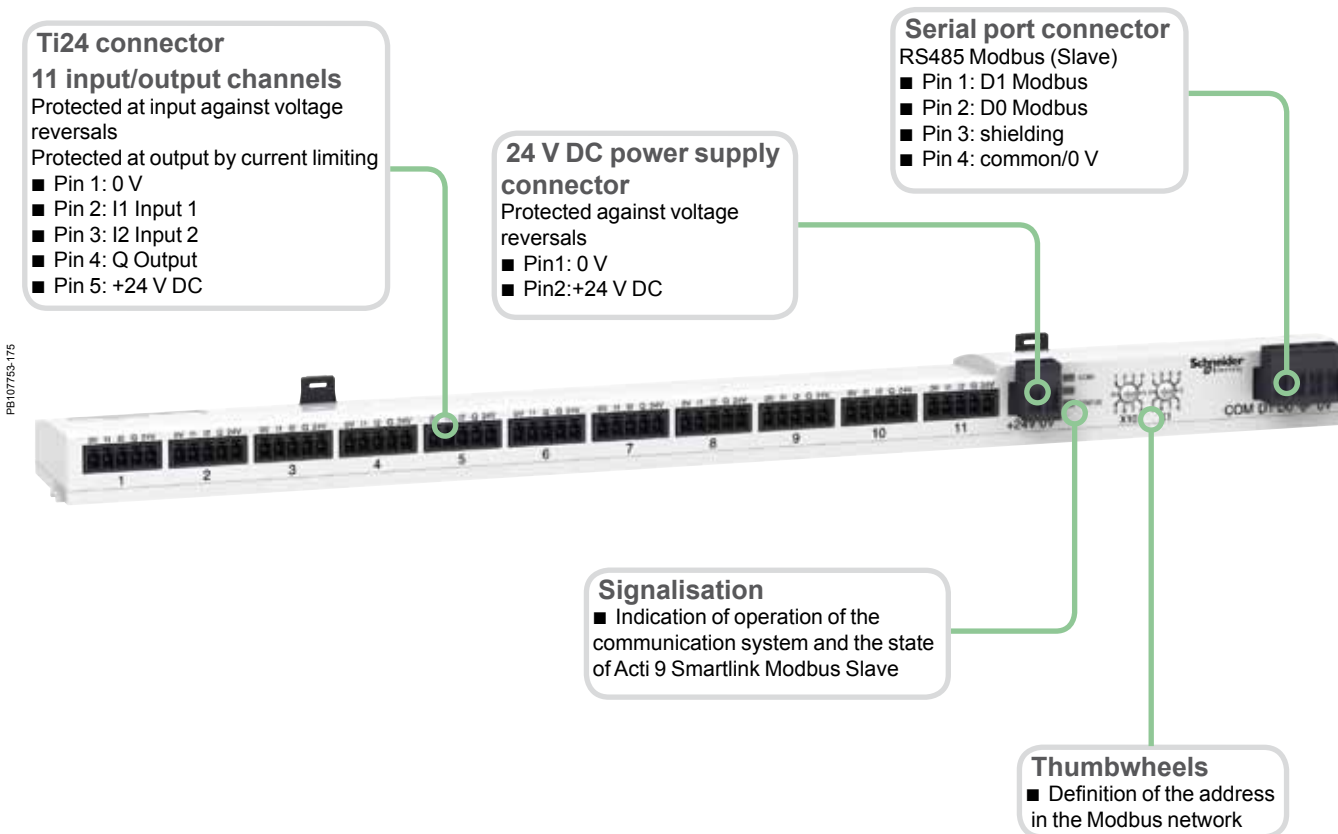

Common technical characteristics

Power supply		
Rated		24 V DC \pm 20 %
Maximum input current		1.5 A
Maximum inrush current		3 A
Meter		
Capacity		2 ³² pulses per input
Input characteristics		
Number of channels	Acti 9 Smartlink Modbus Slave	11 of 2-input channels
	Acti 9 Smartlink Ethernet	7 of 2-input channels
Type of input		Current collector Type 1 IEC 61131-2
Maximum cable length		500 m
Rated voltage		24 V DC
Voltage limits		24 V DC \pm 20 %
Rated current		2.5 mA
Maximum current		5 mA
Filtering time	In state 1	2 ms
	In state 0	2 ms
Isolation		No isolation between channels
Negative sequence voltage protection		Yes
Output characteristics		
Number of output channels	Acti 9 Smartlink Modbus Slave	11
	Acti 9 Smartlink Ethernet	7
Type of output		24 V DC 0.1 A current source
Maximum cable length		500 m
Rated voltage	Voltage	24 V DC
	Maximum current	100 mA
Filtering time	In state 1	2 ms
	In state 0	2 ms
Voltage drop (voltage in state 1)		1 V max
Maximum inrush current		500 mA
Leakage current		0.1 mA
Overvoltage protection		33 V DC
Environmental characteristics		
Temperature	Operating	-25°C ... +60°C (if vertical mounting, limited to 50°C)
	Storage	-40°C...+80°C
Tropicalization		Treatment 2 (relative humidity of 93% at 40°C)
Resistance to voltage dips		10 ms, class 3 as per IEC 61000-4-29
Degree of protection		IP20
Pollution degree		3
Altitude	Operating	0 ... 2000 m
Vibration resistance	As per IEC 60068.2.6	1 g / \pm 3.5 mm - 5 Hz to 300 Hz - 10 cycles
Shock resistance	As per IEC 60068.2.2 7	15 g / 11 ms
Immunity to electrostatic discharge	As per IEC 61000-4-2	Air: 8 kV Contact: 4 kV
Immunity to radiated magnetic fields	As per IEC 61000-4-3	10 V/m - 80 MHz to 3 GHz
Immunity to fast transients	As per IEC 61000-4-4	1 kV for inputs/outputs and Modbus communication. 2 kV for 24 DC power supply - 5 kHz - 100 kHz
Immunity to conducted magnetic fields	As per IEC 61000-4-6	10 V from 150 kHz to 80 MHz
Immunity to magnetic fields at mains frequency	As per IEC 61000-4-8	30 A/m
Resistance to corrosive atmospheres	As per IEC 60721-3-3	Level 3C2 on H ₂ S / SO ₂ / NO ₂ / Cl ₂
Fire resistance	For live parts	At 960°C 30 s / 30 s as per IEC 60 695-2-10 and IEC 60 695-2-11
	For other parts	At 650°C 30 s / 30 s as per IEC 60 695-2-10 and IEC 60 695-2-11
Salt spray test	As per IEC 60068.2.52	Severity 2
Environment		In compliance with the RoHS directive
Additional characteristics		
Duration of saving memory		10 years
Prefabricated cables characteristics		
Dielectric resistance		1 kV / 5 min
Minimum draw-out resistance		20 N

Acti 9 Smartlink Modbus Slave technical characteristics

Characteristics of the Modbus link		
Link	Modbus, RTU, RS485 serial connection	
Transmission	Transfer rate	9600 baud ... 19200 baud, self-adaptable
	Medium	Shielded cable, double twisted pair
Protocol	Master/Slave	
Type of device	Slave	
Modbus addressing range	1 to 99	
Maximum length of the bus	1000 m	
Type of bus connector	4-pin connector	

Acti 9 Smartlink Ethernet technical characteristics

Characteristics of the Ethernet link		
Link	10/100 MB Ethernet	
Protocol	Modbus TCP server http (Web pages)	
Address mode	Static and dynamic (supplied, by default, in dynamic mode)	
Characteristics of Gateway		
Protocol	Modbus TCP/IP -> Modbus SL	
Modbus slave number	8	
Modbus addressing range	1 to 247	
Characteristics of the Modbus Master link		
Link	Modbus serial connection, RTU, RS485	
Transmission	Transfer rate	9600 baud ... 19200 baud, self-adaptable
	Support	Shielded cable, double twisted pair
Maximum length of the bus	1000 m	
Type of bus connector	4-pin connector	
Characteristics of the analog inputs		
Number	2	
Type	Separate configuration for each input, either 0-10 V or 4-20 mA	
Measuring accuracy	1/100 full scale	
Resolution	12 bits	
Acquisition time	500 ms	
Isolation	No isolation between channels	
Power supply	0-24 V DC	
Type of cable	Shielded cable, double twisted pair	
Maximum cable length	30 m	
Protection	Short-circuit protection	

Dimensions (mm)

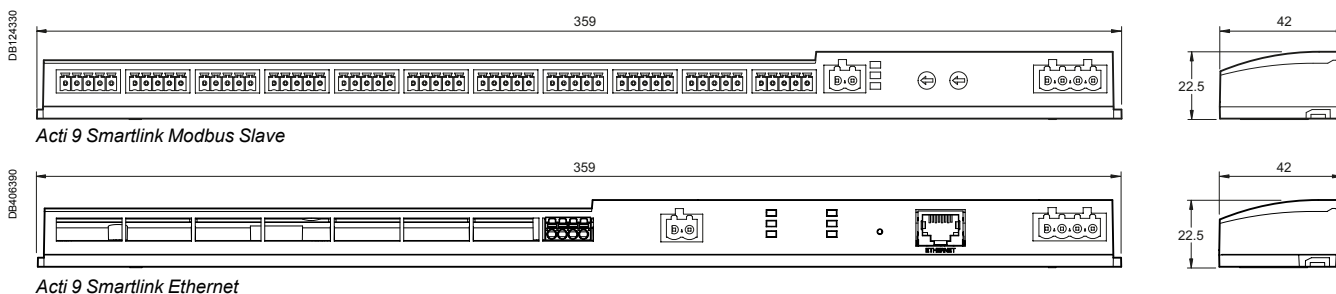

Weight (g)

Acti 9 Smartlink	
Type	
Acti 9 Smartlink Modbus Slave	195
Acti 9 Smartlink Ethernet	180

Connection

	Terminal	Tightening torque	Copper cables		
			Rigid	Flexible	Flexible with ferrule
<p>DB123560</p> <p>Connector cat. no: A9XC2412</p>	Ti24 interface	Spring loaded terminal	DB123545	DB123553	DB123554
<p>DB408517</p>	Analog connector	0.8 N.m	0.1 to 1.5 mm ²	0.1 to 1.5 mm ²	0.1 to 1.5 mm ²
<p>DB124331</p>	Power supply connector	0.8 N.m	0.2 to 1.5 mm ²	0.2 to 1.5 mm ²	0.2 to 1.5 mm ²
<p>DB405141</p>	Modbus connector	0.8 N.m	0.25 mm ²	0.25 mm ²	0.25 mm ²
<p>DB405142</p>					



- The electrical auxiliaries are combined with iC60 circuit breakers, iID residual current circuit breakers, remote tripping switch disconnectors iSW-NA; they enable tripping or remote indication of their position (open/closed/tripped) upon a fault.
- They are fastened by clips (without tools) to the left side of the breaker.
- The iOF/SD+OF auxiliary is a 2-in-1 product: via a mechanical selector switch, it provides two contacts, OF+SD or OF+OF.
- The iOF+SD24 auxiliary can report open/closed (OF) status information and intentional or fault tripping of the associated device (SD) to the Acti 9 Smartlink or a programmable logic controller via the Ti24 interface (24 V DC).

Tripping auxiliaries:

IEC/EN 60947-1

- iMN: undervoltage release
- iMNs: delayed undervoltage release
- iMNx: undervoltage release, independent from supply voltage
- iMX: shunt release
- iMX+OF: shunt release with open/close contact.

EN 50550

- iMSU: overvoltage release.

Indication auxiliaries:

IEC/EN 60947-5-1

- iOF: open/close contact
- iSD: fault indicating contact
- iOF/SD+OF: open/close contact and switchable OF or SD contact
- iOF+SD24: open/close contact OF and default indicating contact SD with Ti24 interface.

IEC/EN 60947-5-4



- iOF+SD24: open/close contact OF and default indicating contact SD with Ti24 interface.

DB404939



DB404940

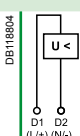
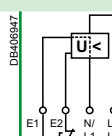

		Tripping							
Auxiliaries		iMN				iMNs		iMNx	
Type		Undervoltage release							
		Instantaneous				Delayed		Independent of the supply voltage	
									
Function		<ul style="list-style-type: none"> Trips the device with which it is combined when its input voltage decreases (between 70 % and 35 % U_n). Prevents device closing again until its input voltage is restored 				<ul style="list-style-type: none"> Not tripping on transient voltage dip (up to 0.2 s) 		<ul style="list-style-type: none"> Tripping of the associated device by opening of the control circuit (e.g. push-button, dry contact) A drop in the supply voltage does not trip the associated device A locking push-button control allows the circuit protected (e.g. machine control) to be placed in safety configuration 	
Wiring diagrams									
Use		<ul style="list-style-type: none"> Emergency stoppage by normally closed push button Ensures the safety of power supply circuits for several machines by preventing "uncontrolled" restarting 				<ul style="list-style-type: none"> Emergency stoppage with fail-safe principle Insensitive to control circuit voltage variation to increase service continuity Important: Before any servicing operation switch off the mains power supply (voltage presence at terminals E1/E2) 			
Catalogue numbers		A9A26960	A9A27108	A9A26961	A9A26959	A9A26963	A9A26969	A9A26971	
iC60, iID, iDPN Vigi, iSW-NA		■	■	■	■	■	■	■	
iC60, iID double terminals		■	■	■	■	■	■	■	
Technical specifications									
Rated voltage (Ue)	V AC	220...240	24	48	115	220...240	220...240	380...415	
	V DC	–	24	48	–	–	–	–	
Standardised operating and non-response to voltage times (Ua)*		–	–	–	–	–	–	–	
Maximum operating time		–	–	–	–	–	–	–	
Minimum non-response time		–	–	–	–	–	–	–	
Operating frequency	Hz	50/60	–	–	400	50/60	50/60	–	
Red mechanical indicator		On front face				On front face		On front face	
Test function		–				–		–	
Width in 9 mm modules		2				2		2	
Operating current		–				–		–	
Number of contacts		–				–		–	
Operating temperature	°C	-35...+70				-35...+70		-35...+70	
Storage temperature	°C	-40...+85				-40...+85		-40...+85	

*(Ua)
Voltages measured between the phase and the neutral conductor, at which the iMSU device must control the associated protective device.

Electrical auxiliaries for iC60, iID, iDPN Vigi, iSW-NA (cont.)

iMSU		iMX		iMX+OF	
Overvoltage release		Shunt release		With Open/Close auxiliary contact	
					

■ Switches off the power supply by opening the breaker with which it is combined, in the event that the phase/neutral voltage is exceeded (loss of neutral). For a four-phase network, use three iMSU tripping auxiliaries

■ Trips the breaker when powered

■ Includes an open/close contact (OF) to indicate the "open" or "closed" position of the breaker

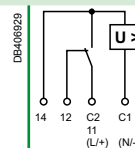
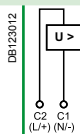
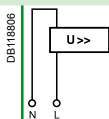

■ Protection of equipment against overvoltages on the electrical network (neutral conductor break)
■ Voltage monitoring between phase and neutral conductors

■ Emergency stoppage by normally open push button

■ Emergency stoppage by normally open push button
■ Remote indication of the position of the associated breaker

A9A26500

A9A26476

A9A26477

A9A26478

A9A26946





A9A26947

A9A26948

■	■	■	■	■	■	■
■	■	■	■	■	■	■

230	100...415	48	12...24	100...415	48	12...24
-	110...130	48	12...24	110...130	48	12...24
255 V AC	275 V AC	300 V AC	350 V AC	400 V AC	-	-
No tripping	15 s	5 s	0.75 s	0.20 s	-	-
	3 s	1 s	0.25 s	0.07 s	-	-
50/60	50/60				50/60	
On front face	On front face				On front face	
-	-				-	
2	2				2	
-	-				10 mA mini, 6 A maxi	
					≤ 24 V DC	6 A
					48 V DC	2 A
					≤ 130 V DC	1 A
					≤ 240 V AC	6 A
					415 V AC	3 A
-	-				1 NO/NC	
-35...+70	-35...+70				-35...+70	
-40...+85	-40...+85				-40...+85	

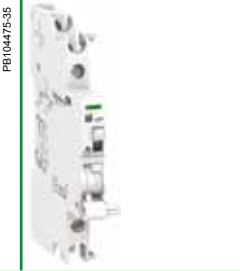
Electrical auxiliaries for iC60, iID, iDPN Vigi, iSW-NA (cont.)

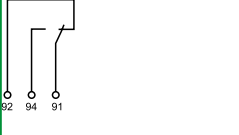
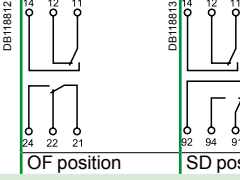
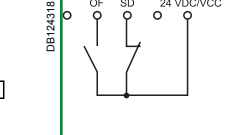
		Indication						
Auxiliaries		iOF	iSD	iOF/SD+OF	iOF+SD24			
Type		Open/close auxiliary contact	Fault indicating contact	Double open/close or fault indicating contact	Double open/close and fault indicating contact			
		 <p>PB104474-35</p>	 <p>PB104476-35</p>	 <p>PB104475-35</p>	 <p>PB107750-35</p> <p>ComReady</p>			
Function		<ul style="list-style-type: none"> Changeover contact indicates "open" or "closed" position of the breaker 	<ul style="list-style-type: none"> Changeover contact indicates position of the breaker; upon: <ul style="list-style-type: none"> electrical fault action on tripping auxiliary Same indication as VISI-TRIP 	<ul style="list-style-type: none"> The iOF/SD+OF auxiliary is a 2-in-1 product: via a mechanical selector switch, it provides two contacts, OF+SD or OF+OF 	<ul style="list-style-type: none"> 2 contacts (1 NO + 1 NC) can report the signalling information of the associated device to the Acti 9 Smartlink or a programmable logic controller: <ul style="list-style-type: none"> electrical fault actuation of the tripping auxiliary "Open" or "Closed" position of the associated device 			
Wiring diagrams		 <p>DB11881/0</p>	 <p>DB11881/1</p>	 <p>DB11881/2 (OF position) DB11881/3 (SD position)</p>	 <p>DB1249/6</p>			
Use		<ul style="list-style-type: none"> Remote indication of the position of the associated breaker 	<ul style="list-style-type: none"> Remote indication of tripping upon a fault of the associated breaker 	<ul style="list-style-type: none"> Remote indication of position and/or tripping upon a fault of the associated breaker 	<ul style="list-style-type: none"> Remote indication of position and tripping upon a fault of the associated breaker 			
Catalogue numbers		A9A26924	A9A26869	A9A26927	A9A26855	A9A26929	A9A26897	
iC60, iID, iDPN Vigi, iSW-NA		■	—	■	—	■	■	
iC60, iID double terminals		—	■	—	■	—	■	
Technical specifications		24...415		24...415		24...415		
Rated voltage (Ue)	V AC	24...415		24...415		24...415		
	V DC	24...130		24...130		24...130		
Operating frequency	Hz	50/60		50/60		50/60		
		—		—		—		
Red mechanical indicator		—		On front face		On front face		
Test function		On toggle		On toggle		On toggle		
Width in 9 mm modules		1		1		1		
Operating current	10 mA mini, 6 A maxi						2 mA mini, 100 mA maxi	
		24 V DC	6 A					
		48 V DC	2 A					
		60 V DC	1.5 A					
		130 V DC	1 A					
		24...240 V AC	6 A					
	415 V AC	3 A						
Number of contacts		1 NO/NC		1 NO/NC		1 NO/NC + 1 NO/NC		
Operating temperature	°C	-35...+70		-35...+70		-35...+70		
		—		—		—		
Storage temperature	°C	-40...+85		-40...+85		-40...+85		
		—		—		—		

Connection

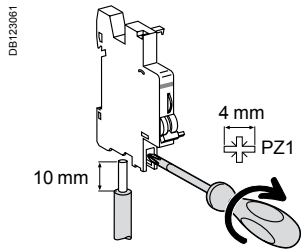

Type	Tightening torque	Copper cables		Multi-cables	
		Rigid	Flexible	Rigid	Cables with ferrule
Indication auxiliaries	1 N.m	1 to 4 mm ²	0.5 to 2.5 mm ²	2 x 2.5 mm ²	2 x 1.5 mm ²
Tripping auxiliaries	1 N.m	1 to 6 mm ²	0.5 to 4 mm ²	2 x 2.5 mm ²	2 x 2.5 mm ²

Ti24 connector connection

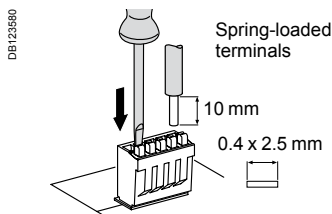

Type	Catalogue numbers	Copper cables	
		Rigid	Flexible
Ti24 interface	A9XC2412	1 x 0,5 à 1,5 mm ²	1 x 0,5 à 1,5 mm ²

Ti24 prefabricated cables connection

Type	Catalogue numbers	Length
Connection for Acti 9 Smartlink		
6 prefabricated	A9XCAS06	100 mm
	A9XCAM06	160 mm
	A9XCAH06	450 mm
	A9XCAL06	870 mm
Connection for PLC type terminals		
6 long prefabricated on a single side	A9XCAU06	870 mm
1 long prefabricated on a single side	A9XCAC01	4000 mm
12 connectors, 5-pins (Ti24)	A9XC2412	-

Technical data

Weight (g)

Electrical auxiliaries	
Type	
iMN	69
iMNs	72
iMNx	79
iMSU	68
iMX	64
iMX+OF	68
iOF	32
iSD	33
iOF/SD+OF	43
iOF+SD24	25

Dimensions (mm)

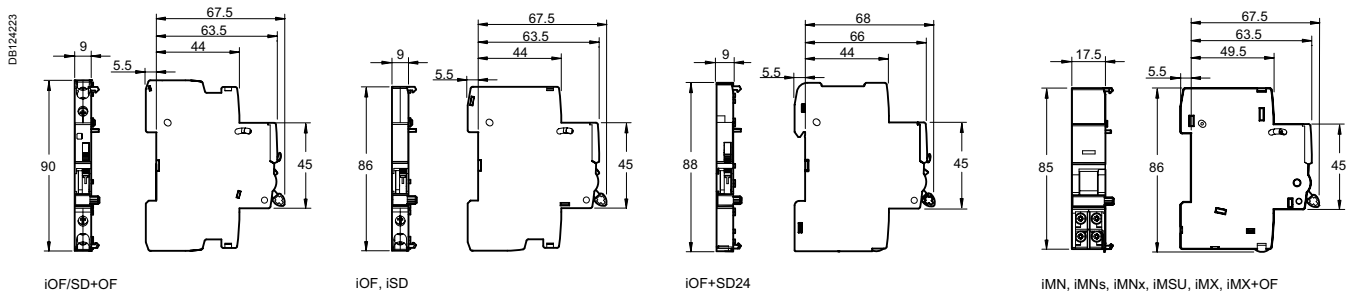

iMDU electrical auxiliary for Reflex iC60

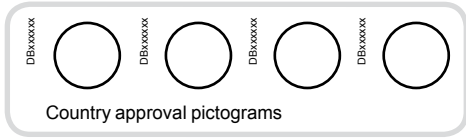

A9C18195

The voltage matching module allows safety voltages of 24 and 48 V AC/DC to be used on the control inputs.

- Only connects to the Reflex iC60 circuit breakers remote controlled by a 220-240 V control voltage
- Galvanic isolation 6000 V
- Maximum combined power between terminals P and Y1/Y2: 100 mA at 230 V and 25°C.

Catalogue numbers

Electrical auxiliary for Reflex iC60		
Type		Width in 9 mm modules
iMDU	A9C18195	1

Diagram

An iMDU electrical auxiliary allows up to a maximum of five Reflex iC60 to be controlled simultaneously at the same input Y1 or Y2.

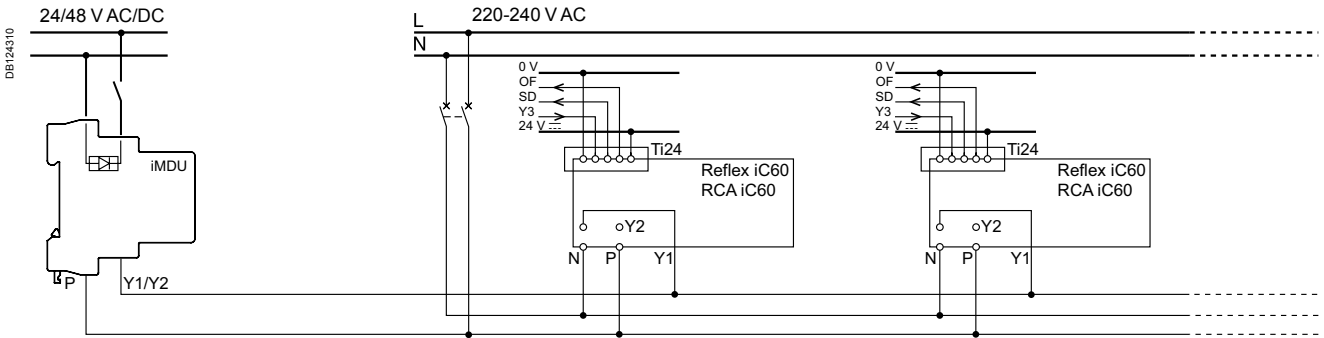

Dimensions (mm)

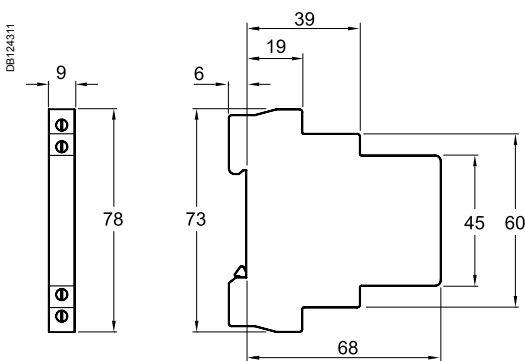

Connection

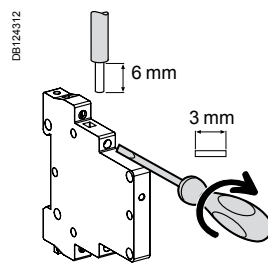

Type	Tightening torque	Copper cables	
		Rigid	Flexible or with ferrule
iMDU	1 N.m	1.5 mm ²	1.5 mm ²

Technical data

Main characteristics		
Control circuit voltage	24...48 V AC/DC	
Insulation voltage (Ui)	500 V	
Additional characteristics		
Degree of protection (IEC 60529)	Device only	IP20
	Device in modular enclosure	IP40 Insulation class II
Operating temperature	-20°C to +60°C	
Storage temperature	-40°C to +80°C	
Tropicalisation	Treatment 2 (relative humidity 95 % at 55°C)	
Weight	53 g	



- The electrical auxiliaries provide the remote tripping or position (open/closed/tripped) indication functions of these devices in the event of a fault.
- They clip on (no tool required) to the left-hand side of the associated device.
- The OF+SD/OF auxiliary is a two-in-one product: a mechanical selector switch is used to select one of two contacts: OF+SD or OF+OF.
- The OF+SD24 auxiliary can report open/closed (OF) status information and intentional or fault tripping of the associated device (SD) to the Acti 9 Smartlink or a programmable logic controller via the Ti24 interface (24 V DC).



- The electrical auxiliaries are not compatible with ID residual current circuit breakers of type B.

Tripping auxiliaries:

IEC/EN 60947-1

- MN: undervoltage release
- MN $\overline{\text{I}}$: delayed undervoltage release
- MNx: undervoltage release, independent of the supply voltage
- MX: shunt release
- MX+OF: shunt release with open/closed contact.

EN 50550

- MSU: overvoltage release.

Indication auxiliaries:



IEC/EN 60947-5-1

- OF.S: open/closed contact for ID
- OF: open/closed contact
- SD: fault indicating contact
- OF+SD/OF: choice of open/closed contact and OF or SD contact via the selector switch
- OF+SD24: open/close contact OF and cfault indicating contact SD with Ti24 interface.

IEC/EN 60947-5-4

- OF+SD24: open/close contact OF and cfault indicating contact SD with Ti24 interface.

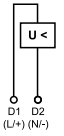
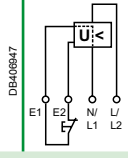

Electrical auxiliaries for C60, C120, DPN, DPN Vigi, ID, C60H-DC, SW60-DC, C60PV-DC, C60NA-DC, C120NA-DC

		Tripping					
Auxiliaries		MN		MN [□]		MNx	
Type		Undervoltage release					
		Instantaneous		Delayed		Independent of the supply voltage	
PE107151-30				PE107152-30			
PE107149-30							
Function		<ul style="list-style-type: none"> Causes the device with which it is associated to trip when its input voltage decreases (between 70 % and 35 % of U_n). Prevents the device from closing until its input voltage has been restored 				<ul style="list-style-type: none"> Tripping of the associated device by opening of the control circuit (e.g. push-button, dry contact) 	
		<ul style="list-style-type: none"> No tripping in the event of transient voltage dips (up to 0.2 s) 				<ul style="list-style-type: none"> A drop in the supply voltage does not trip the associated device A locking push-button control allows the circuit protected (e.g. machine control) to be placed in safety configuration 	
Wiring diagrams							
Utilization		<ul style="list-style-type: none"> Emergency stop via a normally-closed pushbutton Ensures the safety of the power supply circuits of several machines by preventing accidental startups 				<ul style="list-style-type: none"> Fail-safe emergency stop Insensitive to the variation in the control circuit voltage to improve continuity of service Important: Before any servicing operation switch off the mains power supply (voltage presence at terminals E1/E2) 	
Catalogue numbers		A9N26960	A9N26961	A9N26959	A9N26963	A9N26969	A9N26971
C60, C120, DPN, DPN Vigi, ID		■	■	■	■	■	■
C60H-DC, SW60-DC, C60PV-DC, C60NA-DC, C120NA-DC		■	■	■	■	■	■
Technical specifications							
Rated voltage (U _e)	V AC	220...240	48	115	220...240	230	400
	V DC	–	48	–	–	–	–
Standardised operating and non-response to voltage times (U _a)*		–	–	–	–	–	–
Maximum operating time		–	–	–	–	–	–
Minimum non-response time		–	–	–	–	–	–
Operating frequency	Hz	50/60		400	50/60	50/60	
		On front face			On front face	On front face	
Mechanical state indicator light, red		On front face			On front face	On front face	
Test function		–			–	–	
Width in 9 mm modules		2			2	2	
Operating current		–			–	–	
Number of contacts		–			–	–	
Operating temperature	°C	-25...+50			-25...+50	-25...+50	
	°C	-40...+85			-40...+85	-40...+85	
Storage temperature		-40...+85			-40...+85	-40...+85	
Standards							
IEC/EN 60947-1		■			■	■	
IEC/EN 60947-5-1		–			–	–	
EN 60947-2		■			■	■	
EN 62019-2 ⁽¹⁾		–			–	–	

(1) For C120, DPN.

*(U_a): Voltages measured between the phase and the neutral conductor, at which the MSU device must control the associated protective device.

Electrical auxiliaries for C60, C120, DPN, DPN Vigi, ID, C60H-DC, SW60-DC, C60PV-DC, C60NA-DC, C120NA-DC

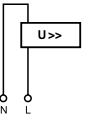
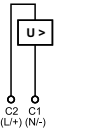
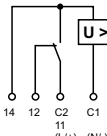
MSU					MX			MX+OF		
Voltage threshold release					Shunt release			With Open/Close auxiliary contact		
										
<ul style="list-style-type: none"> Cuts off the power supply by opening the device with which it is associated when the phase/neutral voltage is exceeded (loss of neutral). For a four-phase network, use three MSU tripping auxiliaries 					<ul style="list-style-type: none"> Trips the associated device when it is powered on 			<ul style="list-style-type: none"> Includes an open/close contact (OF) to indicate the "open" or "closed" position of the breaker 		
										
<ul style="list-style-type: none"> Protection of the devices against overvoltages on the electrical network (break in the neutral conductor) Monitoring the voltage between the phase conductor and the neutral conductor 					<ul style="list-style-type: none"> Emergency stop via a normally-open pushbutton. 			<ul style="list-style-type: none"> Emergency stop via a normally-open pushbutton Remote indication of the position of the associated device 		
A9N26500					A9N26476	A9N26477	A9N26478	A9N26946	A9N26947	A9N26948
■					■	■	■	■	■	■
-					■	■	■	■	■	■
230					100...415	48	12...24	100...415	48	12...24
-					110...130	48	12...24	110...130	48	12...24
255 V AC					275 V AC	300 V AC	350 V AC	400 V AC		
No tripping					15 s	5 s	0.75 s	0.20 s		
					3 s	1 s	0.25 s	0.07 s		
50/60					50/60			50/60		
On front face					On front face			On front face		
-					-			-		
2					2			2		
-					-			10 mA mini, 6 A maxi		
								≤ 24 V DC	6 A	
								48 V DC	2 A	
								≤ 130 V DC	1 A	
								≤ 240 V AC	6 A	
								415 V AC	3 A	
-					-			1 NO/NC		
-25...+50					-25...+50			-25...+50		
-40...+85					-40...+85			-40...+85		
■					■			■		
-					-			-		
-					-			-		
-					-			-		

Electrical auxiliaries for C60, C120, DPN, DPN Vigi, ID, C60H-DC, SW60-DC, C60PV-DC, C60NA-DC, C120NA-DC

		Indication				
Auxiliaries		OF.S	OF	SD	OF+SD/OF	OF+SD24
Type		Open/closed auxiliary contact	Open/closed auxiliary contact	Fault indicating contact	Double open/closed or fault indicating contact	Double open/close and fault indicating contact
Function		<ul style="list-style-type: none"> Changeover contact indicating the "open" or "closed" position of the associated device <p>⚠ Compulsory for the addition of tripping or indication auxiliaries on a residual current circuit breaker ID</p>	<ul style="list-style-type: none"> Changeover contact indicating the "open" or "closed" position of the associated device 	<ul style="list-style-type: none"> Changeover contact indicating the position of the associated device in the event of: <ul style="list-style-type: none"> electrical fault action on the tripping auxiliary <p>⚠ Not compatible with a ID residual current circuit breaker, use an OF+SD/OF in the SD position</p>	<ul style="list-style-type: none"> The OF+SD/OF auxiliary is a two-in-one product: choice of OF + SD or OF + OF contact via the selector switch 	<ul style="list-style-type: none"> 2 contacts (1 NO + 1 NC) can report the signalling information of the associated device to the Acti 9 Smartlink or a programmable logic controller: <ul style="list-style-type: none"> electrical fault actuation of the tripping auxiliary "Open" or "Closed" position of the associated device
Wiring diagrams						
Utilization		<ul style="list-style-type: none"> Remote indication of the position of the associated device 	<ul style="list-style-type: none"> Remote indication of the position of the associated device 	<ul style="list-style-type: none"> Remote fault tripping indication of the associated device 	<ul style="list-style-type: none"> Remote position and/or fault tripping indication of the associated device 	<ul style="list-style-type: none"> Remote indication of position and tripping upon a fault of the associated breaker
Catalogue numbers		A9N26923	A9N26924	A9N26927	A9N26929	A9N26899
ID		■	■	■	■	■
C60, C120, DPN, DPN Vigi, C60H-DC, C60H-DC, SW60-DC, C60PV-DC, C60NA-DC, C120NA-DC		-	■	■	■	■
Technical specifications						
Rated voltage (Ue)	V AC	24...415	24...415	24...415	24...415	-
	V DC	24...130	24...130	24...130	24...130	24
Operating frequency	Hz	50/60	50/60	50/60	50/60	-
Mechanical state indicator		-	-	On front face	On front face	On front face
Test function		-	On front face	On front face	On front face	On toggle
Width in 9 mm modules		1	1	1	1	1
Operating current	10 mA mini, 6 A maxi					2 mA mini, 100 mA maxi
	24 V DC		6 A			
	48 V DC		2 A			
	60 V DC		1.5 A			
	130 V DC		1 A			
	24...240 V AC		6 A			
415 V AC		3 A				
Number of contacts		1 NO/NC	1 NO/NC	1 NO/NC	1 NO/NC + 1 NO/NC	1 NO + 1 NC
Operating temperature	°C	-25...+50	-25...+50	-25...+50	-25...+50	-25...+70
Storage temperature	°C	-40...+85	-40...+85	-40...+85	-40...+85	-40...+85
Standards						
IEC/EN 60947-1		-	-	-	-	-
IEC/EN 60947-5-1		■	■	■	■	■ IEC 60947-5-4
EN 60947-2		-	-	-	-	-
EN 62019-2 ⁽¹⁾		■	■	■	■	-

Connection

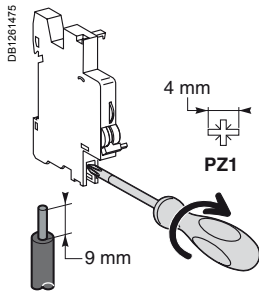

Type	Tightening torque	Copper cables	
		Rigid	Flexible or with ferrule
Indication and tripping auxiliaries	1 N.m	0.5 to 2.5 mm ²	2 x 1.5 mm ²

Ti24 connector connection

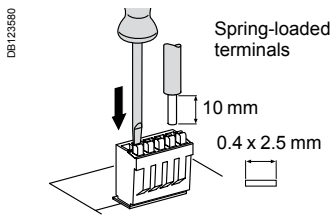

Type	Catalogue numbers	Copper cables	
		Rigid	Flexible
Ti24 interface	A9XC2412	1 x 0.5 to 1.5 mm ²	1 x 0.5 to 1.5 mm ²

Ti24 prefabricated cables connection

Type	Catalogue numbers	Length
Connection for Acti 9 Smartlink		
6 prefabricated	A9XCAS06	100 mm
	A9XCAM06	160 mm
	A9XCAH06	450 mm
	A9XCAL06	870 mm
Connection for PLC type terminals		
6 long prefabricated on a single side	A9XCAU06	870 mm
1 long prefabricated on a single side	A9XCAC01	4000 mm
12 connectors, 5-pins (Ti24)	A9XC2412	-

Electrical auxiliaries for C60, C120, DPN, DPN Vigi, ID, C60H-DC, SW60-DC, C60PV-DC, C60NA-DC, C120NA-DC

Dimensions

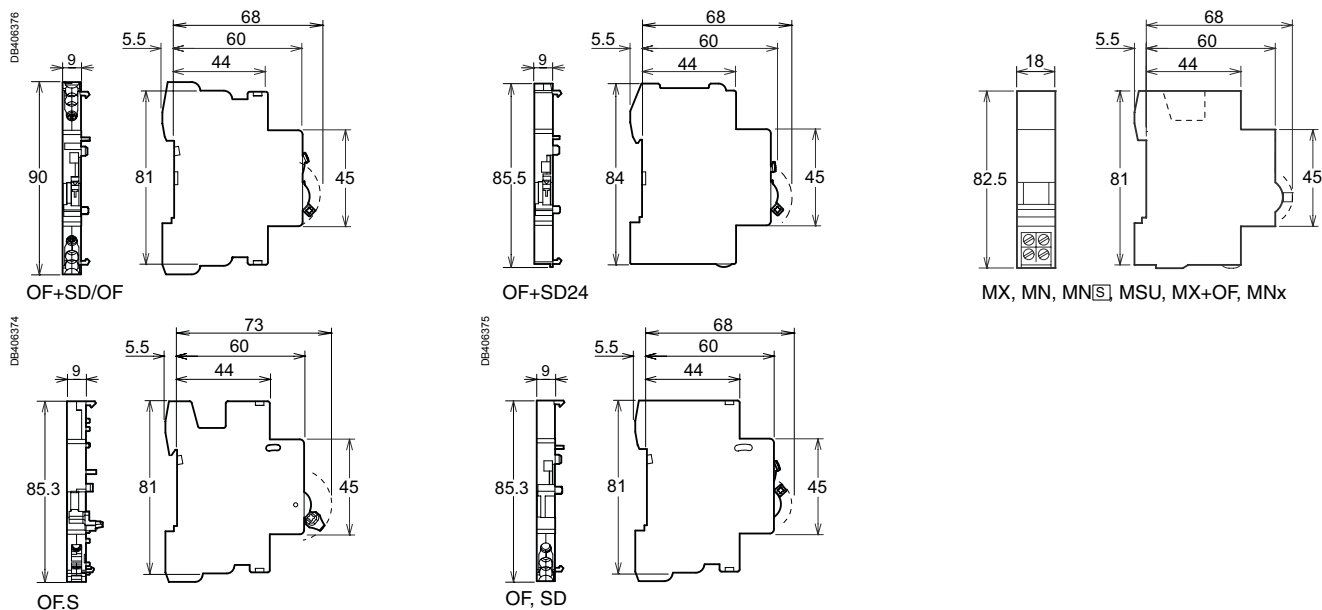

Weight (g)

Electrical auxiliaries	
Type	Weight (g)
MN	66
MN with a square symbol	66
MNx	73
MSU	66
MX	60
MX+OF	65
OF.S	33
OF	30
SD	30
OF+SD/OF	38
OF+SD24	28

- The electrical auxiliaries are combined with NG125 circuit breakers and NG125 switch-disconnectors; they provide the remote tripping or position (open/closed/tripped) indication functions of these devices in the event of a fault.
- They clip on (no tool required) to the left-hand side of the associated device.

IEC/EN 60947-2

- Tripping auxiliaries:
 - MN: undervoltage release
 - MNx: undervoltage release, independent of the supply voltage
 - MX+OF: shunt release with open/closed contact
 - MXV: shunt release for Vigi add-on residual current device.

IEC/EN 60947-5-1

- Indication contacts:
 - OF+OF: open/closed contact
 - OF+SD: fault indicating contact
 - MX+OF: shunt release with open/closed contact
 - SDV: fault indicating contact for Vigi add-on residual current device.

DB123424







Combination table

Electrical auxiliaries		Device
Indication auxiliaries	Tripping auxiliaries	 05862N_LSE-30 NG125
2 (OF+OF or OF+SD)	Max. quantity + 1 (MX+OF or MN or MNx)	

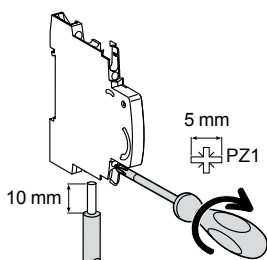

Connection

DB123413





Type	Tightening torque	Copper cables		Multi-cable terminal	
		Rigid	Flexible or with ferrule	Flexible or rigid cables	Cables with ferrule
Indication contacts	1 N.m	 DB122845 0.5 to 2.5 mm ²	 DB123411 0.5 to 1.5 mm ²	 DB123011 2 x 2.5 mm ²	 DB123412 2 x 1.5 mm ²
Tripping auxiliaries	1 N.m	0.5 to 2.5 mm ²	0.5 to 1.5 mm ²	2 x 2.5 mm ²	2 x 1.5 mm ²

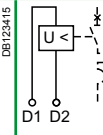
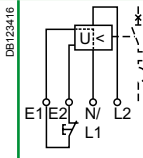
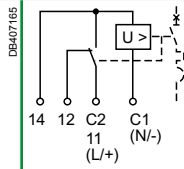

Electrical auxiliaries for NG125 devices and for Vigi NG125 add-on residual current devices (cont.)

		Tripping							
Auxiliaries		MN			MNx		MX+OF		
Type		Undervoltage release						Shunt release	
		Instantaneous			Independent of the supply voltage		With open/closed auxiliary contact		
									
Function		<ul style="list-style-type: none"> Causes tripping of the device with which it is combined when its input voltage decreases (between 70% and 35% of U_n). Prevents closing of the device until its input voltage has been restored 			<ul style="list-style-type: none"> Tripping of the associated device by opening of the control circuit (e.g. push-button, dry contact) A drop in the supply voltage does not trip the associated device A locking push-button control allows the circuit protected (e.g. machine control) to be placed in safety configuration 		<ul style="list-style-type: none"> Causes tripping of the associated device when powered Includes an open/closed contact (OF) to indicate the "open" or "closed" position of the associated device 		
Wiring diagrams									
Utilization		<ul style="list-style-type: none"> Emergency stop by normally-closed pushbutton Ensures safety of the power supply circuits for several machines by preventing untimely restarting 			<ul style="list-style-type: none"> Fail-safe emergency stop Insensitive to variations in the control circuit voltage for improved continuity of service Important: Before any servicing operation switch off the mains power supply (voltage presence at terminals E1/E2) 		<ul style="list-style-type: none"> Provided with a self-interrupting contact 		
Catalogue numbers		19067	19069	19070	19061	19064	19065	19066	19063
Technical specifications									
Rated voltage (U_e)	V AC	230...240	48	—	220...240	230...415	48...130	24	12
	V DC	—	—	48	—	110...130	48	24	12
Operating frequency	Hz	50/60			50/60	50/60			
Mechanical state indicator light, red		On front face			On front face	On front face			
Width in 9 mm modules		2			4	2			
Current rating		—			—	415 V AC		3 A	
		—			—	≤ 240 V AC		6 A	
		—			—	130 V DC		1 A	
		—			—	≤ 48 V DC		3 A	
Number of contacts		—			—	—			
Operating temperature	°C	-25...+60			-25...+60	-25...+60			
Storage temperature	°C	-40...+85			-40...+85	-40...+85			

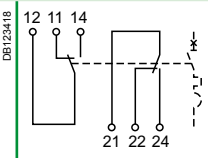
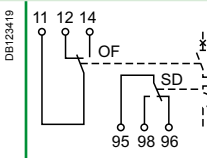
Indication

OF+OF	OF+SD
Auxiliary contact	Fault indicating contact
	
<p>■ Double changeover contact indicating "open" or "closed" position of the associated device</p>	<p>■ Double changeover contact indicating:</p> <ul style="list-style-type: none"> <input type="checkbox"/> the position of the associated device in the event of: <ul style="list-style-type: none"> - electrical fault - actuation of the tripping auxiliary <input type="checkbox"/> the "open" or "closed" position of the associated device
	
<p>■ Remote indication of the position of the associated device</p>	<p>■ Remote indication of tripping upon a fault of the associated device</p>
19071	19072
-	-
-	-
50/60	50/60
-	-
1	1
415 V AC 3 A	415 V AC 3 A
≤ 240 V AC 6 A	≤ 240 V AC 6 A
130 V DC 1 A	130 V DC 1 A
≤ 48 V DC 3 A	≤ 48 V DC 3 A
2 NO/NC	2 NO/NC
-25...+60	-25...+60
-40...+85	-40...+85

Electrical auxiliaries for NG125 devices and for Vigi NG125 add-on residual current devices (cont.)

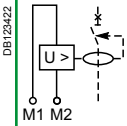
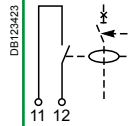
		Indication	
Auxiliaries		MXV	SDV
Type		Shunt release	Vigi fault indicating contact
			
Function		<ul style="list-style-type: none"> At power up, actuates tripping of a circuit breaker or residual current circuit breaker It is provided with a self-interrupting contact 	<ul style="list-style-type: none"> Normally-closed or normally-open contact indicating tripping upon an earth fault (including tripped by MXV)
Wiring diagrams			
Utilization		<ul style="list-style-type: none"> Adaptable to 125 A Vigi add-on residual current device, all types, and to 63 A Vigi add-on residual current device, adjustable Impulse withstand voltage: 6 kV High-impedance input: use an iACTp if the leakage current in the control unit exceeds 1 mA (e.g. illuminated pushbutton) 	
Catalogue numbers		19060	19058 19059
Suitable for the following devices:			
NG125		–	–
Vigi NG125		■	■
Technical specifications			
Rated voltage (Ue)	V AC	110...240	250
	V DC	110	–
Operating frequency	Hz	50/60	50/60
Number of contacts		–	1 NO 1 NC
Current rating		–	0.1 to 1 A (AC14)
Operating temperature	°C	-25...+60	-25...+60
Storage temperature	°C	-40...+85	-40...+85



The RCA remote control system allows:

- Remote electrical control (opening and closing) of circuit breakers with or without Vigi add-on RCD, with or without auxiliary.
- Circuit-breaker resetting after tripping, in accordance with safety principles and the regulations in force.
- Local control by operating handle.
- Circuit placing in safety configuration by padlocking.

2 choices of operation after tripping:

- A: Enabling of remote circuit-breaker resetting;
- B: Inhibition of remote resetting.

The version with Ti24 interface allows:

- Direct interfacing of remote control with a programmable logic controller (PLC), a supervision system and any other communication device, having inputs/outputs in 24 V DC (control, OF and SD indications).
- Fast, reliable connection of the remote control to the Acti 9 Smartlink thanks to the prefabricated cables.
- Remote indication by "OF" potential-free contact.
- Provision of 2 operating modes, "1 and 3".

The iMDU auxiliary allows RCA control in 24/48 V AC/DC.

Catalogue numbers

RCA remote control			
Type			Width in 9 mm modules
For circuit breakers	Voltage		
1P, 1P+N, 2P			
Without Ti24 interface	230 V AC, 50/60 Hz	A9C70112	7
With Ti24 interface	230 V AC, 50/60 Hz	A9C70122	7
For 3P, 4P circuit breakers			
Without Ti24 interface	230 V AC, 50/60 Hz	A9C70114	7
With Ti24 interface	230 V AC, 50/60 Hz	A9C70124	7
Auxiliaries		See module CA907000 and CA907002	



Without Ti24 interface

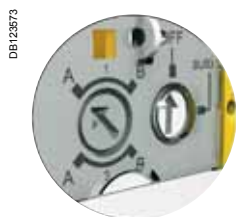
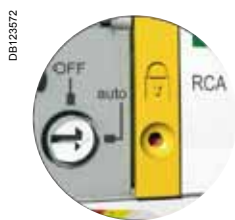

With Ti24 interface

Type		Application
OFF		All remote control inhibited
auto	A	Circuit breaker remote reclosing after tripping allowed
	B	Circuit breaker remote reclosing after tripping inhibited
Green indicator lamp		Remote control possible
Orange indicator lamp		Remote control impossible
1 (Ti24)		Mode 1
3 (Ti24)		Mode 3
Y1		Latched order local control
Y2		Impulse-type or latched order local control (depending on mode)
Y3		Latched order centralized control

Standard RCA

■ The orders received on terminals Y1 and Y2 are taken into account progressively in their order of arrival.

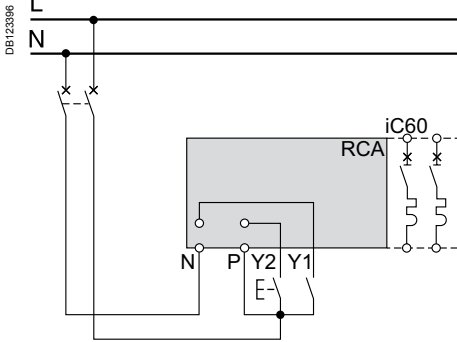

RCA Ti24

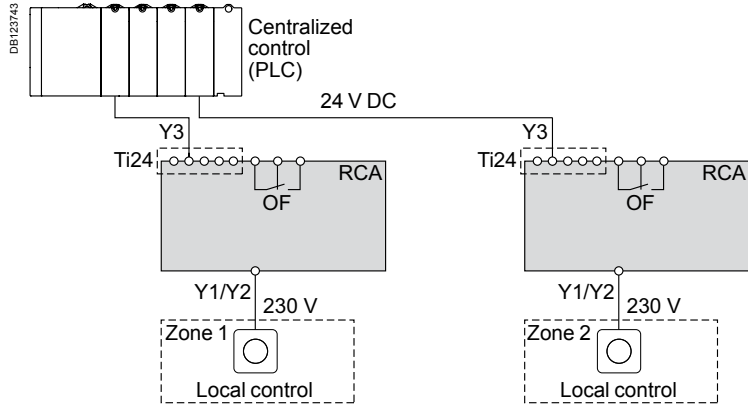

Mode 1: Locally or centrally controlled circuit-breaker opening/closing

- The orders come from various control points, and they are taken into account in their order of arrival
- Y1: Latched order local control
- Y2: Impulse-type local control
- Y3: Latched order centralized control

RCA Ti24 mode 1

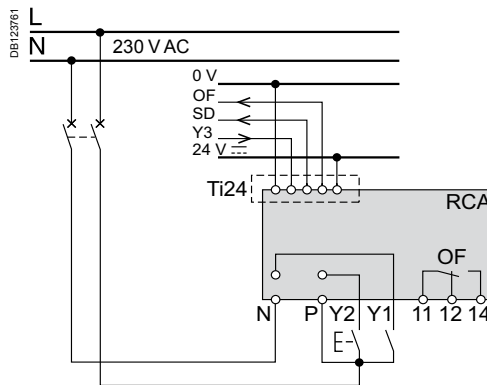

Mode 3: Centrally controlled opening/closing + local override

- 3 positions allowing a choice between override and centralized control:
- Y1: Latched order local control
- Y2: Latched order local control
- Y3: Latched order centralized control

RCA Ti24 mode 3

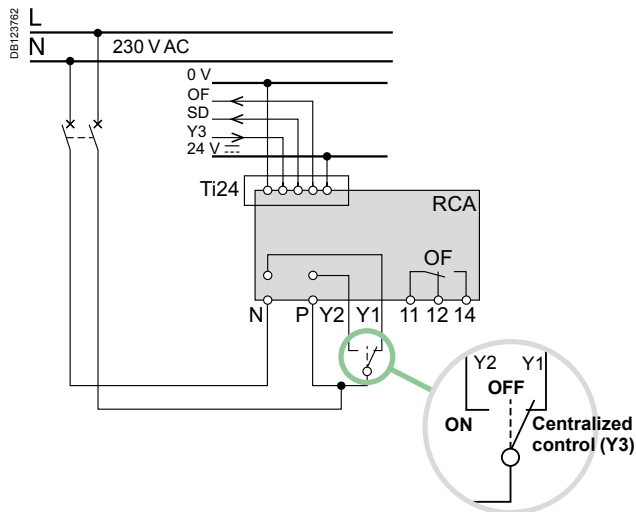

DB123576

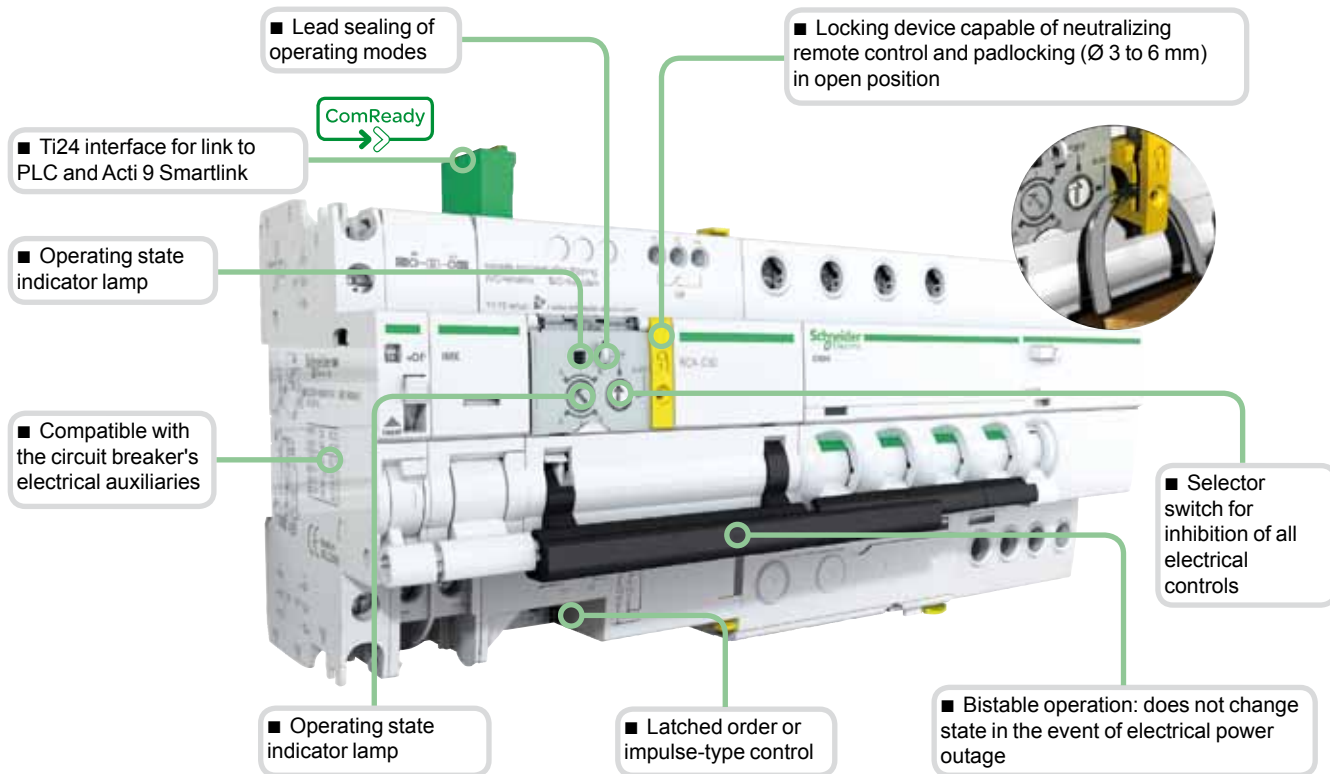

DB123763



DB123578



DB123579



Legend

Type	Application
+24VDC	V DC power supply
Y3	Latched order centralized control
SD	Circuit-breaker tripping information
OF	Control circuit state information (open/closed)
0 V	V DC power supply
Y1	Latched order local control
Y2	Impulse-type or latched order local control (depending on mode)
N	230 V AC power supply
P	
OF	Circuit-breaker state indication contact (open/closed)



Connection

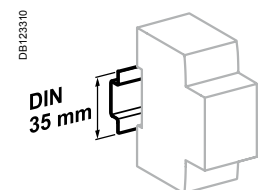
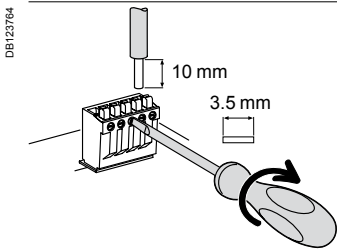
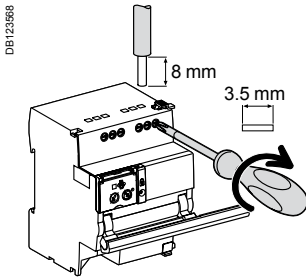
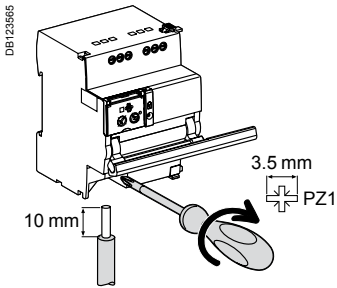

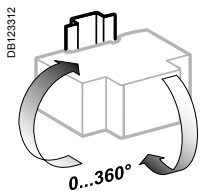

Clip on DIN rail 35 mm.

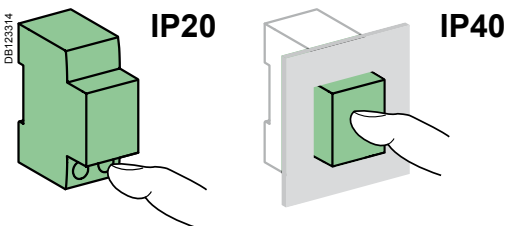

Indifferent position of installation.



Without accessories

Terminal	Tightening torque	Copper cables		
		Rigid	Flexible	Flexible with ferrule
Power supply (N/P) Inputs (Y1/Y2)	1 N.m	DB123545 	DB123553 	DB123554 
Outputs (OF)	0.7 N.m	0.5 to 10 mm ² 2 x 0.5 to 2 x 2.5 mm ²	0.5 to 6 mm ² 2 x 0.5 to 2 x 2.5 mm ²	0.5 to 4 mm ² 2 x 0.5 to 2 x 2.5 mm ²
Ti24 interface	Spring-loaded terminals	0.5 to 2.5 mm ² 2 x 0.5 to 2 x 1.5 mm ²	0.5 to 2.5 mm ² 2 x 0.5 to 2 x 1.5 mm ²	0.5 to 1.5 mm ² 2 x 0.5 to 2 x 1.5 mm ²
		0.5 to 1.5 mm ²	0.5 to 1.5 mm ²	-

Technical data

Control circuit		
Supply voltage (Ue) (N/P)		230 V AC, 50/60 Hz
Control voltage (Uc)	Type 1 inputs (Y1/Y2)	230 V AC (as per IEC 61131-2)
Min. duration of control order (Y2)		≥ 200 ms
Response time (Y2)		< 500 ms
Consumption		≤ 1 W
Thermal self-protection with automatic Reset against overheating of the control circuit due to an abnormal number of operations		
Endurance (O-C) (RCA combined with a circuit breaker)		
Electrical/Mechanical		10,000 cycles
Indication / Remote control		
Potential free changeover contact output (OF)	Min.	24 V AC/DC, 10 mA
	Max.	230 V AC, 1 A
Input (Y1/Y2)	230 V AC	5 mA
Ti24 interface (as per IEC 61131)		
Type 1 input (Y3)	24 V DC	5.5 mA
Output (OF and SD)	24 V DC	In max.: 100 mA
Additional characteristics		
Degree of protection (IEC 60529)	Device only	IP20
	Device in a modular enclosure	IP40 Insulation class II
Insulation voltage (Ui)		400 V
Degree of pollution (IEC 60947)		3
Rated impulse withstand voltage (Uimp)		6 kV
Operating temperature		-25°C to +60°C
Storage temperature		-40°C to +70°C
Tropicalization		Treatment 2 (relative humidity of 93 % at +40°C)

Weight (g)

Remote controls	
Type	RCA
For 1P, 1P+N, 2P circuit breakers	400
For 3P, 3P+N, 4P circuit breakers	430

Dimensions (mm)

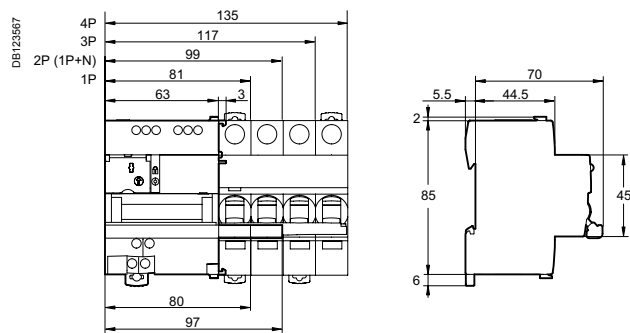

ARA automatic reclosers

For iC60 circuit breakers
and iID residual current circuit breakers



ARA iC60



ARA iID

The ARA reclosing auxiliary can:

- Perform automatic reclosing of the associated protection device, after tripping.
- Increase the availability of installations without supervision, isolated, hard of access and demanding very great availability (mobile telephony systems, motorways, pumping stations, airports, railways, meteorological stations, service stations, automatic teller machines, public lighting, tunnels, etc.), by restoring them to operation without intervention by personnel in the event of a transient fault (atmospheric disturbances, industrial overvoltages, etc.).
- For the ARA iC60, the operator can choose predefined reclosing program which allows the safety and availability of facilities to be reconciled taking into account the facility's environment.
- The circuit is placed in safety configuration by the padlocking device.

Catalogue numbers

ARA iC60				
For circuit breaker				Width in 9 mm modules
1P, 1P+N, 2P	Number of programs	Voltage		
	4	230 V AC, 50/60 Hz	A9C70132	7
3P, 4P	4	230 V AC, 50/60 Hz	A9C70134	7

ARA iID				
For residual current circuit breaker				Width in 9 mm modules
2P	Number of programs	Voltage		
	1	230 V AC, 50/60 Hz	A9C70342	7
4P	1	230 V AC, 50/60 Hz	A9C70344	7
Auxiliaries			See module CA907000 and CA907002	

Diagram

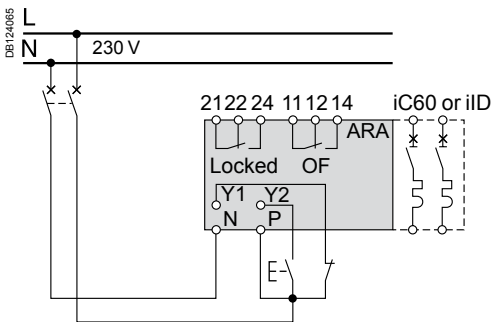

Legend		
Type	Application	
1 2 4 3	Choice of program (ARA iC60)	
Y1	"Remote" inhibition of automatic reclosing	
Y2	Remote control of final reclosing	
N	230 V power supply	
P		
Locked	Automatic recloser inhibition indication contact	
OF	Indicates the state of the circuit breaker or residual current circuit breaker (opened or closed)	
Indicator lamp	Flashing green	ARA automatic recloser operational
	Flashing red	Reclosing cycle in progress
	Fixed red	ARA automatic recloser locked at end of reclosing cycle: circuit breaker or residual current circuit breaker tripped (open)
	Flashing orange	ARA automatic recloser not operational

ARA automatic reclosers (cont.)

For iC60 circuit breakers

and iID residual current circuit breakers





Operating principle

The ARA automatic recloser makes a number of attempts at reclosing depending on the program chosen by the user.

The program includes the following settings:

- A time delay before reclosing (TA).
- A reinitialization time delay (TB).
- A maximum number of reclosing attempts.

If, following these attempts, the fault is still present, the device places itself in waiting for manual reclosing, or final remote reclosing (Y2).

ARA iC60		Number of reclosing attempts	Delay before reclosing	Check time	Final reclosing Y2
			TA	TB	
Program					
DB124061  DB124062  DB124063  DB124064 	1	10 s	6 min.	Once after inhibition	
	3	10 s 1 min. 3 min.	2 min. 6 min. 6 min.		
	5	10 s 1 min. 3 min. 3 min. 3 min.	2 min. 6 min. 6 min. 6 min. 6 min.		
	5	10 s 1 min. 3 min. 4 min. 5 min.	2 min. 6 min. 8 min. 10 min. 12 min.		

ARA iID		Number of reclosing attempts	Delay before reclosing	Check time	Final reclosing Y2
			TA	TB	
Only 1 program available	15	10 s 20 s 40 s 3 min. ...	30 min. 30 min. ...	Once per cycle	

ARA automatic reclosers (cont.)

For iC60 circuit breakers
and iID residual current circuit breakers

ARA iC60 operating diagram

DB404539

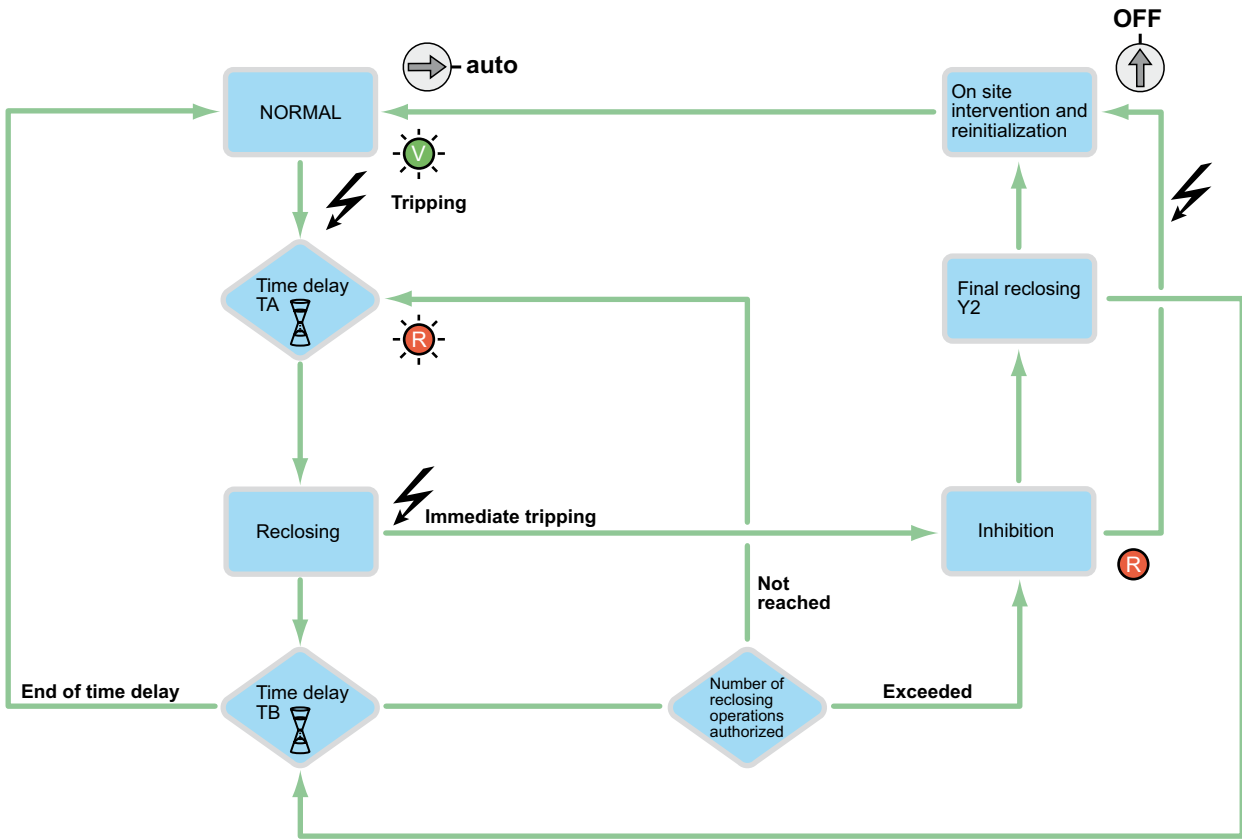

ARA iID operating diagram

DB404538

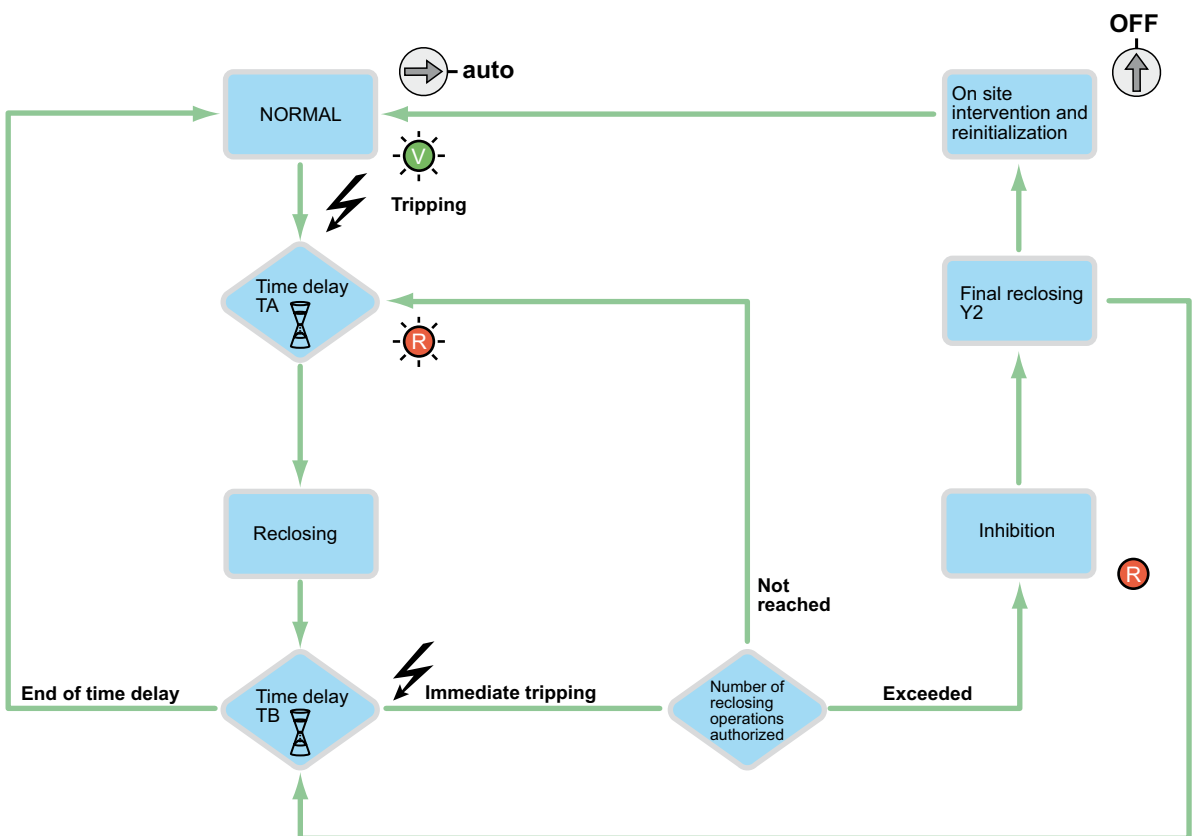

ARA automatic reclosers (cont.)

For iC60 circuit breakers
and iID residual current circuit breakers

PB 00095-104

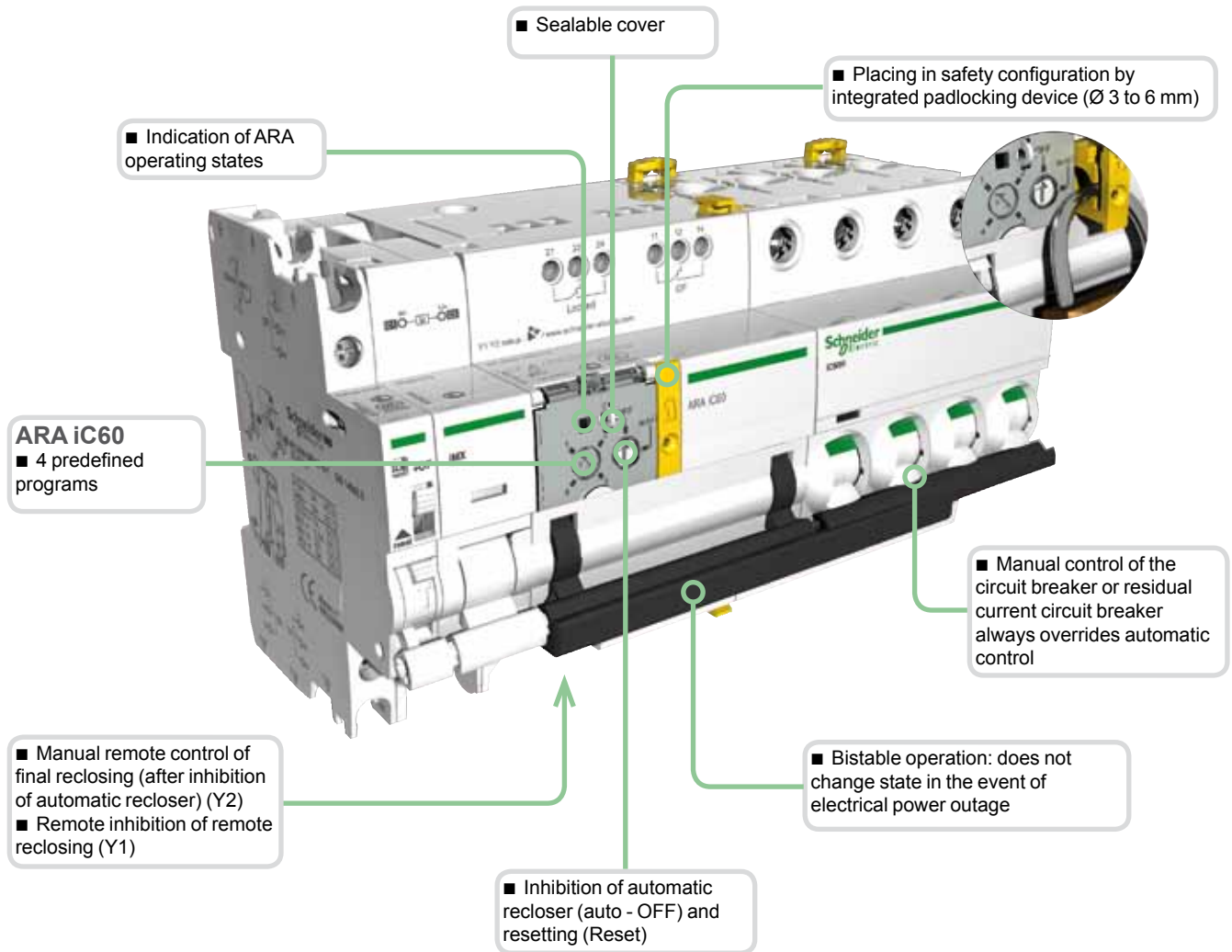

ARA automatic reclosers (cont.)

For iC60 circuit breakers
and iLD residual current circuit breakers

Connection

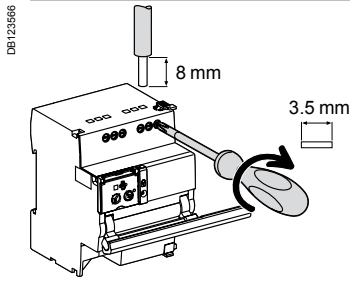
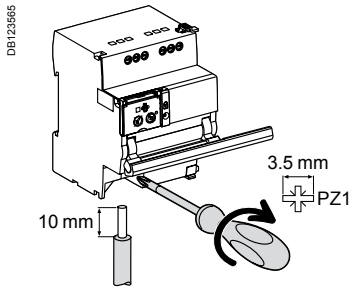

Terminal	Tightening torque	Copper cables		
		Rigid	Flexible	Flexible with ferrule
Power supply (N/P) Inputs (Y1/Y2)	1 N.m	0.5 to 10 mm ² 2 x 0.5 to 2 x 2.5 mm ²	0.5 to 6 mm ² 2 x 0.5 to 2 x 2.5 mm ²	0.5 to 4 mm ² 2 x 0.5 to 2 x 2.5 mm ²
Outputs (OF/Locked)	0.7 N.m	0.5 to 2.5 mm ² 2 x 0.5 to 2 x 1.5 mm ²	0.5 to 2.5 mm ² 2 x 0.5 to 2 x 1.5 mm ²	0.5 to 1.5 mm ² 2 x 0.5 to 2 x 1.5 mm ²

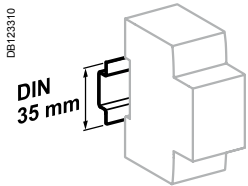

Clip on DIN rail 35 mm.

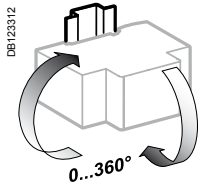

Indifferent position of installation.

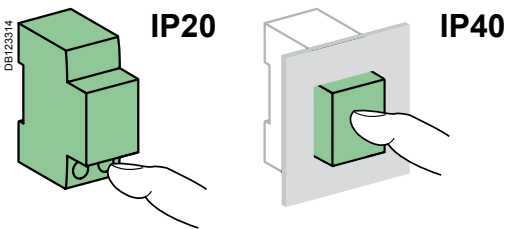

Technical data

Control circuit		
Supply voltage (Ue) (N/P)		230 V AC, 50/60 Hz
Control voltage (Uc)	Type 1 inputs (Y1/Y2)	230 V AC (as per IEC 61131-2)
Min. duration of control order (Y2)		≥ 200 ms
Response time (Y2)		< 500 ms
Consumption		< 2 W
Endurance (O-C) (ARA combined with a circuit breaker)		
Electrical		5000 cycles
Indication / Remote control		
Potential-free changeover contact output (OF/Locked)	Min.	24 V AC/DC, 10 mA
	Max.	230 V AC, 1 A
Input (Y1/Y2)	230 V AC	5 mA
Additional characteristics		
Degree of protection (IEC 60529)	Device only	IP20
	Device in a modular enclosure	IP40
Insulation voltage (Ui)		400 V
Degree of pollution (IEC 60947)		3
Rated impulse withstand voltage (Uimp)		6 kV
Operating temperature		-25°C to +60°C
Storage temperature		-40°C to +70°C
Tropicalization		Treatment 2 (relative humidity of 93 % at +40°C)

Weight (g)

Automatic reclosers	
Type	ARA
For 1P, 1P+N, 2P circuit breakers or iLD residual current circuit breaker	440
For 3P, 4P circuit breakers	470

Dimensions (mm)

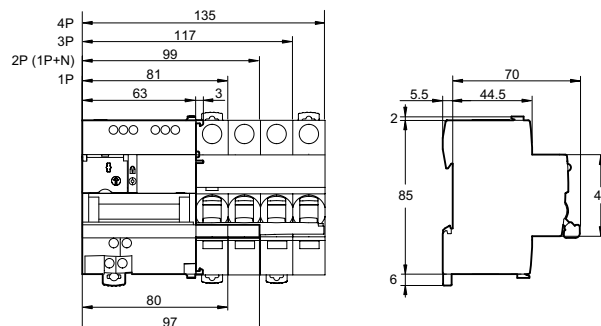

IEC 60669-1 and IEC 60947-5-1

■ iPB pushbuttons are used to control electric circuits by means of pulses.

Catalogue numbers

iPB pushbuttons														
Type	Single				Double		Single + indicator light							
Diagram	1 NC 3 E-7 4		1 NO 1 E-7 2		1 NO + 1 NC 1 3 E-7 2 4		1 NO / 1 NC 1 3 E-7 E-7 2 4		1 NO / 1 NO 1 3 E-7 E-7 2 4		1 NO 1 NC 1 X1 3 X1 E-7 X 2 X2 4 X2		1 NO 1 NC 1 X1- 3 X1 E-7 X 2 X2+ 4 X2+	
Pushbutton Colour	Grey	Red	Grey	Grey	Green/red	Grey/grey	Grey	Grey	Grey	Grey	Grey	Grey		
Indicator light Power supply	-	-	-	-	-	-	110...230 V AC		12...48 V AC/DC					
Indicator light Colour	-	-	-	-	-	-	Green	Red	Green	Red	Green	Red		
Cat. no.	A9E18030	A9E18031	A9E18032	A9E18033	A9E18034	A9E18035	A9E18036	A9E18037	A9E18038	A9E18039				
Width in 9 mm modules	2				2		2							

Connection

	Tightening torque 1 N.m	Copper cables	
		Rigid 	Flexible or with ferrule
		0.5 mm ² min. 2 x 2.5 mm ² max.	0.5 mm ² min. 2 x 2.5 mm ² max.

- Phase-separated wall that can be divided to allow the teeth of all types of comb busbar to pass through.
- Staggered terminals to simplify connection.

Dimensions (mm)

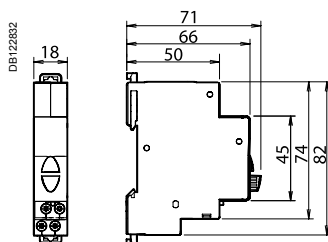



Technical data

Main characteristics	
Pollution degree	3
Power circuit	
Voltage rating (Ue)	250 V AC
Current rating (Ie)	20 A
Additional characteristics	
Endurance (O-C)	30,000 operations AC22 (cos φ = 0.8)
Operating temperature	-35°C... +70°C
Storage temperature	-40°C... +80°C
Tropicalization	Treatment 2 (relative humidity 95 % at 55°C)
LED indicator light	Consumption: 0.3 W Service life: 100,000 hours of constant lighting efficiency Maintenance-free indicator light (non-interchangeable LEDs)

IEC 60669-1 and IEC 60947-5-1

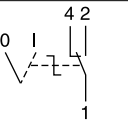
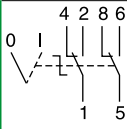
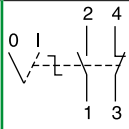
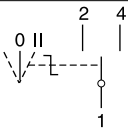
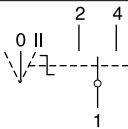

■ ISSW linear switches are used for the manual control of electric circuits.

Catalogue numbers

ISSW linear switches					
Type	2 positions			3 positions	
					
Contact	1 changeover switch	2 changeover switches	1 NO + 1NC	1 changeover switch	2 changeover switches
Diagram					
Cat. no.	A9E18070	A9E18071	A9E18072	A9E18073	A9E18074
Width in 9 mm modules	2	4	2	2	4

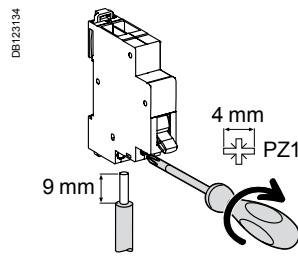
Connection



Tightening torque	Copper cables	
	Rigid	Flexible or with ferrule
1 N.m	 DB122345	 DB122346
	0.5 mm ² min. 2 x 2.5 mm ² max.	0.5 mm ² min. 2 x 2.5 mm ² max.

- Phase-separated wall that can be divided to allow the teeth of all types of comb busbar to pass through.
- Staggered terminals to simplify connection.

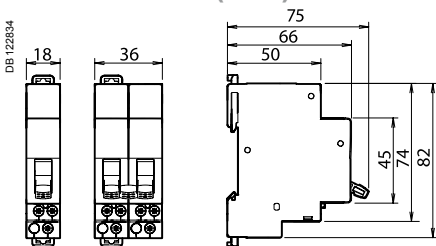

Dimensions (mm)





Technical data

Main characteristics	
Pollution degree	3
Power circuit	
Voltage rating (Ue)	250 V AC
Current rating (Ie)	20 A
Additional characteristics	
Endurance (O-C)	30,000 cycles AC22 (cos φ = 0.8)
Operating temperature	-20°C... +50°C
Storage temperature	-40°C... +70°C
Tropicalization	Treatment 2 (relative humidity 95 % at 55°C)

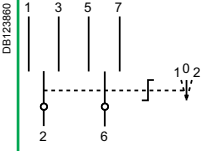
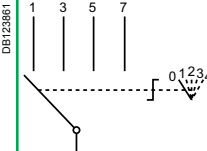
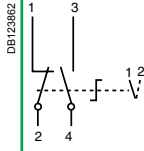
DIN rail selector switches iCMB, iCMD, iCME, iCMC, iCMV and iCMA

		Control																													
Selector switches		iCMB	iCMD	iCME																											
Type		Two-pole with zero setting	4-way	2-way for electronic circuits																											
In compliance with standards		IEC 60947-3 (EN 60947-3) VDE 0660 part. 107 UL	IEC 60947-3 (EN 60947-3) VDE 0660 part. 107 UL	IEC 60947-3 (EN 60947-3) VDE 0660 part. 107 UL																											
																															
Function		<ul style="list-style-type: none"> This two-pole selector switch with zero setting allows manual control of a circuit with 2-way operation with a stop position 	<ul style="list-style-type: none"> This 4-way selector switch allows control of a circuit with operating priorities 	<ul style="list-style-type: none"> This 2-way selector switch is used specially for the control of electronic circuits of low voltage and current level 																											
Wiring diagrams																															
Use		Example: electrically controlled metal screen: <ul style="list-style-type: none"> position 1 = raising position 0 = stop position 2 = lowering 	Example: fan control: <ul style="list-style-type: none"> position 0 = stop position 1 = override operation, slow speed position 2 = override operation, high speed position 3 = remote control position 4 = automatic operation 	<ul style="list-style-type: none"> Voltage range from 30 mV to 600 V AC 																											
Catalogue numbers		A9E15120	A9E15121	A9E15122																											
Technical specifications																															
Rated voltage (Ue)	V AC	415	415	See following table																											
Maximum operating voltage	V	440	440	440																											
Rating	A	10	10	See following table																											
Operating frequency	Hz	50/60	50/60	50/60																											
Width in 9-mm modules		4	4	4																											
Breaking capacity (resistive load)		–	–	<table border="1"> <thead> <tr> <th></th> <th>V AC</th> <th>V DC</th> </tr> </thead> <tbody> <tr> <td>1 V</td> <td>5 A</td> <td>3 A</td> </tr> <tr> <td>12 V</td> <td>1.2 A</td> <td>0.7 A</td> </tr> <tr> <td>24 V</td> <td>0.7 A</td> <td>0.4 A</td> </tr> <tr> <td>48 V</td> <td>0.45 A</td> <td>0.25 A</td> </tr> <tr> <td>110 V</td> <td>0.25 A</td> <td>0.13 A</td> </tr> <tr> <td>240 V</td> <td>0.15 A</td> <td>0.08 A</td> </tr> <tr> <td>300 V</td> <td>0.13 A</td> <td>0.07 A</td> </tr> <tr> <td>440 V</td> <td>0.1 A</td> <td>0.05 A</td> </tr> </tbody> </table>		V AC	V DC	1 V	5 A	3 A	12 V	1.2 A	0.7 A	24 V	0.7 A	0.4 A	48 V	0.45 A	0.25 A	110 V	0.25 A	0.13 A	240 V	0.15 A	0.08 A	300 V	0.13 A	0.07 A	440 V	0.1 A	0.05 A
	V AC	V DC																													
1 V	5 A	3 A																													
12 V	1.2 A	0.7 A																													
24 V	0.7 A	0.4 A																													
48 V	0.45 A	0.25 A																													
110 V	0.25 A	0.13 A																													
240 V	0.15 A	0.08 A																													
300 V	0.13 A	0.07 A																													
440 V	0.1 A	0.05 A																													
Operating temperature	°C	-20...+55	-20...+55	-20...+55																											
Storage temperature	°C	-25...+80	-25...+80	-25...+80																											

DIN rail selector switches iCMB, iCMD, iCME, iCMC, iCMV and iCMA (cont.)

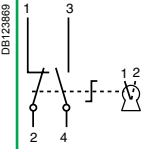
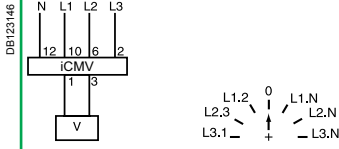
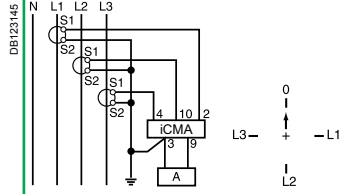
iCMC	iCMV	iCMA
2-way key-actuated	7-position voltmeter	4-position ammeter
IEC 60947-3 (EN 60947-3) VDE 0660 part. 107 UL	IEC 60947-3 (EN 60947-3) VDE 0660 part. 107 UL	IEC 60947-3 (EN 60947-3) VDE 0660 part. 107 UL
		
<p>■ 2-way key-actuated selector switch (key Ronis 601 type) with locking in one or the other position</p>	<p>■ This 7-position voltmeter selector switch makes it possible, with a single voltmeter, to measure in succession the voltages (phase-to-phase and phase-to-neutral) of a three-phase circuit</p>	<p>■ This 4-position ammeter selector switch makes it possible, with a single ammeter (using current transformers), to measure in succession the currents of a three-phase circuit</p>
		
-	-	-
A9E15123	15125	15126
415	415	415
440	440	440
10	10	10
50/60	50/60	
4	4	4
-	-	-
-20...+55	-20...+55	-20...+55
-25...+80	-25...+80	-25...+80

DIN rail selector switches iCMB, iCMD, iCME, iCMC, iCMV and iCMA (cont.)

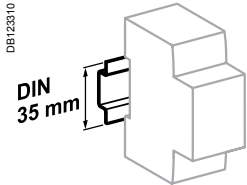

Clip on DIN rail 35 mm.

Connection

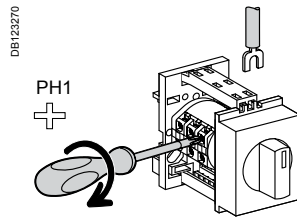

Tightening torque	Copper cables
0.35 N.m	Flexible or rigid with ferrule
	DB122545
	< 1.5 mm ²

■ Connection by jumper terminals with captive screws.

Technical data

Additional characteristics		
Degree of protection	Device only	IP20
Endurance (O-C)	Electrical	1,000,000 switching operations
	Mechanical	2,000,000 switching operations (AC21A-3 x 440 V)

Weight (g)

Selector switches	
Type	Weight (g)
iCMA	58
iCMB	58
iCMC	70
iCMD	58
iCME	44
iCMV	58

Dimensions (mm)

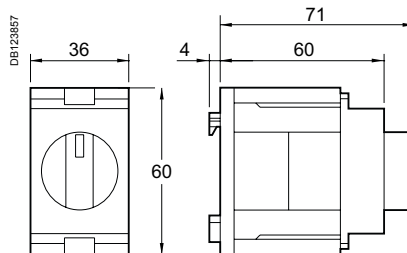

They can be attached to a symmetrical 35 mm rail, in modular cabinets or enclosures, for control and indications auxiliaries: push-buttons, emergency stops, switches, light indicators; for tertiary and industrial applications.



A9A15151



A9A15152

Catalogue numbers

Button holders		
Type		Width in 9 mm modules
Ø 22 mm button holder	A9A15151	6
Universal support	A9A15152	6

Technical data

Main characteristics	Button holder	Universal support
For buttons, switches and indicators with metal or plastic flange Ø 22 of the Schneider Electric XB4 / XB5 type	■	-
For buttons, indicators, light emitting diodes (LED), potentiometers	-	■
Drilling diameter	Ø 22.3 mm	Easy drilling, to be adapted depending on use
Colour	White RAL 9003	
Self-extinguishing insulating material		
Depth under rail 60 mm (same as products)		

Dimensions (mm)

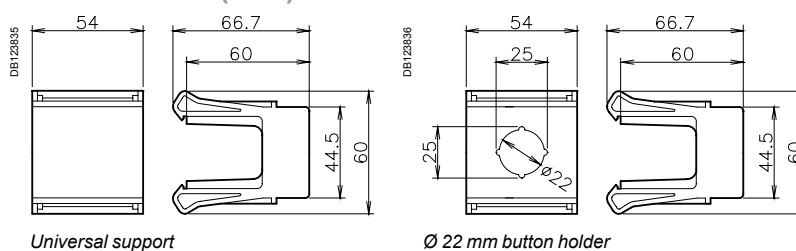

Country approval pictograms

PB115437-40



PB115442-40



IEC/EN 60947-2

The Reflex iC60 devices are integrated control circuit breakers which combine the following main functions in a single device:

- Remote control by latched and/or impulse-type order according to the 3 operating modes to be chosen by the user.
- Circuit breaker, to provide:
 - circuit protection against short-circuit currents,
 - circuit protection against overload currents,
 - disconnection in the industrial sector.

Resetting after a fault is performed manually, by the resetting handle.

The Ti24 interface allows direct interfacing of the Reflex iC60 with a PLC, to:

- Execute remote control (Y3).
- Indicate the state of the control circuit (O/C) and circuit-breaker state information (auto/OFF).
- Connect in a fast way and sure the Reflex iC60 to the Acti 9 Smartlink thanks to the prefabricated cables.

The iMDU auxiliary allows the Reflex iC60 to be controlled in 24/48 V AC/DC.

Alternating current (AC) 50/60 Hz

Ultimate breaking capacity (Icu) as per IEC/EN 60947-2		Voltage (Ue)		Service breaking capacity (Ics)
		220 to 240 V	380 to 415 V	
Ph/Ph (2P, 3P, 4P)		220 to 240 V	380 to 415 V	
Reflex iC60N				
Rating (In)	10 to 40 A	20 kA	10 kA	75 % of Icu
	63 A	20 kA	10 kA	50 % of Icu
Reflex iC60H				
Rating (In)	10 to 40 A	30 kA	15 kA	50 % of Icu

Catalogue numbers

Reflex iC60 circuit breaker

Type	2P			3P			4P		
	Curve			Curve			Curve		
	B	C	D	B	C	D	B	C	D
Reflex iC60N									
10 A	A9C61210	A9C62210	A9C63210	A9C61310	A9C62310	A9C63310	A9C61410	A9C62410	A9C63410
16 A	A9C61216	A9C62216	A9C63216	A9C61316	A9C62316	A9C63316	A9C61416	A9C62416	A9C63416
25 A	A9C61225	A9C62225	A9C63225	A9C61325	A9C62325	A9C63325	A9C61425	A9C62425	A9C63425
40 A	A9C61240	A9C62240	-	A9C61340	A9C62340	-	A9C61440	A9C62440	-
63 A	A9C61263	A9C62263	-	A9C61363	A9C62363	-	A9C61463	A9C62463	-
Reflex iC60H									
10 A	A9C64210	A9C65210	A9C66210	A9C64310	A9C65310	A9C66310	A9C64410	A9C65410	A9C66410
16 A	A9C64216	A9C65216	A9C66216	A9C64316	A9C65316	A9C66316	A9C64416	A9C65416	A9C66416
25 A	A9C64225	A9C65225	A9C66225	A9C64325	A9C65325	A9C66325	A9C64425	A9C65425	A9C66425
40 A	A9C64240	A9C65240	-	A9C64340	A9C65340	-	A9C64440	A9C65440	-
Width in 9 mm modules	9			11			13		
Vigi iC60	Vigi iC60 add-on residual current device, module CA902005			Vigi iC60 add-on residual current device, module CA902005			Vigi iC60 add-on residual current device, module CA902005		
iMDU auxiliary	See module CA907000 and CA907002			See module CA907000 and CA907002			See module CA907000 and CA907002		
Accessories	See module CA907000 and CA907001			See module CA907000 and CA907001			See module CA907000 and CA907001		

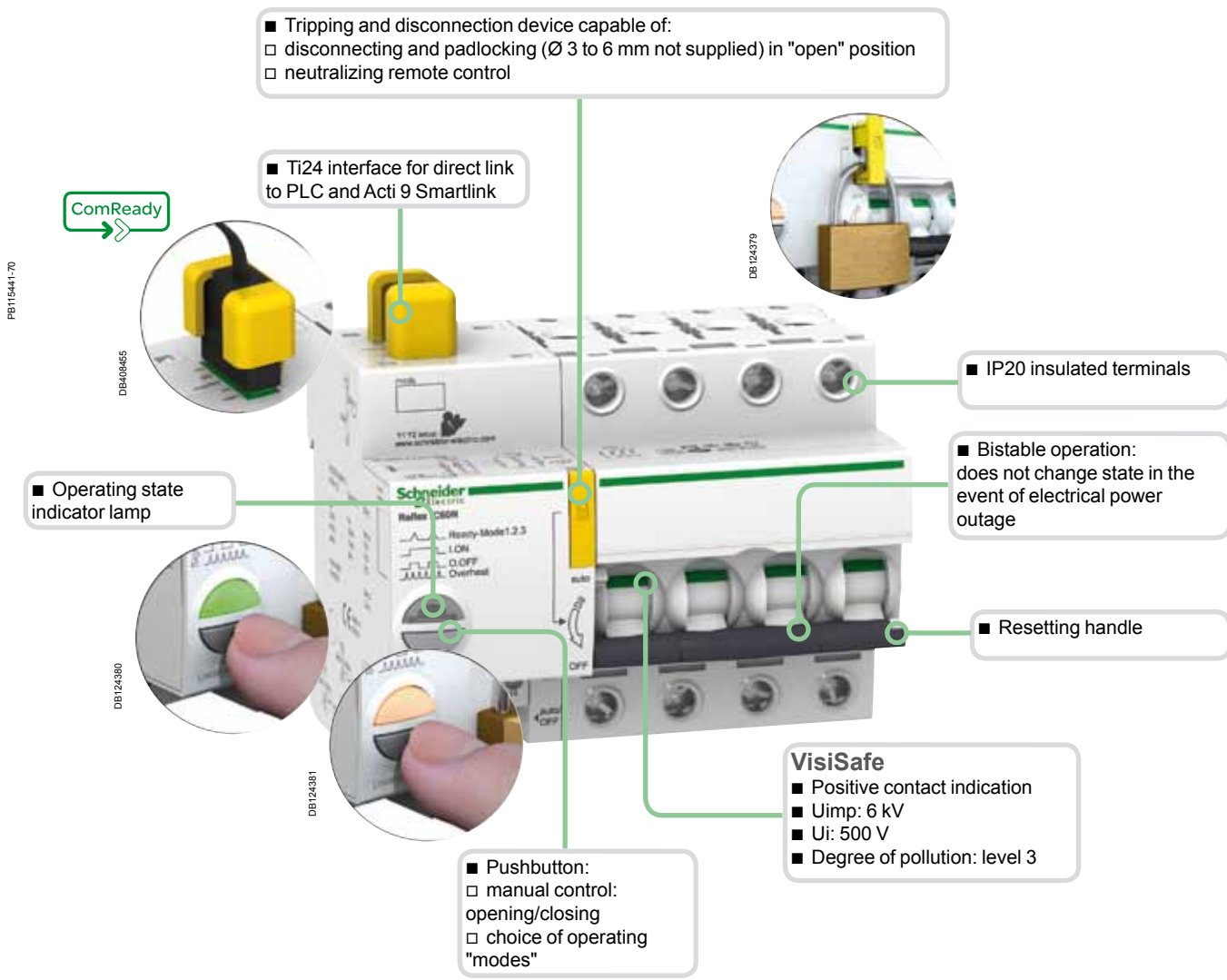

- Longer product service life thanks to:
- good overvoltage withstand capacity: products designed to provide a high industrial performance level (degree of pollution, rated impulse withstand voltage and insulation voltage),
 - high limitation performances,
 - fast closure independent of the speed of resetting of the operating handle.

Legend

Ti24 interface	
+24VDC	V DC power supply
Y3	Remote control by latched order
auto/OFF	Circuit-breaker state information
O/C	Control circuit state information (open/closed)
0 V	V DC power supply

Y1	Latched order control
Y2	Control by impulse-type
N	230 V AC power supply
P	
O/C	Control circuit state indication contact
auto/OFF	Circuit-breaker tripping indication contact

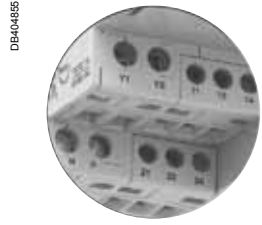

DB123517



■ Operating state indicator lamp

■ Pushbutton for:
□ "mode" selection
□ opening/closing manual control

Remote control is possible by 3 operating modes to be set using the pushbutton on the front panel.

Three types of control: Y1, Y2, Y3

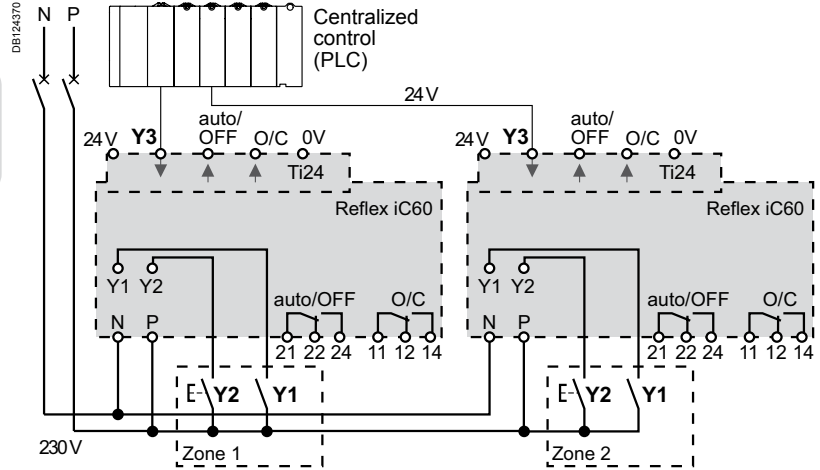

Operating modes

Mode 1: Reflex iC60 opening/closing, locally or centrally controlled

- The opening/closing orders come from various control points, and they are taken into account in their order of arrival
- Y1: latched order local control
- Y2: impulse-type local control
- Y3: latched order centralized control

Mode 2: Reflex iC60 opening/closing, possible inhibition of local impulse-type control

- Y1 is used to inhibit Y2
- Y1: local opening/Y2 inhibition latched order control
- Y2: impulse-type local opening/closing control
- Y3: latched order centralized opening/closing control

Mode 3: Reflex iC60 opening/closing, possible inhibition of centralised latched order control

- Y1 is used to inhibit Y3
- Y3 inhibition local latched order control
- Y2: impulse-type local opening/closing control
- Y3: latched order centralized opening/closing control

Reflex iC60

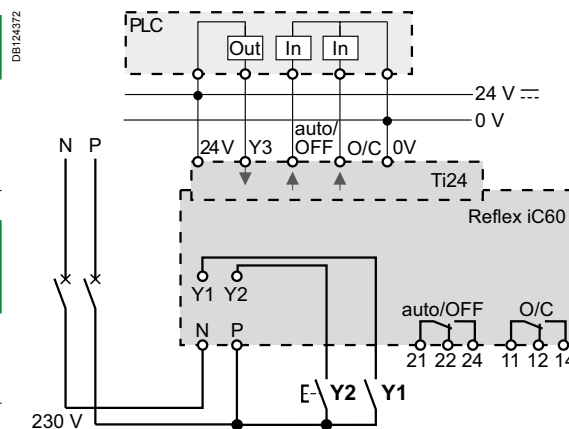
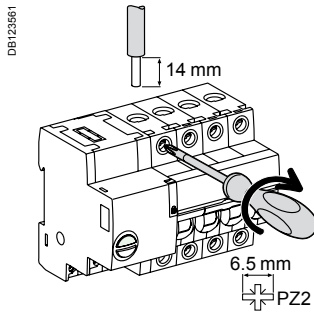

Table of modes

	Mode 1	Mode 2	Mode 3
Reflex iC60	■ Possible mode	■ Possible mode	■ Default mode

Power connection



Terminal	Rating	Tightening torque	Without accessories		With accessories			
			Copper cables		Al terminal 50 mm ²	Screw-on connection for ring terminal	Multi-cable terminal	
			Rigid	Flexible or with ferrule			Rigid cables	Flexible cables
Power	10 to 25 A 40 to 63 A	2 N.m 3.5 N.m	DB1123945 1 to 25 mm ² 1 to 35 mm ²	DB1123946 1 to 16 mm ² 1 to 25 mm ²	DB1122635 Al 50 mm ²	DB118789 Ø 5 mm	DB118787 - 3 x 16 mm ²	- 3 x 10 mm ²

Control connection

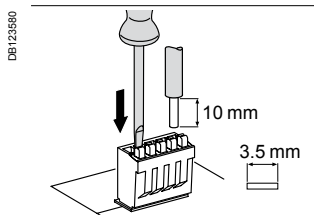
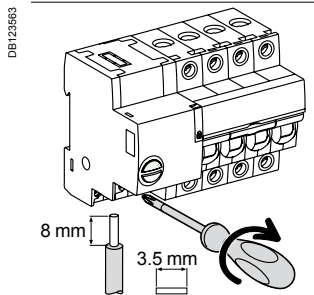
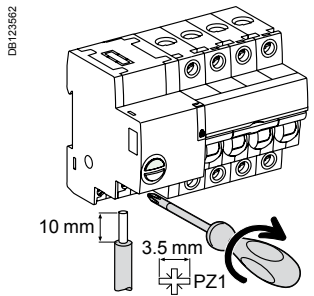

Terminal	Tightening torque	Without accessories		
		Copper cables		
		Rigid	Flexible	Flexible with ferrule
Power supply (N/P) Inputs (Y1/Y2)	1 N.m	DB1123945 1 to 10 mm ²	DB1123953 1 to 6 mm ²	DB1123954 1 to 4 mm ²
Outputs (O/C, auto/OFF)	0.7 N.m	1 to 2.5 mm ²	1 to 2.5 mm ²	1 to 1.5 mm ²
Ti24 interface	Spring-loaded terminals	0.5 to 1.5 mm ²	0.5 to 1.5 mm ²	0.5 to 1.5 mm ²

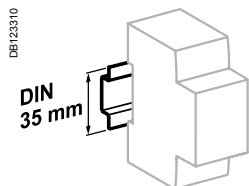

Clip on DIN rail 35 mm.

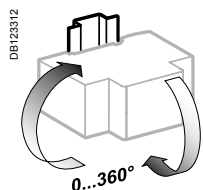

Indifferent position of installation.

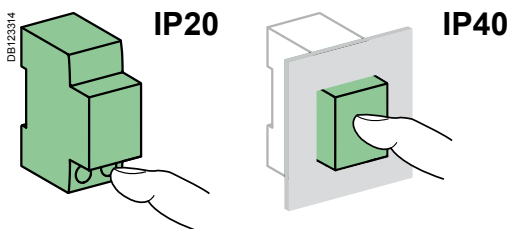

Weight (g)

Circuit breaker	
Type	Reflex iC60
2P	480
3P	620
4P	750

Dimensions (mm)

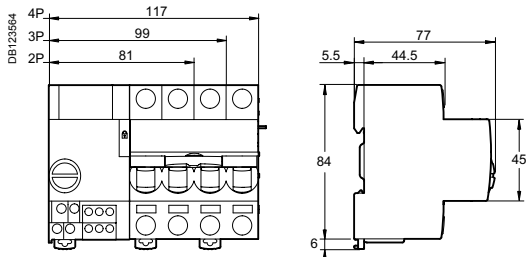

Technical data

Control circuit			
Supply voltage (Ue) (N/P)		230 V AC - 50/60 Hz	
Control voltage (Uc)	Inputs (Y1/Y2)	230 V AC - 23 mA (24...48 V AC/DC, with iMDU auxiliary)	
	Input (Y3)	24 V DC - 5.5 mA	
Min. duration of control impulse (Y2)		≥ 250 ms	
Response time (Y2)		≤ 250 ms	
Maximum continuous apparent power	Inputs (Y1/Y2)	5.3 VA	
	Input Y3	0.12 VA	
Length of control wires	Inputs (Y1/Y2/Y3)	500 m	
Inrush current at 230 V - 50/60 Hz		Measured peak current	Peak current duration
	2P	11.4 Å	11 ms
	3P	21.8 Å	11 ms
	4P	21.8 Å	11 ms
			Rms current measurement
			7.6 A
			14.5 A
			14.5 A

The inrush currents are added in the event of simultaneous control of several Reflex iC60. The controls should therefore be offset by 10 ms (by automaton or time-delay relays).

Power circuit		
Max. working voltage (Ue)		400 V AC
Insulation voltage (Ui)		500 V
Rated impulse withstand voltage (Uimp)	Set to disconnected	6 kV
	Set to Ready	4 kV
Thermal tripping	Reference temperature	50°C
Magnetic tripping	Curve B	4 In ± 20 %
	Curve C	8 In ± 20 %
	Curve D	12 In ± 20 %
Overvoltage category (IEC 60364)		IV
Temperature derating		See module CA908007

Indication / Remote control		
Potential-free changeover contact outputs (O/C, auto/OFF)	Min.	24 V DC - 100 mA
	Max	230 V AC - 1 A

Ti24 interface (as per IEC 61131)		
Outputs (O/C, auto/OFF)	Ti24 interface	24 V DC - 100 mA max

Endurance (O-C)		
Electrical	AC1 - AC7a	Up to 50,000 cycles
	AC5a - AC5b	Up to 15,000 cycles
	AC7c	Up to 20,000 cycles
Mechanical		50,000 cycles

Additional characteristics		
Degree of protection (IEC 60529)	Device only	IP20
	Device in a modular enclosure	IP40 Insulation class II
Degree of pollution		3
Operating temperature		-25°C to +60°C
Storage temperature		-40°C to +85°C
Tropicalization		Treatment 2 (relative humidity of 93 % at 40°C)
Immunity to voltage dips		IEC 61000-4-11 class III
Immunity to power supply frequency variations		IEC 61000-4-28 and IACS E10
Immunity to harmonics		IEC 61000-4-13 class 2
Immunity to electrostatic discharges	Air	8 kV, IEC 61 000-4-2
	Contacts	4 kV, IEC 61 000-4-2
Immunity to stray magnetic fields		10 V/m up to 3 GHz, IEC 61000-4-3
Immunity to fast transients		4 kV from 5 to 100 kHz, IEC 61000-4-4
Immunity to shock waves		IEC 61000-4-5
Immunity to power frequency magnetic fields		10 V from 150 kHz to 80 MHz, IEC 61000-4-6
Immunité aux champs magnétiques à la fréquence du réseau		Level 4 30 A/m to IEC 61000-4-8 and IEC 61000-4-9
Conducted emissions		CISPR 11/22
Radiated emissions		CISPR 11/22



**For the realization of the catalogue France,
replace following catalogue numbers:**

- A9C20834 by A9C24834.
- A9C20732 by A9C24732.
- A9C21732 by A9C25732.

Pages 444, 445 and 454, 455.

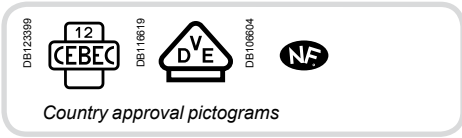

EN 61095, IEC 1095

iCT contactors are available in two versions:

- Contactors without manually-operated
- Contactors with manually-operated.

The breadth of the iCT contactor range satisfies most application cases.
iCT contactors can be combined with auxiliary control, protection and indication functions.

Contactors

iCT 2P



manual control

iCT 4P



- iCT contactors can be used to remote control applications in alternative networks:
 - lighting, heating, ventilation, roller blinds, sanitary hot water
 - mechanical ventilation systems, etc
 - load-shedding of non-priority circuits

Indication iACTs

- This auxiliary allows indication or control of the "open" or "closed" position of the contactor power contacts

Interference filtering iACTp

- This auxiliary is an interference suppressor which limits overvoltages on the control circuit

Dual control iACTc

- Used to control a contactor in impulse-type mode or to combine latched or impulse-type control orders

Control and indication 24 V DC iACT24

- Allows control and indication of a 230 Vac contactor from the Acti 9 Smartlink or by a PLC, by 24 V DC signals
- Also allows control by a maintained signal

Time delay iATEt

- This auxiliary is used to time delay for iCT and iTL. According to cabling, there are 5 possible time delay types:
 - 1 for iTL
 - 4 for iCT

Function type A: late closing
Delay energizing of contactor

Function type B: time delay

- Energize the contactor by closing a push button
- The time delay starts as soon as the control contacts are closed

Function type C: late opening

- Energize the contactor by closing a push button
- The time delay starts when the control contacts are opened

Function type H: fixed time operation

- Operate the contactor for a pre-determined time from the moment of energizing

Contactors

Contactors auxiliaries

		Choice of 50 Hz contactors									
Type		Contactor						Manually-operated contactors			
Rating	A	16	20	25	40	63	100	16	25	40	63
Auxiliaries								Contactors that can be equipped with auxiliaries			
iACTs indication auxiliary		Yes	Yes	Yes				Yes			
iACTp protection auxiliary	By yellow clips	No	No	Yes				No	Yes		
iACTc, iATEt control auxiliary	By yellow clips	No	No	Yes				No	Yes		
iACT24 control auxiliary		Non	No	Yes (for contactors 230 V - 50 Hz)				No	Yes (for contactors 230 V - 50 Hz)		

PE10611E-39

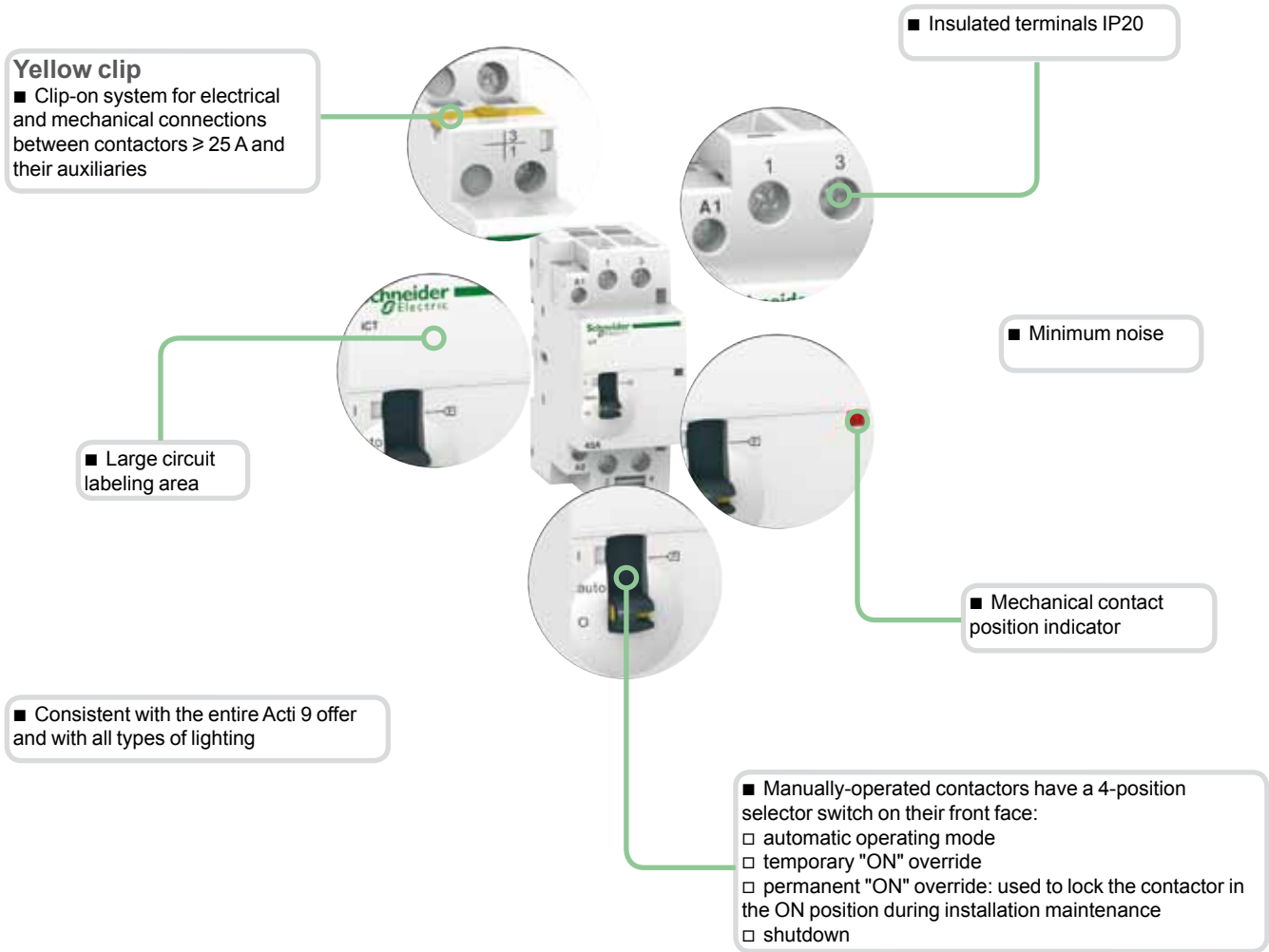

Choice of 60 Hz contactors				
Contactor				Manually-operated contactors
16	25	40	63	40
Contactors that can be equipped with auxiliaries				
Yes				Yes
No	Yes			Yes
No	Yes			Yes
No	Yes			No

Catalogue numbers

ICT contactors - 50 Hz

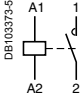
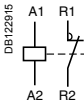
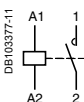
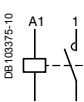
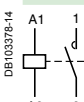
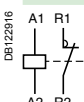
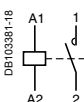
Type						Width in 9 mm modules		
1P	Rating (In)		Control voltage (V AC) (50 Hz)	Contact				
	AC7a	AC7b						
 DB103373-5	16 A	6 A	12	1NO	A9C22011	2		
			24	1NO	A9C22111	2		
			48	1NO	A9C22211	2		
			220	1NO	A9C22511	2		
			230...240	1NO	A9C22711	2		
	25 A	8.5 A	220	1NO	A9C20531	2		
			230...240	1NO	A9C20731	2		
			2P					
 DB122915	16 A	6 A	12	2NO	A9C22012	2		
			24	2NO	A9C22112	2		
			48	2NO	A9C22212	2		
			220	2NO	A9C22512	2		
			230...240	2NO	A9C22712	2		
 DB103377-11			12	1NO+1NC	A9C22015	2		
			24	1NO+1NC	A9C22115	2		
			220	1NO+1NC	A9C22515	2		
			230...240	1NO+1NC	A9C22715	2		
 DB103375-10	20 A	-	230...240	2NO	A9C22722	2		
			25 A	8.5 A	24	2NO	A9C20132	2
					48	2NO	A9C20232	2
					220	2NO	A9C20532	2
					230...240	2NO	A9C20732	2
					220	2NC	A9C20536	2
230...240	2NC	A9C20736	2					
	40 A	15 A	220...240	2NO	A9C20842	4		
	63 A	20 A	24	2NO	A9C20162	4		
			220...240	2NO	A9C20862	4		
	100 A (*)	-	220...240	2NO	A9C20882	6		
	3P							
	 DB103378-14	16 A	6 A	220...240	3NO	A9C22813	4	
25 A				8.5 A	220...240	3NO	A9C20833	4
40 A				15 A	220...240	3NO	A9C20843	6
63 A				20 A	220...240	3NO	A9C20863	6
4P								
 DB122916	16 A	6 A	24	4NO	A9C22114	4		
					220...240	4NO	A9C22814	4
					220...240	2NO+2NC	A9C22818	4
	20 A	-	220...240	4NO	A9C22824	4		
			25 A	8.5 A	24	4NO	A9C20134	4
					220...240	4NO	A9C20834	4
					24	4NC	A9C20137	4
	40 A	15 A	220...240	4NC	A9C20837	4		
			220...240	2NO+2NC	A9C20838	4		
			220...240	4NO	A9C20844	6		
 DB103381-1B	63 A	20 A	24	4NO	A9C20847	6		
			220...240	4NO	A9C20164	6		
			220...240	4NO	A9C20864	6		
			24	4NC	A9C20167	6		
			220...240	4NC	A9C20867	6		
			220...240	2NO+2NC	A9C20868	6		
			220...240	3NO+1NC	A9C20869	6		
	100 A (*)	-	220...240	4NO	A9C20884	12		

(*) do not use for lighting applications

Catalogue numbers

ICT manual control contactor 50 Hz						Width in 9 mm modules	
Type	Rating (In)		Control voltage (V AC) (50/60 Hz)	Contact	Catalogue number		
	AC7a	AC7b					
	16 A	6 A	220	2NO	A9C23512	2	
			230...240	2NO	A9C23712	2	
			220	1NO+1NC	A9C23515	2	
			230...240	1NO+1NC	A9C23715	2	
	25 A	8,5 A	24	2NO	A9C21132	2	
			220	2NO	A9C21532	2	
			230...240	2NO	A9C21732	2	
			24	2NO	A9C21142	2	
40 A	15 A	220...240	2NO	A9C21842	4		
		24	2NO	A9C21162	4		
		220...240	2NO	A9C21862	4		
		24	2NO	A9C21862	4		
	25 A	8,5 A	220...240	3NO	A9C21833	4	
			40 A	15 A	220...240	3NO	A9C21843
		25 A	8,5 A	24	4NO	A9C21134	4
				220...240	4NO	A9C21834	4
40 A		15 A	24	4NO	A9C21144	6	
			220...240	4NO	A9C21844	6	
63 A	20 A	24	4NO	A9C21164	6		
		220...240	4NO	A9C21864	6		

Catalogue numbers

ICT contactors - 60 Hz						
Type	Rating (In)		Control voltage (V AC) (60 Hz)	Contact		Width in 9 mm modules
1P	AC7a	AC7b				
 DB103375-5	25 A	8.5 A	127	1NO	A9C20431	2
			220...240	1NO	A9C20631	2
 DB122915 DB103375-10	16 A	6 A	127	1NO+1NC	A9C22415	2
			220...240	1NO+1NC	A9C22615	2
	25 A	8.5 A	127	2NO	A9C20432	2
			220...240	2NO	A9C20632	2
			127	2NC	A9C20436	2
			220...240	2NC	A9C20636	2
40 A	15 A	127	2NO	A9C20442	4	
		220...240	2NO	A9C20642	4	
 DB103377-11	25 A	8.5 A	127	3NO	A9C20433	4
			220...240	3NO	A9C20633	4
	40 A	15 A	127	3NO	A9C20443	6
			220...240	3NO	A9C20643	6
			127	3NO	A9C20463	6
			220...240	3NO	A9C20663	6
 DB103376-14	25 A	8.5 A	127	3NO	A9C20433	4
			220...240	3NO	A9C20633	4
	40 A	15 A	127	3NO	A9C20443	6
			220...240	3NO	A9C20643	6
			127	3NO	A9C20463	6
			220...240	3NO	A9C20663	6





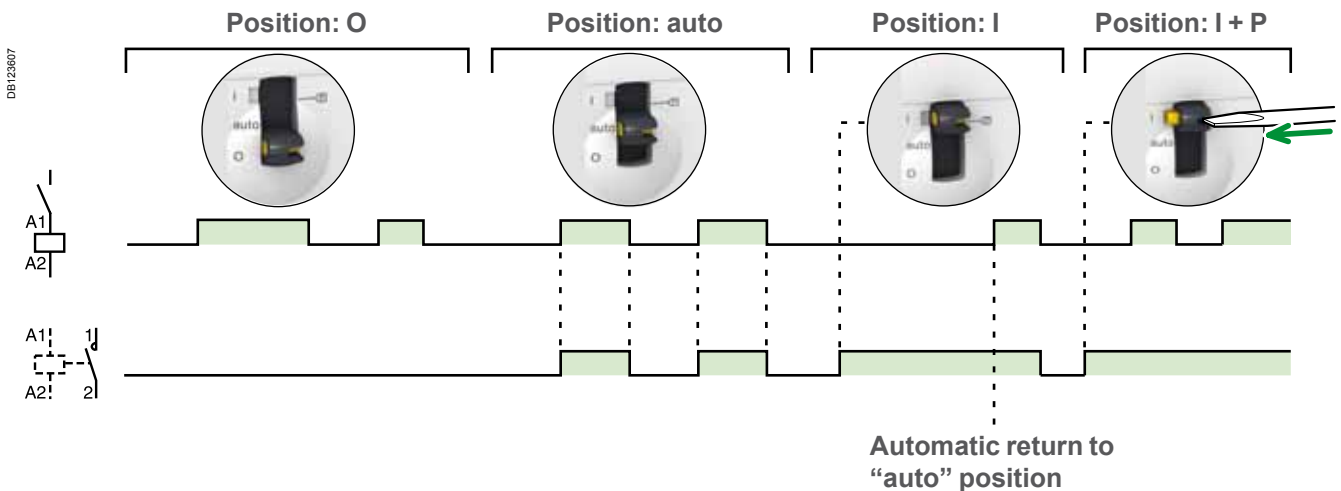

ICT manual control contactor 60 Hz						
Type	Rating (In)		Control voltage (V AC) (60 Hz)	Contact		Width in 9 mm modules
2P	AC7a	AC7b				
 DB106817-24	40 A	15 A	127	2NO	A9C21442	4
			220...240	2NO	A9C21642	4

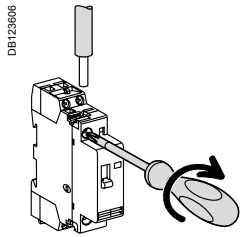
Operation (Manual control contactor)





Connection



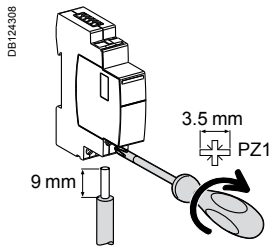

Type	Rating	Length tripping	Circuit	Tightening torque	Copper cables		
					Rigid	Flexible or with ferrule	
iCT	PZ1: 4 mm	16 - 100 A	9 mm	Control	0.8 N.m		
		16 and 25 A					
	PZ2: 6 mm	40 A - 63 A	14 mm	3.5 N.m			
		100 A					
iACTs, iACTp, iACTc, iATEt	PZ1: 4 mm	-	9 mm	-	0.8 N.m		

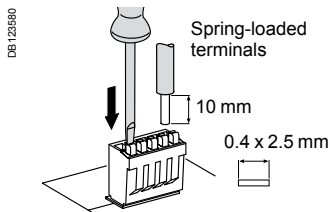

Type	Terminals	Tightening torque	Copper cables		
			Rigid	Flexible	Flexible or with ferrule
iACT24	Power supply (N/P) Input (Y1/Y2)	1 N.m			
			0.5 to 10 mm ² 2 x 0.5 to 2 x 2.5 mm ²	0.5 to 6 mm ² 2 x 0.5 to 2 x 2.5 mm ²	0.5 to 4 mm ² 2 x 0.5 to 2 x 2.5 mm ²

Ti24 connector connection



Type	Catalogue numbers	Copper cables	
		Rigid	Flexible
Ti24 Interface	A9XC2412		
		1 x 0.5 to 1.5 mm ²	1 x 0.5 to 1.5 mm ²

Ti24 prefabricated cables connection

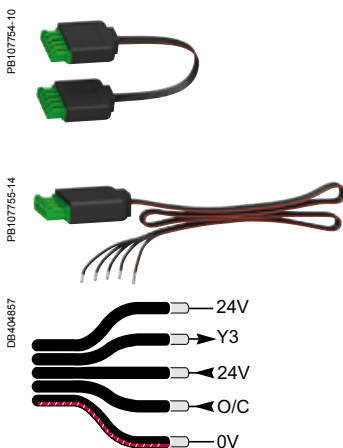

Type	Catalogue numbers	Length
Connection for Acti 9 Smartlink		
6 short prefabricated	A9XCAS06	100 mm
6 medium-sized prefabricated	A9XCAM06	160 mm
6 long prefabricated	A9XCAL06	870 mm
Connection for PLC type terminals		
6 long prefabricated on a single side	A9XCAU06	870 mm

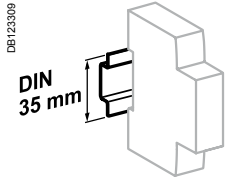

Clip on DIN rail 35 mm.

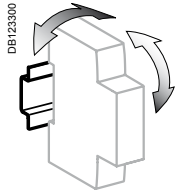

± 30° vertical.

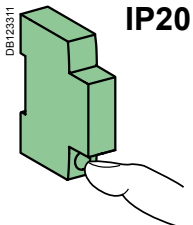

IP20

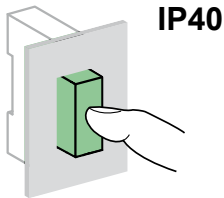

IP40

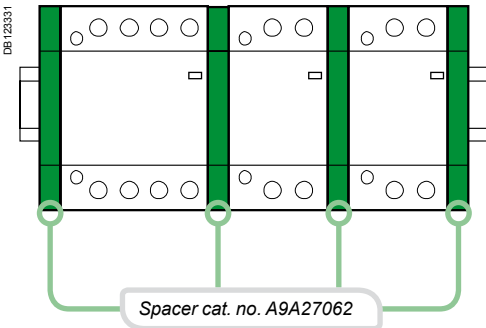

Technical data

Power circuit		
Voltage rating (Ue)	1P, 2P	250 V AC
	3P, 4P	400 V AC
Frequency	50 Hz or 60 Hz	
Type of load	See module CA908026	
Endurance (O-C)		
Electrical	100,000 cycles	
Maximum number of switching operation a day	100	
Additional characteristics		
Insulation voltage (Ui)	500 V AC	
Pollution degree	2	
Rated impulse withstand voltage (Uimp)	2.5 kV (4 kV for 12/24/48 V AC)	
Degree of protection (IEC 60529)	Device only	IP20
	Device in modular enclosure	IP40
Operating temperature	-5°C to +60°C ⁽¹⁾	
Storage temperature	-40°C to +70°C	
Tropicalization (IEC 60068-1)	Treatment 2 (relative humidity 95 % at 55°C)	
ELSV compliance (Extra Low Safety Voltage) for 12/24/48 V AC versions		
The product control conforms to the SELV (safety extra low voltage) requirements		

(1) In the case of contactor mounting in a enclosure for which the interior temperature is in range between 50°C and 60°C, it is necessary to use a spacer, cat. no. A9A27062, between each contactor

Mounting accessories

7	Sealable screw shields for top and bottom	3P, 4P 25 A	A9A15921
		2P 40/63 A	A9A15922
		3P, 4P 40/63 A	A9A15923
8	9 mm spacer		A9A27062
9	Yellow clips		A9C15415
10	Clip-on terminal markers	see module	CA907001

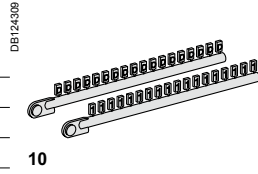

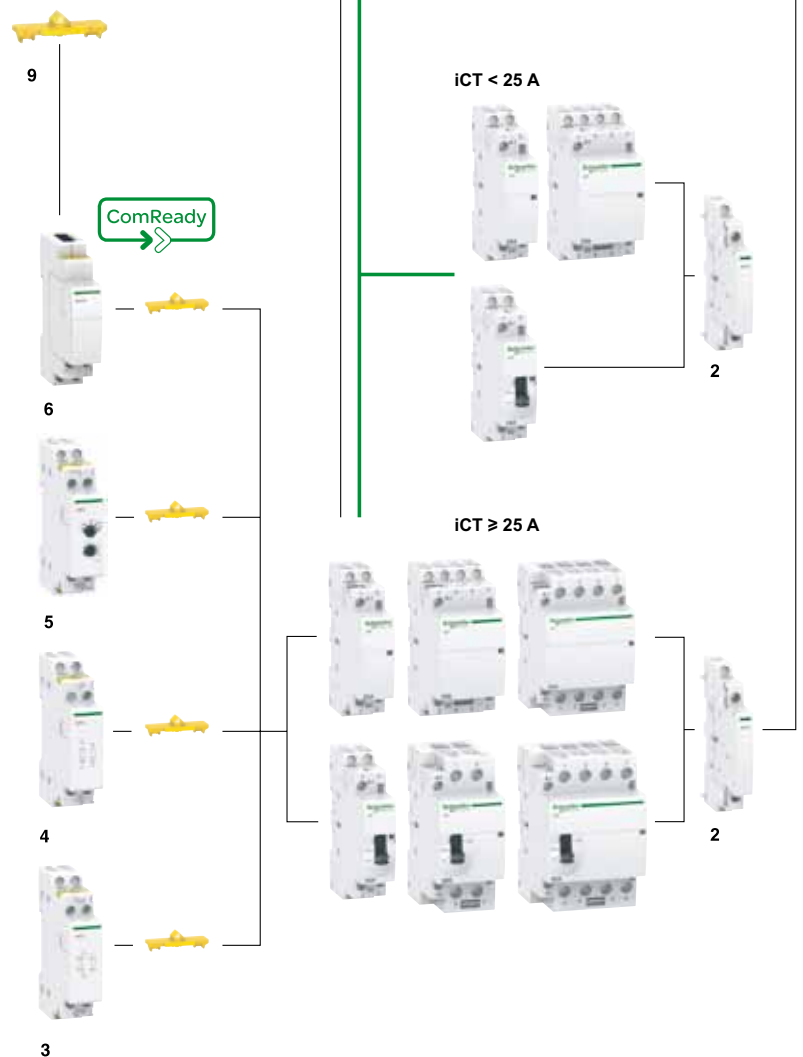

Auxiliaries

Indication			
2	iACTs	1NO + 1NC	A9C15914
		1CO	A9C15915
		2NO	A9C15916
Double control inputs			
3	iACTc	230 V AC	A9C18308
		24 V AC	A9C18309
Coil suppression blocs			
4	iACTp	12...48 V AC	A9C15919
		48...127 V AC	A9C15918
		220...240 V AC	A9C15920
Time delay			
5	iATEt	24...240 V AC	A9C15419
Control and indication			
6	iACT24	230 V AC	A9C15924



ICT contactors

Electrical auxiliaries for iCT

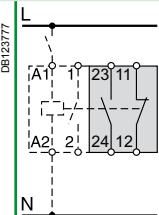
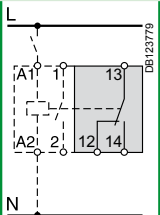
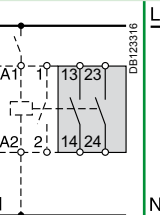
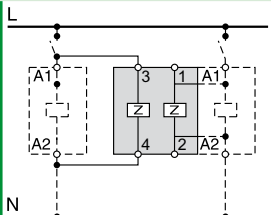
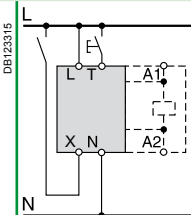
Auxiliaries		Indication			Protection			Control	
Type		iACTs			iACTp			iACTc	
		Indication			Interference filtering			Impulse/latched control	
		With Open/Close auxiliary contact			2 protection circuits				
									
Function		<ul style="list-style-type: none"> This auxiliary allows indication of the "open" or "closed" position of the contactor power contacts 			<ul style="list-style-type: none"> This auxiliary is an interference suppressor which limits overvoltages on the control circuit 			<ul style="list-style-type: none"> This auxiliary, combined with contactors, enables them to be controlled by 2 order types: <ul style="list-style-type: none"> impulse order for local control (input T) latched order for centralised control (input X) the last order received takes priority 	
Wiring diagrams		  							
Mounting		<ul style="list-style-type: none"> Mounted to the right of iCT 			<ul style="list-style-type: none"> Mounted to the left of iCT by yellow clips⁽¹⁾ By wires 			<ul style="list-style-type: none"> Mounted to the left of iCT by yellow clips⁽¹⁾ 	
Use		-			<ul style="list-style-type: none"> The iACTp has 2 separate and identical circuits, allowing it to be combined with 2 different one on the iCT the other by wires 			<ul style="list-style-type: none"> Mains power outages: <ul style="list-style-type: none"> < 70 ms: keeps its initial status > 80 ms: reset put back into operation by manual operation on input X or T. Minimum impulse duration: 250 ms 	
Catalogue numbers		A9C15914	A9C15915	A9C15916	A9C15918	A9C15919	A9C15920	A9C18308	A9C18309
Technical specifications									
Control voltage (U _e)	V AC	24...240			48 ...127	12 ...48	220 ...240	230...240	24...48
	V DC	24...130			-			-	
Control voltage frequency	Hz	50/60			50/60			50/60	
Width in 9 mm modules		1			2			2	
Auxiliary contact (breaking capacity)		<ul style="list-style-type: none"> Minimum: 10 mA at 24 V DC/AC - cos φ = 1 Maximum: <ul style="list-style-type: none"> 5 A at 240 V AC - cos φ = 1 1 A at 130 V DC 			-			-	
Number of contacts		1NO + 1NC	1CO	2NO	-			-	
Operating temperature	°C	-5°C to +50°C			-			-	
Storage temperature	°C	-40°C to +70°C			-			-	
Consumption		-			-			OFF load: 3 VA Inrush ⁽²⁾ : 2 VA Holding ⁽²⁾ : 0.2 VA	

(1) Electrical and mechanical link.

(2) Maximum consumption of all contactors controlled.

iCT contactors

Electrical auxiliaries for iCT (cont.)

Control (cont.)

iATEt

Time delay

PB106125-34



- This auxiliary is used to time delay for iCT and iTL. According to cabling, there are 5 possible time delay types:
- 1 for iTL
- 4 for iCT.

Function type A: late closing

- Delay energizing of contactor.

Function type B: time delay

- Energize the contactor by closing a push button.
- The time delay starts as soon as the control contacts are closed.

Function type C: late opening

- Energize the contactor by closing a push button.
- The time delay starts when the control contacts are opened.

Function type H: fixed time operation

- Operate the contactor for a pre-determined time from the moment of energizing.

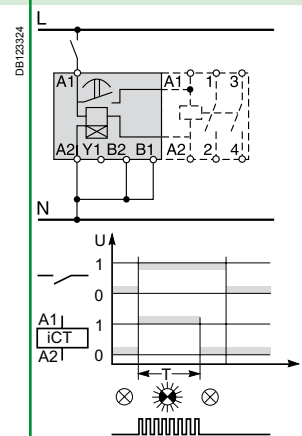
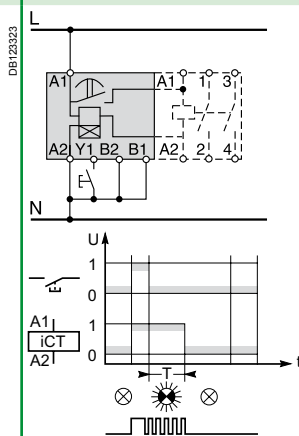
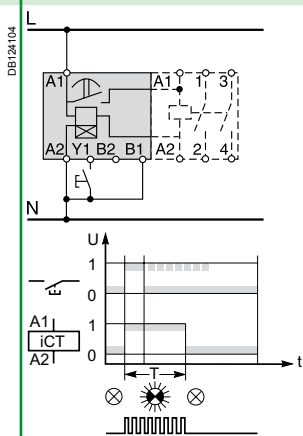
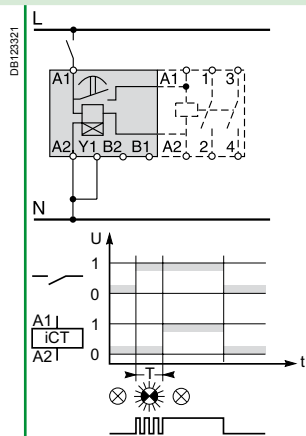

- Mounted to the left of iCT by yellow clips⁽¹⁾

A9C15419

24...240

24...110

50/60

2

-

-

-20°C to +50°C

-40°C to +80°C

Off-load: 5 VA
Inrush⁽²⁾: 3 A
Holding⁽²⁾: 0.2 A



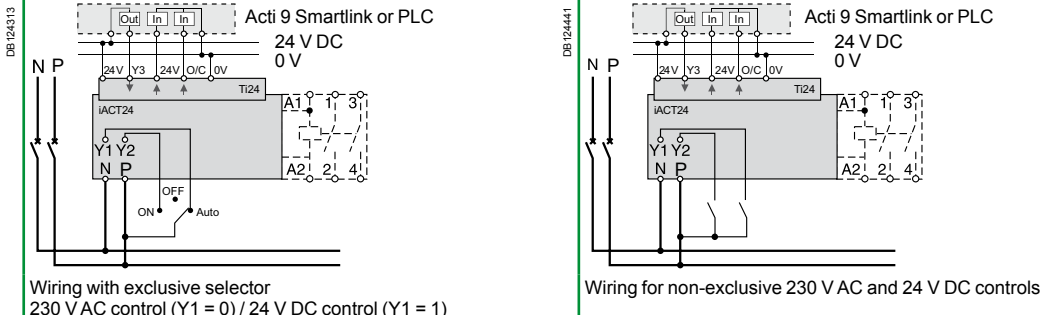

iCT contactors

Electrical auxiliaries for iCT (cont.)

Control and indication

Auxiliary	iACT24	
Type	Control and indication 24 V DC	
	With Ti24 connector	
		
Function	<ul style="list-style-type: none"> ■ This auxiliary allows a contactor to be interfaced with the Acti 9 Smartlink interface or a programmable logic controller (PLC) in 24 V DC (control, O/C indication) ■ 230 V AC control 	
Wiring diagrams	 <p>Wiring with exclusive selector 230 V AC control (Y1 = 0) / 24 V DC control (Y1 = 1)</p> <p>Wiring for non-exclusive 230 V AC and 24 V DC controls</p>	
Mounting	<ul style="list-style-type: none"> ■ To the left of the iCT contactor using the yellow clips ⁽¹⁾. ■ When an iACT24 is used, the A1/A2 terminals of the contactors should not be wired. Only the yellow clips integral with the iACT24 should be used for connection to the coil. 	
Utilization	<ul style="list-style-type: none"> ■ 230 V AC interface: <ul style="list-style-type: none"> □ Y1: enabling of 24 V DC control (Y1 = 1) or inhibition of 24 V DC control (Y1 = 0). □ Y2: 230 V pulse control ■ "Ti24" 24 V DC interface: <ul style="list-style-type: none"> □ Y3: 24 V DC control of iCT closing on rising edge and opening on falling edge □ reading of the contactor status (opened or closed) from the position of the integrated O/C auxiliary contact □ monitoring of connection of the "Ti24" terminal block by the upstream system (PLC, supervision system) via the 24 V terminal (in the centre of the Ti24 terminal block) 	
Catalogue numbers	A9C15924	
Technical specifications		
Control voltage (Ue)	V AC	230, +10 %, -15 % (Y2)
	V DC	24, ± 20 % (Y3)
Control voltage frequency	Hz	50/60
Insulation voltage (Ui)	V AC	250
Rated impulse withstand voltage (Uimp)	kV	8 (OVC IV)
Pollution degree		3
Degree of protection		IP20B device only
		IP40 device in modular enclosure
Width in 9 mm modules		2
Auxiliary contact (O/C) Ti24		24 V DC protected output, min. 2 mA, max. 100 mA
Contact		1 O/C operating category AC 14
Operating temperature	°C	-25°C to +60°C
Storage temperature	°C	-40°C to +80°C
Consumption		<1 W
Standard		IEC/EN 60947-5-1

(1) Mechanical and electrical link.

Security					
Accessories	Sealable screw shields			Yellow clips	Spacer
	 PE104485-15	 PE104486-15	 PE104487-15	 PE108143-10	 PE104483-40
Function	<ul style="list-style-type: none"> ■ Designed to cover terminals to avoid contact with device screws. ■ Allow sealing 			<ul style="list-style-type: none"> ■ Ensure the mechanical and/or electrical link between contactors and their auxiliaries. 	<ul style="list-style-type: none"> ■ Required to reduce temperature rise of modular devices installed side by side. ■ Recommended to separate electronic devices (thermostat, programmable clock, etc.) from electromechanical devices (relays, contactors).
	■ For iCT: 3P, 4P - 25 A	■ For iCT: 2P - 40/63 A	■ For iCT: 3P, 4P - 40/63 A	■ For iCT: ≥ 25 A	
Use	■ Bag of 10 upstream/10 downstream			■ Bag of 10	■ Bag of 5
Catalogue numbers	A9A15921	A9A15922	A9A15923	A9C15415	A9A27062
Technical specifications					
Width in 9 mm modules	4	4	6	–	1
Number of poles	3P, 4P	2P	3P	–	–



Operation of the iACT24

O/C 24 V DC output

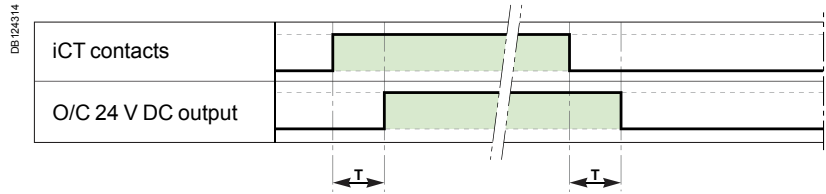

	Parameter	Min	Max
T	Time delay between iACT24 closing and indication	100 ms	200 ms

- Minimum duration of 230 V AC pulse (Y2): 200 ms.
- 30 iACT24 closing or opening actuations are authorized per minute: Minimum time delay between 2 actuations on the iACT4 via Y1, Y2, Y3 (closing or opening of the iCT coil): 220 ms.
- 10 closing or opening actuations spaced 440 milliseconds apart are authorized following no loading of the iACT24 during a period of 20 seconds.

Wiring with exclusive selector 230 V AC control (Y1 = 0) / 24 V DC control (Y1 = 1)

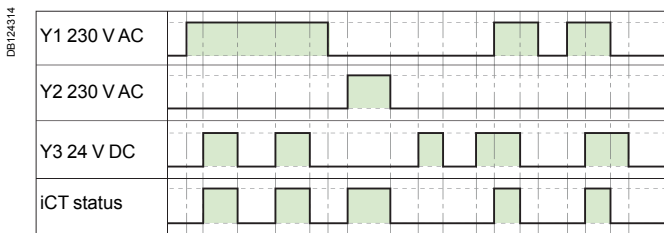
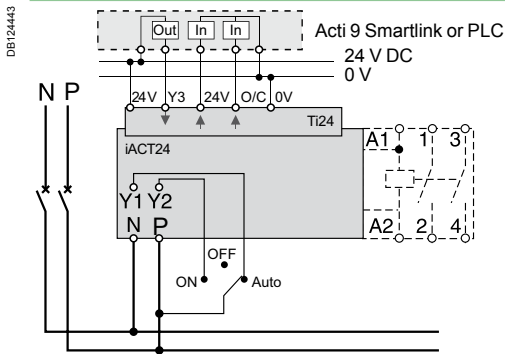

Wiring for non-exclusive 230 V AC and 24 V DC controls

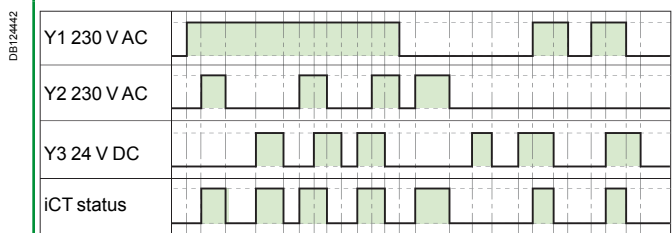
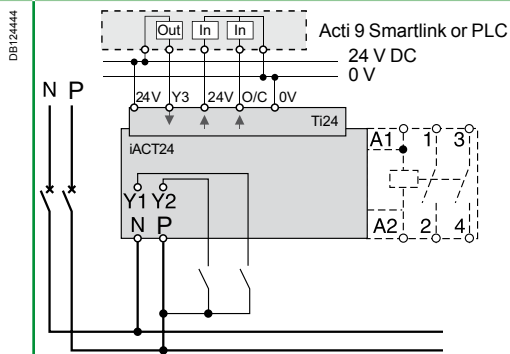

Consumption

iCT contactors - 50 Hz

Type

1P	Rating (In)		Control voltage (V AC) (50 Hz)	Consumption		Max. power	
	AC7a	AC7b		Holding	Inrush		
16 A	5 A	12	3.8 VA	15 VA	1.3 W	A9C22011	
		24	3.8 VA	15 VA	1.3 W	A9C22111	
		48	3.8 VA	15 VA	1.3 W	A9C22211	
		220	3.8 VA	15 VA	1.3 W	A9C22511	
		230...240	2.7 VA	9.2 VA	1.2 W	A9C22711	
25 A	8.5 A	220	3.8 VA	15 VA	1.3 W	A9C20531	
		230...240	2.7 VA	9.2 VA	1.2 W	A9C20731	
2P							
16 A	5 A	12	3.8 VA	15 VA	1.3 W	A9C22012	
		24	3.8 VA	15 VA	1.3 W	A9C22112	
		48	3.8 VA	15 VA	1.3 W	A9C22212	
		220	3.8 VA	15 VA	1.3 W	A9C22512	
		230...240	2.7 VA	9.2 VA	1.2 W	A9C22712	
		12	3.8 VA	15 VA	1.3 W	A9C22015	
		24	3.8 VA	15 VA	1.3 W	A9C22115	
		220	3.8 VA	15 VA	1.3 W	A9C22515	
		230...240	2.7 VA	9.2 VA	1.2 W	A9C22715	
		20 A	6.4 A	230...240	2.7 VA	9.2 VA	1.2 W
25 A	8.5 A	24	3.8 VA	15 VA	1.3 W	A9C20132	
		48	3.8 VA	15 VA	1.3 W	A9C20232	
		220	3.8 VA	15 VA	1.3 W	A9C20532	
		230...240	2.7 VA	9.2 VA	1.2 W	A9C20732	
		220	3.8 VA	15 VA	1.3 W	A9C20536	
230...240	2.7 VA	9.2 VA	1.2 W	A9C20736			
40 A	15 A	220...240	4.6 VA	34 VA	1.6 W	A9C20842	
63 A	20 A	24	4.6 VA	34 VA	1.6 W	A9C20162	
		220...240	4.6 VA	34 VA	1.6 W	A9C20862	
100 A (*)	-	220...240	6.5 VA	53 VA	2.1 W	A9C20882	
3P							
16 A	5 A	220...240	4.6 VA	34 VA	1.6 W	A9C22813	
25 A	8.5 A	220...240	4.6 VA	34 VA	1.6 W	A9C20833	
40 A	15 A	220...240	6.5 VA	53 VA	2.1 W	A9C20843	
63 A	20 A	220...240	6.5 VA	53 VA	2.1 W	A9C20863	
4P							
16 A	5 A	24	4.6 VA	34 VA	1.6 W	A9C22114	
		220...240	4.6 VA	34 VA	1.6 W	A9C22814	
		220...240	4.6 VA	34 VA	1.6 W	A9C22818	
20 A	6.4 A	220...240	4.6 VA	34 VA	1.6 W	A9C22824	
25 A	8.5 A	24	4.6 VA	34 VA	1.6 W	A9C20134	
		220...240	4.6 VA	34 VA	1.6 W	A9C20834	
		24	4.6 VA	34 VA	1.6 W	A9C20137	
		220...240	4.6 VA	34 VA	1.6 W	A9C20837	
		220...240	4.6 VA	34 VA	1.6 W	A9C20838	
40 A	15 A	220...240	6.5 VA	53 VA	2.1 W	A9C20844	
		220...240	6.5 VA	53 VA	2.1 W	A9C20847	
63 A	20 A	24	6.5 VA	53 VA	2.1 W	A9C20164	
		220...240	6.5 VA	53 VA	2.1 W	A9C20864	
		24	6.5 VA	53 VA	2.1 W	A9C20167	
		220...240	6.5 VA	53 VA	2.1 W	A9C20867	
		220...240	6.5 VA	53 VA	2.1 W	A9C20868	
		220...240	6.5 VA	53 VA	2.1 W	A9C20869	
100 A (*)	-	220...240	13 VA	106 VA	4.2 W	A9C20884	

(*) do not use for lighting applications

iCT contactors

Technical advice for iCT (cont.)

Consumption (cont.)

iCT manual control contactor 50 Hz

Type

2P	Rating (In)		Control voltage (V AC) (50 Hz)	Consumption		Max. power	
	AC7a	AC7b		Holding	Inrush		
16 A	5 A		220	2.7 VA	9.2 VA	1.2 W	A9C23512
			230...240	2.7 VA	9.2 VA	1.2 W	A9C23712
			220	3.8 VA	15 VA	1.3 W	A9C23515
			230...240	2.7 VA	9.2 VA	1.2 W	A9C23715
25 A	8.5 A		24	3.8 VA	15 VA	1.3 W	A9C21132
			220	2.7 VA	9.2 VA	1.2 W	A9C21532
			230...240	2.7 VA	9.2 VA	1.2 W	A9C21732
40 A	15 A		24	4.6 VA	34 VA	1.6 W	A9C21142
			220...240	4.6 VA	34 VA	1.6 W	A9C21842
63 A	20 A		24	4.6 VA	34 VA	1.6 W	A9C21162
			220...240	4.6 VA	34 VA	1.6 W	A9C21862
3P							
25 A	8.5 A		220...240	4.6 VA	34 VA	1.6 W	A9C21833
40 A	15 A		220...240	6.5 VA	53 VA	2.1 W	A9C21843
4P							
25 A	8.5 A		24	4.6 VA	34 VA	1.6 W	A9C21134
			220...240	4.6 VA	34 VA	1.6 W	A9C21834
40 A	15 A		24	6.5 VA	53 VA	2.1 W	A9C21144
			220...240	6.5 VA	53 VA	2.1 W	A9C21844
63 A	20 A		24	6.5 VA	53 VA	2.1 W	A9C21164
			220...240	6.5 VA	53 VA	2.1 W	A9C21864

iCT contactors - 60 Hz

Type

1P	Rating (In)		Control voltage (V AC) (60 Hz)	Consumption		Max. power	
	AC7a	AC7b		Holding	Inrush		
25 A	8.5 A		127	3.8 VA	15 VA	1.3 W	A9C20431
			220 ...240	2.7 VA	9.2 VA	0.9 W	A9C20631
2P							
16 A	5 A		127	3.8 VA	15 VA	1.3 W	A9C22415
			220...240	2.7 VA	9.2 VA	0.9 W	A9C22615
25 A	8.5 A		127	3.8 VA	15 VA	1.3 W	A9C20432
			220...240	2.7 VA	9.2 VA	0.9 W	A9C20632
			127	3.8 VA	15 VA	1.3 W	A9C20436
			220...240	2.7 VA	9.2 VA	0.9 W	A9C20636
40 A	15 A		127	4.6 VA	34 VA	1.6 W	A9C20442
			220...240	4.6 VA	34 VA	1.6 W	A9C20642
3P							
25 A	8.5 A		127	4.6 VA	34 VA	1.6 W	A9C20433
			220...240	4.6 VA	34 VA	1.6 W	A9C20633
40 A	15 A		127	6.5 VA	53 VA	2.1 W	A9C20443
			220...240	6.5 VA	53 VA	2.1 W	A9C20643
63 A	20 A		127	6.5 VA	53 VA	2.1 W	A9C20463
			220...240	6.5 VA	53 VA	2.1 W	A9C20663

Dimensions (mm)

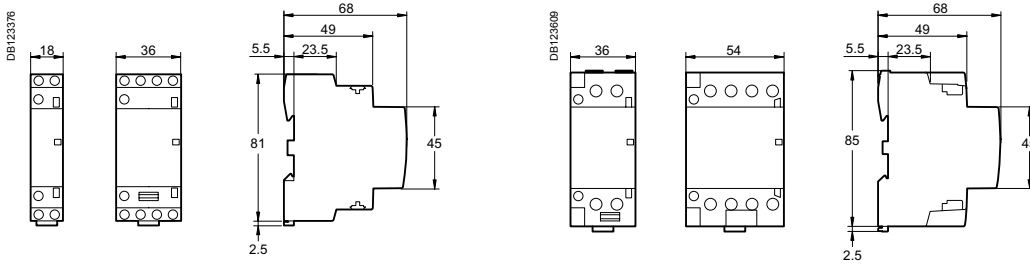

iCT 16/25 A

iCT 40/63 A

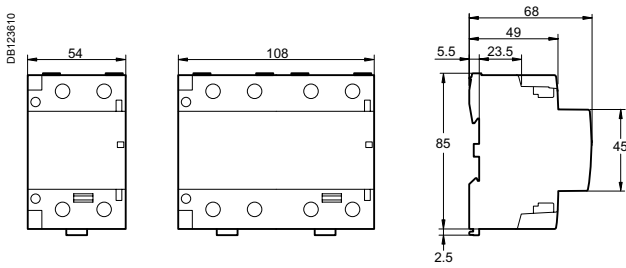

iCT 100 A

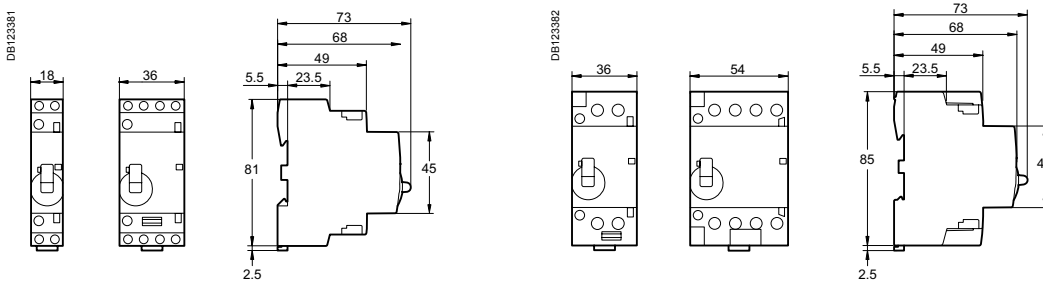

iCT manual control contactor 16/25 A

iCT manual control contactor 40/63 A

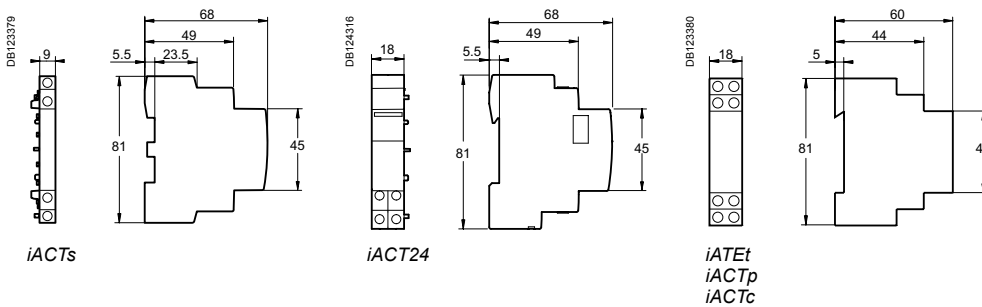

iACTs

iACT24

iATEt
iACTp
iACTc

DB12399
CEBEC 12
DB116819
DVE
iTL, iTLI, iTLs, iTLc, iTLm
Country approval pictograms

IEC/EN 60669-2-2
iTLs: IEC/EN 60947-5-1

> Impulse relays

PB106128-34



PB106128-34



iTL

- The impulse relays are used to control, by means of pushbuttons, lighting circuits consisting of:
 - incandescent lamps, low-voltage halogen lamps, etc. (resistive loads)
 - fluorescent lamps, discharge lamps, etc. (inductive loads)

> Remote indication

PB106133-34



iTLs

- Allows remote indication of its operating state (open/closed)

PB106139-34



Indication iATLs

- Allows remote indication of the associated impulse relay

> Centralised control

PB106130-34



iTLc

- Allows centralised control of a group of TLc impulse relays, whilst at the same time retaining local impulse-type control

PB106137-34



Centralised control iATLc

- Used for centralised control, thanks to a "pilot line", of a group of impulse relays controlling separate circuit, while at the same time maintaining local individual control of each impulse relay

> Latched control

PB106132-34



iTLm

- Operated by latched orders from a changeover contact (switch, time switch, thermostat). Manual control does not work

PB106138-34



Latched control iATLm

- Controls the associated impulse relay by latched orders from a changeover contact

^ Impulse relays

Impulse relays are used:

- Closing of the impulse relay pole(s) is triggered by an impulse on the coil.
- Having two stable mechanical positions, the pole(s) will be opened by the next impulse. Each impulse received by the coil reverses the position of the pole(s).
- Can be controlled by an unlimited number of pushbuttons.
- Zero energy consumption.

PB106131-34



Changeover contact iTLi

- This impulse relay has a changeover contact

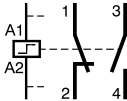

PB106134-34



Extensions iETL

- Used to increase the number of impulse relay poles
- Can be installed on the iTL, iTLi, iTLc, iTLm and iTLs

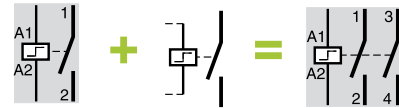

PB106140-34



Centralised control + indication iATLc+s

- Used for centralised control, thanks to a "pilot line", of a group of impulse relays controlling separate circuit, while at the same time maintaining local individual control of each impulse relay
- Remote indication of the mechanical status of each relay

PB106136-34



Multi-level centralised control iATLc+c

- Allows centralised control of a group of iTLc or "iTL + ATLc" impulse relays

PB107742-34



Control and indication 24 V DC iATL24

- Allows control and indication of a 230 V AC impulse relay from the Acti 9 Smartlink or by a PLC, by 24 V DC signals
- Also allows control by a pulsed signal

ComReady

PB106125-34



Time delay iATEt

- Combined with an impulse relay, it automatically disconnects the circuit after a preset time

PB106141-34



Control iATLz

- Must be used when installing several illuminated PBs in parallel to control an impulse relay (prevents operating malfunctions)

PB106142-63



Step by step control iATL4

- Allows step-by-step control of two circuits via a single pushbutton

Mounting accessories

11	Yellow clips	A9C15415
12	9 mm spacer	A9A27062
13	Clip-on terminal markers	see module CA907001

DB 123631

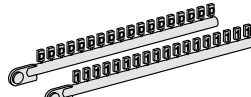

13



12



11

Auxiliaries

Centralised control	Control voltage	Cat. no.
2 iATLc ^{(1),(3)}	24...240 V AC	A9C15404
Indication		
3 iATLs ⁽¹⁾	-	A9C15405
Centralised control + indication		
4 iATLc+s ⁽³⁾	24...240 V AC	A9C15409
Multi-level centralised control		
5 iATLc+c ^{(2),(3)}	24...240 V AC	A9C15410
Step by step control		
6 iATL4	230 V AC	A9C15412
Control by illuminated push-buttons		
7 iATLz	230...240 V AC	A9C15413
Latched control		
8 iATLm ⁽¹⁾	12...240 V AC	A9C15414
Time delay control		
9 iATEt ⁽⁴⁾	24...240 V AC	A9C15419
Control and indication		
10 iATL24	230 V AC	A9C15424

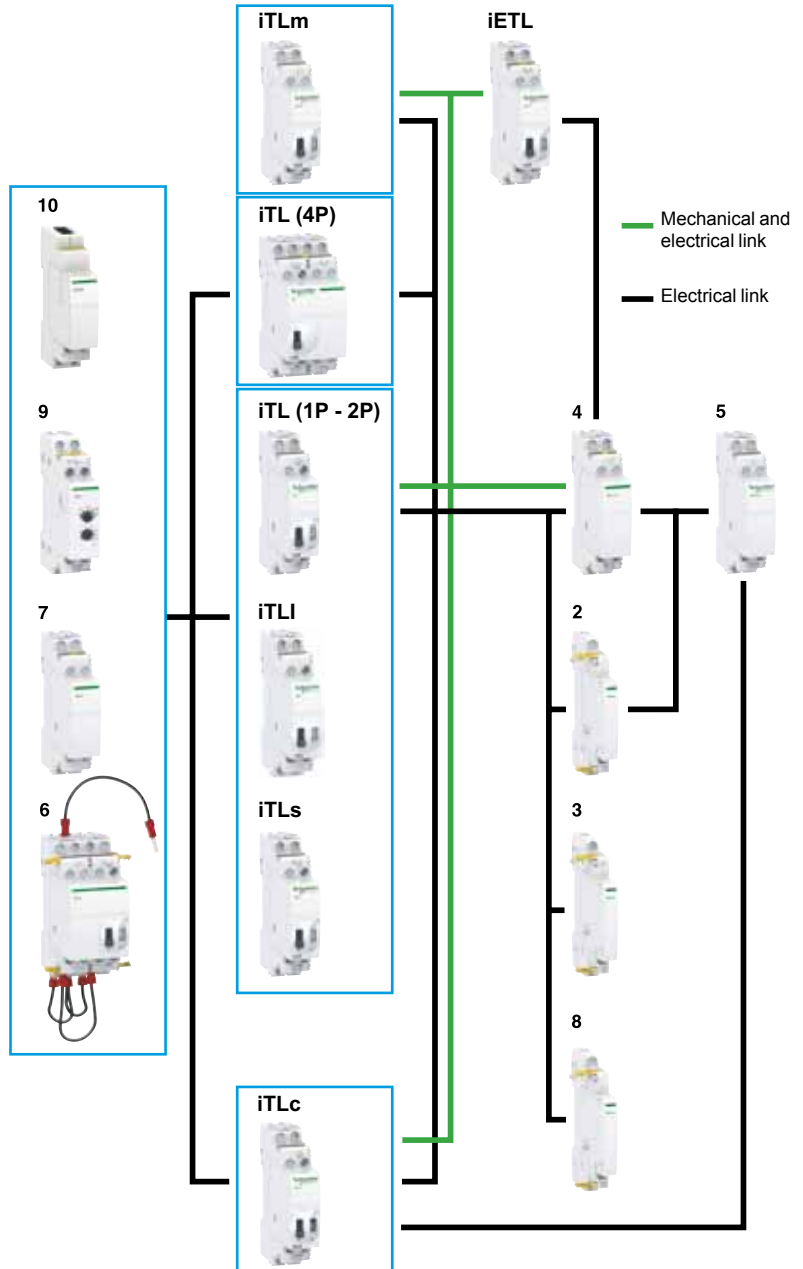

(1) The iATLc, iATLs and iATLm 9 mm auxiliaries must be mounted to the right of an impulse relay.

(2) Connection by traditional cabling.

The iATLc+c must be mounted to the right of an iATLc+s or an iATLc.

(3) The centralised control functions (iTLc, iATLc, iATLc+s, iATLc+c) only operate on AC voltage networks.

(4) iATEt: control voltage: 24...240 V AC, 24...110 V DC.

PE100128-41

Yellow clip
 ■ A simple clip-on system for flexible auxiliaries combination and improved robustness
 ■ For electrical and mechanical connections

■ Insulated terminals IP20

■ Large circuit labeling area

■ Consistent with the entire Acti 9 offer and with all types of lighting

■ Disconnection of remote control by selector switch (except for 4P single-piece iTL) for maintenance operation

■ Manual controls on front face: direct and priority manual control by O-I toggle
 ■ Mechanical contact position indicator

■ Built-in or optional auxiliary function: state indication, centralised control, latched control, control for illuminated pushbutton, step-by-step control, time delay



V AC		Choice impulse relays auxiliaries																			
Type		Standard iTL					Changeover iTLI					iTLC centralised control			iTLm control on latched order		iTLs remote indication				
Rating	A	16					32					16			16		16				
Control voltage (Uc)	V AC	230/240	130	48	24	12	230/240	230/240	130	48	24	12	230/240	48	24	230/240	230/240	48	24		
Auxiliaries																					
Extension																					
iETL		■	■	■	■	■	■	■	■	■	■	■	■	■	■				■	■	■
Centralised control + indication																					
iATLc+s		■	■	■	■	-	■	■	■	-	-	-	-	-	-				■	■	■
Centralised control																					
iATLc		■	■	■	■	-	■	■	■	-	-	-	-	-	-				■	■	■
Indication																					
iATLs		■	■	■	■	-	■	■	■	■	■	■	■	■	■				■	■	■
Multi-level centralised control																					
iATLc+c		■	■	■	■	-	■	■	■	-	-	■	■	■	-				■	■	■
Latched control																					
iATLm		■	■	■	■	■	■	■	■	■	■	-	-	-	-				■	■	■
Control for illuminated Pushbutton																					
iATLz		■	-	-	-	-	■	■	-	-	-	■	-	-	-				■	-	-
Step by step control																					
iATL4		■	-	-	-	-	■	■	-	-	-	■	-	-	-				■	-	-
Time delay control																					
iATEt		■	■	■	■	-	■	■	■	■	-	-	-	-	-				■	■	■
Control and indication																					
iATL24		■	-	-	-	-	■	■	-	-	-	■	-	-	-				■	-	-

V DC		Choice impulse relays auxiliaries																			
Type		Standard iTL					Changeover iTLI					iTLC centralised control			iTLm control on latched order		iTLs remote indication				
Rating	A	16					32					16			16		16				
Control voltage (Uc)	V DC	110	48	24	12	6	110	110	48	24	12	6	-	-	-	110	110	24	12		
Auxiliaries																					
Extension																					
iETL		■	■	■	■	■	■	■	■	■	■	-	-	-	-				■	■	■
Indication																					
iATLs		■	■	■	■	-	■	■	■	■	■	-	-	-	-				■	■	■
Time delay control																					
iATEt		■	■	■	-	-	■	■	■	-	-	-	-	-	-				■	■	-

Catalogue numbers

iTL impulse relays				
Type	1P	2P	3P	4P
Rating (In)	Control voltage (Uc)			
	(V AC) (50/60 Hz)	(V DC)		
16 A	12	6	A9C30011	A9C30012
	24	12	A9C30111	A9C30112
	48	24	A9C30211	A9C30212
	130	48	A9C30311	A9C30312
	230...240	110	A9C30811	A9C30812
Width in 9 mm modules			2	2
32 A	230...240	110	A9C30831	A9C30831 + A9C32836
Width in 9 mm modules			2	4
			A9C30831 + 2 x A9C32836	A9C30831 + 3 x A9C32836
Width in 9 mm modules			2	6

iTLI impulse relays			
Type	2P		
Rating (In)	Control voltage (Uc)		
	(V AC) (50/60 Hz)	(V DC)	
16 A	12	6	A9C30015
	24	12	A9C30115
	48	24	A9C30215
	130	48	A9C30315
	230...240	110	A9C30815
Width in 9 mm modules			2

iETL extensions for iTL and iTLI			
Type	1P	2P	
Rating (In)	Control voltage (Uc)		
	(V AC) (50/60 Hz)	(V DC)	
16 A	12	6	-
	24	12	-
	48	24	-
	130	48	-
	230...240	110	-
32 A	230...240	110	A9C32836
Width in 9 mm modules			2

iTL impulse relays (cont.)

iTLc , iTLm, iTLs

with built-in auxiliary function

Catalogue numbers (cont.)

iTLc impulse relay with centralised control

Type		1P	3P
		1NO	1 NO + 1 NO/NC + 1 NO
Rating (In)	Control voltage (Uc) (V AC) (50/60 Hz)		
16 A	24	A9C33111	A9C33111 + A9C32116
	48	A9C33211	A9C33211 + A9C32216
	230...240	A9C33811	A9C33811 + A9C32816
Width in 9 mm modules		2	4

iTLm impulse relay with latched control

Type		1P	3P
		1NO	1 NO + 1 NO/NC + 1 NO
Rating (In)	Control voltage (Uc) (V AC) (50/60 Hz)		
16 A	230...240	A9C34811	A9C34811 + A9C32816
Width in 9 mm modules		2	4





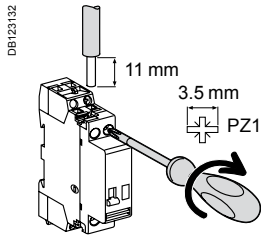

iTLs impulse relay with remote indication*

Type		1P	3P
		1NO	1 NO + 1 NO/NC + 1 NO
Rating (In)	Control voltage (Uc) (V AC) (50/60 Hz) (V DC)		
16 A	24 12	A9C32111	A9C32111 + A9C32116
	48 24	A9C32211	A9C32211 + A9C32216
	230...240 110	A9C32811	A9C32811 + A9C32816
Width in 9 mm modules		2	4



(*) Short circuit protection device for indication contacts : 6 A gG fuse.

Connection



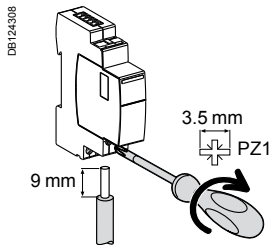

Type	Rating	Circuit	Tightening torque	Copper cables	
				Rigid or with ferrule	Flexible or with ferrule
iTL, iTLi, iTLc, iTLm, iTLs, iETL	16 A	Control	1 N.m		
		Power			
iTL, iETL	32 A	Control	1.2 N.m		
		Power			
iATLs, iATLc, iATLc+s, iATLc+c, iATLm, iATEt, iATL4, iATLz			1 N.m		

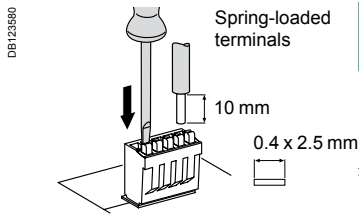

Type	Terminals	Tightening torque	Copper cables		
			Rigid	Flexible	Flexible or with ferrule
iATL24	Power supply (N/P) Input (Y1/Y2)	1 N.m	 0.5 to 10 mm ² 2 x 0.5 to 2 x 2.5 mm ²	 0.5 to 6 mm ² 2 x 0.5 to 2 x 2.5 mm ²	 0.5 to 4 mm ² 2 x 0.5 to 2 x 2.5 mm ²

Ti24 connector connection



Type	Catalogue numbers	Copper cables	
		Rigid	Flexible
Ti24 interface	A9XC2412	 1 x 0.5 to 1.5 mm ²	 1 x 0.5 to 1.5 mm ²

Ti24 prefabricated cables connection

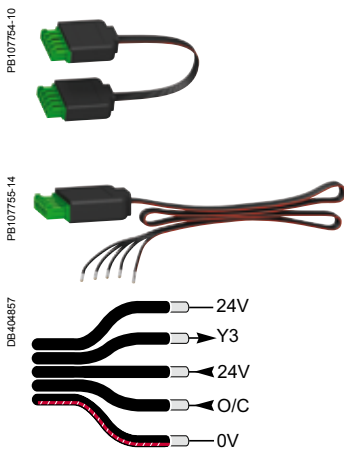

Type	Catalogue numbers	Length
Connection for Acti 9 Smartlink		
6 short prefabricated	A9XCAS06	100 mm
6 medium-sized prefabricated	A9XCAM06	160 mm
6 long prefabricated	A9XCAL06	870 mm
Connection for PLC type terminals		
6 long prefabricated on a single side	A9XCAU06	870 mm

Operation

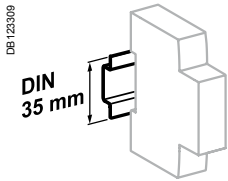
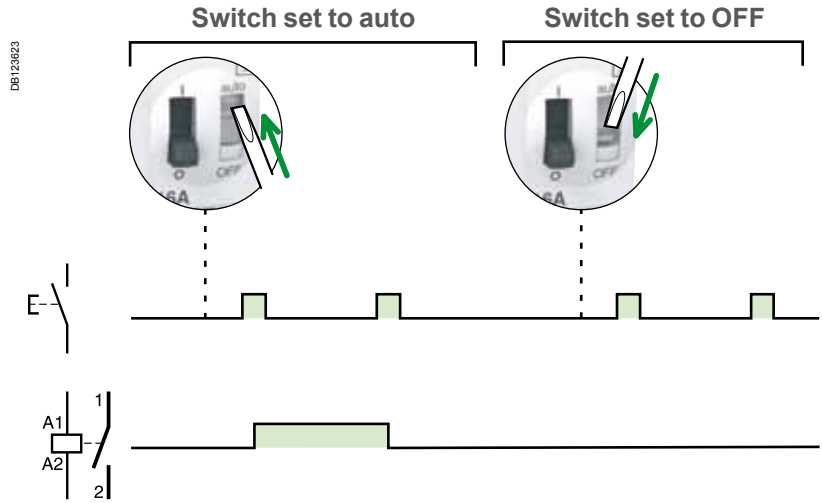

Clip on DIN rail 35 mm.

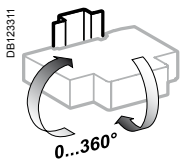

Indifferent position of installation.

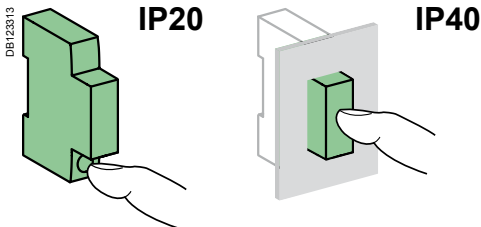





Technical data

Control circuit		iTL and iTLI 16 A iTLc, iTLm, iTLs, iETL 16 A	iTL 32 A, iETL 32 A
Control voltage (Uc)	Tolerance at 50 Hz	+6 %, -15 %	
	Tolerance at 60 Hz	±6 %	
	Tolerance V DC	+6 %, -10 %	
Dissipated power (during the impulse)	1, 2, 3P: 19 VA	19 VA	
	4P: 38 VA		
Illuminated PB control	Max. current 3 mA (if > use an ATLz)		
Operating threshold	Min. 85 % of Un in conformance with IEC/EN60669-2-2		
Duration of the control order	50 ms to 1 s (200 ms recommended)		
Response time	50 ms		
Power circuit			
Voltage rating (Ue)	1P, 2P	24 ...250 V AC	
	3P, 4P	24...415 V AC	
Frequency	50 Hz or 60 Hz		
Maximum number of operations per minute	5		
Maximum number of switching operation a day	100		
Additional characteristics			
Insulation voltage (Ui)	440 V AC		
Pollution degree	3		
Rated impulse withstand voltage (Uimp)	6 kV		
Overvoltage category	IV		
Endurance (O-C)			
Electrical	200,000 cycles (AC21)	50,000 cycles (AC21)	
	100,000 cycles (AC22)	20,000 cycles (AC22)	
Other characteristics			
Degree of protection (IEC 60529)	Device only	IP20	
	Device in modular enclosure	IP40 Insulation class II	
Operating temperature	-20°C to +50°C		
Storage temperature	-40°C to +70°C		
Tropicalization (IEC 60068-1)	Treatment 2 (relative humidity 95 % at 55°C)		

iTL impulse relays (cont.)



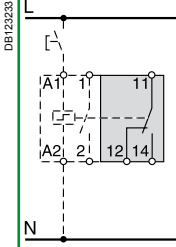
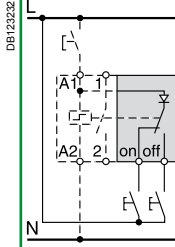
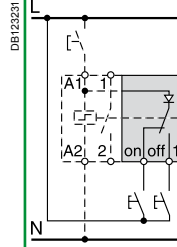
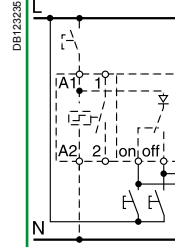

Electrical auxiliaries for iTL impulse relays

		Indication		Control	
Auxiliaries		iATLs	iATLc	iATLc+s	iATLc+c
Type		Indication	Centralised control	Centralised control + indication	Multi-level centralised control
					
Function		<ul style="list-style-type: none"> Allows remote indication of the associated impulse relay 	<ul style="list-style-type: none"> Used for centralised control, thanks to a "pilot line", of a group of impulse relays controlling separate networks, while at the same time maintaining local individual control of each impulse relay 	<ul style="list-style-type: none"> And for remote indication of the mechanical status of each relay 	<ul style="list-style-type: none"> Used to control the centralised controls of a number of impulse relay groups, while at the same time maintaining local individual control and centralised control by level
Wiring diagrams					
Mounting		<ul style="list-style-type: none"> Mounted to the right of iTL by yellow clips 	<ul style="list-style-type: none"> Mounted to the right of iTL by yellow clips 	<ul style="list-style-type: none"> Mounted to the right of iTL by yellow clips 	<ul style="list-style-type: none"> Without mechanical link with impulse relays and auxiliaries
Catalogue numbers		A9C15405	A9C15404	A9C15409	A9C15410
Technical specifications					
Control voltage (Uc)	V AC	–	24...240	24...240	24...240
	V DC	–	–	–	–
Control voltage frequency	Hz	–	50/60	50/60	50/60
Width in 9 mm modules		1	1	2	2
Auxiliary contact (breaking capacity)		<ul style="list-style-type: none"> Minimum: 10 mA at 24 V AC/DC Maximum (IEC 60947-5-1): <ul style="list-style-type: none"> 12...240 V AC 6 A 12...24 V DC 6 A 15...240 V AC 2 A 13...24 V DC 2 A 	–	<ul style="list-style-type: none"> Minimum: 10 mA at 24 V AC/DC Maximum (IEC 60947-5-1): <ul style="list-style-type: none"> 12...240 V AC 6 A 12...24 V DC 6 A 15...240 V AC 2 A 13...24 V DC 2 A 	–
Number of contacts		–	–	–	–
Operating temperature	°C	-20°C to +50°C			
Storage temperature	°C	-40°C to +70°C			

iTL impulse relays (cont.)

Electrical auxiliaries for iTL impulse relays (cont.)

Control

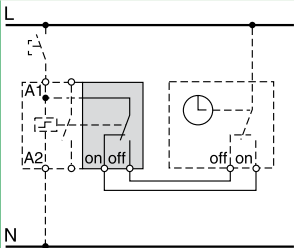
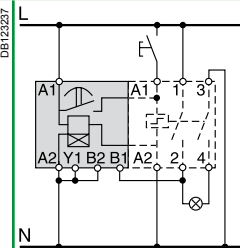
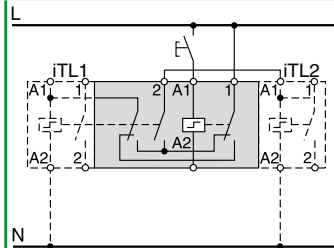
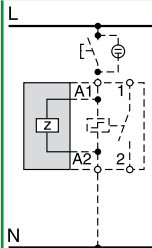
	iATLm	iATEt	iATL4	iATLz
	Latched control	Time delay	Step by step control	Control by illuminated push-buttons
				
	<ul style="list-style-type: none"> Combined with an impulse relay, it operates on latched orders 	<ul style="list-style-type: none"> Combined with an impulse relay, it automatically disconnects the circuit after a preset time 	<ul style="list-style-type: none"> Allows the step by step sequence over 2 circuits 	<ul style="list-style-type: none"> Used to control impulse relays by illuminated push-buttons, without operating risks
				
		<ul style="list-style-type: none"> 5 time setting ranges: <ul style="list-style-type: none"> 1 to 10 s 6 to 60 s 2 to 10 min 6 to 60 min 2 to 10 h 	<ul style="list-style-type: none"> The cycle is as follows: <ul style="list-style-type: none"> 1st impulse - iTL 1 closed, iTL 2 open 2nd impulse - iTL 1 open, iTL 2 closed 3rd impulse - iTL 1 and 2 closed 4th impulse - iTL 1 and 2 open 5th impulse - iTL 1 closed, iTL 2 open, etc 	<ul style="list-style-type: none"> Provide an iATLz when the current drawn up by the illuminated push-buttons is higher than 3 mA (this current is sufficient to keep the coils energised). Above this value, fit one extra iATLz per 3 mA. For example: for 7 mA, fit 2 iATLz
	<ul style="list-style-type: none"> Mounted to the right of iTL by yellow clips 	<ul style="list-style-type: none"> Mounted to the left of iTL by yellow clips 	<ul style="list-style-type: none"> Assembled between 2 impulse relays: according to the auxiliarisation table by yellow clips 	<ul style="list-style-type: none"> Mounted to the left of iTL by yellow clips
	A9C15414	A9C15419	A9C15412	A9C15413
	12...240	24...240	230	230...240
	—	24...110	—	—
	50/60	50/60	50/60	50/60
	1	2	4	2
	—	—	—	—
	—	—	—	—
	-20°C to +50°C	—	—	—
	-40°C to +70°C	—	—	—

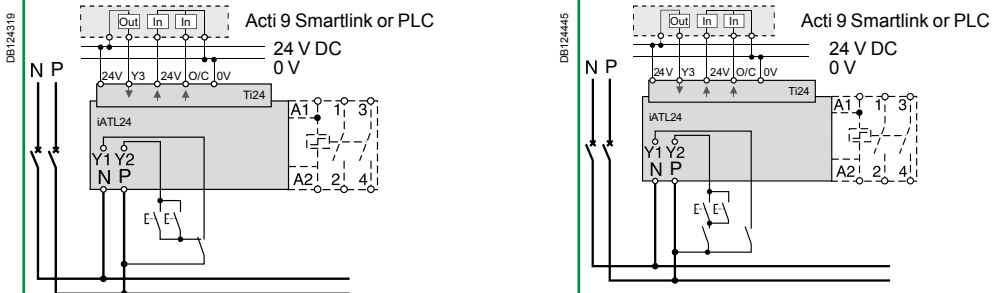
		Control and indication	
Auxiliaire		iATL24	
Type		Control and indication 24 V DC	
		With Ti24 connector	
			
Function		<ul style="list-style-type: none"> ■ This auxiliary allows a impulse relay to be interfaced with the Acti 9 Smartlink interface or a programmable logic controller (PLC) in 24 V DC (control, O/C indication) ■ 230 V AC control 	
Wiring diagrams			
Mounting		<ul style="list-style-type: none"> ■ To the left of the iTL impulse relay using the yellow clips⁽¹⁾. ■ When an iATL24 is used, the A1/A2 terminals of the impulse relay should not be wired. Only the yellow clips integral with the iATL24 should be used for connection to the coil. 	
Utilization		<ul style="list-style-type: none"> ■ 230 V AC interface: <ul style="list-style-type: none"> □ Y1: enabling of 24 V DC control (Y1 = 1) or inhibition of 24 V DC control (Y1 = 0). □ Y2: 230 V pulse control ■ "Ti24" 24 V DC interface: <ul style="list-style-type: none"> □ Y3: 24 V DC control of iTL closing on rising edge and opening on falling edge □ reading of the impulse relay status (opened or closed) from the position of the integrated O/C auxiliary contact □ monitoring of connection of the "Ti24" terminal block by the upstream system (PLC, supervision system) via the 24 V terminal (in the centre of the Ti24 terminal block) 	
Catalogue numbers		A9C15424	
Technical specifications			
Control voltage (Uc)	V AC	230, +10 %, -15 % (Y2)	
	V DC	24, ± 20 % (Y3)	
Control voltage frequency	Hz	50/60	
Insulation voltage (Ui)	V AC	250	
Rated impulse withstand voltage (Uimp)	kV	8 (OVC IV)	
Pollution degree		3	
Degree of protection		IP20B device only	
		IP40 device in modular enclosure	
Width in 9 mm modules		2	
Auxiliary contact (O/C) Ti24		24 V DC protected output, min. 2 mA, max. 100 mA	
Contact		1 O/C operating category AC 14	
Operating temperature	°C	-25°C to +60°C	
	°C	-40°C to +80°C	
Storage temperature	°C	-40°C to +80°C	
Consumption		<1 W	
Standard		IEC/EN 60947-5-1	

(1) Mechanical and electrical connection.

iTL impulse relays (cont.)

Electrical auxiliaries for iTL impulse relays (cont.)



Operation of the iATL24

O/C 24 V DC output

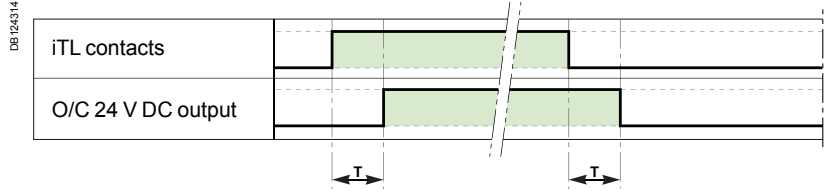

Parameter	Min	Max
T	100 ms	200 ms

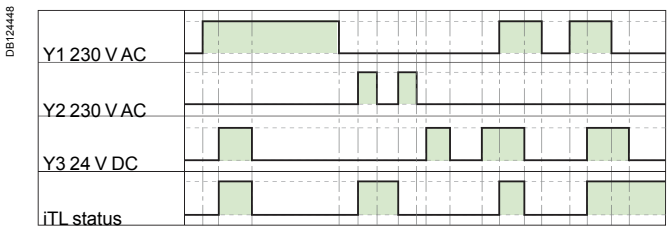
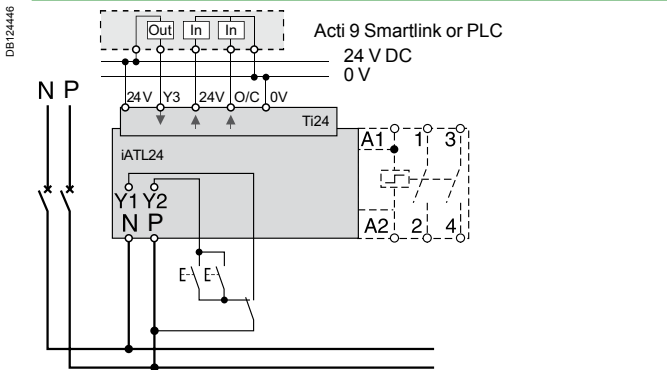

- Minimum duration of 230 V AC pulse (Y2): 200 ms.
- 30 iATL24 closing or opening actuations are authorized per minute: Minimum time delay between 2 actuations on the iATL24 via Y1, Y2, Y3 (closing or opening of the iTL coil): 440 ms.
- 10 closing or opening actuations spaced 440 milliseconds apart are authorized following no loading of the iATL24 during a period of 20 seconds.

Wiring with exclusive selector 230 V AC and 24 V DC controls

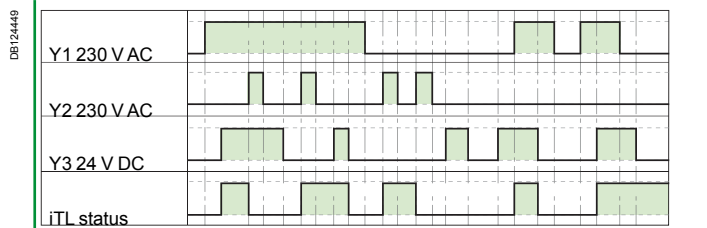
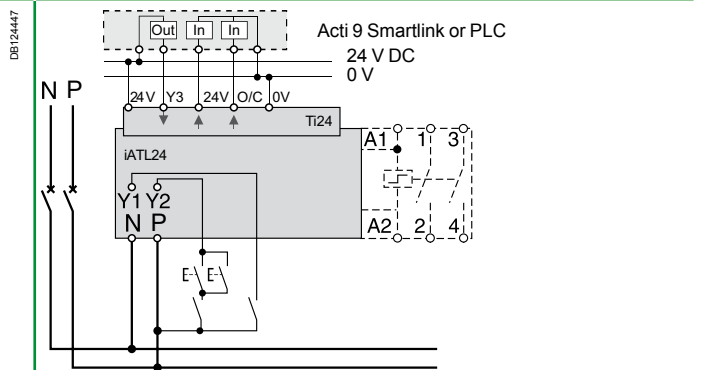

Wiring for non-exclusive 230 V AC and 24 V DC controls



		Security	
Accessories	Yellow clips	Spacer	
	 <p>PB106143-10</p>	 <p>PB104483</p>	
Function	<ul style="list-style-type: none"> Ensure the mechanical and/or electrical link between impulse relays and their auxiliaries (set of 10). 	<ul style="list-style-type: none"> Required to reduce temperature rise of modular devices installed side by side. Recommended to separate electronic devices (thermostat, programmable clock, etc.) from electromechanical devices (relays, contactors). 	
Catalogue numbers	A9C15415	A9A27062	
Technical specifications			
Width in 9 mm modules	-	1	

Dimensions (mm)

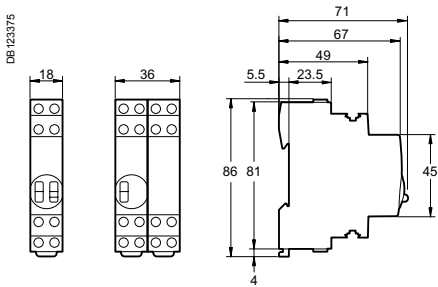

iTL 1P
iTLc
iTLm
iTLs
iTLi
iETL

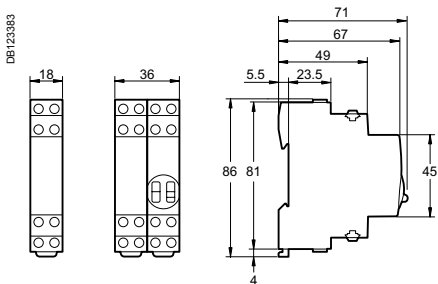

iATLc+s
iATLc+c
iATLz
iATL4

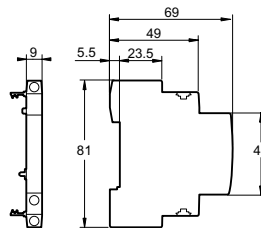

iATLc
iATLs
iATLm

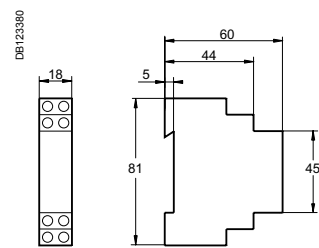

iATeT

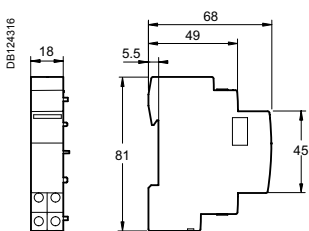

iATL24



The Schneider Electric range of TL impulse relays comprises various offers (Clario, Prodis, Libro) so as to be as competitive as possible in each country, taking into account the specific features of each market:

- installation customs
- price
- approval by local organizations.

Variants

Offers		Pages
Clario	Catalogue numbers	474
Prodis	Catalogue numbers	475
Libro	Catalogue numbers	476
Common pages		477

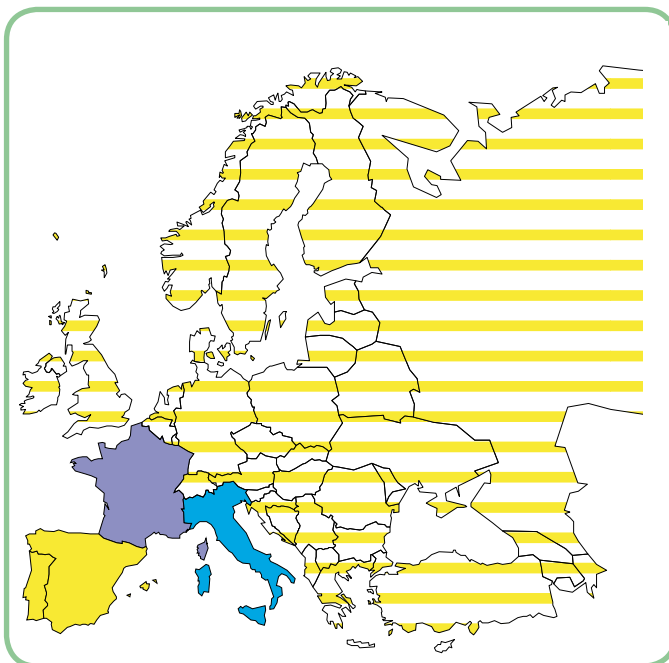

Only the product range to be marketed in your country and validated by the local product manager, in agreement with his Final Distribution (FD) partner should be retained. The others will be removed before publication.

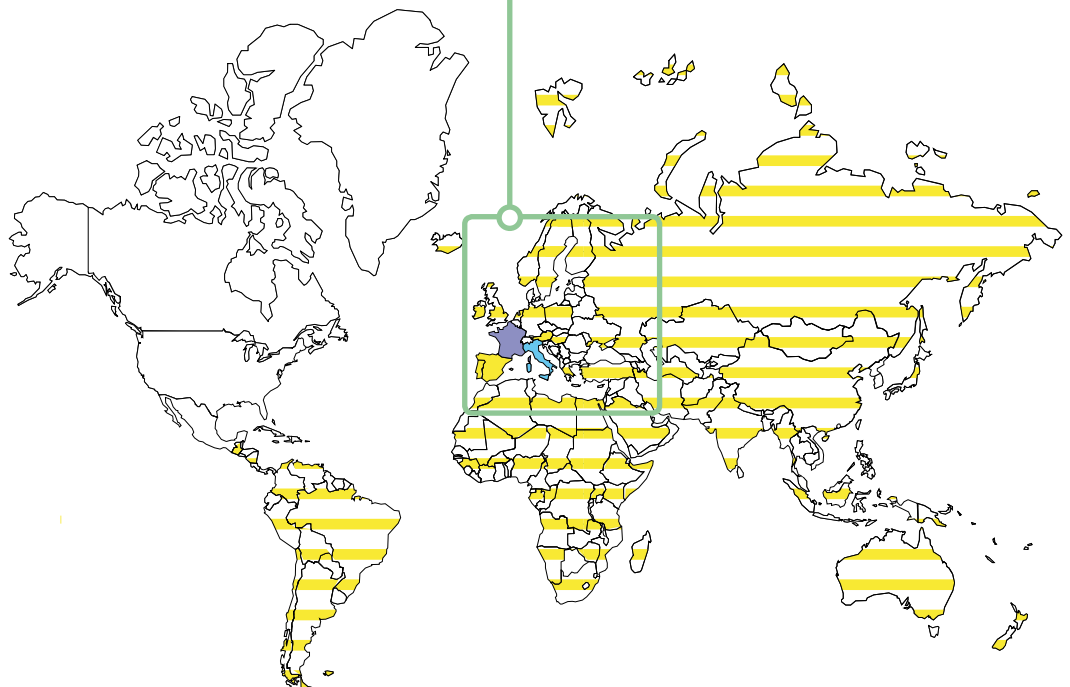

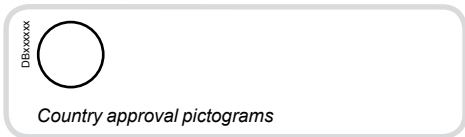

IEC 60669-1 and IEC 60669-2-2

TL impulse relays allow remote control of single-phase circuits.

TL impulse relays are combined with single-phase circuit breakers or residual current devices.

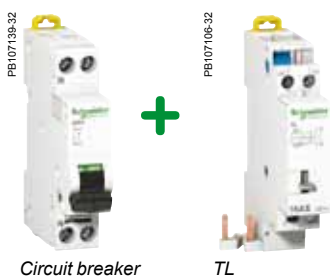

Operation

TL impulse relays:

- have normally open contacts
- are controlled by impulse type electrical orders. One or more control points are possible.

Catalogue numbers

TL impulse relays			
Type	Rating		Width in 9-mm modules
1P			
<p>DB123682</p>	16 A	A9C15488	2
2P			
<p>DB123683</p>	16 A	A9C15489	2

Offer selection see page 473

Clario

This sticker must be removed before publishing



IEC 60669-1 and IEC 60669-2-2

TL impulse relays allow remote control of single-phase circuits.

TL impulse relays are combined with single-phase circuit breakers or residual current devices.

Operation

TL impulse relays:

- have normally open contacts
- are controlled by impulse type electrical orders. One or more control points are possible.

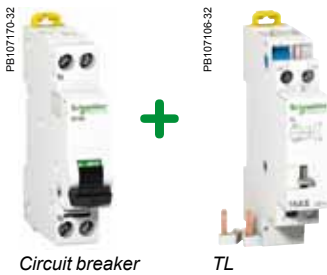

Catalogue numbers

TL impulse relays			
Type	Rating		Width in 9-mm modules
1P			
<p>DB123682</p>	16 A	A9C15506	2
2P			
<p>DB123683</p>	16 A	A9C15507	2



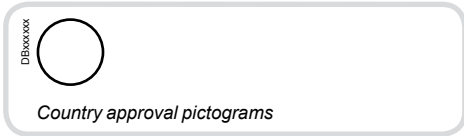

IEC 60669-1 and IEC 60669-2-2

TL impulse relays allow remote control of single-phase circuits.

TL impulse relays are combined with single-phase circuit breakers or residual current devices.

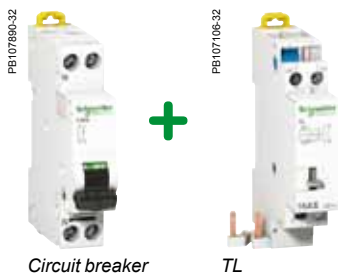

Operation

TL impulse relays:

- have normally open contacts
- are controlled by impulse type electrical orders. One or more control points are possible.

Catalogue numbers

TL impulse relays			
Type	Rating		Width in 9-mm modules
2P			
	16 A	A9C15485	2



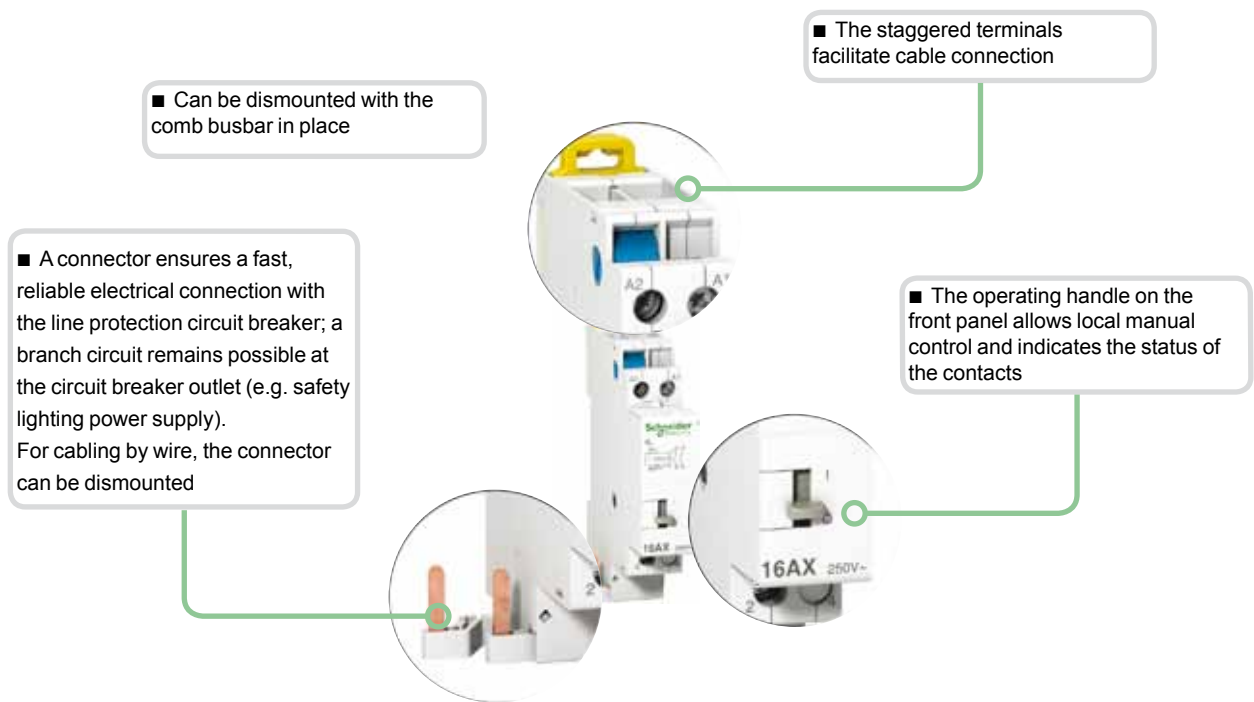

Connection

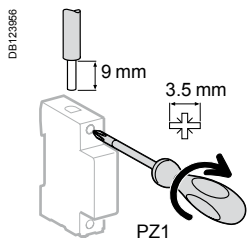

Circuit	Tightening torque	Copper cables	
		Rigid	Flexible or with ferrule
Power	1 N.m	1 x 1 to 4 mm ² 2 x 1 to 2,5 mm ²	1 x 1 to 4 mm ² 2 x 1 to 2,5 mm ²
Control	1 N.m	1 x 0,5 to 1,5 mm ²	1 x 0,5 to 1,5 mm ²

2 possible connections

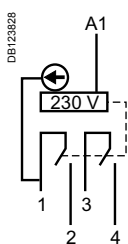

Figure 1:
Coil cabling with 1 wire

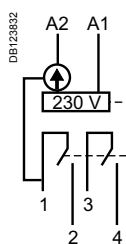

Figure 2:
Coil cabling with 2 wires



■ Cabling with a single wire



■ Standard cabling

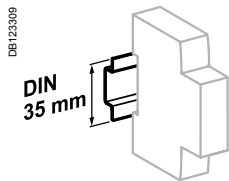

Clip on DIN rail 35 mm.

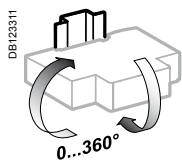

Indifferent position of installation.

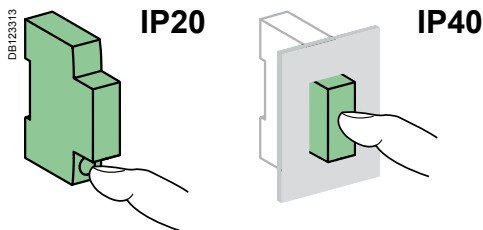

Technical data

Control circuit		
Coil voltage (Uc)	230/240 V AC	
Frequency	50 Hz	
Inrush power	19 VA	
Control by luminous push buttons	Max. current consumption = 3 mA	
Power circuit		
Voltage rating (Ue)	250 V AC	
Frequency	50 Hz	
Max. number of switching operations per minute	5	
Pulse duration	50 ms (recommended value for automatic control: 200 ms)	
Additional characteristics		
Insulation voltage (Ui)	500 V AC	
Noise level at activation	< 60 dBA (to 1 m)	
Pollution degree	3	
Rated impulse withstand voltage (Uimp)	2.5 kV	
Degree of protection (IEC 60529)	Device only Device in modular enclosure	IP20 IP40
Endurance (O-C)	Electrical	200 000 cycles (AC22)
Operating temperature		-20°C to +50°C
Storage temperature		-40°C to +80°C
Tropicalization		Treatment 2 (relative humidity of 95 % at 55°C)

Weight (g)

TL impulse relays	
1P	100
2P	105

Dimensions (mm)

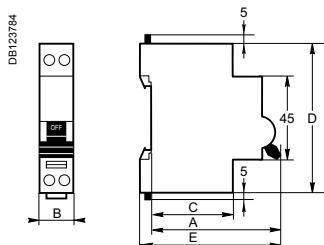

TL impulse relays					
Type	A	B	C	D	E
1P/2P	63	18	44	81	69



The Schneider Electric range of CT contactors comprises various offers (Clario, Prodis, Libro) so as to be as competitive as possible in each country, taking into account the specific features of each market:

- installation customs
- price
- approval by local organizations.

Variants

Offers		Pages
Clario	Catalogue numbers	480
Prodis	Catalogue numbers	481
Libro	Catalogue numbers	482
Common pages		483

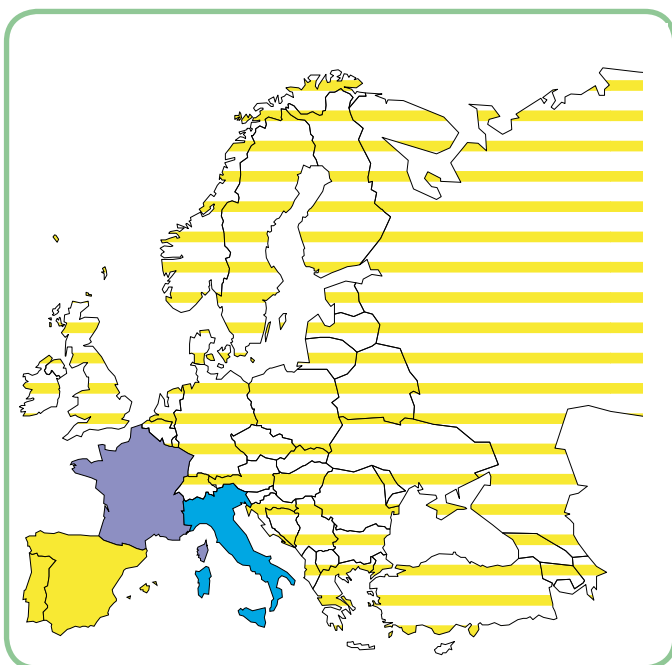

Only the product range to be marketed in your country and validated by the local product manager, in agreement with his Final Distribution (FD) partner should be retained. The others will be removed before publication.

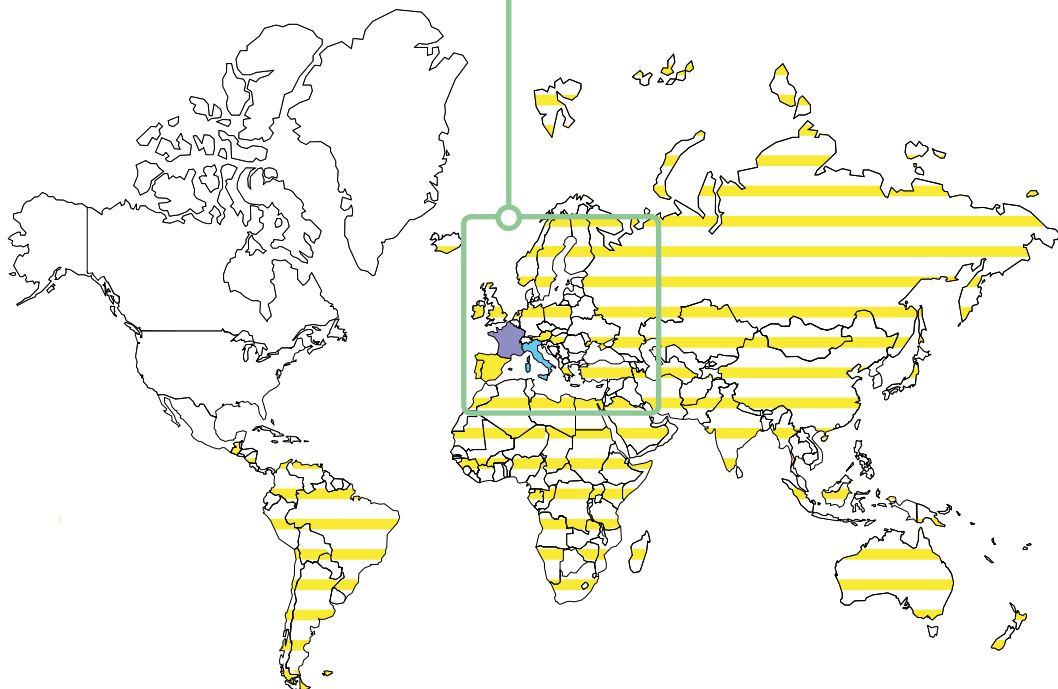

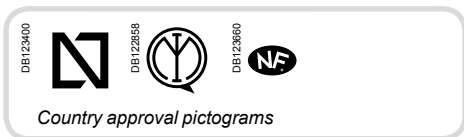

IEC/EN 61095

CT contactors combined with single-phase circuit breakers or residual current devices, allow remote control of single-phase circuits.

Operation

CT contactors:

- have normally open contacts
- are controlled by latched type electrical orders.

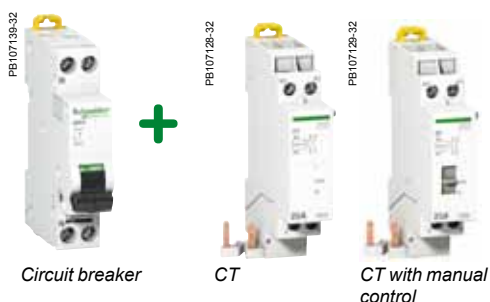

Catalogue numbers

CT contactors			
Type	Rating		Width in 9-mm modules
2P			
<p>DB123663</p>	25 A	A9C15180	2
2P with manual control			
<p>DB123664</p>	25 A	A9C15181	2



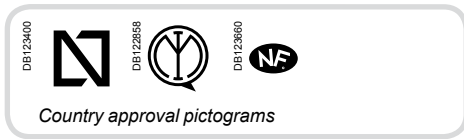

IEC/EN 61095

CT contactors combined with single-phase circuit breakers or residual current devices, allow remote control of single-phase circuits.

Operation

CT contactors:

- have normally open contacts
- are controlled by latched type electrical orders.

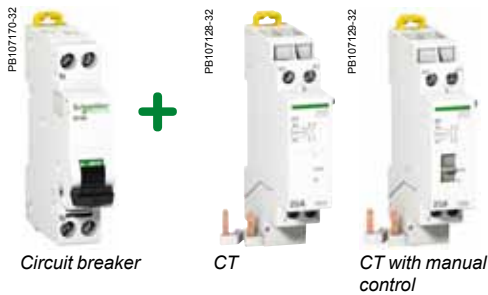

Catalogue numbers

CT contactors			
Type	Rating		Width in 9-mm modules
2P			
	25 A	A9C15185	2
2P with manual control			
	25 A	A9C15186	2



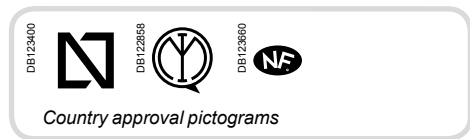

IEC/EN 61095

CT contactors combined with single-phase circuit breakers or residual current devices, allow remote control of single-phase circuits.

Operation

CT contactors:

- have normally open contacts
- are controlled by latched type electrical orders.

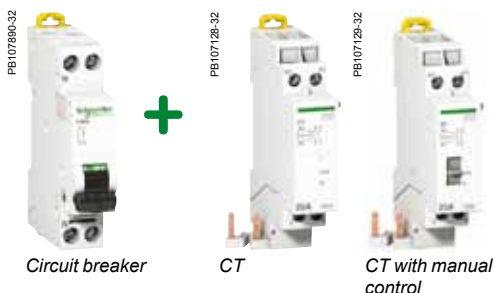

Catalogue numbers

CT contactors			
Type	Rating		Width in 9-mm modules
2P			
	25 A	A9C15182	2
2P with manual control			
	25 A	A9C15183	2



■ The staggered terminals facilitate cable connection

■ Every circuit breaker combined with a CT contactor remains compatible with the indication and tripping auxiliaries

Manual-control CT contactors:
 ■ Have a 3-position selector on the front panel:
 automatic operation
 temporary forced starting
 permanent stoppage

■ A connector ensures a fast, reliable electrical connection with the line protection circuit breaker; a branch circuit remains possible at the circuit breaker outlet (e.g. safety lighting power supply). For cabling by wire, the connector can be dismantled

Connection

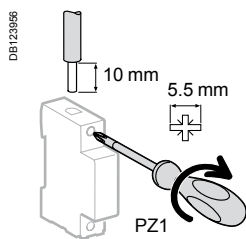

Rating	Tightening torque	Copper cables	
		Rigid	Flexible or with ferrule
25 A	0.8 N.m	 DB122045 ≤ 6 mm ²	 DB122046 ≤ 6 mm ²

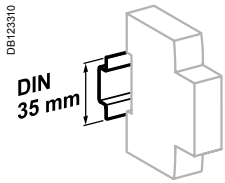

Clip on DIN rail 35 mm.

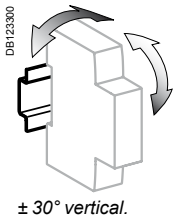

± 30° vertical.

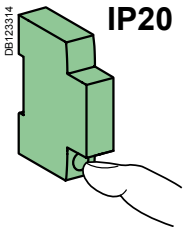

IP20

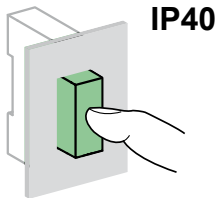

IP40

Technical data

Control circuit		
Coil voltage (Uc)	230 V AC	
Frequency	50 Hz	
Inrush power	15 VA	
Holding power	3.8 VA	
Voltage presence indicating system on front panel	Red indicator: coil energized	
Power circuit		
Voltage rating (Ue)	250 V AC	
Frequency	50 Hz	
Max. number of switching operations per minute	6	
Max. number of switching operations per day	100	
Additional characteristics		
Insulation voltage (Ui)	500 V AC	
Silent operation	< 20 dB	
Pollution degree	2	
Rated impulse withstand voltage (Uimp)	2.5 kV	
Degree of protection (IEC 60529)	Device only Device in modular enclosure	IP20 IP40 Insulation class II
Operating temperature	-5°C to +60°C	
Storage temperature	-40°C to +60°C	
Tropicalization	Treatment 2 (relative humidity 95 % to 55°C)	

Weight (g)

CT contactors	
Standard 2P	110
2P with manual control	120

Dimensions (mm)

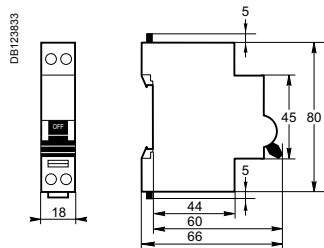

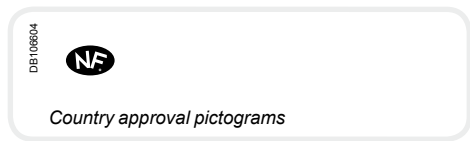

The iTL+ high-performance impulse relay allows remote control of single-phase circuits. It is designed for demanding applications.

EN 60669-2-2

The iTL+ high-performance impulse relay is used for push-button control of lighting circuits consisting of:

- incandescent lamps, low-voltage halogen lamps, etc. (resistive loads)
- fluorescent tubes, discharge lamps, etc. (inductive loads).

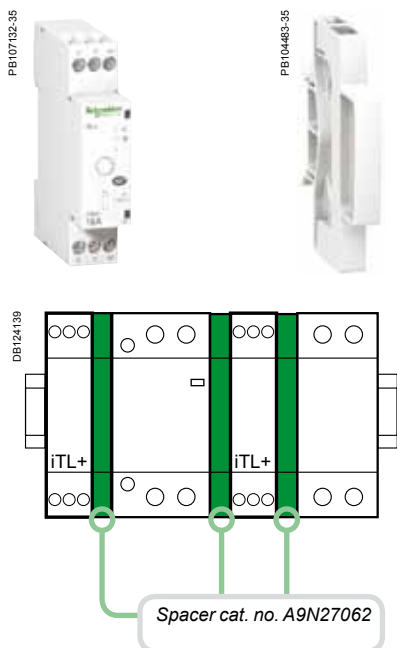

iTL+			
Type	Rating		Width in 9 mm modules
1P+N	16 A	A9C15032	2+1 ⁽¹⁾

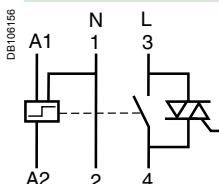

(1) Supplied with a 9 mm spacer (cat. no. A9N27062): to be used for mounting the iTL+ alongside a circuit breaker, contactor, impulse relay, etc., in order to maintain optimal operation.



- It is compulsory:**
- to connect the neutral
 - to keep the same control circuit connection "A1: phase", "A2: neutral"
 - to use the same phase for connection of the power and control functions.

Operation

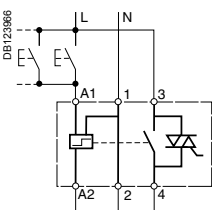
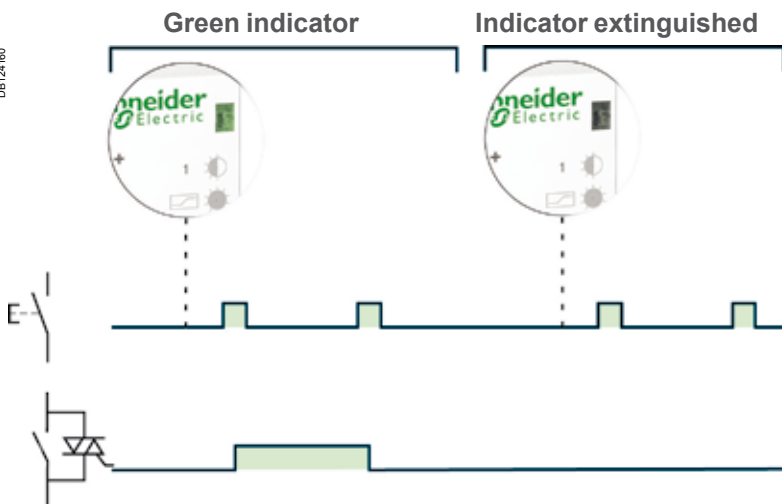

Connection

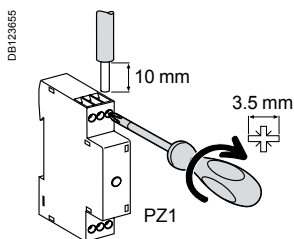

Type	Rating	Tightening torque	Copper cables	
			Rigid or flexible with ferrule	Rigid or flexible without ferrule
iTL+	16 A	1 N.m	<p>DB123669</p> <p>2 x 1.5 mm²</p>	<p>DB123657</p> <p>2 x 2.5 mm² 1 x 4 mm²</p>

iTL+ high-performance impulse relays (cont.)

They combine the benefits of static switching and electromechanical technology: small size, little temperature rise.

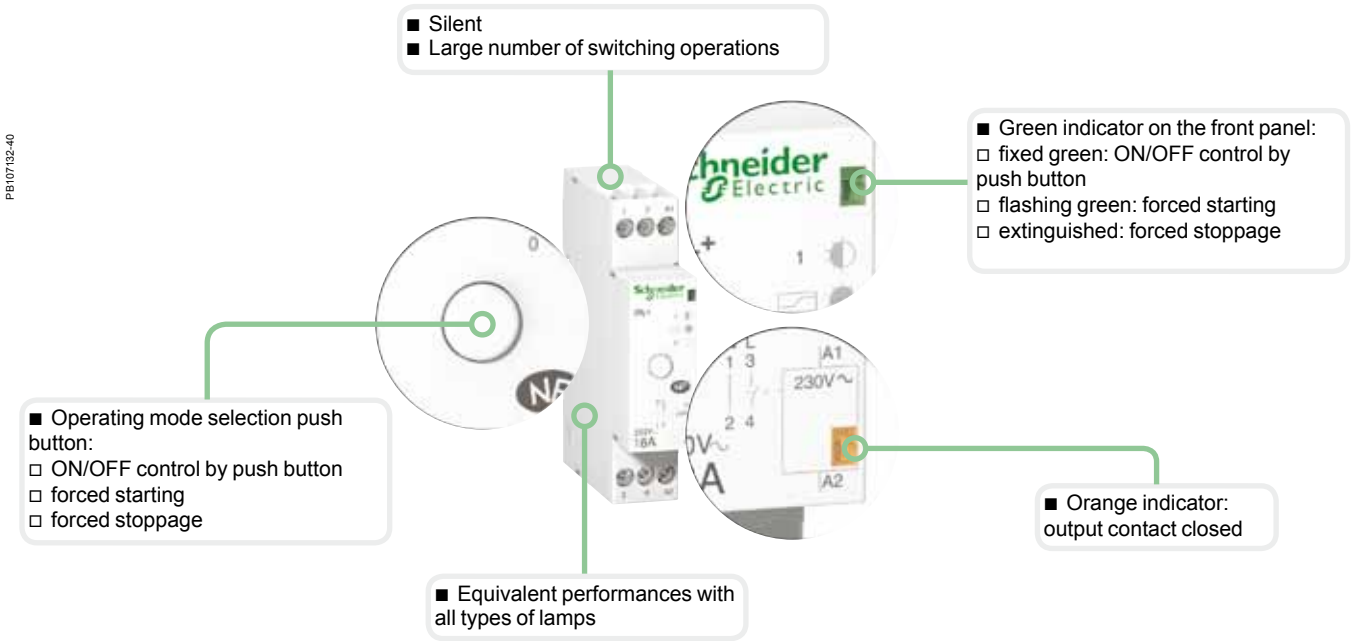

Following a mains failure, the iTL+ returns to 0 position (forced stoppage) irrespective of its initial state.

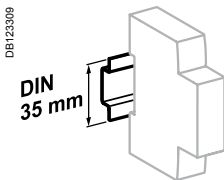

Clip on DIN rail 35 mm.

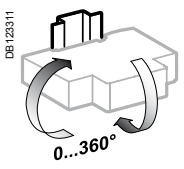

Indifferent position of installation.

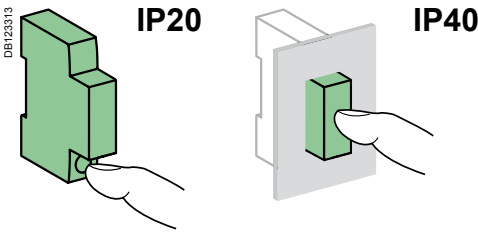

Technical data

Control circuit		
Coil voltage (Uc)		230 V AC
Frequency		50 Hz
Inrush power		11 VA
Holding power		1.1 VA
Control by luminous push button		Max. current 5 mA
Control order duration		50 ms to 1 s (recommended 200 ms)
Power circuit		
Voltage rating (Ue)		230 V AC
Frequency		50 Hz
Electrical load	Minimum	20 W
	Maximum	3600 W
Max. number of switching operations per minute		6
Other characteristics		
Degree of protection (IEC 60529)	Device only	IP20
	Device in modular enclosure	IP40
Endurance (O-C)	Electrical	5.000.000 cycles (AC21 - AC22)
Noise level at activation		< 30 dBA
Operating temperature		-5°C to +55°C
Storage temperature		-40°C to +60°C
Tropicalization (IEC 60068-1)		Treatment 2 (relative humidity of 95 % at 55°C)

Weight (g)

High-performance impulse relays	
Type	iTL+
1P+N	70

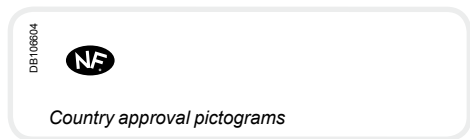

iCT+ high-performance contactors allow remote control of single-phase circuits. They are designed for demanding applications.

EN 60669-2-2

iCT+ high-performance contactors can be used for remote control of applications on AC networks:

- lighting, heating, ventilation, roller blinds, domestic hot water
- mechanical ventilation systems, etc.
- load shedding on non-priority circuits.



iCT+				
Type	Rating	Contact		Width in 9-mm modules
Standard 1P+N				
	20 A	1 NO	A9C15030	2+1 ⁽¹⁾
1P+N with manual control				
	20 A	1 NO	A9C15031	2+1 ⁽¹⁾

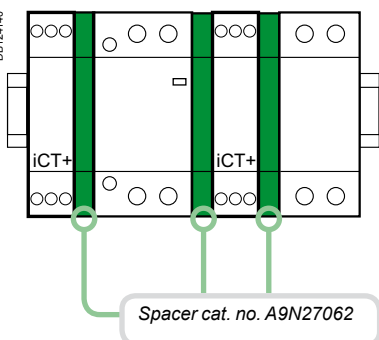

(1) Supplied with a 9 mm spacer (cat. no. A9N27062): to be used for mounting the iCT+ alongside a circuit breaker, contactor, impulse relay, etc., in order to maintain optimal operation.

It is compulsory:

- to connect the neutral
- to keep the same control circuit connection "A1: phase", "A2: neutral"
- to use the same phase for connection of the power and control functions.

Operation (manual-control contactor)

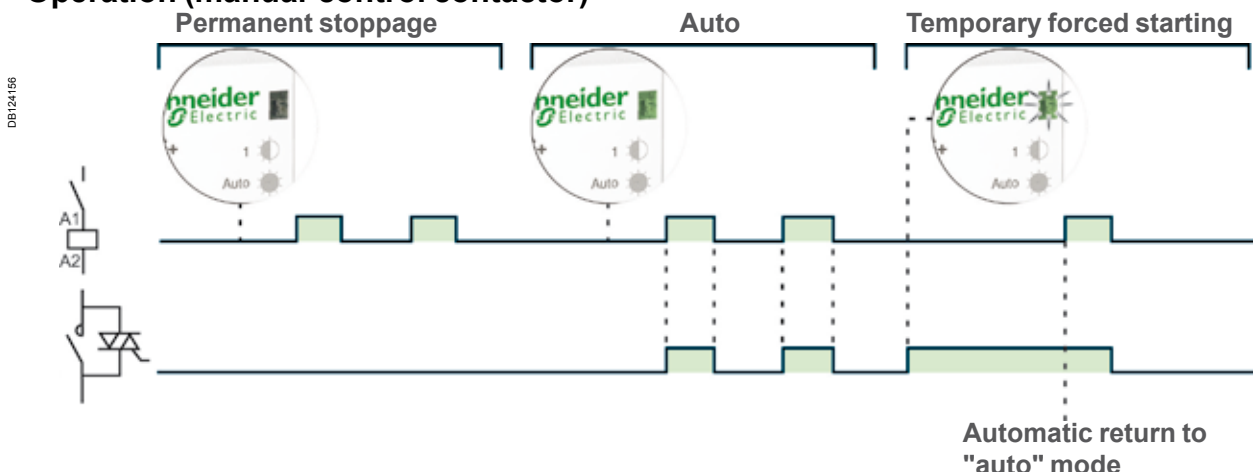

iCT+ high-performance contactors (cont.)

They combine the benefits of static switching and electromechanical technology: small size, little temperature rise.

■ Silent
■ Large number of switching operations

■ Operating mode selection push button:
□ auto operation
□ temporary forced starting*
□ permanent stoppage

■ Equivalent performances with all types of lamps
■ No derating

■ Green indicator on the front panel:
□ fixed green: auto operation
□ flashing green: temporary forced starting
□ extinguished: permanent stoppage

■ Orange indicator: output contact closed

Following a mains failure, the iCT+ returns to "auto" operating mode irrespective of its initial state.

Connection

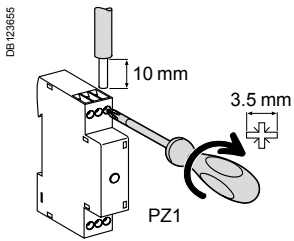

Type	Tightening torque	Copper cables	
		Rigid or flexible with ferrule	Rigid or flexible without ferrule
iCT+	1 N.m	2 x 1.5 mm ²	2 x 2.5 mm ² 1 x 4 mm ²

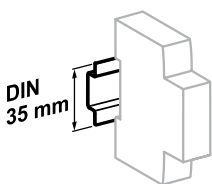

Clip on DIN rail 35 mm.

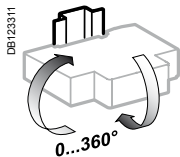

Indifferent position of installation.

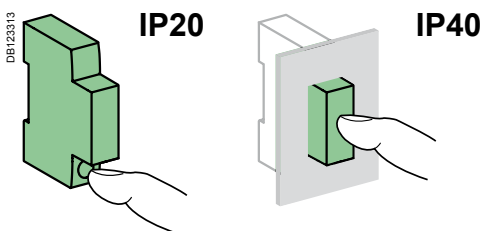

Technical data

Control circuit		
Coil voltage (Uc)		230 V AC (± 10 %)
Frequency		50 Hz
Inrush power		11 VA
Holding power		1.1 VA
Power circuit		
Voltage rating (Ue)		230 V AC (± 10 %)
Frequency		50 Hz
Electrical load	Minimum	20 W
	Maximum	3600 W
Max. number of switching operations per minute		6
Other characteristics		
Endurance (O-C)	Electrical	5.000.000 cycles
Pollution degree		3
Degree of protection (IEC 60529)	Device only	IP20
	Device in modular enclosure	IP40 Insulation class II
Operating temperature		-5°C to +55°C
Storage temperature		-40°C to +60°C
Tropicalization (IEC 60068-1)		2 (relative humidity of 95 % at 55°C)





Weight (g)

High-performance contactors	
Type	iCT+
Standard 1P+N	70
1P+N with manual control	70



IEC 60947-5-1

■ iLL indicator lights light up to indicate that a voltage is present.

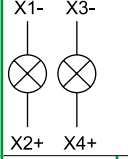
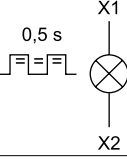
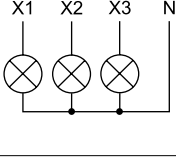
Catalogue numbers

iLL indicator lights										
Type	Single					Double		Flashing light	Three-phase voltage presence indicator light	
										
Diagram										
Colour	Red	Green	White	Blue	Yellow	Green/red	White/white	Red	Red/red/red	
Cat. no.										
12...48 V AC/DC	A9E18330	A9E18331	A9E18332	A9E18333	A9E18334	A9E18335	-	-	-	
110...230 V AC 110...130 V DC	A9E18320	A9E18321	A9E18322	A9E18323	A9E18324	A9E18325	A9E18328	-	-	
110...230 V AC	-	-	-	-	-	-	-	A9E18326	-	
230...400 V AC (3 phases)	-	-	-	-	-	-	-	-	A9E18327	
Width in 9 mm modules	2					2		2	2	

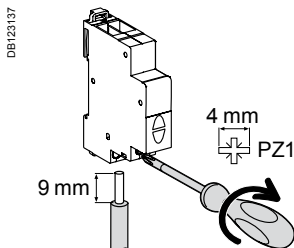
Connection

	Tightening torque	
	Copper cables	Flexible or with ferrule
		
1 N.m	0.5 mm ² min. 2 x 2.5 mm ² max.	0.5 mm ² min. 2 x 2.5 mm ² max.

- Phase-separated wall that can be divided to allow the teeth of all types of comb busbar to pass through.
- Staggered terminals to simplify connection.

Dimensions (mm)

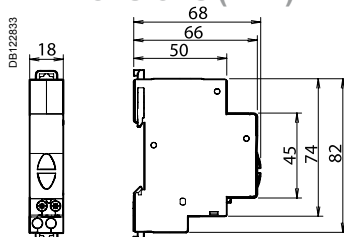

Technical data



Main characteristics	
Pollution degree	3
Power circuit	
Operating frequency	50...60 Hz
Flashing frequency	2 Hz
Additional characteristics	
Operating temperature	-35°C... +70°C
Storage temperature	-40°C... +80°C
Tropicalization	Treatment 2 (relative humidity 95 % at 55°C)
LED indicator light	Consumption per indicator light: 0.3 W Service life: 100,000 hours of constant lighting efficiency Maintenance-free indicator light (non-interchangeable LEDs)



ISO and iRO



Audible indication in housing and the tertiary sector.

Catalogue numbers

Bell and buzzer			
Type	Width in 9 mm modules		
ISO bell 	Voltage (Ue)		
	230 V AC	A9A15320	2
	8...12 V AC	A9A15321	2
iRO buzzer 	230 V AC	A9A15322	2
	8...12 V AC	A9A15323	2
Operating frequency		50...60 Hz	

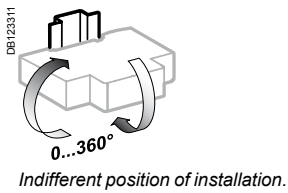
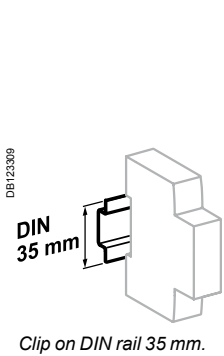
Connection

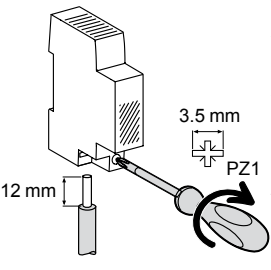

	Copper cables	
	Rigid	Flexible or with ferrule
DB122945		DB122946
1.3 N.m	< 4 mm ²	< 4 mm ²

Technical data

Main characteristics		ISO	iRO
Consumption	8...12 V AC	3.6 VA	
	220...240 V AC	5 VA	
Additional characteristics			
Degree of protection (IEC 60529)	Device only	IP40	
	Device in modular enclosure	IP20	
Operating temperature		-10°C to +40°C	
Storage temperature		-25°C to +60°C	
Sound level (at a distance of 60 cm)		80 dBA	70 dBA

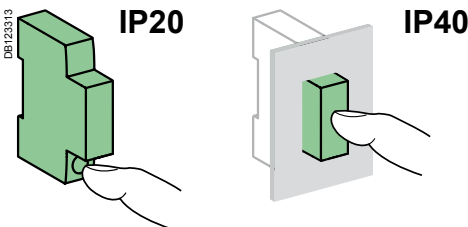

Weight (g)

Bell and buzzer	
Type	Weight (g)
ISO	77
iRO	64

Dimensions (mm)

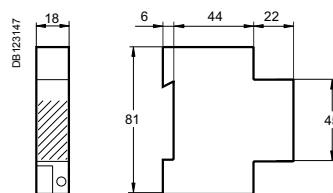

iSO bell and iRO buzzer



Country approval pictogram

PB107156-35



PB107156-35



Bell transformers: EN/IEC 61558-2-8.

Safety transformers: EN/IEC 61558-2-6.

Bell transformers and safety transformers allow for a very low voltage (ELV 8 V, 12 V or 24 V) to be obtained from a low voltage network (LV 230 V).

All Schneider Electric transformers are:

- Safe: primary and secondary circuits are perfectly insulated by each other
- Resistant to short-circuit currents thanks to the built-in device
- Class II with terminal shield (optional).

Catalogue numbers

Bell transformer				
Type	Power	Secondary voltage		Width in 9 mm modules
E56759 	4 VA	8 V AC	A9A15214	4
	8 VA	8 V AC	A9A15215	4
E56760 	4 VA	8-12 V AC	A9A15213	4
	8 VA	8-12 V AC	A9A15216	4
	16 VA	8-12 V AC	A9A15212	4
E56761 	25 VA	12-24 V AC	A9A15215	6

Safety transformer				
Type	Power	Secondary voltage		Width in 9 mm modules
DB124153 	16 VA	12-24 V AC	A9A15218	10
	25 VA	12-24 V AC	A9A15219	10
DB124154 	40 VA	12-24 V AC	A9A15220	10
	63 VA	12-24 V AC	A9A15222	10
DB124155 				
Operating frequency	50/60 Hz			

Terminal shield			
Type			Width in 9 mm modules
	15228		4
	15229		6

Connection

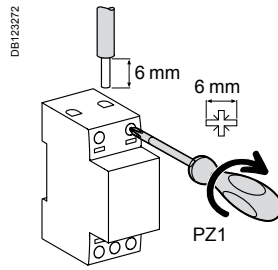

Tightening torque	Copper cables	
	Rigid	Flexible or with ferrule
0.5 N.m	DBI123446 	DBI123446
	< 2.5 mm ²	< 2.5 mm ²

Technical data

Main characteristics

Primary voltage	230 V AC ±10 %
Secondary voltage on load	For bell transformers: 8-12-24 V AC ±15 % For safety transformers: 12-24 V AC ±5 %

Transformer catalogue numbers	Rated secondary voltage	Off load voltage
A9A15214	8 V	12 V
A9A15213	8 V	12 V
	12 V	16 V
A9A15216	8 V	13 V
	12 V	18 V
A9A15212	8 V	13 V
	12 V	18 V
A9A15215	12 V	16 V
	24 V	32 V
A9A15218	12 V	14 V
	24 V	28 V
A9A15219	12 V	14 V
	24 V	28 V
A9A15220	12 V	14 V
	24 V	28 V
A9A15222	12 V	14 V
	24 V	28 V

Additional characteristics

Degree of protection Device only (IEC 60529)	IP20 with terminal shield
Operating temperature	-20°C to +55°C
Storage temperature	-25°C to +80°C

Note: Transformers have an off load operating voltage that is higher than the rated voltage. For loads that are sensitive to overloads (electro-magnetic circuits), the transformer must be made to operate at In. After operation of the protection device upon an overload, cut-off the power supply and let the transformer cool down before restart.

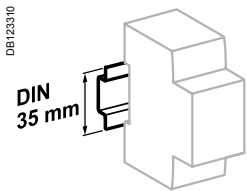

Clip on DIN rail 35 mm.

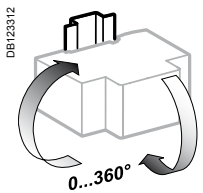

Bell transformer: indifferent position of installation.
Safety transformer: vertical position.

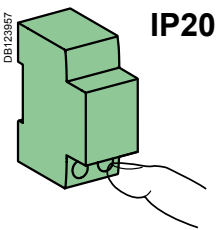

Weight (g)

iTR		
Type	Cat. no.	Weight
Bell	A9A15212	384
	A9A15213	240
	A9A15214	237
	A9A15215	633
	A9A15216	275
Safety	A9A15218	1082
	A9A15219	1125
	A9A15220	1190
	A9A15222	1309

Dimensions (mm)

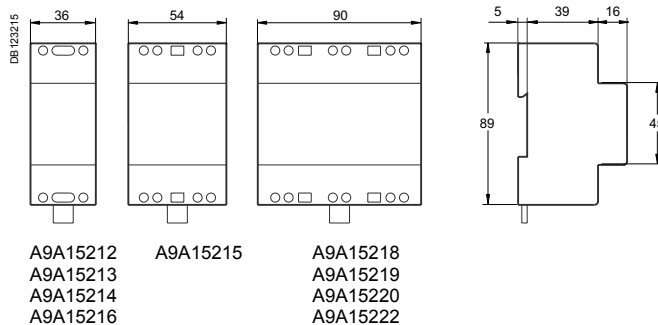

Relays

Time delay relays are used in service sector and industrial buildings for small automatic control systems: ventilation, heating, animation, roller blind servo controls, escalators, pumps, lighting, signalling, monitoring, etc.

> Time delay relays

PB111891-35



iRTA
■ Delays energizing of a load

PB111892-35



iRTB
■ Delays de-energizing of a load upon closing of an auxiliary contact (push button)

PB111893-35



iRTC
■ Delays de-energizing of a load upon opening of an auxiliary contact (push button)

^ Time delay

iRBN and iRTBT relays can interface automatic control system inputs/ outputs with low-voltage devices.

> Interface relays

PB107144-35



iRBN
Low level relay
■ Actuation of low-amperage electronic circuits upon receiving an LV electrical order

PB107164-35



iRTBT
Extra low voltage relay
■ Actuation of LV circuits based on an extra low voltage order

^ Control

Control relays monitor electrical parameters and indicate when they are exceeded

> Control relays

PB107124-35



iRCP
Phase control
■ Monitors the order and asymmetry of phases and the presence of voltage on the 3 phases of a three-phase circuit (power supply of a motor, etc.)

PB107125-35



iRCI
Current control
■ Monitors the current flowing in a circuit and indicates any crossing of the set threshold

^ Monitoring



iRTH

- Applies a time delay to de-energizing of a load



iRTL

- Applies a time delay to energizing and de-energizing of a load during different times, repeatedly (flasher)



iRTMF

- Allows one of the four types of time delay to be selected: A, B, C or H

iRLI and iERL relays are used to relay ON or OFF information to the auxiliary circuits and actuate low-power loads

> Changeover relays



iRLI Changeover

- Relays ON or OFF information to the auxiliary circuits
- Actuates low-power loads



iERL extension

^ Relaying and control



iRCU Voltage control



- Monitors the potential difference of a circuit and indicates any crossing of the set threshold





iRCC Compressor control

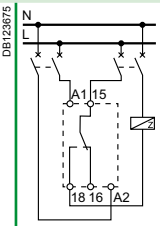
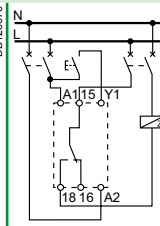
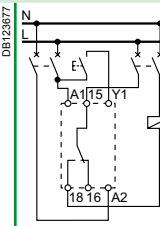
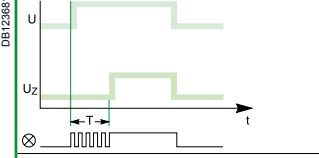
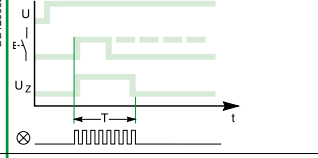
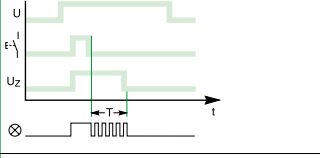

- Monitors the compressor power supply and prevents its immediate restarting upon detection of a power cut or voltage dip

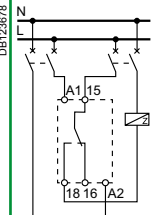
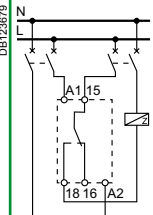
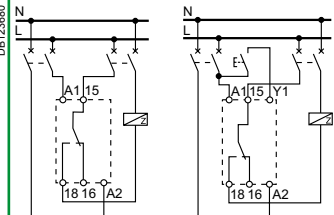
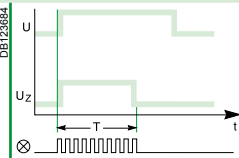
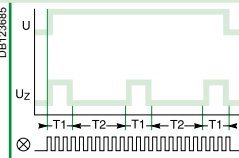

Time delay relays iRTA, iRTB, iRTC, iRTH, iRTL and iRTMF

		Time delay relays		
		iRTA	iRTB	iRTC
Type				
Function		■ Delays energizing of a load	■ Delays de-energizing of a load upon closing of an auxiliary contact (push button)	■ Delays de-energizing of a load upon opening of an auxiliary contact (push button)
Wiring diagrams				
Use		 <ul style="list-style-type: none"> ■ The single time delay cycle starts at switching on of the iRTA relay power supply ■ The load is energized at the end of time delay T 	 <ul style="list-style-type: none"> ■ The single time delay cycle starts at closing of an auxiliary contact (push button) ■ The load is de-energized at the end of time delay T 	 <ul style="list-style-type: none"> ■ The single time delay cycle starts only upon release of an auxiliary contact (push button) ■ The load is de-energized at the end of time delay T
Catalogue numbers		A9E16065	A9E16066	A9E16067
Technical specifications				
Control and power supply voltage (Uc)	V AC	24...240, ±10 %	24...240, ±10 %	24...240, ±10 %
	V DC	24, ±10 %	24, ±10 %	24, ±10 %
Operating frequency	Hz	50/60	50/60	50/60
Time delay range		0.1 s to 100 h	0.1 s to 100 h	0.1 s to 100 h
Precision		±10 % of full scale	±10 % of full scale	±10 % of full scale
Minimum duration of control impulse		100 ms	100 ms	100 ms
Insensitive to brownouts		≤ 20 ms	≤ 20 ms	≤ 20 ms
Max. resetting time per voltage interruption		100 ms	100 ms	100 ms
Accuracy of repetition		±0.5 % at constant parameters	±0.5 % at constant parameters	±0.5 % at constant parameters
Changeover contact (cadmium free)	Mini	Rating 10 mA/5 V DC	Rating 10 mA/5 V DC	Rating 10 mA/5 V DC
	Maxi	Rating 8 A/250 V AC/DC	Rating 8 A/250 V AC/DC	Rating 8 A/250 V AC/DC
Endurance	Mechanical	> 5 x 10 ⁶ switching operations	> 5 x 10 ⁶ switching operations	> 5 x 10 ⁶ switching operations
	Electrical	> 10 ⁵ switching operations (utilization category AC1)	> 10 ⁵ switching operations (utilization category AC1)	> 10 ⁵ switching operations (utilization category AC1)
Display of contact status by green indicator lamp		Flashing during time delay	Flashing during time delay	Flashing during time delay
Degree of protection	Device only	IP20	IP20	IP20
Connection by tunnel terminals	Without ferrule	2 x 2.5 mm ² single-strand	2 x 2.5 mm ² single-strand	2 x 2.5 mm ² single-strand
	With ferrule	2 x 1.5 mm ² multi-strand	2 x 1.5 mm ² multi-strand	2 x 1.5 mm ² multi-strand
Width in 9-mm modules		2	2	2
Operating temperature	°C	-5 ... +55	-5 ... +55	-5 ... +55
Storage temperature	°C	-40 ... +70	-40 ... +70	-40 ... +70

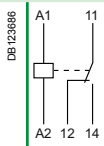
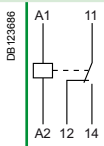

Time delay relays iRTA, iRTB, iRTC, iRTH, iRTL and iRTMF (cont.)

	iRTH	iRTL	iRTMF
			
	<ul style="list-style-type: none"> Applies a time delay to de-energizing of a load 	<ul style="list-style-type: none"> Applies a time delay to energizing and de-energizing of a load during different times, repeatedly (flasher) 	<ul style="list-style-type: none"> Allows one of the four types of time delay to be selected: A, B, C or H
			
			
	<ul style="list-style-type: none"> The single time delay cycle starts at switching on of the iRTH relay power supply The load is de-energized at the end of time delay T 	<ul style="list-style-type: none"> The time delay cycle starts at energizing The load is energized during an adjustable time T1 and then de-energized during an adjustable time T2. This cycle is reproduced until de-energizing of the iRTL relay power supply 	<ul style="list-style-type: none"> Depending on the choice, the iRTMF generates time delay cycles for the iRTA, iRTB, iRTC or iRTH relays
	A9E16068	A9E16069	A9E16070
	24...240, ±10 %	24...240, ±10 %	12...240, ±10 %
	24, ±10 %	24, ±10 %	12...240, ±10 %
	50/60	50/60	50/60
	0.1 s to 100 h	0.1 s to 100 h	0.1 s to 100 h
	±10 % of full scale	±10 % of full scale	±10 % of full scale
	100 ms	100 ms	100 ms
	≤ 20 ms	≤ 20 ms	≤ 20 ms
	100 ms	100 ms	100 ms
	±0.5 % at constant parameters	±0.5 % at constant parameters	±0.5 % at constant parameters
	Rating 10 mA/5 V DC	Rating 10 mA/5 V DC	Rating 10 mA/5 V DC
	Rating 8 A/250 V AC/DC	Rating 8 A/250 V AC/DC	Rating 8 A/250 V AC/DC
	> 5 x 10 ⁶ switching operations	> 5 x 10 ⁶ switching operations	> 5 x 10 ⁶ switching operations
	> 10 ⁵ switching operations (utilization category AC1)	> 10 ⁵ switching operations (utilization category AC1)	> 10 ⁵ switching operations (utilization category AC1)
	Flashing during time delay	Flashing during time delay	Flashing during time delay
	IP20	IP20	IP20
	2 x 2.5 mm ² single-strand	2 x 2.5 mm ² single-strand	2 x 2.5 mm ² single-strand
	2 x 1.5 mm ² multi-strand	2 x 1.5 mm ² multi-strand	2 x 1.5 mm ² multi-strand
	2	2	2
	-5 ... +55	-5 ... +55	-5 ... +55
	-40 ... +70	-40 ... +70	-40 ... +70

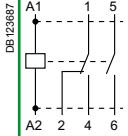
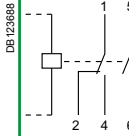

Interface relays			
	iRBN	iRTBT	
Type	Low level	Extra low voltage	
			
Standard	IEC/EN 61810-1	IEC/EN 61810-1	
Function	<ul style="list-style-type: none"> ■ Actuation of low-amperage electronic circuits upon receiving an LV electrical order 	<ul style="list-style-type: none"> ■ Actuation of LV circuits based on an extra low voltage order 	
Wiring diagrams			
Use	<ul style="list-style-type: none"> ■ Inputs of programmable logic controllers, of measuring or supervision circuits, etc. 	<ul style="list-style-type: none"> ■ ELV orders can be issued by a programmable logic controller (24 V DC static outputs), a central fire detection unit, a regulation system, etc. 	
Catalogue numbers	A9A15393	A9A15416	
Technical specifications			
Input control voltage (Uc)	V AC	230, ±10 %	12...24, -15 to +10 %
	V DC	-	12...24, ±20 %
Output contact rating	Mini	5 mA/5 V DC (DC12) 5 mA/5 V AC	10 mA/10 V DC (DC12) 10 mA/10 V AC
	Maxi	1 A/24 V DC (DC12) 5 A/250 V AC	1 A/24 V DC (DC12) 5 A/250 V AC
Operating frequency	Hz	50/60	0...60
Strengthened insulation between ELV/LV circuits		4 kV	4 kV
Consumption	At inrush	5 VA	0.22 W
	At holding	2.5 VA	0.11 W
Endurance	Electrical	100,000 switching operations	100,000 switching operations
Display of voltage presence on the control circuit		By green indicator lamp	By green indicator lamp
Degree of protection	Device only	IP20	IP20
Connection by tunnel terminals		0.5 x 6 mm ²	0.5 x 6 mm ²
Width in 9-mm modules		2	2
Operating temperature	°C	-5 ... +55	-5 ... +55
Storage temperature	°C	-40 ... +70	-40 ... +70

Changeover and extension relays											
	iRLI				iERL						
Type	Changeover relay				Extension for RLI						
											
Standard	IEC/EN 61810-1 and NF C 45-250				IEC/EN 61810-1 and NF C 45-250						
Function	<ul style="list-style-type: none"> Relaying of ON or OFF information to the auxiliary circuits and actuation of low-power loads 				<ul style="list-style-type: none"> Extension allowing additional contacts to be added to the iRLI changeover relays 						
Wiring diagrams											
Use	<ul style="list-style-type: none"> The iRLI relay contains 1 changeover contact (O-C) and 1 normally open contact (N/O) 				<ul style="list-style-type: none"> The iERL extension (max. 3 iERLs for 1 iRLI) contains 1 changeover contact (O-C) and 1 normally open contact (N/O) Can be mounted without any tool and without additional cabling using a yellow clip which performs mechanical assembly and electrical connection between the coils 						
Catalogue numbers	A9E15535	A9E15536	A9E15537	A9E15538	A9E15539	A9E15540	A9E15541	A9E15542			
Technical specifications											
Control voltage (Uc)	V AC	230...240	48	24	12	230...240	48	24	12		
Voltage rating (Ue)	V AC	230									
Insulation voltage (Ui)	V AC	250									
Rating (In)	A	10, cos φ = 1				10, cos φ = 1					
Operating frequency	Hz	50/60				50/60					
Inrush and holding power		4 VA				iRLI + iERL : 8 VA					
Endurance	Electrical	100,000 cycles AC21 (cos φ = 1)				100,000 cycles AC21 (cos φ = 1)					
Direct front face control	Power	By push button				By push button					
	Coil	By selector switch (disconnection)				By selector switch (disconnection)					
Position indicator		Mechanical indicator				Mechanical indicator					
Marking		Clip-on markers on the front panel				Clip-on markers on the front panel					
Degree of protection	Device only	IP20				IP20					
Connection by tunnel terminals		0.5 x 6 mm ²				0.5 x 6 mm ²					
Width in 9-mm modules		2				2					
Operating temperature	°C	-5 ... +55				-5 ... +55					
Storage temperature	°C	-40 ... +70				-40 ... +70					

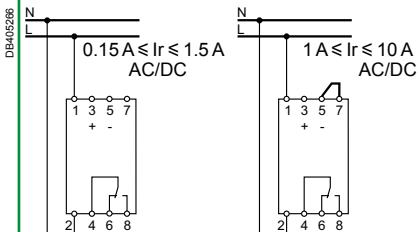
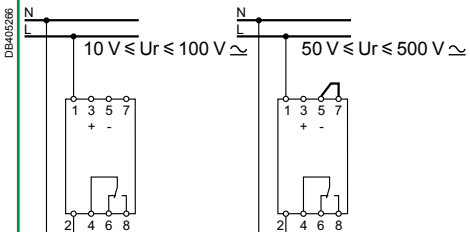

iRCP phase control, iRCI current control, iRCU voltage control and iRCC compressor control relays

Control relays		
Type	iRCI Current control	iRCU Voltage control
		
Function	<ul style="list-style-type: none"> Monitors the current (I_r) flowing in an AC or DC circuit and indicates any crossing of the set threshold 	<ul style="list-style-type: none"> Monitors the voltage variation (U_r) of an AC or DC circuit and indicates any crossing of the set threshold
Wiring diagrams		
Catalogue numbers	A9E21181	A9E21182

Common technical specifications		
Supply voltage (U_c)	V AC	230, -15 % à +10 %
Frequency	Hz	50/60
Parameter setting		<ul style="list-style-type: none"> On the front panel, by direct scale, using a screwdriver
Precision of display		±10 % of full scale
Output by changeover contact		8 A under 250 V AC ($\cos \varphi = 1$)
Indications by LED	Green	Voltage presence
	Red	Fault
Consumption	VA	3
Dissipated power	W	2
Degree of protection	Device only	IP20
Connection by tunnel terminals	Rigid cable	1.5 x 6 mm ²
Width in 9-mm modules		4
Operating temperature	°C	-5 ... +55
Storage temperature	°C	-40 ... +80

Particular technical specifications		
	Threshold adjustable from 10 % to 100 % of I_r	Threshold adjustable from 10 % to 100 % of U_r
	Hysteresis adjustable from 5 % to 50 % of I_r	Hysteresis adjustable from 5 % to 50 % of U_r
	Monitoring of overcurrent and undercurrent (selection by selector switch)	
	Fail-safe contact	
	De-energized	
	Energized with fault	
	Energized without fault	
	Time delay on crossing threshold: 0.1 s to 10 s	
	Possibility of memorizing fault with resetting	
	Compatible with current transformers (CTs) of ratio X/5	<ul style="list-style-type: none"> Automatic recognition of AC voltage or DC voltage. 2 measuring ranges selected by cabling: <ul style="list-style-type: none"> 10 V to 50 V 50 V to 500 V
	<ul style="list-style-type: none"> Automatic recognition of alternating or direct current. 2 measuring ranges selected by cabling: <ul style="list-style-type: none"> 0.15 A to 1.5 A 1 A to 10 A 	

iRCP phase control, iRCI current control, iRCU voltage control and iRCC compressor control relays (cont.)

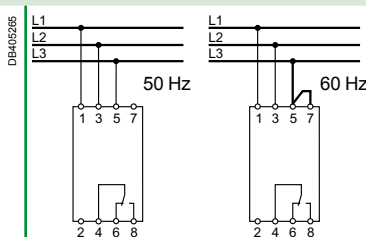
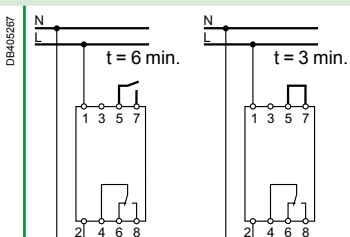
iRCP		iRCC	
Phase control		Compressor control	
			
<p>■ Monitors phases and the presence of voltage on the 3 phases of a three-phase circuit (power supply of a motor, etc.). It indicates any phase loss or inversion</p>		<p>■ Monitors the compressor's power supply and prevents its immediate restarting upon detection of a power cut or voltage dip</p>	
			
A9E21180		A9E21183	
400, ±15 %		230, -15 % à +10 %	
50/60			
■ On the front panel, by direct scale, using a screwdriver			
±10 % of full scale			
8 A under 250 V AC (cos φ = 1)			
Voltage presence			
Fault			
3			
3 (total on the 3 phases)		2	
IP20			
1.5 x 6 mm ²			
4			
-5 ... +55			
-40 ... +80			
Setting of phase asymmetry threshold: 5 % to 2 5% of 400 V		Threshold setting: ±5 % to ±15 % of 230 V	
Hysteresis: fixed, 5 % of asymmetry threshold			
Monitoring of direction of phase rotation			
Monitoring of presence of the 3 phases			
Fail-safe contact		Fail-safe contact	
De-energized		De-energized	
Energized with fault		Energized with fault	
Energized without fault		Energized without fault	
Time delay on tripping: 0.3 s		Time delay on overshoot: 3 or 6 minutes (selection by cabling)	

Technical data

Weight (g)

Relays	
Type	Weight (g)
iRTA, iRTB, iRTC, iRTH, iRBN	65
iRTL	66
iRTMF	68
iRTBT	63
iRLI, iERL	112
iRCP, iRCC	210
iRCI, iRCU	215

Dimensions (mm)

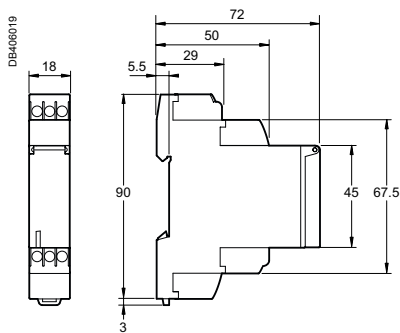

iRTA, iRTB, iRTC, iRTH, iRTL, iRTMF

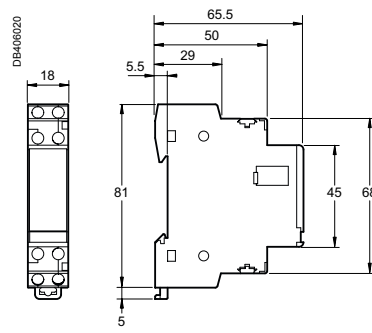

iRBN, iRTBT

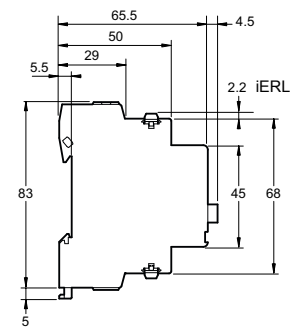

iRLI, iERL

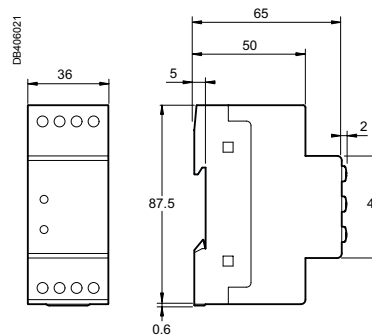

iRCP, iRCI, iRCU, iRCC

CDS
DSE1



Country approval pictograms

DSE1: IEC 64-8

CDS, CDSc : NF C 61.750, EN 500 81.1

When consumption exceeds the selected threshold, the load-shedder temporarily cuts off the power supply to non-priority circuits.

Load-shedders are used to:

- increase the number of loads without modifying the installed power
- reduce the installed power
- prevent nuisance tripping of the upstream circuit breaker.

Load-shedders

PB110008-34



Single-phase DSE1

- Load-shedding and restoration of 1 non-priority channel
- Tripping threshold adjustable from 0.8 kW to 7 kW (by default: 3.7 kW)
- Pre-alarm time before load-shedding (Ton) adjustable from 0 s to 9999 s (by default: 60 s)
- Load-shedding time (Toff) adjustable from 0 s to 9999 s (by default: 120 s)
- Buzzer operating time (Tbe) adjustable from 1 s to 9999 s (by default: 60 s)
- Backlit LCD display, 3 digits after the decimal point

PB107189-34



Single-phase CDS

- Load-shedding and restoration in cascading configuration of 2 non-priority circuits via 2 relays with time-delayed action:
 - load-shedding of circuit 1 only: load restoration after 5 min
 - load-shedding of circuit 1 and circuit 2:
 - load restoration of circuit 2: after 10 min
 - load restoration of circuit 1: 5 min. after circuit 2

PB107190-36



Three-phase CDS

- Load-shedding and restoration separately phase by phase
- 1 relay per phase
- Load-shedding time: 5 min. for each channel

PB107188-36

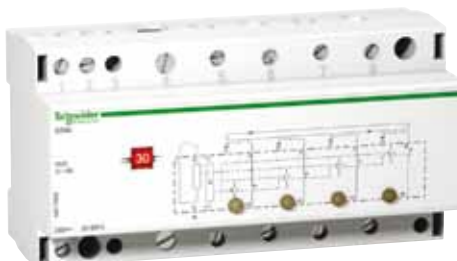

Single-phase CDSc

- Load-shedding and restoration in cascading configuration, then 1 to 4 non-priority circuits successively in turn
- Cyclic load-shedding: changing the order every 5 min.

DSE1

CDS

DSE1, CDS, CDSc load-shedders (cont.)

PB110009-34



DSE1

PB107189-34



CDS 1P

PB107190-36



CDS 3P

PB107188-36

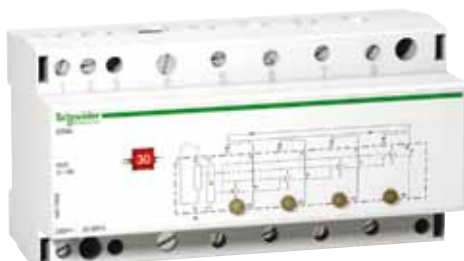

CDSc

Catalogue numbers

DSE1		
Type		Width in 9-mm modules
Single-phase		
	A9C15907	4
CDS		
Type		Width in 9-mm modules
Single-phase		
	A9C15908	10
Three-phase		
	A9C15913	16
CDSc		
Type		Width in 9-mm modules
Single-phase		
	A9C15906	16

Connection

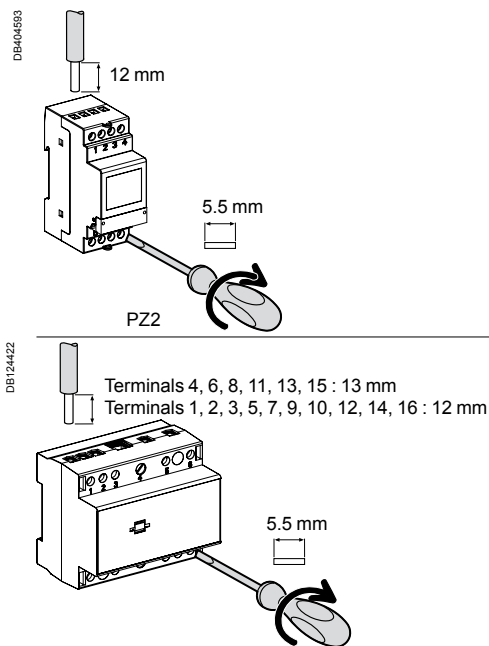

Type	Tightening torque	Copper cables	
		Rigid	Flexible or with ferrule
DSE1	1.2 N.m	6 mm ²	6 mm ²
CDS, CDSc	Priority circuit	10 to 50 mm ²	10 to 35 mm ²
	Non-priority circuit	2.5 to 10 mm ²	2.5 to 10 mm ²

■ Connection via tunnel terminals (captive screws).

Technical data

Main characteristics		DSE1	CDS		CDSc
		1P	1P	3P	1P
Insulation voltage (Ui)		230 V AC	230 V AC	230 V AC	230 V AC
Tension d'emploi (Ue)		230 V AC, -15 %, +10 %	230 V AC	415 V AC	230 V AC
Frequency		50/60 Hz	50/60 Hz		
Threshold		From 3.5 A to 32 A, accuracy ±1 %		5-10-15-20-25-30-40-45-50-60-75-90	
Rating	Priority circuit	32 A (cosφ = 1)		90 A (cosφ = 1)	
	Non-priority circuit	16 A, 250 V AC (cosφ = 1) >16 A relaying by contactor required		Relaying by contactor required	
Load-shedding indication		By red indicator By buzzer		By yellow indicators	
Power consumption		5 VA, backlit 3.5 VA, not backlit		12 VA	
Active power		40 W to 8 kW, 32 A maximum		20 kW maximum	
Control of current greater than 90 A		-		Use of an In/5 current transformer Threshold setting: 5 A	
Forced load-shedding input		-		■	
1 A - 250 V make contact for remote indication		-		2 3 -	
Additional characteristics					
Degree of protection (IEC 60529)	Device only	IP20	IP20		IP20
	Device in modular enclosure	IP40	IP40		IP40
Operating temperature		-5°C to +50°C		-5°C to +55°C	
Storage temperature		-40°C to +70°C		-40°C to +70°C	
Tropicalisation (IEC 60068-1)		Treatment 2 (relative humidity 95 % to 55°C)		Treatment 2 (relative humidity 95 % to 55°C)	

DSE1, CDS, CDSc load-shedders (cont.)

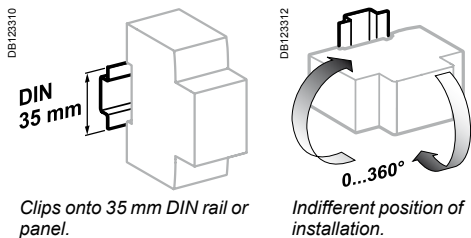

Technical data (cont.)

Weight (g)

Load-shedders			
Type	DSE1	CDS	CDSc
1P	130	300	600
3P	-	500	-

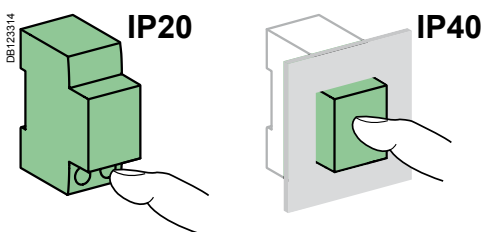

Dimensions (mm)

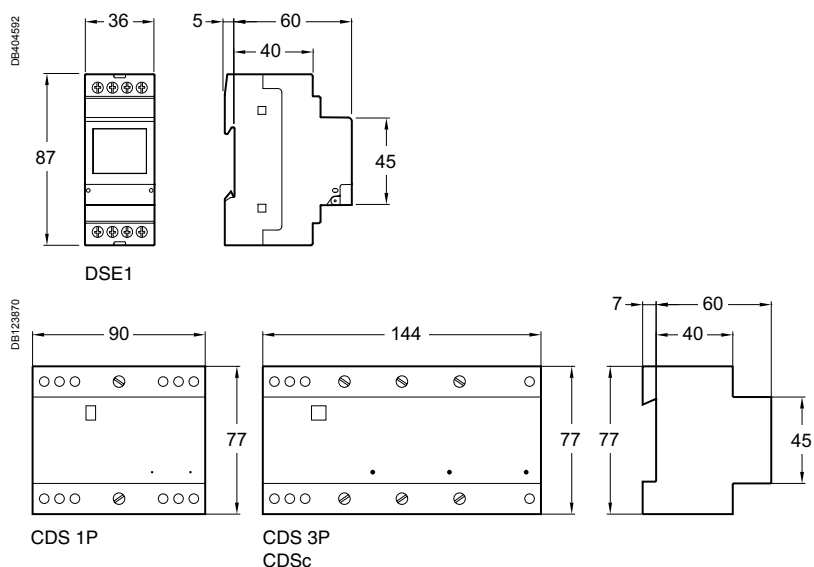

Installation

⚠ Use a contactor for any load-shedding above 16 A.
Designed for load-shedding household equipment circuits, except lighting circuits.
The load is restored without pre-indication.

DSE1

DB4048Z1

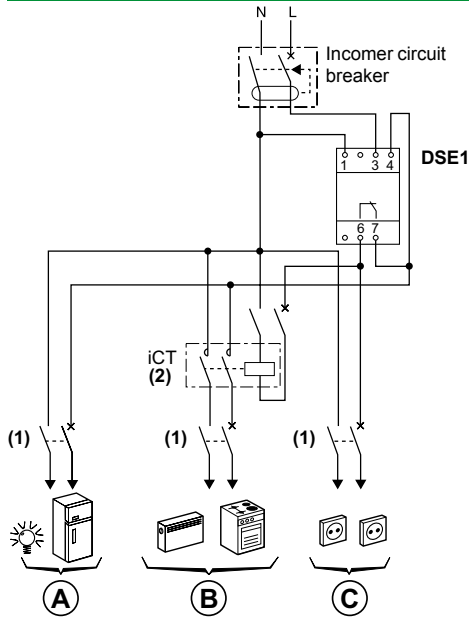

- (1) Determine the circuit-breaker rating according to the cable cross-section.
- (2) Calculate the contactor rating according to the load power.

- A** Non load-sheddable priority loads.
- B** Load-sheddable non-priority loads >16 A (relaying by contactor).
- C** Load-sheddable non-priority loads < 16 A.

Installation (cont.)

⚠ Non-priority outputs must not be connected directly: they must be relayed by means of contactors.
Do not shed circuit loads that include machine and lighting type applications.

CDSc

DB124424

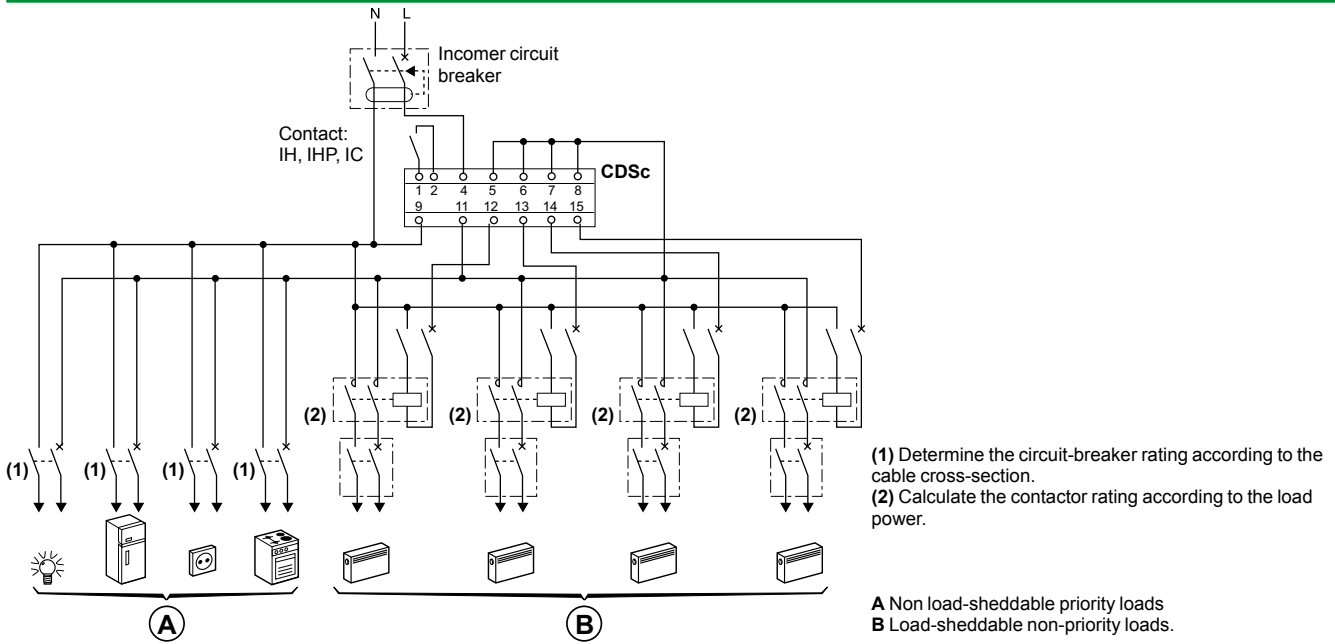

CDS

DB124423

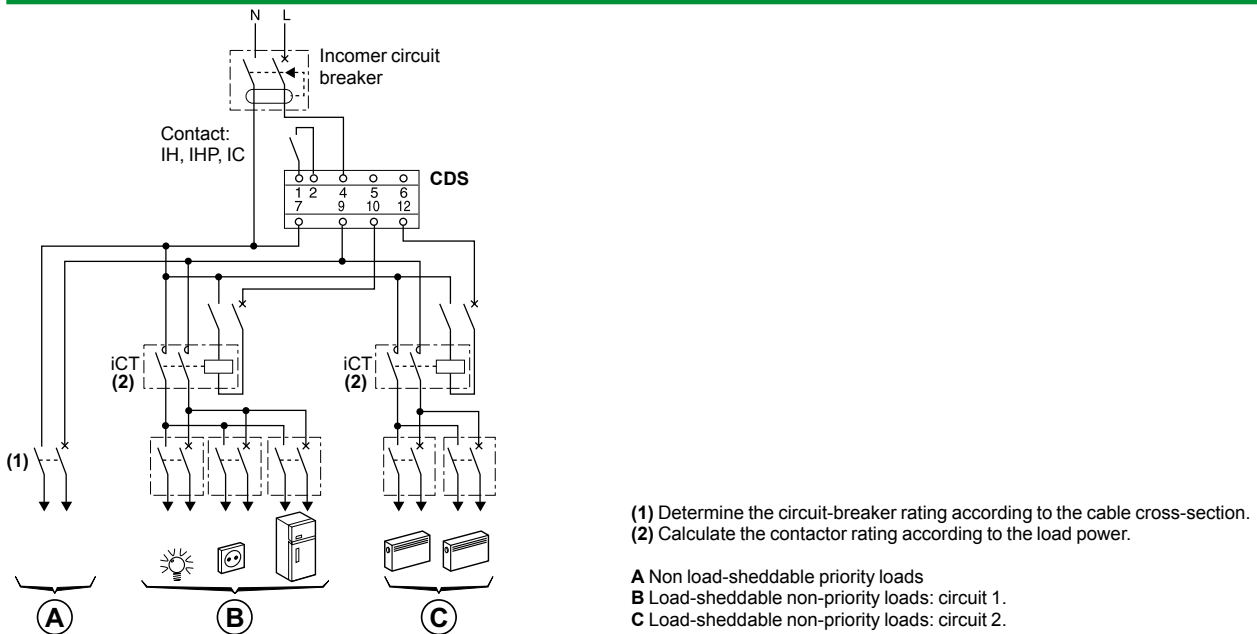













These power sockets allow low-voltage devices to be connected to the electrical network.

The differentiated socket is designed for specific applications (backed-up networks, sockets powered by a UPS, etc.), when it is wanted to highlight specialized power sockets. Its yellow colour allows users to locate and identify it easily.



IEC 60884

Catalogue numbers

iPC 16 A power sockets							
							
Diagram							
Approval pictogram							
Type	Standard	With indicator	Differentiated	Standard	With indicator	Differentiated	Standard
Color	White	White	Yellow	White	White	Yellow	White
Cover	With	With	With	Without	Without	With	With
Cat. no.	A9A15306	A9A15307	15324	A9A15310	A9A15035	15033	A9A15303
Standard	NF C 61314, NBN C 61112		NF C 61314	VDE 0620, NEN 1020	VDE 0620		IMQ as per CEI 2350
Width in 9-mm modules	5						

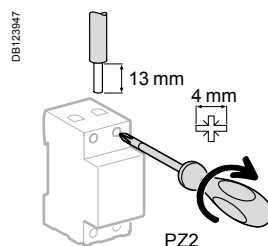
Connection



Type	Tightening torque	Copper cables	
		Rigid	Flexible or with ferrule
iPC 16 A	1.2 N.m		
		10 mm ²	6 mm ²

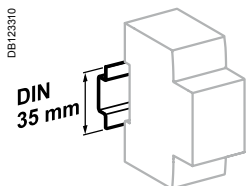

Clip on DIN rail 35 mm.

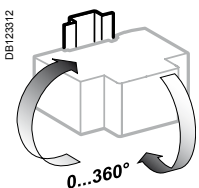

Indifferent position of installation.

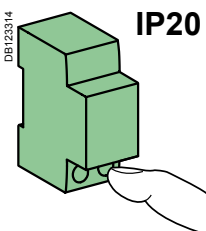

IP20

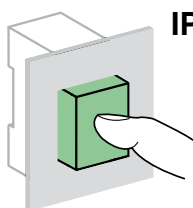

IP40

Technical data

Main characteristics		iPC 16 A
Voltage rating (Ue)		250 V AC
Power on indicator		LED technology long service life: 100,000 hours
Additional characteristics		
Degree of protection (IEC 60529)	Device only	IP20
	Device in modular enclosure	IP40
Operating temperature		-25°C to +70°C
Storage temperature		-40°C to +80°C
Tropicalization (IEC 60068-1)		Treatment 2 (relative humidity of 95 % at 55°C)

Dimensions (mm)

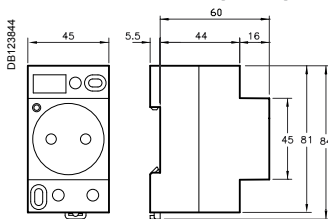

iPC 16 A NF standard

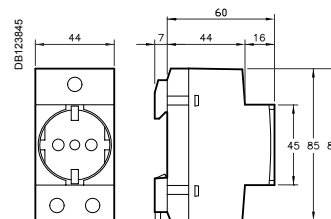

iPC 16 A Italian standard

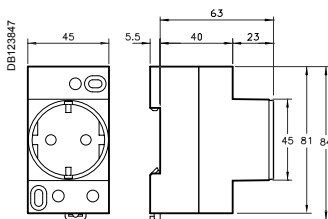

iPC 16 A German standard

Weight (g)

iPC power sockets

Type

iPC 16 A	98
----------	----

> Twilight switches



P111637
P83237

IC100
Adjustable from 2 to 100 lux.
It comes with a wall-mounted cell.



P111639
P116858
P106856

IC2000
Adjustable from 2 to 2000 lux. It comes with a standard wall-mounted or switchboard cell.



P111640
P83237

IC2000P+
It has 3 customisable pre-set programs and 3 setting ranges from 2 to 2100 lux. Its 4 keys and large screen facilitate its programming.
It comes with a wall-mounted cell.



P116857



IC Astro
It operates without photoelectric cell and calculates sunrise and sunset times according to its geographic position.
It can be customised by using its programming function.





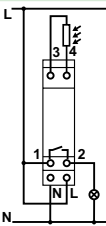
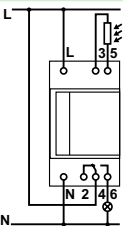
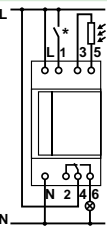

P116858
P116858

IC100kp+
Adjustable from 1 to 99000 lux.
Its 4 keys and large screen facilitate its programming.
It comes with a digital wall-mounted and a memory key.

Selection table





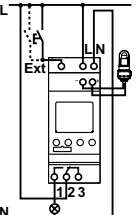
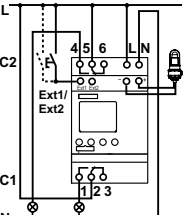
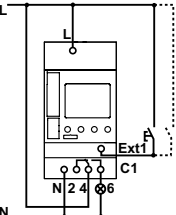
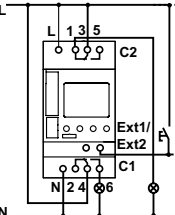

	IC100	IC2000	IC2000P+	
	 P111637 + P108327	 P111639 + P1116888 + P108656	 P111640 + P108327	
Function	The IC100 controls closing of a contact when brightness decreases and drops below the selected threshold. It controls opening of a contact when brightness increases and rises above the selected threshold	The IC2000 control closing of a contact when brightness decreases and drops below the selected threshold. They control opening of a contact when brightness increases and rises above the selected threshold	The IC2000P+ controls lighting according to brightness and time. If brightness drops below the set threshold (twilight function: IC) and if the time program allows relay closing (time switch function), then the lighting circuit is activated	
Wiring diagrams	 P108657	 P108658	 P108659	
Catalogue numbers	15482	CCT15284	CCT15368	
			15483 ⁽¹⁾	
Technical specifications				
Delivered with	Wall-mounted cell	Switchboard cell (15281)	Wall-mounted cell (CCT15268)	Wall-mounted cell
Optional accessories	Wall-mounted cell (CCT15268)	Switchboard cell (15281) Wall-mounted cell (CCT15268)	Wall-mounted cell (CCT15268) Switchboard cell (15281)	Wall-mounted cell (CCT15268)
Adjustable brightness threshold	2 to 100 lx	2 to 2000 lx		Range 1: 2 to 50 lx Range 2: 60 to 300 lx Range 3: 350 to 2100 lx
Voltage rating (Ue) (+10 %, -15 %)	230 V AC, 50/60 Hz	230 V AC, 50/60 Hz		230 V AC, 50/60 Hz
Consumption	6 VA	6 VA		3 VA
Operating temperature	-20°C to +50°C	-25°C to +50°C		-20°C to +50°C
Width (9 mm modules)	2	5		5
Insulation class	Class II	Class II		Class II
Degree of protection	IP20B	IP20B		IP20B
Output contact rating $\cos \varphi = 1$ (under 250 VAC)	16 A	16 A		16 A
$\cos \varphi = 0.6$	10 A	10 A		10 A
Time delays (On and Off)	20 s (On) 80 s (Off)	≥ 60 s		Adjustable from 20 to 140 s (80 s by default)
Operating accuracy	–	–		$\leq \pm 1$ s / day at 20°C.
Monitoring indicator light, not time delayed, lit when brightness is less than the threshold	Red	Red		–
Contact switching indicator light	Green	Green		–
LCD liquid crystal display	–	–		Back-lit
Program saving by lithium battery	–	–		■
Operating reserve	–	–		5-6 years
Location for instruction manual on front face	–	■		■
Cabling test function with a push-button on front face	–	■		–
Number of channels	1	1		1
Control by brightness detection	■	■		■
Coupling with weekly programming	–	–		42 switching times Minimum switching: 1 min Switching accuracy: 1 s
Control by calculation of sunrise/sunset times	–	–		–

Languages: (1) English, french, spanish, italian, german, portuguese, swedish, dutch, finnish, norwegian/danish. (2) English, french, spanish, portuguese, hungarian, polish, romanian, turkish.

IC100kp+ IC100kp+ 1C	IC100kp+ 2C	IC Astro IC Astro 1C	IC Astro 2C
			
<p>The IC100kp+ 1C/2C control lighting according to brightness and time. If brightness drops below the set threshold (twilight function: IC) and if the time program allows relay closing (time switch function), then the lighting circuit is activated</p>		<p>The IC Astro astronomic programmable twilight switch is used to start and stop an electric load (e.g. lighting) according to sunrise and sunset times, without a brightness detector. Sunrise and sunset times are calculated automatically by the IC Astro according to the geographic parameters configured by the user</p>	
			
CCT15490 ⁽²⁾ CCT15491 ⁽³⁾	CCT15492 ⁽²⁾ CCT15493 ⁽³⁾	CCT15223 ⁽²⁾ CCT15224 ⁽³⁾	CCT15243 ⁽²⁾ CCT15244 ⁽³⁾
Digital wall-mounted cell (CCT15260) Memory key (alone) (CCT15861)		–	Memory key (alone) (CCT15861)
Digital wall-mounted cell (CCT15260) Digital switchboard cell (CCT15261) Programming kit for PC (CCT15860) Memory key (alone) (CCT15861)		Programming kit for PC (CCT15860) Memory key (alone) (CCT15861)	
1 to 99000 lx		According to sunrise/sunset times	
230 V AC, 50/60 Hz 3 VA	100-240 V AC, 50/60 Hz	230 V AC, 50/60 Hz 3 VA	6 VA
-30°C to +50°C		-25°C to +45°C	
4	6	5	
Class II IP20C		Class II IP20B	
16 A 10 A		16 A 10 A	
Adjustable from 0 to 59.59 min.		Difference in sunset and/or sunrise times adjustable separately by ±120 min.	
–		–	
–		–	
–		–	
Back-lit		Back-lit	
■ 10 years		■ 6 years	
–		–	
–		–	
1	2	1	2
■ 84 switching times Operating accuracy: < ±1 s / day at 20°C Minimum switching: 1 min Switching accuracy: 1 s		■ 84 switching times (not including sunrise/sunset) Minimum time between 2 switching operations: 1 min. Switching accuracy: 1 s Time accuracy: ±1 s / day	

an, czech, slovak, bulgarian, greek, slovene, serbian, croatian. (3) English, french, italian, german, swedish, dutch, finnish, danish, russian, ukrainian, latvian, lituanien, estonian,

Accessories selection table

	Wall-mounted cell	Switchboard cell	Programming kit for PC	Memory key	Digital wall-mounted cell	Digital switchboard cell	
							
Function	Wall-mounted photoelectric cell	Switchboard photoelectric cell	Consists of a programming device, a memory key, a CDROM and a 2 m USB cable	Saving and duplicating programs	Digital wall-mounted photoelectric cell	Digital wall-mounted photoelectric cell	
Mounting	<ul style="list-style-type: none"> Delivered with its fixing device for IC100 and IC200P+ Replaced by CCT15268 for spare part use Cell connection: by double insulation 2-conductor cable, not to be laid next to mains cables or water ducts, maximum length: 25 m 	Delivered with 1 m cable and its fixing device	<ul style="list-style-type: none"> Delivered with its fixing device Cell connection: by double insulation 2-conductor cable, not to be laid next to mains cables or water ducts, maximum length: 100 m 	–	–	<ul style="list-style-type: none"> Delivered with its fixing device. Cell connection: <ul style="list-style-type: none"> by double insulation 2-conductor cable: <ul style="list-style-type: none"> - 0.5 - 2.5 mm² for CCT15260 - 0.25 - 1.5 mm² for CCT15261 Not to be laid next to mains cables or water ducts, maximum length: <ul style="list-style-type: none"> - 100 m (2 x 1.5 mm²) - 50 m (2 x 0.75 mm²) 	
Catalogue no.	–	CCT15268	15281	CCT15860	CCT15861	CCT15260	CCT15261

Technical specifications

	IP54	IP55	IP65	–	–	IP55	IP66
Degree of protection	IK05	–	IK05	–	–	–	–
Operating temperature	-40°C to +70°C	-40°C to +70°C	-40°C to +70°C	–	–	-40°C to +70°C	-40°C to +70°C
Horizontally orientable	–	–	90°	–	–	90°	90°

Load table

Type of lighting (230 V AC)	Max. power (for higher power, relay with a contactor)					
	IC100	IC2000	IC2000P+	IC Astro	IC100kp+	
Incandescent and halogen lamps	2300 W	2300 W	2300 W	2600 W	2600 W	
LED lamps	Power for one lamp < 2 W	20 W	20 W	20 W	30 W	30 W
	Power for one lamp from 2 to 8 W	55 W	55 W	55 W	100 W	100 W
Non-corrected / serial-corrected / dual mounted fluorescent tubes with conventional ballast	2300 VA	2300 VA	26 x 36 W, 20 x 58 W, 10 x 100 W	26 x 36 W, 20 x 58 W, 10 x 100 W	26 x 36 W, 20 x 58 W, 10 x 100 W	
Parallel corrected fluorescent tubes with conventional ballast	400 VA	400 VA	10 x 36 W, 6 x 58 W, 2 x 100 W	10 x 36 W, 6 x 58 W, 2 x 100 W	10 x 36 W, 6 x 58 W, 2 x 100 W	
Fluorescent tubes with electronic ballast	–	–	9 x 36 W, 6 x 58 W	9 x 36 W, 6 x 58 W	650 VA max.	
Dual-mounted fluorescent tubes with electronic ballast	300 VA	300 VA	5 x (2 x 36 W), 3 x (2 x 58 W)	5 x (2 x 36 W), 3 x (2 x 58 W)	–	
Fluocompact lamps with electronic ballast	9 x 7 W, 7 x 11 W, 7 x 15 W, 7 x 20 W, 7 x 23 W	9 x 7 W, 7 x 11 W, 7 x 15 W, 7 x 20 W, 7 x 23 W	9 x 7 W, 7 x 11 W, 7 x 15 W, 7 x 20 W	9 x 7 W, 7 x 11 W, 7 x 15 W, 7 x 20 W	22 x 7 W, 18 x 11 W, 16 x 15 W, 16 x 20 W, 14 x 23 W	
Fluocompact lamps with conventional ballast	1500 VA	1500 VA	–	–	–	
Parallel-corrected mercury and sodium vapour lamps	400 VA	400 VA	250 VA	250 VA	800 VA max. (80 µF)	
Non-corrected/ serial-corrected mercury and sodium vapour lamps	1000 VA	1000 VA	–	–	–	
Motor	–	–	–	–	2300 VA max.	

Specific technical data

IC2000P+

External input

Voltage rating (Ue)	230 V AC, +10 %, -15 %
Frequency	50/60 Hz
Input current	≤ 2.5 mA
Consumption	≤ 0.4 mW
Cable length	≤ 100 m

IC Astro

Programming longitude	-180° (East) to +180° (West) in steps of 1°
Programming latitude	-90° (South) to +90° (North) in steps of 1°

IC100kp+, IC Astro

Programming accessories	<ul style="list-style-type: none">■ Programming kit for PC consists of a programming device, a memory key, a CDROM and a 2 m USB cable■ Memory key for saving and duplicating programs, delivered on front face
-------------------------	--

External inputs

External inputs for external control with a standard switch or a push-button	<ul style="list-style-type: none">■ 1 input "Ext" for 1 channel versions■ 2 inputs "Ext1" and "Ext2" for 2 channels versions
Voltage rating (Ue)	<ul style="list-style-type: none">■ 230 V AC, +10 %, -15 % for 1 channel versions■ 100-240 V AC +10 %, -15 % for 2 channels versions
Frequency	50/60 Hz
Input current	≤ 0.5 mA
Consumption	≤ 130 mW
Cable length	≤ 100 m

IC2000P+

The IC 2000P+ uses its time programming to define lighting On and Off periods:

- According to three pre-set time programs:
 - "DAYPROG": On time programming from 7 am to 8 pm a validation of the IC function from 7 am to 8 pm,
 - "NIGHTPROG": On time programming from 5 am to 8 am and from 6 pm to 11 pm a validation of the IC function on these two operating periods,
 - "EMPTYPROG": Off time programming throughout the day a no validation of the IC function. These programs can be modified if necessary.
- According to a customised operating period, with possibility of copying to the other days. It is equipped with the following functions:
 - consideration of periods of absence (holidays),
 - temporary or permanent On or Off override,
 - remote control of lighting override by NO external contact,
 - consideration of change to "summer/winter" time, automatic or manual,
 - permanent liquid crystal display: of time and minutes, of day of the week, of the contact output status and current program.

Example

Lighting of a shop window, in the evening, at a time variable according to brightness and switch-off at a set time (e.g. 11 pm). Then in the morning, lighting at a set time (e.g. 4 am) and switch-off at a time variable according to brightness (see Fig. 1).

Configuration

This consists of recording in the memory:

- The language.
- The year, month, day and time.
- One of the 3 pre-set programs:
 - "DAYPROG": "On" time programming from 7 am to 8 pm → validation of the IC function from 7 am to 8 pm,
 - "NIGHTPROG": "On" time programming from 5 am to 8 am and from 6 pm to 11 pm → validation of the IC function on these two operating periods,
 - "EMPTYPROG": "Off" time programming throughout the day → no validation of the IC function. These programs can be modified.
- The brightness threshold. Once this phase is over, your IC 2000P+ operates in AUTO mode according to the items you have chosen.

Programming

The IC2000P+ is used to manage time programs. It allows:

- Creation of a new program with the possibility of copying to the other days.
- Viewing programs in memory.
- Modification of a program in memory, of the time, date, summer/winter time.
- Partial or total deletion of the program (date, time and language are kept).
- Modification of the brightness threshold.
- Separate setting of the time delay on switch-on and switch-off.

Move to On/Off override

- Press briefly (< 2 s) and simultaneously the 2 keys "-", "+" (value setting and navigation keys) on the front face to move to "MAN ON" or "MAN OFF".
 - Press the keys for more than 2 s to move to "PERM ON" or "PERM OFF".
 - Supply of terminal 1 overrides the IC 2000P+ output to the "On" position.
- This external override takes priority over the product On/Off override function (see Fig. 2, 3).

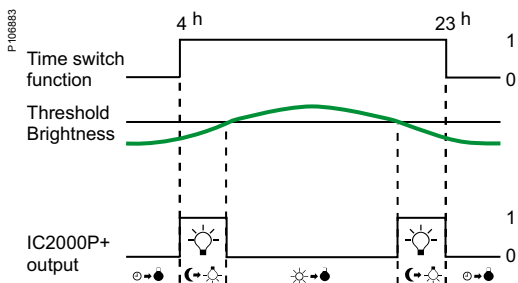

Fig. 1.

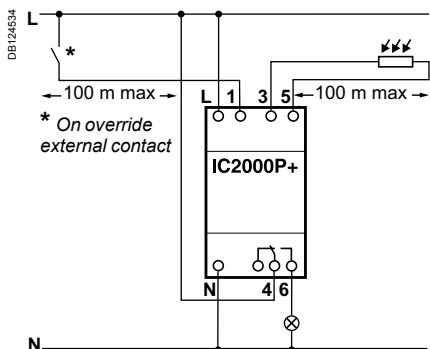

Fig. 2.

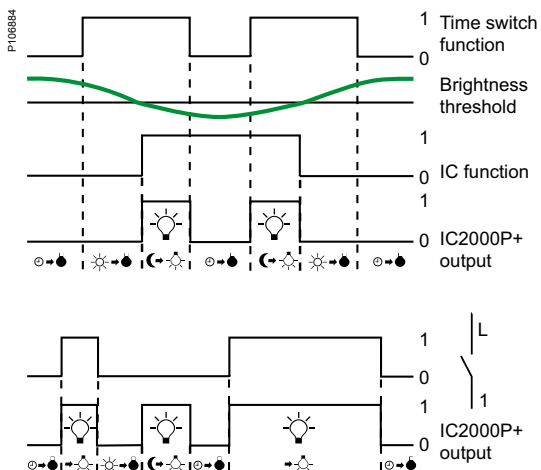

Fig. 3.

IC Astro

The IC Astro is configured according to the place of installation.

- The place of installation of the IC Astro can be configured:
 - either by selecting a country and a town,
 - or by its geographic coordinates (latitude, longitude).
- The IC Astro allows:
 - addition or deletion of a switch-off/switch-on switching operation (Off-On) between the sunset and sunrise times,
 - different programmes each day,
 - difference in sunset and/or sunrise times, adjustable separately by ± 120 min. according to local constraints (mountains, buildings, etc.),
 - consideration of periods of absence (holidays),
 - remote control of lighting override by external standard switch or push-button via the external input (1 external input per channel),
 - re-initialisation of programmes,
 - automatic switching to "summer-winter" time,
 - permanent display by liquid crystals: hours and minutes, day of the week, contact output status, and current programme,
 - manual waiver of the lighting On/Off programme, permanently or temporarily (up to the next switching operation).
 - back-lighting of the screen.

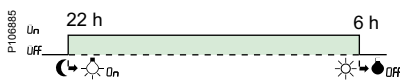

Fig. 3.



Fig. 4.

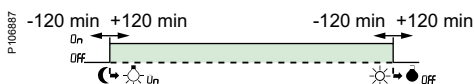

Fig. 5.

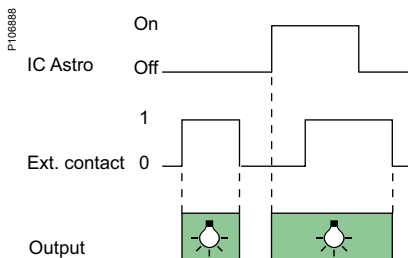

Fig. 6.

Example

Automatically lighting On and Off a shop window in Paris according to sunset and sunrise, example the 20th June.

- At night (10 pm) the lighting switch-on.
- At the morning (6 am) the lighting switch-off.

Configuration

This consists of writing in the memory:

- The language.
- The place of installation, either:
 - by its position (Argentina, China, etc.) and by the closest town,
 - by its geographic coordinates (latitude, longitude, time difference with respect to GMT) (a map is provided with the product).
- The year, month, day and time.
- Once this phase is complete, IC Astro will calculate the sunrise and sunset times and propose a default programme (operation from sunset to sunrise) (see Fig. 3).

Programming an Off period

The IC Astro offers the possibility of adding an "Off" period (programmed switch-off and switch-on) inside the programme, between the sunrise and sunset times (by default it is proposed from 11 pm to 5 am) (see Fig. 4).

Modifying programming and configuration

The twilight switch allows:

- Creation of a new customised programme with possibility of copying onto the other days.
- Display of programmes in memory.
- Deletion, modification or addition of an automatic or programmed switching operation.
- Partial or total deletion of the programme (date, time and language are kept).
- Modification of time, date, summer/winter time.
- Temporary cancellation of the "On" periods by configuring start and end dates and Times of absence (holidays).
- Adjustment of difference in sunset and/or sunrise times by ± 120 min. according to local constraints (mountains, buildings, etc.) (see Fig. 5).

Move to On/Off override

- Briefly press (<2 s) at the same time on the 2 keys "-", "+": (value setting and navigation keys) on the front face to move to "ON TEMP" or "OFF TEMP".
- Hold down (>2 s) the keys to move to "ON PERM" or "OFF PERM".
- The supply of input 5 forces the IC Astro output to the "ON" position. This override takes priority over the product On/Off override function (see Fig. 6).

Connection

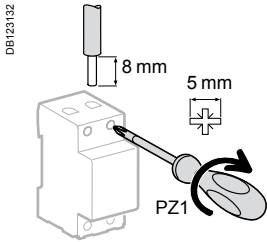

Type	Tightening torque	Copper cables	
		Rigid	Flexible or with ferrule
IC100, IC2000P+	1.2 N.m	DB122346 ≤ 6 mm ²	DB123553 ≤ 6 mm ²
IC2000, IC Astro, IC100kp+	2 screwless / pole	2 x 2.5 mm ²	2 x 2.5 mm ²

IC100, IC Astro are mechanical compatible with electrical distribution comb busbar.

Weight (g)

Twilight switches	1C	2C
IC100	173	
IC2000	280	
IC2000P+	323	
IC Astro	132	
IC100kp+	183	352

Dimensions (mm)

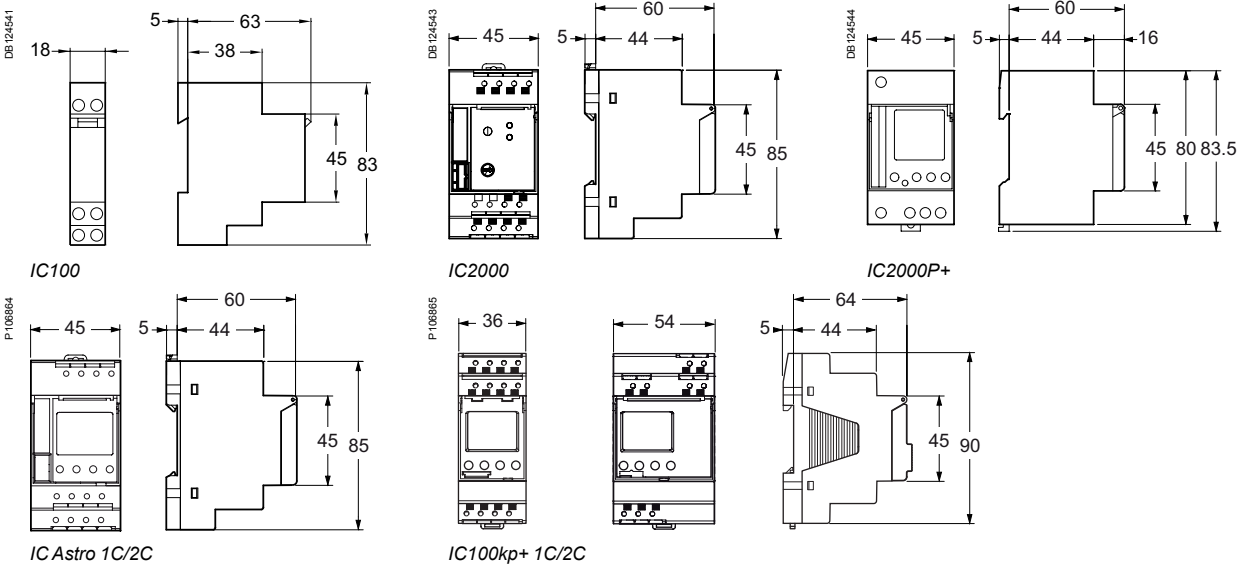

Cells

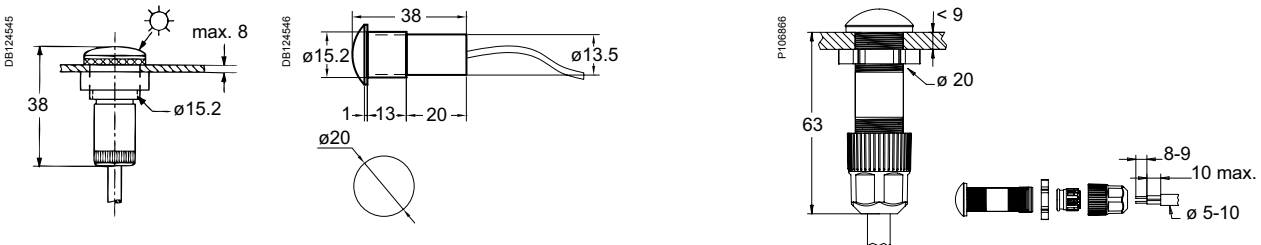

Standard switchboard cell (15281) Fixed externally in vertical position by 2 ø 4 mm screws

Digital switchboard cell (CCT15261)

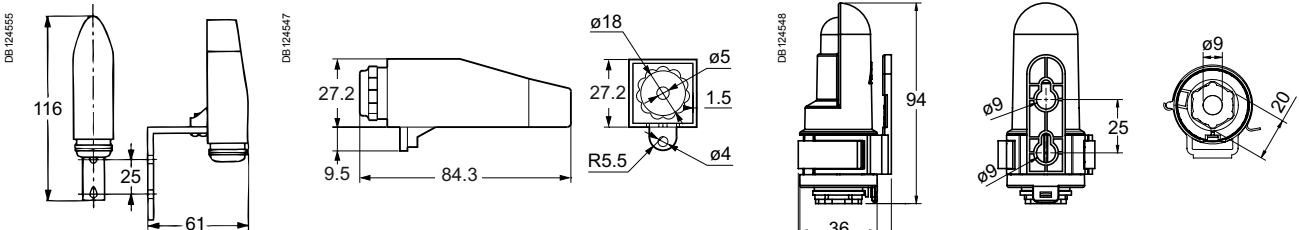

Wall-mounted cell (delivered with IC100, IC2000P+)

Standard and digital wall-mounted cell (CCT15268, CCT15260)



> Time switches

> The 36 and 45 mm digital time switches



IHP 1c **IHP 2c** **IHP+1c** **IHP+2c**

Automatically switch On and Off loads according to the program entered by the user with 4 keys and a display, they operate on a weekly cycle: the same program is repeated week after week.



IHP+ DCF 1c + DCF77 antenna
Synchronised on the frankfort transmitter via the DCF77 antenna.

> The 18 mm digital time switches



IHP 1c/+ 1c

Automatically switch On and Off loads according to the program entered by the user with 4 keys and a display, they operate on a weekly cycle: the same program is repeated week after week.

> The 54 mm mechanical time switches

IH 60mn 1c SRM **IH 24h 1c SRM/ ARM** **IH 24h 2c ARM**

IH 24h + 7j 1+1c ARM **IH 7j 1c ARM**

Automatically switch On and Off loads according to the program entered by the user they operate on an hourly, daily or weekly cycle: the same program is repeated hour after hour (IH 60mn), day after day (IH 24h) or week after week (IH 7j).

> The 18 mm mechanical time switches

IH 24h 1c SRM/ ARM **IHH 7j 1c ARM**

Automatically switch On and Off loads according to the program entered by the user they operate daily on a weekly cycle.

> The digital yearly time switches

ITA 1C **ITA 4C**

They operate on an daily, weekly or yearly program (ITA 1c: 1 channel, ITA 4c: 1, 2, 3 or 4 channels - 2 external inputs).

Selection table

The time switches control opening and closing of one or more separate circuits according to a programming pre-set by the user:

- by memorisation of On and Off switching operations for the IHP and ITA digital time switches
- by positioning of jumpers or captive segments on a programming dial for the IH mechanical time switches.

An IHP, IH or ITA time switch is chosen according to the following criteria:

Designation	Number of channels	Cycle period (d: day)	Minimum time between 2 switching operations	Number of switching operations	Saving on mains cut off	Width (modules of 9 mm)	Override controls On / Off	Output contact changeover switch (cos φ =1)	Time changeover (summer / winter)
The 36 or 45 mm digital time switches									
IHP 1c	1	24 h and/or 7 d	1 min.	56	6 years	5	On / Off	16 A	Auto
IHP + 1c	1	24 h and/or 7 d	1 s	84	6 years	5	On / Off	16 A	Auto
IHP 2c	2	24 h and/or 7 d	1 min.	56	6 years	5	On / Off	16 A	Auto
IHP + 2c	2	24 h and/or 7 d	1 s	84	6 years	5	On / Off	16 A	Auto
IHP+ DCF 1c ⁽¹⁾	1	24 h and/or 7 d	1 s	84	10 years	4	On / Off	16 A	Auto
The 18 mm digital time switches									
IHP 1c 18 mm	1	24 h and/or 7 d	1 min.	56	10 years	2	On / Off	16 A	Auto
IHP + 1c 18 mm	1	24 h and/or 7 d	1 s.	84	10 years	2	On / Off	16 A	Auto
The 36 or 72 mm digital yearly time switches									
ITA 1c ⁽²⁾	1	24 h, 7 d, year	1 s	300	10 years	4	On/Off	16 A	Manual / Auto ⁽³⁾
ITA 4c ⁽²⁾	4	24 h, 7 d, year	1 s	300	10 years	8	On/Off	16 A	Manual / Auto ⁽³⁾
The 54 mm mechanical time switches									
IH 60mn 1c SRM	1	60 min.	37.5 s	48 On - 48 Off	none	6	On / Off	10 A	Manual
IH 24h 1c SRM	1	24 h	15 min.	48 On - 48 Off	none	6	On / Off	16 A	Manual
IH 24h 1c ARM	1	24 h	15 min.	48 On - 48 Off	200 h ⁽⁴⁾	6	On / Off	16 A	Manual
IH 24h 2c ARM	2	24 h	30 min.	24 On - 24 Off	150 h	6	On	16 A	Manual
IH 7j 1c ARM	1	7 days	2 h	42 On - 42 Off	200 h ⁽⁴⁾	6	On / Off	16 A	Manual
IH 24h + 7j 1+1c ARM	1+1	24 h + 7 days	45 min. + 12 h	16 On -16 Off + 7 On -7 Off	150 h	6	On	16 A	Manual
The 18 mm mechanical time switches									
IHH 7j 1c ARM	1	7 days	2 h	42 On - 42 Off	100 h	2	On / Off	16 A	Manual
IH 24h 1c ARM	1	24 h	15 min.	48 On - 48 Off	100 h	2	On / Off	16 A	Manual
IH 24h 1c SRM	1	24 h	15 min.	48 On - 48 Off	none	2	On / Off	16 A	Manual

(1) The IHP+ DCF 1c can be synchronised on the Frankfurt's DCF77 radio station via the DCF77 antenna.

(2) The ITA 1c and ITA 4c can be synchronised on the Frankfurt's DCF77 radio station via the DCF antenna for ITA or GPS antenna for ITA.

(3) Summer/Winter-Time can be set to auto without any antenna.

(4) 110 h for 100 V AC supply voltage.

Back-lit display, random function and pulse programming	"Absence for holidays" function	Screwless connection	Mechanical compatibility with electrical distribution comb busbars	Input for external control	Instruction manual holder on front face	Memory key supplied with the product	Cat. no.
	■	■	■		■		CCT15400 ⁽⁶⁾ , CCT15420 ⁽⁷⁾ , CCT15450 ⁽⁸⁾ , CCT15720 ⁽⁹⁾ , CCT15850 ⁽¹⁰⁾
■ + Cycle programming	■	■	■	1 input	■	■	CCT15401 ⁽⁶⁾ , CCT15451 ⁽⁸⁾ , CCT15721 ⁽⁹⁾ , CCT15851 ⁽¹⁰⁾
	■	■	■		■		CCT15402 ⁽⁶⁾ , CCT15422 ⁽⁷⁾ , CCT15452 ⁽⁸⁾ , CCT15722 ⁽⁹⁾ , CCT15852 ⁽¹⁰⁾
■ + Cycle programming	■	■	■	2 inputs	■	■	CCT15423 ⁽⁷⁾ , CCT15723 ⁽⁹⁾ , CCT15853 ⁽¹⁰⁾
■ + Cycle programming	■	■		1 input		■	CCT15857
	■	■				(12)	CCT15854 ⁽¹¹⁾
■ + Cycle programming	■	■		1 input		■	CCT15838 ⁽¹¹⁾
Back-lit display, pulse and cycle programming	■ ⁽⁵⁾					(13)	CCT15910
Back-lit display, pulse and cycle programming	■ ⁽⁵⁾			2 inputs		(13)	CCT15940
		■					CCT15338
		■					CCT16364
		■					CCT15365
							15337
		■					CCT15367
							15366
							15331
							15336
							15335

(5) Function included and can be realized through special program entry.

(6) English, Russian, Ukrainian, Latvian, Lituanién, Estonian languages.

(7) English, Bulgarian, Greek, Slovene, Serbian, Croatian languages.

(8) English, Hungarian, Polish, Romanian, Czech, Slovak languages.

(9) French, English, Italian, Spanish, German, Portuguese languages.





(10) French, English, Swedish, Dutch, Finnish, Norwegian/Danish languages.

(11) French, English, Italian, Spanish, German, Portuguese, Dutch languages.

(12) Memory key (CCT15861) is not supplied with IHP 1c 18 mm (CCT15854) but this memory key and the programming kit (CCT15860) can be used and operate on IHP 1c 18 mm (see "Accessories selection table").

(13) Memory key (CCT15955) is not supplied with ITA 1c/4c but this memory key and the programming kit (CCT15950) can be used and operate on ITA 1c/4c (see "Accessories selection table").

Selection table Programmable time switches

	IHP 1c	IHP2c	IHP+1c	IHP+2c
				

Function
<ul style="list-style-type: none"> These time switches automatically switch on and off loads according to the program entered by the user They operate on weekly cycle: the same program is repeated week after week They offer automatic summer/winter time change and allow to adjust it according to where you are located The program can be overridden temporary or permanently by pressing 2 keys on the product They also offer holidays program, by configuring the starting and ending dates of the absence.
<ul style="list-style-type: none"> A memory key and a programming kit can be used to duplicate on another IHP+ or to save the program created by the contractor (see "Accessories selection table") Override control with switch or push-button via external input (1 external input for IHP+1c and 2 external inputs for IHP+ 2c)

Wiring diagrams

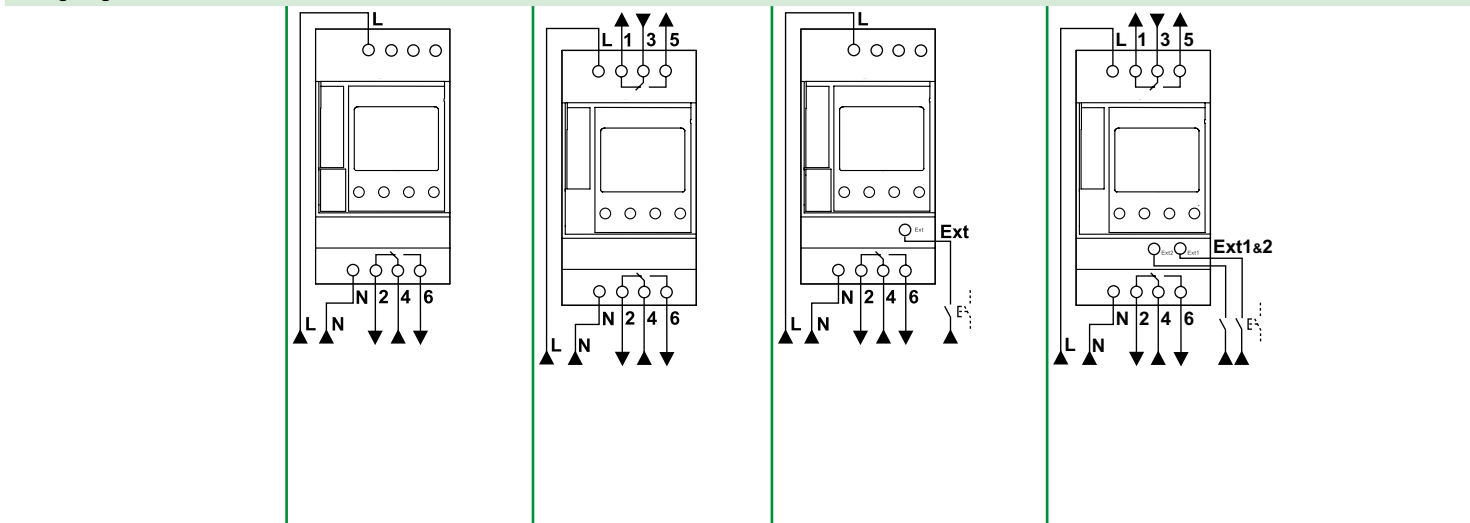





Catalogue numbers	IHP 1c	IHP2c	IHP+1c	IHP+2c
	CCT15400 ⁽¹⁾ CCT15420 ⁽²⁾ CCT15450 ⁽³⁾ CCT15720 ⁽⁴⁾ CCT15850 ⁽⁵⁾	CCT15402 ⁽¹⁾ CCT15422 ⁽²⁾ CCT15452 ⁽³⁾ CCT15722 ⁽⁴⁾ CCT15852 ⁽⁵⁾	CCT15401 ⁽¹⁾ CCT15451 ⁽³⁾ CCT15721 ⁽⁴⁾ CCT15851 ⁽⁵⁾	CCT15423 ⁽²⁾ CCT15723 ⁽⁴⁾ CCT15853 ⁽⁵⁾

Technical specifications		IHP 1c	IHP2c	IHP+1c	IHP+2c
Voltage rating (Ue)		230 V AC, ±10 %, 50/60 Hz	230 V AC, ±10 %, 50/60 Hz	230 V AC, ±10 %, 50/60 Hz	230 V AC, ±10 %, 50/60 Hz
Consumption		0.8 W	0.8 W	0.8 W	0.8 W
Output contact current (250 V AC)	Cos φ = 1	16 A	16 A	16 A	16 A
	Cos φ = 0.6	10 A	10 A	10 A	10 A
Degree of protection		IP20B	IP20B	IP20B	IP20B
Operating temperature		-10°C to +50°C	-10°C to +50°C	-10°C to +50°C	-10°C to +50°C
Time accuracy		± 1 s per day at 20°C	± 1 s per day at 20°C	± 1 s per day at 20°C	± 1 s per day at 20°C
Program saving and time by lithium battery	Lifetime	6 years	6 years	6 years	6 years
	Back-up time, cumulated	6 years	6 years	6 years	6 years
	mains cut off				



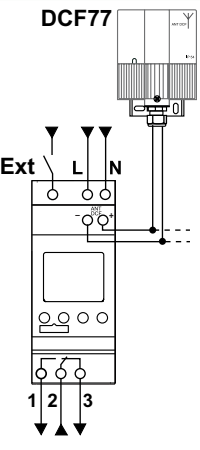
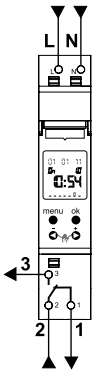
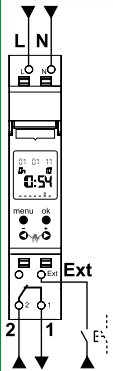
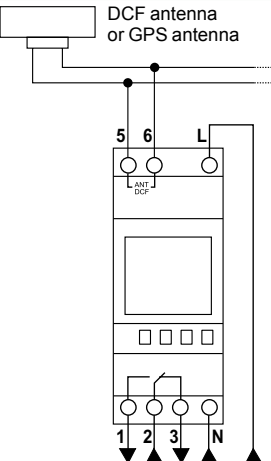
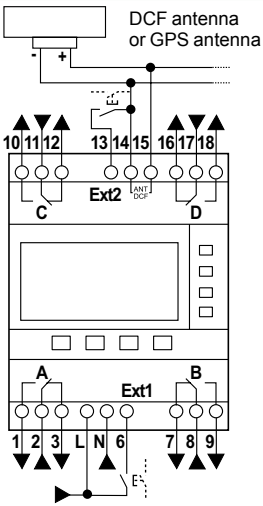

(1) English, russian, ukrainian, latvian, lituanien, estonian. (2) English, bulgarian, greek, slovene, serbian, croatian. (3) English, hungarian, polish, romanian, czech, slovak. (4) French, english, italian, spanish, german, portuguese. (5) French, english, swedish, dutch, finnish, norwegian/danish.

Yearly programmable time switches

	IHP+ DCF 1c	IHP 1c 18 mm	IHP+1c 18 mm	ITA 1c	ITA 4c
					
				<ul style="list-style-type: none"> Weekly or yearly time programming to be distributed over 1 channel 	<ul style="list-style-type: none"> Weekly or yearly time programming to be distributed over 1, 2, 3 or 4 channels Override control with switch or push-button via external inputs
<ul style="list-style-type: none"> A memory key and a programming kit can be used to duplicate on another IHP or to save the program created by the contractor (see "Accessories selection table") 100% time precision enabled via optional DCF77 antenna (to be ordered separately - see "Accessories selection table") 	<ul style="list-style-type: none"> A memory key and a programming kit can be used to duplicate on another IHP or to save the program created by the contractor (see "Accessories selection table") 	<ul style="list-style-type: none"> A memory key and a programming kit can be used to duplicate on another IHP or to save the program created by the contractor (see "Accessories selection table") 		<ul style="list-style-type: none"> A memory key and a programming kit can be used to duplicate on another ITA or to save the program created by the user (see "Accessories selection table"). 	
					
CCT15857	CCT15854 ⁽⁶⁾	CCT15838 ⁽⁶⁾	CCT15910	CCT15940	
230 V AC, ±10 %, 50/60 Hz	230 V AC, +10 %, -15 %, 50/60 Hz	230 V AC, +10 %, -15 %, 50/60 Hz	230 V AC, 50/60 Hz	230 V AC, 50/60 Hz	
1.4 W	0.4 W	0.4 W	1.4 - 1.9 W (depending on the switching status)	1.2 - 3.2 W (depending on the switching status)	
16 A	16 A	16 A	16 A	16 A	
10 A	4 A	4 A	6 A	6 A	
IP20B	IP20B	IP20B	IP20	IP20	
-30°C to +55°C	-25°C to +55°C	-25°C to +55°C	-30°C to +55°C	-30°C to +55°C	
Without antenna: ± 0.25 s per day at 25°C With antenna: 1 s on 1 million years ⁽⁷⁾	± 0.25 s per day at 25°C	± 0.25 s per day at 25°C	Without antenna: ± 0.5 s per day at 20°C With antenna: 1 s on 1 million years ⁽⁷⁾	Without antenna: ± 0.5 s per day at 20°C With antenna: 1 s on 1 million years ⁽⁷⁾	
10 years	10 years	10 years	10 years	10 years	
10 years	10 years	10 years	10 years	10 years	

(6) French, english, italian, spanish, german, portuguese, dutch. (7) Thanks to the synchronisation on the DCF Frankfurt's DCF77 radio station via the DCF antenna or GPS antenna.

Selection table Mechanical time switches

	IH 60mn 1c SRM	IH 24h 1c SRM	IH 24h 1c ARM	IH 24h 2c ARM
P116860		P116861		P116892
				P116816
				



Function

- They operate on hourly, daily or weekly cycle: the same program is repeated hour after hour (IH 60mn), day after day (IH 24h) or week after week (IH 7), (IHH 7)
- The program can be overridden On

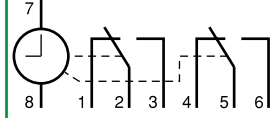
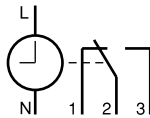
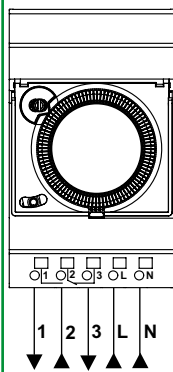
Wiring diagrams



Catalogue numbers		CCT15338	CCT16364	CCT15365	15337
Technical specifications					
Voltage rating (Ue)		230 V AC +10 %, -15%, 50 Hz	230 V AC +10 %, -15%, 50/60 Hz	110-230 V AC +10 %, -15%, 50/60 Hz	230 V AC +10 %, -15%, 50/60 Hz
Consumption		1 VA	2.5 VA	2.5 VA	2.5 VA
Output contact current under 250 VAC	Cos φ = 1	10 A	16 A	16 A	16 A
	Cos φ = 0.6	4 A	4 A	4 A	4 A
Degree of protection		IP20B	IP20B	IP20B	IP20B
Operating temperature		-20°C to +55°C	-20°C to +55°C	-20°C to +55°C	-20°C to +55°C
Time accuracy		±1 s per day at 20°C	±1 s per day at 20°C	±1 s per day at 20°C	±1 s per day at 20°C
Saving of program and time by lithium battery	Lifetime	-	-	6 years	6 years
	Back-up time, cumulated mains cut off	-	-	200 h with 230 V AC 100 h with 100 V AC	150 h
Programming by:	Jumpers (supplied)	-	-	-	4 red + 4 green + 2 white
	Captive segments	96	96	96	-

	IH 24h + 7j 1+1c ARM	IH 7j 1c ARM	IH24h 1c SRM 18 mm	IH 24h 1c ARM 18 mm	IHH 7j 1c ARM 18 mm
P111619		P111663		P111615	P111613

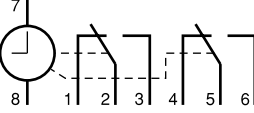
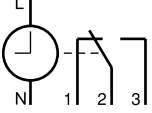
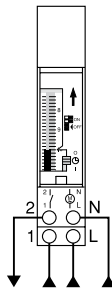



				
---	---	--	--	--

	15366	CCT15367	15335	15336	15331
	230 V AC +10 %, -15%, 50 Hz	110-230 V AC +10 %, -15%, 50/60 Hz	230 V AC, ±10 %, 50/60 Hz	230 V AC, ±10 %, 50/60 Hz	230 V AC, ±10 %, 50/60 Hz
	2.5 VA	2.5 VA	2.5 VA	2.5 VA	2.5 VA
	16 A	16 A	16 A	16 A	16 A
	4 A	4 A	4 A	4 A	4 A
	IP20B	IP20B	IP20B	IP20B	IP20B
	-20°C to +55°C	-20°C to +55°C	-10°C to +50°C	-10°C to +50°C	-10°C to +50°C
	±1 s per day at 20°C	±1 s per day at 20°C	±1 s per day at 20°C	±1 s per day at 20°C	±1 s per day at 20°C
	6 years	6 years	10 years	10 years Exchangeable battery	10 years Exchangeable battery
	150 h	200 h with 230 V AC 100 h with 110 V AC	–	100 h	100 h
	6 yellow (24 h), 12 blue + 2 red (7 days)	–	–	–	–
	–	84	96	96	84

Accessories selection table

Programming kits for PC

Memory keys



	Programming kits for PC		Memory keys	
	IHP+	ITA	IHP+	ITA
				
Function	Consists of a programming device, a memory key, a CDROM and a 2 m USB cable For IHP+ 1c/2c, IHP 1c 18 mm, IHP+ 1c 18 mm	Consists of a programming device, a CDROM and a 1.5 m USB cable For ITA 1c and ITA 4c	Saving and duplicating programs For IHP+ 1c/2c, IHP 1c 18 mm, IHP+ 1c 18 mm, IHP+ DCF 1c	For ITA 1c and ITA 4c
Mounting	–	–	Located on front face	–
Catalogue numbers	CCT15860	CCT15950	CCT15861	CCT15955
Technical specifications				
Degree of protection	–	–	–	–
Operating temperature	–	–	–	–

Specific technical data

IHP+ 1c, IHP+ 2c, IHP+ DCF 1c	
Manual functions	Temporary cancellation of programming for holidays, public holidays, etc. by configuration of the 2 dates - start and end of absence Simulation of presence thanks to random operation during On periods
Pulse functions	Programming of pulses adjustable from 1 to 59 s (pulse takes priority over switching)
Back-lighting of the screen	
External input (only for IHP+ 1c, IHP+ 2c)	
External inputs for external control with a standard switch or a push-button	1 input for IHP+ 1c 2 inputs for IHP+ 2c
Voltage rating (Ue)	230 V AC, +10 %, -15 %
Frequency	50/60 Hz
Input current	≤ 1.2 mA
Consumption	≤ 0.3 mW
Cable length	≤ 100 m
(2) The ITA 1c and ITA 4c can be synchronised on the Frankfurt 's DCF77 radio station via the DCF or GPS antenna	
Automatic on commissioning, then at 1 am, 2 am, 3 am and 4 am every day	
Manual by pressing the IHP or ITA keys or after a "reset"	
Displayed on the screen by the letters RC	
Programming of pulses adjustable from 1 to 59 s (pulse takes priority over switching)	

Antennas

Additional jumpers

	DCF77 antenna for IHP+ DCF	DCF antenna for ITA	GPS antenna for ITA	IH jumpers		
P135728		P140482		P140491		
	Antenna for IHP+ DCF 1c	Antenna for ITA 1c and ITA 4c	Antenna for ITA 1c and ITA 4c	They are used to program a larger number of sequences for: <ul style="list-style-type: none"> ■ IH 24h 2c ARM (15337) ■ IH 24h + 7j 1+1c ARM (15366) 		
	<ul style="list-style-type: none"> ■ 10 IHP+ DCF 1c maximum per antenna, maximum distance between the IHP+ DCF 1c and the antenna: 100 m ■ Outside the electrical switchboard, outdoors, under shelter 	<ul style="list-style-type: none"> ■ 10 ITA maximum per antenna, maximum distance between the ITA and the antenna: 200 m ■ Outside the electrical switchboard, outdoors, under shelter 	<ul style="list-style-type: none"> ■ 10 ITA maximum per antenna, maximum distance between the ITA and the antenna: 200 m ■ Outside the electrical switchboard, outdoors, under shelter 	1 bag containing: <ul style="list-style-type: none"> ■ 5 red ■ 5 green ■ 5 white ■ 5 yellow 		
	MTN6606-0070	CCT15960	CCT15970 ⁽¹⁾	15341		
	IP54	IP54	IP54	–		
	-20 °C to +70 °C	-20 °C to +50 °C	-30 °C to +55 °C	–		

⁽¹⁾ external 12-30 V DC power supply needed

ITA 1c, ITA 4c

Switching functions	On, Off, pulse, cycle, yearly program	
Pulse lenght pulse function (switching time)	1 s to 59 min 59s	
Pulse lenght timer (manual switching)	1 s to 9 h 59 min 59 s	
Pulse/pause length cycle	1 s to 9 h 59 min 59 s	
Minimum interval	1 min	
External inputs (only for ITA 4c)		
External inputs for external control with a standard switch or a push-button	2 inputs : <ul style="list-style-type: none"> ■ Ext1 input: supplied with 230 V AC, ±10%- 50/60 Hz ■ Ext2 input Ext2: potential free 	
Antennas	DCF- ITA	GPS- ITA
Power supply	Via time switch (without battery)	External 12 - 30 V DC
Output	Protocole DCF	DCF time telegraph (no weather data)
Receiver	Narrowband-heterodyne receiver	–
Operation indicator	Flashing LED on receiving	Flashing LED on receiving

Programming principle

- For the digital time switches, this consists of memorising the days and times of the required switching operations.
- For the mechanical time switches, this is performed by positioning captive segments or jumpers on a switching dial.

Example

- Controlling an air conditioner in a hairdressing salon:

	Monday ⁽¹⁾	Tuesday	Wednesday	Thursday ⁽²⁾	Etc.	
On n° 1		08 h 30	08 h 30	08 h 30		Switch on
Off n° 1		12 h 00	12 h 00			Switch off
On n° 2		13 h 30	13 h 30			Switch on
Off n° 2		20 h 00	20 h 00	20 h 00		Switch off

⁽¹⁾ Closed on Mondays

⁽²⁾ Non-stop

Programming by copying or blocks

Whenever identical switching operations are found at the same times, several days in the week, this function lets you program these operations once only. In this case a single switching operation is used. If this function is used wisely, the number of possible switching operations can be greatly increased.

Example

	Monday	Tuesday	Wednesday	Thursday	Friday	
On n°1	10 h 00			10 h 00		Switch on
Off n°1		18 h 00	18 h 00		18 h 00	Switch off

Number of switching operations

Designation	Number of switching operations
IHP 1c	56
IHP + 1c	84
IHP+ DCF 1c	84
IHP 2c	56
IHP + 2c	84
IHP 1c 18 mm	56
IHP + 1c 18 mm	84
ITA 1c, ITA 4c	300
IH 24h 1c ARM	48 On - 48 Off
IH 24h 1c SRM	48 On - 48 Off
IH 60mn 1c SRM	48 On - 48 Off
IH 24h 1c SRM	48 On - 48 Off
IH 24h 1c ARM	48 On - 48 Off
IH 24h 2c ARM	24 On - 24 Off
IH 7j 1c ARM	42 On - 42 Off
IH 24 h + 7j 1+1c ARM	16 On - 16 Off + 7 On - 7 Off

Saving on mains cut off

For digital switches equipped with this function, a lithium battery is used for saving. The program, date and time are preserved. Switching operations are not performed.

Lets you control starting and stopping of a group of loads according to a cycle that is repeated every 60 minutes.

60 min. time programming

Example

Controlling automatic watering	
On n° 1	2 min. 30 s
Off n° 1	5 min.
On n° 2	25 min.
Off n° 2	37 min. 30 s

Relevant time switches

IH 60mn 1c SRM.

Lets you control starting and stopping of one or two groups of loads according to a daily cycle that is repeated, in identical manner, every day of the week.

24 h daily programming

Example

- Controlling a door of a block of flats:
 - from 8 am to 7.30 pm: contact on "On", free access,
 - from 7.30 pm to 8 am the next day: contact on "Off", access by confidential code every day of the week:

	From Monday to Sunday
On n° 1	8 am
Off n° 1	7.30 pm

Relevant time switches

- IH 24h 1c SRM/ARM.
- IH 24h 2c ARM.
- IHP 1c 18 mm.
- IHP + 1c 18 mm.
- IHP+ DCF 1c.
- IHP 1c, IHP + 1c.
- IHP 2c, IHP + 2c.
- ITA 1c, ITA 4c.

Lets you control starting and stopping of one to 4 groups of loads according to a weekly cycle, that can be different each day, repeated each week.

7 days weekly programming

Example

- Controlling an air conditioner in a hairdressing salon:

	Monday	Tuesday	Wednesday	Thursday	Friday	Saturday	Sunday
On n° 1			09 h 00	09 h 00	09 h 00		
Off n° 1			12 h 00	12 h 00			
On n° 2			14 h 00	14 h 00			
Off n° 2			20 h 00	20 h 00	20 h 00		
On n° 3						8 h 30	8 h 30
Off n° 3						12 h 30	12 h 30
On n° 4						14 h 30	14 h 30
Off n° 4						21 h 00	21 h 00

Relevant time switches

- IH 7j 1c ARM.
- IHP 1c, IHP + 1c.
- IHP 2c, IHP + 2c.
- IHP 1c 18 mm.
- IHP + 1c 18 mm.
- IHP+ DCF 1c.
- ITA 1c, ITA 4c.

Lets you control by pulses (adjustable from 1 to 59 s) one to four groups of loads (pulse relays, bells, etc.).

Pulse programming

Example

■ Automatic controlling of bells, lighting and distribution of food: bells sounding the resumption and finish of work (channel 1), lighting of premises (channel 2), feeding fish in the aquarium (channel 3):

	Monday	Tuesday	Wednesday	Thursday	Friday	Saturday	Sunday
Channel 1: bell (20 s pulse order)							
On	08 h 00	08 h 00	08 h 00	08 h 00	07 h 00	09 h 00	–
Duration	20 s	20 s	20 s	20 s	20 s	20 s	–
On	12 h 00	12 h 00	12 h 00	12 h 00	11 h 00	13 h 00	–
Duration	20 s	20 s	20 s	20 s	20 s	20 s	–
On	14 h 00	14 h 00	14 h 00	14 h 00	13 h 00	–	–
Duration	20 s	20 s	20 s	20 s	20 s	–	–
On	18 h 00	18 h 00	18 h 00	18 h 00	16 h 00	–	–
Duration	20 s	20 s	20 s	20 s	20 s	–	–
Channel 2: lighting (latched order)							
On	07 h 30	07 h 30	07 h 30	07 h 30	06 h 30	08 h 30	–
Off	18 h 30	18 h 30	18 h 30	18 h 30	17 h 00	13 h 30	–
Channel 3: aquarium (15 s pulse order)							
On	10 h 00	–	10 h 00	–	10 h 00	–	10 h 00
Duration	15 s	–	15 s	–	15 s	–	15 s

Programming

- Programming of a pulse takes up 2 memory spaces.
- Combination of the two order types (pulse and latched) is possible on the same channel.

Relevant time switches

- IHP + 1c.
- IHP + 1c 18 mm.
- IHP+ DCF 1c.
- IHP + 2c.
- ITA 1c, ITA 4c.

Lets you create special programs for dated days.

Programming special days.

Example

- Controlling lighting and heating in a school:
- basic programming: program lighting (channel 1) and heating (channel 2):

	Monday	Tuesday	Wednesday	Thursday	Friday	Saturday	Sunday
Channel 1: lighting							
On	07 h 00	07 h 00	07 h 00	07 h 00	07 h 00	–	–
Off	20 h 00	20 h 00	16 h 00	20 h 00	16 h 00	–	–
Channel 2: heating							
On	06 h 00	06 h 00	06 h 00	06 h 00	06 h 00	–	–
Off	18 h 00	18 h 00	12 h 00	18 h 00	12 h 00	–	–

- dated programming: periods of non-operation, school holidays, etc.
- Just memorise an Off at the start and another Off at the end of each period of absence:

		Holidays				
		Winter	Spring	Summer	Autumn	End of year
Channel 1: lighting						
Off	Date	20 feb.	17-apr	07-july	23 oct.	18 dec.
	Time	12 h 00	17 h 00	12 h 00	17 h 00	12 h 00
Off	Date	08-march	03-may	9 sept.	2 nov.	4 jan.
	Time	01 h 00	01 h 00	01 h 00	01 h 00	01 h 00
Channel 2: heating						
Off	Date	20 feb.	17-apr		23 oct.	18 dec.
	Time	12 h 00	17 h 00		17 h 00	12 h 00
Off	Date	08-march	03-may		2 nov.	4 jan.
	Time	01 h 00	01 h 00		01 h 00	01 h 00

Relevant time switches



- ITA 1c, ITA 4c.

Load table

Type of lighting (230 V AC)	Max. power (for higher power, relay with a contactor)							
	IHP 45 mm	IHP 18 mm	IHP+ 18 mm	IHP+ DCF 36 mm	IH 18 mm	IH 54 mm	ITA	
Incandescent and halogen lamps	2600 W	1000 W	2000 W	2600 W	1000 W	1000 W	2000 W	
LED lamps	Power for one lamp < 2 W	30 W	6 W	55 W	30 W	15 W	5 W	200 W
	Power for one lamp from 2 to 8 W	100 W	20 W	180 W	100 W	50 W	15 W	200 W
Non-corrected / serial-corrected / dual mounted fluorescent tubes with conventional ballast	2300 VA	1000 VA	2000 VA	1000 VA	700 VA	600 VA	1000 VA	
Parallel corrected fluorescent tubes with conventional ballast	730 W (80 µF)	80 W (14 µF) 2 x 40 W (4.7 µF) 2 x 58 W (7 µF)	1300 W (140 µF)	730 VA (80 µF)	400 W (37 µF)	80 W (12 µF)	550 VA	
Fluocompact lamps with electronic ballast	170 W	30 W	300 W	22 x 7 W, 18 x 11 W, 16 x 15 W, 16 x 20 W, 14 x 23 W	80 W	25 W	200 W	

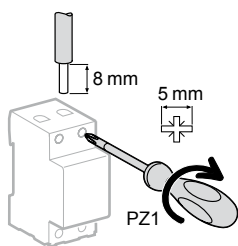
Connection



Type	Tightening torque	Copper cables	
		Rigid	Flexible or with ferrule
IHP 1c, 2c, +1c, +2c	2 screwless / pole		
IHP 18 mm 1c, +1c	2 screwless / pole	2 x 2.5 mm ²	2 x 2.5 mm ²
IHP+ DCF 1c	2 screwless / pole	2 x 2.5 mm ²	2 x 2.5 mm ²
IH	60mn 1c SRM	2 screwless / pole	2 x 2.5 mm ²
	24h 1c SRM, ARM	2 screwless / pole	2 x 2.5 mm ²
	24h 2c ARM	1.2 N.m	≤ 6 mm ²
	7j 1c ARM	2 screwless / pole	2 x 2.5 mm ²
24h + 7j 1+1c ARM	1.2 N.m	≤ 6 mm ²	≤ 6 mm ²
IH 18 mm 24h 1c SRM / ARM	1.2 N.m	≤ 6 mm ²	≤ 6 mm ²
IHH 18 mm 7j 1c ARM	1.2 N.m	≤ 6 mm ²	≤ 6 mm ²
ITA 1c, ITA 4c	1.2 N.m	≤ 6 mm ²	≤ 6 mm ²

IHP 1c/2c, IHP+ 1c/2c are mechanical compatible with electrical distribution comb busbar.

Weight (g)

Time switches		
IHP	1c / 2c	170 / 205
IHP+	1c / 2c	190 / 211
IHP 18 mm	1c / +1c	90
IHP+ DCF	1c	244
IH 54 mm	60mn 1c SRM	208
	24h 1c SRM/ARM	212 / 119
	24h 2c ARM	216
	7j 1c ARM	119
	24h + 7j 1+1c ARM	223
IH 18 mm	24h 1c SRM / ARM	97
IHH 18 mm	7j 1c ARM	101
ITA 1c		152
ITA 4c		303

Dimensions (mm)

IHP time switches

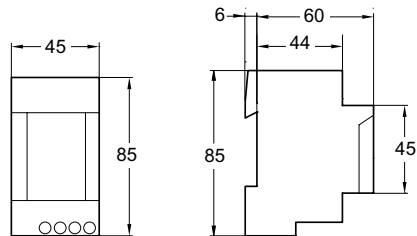

5P (45 mm)
IHP1c, IHP2c, IHP+1c, IHP+2c

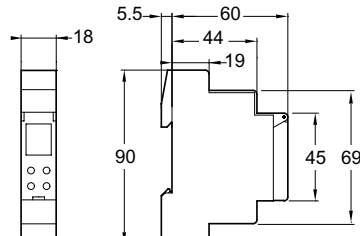

2P (18 mm)
IHP1c, IHP+1c

IHP+ DCF 1c

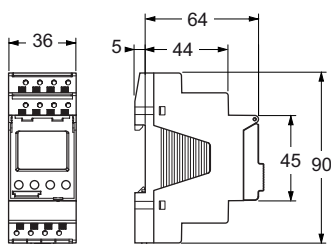

4P (36 mm)
IHP+ DCF 1c

DCF77 antenna for IHP+ DCF 1c

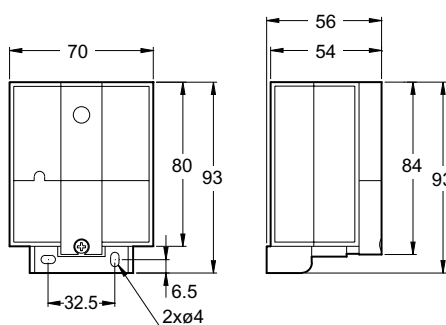

IH, IHH time switches

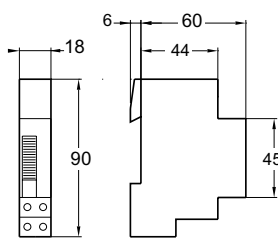

2P (18 mm)
IH 24h 1c SRM/ARM
IHH 7j1c ARM

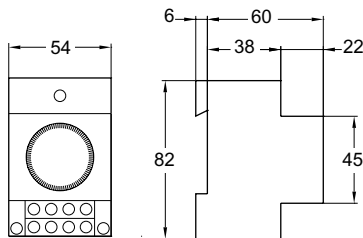

6P (54 mm)
IH 24h 2c ARM,
IH 24h +7j 1+1c ARM

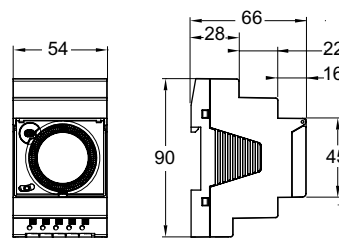

6P (54 mm)
IH 60mn 1c SRM, IH 24h 1c SRM/ARM
IH 7j 1c ARM

ITA yearly time switches

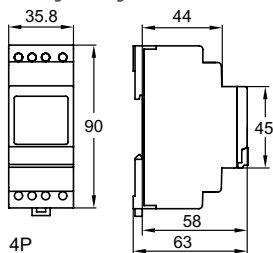

4P

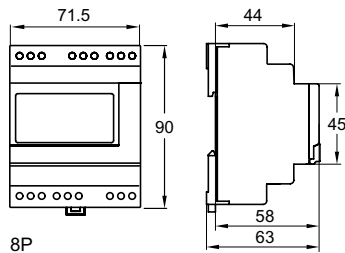

8P

DCF antenna and GPS antenna for ITA

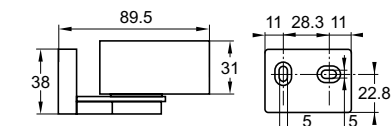
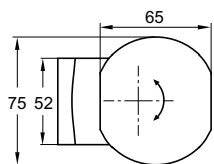

> Timers

> Electromechanical timer



MIN
Adjustable time delay from 1 to 7 min.

> Silent electronic timers

<p>MINs Adjustable time delay from 0.5 to 20 min.</p>	<p>MINp Adjustable time delay from 0.5 to 20 min. with switch-off warning.</p>	<p>MINt Adjustable time delay from 0.5 to 20 min. with switch-off warning and impulse relay function.</p>
--	---	--

Selection table

Type	MIN	MINs
	Electromechanical timer 	Silent electronic timer
Function	These timers allow closing and then opening of a contact in a determined time Control circuit: connected standard or luminous push-buttons. Timer inoperative via self-protection if consumption above 50 mA maximum	
Wiring diagrams		
Mounting	Two operating modes triggered by switch on front face: <ul style="list-style-type: none"> ■ Automatic mode: <ul style="list-style-type: none"> □ operation in timing mode □ time delay adjustable from 1 to 7 min. □ setting in steps of 15 s using knob □ pressing a push-button renews the time delay ■ Manual override mode: constant lighting 	Two operating modes triggered by switch on front face: <ul style="list-style-type: none"> ■ Timer mode: time delay adjustable from 0.5 to 20 min. ■ Permanent mode: constant lighting
Catalogue numbers	15363	CCT15232
Technical specifications		
Voltage rating (Ue) (+10 %, -15 %)	230 V AC, 50 Hz	230 V AC, 50/60 Hz
Consumption	1 VA	< 6 VA
Output contact current Cos φ = 1	16 A	16 A
Degree of protection	IP20B	IP20B
Operating temperature	-10°C to +50°C	-10°C to +50°C
Width (9 mm modules)	2	2
Consumption of connected luminous push-buttons	50 mA maxi	150 mA maxi
Adjustable time delay	1 to 7 min.	0.5 to 20 min.
Long time delay	–	–
Insulation class	–	Class II
1 screw connection per pole for cables up to 6 mm ²	■	■
Selection of the type of connection (3 or 4 wires)	Selector switch	Automatic
Mechanical compatibility with electrical distribution comb busbar	–	■
Switch-off warning function	–	–
Impulse relay function	–	–

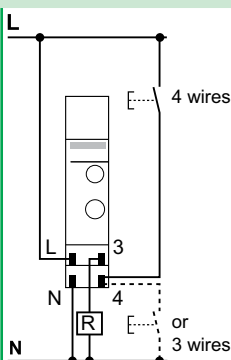
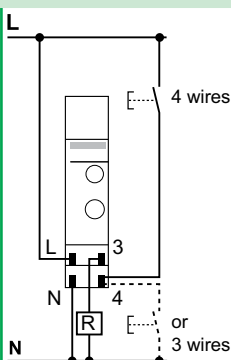
MINp	MINt	Accessory
Silent electronic timer 		Wall mount accessory 
<p>The MINp timer allows closing and then opening of a contact in a determined time, and it also provides warning that the lighting is about to be switched off by flickering of the lamplight (switch-off warning)</p>	<p>The MINt timer is the same as MINp with an "impulse relay" additional function</p>	<p>The MIN timers can be mounted on a wall by using 15359 reference. The protection cover is sealable.</p>
		<p>The 15359 accessory can be also used to mount others 18 mm DIN rail devices (for example: time switches, circuit breakers...).</p>
<ul style="list-style-type: none"> ■ Time delay adjustable from 0.5 to 20 min. ■ Three operating modes triggered by switch on front face: <ul style="list-style-type: none"> <input type="checkbox"/> timer mode with "switch-off warning" function built into the device. The lamp blinks 40 and 30 s before the end of the time delay <input type="checkbox"/> timer mode without "switch-off warning" function <input type="checkbox"/> permanent mode : constant lighting 		
<ul style="list-style-type: none"> ■ Timer mode operation: <ul style="list-style-type: none"> <input type="checkbox"/> pressing a push-button for longer than 2 s: lighting will last for 1 h. Pressing again a push-button for less than 2 s relaunch the time delay of 1 h and pressing again a push-button for more than 2 s switches off the light <input type="checkbox"/> pressing a push-button for less than 2 s launch the pre-set time delay, pressing again a push-button for less than 2 s relaunch the pre-set time delay 	<ul style="list-style-type: none"> ■ Timer mode operation: <ul style="list-style-type: none"> <input type="checkbox"/> pressing a push-button for longer than 2 s: lighting will last for 1 h. Pressing again a push-button for less than 2 s relaunch the time delay of 1 h and pressing again a push-button for more than 2 s switches off the light <input type="checkbox"/> pressing a push-button for less than 2 s launch the pre-set time delay, pressing again a push-button for less than 2 s, switches off the light (impulse relay mode) 	
CCT15233	CCT15234	15359
230 V AC, 50/60 Hz	230 V AC, 50/60 Hz	
< 6 VA	< 6 VA	
16 A	16 A	
IP20B	IP20B	
-25°C to +50°C	-25°C to +50°C	
2	2	See § dimensions
150 mA maxi	150 mA maxi	
0.5 to 20 min.	0.5 to 20 min.	
1 h	1 h	
Class II	Class II	
■ Automatic	■ Automatic	
■	■	
■	■	
-	■	

Load table

Products	MIN	MINs	MINp, MINt
Type of lighting	Maximum power		
230 V incandescent and halogen lamps	2300 W	2300 W	3600 W
LED lamps	Power for one lamp < 2 W	20 W	55 W
	Power for one lamp from 2 to 8 W	90 W	150 W
Non-corrected / serial-corrected / dual mounted fluorescent tubes with conventional ballast	2300 VA	2300 VA	3600 VA ⁽¹⁾
Fluocompact lamps with conventional ballast	2000 VA	1500 VA	1500 VA ⁽¹⁾
Parallel-corrected fluorescent tubes with conventional ballast	1300 VA (70 F)	400 VA (42 µF)	1200 VA (120 µF) ⁽¹⁾
Fluorescent tubes with electronic ballast	300 VA	300 VA	1000 VA
Fluocompact lamps with electronic ballast	9 x 7 W, 6 x 11 W, 5 x 15 W, 5 x 20 W	9 x 7 W, 7 x 11 W, 7 x 15 W, 7 x 20 W, 7 x 23 W	34 x 7 W, 27 x 11 W, 24 x 15 W, 22 x 23 W

⁽¹⁾ The "switch-off warning" function is not available for these types of loads.

Connection

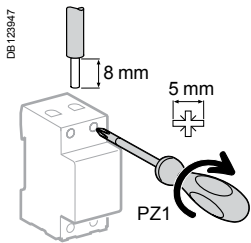

Type	Tightening torque	Copper cables	
		Rigid	Flexible or with ferrule
MIN, MINs, MINp, MINt	1.2 N.m	≤ 6 mm ²	≤ 6 mm ²

Weight (g)

Time switches	
MIN	84
MINs	75
MINp	103
MINt	76

Dimensions (mm)

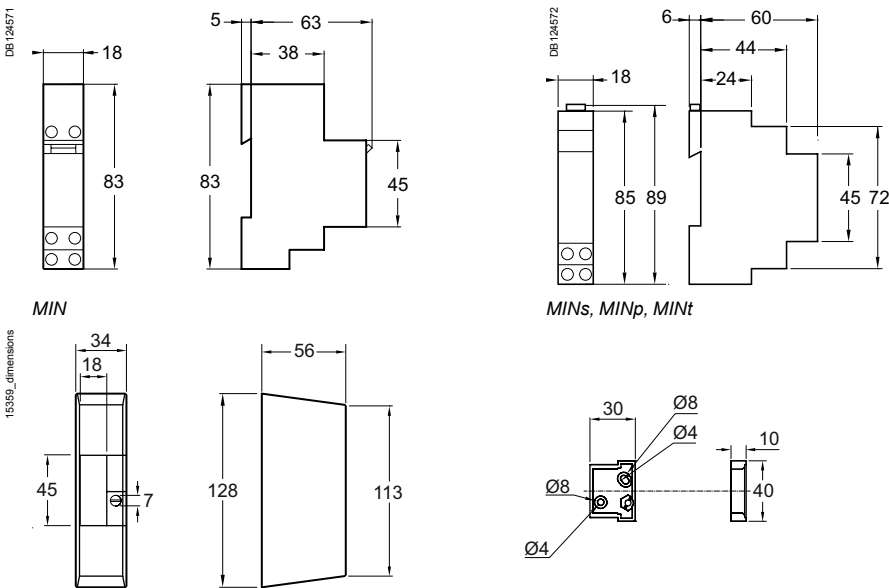

Wall mount accessory

STD and SCU range

STD400RC/RL-DIN & SAE

STD400LED, STD400LED+

STD1000RL-DIN & SAE

SCU10-DIN & SAE

STD

P112246



STD400RC/RL-DIN

P112246



STD400RC/RL-SAE

P112248



STD1000RL-SAE

DB406995



STD400LED

DB406996



STD400LED+

STD

- The STD dimmers modulate incandescent halogen, lighting brightness and motors for unit powers from 40 to 1000 W from one or more switch-on points.
- They can be controlled either with the local control push-button placed on front panel or with auxiliary push-buttons.
- They have soft-On / soft-Off, light level memory and minimum level setting features.
- They are available in 2 different types:
 - DIN type (STD400RC/RL-DIN, STD1000RL-DIN) supplied without digital inputs,
 - SAE type (STD400RC/RL-SAE, STD1000RL-SAE) supplied with 4 digital inputs.

STD LED

- The STD LED dimmers switch and dim the lighting brightness of:
 - incandescent lamps, halogen lamps, (conventional or with electronic transformer),
 - dimmable lamps: fluocompact and LED 230 V.
- The brightness is set via the push buttons connected to the dimmer.
- They have soft-On / soft-Off, light level memory and minimum level setting features.
- The STD LED+ could be used with a movement detector, a presence detector or a programmable time switch. It also provides a staircase function incl. pre-warning.

SCU

P112221-36



SCU10-SAE

SCU





- The SCU dimmers modulate fluorescent lighting brightness for unit powers from 40 to 1500 W from one or more switch-on points.
- They can be controlled either with the local control push-button placed on front panel or with auxiliary push-buttons.
- They have soft-On / soft-Off, light level memory and minimum level setting features.
- They are available in 2 different types:
 - DIN type (SCU10-DIN) supplied without digital inputs,
 - SAE type (SCU10-SAE) supplied with 4 digital inputs.

STD and SCU range (cont.)

STD400RC/RL-DIN & SAE
 STD400LED, STD400LED+
 STD1000RL-DIN & SAE
 SCU10-DIN & SAE

Selection table

STD

	STD400RC/RL-DIN	STD400RC/RL-SAE	STD1000RL-DIN	STD1000RL-SAE
Type	400 W		1000 W	
				

Wiring diagrams

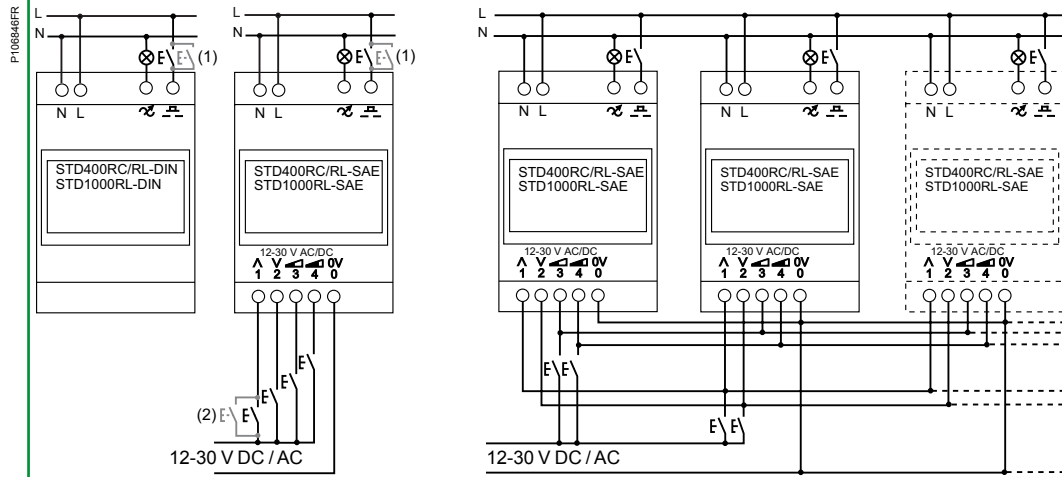

Mounting

With SAE types, it is possible to control a maximum of 20 dimmers combining STD400RC/RL-SAE and STD1000RL-SAE, with only one push-button via the 4 digital inputs

Catalogue numbers	CCTDD20001	CCTDD20002	CCTDD20003	CCTDD20004
--------------------------	-------------------	-------------------	-------------------	-------------------

Technical specifications

Voltage rating (Ue)	230 V AC ± 10 %, 50 Hz			
Control voltage	230 V AC ± 10 %, 50 Hz			
Consumption	0.8 VA			
Power loss	3 W			
Local push-button	Short push for On/Off control, long push for dimming			
Auxiliary push-button input	Short push for On/Off control, long push for dimming: <ul style="list-style-type: none"> ■ up to 25 parallel connected auxiliary push-buttons without indication lamps ■ up to 5 parallel connected auxiliary push-buttons with indication lamps ■ max wire length 50 m 			
The minimum light level setting is adjustable	■			
Indication blue LED (built in the local push-button)	Illuminates during the on-state. The LED is blinking in error mode			
Protection class	-			
Degree of protection	IP20			
Operating temperature	0°C to +40°C, 40°C to +70°C with - 6 W / °C de-rating			
Storage temperature	0°C to +60°C			
Width (module of 9 mm)	4	4	8	8
Protections, fuses	<ul style="list-style-type: none"> ■ Electronic overload, overvoltage and over temperature protection ■ Single shot thermal fuse 			
Standards	According to EN 60669-2-1			
Directives	According to CE, EMC 89/336/EEC and LVD 73/73/23/EEC			

(1) Use of maximum 25 push-buttons without indication lamp and 5 push-buttons with indication lamp, connected in parallel.

(2) Use of maximum 25 push-buttons without indication lamp, connected in parallel, only for STD400RC/RL-SAE and STD1000RL-SAE.

STD400LED

400 W

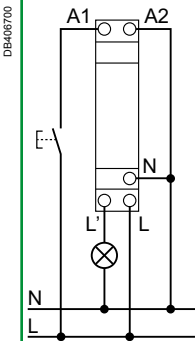

STD400LED+

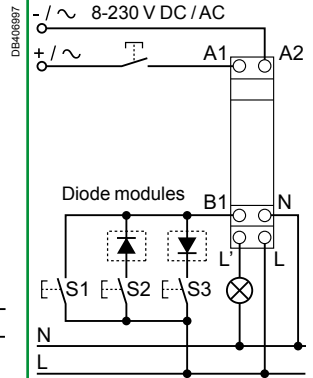
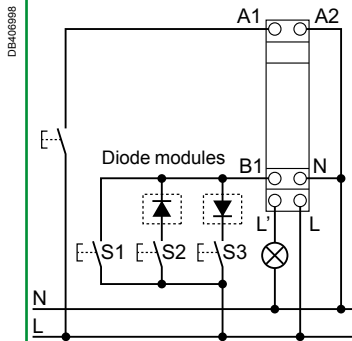

-

The 2 diode modules (supplied) could be used to implement 2 push-buttons, for example (push-button 1 = Switch on/Dim up, push-button 2 = Switch off/dim down) or to manage until 3 scenarios of lighting

CCTDD20016

CCTDD20017

230 V AC +10 %, -15 %, 50 Hz

8...230 V AC/DC

0.3 W

0.2 W

-

Short push for On/Off control, long push for dimming:
 ■ up to 10 parallel connected auxiliary push-buttons without indication lamps
 ■ max wire length 100 m

■

-

II

IP20

-30°C to +50°C

-20°C to +70°C

2

Electronic overload, overvoltage and over temperature protection

According to EN 60669-1, EN 60669-2-1

According to CE, 2004/108/EC, 2006/95/EC, 2011/65/EC

0.2 W

-

Short push for On/Off control, long push for dimming:
 ■ up to 10 parallel connected auxiliary push-buttons without indication lamps
 ■ max wire length 100 m

-

-20°C to +70°C

STD and SCU range (cont.)

STD400RC/RL-DIN & SAE
 STD400LED, STD400LED+
 STD1000RL-DIN & SAE
 SCU10-DIN & SAE

Selection table

SCU

	SCU10-DIN	SCU10-SAE
Type	1 - 10 V	
		

Wiring diagrams

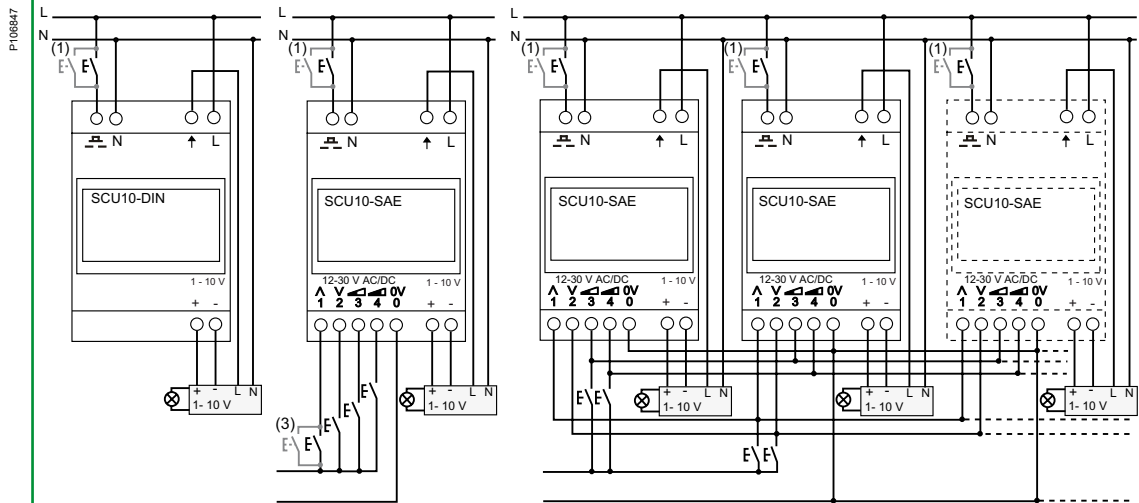

Mounting

With SAE types, it is possible to control a maximum of 20 dimmers combining STD400RC/RL-SAE, STD1000RL-SAE and SCU10-SAE with only one push-button via the 4 digital inputs

Catalogue numbers	CCTDD20011	CCTDD20012
-------------------	------------	------------

Technical specifications

Voltage rating (Ue)	230 V AC ± 10 %, 50 Hz
Consumption	0.8 VA
Power loss	3 W
Current sink for 1-10 V output	0.2- 100 mA
Local push-button	Short push for On/Off control, long push for dimming
Auxiliary push-button input	Short push for On/Off control, long push for dimming: <ul style="list-style-type: none"> ■ up to 25 parallel connected auxiliary push-buttons without indication lamps ■ up to 5 parallel connected auxiliary push-buttons with indication lamps ■ max wire length 50 m
The minimum light level setting is adjustable	■
Indication blue LED (built in the local push-button)	Illuminates during the on-state. The LED is blinking in error mode
Degree of protection	IP20
Operating temperature	0°C to +40°C, 40°C to +70°C with - 6 W /°C de-rating
Storage temperature	0°C to +60°C
Width (module of 9 mm)	8
Protections, fuses	<ul style="list-style-type: none"> ■ Electronic overload, overvoltage and over temperature protection ■ Single shot thermal fuse
Standards	According to EN 60669-2-1
Directives	According to CE, EMC 89/336/EEC and LVD 73/73/23/EEC

(1) Use of maximum 25 push-buttons without indication lamp and 5 push-buttons with indication lamp, connected in parallel.
 (3) Use of maximum 25 push-buttons without indication lamp, connected in parallel, only for SCU10-SAE

STD and SCU range (cont.)

STD400RC/RL-DIN & SAE
 STD400LED, STD400LED+
 STD1000RL-DIN & SAE
 SCU10-DIN & SAE

Specific technical data

SAE types									
Input voltage	12- 30 V AC/DC								
The STD400RC/RL-SAE , STD1000RL-SAE and SCU10-SAE dimmers are supplied with 4 digital inputs	<table border="1"> <tr> <td>Input 1</td> <td>On/Off and dimming up/down or only On and dimming up (depends on function mode)</td> </tr> <tr> <td>Input 2</td> <td>Off and dimming down or only Off (depends on function mode)</td> </tr> <tr> <td>Input 3</td> <td>Adjustable lighting level memory 1 (50 % default)</td> </tr> <tr> <td>Input 4</td> <td>Adjustable lighting level memory 2 (100 % default)</td> </tr> </table>	Input 1	On/Off and dimming up/down or only On and dimming up (depends on function mode)	Input 2	Off and dimming down or only Off (depends on function mode)	Input 3	Adjustable lighting level memory 1 (50 % default)	Input 4	Adjustable lighting level memory 2 (100 % default)
Input 1	On/Off and dimming up/down or only On and dimming up (depends on function mode)								
Input 2	Off and dimming down or only Off (depends on function mode)								
Input 3	Adjustable lighting level memory 1 (50 % default)								
Input 4	Adjustable lighting level memory 2 (100 % default)								
Max wire length	50 m								
Up to 25 push-buttons per input. No push-button with indication lamp									
STD400RC/RL-DIN and STD400RC/RL-SAE dimmers are power regulators designed for all dimmable load types. Dimmers have automatic load type detection and the load regulation method is adjusted to fit the load									

Operation modes for SAE types

- **STD400RC/RL-SAE**, **STD1000RL-SAE** and **SCU10-SAE** dimmers have 2 different operation modes (**A** and **B**) using auxiliary push-buttons connected on digital inputs (1, 2, 3 and 4 terminals).
- Modes **A** and **B** can be changed by pushing the digital inputs 3 and 4 simultaneously for 10 s. After the mode is changed the load and the LED start to blink as long as the inputs are pushed.
- In the mode **A**, the input 1 dims the lights on with a short push and up with a long push and turns light off with a short push and dims the light down with a long push. The direction is changed every time the input 1 is released. The input 2 dims the lights always off.
- In the mode **B**, the input 1 dims lights only up with a long push and turns lights on with a short push. The input 2 dims the lights only down with a long push and turns lights off with a short push.
- Inputs 3 and 4 are for memory places for light levels. The light level is called with a short push and set into the memory with a long push of 3 s.

Common technical data

Common operation mode for SAE & DIN types

- The dimmer is turned On/Off by shortly pushing the front panel push-button. This push-button lights blue when the dimmer is On.
- The light level is controlled by keeping the front panel push-button pushed until wanted level has been reached.
- The direction of dimming (up/down) is changed every time the front panel push-button is released.
- The dimmer has memory function which stores the light level before Off-command. When the dimmer is turned back On, the light level is the same as it was before Off-command.
- Auxiliary push-buttons connected on  terminal have the same functionality as the push-button on the front panel of the dimmer.

STD and SCU range (cont.)

STD400RC/RL-DIN & SAE
 STD400LED, STD400LED+
 STD1000RL-DIN & SAE
 SCU10-DIN & SAE

STD400LED specific technical data

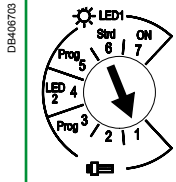
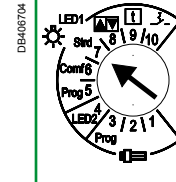
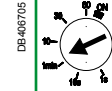
Lamp	Function	Product
		<div style="display: flex; justify-content: space-between;"> <div style="width: 48%;"> <p>STD400LED</p>  <p>DB400703</p> </div> <div style="width: 48%;"> <p>STD400LED+</p>  <p>DB400704</p> </div> </div>
		<div style="display: flex; justify-content: space-between;"> <div style="width: 48%;"> <p>Switch for setting the functions</p> </div> <div style="width: 48%;"> <p>Switch for setting the functions</p> </div> </div>
		<div style="display: flex; justify-content: space-between;"> <div style="width: 48%;"> <p>-</p> </div> <div style="width: 48%;">  <p>DE-400705</p> <p>Potentiometer for setting the dimming time</p> </div> </div>
Dimmable compact fluorescent lamps (CFL)	1	<p>Automatic load detection Start with 100 % Dimming down not possible till after 3 s</p>
	2	<p>No automatic load detection (always with phase section) Start with 50 % Dimming down not possible till after 2 s</p>
	Prog 3	<p>Programming the minimum brightness</p>
Dimmable LED	4	No automatic load (always with phase section) to used if dimming problems with the LEDs
Standard: Incandescent, Halogen, Transformer, Dimmable LEDs ...	Prog 5	Programming the minimum brightness
	6	<p>Standard function: Adjustable switch-on brightness (preset 100 %) Light brightness dimming switch-on after 2 s</p>
	7	Dimmer is always on
	8	-
	9	-
	10	-

STD and SCU range (cont.)

STD400RC/RL-DIN & SAE
 STD400LED, STD400LED+
 STD1000RL-DIN & SAE
 SCU10-DIN & SAE

Load table

STD400RC/RL-DIN, STD400RC/RL-SAE

230 V incandescent and halogen lamps	40 - 400 W
Low voltage halogen lamps with electronic transformer	40 - 400 W
Low voltage halogen lamps with conventional transformer	40 - 400 W
Low voltage halogen lamps with toroidal transformer	40 - 300 W
Motors (fans, ventilators...)	40 - 200 W

STD400LED, STD400LED+

230 V incandescent and halogen lamps	0 - 400 W *
Low voltage halogen lamps with electronic transformer	0 - 300 W
Low voltage halogen lamps with conventional transformer	0 - 400 W *
Low voltage halogen lamps with toroidal transformer	0 - 400 W *
Dimmable fluocompact lamps (CFL)	0 - 80 W
Dimmable LED lamps	0 - 60 W

* In the case of a load of >300 W keep an 8 mm ventilation distance to the right and left.

STD1000RL-DIN, STD1000RL-SAE

230 V incandescent and halogen lamps	60 - 1000 W
Low voltage halogen lamps with conventional transformer	60 - 1000 W
Motors (fans, ventilators...)	60 - 600 W

SCU10-DIN, SCU10-SAE

Mono fluorescent tubes with electronic ballast (dia.26 mm)	50 x 18 W, 40 x 36 W, 25 x 58 W
Duo fluorescent tubes with electronic ballast (dia.26 mm)	40 x 18 W, 20 x 36 W, 12 x 58 W
Fluocompact lamps with electronic ballast	50 max. up to 1500 W

Connection

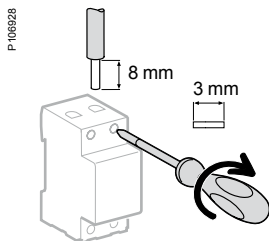

Type	Tightening torque	Copper cables	
		Rigid	Flexible or with ferrule
		DB122945	DB123653
STD and SCU (top connection)	0.5 N.m	< 4 mm ²	< 4 mm ²
STD and SCU (bottom connection)	0.5 N.m	< 2.5 mm ²	< 2.5 mm ²
STD400LED, STD400LED+	0.5 N.m	< 2.5 mm ²	< 2.5 mm ²

Weight (g)

Dimmers

STD400RC/RL-DIN	80
STD400RC/RL-SAE	90
STD1000RL-DIN	120
STD1000RL-SAE, SCU10	130
STD400LED	65
STD400LED+	70

Dimensions (mm)

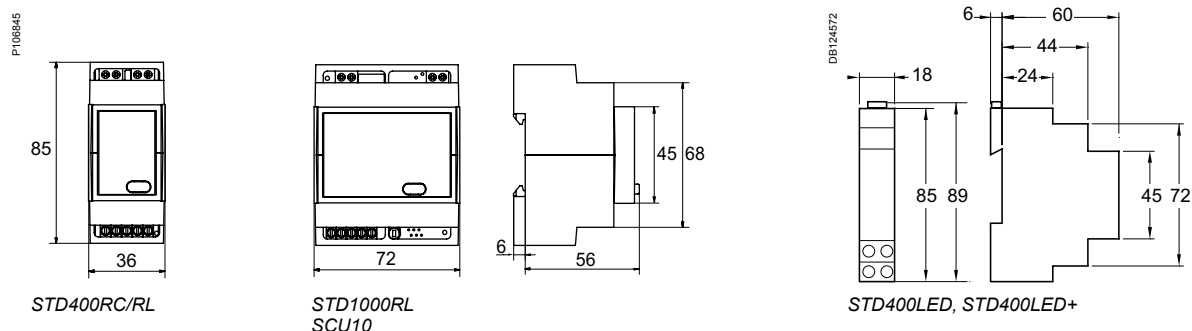





Thermostats

P123732



TH4

For individual and multifamily housing, tertiary premises, TH4 thermostat monitors and regulates ambient temperature from +8°C to +26°C according to 3 temperature set points:

- comfort: while the premises are occupied
- reduced: while the premises are unoccupied
- above freezing: for a prolonged period of non-occupancy.

P123731



TH7

For industrial premises stretching from cold storage to ovens, TH7 thermostat monitors and regulates temperature from -40°C to +80°C with a wide setting range.

It can also be used for frost protections at home.



Programmable thermostat

DB40875





THP1+ 1C

Programmable thermostat control the operating periods of all heating types by monitoring and regulating ambient temperature between 10°C and 30°C, using a programme pre-set by the user.

Selection table

Thermostats

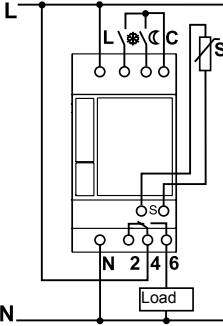
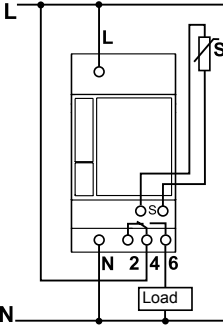
		TH4	TH7
Type		<p>P123732</p> 	<p>P123731</p> 
Function		<p>For individual and multifamily housing, tertiary premises, TH4 thermostat monitors and regulates ambient temperature from +8°C to +26°C according to 3 temperature set points:</p> <ul style="list-style-type: none"> ■ comfort: while the premises are occupied ■ reduced: while the premises are unoccupied ■ above freezing: for a prolonged period of non-occupancy 	<ul style="list-style-type: none"> ■ For industrial premises stretching from cold storage to ovens, TH7 thermostat monitors and regulates temperature from -40°C to +80°C with a wide setting range ■ It can also be used for frost protections at home
Wiring diagrams		<p>P106772</p> 	<p>P106773</p> 
Mounting		Delivered with CCT15846 ambient temperature probe	Delivered without probe
Catalogue numbers		CCT15841	CCT15840
Technical specifications			
Voltage rating (Ue)		230 V AC ± 10 %, 50/60 Hz	
Consumption		< 4 VA	
Output contact current (250 V AC)	Max.	Cos φ = 1	16 A
		Cos φ = 0.6	3 A
	Min.	-	
Power reserve		-	
Time base		-	
Difference between tripping and activation		± 0.2°C	
Degree of protection		IP20	
Operating temperature		-10°C to +55°C	
Storage temperature		-20°C to +60°C	
Set Point accuracy		1°C	
Humidity		15-95 % RH (no condensation)	
Width (module of 9 mm)		5	
Color		White RAL 9003	
Protections, fuses		Internal over voltage protection against surges, internal over temperature protection	
Compliance with Community Directives	Isolating requirements, E.M.C. guidelines and Safety guidelines	EN 60730-2-9	
	RoHS and environmental issues	EU-directive 2002/95/EC (RoHS)	
		WEEE-directive 2002/96/EC (recycling)	
		REACH Regulation (EC) No 1907/2006	

Programmable thermostat

THP1+ 1C

DB-406875



- The THP1+ 1C programmable thermostat controls the operating periods of all heating types by monitoring and regulating ambient temperature between 10°C and 30°C, using a programme pre-set by the user and memorised
- The THP1+ 1C monitors and regulates temperature in a room by comparing the value of the temperature measured by the ambient temperature probe with the value of the setpoint displayed on its front face according to 3 operating modes:
 - comfort: 10°C to 30°C while the premises are occupied
 - reduced: 10°C to 26°C while the premises are unoccupied
 - above freezing: the temperature in the premises is maintained at approximately 10°C
- The THP1+ 1C, can control the following loads:
 - convectors
 - a burner
 - a "hot air" heating system
 - heating valves: hydraulic, electromagnetic or electrothermal

DB-406879

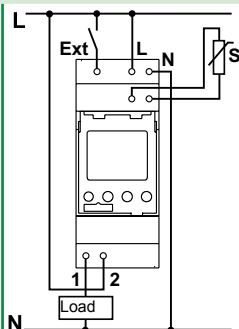

An ambient temperature probe needs to be ordered separately (see next page ref. 15835 or 15836)

CCT15833

230-240 V AC $\pm 10\%$, 50-60 Hz

1.36 VA

10 A

2 A

10 mA (230 V AC, 100 mA (12 V AC/DC))

10 years at 20°C

Quartz

$\pm 0.2^\circ\text{C}$

IP20

0°C to +50°C

-20°C to +70°C

0.1°C

-

4

White RAL 9003

Internal short circuit protection

EN 60730-2-9

2006/95/EC - low voltage directive

2011/65/EU - RoHS directive

2004/108/EC - electromagnetic compatibility

Selection table TH4, TH7

Temperature probes

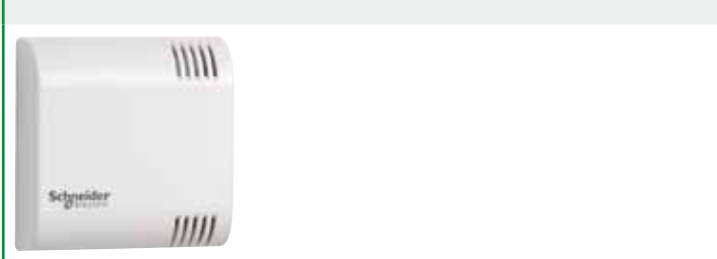
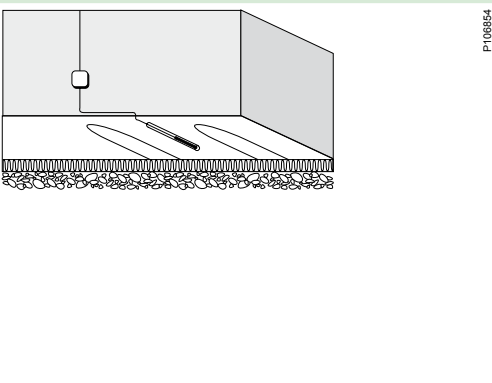
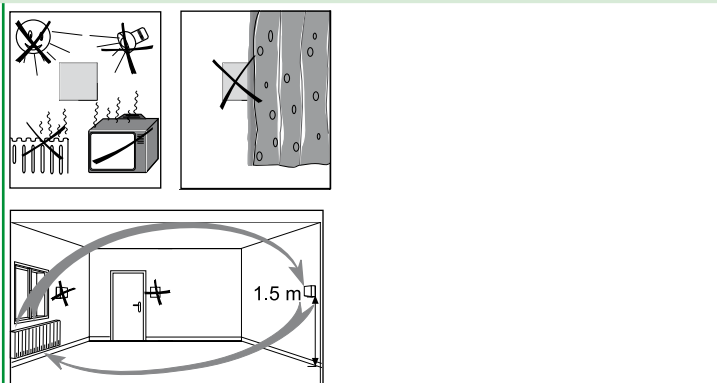
Accessories	Floor temperature probe (with 1.5 m cable)	Ambient temperature probe (with 1.5 m cable)
Type		
Installation		
Mounting	<p>This probe must be placed:</p> <ul style="list-style-type: none"> ■ in a Ø 9 mm tube, embedded in the slab in the middle of a turn ■ one of the ends must run out of a distribution box sealed in the nearest wall (to simplify probe installation or replacement) 	<p>This probe must be fixed 1.50 m above the floor, away from drafts and sources of heat (sun's rays, radiators, machines, etc.)</p>
Catalogue numbers	CCT15845	CCT15846

Note: for all probes, do not run connecting cables alongside power cables.
 TH4 and TH7 probes cables can be extended up to 70 m by using 6/10th telephone cable or up to 150 m by using shielded copper cable.
 THP1+ 1C probes cables can be extended up to 50 m by using 6/10th telephone cable or shielded copper cable.

Specific technical data





TH4		
Settings	Comfort	From +8°C to +26°C
	Reduced	From 0°C to 10°C below the selected "comfort" temperature set point: control (manual or automatic) by external dry contact
	Above freezing	Maintains room temperature according to a factory adjusted temperature set point of +5°C: control (manual or automatic) by external dry contact
Three indicator lights visualise	Green	Above freezing operation
	Yellow	Reduced operation
	Red	Relay: ON
Delivered with ambient temperature probe (CCT15846)		NTC 10 kΩ (25°C) can be extended up to 150 m with shielded copper cable and up to 70 m with telephone cable
Note: however, the set point selected never can't be less than +8°C. Eg. If the reduced set point is selected with a 12°C set point temperature and a 10°C reduction temperature, the operative set point will not be +2°C (12-10) but rather +8°C (+5°C only if the "above freezing" input is closed/active).		
TH7		
Temperature set point settings ⁽¹⁾	Range	6 fixed positions: -40°C, -20°C, 0°C, +20°C, +40°C and +60°C
	Adjustements	From 0°C to 20°C above the selected fixed position
Indicator light	Red	Relay: ON
Delivered without probe		

(1) For example: if "range" is on -40°C, setting is possible between -40°C and -20°C.

THP1+ 1C

Temperature probes

Ambient temperature probes

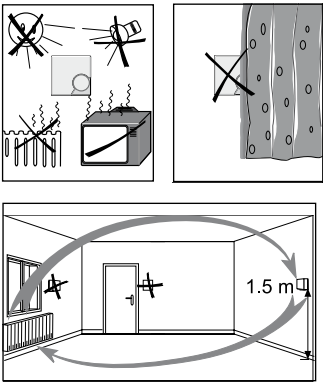
Outside temperature probe (with 2 m cable)		Collar temperature probe (with 1.5 m cable)		Non-adjustable probe		± 3 °C adjustable probe	
P123735		P123736		P126320		049540r	
				P106855			
<p>This probe must be fixed away from:</p> <ul style="list-style-type: none"> ■ the sun preferably facing north ■ all heat sources (chimney, etc.) 		<p>This probe must be fixed on the hot water outgoing pipe (min. \varnothing 21 mm, max. \varnothing 90 mm) approximately 1.50 m from the boiler.</p>		<p>These probes must be fixed 1.50 m above the floor, away from drafts and sources of heat (sun's rays, radiators, machines, etc.)</p>			
CCT15847		CCT15848		15835		15836	

Memory key (optional)

P93581-8_13



Saving and duplicating programs

Catalogue number

CCT15861

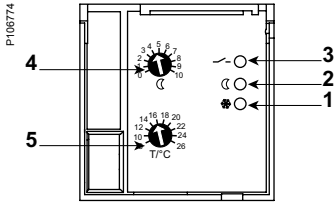

Fig. 1.

TH4

Front face (see Fig. 1)

- 1 Above freezing mode indicator.
- 2 Reduced mode indicator.
- 3 Relay.
- 4 Reduced threshold adjustment (reduction of temperature with respect to the setpoint).
- 5 Temperature threshold adjustment.

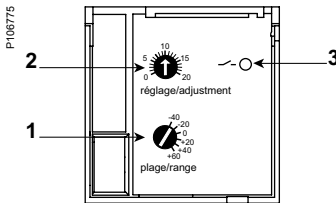

Fig. 2.

TH7

Front face (see Fig. 2)

- 1 Temperature range setting (6 ranges).
- 2 Temperature fine adjustment.
- 3 Relay indicator.

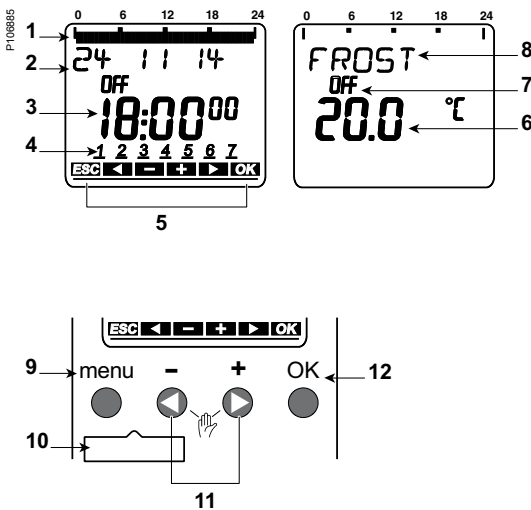

Fig. 3.

THP1+ 1C

Front face (see Fig. 3)

- 1 Programmed switching times
- 2 Date display
- 3 Time display
- 4 Days of the week from 1 to 7
- 5 Display of the active buttons with the relevant function
- 6 Actual temperature: 20°C
- 7 Channel status: ON = On, OFF = Off
- 8 Operating mode: Frost, Comfort, Reduce
- 9 menu: Activate display, Open menu, Cancel menu, ESC (leave menu)
- 10 Memory card interface
- 11 Options are displayed
- 12 OK: Save selection, Confirm selection

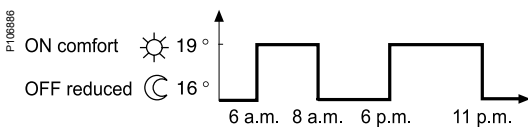

Fig. 4.

THP1+ 1C programming

A programmable clock, built into the THP1+ 1C, is used for programming (see Fig. 4).

- The various operations for updating time and day.
- Programming possibilities:
 - 24 hours and 7 days: a separate programme for each day of the week,
 - up to 42 switching operations memorised,
 - the same switching operation used over several days only counts as one switching operation,
 - Power reserve: 10 years.

Example

- Programming:
 - temperature thresholds: "comfort" 19°C and "reduced" 16°C,
 - presence from 6 a.m. to 8 a.m. and from 6 p.m. to 11 p.m.: "comfort" heating, temperature of 19°C,
 - absence (from 8 a.m. to 6 p.m.) and nighttime (from 11 p.m. to 6 a.m.): "reduced" heating, temperature of 16°C.

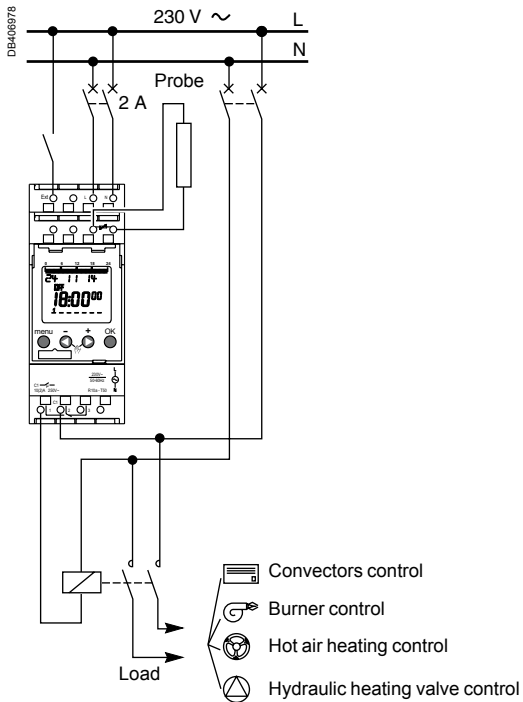

Fig. 5. THP1+ 1C connection example.

Local control

The configuration interface of the THP1+ 1C programmable thermostat consists of a screen and four configuration buttons.

The THP1+ 1C programmable thermostat has a built-in clock and its main menu is used to:

- set the temperatures: "comfort", "reduced" or "frost protection",
- assign these temperatures to a maximum of 42 hourly switching operations over 7 days,
- set the date and time format, the transition to summer or winter time,
- manually override the temperature without changing the hourly switching operations if the premises are not used during holidays, etc.

The option menu can be accessed to set:

- the external input (deactivated, "comfort", "reduced" or "frost protection" temperature),
- the type of heating:
 - heater, convector (NORMAL),
 - inertia heating (UNDERFLOOR),
 - pulsed-air heating (AIR HEATING),
- the temperature compensation to correct the measurement obtained by the temperature probe in the event of an unfavourable location,
- the screen lighting mode:
 - constantly on,
 - off after 1 minute,
- the language used,
- and to reset the parameters (return to factory settings).

Connection

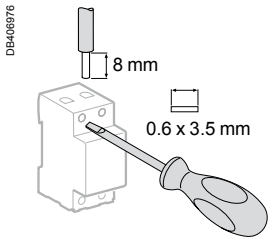

Type	Tightening torque	Copper cables	
		Rigid	Flexible or with ferrule
TH4, TH7, THP1+ 1C	2 screwless / pole	DB1229M5 	DB1235S3
		2 x 2.5 mm ²	2 x 2.5 mm ²

Weight (g)

Thermostats	
TH4, TH7	125
TH4 with probe	205
Programmable thermostat	
THP1+ 1C	184

Dimensions (mm)

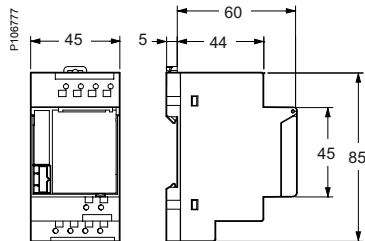

TH4 and TH7 thermostats

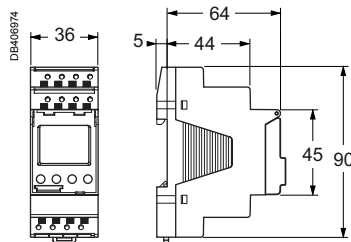

THP1+ 1C programmable thermostat

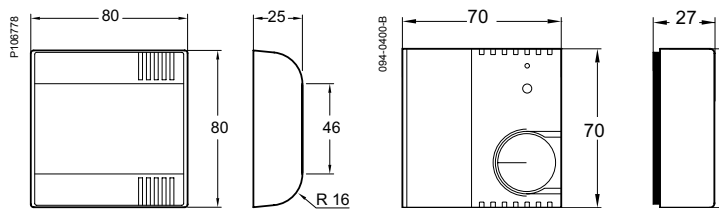

TH4, TH7, ambient temperature probe

THP1+ 1C ambient temperature probes

Compatibility of 50/60 Hz equipment with a 400 Hz network

The performance of products designed for domestic frequencies of 50/60 Hz is impacted by the specific properties of networks of 400 Hz frequency.

Phenomena due to the increased frequency influence the behaviour of the copper components of transformers, cables and protective equipment.

Some types of equipment designed for 50/60 Hz networks may not be suitable. You should check whether or not a product is compatible, and also apply any correction factors given by the manufacturer.

Circuit breakers

Depending on the technologies used, modular circuit breakers designed for 50/60 Hz can be used at 400 Hz.

To choose the performance of a modular circuit breaker:

- do not take any thermal derating into account (In at 400 Hz is equivalent to In at 50 Hz).
- increase the magnetic tripping threshold, according to the table below.
- check that the short-circuit current on the installation is less than the breaking capacity of the circuit breaker. The breaking capacity of the circuit breakers at a frequency of 400 Hz is the same as at frequencies of 50/60 Hz. This characteristic is generally complied with, due to the fact that the short-circuit current of a 400 Hz generator is relatively low. In most cases, the generator Isc does not exceed four times the rated current.

Circuit breaker	Curve	Magnetic trip thresholds		Tolerance
		50 Hz	400 Hz	
iDPN, DPN	B	4 In	6 In	± 20 %
	C	8 In	12 In	
	D	12 In	18 In	
iC60	B	4 In	5.6 In	
	C	8 In	11.2 In	
	D	12 In	16.8 In	
C60	B	4 In	5.1 In	
	C	8.5 In	10.9 In	
	D	12 In	15.4 In	
C120 NG125	The NG125 and C120 circuit breakers are not suitable for networks of 400 Hz frequency. Refer to the Compact NSX offer.			

Earth leakage protection devices

The residual current device trip thresholds designed for 50/60 Hz increase with the frequency, but since the human body is less sensitive to the passage of a current at 400 Hz, protection is still ensured for the users.

According to the IEC 60479-2 standard, at 400 Hz the ventricular fibrillation threshold is higher by a ratio of 6 (which means that the physiological effect of a 180 mA current at 400 Hz will be the same as that of a 30 mA current at 50/60 Hz).

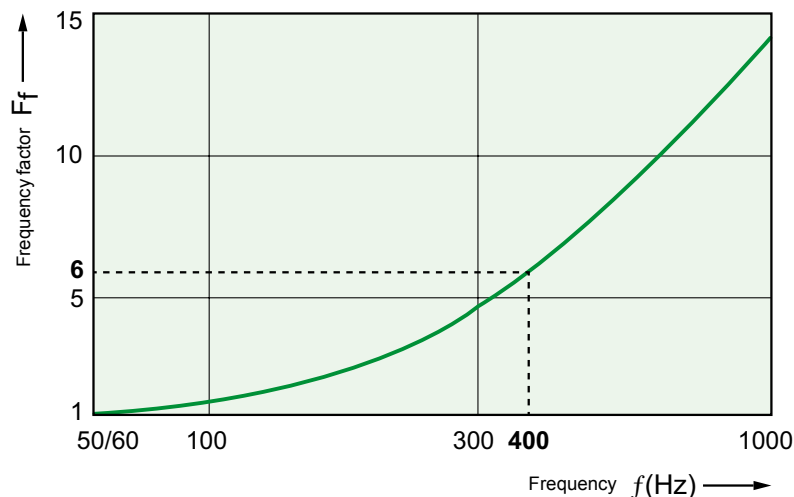

Variations in the ventricular fibrillation threshold for shock durations exceeding the period of cardiac cycle (as per IEC 60479-2).

Compatibility of residual current devices at 400 Hz:

Depending on the type and the technology employed, a residual current device designed for a frequency of 50/60 Hz will or will not be capable of ensuring protection for users in accordance with the requirements of the standard.

Type of protection and type of equipment	Use possible on network of 400 Hz frequency	Limit
A type	Not compatible	Trip threshold exceeding the limit given by the curve
AC type	Not recommended	Excessive sensitivity with risk of unwanted tripping (poor guarantee of continuity of service)
<i>Si</i> type		
iID iTG40	YES	
Vigi iC60	Not compatible	Trip threshold exceeding the limit given by the curve
DPN Vigi, Vigi DPN	YES	

Note: The choice of an iID residual current circuit breaker ensures protection for users at 400 Hz while ensuring good continuity of service.

At 400 Hz, the test function of residual current devices designed for 50/60 Hz is not operational due to the increase in the trip threshold.

Auxiliary function

Voltmetric releases

If a circuit breaker needs to be provided with a voltmetric release whose control circuit is powered by the 400 Hz network, it is necessary to use a release auxiliary of appropriate characteristics for 400 Hz networks:

Type	Voltage	Cat. no.
Undervoltage release iMN	115 V AC - 400 Hz	A9A26959

Influence of temperature on the operation

Devices	Characteristics influenced by temperature	Temperature		
		Min.	Max.	
C60H-DC, C60, C120, NG125, C60PV-DC circuit breakers	Tripping on overload	-30°C	+70°C	
DPN circuit breakers	Tripping on overload	-25°C	+70°C	
iK60 circuit breakers	Tripping on overload	-25°C	+60°C	
iC60a/N/H/L circuit breakers	Tripping on overload	-35°C	+70°C	
Circuit breakers	With Vigi (AC)	-5°C	+60°C	
	With Vigi (A, S/I)	-25°C	+60°C	
Reflex iC60	Tripping on overload	-25°C	+60°C	
iC60N/H RCBO, iC60H2 RCBO	Tripping on overload	-15°C	+60°C	
C60NA-DC, SW60PV-DC, C120NA-DC switch-disconnectors	Maximum operating current	-25°C	+70°C	
iID K residual current circuit breakers	Maximum operating current	-5°C	+60°C	
iID residual current circuit breakers	AC	-5°C	+60°C	
	A, S/I	-25°C	+60°C	
Switches	iSW (Acti 9 design)	-25°C	+60°C	
	iSW	-20°C	+50°C	
	iSW-NA	-35°C	+70°C	
Protection auxiliaries	None	-35°C	+70°C	
RCA, ARA control auxiliaries	None	-25°C	+60°C	
iCT contactors	Installation conditions	-5°C	+60°C	
iTL impulse relays	None	-20°C	+50°C	
Linergy DS	Cat. no. 04040	Maximum operating current	-25°C	+60°C
	Cat. no. 04041			
Linergy FH		Maximum operating current	-25°C	+60°C
iCT, iTL auxiliaries		None	-20°C	+50°C
Linergy DX		Maximum operating current	-25°C	+60°C
Linergy FM	Cat. no. 04000	Maximum operating current	-25°C	+60°C

Note: the temperature considered is the temperature viewed through the device.

Circuit breakers

High temperatures

- A rise in temperature causes lowering of the thermal threshold (tripping on overload).
 - Protection is still ensured: the tripping threshold remains lower than the current acceptable by the cable (I_2)
 - To prevent nuisance tripping, it should be checked that this threshold remains higher than the maximum operating current (I_B) of the circuit, defined by:
 - the rated load currents,
 - the coefficients of expansion and simultaneity of use.
- If the temperature is sufficiently high for the tripping threshold to become lower than the operating current I_B , switchboard ventilation should be provided for.

Low temperatures

- A fall in temperature increases the thermal tripping threshold of the circuit breaker.
- There is no risk of nuisance tripping: the threshold remains higher than the maximum operating current of the circuit (I_B) demanded by the loads.
- It should be checked that the cable remains suitably protected, i.e. that its acceptable current (I_2) is higher than the values shown in the following tables (in amperes).

When the ambient temperature could vary within a broad range, both these aspects must be taken into account:

- the difference between the maximum operating current of the circuit (I_B) and the tripping threshold of the circuit breaker for the minimum ambient temperature,
- the difference between the strength of the cable (I_2) and the maximum tripping threshold of the circuit breaker for the maximum ambient temperature.

Influence of ambient temperature (cont.)

Maximum permissible current

- The maximum current allowed to flow through the device depends on the ambient temperature in which it is placed.
- The ambient temperature is the temperature inside the enclosure or switchboard in which the devices are installed.
- The reference temperature is in a halftone colour for the different devices.

■ When several devices operating simultaneously are mounted side by side in a small enclosure, a temperature rise in the enclosure results in a reduction in the operating current. A reduction coefficient of 0.8 will then have to be assigned to the rating (already derated, if applicable, depending on the ambient temperature).

■ Example:

Depending on the ambient temperature and the method of installation, the table below shows how to determine, for an iC60, the operating currents not to be exceeded for ratings 25 A, 32 A and 40 A (reference temperature 50°C).

Operating current not to be exceeded (A)							
Installation conditions (IEC 60947-2)		iC60 alone			Several iC60 in the same enclosure (calculate with the reduction coefficient indicated below)		
Ambient temperature (°C)		35°C	50°C	65°C	35°C	50°C	65°C
Type	Nominal rating (A)	Actual rating (A)					
iC60	25	26.35	25	23.57	26.35 x 0.8 = 21	25 x 0.8 = 20	23.57 x 0.8 = 19
	32	34	32	29.9	34 x 0.8 = 27	32 x 0.8 = 25.6	29.9 x 0.8 = 24
	40	42.5	40	37.34	42.5 x 0.8 = 34	40 x 0.8 = 32	37.34 x 0.8 = 30

Household (IEC 60898-1)

DPN derating table (IEC 60898-1)

DPN		Ambient temperature (°C)																			
Rating	Curve	-25	-20	-15	-10	-5	0	+5	+10	+15	+20	+25	+30	+35	+40	+45	+50	+55	+60	+65	+70
1 A	B, C, D	1.51	1.47	1.43	1.39	1.35	1.3	1.26	1.21	1.16	1.11	1.06	1	0.94	0.88	0.81	0.73	0.65	0.55	0.43	0.27
2 A	B, C, D	2.47	2.43	2.39	2.35	2.31	2.27	2.23	2.18	2.14	2.09	2.05	2	1.95	1.9	1.85	1.8	1.74	1.69	1.63	1.57
3 A	B, C, D	3.74	3.68	3.62	3.55	3.49	3.42	3.36	3.29	3.22	3.15	3.07	3	2.92	2.85	2.76	2.68	2.6	2.51	2.42	2.32
4 A	B, C, D	4.9	4.82	4.75	4.67	4.59	4.51	4.43	4.35	4.26	4.18	4.09	4	3.91	3.81	3.72	3.62	3.52	3.41	3.3	3.19
6 A	B, C, D	7.04	6.95	6.86	6.77	6.68	6.59	6.49	6.4	6.3	6.2	6.1	6	5.9	5.79	5.68	5.57	5.46	5.35	5.23	5.11
10 A	B	11.7	11.6	11.4	11.3	11.1	11	10.8	10.7	10.5	10.3	10.2	10	9.8	9.7	9.5	9.3	9.1	8.9	8.7	8.5
10 A	C, D	12.1	12	11.8	11.6	11.4	11.2	11	10.8	10.6	10.4	10.2	10	9.8	9.6	9.3	9.1	8.9	8.6	8.4	8.1
13 A	B	15.4	15.2	15	14.8	14.6	14.4	14.1	13.9	13.7	13.5	13.2	13	12.8	12.5	12.3	12	11.8	11.5	11.2	11
13 A	C, D	15.5	15.3	15.1	14.9	14.6	14.4	14.2	14	13.7	13.5	13.3	13	12.8	12.5	12.2	12	11.7	11.4	11.1	10.8
16 A	B, C	18.8	18.5	18.3	18.1	17.8	17.6	17.3	17.1	16.8	16.5	16.3	16	15.7	15.4	15.2	14.9	14.6	14.3	14	13.6
16 A	D	18.9	18.6	18.4	18.1	17.9	17.6	17.4	17.1	16.8	16.6	16.3	16	15.7	15.4	15.1	14.8	14.5	14.2	13.9	13.5
20 A	B	23.4	23.1	22.8	22.5	22.2	21.9	21.6	21.3	21	20.7	20.3	20	19.7	19.3	19	18.6	18.3	17.9	17.5	17.1
20 A	C, D	23.6	23.3	23	22.7	22.4	22	21.7	21.4	21	20.7	20.4	20	19.6	19.3	18.9	18.5	18.1	17.7	17.3	16.9
25 A	B, C, D	29.2	28.8	28.5	28.1	27.8	27.4	27	26.6	26.2	25.8	25.4	25	24.6	24.2	23.7	23.3	22.8	22.4	21.9	21.4
32 A	B, C, D	37.8	37.3	36.8	36.3	35.8	35.3	34.7	34.2	33.7	33.1	32.6	32	31.4	30.8	30.2	29.6	29	28.4	27.7	27
40 A	B, C, D	47.7	47	46.4	45.7	45	44.3	43.7	43	42.2	41.5	40.8	40	39.2	38.4	37.6	36.8	36	35.1	34.2	33.3

iK60 derating table. B curve (IEC 60898-1)

iK60	Ambient temperature (°C)																		
Rating	-25	-20	-15	-10	-5	0	+5	+10	+15	+20	+25	+30	+35	+40	+45	+50	+55	+60	
1 A	1.19	1.17	1.15	1.14	1.12	1.11	1.09	1.07	1.05	1.04	1.02	1	0.98	0.96	0.94	0.92	0.9	0.88	
2 A	2.45	2.41	2.37	2.34	2.3	2.26	2.22	2.17	2.13	2.09	2.04	2	1.95	1.91	1.86	1.81	1.76	1.71	
3 A	3.69	3.63	3.57	3.51	3.45	3.39	3.33	3.27	3.2	3.14	3.07	3	2.93	2.86	2.78	2.71	2.63	2.55	
4 A	4.92	4.84	4.77	4.69	4.61	4.53	4.44	4.36	4.27	4.18	4.09	4	3.91	3.81	3.71	3.61	3.5	3.39	
6 A	7.44	7.32	7.2	7.07	6.95	6.82	6.69	6.56	6.42	6.29	6.14	6	5.85	5.7	5.54	5.38	5.22	5.04	
10 A	11.9	11.8	11.6	11.4	11.3	11.1	10.9	10.8	10.6	10.4	10.2	10	9.8	9.6	9.4	9.2	9	8.8	
16 A	19	18.7	18.5	18.2	18	17.7	17.4	17.1	16.9	16.6	16.3	16	15.7	15.4	15.1	14.8	14.5	14.1	
20 A	23.5	23.2	22.9	22.6	22.3	22	21.7	21.4	21	20.7	20.4	20	19.7	19.3	18.9	18.6	18.2	17.8	
25 A	29.1	28.8	28.4	28	27.7	27.3	26.9	26.6	26.2	25.8	25.4	25	24.6	24.2	23.8	23.3	22.9	22.5	
32 A	37.9	37.4	36.9	36.4	35.9	35.3	34.8	34.3	33.7	33.2	32.6	32	31.4	30.8	30.2	29.6	28.9	28.3	
40 A	47.4	46.7	46.1	45.5	44.8	44.2	43.5	42.8	42.1	41.4	40.7	40	39.3	38.5	37.7	37	36.2	35.3	
50 A	59.9	59.1	58.2	57.4	56.5	55.6	54.7	53.8	52.9	52	51	50	49	48	46.9	45.9	44.8	43.6	
63 A	76.4	75.3	74.1	73	71.8	70.6	69.4	68.2	66.9	65.6	64.3	63	61.6	60.3	58.8	57.4	55.9	54.3	

iK60 derating table. C curve (IEC 60898-1)

iK60	Ambient temperature (°C)																		
Rating	-25	-20	-15	-10	-5	0	+5	+10	+15	+20	+25	+30	+35	+40	+45	+50	+55	+60	
1 A	1.2	1.2	1.2	1.1	1.1	1.1	1.1	1.1	1.1	1	1	1	0.98	0.96	0.94	0.92	0.9	0.88	
2 A	2.4	2.4	2.4	2.3	2.3	2.3	2.2	2.2	2.1	2.1	2	2	1.95	1.91	1.86	1.81	1.76	1.71	
3 A	3.7	3.6	3.6	3.5	3.5	3.4	3.3	3.3	3.2	3.1	3.1	3	2.93	2.86	2.78	2.71	2.63	2.55	
4 A	4.9	4.8	4.8	4.7	4.6	4.5	4.4	4.4	4.3	4.2	4.1	4	3.91	3.81	3.71	3.61	3.5	3.39	
6 A	7.4	7.3	7.2	7.1	6.9	6.8	6.7	6.6	6.4	6.3	6.1	6	5.85	5.7	5.54	5.38	5.22	5.04	
10 A	12.4	12.2	12	11.8	11.6	11.4	11.2	10.9	10.7	10.5	10.2	10	9.8	9.5	9.2	9	8.7	8.4	
16 A	19.4	19.1	18.8	18.5	18.2	17.9	17.6	17.3	17	16.7	16.3	16	15.7	15.3	14.9	14.6	14.2	13.8	
20 A	24	23.6	23.3	23	22.6	22.3	21.9	21.5	21.2	20.8	20.4	20	19.6	19.2	18.8	18.3	17.9	17.5	
25 A	30	29.5	29.1	28.7	28.3	27.8	27.4	26.9	26.4	26	25.5	25	24.5	24	23.5	22.9	22.4	21.8	
32 A	38.8	38.2	37.7	37.1	36.5	35.9	35.3	34.6	34	33.3	32.7	32	31.3	30.6	29.9	29.1	28.4	27.6	
40 A	47.4	46.7	46.1	45.5	44.8	44.2	43.5	42.8	42.1	41.4	40.7	40	39.3	38.5	37.7	37	36.2	35.3	
50 A	59.9	59.1	58.2	57.4	56.5	55.6	54.7	53.8	52.9	51.9	51	50	49	48	46.9	45.9	44.8	43.6	
63 A	76.4	75.3	74.1	73	71.8	70.6	69.4	68.2	66.9	65.6	64.3	63	61.6	60.3	58.8	57.4	55.9	54.3	

Influence of ambient temperature (cont.)

Household (IEC 60898-1) (cont.)

iC60 derating table (IEC 60898-1)

iC60	Ambient temperature (°C)																					
Rating	-35	-30	-25	-20	-15	-10	-5	0	+5	+10	+15	+20	+25	+30	+35	+40	+45	+50	+55	+60	+65	+70
0.5A	0.61	0.6	0.59	0.59	0.58	0.57	0.56	0.55	0.54	0.54	0.53	0.52	0.51	0.5	0.49	0.48	0.47	0.46	0.45	0.44	0.43	0.42
1A	1.22	1.2	1.19	1.17	1.15	1.14	1.12	1.11	1.09	1.07	1.05	1.04	1.02	1	0.98	0.96	0.94	0.92	0.9	0.88	0.86	0.84
2A	2.52	2.49	2.45	2.41	2.37	2.34	2.3	2.26	2.22	2.17	2.13	2.09	2.04	2	1.95	1.91	1.86	1.81	1.76	1.71	1.65	1.59
3A	3.8	3.74	3.69	3.63	3.57	3.51	3.45	3.39	3.33	3.27	3.2	3.14	3.07	3	2.93	2.86	2.78	2.71	2.63	2.55	2.47	2.38
4A	5.07	5	4.92	4.84	4.77	4.69	4.61	4.53	4.44	4.36	4.27	4.18	4.09	4	3.91	3.81	3.71	3.61	3.5	3.39	3.28	3.17
6A	7.67	7.55	7.44	7.32	7.2	7.07	6.95	6.82	6.69	6.56	6.42	6.29	6.14	6	5.85	5.7	5.54	5.38	5.22	5.04	4.87	4.68
10A	12.3	12.1	11.9	11.8	11.6	11.4	11.3	11.1	10.9	10.8	10.6	10.4	10.2	10	9.8	9.6	9.4	9.2	9	8.8	8.5	8.3
13A	15.8	15.6	15.4	15.2	15	14.8	14.6	14.4	14.1	13.9	13.7	13.5	13.2	13	12.8	12.5	12.3	12	11.8	11.5	11.2	10.9
16A	19.5	19.2	19	18.7	18.5	18.2	18	17.7	17.4	17.1	16.9	16.6	16.3	16	15.7	15.4	15.1	14.8	14.5	14.1	13.8	13.4
20A	24.1	23.8	23.5	23.2	22.9	22.6	22.3	22	21.7	21.4	21	20.7	20.4	20	19.7	19.3	18.9	18.6	18.2	17.8	17.4	17
25A	29.8	29.4	29.1	28.8	28.4	28	27.7	27.3	26.9	26.6	26.2	25.8	25.4	25	24.6	24.2	23.8	23.3	22.9	22.5	22	21.5
32A	38.9	38.4	37.9	37.4	36.9	36.4	35.9	35.3	34.8	34.3	33.7	33.2	32.6	32	31.4	30.8	30.2	29.6	28.9	28.3	27.6	26.9
40A	48.6	48	47.4	46.7	46.1	45.5	44.8	44.2	43.5	42.8	42.1	41.4	40.7	40	39.3	38.5	37.7	37	36.2	35.3	34.5	33.6
50A	61.6	60.7	59.9	59.1	58.2	57.4	56.5	55.6	54.7	53.8	52.9	52	51	50	49	48	46.9	45.9	44.8	43.6	42.5	41.3
63A	78.6	77.5	76.4	75.3	74.1	73	71.8	70.6	69.4	68.2	66.9	65.6	64.3	63	61.6	60.3	58.8	57.4	55.9	54.3	52.8	51.1

C60 derating table (IEC 60898-1)

C60	Ambient temperature (°C)																				
Rating	-30	-25	-20	-15	-10	-5	0	+5	+10	+15	+20	+25	+30	+35	+40	+45	+50	+55	+60	+65	+70
0.5A	0.65	0.64	0.63	0.62	0.6	0.59	0.58	0.57	0.55	0.54	0.53	0.51	0.5	0.49	0.47	0.45	0.44	0.42	0.4	0.38	0.36
0.75A	0.98	0.96	0.94	0.92	0.9	0.89	0.87	0.85	0.83	0.81	0.79	0.77	0.75	0.73	0.71	0.68	0.66	0.63	0.61	0.59	0.57
1A	1.2	1.19	1.17	1.16	1.14	1.12	1.11	1.09	1.07	1.05	1.04	1.02	1	0.98	0.96	0.94	0.92	0.9	0.88	0.86	0.84
2A	2.36	2.33	2.3	2.27	2.24	2.22	2.19	2.16	2.13	2.1	2.06	2.03	2	1.97	1.93	1.9	1.87	1.83	1.79	1.76	1.72
3A	3.53	3.49	3.44	3.4	3.36	3.32	3.27	3.23	3.19	3.14	3.09	3.05	3	2.95	2.9	2.85	2.8	2.75	2.7	2.64	2.59
4A	4.59	4.54	4.5	4.45	4.4	4.35	4.3	4.26	4.21	4.15	4.10	4.05	4	3.95	3.89	3.84	3.78	3.73	3.67	3.61	3.55
6A	6.88	6.84	6.79	6.74	6.68	6.63	6.57	6.52	6.46	6.4	6.34	6.28	6	6.22	6.16	6.1	6.04	5.98	5.92	5.86	5.8
8A	10.18	10.01	9.85	9.68	9.51	9.33	9.15	8.97	8.79	8.6	8.4	8.2	8	7.79	7.58	7.36	7.13	6.89	6.65	6.4	6.13
10A	12.1	11.96	11.8	11.6	11.5	11.3	11.1	10.9	10.8	10.6	10.4	10.2	10	9.8	9.6	9.4	9.2	9	8.8	8.5	8.3
13A	15.7	15.5	15.3	15.1	14.9	14.6	14.4	14.2	14	13.7	13.5	13.2	13	12.7	12.5	12.2	12	11.7	11.4	11.1	10.8
16A	18.6	18.4	18.2	18	17.8	17.6	17.4	17.1	16.9	16.7	16.5	16.2	16	15.8	15.5	15.3	15	14.8	14.5	14.2	14
20A	24.4	24.1	23.7	23.4	23	22.7	22.3	22	21.6	21.2	20.8	20.4	20	19.6	19.2	18.7	18.3	17.8	17.4	16.9	16.4
25A	30	29.6	29.2	28.8	28.4	28	27.6	27.2	26.8	26.3	25.9	25.5	25	24.5	24.1	23.6	23.1	22.6	22.1	21.6	21
32A	40.7	39.8	39.2	38.5	37.9	37.2	36.5	35.8	35.1	34.3	33.6	32.8	32	31.2	30.4	29.5	28.6	27.7	26.8	25.6	24.6
40A	51.1	50.1	49.2	48.4	47.5	46.7	45.8	44.9	43.9	43	42	41	40	39	37.9	36.8	35.6	34.5	33.2	31.8	30.5
45A	58.5	57.4	56.4	55.3	54.3	53.2	52.1	51	49.9	48.7	47.5	46.3	45	43.7	42.4	41	39.6	38.1	36.5	35	33.5
50A	64.2	63	61.9	60.8	59.7	58.6	57.4	56.3	55.1	53.8	52.6	51.3	50	48.7	47.3	45.8	44.4	42.8	41.3	39.5	37.9
63A	82.3	80.7	79.2	77.8	76.3	74.7	73.2	71.6	69.9	68.3	66.6	64.8	63	61.1	59.2	57.2	55.2	53.1	50.8	48.7	46.6

C120 derating table (IEC 60898-1)

C120	Ambient temperature (°C)																				
Rating	-30	-25	-20	-15	-10	-5	0	+5	+10	+15	+20	+25	+30	+35	+40	+45	+50	+55	+60	+65	+70
10A	12.9	12.7	12.5	12.2	12	11.8	11.5	11.3	11	10.8	10.5	10.3	10	9.7	9.4	9.1	8.8	8.5	8.2	7.9	7.5
16A	19.4	19.1	18.8	18.6	18.3	18	17.8	17.5	17.2	16.9	16.6	16.3	16	15.7	15.4	15.1	14.7	14.4	14	13.7	13.3
20A	24.6	24.2	23.9	23.5	23.2	22.8	22.4	22	21.6	21.2	20.8	20.4	20	19.6	19.1	18.7	18.2	17.7	17.3	16.8	16.2
25A	30.9	30.5	30	29.5	29.1	28.6	28.1	27.6	27.1	26.6	26.1	25.5	25	24.4	23.9	23.3	22.7	22.1	21.5	20.8	20.1
32A	38.9	38.4	37.9	37.3	36.8	36.2	35.6	35	34.5	33.9	33.3	32.6	32	31.4	30.7	30	29.3	28.6	27.9	27.2	26.4
40A	49.8	49.1	48.3	47.6	46.8	46	45.2	44.4	43.5	42.7	41.8	40.9	40	39.1	38.1	37.1	36.1	35.1	34.1	33	31.8
50A	62.2	61.3	60.4	59.4	58.4	57.5	56.5	55.4	54.4	53.3	52.2	51.1	50	48.8	47.7	46.4	45.2	43.9	42.6	41.2	39.8
63A	78.6	77.5	76.3	75	73.8	72.5	71.3	69.9	68.6	67.3	65.9	64.5	63	61.5	60	58.4	56.8	55.2	53.5	51.7	49.9
80A	98.4	97	95.6	94.2	92.7	91.2	89.7	88.1	86.6	85	83.4	81.7	80	78.3	76.5	74.7	72.8	70.9	69	67	64.9
100A	124.5	122.6	120.7	118.8	116.9	114.9	112.9	110.9	108.8	106.6	104.5	102.3	100	97.7	95.3	92.9	90.4	87.8	85.2	82.5	79.6
125A	157	154.6	152.2	149.7	147.1	144.6	141.9	139.2	136.5	133.7	130.9	128	125	122	118.8	115.6	112.3	108.9	105.4	101.8	98

Tertiary/Industry (IEC 60947-2)

DPN derating table (IEC 60947-2)

DPN		Ambient temperature (°C)																			
Rating	Curve	-25	-20	-15	-10	-5	0	+5	+10	+15	+20	+25	+30	+35	+40	+45	+50	+55	+60	+65	+70
1A	B, C, D	1.66	1.62	1.59	1.55	1.51	1.47	1.43	1.39	1.35	1.3	1.26	1.21	1.16	1.11	1.06	1	0.94	0.88	0.81	0.73
2A	B, C, D	2.64	2.6	2.56	2.52	2.48	2.44	2.4	2.36	2.32	2.28	2.23	2.19	2.14	2.1	2.05	2	1.95	1.9	1.85	1.79
3A	B, C, D	3.97	3.91	3.86	3.8	3.74	3.68	3.61	3.55	3.49	3.42	3.36	3.29	3.22	3.15	3.07	3	2.92	2.85	2.77	2.68
4A	B, C, D	5.19	5.12	5.05	4.98	4.9	4.83	4.75	4.67	4.6	4.52	4.43	4.35	4.27	4.18	4.09	4	3.91	3.81	3.72	3.62
6A	B, C, D	7.42	7.34	7.25	7.16	7.07	6.98	6.89	6.8	6.7	6.61	6.51	6.41	6.31	6.21	6.11	6	5.89	5.78	5.67	5.56
10A	B	12.3	12.2	12.1	11.9	11.8	11.6	11.5	11.3	11.2	11	10.8	10.7	10.5	10.3	10.2	10	9.8	9.7	9.5	9.3
10A	C, D	12.9	12.7	12.5	12.3	12.2	12	11.8	11.6	11.4	11.2	11	10.8	10.6	10.4	10.2	10	9.8	9.6	9.3	9.1
13A	B	16.7	16.5	16.3	16.1	15.8	15.6	15.4	15.1	14.9	14.6	14.4	14.1	13.8	13.6	13.3	13	12.7	12.4	12.1	11.8
13A	C, D	16.9	16.7	16.5	16.2	16	15.7	15.5	15.2	15	14.7	14.4	14.2	13.9	13.6	13.3	13	12.7	12.4	12.1	11.7
16A	B, C	20.4	20.1	19.8	19.6	19.3	19	18.7	18.5	18.2	17.9	17.6	17.3	17	16.7	16.3	16	15.7	15.3	15	14.6
16A	D	20.5	20.2	20	19.7	19.4	19.1	18.8	18.5	18.2	17.9	17.6	17.3	17	16.7	16.3	16	15.7	15.3	14.9	14.6
20A	B	25.3	25	24.7	24.4	24	23.7	23.4	23	22.7	22.3	21.9	21.6	21.2	20.8	20.4	20	19.6	19.2	18.8	18.3
20A	C, D	25.7	25.3	25	24.6	24.3	23.9	23.6	23.2	22.8	22.4	22	21.7	21.3	20.8	20.4	20	19.6	19.1	18.7	18.2
25A	B, C, D	31.6	31.2	30.8	30.4	30	29.6	29.2	28.7	28.3	27.8	27.4	26.9	26.5	26	25.5	25	24.5	24	23.5	22.9
32A	B, C, D	41.1	40.5	40	39.4	38.9	38.3	37.7	37.1	36.5	35.9	35.3	34.7	34	33.4	32.7	32	31.3	30.6	29.9	29.1
40A	B, C, D	52	51.3	50.6	49.8	49.1	48.3	47.6	46.8	46	45.2	44.4	43.5	42.7	41.8	40.9	40	39.1	38.1	37.1	36.1

iC60, Reflex iC60 derating table (IEC 60947-2)

iC60		Ambient temperature (°C)																					
Rating		-35	-30	-25	-20	-15	-10	-5	0	+5	+10	+15	+20	+25	+30	+35	+40	+45	+50	+55	+60	+65	+70
0.5A		0.66	0.65	0.64	0.63	0.63	0.62	0.61	0.6	0.59	0.58	0.57	0.56	0.55	0.54	0.53	0.52	0.51	0.5	0.49	0.48	0.47	0.45
1A		1.32	1.3	1.28	1.27	1.25	1.23	1.21	1.2	1.18	1.16	1.14	1.12	1.1	1.08	1.06	1.04	1.02	1	0.98	0.96	0.93	0.91
2A		2.79	2.75	2.71	2.67	2.63	2.58	2.54	2.5	2.45	2.4	2.36	2.31	2.26	2.21	2.16	2.11	2.05	2	1.94	1.89	1.83	1.76
3A		4.21	4.15	4.08	4.02	3.96	3.89	3.83	3.76	3.69	3.62	3.55	3.48	3.4	3.32	3.25	3.17	3.08	3	2.91	2.82	2.73	2.64
4A		5.62	5.54	5.46	5.37	5.29	5.2	5.11	5.02	4.93	4.83	4.74	4.64	4.54	4.44	4.33	4.22	4.11	4	3.88	3.76	3.64	3.51
6A		8.55	8.42	8.29	8.16	8.03	7.89	7.75	7.61	7.46	7.31	7.16	7.01	6.85	6.69	6.52	6.35	6.18	6	5.81	5.62	5.43	5.22
10A		13.3	13.2	13	12.8	12.6	12.5	12.3	12.1	11.9	11.7	11.5	11.3	11.1	10.9	10.7	10.5	10.2	10	9.8	9.5	9.3	9
13A		17.1	16.9	16.7	16.4	16.2	16	15.8	15.5	15.3	15.1	14.8	14.6	14.3	14.1	13.8	13.6	13.3	13	12.7	12.4	12.1	11.8
16A		21.1	20.8	20.6	20.3	20	19.7	19.5	19.2	18.9	18.6	18.3	18	17.7	17.3	17	16.7	16.3	16	15.7	15.3	14.9	14.5
20A		26	25.7	25.4	25	24.7	24.4	24.1	23.7	23.4	23	22.7	22.3	21.9	21.6	21.2	20.8	20.4	20	19.6	19.2	18.7	18.3
25A		31.9	31.6	31.2	30.8	30.4	30.1	29.7	29.3	28.9	28.5	28.1	27.6	27.2	26.8	26.4	25.9	25.5	25	24.5	24.1	23.6	23.1
32A		42	41.5	41	40.5	39.9	39.4	38.8	38.2	37.7	37.1	36.5	35.9	35.3	34.6	34	33.3	32.7	32	31.3	30.6	29.9	29.1
40A		52.6	51.9	51.3	50.6	49.9	49.2	48.5	47.8	47.1	46.4	45.6	44.9	44.1	43.3	42.5	41.7	40.9	40	39.1	38.2	37.3	36.4
50A		67.1	66.3	65.4	64.5	63.5	62.6	61.6	60.7	59.7	58.7	57.7	56.7	55.6	54.5	53.4	52.3	51.2	50	48.8	47.6	46.3	45
63A		86.3	85.1	83.9	82.7	81.4	80.1	78.9	77.6	76.2	74.9	73.5	72.1	70.7	69.2	67.7	66.2	64.6	63	61.4	59.7	57.9	56.1

Reflex iC60

C60 derating table (IEC 60947-2)

C60		Ambient temperature (°C)																				
Rating		-30	-25	-20	-15	-10	-5	0	+5	+10	+15	+20	+25	+30	+35	+40	+45	+50	+55	+60	+65	+70
0.5A		0.68	0.67	0.66	0.65	0.64	0.63	0.62	0.61	0.6	0.59	0.58	0.56	0.55	0.54	0.53	0.51	0.5	0.49	0.47	0.46	0.44
0.75A		0.93	0.92	0.91	0.9	0.89	0.88	0.87	0.86	0.85	0.83	0.82	0.81	0.8	0.79	0.78	0.76	0.75	0.74	0.72	0.7	0.68
1A		1.31	1.3	1.28	1.27	1.25	1.23	1.21	1.19	1.17	1.15	1.13	1.11	1.09	1.07	1.05	1.02	1	0.98	0.95	0.93	0.91
2A		2.55	2.59	2.56	2.52	2.49	2.45	2.41	2.37	2.34	2.3	2.26	2.22	2.17	2.13	2.09	2.04	2	1.95	1.91	1.88	1.84
3A		3.81	4.04	3.98	3.92	3.85	3.79	3.73	3.66	3.59	3.52	3.45	3.38	3.31	3.23	3.16	3.08	3	2.92	2.83	2.82	2.76
4A		4.9	4.86	4.81	4.76	4.7	4.65	4.59	4.54	4.48	4.42	4.37	4.31	4.25	4.19	4.13	4.06	4	3.94	3.87	3.81	3.74
6A		7.93	7.82	7.71	7.6	7.49	7.38	7.27	7.15	7.03	6.91	6.79	6.66	6.54	6.41	6.27	6.14	6	5.86	5.71	5.56	5.42
8A		10.37	10.23	10.09	9.96	9.82	9.68	9.54	9.4	9.25	9.11	8.96	8.81	8.65	8.49	8.33	8.17	8	7.83	7.65	7.47	7.31
10A		13.3	13.2	13	12.8	12.6	12.4	12.2	12	11.8	11.6	11.4	11.2	10.9	10.7	10.5	10.2	10	9.8	9.5	9.2	9
13A		17	16.9	16.6	16.4	16.2	15.9	15.7	15.4	15.2	14.9	14.7	14.4	14.1	13.9	13.6	13.3	13	12.7	12.4	12.1	11.8
16A		20	19.8	19.5	19.3	19.1	18.8	18.6	18.4	18.1	17.9	17.6	17.3	17.1	16.8	16.6	16.3	16	15.7	15.4	15.1	14.8
20A		26.9	26.6	26.2	25.8	25.4	25	24.6	24.2	23.7	23.3	22.9	22.4	22	21.5	21	20.5	20	19.5	18.9	18.4	17.9
25A		32.9	32.5	32.1	31.6	31.1	30.7	30.2	29.7	29.2	28.7	28.2	27.7	27.2	26.7	26.1	25.6	25	24.4	23.8	23.2	22.6
32A		41.5	41.1	40.5	40	39.4	38.9	38.3	37.7	37.1	36.5	35.9	35.3	34.7	34	33.4	32.7	32	31.3	30.6	29.9	29.1
40A		53.7	52.9	52.2	51.4	50.6	49.8	49	48.2	47.3	46.5	45.6	44.7	43.8	42.9	42	41	40	39	37.9	36.9	35.8
45A		60.8	60.1	59.2	58.3	57.4	56.5	55.5	54.6	53.6	52.6	51.6	50.5	49.5	48.4	47.3	46.2	45	43.8	42.6	41.4	40.1
50A		65	64.3	63.5	62.6	61.7	60.8	59.9	59	58.1	57.1	56.2	55.2	54.2	53.2	52.1	51.1	50	48.9	47.8	46.7	45.5
63A		85.5	84.6	83.3	82	80.7	79.4	78	76.7	75.3	73.9	72.4	70.9	69.4	67.9	66.3	64.7	63	61.3	59.5	57.8	56

Tertiary/Industry (IEC 60947-2) (cont.)

C60H-DC derating table (IEC 60947-2)

C60H-DC Rating	Ambient temperature (°C)																				
	-30	-25	-20	-15	-10	-5	0	+5	+10	+15	+20	+25	+30	+35	+40	+45	+50	+55	+60	+65	+70
0.5 A	0.63	0.62	0.61	0.6	0.59	0.58	0.56	0.55	0.54	0.53	0.51	0.5	0.49	0.47	0.46	0.44	0.43	0.41	0.39	0.38	0.36
1 A	1.18	1.17	1.15	1.14	1.12	1.1	1.09	1.07	1.05	1.04	1.02	1	0.98	0.96	0.94	0.92	0.9	0.88	0.86	0.84	0.82
2 A	2.54	2.5	2.45	2.41	2.36	2.31	2.26	2.21	2.16	2.11	2.06	2	1.94	1.88	1.82	1.76	1.7	1.63	1.56	1.48	1.41
3 A	3.78	3.71	3.65	3.58	3.51	3.45	3.38	3.3	3.23	3.16	3.08	3	2.92	2.84	2.75	2.66	2.57	2.48	2.38	2.27	2.17
4 A	5.08	4.99	4.9	4.81	4.71	4.62	4.52	4.42	4.32	4.22	4.11	4	3.89	3.77	3.65	3.53	3.4	3.27	3.13	2.98	2.83
5 A	6	5.92	5.83	5.74	5.66	5.57	5.48	5.39	5.29	5.2	5.1	5	4.9	4.8	4.69	4.58	4.47	4.36	4.24	4.12	4
6 A	7.26	7.15	7.04	6.94	6.83	6.71	6.6	6.48	6.37	6.25	6.12	6	5.87	5.74	5.61	5.47	5.33	5.19	5.04	4.89	4.73
10 A	12.6	12.4	12.2	11.9	11.7	11.5	11.3	11	10.8	10.5	10.3	10	9.7	9.5	9.2	8.9	8.6	8.3	7.9	7.6	7.2
13 A	15.5	15.3	15.1	14.9	14.6	14.4	14.2	14	13.7	13.5	13.3	13	12.8	12.5	12.2	12	11.7	11.4	11.1	10.8	10.5
15 A	18.6	18.3	18	17.7	17.4	17.1	16.7	16.4	16.1	15.7	15.4	15	14.6	14.3	13.9	13.5	13	12.6	12.2	11.7	11.2
16 A	19.4	19.1	18.9	18.6	18.3	18	17.6	17.3	17	16.7	16.3	16	15.7	15.3	14.9	14.6	14.2	13.8	13.4	13	12.5
20 A	24.1	23.7	23.4	23	22.7	22.3	21.9	21.6	21.2	20.8	20.4	20	19.6	19.2	18.7	18.3	17.9	17.4	16.9	16.4	15.9
25 A	30.4	29.9	29.5	29	28.5	28.1	27.6	27.1	26.6	26.1	25.5	25	24.5	23.9	23.3	22.7	22.1	21.5	20.9	20.2	19.6
30 A	37.4	36.7	36.1	35.5	34.9	34.2	33.5	32.9	32.2	31.5	30.7	30	29.2	28.5	27.7	26.8	26	25.1	24.2	23.2	22.3
32 A	38.5	37.9	37.4	36.8	36.2	35.7	35.1	34.5	33.9	33.3	32.6	32	31.4	30.7	30	29.3	28.6	27.9	27.1	26.3	25.5
40 A	48.9	48.2	47.4	46.7	45.9	45.1	44.3	43.5	42.6	41.8	40.9	40	39.1	38.2	37.2	36.2	35.2	34.2	33.1	32	30.8
50 A	59.9	59.1	58.3	57.4	56.5	55.6	54.7	53.8	52.9	52	51	50	49	48	46.9	45.9	44.8	43.6	42.5	41.3	40.1
63 A	78.2	76.9	75.6	74.3	73	71.7	70.3	68.9	67.5	66	64.5	63	61.4	59.8	58.2	56.5	54.7	52.9	51.1	49.1	47.1

C60PV-DC derating table (IEC 60947-2)

C60PV-DC Rating	Ambient temperature (°C)																				
	-30	-25	-20	-15	-10	-5	0	+5	+10	+15	+20	+25	+30	+35	+40	+45	+50	+55	+60	+65	+70
1 A	1.18	1.17	1.15	1.14	1.12	1.1	1.09	1.07	1.05	1.04	1.02	1	0.98	0.96	0.94	0.92	0.9	0.88	0.86	0.84	0.82
2 A	2.54	2.5	2.45	2.41	2.36	2.31	2.26	2.21	2.16	2.11	2.06	2	1.94	1.88	1.82	1.76	1.7	1.63	1.56	1.48	1.41
3 A	3.78	3.71	3.65	3.58	3.51	3.45	3.38	3.3	3.23	3.16	3.08	3	2.92	2.84	2.75	2.66	2.57	2.48	2.38	2.27	2.17
5 A	6	5.92	5.83	5.74	5.66	5.57	5.48	5.39	5.29	5.2	5.1	5	4.9	4.8	4.69	4.58	4.47	4.36	4.24	4.12	4
8 A	9.64	9.5	9.36	9.22	9.08	8.93	8.78	8.63	8.48	8.32	8.16	8	7.83	7.67	7.49	7.31	7.13	6.95	6.76	6.56	6.36
10 A	12.6	12.4	12.2	11.9	11.7	11.5	11.2	11	10.8	10.5	10.3	10	9.7	9.4	9.2	8.9	8.6	8.2	7.9	7.6	7.2
13 A	15.5	15.3	15.1	14.8	14.6	14.4	14.2	14	13.7	13.5	13.2	13	12.7	12.5	12.2	12	11.7	11.4	11.1	10.8	10.5
15 A	18.6	18.3	18	17.7	17.4	17.1	16.7	16.4	16.1	15.7	15.4	15	14.6	14.3	13.9	13.5	13	12.6	12.2	11.7	11.2
16 A	19.4	19.1	18.9	18.6	18.3	18	17.6	17.3	17	16.7	16.3	16	15.7	15.3	14.9	14.6	14.2	13.8	13.4	13	12.5
20 A	24.1	23.7	23.4	23	22.7	22.3	21.9	21.6	21.2	20.8	20.4	20	19.6	19.2	18.7	18.3	17.9	17.4	16.9	16.4	15.9
25 A	30.4	29.9	29.5	29	28.5	28.1	27.6	27.1	26.6	26.1	25.5	25	24.5	23.9	23.3	22.7	22.1	21.5	20.9	20.2	19.6

C120 derating table (IEC 60947-2)

C120 Rating	Ambient temperature (°C)																				
	-30	-25	-20	-15	-10	-5	0	+5	+10	+15	+20	+25	+30	+35	+40	+45	+50	+55	+60	+65	+70
10 A	14.5	14.3	14	13.8	13.5	13.3	13	12.7	12.5	12.2	11.9	11.6	11.3	11	10.7	10.3	10	9.7	9.3	8.9	8.5
16 A	21.2	21	20.7	20.4	20.1	19.8	19.4	19.1	18.8	18.5	18.2	17.8	17.5	17.1	16.8	16.4	16	15.6	15.2	14.8	14.4
20 A	27	26.6	26.3	25.9	25.5	25	24.6	24.2	23.8	23.3	22.9	22.4	22	21.5	21	20.5	20	19.5	18.9	18.4	17.8
25 A	33.7	33.3	32.8	32.3	31.8	31.3	30.8	30.2	29.7	29.1	28.6	28	27.5	26.9	26.3	25.6	25	24.4	23.7	23	22.3
32 A	42.7	42.1	41.5	40.9	40.3	39.7	39	38.4	37.7	37.1	36.4	35.7	35	34.3	33.5	32.8	32	31.2	30.4	29.6	28.7
40 A	54.8	54	53.2	52.4	51.5	50.7	49.8	48.9	48	47.1	46.1	45.2	44.2	43.2	42.1	41.1	40	38.9	37.7	36.6	35.3
50 A	69.1	68.1	67	65.9	64.8	63.7	62.6	61.5	60.3	59.1	57.9	56.7	55.4	54.1	52.8	51.4	50	48.6	47.1	45.5	43.9
63 A	87.1	85.8	84.5	83.1	81.8	80.4	78.9	77.5	76	74.5	73	71.4	69.8	68.2	66.5	64.8	63	61.2	59.3	57.4	55.4
80 A	103.7	102.4	101	99.7	98.3	96.9	95.5	94.1	92.6	91.1	89.6	88.1	86.5	84.9	83.3	81.7	80	78.3	76.5	74.7	72.9
100 A	137.6	135.5	133.5	131.4	129.2	127.1	124.8	122.6	120.3	118	115.6	113.1	110.6	108.1	105.5	102.8	100	97.2	94.2	91.2	88.1
125 A	174.6	171.9	169.2	166.4	163.6	160.7	157.8	154.9	151.8	148.7	145.6	142.4	139.1	135.7	132.2	128.7	125	121.2	117.3	113.3	109.1

Tertiary/Industry (IEC 60947-2) (cont.)

NG125 derating table (IEC 60947-2)

NG125	Ambient temperature (°C)																				
Rating	-30	-25	-20	-15	-10	-5	0	+5	+10	+15	+20	+25	+30	+35	+40	+45	+50	+55	+60	+65	+70
10 A	13.7	13.5	13.2	13	12.8	12.5	12.3	12	11.7	11.5	11.2	10.9	10.6	10.3	10	9.7	9.4	9	8.7	8.3	7.9
16 A	20.3	20.1	19.8	19.5	19.2	18.9	18.6	18.3	18	17.7	17.4	17	16.7	16.4	16	15.7	15.3	14.9	14.5	14.1	13.7
20 A	26	25.6	25.3	24.9	24.5	24	23.6	23.2	22.8	22.3	21.9	21.4	21	20.5	20	19.5	19	18.5	17.9	17.4	16.8
25 A	33.8	33.2	32.7	32.1	31.5	30.9	30.3	29.7	29.1	28.4	27.8	27.1	26.4	25.7	25	24.3	23.5	22.7	21.9	21	20.1
32 A	41.2	40.6	40	39.4	38.8	38.2	37.5	36.9	36.2	35.6	34.9	34.2	33.5	32.7	32	31.2	30.5	29.7	28.8	28	27.1
40 A	53.5	52.7	51.8	51	50.1	49.1	48.2	47.3	46.3	45.3	44.3	43.3	42.2	41.1	40	38.9	37.7	36.5	35.2	33.9	32.5
50 A	66.3	65.2	64.2	63.1	62.1	61	59.8	58.7	57.5	56.4	55.1	53.9	52.6	51.3	50	48.6	47.2	45.8	44.3	42.7	41.1
63 A	83.4	82.1	80.8	79.5	78.1	76.8	75.4	73.9	72.5	71	69.5	67.9	66.3	64.7	63	61.3	59.5	57.7	55.8	53.9	51.8
80 A	100.4	99.1	97.8	96.4	95	93.6	92.2	90.8	89.3	87.8	86.3	84.8	83.2	81.6	80	78.3	76.6	74.9	73.1	71.3	69.4
100 A	133.4	131.3	129.1	127	124.8	122.5	120.2	117.9	115.5	113.1	110.6	108	105.4	102.7	100	97.2	94.3	91.3	88.2	85	81.6
125 A	165.2	162.7	160.1	157.5	154.8	152.1	149.3	146.5	143.6	140.7	137.7	134.6	131.5	128.3	125	121.6	118.1	114.6	110.9	107	103.1

Tertiaire/Industrie (IEC 60947-3)

SW60-DC derating table (IEC 60947-3)

SW60PV-DC	Ambient temperature (°C)											
Rating	+5	+10	+15	+20	+25	+30	+35	+40	+45	+50	+60	+70
50 A	63	61	60	58	56	54	52	50	48	46	41	35

C60NA-DC derating table (IEC 60947-3)

C60NA-DC	Ambient temperature (°C)											
Rating	+5	+10	+15	+20	+25	+30	+35	+40	+45	+50	+60	+70
50 A	63	61	60	58	56	54	52	50	48	46	41	35

C120NA-DC derating table (IEC 60947-3)

C120NA-DC	Ambient temperature (°C)											
Rating	+5	+10	+15	+20	+25	+30	+35	+40	+45	+50	+60	+70
100 A	113	111	110	108	106	104	102	100	98	96	91	85

Tertiary/Industry (IEC 61009-1)

iC60H2 RCBO derating table (IEC 61009-1)

iC60H2 RCBO	Ambient temperature (°C)															
Rating	-15	-10	-5	0	+5	+10	+15	+20	+25	+30	+35	+40	+45	+50	+55	+60
10 A	12.3	12.2	12	11.8	11.7	11.5	11.3	11.1	11	10.8	10.6	10.4	10.2	10	9.8	9.6
16 A	19.6	19.4	19.1	18.8	18.6	18.3	18	17.8	17.5	17.2	16.9	16.6	16.3	16	15.7	15.4
20 A	24.9	24.6	24.2	23.9	23.5	23.2	22.8	22.4	22	21.6	21.2	20.8	20.4	20	19.6	19.1
25 A	30.2	29.8	29.5	29.1	28.7	28.3	27.9	27.5	27.1	26.7	26.3	25.9	25.4	25	24.6	24.1
32 A	37.9	37.5	37.1	36.7	36.2	35.8	35.3	34.9	34.4	33.9	33.5	33	32.5	32	31.5	31

iC60N/H RCBO derating table (IEC 61009-1)

iC60N/H RCBO	Ambient temperature (°C)															
Rating	-15	-10	-5	0	+5	+10	+15	+20	+25	+30	+35	+40	+45	+50	+55	+60
6 A	8.3	8.15	7.99	7.83	7.67	7.50	7.33	7.16	6.98	6.79	6.6	6.41	6.21	6	5.78	5.56
10 A	12.9	12.7	12.5	12.3	12.1	11.9	11.6	11.4	11.2	11	10.7	10.5	10.3	10	9.7	9.5
16 A	20.9	20.6	20.3	19.9	19.6	19.2	18.8	18.4	18.1	17.7	17.3	16.9	16.4	16	15.6	15.1
20 A	26.3	25.9	25.4	25	24.5	24.1	23.6	23.1	22.6	22.1	21.6	21.1	20.6	20	19.4	18.8
25 A	31.5	31	30.6	30.1	29.6	29.2	28.7	28.2	27.7	27.2	26.6	26.1	25.6	25	24.4	23.8
32 A	39.2	38.7	38.2	37.7	37.2	36.6	36.1	35.5	35	34.4	33.8	33.2	32.6	32	31.4	30.7
40 A	50.2	49.5	48.8	48	47.3	46.5	45.8	45	44.2	43.4	42.6	41.7	40.9	40	39.1	38.2
45 A	55.5	54.7	54	53.2	52.5	51.7	50.9	50.1	49.3	48.5	47.6	46.8	45.9	45	41.9	41

Switches

■ In all cases, the switches are correctly protected against overloads by a circuit breaker with a lower or equal rating, operating at the same ambient temperature.

iCT contactors

In the case of contactor mounting in an enclosure for which the interior temperature is in a range between 50°C and 60°C, it is necessary to use a spacer, cat. no. A9A27062, between each contactor.

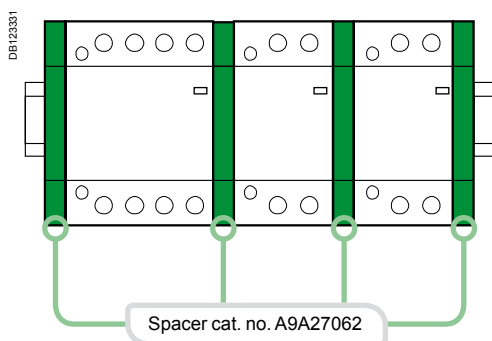

Lineryg DS, Lineryg DX, Lineryg FH, Lineryg FM

In all cases, quick distribution blocks (Lineryg DS: cat. no. 04040, 04041), screw distribution blocks, horizontal comb busbars and quick device feeders (Lineryg FM: cat. no. 04000) are correctly protected against overloads by a circuit breaker with a lower or equal rating, operating at the same ambient temperature.

Acti9 products

The following table indicates the average dissipated power per pole in W for a current equal to the rating of the device and at the operating voltage.

Rating (A)	0.5	1	1.6	2	2.5	3	4	6	6.3	10	12.5	13	16	20	25	32	40	50	63	80	100	125
Circuit breakers																						
iC60N/H/L	2.3	2.3		1.9		2.2	2.4	1.3		2		2	2.1	2.2	2.7	2.8	3.6	4	5.6			
iC60L-MA			0.7		0.2		0.6		0.9	1.1	1.5		1.6		0.8		2					
iK60		2.3		1.9		2.2	2.4	2.7		1.8			2.5	3	3.1	3.5	3.6	4	5.6			
Integrated control circuit breakers																						
Reflex Power circuit										2			2.1		2.7		3.6		5.6			
iC60N/H Control circuit	See module CA904012																					
RCCB																						
iID 2P													0.8		0.9		2.6		2.6	3	5	
iID 4P															0.7		1.9		1.5	2.6	4.3	
iID K															2.7		3.6		5.6			
Add-on residual current devices																						
Vigi iC60 10 mA																3						
Vigi iC60 30 mA																1.4		1.1		2.3		
Vigi iC60 100 mA																1.1				2.3		
Vigi iC60 300 mA																1.3		0.9		2.3		
Vigi iC60 500 mA																1.1		0.9		2.3		
Vigi iC60 1000 mA																				2.3		
Contactors																						
iCT/iCT+ Power circuit													0.6	0.9	1.4		1.5		3.4		4	
iCT/iCT+ Control circuit	See module CA904007																					
Impulse relays																						
iTL/iTL+ Power circuit													0.6			1.5						
iTL/iTL+ Control circuit	See module CA904008																					
Push-buttons																						
iPB														0.6								
Selector switches																						
iSSW															0.8							
iCMA/iCMB/iCMC/ iCMDV/iCMV									0.4													
Load-shedders																						
DSE1, CDS, CDSc																1.8				3		
Relays																						
iRTA, iRTB, iRTC, iRTH, iRTL, iRTMF													2.5									
Switch-disconnectors																						
iSW																	0.6		1.8		4.7	6.4
iSW-NA 2P																	0.7		1.8		3	5
iSW-NA 4P																	0.6		1.5		2.5	4.1
Remote controls																						
RCA, ARA	See module CA904010 and CA904011																					
Indication auxiliaries																						
iOF, iSD, iOF/SD+OF	See module CA908028																					
Tripping auxiliaries																						
iMN, iMNs, iMNx, iMX+OF, iMX, iMSU	See module CA908029																					
Indicator lights																						
iIL	0.3																					
Transformers																						
iTR	4																					

Note: When the enclosure's thermal balance, consider the 4P devices load is only on 3 phases.

RCBO dissipated power per pole is the sum of circuit breaker dissipated power per pole + add-on residual current device dissipated power per pole.

Example: iC60N (25 A) + Vigi iC60 (30 mA) = 2.7 + 1.4 = 4.1 W.

Impedance calculation:

$$Z = P / I^2$$

Z: impedance in Ohms

P: dissipated power in Watts (table values)

I: rating in Amperes

Voltage drop calculation:

$$U = P / I$$

U: voltage drop in Volts

P: dissipated power in Watts (table values)

I: rating in Amperes

Multi 9 products

The following table indicates the average dissipated power per pole in W for a current equal to the rating of the device and at the operating voltage.

Rating (A)	0.5	1	1.6	2	2.5	3	4	6	6.3	10	12.5	13	16	20	25	32	40	50	63	80	100	125
Circuit breakers																						
DPN		2.5		1.9		2.1	2.6	2.7		2.7		3.3	3.2	4.7	4.7	4.6	5.8					
C60/C60H-DC	2.2	2.3		2.6		2.2	2.4	2.7		1.8		2.5	2.5	3	3.1	3.5	4.3	4.8	6.1			
C120										1.3			2.1	2.3	2.5	3.2	3.1	3.2	3	3.2	2	4.1
NG125										1.7			2.4	2.7	2.7	3.8	3.8	4.2	4	5.6	5.2	8
C60L-MA			2.4		2.5		2.4		3	2	2.5		2.6		3		4.6					
NG125L-MA							0.15		0.15	0.2	0.4		0.3		0.6		1.4		2	2.7		
RCCB																						
ID Type A/AC															1.4		3.6		4.4	7.2	18	28
ID Type B															1.2		2.9		7.2	12	18	28
Add-on residual current devices																						
Vigi DPN															1.4		2.1					
Vigi C60															2.8		1.6		3			
Vigi C120																						3.6
Vigi NG125																						4
Residual current device reclosers																						
RED, REDs, REDtest															1.5		2.7		3.1			
Contactors																						
CT/CT+ Power circuit														0.9	1	1.4		1.4		3.4		4
Control circuit	See module 92020																					
Impulse relays																						
TL/TL+ Power circuit													0.9			1.4						
Control circuit	See module 92011																					
Push-buttons																						
BP														0.6								
Selector switches																						
CM														0.8								
CMA/CMB/CMC/CMD/CMV									0.4													
Load-shedders																						
DSE1, CDS, CDS _c																1.8				3		
Relays																						
RTA, RTB, RTC, RTH, RTL, RTMF													2.5									
Switch-disconnectors																						
I, iSW														0.8		1.3	1.1		1.8		3.4	4.2
I-NA																	3.2		3.2			
NG125NA																			2	2.7	4	7
Indication auxiliaries																						
OF, SD, OF+SD/OF	See module 92605																					
Tripping auxiliaries																						
MN, MNs, MNx, MX+OF, MX, MSU	See module 92605																					
Indicator lights																						
V	0.3																					
Transformers																						
TR	4																					

Note: When the enclosure's thermal balance, consider the 4P devices load is only on 3 phases.

RCBO dissipated power per pole is the sum of circuit breaker dissipated power per pole + add-on residual current device dissipated power per pole.

Example: C60N (25 A) + Vigi C60 (25 A) = 3.1 + 1.8 = 4.9 W.

Impedance calculation:

$$Z = P / I^2$$

Z: impedance in Ohms

P: dissipated power in Watts (table values)

I: rating in Amperes

Voltage drop calculation:

$$U = P / I$$

U: voltage drop in Volts

P: dissipated power in Watts (table values)

I: rating in Amperes

Acti 9 devices have successfully passed the environmental resistance tests specified in the building standards (IEC / EN 60898 and 60947-2 for circuit breakers, IEC / EN 61008 for residual current circuit breakers, etc.). Most of these tests were performed under the control of official bodies in different countries: the devices therefore carry the quality mark issued by each of these bodies.

Schneider Electric has also subjected these devices to additional tests with higher requirements, to give users reliability and sturdiness that are unparalleled on the market.

These tests checked that the constraints described below did not have any significant effect on the main functions of the devices:

- Tripping (for protection devices).
- Isolation and dielectric withstand.
- Degree of protection (IP) of the casing.
- Grip on the mounting bracket (rail).
- Manual opening / closing.

Additional checks were performed for certain tests, mentioned in the tables below.

Constraints Type	Atmospheric				
	Humidity	Salt mist	Corrosive atmospheres		Dust
Standard defining the test protocol	IEC 60068-2-78	IEC 60068.2.52	IEC 60721-3-3		
Constraint level applied	Temperature 40°C, relative humidity 93%.	Severity 2 (maritime environment).	Classification 3C2: urban regions with industrial activities, heavy traffic.	Covered swimming pools atmospheres	Plaster deposits + bumps.
Additional checks after constraint		Conductivity, overheating. No corrosion.			Conductivity and overheating.
Circuit breakers					
iK60N	■	■	-	-	■
iC60a/N/H/L	■	■	■	■	■
Residual current circuit breakers					
iID K	■	■	-	-	■
iID	■	■	■	SI only	■
Residual current devices					
iC60a/N/H/L + Vigi iC60	■	■	■	SI only	■
Protection device auxiliaries					
iOF	■	■	■	-	■
iSD	■	■	■	-	■
iOF/SD+OF	■	■	■	-	■
iMN, iMNs	■	■	■	-	■
iMX, iMX+OF	■	■	■	-	■
iMNx	■	■	■	-	■
iMSU	■	■	■	-	
Surge arresters					
iPF	-	-	-	-	-
iPRD	-	■		-	-
Mounting accessories					
Rotary handle	■	■	-	-	■
Plug-in base	■	■	-	-	■
Padlocking device	■	■	■	-	■
Safety accessories					
Screw shield	■	■	■	-	■
Interpole barrier	■	■	■	-	■
Spacer	■	■	■		
Splitter blocks					
Linery FM	■	■	■	-	■
Linery DX	■	■	■	-	■
Comb busbars for iC60	■	■	■	-	■

Mechanical						Storage
Vibrations, impacts and bumps	Vibrations	Bumps (repeated impacts)	Impacts	Impacts on the device	Falls	Damp heat
IEC 60721-3-3	IEC 60068.2-6	IEC 60068-2-27	IEC 60068-2-27	IEC 62262	IEC 60068-2-32	IEC 60068-2-30
Class 3M4: industrial environment with considerable vibrations and impacts (e.g. proximity of machines, circulation of vehicles).	Amplitude: 3.5 mm. Acceleration: 1 g. Directions: 3 axes. Frequency: 5 to 300 Hz.	Acceleration: 15 g. Pulse duration: 6 ms.	Force: 15 g. Pulse duration: 11 ms.	IK 07: 5 impacts of 0.7 J.	Height: 0.8 m, concrete floor.	Db: - Temperature: 55°C. - Relative humidity: 95%.
No power supply fault, no tripping.				Casing, degree of protection (IP).	Casing, degree of protection (IP).	
-	■	■	-	■	■	
■	■	■	■	■	■	
-	■	■	-	■	■	
■	■	■	■	■	■	
■	■	■	■	■	■	
■	■	■	■	■	■	■
■	■	■	■	■	■	■
■	■	■	■	■	■	■
■	■	■	■	■	■	■
■	■	■	■	■	■	■
-	-	-	-	-	■ Height: 0.6 m.	
-	■ Frequency: 8.5 to 100 Hz.	-	-	-		
■	■	■	■	■	■	
■	■	■	■	■	■	
■	■	■	■	■	■	
■	■	■	■	■	■	
■	■	■	■	■	■	
■	■	■	■	■	■	■
■	■	■	■	■	■	■
■	■	■	■	■	■	■

Connection iC60, iID double terminals

Connection between double terminal protection devices

Cable-to-cable

DB404816



Product	Rating	Tightening torque	Back		Front	
			Copper cables		Copper cables	
			Rigid	Flexible or with ferrule	Rigid	Flexible or with ferrule
iC60	0.5 to 25 A 32 to 63 A	2 N.m 3.5 N.m	1 to 16 mm ²	1 to 10 mm ²	1 to 16 mm ²	1 to 16 mm ²
iID	All					

■ Connection by comb busbar or by cable (according to EN 50027).



iC60N



iK60N



iID



iID K



iSW



iSW-NA

Mounting (mm)

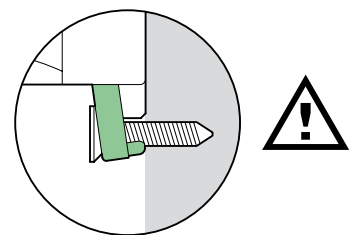
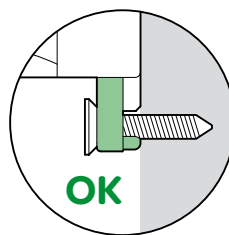
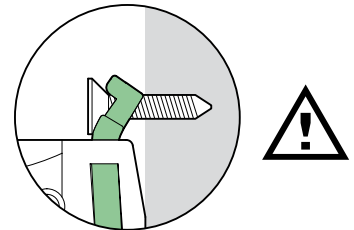
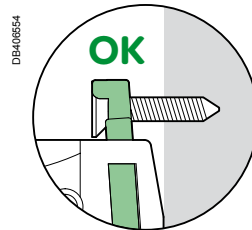
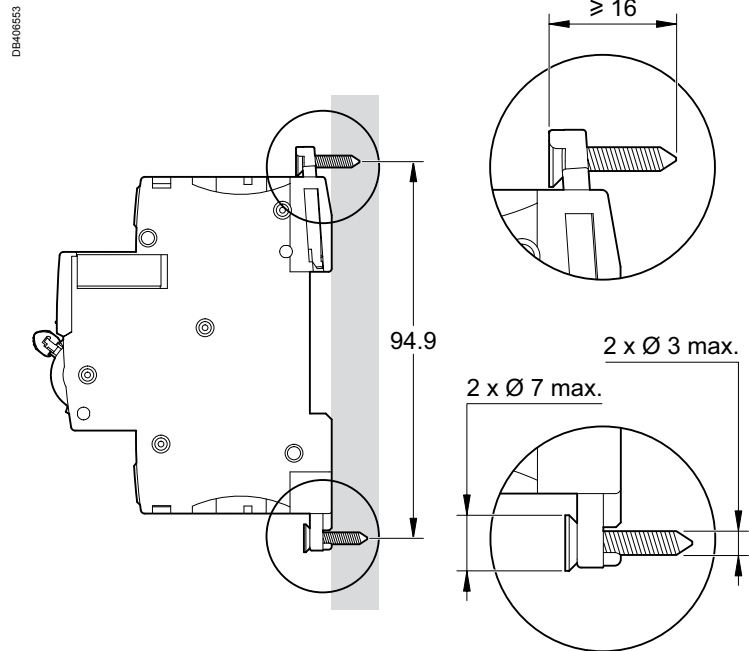

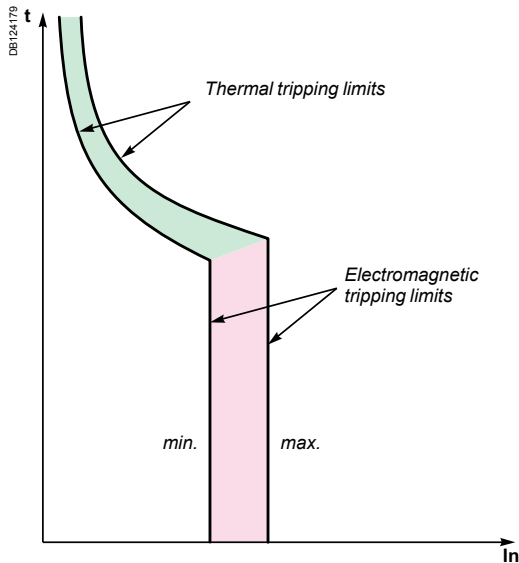

The following curves show the total fault current breaking time, depending on its amperage. For example: based on the curve on page 573, an iC60 circuit breaker of curve C, 20 A rating, will interrupt a current of 100 A (5 times the rated current I_n) in:

- 0.45 seconds at least
- 6 seconds at most.

The circuit breakers' tripping curves consist of two parts:

- tripping of overload protection (thermal tripping device): the higher the current, the shorter the tripping time
- tripping of short-circuit protection (magnetic tripping device): if the current exceeds the threshold of this protection device, the breaking time is less than 10 milliseconds. For short-circuit currents exceeding 20 times the rated current, the time-current curves do not give a sufficiently precise representation. The breaking of high short-circuit currents is characterized by the current limiting curves, in peak current and in energy. The total breaking time can be estimated at 5 times the value of the ratio $(I^2t)/(I)^2$.

Verification of the discrimination between two circuit breakers

By superimposing the curve of a circuit breaker on that of the circuit breaker installed upstream, one can check whether this combination will be discriminating in cases of overload (discrimination for all current values, up to the magnetic threshold of the upstream circuit breaker). This verification is useful when one of the two circuit breakers has adjustable thresholds; for fixed-threshold devices, this information is provided directly by the discrimination tables.

To check discrimination on short circuit, the energy characteristics of the two devices must be compared.

Alternative current 50/60 Hz

iC60a/N/H/L

According to IEC/EN 60898-1 (reference temperature 30°C)

Curves B, C, D rating up to 4 A

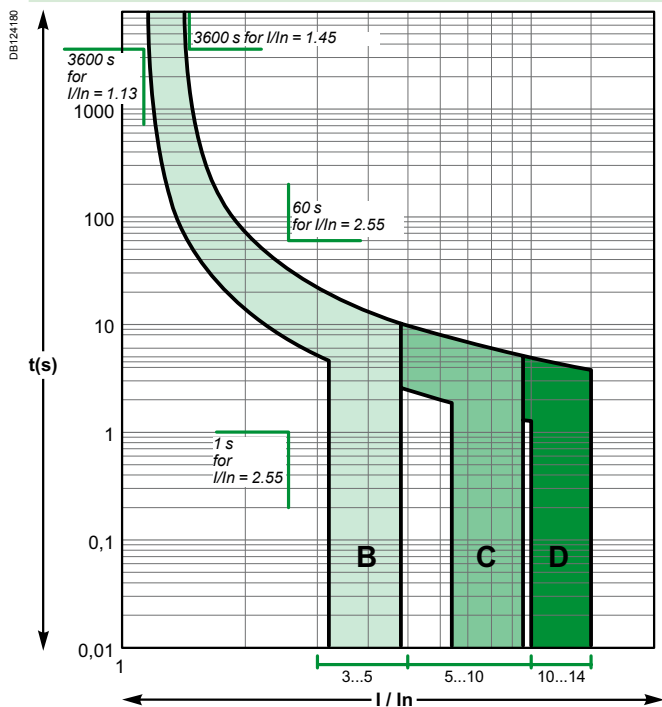

Curves B, C, D rating 6 A to 63 A

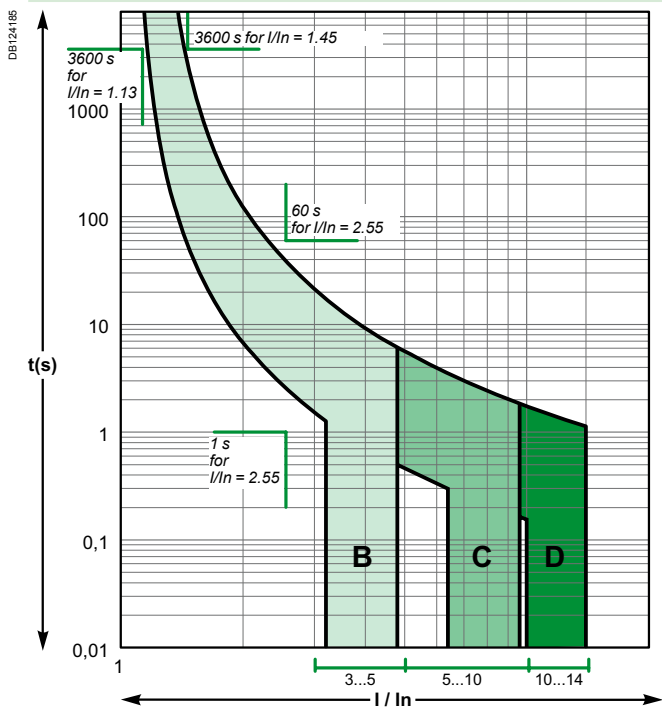

C120N/H

According to IEC/EN 60898-1 (reference temperature 30°C)

Curves B, C, D

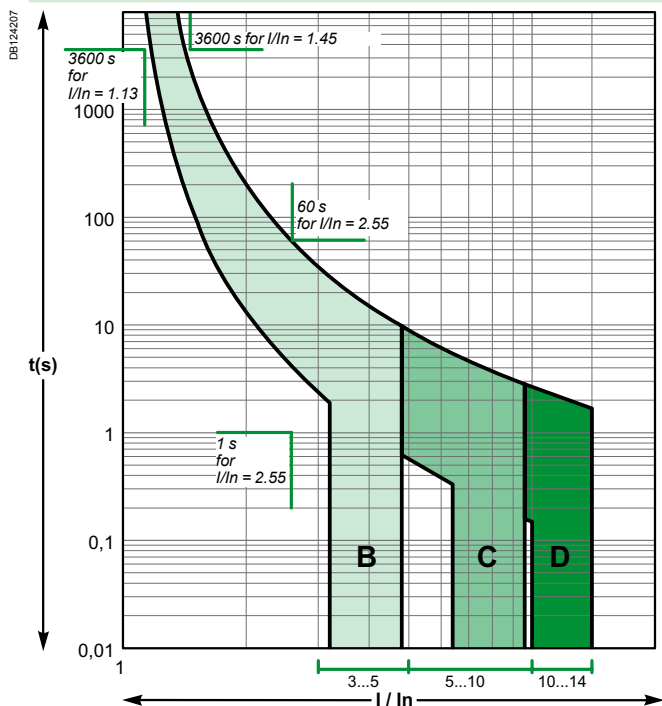

DPN, DPN N, DPN H (circuit-breaker and residual current device)

According to IEC/EN 60898-1 (reference temperature 30°C)

Curves B, C, D

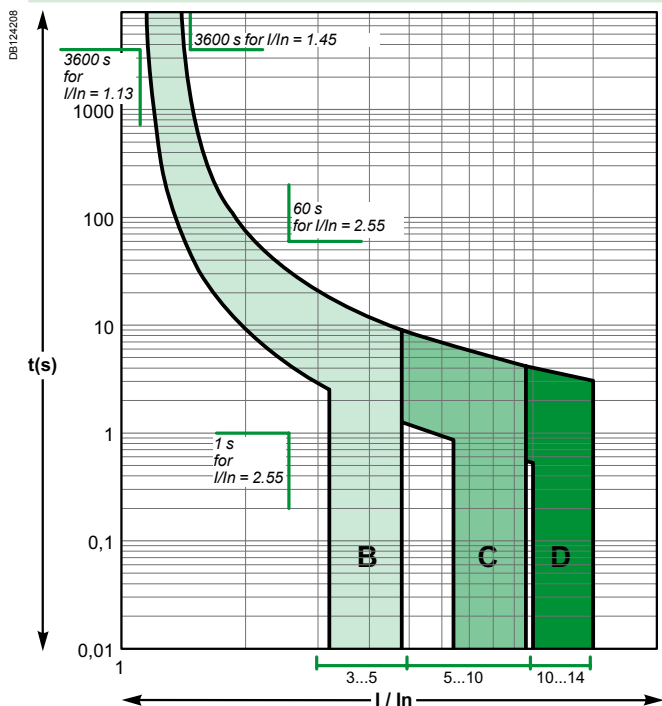

Alternative current 50/60 Hz

iK60

According to IEC/EN 60898-1 (reference temperature 30°C)

Curves B, C

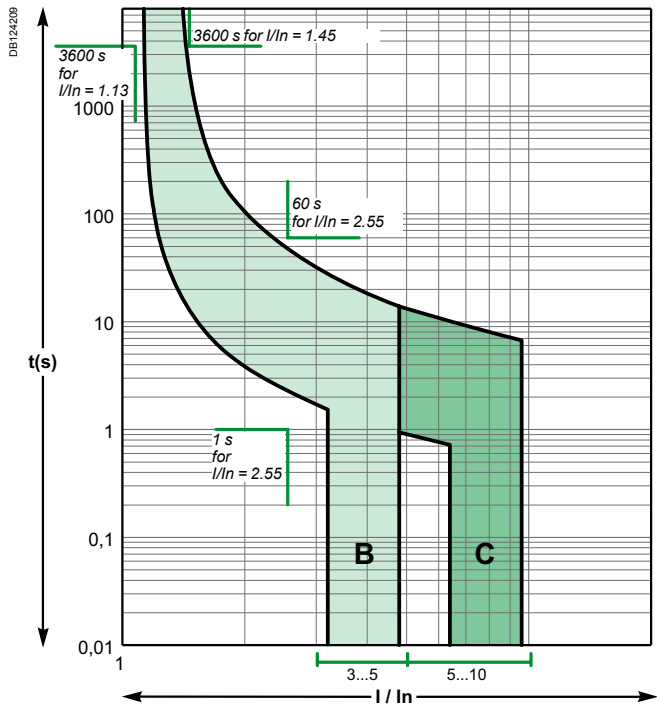

C60

According to IEC/EN 60898-1 (reference temperature 30°C)

Curves B, C, D

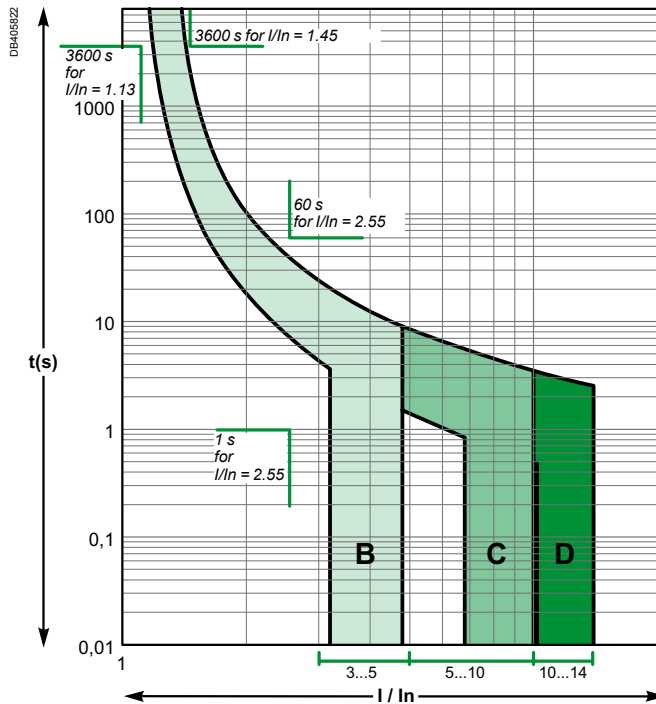

Alternative current 50/60 Hz

iC60N/H/L MCB and iC60 RCBO

According to IEC/EN 60947-2 for MCB and IEC/EN 61009-1 for RCBO (reference temperature 50°C)

Curves B, C, D rating up to 4 A

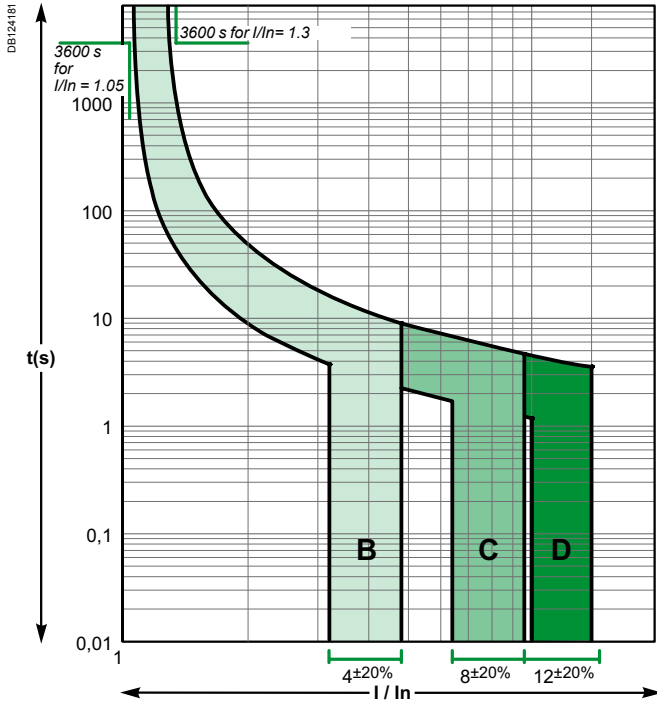

Curves Z, K rating up to 4 A

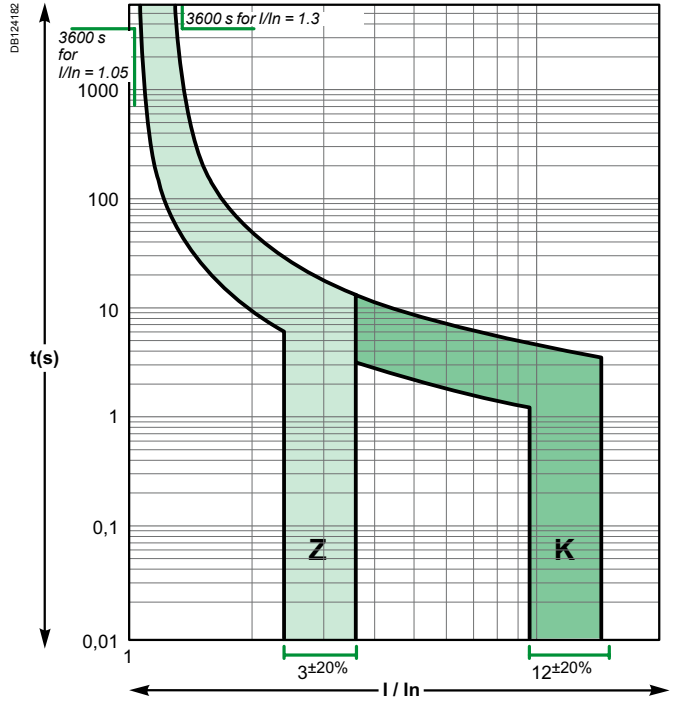

Curves B, C, D rating 6 A to 63 A

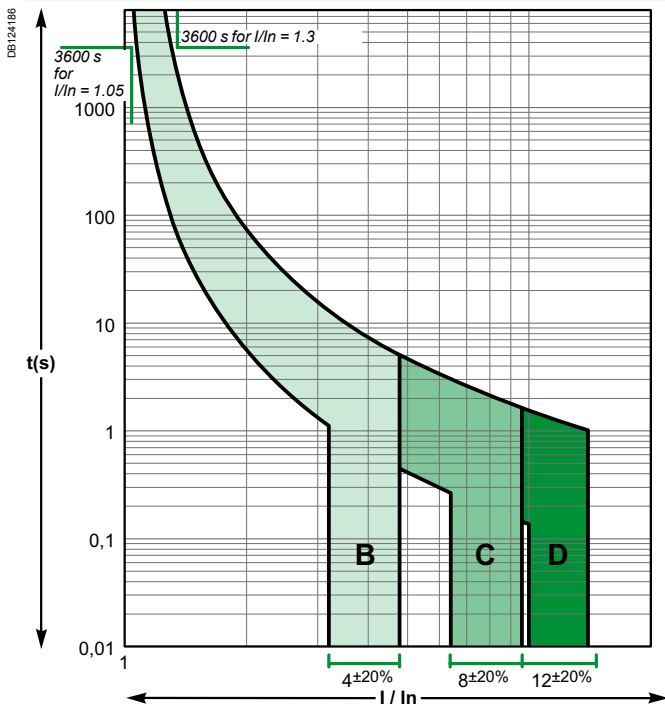

Curves Z, K rating 6 A to 63 A

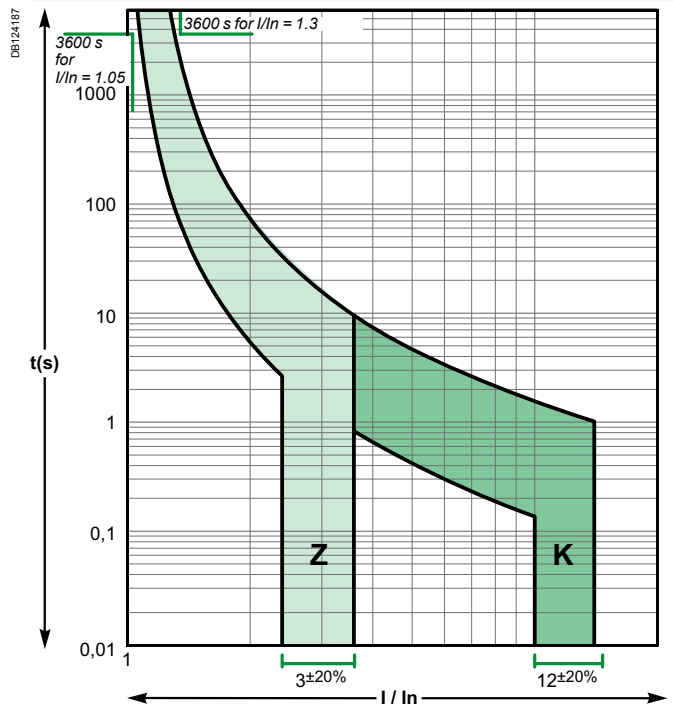

Alternative current 50/60 Hz

Reflex iC60N/H

According to IEC/EN 60947-2 (reference temperature 50°C)

Curves B, C, D

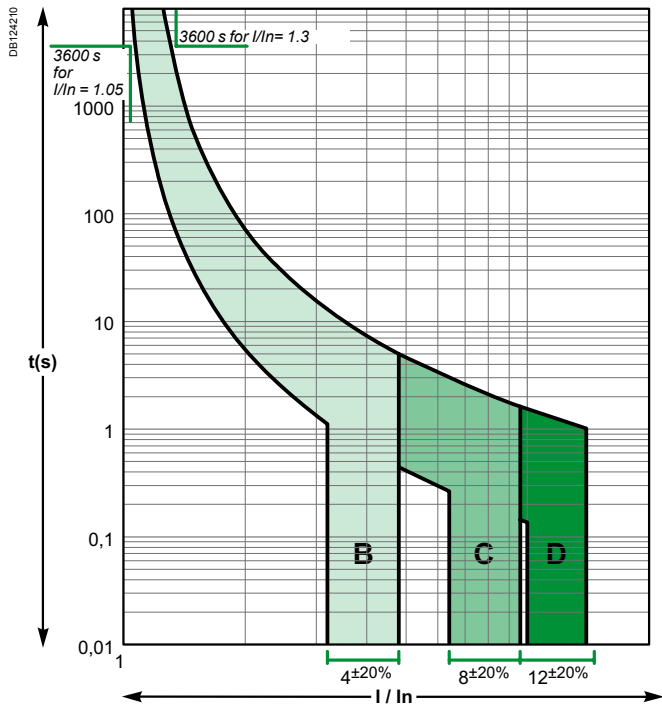

NG125a/N/H/L

According to IEC/EN 60947-2 (reference temperature 40°C)

Curves B, C, D

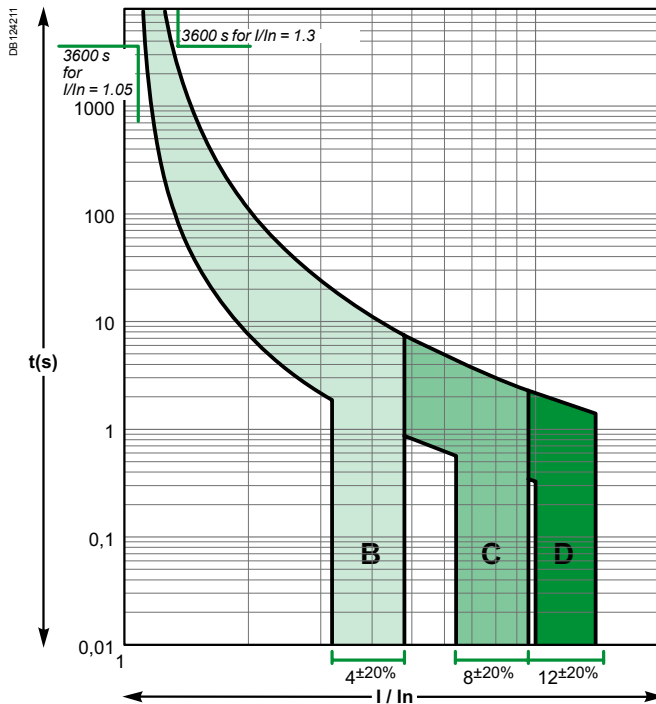

C60

According to IEC/EN 60947-2 (reference temperature 50°C)

Curves B, C, D

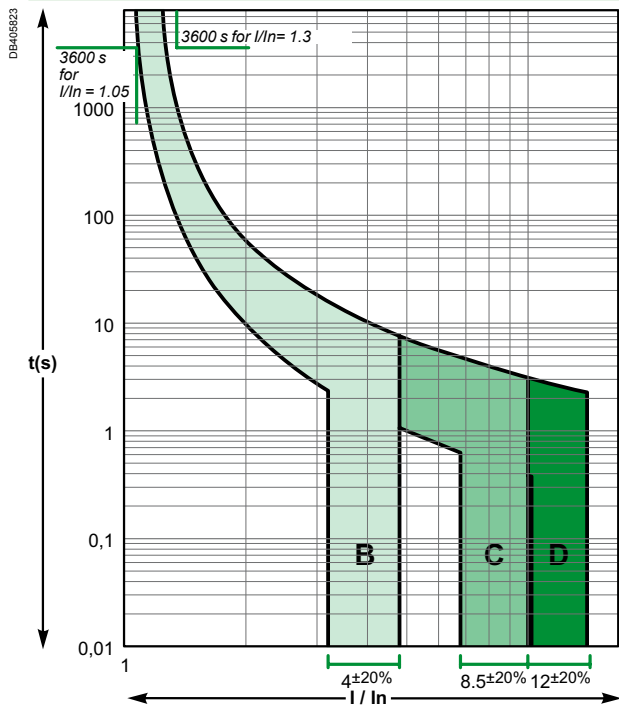

Motor curve

iC60L-MA

According to IEC/EN 60947-2

Curve MA

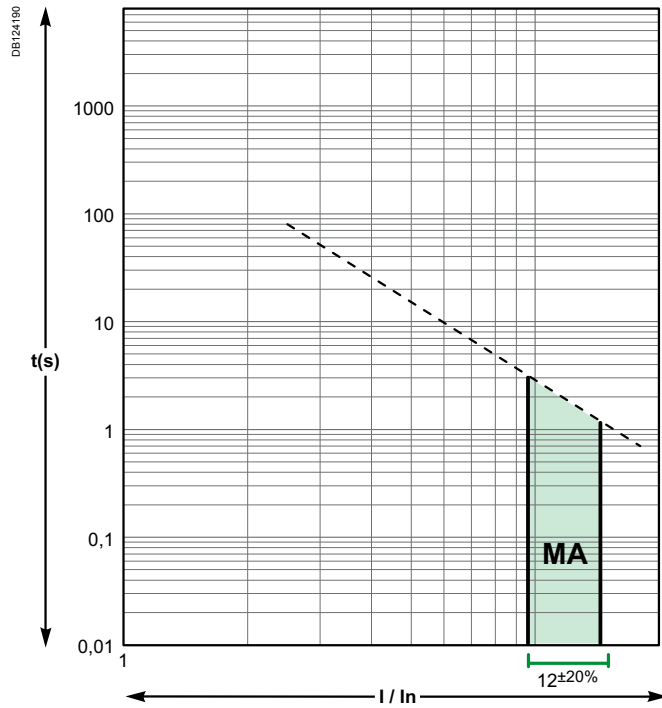

NG125L-MA

According to IEC/EN 60947-2

Curve MA

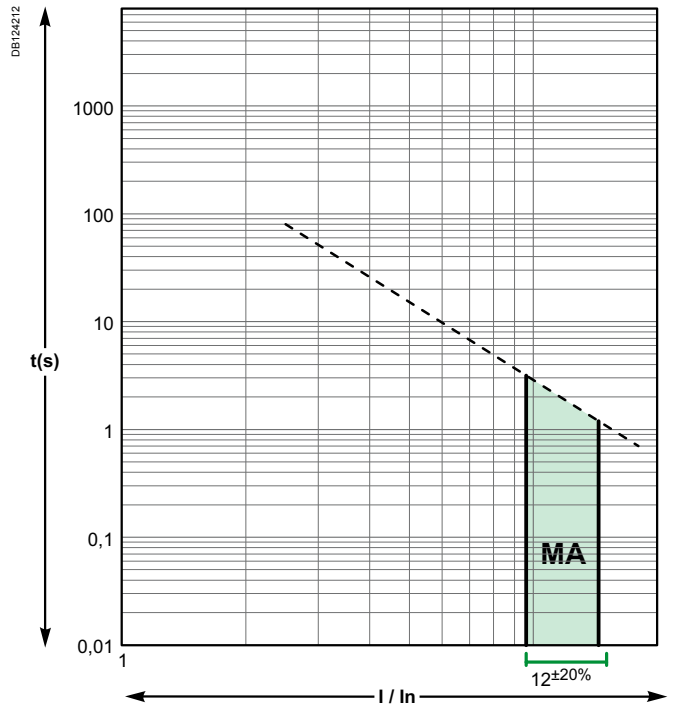

Direct current

iC60N/H/L

According to IEC/EN 60947-2 (reference temperature 50°C)

Curves B, C, D rating up to 4 A

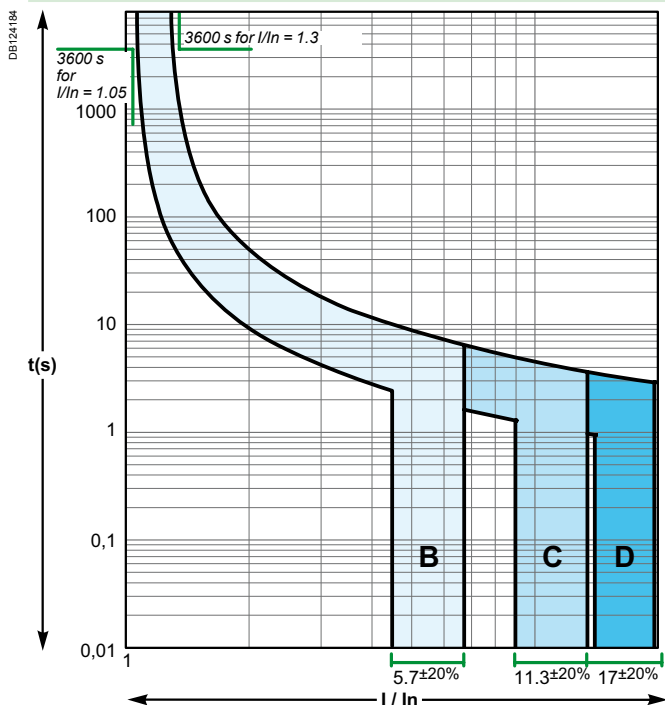

Curves Z, K rating up to 4 A

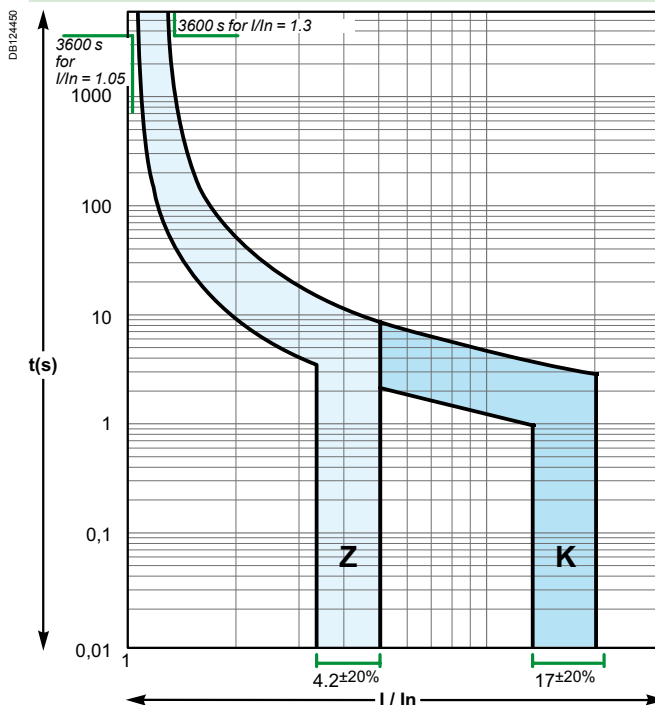

Curves B, C, D rating 6 A to 63 A

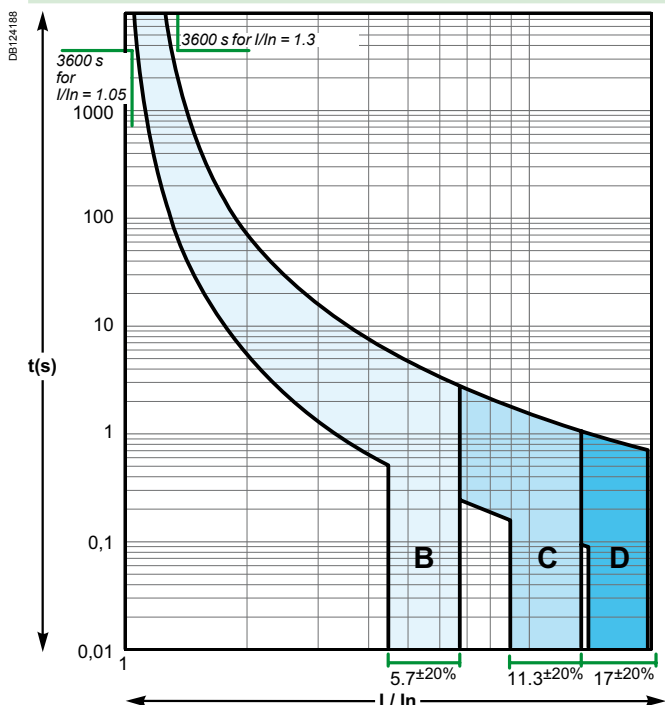

Curves Z, K rating 6 A to 63 A

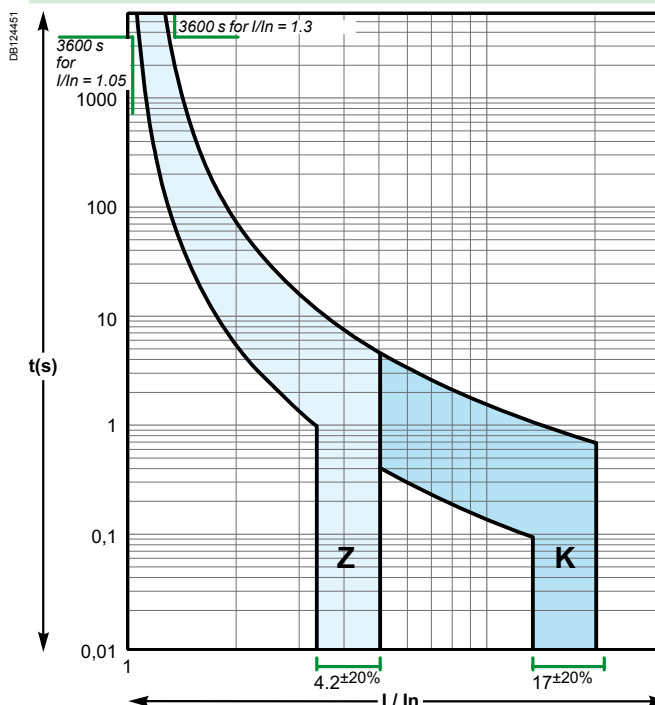

Direct current

C60H-DC

According to IEC/EN 60947-2 (reference temperature 25°C)

Curves B, C, K

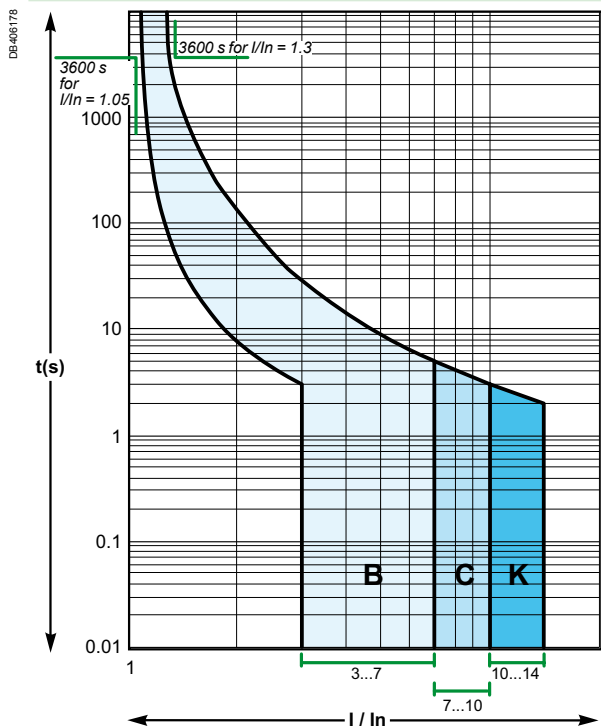

C60

According to IEC/EN 60947-2 (reference temperature 50°C)

Curves B, C, D

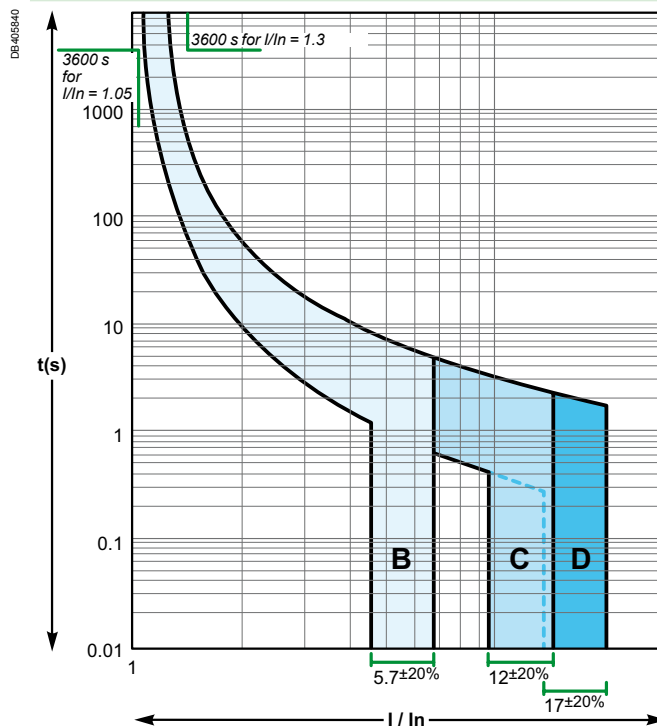

C60PV-DC

According to IEC/EN 60947-2 (reference temperature 50°C)

Curve C

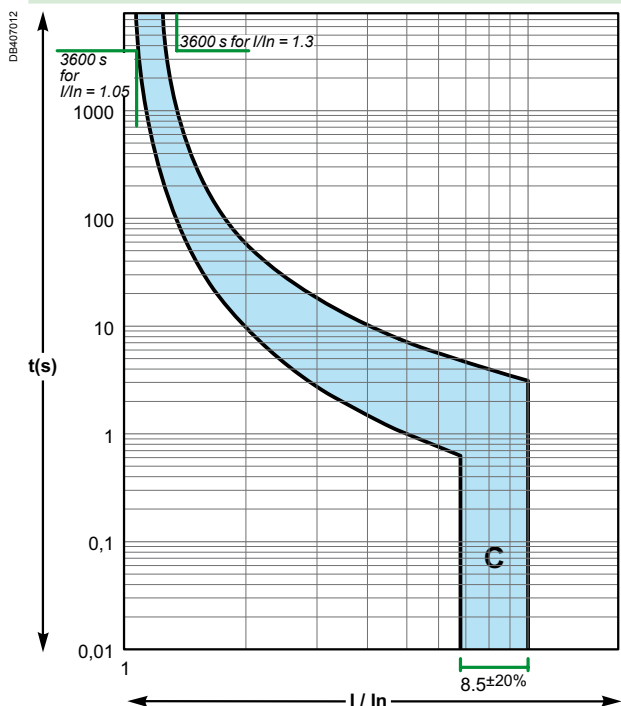

NG125a/N/H/L

According to IEC/EN 60947-2 (reference temperature 40°C)

Curves B, C, D

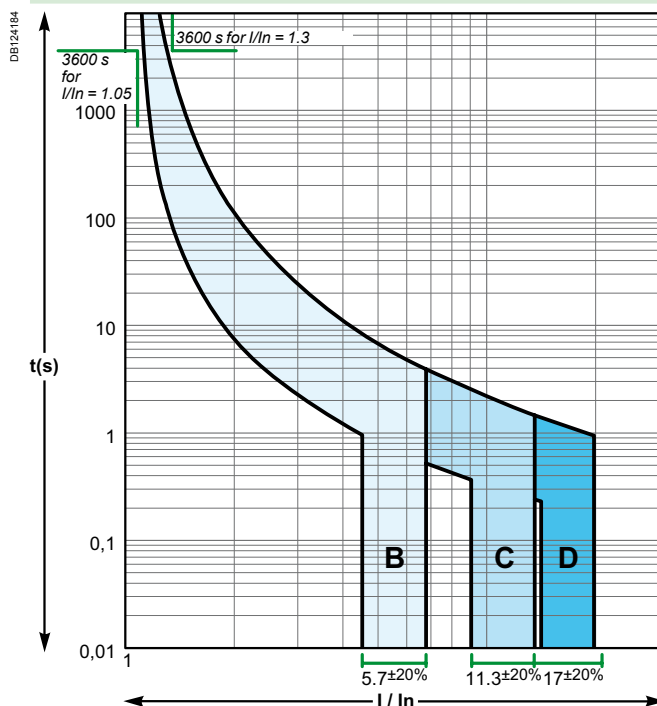

Tripping curves

Coordination with loads

The circuit-breaker characteristics chosen depend on the type of load downstream of the installation.

The rating depends on the size of the cables to be protected and the curves depend on the load inrush current.

Product selection according to the load inrush current

When certain "capacitive" loads are switched on, very high inrush currents appear during the first milliseconds of operation. The following graphs show the average non-tripping curves of our products for this time range (50 μ s to 10 ms).

iC60

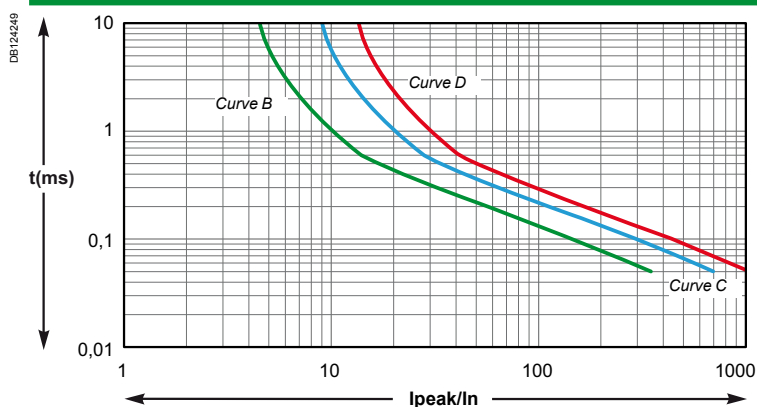

NG125 / C120

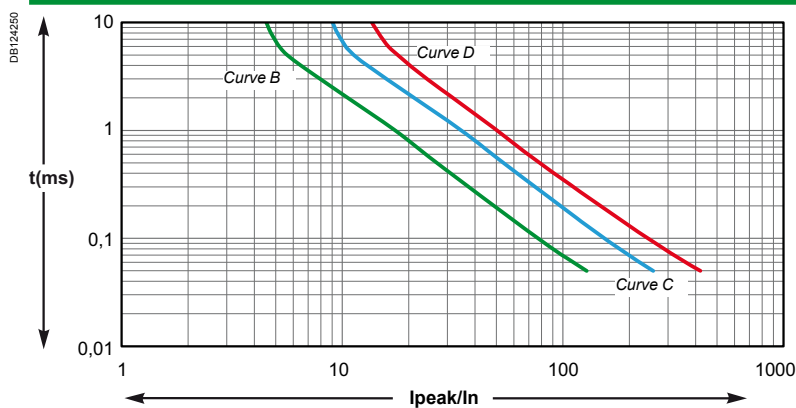

This information allows us to select the most appropriate product, according to the load specifications: curve and rating.

Example

When an iC60 is used with a load with current peaks in the order of 200 I_n during the first 0.1 millisecond, a curve C or D product must be installed.

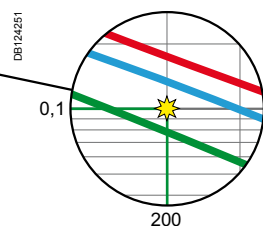
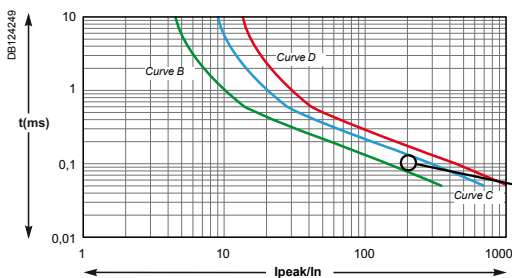

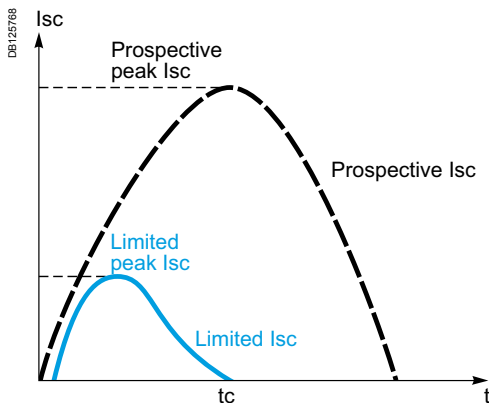

Prospective current and real limit current.

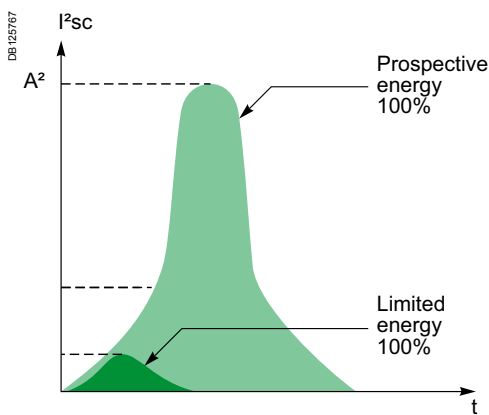

Definition

The limiting capacity of a circuit breaker is its ability to lessen the effects of a short circuit on an electrical installation by reducing the current amplitude and the dissipated power.

Benefits of limiting

Long installation service life

Thermal effects

Lower temperature rise at the conductor level, hence increased service life for cables and all components that are not self-protected (e.g. switches, contactors, etc.)

Mechanical effects

Lower electrodynamic repulsion forces, hence less risk of deformation or breakage of electrical contacts and busbars.

Electromagnetic effects

Less interference on sensitive equipment located in the vicinity of an electric circuit.

Savings through cascading

Cascading is a technique derived directly from current limiting: downstream of a current-limiting circuit breaker it is possible to use circuit breakers of breaking capacity lower than the prospective short-circuit current (in line with the cascading tables). The breaking capacity is heightened thanks to current limiting by the upstream device. Substantial savings can be achieved in this way on switchgear and enclosures.

Discrimination of protection devices

The circuit breakers' current limiting capacity improves discrimination with the protection devices located upstream: this is because the required energy passing through the upstream protection device is greatly reduced and can be not enough to cause it to trip. Discrimination can thus be natural without having to install a time-delayed protection device upstream.

Acti 9 circuit breaker current limiting

Profiting from Schneider Electric's experience and expertise in the field of short-circuit current breaking, the circuit breakers of the Acti 9 range have a top-level current limiting characteristic for modular devices.

This assures them of optimal protection of the entire power distribution system.

Representation: Current limiting curves

The current limiting capacity of a circuit breaker is reflected by 2 curves which give, as a function of the prospective short-circuit current (current which would flow in the absence of a protection device):

- the real peak current (limited)
- the thermal stress (in A²s), this value, multiplied by the resistance of any element through which the short-circuit current passes, gives the power dissipated by this element.

The straight line "10 ms" representing the energy A²s of a prospective short-circuit current of a half-period (10 ms) indicates the energy that would be dissipated by the short-circuit current in the absence of limiting by the protection device (see example).

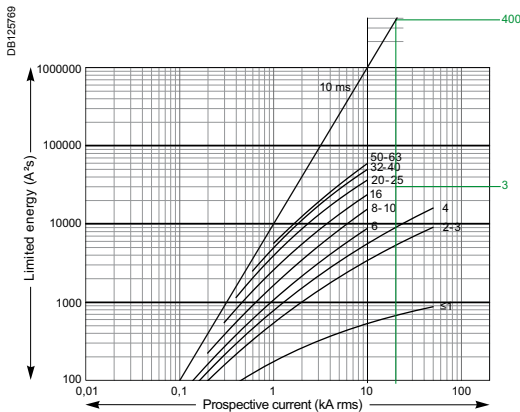

Example

What is the energy limited by an iC60N 25 A circuit breaker for a prospective short-circuit current of 10 kA rms. What is the quality of current limiting?

➤ as shown in the graph opposite:

- this short-circuit current (10 kA rms) is likely to dissipate up to 1,000 kA²s
- the iC60N circuit breaker reduces this thermal stress to: 35 kA²s, which is 22 times less.

Example of use: Stresses acceptable by the cables

The following table shows the thermal stresses acceptable by the cables depending on their insulation, their composition (Cu or Al) and their cross section. Cross-section values are expressed in mm² and stresses in A²s.

S (mm ²)		1.5	2.5	4	6	10
PVC	Cu	2.97 x 10 ⁴	8.26 x 10 ⁴	2.12 x 10 ⁵	4.76 x 10 ⁵	1.32 x 10 ⁶
	Al					5.41 x 10 ⁵
PRC	Cu	4.10 x 10 ⁴	1.39 x 10 ⁵	2.92 x 10 ⁵	6.56 x 10 ⁵	1.82 x 10 ⁶
	Al					7.52 x 10 ⁵
S (mm ²)		16	25	35	50	
PVC	Cu	3.4 x 10 ⁶	8.26 x 10 ⁶	1.62 x 10 ⁷	3.21 x 10 ⁷	
	Al	1.39 x 10 ⁶	3.38 x 10 ⁶	6.64 x 10 ⁶	1.35 x 10 ⁷	
PRC	Cu	4.69 x 10 ⁶	1.39 x 10 ⁷	2.23 x 10 ⁷	4.56 x 10 ⁷	
	Al	1.93 x 10 ⁶	4.70 x 10 ⁶	9.23 x 10 ⁶	1.88 x 10 ⁷	

Example

Is a Cu/PVC cable of cross section 10 mm² protected by a NG125L device?

The above table shows that the acceptable stress is 1.32 x 10⁶ A²s. Any short-circuit current at the point where a NG125L device (I_{cu} = 25 kA) is installed will be limited, with a thermal stress of less than 2.2 x 10⁵ A²s. (Curve on page 589).

The cable is therefore always protected up to the breaking capacity of the circuit breaker.

Limitation curves for network

U_e: 380-415 V AC (Ph/N 220-240 V AC)

DPN (MCB and RCBO)

1P+N / 3P / 3P+N

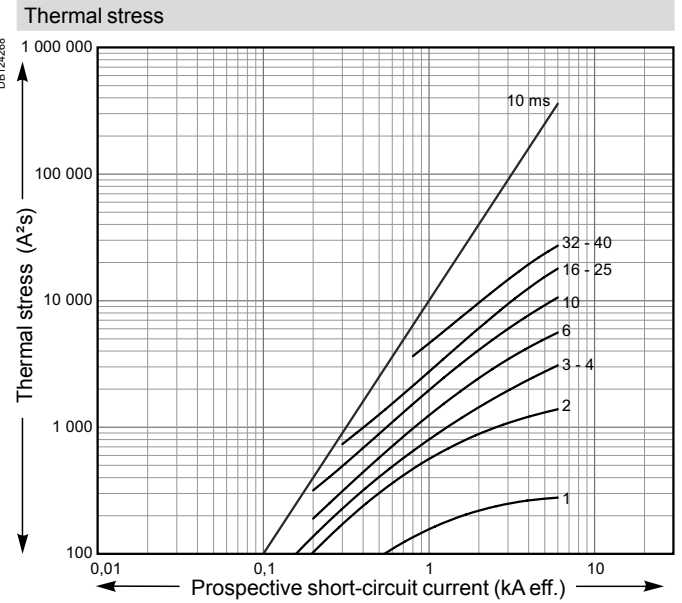
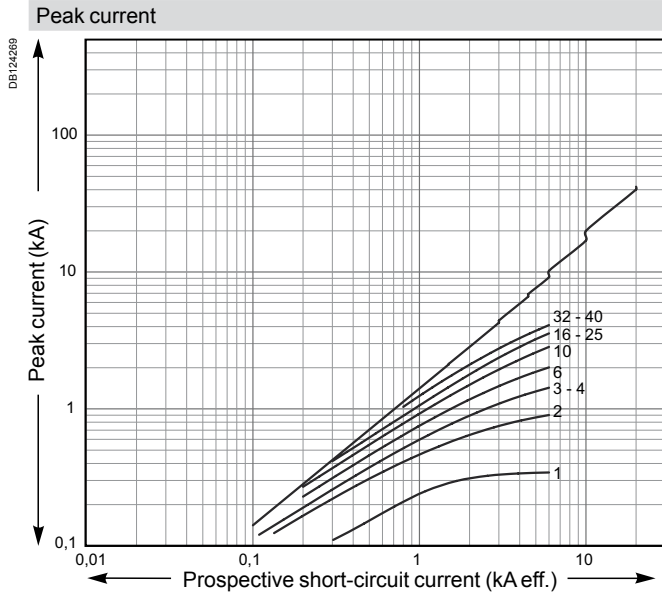

DPN N (MCB and RCBO)

1P+N / 3P / 3P+N

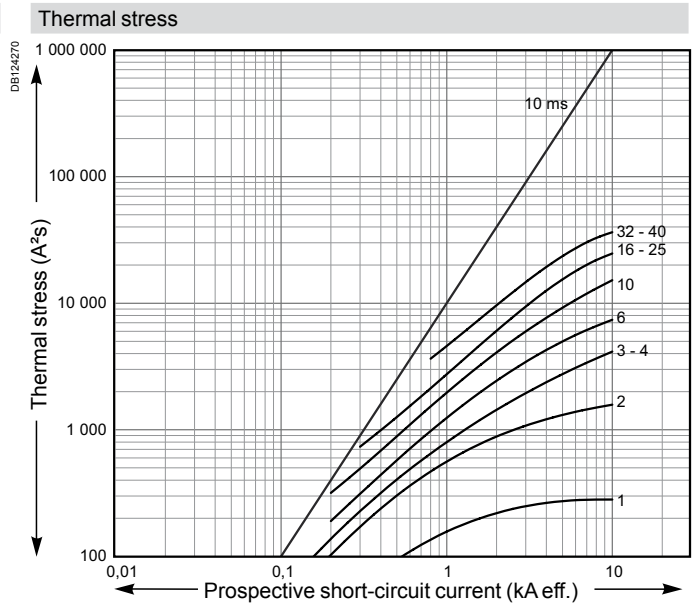
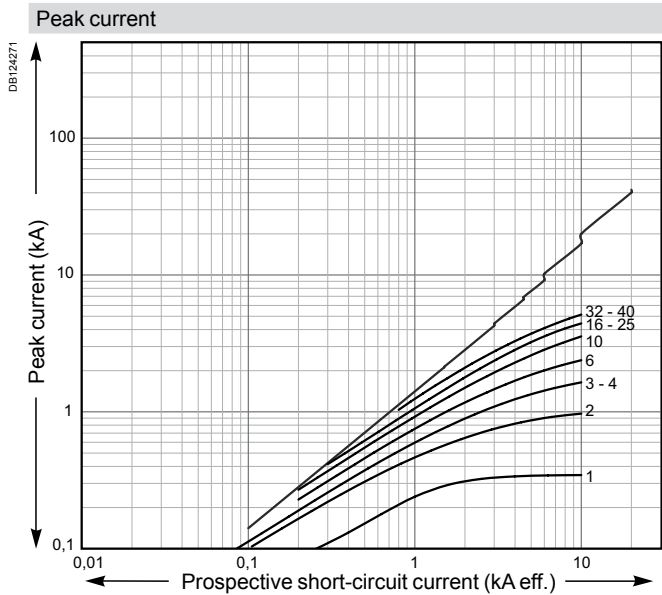

Limitation curves for network

U_e: 380-415 V AC (Ph/N 220-240 V AC)

iC60N

1P / 1P+N / 2P / 3P / 4P

Peak current

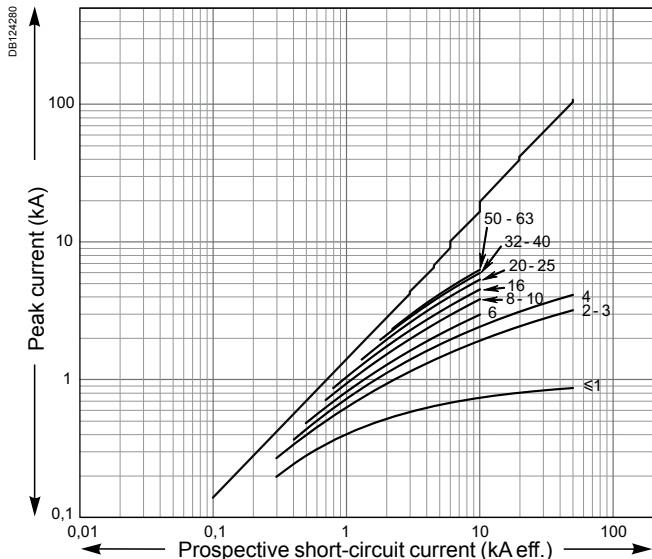

Thermal stress

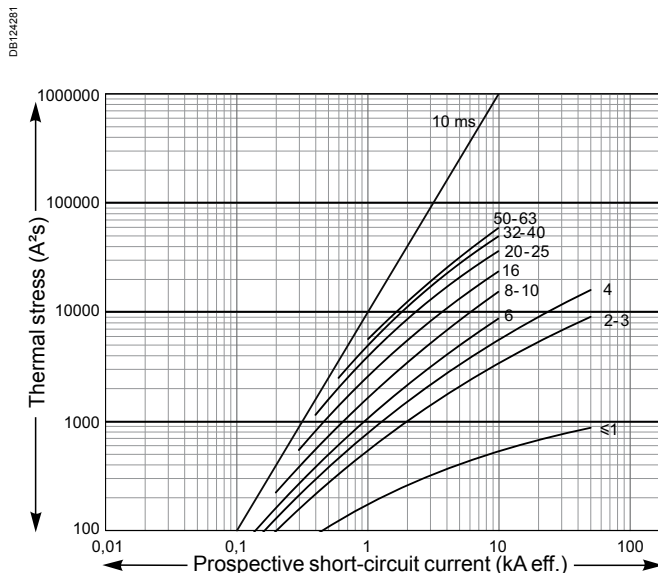

iC60H

1P / 1P+N / 2P / 3P / 4P

Peak current

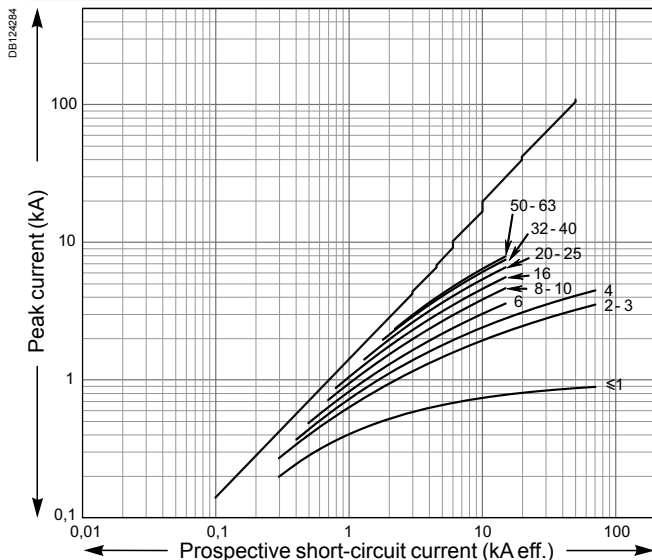

Thermal stress

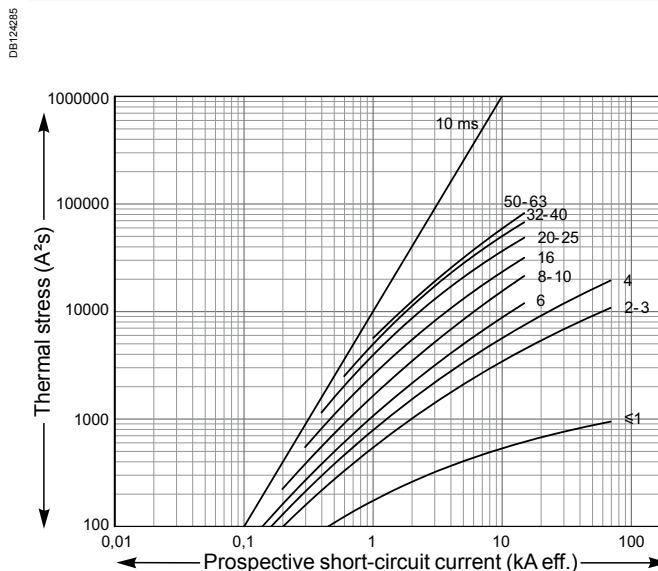

Limitation curves for network

U_e: 380-415 V AC (Ph/N 220-240 V AC)

iC60L

1P / 2P / 3P / 4P

Peak current

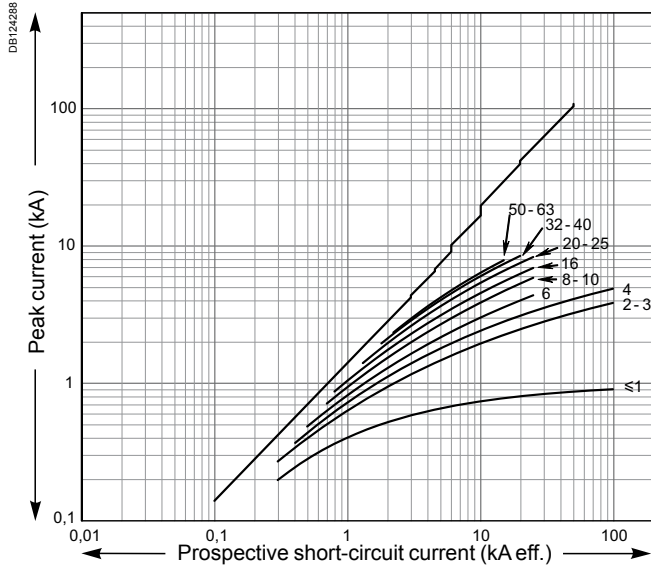

Thermal stress

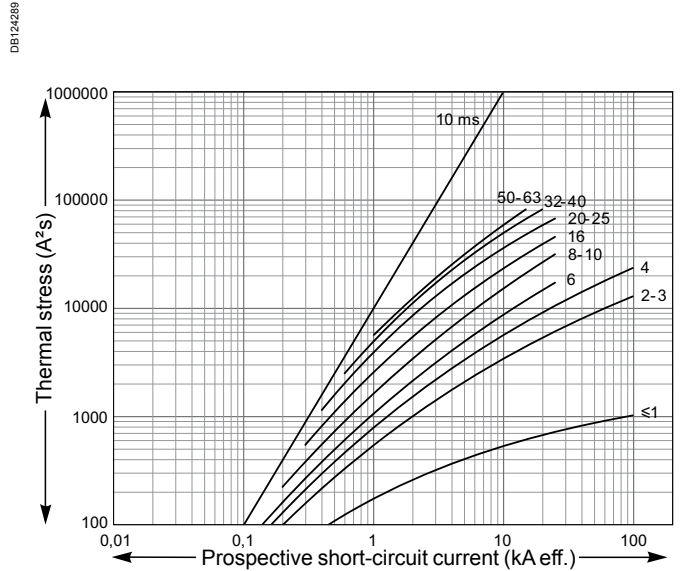

Limitation curves for network

U_e: 380-415 V AC (Ph/N 220-240 V AC)

C60a

1P / 2P / 3P / 3P+N / 4P

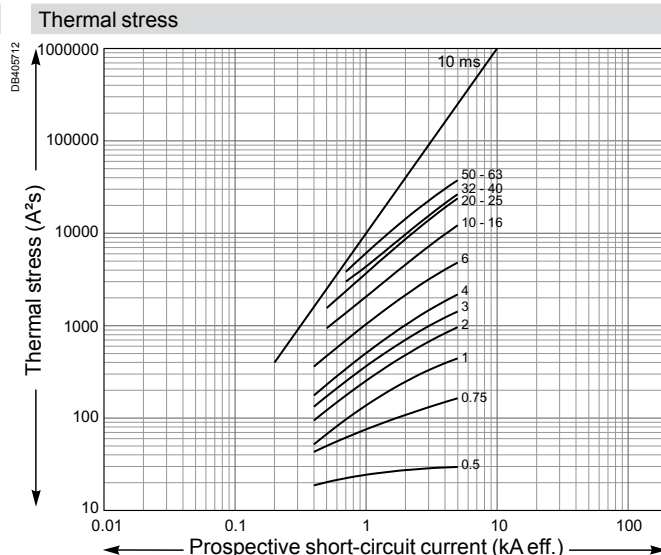
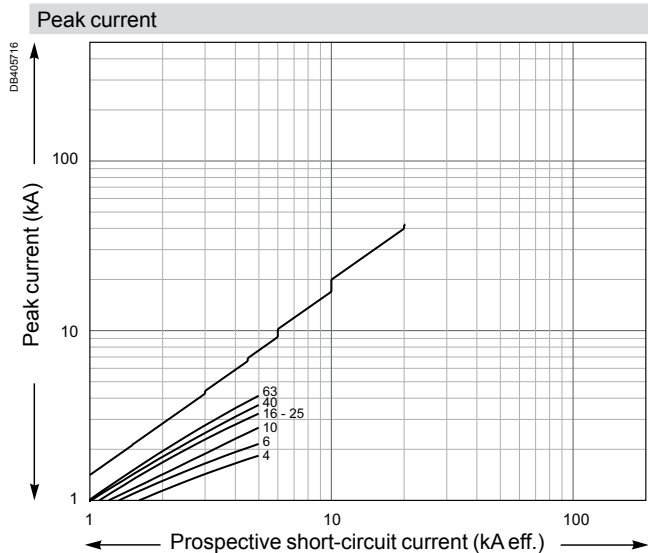

C60N

1P / 1P+N / 2P / 3P / 3P+N / 4P

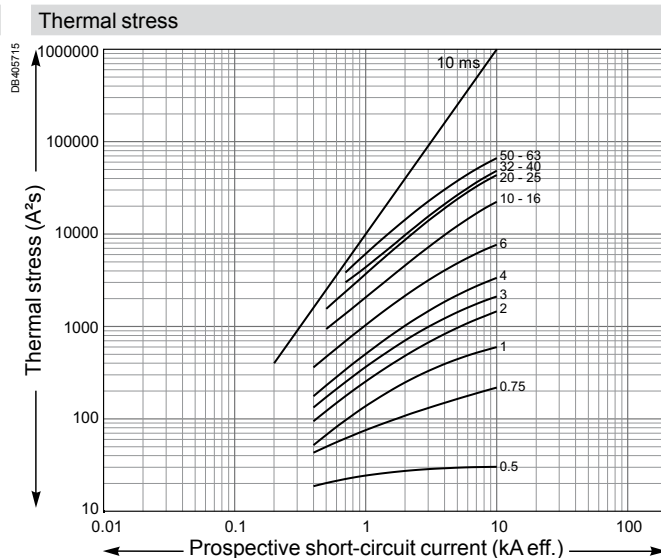
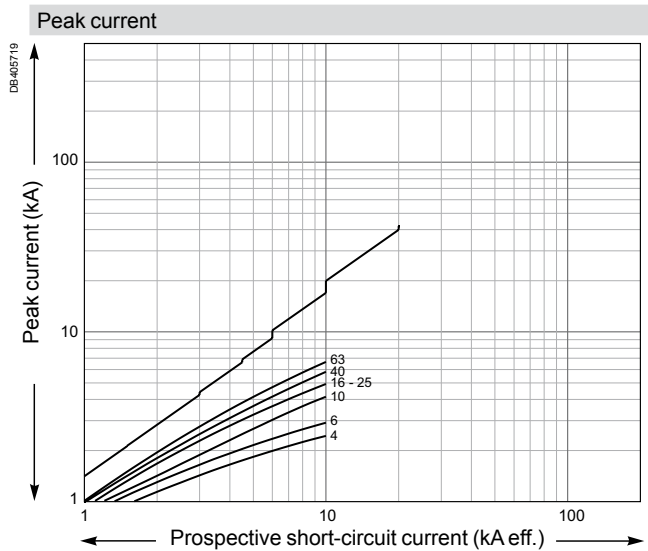

Limitation curves for network

U_e: 380-415 V AC (Ph/N 220-240 V AC)

C60H

1P / 1P+N / 2P / 3P / 3P+N / 4P

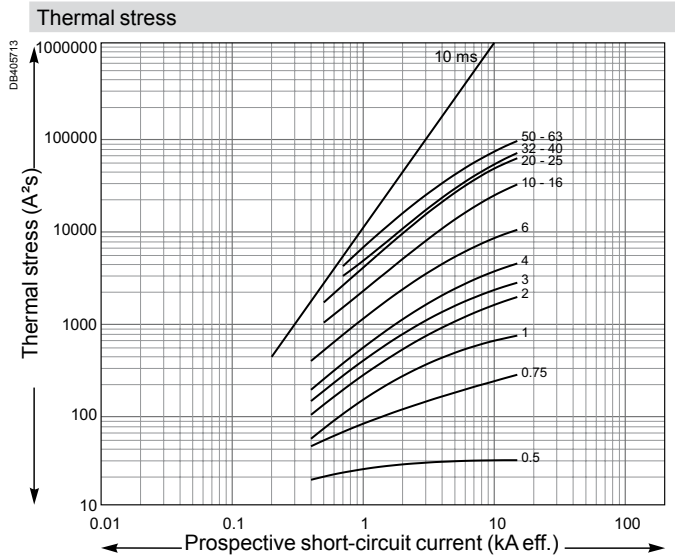
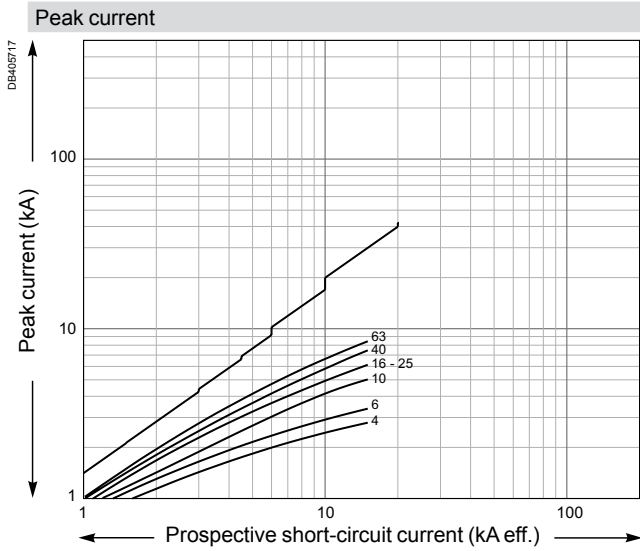

C60L

1P / 2P / 3P / 4P

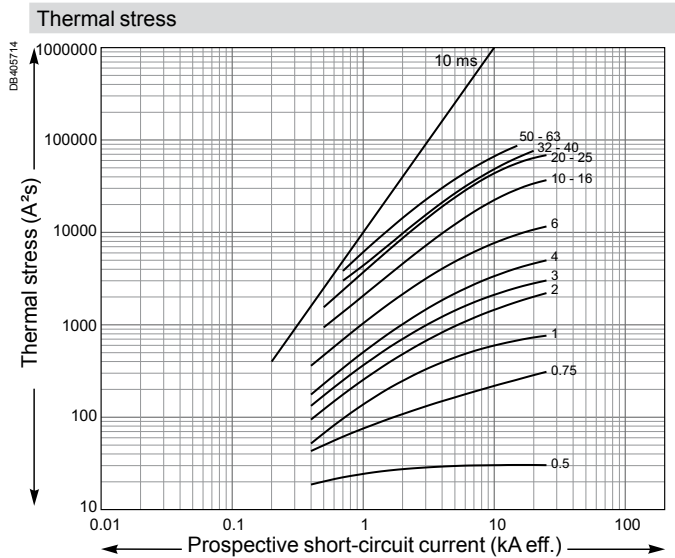
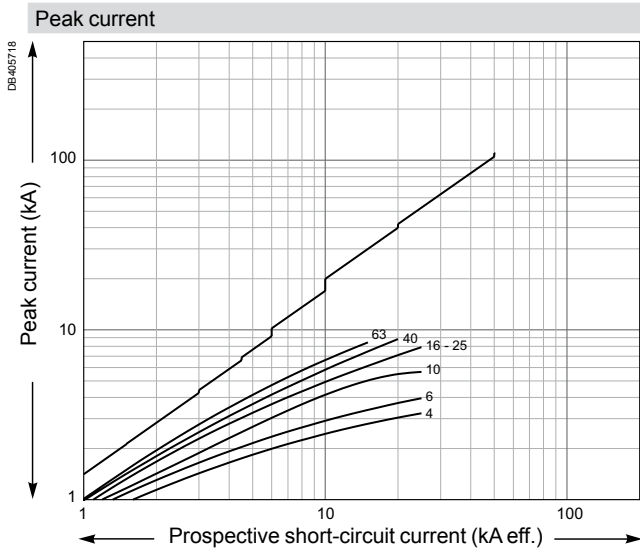

Limitation curves for network U_e: 380-415 V AC (Ph/N 220-240 V AC)

C120N, H

1P / 2P / 3P / 4P

Peak current

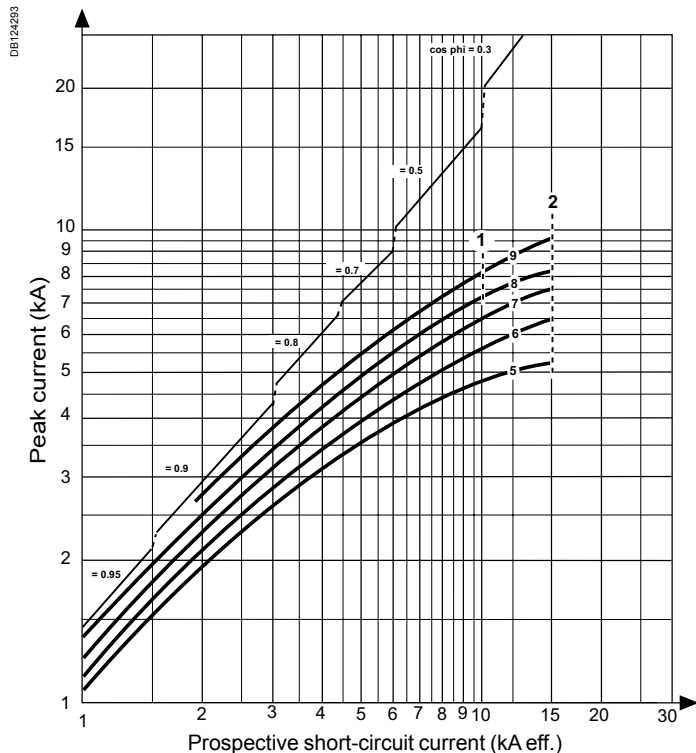

■ Circuit breaker type in accordance with the mark:

- 1: C120N
- 2: C120H
- 5: 10-16 A
- 6: 20-25 A
- 7: 32-40 A
- 8: 50-63 A
- 9: 80-125 A

Thermal stress

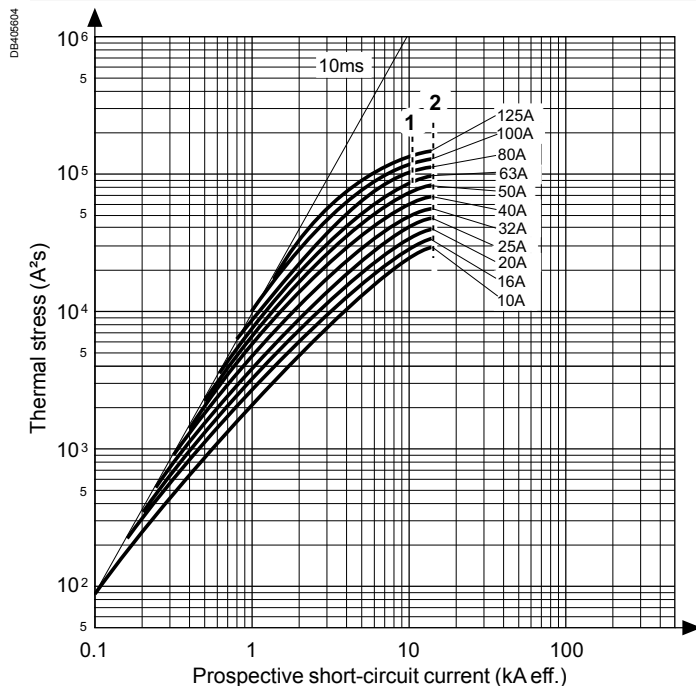

■ Circuit breaker type in accordance with the mark:

- 1: C120N
- 2: C120H

Limitation curves for network

U_e: 380-415 V AC (Ph/N 220-240 V AC)

NG125a, N, H, L

1P / 2P / 3P / 4P

Peak current

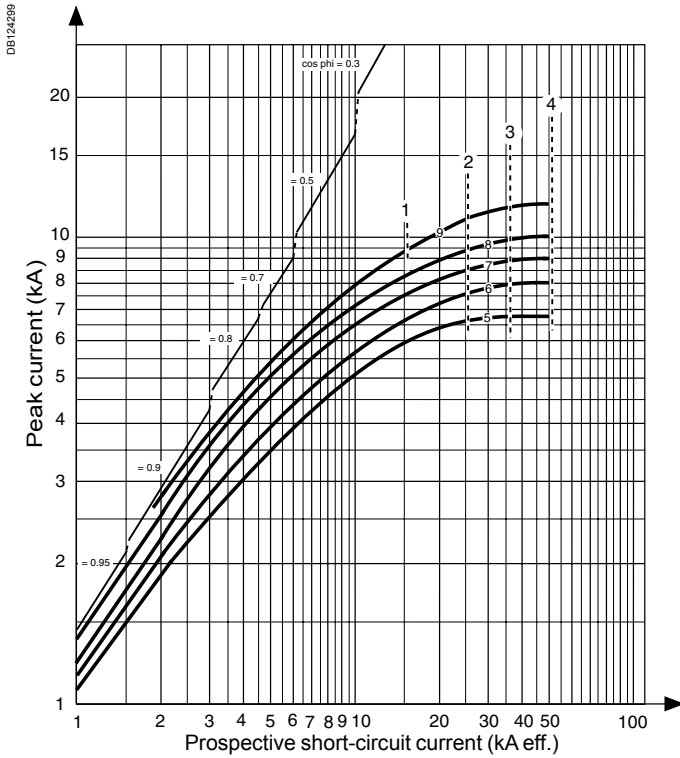

■ Circuit breaker type in accordance with the mark:

- 1: NG125a
- 2: NG125N
- 3: NG125H
- 4: NG125L
- 5: 10-16 A
- 6: 20-25 A
- 7: 32-40 A
- 8: 50-63 A
- 9: 80-125 A

Thermal stress

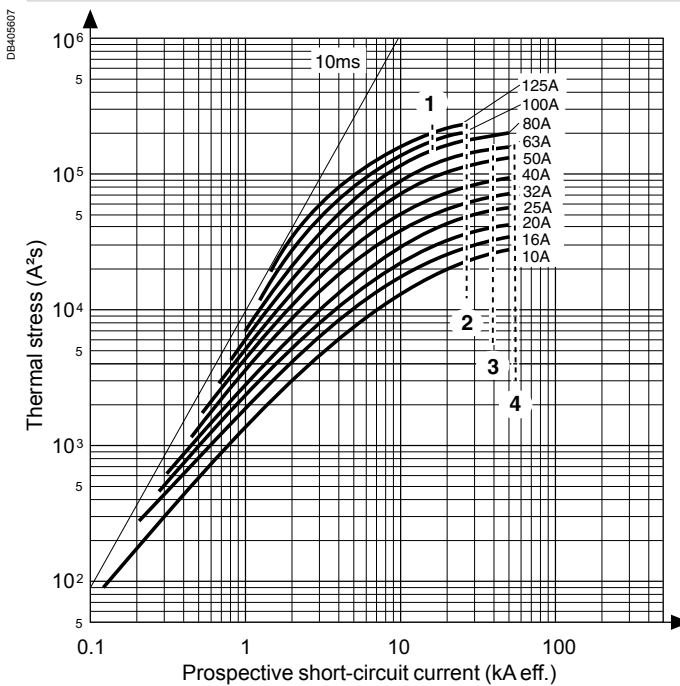

■ Circuit breaker type in accordance with the mark:

- 1: NG125a 80-100-125 A
- 2: NG125N
- 3: NG125H
- 4: NG125L

Limitation curves for network U_e: 440 V AC

C60N

2P / 3P / 4P

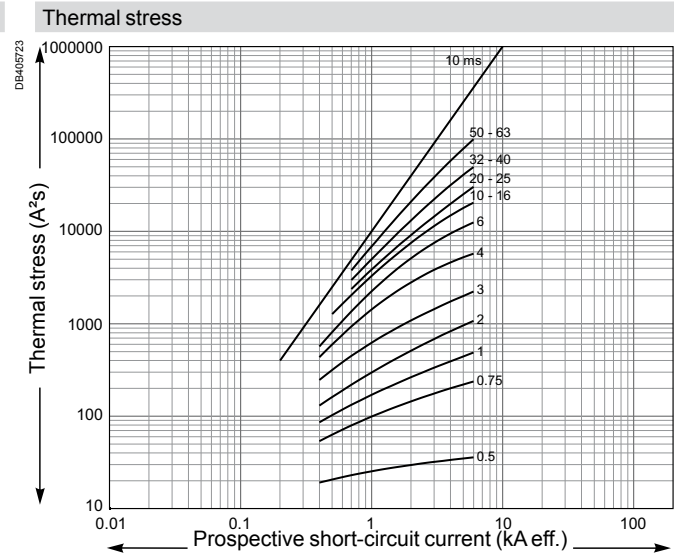
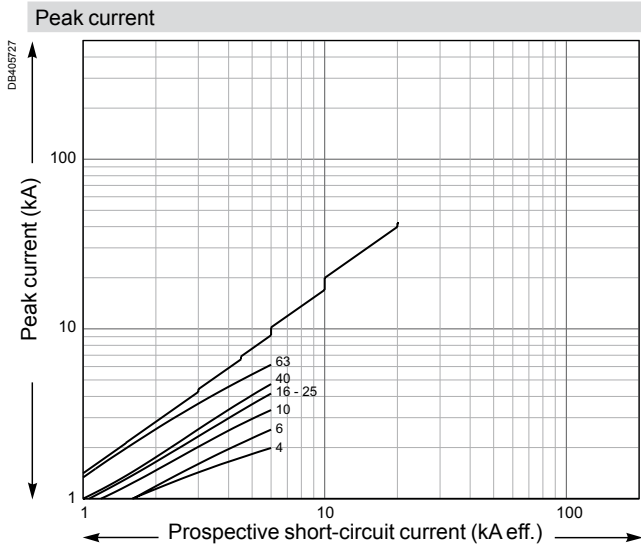

Limitation curves for network U_e: 440 V AC

C60H

2P / 3P / 4P

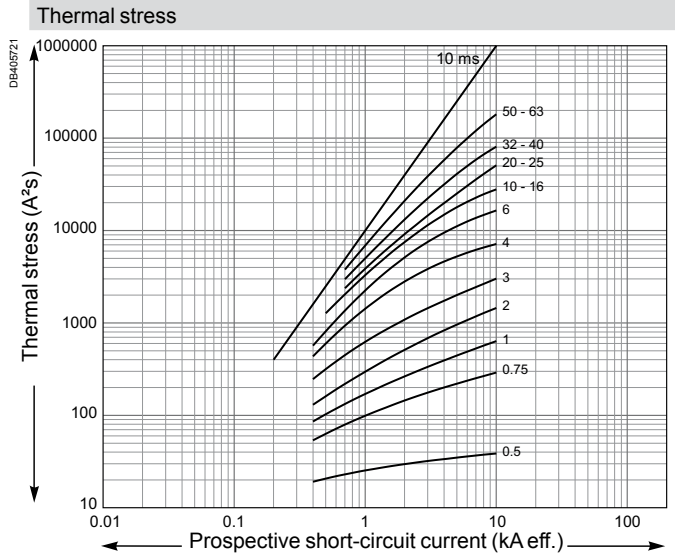
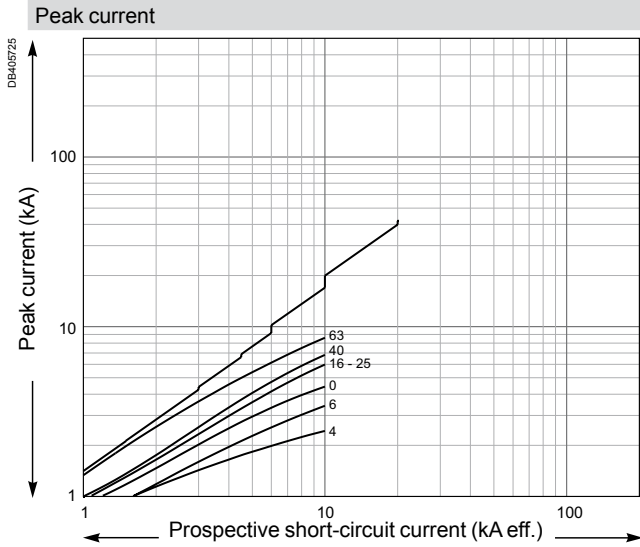

C60L

2P / 3P / 4P

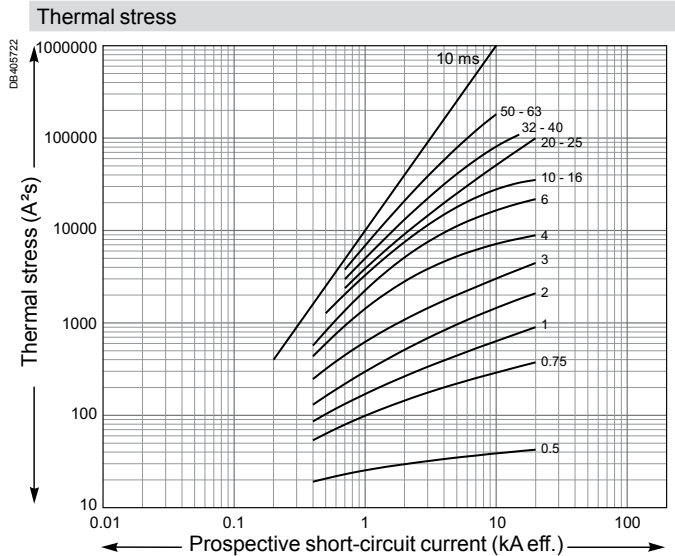
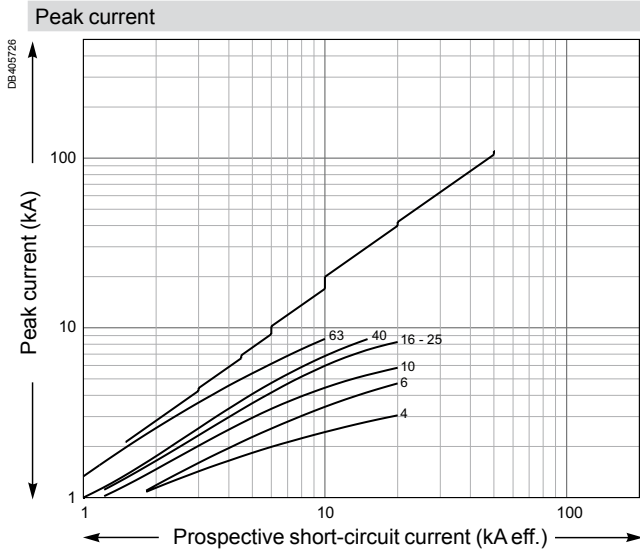

Limitation curves for network U_e: 440 V AC

C120N, H

2P / 3P / 4P

Peak current

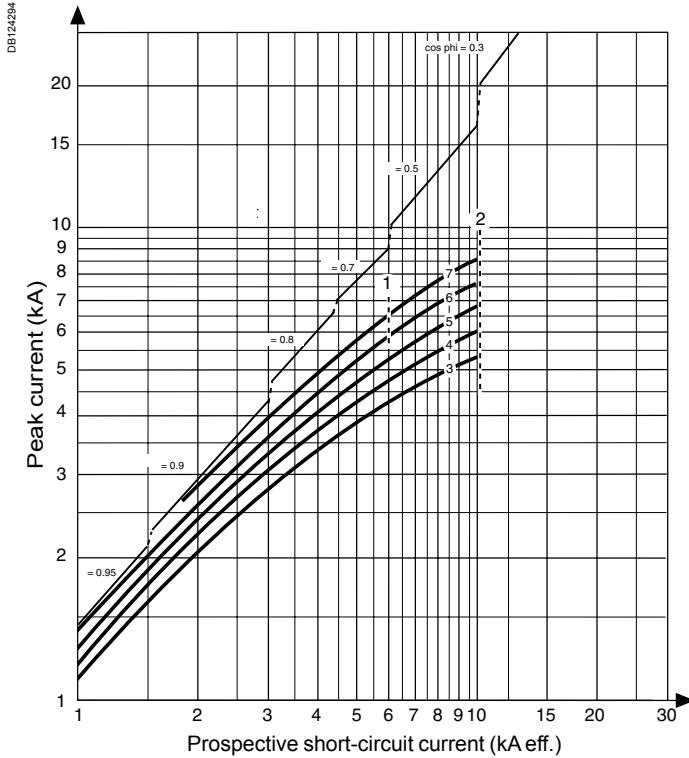

■ Circuit breaker type in accordance with the mark:

- 1: C120N
- 2: C120H
- 3: 0-16 A
- 4: 20-25 A
- 5: 32-40 A
- 6: 50-63 A
- 7: 80-125 A

Thermal stress

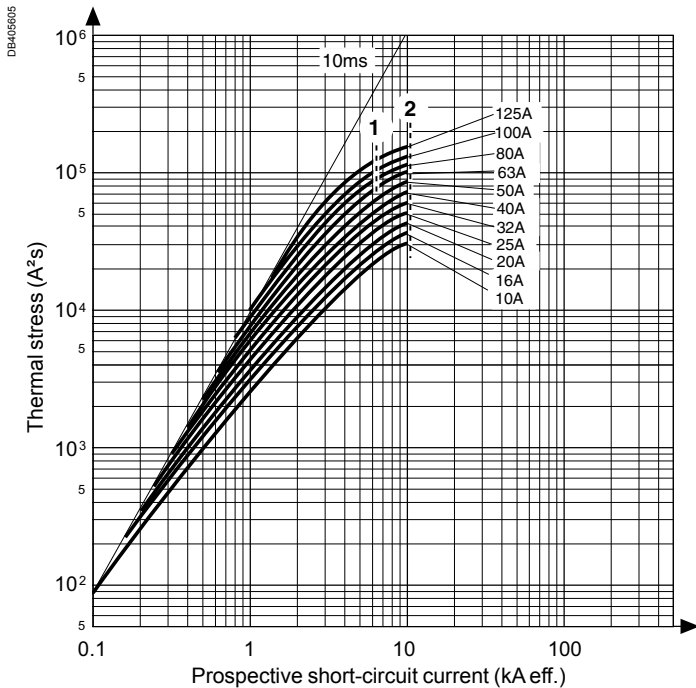

■ Circuit breaker type in accordance with the mark:

- 1: C120N
- 2: C120H

Limitation curves for network

U_e: 550 V AC

NG125a, N, H, L

2P / 3P / 4P

Peak current

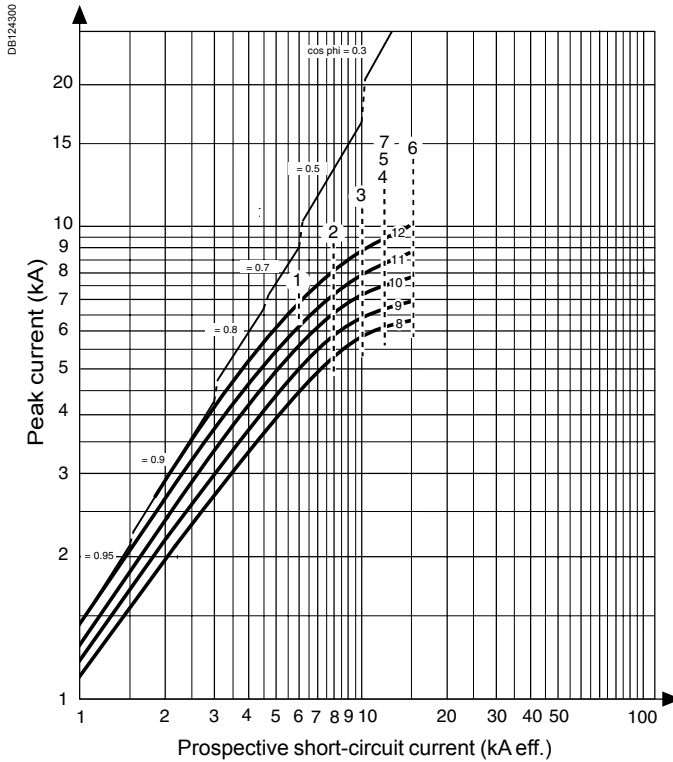

■ Circuit breaker type in accordance with the mark:

- 1: NG125a 3, 4P
- 2: NG125N 2, 3, 4P
- 3: NG125H 3, 4P
- 4-5: NG125H 2P/NG125L 3, 4P
- 6: NG125L 2P
- 7: NG125 LMA 2, 3, 4P
- 8: 10-16 A
- 9: 20-25 A
- 10: 32-40 A
- 11: 50-63 A
- 12: 80-125 A

Thermal stress

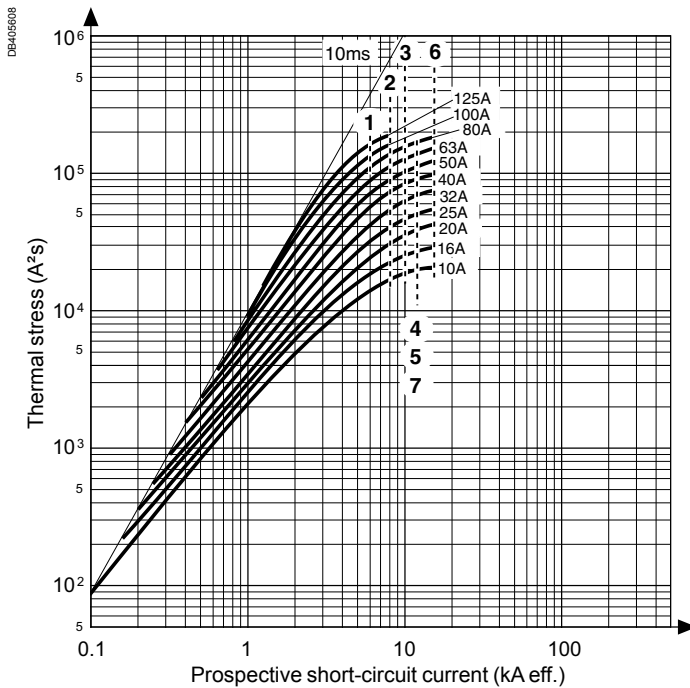

■ Circuit breaker type in accordance with the mark:

- 1: NG125a 3, 4P
- 2: NG125N 2, 3, 4P
- 3: NG125H 3, 4P
- 4-5: NG125H 2P/NG125L 3, 4P
- 6: NG125L 2P
- 7: NG125LMA 2, 3, 4P

Limitation curves for network U_e: 220-240 V AC (Ph/N 110-130 V AC)

C60a

1P / 2P / 3P / 3P+N / 4P

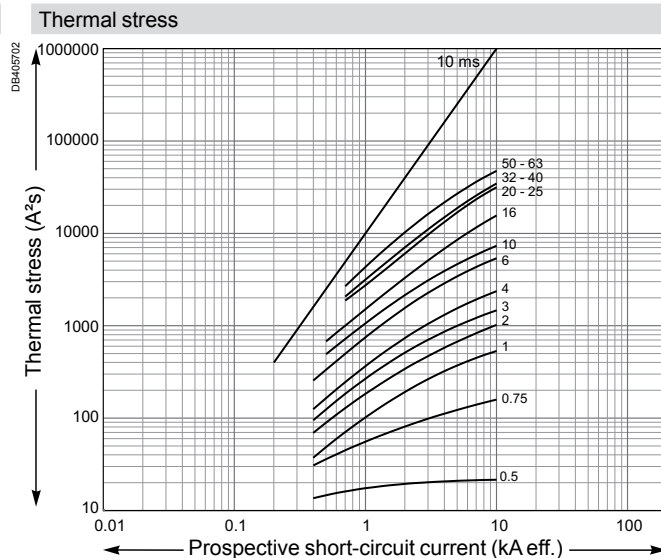
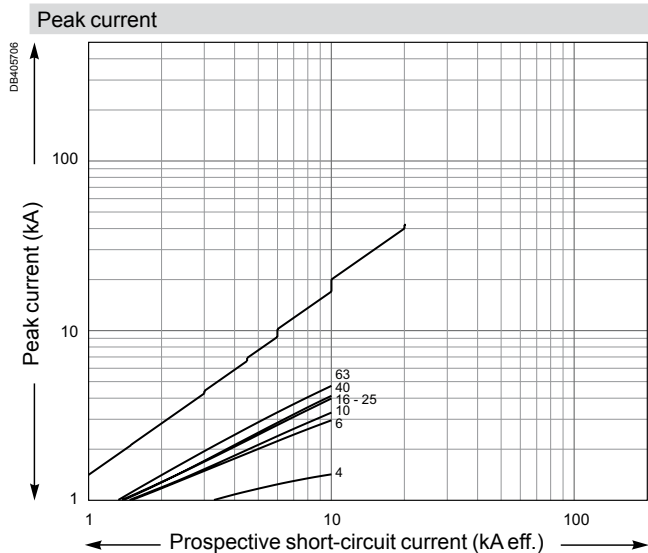

C60N

1P / 1P+N / 2P / 3P / 3P+N / 4P

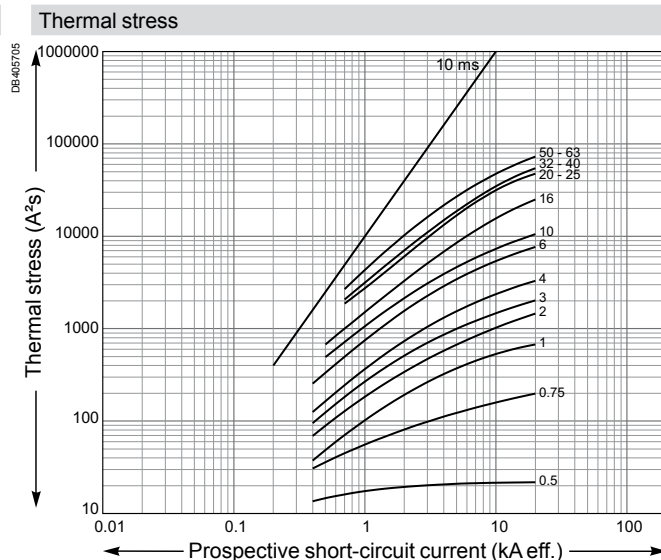
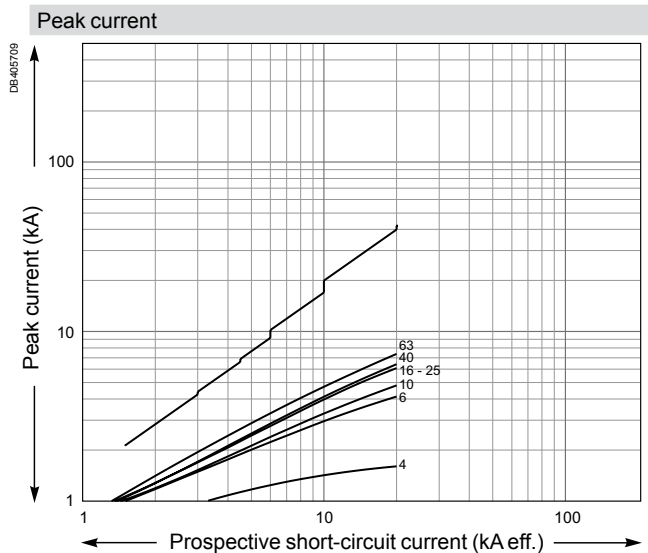

Limitation curves for network

U_e: 220-240 V AC (Ph/N 110-130 V AC)

C60H

1P / 1P+N / 2P / 3P / 3P+N / 4P

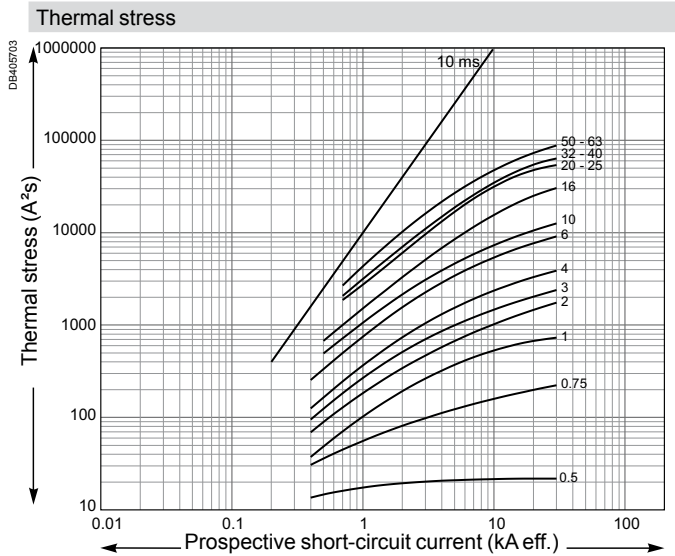
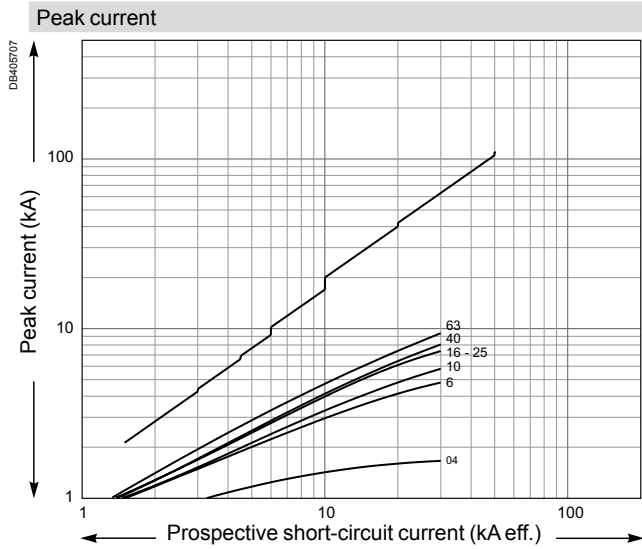

C60L

1P / 2P / 3P / 4P

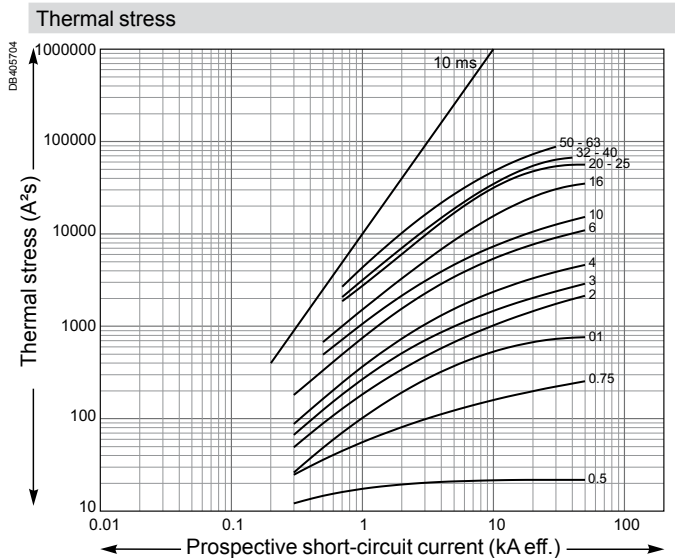
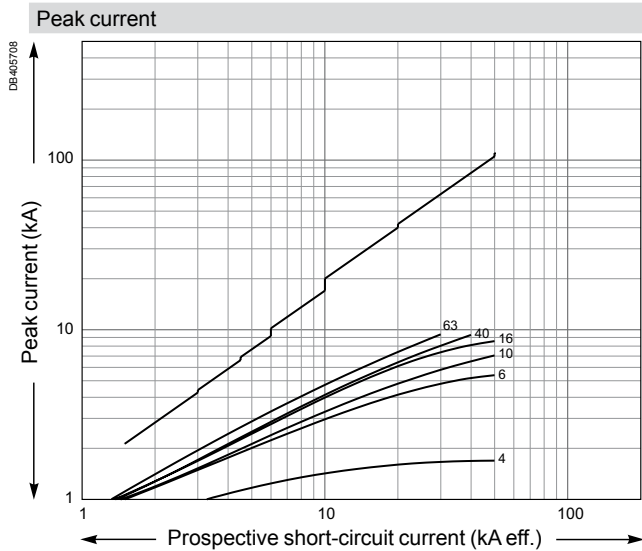

Limitation curves for network

U_e: 220-240 V AC (Ph/N 110-130 V AC)

C120N, H

1P / 2P / 3P / 4P

Peak current

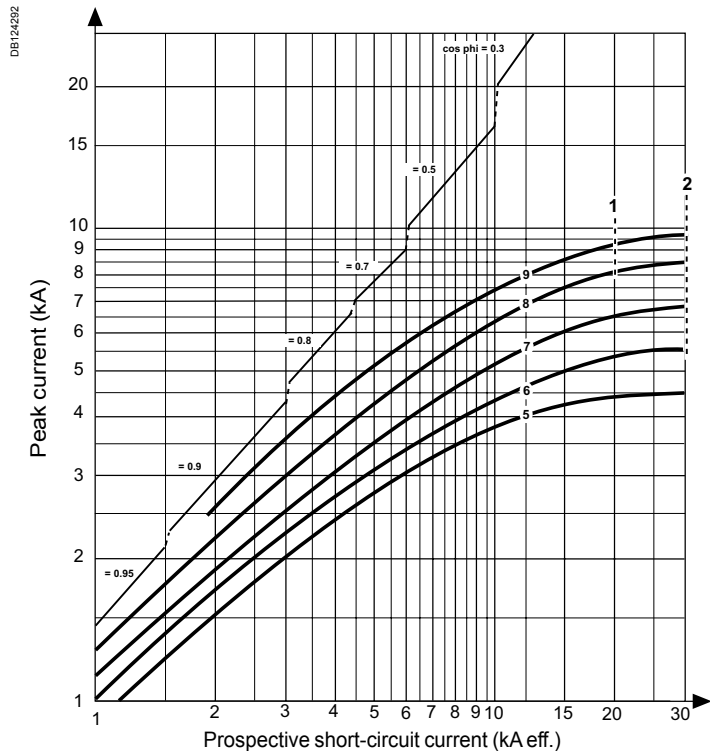

■ Circuit breaker type in accordance with the mark:

- 1: C120N
- 2: C120H
- 5: 10-16 A
- 6: 20-25 A
- 7: 32-40 A
- 8: 50-63 A
- 9: 80-125 A

Thermal stress

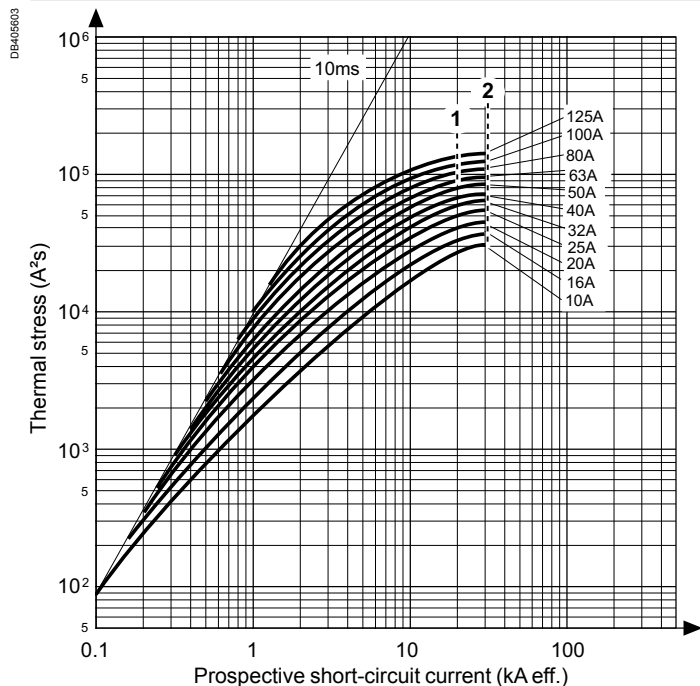

■ Circuit breaker type in accordance with the mark:

- 1: C120N
- 2: C120H

Limitation curves for network

U_e: 220-240 V AC (Ph/N 110-130 V AC)

NG125a, N, H, L

1P / 2P / 3P / 4P

Peak current

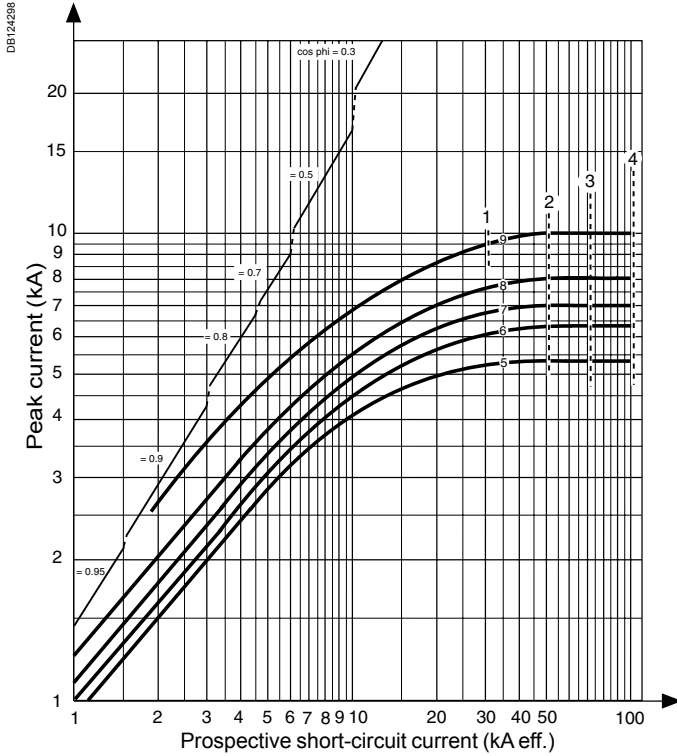

■ Circuit breaker type in accordance with the mark:

- 1: NG125a
- 2: NG125N
- 3: NG125H
- 4: NG125L
- 5: 10-16 A
- 6: 20-25 A
- 7: 32-40 A
- 8: 50-63 A
- 9: 80-125 A

Thermal stress

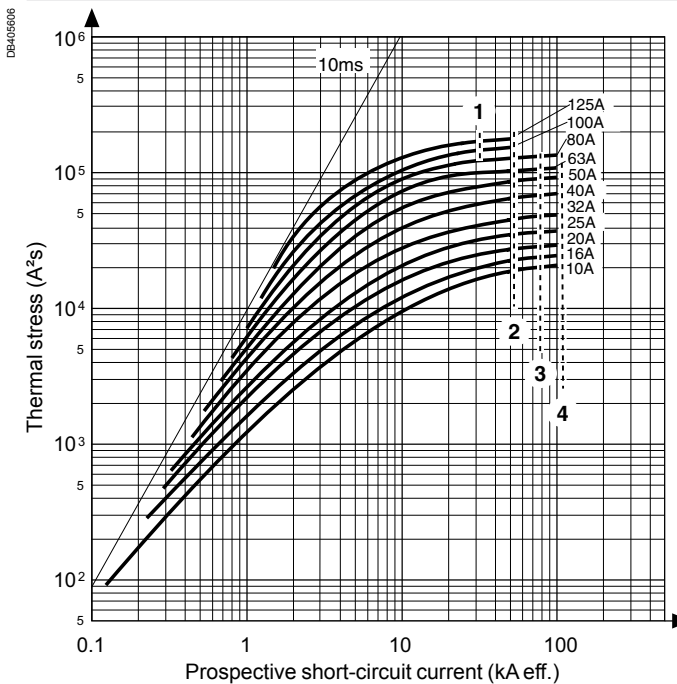

■ Circuit breaker type in accordance with the mark:

- 1: NG125a 80-100-125 A
- 2: NG125N
- 3: NG125H
- 4: NG125L

Limitation curves for direct current network

C60H-DC curve C

1P (220 V) - 2P (440 V)

Peak current

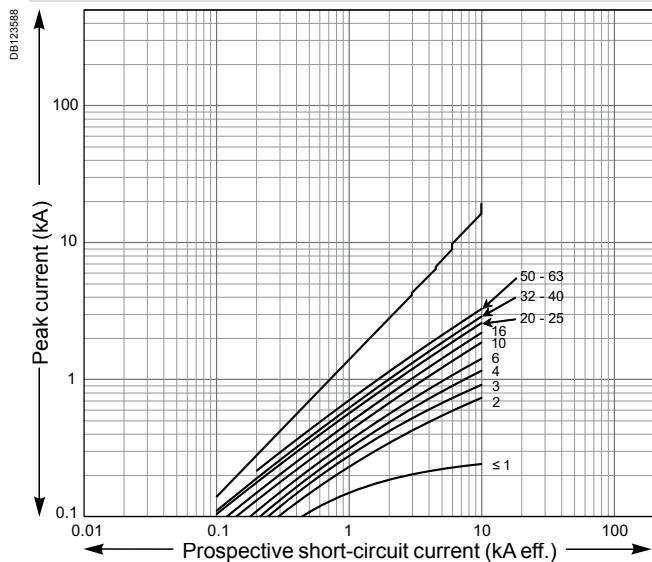

Thermal stress

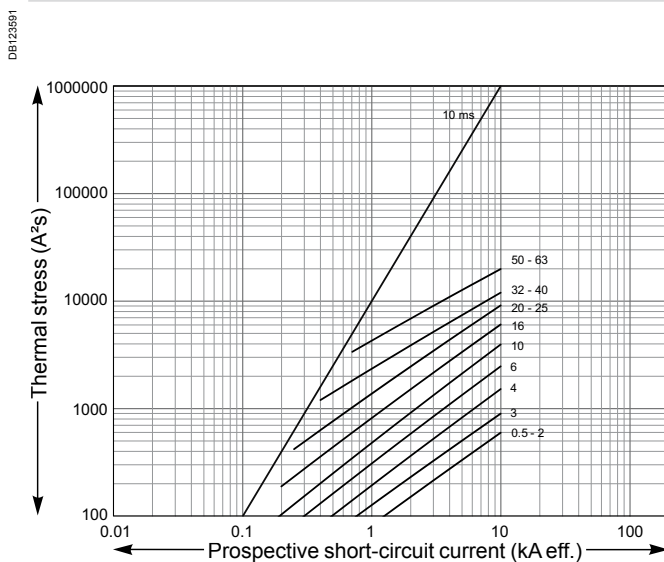

C60H-DC curve C

1P (250 V DC) - 2P (500 V DC)

Peak current

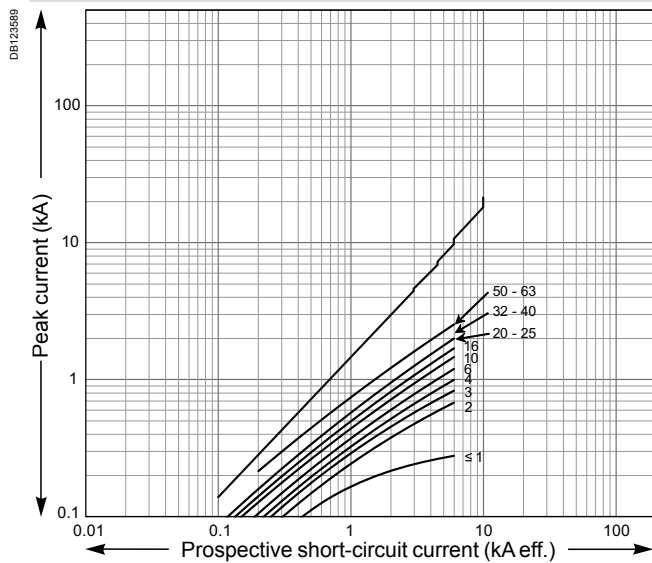

Thermal stress

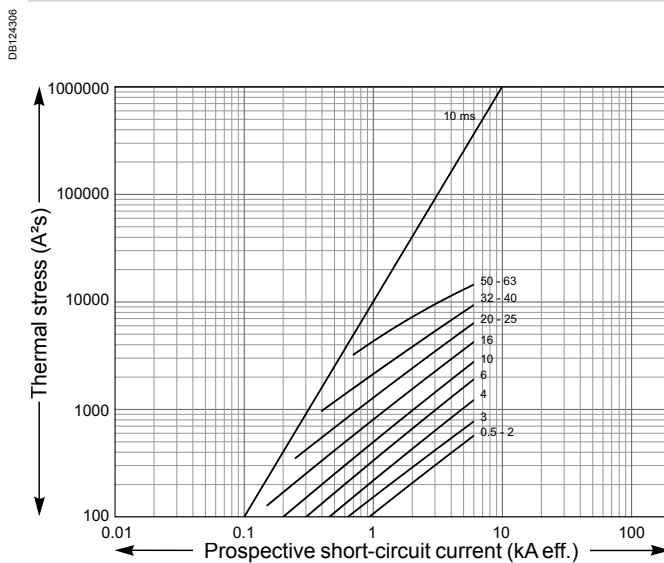

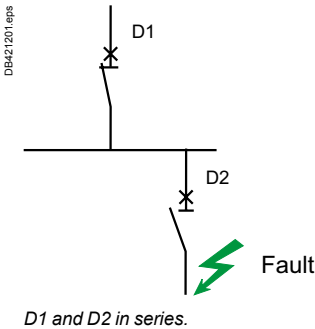

IEC 60947-2, Annex A IEC 60364-4-43 § 434.5.1

What is cascading?

Cascading is the use of the current limiting capacity of circuit breakers at a given point to permit installation of lower-rated and therefore lower-cost circuit breakers downstream.

The upstream Compact circuit breakers acts as a barrier against short-circuit currents. In this way, downstream circuit breakers with lower breaking capacities than the prospective short-circuit (at their point of installation) operate under their normal breaking conditions.

Since the current is limited throughout the circuit controlled by the limiting circuit breaker, cascading applies to all switchgear downstream. It is not restricted to two consecutive devices.

General use of cascading

With cascading, the devices can be installed in different switchboards. Thus, in general, cascading refers to any combination of circuit breakers where a circuit breaker with a breaking capacity less than the prospective I_{sc} at its point of installation can be used. Of course, the breaking capacity of the upstream circuit breaker must be greater than or equal to the prospective short-circuit current at its point of installation.

The combination of two circuit breakers in cascading configuration is covered by the following standards of:

- design and manufacture of circuit breakers (IEC 60947-2, Annex A),
- electrical distribution networks (IEC 60364-4-43 § 434.5.1).

Coordination between circuit breakers

The use of a protective device possessing a breaking capacity less than the prospective short-circuit current at its installation point is permitted as long as another device is installed upstream with at least the necessary breaking capacity. In this case, the characteristics of the two devices must be coordinated in such a way that the energy let through by the upstream device is not more than that which can be withstood by the downstream device and the cables protected by these devices without damage.

Cascading can only be checked by laboratory tests and the possible combinations can be specified only by the circuit breaker manufacturer.

Cascading and protection discrimination

In cascading configurations, due to the Roto-active breaking technique, discrimination is maintained and, in some cases, even enhanced. Consult the enhanced discrimination tables on page 622 for data on discrimination limits.

Cascading tables

Schneider Electric cascading tables are:

- drawn up on the basis of calculations (comparison between the energy limited by the upstream device and the maximum permissible thermal stress for the downstream device)
 - verified experimentally in accordance with IEC standard 60947-2.
- For 50/60 Hz distribution systems with 220-240 V, 380-415 V and 440 V between phases, the tables of the following pages indicate cascading possibilities between upstream Compact and downstream Acti 9 and Compact circuit breakers as well as between upstream Masterpact and downstream Compact circuit breakers. Circuit breaker with Vigi module (Add-On Residual Current Device - RCD): When circuit breakers are equipped with Vigi module, the following cascading tables are still applicable.

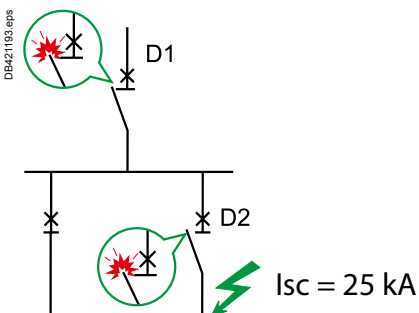
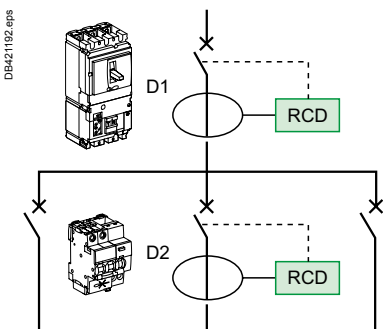

Using the cascading tables

This table takes into account all types of faults: between phases, phase and neutral, phase and earth in all earthing systems.

In IT the following cascading tables can not be used to improve performances in case of "double fault" between two different phases and earth in two different locations of the installation. Each breaker shall comply to IEC60947-2 Annex H to be used in such a system.

Depending on the network and the type of downstream circuit breaker, the selection table below indicates which table should be consulted to find out the cascading value.

Selection table

		Upstream network					
		DB123986.eps L1 _____ N _____		DB123988.eps L1 _____ L2 _____ L3 _____ N _____		DB123987.eps L1 _____ L2 _____ L3 _____	
Type of Downstream network	Type of Downstream protection device	Type of circuit breaker upstream device: 1P, 2P, 3P or 4P circuit breaker					
		Ph/N 110-130 V	Ph/N 220-240 V	Ph/N 110-130 V Ph/Ph 220-240 V	Ph/N 220-240 V Ph/Ph 380-415 V	Ph/Ph 220-240 V	Ph/Ph 380-415 V
DB124079.eps N L1	DB123981.eps 2P	See table Ue: 220-240 V	(1) See table Ue: 380-415 V	See table Ue: 220-240 V	(1) See table Ue: 380-415 V		
	DB124191.eps 1P DB123952.eps 1P+N	See table Ue: 220-240 V	(2) See table Ue: 380-415 V	See table Ue: 220-240 V	(2) See table Ue: 380-415 V		
DB124192.eps L1 L2	DB123991.eps 2P			See table Ue: 220-240 V	See table Ue: 380-415 V	See table Ue: 220-240 V	See table Ue: 380-415 V
DB124080.eps L1 L2 L3	DB123983.eps 3P			See table Ue: 220-240 V	See table Ue: 380-415 V	See table Ue: 220-240 V	See table Ue: 380-415 V
DB124081.eps NL1 L2 L3	DB123994.eps 4P			See table Ue: 220-240 V	See table Ue: 380-415 V		
	DB123993.eps 3P DB123986.eps 3P+N			See table Ue: 220-240 V	See table Ue: 380-415 V		

(1) For fault phase-neutral with upstream protection of neutral, please consult the table Ue: 220-240 V.

(2) For iC60 1P+N circuit breaker connected between phase and neutral under 220-240 V, consult the table Ue: 220-240 V (only for faults between phase and neutral).

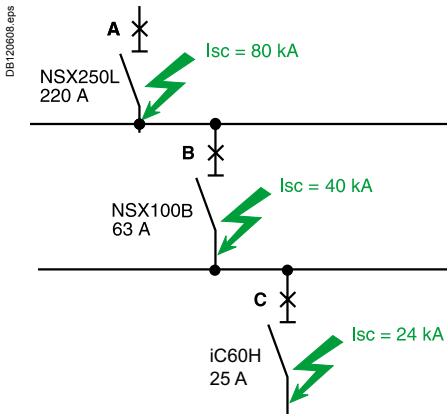

Example of three level cascading

Consider three circuit breakers A, B and C connected in series. The criteria for cascading are fulfilled in the following two cases:

- the upstream device A is coordinated for cascading with both devices B and C (even if the cascading criteria are not fulfilled between B and C). It is simply necessary to check that the combinations A + B and A + C have the required breaking capacity

- each pair of successive devices is coordinated, i.e. A with B and B with C (even if the cascading criteria are not fulfilled between A and C). It is simply necessary to check that the combinations A + B and B + C have the required breaking capacity. The upstream breaker A is a NSX250L (breaking capacity 150 kA) for a prospective I_{sc} of 80 kA across its output terminals.

A NSX100B (breaking capacity 25 kA) can be used for circuit breaker B for a prospective I_{sc} of 40 kA across its output terminals, since the "reinforced" breaking capacity provided by cascading with the upstream NSX250L is 50 kA.

A C60H (breaking capacity 15 kA) can be used for circuit breaker C for a prospective I_{sc} of 24 kA across its output terminals since the "reinforced" breaking capacity provided by cascading with the upstream NSX250L is 25 kA.

Note that the "reinforced" breaking capacity of the C60H with the NSX100B upstream is only 20 kA, but:

- A + B = 50 kA
- A + C = 25 kA.

Downstream	Upstream							
Type	iDPN	iC60	C120	NG125	NG160	NSX100	NSX160	NSX250
380-415 V (Ph/N 220-240 V)								
iDPN 230 Ph/N	page 604	page 604	page 604	page 604	page 604	page 605	page 605	page 606
iC60	page 604	page 604	page 604	page 604	page 604	page 605	page 605	page 606
C120	page 604	page 604	page 604	page 604	page 604	page 605	page 605	page 606
NG125	-	-	-	page 604	page 604	page 605	page 605	page 606
NG160	-	-	-	-	-	page 605	page 605	page 606
NSX100	-	-	-	-	-	page 605	page 605	page 606
NSX160	-	-	-	-	-	-	page 605	page 606
NSX250	-	-	-	-	-	-	-	page 606
440 V								
iC60	-	page 611	-	page 611	-	page 611	page 611	-
NG125	-	page 611	-	page 611	-	page 611	page 611	page 612
NG160	-	-	-	-	-	-	page 611	page 612
NSX100	-	-	-	-	-	page 611	page 611	page 612
NSX160	-	-	-	-	-	-	page 611	page 612
NSX250	-	-	-	-	-	-	-	page 612
220-240 V (Ph/N 110-130 V)								
iDPN 130 Ph/N	page 616	page 616	page 616	page 616	page 616	page 616	page 617	page 618
iC60	page 616	page 616	page 616	page 616	page 616	page 616	page 617	page 618
C120	page 616	page 616	page 616	page 616	page 616	page 616	page 617	page 618
NG125	page 616	page 616	page 616	page 616	page 616	page 616	page 617	page 618
NG160	-	-	-	-	page 616	page 616	page 617	page 618
NSX100	-	-	-	-	page 616	page 616	page 617	page 618
NSX160	-	-	-	-	-	-	page 617	page 618
NSX250	-	-	-	-	-	-	-	page 618

Discrimination enhanced by cascading

Downstream	Upstream			
Type	NG160	NSX100	NSX160	NSX250
380-415 V (Ph/N 220-240 V)				
iC60	page 623	page 625	page 624-625	page 624-626
C120	-	-	-	page 624-626
NG125	-	-	page 624	page 624-626
NG160	-	-	-	page 626
NSX100	-	-	-	page 626
440 V				
iC60	-	page 630	page 629	-
NG125	-	page 630	page 629	page 629
NSX100	-	page 630	-	page 629
220-240 V (Ph/N 110-130 V)				
iC60	-	page 634	page 633-634	page 633-635
C120	-	-	-	page 633-635
NG125	-	-	page 633	page 633-635
NG160	-	-	-	page 636
NSX100	-	-	-	page 636

Downstream Type	Upstream							
	NSX400	NSX630	NS630b	NS800	NS1000 H/L	NS1250 NS1600 H	NS2000 NS2500 NS3200	Masterpact
380-415 V (Ph/N 220-240 V)								
NG160	page 607	page 608	page 609	-	-	-	-	-
NSX100	page 607	page 608	page 609	page 609	page 610	page 610	page 610	page 610
NSX160	page 607	page 608	page 609	page 609	page 610	page 610	page 610	page 610
NSX250	page 607	page 608	page 609	page 609	page 610	page 610	page 610	page 610
NSX400	page 607	page 608	page 609	page 609	page 610	page 610	page 610	page 610
NSX630	-	page 608	page 609	page 609	page 610	page 610	page 610	page 610
NS630b	-	-	page 609	page 609	page 610	page 610	page 610	page 610
NS800	-	-	page 609	page 609	page 610	page 610	page 610	page 610
NS1000	-	-	page 609	page 609	page 610	page 610	page 610	page 610
NS1250	-	-	-	-	page 610	page 610	page 610	page 610
NS1600	-	-	-	-	page 610	page 610	page 610	page 610
440 V								
NG160	page 612	page 613	-	-	-	-	-	-
NSX100	page 612	page 613	page 614	page 614	page 615	page 615	page 615	page 615
NSX160	page 612	page 613	page 614	page 614	page 615	page 615	page 615	page 615
NSX250	page 612	page 613	page 614	page 614	page 615	page 615	page 615	page 615
NSX400	page 612	page 613	page 614	page 614	page 615	page 615	page 615	page 615
NSX630	-	page 613	page 614	page 614	page 615	page 615	page 615	page 615
NS630b	-	-	page 614	page 614	page 615	page 615	page 615	page 615
NS800	-	-	page 614	page 614	page 615	page 615	page 615	page 615
NS1000	-	-	-	-	page 615	page 615	page 615	page 615
NS1250	-	-	-	-	page 615	page 615	page 615	page 615
NS1600	-	-	-	-	page 615	page 615	page 615	page 615
220-240 V (Ph/N 110-130 V)								
NG160	page 619	page 620	-	-	-	-	-	-
NSX100	page 619	page 620	page 621	page 621	page 621	-	-	page 621
NSX160	page 619	page 620	page 621	page 621	page 621	-	-	page 621
NSX250	page 619	page 620	page 621	page 621	page 621	-	-	page 621
NSX400	page 619	page 620	page 621	page 621	page 621	-	-	page 621
NSX630	-	page 620	page 621	page 621	page 621	-	-	page 621

Discrimination enhanced by cascading

Downstream Type	Upstream					
	NSX400	NSX630	NS800	NS1000	NS1250	NS1600
380-415 V (Ph/N 220-240 V)						
NG160	page 627	page 627	-	-	-	-
NSX100	page 627	page 627	page 628	page 628	page 628	page 628
NSX160	page 627	page 627	page 628	page 628	page 628	page 628
NSX250	page 627	page 627	page 628	page 628	page 628	page 628
NSX400	-	-	page 628	page 628	page 628	page 628
NSX630	-	-	page 628	page 628	page 628	page 628
440 V						
NSX100	page 631	page 631	page 632	page 632	page 632	page 632
NSX160	page 631	page 631	page 632	page 632	page 632	page 632
NSX250	page 631	page 631	page 632	page 632	page 632	page 632
NSX400	-	-	page 632	page 632	page 632	page 632
NSX630	-	-	page 632	page 632	page 632	page 632
220-240 V (Ph/N 110-130 V)						
NG160	page 637	page 637	page 637	page 637	-	-
NSX100	page 637	page 637	page 637	page 637	-	-
NSX160	page 637	page 637	page 637	page 637	-	-
NSX250	page 637	page 637	page 637	page 637	-	-
NSX400	page 637	page 637	page 637	page 637	-	-
NSX630	page 637	page 637	page 637	page 637	-	-

Cascading

Upstream: iDPN, iC60, C120, NG125, NG160,
NSX100

Downstream: iDPN, iC60, C120, NG125, NG160,
NSX100

Upstream	iDPN	iC60			C120			NG125			
	iDPN N	iC60N	iC60H	iC60L			C120N	C120H	NG125N	NG125H	NG125L
Breaking capacity (kA)	10	10	15	≤ 25 A	32/40 A	50/63 A	10	15	25	36	50

Downstream													
	In Max (A)	Icu (kA)	Reinforced breaking capacity (kA)										
iDPN	16	6	10	10	10	20	15	10	10	10	10	16	20
	40	6	10	10	10	15	10	10	10	10	10	16	20
iDPNN	16	10			15	25	20	15		15	20	20	25
	40	10			15	20	15	15		15	16	20	25
iC60N	25	10			15	25	20	15		15	25	25	25
	40	10			15		20	15		15	25	25	25
	63	10			15			15		15	25	25	25
iC60H	25	15				25	20				25	36	36
	40	15					20				25	36	36
	63	15									25	36	36
iC60L	25	25										36	50
	40	20									25	36	50
	63	15									25	36	36
C120N	125	10							15	25	25	36	
C120H	125	15								25	25	36	
NG125N	125	25									36	36	
NG125H	80	36										50	

Upstream	NG160			NSX100					
	NG160E	NG160N	NG160H	NSX100B	NSX100F	NSX100N	NSX100H	NSX100S	NSX100L
Breaking capacity (kA)	16	25	36	25	36	50	70	100	150

Downstream												
	In Max (A)	Icu (kA)	Reinforced breaking capacity (kA)									
iDPN	40	6	10	10	10	10	10	10	10	10	10	10
iDPNN	16	10	16	20	20	20	20	20	20	20	20	20
	40	10	16	16	16	16	16	16	16	16	16	16
iC60N	63	10	16	20	25	20	25	30	30	30	30	30
iC60H	40	15	16	25	25	25	36	40	40	40	40	40
	63	15	16	25	25	25	36	36	36	36	36	36
iC60L	25	25					36	40	40	40	40	40
	40	20		25	25	25	36	40	40	40	40	40
	63	15	16	25	25	25	36	36	36	36	36	36
C120N	125	10	16	25	25	25	25	25	25	25	25	25
C120H	125	15	16	25	25	25	25	25	25	25	25	25
NG125N	125	25			36		36	36	36	50	70	70
NG125H	80	36						40	50	70	100	100
NG125L	80	50							70	100	150	150
NSX100B		25					36	36	50	50	50	50
NSX100F		36						50	70	100	150	150
NSX100N		50							70	100	150	150
NSX100H		70								100	150	150
NSX100S		100										150

Cascading

Upstream: NSX160

Downstream: iDPN, iC60, C120, NG125, NG160,
NSX100, NSX160

Upstream	NSX160					
	NSX160B	NSX160F	NSX160N	NSX160H	NSX160S	NSX160L
Breaking capacity (kA)	25	36	50	70	100	150

Downstream								
	In Max (A)	Icu (kA)	Reinforced breaking capacity (kA)					
iDPN	40	6	10	10	10	10	10	10
iDPNN	16	10	20	20	20	20	20	20
	40	10	16	16	16	16	16	16
iC60N	63	10	20	25	30	30	30	30
iC60H	40	15	25	36	40	40	40	40
	63	15	25	30	30	30	30	30
iC60L	25	25		36	40	40	40	40
	40	20	25	36	40	40	40	40
	63	15	25	30	36	36	36	36
C120N	125	10	25	25	25	25	25	25
C120H	125	15	25	25	25	25	25	25
NG125N	125	25		36	36	36	50	70
NG125H	80	36			40	50	70	100
NG125L	80	50				70	100	150
NG160E		16	25	25	30	30	30	30
NG160N		25		36	36	50	50	50
NG160H		36			50	50	50	50
NSX100B		25		36	36	50	50	50
NSX100F		36			50	70	100	150
NSX100H		70					100	150
NSX100S		100						150
NSX160B		25		36	36	50	50	50
NSX160F		36			50	70	100	150
NSX160N		50				70	100	150
NSX160H		70					100	150
NSX160S		100						150

Cascading

Upstream: NSX250

Downstream: iDPN, iC60, C120, NG125, NG160,
NSX100, NSX160, NSX250

Upstream	NSX250					
	NSX250B	NSX250F	NSX250N	NSX250H	NSX250S	NSX250L
Breaking capacity (kA)	25	36	50	70	100	150

Downstream							
	In Max (A)	I _{cu} (kA)	Reinforced breaking capacity (kA)				
iDPN	40	6	10	10	10	10	10
iDPNN	16	10	20	20	20	20	20
	40	10	16	16	16	16	16
iC60N	40	10	20	25	30	30	30
	63	10	20	25	25	25	25
iC60H	40	15	25	30	30	30	30
	63	15	25	25	25	25	25
iC60L	25	25		30	30	30	30
	40	20	25	30	30	30	30
	63	15	25	25	25	25	25
C120N	125	10	25	25	25	25	25
C120H	125	15	25	25	25	25	25
NG125N	125	25		36	36	36	70
NG125H	80	36			40	50	100
NG125L	80	50				70	150
NG160E		16	25	25	30	30	30
NG160N		25		36	36	50	50
NG160H		36			50	50	50
NSX100B		25		36	36	50	50
NSX100F		36			50	70	150
NSX100N		50				70	100
NSX100H		70					100
NSX100S		100					150
NSX160B		25		36	36	50	50
NSX160F		36			50	70	100
NSX160N		50				70	100
NSX160H		70					100
NSX160S		100					150
NSX250B		25		36	36	50	50
NSX250F		36			50	70	100
NSX250N		50				70	100
NSX250H		70					100
NSX250S		100					150

Cascading

Upstream: NSX400

Downstream: NG160, NSX100, NSX160, NSX250,
NSX400

Upstream	NSX400	NSX400N	NSX400H	NSX400S	NSX400L
Breaking capacity (kA)	36	50	70	100	150

Downstream						
	Breaking capacity (kA)	Reinforced breaking capacity (kA)				
NG160E	16	25	25	30	30	30
NG160N	25		36	50	50	50
NG160H	36		50	50	50	50
NSX100B	25	36	36	50	50	50
NSX100F	36		50	70	100	150
NSX100N	50			70	100	150
NSX100H	70				100	150
NSX100S	100					150
NSX160B	25	36	36	50	50	50
NSX160F	36		50	70	100	150
NSX160N	50			70	100	150
NSX160H	70				100	150
NSX160S	100					150
NSX250B	25	36	36	50	50	50
NSX250F	36		50	70	100	150
NSX250N	50			70	100	150
NSX250H	70				100	150
NSX250S	100					150
NSX400F	36		50	70	100	150
NSX400N	50			70	100	150
NSX400H	70				100	150
NSX400S	100					150

Cascading

Upstream: NSX630

Downstream: NG160, NSX100, NSX160, NSX250,
NSX400, NSX630

Ue: 380-415 V AC
(Ph/N 220-240 V)

Upstream	NSX630				
	NSX630F	NSX630N	NSX630H	NSX630S	NSX630L
Breaking capacity (kA)	36	50	70	100	150

Downstream						
	Breaking capacity (kA)	Reinforced breaking capacity (kA)				
NG160E	16	25	25	30	30	30
NG160N	25		36	50	50	50
NG160H	36		50	50	50	50
NSX100B	25	36	36	50	50	50
NSX100F	36		50	70	100	150
NSX100N	50			70	100	150
NSX100H	70				100	150
NSX100S	100					150
NSX160B	25	36	36	50	50	50
NSX160F	36		50	70	100	150
NSX160N	50			70	100	150
NSX160H	70				100	150
NSX160S	100					150
NSX250B	25	36	36	50	50	50
NSX250F	36		50	70	100	150
NSX250N	50			70	100	150
NSX250H	70				100	150
NSX250S	100					150
NSX400F	36		50	70	100	150
NSX400N	50			70	100	150
NSX400H	70				100	150
NSX400S	100					150
NSX630F	36		50	70	100	150
NSX630N	50			70	100	150
NSX630H	70				100	150
NSX630S	100					150

Cascading

Upstream: NS630bN to NS1600N, NS630b, NS800

Downstream: NSX100, NSX160, NSX250, NSX400,
NSX630, NS630b, NS800, NS1000

Upstream	NS630bN to NS1600N	NS630b			NS800		
Breaking capacity (kA)	50	H	L	LB	H	L	LB
		70	150	200	70	150	200

Downstream								
	Breaking capacity (kA)	Reinforced breaking capacity (kA)						
NSX100B	25	50	50	50	50	50	50	50
NSX100F	36	50	70	150	150	70	150	150
NSX100N	50		70	150	150	70	150	150
NSX100H	70			150	150		150	150
NSX100S	100			150	200		150	200
NSX100L	150				200			200
NSX160B	25	50	50	50	50	50	50	50
NSX160F	36	50	70	150	150	70	150	150
NSX160N	50		70	150	150	70	150	150
NSX160H	70			150	150		150	150
NSX160S	100			150	200		150	200
NSX160L	150				200			200
NSX250B	25	50	50	50	50	50	50	50
NSX250F	36	50	70	150	150	70	150	150
NSX250N	50		70	150	150	70	150	150
NSX250H	70			150	150		150	150
NSX250S	100			150	200		150	200
NSX250L	150				200			200
NSX400F	36	50	70	150	150	70	150	150
NSX400N	50		70	150	150	70	150	150
NSX400H	70			150	150		150	150
NSX400S	100			150	200		150	200
NSX400L	150				200			200
NSX630F	36	50	70	150	150	70	150	150
NSX630N	50		70	150	150	70	150	150
NSX630H	70			150	150		150	150
NSX630S	100			150	200		150	200
NSX630L	150				200			200
NS630bN	50		70	150	200	70	150	200
NS630bH	70			150	200		150	200
NS800N	50					70	150	200
NS800H	70						150	200
NS1000N	50							200
NS1000H	70							200

Cascading

Upstream: NS1000, NS1250, NS1600, NS2000,
NS2500, NS3200, Masterpact

Downstream: NSX100-160-250-400-630,
NS630b, NS800-1000-1250-1600

Upstream	NS1000		NS1250H NS1600H	NS2000N NS2500N NS3200N	Masterpact	
	H	L			NT L1	NW L1
Breaking capacity (kA)	70	150	70	70	150	150

Downstream							
	Breaking capacity (kA)	Reinforced breaking capacity (kA)					
NSX100B	25	50	50	50		50	
NSX100F	36	70	150	70		150	
NSX100N	50	70	150	70		150	
NSX100H	70		150			150	
NSX100S	100		150			150	
NSX100L	150						
NSX160B	25	50	50	50		50	
NSX160F	36	70	150	70		150	
NSX160N	50	70	150	70		150	
NSX160H	70		150			150	
NSX160S	100		150			150	
NSX160L	150						
NSX250B	25	50	50	50		50	
NSX250F	36	70	150	70		150	
NSX250N	50	70	150	70		150	
NSX250H	70		150			150	
NSX250S	100		150			150	
NSX250L	150						
NSX400F	36	70	150	70		150	
NSX400N	50	70	150	70		150	
NSX400H	70		150			150	
NSX400S	100		150			150	
NSX400L	150						
NSX630F	36	70	150	70		150	
NSX630N	50	70	150	70		150	
NSX630H	70		150			150	
NSX630S	100		150			150	
NSX630L	150						
NS630bN	50	70	150	70	70	150	65
NS630bH	70		150			150	
NS800N	50		150	70	70	150	65
NS800H	70		150			150	
NS1000N	50		150	70	70	150	65
NS1000H	70		150			150	
NS1250N	50			70	70		65
NS1600N	50				70		65

Cascading

Upstream: iC60, NG125, NSX100, NSX160

Downstream: iC60, C120, NG125, NSX100,
NSX160

Ue: 440 V AC

Upstream	iC60					NG125		
	iC60N	iC60H	iC60L			NG125N	NG125H	NG125L
Breaking capacity (kA)	6	10	20	15	10	20	30	40

Downstream								
	Breaking capacity (kA)	Reinforced breaking capacity (kA)						
iC60N	6		10	20	15	10	20	20
iC60H	10			20	15		20	25
iC60L	≤ 25 A	20						30
	32-40 A	15					20	30
	50-63 A	10					20	25
NG125N	20							30
NG125H	30							40
NG125L	40							40

Upstream	NSX100					
	NSX100B	NSX100F	NSX100N	NSX100H	NSX100S	NSX100L
Breaking capacity (kA)	20	35	50	65	90	130

Downstream							
	Breaking capacity (kA)	Reinforced breaking capacity (kA)					
iC60N	6	15	15	20	20	20	20
iC60H	10	20		25	25	25	25
iC60L	≤ 25 A	20		25	25	25	25
	32-40 A	15	20	20	25	25	25
	50-63 A	10					
NG125N	20		35	35	35	50	65
NG125H	30		35	40	50	65	90
NG125L	40			50	65	90	130
NSX100B	20		35	35	50	50	50
NSX100F	35			50	65	90	130
NSX100N	50				65	90	130
NSX100H	65					90	130
NSX100S	90						130

Upstream	NSX160					
	NSX160B	NSX160F	NSX160N	NSX160H	NSX160S	NSX160L
Breaking capacity (kA)	20	35	50	65	90	130

Downstream							
	Breaking capacity (kA)	Reinforced breaking capacity (kA)					
iC60N	6	15	15	20	20	20	20
iC60H	10	20	20	25	25	25	25
iC60L	≤ 25 A	20		25	25	25	25
	32-40 A	15	20	20	25	25	25
	50-63 A	10					
NG125N	20		35	35	35	50	65
NG125H	30		35	40	50	65	90
NG125L	40			50	65	90	130
NG160E	16	20	20	30	30	30	30
NG160N	25		35	35	50	50	50
NG160H	30			50	50	50	50
NSX100B	20		35	35	50	50	50
NSX100F	35			50	65	90	130
NSX100N	50				65	90	130
NSX100H	65					90	130
NSX100S	90						130
NSX160B	20		35	35	50	50	50
NSX160F	35			50	65	90	130
NSX160N	50				65	90	130
NSX160H	65					90	130
NSX160S	90						130

Cascading

Upstream: NSX250, NSX400

Downstream: NG125, NG160, NSX100, NSX160,
NSX250, NSX400

Ue: 440 V AC

Upstream	NSX250					
	NSX250B	NSX250F	NSX250N	NSX250H	NSX250S	NSX250L
Breaking capacity (kA)	20	35	50	65	90	130

Downstream							
	Breaking capacity (kA)	Reinforced breaking capacity (kA)					
NG125N	20		35	35	35	50	65
NG125H	30		35	40	50	65	90
NG125L	40			50	65	90	130
NG160E	16	20	20	30	30	30	30
NG160N	25		35	35	50	50	50
NG160H	30			50	50	50	50
NSX100B	20		35	35	50	50	50
NSX100F	35			50	65	90	130
NSX100N	50				65	90	130
NSX100H	65					90	130
NSX100S	90						130
NSX160B	20		35	35	50	50	50
NSX160F	35			50	65	90	130
NSX160N	50				65	90	130
NSX160H	65					90	130
NSX160S	90						130
NSX250B	20		35	35	50	50	50
NSX250F	35			50	65	90	130
NSX250N	50				65	90	130
NSX250H	65					90	130
NSX250S	90						130

Upstream	NSX400				
	NSX400F	NSX400N	NSX400H	NSX400S	NSX400L
Breaking capacity (kA)	30	42	65	90	130

Downstream						
	Breaking capacity (kA)	Reinforced breaking capacity (kA)				
NG160E	16	20	30	30	30	30
NG160N	25	30	30	50	50	50
NG160H	30		42	50	50	50
NSX100B	20	30	30	50	50	50
NSX100F	35		42	65	90	130
NSX100N	50			65	90	130
NSX100H	65				90	130
NSX100S	90					130
NSX160B	20	30	30	50	50	50
NSX160F	35		42	65	90	130
NSX160N	50			65	90	130
NSX160H	65				90	130
NSX160S	90					130
NSX250B	20	30	30	50	50	50
NSX250F	35		42	65	90	130
NSX250N	50			65	90	130
NSX250H	65				90	130
NSX250S	90					130
NSX400F	30		42	65	90	130
NSX400N	42			65	90	130
NSX400H	65				90	130
NSX400S	90					130

Cascading

Upstream: NSX630

Downstream: NG160, NSX100, NSX160, NSX250,
NSX400, NSX630

Ue: 440 V AC

Upstream	NSX630	NSX630N	NSX630H	NSX630S	NSX630L
Breaking capacity (kA)	30	42	65	90	130

Downstream						
	Breaking capacity (kA)	Reinforced breaking capacity (kA)				
NG160E	16	20	30	30	30	30
NG160N	25	30	30	50	50	50
NG160H	30		42	50	50	50
NSX100B	20	30	30	50	50	50
NSX100F	35		42	65	90	130
NSX100N	50			65	90	130
NSX100H	65				90	130
NSX100S	90					130
NSX160B	20	35	30	50	50	50
NSX160F	35		42	65	90	130
NSX160N	50			65	90	130
NSX160H	65				90	130
NSX160S	90					130
NSX250B	20	35	30	50	50	50
NSX250F	35		42	65	90	130
NSX250N	50			65	90	130
NSX250H	65				90	130
NSX250S	90					130
NSX400F	30		42	65	90	130
NSX400N	42			65	90	130
NSX400H	65				90	130
NSX400S	90					130
NSX630F	30		42	65	90	130
NSX630N	42			65	90	130
NSX630H	65				90	130
NSX630S	90					130

Cascading

Upstream: NS630bN to NS1600N, NS630b, NS800

Downstream: NSX100, NSX160, NSX250, NSX400,
NSX630, NS630b, NS800

Ue: 440 V AC

Upstream	NS630bN to NS1600N	NS630b			NS800		
Breaking capacity (kA)		H	L	LB	H	L	LB
	50	65	130	200	65	130	200

Downstream								
	Breaking capacity (kA)	Reinforced breaking capacity (kA)						
NSX100B	20	50	50	50	50	50	50	50
NSX100F	35	50	65	130	130	65	130	130
NSX100N	50		65	130	130	65	130	130
NSX100H	65			130	130		130	130
NSX100S	90			130	200		130	200
NSX100L	130				200			200
NSX160B	20	50	50	50	50	50	50	50
NSX160F	35	50	65	130	130	65	130	130
NSX160N	50		65	130	130	65	130	130
NSX160H	65			130	130		130	130
NSX160S	90			130	200		130	200
NSX160L	130				200			200
NSX250B	20	50	50	50	50	50	50	50
NSX250F	35	50	65	130	130	65	130	130
NSX250N	50		65	130	130	65	130	130
NSX250H	65			130	130		130	130
NSX250S	90			130	200		130	200
NSX250L	130				200			200
NSX400F	30	50	65	130	130	65	130	130
NSX400N	42		65	130	130	65	130	130
NSX400H	65			130	130		130	130
NSX400S	90			130	200		130	200
NSX400L	130				200			200
NSX630F	30	50	65	130	130	65	130	130
NSX630N	42		65	130	130	65	130	130
NSX630H	65			130	130		130	130
NSX630S	90			130	200		130	200
NSX630L	130				200			200
NS630bN	50		65	130	200	65	130	200
NS630bH	65			130	200		130	200
NS800N	50					65	130	200
NS800H	65						130	200

Cascading

Upstream: NS1000, NS1250, NS1600, NS2000,
NS2500, NS3200, Masterpact

Downstream: NSX100, NSX160, NSX250, NSX400,
NSX630, NS630b, NS800-1000-1250-1600

Ue: 440 V AC

Upstream	NS1000		NS1250H NS1600H	NS2000N NS2500N NS3200N	Masterpact	
	H	L			NT L1	NW L1
Breaking capacity (kA)	65	130	65	65	130	150

Downstream							
	Breaking capacity (kA)	Reinforced breaking capacity (kA)					
NSX100B	20	50	50	50		50	
NSX100F	35	65	130	65		130	
NSX100N	50	65	130	65		130	
NSX100H	65		130			130	
NSX100S	90		130			130	
NSX100L	130						
NSX160B	20	50	50	50		50	
NSX160F	35	65	130	65		130	
NSX160N	50	65	130	65		130	
NSX160H	65		130			130	
NSX160S	90		130			130	
NSX160L	130						
NSX250B	20	50	50	50		50	
NSX250F	35	65	130	65		130	
NSX250N	50	65	130	65		130	
NSX250H	65		130			130	
NSX250S	90		130			130	
NSX250L	130						
NSX400F	30	65	130	65		130	
NSX400N	42	65	130	65		130	
NSX400H	65		130			130	
NSX400S	90		130			130	
NSX400L	130						
NSX630F	30	65	130	65		130	
NSX630N	42	65	130	65		130	
NSX630H	65		130			130	
NSX630S	90		130			130	
NSX630L	130						
NS630bN	50	65	130	65	65	130	65
NS630bH	65		130			130	
NS800N	50	65	130	65	65	130	65
NS800H	65		130			130	
NS1000N	50	65	130	65	65	130	65
NS1000H	65		130			130	
NS1250N	50			65	65		65
NS1600N	50						65

Cascading

Upstream: iDPN, iC60, C120, NG125, NG160,
NSX100

Downstream: iDPN, iC60, C120, NG125, NG160,
NSX100

U_e: 220-240 V AC
(Ph/N 110-130 V AC)

Upstream	iDPN	iC60			C120			NG125			
	iDPNN	iC60N	iC60H	iC60L			C120N	C120H	NG125N	NG125H	NG125L
				≤ 25 A	32/40 A	50/63 A					
Breaking capacity (kA)	15	20	30	50	36	30	20	30	50	70	100

Downstream													
	In Max (A)	Icu (kA)	Reinforced breaking capacity (kA)										
iDPN	40	10	10	15	20	30	25	20	15	20	20	40	50
iDPNN	40	15		20	30	50	36	30	20	30	30	40	50
iC60N	25	20			30	50	36	30		30	50	50	50
	40	20			30		36	30		30	50	50	50
	63	20			30			30		30	50	50	50
iC60H	25	30				50	36				50	70	70
	40	30					36				50	70	70
	63	30									50	70	70
iC60L	25	50										70	100
	40	36										70	100
	63	30										70	100
C120N	125	20							30		50	70	70
C120H	125	30									50	70	70
NG125N	125	50										70	70
NG125H	80	70											100

Upstream	NG160			NSX100					
	NG160E	NG160N	NG160H	NSX100B	NSX100F	NSX100N	NSX100H	NSX100S	NSX100L
Breaking capacity (kA)	25	40	50	40	85	90	100	120	150

Downstream												
	In Max (A)	Icu (kA)	Reinforced breaking capacity (kA)									
iDPN	16	10	20	20	20	20	20	20	20	20	20	20
	40	10	10	10	10	20	20	20	20	20	20	20
iDPNN	16	15	30	30	30	30	30	30	30	30	30	30
	40	15	15	15	15	30	30	30	30	30	30	30
iC60N	63	20	25	40	50	40	40	60	60	60	60	60
iC60H	63	30		40	50	40	50	80	80	80	80	80
iC60L	25	50		40	50		65	80	80	80	80	80
	40	36		40	50	40	65	80	80	80	80	80
	63	30		40	50	40	65	80	80	80	80	80
C120N	125	20	25	40	40	40	40	50	50	70	70	70
C120H	125	30		40	40	40	40	50	50	70	70	70
NG125N	125	50					60	70	70	85	85	85
NG125H	80	70					85	85	85	100	100	100
NG125L	80	100								120	150	150
NG160E		25			50							
NG160N		40										
NG160H		50										
NSX100B		40					85	90	90	100	100	100
NSX100F		85						90	100	120	150	150
NSX100N		90							100	120	150	150
NSX100H		100								120	150	150
NSX100S		120									150	150

Cascading

Upstream: NSX160

Downstream: iDPN, iC60, C120, NG125, NG160,
NSX100, NSX160

Upstream	NSX160					
	NSX160B	NSX160F	NSX160N	NSX160H	NSX160S	NSX160L
Breaking capacity (kA)	40	85	90	100	120	150

Downstream								
	In Max (A)	Icu (kA)	Reinforced breaking capacity (kA)					
iDPN	40	10	20	20	20	20	20	20
iDPNN	40	15	30	30	30	30	30	30
iC60N	63	20	40	40	60	60	60	60
iC60H	63	30	40	50	80	80	80	80
iC60L	25	50		65	80	80	80	80
	40	36	40	65	80	80	80	80
	63	30	40	65	80	80	80	80
C120N	125	20	40	40	50	50	70	70
C120H	125	30	40	40	50	50	70	70
NG125N	125	50		60	70	70	85	85
NG125H	80	70		85	85	85	100	100
NG125L	80	100					120	150
NG160E		25	40	50	50	50	60	60
NG160N		40		85	90	100	100	100
NG160H		50		85	90	100	100	100
NSX100B		40		85	90	90	100	100
NSX100F		85			90	100	120	150
NSX100N		90				100	120	150
NSX100H		100					120	150
NSX100S		120						150
NSX160B		40		85	90	90	100	100
NSX160F		85			90	100	120	150
NSX160N		90				100	120	150
NSX160H		100					120	150
NSX160S		120						150

Cascading

Upstream: NSX250

Downstream: iDPN, iC60, C120, NG125, NG160,
NSX100, NSX160, NSX250

U_e: 220-240 V AC
(Ph/N 110-130 V AC)

Upstream	NSX250					
	NSX250B	NSX250F	NSX250N	NSX250H	NSX250S	NSX250L
Breaking capacity (kA)	40	85	90	100	120	150

Downstream							
	In Max (A)	I _{cu} (kA)	Reinforced breaking capacity (kA)				
iDPN	40	10	20	20	20	20	20
iDPNN	40	15	30	30	30	30	30
iC60N	63	20	40	40	60	60	60
iC60H	63	30	40	50	65	65	65
iC60L	25	50		65	80	80	80
	40	36	40	65	80	80	80
	63	30	40	50	65	65	65
C120N	125	20	40	40	50	50	70
C120H	125	30	40	40	50	50	70
NG125N	125	50		60	70	70	85
NG125H	80	70		85	85	85	100
NG125L	80	100					120
NG160E		25	40	50	50	50	60
NG160N		40		85	90	100	100
NG160H		50		85	90	100	100
NSX100B		40		85	90	90	100
NSX100F		85			90	100	120
NSX100N		90				100	120
NSX100H		100					120
NSX100S		120					150
NSX160B		40		85	90	90	100
NSX160F		85			90	100	120
NSX160N		90				100	120
NSX160H		100					120
NSX160S		120					150
NSX250B		40		85	90	90	100
NSX250F		85			90	100	120
NSX250N		90				100	120
NSX250H		100					120
NSX250S		120					150

Cascading

Upstream: NSX400

Downstream: NG160, NSX100, NSX160, NSX250,
NSX400

Ue: 220-240 V AC
(Ph/N 110-130 V AC)

Upstream	NSX400 NSX400F	NSX400N	NSX400H	NSX400S	NSX400L
Breaking capacity (kA)	40	85	100	120	150

Downstream						
	Breaking capacity (kA)	Reinforced breaking capacity (kA)				
NG160E	25	40	50	50	60	60
NG160N	40		85	90	100	100
NG160H	50		85	90	100	100
NSX100B	40		85	90	100	100
NSX100F	85			100	120	150
NSX100N	90			100	120	150
NSX100H	100				120	150
NSX100S	120					150
NSX160B	40		85	90	100	100
NSX160F	85			100	120	150
NSX160N	90			100	120	150
NSX160H	100				120	150
NSX160S	120					150
NSX250B	40		85	90	100	100
NSX250F	85			100	120	150
NSX250N	90			100	120	150
NSX250H	100				120	150
NSX250S	120					150
NSX400F	40		85	100	120	150
NSX400N	85			100	120	150
NSX400H	100				120	150
NSX400S	120					150

Upstream	NSX630				
	NSX630F	NSX630N	NSX630H	NSX630S	NSX630L
Breaking capacity (kA)	40	85	100	120	150

Downstream						
	Breaking capacity (kA)	Reinforced breaking capacity (kA)				
NG160E	25	40	50	50	60	60
NG160N	40	40	85	90	100	100
NG160H	50	40	85	90	100	100
NSX100B	40		85	90	100	100
NSX100F	85			100	120	150
NSX100N	90			100	120	150
NSX100H	100				120	150
NSX100S	120					150
NSX160B	40		85	90	100	100
NSX160F	85			100	120	150
NSX160N	90			100	120	150
NSX160H	100				120	150
NSX160S	120					150
NSX250B	40		85	90	100	100
NSX250F	85			100	120	150
NSX250N	90			100	120	150
NSX250H	100				120	150
NSX250S	120					150
NSX400F	40		85	100	120	150
NSX400N	85			100	120	150
NSX400H	100			100	120	150
NSX400S	120				120	150
NSX630F	40		85	100	120	150
NSX630N	85			100	120	150
NSX630H	100			100	120	150
NSX630S	120				120	150

Ue: 220-240 V AC
(Ph/N 110-130 V AC)

Upstream	NS630		NS800-1000			Masterpact	
	NS630bL	NS630LB	NS800L	NS800LB	NS1000L	NT L1	NW L1
Breaking capacity (kA)	150	200	150	200	150	150	150

Downstream								
	Breaking capacity (kA)	Reinforced breaking capacity (kA)						
NSX100B	40	50	50	50	50	50	50	
NSX100F	85	150	150	150	150	150	150	
NSX100N	90	150	150	150	150	150	150	
NSX100H	100	150	150	150	150	150	150	
NSX100S	120	150	200	150	200	150	150	
NSX100L	150		200		200			
NSX160B	40	50	50	50	50	50	50	
NSX160F	85	150	150	150	150	150	150	
NSX160N	90	150	150	150	150	150	150	
NSX160H	100	150	150	150	150	150	150	
NSX160S	120	150	200	150	200	150	150	
NSX160L	150		200		200			
NSX250B	40	50	50	50	50	50	50	
NSX250F	85	150	150	150	150	150	150	
NSX250N	90	150	150	150	150	150	150	
NSX250H	100	150	150	150	150	150	150	
NSX250S	120	150	200	150	200	150	150	
NSX250L			200		200			
NSX400F	40	150	150	150	150	150	150	
NSX400N	85	150	150	150	150	150	150	100
NSX400H	100	150	150	150	150	150	150	
NSX400S	120	150	200	150	200	150	150	
NSX400L	150		200		200			
NSX630F	40	150	150	150	150	150	150	
NSX630N	85	150	150	150	150	150	150	100
NSX630H	100	150	150	150	150	150	150	
NSX630S	120	150	200	150	200	150	150	
NSX630L	150		200		200			

Discrimination enhanced by cascading

With traditional circuit breakers, cascading between two devices generally results in the look of discrimination.

With Compact circuit breakers, the discrimination characteristics in the tables remain applicable and are in some cases even enhanced. Protection discrimination is ensured for short-circuit currents greater than the rated breaking capacity of the circuit breaker and even, in some cases, for its enhanced breaking capacity. In the later case, **protection discrimination is total**, i.e. only the downstream device trips for any and all possible faults at its point in the installation.

Example

Consider a combination between:

- a Compact NSX250H with trip unit TM250D
- a Compact NSX100F with trip unit TM25D.

The discrimination tables indicate total discrimination. Protection discrimination is therefore ensured up to the breaking capacity of the NSX100F, i.e. **36 kA**.

The cascading tables indicate an enhanced breaking capacity of **70 kA**.

The enhanced discrimination tables indicate that in a cascading configuration, discrimination is ensured up to **70 kA**, i.e. for any and all possible faults at that point in the installation.

Enhanced discrimination tables - 380-415 V

For each combination of two circuit breakers, the tables indicate the:

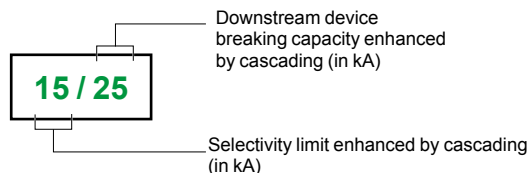

In a table, a box containing two equal values indicates that discrimination is provided up to the reinforced breaking capacity of the downstream device.

These tables apply only to cases with combined discrimination and cascading between two devices. For all other cases, refer to the normal cascading and discrimination tables.

Technical principle

Enhanced discrimination is the result of the exclusive Compact NSX Roto-active breaking technique which operates as follows:

- due to the short-circuit current (electrodynamic forces), the contacts in both devices simultaneously separate. The result is major limitation of the short-circuit current
- the dissipated energy provokes the reflex tripping of the downstream device, but is insufficient to trip the upstream device.

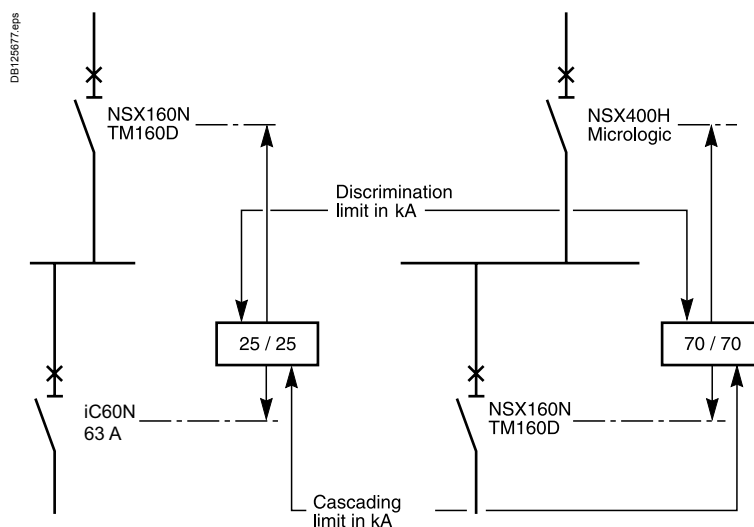

Note: respect the basic rules of discrimination, in terms of overload, short-circuit, see 557E4300.indd/638 and 557E4305.indd/644.

Discrimination enhanced by cascading

Upstream: NG160, TM-D

Downstream: iC60

Upstream	NG160 NG160E	NG160N
Breaking capacity (kA)	16	25
Trip unit	TM-D	TM-D

Downstream			63	80	100	125	160	63	80	100	125	160
Rating (A)		Breaking capacity (kA)	Reinforced breaking capacity (kA)									
iC60N	≤ 20 A	10	10/16	16/16	16/16	16/16	16/16	10/20	16/20	20/20	20/20	20/20
	25 A	10	6/16	6/16	16/16	16/16	16/16	6/20	6/20	20/20	20/20	20/20
	32 A	10	4/16	4/16	7/16	16/16	16/16	4/20	4/20	7/20	20/20	20/20
	40 A	10		4/16	7/16	8/16	8/16		4/20	7/20	8/20	8/20
	50 A	10			5/16	8/16	8/16			5/20	8/20	8/20
	63 A	10				6/16	6/16				6/20	6/20
iC60H	≤ 20 A	15	10/16	16/16	16/16	16/16	16/16	10/25	15/25	25/25	25/25	25/25
	25 A	15	6/16	6/16	16/16	16/16	16/16	6/25	6/25	25/25	25/25	25/25
	32 A	15	4/16	4/16	7/16	16/16	16/16	4/25	4/25	7/25	25/25	25/25
	40 A	15		4/16	7/16	8/16	8/16		4/25	7/25	8/25	8/25
	50 A	15			5/16	8/16	8/16			5/25	8/25	8/25
	63 A	15				6/16	6/16				6/25	6/25
iC60L	≤ 20 A	25						10/25	15/25	25/25	25/25	25/25
	25 A	25						6/25	6/25	25/25	25/25	25/25
	32 A	20						4/25	4/25	7/25	25/25	25/25
	40 A	20							4/25	7/25	8/25	8/25
	50 A	15			5/16	8/16	8/16			5/25	8/25	8/25
	63 A	15				6/16	6/16				6/25	6/25

Upstream	NG160H
Breaking capacity (kA)	36
Trip unit	TM-D

Downstream			63	80	100	125	160
Rating (A)		Breaking capacity (kA)	Reinforced breaking capacity (kA)				
iC60N	≤ 20 A	10	10/25	15/25	20/25	20/25	20/25
	25 A	10	6/25	6/25	20/25	20/25	20/25
	32 A	10	4/25	4/25	7/25	20/25	20/25
	40 A	10		4/25	7/25	8/25	8/25
	50 A	10			5/25	8/25	8/25
	63 A	10				6/25	6/25
iC60H	≤ 20 A	15	10/25	15/25	25/25	25/25	25/25
	25 A	15	6/25	6/25	25/25	25/25	25/25
	32 A	15	4/25	4/25	7/25	25/25	25/25
	40 A	15		4/25	7/25	8/25	8/25
	50 A	15			5/25	8/25	8/25
	63 A	15				6/25	6/25
iC60L	≤ 20 A	25	10/25	15/25	25/25	25/25	25/25
	25 A	25	6/25	6/25	25/25	25/25	25/25
	32 A	20	4/25	4/25	7/25	25/25	25/25
	40 A	20		4/25	7/25	8/25	8/25
	50 A	15			5/25	8/25	8/25
	63 A	15				6/25	6/25

Note: respect the basic rules of discrimination, in terms of overload, short-circuit, see 557E4300.indd/638 and 557E4305.indd/644.

Discrimination enhanced by cascading

Upstream: NSX160, NSX250, TM-D

Downstream: iC60, C120, NG125

Upstream	NSX160 NSX160B	NSX160F	NSX160N	NSX160H	NSX160S	NSX160L
Breaking capacity (kA)	25	36	50	70	100	150
Trip unit	TM-D	TM-D	TM-D	TM-D	TM-D	TM-D

Downstream			80-100	125-160	80-100	125-160	80-100	125-160	80-100	125-160	80-100	125-160	80-100	125-160
Rating (A)	Breaking capacity (kA)	Reinforced breaking capacity (kA)												
iC60N	10			20/20		25/25		30/30		30/30		30/30		30/30
iC60H	≤ 40 A	15		25/25		36/36		40/40		40/40		40/40		40/40
	50-63 A	15		25/25		30/30		30/30		30/30		30/30		30/30
iC60L	≤ 25 A	25				36/36		40/40		40/40		40/40		40/40
	32-40 A	20		25/25		36/36		40/40		40/40		40/40		40/40
	50-63 A	15		25/25		30/30		36/36		36/36		36/36		36/36
NG125N	≤ 20 A	25				36/36		36/36		36/36		50/50		70/70
	25 to 125 A	25												
NG125H	≤ 20 A	36						40/40		50/50		70/70		100/100
	25 to 80 A	36												
NG125L	≤ 20 A	50								70/70		100/100		150/150
	25 to 80 A	50												

Upstream	NSX250 NSX250B	NSX250F	NSX250N	NSX250H	NSX250S	NSX250L
Breaking capacity (kA)	25	36	50	70	100	150
Trip unit	TM-D	TM-D	TM-D	TM-D	TM-D	TM-D

Downstream			200-250	200-250	200-250	200-250	200-250	200-250
Rating (A)	Breaking capacity (kA)	Reinforced breaking capacity (kA)						
iC60N	≤ 40 A	10	20/20	25/25	30/30	30/30	30/30	30/30
	50-63 A	10	20/20	25/25	25/25	25/25	25/25	25/25
iC60H	≤ 40 A	15	25/25	30/30	30/30	30/30	30/30	30/30
	50-63 A	15	25/25	25/25	25/25	25/25	25/25	25/25
iC60L	≤ 25 A	25		30/30	30/30	30/30	30/30	30/30
	32-40 A	20	25/25	30/30	30/30	30/30	30/30	30/30
	50-63 A	15	25/25	25/25	25/25	25/25	25/25	25/25
C120N/H	10/15		25/25	25/25	25/25	25/25	25/25	25/25
NG125N	25			36/36	36/36	36/36	50/50	70/70
NG125H	36				40/40	50/50	70/70	100/100
NG125L	50					70/70	100/100	150/150
NG160E	16			25/25	30/30	30/30	30/30	30/30
NG160N	25			36/36	36/36	50/50	50/50	50/50
NG160H	36				50/50	50/50	50/50	50/50
NSX100B, ≤ 25 A	25			36/36	36/36	50/50	50/50	50/50
TM-D 40-100 A	25			36/36	36/36	36/50	36/50	36/50
NSX100F, ≤ 25 A	36				50/50	70/70	100/100	150/150
TM-D 40-100 A	36				36/50	36/70	36/100	36/150
NSX100N, ≤ 25 A	50					70/70	100/100	150/150
TM-D 40-100 A	50					36/70	36/100	36/150
NSX100H, ≤ 25 A	70						100/100	150/150
TM-D 40-100 A	70						36/100	36/150
NSX100S, ≤ 25 A	100							150/150
TM-D 40-100 A	100							36/150
NSX100B Micrologic	25			2/36	2/36	2/50	2/50	2/50
NSX100F Micrologic	36				2/50	2/70	2/100	2/150
NSX100N Micrologic	50					2/70	2/100	2/150
NSX100H Micrologic	70						2/100	2/150
NSX100S Micrologic	100							2/150

Note: respect the basic rules of discrimination, in terms of overload, short-circuit, see 557E4300.indd/638 and 557E4305.indd/644.

Discrimination enhanced by cascading

Upstream: NSX100, NSX160, Micrologic

Downstream: iC60

Upstream	NSX100 NSX100B	NSX100F	NSX100N	NSX100H	NSX100S	NSX100L
Breaking capacity (kA)	25	36	50	70	100	150
Trip unit	Micrologic	Micrologic	Micrologic	Micrologic	Micrologic	Micrologic

Downstream			40	100	40	100	40	100	40	100	40	100	40	100	
Rating (A)	Breaking capacity (kA)	Reinforced breaking capacity (kA)													
iC60N	≤ 25 A	10	20/20	20/20	25/25	25/25	30/30	30/30	30/30	30/30	30/30	30/30	30/30	30/30	30/30
	32-40 A	10		20/20		25/25		30/30		30/30		30/30		30/30	
	50-63 A	10													
iC60H	≤ 25 A	15	25/25	25/25	36/36	36/36	40/40	40/40	40/40	40/40	40/40	40/40	40/40	40/40	40/40
	32-40 A	15		25/25		36/36		40/40		36/36		36/36		36/36	
	50-63 A	15													
iC60L	≤ 25 A	25			36/36	36/36	40/40	40/40	40/40	40/40	40/40	40/40	40/40	40/40	40/40
	32-40 A	20		25/25		36/36		40/40		40/40		40/40		40/40	
	50-63 A	15													

Upstream	NSX160 NSX160B	NSX160F	NSX160N	NSX160H	NSX160S	NSX160L
Breaking capacity (kA)	25	36	50	70	100	150
Trip unit	Micrologic	Micrologic	Micrologic	Micrologic	Micrologic	Micrologic

Downstream			80	160	80	160	80	160	80	160	80	160	80	160
Rating (A)	Breaking capacity (kA)	Reinforced breaking capacity (kA)												
iC60N	≤ 50 A	10	20/20	20/20	25/25	25/25	25/25	30/30	25/25	30/30	25/25	30/30	25/25	30/30
	63 A	10		20/20		25/25		30/30		30/30		30/30		30/30
iC60H	≤ 40 A	15	25/25	25/25	36/36	36/36	40/40	40/40	40/40	40/40	40/40	40/40	40/40	40/40
	50 A	15	25/25	25/25	30/30	30/30	30/30	30/30	30/30	30/30	30/30	30/30	30/30	30/30
	63 A	15		25/25		30/30		30/30		30/30		30/30		30/30
iC60L	≤ 25 A	25			36/36	36/36	40/40	40/40	40/40	40/40	40/40	40/40	40/40	40/40
	32-40 A	20	25/25	25/25	36/36	36/36	40/40	40/40	40/40	40/40	40/40	40/40	40/40	40/40
	50 A	15	25/25	25/25	30/30	30/30	30/30	36/36	30/30	36/36	30/30	36/36	30/30	36/36
	63 A	15		25/25		30/30		36/36		36/36		36/36		36/36

Note: respect the basic rules of discrimination, in terms of overload, short-circuit, see 557E4300.indd/638 and 557E4305.indd/644.

Discrimination enhanced by cascading

Upstream: NSX250, Micrologic

Downstream: iC60, C120, NG125, NG160, NSX100

Upstream	NSX250 NSX250B	NSX250F	NSX250N	NSX250H	NSX250S	NSX250L
Breaking capacity (kA)	25	36	50	70	100	150
Trip unit	Micrologic	Micrologic	Micrologic	Micrologic	Micrologic	Micrologic

Downstream		250	250	250	250	250	250	
Rating (A)	Breaking capacity (kA)	Reinforced breaking capacity (kA)						
iC60N	≤ 40 A	10	20/20	25/25	30/30	30/30	30/30	30/30
	50-63 A	10	20/20	25/25	25/25	25/25	25/25	25/25
iC60H	≤ 40 A	15	25/25	30/30	30/30	30/30	30/30	30/30
	50-63 A	15	25/25	25/25	25/25	25/25	25/25	25/25
iC60L	≤ 25 A	25		30/30	30/30	30/30	30/30	30/30
	32-40 A	20	25/25	30/30	30/30	30/30	30/30	30/30
	50-63 A	15	25/25	25/25	25/25	25/25	25/25	25/25
C120N/H	10/15	25/25	25/25	25/25	25/25	25/25	25/25	
NG125N	25		36/36	36/36	50/50	50/50	70/70	
NG125H	36			40/40	50/50	70/70	100/100	
NG125L NG125LMA	50				70/70	100/100	150/150	
NG160E	16		25/25	30/30	30/30	30/30	30/30	
NG160N	25		36/36	36/36	50/50	50/50	50/50	
NG160H	36			50/50	50/50	50/50	50/50	
NSX100B, TM-D	≤ 25 A 40-100 A	25		36/36	36/36	50/50	50/50	50/50
NSX100F, TM-D	≤ 25 A 40-100 A	36			50/50	70/70	100/100	150/150
NSX100N, TM-D	≤ 25 A 40-100 A	50			36/50	36/70	36/100	36/150
NSX100H, TM-D	≤ 25 A 40-100 A	70				70/70	100/100	150/150
NSX100S, TM-D	≤ 25 A 40-100 A	100					36/100	36/150
NSX100B	Micrologic	25		36/36	36/36	36/50	36/50	36/50
NSX100F	Micrologic	36			36/50	36/70	36/100	36/150
NSX100N	Micrologic	50				36/70	36/100	36/150
NSX100H	Micrologic	70					36/100	36/150
NSX100S	Micrologic	100						36/150

Note: respect the basic rules of discrimination, in terms of overload, short-circuit, see 557E4300.indd/638 and 557E4305.indd/644.

Discrimination enhanced by cascading

Upstream: NSX400-630, Micrologic

Downstream: NG160, NSX100-250

Upstream	NSX400					NSX630				
	F	N	H	S	L	F	N	H	S	L
Breaking capacity (kA)	36	50	70	100	150	36	50	70	100	150
Trip unit	Micrologic					Micrologic				

Downstream		400	400	400	400	400	630	630	630	630	630
Rating (A)	Breaking capacity (kA)	Reinforced breaking capacity (kA)									
NG160E	16	25/25	30/30	30/30	30/30	30/30	25/25	30/30	30/30	30/30	30/30
NG160N	25	36/36	36/36	50/50	50/50	50/50	36/36	36/36	50/50	50/50	50/50
NG160H	36		50/50	50/50	50/50	50/50		50/50	50/50	50/50	50/50
NSX100B, TM-D	25	36/36	36/36	50/50	50/50	50/50	36/36	36/36	50/50	50/50	50/50
NSX100F, TM-D	36		50/50	70/70	100/100	150/150		50/50	70/70	100/100	150/150
NSX100N, TM-D	50			70/70	100/100	150/150			70/70	100/100	150/150
NSX100H, TM-D	70				100/100	150/150				100/100	150/150
NSX100S, TM-D	100					150/150					150/150
NSX160B, TM-D	25	36/36	36/36	50/50	50/50	50/50	36/36	36/36	50/50	50/50	50/50
NSX160F, TM-D	36		50/50	70/70	100/100	150/150		50/50	70/70	100/100	150/150
NSX160N, TM-D	50			70/70	100/100	150/150			70/70	100/100	150/150
NSX160H, TM-D	70				100/100	150/150				100/100	150/150
NSX160S, TM-D	100					150/150					150/150
NSX250B, TM-D	25						36/36	36/36	50/50	50/50	50/50
NSX250F, TM-D	36							50/50	70/70	100/100	150/150
NSX250N, TM-D	50								70/70	100/100	150/150
NSX250H, TM-D	70									100/100	150/150
NSX250S, TM-D	100										150/150
NSX100B Micrologic	25	36/36	50/50	50/50	50/50	50/50	36/36	50/50	50/50	50/50	50/50
NSX100F Micrologic	36		50/50	70/70	100/100	150/150		50/50	70/70	100/100	150/150
NSX100N Micrologic	50			70/70	100/100	150/150			70/70	100/100	150/150
NSX100H Micrologic	70				100/100	150/150				100/100	150/150
NSX100S Micrologic	100					150/150					150/150
NSX160B Micrologic	25	36/36	50/50	50/50	50/50	50/50	36/36	50/50	50/50	50/50	50/50
NSX160F Micrologic	36		50/50	70/70	100/100	150/150		50/50	70/70	100/100	150/150
NSX160N Micrologic	50			70/70	100/100	150/150			70/70	100/100	150/150
NSX160H Micrologic	70				100/100	150/150				100/100	150/150
NSX160S Micrologic	100					150/150					150/150
NSX250B Micrologic	25						36/36	50/50	50/50	50/50	50/50
NSX250F Micrologic	36							50/50	70/70	100/100	150/150
NSX250N Micrologic	50								70/70	100/100	150/150
NSX250H Micrologic	70									100/100	150/150
NSX250S Micrologic	100										150/150

Note: respect the basic rules of discrimination, in terms of overload, short-circuit, see 557E4300.indd/638 and 557E4305.indd/644.

Discrimination enhanced by cascading

Upstream: NS800-1000-1250-1600, Micrologic
Downstream: NSX100-630

Upstream	NS800				NS1000			NS1250		NS1600	
	N	H	L	LB	N	H	L	N	H	N	H
Breaking capacity (kA)	50	70	150	200	50	70	150	50	70	50	70
Trip unit	Micrologic				Micrologic			Micrologic		Micrologic	

Downstream		800	800	800	800	1000	1000	1000	1250	1250	1600	1600
Rating (A)	Breaking capacity (kA)	Reinforced breaking capacity (kA)										
NSX100B, TM-D/Micrologic	25	50/50	50/50	50/50	50/50	50/50	50/50	50/50	50/50	50/50	50/50	50/50
NSX100F, TM-D/Micrologic	36	50/50	70/70	150/150	150/150	50/50	70/70	150/150	50/50	70/70	50/50	70/70
NSX100N, TM-D/Micrologic	50		70/70	150/150	150/150		70/70	150/150		70/70		70/70
NSX100H, TM-D/Micrologic	70			150/150	150/150			150/150				
NSX100S, TM-D/Micrologic	100			150/150	200/200			150/150				
NSX100L, TM-D/Micrologic	150				200/200							
NSX160B, TM-D/Micrologic	25	50/50	50/50	50/50	50/50	50/50	50/50	50/50	50/50	50/50	50/50	50/50
NSX160F, TM-D/Micrologic	36	50/50	70/70	150/150	150/150	50/50	70/70	150/150	50/50	70/70	50/50	70/70
NSX160N, TM-D/Micrologic	50		70/70	150/150	150/150		70/70	150/150		70/70		70/70
NSX160H, TM-D/Micrologic	70			150/150	150/150			150/150				
NSX160S, TM-D/Micrologic	100			150/150	200/200			150/150				
NSX160L, TM-D/Micrologic	150				200/200							
NSX250B, TM-D/Micrologic	25	50/50	50/50	50/50	50/50	50/50	50/50	50/50	50/50	50/50	50/50	50/50
NSX250F, TM-D/Micrologic	36	50/50	70/70	150/150	150/150	50/50	70/70	150/150	50/50	70/70	50/50	70/70
NSX250N, TM-D/Micrologic	50		70/70	150/150	150/150		70/70	150/150		70/70		70/70
NSX250H, TM-D/Micrologic	70			150/150	150/150			150/150				
NSX250S, TM-D/Micrologic	100			150/150	200/200			150/150				
NSX250L, TM-D/Micrologic	150				200/200							
NSX400F Micrologic	36	50/50	70/70	10/150	10/150	50/50	70/70	15/150	50/50	70/70	50/50	70/70
NSX400N Micrologic	50		70/70	10/150	10/150		70/70	15/150		70/70		70/70
NSX400H Micrologic	70			10/150	10/150			15/150				
NSX400S Micrologic	100			10/150	10/200			15/150				
NSX400L Micrologic	150				10/200							
NSX630F Micrologic	36					50/50	65/70	10/150	50/50	65/70	50/50	65/70
NSX630N Micrologic	50						65/70	10/150		65/70		65/70
NSX630H Micrologic	70							10/150				
NSX630S Micrologic	100							10/150				

Note: respect the basic rules of discrimination, in terms of overload, short-circuit, see 557E4300.indd/638 and 557E4305.indd/644.

Discrimination enhanced by cascading

Upstream: NSX160, NSX250, TM-D

Downstream: iC60, NG125, NSX100

Ue: 440 V AC

Upstream		NSX160 NSX160B		NSX160F		NSX160N		NSX160H		NSX160S		NSX160L	
Breaking capacity (kA)		25		36		50		70		100		150	
Trip unit		TM-D		TM-D		TM-D		TM-D		TM-D		TM-D	
Downstream													
Rating (A)		80-100	125/160	80-100	125/160	80-100	125/160	80-100	125/160	80-100	125/160	80-100	125/160
		Reinforced breaking capacity (kA)											
iC60N	≤ 40 A		15/15		15/15		20/20		20/20		20/20		20/20
	50-63 A		15/15		15/15		20/20		20/20		20/20		20/20
iC60H	≤ 40 A		20/20		20/20		25/25		25/25		25/25		25/25
	50-63 A		20/20		20/20		25/25		25/25		25/25		25/25
iC60L	≤ 40 A		20/20		20/20		25/25		25/25		25/25		25/25
	50-63 A		20/20		20/20		25/25		25/25		25/25		25/25
NG125N	≤ 20 A				35/35		35/35		35/35		50/50		65/65
	> 20 A												
NG125H	≤ 20 A				35/25		40/40		50/50		65/65		90/90
	> 20 A												
NG125L	≤ 20 A						50/50		65/65		90/90		130/130
	>20 A												

Upstream		NSX250 NSX250F		NSX250N		NSX250H		NSX250S		NSX250L			
Breaking capacity (kA)		35		50		65		90		130			
Trip unit		TM-D		TM-D		TM-D		TM-D		TM-D			
Downstream													
Rating (A)		200	250	200	250	200	250	200	250	200	250		
		Reinforced breaking capacity (kA)											
NG125N	20	35/35	35/35	35/35	35/35	35/35	35/35	50/50	50/50	65/65	65/65		
	30	35/35	35/35	40/40	40/40	50/50	50/50	65/65	65/65	90/90	90/90		
NG125H	30			50/50	50/50	65/65	65/65	90/90	90/90	130/130	130/130		
	40												
NSX100B, TM-D	≤ 25 A	20	35/35	35/35	35/35	35/35	50/50	50/50	50/50	50/50	50/50		
	40-100 A	20	35/35	35/35	35/35	35/35	35/50	35/50	35/50	35/50	35/50		
NSX100F, TM-D	≤ 25 A	35			35/35	35/35	65/65	65/65	90/90	90/90	130/130		
	40-100 A	35			35/35	35/35	35/65	35/65	35/90	35/90	35/130		
NSX100N, TM-D	≤ 25 A	50					65/65	65/65	90/90	90/90	130/130		
	40-100 A	50					35/65	35/65	35/90	35/90	35/130		
NSX100H, TM-D	≤ 25 A	65							90/90	90/90	130/130		
	40-100 A	65							35/90	35/90	35/130		
NSX100S, TM-D	≤ 25 A	90									130/130		
	40-100 A	90									35/130		
NSX100B	Micrologic	20	2/35	2/35	2/35	2/35	2/50	2/50	2/50	2/50	2/50		
NSX100F	Micrologic	35			2/50	2/50	2/50	2/50	2/50	2/50	2/50		
NSX100N	Micrologic	50					2/65	2/65	2/90	2/90	2/130		
NSX100H	Micrologic	65							2/90	2/90	2/130		
NSX100S	Micrologic	90									2/130		

Note: respect the basic rules of discrimination, in terms of overload, short-circuit, see 557E4300.indd/638 and 557E4305.indd/644.

Discrimination enhanced by cascading

Upstream: NSX100-250, Micrologic

Downstream: iC60, NG125, NSX100

Ue: 440 V AC

Upstream		NSX100					
		NSX100B	NSX100F	NSX100N	NSX100H	NSX100S	NSX100L
Breaking capacity (kA)		25	36	50	70	100	150
Trip unit		Micrologic	Micrologic	Micrologic	Micrologic	Micrologic	Micrologic
Downstream		160					
Rating (A)		160	160	160	160	160	160
		Reinforced breaking capacity (kA)					
iC60N	≤ 40 A	15/15	15/15	20/20	20/20	20/20	20/20
	50-63 A	6/15	6/15	6/20	6/20	6/20	6/20
iC60H	≤ 40 A	20/20	20/20	25/25	25/25	25/25	25/25
	50-63 A	6/20	6/20	6/25	6/25	6/25	6/25
iC60L	≤ 40 A	20/20	20/20	25/25	25/25	25/25	25/25
	50-63 A	6/20	6/20	6/25	6/25	6/25	6/25

Upstream		NSX160					
		NSX160B	NSX160F	NSX160N	NSX160H	NSX160S	NSX160L
Breaking capacity (kA)		25	36	50	70	100	150
Trip unit		Micrologic	Micrologic	Micrologic	Micrologic	Micrologic	Micrologic
Downstream		160					
Rating (A)		160	160	160	160	160	160
iC60N	≤ 40 A	15/15	15/15	20/20	20/20	20/20	20/20
	50-63 A	15/15	15/15	20/20	20/20	20/20	20/20
iC60H	≤ 40 A	20/20	20/20	25/25	25/25	25/25	25/25
	50-63 A	20/20	20/20	25/25	25/25	25/25	25/25
iC60L	≤ 40 A	20/20	20/20	25/25	25/25	25/25	25/25
	50-63 A	20/20	20/20	25/25	25/25	25/25	25/25
NG125N	≤ 20 A		35/35	35/35	35/35	50/50	65/65
	>20 A						
NG125H	≤ 20 A		35/25	40/40	50/50	65/65	90/90
	>20 A						
NG125L	≤ 20 A			50/50	65/65	90/90	130/130
	>20 A						

Upstream		NSX250					
		NSX250F	NSX250N	NSX250H	NSX250S	NSX250L	
Breaking capacity (kA)		35	50	65	90	130	
Trip unit		Micrologic	Micrologic	Micrologic	Micrologic	Micrologic	
Downstream		250					
Rating (A)		250	250	250	250	250	
		Reinforced breaking capacity (kA)					
NG125N	20	35/35	35/35	35/35	50/50	65/65	
	30	35/35	40/40	50/50	65/65	90/90	
NG125H	40		50/50	65/65	90/90	130/130	
	30						
NSX100B, TM-D	≤ 25 A	20	35/35	35/35	50/50	50/50	
	40-100 A	20	35/35	35/35	35/50	35/50	
NSX100F, TM-D	≤ 25 A	35		35/35	65/65	90/90	
	40-100 A	35		35/35	35/65	35/130	
NSX100N, TM-D	≤ 25 A	50			65/65	90/90	
	40-100 A	50			35/65	35/130	
NSX100H, TM-D	≤ 25 A	65			90/90	130/130	
	40-100 A	65			35/90	35/130	
NSX100S, TM-D	≤ 25 A	90				130/130	
	40-100 A	90				35/130	
NSX100B Micrologic	20	35/35	35/35	35/50	35/50	35/50	
NSX100F Micrologic	35		35/50	35/50	35/50	35/50	
NSX100N Micrologic	50			35/65	35/90	35/130	
NSX100H Micrologic	65				35/90	35/130	
NSX100S Micrologic	90					35/130	

Note: respect the basic rules of discrimination, in terms of overload, short-circuit, see 557E4300.indd/638.

Discrimination enhanced by cascading

Upstream: NSX400-630, Micrologic

Downstream: NSX100-250

Ue: 440 V AC

Upstream	NSX400					NSX630				
	F	N	H	S	L	F	N	H	S	L
Breaking capacity (kA)	30	42	65	90	130	30	42	65	90	130
Trip unit	Micrologic					Micrologic				

Downstream			400	400	400	400	400	630	630	630	630	630
Rating (A)		Breaking capacity (kA)	Reinforced breaking capacity (kA)									
NSX100B	Micrologic	20	30/30	30/30	50/50	50/50	50/50	30/30	30/30	50/50	50/50	50/50
NSX100F	Micrologic	35		42/42	65/65	90/90	130/130		42/42	65/65	90/90	130/130
NSX100N	Micrologic	50			65/65	90/90	130/130			65/65	90/90	130/130
NSX100H	Micrologic	65				90/90	130/130				90/90	130/130
NSX100S	Micrologic	90					130/130					130/130
NSX160B	Micrologic	20	30/30	30/30	50/50	50/50	50/50	30/30	30/30	50/50	50/50	50/50
NSX160F	Micrologic	35		42/42	65/65	90/90	130/130		42/42	65/65	90/90	130/130
NSX160N	Micrologic	50			65/65	90/90	130/130			65/65	90/90	130/130
NSX160H	Micrologic	65				90/90	130/130				90/90	130/130
NSX160S	Micrologic	90					130/130					130/130
NSX250B	Micrologic	20						35/35	30/30	50/50	50/50	50/50
NSX250F	Micrologic	35							42/42	65/65	90/90	130/130
NSX250N	Micrologic	50								65/65	90/90	130/130
NSX250H	Micrologic	65									90/90	130/130
NSX250S	Micrologic	90										130/130

Note: respect the basic rules of discrimination, in terms of overload, short-circuit, see 557E4300.indd/638 and 557E4305.indd/644.

Discrimination enhanced by cascading

Upstream: NS800-1000-1600, Micrologic

Downstream: NSX100-630

Ue: 440 V AC

Upstream	NS800				NS1000			NS1250		NS1600	
	N	H	L	LB	N	H	L	N	H	N	H
Breaking capacity (kA)	50	65	130	200	50	65	130	50	65	50	65
Trip unit	Micrologic				Micrologic			Micrologic		Micrologic	

Downstream		800	800	800	800	1000	1000	1000	1250	1250	1600	1600
Rating (A)	Breaking capacity (kA)	Reinforced breaking capacity (kA)										
NSX100B, TM-D/Micrologic	20	50/50	50/50	50/50	50/50	50/50	50/50	50/50	50/50	50/50	50/50	50/50
NSX100F, TM-D/Micrologic	35	50/50	65/65	130/130	130/130	50/50	65/65	130/130	50/50	65/65	50/50	65/65
NSX100N, TM-D/Micrologic	50		65/65	130/130	130/130		65/65	130/130		65/65		65/65
NSX100H, TM-D/Micrologic	65			130/130	130/130			130/130				
NSX100S, TM-D/Micrologic	90			130/130	200/200			130/130				
NSX100L, TM-D/Micrologic	130				200/200							
NSX160B, TM-D/Micrologic	20	50/50	50/50	50/50	50/50	50/50	50/50	50/50	50/50	50/50	50/50	50/50
NSX160F, TM-D/Micrologic	35	50/50	65/65	130/130	130/130	50/50	65/65	130/130	50/50	65/65	50/50	65/65
NSX160N, TM-D/Micrologic	50		65/65	130/130	130/130		65/65	130/130		65/65		65/65
NSX160H, TM-D/Micrologic	65			130/130	130/130			130/130				
NSX160S, TM-D/Micrologic	90			130/130	200/200			130/130				
NSX160L, TM-D/Micrologic	130				200/200							
NSX250B, TM-D/Micrologic	20	50/50	50/50	50/50	50/50	50/50	50/50	50/50	50/50	50/50	50/50	50/50
NSX250F, TM-D/Micrologic	35	50/50	65/65	130/130	130/130	50/50	65/65	130/130	50/50	65/65	50/50	65/65
NSX250N, TM-D/Micrologic	50		65/65	130/130	130/130		65/65	130/130		65/65		65/65
NSX250H, TM-D/Micrologic	65			130/130	130/130			130/130				
NSX250S, TM-D/Micrologic	90			130/130	200/200			130/130				
NSX250L, TM-D/Micrologic	130				200/200							
NSX400F Micrologic	30	50/50	65/65	10/130	10/200	50/50	65/65	15/130	50/50	65/65	50/50	65/65
NSX400N Micrologic	42		65/65	10/130	10/200		65/65	15/130		65/65		65/65
NSX400H Micrologic	65			10/130	10/200			15/130				
NSX400S Micrologic	90			10/130	10/200			15/130				
NSX400L Micrologic	130				10/200							
NSX630F Micrologic	30					50/50	65/65	10/130	50/50	65/65	50/50	65/65
NSX630N Micrologic	42						65/65	10/130		65/65		65/65
NSX630H Micrologic	65							10/130				
NSX630S Micrologic	90							10/130				

Note: respect the basic rules of discrimination, in terms of overload, short-circuit, see 557E4300.indd/638 and 557E4305.indd/644.

Discrimination enhanced by cascading

Upstream: NSX160, NSX250, TM-D

Downstream: iC60, C120, NG125

Upstream	NSX160 NSX160B	NSX160F	NSX160N	NSX160H	NSX160S	NSX160L
Breaking capacity (kA)	40	85	90	100	120	150
Trip unit	TM-D	TM-D	TM-D	TM-D	TM-D	TM-D

Downstream		80-100	125-160	80-100	125-160	80-100	125-160	80-100	125-160	80-100	125-160	80-100	125-160
Rating (A)	Breaking capacity (kA)	Reinforced breaking capacity (kA)											
iC60N	20		30/30		40/40		60/60		60/60		60/60		60/60
iC60H	30		40/40		50/50		80/80		80/80		80/80		80/80
iC60L	≤ 25 A				65/65		80/80		80/80		80/80		80/80
	32-40 A		40/40		65/65		80/80		80/80		80/80		80/80
	50-63 A		40/40		65/65		80/80		80/80		80/80		80/80
NG125N	≤ 20 A				60/60		70/70		70/70		85/85		85/85
	25 to 125 A												
NG125H	≤ 20 A				85/85		85/85		85/85		100/100		100/100
	25 to 80 A												

Upstream	NSX250 NSX250B	NSX250F	NSX250N	NSX250H	NSX250S	NSX250L
Breaking capacity (kA)	40	85	90	100	120	150
Trip unit	TM-D	TM-D	TM-D	TM-D	TM-D	TM-D

Downstream		200-250	200-250	200-250	200-250	200-250	200-250
Rating (A)	Breaking capacity (kA)	Reinforced breaking capacity (kA)					
iC60N	20	30/30	40/40	60/60	60/60	60/60	60/60
iC60H	30	40/40	50/50	65/65	65/65	65/65	65/65
iC60L	≤ 25 A		65/65	80/80	80/80	80/80	80/80
	32-40 A	40/40	65/65	80/80	80/80	80/80	80/80
	50-63 A	40/40	40/40	65/65	65/65	65/65	65/65
C120N/H	≤ 100 A	40/40	40/40	50/50	50/50	70/70	70/70
	125 A						
NG125N	≤ 100 A		60/60	70/70	70/70	85/85	85/85
	125 A						
NG125H	70		85/85	85/85	85/85	100/100	100/100

Note: respect the basic rules of discrimination, in terms of overload, short-circuit, see 557E4300.indd/638 and 557E4305.indd/644.

Discrimination enhanced by cascading

Upstream: NSX100, NSX160, Micrologic
Downstream: iC60

Upstream	NSX100 NSX100B	NSX100F	NSX100N	NSX100H	NSX100S	NSX100L
Breaking capacity (kA)	40	85	90	100	120	150
Trip unit	Micrologic	Micrologic	Micrologic	Micrologic	Micrologic	Micrologic

Downstream			40	100	40	100	40	100	40	100	40	100	40	100	
Rating (A)	Breaking capacity (kA)	Reinforced breaking capacity (kA)													
iC60N	≤ 25 A	20	40/40	40/40	40/40	40/40	60/60	60/60	60/60	60/60	60/60	60/60	60/60	60/60	60/60
	32-40 A	20		40/40		40/40		60/60		60/60		60/60		60/60	
	50-63 A	20													
iC60H	≤ 25 A	30	40/40	40/40	50/50	50/50	80/80	80/80	80/80	80/80	80/80	80/80	80/80	80/80	80/80
	32-40 A	30		40/40		50/50		80/80		80/80		80/80		80/80	
	50-63 A	30													
iC60L	≤ 25 A	50			65/65	65/65	80/80	80/80	80/80	80/80	80/80	80/80	80/80	80/80	80/80
	32-40 A	36				65/65		80/80		80/80		80/80		80/80	
	50-63 A	30													

Upstream	NSX160 NSX160B	NSX160F	NSX160N	NSX160H	NSX160S	NSX160L
Breaking capacity (kA)	40	85	90	100	120	150
Trip unit	Micrologic	Micrologic	Micrologic	Micrologic	Micrologic	Micrologic

Downstream			80	160	80	160	80	160	80	160	80	160	80	160	
Rating (A)	Breaking capacity (kA)	Reinforced breaking capacity (kA)													
iC60N	≤ 50 A	20	40/40	40/40	40/40	40/40	60/60	60/60	60/60	60/60	60/60	60/60	60/60	60/60	60/60
	63 A	20		40/40		40/40		60/60		60/60		60/60		60/60	
iC60H	≤ 50 A	30	40/40	40/40	50/50	50/50	80/80	80/80	80/80	80/80	80/80	80/80	80/80	80/80	80/80
	63 A	30		40/40		50/50		80/80		80/80		80/80		80/80	
iC60L	≤ 40 A	36			65/65	65/65	80/80	80/80	80/80	80/80	80/80	80/80	80/80	80/80	80/80
	50 A	30	40/40	40/40	65/65	65/65	80/80	80/80	80/80	80/80	80/80	80/80	80/80	80/80	80/80
	63 A	30		40/40		65/65		80/80		80/80		80/80		80/80	

Note: respect the basic rules of discrimination, in terms of overload, short-circuit, see 557E4300.indd/638 and 557E4305.indd/644.

Discrimination enhanced by cascading

Upstream: NSX250, Micrologic

Downstream: iC60, C120, NG125

Upstream	NSX250					
	NSX250B	NSX250F	NSX250N	NSX250H	NSX250S	NSX250L
Breaking capacity (kA)	40	85	90	100	120	150
Trip unit	Micrologic	Micrologic	Micrologic	Micrologic	Micrologic	Micrologic

Downstream		Reinforced breaking capacity (kA)					
Rating (A)	Breaking capacity (kA)	250	250	250	250	250	250
iC60N	20	40/40	40/40	60/60	60/60	60/60	60/60
iC60H	30	40/40	50/50	65/65	65/65	65/65	65/65
iC60L	≤ 25 A		65/65	80/80	80/80	80/80	80/80
	32-40 A		65/65	80/80	80/80	80/80	80/80
	50-63 A	40/40	65/65	65/65	65/65	65/65	65/65
C120N/H	20/30	40/40	40/40	50/50	50/50	70/70	70/70
NG125N	50		60/60	70/70	70/70	85/85	85/85
NG125H	70		85/85	85/85	85/85	100/100	100/100

Note: respect the basic rules of discrimination, in terms of overload, short-circuit, see 557E4300.indd/638 and 557E4305.indd/644.

Discrimination enhanced by cascading

Upstream: NSX250, TM-D-Micrologic

Downstream: NG160, NSX100

Upstream	NSX250 NSX250F	NSX250N	NSX250H	NSX250S	NSX250L
Breaking capacity (kA)	85	90	100	120	150
Trip unit	TM-D	TM-D	TM-D	TM-D	TM-D

Downstream		160	200-250	160	200-250	160	200-250	160	200-250	160	200-250
Rating (A)	Breaking capacity (kA)	Reinforced breaking capacity (kA)									
NG160E	25		40/40		50/50		50/50		60/60		60/60
NG160N/H	50		85/85		90/90		100/100		100/100		100/100
NSX100B, ≤ 25 A	40		85/85		90/90		100/100		100/100		100/100
TM-D 40-100 A	40		36/85		36/90		36/100		36/120		36/150
NSX100F, ≤ 25 A	85				90/90		100/100		120/120		150/150
TM-D 40-100 A	85				36/90		36/100		36/120		36/150
NSX100N, ≤ 25 A	90						100/100		120/120		150/150
TM-D 40-100 A	90						36/100		36/120		36/150
NSX100H, ≤ 25 A	100								120/120		150/150
TM-D 40-100 A	100								36/120		36/150
NSX100S, ≤ 25 A	120										150/150
TM-D 40-100 A	120										36/150
NSX100B Micrologic	40		2/85		2/90		2/100		2/120		2/100
NSX100F Micrologic	85				2/90		2/100		2/120		2/150
NSX100N Micrologic	90						2/100		2/120		2/150
NSX100H Micrologic	100								2/120		2/150
NSX100S Micrologic	120										2/150

Upstream	NSX250 NSX250F	NSX250N	NSX250H	NSX250S	NSX250L
Breaking capacity (kA)	85	90	100	120	150
Trip unit	Micrologic	Micrologic	Micrologic	Micrologic	Micrologic

Downstream		160	200-250	160	200-250	160	200-250	160	200-250	160	200-250
Rating (A)	Breaking capacity (kA)	Reinforced breaking capacity (kA)									
NG160E	25	40/40	40/40	50/50	50/50	50/50	50/50	60/60	60/60	60/60	60/60
NG160N/H	50	85/85	85/85	90/90	90/90	100/100	100/100	100/100	100/100	100/100	100/100
NSX100B, ≤ 25 A	40	85/85	85/85	90/90	90/90	100/100	100/100	100/100	100/100	100/100	100/100
TM-D 40-100 A	40	36/85	36/85	36/90	36/90	36/100	36/100	36/120	36/120	36/150	36/150
NSX100F, ≤ 25 A	85			90/90	90/90	100/100	100/100	120/120	120/120	150/150	150/150
TM-D 40-100 A	85			36/90	36/90	36/100	36/100	36/120	36/120	36/150	36/150
NSX100N, ≤ 25 A	90					100/100	100/100	120/120	120/120	150/150	150/150
TM-D 40-100 A	90					36/100	36/100	36/120	36/120	36/150	36/150
NSX100H, ≤ 25 A	100							120/120	120/120	150/150	150/150
TM-D 40-100 A	100							36/120	36/120	36/150	36/150
NSX100S, ≤ 25 A	120									150/150	150/150
TM-D 40-100 A	120									36/150	36/150
NSX100B Micrologic	40	36/85	36/85	36/90	36/90	36/100	36/100	36/100	36/100	36/100	36/100
NSX100F Micrologic	85			36/90	36/90	36/100	36/100	36/120	36/120	36/150	36/150
NSX100N Micrologic	90					36/100	36/100	36/120	36/120	36/150	36/150
NSX100H Micrologic	100							36/120	36/120	36/150	36/150
NSX100S Micrologic	120									36/150	36/150

Note: respect the basic rules of discrimination, in terms of overload, short-circuit, see 557E4300.indd/638 and 557E4305.indd/644.

Discrimination enhanced by cascading

Upstream: NSX400-630, NS800-1000, Micrologic
Downstream: NG160, NSX100-630

Upstream	NSX400				NSX630				NS800		NS1000
	N	H	S	L	N	H	S	L	L	LB	L
Breaking capacity (kA)	85	100	120	150	85	100	120	150	150	200	150
Trip unit	Micrologic				Micrologic				Micrologic		Micrologic

Downstream		400	400	400	400	630	630	630	630	800	1000
Rating (A)	Breaking capacity (kA)	Reinforced breaking capacity (kA)									
NG160E	25	50/50	50/50	60/60	60/60	50/50	50/50	60/60	60/60		
NG160N/H	50	85/85	90/90	100/100	100/100	85/85	90/90	100/100	100/100		
NSX100B, TM-D	40	85/85	90/90	100/100	100/100	85/85	90/90	100/100	100/100	50/50	50/50
NSX100F, TM-D	85		90/90	120/120	150/150		90/90	120/120	150/150	150/150	150/150
NSX100N, TM-D	90		100/100	120/120	150/150		100/100	120/120	150/150	150/150	150/150
NSX100H, TM-D	100			120/120	150/150			120/120	150/150	150/150	150/150
NSX100S, TM-D	120				150/150				150/150	150/150	200/200
NSX100L, TM-D	150										200/200
NSX160B, TM-D	40	85/85	90/90	100/100	100/100	85/85	90/90	100/100	100/100	50/50	50/50
NSX160F, TM-D	85		90/90	120/120	150/150		90/90	120/120	150/150	150/150	150/150
NSX160N, TM-D	90		100/100	120/120	150/150		100/100	120/120	150/150	150/150	150/150
NSX160H, TM-D	100			120/120	150/150			120/120	150/150	150/150	150/150
NSX160S, TM-D	120				150/150				150/150	150/150	200/200
NSX160L, TM-D	150										200/200
NSX250B, TM-D	40					85/85	90/90	100/100	100/100	50/50	50/50
NSX250F, TM-D	85						90/90	120/120	150/150	150/150	150/150
NSX250N, TM-D	90						100/100	120/120	150/150	150/150	150/150
NSX250H, TM-D	100							120/120	150/150	150/150	150/150
NSX250S, TM-D	120								150/150	150/150	200/200
NSX250L, TM-D	150										200/200
NSX100B Micrologic	40	85/85	90/90	100/100	100/100	85/85	90/90	100/100	100/100	50/50	50/50
NSX100F Micrologic	85		90/90	120/120	150/150		90/90	120/120	150/150	150/150	150/150
NSX100N Micrologic	90		100/100	120/120	150/150		100/100	120/120	150/150	150/150	150/150
NSX100H Micrologic	100			120/120	150/150			120/120	150/150	150/150	150/150
NSX100S Micrologic	120				150/150				150/150	150/150	200/200
NSX100L Micrologic	150										200/200
NSX160B Micrologic	40	85/85	90/90	100/100	100/100	85/85	90/90	100/100	100/100	50/50	50/50
NSX160F Micrologic	85		90/90	120/120	150/150		90/90	120/120	150/150	150/150	150/150
NSX160N Micrologic	90		100/100	120/120	150/150		100/100	120/120	150/150	150/150	150/150
NSX160H Micrologic	100			120/120	150/150			120/120	150/150	150/150	150/150
NSX160S Micrologic	120				150/150				150/150	150/150	200/200
NSX160L Micrologic	150										200/200
NSX250B Micrologic	40					85/85	90/90	100/100	100/100	50/50	50/50
NSX250F Micrologic	85						90/90	120/120	150/150	150/150	150/150
NSX250N Micrologic	90						100/100	120/120	150/150	150/150	150/150
NSX250H Micrologic	100							120/120	150/150	150/150	150/150
NSX250S Micrologic	120								150/150	150/150	200/200
NSX250L Micrologic	150										200/200
NSX400F Micrologic	40								10/150	10/150	15/150
NSX400N Micrologic	85								10/150	10/150	15/150
NSX400H Micrologic	100								10/150	10/150	15/150
NSX400S Micrologic	120								10/150	10/200	15/150
NSX400L Micrologic	150									10/200	
NSX630F Micrologic	40										10/150
NSX630N Micrologic	85										10/150
NSX630H Micrologic	100										10/150
NSX630S Micrologic	120										10/150

Note: respect the basic rules of discrimination, in terms of overload, short-circuit, see 557E4300.indd/638 and 557E4305.indd/644.

Coordination between circuit breakers

Discrimination (Selectivity)

E002487-37.eps



IEC/EN 60947-2

What is discrimination?

It is the coordination of automatic cut-off devices for a fault that occurs at any point in the network to be eliminated by the upstream circuit breaker, the circuit breaker that is immediately upstream of the fault and by that circuit breaker alone!

D0621201.eps

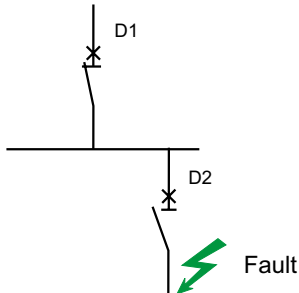

Continuity of service

Discrimination is an essential element that must be taken into account as early as in the design of a low voltage installation to enable continuity of the electricity service.

Production and safety

Discrimination provides much convenience for all users, but it is an essential requirement when continuity of service is of utmost importance.

Discrimination means that only the part with the fault is disconnected. It enables:

- continuity of supply for adjacent circuits,
- localization of the faulty circuit.

For some installations or installation parts:

- operating theatre in clinics and hospitals,
- marine,
- safety equipment,
- production site.

The requirements for continuous electricity often make it necessary to verify the discrimination between upstream and downstream protection devices.

If there is a total lack of discrimination, it will be necessary to try to achieve partial discrimination. Likewise, if there is a limit to the level of discrimination and this proves satisfactory in the majority of cases, it can still be attempted to make it total. Of course, any modification must be made while observing the following main parameters:

- protection of personnel,
- are the thermal stresses I^2t of the cables always taken into account?
- are the breaking capacities of the devices higher than the prospective I_{sc} ?

Finally, when it is not possible to achieve discrimination and it is essential for the correct operation of the installation, the installation of uninterruptible power supplies (UPS) must be considered. Generator units, inverters, etc. are then used.

There are several types of discrimination that can be used separately or together. For protection against overcurrent, this generally concerns current discrimination and time discrimination.

The principle is as follows.

Coordination between circuit breakers

Discrimination (Selectivity)

DB421202.eps

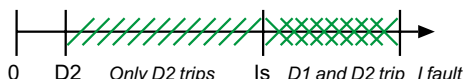
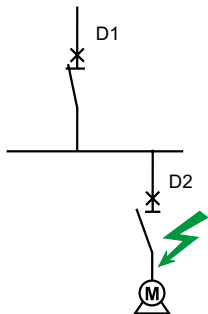

Current and energy discrimination

Discrimination involves ensuring coordination between two circuit breakers in series, so that, in the event of a fault, only one circuit breaker, located immediately upstream of the fault, trips. A discrimination current I_s is defined so that:

- If $I_{\text{fault}} < I_s$: only D2 eliminates the fault, discrimination is ensured,
- If $I_{\text{fault}} > I_s$: both circuit breakers may trip, discrimination is not ensured.

Slight overcurrent or overload

Under the effect of an abnormal inrush current, for example an increase in the resistive torque of a motor, the current going through the circuit is higher than the rated current. These currents may damage the installation (risk of an electrical fire). Devices to protect against overcurrent can be characterized by their operating curves as a function of prospective current I_p :

- the operating curve is time-based when the breaking time is greater than 50 ms (curve $t = f(I_p)$). Discrimination is achieved if the I_n upstream / I_n downstream operation threshold ratio is > 1.3 and if the current offset of the magnetic curves is observed.

This is current discrimination

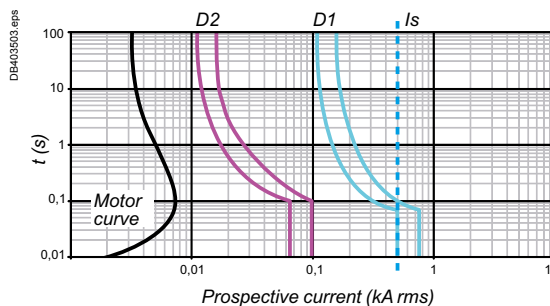

The greater the difference between the ratings of the upstream and downstream circuit breakers, the more "extensive" the discrimination.

Short circuit

For example when there is contact between two phases we are faced with a full insulation fault which risks damaging the installation.

The function that makes it possible to protect against this type of fault is magnetic protection.

To ensure discrimination, we must maintain a ratio between the upstream and downstream protection devices. This is energy discrimination.

- Energy: when the intervention time is less than 50 ms and more particularly less than the time of one half wave (10 ms) of current with limiting circuit breakers.

This is energy discrimination

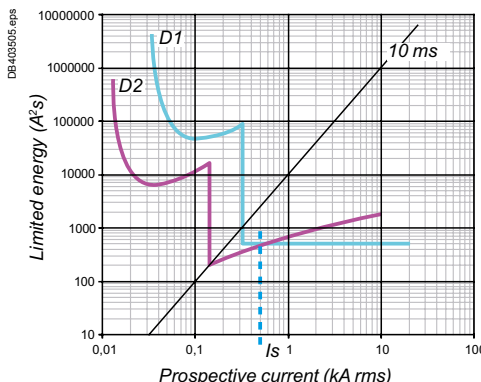

Coordination between circuit breakers

Discrimination (Selectivity)

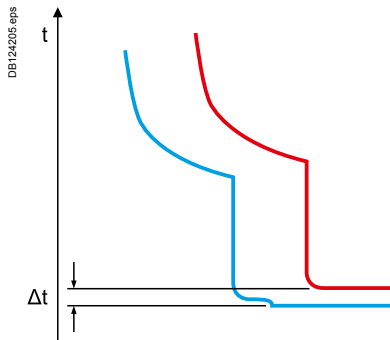

Time discrimination

The principle is based on the time difference (Δt) of the upstream magnetic curve.

To achieve this, it is necessary to have an upstream circuit breaker with time-delay bands.

The delay introduced must make it possible to improve discrimination without endangering the cable or busbars which would then have to withstand the overcurrent for longer (greater thermal effects I^2t and electrodynamic stresses).

Total or partial discrimination

Discrimination may be partial or total, up to the breaking capacity of the downstream circuit breaker. For total discrimination, the characteristics of the upstream device must be higher than those of the downstream device (higher than the breaking capacity of the downstream circuit breaker MCCB).

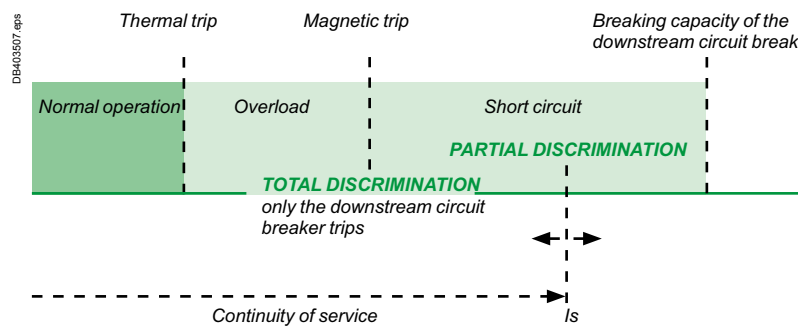

Standard IEC 60947-2 on industrial circuit breakers, and in particular Appendix A, deals with coordination between a circuit-breaker and another device to protect against short circuits combined in the same circuit. This protection device may be a fuse or another circuit breaker.

Coordination between circuit breakers

Discrimination (Selectivity)

Discrimination between modular circuit breakers

We use two types of discrimination when these circuit breakers are combined:

- current discrimination,
- energy discrimination.

For discrimination to be ensured whatever the prospective fault current, 3 conditions have to be fulfilled:

- the upstream and downstream circuit breakers must have different ratings (ratio > 1.3),
- the envelope of their magnetic curves must be different,
- the energy allowed to pass through the downstream circuit breaker when it cuts off must still be less than the operating energy of the upstream trip.

Example

■ Let us take the example of a single phase network where we have a 32 A curve D circuit breaker in series with a 10 A curve D circuit breaker:

- the 32 A circuit breaker protects the 6² cables and the 10 A circuit breaker protects the 1.5² cables. This combination allows discrimination, but up to what threshold?
- if current discrimination is considered ($t = f(I_p)$) it can be seen that the tripping curve of the downstream circuit breaker is well below the non-tripping curve of the upstream circuit breaker,
- furthermore, each circuit breaker is well below the maximum stress permitted by the cables.

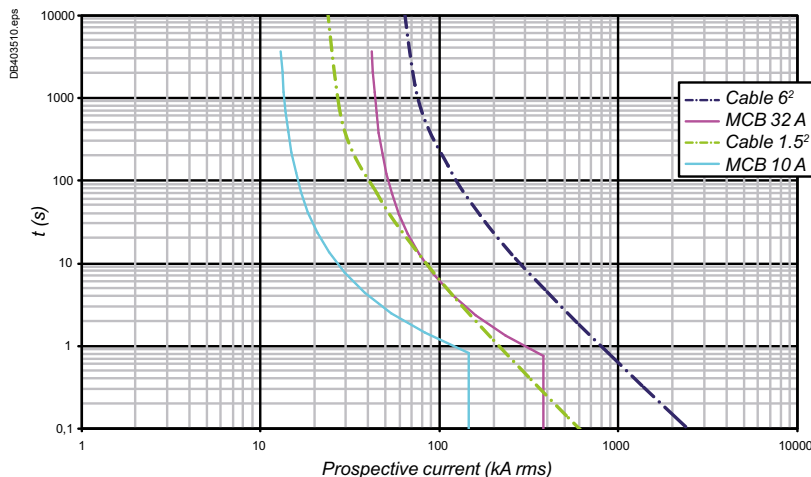
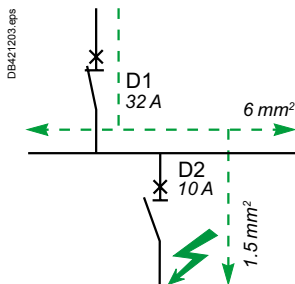

When considering energy discrimination, it is necessary to compare the maximum stresses characterized by the integrals $\int I^2 dt$ relative to the development of the arc in the downstream device and by the sensitivity of the trip unit, still in $\int I^2 dt$, of the upstream device (curves $I^2 t = f(I_p)$).

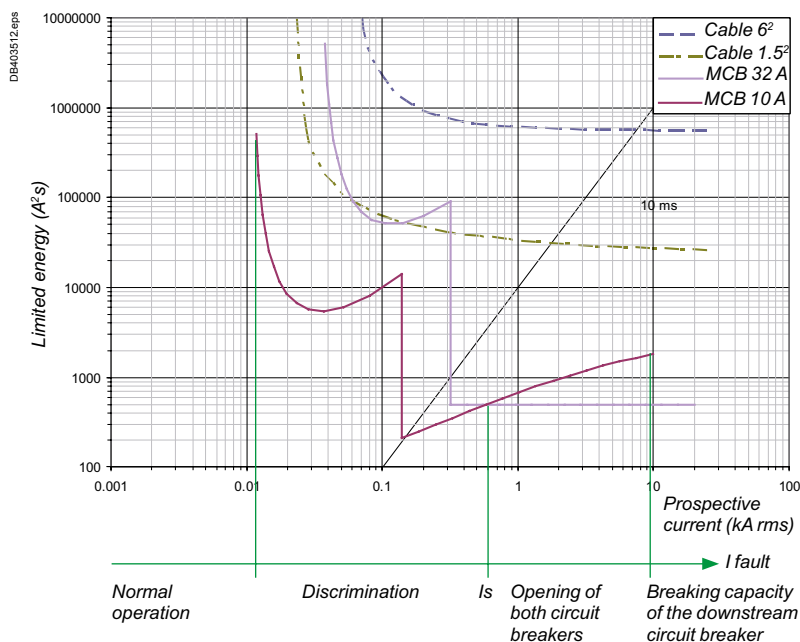

Coordination between circuit breakers

Discrimination (Selectivity)

Discrimination between Compact NSX upstream and modular circuit breakers downstream

Compact NSX circuit breakers have been designed to ensure total discrimination with Acti9 range.

- Total discrimination between Compact NSX 100 A with electronic trip unit and Acti9 circuit breaker up to 40 A.
- Total discrimination between Compact NSX ≥ 160 A with TMD trip unit ≥ 125 A or electronic trip unit and Acti9 up to 63 A.

Discrimination between Compact NSX circuit breakers

Thanks to the Roto-Active breaking principle in the Compact NSX, a combination of Schneider Electric circuit breakers provides an exceptional level of discrimination between protection devices.

This performance is due to the combination and optimization of 3 principles:

- current discrimination,
- energy discrimination,
- time discrimination.

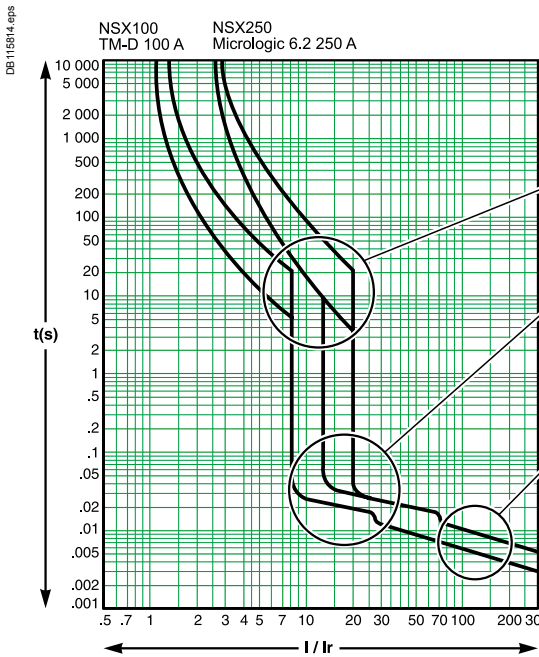

Protection against overloads: current discrimination

The protection is selective if the ratio between the setting thresholds is higher than 1.6 (in the case of two distribution circuit breakers).

Protection against weak short circuits: time discrimination

Tripping of the upstream device has a slight time delay; tripping of the downstream device is faster.

The protection is selective if the ratio between the short-circuit protection thresholds is no less than 1.5.

Protection against high short circuits: energy discrimination

This principle combines the exceptional limiting power of the Compact NSX devices and reflex release, sensitive to the energy dissipated by the short circuit in the device.

When a short circuit is high, if it is seen by two devices, the downstream device limits it greatly. The energy dissipated in the upstream device is insufficient to cause it to trip: there is discrimination whatever the value of the short circuit.

The range has been designed to ensure energy discrimination between NSX630/NSX250/NSX100 or NSX400/NSX160.

Discrimination between Masterpact or Compact NS ≥ 630 A upstream and Compact NSX downstream

Thanks to their high-performance control units and a very innovative design, Masterpact and Compact NS ≥ 630 A devices offer, as standard, a very high level of discrimination with downstream Compact NSX up to 630 A

Respect the basic rules of discrimination for overload and short-circuit, or check that curves do not overlap with Ecodial software.

Check the discrimination limit in tables for high short-circuit current or when using limiter circuit breakers (Masterpact NT L1 or Compact NS L or LB) upstream.

Discrimination between Masterpact or Compact NS ≥ 630 A upstream and downstream

The utilization category of these devices (excepted limiters ones) is B according to IEC 60947 standard. Discrimination is ensured by a combination of current discrimination and time discrimination.

Respect the basic rules of discrimination for overload and short-circuit, or check that curves do not overlap with Ecodial software.

Check the discrimination limit in tables for high short-circuit current or when using limiter circuit breakers (Masterpact NT L1 or Compact NS L or LB).

Basic rules of discrimination for overload and short-circuit

Upstream	Downstream	Thermal protection	Magnetic protection
		I_r upstream / I_r downstream	I_m upstream / I_m downstream
TM	TM or MCB	≥ 1.6	≥ 2
	Micrologic	≥ 1.6	≥ 1.5
Micrologic	TM or MCB	≥ 1.6	≥ 1.5
	Micrologic	≥ 1.3	$\geq 1.5^{(1)}$

(1) See "Additional conditions according to the trip units".

Coordination between circuit breakers

Discrimination (Selectivity)

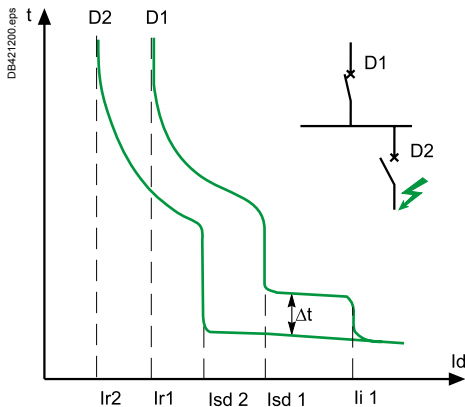

Additional conditions according to the trip units

Short time trip pickup current (I_{sd})

The tables show the limit of discrimination assuming the short time trip pickup current $I_{sd} = 10 \times I_r$.

In many cases, when discrimination is total, a different adjustment may be used provided that the ratio between the magnetic thresholds indicated above is observed.

When downstream breaker is a Compact NSX:

■ upstream circuit breaker magnetic setting shall be higher than downstream instantaneous protection:

NSX 2.2 ou 2.3	Mic 2.2 40	Mic 2.2 100	Mic 2.2 160	Mic 2.2 250	Mic 2.3 400	Mic 2.3 630
Inst.	600 A	1500 A	2400 A	3000 A	4800 A	6900 A

■ or upstream circuit breaker shall be equipped with micrologic type 5 with $t_{sd} \geq 0.1$. When downstream circuit breaker is a Masterpact with micrologic 2, upstream circuit breaker shall be equipped with micrologic type 5 and $t_{sd} \geq 0,1$ and Ii Off. When the limit of discrimination indicated in the table is $10 \times I_r$, the limit of discrimination is in fact the upstream magnetic threshold I_{sd} .

Instantaneous trip pickup current (I_i)

The tables show the limit of discrimination assuming the instantaneous trip pickup current set to its maximum value and when it is inhibited (category B circuit breaker only).

■ When the limit of discrimination indicated in the table is $15 \times I_n$ of the upstream device, the limit of discrimination is in fact the instantaneous trip pickup current of the upstream device.

■ When the upstream device is a type B circuit breaker and the downstream device is type A, the instantaneous trip pickup current of the upstream device may be set to below $15 \times I_n$ as long as it remains higher than the reflex release threshold of the downstream device.

Short time tripping delay (T_{sd})

When the upstream and downstream circuit breakers are fitted with a Micrologic 5.x, 6.x, 7.x: trip unit, the minimum non-tripping time of the upstream device must be greater than the maximum tripping time of the downstream device.

T_{sd} D1 > T_{sd} D2 (One band)

I²t Off / On

The tables show the limit of discrimination assuming function I²t OFF. If this is not the case, the user must verify that the curves do not overlap.

Ground Fault Protection (GFP) (I_g, T_g)

When the upstream and downstream circuit breakers are fitted with a Micrologic 6.x trip unit, the user must verify current and time discrimination:

current discrimination

The setting of the tripping threshold of the upstream GFP is greater than that of the downstream GFP. Because of the tolerances on the settings, a difference of 30 % between the upstream threshold and the downstream threshold is sufficient.

time discrimination

The intentional time-delay setting for the upstream GFP is higher than the opening time of the downstream protection device. Furthermore, it is essential that the intentional time-delay applied to the upstream protection device observes the maximum insulation fault elimination time defined by NEC § 230.95 (i.e. 1 s for 3000 A).

I_g D1 ≥ 1.3 I_g D2 T_g D1 > T_g D2 (One band)

Circuit breaker with vigi module (Add-On Residual Current Device - RCD):

When circuit breakers are equipped with vigi module, discrimination tables are valid for short-circuit. To ensure discrimination in case of earth fault, upstream and downstream vigi modules shall satisfy the following conditions:

■ the sensitivity of the upstream residual current device must be at least equal to three times the sensitivity of the downstream residual current device ($I_{\Delta n} D1 \geq 3 \times I_{\Delta n} D2$),

■ the upstream residual current device must be:

- of the selective (S) type (or setting) if the downstream residual current device is an instantaneous type,
- of the delayed (R) type (or setting) if the downstream residual current device is a selective type.

The minimum non-tripping time of the upstream device will therefore be greater than the maximum tripping time of the downstream device for all current values ($\Delta t (D1) > \Delta t (D2)$).

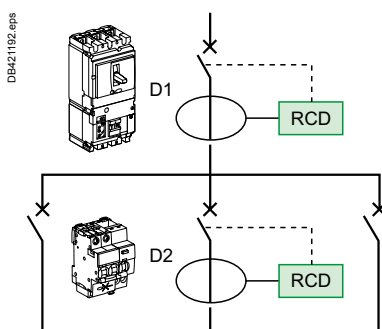

Coordination between circuit breakers

Discrimination of modular circuit breakers

Using the discrimination tables

Depending on the network and the type of downstream circuit breaker, the selection table below indicates which table should be consulted to find out the discrimination value.

The discrimination values are given in colour-coded tables.

■ For 220-240 V/380-415 V 50/60 Hz systems:

□ in the case of a 2P downstream circuit breaker in a single-phase network (220-240 V), refer to the light green tables,

□ in the case of 1P, 1P+N, 3P, 3P+N, 4P and 2P circuit breakers in a two-phase network (380-415 V), refer to the dark green tables.

Selection table

		Upstream network		
		 DB123966 eps	 DB123968 eps	 DB123967 eps
Type of Downstream network	Type of Downstream protection device	Ph/N 220-240 V	Ph/N 220-240 V Ph/Ph 380-415 V	Ph/Ph 380-415 V
 DB124075 eps	 DB123991 eps	□	□	□
	 DB124191 eps	□	□	□
	 DB123992 eps	□	□	□
 DB124192 eps	 DB123991 eps	□	□	□
 DB124080 eps	 DB123993 eps	□	□	□
 DB124081 eps	 DB123994 eps	□	□	□
	 DB123993 eps	□	□	□
	 DB123995 eps	□	□	□

Note: this selection table shows you the colour.

By taking your downstream protection device, the type of upstream network and its voltage you can refer to the corresponding discrimination table.

Coordination between circuit breakers

Discrimination of modular circuit breakers

Example: solution diagram

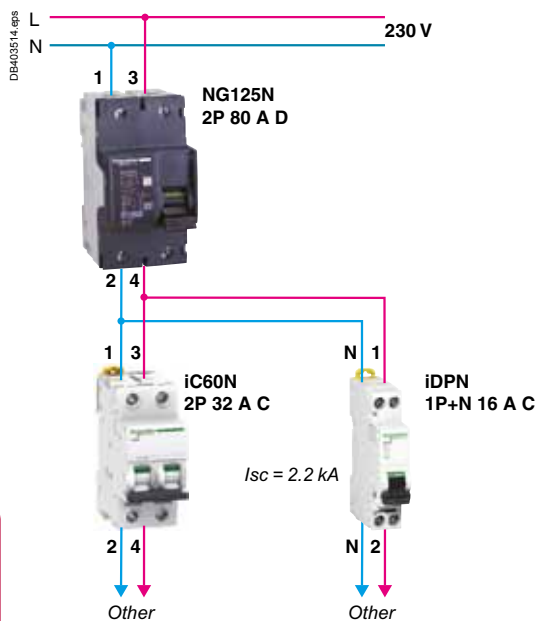

Upstream we have a NG125N 80 A 2P curve D and downstream an iC60N 32 A 2P curve C. The network is 230 V between phase and neutral. By referring to the light green table on the discrimination page for NG125N curve D with iC60 downstream, we find 2200 A.

If the downstream product is replaced by an iDPN 1P+N curve C, you will use the dark green table for NG125N curve D and iDPN1P+N downstream. The discrimination level is 2400 A for a 16 A.

Specifications

We want to achieve continuity of service in the event of a fault downstream of the NG125N 80 A. This circuit has an I_{sc} of 2.2 kA under a voltage of 230 V. By referring to the table for 230 V, 1P+N network, we find that for an upstream NG125N curve D with a rating of 80 A, we can have total discrimination up to 16 A if we use an iC60N 1P+N and up to 32 A with an iC60N 2P.

Upstream		NG125N/H/L										
		Curve D										
In (A)		10	16	20	25	32	40	50	63	80	100	125
Downstream	2P (220-240 V) single-phase network											
Discrimination limit (A)												
iC60N/H/L Curve C	0.5	T	T	T	T	T	T	T	T	T	T	T
	1	T	T	T	T	T	T	T	T	T	T	T
	2	1200	T	T	T	T	T	T	T	T	T	T
	3	21	3400	3400	T	T	T	T	T	T	T	T
	4	18	1200	1300	5800	5600	T	T	T	T	T	T
	6	15	700	720	1900	1900	6000	11000	T	T	T	T
	10		22	480	1200	1200	2200	4200	10000	T	T	T
	13			28	51	900	1800	3000	7300	8000	T	T
	16				35	740	1300	2200	4700	5400	T	T
	20					46	88	1700	3500	3500	6900	T
	25						56	600	2500	2500	4600	6800
	32							80	2000	2200	3400	4400
	40								756	1900	2900	3500
	50									960	2300	2800
	63										2300	2800

4000 Discrimination limit = 4 kA.

T Total discrimination.

No discrimination.

$I_s > I_{sc}$ Total discrimination

Coordination between circuit breakers

Discrimination of modular circuit breakers

Contents

Downstream		Upstream								
Type		iDPN, iDPN N			iC60N/H/L			NG125N/H/L, C120N/H		
	Curve	B	C	D	B	C	D	B	C	D
iDPN	B	page 647	page 648	page 649	page 650	page 651	page 652	page 660	page 662	page 664
	C	page 647	page 648	page 649	page 650	page 651	page 652	page 660	page 662	page 664
	D	page 647	page 648	page 649	page 650	page 651	page 652	page 660	page 662	page 664
iDPN N	B	page 647	page 648	page 649	page 650	page 651	page 652	page 661	page 663	page 665
	C	page 647	page 648	page 649	page 650	page 651	page 652	page 661	page 663	page 665
	D	page 647	page 648	page 649	page 650	page 651	page 652	page 661	page 663	page 665
iC60N/H/L	B	–	–	–	page 654-655	page 656-657	page 658-659	page 666-673	page 668-669	page 670-671
	C	–	–	–	page 654-655	page 656-657	page 658-659	page 666-673	page 668-669	page 670-671
	D	–	–	–	page 654-655	page 656-657	page 658-659	page 666-673	page 668-669	page 670-671
C120, NG125	B	–	–	–	–	–	–	page 672-673	page 674-675	page 676-677
	C	–	–	–	–	–	–	page 672-673	page 674-675	page 676-677
	D	–	–	–	–	–	–	page 672-673	page 674-675	page 676-677

Discrimination between circuit breakers

In the following tables we show the level of discrimination between two LV circuits that are protected by circuit breakers.

This discrimination will be either:

- total: represented by a T (up to the breaking capacity of the downstream device),
- partial: discrimination limit current (Is) indicated. Below this value discrimination is ensured, above this value the upstream device is also involved in breaking,
- zero: no discrimination ensured.

Discrimination table

Upstream: iDPN, iDPN N curve B

Downstream: iDPN/iDPN N curves B, C, D

220-240/380-415 V AC

Upstream		iDPN, iDPN N Curve B										
In (A)		1	2	3	4	6	10	16	20	25	32	40
Downstream												
1P+N												
3P, 3P+N												
Discrimination limit (A)												
iDPN	1		8	12	20	30	70	150	250	350	610	980
iDPN N	2			12	16	30	60	110	180	240	340	450
Curve B	3					30	40	64	140	190	280	350
	4					10	40	64	120	160	220	280
	6						40	64	80	100	130	160
	10							64	80	100	130	160
	16									100	130	160
	20										130	160
	25											160
Discrimination limit (A)												
iDPN	1		6	12	20	30	70	150	250	350	610	980
iDPN N	2				12	30	60	110	180	240	340	450
Curve C	3					13	40	64	140	190	280	350
	4						32	64	120	160	220	280
	6							51	80	100	130	160
	10								64	80	130	160
	16										102	128
	20											128
Discrimination limit (A)												
iDPN	1				12	30	70	150	250	350	610	980
iDPN N	2					19	60	110	180	240	340	450
Curve D	3						32	64	140	190	280	350
	4							51	120	160	220	280
	6								64	80	130	160
	10										102	128
	16											128

Note: if you cannot find your combination, refer to the selection table on page 644.

4000 Discrimination limit = 4 kA.

No discrimination.

Discrimination table

Upstream: iDPN, iDPN N curve C

Downstream: iDPN/iDPN N curves B, C, D

220-240/380-415 V AC

Upstream		iDPN, iDPN N Curve C										
In (A)		1	2	3	4	6	10	16	20	25	32	40
Downstream 1P+N 3P, 3P+N												
Discrimination limit (A)												
iDPN iDPN N Curve B	1		16	24	32	70	180	400	630	1200	T	T
	2			24	32	48	140	270	350	510	820	830
	3				32	48	80	210	290	380	630	650
	4					48	80	130	240	320	480	510
	6						80	130	160	200	320	380
	10							130	160	200	260	320
	16								160	200	260	320
	20										260	320
	25											320
	32											
Discrimination limit (A)												
iDPN iDPN N Curve C	1		16	24	32	70	180	400	630	1200	T	T
	2			24	32	48	140	270	350	510	820	830
	3				9	48	80	210	290	380	630	650
	4					10	80	130	240	320	480	510
	6						80	130	160	200	320	380
	10							130	160	200	260	320
	16								45	200	260	320
	20										260	320
	25											320
	Discrimination limit (A)											
iDPN iDPN N Curve D	1		16	24	32	70	180	400	630	1200	T	T
	2				25	48	140	270	350	510	820	830
	3					13	80	210	290	380	630	650
	4						80	130	240	320	480	510
	6							128	160	200	320	380
	10								128	200	260	320
	16									141	153	320
	20											256

Note: if you cannot find your combination, refer to the selection table on page 644.

4000 Discrimination limit = 4 kA.

T Total discrimination.

No discrimination.

Discrimination table

Upstream: iDPN, iDPN N curve D

Downstream: iDPN/iDPN N curves B, C, D

220-240/380-415 V AC

Upstream	iDPN, iDPN N										
In (A)	Curve D										
	1	2	3	4	6	10	16	20	25	32	40

Downstream	1P+N 3P, 3P+N										
------------	------------------	--	--	--	--	--	--	--	--	--	--

Discrimination limit (A)												
iDPN	1		24	36	70	170	380	1200	T	T	T	T
iDPN N	2			36	48	130	250	490	780	1100	1600	2300
Curve B	3				48	72	210	410	640	890	1400	1900
	4					72	120	330	500	670	970	1400
	6						120	190	390	520	740	1000
	10							190	240	300	580	810
	16									300	380	480
	20										380	480
	25											480
	32											480
	40											480

Discrimination limit (A)												
iDPN	1		24	36	70	170	380	1200	T	T	T	T
iDPN N	2			36	48	130	250	490	780	1100	1600	2300
Curve C	3				9	72	210	410	640	890	1400	1900
	4					10	120	330	500	670	970	1400
	6							190	390	520	740	1000
	10							190	240	300	580	810
	16									300	380	480
	20										380	480
	25											480

Discrimination limit (A)												
iDPN	1		24	36	70	170	380	1200	T	T	T	T
iDPN N	2			36	48	130	250	490	780	1100	1600	2300
Curve D	3					14	210	410	640	890	1400	1900
	4					10	120	330	500	670	970	1400
	6						120	190	390	520	740	1000
	10							190	240	300	580	810
	16									300	380	480
	20										380	480
	25											480

Note: if you cannot find your combination, refer to the selection table on page 644.

4000 Discrimination limit = 4 kA.

T Total discrimination.

No discrimination.

Discrimination table

Upstream: iC60N/H/L curve B

Downstream: iDPN/iDPN N curves B, C, D

220-240/380-415 V AC

Upstream		iC60N/H/L Curve B													
In (A)		2	3	4	6	10	13	16	20	25	32	40	50	63	
Downstream 1P+N 3P, 3P+N															
Discrimination limit (A)															
iDPN iDPN N Curve B	1	8	12	16	30	60	80	110	130	150	270	410	450	620	
	2		12	16	24	40	50	90	80	100	220	300	330	440	
	3				24	40	50	64	80	100	210	270	300	410	
	4				14	40	50	64	80	100	190	270	300	380	
	6					40	50	64	80	100	130	240	250	250	
	10							64	80	100	130	160	200	250	
	16									100	130	160	200	250	
	20										130	160	200	250	
	25												160	200	250
	32													200	250
	40														250
	Discrimination limit (A)														
	iDPN iDPN N Curve C	1		12	16	30	60	80	110	130	150	270	410	450	620
2				5	24	40	50	90	80	100	220	300	330	440	
3					17	40	50	64	80	100	210	270	300	410	
4						34	50	64	80	100	190	270	300	380	
6								47	80	100	130	240	250	250	
10									64	80	130	160	200	250	
16											102	128	200	250	
20													128	160	250
25														160	201
32															201
Discrimination limit (A)															
iDPN iDPN N Curve D	1			12	30	60	80	110	130	150	270	410	450	620	
	2				19	40	50	90	80	100	220	300	330	440	
	3					32	50	64	80	100	210	270	300	410	
	4							51	80	100	190	270	300	380	
	6								59	78	130	240	250	250	
	10										102	128	200	250	
	16												128	160	201
	20													160	201
	25														201

Note: if you cannot find your combination, refer to the selection table on page 644.

4000 Discrimination limit = 4 kA.

No discrimination.

Discrimination table

Upstream: iC60N/H/L curve C

Downstream: iDPN/iDPN N curves B, C, D

220-240/380-415 V AC

Upstream		iC60N/H/L													
		Curve C													
In (A)		1	2	3	4	6	10	13	16	20	25	32	40	50	63
Downstream															
1P+N															
3P, 3P+N															
Discrimination limit (A)															
iDPN	1		16	24	32	48	80	100	210	270	390	540	790	1500	1600
iDPN N	2			24	32	48	80	100	130	160	300	410	540	910	930
Curve B	3				5	48	80	100	130	160	200	260	510	750	760
	4					48	80	100	130	160	200	260	480	720	760
	6						80	100	130	160	200	260	320	400	500
	10							100	130	160	200	260	320	400	500
	16										200	260	320	400	500
	20											260	320	400	500
	25												320	400	500
	32													400	500
	40														500
Discrimination limit (A)															
iDPN	1		16	24	32	48	80	100	210	270	390	540	790	1500	1600
iDPN N	2			24	32	48	80	100	130	160	300	410	540	910	930
Curve C	3					48	80	100	130	160	200	260	510	750	760
	4					14	80	100	130	160	200	260	480	720	760
	6						80	100	130	160	200	260	320	400	500
	10								130	160	200	260	320	400	500
	16										83	260	320	400	500
	20											260	320	400	500
	25												124	400	500
	32													163	500
	40														186
Discrimination limit (A)															
iDPN	1		16	24	32	48	80	100	210	270	390	540	790	1500	1600
iDPN N	2				25	48	80	100	130	160	300	410	540	910	930
Curve D	3						80	100	130	160	200	260	510	750	760
	4						80	100	130	160	200	260	480	720	760
	6							100	130	160	200	260	320	400	500
	10										200	260	320	400	500
	16										83	165	320	400	500
	20												151	400	500
	25													176	500
	32														255

Note: if you cannot find your combination, refer to the selection table on page 644.

4000 Discrimination limit = 4 kA.

No discrimination.

Discrimination table

Upstream: iC60N/H/L curve D

Downstream: iDPN/iDPN N curves B, C, D

220-240/380-415 V AC

Upstream		iC60N/H/L Curve D														
In (A)		1	2	3	4	6	10	13	16	20	25	32	40	50	63	
Downstream																
1P+N																
3P, 3P+N																
Discrimination limit (A)																
iDPN iDPN N Curve B	1		30	50	70	72	120	260	350	540	700	1100	1500	2000	2000	
	2			36	48	72	120	160	190	390	510	700	960	1500	2000	
	3				5	72	120	160	190	360	450	580	840	1200	1500	
	4					72	120	160	190	240	450	580	780	1100	1400	
	6						120	160	190	240	300	380	720	1000	1200	
	10							160	190	240	300	380	480	600	760	
	16										300	380	480	600	760	
	20												380	480	600	760
	25													480	600	760
	32														600	760
	40															760
Discrimination limit (A)																
iDPN iDPN N Curve C	1		30	50	70	72	120	260	350	540	700	1100	1500	2000	2000	
	2			36	48	72	120	160	190	390	510	700	960	1500	2000	
	3				5	72	120	160	190	360	450	580	840	1200	1500	
	4					14	120	160	190	240	450	580	780	1100	1400	
	6						120	160	190	240	300	380	720	1000	1200	
	10							34	190	240	300	380	480	600	760	
	16											300	380	480	600	760
	20												380	480	600	760
	25													124	600	760
	32														163	760
	40															186
Discrimination limit (A)																
iDPN iDPN N Curve D	1		30	50	70	72	120	260	350	540	700	1100	1500	2000	2000	
	2			36	48	72	120	160	190	390	510	700	960	1500	2000	
	3					17	120	160	190	360	450	580	840	1200	1500	
	4					14	120	160	190	240	450	580	780	1100	1400	
	6						120	160	190	240	300	380	720	1000	1200	
	10								57	240	300	380	480	600	760	
	16											83	380	480	600	760
	20												155	151	600	760
	25													124	180	760
	32														163	760
	40															186

Note: if you cannot find your combination, refer to the selection table on page 2.

4000 Discrimination limit = 4 kA.

No discrimination.



Discrimination table

Upstream: iC60N/H/L curve B

Downstream: iC60N/H/L curves B, C, D

220-240/380-415 V AC

Upstream		iC60N/H/L															
		Curve B															
In (A)		1	2	3	4	6	10	13	16	20	25	32	40	50	63		
Downstream		1P, 1P+N 2P (380-415 V) two-phase network 3P, 3P+N 4P															
Discrimination limit (A)																	
iC60N/H/L Curve B	0.5		4	10	40	60	T	T	T	T	T	T	T	T	T		
	1			10	12	16	40	70	120	170	210	300	780	1300	1700	4000	
	2				12	16	30	60	90	130	140	200	370	520	630	960	
	3						30	40	70	90	120	150	250	380	460	670	
	4						30	40	52	90	80	100	250	310	380	470	
	6							40	52	64	80	100	190	290	300	440	
	10									64	80	100	130	240	200	380	
	13										80	100	130	240	200	250	
	16											100	130	160	200	250	
	20												130	160	200	250	
	25													160	200	250	
	32														200	250	
	40															250	
	50															250	
Discrimination limit (A)																	
iC60N/H/L Curve C	0.5			10	40	60	T	T	T	T	T	T	T	T	T		
	1					16	30	70	120	170	210	300	780	1300	1700	4000	
	2					16	18	60	90	130	160	200	370	520	630	960	
	3						15	40	70	90	120	150	250	380	460	670	
	4							27	52	90	80	100	250	310	380	470	
	6									51	80	100	190	290	300	440	
	10										64	80	130	240	200	250	
	13												102	160	200	250	
	16													102	128	200	250
	20														128	160	250
	25															160	200
	32																200
	Discrimination limit (A)																
	iC60N/H/L Curve D	0.5				30	50	T	T	T	T	T	T	T	T	T	
1						12	30	60	120	170	210	300	780	1300	1700	4000	
2							19	40	70	110	140	180	370	520	630	860	
3								31	41	90	120	150	250	380	460	670	
4										48	80	100	220	310	340	470	
6											64	80	190	240	300	380	
10													100	128	200	250	
13														128	160	250	
16														128	160	200	
20															160	200	
25															200		

Note: if you cannot find your combination, refer to the selection table on page 644.

4000 Discrimination limit = 4 kA.

T Total discrimination.

No discrimination.

Discrimination table

Upstream: iC60N/H/L curve B

Downstream: iC60N/H/L curves B, C, D

220-240/380-415 V AC

Upstream		iC60N/H/L														
		Curve B														
In (A)		1	2	3	4	6	10	13	16	20	25	32	40	50	63	
Downstream		2P (220-240 V) single-phase network														
Discrimination limit (A)																
iC60N/H/L Curve B	0.5	4	210	T	T	T	T	T	T	T	T	T	T	T	T	
	1		10	20	20	60	110	260	530	790	2000	T	T	T	T	
	2			12	16	30	70	140	200	250	400	880	1700	2500	5300	
	3					30	40	90	130	160	250	550	800	1100	1400	
	4						40	70	110	120	180	370	520	630	960	
	6							40	52	64	80	100	270	380	460	630
	10									64	80	100	190	290	300	440
	13										80	100	130	240	200	380
	16											100	130	240	200	250
	20												130	160	200	250
	25													160	200	250
	32														200	250
	40															250
	50															250
Discrimination limit (A)																
iC60N/H/L Curve C	0.5		170	T	T	T	T	T	T	T	T	T	T	T	T	
	1				20	60	110	260	530	790	2000	T	T	T	T	
	2				16	18	70	140	200	250	400	880	1700	2500	5300	
	3					15	40	90	130	160	230	550	800	1100	1400	
	4						27	70	90	120	180	370	520	630	860	
	6								51	80	100	230	380	410	630	
	10									64	80	130	240	300	440	
	13											102	240	200	380	
	16												102	128	200	250
	20													128	160	250
	25														160	200
	32															200
	Discrimination limit (A)															
	iC60N/H/L Curve D	0.5			T	T	T	T	T	T	T	T	T	T	T	T
1					12	50	110	260	530	790	2000	T	T	T	T	
2						19	60	120	200	250	350	1100	1700	2500	5300	
3							31	41	110	140	230	490	800	960	1400	
4									48	80	150	310	450	630	860	
6										64	80	230	330	410	500	
10												100	128	200	380	
13													128	160	250	
16													128	160	200	
20														160	200	
25														200		

Note: the discrimination limits given in the table must be compared to the phase/neutral fault current (Ik1).
If the max. phase/earth fault current (If) is high, the discrimination of this fault current should also be verified by referring to the limits given in the dark green part of the table.

Discrimination table

Upstream: iC60N/H/L curve C

Downstream: iC60N/H/L curves B, C, D

220-240/380-415 V AC

Upstream		iC60N/H/L													
		Curve C													
In (A)		1	2	3	4	6	10	13	16	20	25	32	40	50	63
Downstream		1P, 1P+N 2P (380-415 V) two-phase network 3P, 3P+N 4P													
Discrimination limit (A)															
iC60N/H/L	0.5	8	60	T	T	T	T	T	T	T	T	T	T	T	T
Curve B	1	16	24	32	70	180	210	370	590	1100	2400	7000	T	T	
	2		24	32	48	140	160	220	310	460	780	1200	2000	2000	
	3			5	48	120	104	190	280	380	580	820	1400	1400	
	4				14	80	104	130	240	300	430	590	1000	1100	
	6					80	104	130	160	200	380	480	770	850	
	10						104	130	160	200	260	320	680	500	
	13								160	200	260	320	600	500	
	16									200	260	320	600	500	
	20										260	320	400	500	
	25											320	400	500	
	32												400	500	
	40													500	
	50														500
Discrimination limit (A)															
iC60N/H/L	0.5	8	50	T	T	T	T	T	T	T	T	T	T	T	T
Curve C	1	16	24	32	70	180	210	370	590	1100	2400	7900	T	T	
	2		24	32	48	120	160	220	310	460	780	1200	2000	2000	
	3				16	80	104	190	280	380	480	820	1400	1400	
	4				14	80	104	130	160	300	430	590	1000	1100	
	6					80	104	130	160	200	380	480	770	850	
	10							130	160	200	260	320	680	500	
	13								55	200	260	320	600	500	
	16									71	260	320	400	500	
	20										260	320	400	500	
	25											127	400	500	
	32												168	500	
	40													500	
	50														500
Discrimination limit (A)															
iC60N/H/L	0.5		50	T	T	T	T	T	T	T	T	T	T	T	T
Curve D	1		24	32	70	180	210	370	590	1100	2400	7900	T	T	
	2			25	48	120	160	220	310	460	680	1200	2000	2000	
	3				15	80	104	130	240	380	480	710	1400	1400	
	4					28	100	130	160	300	430	590	1000	910	
	6							130	160	200	260	480	770	760	
	10								73	200	260	320	600	500	
	13									79	260	320	600	500	
	16									71	194	320	400	500	
	20											135	400	500	
	25												174	500	
	32													277	
	40														

Note: if you cannot find your combination, refer to the selection table on page 644.

4000 Discrimination limit = 4 kA.

T Total discrimination.

No discrimination.

Discrimination table

Upstream: iC60N/H/L curve C

Downstream: iC60N/H/L curves B, C, D

220-240/380-415 V AC

Upstream		iC60N/H/L													
		Curve C													
In (A)		1	2	3	4	6	10	13	16	20	25	32	40	50	63
Downstream		2P (220-240 V) single-phase network													
Discrimination limit (A)															
iC60N/H/L Curve B	0.5	20	T	T	T	T	T	T	T	T	T	T	T	T	T
	1		20	40	50	120	540	940	2700	T	T	T	T	T	T
	2			24	32	70	210	260	430	800	1500	3600	7900	52000	53000
	3				5	48	140	180	250	450	710	1200	2100	11000	9800
	4					14	120	160	220	310	460	680	940	2000	2000
	6						80	104	130	240	350	510	770	1300	1100
	10							104	130	160	200	380	550	930	950
	13									160	200	260	480	770	760
	16										200	260	320	400	500
	20											260	320	400	500
	25												320	400	500
	32													400	500
	40														500
	50														
Discrimination limit (A)															
iC60N/H/L Curve C	0.5	20	T	T	T	T	T	T	T	T	T	T	T	T	T
	1		20	40	50	120	540	940	2700	T	T	T	T	T	T
	2			24	32	70	210	260	430	660	1500	3600	7900	60000	53000
	3					16	140	180	250	380	710	1200	2100	11000	9800
	4					14	120	104	190	310	460	680	940	2000	2000
	6						80	104	130	160	350	510	620	1300	1100
	10								130	160	200	260	480	770	850
	13									55	200	260	480	770	760
	16										78	260	320	400	500
	20											260	320	400	500
	25												127	400	500
	32													168	500
	40														500
	50														
Discrimination limit (A)															
iC60N/H/L Curve D	0.5		T	T	T	T	T	T	T	T	T	T	T	T	T
	1			30	50	120	540	940	2700	T	T	T	T	T	T
	2				25	48	210	260	430	800	1500	3600	7900	60000	53000
	3					15	120	160	250	380	630	1200	2100	11000	9800
	4						28	100	190	280	460	680	940	2000	2000
	6								130	160	300	450	620	1100	1100
	10									73	200	260	480	770	850
	13										79	260	320	680	760
	16										71	194	320	400	500
	20												135	400	500
	25													174	500
	32														277
	40														

Note: the discrimination limits given in the table must be compared to the phase/neutral fault current (Ik1).
If the max. phase/earth fault current (If) is high, the discrimination of this fault current should also be verified by referring to the limits given in the dark green part of the table.

Discrimination table

Upstream: iC60N/H/L curve D

Downstream: iC60N/H/L curves B, C, D

220-240/380-415 V AC

Upstream	iC60N/H/L													
	Curve D													
In (A)	1	2	3	4	6	10	13	16	20	25	32	40	50	63

Downstream	1P, 1P+N 2P (380-415 V) two-phase network 3P, 3P+N 4P
------------	--

Discrimination limit (A)

iC60N/H/L Curve B	0.5	20	T	T	T	T	T	T	T	T	T	T	T	T	T
1			30	50	70	150	290	510	770	2000	3900	T	T	T	T
2				36	48	110	210	300	450	730	890	1400	2300	5000	6800
3					5	72	180	230	330	550	670	1100	1300	2800	4300
4						72	120	160	290	410	560	840	1000	2000	2400
6							120	160	190	360	450	660	910	1300	1600
10								28	190	240	300	380	720	1100	1400
13										240	300	380	480	900	1100
16											300	380	480	900	1100
20												380	480	600	760
25													480	600	760
32														600	760
40															760
50															

Discrimination limit (A)

iC60N/H/L Curve C	0.5	20	T	T	T	T	T	T	T	T	T	T	T	T	T
1			30	50	70	150	290	510	770	2000	3900	T	T	T	T
2				36	48	110	210	300	450	730	890	1600	2300	5000	6800
3					5	15	120	230	330	550	670	1100	1300	2800	4300
4						13	120	160	290	410	560	710	1000	2000	2400
6							120	160	190	360	450	660	910	1300	1600
10								28	49	240	300	380	720	1100	1100
13										52	300	380	480	900	1100
16											71	380	480	900	760
20												380	480	600	760
25													105	600	760
32														153	760
40															760
50															

Discrimination limit (A)

iC60N/H/L Curve D	0.5	20	T	T	T	T	T	T	T	T	T	T	T	T	T
1			30	50	70	150	290	510	770	2000	3900	T	T	T	T
2				36	48	110	210	300	370	640	890	1600	2300	5000	6800
3						15	120	230	330	450	670	970	1300	2800	3800
4						13	28	160	190	410	560	710	1000	1600	2400
6							32	160	190	240	450	580	810	1300	1600
10								49	73	300	380	480	1100	1100	
13									52	80	380	480	900	1100	
16										71	380	480	900	760	
20											105	135	600	760	
25												105	174	760	
32													153	760	
40														245	
50															

Note: if you cannot find your combination, refer to the selection table on page 644.

4000 Discrimination limit = 4 kA.

T Total discrimination.

No discrimination.

Discrimination table

Upstream: iC60N/H/L curve D

Downstream: iC60N/H/L curves B, C, D

220-240/380-415 V AC

Upstream		iC60N/H/L													
		Curve D													
In (A)		1	2	3	4	6	10	13	16	20	25	32	40	50	63
Downstream		2P (220-240 V) single-phase network													
Discrimination limit (A)															
iC60N/H/L Curve B	0.5	T	T	T	T	T	T	T	T	T	T	T	T	T	T
	1		50	100	130	340	1600	10000	T	T	T	T	T	T	T
	2			50	80	150	350	650	1100	2600	5800	16000	45000	T	T
	3				5	110	240	370	530	920	1600	3800	9500	T	T
	4					72	180	270	370	640	890	1400	2300	7100	12000
	6						120	160	290	480	590	900	1300	2200	2600
	10							28	190	360	450	660	910	1500	1900
	13									240	450	580	810	1300	1600
	16										300	380	720	1100	1400
	20											380	480	900	1100
	25												480	900	760
	32													600	760
	40														760
	50														
Discrimination limit (A)															
iC60N/H/L Curve C	0.5	T	T	T	T	T	T	T	T	T	T	T	T	T	T
	1		50	100	130	340	1600	10000	T	T	T	T	T	T	T
	2			50	70	150	350	580	1100	2600	5800	16000	45000	T	T
	3				5	15	240	370	530	920	1600	3800	9500	T	T
	4					13	180	270	370	640	890	1400	1900	7100	12000
	6						120	160	290	480	590	900	1300	2200	2600
	10							28	190	360	450	660	910	1500	1900
	13									52	300	580	810	1300	1600
	16										71	380	720	1100	1400
	20											380	480	900	1100
	25												105	600	760
	32													153	760
	40														760
	50														
Discrimination limit (A)															
iC60N/H/L Curve D	0.5	T	T	T	T	T	T	T	T	T	T	T	T	T	T
	1		40	80	130	340	1600	10000	T	T	T	T	T	T	T
	2			50	70	150	350	650	1200	2600	5800	16000	45000	T	T
	3					15	210	300	530	920	1600	3800	9500	T	T
	4					13	28	230	370	640	890	1400	1900	7100	12000
	6						32	160	190	420	590	900	1100	2200	2600
	10							49	73	450	660	910	1500	1900	
	13									52	300	380	720	1300	1600
	16										71	380	480	1100	1400
	20											105	480	900	1100
	25												105	174	760
	32													153	760
	40														245
	50														

Note: the discrimination limits given in the table must be compared to the phase/neutral fault current (Ik1).
If the max. phase/earth fault current (If) is high, the discrimination of this fault current should also be verified by referring to the limits given in the dark green part of the table.

Discrimination table

Upstream: NG125N/H/L, C120N/H curve B

Downstream: iDPN curves B, C, D

220-240/380-415 V AC

Upstream		NG125N/H/L, C120N/H										
		Curve B										
In (A)		10	16	20	25	32	40	50	63	80	100	125
Downstream												
1P+N												
3P, 3P+N												
Discriminaaion limit (A)												
iDPN Curve B	1	300	500	700	1000	1500	2000	2500	T	T	T	T
	2	150	300	500	700	1000	1500	2000	T	T	T	T
	3	40	64	300	500	700	1000	1500	T	T	T	T
	4	40	64	80	400	500	700	800	3000	T	T	T
	6	40	64	80	400	500	700	800	3000	T	T	T
	10		64	80	100	130	500	600	1800	3000	T	T
	16				100	130	160	200	1000	2000	3300	3750
	20					52	160	200	1000	1600	2500	3700
	25						59	200	800	1300	2100	3700
	32							200	600	1000	1800	2700
	40								112	320	1600	2400
Discriminaaion limit (A)												
iDPN Curve C	1	300	500	700	1000	1500	2000	2500	T	T	T	T
	2	150	300	500	700	1000	1500	2000	T	T	T	T
	3	40	64	300	500	700	1000	1500	T	T	T	T
	4	40	64	80	400	500	700	800	3000	T	T	T
	6		51	80	100	500	700	800	3000	T	T	T
	10				80	130	500	600	1800	3000	4000	T
	16					98	128	200	1000	2000	3300	3700
	20						128	160	1000	1600	2500	3700
	25							160	201	1300	2100	3700
	32								201	256	1800	2700
	40									255	320	2400
Discriminaaion limit (A)												
iDPN Curve D	1	300	500	700	1000	1500	2000	2500	T	T	T	T
	2	150	300	500	700	1000	1500	2000	T	T	T	T
	3		64	300	500	700	1000	1500	T	T	T	T
	4			80	400	500	700	800	3000	T	T	T
	6					500	700	800	3000	T	T	T
	10							600	1800	3000	4000	T
	16								201	2000	3300	3700
	20								201	256	2500	3700
	25								201	256	320	3700
	32									256	320	400
	40										320	400

Note: if you cannot find your combination, refer to the selection table on page 644.

4000 Discrimination limit = 4 kA.

T Total discrimination.

No discrimination.

Discrimination table

Upstream: NG125N/H/L, C120N/H curve B

Downstream: iDPN N curves B, C, D

220-240/380-415 V AC

Upstream		NG125N/H/L, C120N/H										
		Curve B										
In (A)		10	16	20	25	32	40	50	63	80	100	125
Downstream												
1P+N												
3P, 3P+N												
Discriminaaation limit (A)												
iDPN N Curve B	1	300	500	700	1000	1500	2000	2500	T	T	T	T
	2	150	300	500	700	1000	1500	2000	T	T	T	T
	3	40	64	300	500	700	1000	1500	T	T	T	T
	4	40	64	80	400	500	700	800	3000	T	T	T
	6	40	64	80	400	500	700	800	3000	T	T	T
	10		64	80	100	130	500	600	1800	3000	T	T
	16				100	130	160	200	1000	2000	3300	3750
	20					52	160	200	1000	1600	2500	3700
	25						59	200	800	1300	2100	3700
	32							200	600	1000	1800	2700
	40								112	320	1600	2400
	Discriminaaation limit (A)											
iDPN N Curve C	1	300	500	700	1000	1500	2000	2500	T	T	T	T
	2	150	300	500	700	1000	1500	2000	T	T	T	T
	3	40	64	300	500	700	1000	1500	T	T	T	T
	4	40	64	80	400	500	700	800	3000	T	T	T
	6		51	80	100	500	700	800	3000	T	T	T
	10				80	130	500	600	1800	3000	4000	T
	16					98	128	200	1000	2000	3300	3700
	20						128	160	1000	1600	2500	3700
	25							160	201	1300	2100	3700
	32								201	256	1800	2700
	40									255	320	2400
	Discriminaaation limit (A)											
iDPN N Curve D	1	300	500	700	1000	1500	2000	2500	T	T	T	T
	2	150	300	500	700	1000	1500	2000	T	T	T	T
	3		64	300	500	700	1000	1500	T	T	T	T
	4			80	400	500	700	800	3000	T	T	T
	6					500	700	800	3000	T	T	T
	10							600	1800	3000	4000	T
	16								201	2000	3300	3700
	20								201	256	2500	3700
	25								201	256	320	3700
	32									256	320	400
	40										320	400

Note: if you cannot find your combination, refer to the selection table on page 644.

4000 Discrimination limit = 4 kA.

T Total discrimination.

No discrimination.

Discrimination table

Upstream: NG125N/H/L, C120N/H curve C

Downstream: iDPN curves B, C, D

220-240/380-415 V AC

Upstream		NG125N/H/L, C120N/H										
		Curve C										
In (A)		10	16	20	25	32	40	50	63	80	100	125
Downstream												
1P+N												
3P, 3P+N												
Discrimination limit (A)												
iDPN Curve B	1	300	500	700	1000	T	T	T	T	T	T	T
	2	150	300	500	700	1000	1500	T	T	T	T	T
	3	120	200	300	500	700	1000	1500	T	T	T	T
	4	80	130	170	400	500	700	800	3000	T	T	T
	6	80	130	170	400	500	700	800	3000	T	T	T
	10		130	160	200	350	500	600	1800	3000	T	T
	16				200	270	340	450	1250	2000	3300	3700
	20					52	320	400	1000	1600	2500	3700
	25						59	400	800	1300	2100	3700
	32							95	600	1000	1800	2700
	40								112	700	1600	2400
Discrimination limit (A)												
iDPN Curve C	1	300	500	700	1000	T	T	T	T	T	T	T
	2	150	300	500	700	1000	1500	T	T	T	T	T
	3	120	200	300	500	700	1000	1500	T	T	T	T
	4	21	200	170	400	500	700	800	3000	4500	4500	T
	6	18	200	170	400	500	700	800	3000	4500	4500	T
	10		25	160	200	350	500	600	1800	3000	4500	4500
	16				200	270	340	450	1250	2000	3300	3700
	20					52	320	400	1000	1600	2500	3700
	25						59	400	800	1300	2100	3700
	32							95	800	1000	1800	2700
	40								112	257	1600	2400
Discrimination limit (A)												
iDPN Curve D	1	300	500	700	1000	T	T	T	T	T	T	T
	2	150	300	500	700	1000	1500	T	T	T	T	T
	3	120	200	300	500	700	1000	1500	T	T	T	T
	4	21	200	170	400	500	700	800	3000	4500	4500	T
	6				400	500	700	800	3000	4500	4500	T
	10				200	450	500	600	1800	3000	4500	4500
	16							450	1000	2000	3300	3700
	20								1000	1600	2500	3700
	25								800	1300	2100	3700
	32										1800	2700
	40											2400

Note: if you cannot find your combination, refer to the selection table on page 644.

4000 Discrimination limit = 4 kA.

T Total discrimination.

No discrimination.

Discrimination table

Upstream: NG125N/H/L, C120N/H curve C

Downstream: iDPN N curves B, C, D

220-240/380-415 V AC

Upstream		NG125N/H/L, C120N/H										
		Curve C										
In (A)		10	16	20	25	32	40	50	63	80	100	125
Downstream												
1P+N												
3P, 3P+N												
Discrimination limit (A)												
iDPN N Curve B	1	300	500	700	1000	T	T	T	T	T	T	T
	2	150	300	500	700	1000	1500	T	T	T	T	T
	3	120	200	300	500	700	1000	1500	T	T	T	T
	4	80	130	170	400	500	700	800	3000	T	T	T
	6	80	130	170	400	500	700	800	3000	T	T	T
	10		130	160	200	350	500	600	1800	3000	T	T
	16				200	270	340	450	1250	2000	3300	3700
	20					52	320	400	1000	1600	2500	3700
	25						59	400	800	1300	2100	3700
	32							95	600	1000	1800	2700
	40								112	700	1600	2400
Discrimination limit (A)												
iDPN N Curve C	1	300	500	700	1000	T	T	T	T	T	T	T
	2	150	300	500	700	1000	1500	T	T	T	T	T
	3	120	200	300	500	700	1000	1500	T	T	T	T
	4	21	200	170	400	500	700	800	3000	4500	4500	T
	6	18	200	170	400	500	700	800	3000	4500	4500	T
	10		25	160	200	350	500	600	1800	3000	4500	4500
	16				200	270	340	450	1000	2000	3300	3700
	20					52	320	400	1000	1600	2500	3700
	25						59	400	800	1300	2100	3700
	32							95	800	1000	1800	2700
	40								112	257	1600	2400
Discrimination limit (A)												
iDPN N Curve D	1	300	500	700	1000	T	T	T	T	T	T	T
	2	150	300	500	700	1000	1500	T	T	T	T	T
	3	120	200	300	500	700	1000	1500	T	T	T	T
	4	21	200	170	400	500	700	800	3000	4500	4500	T
	6				400	500	700	800	3000	4500	4500	T
	10				200	450	500	600	1800	3000	4500	4500
	16							450	1000	2000	3300	3700
	20								1000	1600	2500	3700
	25								800	1300	2100	3700
	32										1800	2700
	40											2400

Note: if you cannot find your combination, refer to the selection table on page 644.

4000 Discrimination limit = 4 kA.

T Total discrimination.

No discrimination.

Discrimination table

Upstream: NG125N/H/L, C120N/H curve D

Downstream: iDPN curves B, C, D

220-240/380-415 V AC

Upstream		NG125N/H/L, C120N/H										
		Curve D										
In (A)		10	16	20	25	32	40	50	63	80	100	125
Downstream												
1P+N												
3P, 3P+N												
Discrimination limit (A)												
iDPN Curve B	1	350	T	T	T	T	T	T	T	T	T	T
	2	240	770	830	2000	2200	4800	T	T	T	T	T
	3	180	610	640	1600	1700	3800	T	T	T	T	T
	4	120	450	500	1000	1100	1900	4600	T	T	T	T
	6	120	340	360	730	740	1200	2600	4700	T	T	T
	10		192	240	550	580	860	1600	2800	3500	5600	T
	16				300	380	480	1200	1900	2400	3600	4200
	20					380	480	1000	1500	2000	2900	3300
	25						59	950	1400	1700	2600	2900
	32							600	1100	1600	2200	2600
	40								756	1400	2100	2400
Discrimination limit (A)												
iDPN Curve C	1	350	T	T	T	T	T	T	T	T	T	T
	2	240	770	830	2000	2200	4800	T	T	T	T	T
	3	180	610	640	1600	1700	3800	T	T	T	T	T
	4	120	450	500	1000	1100	1900	4600	T	T	T	T
	6	18	192	360	730	740	1200	2600	4700	T	T	T
	10		29	240	550	580	860	1600	2800	3500	5600	T
	16				49	380	480	1200	1900	2400	3600	4200
	20					52	480	1000	1500	2000	2900	3300
	25						59	600	1400	1700	2600	2900
	32							95	1100	1600	2200	2600
	40								756	960	2100	2400
Discrimination limit (A)												
iDPN Curve D	1	350	T	T	T	T	T	T	T	T	T	T
	2	240	770	830	2000	2200	4800	T	T	T	T	T
	3	120	610	640	1600	1700	3800	T	T	T	T	T
	4	21	450	500	1000	1100	1900	4600	T	T	T	T
	6	18	192	360	730	740	1200	2600	4700	T	T	T
	10		25	240	300	580	860	1600	2800	3500	5600	T
	16				49	380	480	1200	1900	2400	3600	4200
	20					52	480	1000	1500	2000	2900	3300
	25						59	600	756	1700	2600	2900
	32							95	756	1600	2200	2600
	40								756	960	2100	2400

Note: if you cannot find your combination, refer to the selection table on page 644.

4000 Discrimination limit = 4 kA.

T Total discrimination.

No discrimination.

Discrimination table

Upstream: NG125N/H/L, C120N/H curve D

Downstream: iDPN N curves B, C, D

220-240/380-415 V AC

Upstream		NG125N/H/L, C120N/H										
		Curve D										
In (A)		10	16	20	25	32	40	50	63	80	100	125
Downstream												
1P+N												
3P, 3P+N												
Discrimination limit (A)												
iDPN N Curve B	1	350	T	T	T	T	T	T	T	T	T	T
	2	240	770	830	2000	2200	4800	T	T	T	T	T
	3	180	610	640	1600	1700	3800	T	T	T	T	T
	4	120	450	500	1000	1100	1900	4600	T	T	T	T
	6	120	340	360	730	740	1200	2600	4700	6200	T	T
	10		192	240	550	580	860	1600	2800	3500	5600	7300
	16				300	380	480	1200	1900	2400	3600	4200
	20					380	480	1000	1500	2000	2900	3300
	25						59	950	1400	1700	2600	2900
	32							600	1100	1600	2200	2600
	40								756	1400	2100	2400
	Discrimination limit (A)											
iDPN N Curve C	1	350	T	T	T	T	T	T	T	T	T	T
	2	240	770	830	2000	2200	4800	T	T	T	T	T
	3	180	610	640	1600	1700	3800	T	T	T	T	T
	4	120	450	500	1000	1100	1900	4600	T	T	T	T
	6	18	192	360	730	740	1200	2600	4700	6200	T	T
	10		29	240	550	580	860	1600	2800	3500	5600	7300
	16				49	380	480	1200	1900	2400	3600	4200
	20					52	480	1000	1500	2000	2900	3300
	25						59	600	1400	1700	2600	2900
	32							95	1100	1600	2200	2600
	40								756	960	2100	2400
	Discrimination limit (A)											
iDPN N Curve Da	1	350	T	T	T	T	T	T	T	T	T	T
	2	240	770	830	2000	2200	4800	T	T	T	T	T
	3	120	610	640	1600	1700	3800	T	T	T	T	T
	4	21	450	500	1000	1100	1900	4600	T	T	T	T
	6	18	192	360	730	740	1200	2600	4700	6200	T	T
	10		25	240	300	580	860	1600	2800	3500	5600	7300
	16				49	380	480	1200	1900	2400	3600	4200
	20					52	480	1000	1500	2000	2900	3300
	25						59	600	756	1700	2600	2900
	32							95	756	1600	2200	2600
	40								756	960	2100	2400

Note: if you cannot find your combination, refer to the selection table on page 644.

4000 Discrimination limit = 4 kA.

T Total discrimination.

No discrimination.

Discrimination table

Upstream: NG125N/H/L, C120N/H curve B

Downstream: iC60N/H/L curves B, C, D

220-240/380-415 V AC

Upstream	NG125N/H/L, C120N/H										
	Curve B										
In (A)	10	16	20	25	32	40	50	63	80	100	125

Downstream	1P, 1P+N 2P (380-415 V) two-phase network 3P, 3P+N 4P
-------------------	--

Discrimination limit (A)

iC60N/H/L Curve B	0.5	T	T	T	T	T	T	T	T	T	T	T
1		70	150	210	350	550	2000	2500	T	T	T	T
2		60	110	140	230	310	590	630	1200	2100	3900	9700
3		40	90	120	180	220	380	460	770	1400	2000	5300
4		40	64	80	150	190	310	380	570	940	1400	2400
6		15	64	80	100	130	290	300	440	620	930	1700
10			22	80	100	130	200	200	380	550	770	1300
13				28	100	130	160	200	380	480	680	1100
16					35	130	160	200	250	320	600	940
20						46	160	200	250	320	400	850
25							56	200	250	320	400	750
32								80	250	320	400	500
40									250	320	400	500
50										320	400	500
63												500

Discrimination limit (A)

iC60N/H/L Curve B	0.5	T	T	T	T	T	T	T	T	T	T	T
1		70	150	210	350	550	2000	2500	T	T	T	T
2		40	110	140	230	250	590	630	1200	2100	3900	9700
3		30	64	120	180	220	380	460	770	1400	2000	5300
4			64	80	150	190	310	340	570	940	1400	2400
6				80	100	130	290	300	440	620	930	1700
10						130	160	200	380	550	770	1100
13							160	200	250	480	680	940
16								200	250	320	600	940
20										320	400	850
25										320	400	750
32												500
40												500

Discrimination limit (A)

iC60N/H/L Curve D	0.5	T	T	T	T	T	T	T	T	T	T	T
1		60	150	210	350	550	2000	2500	T	T	T	T
2		40	90	140	200	250	520	630	1200	2100	3900	9700
3			64	80	180	220	380	380	770	1200	2000	5300
4				80	150	190	310	340	570	820	1100	2400
6						130	240	200	440	620	930	1700
10								200	380	480	770	1100
13									250	480	680	940
16										320	600	940
20											400	750
25												500
32												

Note: if you cannot find your combination, refer to the selection table on page 644.

4000 Discrimination limit = 4 kA.

T Total discrimination.

No discrimination.

Discrimination table

Upstream: NG125N/H/L, C120N/H curve B

Downstream: iC60N/H/L curves B, C, D

220-240/380-415 V AC

Upstream	NG125N/H/L, C120N/H										
	Curve B										
In (A)	10	16	20	25	32	40	50	63	80	100	125

Downstream	2P (220-240 V) single-phase network										
-------------------	--	--	--	--	--	--	--	--	--	--	--

Discrimination limit (A)												
iC60N/H/L Curve B	0.5	T	T	T	T	T	T	T	T	T	T	T
	1	120	490	T	T	T	T	T	T	T	T	T
	2	60	160	350	500	1200	4200	8100	T	T	T	T
	3	40	110	170	250	520	1300	1900	6700	T	T	T
	4	40	64	80	190	280	630	750	1400	2700	6200	T
	6	15	64	80	150	150	350	430	810	1400	2100	6100
	10		22	80	100	130	160	200	500	840	1300	2500
	13			28	100	130	240	200	440	770	1100	1900
	16				35	130	160	200	380	520	770	1400
	20					46	160	200	250	320	600	1000
	25						56	200	250	320	400	890
	32							80	250	320	400	840
	40								250	320	400	790
	50									320	400	750
63											500	

Discrimination limit (A)												
iC60N/H/L Curve C	0.5	T	T	T	T	T	T	T	T	T	T	T
	1	120	490	T	T	T	T	T	T	T	T	T
	2	60	160	350	500	1200	4200	8100	T	T	T	T
	3	30	110	170	250	520	1300	1900	6700	T	T	T
	4		64	80	190	280	630	750	1400	2700	6200	T
	6			80	150	150	350	430	810	1400	2100	6100
	10					130	160	200	500	840	1300	2500
	13						160	200	440	620	1100	1900
	16							200	380	520	770	1400
	20									320	600	1000
	25									320	400	890
	32											840
	40											500

Discrimination limit (A)												
iC60N/H/L Curve D	0.5	T	T	T	T	T	T	T	T	T	T	T
	1	120	490	T	T	T	T	T	T	T	T	T
	2	60	160	350	500	1200	4200	8100	T	T	T	T
	3		110	170	250	520	1300	1900	6700	T	T	T
	4			80	190	280	630	750	1400	2700	6200	T
	6					150	350	430	810	1400	2100	6100
	10							200	500	840	1300	2500
	13								380	620	930	1900
	16									520	770	1400
	20										600	1000
	25											890
	32											

Note: the discrimination limits given in the table must be compared to the phase/neutral fault current (I_{k1}).
If the max. phase/earth fault current (I_f) is high, the discrimination of this fault current should also be verified by referring to the limits given in the dark green part of the table.

Discrimination table

Upstream: NG125N/H/L, C120N/H curve C

Downstream: iC60N/H/L curves B, C, D

220-240/380-415 V AC

Upstream		NG125N/H/L										
		Curve C										
In (A)		10	16	20	25	32	40	50	63	80	100	125
Downstream		1P, 1P+N 2P (380-415 V) two-phase network 3P, 3P+N 4P										
Discrimination limit (A)												
iC60N/H/L	0.5	T	T	T	T	T	T	T	T	T	T	T
Curve B	1	140	490	920	2300	T	T	T	T	T	T	T
	2	80	250	380	550	1800	2400	8800	10000	13000	T	T
	3	80	190	280	380	1200	1400	4600	8000	8500	14000	T
	4	80	130	240	300	800	820	2000	2300	3400	7000	13000
	6	15	130	160	200	610	650	1400	2300	2300	3600	6400
	10		22	160	200	500	510	1100	1300	1600	2200	3600
	13			28	200	460	470	930	1100	1400	2000	2600
	16				35	380	430	770	950	1200	1700	2300
	20					46	320	680	850	960	1500	2100
	25						56	600	760	960	1200	1800
	32							80	500	640	1200	1500
	40								130	640	800	1500
	50									640	800	1500
	63										800	1000
Discrimination limit (A)												
iC60N/H/L	0.5	T	T	T	T	T	T	T	T	T	T	T
Curve C	1	140	490	920	2300	T	T	T	T	T	T	T
	2	80	250	380	550	2100	2400	8800	10000	13000	T	T
	3	80	190	280	380	1200	1400	4600	8000	8500	14000	T
	4	18	130	160	300	800	820	2000	2300	3400	6000	13000
	6	15	130	160	200	610	650	1400	2300	2300	3600	5500
	10		22	160	200	500	510	930	1300	1400	2200	3100
	13			28	51	420	430	770	1100	1200	2000	2600
	16				35	256	400	770	950	1200	1700	2300
	20					46	320	680	850	960	1500	1800
	25						56	400	760	960	1200	1800
	32							80	500	640	1200	1500
	40								500	640	800	1500
	50									640	800	1000
	63											1000
Discrimination limit (A)												
iC60N/H/L	0.5	T	T	T	T	T	T	T	T	T	T	T
Curve D	1	140	490	920	2300	T	T	T	T	T	T	T
	2	80	250	380	550	1800	2400	8800	10000	13000	T	T
	3	21	190	280	380	1200	1200	4600	8000	8500	14000	T
	4	18	130	160	300	740	740	2000	2300	3400	6000	13000
	6		130	160	200	570	600	1400	1900	1800	3600	5500
	10				200	450	480	930	1300	1400	2200	3100
	13					256	430	770	950	1200	1700	2600
	16						320	770	950	960	1500	2300
	20							400	760	960	1200	1800
	25									640	1200	1500
	32									640	800	1500
	40											1000
	50											

Note: if you cannot find your combination, refer to the selection table on page 644.

4000 Discrimination limit = 4 kA.

T Total discrimination.

No discrimination.

Discrimination table

Upstream: NG125N/H/L, C120N/H curve C

Downstream: iC60N/H/L curves B, C, D

220-240/380-415 V AC

Upstream		NG125N/H/L										
		Curve C										
In (A)		10	16	20	25	32	40	50	63	80	100	125
Downstream		2P (220-240 V) single-phase network										
Discrimination limit (A)												
iC60N/H/L	0.5	T	T	T	T	T	T	T	T	T	T	T
Curve B	1	950	T	T	T	T	T	T	T	T	T	T
	2	210	1900	4200	10000	T	T	T	T	T	T	T
	3	120	780	1300	4700	T	T	T	T	T	T	T
	4	80	310	590	1100	4000	13000	T	T	T	T	T
	6	15	190	330	510	1500	2700	7200	9000	9000	T	T
	10		22	160	300	1000	1400	2700	3500	3500	7400	T
	13			28	200	760	910	2000	2700	2700	4900	8100
	16				35	620	620	1600	2700	2700	3600	5500
	20					46	480	1100	1600	1600	2200	3600
	25						56	930	1200	1200	2000	2600
	32							80	930	960	1700	2300
	40								130	960	1400	2000
	50									640	1200	1900
	63										1200	1700
Discrimination limit (A)												
iC60N/H/L	0.5	T	T	T	T	T	T	T	T	T	T	T
Curve C	1	950	T	T	T	T	T	T	T	T	T	T
	2	210	1900	3500	10000	T	T	T	T	T	T	T
	3	80	670	1300	4700	T	T	T	T	T	T	T
	4	18	310	590	1100	3600	13000	T	T	T	T	T
	6	15	190	290	510	1500	2700	7200	9000	9000	T	T
	10		22	160	200	890	1200	2700	3700	3700	6600	T
	13			28	51	760	770	2000	2700	2700	4000	7200
	16				35	256	620	1600	2700	2700	3600	4600
	20					46	320	1100	1400	1400	2200	3600
	25						56	400	1100	1200	2000	2600
	32							80	500	960	1400	2300
	40								500	640	1200	2000
	50									640	800	1700
	63											1000
Discrimination limit (A)												
iC60N/H/L	0.5	T	T	T	T	T	T	T	T	T	T	T
Curve D	1	950	T	T	T	T	T	T	T	T	T	T
	2	210	1700	3500	10000	T	T	T	T	T	T	T
	3	21	550	1300	4700	T	T	T	T	T	T	T
	4	18	310	520	960	3600	13000	T	T	T	T	T
	6		190	240	460	1500	2700	6400	9000	9000	T	T
	10				200	890	1100	2700	3700	3700	6600	T
	13					256	620	2000	2300	2300	4000	7200
	16						320	1400	2300	2300	3100	4600
	20							400	1400	1400	2200	3100
	25									960	1700	2600
	32									640	1400	2000
	40											1800
	50											

Note: the discrimination limits given in the table must be compared to the phase/neutral fault current (Ik1).
If the max. phase/earth fault current (If) is high, the discrimination of this fault current should also be verified by referring to the limits given in the dark green part of the table.

Discrimination table

Upstream: NG125N/H/L, C120N/H curve D

Downstream: iC60N/H/L curves B, C, D

220-240/380-415 V AC

Upstream	NG125N/H/L, C120N/H										
	Curve D										
In (A)	10	16	20	25	32	40	50	63	80	100	125

Downstream	1P, 1P+N 2P (380-415 V) two-phase network 3P, 3P+N 4P
-------------------	--

Discrimination limit (A)												
iC60N/H/L Curve B	0.5	T	T	T	T	T	T	T	T	T	T	T
	1	410	3800	5200	T	T	T	T	T	T	T	T
	2	240	770	920	2600	2700	7400	14000	T	T	T	T
	3	180	610	640	1300	1600	3600	11000	T	T	T	T
	4	120	450	450	890	1100	1900	4100	11000	13000	T	T
	6	15	340	360	730	740	1300	2600	4700	6200	T	T
	10		22	240	590	660	910	1700	2600	3500	T	T
	13			28	300	580	810	1500	2100	2500	4600	T
	16				35	380	720	1300	1900	2400	3600	T
	20					46	480	1100	1600	2000	3000	3600
	25						56	900	1400	1700	2400	2900
	32							83	1100	1700	2400	2600
	40								1100	1400	2100	2300
	50									1400	2000	2300
63										2000	2300	

Discrimination limit (A)												
iC60N/H/L Curve C	0.5	T	T	T	T	T	T	T	T	T	T	T
	1	410	3800	5200	T	T	T	T	T	T	T	T
	2	240	770	920	2600	2700	7400	T	T	T	T	T
	3	21	530	640	1300	1600	3600	11000	T	T	T	T
	4	18	450	450	890	1100	1900	4100	11000	13000	T	T
	6	15	340	360	730	740	1300	2200	4700	6200	T	T
	10		22	240	590	580	910	1700	2600	3500	T	T
	13			28	51	580	720	1300	2100	2500	4100	T
	16				35	380	480	1100	1900	2400	3600	T
	20					46	88	1100	1600	2000	2700	2900
	25						56	600	1400	1700	2400	2900
	32							80	1100	1400	2400	2600
	40								756	1400	2100	2300
	50									960	2000	2300
63										1800	2300	

Discrimination limit (A)												
iC60N/H/L Curve D	0.5	T	T	T	T	T	T	T	T	T	T	T
	1	410	3800	5200	T	T	T	T	T	T	T	T
	2	240	770	920	2600	2700	6300	T	T	T	T	T
	3	21	530	550	1300	1600	3600	11000	T	T	T	T
	4	18	370	450	890	970	1600	3700	11000	13000	T	T
	6	15	340	360	730	740	1100	2200	4700	5400	T	T
	10		22	240	520	580	810	1500	2600	3000	T	T
	13			28	51	380	720	1300	2100	2500	4100	T
	16				35	380	480	1100	1900	2400	3600	T
	20					46	480	900	1400	1700	2700	2900
	25						56	600	1400	1700	2400	2600
	32							80	1100	1400	2100	2600
	40								756	1400	2100	2300
	50									960	1800	1500
63										1800	1500	

Note: if you cannot find your combination, refer to the selection table on page 644.

4000 Discrimination limit = 4 kA.

T Total discrimination.

No discrimination.

Discrimination table

Upstream: NG125N/H/L, C120N/H curve D

Downstream: iC60N/H/L curves B, C, D

220-240/380-415 V AC

Upstream	NG125N/H/L, C120N/H										
	Curve D										
In (A)	10	16	20	25	32	40	50	63	80	100	125

Downstream	2P (220-240 V) single-phase network										
------------	---	--	--	--	--	--	--	--	--	--	--

Discrimination limit (A)

iC60N/H/L Curve B	0.5	T	T	T	T	T	T	T	T	T	T	T
	1	T	T	T	T	T	T	T	T	T	T	T
	2	1200	T	T	T	T	T	T	T	T	T	T
	3	520	3400	3400	T	T	T	T	T	T	T	T
	4	120	1200	1300	5800	5600	T	T	T	T	T	T
	6	15	700	720	1900	1900	6000	11000	T	T	T	T
	10		22	540	1200	1200	2600	4200	10000	T	T	T
	13			28	300	900	1800	3400	7300	8000	T	T
	16				35	740	1500	2200	4700	5400	T	T
	20					46	910	1700	3500	3500	6900	T
	25						56	1500	2500	2500	5200	6800
	32							83	2000	2400	3400	4400
	40								1800	1900	2900	4000
	50									1900	2800	3300
63										2300	2800	

Discrimination limit (A)

iC60N/H/L Curve C	0.5	T	T	T	T	T	T	T	T	T	T	T
	1	T	T	T	T	T	T	T	T	T	T	T
	2	1200	T	T	T	T	T	T	T	T	T	T
	3	21	3400	3400	T	T	T	T	T	T	T	T
	4	18	1200	1300	5800	5600	T	T	T	T	T	T
	6	15	700	720	1900	1900	6000	11000	T	T	T	T
	10		22	480	1200	1200	2200	4200	10000	T	T	T
	13			28	51	900	1800	3000	7300	8000	T	T
	16				35	740	1300	2200	4700	5400	T	T
	20					46	88	1700	3500	3500	6900	T
	25						56	600	2500	2500	4600	6800
	32							80	2000	2200	3400	4400
	40								756	1900	2900	3500
	50									960	2300	2800
63										2300	2800	

Discrimination limit (A)

iC60N/H/L Curve D	0.5	T	T	T	T	T	T	T	T	T	T	T
	1	T	T	T	T	T	T	T	T	T	T	T
	2	1200	T	T	T	T	T	T	T	T	T	T
	3	21	3000	3400	T	T	T	T	T	T	T	T
	4	18	1100	1300	5800	4500	T	T	T	T	T	T
	6	15	600	600	1600	1600	5300	11000	T	T	T	T
	10		22	420	1000	1100	2200	3400	10000	T	T	T
	13			28	51	900	1700	2600	6400	7100	T	T
	16				35	380	1300	2200	3900	4500	T	T
	20					46	480	1500	3000	3500	6000	T
	25						56	600	2100	2500	4100	5900
	32							80	1800	2200	3400	4400
	40								756	1700	2400	2900
	50									960	2300	2800
63										2000	2300	

Note: the discrimination limits given in the table must be compared to the phase/neutral fault current (I_{k1}).
If the max. phase/earth fault current (I_f) is high, the discrimination of this fault current should also be verified by referring to the limits given in the dark green part of the table.

Discrimination table

Upstream: NG125N/H/L, C120N/H curve B

Downstream: C120, NG125 curves B, C, D

220-240/380-415 V AC

Upstream		NG125N/H/L, C120N/H										
		Curve B										
In (A)		10	16	20	25	32	40	50	63	80	100	125
Downstream		1P, 1P+N 2P (380-415 V) two-phase network 3P, 3P+N 4P										
Discrimination limit (A)												
C120, NG125 Curve B	10			80	100	130	160	200	250	320	400	800
	16				100	130	160	200	250	320	400	750
	20					65	160	200	250	320	400	750
	25						160	200	250	320	400	500
	32							200	250	320	400	500
	40								250	320	400	500
	50									320	400	500
	63										400	500
80											400	400
Discrimination limit (A)												
C120, NG125 Curve C	10					130	160	200	250	320	400	750
	16							200	250	320	400	500
	20								250	320	400	500
	25									320	400	500
	32										400	500
	40											500
Discrimination limit (A)												
C120, NG125 Curve D	10							200	250	320	400	750
	16									320	400	500
	20										400	500
	25											500
	32											

Note: if you cannot find your combination, refer to the selection table on page 644.

4000 Discrimination limit = 4 kA.

No discrimination.

Discrimination table

Upstream : NG125N/H/L, C120N/H curve B

Downstream : C120, NG125 curves B, C, D

220-240/380-415 V AC

Upstream		NG125N/H/L, C120N/H										
		Curve B										
In (A)		10	16	20	25	32	40	50	63	80	100	125
Downstream	2P (220-240 V) single-phase network											
Discrimination limit (A)												
C120, NG125 Curve B	10			80	100	130	260	200	400	540	670	1100
	16				100	130	240	200	250	480	630	910
	20					65	160	200	250	320	600	830
	25						160	200	250	320	400	830
	32							200	250	320	400	750
	40								250	320	400	750
	50									320	400	500
	63										400	500
80											400	
Discrimination limit (A)												
C120, NG125 Curve C	10					130	240	200	250	480	670	980
	16							200	250	320	400	830
	20								250	320	400	830
	25									320	400	750
	32										400	500
	40											500
Discrimination limit (A)												
C120, NG125 Curve D	10							200	250	320	630	980
	16									320	400	750
	20										400	750
	25											500
	32											

Note: the discrimination limits given in the table must be compared to the phase/neutral fault current (I_{k1}).
If the max. phase/earth fault current (I_f) is high, the discrimination of this fault current should also be verified by referring to the limits given in the dark green part of the table.

Discrimination table

Upstream: NG125N/H/L, C120N/H curve C

Downstream: C120, NG125 curves B, C, D

220-240/380-415 V AC

Upstream		NG125N/H/L, C120N/H										
		Curve C										
In (A)		10	16	20	25	32	40	50	63	80	100	125
Downstream		1P, 1P+N 2P (380-415 V) two-phase network 3P, 3P+N 4P										
Discrimination limit (A)												
C120, NG125 Curve B	10		130	160	200	260	320	650	820	960	1300	1700
	16				200	260	320	600	760	800	900	1500
	20					65	320	400	500	640	800	1500
	25						320	400	500	640	800	1000
	32							400	500	640	800	1000
	40								500	640	800	1000
	50									640	800	1000
	63										800	1000
	80											1000
	100											
Discrimination limit (A)												
C120, NG125 Curve C	10		39	160	200	260	320	650	760	900	1200	1700
	16				70	110	320	400	500	640	800	1500
	20					65	124	400	500	640	800	1000
	25						89	149	500	640	800	1000
	32							123	240	640	800	1000
	40								181	269	800	1000
	50									227	800	1000
	63										800	1000
	80											1000
Discrimination limit (A)												
C120, NG125 Curve D	10					260	320	600	760	900	1200	1600
	16						320	400	500	640	800	1000
	20							400	500	640	800	1000
	25								500	640	800	1000
	32										800	1000
	40											1000
50												

Note: if you cannot find your combination, refer to the selection table on page 644.

4000 Discrimination limit = 4 kA.

No discrimination.

Discrimination table

Upstream: NG125N/H/L, C120N/H curve C

Downstream: C120, NG125 curves B, C, D

220-240/380-415 V AC

Upstream		NG125N/H/L, C120N/H											
		Curve C											
In (A)		10	16	20	25	32	40	50	63	80	100	125	
Downstream		2P (220-240 V) single-phase network											
Discrimination limit (A)													
C120, NG125 Curve B	10			130	160	200	480	510	930	1100	1200	1700	2500
	16					200	260	320	800	990	1100	1400	2000
	20						65	320	730	910	1100	1400	1900
	25							320	730	830	960	1200	1600
	32								400	830	960	1200	1600
	40									500	640	800	1500
	50										640	800	1500
	63											800	1000
	80												1000
	100												
Discrimination limit (A)													
C120, NG125 Curve C	10			39	160	200	260	480	870	1100	1200	1700	2500
	16					70	110	320	730	910	1100	1400	2000
	20						65	124	670	830	960	1300	1700
	25							89	149	500	640	1200	1600
	32								123	240	640	800	1500
	40									181	269	800	1000
	50										227	800	1000
	63											800	1000
	80												1000
	Discrimination limit (A)												
C120, NG125 Curve D	10						260	320	800	1100	1100	1600	2200
	16							320	630	830	960	1300	1900
	20								400	760	960	1300	1700
	25									500	640	800	1500
	32											800	1500
	40												1000
	50												

Note: the discrimination limits given in the table must be compared to the phase/neutral fault current (I_{k1}).
If the max. phase/earth fault current (I_f) is high, the discrimination of this fault current should also be verified by referring to the limits given in the dark green part of the table.

Discrimination table

Upstream: NG125N/H/L, C120N/H curve D

Downstream: C120, NG125 curves B, C, D

220-240/380-415 V AC

Upstream		NG125N/H/L, C120N/H										
		Curve D										
In (A)		10	16	20	25	32	40	50	63	80	100	125
Downstream		1P, 1P+N 2P (380-415 V) two-phase network 3P, 3P+N 4P										
Discrimination limit (A)												
C120, NG125 Curve B	10		190	240	300	380	480	970	1300	1600	2200	2500
	16				300	380	480	600	1100	1400	2000	2300
	20					65	480	600	1100	1400	2000	2300
	25						480	600	760	960	1200	1500
	32							600	760	960	1200	1500
	40								760	960	1200	1500
	50									960	1200	1500
	63										1200	1500
	80											1500
	100											
Discrimination limit (A)												
C120, NG125 Curve C	10		190	240	300	380	480	970	1300	1600	2200	2500
	16				70	110	480	600	1100	1400	2000	2300
	20					65	124	600	1100	1400	2000	2300
	25						89	149	760	960	1200	1500
	32							123	240	960	1200	1500
	40								181	269	1200	1500
	50									227	1200	1500
	63										1200	1500
	80											1500
	100											
Discrimination limit (A)												
C120, NG125 Curve D	10		39	240	300	380	480	970	1300	1600	2200	2500
	16				70	110	480	600	1100	1400	2000	2300
	20					65	124	193	1100	1400	2000	2300
	25						89	149	236	960	1200	1500
	32							123	240	960	1200	1500
	40								181	269	1200	1500
	50									227	1200	1500
	63										1200	1500
	80											1500
	100											

Note: if you cannot find your combination, refer to the selection table on page 644.

4000 Discrimination limit = 4 kA.

No discrimination.

Discrimination table

Upstream: NG125N/H/L, C120N/H curve D

Downstream: C120, NG125 curves B, C, D

220-240/380-415 V AC

Upstream		NG125N/H/L, C120N/H										
		Curve D										
In (A)		10	16	20	25	32	40	50	63	80	100	125
Downstream		2P (220-240 V) single-phase network										
Discrimination limit (A)												
C120, NG125 Curve B	10		190	240	250	380	720	1300	2000	2400	3700	4800
	16				300	380	480	1100	1600	1900	2600	3200
	20					65	480	1100	1500	1800	2600	2900
	25						480	600	1200	1400	2100	2400
	32							600	1200	1400	2100	2400
	40								760	960	1200	1500
	50									960	1200	1500
	63										1200	1500
	80											1500
	100											
Discrimination limit (A)												
C120, NG125 Curve C	10		190	240	250	380	720	1300	2000	2400	3700	4800
	16				70	110	480	1100	1600	1900	2600	3200
	20					65	124	1100	1500	1800	2600	2900
	25						89	149	1200	1400	2100	2400
	32							123	240	1400	2100	2400
	40								181	269	1200	1500
	50									227	1200	1500
	63										1200	1500
	80											1500
	100											
Discrimination limit (A)												
C120, NG125 Curve D	10		39	240	250	380	720	1300	2000	2400	3700	4800
	16				70	110	480	1100	1600	1900	2600	3200
	20					65	124	193	1500	1800	2600	2900
	25						89	149	236	1400	2100	2400
	32							123	240	1400	2100	2400
	40								181	269	1200	1500
	50									227	1200	1500
	63										1200	1500
	80											1500
	100											

Note: the discrimination limits given in the table must be compared to the phase/neutral fault current (I_{k1}).
If the max. phase/earth fault current (I_f) is high, the discrimination of this fault current should also be verified by referring to the limits given in the dark green part of the table.

$U_e \leq 440 \text{ V AC}$

Contents

Downstream Type	Upstream								
	NG160	NSX100		NSX160		NSX250		NSX400	NSX630
		TM-D	Micrologic	TM-D	Micrologic	TM-D	Micrologic	Micrologic	Micrologic
iDPN	page 679	page 680	page 681	page 680	page 681	page 680	page 681	page 684	page 684
iDPN N	page 679	page 680	page 681	page 680	page 681	page 680	page 681	page 684	page 684
iC60N/H/L	page 679	page 680	page 681	page 680	page 681	page 680	page 681	page 684	page 684
C120, NG125	page 679	page 680	page 681	page 680	page 681	page 680	page 681	page 684	page 684
NG160	-	page 680	page 681	page 680	page 681	page 680	page 681	page 684	page 684
NSX100	-	page 682	page 683	page 682	page 683	page 682	page 683	page 684	page 684
NSX160	-	page 682	page 683	page 682	page 683	page 682	page 683	page 684	page 684
NSX250	-	page 682	page 683	page 682	page 683	page 682	page 683	page 684	page 684
NSX400	-	-	-	-	-	-	-	page 684	page 684

Discrimination between circuit breakers

In the following tables we show the level of discrimination between two LV circuits that are protected by circuit breakers up to 440 V, 50/60 Hz systems.

This discrimination will be either:

- total: represented by a T (up to the breaking capacity of the downstream device),
- partial: discrimination limit current (Is) indicated. Below this value discrimination is ensured, above this value the upstream device is also involved in breaking,
- zero: no discrimination ensured.

Discrimination table

Upstream: NG160E/N/H

Downstream: iDPN, iC60, C120, NG125

$U_e \leq 440 \text{ V AC}$

Upstream		NG160E/N/H									
In (A)		16	25	32	40	50	63	80	100	125	160
Downstream											
Discrimination limit (kA)											
iDPN Curves B, C	≤ 10	5	5	5	5	5	T	T	T	T	T
	16			3	3	3	T	T	T	T	T
	20				3	3	T	T	T	T	T
	25					3	T	T	T	T	T
	32						4	4	T	T	T
	40							4	T	T	T
Discrimination limit (kA)											
iDPNN Curves C, D	≤ 10	5	5	5	5	5	T	T	T	T	T
	16			3	3	3	T	T	T	T	T
	20				3	3	T	T	T	T	T
	25					3	6	6	T	T	T
	32						4	4	7	T	T
	40							4	7	8	8
Discrimination limit (kA)											
iC60N/H Curves B, C, D	≤ 10	5	5	5	5	5	10	T	T	T	T
	16			3	3	3	10	T	T	T	T
	20				3	3	10	T	T	T	T
	25					3	6	6	T	T	T
	32						4	4	7	T	T
	40							4	7	8	8
	50								5	8	8
	63									6	6
iC60L Curves B-C-D-K-Z	≤ 10	5	5	5	5	5	10	15	T	T	T
	16			3	3	3	10	15	T	T	T
	20				3	3	10	15	T	T	T
	25					3	6	6	T	T	T
	32						4	4	7	T	T
	40							4	7	8	8
	50								5	8	8
	63									6	6
Discrimination limit (kA)											
C120N/H Curves B, C, D	63									1.25	1.25
	80										1.25
	100										1.25
	125										
Discrimination limit (kA)											
NG125N/H/L Curves B, C, D	10	0.6	0.6	0.6	0.6	0.6	0.8	0.8	1	1.25	1.25
	16			0.6	0.6	0.6	0.8	0.8	1	1.25	1.25
	20			0.6	0.6	0.6	0.8	0.8	1	1.25	1.25
	25				0.6	0.6	0.8	0.8	1	1.25	1.25
	32						0.8	0.8	1	1.25	1.25
	40							0.8	1	1.25	1.25
	50							0.8	1	1.25	1.25
	63									1.25	1.25
	80										1.25
	100 (N)										1.25
	125 (N)										

4 Discrimination limit = 4 kA.

T Total discrimination, up to the breaking capacity of the downstream circuit breaker.

No discrimination.

Note: respect the basic rules of discrimination, in terms of overload, short-circuit, see page 557E4300.indd/638.

Discrimination table

Upstream: Compact NSX100-250 TM-D

Downstream: iDPN, iC60, C120,

NG125-160

$U_e \leq 440 \text{ V AC}$

Upstream		NSX100B/F/N/H/S/L/R								NSX160B/F/N/H/S/L				NSX250B/F/N/H/S/L/R			
Trip unit		TM-D								TM-D				TM-D			
In (A)		16	25	32	40	50	63	80	100	80	100	125	160	160	200	250	
Downstream																	
Discrimination limit (kA)																	
iDPN Curves B, C	≤ 10	0.19	0.3	0.4	0.5	0.5	0.5	0.63	0.8	0.63	0.8	T	T	T	T	T	
	16		0.3	0.4	0.5	0.5	0.5	0.63	0.8	0.63	0.8	T	T	T	T	T	
	20			0.4	0.5	0.5	0.5	0.63	0.8	0.63	0.8	T	T	T	T	T	
	25					0.5	0.5	0.63	0.8	0.63	0.8	T	T	T	T	T	
	32						0.5	0.63	0.8	0.63	0.8	T	T	T	T	T	
	40						0.5	0.63	0.8	0.63	0.8	T	T	T	T	T	
Discrimination limit (kA)																	
iDPNN Curves C, D	≤ 10	0.19	0.3	0.4	0.5	0.5	0.5	0.63	0.8	0.63	0.8	T	T	T	T	T	
	16		0.3	0.4	0.5	0.5	0.5	0.63	0.8	0.63	0.8	T	T	T	T	T	
	20			0.4	0.5	0.5	0.5	0.63	0.8	0.63	0.8	T	T	T	T	T	
	25					0.5	0.5	0.63	0.8	0.63	0.8	T	T	T	T	T	
	32						0.5	0.63	0.8	0.63	0.8	T	T	T	T	T	
	40						0.5	0.63	0.8	0.63	0.8	T	T	T	T	T	
Discrimination limit (kA)																	
iC60N/H Curves B, C, D	≤ 10	0.19	0.3	0.4	0.9	0.9	0.9	1.3	3	1.3	3	T	T	T	T	T	
	16		0.3	0.4	0.5	0.5	0.5	1	2	1	2	T	T	T	T	T	
	20			0.4	0.5	0.5	0.5	0.63	1.5	0.63	1.5	T	T	T	T	T	
	25				0.5	0.5	0.5	0.63	1.5	0.63	1.5	T	T	T	T	T	
	32						0.5	0.63	1	0.63	1	T	T	T	T	T	
	40						0.5	0.63	1	0.63	1	T	T	T	T	T	
iC60L Curves B-C-D-K-Z	50							0.63	0.8	0.63	0.8	T	T	T	T	T	
	63							0.8		0.8	0.8	T	T	T	T	T	
	Discrimination limit (kA)																
	C120N/H Curves B, C, D	63							0.8		0.8	2.4	2.4	2.4	T	T	
		80										2.4	2.4	2.4	T	T	
		100													T	T	
125															T		
Discrimination limit (kA)																	
NG125N/H/L Curves B, C, D	10	0.19	0.3	0.4	0.5	0.5	0.5	0.63	0.8	0.63	0.8	T	T	T	T	T	
	16		0.3	0.4	0.5	0.5	0.5	0.63	0.8	0.63	0.8	T	T	T	T	T	
	20			0.4	0.5	0.5	0.5	0.63	0.8	0.63	0.8	T	T	T	T	T	
	25					0.5	0.5	0.63	0.8	0.63	0.8	2.4	2.4	2.4	T	T	
	32						0.5	0.63	0.8	0.63	0.8	2.4	2.4	2.4	T	T	
	40							0.63	0.8	0.63	0.8	2.4	2.4	2.4	T	T	
	50							0.63	0.8	0.63	0.8	2.4	2.4	2.4	T	T	
	63							0.8		0.8	2.4	2.4	2.4	2.4	T	T	
	80											2.4	2.4	2.4	T	T	
	100 (N)														T	T	
	125 (N)															T	
Discrimination limit (kA)																	
NG160E/N/H	16			0.4	0.5	0.5	0.5	0.63	0.8	0.63	0.8	2	2	2	T	T	
	25				0.5	0.5	0.5	0.63	0.8	0.63	0.8	2	2	2	T	T	
	32						0.5	0.63	0.8	0.63	0.8	2	2	2	T	T	
	40							0.63	0.8	0.63	0.8	2	2	2	T	T	
	50							0.63	0.8	0.63	0.8	2	2	2	T	T	
	63							0.8		0.8	2	2	2	2	T	T	
	80										2	2	2	2	T	T	
	100											2	2	2	T	T	
	125														T	T	
	160															T	

4 Discrimination limit = 4 kA.

T Total discrimination, up to the breaking capacity of the downstream circuit breaker.

No discrimination.

Note: respect the basic rules of discrimination, in terms of overload, short-circuit, see page 557E4300.indd/638.

Discrimination table

Upstream: Compact NSX100-250
Micrologic
Downstream: iDPN, iC60, C120,
NG125-160

U_e ≤ 440 V AC

Upstream		NSX100B/F/N/H/S/L/R								NSX160B/F/N/H/S/L				NSX250B/F/N/H/S/L/R			
Trip unit		Micrologic								Micrologic				Micrologic			
Downstream	Rating (A)	40				100				160				250			
	Setting I _r	16	25	32	40	40	63	80	100	80	100	125	160	160	200	250	
Discrimination limit (kA)																	
iDPN Curves B, C	≤ 10	T	T	T	T	T	T	T	T	T	T	T	T	T	T	T	
	16		T	T	T	T	T	T	T	T	T	T	T	T	T	T	
	20			T	T	T	T	T	T	T	T	T	T	T	T	T	
	25				T	T	T	T	T	T	T	T	T	T	T	T	
	32						T	T	T	T	T	T	T	T	T	T	
	40							T	T	T	T	T	T	T	T	T	
Discrimination limit (kA)																	
iDPNN Curves C, D	≤ 10	T	T	T	T	T	T	T	T	T	T	T	T	T	T	T	
	16		T	T	T	T	T	T	T	T	T	T	T	T	T	T	
	20			T	T	T	T	T	T	T	T	T	T	T	T	T	
	25				T	T	T	T	T	T	T	T	T	T	T	T	
	32						T	T	T	T	T	T	T	T	T	T	
	40							T	T	T	T	T	T	T	T	T	
Discrimination limit (kA)																	
iC60N/H Curves B, C, D	≤ 10	T	T	T	T	T	T	T	T	T	T	T	T	T	T	T	
	16		T	T	T	T	T	T	T	T	T	T	T	T	T	T	
	20			T	T	T	T	T	T	T	T	T	T	T	T	T	
iC60L Curves B-C-D-K-Z	25				T	T	T	T	T	T	T	T	T	T	T	T	
	32						T	T	T	T	T	T	T	T	T	T	
	40							T	T	T	T	T	T	T	T	T	
	50								6	6	T	T	T	T	T	T	
	63									6		T	T	T	T	T	
Discrimination limit (kA)																	
C120N/H Curves B, C, D	63								1.5		2.4	2.4	2.4	T	T	T	
	80											2.4	2.4	T	T	T	
	100												2.4	T	T	T	
	125														T	T	
Discrimination limit (kA)																	
NG125N/H/L Curves B, C, D	10	0.6	0.6	0.6	0.6	1.5	1.5	1.5	1.5	T	T	T	T	T	T	T	
	16		0.6	0.6	0.6	1.5	1.5	1.5	1.5	T	T	T	T	T	T	T	
	20			0.6	0.6	1.5	1.5	1.5	1.5	T	T	T	T	T	T	T	
	25				0.6	1.5	1.5	1.5	1.5	2.4	2.4	2.4	2.4	T	T	T	
	32						1.5	1.5	1.5	2.4	2.4	2.4	2.4	T	T	T	
	40						1.5	1.5	1.5	2.4	2.4	2.4	2.4	T	T	T	
	50							1.5	1.5	2.4	2.4	2.4	2.4	T	T	T	
	63								1.5		2.4	2.4	2.4	2.4	T	T	T
	80											2.4	2.4	2.4	T	T	T
	100 (N)													2.4	T	T	T
	125 (N)															T	T
Discrimination limit (kA)																	
NG160E/N/H	16				0.6	1.5	1.5	1.5	1.5	2.4	2.4	2.4	2.4	T	T	T	
	25					1.5	1.5	1.5	1.5	2.4	2.4	2.4	2.4	T	T	T	
	32						1.5	1.5	1.5	2.4	2.4	2.4	2.4	T	T	T	
	40							1.5	1.5	2.4	2.4	2.4	2.4	T	T	T	
	50								1.5	1.5	2.4	2.4	2.4	T	T	T	
	63									1.5		2.4	2.4	T	T	T	
	80											2.4	2.4	T	T	T	
	100												2.4	T	T	T	
	125														T	T	T
	160																T

4 Discrimination limit = 4 kA.

T Total discrimination, up to the breaking capacity of the downstream circuit breaker.

No discrimination.

Note: respect the basic rules of discrimination, in terms of overload, short-circuit, see page 557E4300.indd/638.

Discrimination table

Upstream: Compact NSX100-250 TM-D

Downstream: Compact NSX100-250

TM-D - Micrologic

$U_e \leq 440 \text{ V AC}$

Upstream	NSX100B/F/N/H/S/L/R									NSX160B/F/N/H/S/L				NSX250B/F/N/H/S/L/R		
Trip unit	TM-D									TM-D				TM-D		
In (A)	16	25	32	40	50	63	80	100	80	100	125	160	160	200	250	

Downstream																	
Discrimination limit (kA)																	
Compact NSX100 B/F TM-D	16				0.5	0.5	0.5	0.63	0.8	0.63	0.8	1.25	1.25	1.25	T	T	
	25					0.5	0.5	0.63	0.8	0.63	0.8	1.25	1.25	1.25	T	T	
	32						0.5	0.63	0.8	0.63	0.8	1.25	1.25	1.25	T	T	
	40							0.63	0.8	0.63	0.8	1.25	1.25	1.25	T	T	
	50								0.63	0.8	0.63	0.8	1.25	1.25	1.25	T	T
	63									0.8		0.8	1.25	1.25	1.25	T	T
	80												1.25	1.25	1.25	T	T
100													1.25	1.25	1.25	T	T
Discrimination limit (kA)																	
Compact NSX100 N/H/S/L/R TM-D	16				0.5	0.5	0.5	0.63	0.8	0.63	0.8	1.25	1.25	1.25	T	T	
	25					0.5	0.5	0.63	0.8	0.63	0.8	1.25	1.25	1.25	T	T	
	32						0.5	0.63	0.8	0.63	0.8	1.25	1.25	1.25	36	36	
	40							0.63	0.8	0.63	0.8	1.25	1.25	1.25	36	36	
	50								0.63	0.8	0.63	0.8	1.25	1.25	1.25	36	36
	63									0.8		0.8	1.25	1.25	1.25	36	36
	80												1.25	1.25	1.25	36	36
100													1.25	1.25	36	36	
Discrimination limit (kA)																	
Compact NSX160 B/F/N/H/S/L TM-D	≤ 63												1.25	1.25	1.25	4	5
	80												1.25	1.25	1.25	4	5
	100													1.25	1.25	4	5
	160																5
Discrimination limit (kA)																	
Compact NSX250 B/F/N/H/S/L/R TM-D	≤ 100														1.25	2	2.5
	125															2	2.5
	160																2.5
	200																
Discrimination limit (kA)																	
Compact NSX100 B/F/N/H/S/L/R Micrologic	40						0.5	0.63	0.8	0.63	0.8	1.25	1.25	1.25	2	2.5	
	100												1.25	1.25	2	2.5	
Discrimination limit (kA)																	
Compact NSX160 B/F/N/H/S/L Micrologic	40					0.5	0.63	0.8	0.63	0.8	1.25	1.25	1.25	2	2.5		
	100												1.25	1.25	2	2.5	
	160															2.5	
Discrimination limit (kA)																	
Compact NSX250 B/F/N/H/S/L/R Micrologic	≤ 100														1.25	2	2.5
	160																2.5
	250																

4 Discrimination limit = 4 kA.

T Total discrimination, up to the breaking capacity of the downstream circuit breaker.

No discrimination.

Note: respect the basic rules of discrimination, in terms of overload, short-circuit, see page 557E4300.indd/638.

Discrimination table

Upstream: Compact NSX100-250
Micrologic
Downstream: Compact NSX100-250
TM-D - Micrologic

$U_e \leq 440 \text{ V AC}$

Upstream		NSX100B/F/N/H/S/L/R				NSX160B/F/N/H/S/L				NSX250B/F/N/H/S/L/R						
Trip unit		Micrologic				Micrologic				Micrologic						
Downstream	Rating (A)	40				100				160				250		
	Setting Ir	16	25	32	40	40	63	80	100	80	100	125	160	160	200	250
Discrimination limit (kA)																
Compact NSX100 B/F TM-D	16					1.5	1.5	1.5	1.5	2.4	2.4	2.4	2.4	T	T	T
	25					1.5	1.5	1.5	1.5	2.4	2.4	2.4	2.4	T	T	T
	32						1.5	1.5	1.5	2.4	2.4	2.4	2.4	T	T	T
	40							1.5	1.5	2.4	2.4	2.4	2.4	T	T	T
	50								1.5	2.4	2.4	2.4	2.4	T	T	T
	63										2.4	2.4	2.4	T	T	T
	80											2.4	2.4	T	T	T
	100												2.4	T	T	T
Discrimination limit (kA)																
Compact NSX100 N/H/S/L/R TM-D	16					1.5	1.5	1.5	1.5	2.4	2.4	2.4	2.4	T	T	T
	25					1.5	1.5	1.5	1.5	2.4	2.4	2.4	2.4	T	T	T
	32						1.5	1.5	1.5	2.4	2.4	2.4	2.4	36	36	36
	40							1.5	1.5	2.4	2.4	2.4	2.4	36	36	36
	50								1.5	2.4	2.4	2.4	2.4	36	36	36
	63										2.4	2.4	2.4	36	36	36
	80											2.4	2.4	36	36	36
	100												2.4	36	36	36
Discrimination limit (kA)																
Compact NSX160 ≤ 63 B/F/N/H/S/L TM-D	80										2.4	2.4	2.4	3	3	3
	100											2.4	2.4	3	3	3
	160												2.4	3	3	3
	160															3
Discrimination limit (kA)																
Compact NSX250 ≤ 100 B/F/N/H/S/L/R TM-D	125													3	3	3
	160														3	3
	200															3
	200															
Discrimination limit (kA)																
Compact NSX100 40 B/F Micrologic	100						1.5	1.5	1.5	2.4	2.4	2.4	2.4	T	T	T
	100												2.4	T	T	T
	100						1.5	1.5	1.5	2.4	2.4	2.4	2.4	36	36	36
Compact NSX100 40 N/H/S/L/R Micrologic	100												2.4	36	36	36
	100															
	100															
Discrimination limit (kA)																
Compact NSX160 40 B/F/N/H/S/L Micrologic	100									2.4	2.4	2.4	2.4	3	3	3
	100												2.4	3	3	3
	160															3
Discrimination limit (kA)																
Compact NSX250 ≤ 100 B/F/N/H/S/L/R Micrologic	160													3	3	3
	250															3

4 Discrimination limit = 4 kA.

T Total discrimination, up to the breaking capacity of the downstream circuit breaker.

No discrimination.

Note: respect the basic rules of discrimination, in terms of overload, short-circuit, see page 557E4300.indd/638.

Discrimination table

Upstream: Compact NSX400-630
Micrologic
Downstream: iDPN, iC60, C120, NG125-160, Compact NSX100-400

U_e ≤ 440 V AC

Upstream		NSX400F/N/H/S/L/R					NSX630F/N/H/S/L/R				
Trip unit		Micrologic					Micrologic				
Downstream	Rating (A)	400					630				
	Setting I _r	160	200	250	320	400	250	320	400	500	630
Discrimination limit (kA)											
iDPN		T	T	T	T	T	T	T	T	T	T
iDPNN		T	T	T	T	T	T	T	T	T	T
iC60N/H/L		T	T	T	T	T	T	T	T	T	T
Discrimination limit (kA)											
C120N/H	≤ 80	T	T	T	T	T	T	T	T	T	T
	100		T	T	T	T	T	T	T	T	T
	125			T	T	T	T	T	T	T	T
Discrimination limit (kA)											
NG125N/H/L	≤ 80	T	T	T	T	T	T	T	T	T	T
	100		T	T	T	T	T	T	T	T	T
	125			T	T	T	T	T	T	T	T
Discrimination limit (kA)											
NG160E/N/H	≤ 80	T	T	T	T	T	T	T	T	T	T
	100	T	T	T	T	T	T	T	T	T	T
	125		T	T	T	T	T	T	T	T	T
	160			T	T	T	T	T	T	T	T
Discrimination limit (kA)											
Compact NSX100 B/F/N/H/S/L/R TM-D	≤ 80	T	T	T	T	T	T	T	T	T	T
	100	T	T	T	T	T	T	T	T	T	T
Discrimination limit (kA)											
Compact NSX160 B/F/N/H/S/L TM-D	≤ 100	T	T	T	T	T	T	T	T	T	T
	125		T	T	T	T	T	T	T	T	T
Compact NSX250 B/F/N/H/S/L/R TM-D	≤ 100	4.8	4.8	4.8	4.8	4.8	T	T	T	T	T
	125		4.8	4.8	4.8	4.8	T	T	T	T	T
Compact NSX400 F/N/H/S/L/R Micrologic	160			4.8	4.8	4.8	T	T	T	T	T
	200				4.8	4.8		T	T	T	T
	250					4.8			T	T	T
Discrimination limit (kA)											
Compact NSX100 B/F/N/H/S/L/R Micrologic	40	T	T	T	T	T	T	T	T	T	T
	100	T	T	T	T	T	T	T	T	T	T
Discrimination limit (kA)											
Compact NSX160 B/F/N/H/S/L Micrologic	40	T	T	T	T	T	T	T	T	T	T
	100	T	T	T	T	T	T	T	T	T	T
	160			T	T	T	T	T	T	T	T
Discrimination limit (kA)											
Compact NSX250 B/F/N/H/S/L/R Micrologic	≤ 100	4.8	4.8	4.8	4.8	4.8	T	T	T	T	T
	160			4.8	4.8	4.8	T	T	T	T	T
	250					4.8			T	T	T
Discrimination limit (kA)											
Compact NSX400 F/N/H/S/L/R Micrologic	160						6.9	6.9	6.9	6.9	6.9
	200							6.9	6.9	6.9	6.9
	250								6.9	6.9	6.9
	320									6.9	6.9
	400										6.9

4 Discrimination limit = 4 kA.

T Total discrimination, up to the breaking capacity of the downstream circuit breaker.

No discrimination.

Note: respect the basic rules of discrimination, in terms of overload, short-circuit, see page 557E4300.indd/638.

Discrimination table

Upstream: Masterpact NT06-16 H1/H2 Micrologic
 Downstream: iDPN, iC60, C120, NG125-160,
 Compact NSX100-630

$U_e \leq 440 \text{ V AC}$

Upstream		Masterpact NT06/08/12/16 H1/H2																													
Trip unit		Micrologic 2.0								Micrologic 5.0 - 6.0 - 7.0 Inst : 15 In				Micrologic 5.0 - 6.0 - 7.0 Inst : OFF																	
Downstream	Rating (A)	630			800			1000			1250			1600			630			800			1000			1250			1600		
	Setting Ir	250	400	630	800	1000	1250	1600	250	400	630	800	1000	1250	1600	250	400	630	800	1000	1250	1600	250	400	630	800	1000	1250	1600		
Discrimination limit (kA)																															
iDPN, iDPNN		T	T	T	T	T	T	T	T	T	T	T	T	T	T	T	T	T	T	T	T	T	T	T	T	T	T	T	T		
iC60		T	T	T	T	T	T	T	T	T	T	T	T	T	T	T	T	T	T	T	T	T	T	T	T	T	T	T	T		
C120N/H		T	T	T	T	T	T	T	T	T	T	T	T	T	T	T	T	T	T	T	T	T	T	T	T	T	T	T	T		
NG125N/H		T	T	T	T	T	T	T	T	T	T	T	T	T	T	T	T	T	T	T	T	T	T	T	T	T	T	T	T		
NG125L		T	T	T	T	T	T	T	T	T	T	T	T	T	T	T	T	T	T	T	T	T	T	T	T	T	T	T	T		
NG160E/N/H		T	T	T	T	T	T	T	T	T	T	T	T	T	T	T	T	T	T	T	T	T	T	T	T	T	T	T	T		
Compact NSX100 B/F/N/H/S/L/R TM-D		T	T	T	T	T	T	T	T	T	T	T	T	T	T	T	T	T	T	T	T	T	T	T	T	T	T	T	T		
Compact NSX160 B/F/N/H/S/L TM-D		T	T	T	T	T	T	T	T	T	T	T	T	T	T	T	T	T	T	T	T	T	T	T	T	T	T	T	T		
Compact NSX250 ≤ 125 B/F/N/H/S/L/R TM-D		T	T	T	T	T	T	T	T	T	T	T	T	T	T	T	T	T	T	T	T	T	T	T	T	T	T	T	T		
		160	T	T	T	T	T	T	T	T	T	T	T	T	T	T	T	T	T	T	T	T	T	T	T	T	T	T	T		
		200		T	T	T	T	T	T		T	T	T	T	T		T	T	T	T	T		T	T	T	T	T	T	T		
		250		T	T	T	T	T			T	T	T	T			T	T	T	T			T	T	T	T	T				
Compact NSX100 40 B/F/N/H/S/L/R Micrologic		40	T	T	T	T	T	T	T	T	T	T	T	T	T	T	T	T	T	T	T	T	T	T	T	T	T	T	T		
		100	T	T	T	T	T	T	T	T	T	T	T	T	T	T	T	T	T	T	T	T	T	T	T	T	T	T	T		
Compact NSX160 40 B/F/N/H/S/L Micrologic		40	T	T	T	T	T	T	T	T	T	T	T	T	T	T	T	T	T	T	T	T	T	T	T	T	T	T	T		
		100	T	T	T	T	T	T	T	T	T	T	T	T	T	T	T	T	T	T	T	T	T	T	T	T	T	T	T		
		160	T	T	T	T	T	T	T	T	T	T	T	T	T	T	T	T	T	T	T	T	T	T	T	T	T	T	T		
Compact NSX250 ≤ 100 B/F/N/H/S/L/R Micrologic		≤ 100	T	T	T	T	T	T	T	T	T	T	T	T	T	T	T	T	T	T	T	T	T	T	T	T	T	T	T		
		160	T	T	T	T	T	T	T	T	T	T	T	T	T	T	T	T	T	T	T	T	T	T	T	T	T	T	T		
		250		T	T	T	T	T	T		T	T	T	T			T	T	T	T			T	T	T	T	T				
Compact NSX400 F/N/H/S/L/R Micrologic		160	T	T	T	T	T	T	T	T	T	T	T	T	T	T	T	T	T	T	T	T	T	T	T	T	T	T	T		
		200		T	T	T	T	T			T	T	T	T			T	T	T	T			T	T	T	T	T				
		250		T	T	T	T	T			T	T	T	T			T	T	T	T			T	T	T	T	T				
		320			T	T	T	T				T	T	T	T				T	T	T	T				T	T	T	T		
		400			T	T	T	T				T	T	T	T					T	T	T	T					T	T		
Compact NSX630 F/N/H/S/L/R Micrologic		250		T	T	T	T	T			T	T	T	T	T			T	T	T	T			T	T	T	T	T	T		
		320			T	T	T	T				T	T	T	T					T	T	T	T					T	T		
		400			T	T	T	T				T	T	T	T						T	T	T	T					T		
		500				T	T	T					T	T	T	T						T	T	T	T						
		630					T	T	T					T	T	T												T	T		

Total discrimination, up to the breaking capacity of the downstream circuit breaker.

No discrimination.

Note: respect the basic rules of discrimination, in terms of overload, short-circuit, see page 557E4300.indd/638, or check curves with Curve Direct software.

Discrimination table

Upstream: Masterpact NT06-16 H1

Micrologic

Downstream: Compact NS630b-1600

$U_e \leq 440 \text{ V AC}$

Upstream		Masterpact NT06/08/12/16 H1																			
Trip unit		Micrologic 2.0						Micrologic 5.0 - 6.0 - 7.0 Inst : 15 In						Micrologic 5.0 - 6.0 - 7.0 Inst : OFF							
Downstream	Rating (A)	630		800		1000		1250		1600		630		800		1000		1250		1600	
	Setting Ir	400	630	800	1000	1250	1600	400	630	800	1000	1250	1600	400	630	800	1000	1250	1600		
Discrimination limit (kA)																					
Compact NS630b	250	4	6.3	8	10	12.5	16	9.4	9.4	12	15	18.7	24	T	T	T	T	T	T	T	T
	N/H		6.3	8	10	12.5	16		9.4	12	15	18.7	24		T	T	T	T	T	T	T
	Micrologic	400		6.3	8	10	12.5	16		9.4	12	15	18.7	24		T	T	T	T	T	T
		500			8	10	12.5	16			12	15	18.7	24			T	T	T	T	T
		630				10	12.5	16				15	18.7	24				T	T	T	T
Compact NS800	320		6.3	8	10	12.5	16		9.4	12	15	18.7	24		T	T	T	T	T	T	T
	N/H		6.3	8	10	12.5	16		9.4	12	15	18.7	24		T	T	T	T	T	T	T
	Micrologic	400		6.3	8	10	12.5	16		9.4	12	15	18.7	24		T	T	T	T	T	T
		500			8	10	12.5	16			12	15	18.7	24			T	T	T	T	T
		630				10	12.5	16				15	18.7	24			T	T	T	T	T
Compact NS1000	400		6.3	8	10	12.5	16		9.4	12	15	18.7	24		T	T	T	T	T	T	T
	N/H			6.3	8	10	12.5	16		12	15	18.7	24			T	T	T	T	T	T
	Micrologic	400			8	10	12.5	16			12	15	18.7	24			T	T	T	T	T
		630				10	12.5	16				15	18.7	24				T	T	T	T
		800					12.5	16					18.7	24					T	T	T
Compact NS1250	500			8	10	12.5	16			12	15	18.7	24			T	T	T	T	T	T
	N/H				10	12.5	16				15	18.7	24				T	T	T	T	T
	Micrologic	400				12.5	16					18.7	24					T	T	T	T
		800					16						24							T	T
		1250												24							T
Compact NS1600	630				10	12.5	16				15	18.7	24				T	T	T	T	T
	N/H					12.5	16					18.7	24					T	T	T	T
	Micrologic	400					16						24							T	T
		1250																			T
		1600																			
Compact NS630b	250	4	6.3	8	T	T	T	T	T	T	T	T	T	T	T	T	T	T	T	T	T
	L/LB		6.3	8	T	T	T		T	T	T	T	T	T		T	T	T	T	T	T
	Micrologic	400		6.3	8	T	T	T		T	T	T	T	T		T	T	T	T	T	T
		500			8	T	T	T			T	T	T	T			T	T	T	T	T
		630				T	T	T				T	T	T				T	T	T	T
Compact NS800	320		6.3	8	10	T	T		9.4	T	T	T	T		T	T	T	T	T	T	T
	L/LB		6.3	8	10	T	T		9.4	T	T	T	T		T	T	T	T	T	T	T
	Micrologic	400		6.3	8	10	T	T			T	T	T			T	T	T	T	T	
		500			8	10	T	T				T	T	T				T	T	T	T
		630				10	T	T				T	T	T					T	T	T
Compact NS1000	400		6.3	8	10	12.5	T		9.4	12	T	T	T		T	T	T	T	T	T	T
	L			8	10	12.5	T			12	T	T	T			T	T	T	T	T	T
	Micrologic	400			8	10	12.5	T				T	T	T				T	T	T	T
		630				10	12.5	T				T	T	T					T	T	T
		800					12.5	T					T	T						T	T
	1000						T						T							T	

- T Total discrimination, up to the breaking capacity of the downstream circuit breaker.
- 4 Discrimination limit = 4 kA.
- No discrimination.

Note: respect the basic rules of discrimination, in terms of overload, short-circuit, see page 557E4300.indd/638, or check curves with Curve Direct software.

Ue ≤ 440 V AC

Upstream		Masterpact NT06/08/12/16 H1																	
Trip unit		Micrologic 2.0						Micrologic 5.0 - 6.0 - 7.0 Inst : 15 In						Micrologic 5.0 - 6.0 - 7.0 Inst : OFF					
Downstream	Rating (A)	630		800	1000	1250	1600	630		800	1000	1250	1600	630		800	1000	1250	1600
	Setting Ir	400	630	800	1000	1250	1600	400	630	800	1000	1250	1600	400	630	800	1000	1250	1600
Discrimination limit (kA)																			
Masterpact NT06 H1/H2 Micrologic	250	4	6.3	8	10	12.5	16	9.4	9.4	12	15	18.7	24	T	T	T	T	T	T
	320		6.3	8	10	12.5	16		9.4	12	15	18.7	24		T	T	T	T	T
	400		6.3	8	10	12.5	16		9.4	12	15	18.7	24		T	T	T	T	T
	500			8	10	12.5	16			12	15	18.7	24			T	T	T	T
	630				10	12.5	16				15	18.7	24				T	T	T
Masterpact NT08 H1/H2 Micrologic	320		6.3	8	10	12.5	16		9.4	12	15	18.7	24		T	T	T	T	T
	400		6.3	8	10	12.5	16		9.4	12	15	18.7	24		T	T	T	T	T
	500			8	10	12.5	16			12	15	18.7	24			T	T	T	T
	630				10	12.5	16				15	18.7	24			T	T	T	T
	800					12.5	16					18.7	24				T	T	T
Masterpact NT10 H1/H2 Micrologic	400		6.3	8	10	12.5	16		9.4	12	15	18.7	24		T	T	T	T	T
	500			8	10	12.5	16			12	15	18.7	24			T	T	T	T
	630				10	12.5	16				15	18.7	24				T	T	T
	800					12.5	16					18.7	24					T	T
	1000						16						24						T
Masterpact NT12 H1/H2 Micrologic	500			8	10	12.5	16			12	15	18.7	24			T	T	T	T
	630				10	12.5	16				15	18.7	24				T	T	T
	800					12.5	16					18.7	24					T	T
	1000						16						24						T
	1250																		
Masterpact NT16 H1/H2 Micrologic	630				10	12.5	16				15	18.7	24				T	T	T
	800					12.5	16					18.7	24					T	T
	960						16						24						T
	1250																		
	1600																		
Masterpact NT06 L1 Micrologic	250	4	6.3	8	T	T	T	T	T	T	T	T	T	T	T	T	T	T	T
	320		6.3	8	T	T	T		T	T	T	T	T		T	T	T	T	T
	400		6.3	8	T	T	T		T	T	T	T	T		T	T	T	T	T
	500			8	T	T	T			T	T	T	T			T	T	T	T
	630				T	T	T				T	T	T				T	T	T
Masterpact NT08 L1 Micrologic	320		6.3	8	10	T	T		9.4	T	T	T	T		T	T	T	T	T
	400		6.3	8	10	T	T		9.4	T	T	T	T		T	T	T	T	T
	500			8	10	T	T			T	T	T	T			T	T	T	T
	630				10	T	T				T	T	T				T	T	T
	800					T	T					T	T					T	T
Masterpact NT10 L1 Micrologic	400		6.3	8	10	12.5	T		9.4	12	T	T	T		T	T	T	T	T
	500			8	10	12.5	T			12	T	T	T			T	T	T	T
	630				10	12.5	T				T	T	T				T	T	T
	800					12.5	T					T	T					T	T
	1000						T						T						T

- T Total discrimination, up to the breaking capacity of the downstream circuit breaker.
- 4 Discrimination limit = 4 kA.
- No discrimination.

Note: respect the basic rules of discrimination, in terms of overload, short-circuit, see page 557E4300.indd/638, or check curves with Curve Direct software.

Discrimination table

Upstream: Masterpact NT06-16 H2 Micrologic

Downstream: Compact NS630b-1600

U_e ≤ 440 V AC

Upstream		Masterpact NT06/08/12/16 H2																	
Trip unit		Micrologic 2.0						Micrologic 5.0 - 6.0 - 7.0 Inst : 15 In						Micrologic 5.0 - 6.0 - 7.0 Inst : OFF					
Downstream	Rating (A)	630		800	1000	1250	1600	630		800	1000	1250	1600	630		800	1000	1250	1600
	Setting Ir	400	630	800	1000	1250	1600	400	630	800	1000	1250	1600	400	630	800	1000	1250	1600
Discrimination limit (kA)																			
Compact NS630b N/H Micrologic	250	4	6.3	8	10	12.5	16	9.4	9.4	12	15	18.7	24	42	42	42	42	42	42
	320		6.3	8	10	12.5	16		9.4	12	15	18.7	24		42	42	42	42	42
	400		6.3	8	10	12.5	16		9.4	12	15	18.7	24		42	42	42	42	42
	500			8	10	12.5	16			12	15	18.7	24			42	42	42	42
	630				10	12.5	16				15	18.7	24				42	42	42
Compact NS800 N/H Micrologic	320		6.3	8	10	12.5	16		9.4	12	15	18.7	24		42	42	42	42	42
	400		6.3	8	10	12.5	16		9.4	12	15	18.7	24		42	42	42	42	42
	500			8	10	12.5	16			12	15	18.7	24		42	42	42	42	42
	630				10	12.5	16				15	18.7	24		42	42	42	42	42
	800					12.5	16					18.7	24				42	42	42
Compact NS1000 N/H Micrologic	400		6.3	8	10	12.5	16		9.4	12	15	18.7	24		42	42	42	42	42
	500			8	10	12.5	16			12	15	18.7	24		42	42	42	42	42
	630				10	12.5	16				15	18.7	24			42	42	42	42
	800					12.5	16					18.7	24				42	42	42
	1000						16						24					42	42
Compact NS1250 N/H Micrologic	500			8	10	12.5	16			12	15	18.7	24		42	42	42	42	42
	630				10	12.5	16				15	18.7	24			42	42	42	42
	800					12.5	16					18.7	24				42	42	42
	1000						16						24					42	42
	1250																		42
Compact NS1600 N/H Micrologic	630				10	12.5	16				15	18.7	24			42	42	42	42
	800					12.5	16					18.7	24				42	42	42
	960						16						24					42	42
	1250																		42
	1600																		42
Compact NS630b L/LB Micrologic	250	4	6.3	8	T	T	T	T	T	T	T	T	T	T	T	T	T	T	T
	320		6.3	8	T	T	T		T	T	T	T	T		T	T	T	T	T
	400		6.3	8	T	T	T		T	T	T	T	T		T	T	T	T	T
	500			8	T	T	T			T	T	T	T			T	T	T	T
	630				T	T	T				T	T	T				T	T	T
Compact NS800 L/LB Micrologic	320		6.3	8	10	T	T		9.4	T	T	T	T		T	T	T	T	T
	400		6.3	8	10	T	T		9.4	T	T	T	T		T	T	T	T	T
	500			8	10	T	T			T	T	T	T			T	T	T	T
	630				10	T	T				T	T	T				T	T	T
	800					T	T					T	T					T	T
Compact NS1000 L Micrologic	400		6.3	8	10	12.5	T		9.4	12	T	T	T		T	T	T	T	T
	500			8	10	12.5	T			12	T	T	T			T	T	T	T
	630				10	12.5	T				T	T	T				T	T	T
	800					12.5	T					T	T					T	T
	1000						T						T						T

- T Total discrimination, up to the breaking capacity of the downstream circuit breaker.
- 4 Discrimination limit = 4 kA.
- No discrimination.

Note: respect the basic rules of discrimination, in terms of overload, short-circuit, see page 557E4300.indd/638, or check curves with Curve Direct software.

Discrimination table

Upstream: Masterpact NT06-16 H2 Micrologic

Downstream: Masterpact NT06-16

U_e ≤ 440 V AC

Upstream		Masterpact NT06/08/12/16 H2																	
Trip unit		Micrologic 2.0						Micrologic 5.0 - 6.0 - 7.0 Inst : 15 In						Micrologic 5.0 - 6.0 - 7.0 Inst : OFF					
Downstream	Rating (A)	630		800	1000	1250	1600	630		800	1000	1250	1600	630		800	1000	1250	1600
	Setting Ir	400	630	800	1000	1250	1600	400	630	800	1000	1250	1600	400	630	800	1000	1250	1600
Discrimination limit (kA)																			
Masterpact NT06 H1/H2 Micrologic	250	4	6.3	8	10	12.5	16	9.4	9.4	12	15	18.7	24	42	42	42	42	42	42
	320		6.3	8	10	12.5	16		9.4	12	15	18.7	24		42	42	42	42	42
	400		6.3	8	10	12.5	16		9.4	12	15	18.7	24		42	42	42	42	42
	500			8	10	12.5	16			12	15	18.7	24			42	42	42	42
	630				10	12.5	16				15	18.7	24				42	42	42
Masterpact NT08 H1/H2 Micrologic	320		6.3	8	10	12.5	16		9.4	12	15	18.7	24		42	42	42	42	42
	400		6.3	8	10	12.5	16		9.4	12	15	18.7	24		42	42	42	42	42
	500			8	10	12.5	16			12	15	18.7	24			42	42	42	42
	630				10	12.5	16				15	18.7	24			42	42	42	42
	800					12.5	16					18.7	24				42	42	42
Masterpact NT10 H1/H2 Micrologic	400		6.3	8	10	12.5	16		9.4	12	15	18.7	24		42	42	42	42	42
	500			8	10	12.5	16			12	15	18.7	24			42	42	42	42
	630				10	12.5	16				15	18.7	24				42	42	42
	800					12.5	16					18.7	24					42	42
	1000						16						24						42
Masterpact NT12 H1/H2 Micrologic	500			8	10	12.5	16			12	15	18.7	24			42	42	42	42
	630				10	12.5	16				15	18.7	24				42	42	42
	800					12.5	16					18.7	24					42	42
	1000						16						24						42
	1250																		42
Masterpact NT16 H1/H2 Micrologic	630				10	12.5	16				15	18.7	24				42	42	42
	800					12.5	16					18.7	24					42	42
	960						16						24						42
	1250																		42
	1600																		42
Masterpact NT06 L1 Micrologic	250	4	6.3	8	T	T	T	T	T	T	T	T	T	T	T	T	T	T	T
	320		6.3	8	T	T	T		T	T	T	T	T		T	T	T	T	T
	400		6.3	8	T	T	T		T	T	T	T	T		T	T	T	T	T
	500			8	T	T	T			T	T	T	T			T	T	T	T
	630				T	T	T				T	T	T				T	T	T
Masterpact NT08 L1 Micrologic	320		6.3	8	10	T	T		9.4	T	T	T	T		T	T	T	T	T
	400		6.3	8	10	T	T		9.4	T	T	T	T		T	T	T	T	T
	500			8	10	T	T			T	T	T	T			T	T	T	T
	630				10	T	T				T	T	T				T	T	T
	800					T	T					T	T					T	T
Masterpact NT10 L1 Micrologic	400		6.3	8	10	12.5	T		9.4	12	T	T	T		T	T	T	T	T
	500			8	10	12.5	T			12	T	T	T			T	T	T	T
	630				10	12.5	T				T	T	T				T	T	T
	800					12.5	T					T	T					T	T
	1000						T						T						T

- T Total discrimination, up to the breaking capacity of the downstream circuit breaker.
- 4 Discrimination limit = 4 kA.
- No discrimination.

Note: respect the basic rules of discrimination, in terms of overload, short-circuit, see page 557E4300.indd/638, or check curves with Curve Direct software.

Discrimination table

Upstream: Masterpact NT06-10 L1 Micrologic

Downstream: iDPN, iC60, C120, NG125-160,

Compact NSX100-630

$U_e \leq 440 \text{ V AC}$

Upstream		Masterpact NT06/08/10 L1														
Trip unit		Micrologic 2.0					Micrologic 5.0 - 6.0 - 7.0 Inst : 15 In					Micrologic 5.0 - 6.0 - 7.0 Inst : OFF				
Downstream	Rating (A)	630			800	1000	630			800	1000	630			800	1000
	Setting Ir	250	400	630	800	1000	250	400	630	800	1000	250	400	630	800	1000
Discrimination limit (kA)																
iDPN, iDPNN		T	T	T	T	T	T	T	T	T	T	T	T	T	T	T
iC60		T	T	T	T	T	T	T	T	T	T	T	T	T	T	T
C120N/H		T	T	T	T	T	T	T	T	T	T	T	T	T	T	T
NG125N/H		T	T	T	T	T	T	T	T	T	T	T	T	T	T	T
NG125L		T	T	T	T	T	T	T	T	T	T	T	T	T	T	T
NG160		T	T	T	T	T	T	T	T	T	T	T	T	T	T	T
Compact NSX100 B/F/N/H/S/L/R TM-D		T	T	T	T	T	T	T	T	T	T	T	T	T	T	T
Compact NSX160 B/F TM-D		T	T	T	T	T	T	T	T	T	T	T	T	T	T	T
Compact NSX160 N/H/S/L TM-D		36	36	36	T	T	36	36	36	T	T	36	36	36	T	T
Compact NSX250 B/F/N/H/S/L/R TM-D	≤ 125	20	20	20	T	T	20	20	20	T	T	20	20	20	T	T
	160	20	20	20	T	T	20	20	20	T	T	20	20	20	T	T
	200		20	20	T	T		20	20	T	T		20	20	T	T
	250		20	20	T	T		20	20	T	T		20	20	T	T
Compact NSX100 B/F/N/H/S/L/R Micrologic	40	T	T	T	T	T	T	T	T	T	T	T	T	T	T	T
	100	T	T	T	T	T	T	T	T	T	T	T	T	T	T	T
	160	T	T	T	T	T	T	T	T	T	T	T	T	T	T	T
Compact NSX160 N/H/S/L Micrologic	40	36	36	36	T	T	36	36	36	T	T	36	36	36	T	T
	100	36	36	36	T	T	36	36	36	T	T	36	36	36	T	T
	160	36	36	36	T	T	36	36	36	T	T	36	36	36	T	T
Compact NSX250 B/F/N/H/S/L/R Micrologic	≤ 100	20	20	20	T	T	20	20	20	T	T	20	20	20	T	T
	160		20	20	T	T		20	20	T	T		20	20	T	T
	250		20	20	T	T		20	20	T	T		20	20	T	T
Compact NSX400 F/N/H/S/L/R Micrologic	160	6.3	6.3	6.3	10	15	6.3	6.3	6.3	10	15	6.3	6.3	6.3	10	15
	200		6.3	6.3	10	15		6.3	6.3	10	15		6.3	6.3	10	15
	250		6.3	6.3	10	15		6.3	6.3	10	15		6.3	6.3	10	15
	320		6.3	6.3	10	15			6.3	10	15			6.3	10	15
	400			6.3	10	15			6.3	10	15			6.3	10	15
Compact NSX630 F/N/H/S/L/R Micrologic	250		6.3	6.3	8	10		6.3	6.3	8	10		6.3	6.3	8	10
	320			6.3	8	10			6.3	8	10			6.3	8	10
	400			6.3	8	10			6.3	8	10			6.3	8	10
	500				8	10				8	10				8	10
	630					10					10					10

T Total discrimination, up to the breaking capacity of the downstream circuit breaker.

4 Discrimination limit = 4 kA.

No discrimination.

Note: respect the basic rules of discrimination, in terms of overload, short-circuit, see page 557E4300.indd/638, or check curves with Curve Direct software.

Discrimination table

Upstream: Masterpact NT06-10 L1 Micrologic

Downstream: Compact NS630b-1000, Masterpact NT06-10

$U_e \leq 440 \text{ V AC}$

Upstream		Masterpact NT06/08/10 L1														
Trip unit		Micrologic 2.0					Micrologic 5.0 - 6.0 - 7.0 Inst : 15 In					Micrologic 5.0 - 6.0 - 7.0 Inst : OFF				
Downstream	Rating (A)	630			800	1000	630			800	1000	630			800	1000
	Setting Ir	250	400	630	800	1000	250	400	630	800	1000	250	400	630	800	1000
Discrimination limit (kA)																
Compact NS630b N/H/L/LB Micrologic	250		6.3	6.3	8	10		6.3	6.3	8	10		6.3	6.3	8	10
	320			6.3	8	10			6.3	8	10			6.3	8	10
	400			6.3	8	10			6.3	8	10			6.3	8	10
	500				8	10				8	10				8	10
	630					10					10					10
Compact NS800 N/H/L/LB Micrologic	320			6.3	8	10			6.3	8	10			6.3	8	10
	400			6.3	8	10			6.3	8	10			6.3	8	10
	500				8	10				8	10				8	10
	630					10					10					10
	800															
Compact NS1000 N/H/L Micrologic	400					10					10			6.3	10	10
	500					10					10				10	10
	630					10					10					10
	800															
	1000															
Masterpact NT06 H1/H2/L1 Micrologic	250		6.3	6.3	8	10		6.3	6.3	8	10		6.3	6.3	8	10
	320			6.3	8	10			6.3	8	10			6.3	8	10
	400			6.3	8	10			6.3	8	10			6.3	8	10
	500				8	10				8	10				8	10
	630					10					10					10
Masterpact NT08 H1/H2/L1 Micrologic	320			6.3	8	10			6.3	8	10			6.3	8	10
	400			6.3	8	10			6.3	8	10			6.3	8	10
	500				8	10				8	10				8	10
	630					10					10					10
	800															
Masterpact NT10 H1/H2/L1 Micrologic	400					10					10			6.3	10	10
	500					10					10				10	10
	630					10					10					10
	800															
	1000															

4 Discrimination limit = 4 kA.

No discrimination.

Note: respect the basic rules of discrimination, in terms of overload, short-circuit, see page 557E4300.indd/638, or check curves with Curve Direct software.

Discrimination table

Upstream: Masterpact NW08-20 N1/H1/H2/L1

Micrologic

Downstream: iDPN, iC60, C120, NG125-160,

Compact NSX100-630

$U_e \leq 440 \text{ V AC}$

Upstream		Masterpact NW08/12/16/20 N1/H1/H2/L1																													
Trip unit		Micrologic 2.0								Micrologic 5.0 - 6.0 - 7.0 Inst : 15 In								Micrologic 5.0 - 6.0 - 7.0 Inst : OFF													
Downstream	Rating (A)	800		1000		1250		1600		2000		800		1000		1250		1600		2000		800		1000		1250		1600		2000	
	Setting Ir	320	630	800	1000	1250	1600	2000	320	630	800	1000	1250	1600	2000	320	630	800	1000	1250	1600	2000	320	630	800	1000	1250	1600	2000		
Discrimination limit (kA)																															
iDPN, iDPNN		T	T	T	T	T	T	T	T	T	T	T	T	T	T	T	T	T	T	T	T	T	T	T	T	T	T	T	T		
iC60		T	T	T	T	T	T	T	T	T	T	T	T	T	T	T	T	T	T	T	T	T	T	T	T	T	T	T	T		
C120N/H		T	T	T	T	T	T	T	T	T	T	T	T	T	T	T	T	T	T	T	T	T	T	T	T	T	T	T	T		
NG125N/H		T	T	T	T	T	T	T	T	T	T	T	T	T	T	T	T	T	T	T	T	T	T	T	T	T	T	T	T		
NG125L		T	T	T	T	T	T	T	T	T	T	T	T	T	T	T	T	T	T	T	T	T	T	T	T	T	T	T	T		
NG160E/N/H		T	T	T	T	T	T	T	T	T	T	T	T	T	T	T	T	T	T	T	T	T	T	T	T	T	T	T	T		
Compact NSX100 B/F/N/H/S/L/R TM-D		T	T	T	T	T	T	T	T	T	T	T	T	T	T	T	T	T	T	T	T	T	T	T	T	T	T	T	T		
Compact NSX160 B/F/N/H/S/L TM-D		T	T	T	T	T	T	T	T	T	T	T	T	T	T	T	T	T	T	T	T	T	T	T	T	T	T	T	T		
Compact NSX250 ≤ 125 B/F/N/H/S/L/R TM-D	≤ 125	T	T	T	T	T	T	T	T	T	T	T	T	T	T	T	T	T	T	T	T	T	T	T	T	T	T	T	T		
	160	T	T	T	T	T	T	T	T	T	T	T	T	T	T	T	T	T	T	T	T	T	T	T	T	T	T	T	T		
	200	T	T	T	T	T	T	T	T	T	T	T	T	T	T	T	T	T	T	T	T	T	T	T	T	T	T	T	T		
	250		T	T	T	T	T	T	T	T	T	T	T	T	T	T	T	T	T	T	T	T	T	T	T	T	T	T	T		
Compact NSX100 B/F/N/H/S/L/R Micrologic	40	T	T	T	T	T	T	T	T	T	T	T	T	T	T	T	T	T	T	T	T	T	T	T	T	T	T	T	T		
	100	T	T	T	T	T	T	T	T	T	T	T	T	T	T	T	T	T	T	T	T	T	T	T	T	T	T	T	T		
Compact NSX160 B/F/N/H/S/L Micrologic	40	T	T	T	T	T	T	T	T	T	T	T	T	T	T	T	T	T	T	T	T	T	T	T	T	T	T	T	T		
	100	T	T	T	T	T	T	T	T	T	T	T	T	T	T	T	T	T	T	T	T	T	T	T	T	T	T	T	T		
	160	T	T	T	T	T	T	T	T	T	T	T	T	T	T	T	T	T	T	T	T	T	T	T	T	T	T	T	T		
Compact NSX250 ≤ 100 B/F/N/H/S/L/R Micrologic	≤ 100	T	T	T	T	T	T	T	T	T	T	T	T	T	T	T	T	T	T	T	T	T	T	T	T	T	T	T	T		
	160	T	T	T	T	T	T	T	T	T	T	T	T	T	T	T	T	T	T	T	T	T	T	T	T	T	T	T	T		
	250		T	T	T	T	T	T	T	T	T	T	T	T	T	T	T	T	T	T	T	T	T	T	T	T	T	T	T		
Compact NSX400 F/N/H/S/L/R Micrologic	160	T	T	T	T	T	T	T	T	T	T	T	T	T	T	T	T	T	T	T	T	T	T	T	T	T	T	T	T		
	200	T	T	T	T	T	T	T	T	T	T	T	T	T	T	T	T	T	T	T	T	T	T	T	T	T	T	T	T		
	250	T	T	T	T	T	T	T	T	T	T	T	T	T	T	T	T	T	T	T	T	T	T	T	T	T	T	T	T		
	320		T	T	T	T	T	T	T	T	T	T	T	T	T	T	T	T	T	T	T	T	T	T	T	T	T	T	T		
Compact NSX630 F/N/H/S/L/R Micrologic	400		T	T	T	T	T	T	T	T	T	T	T	T	T	T	T	T	T	T	T	T	T	T	T	T	T	T	T		
	250	T	T	T	T	T	T	T	T	T	T	T	T	T	T	T	T	T	T	T	T	T	T	T	T	T	T	T	T		
	320		T	T	T	T	T	T	T	T	T	T	T	T	T	T	T	T	T	T	T	T	T	T	T	T	T	T	T		
	400		T	T	T	T	T	T	T	T	T	T	T	T	T	T	T	T	T	T	T	T	T	T	T	T	T	T	T		
Compact NSX630 F/N/H/S/L/R Micrologic	250		T	T	T	T	T	T	T	T	T	T	T	T	T	T	T	T	T	T	T	T	T	T	T	T	T	T	T		
	320		T	T	T	T	T	T	T	T	T	T	T	T	T	T	T	T	T	T	T	T	T	T	T	T	T	T	T		
	400		T	T	T	T	T	T	T	T	T	T	T	T	T	T	T	T	T	T	T	T	T	T	T	T	T	T	T		
	500		T	T	T	T	T	T	T	T	T	T	T	T	T	T	T	T	T	T	T	T	T	T	T	T	T	T	T		
Compact NSX630 F/N/H/S/L/R Micrologic	500		T	T	T	T	T	T	T	T	T	T	T	T	T	T	T	T	T	T	T	T	T	T	T	T	T	T	T		
	630				T	T	T	T	T	T	T	T	T	T	T	T	T	T	T	T	T	T	T	T	T	T	T	T	T		

Total discrimination, up to the breaking capacity of the downstream circuit breaker.

No discrimination.

Note: respect the basic rules of discrimination, in terms of overload, short-circuit, see page 557E4300.indd/638, or check curves with Curve Direct software.

Discrimination table

Upstream: Masterpact NW08-20 N1/H1/H2

Micrologic

Downstream: Compact NS630b-1600

$U_e \leq 440 \text{ V AC}$

Upstream		Masterpact NW08/12/16/20 N1/H1/H2																			
Trip unit		Micrologic 2.0						Micrologic 5.0 - 6.0 - 7.0 Inst : 15 In						Micrologic 5.0 - 6.0 - 7.0 Inst : OFF							
Downstream	Rating (A)	800		1000		1250		1600		2000		800		1000		1250		1600		2000	
	Setting Ir	630	800	1000	1250	1600	2000	630	800	1000	1250	1600	2000	630	800	1000	1250	1600	2000		
Discrimination limit (kA)																					
Compact NS630bN/H Micrologic	250	6.3	8	10	12.5	16	20	12	12	15	18.75	24	30	T	T	T	T	T	T	T	
	320	6.3	8	10	12.5	16	20	12	12	15	18.75	24	30	T	T	T	T	T	T	T	
	400	6.3	8	10	12.5	16	20	12	12	15	18.75	24	30	T	T	T	T	T	T	T	
	500		8	10	12.5	16	20		12	15	18.75	24	30		T	T	T	T	T	T	
	630			10	12.5	16	20			15	18.75	24	30			T	T	T	T	T	
Compact NS800N/H Micrologic	320	6.3	8	10	12.5	16	20	12	12	15	18.75	24	30	T	T	T	T	T	T	T	
	400	6.3	8	10	12.5	16	20	12	12	15	18.75	24	30	T	T	T	T	T	T	T	
	500		8	10	12.5	16	20		12	15	18.75	24	30		T	T	T	T	T	T	
	630			10	12.5	16	20			15	18.75	24	30			T	T	T	T	T	
Compact NS1000N/H Micrologic	400	6.3	8	10	12.5	16	20	12	12	15	18.75	24	30	T	T	T	T	T	T	T	
	500		8	10	12.5	16	20		12	15	18.75	24	30		T	T	T	T	T	T	
	630			10	12.5	16	20			15	18.75	24	30			T	T	T	T	T	
	800				12.5	16	20				18.75	24	30				T	T	T	T	
	1000					16	20					24	30					T	T	T	
Compact NS1250N/H Micrologic	500		8	10	12.5	16	20		12	15	18.75	24	30		T	T	T	T	T	T	
	630			10	12.5	16	20			15	18.75	24	30			T	T	T	T	T	
	800				12.5	16	20				18.75	24	30				T	T	T	T	
	1000					16	20					24	30					T	T	T	
	1250						20						30							T	
Compact NS1600N/H Micrologic	630			10	12.5	16	20			15	18.75	24	30			T	T	T	T	T	
	800				12.5	16	20				18.75	24	30				T	T	T	T	
	960					16	20					24	30					T	T	T	
	1250						20						30							T	
	1600													30							
Compact NS630bL/LB Micrologic	250	6.3	8	T	T	T	T	T	T	T	T	T	T	T	T	T	T	T	T	T	
	320	6.3	8	T	T	T	T	T	T	T	T	T	T	T	T	T	T	T	T	T	
	400	6.3	8	T	T	T	T	T	T	T	T	T	T	T	T	T	T	T	T	T	
	500		8	T	T	T	T		T	T	T	T	T	T		T	T	T	T	T	
	630			T	T	T	T			T	T	T	T			T	T	T	T		
Compact NS800 L/LB Micrologic	320	6.3	8	10	T	T	T	T	T	T	T	T	T	T	T	T	T	T	T	T	
	400	6.3	8	10	T	T	T	T	T	T	T	T	T	T	T	T	T	T	T	T	
	500		8	10	T	T	T		T	T	T	T	T	T		T	T	T	T	T	
	630			10	T	T	T			T	T	T	T	T			T	T	T	T	
	800				T	T	T			T	T	T	T				T	T	T		
Compact NS1000L Micrologic	400	6.3	8	10	12.5	T	T	12	12	T	T	T	T	T	T	T	T	T	T	T	
	500		8	10	12.5	T	T		12	T	T	T	T	T		T	T	T	T	T	
	630			10	12.5	T	T			T	T	T	T	T			T	T	T	T	
	800				12.5	T	T				T	T	T	T				T	T	T	
	1000					T	T					T	T	T					T		

- T Total discrimination, up to the breaking capacity of the downstream circuit breaker.
- 4 Discrimination limit = 4 kA.
- No discrimination.

Note: respect the basic rules of discrimination, in terms of overload, short-circuit, see page 557E4300.indd/638, or check curves with Curve Direct software.

Discrimination table

Upstream: Masterpact NW08-20 N1/H1/H2

Micrologic

Downstream: Masterpact NT06-16

$U_e \leq 440 \text{ V AC}$

Upstream		Masterpact NW08/12/16/20 N1/H1/H2																			
Trip unit		Micrologic 2.0						Micrologic 5.0 - 6.0 - 7.0 Inst : 15 In						Micrologic 5.0 - 6.0 - 7.0 Inst : OFF							
Downstream	Rating (A)	800		1000		1250		1600		2000		800		1000		1250		1600		2000	
	Setting I _r	630	800	1000	1250	1600	2000	630	800	1000	1250	1600	2000	630	800	1000	1250	1600	2000		
Discrimination limit (kA)																					
Masterpact NT06 H1/H2	250	6.3	8	10	12.5	16	20	12	12	15	18.75	24	30	T	T	T	T	T	T	T	
	320	6.3	8	10	12.5	16	20	12	12	15	18.75	24	30	T	T	T	T	T	T	T	
	400	6.3	8	10	12.5	16	20	12	12	15	18.75	24	30	T	T	T	T	T	T	T	
	500		8	10	12.5	16	20		12	15	18.75	24	30		T	T	T	T	T	T	
	630			10	12.5	16	20			15	18.75	24	30			T	T	T	T	T	
Masterpact NT08 H1/H2	320	6.3	8	10	12.5	16	20	12	12	15	18.75	24	30	T	T	T	T	T	T	T	
	400	6.3	8	10	12.5	16	20	12	12	15	18.75	24	30	T	T	T	T	T	T	T	
	500		8	10	12.5	16	20		12	15	18.75	24	30		T	T	T	T	T	T	
	630			10	12.5	16	20			15	18.75	24	30			T	T	T	T	T	
Masterpact NT10 H1/H2	400	6.3	8	10	12.5	16	20	12	12	15	18.75	24	30	T	T	T	T	T	T	T	
	500		8	10	12.5	16	20		12	15	18.75	24	30		T	T	T	T	T	T	
	630			10	12.5	16	20			15	18.75	24	30			T	T	T	T	T	
	800				12.5	16	20				18.75	24	30				T	T	T	T	
Masterpact NT12 H1/H2	500		8	10	12.5	16	20		12	15	18.75	24	30		T	T	T	T	T	T	
	630			10	12.5	16	20			15	18.75	24	30			T	T	T	T	T	
	800				12.5	16	20				18.75	24	30				T	T	T	T	
	1000					16	20					24	30					T	T	T	
Masterpact NT16 H1/H2	500		8	10	12.5	16	20		12	15	18.75	24	30		T	T	T	T	T	T	
	630			10	12.5	16	20			15	18.75	24	30			T	T	T	T	T	
	800				12.5	16	20				18.75	24	30				T	T	T	T	
	1000					16	20					24	30					T	T	T	
Masterpact NT06L	250	6.3	8	T	T	T	T	T	T	T	T	T	T	T	T	T	T	T	T	T	
	320	6.3	8	T	T	T	T	T	T	T	T	T	T	T	T	T	T	T	T	T	
	400	6.3	8	T	T	T	T	T	T	T	T	T	T	T	T	T	T	T	T	T	
	500		8	T	T	T	T		T	T	T	T	T		T	T	T	T	T	T	
	630			T	T	T	T			T	T	T	T			T	T	T	T	T	
Masterpact NT08L	320	6.3	8	10	T	T	T	T	T	T	T	T	T	T	T	T	T	T	T	T	
	400	6.3	8	10	T	T	T	T	T	T	T	T	T	T	T	T	T	T	T	T	
	500		8	10	T	T	T		T	T	T	T	T		T	T	T	T	T	T	
	630			10	T	T	T			T	T	T	T			T	T	T	T	T	
	800				T	T	T			T	T	T	T				T	T	T	T	
Masterpact NT10L	400	6.3	8	10	12.5	T	T	12	12	T	T	T	T	T	T	T	T	T	T	T	
	500		8	10	12.5	T	T		12	T	T	T	T		T	T	T	T	T	T	
	630			10	12.5	T	T			T	T	T	T			T	T	T	T	T	
	800				12.5	T	T				T	T	T				T	T	T	T	
	1000					T	T					T	T					T	T	T	

- T Total discrimination, up to the breaking capacity of the downstream circuit breaker.
- 4 Discrimination limit = 4 kA.
- No discrimination.

Note: respect the basic rules of discrimination, in terms of overload, short-circuit, see page 557E4300.indd/638, or check curves with Curve Direct software.

Discrimination table

Upstream: Masterpact NW08-20 N1/H1 Micrologic

Downstream: Masterpact NW08-20

U_e ≤ 440 V AC

Upstream		Masterpact NW08/12/16/20 N1/H1																	
Trip unit		Micrologic 2.0						Micrologic 5.0 - 6.0 - 7.0 Inst : 15 In						Micrologic 5.0 - 6.0 - 7.0 Inst : OFF					
Downstream	Rating (A)	800		1000	1250	1600	2000	800		1000	1250	1600	2000	800		1000	1250	1600	2000
	Setting Ir	630	800	1000	1250	1600	2000	630	800	1000	1250	1600	2000	630	800	1000	1250	1600	2000
Discrimination limit (kA)																			
Masterpact NW08 N1/H1/L1 Micrologic	320	6.3	8	10	12.5	16	20	12	12	15	18.75	24	30	T	T	T	T	T	T
	400	6.3	8	10	12.5	16	20	12	12	15	18.75	24	30	T	T	T	T	T	T
	500		8	10	12.5	16	20		12	15	18.75	24	30		T	T	T	T	T
	630			10	12.5	16	20			15	18.75	24	30			T	T	T	T
Masterpact NW10 N1/H1/L1 Micrologic	400	6.3	8	10	12.5	16	20	12	12	15	18.75	24	30	T	T	T	T	T	T
	500		8	10	12.5	16	20		12	15	18.75	24	30		T	T	T	T	T
	630			10	12.5	16	20			15	18.75	24	30			T	T	T	T
	800				12.5	16	20				18.75	24	30				T	T	T
Masterpact NW12 N1/H1/L1 Micrologic	500		8	10	12.5	16	20		12	15	18.75	24	30		T	T	T	T	T
	630			10	12.5	16	20			15	18.75	24	30			T	T	T	T
	800				12.5	16	20				18.75	24	30				T	T	T
	1000					16	20					24	30					T	T
	1250						20						30						T
Masterpact NW16 N1/H1/L1 Micrologic	630			10	12.5	16	20			15	18.75	24	30			T	T	T	T
	800				12.5	16	20				18.75	24	30				T	T	T
	960					16	20					24	30					T	T
	1250						20						30						T
Masterpact NW20 N1/H1/L1 Micrologic	800				12.5	16	20				18.75	24	30				T	T	T
	1000					16	20					24	30					T	T
	1250						20						30						T
	1600																		
Masterpact NW08 H2 Micrologic	320	6.3	8	10	12.5	16	20	12	12	15	18.75	24	30	T	T	T	T	T	T
	400	6.3	8	10	12.5	16	20	12	12	15	18.75	24	30	T	T	T	T	T	T
	500		8	10	12.5	16	20		12	15	18.75	24	30		T	T	T	T	T
	630			10	12.5	16	20			15	18.75	24	30			T	T	T	T
Masterpact NW10 H2 Micrologic	400	6.3	8	10	12.5	16	20	12	12	15	18.75	24	30	T	T	T	T	T	T
	500		8	10	12.5	16	20		12	15	18.75	24	30		T	T	T	T	T
	630			10	12.5	16	20			15	18.75	24	30			T	T	T	T
	800				12.5	16	20				18.75	24	30				T	T	T
	1000					16	20					24	30					T	T
Masterpact NW12 H2 Micrologic	500		8	10	12.5	16	20		12	15	18.75	24	30		T	T	T	T	T
	630			10	12.5	16	20			15	18.75	24	30			T	T	T	T
	800				12.5	16	20				18.75	24	30				T	T	T
	1000					16	20					24	30					T	T
Masterpact NW16 H2 Micrologic	630			10	12.5	16	20			15	18.75	24	30			T	T	T	T
	800				12.5	16	20				18.75	24	30				T	T	T
	960					16	20					24	30					T	T
	1250						20						30						T
	1600																		
Masterpact NW20 H2 Micrologic	800				12.5	16	20				18.75	24	30				T	T	T
	1000					16	20					24	30					T	T
	1250						20						30						T
	1600																		

T Total discrimination, up to the breaking capacity of the downstream circuit breaker.

4 Discrimination limit = 4 kA.

□ No discrimination.

Note: respect the basic rules of discrimination, in terms of overload, short-circuit, see page 557E4300.indd/638, or check curves with Curve Direct software.

Discrimination table

Upstream: Masterpact NW08-20 H2 Micrologic

Downstream: Masterpact NW08-20

$U_e \leq 440 \text{ V AC}$

Upstream		Masterpact NW08/12/16/20 H2																	
Trip unit		Micrologic 2.0						Micrologic 5.0 - 6.0 - 7.0 Inst : 15 In						Micrologic 5.0 - 6.0 - 7.0 Inst : OFF					
Downstream	Rating (A)	800		1000	1250	1600	2000	800		1000	1250	1600	2000	800		1000	1250	1600	2000
	Setting Ir	630	800	1000	1250	1600	2000	630	800	1000	1250	1600	2000	630	800	1000	1250	1600	2000
Discrimination limit (kA)																			
Masterpact NW08 N1/H1/L1 Micrologic	320	6.3	8	10	12.5	16	20	12	12	15	18.75	24	30	T	T	T	T	T	T
	400	6.3	8	10	12.5	16	20	12	12	15	18.75	24	30	T	T	T	T	T	T
	500		8	10	12.5	16	20		12	15	18.75	24	30		T	T	T	T	T
	630			10	12.5	16	20			15	18.75	24	30			T	T	T	T
Masterpact NW10 N1/H1/L1 Micrologic	400	6.3	8	10	12.5	16	20	12	12	15	18.75	24	30	T	T	T	T	T	T
	500		8	10	12.5	16	20		12	15	18.75	24	30		T	T	T	T	T
	630			10	12.5	16	20			15	18.75	24	30			T	T	T	T
	800				12.5	16	20				18.75	24	30				T	T	T
Masterpact NW12 N1/H1/L1 Micrologic	500		8	10	12.5	16	20		12	15	18.75	24	30		T	T	T	T	T
	630			10	12.5	16	20			15	18.75	24	30			T	T	T	T
	800				12.5	16	20				18.75	24	30				T	T	T
	1000					16	20					24	30					T	T
Masterpact NW16 N1/H1/L1 Micrologic	630			10	12.5	16	20			15	18.75	24	30			T	T	T	T
	800				12.5	16	20				18.75	24	30				T	T	T
	960					16	20					24	30					T	T
	1250						20						30						T
Masterpact NW20 N1/H1/L1 Micrologic	800				12.5	16	20				18.75	24	30					T	T
	1000					16	20					24	30						T
	1250						20						30						T
	1600																		
Masterpact NW08 H2 Micrologic	320	6.3	8	10	12.5	16	20	12	12	15	18.75	24	30	82	82	82	82	82	82
	400	6.3	8	10	12.5	16	20	12	12	15	18.75	24	30	82	82	82	82	82	82
	500		8	10	12.5	16	20		12	15	18.75	24	30		82	82	82	82	82
	630			10	12.5	16	20			15	18.75	24	30			82	82	82	82
Masterpact NW10 H2 Micrologic	400	6.3	8	10	12.5	16	20	12	12	15	18.75	24	30	82	82	82	82	82	82
	500		8	10	12.5	16	20		12	15	18.75	24	30		82	82	82	82	82
	630			10	12.5	16	20			15	18.75	24	30			82	82	82	82
	800				12.5	16	20				18.75	24	30				82	82	82
Masterpact NW12 H2 Micrologic	500		8	10	12.5	16	20		12	15	18.75	24	30		82	82	82	82	82
	630			10	12.5	16	20			15	18.75	24	30			82	82	82	82
	800				12.5	16	20				18.75	24	30				82	82	82
	1000					16	20					24	30					82	82
Masterpact NW16 H2 Micrologic	630			10	12.5	16	20			15	18.75	24	30		82	82	82	82	82
	800				12.5	16	20				18.75	24	30			82	82	82	82
	960					16	20					24	30				82	82	82
	1250						20						30					82	82
Masterpact NW20 H2 Micrologic	800				12.5	16	20				18.75	24	30				82	82	82
	1000					16	20					24	30					82	82
	1250						20						30						82
	1600																		82

T Total discrimination, up to the breaking capacity of the downstream circuit breaker.

4 Discrimination limit = 4 kA.

No discrimination.

Note: respect the basic rules of discrimination, in terms of overload, short-circuit, see page 557E4300.indd/638, or check curves with Curve Direct software.

Discrimination table

Upstream: Masterpact NW08-20 L1 Micrologic

Downstream: Compact NS630b-1600

Ue ≤ 440 V AC

Upstream		Masterpact NW08/12/16/20 L1																			
Trip unit		Micrologic 2.0						Micrologic 5.0 - 6.0 - 7.0 Inst : 15 In						Micrologic 5.0 - 6.0 - 7.0 Inst : OFF							
Downstream	Rating (A)	800		1000		1250		1600		2000		800		1000		1250		1600		2000	
	Setting Ir	630	800	1000	1250	1600	2000	630	800	1000	1250	1600	2000	630	800	1000	1250	1600	2000		
Discrimination limit (kA)																					
Compact NS630bN/H Micrologic	250	6.3	8	10	12.5	16	20	12	12	15	18.75	24	30	37	37	37	37	37	37	37	37
	320	6.3	8	10	12.5	16	20	12	12	15	18.75	24	30	37	37	37	37	37	37	37	37
	400	6.3	8	10	12.5	16	20	12	12	15	18.75	24	30	37	37	37	37	37	37	37	37
	500		8	10	12.5	16	20		12	15	18.75	24	30		37	37	37	37	37	37	37
Compact NS800N/H Micrologic	320	6.3	8	10	12.5	16	20	12	12	15	18.75	24	30	37	37	37	37	37	37	37	37
	400	6.3	8	10	12.5	16	20	12	12	15	18.75	24	30	37	37	37	37	37	37	37	37
	500		8	10	12.5	16	20		12	15	18.75	24	30		37	37	37	37	37	37	37
	630			10	12.5	16	20			15	18.75	24	30			37	37	37	37	37	37
Compact NS1000N/H Micrologic	400	6.3	8	10	12.5	16	20	12	12	15	18.75	24	30	37	37	37	37	37	37	37	37
	500		8	10	12.5	16	20		12	15	18.75	24	30		37	37	37	37	37	37	37
	630			10	12.5	16	20			15	18.75	24	30			37	37	37	37	37	37
	800				12.5	16	20				18.75	24	30				37	37	37	37	37
Compact NS1250N/H Micrologic	500		8	10	12.5	16	20		12	15	18.75	24	30		37	37	37	37	37	37	37
	630			10	12.5	16	20			15	18.75	24	30			37	37	37	37	37	37
	800				12.5	16	20				18.75	24	30				37	37	37	37	37
	1250					16	20					24	30					37	37	37	37
Compact NS1600N/H Micrologic	630			10	12.5	16	20			15	18.75	24	30			37	37	37	37	37	37
	800				12.5	16	20				18.75	24	30				37	37	37	37	37
	960					16	20					24	30					37	37	37	37
	1600						20						30								37
Compact NS630bL/LB Micrologic	250	6.3	8	10	T	T	T	T	T	T	T	T	T	T	T	T	T	T	T	T	T
	320	6.3	8	10	T	T	T	T	T	T	T	T	T	T	T	T	T	T	T	T	T
	400	6.3	8	10	T	T	T	T	T	T	T	T	T	T	T	T	T	T	T	T	T
	500		8	10	T	T	T		T	T	T	T	T	T		T	T	T	T	T	T
Compact NS800L/LB Micrologic	320	6.3	8	10	12.5	T	T	12	12	T	T	T	T	T	T	T	T	T	T	T	T
	400	6.3	8	10	12.5	T	T	12	12	T	T	T	T	T	T	T	T	T	T	T	T
	500		8	10	12.5	T	T		12	T	T	T	T	T		T	T	T	T	T	T
	630			10	12.5	T	T			T	T	T	T	T			T	T	T	T	T
Compact NS1000L Micrologic	400	6.3	8	10	12.5	T	T	12	12	T	T	T	T	T	T	T	T	T	T	T	T
	500		8	10	12.5	T	T		12	T	T	T	T	T		T	T	T	T	T	T
	630			10	12.5	T	T			T	T	T	T	T			T	T	T	T	T
	800				12.5	T	T				T	T	T	T				T	T	T	T
1000					T	T						T	T					T	T	T	T

- T Total discrimination, up to the breaking capacity of the downstream circuit breaker.
- 4 Discrimination limit = 4 kA.
- No discrimination.

Note: respect the basic rules of discrimination, in terms of overload, short-circuit, see page 557E4300.indd/638, or check curves with Curve Direct software.

Discrimination table

Upstream: Masterpact NW08-20 H2 Micrologic

Downstream: Masterpact NW08-20

Ue ≤ 440 V AC

Upstream		Masterpact NW08/12/16/20 H2																			
Trip unit		Micrologic 2.0						Micrologic 5.0 - 6.0 - 7.0 Inst : 15 In						Micrologic 5.0 - 6.0 - 7.0 Inst : OFF							
Downstream	Rating (A)	800		1000		1250		1600		2000		800		1000		1250		1600		2000	
	Setting Ir	630	800	1000	1250	1600	2000	630	800	1000	1250	1600	2000	630	800	1000	1250	1600	2000		
Discrimination limit (kA)																					
Masterpact NW08 N1/H1/L1 Micrologic	320	6.3	8	10	12.5	16	20	12	12	15	18.75	24	30	T	T	T	T	T	T	T	
	400	6.3	8	10	12.5	16	20	12	12	15	18.75	24	30	T	T	T	T	T	T	T	
	500		8	10	12.5	16	20		12	15	18.75	24	30		T	T	T	T	T	T	
	630			10	12.5	16	20			15	18.75	24	30			T	T	T	T	T	
Masterpact NW10 N1/H1/L1 Micrologic	400	6.3	8	10	12.5	16	20	12	12	15	18.75	24	30	T	T	T	T	T	T	T	
	500		8	10	12.5	16	20		12	15	18.75	24	30		T	T	T	T	T	T	
	630			10	12.5	16	20			15	18.75	24	30			T	T	T	T	T	
	800				12.5	16	20				18.75	24	30				T	T	T	T	
Masterpact NW12 N1/H1/L1 Micrologic	500		8	10	12.5	16	20		12	15	18.75	24	30		T	T	T	T	T	T	
	630			10	12.5	16	20			15	18.75	24	30			T	T	T	T	T	
	800				12.5	16	20				18.75	24	30				T	T	T	T	
	1000					16	20					24	30					T	T	T	
Masterpact NW16 N1/H1/L1 Micrologic	630			10	12.5	16	20			15	18.75	24	30			T	T	T	T	T	
	800				12.5	16	20				18.75	24	30				T	T	T	T	
	960					16	20					24	30					T	T	T	
	1250						20						30							T	
Masterpact NW20 N1/H1/L1 Micrologic	800				12.5	16	20				18.75	24	30				T	T	T	T	
	1000					16	20					24	30					T	T	T	
	1250						20						30							T	
	1600																				
Masterpact NW08 H2 Micrologic	320	6.3	8	10	12.5	16	20	12	12	15	18.75	24	30	82	82	82	82	82	82	82	
	400	6.3	8	10	12.5	16	20	12	12	15	18.75	24	30	82	82	82	82	82	82	82	
	500		8	10	12.5	16	20		12	15	18.75	24	30		82	82	82	82	82	82	
	630			10	12.5	16	20			15	18.75	24	30			82	82	82	82	82	
Masterpact NW10 H2 Micrologic	400	6.3	8	10	12.5	16	20	12	12	15	18.75	24	30	82	82	82	82	82	82	82	
	500		8	10	12.5	16	20		12	15	18.75	24	30		82	82	82	82	82	82	
	630			10	12.5	16	20			15	18.75	24	30			82	82	82	82	82	
	800				12.5	16	20				18.75	24	30				82	82	82	82	
Masterpact NW12 H2 Micrologic	500		8	10	12.5	16	20		12	15	18.75	24	30		82	82	82	82	82	82	
	630			10	12.5	16	20			15	18.75	24	30			82	82	82	82	82	
	800				12.5	16	20				18.75	24	30				82	82	82	82	
	1000					16	20					24	30					82	82	82	
Masterpact NW16 H2 Micrologic	630			10	12.5	16	20			15	18.75	24	30			82	82	82	82	82	
	800				12.5	16	20				18.75	24	30				82	82	82	82	
	960					16	20					24	30					82	82	82	
	1250						20						30							82	
Masterpact NW20 H2 Micrologic	800				12.5	16	20				18.75	24	30				82	82	82	82	
	1000					16	20					24	30					82	82	82	
	1250						20						30							82	
	1600																				

- T Total discrimination, up to the breaking capacity of the downstream circuit breaker.
- 4 Discrimination limit = 4 kA.
- No discrimination.

Note: respect the basic rules of discrimination, in terms of overload, short-circuit, see page 557E4300.indd/638, or check curves with Curve Direct software.

Discrimination table

Upstream: Masterpact NW08-20 L1 Micrologic

Downstream: Compact NS630b-1600

$U_e \leq 440 \text{ V AC}$

Upstream		Masterpact NW08/12/16/20 L1																			
Trip unit		Micrologic 2.0						Micrologic 5.0 - 6.0 - 7.0 Inst : 15 In						Micrologic 5.0 - 6.0 - 7.0 Inst : OFF							
Downstream	Rating (A)	800		1000		1250		1600		2000		800		1000		1250		1600		2000	
	Setting I _r	630	800	1000	1250	1600	2000	630	800	1000	1250	1600	2000	630	800	1000	1250	1600	2000		
Discrimination limit (kA)																					
Compact NS630bN/H Micrologic	250	6.3	8	10	12.5	16	20	12	12	15	18.75	24	30	37	37	37	37	37	37	37	
	320	6.3	8	10	12.5	16	20	12	12	15	18.75	24	30	37	37	37	37	37	37	37	
	400	6.3	8	10	12.5	16	20	12	12	15	18.75	24	30	37	37	37	37	37	37	37	
	500		8	10	12.5	16	20		12	15	18.75	24	30		37	37	37	37	37	37	
	630			10	12.5	16	20			15	18.75	24	30			37	37	37	37	37	
Compact NS800N/H Micrologic	320	6.3	8	10	12.5	16	20	12	12	15	18.75	24	30	37	37	37	37	37	37	37	
	400	6.3	8	10	12.5	16	20	12	12	15	18.75	24	30	37	37	37	37	37	37	37	
	500		8	10	12.5	16	20		12	15	18.75	24	30		37	37	37	37	37	37	
	630			10	12.5	16	20			15	18.75	24	30			37	37	37	37	37	
	800				12.5	16	20				18.75	24	30			37	37	37	37	37	
Compact NS1000N/H Micrologic	400	6.3	8	10	12.5	16	20	12	12	15	18.75	24	30	37	37	37	37	37	37	37	
	500		8	10	12.5	16	20		12	15	18.75	24	30		37	37	37	37	37	37	
	630			10	12.5	16	20			15	18.75	24	30			37	37	37	37	37	
	800				12.5	16	20				18.75	24	30				37	37	37	37	
	1000					16	20					24	30					37	37	37	
Compact NS1250N/H Micrologic	500		8	10	12.5	16	20		12	15	18.75	24	30		37	37	37	37	37	37	
	630			10	12.5	16	20			15	18.75	24	30			37	37	37	37	37	
	800				12.5	16	20				18.75	24	30				37	37	37	37	
	1000					16	20					24	30					37	37	37	
	1250						20						30							37	
Compact NS1600N/H Micrologic	630			10	12.5	16	20			15	18.75	24	30			37	37	37	37	37	
	800				12.5	16	20				18.75	24	30				37	37	37	37	
	960					16	20					24	30					37	37	37	
	1250						20						30							37	
	1600												30							37	
Compact NS630bL/LB Micrologic	250	6.3	8	10	T	T	T	T	T	T	T	T	T	T	T	T	T	T	T	T	
	320	6.3	8	10	T	T	T	T	T	T	T	T	T	T	T	T	T	T	T	T	
	400	6.3	8	10	T	T	T	T	T	T	T	T	T	T	T	T	T	T	T	T	
	500		8	10	T	T	T	T	T	T	T	T	T	T	T	T	T	T	T	T	
	630			10	T	T	T			T	T	T	T			T	T	T	T	T	
Compact NS800L/LB Micrologic	320	6.3	8	10	12.5	T	T	12	12	T	T	T	T	T	T	T	T	T	T	T	
	400	6.3	8	10	12.5	T	T	12	12	T	T	T	T	T	T	T	T	T	T	T	
	500		8	10	12.5	T	T		12	T	T	T	T	T		T	T	T	T	T	
	630			10	12.5	T	T			T	T	T	T	T		T	T	T	T	T	
	800				12.5	T	T				T	T	T			T	T	T	T	T	
Compact NS1000L Micrologic	400	6.3	8	10	12.5	T	T	12	12	T	T	T	T	T	T	T	T	T	T	T	
	500		8	10	12.5	T	T		12	T	T	T	T	T		T	T	T	T	T	
	630			10	12.5	T	T			T	T	T	T			T	T	T	T	T	
	800				12.5	T	T				T	T	T				T	T	T	T	
	1000					T	T					T	T					T	T	T	

- T Total discrimination, up to the breaking capacity of the downstream circuit breaker.
- 4 Discrimination limit = 4 kA.
- No discrimination.

Note: respect the basic rules of discrimination, in terms of overload, short-circuit, see page 557E4300.indd/638, or check curves with Curve Direct software.

Discrimination table

Upstream: Masterpact NW25-40 H1/H2,
Masterpact NW40b-63 H1 Micrologic
Downstream: iDPN, iC60, C120, NG125-160,
Compact NSX100-630, NS630b-3200

U_e ≤ 440 V AC

Upstream	Masterpact NW25/32/40 H1/H2	Masterpact NW40b 50/63 H1	Masterpact NW25/32/40 H1/H2	Masterpact NW40b 50/6 3H1	Masterpact NW25/32/40 H1/H2	Masterpact NW40b 50/63 H1
Trip unit	Micrologic 2.0		Micrologic 5.0 - 6.0 - 7.0 Inst : 15 In		Micrologic 5.0 - 6.0 - 7.0 Inst : OFF	

Downstream	Rating (A)	2500	3200	4000	4000	5000	6300	2500	3200	4000	4000	5000	6300	2500	3200	4000	4000	5000	6300
Discrimination limit (kA)																			
iDPN, iDPNN		T	T	T	T	T	T	T	T	T	T	T	T	T	T	T	T	T	T
iC60		T	T	T	T	T	T	T	T	T	T	T	T	T	T	T	T	T	T
C120N/H		T	T	T	T	T	T	T	T	T	T	T	T	T	T	T	T	T	T
NG125N/H/L		T	T	T	T	T	T	T	T	T	T	T	T	T	T	T	T	T	T
NG160E/N/H		T	T	T	T	T	T	T	T	T	T	T	T	T	T	T	T	T	T
Compact NSX B/F/H/N/S/L/R TM-D	NSX100	T	T	T	T	T	T	T	T	T	T	T	T	T	T	T	T	T	T
	NSX250	T	T	T	T	T	T	T	T	T	T	T	T	T	T	T	T	T	T
Compact NSX160 B/F/H/N/S/L TM-D		T	T	T	T	T	T	T	T	T	T	T	T	T	T	T	T	T	T
Compact NSX B/F/H/N/S/L/R Micrologic	NSX100	T	T	T	T	T	T	T	T	T	T	T	T	T	T	T	T	T	T
	NSX250	T	T	T	T	T	T	T	T	T	T	T	T	T	T	T	T	T	T
F/H/N/S/L/R Micrologic	NSX400	T	T	T	T	T	T	T	T	T	T	T	T	T	T	T	T	T	T
	NSX630	T	T	T	T	T	T	T	T	T	T	T	T	T	T	T	T	T	T
Compact NSX160 B/F/H/N/S/L Micrologic		T	T	T	T	T	T	T	T	T	T	T	T	T	T	T	T	T	T
Compact NS N Micrologic	NS630b	25	32	40	40	T	T	37.5	48	T	T	T	T	T	T	T	T	T	T
	NS800	25	32	40	40	T	T	37.5	48	T	T	T	T	T	T	T	T	T	T
	NS1000	25	32	40	40	T	T	37.5	48	T	T	T	T	T	T	T	T	T	T
	NS1250	25	32	40	40	T	T	37.5	48	T	T	T	T	T	T	T	T	T	T
	NS1600	25	32	40	40	T	T	37.5	48	T	T	T	T	T	T	T	T	T	T
Compact NS H Micrologic	NS630b	25	32	40	40	50	63	37.5	48	60	60	T	T	T	T	T	T	T	T
	NS800	25	32	40	40	50	63	37.5	48	60	60	T	T	T	T	T	T	T	T
	NS1000	25	32	40	40	50	63	37.5	48	60	60	T	T	T	T	T	T	T	T
	NS1250	25	32	40	40	50	63	37.5	48	60	60	T	T	T	T	T	T	T	T
	NS1600	25	32	40	40	50	63	37.5	48	60	60	T	T	T	T	T	T	T	T
Compact NS N Micrologic	NS1600b	25	32	40	40	50	63	37.5	48	60	60	T	T	T	T	T	T	T	T
	NS2000	25	32	40	40	50	63	37.5	48	60	60	T	T	T	T	T	T	T	T
	NS2500	25 ⁽¹⁾	32	40	40	50	63	37,5 ⁽¹⁾	48	60	60	T	T	T ⁽¹⁾	T	T	T	T	T
	NS3200		32 ⁽¹⁾	40	40	50	63		48 ⁽¹⁾	60	60	T	T		T ⁽¹⁾	T	T	T	T
Compact NS H Micrologic	NS1600b	25	32	40	40	50	63	37,5	48	60	60	75	T	T	T	T	T	T	T
	NS2000	25	32	40	40	50	63	37,5	48	60	60	75	T	T	T	T	T	T	T
	NS2500	25 ⁽¹⁾	32	40	40	50	63	37,5 ⁽¹⁾	48	60	60	75	T	T ⁽¹⁾	T	T	T	T	T
	NS3200		32 ⁽¹⁾	40	40	50	63		48 ⁽¹⁾	60	60	75	T		T ⁽¹⁾	T	T	T	T
Compact NS L Micrologic	NS630b	T	T	T	T	T	T	T	T	T	T	T	T	T	T	T	T	T	T
	NS800	T	T	T	T	T	T	T	T	T	T	T	T	T	T	T	T	T	T
	NS1000	T	T	T	T	T	T	T	T	T	T	T	T	T	T	T	T	T	T
Compact NS LB Micrologic	NS630b	T	T	T	T	T	T	T	T	T	T	T	T	T	T	T	T	T	T
	NS800	T	T	T	T	T	T	T	T	T	T	T	T	T	T	T	T	T	T

(1) With I_r upstream > 1,3 I_r downstream.

T Total discrimination, up to the breaking capacity of the downstream circuit breaker.

4 Discrimination limit = 4 kA.

No discrimination.

Note: respect the basic rules of discrimination, in terms of overload, short-circuit, see page 557E4300.indd/638, or check curves with Curve Direct software.

Discrimination table

Upstream: Masterpact NW25-40 H1 Micrologic

Downstream: Masterpact NT06-16,

Masterpact NW08-20

$U_e \leq 440 \text{ V AC}$

Upstream		Masterpact NW25/32/40 H1								
Trip unit		Micrologic 2.0			Micrologic 5.0 - 6.0 - 7.0 Inst : 15 In			Micrologic 5.0 - 6.0 - 7.0 Inst : OFF		
Downstream	Rating (kA)	2500	3200	4000	2500	3200	4000	2500	3200	4000
Discrimination limit (A)										
Masterpact NT H1 Micrologic	NT06	25	32	40	37.5	T	T	T	T	T
	NT08	25	32	40	37.5	T	T	T	T	T
	NT10	25	32	40	37.5	T	T	T	T	T
	NT12	25	32	40	37.5	T	T	T	T	T
	NT16	25	32	40	37.5	T	T	T	T	T
Masterpact NT H2 Micrologic	NT06	25	32	40	37.5	48	T	T	T	T
	NT08	25	32	40	37.5	48	T	T	T	T
	NT10	25	32	40	37.5	48	T	T	T	T
	NT12	25	32	40	37.5	48	T	T	T	T
	NT16	25	32	40	37.5	48	T	T	T	T
Masterpact NW N1 Micrologic	NW08	25	32	40	37.5	T	T	T	T	T
	NW10	25	32	40	37.5	T	T	T	T	T
	NW12	25	32	40	37.5	T	T	T	T	T
	NW16	25	32	40	37.5	T	T	T	T	T
Masterpact NW H1 Micrologic	NW08	25	32	40	37.5	48	60	T	T	T
	NW10	25	32	40	37.5	48	60	T	T	T
	NW12	25	32	40	37.5	48	60	T	T	T
	NW16	25	32	40	37.5	48	60	T	T	T
	NW20	25	32	40	37.5	48	60	T	T	T
	NW25	25 ⁽¹⁾	32	40	37,5 ⁽¹⁾	48	60	T ⁽¹⁾	T	T
Masterpact NW H2 Micrologic	NW08	25	32 ⁽¹⁾	40		48 ⁽¹⁾	60		T ⁽¹⁾	T
	NW10	25	32	40	37,5	48	60	T	T	T
	NW12	25	32	40	37,5	48	60	T	T	T
	NW16	25	32	40	37,5	48	60	T	T	T
	NW20	25	32	40	37,5	48	60	T	T	T
	NW25	25 ⁽¹⁾	32	40	37,5 ⁽¹⁾	48	60	T ⁽¹⁾	T	T
Masterpact NW H3 Micrologic	NW08	25	32 ⁽¹⁾	40		48 ⁽¹⁾	60		T ⁽¹⁾	T
	NW10	25	32	40	37,5	48	60	T	T	T
	NW12	25	32	40	37,5	48	60	T	T	T
	NW16	25	32	40	37,5	48	60	T	T	T
Masterpact NT L1 Micrologic	NT06	T	T	T	T	T	T	T	T	T
	NT08	T	T	T	T	T	T	T	T	T
	NT10	T	T	T	T	T	T	T	T	T
Masterpact NW L1 Micrologic	NW08	25	32	40	37.5	48	60	T	T	T
	NW10	25	32	40	37.5	48	60	T	T	T
	NW12	25	32	40	37.5	48	60	T	T	T
	NW16	25	32	40	37.5	48	60	T	T	T
Masterpact NW L1 Micrologic	NW20	25	32	40	37.5	48	60	T	T	T

⁽¹⁾ With I_r upstream > 1,3 I_r downstream.

Total discrimination, up to the breaking capacity of the downstream circuit breaker.

Discrimination limit = 4 kA.

No discrimination.

Note: respect the basic rules of discrimination, in terms of overload, short-circuit, see page 557E4300.indd/638, or check curves with Curve Direct software.

Discrimination table

Upstream: Masterpact NW25-40 H2,
Masterpact NW40b-63 H1 Micrologic
Downstream: Masterpact NT06-16,
Masterpact NW08-50

$U_e \leq 440 \text{ V AC}$

Upstream	Masterpact NW25/32/40 H2	Masterpact NW40b 50/63 H1	Masterpact NW25/32/40 H2	Masterpact NW40b 50/63 H1	Masterpact NW25/32/40 H2	Masterpact NW40b 50/63 H1
Trip unit	Micrologic 2.0		Micrologic 5.0 - 6.0 - 7.0 Inst : 15 In		Micrologic 5.0 - 6.0 - 7.0 Inst : OFF	

Downstream	Rating (A)	2500	3200	4000	4000	5000	6300	2500	3200	4000	4000	5000	6300	2500	3200	4000	4000	5000	6300
Discrimination limit (kA)																			
Masterpact NT H1 Micrologic	NT06	25	32	40	40	T	T	37.5	T	T	T	T	T	T	T	T	T	T	T
	NT08	25	32	40	40	T	T	37.5	T	T	T	T	T	T	T	T	T	T	T
	NT10	25	32	40	40	T	T	37.5	T	T	T	T	T	T	T	T	T	T	T
	NT12	25	32	40	40	T	T	37.5	T	T	T	T	T	T	T	T	T	T	T
Masterpact NT H2 Micrologic	NT06	25	32	40	40	T	T	37.5	48	T	T	T	T	T	T	T	T	T	T
	NT08	25	32	40	40	T	T	37.5	48	T	T	T	T	T	T	T	T	T	T
	NT10	25	32	40	40	T	T	37.5	48	T	T	T	T	T	T	T	T	T	T
	NT12	25	32	40	40	T	T	37.5	48	T	T	T	T	T	T	T	T	T	T
Masterpact NW N1 Micrologic	NW08	25	32	40	40	T	T	37.5	T	T	T	T	T	T	T	T	T	T	T
	NW10	25	32	40	40	T	T	37.5	T	T	T	T	T	T	T	T	T	T	T
	NW12	25	32	40	40	T	T	37.5	T	T	T	T	T	T	T	T	T	T	T
	NW16	25	32	40	40	T	T	37.5	T	T	T	T	T	T	T	T	T	T	T
Masterpact NW H1 Micrologic	NW08	25	32	40	40	50	63	37.5	48	60	60	T	T	T	T	T	T	T	T
	NW10	25	32	40	40	50	63	37.5	48	60	60	T	T	T	T	T	T	T	T
	NW12	25	32	40	40	50	63	37.5	48	60	60	T	T	T	T	T	T	T	T
	NW16	25	32	40	40	50	63	37.5	48	60	60	T	T	T	T	T	T	T	T
	NW20	25	32	40	40	50	63	37.5	48	60	60	T	T	T	T	T	T	T	T
	NW25	25 ⁽¹⁾	32	40	40	50	63	37.5 ⁽¹⁾	48	60	60	T	T	T ⁽¹⁾	T	T	T	T	T
Masterpact NW H2 Micrologic	NW32		32 ⁽¹⁾	40	40	50	63		48 ⁽¹⁾	60	60	T	T		T ⁽¹⁾	T	T	T	T
	NW40			40 ⁽¹⁾	40 ⁽¹⁾	50	63			60 ⁽¹⁾	60	T	T			T ⁽¹⁾	T ⁽¹⁾	T	T
	NW08	25	32	40	40	50	63	37.5	48	60	60	75	94	82	82	82	T	T	T
	NW10	25	32	40	40	50	63	37.5	48	60	60	75	94	82	82	82	T	T	T
	NW12	25	32	40	40	50	63	37.5	48	60	60	75	94	82	82	82	T	T	T
	NW16	25	32	40	40	50	63	37.5	48	60	60	75	94	82	82	82	T	T	T
Masterpact NW H1	NW20	25	32	40	40	50	63	37.5	48	60	60	75	94	82	82	82	T	T	T
	NW25	25 ⁽¹⁾	32	40	40	50	63	37.5 ⁽¹⁾	48	60	60	75	94	82 ⁽¹⁾	82	82	T	T	T
	NW32		32 ⁽¹⁾	40	40	50	63		48 ⁽¹⁾	60	60	75	94		82 ⁽¹⁾	82	T	T	T
	NW40			40 ⁽¹⁾	40 ⁽¹⁾	50	63			60 ⁽¹⁾	60	75	94			82 ⁽¹⁾	T ⁽¹⁾	T	T
	NW40b			40 ⁽¹⁾	40 ⁽¹⁾	50	63			60 ⁽¹⁾	60 ⁽¹⁾	75	94			T ⁽¹⁾	T ⁽¹⁾	T	T
	NW50					50 ⁽¹⁾	63					75 ⁽¹⁾	94				T ⁽¹⁾	T	
Masterpact NW H3 Micrologic	NW20	25	32	40	40	50	63	37.5	48	60	60	75	94	82	82	82	T	T	T
	NW25	25 ⁽¹⁾	32	40	40	50	63	37.5 ⁽¹⁾	48	60	60	75	94	82 ⁽¹⁾	82	82	T	T	T
	NW32		32 ⁽¹⁾	40	40	50	63		48 ⁽¹⁾	60	60	75	94		82 ⁽¹⁾	82	T	T	T
	NW40			40 ⁽¹⁾	40 ⁽¹⁾	50	63			60 ⁽¹⁾		75	94			82 ⁽¹⁾	T ⁽¹⁾	T	T
Masterpact NW H2	NW40b				40 ⁽¹⁾	50	63			60 ⁽¹⁾	60 ⁽¹⁾	75	94			T ⁽¹⁾	T ⁽¹⁾	T	T
	NW50					50 ⁽¹⁾	63					75 ⁽¹⁾	94				T ⁽¹⁾	T	
Masterpact NT L1 Micrologic	NT06	T	T	T	T	T	T	T	T	T	T	T	T	T	T	T	T	T	T
	NT08	T	T	T	T	T	T	T	T	T	T	T	T	T	T	T	T	T	T
	NT10	T	T	T	T	T	T	T	T	T	T	T	T	T	T	T	T	T	T
Masterpact NW L1 Micrologic	NW08	25	32	40	40	50	63	37.5	48	60	60	75	94	T	T	T	T	T	T
	NW10	25	32	40	40	50	63	37.5	48	60	60	75	94	T	T	T	T	T	T
	NW12	25	32	40	40	50	63	37.5	48	60	60	75	94	T	T	T	T	T	T
	NW16	25	32	40	40	50	63	37.5	48	60	60	75	94	T	T	T	T	T	T
NW20	25	32	40	40	50	63	37.5	48	60	60	75	94	T	T	T	T	T	T	

⁽¹⁾ With I_r upstream $> 1,3 I_r$ downstream.

- T Total discrimination, up to the breaking capacity of the downstream circuit breaker.
- 4 Discrimination limit = 4 kA.
- No discrimination.

Note: respect the basic rules of discrimination, in terms of overload, short-circuit, see page 557E4300.indd/638, or check curves with Curve Direct software.

Discrimination table

Upstream: Masterpact NW20-40 H3, Masterpact
NW40b-63 H2 Micrologic

Downstream: iDPN, iC60, C120, NG125-160,

Compact NSX100-630, NS630b-3200

$U_e \leq 440 \text{ V AC}$

Upstream	Masterpact NW20/25/32/40 H3						Masterpact NW40b 50/63 H2						Masterpact NW20/25/32/40 H3						Masterpact NW40b 50/63 H2																	
	Micrologic 2.0												Micrologic 5.0 - 6.0 - 7.0 Inst : 15 In												Micrologic 5.0 - 6.0 - 7.0 Inst : OFF											
Trip unit	Micrologic 2.0												Micrologic 5.0 - 6.0 - 7.0 Inst : 15 In												Micrologic 5.0 - 6.0 - 7.0 Inst : OFF											
Downstream Rating (A)	2000	2500	3200	4000	4000	5000	6300	2000	2500	3200	4000	4000	5000	6300	2000	2500	3200	4000	4000	5000	6300	2000	2500	3200	4000	4000	5000	6300								
Discrimination limit (kA)																																				
iDPN, iDPNN	T	T	T	T	T	T	T	T	T	T	T	T	T	T	T	T	T	T	T	T	T	T	T	T	T	T	T	T								
iC60	T	T	T	T	T	T	T	T	T	T	T	T	T	T	T	T	T	T	T	T	T	T	T	T	T	T	T	T								
C120N/H	T	T	T	T	T	T	T	T	T	T	T	T	T	T	T	T	T	T	T	T	T	T	T	T	T	T	T	T								
NG125N/H/L	T	T	T	T	T	T	T	T	T	T	T	T	T	T	T	T	T	T	T	T	T	T	T	T	T	T	T	T								
NG160E/N/H	T	T	T	T	T	T	T	T	T	T	T	T	T	T	T	T	T	T	T	T	T	T	T	T	T	T	T	T								
Compact NSX100 B/F/H/N/S/L/R TM-D	NSX100	T	T	T	T	T	T	T	T	T	T	T	T	T	T	T	T	T	T	T	T	T	T	T	T	T	T	T								
	NSX250	T	T	T	T	T	T	T	T	T	T	T	T	T	T	T	T	T	T	T	T	T	T	T	T	T	T	T								
Compact NSX160 B/F/H/N/S/L TM-D	T	T	T	T	T	T	T	T	T	T	T	T	T	T	T	T	T	T	T	T	T	T	T	T	T	T	T	T								
Compact B/F/H/N/S/L/R Micrologic	NSX100	T	T	T	T	T	T	T	T	T	T	T	T	T	T	T	T	T	T	T	T	T	T	T	T	T	T	T								
	NSX250	T	T	T	T	T	T	T	T	T	T	T	T	T	T	T	T	T	T	T	T	T	T	T	T	T	T	T								
Compact NSX160 B/F/H/N/S/L Micrologic	T	T	T	T	T	T	T	T	T	T	T	T	T	T	T	T	T	T	T	T	T	T	T	T	T	T	T	T								
Compact F/H/N/S/L/R	NSX400	T	T	T	T	T	T	T	T	T	T	T	T	T	T	T	T	T	T	T	T	T	T	T	T	T	T	T								
	NSX630	T	T	T	T	T	T	T	T	T	T	T	T	T	T	T	T	T	T	T	T	T	T	T	T	T	T	T								
Compact N Micrologic	NS630b	20	25	32	40	40	T	T	30	37.5	48	T	T	T	T	T	T	T	T	T	T	T	T	T	T	T	T	T								
	NS800	20	25	32	40	40	T	T	30	37.5	48	T	T	T	T	T	T	T	T	T	T	T	T	T	T	T	T	T								
	NS1000	20	25	32	40	40	T	T	30	37.5	48	T	T	T	T	T	T	T	T	T	T	T	T	T	T	T	T	T								
	NS1250	20	25	32	40	40	T	T	30	37.5	48	T	T	T	T	T	T	T	T	T	T	T	T	T	T	T	T	T								
	NS1600	20	25	32	40	40	T	T	30	37.5	48	T	T	T	T	T	T	T	T	T	T	T	T	T	T	T	T	T								
Compact H Micrologic	NS630b	20	25	32	40	40	50	63	30	37.5	48	60	60	T	T	65	65	65	65	T	T	T	T	T	T	T	T	T	T							
	NS800	20	25	32	40	40	50	63	30	37.5	48	60	60	T	T	65	65	65	65	T	T	T	T	T	T	T	T	T	T							
	NS1000	20	25	32	40	40	50	63	30	37.5	48	60	60	T	T	65	65	65	65	T	T	T	T	T	T	T	T	T	T							
	NS1250	20	25	32	40	40	50	63	30	37.5	48	60	60	T	T	65	65	65	65	T	T	T	T	T	T	T	T	T	T							
	NS1600	20	25	32	40	40	50	63	30	37.5	48	60	60	T	T	65	65	65	65	T	T	T	T	T	T	T	T	T	T							
Compact N Micrologic	NS1600b	20	25	32	40	40	50	63	30	37.5	48	60	60	T	T	65	65	65	65	T	T	T	T	T	T	T	T	T	T							
	NS2000	20 ⁽¹⁾	25	32	40	40	50	63	30 ⁽¹⁾	37.5	48	60	60	T	T	65 ⁽¹⁾	65	65	65	T	T	T	T	T	T	T	T	T	T							
	NS2500		25 ⁽¹⁾	32	40	40	50	63		37.5 ⁽¹⁾	48	60	60	T	T		65 ⁽¹⁾	65	65	T	T	T	T	T	T	T	T	T	T							
	NS3200			32 ⁽¹⁾	40	40	50	63			48 ⁽¹⁾	60	60	T	T			65 ⁽¹⁾	65	T	T	T	T	T	T	T	T	T	T							
Compact H Micrologic	NS1600b	20	25	32	40	40	50	63	30	37.5	48	60	60	75	T	65	65	65	65	T	T	T	T	T	T	T	T	T	T							
	NS2000	20 ⁽¹⁾	25	32	40	40	50	63	30 ⁽¹⁾	37.5	48	60	60	75	T	65 ⁽¹⁾	65	65	65	T	T	T	T	T	T	T	T	T	T							
	NS2500		25 ⁽¹⁾	32	40	40	50	63		37.5 ⁽¹⁾	48	60	60	75	T		65 ⁽¹⁾	65	65	T	T	T	T	T	T	T	T	T	T							
	NS3200			32 ⁽¹⁾	40	40	50	63			48 ⁽¹⁾	60	60	75	T			65 ⁽¹⁾	65	T	T	T	T	T	T	T	T	T	T							
Compact L Micrologic	NS630b	T	T	T	T	T	T	T	T	T	T	T	T	T	T	T	T	T	T	T	T	T	T	T	T	T	T	T								
	NS800	T	T	T	T	T	T	T	T	T	T	T	T	T	T	T	T	T	T	T	T	T	T	T	T	T	T	T								
	NS1000	T	T	T	T	T	T	T	T	T	T	T	T	T	T	T	T	T	T	T	T	T	T	T	T	T	T	T								
Compact LB Micrologic	NS630b	T	T	T	T	T	T	T	T	T	T	T	T	T	T	T	T	T	T	T	T	T	T	T	T	T	T	T								
	NS800	T	T	T	T	T	T	T	T	T	T	T	T	T	T	T	T	T	T	T	T	T	T	T	T	T	T	T								

(1) With I_r upstream > 1,3 I_r downstream.

Total discrimination, up to the breaking capacity of the downstream circuit breaker.

4 Discrimination limit = 4 kA.

No discrimination.

Discrimination table

Upstream: Masterpact NW20-40 H3,
 Masterpact NW40b-63 H2 Micrologic
 Downstream: Masterpact NT06-16,
 Masterpact NW08-50

$U_e \leq 440 \text{ V AC}$

Upstream		Masterpact NW20/25/32/40 H3				Masterpact NW40b 50/63 H2				Masterpact NW20/25/32/40 H3				Masterpact NW40b 50/63 H2				Masterpact NW20/25/32/40 H3				Masterpact NW40b 50/63 H2							
Trip unit		Micrologic 2.0								Micrologic 5.0 - 6.0 - 7.0 Inst : 15 In								Micrologic 5.0 - 6.0 - 7.0 Inst : OFF											
Downstream	Rating (A)	2000	2500	3200	4000	4000	5000	6300	2000	2500	3200	4000	4000	5000	6300	2000	2500	3200	4000	4000	5000	6300	2000	2500	3200	4000	4000	5000	6300
Discrimination limit (kA)																													
Masterpact NT H1 Micrologic	NT06	20	25	32	40	40	T	T	30	37.5	T	T	T	T	T	T	T	T	T	T	T	T	T	T	T	T	T	T	
	NT08	20	25	32	40	40	T	T	30	37.5	T	T	T	T	T	T	T	T	T	T	T	T	T	T	T	T	T	T	
	NT10	20	25	32	40	40	T	T	30	37.5	T	T	T	T	T	T	T	T	T	T	T	T	T	T	T	T	T	T	
	NT12	20	25	32	40	40	T	T	30	37.5	T	T	T	T	T	T	T	T	T	T	T	T	T	T	T	T	T	T	
Masterpact NT H2 Micrologic	NT06	20	25	32	40	40	T	T	30	37.5	48	T	T	T	T	T	T	T	T	T	T	T	T	T	T	T	T	T	
	NT08	20	25	32	40	40	T	T	30	37.5	48	T	T	T	T	T	T	T	T	T	T	T	T	T	T	T	T	T	
	NT10	20	25	32	40	40	T	T	30	37.5	48	T	T	T	T	T	T	T	T	T	T	T	T	T	T	T	T	T	
	NT12	20	25	32	40	40	T	T	30	37.5	48	T	T	T	T	T	T	T	T	T	T	T	T	T	T	T	T	T	
Masterpact NW N1 Micrologic	NW08	20	25	32	40	40	T	T	30	37.5	T	T	T	T	T	T	T	T	T	T	T	T	T	T	T	T	T	T	
	NW10	20	25	32	40	40	T	T	30	37.5	T	T	T	T	T	T	T	T	T	T	T	T	T	T	T	T	T	T	
	NW12	20	25	32	40	40	T	T	30	37.5	T	T	T	T	T	T	T	T	T	T	T	T	T	T	T	T	T	T	
	NW16	20	25	32	40	40	T	T	30	37.5	T	T	T	T	T	T	T	T	T	T	T	T	T	T	T	T	T	T	
Masterpact NW H1 Micrologic	NW08	20	25	32	40	40	50	63	30	37.5	48	60	60	T	T	T	T	T	T	T	T	T	T	T	T	T	T	T	
	NW10	20	25	32	40	40	50	63	30	37.5	48	60	60	T	T	T	T	T	T	T	T	T	T	T	T	T	T	T	
	NW12	20	25	32	40	40	50	63	30	37.5	48	60	60	T	T	T	T	T	T	T	T	T	T	T	T	T	T	T	
	NW16	20	25	32	40	40	50	63	30	37.5	48	60	60	T	T	T	T	T	T	T	T	T	T	T	T	T	T	T	
	NW20	20 ⁽¹⁾	25	32	40	40	50	63	30 ⁽¹⁾	37.5	48	60	60	T	T	T ⁽¹⁾	T	T	T	T	T	T	T	T	T	T	T	T	T
	NW25		25 ⁽¹⁾	32	40	40	50	63		37.5 ⁽¹⁾	48	60	60	T	T		T ⁽¹⁾	T	T	T	T	T	T	T	T	T	T	T	T
	NW32			32 ⁽¹⁾	40	40	50	63			48 ⁽¹⁾	60	60	T	T			T ⁽¹⁾	T	T	T	T	T	T	T	T	T	T	T
Masterpact NW H2 Micrologic	NW08	20	25	32	40	40	50	63	30	37.5	48	60	60	75	94	65	65	65	65	T ⁽¹⁾	T ⁽¹⁾	T ⁽¹⁾	T ⁽¹⁾	T ⁽¹⁾	T ⁽¹⁾	T ⁽¹⁾	T ⁽¹⁾	T ⁽¹⁾	
	NW10	20	25	32	40	40	50	63	30	37.5	48	60	60	75	94	65	65	65	65	T	T	T	T	T	T	T	T	T	
	NW12	20	25	32	40	40	50	63	30	37.5	48	60	60	75	94	65	65	65	65	T	T	T	T	T	T	T	T	T	
	NW16	20	25	32	40	40	50	63	30	37.5	48	60	60	75	94	65	65	65	65	T	T	T	T	T	T	T	T	T	
	NW20	20 ⁽¹⁾	25	32	40	40	50	63	30 ⁽¹⁾	37.5	48	60	60	75	94	65 ⁽¹⁾	65	65	65	T	T	T	T	T	T	T	T	T	T
	NW25		25 ⁽¹⁾	32	40	40	50	63		37.5 ⁽¹⁾	48	60	60	75	94		65 ⁽¹⁾	65	65	T	T	T	T	T	T	T	T	T	T
	NW32			32 ⁽¹⁾	40	40	50	63			48 ⁽¹⁾	60	60	75	94			65 ⁽¹⁾	65	T	T	T	T	T	T	T	T	T	T
Masterpact NW H1	NW40b				40 ⁽¹⁾	40 ⁽¹⁾	50	63				60 ⁽¹⁾	75	94	94				65 ⁽¹⁾	T ⁽¹⁾	T	T	T	T	T	T	T	T	
	NW50						50 ⁽¹⁾	63					75 ⁽¹⁾	94	94						T ⁽¹⁾	T	T	T	T	T	T	T	
Masterpact NW H3 Micrologic	NW20	20 ⁽¹⁾	25	32	40	40	50	63	30 ⁽¹⁾	37.5	48	60	60	75	94	65 ⁽¹⁾	65	65	65	120	120	120							
	NW25		25 ⁽¹⁾	32	40	40	50	63		37.5 ⁽¹⁾	48	60	60	75	94		65 ⁽¹⁾	65	65	120	120	120							
	NW32			32 ⁽¹⁾	40	40	50	63			48 ⁽¹⁾	60	60	75	94			65 ⁽¹⁾	65	120	120	120							
	NW40				40 ⁽¹⁾	40 ⁽¹⁾	50	63				60 ⁽¹⁾	60	75	94				65 ⁽¹⁾	120 ⁽¹⁾	120	120							
Masterpact NW H2	NW40b				40 ⁽¹⁾	40 ⁽¹⁾	50	63				60 ⁽¹⁾	75	75	94				65 ⁽¹⁾	120 ⁽¹⁾	120	120							
	NW50						50 ⁽¹⁾	63					75 ⁽¹⁾	94	94						120 ⁽¹⁾	120	120						
Masterpact NT L1 Micrologic	NT06	T	T	T	T	T	T	T	T	T	T	T	T	T	T	T	T	T	T	T	T	T	T	T	T	T	T	T	
	NT08	T	T	T	T	T	T	T	T	T	T	T	T	T	T	T	T	T	T	T	T	T	T	T	T	T	T	T	
	NT10	T	T	T	T	T	T	T	T	T	T	T	T	T	T	T	T	T	T	T	T	T	T	T	T	T	T	T	
Masterpact NW L1 Micrologic	NW08	20	25	32	40	40	50	63	30	37.5	48	60	60	75	94	100	100	100	100	T	T	T	T	T	T	T	T	T	
	NW10	20	25	32	40	40	50	63	30	37.5	48	60	60	75	94	100	100	100	100	T	T	T	T	T	T	T	T	T	
	NW12	20	25	32	40	40	50	63	30	37.5	48	60	60	75	94	100	100	100	100	T	T	T	T	T	T	T	T	T	
	NW16	20	25	32	40	40	50	63	30	37.5	48	60	60	75	94	100	100	100	100	T	T	T	T	T	T	T	T	T	
Masterpact NW L1 Micrologic	NW20	20	25	32	40	40	50	63		37.5	48	60	60	75	94		100	100	100	T	T	T	T	T	T	T	T	T	

(1) With I_r upstream > 1,3 I_r downstream.

- T Total discrimination, up to the breaking capacity of the downstream circuit breaker.
- 4 Discrimination limit = 4 kA.
- No discrimination.

Discrimination table

Upstream: type gG BS88 and NH fuse

Downstream: iC60 circuit breaker

Selectivity

Selectivity between MCB iC60 and fuse gG in upstream according to the IEC 60947-2 annexe A.

The table below shows the limits of selectivity for a short-circuit current in kA with a fuse in upstream and a MCB iC60 in downstream.

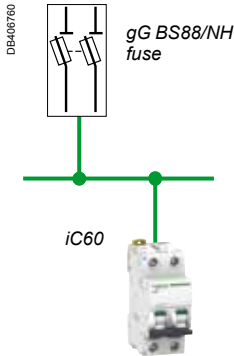

Upstream		Fuse gG BS88 and NH													
In (A)		16	20	25	32	40	50	63	80	100	125	160	200	250	
Downstream Rating (A)															
Discrimination limit (kA)															
iC60 Curve B	1	1.5	4.8	T	T	T	T	T	T	T	T	T	T	T	
	2	0.6	1	2.1	4.5	8.7	29.5	T	T	T	T	T	T	T	
	4		0.5	0.9	1.7	2.7	5.3	15.1	T	T	T	T	T	T	
	6		0.4	0.7	1.2	1.9	3.4	6.9	19	T	T	T	T	T	
	10			0.6	0.9	1.4	2.3	3.9	8.4	16	T	T	T	T	
	16				0.7	1.1	1.8	2.8	5.3	9.3	17.5	T	T	T	
	20					0.9	1.5	2.3	4.2	7.1	12	T	T	T	
	25					0.8	1.3	2.1	3.7	6.1	9.7	T	T	T	
	32						1.2	1.9	3.2	5.1	7.6	19.6	T	T	
	40						1.1	1.7	2.9	4.6	6.7	13.8	T	T	
	50							1.5	2.6	4.2	6.1	12.3	T	T	
	63									4	6	11.7	T	T	
Discrimination limit (kA)															
iC60 Curve C	1	1.5	4.8	T	T	T	T	T	T	T	T	T	T	T	
	2	0.6	1	2.1	4.5	8.7	29.5	T	T	T	T	T	T	T	
	4		0.5	0.9	1.7	2.7	5.3	15.1	T	T	T	T	T	T	
	6		0.4	0.7	1.2	1.9	3.4	6.9	19	T	T	T	T	T	
	10			0.6	0.9	1.4	2.3	3.9	8.4	16	T	T	T	T	
	16					1.1	1.8	2.8	5.3	9.3	17.5	T	T	T	
	20					0.9	1.5	2.3	4.2	7.1	12	T	T	T	
	25						1.3	2.1	3.7	6.1	9.7	T	T	T	
	32							1.9	3.2	5.1	7.6	19.6	T	T	
	40								2.9	4.6	6.7	13.8	T	T	
	50									2.6	4.2	6.1	12.3	T	T
	63									4	6	11.7	T	T	
Discrimination limit (kA)															
iC60 Curve D	1	1.5	4.8	T	T	T	T	T	T	T	T	T	T	T	
	2	0.6	1	2.1	4.5	8.7	29.5	T	T	T	T	T	T	T	
	4		0.5	0.9	1.7	2.7	5.3	15.1	T	T	T	T	T	T	
	6			0.7	1.2	1.9	3.4	6.9	19	T	T	T	T	T	
	10				0.9	1.4	2.3	3.9	8.4	16	T	T	T	T	
	16					1.1	1.8	2.8	5.3	9.3	17.5	T	T	T	
	20						1.5	2.3	4.2	7.1	12	T	T	T	
	25							2.1	3.7	6.1	9.7	T	T	T	
	32								3.2	5.1	7.6	19.6	T	T	
	40									2.9	4.6	6.7	13.8	T	T
	50										4.2	6.1	12.3	T	T
	63										6	11.7	T	T	

19 Please respect the breaking capacity of the circuit breaker (iC60N: 10 kA, iC60H: 15 kA)

1.9 Discrimination limit (kA) = 1.9 kA.

T Total discrimination.

No discrimination.

Example:

Combination of a fuse gG 63 A in upstream with a MCB iC60 of 25 A B curve in downstream, selectivity up to a short circuit current of 2.1 kA.

Cascading

The table below shows the enhanced breaking capacity thanks to cascading of the iC60 MCB and the maximum rating of the upstream fuse.

Upstream	In (A)	Fuse gG BS88 and NH		
		16-100	125	160
Downstream device				
iC60N	10 kA	50 kA	35 kA	-
iC60H	15 kA			
iC60L	25-20-15 kA			

The enhanced breaking capacity is indicated in kA according to IEC 60947-2 annex A.

Discrimination table

Upstream: type gG Diazed D02 fuse
Downstream: iC60 circuit breaker

Selectivity

Selectivity between MCB iC60 and fuse gG in upstream according to the IEC 60947-2 annexe A.

The table below shows the limits of selectivity for a short-circuit current in kA with a fuse in upstream and a MCB iC60 in downstream.

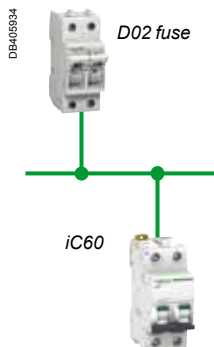

Upstream	In (A)	Type gG Diazed D02 fuse						
		20	25	32	35	40	50	63

Downstream Rating (A)

Discrimination limit (kA)

iC60 Curve B	Rating (A)	Discrimination limit (kA)						
		6	10	13	16	20	25	32
	6	0.7	1	1.9	2.2	3.7	5	6.7
	10	0.5	0.8	1.5	1.6	2.4	3.3	4.1
	13		0.7	1.2	1.5	2	2.6	3.5
	16		0.6	1.1	1.2	1.9	2.2	2.9
	20				1	1.6	1.9	2.4
	25					1.4	1.7	2
	32						1.6	1.9
	40						1.4	1.8
	50							1.6
	63							

Discrimination limit (kA)

iC60 Curve C	Rating (A)	Discrimination limit (kA)						
		6	10	13	16	20	25	32
	6	0.7	1	1.9	2.2	3.7	5	6.7
	10			1.5	1.6	2.4	3.3	4.1
	13				1.5	2	2.6	3.5
	16					1.9	2.2	2.9
	20						1.9	2.4
	25						1.7	2
	32							1.9
	40							

Discrimination limit (kA)

iC60 Curve D	Rating (A)	Discrimination limit (kA)						
		6	10	13	16	20	25	32
	6		1	1.9	2.2	3.7	5	6.7
	10				1.6	2.4	3.3	4.1
	13					2	2.6	3.5
	16						2.2	2.9
	20						1.9	2.4
	25							2
	32							

1.9 Discrimination limit (kA) = 1.9 kA.

No discrimination.

Example:

Combination of a fuse gG 63 A in upstream with a MCB iC60 of 25 A B curve in downstream, selectivity up to a short circuit current of 2 kA.

Cascading

The table below shows the enhanced breaking capacity thanks to cascading of the iC60 MCB and the maximum rating of the upstream fuse.

Upstream	In (A)	Type gG Diazed D02 fuse	
		20 – 63	
Downstream device			
iC60N	10 kA	50 kA	
iC60H	15 kA		
iC60L	25-20-15 kA		

The enhanced breaking capacity is indicated in kA according to IEC 60947-2 annex A.

Discrimination table

Upstream: type gG Diazed D02 fuse

Downstream: iC60 circuit breaker

Coordination with an iID RCCB

The table below shows the enhanced breaking capacity thanks to cascading of the iC60 MCB and the maximum rating of the upstream fuse, coordinated with an iID residual current circuit breaker.

Upstream		Type gG Diazed D02 fuse
In (A)		20 – 63
iID	Downstream device	
	iC60N 10 kA	30 kA
	iC60H 15 kA	
	iC60L 25-20-15 kA	

The enhanced breaking capacity is indicated in kA according to IEC 60947-2 annex A.

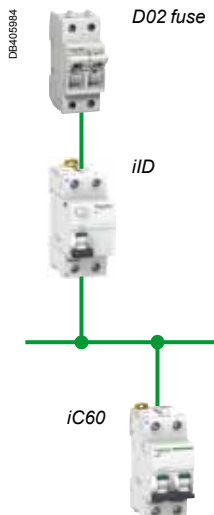

Circuit breakers for direct current applications

Complementary
technical information



Circuit breakers for direct current applications

Contents

Typical applications	710
Types of direct current networks	710
24 - 48 V direct current protection solution	711
Constraints related to "direct current" applications	713
Type of load	713
Time constant	714
Tripping curves	715
Example	715
Continuity of service of the solutions	716
Discrimination of the direct current protection devices	716
Total discrimination solutions	716
Coordination with loads	718
Example	718
The personal protection	719
Examples of applications	720
Industrial applications	720
Tertiary applications	722

Circuit breakers for direct current applications (cont.)

24 V - 48 V direct current applications

Typical applications

Direct current has been used for a long time, and in many fields. It offers major advantages, in particular immunity to electrical interference. Moreover, direct-current installations are now simpler, because they benefit from the development of power supplies with electronic converters and batteries.

- Communication or measurement network:
 - 48 V DC switched telephone network,
 - 4-20 mA current loop.
- Electrical supply for industrial PLCs:
 - PLCs and peripheral devices (24 or 48 V DC).
- Auxiliary uninterruptible direct current power supply:
 - relays or electronic protection units for MV cubicles,
 - switchgear opening / closing trip units,
 - LV control and monitoring relays,
 - indicator lights,
 - circuit-breaker or on/off switch motor drives,
 - power contactor coils,
 - control/monitoring and supervision devices with communication that can be powered via a separate uninterruptible power supply.
- 24 to 48 V DC wind application:
 - isolated homes,
 - cottages, bungalows, mountain refuges,
 - pumps, street lighting,
 - measuring instruments, data acquisition,
 - telecommunication relays,
 - industrial applications.

Types of direct current networks

According to the types of DC networks illustrated below, we can identify the risks to the installation and define the best means of protection.

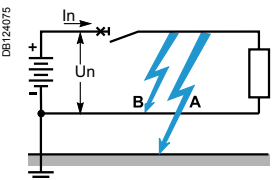
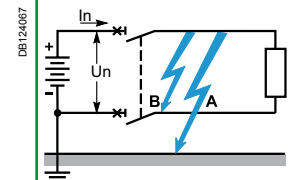
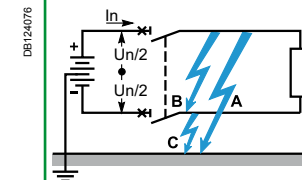
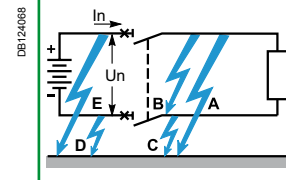
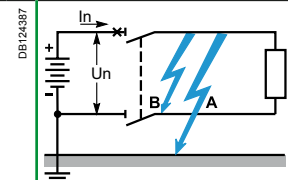
Earthed		Isolated from earth	
I: Earthed (or grounded) polarity (in this case negative)		II: Earthed mid-point	III: Isolated polarities
1 pole (1P isolation)	2 poles (2P isolation)	2 poles	2 poles
			
	2 poles (1P isolation 1P+N)		
			
Worst-case faults			
Fault A and fault B (if only one polarity is protected)		Fault B	Double fault A and D or C and E

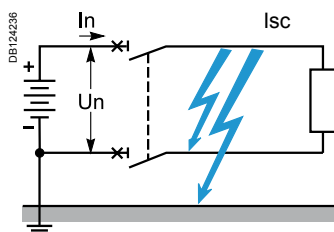

For further information on the types of networks and the faults that characterise them, refer to the direct current circuit breaker (LV) selection guide, 220E2100.indd.

For all these configurations, we propose a single protection solution that depends only on the requirement for the nominal current I_n and the short-circuit current I_{sc} at the installation point concerned.

The second important point in our solution is the fact that the protection is implemented by non-polarised circuit breakers that can operate efficiently, whatever the direction of the direct current.

Circuit breakers for direct current applications (cont.)

24 V - 48 V direct current applications

24 - 48 V direct current protection solution

The performance levels shown in the tables below correspond to the most critical faults according to the network configuration.

- Breaking on one pole.
- Fault between polarity and earth (Fault A).

Standard solution depending on the network and the requirements of the installation (I_n / I_{sc})

In addition to the parameters shown on the following pages, the tables below illustrate our range of circuit breakers according to the nominal current of the load and short-circuit current at the point of installation.

- Circuit breaker rating.
- Breaking capacity of the circuit breaker.

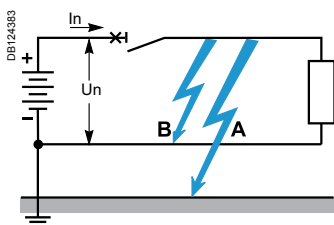

1 pole isolation solution (1P)



Circuit breakers for direct current applications (cont.)

24 V - 48 V direct current applications

2 pôles isolation solution (2P)

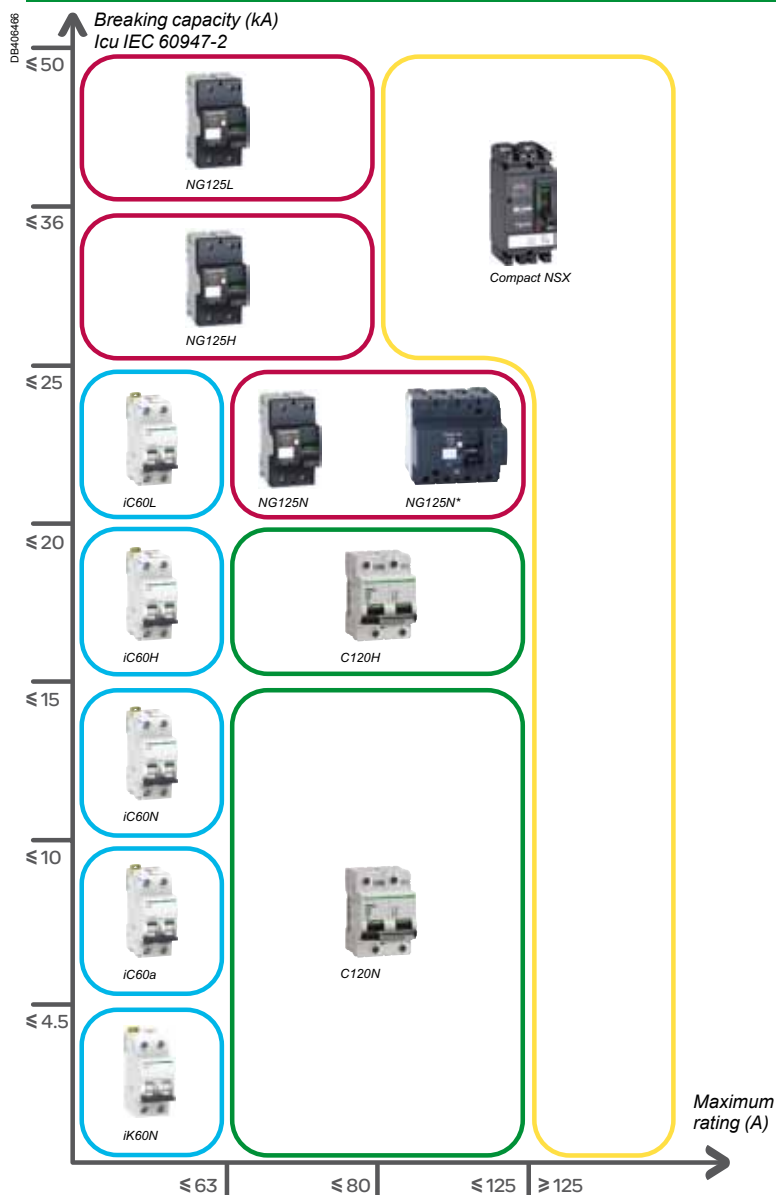
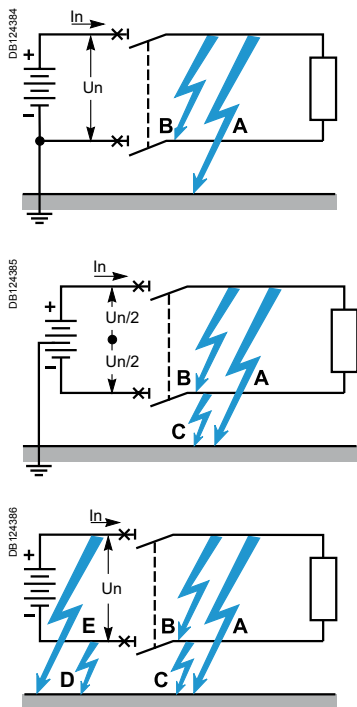

(*) 3P NG125N connected in a two-pole configuration to reach 125 A (1P / 2P NG125 has a maximum rating of 80 A).

1 pole isolation solution (1P+N)

Specific use of the iDPN range in a network with one polarity earthed and both poles isolated: compact solution (1P+N in 18 mm).

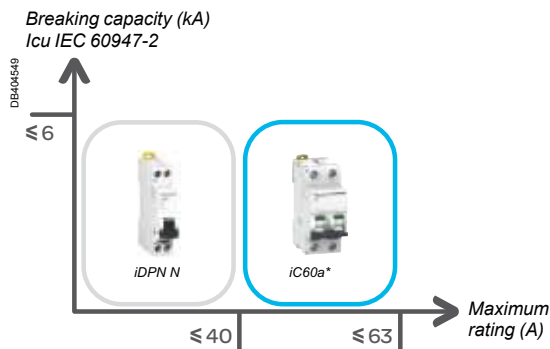
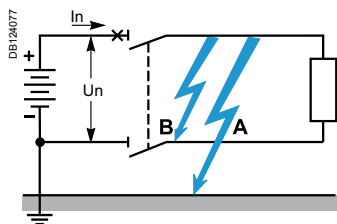

(*) iC60a breaking capacity I_{cu} = 10 kA.

Constraints related to "direct current" applications

In direct current, inductors and capacitors do not disturb the operation of the installation in steady state. Capacitors are charged and inductors no longer oppose changes in the current.

However, they create transient phenomena when the circuit opens or closes, during which time the current varies. Actual loads have both characteristics and generate oscillatory phenomena.

Type of load

Inductive load

An inductive load will tend to lengthen the current interrupt or establishment time, because the inductance L then opposes the change in the current ($L di/dt$). The transient phenomenon will mainly be characterised by a time constant imposed by the load and whose value corresponds approximately to the interrupt or closing time that the switchgear has to withstand. In addition, during the interrupt time, the switchgear must be able to withstand the additional energy stored in the inductor in steady state.

An inductive load therefore requires particular attention with respect to its time constant.

A low value (typically < 5 ms) facilitates interruption.

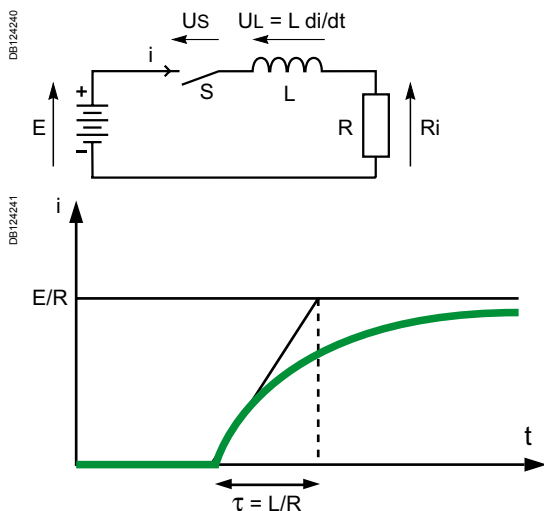

Inductive load

Capacitive load

During a closing operation, a capacitive load will cause an inrush current due to the load on the capacitor, virtually under short-circuit condition at the beginning of the phenomenon.

On opening, it will tend to discharge. The time constant is generally very low (< 1 ms) and its effect is secondary with respect to the inrush current. A capacitive load will require particular attention to the inrush or discharge current surges.

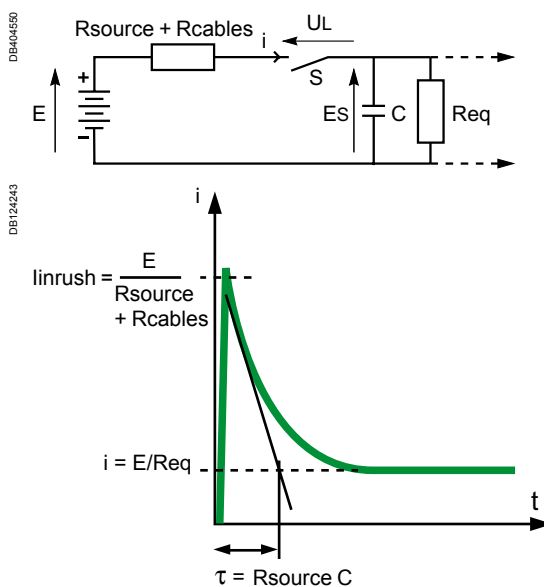

Capacitive load

Circuit breakers for direct current applications (cont.)

24 V - 48 V direct current applications

Time constant L/R

When a short-circuit occurs across the terminals of a direct current circuit, the current increases from the operating current ($< I_n$) to the short-circuit current I_{sc} during a time depending on the resistance R and the inductance L of the short-circuited loop.

The equation that governs the current in this loop is: $U = Ri + Ldi/dt$.

A short-circuit current is established (neglecting I_n with respect to I_{sc}) by the equation:

$$i = I_{sc} (1 - \exp(-t/\tau)),$$

where $\tau = L/R$ is the time constant used to establish the short-circuit.

In practice, after a time $t = 3\tau$ the short-circuit is considered to be established, because the value of $\exp(-3) = 0.05$ is negligible compared to 1.

The lower the corresponding time constant (e.g. battery circuit), the faster a short-circuit is established.

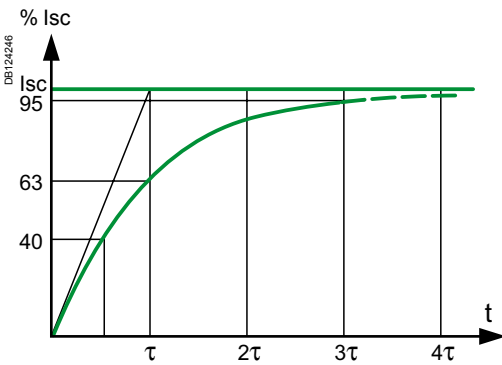
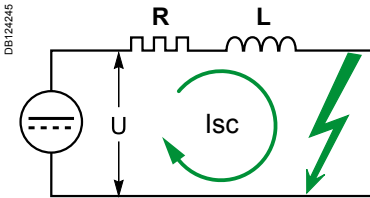

L/R	Description	DC applications
2 ms	Very fast short-circuit	<ul style="list-style-type: none"> ■ Photovoltaic applications
5 ms	Fast short-circuit established	<ul style="list-style-type: none"> ■ Resistive or slightly inductive circuits: <ul style="list-style-type: none"> <input type="checkbox"/> indicator light <input type="checkbox"/> trip units (MN, MX) <input type="checkbox"/> motor armatures <input type="checkbox"/> battery charger/uninterruptible power supply (UPS) ■ Capacitive circuits: electronic controller
15 ms	Standardised value used in standard IEC 60947-2	<ul style="list-style-type: none"> ■ Inductive circuits: <ul style="list-style-type: none"> <input type="checkbox"/> electromagnetic coil <input type="checkbox"/> contactor coil <input type="checkbox"/> motor inductor
30 ms	Slower short-circuit established	<ul style="list-style-type: none"> ■ Highly inductive circuits: <ul style="list-style-type: none"> <input type="checkbox"/> electromagnetic coil <input type="checkbox"/> contactor coil <input type="checkbox"/> motor inductor

In general, the system time constant is calculated under worst case conditions, across the terminals of the generator.

Circuit breakers for direct current applications (cont.)

24 V - 48 V direct current applications

Tripping curves

We can choose our solution according to the inrush currents generated by our loads, in the same way as for alternating current. In direct current, the same thermal tripping curves are obtained as in alternating current. The only difference is that the magnetic thresholds are offset by a coefficient $\sqrt{2}$ compared to the curves obtained in alternating current.

Characteristics of the various curves and their applications:

Curves	Magnetic thresholds		DC applications
	AC	DC	
Z	2.4 to 3.6 In	3.4 to 5 In	<ul style="list-style-type: none"> Resistive loads Loads with electronic circuits
B	3.2 to 4.8 In	4.5 to 6.8 In	<ul style="list-style-type: none"> Motor inductor: starting current 2 to 4 In Battery charger/Uninterruptible power supply (UPS)
C	6.4 to 9.6 In	9.05 to 13.6 In	<ul style="list-style-type: none"> Electronic controller
D and K	9.6 to 14.4 In	13.6 to 20.4 In	<ul style="list-style-type: none"> Electromagnetic coil: inrush overvoltage 10 to 20 Un LV relay Trip units (MN, MX) Indicator light PLCs (industrial programmable logic controllers)

The figures opposite are iC60 tripping curves showing DC magnetic thresholds and normative limits

Example

Protection of the 4 mm² cable supplying a load at In = 30 A with a 32 A rating and a tripping curve that allows the starting current for this load to be absorbed.

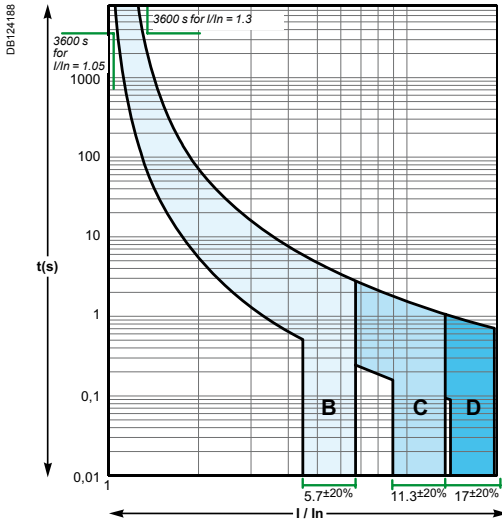

Curves B, C, D, ratings 6 A to 63 A

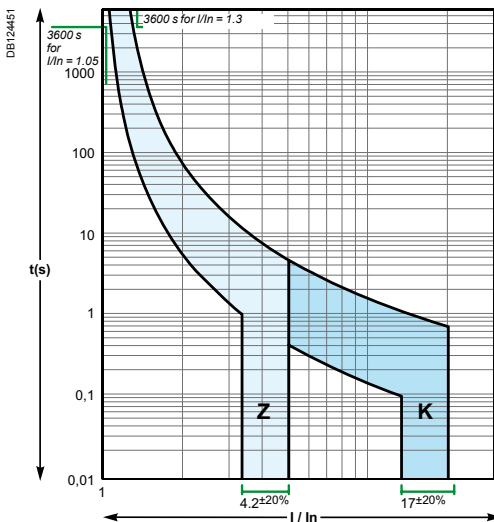

Curves Z, K, ratings 6 A to 63 A

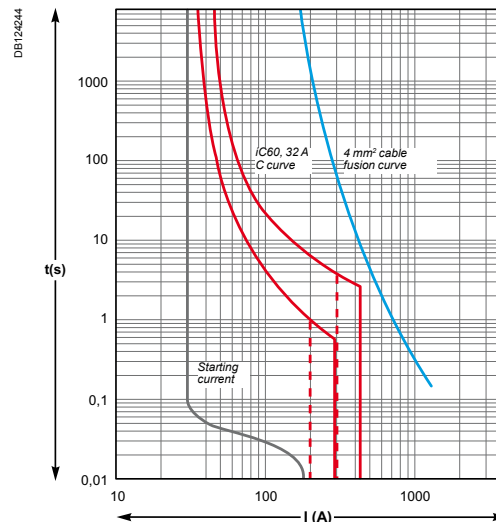

Curve C, rating 32 A (AC magnetic thresholds in dotted lines)

Circuit breakers for direct current applications (cont.)

24 V - 48 V direct current applications

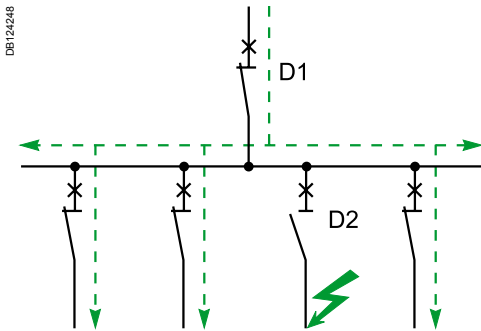
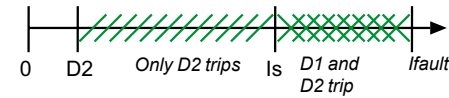
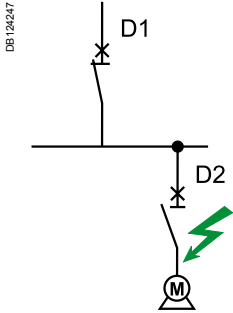

Continuity of service of the solutions

Discrimination of the direct current protection devices

Discrimination is a key element that must be taken into account right from the design stage of a low-voltage installation to allow continuity of service of the electrical power.

Discrimination involves coordination between two circuit breakers connected in series, so that in the event of a fault, only the circuit breaker positioned immediately upstream of the fault trips. A discrimination current I_s is defined as:

- $I_{\text{fault}} < I_s$: only D2 removes the fault, discrimination ensured,
- $I_{\text{fault}} > I_s$: both circuit breakers may trip, discrimination not ensured.

Discrimination may be partial or total, up to the breaking capacity of the downstream circuit breaker. To ensure total discrimination, the characteristics of the upstream device must be higher than those of the downstream one.

The same principles apply to designing both direct current and alternating current installations. Only the limit currents change when direct current is used.

Once again, we find the same concepts of discrimination:

- **total**: up to the breaking capacity of the downstream device. Our tests have been performed at up to 25 kA or 50 kA depending on the breaking capacity of the devices in question.
- **partial**: indication of the discrimination limit current I_s . Discrimination is ensured below this value; above this value, the upstream device participates in the breaking process,
- **none**: no discrimination ensured, the upstream and downstream circuit breakers will trip.

For further information about the discrimination concept for protection devices in general, refer to technical supplement 557E4300, "Discrimination of modular circuit breakers".

Total discrimination solutions

In the following tables, we offer you solutions that favour continuity of service (total discrimination between circuit breakers), for different short-circuit currents.

Total discrimination: 10 kA

		Upstream Curve C Time constant (L/R) = 15 ms								
		iC60a				C120N			NSX	
In (A)		10 - 16	20 - 25	32	40	50 - 63	80	100	125	≥ 100
Downstream										
iC60a	≤ 3	T	T	T	T	T	T	T	T	T
Curves B,C	4		T	T	T	T	T	T	T	T
	6			T	T	T	T	T	T	T
	10				T	T	T	T	T	T
	13					T	T	T	T	T
	16 to 25						T	T	T	T
	32							T	T	T
	40								T	T
	50 - 63								T	T

T Total discrimination.
 No discrimination.

Circuit breakers for direct current applications (cont.)

24 V - 48 V direct current applications

Total discrimination: 15 kA

		Upstream		Curve C		Time constant (L/R) = 15 ms				
In (A)		iC60N				C120N			NSX	
		10 - 16	20 - 25	32	40	50 - 63	80	100	125	≥ 100
Downstream										
iC60N	≤ 3	T		T	T	T	T	T	T	T
Curves B,C	4		T	T	T	T	T	T	T	T
	6				T	T	T	T	T	T
	10					T	T	T	T	T
	13						T	T	T	T
	16 to 25						T	T	T	T
	32							T	T	T
	40							T	T	T
	50 - 63								T	T

Total discrimination: 20 kA

		Upstream		Curve C		Time constant (L/R) = 15 ms				
In (A)		iC60H				C120H			NSX	
		10 - 16	20 - 25	32	40	50 - 63	80	100	125	≥ 100
Downstream										
iC60H	≤ 3	T		T	T	T	T	T	T	T
Curves B,C	4		T	T	T	T	T	T	T	T
	6				T	T	T	T	T	T
	10						T	T	T	T
	13						T	T	T	T
	16 to 25						T	T	T	T
	32							T	T	T
	40								T	T
	50 - 63								T	T

Total discrimination: 25 kA

		Upstream		Curve C		Time constant (L/R) = 15 ms				
In (A)		iC60L				NG125N			NSX	
		10 - 16	20 - 25	32	40	50 - 63	80	100	125	≥ 100
Downstream										
iC60L	≤ 3	T	T	T	T	T	T	T	T	T
Curves B,C	4		T	T	T	T	T	T	T	T
	6				T	T	T	T	T	T
	10						T	T	T	T
	13						T	T	T	T
	16 to 25						T	T	T	T
	32								T	T
	40								T	T
	50 - 63									T

Total discrimination: 36 kA

		Upstream		Curve C		Time constant (L/R) = 15 ms	
In (A)		NG125H		NSX			
		80		≥ 100			
Downstream							
NG125H	10	T		T			
Curves B,C	16 to 63				T		

Total discrimination: 50 kA

		Upstream		Curve C		Time constant (L/R) = 15 ms	
In (A)		NG125L		NSX			
		80		≥ 100			
Downstream							
NG125L	10	T		T			
Curves B,C	16 to 63				T		

Total discrimination.

No discrimination.

Circuit breakers for direct current applications (cont.)

24 V - 48 V direct current applications

Coordination with loads

As seen above, the circuit-breaker characteristics chosen depend on the type of load downstream of the installation.

The rating depends on the size of the cables to be protected and the curves depend on the load inrush current.

Product selection according to the load inrush current

When certain "capacitive" loads are switched on, very high inrush currents appear during the first milliseconds of operation. The following graphs show the average DC non-tripping curves of our products for this time range (50 μ s to 10 ms).

iC60

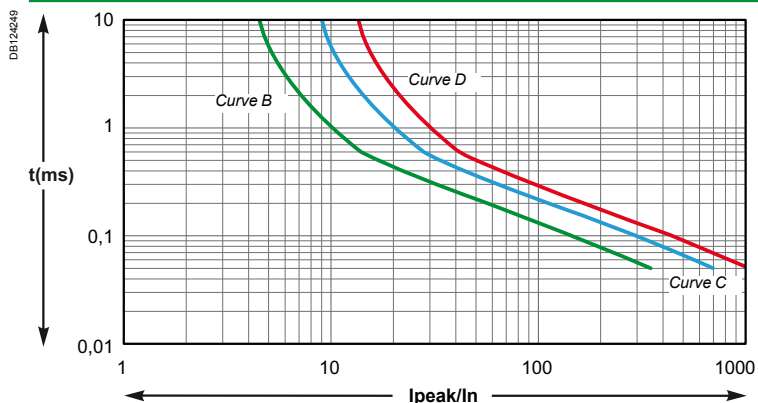

NG125 / C120

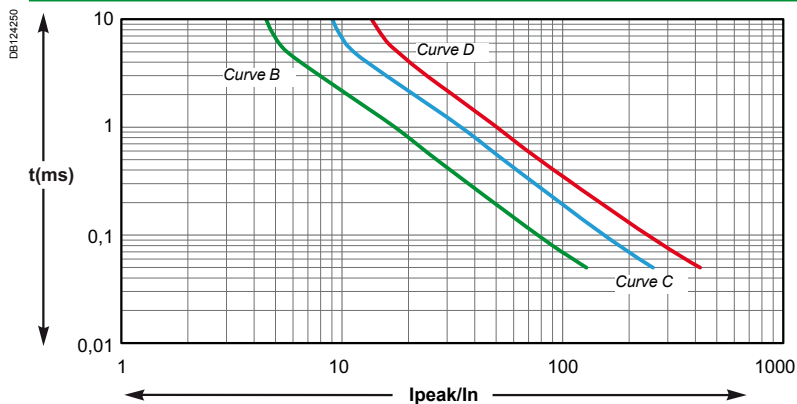

This information allows us to select the most appropriate product, according to the load specifications: curve and rating.

Example

When an iC60 is used with a load with current peaks in the order of 200 I_n during the first 0.1 millisecond, a curve C or D product must be installed.

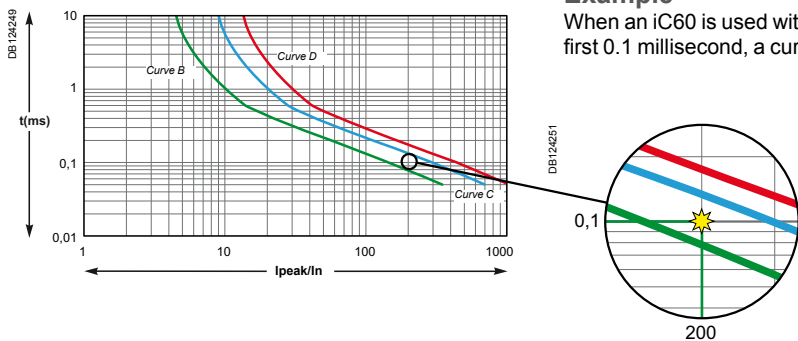

Circuit breakers for direct current applications (cont.)

24 V - 48 V direct current applications

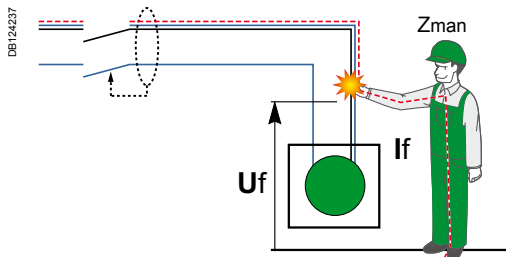
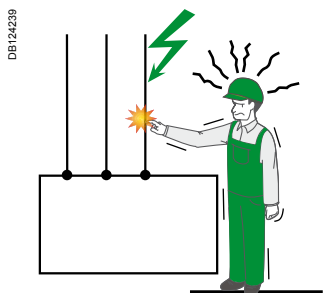
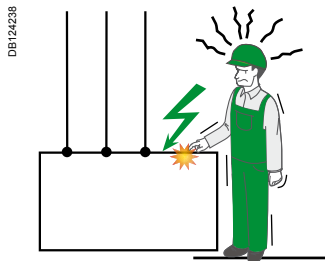

Standards: IEC 60479-2, NF C 15100, IEC 60755.

Personal protection

Personal protection (earth-leakage protection) is not mandatory for this voltage range (24-48 V DC).

In fact, according to the standards currently in force, the minimum ventricular fibrillation current **If** for human beings is in the order of 25 mA for alternating current (50 Hz), whereas for direct current, it is more than 50 mA.

The table below shows the data according to the standards and conditions:

Environment		Voltage specifications	
		AC	DC
Dry environment	$U_f = Z \times I_f$	50 V	100 V
Wet environment	$U_f = Z \times I_f$	25 V	50 V

With **Z** corresponding to the impedance of the human body in the different types of environment, **If** being the current passing through the body and **Uf** the minimum contact voltage required to reach the danger current.

Under normal operating conditions, this voltage range (< 50 V) is therefore not dangerous to human beings.

Circuit breakers for direct current applications (cont.)

24 V - 48 V direct current applications

Examples of applications

Industrial applications

Monitoring of agro-food tanks with 24 V DC converters for probes and other sensors

- Isolated network:
- $I_{sc} = 25 \text{ kA}$,
- $I_n = 40 \text{ A}$.

Solution

iC60L 2P 40 A + 24 V converters

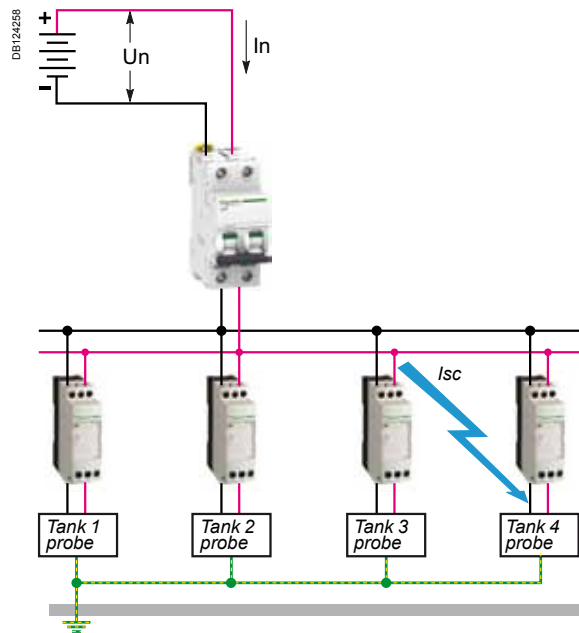

Control of industrial process measurement by 12/24/48 V DC control

- Isolated network:
- $I_{sc} = 20 \text{ kA}$,
- $I_n = 40 \text{ A}$.

Solution

iC60H 2P 40 A + DC solid-state relays

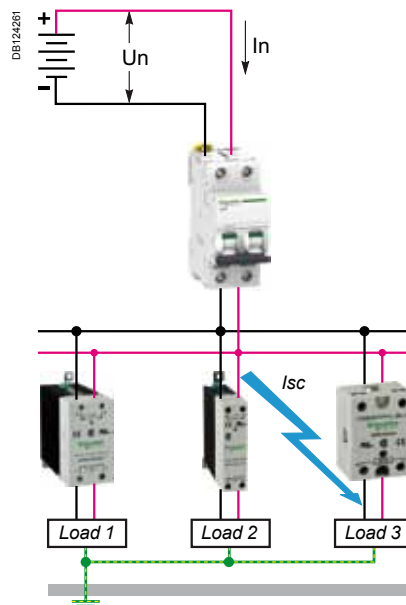

Circuit breakers for direct current applications (cont.)

24 V - 48 V direct current applications

24 V DC generator power supply protection

- Earthed network:
- $I_{sc} = 10 \text{ kA} / I_n = 63 \text{ A}$,
- $I_{sc} = 10 \text{ kA} / I_n = 20 \text{ A}$.

Solution

iC60N 2P 63 A + iC60N 2P 20 A + DC loads

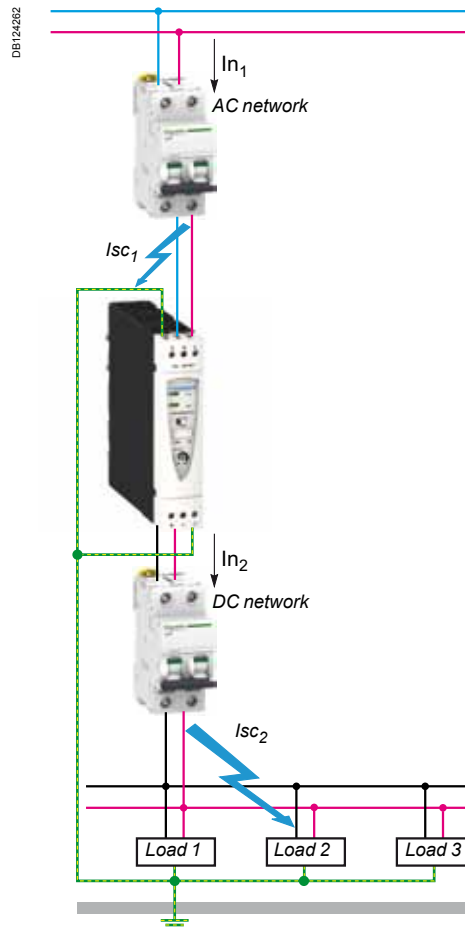

Circuit breakers for direct current applications (cont.)

24 V - 48 V direct current applications

Tertiary applications

Control and monitoring of the 48 V DC emergency lighting distribution for a shopping centre

■ Mid-point of the network:

- $I_{sc} = 20 \text{ kA}$,
- $I_n = 125 \text{ A}$.

Solution

NG125H 3P 125 A + power contactors

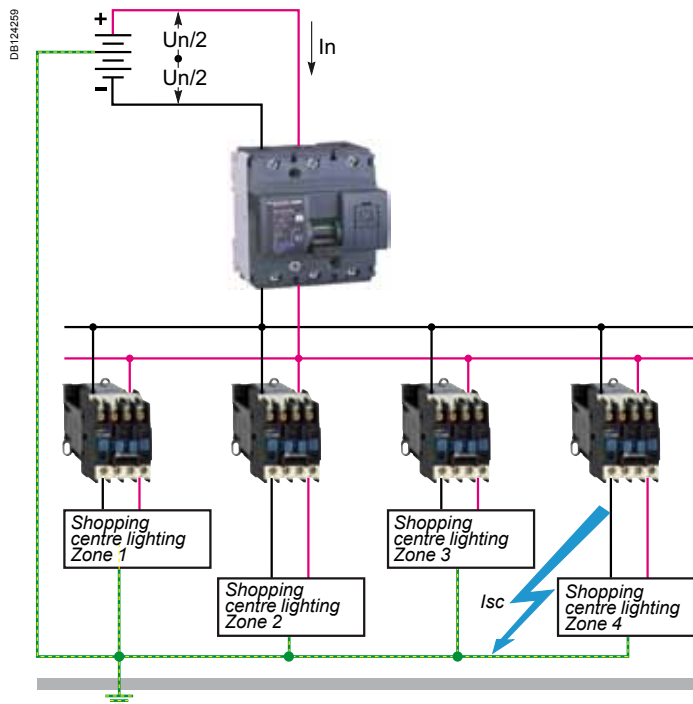

Major airport in France, 48 V DC emergency lighting for runways

■ Isolated network:

- $I_{sc} = 50 \text{ kA}$,
- $I_n = 80 \text{ A}$.

Solution

NG125L 2P 80 A + impulse relays

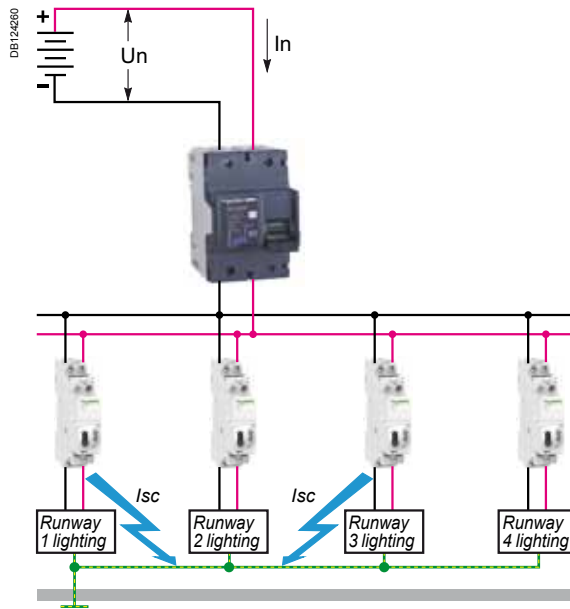

Circuit breakers for direct current applications (cont.)

24 V - 48 V direct current applications

Power supply protection by 24 V DC direct current generator

- Earthed network:
 - $I_{sc1} = 10 \text{ kA} / I_n = 40 \text{ A}$,
 - $I_{sc2} = 10 \text{ kA} / I_n = 2/4/6 \text{ A}$.

Solution

iC60N 2P 40 A + iC60N 2P 2/4/6 A + PLC inputs + DC loads

The Phaseo network failure solution provides the installation (or part thereof) with a 24 V DC power supply in the event of a mains voltage failure:

- throughout the mains failure, to ensure the continuity of service of the installation.
- during a limited time to allow:
 - data to be backed up,
 - actuators to be put in the fallback position,
 - a generating set to be started up,
 - the operating systems to be shut down,
 - remote supervision data to be transmitted.

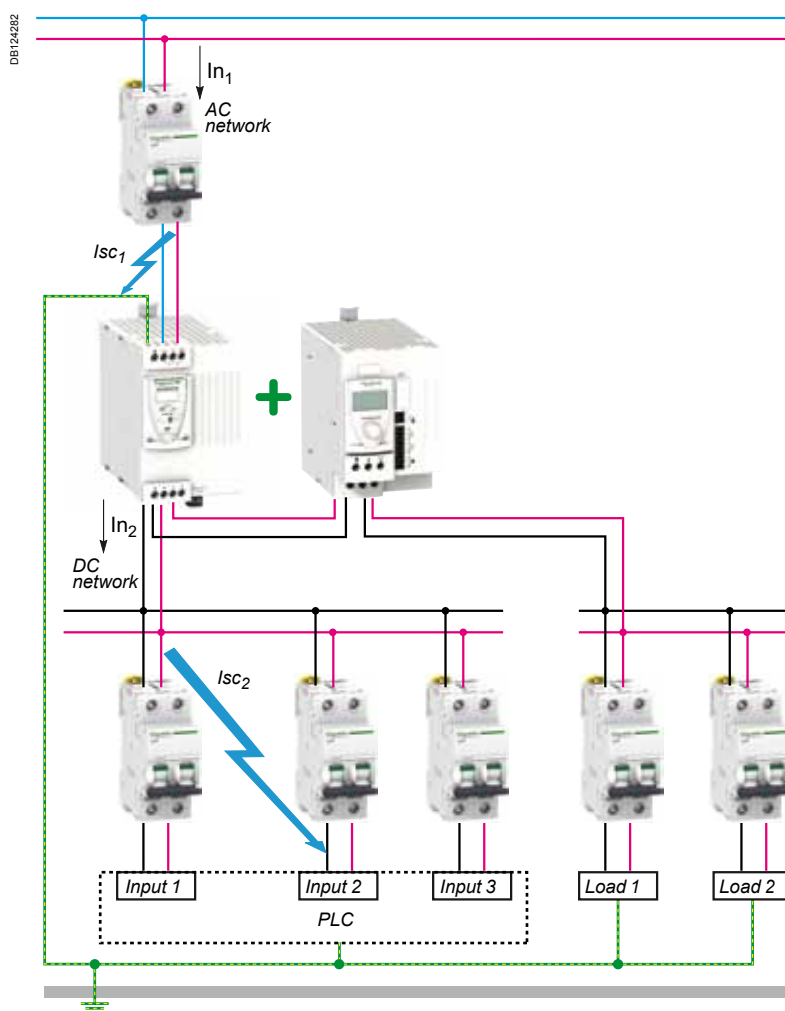

Make the most of your energy™

www.schneider-electric.com

Schneider Electric Industries SAS

35, rue Joseph Monier
CS 30323
F- 92506 Rueil Malmaison Cedex

RCS Nanterre 954 503 439
Capital social 896 313 776 €
www.schneider-electric.com

As standards, specifications and designs change from time to time, please ask for confirmation of the information given in this publication.



Printed on ecological paper

Publication: Schneider Electric Industries SAS
Design-Layout: SEDOC

Direct current distribution

Choosing and implementing protective devices

Complementary
technical information

This document illustrates the use of the Acti9 product range for the protection of direct current distribution applications of voltage less than 500 V.

There is also a circuit breaker offer dedicated to photovoltaic applications: C60PV-DC (low breaking capacity 1.5 kA and higher voltage 800 V).

Choice

Choosing the rating

The thermal tripping curve of a circuit breaker is the same in direct current as in alternating current (50/60 Hz). The rule for choosing is therefore the same: to ensure protection against circuit overloads, choose a circuit breaker with a rating (I_n) less than or equal to the current (I_z) allowed to pass through the cable.

Circuits with momentary current direction reversal

In the case of circuits with momentary current direction reversal:

- C60H-DC circuit breakers cannot be used
- iC60 circuit breakers can be used

Examples of circuits with momentary current direction reversal

- Paralleled energy sources (photovoltaic cells, generators, generating sets, etc.).

DBI125710

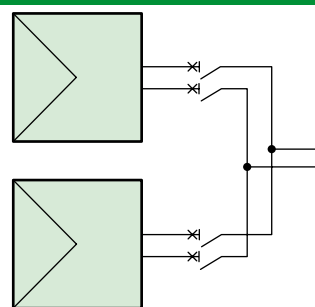

- Batteries with rectifier/charger.

DBI125711

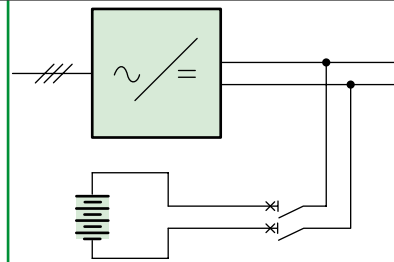

- Motor protective devices capable of operating as a generator.

DBI125712

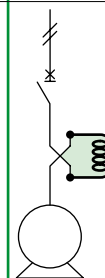

- Use of the C60PV-DC is specifically dedicated to photovoltaic (PV) applications (generally higher voltages with low breaking capacity).

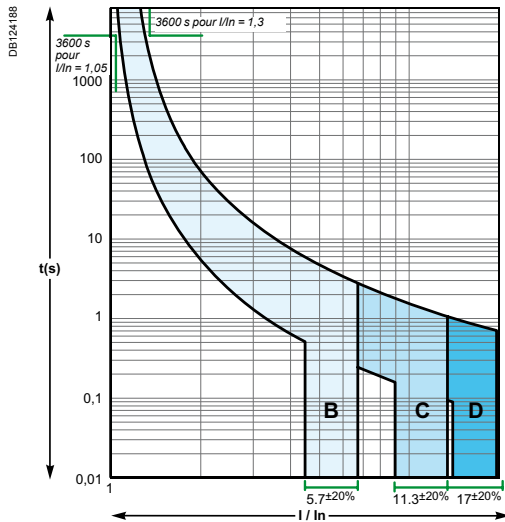

Example: iC60, B, C, D curves, ratings from 6 A to 63 A.

Choosing the curve

The magnetic tripping threshold must be:

- higher than the inrush currents due to loads (motors, capacitors, etc.)
- lower than the short-circuit current at the installation point, which depends on:
 - the short-circuit power of the source (indicated by the manufacturer),
 - the impedance of the supply line.

In direct current:

- the short-circuit power of the sources is generally low: batteries, photovoltaic panels, generators, electronic converters, etc
- the loads generate lower inrush currents than in alternating current (e.g. motor start-up: 2 to 4 times the rated current)
- the magnetic threshold of Acti 9 circuit breakers (relative to the rated current) is higher than in alternating current.

Circuit breaker	iC60 / C120 / NG125				C60H-DC
	Z	B	C	D	C
Magnetic tripping threshold	3,4 ...5 In	4,5 ...7 In	9...14 In	14...20 In	7....10 In

➤ Generally, choose a C60H-DC circuit breaker or a B-curve iC60 circuit breaker.

Note: It may be necessary to choose a C curve or a D curve for very high inrush current applications (e.g., electronic equipment with particularly large capacitive filters).

Choosing the breaking capacity

The choice of circuit breaker with respect to the breaking capacity depends on:

- the earthing system
- the network voltage
- the short-circuit current at the installation point in question.

Note: The breaking capacities are given for a time constant (L/R) equal to 0.015 s..

Reading the tables

- Select the table according to the earthing system.
- Select the circuit breaker corresponding to the network:
 - the circuit breaker(s) to be installed is/are identified based on the rating and short-circuit current,
 - the type of connection (number of poles, position relative to the load, isolation of polarities) is indicated according to the voltage.

iC60, C120, NG125 offer

Choosing circuit breakers for distribution with earthed polarity

The following tables show the number of poles connected in series according to the DC network voltage, and the circuit breaking performance of our circuit breaker range.

Breaking capacity for a maximum voltage per pole of: 60 V DC for the iC60 offers and 125 V DC for the C120 and NG125 offers

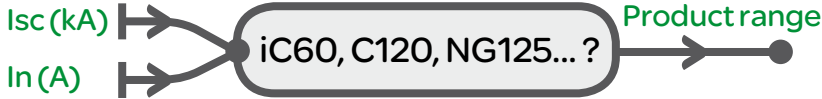

Fault condition analysis 1

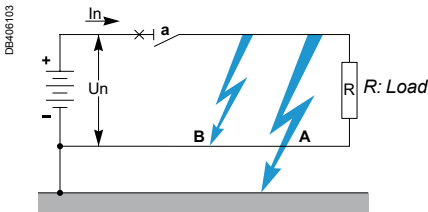

1 The figure shows a source with the negative polarity earthed.

Fault	Fault current (max.)	Voltage	Poles involved in breaking	Breaking characteristics
A, B	Isc	Un	a	Isc at Un on the poles connected to the positive polarity

Isc: presumed short-circuit current.
Un: rated network voltage.

> All the circuit-breaker poles must be on the non-earthed polarity.

Fault condition analysis 2

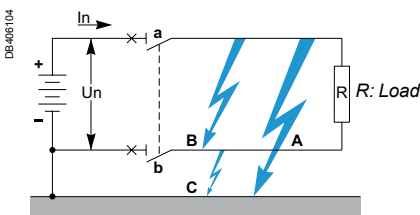

2 The figure shows a source with the negative polarity earthed.

Fault	Fault current (max.)	Voltage	Poles involved in breaking	Breaking characteristics
A	Isc	Un	a	Isc at Un on the poles connected to the positive polarity
B	Isc	Un	a + b	Isc at Un on all the poles connected in series
C	-	-	b	No breaking needed

Isc: presumed short-circuit current.
Un: rated network voltage.

> All the circuit-breaker poles must be on the non-earthed polarity. One pole on the earthed polarity will allow isolation to be performed.

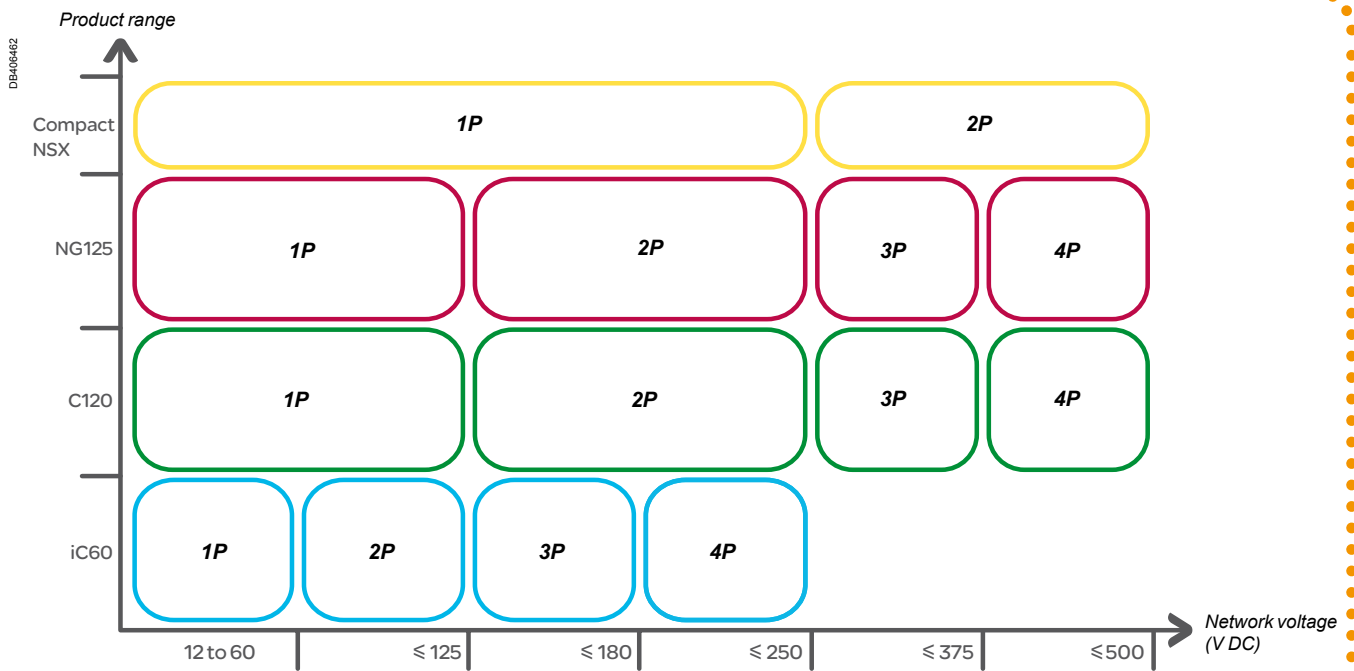

Isolation	Number of poles and connection diagram			
	1P	2P	3P	4P
Not required ①	DB405938 	DB405939 	DB405940 	DB405941
Required ②	DB405942 	DB405943 	DB405944 	

R: Load.

iC60, C120, NG125 offer

Choosing circuit breakers for distribution with earthed mid-point

The following tables show the number of poles connected in series according to the DC network voltage, and the circuit breaking performance of our circuit breaker range.

Breaking capacity for a maximum voltage per pole of: 60 V DC for the iC60 offers and 125 V DC for the C120 and NG125 offers



Fault condition analysis

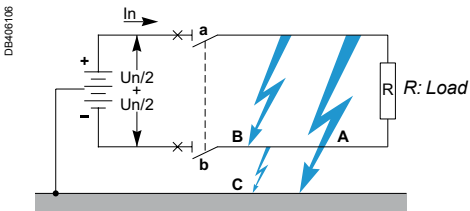

Fault	Fault current (max.)	Voltage	Poles involved in breaking	Breaking characteristics
A	I _{sc}	Un/2	a	I _{sc} at Un/2 on the poles connected to the positive polarity
B	I _{sc}	Un	a + b	I _{sc} at Un on all the poles connected in series
C	I _{sc}	Un/2	b	I _{sc} at Un/2 on the poles connected to the negative polarity

I_{sc}: presumed short-circuit current.
Un: rated network voltage.

> The circuit-breaker poles must be distributed symmetrically over the two polarities.

Obviously, this connection provides isolation.

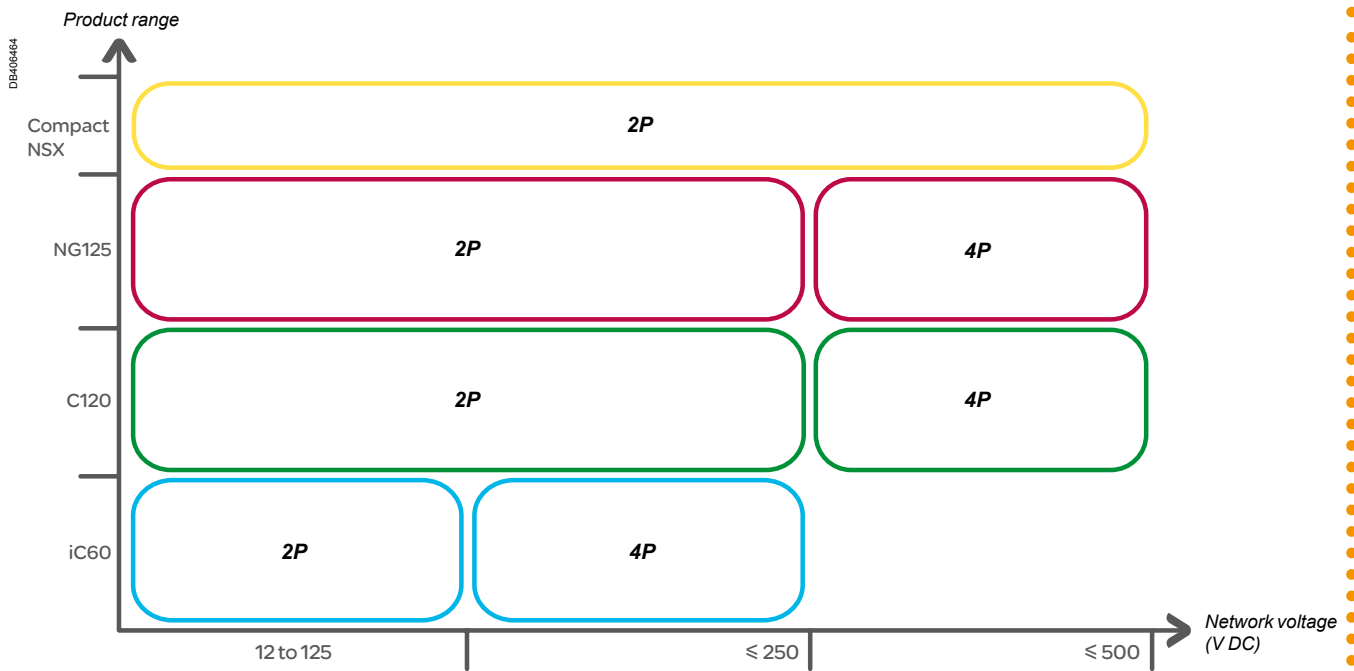

Isolation	Number of poles and connection diagram	
Required or not	2P	4P

R: Load.

iC60, C120, NG125 offer

Choosing circuit breakers for distribution isolated from earth

The following tables show the number of poles connected in series according to the DC network voltage, and the circuit breaking performance of our circuit breaker range.

Breaking capacity for a maximum voltage per pole of: 60 V DC for the iC60 offers and 125 V DC for the C120 and NG125 offers



Fault condition analysis

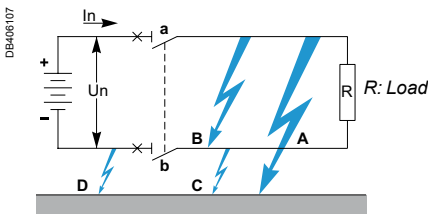

The figure shows a source in IT system with a second fault (D) on the negative polarity.

Fault	Fault current (max.)	Voltage	Poles involved in breaking	Breaking characteristics
A	Low	Low	a	No breaking needed
A and D	$I_d^{(1)}$	U_n	a	I_d at U_n on the poles connected to the positive polarity
B	I_{sc}	U_n	a + b	I_{sc} at U_n on all the poles connected in series
C	Low	Low	b	No breaking needed

I_{sc} : presumed short-circuit current.
 U_n : rated network voltage.

(1) Fault current values acceptable according to the installation rules.

- If $I_{sc} < 10$ kA: fault current $\leq 0.15 I_{sc}$.
- If $I_{sc} > 10$ kA: fault current $\leq 0.25 I_{sc}$.

> The circuit-breaker poles must be distributed symmetrically over the two polarities.

Obviously, this connection provides isolation.

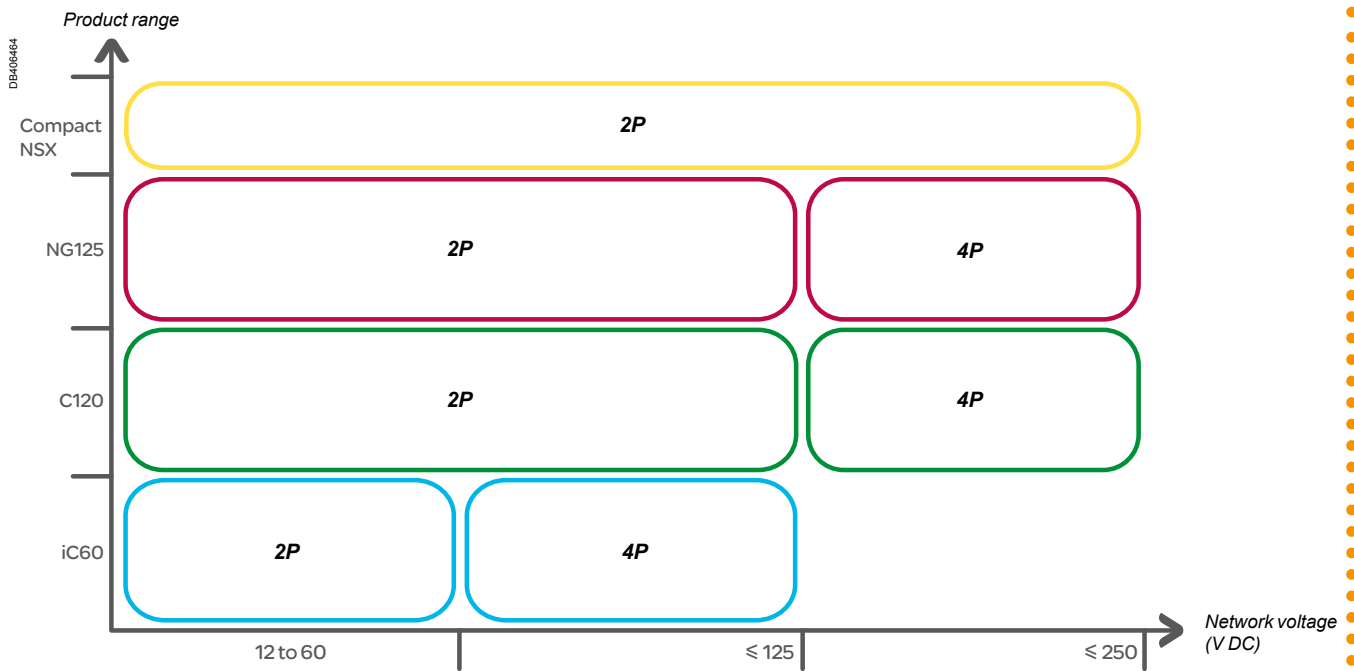

Isolation	Number of poles and connection diagram	
Required or not	2P	4P

R: Load.

Direct current distribution

Choosing and implementing circuit breakers

C60H-DC offer

Unlike the preceding offers, the C60H-DC offer comprises polarised circuit breakers reserved exclusively for direct current applications. As we saw earlier, it is therefore not compatible in the case of circuits with (even momentary) current direction reversal. The same applies to "mixed" networks operating successively in AC and DC (e.g. safety devices).

It is an offer corresponding to the C curve and ranging up to 63 A.

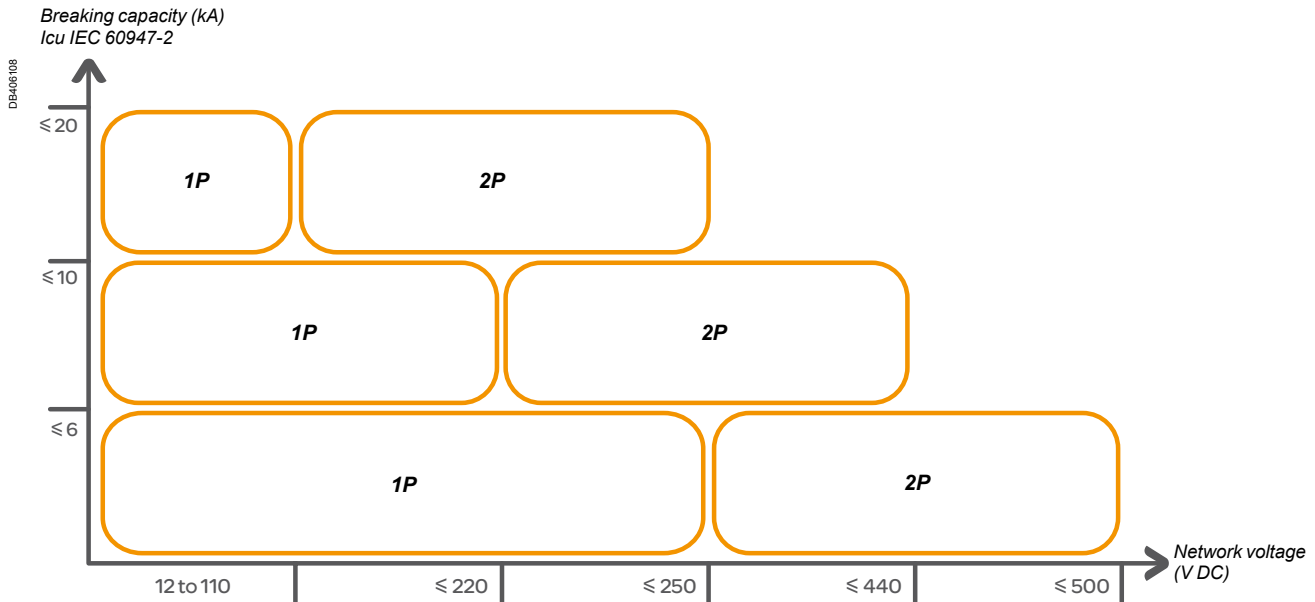

Choosing circuit breakers for distribution with earthed polarity

"-" polarity earthed

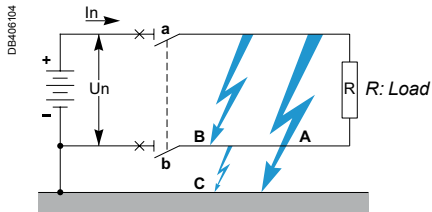

The figure shows a source with the negative polarity earthed.

"+" polarity earthed

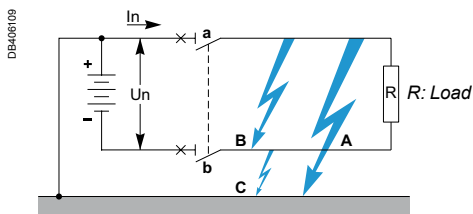

The figure shows a source with the positive polarity earthed.

Isolation	Number of poles and connection diagram	
	1P	2P
Not required		
Required		
Isolation	Number of poles and connection diagram	
	1P	2P
Not required		
Required		

R: Load.

Fault condition analysis with "-" polarity earthed

Fault	Fault current (max.)	Voltage	Poles involved in breaking	Breaking characteristics
A	Isc	Un	a	Isc at Un on the pole connected to the positive polarity
B	Isc	Un	a + b	Isc at Un on the both poles
C	-	-	b	No breaking needed

Isc: presumed short-circuit current.
Un: rated network voltage.

> All the circuit-breaker poles must be on the non-earthed polarity. One pole on the earthed polarity will allow isolation to be performed.

C60H-DC offer

Choosing circuit breakers for distribution with earthed mid-point

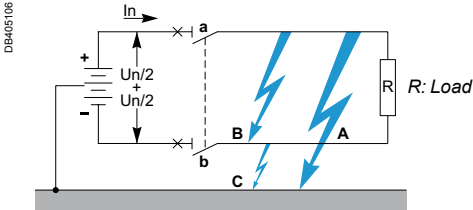

The figure shows a source with earthed mid-point.

Isolation	Number of poles and connection diagram
Required or not	2P

R: Load.

Fault condition analysis

Fault	Fault current (max.)	Voltage	Poles involved in breaking	Breaking characteristics
A	Isc	Un/2	a	Isc at Un/2 on the pole connected to the positive polarity
B	Isc	Un	a + b	Isc at Un on the both poles
C	Isc	Un/2	b	Isc at Un/2 on the pole connected to the negative polarity

Isc: presumed short-circuit current.
Un: rated network voltage.

➤ The circuit-breaker poles must be distributed symmetrically over the two polarities.

Obviously, this connection provides isolation.

Choosing circuit breakers for distribution isolated from earth

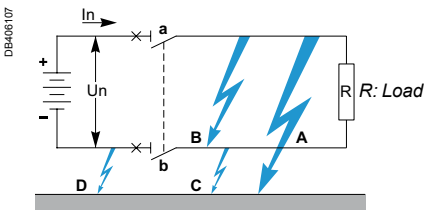

The figure shows a source in IT system with a second fault (D) on the negative polarity.

Isolation	Number of poles and connection diagram
Required or not	2P

R: Load.

Fault condition analysis

Fault	Fault current (max.)	Voltage	Poles involved in breaking	Breaking characteristics
A	Low	Low	a	No breaking needed
A and D	Id ⁽¹⁾	Un	a	Id at Un on the pole connected to the positive polarity
B	Isc	Un	a + b	Isc at Un on the both poles
C	Low	Low	b	No breaking needed

Isc: presumed short-circuit current.
Un: rated network voltage.

(1) Fault current values acceptable according to the installation rules.

- If Isc < 10 kA: fault current ≤ 0.15 Isc.
- If Isc > 10 kA: fault current ≤ 0.25 Isc.

➤ The circuit-breaker poles must be distributed symmetrically over the two polarities.

Obviously, this connection provides isolation.

Connection

Series connection

In the preceding offers we extensively used the principle of series connection of products. Series connection of the poles, by dividing the voltage per pole, optimizes the circuit breaking performance for high-voltage networks.

Series connection of the poles of a circuit breaker used in direct current therefore makes it possible to:

- divide the network voltage by the number of poles
- have the rated current for each pole
- have the circuit breaker's breaking capacity for all the poles.

Direction of cabling and cable length

In the case of series connection, the direction of cabling has a major impact on the product's performance.

Usually the first product cabling method ① will be used. For special applications where there is only a single possible current direction, the second cabling method ② is preferable, especially for electrical endurance properties.

Subsequently the cable cross section and length combination should be optimized, depending on the loads. Generally, a greater length and cross section improves performance.

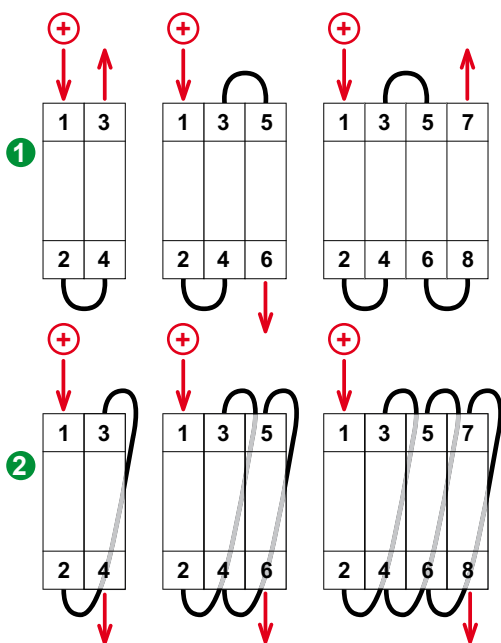

Rating (In)	Cross section (mm ²)	Min. shunt length (mm)
≤ 63 A	≤ 16	500
	25	200
	35	100
≤ 125 A	35	300
	50	200

Note: This table gives the minimum cable (shunt) lengths optimizing the equipment's performance according to the cable cross sections.

Clarification concerning voltage drops

Importance of allowing for voltage drops

Voltage drops are an issue that must be taken into account especially in direct current distribution due to:

- the common use of very low voltage (24, 48 or sometimes 12 V):
 - for a given resistance and current in a circuit, relative voltage drops increase as the voltage is lowered,
 - the natural voltage drop of batteries in power reserve mode, as they are discharged,
 - the criticality of the associated applications, often requiring a high level of security and continuity of service.

Cause of voltage drops

Voltage drops are caused by the sum of the resistances in series in the circuit:

- internal resistance (r) of the source
- resistance of connecting cables
- internal resistance of control and protection switchgear, often significant for circuit breakers of low rating (a few amperes) powered at very low voltage
 - it is generally expressed in mΩ
 - in the absence of data directly from the manufacturer, it can be calculated by dividing the power consumption by the square of the current: $r = P/I^2$
 - spurious resistance of connections.

Voltage drops in the circuit must be less than the rated operating tolerances of the various loads in steady-state conditions and especially at start-up (inrush current).

Table G.52.1 – Voltage drop

Type of installation	Lighting %	Other uses %
A – Low voltage installations supplied directly from a public low voltage distribution system	3	5
B – Low voltage installation supplied from private LV supply*	6	8

* As far as possible, it is recommended that voltage drop within the final circuits do not exceed those indicated in installation type A.

When the main wiring systems of the installations are longer than 100 m, these voltage drops may be increased by 0.005 % per metre of wiring system beyond 100 m, without this supplement being greater than 0.5 %.

Voltage drop is determined from the demand by the current-using equipment, applying diversity factors where applicable, or from the values of the design current of the circuits.

IEC 60364-5-52 standard.

The multipolar low rating use (< 4 A) is not suitable for very low voltage networks (< 24 V DC).

Direct current distribution

Choosing and implementing circuit breakers

Examples of choices

Example 1

In a direct current distribution system, powered by a rectifier/charger of voltage 125 V with earthed "-" polarity, which circuit breakers should be installed to protect:

- the battery outgoing feeder of permissible current $I_z = 69$ A, operating current $I_b = 55$ A, and short-circuit current 10 kA?
- a lighting outgoing feeder of permissible current $I_z = 22$ A, operating current $I_b = 18$ A, and short-circuit current 10 kA?

If the battery outgoing feeder is with momentary current direction reversal, choose an iC60 circuit breaker:

Circuit to be protected	Choice of circuit breaker	
$I_b = 55$ A, $I_z = 69$ A	Rating	$I_n = 63$ A
No high current peak	Curve	B
$U_n = 125$ V, $I_{sc} = 10$ kA, "-" earthed	Breaking capacity	iC60N
	Connection	2 poles in series on "+"
Isolation required		1 pole on "-"

➤ Choose a B-curve iC60N 3P 63 A circuit breaker with 2 poles connected to the positive polarity.

If the lighting outgoing feeder is without momentary current direction reversal, choose a C60H-DC circuit breaker:

Circuit to be protected	Choice of circuit breaker	
$I_b = 18$ A, $I_z = 22$ A	Rating	$I_n = 20$ A
No high current peak	Curve	C
$U_n = 125$ V, $I_{sc} = 10$ kA, "-" earthed	Breaking capacity	C60H-DC
	Connection	1 pole on "+"
Isolation not required		No pole on "-"

➤ Choose a C60H-DC 1P 20 A circuit breaker with 1 pole connected to positive polarity.

Example 2

In a direct current distribution system, powered by a rectifier/charger of voltage 125 V, with earthed mid-point, which circuit breakers should be installed to protect:

- the battery outgoing feeder of permissible current $I_z = 69$ A, operating current $I_b = 55$ A, and short-circuit current 20 kA?
- a lighting outgoing feeder of permissible current $I_z = 22$ A, operating current $I_b = 18$ A, and short-circuit current 20 kA?

If the battery outgoing feeder is with momentary current direction reversal, choose an iC60 circuit breaker of characteristics in compliance with the installation:

Circuit to be protected	Choice of circuit breaker	
$I_b = 55$ A, $I_z = 69$ A	Rating	$I_n = 63$ A
No high current peak	Curve	B
$U_n = 125$ V, $I_{sc} = 20$ kA, earthed mid-point	Breaking capacity	iC60H
	Connection	1 pole on "+" 1 pole on "-"
Isolation required		Provided by both poles

➤ Choose a B-curve iC60H 2P 63 A circuit breaker, connected symmetrically to the "+" and "-" polarities.

Direct current distribution

Choosing and implementing circuit breakers

If the lighting outgoing feeder is without momentary current direction reversal, choose a C60H-DC circuit breaker:

Circuit to be protected	Choice of circuit breaker	
$I_b = 18 \text{ A}$, $I_z = 22 \text{ A}$	Rating	$I_n = 20 \text{ A}$
$U_n = 125 \text{ V}$, $I_{sc} = 20 \text{ kA}$, earthed mid-point	Breaking capacity	C60H-DC
	Connection	1 pole on "+"
1 pole on "-"		
Isolation not required	Provided by both poles	

➤ Choose a C60H-DC 2P 20 A circuit breaker connected symmetrically to the "+" and "-" polarities.

Example 3

In a direct current distribution system powered by two rectifiers in parallel $U_n = 250 \text{ V}$, $I_{sc} (2 \text{ sources}) = 35 \text{ kA}$, in IT system, which circuit breakers should be installed to protect:

- the pair of rectifiers of permissible current $I_z = 69 \text{ A}$ and operating current $I_b = 55 \text{ A}$?
- a lighting outgoing feeder of permissible current $I_z = 22 \text{ A}$ and operating current $I_b = 18 \text{ A}$?

If the pair of rectifiers is with momentary current direction reversal, choose an iC60 circuit breaker:

Circuit to be protected	Choice of circuit breaker	
$I_b = 55 \text{ A}$, $I_z = 69 \text{ A}$	Rating	$I_n = 63 \text{ A}$
No high current peak	Curve	B or C (the magnetic threshold is far lower than the short-circuit current)
$U_n = 250 \text{ V}$, $I_{sc} = 35 \text{ kA}$, IT system	Breaking capacity	NG125L
	Connection	2 poles on "+"
2 poles on "-"		
Isolation required	Provided by the 4 poles	

➤ Choose an NG125L 4P 63 A circuit breaker connected symmetrically to the "+" and "-" polarities.

The lighting outgoing feeder is without momentary current direction reversal but the short-circuit current is too great to choose a C60H-DC circuit breaker.

Circuit to be protected	Choice of circuit breaker	
$I_b = 18 \text{ A}$, $I_z = 22 \text{ A}$	Rating	$I_n = 20 \text{ A}$
No high current peak	Curve	B
$U_n = 250 \text{ V}$, $I_{sc} = 35 \text{ kA}$, IT system	Breaking capacity	NG125L
	Connection	2 poles on "+"
2 poles on "-"		
Isolation not required	Provided by the 4 poles	

➤ Choose a B-curve NG125L 4P 20 A circuit breaker connected symmetrically to the two "+" and "-" polarities.

Residual current devices do not work on a direct current distribution system.

Earth leakage protection can be provided by circuit breakers or residual current circuit breakers installed on the upstream AC distribution system.

Standard IEC 60479-1 determines applicable values for the protection of users.

Residual current devices

DC networks isolated from any AC network

Residual current devices will not work with a direct current distribution system powered directly by a battery, a generating set, photovoltaic cells, etc., or a rectifier with galvanic insulation. In this case protection for users is provided by choosing a network voltage that is not dangerous and an appropriate earthing system.

Safe direct current network voltage

Environment	TN-S system		IT system
	Earthed polarity	Earthed mid-point	
Dry	100 V	200 V	100 V
Wet	50 V	100 V	50 V
Immersed	25 V	50 V	25 V

DC networks connected to an AC network

In the case of a direct current distribution system powered by an AC/DC converter (without galvanic insulation), earth leakage protection can be provided by circuit breakers or residual current circuit breakers installed on the AC network upstream of the converter.

Protection against direct contact

Earth leakage protection of high sensitivity ($I_{\Delta n} = 30 \text{ mA}$) is compulsory if certain circuits operating on direct current entail risks of barring of live parts (see installation standards). This protection system should be chosen as follows:

- type A or si (bipolar), if the converter is powered by a single-phase supply
- type B, if the converter is powered by a three-phase supply.

The choice of this protection system does not depend on the earthing system.

Protection against indirect contact

Protection against indirect contact		Medium-sensitivity earth leakage protection $I_{\Delta n} \geq 300 \text{ mA}$		
Upstream power supply		Three-phase		Single-phase
Characteristics of direct-current circuits to be protected		Without double insulation	With double insulation	
Upstream earthing system	TT or IT with non-interconnected exposed conductive parts	Type B	Type A	
	TN-S IT	Type A		

Fire protection

Fire protection		Medium-sensitivity earth leakage protection $I_{\Delta n} = 300 \text{ mA}$		
Upstream power supply		Single-phase or three-phase		
Characteristics of direct-current circuits to be protected		Humid or dusty environments, ancient installations and buildings		
Upstream earthing system		No influence		
		Type A		

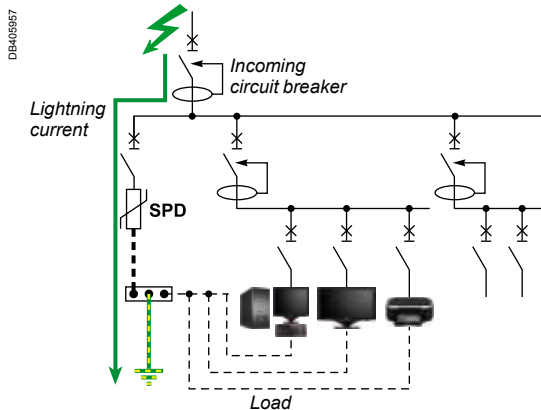

Surge protective device

In fact the operating principle of the surge protective device remains identical in direct current; the surge protective devices capture and conduct to earth the current of electric overvoltages.

Particularly if the direct current is implemented by a rectifier without galvanic insulation and if the AC network already contains a surge protective device, there will be no need for a specific protective device.

Otherwise, the surge protective device should be adapted "finely" to the network voltage (and the overvoltage resistance of the loads, which is linked to the network voltage).

Type 3

Fine protection very close to the loads

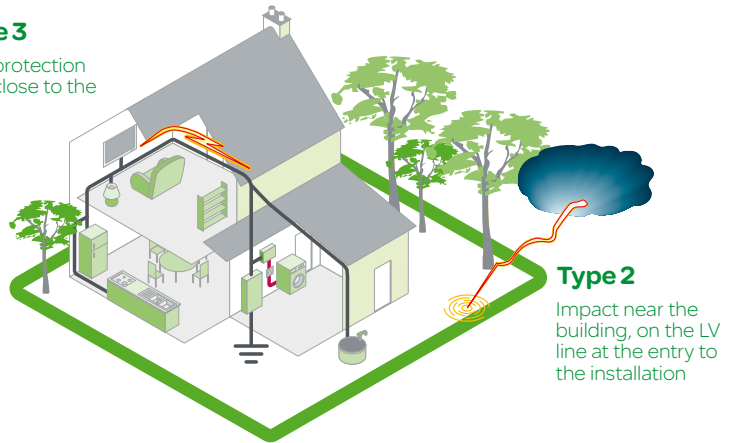

Type 1 surge protective device

The type 1 surge protective device is recommended in the specific case of service-sector and industrial buildings, protected by a lightning rod or a meshed cage. It protects electrical installations against direct lightning strokes. It can discharge the back-current from lightning spreading from the earth conductor to the network conductors.

Type 1 surge protective devices are characterized by a 10/350 μ s current wave.

Type 2 surge protective device

The type 2 surge protective device is the main protection system for all low-voltage electrical installations. Installed in each electrical switchboard, it prevents the spread of overvoltages in the electrical installations and protects the loads.

Type 2 surge protective devices are characterized by an 8/20 μ s current wave.

Type 3 surge protective device

These surge protective devices have a low discharge capacity. They must therefore mandatorily be installed as a supplement to type 2 surge protective devices and in the vicinity of sensitive loads.

Type 3 surge protective devices are characterized by a combination of voltage waves (1.2/50 μ s) and current waves (8/20 μ s).

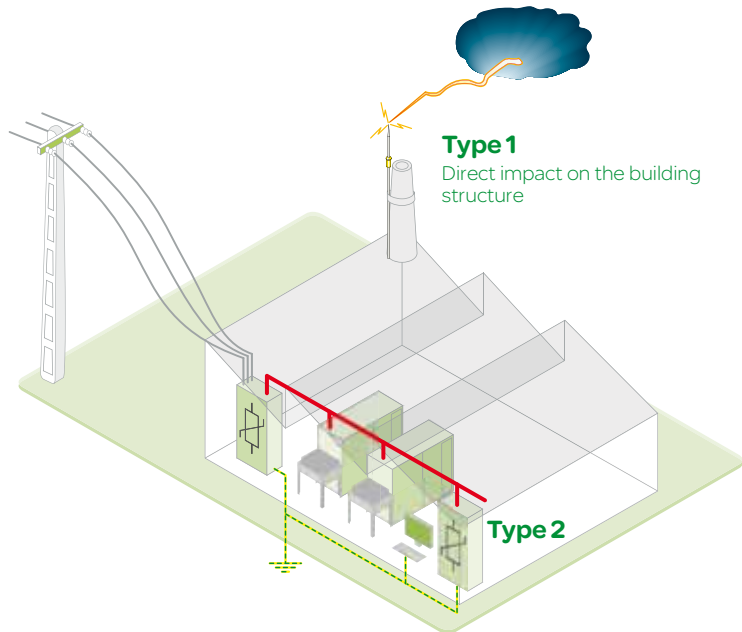

Generally the direct current switching voltage should be assigned a coefficient of $\sqrt{2}$ compared with alternating current. Apart from this the principle for choosing devices according to the networks remains the same.

Network voltage	Comments	Offer
24 / 48 V	Communication	iPRI
< 200 V	Communication	iPRC
200 to 400 V	Type 2 and 3	iPRD, iPF
200 to 400 V	Type 1 and 2	iPRF1, PRD1
200 to 400 V	Type 1	PRD1 Master, PRF1 Master
600 or 1000 V	PV applications	iPRD-DC

Coordination with disconnectors

A study is underway on the coordination of our surge protective devices on direct current networks; it will enable this document to be supplemented at a later stage.

DE400800

Table 6 – Equipment having a nominal voltage below 120 V a.c. or below 750 V d.c.

DC		AC	
Nominal values		Nominal values	
Preferred V	Supplementary V	Preferred V	Supplementary V
6	2,4	6	5
	3		
	4		
	4,5		
	5		
12	7,5	12	15
	9		
24	15	24	
36	30		36
48	40	48	
60	80	60	100
72			
96			
110	125	110	
220	250		
440	600		

NOTE 1 Because the voltage of the primary and secondary cells is below 2,4 V, and the choice of the type of cell to be used in various applications will be based on properties other than the voltage, these values are not included in the table. The relevant IEC technical committees may specify types of cells and related voltages for specific applications.

NOTE 2 It is recognized that for technical and economic reasons, additional voltages may be required for certain specific fields of application.

IEC 60038 standard.

The installation rules of the IEC 60364 standard apply to direct current distribution systems.

Network voltage

24 V, 48 V, 60 V, 125 V, 250 V, 500 V, 750 V.

These voltages often depend on the application or the sources used, for example:

- batteries on single-phase DC charger: voltage 240 V DC,
- batteries on three-phase DC charger: voltage 440 V DC.

Overcurrent protection

Short-circuit current

The short-circuit current depends on the source. For a distribution system powered by a battery, it can be calculated by the formula $I_{sc} \text{ (in A)} = kC$ with:

- C the battery capacity in Ah,
- k a coefficient close to 10 and in any case always less than 20.

Example

A 125 V battery of capacity 220 Ah delivers a short-circuit current I_{sc} between 2.2 kA and 4.4 kA.

Note: Since the I_{sc} current value is relatively low and the distribution system is not very extensive, the maximum short-circuit current I_{sc} at any point of the installation is taken as equal to the short-circuit current I_{sc} of the source (value by excess).

Overload protection

For a load of operating current I_b and a duct of permissible current I_z , the duct protection by a distribution circuit breaker must have a rating I_n such that: $I_b \leq I_n \leq I_z$.

Short-circuit protection

The installation standards impose no particular constraint: a magnetic tripping threshold I_m such that $5 I_n \leq I_m \leq 10 I_n$ is generally advisable.

Appendix 1

iC60, C120, NG125 offer

Choosing circuit breakers for distribution with earthed polarity

The following tables show the number of poles connected in series according to the DC network voltage, and the circuit breaking performance of our circuit breaker range.

Breaking capacity for a maximum voltage per pole of: 72 V DC for the iC60 offers and 144 V DC for the C120 and NG125 offers



Fault condition analysis, see page 728.

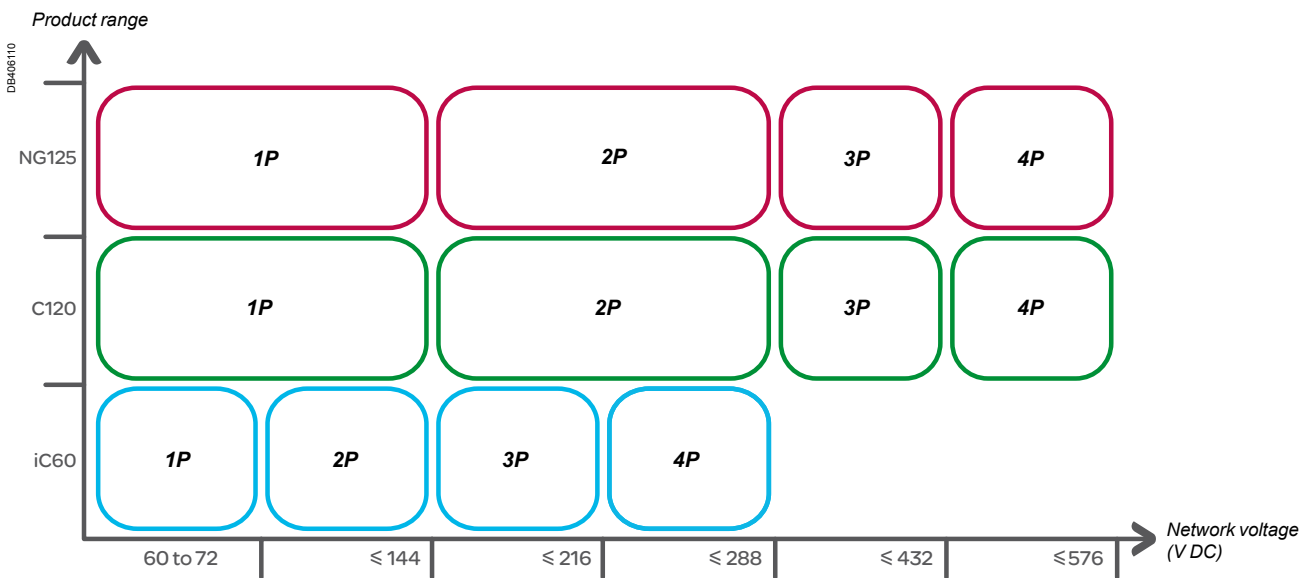

Isolation, number of poles and connection diagram, see page 729.

Appendix 2

iC60, C120, NG125 offer

Choosing circuit breakers for distribution with earthed mid-point

The following tables show the number of poles connected in series according to the DC network voltage, and the circuit breaking performance of our circuit breaker range.

Breaking capacity for a maximum voltage per pole of: 72 V DC for the iC60 offers and 144 V DC for the C120 and NG125 offers

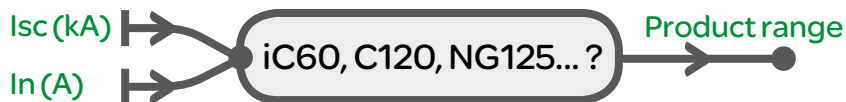

Fault condition analysis, see page 730.

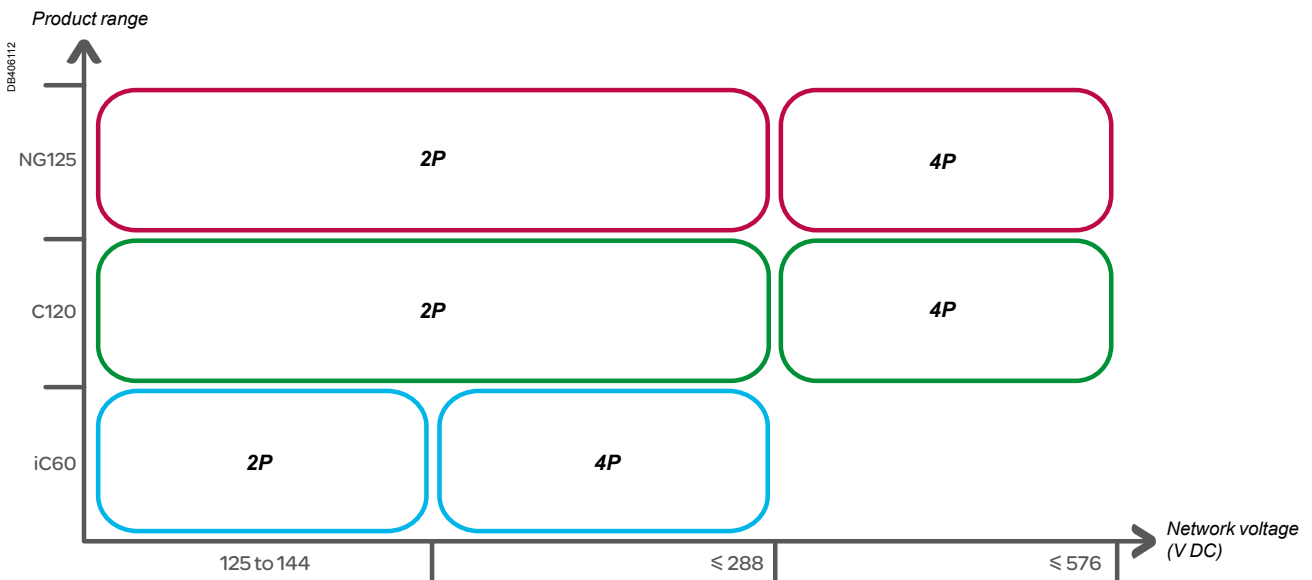

Isolation, number of poles and connection diagram, see page 731.

Appendix 3

iC60, C120, NG125 offer

Choosing circuit breakers for distribution isolated from earth

The following tables show the number of poles connected in series according to the DC network voltage, and the circuit breaking performance of our circuit breaker range.

Breaking capacity for a maximum voltage per pole of: 72 V DC for the iC60 offers and 144 V DC for the C120 and NG125 offers

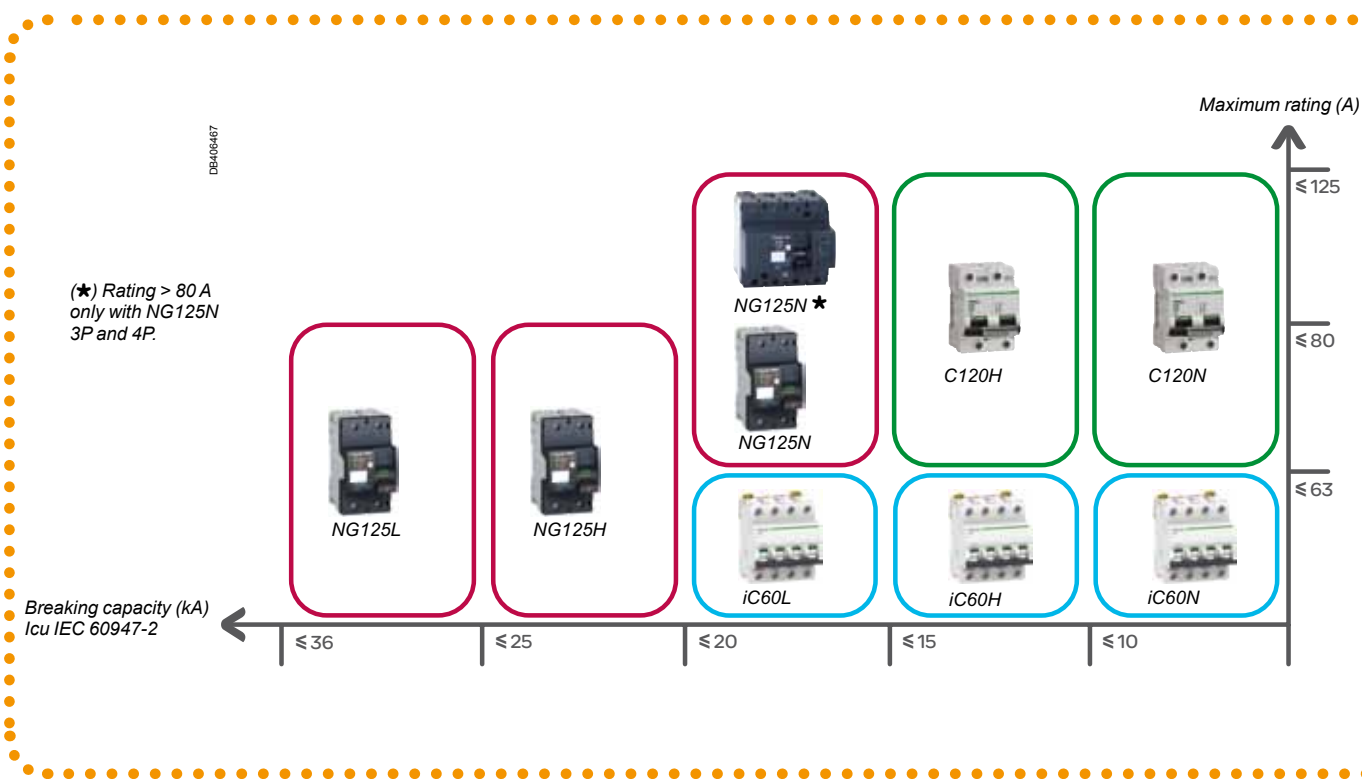
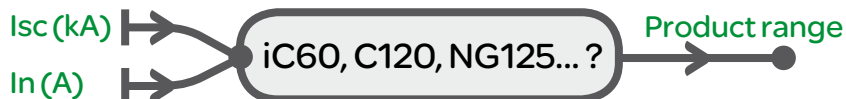

Fault condition analysis, see page 732.

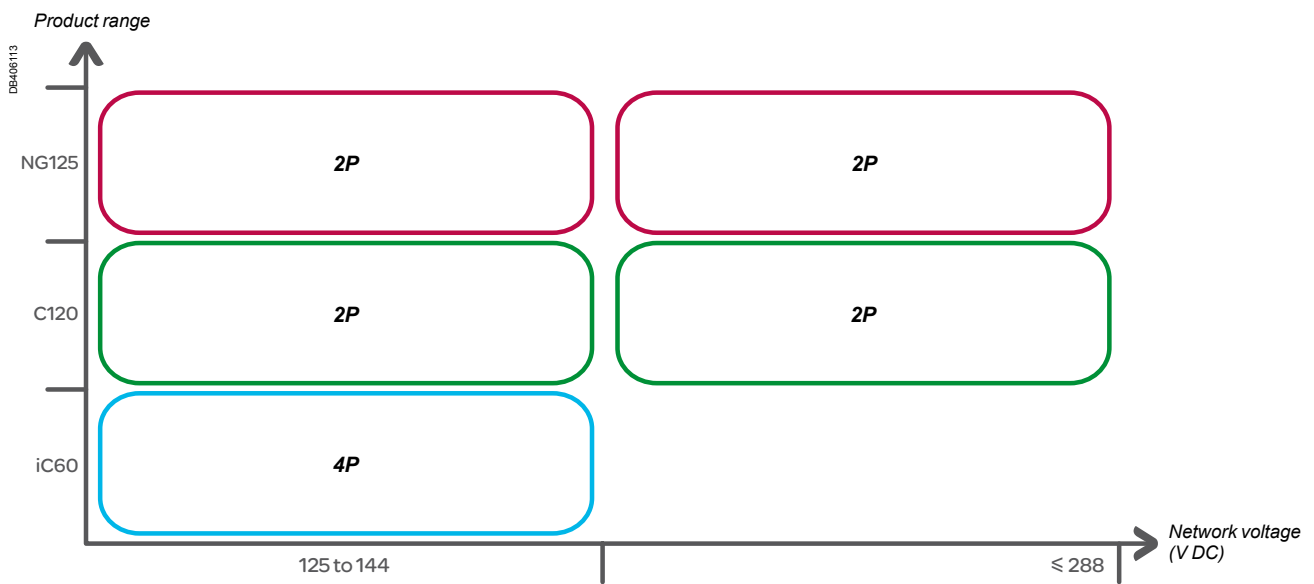

Isolation, number of poles and connection diagram, see page 733.

Make the most of your energy™

www.schneider-electric.com

Schneider Electric Industries SAS

35, rue Joseph Monier
CS 30323
F- 92506 Rueil Malmaison Cedex

RCS Nanterre 954 503 439
Capital social 896 313 776 €
www.schneider-electric.com

As standards, specifications and designs change from time to time, please ask for confirmation of the information given in this publication.



Printed on ecological paper

Publication : Schneider Electric Industries SAS
Design-Layout: SEDOC

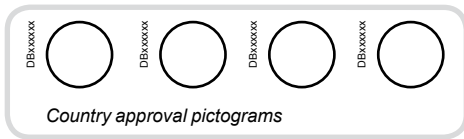

(Basic functions)

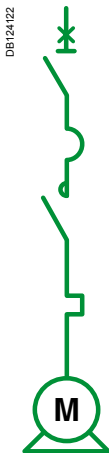

MA circuit breaker:
short-circuit protection
and isolation

Contactor:
control

Thermal relay:
overload protection

IEC 60947-4-1

Types of co-ordination

Standard IEC 60947.4 defines tests at various current levels with the aim of placing the switchgear in extreme conditions. According to the state of components after testing, the standard defines 2 types of coordination.

■ Type 1:

Deterioration of the contactor and relay is accepted under 2 conditions:

- there is no risk for the operator,
- parts other than the contactor and relay must not be damaged.

■ Type 2:

Welding of the contactor or starter contacts is accepted only if they can easily be separated:

- after type 2 coordination tests, the functions of the protection and control switchgear are operational.

Which type to choose?

The choice of coordination type depends on the operating parameters. It must be suitable for the user's needs and ensure optimised cost of the installation.

■ Type 1:

- qualified maintenance service,
- reduced volume and cost of switchgear,
- continuity of supply not required or ensured by replacing the faulty motor rack.

■ Type 2:

- continuity of supply vital,
- reduced maintenance service,
- specifications stipulating type 2.

The various thermal relay classes: the thermal relay class must be appropriate for the motor starting time.

Classes	Tripping time at 7.2 I _r (s)
10/10 A	2 to 10
20	6 to 20

Type 1 of co-ordination

- Starting: normal (Class 10).
- Breaking performance: equal to the breaking capacity of the circuit breaker only.
- Temperature: 40°C.

Catalogue numbers

Motor								Circuit breaker			Contactor	Thermal relay	
220 to 230 V		380 to 400 V		415 V		440 V ⁽¹⁾		Type	Rating (A)	I _{rm} (A)	Type	Type	Irth
P (kW)	I (A)	P (kW)	I (A)	P (kW)	I (A)	P (kW)	I (A)						
-	-	0.37	1.2	0.37	1.1	0.37	1	iC60LMA-NG125LMA	1.6	20	LC1-D09	LRD-06	1 to 1.6
-	-	0.55	1.6	0.55	1.5	0.55	1.4	iC60LMA-NG125LMA	1.6	20	LC1-D09	LRD-06	1.25 to 2
0.37	2	0.75	2	0.75	1.8	0.75	1.7	iC60LMA-NG125LMA	2.5	30	LC1-D09	LRD-07	1.6 to 2.5
-	-	-	-	1.1	2.6	-	-	iC60LMA-NG125LMA	4	50	LC1-D09	LRD-08	2.5 to 4
0.55	2.8	1.1	2.8	1.5	3.4	1.5	3.1	iC60LMA-NG125LMA	4	50	LC1-D09	LRD-08	2.5 to 4
11	5	2.2	5.3	2.2	4.8	2.2	4.5	iC60LMA-NG125LMA	6.3	75	LC1-D09	LRD-10	4 to 6
1.5	6.5	3	7	3	6.5	3	5.8	iC60LMA-NG125LMA	10	120	LC1-D09	LRD-12	5.5 to 8
2.2	9	4	9	4	8.2	4	7.9	iC60LMA-NG125LMA	10	120	LC1-D09	LRD-14	7 to 10
-	-	5.5	12	5.5	11	-	-	iC60LMA-NG125LMA	12.5	150	LC1-D12	LRD-16	9 to 13
4	15	7.5	16	7.5	14	7.5	13.7	iC60LMA-NG125LMA	16	190	LC1-D18	LRD-21	12 to 18
-	-	-	-	9	17	9	16.9	iC60LMA-NG125LMA	25	300	LC1-D18	LRD-21	12 to 18
5.5	20	11	23	11	21	11	20.1	iC60LMA-NG125LMA	25	300	LC1-D25	LRD-22	16 to 24
7.5	28	15	30	15	28	15	26.5	iC60LMA-NG125LMA	40	480	LC1-D32	LRD-32	23 to 32
-	-	18.5	37	-	-	-	-	iC60LMA-NG125LMA	40	480	LC1-D40A	LRD-340	30 to 40
11	39	-	-	22	40	22	39	iC60LMA-NG125LMA	40	480	LC1-D40A	LRD-350	37 to 50
-	-	22	43	25	47	-	-	NG125LMA	63	750	LC1-D40A	LRD-350	37 to 50
15	52	-	-	-	-	30	51.5	NG125LMA	63	750	LC1-D50A	LRD-365	48 to 65

(1) 480 V Nema.

The examples of photovoltaic installation architectures presented in this document illustrate the use of direct current circuit breakers dedicated to protection of the modules and cables of the PV strings, to protect against overloads and short circuits. To ensure the safety of the photovoltaic installation it is necessary, in the cases described below, to combine the C60PV-DC circuit breaker with other protective or fault detection devices on the DC side.

Installation from 10 to 100 kW - $U_e \leq 800$ V DC

In the case of a PV architecture without an earthed polarity on the DC side and with a PV inverter without galvanic isolation, it is necessary to:

- protect each string of photovoltaic modules with a C60PV-DC installed in the junction box near the PV modules
 - add a residual current device on the AC side of the PV inverter so that the latter trips as soon as an earth fault occurs on the DC side.
- It is necessary to intervene immediately on the site at the first default.**

Restarting will be possible only after eliminating the fault.

DE408329

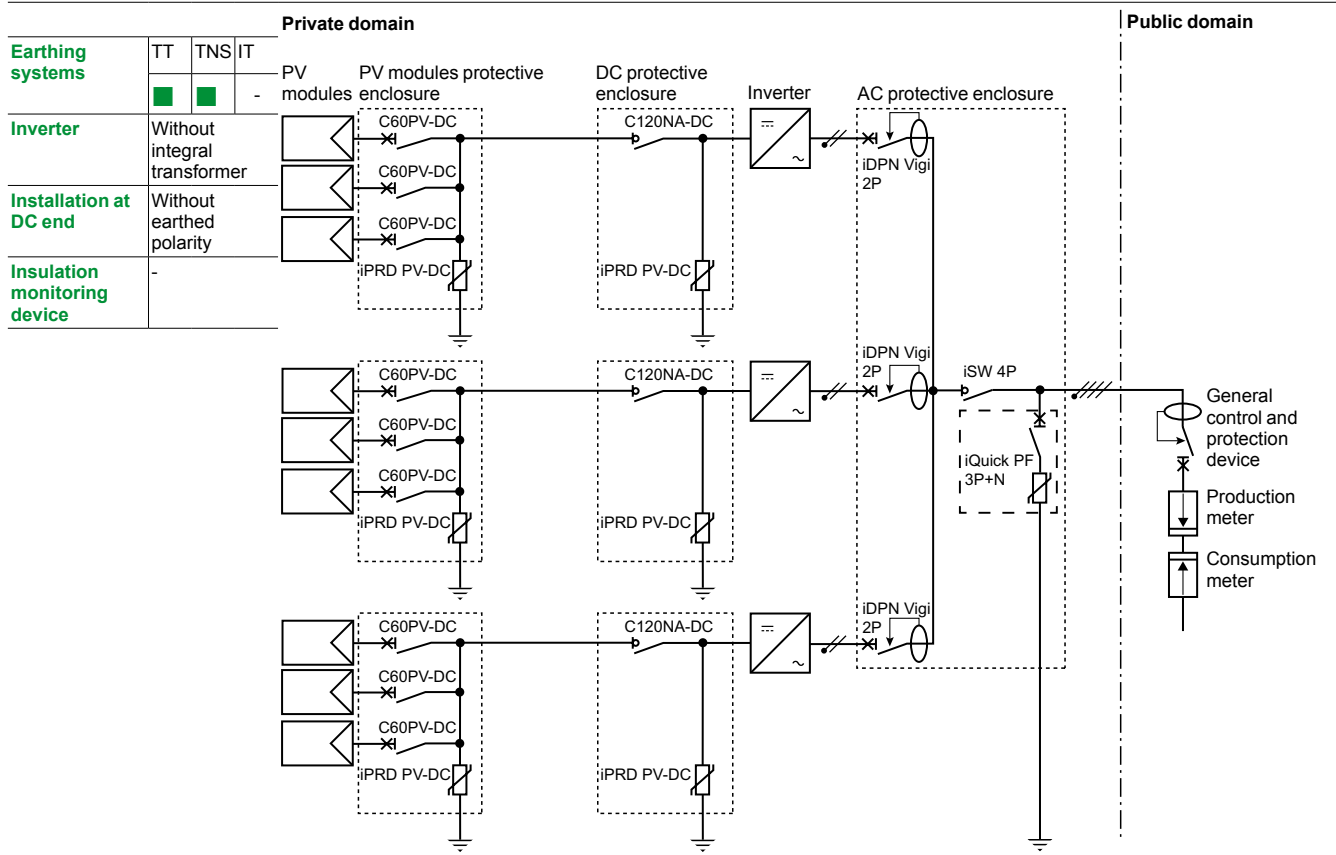

Installation from 10 to 100 kW - $U_e \leq 800$ V DC

In the case of a PV architecture without an earthed polarity on the DC side and with a PV inverter or with galvanic isolation, it is necessary to:

- protect each string of photovoltaic modules with a C60PV-DC installed in the junction box near the PV modules;
- add an insulation monitoring device on the DC side of the PV inverter in order to indicate a first earth fault and actuate stoppage of the inverter as soon as it occurs.

It is necessary to intervene immediately on the site at the first default.

Restarting will be possible only after eliminating the fault.

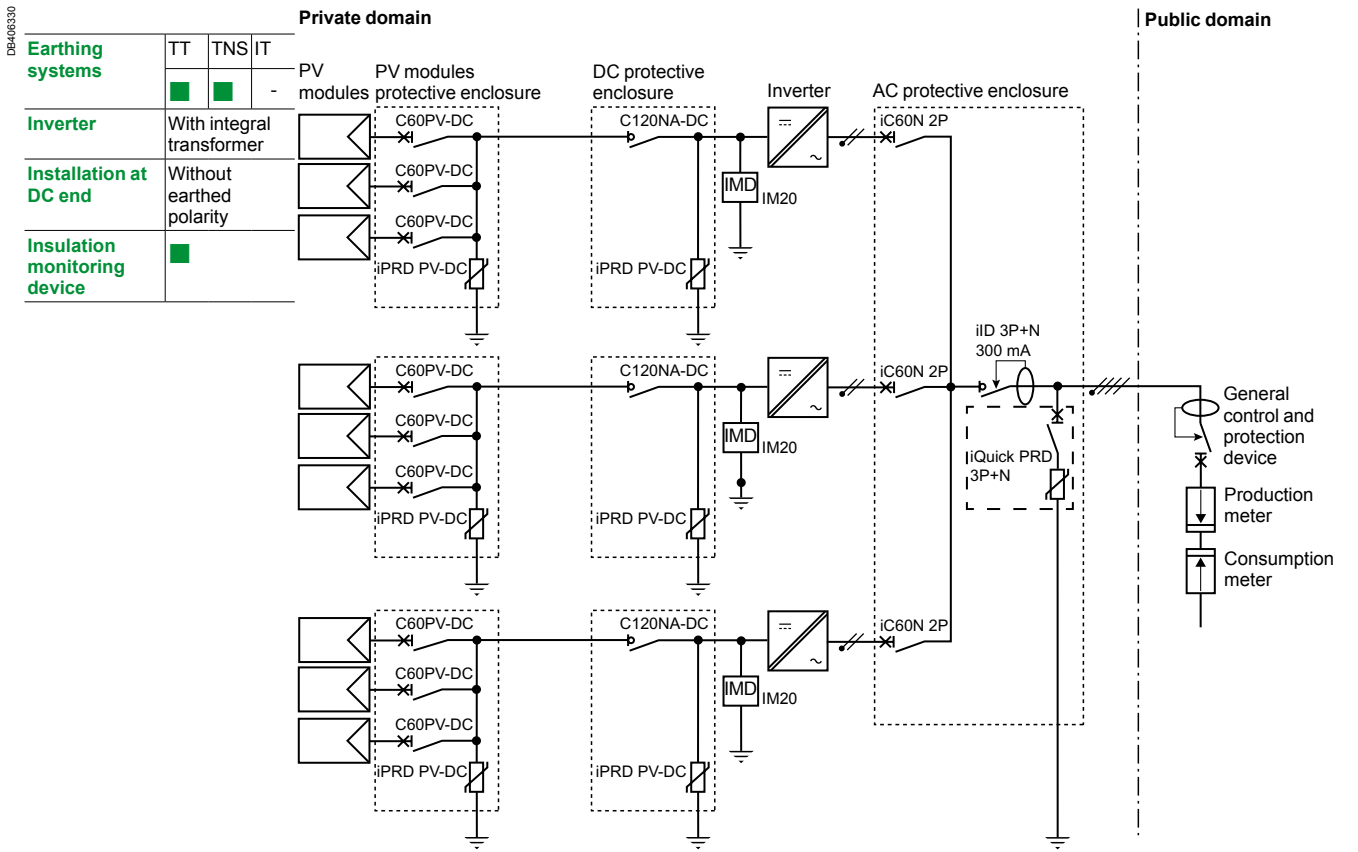

Installation from 10 to 100 kW - $U_e \leq 800$ V DC

In the case of a **PV architecture with an earthed polarity on the DC side and with a PV inverter having galvanic isolation**, it is necessary to:

- protect each string of photovoltaic modules with a C60PV-DC installed in the junction box near the PV modules
- add a C60PV-DC earth protection circuit breaker, with all poles in series, on the DC side of the PV inverter.

PV inverter stoppage is actuated via an auxiliary contact combined with the earth protection circuit breaker. Polarity earthing and the protective device should not be implemented if the PV inverter already has an earthed polarity.

It is necessary to intervene immediately on the site at the first default.
Restarting will be possible only after eliminating the fault.

DE408331

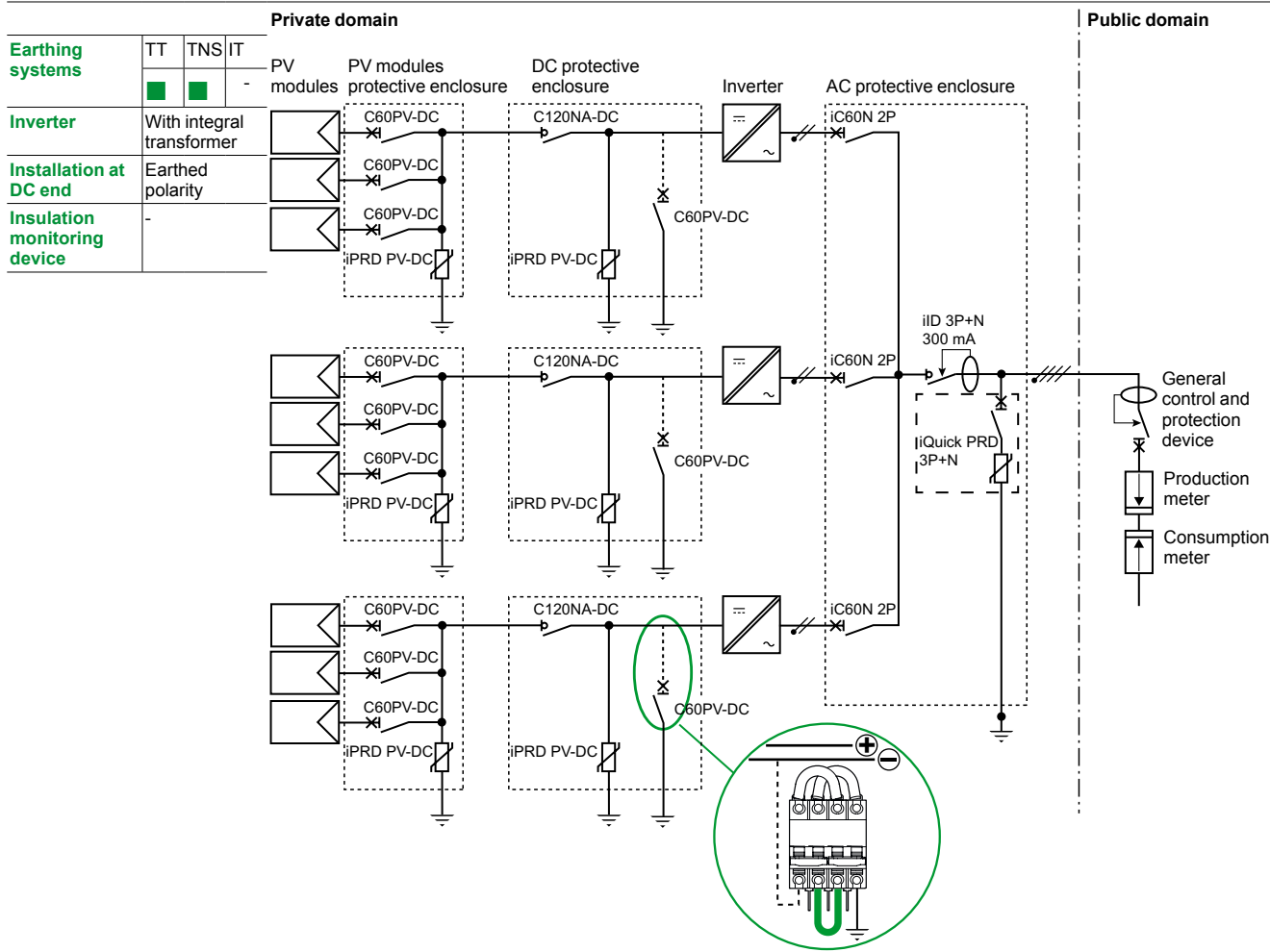

Installation > 100 kW - U_e ≤ 800 V DC

In the case of a PV architecture without an earthed polarity on the DC side and a central PV inverter having galvanic isolation, it is necessary to:

- protect each string of photovoltaic modules with a C60PV-DC installed in the protection cabinet for the PV strings located near the PV modules
- add an insulation monitoring device (IMD) on the DC side of the PV inverter (and on the AC side if IT earthing system on AC side) in order to indicate a first earth fault and actuate stoppage of the PV inverter as soon as it occurs.

It is necessary to intervene immediately on the site at the first default.
Restarting will be possible only after eliminating the fault.

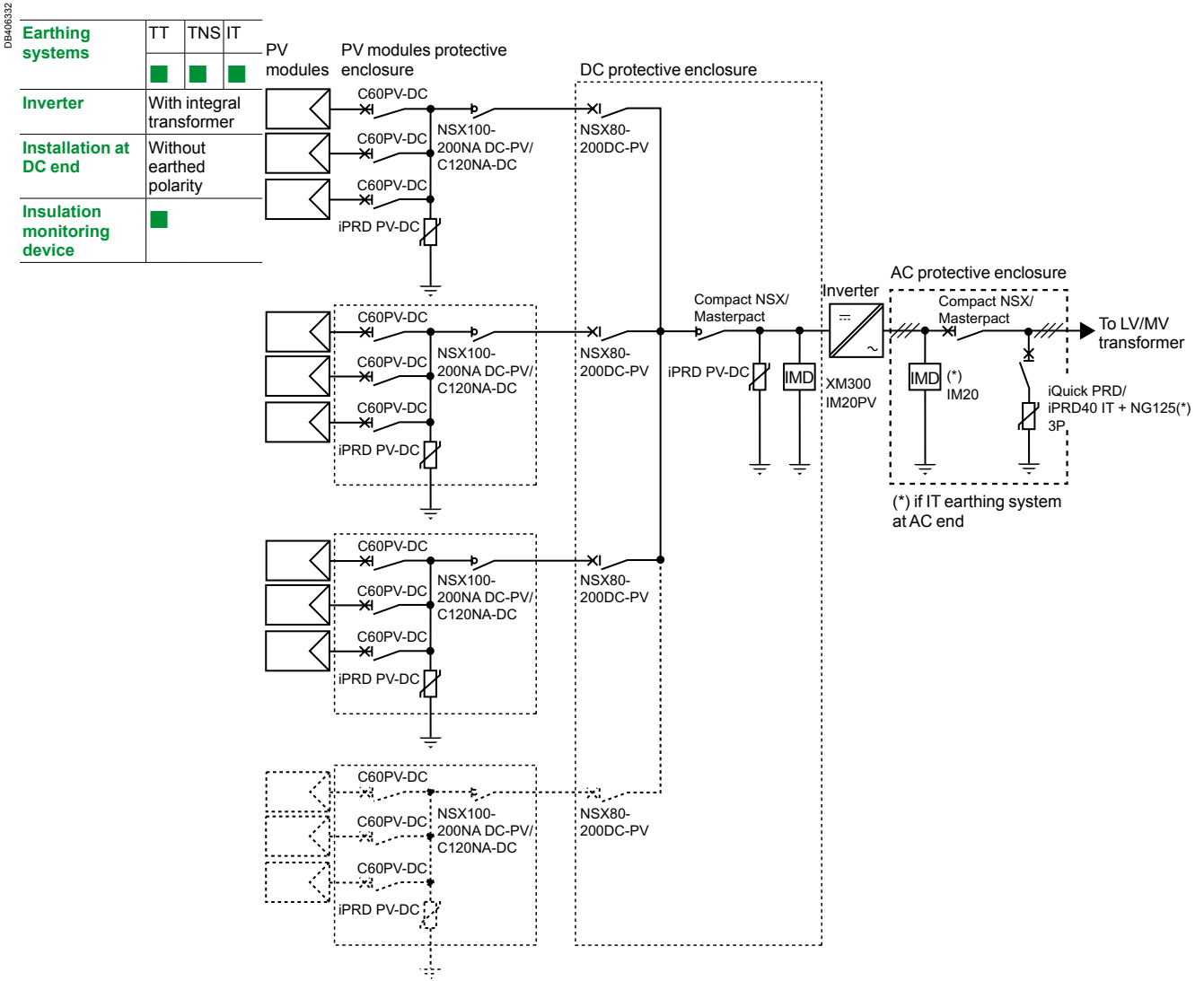

Installations > 100 kW - $U_e \leq 800$ V DC

In the case of a PV architecture with an earthed polarity on the DC side and a central inverter having galvanic isolation and an IT earthing system on the AC side, it is necessary to:

- protect each string of photovoltaic modules with a C60PV-DC installed in the protection cabinet for the PV strings located near the PV modules
- add a C60PV-DC earth protection circuit breaker, with all poles in series, on the DC side of the PV inverter.

PV inverter stoppage is actuated via an auxiliary contact combined with the earth protection circuit breaker. Polarity earthing and the protective device should not be implemented if the PV inverter already has an earthed polarity.

If the Isc of the DC installation exceeds 1.5 kA, replace the C60PV-DC earth protection circuit breaker with an NSX80 DC PV provided with a 16 A release.

It is necessary to intervene immediately on the site at the first default.

Restarting will be possible only after eliminating the fault.

DB406333

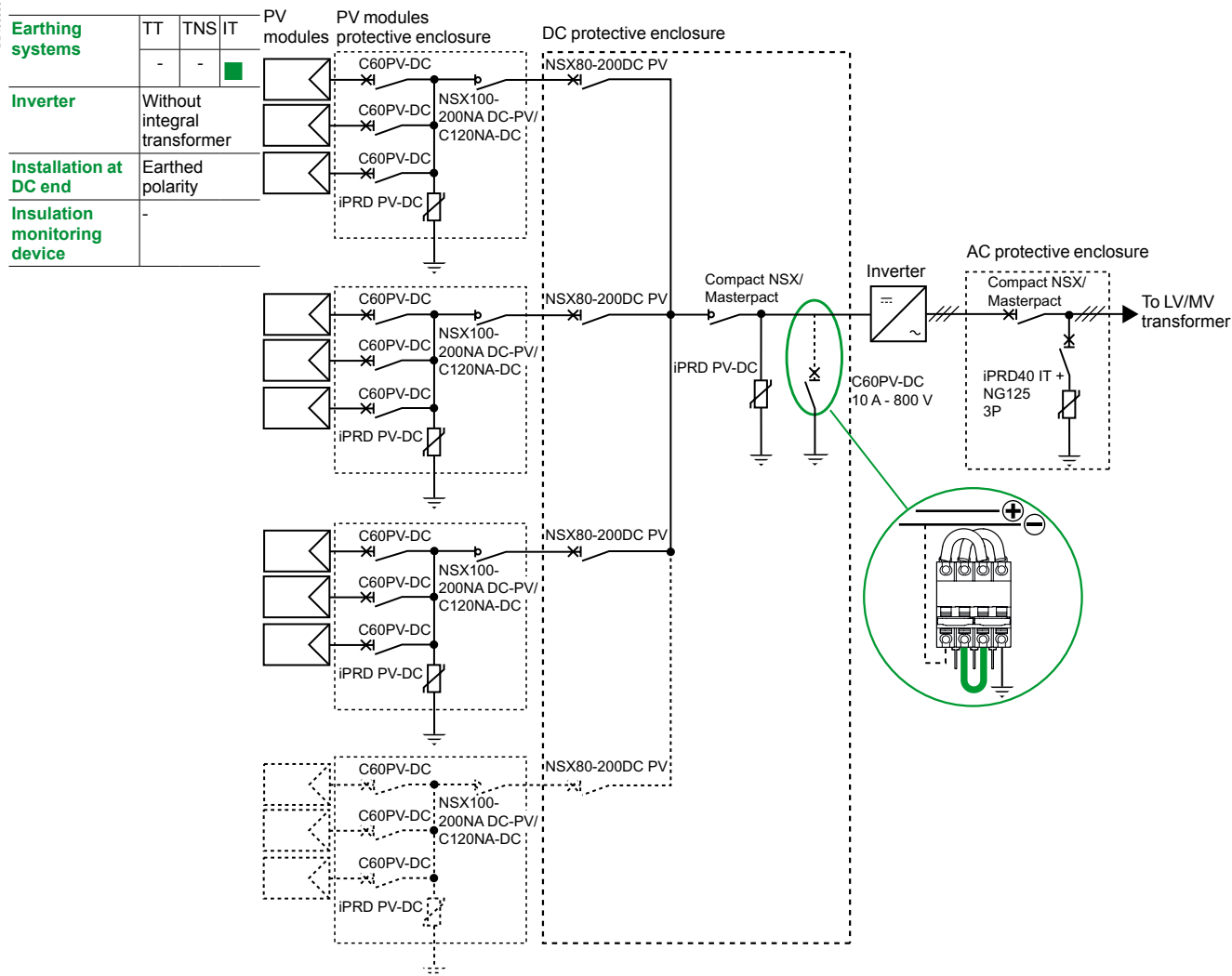

Examples of using C120NA-DC switch-disconnector Architectures

10 kW-100 kW grid-connected PV system (small buildings)

Three-phase multi-input inverter without array box

Typically, 10 kW to 36 kW grid-connected inverters with $U_{OC,MAX}$ probably higher than 600 V (i.e. 800 V or 1000 V) and $I_{SCTC} < 125 A$, $I_{AC} < 63 A$. In this range of power, inverters usually have between 2 and 4 maximum power point tracking (MPPT) inputs, so the number of strings in the same DC sub-network is equal to one or two. There is no need for string protection. A PV main switch for each MPPT input is necessary. When an inverter is indoors, additional remote-controlled switches at DC cable entry point are recommended for emergency services.

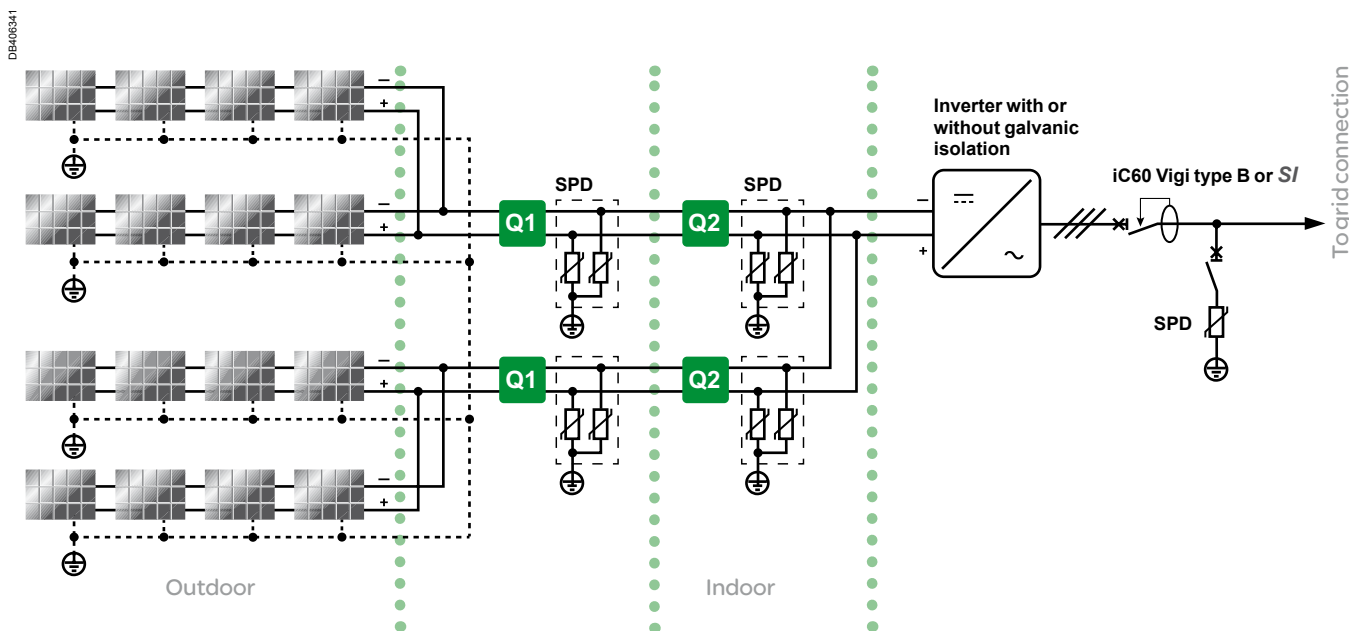

	String junction box	PV main switch
Needs	Switchgears and control	
Isolation	■	■ (b)
Switching (making and breaking rated current)	■ DC21B	■ (b) DC21B
Control	■ (a)	■ (b)
Schneider Electric offer	"Q1" C60NA-DC + MX / MN or C120NA-DC + MX / MN	"Q2" INS PV or C60NA-DC or C120NA-DC

(a) Remote switching for emergency services located as closely as possible to the PV modules or to the point of entry of DC cables in the building.
 (b) Service and emergency switching.

- If the inverter provides at least simple separation:
 - without functional earthing: insulation monitoring is necessary, it's usually done by the inverter in this range of power
 - with functional earthing: the earthing shall be done with a DC MCB breaker (C60PV 4P series 2 – 10 A) or a fuse.

Examples of using C120NA-DC switch-disconnector Architectures (cont.)

10 kW-100 kW grid-connected PV system (small buildings)

Three-phase inverter with one array box

Typically, 30 kW to 60 kW grid-connected inverters. $U_{OC,MAX}$ is generally higher than 600 V (up to 1000 V), I_{SCTC} does not exceed 200 A, I_{AC} does not exceed 100 A. This design has more than 2 strings. Reverse current protection is therefore necessary. A main PV switch is required. When an inverter is inside, additional remote-controlled switches at DC cable entry point are recommended for emergencies.

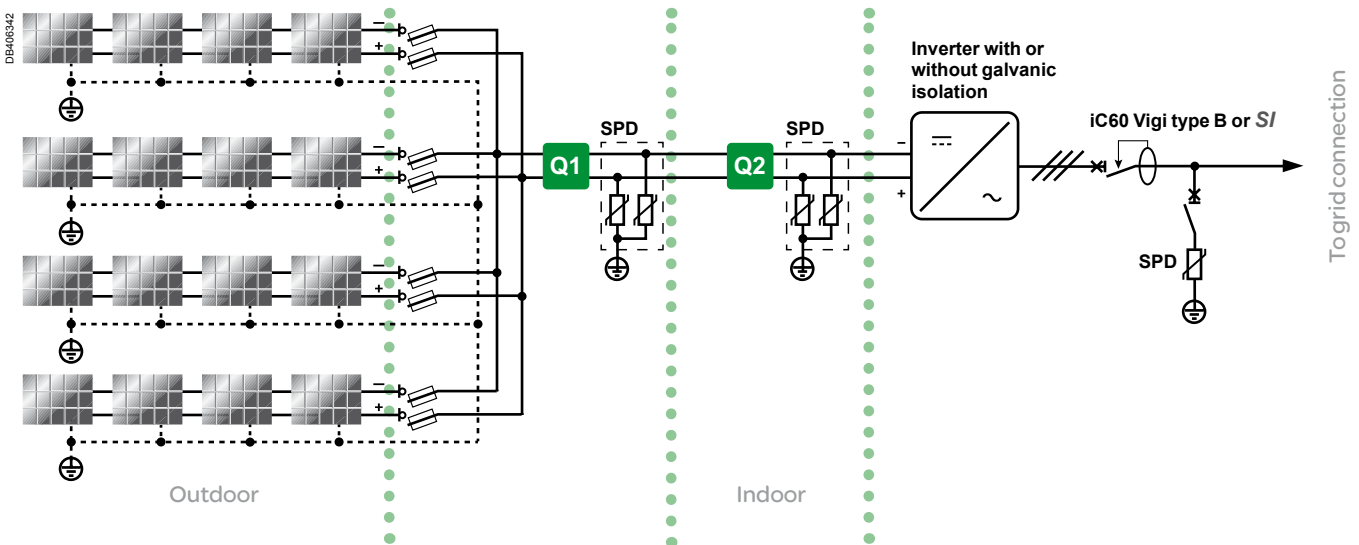

	String / Array junction box	PV array main switch
Needs	Switchgears and control	
Isolation	■	■ (b)
Switching (Making & breaking rated current)	■ DC21B	■ (b) DC21B
Control	■ (a)	■ (b)
Schneider Electric offer	"Q0" TeSys DF "Q1" Compact NSX DC PV + MX / MN or C120NA-DC + MX / MN	"Q2" Compact NSX DC PV or C120NA-DC

(a) Remote switching for emergency services located as closely as possible to the PV modules or to the point of entry of DC cables in the building. The main switch in array box can be equipped with tripping coil.
 (b) Service and emergency switching.

- If the inverter provides at least simple separation:
 - without functional earthing: insulation monitoring is necessary
 - with functional earthing: the earthing shall be done with a DC MCB breaker (C60PV 4P series 2 – 10 A) or a fuse.

Examples of using C120NA-DC switch-disconnector Architectures (cont.)

10 kW-100 kW grid-connected PV system (small buildings)

Three-phase inverter with two array boxes

Typically, 60 kW to 100 kW grid-connected inverters with 2 arrays. Array cable protection is not necessary for 2 or 3 arrays.

The I_{SCTC} array ≤ 200 A, $I_{SCTC} \leq 400$ A, and $I_{ACMAX} \leq 200$ A. A PV main switch is required close to the inverter. Remotely operated switches in array boxes allow disconnects to be located close to the PV modules in the event of emergencies.

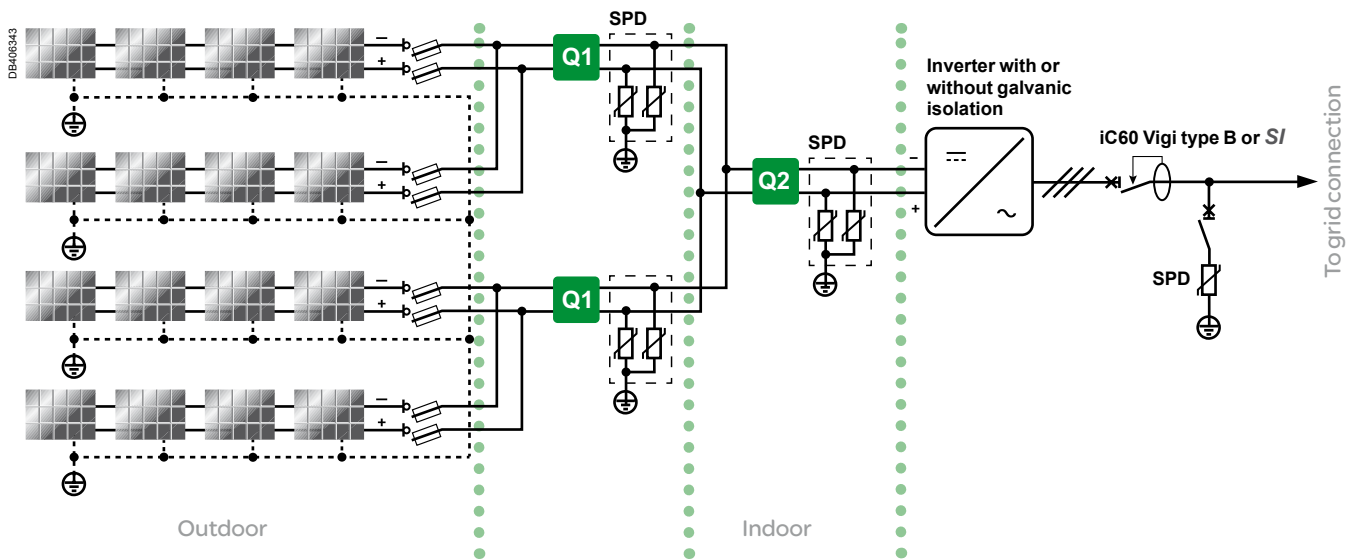

	String	Array junction box	PV generator main switch
Needs	Switchgears and control		
Isolation	■	■	■ (b)
Switching (making and breaking rated current)		■ DC22A	■ (b) DC22A
Control		■ (a)	■ (b)
Schneider Electric offer	"Q0" TeSys DF	"Q1" Compact NSX NA DC PV or C60NA-DC or C120NA-DC	"Q2" C120NA-DC or Compact NSX NA DC PV

(a) If emergency service switching is required, switches in array boxes can be equipped with tripping coils and motor mechanisms for remote reclosing.

(b) Service and emergency switching.

- If the inverter provides at least simple separation:
 - without functional earthing: insulation monitoring is necessary
 - with functional earthing: the earthing shall be done with a DC MCB breaker (C60PV 4P series 2 – 10 A) or a fuse.

Examples of using C120NA-DC switch-disconnector

Architectures (cont.)

150 kW-500 kW grid-connected PV system (large buildings and farms)

Multi three-phase inverter design without array box
Typically, 10 x 20 to 20 x 30 kW grid-connected inverters. $U_{OC\ MAX} \leq 1000\ V$.
One or two string per inverter. $I_{AC\ MAX} 50\ A$ for one inverter.

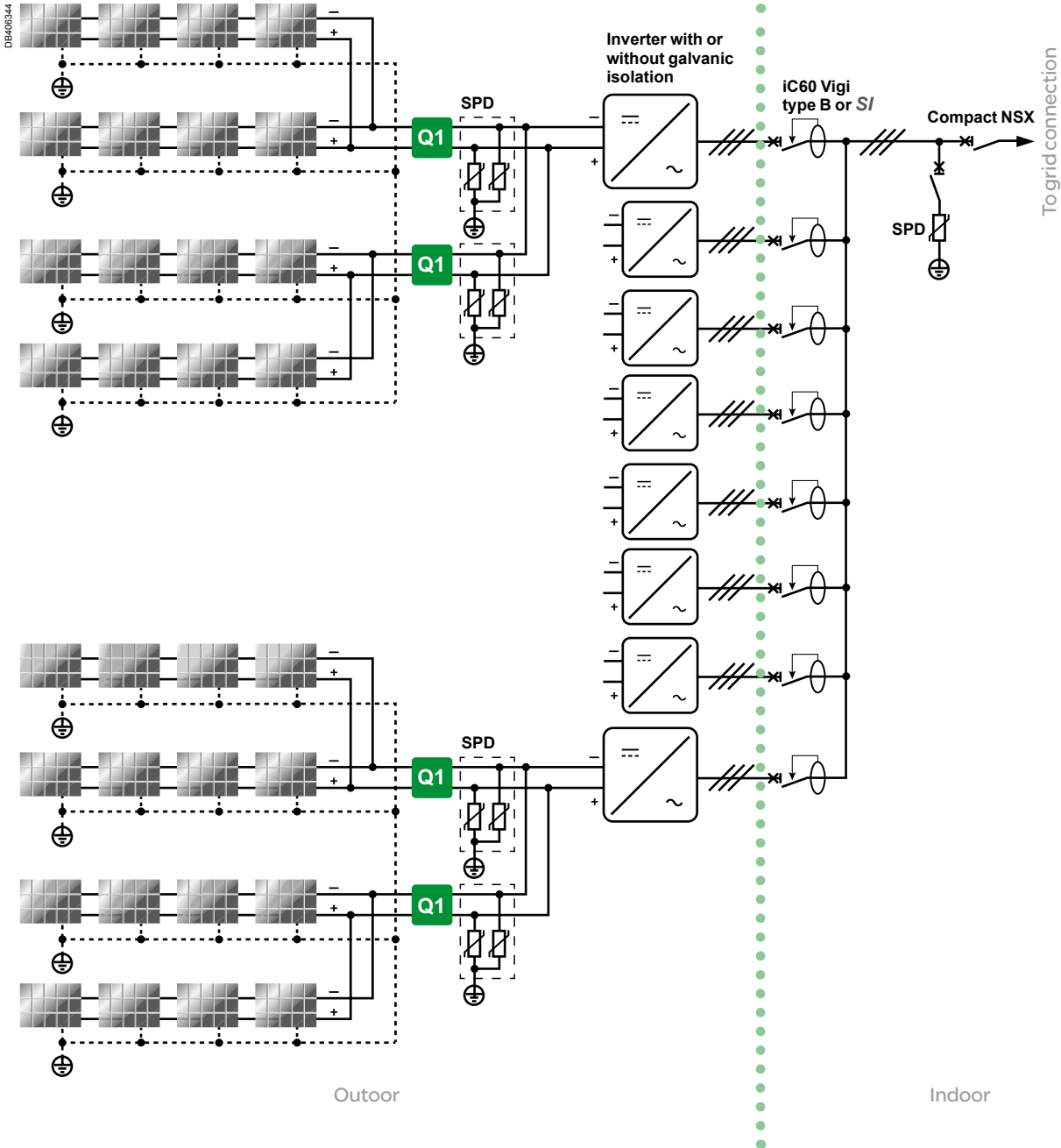





String / Array junction box	
Needs	Switchgears and control
Schneider Electric offer	"Q1" C60NA-DC or C120NA-DC or SW60DC See 10 to 36 kW design

Compact NSX with Micrologic trip unit ensures full selectivity with iC60 up to 40 A and offer advanced measurement and communication capabilities.



Acti 9 Smartlink and enclosure/cubicle mounting compatibility

Enclosures configuration	Type of Acti 9 Smartlink mounting above DIN rail in all cases					TOP fed		
	Functional units Height in 50 mm Vertical modules	Power downstream cabling Power upstream cabling					DIN rail	Linergy FM 80 A
24-horizontal modules		Strands	Wiring band (cat. no. 04239)	Single cable trough support + cable trough 30 or 40	Adaptable cable trough support + cable trough 60	Cable trough behind the rail		
Pragma Evolution - Surface mounting								
	3 modules 150 mm	■					☑	☑
Prisma Plus Pack - 160 A and 250 A								
	3 modules 150 mm	■	■				☑	☑
Prisma Plus G - Enclosure and cubicle								
	3 modules 150 mm	■	■				☑	☑
	4 modules 200 mm	■	■	■			☑	☑
	5 modules 250 mm	■	■	■	■		☑	☑
Prisma Plus P – Cubicle								
	3 modules 150 mm	■	■			■	☑	☑
	4 modules 200 mm	■	■	■		■	☑	☑
	5 modules 250 mm	■	■	■	■	■	☑	☑

		Bottom fed			
	Linergy FM 200 A	DIN rail (without comb busbar)		DIN rail + comb busbar (bottom position only)	
		Downstream cabling (in foot band)	Downstream cabling (in cable trough)	Downstream cabling (in foot band)	Downstream cabling (in cable trough)
		<input checked="" type="checkbox"/>			
		<input checked="" type="checkbox"/>			
		<input checked="" type="checkbox"/>			
		<input checked="" type="checkbox"/>	<input checked="" type="checkbox"/>	<input checked="" type="checkbox"/>	
	<input checked="" type="checkbox"/>	<input checked="" type="checkbox"/>	<input checked="" type="checkbox"/>	<input checked="" type="checkbox"/>	<input checked="" type="checkbox"/>
		<input checked="" type="checkbox"/>			
		<input checked="" type="checkbox"/>	<input checked="" type="checkbox"/>	<input checked="" type="checkbox"/>	<input checked="" type="checkbox"/>
	<input checked="" type="checkbox"/>	<input checked="" type="checkbox"/>	<input checked="" type="checkbox"/>	<input checked="" type="checkbox"/>	<input checked="" type="checkbox"/>

Key

- Compatible
- Incompatible or not applicable

Installation

On DIN rail

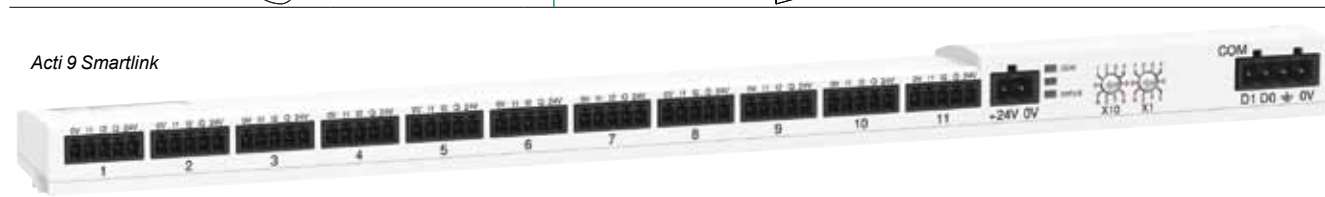
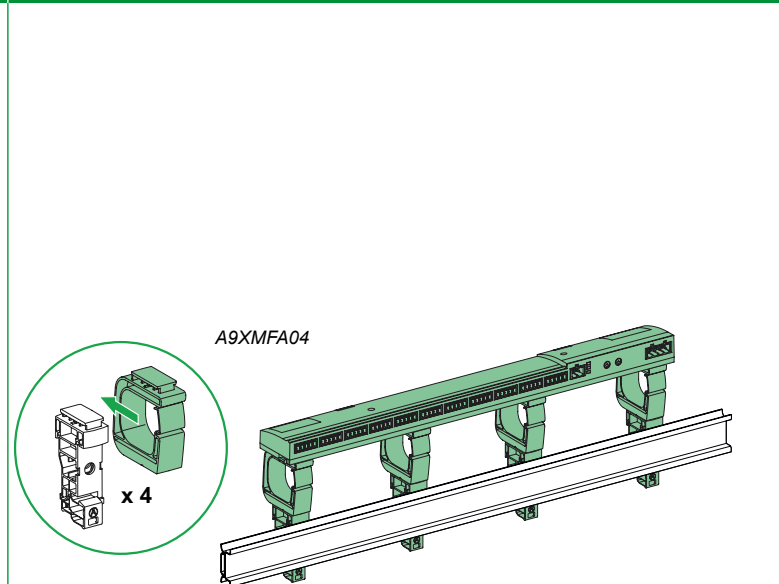
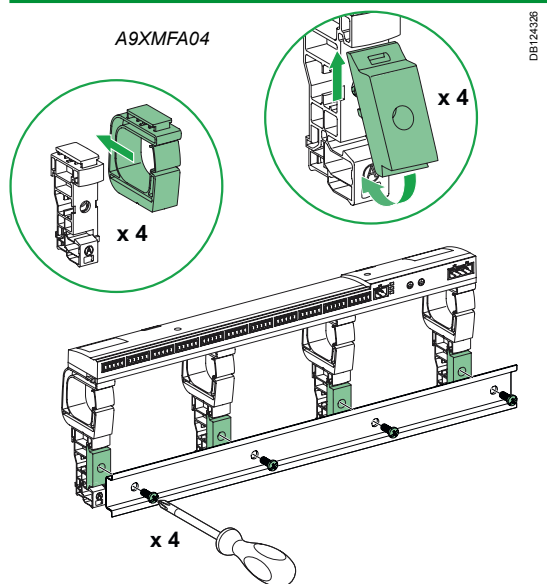

On Linergy FM 80 A cat. no.: 04000

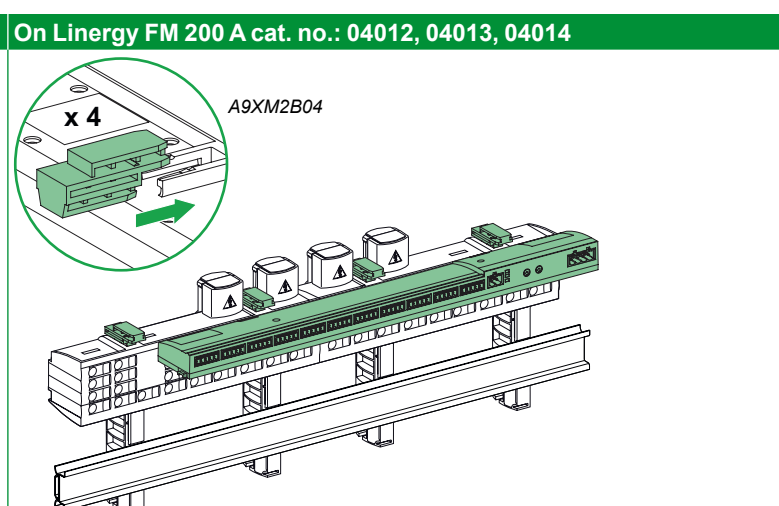
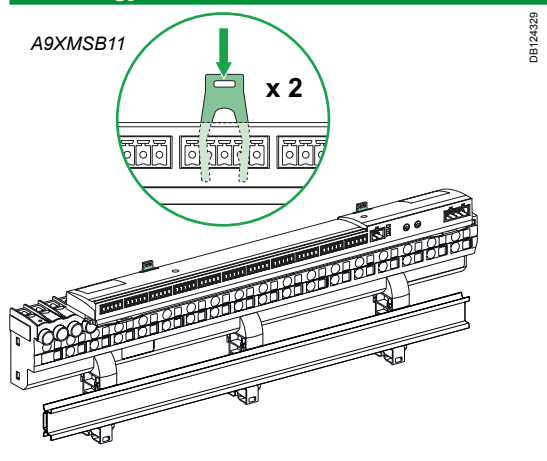

For back panel

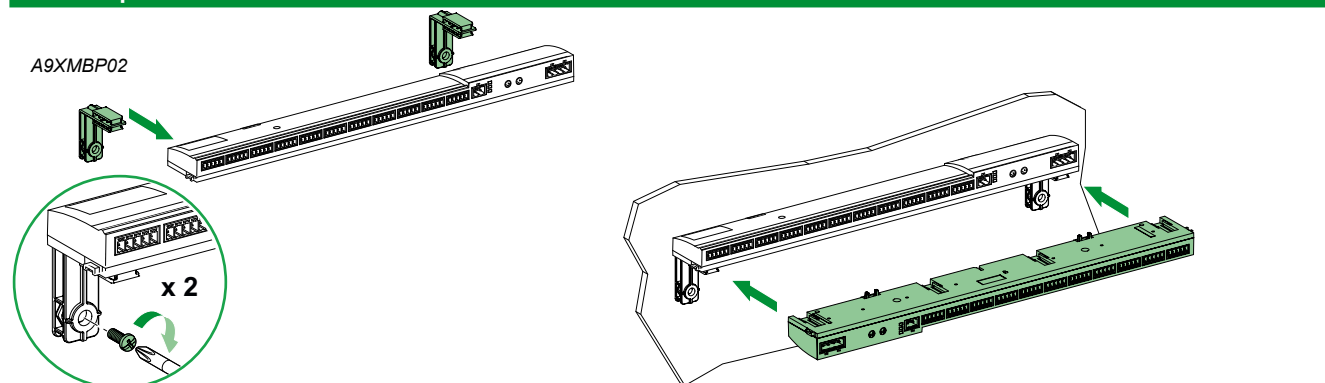

Residual current devices are vital for the safety of people.

That is why:

- the electrical installation operation and maintenance standards require these protection devices to be tested at regular intervals,
 - les the product standards IEC 61008 and IEC 61009 require such devices to be fitted with a test button (marked "T") on the front panel.
- The user can therefore check and be certain that the device is working correctly.

The test button provides reliable information about how the device is working: tripping as soon as the button is pressed guarantees that the protection is working properly. If the device fails to trip, it must be examined to determine the cause of this malfunction.

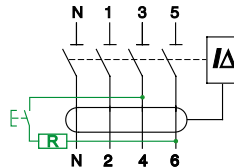

Example iLD

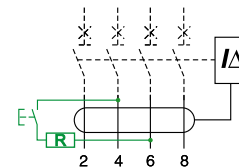

Example Vigi iC60





Test frequency

The residual current devices must be tested as frequently as required by the installation regulations and/or the safety regulations currently in force.

In the absence of any regulations, Schneider Electric recommends the test to be carried out:

- after initial connection and any subsequent reconnection,
- every years, for devices recently installed in good environmental conditions (no dust, corrosion, humidity, etc.),
- every 3 months, for devices that have been in use for seven years or more in good environmental conditions,
- every months, for devices used in corrosive or harsh environmental conditions or highly exposed to lightning strikes.



Procedure

<p>The residual current device is powered on and the loads are connected.</p>	<p>Briefly press the test button marked "T" on the front panel.</p> <p> Pressing the test button too long can seriously damage the device.</p>	<p>The residual current device should trip instantly. If it fails to trip, the additional checks described below should be performed.</p>	<p>When the test is finished, put the residual current device back into service.</p>
			

Failure to trip during the test

Failure to trip during the test is often due to a cause that is external to the residual current device.

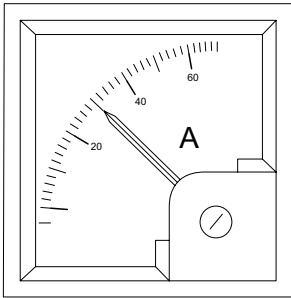
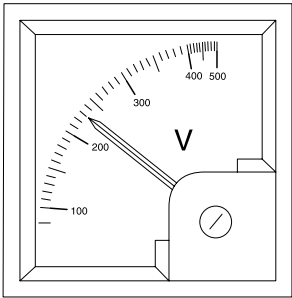
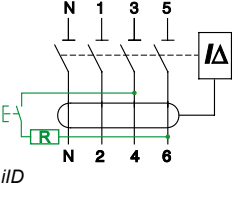
The table below shows the possible causes, the additional checks and tests to be carried out and the corrective actions to be taken, depending on the results. After a corrective action has been performed, repeat the test until a correct result is obtained.

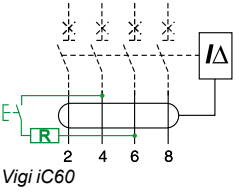
Cause of the malfunction			
Network frequency	Network voltage	Connection (three-pole or four-pole device)	Load leakage currents
Additional test			
Check that the network frequency is the same as the frequency read on the device.	Check that the mains voltage is the same as that indicated on the front face of the device.	Measure the voltage between terminals: <ul style="list-style-type: none"> ■ 3 and 6 for iID ■ 4 and 6 for Vigi iC60. This voltage must be between 85 % and 110 % of the voltage indicated on the device ⁽¹⁾ .	Disconnect the loads and press the test button again.
		 iID	
		 Vigi iC60	
Incorrect test result			
If the network frequency is different, the button test is not significant.	<ul style="list-style-type: none"> ■ If the voltage measured is less than 85 % of that indicated on the device, the test button may not work, although the protection device will continue to function ⁽¹⁾. ■ If the voltage measured is more than 110 % of the voltage indicated on the device there is a risk that the device will be destroyed. 	The incorrect voltage may be due to a connection error (e.g. phase/neutral inversion/missing phase, etc.). The Acti 9 three-pole and four-pole residual current devices cannot be used on single-phase circuits. The Acti 9 four-pole residual current devices can be used normally on three-phase circuits without neutral.	If the device trips, the earth leakage protection is working correctly.
Corrective actions			
The device must be checked by an external device (see below).	If the voltage measured is different from the rated voltage of the mains, look for the problem on the power supply or on the downstream circuits (lines, loads): <ul style="list-style-type: none"> ■ if the rated voltage of the mains is lower than that indicated on the device it must be replaced by a device with a suitable rated voltage the next time it is shut down ■ if the rated voltage of the mains is higher than the voltage indicated on the device it must immediately be replaced by a device with a suitable rated voltage. 	Modify the connection to obtain the rated voltage (phase-phase) between terminals.	Measure the permanent leakage current of each load. <ul style="list-style-type: none"> ■ in the event of abnormal load leakage, correct the insulation fault. ■ otherwise, separate the circuits to reduce the permanent leakage currents seen by each residual current device.

⁽¹⁾ In most cases, the test button on the Acti 9 residual current devices functions at down to 50 % of the rated voltage.

If none of the additional tests indicate a fault, the residual current device is faulty. Checking with an external device (see below) will show whether or not it has to be replaced urgently.

Test result	Positive	Negative
Diagnosis	<ul style="list-style-type: none"> ■ the earth leakage protection device is working properly ■ the test circuit is faulty 	Earth leakage protection is not working
Corrective actions		
	The residual current device must be replaced quickly (as soon as it is no longer being used).	 The residual current device must be replaced immediately

Some tertiary and industrial installation safety regulations require residual current devices to be checked with a specific device.

Checking with a specific test device

For the tests performed to be valid, these devices must comply with IEC 61557-6.

These devices are used to check:

- the operating voltage
- the tripping threshold (according to the sensitivity $I_{\Delta n}$) of the residual current device
- the tripping times at $I_{\Delta n}$, $2 \times I_{\Delta n}$, $5 \times I_{\Delta n}$, etc. The normal values are shown on pages CT6-1 and CT6-4.

With an IT earthing system (isolated neutral), a first insulation fault should be created artificially to allow a fault current to circulate during the tests.

Procedure

- Disconnect the fixed and mobile loads (if the residual current device protects the power outlets).
- Connect the test device to the downstream terminals of the residual current device or to a downstream power outlet.



Earth leakage protection

Response time of high-sensitivity residual current devices

All the high-sensitivity residual current devices (30 mA) in the Acti 9 range conform to the IEC/EN 61008 and IEC/EN 61009 standards. The response times defined by these standards guarantee their effectiveness in protecting people against direct contacts.

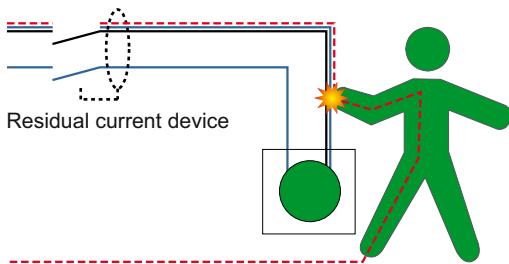

Response time

The response time of a residual current device is the time between the appearance of a dangerous leakage current and the interruption of the circuit.

For a residual current device with a sensitivity of $I_{\Delta n}$ 30 mA:

Fault current (mA)		Maximum response time (ms)
$I_{\Delta n}/2$	15 mA	No tripping
$I_{\Delta n}$	30 mA	300 ms
$2 \times I_{\Delta n}$	60 mA	150 ms
$5 \times I_{\Delta n}$	150 mA	40 ms

These response times conform to the specifications of the IEC/EN 61008 and IEC/EN 61009 standards.

They guarantee protection of people against direct contacts for the following reasons :

- When a person comes into direct contact with a live conductor, the current passes directly through the human body.
- This current, with the same magnitude, is detected by the residual current device.

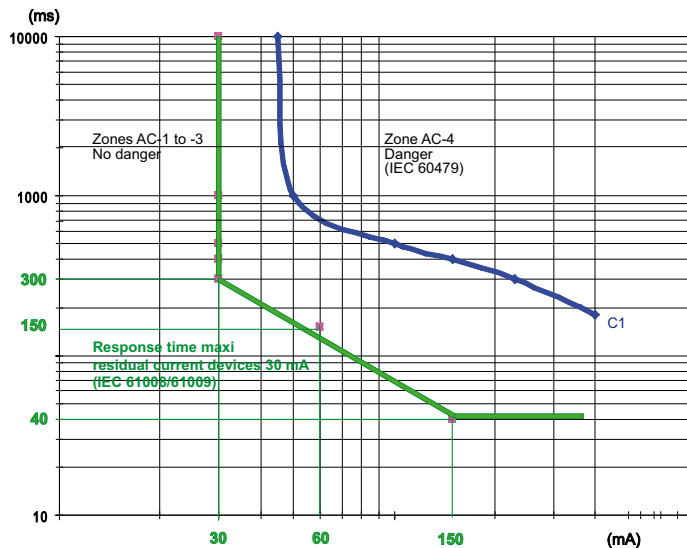

■ The IEC 60479 technical report studies the sensitivity of the human body to the electric current. Curve c1 defines for each current value the maximum time before the current causes injury to a person.

■ Superimposing the two curves shows that the above response times protects the users.

Measuring the response time

If the user wishes to check the response time of his residual current devices, he should follow a specific procedure to:

- establish a leakage current of calibrated magnitude
- measure the exact response time.

Procedure

The measuring instruments must conform to IEC/EN 61557-6.

Carry out the operations in the following order according to the safety instructions:

- disconnect the loads
- install the measuring instrument downstream of the residual current device to be tested (for example on a power outlet)
- perform the measurement.

Earth leakage protection

Response time of medium-sensitivity residual current devices

Response time of iC60 Vigi and iLD60 residual current devices

The medium-sensitivity residual current devices (100...1000 mA) in the Acti 9 range conform to IEC/EN 61008 and 61009:

- their response time guarantees personal protection against indirect contacts and fire risks
- in the case of selective versions (S), a "non-tripping time" guarantees discrimination with the residual current devices installed downstream.

Instantaneous residual current devices

		Sensitivity (I Δ n)			
		100 mA	300 mA	500 mA	
Fault current (mA)	I Δ n/2	50	150	250	No tripping
					Max. response time
	I Δ n	100	300	500	300 ms
	2 x I Δ n	200	600	1000	150 ms
	5 x I Δ n	500	1500	2500	40 ms
500 A					40 ms

Selective (S) and time-delayed (R) residual current devices

Residual current device	Sensitivity (I Δ n)				Type				
	100 mA	300 mA	500 mA	1000 mA	Selective (S)		Time-delayed (R)		
Fault current (mA)	I Δ n/2	50	150	250	500	No tripping		No tripping	
						Non-tripping time	Response time	Non-tripping time	Response time
	I Δ n	100	300	500	1000	130 ms	500 ms	300 ms	1000 ms
	2 x I Δ n	200	600	1000	2000	60 ms	200 ms	150 ms	500 ms
	5 x I Δ n	500	1500	2500	5000	50 ms	150 ms	150 ms	300 ms
500 A					40 ms	150 ms	150 ms	300 ms	

Definitions

Response time

Time between the appearance of a hazardous leakage current and circuit power down.

Non-tripping time

For selective and time-delayed devices, the non-tripping time is the time between the appearance of a hazardous leakage current and the device tripping.

If the leakage current disappears before this time, the device does not trip.

This fast disappearance of the leakage current can be due to:

- the transient nature of the fault (e.g. the current generated by a switching surge)
- the interruption of the fault current by another faster residual current device situated downstream.

Selective and time-delayed devices therefore afford the user:

- better immunity against nuisance tripping
- total discrimination between residual current devices.

Earth leakage protection

Response time of medium-sensitivity residual current devices

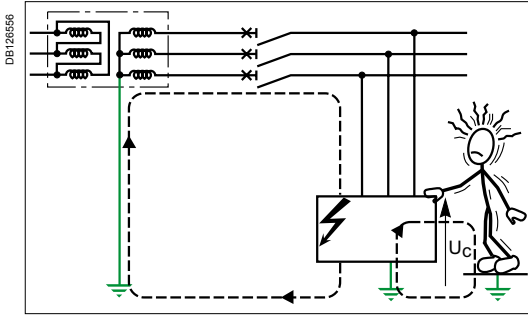

Protection against indirect contacts

The response times of residual current devices guarantee personal protection against indirect contacts, in conformance with the requirements of the installation standards (IEC 60364 or equivalent).

Indirect contacts

A person who comes into contact with an accidentally live frame caused by an insulation fault experiences an indirect contact: the contact voltage U_c creates a current that passes through the human body.

Maximum breaking time

The maximum breaking time required by the installation standards, in the event of an insulation fault, depends on:

- the network voltage
- the earthing system.

Maximum breaking time for terminating circuits (ms)

Earthing system	Network phase/neutral voltage			
	50...120V	120...230V	230...400V	> 400 V
TN or IT	800	400	200	100
TT	300	200	70	40

Note: a breaking time of no more than 5 s is permitted for distribution circuits to ensure discrimination with the devices installed on the terminating circuits. This time should be reduced to the essential minimum.

These times are based on the maximum prospective values of the contact voltage U_c and on the contact times authorised by technical report IEC 60479.

Example

On a three-phase phase/neutral voltage network $U_o = 230\text{ V}$ in a TT system:

- the resistance of the neutral earth connection R_n is $10\ \Omega$,
- the resistance of the operating frame earth connection R_A is $100\ \Omega$.

In the event of an insulation fault, the leakage current I_d is equal to: $U_o / (R_A + R_n)$ i.e. $230\text{ V} / 110\ \Omega = 2.1\text{ A}$.

The contact voltage U_c is therefore $I_d \times R_A$ i.e. $2.1\text{ A} \times 100\ \Omega = 210\text{ V}$.

■ Protection sensitivity

The residual current device must trip as soon as the leakage current corresponds to a hazardous situation, i.e. a contact voltage of 50 V (in a dry atmosphere). Hence, $I_{\Delta n} = 50\text{ V} / R_A$, i.e. $50\text{ V} / 100\ \Omega = 500\text{ mA}$.

■ Maximum breaking time

For a 230 V phase/neutral voltage network in a TT system, the IEC 60364 standard requires a maximum breaking time of 200 ms .

For the 2.1 A leakage current:

- an instantaneous residual current device with a sensitivity of 300 mA will power down the circuit in less than 40 ms ,
- an instantaneous residual current device with a sensitivity of 500 mA will power down the circuit in less than 60 ms .

Note: For well-designed and regularly maintained electrical installations, the resistance of the operating frame earth connection can be less than $100\ \Omega$.

Use of the time-delayed residual current devices

In accordance with the breaking times required by the installation standards (above), the selective and time-delayed residual current devices can be used in the following cases:

Circuit	Network voltage (phase/neutral)	Residual current device		
		Instantaneous I	Selective S	Time-delayed R
Terminating circuit	$\leq 230\text{ V}$	■	■	(1)
	$> 230\text{ V}$	■		
Sub-distribution or general		■	■	■

(1) Only in a TN system for a phase/neutral voltage $< 120\text{ V}$.

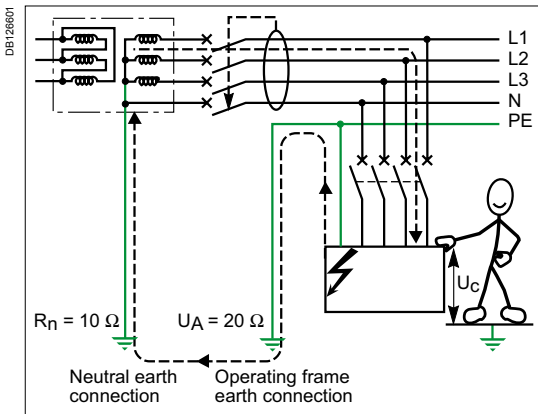

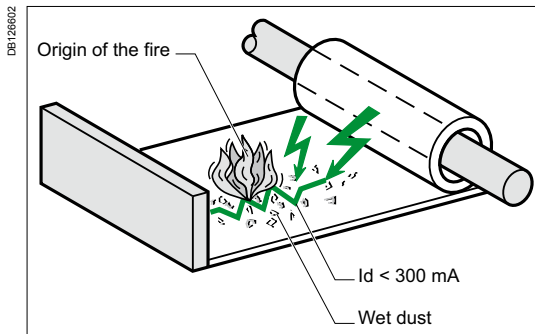

The response times of residual current devices with a sensitivity of 300 mA guarantee protection against fires generated by leakage currents

Protection against fire hazards

Most fires of electrical origin are caused by the creation and propagation of electric arcs in building materials, in the presence of moisture, dust, pollution, etc. These arcs appear and develop due to the wear and tear or ageing of the insulating materials. The fire risk occurs when the leakage currents reach a few hundred milliamps for a few seconds.

For fault currents of this magnitude, residual current devices with a sensitivity of 300 or 500 mA trip in less than a second, whether they be instantaneous, selective or time-delayed.

IEC 60364-4-42 (subclause 422.3.10) states that it is mandatory to install a residual current device with a sensitivity less than or equal to 500 mA:

- on premises with a risk of explosion (BE3)
- on premises with a risk of fire (BE2)
- in agricultural and horticultural buildings
- for circuits supplying fair, exhibition and entertainment equipment
- on temporary outdoor leisure facilities.

In certain countries, the installation rules and/or local safety regulations require a sensitivity of 300 mA.

Earth leakage protection

Response time of medium-sensitivity residual current devices

Discrimination of residual current devices

The non-tripping times of type (S) and (R) residual current devices ensure discrimination with the residual current devices located downstream.

Combination rules

To ensure discrimination between two cascading residual current devices, the following two conditions must be met simultaneously:

- the sensitivity of the upstream device must be at least 3 times the sensitivity of the downstream residual current device
- the upstream residual current device must be one of the following types:
 - Selective (S) if the downstream residual current device is instantaneous,
 - Time-delayed (R) if the downstream residual current device is selective (S).

The figure below shows how compliance with these rules provides discrimination on three levels: whatever the value of the fault current, it will be interrupted by the device situated immediately upstream of the fault and only by this device.

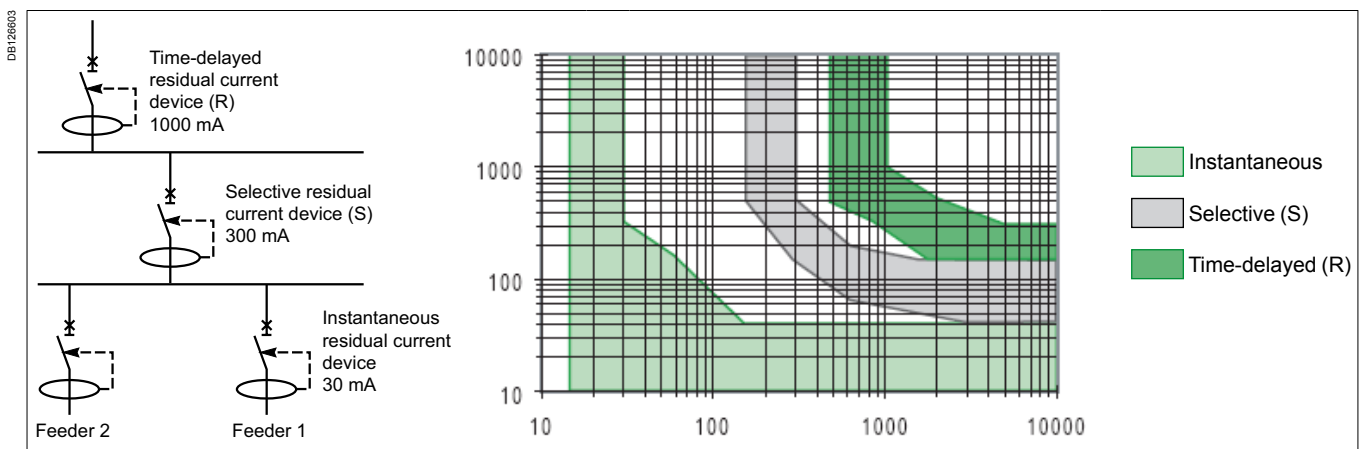

Example:

In the above diagram for a fault current of 1000 mA:

- if the fault occurs downstream of the 30 mA residual current device, the latter will interrupt the current in less than 40 ms, whereas type S and R devices "wait" for 80 ms and 200 ms respectively. Therefore, neither of the two devices trips.
- if the fault occurs downstream of the type S residual current device, the latter will interrupt the current in less than 175 ms, whereas the type R device "wait" for 200 ms and therefore does not trip.

If these cascading combination rules are complied with, the level of continuity of service provided to the user depends on the way in which the "horizontal discrimination" is implemented: the terminal feeders must be divided into as many circuits as necessary, each protected by a residual current device.

Some types of electrical and electromagnetic interference caused by the network or its environment may affect the operation of earth leakage protection devices and result in:

- **Nuisance tripping** (tripping in a non-dangerous situation). Such tripping is often repetitive, which is highly detrimental to satisfying the user's energy requirements.
- **Risk of non-tripping** in dangerous situations. This risk must be carefully analysed, because it affects people's safety. The standards define three categories of earth leakage protection devices according to their ability to control these types of situation.

- The risk of interference must be taken into account when selecting earth leakage protection devices (see module CA902000), according to the loads supplied and the environment.

- The explanations given below specify the main types of interference, their origin and how Schneider Electric's earth leakage protection devices respond, according to their type.

Nuisance tripping

This type of tripping is caused by the combination of two factors:

- A transient or continuous high-frequency voltage that is superimposed on the normal network voltage (50 Hz).
 - The presence of capacitors between the electrical network and the earth (or frames). As these capacitors are exposed to a high-frequency voltage, a current which can trip an earth leakage protection device flows to earth.
- The causes, duration and frequency spectra of such interference, which is often difficult to identify, can vary greatly, as shown in the examples below.

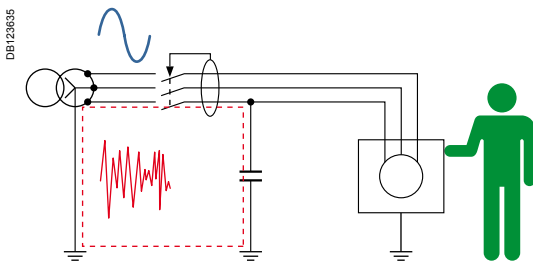

High-frequency harmonics

The current absorbed by non-linear loads such as IT equipment power supplies, frequency converters, variable speed drive motor controls, electronic ballast lights, etc. includes high-order harmonics.

If the natural capacitances of the protected circuit are significant (between the cables and earth, or between the live parts of the devices and their frames), earth leakage protection devices may be tripped, although no danger is present.

This risk of nuisance tripping is all the more likely to occur when a large number of identical loads are supplied in parallel and protected by the same earth leakage protection device.

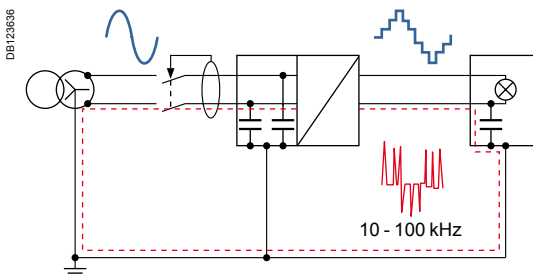

Low-frequency continuous leakage currents

These leakage currents are mainly generated by the filtering capacitors in the power supply stage of electronic devices. Depending on the number of devices protected by the same earth leakage protection device, these leakage currents may:

- Increase the risk of tripping in the event of high-frequency interference.
- Cause frequent tripping

To guarantee satisfactory operation, these continuous leakage currents must not exceed 25% of the sensitivity ($I_{\Delta n}$) of the earth leakage protection device, by limiting the number of "interfering" loads protected by the same earth leakage protection device.

- If more accurate data is unavailable, the leakage current can be estimated on the following basis, for a 230 V, 50 Hz network:

- heating floor: 1 mA / kW,
- fax, printer: 1 mA,
- PC, workstation: 2 mA,
- photocopier: 1.5 mA.

If long cables are installed downstream of the earth leakage protection devices, it may be necessary to take the natural capacitance formed by the cable/earth pair into account (order of magnitude: at 230 V, approximately 1.5 mA for 100 m).

Electrical and electromagnetic interference

Operation of earth leakage protection devices (cont.)

Switching capacitive or inductive components

- Switching on capacitors creates a transient inrush current similar to that shown in Fig. 1.
- Switching off inductive components, such as power supply transformers used for lighting (halogen or fluorescent) creates brief voltage surges, the frequency of which can reach 10 MHz.

Common mode voltage surges

Electrical networks can be exposed to transient voltage surges caused by:

- Lightning strikes: these voltage surges are represented normatively by a 1.2/50 μ s voltage waveform (see Fig. 2). The currents induced by these voltage surges are represented by a normalised 8/20 μ s waveform (see Fig. 3).
- Sudden changes in network operating conditions (faults, blown fuses, inductive load switching, MV switchgear operations, etc.).

When a fault occurs in an IT system (isolated neutral), a transient leakage current is created due to the sudden change in potential with respect to earth. A similar phenomenon can occur when a UPS switches between the mains supply and the battery supply, whilst the output neutral is briefly disconnected from the earth (then reconnected with a slight phase lag).

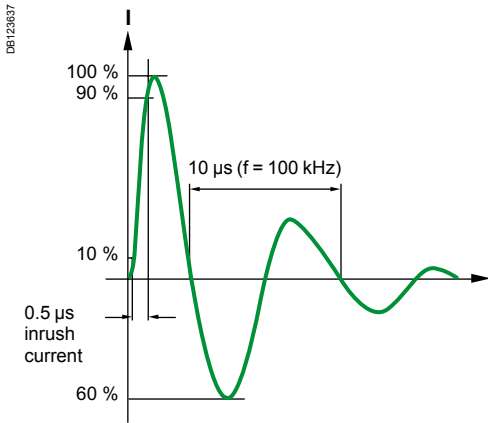

Fig. 1: 0.5 μ s/100 kHz normalised current waveform

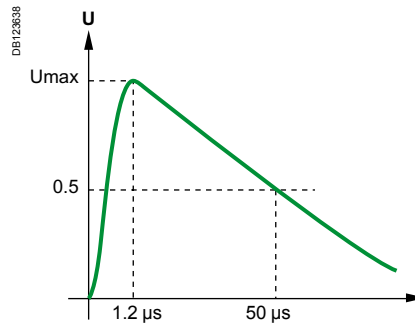

Fig. 2: 8/20 μ s normalised current waveform

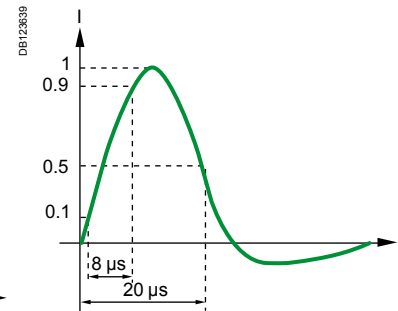

Fig. 3: 1.2/50 μ s normalised voltage waveform

Immunity of Schneider Electric earth leakage protection devices

The *SI* earth leakage protection devices, exclusive to Schneider Electric, demonstrated their immunity to nuisance tripping in all the cases of interference indicated below:

Interference	Non-tripping test conditions	Performance required by the IEC 61008 / 61009 standards	Performance of Schneider Electric's <i>SI</i> type earth leakage protection devices
Continuous interference			
Flow of harmonic currents to earth	1 kHz sine wave	-	8 x I Δ n
Transient interference			
Voltage surge induced by a lightning strike	1.2/50 μ s pulse (IEC/EN 61000-4-5)	4 kV between 5 kV conductors / earth	4.5 kV between 5.5 kV conductors / earth
Current induced by a lightning strike	8/20 μ s pulse (IEC/EN 61008)	250 A	5 kA
Operating transient current; indirect lightning strike current	0.5 μ s/100 kHz waveform (IEC/EN 61008)	200 A	400 A
Surge protective device operation downstream of the earth leakage protection device; switching on of capacitors	10 ms pulse	-	500 A
Electromagnetic compatibility			
Switching of inductive loads, fluorescent lighting, motors, etc.	Repeated bursts (IEC 61000-4-4)	4 kV / 2.5 kHz	5 kV / 2.5 kHz 4 kV / 400 kHz
Fluorescent lighting, circuits controlled by thyristors	150 kHz to 230 MHz conducted RF waves (IEC 61000-4-16)	3 V (IEC) 10 V (EN)	30 V
Radio waves (TV and radios, transmitters, telecommunication, etc.)	80 MHz to 1 GHz transmitted RF waves (IEC 61000-4-3)	3 V / m (IEC) 10 V / m (EN)	30 V / m

Electrical and electromagnetic interference

Operation of earth leakage protection devices (cont.)

Risk of non-tripping in a dangerous situation

When an insulation fault occurs in the DC stage of a switch-mode power supply (e.g. variable speed drive) or on a DC network supplied by a converter, the leakage current is rectified and is no longer a sine wave. This current waveform may not be transmitted correctly by the transformer located inside the earth leakage protection device. Consequently, a leakage current with a dangerous amplitude (greater than the nominal sensitivity of the earth leakage protection device) may not cause it to trip.

In order to select earth leakage protection devices that are appropriate to each situation, the IEC 60755 and IEC 61008 standards define three types of earth leakage protection devices, according to the waveforms that cause them to trip.

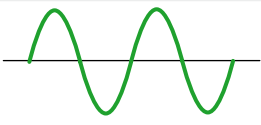
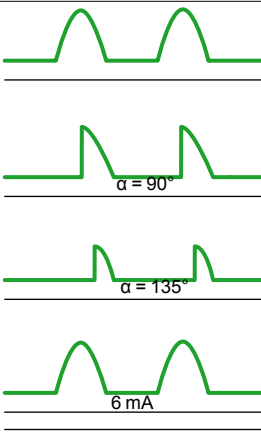
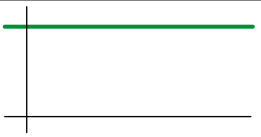
Type of earth leakage protection device	Checking fault-current tripping		Supply circuit protection
	Waveform	RMS value	
AC type	 <p>DB123640</p>	$I_{\Delta n}$	Current loads
A type	 <p>DB123641</p>	$1.4 I_{\Delta n}$	Single-phase loads with rectifiers (low-power variable speed drive, rectifier/charger, etc.)
B type	 <p>DB123642</p>	$2 I_{\Delta n}$	Three-phase loads with rectifiers (three-phase high-power high-duty variable speed drive, three-phase rectifier/charger, etc.)

Schneider Electric's **SI** earth leakage protection devices are also protected against the risk of non-tripping due to atmospheric conditions:

- Very cold temperatures (risk of mechanical parts freezing up): up to -25°C .
- Corrosive chemical agents (risk of corrosion of alloys used to manufacture sensitive mechanical components). For information on using earth leakage protection devices in corrosive atmospheres, see module CA908027.

Coordination

Switches and residual current circuit breakers protection

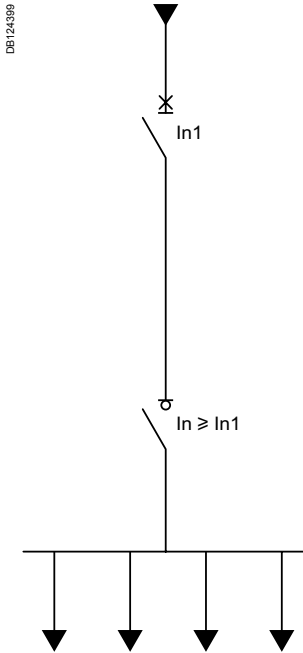

Like all the components of the electrical installation, switches must be protected:

- against overloads;
- against short circuits.

Coordination between the switches and its protection device must be guaranteed and proved by the manufacturer.

Moreover, in a TN earthing, it must be ensured that the protection devices are capable of interrupting earth fault currents of high amperage.

Overload protection

■ The current rating of the switches is the maximum current that it can withstand without being damaged.

■ It is protected against overloads by the circuit breaker located upstream on its power supply line⁽¹⁾.

As a consequence:

The rating of the switches must be equal to or greater than the rating of the circuit breaker located upstream.

Be careful: only the circuit breaker ensure the protection against overloads.

For example: on a circuit protected by an 32 A iC60 circuit breaker, an iSW-NA switches of rating 40 A or 63 A must be installed.

(1) In some countries, the installation standards consider that overload protection can be provided by all the downstream circuit breakers, if the sum of their ratings is less than or equal to the rating of the residual current circuit breaker.

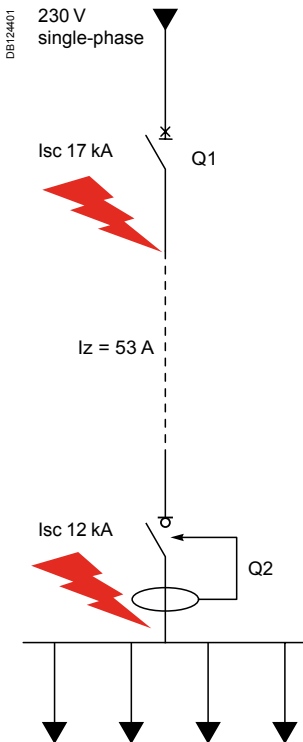

Short-circuit protection

■ The switches is protected against short circuits by the circuit breaker (or fuse) located upstream on its power supply line⁽²⁾.

■ To prevent any damage, the circuit breaker must sufficiently limit any short-circuit current that could pass through the switches (up to the max. short-circuit current I_{sc} at its installation point).

The short-circuit withstand of the switches and residual current circuit breaker is given in the following tables, as a function of the upstream circuit breaker. It must be greater than or equal to the prospective short-circuit current I_{sc} at its installation point.

(2) Exemption in case of special installation described at the end of this document, page 782.

Example

Choice of protection devices Q1 and Q2 in the diagram opposite:

Circuit breaker Q1		
Rated current	Less than or equal to the cable withstand I _z	50 A
Breaking capacity	Greater than or equal to the short-circuit current I _{sc} (17 kA)	iC60N 2P or C120N 2P (20 kA under 230 V)
Residual current circuit breaker Q2		
Rated current	Greater than or equal to that of circuit breaker Q1	63 A
Short-circuit withstand (I _{nc})	Greater than or equal to the short-circuit current I _{sc} (12 kA)	Based on the tables opposite: ■ with iC60N: 20 kA: is suitable ■ with C120N: 20 kA: is suitable

Coordination

Residual current circuit breakers protection

Protection against earth fault currents

In the event of an insulation fault in a TN system, the phase-to-earth fault current is equal to the phase-to-neutral fault current.

- The residual current circuit breaker interrupts this current, if it does not exceed its specific breaking capacity $I_{\Delta m}$.
- If the fault current exceeds this value, it must be interrupted by the circuit breaker located upstream.

Therefore, the magnetic threshold (instantaneous tripping threshold) of the circuit breaker must always be less than or equal to the breaking capacity of the residual current circuit breaker ($I_{\Delta m}$).

Breaking and making capacity ($I_{\Delta m}$) of iID residual current circuit breakers

Rating (A)	iID type AC, A, SI	RCCB-ID type B
16	1500	-
25	1500	500
40	1500	500
63	1500	630
80	1500	800
100	1500	-
125	1250	1250

The combination of an iID residual current circuit breaker and an iC60 circuit breaker of appropriate rating naturally satisfies this condition.

Example:

- iID RCCB, rating 63 A: $I_{\Delta m} = 1500$ A;
- iC60N circuit breakers of rating 63 A:
 - B curve: magnetic threshold 189 to 315 A;
 - C curve: magnetic threshold 315 to 630 A;
 - D curve: magnetic threshold 630 to 882 A.

The condition is satisfied whatever the iC60 circuit breaker (of rating at most equal to 63 A).

For protection by fuse, the user should check that the fuse blowing time is less than the residual current circuit breaker's response time for a fault current of amplitude superior than $I_{\Delta m}$, i.e.: type Δ : 40 ms.

Using the coordination tables

This table takes in account:

- all types of faults: between phases, phase and neutral and between phase and earth.

- all earthing systems except IT.

See comment here below.

Depending on the network and the type of protection, the selection table below indicates which table should be consulted to find out the coordination value.

Selection table

		Upstream network					
		DB123896 eps L1 ——— N ———		DB123898 eps L1 ——— L2 ——— L3 ——— N ———		DB123897 eps L1 ——— L2 ——— L3 ———	
Type of Downstream network	Type of protection device	Ph/N 110-130 V	Ph/N 220-240 V	Ph/N 110-130 V Ph/Ph 220-240 V	Ph/N 220-240 V Ph/Ph 380-415 V	Ph/Ph 220-240 V	Ph/Ph 380-415 V
DB124079 eps N L1	DB123891 eps 2P	See table Ue: 220-240 V	See table Ue: 220-240 V	See table Ue: 220-240 V	See table Ue: 220-240 V	(1)	(1)
	DB124191 eps 1P DB123892 eps 1P+N	See table Ue: 220-240 V	See table Ue: 380-415 V	See table Ue: 220-240 V	See table Ue: 380-415 V	(2)	(2)
DB124192 eps L1 L2	DB123891 eps 2P			See table Ue: 220-240 V	See table Ue: 380-415 V	See table Ue: 220-240 V	See table Ue: 380-415 V
DB124080 eps L1 L2 L3	DB123892 eps 3P			See table Ue: 220-240 V	See table Ue: 380-415 V	See table Ue: 220-240 V	See table Ue: 380-415 V
DB124081 eps N L1 L2 L3	DB123894 eps 4P			See table Ue: 220-240 V	See table Ue: 380-415 V		
	DB123983 eps 3P DB123985 eps 3P+N			See table Ue: 220-240 V	See table Ue: 380-415 V		

(1) For fault phase-earth please consult the table Ue: 380-415 V.

(2) For iC60 1P+N circuit breaker connected between phase and neutral under 220-240 V, consult the table Ue: 220-240 V (only for faults between phase and neutral).

Coordination

Upstream: iDPN, iC60

Downstream: switch-disconnectors,
residual current circuit breakers

Ue: 380-415 V and Ue: 220-240 V

Protection by circuit breaker				Ue: 380-415 V			Ue: 220-240 V		
Downstream		Upstream Circuit breaker							
Product	Ratings (A)	Product	Ratings (A)	0.5 to 25	32-40	50-63	0.5 to 25	32-40	50-63
iID NG125NA iSW-NA INS	All	iDPN	iDPN	6	6		6	6	
			iDPN N	10	10		10	10	
		iC60	iC60a	6	6	6	10	10	10
			iC60N	10	10	10	20	20	20
			iC60H	15	15	15	30	30	30
	iC60L	25	20	15	50	36	30		
iSW	20 to 32	iDPN	iDPN	4.5	4.5		4.5	4.5	
			iDPN N	4.5	4.5		4.5	4.5	
		iC60	iC60a/N/H/L	4.5	4.5	3	5.5	5.5	4
	40 to 125	iDPN	iDPN	6	6		6	6	
			iDPN N	10	10		10	10	
		iC60	iC60a	6	6	6	10	10	10
			iC60N	10	10	10	20	20	20
			iC60H	15	15	15	30	30	30
			iC60L	25	20	15	50	36	30
RCCB-ID type B	All	iDPN	iDPN	6	6				
			iDPN N	10	10				
		iC60	iC60a	6	6	6			
RCCB-ID	125		iC60a	10	10	10			
			iC60N	15	15	15			
			iC60H	25	20	15			
			iC60L						

- 10** Total coordination up to the MCB breaking capacity: Value of Short circuit withstand of the circuit breaker - Switch-disconnector or residual current circuit breaker combination (kA rms)
- 4.5** Coordination limit: Value of Short circuit withstand of the circuit breaker - Switch-disconnector or residual current circuit breaker combination (kA rms)
- No coordination

Coordination

Upstream: C120, NG125, NG160,
NSX100, NSX160

Downstream: switch-disconnectors,
residual current circuit breakers

Ue: 380-415 V and Ue: 220-240 V

Protection by circuit breaker				Ue: 380-415 V							Ue: 220-240 V							
Downstream		Upstream Circuit breaker		0.5 to 25	32-40	50-63	80	100	125	160	0.5 to 25	32-40	50-63	80	100	125	160	
Product	Ratings (A)	Product	Ratings (A)															
iID iSW-NA	≤ 63	C120	C120N	10	10	10	6	6	6		20	20	20	12	12	12		
			C120H	15	15	15	6	6	6		30	30	30	12	12	12		
		NG125	NG125a				4	4	4						8	8	8	
			NG125N	16	16	16	6	6	6		30	30	30	12	12	12		
			NG125H	20	16	16	6				40	30	30	12				
			NG125L	25	20	16	6				50	36	30	12				
		NG160	NG160	7	7	7	4	4	4	4	8	8	8	5	5	5	5	
NSX	NSX100/160	5	5	5	4	4	4	4	6	6	6	5	5	5	5			
iID iSW-NA	80 to 100	C120	C120N	10	10	10	10	10	10		20	20	20	20	20	20		
			C120H	15	15	15	10	10	10		30	30	30	20	20	20		
		NG125	NG125a				6	6	6					12	12	12		
			NG125N	16	16	16	10	10	10		30	30	30	20	20	20		
			NG125H	20	16	16	10				36	30	30	20				
			NG125L	25	20	16	10				50	36	30	20				
		NG160	NG160	7	7	7	7	7	7	7	8	8	8	8	8	8	8	
NSX	NSX100/160	5	5	5	5	5	5	5	6	6	6	6	6	6	6			
iSW	20 to 32	C120	C120N/H	3	3						4.5	4.5						
		NG125	NG125N/H/L	3	3						4.5	4.5						
NG125NA INS	All	C120	C120N	10	10	10	10	10	10		20	20	20	20	20	20		
			C120H	15	15	15	15	15	15		30	30	30	30	30	30		
		NG125	NG125a				16	16	16					16	16	16		
			NG125N	25	25	25	25	25	25		50	50	50	50	50	50		
			NG125H	36	36	36	36				70	70	70	70				
NG125L	50	50	50	50				100	100	100	100							
NG125NA	All	NG160	NG160E	16	16	16	16	16	16	16	25	25	25	25	25	25	25	
			NG160N	25	25	25	25	25	25	25	40	40	40	40	40	40		
			NG160H	36	36	36	36	36	36	36	50	50	50	50	50	50		
		NSX	NSX100B/160B	25	25	25	25	25	25	25	25	40	40	40	40	40	40	
			NSX100F/160F	36	36	36	36	36	36	36	36	50	50	50	50	50	50	
			NSX100N/H/S/L	36	36	36	36	36	36	36	36	50	50	50	50	50	50	
			NSX160N/H/S/L	36	36	36	36	36	36	36	36	50	50	50	50	50	50	
RCCB-ID type B RCCB-ID	All 125	C120	C120N/H	7	7	7	7	5	5									
			NG125	NG125a				8	8	8								
		NG125	NG125N	15	15	15	15	10	10									
			NG125H/L	15	15	15	15											
NG160	NG160	7	7	7	5	5	5	4										
	NSX	NSX100/160	4	4	4	4	4	4	4									

10 Total coordination up to the MCB breaking capacity: Value of Short circuit withstand of the circuit breaker - Switch-disconnector or residual current circuit breaker combination (kA rms)

4.5 Coordination limit: Value of Short circuit withstand of the circuit breaker - Switch-disconnector or residual current circuit breaker combination (kA rms)

No coordination

Coordination

Upstream: fuses gG
Downstream: switch-disconnectors,
residual current circuit breakers

Ue: 380-415 V and Ue: 220-240 V

Protection by fuse

Ue: 380-415 V

Ue: 220-240 V

Downstream		Upstream Fuse											
Product	Ratings (A)	Product	Ratings (A)	16	20	25	32	40	63	80	100	125	
iID	16 to 40	Fuse gG		100	100	100	80	80	30	10			
	63 to 100			100	100	100	80	80	30	15	10	5	
iSW	20 to 32			60	40	25	15	8					
	40 to 63			60	40	25	20	10	10				
iSW-NA	100 to 125			60	40	25	20	10	10	10	10	10	10
	40			100	100	100	80	80	30	15			
NG125NA	63 to 100			100	100	100	80	80	30	15	10	5	
	125			100	100	100	80	80	50	50	50	50	
RCCB-ID type B	25			100	100	100	80						
	40 à 80			100	100	100	100	80	30	20			
RCCB-ID	125			100	100	100	100	80	30	20	10	10	
				100	100	100	100	80	30	20	10	10	

100 Total coordination up to the fuse breaking capacity: Value of Short circuit withstand of the fuse - Switch-disconnector or residual current circuit breaker combination (kA rms)

30 Coordination limit: Value of Short circuit withstand of the fuse - Switch-disconnector or residual current circuit breaker combination (kA rms)

No coordination

Coordination

Upstream: NSX100/160

Downstream: modular residual current circuit breakers and modular circuit breakers

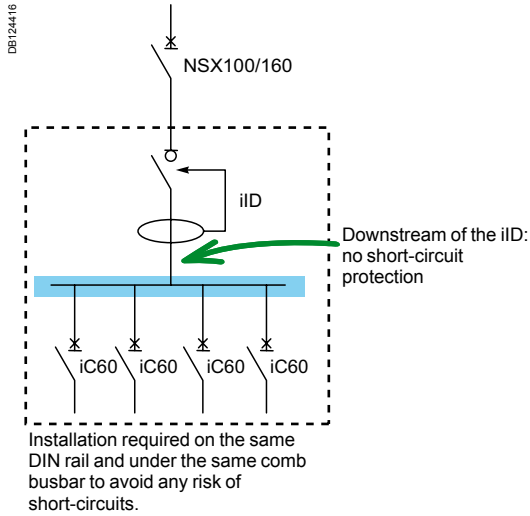

2P residual current circuit breakers installed between a NSX100/160 and a circuit breaker (220 V to 240 V single-phase circuit)

Protection by circuit breaker

Upstream	Residual current circuit breakers 2P ratings (A)		
	25	40	63
Downstream Circuit breakers			
iDPN	6	6	-
iDPN N	7.5	7.5	-
iC60N	20	20	20
iC60H	30	30	30
iC60L	50	36	30

Short-circuit current withstand of the circuit breakers-residual current circuit breakers combination (kA r.m.s.)

4P residual current circuit breakers installed between a NSX100/160 and a circuit breaker (380 V to 415 V three-phase circuit)

Protection by circuit breaker

Upstream	Residual current circuit breakers 4P ratings (A)		
	25	40	63
Downstream Circuit breakers			
iDPN	2	2	-
iDPN N	3	3	-
iC60N	10	10	10
iC60H	15	15	15
iC60L	20	20	15

Short-circuit current withstand of the circuit breakers-residual current circuit breakers combination (kA r.m.s.)

Cascading

RCBO's protection

Upstream: NG125, NG160, NSX100, NSX160, NSX250

Downstream: iDPN Vigi, iC60 Vigi

Ue: 380-415 V (Ph/N 220-240 V)

TT and TN earthing systems

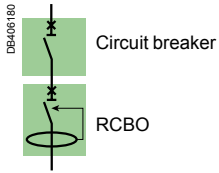

Upstream	NG125		NG160			NS(X)100			NS(X)160			NS(X)250		
	N	L	E	N	H	B	F	N	B	F	N	B	F	N
Breaking capacity (kA)	25	50	16	25	36	25	36	50	25	36	50	25	36	50

Downstream																	
RCBO's	Breaking capacity (kA)	In (A)	Reinforced breaking capacity (kA)														
			iDPN N/H Vigi	10	1 to 16	20	25	16	20	20	20	20	20	20	20	20	20
		20 to 40	16	25	16	16	16	16	16	16	16	16	16	16	16	16	
iC60N Vigi	10	0.5 to 40	25	25	16	20	25	20	25	30	20	25	30	20	25	30	
		50 to 63	25	25	16	20	25	20	25	30	20	25	30	20	25	25	
iC60H Vigi	15	0.5 to 40	25	36	16	25	25	25	36	36	40	25	36	40	25	30	30
		50 to 63	25	36	16	25	25	36	36	36	25	30	30	25	25	25	
iC60L Vigi	25	0.5 to 25	-	50	-	-	-	-	36	40	-	36	40	-	30	30	
	20	32 to 40	25	50	-	25	25	25	36	40	25	36	40	25	30	30	
	15	50 to 63	25	36	16	25	25	25	36	36	25	30	36	25	25	25	

Cascading (cont.)

RCBO's protection

Upstream: iC60, NSX100, NSX160, NSX250

Downstream:

iSPN Vigi, iC60N RCBO, iC60H RCBO, iC60H2 RCBO

U_e: 380-415 V (Ph/N 220-240 V)

3P, 3P+N, 4P products

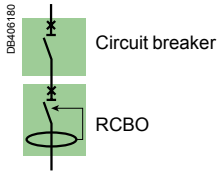

Upstream	iC60					NSX100					
	N	H	L			B	F	N	H	S	L
Breaking capacity (kA rms)	10	15	25	20	15	25	36	50	70	100	150

Downstream														
RCBO's	Breaking capacity (kA)	In (A)	Reinforced breaking capacity - Maximum of three-phases short circuit IK3 (kA)											
iSPN Vigi	6	6 to 16	10	10	20	15	10	20	20	20	20	20	20	20
		20 to 32	10	10	15	10	10	16	16	16	16	16	16	16
iC60N RCBO	6	6 to 16	10	15	25	20	15	20	20	20	20	20	20	20
		20 to 45	10	15	25	20	15	16	16	16	16	16	16	16
iC60H RCBO	10	6 to 40	10	15	25	20	15	25	36	40	40	40	40	40
		45	10	15	25	20	15	25	36	36	36	36	36	36
iC60H2 RCBO	10	10 to 32	10	15	25	20	15	25	36	40	40	40	40	40

Upstream	NSX160						NSX250					
	B	F	N	H	S	L	B	F	N	H	S	L
Breaking capacity (kA rms)	25	36	50	70	100	150	25	36	50	70	100	150

Downstream														
RCBO's	Breaking capacity (kA)	In (A)	Reinforced breaking capacity - Maximum of three-phases short circuit IK3 (kA)											
iSPN Vigi	6	6 to 16	20	20	20	20	20	20	16	16	16	16	16	16
		20 to 32	16	16	16	16	16	16	10	10	10	10	10	10
iC60N RCBO	6	6 to 16	20	20	20	20	20	20	16	16	16	16	16	16
		20 to 45	16	16	16	16	16	16	10	10	10	10	10	10
iC60H RCBO	10	6 to 40	25	36	40	40	40	40	25	30	30	30	30	30
		45	25	30	30	30	30	30	25	25	25	25	25	25
iC60H2 RCBO	10	10 to 32	25	36	40	40	40	40	25	30	30	30	30	30

The phase-neutral or phase-earth short circuit can be up to 0.9 times IK3

Coordination of Surge protection devices

> Design guide

Surge arresters for commercial
and industrial buildings



➤ Coordination between the surge protective device and its disconnect circuit breaker

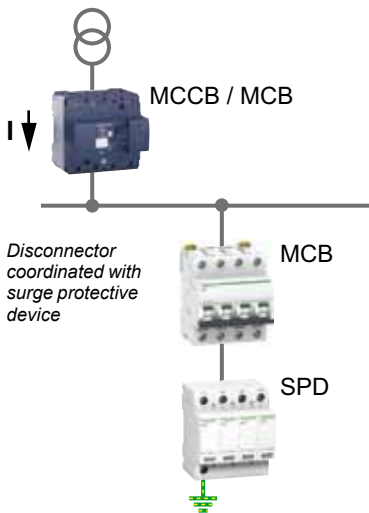

MCCB = Molded-case circuit breaker.
MCB = Modular circuit breaker.
SPD = Surge protective device.

An external disconnecting device must be coordinated with a surge protective device in order to achieve:

- continuity of service:
 - do not trip due to surge current,
 - do not increase (Up) voltage protection level.
- effective protection against all types of overcurrents:
 - overload due to SPD aging,
 - short circuit of low intensity (impedant) due to temporary overvoltages,
 - short circuit of high intensity due to SPD degradation.

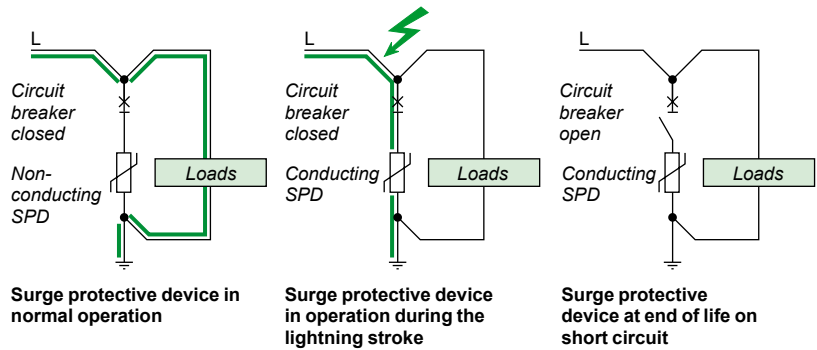

The disconnecting device must be coordinated with the surge protective device. It is designed to meet the following two constraints:

Resistance to lightning current



The resistance to lightning current is an essential characteristic of the surge protective device's external disconnecting device. The device must be capable of passing the following standardized tests: not trip upon 15 successive impulse currents at I_n .

Resistance to short-circuit current

The breaking capacity is determined by the installation rules (IEC 60364 standard):

- the external disconnecting device must have a breaking capacity equal to or greater than the presumed short-circuit current I_{sc} at the point of installation.
- when this device is integrated into the surge protective device, conformity with product standard IEC 61643-11 naturally ensures protection.

Surge protective device coordination (cont.)

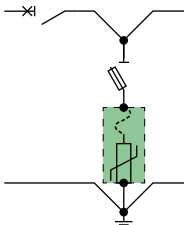
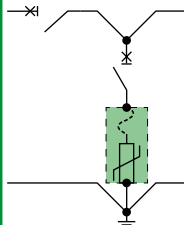
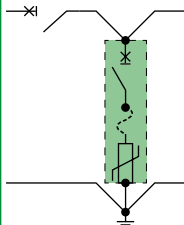
			
External disconnecting device	Fuse protection combined with the SPD	Circuit breaker protection combined with the SPD	Circuit breaker protection integrated into the SPD
			
Lightning protection of equipment	=	=	=
Protection of installation (at end of the surge protective device's life)	=	+	++
	All types of disconnecting devices protect the equipment satisfactorily	Achieved if compliance with the MCB/SPD coordination table	Achieved during product design
Continuity of service (at end of the surge protective device's life)	+	+	+
	Protection from (impedant) short circuits of low intensity not well ensured	Only the surge protective device circuit is shut down	Protection against (impedant) short circuits of low intensity
Maintenance (at end of the surge protective device's life)	=	+	+
	Change of fuses	Immediate resetting	

Main reasons why the disconnecting device recommended by the manufacturer should be used:

- if the disconnecting device's rating is lower than the recommended rating: risk of the disconnecting device opening in normal operation.
- if the disconnecting device's rating is higher than the recommended rating: risk of non-disconnection during a temporary voltage surge.

Surge protective device coordination (cont.)

➤ Coordination between the surge protective device and its disconnect circuit breaker in the event of a short circuit

This table shows: the rating, curve and short circuit current level of the disconnector coordinated with the surge protective device.

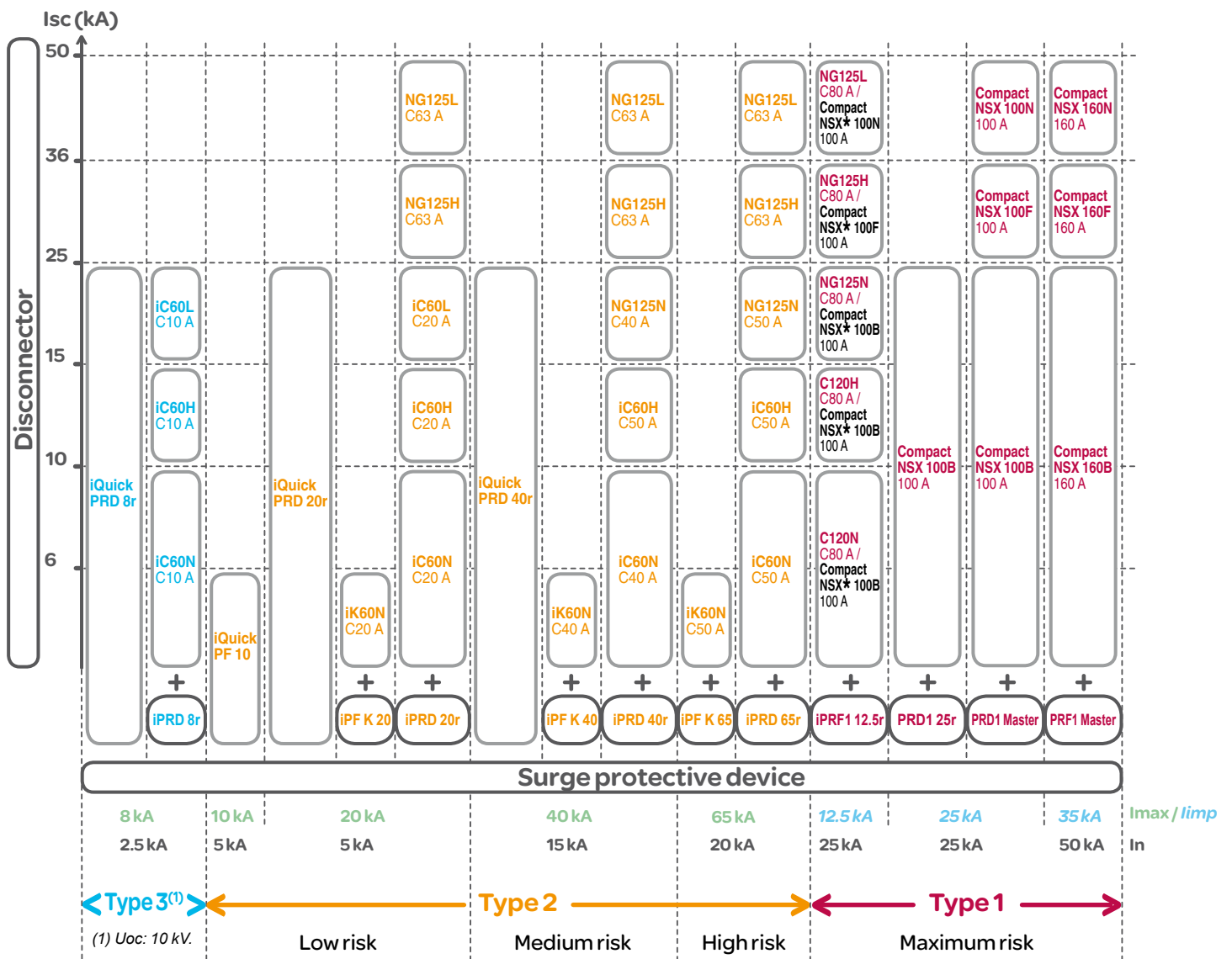

(*) For lightning impulse current withstand

Surge protective device coordination (cont.)

➤ Coordination between the surge protective device and its disconnect fuse in the event of a short circuit

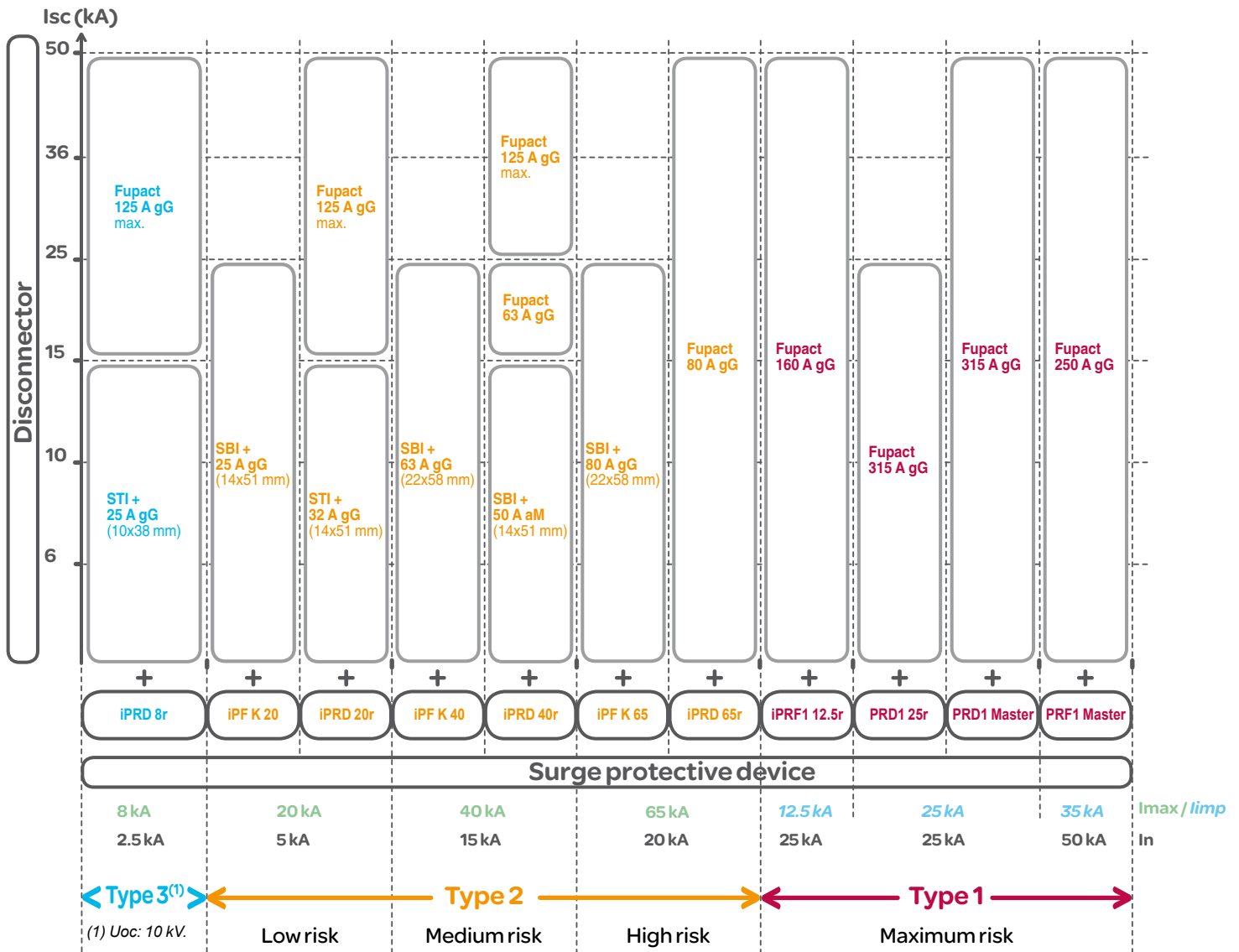

> Coordination between two surge protective devices, upstream/downstream

When two surge protective devices are installed in an electrical installation, coordination is needed according to IEC 61643-12 to obtain an acceptable stress distribution between the two surge protective devices according to their permissible energy "E".

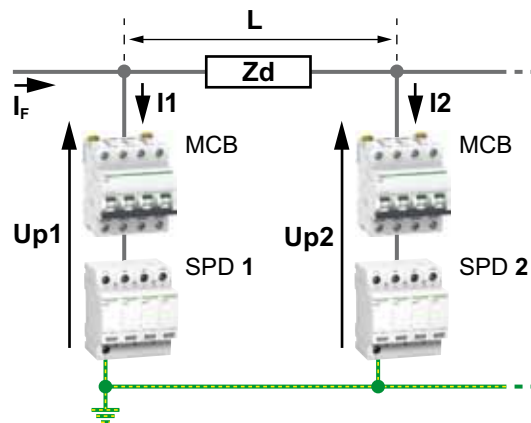

L and Z_d represent the cable length and impedance respectively between the 2 surge protective devices.

Up2: level of protection of surge protective device SPD2.

Uw: impulse withstand voltage of the equipment to be protected.

I_{max}: maximum discharge current.

I_ε: lightning current:

$\leq I_{max}$ of SPD1

$= I_1 + I_2$

E: permissible energy.

MCB: modular circuit breaker.

SPD: surge protective device.

For coordination between two surge protective devices, a minimum cable length between these 2 surge protective devices is needed to ensure that:

- **$I_2 < I_{max}$ SPD2.**
- **$Up2 < Uw$.**
- **$E2 < E_{max}$ SPD2.**

Surge protective device coordination (cont.)

Minimum distance between two surge protective devices, upstream/downstream

For a cable section of 16 mm² and an impulse current equal to the maximum discharge current (I_{max}) of the upstream surge protective device.

Example

If iPRD65r is installed in the incoming panelboard, the second SPD iPRD8r must be installed at a cable length of 8 meters from the first one.

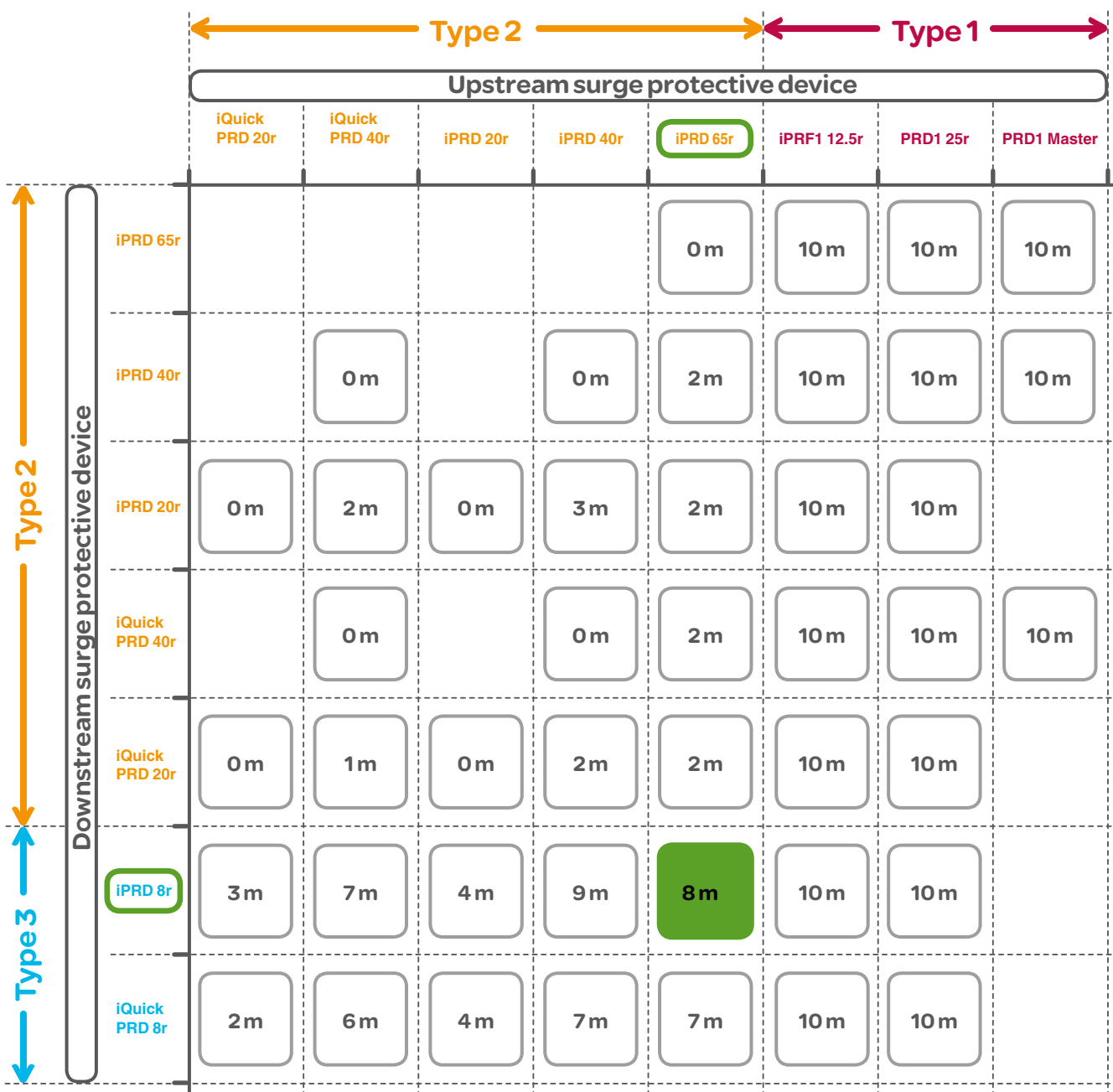

> Cascading in the event of a short circuit between the surge protective device disconnecter and the upstream circuit breaker

What is cascading?

Cascading means using the circuit breakers' limiting power, which allows circuit breakers of lower performance to be installed downstream.

The upstream circuit breakers then act as a barrier for major short-circuit currents. They thus enable circuit breakers of breaking capacity lower than the presumed short-circuit current (at their point of installation) to be loaded in their normal breaking conditions.

Since current limiting takes place all along the circuit controlled by the upstream current-limiting circuit breaker, cascading concerns all the devices located downstream of that circuit breaker.

It is not restricted to two consecutive devices.

Case 1

Disconnect circuit breaker not integrated into the surge protective device.

For this type of study, refer to the existing coordination tables.
> see 557F4200 catalogue module.

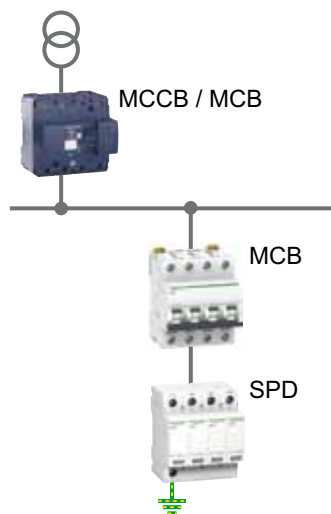

MCCB = Molded-case circuit breaker.
MCB = Modular circuit breaker.
SPD = Surge protective device.

Surge protective device coordination (cont.)

Case 2

Disconnect circuit breaker integrated into the surge protective device.

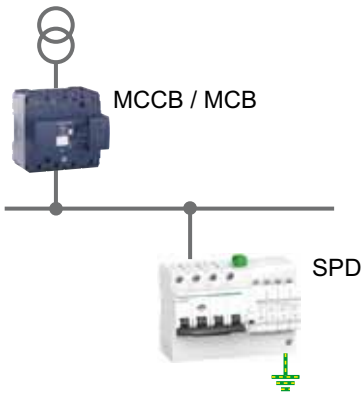

MCCB = Molded-case circuit breaker.
MCB = Modular circuit breaker.
SPD = Surge protective device.

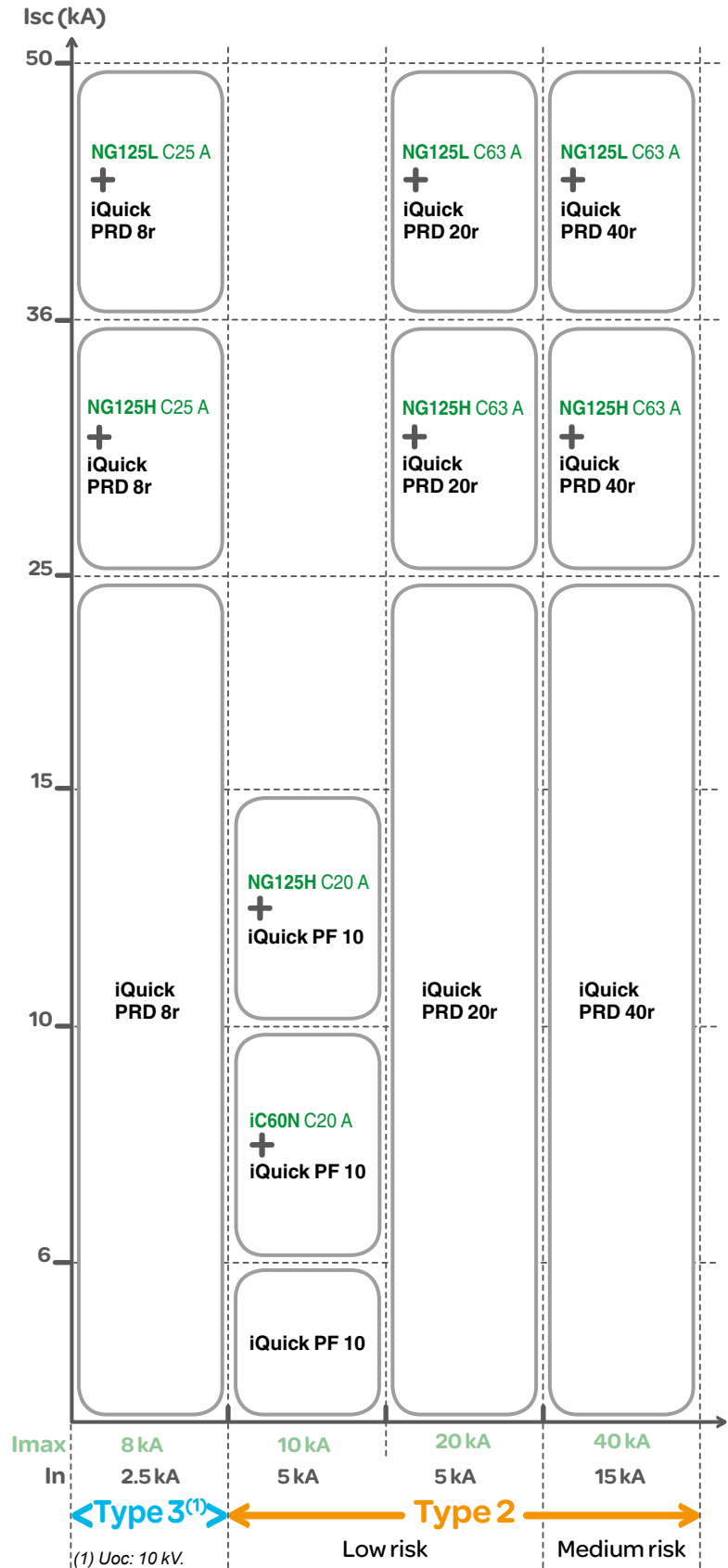

Schneider Electric Industries SAS

35, rue Joseph Monier
CS 30323
F- 92506 Rueil Malmaison Cedex

www.schneider-electric.com

As standards, specifications and designs change from time to time, please ask for confirmation of the information given in this publication.



Printed on ecological paper

Publication: Schneider Electric
Photos: Schneider Electric
Printing:

SBI / STI Fuse cartridges

aM fuses curves

8.5 x 31.5 - 10.3 x 38 - 14 x 51 - 22 x 58

aM fuses curves

Time/Current operating curves

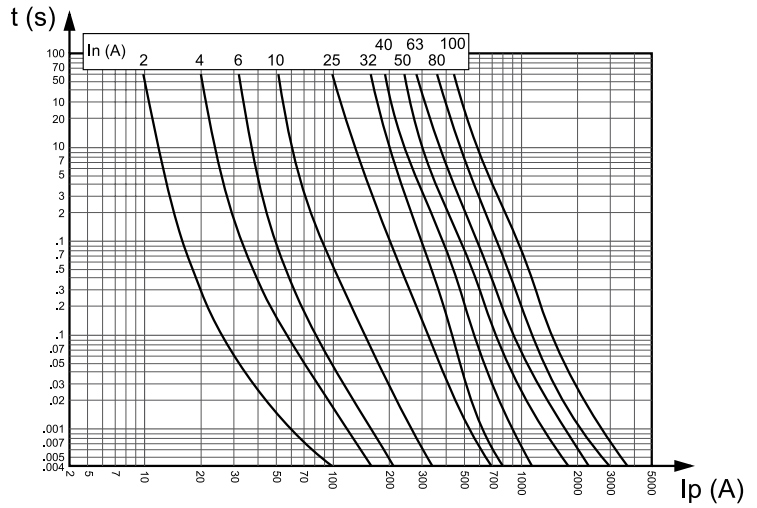

Current limitation curves

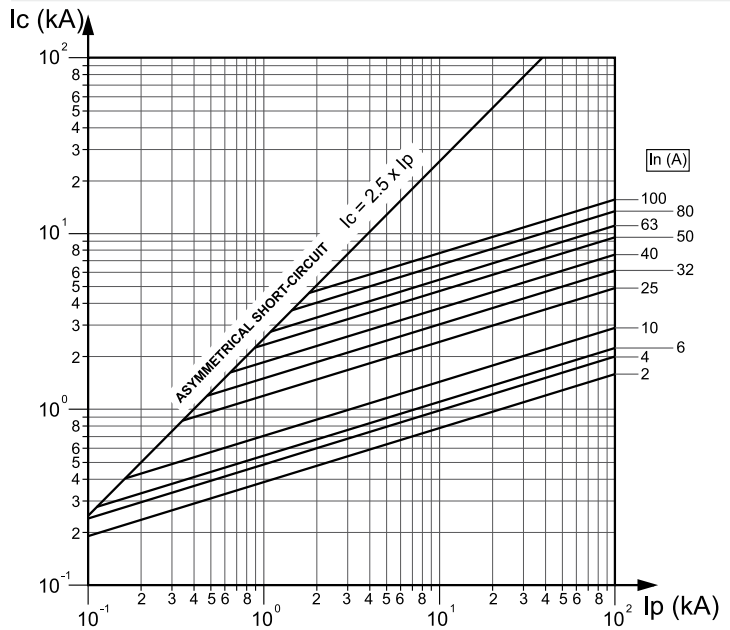

SBI / STI Fuse cartridges

aM fuses curves

8.5 x 31.5 - 10.3 x 38 - 14 x 51 - 22 x 58 (cont.)

aM fuses curves

Thermal stress limitation curves

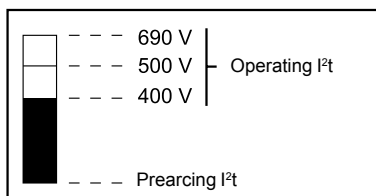
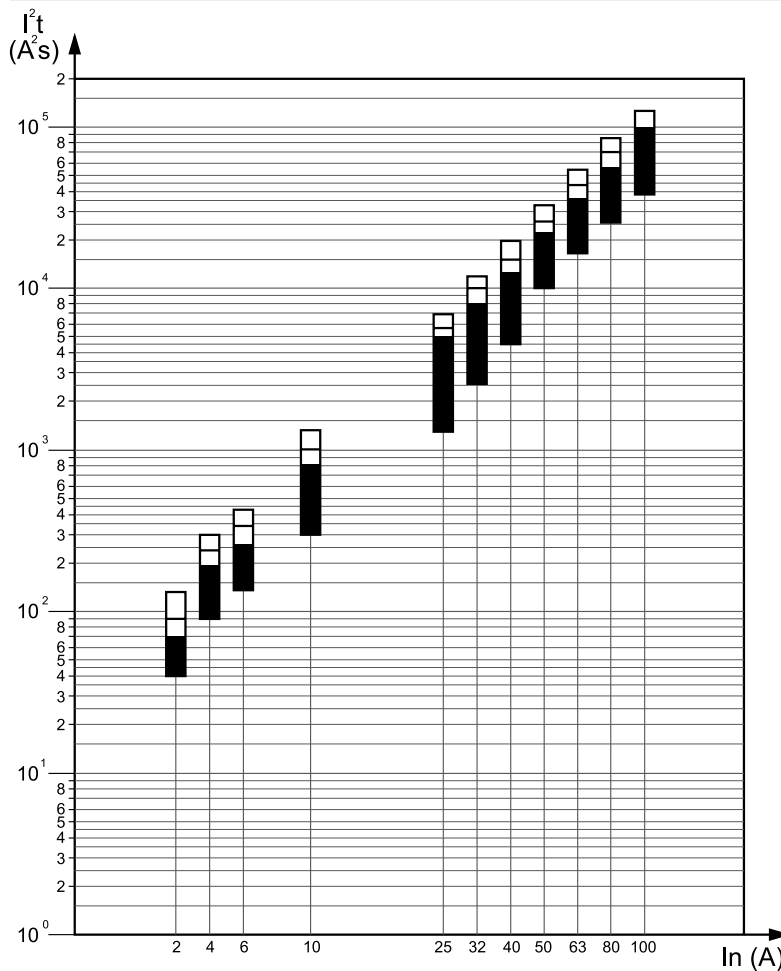

Dissipated power (in Watts)

In	Dimensions (mm)	
	14 x 51	22 x 58
10 A	-	-
16 A	-	-
25 A	1.80 W	-
32 A	2.10 W	-
40 A	2.60 W	3.20 W
50 A	2.90 W	3.90 W
63 A	-	4.60 W
80 A	-	5.60 W
100 A	-	6.50 W

SBI / STI Fuse cartridges

gG fuses curves

8.5 x 31.5 - 10.3 x 38 - 14 x 51 - 22 x 58

gG fuses curves

Time/Current operating curves

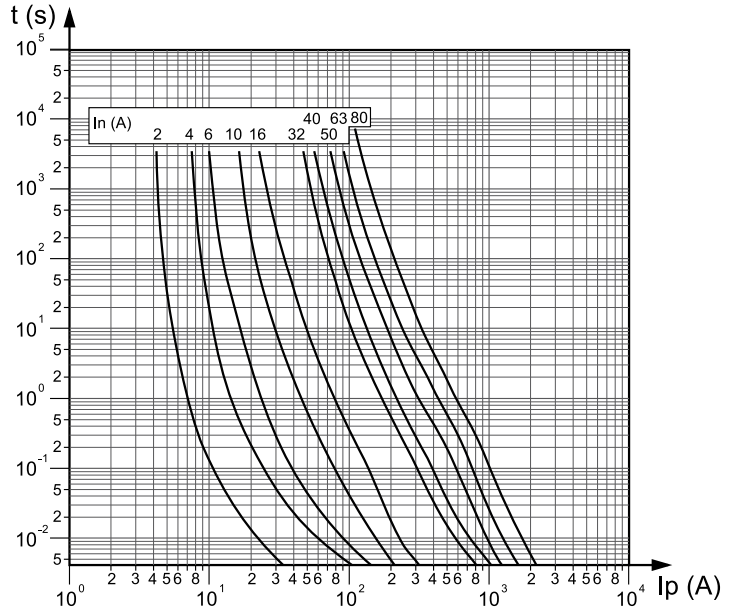

Current limitation curves

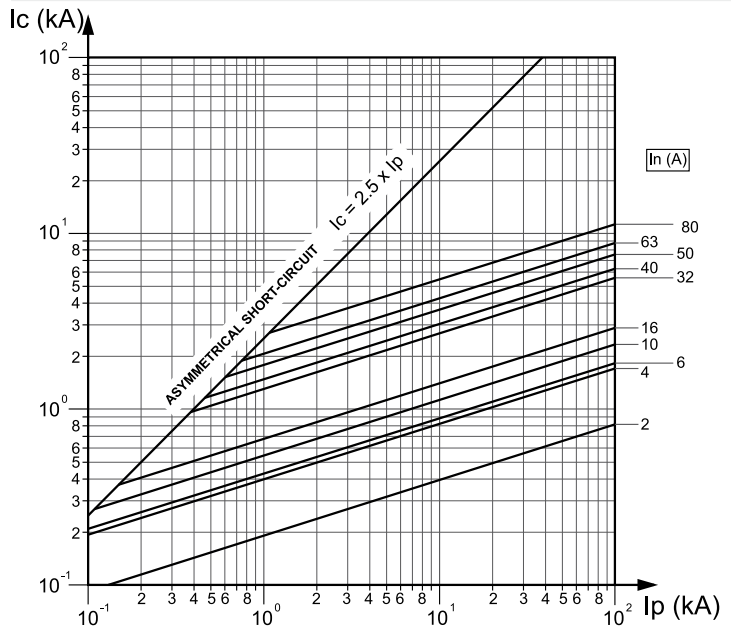

SBI / STI Fuse cartridges

gG fuses curves

8.5 x 31.5 - 10.3 x 38 - 14 x 51 - 22 x 58 (cont.)

gG fuses curves

Thermal stress limitation curves

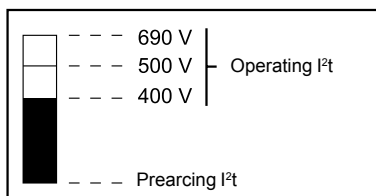
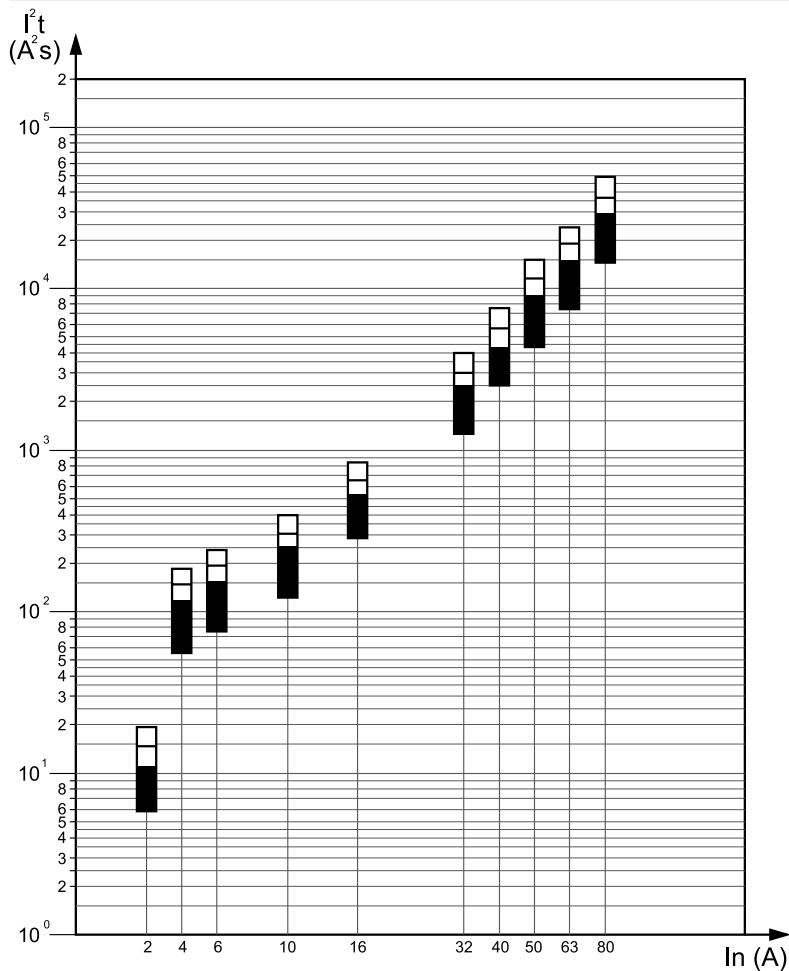

Dissipated power (in Watts)

In	Dimensions (mm)	
	14 x 51	22 x 58
10 A	1.80 W	-
16 A	2.55 W	-
25 A	3.80 W	4.30 W
32 A	4.40 W	5.10 W
40 A	-	5.50 W
50 A	-	6.70 W
63 A	-	8 W
80 A	-	5.60 W
100 A	-	6.50 W

Coordination of switchgear with loads

Circuit breakers

Use of circuit breakers

The new lighting technologies with electronic interfaces (ballasts, drivers) cause a high transient inrush current at power up that can trip the circuit breaker. These phenomena are particularly increased with LED lighting.

Coordination curves between the number of LED luminaires and the circuit breaker rating:

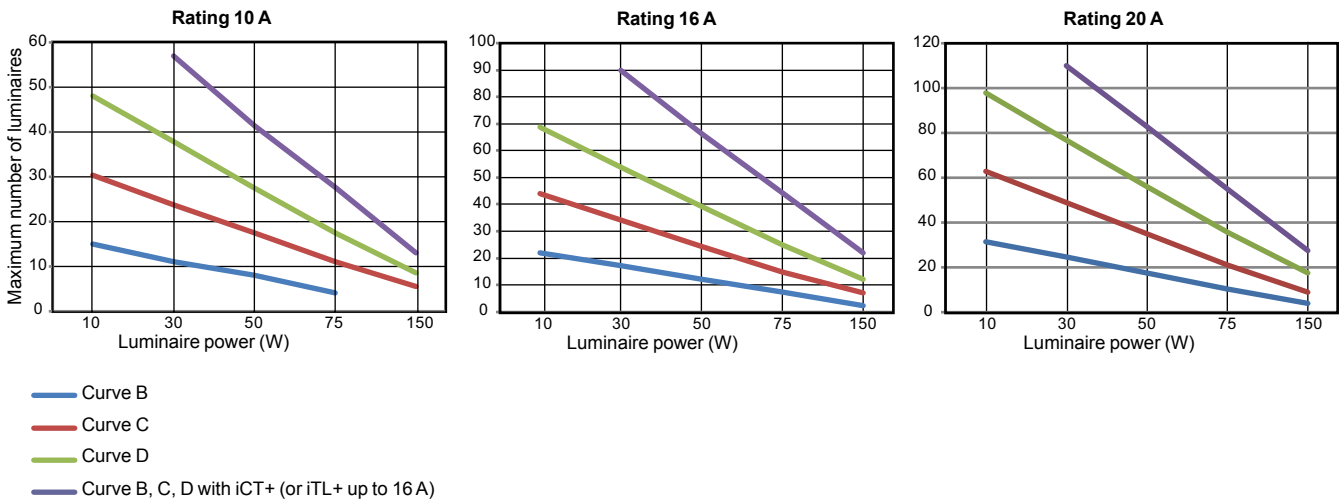

Maximum number of luminaires depending on the circuit breaker rating and curve

Unit power of the luminaire (W)	Circuit breaker rating	10 A				16 A				20 A			
		Curve B	C	D	B, C, D with iCT+ or iTL+	B	C	D	B, C, D with iCT+ or iTL+	B	C	D	B, C, D with iCT+
10		15	30	48	-	22	44	69	-	32	63	98	-
30		11	24	38	57	17	34	54	90	25	49	77	110
50		8	17	27	41	12	25	39	66	18	35	56	83
75		4	11	17	28	7	15	25	44	11	21	36	55
150		-	5	9	13	2	7	12	22	4	9	18	28

According to the control device used, the transient current surge may:

- require the circuit breaker to be derated according to the number of luminaires / circuit breaker rating coordination curves, when using standard control devices: CT, TL (electromechanical control device),
- be reduced by the use of the following technologies:
 - softStart: using a command integrated in the driver or a dimmer switch,
 - controlled contactor (iTL+, iCT+) (closes when the voltage passes through "0", derating is related to the Cos phi of the lighting circuit).

These technologies allow circuit breakers without derating related to the technology of the lamps to be used.

Example:

Circuit rated power = 230 V AC x Circuit breaker rating x Cos phi.

Coordination of switchgear with loads

iCT, iCT+, iTL, iTL+, Reflex iC60

General comment

Modular contactors and impulse relays do not use the same technologies. Their rating is determined according to different standards and does not correspond to the rated current of the circuit. For example, for a given rating, an impulse relay is more efficient than a modular contactor for the control of light fittings with a strong inrush current, or with a low power factor (non-compensated inductive circuit).

Relay rating

- The table below shows the maximum number of light fittings for each relay, according to the type, power and configuration of a given lamp. As an indication, the total acceptable power is also mentioned.
- These values are given for a 230 V circuit with 2 active conductors (single-phase phase/neutral or two-phase phase/phase). For 110 V circuits, divide the values in the table by 2.
- To obtain the equivalent values for the entire 230 V three-phase circuit, multiply the number of lamps and the maximum power output:
 - by $\sqrt{3}$ (1.73) for circuits with 230 V between phases without neutral;
 - by $\sqrt{3}$ for circuits with 230 V between phase and neutral or 400 V between phases.

Note: The power ratings of the lamps most commonly used are shown in bold. For powers not mentioned, use a proportional rule with the nearest values.

Choice table

Products		iCT contactors					iCT+ contactors		
Type of lamp		Maximum number of light fittings for a single-phase circuit and maximum power output per circuit							
		16 A	25 A	40 A	63 A	20 A			
Basic incandescent lamps, LV halogen lamps, replacement mercury vapour lamps (without ballast)									
	40 W	38	1550 W	57	2300 W	115	4600 W	172	6900 W
	60 W	30	to	45	to	85	to	125	to
	75 W	25	2000 W	38	2850 W	70	5250 W	100	7500 W
	100 W	19		28		50		73	
ELV 12 or 24 V halogen lamps									
With ferromagnetic transformer	20 W	15	300 W	23	450 W	42	850 W	63	1250 W
	50 W	10	to	15	to	27	to	42	to
	75 W	8	600 W	12	900 W	23	1950 W	35	2850 W
	100 W	6		8		18		27	
With electronic transformer	20 W	62	1250 W	90	1850 W	182	3650 W	275	5500 W
	50 W	25	to	39	to	76	to	114	to
	75 W	20	1600 W	28	2250 W	53	4200 W	78	6000 W
	100 W	16		22		42		60	
Fluorescent tubes with starter and ferromagnetic ballast									
1 tube without compensation ⁽¹⁾	15 W	22	330 W	30	450 W	70	1050 W	100	1500 W
	18 W	22	to	30	to	70	to	100	to
	20 W	22	850 W	30	1200 W	70	2400 W	100	3850 W
	36 W	20		28		60		90	
	40 W	20		28		60		90	
	58 W	13		17		35		56	
	65 W	13		17		35		56	
	80 W	10		15		30		48	
	115 W	7		10		20		32	
1 tube with parallel compensation ⁽²⁾	15 W	5 μF	15	200 W	20	300 W	40	600 W	60
	18 W	5 μF	15	to	20	to	40	to	60
	20 W	5 μF	15	800 W	20	1200 W	40	2400 W	60
	36 W	5 μF	15		20		40		60
	40 W	5 μF	15		20		40		60
	58 W	7 μF	10		15		30		43
	65 W	7 μF	10		15		30		43
	80 W	7 μF	10		15		30		43
	115 W	16 μF	5		7		14		20
2 or 4 tubes with series compensation	2 x 18 W	30	1100 W	46	1650 W	80	2900 W	123	4450 W
	4 x 18 W	16	to	24	to	44	to	68	to
	2 x 36 W	16	1500 W	24	2400 W	44	3800 W	68	5900 W
	2 x 58 W	10		16		27		42	
	2 x 65 W	10		16		27		42	
	2 x 80 W	9		13		22		34	
	2 x 115 W	6		10		16		25	
Fluorescent tubes with electronic ballast									
1 or 2 tubes	18 W	74	1300 W	111	2000 W	222	4000 W	333	6000 W
	36 W	38	to	58	to	117	to	176	to
	58 W	25	1400 W	37	2200 W	74	4400 W	111	6600 W
	2 x 18 W	36		55		111		166	
	2 x 36 W	20		30		60		90	
	2 x 58 W	12		19		38		57	

4660 W x
Cos phi

iTl impulse relays				iTl+ impulse relays				Reflex iC60 (C curve)							
Maximum number of light fittings for a single-phase circuit and maximum power output per circuit															
16 A		32 A		16 A		10 A		16 A		25 A		40 A		63 A	
40	1500 W	106	4000 W	3680 W x Cos phi	28	1120 W	46	1840 W	70	2800 W	140	5600 W	207	8280 W	
25	to	66	to		23	to	36	to	55	to	103	to	152	to	
20	1600 W	53	4200 W		29	2175 W	31	2600 W	46	3600 W	80	6800 W	121	9800 W	
16		42			15		23		33		60		88		
70	1350 W	180	3600 W		11	220 W	19	380 W	27	540 W	50	1000 W	75	1500 W	
28	to	74	to		8	to	12	to	19	to	33	to	51	to	
19	1450 W	50	3750 W		7	500 W	10	800 W	14	1050 W	27	2200 W	43	3300 W	
14		37			5		8		10		22		33		
60	1200 W	160	3200 W		47	940 W	74	1480 W	108	2160 W	220	4400 W	333	6660 W	
25	to	65	to		19	to	31	to	47	to	92	to	137	to	
18	1400 W	44	3350 W	15	1200 W	24	2000 W	34	2600 W	64	5100 W	94	7300 W		
14		33		12		20		26		51		73			
83	1250 W	213	3200 W	16	244 W	26	390 W	37	555 W	85	1275 W	121	1815 W		
70	to	186	to	16	to	26	to	37	to	85	to	121	to		
62	1300 W	160	3350 W	16	647 W	26	1035 W	37	1520 W	85	2880 W	121	4640 W		
35		93		15		24		34		72		108			
31		81		15		24		34		72		108			
21		55		9		15		21		43		68			
20		50		9		15		21		43		68			
16		41		8		12		19		36		58			
11		29		6		9		12		24		38			
60	900 W	160	2400 W	11	165 W	19	285 W	24	360 W	48	720 W	72	1080 W		
50		133		11	to	19	to	24	to	48	to	72	to		
45		120		11	640 W	19	960 W	24	1520 W	48	2880 W	72	4080 W		
25		66		11		19		24		48		72			
22		60		11		19		24		48		72			
16		42		8		12		19		36		51			
13		37		8		12		19		36		51			
11		30		8		12		19		36		51			
7		20		4		7		9		17		24			
56	2000 W	148	5300 W	23	828 W	36	1296 W	56	2016 W	96	3456 W	148	5328 W		
28		74		12	to	20	to	29	to	52	to	82	to		
28		74		12	1150 W	20	1840 W	29	2760 W	52	4600 W	82	7130 W		
17		45		8		12		20		33		51			
15		40		8		12		20		33		51			
12		33		7		11		15		26		41			
8		23		5		8		12		20		31			
80	1450 W	212	3800 W	56	1008 W	90	1620 W	134	2412 W	268	4824 W	402	7236 W		
40	to	106	to	28	to	46	to	70	to	142	to	213	to		
26	1550 W	69	4000 W	19	1152 W	31	1798 W	45	2668 W	90	5336 W	134	8120 W		
40		106		27		44		67		134		201			
20		53		16		24		37		72		108			
13		34		9		15		23		46		70			

Coordination of switchgear with loads

iCT, iCT+, iTL, iTL+, Reflex iC60

Choice table (cont.)

Products		iCT contactors						iCT+ contactors			
Type of lamp		Maximum number of light fittings for a single-phase circuit and maximum power output per circuit									
		16 A		25 A		40 A		63 A		20 A	
Compact fluorescent lamps											
With external electronic ballast	5 W	210	1050 W	330	1650 W	670	3350 W	Non testé			
	7 W	150	to	222	to	478	to				
	9 W	122	1300 W	194	2000 W	383	4000 W				
	11 W	104		163		327					
	18 W	66		105		216					
	26 W	50		76		153					
With integral electronic ballast (replacement for incandescent lamps)	5 W	160	800 W	230	1150 W	470	2350 W	710	3550 W		
	7 W	114	to	164	to	335	to	514	to		
	9 W	94	900 W	133	1300 W	266	2600 W	411	3950 W		
	11 W	78		109		222		340			
	18 W	48		69		138		213			
	26 W	34		50		100		151			
LED lamps											
With driver	10 W	48	500 W	69	700 W	98	1000 W	200	2000 W		
	30 W	37	to	54	to	77	to	157	to		
	50 W	27	1400 W	39	1950 W	56	3000 W	114	6200 W		
	75 W	17		25		36		73			
	150 W	9		12		18		37			
	200 W	7		9		15		31			
Low-pressure sodium vapour lamps with ferromagnetic ballast with external ignitor											
Without compensation ⁽¹⁾	35 W	5	270 W	9	320 W	14	500 W	24	850 W		
	55 W	5	to	9	to	14	to	24	to		
	90 W	3	360 W	6	720 W	9	1100 W	19	1800 W		
	135 W	2		4		6		10			
	180 W	2		4		6		10			
With parallel compensation ⁽²⁾	35 W	20 µF	3	100 W	5	175 W	10	350 W	15	550 W	
	55 W	20 µF	3	to	5	to	10	to	15	to	
	90 W	26 µF	2	180 W	4	360 W	8	720 W	11	1100 W	
	135 W	40 µF	1		2		5		7		
	180 W	45 µF	1		2		4		6		
High-pressure sodium vapour lamps											
Metal-iodide lamps											
With ferromagnetic ballast with external ignitor, without compensation ⁽¹⁾	35 W	16	600 W	24	850 W	42	1450 W	64	2250 W		
	70 W	8		12	to	20	to	32	to		
	150 W	4		7	1200 W	13	2000 W	18	3200 W		
	250 W	2		4		8		11			
	400 W	1		3		5		8			
	1000 W	0		1		2		3			
With ferromagnetic ballast with external ignitor and parallel compensation ⁽²⁾	35 W	6 µF	12	450 W	18	650 W	31	1100 W	50	1750 W	
	70 W	12 µF	6	to	9	to	16	to	25	to	
	150 W	20 µF	4	1000 W	6	2000 W	10	4000 W	15	6000 W	
	250 W	32 µF	3		4		7		10		
	400 W	45 µF	2		3		5		7		
	1000 W	60 µF	1		2		3		5		
	2000 W	85 µF	0		1		2		3		
With electronic ballast	35 W	24	850 W	38	1350 W	68	2400 W	102	3600 W		
	70 W	18	to	29	to	51	to	76	to		
	150 W	9	1350 W	14	2200 W	26	4000 W	40	600 W		

4660 W x
Cos phi

(1) Circuits with non-compensated ferromagnetic ballasts consume twice as much current for a given lamp power output. This explains the small number of lamps in this configuration.

(2) The total capacitance of the power factor correction capacitors in parallel in a circuit limits the number of lamps that can be controlled by a contactor. The total downstream capacitance of a modular contactor of rating 16, 25, 40 or 63 A should not exceed 75, 100, 200 or 300 µF respectively. Allow for these limits to calculate the maximum acceptable number of lamps if the capacitance values are different from those in the table.

iTL impulse relays				iTL+ impulse relays				Reflex iC60 (C curve)																																																																																																																																																																																																																																																																																																																																																																																																																																																																																																																																																																																																		
Maximum number of light fittings for a single-phase circuit and maximum power output per circuit																																																																																																																																																																																																																																																																																																																																																																																																																																																																																																																																																																																																										
16 A		32 A		16 A		10 A		16 A		25 A		40 A		63 A																																																																																																																																																																																																																																																																																																																																																																																																																																																																																																																																																																																												
240	1200 W	630	3150 W	3680 W x Cos phi	158	790 W	251	1255 W	399	1995 W	810	4050 W	Usage peu fréquent																																																																																																																																																																																																																																																																																																																																																																																																																																																																																																																																																																																													
171	to	457	to		138	1450 W	366	3800 W	92	962 W	181	to			268	to	578	to	118		318		79		147	1560 W	234	2392 W	463	4706 W	77		202		49		80		196		396		55		146		37		60		127		261		170	850 W	390	1950 W	121	605 W	193	959 W	278	1390 W	568	2840 W	859	4295 W	121	to	285	to	85	to	137	to	198	to	405	to	621	to	100	1050 W	233	2400 W	71	650 W	113	1044 W	160	1560 W	322	3146 W	497	4732 W	86		200		59		94		132		268		411		55		127		36		58		83		167		257		40		92		25		40		60		121		182		69	700 W	98	1000 W	30	300 W	44	450 W	71	700 W	108	1050 W	146	1450 W	54	to	77	to	24	to	34	to	55	to	83	to	113	to	39	1950 W	56	3000 W	17	850 W	25	1250 W	40	2000 W	61	3050 W	83	4150 W	25		36		11		15		24		37		50		12		18		5		7		11		17		23		9		15		-		6		10		15		20		Non testé, utilisation peu fréquente				4	153 W	7	245 W	11	385 W	17	595 W	29	1015 W					4	to	7	to	11	to	17	to	29	to					3	253 W	4	405 W	8	792 W	11	1198 W	23	2070 W					2		3		5		8		12						1		2		4		7		10		38	1350 W	102	3600 W	3	88 W	4	140 W	7	245 W	12	420 W	19	665 W	24		63		3	to	4	to	7	to	12	to	19	to	15		40		2	169 W	3	270 W	5	450 W	8	720 W	13	1440 W	10		26		1		2		3		5		9		7		18		0		1		2		4		8		Non testé, utilisation peu fréquente				12	416 W	19	400 W	28	980 W	50	1750 W	77	2695 W					7	to	11	to	15	to	24	to	38	to					3	481 W	5	750 W	9	1350 W	15	2500 W	22	4000 W					2		3		5		10		13						0		1		3		6		10						0		0		2		2		3		34	1200 W	88	3100 W	14	490 W	17	595 W	26	910 W	43	1505 W	70	2450 W	17	to	45	to	8	to	9	to	13	to	23	to	35	to	8	1350 W	22	3400 W	5	800 W	6	1200 W	9	2200 W	14	4400 W	21	7000 W	5		13		3		4		5		10		14		3		8		2		3		4		7		9		1		3		0		1		2		4		7		0		1		0		0		1		2		3		38	1350 W	87	3100 W	15	525 W	24	840 W	38	1330 W	82	2870 W	123	4305 W	29	to	77	to	11	to	18	to	29	to	61	to	92	to	14	2200 W	33	5000 W	6	844 W	9	1350 W	14	2100 W	31	4650 W	48	7200 W
138	1450 W	366	3800 W		92	962 W	181	to	268	to	578	to			118		318		79		147	1560 W	234	2392 W	463	4706 W	77		202		49		80		196		396		55		146		37		60		127		261		170	850 W	390	1950 W	121	605 W	193	959 W	278	1390 W	568	2840 W	859	4295 W	121	to	285	to	85	to	137	to	198	to	405	to	621	to	100	1050 W	233	2400 W	71	650 W	113	1044 W	160	1560 W	322	3146 W	497	4732 W	86		200		59		94		132		268		411		55		127		36		58		83		167		257		40		92		25		40		60		121		182		69	700 W	98	1000 W	30	300 W	44	450 W	71	700 W	108	1050 W	146	1450 W	54	to	77	to	24	to	34	to	55	to	83	to	113	to	39	1950 W	56	3000 W	17	850 W	25	1250 W	40	2000 W	61	3050 W	83	4150 W	25		36		11		15		24		37		50		12		18		5		7		11		17		23		9		15		-		6		10		15		20		Non testé, utilisation peu fréquente				4	153 W	7	245 W	11	385 W	17	595 W	29	1015 W					4	to	7	to	11	to	17	to	29	to					3	253 W	4	405 W	8	792 W	11	1198 W	23	2070 W					2		3		5		8		12						1		2		4		7		10		38	1350 W	102	3600 W	3	88 W	4	140 W	7	245 W	12	420 W	19	665 W	24		63		3	to	4	to	7	to	12	to	19	to	15		40		2	169 W	3	270 W	5	450 W	8	720 W	13	1440 W	10		26		1		2		3		5		9		7		18		0		1		2		4		8		Non testé, utilisation peu fréquente				12	416 W	19	400 W	28	980 W	50	1750 W	77	2695 W					7	to	11	to	15	to	24	to	38	to					3	481 W	5	750 W	9	1350 W	15	2500 W	22	4000 W					2		3		5		10		13						0		1		3		6		10						0		0		2		2		3		34	1200 W	88	3100 W	14	490 W	17	595 W	26	910 W	43	1505 W	70	2450 W	17	to	45	to	8	to	9	to	13	to	23	to	35	to	8	1350 W	22	3400 W	5	800 W	6	1200 W	9	2200 W	14	4400 W	21	7000 W	5		13		3		4		5		10		14		3		8		2		3		4		7		9		1		3		0		1		2		4		7		0		1		0		0		1		2		3		38	1350 W	87	3100 W	15	525 W	24	840 W	38	1330 W	82	2870 W	123	4305 W	29	to	77	to	11	to	18	to	29	to	61	to	92	to	14	2200 W	33	5000 W	6	844 W	9	1350 W	14	2100 W	31	4650 W	48	7200 W				
118		318			79		147	1560 W	234	2392 W	463	4706 W			77		202		49		80		196		396		55		146		37		60		127		261		170	850 W	390	1950 W	121	605 W	193	959 W	278	1390 W	568	2840 W	859	4295 W	121	to	285	to	85	to	137	to	198	to	405	to	621	to	100	1050 W	233	2400 W	71	650 W	113	1044 W	160	1560 W	322	3146 W	497	4732 W	86		200		59		94		132		268		411		55		127		36		58		83		167		257		40		92		25		40		60		121		182		69	700 W	98	1000 W	30	300 W	44	450 W	71	700 W	108	1050 W	146	1450 W	54	to	77	to	24	to	34	to	55	to	83	to	113	to	39	1950 W	56	3000 W	17	850 W	25	1250 W	40	2000 W	61	3050 W	83	4150 W	25		36		11		15		24		37		50		12		18		5		7		11		17		23		9		15		-		6		10		15		20		Non testé, utilisation peu fréquente				4	153 W	7	245 W	11	385 W	17	595 W	29	1015 W					4	to	7	to	11	to	17	to	29	to					3	253 W	4	405 W	8	792 W	11	1198 W	23	2070 W					2		3		5		8		12						1		2		4		7		10		38	1350 W	102	3600 W	3	88 W	4	140 W	7	245 W	12	420 W	19	665 W	24		63		3	to	4	to	7	to	12	to	19	to	15		40		2	169 W	3	270 W	5	450 W	8	720 W	13	1440 W	10		26		1		2		3		5		9		7		18		0		1		2		4		8		Non testé, utilisation peu fréquente				12	416 W	19	400 W	28	980 W	50	1750 W	77	2695 W					7	to	11	to	15	to	24	to	38	to					3	481 W	5	750 W	9	1350 W	15	2500 W	22	4000 W					2		3		5		10		13						0		1		3		6		10						0		0		2		2		3		34	1200 W	88	3100 W	14	490 W	17	595 W	26	910 W	43	1505 W	70	2450 W	17	to	45	to	8	to	9	to	13	to	23	to	35	to	8	1350 W	22	3400 W	5	800 W	6	1200 W	9	2200 W	14	4400 W	21	7000 W	5		13		3		4		5		10		14		3		8		2		3		4		7		9		1		3		0		1		2		4		7		0		1		0		0		1		2		3		38	1350 W	87	3100 W	15	525 W	24	840 W	38	1330 W	82	2870 W	123	4305 W	29	to	77	to	11	to	18	to	29	to	61	to	92	to	14	2200 W	33	5000 W	6	844 W	9	1350 W	14	2100 W	31	4650 W	48	7200 W																
77		202			49		80		196		396				55		146		37		60		127		261		170	850 W	390	1950 W	121	605 W	193	959 W	278	1390 W	568	2840 W	859	4295 W	121	to	285	to	85	to	137	to	198	to	405	to	621	to	100	1050 W	233	2400 W	71	650 W	113	1044 W	160	1560 W	322	3146 W	497	4732 W	86		200		59		94		132		268		411		55		127		36		58		83		167		257		40		92		25		40		60		121		182		69	700 W	98	1000 W	30	300 W	44	450 W	71	700 W	108	1050 W	146	1450 W	54	to	77	to	24	to	34	to	55	to	83	to	113	to	39	1950 W	56	3000 W	17	850 W	25	1250 W	40	2000 W	61	3050 W	83	4150 W	25		36		11		15		24		37		50		12		18		5		7		11		17		23		9		15		-		6		10		15		20		Non testé, utilisation peu fréquente				4	153 W	7	245 W	11	385 W	17	595 W	29	1015 W					4	to	7	to	11	to	17	to	29	to					3	253 W	4	405 W	8	792 W	11	1198 W	23	2070 W					2		3		5		8		12						1		2		4		7		10		38	1350 W	102	3600 W	3	88 W	4	140 W	7	245 W	12	420 W	19	665 W	24		63		3	to	4	to	7	to	12	to	19	to	15		40		2	169 W	3	270 W	5	450 W	8	720 W	13	1440 W	10		26		1		2		3		5		9		7		18		0		1		2		4		8		Non testé, utilisation peu fréquente				12	416 W	19	400 W	28	980 W	50	1750 W	77	2695 W					7	to	11	to	15	to	24	to	38	to					3	481 W	5	750 W	9	1350 W	15	2500 W	22	4000 W					2		3		5		10		13						0		1		3		6		10						0		0		2		2		3		34	1200 W	88	3100 W	14	490 W	17	595 W	26	910 W	43	1505 W	70	2450 W	17	to	45	to	8	to	9	to	13	to	23	to	35	to	8	1350 W	22	3400 W	5	800 W	6	1200 W	9	2200 W	14	4400 W	21	7000 W	5		13		3		4		5		10		14		3		8		2		3		4		7		9		1		3		0		1		2		4		7		0		1		0		0		1		2		3		38	1350 W	87	3100 W	15	525 W	24	840 W	38	1330 W	82	2870 W	123	4305 W	29	to	77	to	11	to	18	to	29	to	61	to	92	to	14	2200 W	33	5000 W	6	844 W	9	1350 W	14	2100 W	31	4650 W	48	7200 W																												
55		146			37		60		127		261				170	850 W	390	1950 W	121	605 W	193	959 W	278	1390 W	568	2840 W	859	4295 W	121	to	285	to	85	to	137	to	198	to	405	to	621	to	100	1050 W	233	2400 W	71	650 W	113	1044 W	160	1560 W	322	3146 W	497	4732 W	86		200		59		94		132		268		411		55		127		36		58		83		167		257		40		92		25		40		60		121		182		69	700 W	98	1000 W	30	300 W	44	450 W	71	700 W	108	1050 W	146	1450 W	54	to	77	to	24	to	34	to	55	to	83	to	113	to	39	1950 W	56	3000 W	17	850 W	25	1250 W	40	2000 W	61	3050 W	83	4150 W	25		36		11		15		24		37		50		12		18		5		7		11		17		23		9		15		-		6		10		15		20		Non testé, utilisation peu fréquente				4	153 W	7	245 W	11	385 W	17	595 W	29	1015 W					4	to	7	to	11	to	17	to	29	to					3	253 W	4	405 W	8	792 W	11	1198 W	23	2070 W					2		3		5		8		12						1		2		4		7		10		38	1350 W	102	3600 W	3	88 W	4	140 W	7	245 W	12	420 W	19	665 W	24		63		3	to	4	to	7	to	12	to	19	to	15		40		2	169 W	3	270 W	5	450 W	8	720 W	13	1440 W	10		26		1		2		3		5		9		7		18		0		1		2		4		8		Non testé, utilisation peu fréquente				12	416 W	19	400 W	28	980 W	50	1750 W	77	2695 W					7	to	11	to	15	to	24	to	38	to					3	481 W	5	750 W	9	1350 W	15	2500 W	22	4000 W					2		3		5		10		13						0		1		3		6		10						0		0		2		2		3		34	1200 W	88	3100 W	14	490 W	17	595 W	26	910 W	43	1505 W	70	2450 W	17	to	45	to	8	to	9	to	13	to	23	to	35	to	8	1350 W	22	3400 W	5	800 W	6	1200 W	9	2200 W	14	4400 W	21	7000 W	5		13		3		4		5		10		14		3		8		2		3		4		7		9		1		3		0		1		2		4		7		0		1		0		0		1		2		3		38	1350 W	87	3100 W	15	525 W	24	840 W	38	1330 W	82	2870 W	123	4305 W	29	to	77	to	11	to	18	to	29	to	61	to	92	to	14	2200 W	33	5000 W	6	844 W	9	1350 W	14	2100 W	31	4650 W	48	7200 W																																								
170	850 W	390	1950 W		121	605 W	193	959 W	278	1390 W	568	2840 W			859	4295 W	121	to	285	to	85	to	137	to	198	to	405	to	621	to	100	1050 W	233	2400 W	71	650 W	113	1044 W	160	1560 W	322	3146 W	497	4732 W	86		200		59		94		132		268		411		55		127		36		58		83		167		257		40		92		25		40		60		121		182		69	700 W	98	1000 W	30	300 W	44	450 W	71	700 W	108	1050 W	146	1450 W	54	to	77	to	24	to	34	to	55	to	83	to	113	to	39	1950 W	56	3000 W	17	850 W	25	1250 W	40	2000 W	61	3050 W	83	4150 W	25		36		11		15		24		37		50		12		18		5		7		11		17		23		9		15		-		6		10		15		20		Non testé, utilisation peu fréquente				4	153 W	7	245 W	11	385 W	17	595 W	29	1015 W					4	to	7	to	11	to	17	to	29	to					3	253 W	4	405 W	8	792 W	11	1198 W	23	2070 W					2		3		5		8		12						1		2		4		7		10		38	1350 W	102	3600 W	3	88 W	4	140 W	7	245 W	12	420 W	19	665 W	24		63		3	to	4	to	7	to	12	to	19	to	15		40		2	169 W	3	270 W	5	450 W	8	720 W	13	1440 W	10		26		1		2		3		5		9		7		18		0		1		2		4		8		Non testé, utilisation peu fréquente				12	416 W	19	400 W	28	980 W	50	1750 W	77	2695 W					7	to	11	to	15	to	24	to	38	to					3	481 W	5	750 W	9	1350 W	15	2500 W	22	4000 W					2		3		5		10		13						0		1		3		6		10						0		0		2		2		3		34	1200 W	88	3100 W	14	490 W	17	595 W	26	910 W	43	1505 W	70	2450 W	17	to	45	to	8	to	9	to	13	to	23	to	35	to	8	1350 W	22	3400 W	5	800 W	6	1200 W	9	2200 W	14	4400 W	21	7000 W	5		13		3		4		5		10		14		3		8		2		3		4		7		9		1		3		0		1		2		4		7		0		1		0		0		1		2		3		38	1350 W	87	3100 W	15	525 W	24	840 W	38	1330 W	82	2870 W	123	4305 W	29	to	77	to	11	to	18	to	29	to	61	to	92	to	14	2200 W	33	5000 W	6	844 W	9	1350 W	14	2100 W	31	4650 W	48	7200 W																																																				
121	to	285	to		85	to	137	to	198	to	405	to			621	to	100	1050 W	233	2400 W	71	650 W	113	1044 W	160	1560 W	322	3146 W	497	4732 W	86		200		59		94		132		268		411		55		127		36		58		83		167		257		40		92		25		40		60		121		182		69	700 W	98	1000 W	30	300 W	44	450 W	71	700 W	108	1050 W	146	1450 W	54	to	77	to	24	to	34	to	55	to	83	to	113	to	39	1950 W	56	3000 W	17	850 W	25	1250 W	40	2000 W	61	3050 W	83	4150 W	25		36		11		15		24		37		50		12		18		5		7		11		17		23		9		15		-		6		10		15		20		Non testé, utilisation peu fréquente				4	153 W	7	245 W	11	385 W	17	595 W	29	1015 W					4	to	7	to	11	to	17	to	29	to					3	253 W	4	405 W	8	792 W	11	1198 W	23	2070 W					2		3		5		8		12						1		2		4		7		10		38	1350 W	102	3600 W	3	88 W	4	140 W	7	245 W	12	420 W	19	665 W	24		63		3	to	4	to	7	to	12	to	19	to	15		40		2	169 W	3	270 W	5	450 W	8	720 W	13	1440 W	10		26		1		2		3		5		9		7		18		0		1		2		4		8		Non testé, utilisation peu fréquente				12	416 W	19	400 W	28	980 W	50	1750 W	77	2695 W					7	to	11	to	15	to	24	to	38	to					3	481 W	5	750 W	9	1350 W	15	2500 W	22	4000 W					2		3		5		10		13						0		1		3		6		10						0		0		2		2		3		34	1200 W	88	3100 W	14	490 W	17	595 W	26	910 W	43	1505 W	70	2450 W	17	to	45	to	8	to	9	to	13	to	23	to	35	to	8	1350 W	22	3400 W	5	800 W	6	1200 W	9	2200 W	14	4400 W	21	7000 W	5		13		3		4		5		10		14		3		8		2		3		4		7		9		1		3		0		1		2		4		7		0		1		0		0		1		2		3		38	1350 W	87	3100 W	15	525 W	24	840 W	38	1330 W	82	2870 W	123	4305 W	29	to	77	to	11	to	18	to	29	to	61	to	92	to	14	2200 W	33	5000 W	6	844 W	9	1350 W	14	2100 W	31	4650 W	48	7200 W																																																																		
100	1050 W	233	2400 W		71	650 W	113	1044 W	160	1560 W	322	3146 W			497	4732 W	86		200		59		94		132		268		411		55		127		36		58		83		167		257		40		92		25		40		60		121		182		69	700 W	98	1000 W	30	300 W	44	450 W	71	700 W	108	1050 W	146	1450 W	54	to	77	to	24	to	34	to	55	to	83	to	113	to	39	1950 W	56	3000 W	17	850 W	25	1250 W	40	2000 W	61	3050 W	83	4150 W	25		36		11		15		24		37		50		12		18		5		7		11		17		23		9		15		-		6		10		15		20		Non testé, utilisation peu fréquente				4	153 W	7	245 W	11	385 W	17	595 W	29	1015 W					4	to	7	to	11	to	17	to	29	to					3	253 W	4	405 W	8	792 W	11	1198 W	23	2070 W					2		3		5		8		12						1		2		4		7		10		38	1350 W	102	3600 W	3	88 W	4	140 W	7	245 W	12	420 W	19	665 W	24		63		3	to	4	to	7	to	12	to	19	to	15		40		2	169 W	3	270 W	5	450 W	8	720 W	13	1440 W	10		26		1		2		3		5		9		7		18		0		1		2		4		8		Non testé, utilisation peu fréquente				12	416 W	19	400 W	28	980 W	50	1750 W	77	2695 W					7	to	11	to	15	to	24	to	38	to					3	481 W	5	750 W	9	1350 W	15	2500 W	22	4000 W					2		3		5		10		13						0		1		3		6		10						0		0		2		2		3		34	1200 W	88	3100 W	14	490 W	17	595 W	26	910 W	43	1505 W	70	2450 W	17	to	45	to	8	to	9	to	13	to	23	to	35	to	8	1350 W	22	3400 W	5	800 W	6	1200 W	9	2200 W	14	4400 W	21	7000 W	5		13		3		4		5		10		14		3		8		2		3		4		7		9		1		3		0		1		2		4		7		0		1		0		0		1		2		3		38	1350 W	87	3100 W	15	525 W	24	840 W	38	1330 W	82	2870 W	123	4305 W	29	to	77	to	11	to	18	to	29	to	61	to	92	to	14	2200 W	33	5000 W	6	844 W	9	1350 W	14	2100 W	31	4650 W	48	7200 W																																																																																
86		200			59		94		132		268				411		55		127		36		58		83		167		257		40		92		25		40		60		121		182		69	700 W	98	1000 W	30	300 W	44	450 W	71	700 W	108	1050 W	146	1450 W	54	to	77	to	24	to	34	to	55	to	83	to	113	to	39	1950 W	56	3000 W	17	850 W	25	1250 W	40	2000 W	61	3050 W	83	4150 W	25		36		11		15		24		37		50		12		18		5		7		11		17		23		9		15		-		6		10		15		20		Non testé, utilisation peu fréquente				4	153 W	7	245 W	11	385 W	17	595 W	29	1015 W					4	to	7	to	11	to	17	to	29	to					3	253 W	4	405 W	8	792 W	11	1198 W	23	2070 W					2		3		5		8		12						1		2		4		7		10		38	1350 W	102	3600 W	3	88 W	4	140 W	7	245 W	12	420 W	19	665 W	24		63		3	to	4	to	7	to	12	to	19	to	15		40		2	169 W	3	270 W	5	450 W	8	720 W	13	1440 W	10		26		1		2		3		5		9		7		18		0		1		2		4		8		Non testé, utilisation peu fréquente				12	416 W	19	400 W	28	980 W	50	1750 W	77	2695 W					7	to	11	to	15	to	24	to	38	to					3	481 W	5	750 W	9	1350 W	15	2500 W	22	4000 W					2		3		5		10		13						0		1		3		6		10						0		0		2		2		3		34	1200 W	88	3100 W	14	490 W	17	595 W	26	910 W	43	1505 W	70	2450 W	17	to	45	to	8	to	9	to	13	to	23	to	35	to	8	1350 W	22	3400 W	5	800 W	6	1200 W	9	2200 W	14	4400 W	21	7000 W	5		13		3		4		5		10		14		3		8		2		3		4		7		9		1		3		0		1		2		4		7		0		1		0		0		1		2		3		38	1350 W	87	3100 W	15	525 W	24	840 W	38	1330 W	82	2870 W	123	4305 W	29	to	77	to	11	to	18	to	29	to	61	to	92	to	14	2200 W	33	5000 W	6	844 W	9	1350 W	14	2100 W	31	4650 W	48	7200 W																																																																																														
55		127		36		58		83		167		257		40		92		25		40		60		121		182		69	700 W	98	1000 W	30	300 W	44	450 W	71	700 W	108	1050 W	146	1450 W	54	to	77	to	24	to	34	to	55	to	83	to	113	to	39	1950 W	56	3000 W	17	850 W	25	1250 W	40	2000 W	61	3050 W	83	4150 W	25		36		11		15		24		37		50		12		18		5		7		11		17		23		9		15		-		6		10		15		20		Non testé, utilisation peu fréquente				4	153 W	7	245 W	11	385 W	17	595 W	29	1015 W					4	to	7	to	11	to	17	to	29	to					3	253 W	4	405 W	8	792 W	11	1198 W	23	2070 W					2		3		5		8		12						1		2		4		7		10		38	1350 W	102	3600 W	3	88 W	4	140 W	7	245 W	12	420 W	19	665 W	24		63		3	to	4	to	7	to	12	to	19	to	15		40		2	169 W	3	270 W	5	450 W	8	720 W	13	1440 W	10		26		1		2		3		5		9		7		18		0		1		2		4		8		Non testé, utilisation peu fréquente				12	416 W	19	400 W	28	980 W	50	1750 W	77	2695 W					7	to	11	to	15	to	24	to	38	to					3	481 W	5	750 W	9	1350 W	15	2500 W	22	4000 W					2		3		5		10		13						0		1		3		6		10						0		0		2		2		3		34	1200 W	88	3100 W	14	490 W	17	595 W	26	910 W	43	1505 W	70	2450 W	17	to	45	to	8	to	9	to	13	to	23	to	35	to	8	1350 W	22	3400 W	5	800 W	6	1200 W	9	2200 W	14	4400 W	21	7000 W	5		13		3		4		5		10		14		3		8		2		3		4		7		9		1		3		0		1		2		4		7		0		1		0		0		1		2		3		38	1350 W	87	3100 W	15	525 W	24	840 W	38	1330 W	82	2870 W	123	4305 W	29	to	77	to	11	to	18	to	29	to	61	to	92	to	14	2200 W	33	5000 W	6	844 W	9	1350 W	14	2100 W	31	4650 W	48	7200 W																																																																																																															
40		92		25		40		60		121		182		69	700 W	98	1000 W	30	300 W	44	450 W	71	700 W	108	1050 W	146	1450 W	54	to	77	to	24	to	34	to	55	to	83	to	113	to	39	1950 W	56	3000 W	17	850 W	25	1250 W	40	2000 W	61	3050 W	83	4150 W	25		36		11		15		24		37		50		12		18		5		7		11		17		23		9		15		-		6		10		15		20		Non testé, utilisation peu fréquente				4	153 W	7	245 W	11	385 W	17	595 W	29	1015 W					4	to	7	to	11	to	17	to	29	to					3	253 W	4	405 W	8	792 W	11	1198 W	23	2070 W					2		3		5		8		12						1		2		4		7		10		38	1350 W	102	3600 W	3	88 W	4	140 W	7	245 W	12	420 W	19	665 W	24		63		3	to	4	to	7	to	12	to	19	to	15		40		2	169 W	3	270 W	5	450 W	8	720 W	13	1440 W	10		26		1		2		3		5		9		7		18		0		1		2		4		8		Non testé, utilisation peu fréquente				12	416 W	19	400 W	28	980 W	50	1750 W	77	2695 W					7	to	11	to	15	to	24	to	38	to					3	481 W	5	750 W	9	1350 W	15	2500 W	22	4000 W					2		3		5		10		13						0		1		3		6		10						0		0		2		2		3		34	1200 W	88	3100 W	14	490 W	17	595 W	26	910 W	43	1505 W	70	2450 W	17	to	45	to	8	to	9	to	13	to	23	to	35	to	8	1350 W	22	3400 W	5	800 W	6	1200 W	9	2200 W	14	4400 W	21	7000 W	5		13		3		4		5		10		14		3		8		2		3		4		7		9		1		3		0		1		2		4		7		0		1		0		0		1		2		3		38	1350 W	87	3100 W	15	525 W	24	840 W	38	1330 W	82	2870 W	123	4305 W	29	to	77	to	11	to	18	to	29	to	61	to	92	to	14	2200 W	33	5000 W	6	844 W	9	1350 W	14	2100 W	31	4650 W	48	7200 W																																																																																																																													
69	700 W	98	1000 W	30	300 W	44	450 W	71	700 W	108	1050 W	146	1450 W	54	to	77	to	24	to	34	to	55	to	83	to	113	to	39	1950 W	56	3000 W	17	850 W	25	1250 W	40	2000 W	61	3050 W	83	4150 W	25		36		11		15		24		37		50		12		18		5		7		11		17		23		9		15		-		6		10		15		20		Non testé, utilisation peu fréquente				4	153 W	7	245 W	11	385 W	17	595 W	29	1015 W					4	to	7	to	11	to	17	to	29	to					3	253 W	4	405 W	8	792 W	11	1198 W	23	2070 W					2		3		5		8		12						1		2		4		7		10		38	1350 W	102	3600 W	3	88 W	4	140 W	7	245 W	12	420 W	19	665 W	24		63		3	to	4	to	7	to	12	to	19	to	15		40		2	169 W	3	270 W	5	450 W	8	720 W	13	1440 W	10		26		1		2		3		5		9		7		18		0		1		2		4		8		Non testé, utilisation peu fréquente				12	416 W	19	400 W	28	980 W	50	1750 W	77	2695 W					7	to	11	to	15	to	24	to	38	to					3	481 W	5	750 W	9	1350 W	15	2500 W	22	4000 W					2		3		5		10		13						0		1		3		6		10						0		0		2		2		3		34	1200 W	88	3100 W	14	490 W	17	595 W	26	910 W	43	1505 W	70	2450 W	17	to	45	to	8	to	9	to	13	to	23	to	35	to	8	1350 W	22	3400 W	5	800 W	6	1200 W	9	2200 W	14	4400 W	21	7000 W	5		13		3		4		5		10		14		3		8		2		3		4		7		9		1		3		0		1		2		4		7		0		1		0		0		1		2		3		38	1350 W	87	3100 W	15	525 W	24	840 W	38	1330 W	82	2870 W	123	4305 W	29	to	77	to	11	to	18	to	29	to	61	to	92	to	14	2200 W	33	5000 W	6	844 W	9	1350 W	14	2100 W	31	4650 W	48	7200 W																																																																																																																																											
54	to	77	to	24	to	34	to	55	to	83	to	113	to	39	1950 W	56	3000 W	17	850 W	25	1250 W	40	2000 W	61	3050 W	83	4150 W	25		36		11		15		24		37		50		12		18		5		7		11		17		23		9		15		-		6		10		15		20		Non testé, utilisation peu fréquente				4	153 W	7	245 W	11	385 W	17	595 W	29	1015 W					4	to	7	to	11	to	17	to	29	to					3	253 W	4	405 W	8	792 W	11	1198 W	23	2070 W					2		3		5		8		12						1		2		4		7		10		38	1350 W	102	3600 W	3	88 W	4	140 W	7	245 W	12	420 W	19	665 W	24		63		3	to	4	to	7	to	12	to	19	to	15		40		2	169 W	3	270 W	5	450 W	8	720 W	13	1440 W	10		26		1		2		3		5		9		7		18		0		1		2		4		8		Non testé, utilisation peu fréquente				12	416 W	19	400 W	28	980 W	50	1750 W	77	2695 W					7	to	11	to	15	to	24	to	38	to					3	481 W	5	750 W	9	1350 W	15	2500 W	22	4000 W					2		3		5		10		13						0		1		3		6		10						0		0		2		2		3		34	1200 W	88	3100 W	14	490 W	17	595 W	26	910 W	43	1505 W	70	2450 W	17	to	45	to	8	to	9	to	13	to	23	to	35	to	8	1350 W	22	3400 W	5	800 W	6	1200 W	9	2200 W	14	4400 W	21	7000 W	5		13		3		4		5		10		14		3		8		2		3		4		7		9		1		3		0		1		2		4		7		0		1		0		0		1		2		3		38	1350 W	87	3100 W	15	525 W	24	840 W	38	1330 W	82	2870 W	123	4305 W	29	to	77	to	11	to	18	to	29	to	61	to	92	to	14	2200 W	33	5000 W	6	844 W	9	1350 W	14	2100 W	31	4650 W	48	7200 W																																																																																																																																																									
39	1950 W	56	3000 W	17	850 W	25	1250 W	40	2000 W	61	3050 W	83	4150 W	25		36		11		15		24		37		50		12		18		5		7		11		17		23		9		15		-		6		10		15		20		Non testé, utilisation peu fréquente				4	153 W	7	245 W	11	385 W	17	595 W	29	1015 W					4	to	7	to	11	to	17	to	29	to					3	253 W	4	405 W	8	792 W	11	1198 W	23	2070 W					2		3		5		8		12						1		2		4		7		10		38	1350 W	102	3600 W	3	88 W	4	140 W	7	245 W	12	420 W	19	665 W	24		63		3	to	4	to	7	to	12	to	19	to	15		40		2	169 W	3	270 W	5	450 W	8	720 W	13	1440 W	10		26		1		2		3		5		9		7		18		0		1		2		4		8		Non testé, utilisation peu fréquente				12	416 W	19	400 W	28	980 W	50	1750 W	77	2695 W					7	to	11	to	15	to	24	to	38	to					3	481 W	5	750 W	9	1350 W	15	2500 W	22	4000 W					2		3		5		10		13						0		1		3		6		10						0		0		2		2		3		34	1200 W	88	3100 W	14	490 W	17	595 W	26	910 W	43	1505 W	70	2450 W	17	to	45	to	8	to	9	to	13	to	23	to	35	to	8	1350 W	22	3400 W	5	800 W	6	1200 W	9	2200 W	14	4400 W	21	7000 W	5		13		3		4		5		10		14		3		8		2		3		4		7		9		1		3		0		1		2		4		7		0		1		0		0		1		2		3		38	1350 W	87	3100 W	15	525 W	24	840 W	38	1330 W	82	2870 W	123	4305 W	29	to	77	to	11	to	18	to	29	to	61	to	92	to	14	2200 W	33	5000 W	6	844 W	9	1350 W	14	2100 W	31	4650 W	48	7200 W																																																																																																																																																																							
25		36		11		15		24		37		50		12		18		5		7		11		17		23		9		15		-		6		10		15		20		Non testé, utilisation peu fréquente				4	153 W	7	245 W	11	385 W	17	595 W	29	1015 W					4	to	7	to	11	to	17	to	29	to					3	253 W	4	405 W	8	792 W	11	1198 W	23	2070 W					2		3		5		8		12						1		2		4		7		10		38	1350 W	102	3600 W	3	88 W	4	140 W	7	245 W	12	420 W	19	665 W	24		63		3	to	4	to	7	to	12	to	19	to	15		40		2	169 W	3	270 W	5	450 W	8	720 W	13	1440 W	10		26		1		2		3		5		9		7		18		0		1		2		4		8		Non testé, utilisation peu fréquente				12	416 W	19	400 W	28	980 W	50	1750 W	77	2695 W					7	to	11	to	15	to	24	to	38	to					3	481 W	5	750 W	9	1350 W	15	2500 W	22	4000 W					2		3		5		10		13						0		1		3		6		10						0		0		2		2		3		34	1200 W	88	3100 W	14	490 W	17	595 W	26	910 W	43	1505 W	70	2450 W	17	to	45	to	8	to	9	to	13	to	23	to	35	to	8	1350 W	22	3400 W	5	800 W	6	1200 W	9	2200 W	14	4400 W	21	7000 W	5		13		3		4		5		10		14		3		8		2		3		4		7		9		1		3		0		1		2		4		7		0		1		0		0		1		2		3		38	1350 W	87	3100 W	15	525 W	24	840 W	38	1330 W	82	2870 W	123	4305 W	29	to	77	to	11	to	18	to	29	to	61	to	92	to	14	2200 W	33	5000 W	6	844 W	9	1350 W	14	2100 W	31	4650 W	48	7200 W																																																																																																																																																																																					
12		18		5		7		11		17		23		9		15		-		6		10		15		20		Non testé, utilisation peu fréquente				4	153 W	7	245 W	11	385 W	17	595 W	29	1015 W					4	to	7	to	11	to	17	to	29	to					3	253 W	4	405 W	8	792 W	11	1198 W	23	2070 W					2		3		5		8		12						1		2		4		7		10		38	1350 W	102	3600 W	3	88 W	4	140 W	7	245 W	12	420 W	19	665 W	24		63		3	to	4	to	7	to	12	to	19	to	15		40		2	169 W	3	270 W	5	450 W	8	720 W	13	1440 W	10		26		1		2		3		5		9		7		18		0		1		2		4		8		Non testé, utilisation peu fréquente				12	416 W	19	400 W	28	980 W	50	1750 W	77	2695 W					7	to	11	to	15	to	24	to	38	to					3	481 W	5	750 W	9	1350 W	15	2500 W	22	4000 W					2		3		5		10		13						0		1		3		6		10						0		0		2		2		3		34	1200 W	88	3100 W	14	490 W	17	595 W	26	910 W	43	1505 W	70	2450 W	17	to	45	to	8	to	9	to	13	to	23	to	35	to	8	1350 W	22	3400 W	5	800 W	6	1200 W	9	2200 W	14	4400 W	21	7000 W	5		13		3		4		5		10		14		3		8		2		3		4		7		9		1		3		0		1		2		4		7		0		1		0		0		1		2		3		38	1350 W	87	3100 W	15	525 W	24	840 W	38	1330 W	82	2870 W	123	4305 W	29	to	77	to	11	to	18	to	29	to	61	to	92	to	14	2200 W	33	5000 W	6	844 W	9	1350 W	14	2100 W	31	4650 W	48	7200 W																																																																																																																																																																																																			
9		15		-		6		10		15		20		Non testé, utilisation peu fréquente				4	153 W	7	245 W	11	385 W	17	595 W	29	1015 W					4	to	7	to	11	to	17	to	29	to					3	253 W	4	405 W	8	792 W	11	1198 W	23	2070 W					2		3		5		8		12						1		2		4		7		10		38	1350 W	102	3600 W	3	88 W	4	140 W	7	245 W	12	420 W	19	665 W	24		63		3	to	4	to	7	to	12	to	19	to	15		40		2	169 W	3	270 W	5	450 W	8	720 W	13	1440 W	10		26		1		2		3		5		9		7		18		0		1		2		4		8		Non testé, utilisation peu fréquente				12	416 W	19	400 W	28	980 W	50	1750 W	77	2695 W					7	to	11	to	15	to	24	to	38	to					3	481 W	5	750 W	9	1350 W	15	2500 W	22	4000 W					2		3		5		10		13						0		1		3		6		10						0		0		2		2		3		34	1200 W	88	3100 W	14	490 W	17	595 W	26	910 W	43	1505 W	70	2450 W	17	to	45	to	8	to	9	to	13	to	23	to	35	to	8	1350 W	22	3400 W	5	800 W	6	1200 W	9	2200 W	14	4400 W	21	7000 W	5		13		3		4		5		10		14		3		8		2		3		4		7		9		1		3		0		1		2		4		7		0		1		0		0		1		2		3		38	1350 W	87	3100 W	15	525 W	24	840 W	38	1330 W	82	2870 W	123	4305 W	29	to	77	to	11	to	18	to	29	to	61	to	92	to	14	2200 W	33	5000 W	6	844 W	9	1350 W	14	2100 W	31	4650 W	48	7200 W																																																																																																																																																																																																																	
Non testé, utilisation peu fréquente				4	153 W	7	245 W	11	385 W	17	595 W	29	1015 W					4	to	7	to	11	to	17	to	29	to					3	253 W	4	405 W	8	792 W	11	1198 W	23	2070 W					2		3		5		8		12						1		2		4		7		10		38	1350 W	102	3600 W	3	88 W	4	140 W	7	245 W	12	420 W	19	665 W	24		63		3	to	4	to	7	to	12	to	19	to	15		40		2	169 W	3	270 W	5	450 W	8	720 W	13	1440 W	10		26		1		2		3		5		9		7		18		0		1		2		4		8		Non testé, utilisation peu fréquente				12	416 W	19	400 W	28	980 W	50	1750 W	77	2695 W					7	to	11	to	15	to	24	to	38	to					3	481 W	5	750 W	9	1350 W	15	2500 W	22	4000 W					2		3		5		10		13						0		1		3		6		10						0		0		2		2		3		34	1200 W	88	3100 W	14	490 W	17	595 W	26	910 W	43	1505 W	70	2450 W	17	to	45	to	8	to	9	to	13	to	23	to	35	to	8	1350 W	22	3400 W	5	800 W	6	1200 W	9	2200 W	14	4400 W	21	7000 W	5		13		3		4		5		10		14		3		8		2		3		4		7		9		1		3		0		1		2		4		7		0		1		0		0		1		2		3		38	1350 W	87	3100 W	15	525 W	24	840 W	38	1330 W	82	2870 W	123	4305 W	29	to	77	to	11	to	18	to	29	to	61	to	92	to	14	2200 W	33	5000 W	6	844 W	9	1350 W	14	2100 W	31	4650 W	48	7200 W																																																																																																																																																																																																																															
				4	to	7	to	11	to	17	to	29	to					3	253 W	4	405 W	8	792 W	11	1198 W	23	2070 W					2		3		5		8		12						1		2		4		7		10		38	1350 W	102	3600 W	3	88 W	4	140 W	7	245 W	12	420 W	19	665 W	24		63		3	to	4	to	7	to	12	to	19	to	15		40		2	169 W	3	270 W	5	450 W	8	720 W	13	1440 W	10		26		1		2		3		5		9		7		18		0		1		2		4		8		Non testé, utilisation peu fréquente				12	416 W	19	400 W	28	980 W	50	1750 W	77	2695 W					7	to	11	to	15	to	24	to	38	to					3	481 W	5	750 W	9	1350 W	15	2500 W	22	4000 W					2		3		5		10		13						0		1		3		6		10						0		0		2		2		3		34	1200 W	88	3100 W	14	490 W	17	595 W	26	910 W	43	1505 W	70	2450 W	17	to	45	to	8	to	9	to	13	to	23	to	35	to	8	1350 W	22	3400 W	5	800 W	6	1200 W	9	2200 W	14	4400 W	21	7000 W	5		13		3		4		5		10		14		3		8		2		3		4		7		9		1		3		0		1		2		4		7		0		1		0		0		1		2		3		38	1350 W	87	3100 W	15	525 W	24	840 W	38	1330 W	82	2870 W	123	4305 W	29	to	77	to	11	to	18	to	29	to	61	to	92	to	14	2200 W	33	5000 W	6	844 W	9	1350 W	14	2100 W	31	4650 W	48	7200 W																																																																																																																																																																																																																																													
				3	253 W	4	405 W	8	792 W	11	1198 W	23	2070 W					2		3		5		8		12						1		2		4		7		10		38	1350 W	102	3600 W	3	88 W	4	140 W	7	245 W	12	420 W	19	665 W	24		63		3	to	4	to	7	to	12	to	19	to	15		40		2	169 W	3	270 W	5	450 W	8	720 W	13	1440 W	10		26		1		2		3		5		9		7		18		0		1		2		4		8		Non testé, utilisation peu fréquente				12	416 W	19	400 W	28	980 W	50	1750 W	77	2695 W					7	to	11	to	15	to	24	to	38	to					3	481 W	5	750 W	9	1350 W	15	2500 W	22	4000 W					2		3		5		10		13						0		1		3		6		10						0		0		2		2		3		34	1200 W	88	3100 W	14	490 W	17	595 W	26	910 W	43	1505 W	70	2450 W	17	to	45	to	8	to	9	to	13	to	23	to	35	to	8	1350 W	22	3400 W	5	800 W	6	1200 W	9	2200 W	14	4400 W	21	7000 W	5		13		3		4		5		10		14		3		8		2		3		4		7		9		1		3		0		1		2		4		7		0		1		0		0		1		2		3		38	1350 W	87	3100 W	15	525 W	24	840 W	38	1330 W	82	2870 W	123	4305 W	29	to	77	to	11	to	18	to	29	to	61	to	92	to	14	2200 W	33	5000 W	6	844 W	9	1350 W	14	2100 W	31	4650 W	48	7200 W																																																																																																																																																																																																																																																											
				2		3		5		8		12						1		2		4		7		10		38	1350 W	102	3600 W	3	88 W	4	140 W	7	245 W	12	420 W	19	665 W	24		63		3	to	4	to	7	to	12	to	19	to	15		40		2	169 W	3	270 W	5	450 W	8	720 W	13	1440 W	10		26		1		2		3		5		9		7		18		0		1		2		4		8		Non testé, utilisation peu fréquente				12	416 W	19	400 W	28	980 W	50	1750 W	77	2695 W					7	to	11	to	15	to	24	to	38	to					3	481 W	5	750 W	9	1350 W	15	2500 W	22	4000 W					2		3		5		10		13						0		1		3		6		10						0		0		2		2		3		34	1200 W	88	3100 W	14	490 W	17	595 W	26	910 W	43	1505 W	70	2450 W	17	to	45	to	8	to	9	to	13	to	23	to	35	to	8	1350 W	22	3400 W	5	800 W	6	1200 W	9	2200 W	14	4400 W	21	7000 W	5		13		3		4		5		10		14		3		8		2		3		4		7		9		1		3		0		1		2		4		7		0		1		0		0		1		2		3		38	1350 W	87	3100 W	15	525 W	24	840 W	38	1330 W	82	2870 W	123	4305 W	29	to	77	to	11	to	18	to	29	to	61	to	92	to	14	2200 W	33	5000 W	6	844 W	9	1350 W	14	2100 W	31	4650 W	48	7200 W																																																																																																																																																																																																																																																																									
				1		2		4		7		10		38	1350 W	102	3600 W	3	88 W	4	140 W	7	245 W	12	420 W	19	665 W	24		63		3	to	4	to	7	to	12	to	19	to	15		40		2	169 W	3	270 W	5	450 W	8	720 W	13	1440 W	10		26		1		2		3		5		9		7		18		0		1		2		4		8		Non testé, utilisation peu fréquente				12	416 W	19	400 W	28	980 W	50	1750 W	77	2695 W					7	to	11	to	15	to	24	to	38	to					3	481 W	5	750 W	9	1350 W	15	2500 W	22	4000 W					2		3		5		10		13						0		1		3		6		10						0		0		2		2		3		34	1200 W	88	3100 W	14	490 W	17	595 W	26	910 W	43	1505 W	70	2450 W	17	to	45	to	8	to	9	to	13	to	23	to	35	to	8	1350 W	22	3400 W	5	800 W	6	1200 W	9	2200 W	14	4400 W	21	7000 W	5		13		3		4		5		10		14		3		8		2		3		4		7		9		1		3		0		1		2		4		7		0		1		0		0		1		2		3		38	1350 W	87	3100 W	15	525 W	24	840 W	38	1330 W	82	2870 W	123	4305 W	29	to	77	to	11	to	18	to	29	to	61	to	92	to	14	2200 W	33	5000 W	6	844 W	9	1350 W	14	2100 W	31	4650 W	48	7200 W																																																																																																																																																																																																																																																																																							
38	1350 W	102	3600 W	3	88 W	4	140 W	7	245 W	12	420 W	19	665 W	24		63		3	to	4	to	7	to	12	to	19	to	15		40		2	169 W	3	270 W	5	450 W	8	720 W	13	1440 W	10		26		1		2		3		5		9		7		18		0		1		2		4		8		Non testé, utilisation peu fréquente				12	416 W	19	400 W	28	980 W	50	1750 W	77	2695 W					7	to	11	to	15	to	24	to	38	to					3	481 W	5	750 W	9	1350 W	15	2500 W	22	4000 W					2		3		5		10		13						0		1		3		6		10						0		0		2		2		3		34	1200 W	88	3100 W	14	490 W	17	595 W	26	910 W	43	1505 W	70	2450 W	17	to	45	to	8	to	9	to	13	to	23	to	35	to	8	1350 W	22	3400 W	5	800 W	6	1200 W	9	2200 W	14	4400 W	21	7000 W	5		13		3		4		5		10		14		3		8		2		3		4		7		9		1		3		0		1		2		4		7		0		1		0		0		1		2		3		38	1350 W	87	3100 W	15	525 W	24	840 W	38	1330 W	82	2870 W	123	4305 W	29	to	77	to	11	to	18	to	29	to	61	to	92	to	14	2200 W	33	5000 W	6	844 W	9	1350 W	14	2100 W	31	4650 W	48	7200 W																																																																																																																																																																																																																																																																																																					
24		63		3	to	4	to	7	to	12	to	19	to	15		40		2	169 W	3	270 W	5	450 W	8	720 W	13	1440 W	10		26		1		2		3		5		9		7		18		0		1		2		4		8		Non testé, utilisation peu fréquente				12	416 W	19	400 W	28	980 W	50	1750 W	77	2695 W					7	to	11	to	15	to	24	to	38	to					3	481 W	5	750 W	9	1350 W	15	2500 W	22	4000 W					2		3		5		10		13						0		1		3		6		10						0		0		2		2		3		34	1200 W	88	3100 W	14	490 W	17	595 W	26	910 W	43	1505 W	70	2450 W	17	to	45	to	8	to	9	to	13	to	23	to	35	to	8	1350 W	22	3400 W	5	800 W	6	1200 W	9	2200 W	14	4400 W	21	7000 W	5		13		3		4		5		10		14		3		8		2		3		4		7		9		1		3		0		1		2		4		7		0		1		0		0		1		2		3		38	1350 W	87	3100 W	15	525 W	24	840 W	38	1330 W	82	2870 W	123	4305 W	29	to	77	to	11	to	18	to	29	to	61	to	92	to	14	2200 W	33	5000 W	6	844 W	9	1350 W	14	2100 W	31	4650 W	48	7200 W																																																																																																																																																																																																																																																																																																																			
15		40		2	169 W	3	270 W	5	450 W	8	720 W	13	1440 W	10		26		1		2		3		5		9		7		18		0		1		2		4		8		Non testé, utilisation peu fréquente				12	416 W	19	400 W	28	980 W	50	1750 W	77	2695 W					7	to	11	to	15	to	24	to	38	to					3	481 W	5	750 W	9	1350 W	15	2500 W	22	4000 W					2		3		5		10		13						0		1		3		6		10						0		0		2		2		3		34	1200 W	88	3100 W	14	490 W	17	595 W	26	910 W	43	1505 W	70	2450 W	17	to	45	to	8	to	9	to	13	to	23	to	35	to	8	1350 W	22	3400 W	5	800 W	6	1200 W	9	2200 W	14	4400 W	21	7000 W	5		13		3		4		5		10		14		3		8		2		3		4		7		9		1		3		0		1		2		4		7		0		1		0		0		1		2		3		38	1350 W	87	3100 W	15	525 W	24	840 W	38	1330 W	82	2870 W	123	4305 W	29	to	77	to	11	to	18	to	29	to	61	to	92	to	14	2200 W	33	5000 W	6	844 W	9	1350 W	14	2100 W	31	4650 W	48	7200 W																																																																																																																																																																																																																																																																																																																																	
10		26		1		2		3		5		9		7		18		0		1		2		4		8		Non testé, utilisation peu fréquente				12	416 W	19	400 W	28	980 W	50	1750 W	77	2695 W					7	to	11	to	15	to	24	to	38	to					3	481 W	5	750 W	9	1350 W	15	2500 W	22	4000 W					2		3		5		10		13						0		1		3		6		10						0		0		2		2		3		34	1200 W	88	3100 W	14	490 W	17	595 W	26	910 W	43	1505 W	70	2450 W	17	to	45	to	8	to	9	to	13	to	23	to	35	to	8	1350 W	22	3400 W	5	800 W	6	1200 W	9	2200 W	14	4400 W	21	7000 W	5		13		3		4		5		10		14		3		8		2		3		4		7		9		1		3		0		1		2		4		7		0		1		0		0		1		2		3		38	1350 W	87	3100 W	15	525 W	24	840 W	38	1330 W	82	2870 W	123	4305 W	29	to	77	to	11	to	18	to	29	to	61	to	92	to	14	2200 W	33	5000 W	6	844 W	9	1350 W	14	2100 W	31	4650 W	48	7200 W																																																																																																																																																																																																																																																																																																																																															
7		18		0		1		2		4		8		Non testé, utilisation peu fréquente				12	416 W	19	400 W	28	980 W	50	1750 W	77	2695 W					7	to	11	to	15	to	24	to	38	to					3	481 W	5	750 W	9	1350 W	15	2500 W	22	4000 W					2		3		5		10		13						0		1		3		6		10						0		0		2		2		3		34	1200 W	88	3100 W	14	490 W	17	595 W	26	910 W	43	1505 W	70	2450 W	17	to	45	to	8	to	9	to	13	to	23	to	35	to	8	1350 W	22	3400 W	5	800 W	6	1200 W	9	2200 W	14	4400 W	21	7000 W	5		13		3		4		5		10		14		3		8		2		3		4		7		9		1		3		0		1		2		4		7		0		1		0		0		1		2		3		38	1350 W	87	3100 W	15	525 W	24	840 W	38	1330 W	82	2870 W	123	4305 W	29	to	77	to	11	to	18	to	29	to	61	to	92	to	14	2200 W	33	5000 W	6	844 W	9	1350 W	14	2100 W	31	4650 W	48	7200 W																																																																																																																																																																																																																																																																																																																																																													
Non testé, utilisation peu fréquente				12	416 W	19	400 W	28	980 W	50	1750 W	77	2695 W					7	to	11	to	15	to	24	to	38	to					3	481 W	5	750 W	9	1350 W	15	2500 W	22	4000 W					2		3		5		10		13						0		1		3		6		10						0		0		2		2		3		34	1200 W	88	3100 W	14	490 W	17	595 W	26	910 W	43	1505 W	70	2450 W	17	to	45	to	8	to	9	to	13	to	23	to	35	to	8	1350 W	22	3400 W	5	800 W	6	1200 W	9	2200 W	14	4400 W	21	7000 W	5		13		3		4		5		10		14		3		8		2		3		4		7		9		1		3		0		1		2		4		7		0		1		0		0		1		2		3		38	1350 W	87	3100 W	15	525 W	24	840 W	38	1330 W	82	2870 W	123	4305 W	29	to	77	to	11	to	18	to	29	to	61	to	92	to	14	2200 W	33	5000 W	6	844 W	9	1350 W	14	2100 W	31	4650 W	48	7200 W																																																																																																																																																																																																																																																																																																																																																																											
				7	to	11	to	15	to	24	to	38	to					3	481 W	5	750 W	9	1350 W	15	2500 W	22	4000 W					2		3		5		10		13						0		1		3		6		10						0		0		2		2		3		34	1200 W	88	3100 W	14	490 W	17	595 W	26	910 W	43	1505 W	70	2450 W	17	to	45	to	8	to	9	to	13	to	23	to	35	to	8	1350 W	22	3400 W	5	800 W	6	1200 W	9	2200 W	14	4400 W	21	7000 W	5		13		3		4		5		10		14		3		8		2		3		4		7		9		1		3		0		1		2		4		7		0		1		0		0		1		2		3		38	1350 W	87	3100 W	15	525 W	24	840 W	38	1330 W	82	2870 W	123	4305 W	29	to	77	to	11	to	18	to	29	to	61	to	92	to	14	2200 W	33	5000 W	6	844 W	9	1350 W	14	2100 W	31	4650 W	48	7200 W																																																																																																																																																																																																																																																																																																																																																																																									
				3	481 W	5	750 W	9	1350 W	15	2500 W	22	4000 W					2		3		5		10		13						0		1		3		6		10						0		0		2		2		3		34	1200 W	88	3100 W	14	490 W	17	595 W	26	910 W	43	1505 W	70	2450 W	17	to	45	to	8	to	9	to	13	to	23	to	35	to	8	1350 W	22	3400 W	5	800 W	6	1200 W	9	2200 W	14	4400 W	21	7000 W	5		13		3		4		5		10		14		3		8		2		3		4		7		9		1		3		0		1		2		4		7		0		1		0		0		1		2		3		38	1350 W	87	3100 W	15	525 W	24	840 W	38	1330 W	82	2870 W	123	4305 W	29	to	77	to	11	to	18	to	29	to	61	to	92	to	14	2200 W	33	5000 W	6	844 W	9	1350 W	14	2100 W	31	4650 W	48	7200 W																																																																																																																																																																																																																																																																																																																																																																																																							
				2		3		5		10		13						0		1		3		6		10						0		0		2		2		3		34	1200 W	88	3100 W	14	490 W	17	595 W	26	910 W	43	1505 W	70	2450 W	17	to	45	to	8	to	9	to	13	to	23	to	35	to	8	1350 W	22	3400 W	5	800 W	6	1200 W	9	2200 W	14	4400 W	21	7000 W	5		13		3		4		5		10		14		3		8		2		3		4		7		9		1		3		0		1		2		4		7		0		1		0		0		1		2		3		38	1350 W	87	3100 W	15	525 W	24	840 W	38	1330 W	82	2870 W	123	4305 W	29	to	77	to	11	to	18	to	29	to	61	to	92	to	14	2200 W	33	5000 W	6	844 W	9	1350 W	14	2100 W	31	4650 W	48	7200 W																																																																																																																																																																																																																																																																																																																																																																																																																					
				0		1		3		6		10						0		0		2		2		3		34	1200 W	88	3100 W	14	490 W	17	595 W	26	910 W	43	1505 W	70	2450 W	17	to	45	to	8	to	9	to	13	to	23	to	35	to	8	1350 W	22	3400 W	5	800 W	6	1200 W	9	2200 W	14	4400 W	21	7000 W	5		13		3		4		5		10		14		3		8		2		3		4		7		9		1		3		0		1		2		4		7		0		1		0		0		1		2		3		38	1350 W	87	3100 W	15	525 W	24	840 W	38	1330 W	82	2870 W	123	4305 W	29	to	77	to	11	to	18	to	29	to	61	to	92	to	14	2200 W	33	5000 W	6	844 W	9	1350 W	14	2100 W	31	4650 W	48	7200 W																																																																																																																																																																																																																																																																																																																																																																																																																																			
				0		0		2		2		3		34	1200 W	88	3100 W	14	490 W	17	595 W	26	910 W	43	1505 W	70	2450 W	17	to	45	to	8	to	9	to	13	to	23	to	35	to	8	1350 W	22	3400 W	5	800 W	6	1200 W	9	2200 W	14	4400 W	21	7000 W	5		13		3		4		5		10		14		3		8		2		3		4		7		9		1		3		0		1		2		4		7		0		1		0		0		1		2		3		38	1350 W	87	3100 W	15	525 W	24	840 W	38	1330 W	82	2870 W	123	4305 W	29	to	77	to	11	to	18	to	29	to	61	to	92	to	14	2200 W	33	5000 W	6	844 W	9	1350 W	14	2100 W	31	4650 W	48	7200 W																																																																																																																																																																																																																																																																																																																																																																																																																																																	
34	1200 W	88	3100 W	14	490 W	17	595 W	26	910 W	43	1505 W	70	2450 W	17	to	45	to	8	to	9	to	13	to	23	to	35	to	8	1350 W	22	3400 W	5	800 W	6	1200 W	9	2200 W	14	4400 W	21	7000 W	5		13		3		4		5		10		14		3		8		2		3		4		7		9		1		3		0		1		2		4		7		0		1		0		0		1		2		3		38	1350 W	87	3100 W	15	525 W	24	840 W	38	1330 W	82	2870 W	123	4305 W	29	to	77	to	11	to	18	to	29	to	61	to	92	to	14	2200 W	33	5000 W	6	844 W	9	1350 W	14	2100 W	31	4650 W	48	7200 W																																																																																																																																																																																																																																																																																																																																																																																																																																																															
17	to	45	to	8	to	9	to	13	to	23	to	35	to	8	1350 W	22	3400 W	5	800 W	6	1200 W	9	2200 W	14	4400 W	21	7000 W	5		13		3		4		5		10		14		3		8		2		3		4		7		9		1		3		0		1		2		4		7		0		1		0		0		1		2		3		38	1350 W	87	3100 W	15	525 W	24	840 W	38	1330 W	82	2870 W	123	4305 W	29	to	77	to	11	to	18	to	29	to	61	to	92	to	14	2200 W	33	5000 W	6	844 W	9	1350 W	14	2100 W	31	4650 W	48	7200 W																																																																																																																																																																																																																																																																																																																																																																																																																																																																													
8	1350 W	22	3400 W	5	800 W	6	1200 W	9	2200 W	14	4400 W	21	7000 W	5		13		3		4		5		10		14		3		8		2		3		4		7		9		1		3		0		1		2		4		7		0		1		0		0		1		2		3		38	1350 W	87	3100 W	15	525 W	24	840 W	38	1330 W	82	2870 W	123	4305 W	29	to	77	to	11	to	18	to	29	to	61	to	92	to	14	2200 W	33	5000 W	6	844 W	9	1350 W	14	2100 W	31	4650 W	48	7200 W																																																																																																																																																																																																																																																																																																																																																																																																																																																																																											
5		13		3		4		5		10		14		3		8		2		3		4		7		9		1		3		0		1		2		4		7		0		1		0		0		1		2		3		38	1350 W	87	3100 W	15	525 W	24	840 W	38	1330 W	82	2870 W	123	4305 W	29	to	77	to	11	to	18	to	29	to	61	to	92	to	14	2200 W	33	5000 W	6	844 W	9	1350 W	14	2100 W	31	4650 W	48	7200 W																																																																																																																																																																																																																																																																																																																																																																																																																																																																																																									
3		8		2		3		4		7		9		1		3		0		1		2		4		7		0		1		0		0		1		2		3		38	1350 W	87	3100 W	15	525 W	24	840 W	38	1330 W	82	2870 W	123	4305 W	29	to	77	to	11	to	18	to	29	to	61	to	92	to	14	2200 W	33	5000 W	6	844 W	9	1350 W	14	2100 W	31	4650 W	48	7200 W																																																																																																																																																																																																																																																																																																																																																																																																																																																																																																																							
1		3		0		1		2		4		7		0		1		0		0		1		2		3		38	1350 W	87	3100 W	15	525 W	24	840 W	38	1330 W	82	2870 W	123	4305 W	29	to	77	to	11	to	18	to	29	to	61	to	92	to	14	2200 W	33	5000 W	6	844 W	9	1350 W	14	2100 W	31	4650 W	48	7200 W																																																																																																																																																																																																																																																																																																																																																																																																																																																																																																																																					
0		1		0		0		1		2		3		38	1350 W	87	3100 W	15	525 W	24	840 W	38	1330 W	82	2870 W	123	4305 W	29	to	77	to	11	to	18	to	29	to	61	to	92	to	14	2200 W	33	5000 W	6	844 W	9	1350 W	14	2100 W	31	4650 W	48	7200 W																																																																																																																																																																																																																																																																																																																																																																																																																																																																																																																																																			
38	1350 W	87	3100 W	15	525 W	24	840 W	38	1330 W	82	2870 W	123	4305 W	29	to	77	to	11	to	18	to	29	to	61	to	92	to	14	2200 W	33	5000 W	6	844 W	9	1350 W	14	2100 W	31	4650 W	48	7200 W																																																																																																																																																																																																																																																																																																																																																																																																																																																																																																																																																																	
29	to	77	to	11	to	18	to	29	to	61	to	92	to	14	2200 W	33	5000 W	6	844 W	9	1350 W	14	2100 W	31	4650 W	48	7200 W																																																																																																																																																																																																																																																																																																																																																																																																																																																																																																																																																																															
14	2200 W	33	5000 W	6	844 W	9	1350 W	14	2100 W	31	4650 W	48	7200 W																																																																																																																																																																																																																																																																																																																																																																																																																																																																																																																																																																																													

Note: Reflex iC60

High-pressure sodium vapour lamp with electronic ballast

For the 10 A and 16 A B-curve ratings, the number of lamps should be reduced by 10 % to limit unwanted magnetic tripping.

LED lamp

B-curve ratings, the number of lamps should be reduced by 50 %.

D-curve ratings, the number of lamps should be increased by 50 %.

Coordination of switchgear with loads

iTL, iCT

Heating application

■ Impulse relay rating to be chosen according to the power to be controlled.

230 V heating

Type	Maximum power for a given rating	
	iTL impulse relays	
Single-phase circuit	16 A	32 A
Heating (AC1)	3.6 kW	7.2 kW

■ Contactor rating to be chosen according to the power to be controlled and the number of operations a day.

230 V heating

Type of heating application	Maximum power for a given rating			
	iCT contactors			
Number of operations / day	25 A	40 A	63 A	100 A
25	5.4 kW	8.6 kW	14 kW	21.6 kW
50	5.4 kW	8.6 kW	14 kW	21.6 kW
75	4.6 kW	7.4 kW	12 kW	18 kW
100	4 kW	6 kW	9.5 kW	14 kW
250	2.5 kW	3.8 kW	6 kW	9 kW
500	1.7 kW	2.7 kW	4.5 kW	6.8 kW

400 V heating

25	16 kW	26 kW	41 kW	63 kW
50	16 kW	26 kW	41 kW	63 kW
75	14 kW	22 kW	35 kW	52 kW
100	11 kW	17 kW	26 kW	40 kW
250	5 kW	8 kW	13 kW	19 kW
500	3.5 kW	6 kW	9 kW	14 kW

Small motor application

Contactor rating to be chosen according to the power to be controlled.

Asynchronous single-phase motor with capacitor

Small motor application type	Maximum power for a given rating		
	iCT contactors		
Voltage	25 A	40 A	63 A
230 V	1.4	2.5	4

Asynchronous three-phase motor

400 V	4	7.5	15
-------	---	-----	----

Universal motor

230 V	0.9	1.4	2.2
-------	-----	-----	-----

Auxiliary indicating contacts for Acti 9 protective devices

Table showing state of auxiliary contacts according to the main device and the type of fault.

Functions and use	Main device		Auxiliary contacts	
	Circuit breaker	Residual current circuit breaker	OF	SD
Closed	<p>DB123286</p>	<p>DB123289</p>	<p>DB123292</p>	
Manually opened	<p>DB123277</p>	<p>DB123278</p>	<p>DB123290</p>	
Tripped by release auxiliary (iMN, iMX)	<p>DB404827</p>	<p>DB404829</p>	<p>DB123291</p>	
Tripped upon overload or short circuit	<p>DB123285</p>	-	<p>DB123291</p>	
Tripped upon earth fault	<p>DB404826</p>	<p>DB123287</p>	<p>DB123291</p>	

Auxiliary indicating contacts for Acti 9 protective devices (cont.)

Function

RESET (SD contact)

When the main device is tripped and the fault has been eliminated, it is possible to switch the SD contact manually, via the "RESET" button on the front panel. The unit is then in "device opened manually" configuration.

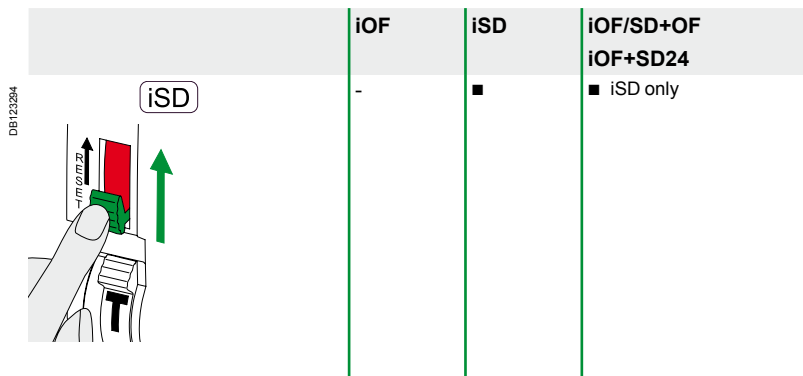

TEST (SD or OF contact)

When the main device is opened or tripped, the TEST button can be used to check the satisfactory operation of the indicating circuit by simulating operation of the main device. This operation also modifies the position of the indicator on the front panel of the iSD auxiliary.

On the double contact (iOF/SD+OF or iOF+SD24), this function can be implemented only for the SD indicating circuit.

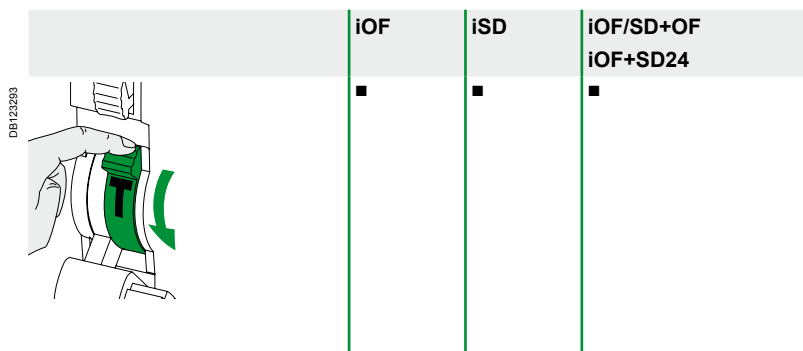

iOF/SD+OF double contact

Change of function of the second contact from OF to SD.

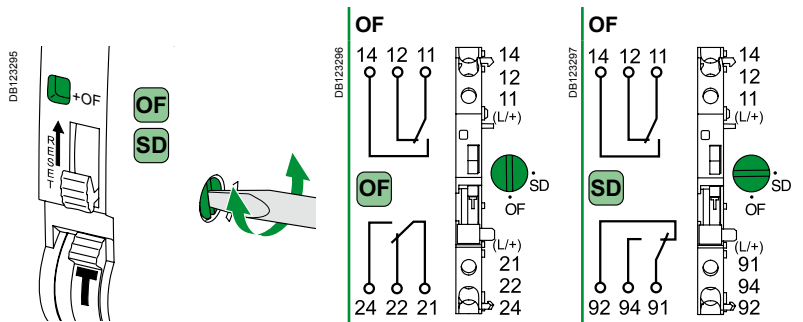

Technical data

Main characteristics		iOF, iSD, iOF/SD+OF		iOF+SD24
		IEC/EN 60947-5-1		IEC/EN 60947-5-1, IEC/EN 60947-5-4
Insulation voltage (Ui)		400 V AC		500 V AC
Degree of pollution		3		3
Rated impulse withstand voltage (Uimp)		4 kV (6 kV relative to the associated protective device)		4 kV (6 kV relative to the associated protective device)
Current rating (A)	Min.	24 V, 10 mA		24 V ± 20 %, 2 mA mini, 100 mA maxi Low level contact: compatible with IEC/EN 61131-2 Programmable Controllers, suitable for any connection to 24 V DC PLCs
	Maxi	AC12 415 V AC	3 A	
		AC12 ≤ 240 V AC	6 A	
		DC12 130 V DC	1 A	
		DC12 60 V DC	1.5 A	
		DC12 48 V DC	2 A	
DC12 24 V DC	6 A			
Additional characteristics				
Degree of protection (IEC 60529)	Device only	IP20		IP20
	Device in a modular enclosure	IP40 Insulation class II		IP40 Insulation class II
Endurance (O-C)	Electrical	20,000 cycles		20,000 cycles
Overvoltage category (IEC 60364)		III		III
Short-circuit resistance		1 kA		1 kA
Rating of device for auxiliary contact protection against short circuits	Circuit breaker	iC60 - C curve - 6 A		iC60 - C curve - 6 A
	Fuse	6 A, 500 V type Gg 10.3 x 38 mm		6 A, 500 V type Gg 10.3 x 38 mm
Operating temperature		-35°C to +70°C		-20°C to +60°C
Storage temperature		-40°C to +85°C		-40°C to +85°C

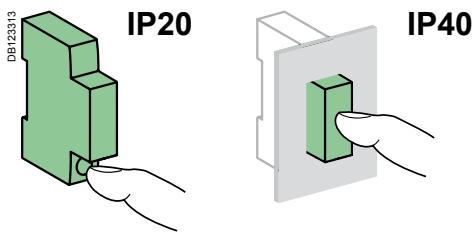

iOF+SD24 connection

The indicating auxiliary iOF+SD24 can be connected with a factory-built link, **A9XCAU06**: moulded connector (iOF+SD24 side) and with the 5 wires (PLC side).

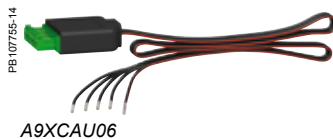

A9XCAU06

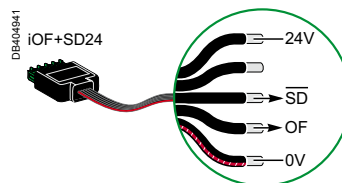

Or using a Ti24 5-point connector, **A9XC2412**

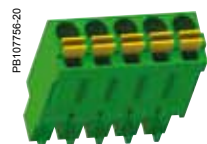

A9XC2412

Auxiliary trip units for Acti 9 protective devices

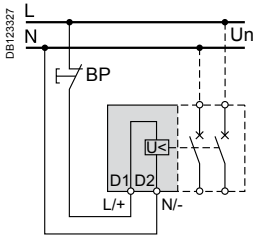

iMN/iMNs powered by main network

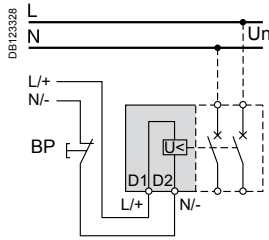

iMN/iMNs with separate power supply

iMN, iMNs: undervoltage release units

Function

- Tripping of the associated protective device, when the voltage across its terminals falls:
 - either by opening the control circuit (e.g. push-button),
 - or by lowering the supply voltage.
- Resetting of the protective device is possible only after the voltage across the terminals of the auxiliary has returned to its nominal value.
- The iMNs undervoltage release does not perform tripping in the event of a voltage drop lasting less than 200 ms.
- A locking push-button control allows the circuit protected by the circuit breaker (e.g. machine control) to be placed in safety configuration.

Technical data

Auxiliary trip units		iMN			iMNs	
Catalogue numbers		A9A26960	A9A26961	A9A26959	A9A26963	
Main characteristics						
Rated voltage ⁽¹⁾ (Un)		220...240 V, 50/60 Hz	48 V, 50/60 Hz	48 V DC	115 V, 400 Hz	220...240 V, 50/60 Hz
Holding current ⁽²⁾	A	0.014	0.022	0.034	0.017	0.014
Power consumption	VA	3.3	1.6	1.1	2	3.4
Tripping						
Threshold (V)		Between 0.35 and 0.75 of Un				
Duration of voltage dip (ms)	Min.	30	8	8	30	200
Restoration						
Threshold (V)	Min.	187	40.8	40.8	98	187
Additional characteristics						
Endurance		20,000 operations				
Insulation voltage (Ui)		400 V				
Degree of pollution		3				
Rated impulse withstand voltage (Uimp)		4 kV (6 kV relative to the associated protective device)				

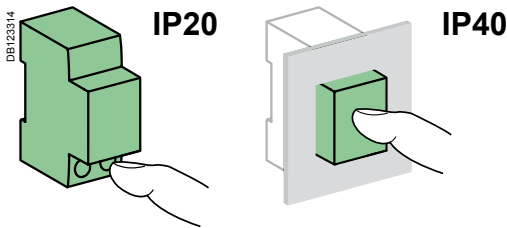

(1) For a lower power supply (e.g., control by a PLC output), an iRTBT interface must be implemented (see page 813).
 (2) This characteristic must be taken into account to define the number of multiple controls by switches provided with an indicator lamp.

Operation timing chart

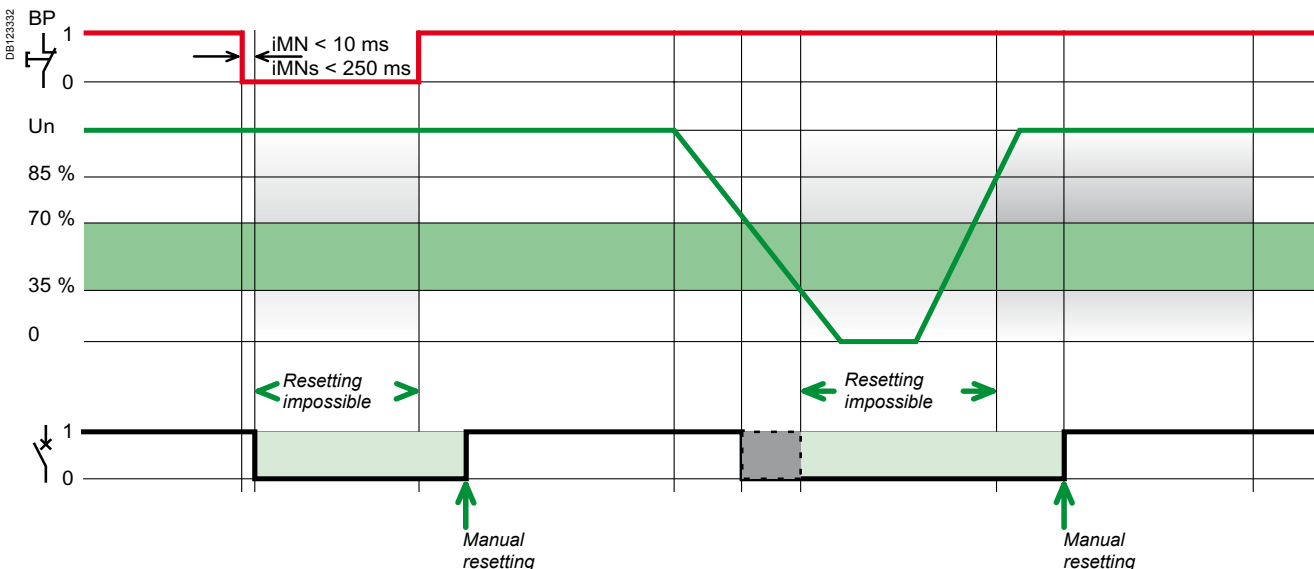

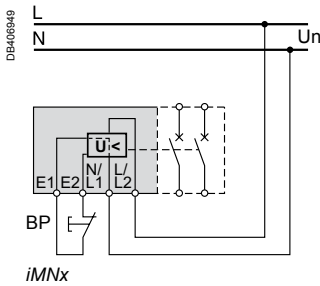

iMNx: trip units with push-button control

Function

- Tripping of the associated protective device by opening of the control circuit (e.g. push-button, dry contact).
- A drop in the supply voltage does not trip the associated protective device.
- A locking push-button control allows the circuit protected by the circuit breaker (e.g. machine control) to be placed in safety configuration.

Important: Before any servicing operation switch off the mains power supply (voltage presence at terminals E1/E2)

Technical data

Auxiliary trip units		iMNx	
Catalogue numbers	A9A26969	A9A26971	
Main characteristics			
Rated voltage ⁽¹⁾ (Un)	220...240 V, 50/60 Hz	380...415 V, 50/60 Hz	
Operation Voltage	Un -30 % to Un +10 %		
Consumption current (at Un)	A	0.014	
Power consumption (at Un)	VA	3.3	
Tripping			
Control-circuit opening duration (ms)	Min.	30	
Additional characteristics			
Endurance	20,000 operations		
Insulation voltage (Ui)	400 V		
Degree of pollution	3		
Rated impulse withstand voltage (Uimp)	4 kV (6 kV relative to the associated protective device)		

(1) For a lower supply voltage (e.g., control by a PLC output), an iRTBT interface must be implemented (see page 813).

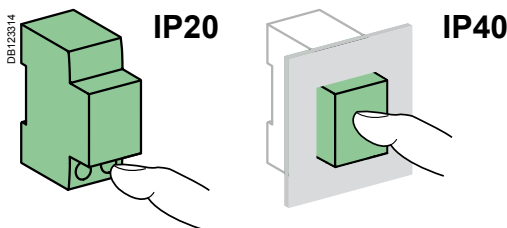

Operation timing chart

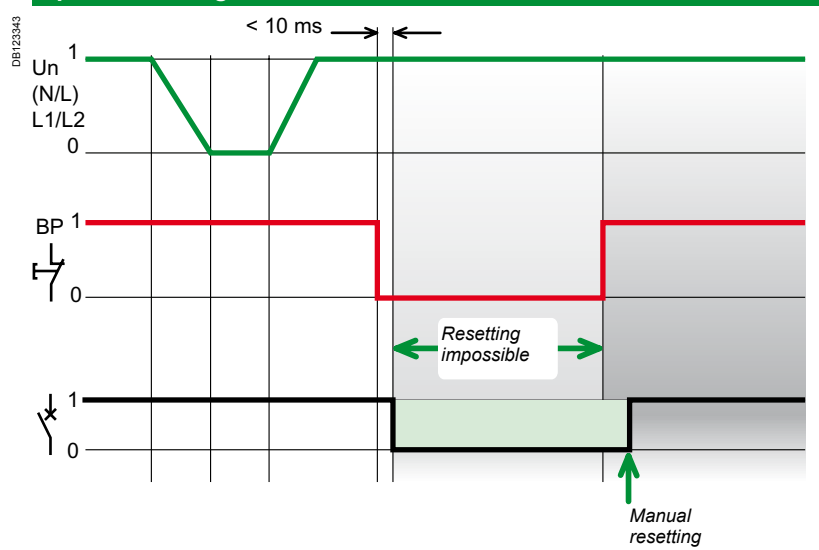

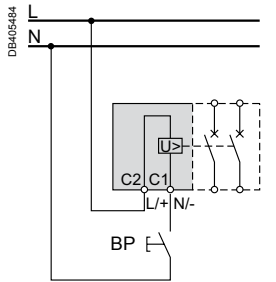

iMX powered by main network

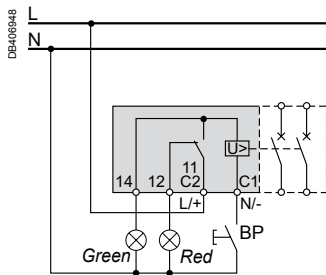

Control by N/O push-button with verification of voltage presence (iMX+OF)

iMX, iMX+OF: shunt release units

Function

- Tripping of the associated protective device when a voltage appears across the terminals of the auxiliary (control by: N/O push-button, dry contact, etc.).
- Resetting of the protective device is possible only when the voltage across the terminals of the auxiliary has disappeared.
- A locking push-button control allows the circuit protected by the circuit breaker (e.g. machine control) to be placed in safety configuration.

Operation timing chart

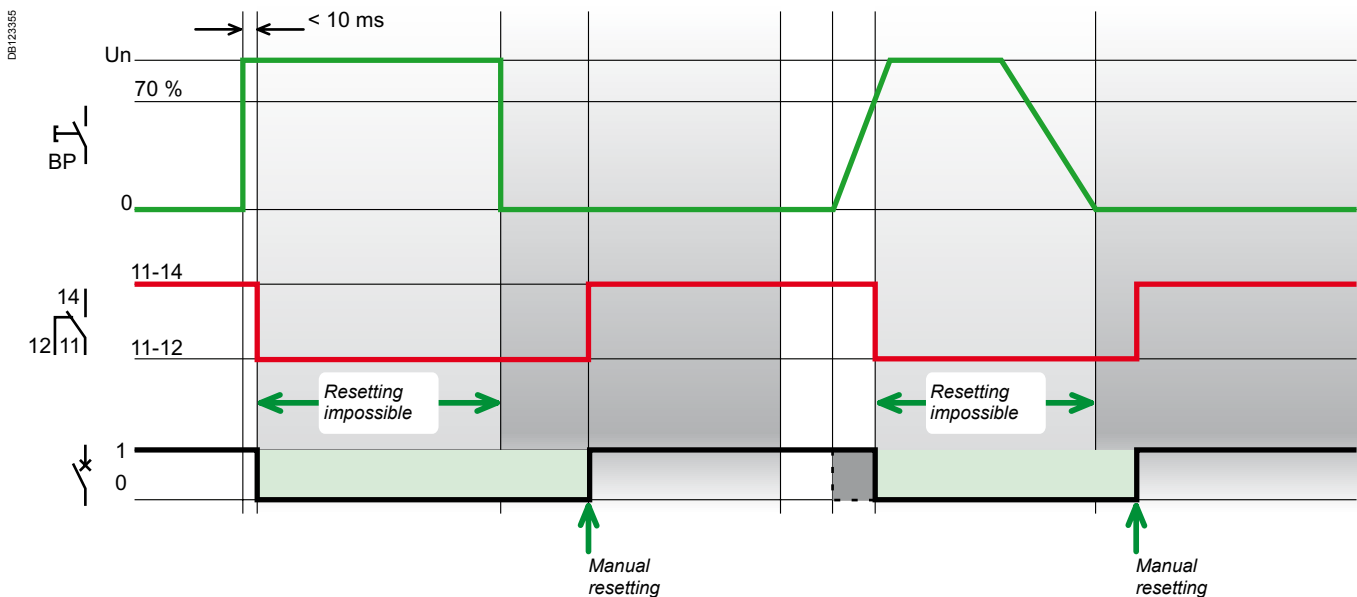

Technical data

Auxiliary trip units			iMX			iMX + OF									
Catalogue numbers			A9A26476	A9A26477	A9A26478	A9A26946	A9A26947	A9A26948							
Main characteristics															
Rated voltage ⁽¹⁾ (U _n)			100...415 V, 50/60 Hz	48 V, 50/60 Hz	12...24 V, 50/60 Hz	100...415 V, 50/60 Hz	48 V, 50/60 Hz	12...24 V, 50/60 Hz							
			110...130 V DC	48 V DC	12...24 V DC	110...130 V DC	48 V DC	12...24 V DC							
Tripping															
Threshold (V)			70 % of U _e												
Control signal duration (ms)			Min.	8	8	8	8	8							
Inrush current			A	0.4...1.5 (V AC) 0.3 (V DC)	1 (V AC) 0.7 (V DC)	4...7.7 (V AC) 2.5...5.8 (V DC)	0.4...1.5 (V AC) 0.3 (V DC)	1 (V AC) 0.7 (V DC)	4...7.7 (V AC) 2.5...5.8 (V DC)						
Caractéristiques complémentaires															
Endurance			20,000 operations			20,000 cycles (O-C)									
Auxiliary contacts (11, 12, 14)			Current rating (A)	Min.	24 V, 10 mA										
				Max.	AC12 415 V AC	3 A	AC12 ≤ 240 V AC	6 A	DC12 130 V DC	1 A	DC12 60 V DC	1.5 A	DC12 48 V DC	2 A	DC12 24 V DC
Insulation voltage (U _i)			400 V												
Degree of pollution			3												
Rated impulse withstand voltage (U _{imp})			4 kV (6 kV relative to the associated protective device)												

(1) For a lower power supply (e.g., control by a PLC output), an iRTBT interface must be implemented (see page 813)

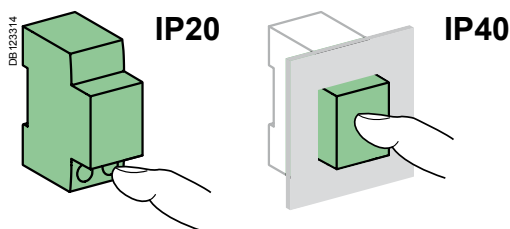

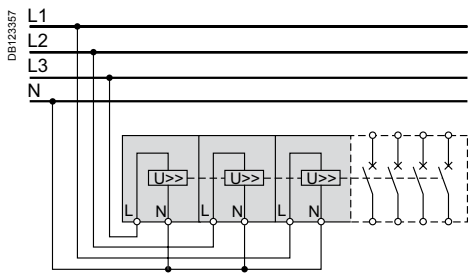

Three-phase power supply monitoring

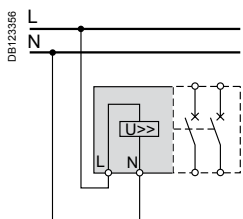

Single-phase power supply monitoring

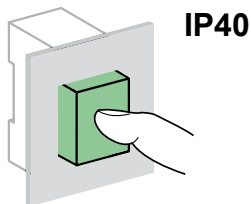
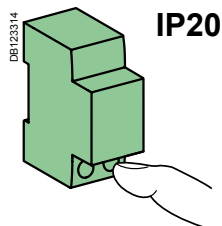

iMSU: overvoltage release units

Function

- Tripping of the associated protective device when the voltage across its terminals exceeds its nominal value.
- This auxiliary can protect sensitive loads from mains voltage fluctuations, in particular those due to breakage of the neutral conductor.
- Resetting of the protective device is possible only when the voltage across the terminals of the auxiliary has returned to its nominal value.
- When assembling with the associated device:
 - take the operating temperature range of the associated protective device into account
 - when the assembly is complete, test the handle of the associated protective device.

Technical data

Auxiliary trip units		iMSU
Catalogue numbers		A9A26500
Main characteristics		
Rated voltage (Un)	230 V, 50/60 Hz	
Power consumption (at Un)	A	0.002
Power consumption	Holding	VA
	Inrush	V \hat{A}
		128
Insulation voltage (Ui)	400 V	
Degree of pollution	3	
Rated impulse withstand voltage (Uimp)	4 kV (6 kV relative to the associated protective device)	
Additional characteristics		
Endurance	20,000 operations	

Standardised operating and non-response to voltage (Ua) times

	255 V AC	275 V AC	300 V AC	350 V AC	400 V AC
Maximum operating time	Pas de déclenchement	15 s	5 s	0.75 s	0.20 s
Minimum non-response time		3 s	1 s	0.25 s	0.07 s

(Ua)

Voltages measured between the phase and the neutral conductor, at which the iMSU device must control the associated protective device.

063960A_SE-40



"Low-level" control

The iRTBT relay cat. no. A9A15416 allows the auxiliary trip units to be controlled by a low-level signal (e.g. iMN).

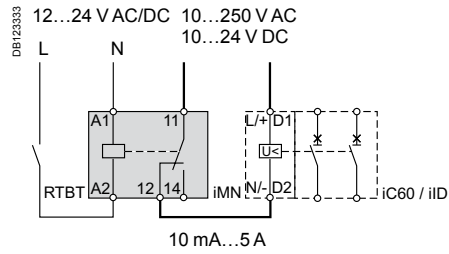

iRTBT relay

Inputs (A1, A2)		12...24 V AC/DC, 0...60 Hz
Outputs (11 and 12, 11 and 14)	Mini	10 mA/10 V DC (DC12) 10 mA/10 V AC
	Maxi	1 A/24 V DC (DC12) 5 A/250 V AC

Electrical auxiliaries for iC60, iID, iSW-NA, ARA and RCA

The mounting order for the various auxiliaries must be complied with.
The tripping auxiliaries (iMN, iMX) should be mounted first, as close as possible to the circuit breaker or the residual current circuit breaker. Then, the indicating auxiliaries (iOF, iSD) should be mounted, complying with their position shown in the following table.

Indicating auxiliaries

PE104474-25



PE104475-25



DB1123593













1 (iOF/SD+OF or iOF+SD24 or iSD)	1 iOF/SD+OF
1 iOF	1 (iSD or iOF or iOF/SD+OF)
None	1 iOF+SD24
None	None
1 iSD	1 iSD
None	1 (iSD or iOF or iOF/SD+OF or iOF+SD24)
1 iOF	1 (iSD or iOF or iOF/SD+OF)
None	1 (iSD or iOF or iOF/SD+OF or iOF+SD24)
1 iOF	1 (iSD or iOF or iOF/SD+OF)



The tripping auxiliaries should be installed first.
Comply with the position of the SD function.

Electrical auxiliaries for iC60, iID, iSW-NA, ARA and RCA (cont.)

Tripping auxiliaries	Remote control	Device	Vigi iC60
 PB104496-25	ARA automatic recloser or RCA remote control	iC60 circuit breaker or iID residual current circuit breaker or iSW-NA switch-disconnector	Vigi iC60 add-on residual current device
1 (iMN, iMNs, iMNx or iMX, iMX+OF or iMSU) max.	-	 PB104437-25 <i>iC60</i>	 PB104466-25 <i>Vigi iC60</i>
2 (iMN, iMNs, iMNx or iMX, iMX+OF or iMSU) max.	-		
2 (iMN, iMNs, iMNx or iMX, iMX+OF or iMSU) max.	-		
3 iMSU max.	-		
1 (iMN, iMNs, iMNx or iMX, iMX+OF or iMSU) max.	-	 PB104472-25 <i>iID/iSW-NA</i>	
1 (iMN, iMNs, iMNx or iMX, iMX+OF or iMSU) max.	 PB100256-25 <i>ARA</i>	 PB104437-25 <i>iC60</i>	 PB104466-25 <i>Vigi iC60</i>
None		 PB104472-25 <i>iID</i>	
1 (iMX or iMN or iMSU) max.	 PB100253-25 <i>RCA</i>	 PB104437-25 <i>iC60</i>	 PB104437-25 <i>Vigi iC60</i>
None			

Schneider Electric Industries SAS
35, rue Joseph Monier
CS 30323
F- 92506 Rueil Malmaison Cedex

www.schneider-electric.com

As standards, specifications and designs change from time to time, please ask for confirmation of the information given in this publication.



Printed on ecological paper

Publishing: Schneider Electric
Design: Sonovision
Printing: