

# Data Bulletin

## Circuit Breaker Characteristic Trip Curves and Coordination Class 0600

### TRIP CURVES AND COORDINATION

A coordination study is an organized effort to achieve optimum electrical distribution system protection by determining the appropriate frame sizes, ampere ratings and settings of overcurrent protective devices. When an overcurrent occurs in a properly coordinated distribution system, only the protective device nearest the fault will open. Lack of coordination between overcurrent devices can result in upstream devices opening, needlessly interrupting electrical distribution in other parts of the system.

Circuit breaker operating characteristics are graphically presented on time/current characteristic curves commonly called trip curves. To determine if proper coordination exists between molded case circuit breakers, a comparison of circuit breaker characteristic trip curves is necessary.

### CIRCUIT BREAKER TRIP CURVES

The tripping characteristics of molded case circuit breakers can be represented by a characteristic tripping curve that plots tripping time versus current level. The curve shows the amount of time required for a circuit breaker to trip at a given overcurrent level.

Manufacturing tolerances result in a curve that is a band bound by minimum and maximum values of total clearing time. Total clearing time is the sum of the circuit breaker's sensing time, unlatching time, mechanical operating time and arcing time. For currents in excess of 125% of the circuit breaker rating at an ambient of 40°C, the circuit breaker will automatically open the circuit within limits specified by the band.

These limits are derived from actual test data and are within the limits established in Underwriters Laboratories Standard 489 for proper conductor protection.

*See Figure 1 for an example of a thermal-magnetic circuit breaker trip curve.*

### Thermal Tripping Characteristics

The upper-left portion of each trip curve displays the circuit breaker's thermal response. On low-fault current levels, up to the magnetic tripping level, thermal tripping occurs when a bimetal conductor in the breaker responds to heat associated with the overcurrent. The bimetal conductor deflects, de-latching the mechanism and mechanically causing the circuit breaker to trip and open the circuit. The larger the overload, the faster the breaker will operate to clear the circuit (referred to as inverse time characteristics).

### Magnetic Tripping Characteristics

The lower right portion of the curve displays the magnetic tripping response of the circuit breaker. This takes place when overcurrents of sufficient magnitude operate an integral magnetic armature which de-latches the mechanism. Magnetic tripping occurs with no intentional time delay.

The magnetic limits of Square D residential and industrial 100 A and smaller frame thermal-magnetic breakers are factory set at the time of manufacture and are non-adjustable. Thermal-magnetic circuit breakers 250 A frame and larger have an instantaneous magnetic trip which in most cases is adjustable from 5 to 10 times the circuit breaker's ampere rating. A single magnetic adjustment on the face of each circuit breaker sets the limits of the magnetic trip mechanism, which simultaneously adjusts all poles of the two or three pole breaker to the same magnetic trip level.

The tolerance on the nominal instantaneous trip levels on the HI setting are within the range of  $\pm 20\%$  and within  $\pm 25\%$  when on any other setting.

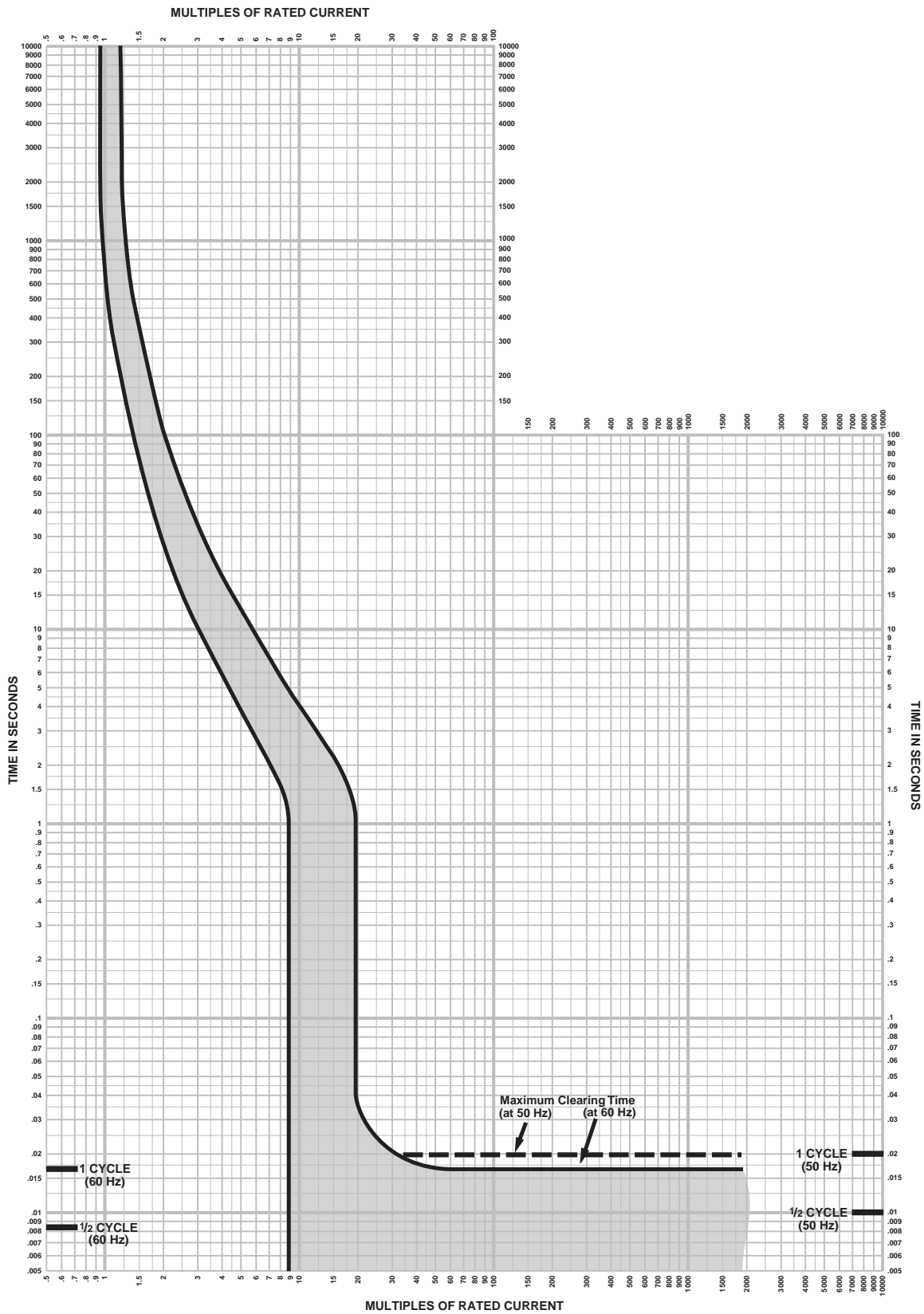

Figure 1: Thermal-magnetic Time/Current Characteristic Curve

### Electronic Tripping Characteristics

Electronic trip circuit breakers are characterized by their adjustability. By adjusting the settings of the available trip unit functions, different tripping characteristics can be achieved.

Figure 2 shows various discrete segments of the trip curve that can be adjusted on an electronic trip circuit breaker. The following paragraphs describe the functions, their adjustments and how they affect the trip curve.

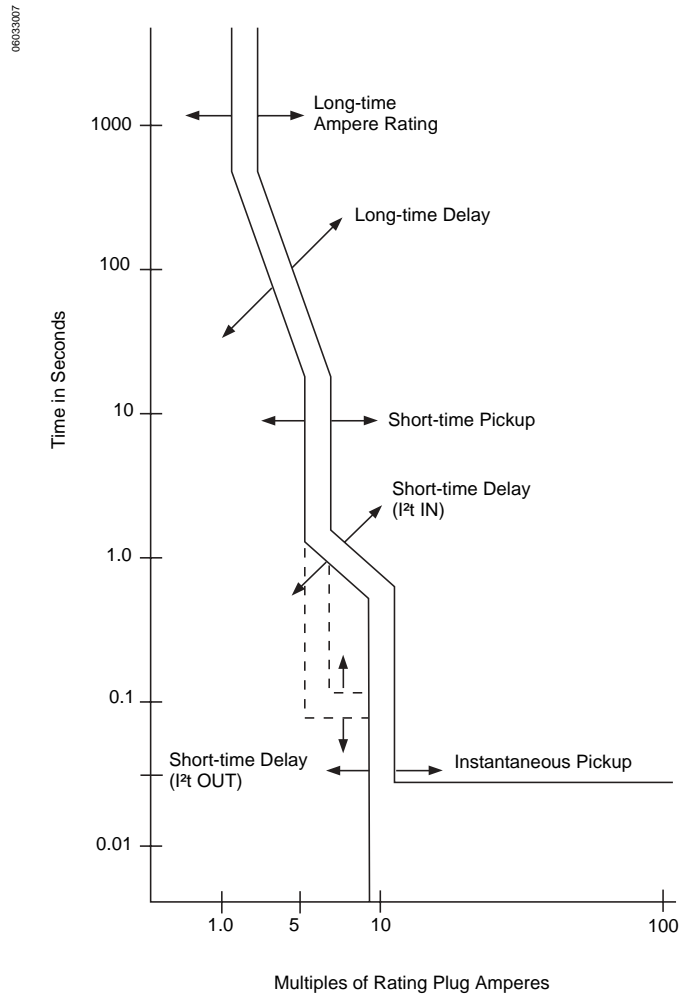

Figure 2: Electronic Trip Characteristic Curve

## MICROLOGIC® TRIP FUNCTIONS

### Long-time Ampere Rating and Delay

This adjustable function simulates the effect of a bimetal conductor in a thermal-magnetic circuit breaker. It reacts to overload conditions and determines how much current the circuit breaker will carry continuously. The nominal pickup point where a circuit breaker trip unit detects an overload is at 1.075 times the selected ampere rating. After the circuit breaker has picked up, it will not trip until the delay determined by the long-time delay adjustment has been achieved.

### Short-time Pickup and Delay

The short-time function allows the circuit breaker to delay before tripping on high level overcurrents, resulting in maximum coordination.

I<sup>2</sup>t IN—results in an inverse-time delay characteristic that most closely parallels time/current characteristics of fuses.

I<sup>2</sup>t OUT—results in a constant delay characteristic that coordinates best with thermal-magnetic and electronic trip circuit breakers. For Square D electronic trip circuit breakers, the short-time delay switch adjustment allows constant delay times of 0.1, 0.2, 0.32, and 0.5 seconds as noted on the time/current characteristic curves.

A short-time delay override is placed into all circuit breakers to instantaneously trip them in the event of an extremely high level of short circuit. On circuit breakers with the instantaneous pickup adjustment turned off (O), this particular function is referred to as short-time withstand rating, displayed on the trip curve and is plotted according to absolute amperes instead of the normal multiples of the rating plug.

Trip curves for circuit breakers with the short-time delay function also indicate the maximum unrestrained short-time delay of the Zone Selective Interlocking function. This is the maximum delay a circuit breaker will have during short time overcurrent condition when the circuit breaker does not receive a signal from a Zone Selectively Interlocked downstream circuit breaker. The maximum value of this delay is shown by a single line on the trip curve.

The maximum unrestrained delay stays constant for all switch settings on the short-time delay function (*see Figure 3*).

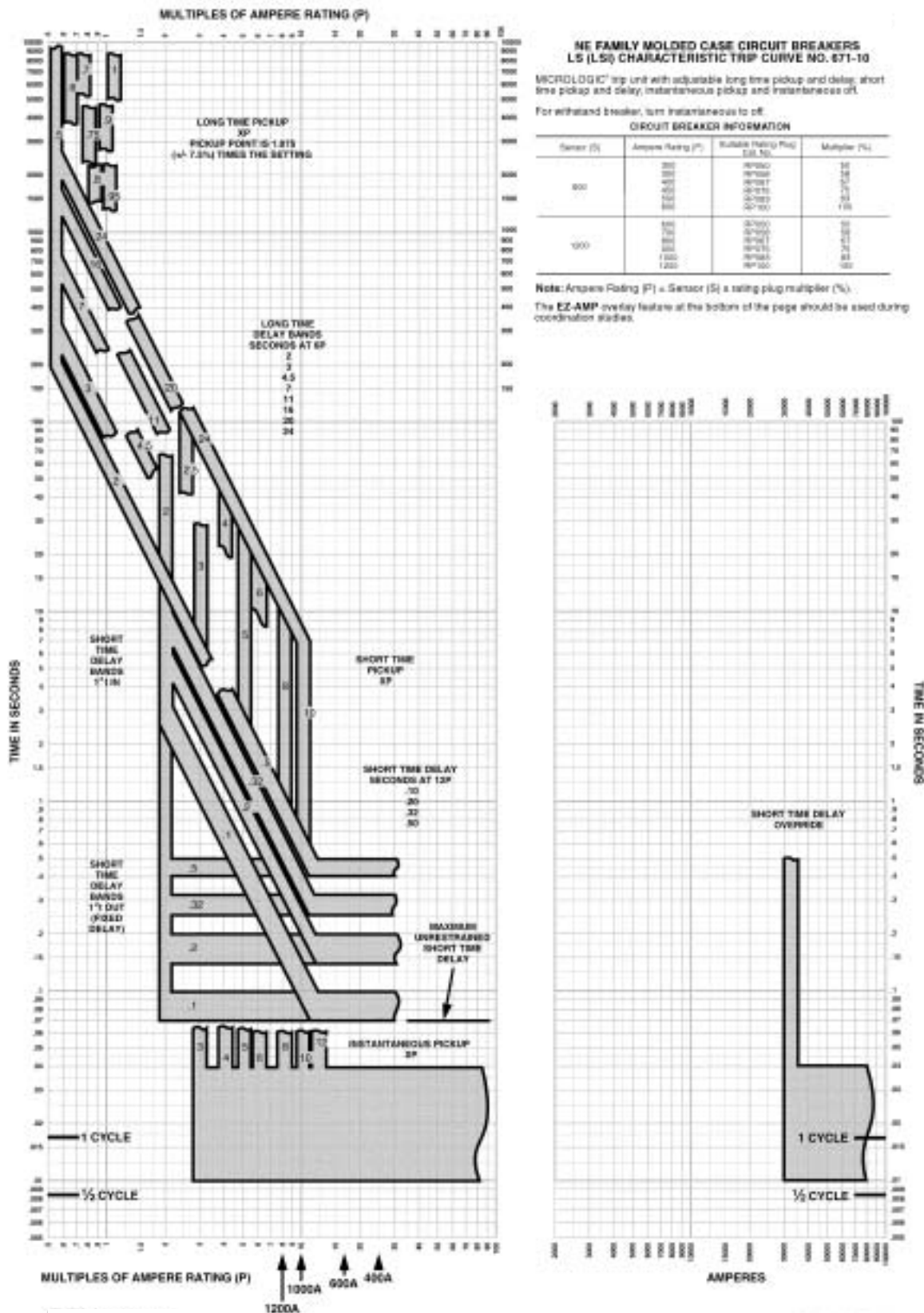

Figure 3: Maximum Unrestrained Short-time Delay

**Instantaneous Pickup**

The instantaneous pickup function simulates the magnetic characteristic of a thermal-magnetic circuit breaker. This function trips the circuit breaker with no intentional time delay. In circuit breakers with both short-time and instantaneous pickup, the instantaneous pickup will override the short-time pickup if the instantaneous pickup is set at the same or lower setting than the short-time pickup.

**Ground-fault Pickup and Delay**

The ground-fault function is divided into pickup and delay components (see *Figure 4*). The pickup portion determines at what point the circuit breaker will begin detecting a ground fault. The delay adjustment determines how long the circuit breaker will delay tripping after a ground-fault has been detected. It is supplied with both an “I<sup>2</sup>t IN” and an “I<sup>2</sup>t OUT” function on the LE, ME, NE, PE and SE circuit breakers.

In a circuit breaker with the ground-fault function, there is a maximum unrestrained ground-fault delay provided. This delay determines the maximum amount of time the circuit breaker will delay during a ground-fault condition when not restrained by a downstream breaker. The maximum delay is shown by a single line and stays constant for all ground-fault delay switch settings.

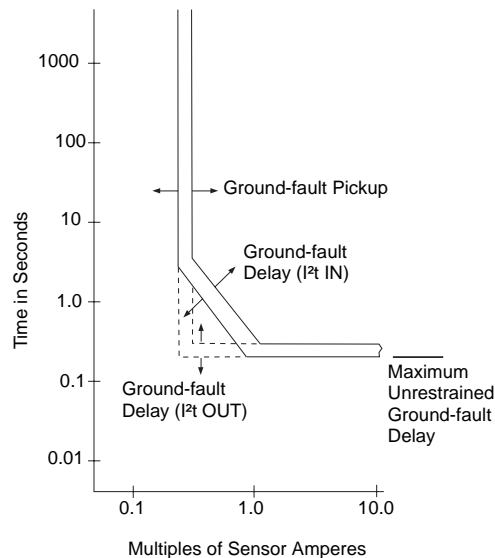

**Figure 4: Ground-fault Characteristic Curve**

**SQUARE D TRIP CURVES**

Time/current characteristic curves of Square D circuit breakers are plotted logarithmically. The vertical axis of these log-log curves display a range of time from 0.005 to 10,000 seconds. The horizontal axis on thermal-magnetic trip curves shows values of available current in multiples of the circuit breaker’s ampere rating from 0.5 to 100 times the rated current.

The trip curves for electronic trip breakers are plotted like thermal-magnetic trip curves except that multiples of rating plug or sensor amperage are labeled on the horizontal axis.

Trip curves are also supplied for the ground-fault function available in electronic trip breakers. These ground-fault trip curves have a horizontal axis which shows values of the ground-fault current in multiples of the breaker sensor rating.

### Application Information

The upper right hand corner of each trip curve lists the circuit breaker description, curve number and ampere rating.

The application information provided includes the circuit breaker's prefix, continuous ampere rating, maximum ac voltage and the number of poles. Below is the information found on Curve No. 655-1.

Circuit Breaker Prefix	Continuous Ampere Rating	Maximum AC Voltage	Number of Poles
KA, KH	70-100	600	2, 3

## CIRCUIT BREAKER COORDINATION

### Using Trip Curves for Coordination

Circuit breaker coordination is the process of selecting and applying circuit breakers in an electrical distribution system to localize a fault condition and restrict power outages to the equipment affected.

Proper coordination requires a comparison of the operating characteristics of the circuit breakers in a system. Using the trip curves is a quick and easy way to determine if coordination exists when sizing molded case circuit breakers or reviewing an existing distributing system.

Trip curves have traditionally been printed on a tissue stock to facilitate coordination studies. By overlaying the trip curves of two circuit breakers, you can determine whether coordination exists. If the trip curves of two circuit breakers intersect, the area of intersection indicates conditions under which both circuit breakers may trip. If such a pair of circuit breakers were used in an electrical distribution system, those conditions could result in both circuit breakers tripping, needlessly interrupting power to some portions of the electrical distribution system.

On the other hand, if the trip curves of two circuit breakers are distinctly separate and do not intersect, the circuit breakers are said to be coordinated.

To properly overlay trip curves for a coordination study, it is necessary to be sure to align the current axis at a common point. Since this axis is expressed in multiples of rated current, rather than in absolute current values, you must establish a common ampere point on the curves and align them on that point.

Trip curves for Square D thermal magnetic circuit breakers incorporate an EZ-AMP overlay method in which a reference point has already been calculated and labeled with an arrow on the trip curve (see *Figure 5*).

If a common point is not already established, determine the point where the multiple of current rating equals the same absolute amperage for each trip curve. The curves may then be aligned at those points.

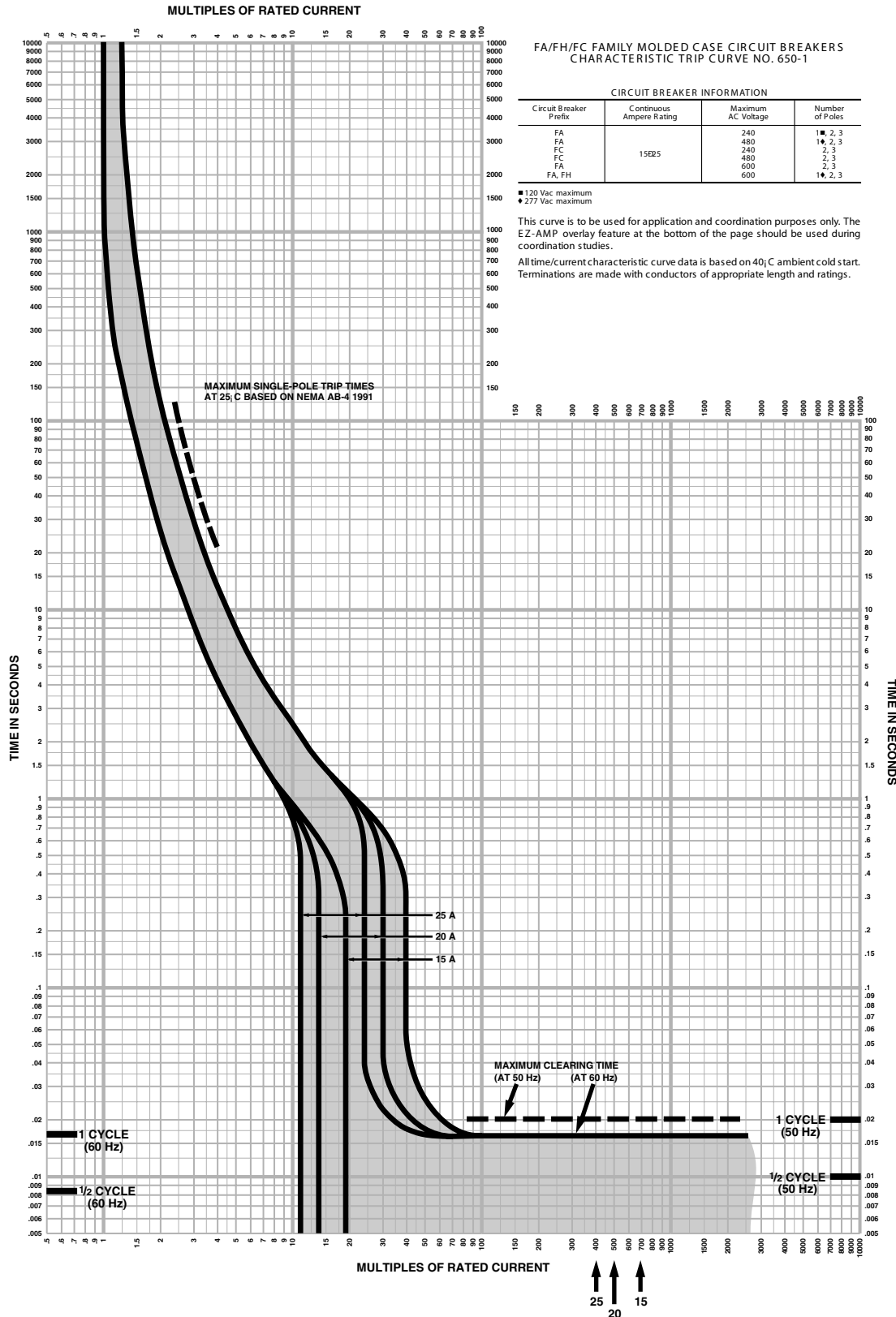

Figure 5: EZ-AMP Overlay Feature



## EZ-AMP OVERLAY METHOD

The EZ-AMP overlay method of circuit breaker coordination simplifies the procedure required when conducting a coordination study.

All Square D thermal-magnetic circuit breaker trip curves that display the EZ-AMP feature include bold arrows at the bottom of the curve to identify a common reference point of 10,000 RMS symmetrical amperes. For each circuit breaker ampere rating listed on a curve, there is a bold arrow labeled with the appropriate value of rated current. These arrows represent the EZ-AMP reference point.

Example: FA/FH circuit breaker family trip curve number 650-1 contains time/current characteristics for 15, 20 and 25 A FA and FH circuit breakers. See Figure 5.

The 10,000 A reference for the 15 A breaker is shown by the EZ-AMP arrow positioned at 667 multiples of rated current (10,000 divided by 15 = 667). Similarly, the 20 A EZ-AMP arrow is located at 500 times rated current (10,000 divided by 20 = 500) and the 25 A EZ-AMP arrow is at 400 times rated current (10,000 divided by 25 = 400). This EZ-AMP system makes coordination studies using these time curves much easier by eliminating the need to calculate a common reference point.

### Conducting a Sample Coordination Study

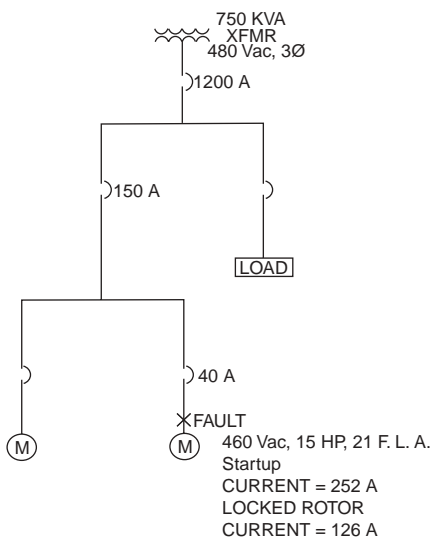

Figure 6: One-line Diagram

First, prepare a system one-line diagram showing all pertinent data including type and ratings for all circuit breakers, available short circuit currents and any special requirements stipulated by load characteristics. The one-line diagram for a sample coordination study is shown in Figure 6.

Begin the coordination study with the branch circuit devices (with fixed characteristics) nearest to load and work toward the source.

Given the time/current characteristics of the sample motor load, the branch circuit breaker can be selected to provide protection during start-up, normal operation and overcurrent situation.

- Using the motor selection table on page 6-28 of the 172 Square D Digest, a 40 A FA circuit breaker was chosen to protect a 15 horsepower motor at 460 volts ac (motors are sized @ 460 Vac to compensate for voltage drop from the transformer). Trip curve number 650-3 is shown (see Figure 7) with the motor's time/current characteristics plotted. Since the curves do not intersect each other, the circuit breaker should not trip at any time during start-up or normal full load operation of the motor. Should a locked rotor condition occur, the motor will continuously draw a current of 126 A. The circuit breaker trip curve shows the 40 A FA breaker will trip within the range of 9–40 seconds, thus protecting the conductors from damage.

- The 40 A FA branch circuit breaker is to be coordinated with a 150 A KA circuit breaker. To compare trip curves of thermal-magnetic circuit breakers (applied at the same voltage), the EZ-AMP overlay method may be used.

- Simply place curve number 655-2 (KA 150 A) on top of curve number 650-3 (FA 40 A).

- Line up the 150 A EZ-AMP arrow on curve number 655-2 directly on top of the 40 A EZ-AMP arrow on curve number 650-3.

Once the arrows are properly aligned, the EZ-AMP overlay procedure is completed and the curves now have common values of applied current (see Figure 8). The curves can now be compared to see if coordination exists between the two circuit breakers.

When the KA circuit breaker's adjustable magnetic trip is at the low setting, the FA and KA circuit breakers curves intersect, showing that coordination does not exist. Adjusting the KA circuit breaker's magnetic trip to the high setting ensures proper coordination.

Finally, determine if the 150 A KA and the upstream 1200 A NA breakers will coordinate. Once again, use the EZ-AMP feature to overlay curve number 655-2 (KA 150 A) on top of curve 670-10 (NA 1200 A). Be sure to line up the correct 150 A and 1200 A EZ-AMP arrows.

Remember that the KA circuit breaker must have the adjustable magnetic setting on high to coordinate with the downstream FA circuit breaker.

Figure 9 shows that KA/NA coordination exists with the KA magnetic setting on high and the NA magnetic setting on low or high. Coordination studies on systems which include electronic trip circuit breakers are performed following a procedure similar to that with thermal-magnetic circuit breakers. Since electronic trip circuit breaker trip curves do not utilize the EZ-AMP feature, the 10,000 A point on the trip curve must be established when coordinating with thermal-magnetic circuit breakers.

If a standard circuit breaker is being lined up with an electronic trip circuit breaker with a 1200 A rating plug, the EZ-AMP arrow on the downstream breaker would line up with the 8.3 multiple on the electronic trip circuit breaker curve ( $10,000 \text{ divided by } 1200 = 8.3$ ). Figure 10 shows that coordination exists between a 150 A KA circuit breaker and an NX circuit breaker with an LSI trip unit and a 1200 A rating plug.

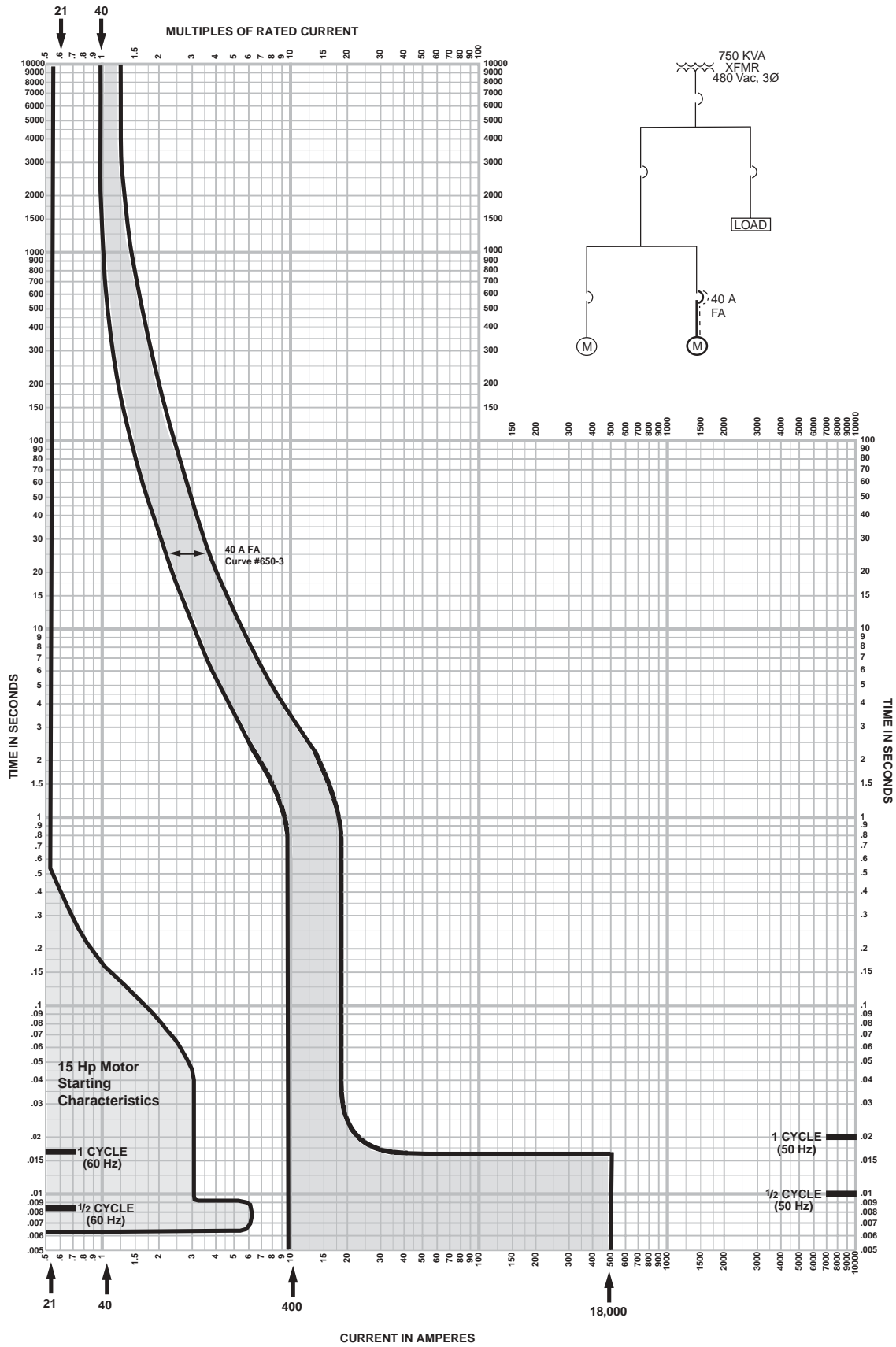

Figure 7: FA 35–50 A Circuit Breaker and Motor Coordination

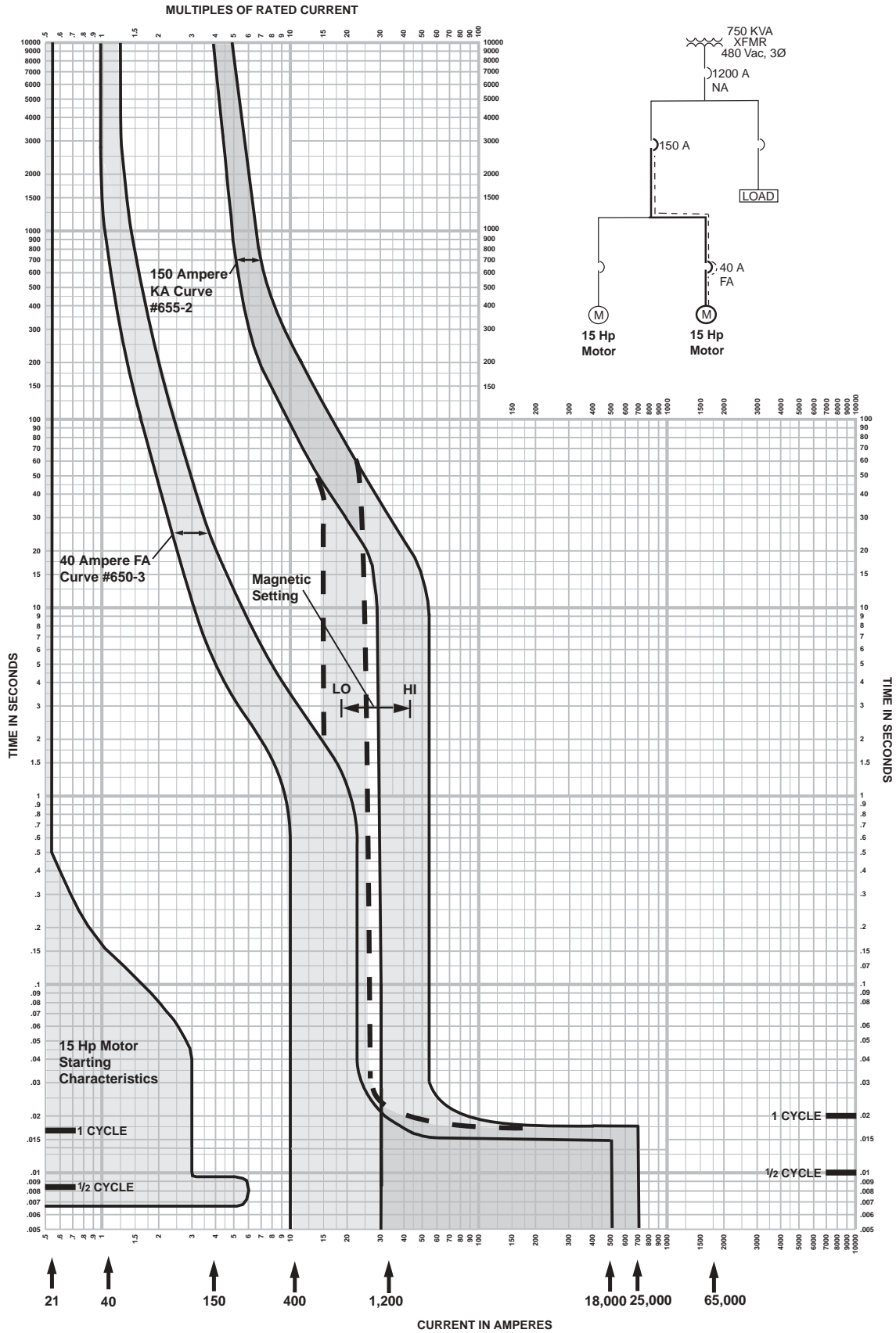

Figure 8: FA 40 A and KA 150 A Circuit Breaker and Motor Coordination

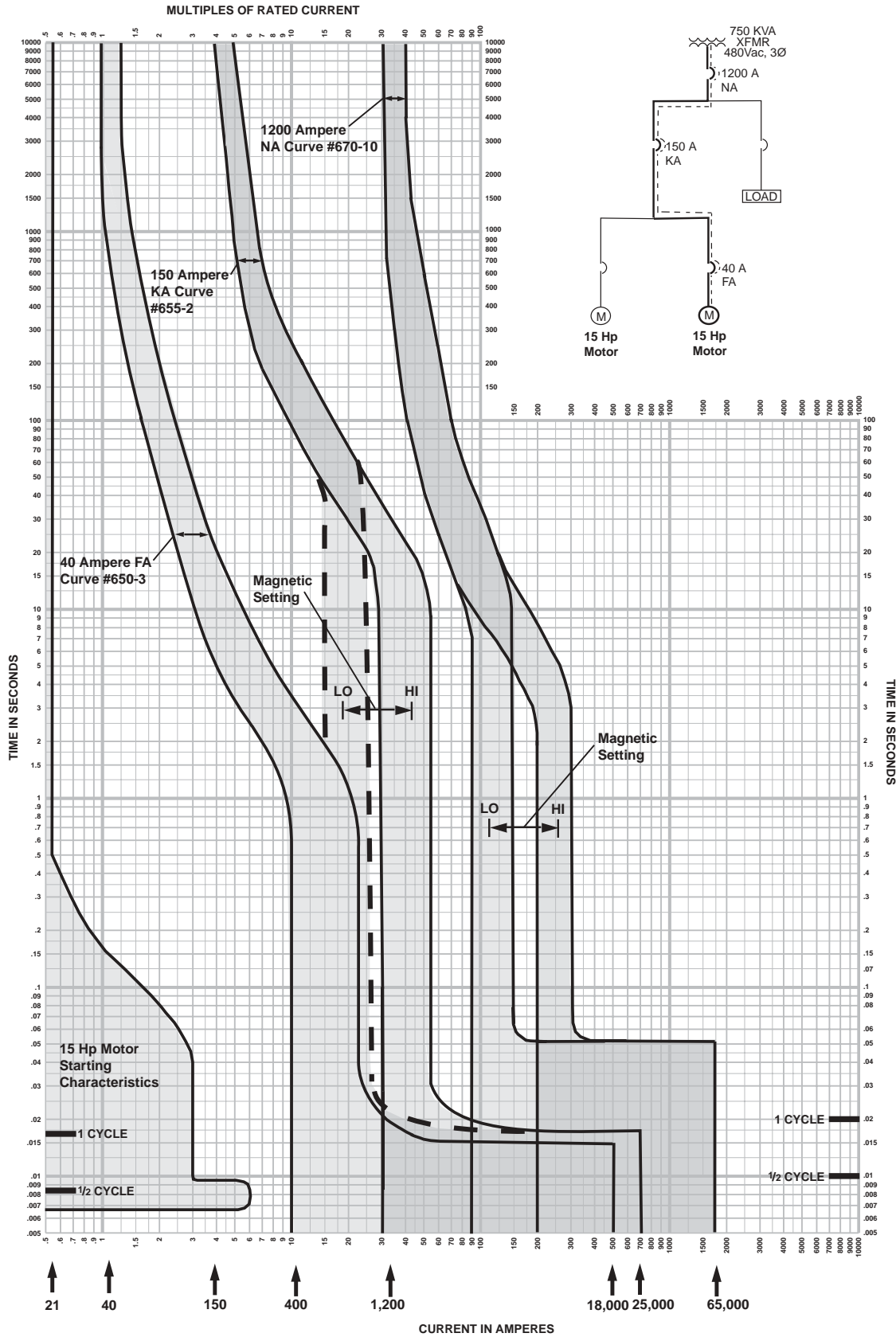

Figure 9: FA 40 A, KA 150 A and NA 1200 A Circuit Breakers and Motor Coordination

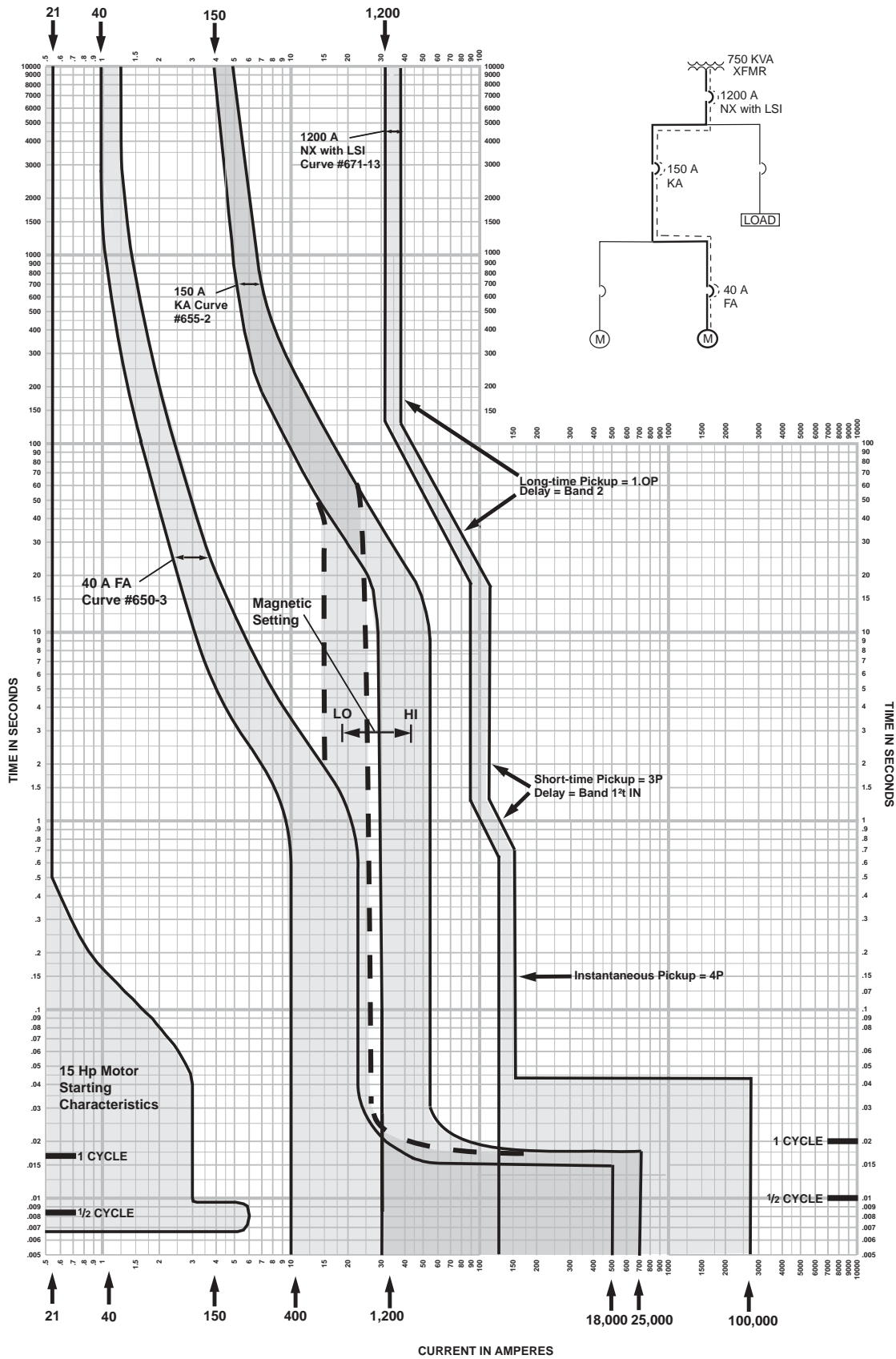

Figure 10: FA 40 A, KA 150 A and NE 1200 A Circuit Breakers and Motor Coordination

### 30-cycle Short-time Withstand Rating

It's possible to overcome the conventional thermal-magnetic circuit breakers by using electronic trip circuit breakers that have a 30-cycle short time withstand rating.

A 30-cycle short time withstand rating is the level of RMS symmetrical current that a circuit breaker can carry with the contacts in the closed position for a maximum of 30 cycles.

Although not required by the Underwriter's Laboratories Std. 489, "Molded Case Circuit Breakers and Circuit Breaker Enclosures", UL Listed Molded Case Circuit Breakers are now available with the 30-cycle ratings.

Under fault conditions, conventional thermal-magnetic circuit breakers can't remain closed for 30 cycles. The magnetic trip element will open the contacts instantaneously. However, electronic trip circuit breakers can be configured without this instantaneous trip characteristic.

Let's see how using an electronic trip circuit breaker equipped with the "instantaneous off" function affects our example.

As we have demonstrated with the NX breaker, the switchboard will have the same coordination limitations as it did with the thermal-magnetic MAIN breaker. That's because the instantaneous function is designed to replicate the thermal-magnetic circuit breaker (see *Figure 3, page 5*).

The solution is to apply an electronic trip MAIN circuit breaker with an instantaneous off trip function (types LS or LSG). Although this NE circuit breaker does have the instantaneous off function, a built in short-time delay override circuit will trip the circuit breaker instantaneously when the current level exceeds the short time withstand rating (35,000 amperes). The short-time delay override feature protects a circuit breaker from damage when short circuit currents exceed its short time withstand rating. Figure 11 shows how system coordination is improved by selecting the NE circuit breaker with the instantaneous off function.

The short time delay function can be adjusted such that the NE breaker will remain closed, or withstand, currents up to 35,000 amperes for a maximum of 30 cycles. This allows the 150 A KA circuit breaker to clear the overcurrent while the NE breaker remains closed to supply power to the unaffected areas. System coordination through 35,000 amperes is now achieved.

The key to safely applying electronic trip circuit breakers with an instantaneous off function is to select breakers that have a 30-cycle short-time withstand rating.

The Square D circuit breakers that have withstand ratings are shown in Table 1.

**Table 1: 30-cycle Short-time Withstand Ratings**

Breaker Prefix	Frame Size (Amperes)	30-cycle Withstand Rating (RMS Symmetrical Amperes)
ME	250–400	8000
ME	800	12,000
NE	1200	35,000
PE	1200–1600	18,000
PE	2000	18,000
PE	2500	18,000
SE	800–3000	40,000
SE	4000	50,000
SEH	800–3000	40,000
SEH	4000	50,000

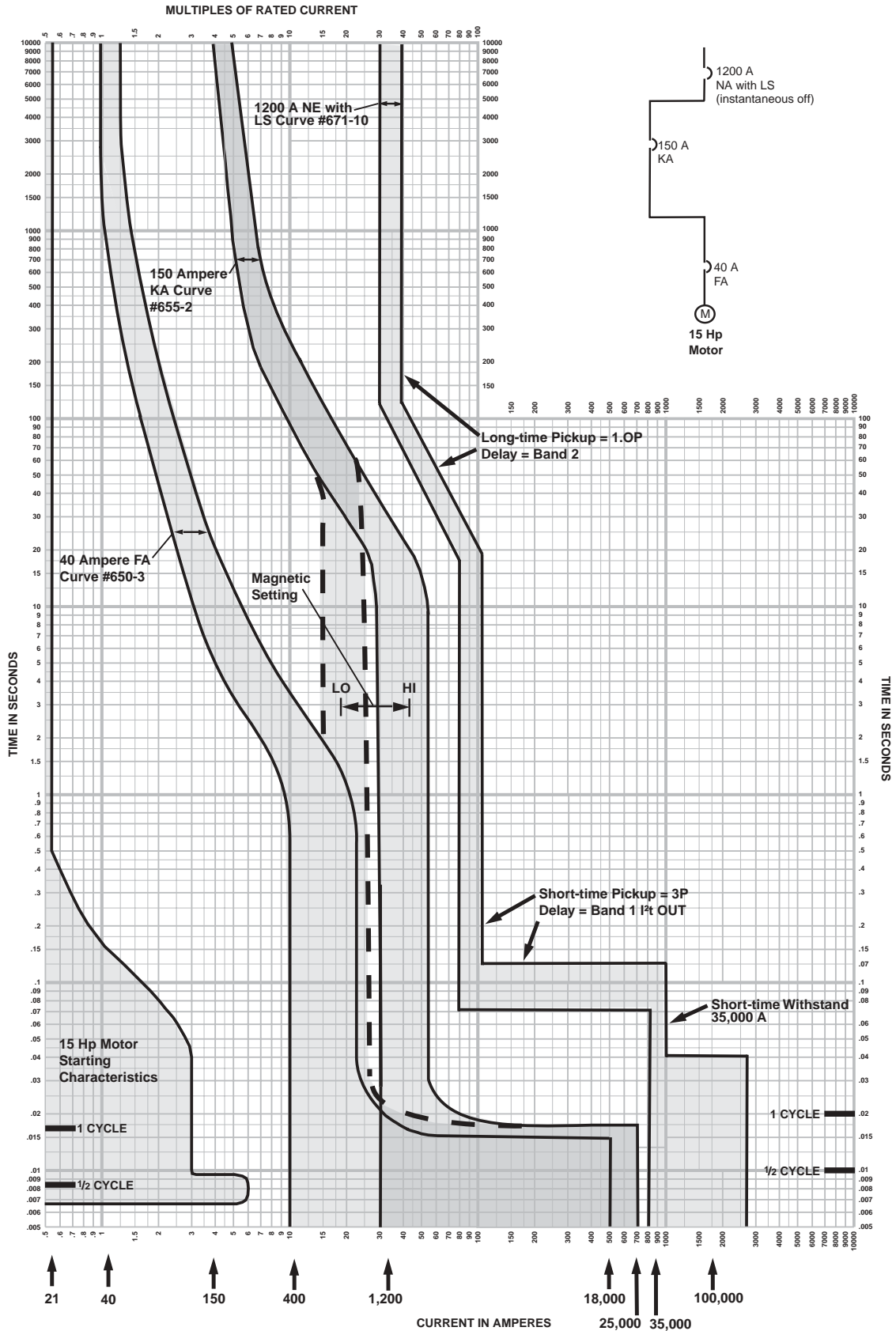

Figure 11: FA 40 A, KA 150 A and NE 1200 LS Circuit Breakers and Motor Coordination



### **Coordination Under Ground-fault Conditions**

It is estimated that over 80% of all overcurrent occurrences are ground-faults. If ground-fault protection is only supplied on the service entrance main device, meeting minimum NEC ground-fault requirements, limited coordination may result. In this case, a ground-fault occurring in a branch circuit may ultimately trip the main device in the service entrance switchboard, simply because it is the only device with equipment ground-fault protection. By supplying multilevels of ground-fault protection, it is possible to isolate ground-faults to feeders and branch circuits or to any portion of the system with ground-fault protection.

A Compact Disk containing characteristic tripping curves can be obtained from the Square D Literature Center at "SquareD@Banta.com" or fax 1-888-378-4340. Please provide the order number "0110TC9601R3/01" in addition to a name and shipping address for each CD requested. The recipient's name will be added to our database for future update mailings.

For more information on coordination, trip curves or other topics relating to the use and application of circuit breakers, contact your local Square D field office at 1-888-Square D (1-888-778-2733).

Square D Company  
PO Box 3069  
3700 Sixth St SW  
Cedar Rapids IA 52406-3069 USA  
1-888-SquareD (1-888-778-2733)  
[www.SquareD.com](http://www.SquareD.com)

Electrical equipment should be serviced only by qualified personnel. No responsibility is assumed by Schneider Electric for any consequences arising out of the use of this material.

Bulletin No. 0600DB0105 August 2001 Replaces SD354R2 dated 10/89.