

Section 23

Automation Products



Modicon Zelio Logic Controller



Modicon M221



Modicon M262



Modicon M241 PLC



Modicon M340 PAC



Lexium 28 Servo Solution



Harmony ST6 HMI



Lexium Cobot (Collaborative Robot)



Modicon M173

Programmable Controllers

23-2

Zelio Logic Smart Relays	23-2
Modicon PLCs	23-2
Modicon™ M221 PLC	23-2
Modicon™ M241 PLC	23-2
Modicon™ M251 PLC	23-3
Modicon™ M258 PLC	23-3
Modicon™ M262 Logic/Motion Controller	23-4
Modicon™ Momentum™ PLC	23-4
PLC and PAC Software	23-5
Modicon PACs	23-6
Modicon™ M340 PAC	23-6
Modicon™ M580 ePAC	23-6

HMI Products

23-7

Harmony™ Small Panels	23-7
Harmony ST6 Basic HMI	23-7
Harmony™ STO Small Touchscreen HMI	23-8
Harmony™ STU Small Touchscreen HMI	23-8
Harmony™ SCU Small HMI Controllers	23-8
Harmony™ Advanced Panels	23-9
Harmony™ Universal Panels	23-10
Accessories for HMI Products	23-12
Harmony™ Industrial PC Products	23-13
Harmony P6 Modular Box PCs and Displays	23-13
Harmony™ Edge Box	23-14

Software for HMI Products

23-15

EcoStruxure™ HMI Configuration Software	23-15
EcoStruxure™ Machine SCADA Expert	23-15
EcoStruxure™ Operator Terminal Expert	23-15
EcoStruxure™ Secure Connect Advisor	23-15
Vijeo™ HMI Configuration Software	23-16
Vijeo™ Designer HMI Software	23-16
Vijeo™ Design'Air HMI Application	23-16
Vijeo™ Design'Air Plus	23-16

Distributed I/O Products

23-17

Modicon™ TM3 Bus Coupler Modules	23-17
Modicon™ STB Distributed I/O Platform	23-17
Modicon™ Telefast™ ABE7	23-17
Modicon™ I/O Blocks (IP67)	23-17
Modicon™ Momentum™ Controller and IP20 Monoblock I/Os	23-18

Network Products and Systems

23-19

Ethernet TCP/IP	23-19
CANopen	23-19

Motion Control and Robotics

23-20

Lexium™ Linear Motion	23-20
Lexium™ Integrated Drives	23-21
Lexium™ Servo Drives and Motors	23-22
Motion and Drive Controllers	23-23
Multi Carrier Systems and Stepper Drives	23-24

Controllers (PLC) for Commercial Machines

23-25

Modicon M171/M172/M173 HVAC Solutions	23-25
---------------------------------------	-------



Zelio Logic Smart Relays

For applications that require more flexibility than a simple relay, timer or counter, but are too simple for the smallest Nano PLC, Zelio Logic smart relays are available. Designed to accept and control outputs just like a relay, Zelio Logic features logic programming with Function Block Diagram (FBD) or Ladder Logic Programming using either the front panel or by utilizing ZelioSoft software. For more information, refer to www.se.com/us/en/Zelio Logic or catalog [DIA3ED2111202EN](#).

Catalog Number	Description	Inputs	Outputs	Supply Volts
SR2A101FU	SR2 with Display	6 Digital	4 Relay	120 Vac
SR2B121BD	SR2 with Display	8 Digital, 4 Analog	4 Relay	24 Vdc
SR2B121FU	SR2 with Display	8 Digital	4 Relay	120 Vac
SR2D101FU	SR2 without Display	6 Digital	4 Relay	120 Vac
SR3B101BD	SR3 with Display	6 Digital, 4 Analog	4 Relay	24 Vdc
SR3B101FU	SR3 with Display	6 Digital	4 Relay	120 Vac
SR3B261BD	SR3 with Display	16 Digital, 6 Analog	10 Relay	24 Vdc
SR3B261FU	SR3 with Display	16 Digital	10 Relay	120 Vac
SR3XT101FU	SR3 Expansion	6 Digital	4 Relay	—
SR3XT61FU	SR3 Expansion	4 Digital	2 Relay	—

Catalog Number	Description
SR2MEM02	Memory Cartridge
SR2USB01	USB Programming Cable

Modicon™ M221 PLC

Providing “Best in Class” performance for compact machine automation, the Modicon M221 PLC features intuitive machine programming using **EcoStruxure™ Machine Expert Basic Software** (formerly SoMachine), ready-to-use applications and standard function blocks. Its flexible and scalable machine control allows you to easily upgrade to higher performance platforms when necessary. With Ethernet, USB and serial ports, the Modicon M221 PLC provides optimum connectivity for simplified machine integration and maintenance. See catalog [DIA3ED2140110EN](#).



TM221ME16T



TM221CE16R

Catalog Number	Description	Inputs	Outputs	Supply Volts
TM221C16R	Compact PLC 16 I/O Relay	9 Digital, 2 Analog	7 Relay	120 AC
TM221C24R	Compact PLC 24 I/O Relay	14 Digital, 2 Analog	10 Relay	120 AC
TM221C40R	Compact PLC 40 I/O Relay	24 Digital, 2 Analog	16 Relay	120 AC
TM221CE16R	Ethernet Compact PLC 16 I/O Relay	9 Digital, 2 Analog	7 Relay	120 AC
TM221CE16T	Ethernet Compact PLC 16 I/O PNP Transistor	9 Digital, 2 Analog	7 PNP	24 DC
TM221CE24R	Ethernet Compact PLC 24 I/O Relay	14 Digital, 2 Analog	10 Relay	120 AC
TM221CE24T	Ethernet Compact PLC 24 I/O PNP Transistor	14 Digital, 2 Analog	10 PNP	24 DC
TM221CE40R	Ethernet Compact PLC 40 I/O Relay	24 Digital, 2 Analog	16 Relay	120 AC
TM221CE40T	Ethernet Compact PLC 40 I/O PNP Transistor	24 Digital, 2 Analog	16 PNP	24 DC
TM221ME16R	Ethernet Modular PLC 16 I/O Relay	8 Digital, 2 Analog	8 Relay	24 DC
TM221ME16T	Ethernet Modular PLC 16 I/O PNP Transistor	8 Digital, 2 Analog	8 PNP	24 DC

Modicon™ M241 PLC

Designed for high-performance compact machines, incorporating speed and position control functions—the Modicon M241 PLC features a dual core processor—that provides tremendous processing power and memory size for complex applications. Machine programming is highly intuitive using **EcoStruxure Machine Expert Software** (formerly SoMachine), function blocks and ready-to-use applications. And, the M241 PLC’s simplified motor control integration and wiring allow for quick start-up and commissioning.



TM241CE40T

Catalog Number	Communication	Inputs	Outputs	Supply Volts
TM241CE24R	Modbus TCP, EthernetIP, Modbus Serial, Ascii [1]	14 Digital	4 PNP, 6 Relay	24 dc
TM241CE24T		14 Digital	10 PNP	
TM241CE40R		24 Digital	4 PNP, 12 Relay	
TM241CE40T		24 Digital	16 PNP	
TM241CEC24R	Modbus TCP, EthernetIP, Modbus Serial, Ascii, CanOpen, CAN J1939 [1]	14 Digital	4 PNP, 6 Relay	
TM241CEC24T		14 Digital	10 PNP	
TM241CEC24U		14 Digital	10 NPN	

Additional versions available, please see [Modicon M241 Micro PLC](#) or catalog [DIA3ED2140107EN](#) for additional information.

[1] NOTE: Profibus DB is available via TM4 expansion module.



TM251MESE

TM251MES



Modicon TM3 Expansion I/O Modules for M221, M241, and M251



Modicon™ M251 PLC

The Modicon M251 PLC provides innovative, high-performance solutions for modular machines and distributed architectures with line control. Its intuitive [EcoStruxure Machine Expert](#) software (formerly SoMachine), ready-to-use applications and function blocks allow you to optimize your programming time. And, its flexible and scalable machine control allows you to change the PLC hardware type to fit the application, using the same programming across the range. The M251 PLC allows you to stay connected everywhere via Ethernet, wireless access, web servers and remote visualization, simplifying machine integration and maintenance. Its integrated Ethernet switch—on a separate channel from the machine control network—allows data exchange with other machines and system networks, while keeping the machine control on a dedicated high-performance local network.

Catalog Number	Description	Com 1	Com 2	Supply Volts
The M251 can be further enhanced using the TM3 (I/O & Safety), TM4 (communication), and TMC (I/O) expansion modules.				
TM251MESE	Dual Channel Ethernet PLC	Dual Port Ethernet	Ethernet as Master	24 dc
TM251MES	Ethernet and CANopen PLC	Dual Port Ethernet	CANopen as Master	24 dc

Additional versions available, please see [Modicon M251](#) and catalog [DIA3ED2140108EN](#) for additional information.

Catalog Number	Description
TM3 I/O Expansion Modules for M221, M241, M251 PLCs. Up to 7 modules per PLC. Add TM3XTRA1 + TM3XREC1 to add 8-14 TM3 modules. Additional TM3 modules are available.	
TM3AI4	I/O Module 4 Analog Inputs
TM3AI8	I/O Module 8 Analog Inputs
TM3AM6	I/O Module 4 Analog Inputs and 2 Analog Outputs
TM3AQ2	I/O Module 2 Analog Outputs
TMA3Q4	I/O Module 4 Analog Outputs
TMA3DI16	I/O Module 16 Inputs
TM3DI8	I/O Module 8 Inputs
TM3DI8A	I/O Module 8 Inputs 120 Vac
TM3DM8R	I/O Module 8 IO Relays
TM3DQ16R	I/O Module 16 Outputs Relays
TM3DQ16T	I/O Module Outputs Transistor PNP
TM3DQ8R	I/O Module 8 Outputs Relays
TM3DQ8T	I/O Module Outputs Transistor PNP
TM3TI4	I/O Module 4 Inputs Temperature
TM3TI8T	I/O Module 8 Inputs Temperature
TM3XTRA1	I/O Expansion Transmitter for 8-14 TM3 Modules
TM3XREC1	I/O Expansion Receiver for 8-14 TM3 Modules

Modicon™ M258 PLC

The Modicon M258 logic controller is a compact, high-performance and fully expandable PLC. It forms a part of Flexible Machine Control approach, a key component of Machine Struxure, which brings you maximum flexibility and ensures the most optimized control solution. This PLC is designed for machine manufacturers (OEMs) focusing on applications such as packaging, conveying and storage, textiles and woodworking, etc. It offers high-performance solutions for speed control, counting, axis control, and communication functions. The Modicon M258 logic controller's dual-core processor provides extremely high performance. Core 1 is dedicated exclusively to managing program tasks and offers the maximum resources for real-time execution of the application code. Core 2 is dedicated to executing communication tasks, which have no impact on the application performance. More information is available at [Modicon M258 PLC](#) and in catalog [DIA6ED2100402EN](#).



TM262M15MESS8T

New!

Modicon™ M262 Logic/Motion Controller

As the latest controller for Logic and Motion with cloud protocols (MQTT, HTTP, JSON, OPC UA) and encryption (TLS), the Modicon M262 is made for you. Modicon controllers are a key part of our EcoStruxure™ Machine that provides complete architecture from Connected Products and Edge Control to Apps, Analytics, and services. Modicon M262 controllers embed Industrial Internet of Things (IIoT) protocols and encryption to provide direct cloud connectivity and digital services. The Modicon M262 Logic/Motion controller offer is made for performance-demanding machines. M262 controllers are IIoT-ready (MQTT, HTTP, OPC UA, TLS) and combine logic, motion, and safety control applications. **TM262L** is for logic control of multiple input/output arrangements. **TM262M** is for motion control of up to 16 synchronized axes, embedding a safety control application capable of attaining Safety Integrity Level (SIL) 3. More information is available at [Modicon M262](#) and in catalog [DIA3ED2180503EN](#).

Catalog Number	I/O	Execution Speed ns/Instruction	Maximum No. of Sync Axes	Embedded Communication Networks		
				Ethernet	Sercos	Serial
Logic Controllers						
TM262L10MESE8T	4 fast digital inputs / 4 fast digital outputs	5	—	2	—	1
TM262L20MESE8T	4 fast digital inputs / 4 fast digital outputs	3	—	2	—	1
Motion Controllers						
TM262M15MESS8T	4 fast digital inputs / 4 fast digital outputs + 1 encoder input (Incremental/SSI, 5/24 Vdc)	5	4 Axes	2	1	1
TM262M25MESS8T		3	8 Axes	2	1	1
TM262M35MESS8T		3	16 Axes	2	1	1

Modicon™ Momentum™ PLC

The small footprint and open architecture of the Momentum PLC product line make it extremely versatile for a variety of automation applications. The Momentum PLC is ideal for PC-based control, distributed control, distributed I/O, and traditional, standalone PLC control. The Momentum PLC product line includes I/O bases and communication adapters that are interchangeable and snap together to deliver optimal flexibility throughout the control system life cycle. Using Ethernet as its communications backbone, the Modicon Momentum CPU delivers all the performance benefits of real-time control. The open architecture of the Momentum CPU makes it a universal controller for distributed I/O, compatible with many of the major fieldbus and control network environments. An integral Ethernet port in the Momentum CPU allows users to perform a wide range of functions over Ethernet, including data acquisition, peer-to-peer communications, and I/O scanning. Embedded web pages enable the use of a standard web browser to read status and diagnostic information from the processor. The Momentum CPU not only seamlessly connects I/O and other control devices via open standards; it delivers the performance of a full function, real-time controller for standalone and distributed system configurations in one money saving unit. Additional information can be found at [Modicon Momentum](#) on the www.se.com/us website.





EcoStruxure Machine Expert Software

EcoStruxure Machine Expert (formerly known as SoMachine) is the OEM solution software for developing, configuring, and commissioning the entire machine in a single software environment, including logic, motion control, HMI, and related network automation functions. EcoStruxure Machine Expert allows you to program and commission all the elements in Schneider Electric’s Flexible and Scalable Control platform, the comprehensive solution-oriented offer for OEMs, which helps you achieve the most optimized control solution for each machine’s requirements. Flexible and Scalable Control platforms include:

Match your controller to the available software package:

MachineStruxure Product Range	Schneider Electric Software	Software Distribution
Zelio Logic: Smart Relays 10 to 40 I/O	Zelio Soft: Zelio Logic configuration software	Free to Download
Modicon M171 / M172: HVAC Logic Controller	EcoStruxure Machine Expert HVAC	Available to order
Modicon M221 Nano PLC	EcoStruxure Machine Expert Basic	Free to Download
Modicon Motion: M221, M241, M251, M258, M262LMC058	EcoStruxure Machine Expert NOTE: Vijeo™ Designer and Basic are included	Available to order
Harmony™ HMI: SCU and XBT GC		
PacDrive Motion Controller	EcoStruxure Machine Expert	Available to order

More information is available at [EcoStruxure Machine Expert](http://www.se.com/us/EcoStruxureMachineExpert) on www.se.com/us and in catalog [DIA3ED2180701EN](#).

EcoStruxure Control Expert Software

EcoStruxure Control Expert software is the common programming, debugging, and operating software for Modicon M340, M580, M580S, Premium, Momentum, and Quantum ranges.



Features

- 5 IEC61131-3 languages + Legacy LL984
- FDT / DTM standard for EcoStruxure Field Device integration
- Cybersecurity and traceability
- Change Configuration on the Fly (CCOTF)
- Standard objects and libraries
- Customizable integrated Function Block Library (DFB)
- PLC simulator on PC, built-in test and diagnostic
- Animation tables, operator screens and trending tool
- Integrated conversion tools from Concept, ProWORX, PL7 Pro
- ACR available for Section 508/VPAT requirements

More details are available at [EcoStruxure Control Expert Software](http://www.se.com/us/EcoStruxureControlExpertSoftware) on www.se.com/us and catalog [MKTED2140504EN](#).



Modicon™ M340 PAC

Our latest midrange PAC is the most integrated ever! Highly requested by industrial OEMs and end users, the all-power-inside concept boasts high-performance processing and small size to create a system that provides flexibility beyond any before. With up to three built-in CPU communication ports, large memory options, sixty-four channel high-density modules, and embedded web servers, the Modicon M340 is a powerful solution for industrial OEMs and end users demanding more productivity in their PACs.

The Modicon M340 PAC supports advanced communications such as enhanced Ethernet/IP which support Ethernet/IP, Modbus TCP/IP, and daisy chain loop communications on the same four-port, rack mounted switch module. It will also support DNP3.0 in serial or Ethernet in a rack-mounted RTU module. The Modicon M340 PAC is programmed with Unity Pro software, which allows users to dramatically reduce setup time and effort with features like drag 'n drop CANopen bus setup and standard IEC 61131-3 language selection. Designers gain fast, easy and efficient startups.

More information is available at [Modicon M340 PAC](#) on www.se.com/us and in the latest Modicon M340 catalogs and brochures.



Modicon™ M580 ePAC

The Modicon M580 ePAC (Ethernet Programmable Automation Controllers) features openness, flexibility, robustness and sustainability. The M580 ePAC is designed with an Ethernet backbone to optimize connectivity and communications. The microprocessor has three native Ethernet ports on the chip. Schneider Electric collaborated with the supplier to design the microprocessor, and in 2013 the supplier agreed to provide the microprocessor for 20 years, helping to protect customers' long-term investments. The powerful processors offer high levels of computation for complex networked communication, display and control applications.

The M580 ePAC is designed for cybersecurity. It has an Achilles Level 2 certification. Achilles Level 2 certification by Wurdtech is considered to be the best cybersecurity certification available for PACs. The M580 has other advanced embedded cyber security features that are defined by IEC 62443. This includes, but is not limited to the ability to disable unused services, control of remote access to the PAC and integrity checks of Unity Pro executable files. The M580 ePAC supports X80 common I/O modules which can be easily integrated into its architecture.

More details are available at [Modicon M580 PAC Controller](#) on www.se.com/us and in catalog [DIA6ED2151012EN](#).

Harmony Small Panels HMI Products

The Harmony STO, STU, SCU, and ST6, Small Panels have been specifically designed to satisfy the requirement for panels that are compact and easy to use. These terminals are easy to configure, and they work seamlessly with other Schneider Electric equipment to provide a complete automation solution, dedicated to simple or compact machines.



Harmony ST6 Basic HMI Range

New!

Harmony ST6 Basic HMI

Harmony ST6 is available in three models:

- Basic HMI
- Basic Web HMI
- Basic Modular HMI

Features

- High-resolution screen powered by EcoStruxure Operator Terminal Expert software, with multi-screen and layout objects (Dock Panel) functions, to combine more information in one page for easy operation.
- Tool-free fastener for fast and easy mounting.
- Ability to access all HTML5 servers with Basic Web HMI, **Harmony** STW6 version.
- Availability of Web Viewer function on **Harmony** HMIST6 and HMISTM6 versions that allows remote visualization of the HMI application on PC/Tablet/Smartphone.
- Basic HMI, **Harmony** ST6, and STM6 with the best-in-class user interface for multi-device connection: 2 x Ethernet ports with Dual IP, 2x COM (except 4" model)/USB host and device.
- Basic Web HMI, **Harmony** STW6 with 2 x Ethernet ports with one IP address for daisy chain connection (except 4" model).
- Enhanced cybersecurity from application to firmware level.
- EcoStruxure Secure Connect Advisor, pre-installed on **Harmony** HMIST6 and HMISTM6 versions, for secure remote maintenance of HMI and connected devices.

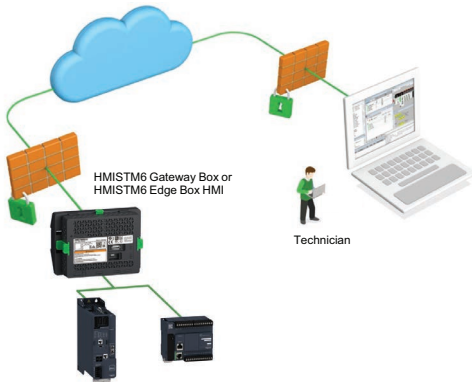

Table 23.1: Harmony ST6 Basic Range

Description	Catalog Number
ST6 Basic HMI	
4-inch wide touch panel display, 1 COM, 1 Ethernet, USB host and device, 24 Vdc	HMIST6200
7-inch wide touch panel display, 2 COM, 2 Ethernet, USB host and device, 24 Vdc	HMIST6400
10-inch wide touch panel display, 2 COM, 2 Ethernet, USB host and device, 24 Vdc	HMIST6500
12-inch wide touch panel display, 2 COM, 2 Ethernet, USB host and device, 24 Vdc	HMIST6600
15-inch wide touch panel display, 2 COM, 2 Ethernet, USB host and device, 24 Vdc	HMIST6700
STW6 Basic Web HMI	
4-inch wide touch panel display, 1 Ethernet, USB host and device, 24 Vdc	HMISTW6200
7-inch wide touch panel display, 1 Ethernet, USB host and device, 24 Vdc, 1 IP address for daisy chain connection	HMISTW6400
10-inch wide touch panel display, 1 Ethernet, USB host and device, 24 Vdc, 1 IP address for daisy chain connection	HMISTW6500
12-inch wide touch panel display, 1 Ethernet, USB host and device, 24 Vdc, 1 IP address for daisy chain connection	HMISTW6600
15-inch wide touch panel display, 1 Ethernet, USB host and device, 24 Vdc, 1 IP address for daisy chain connection	HMISTW6700
STM6 Basic Modular HMI	
4-inch wide touch panel display, 1 COM, 2 Ethernet, USB host and device, 24 Vdc	HMISTM6200
7-inch wide touch panel display, 1 COM, 2 Ethernet, USB host and device, 24 Vdc	HMISTM6400

For complete information, see **Harmony ST6** on www.se.com/us and product catalog [DIA5ED2181202EN](#).



Harmony™ STO Small Touchscreen HMI

With screen quality based on ppi similar to Harmony GTU, the Harmony STO7 series of 4.3-inch color screens support crisp, clear visualization on a high quality display. This enables you to create more attractive and distinguished applications for industry.

Features

- TFT color screen with 480 x 272 pixels
- Removable logo stickers
- Larger screen with full-size ratio in the 4.3 inch class
- Three versions for various communication types
- 26 MB application memory
- Operating temperature: 32—122 °F (0—50 °C)
- Programs with EcoStruxure™ Operator Terminal Expert
- IP65, NEMA 4X (indoor use)
- Certifications include CE, cULus, Class 1 Div 2

Catalog Number	Colors	Com Port	Ethernet
HMISTO705	64k	1 x RS232	—
HMISTO715	64k	1 x RS422/485	—
HMISTO735	64k	—	1 x 10/100BaseT

For complete information and the latest updates, see:

- Product Range [Harmony STO & STU](#) on www.se.com/us
- Product Catalog [DIA5ED2130607EN](#)

Harmony™ STU Small Touchscreen HMI

The Harmony STU is a compact HMI that is mounted using a 22 mm diameter hole - similar to a push button. This helps reduce overall cost by minimizing the labor for installing the HMI. The STU is a cost-effective solution for machine builders.

Features:

- 3.5 or 5.7 inch TFT color display, QVGA (320 x 240)
- Resistive touch screen
- One USB v2.0 host-type A port + one USB v2.0 mini-B port
- Serial and Ethernet communication ports
- Powered by 24 Vdc
- Operating temperature: 32–122°F (0–50°C)
- Configured by Vijeo Designer
- IP65, NEMA 4X (indoor use)
- Certifications include CE, cULus, Class 1 Div. 2, Marine

Catalog Number	Screen Size	Com Port	Ethernet
HMISTU655	3.5 in. TFT Color (320x240)	RS232C/RS485 (RJ45)	Ethernet (RJ45)
HMISTU855	5.7 in. TFT Color (320x240)	RS232C/RS485 (RJ45)	Ethernet (RJ45)

For complete information and the latest updates, see:

- Product Range [Harmony STO & STU](#) on www.se.com/us
- Product Catalog [DIA5ED2130607EN](#)

Harmony™ SCU Small HMI Controllers

The ultra-compact range of Harmony SCU small HMI controllers is part of Schneider Electric's Flexible Machine Control concept. The Harmony SCU HMI Controllers product offer brings together HMI and control functions within a single product. This reduces the amount of equipment required and the associated costs throughout the life cycle of the machine. Mounting through a 22 mm hole considerably simplifies installation.

Features:

- 3.5 or 5.7 inch TFT color display, QVGA (320 x 240), resistive touch screen
- One USB v2.0 host type A port + one USB v2.0 mini-B port
- Serial, Ethernet and CANopen communication ports
- Removable terminal blocks for I/O connections
- Powered by 24 V dc
- Operating temperature: 32–122°F (0–50°C)
- IP65 NEMA 4X (indoor use)
- Certifications include CE, cULus, Class 1 Div. 2

Catalog Number	Screen Size	Digital Inputs	High Speed Counter Inputs	Digital Relay Outputs	Pulse Train Outputs	Analog Inputs	Temperature Inputs	Analog Outputs
HMISCU6A5	3.5 in.	14	2	8	2	—	—	—
HMISCU6B5	3.5 in.	6	2	6	2	2	2	2
HMISCU8A5	5.7 in.	14	2	8	2	—	—	—
HMISCU8B5	5.7 in.	6	2	6	2	2	2	2

For complete information and the latest updates, see:

- Product Range [Harmony SCU](#) on www.se.com/us
- Product Catalog [DIA5ED2130505EN](#)



Harmony™ Advanced Panels HMI Products

The Harmony Advanced Panels are touch screen HMIs that are designed for the most demanding industrial applications. Choose between several platforms and screen sizes for the best cost and performance to suit your needs.

Harmony™ GTO Optimized Panels

The Harmony GTO Optimized Panels are ideal for OEMs that need a cost-effective solution with enough functionality for demanding applications. The GTO's built-in connectivity includes serial ports, Ethernet, and USB. Via Ethernet, they support a Web server, FTP, e-mail, and remote access from a PC, smart phone, or tablet applications. The panels are designed for industrial environments. A stainless steel version is available that is resistant to high-pressure cleaning (conforming to DIN 40050–9).

Features:

- TFT color LCD display with 50,000 hour backlight
- Resistive analog touch screen
- One USB v2.0 host type A port + one USB v2.0 mini-B port
- Powered by 244 V dc
- Configured by Vijeo Designer
- IP65, NEMA 4X (indoor use), IP66K for Stainless Steel models
- Certifications include CE, cULus, Class 1 Div. 2, Marine



Table 23.2: GTO Optimized Panels

Catalog No.	Screen Size	Stainless Steel	Function Keys	Com Ports	Ethernet	SD Card Socket	Operating Temp
HMIGTO1300	3.5 in. QVGA (320x240)	—	Yes	2 Ports	—	—	32—131 °F (0—55 °C)
HMIGTO1310	3.5 in. QVGA (320x240)	—	Yes	1 Port	1 Port	Yes	32—131 °F (0—55 °C)
HMIGTO2300	5.7 in. QVGA (320x240)	—	—	2 Ports	—	—	32—131 °F (0—55 °C)
HMIGTO2310	5.7 in. QVGA (320x240)	—	—	2 Ports	1 Port	Yes	32—131 °F (0—55 °C)
HMIGTO2315	5.7 in. QVGA (320x240)	Yes	—	2 Ports	1 Port	Yes	32—131 °F (0—55 °C)
HMIGTO3510	7.0 in. WVGA (800x480)	—	Yes	2 Ports	1 Port	Yes	32—131 °F (0—55 °C)
HMIGTO4310	7.5 in. VGA (640x480)	—	—	2 Ports	1 Port	Yes	32—131 °F (0—55 °C)
HMIGTO5310	10.4 in. VGA (640x480)	—	—	2 Ports	1 Port	Yes	32—131 °F (0—55 °C)
HMIGTO5315	10.4 in. VGA (640x480)	Yes	—	2 Ports	1 Port	Yes	32—131 °F (0—55 °C)
HMIGTO6310	12.1 in. SVGA (800x600)	—	—	2 Ports	1 Port	Yes	32—131 °F (0—55 °C)
HMIGTO6315	12.1 in. SVGA (800x600)	Yes	—	2 Ports	1 Port	Yes	32—131 °F (0—55 °C)

For complete information and the latest updates, see:

- Product Range [Harmony GTO](#) on [www.se.com/us](#)
- Product Catalog [DIA5ED2130616EN](#)



Harmony™ GTU Universal Panels

The Harmony GTU Universal Panels are a high performance HMI product range designed with the uniqueness of modularity that allows you to select and assemble the best combination of display unit and CPU module for the application requirements. Harmony GTU features operator efficiency, simplified installation and flexibility that fits almost any system. This product range includes: display modules (Advanced and Smart) and CPU box modules (Premium and Open).

Key features of the Harmony GTU:

Premium Box CPU Module:

- Harmony proprietary OS
- SD Card for OS and application
- Second SD Card socket for user data
- 2x USB 2.0 (Type A) and 1x USB 2.0 (mini-B)

Open Box CPU Module:

- Window Embedded 7 OS
- CFast Card for OS and application
- SD and CFast Card sockets for user data
- 3x USB 2.0 (Type A) and 1x USB 2.0 (mini-B)
- DVI-D output for external monitor

CPU Box Type	Catalog Number	Operating System	Video Out	Com Ports	Ethernet	USB 2.0 Ports	Memory Card Socket
Standard Box	HMIG2U	Proprietary OS	—	1x RS232 1x RS485	2x 100 Mb	2x (Type A) 1x (mini-B)	On board Flash (1 GB) 64 MB user data
Premium Box	HMIG3U	Proprietary OS	—	2 Ports	2 Ports	3x (Type A) 1x (mini-B)	1x CD for system (included) 1x SD socket for user data
Open Box	HMIG5U2	WEST7 OS	DVI-D	2 Ports	2 Ports	3x (Type A) 1x (mini-B)	1x CFast for system (included) 1x CFast socket for user data 1x SD socket for user data
Open Box	HMIG5U21	Windows 10 IoT Enterprise	DVI-D	2 Ports	2 Ports	3x (Type A) 1x (mini-B)	1x CFast for system (included) 1x CFast socket for user data 1x SD socket for user data
Open Box	HMIG5U22	Windows 10 IoT Enterprise	DVI-D	2 Ports	2 Ports	3x (Type A) 1x (mini-B)	1x CFast for system (included) 1x CFast socket for user data 1x SD socket for user data

Common Features:

- Modular design, any combination of display module and CPU box
- Two serial and two Ethernet ports for communications
- Powered by 12–24 Vdc
- Operating temperature: 32–140°F (0–60°C)
- Configured by Vijeo Designer
- IP66/67, NEMA 4X (indoor use)
- Certifications include: CE, cULus, Class 1 Div. 2, Marine



HMIDT732FC

Smart Display Module:

- 16M color TFT LCD display (4:3 format)
- Resistive analog touch screen, multi-touch capable
- Front panel USB 2.0 ports, 1x (Type A) and 1x (mini-B)
- Sensor for automatic backlight brightness control

Advanced Display Module:

- 262k color TFT LCD display (16:9 format)
- Resistive analog touch screen, single touch

Display Type	Catalog No.	Screen Size	Front USB Ports	Brightness Sensor	Built-in Wireless LAN	Multi-touch Capable [1]
Smart Display (4:3 or 16:9) 16 M Colors	HMIDT542	10.4 in. SVGA (800x600)	Yes	Yes	—	Yes
	HMIDT642	12.1 in. XGA (1024x768)	Yes	Yes	—	Yes
	HMIDT643	12.1 in. XGA (1024x768)	Yes	Yes	Yes	Yes
	HMIDT732	15.0 in. XGA (1024x768)	Yes	Yes	—	Yes
	HMIDT752	15.0 in. W FWXGA (1366x768)	Yes	Yes	—	Yes
	HMIDT952	19.0 in. W FWXGA (1366x768)	Yes	Yes	—	Yes
Advanced Display (16:9) 262k Colors	HMIDT351	7.0 in. WVGA (800x480)	—	—	—	—
	HMIDT551	10.1 in. WVGA (1280x800)	—	—	—	—
	HMIDT651	12.1 in. WVGA (1280x800)	—	—	—	—

For complete information and the latest updates, see:

- Product Range [Harmony GTU HMI](#) on www.se.com/us
- Product Catalog [DIA5ED2140401EN](#)

[1] Projects created in Vijeo Designer do not support multi-touch.

New!

Harmony GTUX™ Universal Panels

Harmony GTUX is a modularly designed robust terminal suitable for harsh outdoor environments. Features like high brightness and UV protection against direct sunlight, protection against water and dust, and supporting a wide range of temperatures make it an ideal choice for direct outdoor operation in O&G, WWW, and MMM segments.

Features

- A wide temperature range from -30 °C to +70 °C
- Sunlight readable: High brightness LCD (1000 cd/m²), anti-glare surface
- Robustness: UV protection, conformal coated (fully coated)
- Dust and water proof: IP66F, IP67F, and NEMA4X (outdoor use)
- Environmental standard: Class 1, Div 2, ATEX/IECEX Zone 2/22
- Variety of interfaces, including dual Ethernet ports
- Modular design with stainless front face



HMIG3X Base Unit

Table 23.3: Harmony GTUX Base Units

CPU Box Type	Catalog Number	Operating System	Conformal Coated	Com Ports	Ethernet	USB 2.0 Ports	Memory Card Socket
eXtreme Box	HMIG3X	Proprietary OS	Partially coated	1x RS232/422/485 1x RS485	2x 10/100/1000BaseT	2x (Type A) 1x (mini-B)	2x SD card
eXtreme Box Fully Coated	HMIG3XFH	Proprietary OS	Fully coated 3C3	1x RS232/422/485 1x RS485	2x 10/100/1000BaseT	2x (Type A) 1x (mini-B)	2x SD card



HMIDT35X Display

Table 23.4: Touchscreen Displays

CPU Box Type	Catalog Number	Screen Size	Conformal Coated	Operating Temperature	Supply Voltage	Touch Screen	Memory Card Socket
eXtreme Displays	HMIDT35X	7 in. W WVGA (800x480)	Partially coated	-30 to +65 °C	12-24 Vdc	Single Touch Analog Resistive	1000 cd/m ²
	HMIDT35XFH	7 in. W WVGA (800x480)	Fully coated 3C3	-30 to +65 °C	12-24 Vdc	Single Touch Analog Resistive	1000 cd/m ²
	HMIDT65X	12.1 in. W WXGA (1280x800)	Partially coated	-30 to +70 °C	12-24 Vdc	Single Touch Analog Resistive	1000 cd/m ²
	HMIDT65XFH	12.1 in. W WXGA (1280x800)	Fully coated 3C3	-30 to +70 °C	12-24 Vdc	Single Touch Analog Resistive	1000 cd/m ²
	HMIDT75X	15.6 in. W FWXGA (1366x768)	Partially coated	-20 to +60 °C	12-24 Vdc	Single Touch Analog Resistive	1000 cd/m ²
	HMIDT75XFH	15.6 in. W FWXGA (1366x768)	Fully coated 3C3	-20 to +60 °C	12-24 Vdc	Single Touch Analog Resistive	1000 cd/m ²

For complete information and the latest updates, see:

- Product Range [Harmony GTUX eXtreme HMI](#) on www.se.com/us
- Product Catalog [DIA5ED2181203EN](#)

USB Accessories for Harmony™ HMI Terminals

Harmony HMI functionality can be extended with USB connected accessories. These innovative accessories are easy to install and can be operated with HMI terminals. Their configuration is part of the overall HMI project and is stored in the terminal memory. The illuminated switch panel is mounted with a 22 mm hole, simplifying installation.

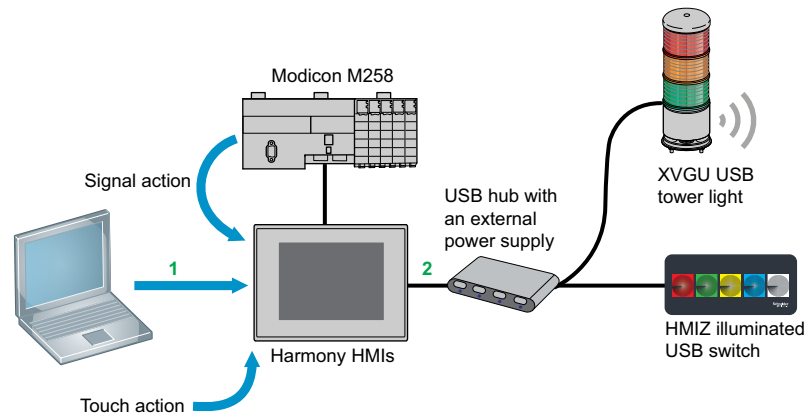

Harmony™ XVGU Tower Light

The monolithic USB tower lights of the Harmony XVGU product range have LEDs that are unique and simple-to-use. The states and patterns are directly set and modified in the HMI application. The XVGU tower lights provide long distance indication of the operating status or sequences of a machine or installation, both visually by illuminated signaling units with 360° visibility, and audibly by a buzzer.

Key features of the Harmony XVGU USB Tower Light:

- Unique one-piece LED tower design, 60 mm
- Three transparent signaling layers
- Two-tone buzzer with three level volume control and multi-color programmable lights
- Variety of signal patterns (flashing/non-flashing lights)
- Power and signaling managed by the HMI
- Installation options (on direct base or tube plate)

Catalog Number: XVGU3SHAV (100 mm length pole with mounting base)

Catalog Number: XVGU3SWV (direct base mounting)

See Catalog [DIA5ED2130901EN](#) for more information.



Harmony™ HMIZRA1 Illuminated Switch Panel

The illuminated USB switch is uniquely designed for easy visualization and quick acknowledgement of alarm (wide view angle and brightness). This switch with tactile feedback can also be used as function keys in HMI applications that involve repetitive operations in dirty environments. This keeps the touch panel clean and protected by avoiding continuous finger contact.

Key features of the Illuminated USB Switch:

- Five programmable switches with tactile feedback
- Dynamic light changes and flashing to display machine status
- Easy mounting with one-cable connection and a 22.5 mm hole
- Programmable six-color LED illumination per switch
- Connect to the Harmony HMI via USB
- Mount to the panel through a 22 mm hole
- Powered by the HMI via the USB cable
- Configured in Vijeo Designer
- IP65, NEMA 4X (indoor use)
- Certifications include CE, cULus, Class 1 Div. 2



HMIZRA1
Illuminated Switch Panel

Catalog Number: [HMIZRA1](#)

More details are available at [Harmony Accessories](#) and in catalog [DIA5ED2130901EN](#)



Harmony™ Panel PC

The Harmony Panel PC is a family of panel-mounted all-in-one industrial PCs, certified for automation applications.

Features of the Harmony Panel PCs:

- TFT color LCD display, available in 10.4, 12.1, 15.0, and 19.0 in. screen sizes
- Resistive analog touch screen
- Stainless steel models available
- Variety of CPUs and performance levels
- Options for mass storage (HDD, SSD, memory card, DVD-RW, RAID)
- Variety of Windows operating systems options
- Options for add-in card slots
- Communication options including COM ports, Ethernet, and USB
- Fanless models available
- Supply power, 100...240 V ac or 24 V dc with option for battery back-up
- Vijeo Designer Run-time trial mode pre-installed
- IP65, NEMA 4X (indoor use)
- Certifications include CE, cULus, Class 1 Div. 2

New!

Harmony P6 Modular Box PCs and Displays

Harmony P6 Industrial PC connects Operational Technology (OT) to the field of Information Technology for the IIoT.

This range features interface modularity with slot-in design for HDD/SSD and optional PCI/PCIe slots and slot-in design of operational interfaces. The two standard Ethernet ports allow OT and IT communications to be separated if necessary.

Features

- Versatile and open to applications running Windows software at the Edge: HMI, SCADA, IIoT Edge, engineering and maintenance tools, and thin clients.
- Best-in-class visualization and control with associated software enhancing the operator experience.
- Leverage crew reactivity for business maximization with 4 high-performing Intel CPU cores for industry.
- Modern display design for best visibility and operability for increased ease of use.
- Consistent operator workstations at the edge with modularity to make Box PCs, Panel PCs, and monitors for the ergonomic environment while using the application.
- Designed accordingly to IEC62443 Cybersecurity standard for control systems.
- Enhanced security with associated software, Achilles and Trellix.
- EcoStruxure Secure Connect for remote connections.
- New online configurator with an enlarged line-up, linked with EcoStruxure Plant Builder V5 for faster deliveries

For more information, visit the [Harmony P6](#) product overview on [www.se.com/us](#) and catalog [DIA5ED2140501EN](#).



Harmony P6
Modular Box PCs and Displays

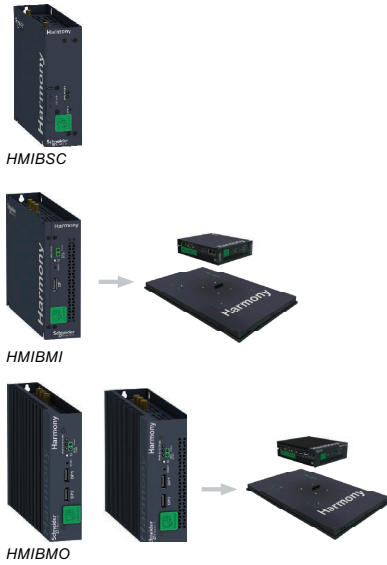

Harmony™ Edge Box

Harmony Edge Box offers edge control for EcoStruxure™ Machine and EcoStruxure Plant.

HMIBMI

- Intel Atom “Apollo lake” E3930 Dual-core 1.8 GHz fanless
- 4 GB RAM, 2x Ethernet, 1x COM, 2x USB, 1x DP (working with modular display HMIDM mounted)
- 64 or 128 GB eMMC (soldered), 1x mini PCIe slot [2], antenna connectors
- Runs Node-RED to wired devices on the Industrial Internet of Things

HMIBMO

- Intel Atom “Apollo lake” E3930 Dual-core 1.8 GHz fanless
- 4 or 8 GB RAM, 2x Ethernet (supporting real time), 2x COM, 4x USB, 2x DP (both working with modular display HMIDM mounted)
- 64 or 250 GB M.2 SSD, 1x mini PCIe slot (without optional interface) [2], antenna connectors
- Expandable model with HDD/SSD 2.5" slot and optional interface for Mini PCIe [2]
- Runs Node-RED to wired devices on the Industrial Internet of Things

Table 23.5: Harmony™ Edge Box

Family	Catalog Number	Operating System	CPU	Storage	RAM	TPM	Configured to order
HMIBMO Optimized	HMIBMIEA5DD1E01	Win10 IOT Enterprise	Intel Atom E3930 Dual Core	64 GB M.2 SSD	4 GB	Yes	Yes
	HMIBMIEA5DD1101	Win10 IOT Enterprise	Intel Atom E3930 Dual Core	64 GB M.2 SSD	4 GB	No	No
	HMIBMIEA5DD110L	Win10 IOT Enterprise	Intel Atom E3930 Dual Core	250 GB M.2 SSD	8 GB	No	No
	HMIBMIEA5DD1001	No OS	Intel Atom E3930 Dual Core	64 GB M.2 SSD	4 GB	No	No
	HMIBMIEA5DD100A	No OS	Intel Atom E3930 Dual Core	250 GB M.2 SSD	8 GB	No	Yes
HMIBMI IIoT	HMIBMIEA5DD1E01	Win10 IOT Enterprise	Intel Atom E3930 Dual Core	64 GB eMMC	4 GB	Yes	Yes
	HMIBMIEA5DD1101	Win10 IOT Enterprise	Intel Atom E3930 Dual Core	64 GB eMMC	4 GB	No	No
	HMIBMIEA5DD110L	Win10 IOT Enterprise	Intel Atom E3930 Dual Core	128 GB eMMC	4 GB	No	No
	HMIBMIEA5DD1001	No OS	Intel Atom E3930 Dual Core	64 GB eMMC	4 GB	No	No
	HMIBMIEA5DD100A	No OS	Intel Atom E3930 Dual Core	64 GB eMMC	4 GB	No	No

[2] Mini PCIe cards not requiring optional interface (no external connector): Cellular WiFi, Saved RAM, etc. Mini PCIe cards requiring optional interface: COM, USB, Audio, Video, Fieldbus, I/O, etc.

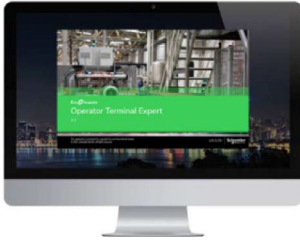

EcoStruxure™ Machine SCADA Expert
Lite SCADA for line management

EcoStruxure Machine SCADA Expert (formerly known as Vijeo XL) is a powerful software for developing HMI, SCADA, OEE and Dashboard projects dedicated to Line Management & Lite Supervision applications to run in Magelis Industrial PC and GTU Open Box. The bundle offer *Magelis Industrial PC and GTU Open Box saves you time and resources on validation of hardware, software and OS.

For More information, refer to [EcoStruxure Machine SCADA Expert](#) and Catalog [DIA5ED2171201EN](#)

EcoStruxure™ Operator Terminal Expert
Touchscreen Configuration Software

A new-generation of software providing a superior user experience with the latest UI design and gestures:

Operate intuitively

- Go beyond the limitations of the physical screen size to improve productivity

Reduce time to market

- Efficient and intuitive engineering for faster customization and modification

Improve efficiency

- High usability and image quality for the operator (experience design)

Catalog Number	Description
HMIEELCZLSPAZZ	EcoStruxure Operator Terminal Expert, Basic Buildtime License (Digital)
HMIPELCZLSPAZZ	EcoStruxure Operator Terminal Expert, Professional Buildtime License (Digital)
HMIPELCZLGPAAZ	EcoStruxure Operator Terminal Expert, Professional Buildtime Group License (Digital)
HMIPELCZLTPAAZ	EcoStruxure Operator Terminal Expert, Professional Buildtime Team License (Digital)
HMIRTWCZLSPAZZ	EcoStruxure Operator Terminal Expert, Runtime License (Digital)



EcoStruxure™ Secure Connect Advisor

- Provides a secure connection between remote display units on the work site (via SiteManager Embedded) and computers or smart devices in the office (via LinkManager) over a secure central server (GateManager).
- With EcoStruxure Secure Connect Advisor, maintenance personnel can access Schneider Electric software and update it remotely and securely via the HMI, PLC, and other connected devices as if they were on site.
- Troubleshooting and repairs can be performed remotely upon request.



Table 23.6: EcoStruxure Secure Connect Advisor for Harmony iPCs/GTO/GTU/ST6

Catalog Number	Description
VJOCNTPACKESS	Secure Connect Essential Pack
VJOCNTPACKENT	Secure Connect Enterprise Pack
VJOCNTFREE30	Secure Connect 30 days Free Trial
VJOCNTLML	Secure Connect LinkManager License
VJOCNTSMBASIC	Secure Connect SiteManager Basic License
VJOCNTSMEXT5	Secure Connect SiteManager Ext 5 Lic
VJOCNTSMEXT10	Secure Connect SiteManager Ext 10 Lic
VJOCNTGMPREM	Secure Connect GateManager Prem Access
VJOCNTSTAT	Secure Connect User statistics



Vijeo™ Designer HMI Software

Vijeo Designer is the configuration software for creating operator interface applications for Harmony HMI's and Industrial PCs. It is the ideal design tool for the simplest control application right up to the most complex HMI installations. It offers advanced script functions, recipe management, alarm management, data management, remote access, e-mail and multi-protocol connectivity.

Vijeo Designer features a screen graphics editor, including simple objects, a library of animated objects (bar graphs, meters, charts and tanks), and preconfigured advanced objects (buttons, lamps, numeric and message displays and enumerated lists).

Vijeo Designer has advanced communication support for Schneider Electric products. It also includes drivers for several third-party PLCs and devices.

Table 23.7: Vijeo Designer Buildtime Licenses

Catalog Number	Format	Description
VJDBTPRO1P	Digital	Single license, 1 station
VJDUBTPRO1P	Digital	Single upgrade license
VJDBTPRO3P	Digital	Group license, 3 stations
VJDBTPRO10P	Digital	Team license, 10 stations
VJDBTPRO100P	Digital	Entity license, 100 stations

Table 23.8: Vijeo Designer Runtime Licenses

Catalog Number	Format	Description
VJDRTPROH1P	Digital	Vijeo Designer Harmony P6 Single license, 1 station
VJDHPCZLSPAZZ	Digital	Vijeo Designer, Harmony PC (HMIBMP, HMIBMU, HMIPSO, HMIPSP, HMIPEP) / Harmony P6 Single license, 1 station
VJDRPCZLSPAZZ	Digital	Vijeo Designer, Standard PC & Harmony PC (except HMIBMP, HMIBMU, HMIPSO, HMIPSP, HMIPEP) Single license, 1 station

For more information, refer to [Vijeo Designer HMI Software](#) and catalog [DIA5ED2130614EN](#).

Vijeo™ Design'Air HMI Application

Vijeo Design'Air is an HMI application for Android and iOS tablets and smartphones. This feature enables you to remotely connect to a Harmony HMI terminal over a WiFi network and have a graphical view of the HMI terminal on your tablet and smartphone.



During the design phase, you have the ability to set the HMI terminal to be detectable by Vijeo Design'Air. You can secure access to the HMI by requiring user authentication during login. You can also configure the HMI's accessibility level to view only or full control. In this configuration, the HMI terminal acts as the server, while the tablet or smartphone acts as the client. The server and client communicate over a WiFi wireless, 3G, 4G, or LTE network.

After a connection is established, you can use some of the functionalities of tablets and smartphones to remotely interact with the HMI terminal. For example, you can perform touch or swipe actions to start or stop a process or to navigate between screens. You can also use pinch action to zoom in and out of a screen for better viewing.

Download Vijeo Design'Air from Google Play® or the App Store® in iTunes®.

For more information, refer to [Vijeo Designer HMI Software](#) and catalog [DIA5ED2130614EN](#).

Vijeo™ Design'Air Plus

Vijeo Design'Air Plus is a feature in Vijeo Designer and application for Android and iOS tablets and smartphones. Vijeo Design'Air Plus enables you to create a tablet/smartphone project specifically for the tablet or smartphone display size. At runtime, an operator can access the user application to display data and control automation processes on the tablet or smartphone.



You can use Vijeo Designer's drawing tools to create and edit a visual representation of the automation process. You can draw shapes and parts (such as rectangles, arcs, and pies), Toolchest parts (such as numeric displays, switches, and bar graphs), use the gradient feature to enhance the color of the drawn objects, and set up an Alarm Panel for remote alarm monitoring.

Vijeo Design'Air Plus provides operators with the capability to select a user application, and on successful login, download and launch the tablet/smartphone application. The operator can view and monitor an automation process, and for example, change values in numeric displays and string displays. In the Alarm Panel, the operator can monitor and acknowledge alarms.

Download Vijeo Design'Air Plus from Google Play® or the App Store® in iTunes®.

For more information, refer to [Vijeo Designer HMI Software](#) and catalog [DIA5ED2130614EN](#).

New!

Modicon™ TM3 Bus Coupler Modules

The Modicon TM3 Bus Coupler enables the creation of separate groups of industrial TM3 I/Os, each positioned as near to the machine as possible, that are managed by a master controller via a fieldbus.

The TM3 Bus Coupler is offered with the following options:

- TM3BCEIP: EtherNet/IP and Modbus/TCP support
- TM3BCCO: CANopen support
- TM3BCSL: Modbus Serial Line support

Main features:

- Full and simple integration with Modicon M221, M241, M251, and M262 controllers
- Digitization: WebServer embedded, cybersecurity, and discovery service
- Connectivity: Two isolated RJ45 ports, USB port, EtherNet/IP and Modbus/TCP support, CANopen and Modbus serial line support
- Used in third party controller architectures



TM3BCEIP

TM3BCCO

TM3BCSL

Table 23.9: Modicon TM3 Bus Couplers

Catalog Number	Description
TM3BCEIP	Ethernet interface, Modicon TM3 bus coupler module
TM3BCCO	CANopen interface, Modicon TM3 bus coupler module
TM3BCSL	Serial Line interface, Modicon TM3 bus coupler module

More information is available in catalog [DIA3ED2140109EN](#).

Modicon™ STB Distributed I/O Platform

The Modicon STB is a highly modular distributed I/O platform, integrated wiring solution, and power management system that delivers effective and targeted control. Compatible with most major fieldbus networks: Modbus, Ethernet, CANopen, Devicenet, PROFIBUS, and Interbus. More information is available at [Modicon STB Modular Distributed I/O](#).



Modicon™ Telefast™ ABE7 Sub-bases, IP20

The Modicon Telefast ABE7 pre-wired system enables connection and adaptation of control signals of industrial PLC cards that are fitted with HE10 connectors. It rationalizes cabling by replacing PLC terminals and traditional terminal blocks—thus improving simplicity and economy. For more information, refer to [Advantys Telefast ABE7](#) and catalog [DIA3ED2160602EN](#).

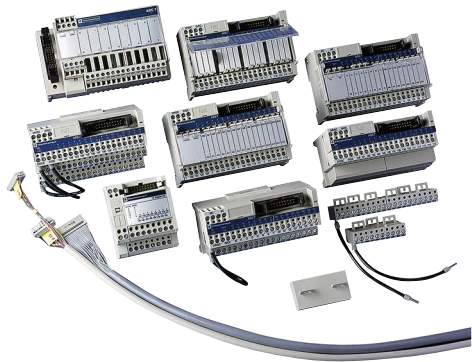

Modicon™ TM7 I/O Blocks, IP67

Compact and flexible, the TM7 IP67 I/O Blocks allow connection of sensors and actuators at the heart of processes or machines in severe environments. The wide range of modules provides solutions to match your exact needs. It includes connectivity to CANopen.

For more information, refer to [Modicon TM7 Remote I/O for Harsh Environments](#) and catalog [DIA3ED2140405EN](#)

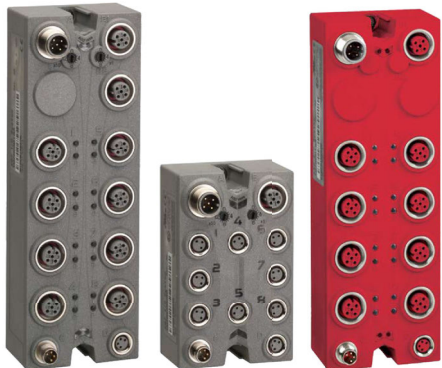

Modicon™ Momentum™ Distributed I/O and PLC

The small footprint and open architecture of the Momentum PLC product line make it extremely versatile for a variety of automation applications. The Momentum PLC is ideal for PC-based control, distributed control, distributed I/O, and traditional, standalone PLC control. Momentum PLC options and accessories include: I/O bases, processor adapters, option adapters and communication adapters that are interchangeable and snap together to deliver optimal flexibility throughout the control system lifecycle. Using Ethernet as its communications backbone, the Modicon Momentum M1E Processor delivers all the performance benefits of real-time control. The open architecture of the M1E processor makes it a universal controller for distributed I/O, compatible with many of the major fieldbus and control network environments. An integral Ethernet port in the M1E allows users to perform a wide range of functions over Ethernet, including data acquisition, peer-to-peer communications, and I/O scanning.



Five embedded web pages enable the use of a standard web browser to read status and diagnostic information from the processor. The most recent addition to the Momentum product offer is the Momentum M1E ConneXium switch. This model combines the power and functionality of the M1E processor with the communication versatility of four Modbus Ethernet TCP/IP ports. The award winning M1E not only seamlessly connects I/O and other control devices via open standards; it delivers the performance of a full function, real-time controller for stand-alone and distributed system configurations in one money-saving unit.

For more information, refer to [Modicon Momentum](#) and catalog [MKTED205061EN-US](#)

Ethernet TCP/IP Products

The recognition of Ethernet TCP/IP, both in organizations and on the internet, has made it the communication standard of today. Its wide use is leading to a reduction in connection costs, increased performance and the addition of new functions, which all combine to ensure its durability.

Ethernet TCP/IP meets the connection requirements of every application:

- Twisted pair copper cables for simplicity and low cost
- Optical fiber for immunity to interference and for long distances
- Communication redundancy, inherent in the IP (internet protocol)
- Remote point-to-point access via the telephone network or the Internet for the cost of a local call

Ethernet TCP/IP, a truly open technology, supports all types of communication:

- Web pages
- File transfer
- Industrial messaging

With its high speed, the network no longer limits the performance of the application. The architecture can evolve without any difficulty. The products or devices remain compatible, ensuring the long-term durability of the system.

More information on Ethernet and Ethernet Products is available in catalog [MKTED208054EN-US](#).

ConneXium Industrial Firewalls

The ConneXium line of networking products offers a complete range of Ethernet switches (managed and unmanaged), hubs, transceivers, gateways, cabling, and diagnostic monitoring software for demanding industrial environments. With fiber and redundant capabilities, along with advanced filtering and security features, ConneXium products improve the performance and security of the network. More details can be found at [www.se.com/us/en](#).

CANopen Network Products

CANopen is an open network that is supported by over 400 companies world wide and promoted by CAN in Automation. CANopen is standardized in the EN50325-4 and in ISO15745-2 for its device description.

The main reason for using a network is the performance and the flexibility to adapt the network exactly to the requirements of the application. CANopen provides a unique feature for the adaptation of the data transmission. Based on the producer/consumer model, CANopen allows for a data transmission broadcast, peer-to-peer, change-of-state and cyclic communication. This means it transmits data only when required or on a specified time base. Process data objects can be individually configured. Parameters can be changed at runtime.

CANopen combines ease of installation with inexpensive devices. CANopen provides an integrated equipotential bounding in the cable. Therefore, an additional cable or stranded copper ribbon to achieve the same potential on all network devices is not necessary. Installation costs are heavily reduced.

More information on CANopen and CANopen Products is available in catalog [MKTED208054EN-US](#).



Motion Configurator

Our [Motion Configurator](#) helps users find the best solution for their application needs, providing full guidance through the selection process even for multiple product ranges. It grants easy access and use for everybody, even those with no expertise in robotics and motion. You will be guided to choose between Lexium servo drives, integrated drives, motors, and robotics series. Create and compare the optimal bundles for your machine application.

How does the Motion Configurator work?

When launching the tool, you will easily go through the main steps:

- Provide the settings and specificities for your application.
- Compare and select the perfect bundle among the proposed results.
- Make the most of your configuration by saving it, sharing it with your team, and downloading the documentation and the bill of materials.
- Manage your configurations and directly order them easily with [mySchneider](#) logged-in experience.



Lexium Cobot (Collaborative Robots)

Lexium Cobots take on monotonous, tedious, repetitive or physically demanding tasks. They can work in environments which are hazardous to people and can be easily applied to existing or new production lines in a variety of different industries.



Cobot and Controller

Table 23.10: Lexium Cobot and Controller Options

Payload (Max.)	Power (Max.)	Operating Radius	Controller Catalog Number	Cobot Catalog Number
6.61 lb (3 kg)	150 W	24.65 in (626 mm)	LXMRL03C1000	LXMRL03S0000
11.02 lb (5 kg)	350 W	37.56 in (954 mm)	LXMRL07C1000	LXMRL05S0000
15.43 lb (7 kg)	350 W	32.24 in (819 mm)		LXMRL07S0000
26.46 lb (12 kg)	500 W	52.24 in (1327 mm)	LXMRL12C1000	LXMRL12S0000
39.68 lb (18 kg)	600 W	42.24 in (1073 mm)		LXMRL18S0000

Links to Websites and Downloads:

[Lexium Cobot](#) on [www.se.com/us](#)

[Catalog DIA7ED2220801EN](#): Lexium Cobot Collaborative Robots



PacDrive 3 Robotics

Delta robots for pick and place solutions. The robotics solution is an add-on to the PacDrive product line, designed to satisfy the rapidly rising demand for the integration of robots into machine design: using Lexium 52, Lexium 62 servo motors or Lexium 62 ILM integrated servo motors for robot kinematics with up to 6 axes allows full integration into the PacDrive automation solution. Users can select library functions for integrating robots into the IEC 61131-3-compliant machine program structures of PacDrive LMC Eco/Pro/Pro 2 controllers.

Links to Websites and Downloads:

[PacDrive 3 Robotics](#) on [www.se.com/us](#)

[Catalog DIA3ED2160301EN](#): PacDrive 3 General Presentation

[Catalog DIA3ED2160307EN](#): Lexium T and P Delta Robots

Lexium Cartesian Robots

Portal axes, Linear tables, Cantilever axes, Multi axes systems.

Links to Websites and Downloads:

[Catalog DIA7ED2210101EN](#): Lexium Cartesian Robots

[Lexium CAS 4](#): Cantilever axes with moving axis body Standardized telescopic axes for a wide range of linear movements.

[Lexium MAX](#): Multi-axis systems for 1, 2 or 3-dimensional positioning solutions.

[Lexium PAS, PAD](#): Portal axes with movable carriage and fixed axis.

[Lexium TAS](#): Linear tables with movable carriage and fixed axis.



Lexium 32i Integrated Servo

Lexium 32i Series Integrated Servo Drives

With servo motor and drive integrated in one housing, the Lexium 32i is designed for application areas requiring high precision and advanced motor control. Unlike traditional servo drives that are installed in a cabinet, the Lexium 32i servo drive is installed directly on the machine to help you improve cost, energy, and can reduce cabinet space by up to 60%. Thanks to standard safety functions (STO), communication options, backup memory card, and its modular design the Lexium 32i sets itself apart in the market place to meet the needs of today's machine builders.

Table 23.11: Lexium 32i Characteristics

Input Voltage	Single phase: 115–240 Vdc 3-phase: 208–480 Vac
Motor Size	400 W–2.1 kW
Control Options	CANopen, CANmotion, EtherCAT, ProfiNet

Links to Websites and Downloads:

- [Lexium 32i Integrated Servo Drives](http://www.se.com/us) on www.se.com/us
- [SoMove FDT Standalone Commissioning \(Free\) Software](#)
- [Motion Sizer \(Free\) Software](#)

Lexium 62 ILM Integrated Servo Modules

Lexium 62 ILM integrated servo modules can be controlled with all PacDrive LMC Pro and Eco series motion controllers via Sercos communication. All of the system's main components are equipped with electronic name plates that allow the controller to automatically detect and configure the drives.



Lexium 62 ILM

Links to Websites and Downloads:

- [Lexium 62 ILM](http://www.se.com/us) on www.se.com/us
- [Catalog DIA7ED2160306EN: Lexium 62 ILM Integrated Servo Modules](#)

Lexium ILA, ILE, ILS Integrated Drives

The Lexium ILA, ILE, and ILS drive series is an integrated, or combination, drive and motor series. This series comes in 3 different motor versions (DC brushless, stepper, and servo). Safe Torque Off (STO), highly customizable cable entry and communication options combined with detailed user guides, function blocks, and sample code, make this product ideal for use with both our Modicon and 3rd party controllers.



Lexium ILA
Combination Stepper Motor



Lexium ILE
Combination DC Brushless Motor



Lexium ILS
Combination Stepper Motor

Table 23.12: Lexium ILx Characteristics

Input Voltage	12–48 Vdc
Motor Size	150–305 W
Control Options	CANopen, Modbus TCP/IP, Ethernet/IP, EtherCAT, Ethernet Powerlink, Modbus RS485, DeviceNet, Profibus DP, Pulse & Direction, & Motion Table

Links to Websites and Downloads:

- [Lexium ILA, ILE, and ILS Integrated Drives](http://www.se.com/us) on www.se.com/us
- [Lexium CT Commissioning \(Free\) Software](#)



Lexium 28 Servo Drive



BCH2 Servo Motor

Lexium 28 Series Servo Drives and Motors

Optimized for easy integration and commissioning through Pulse & Direction, Analog, CanOpen, or CanMotion technology. Thanks to its compact form factor, and Safe Torque Off (STO) capability; the Lexium 28 range of AC-servo drives and motors from Schneider Electric delivers industry-leading performance and value.

Table 23.13: Lexium 28 Characteristics

Input Voltage	200/240 Vac
Motor Size	50 W–4.5 kW
Control Options	CANopen, CANmotion, EtherCat, Pulse & Direction, Analog, & Motion Table

Links to Websites and Downloads:

[Lexium 28 Servo Drives and Motors](#) on www.se.com/us

[Catalog DIA7ED2150401EN](#): Lexium 28 Servo Drives and BCH2 Servo Motors

[SoMove Commissioning \(Free\) Software](#)

[Motion Sizer \(Free\) Software](#)

Lexium 32 Series Servo Drives and Motors

The Lexium 32 servo drive offer is designed to simplify the life cycle of machines. SoMove setup software, a backup memory card, side-by-side mounting, and easily accessible color-coded plug-in connectors all help to make installation, setup, and maintenance easier. The compact size of the servo drives and servo motors provides maximum power in the minimum space, which helps to reduce overall machine size and costs. The ability to use 3rd party motors, multiple communication cards, as well as standard encoders, enable adaptation to numerous types of control system architecture for industry. An integrated safety function and access to additional safety functions reduce design times and make it easier to comply with safety standards.



Lexium 32 Servo Drive



BMH Servo Motor



BSH Servo Motor

Table 23.14: Lexium 32 Characteristics

Input Voltage	Single phase: 115–240 Vdc 3-phase: 208–480 Vac
Motor Size	150 W–7 kW (up to 11 kW with 3 rd party motors)
Control Options	CANopen, CANmotion, Modbus TCP, Modbus Serial, EtherCat, Sercos III, Profibus DP, DeviceNet, EtherNet/IP, Pulse & Direction, Analog, & Motion Table

Links to Websites and Downloads:

[Lexium 32 Servo Drives and Motors](#) on www.se.com/us

[SoMove FDT Standalone \(Free\) Commissioning Software](#)

[Motion Sizer \(Free\) Software](#)



PacDrive Family

PacDrive 3 for Motion Centric Machines

PacDrive 3 is based upon proven logic motion technology, which unifies PLC, motion, and robotics control functionality on a single hardware platform. With its centralized system architecture, PacDrive 3 is the ideal solution for controlling a broad range of servo-driven production and packaging machines, as well as material handling equipment and robotics, using fully integrated, IEC 61131-3-compliant program structures. More than 80,000 machines worldwide are controlled by PacDrive to this day.

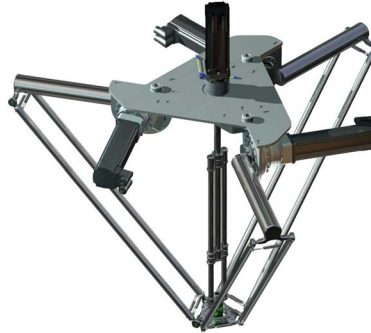

PacDrive 3 Robotics
Lexium T and Lexium P Delta Robots

Links to Websites and Downloads on www.se.com/us

- [PacDrive 3 – A Complete Solution for Motion Centric Machines](#)
- [Catalog DIA3ED2160301EN: PacDrive 3 General Presentation](#)
- [Motion Sizer \(Free\) Software](#)
- [EcoStruxure™ Machine Expert Programming Software](#)

PacDrive 3 LMC Pro / LMC Eco Controllers

PacDrive LMC motion controllers are a broad family of twelve different controllers, with a powerful CPU for applications requiring 0 to 130 synchronized axes (at 1 msec network update rate)

- up to 130 servo axes, and up to 255 virtual axes
- with multiple fieldbuses used in parallel to Sercos: CANopen, Profibus DP, etc.

All controllers are software-compatible, thanks to EcoStruxure™ Machine Expert programming software, a Logic Motion Runtime software: v same runtime v same libraries v same engineering tool v same diagnostic tools v same support of drives, IOs, etc. Up to 4096 dynamic electronic cam disks can be programmed to operate in parallel. The program can switch between electronic cam disks during operation. All controllers have an integrated PLC (5 µsec for 1000-bit instructions).

Links to Websites and Downloads:

- [PacDrive 3 LMC Pro / LMC Eco](http://www.se.com/en) on www.se.com/en
- [PacDrive 3 LMC Eco/Pro2 Motion Controllers Catalog](#) Document Number DIA7ED2160303EN



Modicon M262 Logic/Motion Controller

IIoT-ready Logic and Motion Controller for Performance Machines

With embedded Cloud protocols such as MQTT, OPC UA Server and Client, API, and TLS encryption, **Modicon M262**, our IIoT-ready logic and motion controller, can be directly connected to the cloud and push data to [EcoStruxure Machine Advisor](#) while taking care of cybersecurity. As an edge controller, it provides benchmark performance with 3 ns/inst. for logic applications and up to 24 synchronized axes in 4 ms or 8 axes in 1 ms for motion with an all-in-one motion controller. With its dual-core CPU, it efficiently manages parallel application and communication.



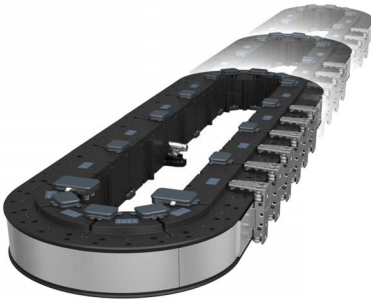

Image Callout

Lexium MC12 Multi Carrier

The Lexium MC 12 Multi Carrier System is an innovative transportation system for moving, positioning or grouping objects in machines for discrete processes. It consists of long stator motors on which multiple carrier units can be moved independently from each other. This creates new freedom for designing faster and more flexible machines with less footprint. Typical fields of applications are, for example, packaging and filling processes or assembly applications.

Links to Websites and Downloads:

[Lexium MC12 Multi Carrier](http://www.se.com/us) on www.se.com/us

[Lexium MC12 Catalog](#) Document Number DIA7ED2210701EN



Lexium SD3 Stepper Drives and Motors

Lexium SD3 and Motors

3-phase stepper drives and stepper motors for motion control.

The Lexium SD3 with its excellent constant velocity characteristics is ideal for applications such as scanning. High torque is available even at low speeds. Therefore, the stepper motor is particularly suitable for short-distance positioning, such as labelling. It also provides a high holding torque, yet another advantage that makes it an optimum solution in applications such pick and place, etc.

Links to Websites and Downloads:

[SD3 Stepper Drives and Motors](http://www.se.com/us) on www.se.com/us

Refer to [Modicon MCM Online](#)

Modicon M171/M172/M173

Flexible and Scalable Performance

Whether you specialize in chillers, Air Handling Units for commercial buildings, residential, or industrial applications, with Modicon M171/M172/M173 logic controllers, EcoStruxure Machine is well positioned: Multiple BMS connectivity, embedded or as an option, and an embedded web server make remote control and remote access simple to implement, while a unique software environment supports the development of algorithms and functions that can be used on any platform.

Connected







Modicon M171/M172/M173 logic controllers offer a wide choice of connectivity options to support integration with a variety of BMS: A ready-to-connect device, the Modicon M172 embeds Ethernet, Modbus, and BACnet protocols as standard and LonWorks or Konnex protocols as optional. Furthermore, the integrated webserver enables solutions for remote control or cloud connectivity. It simplifies the maintenance thanks to the built-in WebVisu that is compatible with standard Web browsers.

Efficient

EcoStruxure Machine Expert - HVAC 2.0 provides advanced algorithms for greater energy efficiency in Modicon M171/M172/M173-based automation. Ready-to-use TVDAs (tested, validated, and documented architectures) and AFBs- (application function block) libraries dedicated to HVAC applications are reducing the time to market.

Sustainable

Modicon M171/M172/M173 products adhere to refrigerant compliance and RoHS guidelines. Also see [Green Premium Products](#) on [www.se.com/us](#)

IIoT Secure Interfaces	Logic controllers	Remote displays	I/O Expansion modules Communication modules	Measurement accessories
 <p data-bbox="199 1249 303 1270">IIoT Plug-in</p>  <p data-bbox="199 1480 319 1501">IIoT Gateway</p>	 <p data-bbox="462 1092 989 1113">M172, for any size of connectable or connected machine</p>			 <p data-bbox="1260 1249 1460 1270">Temperature sensors</p>
	 <p data-bbox="462 1354 941 1375">M173 Optimized, for simple and compact machines</p>			 <p data-bbox="1260 1480 1460 1522">Humidity and temperature sensors</p>
	 <p data-bbox="462 1617 941 1638">M171 Optimized, for simple and compact machines</p>			

Links to Websites and Downloads on [www.se.com/us](#)

[Modicon M171/M172/M173 Logic Controllers](#) on [www.se.com/us](#)

[Modicon M171/M172/M173 Catalog](#) Document Number DIA3ED2151001EN

Refer to [Modicon MCM Online](#)



M171 Logic Controllers

Features:

- Simple and compact machines
- Minimal installation time — (DIN rail or flush mounting)

Links to Websites and Downloads on [www.se.com/us](#)

- Catalog: [Modicon M171/M172/M173 Logic Controllers for HVAC and Pumping Applications](#) Document Number DIA3ED2151001EN
- Visit [Modicon M171/M172/M173 Logic Controllers](#) on [www.se.com/us](#) for:
 - Complete product and accessory listings
 - Product selector
 - Related catalogs and technical documentation
 - Software and firmware downloads



M172 Logic Controllers

Logic controllers for any size of connectable or connected HVAC machine: manage small to large HVAC machines, and boosters for buildings, connectable to BMS or the cloud.

Links to Websites and Downloads on [www.se.com/us](#)

- Catalog: [Modicon M171/M172/M173 Logic Controllers for HVAC and Pumping Applications](#) Document Number DIA3ED2151001EN
- Visit [Modicon M171/M172/M173 Logic Controllers](#) on [www.se.com/us](#) for:
 - Complete product and accessory listings
 - Product selector
 - Related catalogs and technical documentation
 - Software and firmware downloads

New!

M173 Logic Controllers

Features:

- Green Premium Product
- 1MB — to support simple and complex programs
- Adaptive — One unit for super compact machines; for bigger machines, just add I/O expansions
- Multiple connection capabilities (Modbus RTU client and server, CANopen, USB-C, Remote display bus)
- Flexible and configurable
- Integrated EEVD
- Ready-to-use assets — many templates, libraries, function blocks available
- IoT on deck — straightforward connection to the Secure Interface: cybersecure IoT module



Table 23.15: Modicon TM173O PLCs

Description	Catalog Number
TM173 optimized, display, 22 I/Os, 24 Vac/dc, 2 x RS485	TM173ODM22R
TM173 optimized, display, 22 I/Os, 24 Vac/dc, 2 x RS485, 2 x SSR	TM173ODM22S
TM173 optimized, 22 I/Os, 24 Vac/dc, 2 x RS485	TM173OBM22R

Links to Websites and Downloads on [www.se.com/us](#)

- Catalog: [Modicon M171/M172/M173 Logic Controllers for HVAC and Pumping Applications](#) Document Number DIA3ED2151001EN
- Visit [Modicon M171/M172/M173 Logic Controllers](#) on [www.se.com/us](#) for:
 - Complete product and accessory listings
 - Product selector
 - Related catalogs and technical documentation
 - Software and firmware downloads