

Section 21







Terminal Blocks

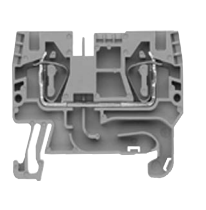

Selection Guide	21-1
Terminal Block Selection Guide	21-1
IEC Style Terminal Blocks	21-3
Spring Terminal Blocks	21-3
Passthrough	21-3
Grounding	21-4
Double and Triple Deck, Grounding, Component Carriers, Blade Isolators	21-5
Miniature Spring Passthrough and Grounding	21-6
Screw Terminal Blocks	21-7
Passthrough and Grounding	21-7
Lug/Lug, Double and Triple Deck Passthrough, Grounding	21-9
Blade Isolators, Component Carriers, Fused, Measuring, Grounding	21-10
Miniature Passthrough and Hybrid Passthrough	21-11
Push-in Terminal Blocks	21-12
Passthrough and Grounding	21-13
Double Deck Passthrough, Blade Isolators, Component Carriers	21-15
Accessories	21-16
Linergy Marking Accessories	21-16
Linergy Labeling System	21-17
Mounting Track and End Clamps	21-18
NEMA Style Terminal Blocks	21-19
Type G Terminal Blocks	21-19
Selection Guide	21-19
Terminal Block Assemblies	21-21
Type G Terminal Block Accessories	21-22
Mounting Track, End Clamps, Jumpers, Fanning Strips	21-22
Marking Accessories	21-23
Thermal-Magnetic Circuit Protectors	21-24
Type GCB Circuit Protectors	21-24
Type GB2 Circuit Protectors	21-25
Power Distribution Blocks	21-26
IEC NSYEB Power Distribution Blocks	21-26
Enclosed Power Distribution Blocks	21-26
NEMA Type LB Power Distribution Blocks	21-27
LB Open Power Distribution Blocks	21-27
Fuseholders	21-28
Type FB Fuseholders	21-28
TeSys DF Fuseholders	21-29
Cable Ends	21-30
DZ5 and AZ5 Cable Ends	21-30
AR1 and AT1 Cable End Accessories	21-31
Advantys Telefast ABE 7 Pre-Wired System	21-32
Prewired Connection System	21-32
Telefast ABE 7 Pre-Wired Sub-Bases	21-32

Terminal Block Panorama

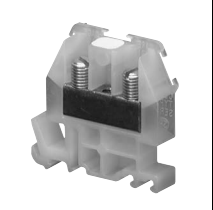









Table 21.1: Product Panorama

					
Product Family	NSYTRV	NSYTRR	NSYTRP	NSYTRH	9080G
Type of product	IEC screw technology	IEC spring technology	IEC push-in technology	IEC hybrid (screw and insulation displacement connection)	NEMA screw technology
Mounting	DIN 3	DIN 3	DIN 3	DIN 3	DIN 3 and Square D track ^[1]
Maximum rated voltage (V)	600	600	600	600	600 ^[2]
Maximum rated current per UL (A)	285	85	30	15	255
Ambient air temperature	-40 to +266 °F (-40 to 130 °C)				
Approvals ^[3]	 UL File E87739 CCN XCFR2	UL File E87739 CCN XCFR2	UL File E87729 CCN XCFR2	UL File E87729 CCN XCFR2	UL File E60616 CCN XCFR2
	 CSA File 25644 Class 6228-01	CSA File 25644 Class 6228-01	CSA File 25644 Class 6228-01	CSA File 25644 Class 6228-01	CSA File 25644 Class 6228-01
Color	Gray Blue Orange Red Green White Black Yellow Brown Green/Yellow	Gray Blue Orange Green/Yellow	Gray Blue Orange Green/Yellow	Gray Green/Yellow	Natural (White) Black Blue Green Gray Orange Red Yellow Brown
Conforming to Standards	RoHS CE	RoHS CE	RoHS CE	RoHS CE	RoHS CE

[1] 9080GK6 can be mounted directly to a panel or on Square D track.
 [2] 9080GT6 is 120 V.
 [3] Refer to catalogs 9080CT1301 and 9080CT9601 for a complete list of certifications.

Passthrough

Table 21.2: Spring Passthrough Blocks [1]

Description	Maximum Voltage	Maximum Current	Block			End Barrier[2]		
			Color	Catalog Number	Std. Pack[3]	Color	Catalog Number	Std. Pack[3]
 5.2 mm (0.21 in.) wide Two Terminals Solid or Stranded Copper Wire 28–12 AWG	600 V	20 A	Grey	NSYTRR22	50	Grey	NSYTRACR22	50
			Blue	NSYTRR22BL		Blue	NSYTRACR22BL	
			Orange	NSYTRR22AR		Grey	NSYTRACR22	
 5.2 mm (0.21 in.) wide Three Terminals Solid or Stranded Copper Wire 28–12 AWG	600 V	20 A	Grey	NSYTRR23	50	Grey	NSYTRACR23	50
			Blue	NSYTRR23BL		Blue	NSYTRACR23BL	
			Orange	NSYTRR23AR		Grey	NSYTRACR23	
 5.2 mm (0.21 in.) wide Four Terminals Solid or Stranded Copper Wire 28–12 AWG	600 V	20 A	Grey	NSYTRR24	50	Grey	NSYTRACR24	50
			Blue	NSYTRR24BL		Blue	NSYTRACR24BL	
			Orange	NSYTRR24AR		Grey	NSYTRACR24	
 6.2 mm (0.24 in.) wide Two Terminals Solid or Stranded Copper Wire 28–10 AWG	600 V	30 A	Grey	NSYTRR42	50	Grey	NSYTRACR42	50
			Blue	NSYTRR42BL		Grey	NSYTRACR42	
			Orange	NSYTRR42AR		Grey	NSYTRACR42	
 6.2 mm (0.24 in.) wide Three Terminals Solid or Stranded Copper Wire 28–10 AWG	600 V	30 A	Grey	NSYTRR43	50	Grey	NSYTRACR43	50
			Blue	NSYTRR43BL		Grey	NSYTRACR43	
 6.2 mm (0.24 in.) wide Four Terminals Solid or Stranded Copper Wire 28–10 AWG	600 V	30 A	Grey	NSYTRR44	50	Grey	NSYTRACR44	50
			Blue	NSYTRR44BL		Grey	NSYTRACR44	
 8.2 mm (0.32 in.) wide Two Terminals Solid or Stranded Copper Wire 28–8 AWG	600 V	50 A	Grey	NSYTRR62	50	Grey	NSYTRACR62	50
			Blue	NSYTRR62BL		Grey	NSYTRACR62	
 8.2 mm (0.32 in.) wide Three Terminals Solid or Stranded Copper Wire 24–8 AWG	600 V	50 A	Grey	NSYTRR63	50	Grey	NSYTRACR63	50
 10.2 mm (0.40 in.) wide Two Terminals Solid or Stranded Copper Wire 16–6 AWG	600 V	66 A	Grey	NSYTRR102	50	Grey	NSYTRACRR102	50
			Blue	NSYTRR102BL		Grey	NSYTRACRR102	
 12.2 mm (0.48 in.) wide Two Terminals Solid or Stranded Copper Wire 16–4 AWG	600 V	85 A	Grey	NSYTRR162	50	Grey	NSYTRACR162	50
			Blue	NSYTRR162BL		Grey	NSYTRACR162	

NOTE: For a complete listing of these products, see [Linergy TR Terminal Blocks](#) online or catalog **9080CT1301**.



File:
E87739
CCN:
XCFR2



File:
256444
Class:
6228-01



RoHS
Compliant

For track and accessories, see [Mounting Track and End Clamps](#), page 21-18.

[1] Some products may be discontinued. Refer to [www.se.com/us](#) for the most current product information.

[2] One end-barrier is required for each assembly of like blocks.

[3] Orders must specify the standard package quantity (Std. Pack) or multiples of that quantity.

Grounding

Table 21.3: Spring Grounding Blocks [4]

Description	Block			End Barrier [5]		
	Color	Catalog Number	Std. Pack [6]	Color	Catalog Number	Std. Pack [6]
 Grounding Block Two Terminals Solid or Stranded Copper Wire 28–12 AWG 5.2 mm (0.21 in.) wide	Green / Yellow	NSYTRR22PE	50	Grey	NSYTRACR22	50
 Grounding Block Three Terminals Solid or Stranded Copper Wire 28–12 AWG 5.2 mm (0.21 in.) wide	Green / Yellow	NSYTRR23PE	50	Grey	NSYTRACR23	50
 Grounding Block Four Terminals Solid or Stranded Copper Wire 28–12 AWG 5.2 mm (0.21 in.) wide	Green / Yellow	NSYTRR24PE	50	Grey	NSYTRACR24	50
 Grounding Block Two Terminals Solid or Stranded Copper Wire 28–10 AWG 6.2 mm (0.24 in.) wide	Green / Yellow	NSYTRR42PE	50	Grey	NSYTRACR42	50
 Grounding Block Three Terminals Solid or Stranded Copper Wire 28–10 AWG 6.2 mm (0.24 in.) wide	Green / Yellow	NSYTRR43PE	50	Grey	NSYTRACR43	50
 Grounding Block Four Terminals Solid or Stranded Copper Wire 28–10 AWG 6.2 mm (0.24 in.) wide	Green / Yellow	NSYTRR44PE	50	Grey	NSYTRACR44	50
 Grounding Block Two Terminals Solid or Stranded Copper Wire 24–8 AWG 8.2 mm (0.32 in.) wide	Green / Yellow	NSYTRR62PE	50	Grey	NSYTRACR62	50
 Grounding Block Two Terminals Solid or Stranded Copper Wire 16–6 AWG 10.2 mm (0.40 in.) wide	Green / Yellow	NSYTRR102PE	50	Grey	NSYTRACR102	50
 Grounding Block Two Terminals Solid or Stranded Copper Wire 16–4 AWG 12.2 mm (0.48 in.) wide	Green / Yellow	NSYTRR162PE	50	Grey	NSYTRACR162	10

NOTE: For a complete listing of these products, see [Linergy TR Terminal Blocks](#) online or catalog 9080CT1301.



File:
E87739
CCN:
XCFR2



File:
256444
Class:
6228-01



RoHS
Compliant

For track and accessories, see [Mounting Track and End Clamps](#), page 21-18.

[4] Some products may be discontinued. Refer to [www.se.com/us](#) for the most current product information.

[5] One end-barrier is required for each assembly of like blocks.

[6] Orders must specify the standard package quantity (Std. Pack) or multiples of that quantity.

Double and Triple Deck, Grounding, Component Carriers, Blade Isolators

Table 21.4: Spring Double and Triple Deck Passthrough [7]



Description	Max. Voltage	Max. Current [8]	Block			End Barrier [9]		
			Color	Catalog Number	Std. Pack [10]	Color	Catalog Number	Std. Pack [10]
 5.2 mm (0.21 in.) wide	600 V	20 A	Grey	NSYTRR24D	50	Grey	NSYTRACRE24	50
			Blue	NSYTRR24DBL		Grey	NSYTRACRE24	
 6.2 mm (0.24 in.) wide	600 V	30 A	Grey	NSYTRR44D	50	Grey	NSYTRACRE44	50
			Blue	NSYTRR44DBL		Grey	NSYTRACRE44	
 5.2 mm (0.21 in.) wide	600 V	20 A	Grey	NSYTRR26T	50	Grey	NSYTRACRE26	50
			Blue	NSYTRR26TBL		Grey	NSYTRACRE26	

Table 21.5: Spring Grounding Double Deck [7]

Description	Block			End Barrier [9]		
	Color	Catalog Number	Std. Pack [10]	Color	Catalog Number	Std. Pack [10]
 5.2 mm (0.21 in.) wide	Green/Yellow	NSYTRR24DPE	50	Grey	NSYTRACRE24	50
 6.2 mm (0.24 in.) wide	Green/Yellow	NSYTRR44DPE	50	Grey	NSYTRACRE44	50

Table 21.6: Spring Component Carriers [7]

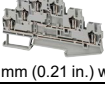

Description	Max. Voltage	Max. Current [8]	Color	Catalog Number	Std. Pack [10]	End Barrier [9]			
						Color	Catalog Number	Std. Pack [10]	
 5.2 mm (0.21 in.) wide	300 V	16 A	Grey	NSYTRR22TB	50	Grey	NSYTRACR23	50	
			Depends on fuse or diode used	Black	NSYTRASF520	10	Not required		
				Black	NSYTRASF520M	10			
				Black	NSYTRASF520B	10			
			Grey	NSYTRASV1	10				
			Grey	NSYTRASV2	10				
 5.2 mm (0.21 in.) wide	300 V	16 A	Grey	NSYTRR23TB	50	Grey	NSYTRACR24	50	
			Depends on fuse or diode used	Black	NSYTRASF520	10	Not required		
				Black	NSYTRASF520M	10			
				Black	NSYTRASF520B	10			
			Grey	NSYTRASV1	10				
			Grey	NSYTRASV2	10				

Table 21.7: Spring Blade Isolators [7]

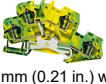
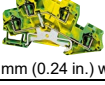
Description	Max. Voltage	Max. Current [8]	Block			End Barrier [9]		
			Color	Catalog Number	Std. Pack [10]	Color	Catalog Number	Std. Pack [10]
 5.2 mm (0.21 in.) wide	600 V	16 A	Grey	NSYTRR22SC	50	Grey	NSYTRACR23	50
			Orange	NSYTRR22SCAR		Grey	NSYTACR23	
 5.2 mm (0.21 in.) wide	600 V	16 A	Grey	NSYTRR23SC	50	Grey	NSYTACR24	50
			Orange	NSYTRR23SCAR		Grey	NSYTACR24	
 5.2 mm (0.21 in.) wide	300 V	10 A	Grey	NSYTRR24SCD	50	Not required for this block.		

NOTE: For a complete listing of these products, see **Linergy TR Terminal Blocks** online or catalog **9080CT1301**.

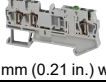
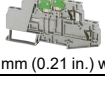

File: E87739
CCN: XCFR2



File: 256444
Class: 6228-01



RoHS Compliant

For track and accessories, see **Mounting Track and End Clamps**, page 21-18.

[7] Some products may be discontinued. Refer to www.se.com/us for the most current product information.

[8] These maximum current values assume the use of insulated copper conductors with 167 °F (75 °C) temperature rating and are calculated based on NEC Article 310, Table 310-16. In most cases this value is the maximum ampacity of the wire which has the greatest current carrying capacity. The actual allowable current for a particular application depends on the size, insulation class, and other characteristics of the wire used. The UL ratings are shown. The CSA rating may be higher or lower. Refer to the catalog for CSA ratings.

[9] One end-barrier is required for each assembly of like blocks.

[10] Orders must specify the standard package quantity (Std. Pack) or multiples of that quantity.

Miniature Spring Passthrough and Grounding

Table 21.8: Miniature Spring Passthrough DIN Rail Mounting [11]



Description	Maximum Voltage	Maximum Current [12]	Block			End Barrier [13]		
			Color	Catalog Number	Std. Pack [14]	Color	Catalog Number	Std. Pack [14]
 5.2 mm (0.21 in.) wide Two Terminals Solid or Stranded Copper Wire 28–12 AWG Mount on DIN Rail 15 x 7.2 mm	600 V	20 A	Grey	NSYTRR22M	50	Grey	NSYTRACRM22	50
			Blue	NSYTRR22MBL		Grey	NSYTRACRM22	
 10.4 mm (0.41 in.) wide Four Terminals Solid or Stranded Copper Wire 28–12 AWG Mount on DIN Rail 15 x 7.2 mm	600 V	20 A	Grey	NSYTRR24M	50	Grey	NSYTRACRM22	50
			Blue	NSYTRR24MBL		Grey	NSYTRACRM22	

Table 21.9: Miniature Spring Grounding Type [11]

Description	Block			End Barrier [13]		
	Color	Catalog Number	Std. Pack [14]	Color	Catalog Number	Std. Pack [14]
 5.2 mm (0.21 in.) wide Grounding Block, Two Terminals, Solid or Stranded Copper Wire 28–12 AWG Mount on DIN Rail 15 x 7.2 mm	Green/Yellow	NSYTRR22MPE	50	Grey	NSYTRACRM22	50

Table 21.10: Miniature Spring Passthrough Direct Mounting and for Micro-Perforated Mounting Plates [11]

Description	Maximum Voltage	Maximum Current [12]	Block			End Barrier [13]		
			Color	Catalog Number	Std. Pack [14]	Color	Catalog Number	Std. Pack [14]
 5.2 mm (0.21 in.) wide Direct Mounting (Flange) Two Terminals Solid or Stranded Copper Wire 28–12 AWG	600 V	20 A	Grey	NSYTRR22MF	50	Grey	NSYTRACRM22	50
			Blue	NSYTRR22MFBL		Grey	NSYTRACRM22	
			Grey	NSYTRR22MFF [15]		Grey	NSYTRACRM22 or NSYTRACRMF22 [15]	
 10.4 mm (0.41 in.) wide Direct Mounting (Flange) Four Terminals Solid or Stranded Copper Wire 28–12 AWG	600 V	20 A	Grey	NSYTRR24MF	50	Grey	NSYTRACRM22	50
			Blue	NSYTRR24MFBL		Grey	NSYTRACRM22	
			Grey	NSYTRR24MFF [15]		Grey	NSYTRACRM22 or NSYTRACRMF22 [15]	
 5.2 mm (0.21 in.) wide For Micro-Perforated Mounting Plates Two Terminals Solid or Stranded Copper Wire 28–12 AWG	600 V	20 A	Grey	NSYTRR22MP	50	Grey	NSYTRACRM22	50
			Blue	NSYTRR22MPBL		Grey	NSYTRACRM22	
 10.4 mm (0.41 in.) wide For Micro-Perforated Mounting Plates Four Terminals Solid or Stranded Copper Wire 28–12 AWG	600 V	20 A	Grey	NSYTRR24MP	50	Grey	NSYTRACRM22	50
			Blue	NSYTRR24MBL		Grey	NSYTRACRM22	

NOTE: For a complete listing of these products, see [Linergy TR Terminal Blocks](#) online or catalog 9080CT1301.



File: E87739, CCN: XCFR2



File: 256444, Class: 6228-01

RoHS
CompliantFor track and accessories, see [Mounting Track and End Clamps](#), page 21-18.

[11] Some products may be discontinued. Refer to [www.se.com/us](#) for the most current product information.

[12] These maximum current values assume the use of insulated copper conductors with 167 °F (75 °C) temperature rating and are calculated based on NEC Article 310, Table 310-16. In most cases this value is the maximum ampacity of the wire which has the greatest current carrying capacity. The actual allowable current for a particular application depends on the size, insulation class, and other characteristics of the wire used. The UL ratings are shown. The CSA rating may be higher or lower. Refer to the catalog for CSA ratings.

[13] One end-barrier is required for each assembly of like blocks.

[14] Orders must specify the standard package quantity (Std. Pack) or multiples of that quantity.

[15] With flange. Can only be used at the end of a group of terminals.

Passthrough and Grounding

Table 21.11: Screw Type Passthrough Blocks [16]

Description	Maximum Voltage	Maximum Current [17]	Block			End Barrier [18]		
			Color	Catalog Number	Std. Pack [19]	Color	Catalog Number	Std. Pack [19]
 5.2 mm (0.21 in.) wide Two Terminals Solid or Stranded Copper Wire 26–12 AWG	600 V	20 A	Grey	NSYTRV22	50	Grey	NSYTRAC22	50
			Blue	NSYTRV22BL		Blue	NSYTRAC22BL	
			Orange	NSYTRV22AR		Grey	NSYTRAC22	
			Red	NSYTRV22RD		Grey	NSYTRAC22	
			White	NSYTRV22WH		Grey	NSYTRAC22	
 6.2 mm (0.24 in.) wide Two Terminals Solid or Stranded Copper Wire 26–10 AWG	600 V	00 A	Grey	NSYTRV42	50	Grey	NSYTRAC22	50
			Blue	NSYTRV42BL		Blue	NSYTRAC22BL	
			Orange	NSYTRV42AR		Grey	NSYTRAC22	
			Red	NSYTRV42RD		Grey	NSYTRAC22	
			Green	NSYTRV42GN		Grey	NSYTRAC22	
			White	NSYTRV42WH		Grey	NSYTRAC22	
			Black	NSYTRV42BK		Grey	NSYTRAC22	
			Brown	NSYTRV42BR		Grey	NSYTRAC22	
			Yellow	NSYTRV42YE		Grey	NSYTRAC22	
 8.2 mm (0.32 in.) wide Two Terminals Solid or Stranded Copper Wire 24–8 AWG	600 V	50 A	Grey	NSYTRV62	50	Grey	NSYTRAC22	50
			Blue	NSYTRV62BL		Blue	NSYTRAC22BL	
 10.2 mm (0.40 in.) wide Two Terminals Solid or Stranded Copper Wire 20–6 AWG	600 V	65 A	Grey	NSYTRV102	50	Grey	NSYTRAC22	50
			Blue	NSYTRV102BL		Blue	NSYTRAC22BL	
 12.2 mm (0.48 in.) wide Two Terminals Solid or Stranded Copper Wire 16–4 AWG	600 V	85 A	Grey	NSYTRV162	50	Grey	NSYTRAC162	50
			Blue	NSYTRV162BL		Grey	NSYTRAC162	
 16 mm (0.63 in.) wide Two Terminals Solid or Stranded Copper Wire 14–1/0 AWG	600 V	150 A	Grey	NSYTRV352	50	Not required for these blocks.		
			Blue	NSYTRV352BL				
 20 mm (0.79 in.) wide Two Terminals Solid or Stranded Copper Wire 6–1/0 AWG	600 V	150 A	Grey	NSYTRV502	50	Not required for these blocks.		
			Blue	NSYTRV502BL				

NOTE: For a complete listing of these products, see catalog [9080CT1301](#).



File: E87739; CCN: XCFR2



File: 256444; Class: 6228-01



RoHS Compliant

For track and accessories, see [page 21-18](#).

[16] Some products may be discontinued. Refer to [www.se.com/us](#) for the most current product information.

[17] These maximum current values assume the use of insulated copper conductors with 167 °F (75 °C) temperature rating and are calculated based on NEC Article 310, Table 310-16. In most cases this value is the maximum ampacity of the wire which has the greatest current carrying capacity. The actual allowable current for a particular application depends on the size, insulation class, and other characteristics of the wire used. The UL ratings are shown. The CSA rating may be higher or lower. Refer to the catalog for CSA ratings.

[18] One end-barrier is required for each assembly of like blocks.

[19] Orders must specify the standard package quantity (Std. Pack) or multiples of that quantity.

Table 21.12: Screw Type Grounding Blocks [20]

Description		Block			End Barrier [21]		
		Color	Catalog Number	Std. Pack [22]	Color	Catalog Number	Std. Pack [22]
	Two Terminals, Solid or Stranded Copper Wire, 26–12 AWG	Green/Yellow	NSYTRV22PE	50	Grey	NSYTRAC22	50
	Two Terminals, Solid or Stranded Copper Wire, 26–10 AWG	Green/Yellow	NSYTRV42PE	50	Grey	NSYTRAC22	50
	Two Terminals, Solid or Stranded Copper Wire, 24–8 AWG	Green/Yellow	NSYTRV62PE	50	Grey	NSYTRAC22	50
	Two Terminals, Solid or Stranded Copper Wire, 20–6 AWG	Green/Yellow	NSYTRV102PE	50	Grey	NSYTRAC22	50
	Grounding Block, Two Terminals, Solid or Stranded Copper Wire, 16–4 AWG	Green/Yellow	NSYTRV162PE	50	Grey	NSYTRAC162	50
	Two Terminals, Solid or Stranded Copper Wire, 14–1/0 AWG	Green/Yellow	NSYTRV352PE	50	Not required for this block.		
	Two Terminals, Solid or Stranded Copper Wire, 6–1/0 AWG	Green/Yellow	NSYTRV502PE	50	Not required for this block.		

NOTE: For a complete listing of these products, see [Linergy TR Terminal Blocks](#) online or catalog [9080CT1301](#).



File: E87739; CCN: XCFR2



File: 256444; Class: 6228-01



RoHS Compliant

For track and accessories, see page 21-18.

[20] Some products may be discontinued. Refer to [www.se.com/us](#) for the most current product information.

[21] One end-barrier is required for each assembly of like blocks.

[22] Orders must specify the standard package quantity (Std. Pack) or multiples of that quantity.

Lug/Lug, Double and Triple Deck Passthrough, Grounding

Table 21.13: Passthrough, Lug/Lug, and Lug/Clamp [23]





Description	Block				Partition Cover		
	Maximum Current ^[24]	Color	Catalog Number	Std. Pack ^[25]	Color	Catalog Number	Std. Pack ^[25]
 20.3 mm (0.80 in.) wide Passthrough Solid or Stranded Copper Wire 4–3/0 AWG Screw thread M8 Maximum Voltage–600 V	192 A	Grey	NSYTRV702	10	Not required for this block.		
 40 mm (1.58 in.) wide Lug to Lug Solid or Stranded Copper Wire 2–4/0 AWG Screw thread M12 Maximum Voltage–600 V	230 A	Grey	NSYTRV952BB	10	Grey	NSYTRAC952	10
 40 mm (1.58 in.) wide Solid or Stranded Copper Wire 2–4/0 AWG Screw thread M12 Maximum Voltage–600 V	230 A	Grey	NSYTRV952BC	10	Grey	NSYTRAC952	10
 46 mm (1.81 in.) wide Lug to Lug Solid or Stranded Copper Wire 2–300 AWG/kcmil Screw thread M12 Maximum Voltage–600 V	285 A	Grey	NSYTRV1502BB	10	Grey	NSYTRAC952	10

Table 21.14: Screw Type Double and Triple Deck Passthrough [23]





Description	Maximum Voltage	Maximum Current ^[24]	Block			End Barrier ^[26]		
			Color	Catalog Number	Std. Pack ^[25]	Color	Catalog Number	Std. Pack ^[25]
 6.2 mm (0.24 in.) wide Double Deck, One Pole, Three Terminals Solid or Stranded Copper Wire 26–10 AWG	150 V	30 A	Grey	NSYTRV43	50	Grey	NSYTRAC23	50
			Blue	NSYTRV43BL		Grey	NSYTRAC23	
 6.2 mm (0.24 in.) wide Double Deck, One Pole, Four Terminals Solid or Stranded Copper Wire 26–10 AWG	150 V	30 A	Grey	NSYTRV44	50	Grey	NSYTRAC24	50
			Blue	NSYTRV44BL		Grey	NSYTRAC24	
 5.2 mm (0.21 in.) wide Double Deck, Two Poles, Four Terminals Solid or Stranded Copper Wire 26–12 AWG	600 V	20 A	Grey	NSYTRV24D	50	Grey	NSYTRACE24	50
			Blue	NSYTRV24DBL		Grey	NSYTRACE24	
 6.2 mm (0.24 in.) wide Double Deck, Two Poles, Four Terminals Solid or Stranded Copper Wire 26–10 AWG	600 V	30 A	Grey	NSYTRV44D	50	Grey	NSYTRACE24	50
			Blue	NSYTRV44DBL		Grey	NSYTRACE24	
 5.2 mm (0.21 in.) wide Triple Deck, Three Poles, Six Terminals Solid or Stranded Copper Wire 26–10 AWG	600 V	20 A	Grey	NSYTRV26T	50	Grey	NSYTRACE26	50

Table 21.15: Screw Type Grounding Double Deck [23]

Description	Block			End Barrier ^[26]		
	Color	Catalog Number	Std. Pack ^[25]	Color	Catalog Number	Std. Pack ^[25]
 6.2 mm (0.24 in.) wide Grounding Block, One Pole, Three Terminals Solid or Stranded Copper Wire 26–12 AWG	Green/Yellow	NSYTRV43PE	50	Grey	NSYTRAC23	50
 6.2 mm (0.24 in.) wide Grounding Block, One Pole, Four Terminals Solid or Stranded Copper Wire 26–12 AWG	Green/Yellow	NSYTRV44PE	50	Grey	NSYTRAC24	50
 5.2 mm (0.21 in.) wide Grounding Block, One Pole, Four Terminals Solid or Stranded Copper Wire 26–12 AWG	Green/Yellow	NSYTRV24DPE	50	Grey	NSYTRACE24	50
 6.2 mm (0.24 in.) wide Grounding Block, One Pole, Four Terminals Solid or Stranded Copper Wire 26–10 AWG	Green/Yellow	NSYTRV44DPE	50	Grey	NSYTRACE24	50

NOTE: For a complete listing of these products, see [Linergy TR Terminal Blocks](#) online.



File: E87739
CCN: XCFR2



File: 256444
Class: 6228-01



RoHS Compliant

For track and accessories, see [page 21-18](#).

[23] Some products may be discontinued. Refer to [www.se.com/us](#) for the most current product information.

[24] These maximum current values assume the use of insulated copper conductors with 167 °F (75 °C) temperature rating and are calculated based on NEC Article 310, Table 310-16. In most cases this value is the maximum ampacity of the wire which has the greatest current carrying capacity. The actual allowable current for a particular application depends on the size, insulation class, and other characteristics of the wire used. The UL ratings are shown. The CSA rating may be higher or lower. Refer to the catalog for CSA ratings.

[25] Orders must specify the standard package quantity (Std. Pack) or multiples of that quantity.

[26] One end-barrier is required for each assembly of like blocks.

Blade Isolators, Component Carriers, Fused, Measuring,
Grounding

Table 21.16: Screw Type Blade Isolators [27]



Description	Maximum Voltage	Maximum Current [28]	Block			End Barrier [29]		
			Color	Catalog Number	Std. Pack [30]	Color	Catalog Number	Std. Pack [30]
 6.2 mm (0.24 in.) wide Blade Isolator Two Terminals Solid or Stranded Copper Wire 26–10 AWG	600 V	16 A	Grey	NSYTRV42SC	50	Not required for this block.		
			Grey with Test Points	NSYTRV42ST				
			Orange with Test Points	NSYTRV42STAR				
 6.2 mm (0.24 in.) wide Blade Isolator Double Deck Four Terminals Solid or Stranded Copper Wire 26–10 AWG	300 V	30 A	Grey	NSYTRV42SCD	50	Grey	NSYTRACE24	50

Table 21.17: Screw Type Component Carrier [27]







Description	Maximum Voltage	Maximum Current [28]	Color	Catalog Number	Std. Pack [30]	End Barrier [29]
 6.2 mm (0.24 in.) wide For fuse 5 x 20 mm For fuse 5 x 20 mm 110–250 V LED For fuse 5 x 20 mm 12–30 V LED For component With 1N4007 diode	Depends on fuse or diode used		Black	NSYTRASF520	10	Not required
				NSYTRASF520M	10	
				NSYTRASF520B	10	
				NSYTRASV1	10	
				NSYTRASV2	10	

Table 21.18: Fused Terminal Blocks [27]

Description	Color	Catalog Number	Std. Pack [30]	End Barrier [29]		
				Color	Catalog Number	Std. Pack [30]
 12 mm (0.47 in.) wide Fuse Block For G-fuse cartridge 5x20 mm Solid or Stranded Copper Wire 24–6 AWG Maximum Voltage 300 V Maximum Current 20 A [28]	Without Indicator Lamp	Black	NSYTRV162SF	50	Not required for this block.	
 8.2 mm (0.32 in.) wide Lever-Type Fuse For G-fuse cartridge 5x20 mm Solid or Stranded Copper Wire 26–10 AWG Maximum Voltage 600 V Maximum Current 12 A [28]	Without Indicator Lamp	Black	NSYTRV42SF5	50	Not required for this block.	
	With Light Indicator, 12–30 V AC/DC [31]	Black	NSYTRV42SF5LD	50		
 10.2 mm (0.40 in.) wide Lever-Type Fuse For G-fuse cartridge 6.3x32 mm Solid or Stranded Copper Wire 26–8 AWG Maximum Voltage 600 V Maximum Current 10 A [28]	Without Indicator Lamp	Black	NSYTRV42SF6	50	Not required for this block.	
	With Light Indicator, 12–30 V AC/DC [31]	Black	NSYTRV42SF6LD	50		
	With Light Indicator, 110–250 V AC/DC [31]	Black	NSYTRV42SF6LA	50		

These measuring transducer terminal blocks with screw connection technology are characterized by easy operation and clarity. All switching statuses are clearly visible. The extensive range of flexible accessories saves cost and time when executing transducer test circuit tasks.

Table 21.19: Measuring and Grounding Terminal Blocks [27]

Description	Maximum Voltage	Maximum Current [28]	Block			End Barrier [29]		
			Color	Catalog Number	Std. Pack [30]	Color	Catalog Number	Std. Pack [30]
 8.2 mm (0.32 in.) wide Blade Isolator Double Deck Solid or Stranded Copper Wire 24–8 AWG	600 V	30 A	Grey	NSYTRV62TTD	50	Grey	NSYTRACT22	50
 8.2 mm (0.32 in.) wide Passthrough Two Terminals Solid or Stranded Copper Wire 24–8 AWG	600 V	30 A	Grey	NSYTRV62TT	50			
 8.2 mm (0.32 in.) wide Grounding Block Two Terminals Solid or Stranded Copper Wire 24–8 AWG	N/A	N/A	Green/ Yellow	NSYTRV62TTPE	50			

NOTE: For a complete listing of these products, see [Linergy TR Terminal Blocks](#) online or catalog 9080CT1301.

[27] Some products may be discontinued. Refer to [www.se.com/us](#) for the most current product information.

[28] These maximum current values assume the use of insulated copper conductors with 167 °F (75 °C) temperature rating and are calculated based on NEC Article 310, Table 310-16. In most cases this value is the maximum ampacity of the wire which has the greatest current carrying capacity. The actual allowable current for a particular application depends on the size, insulation class, and other characteristics of the wire used. The UL ratings are shown. The CSA ratings may be higher or lower. Refer to the catalog for CSA ratings.

[29] One end-barrier is required for each assembly of like blocks.

[30] Orders must specify the standard package quantity (Std. Pack) or multiples of that quantity.

[31] When voltage is applied within the minimum and maximum limits, the LED will illuminate.



File:
E87739
CCN:
XCFR2



File:
256444
Class:
6228-01



RoHS
Compliant

For track and accessories, see [Mounting Track and End Clamps](#), page 21-18.

Miniature Passthrough and Hybrid Passthrough

Table 21.20: Screw Type Miniature Passthrough [32]





Description	Maximum Voltage	Maximum Current [33]	Block			End Barrier [34]		
			Color	Catalog Number	Std. Pack [35]	Color	Catalog Number	Std. Pack [35]
 Two Terminals Solid or Stranded Copper Wire 24–12 AWG Mount on DIN rail, 5 x 5 mm 5.2 mm (0.21 in.) wide	600 V	20 A	Grey	NSYTRV22M	50	Grey	NSYTRACM22	50
			Blue	NSYTRV22MBL		Grey	NSYTRACM22	
 Two Terminals Solid or Stranded Copper Wire 24–10 AWG Mount on DIN rail, 5 x 5 mm 6.2 mm (0.24 in.) wide	600 V	30 A	Grey	NSYTRV42M	50	Grey	NSYTRACM22	50
			Blue	NSYTRV42MBL		Grey	NSYTRACM22	

Table 21.21: Screw Type Miniature Grounding Blocks [32]

Description	Block			End Barrier [34]		
	Color	Catalog Number	Std. Pack [35]	Color	Catalog Number	Std. Pack [35]
 Grounding Block Two Terminals Solid or Stranded Copper Wire 24–12 AWG Mount on DIN rail, 5 x 5 mm 5.2 mm (0.21 in.) wide	Green/Yellow	NSYTRV22MPE	50	Grey	NSYTRACM22	50
 Grounding Block Two Terminals Solid or Stranded Copper Wire 24–10 AWG Mount on DIN rail, 5 x 5 mm 6.2 mm (0.24 in.) wide	Green/Yellow	NSYTRV42MPE	50	Grey	NSYTRACM22	50

NOTE: For a complete listing of these products, see [Linergy TR Terminal Blocks](#) online or catalog **9080CT1301**.



File:
E87739
CCN:
XCFR2



File:
256444
Class:
6228-01



RoHS
Compliant

For track and accessories, see [Mounting Track and End Clamps](#), page 21-18.

[32] Some products may be discontinued. Refer to [www.se.com/us](#) for the most current product information.

[33] These maximum current values assume the use of insulated copper conductors with 167 °F (75 °C) temperature rating and are calculated based on NEC Article 310, Table 310-16. In most cases this value is the maximum ampacity of the wire which has the greatest current carrying capacity. The actual allowable current for a particular application depends on the size, insulation class, and other characteristics of the wire used. The UL ratings are shown. The CSA rating may be higher or lower. Refer to the catalog for CSA ratings.

[34] One end-barrier is required for each assembly of like blocks.

[35] Orders must specify the standard package quantity (Std. Pack) or multiples of that quantity.

Table 21.22: Hybrid Blocks—Screw and Insulation Displacement Connection (IDC) Passthrough [36]





Description	Maximum Voltage	Maximum Current [37]	Block			End Barrier [38]		
			Color	Catalog Number	Std. Pack [39]	Color	Catalog Number	Std. Pack [39]
 Two Terminals Solid or Stranded Copper Wire 24–16 AWG 5.2 mm (0.21 in.) wide	600 V	10 A	Grey	NSYTRH12	50	Grey	NSYTRACH12	50
 Three Terminals Solid or Stranded Copper Wire 24–16 AWG 5.2 mm (0.21 in.) wide	600 V	10 A	Grey	NSYTRH13	50	Grey	NSYTRACH13	50
 Three Terminals Solid or Stranded Copper Wire 20–14 AWG 6.2 mm (0.24 in.) wide	600 V	15 A	Grey	NSYTRH22	50	Grey	NSYTRACH22	50

Table 21.23: Hybrid Grounding Block—Screw and Insulation Displacement Connection (IDC) Passthrough [36]

Description	Block			End Barrier [38]		
	Color	Catalog Number	Std. Pack [39]	Color	Catalog Number	Std. Pack [39]
 Grounding Block Two Terminals Solid or Stranded Copper Wire 24–16 AWG 5.2 mm (0.21 in.) wide	Green/Yellow	NSYTRH12PE	50	Grey	NSYTRACH12	50

NOTE: For a complete listing of these products, see [Linergy TR Terminal Blocks](#) online or catalog 9080CT1301.



File:
E87739
CCN:
XCFR2



File:
256444
Class:
6228-01



RoHS
Compliant

For track and accessories, see [Mounting Track and End Clamps](#), page 21-18.

[36] Some products may be discontinued. Refer to [www.se.com/us](#) for the most current product information.

[37] These maximum current values assume the use of insulated copper conductors with 167 °F (75 °C) temperature rating and are calculated based on NEC Article 310, Table 310-16. In most cases this value is the maximum ampacity of the wire which has the greatest current carrying capacity. The actual allowable current for a particular application depends on the size, insulation class, and other characteristics of the wire used. The UL ratings are shown. The CSA rating may be higher or lower. Refer to the catalog for CSA ratings.

[38] One end-barrier is required for each assembly of like blocks.

[39] Orders must specify the standard package quantity (Std. Pack) or multiples of that quantity.

Passthrough and Grounding

Push-in technology terminal blocks feature simple handling and direct, tool-free connections. When pushing in solid wires or wires with ferrules, the contact spring is automatically opened and ensures the required pressure force against the current bar.

Table 21.24: Push-in Passthrough Blocks [40]

Description	Maximum Voltage	Maximum Current [41]	Block			End Barrier [42]		
			Color	Catalog Number	Std. Pack [43]	Color	Catalog Number	Std. Pack [43]
 Two Terminals Solid or Stranded Copper Wire 24–12 AWG 5.2 mm (0.21 in.) wide	600 V	20 A	Grey	NSYTRP22	50	Grey	NSYTRACR22	50
			Blue	NSYTRP22BL		Blue	NSYTRACR22BL	
			Orange	NSYTRP22AR		Grey	NSYTRACR22	
 Three Terminals Solid or Stranded Copper Wire 24–12 AWG 5.2 mm (0.21 in.) wide	600 V	20 A	Grey	NSYTRP23	50	Grey	NSYTRACR23	50
			Blue	NSYTRP23BL		Blue	NSYTRACR23BL	
			Orange	NSYTRP23AR		Grey	NSYTRACR23	
 Four Terminals Solid or Stranded Copper Wire 24–12 AWG 5.2 mm (0.21 in.) wide	600 V	20 A	Grey	NSYTRP24	50	Grey	NSYTRACR24	50
			Blue	NSYTRP24BL		Blue	NSYTRACR24BL	
 Two Terminals Solid or Stranded Copper Wire 24–10 AWG 6.2 mm (0.24 in.) wide	600 V	30 A	Grey	NSYTRP42	50	Grey	NSYTRACR42	50
			Blue	NSYTRP42BL		Grey	NSYTRACR42	
 Three Terminals Solid or Stranded Copper Wire 24–10 AWG 6.2 mm (0.24 in.) wide	600 V	30 A	Grey	NSYTRP43	50	Grey	NSYTRACP43	50
			Blue	NSYTRP43BL		Grey	NSYTRACP43	
 Four Terminals Solid or Stranded Copper Wire 24–10 AWG 6.2 mm (0.24 in.) wide	600 V	30 A	Grey	NSYTRP44	50	Grey	NSYTRACP44	50
			Blue	NSYTRP44BL		Grey	NSYTRACP44	

NOTE: For a complete listing of these products, see catalog [9080CT1301](#).



File:
E87739
CCN:
XCFR2



File:
256444
Class:
6228-01



RoHS
Compliant

For track and accessories, see [Mounting Track and End Clamps, page 21-18](#).







[40] Some products may be discontinued. Refer to [www.se.com/us](#) for the most current product information.

[41] These maximum current values assume the use of insulated copper conductors with 167 °F (75 °C) temperature rating and are calculated based on NEC Article 310, Table 310-16. In most cases this value is the maximum ampacity of the wire which has the greatest current carrying capacity. The actual allowable current for a particular application depends on the size, insulation class, and other characteristics of the wire used. The UL ratings are shown. The CSA rating may be higher or lower. Refer to the catalog for CSA ratings.

[42] One end-barrier is required for each assembly of like blocks.

[43] Orders must specify the standard package quantity (Std. Pack) or multiples of that quantity.

Table 21.25: Push-in Grounding Blocks [44]

Description	Block			End Barrier [45]			
	Color	Catalog Number	Std. Pack [46]	Color	Catalog Number	Std. Pack [46]	
 5.2 mm (0.21 in.) wide Grounding Block Two Terminals Solid or Stranded Copper Wire 24–12 AWG	Green/Yellow	NSYTRP22PE	50	Grey	NSYTRACR22	50	
 5.2 mm (0.21 in.) wide Grounding Block Three Terminals Solid or Stranded Copper Wire 24–12 AWG	Green/Yellow	NSYTRP23PE	50	Grey	NSYTRACR23	50	
 5.2 mm (0.21 in.) wide Grounding Block Four Terminals Solid or Stranded Copper Wire 24–12 AWG	Green/Yellow	NSYTRP24PE	50	Grey	NSYTRACR24	50	
 6.2 mm (0.24 in.) wide Grounding Block Two Terminals Solid or Stranded Copper Wire 24–10 AWG	Green/Yellow	NSYTRP42PE	50	Grey	NSYTRACR42	50	
 6.2 mm (0.24 in.) wide Grounding Block Three Terminals Solid or Stranded Copper Wire 24–10 AWG	Green/Yellow	NSYTRP43PE	50	Grey	NSYTRACP43	50	
 6.2 mm (0.24 in.) wide Grounding Block Four Terminals Solid or Stranded Copper Wire 24–10 AWG	Green/Yellow	NSYTRP44PE	50	Grey	NSYTRACP44	50	

NOTE: For a complete listing of these products, see [Linergy TR Terminal Blocks](#) online or catalog 9080CT1301.



File:
E87739
CCN:
XCFR2



File:
702070
Class:
6228-01



RoHS
Compliant

For track and accessories, see [Mounting Track and End Clamps](#), page 21-18.

[44] Some products may be discontinued. Refer to [www.se.com/us](#) for the most current product information.

[45] One end-barrier is required for each assembly of like blocks.

[46] Orders must specify the standard package quantity (Std. Pack) or multiples of that quantity.

Double Deck Passthrough, Blade Isolators, Component Carriers

Table 21.26: Push-in Double Deck Passthrough and Grounding Terminal Blocks [47]



Description	Maximum Voltage	Maximum Current [48]	Block			End Barrier [49]		
			Color	Catalog Number	Std. Pack [50]	Color	Catalog Number	Std. Pack [50]
 Double Deck Passthrough Four Terminals Solid or Stranded Copper Wire 26–12 AWG 5.2 mm (0.21 in.) wide	600 V	20 A	Grey	NSYTRP24D	50	Grey	NSYTRACRE24	50
			Blue	NSYTRP24DBL		Grey	NSYTRACRE24	
 Double Deck Grounding Block Four Terminals Solid or Stranded Copper Wire 26–12 AWG 5.2 mm (0.21 in.) wide	N/A	N/A	Green/Yellow	NSYTRP24DPE	50	Grey	NSYTRACRE24	50

Table 21.27: Push-in Blade Isolators [47]



Description	Maximum Voltage	Maximum Current [51]	Block			End Barrier [49]		
			Color	Catalog Number	Std. Pack [50]	Color	Catalog Number	Std. Pack [50]
 Blade Isolator Two Terminals Solid or Stranded Copper Wire 26–12 AWG 5.2 mm (0.21 in.) wide	300 V	20 A	Grey	NSYTRP22SC	50	Grey	NSYTRACPK22	50
 Blade Isolator Three Terminals Solid or Stranded Copper Wire 26–12 AWG 5.2 mm (0.21 in.) wide	300 V	20 A	Grey	NSYTRP23SC	50	Grey	NSYTRACPK23	50
 Blade Isolator Four Terminals Solid or Stranded Copper Wire 26–12 AWG 5.2 mm (0.21 in.) wide	300 V	20 A	Grey	NSYTRP24SC	50	Grey	NSYTRACPK24	50

Table 21.28: Push-In Type Component Carriers [47]

Description	Maximum Voltage	Maximum Current [51]	Color	Catalog Number	Std. Pack [50]	End Barrier [49]					
						Color	Catalog Number	Std. Pack [50]			
 Component Carrier Two Terminals Solid or Stranded Copper Wire 26–12 AWG 5.2 mm (0.21 in.) wide	300 A	20 A	Grey	NSYTRP22TB	50	Grey	NSYTRACPK22	50			
				Depends on fuse or diode used	Black				NSYTRASF520	10	Not required
					Black				NSYTRASF520M	10	
					Black				NSYTRASF520B	10	
				Grey	NSYTRASV1				10		
Grey	NSYTRASV2	10									
 Component Carrier Two Terminals Solid or Stranded Copper Wire 24–12 AWG 6.2 mm (0.24 in.) wide	300 A	20 A	Grey	NSYTRP42TB	50	Grey	NSYTRACR42	50			
				Depends on fuse or diode used	Black				NSYTRASF520	10	Not required
					Black				NSYTRASF520M	10	
					Black				NSYTRASF520B	10	
				Grey	NSYTRASV1				10		
Grey	NSYTRASV2	10									

NOTE: For a complete listing of these products, see [Linergy TR Terminal Blocks](#) online or catalog **9080CT1301**.

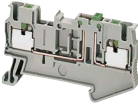
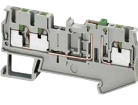
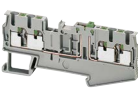
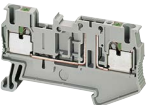
[47] Some products may be discontinued. Refer to [www.se.com/us](#) for the most current product information.

[48] These maximum current values assume the use of insulated copper conductors with 167 °F (75 °C) temperature rating and are calculated based on NEC Article 310, Table 310-16. In most cases this value is the maximum ampacity of the wire which has the greatest current carrying capacity. The actual allowable current for a particular application depends on the size, insulation class, and other characteristics of the wire used. The UL ratings are shown. The CSA rating may be higher or lower. Refer to the catalog for CSA ratings.

[49] One end-barrier is required for each assembly of like blocks.

[50] Orders must specify the standard package quantity (Std. Pack) or multiples of that quantity.

[51] These maximum current values assume the use of insulated copper conductors with 167 °F (75 °C) temperature rating and are calculated based on NEC Article 310, Table 310-16. In most cases this value is the maximum ampacity of the wire which has the greatest current carrying capacity. The actual allowable current for a particular application depends on the size, insulation class, and other characteristics of the wire used. The UL ratings are shown. The CSA rating may be higher or lower. Refer to the catalog for CSA ratings.



File:
E87739
CCN:
XCFR2



File:
256444
Class:
6228-01









RoHS
Compliant

For track and accessories, see Mounting Track and End Clamps, page 21-18.

Linery Marking Accessories

Table 21.29: Markers [52]





Description	Marking	Catalog Number	Std Pack[53]	
 <p>Black horizontal markings on white background For 5.2 mm (0.21 in.) wide blocks Lateral sides for NSYTRV terminal blocks Central shaft for NSYTRR / NSYTRP / NSYTRH terminal blocks</p>	1 to 10	NSYTRAB510	10	
	11 to 20	NSYTRAB520	10	
	21 to 30	NSYTRAB530	10	
	31 to 40	NSYTRAB540	10	
	41 to 50	NSYTRAB550	10	
	51 to 60	NSYTRAB560	10	
	61 to 70	NSYTRAB570	10	
	71 to 80	NSYTRAB580	10	
	81 to 90	NSYTRAB590	10	
	91 to 100	NSYTRAB5100	10	
	1 to 100	NSYTRAB51100	1	
	L1, L2, L3, N, PE	NSYTRAB5L1N	10	
	 <p>Black horizontal markings on white background For 6.2 mm (0.24 in.) wide blocks Lateral sides for NSYTRV terminal blocks Central shaft for NSYTRR / NSYTRP / NSYTRH terminal blocks</p>	1 to 10	NSYTRAB610	10
		11 to 20	NSYTRAB620	10
		21 to 30	NSYTRAB630	10
31 to 40		NSYTRAB640	10	
41 to 50		NSYTRAB650	10	
51 to 60		NSYTRAB660	10	
61 to 70		NSYTRAB670	10	
71 to 80		NSYTRAB680	10	
81 to 90		NSYTRAB690	10	
91 to 100		NSYTRAB6100	10	
1 to 100		NSYTRAB61100	1	
L1, L2, L3, N, PE		NSYTRAB6L1N	10	
 <p>Black horizontal markings on white background For 8.2 mm (0.32 in.) wide blocks Lateral sides for NSYTRV terminal blocks Central shaft for NSYTRR / NSYTRP / NSYTRH terminal blocks</p>		1 to 10	NSYTRAB810	10
		11 to 20	NSYTRAB820	10
		21 to 30	NSYTRAB830	10
	31 to 40	NSYTRAB840	10	
	41 to 50	NSYTRAB850	10	
	51 to 60	NSYTRAB860	10	
	61 to 70	NSYTRAB870	10	
	71 to 80	NSYTRAB880	10	
	81 to 90	NSYTRAB890	10	
	91 to 100	NSYTRAB8100	10	
	1 to 100	—	—	
	L1, L2, L3, N, PE	—	—	
	 <p>Flat markers Black horizontal markings on white background Lateral sides for NSYTRV terminal blocks Central shaft for NSYTRR / NSYTRP / NSYTRH terminal block</p>	1 to 10	NSYTRAB1010	10
		11 to 20	NSYTRAB1020	10
		21 to 30	NSYTRAB1030	10
31 to 40		NSYTRAB1040	10	
41 to 50		NSYTRAB1050	10	
51 to 60		NSYTRAB1060	10	
61 to 70		NSYTRAB1070	10	
71 to 80		NSYTRAB1080	10	
81 to 90		NSYTRAB1090	10	
91 to 100		NSYTRAB10100	10	
1 to 100		—	—	
L1, L2, L3, N, PE		—	—	
 <p>Flat markers Black horizontal markings on white background For 5.2 mm (0.21 in.) wide blocks Lateral sides for NSYTRV terminal blocks Central shaft for NSYTRR / NSYTRP / NSYTRH terminal blocks</p>		1 to 10	NSYTRABF510	10
		11 to 20	NSYTRABF520	10
		21 to 30	NSYTRABF530	10
	31 to 40	NSYTRABF540	10	
	41 to 50	NSYTRABF550	10	
	51 to 60	—	—	
	61 to 70	—	—	
	71 to 80	—	—	
	81 to 90	—	—	
	91 to 100	—	—	
	1 to 100	—	—	
	L1, L2, L3, N, PE	—	—	
	 <p>Flat markers Black horizontal markings on white background For 6.2 mm (0.24 in.) wide blocks Lateral sides for NSYTRV terminal blocks Central shaft for NSYTRR / NSYTRP / NSYTRH terminal block</p>	1 to 10	NSYTRABF610	10
		11 to 20	NSYTRABF620	10
		21 to 30	NSYTRABF630	10
31 to 40		NSYTRABF640	10	
41 to 50		NSYTRABF650	10	
51 to 60		—	—	
61 to 70		—	—	
71 to 80		—	—	
81 to 90		—	—	
91 to 100		—	—	
1 to 100		—	—	
L1, L2, L3, N, PE		—	—	

NOTE: Refer to catalog 9080CT1301 for additional labeling options.

[52] Some products may be discontinued. Refer to www.se.com/us for the most current product information.
[53] For blocks 12.2 mm (0.48 in.) or wider, the strip must be broken and the individual marking characters used.

Lineray Labeling System

Table 21.30: Blank Markers [54]

Description		Catalog Number	Std. Pack
 Blank marking cards for 5.2 mm (0.21 in.) wide blocks	72 characters (6 strips)	NSYTRABPV5	10
	Plotter adapter for marking cards	NSYTRABMP1	1
 Blank marking cards for 6.2 mm (0.24 in.) wide blocks	60 characters (6 strips)	NSYTRABPV6	10
	Plotter adapter for marking cards	NSYTRABMP1	1
 Blank marking cards for 8.2 mm (0.32 in.) wide blocks	42 characters (6 strips)	NSYTRABPV8	10
	Plotter adapter for marking cards	NSYTRABMP1	1
 Blank flat marking cards for 5.2 mm (0.21 in.) wide blocks	72 characters (6 strips)	NSYTRABFPV5	10
	Plotter adapter for marking cards	NSYTRABMP2	1
 Blank flat marking cards for 6.2 mm (0.24 in.) wide blocks	60 characters (6 strips)	NSYTRABFPV6	10
	Plotter adapter for marking cards	NSYTRABMP2	1

RoHS Compliant





NOTE: Refer to catalog **9080CT1301** for additional labeling options.

[54] Some products may be discontinued. Refer to www.se.com/us for the most current product information.

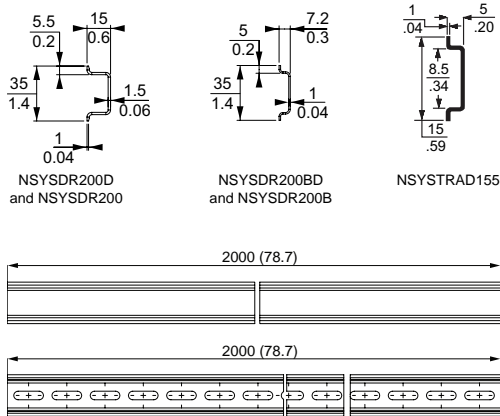
Mounting Track and End Clamps

Table 21.31: DIN 3 Track—78.74 inches (2 meter) length [1]



Description	Length		Catalog Number	Std. Pack [2]
	In.	mm		
DIN 3				
Symmetrical rail 35x15 mm depth, 1.5 mm thick galvanized steel, Prepunched	78.74	2000	NSYSR200D	20
Symmetrical rail 35x15 mm depth, 1.5 mm thick galvanized steel, No mounting holes	78.74	2000	NSYSR200	20
Symmetrical rail 35x7.2 mm depth, 1 mm thick galvanized steel, Prepunched	78.74	2000	NSYSR200BD	20
Symmetrical rail 35x7.2 mm depth, 1 mm thick galvanized steel, No mounting holes	78.74	2000	NSYSR200B	20
DIN 2				
Symmetrical rail 15x5 mm depth, 1 mm thick galvanized steel, Prepunched	78.74	2000	NSYTRAD155	5
End Clamps				
 Plastic clip-on end clamp for 35 mm DIN 3 track	0.21	5.2	NSYTRAAB35	50
 Plastic clip-on end clamp with screw for 35 mm DIN 3 track	0.37	9.5	NSYTRAABV35	50
 Plastic clip-on end clamp for 15 mm DIN 2 track	0.21	5.2	NSYTRAAB15	50
 Polycarbonate end clamp for 35 mm DIN 3 track	0.31	8	9080MHA10	50
RoHS Compliant				

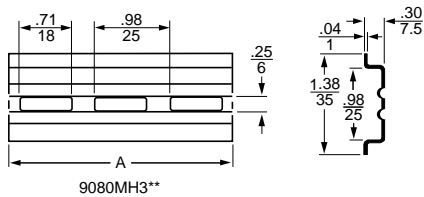
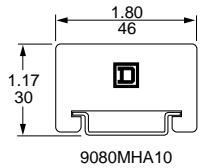







Table 21.32: DIN 3 Track – Various Lengths [1]

Description	Length		Class 9080 Type	Std. [2] Pack	
	In.	mm			
Galvanized steel, no mounting holes	3	0.08	9080MH203	10	
	6	0.15	9080MH206		
	7	0.18	9080MH207		
	8	0.20	9080MH208		
	12	0.30	9080MH212		
	16	0.41	9080MH216		
	19.68	500	9080MH220		
	39.37	1000	9080MH239		
	78.74	2000	9080MH279		
	Symmetrical rail 35 x 7.5 mm (1.38 in. x 0.295 in.) in compliance with EN 50022 standard (DIN 46277-3).	3	0.08		9080MH303
4		0.10	9080MH304		
5		0.13	9080MH305		
6		0.15	9080MH306		
7		0.18	9080MH307		
8		0.20	9080MH308		
9		0.23	9080MH309		
10		0.25	9080MH310		
11		0.28	9080MH311		
12		0.30	9080MH312		
13		0.33	9080MH313		
14		0.36	9080MH314		
15		0.38	9080MH315		
16		0.41	9080MH316		
17		0.43	9080MH317		
18		0.46	9080MH318		
19.68		500	9080MH320		
39.37		1000	9080MH339		
78.74		2000	9080MH379		
High rise track	Aluminum	39.37	1000	9080MH439	2

[1] Some products may be discontinued. Refer to www.se.com/us for the most current product information.
[2] Orders must specify the standard package quantity (Std. Pack) or multiples of that quantity.

Selection Guide

Table 21.33: Type G Selection Guide [1]

Description	Max. Voltage	Max. Current [2]	Blocks			End Barriers [3]		Blocks per ft.	Maximum Wire Combinations	
			Color	Type	Std. Pack [4]	Type	Std. Pack [4]		Copper Wire (stranded or solid)	
 <p>Solderless Box Lug for #22 to #8 AWG wire. Mounts on standard 9080GH track or 35 mm DIN 3 track. Fingersafe per DIN 60529.</p>	600 V	60 A	Natural	9080GR6	50	9080GM6B	10	34	1 #8	1-4 #16 1-5 #18 1-8 #20 1-10 #22
			Black	9080GRB6		9080GMB6B				
			Blue [1]	9080GRL6		9080GML6B				
			Green [1]	9080GRG6		9080GMG6B				
			Gray	9080GRE6		9080GME6B				
			Orange [1]	9080GRS6		9080GMS6B				
			Red	9080GRR6		9080GMR6B				
			Yellow [1]	9080GRY6		9080GMY6B				
			Brown [1]	9080GRN6		9080GMN6B				
 <p>Solderless Box Lug for #22 to #10 AWG wire. Can be mounted directly to a panel or can be mounted on 9080GH track.</p>	600 V	40 A	Natural	9080GK6	50	9080GK6B	50	34	1-4 #16 1 #10 1-2 #12 1-2 #14	1-4 #16 1-5 #18 1-8 #20 1-10 #22
			Black	9080GKB6						
			Blue	9080GKL6						
			Green	9080GKG6						
			Gray [1]	9080GKE6						
			Orange	9080GKS6						
			Red	9080GKR6						
Yellow [1]	9080GKY6									
 <p>High Density Solderless Box Lug for #22 to #10 AWG wire. Mounts on standard 9080GH track or 35 mm DIN 3 track. Fingersafe per DIN 60529.</p>	600 V	30 A	Natural	9080GM6	50	9080GM6B	10	51	1 #10 1 #12 1 #14 1-2 #16	1-2 #18 1-5 #20 1-8 #22 1-2 #16
			Black	9080GMB6		9080GMB6B				
			Blue [1]	9080GML6		9080GML6B				
			Green [1]	9080GMG6		9080GMG6B				
			Gray	9080GME6		9080GME6B				
			Orange [1]	9080GMS6		9080GMS6B				
			Red	9080GMR6		9080GMR6B				
			Yellow [1]	9080GMY6		9080GMY6B				
			Brown [1]	9080GMN6		9080GMN6B				
 <p>Solderless Box Lug for #18 to #4 AWG wire. Mounts on standard 9080GH track or 35 mm DIN 3 track.</p>	600 V	85 A	Natural	9080GC6	50	9080GC6B	10	28	1 #4 1 #6 1-2 #8 1-4 #10	1-5 #12 1-6 #14 1-6 #16 1-8 #18
 <p>Solderless Box Lug for #12 to #1/0 AWG wire. Mounts on standard 9080GH track or 35 mm DIN 3 track.</p>	600 V	170 A	Natural	9080GD6	10	9080GD6B	10	17	1 1/0 1 #1 1 #2 1-2 #4	1-3 #6 1-5 #8 1-6 #10 1-7 #12
 <p>Solderless Box Lug for #6 AWG to 250 kcmil wire. [5] Mounts on standard 9080GH track or 35 mm DIN 3 track.</p>	600 V	255 A	Natural	9080GE6	10	None Required	10	10	1 250 kcmil [5]	
									1 4/0 1 3/0 1 2/0 1 1/0	1 #1 1 #2 1 #4 1 #6



File: E60616
CCN: XCFR2



File: 062144
Class:3211-07



RoHS Compliant

For standard or custom assemblies, see [Terminal Block Assemblies, page 21-21](#).

For mounting track and accessories, see [Mounting Track, End Clamps, Jumpers, Fanning Strips, page 21-22](#).

For DIN 3 track and end clamps, see [Mounting Track and End Clamps, page 21-18](#).

Table 21.34: How to Order

To Order Specify	Catalog Number	
• Class Number	Class	Type
• Type Number	9080	GR6

[1] Some products may be discontinued. Refer to www.se.com/us for the most current product information.

[2] These maximum current values assume the use of insulated copper conductors with 75 °C (167 °F) temperature rating, temperature rating, and are calculated based on NEC Article 310, Table 310-16. In most cases this value is the maximum ampacity of that wire or combination of wires (as listed in the above table) which has the greatest current carrying capacity. The actual allowable current for a particular application depends on the number, size, insulation class, and other characteristics of the wires used. The lower of the UL and CSA ratings are shown.







[3] One end-barrier is required for each assembly of like blocks.

[4] Orders must specify standard package quantity or multiples of that quantity.

[5] Terminals are tin plated, making them suitable for use with either copper or aluminum wire.

Selection Guide

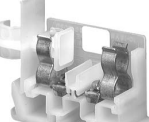
Table 21.35: Type G Selection Guide [6]

Description	Max. Voltage	Max. Current [7]	Blocks		End Barriers [8]		Bloc-ks per ft.	Maximum Wire Combinations	
			Type	Std. Pack [9]	Type	Std. Pack [10]		Copper Wire (stranded or solid)	
 Self-Lifting Pressure Wire Connector for #18 to #12 AWG wire. Mounts on standard 9080GH track or 35 mm DIN 3 track.	600 V	40 A	9080GP6	50	9080GP6B	10	32	1 or 2 1 or 2 1 or 2 1 or 2	#12 #14 #16 #18
 Flat Terminal Connector for #22 to #12 AWG wire. Screws are #6-32 x 5/16 in. for ring or spade lugs, 5/16 in. wide maximum. Mounts on standard 9080GH track or 35 mm DIN 3 track. Fingersafe per DIN 60529.	600 V	40 A	9080GA6	50	9080GP6B	10	32	1 or 2 Conductors Per Screw #12–22	
 Circuit Isolating Switch [11] with self-lifting pressure connectors for #18 to #10 AWG wire. Mounts on standard 9080GH track or 35 mm DIN 3 track.	600 V	30 A	9080GG6 [6]	10	9080GF6B	10	16	1 1 1 1-4 1-4	#10 #12 #14 #16 #18
 Slip-on Connectors for #22 to #12 AWG wire. Tabs accept 0.250 x 0.032 in. slip-on connectors. Mounts on standard 9080GH track or 35 mm DIN 3 track.	600 V	20 A	9080GS6	10	9080GF6B	10	16	1-2 1-2 1-2 1-2 1-2 1-2	#12 #14 #16 #18 #20 #22
 Fuse Block for 13/32 in. Dia. x 1-1/2 in. ferrule fuse with self-lifting pressure connectors. Fuse puller is included as standard. Fuses are not included. Mounts on standard 9080GH track or 35 mm DIN 3 track. Fingersafe per DIN 60529.	600 V	30 A	9080GF6	10	9080GF6B	10	16	1 1 1 1-4 1-4	#10 #12 #14 #16 #18
 Fuse Puller [12]	—	—	9080GH63	50	N/A		N/A	N/A	
 Blown Fuse Indicator/ Pullers are neon pilot lights which plug on to the fuse in a standard Type GF6 fuse block.	120–240 V	—	9080GLP3	10	N/A		N/A	N/A	
	277–600 V	—	9080GLP6	10	N/A		N/A		

For standard or custom assemblies, see [Terminal Block Assemblies, page 21-21](#).
For mounting track and accessories, see [Mounting Track, End Clamps, Jumpers, Fanning Strips, page 21-22](#).
For DIN 3 track and end clamps, see [Mounting Track and End Clamps, page 21-18](#).

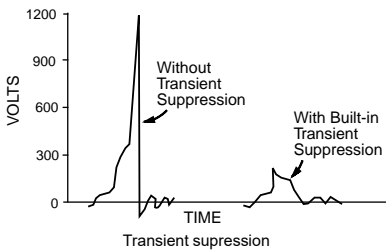

Table 21.36: How to Order

To Order Specify	Catalog Number	
• Class Number	Class	Type
• Type Number	9080	GP6

Terminal Blocks:



File: E60616
CCN: XCFR2



File: 062144
Class: 3211-07



RoHS Compliant

Blown Fuse Indicator:



File: E63698
CCN: JDV5



File: 025490
Class: 3211-07

RoHS Compliant

[6] Some products may be discontinued. Refer to www.se.com/us for the most current product information.
[7] These maximum current values assume the use of insulated copper conductors with 75 °C (167 °F) temperature rating, and are calculated based on NEC Article 310, Table 310-16. In most cases this value is the maximum ampacity of that wire or combination of wires (as listed in the above table) which has the greatest current carrying capacity. The actual allowable current for a particular application depends on the number, size, insulation class, and other characteristics of the wires used. The lower of the UL and CSA ratings are shown.
[8] One end-barrier is required for each assembly of like sections.
[9] Orders must specify standard package quantity or multiples of that quantity.
[10] Orders must specify standard package quantity or multiples of that quantity.
[11] Not intended to make or break a live circuit. Power must be disconnected from the circuit before operation of the switch.
[12] Fuse puller is supplied as standard with Class 9080 Type GF6 fuse block. The 9080GH63 is a replacement fuse puller.

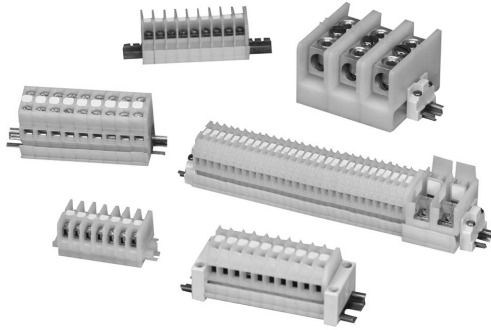

Terminal Block Assemblies
Custom Terminal Block Assemblies

Order an assembly built as required for the application. As standard, custom assemblies use 9080GH mounting track with screw on end clamps. Other options are available from the table below.

One terminal block type: The number of blocks in the assembly is added to the end of the catalog number of the desired block. Example: an assembly of **25** 9080GR6 blocks would be **9080GR625**.

More than one terminal block type in an assembly: A detailed drawing or sketch of the desired assembly must accompany the order.

Table 21.37: Custom Terminal Block Assembly Options [13]

Option	Suffix	Example
Substitute slip-in end clamps	C	9080GR625C
Substitute snap-off channel	B	9080GR625BC [14]
For direct mount assembly of 9080GK6 blocks	D	9080GK67D
Add a blank vinyl marking strip	M	9080GR625M
Add pre-marked (1–25 only) marking strip	MPO	9080GR625MPO
Mount on 35 mm DIN 3 track instead of 9080GH track	T	9080GR625T

Table 21.38: How to Order

To Order Specify	Catalog Number	
• Class Number	Class	Type
• Type Number	9080	GA612

[13] Some products may be discontinued. Refer to www.se.com/us for the most current product information.

[14] The 9080GH10 screw-on end clamp is **not** recommended for use with snap-off channel. It is recommended that the 9080GH11 slip-in end clamp be used. Therefore, when the suffix **B** is used, it should be followed by the suffix **C**.

Mounting Track, End Clamps, Jumpers, Fanning Strips



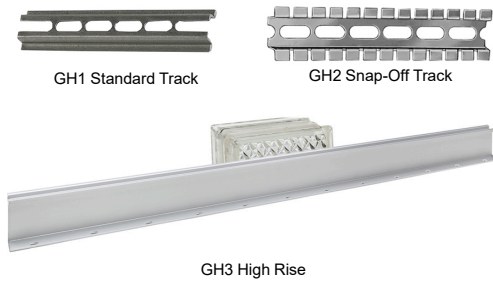







Table 21.39: 3/4 in. Mounting Track [15]



Style	Length (in.)	Type	Std. Pack [16]
Standard Track	3	9080GH103	5
	4	9080GH104	5
	5	9080GH105	5
	6	9080GH106	5
	7	9080GH107	5
	8	9080GH108	5
	9	9080GH109	5
	10	9080GH110	5
	12	9080GH112	5
	13	9080GH113	5
	14	9080GH114	5
	15	9080GH115	5
	16	9080GH116	5
	18	9080GH118	5
	24	9080GH124	5
Snap-Off Track	36	9080GH136	5
	48	9080GH148	5
	72	9080GH172	5
High Rise	36	9080GH236	20
	48	9080GH248	20
	72	9080GH272	20
	36	9080GH336	2

NOTE: For additional track and appropriate end clamps, see Mounting Track and End Clamps, page 21-18.

Table 21.40: End Clamps, Jumpers, and Fanning Strips [15]

Description	Type	Std. Pack [16]
End Clamps		
 Screw-on End Clamp (Not recommended for use on snap-off mounting track)	9080GH10	50
 (Discontinued) Slip-in End Clamp (Not for use with 9080 GE6, GK6 blocks)	9080GH11	50
Jumpers		
 (Discontinued) 2-pole jumper for GM6	9080GH700	20
 6-pole jumper for GM6	9080GH710	10
 6-pole jumper for GK6, GR6	9080GH73	10
 2-pole jumper for GC6	9080GH74	10
 6-pole jumper for GC6	9080GH75	10
 2-pole jumper for GD6	9080GH76	10
 2-pole jumper for GA6, GP6	9080GH78	10
 (Discontinued) 6-pole jumper for GA6, GP6	9080GH79	10
Fanning Strips		
 (Discontinued) Snap-together fanning strip section for GK6, GR6 blocks	9080GH52	10

[15] Some products may be discontinued. Refer to www.se.com/us for the most current product information.

[16] Orders must specify the standard package quantity (Std. Pack) or multiples of that quantity.

Marking Accessories

Table 21.41: Marking and Additional Accessories [17]









Description	Type	Std. Pack [18]	
 25 ft blank vinyl marking strip	9080GH220	1	
Vinyl marking strip numbered 1-25 	For GK6, GR6	9080GH21	5
	For GA6, GP6	9080GH22	5
	For GM6	9080GH230	5
 Blank pin-feed marking tabs—6 x 20 (total 120) marking tabs for GD6, GR6, and GT6 blocks	9080GH200	20	
 Pre-marked 01 to 50 (2 sets) plus 20 various marking tabs (total 120 marking tabs) for GD6, GR6, and GT6 blocks	9080GH210	5	
 Marking strip end plug for GK6, GR6, GM6, GA6, GP6, GC6, GD6, GE6, and GT6 blocks	9080GH60	50	
 Transition barrier between GK6 and all other G blocks	9080GH61	50	
 Cover for GR6 or GR6T blocks	9080GH62	50	
 (Discontinued) Angle bracket kit—for mounting 9080GH or MH track to panel at 45° angle. Includes 2 brackets and hardware for mounting the track to the brackets	9080MH82	1	

Table 21.42: How to Order

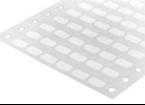
To Order Specify	Catalog Number	
<ul style="list-style-type: none"> • Class Number • Type Number 	Class	Type
	9080 (prefix)	GH10

[17] Some products may be discontinued. Refer to www.se.com/us for the most current product information.

[18] Orders must specify the standard package quantity (Std. Pack) or multiples of that quantity.



GCB100

GCB Thermal-Magnetic Circuit Protectors

Table 21.43: 9080GCB Thermal-Magnetic Circuit Protectors [1]

Maximum Current [2]	Internal Resistance Ω	Maximum Voltage	Catalog Number	
0.1	133	250 Vac 65 Vdc	9080GCB01	
0.5	6.6		9080GCB05	
0.8	2.55		9080GCB08	
1.0	1.97		9080GCB10	
1.2	1.22		9080GCB12	
1.5	0.86		9080GCB15	
2.0	0.49		9080GCB20	
2.5	0.31		9080GCB25	
3.0	0.20		9080GCB30	
4.0	0.10		9080GCB40	
5.0	0.08		9080GCB50	
7.0	0.03		9080GCB70	
10.0	<0.02		125 Vac 65 Vdc	9080GCB100
15.0	<0.02			9080GCB150

Table 21.44: Inrush Ratio Correction Table

NOTE: For resistive loads, use inrush correction factor of 1.0.

Inrush Ratio	1:1 to 1:4	1:5	1:6	1:7	1:8
Factor	1.3	1.4	1.5	1.6	1.7

Table 21.45: Ambient Temperature Correction Table

Ambient Temperature	70 °F (21.1 °C)	100 °F (37.8 °C)	120 °F (48.9 °C)	140 °F (60 °C)	160 °F (71.1 °C)	180 °F (82.2 °C)	200 °F (93.3 °C)
Factor	1.0	1.1	1.2	1.3	1.4	1.5	1.6

Table 21.46: Tripping Times in Seconds at 70 °F (21.1 °C)

NOTE: When several protectors are channel mounted adjacent to each other, the "no trip" current will be 80% of rated current at 70 °F.

Percent Rated Current	100%	200%	300%	400%	500%	600%	1000%	2000% and greater
Tripping Time (s)	no trip	10–40	38	1.5–9	0.8–6	0.003–4	0.003–2	Max. 0.02

Selection

To properly select a Class 9080 Type GCB circuit protector, follow these steps:

- Determine the inrush correction factor from Table 21.44.
- Determine the temperature correction factor from Table 21.45.
- Determine the sealed current of the load that is being protected.
- Multiply the sealed current by the two correction factors and choose the closest circuit protector.

NOTE: Choosing a circuit protector with a value lower than the calculated value might cause nuisance tripping, while choosing the larger might provide a protector that will not properly protect the load.



File: E233026
CCN:QVNU2



File: 025490
Class: 3211-07



Example: Solenoid with sealed current of 0.75 A, an inrush ratio of 1:6, and in an ambient temperature of 85°F: 0.75 x 1.5 x 1.05 = 1.18. Choose the 1.2 A protector.

Tripping Time: Tripping time of the circuit protector is determined from Table 21.46. Divide the circuit protector value by the temperature correction factor from Table 21.45 to determine actual rated current referenced in Table 21.46.

Table 21.47: How to Order

To Order Specify	Catalog Number	
• Class Number	Class	Type
• Type Number	9080	GH10

[1] Some products may be discontinued. Refer to www.se.com/us for the most current product information.

[2] These maximum current values assume the use of insulated copper conductors with 167 °F (75 °C) temperature rating and are calculated based on NEC Article 310, Table 310-16. In most cases this value is the maximum ampacity of the wire which has the greatest current carrying capacity. The actual allowable current for a particular application depends on the size, insulation class, and other characteristics of the wire used. The UL ratings are shown. The CSA rating may be higher or lower. Refer to the catalog for CSA ratings.

GB2 Thermal-Magnetic Circuit Protectors

Table 21.48: GB2CB One Pole Thermal-Magnetic Circuit Protectors [1]



1-Pole GB2CB

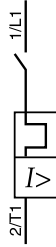

Description	Max. Voltage	Thermal Rating	Catalog Number [2]
One pole Thermal Magnetic Circuit Protector	300 Vac	0.5 A	GB2CB05
		1 A	GB2CB06
		2 A	GB2CB07
		3 A	GB2CB08
		4 A	GB2CB09
		5 A	GB2CB10
		6 A	GB2CB12
		8 A	GB2CB14
		10 A	GB2CB16
		12 A	GB2CB20



File: 081630
Class: 3215-30



IEC 157-1
VDE 0660

Table 21.49: GB2CD Two Pole Thermal-Magnetic Circuit Protectors [1]



2-Pole GB2CD

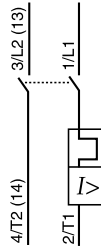

Description	Max. Voltage	Thermal Rating	Catalog Number [2]
Two pole Thermal Magnetic Circuit Protector	300 Vac	0.5 A	GB2CD05
		1 A	GB2CD06
		2 A	GB2CD07
		3 A	GB2CD08
		4 A	GB2CD09
		5 A	GB2CD10
		6 A	GB2CD12
		8 A	GB2CD14
		10 A	GB2CD16
		12 A	GB2CD20



File: 081630
Class: 3215-30



IEC 157-1
VDE 0660

[1] Some products may be discontinued. Refer to www.se.com/us for the most current product information.

[2] Must order in multiples of 6.

Enclosed Power Distribution Blocks

- Finger safe from the front, for isolation of live parts
- Up to 760 A, to meet a wide range of application needs
- Short-Circuit Current Rating up to 100 kA with fuses, not limited by the 10 kA default
- Panel or 35 mm DIN rail mount, for application flexibility
- Gangable to create multipole configurations
- Flexible stranded wire compliant, expands usability
- The UL Listed blocks meet feeder circuit spacing requirements.
- For the short-circuit current ratings, wire classes, tightening torques, dimensions, and more, see catalog 9080CT9603.

Table 21.50: Power Distribution Blocks with AL Lugs (accepts CU or AL conductors) [1]



Wire Range		Mounting	Current Rating	Type
Line Side	Load Side			
CU (1) 14-2 AWG (2.5-35 mm ²)	CU (4) 14-10 AWG (2.5-6 mm ²)	35 mm DIN rail or panel mount	CU 115A	NSYEBAD11614
CU (1) 14 AWG-3/0 (2.5-70 mm ²) AL (1) 6 AWG-3/0	CU (1) 14 AWG-3/0 (2.5-70 mm ²) AL (1) 6 AWG-3/0	Panel mount	CU 200 A AL 155 A	NSYEBAP12611
CU (1) 14 AWG-3/0 (2.5-70 mm ²) AL (1) 6 AWG-3/0	CU (4) 14-2 AWG (2.5-35 mm ²) AL (4) 6-2 AWG	35 mm DIN rail	CU 200 A AL 155 A	NSYEBAD12614
CU (1) 14 AWG-3/0 (2.5-70 mm ²) AL (1) 6 AWG-3/0	CU (4) 14-2 AWG (2.5-35 mm ²) AL (4) 6-2 AWG	Panel mount	CU 200 A AL 155 A	NSYEBAP12614
CU (1) 6 AWG-400 kcmil (16-185 mm ²) CU (1) 14 AWG-3/0 (2.5-70 mm ²) AL (1) 6 AWG-400 kcmil AL (1) 6 AWG-3/0	CU (8) 14-2 AWG (2.5-35 mm ²) AL (8) 6-2 AWG	35 mm DIN rail	CU 335 A AL 270 A	NSYEBAD13618
CU (1) 6 AWG-400 kcmil (16-185 mm ²) CU (1) 14 AWG-3/0 (2.5-70 mm ²) AL (1) 6 AWG-400 kcmil AL (1) 6 AWG-3/0	CU (8) 14-2 AWG (2.5-35 mm ²) AL (8) 6-2 AWG	Panel mount	CU 335 A AL 270 A	NSYEBAP13618
CU (2) 6 AWG-250 kcmil (16-120 mm ²) AL (2) 6 AWG-250 kcmil	CU (2) 6 AWG-250 kcmil (16-120 mm ²) AL (2) 6 AWG-250 kcmil	Panel mount	CU 510 A AL 410 A	NSYEBAP25622
CU (2) 4 AWG-500 kcmil (25-240 mm ²) AL (2) 4 AWG-500 kcmil	CU (8) 14 AWG-2/0 (2.5-50 mm ²) AL (8) 6 AWG-2/0 kcmil	Panel mount	CU 760 A AL 620 A	NSYEBAP27628

Table 21.51: Power Distribution Blocks with CU Lugs (accepts only CU conductors)



Wire Range		Mounting	Current Rating	Type
Line Side	Load Side			
CU (1) 14 AWG-3/0 (2.5-70 mm ²)	CU (4) 14-2 AWG (2.5-35 mm ²)	35 mm DIN rail	CU 200 A	NSYEBCD12614
CU (1) 14 AWG-3/0 (2.5-70 mm ²)	CU (4) 14-2 AWG (2.5-35 mm ²)	Panel mount	CU 200 A	NSYEBCP12614
CU (1) 6 AWG-400 kcmil (16-185 mm ²) CU (1) 14 AWG-3/0 (2.5-70 mm ²)	CU (8) 14-2 AWG (2.5-35 mm ²)	Panel mount	CU 335 A	NSYEBCP13618
CU (2) 6 AWG-250 kcmil (16-120 mm ²)	CU (2) 6 AWG-250 kcmil (16-120 mm ²)	Panel mount	CU 510 A	NSYEBCP25622
CU (2) 4 AWG-500 kcmil (25-240 mm ²)	CU (8) 14 AWG-2/0 (2.5-50 mm ²)	Panel mount	CU 760 A	NSYEBCP27628

Table 21.52: Terminal Plugs (for plugging unused openings)



Plug Size	For use with	Type
2 AWG	NSYEB**13618	NSYEBP2
2/0 AWG	NSYEB**13618, NSYEB**27628	NSYEBP20
250 kcmil	NSYEB**25622	NSYEBP250
400 kcmil	NSYEB**13618	NSYEBP400
500 kcmil	NSYEBAP27622, NSYEB**27628	NSYEBP500



UL E323110 QPQS
All except
NSYEB**13618 and
NSYEB**25622



File: 70361
Class: 6228-01

RoHS
Compliant



UL E60616 XCFR2
NSYEB**13618
NSYEB**25622



CE Marked

UL 94V-0 flammability rating

[1] Some products may be discontinued. Refer to www.se.com/us for the most current product information.

LB Open Power Distribution Blocks

Table 21.53: Aluminum Power Distribution Blocks [2]

Lug Wire Range [3]		Aluminum [4]		
Main	Branch	One Pole Type	Two Pole Type	Three Pole Type
(1) #14-2/0	(1) #14-2/0	9080LBA162101	9080LBA262101	9080LBA362101
(1) #6-350 kcmil	(1) #6-350 kcmil	9080LBA163101	9080LBA263101	9080LBA363101
(1) #4-600 kcmil	(1) #4-600 kcmil	9080LBA164101	N/A	9080LBA364101
(2) #4-350 kcmil	(2) #4-350 kcmil	9080LBA165202	9080LBA265202	9080LBA365202
(2) #6-500 kcmil	(2) #4-500 kcmil	9080LBA1652021	9080LBA2652021	9080LBA3652021
(1) #14-2/0	(4) #14-4	9080LBA162104	9080LBA262104	9080LBA362104
(1) #14-2/0	(6) #14-4	N/A	N/A	9080LBA362106
(1) #6-400 kcmil	(4) #14-2	9080LBA163104	9080LBA263104	9080LBA363104
(1) #6-400 kcmil	(6) #14-2	9080LBA163106	9080LBA263106	9080LBA363106
(1) #6-400 kcmil	(8) #14-2	9080LBA164108	9080LBA264108	9080LBA364108
(1) #4-500 kcmil	(6) #14-2/0	9080LBA165106	9080LBA265106	9080LBA365106
(1) #4-500 kcmil	(12) #14-2	9080LBA165112	9080LBA265112	9080LBA365112
(2) #14-2/0	(6) #14-4	9080LBA163206	9080LBA263206	9080LBA363206
(2) #6-500 kcmil	(8) #14-2/0	9080LBA165208	9080LBA265208	9080LBA365208
(2) #6-500 kcmil	(12) #14-4	9080LBA165212	9080LBA265212	9080LBA365212



Table 21.54: Miniature Aluminum Power Distribution Blocks [2]

Lug Wire Range [3]		Aluminum [4]		
Main	Branch	One Pole Type	Two Pole Type	Three Pole Type
(1) #14-2	(1) #14-2	9080LBA161101	N/A	9080LBA361101
(1) #14-2	(4) #18-10	9080LBA161104	9080LBA261104	9080LBA361104



Table 21.55: Copper Power Distribution Blocks [2]

Lug Wire Range [3]		Copper [5]		
Main	Branch	One Pole Type	Two Pole Type	Three Pole Type
(1) #18-1/0	(1) #18-1/0	9080LBC162101	N/A	9080LBC362101
(1) #6-250 kcmil	(1) #6-250 kcmil	9080LBC163101	N/A	9080LBC363101
(1) #14-2/0	(4) #14-4	9080LBC162104	9080LBC262104	9080LBC362104
(1) #4-500 kcmil	(6) #14-2	9080LBC163106	9080LBC263106	9080LBC363106
(2) #14-2/0	(6) #14-4	9080LBC163206	9080LBC263206	9080LBC363206
(2) #4-500 kcmil	(8) #14-2/0	9080LBC165208	N/A	9080LBC365208
(2) #6-500 kcmil	(12) #14-2	9080LBC165212	N/A	9080LBC365212



Table 21.56: Clear Plastic Covers (0.045 in. thick) [2]

For LBA Type[6]	Type	Dim. A	Dim. B
LBA161...	9080LB11	0.824	2.31
LBA261...	9080LB12	1.459	2.31
LBA361	9080LB13	2.094	2.31
LBA162..., LBC162	9080LB21	1.062	2.750
LBA262..., LBC262	9080LB22	1.875	2.750
LBA362..., LBC362 [7]	9080LB23	2.688	2.750
LBA163..., LBC163	9080LB31	1.782	3.813
LBA263..., LBC263	9080LB32	3.313	3.813
LBA363... LBC363	9080LB33	4.844	3.813
LBA164...	9080LB41	2.125	4.563
LBA264...	9080LB42	4.000	4.563
LBA364...	9080LB43	5.875	4.563
LBA165..., LBC165	9080LB51	2.719	5.313
LBA265..., LBC265	9080LB52	5.656	5.313
LBA365..., LBC365	9080LB53	8.375	5.313

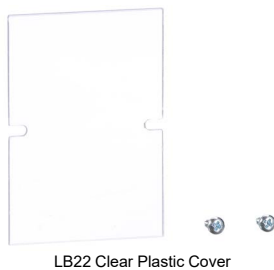

Table 21.57: How to Order

To Order Specify	Catalog Number
• Class Number (prefix)	9080
• Type Number	LBA162101

Application Information

Voltage Rating-Class B and C-600 V

Blocks are rated based on NEC Table 310-16 using 167 °F (75 °C) wire. Aluminum blocks are tin-plated high conductive aluminum. Copper blocks are tin-plated high conductive copper.

Housing material:

- Miniature Blocks are made from high impact thermoplastic rated at 257 °F (125 °C) max. and -40 °F (-40 °C) min.
- Full Size Blocks are made from general purpose phenolic rated at 302 °F (150 °C) max. and -40 °F (-40 °C) min.

[2] Some products may be discontinued. Refer to www.se.com/us for the most current product information.
 [3] Lugs suitable for use with 75 °C (167 °F) conductors.
 [4] Aluminum blocks will accept either aluminum or copper conductors.
 [5] Copper blocks will accept copper conductors only.
 [6] These covers must be ordered in multiples of 5. Each cover comes with two self-tapping screws.
 [7] Will not work on a 9080LBA362106 block.

All blocks have a flammability rating of UL 94V-0.
For the short-circuit current ratings and dimensions, see catalog 9080CT9603.

Fuseholders and Track Adapter

Table 21.58: 250 V—Classes H and R [1]

Rating (A) [2]	No. of Poles	Class H	Class R [3][4]	Lug Wire Range
		Type	Type	
30[5]	1	9080FB1211	9080FB1211R	#14–10 Cu
	2	9080FB2211	9080FB2211R	
	3	9080FB3211	9080FB3211R	
60[5]	1		9080FB1221R	#14–2 Cu or Al
	2		9080FB2221R	



FB3211

FB3211R

Application Information [1]

Clip material:

- All 30 and 60 A fuse clips are copper alloy tin plated.
- All 100 and 200 A fuse clips are one piece aluminum with copper spring tin plated.
- All Class H, R and J fuses are standard with reinforced fuse clips.

Lug termination:

- All 30 A blocks have pressure wire connectors.
- All 60, 100 and 200 A blocks have box lug connectors.

Table 21.59: 600 V—Classes H and R [1]

Rating (A) [2]	No. of Poles	Class H	Class R [3][4]	Lug Wire Range
		Type	Type	
30[6]	1	9080FB1611		#14–10 Cu
	2	9080FB2611		
	3	9080FB3611	9080FB3611R	
60[6]	1		9080FB1621R	#14–2 Cu or Al
	3		9080FB3621R	
100[6]	3		9080FB3631R	#6–2/0 Cu or Al

Table 21.60: 600 V Series—Miniature Fuse Dimension (13/32 x 1-1/2 in.) [1]

Rating (A) [2]	No. of Poles	Type M	Class CC [3][4]	Lug Wire Range
		Type	Type	
30[5]	1	9080FB1611M	9080FB1611CC	#14–10 Cu
	2	9080FB2611M	9080FB2611CC	
	3	9080FB3611M	9080FB3611CC	

Table 21.61: 600 V—Class H Only (Copper Only) [1]

Rating (A) [2]	No. of Poles	Class H	Lug Wire Range
		Type	
30[6]	1	9080FB1611	#14–10 Cu
	2	9080FB2611	
	3	9080FB3611	
100[6]	3	9080FB3631C	#6–2/0 Cu

Table 21.62: 600 V—Class J [1]

Rating (A) [2]	No. of Poles	Class J [3]	Lug Wire Range
		Type	
30[6]	2	9080FB2611J	#2–14 AWG Cu–Al
	3	9080FB3611J	
	3	9080FB3621J	

Table 21.63: Track Adapter [1]





Description	Type	Std. Pack [7]
 35 mm DIN 3 Track Adapter For 9080 FB*211, FB*211R, FB*611M, and FB*611CC Fuseholders	9080FBDIN3	100

Table 21.64: Fuse Sizes—(Diameter x Length)

A	Class of Fuse			
	Class H/R—300 V	Class H/R—600 V	Class M/CC—600 V	Class J—600 V
30	9/16 x 2 in.	13/16 x 5 in.	13/32 x 1-1/2 in.	13/16 x 2-1/4 in.
60	13/16 x 3 in.	1-1/16 x 5-1/2 in.	N/A	1-1/16 x 2-3/8 in.
100	1 x 7-7/8 in.	1 x 7-7/8 in.	N/A	N/A
200	1-1/2 x 7-1/8 in.	1-3/4 x 9-5/8 in.	N/A	N/A

	File: E40747 CCN: IZLT2	Type M fuseholders
	File: E40747 CCN: IZLT	Types H, R, J, and CC
	File: 70360 Class: 6225-01	
Flammability rating of all FB fuse blocks is UL 94V-0. RoHS Compliant		

[1] Some products may be discontinued. Refer to www.se.com/us for the most current product information.
 [2] Specified wire ranges are based on 167 °F (75 °C) wire. Wires with temperature ratings other than 167 °F (75 °C) are approved while observing NEC Article 310 wire tables for allowable ampacities of insulated conductors.
 [3] Class R, J and CC fuse blocks are tested and approved for 200,000 AIC in accordance with UL 512.
 [4] Class R and CC fuseholders accept current limiting Class R & CC fuses only.
 [5] Base is high impact thermoplastic—maximum operating temperature 257 °F (125 °C).
 [6] Base is general purpose phenolic—maximum operating temperature 302 °F (150 °C).
 [7] Orders must specify the standard package quantity (Std. Pack) or multiples of that quantity.

Table 21.65: How to Order

To Order Specify	Catalog Number
• Class Number	9080
• Type Number	FB1211

Modular Fuseholders

Table 21.66: Modular Fuse Holders, TeSys DF [1]

Rated Thermal Current	Type of Fuse	Composition	Blown Fuse Indicator	Standard Pack Quantity	Catalog Number
30 A	Class CC	1 Pole	No	1 Pole	DFCC1
			Yes		DFCC1V
		2 Pole	No	2 Pole	DFCC2
			Yes		DFCC2V
		3 Pole	No	3 Pole	DFCC3
			Yes		DFCC3V

 File: E310269, CCN: IZLT

Also see [TeSys DF and LS1 Fuse Carriers](#) on [www.se.com/us](#)



DFCC1



DFCC2V

[1] For additional fuse holders and information, refer to Catalog [9080CT0801](#).

With and Without Marking Flags, Dual Wire

Conform to NF C 63-023 Standard
Mark and terminate wires simultaneously

Strip the wire, insert it into the cable end and crimp it.
Up to 7 markers can be used.

Table 21.67: Without Marking Flag

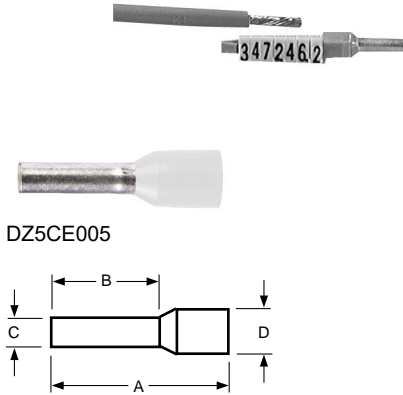

Wire Size		Sleeve color	Dimensions (mm)				Catalog Number [1][2]	Std. Pack [3]
AWG	mm ²		A	B	C	D		
26	0.25	Yellow	11	6.2	1.2	2.2	DZ5CE002L6	
			13	8.2				
24	0.34	Green	11	6.2	1.2	2.2	DZ5CE003L6	
			13	8.2				
22	0.50	White	11	6.2	1.4	3	DZ5CE005L6[4]	
			13	8.2			DZ5CE005[4]	
			16.8	12			DZ5CE005L12	
20	0.75	Blue	11	6.2	1.6	3.1	DZ5CE007L6[4]	
			13	8.2			DZ5CE007[4]	
18	1.00	Red	11.5	6.2	1.8	3.4	DZ5CE010L6[4]	
			13.5	8.2			DZ5CE010[4]	
			16.8	12			DZ5CE010L12	
16	1.50	Black	11.5	6.2	2.1	4	DZ5CE015L6[4]	
			13.5	8.2			DZ5CE015[4]	
			22.8	17.7			DZ5CE0153[4]	
14	2.00	Yellow	14.5	8.2	2.35	4.2	DZ5CE020	
			14.5	8.2			DZ5CE025[4]	
14	2.50	Gray	24	17.7	2.7	4.6	DZ5CE0253[4]	
			17.3	9.8			DZ5CE042[4]	
12	4.00	Orange	25.5	17.5	3.3	5.5	DZ5CE043[4]	
			20	11.5			3.95	7
10	6.00	Green	26	17.5	3.95	7		

Table 21.68: With Marking Flag

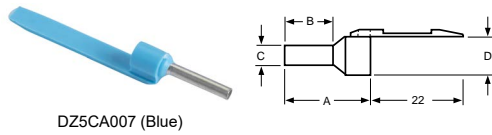

26	0.25	Yellow	13	8.2	1.2	2.2	DZ5CA002	1000
24	0.34	Green					DZ5CA003	
22	0.50	White					DZ5CA005[4]	
20	0.75	Blue	13.5	8.2	1.6	3.1	DZ5CA007[4]	1000
18	1.00	Red					DZ5CA010[4]	
16	1.50	Black					DZ5CA015[4]	
14	2.50	Gray	14.5		2.7	4.6	DZ5CA025[4]	

Table 21.69: Marking Flag Optional [5]

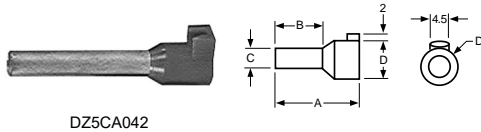

12	4.00	Orange	19.5	11.5	3.3	5.5	DZ5CA042[4]	1000
			25.5	17.5	3.3	5.5	DZ5CA043[4]	
10	6.00	Green	20	11.5	3.95	7	DZ5CA062	100
			26	17.5	3.95	7	DZ5CA063	
8	10.00	Brown	21.5	12	4.95	8.4	DZ5CA102	100
			27	17.5	4.95	8.4	DZ5CA103	
			23.5	12	6.35	9.8	DZ5CA162	
6	16.00	White	29	17.5	6.35	9.8	DZ5CA163	100
			30	17.5	8.15	12	DZ5CA253	
4	25.00	Black	30	16	9	13.5	DZ5CA352	20
			39	25	9	13.5	DZ5CA353	
2	35.00	Red	36	20	11	15.7	DZ5CA502	20
			41	25	11	15.7	DZ5CA503	

Table 21.70: Dual Wire Cable Ends

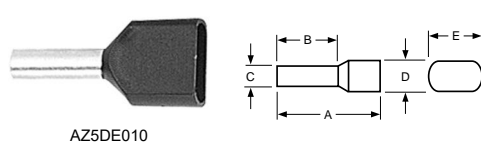

Wire Size	Sleeve color	A	B	C	D	E	Catalog Number	Std. Pack
22	White	13	8	1.4	2.5	4.7	AZ5DE005	500
20	Blue			1.6	2.8	5.0	AZ5DE007	
18	Red	13.5	8	1.8	3.4	5.4	AZ5DE010	
16	Black			2.1	3.6	6.6	AZ5DE015	
14	Gray	24	10	2.7	4.2	7.8	AZ5DE025	250

RoHS Compliant

[1] Bold faced catalog numbers are stocked in the United States.
 [2] CE Marked.
 [3] Orders must specify the standard package quantity (Std. Pack) or multiples of that quantity.
 [4] These catalog numbers are UL Component Recognized (File E164872 CCN ZMMT2) provided the AT1PA crimping tool is used to crimp the cable end.
 [5] Will accept an AR1SC03 cable marker.

Cable End Markers and Tools

Table 21.71: Cable End Markers & Accessories

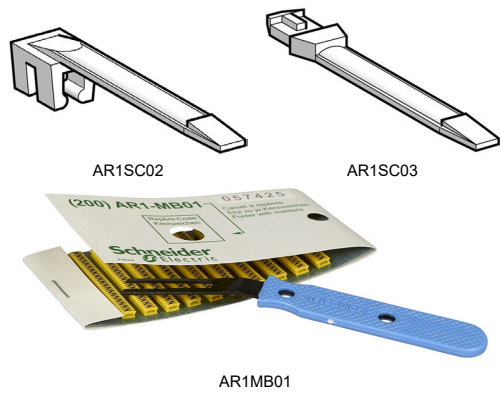

Style	Catalog Number	Std. Pack [6]
Adjustable collar type marker holder for #14 to #2 wire	AR1SC01	100
Clip-on marker holder for #18 to #16 wire (7 markers max.)	AR1SC02	
Cable end marker tags for DZ5CA042 to DZ5CA253	AR1SC03	
Card of 200 yellow markers with black numeral 0 thru 9	AR1MA01 [7]	1
Card of 200 yellow markers with black letters A thru Z	AR1MB01 [7]	1
Card of 200 black markers with a white 0 marked on them	AR1MC010	200
Card of 200 brown markers with a white 1 marked on them	AR1MC011	200
Card of 200 red markers with a black 2 marked on them	AR1MC012	200
Card of 200 orange markers with a black 3 marked on them	AR1MC013	200
Card of 200 yellow markers with a black 4 marked on them	AR1MC014	200
Card of 200 green markers with a black 5 marked on them	AR1MC015	200
Card of 200 blue markers with a black 6 marked on them	AR1MC016	200
Card of 200 violet markers with a black 7 marked on them	AR1MC017	200
Card of 200 gray markers with a black 8 marked on them	AR1MC018	200
Card of 200 white markers with a black 9 marked on them	AR1MC019	200
Card of 200 blank yellow markers	AR1MA0196	1
Card of 200 blank green markers	AR1MA0197	1
Card of 200 yellow markers with a black + marked on them	AR1MA0198	1
Card of 200 yellow markers with a black — marked on them	AR1MA0199	1
Complete set of numeral markers 0 thru 9, plus one card each of the "+", "-", yellow blanks, and green blanks/one AT1PA1 positioning tool. Each kit has 200 of each item.	AR1MA01	1
Complete set of letter markers A thru Z, plus one card each of the "+", "-", yellow blanks, and green blanks/one AT1PA1 positioning tool. Each kit has 200 of each item.	AR1MB01	1

Table 21.72: Cable End Tools

Description	Catalog Number
Cable end marker positioning tool	AT1PA1
Automatic stripping and cutting tool for 0.8 mm to 4 mm cable, adjustable stripping length	AT1PA7
Crimping tool for cable ends 0.5 mm ² to 16 mm ²	AT1PA2
Crimping tool for cable ends 10 mm ² to 35 mm ²	AT1PA4
Organizing case for cable ends—holds stripping tool and cable ends (not supplied)	AT1HB2



[6] Orders must specify the standard package quantity (Std. Pack) or multiples of that quantity.
 [7] Complete the catalog number by adding the number or letter desired.
 Examples: AR1 MA015 is a card of 200 yellow markers with a black 5 marked on them.
 R1 MB01T is a card of 200 yellow markers with a black T marked on them.



Telefast ABE 7 Pre-Wired Sub-Bases

Telefast is a substitution of traditional screw terminal blocks for a fast connection of high-density I/O modules to operative parts. It offers protection, distribution, visualization, and adaptation of the signals.

Features:

- A selection of most used and qualified Telefast sub-bases for rapid connection of I/O modules (discrete, analog, and counter) to sensors or actuator
- A substitute for the terminal block, remotely locating and partly eliminating the single-wire connection
- Provide relay and connection functions, with or without polarity distribution, reduce wiring time, and eliminate the risk of error Functions
- Adapting I/O current/voltage for PLCs
- Distributing signals, commons (24 or 0V) and earth for connecting 1/2/3 wire signals
- Channel isolation, protection, and LED diagnostics
- Various relay contact combinations 1N/O, 1C/O, 2C/O
- Prewiring cabinets
- Easy wiring suitable for PLC high-density I/O modules

Visit [Telefast ABE 7](http://www.se.com/us) on www.se.com/us for the latest product information.