







Section 19

Push Buttons and Operator Interface





Selection Guide	19-2
Push Buttons and Pilot Lights	19-2
Control Stations	19-3
Pendant Stations	19-4
Tower Lights and Beacons	19-5
22 and 30 mm Most Common Complete Operators	19-8
XB4–XB5 Common Operators, Complete with Contact Blocks	19-8
Type K, SK Common Operators, Complete with Contact Blocks	19-9
22 mm Push Buttons	19-10
XB4 Complete Devices	19-10
XB5 Complete Devices	19-24
XB5R Plastic and XB4R Metal Wireless, Batteryless Push Buttons	19-41
XB7 Push Buttons	19-44
30 mm Push Buttons	19-47
16 mm Push Buttons	19-66
XB6 Complete Devices	19-66
Rotary Cam Switches	19-68
Control Stations and Enclosures	19-72
XAL 22 mm Control Stations	19-72
XAP 22 mm Enclosures and Accessories	19-73
9001B Standard Duty Control Stations	19-74
30 mm Control Stations and Enclosures	19-75
30 mm Enclosures	19-76
Pendant Stations	19-78
Wireless Remote Control System	19-78
Type BW Pendant Stations	19-81
XAC Standard Duty Pistol Grips, Enclosures, Contact Blocks	19-82
Type XACA Worksheet	19-83
Tower Lights and Beacons	19-84
Signaling Units	19-89
Foot Switches	19-96

Push Button Selection Guide

Family	XB4	XB5	XB7	9001K	9001SK	9001KX
						
Type of Product	**22 mm Push Button (metal)	**22 mm Push Button (plastic)	***22mm Push Button (plastic)	****30 mm Push Button (metal)	****30 mm Push Button (plastic)	****30 mm Push Button (metal, square)
Mounting Hole Diameter	22.5 mm	22.5 mm	22.5 mm	31 mm (1.22 in)	31 mm (1.22 in)	31 mm (1.22 in)
Approvals	UL Listed File E164353, CCN NKCR UL Recognized File E164353, CCN NKCR2	UL Listed File E164353, CCN NKCR UL Recognized File E164353, CCN NKCR2	UL File E164353, CCN NKCR	UL File E78403, CCN NKCR	UL File E78403, CCN NKCR	UL File E78403, CCN NKCR
	CSA File LR44087, Class 3211-03	CSA File LR44087, Class 3211-03	CSA File LR44087-122, Class 3211-03	CSA File LR25490, Class 3211-03	CSA File LR25490, Class 3211-03	CSA File LR25490, Class 3211-03
	CE Marked RoHS Compliant	CE Marked RoHS Compliant	CE Marked RoHS Compliant	CE Marked RoHS Compliant	CE Marked RoHS Compliant	CE Marked RoHS Compliant
Conforming to Standards	EN/IEC 60947-1, EN/IEC 60947-5-1, EN/IEC 60947-5-4, EN/IEC 60947-5-5	EN/IEC 60947-1, EN/IEC 60947-5-1, EN/IEC 60947-5-4, EN/IEC 60947-5-5	EN/IEC 60947-1, EN/IEC 60947-5-1 for push buttons, pilot lights, illuminated push buttons and selector switches EN/IEC 60947-1, EN/IEC 60947-5-1, EN/IEC 60947-5-5,	EN/IEC 60947-1	EN/IEC 60947-1	EN/IEC 60947-1
	EN/IEC 60204-1 and EN/ISO 13850: 2006 (trigger action and mechanical latching emergency stop push buttons)	EN/IEC 60204-1 and EN/ISO 13850: 2006 (trigger action and mechanical latching emergency stop push button).	EN/IEC 60204-1 and EN/ISO 13850 for Emergency Stop trigger action push buttons	EN/IEC60947-5-1	EN/IEC60947-5-1	EN/IEC60947-5-1
	EN/IEC 60364-5-53 (emergency switching of mechanical latching push buttons)	EN/IEC 60364-5-53 (emergency switching of mechanical latching push buttons)		EN/IEC60947-5-4	EN/IEC60947-5-4	EN/IEC60947-5-4
	—	EN81-1 (emergency stop trigger action and mechanical latching push buttons with mechanical state indicator)				
	JIS C 4520	JIS C 4520		JIS C 4520 and 852	JIS C 4520 and 852	JIS C 4520 and 852
	UL 508	UL 508	UL 508	UL 508	UL 508	UL 508
	CSA C22.2 No.14	CSA C22.2-2 No.14	CSA C22.2 No.14	CSA C22.2 No.14	CSA C22.2 No.14	CSA C22.2 No.14
	GOST	GOST				
CCC	CCC	CCC				
			GB 14048.5 for all XB7 range			
Degree of Protection	IP65, IP69, IP69K IP66 for booted NEMA 1, 2, 3, 4, 4X, 12, 13	IP65, IP69, IP69K IP66 for booted NEMA 1, 2, 3, 3R, 4, 4X, 12, 13	IP54, IP65 — NEMA 3, 4, 12	IP65 — NEMA 1, 2, 3, 3R, 4, 12, 13	IP65 — NEMA 1, 2, 3, 3R, 4, 4X, 12, 13	IP66 — NEMA 1, 2, 3, 3R, 4, 12, 13
Operating Temperature F° (C°)	-40 to 158 (-40 to 70)	-40 to 158 (-40 to 70)	-13 to 158 (-25 to 70)	-22 to 140 (-30 to 60)	-22 to 140 (-30 to 60)	-22 to 140 (-30 to 60)
Storage Temperature F° (C°)	-40 to 158 (-40 to 70)	-40 to 158 (-40 to 70)	-40 to 158 (-40 to 70)	-40 to 158 (-40 to 70)	-40 to 158 (-40 to 70)	-40 to 158 (-40 to 70)
Electric Shock Protection	Class I	Class I	—	Class II	Class II	Class II
Electrical Consumption						
LED	24 Vac/Vdc: 18 mA 120 Vac: 14 mA	24 Vac/Vdc: 18 mA 120 Vac: 14 mA	Illuminated Push Buttons: 24V - 18mA 120V - 12mA 230V - 22mA Pilot Lights 24V - 20mA 120V - 18mA 230V - 16mA	Incandescent and LED bulbs. For ratings, see Standard Light Modules, page 19-63.	Incandescent and LED bulbs. For ratings, see Standard Light Modules, page 19-63.	Incandescent
	240 Vac: 14 mA	240 Vac: 14 mA				
Rated Operational Characteristics	AC-15; B600 Ue = 600 Vac and Ie = 1.2 A Ue = 240 Vac and Ie = 3 A Ue = 120 Vac and Ie = 6 A Continuous 10 A	AC-15; B600 Ue = 600 Vac and Ie = 1.2 A Ue = 240 Vac and Ie = 3 A Ue = 120 Vac and Ie = 6 A Continuous 10 A	AC-14; D300 Ue = 240 Vac and Ie = 0.3A Ue = 120 Vac and Ie = 0.6A Continuous 4 A	AC-15; A600 Continuous 10 A	AC-15; A600 Continuous 10 A	AC-15; A600 Continuous 10 A
	DC-13; Q600 Ue = 600 Vdc and Ie = 0.1 A Ue = 250 Vdc and Ie = 0.27 A Ue = 125 Vdc and Ie = 0.55 A	DC-13; Q600 Ue = 600 Vdc and Ie = 0.1 A Ue = 250Vdc and Ie = 0.27 A Ue = 125 Vdc and Ie = 0.55 A	DC-13; R300 Ue = 250 Vdc and Ie = 0.1A Ue = 125 Vdc and Ie = 0.22A	DC-13; Q600 Ue = 600 Vdc and Ie = 0.1 A Ue = 250 Vdc and Ie = 0.27 A Ue = 125 Vdc and Ie = 0.55 A	DC-13; Q600 Ue = 600 Vdc and Ie = 0.1 A Ue = 250 Vdc and Ie = 0.27 A Ue = 125 Vdc and Ie = 0.55 A	DC-13; Q600 Ue = 600 Vdc and Ie = 0.1 A Ue = 250 Vdc and Ie = 0.27 A Ue = 125 Vdc and Ie = 0.55 A
Connection Type	IP20 Fingersafe Screw or Spring Terminal		Screw and captive clamp terminal connections Faston clip connections (pilot lights)	IP20 Fingersafe Screw Terminal		
	Screw Terminal:	Spring Terminal:				
Cable Size	1 x 24 AWG (0.22 mm ²) min. 2 x 14 AWG (2.5 mm ²) max. 2 x 16 AWG (1.5 mm ²) max.	1 x 24 AWG (0.22 mm ²) min. 2 x 14 AWG (2.5 mm ²) max. 2 x 16 AWG (1.5 mm ²) max.		1 x 24 AWG (0.22 mm ²) min. 2 x 16 AWG (1.5 mm ²) max	1 x 24 AWG (0.22 mm ²) min. 2 x 16 AWG (1.5 mm ²) max	1 x 24 AWG (0.22 mm ²) min. 2 x 16 AWG (1.5 mm ²) max
Digest Location	XB4, page 19-10	XB5, page 19-24	XB7, page 19-44	Type K, page 19-47	Type SK, page 19-55	KX, page

Control Station Selection Guide

Family	XAL	XAP	9001B
	 <p>XALD02</p> <p>XALDW01</p>	 <p>XAPA1100</p> <p>XAPA1104</p>	 <p>NEMA 1 Surface Mounting 9001BG**</p> <p>NEMA 1 Flush Mounting 9001BF**</p> <p>NEMA 4 9001BW**</p> <p>NEMA 7 and 9 9001BR**</p>
Type of Product/Material	XALD—Polycarbonate XALK—Polycarbonate	XAPA—glass filled polyester XAPG—die cast zinc XAPE—anodized aluminum	9001BG—plastic cover 9001BF—stainless steel 9001BW—die cast zinc 9001BR—cast aluminum
Number of holes	1 to 3	0 to 16	1 to 3
Type of Operators	XB5 (22mm)	XB5 (22mm)	Built in
Available without Operators	Yes	Yes	No
Available with Operators	Yes	No	Yes
Approvals	UL File E164353 CCN NKCR CSA File LR 44087 Class 3211-03	UL File E164353 CCN NKCR CSA File LR 44087 Class 3211-03	UL File E78403 CCN NKCR CSA File LR 25490 Class 3211-03
Conforming to Standards	CE Marked EN/IEC 60947-1, EN/IEC 60947-5-1, EN/IEC 60947-5-4, JIS C 4520 UL 508 CSA C22.2 No.14	CE Marked EN/IEC 60947-1, EN/IEC 60947-5-1, EN/IEC 60947-5-4, JIS C 4520 UL 508 CSA C22.2 No.14	CE Marked EN/IEC 60947-1, EN/IEC 60947-5-1, EN/IEC 60947-5-4, JIS C 4520 UL 508 CSA C22.2 No.14
Degree of Protection	1, 4, 4X, 13 IP65 IP66 - Booted	XAPA - 4, 4X, 12, IP65 XAPG - 4, 12, IP65 XAPE - 4, 4X, 12, IP65	9001BG - 1 9001BF - 1 9001BW - 4 9001BR - 7, 9
Operating Temperature F° (C°)	-13 to 158 (-25 to 70)	-13 to 158 (-25 to 70)	
Storage Temperature F° (C°)	-40 to 158 (-10 to 70)	-40 to 158 (-10 to 70)	
Cable Entry	No. 13 knock out	XAPA—undrilled XAPG—Tapped 3/4NPT XAPE—flush mount (n/a)	9001BG—1/2 & 3/4 knockout 9001BF—N/A 9001BW—1/2-14NPT 9001BR—1/2-14NPT
Digest Location	XAL, page 19-72	XAP, page 19-72	9001B, page 19-74

Pendant Station Selection Guide

Family	ZAR eXL Hoist Compact	ZAR Pocket Remote	9001BW	XACA2	XACA0
					
Type of Product	*Wireless Pendant	*Wireless Remote	**2-Button Pendant	**2-Button Pistol Grip Pendant	**General Purpose Pendant
Number of operators	6 motion, 2 auxilliary	3, 4, 6, 8, and 10	2	2	2, 3, 4, 6, 8, 12
Approvals	UL/CSA, CE, EAC	UL, CE	UL File E78403 CNN NKCR CSA File LR25490 Class 3211-03	UL File E164353 CNN NKCR CSA File LR 44087 Class 3211-03	UL File E164353 CNN NKCR CSA File LR 44087 Class 3211-03
Conforming to Standards	For receiver: EN 300 328 V2.1.1: 2016-11 EN 301 489-1 V2.1.1: 2017-02 EN 301 489-17 V3.1.1: 2017-02 EN 60950-1:2006 + A11: 2009 EN 50581: 2012 EN ISO 13849-1:2016 For transmitter: EN 300 440 V2.1.1: 2017-03 EN 301 489-1 V2.1.1: 2017-02 EN 301 489-3 V2.1.1: 2017-03 EN 60950-1:2006 + A11: 2009 + A1: 2010 + A12: 2011 EN 62479: 2010 EN 50581: 2012 EN ISO 13849-1:2016	For receiver: EN 300 328 V2.1.1: 2016-11 EN 301 489-1 V2.1.1: 2017-02 EN 301 489-17 V3.1.1: 2017-02 EN 60950-1:2006 + A11: 2009 EN 50581: 2012 For transmitter: EN 300 440 V2.1.1: 2017-03 EN 301 489-1 V2.1.1: 2017-02 EN 301 489-3 V2.1.1: 2017-03 EN 60950-1:2006 + A11: 2009 + A1: 2010 + A12: 2011 EN 62479: 2010 EN 50581: 2012	CE Marked	EN/IEC 60947-5-1, EN/IEC 60204-32, EN/IEC 60947-5-5, and EN/ISO 13850 (for versions with trigger action emergency stop) UL 508 CSA C22-2 No. 14 RoHS compliant	EN/IEC 60947-5-1, EN/IEC 60204-32, EN/IEC 60947-5-5, and EN/ISO 13850 (for versions with trigger action emergency stop) UL 508 CSA C22-2 No. 14 RoHS compliant
Degree of Protection	Transmitter: IP65/NEMA 4, Receiver: IP66	IP67 for transmitter and IP66 for receiver	NEMA 1, 3, 3R, 4, 4X	NEMA 1, 4, 4X, 5 IP65 IK08	NEMA 1, 4, 4X, 5 IP65 IK08
Operating Temperature F° (C°)	-4 to 131 (-20 to 55)	-4...131 °F (-20...55 °C)	-13 to 140 (-25 to 60)	-13 to 140 (-25 to 60)	-13 to 140 (-25 to 60)
Storage Temperature F° (C°)	-4 to 113 (-20 to 45)	-4...113 °F (-20...45 °C)	-40 to 158 (-40 to 70)	-40 to 158 (-40 to 70)	-40 to 158 (-40 to 70)
Housing Material	Polyurethane	Polyurethane	Polycarbonate / PET Polyester Blend	Yellow Polypropylene	Yellow Polypropylene
Rated Operational Characteristics [1]	—	—	AC - B600 DC - P600	AC-15: A600 or Ue = 600V, Ie = 1.2A or Ue = 240V, Ie = 3A DC-13: Q600 or Ue = 600V, Ie = 0.1A or Ue = 250V, Ie = 0.27A	AC-15: A600 or Ue = 600V, Ie = 1.2A or Ue = 240V, Ie = 3A DC-13: Q600 or Ue = 600V, Ie = 0.1A or Ue = 250V, Ie = 0.27A
Thermal Current	—	—	Continuous 5A	Continuous 10A	Continuous 10A
Connection Type	—	—	1/2 in. NPT screw clamp terminals	8–26 mm cable entry screw clamp terminals	8–26 mm cable entry screw clamp terminals
Cable Size	Receiver: PVC torsion cable, largest single wire Ø 0.21 mm/0.008 in., outer Ø 12.0 mm/0.47 in.	Receiver: PVC torsion cable, largest single wire Ø 0.21 mm (0.008 in.), outer Ø 12.0 mm (0.47 in.)	—	1 x 0.5 mm² (20AWG) min. 2 x 1.5 mm² (16AWG) max. 1 x 2.5 mm² (14AWG) max.	1 x 14 AWG (copper only)
Digest Location	XAR, page	XAR, page	Type BW, page 19-81	XAC, page 19-82	XAC, page 19-82

[1] OSHA Section 1910.179, *Overhead and Gantry Cranes*, limits voltage at pendant push buttons to 150 Vac or 300 Vdc max.

Tower Lights and Beacons Selection Guide (1 of 2)

Family	XVB L	XVB C
		
Type of Product	Beacon	Tower Light
Diameter	70mm	70mm
Features	Product for Customer Configuration	Product for Customer Configuration
Approvals	UL File E164353 CCN NKCR CSA File LR 44087 Class 3211 03	UL File E164353 CCN NKCR CSA File LR 44087 Class 3211 03
Conforming to Standards	CE Marked IEC/EN 60947-5-1 UL 508 CSA 22.2 No 14	CE Marked IEC/EN 60947-5-1 UL 508 CSA 22.2 No 14
Degree of Protection	IP65	IP65
Operating Temperature F° (C°)	-13 to 122 (-25 to 50)	-13 to 122 (-25 to 50)
Storage Temperature F° (C°)	-40 to 158 (-40 to 70)	-40 to 158 (-40 to 70)
Light Source	LED / Incandescent	LED / Incandescent
Electrical Consumption		
LED Steady	24 Vac/dc: < 30 mA 120-230 Vac: < 30 mA	24 Vac/dc: < 30 mA 120-230 Vac: < 30 mA
LED Flashing with Buzzer	24 Vac/dc: < 40 mA 120-230 Vac: < 15mA 1 Hz (1 flash per second)	24 Vac/dc: < 40 mA 120-230 Vac: < 15mA 1 Hz (1 flash per second)
Strobe (Energized)	24 Vdc: 5 Joules unit: < 430 mA; 10 J unit: < 850 mA 120 Vac: 5 Joules unit: < 130 mA; 10 J unit: < 260 mA 230 Vac: 5 Joules unit: < 105 mA; 10 J unit: < 210 mA 1 Hz (1 flash per second)	24 Vdc: 5 Joules unit: < 430 mA; 10 J unit: < 850 mA 120 Vac: 5 Joules unit: < 130 mA; 10 J unit: < 260 mA 230 Vac: 5 Joules unit: < 105 mA; 10 J unit: < 210 mA 1 Hz (1 flash per second)
Audible Sounders	12-48 Vac/dc: < 20 mA 120-230 Vac: < 50 mA 90 decibels at 1 meter	12-48 Vac/dc: < 20 mA 120-230 Vac: < 50 mA 90 decibels at 1 meter
Connection Type	Screw Clamp	Screw Clamp
Cable Size	1 x 16 AWG (1.5 mm ²) With Cable End	1 x 16 AWG (1.5 mm ²) With Cable End
Digest Location	XVB 70 mm Beacons, page 19-84	XVB 70 mm Components, page 19-85

Tower Lights and Beacons Selection Guide (2 of 2)

Family	XVC 4	XVC 6	XVC 1	XVU	XVGU	XVR	XVS
							
Type of Product	*Tower Light	*Tower Light	*Tower Light	**Tower Light	**Tower Light	***Rotating Beacon	***Siren and Electronic Alarm
Diameter	40 mm	60 mm	100 mm	60mm	60mm	84/100/106/120/130 mm	—
Features	All devices are pre-assembled and pre-wired			Programmable LED module with multiple colors, flashing, blinking, and rotating	Programmable with Magelis through USB	All devices are pre-assembled and pre-wired. XVR12***S includes buzzer: 50 to 90 decibels XVR3***S includes buzzer: 70 to 90 decibels	Adjustable Tones XVS14BMW, 0 to 105 decibels, 43 tones XVS72BM**, 0 to 90 decibels, 16 tones XVSV****, 0 to 89/97dB, 6 channels, 63 messages, 256 sec XVSV**** Programmable with software
Approvals	UL Recognized E164353 CNN NKCR	UL Recognized E164353 CNN NKCR	UL Recognized E164353 CNN NKCR	UL file: E164353 CCN : NKCR	UL File E164353 CCN NKCR	UL Recognized E164353 CNN NKCR	UL Recognized E164353 CNN UCST
	CSA LR44087 Class 3211-03	CSA LR44087 Class 3211-03	CSA LR44087 Class 3211-03	CSA File : 225619 CLASS : 3211-07	cUL File: E164353 CCN: NKCR7	CSA LR44087 Class 3211-03	CSA LR44087 Class 3211-03
	CE Marked	CE Marked	CE Marked	CE Marked	CE Marked	CE Marked	CE Marked
	EN61000-6-2	EN61000-6-2	EN61000-6-2	EN 60947-1	EN 61000-6-2	EN61000-6-2	ce
	EN61000-6-3	EN61000-6-3	EN61000-6-3	EN 60947-5-1		EN61000-6-4	UKCA
Conforming to Standards	—	EN61000-6-4	EN61000-6-4		EN 61000-6-2	—	EN61000-6-2, EN61000-6-3, EN60947-1, EN60947-5-1
	UL 508	UL 508	UL 508	UL508	UL508	UL 508	UL 508
	CSA 22.2 No. 14	CSA 22.2 No. 14	CSA 22.2 No. 14	CSA C22.2 No. 14	CSA C22.2 No. 14	CSA 22.2 No. 14	CSA 22.2 No. 14 (excluding XVSV)
Degree of Protection	IP54	IP54	IP54	IP65	IP42	XVR08 - XVR13: IP23 / IP55 / IP65 / IP66 / IP67 XVR3: IP23 / IP65 - NEMA 4/4X - Up to 7.1gn vibration resistance	IP53 / IP54 / IP65
Operating Temperature F° (C°)	-13 to122 (-25 to 50)	-13 to122 (-25 to 50)	-13 to122 (-25 to 50)	-13 to 122 (-25 to 50)	32 to 131 (0 to 55)	-14 to 122 (-10 to 50) / (-20 to 50)	-4 to 122 (-20 to 50) (-20 to 60 XVSV)
Storage Temperature F° (C°)	-40 to 158 (-40 to 70)	-40 to 158 (-40 to 70)	-40 to 158 (-40 to 70)	-13 to 150 (-25 to 65)	-31 to 158 (-35 to 70)	-31 to 158 (-35 to 70)	-31 to 158 (-35 to 70) (-10 to 55 XVSV)
Light Source	LED	LED	LED	LED	LED	LED	—
Electrical Consumption				Body unit ≤ 400mA	400mA		
LED Steady	24 V: 1 unit = 40mA; 2 unit = 80mA; 3 unit = 120mA; 4 unit = 160mA; 5 unit = 200mA		24 V: 1 unit = 100mA; 2 unit = 200mA; 3 unit = 300mA; 4 unit = 400mA; 5 unit = 500mA	LED Units ≤ 50 mA	Programmable with Magelis through USB	XVR08, XVR10, XVR12, and XVR13 (without buzzer) 12 Vac/dc: 360mA 24 Vac/dc: 180mA XVR3 (with-w/o buzzer) Rotating, Flashing, Blinking (10 modes) 12-24V DC: 3000mA 48V DC: 1000mA 100-230V AC: 500mA	—
LED Flashing ** with Buzzer	**24 V: 1 unit = 90 mA; 2 unit = 130 mA; 3 unit = 170 mA; 4 unit = 210 mA; 5 unit = 250 mA 0.7 to 3 Hz (1 flash per 0.7 to 3 sec)		24 V: 1 unit = 150mA; 2 unit = 250mA; 3 unit = 350mA; 4 unit = 450mA; 5 unit = 550mA 3 to 3.5 Hz (1 flash per 3 to 3.5 sec)	Buzzer ≤ 70 mA Flasher and multi-color ≤ 70 mA	Programmable with Magelis through USB	XVR12 with buzzer: 12 Vac/dc: 400 mA 24 Vac/dc: 230 mA 3 Hz (1 flash per 3 sec) XVR3 (with-w/o buzzer) Rotating, Flashing, Blinking (10 modes) 12-24V DC, 48V DC: 3000mA 48V DC: 1000mA 100-230V AC: 500mA	—
Strobe (Energized)	—	—	—	—	—	—	—
Audible Sounders	70 to 85 decibels at 1 meter	70 to 85 decibels at 1 meter	60 to 85 decibels at 1 meter	—	—	—	XVS14BMW 12 Vdc: 350mA 24 Vdc: 400 mA 105 decibels at 1 m XVS72BM 12 Vdc: 280 mA 24 Vdc: 190 mA 90 decibels at 1 m XVS77BBN

Family	XVC 4	XVC 6	XVC 1	XVU	XVGU	XVR	XVS
							24 Vdc: 75mA - 89dB at 1m XVSV9MBN 100 Vac: 100mA - 97dB at 1 m
Connection Type	Pre-Wired, Color-Coded Wires cable length: 600mm XVC4** 900mm XVC4**K 500mm XVC4**5S	Pre-Wired, Color-Coded Wires cable length: 600mm XVC6** 850mm XVC6**K 550mm XVC6**5S 850mm XVC6**5SK	Pre-Wired, Color-Coded Wires cable length: 500mm XVC1**K 500mm XVC6**5S 850mm XVC6**5SK	Screw Clamp	USB power cable: - 300 mm/11.81 in. for tube mounting - 400 mm/15.75 in. for direct mounting	Pre-Wired cable length: 500mm XVR08*** 400mm XVR10*** 400mm XVR12*** 400mm XVR13*** 400mm XVR3***	XVS14BMW Pre-Wired, Color-Coded Wires cable length: 500mm XVS14 XVS72BM** Not Pre-Wired
Cable Size	22 AWG (0.33 mm ²)	22 AWG (0.33 mm ²)	22 AWG (0.33 mm ²)	22 - 16 AWG	—	16 AWG (1.25 mm ²) XVR13*** 18 AWG (0.75 mm ²) 20 AWG (0.57 mm ²) XVR3***	See each product data sheet
Digest Location	XVC, page 19-87	XVC, page 19-87	XVC, page 19-87	XVU, page	XVGU, page	XVR, page 19-93	XVS, page 19-95
<p>For Tower Lights catalog numbers: ● O first dot denotes voltage selection ○ ● second dot denotes color selection</p>							

XB4–XB5 Common Operators

Table 19.1: BLACK—Start Push Buttons (flush head)





Operator Style	Description	Contact Block	Type	Legend Plate
XB4 Die Cast Chrome		 1 N.O.	XB4BA21	ZBY2303
XB5 Double Insulated		 1 N.O.	XB5AA21	ZBY2303

Table 19.2: RED—Stop Push Buttons (extended head)





Operator Style	Description	Contact Block	Type	Legend Plate
XB4 Die Cast Chrome		 1 N.C.	XB4BL42	ZBY2304
XB5 Double Insulated		 1 N.C.	XB5AL42	ZBY2304

Table 19.3: BLACK—Off-On Selector Switch





Operator Style	Description	Contact Block	Type	Legend Plate
XB4 Die Cast Chrome		 1 N.O.	XB4BD21	ZBY2367
XB5 Double Insulated		 1 N.O.	XB5AD21	ZBY2367

Table 19.4: Hand-Off-Auto Selector Switch





Operator Style	Description	Contact Block	Type	Legend Plate
XB4 Die Cast Chrome		 2 N.O.	XB4BD33	ZBY2387
XB5 Double Insulated		 2 N.O.	XB5AD33	ZBY2387

Table 19.5: RED—120 Vac LED—On Pilot Light



Operator Style	Description	Contact Block	Type	Legend Plate
XB4 Die Cast Chrome		120 Vac Red LED	XB4BVG4	ZBY2311
XB5 Double Insulated		120 Vac Red LED	XB5AVG4	ZBY2311

Table 19.6: GREEN—120 Vac LED—Off Pilot Light



Operator Style	Description	Contact Block	Type	Legend Plate
XB4 Die Cast Chrome		120 Vac Green LED	XB4BVG3	ZBY2312
XB5 Double Insulated		120 Vac Green LED	XB5AVG3	ZBY2312

Table 19.7: RED—40 mm Mushroom Stop (Push-Pull)









Operator Style	Description	Contact Block	Type	Legend Plate
XB4 Die Cast Chrome		 1 N.C.	XB4BT42	ZBY9320
XB5 Double Insulated		 1 N.C.	XB5AT42	ZBY9320

Table 19.8: RED—40 mm Mushroom Emergency Stop (Trigger Action, Turn-to-Release)

Operator Style	Description	Contact Block	Type	Legend Plate 60 mm Round
XB4 Die Cast Chrome		 1 N.O. / 1 N.C.	XB4BS8445	ZBY9320
XB5 Double Insulated		 1 N.O. / 1 N.C.	XB5AS8445	ZBY9320

When ordering, please specify:

Quantity
Type or Catalog Number

Type K and SK Common Operators

Table 19.9: BLACK—Start Push Buttons





Operator Style	Description	Contact Block	Type [1]	Legend Plate [1]
30 mm Industrial (Metal)			KR1BH13	KN201
30 mm Corrosion Resistant (Non-Metallic)			SKR1BH13	KN101SP

Table 19.10: RED—Stop Push Buttons





Operator Style	Description	Contact Block	Type [1]	Legend Plate [1]
30 mm Industrial (Metal)			KR1RH13	KN202
30 mm Corrosion Resistant (Non-Metallic)			SKR1RH13	KN102RP

Table 19.11: BLACK—Off-On Selector Switch



Operator Style	Description	Contact Sequence (Contact Block Included)	Type [1]	Legend Plate [1]
30 mm Industrial (Metal)			KS11BH13	KN244
30 mm Corrosion Resistant (Non-Metallic)			SKS11BH13	KN144SP

Table 19.12: BLACK—Hand-Off-Auto Selector Switch



Operator Style	Description	Contact Sequence (Contact Block Included)	Type [1]	Legend Plate [1]
30 mm Industrial (Metal)			KS43BH13	KN260
30 mm Corrosion Resistant (Non-Metallic)			SKS43BH13	KN160SP

Table 19.13: RED—120 Vac—On Pilot Light



Operator Style	Description	Type [1]	Legend Plate [1]
30 mm Industrial (Metal)		KP1R31	KN203
30 mm Corrosion Resistant (Non-Metallic)		SKP1R31	KN103SP

Table 19.14: GREEN—120 Vac—Off Pilot Light

Operator Style	Description	Type [1]	Legend Plate [1]
30 mm Industrial (Metal)		KP1G31	KN204
30 mm Corrosion Resistant (Non-Metallic)		SKP1G31	KN104SP

Table 19.15: RED—120 Vac—On Push-To-Test Pilot Light





Operator Style	Description	Type [1]	Legend Plate [1]
30 mm Industrial (Metal)		KT1R31	KN203
30 mm Corrosion Resistant (Non-Metallic)		SKT1R31	KN103SP

Table 19.16: GREEN—120 Vac—Off Push-To-Test Pilot Light

Operator Style	Description	Type [1]	Legend Plate [1]
30 mm Industrial (Metal)		KT1G31	KN204
30 mm Corrosion Resistant (Non-Metallic)		SKT1G31	KN104RP

When ordering, please specify:

Quantity
Class Number (if appropriate)
Type or Catalog Number

[1] When ordering, add prefix 9001 to the catalog number.

XB4 Complete Devices—Non-Illuminated

Table 19.17: Non-Illuminated Push Buttons, Momentary (screw clamp terminal connections)



Shape of Head	Type of Push	Type of Contact		Marking	Cap Color	Catalog Number	Components
		N.O.	N.C.				
	Flush	1	—	—	Black	XB4BA21	(ZB4BZ101 + ZB4BA2)
					Green	XB4BA31	(ZB4BZ101 + ZB4BA3)
					Yellow	XB4BA51	(ZB4BZ101 + ZB4BA5)
					Blue	XB4BA61	(ZB4BZ101 + ZB4BA6)
		—	1	—	Red	XB4BA42	(ZB4BZ102 + ZB4BA4)
					Black	XB4BA25	(ZB4BZ105 + ZB4BA2)
					Green	XB4BA35	(ZB4BZ105 + ZB4BA3)
					Red	XB4BA45	(ZB4BZ105 + ZB4BA4)
1	1	—	Yellow	XB4BA55	(ZB4BZ105 + ZB4BA5)		
			Blue	XB4BA65	(ZB4BZ105 + ZB4BA6)		
	Flush	1	—	"I" (white)	Green	XB4BA3311	(ZB4BZ101 + ZB4BA331)
	Flush	—	1	"O" (white)	Red	XB4BA4322	(ZB4BZ102 + ZB4BA432)
	Flush with clear silicone boot (color of pusher unobscured)	1	—	—	Black	XB4BP21	(ZB4BZ101 + ZB4BP2)
					Green	XB4BP31	(ZB4BZ101 + ZB4BP3)
					Yellow	XB4BP51	(ZB4BZ101 + ZB4BP5)
		—	1	—	Blue	XB4BP61	(ZB4BZ101 + ZB4BP6)
					Red	XB4BP42	(ZB4BZ102 + ZB4BP4)
	Extended	—	1	—	Red	XB4BL42	(ZB4BZ102 + ZB4BL4)
					Red	XB4BL45	(ZB4BZ105 + ZB4BL4)
	Mushroom head Ø 40 mm	1	—	—	Black	XB4BC21	(ZB4BZ101 + ZB4BC2)

Table 19.18: Two Button Push Buttons, Momentary (screw clamp terminal connections)



XB4BL73415

Shape of Head	Type of Push	Type of Contact		Marking	Degree of Protection	Catalog Number	Components
		N.O.	N.C.				
	One flush green push* One extended red push**	1	1	**"I" (white) ***"O" (white)	IP66 IP69K	XB4BL73415	(ZB4BZ105 + ZB4BL7341)

Table 19.19: Two Button Push Buttons, Momentary + one white central pilot light (screw clamp terminal connections)



XB4BL73731•5

Shape of Head	Type of Push	Type of Contact		Marking	Degree of Protection	Pilot Light Voltage	Catalog Number
		N.O.	N.C.				
	One flush green push* One extended red push** One white central pilot light block	1	1	**"I" (white) ***"O" (white)	IP66 IP69K	24 120 240	XB4BW73731B5 XB4BW73731G5 XB4BW73731M5

Table 19.20: Three Button Push Buttons, Momentary (screw clamp terminal connections)



XB4BA731327

Shape of Head	Type of Push	Type of Contact		Degree of Protection	Marking and Cap Color	Catalog Number
		N.O.	N.C.			
	Two flush pushes + one central projecting red push*	2	1	IP66 IP69K	White "I" on green background White "II" on green background *White "Stop" on red background	XB4BA731327
					Black "—" on white background White "—" on black background *White "Stop" on red background	XB4BA711237

For Legends, refer to [XB4 Legend Holders](#), page 19-24, [XB4 Legend Inserts](#), page and [XB4 Legend Sheets](#), page .
For Caps, refer to [XB4 Accessories](#), page .

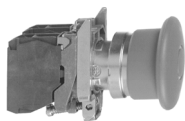

XB4BT845



XB4BS9445



XB4BS542



XB4BG33

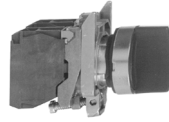

XB4BD33

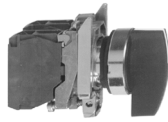

XB4BJ33

Table 19.21: Non-Illuminated Trigger Action Emergency Stop Push Buttons, Ø 40 mm, Red (screw clamp terminal connections)

Shape of Head	Type of Push	Type of Contact			Catalog Number	Components
		N.O.	N.C.			
	Trigger action push-pull [1]	1	1		XB4BT845	(ZB4BZ105 + ZB4BT84)
	Trigger action turn-to-release [1]	1	1		XB4BS8445	(ZB4BZ105 + ZB4BS844)
		1	2		XB4BS84441	(ZB4BZ141 + ZB4BS844)
	Trigger action Key release [1] (No. 455)	1	1		XB4BS9445	(ZB4BZ105 + ZB4BS944)
	Trigger action Push-pull [1]	—	1		XB4BT842	(ZB4BZ102 + ZB4BT84)
	Trigger action Turn-to-release [1]	—	1		XB4BS8442	(ZB4BZ102 + ZB4BS844)
	Trigger action Key release [1] (No. 455)	—	1		XB4BS9442	(ZB4BZ102 + ZB4BS944)

Table 19.22: Non-Illuminated Selector Switches and Key Switches (screw clamp terminal connections) [2]

Shape of Head	Type of Operator	Type of Contact		Number and Type of Positions	Catalog Number	Components
		N.O.	N.C.			
	Standard lever, black	1	—	2-maintained		XB4BD21 (ZB4BZ101 + ZB4BD2)
		1	1	2-maintained		XB4BD25 (ZB4BZ105 + ZB4BD2)
		2	—	3-maintained		XB4BD33 (ZB4BZ103 + ZB4BD3)
	Extended lever, black	1	—	3-momentary to center		XB4BD53 (ZB4BZ103 + ZB4BD5)
		2	—	2-maintained		XB4BJ21 (ZB4BZ101 + ZB4BJ2)
				3-momentary to center		XB4BJ33 (ZB4BZ103 + ZB4BJ3)
	Key (No. 455)	1	—	2-maintained		XB4BG21 (ZB4BZ101 + ZB4BG2)
				2-momentary to left		XB4BG41 (ZB4BZ101 + ZB4BG4)
				3-momentary to center		XB4BG61 (ZB4BZ101 + ZB4BG6)
		2	—	3-momentary to center		XB4BG03 (ZB4BZ103 + ZB4BG0)
				3-momentary to center		XB4BG33 (ZB4BZ103 + ZB4BG3)

NOTE: The symbol indicates key withdrawal position(s).

For Legends, refer to [XB4 Legend Holders, page 19-24](#), [XB4 Legend Inserts, page](#) and [XB4 Legend Sheets, page](#).

[1] Trigger action mushroom heads are tamper proof in that a change of contact state is not possible by teasing or floating the operator. For emergency stop applications, always use a trigger action push button (per EN/IEC 13850).

[2] For contact configurations, see [Sequence of Contacts on Selector Switch Bodies, page 19-16](#).

XB4 Complete Devices—Illuminated

Table 19.23: Pilot Lights with Protected LED™ (screw clamp terminal connections) [3]



XB4BVB5

Shape of Head	Supply Voltage	Color	Catalog Number	Components
	24 Vac/Vdc	White	XB4BVB1	(ZB4BVB1 + ZB4BV013)
		Green	XB4VB3	(ZB4BVB3 + ZB4BV033)
		Red	XB4VB4	(ZB4BVB4 + ZB4BV043)
		Yellow	XB4VB5	(ZB4BVB5 + ZB4BV053)
		Blue	XB4VB6	(ZB4BVB6 + ZB4BV063)
		110–120 Vac	White	XB4VG1
	Green	XB4VG3	(ZB4VG3 + ZB4BV033)	
	Red	XB4VG4	(ZB4VG4 + ZB4BV043)	
	Yellow	XB4VG5	(ZB4VG5 + ZB4BV053)	
	Blue	XB4VG6	(ZB4VG6 + ZB4BV063)	

Table 19.24: Pilot Lights for BA9s Bulb (screw clamp terminal connections)



XB4BV64

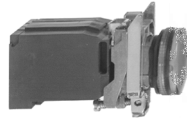

XB4BV33

Shape of Head	Supply Voltage	Color	Catalog Number	Components
Direct supply, for BA9s (incandescent, LED, neon) V < 250 V, 2.4 W bulb (bulb not included)				
	< 250 Vac/Vdc	White	XB4BV61	(ZB4BV6 + ZB4BV01)
		Green	XB4BV63	(ZB4BV6 + ZB4BV03)
		Red	XB4BV64	(ZB4BV6 + ZB4BV04)
		Yellow	XB4BV65	(ZB4BV6 + ZB4BV05)
Transformer type with 1.2 VA, 6 V secondary. BA9s incandescent bulb included				
	110–120 Vac 50/60 Hz	White	XB4BV31	(ZB4BV3 + ZB4BV01)
		Green	XB4BV33	(ZB4BV3 + ZB4BV03)
		Red	XB4BV34	(ZB4BV3 + ZB4BV04)
		Yellow	XB4BV35	(ZB4BV3 + ZB4BV05)

Table 19.25: Illuminated Push Buttons, Momentary (screw clamp terminal connections) [3]

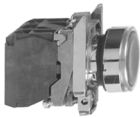

XB4BW33B5

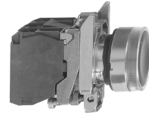

XB4BW3465

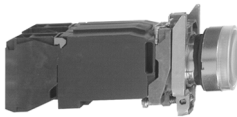

XB4BW3545

Shape of Head	Description	Type of Contact		Supply Voltage	Color of Push	Catalog Number	Components					
		N.O.	N.C.									
Flush												
		1	1	24 Vac/Vdc	White	XB4BW31B5	(ZB4BW0B15 + ZB4BW313)					
					Green	XB4BW33B5	(ZB4BW0B35 + ZB4BW333)					
					Red	XB4BW34B5	(ZB4BW0B45 + ZB4BW343)					
					Yellow	XB4BW35B5	(ZB4BW0B55 + ZB4BW353)					
					Blue	XB4BW36B5	(ZB4BW0B65 + ZB4BW363)					
					110–120 Vac	White	XB4BW31G5	(ZB4BW0G15 + ZB4BW313)				
				Green	XB4BW33G5	(ZB4BW0G35 + ZB4BW333)						
				Red	XB4BW34G5	(ZB4BW0G45 + ZB4BW343)						
				Yellow	XB4BW35G5	(ZB4BW0G55 + ZB4BW353)						
				Blue	XB4BW36G5	(ZB4BW0G65 + ZB4BW363)						
					Direct supply for BA9s 2.4 W max. bulb not included	1	1	< 250 Vac/Vdc	White	XB4BW3165	(ZB4BW065 + ZB4BW31)	
									Green	XB4BW3365	(ZB4BW065 + ZB4BW33)	
Red	XB4BW3465	(ZB4BW065 + ZB4BW34)										
Yellow	XB4BW3565	(ZB4BW065 + ZB4BW35)										
White	XB4BW3135	(ZB4BW035 + ZB4BW31)										
Green	XB4BW3335	(ZB4BW035 + ZB4BW33)										
	Transformer type 1.2 VA, 6 V secondary. BA9s incandescent bulb included	1	1	110–120 Vac 50/60 Hz	White	XB4BW3135	(ZB4BW035 + ZB4BW31)					
					Green	XB4BW3335	(ZB4BW035 + ZB4BW33)					
					Red	XB4BW3435	(ZB4BW035 + ZB4BW34)					
					Yellow	XB4BW3535	(ZB4BW035 + ZB4BW35)					
					White	XB4BW3145	(ZB4BW045 + ZB4BW31)					
					Green	XB4BW3345	(ZB4BW045 + ZB4BW33)					
				230–240 Vac 50/60 Hz	Red	XB4BW3445	(ZB4BW045 + ZB4BW34)					
					Yellow	XB4BW3545	(ZB4BW045 + ZB4BW35)					
					Extended							
							1	1	24 Vac/Vdc	White	XB4BW11B5	(ZB4BW0B15 + ZB4BW113)
										Green	XB4BW13B5	(ZB4BW0B35 + ZB4BW133)
										Red	XB4BW14B5	(ZB4BW0B45 + ZB4BW143)
Yellow	XB4BW15B5	(ZB4BW0B55 + ZB4BW153)										
Blue	XB4BW16B5	(ZB4BW0B65 + ZB4BW163)										
110–120 Vac	White	XB4BW11G5	(ZB4BW0G15 + ZB4BW113)									
Green	XB4BW13G5	(ZB4BW0G35 + ZB4BW133)										
Red	XB4BW14G5	(ZB4BW0G45 + ZB4BW143)										
Yellow	XB4BW15G5	(ZB4BW0G55 + ZB4BW153)										
Blue	XB4BW16G5	(ZB4BW0G65 + ZB4BW163)										

For legends, refer to XB4 Legend Holders, page 19-24, XB4 Legend Inserts, page , and XB4 Legend Sheets, page .

[3] For 240 V LED, replace the last “B” or “G” in the catalog number with an “M”. For example, XB4BV61 (24 V) becomes XB4BVM1 (240 V—AC only).

XB4 Operators

Table 19.26: Non-Illuminated Operators, Momentary—Unmarked



Shape of Head	Type of Push	Cap Color	Catalog Number
	Flush, without color cap [4]	—	ZB4BA0
	Flush, with set of 6 color caps	White Black Green Red Yellow Blue	ZB4BA9
	Flush	White Black Green Red Yellow Blue Gray	ZB4BA1 ZB4BA2 ZB4BA3 ZB4BA4 ZB4BA5 ZB4BA6 ZB4BA8
	Flush with transparent cap, for insertion of legend [5]	White Green Red Yellow Blue	ZB4BA18 ZB4BA38 ZB4BA48 ZB4BA58 ZB4BA68
	Booted Flush (clear silicone) Cap color unobscured	White Black Green Red Yellow Blue	ZB4BPA1 ZB4BPA2 ZB4BPA3 ZB4BPA4 ZB4BPA5 ZB4BPA6
	Booted Extended (clear silicone) Cap color unobscured	White Black Green Red Yellow Blue	ZB4BP1 ZB4BP2 ZB4BP3 ZB4BP4 ZB4BP5 ZB4BP6
	Booted (colored silicone) Cap color unobscured	White Black Green Red Yellow Blue	ZB4BP1S ZB4BP2S ZB4BP3S ZB4BP4S ZB4BP5S ZB4BP6S
	Booted (clear silicone) for insertion of legend [5] Cap color unobscured	White Green Red Yellow Blue	ZB4BP18 ZB4BP38 ZB4BP48 ZB4BP58 ZB4BP68
	Extended	White Black Green Red Yellow Blue	ZB4BL1 ZB4BL2 ZB4BL3 ZB4BL4 ZB4BL5 ZB4BL6
	Guarded Head	White Black Green Red Yellow Blue	ZB4BA16 ZB4BA26 ZB4BA36 ZB4BA46 ZB4BA56 ZB4BA66



Table 19.27: Non-Illuminated Operators, Momentary—Premarked

Shape of Head	Type of Push	Marking Text	Marking Color	Cap Color	Catalog Number	
	Flush	I	White	Green	ZB4BA331	
			Black	White	ZB4BA131	
		START	White	Green	ZB4BA333	
			Black	White	ZB4BA133	
		ON	White	Green	ZB4BA341	
			Black	White	ZB4BA141	
		RESET	White	Black	ZB4BA222	
		JOG	White	Black	ZB4BA245	
		O	White	Red	ZB4BA432	
		STOP	White	Black	Red	ZB4BA232
				Red	Black	ZB4BA434
		OFF	White	Red	Black	ZB4BA234
				Black	Red	ZB4BA435
↑ [6]	White	Black	White	ZB4BA334		
		White	Black	ZB4BA335		
	Extended	O	White	Red	ZB4BL432	
			Black	Red	ZB4BL232	
		STOP	White	Red	Black	ZB4BL434
				Black	Red	ZB4BL234
OFF	White	Red	Black	ZB4BL435		
		Black	Red	ZB4BL235		

For Legends, refer to [XB4 Legend Holders, page 19-24](#), [XB4 Legend Inserts, page](#) , and [XB4 Legend Sheets, page](#) .

[4] Color cap to be ordered separately, see [XB4 Accessories, page](#) .
 [5] For legend ordering information, see [XB4 Legend Sheets, page](#) .
 [6] Cap supplied not clipped-in, allowing orientation of arrow in any one of 4 directions:



ZB4BH02

Table 19.28: Non-Illuminated Push-on/Push-off Operators

Shape of Head	Type of Push	Color of Push	Catalog Number
	Flush	White	ZB4BH01
		Black	ZB4BH02
		Green	ZB4BH03
		Red	ZB4BH04
		Yellow	ZB4BH05
		Blue	ZB4BH06
	Extended	White	ZB4BH1
		Black	ZB4BH2
		Green	ZB4BH3
		Red	ZB4BH4
		Yellow	ZB4BH5
		Blue	ZB4BH6

Table 19.29: Three Head Operators, Momentary

Shape of Head	Description	Marking	Cap Color	Degree of Protection	Catalog Number
Premarked					
	Two flush + one central projecting red push marked "Stop"	"I" (white)	Green	IP66 IP69K	ZB4BA73132
		"II" (white)	Green		ZB4BA73133
		"=" (white)	Green		ZB4BA73134
		"#" (white)	Green		ZB4BA73135
		"+" (white)	Green		ZB4BA71115
		"-" (white)	White		ZB4BA71123
		"=" (black)	White		ZB4BA71124
		"#" (black)	Black		
		"#" (white)	Black		
Without caps					
	Two flush without caps	—	—	IP66 IP69K	ZB4BA791



ZB4BA73133



ZB4BA71124

Table 19.30: Two Head Operators, Momentary

Shape of Head	Description	Marking	Cap Color	Degree of Protection	Catalog Number
No Marking					
	Two flush	—	Green Red	IP66 IP69K	ZB4BA7340
		—	White Black		ZB4BA7120
	One flush One extended	—	Green Red		ZB4BL7340
Premarked					
	Two flush	"I" (white) "O" (white)	Green Red	IP66 IP69K	ZB4BA7341
		"I" (black) "O" (white)	White Black		ZB4BA7121
	One flush One extended	"I" (white) "O" (white)	Green Red		ZB4BL7341
Without caps					
	Two flush without caps	—	—	IP66 IP69K	ZB4BA79



ZB4BA7121



ZB4BL7341

For Legends, refer to XB4 Legend Holders, page 19-24, XB4 Legend Inserts, page , and XB4 Legend Sheets, page .

XB4 Operators and Emergency Stop Operators

Table 19.31: Mushroom Heads, Momentary



Shape of Head	Diameter of Head	Color of Head	Catalog Number
	30 mm	Black	ZB4BC24
		Green	ZB4BC34
		Red	ZB4BC44
		Yellow	ZB4BC54
	40 mm	Blue	ZB4BC64
		Black	ZB4BC2
		Green	ZB4BC3
		Red	ZB4BC4
		Yellow	ZB4BC5
		Blue	ZB4BC6
	60 mm	Black	ZB4BR2
		Green	ZB4BR3
		Red	ZB4BR4
		Yellow	ZB4BR5
		Blue	ZB4BR6

Table 19.32: Mushroom Heads for Maintained Push Buttons

Shape of Head	Type of Push	Diameter of Head	Color	Catalog Number
For use in Emergency Stop applications				
	Trigger action Push-pull [7]	40 mm	Red	ZB4BT84
		60 mm	Red	ZB4BX84
	Trigger action Turn-to-release [7]	30 mm	Red	ZB4BS834
		40 mm	Red	ZB4BS844
		40 mm	Red marked "EMO"	ZB4BS84430
	Trigger action Key release (No. 455) [7]	60 mm	Red	ZB4BS864
		30 mm	Red	ZB4BS934
		40 mm	Red	ZB4BS944 [8]
60 mm	Red	ZB4BS964		
For use in non-Emergency Stop applications				
	Push-pull	40 mm	Black	ZB4BT2
		60 mm	Black	ZB4BX2
	Turn-to-release	30 mm	Black	ZB4BS42
		40 mm	Black	ZB4BS52
			Yellow	ZB4BS55
			Yellow marked "Robot Stop"	ZB4BS5550
	Key release (No. 455)	60 mm	Black	ZB4BS62
		30 mm	Black	ZB4BS72
		40 mm	Black	ZB4BS12
		60 mm	Black	ZB4BS22

Table 19.33: Circular Legends for Emergency Stop Mushroom Heads (yellow background)

Diameter	Text	Catalog Number
90 mm	Blank	ZBY8101
	EMERGENCY STOP	ZBY8330
60 mm Bezeled	Blank	ZBY9121
	Emergency Stop	ZBY9320
	Prada de Emergencia	ZBY9420
	Not Halt	ZBY9220

For Legends, refer to [XB4 Legend Holders](#), page 19-24, [XB4 Legend Inserts](#), page , and [XB4 Legend Sheets](#), page .

[7] Trigger action mushroom heads are tamper proof in that a change of contact state is not possible by teasing or floating the operator. For emergency stop applications, always use a trigger action push button (per EN/IEC 13850).

[8] Other key numbers:

- key no. 421E: add the suffix 12 to the catalog number.
- key no. 458A: add the suffix 10 to the catalog number.
- key no. 520E: add the suffix 14 to the catalog number.
- key no. 3131A: add the suffix 20 to the catalog number.

Example: The catalog number for a Ø 40 mm red mushroom head for a trigger action, maintained push button, with release by key no. 421E becomes: ZB5AS94412.

XB4 Selector Switches

Table 19.34: Non-Illuminated Selector Switches [9]

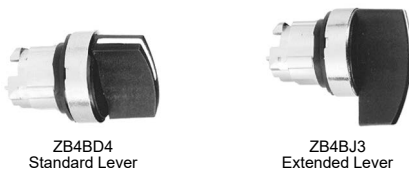

Color	Number and Type of Positions		Standard Lever [10]	Extended Lever
			Catalog Number	
Black	2-maintained		ZB4BD2	ZB4BJ2
Black	2-momentary from right to left		ZB4BD4	ZB4BJ4
Black	3-maintained		ZB4BD3	ZB4BJ3
Black	3-momentary to center		ZB4BD5	ZB4BJ5
Black	3-momentary from left to center		ZB4BD7	ZB4BJ7
Black	3-momentary from right to center		ZB4BD8	ZB4BJ8

Table 19.35: Non-Illuminated Key Switches [9]

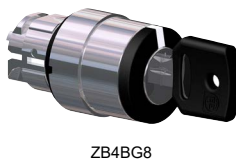

Type of Operator	Number and Type of Positions		Catalog Number	
	2-maintained		ZB4BG2	
			ZB4BG02	
			ZB4BG4	
	2-momentary from right to left		ZB4BG6	
		3-maintained		ZB4BG0
				ZB4BG3
	ZB4BG03			
	ZB4BG04			
	ZB4BG5			
	ZB4BG9			
	3-momentary from left to center		ZB4BG1	
			ZB4BG01	
	3-momentary to center		ZB4BG7	
		3-momentary from right to center		ZB4BG8
	ZB4BG05			
	ZB4BG08			

Key (No. 455)
NOTE: The symbol indicates key withdrawal position(s).
Other key numbers:
 —key no. 421E: add the suffix 12 to the catalog number.
 —key no. 458A: add the suffix 10 to the catalog number.
 —key no. 520E: add the suffix 14 to the catalog number.
 —key no. 3131A: add the suffix 20 to the catalog number.
 —key no. 8D1: add the suffix D to the catalog number.
Example: The catalog number for a head with key no. 421E for a 2 position maintained, lockable selector switch, with key withdrawal from the left-hand position, becomes: ZB5AG212

Table 19.36: Sequence of Contacts on Selector Switch Bodies

Unit Type	Selector Switches															
	2-position						3-position									
	315°			45°			315°			0°			45°			
Operator Plunger Position	Up															
	Down															
Contact Block Location	L	C	R	L	C	R	L	C	R	L	C	R	L	C	R	
Contacts	N.O.	O	O	O	X	X	X	X	X	O	O	O	O	O	X	X
	N.C.	X	X	X	O	O	O	O	O	X	X	X	X	X	O	O

For Legends, refer to [XB4 Legend Holders](#), page 19-24, [XB4 Legend Inserts](#), page , and [XB4 Legend Sheets](#), page .
 For Selector Switch Sequence, refer to [Sequence of Contacts on Illuminated Selector Switch Bodies](#), page 19-19.

[9] For contact configurations, see [Sequence of Contacts on Selector Switch Bodies](#), page 19-16.

[10] For colored lever, add the following code to the end of part number: 01–white, 03–green, 04–red, 05–yellow, 06–blue (Example: ZB4BD204).

XB4 Specialty Operators

Table 19.37: Potentiometer Operator (with Mounting Collar)

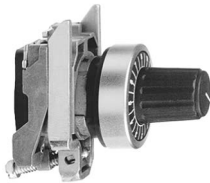

ZB4BD922



XB4BD912R1K



ZB4BD28



XB4BA8•1

Shape of Head	Description	Application	Catalog Number
	For potentiometer with shaft length 1.73 to 1.97 in. (45 to 50 mm) (potentiometer not included)	For shaft Ø 1/4 in. (6.35 mm)	ZB4BD922
		For shaft Ø 0.24 in. (6 mm)	ZB4BD912

Table 19.38: Complete Potentiometers

Description	Resistance (k Ω)	Weight (kg/lb)	Catalog Number
+/- 10% linear mode precision complete potentiometer with screw terminals	1	0.095/0.209	XB4BD912R1K
	4.7	0.095/0.209	XB4BD912R4K7
	10	0.095/0.209	XB4BD912R10K
	47	0.095/0.209	XB4BD912R47K
	100	0.095/0.209	XB4BD912R100K
	470	0.095/0.209	XB4BD912R470K

Table 19.39: Two Position Toggle Switch

Shape of Head	Color	Type of Positions	Catalog Number
	Black	Maintained	ZB4BD28
	Black	Momentary	ZB4BD48

Table 19.40: Reset Operators, Flush, Adjustable Shaft

Shape of Head	Travel		Actuation Distance		Color	Catalog Number
	in.	mm	in.	mm		
	0.39	10	0.24–0.63	6–16	Black	XB4BA821
					Red	XB4BA841
					Blue	XB4BA861
			0.63–1.02	16–26	Black	XB4BA822
					Red	XB4BA842
					Blue	XB4BA862
	0.55	14	1.18–5.12	30–130	Black	XB4BA921
					Red	XB4BA941
					Blue	XB4BA961
			5.12–10.12	130–257	Black	XB4BA922
					Red	XB4BA942
					Blue	XB4BA962

For Legends, refer to [XB4 Legend Holders](#), page 19-24, [XB4 Legend Inserts](#), page , and [XB4 Legend Sheets](#), page .

XB4 Pilot Lights

Table 19.41: Pilot Light Heads



Shape of Head	For Use with Body Comprising Light Module Type	Color of Lens	Catalog Number
	Protected LED™ only	White Green Red Yellow Blue	ZB4BV013 ZB4BV033 ZB4BV043 ZB4BV053 ZB4BV063
	Protected LED only Fresnel (jeweled) lens [11]	White Green Red Amber Blue	ZB4BV013S ZB4BV033S ZB4BV043S ZB4BV053S ZB4BV063S
	For BA9s incandescent bulb, neon or LED only [12]	White Green Red Yellow Blue Clear	ZB4BV01 ZB4BV03 ZB4BV04 ZB4BV05 ZB4BV06 ZB4BV07
	For BA9s incandescent bulb, neon or LED Fresnel (jeweled) lens [12]	White Green Red Amber Blue Clear	ZB4BV01S ZB4BV03S ZB4BV04S ZB4BV05S ZB4BV06S ZB4BV07S

Table 19.42: Complete Bodies (Mounting Collar + Light Module for BA9s Incandescent Bulb, Neon or LED)

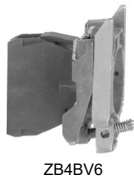

Description	Light Source	Supply Voltage (V)	Catalog Number
Screw clamp terminal connections			
Direct supply	BA9s bulb 2.4 W max. Not included [12]	<250	ZB4BV6
Direct supply	BA9s incandescent bulb included	24 v 2 Watt	ZB4BV624
Direct supply	BA9s incandescent bulb included	120 v 2.4 Watt	ZB4BV6120
Transformer type 1.2 VA, 6 V secondary	BA9s incandescent bulb included	110–120 Vac 50/60 Hz	ZB4BV3
		230–240 Vac 50/60 Hz	ZB4BV4
		400–50 Hz	ZB4BV5
		440–480 Vac 60 Hz	ZB4BV8
		550–600 Vac 60 Hz	ZB4BV9

Table 19.43: Complete Bodies (Mounting Collar + Light Module with Protected LED™) [13]

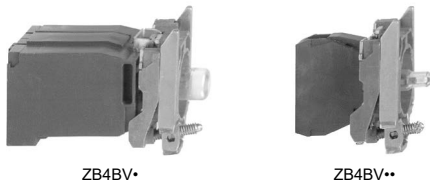

Light Source	Supply Voltage	Color of Light Source	Catalog Number
Screw clamp terminal connections [14]			
	12 Vac/Vdc	White Green Red Yellow Blue	ZB4BVJ1 ZB4BVJ3 ZB4BVJ4 ZB4BVJ5 ZB4BVJ6
	24 Vac/Vdc	White Green Red Yellow Blue	ZB4BV81 ZB4BV83 ZB4BV84 ZB4BV85 ZB4BV86
	24–120 Vac/Vdc	White Green Red Yellow Blue	ZB4BVBG1 ZB4BVBG3 ZB4BVBG4 ZB4BVBG5 ZB4BVBG6
	110–120 Vac	White Green Red Yellow Blue	ZB4BVG1 ZB4BVG3 ZB4BVG4 ZB4BVG5 ZB4BVG6
	24 Vac/Vdc	White Green Red Yellow Blue	ZB4BV18B1 ZB4BV18B3 ZB4BV18B4 ZB4BV18B5 ZB4BV18B6
	110–120 Vac	White Green Red Yellow Blue	ZB4BV18G1 ZB4BV18G3 ZB4BV18G4 ZB4BV18G5 ZB4BV18G6

For Legends, refer to XB4 Legend Holders, page 19-24, XB4 Legend Inserts, page and XB4 Legend Sheets, page .

[11] For use in bright ambient conditions, for example, in sunlight.

[12] Order bulb separately; see BA9s Bulbs and Associated Accessories, page . For BA9 LED, see LED, BA9s Base, page .

[13] For 240 V LED, replace the last "B" or "G" in the catalog number with an "M". For example, ZB4BV81 (24 V) becomes ZB4BVM1 (240 V).

[14] For Quick-Connect version, add "3" to the end of the catalog number Example: ZB4BVJ13 (Quick-Connect size 1 x 1/40" or 2 x 0.110").

XB4 Illuminated Operators

Table 19.44: Heads for Momentary Illuminated Push Buttons



Shape of Head	Type of Push	Color	Catalog Number
Only use with Protected LED™ light modules			
	Flush	White	ZB4BW313
		Green	ZB4BW333
		Red	ZB4BW343
		Yellow	ZB4BW353
		Blue	ZB4BW363
	Flush with clear silicone boot	White	ZB4BW513
		Green	ZB4BW533
		Red	ZB4BW543
		Yellow	ZB4BW553
		Blue	ZB4BW563
	Flush for insertion of legend	White	ZB4BA18
		Green	ZB4BA38
		Red	ZB4BA48
		Yellow	ZB4BA58
		Blue	ZB4BA68
	Extended	White	ZB4BW113
		Green	ZB4BW133
		Red	ZB4BW143
		Yellow	ZB4BW153
		Blue	ZB4BW163
	Mushroom (40 mm)	Clear	ZB4BW413
		Green	ZB4BW433
		Red	ZB4BW443
		Yellow	ZB4BW453
		Blue	ZB4BW463
Only use with light modules for a BA9s incandescent bulb, neon or LED			
	Flush	White	ZB4BW31
		Green	ZB4BW33
		Red	ZB4BW34
		Yellow	ZB4BW35
		Blue	ZB4BW36
		Clear	ZB4BW37
	Extended	White	ZB4BW11
		Green	ZB4BW13
		Red	ZB4BW14
		Yellow	ZB4BW15
		Blue	ZB4BW16
		Clear	ZB4BW17

Table 19.45: Heads for Maintained Illuminated Push Buttons



Shape of Head	Type of Push	Color of Lens	Catalog Number
Only use with Protected LED light modules			
	Push/Pull Mushroom (40 mm)	Clear	ZB4BW613
		Green	ZB4BW633
		Red	ZB4BW643
		Yellow	ZB4BW653
		Blue	ZB4BW663

Table 19.46: Illuminated Push-On/Push-Off Operators



Shape of Head	Type of Push	Color of Lens	Catalog Number
Only use with Protected LED light modules			
	Flush	White	ZB4BH013
		Green	ZB4BH033
		Red	ZB4BH043
		Yellow	ZB4BH053
		Blue	ZB4BH063
	Extended	White	ZB4BH13
		Green	ZB4BH33
		Red	ZB4BH43
		Yellow	ZB4BH53
		Blue	ZB4BH63

For Legends, refer to XB4 Legend Holders, page 19-24, XB4 Legend Inserts, page . and XB4 Legend Sheets, page .



ZB4BW7A3741



ZB4BW7A1721

Table 19.47: Two Button with Clear Pilot Light, Momentary

Shape of Head	Description	Marking	Cap Color	Degree of Protection	Catalog Number
No Marking					
Protected LED	Two flush	—	Green Red	IP66 IP69K	ZB4BW7A3740
		—	White Black		ZB4BW7A1720
Protected LED	One flush One extended	—	Green Red		ZB4BW7L3740
Premarked					
Protected LED	Two flush	"I" (white) "O" (white)	Green Red	IP66 IP69K	ZB4BW7A3741
		"I" (black) "O" (white)	White Black		ZB4BW7A1721
Protected LED	One flush One extended	"I" (white) "O" (white)	Green Red		ZB4BW7L3741
Protected LED	Two flush	"4" (black) "4" (white)	White Black		ZB4BW7A1724
Protected LED	Two flush	"+" (black) "-" (white)	White Black		ZB4BW7A1715
Without caps					
	Two flush without caps	—	—	IP66 IP69K	ZB4BW7A9



ZB4BK1343

Table 19.48: Illuminated Selector Switches, Standard Lever

Shape of Head	Number and Type of Positions	Catalog Number [15]	
Only use with Protected LED light modules			
	2-maintained		ZB4BK12•3
	2-momentary from right to left		ZB4BK14•3
	3-maintained		ZB4BK13•3
	3-momentary to center		ZB4BK15•3
	3-momentary from right to center		ZB4BK18•3
	3-momentary from left to center		ZB4BK17•3

Table 19.49: Sequence of Contacts on Illuminated Selector Switch Bodies

Unit Type	Selector Switches									
	2-position				3-position					
Operator Plunger Position	Up									
	Down									
Contact Block Location	L	R	L	R	L	R	L	R	L	R
	N.O.	O	O	X	X	X	O	O	O	X
Contacts	N.C.	X	X	O	O	O	X	X	X	O

Note: L=Left, R=Right, O=Open, X=Closed

2 Position Selector Switch			3 Position Selector Switch		
		Contact block guide			Contact block guide
O	X	1 N.O. (left or right)	O	O	1 N.O. (left)
X	O	1 N.C. (left or right)	X	O	2 N.O. wired in parallel (side by side)
O	X	1 N.O. (right)	X	O	1 N.O. (right)
		and	O	X	1 N.C. (right)
X	O	1 N.C. (left)	X	X	1 N.C. (left)
			O	X	2 N.C. wired in series (side by side)

For Legends, refer to XB4 Legend Holders, page 19-24, XB4 Legend Inserts, page , and XB4 Legend Sheets, page .

For Caps, refer to XB4 Accessories, page .

[15] • Designate color as follows: 1—white, 3—green, 4—red, 5—yellow, 6—blue.

XB4 Electrical Components

Table 19.50: Contact Blocks (Mounting Collar with Contact Blocks)

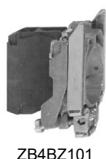

Description	Type of Contact		Catalog Number
	N.O.	N.C.	
Screw clamp terminal connections	1	—	ZB4BZ101
	—	1	ZB4BZ102
	2	—	ZB4BZ103
	—	2	ZB4BZ104
	1	1	ZB4BZ105
	1	2	ZB4BZ141

For Quick-Connect version add "3" to the end of the catalog number Example: ZB4BZ1013 (Quick-Connect size 1 x 0.250" or 2 x 0.110").
For Ring Tongue compatible blocks add "9" to the end of the catalog number (Example: ZB4BZ1029).
Electrical components with connection by printed circuit board pins are available. Refer to Catalog 9001CT0001.
Electrical components with connection by plug-in connector are available. Refer to Catalog 9001CT0001.

Table 19.51: Complete Bodies

(Mounting Collar + Single Contact Block + Light Module with Protected LED™)

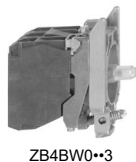

Light Source	Type of Contact [16]		Color	Supply Voltage [17]		
	N.O.	N.C.		24 Vac/Vdc	110–120 Vac	
Screw clamp terminal connections						
Protected LED	1	—	White	ZB4BW0B11	ZB4BW0G11	
			Green	ZB4BW0B31	ZB4BW0G31	
			Red	ZB4BW0B41	ZB4BW0G41	
			Yellow	ZB4BW0B51	ZB4BW0G51	
	—	1	Blue	ZB4BW0B61	ZB4BW0G61	
			White	ZB4BW0B12	ZB4BW0G12	
			Green	ZB4BW0B32	ZB4BW0G32	
			Red	ZB4BW0B42	ZB4BW0G42	
	2	—	Yellow	ZB4BW0B52	ZB4BW0G52	
			Blue	ZB4BW0B62	ZB4BW0G62	
			White	ZB4BW0B13	ZB4BW0G13	
			Green	ZB4BW0B33	ZB4BW0G33	
	1	1	Red	ZB4BW0B43	ZB4BW0G43	
			Yellow	ZB4BW0B53	ZB4BW0G53	
			Blue	ZB4BW0B63	ZB4BW0G63	
			White	ZB4BW0B15	ZB4BW0G15	
				Green	ZB4BW0B35	ZB4BW0G35
				Red	ZB4BW0B45	ZB4BW0G45
				Yellow	ZB4BW0B55	ZB4BW0G55
				Blue	ZB4BW0B65	ZB4BW0G65

Table 19.52: Mounting Collar, Contact Block and Light Module (with screw clamp terminal connections)



Supply	Light Source	Supply Voltage	Type of Contact [18]		Color of Light Source	Catalog Number
			N.O.	N.C.		
Screw clamp terminal connections						
Direct supply	BA9s 2.4 W max. bulb Not included [19]	< 250 Vac/Vdc	1	—	—	ZB4BW061
			—	1	—	ZB4BW062
			2	—	—	ZB4BW063
			1	1	—	ZB4BW065
Transformer type 1.2 VA, 6 V secondary	BA9s incandescent bulb included	110–120 Vac 50/60 Hz	1	—	—	ZB4BW031
			1	1	—	ZB4BW035
		230–240 Vac 50/60 Hz	1	—	—	ZB4BW041
			1	1	—	ZB4BW045
		440–480 Vac 60 Hz	1	—	—	ZB4BW081

[16] Can be fitted with additional contact blocks, see Table 19.54 Add-On Contact Block (with screw clamp terminal connections), page 19-22.
[17] For 240V LED, replace the "B" or "G" with "M". (Example: change "ZB4BW0B11 (24V)" to ZB4BW0M11 (240V))
[18] Can be fitted with additional contact blocks, see Table 19.54 Add-On Contact Block (with screw clamp terminal connections), page 19-22.
[19] Order bulb separately, see BA9s Bulbs and Associated Accessories.

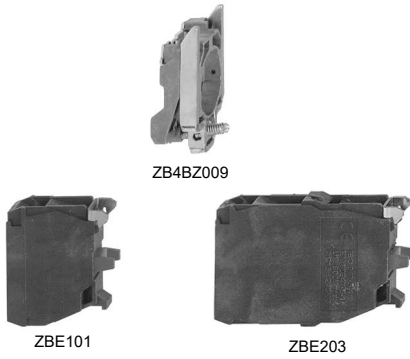

Table 19.53: Body/Mounting Collar

For use with	Catalog Number
Electrical block (contact or light module)	ZB4BZ009

Table 19.54: Add-On Contact Block (with screw clamp terminal connections) [20][21]

Description	Type of Contact		Catalog Number
	N.O.	N.C.	
Standard single contact blocks [22][23]	1	—	ZBE101
	—	1	ZBE102
Standard double contact blocks [22][23]	2	—	ZBE203
	—	2	ZBE204
	1	1	ZBE205
Special contact blocks for low power switching [24]	1	—	ZBE1016
	—	1	ZBE1026
Low-power switching	Dusty environment [24] (IP5X, 50 µm dust)	—	ZBE1016P
		1	ZBE1026P
Staggered contacts	Early make N.O.	1	ZBE201
	Late break N.C.	—	ZBE202
	Overlapping N.O.+N.C.	1	ZB4BZ106
	Staggered N.O.+N.C.	—	ZB4BZ107

Table 19.55: Light Modules (with screw clamp terminal connections) [20][21]

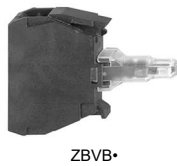

Description	Supply Voltage	Color of Light Source	Catalog Number
Protected LED	12 Vac/Vdc	White	ZBVJ1
		Green	ZBVJ3
		Red	ZBVJ4
		Yellow	ZBVJ5
		Blue	ZBVJ6
		White	ZBVB1
	24 Vac/Vdc	Green	ZBVB3
		Red	ZBVB4
		Yellow	ZBVB5
		Blue	ZBVB6
		White	ZBVG1
		Green	ZBVG3
	110–120 Vac	Red	ZBVG4
		Yellow	ZBVG5
		Blue	ZBVG6
		White	ZBVBG1
		Green	ZBVBG3
		Red	ZBVBG4
	24–120 Vac/Vdc	Yellow	ZBVBG5
		Blue	ZBVBG6
		White	ZBVM1
		Green	ZBVM3
		Red	ZBVM4
		Yellow	ZBVM5
230–240 Vac	Blue	ZBVM6	
	White	ZBVM1	
Direct supply for BA9s 2.4 W max. bulb not included See BA9s Bulbs and Associated Accessories , page	< 250 Vac/Vdc	—	ZBV6

[20] Electrical components with connection by printed circuit board pins are available. Refer to Catalog 9001CT0001 for more details.

[21] Electrical components with connection by plug-in connector are available. Refer to Catalog 9001CT0001 for more details.

[22] For Quick-Connect version add "3" to the end of the catalog number Example: ZBE1013 (Quick-Connect size 1 x 0.250 in. or 2 x 0.110 in.).

[23] For Ring Tongue compatible blocks add "9" to the end of the catalog number (Example: ZBE1029).

[24] Cannot stack additional contact blocks onto these blocks.



ZB4BZ009



ZB4BZ1015

Table 19.56: Body/Mounting Collar

For use with	Catalog Number
Contact block or light module	ZB4BZ009

Table 19.57: Light Modules [25]

Spring Terminal Connections			
Description	Supply voltage	Color of light source	Catalog Number
Integral LED (to combine with heads for integral LED) Protected LED	12 Vac/Vdc	White	ZBVJ15
		Green	ZBVJ35
		Red	ZBVJ45
		Orange	ZBVJ55
		Blue	ZBVJ65
	24 Vac/Vdc	White	ZBVB15
		Green	ZBVB35
		Red	ZBVB45
		Orange	ZBVB55
		Blue	ZBVB65
	110–120 Vac	White	ZBVG15
		Green	ZBVG35
		Red	ZBVG45
		Orange	ZBVG55
		Blue	ZBVG65
	230–240 Vac	White	ZBVM15
		Green	ZBVM35
		Red	ZBVM45
		Orange	ZBVM55
		Blue	ZBVM65

[25] Additional blocks **cannot** be attached to the back of these contact blocks or light modules. However, spring terminal contact blocks can be mounted behind screw terminal contact blocks.

XB4 Legend Holders

Table 19.58: Standard (30 x 40 mm) Legend Holders for 8 x 27 mm Legends

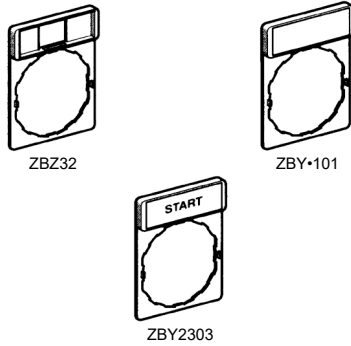

Description	Legend		Catalog Number
	Color	Text	
Without legend [26]	—	—	ZBZ32
With blank legend (for engraving)	Black or red background	—	ZBY2101
	White or yellow background	—	ZBY4101
Custom Legend (Specify Engraving) 2 lines of 11 characters (including spaces) maximum per line	Black background	White	ZBY2002
	Red background	White	ZBY2004
	White background	Black	ZBY4001
	Yellow background	Black	ZBY4005
With legend marked with international language	Black or red background [27]	O (black background)	ZBY2146
		O (red background)	ZBY2931
		I	ZBY2147
		II	ZBY2148
		O-I	ZBY2178
		I-II	ZBY2179
		I-O-II	ZBY2186
		With legend marked with English language	Black or red background [27]
AUTO-HAND	ZBY2364		
AUTO-O-HAND	ZBY2385		
CLOSE	ZBY2314		
DOWN	ZBY2308		
EMERGENCY STOP	ZBY2330		
FAST	ZBY2328		
FORWARD	ZBY2305		
FOR-REV	ZBY2371		
HAND	ZBY2316		
HAND-OFF-AUTO	ZBY2387		
INCH	ZBY2321		
JOG	ZBY2382		
LEFT	ZBY2310		
OFF	ZBY2312		
OFF-ON	ZBY2367		
ON	ZBY2311		
OPEN	ZBY2313		
POWER ON	ZBY2326		
RESET (red background)	ZBY2323		
RESET (black background)	ZBY2322		
REVERSE	ZBY2306		
RIGHT	ZBY2309		
RUN	ZBY2334		
SLOW	ZBY2327		
START	ZBY2303		
STOP	ZBY2304		
STOP-START	ZBY2366		
UP	ZBY2307		



XB5 Complete Devices

Table 19.59: Non-Illuminated Push Buttons, Momentary (screw clamp terminal connections)

Shape of Head	Type of Push	Type of Contact		Marking	Cap Color	Catalog Number	Components
		N.O.	N.C.				
⊙	Flush	1	—	—	Black	XB5AA21	(ZB5AZ101 + ZB5AA2)
					Green	XB5AA31	(ZB5AZ101 + ZB5AA3)
					Yellow	XB5AA51	(ZB5AZ101 + ZB5AA5)
					Blue	XB5AA61	(ZB5AZ101 + ZB5AA6)
		1	1	—	Red	XB5AA42	(ZB5AZ102 + ZB5AA4)
					Black	XB5AA25	(ZB5AZ105 + ZB5AA2)
					Green	XB5AA35	(ZB5AZ105 + ZB5AA3)
					Red	XB5AA45	(ZB5AZ105 + ZB5AA4)
⊙	Flush	1	—	"I" (white)	Green	XB5AA3311	(ZB5AZ101 + ZB5AA331)
					Red	XB5AA4322	(ZB5AZ102 + ZB5AA432)
⊙	Flush with clear silicone boot (color of pusher unobscured)	1	—	—	Black	XB5AP21	(ZB5AZ101 + ZB5AP2)
					Green	XB5AP31	(ZB5AZ101 + ZB5AP3)
					Yellow	XB5AP51	(ZB5AZ101 + ZB5AP5)
		—	1	—	Blue	XB5AP61	(ZB5AZ101 + ZB5AP6)
					Red	XB5AP42	(ZB5AZ102 + ZB5AP4)
					Red	XB5AL45	(ZB5AZ102 + ZB5AL4)
⊙	Extended	1	1	—	Red	XB5AL42	(ZB5AZ105 + ZB5AL4)
					Red	XB5AL45	(ZB5AZ105 + ZB5AL4)
⊙	Mushroom head Ø 40 mm	1	—	—	Black	XB5AC21	(ZB5AZ101 + ZB5AC2)

[26] For marked legends, see, [Marked Legends for 30 x 40 mm legend holders](#), page .

[27] Start functions: white letters on black background. Stop functions: white letters on red background (unless otherwise specified above).



XB5AL73415

Table 19.60: Two Button Push Buttons, Momentary (screw clamp terminal connections)

Shape of Head	Type of Push	Type of Contact		Marking	Degree of Protection	Catalog Number	Components
		N.O.	N.C.				
	One flush green push* One extended red push**	1	1	**"I" (white) ***"O" (white)	IP66 IP69K	XB5AL73415	(ZB5AZ105 + ZB5AL7341)



XB5AW73731-5

Table 19.61: Two Button Push Buttons, Momentary + one white central pilot light (screw clamp terminal connections)

Shape of Head	Type of Push	Type of Contact		Marking	Degree of Protection	Pilot Light Voltage	Catalog Number
		N.O.	N.C.			24	120
	One flush green push* One extended red push** One white central pilot light block	1	1	**"I" (white) ***"O" (white)	IP66 IP69K	24	XB5AW73731B5
						120	XB5AW73731G5
						240	XB5AW73731M5



XB5AA731327

Table 19.62: Three Button Push Buttons, Momentary (screw clamp terminal connections)

Shape of Head	Type of Push	Type of Contact		Degree of Protection	Marking and Cap Color	Catalog Number
		N.O.	N.C.			XB5AA731327
	Two flush pushes + one central projecting red push*	2	1	IP66 IP69K	White "I" on green background White "II" on green background *White "Stop" on red background	XB5AA731327
					Black "↔" on white background White "↔" on black background *White "Stop" on red background	XB5AA711237

For Legends, see [XB5 Legend Holders](#), page 19-40 and [XB5 Legend Inserts](#), page .
Caps, see [XB5 Accessories](#), page .

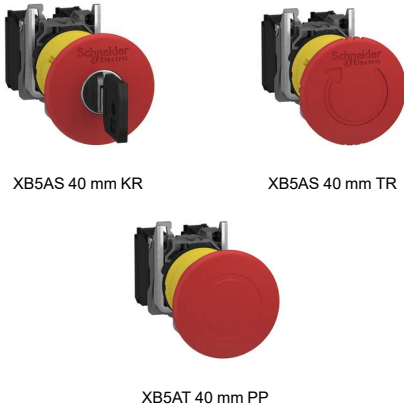

Table 19.63: Non-Illuminated Trigger Action Emergency Stop Push Buttons, Ø 40 mm (Red) (screw clamp terminal connections)

Shape of Head	Type of Push	Type of Contact		Catalog Number	Components
		N.O.	N.C.		
	Trigger action push-pull [28]	1	1	XB5AT845	(ZB5AZ105 + ZB5AT84)
	Trigger action turn-to-release [28]	1	1	XB5AS8445	(ZB5AZ105 + ZB5AS844)
		—	2	XB5AS8444	(ZB5AZ104 + ZB5AS844)
	Trigger action Key release (No. 455) [28]	1	1	XB5AS9445	(ZB5AZ105+ ZB5AS944)
	Trigger action Push-pull [28]	—	1	XB5AT842	(ZB5AZ102 + ZB5AT84)
	Trigger action Turn-to-release [28]	—	1	XB5AS8442	(ZB5AZ102 + ZB5AS844)
	Trigger action Key release (No. 455) [28]	—	1	XB5AS9442	(ZB5AZ102 + ZB5AS944)

Table 19.64: Non-Illuminated Selector Switches and Key Switches (screw clamp terminal connections) [29]



Shape of Head	Type of Operator	Type of Contact		Number and Type of Positions	Catalog Number	Components
		N.O.	N.C.			
	Standard lever, black	1	—	2-maintained		XB5AD21 (ZB5AZ101 + ZB5AD2)
		1	1	2-maintained		XB5AD25 (ZB5AZ105 + ZB5AD2)
		2	—	3-maintained		XB5AD33 (ZB5AZ103 + ZB5AD3)
3-momentary to center				XB5AD53 (ZB5AZ103 + ZB5AD5)		
	Extended lever, black	1	—	2-maintained		XB5AJ21 (ZB5AZ101 + ZB5AJ2)
		2	—	3-maintained		XB5AJ33 (ZB5AZ103 + ZB5AJ3)
				3-momentary to center		XB5AJ53 (ZB5AZ103 + ZB5AJ5)
	Key (No. 455)	1	—	2-maintained		XB5AG21 (ZB5AZ101 + ZB5AG2)
				2-momentary to left		XB5AG61 (ZB5AZ101 + ZB5AG6)
		2	—	3-maintained		XB5AG03 (ZB5AZ103 + ZB5AG0)
						XB5AG33 (ZB5AZ103 + ZB5AG3)

NOTE: The symbol indicates key withdrawal position(s).

For Legends, see [XB5 Legend Holders](#), page 19-40 and [XB5 Legend Inserts Only](#), page

[28] Trigger action mushroom heads are tamper proof in that a change of contact state is not possible by teasing or floating the operator. For emergency stop applications, always use a trigger action push button (per EN/IEC 13850).

[29] For contact configurations, see [Sequence of Contacts on Selector Switch Bodies](#), page 19-32.



XB5AVB1





XB5EVG1

Table 19.65: Pilot Lights with Protected LED™ (screw clamp terminal connections)

[30]

Shape of Head	Supply Voltage	Color	Monolithic Units	Complete Units	Complete Unit Components
	24 Vac/Vdc	White	XB5EVB1	XB5AVB1	(ZB5AVB1 + ZB5AV013)
		Green	XB5EVB3	XB5AVB3	(ZB5AVB3 + ZB5AV033)
		Red	XB5EVB4	XB5AVB4	(ZB5AVB4 + ZB5AV043)
		Orange	XB5EVB5	XB5AVB5	(ZB5AVB5 + ZB5AV053)
		Blue	XB5EVB6	XB5AVB6	(ZB5AVB6 + ZB5AV063)
		Yellow	XB5EVB8	—	—
	110–120 Vac	White	XB5EVG1	XB5AVG1	(ZB5AVG1 + ZB5AV013)
		Green	XB5EVG3	XB5AVG3	(ZB5AVG3 + ZB5AV033)
		Red	XB5EVG4	XB5AVG4	(ZB5AVG4 + ZB5AV043)
		Orange	XB5EVG5	XB5AVG5	(ZB5AVG5 + ZB5AV053)
		Blue	XB5EVG6	XB5AVG6	(ZB5AVG6 + ZB5AV063)
		Yellow	XB5EVG8	—	—
	230–240 Vac	White	XB5EVM1	XB5AVM1	(ZB5AVM1 + ZB5AV013)
		Green	XB5EVM3	XB5AVM3	(ZB5AVM3 + ZB5AV033)
		Red	XB5EVM4	XB5AVM4	(ZB5AVM4 + ZB5AV043)
		Orange	XB5EVM5	XB5AVM5	(ZB5AVM5 + ZB5AV053)
		Blue	XB5EVM6	XB5AVM6	(ZB5AVM6 + ZB5AV063)
		Yellow	XB5EVM8	—	—

Table 19.66: Pilot Lights for BA9s Bulb (screw clamp terminal connections)

Shape of Head	Supply Voltage	Color	Catalog Number	Components
Direct supply, for BA9s (incandescent, LED, neon) V < 250 V, 2.4 W bulb (bulb not included) [31]				
	< 250 Vac/Vdc	White	XB5AV61	(ZB5AV6 + ZB5AV01)
		Green	XB5AV63	(ZB5AV6 + ZB5AV03)
		Red	XB5AV64	(ZB5AV6 + ZB5AV04)
		Yellow	XB5AV65	(ZB5AV6 + ZB5AV05)
Transformer type with 1.2 VA, 6 V secondary. BA9s incandescent bulb included				
	110–120 Vac 50/60 Hz	White	XB5AV31	(ZB5AV3 + ZB5AV01)
		Green	XB5AV33	(ZB5AV3 + ZB5AV03)
		Red	XB5AV34	(ZB5AV3 + ZB5AV04)
		Yellow	XB5AV35	(ZB5AV3 + ZB5AV05)



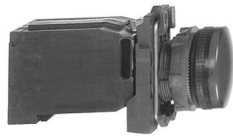

XB5AV63



XB5AV34

Table 19.67: Illuminated Push Buttons, Momentary (screw clamp terminal connections) [30]

Shape of Head	Description	Type of Contact		Supply Voltage	Color of Push	Catalog Number	Components					
		N.O.	N.C.									
Flush												
	Protected LED	1	1	24 Vac/Vdc	White	XB5AW31B5	(ZB5AW0B15 + ZB5AW313)					
					Green	XB5AW33B5	(ZB5AW0B35 + ZB5AW333)					
					Red	XB5AW34B5	(ZB5AW0B45 + ZB5AW343)					
					Yellow	XB5AW35B5	(ZB5AW0B55 + ZB5AW353)					
					Blue	XB5AW36B5	(ZB5AW0B65 + ZB5AW363)					
					White	XB5AW31G5	(ZB5AW0G15 + ZB5AW313)					
				110–120 Vac	Green	XB5AW33G5	(ZB5AW0G35 + ZB5AW333)					
					Red	XB5AW34G5	(ZB5AW0G45 + ZB5AW343)					
					Yellow	XB5AW35G5	(ZB5AW0G55 + ZB5AW353)					
					Blue	XB5AW36G5	(ZB5AW0G65 + ZB5AW363)					
					White	XB5AW3165	(ZB5AW065 + ZB5AW31)					
					Green	XB5AW3365	(ZB5AW065 + ZB5AW33)					
	Direct supply for BA9s 2.4 W max. bulb not included	1	1	< 250 Vac/Vdc	Red	XB5AW3465	(ZB5AW065 + ZB5AW34)					
					Yellow	XB5AW3565	(ZB5AW065 + ZB5AW35)					
					White	XB5AW3135	(ZB5AW035 + ZB5AW31)					
					Green	XB5AW3335	(ZB5AW035 + ZB5AW33)					
					Red	XB5AW3435	(ZB5AW035 + ZB5AW34)					
					Yellow	XB5AW3535	(ZB5AW035 + ZB5AW35)					
				110–120 Vac 50/60 Hz	White	XB5AW3145	(ZB5AW045 + ZB5AW31)					
					Green	XB5AW3345	(ZB5AW045 + ZB5AW33)					
					Red	XB5AW3445	(ZB5AW045 + ZB5AW34)					
					Yellow	XB5AW3545	(ZB5AW045 + ZB5AW35)					
					Extended							
						Protected LED	1	1	24 Vac/Vdc	White	XB5AW11B5	(ZB5AW0B15 + ZB5AW113)
Green	XB5AW13B5	(ZB5AW0B35 + ZB5AW133)										
Red	XB5AW14B5	(ZB5AW0B45 + ZB5AW143)										
Yellow	XB5AW15B5	(ZB5AW0B55 + ZB5AW153)										
Blue	XB5AW16B5	(ZB5AW0B65 + ZB5AW163)										
White	XB5AW11G5	(ZB5AW0G15 + ZB5AW113)										
110–120 Vac	Green	XB5AW13G5	(ZB5AW0G35 + ZB5AW133)									
	Red	XB5AW14G5	(ZB5AW0G45 + ZB5AW143)									
	Yellow	XB5AW15G5	(ZB5AW0G55 + ZB5AW153)									
	Blue	XB5AW16G5	(ZB5AW0G65 + ZB5AW163)									



XB5AW31B5



XB5AW3465



XB5AW3335

For legends, see [XB5 Legend Holders](#), page 19-40 and [XB5 Legend Inserts Only](#), page [30]
For LEDs, see [LED](#), [BA9s Base](#), page [31]

[30] For 240V LED, replace the "B" or "G" with "M". (Example: XB5APVB1 (24 V) to XB5APVM1 (240 Vac only))

[31] For bulb information, refer to [BA9s Bulbs and Associated Accessories](#), page [31]

XB5 Non-Illuminated Operators

Table 19.68: Non-Illuminated Operators, Momentary—Unmarked



Shape of Head	Type of Push	Cap Color	Catalog Number
	Flush, without color cap [32]	—	ZB5AA0
	Flush, with set of 6 color caps	6 colors [33]	ZB5AA9
	Flush	White	ZB5AA1
		Black	ZB5AA2
		Green	ZB5AA3
		Red	ZB5AA4
		Yellow	ZB5AA5
		Blue	ZB5AA6
	Flush with transparent cap, for insertion of legend [34]	Gray	ZB5AA8
		White	ZB5AA18
		Green	ZB5AA38
		Red	ZB5AA48
		Yellow	ZB5AA58
		Blue	ZB5AA68
	Extended	White	ZB5AL1
		Black	ZB5AL2
		Green	ZB5AL3
		Red	ZB5AL4
		Yellow	ZB5AL5
		Blue	ZB5AL6
	Booted Flush (clear) Cap color unobscured	White	ZB5APA1
		Black	ZB5APA2
		Green	ZB5APA3
		Red	ZB5APA4
		Yellow	ZB5APA5
		Blue	ZB5APA6
	Booted Extended (clear) Cap color unobscured	White	ZB5AP1
		Black	ZB5AP2
		Green	ZB5AP3
		Red	ZB5AP4
		Yellow	ZB5AP5
		Blue	ZB5AP6
	Booted (colored) Cap color unobscured	White	ZB5AP1S
		Black	ZB5AP2S
		Green	ZB5AP3S
		Red	ZB5AP4S
		Yellow	ZB5AP5S
		Blue	ZB5AP6S
	Booted (clear) for insertion of legend [34] Cap color unobscured	White	ZB5AP18
		Green	ZB5AP38
		Red	ZB5AP48
		Yellow	ZB5AP58
		Blue	ZB5AP68
		White	ZB5AA14
	Flush Plunger (with high guard)	Black	ZB5AA24
		Green	ZB5AA34
		Red	ZB5AA44
		Yellow	ZB5AA54
		Blue	ZB5AA64
		White	ZB5CA1
	Flush	Black	ZB5CA2
		Green	ZB5CA3
		Red	ZB5CA4
		Yellow	ZB5CA5
		Blue	ZB5CA6
		White	ZB5CL1
	Extended	Black	ZB5CL2
		Green	ZB5CL3
		Red	ZB5CL4
		Yellow	ZB5CL5
		Blue	ZB5CL6
		White	ZB5AA16
	Heads only Recessed (high guard)	Black	ZB5AA26
		Green	ZB5AA36
		Red	ZB5AA46
		Yellow	ZB5AA56
		Blue	ZB5AA66
		White	ZB5CA16
	Heads only Recessed (high guard)	Black	ZB5CA26
		Green	ZB5CA36
		Red	ZB5CA46
		Yellow	ZB5CA56
		Blue	ZB5CA66

For Legends, see [XB5 Legend Holders, page 19-40](#) and [XB5 Legend Inserts Only, page](#)

[32] Order color cap separately, see [XB5 Accessories, page](#) .
 [33] Six colored caps included with head (white, black, green, red, yellow, blue).
 [34] For legend ordering information see [XB5 Accessories, page](#) .



Table 19.69: Non-Illuminated Operators, Momentary—Premarked

Shape of Head	Type of Push	Marking		Cap Color	Catalog Number
		Text	Color		
	Flush	I	White	Green	ZB5AA331
			Black	White	ZB5AA131
		START	White	Green	ZB5AA333
			Black	White	ZB5AA133
		ON	White	Green	ZB5AA341
			Black	White	ZB5AA141
		T	White	Green	ZB5AA345
		O	White	Red	ZB5AA432
			Black	Black	ZB5AA232
		STOP	White	Red	ZB5AA434
				Black	ZB5AA234
		OFF	White	Red	ZB5AA435
UP	Black	White	ZB5AA235		
DOWN	White	Black	ZB5AA344		
	Black	White	ZB5AA334		
↑ [35]	Black	White	ZB5AA335		
	White	Black	ZB5AA432		
	Extended	O	White	Red	ZB5AL432
			Black	Black	ZB5AL232
			Red	Red	ZB5AL434
STOP	White	Black	ZB5AL234		
		Red	ZB5AL435		
OFF	White	Black	ZB5AL235		
	Flush	I	White	Green	ZB5CA331
			Black	White	ZB5CA432

Table 19.70: Mushroom Heads, Momentary

Shape of Head	Diameter of Head	Color of Head	Catalog Number	
	30 mm	Black	ZB5AC24	
		Green	ZB5AC34	
		Red	ZB5AC44	
		Yellow	ZB5AC54	
	40 mm	Blue	ZB5AC64	
		Black	ZB5AC2	
		Green	ZB5AC3	
		Red	ZB5AC4	
	60 mm	Yellow	ZB5AC5	
		Blue	ZB5AC6	
		Black	ZB5AR2	
		Green	ZB5AR3	
		Red	ZB5AR4	
		Yellow	ZB5AR5	
			Blue	ZB5AR6

For legends, see XB5 Legend Holders, page 19-40 and XB5 Legend Inserts Only, page

[35] Cap supplied not clipped-in, allowing orientation of arrow in any one of 4 directions:



ZB5AH04

Table 19.71: Non-Illuminated Push-on/Push-off Operators

Shape of Head	Type of Push	Color of Push	Catalog Number
	Flush	White	ZB5AH01
		Black	ZB5AH02
		Green	ZB5AH03
		Red	ZB5AH04
		Yellow	ZB5AH05
		Blue	ZB5AH06
	Extended	White	ZB5AH1
		Black	ZB5AH2
		Green	ZB5AH3
		Red	ZB5AH4
		Yellow	ZB5AH5
		Blue	ZB5AH6
	Flush	White	ZB5CH01
		Black	ZB5CH02
		Green	ZB5CH03
		Red	ZB5CH04
		Yellow	ZB5CH05
		Blue	ZB5CH06



ZB5AL7341



ZB5AA7121

Table 19.72: Two Head Operators, Momentary

Shape of Head	Description	Marking	Cap Color	Degree of Protection	Catalog Number
No Marking					
	Two flush	—	Green Red	IP66 IP69K	ZB5AA7340
		—	White Black		ZB5AA7120
	One flush One extended	—	Green Red	IP66 IP69K	ZB5AL7340
Premarked					
	Two flush	"I" (white) "O" (white)	Green Red	IP66 IP69K	ZB5AA7341
		"I" (black) "O" (white)	White Black		ZB5AA7121
	One flush One extended	"I" (white) "O" (white)	Green Red	IP66 IP69K	ZB5AL7341
Without caps					
	Two flush without caps	—	—	IP66 IP69K	ZB5AA79

Table 19.73: Three Head Operators, Momentary

Shape of Head	Description	Marking	Cap Color	Degree of Protection	Catalog Number
Premarked					
	Two flush + one central projecting red push marked "Stop"	"I" (white) "II" (white)	Green Green	IP66 IP69K	ZB5AA73132
		"←" (white) "→" (white)	Green Green		ZB5AA73133
		"↑" (white) "↓" (white)	Green Green		ZB5AA73134
		"+" (white) "-" (white)	Green Green		ZB5AA73135
		"+" (black) "-" (black)	White White		ZB5AA71115
		"←" (black) "→" (white)	White Black		ZB5AA71123
		"↑" (black) "↓" (white)	White Black		ZB5AA71124
		"I" (white) "II" (white)	Black Black		ZB5AA72124
Without caps					
	Two flush without caps	—	—	IP66 IP69K	ZB5AA791

For caps, see [XB5 Accessories](#), page



ZB5AA73133



ZB5AA71124

XB5 Emergency Stop Operators

Table 19.74: Mushroom Heads for Maintained Push Buttons



Shape of Head	Type of Push	Diameter of Head	Color	Catalog Number
For use in Emergency Stop applications				
	Trigger action Push-pull [36]	30 mm	Red	ZB5AT844
		40 mm	Red	ZB5AT84
		60 mm	Red	ZB5AX84
	Trigger action Turn-to-release [36]	30 mm	Red	ZB5AS834
		40 mm	Red	ZB5AS844
		60 mm	Red	ZB5AS864
	Trigger action Key release (No. 455) [36]	30 mm	Red	ZB5AS934
		40 mm	Red	ZB5AS944 [37]
		60 mm	Red	ZB5AS964
For use in non-Emergency Stop applications				
	Push-pull	30 mm	Black	ZB5AT24
		40 mm	Black	ZB5AT2
		60 mm	Black	ZB5AX2
	Turn-to-release	30 mm	Black	ZB5AS42
		40 mm	Black	ZB5AS52
		60 mm	Yellow	ZB5AS55
	Key release (No. 455)	30 mm	Black	ZB5AS62
		40 mm	Black	ZB5AS72
		60 mm	Black	ZB5AS12
	Key release (No. 455)	30 mm	Black	ZB5AS22
		40 mm	Black	ZB5AS12
		60 mm	Black	ZB5AS22

Table 19.75: Circular Legends for Emergency Stop Mushroom Heads (yellow background)



Diameter	Text	Catalog Number
90 mm	Blank	ZBY8101
	EMERGENCY STOP	ZBY8330
60 mm Bezeled	Blank	ZBY9121
	Emergency Stop	ZBY9320
	Prada de Emergencia	ZBY9420
	Not Halt	ZBY9220

For Legends, see XB5 Legend Holders, page 19-40 and XB5 Legend Inserts, page

[36] Trigger action mushroom heads are tamper proof in that a change of contact state is not possible by teasing or floating the operator. For emergency stop applications, always use a trigger action push button (per EN/IEC 13850).

[37] Other key numbers:

- key no. 421E: add the suffix 12 to the catalog number.
- key no. 458A: add the suffix 10 to the catalog number.
- key no. 520E: add the suffix 14 to the catalog number.
- key no. 3131A: add the suffix 20 to the catalog number.

Example: The catalog number for a Ø 40 mm red mushroom head for a trigger action, maintained push button, with release by key no. 421E becomes: ZB5AS94412.

XB5 Selector Switches

Table 19.76: Non-Illuminated Selector Switches



Color	Number and Type of Positions	Diagram	Standard Lever [38]	Extended Lever [38]
			Catalog Number	
Black	2-maintained		ZB5AD2	ZB5AJ2
Black	2-momentary from right to left		ZB5AD4	ZB5AJ4
Black	3-maintained		ZB5AD3	ZB5AJ3
Black	3-momentary to center		ZB5AD5	ZB5AJ5
Black	3-momentary from left to center		ZB5AD7	ZB5AJ7
Black	3-momentary from right to center		ZB5AD8	ZB5AJ8



Table 19.77: Non-Illuminated Key Switches

Type of Operator	Number and Type of Positions	Catalog Number [39]	
<p>Key (No. 455) [39]</p> <p>NOTE: The symbol indicates key withdrawal position(s).</p>	2-maintained		ZB5AG2
			ZB5AG4
			ZB5AG02
	2-momentary from right to left		ZB5AG6
		3-maintained	
			ZB5AG3
			ZB5AG5
			ZB5AG9
			ZB5AG09
			ZB5AG1
	3-momentary from left to center		ZB5AG7
	3-momentary to center		ZB5AG8
			ZB5AG08
			ZB5AG05

Table 19.78: Sequence of Contacts on Selector Switch Bodies

Unit Type	Selector Switches																
	2-position						3-position										
		315°		45°		315°			0°			45°					
Note: L=Left, C=Center, R=Right, O=Open, X=Closed																	
Operator Plunger Position	Up	[Diagram]		[Diagram]		[Diagram]			[Diagram]			[Diagram]					
	Down	[Diagram]		[Diagram]		[Diagram]			[Diagram]			[Diagram]					
Contact Block Location		L	C	R	L	C	R	L	C	R	L	C	R	L	C	R	
Contacts		N.O.	O	O	O	X	X	X	X	X	O	O	O	O	X	X	X
		N.C.	X	X	X	O	O	O	O	O	X	X	X	X	X	O	O

For Selector Switch Sequence, see [Sequence of Contacts on Illuminated Selector Switch Bodies](#), page 19-19

[38] For colored lever, add the following code to the end of catalog number: 01—white, 03—green, 04—red, 05—yellow, 06—blue (Example: ZB5AD204).

[39] Other key numbers:

- key no. 421E: add the suffix 12 to the catalog number.
- key no. 458A: add the suffix 10 to the catalog number.
- key no. 520E: add the suffix 14 to the catalog number.
- key no. 3131A: add the suffix 20 to the catalog number.
- key no. 8D1: add the suffix D to the catalog number.

Example: The catalog number for a head with key no. 421E for a 2 position maintained, lockable selector switch, with key withdrawal from the left-hand position, becomes: ZB5AG212

XB5 Specialty Operators

Table 19.79: Reset Operators

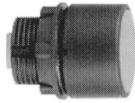

XB5AA

Shape of Head	Actuation Distance		Text	Color	Catalog Number
	in	mm			
Flush					
Adjustable Shaft Shaft only (short) is W40437632					
	0.67–4.72	17–120	Without	Green	XB5AA831
				Red	XB5AA841
				Blue	XB5AA861
			O	XB5AA84101	
			R	XB5AA86102	
	4.72–10.12	120–257	Without	Green	XB5AA832
				Red	XB5AA842
				Blue	XB5AA862
			O	XB5AA84201	
			R	XB5AA86202	
Extended					
	0.67–4.72	17–120	O	Red	XB5AL84101
	4.72–10.12	120–257	O	Red	XB5AL84201

Table 19.80: Potentiometer Operator (with Mounting Collar)



XB5AD912R1K

Shape of Head	Description	Application	Catalog Number
	For potentiometer with shaft length 1.73 to 1.97 in. (44 to 50 mm) (potentiometer not included)	For shaft Ø 0.25 in. (6.35 mm)	ZB5AD922
		For shaft Ø 0.24 in. (6 mm)	ZB5AD912

Table 19.81: Complete Potentiometers

Description	Resistance (k Ω)	Weight (kg/lb)	Catalog Number
+/- 10% linear mode precision complete potentiometer with screw terminals	1	0.048/0.106	XB5AD912R1K
	4.7	0.048/0.106	XB5AD912R4K7
	10	0.048/0.106	XB5AD912R10K
	47	0.048/0.106	XB5AD912R47K
	100	0.048/0.106	XB5AD912R100K
	470	0.048/0.106	XB5AD912R470K

Table 19.82: Hour Counters (UR E191025, XHNR2 and XHNR8)



XB5DS•

Characteristics	Supply Voltage	Catalog Number
Indication 0–9999.9 (IP40 NEMA 1)	12–24 Vdc or Vac, 50/60 Hz	XB5DSB
	120 Vac, 60 Hz	XB5DSG
	230–240 Vac, 50 Hz	XB5DSM

Table 19.83: Buzzer (UR E191025, XHNR2 and XHNR8)



XB5KS•

Characteristics	Supply Voltage	Catalog Number
85 db buzzer:4kHz, continuous or intermittent (IP40 NEMA 1)	24 Vdc or Vac, 50/60 Hz	XB5KSB
	120 Vac, 60 Hz	XB5KSG

Table 19.84: Two Position Toggle Switch



ZB5AD28

Shape of Head	Color	Type of Positions	Catalog Number
	Black	Maintained	ZB5AD28
	Black	Momentary	ZB5AD48

For legends, see XB5 Legend Holders, page 19–40, XB5 Legend Inserts, page , and Sheets of Legends for Push Buttons, Switches, and Pilot Lights, page .

XB5 Pilot Lights



ZB5AV053





ZB5AV01



ZB5CV063

Table 19.85: Pilot Light Heads

Shape of Head	For use with Body Comprising Light Module Type	Color of Lens	Catalog Number
	Protected LED™ only	White Green Red Yellow Blue	ZB5AV013 ZB5AV033 ZB5AV043 ZB5AV053 ZB5AV063
	Protected LED only Fresnel (jeweled) lens [40]	White Green Red Amber Blue	ZB5AV013S ZB5AV033S ZB5AV043S ZB5AV053S ZB5AV063S
	For BA9s incandescent bulb, neon or LED only [41]	White Green Red Yellow Blue Clear	ZB5AV01 ZB5AV03 ZB5AV04 ZB5AV05 ZB5AV06 ZB5AV07
	For BA9s incandescent bulb, neon or LED Fresnel (jeweled) lens [41]	White Green Red Amber Blue Clear	ZB5AV01S ZB5AV03S ZB5AV04S ZB5AV05S ZB5AV06S ZB5AV07S
	Protected LED only	White Green Red Yellow Blue	ZB5CV013 ZB5CV033 ZB5CV043 ZB5CV053 ZB5CV063

For legends, refer to XB5 Legend Holders, page 19-40, XB5 Legend Inserts, page , and Sheets of Legends for Push Buttons, Switches, and Pilot Lights, page

Table 19.86: Complete Bodies (Mounting Collar + Light Module for BA9s Incandescent Bulb, Neon or LED)

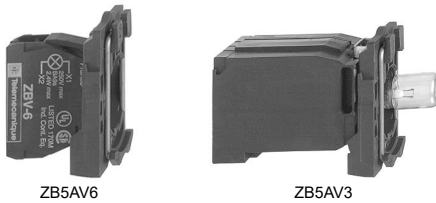

ZB5AV6

ZB5AV3

Description	Light Source	Supply Voltage (V)	Catalog Number
Screw clamp terminal connections			
Direct supply	BA9s bulb 2.4 W max. Not included [41]	<250	ZB5AV6
Direct supply	BA9s incandescent, bulb included	24 V 2 W	ZB5AV624
Direct supply	BA9s incandescent, bulb included	120 V 2.4 W	ZB5AV6120
Transformer type 1.2 VA, 6 V secondary	BA9s incandescent bulb included	110–120 Vac, 50/60 Hz	ZB5AV3
		230–240 Vac, 50/60 Hz	ZB5AV4
		400–50 Hz	ZB5AV5
		440–480 Vac, 60 Hz	ZB5AV8
		550–600 Vac, 60 Hz	ZB5AV9

Table 19.87: Complete Bodies (Mounting Collar + Protected LED™ Light Module) [42][43]



ZB5AV••

Light Source	Supply Voltage	Color of Light Source	Catalog Number	
Screw clamp terminal connections				
	12 Vac/Vdc	White Green Red Yellow Blue	ZB5AVJ1 ZB5AVJ3 ZB5AVJ4 ZB5AVJ5 ZB5AVJ6	
		24 Vac/Vdc	White Green Red Yellow Blue	ZB5AVB1 ZB5AVB3 ZB5AVB4 ZB5AVB5 ZB5AVB6
			24–120 Vac/Vdc	White Green Red Yellow Blue
	110–120 Vac			White Green Red Yellow Blue
		24 Vac/Vdc		White Green Red Yellow Blue
			110–120 Vac	White Green Red Yellow Blue

[40] For use in bright ambient conditions (i.e., sunlight).

[41] Order bulb separately; see BA9s Bulbs, page . For BA9 LED, see Lamps, BA9s Base, page .

[42] For Quick-Connect version, add "3" to the end of the catalog number Example: ZB5AVJ13 (Quick-Connect size 1 x 0.250" or 2 x 0.110").

[43] For 240 V LED, replace the "B" or "G" with "M". (Example: ZB5AVB1 (24V) to ZB5AVM1 (240V))



ZB5AW313



ZB5AW363



ZB5AW143



ZB5CW313

XB5 Illuminated Operators

Table 19.88: Heads for Momentary Illuminated Push Buttons

Shape of Head	Type of Push	Color	Catalog Number		
Only use with Protected LED™ light modules					
	Flush	White	ZB5AW313		
		Green	ZB5AW333		
		Red	ZB5AW343		
		Yellow	ZB5AW353		
	Flush with clear boot	Blue	ZB5AW363		
		White	ZB5AW513		
		Green	ZB5AW533		
		Red	ZB5AW543		
	Flush for insertion of legend	Yellow	ZB5AW553		
		Blue	ZB5AW563		
		White	ZB5AA18		
		Green	ZB5AA38		
	Extended	Red	ZB5AA48		
		Yellow	ZB5AA58		
		Blue	ZB5AA68		
		White	ZB5AA113		
	Extended	Green	ZB5AW133		
		Red	ZB5AW143		
		Yellow	ZB5AW153		
		Blue	ZB5AW163		
	Flush for insertion of legend	White	ZB5CW313		
		Green	ZB5CW333		
		Red	ZB5CW343		
		Yellow	ZB5CW353		
	Extended	Blue	ZB5CW363		
		White	ZB5CW113		
		Green	ZB5CW133		
		Red	ZB5CW143		
	Extended	Yellow	ZB5CW153		
		Blue	ZB5CW163		
		White	ZB5AW31		
		Green	ZB5AW33		
	Flush	Red	ZB5AW34		
		Yellow	ZB5AW35		
		Blue	ZB5AW36		
		Clear	ZB5AW37		
	Extended	White	ZB5AW11		
		Green	ZB5AW13		
		Red	ZB5AW14		
		Yellow	ZB5AW15		
	Extended	Blue	ZB5AW16		
		Clear	ZB5AW17		
		Only use with light modules for a BA9s incandescent bulb, neon or LED			
			Flush	White	ZB5AW31
Green	ZB5AW33				
Red	ZB5AW34				
Yellow	ZB5AW35				
	Extended	Blue	ZB5AW36		
		Clear	ZB5AW37		
		White	ZB5AW11		
		Green	ZB5AW13		
	Extended	Red	ZB5AW14		
		Yellow	ZB5AW15		
		Blue	ZB5AW16		
		Clear	ZB5AW17		

Table 19.89: Illuminated Push-on/Push-off Operators

Shape of Head	Type of Push	Color of Lens	Catalog Number
Only use with Protected LED light modules			
	Flush	White	ZB5AH013
		Green	ZB5AH033
		Red	ZB5AH043
		Yellow	ZB5AH053
	Extended	Blue	ZB5AH063
		White	ZB5AH113
		Green	ZB5AH333
		Red	ZB5AH433
	Extended	Yellow	ZB5AH533
		Blue	ZB5AH633

For legends, refer to XB5 Legend Holders, page 19-40, XB5 Legend Inserts, page , and Sheets of Legends for Push Buttons, Switches, and Pilot Lights, page



ZB5AW33



ZB5AW7A3741



ZB5AW7A1721

Table 19.90: Two Button with Clear Pilot Light, Momentary

Shape of Head	Description	Marking	Cap Color	Degree of Protection	Catalog Number
No Marking					
	Two flush	—	Green Red	IP66 IP69K	ZB5AW7A3740
		—	White Black		ZB5AW7A1720
	One flush One extended	—	Green Red		ZB5AW7L3740
Premarked					
	Two flush	"I" (white) "O" (white)	Green Red	IP66 IP69K	ZB5AW7A3741
		"I" (black) "O" (white)	White Black		ZB5AW7A1721
	One flush One extended	"I" (white) "O" (white)	Green Red		ZB5AW7L3741
	Two flush	"i" (black) "I" (white)	White Black		ZB5AW7A1724
	Two flush	"+" (black) "- " (black)	White White		ZB5AW7A1715
Without caps					
Two flush without caps		—	—	IP66, IP69K	ZB5AW7A9

Table 19.91: Heads for Maintained Illuminated Push Buttons

Shape of Head	Type of Push	Color	Catalog Number
Only use with Protected LED light modules			
	Turn-to-Release Mushroom (40 mm)	White	ZB5AW713
		Green	ZB5AW733
		Red	ZB5AW743
		Yellow	ZB5AW753
		Blue	ZB5AW763

Table 19.92: Emergency Stop, Trigger Action and Mech Latching Push Button with Mech State Indicator for Elevator Inspection Box Applications—Heads Only

Shape of Head	Type of Reset	Color	Catalog Number
	Push-pull (40 mm)	Red	ZB5AT8643M

NOTE: ZB5AT8643M not to be used with ZBZ16* guard.

Table 19.93: Illuminated Selector Switches, Standard Lever

Shape of Head	Number and Type of Positions	Catalog Number [44]
Only use with Protected LED light modules		
	2-maintained	ZB5AK12•3
	2-momentary from right to left	ZB5AK14•3
	3-maintained	ZB5AK13•3
	3-momentary to center	ZB5AK15•3
	3-momentary from right to center	ZB5AK18•3
	3-momentary from left to center	ZB5AK17•3

Table 19.94: Sequence of Contacts on Selector Switch Bodies

Unit Type	Selector Switches											
	2-position						3-position					
Operator Plunger Position	315°		45°		315°		0°		45°		315°	
	Up	[Diagram]		[Diagram]		[Diagram]		[Diagram]		[Diagram]		[Diagram]
Down	[Diagram]		[Diagram]		[Diagram]		[Diagram]		[Diagram]		[Diagram]	
Contact Block Location	L	C	R	L	C	R	L	C	R	L	C	R
Contacts	N.O.	O	O	O	X	X	X	X	O	O	O	O
	N.C.	X	X	X	O	O	O	O	X	X	X	X

For legends, see XB5 Legend Holders, page 19-40, XB5 Legend Inserts, page , and Sheets of Legends for Push Buttons, Switches, and Pilot Lights, page .
For Caps, see Lens Caps, page

[44] • Designate color as follows: 1—white, 3—green, 4—red, 5—yellow, 6—blue

XB5 Electrical Components

NOTE: For the Quick-Connect version, add the numeral **3** to the end of the number.
Example: ZB5AZ1013 (Quick-Connect size 1 x 0.250" or 2 x 0.110").



Table 19.95: Contact Blocks
(Mounting Collar with Contact Blocks) [45] [46] [47]

Description	Type of Contact		Catalog Number
	N.O.	N.C.	
Screw clamp terminal connections	1	—	ZB5AZ101
	—	1	ZB5AZ102
	2	—	ZB5AZ103
	—	2	ZB5AZ104
	1	1	ZB5AZ105
	1	2	ZB5AZ141



Table 19.96: Complete Bodies
(Mounting Collar + Single Contact Block + Light Module with Protected LED™)

Light Source	Type of Contact [48]		Color	Supply Voltage [49]		Catalog Number
	N.O.	N.C.		24 Vac/Vdc	110–120 Vac	
Screw clamp terminal connections						
Protected LED	1	—	White	ZB5AW0B11	ZB5AW0G11	
			Green	ZB5AW0B31	ZB5AW0G31	
			Red	ZB5AW0B41	ZB5AW0G41	
			Yellow	ZB5AW0B51	ZB5AW0G51	
			Blue	ZB5AW0B61	ZB5AW0G61	
	—	1	White	ZB5AW0B12	ZB5AW0G12	
			Green	ZB5AW0B32	ZB5AW0G32	
			Red	ZB5AW0B42	ZB5AW0G42	
			Yellow	ZB5AW0B52	ZB5AW0G52	
			Blue	ZB5AW0B62	ZB5AW0G62	
	2	—	White	ZB5AW0B13	ZB5AW0G13	
			Green	ZB5AW0B33	ZB5AW0G33	
			Red	ZB5AW0B43	ZB5AW0G43	
			Yellow	ZB5AW0B53	ZB5AW0G53	
			Blue	ZB5AW0B63	ZB5AW0G63	
	1	1	White	ZB5AW0B15	ZB5AW0G15	
			Green	ZB5AW0B35	ZB5AW0G35	
			Red	ZB5AW0B45	ZB5AW0G45	
			Yellow	ZB5AW0B55	ZB5AW0G55	
			Blue	ZB5AW0B65	ZB5AW0G65	

For LEDs, see [LED](#), [BA9s Base](#), [page](#) .

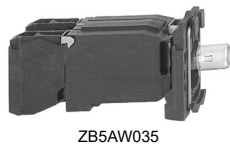
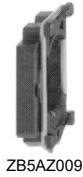

Table 19.97: Mounting Collar, Contact Block and Light Module
(with screw clamp terminal connections)

Supply	Light Source	Supply Voltage	Type of Contact [48]		Color of Light Source	Catalog Number
			N.O.	N.C.		
Screw clamp terminal connections						
Direct supply	BA9s 2.4 W max. bulb Not included [50]	< 250 Vac/ Vdc	1	—	—	ZB5AW061
			—	1	—	ZB5AW062
			2	—	—	ZB5AW063
Transformer type 1.2 VA, 6 V secondary	BA9s incandescent bulb included	110–120 Vac 50/60 Hz	1	1	—	ZB5AW065
			1	—	—	ZB5AW031
		230–240 Vac 50/60 Hz	1	1	—	ZB5AW035
			1	—	—	ZB5AW041
			1	1	—	ZB5AW045

[45] For Ring Tongue compatible blocks add "9" to the end of the catalog number (Example: ZB5AZ1029).
 [46] Electrical components with connection by printed circuit board pins are available. Refer to Catalog [9001CT0001](#) for more information.
 [47] Electrical components with connection by plug-in connector are available. Refer to Catalog [9001CT0001](#) for more information.
 [48] Can be fitted with additional contact blocks, see [Table 19.99 Add-On Contact Blocks](#), [page 19-38](#).
 [49] For 240V LED, replace the "B" or "G" with "M". (Example: change "ZB5AW0B11 (24 V)" to ZB5AW0M11 (240 V))
 [50] Order bulbs separately, see [BA9s Bulbs and Associated Accessories](#), [page](#)



ZB5AZ009



ZBE101



ZBE203

Table 19.98: Body/Mounting Collar

For use with	Catalog Number
Electrical block (contact or light module)	ZB5AZ009

Table 19.99: Add-On Contact Block (with screw clamp terminal connections) [51][52]

Description	Type of Contact		Catalog Number
	N.O.	N.C.	
Standard single contact blocks[53][54]	1	—	ZBE101
	—	1	ZBE102
Standard double contact blocks[53][54]	2	—	ZBE203
	—	2	ZBE204
	1	1	ZBE205
Special contact blocks for low-power switching [55]	1	—	ZBE1016
	—	1	ZBE1026
Low-power switching	1	—	ZBE1016P
	—	1	ZBE1026P
Staggered contacts	Early make N.O.	—	ZBE201
	Late break N.C.	1	ZBE202
	Overlapping N.O. + N.C.	1	ZB4BZ106
	Staggered N.O. + N.O.	—	ZB4BZ107

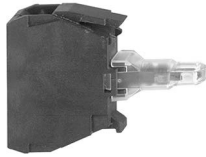

ZBVB•

Table 19.100: Light Modules (with screw clamp terminal connections)[51][52]

Description	Supply Voltage	Color of Light Source	Catalog Number
Protected LED	12 Vac/Vdc	White	ZBVJ1
		Green	ZBVJ3
		Red	ZBVJ4
		Yellow	ZBVJ5
		Blue	ZBVJ6
		White	ZBVB1
	24 Vac/Vdc	Green	ZBVB3
		Red	ZBVB4
		Yellow	ZBVB5
		Blue	ZBVB6
		White	ZBVG1
		Green	ZBVG3
	110–120 Vac	Red	ZBVG4
		Yellow	ZBVG5
		Blue	ZBVG6
		White	ZBVBG1
		Green	ZBVBG3
		Red	ZBVBG4
	24–120 Vac/Vdc	Yellow	ZBVBG5
		Blue	ZBVBG6
		White	ZBVM1
		Green	ZBVM3
		Red	ZBVM4
		Yellow	ZBVM5
230–240 Vac	Blue	ZBVM6	
	—	—	ZBV6

For LEDs, see [LED](#), [BA9s Base](#), [page](#) .

[51] Electrical components with connection by printed circuit board pins are available. Refer to Catalog [9001CT0001](#) for more details.

[52] Electrical components with connection by plug-in connector are available. Refer to Catalog [9001CT0001](#) for more details.

[53] For Quick-Connect version add "3" to the end of the catalog number (Example: ZBE1013) (Quick-Connect size 1 x 0.250 in. or 2 x 0.110 in.).

[54] For Ring Tongue compatible blocks add "9" to the end of the catalog number (Example: ZBE1029).

[55] Cannot stack additional contact blocks onto these blocks.



ZB5AZ009



ZB4BZ1015

Table 19.101: Body/Mounting Collar

For use with	Catalog Number
Contact block or light module	ZB5AZ009

Table 19.102: Light Modules [56]

Spring Terminal Connections			
Description	Supply voltage	Color of light source	Catalog Number
Integral LED (to combine with heads for integral LED) Protected LED	12 Vac/Vdc	White	ZBVJ15
		Green	ZBVJ35
		Red	ZBVJ45
		Orange	ZBVJ55
		Blue	ZBVJ65
	24 Vac/Vdc	White	ZBVB15
		Green	ZBVB35
		Red	ZBVB45
		Orange	ZBVB55
		Blue	ZBVB65
	110–120 Vac	White	ZBVG15
		Green	ZBVG35
		Red	ZBVG45
		Orange	ZBVG55
	230–240 Vac	Blue	ZBVG65
		White	ZBVM15
		Green	ZBVM35
		Red	ZBVM45
		Orange	ZBVM55
			Blue

[56] Additional blocks **cannot** be attached to the back of these contact blocks or light modules. However, spring terminal contact blocks can be mounted behind screw terminal contact blocks.

XB5 Legend Holders

Table 19.103: Standard (30 x 40 mm) Legend Holders for 8 x 27 mm Legends

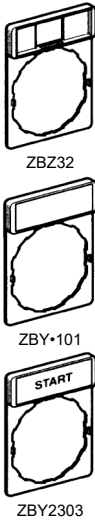

Description	Legend		Catalog Number
	Color	Text	
Without legend [57]	—	—	ZBZ32
With blank legend (for engraving)	Black or red background	—	ZBY2101
	White or yellow background	—	ZBY4101
Custom Legend (Specify Engraving) 2 lines of 11 characters (including spaces) maximum per line	Black background	White	ZBY2002
	Red background	White	ZBY2004
	White background	Black	ZBY4001
	Yellow background	Black	ZBY4005
With legend marked with international language	Black or red background [57]	O (black background)	ZBY2146
		O (red background)	ZBY2931
		I	ZBY2147
		II	ZBY2148
		O-I	ZBY2178
		I-II	ZBY2179
		I-O-II	ZBY2186
		With legend marked with English language	Black or red background [58]
AUTO-HAND	ZBY2364		
AUTO-O-HAND	ZBY2385		
CLOSE	ZBY2314		
DOWN	ZBY2308		
EMERGENCY STOP	ZBY2330		
FAST	ZBY2328		
FORWARD	ZBY2305		
FOR-REV	ZBY2371		
HAND	ZBY2316		
HAND-OFF-AUTO	ZBY2387		
INCH	ZBY2321		
JOG	ZBY2382		
LEFT	ZBY2310		
OFF	ZBY2312		
OFF-ON	ZBY2367		
ON	ZBY2311		
OPEN	ZBY2313		
POWER ON	ZBY2326		
RESET (red background)	ZBY2323		
RESET (black background)	ZBY2322		
REVERSE	ZBY2306		
RIGHT	ZBY2309		
RUN	ZBY2334		
SLOW	ZBY2327		
START	ZBY2303		
STOP	ZBY2304		
STOP-START	ZBY2366		
UP	ZBY2307		

[57] For legends, see [XB5 Legend Inserts Only](#), page .

[58] Start functions: white letters on black background. Stop functions: white letters on red background (unless otherwise specified above).

New!

XB5R Plastic and XB4R Metal Wireless, Batteryless Push Buttons

Table 19.104: Ready-to-use Packs [59]



XB5RFA02

Description	Transmitter Type	Voltage Receiver V	Receiver Type	Catalog Number
Packs include: - 1 push button/transmitter - 1 receiver The push button and receiver are factory-paired [60]	Ø 22 mm plastic head + 1 set of 10 different colored caps	~ / --- 24 to 240	Programmable receiver with: - 2 relay outputs type RT 3A[61]	XB5RFA02
	Ø 22 mm metallic head + 1 set of 10 different colored caps			XB4RFA02
Packs include: - 1 push button/transmitter in handy box [63] - 1 receiver The push button and receiver are factory-paired [60]	Ø 22 mm plastic head	--- 24	Non-programmable receiver with: - 1 relay output type RT 3A[62]	XB5RFB01
	Ø 22 mm metallic head			XB4RFB01
Packs include: - 1 push button/transmitter - 1 receiver The push button and receiver are factory-paired [60]	Ø 22 mm plastic head + 1 set of 10 different colored caps	~ / --- 24 to 240	Programmable receiver with: - 2 relay outputs type RT 3A[61]	XB5RMA04
	Ø 22 mm metallic head + 1 operator head			XB5RMB03



ZBRT1

Table 19.105: Transmitter Components for Wireless, Batteryless Push Buttons

Description	Type of Push	Cap Color	Catalog Number
Transmitter for wireless, batteryless push buttons [64] [65]	1 radio frame sent at the push of the button	—	ZBRT1
	Dual Action: 1 radio frame sent at the push of the button 1 radio frame sent at therelease of the button	—	ZBRT2
Wireless, batteryless push buttons including: - a transmitter fitted with mounting collar - a spring return push button head with clipped-in cap [66]	Plastic	White	ZB5RTA1
		Black	ZB5RTA2
		Green	ZB5RTA3
		Green with white "I"	ZB5RTA331
		Red	ZB5RTA4
		Red with white "O"	ZB5RTA432
	Metal	Yellow	ZB5RTA5
		Blue	ZB5RTA6
		White	ZB4RTA1
		Black	ZB4RTA2
		Green	ZB4RTA3
		Red	ZB4RTA4
		Yellow	ZB4RTA5

[59] Wireless and batteryless push button and receiver, factory-paired.
 [60] For additional components, these devices can be field-paired.
 [61] Supplied with output function set to momentary. Outputs programmable to maintained and Start-Stop.
 [62] Non-programmable momentary output function.
 [63] Supplied with a magnet.
 [64] Mounting collar ZB5AZ009 (plastic) or ZB4BZ009 (metal) to be ordered separately.
 [65] Only heads ZB4RZA0 and ZB5RZA0 are mechanically compatible.
 [66] This cap is fitted by Schneider Electric and cannot be removed (risk of damage).



ZBRRA

Table 19.106: Programmable Receivers

Description	Output Type	Voltage Receiver V	Catalog Number
Programmable receivers equipped with: - 2 buttons ("Scroll-through", "Ok") - 6 indicating LEDs (power ON, outputs, signal strength)	4 PNP outputs, 200 mA / 24 V	--- 24	ZBRRC
	2 relay outputs type RT 3A [67]	~ / --- 24 to 240	ZBRRD
	2 relay outputs type RT 3A [67]	~ / --- 24 to 240	ZBRRA

NOTE: Also refer to Access Point for advanced features in programmable receivers.



ZBRM22



ZBRACS



XALD02H7

Table 19.107: Boxes for Wireless, Batteryless Push Buttons

Description	For use with:	Marking	Sold in lots of	Catalog Number
Mobile box, plastic, empty [68]	For mobile and fixed applications with wireless and batteryless push buttons	1 cut-out	1	ZBRM21
	Support for tube or wall specific for ZBRM21 and ZBRM22	2 cut-outs	1	ZBRM22
Empty plastic boxes for wireless and batteryless push buttons [69]	For fixed or on-board wireless and batteryless push buttons	—	1	ZBRACS
		1 cut-out	1	XALD01H7
		2 cut-outs	1	XALD02H7

New!

XB5R and XB4R Accessories

Table 19.108: Accessories

Description	For use with:	Marking	Sold in lots of	Catalog Number
External antenna [70]	Between transmitter and receiver, used to increase the range and/or get around obstacles	~ / --- 24 to 240 V - 5m cable - 1 power-ON LED - 2 LEDs reception/transmission	1	ZBRA1
Mounting collar	-	Plastic	10	ZB5AZ009
		Metal	10	ZB4BZ009
External antenna access point 2 m/6.56 ft cable with 1 RF connector	Access point (ZBRN1 or ZBRN2) Used to increase the distance of transmission			ZBRA2

NOTE: The ZBRN2 has embedded communication port for Modbus Serial Line, where as ZBRN1 must be plugged with a communication module to support different protocols.

New!

ZBRN1 and ZBRN2 Access Points

The access point of Harmony® wireless and batteryless range provides network connectivity openness by operating as an intermediate equipment between the transmitter and the PLC (Programmable Logic Controller). The access point receives radio signals from the transmitters and converts them to communication protocols. Based on the model, it is connected to the PLC using either RS485 Modbus™ Serial line or Modbus/TCP protocol.

The access point can be used with transmitters such as XB4R and XB5R wireless and batteryless push buttons, rope pull switch, mushroom head push button (1), and all PLCs that support Modbus Serial line over RS485 or Modbus/TCP protocols.

Depending on the application, an external or a relay antenna can be used to improve signal reception. An access point can support up to 60 radio transmitters



ZBRA1



ZBRA2

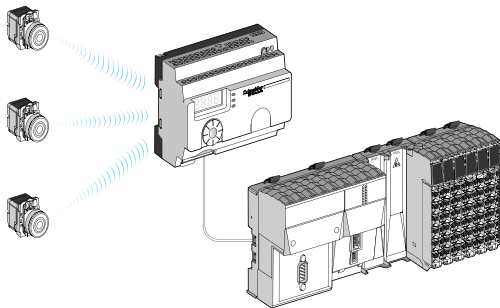

Radio transmission between 3 transmitters and 1 Access Point

[67] Supplied with output function set to momentary Outputs programmable to maintained and Start-Stop.

[68] Cannot be used for wired contacts (no cable gland outlet).

[69] Box equipped with cable gland outlets, compatible with Harmony ZB5 push button heads.

[70] Not wired to the receiver.

Refer to Catalog [DIA5ED21214EN](#)



ZBRN2



ZBRN1



ZBRCETH

Table 19.109: Configurable Access Points

Description	Data Function	Output Type	Receiver Voltage (V)	Catalog Number
Configurable access points equipped with: - 7-segment display - jog dial - 8 indicating LEDs (power ON, functions mode, communication status, signal strength) - external antenna connector and protective plug	Monostable (adjustable from 100 ms to 1 s)	2 RS485 connectors that provides connectivity for Modbus RS485 Serial line	$\sim/\text{---}$ 24 to 240	ZBRN2
	Monostable (adjustable from 100 ms to 1 s)	1 slot for communication module ZBRCETH (should be ordered separately)	$\sim/\text{---}$ 24 to 240	ZBRN1

Table 19.110: Communication Module

Description	Characteristics	Communication Port	Catalog Number
Modbus/TCP network communication module	Modbus/TCP protocol with embedded Web pages in 5 languages for configuration, monitoring and diagnostics	2 RJ45 connectors that provides connectivity for daisy chain and daisy chain loop operation	ZBRCETH

New!

XB7 Push Buttons

Table 19.111: Push Buttons Without Marking



Shape of Head	Type of Push Button	Type of Contact		Marking		Color of Push Button	Sold in Lots of	Catalog Number
		N.O.	N.C.	Text	Color			
Spring return push button without marking								
○	Flush	1	—	—	—	White	10	XB7NA11
		1	—	—	—	Black	10	XB7NA21
		1	—	—	—	Green	10	XB7NA31
		1	—	—	—	Yellow	10	XB7NA81
		1	1	—	—	White	10	XB7NA15
		1	1	—	—	Black	10	XB7NA25
		1	1	—	—	Green	10	XB7NA35
		1	1	—	—	Red	10	XB7NA45
		1	1	—	—	Blue	10	XB7NA65
		—	1	—	—	Red	10	XB7NA42
		2	—	—	—	Black	10	XB7NA23
		2	—	—	—	Green	10	XB7NA33
		—	1	—	—	Red	10	XB7NL42
		1	1	—	—	Red	10	XB7NL45
Latching push button without marking								
○	Flush	1	—	—	—	Black	10	XB7NH21
		1	—	—	—	Green	10	XB7NH31
		1	1	—	—	Black	10	XB7NH25
		1	1	—	—	Green	10	XB7NH35

Table 19.112: Push Buttons With Marking



Shape of Head	Type of Push Button	Type of Contact		Marking		Color of Push Button	Sold in Lots of	Catalog Number
		N.O.	N.C.	Text	Color			
Spring return push button with marking								
○	Flush	1	—	I	White	Green	10	XB7NA3131
		1	—	START	White	Green	10	XB7NA3133
		1	—	†	Black	White	10	XB7NA11341
		1	—	‡	White	Black	10	XB7NA21343
		1	—	‡	White	Black	10	XB7NA21341
		—	1	STOP	White	Red	10	XB7NA4234
		1	1	STOP	White	Red	10	XB7NA4534
		1	1	†	Black	White	10	XB7NA15341
		1	1	O	White	Red	10	XB7NL4532

New!

XB7 Illuminated Push Buttons with Projecting Push

Table 19.113: With Integral LED



XB7NW33•1

Shape of head	Type of push and contacts	Color of lens	Sold in lots of	Unit reference by supply voltage [71]		
				24 V ~/—	120 V ~	230 V ~
	Spring return push with N.O. and N.C. contacts [71]	Green	10	XB7NW33B1	—	XB7NW33M1
		Red	10	XB7NW34B1	XB7NW34G1	XB7NW34M1
		Red	10	XB7NW34B2	—	XB7NW34M2
		Orange	10	XB7NW35B1	—	—
		Blue	10	XB7NW36B1	—	—
		Clear	10	XB7NW37B1	—	—
	Yellow	10	XB7NW38B1	—	—	
	Latching push	Green	10	XB7NJ03B1	—	XB7NJ03M1
		Red	10	XB7NJ04B1	—	XB7NJ04M1

New!

XB7 Pilot Lights

Table 19.114: With Integral LED



XB7EV08•P

Shape of head	Type of light source (included)	Color of lens	Sold in lots of	Catalog Number by supply voltage [72]		
				24 V ~/—	120 V ~	230 V ~
	Integral LED	Green	10	XB7EV03BP	XB7EV03GP	XB7EV03MP
		Red	10	XB7EV04BP	XB7EV04GP	XB7EV04MP
		Yellow	10	XB7EV05BP	XB7EV05GP	XB7EV05MP
		Blue	10	XB7EV06BP	XB7EV06GP	XB7EV06MP
		Clear	10	XB7EV07BP	XB7EV07GP	XB7EV07MP
		Orange	10	XB7EV08BP	XB7EV08GP	XB7EV08MP

Table 19.115: With BA 9s base fitting



XB7EV75P

Shape of head	Supply	Color of lens	Sold in lots of	Catalog Number [72]	
				With bulb	Without bulb
	With resistor, for 130 V, 2.6 W bulb Supply voltage: 230 V ~, 50-60 Hz	Green	10	XB7EV73P	—
		Red	10	XB7EV74P	—
		Yellow	10	XB7EV75P	—
		Orange	10	XB7EV78P	—
	Direct for BA 9s base fitting incandescent bulb Supply voltage: ≤ 250 V [73]	Green	10	—	XB7EV63P
		Red	10	—	XB7EV64P
		Yellow	10	—	XB7EV65P
		Clear	10	—	XB7EV67P
		Orange	10	—	XB7EV68P

[71] All product references ending in "1" are for products with "NO" contacts (example: XB7NW34B1). All product references ending in "2" are for products with "NC" contacts (example: XB7NW34B2).

[72] For Faston connection version (1 x 6.35 mm and 2 x 2.8 mm), add the number "3" to the end of the reference. Example: XB7EV07BP becomes XB7EV07BP3.

[73] Bulb characteristics for direct supply pilot lights: 250 V, 2.6 W.

New!

XB7 Selector Switches and Key Switches

Table 19.116: Title



Shape of head	Type of operator	Type of contact		Number and type of positions	Sold in lots of	Catalog Number	
		N.O.	N.C.				
	Standard handle, black	1	—	2, maintained		10	XB7ND21
		1	1	2, maintained		10	XB7ND25
		2	—	3, maintained		10	XB7ND33
	Key (key No. 455)	1	—	2, key withdrawal in LH position		10	XB7NG21
		2	—	3, key withdrawal in center position		10	XB7NG33

NOTE: The symbol indicates key withdrawal position(s).

New!

XB7 Mushroom Head Push Buttons

Table 19.117: Ø 40 mm Emergency Stop Trigger Action and Mechanically Latching Mushroom Head Pushbuttons



Shape of head	Type of push	Standards	Type of contact		Color	Sold in lots of	Catalog Numbers
			N.O.	N.C.			
	Turn to release	EN/IEC 60204-1, EN/ISO 13850, EN/IEC 60947-5-5, Machinery directive 2006/42/EC and UL	—	1	Red	10	XB7NS8442
			1	1	Red	10	XB7NS8445
	Push-pull		—	2	Red	10	XB7NS8444
			—	1	Red	10	XB7NT842
			1	1	Red	10	XB7NT845
			—	2	Red	10	XB7NT844
	Key release (n° 455)		—	2	Red	10	XB7NS9444
			—	1	Red	10	XB7NS9445

Table 19.118: Circular Legends, Yellow, For Mushroom Head Push Buttons

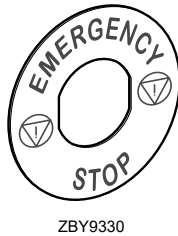







Used for "Emergency Stop" function [74]			
Conforming to Standards	Diameter (mm)	Marking on Yellow Background	Catalog Number
EN/IEC 60204-1 and EN/ISO 13850 [74]	60	ARRET D'URGENCE	ZBY9130
		NOT-HALT	ZBY9230
		PARADA DE EMERGENCIA	ZBY9430
		ARRESTO DE EMERGENZA	ZBY9630
	90	ARRET D'URGENCE	ZBY8130
		EMERGENCY STOP	ZBY8330
		PARADA DE EMERGENCIA	ZBY8430
		ARRESTO DE EMERGENZA	ZBY8630

[74] For compliance with standard EN/ISO 13850, paragraph 4.4.6, the Emergency stop logo has been added.

Type K Heavy Duty Operators

Table 19.119: Non-Illuminated Momentary Push Button Operators

Description		Color	Operator with 1 N.O. and 1 N.C. Contact (KA1) [1]	Operator with 1 N.O. Contact (KA2) [1]	Operator with 1 N.C. Contact (KA3) [1]	Operator Only with No Contacts [1]		
 9001KR1B	Full Guard	Black	KR1BH13	KR1BH5	KR1BH6	KR1B		
		Red	KR1RH13	KR1RH5	KR1RH6	KR1R		
		Green	KR1GH13	KR1GH5	KR1GH6	KR1G		
		Universal [2]	KR1UH13	KR1UH5	KR1UH6	KR1U		
		Other [3]	KR1■H13	KR1■H5	KR1■H6	KR1■		
 9001KR3B	No Guard	Black	KR3BH13	KR3BH5	KR3BH6	KR3B		
		Red	KR3RH13	KR3RH5	KR3RH6	KR3R		
		Green	KR3GH13	KR3GH5	KR3GH6	KR3G		
		Universal [2]	KR3UH13	KR3UH5	KR3UH6	KR3U		
		Other [3]	KR3■H13	KR3■H5	KR3■H6	KR3■		
 9001KR2B	Extended Guard	Black	KR2BH13	KR2BH5	KR2BH6	KR2B		
		Red	KR2RH13	KR2RH5	KR2RH6	KR2R		
		Green	KR2GH13	KR2GH5	KR2GH6	KR2G		
		Universal [2]	KR2UH13	KR2UH5	KR2UH6	KR2U		
		Other [3]	KR2■H13	KR2■H5	KR2■H6	KR2■		
 9001KR4B	1-3/8 in. (35 mm) Diameter Mushroom Button	Snap-In Plastic Mushroom Button						
		Black	KR4BH13	KR4BH5	KR4BH6	KR4B		
		Red	KR4RH13	KR4RH5	KR4RH6	KR4R		
		Red [4]	KR4R05H13	KR4R05H5	KR4R05H6	KR4R05		
		Green	KR4GH13	KR4GH5	KR4GH6	KR4G		
		Other [3]	KR4■H13	KR4■H5	KR4■H6	KR4■		
		Screw-On Mushroom Button with Set Screw Security, Plastic Head						
		Black	KR24BH13	KR24BH5	KR24BH6	KR24B		
		Red	KR24RH13	KR24RH5	KR24RH6	KR24R		
		Green	KR24GH13	KR24GH5	KR24GH6	KR24G		
		Other [3]	KR24■H13	KR24■H5	KR24■H6	KR24■		
		 9001KR24BM	1-1/2 in. (40 mm) Diameter Mushroom Button	Screw-On Metal Mushroom Button with Set Screw Security				
				Black	—	—	—	9001KR24BM
Red	—			—	—	9001KR24RM		
Green	—			—	—	9001KR24GM		
 9001KR5B	2-1/4 in. (57 mm) Diameter Mushroom Button	Snap-In Plastic Mushroom Button						
		Black	KR5BH13	KR5BH5	KR5BH6	KR5B		
		Red	KR5RH13	KR5RH5	KR5RH6	KR5R		
		Red [4]	KR5R05H13 [4]	KR5R05H5 [4]	KR5R05H6 [4]	KR5R05 [4]		
		Green	KR5GH13	KR5GH5	KR5GH6	KR5G		
		Other [3]	KR5■H13	KR5■H5	KR5■H6	KR5■		
		Screw-On Mushroom Button with Set Screw Security, Plastic Head						
		Black	KR25BH13	KR25BH5	KR25BH6	KR25B		
		Red	KR25RH13	KR25RH5	KR25RH6	KR25R		
		Green	KR25GH13	KR25GH5	KR25GH6	KR25G		
		Other [3]	KR25■H13	KR25■H5	KR25■H6	KR25■		
		 9001KR25BM	2-3/8 in. (60 mm) Diameter Mushroom Button	Screw-On Metal Mushroom Button with Set Screw Security				
				Black	—	—	—	9001KR25BM
Red	—			—	—	9001KR25RM		
		Green	—	—	9001KR25GM			

NOTE: To select contact blocks, light modules, and accessories, see [Type KA Contact Blocks](#), page 19-62.





Table 19.120: Color Codes

Color	KR1, 2, 3 Place Color Code in Type Number	KR4, 5, 24, 25 Place Color Code in Type Number
Blue	L	L
Yellow	Y	Y
White	W	—
Orange	S	S
Gray	E	—

NOTE: For use in hazardous locations—See [Square D Offering According to Class, Division, and Group](#), page 19-64. Contact blocks and legend plate not included unless otherwise noted.

[1] When ordering, add prefix 9001 to the catalog number.
 [2] The universal push button operators contain one each of the following color inserts: black, red, green, yellow, orange, blue and white.
 [3] ■ Choose color code from [Table 19.122 Color Codes for Type K Operators](#), page 19-48.
 [4] Knob has the words "Emergency Stop" in raised letters highlighted in white for readability.

Table 19.121: 30 mm Multifunction Operators

Description [5]		Color	With 2 N.C. Contacts (1 KA3, 1 KA5) [6]	With 1 N.O. & 1 N.C. Contact (1 KA1) [6]	Without Contacts [6] [7]
Non-Illuminated Push-Pull Mushroom Operators					
	3 Position, Plastic Head 1-5/8 in. (40 mm), Screw-On Momentary Pull Maintained Neutral Momentary Push [8]	Red Green Other [9]	KR8RH25 KR8GH25 KR8▼H25	— — —	KR8R KR8G KR8▼
	2 Position, Plastic Head 1-5/8 in. (40 mm), Screw-On Maintained Pull Maintained Push [10]	Red [11] Green Other [9]	— — —	KR9RH13 KR9GH13 KR9▼H13	KR9R KR9G KR9▼
	2 Position, Plastic Head 1-5/8 in. (40 mm), Screw-On Head with Set Screw Maintained Pull Maintained Push [10]	Red	—	KR9R94H13	KR9R94
	2 Position, Metal Head 1-1/2 in. (40 mm) Diameter Maintained Pull Maintained Push	Black	—	—	9001KR9BM94
		Red	—		9001KR9RM94
	2 Position, Metal Head 2-3/8 in. (60 mm) Diameter Maintained Pull Maintained Push	Green	—	—	9001KR9GM94
		Black	—		9001KR9BM95
		Red	—		9001KR9RM95
		Green	—		9001KR9GM95
Description	Color	With 1 N.O. & 1 N.C. Contact (KA1)	With 2 N.O. & 2 N.C. Contacts (KA2)	Without Contacts	
Non-Illuminated Turn-to-Release Mushroom Operators					
	2 Position, Plastic Head Turn-to-Release Trigger Action	Red	KR16H13	KR16H2	KR16



9001KR9P1
1.625 in. Diameter Knob
For 1-3/8 in. or 2-1/4 in. Diameter Knob [5]
Includes Type KN379
Legend Plate Marked
Pull To Start Push To Stop

Screw-On Plastic Illuminated Push-Pull Mushroom Operators [6] [12] [9]

Description [5]	Voltage	With Red Knob and 2 N.C. Contacts (1 KA3, 1 KA5)	With Other Color Knob and 2 N.C. Contacts (1 KA3, 1 KA5)	With Other Color Knob Without Contacts [7]
3 Position Illuminated Momentary Pull Maintained Neutral Momentary Push [8]	110-120 V, 50-60 Hz Other—Transformer, LED, Flashing [13] Other—Full Voltage, Resistor, Neon [14]	KR8P1RH25 KR8P▲RH25 KR8P▲RH25	KR8P1▼H25 KR8P▲▼H25 KR8P▲▼H25	KR8P1▼ KR8P▲▼ KR8P▲▼
Description [5]	Voltage	With Red [11] Knob & 1 N.O. & 1 N.C. Contact (KA1)	With Other Color Knob and 1 N.O. & 1 N.C. Contact (KA1)	With Other Color Knob Without Contacts
2 Position Illuminated Maintained Pull Maintained Push	110-120 V, 50-60 Hz Other—Transformer, LED, Flashing [13] Other—Full Voltage, Resistor, Neon [14]	KR9P1RH13 KR9P▲RH13 KR9P▲RH13	KR9P1▼H13 KR9P▲▼H13 KR9P▲▼H13	KR9P1▼ KR9P▲▼ KR9P▲▼

Table 19.122: Color Codes for 30 mm Multifunction Operators ▼

Color	KR8, KR9
Black [15]	B
Red	R
Green	G
Blue	L
Yellow	Y
White	W
Orange [15]	S
Clear	C
Amber	A
Gray	—

Table 19.123: Contact Sequences

9001 KR8RH1 or H13				
		Pull	Ctr	Push
(KA1)	KA3	X	O	O
	KA2	O	O	X
9001 KR8RH25				
	KA3	X	O	O
	KA5	X	X	O

NOTE: To select contact blocks, light modules, and accessories, see Type KA Contact Blocks, page 19-62.

[5] For 1-3/8 in. or 2-1/4 in. Dia. Knob:

- a) Order Type -20 or -21 knob from Additional Accessories for Type K and SK Operators, page 19-48.
- b) Order 9001K54 adapter—allows Type -20 or -21 knob to fit on push pull operators. Voids UL and NEMA 6 rating.
- c) Can order assembled operator by adding color code to Type -20 or -21. **Example:** 9001KR9R would be 9001KR9R20 or 9001KR9R21.

[6] When ordering, add prefix 9001 to the catalog number.

[7] These operators can be ordered complete with contact blocks. For maximum block usage, see "H" Codes, page 19-65. Add the chosen "H" number to the end of the operator.

[8] For contact sequences, see Table 19.123 Contact Sequences, page 19-48

[9] ▼ Choose one color from the Color Codes table here, and insert the color code in Type number. **Example:** KR9 with a yellow knob = KR9Y

[10] For color codes, see Color Codes for 30 mm Multifunction Operators, page 19-48.

[11] To obtain a red knob with "Push Emergency Stop" printed on the red knob—substitute "R05" in place of "R"





[12] ▲ Add the voltage assembly code as chosen from Table 19.167 Standard Light Modules for Types K, SK, and KX Control Units, page 19-63. **Example:** KR8P with a 277 V 50-60 Hz voltage = KR8P8.

[13] The knob must be the same color as the LED light module chosen, for example, for a green LED, use a green knob.

[14] On neon light modules, use clear knobs only.

[15] These colors are not available on illuminated push-pull operators.

Table 19.124: Illuminated Momentary Push Button Operators

Description		Voltage and Frequency	Style	With Red Color Cap and 1 N.O. and 1 N.C. Contact (KA1) [16]	With Green Color Cap and 1 N.O. and 1 N.C. Contact (KA1) [16]	With Other Color Cap Without Contact Block [17] [18] [16]
 9001K1L1	Full Guard Illuminated Push Button Clear Plastic Top	110–120 V, 50–60 Hz	Transformer	K1L1RH13	K1L1GH13	K1L1▼
		220–240 V, 50–60 Hz	Transformer	K1L7RH13	K1L7GH13	K1L7▼
		24–28 Vac/Vdc	Full Voltage	K1L35RH13	K1L35GH13	K1L35▼
		For other voltages [19]■	Transformer or Flashing	K1L■RH13	K1L■GH13	K1L■▼
			Full Voltage	K1L■RH13	K1L■GH13	K1L■ [18]
			Resistor or Neon [20]	K1L■RH13	K1L■GH13	K1L■▼
LED [21]	K1L■RH13	K1L■GH13	K1L■▼			
 9001K3L1	Full Guard Illuminated Push Button Metal Top	110–120 V, 50–60 Hz	Transformer	K3L1RH13	K3L1GH13	K3L1▼
		220–240 V, 50–60 Hz	Transformer	K3L7RH13	K3L7GH13	K3L7▼
		24–28 Vac/Vdc	Full Voltage	K3L35RH13	K3L35GH13	K3L35▼
		For other voltages [19]■	Transformer or Flashing	K3L■RH13	K3L■GH13	K3L■▼
			Full Voltage	K3L■RH13	K3L■GH13	K3L■ [18]
			Resistor or Neon [20]	K3L■RH13	K3L■GH13	K3L■▼
LED [21]	K3L■RH13	K3L■GH13	K3L■▼			
 9001K2L1	No Guard Illuminated Push Button	110–120 V, 50–60 Hz	Transformer	K2L1RH13	K2L1GH13	K2L1▼
		220–240 V, 50–60 Hz	Transformer	K2L7RH13	K2L7GH13	K2L7▼
		24–28 Vac/Vdc	Full Voltage	K2L35RH13	K2L35GH13	K2L35▼
		For other voltages [19]■	Transformer or Flashing	K2L■RH13	K2L■GH13	K2L■ [18]
			Full Voltage	K2L■RH13	K2L■GH13	K2L■▼
			Resistor or Neon [20]	K2L■RH13	K2L■GH13	K2L■▼
LED [21]	K2L■RH13	K2L■GH13	K2L■▼			
 9001K2LR20	1-3/8 in. (35 mm) Illuminated Mushroom, Screw-On Plastic Head	110–120 V, 50–60 Hz	Transformer	K2L1R20H13	K2L1G20H13	Order K2L■▼ Above [22]
		220–240 V, 50–60 Hz	Transformer	K2L7R20H13	K2L7G20H13	
		24–28 Vac/Vdc	Full Voltage	K2L35R20H13	K2L35G20H13	
		For other voltages [19]■	Transformer or Flashing	K2L■R20H13	K2L■G20H13	
			Full Voltage	K2L■R20H13	K2L■G20H13	
			Resistor or Neon [20]	K2L■R20H13	K2L■G20H13	
LED [21]	K2L■R20H13	K2L■G20H13				
 9001K2LR21	2-1/4 in. (57 mm) Illuminated Mushroom, Screw-On Plastic Head	110–120 V, 50–60 Hz	Transformer	K2L1R21H13	K2L1G21H13	Order K2L■▼ Above [22]
		220–240 V, 50–60 Hz	Transformer	K2L7R21H13	K2L7G21H13	
		24–28 Vac/Vdc	Full Voltage	K2L35R21H13	K2L35G21H13	
		For other voltages [19]■	Transformer or Flashing	K2L■R21H13	K2L■G21H13	
			Full Voltage	K2L■R21H13	K2L■G21H13	
			Resistor or Neon [20]	K2L■R21H13	K2L■G21H13	
LED [21]	K2L■R21H13	K2L■G21H13				

NOTE: To select contact blocks, light modules, and accessories, see Type KA Contact Blocks, page 19-62.

Table 19.125: Color Caps

Color	Color Codes ▼		
	K1L, K2L, K3L	1-3/8 in. Mushroom	2-1/4 in. Mushroom
Red	R	R20	R21
Green	G	G20	G21
Blue	L	L20	L21
Yellow	Y	Y20	Y21
White	W	W20	W21
Clear	C	C20	C21
Amber	A	A20	A21

NOTE: UL Types 4, 13/NEMA 4, 13 For use in hazardous locations—See Square D Offering According to Class, Division, and Group, page 19-64. Contact blocks and legend plate not included unless otherwise noted.

[16] When ordering, add prefix 9001 to the catalog number.

[17] These operators can be ordered complete with contact blocks. For maximum block usage, refer to bullets to the right of "H" Codes, page 19-65. Add the "H" number to the end of the operator type number. Additional "H" numbers are available.

[18] Add the color code as chosen from the color cap table. Example: K2L25 with a blue 1-3/8 in. mushroom button = K2L25L20.

[19] ■ Add the voltage assembly code as chosen from Standard and Shallow Depth Light Modules, page 19-63. Example: K2L with 240 Vac/Vdc = K2L25.

[20] On neon light modules, use clear color caps only.

[21] The cap must be the same color as the LED light module chosen, e.g., for red LED, use red color cap.

[22] The only difference between a no guard (K2L_) operator and mushroom button operator is the color cap.

9001K 2-Position Selector Switches

Table 19.126: 2-Position Selector Switches

Contact Block Required			1 — Contact Closed 0 — Contact Open							
Contact Block Position	Quantity and Type KA1 or KA2 or KA3		Mount on Side KA1 or KA2 or KA3		Left Right		Left Right			
	<p>Top View</p>		or		KA1 #2	or		1	0	0
									0	1
			or		KA1 #1	or			1	0
									0	1
	For cam, see Type K, KX, and SK Selector Switch Guide, page 19-53.								E	D
Non-Illuminated Operators							Cat. No. [23]		Cat. No. [23]	
Manual Return [24], Operator Only (without contact blocks)										
Without Knob							KS11		KS12	
With Knob (select style and color from Table 19.127 Selector Switch Assembly Codes, page 19-50) [25]							KS11♦		KS12♦	
Key Operated with E10 Key (Code 1,2,3) [25]							KS11K♦		KS12K♦	
Operator with Contact Blocks and Standard black knob										
With 1 KA1 on Side #2							KS11BH13		—	
With 1 KA1 on Side #1							KS11BH1		—	
With 1 KA1 on Side #1 and 1 KA1 on side #2							KS11BH2		—	
Spring Return from Left [24], Operator Only (without contact blocks)										
Without Knob							KS25		—	
With Knob (select style and color from Table 19.127 Selector Switch Assembly Codes, page 19-50) [25]							KS25♦		—	
Key Operated with E10 Key (Code 2 only) [26]							KS25K2		—	
Spring Return from Right [24], Operator Only (without contact blocks)										
Without Knob							—		KS34	
With Knob (select style and color from Table 19.127 Selector Switch Assembly Codes, page 19-50) [25]							—		KS34♦	
Key Operated with E10 Key (Code 1 only)							—		KS34K1	
Illuminated Operators							Cat. No. [23]		Cat. No. [23]	
Manual Return [24], Operator Only (without contact blocks)										
Without Knob, 110-120V 50-60 Hz Transformer							K11J1		K12J1	
With Standard Red Knob, 110-120V 50-60 Hz Transformer							K11J1R		K12J1R	
With Other Color Knob and other voltage Light Module [27], [25]							K11J♦		K12J♦	
Spring Return from Left [24], Operator Only (without contact blocks)										
Without Knob, 110-120V 50-60 Hz Transformer							K25J1		—	
With Standard Red Knob, 110-120V 50-60 Hz Transformer							K25J1R		—	
With Other Color Knob and other voltage Light Module [27], [25]							K25J♦		—	
Spring Return from Right [24], Operator Only (without contact blocks)										
Without Knob, 110-120V 50-60 Hz Transformer							—		K34J1	
With Standard Red Knob, 110-120V 50-60 Hz Transformer							—		K34J1R	
With Other Color Knob and other voltage Light Module [27], [25]							—		K34J♦	

Table 19.127: Selector Switch Assembly Code and Knob Cat. No.

Color	Standard Knob		Gloved Hand Knob	
	♦ Knob Code	Cat. No. [23]	♦ Knob Code	Cat. No. [23]
Black	B	B11	FB	B25
Red	R	R8	FR	R24
Green	G	G8	FG	G24
Yellow	Y	Y8	FY	Y24
Blue	L	L8	FL	L24
White	W	W8	FW	W24
Amber	A	A8	FA	A24
Clear	C	C8	FC	C24

Table 19.128: Key Withdrawal Codes

Code	Position
1	Left Only
2	Right Only
3	Left and Right

70

2 Position

NOTE: To select and order Contact Blocks, Light Modules, Knobs, and Accessories, see Type KA Contact Blocks, page 19-62 through Hermetically Sealed Power Reed Contact Blocks, page 19-64.

[23] When ordering, add prefix 9001 to the catalog number.

[24] These operators can be ordered complete with contact blocks. Add the "H code" from "H" Codes, page 19-65 as needed for your application.

[25] ♦ Add the knob color code from Table 19.127 Selector Switch Assembly Codes, page 19-50

[26] Add the key withdrawal code from Table 19.128 Key Withdrawal Codes, page 19-50

[27] ■ Add the voltage assembly code as chosen from Standard and Shallow Depth Light Modules, page 19-63. Example: K25J■ with 208Vac = K25J3

9001K 3-Position Selector Switches

Table 19.129: 3-Position Selector Switches

Contact Block Required				1 - Contact Closed 0 - Contact Open																										
Contact Block Position	Quantity and Type		Mount on Side	↕↕↕	↕↕↕	↕↕↕	↕↕↕	↕↕↕	↕↕↕	↕↕↕	↕↕↕	↕↕↕	↕↕↕	↕↕↕																
				Left	Right	Left	Right	Left	Right	Left	Right	Left	Right	Left	Right	Left	Right													
<p>Top View</p>	KA1	KA3 #2	KA1 #2	1	0	0	1	0	0	0	0	1	1	0	0	1	0	0	1	0	0	1	0	0	0	1	0	1	1	0
				0	1	1	0	0	1	0	1	0	0	1	0	0	1	1	0	1	1	1	0	0	0	0	1	0	0	1
	KA1	KA3 #1	KA1 #1	0	0	1	1	0	0	0	0	1	1	0	0	0	0	1	1	0	1	0	0	1	1	0	1	0	0	1
				1	1	0	0	0	1	0	1	0	0	1	0	0	0	1	1	0	0	0	1	0	1	0	0			
For cam, see Type K, KX, and SK Selector Switch Guide, page 19-53.				B	C	D	E	F	G	J	L	M																		
Non-Illuminated Operators				Cat. No.	Cat. No.	Cat. No.	Cat. No.	Cat. No.	Cat. No.	Cat. No.	Cat. No.	Cat. No.	Cat. No.																	
Manual Return, Operator Only (without contact blocks) [29]																														
Without Knob				KS42	KS43	KS44	KS45	KS46	KS47	KS49	KS401	KS402																		
With Knob [30]				KS42+	KS43+	KS44+	KS45+	KS46+	KS47+	KS49+	KS401+	KS402+																		
Key Operated with E10 Key (Code 4 through 10) [31]				KS42K▼	KS43K▼	KS44K▼	KS45K▼	KS46K▼	KS47K▼	KS49K▼	KS401K▼	KS402K▼																		
Operator with Contact Blocks and Standard black knob [32]																														
With 1 KA1 on Side #2 (H13)				KS42B-H13	KS43B-H13	KS44B-H13	KS45BH13	KS46BH13	KS47BH13	KS49BH13	KS401B-H13	KS402B-H13																		
With 1 KA1 on Side #1 (H1)				KS42BH1	KS43BH1	KS44BH1	KS45BH1	KS46BH1	KS47BH1	KS49BH1	KS401BH1	KS402BH1																		
With 1 KA1 on Side #1 and 1 KA1 on side #2 (H2)				KS42BH2	KS43BH2	KS44BH2	KS45BH2	KS46BH2	KS47BH2	KS49BH2	KS401BH2	KS402BH2																		
Spring Return from Left to Center, Operator Only (without contact blocks) [29]																														
Without Knob				KS62	KS63	KS64	KS65	KS66	KS67	KS69	KS601	KS602																		
With Knob [30]				KS62+	KS63+	KS64+	KS65+	KS66+	KS67+	KS69+	KS601+	KS602+																		
Key Operated with E10 Key (Code 5, 6 or 9 only) [31]				KS62K▼	KS63K▼	KS64K▼	KS65K▼	KS66K▼	KS67K▼	KS69K▼	KS601K▼	KS602K▼																		
Spring Return from Right to Center, Operator Only (without contact blocks) [29]																														
Without Knob				KS72	KS73	KS74	KS75	KS76	KS77	KS79	KS701	KS702																		
With Knob [30]				KS72+	KS73+	KS74+	KS75+	KS76+	KS77+	KS79+	KS701+	KS702+																		
Key Operated with E10 Key (Code 4, 5 or 7 only) [31]				KS72K▼	KS73K▼	KS74K▼	KS75K▼	KS76K▼	KS77K▼	KS79K▼	KS701K▼	KS702K▼																		
Spring Return from Both Sides to Center, Operator Only (without contact blocks) [29]																														
Without Knob				KS52	KS53	KS54	KS55	KS56	KS57	KS59	KS501	KS502																		
With Knob [30]				KS52+	KS53+	KS54+	KS55+	KS56+	KS57+	KS59+	KS501+	KS502+																		
Key Operated with E10 Key (Code 4, 5 or 7 only) [31]				KS52K▼	KS53K▼	KS54K▼	KS55K▼	KS56K▼	KS57K▼	KS59K▼	KS501K▼	KS502K▼																		
Illuminated Operators				Cat. No.	Cat. No.	Cat. No.	Cat. No.	Cat. No.	Cat. No.	Cat. No.	Cat. No.	Cat. No.	Cat. No.																	
Manual Return, Operator Only (without contact blocks) [29]																														
Without Knob, 110-120V 50-60 Hz Transformer				K42J1	K43J1	K44J1	K45J1	K46J1	K47J1	K49J1	K401J1	K402J1																		
With Standard Red Knob, 110-120V 50-60 Hz Transformer				K42J1R	K43J1R	K44J1R	K45J1R	K46J1R	K47J1R	K49J1R	K401J1R	K402J1R																		
With Other Color Knob and other voltage Light Module [33] [30]				K42J#	K43J#	K44J#	K45J#	K46J#	K47J#	K49J#	K401J#	K402J#																		
Spring Return from Left to Center, Operator Only (without contact blocks) [29]																														
Without Knob, 110-120V 50-60 Hz Transformer				K62J1	K63J1	K64J1	K65J1	K66J1	K67J1	K69J1	K601J1	K602J1																		
With Standard Red Knob, 110-120V 50-60 Hz Transformer				K62J1R	K63J1R	K64J1R	K65J1R	K66J1R	K67J1R	K69J1R	K601J1R	K602J1R																		
With Other Color Knob and other voltage Light Module [33] [30]				K62J#	K63J#	K64J#	K65J#	K66J#	K67J#	K69J#	K601J#	K602J#																		
Spring Return from Right to Center, Operator Only (without contact blocks) [29]																														
Without Knob, 110-120V 50-60 Hz Transformer				K72J1	K73J1	K74J1	K75J1	K76J1	K77J1	K79J1	K701J1	K702J1																		
With Standard Red Knob, 110-120V 50-60 Hz Transformer				K72J1R	K73J1R	K74J1R	K75J1R	K76J1R	K77J1R	K79J1R	K701J1R	K702J1R																		
With Other Color Knob and other voltage Light Module [33] [30]				K72J#	K73J#	K74J#	K75J#	K76J#	K77J#	K79J#	K701J#	K702J#																		
Spring Return from Both Sides to Center, Operator Only (without contact blocks) [29]																														
Without Knob, 110-120V 50-60 Hz Transformer				K52J1	K53J1	K54J1	K55J1	K56J1	K57J1	K59J1	K501J1	K502J1																		
With Standard Red Knob, 110-120V 50-60 Hz Transformer				K52J1R	K53J1R	K54J1R	K55J1R	K56J1R	K57J1R	K59J1R	K501J1R	K502J1R																		
With Other Color Knob and other voltage Light Module [33] [30]				K52J#	K53J#	K54J#	K55J#	K56J#	K57J#	K59J#	K501J#	K502J#																		

Table 19.130: Selector Switch Assembly Code and Knob Cat. No. [28]

Color	Standard Knob		Gloved Hand Knob	
	[30] Knob Code	Cat. No. [28]	[30] Knob Code	Cat. No. [28]
Black	B	B11	FB	B25
Red	R	R8	FR	R24
Green	G	G8	FG	G24
Yellow	Y	Y8	FY	Y24
Blue	L	L8	FL	L24
White	W	W8	FW	W24
Amber	A	A8	FA	A24
Clear	C	C8	FC	C24

Table 19.131: Key Withdrawal Codes [34]

Code	Position
4	Left Only
5	Center Only
6	Right Only
7	Left and Center
8	Left and Right
9	Center and Right
10	Left, Center, and Right

3 Position

NOTE: To select and order Contact Blocks, Light Modules, Knobs, and Accessories, see Type KA Contact Blocks, page 19-62 through Hermetically Sealed Power Reed Contact Blocks, page 19-64.

[28] When ordering, add prefix 9001 to the catalog number.

[29] These operators can be ordered complete with contact blocks. Add the "H code" from "H Codes, page 19-65 as needed for your application.

[30] Add the knob color code from Table 19.130 Selector Switch Assembly Code, page 19-51. For LED, knob color must match LED.

[31] Add the key withdrawal code from Key Withdrawal Codes table. Example: KS43K with key withdrawal in the right position only = KS43K6.

[32] For other color knobs replace the B with knob color code from the Selector Switch Assembly Code table.

[33] Add the voltage assembly code as chosen from page 19-86.

[34] Add the key withdrawal code from Key Withdrawal Codes table. Example: KS43K with key withdrawal in the right position only = KS43K6.

9001K 4-Position Selector Switches

Table 19.132: 4-Position Selector Switches

Contact Block Required							
Contact Block Position	Quantity and Type KA1 or KA2 or KA3		Mount on Side KA1 or KA2 or KA3		1—Contact Closed 0—Contact Open		
<p>Top View</p>	KA1	or	KA3	KA1 #2	or	KA3 #2	1 0 0 0
			KA2			KA2 #2	0 0 1 0
	KA1	or	KA3	KA1 #1	or	KA3 #1	0 0 0 1
			KA2			KA2 #1	0 1 0 0
For cam, see Type K, KX, and SK Selector Switch Guide, page 19-53.							
Non-Illuminated Operators						Cat. No. [35]	
Manual Return [36], Operator Only (without contact blocks)							
Without Knob						KS88	
With Knob♦[37]						KS88♦	
Key Operated with E10 Key (Codes 11, 12, 13, 14, 15)						KS88K[38]	
Illuminated Operators						Cat. No. [35]	
Manual Return [36], Operator Only (without contact blocks)							
Without Knob, 110-120V 50-60 Hz Transformer						K88J1	
With Standard Red Knob, 110-120V 50-60 Hz Transformer						K88J1R	
With Other Color Knob and other voltage Light Module ■[39] ♦[37][40]						K88J♦	

Table 19.133: Selector Switch Assembly Code and Knob Cat. No.

Color	Standard Knob		Gloved Hand Knob	
	Knob Code	Cat. No.	Knob Code	Cat. No.
Black	B	B11	FB	B25
Red	R	R8	FR	R24
Green	G	G8	FG	G24
Yellow	Y	Y8	FY	Y24
Blue	L	L8	FL	L24
White	W	W8	FW	W24
Amber	A	A8	FA	A24
Clear	C	C8	FC	C24

Table 19.134: Key Withdrawal Codes

Code	Position
11	1 and 4
12	4 only
13	1 only
14	1, 2, 3 and 4
15	2, 3, and 4

NOTE: To select and order Contact Blocks, Light Modules, Knobs, and Accessories, see Type KA Contact Blocks, page 19-62 through Hermetically Sealed Power Reed Contact Blocks, page 19-64.



Potentiometers with Dial Plate

Table 19.135: Potentiometers with Dial Plate (not UL listed)—Maximum Voltage 300 Vac

Power	Description	Ratings	Type
2 W	Operator Only, for Single Potentiometer	NEMA 4, 13	K20
	Operator with Single Potentiometer		K21

Table 19.136: Potentiometer Suffixes

Single Potentiometer			
Suffix [41]	Resistance	Suffix [41]	Resistance
01	50 Ω	07	5 kΩ
02	100 Ω	08	10 kΩ
04	500 Ω	09	25 kΩ
05	1 kΩ	13	500 kΩ
39	2 kΩ	37	750 kΩ
06	2.5 kΩ	14	1 MΩ
Tandem Potentiometer			
Suffix [41]	Resistance		Rear
	Front	1 kW	
82	1 kW	1 kW	

NOTE: Any potentiometer with a shaft 7/8" long and 1/4" diameter may be used with these operators.

[35] When ordering, add prefix 9001 to the catalog number.

[36] These operators can be ordered complete with contact blocks. Add the "H" code from "H" Codes, page 19-65 as needed for your application.

[37] ♦ Add the knob color code from the Selector Switch Assembly Code table. For LED, knob color must match LED.

[38] Add the key withdrawal code from the Key Withdrawal Codes table.

[39] ■ Add the key withdrawal code from Key Withdrawal Codes table. Example: KS43K with key withdrawal in the right position only = KS43K6.

[40] Add the knob color code from the Selector Switch Assembly Code table. For LED, knob color must match LED.

[41] For the complete part number, add the suffix from Table 19.136 Potentiometer Suffixes, page 19-52 to the catalog number. Example: 9001K2105.

Type K, KX, and SK Selector Switch Guide

Table 19.137: 2 Position Selector Switch

If you require contact sequence—		Use Cam Type	Use Contact Block Type	Mount on side no. [42]
↖	↗			
1	0	E	KA3	1 or 2
		D	KA2	1 or 2
0	1	E	KA2	1 or 2
		D	KA3	1 or 2

Table 19.138: 3 Position Selector Switch

If you require contact sequence—			Use Cam Type	Use Contact Block Type	Mount on side no. [42]			
↖	↑	↗						
1	0	0	G	M	KA2	1		
				L	KA2	2		
			C	E	KA3	1		
			B	C	E	F	G	J
0	1	0			G	J	KA5 [43]	2
			D	E	J	L	KA2	1
			D	E	KA2	2		
				F	KA3	1		
0	0	1		L	KA3	2		
			C	F	KA2	1 or 2		
			B	D	G	L	KA3	1
			B	D	KA3	2		
1	1	0			M	KA2	2	
					KA2	1		
					KA5 [43]	1		
			B					
0	1	1			M	KA3	2	
					G	J	KA2	2
					G	KA5 [43]	1	
					L	KA5 [43]	2	
1	0	1		M	KA3	1		
				J	KA3	1		
			D	E	J	L	KA5 [43]	1
			D	E	KA5 [43]	2		

Table 19.139: 4 Position Selector Switch

If you require contact sequence—				Use Cam Type	Use Contact Block Type	Mount on side no. [42]
↖	↖	↗	↗			
1	0	0	0	H	(A) KA3	2
0	1	0	0	H	(B) KA2	1
0	0	1	0	H	(C) KA2	2
0	0	0	1	H	(D) KA3	1
1	0	0	1	H	A & D Wired in Parallel	
1	1	0	0	H	A & B Wired in Parallel	
0	1	1	0	H	B & C Wired in Parallel	
0	0	1	1	H	C & D Wired in Parallel	
1	1	1	0	H	A, B & C Wired in Parallel	
0	1	1	1	H	B, C & D Wired in Parallel	
1	0	1	0	H	A & C Wired in Parallel	
0	1	0	1	H	B & D Wired in Parallel	
1	1	0	1	H	KA5 [43]	2
1	0	1	1	H	KA5 [43]	1

NOTE: For Outline Dimensions see Catalog 9001CT1103

NOTE: When ordering, add prefix 9001 to the catalog number.

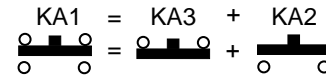

When ordering, please specify:

- Quantity
- Class Number
- Type or Catalog Number

For "H" Numbers, see Type K, SK, and KX Contact Block "H" Numbers, page 19-65

Selection
Shown below is a simplified method of selecting a selector switch to meet almost any combination of contact sequences.

Step No. 1
Determine the contact sequence(s) required. Set up a target table like the one shown for the example below.

Contact Sequence 0—contact open 1— contact closed	↖	↑	↗
A	1	0	0
B	0	1	0
C	0	0	1

Step No. 2
Look for a cam type common to all sequences in:
Table 19.137 2 Position Selector Switch, page 19-53,
Table 19.138 3 Position Selector Switch, page 19-53, or
Table 19.139 4 Position Selector Switch, page 19-53.
For the example above, Table 19.138 3 Position Selector Switch, page 19-53 would be used.
For the contact sequences A (1 0 0), B (0 1 0) and C (0 0 1) of the example above, cam types F and L are common to all three sequences.

Step No. 3
Next, use the cam type common to all the sequences (if several cam types are common, choose one) to find the operator type number. Go to the proper reference topic as indicated in the table below:

Number of Positions	Push Button Line	Reference topics
2	Type K, Type SK, Type KX	Type K, page 19-50 Type SK, page 19-58 "H" Numbers, page 19-65 Type KX with Contacts, page 19-59 Type KX without Contacts, page 19-59
3	Type K, Type SK, Type KX	Type K, page 19-51 Type SK, page 19-59 "H" Numbers, page 19-65 Type KX with Contacts, page 19-59 Type KX without Contacts, page 19-59
4	Type K, Type SK, Type KX	Type K, page 19-52 Type SK, page 19-60 Type KX, page 19-60

If for the example above a manual return operator with a standard black knob is required and:
The F cam type is chosen, the operator type number is:

- Type K—Class 9001 Type KS46B, page 19-51
- Type SK—Class 9001 Type SKS46B, page 19-59
- Type KX—Class 9001 Type KXSDFB, page 19-59

The L cam type is chosen, the operator type number is:

- Type K—Class 9001 Type KS401B, page 19-51
- Type SK—Class 9001 Type SKS401B, page 19-59
- Type KX—Class 9001 Type KXSDLB, page 19-59

Step No. 4:
Determine the contact blocks required by using the same table in Step No. 2.
If, for the example above, the F cam type is chosen:

- Use a 9001KA3 mounted on side no. 2 for sequence A (1 0 0).
- Use a 9001KA3 mounted on side no. 1 for sequence B (0 1 0).
- Use a 9001KA2 mounted on side no. 1 or 2 for sequence C (0 0 1).

If, for the example above, the L cam type is chosen:

- Use a 9001KA2 mounted on side no. 2 for sequence A (1 0 0).
- Use a 9001KA2 mounted on side no. 1 or a 9001KA3 mounted on side no. 2 for sequence B (0 1 0).
- Use a 9001KA3 mounted on side no. 1 for sequence C (0 0 1).

One Type KA1 double circuit block can be used in place of one Type KA2 single circuit block plus one Type KA3 single circuit block mounted on the same side.

[42] See Type K, SK, and KX Contact Block "H" Numbers, page 19-65

[43] Type KA5 must be the last block on either side. If more than one KA5 is required on either side—contact your local Square D sales office.

Type K Heavy Duty Pilot Lights

When ordering, add prefix 9001 to the catalog number.

Table 19.140: Pilot Lights—UL Types 4, 13/NEMA 4 & 13[44][45]



Description	Voltage	Style	With Red Fresnel Color Cap [46]	With Green Fresnel Color Cap [46]	With Other Color Cap [46] [47]	Without Color Cap [46]
 Standard Pilot Light (Plastic Fresnel Color Cap Shown)	110–120 V, 50–60 Hz 220–240 V, 50–60 Hz 24–28 Vac/Vdc	Transformer Transformer Full Voltage	KP1R31 KP7R31 KP35R31	KP1G31 KP7G31 KP35G31	KP1■ KP7■ KP35■	KP1 KP7 KP35
	For other voltages see Standard and Shallow Depth Light Modules, page 19-63.	Transformer, Flashing or LED [48] Full Voltage, Neon or Resistor [49]	KP▲R31 KP▲R31	KP▲G31 KP▲G31	KP▲■ KP▲■	KP▲ KP▲
 Push-To-Test Pilot Light (Glass Color Cap Shown)	110–120 V, 50–60 Hz 220–240 V, 50–60 Hz 24–28 Vac/Vdc	Transformer Transformer Full Voltage	KT1R31 KT7R31 KT35R31	KT1G31 KT7G31 KT35G31	KT1■ KT7■ KT35■	KT1 KT7 KT35
	For other voltages see Standard and Shallow Depth Light Modules, page 19-63.	Transformer, Flashing or LED [48] Full Voltage, Neon or Resistor [49]	KT▲R31 KT▲R31	KT▲G31 KT▲G31	KT▲■ KT▲■	KT▲ KT▲
 Remote Test Pilot Light (Glass Color Cap Shown)	120 Vac Only 24–28 Vac Only for other voltages	Resistor [50] Full Voltage [50]	KTR38R31 KTR35R31	KTR38G31 KTR35G31	KTR38■ KTR35■	KTR38 KTR35
	See Standard and Shallow Depth Light Modules, page 19-63.[50]	Full Voltage or Resistor [50]	KTR▲R31	KTR▲G31	KTR▲■	KTR▲

Table 19.141: Color Caps

Color	Plastic Fresnel	Plastic Dorned	Glass
Amber	A31	A9	A6
Blue	L31	L9	L6
Clear	C31	C9	C6
Green	G31	G9	G6
Red	R31	R9	R6
White	W31	W9	W6
Yellow	Y31	Y9	Y6

Typical Wiring Diagram

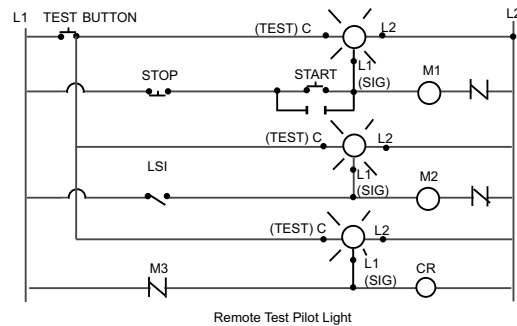
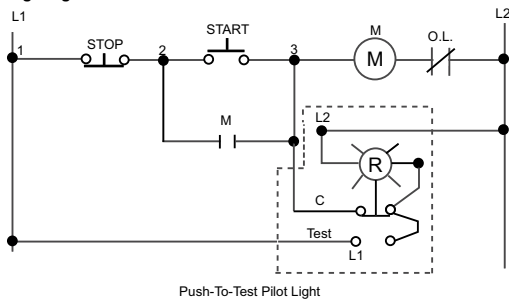

For Contact Blocks, see Type KA Contact Blocks, page 19-62
For Light Modules, see Standard and Shallow Depth Light Modules, page 19-63
For Accessories, see Type K and SK Accessories, page

[44] For use in hazardous locations, see Square D Offering According to Class, Division, and Group, page 19-64

[45] Legend plates not included.

[46] When ordering, add prefix 9001 to the catalog number.

[47] ■ Add the color code as chosen from Table 19.141 Color Caps, page 19-54. EXAMPLE: KP1 with a blue fresnel cap = KP1L31

[48] The cap must be the same color as the LED light module chosen, e.g., for green LED, use green color cap.

[49] On neon light modules, use clear color caps only.

[50] On remote test pilot lights use only full voltage or resistor voltage assembly codes. Do not choose LED (exception - these LED codes are allowed: 38LG, 38LL, 38LR, 38LW, 38LY), neon or transformer codes. For AC use only.

**30 mm Momentary Push Button Operators, UL Types 4, 4X, 13/
NEMA 4, 4X, 13**

Table 19.142: Non-Illuminated Momentary Push Button Operators^[51]





Description	Color	Operator with 1 N.O. and 1 N.C. Contact (KA1)	Operator with 1 N.O. Contact (KA2)	Operator with 1 N.C. Contact (KA3)	Operator Only No Contacts ^[52]
 9001SKR1B Full Guard	Black	SKR1BH13	SKR1BH5	SKR1BH6	SKR1B
	Red	SKR1RH13	SKR1RH5	SKR1RH6	SKR1R
	Green	SKR1GH13	SKR1GH5	SKR1GH6	SKR1G
	Universal ^[53]	SKR1UH13	SKR1UH5	SKR1UH6	SKR1U
	Other ^[54]	SKR1■H13	SKR1■H5	SKR1■H6	SKR1■
 9001SKR3B No Guard	Black	SKR3BH13	SKR3BH5	SKR3BH6	SKR3B
	Red	SKR3RH13	SKR3RH5	SKR3RH6	SKR3R
	Green	SKR3GH13	SKR3GH5	SKR3GH6	SKR3G
	Universal ^[53]	SKR3UH13	SKR3UH5	SKR3UH6	SKR3U
	Other ^[54]	SKR3■H13	SKR3■H5	SKR3■H6	SKR3■
 9001SKR2B Extended Guard	Black	SKR2BH13	SKR2BH5	SKR2BH6	SKR2B
	Red	SKR2RH13	SKR2RH5	SKR2RH6	SKR2R
	Green	SKR2GH13	SKR2GH5	SKR2GH6	SKR2G
	Universal ^[53]	SKR2UH13	SKR2UH5	SKR2UH6	SKR2U
	Other ^[54]	SKR2■	SKR2■H5	SKR2■H6	SKR2■
 9001SKR4B 1-3/8 in. (35 mm) Mushroom Button	Snap-In Mushroom Button				
	Black	SKR4BH13	SKR4BH5	SKR4BH6	SKR4B
	Red	SKR4RH13	SKR4RH5	SKR4RH6	SKR4R
	Red ^[55]	SKR4R05H13	SKR4R05H5	SKR4R05H6	SKR4R05
	Green	SKR4GH13	SKR4GH5	SKR4GH6	SKR4G
	Other ^[56]	SKR4▲H13	SKR4▲H5	SKR4▲H6	SKR4▲
	Screw-On Mushroom Button with Set Screw Security				
	Black	SKR24BH13	SKR24BH5	SKR24BH6	SKR24B
	Red	SKR24RH13	SKR24RH5	SKR24RH6	SKR24R
	Green	SKR24GH13	SKR24GH5	SKR24GH6	SKR24G
Other ^[56]	SKR24▲H13	SKR24▲H5	SKR24▲H6	SKR24▲	
 9001SKR5 2-1/4 in. (57 mm) Mushroom Button	Snap-In Mushroom Button, Plastic Head				
	Black	SKR5BH13	SKR5BH5	SKR5BH6	SKR5B
	Red	SKR5RH13	SKR5RH5	SKR5RH6	SKR5R
	Red ^[55]	SKR5R05H13	SKR5R05H5	SKR5R05H6	SKR5R05
	Green	SKR5GH13	SKR5GH5	SKR5GH6	SKR5G
	Other ^[56]	SKR5▲H13	SKR5▲H5	SKR5▲H6	SKR5▲
	Screw-On Mushroom Button with Set Screw Security, Plastic Head				
	Black	SKR25BH13	SKR25BH5	SKR25BH6	SKR25B
	Red	SKR25RH13	SKR25RH5	SKR25RH6	SKR25R
	Green	SKR25GH13	SKR25GH5	SKR25GH6	SKR25G
Other ^[56]	SKR25▲H13	SKR25▲H5	SKR25▲H6	SKR25▲	

Table 19.143: Color Codes

Color	■ SKR1, 2, 3 Place Color Code in Type Number	▲ SKR4, 5, 24, 25 Place Color Code in Type Number
Blue	L	L
Yellow	Y	Y
White	W	—
Orange	S	S
Gray	E	—

NOTE: To select and order Contact Blocks, Light Modules, Knobs, and Accessories, see *Type KA Contact Blocks*, page 19-62 through *Hermetically Sealed Power Reed Contact Blocks*, page 19-64.

NOTE: For use in hazardous locations—See *Square D Offering According to Class, Division, and Group*, page 19-64. Contact blocks and legend plate not included unless otherwise noted.

^[51] When ordering, add prefix 9001 to the catalog number.

^[52] These operators can be ordered complete with contact blocks. For maximum block usage, see "H" Codes, page 19-65. Add the "H" number to the end of the operator type number.

^[53] The universal push button operators include one each of the following color inserts: black, red, green, yellow, orange, blue and white.

^[54] ■ See Table 19.143 Color Codes, page 19-55.

^[55] Knob has the words "Emergency Stop" in raised letters highlighted in white for readability.

^[56] ▲ See Table 19.143 Color Codes, page 19-55.

30 mm Multifunction Operators UL Types 4, 4X, 13/NEMA 4, 4X, 13

Table 19.144: Non-Illuminated Push-Pull Screw-on Mushroom Operators, Plastic Head^[57]

Description	Color	With 2 N.C. Contacts (1 KA3, 1 KA5)	With 1 N.O. / 1 N.C. Contact (1 KA1)	Without Contacts ^[58]
		3 Position		
Momentary Pull-Maintained Neutral-Momentary Push ^[59]	Red	SKR8RH25	—	SKR8R
	Green	SKR8GH25	—	SKR8G
	Other ^[60]	SKR8▲H25	—	SKR8▲
2 Position^[61]				
Maintained Pull-Maintained Push	Red	—	SKR9RH13	SKR9R
	Green	—	SKR9GH13	SKR9G
	Other ^[60]	—	SKR9▲H13	SKR9▲



9001SKR9R
Non-Illuminated
1-5/8 in. Diameter Knob
Includes Type KN179WP
Legend Plate Marked
Pull To Start Push To Stop

Table 19.145: Non-Illuminated Turn-to-Release Mushroom Operators^[57]

Description	Color	With 1 N.O. Contact (KA1)	With 2 N.O. / 2 N.C. Contacts (2 KA1)	Without Contacts
2 Position, Plastic Head Turn-to-Release Trigger Action	Red	SKR16H13	SKR16H2	SKR16



9001SKR16H2

Table 19.146: Screw-On Plastic Illuminated Push-Pull Mushroom Operators^[57]

Illuminated	Description	Voltage	With Red Knob and 2 N.C. Contacts (1 KA3, 1 KA5) ^[62]	With Other Color Knob and 2 N.C. Contacts ^[60] ^[62]	With Other Color Knob Without Contacts ^[58] ^[60] ^[62]	
 9001SKR9P1 Illuminated 1-5/8 in. Diameter Knob Includes Type KN179WP Legend Plate Marked Pull to Start Push To Stop	3 Position					
	Momentary Pull-Maintained Neutral-Momentary Push ^[63]	110–120 V, 50–60 Hz	SKR8P1RH25	SKR8P1▲H25	SKR8P1▲	
		Other—Transformer, LED, Flashing ^[64]	SKR8P♦RH25	SKR8P♦▲H25	SKR8P♦▲	
		Other—Full Voltage, Resistor, Neon ^[59]	SKR8P♦RH25	SKR8P♦▲H25	SKR8P♦▲	
	Description		Voltage	With Red ^[61] Knob and 1 N.O. & 1 N.C. Contact (KA1)	With Other Color Knob and 1 N.O. & 1 N.C. Contact (KA1) ^[60]	With Other Color Knob Without Contacts ^[60]
	2 Position					
Maintained Pull-Maintained Push	110–120 V, 50–60 Hz	SKR9P1RH13	SKR9P1▲H13	SKR9P1▲		
	Other—Transformer, L.E.D., Flashing ^[64]	SKR9P♦RH13	SKR9P♦▲H13	SKR9P♦▲		
	Other—Full Voltage, Resistor, Neon ^[59]	SKR9P♦RH13	SKR9P♦▲H13	SKR9P♦▲		

Table 19.147: Color Codes

Color	SKR11, SKR12	SKR8, SKR9
Black ^[65]	B	B
Red	R	R
Green	G	G
Blue	L	L
Yellow	Y	Y
White	W	W
Orange ^[65]	S	S
Clear	—	C
Amber	—	A
Gray	E	—

Table 19.148: Positions for 9001SKR8RH1 or H13

	9001SKR8RH1 or H13		
	PULL	CTR	PUSH
(KA1)	KA3	O	O
	KA2	O	X

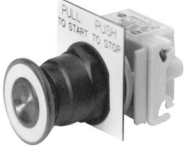
Table 19.149: Positions for 9001SKR8H25

	9001SKR8H25		
	PULL	CTR	PUSH
KA3	X	O	O
KA5	X	X	O
KA2	O	O	X

NOTE: To select and order Contact Blocks, Light Modules, Knobs, and Accessories, see [Type KA Contact Blocks, page 19-62](#) through [Hermetically Sealed Power Reed Contact Blocks, page 19-64](#).

^[57] When ordering, add prefix 9001 to the catalog number.

^[58] These operators can be ordered complete with contact blocks. For maximum block usage, see "H" Codes, [page 19-65](#). Add the chosen "H" number to the end of the operator.

^[59] On neon light modules, use clear knobs only.

^[60] ▲ See [Table 19.147 Color Codes, page 19-56](#) and insert the color code in the Type number. Example: SKR9() with a yellow knob = SKR9Y

^[61] To obtain a red knob with "Push Emergency Stop" printed on the red knob—substitute "R05" in place of "R"

^[62] ♦ Add the voltage assembly code as chosen from [Standard and Shallow Depth Light Modules, page 19-63](#). Example: SKR8P♦ with 277 V 50–60 Hz = SKR8P8

^[63] For positions, refer to [Table 19.148 Positions for 9001SKR8RH1 or H13, page 19-56](#) and [Table 19.149 Positions for 9001SKR8H25, page 19-56](#).

^[64] The knob must be the same color as the LED light module chosen, for example, for a green LED, use a green knob.

^[65] These colors are not available on illuminated push-pull operators.

Type SK Corrosion Resistant Illuminated Operators

Table 19.150: Illuminated Push Button Operators





Description	Voltage and Frequency	Style	With Red Color Cap and 1 N.O. and 1 N.C. Contact (KA1) [66]	With Green Color Cap and 1 N.O. and 1 N.C. Contact (KA1) [66]	With Other Color Cap Without Contact Blocks [67] [68]
 9001SK1L1 Full Guard Illuminated Push Button	110–120 V, 50–60 Hz	Transformer	SK1L1RH13	SK1L1GH13	SK1L1
	220–240 V, 50–60 Hz	Transformer	SK1L7RH13	SK1L7GH13	SK1L7
	24–28 Vac/Vdc	Full Voltage	SK1L35RH13	SK1L35GH13	SK1L35
	For other voltages See Table [68]	Transformer, Flashing	SK1L■RH13	SK1L■GH13	SK1L■
		Full Voltage	SK1L■RH13	SK1L■GH13	SK1L■
		Resistor, Neon [69]	SK1L■RH13	SK1L■GH13	SK1L■
LED [70]	SK1L■RH13	SK1L■GH13	SK1L■ [71]		
 9001SK2L1 No Guard Illuminated Push Button	110–120 V, 50–60 Hz	Transformer	SK2L1RH13	SK2L1GH13	SK2L1
	220–240 V, 50–60 Hz	Transformer	SK2L7RH13	SK2L7GH13	SK2L7
	24–28 Vac/Vdc	Full Voltage	SK2L35RH13	SK2L35GH13	SK2L35
	For other voltages See Table [68]	Transformer, Flashing	SK2L■RH13	SK2L■GH13	SK2L■
		Full Voltage	SK2L■RH13	SK2L■GH13	SK2L■
		Resistor, Neon [69]	SK2L■RH13	SK2L■GH13	SK2L■
LED [70]	SK2L■RH13	SK2L■GH13	SK2L■ [71]		
 9001SK2L1R20 1-3/8 in. (35 mm) Illuminated Mushroom, Screw-On Plastic Head	110–120 V, 50–60 Hz	Transformer	SK2L1R20H13	SK2L1G20H13	Order SK2L■ [71][72]
	220–240 V, 50–60 Hz	Transformer	SK2L7R20H13	SK2L7G20H13	
	24–28 Vac/Vdc	Full Voltage	SK2L35R20H13	SK2L35G20H13	
	For other voltages See Table [68]	Transformer, Flashing	SK2L■R20H13	SK2L■G20H13	
		Full Voltage	SK2L■R20H13	SK2L■G20H13	
		Resistor, Neon [69]	SK2L■R20H13	SK2L■G20H13	
LED [70]	SK2L■R20H13	SK2L■G20H13			
 9001SK2L1R21 2-1/4 in. (57 mm) Illuminated Mushroom, Screw-On Plastic Head	110–120 V, 50–60 Hz	Transformer	SK2L1R21H13	SK2L1G21H13	Order SK2L■ [71][72]
	220–240 V, 50–60 Hz	Transformer	SK2L7R21H13	SK2L7G21H13	
	24–28 Vac/Vdc	Full Voltage	SK2L35R21H13	SK2L35G21H13	
	For other voltages See Table [68]	Transformer, Flashing	SK2L■R21H13	SK2L■G21H13	
		Full Voltage	SK2L■R21H13	SK2L■G21H13	
		Resistor, Neon [69]	SK2L■R21H13	SK2L■G21H13	
LED [70]	SK2L■R21H13	SK2L■G21H13			

Table 19.151: Color Caps

Color	Color Codes		
	SK1L/SK2L	1-3/8 in. (35 mm) Mushroom	2-1/4 in. (57 mm) Mushroom
Red	R	R20	R21
Green	G	G20	G21
Blue	L	L20	L21
Yellow	Y	Y20	Y21
White	W	W20	W21
Clear	C	C20	C21
Amber	A	A20	A21

NOTE: To select and order Contact Blocks, Light Modules, Knobs, and Accessories, see Type KA Contact Blocks, page 19-62 through Hermetically Sealed Power Reed Contact Blocks, page 19-64.

NOTE: For use in hazardous locations—See Square D Offering According to Class, Division, and Group, page 19-64. Contact blocks and legend plate not included unless otherwise noted.

[66] When ordering, add prefix 9001 to the catalog number.

[67] These operators can be ordered complete with contact blocks. For maximum block usage, see "H" Codes, page 19-65. Add the "H" number to the end of the operator type number.

[68] ■ Add the voltage assembly code as chosen from Standard and Shallow Depth Light Modules, page 19-63. **EXAMPLE:** SK2L_ with 240 Vac/Vdc = SK2L25.

[69] On neon light modules, use clear color caps only.

[70] Add the color code as chosen from the color cap table below. **EXAMPLE:** SK2L25 with a blue 1-3/8 in. mushroom button = SK2L25L20.

[71] The cap must be the same color as the LED light module chosen, e.g., for green LED, use green color cap.

[72] The only difference between a no guard (SK2L) operator and mushroom button operator is the color cap.

9001SK 2-Position Selector Switches

Table 19.152: 2-Position Selector Switches

Contact Block Required				1—Contact Closed 0—Contact Open						
Contact Block Position	Quantity and Type KA1 or KA2 or KA3		Mount on Side KA1 or KA2 or KA3		Left	Right	Left	Right		
<p>Top View</p>	KA1	or	KA3	KA1 #2	or	KA3 #2	1	0	0	1
			KA2			KA2 #2	0	1	1	0
	KA1	or	KA3	KA1 #1	or	KA3 #1	1	0	0	1
			KA2			KA2 #1	0	1	1	0
For Cam, see Type K, KX, and SK Selector Switch Guide, page 19-53							E	D		
Non-Illuminated Operators							Type [73]		Type [73]	
Manual Return [74], Operator Only (without contact blocks)										
Without Knob							SKS11		SKS12	
With Knob [75]							SKS11♦		SKS12♦	
Operator with Contact Blocks and Standard black knob										
With 1 KA1 on Side #2							SKS11BH13		—	
With 1 KA1 on Side #1							SKS11BH1		—	
With 1 KA1 on Side #1 and 1 KA1 on side #2							SKS11BH2		—	
Spring Return from Left [74], Operator Only (without contact blocks)										
Without Knob							SKS25		—	
With Knob [75]							SKS25♦		—	
Spring Return from Right [74], Operator Only (without contact blocks)										
Without Knob							—		SKS34	
With Knob [75]							—		SKS34♦	
Illuminated Operators							Type [73]		Type [73]	
Manual Return [74], Operator Only (without contact blocks)										
Without Knob, 110-120V 50-60 Hz Transformer							SK11J1		SK12J1	
With Standard Red Knob, 110-120V 50-60 Hz Transformer							SK11J1R		SK12J1R	
With other Color Knob [75] and other Voltage Light Module [76]							SK11J♦		SK12J♦	
Spring Return from Left [74], Operator Only (without contact blocks)										
Without Knob, 110-120V 50-60 Hz Transformer							SK25J1		—	
With Standard Red Knob, 110-120V 50-60 Hz Transformer							SK25J1R		—	
With other Color Knob [75] and other Voltage Light Module [76]							SK25J♦		—	
Spring Return from Right [74], Operator Only (without contact blocks)										
Without Knob, 110-120V 50-60 Hz Transformer							—		SK34J1	
With Standard Red Knob, 110-120V 50-60 Hz Transformer							—		SK34J1R	
With other Color Knob [75] and other Voltage Light Module [76]							—		SK34J♦	

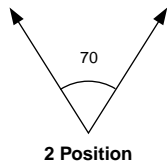

Table 19.153: Selector Switch Assembly Code and Knob Cat. No.

Color	Standard Knob		Gloved Hand Knob	
	Knob Code	Cat. No. [73]	Knob Code	Cat. No. [73]
Black	B	B11	FB	B25
Red	R	R8	FR	R24
Green	G	G8	FG	G24
Yellow	Y	Y8	FY	Y24
Blue	L	L8	FL	L24
White	W	W8	FW	W24
Amber	A	A8	FA	A24
Clear	C	C8	FC	C24

Contact Blocks: Contact Blocks, page 19-62, Hermetically Sealed Logic Reed Contact Blocks, page 19-64, Hermetically Sealed Power Reed Contact Blocks, page 19-64
Light Modules: Standard Light Modules, page 19-63
Knobs and Accessories: Additional Accessories for Type K and SK Operators, page

[73] When ordering, add prefix 9001 to the catalog number.

[74] These operators can be ordered complete with contact blocks. For maximum block usage, see "H" Codes, page 19-65. Add the chosen "H" number to the end of the operator.

[75] ♦ Add the knob color code chosen from Table 19.153 Selector Switch Assembly Code and Knob Cat. No., page 19-58. For LED, knob color must match LED.

[76] ■ Add the voltage assembly code as chosen from Standard Light Modules, page 19-63. Example: K25J with 208Vac = K25J3

9001SK 3-Position Selector Switches

Table 19.154: 3-Position Selector Switches

Contact Block Required			1 — Contact Closed						0 — Contact Open																						
Contact Block Position	Quantity and Type	Mount on Side	↕↕↕		↕↕↕		↕↕↕		↕↕↕		↕↕↕		↕↕↕		↕↕↕																
<p>Top View</p>	KA1	KA3	KA1 #2	KA3 #2	1	0	0	1	0	0	0	0	1	1	0	0	1	0	0	1	0	0	1	0	0	0	1	0	1	1	0
	KA2	KA2			KA2 #2	0	1	1	0	0	1	0	1	0	0	1	0	0	0	1	0	1	1	0	1	1	1	0	0	0	0
	KA1	KA3	KA1 #1	KA3 #1	0	0	1	1	0	0	0	0	1	1	0	0	0	1	0	0	0	1	1	0	1	0	0	1	0	1	1
	KA2	KA2			KA2 #1	1	1	0	0	0	1	0	1	0	0	1	0	0	0	1	1	0	0	0	1	0	0	1	0	0	0
For Cam, see Type K, KX, and SK Selector Switch Guide, page 19-53					B		C		D		E		F		G		J		L		M										

Non-Illuminated Operators [77]	Type	Type	Type	Type	Type	Type	Type	Type	Type
Manual Return, Operator Only (without contact blocks) [78]									
Without Knob	SKS42	SKS43	SKS44	SKS45	SKS46	SKS47	SKS49	SKS401	SKS402
With Knob [79]	SKS42♦	SKS43♦	SKS44♦	SKS45♦	SKS46♦	SKS47♦	SKS49♦	SKS401♦	SKS402♦
Operator with Contact Blocks and Standard black knob [80]									
With 1 KA1 on Side #2 (H13)	SKS42B-H13	SKS43B-H13	SKS44B-H13	SKS45B-H13	SKS46BH13	SKS47B-H13	SKS49B-H13	SKS401B-H13	SKS402B-H13
With 1 KA1 on Side #1 (H1)	SKS42B-H1	SKS43BH1	SKS44BH1	SKS45B-H1	SKS46BH1	SKS47BH1	SKS49BH1	SKS401BH1	SKS402BH1
With 1 KA1 on Side #1 and 1 KA1 on side #2 (H2)	SKS42B-H2	SKS43BH2	SKS44BH2	SKS45B-H2	SKS46BH2	SKS47BH2	SKS49BH2	SKS401BH2	SKS402BH2
Spring Return from Left to Center, Operator Only (without contact blocks) [78]									
Without Knob	SKS62	SKS63	SKS64	SKS65	SKS66	SKS67	SKS69	SKS601	SKS602
With Knob [79]	SKS62♦	SKS63♦	SKS64♦	SKS65♦	SKS66♦	SKS67♦	SKS69♦	SKS601♦	SKS602♦
Spring Return from Right to Center, Operator Only (without contact blocks) [78]									
Without Knob	SKS72	SKS73	SKS74	SKS75	SKS76	SKS77	SKS79	SKS701	SKS702
With Knob [79]	SKS72♦	SKS73♦	SKS74♦	SKS75♦	SKS76♦	SKS77♦	SKS79♦	SKS701♦	SKS702♦
Spring Return from Both Sides to Center, Operator Only (without contact blocks) [78]									
Without Knob	SKS52	SKS53	SKS54	SKS55	SKS56	SKS57	SKS59	SKS501	SKS502
With Knob [79]	SKS52♦	SKS53♦	SKS54♦	SKS55♦	SKS56♦	SKS57♦	SKS59♦	SKS501♦	SKS502♦
Illuminated Operators [77]									
Manual Return, Operator Only (without contact blocks) [78]									
Without Knob, 110-120V 50-60 Hz Transformer	SK42J1	SK43J1	SK44J1	SK45J1	SK46J1	SK47J1	SK49J1	SK401J1	SK402J1
With Standard Red Knob, 110-120V 50-60 Hz Transformer	SK42J1R	SK43J1R	SK44J1R	SK45J1R	SK46J1R	SK47J1R	SK49J1R	SK401J1R	SK402J1R
With other Color Knob [79] and other Voltage Light Module [81]	SK42J♦	SK43J♦	SK44J♦	SK45J♦	SK46J♦	SK47J♦	SK49J♦	SK401J♦	SK402J♦
Spring Return from Left to Center, Operator Only (without contact blocks) [78]									
Without Knob, 110-120V 50-60 Hz Transformer	SK62J1	SK63J1	SK64J1	SK65J1	SK66J1	SK67J1	SK69J1	SK601J1	SK602J1
With Standard Red Knob, 110-120V 50-60 Hz Transformer	SK62J1R	SK63J1R	SK64J1R	SK65J1R	SK66J1R	SK67J1R	SK69J1R	SK601J1R	SK602J1R
With other Color Knob [79] and other Voltage Light Module [81]	SK62J♦	SK63J♦	SK64J♦	SK65J♦	SK66J♦	SK67J♦	SK69J♦	SK601J♦	SK602J♦
Spring Return from Right to Center, Operator Only (without contact blocks) [78]									
Without Knob, 110-120V 50-60 Hz Transformer	SK72J1	SK73J1	SK74J1	SK75J1	SK76J1	SK77J1	SK79J1	SK701J1	SK702J1
With Standard Red Knob, 110-120V 50-60 Hz Transformer	SK72J1R	SK73J1R	SK74J1R	SK75J1R	SK76J1R	SK77J1R	SK79J1R	SK701J1R	SK702J1R
With other Color Knob [79] and other Voltage Light Module [81]	SK72J♦	SK73J♦	SK74J♦	SK75J♦	SK76J♦	SK77J♦	SK79J♦	SK701J♦	SK702J♦
Spring Return from Both Sides to Center, Operator Only (without contact blocks) [78]									
Without Knob, 110-120V 50-60 Hz Transformer	SK52J1	SK53J1	SK54J1	SK55J1	SK56J1	SK57J1	SK59J1	SK501J1	SK502J1
With Standard Red Knob, 110-120V 50-60 Hz Transformer	SK52J1R	SK53J1R	SK54J1R	SK55J1R	SK56J1R	SK57J1R	SK59J1R	SK501J1R	SK502J1R
With other Color Knob [79] and other Voltage Light Module [81]	SK52J♦	SK53J♦	SK54J♦	SK55J♦	SK56J♦	SK57J♦	SK59J♦	SK501J♦	SK502J♦

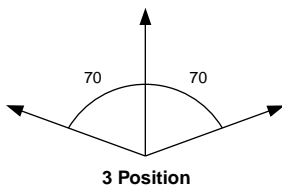

Table 19.155: Selector Switch Assembly Code and Knob Cat. No.

Color	Standard Knob		Gloved Hand Knob	
	[82] Knob Code	Cat. No. [77]	[82] Knob Code	Cat. No. [77]
Black	B	B11	FB	B25
Red	R	R8	FR	R24
Green	G	G8	FG	G24
Yellow	Y	Y8	FY	Y24
Blue	L	L8	FL	L24
White	W	W8	FW	W24
Amber	A	A8	FA	A24
Clear	C	C8	FC	C24

Contact Blocks: Contact Blocks, page 19-62, Hermetically Sealed Logic Reed Contact Blocks, page 19-64, Hermetically Sealed Power Reed Contact Blocks, page 19-64
 Light Modules: Standard Light Modules, page 19-63
 Knobs and Accessories: Additional Accessories for Type K and SK Operators, page

[77] When ordering, add prefix 9001 to the catalog number.
 [78] These operators can be ordered complete with contact blocks. Add the "H code" from "H Codes, page 19-65 as needed for your application.
 [79] ♦ Add the knob color code chosen from the Selector Switch Assembly Code table. For LED, knob color must match LED.
 [80] For other color knobs replace the B with knob color code. See Table 19.155 Selector Switch Assembly Code and Knob Cat. No., page 19-59.
 [81] ■ Add the voltage assembly code as chosen from Standard Light Modules, page 19-63. Example: K25J with 208Vac = K25J3
 [82] Add the knob color code. For LED, knob color must match LED.

9001SK 4-Position Selector Switches

Table 19.156: 4-Position Selector Switches

Contact Block Required						1 — Contact Closed 0 — Contact Open				
Contact Block Position	Quantity and Type			Mount on Side						
 Top View	 KA1	or	 KA3	KA1 #2	or	 KA3 #2	1	0	0	0
			 KA2			 KA2 #2	0	0	1	0
	 KA1	or	 KA3	KA1 #1	or	 KA3 #1	0	0	0	1
			 KA2			 KA2 #1	0	1	0	0
Cam (see Type K, KX, and SK Selector Switch Guide, page 19-53)						H				

Non-Illuminated Operators	Type [83]
Manual Return [84], Operator Only (without contact blocks)	
Without Knob	SKS88
With other Color Knob [85]	SKS88♦
Illuminated Operators	Type [83]
Manual Return [84], Operator Only (without contact blocks)	
Without Knob, 110-120V 50-60 Hz Transformer	SK88J1
With Standard Red Knob, 110-120V 50-60 Hz Transformer	SK88J1R
With other Color Knob [85] and other Voltage Light Module [86]	SK88J♦

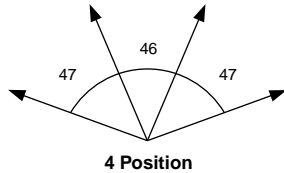

Table 19.157: Selector Switch Assembly Code and Knob Cat. No.

Color	Standard Knob		Gloved Hand Knob	
	[87] Knob Code	Cat. No. [83]	[87] Knob Code	Cat. No. [83]
Black	B	B11	FB	B25
Red	R	R8	FR	R24
Green	G	G8	FG	G24
Yellow	Y	Y8	FY	Y24
Blue	L	L8	FL	L24
White	W	W8	FW	W24
Amber	A	A8	FA	A24
Clear	C	C8	FC	C24

For Contact Blocks, see Contact Blocks, page 19-62, Hermetically Sealed Logic Reed Contact Blocks, page 19-64, Hermetically Sealed Power Reed Contact Blocks, page 19-64
 For Light Modules, see Standard Light Modules, page 19-63
 For Knobs and Accessories, see Additional Accessories for Type K and SK Operators, page

Potentiometers with Dial Plate

Table 19.158: Potentiometers with Dial Plate (not UL listed)—Maximum Voltage 300 Vac

Power	Description	Ratings	Type
2 W	Operator Only, for Single Potentiometer	NEMA 4, 13	SK20
	Operator with Single Potentiometer		SK21
	Operator Only, for Tandem Potentiometer		SK22
	Operator with Tandem Potentiometer		SK23
When ordering, add prefix 9001 to the catalog number.			

Table 19.159: Potentiometer Suffixes

Single Potentiometer			
Suffix [88]	Resistance	Suffix [88]	Resistance
01	50 Ω	07	5 kΩ
02	100 Ω	08	10 kΩ
04	500 Ω	09	25 kΩ
05	1 kΩ	13	500 kΩ
39	2 kΩ	37	750 kΩ
06	2.5 kΩ	14	1 MΩ
Tandem Potentiometer			
Suffix [88]	Resistance		
	Front	Rear	
82	1 kΩ	1 kΩ	

NOTE: Any potentiometer with a shaft 7/8 in. long and 1/4 in. diameter may be used with these operators.

[83] When ordering, add prefix 9001 to the catalog number.

[84] These operators can be ordered complete with contact blocks. Add the "H" code from "H" Codes, page 19-65 as needed for your application.

[85] ♦ Add the knob color code chosen from the Selector Switch Assembly Code table. For LED, knob color must match LED.

[86] ■ Add the voltage assembly code as chosen from Standard Light Modules, page 19-63. Example: K25J with 208Vac = K25J3

[87] Add the knob color code from Table 19.237. For LED, knob color must match LED

[88] For the complete part number, add the suffix from this table to the catalog number from Table 19.158 Potentiometers with Dial Plate, page 19-60. Example: 9001K2105.

Type SK Corrosion Resistant Pilot Lights

Table 19.160: Pilot Lights—UL Types 4, 4X, [89]



Description			Voltage	Style	With Red Fresnel Color Cap [90]	With Green Fresnel Color Cap [90]	With Other Color Cap [90] [91]	Without Color Cap [90]
	9001SKP1	Standard Pilot Light (Fresnel color cap shown)	110–120 V, 50–60 Hz	Transformer	SKP1R31	SKP1G31	SKP1■	SKP1
			220–240 V, 50–60 Hz	Transformer	SKP7R31	SKP7G31	SKP7■	SKP7
			24–28 Vac/Vdc	Full Voltage	SKP35R31	SKP35G31	SKP35■	SKP35
			For other voltages [90]	Transformer, Flashing or LED [92] Full Voltage, Neon or Resistor [93]	SKP▲R31 SKP▲G31	SKP▲G31 SKP▲■	SKP▲■	SKP▲
	9001SKT1	Push-To-Test Pilot Light (Fresnel color cap shown)	110–120 V, 50–60 Hz	Transformer	SKT1R31	SKT1G31	SKT1■	SKT1
			220–240 V, 50–60 Hz	Transformer	SKT7R31	SKT7G31	SKT7■	SKT7
			24–28 Vac/Vdc	Full Voltage	SKT35R31	SKT35G31	SKT35■	SKT35
			For other voltages [90]	Transformer, Flashing or LED [92] Full Voltage, Neon or Resistor [93]	SKT▲R31 SKT▲R31	SKT▲G31 SKT▲G31	SKT▲■ SKT▲■	SKT▲ SKT▲
	9001SKTR38	Remote Test Pilot Light (Fresnel color cap shown)	120 Vac Only	Resistor	SKTR38R31	SKTR38G31	SKTR38■	SKTR38
			24–28 Vac Only	Full Voltage	SKTR35R31	SKTR35G31	SKTR35■	SKTR35
			For other voltages [90] [91] [94]	Full Voltage or Resistor [95]	SKTR▲R31	SKTR▲G31	SKTR▲■	SKTR▲



Table 19.161: Color Caps

Color	Plastic Fresnel [96]	Plastic Domed [96]
Amber	A31	A9
Blue	L31	L9
Clear	C31	C9
Green	G31	G9
Red	R31	R9
White	W31	W9
Yellow	Y31	Y9

Typical Wiring Diagram

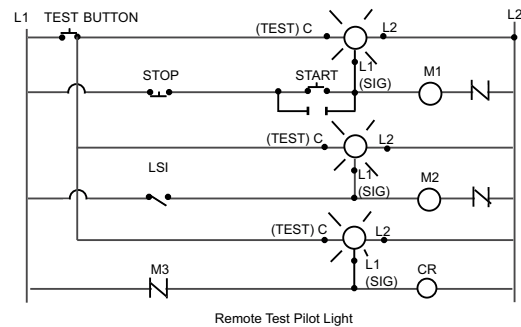
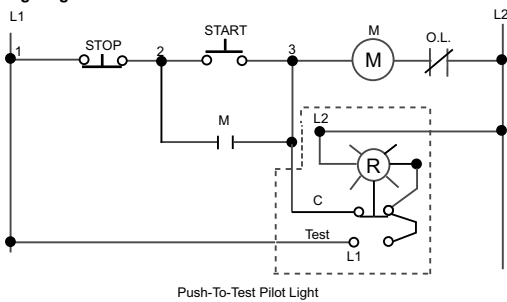

NOTE: To select and order Contact Blocks, Light Modules, Knobs, and Accessories, see Type KA Contact Blocks, page 19-62 through Hermetically Sealed Power Reed Contact Blocks, page 19-64.
NOTE: For use in hazardous locations—See Square D Offering According to Class, Division, and Group, page 19-64. Contact blocks and legend plate not included unless otherwise noted.

[89] When ordering, add prefix 9001 to the catalog number.
 [90] ▲ Add the voltage assembly code as chosen from Standard and Shallow Depth Light Modules, page 19-63. **EXAMPLE:** SKT***R31 with 208 Vac red LED voltage = SKT37LRR31.
 [91] ■ Add the color code as chosen from the color cap table below. **EXAMPLE:** SKP1 with a blue fresnel cap = SKP1L31.
 [92] The cap must be the same color as the LED light module chosen, e.g., for a green LED, use a green color cap.
 [93] On neon light modules, use clear color caps only.
 [94] Use only full voltage or resistor voltage assembly codes on remote test pilot lights. Do not choose LED, neon or transformer codes. For AC use only.
 [95] Use only full voltage or resistor voltage assembly codes on remote test pilot lights. Do not choose LED (exception — these LED codes are allowed: 38LG, 38LL, 38LR, 38LW, 38LY), neon or transformer codes. For AC use only.
 [96] Add the color code as chosen from the color cap table below. **EXAMPLE:** SKP1 with a blue fresnel cap = SKP1L31.

Table 19.162: Standard Contact Blocks

















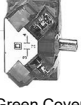

Description	Symbol	Type
 (Clear Cover)	 Direct-Acting	KA1
 (Green Cover)		KA2
 (Red Cover)	 Direct-Acting	KA3
 (Clear Cover)	 N.O. Contact Early Closing	KA4
 (Red Cover)	 N.C. Contact Late Opening	KA5
 (Green Cover)	 N.O. Contact Early Closing	KA6

Table 19.163: Additional Circuit Arrangements

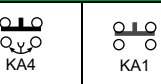
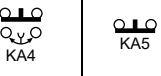
Description	Symbol	Type
Sequencing [97] N.O. Contact of KA4 closes before N.O. Contact on KA1		Order One Type KA4 and One Type KA1
Overlapping [97] N.O. Contact of KA4 closes before N.C. Contact of KA5 Opens		Order One Type KA4 and One Type KA5

Type KA Contact Blocks

The Class 9001 Type KA contact blocks are Fingersafe® contact blocks (meeting VDE 0106 Part 100). They have one screw mounting and captive (backed out) plus/minus terminal screws. These contact blocks are double-break, direct-acting contacts. Because of the wiping action of these contacts, they are suitable for use with programmable controllers. All contact blocks listed below accept up to 2 #12–#24 AWG solid or stranded wires. Recommended tightening torque for screw terminals is 7 lb-in.

Symbol	Contact Blocks with Binder Head Screws (not Fingersafe)		Gold Flashed Contacts with Standard Pressure Wire Terminals
	Type [98]	Quantity [99]	Type [98]
	KA21	25–Up	KA31
	KA22	25–Up	KA32
	KA23	25–Up	KA33
 N.O. Early Closing	KA24	25–Up	KA34
 N.C. Contact Late Opening	KA25	25–Up	KA35

Contact blocks listed below are not Fingersafe, but provide:

- Terminals that accept ring tongue/fork tongue connectors
- Short single circuit contact blocks (0.75" deep vs. 0.97" deep on the Fingersafe)
- Same as old style Series G product available prior to March, 1989.
- For assembled operators, use form Y238 (add to catalog number as suffix, for example: 9001KRU1H13Y238)



Table 19.164: Contact blocks (not Fingersafe)







Symbol	Type [98]	Symbol	Type [98]
	KA1G	 N.O. Contact Early Closing	KA4G
	KA2G	 N.C. Contact Late Opening	KA5G
	KA3G	 N.O. Contact Early Closing	KA6G

Table 19.165: Contact blocks with Quick-Connect terminals (not Fingersafe)



Symbol	Type [98]
	KA12
	KA13

Table 19.166: Maximum Current Ratings for Control Circuit Contacts—Types KA1–KA6, KA21–KA25, KA31–KA35, KA1G–KA6G

Volts	AC						Volts	DC				
	Inductive (NEMA / UL Type A600) 35% Power Factor							Inductive and Resistive (NEMA Q600)				
	Make		Break		Continuous Carrying Amperes	Resistive 75% Power Factor Make, Break and Continuous Amperes		Make and Break				Continuous Carrying Capacity
	Amperes	VA	Amperes	VA				KA1	KA2 KA3	KA4	KA5 KA6	
120	60	7200	6.0	720	10	10	125	0.55	0.55	—	—	2.5
240	30		3.0				250	0.27	0.27	—	—	
480	15		1.5				600	0.10	0.10	—	—	
600	12		1.2									

[97] For push buttons or two-position selector switches only. For sequencing or overlapping contacts on other operators, refer to catalog 9001CT0001.

[98] When ordering, add prefix 9001 to the catalog number.

[99] Minimum order quantity is 25.

Standard and Shallow Depth Light Modules

Table 19.167: Standard Light Modules for Types K, SK, and KX Control Units [100][101][102][103]

	Voltage	Description	Light Module	Voltage Assembly Code	Rating	Temperature Code T-Code	Replacement Lamp
			Type [104]				Part Number [100]
	All	Full Voltage (without Bayonet Base Lamp)	KM40	40	—	—	None
	6 Vac/Vdc	Full Voltage	KM31	31	.9 VA	T5	2550101020
	6 Vac/Vdc	LED Red	KM31LR	31LR		T6	6508805201
	6 Vac/Vdc	LED Green	KM31LG	31LG		T6	6508805203
	6 Vac/Vdc	LED Yellow	KM31LY	31LY		T6	6508805202
	12–14 Vac/Vdc	Full Voltage	KM32	32	1.2 VA	T5	2550101037
	12–14 Vac/Vdc	LED Red	KM32LR	32LR		T6	6508805201
	12–14 Vac/Vdc	LED Green	KM32LG	32LG		T6	6508805203
	12–14 Vac/Vdc	LED Yellow	KM32LY	32LY		T6	6508805202
	18 Vac/Vdc	Resistor	KM33	33	1.4 VA	T5	2550101037
	24–28 Vac/Vdc	Full Voltage	KM35	35	1.2 VA	T3C	2550101002
	24–28 Vac/Vdc	LED Red	KM35LR	35LR	.28 VA	T4	6508805210
	24–28 Vac/Vdc	LED Green	KM35LG	35LG	.28 VA	T4	6508805212
	24–28 Vac/Vdc	LED Yellow	KM35LY	35LY	.28 VA	T4	6508805211
	24–28 Vac/Vdc	LED White	KM35LW	35LW	.28 VA	T4	6508805214
	24–28 Vac/Vdc	LED Blue	KM35LL	35LL	.28 VA	T4	6508805213
	48 Vac/Vdc	Full Voltage	KM36	36	2.6 VA	T3A	2550101025
	110–120 V, 50–60 Hz	LED Red	KM1LR	1LR		T6	6508805201
	110–120 V, 50–60 Hz	LED Green	KM1LG	1LG		T6	6508805203
	110–120 V, 50–60 Hz	LED Yellow	KM1LY	1LY		T6	6508805202
	110–120 V, 50–60 Hz	Transformer	KM1	1	2.4 VA	T6	2550101020
	110–120 V, 50–60 Hz	Flashing	KMF1	F1	.85 VA	T6	2550101036
	120 Vac/Vdc	Full Voltage/Resistor	KM38	38	3.0 VA	T4	2550101027
	120 Vac/Vdc	Neon [105]	KM11	11	0.2 VA	T6	2550101013
	120 Vac/Vdc	LED Red	KM38LR	38LR	1.4 VA	T4A	6508805210
	120 Vac/Vdc	LED Green	KM38LG	38LG	1.4 VA	T4A	6508805212
	120 Vac/Vdc	LED Yellow	KM38LY	38LY	1.4 VA	T4A	6508805211
	120 Vac/Vdc	LED White	KM38LW	38LW	1.4 VA	T4A	6508805214
	120 Vac/Vdc	LED Blue	KM38LL	38LL	1.4 VA	T4A	6508805213
	208–220 V, 50–60 Hz	Transformer	KM3	3	2.5 VA	T6	2550101020
	208–220 V, 50–60 Hz	LED Red	KM3LR	3LR		T6	6508805201
	208–220 V, 50–60 Hz	LED Green	KM3LG	3LG		T6	6508805203
	208–220 V, 50–60 Hz	LED Yellow	KM3LY	3LY		T6	6508805202
	208–220 V, 50–60 Hz	LED White	KM3LW	3LW		T6	6508805215
	208–220 V, 50–60 Hz	LED Blue	KM3LL	3LL		T6	6508805216
	220–240 V, 50–60 Hz	Transformer	KM7	7	2.0 VA	T6	2550101020
	220–240 V, 50–60 Hz	LED Red	KM7LR	7LR		T6	6508805201
	220–240 V, 50–60 Hz	LED Green	KM7LG	7LG		T6	6508805203
	220–240 V, 50–60 Hz	LED Yellow	KM7LY	7LY		T6	6508805202
	220–240 V, 50–60 Hz	LED White	KM7LW	7LW		T6	6508805215
	220–240 V, 50–60 Hz	LED Blue	KM7LL	7LL		T6	6508805216
	240 Vac/Vdc	Resistor	KM25	25	6.0 VA	T3A	2550101027
	240 Vac/Vdc	Neon [105]	KM12	12	0.3 VA	T6	2550101013
	277 V, 50–60 Hz	Transformer	KM8	8	2.4 VA	T6	2550101020
	380–480 V, 50–60 Hz	Transformer	KM5	5	2.8 VA	T6	2550101020
	480 Vac/Vdc	Neon [105]	KM14	14	0.5 VA	T6	2550101013
	550–600 V, 50–60 Hz	Transformer	KM6	6	2.5 VA	T6	2550101020

NOTE: Light modules are available in other voltages. For additional information, refer to Catalog 9001CT0001.

The products in Table 19.167 have been assigned Temperature Classifications (T-Codes) in accordance with UL 121201 (2017) — Nonincendive Electrical Equipment for Use in Class I and II, Division 2 and Class III, Divisions 1 and 2 Hazardous (Classified) Locations. These codes can aid the user in proper application of these products in accordance with ISO/ISA/IEC 60079-0 (2017–12) Explosive Atmospheres — Part 0: Equipment — General Requirements and the National Electric Code NFPA 70 — Article 500.

NOTE: Light modules shown in Table 19.168 are not UL Certified for use in hazardous locations.

Table 19.168: Shallow Depth Light Modules For Types K and SK Control Units [100][102][106][101]

	Voltage	Description	Light Module	Voltage Assembly Code	Rating	Temperature Code T-Code	Replacement Lamp
			Type [104]				Part Number
	24–28 Vac/Vdc	Full Voltage	KM55	55	1.2 VA	—	2550101002
		LED Red	KM55LR	55LR	0.5 VA	—	6508805204
		LED Green	KM55LG	55LG		—	6508805206
		LED Yellow	KM55LY	55LY		—	6508805205
	110–120 Vac/Vdc	Full Voltage	KM58	58	3.0 VA	—	2550101027
		LED Red	KM58LR	58LR	0.5 VA	—	6508805204
		LED Green	KM58LG	58LG		—	6508805206
		LED Yellow	KM58LY	58LY		—	6508805205



File: E78403
CCN: NKCR



File: LR25490
Class: 3211 03



marked

[100] For use with all operators except KX and remote test pilot.

[101] For use in hazardous locations—See Square D Offering According to Class, Division, and Group, page 19-64.

[102] With LED light modules, use either a clear color cap or a cap the same color as the LED.

[103] With neon type light modules, use a clear color cap only.



[104] When ordering, add prefix 9001 to the catalog number.

[105] Not for use on KX operators.

[106] Reduces the depth of illuminated push buttons with contact blocks by over 33%.

Hazardous locations do not always require the use of explosion-proof equipment like the Class 9001 Type BR control stations. Selecting the most appropriate device for the location can save you money. For more information on the types of hazardous locations, contact your local electrical inspector.

Table 19.169: Hazardous Locations

Types K, SK  File: E10054 (N) CCN: NOIV  File: LR26817 Class: 3218 02

Square D Offering According to Class, Division, and Group

Table 19.170: Square D Offering According to Class, Division, and Group

Class	For		Use
	Division	Group(s)	
I	1	A	1. Intrinsically Safe System
I	1	B, C, D	1. 9001 BR station
			2. Intrinsically Safe System
I	2	A	1. 9001 K, SK, KX control stations with restrictions [107] [108]
			2. Intrinsically Safe System
I	2	B, C, D	1. 9001 BR station
			2. 9001 K, SK, KX control stations with restrictions [107] [108]
			3. Intrinsically Safe System
II	1	E, F, G	1. 9001 BR station
			2. Intrinsically Safe System
II	2	E, F	1. 9001 BR station
			2. 9001 K, SK, KX control stations with restrictions [107] [108]
			3. Intrinsically Safe System
II	2	G	1. 9001 BR station
			2. 9001 K, SK, KX control stations with restrictions [109] [108]
			3. Intrinsically Safe System
III	1, 2	—	1. 9001 BR Station
			2. 9001 K, SK, KX control stations with restrictions [109] [108]
			3. Intrinsically Safe System

Hermetically Sealed Logic Reed Contact Blocks

Table 19.171: Hermetically Sealed Logic Reed Contact Blocks [110] [111]

Suitable for use on low energy level circuits

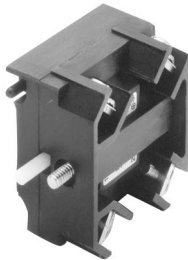

Description	Symbol	Type [112]
The maximum number of logic and/or power reed contact blocks per operator is as indicated on individual selection tables for standard contact blocks, except : <ul style="list-style-type: none"> On 3 position selector switches with cams C, D, E, F, G, L, or M, mount reed blocks on one side only (either side), maximum 2 in tandem. On 4 position selector switches, mount reed blocks on one side only (either side), maximum 2 in tandem. On joysticks or on Type KR8 or SKR8 push-pull operators, mount reed blocks on one side only (either side), maximum 2 in tandem. 		KA41
		KA42
		KA43
		KA44
		KA45

Max. Vac/Vdc	Maximum Load		
	Resistive	Inductive	Continuous
32/30	.25 A	.10 A	.5 A
120/100	8 VA	3 VA	.5 A

Hermetically Sealed Power Reed Contact Blocks

Table 19.172: Hermetically Sealed Power Reed Contact Blocks [110] [111] [113]



Description	Symbol	Type [112]
The maximum number of logic and/or power reed contact blocks per operator is as indicated on individual selection tables for standard contact blocks, except : <ul style="list-style-type: none"> On 3 position selector switches with cams C, D, E, F, G, L, or M, mount reed blocks on one side only (either side), maximum 2 in tandem. On 4 position selector switches, mount reed blocks on one side only (either side), maximum 2 in tandem. On joysticks or on Type KR8 or SKR8 push-pull operators, mount reed blocks on one side only (either side), maximum 2 in tandem. 		KA51
		KA52
		KA53
		KA54
		KA55

Volts	Make		Break		Continuous
	A	VA	A	VA	
AC NEMA C300 [114]					
120	10.00	1200	1.000	120	3.0
240	5.00		.500		
DC NEMA Q150 [115]					
115	.50	58	.50	58	3.0

[107] Any Class 9001 Type K, SK or KX operator can be used in an area classified as Class I, Division 2 hazardous locations, if:

- Only logic (KA40 series) or power (KA50 series) reed contact blocks are used.
- All Type K and SK illuminated operators are UL approved for use in Class I Division 2 areas. (Add Form Y243 to single lamp Push-To-Test pilot lights.)
- Type KX illuminated operators do not use 4 lamp light modules, or 2 lamp light modules other than the transformer type. (Add Form Y243 to single lamp Push-To-Test pilot lights.)
- The operators are mounted in any NEMA 4 & 13 enclosures.

[108] UL Listed: File E10054(N), CCN NOIV.

[109] Any Class 9001 Type K, SK, or KX operator mounted in a Class 9001 Type KY, KYSS, KYAF, SKY enclosure may be used, except potentiometer operators.

[110] Not for use in pendant stations.

[111] When ordering, add prefix 9001 to the catalog number.

[112] All contact blocks listed below accept #12–18 solid or stranded wire.

[113] The power reed contact blocks can be used with standard industrial relays and starters through NEMA Size 4. Minimum voltage is 5 V and the minimum current is 1 mA.

[114] Inductive Rating—35% Power Factor.

[115] Inductive and Resistive Ratings

Type K, SK, and KX Contact Block "H" Numbers

The design of Class 9001 Type KA contact blocks allows them to be mounted side by side and/or in tandem. This enables you to specify an operator and a specific arrangement of contact blocks (shipped fully assembled) with a single Type number.

Table 19.173: "H" Codes

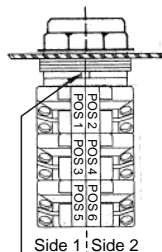
	Suffix No. (Add to Operator Type)	Positions					
		1	2	3	4	5	6
 <p>Example: A Type KR1B push button with 2 Type KA1 contact blocks would be Class 9001 Type KR1BH2.</p> <p>Side 1 Side 2 Locating Nib</p>	H1	KA1					
	H2	KA1	KA1				
	H3	KA1	KA1	KA1	KA1		
	H4	KA1	KA1				
	H5	KA2					
	H6	KA3					
	H7	KA2	KA2				
	H8	KA3	KA3				
	H9	KA4	KA1				
	H10	KA4	KA5				
	H11	KA1	KA1		KA1		
	H12	KA2	KA3	KA2	KA3		
	H13		KA1				
	H14		KA3				
	H15	KA2	KA3	KA2	KA3		
	H16	KA2	KA3				
	H17	KA1	KA1	KA2			
	H18	KA3	KA1	KA2			
	H19	KA1	KA1	KA3		KA3	
	H21	KA2	KA3	KA1	KA1	KA1	
H23	KA1	KA1	KA1	KA1	KA1	KA1	
H24	KA1	KA2					
H25	KA5	KA3					

NOTE: For "H" Codes not in this table, contact your local Schneider Electric Customer Care Center.

Mounting Hole for All Types K, SK, and KX Control Units

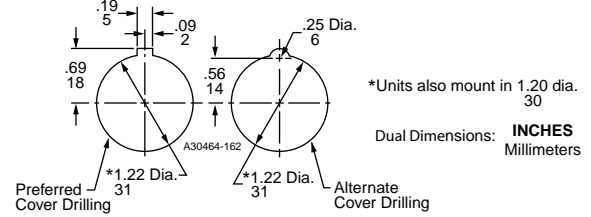

Hole Punch: Use Greenlee Tool #60242 to punch mounting hole and notch.

Maximum Contact Block Usage (Includes Types K, SK and KX)

- **2 blocks mounted side by side only:** Any 2, 3 or 4 position spring return selector switch (non-illuminated, illuminated or keyed).
- **2 blocks mounted in tandem 1 side only:** Any 2 operator interlocked push button.
- **2 blocks mounted in tandem (total of four blocks):** Any selector push button, keyed push button, 2, 3, or 4 position maintained selector switch (non-illuminated, illuminated or keyed), push-pull operators (non-illuminated or illuminated), joy stick, dual push button.
- **3 blocks mounted in tandem (total of six blocks):** Single momentary push buttons (non-illuminated or illuminated).

Table 19.174: Dimensions When Using Contact Blocks

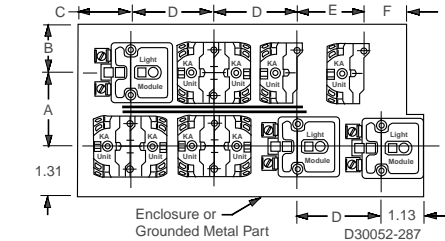
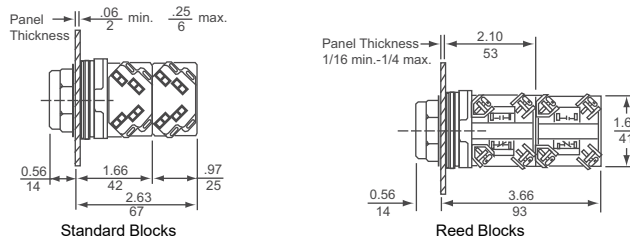

Table 19.175: Basic Operators (Without Color Caps, Mushroom Buttons, Knobs, Selector Switch Cams, Contact Blocks, Light Modules, or Legend Plates)

Description	For UL Types/NEMA	
	1, 3R, 4, 12, 13 [116]	4, 4X, 13 [116]
Non-Illuminated Push Button (Extended Guard)	KR2	SKR2
Non-Illuminated Push Button (No Guard)	KR3	SKR3
Non-Illuminated Push Button (Mushroom Button/Screw-On)	KR20	SKR20
Non-Illuminated Dual Push Button (Momentary)	KR6	—
Non-Illuminated Dual Push Button (Momentary Interlocked)	KR67	—
Non-Illuminated Dual Push Button (Maintained Interlocked)	KR7	—
Momentary Pull—Maintained Neutral—Momentary Push	KR8 [117] [118]	SKR8 [117]
Maintained Pull—Maintained Push	KR9 [117] [118]	SKR9 [117]
Illuminated Push Button (Full Guard—Plastic Top)	K1L [119]	SK1L [119]
Illuminated Push Button and Push-To-Test (No Guard)	K2L [119] [120]	SK2L [119] [120]
Illuminated Push Button (Full Guard—Metal Top)	K3L [119]	—
Standard Pilot Light	KP	SKP
3 Position Maintained Selector Switch	KS4 [117]	SKS4 [117]
3 Position Spring Return Both Sides To Center—Selector Switch	KS5 [117]	SKS5 [117]
3 Position Spring Return Left To Center—Selector Switch	KS6 [117]	SKS6 [117]
3 Position Spring Return Right To Center—Selector Switch	KS7 [117]	SKS7 [117]

Table 19.176: Min. Centerline Spacing, Type K & SK Control Units

Legend Plate	Operator	Centerline Spacing (in.)					
		A	B	C	D	E	F
Legend Plate Orientation Position #1							
KN2	Standard Push Button	1.75	1.31	1.44	2.25	1.69	0.88
	1.375 in. Dia. Mushroom	1.75	1.31	1.44	2.25	1.69	0.88
KN5	2.25 in. Dia. Mushroom	2.25	1.31	1.44	2.25	2.25	1.12
	Selector Switch Knobs	1.75	1.31	1.44	2.25	1.69	0.88
KN3	Standard Push Button	2.00	1.31	1.44	2.25	1.75	0.88
	1.375 in. Dia. Mushroom	2.00	1.31	1.44	2.25	1.75	0.88
KN3	2.25 in. Dia. Mushroom	2.25	1.31	1.44	2.25	2.25	1.12
	Selector Switch Knobs	2.00	1.31	1.44	2.25	1.75	0.88
KN4	Standard Push Button	1.94	1.31	1.44	2.25	1.62	0.88
	1.375 in. Dia. Mushroom	1.94	1.31	1.44	2.25	1.62	0.88
KN4	2.25 in. Dia. Mushroom	2.25	1.31	1.44	2.25	2.25	1.12
	Selector Switch Knobs	1.74	1.31	1.44	2.25	1.62	0.88
KN6	Standard Push Button	2.38	1.62	1.44	2.25	2.25	1.12
	1.375 in. Dia. Mushroom	2.38	1.62	1.44	2.25	2.25	1.12
KN6	2.25 in. Dia. Mushroom	2.38	1.62	1.44	2.25	2.25	1.12
	Selector Switch Knobs	2.38	1.62	1.44	2.25	2.25	1.12
Legend Plate Orientation Position #2							
KN2	Standard Push Button	1.62	1.31	1.44	2.25	1.75	0.88
	1.375 in. Dia. Mushroom	1.62	1.31	1.44	2.25	1.75	0.88
KN5	2.25 in. Dia. Mushroom	2.25	1.31	1.44	2.25	2.25	1.12
	Selector Switch Knobs	1.62	1.31	1.44	2.25	1.75	0.88
KN3	Standard Push Button	1.75	1.31	1.44	2.25	2.00	0.88
	1.375 in. Dia. Mushroom	1.75	1.31	1.44	2.25	2.00	0.88
KN3	2.25 in. Dia. Mushroom	2.25	1.31	1.44	2.25	2.25	1.12
	Selector Switch Knobs	1.75	1.31	1.44	2.25	2.00	0.88
KN4	Standard Push Button	1.62	1.31	1.44	2.25	1.94	1.00
	1.375 in. Dia. Mushroom	1.62	1.31	1.44	2.25	1.94	1.00
KN4	2.25 in. Dia. Mushroom	2.25	1.31	1.44	2.25	2.25	1.12
	Selector Switch Knobs	1.62	1.31	1.44	2.25	1.94	1.00
KN6	Standard Push Button	2.25	1.31	1.62	2.38	2.38	0.88
	1.375 in. Dia. Mushroom	2.25	1.31	1.62	2.38	2.38	0.88
KN6	2.25 in. Dia. Mushroom	2.25	1.31	1.62	2.38	2.38	1.12
	Selector Switch Knobs	2.25	1.31	1.62	2.38	2.38	0.88

[116] When ordering, add prefix 9001 to the catalog number.

[117] Operator can be converted to an illuminated operator by removing the liner (6512240601) and adding a light module.

[118] These operators can be supplied with 1-3/8 in. or 2-1/4 in. dia. mushroom buttons. For 1-3/8 in.: add () 20 to type number. For 2-1/4 in.: Add () 21 to type number. The () refers to the color chosen—see Additional Accessories for Type K and SK Operators, page . Voids UL and NEMA 6 Rating.

[119] Operator can be converted to a non-illuminated operator by adding liner (6512240601).

[120] Operator includes jumper wires for push-to-test conversion.

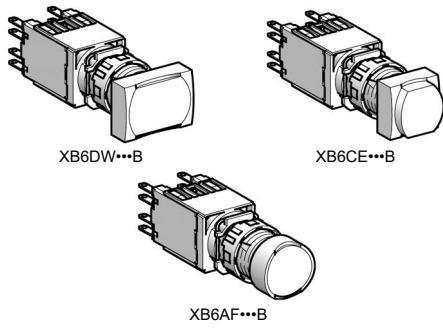

XB6 Complete Devices

**Table 19.177: Illuminated Push Buttons (12–24 Vac/Vdc LED included)
Complete Units with Quick Connectors/Solder Tabs**

Type of Operator	Type of Contact		Color	Rectangular	Square	Round
	N.O.	N.C.		Catalog Number		
Flush, spring return	1	—	White	XB6DW1B1B	XB6CW1B1B	XB6AW1B1B
			Green	XB6DW3B1B	XB6CW3B1B	XB6AW3B1B
	—	1	Red	XB6DW4B2B	XB6CW4B2B	XB6AW4B2B
			White	XB6DW1B5B	XB6CW1B5B	XB6AW1B5B
	1	1	Green	XB6DW3B5B	XB6CW3B5B	XB6AW3B5B
			Red	XB6DW4B5B	—	XB6AW4B5B
			Yellow	XB6DW5B5B	XB6CW5B5B	—
			Blue	XB6DW6B5B	—	XB6AW6B5B
			Green	XB6DF3B1B	XB6CF3B1B	XB6AF3B1B
			Yellow	XB6DF5B1B	—	—
	1	1	White	XB6DF1B5B	XB6CF1B5B	XB6AF1B5B
			Green	XB6DF3B5B	XB6CF3B5B	XB6AF3B5B
Red			XB6DF4B5B	—	—	
White			—	XB6CE1B1B	—	
Extended, spring return	1	—	Green	—	—	XB6AE3B1B
			Green	—	—	XB6AE3B5B
			Green	—	—	XB6AE3B5B

For Legends, see XB6 Legend Plates and Legends , page

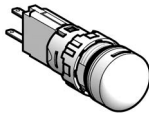

XB6AV**B

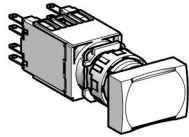

XB6DA**B

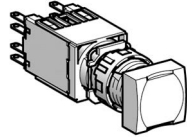

XB6CA**B

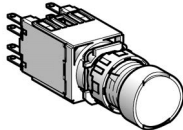

XB6AA**B

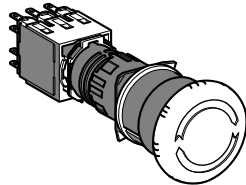

XB6AS8345B

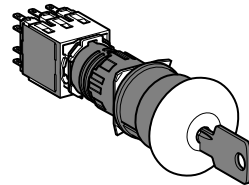

XB6AS9345B

Table 19.178: Pilot Lights (120 Vac LED)
Complete Units with Quick Connectors/Solder Tabs

Color	Rectangular	Square	Round
	Catalog Number		
Green	—	—	XB6AV3GB
Red	—	—	XB6AV4GB
Yellow	—	—	XB6AV5GB

Table 19.179: Push Buttons (Non-Illuminated)
Complete Units with Quick Connectors/Solder Tabs

Type of Push	Type of Contact		Color	Rectangular	Square	Round
	N.O.	N.C.		Catalog Number		
Flush, spring return	1	—	White	XB6DA11B	XB6CA11B	—
			Black	—	XB6CA21B	XB6AA21B
			Green	XB6DA31B	—	XB6AA31B
			Blue	XB6DA61B	—	—
	—	1	Black	XB6DA22B	—	—
			Black	—	XB6CA25B	XB6AA25B
			Green	XB6DA35B	—	XB6AA35B
			Red	XB6DA45B	XB6CA45B	—

Table 19.180: Trigger Action Emergency Stop Mushroom Head Push Buttons (Color Red) [1]

Shape of Head	Type of Push	Type of Contact		Diameter of Head (mm)	Catalog Number
		N.O.	N.C.		
○	Turn-to-release	—	1	30	XB6AS8342B
		1	1	30	XB6AS8345B
⊕	Key release	—	1	30	—
		1	1	30	—

For Legends, see [XB6 Legend Plates and Legends](#), page

[1] Complies with ISO 13850 standards for Emergency Stop push buttons when used with circular Legend Plate ZB6Y7330 (see [Circular Legends](#), 45 mm, page)

Class 9003
Type K Rotary Cam Switches

Applications		Used in building control panels and consoles, Type K cam switches allow control of processes and utilities in industry and buildings, and direct control for simple machines.					
							
Functions	Off-On/On-Off switches	1 to 6-pole	1 to 6-pole				
	Stepping switches	2 to 12-position, 1 to 4-pole	—				
	Changeover switches	1 to 5-pole	1 to 4-pole				
	Measurement switches	Voltmeter and ammeter	—				
	Reversing switches	2 and 3-pole	2 and 3-pole				
	Reversing star-delta switches	Star-delta	Star-delta				
	Pole change switches	2 and 3-speed	2-speed				
Conventional rated thermal current (Ith)		20 A	32 A	50 A	63 A	115 A	150 A
Electrical operating characteristics		690 V	690 V	690 V	690 V	690 V	690 V
		AC-3 - 3-phase	AC-3 - 3-phase	AC-3 - 3-phase	AC-3 - 3-phase	AC-3 - 3-phase	AC-3 - 3-phase
		230 V - 2.2 kW - 8.3 A	230 V - 5.5 kW	230 V - 7.5 kW	230 V - kW	230 V - 5 kW	230 V - 22 kW
		AC - 15	AC - 15	AC - 15	—	—	—
		230 V - 4 A	230 V - 14 A	230 V - 6 A	—	—	—
Front plate degree of protection		IP 40 IP 65 (with seal)	IP 40				
Product Composition		Complete switches and custom Adaptable sub-assemblies	Complete switches				
Compatibility		Ø 22 control and signalling units		—			
Mounting	Front Mounting	Multi-fixing Single Ø 22 hole	By 4 holes on 48 mm centers			By 4 holes on 68 mm centers	
	Rear Mounting	Screw fixing, 4 holes on 36 mm centers	Screw fixing, 4 holes on 48 mm centers			Screw fixing, 4 holes on 68 mm centers	
Front plate dimensions (mm)		45 x 45 60 x 60 (adaptable sub-assemblies)	64 x 64			88 x 88	
Operating heads		Black and red standard and long handles	Black standard handle Metallic legend, black marking				
		Key operator					
		Metallic head					
		Metallic legend with black marking or black legend with white marking					
		UL-CSA					
Approvals		EN/IEC 60947-3 EN/IEC 60947-5-1	cULus EN/IEC 60947-3				
Type		Type K2	Type K30–K150				
Cam switch model [1]		Class 9003, K2	K30	K50	K63	K115	K150

[1] Incomplete part numbers. Contact your local supplier for assistance.

Instructions for 9003K2 Key Sheet

The Key Sheet for ordering a 9003K2 cam switch is on [page 19-70](#), and an example of a completed key sheet is on [page 19-71](#). The instructions below are for filling out the key sheet on [page 19-70](#).

1. Select the box for K2 (20 A).
2. Identify the Product quantity in the box provided.
3. Verify front mounting by selecting the box: Front Mounting.
4. If ordering a base/contact block only, select 22 mm plastic or 22 mm metal mounting. Then complete the following:
 - a. ③ Switching Angle (positions)
 - b. ④ Contact scheme and jumpers (pre-wired)
5. If ordering a complete switch (base/contact block, head, legend), check the box. Then complete the following:
 - a. ① Operating head preference
 - b. ② Legend preference
 - c. ③ Switching angle (positions)
 - d. ④ Contact scheme and jumpers (pre-wired)
6. Operating head preference ① (identify the operating head preferred)
7. Legend preference ② (identify the legend preference)
8. Switching angle (positions) ③ and special legend marking
 - a. Identify whether the switch need is 30° or 60°, or 45° or 90° switching angle.
 - b. Fill in the legend markings desired at the positions indicated. Zero degrees is always straight up.
9. The rotation of the operator stops clockwise at the top or 0° position. If full rotation through 360° is desired, the Full rotation through 360° box must be checked.
10. Contact scheme and jumpers (pre-wired) ④
 - a. If jumpers are desired to be pre-wired, draw a horizontal line between the terminals to be jumpered per the example on [page 19-71](#).
 - b. Refer to the Legend at the bottom of [page 19-70](#) for contact sequences, i.e.: X indicates contact closure. See [page 19-71](#) for examples of filling in this portion of the key sheet.

XAL Control Stations, Enclosures, and Accessories

Table 19.181: Start or Stop Function Polycarbonate; Light gray base, RAL7035; Dark gray lid, RAL7016



XALD101H29H7

Description	Type of Push	Type of Contact		Marking	Catalog Number
		N.O.	N.C.		
Marking on Legend Holder					
1 momentary push button	Flush black	1	—	Start	XALD101H29H7
	Flush red	—	1	Stop	XALD111H29H7
Marking on Legend Holder					
1 mushroom head push button Ø 40 mm, momentary	Red	—	1	Stop on red legend	XALD164H29H7

Table 19.182: Trigger Action Emergency Stop Polycarbonate; Light gray base, RAL7035; Yellow lid, RAL1012



XALK174H7

Description	Type	Type of Contact		Catalog Number
		N.O.	N.C.	
1 mushroom head push button Ø 40 mm, red Turn-to-release	Trigger action [1]	—	1	XALK178H7
1 mushroom head push button Ø 40 mm, red Key release (Key No. 455)	Trigger action [1]	—	1	XALK188H7
1 mushroom head push button Ø 40 mm, red Push-pull	Trigger action [2]	—	1	XALK198H7

Table 19.183: Start-Stop Function Polycarbonate; Light gray base, RAL7035; Dark gray lid, RAL7016



XALD211H29H7

XALD321H29H7

Description	Type of Push	Type of Contact		Text	Catalog Number
		N.O.	N.C.		
2 momentary push buttons	1 flush black 1 flush red	1 —	— 1	Start Stop	XALD211H29H7
	1 flush black 1 flush black	1 1	— —	Forward Reverse	XALD251H29H7

Table 19.184: Three Function Polycarbonate; Light gray base, RAL7035; Dark gray lid, RAL7016

Description	Type of Push	Type of Contact		Text	Catalog Number
		N.O.	N.C.		
3 momentary push buttons (no markings)	1 flush black 1 flush red 1 flush black	1	—	Open	XALD351H29H7
		—	1	Stop	
		1	—	Close	
		1	—	Forward	XALD311H29H7
		—	1	Stop	
		1	—	Reverse	
1	—	1	—	Up	XALD321H29H7
		—	1	Stop Down	

Table 19.185: Empty Enclosures [3]



Description	Number of Holes	Catalog Number
For normal environments, CSA approved and UL Listed (with stainless steel lid mounting screws)		
Light gray base RAL7035 Dark gray lid RAL7016	1	XALD01H7
	2	XALD02H7
	3	XALD03H7
	4	XALD04H7
	5	XALD05H7
Light gray base RAL7035 Yellow lid RAL1012	1	XALK01H7

[1] Emergency Stop (EN / IEC 13850)

[2] Emergency Off (IEC 60364-5-53)

[3] For customer assembly using XB5 operators and standard screw-terminal contact blocks, see XB5 Non-Illuminated Operators, page 19-28. Either mounting method can be used: contact block ZENL mounting on metal plate, or contact block ZBE mounting on operator with mounting collar.

XAP Enclosures and Accessories

Table 19.186: Undrilled Enclosures, Glass-Reinforced Polyester



XAPA1100



XAPA1104

Type		H x W Dimensions		Catalog Number
		IN	mm	
NEMA 4, 4X, 13 Usable depth 3.27 in. (83 mm)	Without hinges	3.34 x 5.75	85 x 146	XAPA1100
		3.34 x 8.90	85 x 226	XAPA2100
		5.95 x 9.49	151 x 241	XAPA3100

Table 19.187: Drilled Insulated Enclosures, Glass-Reinforced Polyester [4]

Type	Number of Knockouts 22 mm	Number of Rows		H x W Dimensions		Catalog Number
		Vertical	Horizontal	IN	mm	
NEMA 4, 4X, 13 Usable depth 3.27 in. (83 mm) 1.58 in. (40 mm) centerline spacing of holes	1	1	1	3.35 X 5.75	85 X 146	XAPA1110
	2	1	2	3.35 X 5.75	85 X 146	XAPA1120
	4	2	2	3.35 X 5.75	85 X 146	XAPA1104
	8	2	4	3.35 X 8.90	85 X 226	XAPA2108
	16	4	4	5.94 X 9.49	151 X 241	XAPA3116

Table 19.188: Drilled Die Cast Enclosures (Painted Gray RAL7032) [5]

	Type	Material	Usable Depth		Number of 22 mm holes	H x W x D Dimensions		Catalog Number		
			IN	mm		IN	mm			
 XAPG29703	NEMA 4, 13 1.18 in. (30 mm) centerline spacing of holes for horizontal mount	Zinc	1.93	49	2	3.15 x 3.15 x 2.03	80 x 80 x 51.5	XAPG19702		
					3	5.12 x 3.15 x 2.03	130 x 80 x 51.5	XAPG29703		
					4	6.90 x 3.15 x 2.03	175 x 80 x 51.5	XAPG39704		
					2.93	74.5	4	6.90 x 3.15 x 3.03	175 x 80 x 77	XAPG39804
					1		3.15 x 3.15 x 2.03	80 x 80 x 51.5	XAPG19201	
	NEMA 4, 13 1.58 in. (40 mm) centerline spacing of holes for vertical mount	Zinc	1.93	1.93	2	5.12 x 3.15 x 2.03	130 x 80 x 51.5	XAPG29202		
					3	6.90 x 3.15 x 2.03	175 x 80 x 51.5	XAPG39203		
					2.93	74.5	1	3.15 x 3.15 x 3.03	80 x 80 x 77	XAPG19501
					2		5.12 x 3.15 x 3.03	130 x 80 x 77	XAPG29502	
					3		6.90 x 3.15 x 3.03	175 x 80 x 77	XAPG39503	
	Aluminum	2.93	74.5	4	8.66 x 3.15 x 3.03	220 x 80 x 77	XAPG49504			
5				12.20 x 3.35 x 3.03	310 x 85 x 77	XAPG59505				

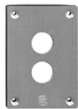

XAPE302

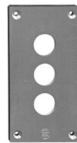

XAPE303

Table 19.189: Drilled Flush Plates [6]

Type	Material	Number of 22 mm holes	H x W x D Dimensions		Catalog Number
			IN	mm	
NEMA 4, 13 1.18 in. (30 mm) centerline spacing of holes	Anodized Aluminum	1	2.83 x 2.83	72 x 72	XAPE301
		2	4.13 x 2.83	105 x 72	XAPE302
		3	5.43 x 2.83	138 x 72	XAPE303
		4	6.73 x 2.83	171 x 72	XAPE304
		5	8.03 x 2.83	204 x 72	XAPE305

Table 19.190: Optional Back Box (for finger protection, if required)

Type	Material	For Use With	Catalog Number
Protective rear covers	Insulating Fiberglass	Flush plate XAPE301	XAPE901
		Flush plate XAPE302	XAPE902
		Flush plate XAPE303	XAPE903
		Flush plate XAPE304	XAPE904
		Flush plate XAPE305	XAPE905

[4] Uses standard XB5 products from XB5 Complete Devices, page 19-24 through XB5 Accessories, page . Do not use ZENL style contact blocks.
 [5] Can use either XB4 or XB5 products.
 [6] Can use either XB4 or XB5 products.

9001B Standard Duty Control Stations

Table 19.191: Control Stations



No. of Buttons	Nameplate Markings and Features	Contact Symbol [7]	Surface Mounting NEMA1	Stainless Steel Flush Plate [8]	Watertight and Dusttight NEMA4	For Hazardous Locations NEMA 7 & 9 [9]
			Type [10]	Type [10]	Type [10]	Type [10]
	Stop (Mushroom Button)	3	—	—	BW151	BR103
	Stop (Lockout)	3	—	—	BW148	BR104
	Off-On (Selector Switch)	19	BG111	—	—	—
	Hand-Off-Auto (Selector Switch)	17	BG112	—	—	—
2	Start-Stop	145	BG201	BF201	BW240	BR204
	Start-Stop (Mushroom on Stop)	145	BG203	—	BW250	—
	Start-Stop (Lockout on Stop)	145	BG204	—	BW241	BR204
	Forward-Reverse	146	BG206	—	BW242	—
	Open-Close	146	BG207	—	BW244	—
	Up-Down	146	BG208	—	BW243	BR208
	Raise-Lower	146	BG209	—	—	—
	On-Off	145	—	—	BW245	—
	On-Off	146	—	BF211	—	—
	Universal (w/o legend inserts)	25	BG214	—	BW260	—
	Start-Stop (Maintained Contact)	10	BG215	—	BW255	—
	On -Off (Maintained Contact)	10	—	—	BW256	BR216
Universal (Maintained contact w/o legend inserts)	10	—	—	—	BR218	
	Forward-Reverse-Stop	109	BG302	—	—	—
	Opn-Close-Stop	109	BG303	—	—	—
	Up-Down-Stop	109	BG305	—	—	—
	Start-Jog-Stop	109	BG316	—	—	—
	Universal (w/o legend inserts)	8	BG307	—	—	—
Start-Stop, Red Pilot Light: 120Vac/dc	145 & 121	BG308	—	—	—	

For Replacement Interiors, see Replacement Interiors for Type B Standard Duty Push Button Stations, page 19-75.

For Ratings, see Electrical Contact Ratings, page 19-75.

[7] See Replacement Interiors For Type B Standard Duty Push Button Stations , page 19-75.
 [8] Uses standard 2.0 or 2.13 in. deep wall boxes, single gang for Types BF1 and BF2, two gang for Type BF3
 [9] Also rated for Class I, Division I and II, Groups B, C, or D; Class II, Division I and II, Groups E, F, or G
 [10] When ordering, add prefix 9001 to the catalog number.

Replacement Parts for Type B Standard Duty Control Stations

NOTE: Contact block assemblies for all Type BG stations include cover and contact block. Replacement contact block assemblies and terminal block wiring receptacles for push buttons have provision for 1 N.O. & 1 N.C. circuit on each button. Unneeded circuits need not be wired.

Table 19.192: Mounting Bracket

Description	Catalog Number
C-Shaped Mounting Bracket for 9001BR Interior	3110112001



Type BGC214
(Type BGC contact block assemblies include cover.)

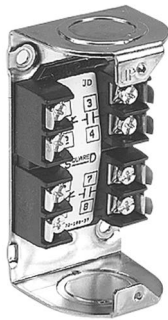

Type BGB214



BOC361

Table 19.193: Electrical Contact Ratings [11]

Volts	AC—NEMA B600					Volts	DC—NEMA P600	
	Inductive 35% Power Factor				Continuous Carrying Amperes		Inductive and Resistive	
	Make		Break				Make and Break Amperes	Continuous Carrying Amperes
A	VA	A	VA	5	5	5		
120	30.5	3600	3.75	360	5	120	1.1	5
240	15	3600	1.5	360	5	240	0.55	5
480	7.5	3600	.75	360	5	600	0.2	5
600	6	3600	.6	360	5			



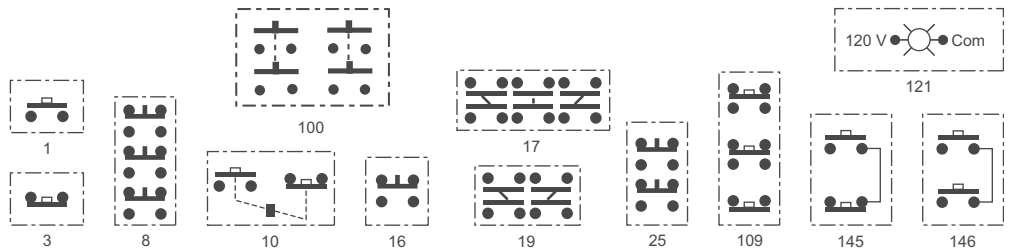

Contact Symbols

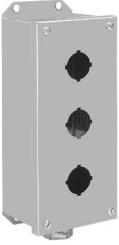

[11] OSHA Regulation, Section 1910.70, Overhead and Gantry Cranes, limits the voltage of pendant push buttons to 150 Vac or 300 Vdc.

9001KY and 9001SKY Control Stations

Table 19.194: Empty Enclosures (for Customer Assembly) [12]

	UL Types 1, 3 and 13/ NEMA 1, 3, and 13	UL Types 1, 3, 4 and 13/ NEMA 1, 3, 4 and 13	UL Types 1, 3, 4, 4X and 13/ NEMA 1, 3, 4, 4X and 13	
				
No of Holes	Sheet Steel Type	Die Cast Zinc Type	Stainless Steel (304) Type	Polymeric (Plastic) Type
1	KYAF1	KY1	KYSS1	SKY1
2	KYAF2	KY2 [13]	KYSS2	SKY2
3	KYAF3	KY3 [13]	KYSS3	SKY3
4	KYAF4	KY4 [13]	KYSS4	SKY4
6	KYAF6	KY6	KYSS6	—

NOTE: See Assembled Control Stations , page 19-76

Table 19.195: Guarded Enclosures



KYG1Y
(mushroom head not included)

No of Holes	UL Types 1, 3, 4 and 13/ NEMA 1, 3, 4 and 13		
	Cover Color	Die Cast Zinc Box Color	Type
1	Gray	Gray	KYG1 [14]
1	Yellow	Gray	KYG1Y [14]

NOTE: See Assembled Control Stations , page 19-76

Table 19.196: Stainless Steel (302) NEMA 1 Flush Plates [15]



K26

No of Holes	Description	Type
1	1 Hole flush plate, cover screws, insulating liners	K25
2	2 Hole flush plate, cover screws, insulating liners	K26
3	3 Hole flush plate, cover screws, insulating liners	K27
4	4 Hole flush plate, cover screws, insulating liners	K28

Assembled 9001KY/SKY Control Stations

Table 19.197: Assembled Control Stations

	No of Holes	Operator Style and Features	Type	Consists of			
				Enclosure	Operators	Contact Blocks	Legend Plates
		UL Types 1, 3, 4 and 13/NEMA 1, 3, 4 and 13 Die Cast Zinc Enclosure [16]					
	1	Selector Switch (3 Pos Maintained)	—	KY1	KS43B	KA1	Hand-Off-Auto
		Selector Switch (2 Pos Maintained)	—	KY1	KS11B	KA1	Off-On
		Push Button (Momentary)	KYK11	KY1	KR1B	KA1	Start
		Push Button (Momentary)	—	KY1	KR1R	KA1	Stop
		Mushroom Button (Momentary)	KYK14	KY1	KR4R	KA1	Stop
		Push Button (with Lockout)	—	KY1	KR3R, K4	KA1	Stop
		Break Glass Operator	KYK116	KY1	K15	KA1	To Stop—Break Glass
		Break Glass Operator (Red Enclosure)	KYK117	KY1S1	K15	KA1	To Stop—Break Glass
	2	2 Push Buttons (Lockout on Stop)	—	KY2	KR1B, KR3R, K4	KA1, KA1	Jog-Stop
		2 Push Buttons	KYK218	KY2	KR1B, KR3R	KA1, KA1	On-Off
		2 Push Buttons	KYK26	KY2	KR1B, KR1B	KA1, KA1	Open-Close
		2 Push Buttons	KYK25	KY2	KR1B, KR1B	KA1, KA1	Up-Down
		2 Push Buttons	KYK21	KY2	KR1B, KR3R	KA1, KA1	Start-Stop
		2 Push Buttons (with Sealed Contacts) [17]	—	KY2	KR1B, KR3R	KA51, KA51	Start-Stop
Type KYK31	2 Push Buttons (Lockout on Stop)	KYK23	KY2	KR1B, KR3R, K4	KA1, KA1	Start-Stop	
	2 Push Buttons (Maintained/Interlocked)	KYK27	KY2	KR11GR	KA1	Start-Stop	
	1 Push Button, 1 Mushroom Button	—	KY2	KR1B, KR4R	KA1, KA1	Start-Stop	

[12] When ordering, add prefix 9001 to the catalog number.

[13] Only KN200 series legend plates will fit upright on these enclosures with their long axis vertical.



[14] Includes 1" NPT threaded conduit opening.

[15] To be used with a standard 2 x 3 in. general purpose switch box. A 2.5 in. deep switch box should be used if two Type KA contact blocks are mounted side by side. If two Type KA contact blocks are mounted in tandem, a 3.5 in. deep box should be used.

[16] Uses 9001K metal operators and metal legend plates.

[17] Control Station consists of components that are UL listed for use in Class 1, Division 2, Groups A, B, C, or D.

Table 19.197 Assembled Control Stations (cont'd.)

	No of Holes	Operator Style and Features	Type	Consists of			Legend Plates	
				Enclosure	Operators	Contact Blocks		
	3	3 Push Buttons	KYK31	KY3	KR1B, KR1B, KR3R	KA1, KA1, KA1	Forward; Reverse; Stop	
		3 Push Buttons (Lockout on Stop)	—	KY3	KR1B, KR1B, KR3R, K4	KA1, KA1, KA1	Forward; Reverse; Stop	
		3 Push Buttons (With Sealed Contacts & Lockout on Stop) [18]	—	KY3	KR1B, KR1B, KR3R, K4	KA51, KA51, KA51	Forward; Reverse; Stop	
		3 Push Buttons	KYK33	KY3	KR1B, KR1B, KR3R	KA1, KA1, KA1	Open; Close; Stop	
		Red 120v Pilot Light, 2 Push Buttons	KYK317	KY3	KP1R31, KR1B, KR3R	KA2, KA3	Start; Stop	
	3 Push Buttons	KYK32	KY3	KR1B, KR1B, KR3R	KA1, KA1, KA1	Up; Down; Stop		
	3 Push Buttons (Lockout on Stop)	—	KY3	KR1B, KR1B, KR3R, K4	KA1, KA1, KA1	Up; Down; Stop		
	UL Types 1, 3, 4 and 13/NEMA 1, 3, 4 and 13—Stainless Steel (304) [19]							
	1	Push Button (Momentary)	KYSS101	KYSS1	KR1B	KA1	Start	
		Push Button (Momentary)	—	KYSS1	KR1B	KA3	Stop	
Selector Switch (2 Pos Maintained)		—	KYSS1	KS11B	KA1	Off-On		
Selector Switch (3 Pos Maintained)		KYSS111	KYSS1	KS43B	KA1	Hand-Off-Auto		
2		2 Push Buttons	KYSS201	KYSS2	KR1B, KR3R	KA1, KA3	Start; Stop	
	2 Push Buttons (Lockout on Stop)	—	KYSS2	KR1B, KR3R, K5	KA1, KA3	Start; Stop		
	2 Push Buttons (Maintained with Interlock)	—	KYSS2	KR11U	KA1, KA1	Start; Stop		
	2 Push Buttons	—	KYSS2	KR1B, KR1B	KA1, KA1	Up; Down		
UL Types 1, 3, 4, 4X and 13/NEMA 1, 3, 4, 4X and 13—Stainless Steel (304) [20]								
	1	Push Button (Momentary)	—	KYSS1	SKR1B	KA1	Start	
		Push Button (Momentary)	KYSK103	KYSS1	SKR3R	KA3	Stop	
		Selector Switch (2 Pos Maintained)	—	KYSS1	SKS11B	KA1	Off-On	
		Selector Switch (3 Pos Maintained)	KYSK111	KYSS1	SKS43B	KA1	Hand-Off-Auto	
	2	2 Push Buttons	KYSK201	KYSS2	SKR1B, SKR3R	KA1, KA3	Start; Stop	
		2 Push Buttons (Lockout on Stop)	—	KYSS2	SKR1B, SKR3R, K5	KA1, KA3	Start; Stop	
		2 Push Buttons (Maintained with Interlock)	—	KYSS2	SKR11U	KA1, KA1	Start; Stop	
		2 Push Buttons	—	KYSS2	SKR1B, SKR1B	KA1, KA1	Up; Down	
	UL Types 1, 3, 4, 4X and 13/NEMA 1, 3, 4, 4X and 13—Polymeric (Plastic) [20]							
	1	Selector Switch (3 Pos Maintained)	SKY111	SKY1	SKS43B	KA1	Hand-Off-Auto	
Selector Switch (2 Pos Maintained)		—	SKY1	SKS11B	KA1	Off-On		
Selector Switch (2 Pos Maintained with Sealed Contacts) [18]		—	SKY1	SKS11B	KA51	Off-On		
Push Button (with Lockout)		SKY105	SKY1	SKR3R, K5	KA3	Stop		
2	2 Push Buttons	SKY201	SKY2	SKR1B, SKR3R	KA1, KA3	Start-Stop		
	2 Push Buttons (Lockout on Stop)	SKY203	SKY2	SKR1B, SKR1R, K5	KA1, KA3	Start-Stop		
	2 Push Buttons (With Sealed Contacts) [18]	—	SKY2	SKR1B, SKR3R	KA51, KA51	Start-Stop		
	2 Push Buttons (With Sealed Contacts) [18]	—	SKY2	SKR1B, SKR3R	KA51, KA51	On-Off		
	2 Push Buttons	—	SKY2	SKR1B, SKR1B	KA1, KA1	Up-Down		
3	3 Push Buttons	SKY302	SKY3	SKR1B, SKR1B, SKR3R	KA1, KA1, KA3	Up-Down-Stop		
	3 Push Buttons	—	SKY3	SKR1B, SKR1B, SKR3R	KA1, KA1, KA3	Open-Close-Stop		
		Red 120v Pilot Light, 2 Push Buttons	—	SKY3	SKP1R31, SKR1B, SKR3R	KA1, KA3	Start-Stop	
UL Types 1, 3, 4 and 13/NEMA 1, 3, 4 and 13 Die Cast Zinc Enclosures with Integral Guard								
	1	Guarded Enclosure (grey) with 120V Red LED Pilot Light	—	KYG1	KP38LRR9	—	order separately	
		Guarded Enclosure (grey) with 120V Green LED Pilot Light	—	KYG1	KP38LGG9	—	order separately	
		Guarded Enclosure (Yellow Cover) with Red Push-Pull Mushroom	KYG1Y1 [21]	KYG1Y	KR9R	KA3	Push to Stop/ Pull to Start	
		Guarded Enclosure (Yellow Cover) with Red Turn-To Release Mushroom	KYG1Y2 [21]	KYG1Y	KR16	KA3	Emergency Stop	

[18] Control Station consists of components that are UL listed for use in Class 1, Division 2, Groups A, B, C, or D.
 [19] Uses 9001K metal operators and plastic legend plates.
 [20] Uses 9001SK plastic operators and plastic legend plates.
 [21] Includes 1" NPT threaded conduit opening.

Harmony® eXLhoist

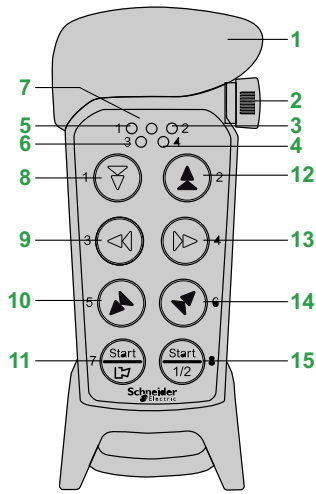

Front view of ZART8LS remote device

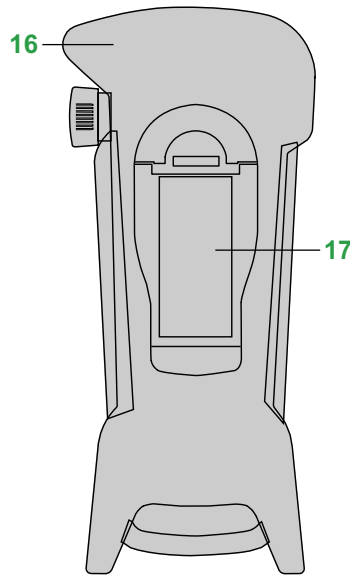

Rear view of remote device

Remote Control Device Description

Front View	
1	Rubber cover
2	Stop button
3	LED 2 (red)
4	LED 4 (red)
5	LED 1 (red)
6	LED 3 (red)
7	Top LED (red, green)
8	Button 1
9	Button 3
10	Button 5
11	Button 7-left start button
12	Button 2
13	Button 4
14	Button 6
15	Button 8-right start button
Rear View	
16	Rubber protection cover
17	Battery pack

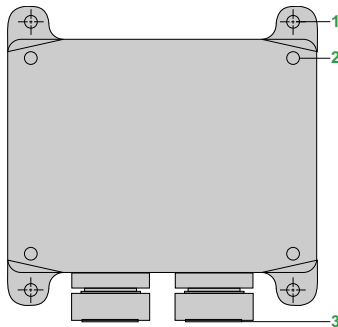

Front view of base station

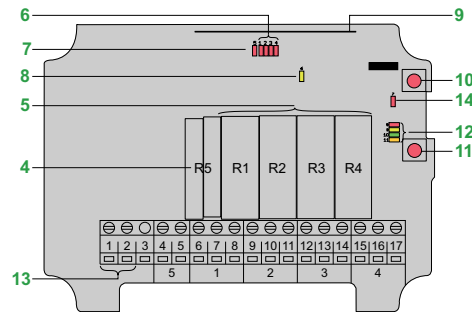

Internal board view of base station

Base Station

Front View	
1	4 x Ø5 mm/0.20 in. holes for standard mounting on a support
2	4 x screws to maintain the cover of the receiver
3	2 x cable glands for cables Ø 6...13 mm/0.25...0.50 in.
Internal Board View	
4	Stop relays
5	Relays R1 ...R4
6	Relay LEDs (red)
7	Stop relay LED (red)
8	Power LED (yellow)
9	Radio module
10	Function button (cancel)
11	Select button (OK)
12	Function LEDs (8 = red, 9 = yellow, 10 = green, 11 = orange)
13	Terminal block for input power
14	PLd (Performance Level d) status LED
Expansion Board View	
15	Relays R6...R11
16	Relay LEDs (red)
17	Communication LED (green)

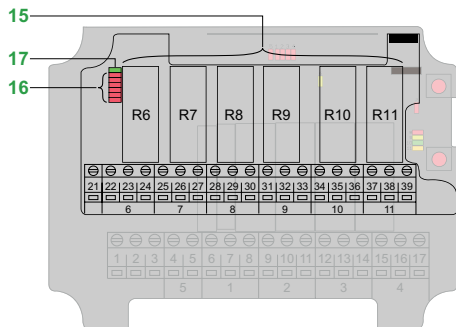

Expansion board view of base station



ZART8LS



ZARB10WS

Remote Control Device and Base Station

Table 19.198: Remote Control Device

Description	Characteristics		Reference		Weight kg/lb
	Motion push buttons	Auxiliary push buttons	Standard	MBC ^[1]	
With LEDs	6	1	ZART8LS	—	0.300/0.661

Table 19.199: Base Station

Description	Characteristics		Power Supply (V)	Reference		Weight kg/lb
	Outputs	Inputs		Standard	MBC ^[1]	
Wired connection cable gland	10 relays + 2 safety relays	—	~ 48–240	ZARB10WS	—	0.430/0.947
Wired connection (pre-wired with 1.5 m/4.92 ft cable)	10 relays + 2 safety relays	—	~ 48–240	ZARB10WSP	—	0.880/1.940

Accessories

Table 19.200: Accessories

Description	Characteristics	Reference	Weight kg/lb
Multi-charger power supply 6W, 5 Vdc /1.2 A (for ZARC702 Li-Ion rechargeable battery only)	~100–240 V power supply	ZARC701	0.100/0.220
Li-Ion rechargeable battery with battery table charger	83 x 46 mm/ 3.268 x 1.811 in.	ZARC702	0.050/0.110
Battery pack for 3 x AAA (batteries not included)	83 x 46 mm/ 3.268 x 1.811 in.	ZARC704	0.020/0.044
Battery table charger, (for ZARC702 Li-Ion rechargeable battery only)	5 Vdc power supply	ZARC703	0.120/0.265
Front label cover for ZART8LS push buttons	120 x 60 mm/ 4.724 x 2.362 in.	ZARC705	0.005/0.011
Rubber protection cover for ZART8LS	Rubber material, black	ZARC706	0.107/0.24
Shoulder belt to support ZART8LS	Nylon material, black	ZARC707	0.130/0.29



ZARC701



ZARC702



ZARC703



ZARC704



ZARC705



ZARC706



ZARC707

[1] MBC: Multi base control (tandem).



ZARTxx + ZARB05WSP

Table 19.201: Transmitter — Pocket Remote

Description	Battery	Number of Pushbuttons	Reference	Weight kg/lb
Single-step pushbutton	2 x 1.5 V AAA/LR06 Alkaline ^[2]	3	ZART03	0.135/0.298
		4	ZART04	
		6	ZART06	
		8	ZART08	
		10	ZART10	

Table 19.202: Receiver — Pocket Remote

Description	Relay outputs	Power supply V	Reference	Weight kg/lb
Wired connection (pre-wired with 1.5 m/4.92 ft cable)	5 relays	12–24	ZARB05WSP	0.400/0.882
	11 relays	12–24	ZARB11WSP	

Table 19.203: Accessories — Pocket Remote

Description	For use with	Sold in lots of ^[3]	Reference	Weight kg/lb
Customizable label kit for remote transmitter 66 x 114 mm/2.60 x 4.49 in.	ZART03, ZART04, ZART06, ZART08, ZART10	1	ZARC620 ^[4]	0.135/0.298

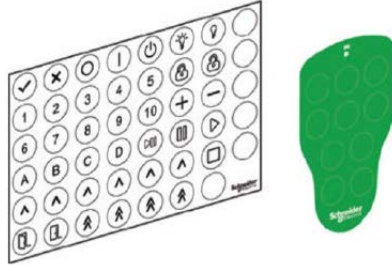

ZARC620

^[2] 2 batteries are included in packaging.

^[3] Pack consists of 5 sheets of label kit.

^[4] 1 polyester base layer for graphic printing, 1 set of unique legends.

Type BW Pendant Stations and Accessories

This pre-assembled, two-button station now comes complete with internal and external strain relief. Oversized finger grips on the rear of the enclosure make it easy to grip and operate.

- Well suited for standard hoist applications
- Push button legend inserts
- Field-installable mushroom button
- Full cover gasket, to exclude harmful contaminants

Table 19.204: BW90 and BW100 Pendant Stations – with cord connector and strain relief

Description	Legend Insert Markings	Mechanical Interlock	Enclosure Color		Contact Symbol	Replacement Interior [5]		
			Yellow	Red		9001 Type	Contact Symbol	
 BW90 / BW100	Single Speed	Up-Down	Yes	BW92Y	—	146	BOC368	146
		Forward-Reverse	Yes	BW93Y	—	146	BOC368	146
		On-Off [6]	Yes	BW94Y	—	10	—	147
		Start-Stop	No	BW95Y	—	145	—	25
		Start-Stop [6]	Yes	BW96Y	—	10	—	147
		On-Off [6]	No	—	—	146	—	25
	Two Speed	Up-Down	Yes	BW98Y	—	100	—	—
		without Inserts	Yes	BW90YU	—	147	—	25
		without Inserts	No	BW91YU	—	25	—	25
		without Inserts [6]	Yes	—	—	147	—	147
		without Inserts	Yes	BW100YU	BW100RU	150	—	150
		Up-Down	Yes	BW102Y	—	150	—	150

Table 19.205: Hanger Brackets

Description	Form
 Y236 External Bracket (cannot be field installed)	Y236

Table 19.206: Strain Relief Replacement

Description	Type
 BWSR Strain Relief Replacement	BWSR

Table 19.207: Interchangeable Legend Inserts for Type BW Pendant Stations [7]

Marking	Type
Forward	B255
Reverse	B256
Up	B253
Down	B254

Table 19.208: Replacement Enclosures

Description	Color	Type
Box & Cover with 4 screws	Yellow	BWRY
	Red	BWRR
	Black	BWRB

Table 19.209: Electrical Contact Ratings [8]

Volts	AC—NEMA B600					Continuous Carrying Amperes	Resistive 75% Power Factor Make, Break and Continuous Carrying Amperes	DC—NEMA P600		
	Inductive 35% Power Factor		Break		Inductive and Resistive			Volts	Make and Break Amperes	Continuous Carrying Amperes
	Make	VA	A	VA						
120	30.5	3600	3.75	360	5	5	120	1.1	5	
240	15	3600	1.5	360	5	5	240	0.55	5	
480	7.5	3600	.75	360	5	5	600	0.2	5	
600	6	3600	.6	360	5	5				

Contact Symbols (Type BW Pendant Stations)

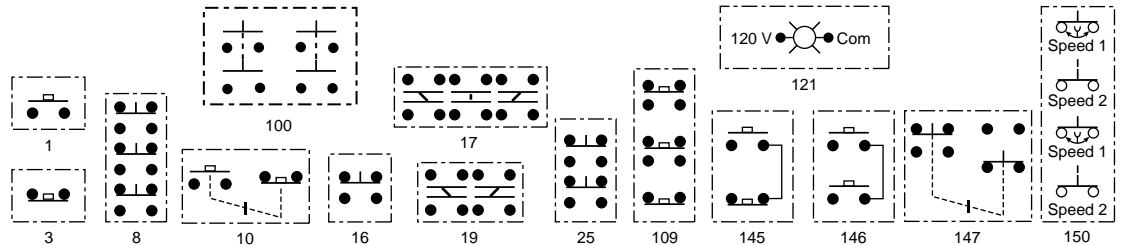

[5] Includes gasket
 [6] Maintained Contact
 [7] Order must specify a quantity of 10 or multiples of 10.
 [8] OSHA Regulation, Section 1910.70, Overhead and Gantry Cranes, limits the voltage of pendant push buttons to 150 Vac or 300 Vdc.

XAC Pistol Grip Stations and General Purpose Pendants

XAC pendant stations are designed for standard- or medium-duty control circuit applications.

- Single- or two-speed versions
- Double insulated
- Shock and corrosion resistant
- 2, 4, 6, 8, 12 element versions
- Ease of operation

Table 19.210: Pistol Grip Stations

Description	Speeds	Function		Catalog Number
		1 speed	2 speed	
1 N.O. contact per operator 2 Mechanically interlocked operators	1	↑ ↓		XACA201 [9]
2 N.O. (staggered) contacts per operator 2 Mechanically interlocked operators	2		↑ ↓	XACA207 [9]
1 N.O. + 1 N.C. 2 Mechanically interlocked operators	1	↑ ↓		XACA205 [9]
1 N.O. contact per direction 1 Mechanically interlocked 2 way toggle	1	↑ ↓		XACD21A0101 [10]

NOTE: Legends are required to achieve NEMA4 rating.



XACA201



XACA06



XACA03 with operators

Table 19.211: General Purpose Pendants [11][12]

Enclosures	Catalog Number
2 hole enclosure	XACA02H7
3 hole enclosure	XACA03H7
4 hole enclosure	XACA04H7
6 hole enclosure	XACA06H7
8 hole enclosure	XACA08H7
12 hole enclosure	XACA12H7

To place a custom pendant order, use the worksheet [Type XACA Worksheet](#), page 19-83 as a guide. Orders must be placed through the Product Selector in Quote to Cash. There is a 10% charge for assembly.

XAC Contact Blocks

Table 19.212: Contact Blocks for Operators in Cover

Description	Wiring Diagram	Catalog Number
1 N.O./spring return/1 speed	—	ZB2BE101
1 N.C./spring return/1 speed	—	ZB2BE102
1 N.O. early close & 1 N.C. & 1 N.O./spring return/2 speed	Figure 1	XENG1191
1 N.C. & 2 N.O./spring return/1 speed	Figure 2	XENG1491
1 N.O. & 1 N.O. latching/1 speed/interlocked	Figure 3	XENG3781
1 N.O. & 1 N.C. latching/1 speed/interlocked	Figure 4	XENG3791
3 N.C.—all direct acting	Figure 5	XENT1192



ZB2BE10

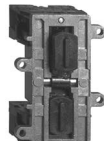

XENG37



XENG1191



XACS10

Table 19.213: Contact Blocks for Operators in Base of Enclosure [13]

Description	Catalog Number
1 N.O./1 speed	XACS101
1 N.C./1 speed	XACS102
2 N.C./1 speed	XACS104

Wiring Diagrams

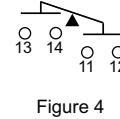
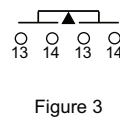
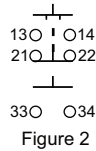
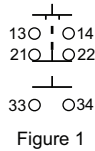

N/C + N/C + N/C with positive opening operation

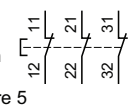

[9] These units are available with factory installed E-stops. Add a "3" to the end of the catalog number for standard E-stop or add a "4" for a trigger action E-stop.

[10] These units are available with a factory installed E-stop. Use XACD22 *** for a standard E-stop or XACD24*** for a trigger action E-stop.

[11] Standard enclosures include internal mounting plate, cable sleeve for 8 to 26 mm, internal cable clamp, suspension ring and cable tie.

[12] For ordering information on custom built XACA pendants, visit our website at www.Schneider-Electric.us.

[13] Cannot be used with XACA03 pendant.

Type XACA Worksheet

Use this worksheet to assist in component selection. Custom orders for XACA pendant stations must be placed through the Product Selector in Quote to Cash. There is a 10% charge for assembly.

XACA Order Guide Instructions

Custom built pendant stations

1. Determine the number of operators needed, then choose an enclosure with a corresponding number of holes.
2. Select the type of operator, contact block, and appropriate nameplate for each function required.
3. Check for special functions that may be required. These items could include mechanical interlocks, adapters for self-supporting cable, lower support rings, protective guards, etc.

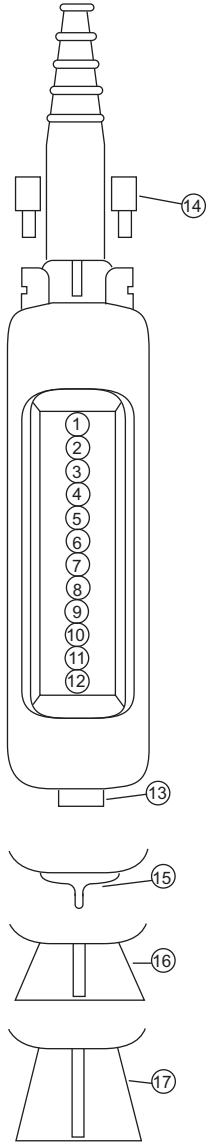

Mechanical Interlock (XACA009)

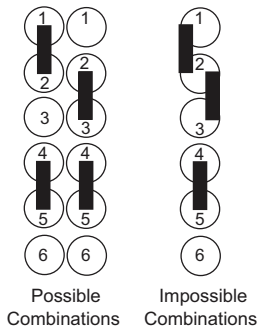

Functions (optional)	Catalog number of enclosure	XACA	<input type="checkbox"/>	<input type="checkbox"/>	<input type="checkbox"/>	<input type="checkbox"/>
	Mechanical interlock (draw a vertical line between the 2 units to be interlocked ^)	Legends	Contact blocks and pilot light bodies	Push button Pilot light or Blanking plug		
	1					
	2					
	3					
	4					
	5					
	6					
	7					
	8					
	9					
	10					
	11					
	12					

▲ Mechanical interlock XACA009 Number of XACA009 required

Unit mounted in base of station (facing downwards)

	13			
--	----	--	--	--

Attachments

Position	Type	Catalog No.
14	Adapters for self-supporting cable type BBAP (available only with cable sleeve Ø8–26 mm)	XACB961
15	Lower support ring	XACA971
16	Protective guard for base mounted selector switch or 40 mm emergency-stop push button	XACA982
17	Protective guard for key switch	XACA983

XVB 70 mm Diameter Beacons

Table 19.214: XVB Beacons with Steady Light



XVBL3*

XVBL4B*

Description	Light Source and Voltage	Color	Catalog Number
Complete unit, includes: 1 lens unit 1 base unit (direct or tube mounting)	Bulb (10 W max) not included 250 V max (must order bulb separately) ^[1]	Green	XVBL33
		Red	XVBL34
		Amber	XVBL35
		Blue	XVBL36
		Clear	XVBL37
		Yellow	XVBL38

Table 19.215: XVB Beacons with Flashing Light (one flash per second)

Description	Light Source and Voltage	Color	Catalog Number
Complete unit, includes: 1 lens unit 1 base unit (direct or tube mounting)	Bulb (10 W max) not included 24 Vac 24–48 Vdc (must order bulb separately) ^[1]	Green	XVBL4B3
		Red	XVBL4B4
		Amber	XVBL4B5
	Bulb (10 W max) not included 48–230 Vac (must order bulb separately) ^[1]	Red	XVBL4M4
		Amber	XVBL4M5
		Yellow	XVBL4M8

Table 19.216: XVB Beacons with 10 Joule Strobe (2.75 in./70 mm diameter) ^[2]



XVBL6B*
5 Joule

XVBL8B*
10 Joule

Description	Light Source and Voltage	Color	Catalog Number ^[3]
Complete unit, includes: 1 lens unit 1 base unit (direct or tube mounting)	Strobe 24 Vac/Vdc (includes bulb)	Red	XVBL8B4
		Amber	XVBL8B5
		Blue	XVBL8B6
		Clear	XVBL8B7
		Yellow	XVBL8B8
	Strobe 120 Vac (includes bulb)	Red	XVBL8G4
		Amber	XVBL8G5
		Blue	XVBL8G6
		Yellow	XVBL8G8

NOTE: There are no replacement lenses for strobes.

[1] For bulbs, see XVB Accessories, page 19-86.

[2] Important: Discharge tube elements are not suitable for continuous-operation signaling due to temperature rise caused by the discharge tube.

[3] For 5 Joule units, specify XVBL6**, instead of XVBL8**.

XVB 70 mm Components

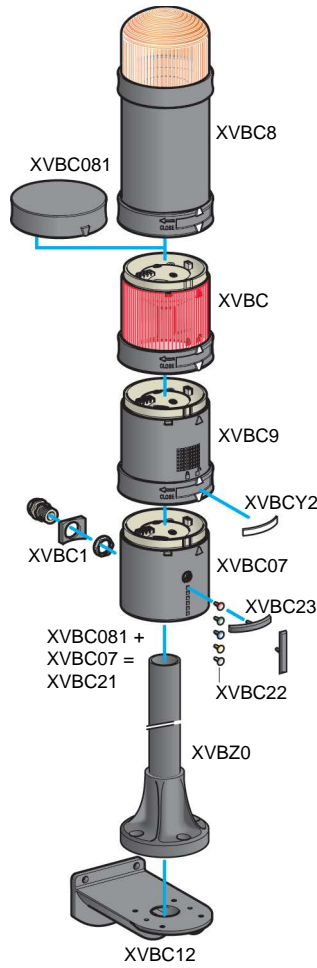

Table 19.217: XVB Lens Units for Steady Light

Description	Light Source and Voltage	Color	Catalog Number
Illuminated lens unit	Bulb (10 W max) not included 250 Vac/Vdc max (must order bulb separately [4])	Green	XVCB33
		Red	XVCB34
		Orange	XVCB35
		Blue	XVCB36
		Clear	XVCB37
		Yellow	XVCB38

Table 19.218: XVB Lens Unit for Flashing Light

Description	Light Source and Voltage	Color	Catalog Number
Illuminated lens unit	Bulb (10 W max) not included 24 Vac 24–48 Vdc (must order bulb separately [4])	Green	XVCB4B3
		Red	XVCB4B4
		Orange	XVCB4B5
		Blue	XVCB4B6
		Yellow	XVCB4B8
		Green	XVCB4M3
	Bulb (10 W max) not included 48–230 Vac (must order bulb separately [4])	Red	XVCB4M4
		Orange	XVCB4M5
		Blue	XVCB4M6
		Yellow	XVCB4M8

NOTE: There are no replacement lenses units for the XVCB8** strobes.

Table 19.219: XVB Lens Units with 10 Joule Strobe

Description	Light Source and Voltage	Color	Catalog Number [5]
Lens unit with integral 10 Joule strobe	Strobe 24 Vac/Vdc (includes bulb)	Red	XVCB8B4
		Orange	XVCB8B5
		Blue	XVCB8B6
		Clear	XVCB8B7
		Yellow	XVCB8B8
		Red	XVCB8G4
	Strobe 120 Vac (includes bulb)	Orange	XVCB8G5
		Blue	XVCB8G6
		Yellow	XVCB8G8

Table 19.220: Audible Sounder Units

Description	Supply Voltage	Catalog Number
Sounder unit 90 dB at 1 m	12–48 Vac/Vdc	XVCB9B
Adjustable from 75–90 dB Continuous or intermittent modes	120–230 Vac	XVCB9M

Table 19.221: Base Units + Cover

Description	Catalog Number
Base unit + cover for direct or tube mounting, bottom or side cable entry (includes gasket)	XVCB21

[4] For bulbs, see [XVB Accessories](#), page 19-86.
[5] For 5 Joule units, specify XVCB6**, instead of XVCB8**

XVB 70 mm Accessories

Table 19.222: XVB Accessories

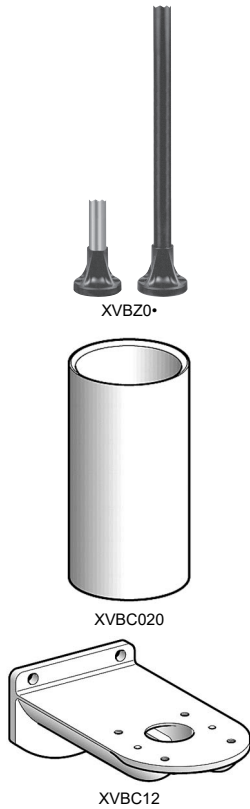

Description	Characteristics		Catalog Number	
	in.	mm		
Black tube with integral black plastic mounting base (includes gasket)	4.72	120	XVBZ02	XVBZ02A [6]
	15.75	400	XVBZ03	—
	31.50	800	XVBZ04	—
Support tube concealment cover	3.94	100	XVC020	
Incandescent bulbs bayonet type BA 15d, 10 Watts	24 Vac/Vdc		DL1BLB	
	120 Vac/Vdc		DL1BLG	
	230 Vac/Vdc		DL1BLM	
Incandescent bulbs bayonet type BA 15d, 7 Watts	24 Vac/Vdc		DL1BEB	
	120 Vac/Vdc		DL1BEG	
	230 Vac/Vdc		DL1BEM	
Steady-On LED bulbs bayonet type BA 15d (sold as single) [7]	24 Vac/Vdc	White	DL1BDB1	
		Green	DL1BDB3	
		Red	DL1BDB4	
		Blue	DL1BDB6	
		Yellow	DL1BDB8	
	120 Vac	Amber	DL1BDB5	
		White	DL1BDG1	
		Green	DL1BDG3	
		Red	DL1BDG4	
		Blue	DL1BDG6	
	24 Vac/Vdc	Yellow	DL1BDG8	
		Amber	DL1BDG5	
		White	DL1BKB1	
		Green	DL1BKB3	
		Red	DL1BKB4	
120 Vac	Amber	DL1BKB5		
	Red	DL1BKG4		
	Adapter for side entry through base unit	With CM12 (p. 13.5) cable gland, for cable size of 0.4 to 0.55 in. (10 to 14 mm) diameter		XVC14
Conduit adapter	1/2 in. NPT (for customer supplied tubing)		XVC00	

Wiring Diagrams, Base Units

Screw terminals
Torque to 4.4 in-lb (0.5 N•m)

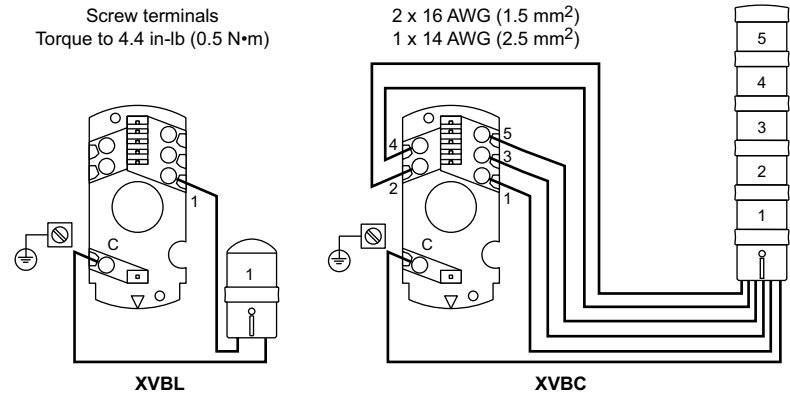

[6] Aluminum tube.

[7] For 240 Vac, replace the B or G in the catalog number with M—for example, DL1BDM1. For flashing LEDs, refer to catalog 9001CT0001.

XVC Tower Lights and Accessories

Table 19.223: XVC4 Tower Lights — 40 mm diameter (1.5 inches)



Description	Light source (included)	Voltage	Signaling colors [8]		Catalog Number
			Steady	Flashing	
With support tube mounting					
Without buzzer	LED for steady light only	24 Vdc	R	—	XVC4B1
			R, O	—	XVC4B2
			R, O, G	—	XVC4B3
			R, O, G, B	—	XVC4B4
			R, O, G, B, C	—	XVC4B5
		100-240 Vac	R, O, G	—	XVC4M3
With buzzer + flashing light	LED for steady or flashing light [9]	24 Vdc	R	R	XVC4B15S
			R, O	R, O	XVC4B25S
			R, O, G	R, O, G	XVC4B35S
			R, O, G, B	R, O, G, B	XVC4B45S
			R, O, G, B, C	R, O, G, B, C	XVC4B55S
			R	R	XVC4M15S
		100-240 Vac	R, O, G	R, O, G	XVC4M35S
For base mounting					
Without buzzer	LED for steady light only	24 Vdc	R	—	XVC4B1K
			R, O	—	XVC4B2K
			R, O, G	—	XVC4B3K
			R, O, G, B	—	XVC4B4K
			R, O, G, B, C	—	XVC4B5K



Table 19.224: Accessories for XVC4

Description	Diameter mm	Minimum height to be added mm	Catalog Number
Die-cast metal mounting base (for use with XVC4** and XVC4**5S with support tube)	90	32	XVCZ11

Table 19.225: XVC Tower Lights — 100 mm diameter (4 inches)



Description	Light source (included)	Voltage Vdc	Signaling colors [8]		Catalog Number
			Steady	Flashing	
For base mounting					
Without buzzer With flashing light	LED for steady or flashing light [9]	24	R	R	XVC1B1K
			R, O, G	R, O, G	XVC1B3K
			R, O, G, B	R, O, G	XVC1M3K
		100-240 Vac	R, O, G, B, C	R, O, G, B, C	XVC1M5K
With buzzer + flashing light	LED for steady or flashing light [9]	24	R, O, G	R, O, G	XVC1B3SK

Table 19.226: Accessories for XVC1

Description	Diameter mm	Height mm	Catalog Number
Mount tube and base	140	300	XVCZ13
L-shape mount bracket	—	—	XVCZ23



[8] Signaling colors: R = Red, G = Green, O = Orange, B = Blue, C = Clear. The colors are listed in the mounting order of the illuminated units from top to bottom.
[9] Flashing light function selected by wiring or programming.



XVC6B5K



XVC6B55SK



XVCZ02



XVCZ12

Table 19.227: XVC6 Tower Lights, 60 mm diameter (2.375 inches)

Description	Light source (included)	Voltage	Signaling colors [10]		Catalog Number
			Steady	Flashing	
With support tube mounting					
Without buzzer	LED for steady light only	24 Vdc	R	–	XVC6B1
			R, O, G	–	XVC6B3
			R, O, G, B	–	XVC6B4
		100-240 Vac	R, O, G, B, C	–	XVC6B5
			R, O, G	–	XVC6M3
			R, O, G, B	–	XVC6M4
With buzzer + flashing light	LED for steady or flashing light [11]	24 Vdc	R, O, G	R, O, G	XVC6B35S
			R, O, G, B	R, O, G, B	XVC6B45S
			R, O, G, B, C	R, O, G, B, C	XVC6B55S
		100-240 Vac	R	R	XVC6M15S
			R, O, G	R, O, G	XVC6M35S
			R, O, G, B	R, O, G, B	XVC6M45S
For base mounting					
Without buzzer	LED for steady light only	24 Vdc	R, O, G	–	XVC6B3K
		100-240 Vac	R, O, G	–	XVC6M3K
With buzzer + flashing light	LED for steady or flashing light [11]	24 Vdc	R	R	XVC6B15SK
			R, O	R, O	XVC6B25SK
			R, O, G	R, O, G	XVC6B35SK
			R, O, G, B	R, O, G, B	XVC6B45SK
			R, O, G, B, C	R, O, G, B, C	XVC6B55SK
		100-240 Vac	R	R	XVC6M15SK
			R, O, G	R, O, G	XVC6M35SK
			R, O, G, B	R, O, G, B	XVC6M45SK
			R, O, G, B, C	R, O, G, B, C	XVC6M55SK

Table 19.228: Accessories for XVC6

Description	Diameter mm	Minimum height to be added mm	Catalog Number
Die-cast metal mounting base for XVC6B• and XVC6B•5S with support tube.	100	30	XVCZ02
Stamped metal mounting base for XVC6B• K and XVC6B•5SK	84	21.6	XVCZ12

[10] Signaling colors: R = Red, G = Green, O = Orange, B = Blue, C = Clear. The colors are listed in the mounting order of the illuminated units from top to bottom.

[11] Flashing light function selected by wiring or programming.

Tower Lights For Customer Assembly (up to 5 units)

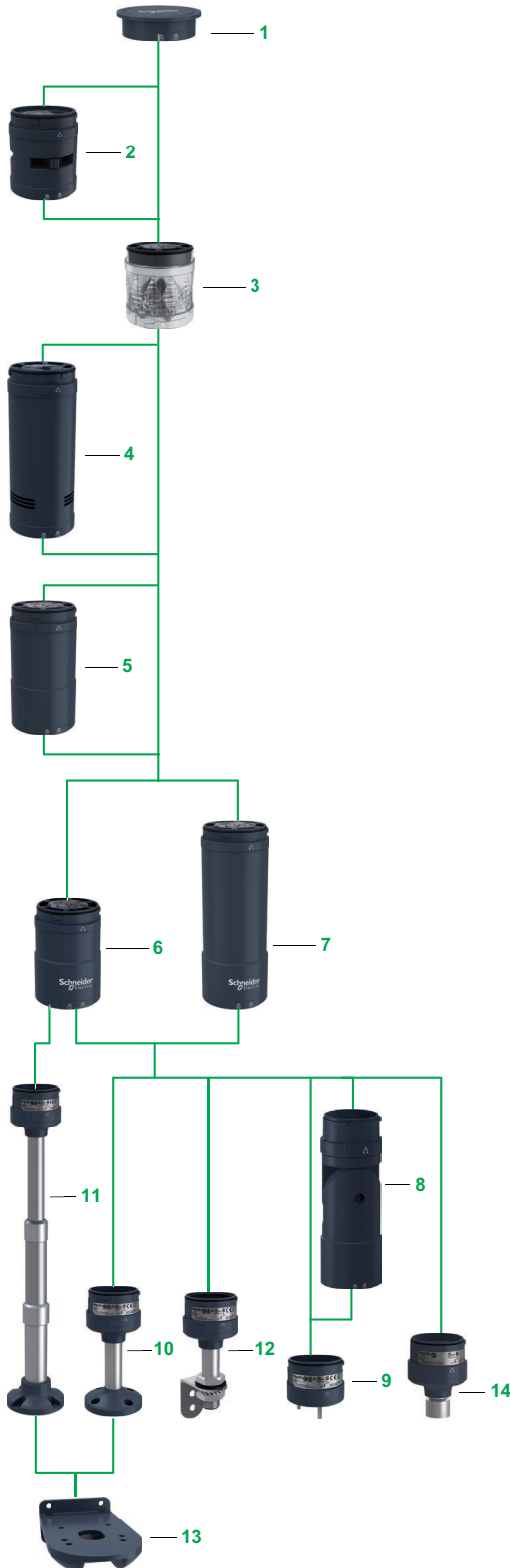

Tower Lights	
The XVU tower lights are customer assembled products comprising:	
1	Top cover (black or silver)
2	Buzzer unit (black or silver) ^[12]
3	Illuminated units: ^[13]
3.1	LED illuminated units with steady or blinking light signaling (colors: green, red, orange, blue, white, or yellow)
3.2	Multi-color LED unit (colors: green, red, orange, blue, white, or yellow. Patterns: steady, blinking, flashing, or rotating)
3.3	Pulse signal multi-color LED unit (colors: green, red, orange, or blue. Patterns: steady, blinking, flashing, or rotating) ^{[14][15]}
4	Sound units
4.1	Sound unit
4.2	Sound unit, plus signal ^[15]
5	Extender unit (black or silver)
6	Base unit, DC (black or silver)
7	Base unit, AC (black or silver)
8	Flexible mounting unit
9	Direct mounting plate (black or silver)
10	100 mm/3.927 in., 400 mm/15.748 in., or 800 mm/31.496 in. pole with integrated mounting plate (black or silver for 100 mm pole, and black for 400 mm and 800 mm pole)
11	Adjustable height pole from 210 to 385 mm/8.268 to 15.157 in. ^[16] with integrated mounting plate
12	100 mm/3.927 in., 250 mm/9.842 in., or 400 mm/15.748 in. pole with metal bracket (black)
13	Mounting plate for use on vertical support (black) ^[17]
14	½" NPT conduit adapter for customer supplied tubing

Composition

- XVU tower lights are customer assembled signaling units that are mounted vertically or horizontally with the support of a mounting accessory.
- Maximum of 5 illuminated units or 4 illuminated units with 1 audible unit can be assembled. The illuminated or audible unit^[18], stack vertically.
- With the indicator marks on these units they can be easily assembled.
- Electrical connections between each unit are made automatically as they are mechanically assembled.
- The signaling units are identical in size and their positioning is unrestricted.

Mounting

- Horizontal mounting: Fixed into support panel with direct mounting plate, poles or adjustable height pole with integrated mounting plate
- Vertical mounting: Fixed into support panel with mounting plate using pole with metal bracket or mounting plate for use on vertical support
- Horizontal or vertical mounting: Fixed into support panel with mounting plate using flexible mounting unit
- Mounting plate with aluminium 1/2" NPT adapter.

Cabling

By means of spring cage connection terminal block incorporated in mounting unit (Direct mounting plate, pole with plate, adjustment pole)

[12] Always mounted on the top .
 [13] Up to 5 LED illuminated units without sound unit; Up to 4 LED illuminated units with sound unit .
 [14] Pulse signal multi-color LED unit cannot be combined with standard sound unit (XVUC9V).
 [15] Up to 4 illuminated and sound units when pulse signal technology is used.
 [16] Only for DC body unit.
 [17] Compatible with XVUZ02, XVUZ02Q, XVUZ03, XVUZ400, XVUZ800, and XVUZ05.
 [18] Sound unit cannot be combined with buzzer unit at the same time.

Illuminated Units, High Flash LED Units



XVUC23
XVUC43



XVUC24
XVUC44



XVUC25
XVUC45



XVUC6
XVUC46



XVUC27
XVUC47



XVUC28
XVUC48



XVUC29
XVUC29P

Illuminated LED Units: IP 65						
Description	Signaling Type	Characteristics		Color	Reference	Weight kg/lb
		Voltage	Power			
High brightness LED Units	Steady	24 V	2.5 W	Green	XVUC23	0.064/0.141
		24 V	2.0 W	Red	XVUC24	0.064/0.141
		24 V	2.0 W	Orange	XVUC25	0.064/0.141
		24 V	2.5 W	Blue	XVUC26	0.064/0.141
		24 V	2.5 W	White	XVUC27	0.064/0.141
	Blinking	24 V	1.2 W	Green	XVUC43	0.064/0.141
		24 V	0.9 W	Red	XVUC44	0.064/0.141
		24 V	0.9 W	Orange	XVUC45	0.064/0.141
		24 V	1.2 W	Blue	XVUC46	0.064/0.141
		24 V	1.2 W	White	XVUC47	0.064/0.141
Multi-color LED unit	Steady/ blinking/ flashing/ rotating	24 V	1.5 W	Multi-color (green, red, orange, blue, white, and yellow)	XVUC29	0.064/0.141
Pulse signal Multi-color LED unit [19]	Steady/ blinking/ flashing/ rotating	24 V	1.7 W	Multi-color (green, red, orange, and blue)	XVUC29P	0.069/0.152

[19] 1 signal wire, 2 power wires. Adaptable for both NPN and PNP. Controlled by PLC dynamically.

Audible and Base Units



XVUC9S



XVUC9SQ



XVUC9V



XVUC21BQ



XVUC21M

Audible Units: IP 54					
Description	Characteristics		Color	Reference	Weight kg/lb
	Voltage	Power			
Buzzer, adjustable 70...85 dB at 1 m/3.281 ft (4 configurations of audible signal)	24 V	1.7 W	Black	XVUC9S	0.077/0.170
			Silver	XVUC9SQ	0.077/0.170
Sound, adjustable 0...86 dB at 1m/3.281 ft (4 channels)	24 V	1.7 W	Black	XVUC9V	0.217/0.480
Sound unit, pulse signal 0...86 dB at 1m/3.281 ft (16 channels) ^[20]	24 V	4.1 W	Black	XVUC9VP	0.219/0.483

Base Units: IP 65				
Description	Voltage	Color	Reference	Weight kg/lb
Base unit with top cover ^[21]	24 Vac/Vdc	Black	XVUC21B	0.110/0.243
		Silver	XVUC21BQ	0.110/0.243
	100 to 240 Vac	Black	XVUC21M ^[22]	0.235/0.518
		Black	XVUC21MP ^[23]	0.235/0.518

[20] 1 signal wire, 2 power wires. Adaptable for both NPN and PNP. 16 channels can be controlled by PLC.
 [21] Direct mounting plate XVUZ01• needed for direct mounting.
 [22] NPN type.
 [23] PNP type.

Accessories

Accessories					
Description	Voltage	Height of aluminum pole mm/in.	Color	Reference	Weight kg/lb
Body extender	24 Vac/Vdc	—	Black	XVUC020	0.093/0.205
Direct Mounting Plate		—	Black	XVUZ01 [24]	0.063/0.139
				XVUZ03 [25]	0.063/0.139
				XVUZ04 [26]	0.063/0.139
			Silver	XVUZ01Q [25]	0.063/0.139
Mounting plate with aluminum pole		100/3.927	Black	XVUZ02	0.132/0.291
		100/3.927	Silver	XVUZ02Q	0.132/0.291
		400/15.748	Black	XVUZ400	0.236/0.520
		800/31.496	Black	XVUZ800	0.430/0.945
Mounting plate with adjustable height aluminum pole [27]		210 to 385/ 8.268 to 15.157	Black	XVUZ05	0.253/0.558
Flexible mounting unit for use on horizontal or vertical support, IP 55		—	Black	XVUZ06	0.193/0.425
Metal bracket with aluminum pole, IP42		100/3.927	Black	XVUZ100T	0.220/0.485
		250/9.842	Black	XVUZ250T	0.240/0.529
		400/15.74	Black	XVUZ400T	0.320/0.705
Mounting plate for use on vertical support		—	Black	XVUZ12	0.360/0.794
Mounting plate with aluminium 1/2" NPT adapter		—	Black	XVUZ00	0.095/0.209



XVUC020



XVUZ01Q

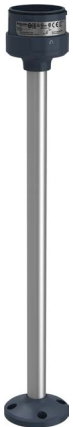

XVUZ400



XVUZ05



XVUZ100T



XVUZ06



XVUZ12



XVUZ00

[24] Three-pin mounting.
[25] Two-pin mounting.
[26] Four-pin mounting.
[27] Only for use with DC body unit.

XVR Pre-Wired Beacons and Accessories
Table 19.229: XVR Pre-Wired Rotating Mirror Beacons



Diameter (mm)	Sound Option	Enclosure Rating	Voltage	Color	Catalog Number
Ø 84	Without buzzer	IP 23 (IP 65 with accessories)	24 Vac/Vdc	Red	XVR08B04
				Orange	XVR08B05
				Green	XVR08B03
				Blue	XVR08B06
Ø 106	Without buzzer	IP 23 (IP 55 with accessories)	24 Vac/Vdc	Red	XVR10B04
				Orange	XVR10B05
Ø 120	Without buzzer	IP 23	24 Vac/Vdc	Red	XVR12B04
				Orange	XVR12B05
				Blue	XVR12B06
Ø 120	With buzzer	IP 23	24 Vac/Vdc	Red	XVR12B04S
				Orange	XVR12B05S
				Blue	XVR12B06S
Ø 130	Without buzzer	IP 23 Resistant to vibration	24 Vdc	Red	XVR13B04
				Orange	XVR13B05

Table 19.230: XVR Accessories



Description	Diameter (mm)	Height (mm)	Catalog Number
Rubber base to increase the IP degree of protection	84	—	XVRZ081
Mount tube and base	106, 120 and 130	300	XVCZ13
L-shape mounting bracket	84, 106 and 120	—	XVCZ23

XVR Complete Pre-Cabled Motor-Less Rotating/Flashing Beacons

Table 19.231: Complete, Pre-cabled Motor-less Rotating/Flashing Beacons



XVR3B04S



XVR3E06

Diameter (Ø mm/in.)	Sound option	IP Degree of Protection	Voltage V	Color	Reference Number	Weight (kg/lb)	
100/3.94	Without buzzer	IP 65 (upright) IP 23 (sideways, inverted)	12-24	Green	XVR3B03	0.484/1.067	
				Red	XVR3B04		
				Orange	XVR3B05		
			100-230	Blue	XVR3B06		
				Green	XVR3M03		
				Red	XVR3M04		
	With buzzer	IP 23 (upright, sideways, inverted)	12-24	Orange	XVR3M05		0.538/1.186
				Blue	XVR3M06		
				Green	XVR3B03S		
			100-230	Red	XVR3B04S		
				Orange	XVR3B05S		
				Blue	XVR3B06S		
Without buzzer	IP 65 (upright) IP 23 (sideways, inverted)	100-230	Green	XVR3M03S	0.484/1.067		
			Red	XVR3M04S			
			Orange	XVR3M05S			
		48	Blue	XVR3M06S			
			Green	XVR3E03			
			Red	XVR3E04			
				Orange	XVR3E05		
				Blue	XVR3E06		

Dimensions

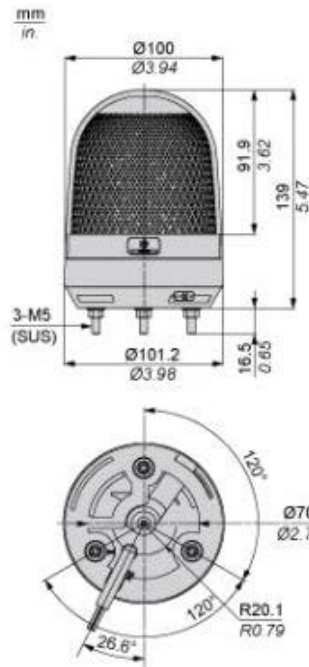

Panel Cut-out

Straight wiring

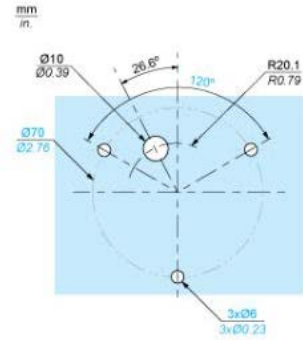

Side wiring

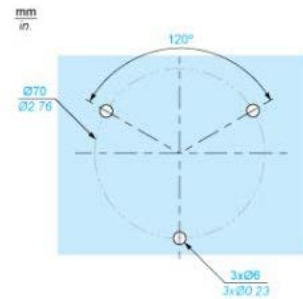

XVS Sirens and Electronic Alarms

Table 19.232: XVS Sirens and Electronic Alarms

Description	Voltage	Color	Catalog Number
Multisound siren 105 dB, 43 tones	12/24 Vdc	White	XVS14BMW
Electronic alarms 90 dB, 16 tones Panel Mount DIN72	12/24 Vac/Vdc	PNP, Black	XVS72BMBP
		PNP, White	XVS72BMW/P
		NPN, Black	XVS72BMBN
		NPN, White	XVS72BMWN



XVS14BMW



XVS72BM

Table 19.233: XVS Dimensions (mm)

XVS 14BMW

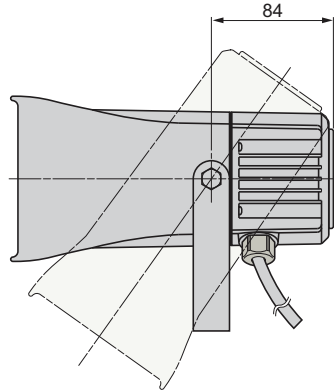
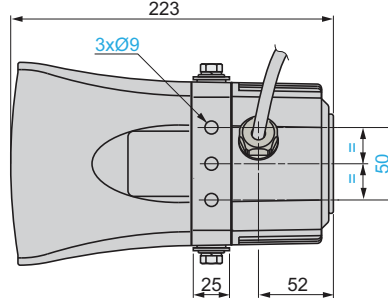

XVS 72BM●●

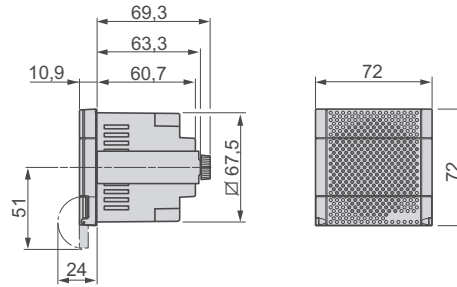

XVSV7BBN and XVSV9MWN

XVSV Editable Voice Alarms

Table 19.234: XVSV Editable Voice Alarms

Description	Voltage V	Color	Reference	Weight kg/lb
Editable alarms, DIN72	12–24	NPN, Black	XVSV7BBN	0.142/0.313
		NPN, White	XVSV7BWN	
		PNP, Black	XVSV7BBP	
Editable alarms, DIN96	12–24	NPN, Black	XVSV9BBN	0.268/0.591
		NPN, White	XVSV9BWN	
	100–230	PNP, Black	XVSV9BBP	0.267/0.589
		NPN, Black	XVSV9MBN	
Wall mounting plate for DIN72 and DIN96			XVSZ016	0.148/0.326

Heavy Duty Industrial Foot Switches—Oiltight, Watertight, Dusttight and Driptight Enclosure, NEMA 2, 4 and 13

⚠ DANGER

HAZARDOUS APPLICATIONS

Do not use foot switches on machines without point-of-operation protection.

Failure to follow these instructions will result in death, serious injury, or equipment damage.



9002AW2
Type AW Foot Switch with
Top Pedal Shield and Side
Shields



9002AW132
Type AW with Oversized
Pedal Shield and Side Shields



9002AW117
Type AW Foot Switch with
Oversized Pedal Shield, Side
Shields and Safety Door



9002AW1
Type AW Foot Switch
without Pedal Shield

Foot Switch Selection

Foot switches are used to control many industrial processes, while leaving the operator's hands free to perform other functions. The type or model of foot switch suitable for each application will vary depending on factors such as the control function required, degree of protection required, production methods, unusual conditions, government regulations, etc. In some applications more than one foot switch may be required, as when two or more persons are operating a machine. In these cases, safe practice and regulations require that the foot switches be wired in series making it necessary that each operator's foot switch be actuated before the machine will cycle.

Only the user can be aware of all the conditions and factors present during setup, operation and maintenance of the machine; therefore, only the user can determine which foot switch(es) can be properly used. When selecting a foot switch for a particular application, the user should refer to the applicable ANSI standards and OSHA regulations. The National Safety Council's Accident Prevention Manual also provides much useful information.

In some applications, such as power presses, additional operator protection such as point-of-operation guarding must be provided when a foot switch is used as an actuator. This is necessary since the operator's hands and other parts of the body are free to enter the pinch point area and serious injury can occur. The shielding provided on foot switches cannot protect an operator from injury. For this reason the foot switch cannot be substituted for or take the place of point-of-operation protection.

A Trilingual Danger Sign regarding the need for point-of-operation protection is supplied with each foot switch. The sign incorporates three languages: English, Spanish and French. Additional copies of the sign are available by contacting your Square D sales office.

Type AW Fully Shielded Foot Switch with Oversized Pedal Shield, Side Shields and Safety Door. The Safety Door is interlocked with the pedal to prevent operation due to shock or vibration. It prevents accidental pedal operation by requiring a simple but intentional motion to lift the door before inserting the foot.

Operating Temperature:
-30 to +60 °C (-22 to +140 °F)



9002AW124

Table 19.235: Foot Switch Catalog Numbers [1]

Description	Features	Fully Shielded with Oversized Pedal Shield, Side Shields and Safety Door	With Oversized Pedal Shield and Side Shields	With Pedal Shield and Side Shields	UNSHIELDED (See Warning note[2])
		Catalog Number	Catalog Number	Catalog Number	Catalog Number
Single Pole [3] Double Throw	Spring Return With Mechanical Latch	AW117	AW132	AW2 AW7	AW1
Two Pole [3] Double Throw	Spring Return With Mechanical Latch	AW124 [4]	AW133	AW14 AW15	AW13
Two Stage [3] (One Pole Each Stage) Table 1	Spring Return With Mechanical Latch in 1st Stage With Mechanical Latch in 2nd Stage	AW119	AW134	AW6 AW9	AW5
Four Stage [3] (One Pole Each Stage) Table 2	Spring Return	AW123	—	—	AW21
Single Pole Single Throw	Maintained Contact—Push On/Push Off	—	—	AW12	AW11
Replacement Cover Assembly	—	—	—	AC8 [5]	—



File: E78403
CCN: NKCR



File: LR25490
Class: 3211-03

For replacement parts for Class 9002 Type AW: See instruction bulletin 65013-010-31. Also see Table 19.237 Contact Symbol—Two Stage, page 19-98 and Table 19.238 Contact Symbol—Four Stage, page 19-98.

Approximate Dimensions

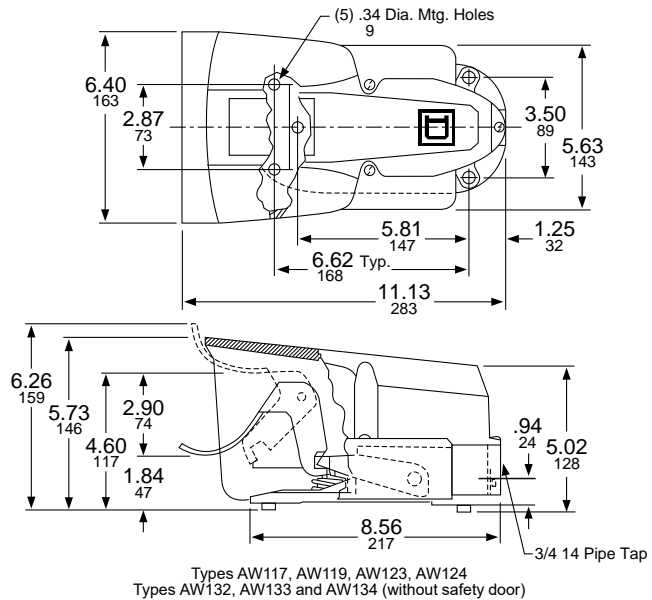
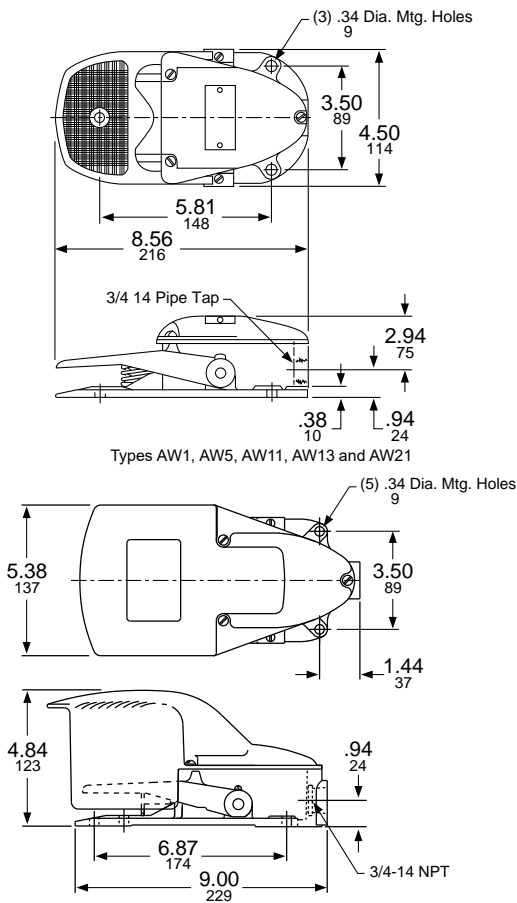

Dual Dimensions: INCHES
Millimeters

- [1] When ordering, add prefix "9002" to the catalog number.
- [2] WARNING: These foot switches must not be used to operate machines or equipment where the possibility of operator injury exists. Typical uses include Emergency Stop functions, "Dead Man" controls, signal functions (lights, bells, etc.).
- [3] A single pole snap switch that contains two double break contact elements (1 N.O. and 1 N.C.) must be used on circuits of same polarity. A double pole snap switch contains two electrically separated sets of contact elements allowing use on circuits of opposite polarity. Each set that contains two double break contact elements (1 N.O. and 1 N.C.) must be used on circuits of same polarity.
- [4] 2 N.O. and 2 N.C. isolated, direct acting contacts.
- [5] For replacement cover drilled to accept latch. For Series C foot switches order AC9. No replacement cover available for Series A or B devices drilled to accept latch. AC8 is spring return only.

Table 19.236: Maximum Current Ratings For Control Circuit Contacts

Type	Volts	AC Amperes			Volts	DC Amperes		
		Inductive 35% Power Factor		Resistive 75% Power Factor		Inductive and Resistive		
		Make	Break	Make, Break and Continuous		Make and Break		Continuous
						Single Throw	Double Throw	
AW1 through AW09, AW117, AW119, AW132	120	40	15	15	125 250 600	2.0	0.5	15
	240	20	10	10		0.5	0.2	15
	480	10	6	6		0.1	0.02	15
	600	8	5	5				
AW13, AW14, AW15, AW133	120	30	3	3	125 250 600 —	1.0	0.2	10
	240	15	1.5	1.5		0.3	0.1	10
	480	7.5	0.75	0.75		0.1	—	10
	600	6	0.6	0.6		—	—	—
AW11, AW12	115	36	6	—	125 250	2.2	—	—
	230	18	3	—		1.1	—	—
AW21 AW123	120	15.0	1.5	10	— — — —	—	—	—
	240	7.5	0.75	10		—	—	—
	480	3.75	0.375	10		—	—	—
	600	3.0	0.3	10		—	—	—
AW124	120	60	6	10	120 240 600	1.1	—	10
	240	30	3	10		0.55	—	10
	480	15	1.5	10		0.2	—	10
	600	12	1.2	10				

NOTE: Double throw switches are rated 250 Vdc maximum.

Table 19.237: Contact Symbol—Two Stage

Unit	Snap Switch		Pedal		
	Circuit		Up	Half Down	Full Down
1	A1		0	1	1
	B1		1	0	0
2	A2		1	1	0
	B2		0	0	1

NOTE: 0 = Open 1 = Closed

Table 19.238: Contact Symbol—Four Stage

Unit	Snap Switch		Pedal Position			
	Circuit		Up → Down			
1	1A1		0	0	1	1
	1B1		1	1	0	0
	2A1		0	1	1	1
	2B1		1	0	0	0
2	1A2		1	1	1	0
	1B2		0	0	0	1
	2A2		1	1	1	0
	2B2		0	0	0	1