

Section 12

Busway

Powerbus™ Busway	12-2
Powerbus™ Busway	12-2
Powerbus Plug-In Units	12-3
Powerbus Plug-in Units with Metering	12-5
I-Line™ Busway	12-6
Standard Components	12-6
I-Line™ II Busway	12-7
800 A–5000 A Busway	12-7
I-Line™ II Straight Lengths, Fittings, and Accessories	12-7
800 A to 5000 A "Factory Assembled" Busway Systems (or Components)	12-9
Additions, Accessories, and Electrical Data	12-10
Electrical Data for I-Line II Busway	12-10
Plug-In Units	12-10
Fusible Plug-In Units, Class R Fuse Kits, and Hooksticks	12-10
Surge Protective Device Plug-In Units	12-11
PowerPact™ H-, and J-Frame Plug-in Units	12-12
PowerPact™ H-, J-, and L-Frame Plug-in Units with Electronic Trip	12-13
H-, J-, and L-Frame Plug-In Units with Electronic Trip and Communication	12-15
PowerPact™ M-Frame Plug-in Units with Basic Electronic Trip	12-15
PowerPact™ P-Frame Plug-in Units	12-16
PowerPact™ R-Frame Plug-in Units	12-17
Power-Zone™ Busway	12-18
Non-Segregated Bus	12-18



Powerbus 100-400 A

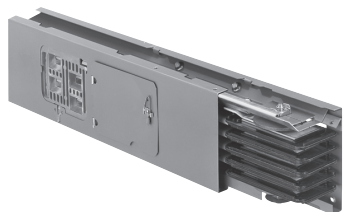

I-Line Plug-in Busway 225-600 A

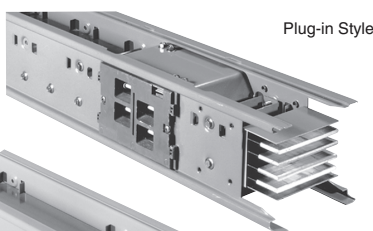

Plug-in Style

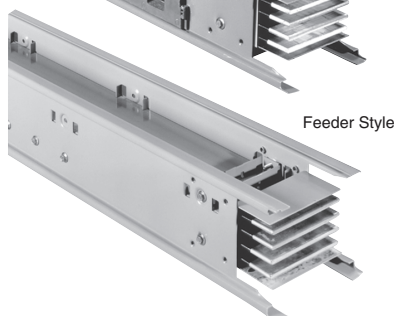

Feeder Style

I-Line II Busway 800-5000 A



I-Line Plug-in Units



Power-Zone Busway

Distinct service advantages make your Busway installation “hassle-free”

- **Missing Link** program guarantees shipment in a maximum of 5 working days of a small quantity (10 pieces or less) of standard indoor feeder straight lengths and fittings for US destinations. Orders for international destinations require 2 additional days for processing. The quantity of working days guaranteed by this program excludes the day of receipt of the order. Contact your local sales office for outdoor busway and for additional details of this program.
- **Measurement Services** are offered for your critical and complex projects. Schneider Electric will assist with field measurement and assume responsibility for the layout and exact fit of all components. Contact your local Schneider Electric sales office for exact details.
- **Emergency Service**; we are on call 24 hours a day, 7 days a week, 365 days a year. For emergencies, call 1-888-SquareD (1-888-778-2733).
- **Quick Ship** program provides product availability for time sensitive orders. The program is available through the product selectors and offers a limited selection of I-Line busway footage and fittings. Contact your local Schneider Electric sales office for exact details.

Powerbus Busway Construction

Powerbus busway construction consists of a light-weight electrical grade all-aluminum housing with up to five (5) silver-plated copper conductor bars for maximum electrical efficiency. The total product offer includes straight sections, fittings, accessories, and plug-in units for a total installation. This busway is available in 400 A, 225 A and 100 A ratings. A 50% integral ground is standard.

Straight Sections

Straight sections of busway are available in 10 ft. and 4 ft. lengths in a painted black finish. The Enhanced busway offer includes 10 plug-in openings on each side of a 10 ft. section and 3 plug-in openings on each side of a 4 ft. section.

Metering and Communications Options

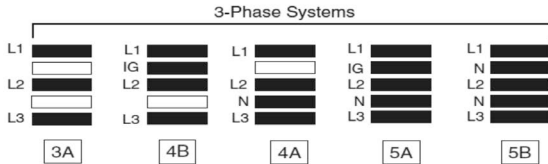

Single phase systems and DC systems are also available. Contact your local Schneider Electric representative.

Powerbus busway tap boxes and plug-in units are available with optional metering and communication capabilities, which include an integrated display and the ability to remotely monitor the busway.

Table 12.1: 3Ø3W—Powerbus Straight Lengths and Fittings—600 V Maximum

Amperage	Component	Configuration 3A—Catalog No.[1]	Configuration 4B—Catalog No.[1]
100 A	Enhanced Straight 10 ft.	PBCE3A100AST120B	PBCE4B100AST120B
	Enhanced Straight 4 ft.	PBCE3A100AST048B	PBCE4B100AST048B
	Elbow – Left	PBCF3A100ALLB	PBCF4B100ALLB
	Elbow – Right	PBCF3A100ALRB	PBCF4B100ALRB
	Cross Fitting	PBCF3A100ACRB	PBCF4B100ACRB
	Tap Box	PBCF3A100ATBB	PBCF4B100ATBB
	Tap Box w/Meter[2][3]	PBCF3A100ATBM()B	PBCF4B100ATBM()B
225 A	Enhanced Straight 10 ft.	PBCE3A225AST120B	—
	Enhanced Straight 4 ft.	PBCE3A225AST048B	PBCE4B225AST048B
	Elbow – Left	PBCF3A225ALLB	PBCF4B225ALLB
	Elbow – Right	PBCF3A225ALRB	PBCF4B225ALRB
	Cross Fitting	PBCF3A225ACRB	PBCF4B225ACRB
	Tap Box	PBCF3A225ATBB	PBCF4B225ATBB
	Tap Box w/Meter[3]	PBCF3A225ATBM()B	PBCF4B225ATBM()B
400 A	Enhanced Straight 10 ft.	PBCE3A400AST120B	PBCE4B400AST120B
	Enhanced Straight 4 ft.	PBCE3A400AST048B	PBCE4B400AST048B
	Elbow – Left	PBCF3A400ALLB	PBCF4B400ALLB
	Elbow – Right	PBCF3A400ALRB	PBCF4B400ALRB
	Cross Fitting	PBCF3A400ACRB	PBCF4B400ACRB
	Tap Box	PBCF3A400ATBB	PBCF4B400ATBB
	Tap Box w/Meter[3]	PBCF3A400ATBM()B	PBCF4B400ATBM()B

Table 12.2: 3Ø4W—Straight Lengths and Fittings—600 V Maximum

Amperage	Component	Configuration 4A—Catalog No.[1]	Configuration 5A—Catalog No.[1]	Configuration 5B—Catalog No.[1]
100 A	Enhanced Straight 10 ft.	PBCE4A100AST120B	PBCE5A100AST120B	PBCE5B100AST120B
	Enhanced Straight 4 ft.	PBCE4A100AST048B	PBCE5A100AST048B	PBCE5B100AST048B
	Elbow – Left	PBCF4A100ALLB	PBCF5A100ALLB	PBCF5B100ALLB
	Elbow – Right	PBCF4A100ALRB	PBCF5A100ALRB	PBCF5B100ALRB
	Cross Fitting	PBCF4A100ACRB	PBCF5A100ACRB	PBCF5B100ACRB
	Tap Box	PBCF4A100ATBB	PBCF5A100ATBB	PBCF5B100ATBB
	Tap Box w/Meter[2][3]	PBCF4A100ATBM()B	PBCF5A100ATBM()B	PBCF5B100ATBM()B
225 A	Enhanced Straight 10 ft.	PBCE4A225AST120B	PBCE5A225AST120B	PBCE5B225AST120B
	Enhanced Straight 4 ft.	PBCE4A225AST048B	PBCE5A225AST048B	PBCE5B225AST048B
	Elbow – Left	PBCF4A225ALLB	PBCF5A225ALLB	PBCF5B225ALLB
	Elbow – Right	PBCF4A225ALRB	PBCF5A225ALRB	PBCF5B225ALRB
	Cross Fitting	PBCF4A225ACRB	—	PBCF5B225ACRB
	Tap Box	PBCF4A225ATBB	PBCF5A225ATBB	PBCF5B225ATBB
	Tap Box w/Meter[3]	PBCF4A225ATBM()B	PBCF5A225ATBM()B	PBCF5B225ATBM()B
400 A	Enhanced Straight 10 ft.	PBCE4A400AST120B	PBCE5A400AST120B	PBCE5B400AST120B
	Enhanced Straight 4 ft.	PBCE4A400AST048B	PBCE5A400AST048B	PBCE5B400AST048B
	Elbow – Left	PBCF4A400ALLB	PBCF5A400ALLB	PBCF5B400ALLB
	Elbow – Right	PBCF4A400ALRB	PBCF5A400ALRB	PBCF5B400ALRB
	Cross Fitting	PBCF4A400ACRB	PBCF5A400ACRB	PBCF5B400ACRB
	Tap Box	PBCF4A400ATBB	PBCF5A400ATBB	PBCF5B400ATBB
	Tap Box w/Meter[3]	PBCF4A400ATBM()B	PBCF5A400ATBM()B	PBCF5B400ATBM()B

[1] Busway catalog numbers shown include a black painted finish. Contact your local Schneider Electric representative for a natural aluminum finish option.

[2] For 100 A busway only, add an (L), for top cable access, or a (U), for bottom cable access, before the last letter in the catalog no., which is (B).

[3] Replace the () in the Tap Box w/Meter catalog number with the meter suffix number in Table 12.3 Meter Suffix Number, page 12-3. The meter will be configured based on system voltage.

Table 12.3: Meter Suffix Number

Meter Suffix	System Voltage
1	208Y/120 V 3Ø4W
2	240 V 3Ø3W
4	415/240 V 3Ø4W
5	480Y/277 V 3Ø4W

Table 12.4: Accessories^[4]

Description	100 A	225 A	400 A
	Catalog No.	Catalog No.	Catalog No.
Standard Hanger	PB100FH	PB225FH	PB400FH
Side Mount Hanger	PB100HFW	PB225HFW	PB400HFW
Vertical Sway Brace	PB100VSB	PB225VSB	PB400VSB
End Closure	PB100AEC	PB225AEC	PB400AEC
Wall Flange	PB100WF	PB225WF	PB400WF
Plug-in Opening Cover	PBPIOCVR	PBPIOCVR	PBPIOCVR

Table 12.5: Hooksticks

Length	Catalog No.
8'	515608
14'	515614
4'—8' extension pole ^[5]	PBHS0408
8'—15' extension pole ^[5]	PBHS0815

Powerbus Plug-In Units

Powerbus plug-in units are rated maximum 100 A and may be offered as field installable or factory assembled units. All units conform to NEMA type 1. An optional kit is available for QO units to raise the protection to IP54. This kit raises the QOR unit to moisture protection of IPX3.

Three-Phase Systems

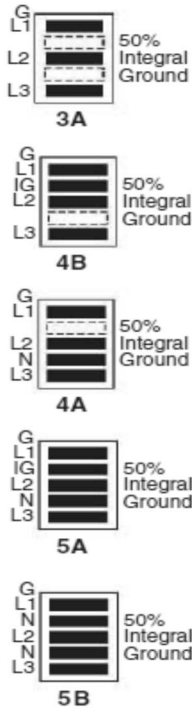
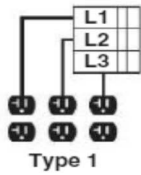

Table 12.6: Plug-In Units—Circuit breakers not included

Busbar Configuration	3 Spaces for QO/QOB Circuit Breakers	3 Spaces for QO/QOB Circuit Breakers 3 Openings for Receptacles ^[6]	
	Tap Box ^[7]	QO Unit	QOR Unit
	Catalog Number	Catalog Number	Catalog Number
4B	PBPTB4B100	PBPQO4B100	PBPQOR4B100
3A	PBPTB3A100	PBPQO3A100	PBPQOR3A100
4A	PBPTB4A100	PBPQO4A100	PBPQOR4A100
5A	PBPTB5A100	PBPQO5A100	PBPQOR5A100

^[4] For the NetShelter™ IT Rack-Mounting Bracket, refer to 5600CT9101.
^[5] For single-pole operation on QO and ED circuit breakers.
^[6] Certain NEMA receptacles can be field installed in this unit. Consult your local Schneider Electric representative.
^[7] Plug-in tap box to be installed on 100 A and 225 A busways only.



Type 1

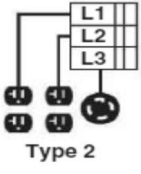

Type 2

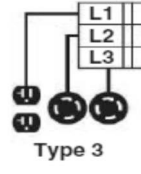

Type 3

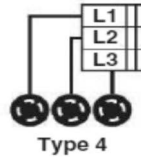

Type 4

Table 12.7: 120 V Factory Assembled Units: 1-pole QO/QOB circuit breakers with NEMA 5-15R or 5-20R receptacles^{[8][9]}

Circuit Breaker Rating	Type	4A Configuration Catalog Number	5A Configuration Catalog Number	5B Configuration Catalog Number
Type 1 (3 circuit breakers w. 3 duplex receptacles)				
15	QO	PBPQOR4A100M115	PBPQOR5A100M115	PBPQOR5B100M115
15	QOB	PBPQOR4A100M115B	PBPQOR5A100M115B	PBPQOR5B100M115B
20	QO	PBPQOR4A100M120	PBPQOR5A100M120	PBPQOR5B100M120
20	QOB	PBPQOR4A100M120B	PBPQOR5A100M120B	PBPQOR5B100M120B
Type 2 (3 circuit breakers w. 2 duplex/1 locking recept.)				
15	QO	PBPQOR4A100M215	PBPQOR5A100M215	PBPQOR5B100M215
15	QOB	PBPQOR4A100M215B	PBPQOR5A100M215B	PBPQOR5B100M215B
20	QO	PBPQOR4A100M220	PBPQOR5A100M220	PBPQOR5B100M220
20	QOB	PBPQOR4A100M220B	PBPQOR5A100M220B	PBPQOR5B100M220B
Type 3 (3 circuit breakers w. 1 duplex/2 locking recept.)				
15	QO	PBPQOR4A100M315	PBPQOR5A100M315	PBPQOR5B100M315
15	QOB	PBPQOR4A100M315B	PBPQOR5A100M315B	PBPQOR5B100M315B
20	QO	PBPQOR4A100M320	PBPQOR5A100M320	PBPQOR5B100M320
20	QOB	PBPQOR4A100M320B	PBPQOR5A100M320B	PBPQOR5B100M320B
Type 4 (3 circuit breakers w. 3 locking receptacles)				
15	QO	PBPQOR4A100M415	PBPQOR5A100M415	PBPQOR5B100M415
15	QOB	PBPQOR4A100M415B	PBPQOR5A100M415B	PBPQOR5B100M415B
20	QO	PBPQOR4A100M420	PBPQOR5A100M420	PBPQOR5B100M420
20	QOB	PBPQOR4A100M420B	PBPQOR5A100M420B	PBPQOR5B100M420B

Table 12.8: Factory Assembled Units: One (1) QOU circuit breaker and one (1) drop cord with connector^{[10][11]}

Circuit Breaker Rating	Poles	NEMA Connector	Drop Cord Length (ft)	4A Configuration Catalog Number	5A Configuration Catalog Number	5B Configuration Catalog Number
15 A	1	L5-15	3	PBPQOU4A100COOL515	PBPQOU5A100COOL515	PBPQOU5B100COOL515
20 A	1	L5-20	3	PBPQOU4A100COOL520	PBPQOU5A100COOL520	PBPQOU5B100COOL520
30 A	1	L5-30	3	PBPQOU4A100COOL530	PBPQOU5A100COOL530	PBPQOU5B100COOL530
15 A	2	L6-15	3	PBPQOU4A100COOL615	PBPQOU5A100COOL615	PBPQOU5B100COOL615
20 A	2	L6-20	3	PBPQOU4A100COOL620	PBPQOU5A100COOL620	PBPQOU5B100COOL620
30 A	2	L6-30	3	PBPQOU4A100COOL630	PBPQOU5A100COOL630	PBPQOU5B100COOL630
20 A	3	L21-20	3	PBPQOU4A100COOL2120	PBPQOU5A100COOL2120	PBPQOU5B100COOL2120
30 A	3	L21-30	3	PBPQOU4A100COOL2130	PBPQOU5A100COOL2130	PBPQOU5B100COOL2130
15 A	1	L5-15	6	PBPQOU4A100FOOL515	PBPQOU5A100FOOL515	PBPQOU5B100FOOL515
20 A	1	L5-20	6	PBPQOU4A100FOOL520	PBPQOU5A100FOOL520	PBPQOU5B100FOOL520
30 A	1	L5-30	6	PBPQOU4A100FOOL530	PBPQOU5A100FOOL530	PBPQOU5B100FOOL530
15 A	2	L6-15	6	PBPQOU4A100FOOL615	PBPQOU5A100FOOL615	PBPQOU5B100FOOL615
20 A	2	L6-20	6	PBPQOU4A100FOOL620	PBPQOU5A100FOOL620	PBPQOU5B100FOOL620
30 A	2	L6-30	6	PBPQOU4A100FOOL630	PBPQOU5A100FOOL630	PBPQOU5B100FOOL630
20 A	3	L21-20	6	PBPQOU4A100FOOL2120	PBPQOU5A100FOOL2120	PBPQOU5B100FOOL2120
30 A	3	L21-30	6	PBPQOU4A100FOOL2130	PBPQOU5A100FOOL2130	PBPQOU5B100FOOL2130

[8] Many more factory assembled units are available using combinations of 1P/2P/3P circuit breakers with other NEMA receptacles. Maximum of 3 breaker spaces available. Consult your local Schneider Electric representative.
 [9] See Digest Section 7, QO™ and QOU Miniature Circuit Breakers, page 7-11 for QOU circuit breaker information.
 [10] Factory assembled units are available using combinations of 1P/2P/3P circuit breakers with other NEMA and IEC type receptacles. Maximum of three drop cords with six breaker spaces available. Consult your local Schneider Electric representative.
 [11] See Digest Section 7, QO™ and QOU Miniature Circuit Breakers, page 7-11 for QOU circuit breaker information. Catalog numbers shown have the breaker in the top slot in the front cover and the drop cord in the left position in the base of the unit. Other combinations are available.

Powerbus Plug-in Units with Metering

Powerbus plug-in units with metering are rated maximum 100 A and are offered as factory assembled units. All units conform to NEMA type 1.

Table 12.9: Factory Assembled Units with NEMA Connectors and Metering^{[12][13]}

Circuit Breaker		NEMA Connector	Drop Cord Length (ft)	Catalog Number ^{[14][15]}		
Rating	Poles			4A Configuration	5A Configuration	5B Configuration
15 A	1	L5-15	3	PBPEDU4A100COOL515M()	PBPEDU5A100COOL515M()	PBPEDU5B100COOL515M()
20 A	1	L5-20	3	PBPEDU4A100COOL520M()	PBPEDU5A100COOL520M()	PBPEDU5B100COOL520M()
30 A	1	L5-30	3	PBPEDU4A100COOL530M()	PBPEDU5A100COOL530M()	PBPEDU5B100COOL530M()
15 A	2	L6-15	3	PBPEDU4A100COOL615M()	PBPEDU5A100COOL615M()	PBPEDU5B100COOL615M()
20 A	2	L6-20	3	PBPEDU4A100COOL620M()	PBPEDU5A100COOL620M()	PBPEDU5B100COOL620M()
30 A	2	L6-30	3	PBPEDU4A100COOL630M()	PBPEDU5A100COOL630M()	PBPEDU5B100COOL630M()
20 A	3	L21-20	3	PBPEDU4A100COOL2120M()	PBPEDU5A100COOL2120M()	PBPEDU5B100COOL2120M()
30 A	3	L21-30	3	PBPEDU4A100COOL2130M()	PBPEDU5A100COOL2130M()	PBPEDU5B100COOL2130M()
15 A	1	L5-15	6	PBPEDU4A100FOOL515M()	PBPEDU5A100FOOL515M()	PBPEDU5B100FOOL515M()
20 A	1	L5-20	6	PBPEDU4A100FOOL520M()	PBPEDU5A100FOOL520M()	PBPEDU5B100FOOL520M()
30 A	1	L5-30	6	PBPEDU4A100FOOL530M()	PBPEDU5A100FOOL530M()	PBPEDU5B100FOOL530M()
15 A	2	L6-15	6	PBPEDU4A100FOOL615M()	PBPEDU5A100FOOL615M()	PBPEDU5B100FOOL615M()
20 A	2	L6-20	6	PBPEDU4A100FOOL620M()	PBPEDU5A100FOOL620M()	PBPEDU5B100FOOL620M()
30 A	2	L6-30	6	PBPEDU4A100FOOL630M()	PBPEDU5A100FOOL630M()	PBPEDU5B100FOOL630M()
20 A	3	L21-20	6	PBPEDU4A100FOOL2120M()	PBPEDU5A100FOOL2120M()	PBPEDU5B100FOOL2120M()
30 A	3	L21-30	6	PBPEDU4A100FOOL2130M()	PBPEDU5A100FOOL2130M()	PBPEDU5B100FOOL2130M()

Table 12.10: Factory Assembled Units with IEC Connectors and Metering^{[12][13]}

Circuit Breaker		IEC 60309 Connector ^[16]	Drop Cord Length (ft)	Catalog Number ^{[15][17]}		
Rating	Poles			4A Configuration	5A Configuration	5B Configuration
20	2	2-Pole, 3-Wire Grounding	3	PBPEDU4A100COOS3420M()	PBPEDU5A100COOS3420M()	PBPEDU5B100COOS3420M()
30	2	2-Pole, 3-Wire Grounding	3	PBPEDU4A100COOS3430M()	PBPEDU5A100COOS3430M()	PBPEDU5B100COOS3430M()
60	2	2-Pole, 3-Wire Grounding	3	PBPEDU4A100COOS3460M()	PBPEDU5A100COOS3460M()	PBPEDU5B100COOS3460M()
20	3	3-Pole, 4-Wire Grounding	3	PBPEDU4A100COOS4420M()	PBPEDU5A100COOS4420M()	PBPEDU5B100COOS4420M()
30	3	3-Pole, 4-Wire Grounding	3	PBPEDU4A100COOS4430M()	PBPEDU5A100COOS4430M()	PBPEDU5B100COOS4430M()
60	3	3-Pole, 4-Wire Grounding	3	PBPEDU4A100COOS4460M()	PBPEDU5A100COOS4460M()	PBPEDU5B100COOS4460M()
20	3	4-Pole, 5-Wire Grounding	3	PBPEDU4A100COOS5420M()	PBPEDU5A100COOS5420M()	PBPEDU5B100COOS5420M()
30	3	4-Pole, 5-Wire Grounding	3	PBPEDU4A100COOS5430M()	PBPEDU5A100COOS5430M()	PBPEDU5B100COOS5430M()
60	3	4-Pole, 5-Wire Grounding	3	PBPEDU4A100COOS5460M()	PBPEDU5A100COOS5460M()	PBPEDU5B100COOS5460M()

Table 12.11: Meter Suffix Number

Meter Suffix ^[18]	System Voltage
1	208Y/120 V 3Ø4W
2	240 V 3Ø3W
4	415/240 V 3Ø4W
5	480Y/277 V 3Ø4W

Table 12.12: Gateway Plug-in Unit (480 V Max)^[19]

4A Configuration	5A Configuration	5B Configuration
Catalog No.	Catalog No.	Catalog No.
PBPEGX4A100T	PBPEGX5A100T	PBPEGX5B100T

Table 12.13: NEMA Receptacles and Connectors^[20]

Wiring	Voltage	NEMA Non-Locking			NEMA Locking		
		15 A	20 A	30 A	15 A	20 A	30 A
2-pole, 3-wire grounding	120	5-15	5-20	5-30	L5-15	L5-20	L5-30
2-pole, 3-wire grounding	240	6-15	6-20	6-30	L6-15	L6-20	L6-20
3-pole, 4-wire grounding	120/240	14-15	14-20	14-30	—	L14-20	L14-30
3-pole, 4-wire grounding	3Ø 240	15-15	15-20	15-30	—	L15-20	L15-30
4-pole, 5-wire grounding	3ØY 120/208	—	—	—	—	L21-20	L21-30

Table 12.14: Short Circuit Current Rating^[21]

Product	Short-Circuit Current Rating KA, RMS Symmetrical UL 3-Cycle Test
100 A	14 kA
225 A	22 kA
400 A	35 kA

[12] See Digest Section 9, For NF Merchandised Panelboards, page 9-25 for ED circuit breaker information. Catalog numbers shown have the breaker in the top slot in the front cover and the drop cord in the left position in the base of the unit. Other combinations are available. The Power Meter display will be located below the breaker space. For remote monitoring capabilities, a gateway is required. The gateway is located in the tap box with metering or in a separate gateway plug-in unit listed below. The units with metering can be daisy-chained together back to the gateway. A maximum of 30 units should be daisy-chained together to one gateway.

[13] Factory assembled units are available using combinations of 1P/2P/3P circuit breakers with other NEMA and IEC type receptacles. Maximum of three drop cords with three breaker spaces available. Consult your local Schneider Electric representative.

[14] For IP54 splash resistant construction, add an "M54" suffix.

[15] For metering, replace () in catalog number with the appropriate number in Table 12.11 Meter Suffix Number, page 12-5. Connectors must be rated for appropriate voltages.

[16] Other IEC Connectors are available.

[17] For the offer without metering, do not use the suffix "M" or any numbers following.

[18] Replace () in above tables with the appropriate meter suffix number. Connectors must be rated for appropriate voltages.

[19] For remote monitoring capabilities, a gateway is required. The gateway is located in the tap box with metering or in a separate gateway plug-in unit listed above. Units with metering can be daisy-chained together back to the gateway. A maximum of 30 units should be daisy-chained together to one gateway.

[20] Additional NEMA, IEC, and California Standard type receptacles and connectors are available.

[21] See 5600CT9101 for fuse and circuit breaker series connected ratings.

I-Line™ Standard Components and Accessories

Table 12.15: Standard Components—Aluminum

Aluminum		G PH PH PH N		G PH PH PH N		G PH PH PH N		G PH PH PH N		G PH PH PH N	
Number of Poles and Voltage	Rating (A)	10'-0" Length	6'-0" Length	Front Elbow ^[1]	Top Elbow ^[1]	Plug-In Tee	Plug-In Tap Box				
		Catalog No.	Catalog No.	Catalog No.	Catalog No.	Catalog No.	Catalog No.				
3Ø3W	225	AP30210	AP3026	AP302LF ()	AP302LT ()	PTT23W	—				
	400	AP30410	AP3046	AP304LF ()	AP304LT ()	PTT33W	PBTB306				
	600	AP30610	AP3066	AP306LF ()	AP306LT ()	PTT43W	PBTB306				
3Ø4W	225	AP50210	AP5026	AP502LF ()	AP502LT ()	PTT24W	PTB502				
	400	AP50410	AP5046	AP504LF ()	AP504LT ()	PTT34W	PBTB506				
	600	AP50610	AP5066	AP506LF ()	AP506LT ()	PTT44W	PBTB506				
3Ø3W + Integral Ground Bus	225	AP302G10	AP302G6	AP302GLF ()	AP302GLT ()	PTT23WG	PTB302G				
	400	AP304G10	AP304G6	AP304GLF ()	AP304GLT ()	PTT33WG	PBTB306G				
	600	AP306G10	AP306G6	AP306GLF ()	AP306GLT ()	PTT43WG	PBTB306G				
3Ø4W + Integral Ground Bus	225	AP502G10	AP502G6	AP502GLF ()	AP502GLT ()	PTT24WG	PTB502G				
	400	AP504G10	AP504G6	AP504GLF ()	AP504GLT ()	PTT34WG	PBTB506G				
	600	AP506G10	AP506G6	AP506GLF ()	AP506GLT ()	PTT44WG	PBTB506G				

Table 12.16: Standard Components—Copper

Copper		G PH PH PH N		G PH PH PH N		G PH PH PH N		G PH PH PH N		G PH PH PH N	
Number of Poles and Voltage	Rating (A)	10'-0" Length	6'-0" Length	Front Elbow ^[1]	Top Elbow ^[1]	Plug-In Tee	Plug-In Tap Box				
		Catalog No.	Catalog No.	Catalog No.	Catalog No.	Catalog No.	Catalog No.				
3Ø3W	225	CP30210	—	CP302LF ()	CP302LT ()	PTT23W	—				
	400	CP30410	CP3046	CP304LF ()	CP304LT ()	PTT33W	PBTB306				
	600	CP30610	CP3066	CP306LF ()	CP306LT ()	PTT43W	PBTB306				
3Ø4W	225	CP50210	—	CP502LF ()	CP502LT ()	PTT24W	—				
	400	CP50410	CP5046	CP504LF ()	CP504LT ()	PTT34W	PBTB506				
	600	CP50610	CP5066	CP506LF ()	CP506LT ()	PTT44W	PBTB506				
3Ø3W + Integral Ground Bus	225	CP302G10	—	CP302GLF ()	CP302GLT ()	PTT23WG	PTB302G				
	400	CP304G10	CP304G6	CP304GLF ()	CP304GLT ()	PTT33WG	PBTB306G				
	600	CP306G10	CP306G6	CP306GLF ()	CP306GLT ()	PTT43WG	PBTB306G				
3Ø4W + Integral Ground Bus	225	CP502G10	—	CP502GLF ()	CP502GLT ()	PTT24WG	PTB502G				
	400	CP504G10	CP504G6	CP504GLF ()	CP504GLT ()	PTT34WG	PBTB506G				
	600	CP506G10	CP506G6	CP506GLF ()	CP506GLT ()	PTT44WG	PBTB506G				

Table 12.17: Common Accessories

Ampere Rating		Hanger ^[2]				End Closure	Wall Flange	Floor Flange
Aluminum	Copper	Flatwise	Vertical	Edgewise	Seismic	Catalog No.	Catalog No.	Catalog No.
225	225	HP2F	HP2V	HP3E	HP2SH	ACP2EC	ACP2WF	ACP2FF
400	400	HP3F	HP3V	HP3E	HP3SH	ACP3EC	ACP3WF	ACP3FF
—	600	HP3F	HP3V	HP3E	HP3SH	ACP3EC	ACP3WF	ACP3FF
600	—	HP5F	HP4V	HP5E	HP5SH	ACP4EC	ACP4WF	ACP4FF

[1] Add "I" for inside elbow; add "O" for outside elbow.

[2] For seismic applications, seismic hangers must be used with horizontal mount flatwise or edgewise busway. Vertical mount busway may use standard fixed or spring hangers.

I-Line™ II Straight Lengths, Fittings, and Accessories

Table 12.18: Straight Lengths (10 ft.) and Plug-in Tap Box

Number of Poles	Ampere Rating	Aluminum		Both Aluminum and Copper	Copper	
		G PH PH PH N	G PH PH PH N	G PH PH PH N	G PH PH PH N	G PH PH PH N
		10'0" Length		Plug-In Tap Box ^{[1][2]}	10'0" Length	
Feeder Style ^[3]	Plug-In Style ^[4]	Feeder Style ^[3]	Plug-In Style ^[4]			
		Catalog No.	Catalog No.	Catalog No.	Catalog No.	Catalog No.
3Ø3W + Integral Ground Bus	800	AF2308G10ST	AP2308G10ST	PTB316G()	CF2308G10ST	CP2308G10ST
	1000	AF2310G10ST	AP2310G10ST	PTB316G()	CF2310G10ST	CP2310G10ST
	1200	AF2312G10ST	AP2312G10ST	PTB316G()	CF2312G10ST	CP2312G10ST
	1350	—	—	PTB316G()	—	—
	1600	AF2316G10ST	AP2316G10ST	PTB316G()	CF2316G10ST	CP2316G10ST
	2000	AF2320G10ST	AP2320G10ST	—	CF2320G10ST	CP2320G10ST
	2500	AF2325G10ST	AP2325G10ST	—	—	—
3Ø4W + Integral Ground Bus	3000	AF2330G10ST	AP2330G10ST	—	—	CP2330G10ST
	800	AF2508G10ST	AP2508G10ST	PTB516G()	CF2508G10ST	CP2508G10ST
	1000	AF2510G10ST	AP2510G10ST	PTB516G()	CF2510G10ST	CP2510G10ST
	1200	AF2512G10ST	AP2512G10ST	PTB516G()	CF2512G10ST	CP2512G10ST
	1350	—	—	PTB516G()	—	—
	1600	AF2516G10ST	AP2516G10ST	PTB516G()	CF2516G10ST	CP2516G10ST
	2000	AF2520G10ST	AP2520G10ST	—	CF2520G10ST	CP2520G10ST
	2500	AF2525G10ST	AP2525G10ST	—	—	—
3000	AF2530G10ST	AP2530G10ST	—	—	CP2530G10ST	

Table 12.19: Fittings (All Feeder Style)

Number of Poles	Ampere Rating	Aluminum			Copper		
		End Tap Box	Edgewise Elbow	Flatwise Elbow	End Tap Box	Edgewise Elbow	Flatters Elbow
		Catalog No.	Catalog No.	Catalog No.	Catalog No.	Catalog No.	
3Ø3W with Integral Ground Bus	800	AF2308GETBMB	AF2308GLEM11	AF2308GLFM11	CF2308GETBMB	CF2308GLEM11	CF2308GLFM11
	1000	AF2310GETBMB	AF2310GLEM11	AF2310GLFM12	CF2310GETBMB	CF2310GLEM11	CF2310GLFM11
	1200	AF2312GETBMB	AF2312GLEM11	AF2312GLFM12	CF2312GETBMB	CF2312GLEM11	CF2312GLFM12
	1350	—	AF2313GLEM11	AF2313GLFM13	CF2313GETBMB	CF2313GLEM11	CF2313GLFM12
	1600	AF2316GETBMB	AF2316GLEM11	AF2316GLFM13	CF2316GETBMB	CF2316GLEM11	CF2316GLFM12
	2000	AF2320GETBMB	AF2320GLEM11	AF2320GLFM15	CF2320GETBMB	CF2320GLEM11	CF2320GLFM13
	2500	AF2325GETBMB	AF2325GLEM11	AF2325GLFM17	CF2325GETBMB	CF2325GLEM11	CF2325GLFM15
	3000	AF2330GETBMB	AF2330GLEM11	AF2330GLFM18	CF2330GETBMB	CF2330GLEM11	CF2330GLFM16
	3200	—	—	—	—	CF2332GLEM11	CF2332GLFM17
	4000	—	AF2340GLEM11	AF2340GLFM22	CF2340GETBMB	CF2340GLEM11	CF2340GLFM21
5000	—	—	—	CF2350GETBMB	CF2350GLEM11	CF2350GLFM21	
3Ø4W with Integral Ground Bus	800	AF2508GETBMB	AF2508GLEM11	AF2508GLFM11	CF2508GETBMB	CF2508GLEM11	CF2508GLFM11
	1000	AF2510GETBMB	AF2510GLEM11	AF2510GLFM12	CF2510GETBMB	CF2510GLEM11	CF2510GLFM11
	1200	AF2512GETBMB	AF2512GLEM11	AF2512GLFM12	CF2512GETBMB	CF2512GLEM11	CF2512GLFM12
	1350	—	AF2513GLEM11	AF2513GLFM13	CF2513GETBMB	CF2513GLEM11	CF2513GLFM12
	1600	AF2516GETBMB	AF2516GLEM11	AF2516GLFM13	CF2516GETBMB	CF2516GLEM11	CF2516GLFM12
	2000	AF2520GETBMB	AF2520GLEM11	AF2520GLFM15	CF2520GETBMB	CF2520GLEM11	CF2520GLFM13
	2500	AF2525GETBMB	AF2525GLEM11	AF2525GLFM17	CF2525GETBMB	CF2525GLEM11	CF2525GLFM15
	3000	AF2530GETBMB	AF2530GLEM11	AF2530GLFM18	CF2530GETBMB	CF2530GLEM11	CF2530GLFM16
	3200	—	—	—	—	CF2532GLEM11	CF2532GLFM17
	4000	AF2540GETBMB	AF2540GLEM11	AF2540GLFM22	CF2540GETBMB	CF2540GLEM11	CF2540GLFM21
5000	—	—	—	CF2550GETBMB	CF2550GLEM11	CF2550GLFM21	

[1] To complete the catalog number, replace the blank with an "H" for the plug-in unit to be mounted on horizontally-oriented busway and "V" for the plug-in unit to be mounted on vertically-oriented busway.
 [2] Cannot be used for 800 A copper busway.
 [3] Feeder style available in lengths from 16 to 120 inches.
 [4] Plug-in style also available in 4, 6, and 8 foot lengths.

Table 12.20: Accessories

Ampere Rating		Hangers ^[5]				End Closure	Wall Flange	
Al	Cu	Horizontal Mount Busway		Vertical Mount Busway		Seismic	Catalog No.	Catalog No.
		Flatwise	Edgewise	Fixed	Spring			
—	800	HF38F	HF43E	HFV	HFVS1	HF38SH	ACF38EC	ACF38WF
800	1000	HF43F	HF43E	HFV	HFVS1	HF43SH	ACF43EC	ACF43WF
1000	1200	HF53F	HF58E	HFV	HFVS1	HF53SH	ACF53EC	ACF53WF
—	1350	HF58F	HF58E	HFV	HFVS2	HF58SH	ACF58EC	ACF58WF
1200	—	HF63F	HF67E	HFV	HFVS1	HF63SH	ACF63EC	ACF63WF
—	1600	HF67F	HF67E	HFV	HFVS2	HF67SH	ACF67EC	ACF67WF
1350	—	HF73F	HF78E	HFV	HFVS1	HF73SH	ACF73EC	ACF73WF
—	2000	HF78F	HF78E	HFV	HFVS2	HF78SH	ACF78EC	ACF78WF
1600	—	HF88F	HF88E	HFV	HFVS1	HF88SH	ACF88EC	ACF88WF
2000	—	HF13F	HF13E	HFV	HFVS2	HF13SH	ACF13EC	ACF13WF
—	2500	HF13F	HF13E	HFV	HFVS8	HF13SH	ACF13EC	ACF13WF
2500	—	HF16F	HF16E	HFV	HFVS2	HF16SH	ACF17EC	ACF17WF
—	3000	HF15F	HF15E	HFV	HFVS8	HF15SH	ACF15EC	ACF15WF
—	3200	HF16F	HF16E	HFV	HFVS8	HF16SH	ACF17EC	ACF17WF
3000	—	HF19F	HF19E	HFV	HFVS8	HF19SH	ACF19EC	ACF19WF
4000	—	HF26F	HF26E	HFV	HFVS8	HF26SH	ACF26EC	ACF26WF
—	4000	HF24F	HF24E	HFV	HFVS8	HF24SH	ACF24EC	ACF24WF
—	5000	HF25F	HF26E	HFV	HFVS8	HF25SH	ACF25EC	ACF25WF

^[5] For seismic applications, seismic hangers must be used with horizontal mount flatwise or edgewise busway. Vertical mount busway may use standard fixed or spring hangers.

Standard Straight Lengths

The basic component of a busway system is a straight section with a “joint pak” factory-affixed to one end. Plug-in busway is available in standard lengths of 4, 6, 8, and 10 feet. Feeder busway is available in lengths from 16” to 120” in increments of 1”.

Riser Busway

We also offer a “Riser” Plug-In busway with openings on one side only for riser installations. This busway offers the same short circuit ratings as our standard plug-in busway.

Indoor Drip Resistant and IP54 Splash Resistant Busway

These water resistant features are available as an option for indoor plug-in and feeder busway.

Outdoor Construction

Outdoor construction is only available in feeder busway. It prevents the entry of rain and can be installed in any mounting position.

High Short Circuit Bracing

I-Line busway is available with either standard short circuit bracing or high short circuit bracing. [Electrical Data for I-Line II Busway, page 12-10](#) lists maximum short circuit ratings for each busway type and rating.

Hangers

Indoor horizontal busway requires one hanger for every 10 feet of busway. Vertical indoor busway requires one hanger for every 16 feet. Outdoor feeder busway requires one hanger for every 5 feet in horizontal mounting and one hanger for every 10 feet in vertical mounting.

Elbows

90° elbows are standard. 91° elbows to 179° elbows in 1° increments are also available.

Tee

90° flatwise tees fittings are standard. Edgewise tees and crosses are also available.

Indoor Tap Boxes

Feeder cable tap boxes are used at the end (-ETBMB) or center (-CTB) of a busway run and incorporate a short section of busway into their construction. See [5600CT9101](#) for the length of the tap box.

Plug-in cable tap boxes are plugged into the side of the busway (at any opening except the very last opening of a run).

Lugs other than standard mechanical lugs are available.

Service Heads

Service heads are of outdoor construction and include Square D™ brand standard lugs.

Unfused Reducer

Unfused reducers are used to reduce from a higher amperage busway to a lower amperage.

NOTE: The National Electric Code does not allow the use of unfused reducers in vertical riser installations. Refer to the NEC for restrictions in industrial installations.

Fused or Circuit Breaker Cubicle

These are used as in-line overcurrent protection devices. They can be used in conjunction with an unfused reducer to offer a device which reduces a run of busway in ampacity and offers overcurrent protection.

I-Line to I-Line II Adapter

This adapter is used to join I-Line II busway (800 A–5000 A) to existing installations of original I-Line busway. If connecting to an existing “slot end” of original I-Line, use a “bolt end” adapter (-12B), and vice versa.

Expansion Fittings

The expansion fitting is built into a 3 ft. – 4 in. straight length for 800 A–5000 A and a 5 feet – 0 inch straight length for 225 A–600 A. Limit of expansion or contraction is ±1-1/2 inches. Not available in outdoor construction.

Bussed Transformer Connection

A bussed transformer connection is used when the busway physically attaches (other than cable) to a three phase transformer. For power company vault termination information, consult the factory.

Transformer Taps

Transformer taps are used to make cable connection to transformers. Lugs other than standard Square D brand lugs are available. Note that taps need **NOT** be located directly above transformers for cable connections.

Connection to Competitive Busway

Consult your nearest Schneider Electric sales office.

Electrical Data for I-Line II Busway

Standards:	UL857 (File Number E22182); CSA C22.2 No. 27-1994 (File Number LL-61778); IEC 61439-6
Systems:	AC-3Ø3W, 3Ø4W, 1Ø2W, 1Ø3W. DC-2-pole. All neutrals are 100% capacity.
Voltage:	600 volts AC/DC, 50 Hz and 60 Hz
Integral Ground:	50% capacity as standard for 800 A to 5000 A, as an option on 225 A to 600 A
Enclosure:	Indoor, indoor drip resistant, indoor splash resistant (IP54), and outdoor (indoor drip resistant, indoor splash resistant (IP54), and outdoor are available in I-Line II [800-5000 A] busway only)

Table 12.21: Short Circuit Ratings: UL 3 Cycle Test (KA, RMS Symmetrical)^[6]

Ampere Rating	Aluminum				Copper			
	AOF2 AF2	AOFH AFH2	AP AP2/AR2	APH APH2/ ARH2	COF2 CF2	COFH CFH2	CP CP2/CR2	CPH CPH2/ CRH2
225	—	—	22	—	—	—	22	—
400	—	—	22	42	—	—	22	42
600	—	—	22	42	—	—	22	42
800	50	85	50	75	50	85	50	75
1000	50	100	50	100	50	85	50	75
1200	50	100	50	100	50	100	50	100
1350	50	100	50	100	50	100	50	100
1600	50	100	50	100	50	100	50	100
2000	100	150	125	150	50	100	65	100
2500	100	150	125	150	100	150	125	150
3000	100	150	125	150	100	150	125	150
3200	—	—	—	—	100	150	125	150
4000	150	200	200	200	150	200	200	200
5000	—	—	—	—	150	200	200	200

Fusible Plug-In Units, Class R Fuse Kits, and Hooksticks

Table 12.22: Fusible Plug-In Units^[7]

Ampere Rating	Type of Connection	240 Vac 3-Pole, 3 Fuse + G	120/208 Vac, (240 Vac Max.) 4-Pole, 3 Fuse + G	600 Vac 3-Pole, 3 Fuse + G	277/480 Vac, (600 Vac Max.) 4-Pole, 3 Fuse + G
		Catalog No.	Catalog No.	Catalog No.	Catalog No.
30	Plug-in	PQ3203G	PQ4203G	PQ3603G	PQ4603G
60		PQ3206G	PQ4206G	PQ3606G	PQ4606G
100		PQ3210G	PQ4210G	PQ3610G	PQ4610G
200		PQ3220G	PQ4220G	PQ3620G	PQ4620G
200 ^[8]		PS3220G ^[8]	PS4220G ^[8]	PS3620G ^[8]	PS4620G ^[8]
400		PBQ3640G ^[9]	PBQ4640G ^[9]	PBQ3640G ^[9]	PBQ4640G ^[9]
600		PBQ3660G ^[9]	PBQ4660G ^[9]	PBQ3660G ^[9]	PBQ4660G ^[9]
800	Bolt-on	—	—	PTQ36080G() ^[10]	PTQ46080G() ^[10]
1000		—	—	PTQ36100G() ^[10]	PTQ46100G() ^[10]
1200		—	—	PTQ36120G() ^[10]	PTQ46120G() ^[10]

Class J Fuses – Provisions for installing Class J fuses are included in 30 through 600 A fusible devices. Conversion to Class J fuse spacing requires relocating the load side fuse base assembly from standard Class H fuse location to an alternate position in the enclosure.



"Hook-Swing" Mounting

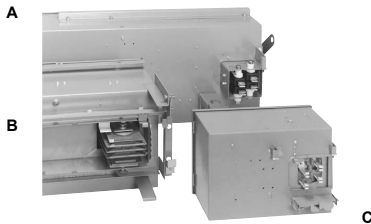

A – High Ampere Plug-In Connection
B – High Ampere Bolt-On Connection
C – Low Ampere Plug-In Connection

There are three different types of plug-in connections:

- High Ampere Bolt-On Connection (catalog numbers that begin with "PT")—bolted "joint pack" type connection
 - Used on I-Line™/I-Line II busway amperages 800 A aluminum and greater.
 - Used on I-Line™/I-Line II busway amperages 1000 A copper and greater.
- High Ampere Plug-In Connection (catalog numbers that begin with "PB")—individual bolted jaws for connections
- Low Ampere Plug-In Connection (catalog numbers that begin with "P," except for "PB" and "PT")—spring pressure jaws for connection

Table 12.23: Class R Fuse Kits^[11]

Switch Size (A)	Voltage Rating	Kit ^[11] Catalog No.
30	250 V ^[12]	QMB30R
	600 V ^[12]	QMB36R
60	250 V ^[12]	QMB36R
	600 V ^[12]	QMB60R
100 200	All	HRK1020
400 600	All	QMB4060R

Class R Fuse Kits when installed reject all but class R fuses.

^[6] 6-cycle and 30-cycle, and fuse/circuit breaker series connected ratings are available. Please reference 5600CT9101.

^[7] For IP54 splash resistant construction, add an "M54" suffix.

^[8] For use on vertical riser applications only.

^[9] For vertical riser applications, order auxiliary mounting kit—Catalog Number PBQ4060RMK.

^[10] This device uses bolt-on connection. It may be used only on plug-in busway with same number of poles. To complete the catalog number, replace the blank with an "H" for the plug-in unit to be mounted on horizontally-oriented busway and "V" for the plug-in unit to be mounted on vertically-oriented busway. Not for use on 800 A copper busway.

^[11] Kit must be field installed.

^[12] Contains parts to convert two units.

Table 12.24: Hooksticks

Length	Catalog No.
8'	515608
14'	515614

Surge Protective Device Plug-In Units

All Busway SPD Plug-In Units include as standard:

- Individually Fused Modules
- Circuit Breaker Disconnect
- Cover Mounted Diagnostic Panel
- EMI/RFI Filter
- Audible Alarm with Test/Disable/Enable

Table 12.25: Surge Capacity

System Voltage	160,000 Amperes Per Phase	240,000 Amperes Per Phase
	Catalog Number ^[13]	Catalog Number ^[13]
208Y/120 Vac, 3Ø4W/Grd.	PIU2IMA16	PIU2IMA24
240Y/120 Vac, 3Ø4W/Grd.	PIU3IMA16	PIU3IMA24
480Y/277 Vac, 3Ø4W/Grd.	PIU4IMA16	PIU4IMA24
600Y/347 Vac, 3Ø4W/Grd.	PIU8IMA16	PIU8IMA24

Table 12.26: Options

Description	When Required Add Suffix to Catalog Number
Surge Counter and Dry Contacts	—
Remote Monitor with Dry Contacts	M

[13] For IP54 splash resistant construction, add an "M54" suffix.

H- and J-Frame Plug-In Units

Table 12.27: H-Frame Circuit Breaker Plug-in Units—Standard (80%) Rated—3Ø3W

Trip Rating Ampere	D Interrupting	G Interrupting	J Interrupting	L Interrupting
	Catalog No. [14]	Catalog No. [14]	Catalog No. [14]	Catalog No. [14]
3Ø3W + G, 600 Vac 50/60 Hz				
15	PHD36015G	PHG36015G	PHJ36015G	PHL36015G
20	PHD36020G	PHG36020G	PHJ36020G	PHL36020G
30	PHD36030G	PHG36030G	PHJ36030G	PHL36030G
40	PHD36040G	PHG36040G	PHJ36040G	PHL36040G
50	PHD36050G	PHG36050G	PHJ36050G	PHL36050G
60	PHD36060G	PHG36060G	PHJ36060G	PHL36060G
70	PHD36070G	PHG36070G	PHJ36070G	PHL36070G
80	PHD36080G	PHG36080G	PHJ36080G	PHL36080G
90	PHD36090G	PHG36090G	PHJ36090G	PHL36090G
100	PHD36100G	PHG36100G	PHJ36100G	PHL36100G
125	PHD36125G	PHG36125G	PHJ36125G	PHL36125G
150	PHD36150G	PHG36150G	PHJ36150G	PHL36150G

Table 12.28: H-Frame Circuit Breaker Plug-in Units—Standard (80%) Rated—3Ø4W

Trip Rating Ampere	D Interrupting	G Interrupting	J Interrupting	L Interrupting
	Catalog No. [14]	Catalog No. [14]	Catalog No. [14]	Catalog No. [14]
3Ø4W + G, 600 Vac Max. 50/60 Hz				
15	PHD36015GN	PHG36015GN	PHJ36015GN	PHL36015GN
20	PHD36020GN	PHG36020GN	PHJ36020GN	PHL36020GN
30	PHD36030GN	PHG36030GN	PHJ36030GN	PHL36030GN
40	PHD36040GN	PHG36040GN	PHJ36040GN	PHL36040GN
50	PHD36050GN	PHG36050GN	PHJ36050GN	PHL36050GN
60	PHD36060GN	PHG36060GN	PHJ36060GN	PHL36060GN
70	PHD36070GN	PHG36070GN	PHJ36070GN	PHL36070GN
80	PHD36080GN	PHG36080GN	PHJ36080GN	PHL36080GN
90	PHD36090GN	PHG36090GN	PHJ36090GN	PHL36090GN
100	PHD36100GN	PHG36100GN	PHJ36100GN	PHL36100GN
125	PHD36125GN	PHG36125GN	PHJ36125GN	PHL36125GN
150	PHD36150GN	PHG36150GN	PHJ36150GN	PHL36150GN

Table 12.29: J-Frame Circuit Breaker Plug-in Units—Standard (80%) Rated—3Ø3W

Trip Rating Ampere	D Interrupting	G Interrupting	J Interrupting	L Interrupting
	Catalog No. [14]	Catalog No. [14]	Catalog No. [14]	Catalog No. [14]
3Ø3W + G, 600 Vac 50/60 Hz				
175	PJD36175G	PJG36175G	PJJ36175G	PJL36175G
200	PJD36200G	PJG36200G	PJJ36200G	PJL36200G
225	PJD36225G	PJG36225G	PJJ36225G	PJL36225G
250	PJD36250G	PJG36250G	PJJ36250G	PJL36250G

Table 12.30: J-Frame Circuit Breaker Plug-in Units—Standard (80%) Rated—3Ø4W

Trip Rating Ampere	D Interrupting	G Interrupting	J Interrupting	L Interrupting
	Catalog No. [14]	Catalog No. [14]	Catalog No. [14]	Catalog No. [14]
3Ø4W + G, 600 Vac Max. 50/60 Hz				
175	PJD36175GN	PJG36175GN	PJJ36175GN	PJL36175GN
200	PJD36200GN	PJG36200GN	PJJ36200GN	PJL36200GN
225	PJD36225GN	PJG36225GN	PJJ36225GN	PJL36225GN
250	PJD36250GN	PJG36250GN	PJJ36250GN	PJL36250GN

Table 12.31: Circuit Breaker Interrupting Ratings

Interrupting Ratings (kA)	D	G	J	L	R
240 V	25	65	100	125	200
480 V	18	35	65	100	200
600 V	14	18	25	50	100

[14] For IP54 splash resistant construction, add an "M54" suffix.

H-, J-, and L-Frame Plug-In Units with Electronic Trip

Table 12.32: H- and J-Frame Circuit Breaker Plug-in Units with Electronic Trip—Standard (80%) Rated—3Ø3W

Trip Rating Ampere	Trip Function ^[15]	Trip Unit ^[16]	D Interrupting	G Interrupting	J Interrupting	L Interrupting
			Catalog Number ^{[17][18][19]}	Catalog Number ^{[17][18][19]}	Catalog Number ^{[17][18][19]}	Catalog Number ^{[17][18][19]}
MicroLogic Standard Trip Unit						
3Ø3W + G, 600 Vac 50/60 Hz						
60	LI	3.2	PHD36060GU31X	PHG36060GU31X	PHJ36060GU31X	PHL36060GU31X
100			PHD36100GU31X	PHG36100GU31X	PHJ36100GU31X	PHL36100GU31X
150			PHD36150GU31X	PHG36150GU31X	PHJ36150GU31X	PHL36150GU31X
250			PJD36250GU31X	PJG36250GU31X	PJJ36250GU31X	PJL36250GU31X
60	LSI	3.2 S	PHD36060GU33X	PHG36060GU33X	PHJ36060GU33X	PHL36060GU33X
100			PHD36100GU33X	PHG36100GU33X	PHJ36100GU33X	PHL36100GU33X
150			PHD36150GU33X	PHG36150GU33X	PHJ36150GU33X	PHL36150GU33X
250			PJD36250GU33X	PJG36250GU33X	PJJ36250GU33X	PJL36250GU33X
MicroLogic Ammeter Trip Unit						
3Ø3W + G, 600 Vac 50/60 Hz						
60	LSI	5.2 A	PHD36060GU43X	PHG36060GU43X	PHJ36060GU43X	PHL36060GU43X
100			PHD36100GU43X	PHG36100GU43X	PHJ36100GU43X	PHL36100GU43X
150			PHD36150GU43X	PHG36150GU43X	PHJ36150GU43X	PHL36150GU43X
250			PJD36250GU43X	PJG36250GU43X	PJJ36250GU43X	PJL36250GU43X
MicroLogic Energymeter Trip Unit						
3Ø3W + G, 600 Vac 50/60 Hz						
60	LSI	5.2 E	PHD36060GU53X	PHG36060GU53X	PHJ36060GU53X	PHL36060GU53X
100			PHD36100GU53X	PHG36100GU53X	PHJ36100GU53X	PHL36100GU53X
150			PHD36150GU53X	PHG36150GU53X	PHJ36150GU53X	PHL36150GU53X
250			PJD36250GU53X	PJG36250GU53X	PJJ36250GU53X	PJL36250GU53X

Table 12.33: H- and J-Frame Circuit Breaker Plug-in Units with Electronic Trip—Standard (80%) Rated—3Ø4W

Trip Rating Ampere	Trip Function ^[15]	Trip Unit ^[16]	D Interrupting	G Interrupting	J Interrupting	L Interrupting
			Catalog Number ^{[17][18][19]}	Catalog Number ^{[17][18][19]}	Catalog Number ^{[17][18][19]}	Catalog Number ^{[17][18][19]}
MicroLogic Standard Trip Unit						
3Ø4W + G, 600 Vac 50/60 Hz						
60	LI	3.2	PHD36060GNU31X	PHG36060GNU31X	PHJ36060GNU31X	PHL36060GNU31X
100			PHD36100GNU31X	PHG36100GNU31X	PHJ36100GNU31X	PHL36100GNU31X
150			PHD36150GNU31X	PHG36150GNU31X	PHJ36150GNU31X	PHL36150GNU31X
250			PJD36250GNU31X	PJG36250GNU31X	PJJ36250GNU31X	PJL36250GNU31X
60	LSI	3.2 S	PHD36060GNU33X	PHG36060GNU33X	PHJ36060GNU33X	PHL36060GNU33X
100			PHD36100GNU33X	PHG36100GNU33X	PHJ36100GNU33X	PHL36100GNU33X
150			PHD36150GNU33X	PHG36150GNU33X	PHJ36150GNU33X	PHL36150GNU33X
250			PJD36250GNU33X	PJG36250GNU33X	PJJ36250GNU33X	PJL36250GNU33X
MicroLogic Ammeter Trip Unit						
3Ø4W + G, 600 Vac 50/60 Hz						
60	LSI	5.2 A	PHD36060GNU43X	PHG36060GNU43X	PHJ36060GNU43X	PHL36060GNU43X
100			PHD36100GNU43X	PHG36100GNU43X	PHJ36100GNU43X	PHL36100GNU43X
150			PHD36150GNU43X	PHG36150GNU43X	PHJ36150GNU43X	PHL36150GNU43X
250			PJD36250GNU43X	PJG36250GNU43X	PJJ36250GNU43X	PJL36250GNU43X
60	LSIG	6.2 A	PHD36060GNU44X	PHG36060GNU44X	PHJ36060GNU44X	PHL36060GNU44X
100			PHD36100GNU44X	PHG36100GNU44X	PHJ36100GNU44X	PHL36100GNU44X
150			PHD36150GNU44X	PHG36150GNU44X	PHJ36150GNU44X	PHL36150GNU44X
250			PJD36250GNU44X	PJG36250GNU44X	PJJ36250GNU44X	PJL36250GNU44X
MicroLogic Energymeter Trip Unit						
3Ø4W + G, 600 Vac 50/60 Hz						
100	LSI	5.2 E	—	—	—	PHL36100GNU53X
250			PJD36250GNU53X	—	—	PJJ36250GNU53X

[15] If alternate trip functions are required, contact your local Schneider Electric field office for pricing.

[16] For Trip Unit information, refer to [MicroLogic Trip Units](#), page 7-65.

[17] For communication capabilities, add the communication suffix as shown in [Communication Suffix](#), page 12-15. The communication package will be configured based on the system voltage specified by the communication suffix.

[18] For availability on 100% rated, see [5600CT9101](#).

[19] For IP54 splash resistant construction, add an "M54" suffix.

Table 12.34: L-Frame Circuit Breaker Plug-in Units with Electronic Trip—Standard (80%) Rated—3Ø3W

Trip Rating Ampere	Trip Function [20][21]	Trip Unit[22]	G Interrupting	J Interrupting	L Interrupting	R Interrupting
			Catalog Number[23][24][25] [26]	Catalog Number[23][24][25] [26]	Catalog Number[23][24][25] [26]	Catalog Number[23][24][25] [26]
Basic Electronic Trip Unit						
3Ø3W + G, 600 Vac 50/60 Hz						
250	LI	1.0	PBLG36250G	—	—	—
MicroLogic Standard Trip Unit						
3Ø3W + G, 600 Vac 50/60 Hz						
250	LI	3.3	—	—	—	PBLR36250GU31X
250	LSI	3.3 S	PBLG36250GU33X	PBLJ36250GU33X	PBL36250GU33X	—
MicroLogic Energymeter Trip Unit						
3Ø3W + G, 600 Vac 50/60 Hz						
400	LSI	5.3 E	PBLG36400GU53X	PBLJ36400GU53X	PBL36400GU53X	PBLR36400GU53X
600			PBLG36600GU53X	PBLJ36600GU53X	PBL36600GU53X	PBLR36600GU53X

Table 12.35: L-Frame Circuit Breaker Plug-in Units with Electronic Trip—Standard (80%) Rated—3Ø4W

Trip Rating Ampere	Trip Function [20][21]	Trip Unit[22]	G Interrupting	J Interrupting	L Interrupting	R Interrupting
			Catalog Number[23][24][25] [26]	Catalog Number[23][24][25] [26]	Catalog Number[23][24][25] [26]	Catalog Number[23][24][25] [26]
Basic Electronic Trip Unit						
3Ø4W + G, 600 Vac 50/60 Hz						
250	LI	1.0	PBLG36250GN	—	—	—
400			—	PBLJ36400GN	—	—
MicroLogic Standard Trip Unit						
3Ø4W + G, 600 Vac 50/60 Hz						
250	LI	3.3	—	PBLJ36250GNU31X	PBL36250GNU31X	PBLR36250GNU31X
400			PBLG36400GNU31X	—	—	PBLR36400GNU31X
600			—	—	—	PBLR36600GNU31X
250	LSI	3.3 S	PBLG36250GNU33X	PBLJ36250GNU33X	PBL36250GNU33X	PBLR36250GNU33X
400			—	—	—	PBLR36400GNU33X
600			—	—	—	PBLR36600GNU33X
MicroLogic Ammeter Trip Unit						
3Ø4W + G, 600 Vac 50/60 Hz						
400	LSI	5.3 A	—	—	—	PBLR36400GNU43X
600			—	—	—	PBLR36600GNU43X
400	LSIG	6.3 A	—	—	—	PBLR36400GNU44X
600			—	—	—	PBLR36600GNU44X
MicroLogic Energymeter Trip Unit						
3Ø4W + G, 600 Vac 50/60 Hz						
400	LSI	5.3 E	PBLG36400GNU53X	PBLJ36400GNU53X	PBL36400GNU53X	PBLR36400GNU53X
600			PBLG36600GNU53X	PBLJ36600GNU53X	PBL36600GNU53X	PBLR36600GNU53X
400	LSIG	6.3 E	PBLG36400GNU54X	PBLJ36400GNU54X	PBL36400GNU54X	PBLR36400GNU54X
600			PBLG36600GNU54X	PBLJ36600GNU54X	PBL36600GNU54X	PBLR36600GNU54X

[20] If alternate trip functions are required, contact your local Schneider Electric field office for pricing.

[21] L-frame circuit breaker plug-in units with basic electronic trip units have a fixed, long-time and adjustable, instantaneous setting.

[22] For Trip Unit information, refer to [MicroLogic Trip Units](#), page 7-65.

[23] For communication capabilities, add the communication suffix as shown in [Communication Suffix](#), page 12-15. The communication package will be configured based on the system voltage specified by the communication suffix.

[24] For availability on 100% rated, see 5600CT9101.

[25] For IP54 splash resistant construction, add an "M54" suffix.

[26] For vertical riser applications, order auxiliary mounting kit—Catalog Number PBQ4060RMK.

H-, J-, and L-Frame Plug-In Units with Electronic Trip and Communication

Hardware communication packages are now available on PowerPac™ H-, J-, and L-Frame Plug-in Units with Electronic Trip. These hardware communication packages will provide you the capability to access and monitor circuit breaker data from these plug-in units. The packages are available in Modbus™ and Ethernet.

Add the appropriate communication system voltage suffix to the end of the associated H-, J-, or L-Frame breaker with electronic trip, for example: PHD36060GNU31XIFE4.

Table 12.36: Communication Suffix^[27]

System Voltage	Communication	Communication Type Suffix	System Voltage Suffix
Up to 480Y/277 V	Ethernet	IFE	4
	Modbus	IFM	
480 V only	Ethernet	IFE	5
	Modbus	IFM	
600Y/347 V, 600 V	Ethernet	IFE	6
	Modbus	IFM	

M-Frame Plug-In Units
Table 12.37: M-Frame Circuit Breaker Plug-in Units with Adjustable Basic Electronic Trip Unit (ET 1.0)^{[28][29][30]}

Frame Rating Ampere	System	G Interrupting Catalog Number ^[31]	J Interrupting Catalog Number ^[31]
800	3Ø3W + G	PTMG36800G()	PTMJ36800G()
	3Ø4W + G	PTMG36800GN()	PTMJ36800GN()

^[27] Communication packages are housed in a separate enclosure mounted adjacent to the plug-in units.

^[28] The ET 1.0 trip unit cannot be field replaced or have the long-time trip point setting adjusted.

^[29] All these devices use bolt-on connection. It may be used only on busway with same number of poles. Not for use on 800 A copper busway. To complete the catalog number, replace the blank with an "H" for horizontal applications and "V" for vertical applications.

^[30] All M-frame plug-in units are 800 A frame, and the trip setting can be adjusted to 300 A, 350 A, 400 A, 450 A, 500 A, 600 A, 700 A, or 800 A.

^[31] For IP54 splash resistant construction, add an "M54" suffix.

P-Frame Plug-In Units

Table 12.38: P-Frame Circuit Breaker Plug-in Units—3Ø3W^[32]

Trip Rating Ampere	Trip Function ^[33]	Trip Unit ^[34]	Interrupting Rating	
			G	J
			Catalog Number ^{[35][36][37][38]}	Catalog Number ^{[35][36][37][38]}
MicroLogic Standard Trip Unit				
3Ø3W + G, 600 Vac 50/60 Hz				
400	LI	3.0	PTPG36040G()U31A	PTPJ36040G()U31A
600			PTPG36060G()U31A	PTPJ36060G()U31A
800			PTPG36080G()U31A	PTPJ36080G()U31A
1000			PTPG36100G()U31A	PTPJ36100G()U31A
1200			PTPG36120G()U31A	PTPJ36120G()U31A
400	LSI	5.0	PTPG36040G()U33A	PTPJ36040G()U33A
600			PTPG36060G()U33A	PTPJ36060G()U33A
800			PTPG36080G()U33A	PTPJ36080G()U33A
1000			PTPG36100G()U33A	PTPJ36100G()U33A
1200			PTPG36120G()U33A	PTPJ36120G()U33A
MicroLogic Ammeter Trip Unit				
3Ø3W + G, 600 Vac 50/60 Hz				
400	LI	3.0 A	PTPG36040G()U41A	PTPJ36040G()U41A
600			PTPG36060G()U41A	PTPJ36060G()U41A
800			PTPG36080G()U41A	PTPJ36080G()U41A
1000			PTPG36100G()U41A	PTPJ36100G()U41A
1200			PTPG36120G()U41A	PTPJ36120G()U41A
400	LSI	5.0 A	PTPG36040G()U43A	PTPJ36040G()U43A
600			PTPG36060G()U43A	PTPJ36060G()U43A
800			PTPG36080G()U43A	PTPJ36080G()U43A
1000			PTPG36100G()U43A	PTPJ36100G()U43A
1200			PTPG36120G()U43A	PTPJ36120G()U43A
400	LSIG	6.0 A	PTPG36040G()U44A	PTPJ36040G()U44A
600			PTPG36060G()U44A	PTPJ36060G()U44A
800			PTPG36080G()U44A	PTPJ36080G()U44A
1000			PTPG36100G()U44A	PTPJ36100G()U44A
1200			PTPG36120G()U44A	PTPJ36120G()U44A

Table 12.39: P-Frame Circuit Breaker Plug-in Units—3Ø4W

Trip Rating Ampere	Trip Function	Trip Unit	Interrupting Rating	
			G	J
			Catalog Number ^{[35][36][37]}	Catalog Number ^{[35][36][37]}
MicroLogic Standard Trip Unit				
3Ø4W + G, 600 Vac 50/60 Hz				
400	LI	3.0	PTPG36040GN()U31A	PTPJ36040GN()U31A
600			PTPG36060GN()U31A	PTPJ36060GN()U31A
800			PTPG36080GN()U31A	PTPJ36080GN()U31A
1000			PTPG36100GN()U31A	PTPJ36100GN()U31A
1200			PTPG36120GN()U31A	PTPJ36120GN()U31A
400	LSI	5.0	PTPG36040GN()U33A	PTPJ36040GN()U33A
600			PTPG36060GN()U33A	PTPJ36060GN()U33A
800			PTPG36080GN()U33A	PTPJ36080GN()U33A
1000			PTPG36100GN()U33A	PTPJ36100GN()U33A
1200			PTPG36120GN()U33A	PTPJ36120GN()U33A
MicroLogic Ammeter Trip Unit				
3Ø4W + G, 600 Vac 50/60 Hz				
400	LI	3.0 A	PTPG36040GN()U41A	PTPJ36040GN()U41A
600			PTPG36060GN()U41A	PTPJ36060GN()U41A
800			PTPG36080GN()U41A	PTPJ36080GN()U41A
1000			PTPG36100GN()U41A	PTPJ36100GN()U41A
1200			PTPG36120GN()U41A	PTPJ36120GN()U41A
400	LSI	5.0 A	PTPG36040GN()U43A	PTPJ36040GN()U43A
600			PTPG36060GN()U43A	PTPJ36060GN()U43A
800			PTPG36080GN()U43A	PTPJ36080GN()U43A
1000			PTPG36100GN()U43A	PTPJ36100GN()U43A
1200			PTPG36120GN()U43A	PTPJ36120GN()U43A
400	LSIG	6.0 A	PTPG36040GN()U44A	PTPJ36040GN()U44A
600			PTPG36060GN()U44A	PTPJ36060GN()U44A
800			PTPG36080GN()U44A	PTPJ36080GN()U44A
1000			PTPG36100GN()U44A	PTPJ36100GN()U44A
1200			PTPG36120GN()U44A	PTPJ36120GN()U44A

[32] The 250 A is available as a special device. Contact your local Schneider Electric field office for ordering information.

[33] If alternate trip functions are required, contact your local Schneider Electric field office for pricing.

[34] For Trip Unit information, refer to [MicroLogic Trip Units](#), page 7-65.

[35] Listed catalog numbers are for 80% rated circuit breakers. For 100% rated circuit breakers, replace the blank with an "HC" for horizontal applications and "VC" for vertical applications. For example, the catalog number for a 100% standard trip unit with standard LI trip functions at 800 A 3Ø3W for a horizontal application would be PTPG36080GHCU31A.

[36] The standard rating plug supplied with a trip unit will be the "A" rating plug. To specify an alternative rating plug, replace the "A" at the end of the catalog number with the applicable suffix letter. See [Table 7.126 Rating Plugs](#), page 7-68 for rating plug catalog suffix letters.

[37] All these devices use bolt-on connection. It may be used only on busway with same number of poles. Not for use on 800 A copper busway. To complete the catalog number, replace the blank with an "H" for horizontal applications and "V" for vertical applications.

[38] For IP54 splash resistant construction, add an "M54" suffix.

R-Frame Plug-In Units

Table 12.40: R-Frame Circuit Breaker Plug-in Units—3Ø3W^[39]

Trip Rating Ampere	Trip Function	Trip Unit	Interrupting Rating		
			G	J	L
			Catalog Number ^[40] [41][42][43]	Catalog Number ^[40] [41][42][43]	Catalog Number ^[40] [41][42][43]
MicroLogic Standard Trip Unit					
3Ø3W + G, 600 Vac 50/60 Hz					
800	LI	3.0	PTRG36080G()U31A	PTRJ36080G()U31A	PTRL36080G()U31A
1000			PTRG36100G()U31A	PTRJ36100G()U31A	PTRL36100G()U31A
1200			PTRG36120G()U31A	PTRJ36120G()U31A	PTRL36120G()U31A
1600			PTRG36160G()U31A	PTRJ36160G()U31A	PTRL36160G()U31A
800	LSI	5.0	PTRG36080G()U33A	PTRJ36080G()U33A	PTRL36080G()U33A
1000			PTRG36100G()U33A	PTRJ36100G()U33A	PTRL36100G()U33A
1200			PTRG36120G()U33A	PTRJ36120G()U33A	PTRL36120G()U33A
1600			PTRG36160G()U33A	PTRJ36160G()U33A	PTRL36160G()U33A
MicroLogic Ammeter Trip Unit					
3Ø3W + G, 600 Vac 50/60 Hz					
800	LI	3.0 A	PTRG36080G()U41A	PTRJ36080G()U41A	PTRL36080G()U41A
1000			PTRG36100G()U41A	PTRJ36100G()U41A	PTRL36100G()U41A
1200			PTRG36120G()U41A	PTRJ36120G()U41A	PTRL36120G()U41A
1600			PTRG36160G()U41A	PTRJ36160G()U41A	PTRL36160G()U41A
800	LSI	5.0 A	PTRG36080G()U43A	PTRJ36080G()U43A	PTRL36080G()U43A
1000			PTRG36100G()U43A	PTRJ36100G()U43A	PTRL36100G()U43A
1200			PTRG36120G()U43A	PTRJ36120G()U43A	PTRL36120G()U43A
1600			PTRG36160G()U43A	PTRJ36160G()U43A	PTRL36160G()U43A
800	LSIG	6.0 A	PTRG36080G()U44A	PTRJ36080G()U44A	PTRL36080G()U44A
1000			PTRG36100G()U44A	PTRJ36100G()U44A	PTRL36100G()U44A
1200			PTRG36120G()U44A	PTRJ36120G()U44A	PTRL36120G()U44A
1600			PTRG36160G()U44A	PTRJ36160G()U44A	PTRL36160G()U44A

Table 12.41: R-Frame Circuit Breaker Plug-in Units—3Ø4W^[39]

Trip Rating Ampere	Trip Function	Trip Unit	Interrupting Rating		
			G	J	L
			Catalog Number ^[40] [41][42][43]	Catalog Number ^[40] [41][42][43]	Catalog Number ^[40] [41][42][43]
MicroLogic Standard Trip Unit					
3Ø4W + G, 277/480 Vac (600 Vac Max.) 50/60 Hz					
800	LI	3.0	PTRG36080GN()U31A	PTRJ36080GN()U31A	PTRL36080GN()U31A
1000			PTRG36100GN()U31A	PTRJ36100GN()U31A	PTRL36100GN()U31A
1200			PTRG36120GN()U31A	PTRJ36120GN()U31A	PTRL36120GN()U31A
1600			PTRG36160GN()U31A	PTRJ36160GN()U31A	PTRL36160GN()U31A
800	LSI	5.0	PTRG36080GN()U33A	PTRJ36080GN()U33A	PTRL36080GN()U33A
1000			PTRG36100GN()U33A	PTRJ36100GN()U33A	PTRL36100GN()U33A
1200			PTRG36120GN()U33A	PTRJ36120GN()U33A	PTRL36120GN()U33A
1600			PTRG36160GN()U33A	PTRJ36160GN()U33A	PTRL36160GN()U33A
MicroLogic Ammeter Trip Unit					
3Ø4W + G, 277/480 Vac (600 Vac Max.) 50/60 Hz					
800	LI	3.0 A	PTRG36080GN()U41A	PTRJ36080GN()U41A	PTRL36080GN()U41A
1000			PTRG36100GN()U41A	PTRJ36100GN()U41A	PTRL36100GN()U41A
1200			PTRG36120GN()U41A	PTRJ36120GN()U41A	PTRL36120GN()U41A
1600			PTRG36160GN()U41A	PTRJ36160GN()U41A	PTRL36160GN()U41A
800	LSI	5.0 A	PTRG36080GN()U43A	PTRJ36080GN()U43A	PTRL36080GN()U43A
1000			PTRG36100GN()U43A	PTRJ36100GN()U43A	PTRL36100GN()U43A
1200			PTRG36120GN()U43A	PTRJ36120GN()U43A	PTRL36120GN()U43A
1600			PTRG36160GN()U43A	PTRJ36160GN()U43A	PTRL36160GN()U43A
800	LSIG	6.0 A	PTRG36080GN()U44A	PTRJ36080GN()U44A	PTRL36080GN()U44A
1000			PTRG36100GN()U44A	PTRJ36100GN()U44A	PTRL36100GN()U44A
1200			PTRG36120GN()U44A	PTRJ36120GN()U44A	PTRL36120GN()U44A
1600			PTRG36160GN()U44A	PTRJ36160GN()U44A	PTRL36160GN()U44A

[39] The 600 A is available as a special device. Contact your local Schneider Electric field office for ordering information.

[40] Listed catalog numbers are for 80% rated circuit breakers. For 100% rated circuit breakers, replace the blank with an "HC" for horizontal applications and "VC" for vertical applications. For example, the catalog number for a 100% standard trip unit with standard LI trip functions at 800 A 3Ø3W for a horizontal application would be PTPG36080GHCU31A.

[41] The standard rating plug supplied with a trip unit will be the "A" rating plug. To specify an alternative rating plug, replace the "A" at the end of the catalog number with the applicable suffix letter. See Table 7.126 Rating Plugs, page 7-68 for rating plug catalog suffix letters.

[42] All these devices use bolt-on connection. It may be used only on busway with same number of poles. Not for use on 800 A copper busway. To complete the catalog number, replace the blank with an "H" for horizontal applications and "V" for vertical applications.

[43] For IP54 splash resistant construction, add an "M54" suffix.

Non-Segregated Bus

- Non-segregated phase bus
- 600 V through 38 kV (1200 A–6000 A)
- Aluminum, steel or stainless steel housing
- Aluminum or copper bus bars
- Insulated with fluidized bed epoxy (5 kV–38 kV)
- Complete line of fittings provides for any configuration
- Indoor trapeze and outdoor column supports
- For use in utilities, industrial and commercial facilities



PowerZone™ bus is custom designed, manufactured and tested per ANSI C37.23 standards to meet customer specifications. The 600 V product is also UL Listed. It is a completely coordinated package of equipment with all the auxiliary material and supports for connecting transformers, switchgear, MCCs, and motors, in all types of utility, industrial, and commercial facilities.

Bus Options

Some available options are special momentary rating, special housing material and/or finish, special conductor supports, heaters and thermostats, and ground bus.

Weatherproof Bus

All weatherproof runs must be equipped with strip heaters to eliminate condensation and, if applicable, a thermostat. A heater should be used for every seven (7) foot of bus and no more than 20 heaters can be controlled by one thermostat. Also, each bus run should have its own thermostat. The heaters are rated 240 V, 500 watts and operate at 120 V, 125 watts.

Flanged Ends

A flanged end is used to terminate the bus into switchgear, motor control centers, switchboards, or any rigid bus-to-bus connection. It consists of a gasketed equipment flange, up to 1'-0" of 3Ø3W conductor (3Ø4W as applicable), necessary insulation tapes, and required bolting hardware.

Cable Tap Box

A cable tap box includes a gasketed and accessible termination box, lugs, necessary insulation tape (between bus and lugs only), and required bolting hardware. Lug sizes and quantity should be specified by purchaser.

Transformer/Generator Connection

This type of termination should be used whenever the bus is connecting to a transformer, generator, motor, switch or any connection where the bus bars are connecting to porcelain mounted equipment terminals. It will include the same components as a flanged end plus one set of flexible braid type connectors and a terminal box (if required).

Bushing Box (Weatherhead)

A bushing box is used on service entrance run where the cable connection to the bus must be made via porcelain bushings. It is comprised of the same components as a transformer connection plus 3 through stud type apparatus bushings, bushing stud connectors (lug pads) and a strip heater.

Ground Bus

The bus housing is designed and constructed to provide an electrically continuous ground path. The side rails of the bus housings are capable of carrying the full rated phase current continuously and, under short circuit conditions, are capable of carrying up to 60 kA RMS asymmetrical fault current for 3 seconds. Consequently, a separate ground bus is not necessary unless specified.

Wall Entrance Seal

A wall entrance seal consists of a wall throat, wall flange (one side of wall only), and a barrier which prevents air or vapor from passing from one room to another or from outdoors to indoors. It also carries a 1/2 hour fire rating. Consult factory for higher fire ratings.

Table 12.42: Wall Flange

Description
Optional (in addition to wall entrance seal)
Aluminum
14 Gauge Steel
14 Gauge 304 Stainless Steel
14 Gauge 316 Stainless Steel

Equipment Entrance Seal

An equipment entrance seal should be used whenever a barrier is required to prevent the passing of flame and/or gasses between the bus housing and the terminating equipment.

Expansion Fittings

An expansion fitting is used to counteract the strain placed on the bus due to the expansion and contraction of the building or the bus itself. One should be used whenever the bus run crosses a building expansion joint and whenever a straight run of bus exceeds 60 feet.

Flexible Housing (Misalignment) Collar

Required at terminations or wall penetrations when vibrations due to seismic forces may cause damage to the bus. It may also be used to adjust for the “settling” of terminating equipment after installation.

Supporting Steel (Hangers)

Supports should be added on the basis of one for every 10 ft. for indoor and one for every 12 ft. for outdoor. Indoor supports are a trapeze type hanger while outdoor supports are a single or double column type support. Consult factory for other type supports.

Table 12.43: Hangers/Supports

Support Description	Maximum Height Options
Indoor Trapeze Hanger	—
Outdoor, Single Column Support	12 feet
Outdoor, Double Column Support	22 feet

Hazardous or Seismic Locations

Consult factory for bus runs which are to be installed in a location which is classified as hazardous or in a seismic location.

Standard Construction

Standard construction is as follows:

- Conductor (plating): Copper (silver) or Aluminum (tin)
- Conductor Insulation (5 kV through 38 kV only): epoxy
- Conductor Supports: Glass reinforced polyester blocks (5 kV and 15 kV); porcelain (38 kV)
- Housing Material: Extruded Aluminum (1/8-inch Nominal)
- Housing Construction: Totally Enclosed Non-ventilated
- Joint Insulation: EPR and PVC tape
- BIL Rating: 30 kV (600 V), 60 kV (5 kV) and 95 kV (15 kV)
- Momentary (Short Circuit) Rating: 75 kA (600 V), 60 kA (5 kV, 15 kV), and 39 kA (38 kV)
- Ground Conductor: Housing (100% rated)

Table 12.44: Bus Enclosures

Material and Finish
Painted Aluminum (1/8" Nominal)
Painted 14 Gauge Steel
Painted 11 Gauge Steel
Painted 14 Gauge 304 Stainless Steel
Painted 14 Gauge 316 Stainless Steel

Table 12.45: Momentary (Asymmetrical Short Circuit) Ratings

Voltage Class	Ampere Options
600 V	75 kA
	100 kA
	125 kA
	150 kA
5 kV 15 kV	60 kA
	80 kA
	100 kA
	150 kA
38 kV	39 kA
	49 kA
	62 kA
	100 kA