

# Section 11

## Switchboards and Switchgear



FlexSet Switchboard



Metalclad and HVL/cc Switchgear



Unit Substation



Model III Package Unit Substation

### Low Voltage Switchboards 11-2

FlexSeT Switchboards (cULus Listed)	11-2
Power-Style QED-2 Switchboards (UL Listed)	11-7
Power-Style Commercial Multi-Metering Switchboards (UL Listed)	11-8
Speed-D SB/SF Switchboards (UL Listed)	11-9
Power-Style QED-6 Switchboards (UL Listed)	11-13

### Low Voltage Switchgear 11-15

Power-Zone™ 4 Low Voltage Switchgear with MasterPacT™ MTZ or NW/NT Circuit Breakers	11-15
Power-Zone™ 4 Arc Resistant Switchgear with ArcBlok Technology	11-16
Built on the Legendary Performance and Reliability of the MasterPacT Line	11-16

### Medium Voltage Switchgear 11-17

Air-Insulated Switchgear for Primary Distribution	11-17
SureSeT™ Medium Voltage Metalclad Switchgear (UL Listed)	11-17
Masterclad™ Medium Voltage Metalclad Switchgear (UL Listed)	11-19
Gas-Insulated Switchgear (GIS) for Primary Distribution	11-21
GHA Gas-Insulated Switchgear (UL Listed)	11-21
CBGS-0 Gas-Insulated Switchgear (UL Listed)	11-22
Air-Insulated Switchgear for Secondary Distribution	11-23
HVL/cc Metal-Enclosed Load Interrupter Switchgear—Full Range	11-23
HVL/cc Switchgear Quick Ship Program—5–15 kV, 600 A	11-25
HVL Metal-Enclosed Load Interrupter Switchgear—Full Range	11-30
HVL Switchgear Quick Ship Program—5 kV–15 kV, 600 A	11-31
HVL Switches for Power-Dry II™, Power-Cast II™, and Uni-Cast II™ Transformer Connections	11-32
Square D™ Brand DIN/E Fuse Selection Tables—HVL	11-34
Boric Acid Fuse Selection Tables—HVL	11-35
MiniBreak™ Compact Height Switches—5.5 kV, 200 A	11-36
Gas-Insulated Ring Main Units for Secondary Distribution Systems	11-38
DVCAS Switchgear	11-38
Shielded and Solid Insulation System (SSIS)	11-40
Premset Compact Vacuum Circuit Breaker Switchgear with Shielded Solid Insulation System (2SIS)	11-40

### Medium Voltage Unit Substations 11-41

Power-Zone Load Center Unit Substations	11-41
Power-Zone Model III Package Unit Substations	11-41

### Medium Voltage Controllers 11-44

MotorSeT™ Medium Voltage Motor Controllers (UL Listed)	11-44
--	-------

11 SWITCHBOARDS AND SWITCHGEAR

Table 11.1: Low Voltage Switchboards

Description	Speed-D	FlexSeT	QED-2	QED-6
Amperage Range	400-800 A	2000 A, 400-1600 A Backfed Main	400-5000 A (6000 A cross bus available)	800-5000 A (6000 A cross bus available)
Voltages	120/240 1P 208Y/120 3P 240/120 3P 480Y/277 3P	208Y/120 3P 240 480Y/277 3P	120/240 1P 208Y/120 3P 240/120 3P 480Y/277 3P 600Y/347 3P	208Y/120 3P 240/120 3P 480Y/277 3P 600Y/347 3P
Max AIC	200 kA	65 kA	200 kA	200 kA
Enclosure Ratings	NEMA 1 NEMA 3R	NEMA 1 NEMA 3R	NEMA 1 NEMA 3R	NEMA 1
Incoming Connection	Cable	Cable (left incoming only)	Cable Busway Transformer (close coupled) Connect to Existing	Cable Busway Transformer (close coupled) Connect to Existing
Mounting Type	Free-Standing	Free-Standing	Free-Standing	Free-Standing
Arc Flash Mitigation	None	MMS	ERMS MMS ArcBlok	ERMS
Main Mounting	Unit Mounted I-Line Mounted	Unit Mounted I-Line (backfed)	Unit Mounted I-Line (backfed) Drawout	Drawout
Branch Mounting	I-Line Plug On	I-Line	I-Line Unit Mounted Drawout	Drawout
Utility Metering	EUSERC	EUSERC	EUSERC Non-EUSERC	EUSERC Non-EUSERC
Metering	Trip Unit	Power Meter	Power Meter ION Meter Trip Unit	Power Meter ION Meter Trip Unit
Surge Ratings	Available via NQ plug on option or I-line Enable	240 kA	Up to 480 kA	Up to 480 kA
Special Options and Features	Compact footprint for applications requiring lower amperage with utility metering	Backfed Main on Distribution section, swingable main for labor saving, ready to assemble switchboard built by distributors, short leadtimes	CTM ArcBlok ASCO Auto Transfer Switches Multi-Source Options Highly customizable	CTM Service Ready Multi-Source Options Highly customizable

11 SWITCHBOARDS AND SWITCHGEAR



### FlexSeT Switchboards (cULus Listed)



FlexSeT is a complete low voltage Switchboard offer and service model that enables new methods of assembly, installation, and maintenance, while delivering unprecedented availability, reliability, and modularity. FlexSeT customers will benefit from dramatically reduced lead times with design flexibility through a modern and innovative switchboard system, offering an end-to-end digital experience.

Designed with the entire product lifecycle experience in mind, FlexSeT is a product developed with a fully customer centric approach, making everything simpler and faster from ordering to maintenance without compromising quality or safety, all while ensuring compliance to UL Standards.

FlexSeT is delivered on-time with the shortest lead time in the market! The complete offer can shorten delivery to days instead of weeks. Even with configuration changes at virtually any part of the ordering process. The product modularity allows for adaptations without risks to your project timelines as features are added or removed in the lineup.

**Product Design and Key Features Highlights**

Years of leadership in the switchboard market have provided Schneider Electric with the expertise to drive innovation. FlexSeT switchboards are designed to take solutions to a whole new level, making the best switchboards in the market even better.

Designed to be assembled anywhere without the need of heavy machinery or complex tools, FlexSeT is structured to be simple and intuitive, not only for assembly but also for operation and maintenance.

FlexSeT modularity comes in the form of kits and design features that allow for quick and easy installation, removal, or replacement. This makes installation and operation more intuitive and faster with the benefit of improved efficiency.



**Swingable Main**  
The main breaker assembly is mounted on a robust hinge system. This feature enables the use of cable pulling machines in the equipment space and exposes the wire terminals for easier and faster connection.

**Bussing System**  
The bussing designs deliver reliable connections with quick and easy installation! Visi-tite™ bolts ensure proper torquing while the bus bridge connects all phases simultaneously in one simple operation. The bussing has an enclosed design which greatly reduces the points of exposed bus bars.



**Backfed Main at 1600 A**  
Main breaker and the I-Line™ stack in one single section to provide unmatched footprint performance.



**I-Line Bus Stack with Neutral Bar**  
The I-Line bus stack, which has been benefitting our customers for years, has now gotten even better by having the Neutral within the stack.

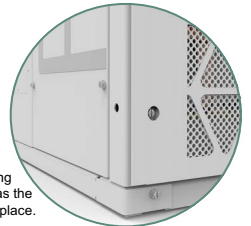

**Captive Hardware**  
No lost time in removing and replacing covers as the hardware is always in place.

**Plug-on Neutral**  
From Panelboards to Switchboards! Land the neutral closer to the load, reducing complexity and making wiring cleaner and more efficient.

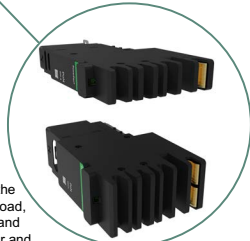

**Digital Journey and Tools**

FlexSeT has taken advantage of the latest digital and end-to-end cyber-secured technology to drive customer satisfaction for the best possible experience throughout the lifecycle.

Digital tools are used in every aspect of the product starting at the quoting and ordering process with **FlexSeT Design™**. The new product selector is intuitive by nature and provides logic and pricing live at each selection, surfacing the right information to make informed decisions

Schneider Electric's **Asset Lifecycle Management™** (ALM) system tracks and stores all documentation for each feature and component of a FlexSeT Switchboard. The documentation specific to each order and configuration is stored digitally, cyber-secured, and is accessible at anytime with a simple QR scan. This information is linked and stored directly from FlexSeTDesign and updated with any change.

The assembly process is executed with **FlexSeT Build™**, an interactive step by step guide for the assembler that help ensure the quality and integrity of the product. The app ensures each assembly step is properly executed from start to finish and inspected for compliance subsequently. Furthermore, FlexSeT Build™ is directly linked and paired with physical assembly tools that ensure proper technical aspects are adhered to, with live verification throughout the assembly. The testing of every section is also completed with FlexSeT Build™ as the last step. A successful result is required in order to generate and apply the UL label of certification. Each FlexSeT section assembled will have a final report with Digital Artifacts and Photos for quality assurance and compliance.

The UL Mark and Certification Labels are issued digitally at the conclusion of each successful assembly. The auditing of an assembled FlexSeT switchboard is done via digital artifacts and critical quality data collected during assembly and quality control process.

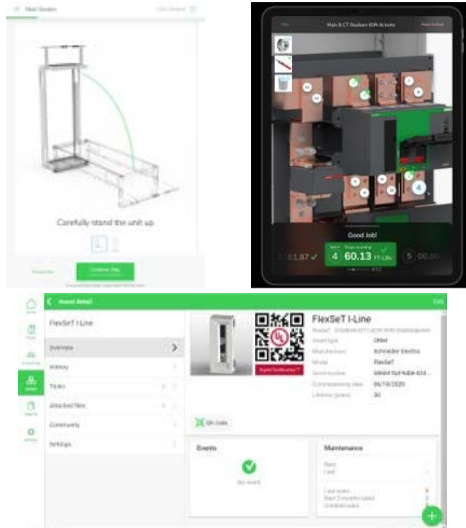

### Features and Specifications Summary

Just like all Schneider Electric products, FlexSeT is always evolving to bring the best features to market with the latest technology, and will continue to develop and enhance customer solutions, constantly improving the offer!

Here are the latest features for FlexSeT Switchboards:

- Designed, listed, and assembled in accordance with UL 891 Standards
- NEMA 1 enclosure
- All front and side covers use captive hardware
- Front and rear accessible
- Swingable main breaker mounting assembly
- Main breaker ampacities—100% rated up to 65 kA
  - Backfed: 400 A, 600 A, 800 A, 1000 A, 1200 A, 1600 A
  - Individually mounted: 400 A to 2000 A
- All copper system bussing rated for 2000 A, including neutrals
- Plug-on neutral for group mounted devices
- 2000 A I-Line™ feeder section with neutral bar within the stack—feeders from 15 A up to 1200 A
- Splice bridge with extending bussing
- Visi-Tite™ bolts on all torque-required bussing connections
- Swingable instrument compartment—separated and modularized
- Available devices:
  - PowerLogic™ power meter PM5563
  - Surge protective device—rated up to 240 kA
  - Maintenance mode setting (MMS) switch—compliant with NEC 240.87 Arc Energy Reduction requirements
  - SmartCell™ compatible!
- Digital Asset Lifecycle Management—all drawings, test reports, and instruction/installation manuals are cyber-secured and available online

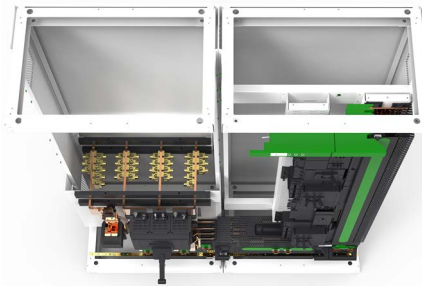
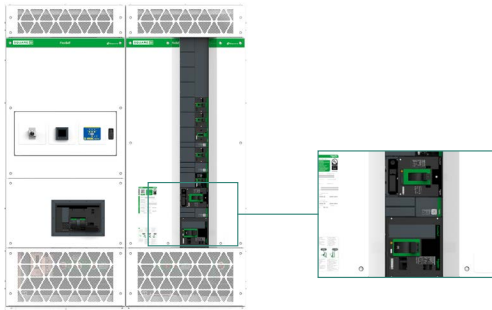
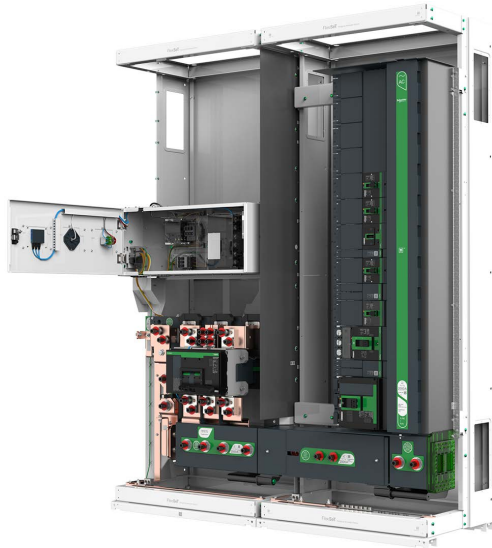

11 SWITCHBOARDS AND SWITCHGEAR



### Partner Support Program

The Partner Support Program is in place to support and grow our partner business through fast and reliable service using a best-in-class process that is simple and smooth utilizing a self-help guide.

A dedicated Partner Support Program specialist is assigned to each partner with the mission to support, train, and certify partners to build FlexSeT switchboards with the high level of quality and safety standards expected of Schneider Electric products, as well as provide an ongoing and dedicated direct line of support.

### Customer Care Center and Technical Support

For any inquiries on FlexSeT and other Schneider Electric products, please contact our customer service and technical support personnel at 1-888-778-2733 anytime. Our support teams can assist with any questions you might have and help you with the solutions you need.

### Catalog of Kits and Parts

Use the commercial reference numbers listed in the following tables to order new/replacement kits and parts as needed. The modularity of the FlexSeT switchboard design makes it easy for the equipment to expand according to our customer needs. Many applications are retrofittable. New functionality can be added by purchasing the kits below and installing on existing installed equipment. Certain spare parts are provided for replacement as needed by the customer.

Please consult Schneider Electric instruction bulletins [JYT1078000](#), *FlexSeT Switchboards*, or [NNZ9919501](#), *FLEXPON 570/1200/1200S Plug-on Neutrals*, for references on certain selections, based on application and technical specifications.



**Table 11.2: Field Installable—Individually Mounted Devices (Installed in the Instrument Compartment)**

Kit Description	Application	Maximum Voltage	Catalog No.	Installation Site
Instrument compartment box [1]	Enclosure for MMS/Trip unit, PM 5563, and SPD	600	FLEXINSTRCOMP	Partner/Field
MMS/Trip unit	Incident energy reduction switch; Low/no power circuit breaker trip		FLEXIMAMMS	
Power meter 5563	Power metering and monitoring		FLEXIMAMETER	
208 V SPD	Surge protection		208	
480 V SPD		480	FLEXIMA480SPD	
ENCT	Radial ground fault protection 400–2000 A	600	FLEXNCT2000	Field
120 Vac shunt trip [2]	Powerpact M/P/R remote tripping		S33661	
24 Vdc shunt trip [2]			S33659	

**Table 11.3: Field Installable—Group Mounted Devices (Installed on the I-Line Stack)**

Kit Description	Application	Maximum Voltage	Catalog No.	Plug-on Neutral Required	Installation Site
240 V MMS/Trip unit	Incident energy reduction switch; Low/no power circuit breaker trip	240	ICWL22X2BFMMMS	No	Partner/Field
480 V MMS/Trip unit		480	ICWL24X2BFMMMS		
600 V MMS/Trip unit		600	ICWL26X2BFMMMS		
208 V SPD	Surge protection	220	FLEXGRP208SPD	Yes	
480 V SPD		480	FLEXGRP480SPD		
Power meter 5563	Power metering and monitoring	480	FLEXGRPPM5563	No	Field
120 Vac shunt trip [2]	Powerpact M/P/R remote tripping	S33661			
24 Vdc shunt trip [2]		S33659			
1200 A plug-on neutral with sensor [3]	Neutral termination device with LSIg circuit breakers	600	FLEXPON1200S	—	Partner/Field
1200 A plug-on neutral [3]	Neutral termination device		FLEXPON1200		
570 A plug-on neutral [3]			FLEXPON570		

**FlexSeT Circuit Breakers—Prewired for MMS and Ground Fault Applications**

Please use the following table as a reference-specific circuit breakers. These circuit breakers are PowerPact™ Series with a wire harness pre-installed according to application needs. If MMS, or ground fault protection are needed in main or feeder applications, these circuit breakers must be used. These circuit breakers should not be installed in QED-2 Switchboards.

The I-Line™ feeder section in FlexSeT switchboards is fully compatible with any plug-on circuit breaker used in QED-2 Switchboards. The circuit breakers listed in the table are specific only to applications mentioned above, where a harness is provided for ease of installation.

**Table 11.4: FlexSeT Circuit Breakers**

Description	Application	Mounting Type	Trip Unit	Pre-Wired Harness	Catalog No.
600 V, 1200 A circuit breaker	Main or feeder; MMS and ground fault capable	I-Line Group Mounted	6.0 A (LSIG)	MMS, Trip Unit Power, and ENCT	PJA36100U44AFLEX
600 V, 800 A circuit breaker	Main or feeder; MMS capable	I-Line Group Mounted	5.0 A (LSI)	MMS and Trip Unit Power	PJA36120U43AFLEX
600 V, 1200 A circuit breaker	Main or feeder; MMS and ground fault capable	I-Line Group Mounted	6.0 A (LSIG)	MMS, Trip Unit Power, and ENCT	PJA36120U44AFLEX
600 V, 400 A circuit breaker	Main or feeder; MMS capable	Unit Mount	5.0 A (LSI)	MMS and Trip Unit Power	PJF36040CU43AFLEX
600 V, 400 A circuit breaker	Main or feeder; MMS and ground fault capable	Unit Mount	6.0 A (LSIG)	MMS, Trip Unit Power, and ENCT	PJF36040CU44AFLEX
600 V, 400 A circuit breaker	Main or feeder; MMS capable	Unit Mount	5.0 A (LSI)	MMS and Trip Unit Power	PJF36040U43AFLEX
600 V, 400 A circuit breaker	Main or feeder; MMS and ground fault capable	Unit Mount	6.0 A (LSIG)	MMS, Trip Unit Power, and ENCT	PJF36040U44AFLEX
600 V, 600 A circuit breaker	Main or feeder; MMS capable	Unit Mount	5.0 A (LSI)	MMS and Trip Unit Power	PJF36060CU43AFLEX
600 V, 600 A circuit breaker	Main or feeder; MMS and ground fault capable	Unit Mount	6.0 A (LSIG)	MMS, Trip Unit Power, and ENCT	PJF36060CU44AFLEX
600 V, 600 A circuit breaker	Main or feeder; MMS capable	Unit Mount	5.0 A (LSI)	MMS and Trip Unit Power	PJF36060U43AFLEX
600 V, 600 A circuit breaker	Main or feeder; MMS and ground fault capable	Unit Mount	6.0 A (LSIG)	MMS, Trip Unit Power, and ENCT	PJF36060U44AFLEX
600 V, 800 A circuit breaker	Main or feeder; MMS capable	Unit Mount	5.0 A (LSI)	MMS and Trip Unit Power	PJF36080CU43AFLEX
600 V, 800 A circuit breaker	Main or feeder; MMS and ground fault capable	Unit Mount	6.0 A (LSIG)	MMS, Trip Unit Power, and ENCT	PJF36080CU44AFLEX
600 V, 800 A circuit breaker	Main or feeder; MMS capable	Unit Mount	5.0 A (LSI)	MMS and Trip Unit Power	PJF36080U43AFLEX
600 V, 800 A circuit breaker	Main or Feeder - MMS and Ground Fault Capable	Unit Mount	6.0 A (LSIG)	MMS, Trip Unit Power, and ENCT	PJF36080U44AFLEX
600 V, 1000 A circuit breaker	Main or Feeder - MMS Capable	Unit Mount	5.0 A (LSI)	MMS and Trip Unit Power	PJF36100CU43AFLEX

[1] Required for MMS/Trip unit, PM5563, or SPD installation only. An instrument compartment for field installation needs to be ordered with an instrument compartment cover (catalog number 80210-181-50) in the Table 11.5 FlexSeT Spare Parts, page 11-6 table. Not required for ENCT or shunt trip kits.

[2] Shunt trip kits to be shipped from partner to field job site for contractor installation only.

[3] Plug-on neutrals have limited amounts of devices that can be provided. Please consult the FlexSeT PON instruction bulletin (NNZ9919501) to determine the right allocation per circuit breakers and other devices.

Table 11.4 FlexSeT Circuit Breakers (cont'd.)

Description	Application	Mounting Type	Trip Unit	Pre-Wired Harness	Catalog No.
600 V, 1000 A circuit breaker	Main or feeder; MMS and ground fault capable	Unit Mount	6.0 A (LSIG)	MMS, Trip Unit Power, and ENCT	PJF36100CU44AFLEX
600 V, 1000 A circuit breaker	Main or feeder; MMS capable	Unit Mount	5.0 A (LSI)	MMS and Trip Unit Power	PJF36100U43AFLEX
600 V, 1000 A circuit breaker	Main or feeder; MMS and ground fault capable	Unit Mount	6.0 A (LSIG)	MMS, Trip Unit Power, and ENCT	PJF36100U44AFLEX
600 V, 1200 A circuit breaker	Main or feeder; MMS capable	Unit Mount	5.0 A (LSI)	MMS and Trip Unit Power	PJF36120CU43AFLEX
600 V, 1200 A circuit breaker	Main or feeder; MMS and ground fault capable	Unit Mount	6.0 A (LSIG)	MMS, Trip Unit Power, and ENCT	PJF36120U44AFLEX
600 V, 1200 A circuit breaker	Main or feeder; MMS capable	Unit Mount	5.0 A (LSI)	MMS and Trip Unit Power	PJF36120U43AFLEX
600 V, 1200 A circuit breaker	Main or feeder; MMS and ground fault capable	Unit Mount	6.0 A (LSIG)	MMS, Trip Unit Power, and ENCT	PJF36120U44AFLEX
600 V, 1000 A circuit breaker	Main or feeder; MMS and ground fault capable	I-Line Group Mounted	6.0 A (LISG)	MMS, Trip Unit Power, and ENCT	RKA36100CU44AFLEX
600 V, 1200 A circuit breaker	Main or feeder; MMS capable	I-Line Group Mounted	5.0 A (LSI)	MMS and Trip Unit Power	RKA36120CU43AFLEX
600 V, 1200 A circuit breaker	Main or feeder; MMS and ground fault capable	I-Line Group Mounted	6.0 A (LISG)	MMS, Trip Unit Power, and ENCT	RKA36120CU44AFLEX
600 V, 1000 A circuit breaker	Main or feeder; MMS capable	Unit Mount	5.0 A (LSI)	MMS and Trip Unit Power	RKF36100CU43AFLEX
600 V, 1000 A circuit breaker	Main or feeder; MMS and ground fault capable	Unit Mount	6.0 A (LISG)	MMS, Trip Unit Power, and ENCT	RKF36100U44AFLEX
600 V, 1200 A circuit breaker	Main or feeder; MMS capable	Unit Mount	5.0 A (LSI)	MMS and Trip Unit Power	RKF36120CU43AFLEX
600 V, 1200 A circuit breaker	Main or feeder; MMS and ground fault capable	Unit Mount	6.0 A (LISG)	MMS, Trip Unit Power, and ENCT	RKF36120U44AFLEX
600 V, 1200 A circuit breaker	Main or feeder; MMS capable	Unit Mount	5.0 A (LSI)	MMS and Trip Unit Power	RKF36120U43AFLEX
600 V, 1200 A circuit breaker	Main or feeder; MMS and ground fault capable	Unit Mount	6.0 A (LISG)	MMS, Trip Unit Power, and ENCT	RKF36120U44AFLEX
600 V, 1600 A circuit breaker	Main or feeder; MMS capable	Unit Mount	5.0 A (LSI)	MMS and Trip Unit Power	RKF36160CU43AFLEX
600 V, 1600 A circuit breaker	Main or feeder; MMS and ground fault capable	Unit Mount	6.0 A (LISG)	MMS, Trip Unit Power, and ENCT	RKF36160U44AFLEX
600 V, 1600 A circuit breaker	Main or feeder; MMS capable	Unit Mount	5.0 A (LSI)	MMS and Trip Unit Power	RKF36160U43AFLEX
600 V, 1600 A circuit breaker	Main or feeder; MMS and ground fault capable	Unit Mount	6.0 A (LISG)	MMS, Trip Unit Power, and ENCT	RKF36160U44AFLEX
600 V, 2000 A circuit breaker	Main or feeder; MMS capable	Unit Mount	5.0 A (LSI)	MMS and Trip Unit Power	RKF36200CU43AFLEX
600 V, 2000 A circuit breaker	Main or feeder; MMS and ground fault capable	Unit Mount	6.0 A (LISG)	MMS, Trip Unit Power, and ENCT	RKF36200U44AFLEX
600 V, 2000 A circuit breaker	Main or feeder; MMS capable	Unit Mount	5.0 A (LSI)	MMS and Trip Unit Power	RKF36200U43AFLEX
600 V, 2000 A circuit breaker	Main or feeder; MMS and ground fault capable	Unit Mount	6.0 A (LISG)	MMS, Trip Unit Power, and ENCT	RKF36200U44AFLEX
600 V, 2500 A circuit breaker	Main or feeder; MMS capable	Unit Mount	5.0 A (LSI)	MMS and Trip Unit Power	RKF36250U43AFLEX
600 V, 2500 A circuit breaker	Main or feeder; MMS and ground fault capable	Unit Mount	6.0 A (LISG)	MMS, Trip Unit Power, and ENCT	RKF36250U44AFLEX

Spare Parts

These kits can be ordered for replacing parts, as necessary. The following table lists commercial kits for parts sold in individual or paired quantities. These kits can be ordered for replacing parts, as necessary. If a needed part or hardware is not listed, please contact Customer Service or the Partner Support Program Team.

Table 11.5: FlexSeT Spare Parts

Description	Catalog No. [4]	Parts List [4]
Instrument compartment front cover assembly	80210-181-50	—
Deadfront covers	80210-219-50	80210-070-50
		80210-071-50
Barriers	80210-219-51	80211-011-01
		80211-015-01
Vented covers	80210-219-52	80210-072-50
		80210-073-50
Bracing	80210-219-53	2 x 80210-080-50
Rear corner channel	80210-219-54	2 x 80210-020-50
Front corner channel	80210-219-55	2 x 80210-013-01
Escutcheon package	80210-219-57	80210-095-50
RCC main package	80210-219-58	2 x 80210-020-51
Rodent Barrier	80210-219-59	2 x 80210-010-01
Access cover	80210-219-60	2 x 80210-003-01
Base assembly with rivets	80210-074-50	80210-074-50
Frame with ground bus	80210-087-50	80210-087-50
Frame with ground bus and lugs	80210-087-51	80210-087-51
1600 A MCCB backed bus bar assembly	80210-090-50	—

[4] Contact Customer Care



**QED-2 Switchboard**

The industry exclusive I-line design enables quick installation of group mounted breakers with one single screw and a flathead screwdriver.

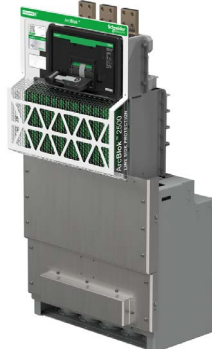

**ArcBlok 2500**

Line side arc flash hazard protection, reduces incident energy exposure to less than 1.2 cal/cm<sup>2</sup>



**TH110 Temperature Sensor for Continuous Thermal Monitoring**

Remote monitoring and alarming of cable connection temperatures reduces risks and help prevent connection failures.

**Power-Style QED-2 Switchboards (UL Listed)**

QED-2 low voltage switchboards from Schneider Electric are built to last with durable construction and flexible design. These free-standing structures can contain circuit breaker overcurrent protection up to 5000 A at a maximum voltage of 600 Vac.

QED-2 is future ready with the options of having advanced metering, continuous thermal monitoring, ArcBlok, and communicating trip units. Pair QED-2 with EcoStruxure Power, Asset Advisor, or Energy Hub.

QED-2 offers a wide variety of features and pre-engineered designs with optimized lead times. Custom versions of switchboards are also available to accommodate project-specific design criteria. The QED-2 frame allows various special components to be mounted in the switchboard, saving time, money and space in the field. These components include automatic throwover systems, automatic transfer switches, and special metering systems. This flexibility means the QED-2 switchboard can meet customer requirements on the most complex applications.

**Features**

**Structure**

- QED-2 switchboards are designed, listed, and built to UL 891
- Switchboard ratings through 5000 A, 200 kA

**Service**

- Single and multiple source configurations
- Cable, busway, transformer, or bussed incoming connections
- Front accessible load connections
- Hot or cold sequence utility metering

**Devices**

- PowerPacT™ electronic molded case circuit breakers
- MasterPacT™ stored energy fixed or drawout circuit breakers
- Thermal-magnetic circuit breakers
- Group-mounted I-line circuit breakers
- Stacked breaker designs for PowerPacT and MasterPacT circuit breakers to optimize overall layout
- Main and branch devices in single section configuration

**Safety**

- Energy-reduction maintenance switch available for single-mount and group-mounted devices
- ArcBlok line side arc flash hazard reduction
- Continuous thermal monitoring
- Remote status indication and control
- Internally-mounted Surgelogic™ surge protection

**Connectivity**

- EcoStruxure Power Monitoring Expert, Asset Advisor, and Energy Hub
- PowerLogic customer metering, including options for custom communications and interwiring
- Networked communications capabilities provide direct access to energy management at main and feeder level

**Source control**

- Quick Connect Generator option available
- ASCO automatic transfer switches available for load transfer between alternate sources of power
- Multiple source configurations including main-tie-mains and automatic transfer schemes

**Power-Style Commercial Multi-Metering Switchboards (UL Listed)**

- Designed, built, and listed to UL 891
- Lever bypass and EUSERC non-lever bypass
- Hot or cold sequence metering—EUSERC, NEMA, LOCAL
- Front and rear alignment standard
- Switchboard ratings through 4000 A, 100 kA
- Meter sections in either three- or six-socket section configuration
- Tenant mains either circuit breaker or fusible
- 60–200 A without lever bypass with self-contained meter sockets, 5- or 7-jaw, ring type and test block where required
- 60–200 A lever bypass with self-contained meter sockets, 7-jaw, ringless
- Factory-installed devices with completely wired from meter socket to disconnect
- Provisions for adding future tenants available, as well as future sections
- Sections in either NEMA 1 or NEMA 3R construction
- For use on 120/240 V, 120/208 V, and 277/480 V systems
- Integrated, front-accessible wireway for top exiting load cables
- Customer access area for top exiting load cables



Lever Bypass  
Class 2755



EUSERC  
Class 2756





Speed-D Switchboard shown with optional underground pull section

## Speed-D SB/SF Switchboards (UL Listed)

- UL Listed
- California Energy Commission (CEC) Title 24 compliant configurations available for California installations
- Hot sequence utility compartment per EUSERC requirements
- Single service disconnect rated 400, 600, or 800 A with either type of distribution interiors, NQ up to 240 Vac, I-Line™ through 480 Vac
- Meter doors can be 15 inches high with one meter socket and test block, or 30 inches high with two meter sockets and test block
- Meter sockets can be 6-, 8-, 13-, or 15-jaw meter sockets with test block, based on application
- Solar ready configurations are now available, using a back-fed circuit breaker on the I-Line stack
- Accessories include:
  - Underground pull sections with and without lug landing
  - Loadside wireway
  - Bus links for donut-type current transformers
  - Double padlock hasp attachments
  - Plug-on distribution panel
  - Subfeed circuit breakers
- Full height add-on I-Line distribution section
- Stand-alone I-Line distribution section

### Application

Suitable for use as service entrance equipment on ac systems. Sections contain metering compartment, barriers, main disconnects, distribution panel, neutral bus, and grounding provisions.

### Metering

C/T compartment with two 15-inch blank meter doors. (Order doors with meter socket from [Table 11.10 Meter Door Selection, page 11-11.](#)) Incoming cable lugs are for top feed with one twin conductor 2 AWG–600 kcmil lug per phase and neutral, suitable for aluminum or copper cables. Optional single conductor lug is available. Refer to [Table 11.11 Accessories, page 11-11.](#)

### Mains

Main breaker can be LH, MJ, PowerPact L, or PowerPact P. Standard and advanced electronic trip units available for PowerPact breakers. Main breakers with Energy or Power trip units comply with CEC Title 24 metering requirements.

### Branches

NQ distribution bus is rated 400 A and provides mounting space for QO™/QOB Type (150 A maximum) circuit breakers. Panel provides space for mounting 42 single pole circuit breakers. One or two individually mounted 225 A maximum circuit breakers can be added with bus connectors. (Order subfeed circuit breakers from [Table 11.12 Subfeed Circuit Breakers \(Series E4\), page 11-12.](#))

I-Line™ distribution bus is rated 400, 600, or 800 A and will accept 27 inches of I-Line circuit breakers on the left side with a maximum frame size of “J”. The right side will accept either a QO plug-on distribution panel (240 V only) or LA or LH I-Line circuit breaker, which allows for a back-fed solar power source.

### Enclosure

Totally enclosed front accessible with ANSI 49 gray baked enamel finish. Dimensions are 90 in. (H) x 36 in. (W) x 14 in. (D) for indoor and 90 in. (H) x 36 in. (W) x 24.5 in. (D) for outdoor enclosures.

**EUSERC Utility Metering, Main Disconnects and Distribution Panel (UL Listed)**

**Table 11.6: Single Main Circuit Breaker with Distribution (Series E4)**

System	Service Voltage	Mains Ratings (A)	Main Breaker Trip Unit	SCCR 240 V Max.	SCCR 480 V Max.	Distribution Interior	Circuit Breaker Catalog No.		
							Indoor	Outdoor	
1Ø3W	120/240	400	Thermal Magnetic	65	—	NQ	SB124QS	SB124QR	
						I-Line	SB124IS	SB124IR	
						None	SB124WS	SB124WR	
			LSI Standard Electronic	100		NQ	SB124QSJS	SB124QRJS	
						I-Line	SB124ISJS	SB124IRJS	
						None	SB124WSJS	SB124WRJS	
		LSI Energy Electronic	100	NQ	SB124QSJE	SB124QRJE			
				I-Line	SB124ISJE	SB124IRJE			
				None	SB124WSJE	SB124WRJE			
		600	400	LI Basic Electronic	65	—	I-Line	SB126IS	SB126IR
							None	SB126WS	SB126WR
							NQ	SB324QS	SB324QR
LSI Standard Electronic	100			None	SB324WS		SB324WR		
				NQ	SB324QSJS		SB324QRJS		
				None	SB324WSJS		SB324WRJS		
3Ø4W [5]	208Y/120 240/120	400	Thermal Magnetic	65	—	NQ	SB324QS	SB324QR	
						I-Line	SB324IS	SB324IR	
						None	SB324WS	SB324WR	
		LSI Standard Electronic	100			NQ	SB324QSJS	SB324QRJS	
						I-Line	SB324ISJS	SB324IRJS	
						None	SB324WSJS	SB324WRJS	
	LSI Energy Electronic	100	NQ	SB324QSJE	SB324QRJE				
			I-Line	SB324ISJE	SB324IRJE				
			None	SB324WSJE	SB324WRJE				
	208Y/120 240/120 480Y/277	400	Thermal Magnetic	65	35	I-Line	SB344IS	SB344IR	
						None	SB344WS	SB344WR	
						NQ	SB344QS	SB344QR	
LSI Standard Electronic		100	65			I-Line	SB344ISJS	SB344IRJS	
			65			None	SB344WSJS	SB344WRJS	
			65			NQ	SB344QSJS	SB344QRJS	
LSI Energy Electronic	100	65	I-Line	SB344ISJE	SB344IRJE				
		65	None	SB344WSJE	SB344WRJE				
		65	NQ	SB344QSJE	SB344QRJE				
600	400	LI Basic Electronic	65	50	I-Line	SB346IS	SB346IR		
					65	None	SB346WS	SB346WR	
					65	NQ	SB346QS	SB346QR	
		LSI Standard Electronic			100	65	I-Line	SB346ISJS	SB346IRJS
						65	None	SB346WSJS	SB346WRJS
						65	NQ	SB346QSJS	SB346QRJS
LSI Energy Electronic	100	65	I-Line	SB346ISJE	SB346IRJE				
		65	None	SB346WSJE	SB346WRJE				
		65	NQ	SB346QSJE	SB346QRJE				
800	400	LI Basic Electronic	65	65	I-Line	SB348IS	SB348IR		
					65	None	SB348WS	SB348WR	
					65	NQ	SB348QS	SB348QR	
		LSI Standard Electronic			100	65	I-Line	SB348ISJS	SB348IRJS
						65	None	SB348WSJS	SB348WRJS
						65	NQ	SB348QSJS	SB348QRJS
LSI Power Electronic	100	65	I-Line	SB348ISJP	SB348IRJP				
		65	None	SB348WSJP	SB348WRJP				
		65	NQ	SB348QSJP	SB348QRJP				

**Table 11.7: Single Main Circuit Breaker with Solar Feed**

System	Service Voltage	I-Line Bus Rating (A)	Mains Ratings (A)	Main Breaker Trip Unit	Solar Feed Maximum (A)	SCCR 240 V Max.	SCCR 480 V Max.	Circuit Breaker Catalog No.					
								Indoor	Outdoor				
1Ø3W	120/240	1200	400	Thermal Magnetic	800	65	—	SB124IS8S	SB124IR8S				
								LSI Standard Electronic	100	SB124ISJS8S	SB124IRJS8S		
										LSI Energy Electronic	100	SB124ISJE8S	SB124IRJE8S
			600	LI Basic Electronic		65						SB126IS6S	SB126IR6S
400	Thermal Magnetic				800			65	35			SB344IS8S	SB344IR8S
								LSI Standard Electronic	100	65	65	SB344ISJS8S	SB344IRJS8S
			LSI Energy Electronic	100		65				65	SB344ISJE8S	SB344IRJE8S	
600	LI Basic Electronic				600	65				50	SB346IS6S	SB346IR6S	
								800	LI Basic Electronic		400	65	50
			LSI Standard Electronic	100									
LSI Power Electronic	100				65	SB348ISJP4S				SB348IRJP4S			

[5] Can be used on 3Ø3W Delta voltage systems (for example, 240 V Delta or 480 V Delta).

**Table 11.8: Single Main Fusible Disconnect with Distribution (Series E4)**

System	Service Voltage	Mains Ratings (A)	Distribution Interior	SCCR 240 V Max.	SCCR 480 V Max.	Fusible Disconnect Catalog No.	
						Indoor	Outdoor
1Ø3W	120/240	400	NQ	65	—	SF124QS	SF124QR
			I-Line	100	—	SF124IS	SF124IR
			None	200	—	SF124WS	SF124WR
			I-Line	100	—	SF126IS	SF126IR
3Ø4W [6]	208Y/120 240/120	400	NQ	65	—	SF324QS	SF324QR
			None	200	—	SF324WS	SF324WR
3Ø4W [6]	208Y/120 240/120	400	I-Line	100	65	SF344IS	SF344IR
			None	200	200	SF344WS	SF344WR
3Ø4W [6]	208Y/120 240/120	600	I-Line	100	65	SF346IS	SF346IR
			None	200	200	SF346WS	SF346WR
3Ø4W [6]	208Y/120 240/120	800	I-Line	100	65	SF348IS	SF348IR
			None	200	200	SF348WS	SF348WR

**Merchandised Options**

**Table 11.9: I-Line Distribution Section (Series E4)**

System	Service Voltage	Mains Ratings (A)	Distribution Interior	SCCR 240 V Max.	SCCR 480 V Max.	Distribution Type	Catalog No.	
							Indoor	Outdoor
3Ø4W	208Y/120 240/120 480Y/277	800	I-Line	65 k	65 k	Add-on distribution section, must be connected to an SB UCT and main section without distribution panel, such as SB348WS. <b>An I-Line plug-on subfeed lug kit must be ordered to terminate the distribution section.</b>	SBAD800	SBAD800R
3Ø4W	208Y/120 240/120 480Y/277	800	I-Line	125 k	100 k	Stand-alone distribution section not connected to an SB section. <b>A back-fed main circuit breaker or I-Line plug-on subfeed lug kit must be ordered to terminate the distribution section. (Non-ULSE)</b>	SBSAD800	SBSAD800R

**Table 11.10: Meter Door Selection**

Meter Socket Jaws	15-inch High Door With One Meter Socket and Test Block	30-inch High Door With Two Meter Sockets and Test Blocks
	Catalog No.	Catalog No.
6 [7]	SBA15D6MS	—
8	SBA15D8MS	—
13	SBA15D13MS	SBA30D13MS
15	SBA15D15MS	SBA30D15MS
Blank	SBA15DBC	—
[8]	SBA15DMS	—

**NOTE:** To order structure with meter door factory-installed, add door catalog number as suffix to structure (for example, SF344IS-15D13MS).

**Table 11.11: Accessories**

Description	Catalog No.			
<b>Indoor underground pull section</b> (w/o lug landing)—26-in. (W) Order separate SA8LL lug kit below if required.	SA26PS			
<b>Outdoor (3R) underground pull section</b> (w/o lug landing)—26 in. (W) x 24.5 in. (D) Order separate SA8LL lug landing kit below when required.	SA26PSR			
<b>Lug landing kit</b> —800 A max. For terminating utility service cables in indoor or outdoor underground pull sections.	SA8LL [9]			
<b>Single barrel lug kit</b> —Kit provides single barrel lugs and pad in lieu of twin barrel lug provided with service section. Mechanical lugs provided are sized to fit 1-3/0–750 kcmil cable. Two lugs per phase are supplied.	SA7PL			
<b>Loadside wireway</b> —11.5 in. (W) x 14 in. (D)—indoor only	SA10LW			
<b>Bus link kit</b> —800 A max.—Order one kit per phase for 400, 600, and 800 A.	SA10BL			
<b>Double padlock hasp attachment</b> —For mounting two padlocks on door handle of rainproof enclosure. Padlocks not included.	SS2PL			
<b>Plug-On Distribution Panel</b> —mounts on right side of I-Line interior. Cannot be used with LA/LH branch circuit breaker. Panel rated 225 A for 240 V applications. For QO™ type plug-on circuit breakers only.	System	Phase	Pole Spaces	Catalog No.
	1Ø	AC	12	SS212AC
	3Ø	ABC		SS312
	3Ø	AB		SS212AB [10]

[6] Can be used on 3Ø3W Delta voltage systems (for example, 240 V Delta or 480 V Delta).  
 [7] 6-jaw meter socket can also be used on 4- and 5-jaw applications.  
 [8] Door with provisions for mounting meter socket.  
 [9] All EUSERC Utilities (except Arizona Public Service and Salt River Project) require a lug landing kit SA8LL.  
 [10] To be used on 120/240 V, 3Ø4W delta applications.

**Table 11.12: Subfeed Circuit Breakers (Series E4)**

Description	Rating (A)	2-Pole Catalog No. [11]		3-Pole Catalog No.	
		Left	Right	Left	Right
<b>Subfeed Circuit Breaker Kit [12]</b> Includes circuit breaker, connectors and mounting hardware. The complete kit, mounting hardware, circuit breaker and connectors will be shipped direct from plant. Delivery is stock to three days.	100	SASFBH100L()	SASFBH100R()	SASFBH100L	SASFBH100R
	110	SASFBH110L()	SASFBH110R()	SASFBH110L	SASFBH110R
	125	SASFBH125L()	SASFBH125R()	SASFBH125L	SASFBH125R
	150	SASFBH150L()	SASFBH150R()	SASFBH150L	SASFBH150R
	175	SASFBJ175L()	SASFBJ175R()	SASFBJ175L	SASFBJ175R
	200	SASFBJ200L()	SASFBJ200R()	SASFBJ200L	SASFBJ200R
	225	SASFBJ225L()	SASFBJ225R()	SASFBJ225L	SASFBJ225R

**Ordering Information**

- Service section:** Order service section from Table 11.6 Single Main Circuit Breaker with Distribution (Series E4), page 11-10, Table 11.8 Single Main Fusible Disconnect with Distribution (Series E4), page 11-11, as determined by mains rating, voltage, and system.
- Meter doors:** Order meter door from Table 11.10 Meter Door Selection, page 11-11 as determined by the height and utility metering requirements.
- Accessories and subfeeds:** Order as required from Table 11.11 Accessories, page 11-11 and/or Table 11.12 Subfeed Circuit Breakers (Series E4), page 11-12.
- Circuit breakers:** Order devices as determined by voltage, trip rating, AIR, and mounting space.
  - QO, QOB, QO-VH, QOB-VH: See Digest Section 1 or Section 7.
  - I-Line: See Digest Section 9.

[11] Two pole circuit breaker catalog numbers are completed by adding required phase connection letters as suffix (for example, SASFBH100LAC).

[12] Cannot use subfeed circuit breaker kit with multiple mains service section switchboards.

**Power-Style QED-6 Switchboards (UL Listed)**

**MasterPacT™ MTZ, NW, NT, and PowerPacT™ H and J Circuit Breakers**

The QED-6 switchboard is designed to provide excellent distribution, protection, and power quality management in commercial electrical equipment. The circuit protection components of the switchboard are the MasterPacT MTZ2, MTZ3 or NW circuit breakers in 800–6000 A frame sizes, MasterPacT MTZ1 or NT circuit breakers in 800–1200 A frame sizes, and PowerPacT H and J circuit breakers in 150–250 A frame sizes. These circuit breakers deliver maximum system uptime, system selectivity, ease of maintenance, and reliable circuit protection.

QED-6 switchboard features include: MasterPacT MTZ2, MTZ3 or NW UL 489 Listed circuit breakers for main and feeder devices, MasterPacT MTZ1 or NT UL 489 Listed circuit breakers for feeder devices, PowerPacT H and J UL 489 Listed circuit breakers for feeder devices, and a wide range of designs and options. Highly flexible drawout circuit breakers can meet a wide variety of power distribution requirements. Choices include drawout construction in PowerPacT H and J circuit breakers, and optional prepared drawout spaces that are equipped with all specified control functions. This capability allows quick additions for load upgrades.

- QED-6 switchboards are designed, listed, and built to UL 891; MasterPacT and PowerPacT circuit breakers are designed, listed, and built to UL 489
- Circuit breakers are individually mounted, rear connected; MasterPacT MTZ, NW and NT circuit breakers are drawout; PowerPacT H and J breakers are drawout
- Family of field installable and upgradeable MicroLogic™ trip units with optional EcoStruxure Power™ data communications features
- Switchboard ratings up to 150 kA short-circuit current rating for services 1600–6000 A at 480 V and 100 kA at 600 V
- Up to (12) 250 A PowerPacT H and J circuit breakers in a single 30-inch wide section
- Up to (8) 1200 A frame MasterPacT MTZ1/NT circuit breakers in a single 30-inch wide section
- Flexible branch circuit breaker locations: MasterPacT and PowerPacT circuit breakers can be mixed in a single 30-inch wide section (15–2000 A)
- Compartmentalization: separate compartments for circuit breakers, bussing, and load cabling
- Available in 54-, 60-, 72-, and 80-inch deep construction
- Available in NEMA 3R outdoor walk-in enclosures
- Mixing of MTZ and NW/NT circuit breakers are not offered in factory configured sections but can be field retrofitted as such
- MasterPacT and PowerPacT circuit breakers are field maintainable



QED-6 Switchboard with MasterPacT MTZ Circuit Breakers (Class 2746)



QED-6 Switchboard with MasterPacT NW/NT and PowerPacT H/J Circuit Breakers (Class 2746)

**Table 11.13: Circuit Breaker Selection**

Rating (A) (Frame)	Circuit Breakers
150–250	PowerPacT H, J
800–1200	MasterPacT MTZ1/NT
800–6000	MasterPacT MTZ2, 3/NW

QED-6 switchboards are reliable power protection equipment when working with telecommunication facilities, e-business servers, or mainframes that perform critical business transactions. These types of facilities cannot afford downtime.

QED-6 rear-connected switchboards are designed as standalone switchboards or as an integral part of the low voltage equipment lineup in a user's power unit substation.

**Specify QED-6 Switchboards**

When drawout construction is required for quick circuit breaker changeout; system requirements call for circuit breakers to close within five cycles; stored energy circuit breakers are required; front access to control wires is desired; ease of installation, maintenance, and upgrade of circuit breaker compartmentalization is required; system integrity and segregation of circuit breaker compartments from bus and cable compartments is required; equipment isolation is required.

**Benefits/Values of Circuit Breaker Performance**

MasterPacT MTZ, NW and NT circuit breakers are designed to provide maximum protection and reliable operation with a long service life. They exceed all UL 489 endurance testing requirements and are certified to a minimum of 10,000 operations through the 3000 A frame.



**System Coordination**

Short-time ratings are high, giving users excellent system coordination and selectivity with downstream breakers.

**High Short-Circuit Current Ratings (SCCR)**

Up to 200 k AIR at 240 V, 150 k AIR at 480 V, and 100 k AIR at 600 V, which allows customers to design systems with high fault current and paralleling schemes.

**Arc Flash Limiting (LF) Feeder Breakers**

High speed operation of MasterPact MTZ, NW and NT circuit breakers (150 k AIR at 480 V) helps reduce arc flash incident energy (cal/cm<sup>2</sup>) on downstream equipment.

**Ease of Installation and Maintenance**

Thru-the-door construction, an easy to operate drawout mechanism, and front access to all control wiring make this equipment easy to install, maintain, and upgrade. Load connections in the cable compartment are easily accessible in the rear of the switchboard. Remote racking of the MasterPact circuit breaker is also available with the optional remote racking tool, which, if required, is field installable.

**Ability to Upgrade**

UL Listed, field-installable accessories include: motor operators, shunt trips, under voltage devices, trip units, and communication modules for trip units. Manually operated circuit breakers are field convertible to electrical operation.

**Open Communication System**

The MicroLogic trip units in MasterPact circuit breakers use the Ethernet TCP/IP or Modbus™ serial protocol. These are widely accepted protocols which allow QED-6 to be integrated into new or many existing communication systems.

**Adaptable**

Drawout circuit breakers, front access control wiring, and expandable lineups are quickly adaptable to changing load and control requirements.

**Expandable**

MasterPact circuit breakers have many control termination points, giving the equipment extensive flexibility and expandability for sophisticated control schemes.



**Power-Zone™ 4 Low Voltage Switchgear with MasterPac™ MTZ or NW/NT Circuit Breakers**

Square D™ brand Power-Zone™ 4 low voltage, metal-enclosed, drawout switchgear is designed to provide superior electrical distribution, protection, and power quality management. The prime components of the switchgear are the MasterPac™ ANSI rated circuit breaker. Power-Zone 4 switchgear is designed to maximize the functionality of the MasterPac circuit breakers, which, in turn, deliver maximum uptime, system selectivity, ease of maintenance, and reliable circuit protection. All of these features are packed into the smallest footprint available for low voltage drawout switchgear.

- Power-Zone 4 is designed and built to ANSI® C37.20.1 and is Listed to UL 1558
- MasterPac MTZ, NW and NT drawout low voltage power circuit breakers are designed and built to ANSI C37.13 and C37.16. Listed to UL 1066
- Short-circuit current rating up to 200 kA at 240 V and 480 V without fuses
- High short-time withstand ratings up to 100 kA for 1 second, minimum
- Arc flash limiting (L1F) MasterPac MTZ2 or NW feeder breakers available in 800, 1600, and 2000 A ratings
- Family of field installable and upgradeable MicroLogic™ trip units with optional EcoStruxure Power™ data communications features
- Power-Zone 4 switchgear can offer optional factory integrated data communications capability with Ethernet (Modbus TCP/IP) connectivity to EcoStruxure Power Edge Control or Asset Management software
- Smallest equipment footprint available in this product class
- Front access to all control and communications wire connections
- Bolted copper bus provided as standard (up to 6000 A maximum)
- Large rear cable compartment pull area allowing maximum room for power cables
- Horizontal bus provision for future equipment expansion
- System designed for maximum uptime with low maintenance
- Modular circuit breaker designed for easy addition of control accessories
- Available in NEMA 3R outdoor walk-in enclosures
- Available in 42" deep, front accessible only version for greater layout flexibility and optimized electrical house footprint
- Available Arc Resistant construction certified to ANSI C37.20.7. See [Power-Zone™ 4 Arc Resistant Switchgear with ArcBlok Technology](#), page 11-16.

MasterPac MTZ2, 3 or NW circuit breakers are available in various levels of interrupting ratings from 42–200 kA at 480 V and 130 kA at 600 V.

The MasterPac MTZ1 or NT circuit breaker is available in an 800 A frame size and 42 kA at 480 V interrupting rating. Up to 8 MasterPac MTZ1 or NT circuit breakers can be mounted in a 30-inch wide section. (Not available for 600 V.)

Circuit breakers of like frame sizes and interrupting ratings are interchangeable.

**Table 11.14: Equipment Ratings**

Application Voltage Systems		Ampacities
600 Vac Maximum		1600 A–6000 A (Main circuit breaker or main lugs only)
1Ø3W, 3Ø3W, 3Ø4W		
50/60 Hz		

Short-Circuit Current Ratings			Short-Time Withstand Ratings
240 V	480 V	600 V	
42 kA	42 kA	42 kA	42 kA
65 kA	65 kA	65 kA	65 kA
85 kA	85 kA	85 kA	85 kA
200 kA	200 kA	130 kA	100 kA (maximum)



Power-Zone 4 Low Voltage Switchgear with MasterPac™ MTZ Circuit Breakers (Class 6037)



Power-Zone 4 Low Voltage Switchgear with MasterPac™ NW Circuit Breakers (Class 6037)



Power-Zone 4 Front Accessible Low Voltage Switchgear (Class 6037)

**NOTE:** Shown with MasterPac™ MTZ circuit breakers. MasterPac™ NW circuit breakers are also available.

## Power-Zone™ 4 Arc Resistant Switchgear with ArcBlok Technology

### Protecting Your Personnel and Equipment from an Arc Flash

Power-Zone 4 arc resistant switchgear with MasterPact ArcBlok technology offers patented, superior arc flash protection for operators and maintenance personnel. The arc flash containment features are unique to the industry in both the circuit breaker compartment and the structure.

Power-Zone 4 Arc Resistant Switchgear with ArcBlok Technology is certified to comply with ANSI C37.20.7 IEEE Guide for Testing Metal-Enclosed Switchgear Rated Up to 38 kV for Internal Arcing Faults, and third-party (UL) witnessed as arc resistant switchgear. Refer to Data Bulletin 6037DB1302 for the complete UL Witness Certification Summary.

#### Features

- MasterPact MTZ2, 3/NW circuit breakers with patented ArcBlok technology (up to 5000 A)
- Rated for systems with up to 100kA, 635V fault current
- 60 in. deep x 22 in. wide (smallest arc resistant footprint in the industry)
- 22 in., 36 in. section widths
- 60 in., 72 in., 80 in. section depths
- Internal arc gas management system for optimized cooling
- ANSI Type 2B Rating
- NEMA 1 enclosure

#### Available Options

- Insulated copper bus
- Zone selective interlocking
- High-resistance grounding
- Energy reduction maintenance switch
- Section barriers (rear, cable, and side)
- Circuit breaker remote racking
- ANSI Type 2B rated arc plenum exhaust



Arc Resistant Power-Zone 4 Low Voltage Switchgear (Class 6037)

**NOTE:** Shown with MasterPact NW ArcBlok circuit breakers. MasterPact MTZ2,3 ArcBlok circuit breakers are also available.

11 SWITCHBOARDS AND SWITCHGEAR

## Built on the Legendary Performance and Reliability of the MasterPact Line

MasterPact MTZ circuit breakers prepare you for the future of power distribution. Smart connectivity. Remote monitoring. Easy customization via digital modules. MasterPact MTZ circuit breakers bring the future-ready EcoStruxure Power capabilities you need to build smart, dependable, and sustainable power distribution systems:

- Smartphone connectivity for wireless alerts and maintenance
- Precision Class 1 power meter built in for energy-saving capabilities
- Easy customization via digital modules
- Intuitive MicroLogic™ X control unit
- Robust performance, even in harsh environments
- Seamless integration with building and energy management systems via EcoStruxure Power architecture
- Designed and tested to applicable standards for ANSI, UL and IEC



With Masterpact MTZ breakers, enhanced connectivity equips you for the future of power distribution. Available from 800 A to 6000 A.



*New!*

**SureSeT™ Medium Voltage Metalclad Switchgear (UL Listed)**

**Product Description**

Schneider Electric's Square D SureSeT™ metal-clad switchgear powered by EvoPacT™ vacuum circuit breakers provides control and protection of medium voltage power equipment.

SureSeT offers a two-high breaker design in a narrow 26 in. wide footprint that is fully compartmentalized for breaker, auxiliary equipment, and low voltage compartment. SureSeT is designed to be configured in various combinations to meet customer requirements. It is enabled with Circuit Breaker Monitoring.

SureSeT switchgear with EvoPacT circuit breakers is tested in accordance with ANSI C37.20.2. EvoPacT circuit breakers are tested per ANSI C37.09. SureSeT and EvoPacT are UL and cUL listed.

**Smart Through Design**

- EvoPacT breaker tested to 30,000 breaker open/close operations and 1,000 breaker racking operations
- SureSeT switchgear uses only Schneider Electric in-house designed key components: breaker mechanism, vacuum interrupter bottles, contact, etc.
- Breaker designed with integrated racking mechanism allowing for ease of maintenance
- Fillable frame design for low voltage compartments. That is, the original equipment manufacturers (OEM) and panel builders can wire low voltage devices ahead for ease of assembly.
- Circuit breaker health monitoring uses sensors embedded within the circuit breaker to measure strategic data of the most critical points including:
  - Thermal monitoring of circuit breaker primary connections
  - Operating speed of circuit breaker mechanism
  - Vacuum interrupters contact erosion gap
  - Health of closing and tripping coils
  - Health of spring charging motors
  - Health of circuit breaker/VT/CPT racking motors, when equipped

Alarms and notifications are displayed on the HMI screen when action is required.

For more information on this product, contact your Schneider Electric sales representative.

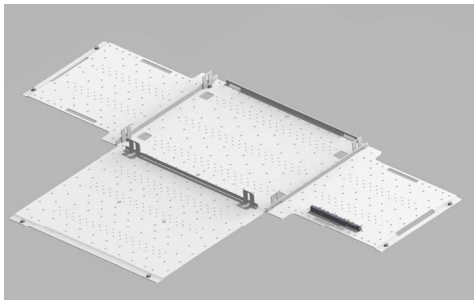

**Table 11.15: Ratings**

Maximum Voltages	4.76 kV, 15 kV
Continuous Current – Circuit Breakers	1200 A, 2000 A
Continuous Current – Main Bus	2000 A
Symmetrical Interrupting Capacity	25 kA, 40 kA
Basic Impulse Level	95 kV, peak (impulse) dielectric withstand
Enclosure	NEMA Type 1 – Indoor enclosure
Paint Color	White RAL 9003 finish standard. Additional colors selectable with customer provided paint sample with additional cost and lead time.

**Standard Features**

**SureSeT is metal-clad switchgear as defined by ANSI C37.20.2 and includes:**

- Withdrawable circuit breakers
- Fully compartmentalized construction
- Grounded metal barriers enclose all live components
- Automatic shutters over primary contacts
- Fluidized-bed epoxy insulated bus
- Mechanical and electrical interlocks
- Disconnect type voltage transformers or low power voltage transformers
- Fixed control power transformer with draw out primary fuses
- Grounded breaker truck in and between test-disconnected and connected positions
- Low voltage control compartment isolated from primary voltage areas
- Front and rear access required

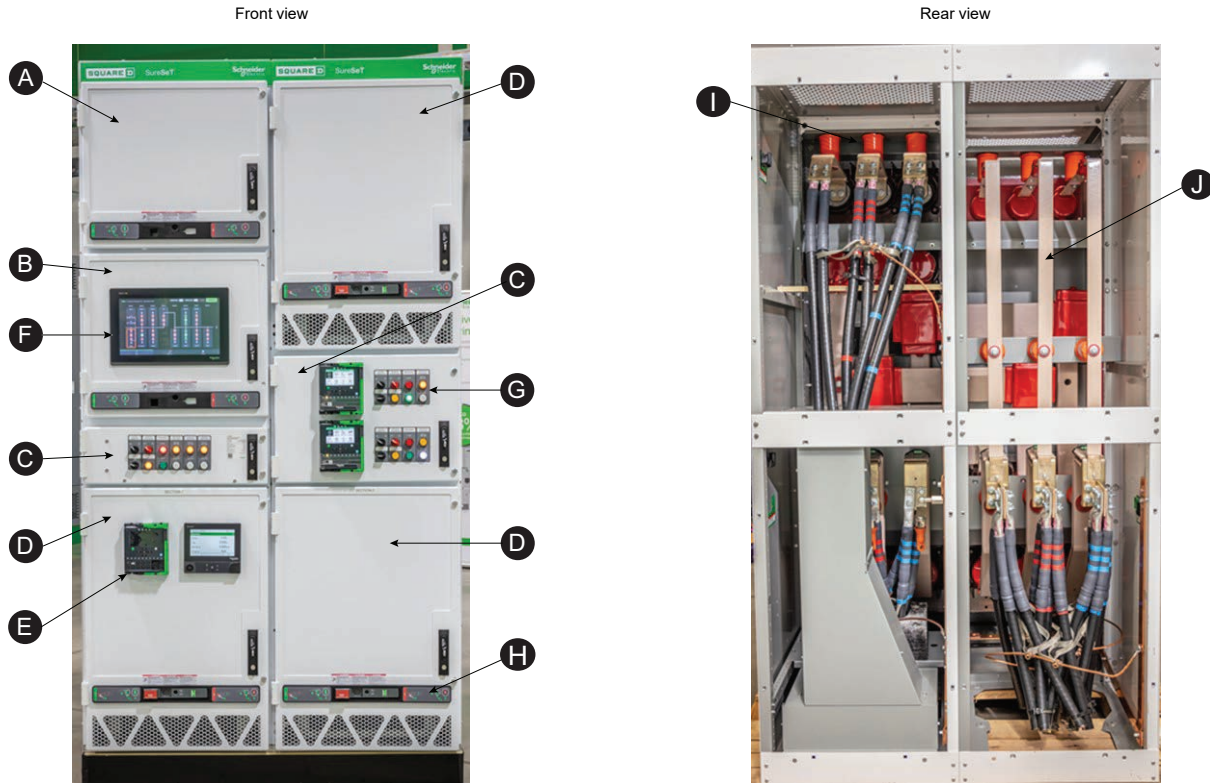

Table 11.16: Legend

A	Auxiliary compartment – Position A	F	Human Machine Interface (HMI) screen (only available with Digital Monitoring package)
B	Auxiliary compartment – Position B	G	Control panel with local/remote switch, operational pushbuttons, and racking time delay
C	Low voltage compartment	H	Racking mechanism faceplate
D	Upper and lower circuit breaker compartment	I	Cable connections
E	Instruments can be mounted on the panel doors in front of the circuit breakers or auxiliary drawouts.	J	Busbar connection for auxiliary to main

For more details on circuit breaker cubicle, refer to the [EvoPacT™ ANSI](#) product range online.

Technical Characteristics

Table 11.17: SureSeT Switchgear Characteristics

Main Characteristics	
Brand	Square D™ by Schneider Electric
Range series of product	SeT Series
Range of product	SureSeT
Product or component type	Metal-Clad MV Switchgear
Insulation types	Group A – Bushings and stand-off insulators are molded fiberglass polyester. Group B – Bushings are epoxy, stand-off insulators are porcelain.
Ratings of SureSeT switchgear with EvoPacT Series	
Rated maximum voltage range available (kV rms)	5–15.0
Rated power frequency withstand range available (kV rms)	19–36
Rated lightning impulse withstand insulation levels available (kV peak)	60–95
Rated frequency (Hz)	60
Rated continuous current range available (A)	1200–2000
Rated momentary withstand current range available (kA peak)	65–104
Rated 2 second short-time withstand current (kA sym)	25–40
Enclosure category	B
Internal arc withstand	Non-Arc rated
Schneider Electric environmental Eco-Design Level	Green Premium 2
RoHS compliant	Applicable
REACH compliant	Applicable
California Proposition 65	Applicable
Ambient and Operating Conditions	
Type	Type 1 Indoor
Applicable Codes and Standards	
cULus	Listed
IEEE	Compliant
NEMA	Compliant
CSA	Compliant
IEC/IEEE	Compliant
Seismic IBC / ASCE 7	Compliant
3-cycle interrupting rating	Rated
ANSI/IEEE C37.20.2, C37.09, C37.54, C37.55	Rated



**Dimensions and Weight**

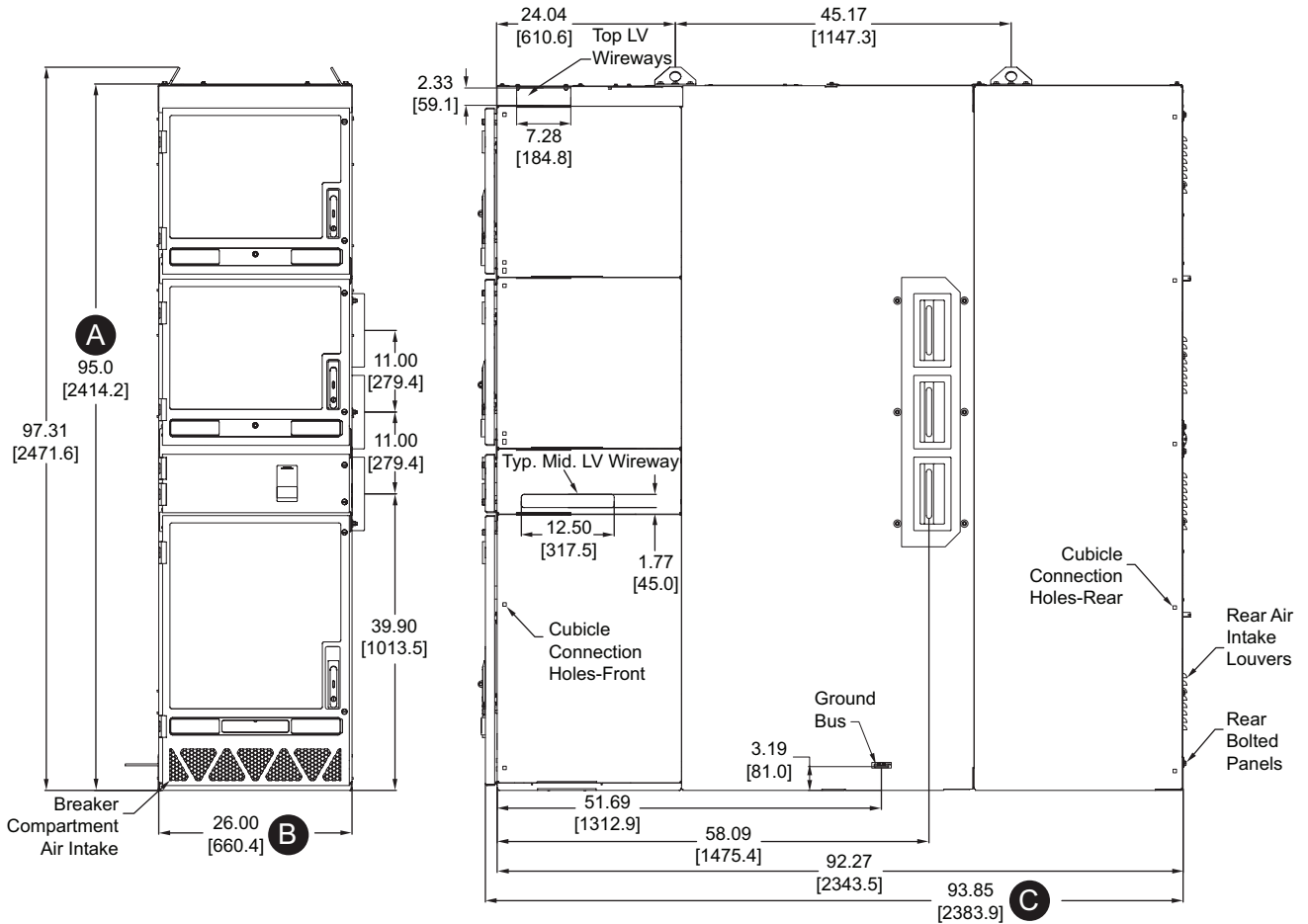

**Table 11.18: Switchgear and Component Approximate Dimensions**

Item	Description	
A	Section Height	95 in. (2,413 mm)
B	Section Width	26 in. (660 mm)
C	Section Depth	92.5 in. (2,350 mm)

**Masterclad™ Medium Voltage Metalclad Switchgear (UL Listed)**  
**The Reliability of a Quality Design**

Masterclad™ offers a customizable solution for demanding medium voltage applications. Rugged construction is coupled with low maintenance 3-cycle vacuum circuit breaker.

A comprehensive design testing program has been performed by Schneider Electric. The switchgear and breakers are designed and tested in accordance with all applicable ANSI Standards C37.04, C37.06, C37.09, and C37.20.2. The switchgear and breakers meet the requirements of ANSI, IEEE, NEMA, and exceeds most IEC standards.



Listed Metalclad Switchgear



Two-high Masterclad 5–27 kV Indoor, Metalclad Switchgear

**Table 11.19: Ratings**

Nominal voltage (kV)	4.16	7.2	13.8	24.9
Maximum voltage (kV)	4.76	8.25	15.0	27.0
BIL (kV)	60	95	95	125
Frequency (Hz)	50/60			
Continuous amperes (A)	1200–4000			1200–2000
MVA (reference only)	250	350	500	500
Short-time rating (kA) 3 seconds	40	50	63	50
Close and latch rating (kA) (peak)	104	130	164	130



Vacuum VR Circuit Breaker for Masterclad Switchgear



Masterclad 27 kV, Outdoor Non Walk-in, Metalclad Switchgear

### Type VR Vacuum Circuit Breaker

The VR breaker is a horizontal drawout type designed to provide long life, reduced maintenance, and ease of handling. The Type RI advanced design motor-charged stored energy mechanism is a model of reliability with simplicity—with an operating life exceeding ANSI requirements. The VR circuit breaker is UL labeled and includes a permanently mounted manual charging handle.

Standard features include:

- 3-cycle interrupting rating
- Rated per ANSI/IEEE C37.06, C37.09, C37.013, C37.54
- UL Listed
- Motor operated, spring-charged, stored-energy operating mechanism
- Permanently mounted manual charging handle
- Five normally open and normally closed auxiliary contacts
- Wheels that roll directly to floor level from lower cell

### Switchgear Construction

- High-speed operation—3—cycles
- Removable (draw-out) circuit breaker
- Grounded metal barriers enclose all live parts
- Automatic shutters driven by breaker racking mechanism
- Closed door breaker position indication
- Closed door breaker racking mechanism
- Insulated main bus—aluminum or copper
- Standard glass polyester insulators or optional epoxy and porcelain insulators
- Mechanical interlocks
- Disconnect type CPT and VT trucks
- Grounded breaker truck in and between test/disconnected and connected positions
- Low voltage instrument/control compartment isolated from primary voltage areas
- Compliance to ANSI/IEEE standards C37.20.2 and C37.55 (designed and tested to comply with or exceed ANSI and IEEE standards)
- ISO 9001 Certification (Designed and manufactured in a facility that is Quality Systems Certified by Underwriters Laboratories, Inc.® to ISO 9001)
- Indoor NEMA 1 enclosure
- Outdoor NEMA 3R enclosure
  - Walk-in enclosure
  - Non walk-in enclosure



Listed Metal-Enclosed Interrupter Switchgear

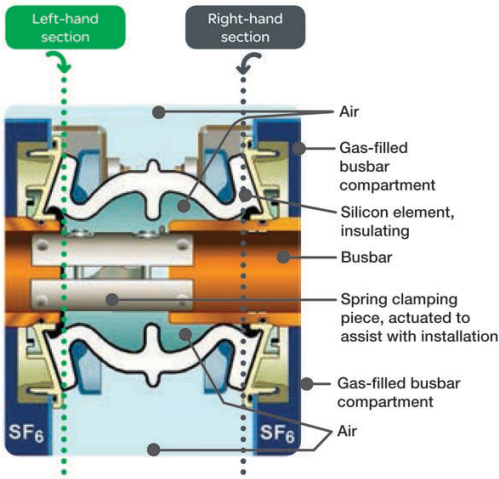

**GHA Gas-Insulated Switchgear (UL Listed)**

Easy, innovative, and economical up to 38kV

GHA Medium Voltage (MV) switchgear is an ideal solution for a variety of applications and requirements. GHA is well suited for public and industrial distribution networks, infrastructure projects, petrochemical oil and gas industries, and container substations to name a few. This compact and modular switchgear offers both flexibility and a long, low-maintenance service life.

Each section consists of sealed-for-life SF<sub>6</sub> modules, which contain the fixed vacuum circuit breaker, disconnect switch, and innovative busbar system. By design, there is no gas handling throughout the service life of the equipment, from installation until recycling at the end of life of the switchgear. Utilize the cutting-edge B-link busbar to easily install, extend, or replace gear in the middle of a lineup, without handling SF<sub>6</sub>. Like the gas-filled modules, the B-link system does not require any maintenance.

Front accessible and ideal for a variety of applications, GHA represents the new generation of robust, extremely compact, and low maintenance MV switchgear.

**Table 11.20: Ratings**

Rated Voltage (kV)	Rated Lightning Impulse Withstand Voltage (kV)	Rated Power Frequency Withstand Voltage (kV)	Rated Short-Time Withstand Current (kA)	Rated Busbar Current (A)	Rated Current of Outgoing Feeders (A)	Arc Resistant per IEEE C37.20.7
12	75	28	40	2500	2500	40 ka duration for 0.5 seconds
15	95	38	40	2500	2500	
27	125	50	40	2500	2500	
38	170	80	40	2500	2500	

**Table 11.21: Dimensions**

Electrical Characteristics		Dimensions (in./mm)				
Rated Voltage (kV)	Rated nominal current (A)	Cubical Width			Depth	Section Height
		Main/Feeder	Bus Tie with Circuit Breaker	Bus Sectionalizer		
12 17.5 24 38	≤ 1200 2500	23.6/600	31.5/800	23.6/600	62.8/1595	94.5/2400 (with 31.5/800 LV compartment)

**CBGS-0 Gas-Insulated Switchgear (UL Listed)**

Easy innovative and economical up to 38kV

CBGS-0 Medium Voltage (MV) switchgear is compact and easy to install and operate. Due to the insulating gas as well as the solidly insulated busbar and cable connections the medium voltage circuit is protected from environmental influences reducing the risk of arc flash events.

Each section consists of a sealed-for-life SF<sub>6</sub> tank which contains the fixed SF<sub>6</sub> range circuit breaker and disconnect switch. By design there is no gas handling throughout the service life of the equipment from installation until recycling at the end of life of the switchgear.

Front accessible and ideal for a variety of applications from transformer substations to primary power distribution in markets ranging from mining and metals renewable installations container substations and heavy industry where space is at a premium.



Listed Metal-Enclosed Interrupter Switchgear

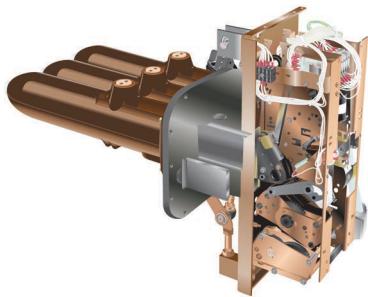

CBGS-0 Circuit Breaker

**Table 11.22: Ratings**

Rating	Main/Feeder	Bus Section	Bus Riser	Disconnecting Switch	Auxiliary Services
Nominal voltage (kV)	15 27 38	15 27 38	15 27 38	15 27 38	15 27 38
Busbar system rated current (A)	1200/2000	1200/2000	1200/2000	1200/2000	1200/2000
Outgoing rated current (A)	1200/2000	1200/2000	1200/2000	1200/2000	—
Short-time withstand current (kA)	25–31.5	25–31.5	25–31.5	25–31.5	Limited by the fuse

**Table 11.23: General Electrical Characteristics**

Rated Voltage		kV Rating	
		27	38
Rated Insulation Level	Power frequency 60 Hz. (efficient kV)	60	70
	Lightning impulse withstand voltage (kV peak)	125	150
Rated normal current (A)	Busbar system	1200/2000	
	Incoming/outgoing	1200/2000	
Short circuit breaking current (kA)		25/31.5	
Short circuit breaking current (kA peak)		63/80	
Short time withstand current (kA/s)		Max 25/2–31.5/2	
Gas pressure at 200 °C (psi)		18.85	
Standard degrees of protection	High voltage compartment	IP65	
	Low voltage compartment	IP3X–IP41	

**Table 11.24: Dimensions and Weights**

Modular Functional Unit (s)	Continuous Current Rating (A)	Dimensions Inches (mm)			Weight lbs. (kg)
		Width	Depth	Height	
Main/feeder bus section	1200	23.5 (600)	55.1 (1400)	92.5 (2350)	1598 (725)
	2000	47.2 (1200)			2249 (1020)
Bus riser disconnecting switch	1200	23.5 (600)			1058 (480)
	2000	47.2 (1200)			2052 (930)
VT auxiliary section	Not applicable	23.5 (600)			926 (420)

**HVL/cc Metal-Enclosed Load Interrupter Switchgear—Full Range**

Square D™ brand HVL/cc metal-enclosed load interrupter switchgear with a sealed switch enclosure contains the contact arcing from switch contacts (all interruption takes place within the sealed enclosure), a critical concern in gaseous environments – Class 1 Div 2 certified. The permanently sealed switch help prevent switch contamination, especially important in dusty environments, thus eliminating maintenance on main and ground switch contacts.

Its compact size is made up of modular units, making the HVL/cc easy to expand future extensions and connections to existing equipment and ideal for retrofit applications. With front access, only options available at system voltages below 17.5 kV can be positioned against walls, in small rooms, or in prefabricated buildings. The small footprint can result in considerable cost savings from the reduction of building or room sizes.

The HVL/cc switch can be equipped with either an over-toggle mechanism (OTM), which is standard, or an optional stored energy mechanism (SEM). Top or bottom cable entry enhances installation flexibility. Enclosures are free-standing and suitable for both indoor (NEMA 1) and outdoor (NEMA 3R) applications.

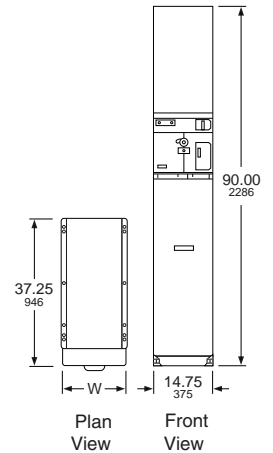
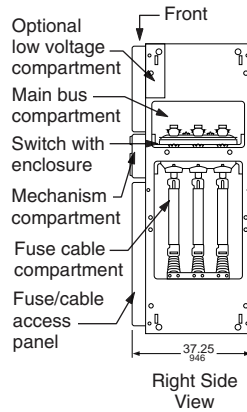

**Table 11.25: HVL/cc Load Interrupter Switches— Full Range 600/1200 A Ratings**

Switch (kV)—maximum design	5.5	17.5	17.5	25.8	38
BIL (kV)	60	95	95	125	150
Frequency (Hz)	50/60	50/60	50/60	50/60	50/60
Withstand (kV)	19	36	36	50	80
Continuous current (A)	600/1200	600/1200	600/1200	600	600
Interrupting current (A)	600/1200	600/1200	600/1200	600	600
Fault close (kA asymmetrical)	40	40	40	32	32
Momentary current (kA asymmetrical)	40	40	40	32	32
Short time current (kA symmetrical)	25	25	25	25	25
Electrical endurance (number of operations at 80% P.F.)	100/600 A 26/1200 A	100/600 A 26/1200 A	100/600 A 26/1200 A	100	100
Mechanical endurance (number of operations)	1000	1000	1000	1000	1000



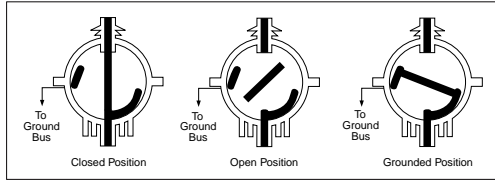

**Switch Standard Features**

- Switch Positions: Closed, open, and internally grounded (optional) (connects switch contacts to ground)
- Enclosure: Epoxy
- Medium: Sulphur hexafluoride
- Maintenance: Maintenance free main switch contact sealed for life
- Pressure:
  - 5.8 PSI ( $\leq 17.5$  kV)
  - 22 PSI (25.8–38 kV)
- View ports to show switch blade position

**Options**

- Internal ground switch: Has full fault making capability
- Fuselogic™ system
- Infrared viewing windows
- Class I, Division 2
- Fast/auto transfer configuration (main-main and main-tie-main)
- Duplex configurations
- Powerlogic™ metering
- 20-inch or 29.5-inch wide enclosures
- Duplex configuration with mechanical interlock blocks simultaneous closure of both switches
- Ground switch (fault close rated)
- Thermal monitoring
- Motor operator
- Under coated base channels
- Insulated bus
- Lug termination boots
- Key locks

**Fuselogic™**

Fuselogic is a protection system that provides the ultimate in medium voltage fuse protection. This patented system utilizes Square D™ brand current-limiting fuses with mechanical sensors that function without any auxiliary power requirements. Several combinations of Fuselogic functions can be combined to provide simple blown fuse indication contacts with mechanical lockout to anti-single phasing protection. Anti-single phasing requires the optional stored energy mechanism. Fuselogic is available on both HVL/cc and HVL switches.

**Switchgear Standard Features**

- Compartmentalization – up to five isolated compartments for the switch, bus, fuse/cable, mechanism and optional low voltage and control components; blocks inadvertent access to main bus compartment when accessing fuse/cable compartment.
- 11 gauge steel enclosure
- Epoxy insulators
- Fuse/cable access panel interlocked with switch
- Front access only options available at system voltages below 17.5 kV
- Animated mechanism mimic bus
- Padlocking provision—open or closed (OTM); open-only (SEM)
- Top or bottom cable entry
- UL/CUL Listed, IEEE C37.20.3
- Live line indicators on all incoming switch bays and outgoing feeder circuits
- Cable lugs included for one cable per phase
- Tin plated copper bus for lineups
- Square D™ TGIC polyester powder paint system, toughest in the industry



**Table 11.26: Surge Arresters**

System L-L Voltage kV		Arrester MCOV-kV	
Nominal	Maximum	Effectively Grounded Neutral Circuits	Impedance Grounded and Ungrounded Circuits
2.4	2.54	—	2.55
4.16	4.4	2.55	5.1
4.8	5.08	—	5.1
6.9	7.26	—	7.65
12.0	12.7	7.65	12.70
12.47	13.2	7.65	12.70
13.2	13.97	8.4	—
13.8	14.52	8.4	—

**HVL/cc Switchgear Quick Ship Program—5–15 kV, 600 A**

The HVL/cc quick ship program provides basic fused and unfused load interrupter switch configurations for standalone or transformer primary applications. The Quick Ship program offers faster delivery, but with fewer options.

Three-pole, 600 A individual HVL/cc switches are available in free-standing indoor (NEMA 1) enclosures. These switches are available unfused or with provisions for Square D™ brand current-limiting DIN/E fuses. Factory optional accessories include auxiliary bays, main bus, auxiliary switches, and distribution class surge arresters. The fuse access panel is mechanically interlocked with the switch mechanism. Key interlocks are not an available option with Digest-listed HVL/cc switches. (1) Set screw type lugs for (2) #2–350 kcmil copper or aluminum cables are provided for line and load connections. **Fuses are not furnished with this equipment.** For fuse information, refer to [General Purpose E-Rated Current-Limiting Fuses: Type DIN/E for HVL/cc Switches, page 11-28](#).

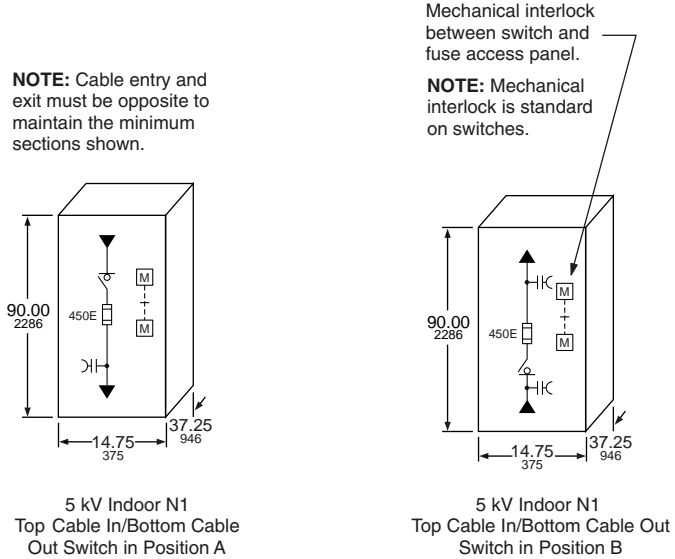

**Provisions for Future Expansion**

- All “single” HVL/cc switches have provisions for future expansion on either side
- Order main bus kits for copper 600 A bus

**600 A Single Switch Unfused**

- Manual over-toggle mechanism, no grounding switch
- Includes (1) set screw for (2) #2–350 kcmil Cu or Al conductors per phase
- Application A = Top entry (incoming—cable or main bus), bottom exit (load—cable or main bus)
- Application B = Bottom entry (incoming—cable or main bus), top exit (load—cable or main bus)

**Table 11.27: Unfused Switch Selection**

Catalog No.	kV Rating	Fuse Range	Application	Width	
				in	mm
HVLC14305N	4.76	—	A	14.75	375
HVLC20305N	4.76	—	A	20.00	508
HVLC14315N	15	—	A	14.75	375
HVLC20315N	15	—	A	20.00	508
HVLCB14305N	4.76	—	B	14.75	375
HVLCB20305N	4.76	—	B	20.00	508
HVLCB14315N	15	—	B	14.75	375
HVLCB20315N	15	—	B	20.00	508

600 A Single Switch Fused

- Provisions only for Square D™ brand current-limiting DIN/E fuses—order separately
- Manual over-toggle mechanism, no grounding switch
- Includes (1) set screw lug for (2) #2–350 kcmil Cu or Al conductor per phase
- Application A = Top entry (incoming—cable or main bus), bottom exit (load—cable or main bus)
- Application B = Bottom entry (incoming—cable or main bus), top exit (load—cable or main bus)

Table 11.28: Fused Switch Selection

Catalog No.	kV Rating	Fuse Range	Application	Width	
				in	mm
HVLCCA14305D	4.76	10–450E	A	14.75	375
HVLCCA20305D	4.76	10–450E	A	20.00	508
HVLCCA14315D	15	10–200E	A	14.75	375
HVLCCA20315D	15	10–200E	A	20.00	508
HVLCCB14305D	4.76	10–450E	B	14.75	375
HVLCCB20305D	4.76	10–450E	B	20.00	508
HVLCCB14315D	15	10–200E	B	14.75	375
HVLCCB20315D	15	10–200E	B	20.00	508

600 A Incoming Line Auxiliary Bay

For bottom incoming cable to application A (bottom cable exit) switch(es), order 600 A tin plated Cu main bus to adjacent section from bus table. Includes (1) set screw lug for (2) #2–350 kcmil Cu or Al conductor per phase.

Table 11.29: Bays for Bottom Entry/Bottom Exit Cables

Catalog No.	kV Rating	Fuse Range	Application	Width	
				in	mm
HVLCCA14A	4.76/15	—	A	14.75	375
HVLCCA20A	4.76/15	—	A	20.00	508

For top incoming cable to application B (top cable exit) switch(es), order 600 A tin plated Cu main bus to adjacent section from main bus kits table. Includes (1) set screw lug for (2) #2–350 kcmil Cu or Al conductor per phase.

Table 11.30: Bays for Top Entry/Top Exit Cables

Catalog No.	kV Rating	Fuse Range	Application	Width	
				in	mm
HVLCCB14A	4.76/15	—	B	14.75	375
HVLCCB20A	4.76/15	—	B	20.00	508

600 A Tin Plated Copper Main Bus Kits

Table 11.31: Bus Kits

Catalog No.	Left (From) Application	Width		Right (To) Application	Width	
		in	mm		in	mm
HVLCMBBA14A14	A	14.75	375	A	14.75	375
HVLCMBBA14A20	A	14.75	375	A	20.00	508
HVLCMBBA20A14	A	20.00	508	A	14.75	375
HVLCMBBA20A20	A	20.00	508	A	20.00	508
HVLCMBBB14B14	B	14.75	375	B	14.75	375
HVLCMBBB14B20	B	14.75	375	B	20.00	508
HVLCMBBB20B14	B	20.00	508	B	14.75	375
HVLCMBBB20B20	B	20.00	508	B	20.00	508

Ratings

HVL/cc Switch with manually operated type OTM mechanism in cubicle enclosure (does not include internal ground switch). Ratings are based on an X/R ratio of 1.6.

Table 11.32: HVL/cc Switch Ratings

Switch (kV)—maximum design	5.5	17.5
BIL (kV)	60	95
Frequency (Hertz)	50/60	50/60
Withstand (kV)	19	36
Continuous current (amperes)	600	600
Interrupting current (amperes)	600	600
Fault close (amperes asymmetrical)	40,000	40,000
Integrated switch and fuse rating (amperes symmetrical) <sup>[1]</sup>	65,000	65,000
Momentary current (amperes asymmetrical)	40,000	40,000
Short time current, 2 seconds (amperes symmetrical)	25,000	25,000
Operations at Full Load	100	100
Mechanical Endurance (number of operations)	1000	1000

[1] 50,000 for 630 A fuse.

**Factory Modifications**

**Table 11.33: Factory Modifications**

Catalog No.	Description
HVLC-CX3	Auxiliary switch 2 N.O.–2 N.C. contact

**Distribution Class Surge Arresters**

(One Set of Three) Switch Load Side Connected or Incoming Line Bay)

**Table 11.34: Surge Arresters**

Catalog No.	kV Rating	Section Width Minimum Required	
		in	mm
HVLCDSA3	3 kV, 2.55 kV MCOV	14.75	375
HVLCDSA6	6 kV, 5.10 kV MCOV	14.75	375
HVLCDSA9	9 kV, 7.65 kV MCOV	14.75	375
HVLCDSA10	10 kV, 8.40 kV MCOV	14.75	375
HVLCDSA12	12 kV, 10.20 kV MCOV	14.75	375
HVLCDSA15	15 kV, 12.70 kV MCOV	20.00	508
HVLCDSA18	18 kV, 15.3 kV MCOV	20.00	508

**600 A “Single” HVL/cc Switch with PROVISIONS ONLY for Square D™ brand Current-Limiting, Non-Disconnect Type Fuses for Cable Connection to Power-Dry™, Power-Cast™, and Uni-Cast™ Transformers**

(FLC = 300 A MAXIMUM)

RH—Transformer on right, LH—Transformer on Left

Application A = Top Entry (Incoming Cables)

Application B = Bottom Entry (Incoming Cables)

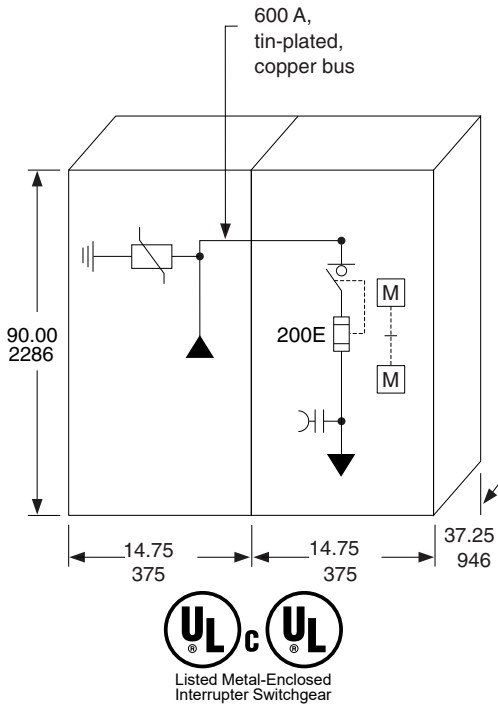

**Table 11.35: 600 A “Single” HVL/cc Switch Selection**

Catalog No.	kV Rating	Fuse Range	Ap- plication	Width		RH / LH
				in	mm	
HVLC14405DGR	4.76	10–450E	A	14.75	375	RH
HVLC20405DGR	4.76	10–450E	A	20.00	508	RH
HVLC14405DGL	4.76	10–450E	A	14.75	375	LH
HVLC20405DGL	4.76	10–450E	A	20.00	508	LH
HVLC14415DGR	15	10–200E	A	14.75	375	RH
HVLC20415DGR	15	10–200E	A	20.00	508	RH
HVLC14415DGL	15	10–200E	A	14.75	375	LH
HVLC20415DGL	15	10–200E	A	20.00	508	LH
HVLCB14405DGR	4.76	10–450E	B	14.75	375	RH
HVLCB20405DGR	4.76	10–450E	B	20.00	508	RH
HVLCB14405DGL	4.76	10–450E	B	14.75	375	LH
HVLCB20405DGL	4.76	10–450E	B	20.00	508	LH
HVLCB14415DGR	15	10–200E	B	14.75	375	RH
HVLCB20415DGR	15	10–200E	B	20.00	508	RH
HVLCB14415DGL	15	10–200E	B	14.75	375	LH
HVLCB20415DGL	15	10–200E	B	20.00	508	LH

**NOTE:** Switches with transformer connections are painted ANSI 49. Standalone switches are painted ANSI 61. Transformer connections in HVL/cc switches are based on standard Square D™ brand transformer connections. If these switches are used to connect to other manufacturers' transformers, then connections must match standard Square D™ brand transformer connections. (Cable connections are furnished with the transformer.)

**General Purpose E-Rated Current-Limiting Fuses: Type DIN/E for HVL/cc Switches**

- Integrated rating for 600 A HVL/cc switches with Square D™ brand DIN/E fuses listed below is 65 kA rms symmetrical amperes.
- Current-limiting fuses increase the integrated short-circuit current rating because of their energy-limiting capabilities.
- To increase the short-circuit current rating of the entire lineup of switchgear, current-limiting fuses must be used in the entrance sections.

**Table 11.36: Fuse Selection**

Catalog No.	kV Rating	Fuse Rating	Set of Fuses [2]	Fuse Size	Section Width Required	
					in	mm
55DE010	5.5	10E	1	Actual	14.75	375
55DE015	5.5	15E	1	Actual	14.75	375
55DE020	5.5	20E	1	Actual	14.75	375
55DE025	5.5	25E	1	Actual	14.75	375
55DE030	5.5	30E	1	Actual	14.75	375
55DE040	5.5	40E	1	Actual	14.75	375
55DE050	5.5	50E	1	Actual	14.75	375
55DE065	5.5	65E	1	Actual	14.75	375
55DE080	5.5	80E	1	Actual	14.75	375
55DE100	5.5	100E	1	Actual	14.75	375
55DE125	5.5	125E	1	Actual	14.75	375
55DE150	5.5	150E	1	Actual	14.75	375
55DE175	5.5	175E	1	Actual	14.75	375
55DE200	5.5	200E	1	Actual	14.75	375
55DE250	5.5	250E	1	Actual	14.75	375
55DE300	5.5	300E	1	Actual	14.75	375
55DE350	5.5	350E	1	Actual	14.75	375
55DE400	5.5	400E	1	Actual	14.75	375
55DE450	5.5	450E	1	Actual	14.75	375
175DE010	15.5	10E	1	Actual	14.75	375
175DE015	15.5	15E	1	Actual	14.75	375
175DE020	15.5	20E	1	Actual	14.75	375
175DE025	15.5	25E	1	Actual	14.75	375
175DE030	15.5	30E	1	Actual	14.75	375
175DE040	15.5	40E	1	Actual	14.75	375
175DE050	15.5	50E	1	Actual	14.75	375
175DE065	15.5	65E	1	Actual	14.75	375
175DE080	15.5	80E	1	Actual	14.75	375
175DE100	15.5	100E	1	Actual	14.75	375
175DE125	15.5	125E	1	Actual	14.75	375
175DE150	15.5	150E	1	Actual	14.75	375
155DE175	15.5	175E	1	Actual	14.75	375
155DE200	15.5	200E	1	Actual	14.75	375

**600 A “Duplex” HVL/cc Switch with PROVISIONS ONLY for Square D™ brand Current-Limiting, Non-Disconnect Type Fuses for Cable Connection to Power-Dry, Power-Cast, and Uni-Cast Transformers**

- FLC = 300 A maximum
- RH—Transformer on right
- LH—Transformer on left includes mechanical interlock to prevent paralleling of sources
- Application A = top entry (incoming cables)
- Application B = bottom entry (incoming cables)

**Table 11.37: 600 A “Duplex” HVL/cc Switch Selection**

Catalog No.	kV Rating	Fuse Range	Applicati-on	Width		RH / LH
				in	mm	
HVLC A14505DGR	4.76	10–450E	A	14.75	375	RH
HVLC A20505DGR	4.76	10–450E	A	20.00	508	RH
HVLC A14505DGL	4.76	10–450E	A	14.75	375	LH
HVLC A20505DGL	4.76	10–450E	A	20.00	508	LH
HVLC A14515DGR	15	10–200E	A	14.75	375	RH
HVLC A20515DGR	15	10–200E	A	20.00	508	RH
HVLC A14515DGL	15	10–200E	A	14.75	375	LH
HVLC A20515DGL	15	10–200E	A	20.00	508	LH
HVLC B14505DGR	4.76	10–450E	B	14.75	375	RH
HVLC B20505DGR	4.76	10–450E	B	20.00	508	RH
HVLC B14505DGL	4.76	10–450E	B	14.75	375	LH
HVLC B20505DGL	4.76	10–450E	B	20.00	508	LH
HVLC B14515DGR	15	10–200E	B	14.75	375	RH
HVLC B20515DGR	15	10–200E	B	20.00	508	RH
HVLC B14515DGL	15	10–200E	B	14.75	375	LH
HVLC B20515DGL	15	10–200E	B	20.00	508	LH

[2] Each set of fuses contains three fuses, so, for example, two sets of fuses yield a total of six fuses.



**Ordering Information**

1. Select switch catalog number based on fused or unfused and cable entry locations (top or bottom) from [Table 11.27 Unfused Switch Selection, page 11-25](#), or [Table 11.28 Fused Switch Selection, page 11-26](#).
2. Select incoming line auxiliary bay from [Table 11.29 Bays for Bottom Entry/Exit Cables, page 11-26](#), or [Table 11.30 Bays for Top Entry/Exit Cables, page 11-26](#), if required.
3. Select main bus from [Table 11.31 Bus Kits, page 11-26](#), if required.
4. Select catalog numbers for factory modifications from [Table 11.33 Factory Modifications, page 11-27](#), if required.
5. If fused, select DIN/E fuses from [Table 11.36 Fuse Selection, page 11-28](#).

**Ordering Example**

Order indoor 600 A, 5 kV, HVL/cc switch with bottom incoming and bottom outgoing cables (1) #2 AWG per phase, (1) set 200E fuses, and (1) set 6 kV surge arresters.

Order:	Catalog No.
Switch w/fuse provisions and bottom exit load cables	HVLCCA14305D
600 incoming line auxiliary bay (Application A—bottom entry)	HVLCCA14A
Main Bus (Application A—14 in. to Application A—14 in.)	HVLCCMBA14A14
6 kV LAs	HVLCDSA6
Set 200E fuses	55DE200

**HVL Metal-Enclosed Load Interrupter Switchgear—Full Range**

HVL™ 5–38 kV Load Interrupter is the most popular ANSI-rated go to switchgear in its class in America. Among medium voltage interrupter switchgear, both the switch and the enclosure stand as industry benchmarks in the areas of design, manufacturing, and performance. Load interrupter switchgear must perform a number of critical functions in a unit substation - protecting equipment and disconnecting faulted lines and transformers. Designed and tested to the latest applicable standards, HVL has been engineered to provide superior protection for your distribution system.

HVL switchgear is available for various applications and configurations, including:

- Individual service entrance bays
- Multiple-bay lineups incorporating HVL load interrupters
- Substation primaries

Square D™ brand metal-enclosed switchgear has become an industry standard for its better system performance, lower maintenance cost, easier system expansion, and reduced system expense.

A full range of ratings and options are available but not listed in this publication. Contact your nearest Schneider Electric sales office or your local Schneider Electric distributor.



Listed Metal-Enclosed Interrupter Switchgear

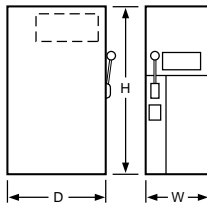

Side view Front view

Recommended power cable conduit area

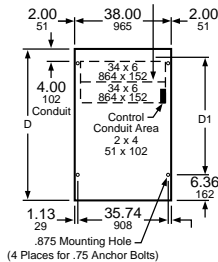

**Table 11.38: Ratings**

Maximum design voltage (kV)	4.76	15	17	25.8	29	38
BIL (kV)	60	95	95	125	125	150
Frequency (Hz)	50/60	50/60	50/60	50/60	50/60	50/60
Continuous amperes	600/1200	600/1200	600	600/1200	600/1200	600
Interrupting amperes	600/1200	600/1200	600	600	400	400
Momentary (kA asymmetrical)	40/61/80	40/61/80	61	40/61	40/61	40
Fault close (kA asymmetrical)	40/61	40/61	40	28	28	20
Capacitor switching (kVAR)	2400	2400	—	—	—	—
Short time rating 2 seconds (kA symmetrical)	25/38/50	25/38/50	25	25	25	25
Low frequency withstand (kV)	19	36	36	60	60	80

**Standard Features**

- 11 gauge steel enclosure
- Direct drive mechanism for quick make and break operation
- Permanently attached operating handle
- Visible isolation viewing window for switch blade position
- Mechanical interlocked fuse access door
- Provision for padlock and key interlock
- Highly flexible design
- ANSI 61 paint
- Upright or inverted switch mounting
- Heaters for outdoor equipment

**Options**

- Outdoor construction
- Square D™ brand DIN-style current-limiting fuses
- Boric acid fuses
- Silver or tin plated copper bus
- 600, 1200, or 2000 A main bus
- Heat shrink insulated bus
- Motor operator
- Shunt trip
- Fuselogic™ tripping system (SEM type mechanism only)
- Roof bushings
- Key interlocks
- Surge arresters
- Utility metering bays
- Duplex switch
- Transformer connections
- Infrared windows for thermal scanning of connections
- Floor plates
- Undercoated base channels
- Dual shunt trip
- Heaters
- Mimic bus placard
- Switch position auxiliary contacts
- Automated switching
- Viewing window on fuse access door
- Tamperproof hardware
- CS-3 Type fuse mounting
- Hard bus to transformer mounting
- EcoStruxure temperature monitoring

**Fuselogic™**

Fuselogic is a protection system that provides the ultimate in medium voltage equipment protection. This patented system utilizes the CS-3 Type striker type current-limiting fuses with mechanical sensors that function without any auxiliary power requirements. Several configurations of Fuselogic functions can be combined to provide simple blown fuse indication during operation contacts or closing of the switch with mechanical lockout to help prevent anti-single phasing protection. Anti-single phasing requires the optional stored energy mechanism (SEM). Fuselogic is available on both HVL/cc™ and HVL switches.

**HVL Switchgear Quick Ship Program—5 kV–15 kV, 600 A**

The HVL quick ship program provides basic fused and unfused load interrupter switch configurations for stand-alone or transformer primary applications. The Quick Ship program offers faster delivery, but with fewer options.

Three-pole, 600 A individual HVL switches are available in free-standing indoor (NEMA 1) or outdoor (NEMA 3R) enclosures. The switches used in these enclosures are UL Recognized and are listed under Category WIQG2 in File E140591(M). These switches are available unfused or with provisions for DIN—style, Square D™ brand current-limiting fuses, CS-3 Type or for boric acid fuses. Factory optional accessories include auxiliary switches, extra cable terminating lugs and distribution class surge arresters. The door is mechanically interlocked with the switch operating handle and provisions for key interlocks and padlocks are standard. Set screw type lugs for one #2 solid—600 kcmil copper or aluminum cables are provided for line and load connections. Other standard features include a bolted enclosure with a viewing window, ground pad, and space heater (NEMA 3R only). Control power for heater must be from external source. **Fuses are not furnished with this equipment.** For fuse information, refer to [DIN/E Current-Limiting Fuses, Non-Disconnecting Type](#), page 11-34, or [Boric Acid Fuses](#), page 11-35. Many of the fuses listed in these tables are available from stock. Switches are listed in the tables below and on page 11-32.

**Table 11.39: 600 A “Single” Switch Unfused**

Catalog No.	kV Rating	Fuse Range	Enclosure Type
<a href="#">HVL305NG</a>	4.76	—	NEMA 1
<a href="#">HVL305NW</a>	4.76	—	NEMA 3R
<a href="#">HVL315NG</a>	15	—	NEMA 1
<a href="#">HVL315NW</a>	15	—	NEMA 3R

**Table 11.40: 600 A “Single” Switch with PROVISIONS ONLY for Square D™ brand Current-Limiting, Non-Disconnect Type Fuses**

Catalog No.	kV Rating	Fuse Range	Enclosure Type
<a href="#">HVL305DEG</a>	4.76	10–450E	NEMA 1
<a href="#">HVL305DEW</a>	4.76	10–450E	NEMA 3R
<a href="#">HVL315DEG1</a>	15	10–100E	NEMA 1
<a href="#">HVL315DEG2</a>	15	125–200E	NEMA 1
<a href="#">HVL315DEW1</a>	15	10–100E	NEMA 3R
<a href="#">HVL315DEW2</a>	15	125–200E	NEMA 3R

**Table 11.41: 600 A “Single” Switch with PROVISIONS ONLY for S&C Boric Acid Non-Disconnect Type Fuses [3]**

Catalog No.	kV Rating	Fuse Range	Enclosure Type
<a href="#">HVL305BG</a>	4.76	10E–400E	NEMA 1
<a href="#">HVL305BW</a>	4.76	10E–400E	NEMA 3R
<a href="#">HVL315BG</a>	15	10E–400E	NEMA 1
<a href="#">HVL315BW</a>	15	10E–400E	NEMA 3R
<a href="#">HVL317BG</a>	17	10E–400E	NEMA 1
<a href="#">HVL317BW</a>	17	10E–400E	NEMA 3R

**Table 11.42: Ratings**

Max. Design Voltage (kV)	4.76	15.0
BIL (kV)	60	95
Frequency (Hz)	50/60	50/60
Continuous amperes	600	600
Interrupting amperes	600	600
Momentary (amperes asymmetrical)	40,000	40,000
Fault close (amperes asymmetrical)	40,000	40,000
Capacitor switching (kVAR)	2,400	2,400
Short-time rating, 2 seconds (amperes symmetrical)	25,000	25,000
Low frequency withstand (kV)	19	36

**Table 11.43: Distribution Class Surge Arresters**

System L-L Voltage kV		Arrester MCOV-kV	
Nominal	Maximum	Effectively Grounded Neutral Circuits	Impedance Grounded and Ungrounded Circuits
2.4	2.54	—	2.55
4.16	4.4	2.55	5.1
4.8	5.08	—	5.1
6.9	7.26	—	7.65
12.0	12.7	7.65	12.70
12.47	13.2	7.65	12.70
13.2	13.97	8.4	—
13.8	14.52	8.4	—

**Table 11.44: Enclosure Type**

Type	W		D		H		Weight	
	in	mm	in	mm	in	mm	lbs	kg
Indoor	38.00	965	54.50	1384	90.00	2286	1200	545
Outdoor	38.00	965	60.00	1524	97.50	2477	1400	636

**Provisions for Future Expansion**

All “single” Digest switches have provisions for future expansion on either side. Order kits HVMB for top crossover copper 600 A bus and HVLC for line connections to the top bus. (See [Table 11.49 Factory Modifications](#), page 11-33.)

[3] Boric acid fuses may increase lead times. Contact the factory for availability.

**HVL Switches for Power-Dry II™, Power-Cast II™, and Uni-Cast II™ Transformer Connections**

HVL switches can be configured for close coupling cable connections to listed dry type transformers for primary main switches of unit substations. These are listed in the tables below with current-limiting or boric acid fuses. Both single and duplex switch mains are included in this selection. Transformers are listed on Digest Section 14: "Medium Voltage Distribution Transformers" and may not be suitable for close coupling. For transformer availability and specific configurations, contact your local Schneider Electric sales office. All connections in this digest are based on standard Square D™ brand transformer connections. If these switches are used to connect to other manufacturers' transformers, then connections must coordinate with standard Square D™ brand transformer connections. (Cable connections are furnished with the transformer.)

**Table 11.45: 600 A "Single" Switch with PROVISIONS ONLY for Square D™ brand Current-Limiting, Non-Disconnect Type Fuses for Cable Connection to Power-Dry II, Power-Cast II, and Uni-Cast II Transformers**  
(FLC = 300 A max.) RH—Transformer on Right, LH—Transformer on Left

Catalog No.	kV Rating	Fuse Range	Enclosure Type	RH / LH
HVL405DEGR	4.76	10–450E	NEMA 1	RH
HVL405DEGL	4.76	10–450E	NEMA 1	LH
HVL405DEWRH	4.76	10–450E	NEMA 3R	RH
HVL405DEWLH	4.76	10–450E	NEMA 3R	LH
HVL415DEGR1	15	10–100E	NEMA 1	RH
HVL415DEGR2	15	125–200E	NEMA 1	RH
HVL415DEGL1	15	10–100E	NEMA 1	LH
HVL415DEGL2	15	125–200E	NEMA 1	LH
HVL415DEWR1H	15	10–100E	NEMA 3R	RH
HVL415DEWR2H	15	125–200E	NEMA 3R	RH
HVL415DEWL1H	15	10–100E	NEMA 3R	LH
HVL415DEWL2H	15	125–200E	NEMA 3R	LH

**Table 11.46: 600 A "Duplex" Switch with PROVISIONS ONLY for Square D™ brand Current-Limiting, Non-Disconnect Type Fuses for Cable Connection to Power-Dry II, Power-Cast II, and Uni-Cast II Transformers**  
(FLC = 300 A max.) RH—Transformer on Right, LH—Transformer on Left

Catalog No.	kV Rating	Fuse Range	Enclosure Type	RH / LH
HVL505DEGR	4.76	10–450E	NEMA 1	RH
HVL505DEGL	4.76	10–450E	NEMA 1	LH
HVL505DEWRH	4.76	10–450E	NEMA 3R	RH
HVL505DEWLH	4.76	10–450E	NEMA 3R	LH
HVL515DEGR1	15	10–100E	NEMA 1	RH
HVL515DEGR2	15	125–200E	NEMA 1	RH
HVL515DEGL1	15	10–100E	NEMA 1	LH
HVL515DEGL2	15	125–200E	NEMA 1	LH
HVL515DEWR1H	15	10–100E	NEMA 3R	RH
HVL515DEWR2H	15	125–200E	NEMA 3R	RH
HVL515DEWL1H	15	10–100E	NEMA 3R	LH
HVL515DEWL2H	15	125–200E	NEMA 3R	LH

**Table 11.47: 600 A "Single" Switch with PROVISIONS ONLY for S&C Boric Acid Non-Disconnect Type Fuses for Cable Connection to Power-Dry II, Power-Cast II, and Uni-Cast II Transformers** [4]  
(FLC = 300 A max.) RH—Transformer on Right, LH—Transformer on Left

Catalog No.	kV Rating	Fuse Range	Enclosure Type	RH / LH
HVL405BGR	4.76	10E–400E	NEMA 1	RH
HVL405BGL	4.76	10E–400E	NEMA 1	LH
HVL405BWRH	4.76	10E–400E	NEMA 3R	RH
HVL405BWLH	4.76	10E–400E	NEMA 3R	LH
HVL415BGR	15	10E–400E	NEMA 1	RH
HVL415BGL	15	10E–400E	NEMA 1	LH
HVL415BWRH	15	10E–400E	NEMA 3R	RH
HVL415BWLH	15	10E–400E	NEMA 3R	LH

[4] Includes fuse holder only. See Boric Acid Fuses , page 11-35 for fuse refills. Boric acid fuses may increase lead times. Contact the factory for availability.

**Table 11.48: 600 A “Duplex” Switch with PROVISIONS ONLY for S&C Boric Acid Non-Disconnect Type Fuses for Cable Connection to Power-Dry II, Power-Cast II, and Uni-Cast II Transformers [5]**

(FLC = 300 A max.) RH—Transformer on Right, LH—Transformer on Left

Catalog No.	kV Rating	Fuse Range	Enclosure Type	RH / LH
HVL505BGR	4.76	10E-400E	NEMA 1	RH
HVL505BGL	4.76	10E-400E	NEMA 1	LH
HVL505BWRH	4.76	10E-400E	NEMA 3R	RH
HVL505BWLH	4.76	10E-400E	NEMA 3R	LH
HVL515BGR	15	10E-400E	NEMA 1	RH
HVL515BGL	15	10E-400E	NEMA 1	LH
HVL515BWRH	15	10E-400E	NEMA 3R	RH
HVL515BWLH	15	10E-400E	NEMA 3R	LH

**NOTE:** Switches with transformer connections are painted ANSI 49. Standalone switches are painted ANSI 61.

### Fuse Selection

The rule of thumb method for selecting fuses for transformer protection is 1.33 times the self-cooled full load current of the transformer or the next higher fuse rating. Selection of the fuse is the customer’s responsibility and should be based on transformer and system characteristics.

- **Maximum Fuse Size:**  
Maximum fuse size should be determined by comparing the fuse total clearing curve to the transformer damage curve. Contact Schneider Electric for transformer overload and short-circuit withstand capability.
- **Minimum Fuse Size:**  
Minimum fuse size shall carry the transformer magnetizing inrush current of 12 times full load amperes for 0.1 second.

**Table 11.49: Factory Modifications**

Catalog No.	Description
HVMB	Main Bus Kit, 600 A copper
HVLC	Line side connector kit (main bus) 600 A with 2-1/0=500 MCM lugs (bottom entry only) Provisions for key interlocks—Type KFL Kirk key lock with a 0-inch bolt projection (Kirk item master number KFL000010SH)
HVLX3	Auxiliary switch 2 N.O.—2 N.C. contact
HVLC2	Set screw type lugs 1/0—500 kcmil (qty. 3)
<b>Distribution Class Surge Arresters [6]</b>	
HVDSA3	3 kV, 2.55 MCOV
HVDSA6	6 kV, 5.10 MCOV
HVDSA9	9 kV, 7.65 MCOV
HVDSA10	10 kV, 8.40 MCOV
HVDSA12	12 kV, 10.20 MCOV
HVDSA15	15 kV, 12.70 MCOV

### Standard Features

- Switches for transformer primaries are cable connected only.
- Key interlocks must be ordered and coordinated by customer.
- Standard color is ANSI 61 for standalone units; ANSI 49 for switches connecting to transformers.
- If switches are purchased to coordinate with Square D™ brand transformers, composite drawings and shipment coordination will not be available.
- Switches are not designed for any special dimensions for retrofit purposes. For dimensions other than shown, contact your nearest Schneider Electric sales office or your local Schneider Electric distributor.

### Ordering Information

1. Select switch catalog number based on fused or unfused and enclosure type.
2. Select catalog numbers for factory modifications from the table above.
3. If fused, select fuse from [DIN/E Current-Limiting Fuses, Non-Disconnecting Type \(Extended Travel Blown Fuse Indicator\)](#), page 11-34 or [Boric Acid Fuses](#), page 11-35.
4. Price switch and fuses separately. Switches are furnished with provisions only for current-limiting fuse or boric acid fuse.

[5] Includes fuse holder only. See [Boric Acid Fuses](#), page 11-35 for fuse refills. Boric acid fuses may increase lead times. Contact the factory for availability.

[6] Load side connected



Square D™ Brand DIN/E Fuse Selection Tables—HVL

Table 11.50: DIN/E Current-Limiting Fuses, Non-Disconnecting Type [7][8][9]  
(Extended Travel Blown Fuse Indicator [10])

Continuous Current	Fuse Mounting Clip [11]		Catalog No. [12][13]
	Centers (in)	Diameter (mm)	
<b>5 kV Fuse</b>			
10E	17.4	51	55DE010
15E	17.4	51	55DE015
20E	17.4	51	55DE020
25E	17.4	51	55DE025
30E	17.4	51	55DE030
40E	17.4	51	55DE040
50E	17.4	51	55DE050
65E	17.4	51	55DE065
80E	17.4	51	55DE080
100E	17.4	51	55DE100
125E	17.4	76	55DE125
150E	17.4	76	55DE150
175E	17.4	76	55DE175
200E	17.4	76	55DE200
250E	17.4	76	55DE250
300E	17.4	76	55DE300
350E	17.4	76	55DE350
400E	17.4	76	55DE400
450E	17.4	76	55DE450
<b>15 kV Fuse</b>			
10E	17.4	51	175DE010
15E	17.4	51	175DE015
20E	17.4	51	175DE020
25E	17.4	51	175DE025
30E	17.4	51	175DE030
40E	17.4	76	175DE040
50E	17.4	76	175DE050
65E	17.4	76	175DE065
80E	17.4	76	175DE080
100E	17.4	88	175DE100
125E	21.14	88	175DE125
150E	21.14	88	175DE150
175E	21.14	88	155DE175
200E	21.14	88	155DE200

[7] Square D™ brand DIN/E fuses are shown in this table. For fuses produced by other manufacturers, contact your nearest Schneider Electric sales office or your local Schneider Electric distributor.

[8] Current-limiting fuses will increase the integrated short-circuit ratings beyond the non-fusible units. Contact your nearest Schneider Electric sales office or your local Schneider Electric distributor.

[9] Caution—These fuses will not work for the MiniBreak. See Table 11.54 Current-Limiting Fuses, page 11-36 for the appropriate MiniBreak fuses.

[10] HVLcc Only.

[11] All fuses are single barrel arrangement with ferrule diameters per the chart.

[12] Contact your Schneider Electric representative for current stock quantities.

[13] Includes one set of three fuses, packed in a single box.

**Boric Acid Fuse Selection Tables—HVL**

**Table 11.51: Boric Acid Fuses [14]**

Continuous Current	Fuse Type [15]	Catalog No.	Fuse Type [16]	Catalog No. [17][18]
<b>5 kV Fuse Refill</b>				
10E	SM-5S	5SM5010	RBA400	405WBAF010
15E	SM-5S	5SM5015	RBA400	405WBAF015
20E	SM-5S	5SM5020	RBA400	405WBAF020
25E	SM-5S	5SM5025	RBA400	405WBAF025
30E	SM-5S	5SM5030	RBA400	405WBAF030
40E	SM-5S	5SM5040	RBA400	405WBAF040
50E	SM-5S	5SM5050	RBA400	405WBAF050
65E	SM-5S	5SM5065	RBA400	405WBAF065
80E	SM-5S	5SM5080	RBA400	405WBAF080
100E	SM-5S	5SM5100	RBA400	405WBAF100
125E	SM-5S	5SM5125	RBA400	405WBAF125
150E	SM-5S	5SM5150	RBA400	405WBAF150
175E	SM-5S	5SM5175	—	—
200E	SM-5S	5SM5200	RBA400	405WBAF200
250E	SM-5S	5SM5250	RBA400	405WBAF250
300E	SM-5S	5SM5300	RBA400	405WBAF300
400E	SM-5S	5SM5400	RBA400	405WBAF400
<b>15 kV Fuse Refill</b>				
10E	SM-5S	15SM5010	RBA400	415WBAF010
15E	SM-5S	15SM5015	RBA400	415WBAF015
20E	SM-5S	15SM5020	RBA400	415WBAF020
25E	SM-5S	15SM5025	RBA400	415WBAF025
30E	SM-5S	15SM5030	RBA400	415WBAF030
40E	SM-5S	15SM5040	RBA400	415WBAF040
50E	SM-5S	15SM5050	RBA400	415WBAF050
65E	SM-5S	15SM5065	RBA400	415WBAF065
80E	SM-5S	15SM5080	RBA400	415WBAF080
100E	SM-5S	15SM5100	RBA400	415WBAF100
125E	SM-5S	15SM5125	RBA400	415WBAF125
150E	SM-5S	15SM5150	RBA400	415WBAF150
175E	SM-5S	15SM5175	—	—
200E	SM-5S	15SM5200	RBA400	415WBAF200
250E	SM-5S	15SM5250	RBA400	415WBAF250
300E	SM-5S	15SM5300	RBA400	415WBAF300
400E	SM-5S	15SM5400	RBA400	415WBAF400

[14] S&C Boric Acid Fuses  
Type SM-5S fuses are manufactured by the S&C Electric Company. SM-5S has a 25.0 kA symmetrical short-circuit rating from 2.4 kV to 17.0 kV. For 16.5 kV ratings, only S&C boric acid fuses can be used.

[15] Cutler-Hammer - Westinghouse Fuses  
Type RBA-400 fuses are manufactured by Cutler-Hammer - EATON Corporation. RBA-400 has a 37.5 kA symmetrical ampere short-circuit rating from 2.4 kV to 4.8 kV and 29.4 kA symmetrical from 12 kV to 13.8 kV.

[16] Caution—These fuses will not work for the MiniBreak. See Table 11.54 Current-Limiting Fuses, page 11-36 for the appropriate MiniBreak fuses.

[17] Contact your Schneider Electric representative for current stock quantities.

[18] Includes one set of three fuses, packed in a single box.

**MiniBreak™ Compact Height Switches— 5.5 kV, 200 A**

The Square D™ brand MiniBreak compact height switch enclosure is only 66-inches high and contains a single 3-pole load interrupter switch, rated 5.5 kV and 200 A. Enclosures are free-standing and suitable for both indoor (NEMA 1) and outdoor (NEMA 3R) applications. These switches are available unfused or with provisions for ANSI-style, 3-inch-barrel fuses rated from 10E A to 200E A. Factory-installed accessories include an auxiliary switch, strip heaters, and provisions for a “lock open” only key interlock. The door is mechanically interlocked with the switch operating handle. Set screw cable lugs for #14 solid—2/0 stranded aluminum or copper cable are provided for two line and one load connections. **Fuses are not furnished with this equipment.** For fuse information, see Table 11.54 Current-Limiting Fuses, Non-Disconnect Type. The Fused switches and many of the fuses listed in this table are available from stock.



MiniBreak Switch Enclosure with Door (Class 6042)

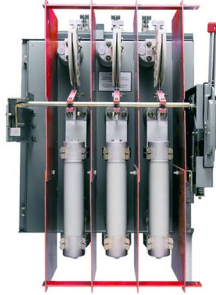

MiniBreak Switch Interior Showing Fuses (Class 6042)

**Table 11.52: Ratings**

Max. design voltage (kV)	5.5
BIL (kV)	60
Frequency (Hz)	60
Continuous amperes	200
Interrupting amperes	200
Momentary (amperes asymmetrical)	20,000
Fault close (amperes asymmetrical)	20,000
Capacitor switching (kVAR)	None
Short time, 2 seconds (amperes symmetrical)	12,500
Low frequency withstand (kV)	19
Fuse integrated (symmetrical)	63,000

**NOTE:** 1200 hp maximum.

**Ordering Information**

**Table 11.53: 5 kV—200 A Switch**

Type	Switch Catalog No.
Unfused	HVMB305200U
Fused	HVMB305200

1. Select switch catalog number based on fused or unfused.
2. Select catalog numbers for modifications from Factory Modifications table.
3. If fused, select 5 kV, 200 A maximum current-limiting fuse from table below.
4. Price switch and fuses separately. Switches are furnished with provisions only for fuses.
5. Weight 450 lbs (204 kg).

**Table 11.54: Current-Limiting Fuses, Non-Disconnect Type**

Continuous Current	Fuse Mounting Clip		Catalog Number [19] [20]
	Size	Centers	
<b>5 kV Fuse</b>			
10E	D	12"	5GS010
15E			5GS015
20E			5GS020
25E			5GS025
30E			5GS030
40E	D	12"	5GS040
50E			5GS050
65E			5GS065
80E			5GS080
100E			5GS100
125E	D	12"	5GS125
150E			5GS150
175E			5GS175
200E			5GS200

**Table 11.55: Factory Modifications**

Catalog No.	Description
HVMX1	Auxiliary switch, 1-N.O. and 1-N.C. contacts
HVMK1	Provisions for lock open only key interlock—Type KFL Kirk key lock with a 0-inch bolt projection (Kirk item master number KFL000010SH)
HVMH1	Strip heater 100 W @ 120 V
HVMH2	Strip heater with thermostat 100 W @ 120 V
HVMSA3	Distribution class surge arrester (set of three arresters) 3 kV, 2.55 MCOV [21]
HVMSA6	Distribution class surge arrester (set of three arresters) 6 kV, 5.10 MCOV [21]

[19] Contact your Schneider Electric representative for current stock quantities.

[20] Includes one set of three fuses, packed in a single box.

[21] Arresters are line side connected.

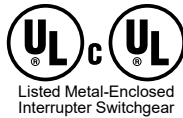

**Ordering Example**

Order one (1), 5 kV, 200 A switch with 65E current-limiting fuses. Provide one auxiliary switch with 1-N.O. and 1-N.C. contact and with provision for installing a "lock open" key interlock on the switch operating mechanism.

Order:	Catalog No.
Switch with enclosure	HVMB305200
Auxiliary switch	HVMX1
Key interlock adapter	HVMK1
Fuses (set of three, from Table 11.54 Current-Limiting Fuses, Non-Disconnect Type, page 11-36. [22] [23])	5GS065

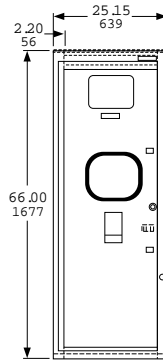

Front View

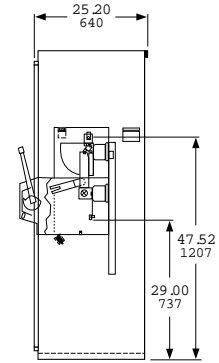

Section View (unfused)

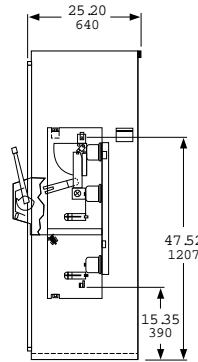

Section View (fused)

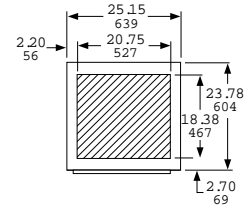

Bottom View  
Selected Area Recommended (bottom conduit entrance)

[22] For fuses produced by other manufacturers, contact your nearest Schneider Electric sales office or your local Schneider Electric distributor.

[23] Current-limiting fuses will increase the integrated short-circuit ratings beyond the non-fusible units. Contact your nearest Schneider Electric sales office or your local Schneider Electric distributor.

### DVCAS Switchgear

DVCAS medium voltage (MV) switchgear from Schneider Electric is designed to meet the electrical switching, protection, and connection needs of wind farm applications up to 38 kV. Three different modules are available:

- Transformer protection module D
- Outgoing line module O
- Incoming line module I

For standard wind power applications, a maximum of four modules can be connected in various configurations to provide the most commonly used wind power functions.

DVCAS switchgear is designed, manufactured, and tested in accordance with the following standards:

- C37.20.3-9
- C37.54
- CAN/CSA C22.2 No.31-M89
- UL Listed
- IEEE Cable Bushings

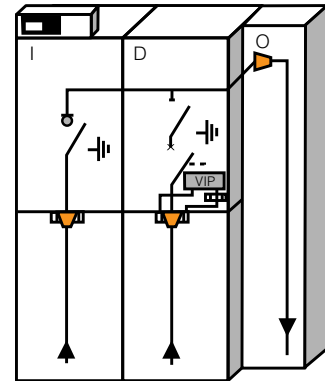

Typical IDO Configuration

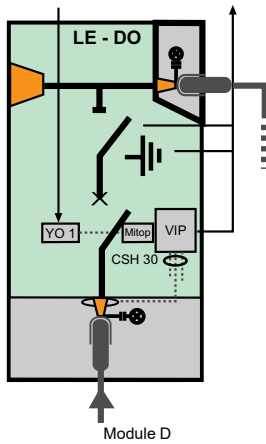

Module D

### Transformer Protection Module D

DVCAS switchgear module D provides transformer protection. Construction features include:

- Metal base frame
- Operating mechanism and relay compartment
  - disconnecter operating mechanism
  - operating mechanism of the circuit breaker
  - protection relay VIP, Sepam, or Micom
  - zero sequence current transformer CSH 30
- MV cable compartment
  - bushings for cable connection
  - Three CRc current sensors per phase
- Stainless steel, gas-tight tank
  - busbar system
  - three position disconnecter
  - circuit breaker

**Outgoing Line Module O**

DVCAS switchgear module O functions as an outgoing line to a downstream wind generator. There are two medium voltage cables per phase. Construction features include:

- Metal base frame
- Voltage presence indicator
- MV cable compartment
  - bushings for cable connection
  - clamps for MV cable connection

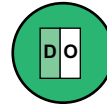

**D + O**  
Transformer protection + Outgoing line

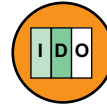

**(I + D + O)**  
Incoming line + Transformer protection + Outgoing line

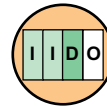

**(I + I + D + O)**  
Two Incoming lines + Transformer protection + Outgoing line

**Recommended Configurations**

**Incoming Line Module I**

DVCAS switchgear module I is a three-position switch-disconnector. It is recommended for the incoming line function from an upstream wind generator for the following reasons:

- Reduces downtime caused by faults
- Helps with fault detection
- Reduces interruptions due to maintenance work
- Improves energization works

Module I is always connected to module D on the right with single-phase, coupling bushings. Construction features include:

- Metal base frame
  - operating mechanism of the switch-disconnector
  - motor for the operating mechanism (optional)
- MV cable compartment
  - bushings for cable connection
- Stainless steel, gas-tight tank
  - busbar system
  - three position disconnector

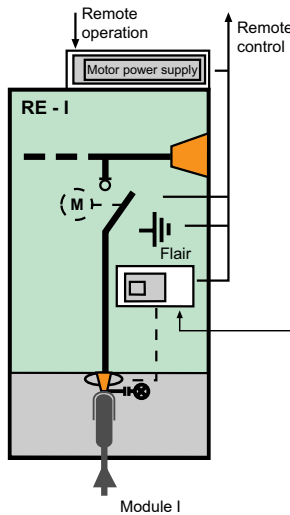

**Table 11.56: Ratings**

Type	Rating
Frequency (Hz)	50/60
Rated voltage (kV)	38
<b>Insulation level</b>	
Power frequency withstand voltage (kV)	70
Lightning impulse withstand voltage, peak (kV)	170
Rated current of the main busbar (A)	600
Short time withstand current (kA/s)	20/3 [24]
Short circuit breaking current capacity (kA)	20 [24]
Short circuit making capacity, peak (kA)	50
Internal arc withstand IAC AFL (kJ/1s)	20 [24]
<b>Degree of protection (NEMA/IP)</b>	
HV compartment	6/67
LV and operating mechanism compartment	6P/3X
SF6 gas pressure at 20 °C (PSI/bar)	4.35/0.3

[24] 25 kA for circuit breaker switchgear module D.



**Premset Compact Vacuum Circuit Breaker Switchgear with Shielded Solid Insulation System (2SIS)**

Premset is 15 kV vacuum circuit breaker switchgear technology that takes advantage of the innovative shielded solid insulated system (2SIS). 2SIS creates a three-layered system (medium voltage conductive layer, epoxy insulating layer, and grounded shield layer) throughout the entire switchgear that optimizes performance and increases life expectancy. Premset reduces the opportunity of arc flash or contact with live parts by insulating and screening all live parts in an epoxy dielectric molding. In addition, a grounded shield layer helps reduce the likelihood of exposure to electrical hazards while at the same time better protecting the insulating material from harsh environmental conditions such as moisture, dust, chemicals, and vermin.

Premset delivers a compact architecture that is both modular and flexible. It allows for front-only accessibility (bottom incoming cables) and the smallest 15 kV vacuum circuit breaker footprint on the market. Plug-and-play design of accessories and auxiliaries makes even last minute or field modifications possible. Modular design improves cost savings and optimizes delivery times. Premset's modular configurations make it a great fit for applications and intuitive to learn for operators. Premset has options for both indoor and outdoor enclosures with transitions to dry type transformers.



Shielded Solid Insulation System (2SIS)

**Table 11.57: Premset Ratings**

Voltage Class	5 and 15 kV			
Bus Current Rating	600 and 1200 A		1200 A	
Circuit Breaker Current Rating	100 A	200 A	600 A	1200 A
Maximum Short-Time Interrupting Current	25 kA (2 seconds)			
Rated BIL Withstand Voltage	95 kV			



11 SWITCHBOARDS AND SWITCHGEAR



Listed Metal-Enclosed Interrupter Switchgear

**Table 11.58: Dimensions**

Indoor	600 A	14.76 in. (375 mm) x 96.76 in. (2458 mm) x Various
	1200 A	29.53 in. (750 mm) x 96.76 in. (2458 mm) x Various
Outdoor	600 A	14.76 in. (375 mm) x 99.77 in. (2534 mm) x Various
	1200 A	29.53 in. (750 mm) x 99.77 in. (2534 mm) x Various



Unit Substation

**Power-Zone Load Center Unit Substations**

**Table 11.59: Complete Close Coupled Unit Substations Available**

Product Type	Class Nos.	Digest Section
<b>Primary Section</b>		
Medium voltage load interrupter switchgear	6040, 6045	11
Metalclad switchgear	6055	
Low voltage Power-Style™ QED switchboard	2741–2744	
Air terminal chamber	7240, 7310, 7320, 7421–23	
<b>Transformer Section</b>		
Open, ventilated dry—Power-Dry™	7421–23	14
Open, ventilated dry/cast resin combination—Uni-Cast™	7320	
Open, ventilated cast resin—Power-Cast™	7310	
Mineral oil or high fire point fluid—liquid	7240	
<b>Secondary Section</b>		
Medium voltage load interrupter switchgear	6040	11
Metalclad switchgear	6055	
Medium voltage motor control center	8198	
Low voltage Power-Style QED switchboard	2741–2744	
Air terminal chamber	7240, 7310, 7320, 7421–23	
Low voltage drawout switchgear	6037	
Low voltage Model 6 motor control centers	8998	15

**Power-Zone Model III Package Unit Substations**

**General**

Power-Zone Model III package unit substations combine a primary switch, dry-type transformer, and I-Line™ distribution section into a single, compact unit. All components are engineered, manufactured, and tested by Schneider Electric. The substation is available with a UL listing.

The Model III is only 49 inches deep and 90 inches high, which allows the entire substation to pass through standard size doorways and narrow hallways.

The Model III is front accessible; the transformer taps are accessible from the side. For proper ventilation, a minimum distance of 12 inches should be maintained on the transformer side of the equipment.

Model III package unit substations are ideal for renovations and high rise applications requiring increased customer electrical demand as well as new construction requiring multiple zones and a small footprint.

**75–1000 kVA at 480 V; 75–500 kVA at 240 V**

Available with primary voltages of 2400–13800 V. Forced air cooling (AA/FA) provides an additional 33%. Features 220 °C insulation and 150 °C, 115 °C, or 80 °C temperature rise. Largest 80 °C or 115 °C rise unit available is 750 kVA.

The secondary circuit breaker distribution section may be equipped with an individually mounted secondary main breaker or an I-Line distribution panelboard. Branch circuit breakers from PowerPact™ B to PowerPact RLC 1200 A may be installed. PowerPact M-, P-, and R-frame molded case circuit breakers are available with electronic trip units.

Additional options include PowerLogic™ and ION™ series metering, surge arresters, and I-Line™ plug-on units with a Surgeloc™ Surge Protective Device (SPD).



Model III Package Unit Substation with HVL/cc Load Interrupter Switch (on left)

**Incoming Line Section**

Most Model IIIs are supplied with a Square D™ brand fused HVL/cc 600 A load interrupter switch. The HVL/cc offers the smallest footprint in the industry and is an exclusive sealed interruption type compartmentalized switch. Where switching and overcurrent protection are provided elsewhere, a full-height air-filled terminal chamber can be provided in place of the switch.

**Table 11.60: Primary Switch Ratings, Type HVL/cc**

Nominal Voltage	4.16	13.8
BIL	60	95
Continuous amperes	600	600
Interrupting amperes	600	600
Fault close (kA asymmetrical)	40	40
Momentary current (kA asymmetrical 10 cycles)	40	40
Duty-cycle-fault-close (number of operations)	4	4
Grounding switch fault close (kA asymmetrical)	40	40
Short-time rating (kA asymmetrical 2 seconds)	25	25
Dielectric withstand (kV 1 minute)	19	36
Electrical endurance (close-open)	100	100
Mechanical endurance (close-open)	1000	1000

**Transformer Section**

Special barrel wound dry-type transformers employing resin encapsulated VPI (Vacuum Pressure Impregnation) techniques are used to achieve the low-loss, compact design necessary for the space-saving package substation concept. Class H, 220 °C insulation is used throughout. Temperature rise is 150 °C as standard, although 80 °C or 115 °C low temperature premium transformers are available through 750 kVA. Aluminum windings are standard with copper as an option. Four full capacity 2-1/2 percent taps are provided—two above nominal voltage and two below.

Fan cooling is optional. When selected, it increases the capacity rating of the transformer an additional 33 percent. The Model 98 digital controller is employed. This system provides precision control through the use of three high accuracy thermocouple type sensors—one in each phase of the windings.

The controller has a membrane front panel for displaying the temperature of all three phases with individual readings. The hottest phase is automatically displayed. The Model 98 digital controller features simple three-button operation with fan, alarm and trip function settings and is Powerlogic™ compatible.

**Table 11.61: Transformer Basic Insulation Levels**

KV Class	Primary Voltages	BIL	600 Hz Test
1.2	< 600 V Secondary	10	4 kV
2.5	2400	20	10 kV
5.0	4160, 4800	30	12 kV
7.2	6900, 7200	30	12 kV
8.7	8320	45	19 kV
15.0	12, 12.47, 13.2, 13.8	60	31 kV

11 SWITCHBOARDS AND SWITCHGEAR

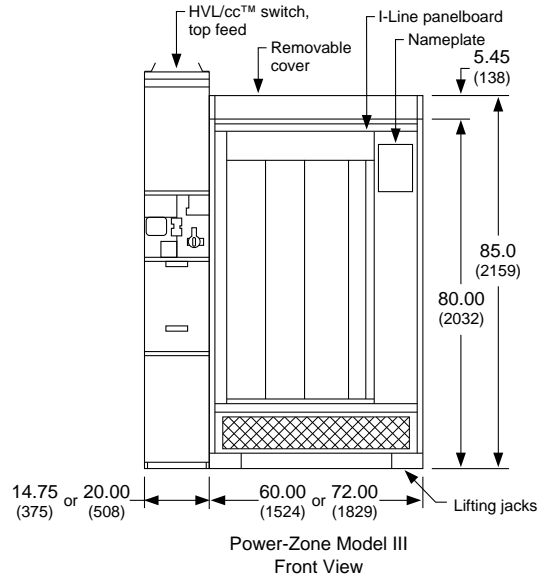

**Distribution Section**

**I-Line™ Mounted Molded Case Circuit Breakers**

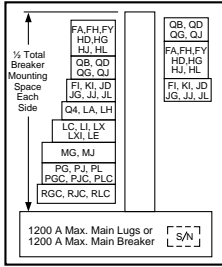

HCR-U 1200 A  
I-Line panelboards can be used for up to 600 Vac. They are UL Listed under File E33139.

Molded case circuit breakers are group mounted in an I-Line panelboard section offering the inherent ease of installation for which the plug-on I-Line circuit breaker has become known. All circuit breakers are quick-make, quick-break, thermal magnetic, permanent trip type and are factory-calibrated and sealed for accurate overcurrent response and maximum short-circuit strength. PowerPact™ P and R circuit breakers are available with solid-state MicroLogic™ trip units. Current limiting high interrupting capacity FI, KI, and LI circuit breakers are also available. Circuit breakers may be safely back-fed for use as main circuit breakers. All circuit breakers are UL listed and carry integrated equipment rating when used exclusively with other Square D™ brand circuit breakers in intended assemblies.

I-Line panel is available in 1200 A. Maximum mounting space is 108 inches. Tin-plated copper bus is standard.

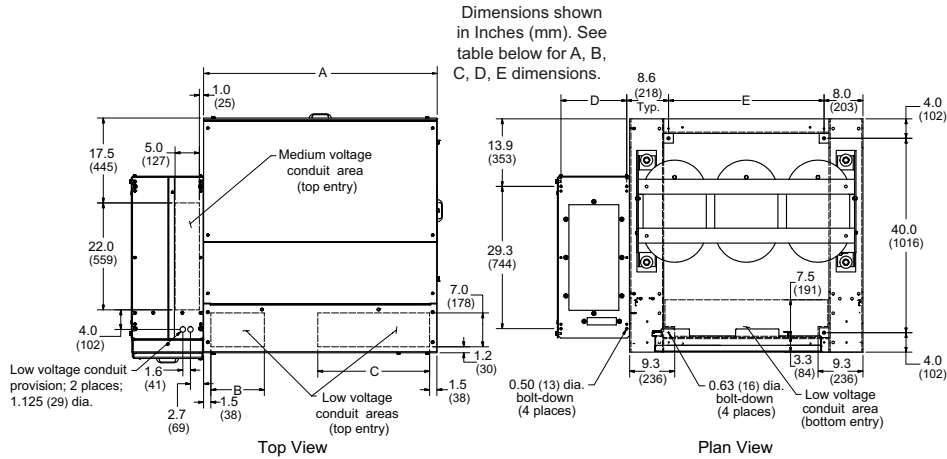

**Table 11.62: Substation Dimensions and Approximate Weights**

kVA	Temperature Rise ° C	Dimensions (for drawing shown)					Estimated Weight
		A	B	C	D	E	
75	80, 115, 150	48	11.0	23.0	13.5	32.0	3600
112.5							
150							
225	80, 115, 150	48	11.0	23.0	13.5	32.0	4500
300							
500	150	60	18.5	27.0	18.75	44.0	6000
500	80, 115						6200
750	80, 115, 150	60	18.5	27.0	18.75	44.0	6700
1000	150						7500

Contact your nearest Schneider Electric sales office for ordering assistance.

*New!*

**MotorSeT™ Medium Voltage Motor Controllers (UL Listed)  
Coming soon!**

*MotorSeT™ – The next generation of our Medium Voltage Motor Control Centers.*

The offer will be released in several phases. The first waves will be across-the-line (full voltage non-reversing and reversing) starters and reduced voltage soft starters, including 1-high and 2-high designs as well as a compact 20-inch footprint version.

Future waves will include higher voltage versions (> 4, 160 V and up to 7,200 V) rated ATLS and RVSS, and arc-resistant enclosures. Look for updates on **MotorSeT** on [www.se.com/us](http://www.se.com/us) for additional information and updates on releases.

