

Section 3

Safety Switches



Light Duty



General Duty



Heavy Duty



Stainless Steel Heavy Duty

EZ Selector - Selection Assistance	3-2
<hr/>	
Safety Switches EZ Selector - Selection Assistance	3-2
Steps to select a safety switch	3-2
Wiring Diagrams	3-3
Enclosure Options	3-4
Class H, R, J, and L Fuse Provisions	3-4
Light Duty Safety Switches	3-5
<hr/>	
Light Duty—Visible Blades 10 kA Short Circuit Current Rating	3-5
General Duty Safety Switches	3-6
<hr/>	
General Duty—Up to 100 kA Short Circuit Current Rating	3-6
240 Volt – Single Throw Fusible Switches	3-6
240 Volt—Single Throw Non-Fusible Switches	3-7
Accessories and Lug Data	3-8
Field-Installed Fuse Puller Kits	3-8
Field-Installed Electrical Interlock Kits	3-8
Equipment Grounding Kits	3-8
Field-Installed Lug Kit 400–600 A	3-8
Terminal Lug Data	3-9
Dimensions for General Duty Safety Switches	3-9
Heavy Duty Safety Switches	3-10
<hr/>	
240 Volt—Single Throw Fusible Switches	3-10
600 Volt—Single Throw Fusible Switches	3-11
600 Volt—Single Throw Non-Fusible Switches	3-12
UL Listed Maximum Short Circuit Current Ratings—AC only	3-13
Special Applications	3-14
Accessories and Special Features	3-16
Dimensions for Heavy Duty Safety Switches	3-22
Dimensions for NEMA Type 1 and 3R Safety Switches	3-22
Dimensions for NEMA Type 4, 4X, 5, 7, 9, and 12 Safety Switches	3-24
Double Throw Safety Switches	3-25
<hr/>	
Fusible and Non-Fusible Overview	3-25
240 Volt — Double Throw Safety Switches	3-26
600 Volt — Double Throw Safety Switches	3-27
Accessories and Lug Data	3-28
Terminal Lug Data	3-30
Application Data	3-30
Dimensions for Double Throw Safety Switches	3-31
Dimensions for DT/DTU (Series F) Safety Switches 30–100 A	3-31
Dimensions for DTU (Series A E T4) Safety Switches 200–600 A	3-32



SAFETY SWITCHES

3

Steps to select a safety switch

1. Select product type:
 - General duty safety switch
 - Heavy duty safety switch
 - Double throw safety switch
2. Select switch type.
3. Select fuse type: fused, non-fused, cartridge, class T or plug
4. Select maximum voltage: 240 Vac / 250 Vdc, 600 Vac / 600 Vdc
5. Select amperes:
 - General/light duty – 30 A, 60 A, 100 A, 200 A, 400 A, 800 A
 - Heavy duty – 30 A, 60 A, 100 A, 200 A, 225 A, 400 A, 600 A, 800 A, 1200 A
 - Double throw – 30 A, 60 A, 100 A, 200 A, 600 A
6. Select number of poles:
 - General/light duty – 1, 2 or 3
 - Heavy duty – 2, 3, 4 or 6
 - Double Throw – 2, 3, 4 or 6
7. Select if neutral is needed.
8. Select enclosure type:
 - General/light duty – NEMA 1, NEMA 3R
 - Heavy duty – NEMA1, NEMA 12K, NEMA 3R, 5, 12, NEMA 4, 4X, 5 (stainless steel 304), NEMA 4, 4X, 5 (stainless steel 316)
 - Double throw – NEMA1, NEMA 12K, NEMA 3R, 5, 12, NEMA 4, 4X, 5 (stainless steel 304)
 - Optional enclosure types for special heavy duty applications.

Wiring Diagrams

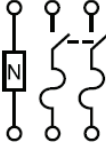
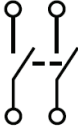
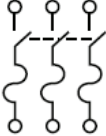
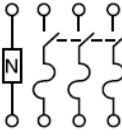
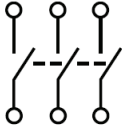
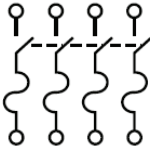
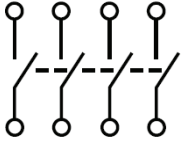
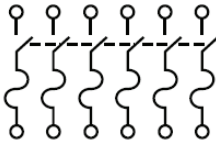
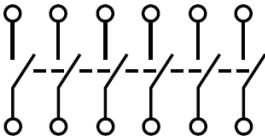
Fuse	Fused with Neutral	Non-Fused
	<p>Two-wire (1 blade and fuse holder)</p> 	
<p>Two-wire (2 blades and fuse holder)</p> 	<p>Three-wire (2 blades and fuse holder)</p> 	<p>Two-wire (2 blades)</p> 
<p>Three-wire (3 blades and fuse holders)</p> 	<p>Four-wire (3 blades and fuse holders)</p> 	<p>Three-wire (3 blades)</p> 
<p>Four-wire (4 blades and fuse holders)</p> 		<p>Four wires (4 blades)</p> 
<p>Six-wire (6 blades and fuse holders)</p> 		<p>Six-wires (6 blades)</p> 

Enclosure Options

Enclosure units are third party certified to UL 50E by Underwriters Laboratories

Type 1	Design for indoor use provide degree of protection against access to hazardous parts, protects against ingress of solid foreign objects.
Type 3R	Design for indoor or outdoor use provide degree of protection against access to hazardous parts, protects against ingress of solid foreign objects, degree of protection to due ingress of water (rain, sleet, snow) and will remain undamaged by external formation of ice.
Type 4X	Design for indoor or outdoor use provide degree of protection against access to hazardous parts, prevents ingress of solid foreign objects, degree of protection to due ingress of water (rain, sleet, snow, splashing water, and hose directed water) and provides additional protection against corrosion, and will remain undamaged by external formation of ice.
Type 12	Design for indoor use provide degree of protection against access to hazardous parts, protects against ingress of solid foreign objects (falling dirt and circulating dust, lint, fibers, and flyings) provide degree of protection due to ingress of water (dripping and light splashing).

- Type 4X enclosures can be used for Type 4 or Type 5 Applications.
- Type 12 enclosures can be used for Type 5 applications and Type 3R via removal of drip hole knock out or drain screw.
- Type 3R (800 and 1200 A Heavy Duty) are shipped as Type 5 - must remove drain screw for Type 3R applications.

Class H, R, J, and L Fuse Provisions

Plug Type Fuses: Fuses for standard circuits (not high-voltage appliance circuits) are called plug fuses and have screw-in bases. There are two different types of bases and screw-in fuses: the Edison base (found on Type T fuses) and the rejection base (found on Type S fuses).

Class H or K Fuse Provisions: Fusible Square D 30–600 A heavy duty safety switches accept Class H or K fuses as standard. With Class H or K fuses installed, the switch is UL Listed for use on systems with up to 10 kA available short circuit current.

Class R Fuse Provisions: Fusible Square D 30–600 A heavy duty safety switches will accept Class R fuses as standard. A field-installed rejection kit is available which, when installed, accepts only Class R fuses. With the installation of the rejection kit and Class R fuses, the switch is UL Listed for use on systems with up to 200 kA available short circuit current.

Class J Fuse Provisions: Provisions for installing Class J fuses are included in 30–400 A 600 Volt, and 100–400 A 240 Volt, fusible heavy duty safety switches. Conversion to Class J fuse spacing requires relocating the load side fuse base assembly from the standard Class H fuse location to an alternate position as marked in the enclosure. With Class J fuses installed, the switch is UL Listed for use on systems with up to 200 kA available short circuit current. Switches rated 600 A, 240 or 600 Volt require the addition of an adapter kit: H600J.

Class L Fuse Provisions: Fusible 800 and 1200 A safety switches use Class L bolt-in fuses and are rated for use on systems with up to 200 kA at 600 Vac maximum. 1200 A switches accept class L fuses from 601–1200 A, 800 A switches accept Class L fuses from 601–800 A.

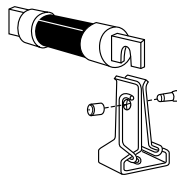

Class R Fuse



L111N

Light Duty—Visible Blades 10 kA Short Circuit Current Rating

The Square D light duty enclosed switch is ideal for home applications in disconnecting power to workshops, hobby rooms, furnaces, and garages.

The light duty safety switch has visible blades and a ground lug as standard features. NEC 2023 protects against these units from being applied in any application, for compliance with NE2023 obtain Heavy Duty Safety Switch.

Table 3.1: Light Duty 120 V or 120/240 Volt — Single Throw Fusible Switches

System	Amperes	NEMA Type 1 Indoor Cat. No.	Equipment Ground Kit	Horsepower Ratings			
				Std (Fast Acting One-Time Fuses)		Max (Dual Element Time-Delay Fuses)	
				1Ø	3Ø	1Ø	3Ø
2 Wire (1 Blade and Fuseholder, 1 Neutral) – 120 Vac Plug Type Fuses							
	30	L111N	Standard	—	—	—	—
3 Wire (2 Blade and Fuseholder, 1 Neutral) – 120/240 Vac Plug Type Fuses							
	30	L211N	Standard	1/2	2	1-1/2	3
3 Wire (2 Blade and Fuseholder, 1 Neutral) – 120/240 Vac Cartridge Type Fuses							
	30	L221N	Standard	1/2	2	1-1/2	3



D223N

General Duty—Up To 100 kA Short Circuit Current Rating

General duty safety switches are designed for residential and commercial applications where durability and economy are prime considerations. Typical loads are lighting, air conditioning, and appliances. They are suitable for use as service equipment when equipped with a factory or field-installed neutral assembly or a field-installed service grounding kit, (see page 3-8) as applicable.

General duty safety switches are UL Listed, File E2875, and meet or exceed the NEMA Standard KS1. NEC 2023 protects against these units from being applied in any application; for compliance with NE2023 obtain Heavy Duty Safety Switch.

240 Volt – Single Throw Fusible Switches

Table 3.2: Fusible Single Throw Safety Switches

System	Amperes	NEMA TYPE 1 Cat. No.	NEMA Type 3R [1] Cat. No.	Class R Fuse Kits [2] Cat. No.	Line Side Barrier	Horsepower Ratings			
						Std. (Fast Acting One-Time Fuses)		Max. (Dual Element Time-Delay Fuses)	
						1Ø	3Ø	1Ø	3Ø
2 Wire (1 Blade and Fuseholder, 1 Neutral)—120 Vac									
Use Light Duty Devices or use three-wire devices									
3 Wire (2 Blade and Fuseholder, 1 Neutral) – 120/240 Vac Plug Type Fuses									
	30	D211N	D211NRB	—	—	1-1/2	—	3	—
3 Wire (2 Blade and Fuseholder, 1 Neutral) –240 Vac Cart. Type Fuses									
	30	D221N	D221NRB	DRK30	—	1-1/2	3 [3]	3	7-1/2 [3]
	60	D222N	D222NRB	RFK03H	Factory Included	3	7-1/2 [3]	10	15 [3]
	100	D223N	D223NRB	RFK10	Factory Included	7-1/2	15 [3]	15	30 [3]
	200	D224N [4]	D224NRB [4]	HRK1020	Factory Included	15	25 [3]	—	60 [3]
	400	D225N	D225NR	DRK40	LSBI02	—	—	—	—
600 [5]	D226N	D226NR	DRK600	LSBI02	—	—	—	—	
4 Wire (3 Blade and Fuseholder, 1 Neutral) –240 Vac Cart. Type Fuses									
	30	D321N	D321NRB	DRK30	—	1-1/2	3	3	7-1/2
	60	D322N	D322NRB	RFK03H	Factory Included	3	7-1/2 [6]	10	15 [6]
	100	D323N	D323NRB	RFK10	Factory Included	7-1/2	15 [6]	15	30 [6]
	200	D324N [4]	D324NRB [4]	HRK1020	Factory Included	15	25 [6]	—	60 [6]
	400	D325N	D325NR	DRK40	LSBI02	—	50	—	—
	600 [5]	D326N	D326NR	DRK600	LSBI02	—	75	—	150
4 Wire (3 Blade and Fuseholder, 1 Neutral) –240 Vac CLASS T Type Fuses									
	400 [7]	D325NT	D325NTR	DRK40	LSBI02	—	50	—	—
	600 [7]	D326NT	D326NTR	DRK600	LSBI02	—	75	—	150
	800 [7]	T327N	T327NR	—	LSBI02	—	100	—	—

Table 3.3: Fusible Switch UL Listed Maximum Short Circuit Current Ratings — AC Only

Fuse Class	UL Listed Short Circuit Rating
Plug	10 kA
H, K	10 kA
R	10 kA [8]
R with Rejection Fuse Clips	100 kA
J	100 kA
T	100 kA

[1] Bolt-on hubs —Refer to Rainproof Bolt-On Hubs., page 3-16

[2] When properly installed, the Class R Fuse Kit accepts only Class R fuses.

[3] For corner grounded delta systems, use switching poles for ungrounded conductors. See data bulletin 2700DB0202 for additional information.

[4] For 200% neutral, order (1) additional neutral kit SN20A and (1) neutral jumper kit SN20NI.

[5] Order Class J Fuse Kit GDJK600 if using Class J fuses.



[6] If corner grounded delta system, use outer switching poles for ungrounded conductors.

[7] D325NT, D325NTR, D326NT, D326NTR, T327N and T327NR accept only 300Vac Class T fuses.

[8] Class R fuses are rated for 100 kA, however without the rejection fuse clips - system is limited to 10 kA since Class H or K fused could be installed in the future.

240 Volt—Single Throw Non-Fusible Switches

Table 3.4: Non-Fusible Single Throw Safety Switches

System	Amperes	NEMA Type 1	NEMA Type 3R [9]	Line Side Barriers [10]	Equipment Ground Kit	Neutral Kit	Horsepower Ratings (Max.) Max. (Dual Element Time-Delay Fuses)	
		Cat. No.	Cat. No.				1Ø	3Ø
2 Wire (2 Blade)—240 Vac								
	30	—	DU221RB	—	PK3GTA1	—	3	—
	60	—	DU222RB	—	GTK03	—	10	—
	100	Use three wire switch	—	—	—	—	—	—
	200		—	—	—	—	—	
	400		—	—	—	—	—	
600	—		—	—	—	—		
3 Wire (3 Blade)—240 Vac								
	30	DU321	DU321RB	—	PK3GTA1	—	3	7-1/2
	60	DU322	DU322RB	—	GTK03	—	10	15
	100	DU323 [11]	DU323RB [11]	Factory Included	GTK0610	—	10	30
	200	DU324 [12]	DU324RB [12]	Factory Included	PKOGTA2	—	15	60
	400	DU325	—	LSBI02	PKOGTA2	—	—	125
	600	DU326 [13]	—	LSBI02	PKOGTA2	—	—	150

System equal or less than 10 kA SCCR — Any Brand of circuit breaker or fuse not exceeding the ampere rating of the switch may be used in conjunction with a non-fusible safety switch.

Systems above 10kA SCCR — The UL listed short circuit current rating for Square D non-fusible switches is based upon the switch being used in conjunction with fuses or Square D circuit breakers or Mag-Gard motor circuit protection.

Table 3.5: Non-Fusible Safety Switch Short Circuit Current Rating

Fuse Class or Circuit Breaker Type [14]	UL Listed Short Circuit Rating
Any Brand Circuit Breaker	10 kA
H or J PowerPact Circuit Breaker	Up to 65 kA [15]
H, K	10 kA
J, R	100 kA [16]
T	100 kA [17]

[9] Bolt-on hubs—Refer to Hubs, page 3-16.

[10] Factory included to protect against inadvertent contact with live parts per UL 869A and NEC Service entrance barrier requirements.

[11] If a neutral assembly is required, order and field install SN0610.

[12] If a neutral assembly is required, order and field install a SN20A Neutral Assembly Kit. For a 200% neutral application, order and field install (2) SN20A Neutral Assembly Kits and (1) SN20NI Neutral Jumper Kit.

[13] If a neutral assembly is required, order and field install D600SN.

[14] Ampere rating of fuse or circuit breaker not to exceed switch ampere rating.

[15] Only applicable to DU324 and DU324RB. HD, JD = 25 kA maximum.

[16] SCCR = 50 kA, applicable to DU222RB, DU322 and DU322RB.

[17] Only applicable to DU323, DU323RB, DU325 and DU326.

Field-Installed Fuse Puller Kits

Kit consists of three fuse pullers as required for a 3P, fusible, 60 or 100 A general duty switch. Kits can be installed only in 60 or 100 A Series F fusible switches.



FPK03 Fuse Puller Kit
Series F Fusible Switches Only

Table 3.6: Fuse Puller Kits

Switch Ampere Rating	Series No.	Cat. No.
60	F	FPK03
100	F	FPK0610

Field-Installed Electrical Interlock Kits

Electrical interlocks for Series F 100–200 A general duty safety switches & Series F 60 A fusible general duty safety switches are available in kit form for field installation. Each kit contains instructions for proper field mounting. A pivot arm operates from switch mechanism, breaking the control circuit before the main switch blades break. Switches with electrical interlocks installed are UL Listed.



EIK031

EIK1

Table 3.7: Electrical Interlock Kit

Switch Amperes Rating	Electrical Interlock Kit Cat. No. [18]
Fusible Series F 60	EIK031 or EIK032
Series F 100–200	EIK1 or EIK2

Table 3.8: Electrical Interlock Contact Ratings [19]

Interlock Type	AC 50 or 60Hz				DC		
	Volts	Make	Break	Cont.	Volts	Make / Break	Cont.
1 N. O. / 1 N. C. Contact (-1 Suffix [20])	120	40.00 A	15.00 A	15.00 A	115	0.50 A	15.00 A
	240	20.00 A	10.00 A	15.00 A	230	0.25 A	15.00 A
2 N. O. / 2 N. C. Contacts (-2 Suffix [21])	120	30.00 A	3.00 A	10.00 A	115	1.00 A	10.00 A
	240	15.00 A	1.5 A	10.00 A	230	0.30 A	10.00 A

Equipment Grounding Kits

Table 3.9: Equipment Grounding Kits



PK3GTA1

GTK0610

PKOGTA2

Switch Ampere Rating	Cat. No.	Lug Wire Range (AWG)
30 [22]	Std.	(1) 14 – 10 Cu or (1) 12 – 8 Al
30	PK3GTA1	(3) 14 – 4 Cu or (3) 12 – 4 Al or (6) 14 – 12 Cu or (6) 12 – 10 Al
60 [23]	GTK03	(2) 14 – 4 Cu or (2) 12 – 4 Al (4) 14 – 12 Cu or (4) 12 – 10 Al
100	GTK0610	(2) 14 – 1/0 Cu or (2) 12 – 1/0 Al (2) 14 – 6 Cu or (2) 12 – 6 Al
200	PKOGTA2	(2) 10 – 2/0 Cu or (2) 6 – 2/0 Cu Al
400, 600	PKOGTA2 [24]	(2) 10 – 2/0 Cu or (2) 6 – 2/0 Cu Al
800	PKOGTA3	(6) 6 – 3/0 Al/Cu Max.

Field-Installed Lug Kit 400–600 A

Table 3.10: Field-Installed Lug Kit 400–600 A

Switch Ampere Rating	Lug Kit Cat. No.	Wire Range/NEC	Lug Wire Range
400 or 600 Series [25]	GD4060LK	1-1/0-600 kcmil 2-1/0-500 kcmil 4-1/0-250 kcmil	2-1/0-600 kcmil 4-1/0-250 kcmil

Line Side Barrier Kits

The field instable line side barrier kits are required to meet National Electric Code (NFPA 70) for service entrance applications. Barrier kits protect against inadvertent contact with line side, uninsulated, ungrounded or service terminal live parts.

Table 3.11: Line Side Barrier Kits for General Duty Safety Switches

Amperes	Voltage	Blades/Fuses	Catalog
30	600	2 or 3	LSBD602
60 [26]	240	2 or 3	LSBD202
60	600	2 or 3	LSBC02
100	240 / 600		
200	240	2	LSBE202
		3	LSBE203
		3	LSBE603
400 / 600 / 800	240	2 or 3	LSBI02

[18] Electrical interlock kit catalog numbers with -1 suffix indicate one normally open and one normally closed contact; -2 indicates two normally open and two normally closed contacts. Kits are UL Listed.

[19] Single-pole single-throw interlock kits are rated 1/2 hp at 110 and 220 Vac.

[20] -1 Suffix uses a 9007A01 limit switch.

[21] -2 Suffix uses a 9007C03 limit switch.

[22] Light duty switches only.

[23] 60 A non-fusible switches accept PK3GTA1.

[24] Two required if ground conductors are run in parallel.

[25] Not suitable for use on 400 A NEMA Type 3R.

[26] Only for Fused applications

Terminal Lug Data

Table 3.12: Terminal Lug Data [27]

Amperes	Conductors Per Phase	Wire Range Wire Bending Space Per NEC Table 312.6 AWG/kcmil	Lug Wire Range AWG/kcmil
30 [28]	1	12-8 (Al) or 14-8 (Cu)	12-8 (Al) or 14-8 (Cu)
30	1	12-6 (Al) or 14-6 (Cu)	12-6 (Al) or 14-6 (Cu)
60	1	12-3 (Al) or 14-3 (Cu)	12-2 (Al) or 14-2 (Cu)
100	1	12-1 (Al) or 14-1 (Cu)	12-1/0 (Al) or 14-1/0 (Cu)
200	1	6-250 (Al/Cu)	6-300 (Al/Cu)
400 NEMA Type 1	1 or 2	1/0-600 (Al/Cu) or 1/0-300 (Al/Cu)	(1) 1/0-750 (Al/Cu) or (2) 1/0-300 (Al/Cu)
400 NEMA Type 3R	2	1/0-250 (Al/Cu)	(1) 1-600 (Al/Cu) or (2) 1/0-250 (Al/Cu)
600	2	4-500 (Al/Cu)	4-600 (Al/Cu)
800	3	3/0-500 (Al/Cu)	3/0-500 (Al/Cu)

Dimensions for General Duty Safety Switches

Table 3.13: Approximate Dimensions

Cat.No.	Series	H		W		W/H		D		Std. Pack
		in.	mm	in.	mm	in.	mm	in.	mm	
L111N	E2	7.63	194	5.00	127	127	156	4.00	102	1
L211N	E2	7.63	194	5.00	127	6.13	156	4.00	102	1
L221N	E2	7.63	194	5.00	127	6.13	156	4.00	102	1
D211N	E3	9.25	235	6.75	171	7.25	184	3.63	92	5
D211NRB	E2	9.63	245	7.25	184	7.75	197	3.75	95	5
D221N	E3	9.25	235	6.75	171	7.25	184	3.63	92	5
D221NRB	E3	9.63	245	7.25	184	7.75	197	3.75	95	5
D222N	F1	14.63	372	6.50	165	7.45	189	4.88	124	1
D222NRB	F1	14.88	378	6.63	168	7.45	189	4.88	124	1
D223N	F3	17.50	445	8.50	216	10.50	267	6.50	165	1
D223NRB	F3	17.50	445	8.50	216	10.50	267	6.50	165	1
D224N	F1	29.00	737	17.25	438	19.00	483	8.25	210	1
D224NRB	F1	29.25	743	17.25	438	19.00	483	8.25	210	1
D225N	E3	45.12	1146	24.00	610	24.88	632	8.88	226	1
D225NR	E1	30.63	778	21.38	543	22.25	565	10.13	257	1
D226N	E3	49.13	1248	24.00	610	24.88	632	8.88	226	1
D226NR	E1	49.13	1248	24.75	629	25.13	638	8.88	226	1
D321N	E3	9.25	235	6.75	171	7.25	184	3.63	92	5
D321NRB	E3	9.63	245	7.25	184	7.75	197	3.75	95	5
D322N	F1	14.63	372	6.50	165	7.45	189	4.88	124	1
D322NRB	F1	14.88	378	6.63	168	7.45	189	4.88	124	1
D323N	F3	17.50	445	8.50	216	10.50	267	6.50	165	1
D323NRB	F3	17.50	445	8.50	216	10.50	267	6.50	165	1
D324N	F1	29.00	737	17.25	438	19.00	483	8.25	210	1
D324NRB	F1	29.25	743	17.25	438	19.00	483	8.25	210	1
D325N	E3	45.12	1146	24.00	610	24.88	632	8.88	226	1
D325NT	E3	45.12	1146	24.00	610	24.88	632	8.88	226	1
D325NR	E1	30.63	778	21.38	543	22.25	565	10.13	257	1
D325NTR	E1	30.63	778	21.38	543	22.25	565	10.13	257	1
D326N	E3	49.13	1248	24.00	610	24.88	632	8.88	226	1
D326NT	E3	49.13	1248	24.00	610	24.88	632	8.88	226	1
D326NR	E1	49.13	1248	24.75	629	25.13	638	8.88	226	1
D326NTR	E1	49.13	1246	24.75	629	25.13	638	8.88	226	1
DU221RB	E2	9.63	245	7.25	184	7.75	197	3.75	95	5
DU222RB	E1	9.63	245	7.25	184	7.75	197	3.75	95	5
DU321	E2	9.25	235	6.75	171	7.25	184	3.63	92	5
DU321RB	E2	9.63	245	7.25	184	7.75	197	3.75	95	5
DU322	E1	9.25	235	6.75	171	7.25	184	3.63	92	5
DU322RB	E1	9.63	245	7.25	184	7.75	197	3.75	95	5
DU323	F3	17.50	445	8.50	216	10.50	267	6.50	165	1
DU323RB	F3	17.50	445	8.50	216	10.50	267	6.50	165	1
DU324	F1	29.00	737	17.25	438	19.00	483	8.25	210	1
DU324RB	F1	29.25	743	17.25	438	19.00	483	8.25	210	1
DU325	E3	45.12	1146	24.00	610	24.88	632	8.88	226	1
DU326	E3	49.13	1248	24.00	610	24.88	632	8.88	226	1
T327N	E1	49.13	1248	24.00	610	24.88	632	8.88	226	1
T327NR	E1	49.13	1248	24.75	629	25.13	638	8.88	226	1

SAFETY SWITCHES

3

[27] 30-100 A switches suitable for 60°C or 75°C conductors. 200-800 A switches suitable for 75°C conductors.
[28] Light duty switches only.

Heavy Duty Safety Switches



NEMA Type 1



NEMA Type 3R



NEMA Type 12



NEMA Type 4, 4x, 5
Stainless Steel

Visible blade heavy duty safety switches are designed for application where maximum performance and continuity of service are required. Heavy duty safety switches feature quick-make, quick-break operating mechanism, a dual cover interlock and a color coded indicator handle. They are suitable for use as service equipment when equipped with a field- or factory-installed neutral assembly or equipment grounding kit, unless a 600Y/347 V or 480 Y/277 V, 1000 A or greater, solidly grounded WYE system is used, per NEC 230-95. Heavy duty safety switches are UL Listed (except as noted). Files E2875 and E154828 meet or exceed the NEMA Standard KS1. For UL Listed short circuit current ratings, see UL Listed Maximum Short Circuit Current Ratings-AC only, page 3-13.

Table 3.14: 240 Volt — Single Throw Fusible Switches

System	Amp	Type 1	Type 3R [1]	Type 12[1]	Type 4X 304 SS[1]	Line Side Barriers [2]	Horsepower Ratings				250 Vdc [3]
							Std (Fast Acting One-Time Fuses)		Max (Dual Element Time-Delay Fuses)		
							1Ø	3Ø [4]	1Ø	3Ø [4]	
2 Wire (2 Blade and Fuseholder) – 240 Vac 250 Vdc											
	30	Use device with factory neutral		VH221AWKGL [5]	VH221DSGL [5]	Factory Included	1-1/2	3	3	7-1/2	5
	30			VH2213AWKGL [5]	VH2213DSGL [5]	Factory Included	1-1/2	—	3	—	5
	60			VH222AWKGL [5]	VH222DSGL [5]	Factory Included	3	7-1/2	10	15	10
	100			VH223AWKGL [5]	VH223DSGL [5]	Factory Included	7-1/2	15	15	30	20
	200			VH224AWKGL [5]	VH224DSGL [5]	Factory Included	15	25	—	60	40
	400	H225	H225R	H225AWK	H225DS	LSBG202	—	—	—	—	50
	600	H226	H226R	H226AWK	H226DS	LSBG202	—	75	—	200	50
	800	H227	H227R	H227AWK	—	LSBF202	50	—	—	—	50
1200	H228	H228R	H228AWK	—	LSBF202	50	—	—	—	50	
3 Wire (2 Blade and Fuseholder, 1 neutral) – 240 Vac 250 Vdc											
	30	VH221N	VH221NRB	VH221NAWKGL [5]	VH221NDSGL [5]	Factory Included	1-1/2	3	3	7-1/2	5
	60	VH222N	VH222NRB	VH222NAWKGL [5]	VH222NDSGL [5]	Factory Included	3	7-1/2	10	15	10
	100	VH223N	VH223NRB	VH223NAWKGL [5]	VH223NDSGL [5]	Factory Included	7-1/2	15	15	30	20
	200	VH224N	VH224NR [6]	VH224NAWKGL [5]	VH224NDSGL [5]	Factory Included	15	25	—	60	40
	400	H225N	H225NR	H225NAWK	H225NDS	LSBG202	—	50	—	125	50
	600	H226N	H226NR	H226NAWK	H226NDS	LSBG202	—	75	—	200	50
	800	H227N	H227NR	H227NAWK	—	LSBF202	50	—	—	—	50
	1200	H228N	H228NR	H228NAWK	—	LSBF202	50	—	—	—	50
3 Wire (3 Blade and Fuseholder) – 240 Vac 250 Vdc											
	30	Use device with factory neutral		VH321AWKGL [5]	VH321DSGL [5]	Factory Included	1-1/2	3	3	7-1/2	5
	60			VH322AWKGL [5]	VH322DSGL [5]	Factory Included	3	7-1/2	10	15	10
	100			VH323AWKGL [5]	VH323DSGL [5]	Factory Included	7-1/2	15	15	30	20
	200			VH324AWKGL [5]	VH324DSGL [5]	Factory Included	15	25	—	60	40
	400	H325	H325R	H325AWK	H325DS	LSBG203	—	50	—	125	50
	600	H326	H326R	H326AWK	H326DS	LSBG203	—	75	—	200	50
	800	H327	H327R	H327AWK	—	LSBF203	50	—	—	—	50
	1200	H328	H328R	H328AWK	—	LSBF203	50	—	—	—	50
4 Wire (3 Blade and Fuseholder, 1 neutral) – 240 Vac 250 Vdc											
	30	VH321N	VH321NRB	VH321NAWKGL [5]	VH321NDSGL [5]	Factory Included	1-1/2	3	3	7-1/2	5
	60	VH322N	VH322NRB	VH322NAWKGL [5]	VH322NDSGL [5]	Factory Included	3	7-1/2	10	15	10
	100	VH323N	VH323NRB	VH323NAWKGL [5]	VH323NDSGL [5]	Factory Included	7-1/2	15	15	30	20
	200	VH324N	VH324NR [6]	VH324NAWKGL [5]	VH324NDSGL [5]	Factory Included	15	25	—	60	40
	400	H325N	H325NR	H325NAWK	H325NDS	LSBG203	—	50	—	125	50
	600	H326N	H326NR	H326NAWK	H326NDS	LSBG203	—	75	—	200	50
	800	H327N	H327NR	H327NAWK	—	LSBF203	50	—	—	—	50
	1200	H328N	H328NR	H328NAWK	—	LSBF203	50	—	—	—	50

Accessories: see page 3-16

Dimensions: NEMA Type 1 and 3R, see page 3-22

Dimensions: NEMA Type 4, 4X and 5 Stainless and NEMA Type 12, see page 3-24

[1] For rainproof bolt-on hubs and water resistant hubs.

[2] Factory included to protect against inadvertent contact with live parts per .UL 869A and NEC Service entrance barrier requirements.

[3] For switching dc, use two outside switching poles.



[4] For corner grounded delta systems, use switching poles for ungrounded conductors. See data bulletin 2700DB0202 for additional information.

[5] Ground Lug Factory Included.

[6] This catalog is shipped with HUB provision and knockouts.

600 Volt—Single Throw Fusible

Table 3.15: 600 Volt—Single Throw Fusible



System	Amp	Type 1	Type 3R [7]	Type 12 [7]	Type 4X 304 SS [7]	Line Side Barriers	Horsepower Ratings					
							Std (Fast Acting One-Time Fuses)		Max (Dual Element Time-Delay Fuses)		250 Vdc [8]	600 Vdc
							1Ø	3Ø	1Ø	3Ø		
2 Wire (2 Blade and Fuseholder) – 600 Vac 600 Vdc												
	30	Use device with three blade										
	60	Use device with three blade										
	100	Use device with three blade										
	200	Use device with three blade										
	400	H265	H265R	H265AWK	H265DS	LSBG602	100	250	—	—	50	50
	600	H266	H266R	H266AWK	H266DS	LSBG602	150	400	—	—	50	50
	800	H267	H267R	H267AWK	—	LSBF602	—	—	—	—	—	50
1200	H268	H268R	H268AWK	—	LSBF602	—	—	—	—	—	50	
3 Wire (3 Blade and Fuseholder) – 600 Vac 600 Vdc												
	30	VH361	VH361RB	VH361AWKGL [9]	VH361DSGL [9]	Factory Included	5	15	7-1/2	20	5	15
	30	—	—	VH3613AWKGL [9]	VH3613DSGL [9]	Factory Included	5	15	7-1/2	20	—	15
	60	VH362	VH362RB	VH362AWKGL [9]	VH362DSGL [9]	Factory Included	15	30	15	50	—	30
	100	VH363	VH363RB	VH363AWKGL [9]	VH363DSGL [9]	Factory Included	25	60	30	100	—	50
	200	VH364	VH364R [10]	VH364AWKGL [9]	VH364DSGL [9]	Factory Included	50	125	60	150	40	50
	400	H365	H365R	H365AWK	H365DS	LSBG602	100	250	125	350	50	50
	600	H366	H366R	H366AWK	H366DS	LSBG602	150	400	200	500	50	50
	800	H367	H367R	H367AWK	—	LSBF602	200	500	250	500	—	50
1200	H368	H368R	H368AWK	—	LSBF602	200	500	250	500	—	50	
4 Wire (3 Blade and Fuseholder, 1 neutral) – 600 Vac 600 Vdc												
	30	VH361N	VH361NRB	VH361NAWKGL [9]	VH361NDSGL [9]	Factory Included	5	15	7-1/2	20	5	15
	60	VH362N	VH362NRB	VH362NAWKGL [9]	VH362NDSGL [9]	Factory Included	15	30	15	50	—	30
	100	VH363N	VH363NRB	VH363NAWKGL [9]	VH363NDSGL [9]	Factory Included	25	60	30	100	—	50
	200	VH364N	VH364NR [10]	VH364NAWKGL [9]	VH364NDSGL [9]	Factory Included	50	125	60	150	40	50
	400	H365N	H365NR	H365NAWK	H365NDS	LSBG602	100	250	125	350	50	50
	600	H366N	H366NR	H366NAWK	H366NDS	LSBG602	150	400	200	500	50	50
	800	H367N	H367NR	H367NAWK	—	LSBF602	200	500	250	500	—	50
	1200	H368N	H368NR	H368NAWK	—	LSBF602	200	500	250	500	—	50

Accessories: see page 3-16

Dimensions: NEMA Type 1 and 3R, see page 3-22

Dimensions: NEMA Type 4, 4X and 5 Stainless and NEMA Type 12, see page 3-24

Table 3.16: 4-Pole and 6-Pole - Single Throw Fusible (NOT SUITABLE FOR SERVICE ENTRANCE)

System	Amperes	Type 12	Type 4X	Class R Fuse KITS	Line Side Barriers	Horsepower Ratings Max (Dual Element Time-Delay Fuses)							
						240 V		480 V		600 V		250 Vdc	600 Vdc
						2Ø	3Ø	2Ø	3Ø	2Ø	3Ø		
4-Wire (4 Blades and fuse holders) - 600 Vac 600 Vdc													
	30	H461AWK	H461DS	RFK03L	FactoryIncluded	10	10	20	20	25	30	10	15
	60	H462AWK	H462DS	RFK03H	FactoryIncluded	20	20	40	50	50	60	10	30
	100	H463AWK	H463DS	RFK10	FactoryIncluded	30	40	50	75	50	75	20	30
	200	H464AWK	H464DS	HRK1020	FactoryIncluded	50	60	50	125	50	150	40	50
	400	H465AWK	H465DS	HRK4060	Qty. (2): LSBG602	—	125	—	250	—	350	50	50
6-Wire (6 Blades and fuse holders) – 600 Vac 600 Vdc													
	100	H663AWK	H663DS	RFK10	FactoryIncluded	—	50	—	75	—	75	—	—
	200	H664AWK	H664DS	HRK1020	FactoryIncluded	—	60	—	125	—	150	—	—

[7] For rainproof bolt-on hubs and water resistant hubs.

[8] For switching dc, use two outside switching poles.

[9] Ground Lug Factory Included.

[10] This catalog is shipped with HUB provision and knockouts.

600 Volt—Single Throw Non-Fusible

Table 3.17: 600 Volt—Single Throw Non-Fusible





System	Amp	Type 1	Type 3R [11]	Type 12 [11]	Type 4X 304 SS [11]	Line Side Barriers [12]	Horsepower Ratings					
							Std (Fast Acting One-Time Fuses)		Max (Dual Element Time-Delay Fuses)		250 Vdc [13]	600 Vdc
							1Ø	3Ø	1Ø	3Ø		
2 Wire (2 Blade) – 600 Vac 600 Vdc [14]												
	400	HU265	HU265R	HU265AWK	HU265DS	LSBG602	—	125	—	250	50	50
	600	HU266	HU266R	HU266AWK	HU266DS	LSBG602	—	200	—	400	50	50
	800	HU267	HU267R	HU267AWK	—	LSBF602	—	—	—	—	—	50
	1200	HU268	HU268R	HU268AWK	—	LSBF602	—	—	—	—	—	50
3 Wire (3 Blade) – 600 Vac 600 Vdc												
	30	VHU361	VHU361RB	VHU361AWKGL [15]	VHU361DSGL [15]	Factory Included	5	15	7-1/2	20	5	15
	30	—	—	VHU3613AWKGL [15]	VHU3613DSGL [15]	Factory Included	5	15	7-1/2	20	—	15
	60	VHU362	VHU362RB	VHU362AWKGL [15]	VHU362DSGL [15]	Factory Included	15	30	15	50	—	30
	100	VHU363	VHU363RB	VHU363AWKGL [15]	VHU363DSGL [15]	Factory Included	25	60	30	100	—	50
	200	VHU364	VHU364R [16]	VHU364AWKGL [15]	VHU364DSGL [15]	Factory Included	50	125	60	150	40	50
	400	HU365	HU365R	HU365AWK	HU365DS	LSBG602	100	250	125	350	50	50
	600	HU366	HU366R	HU366AWK	HU366DS	LSBG602	150	400	200	500	50	50
	800	HU367	HU367R	HU367AWK	—	LSBF602	200	500	250	500	—	50
	1200	HU368	HU368R	HU368AWK	—	LSBF602	200	500	250	500	—	50
	1200	HU268	HU268R	HU268AWK	—	LSBF602	—	—	—	—	—	50

Table 3.18: 4-Pole and 6-Pole - Single Throw Non-Fusible (NOT SUITABLE FOR SERVICE ENTRANCE)

System	Amperes	Type 12	Type 4X	Class R Fuse KITS	Line Side Barriers	Horsepower Ratings Max (Dual Element Time-Delay Fuses)							
						240 V		480 V		600 V		250 Vdc	600 Vdc
						2Ø	3Ø	2Ø	3Ø	2Ø	3Ø		
4-Wire (4 Blades) - 600 Vac 600 Vdc													
	30	—	HU461DS	RFK03L	FactoryIncluded	10	10	20	20	25	30	10	15
	30	HU461AWK (SeriesF6)	—	—	FactoryIncluded	10	10	20	20	25	30	5	15
	60	HU462AWK	HU462DS	RFK03H	FactoryIncluded	20	20	40	50	50	60	10	30
	100	HU463AWK	HU463DS	RFK10	FactoryIncluded	30	40	50	75	50	75	20	30
	200	HU464AWK	HU464DS	HRK1020	FactoryIncluded	50	60	50	125	50	150	40	50
	400	HU465AWK	HU465DS	HRK4060	Qty. (2): LSBG602	—	125	—	250	—	350	50	50
6-Wire (6 Blades) - 600 Vac 600 Vdc													
	30	HU661AWK	HU661DS	—	FactoryIncluded	—	10	—	20	—	30	—	—
	60	HU662AWK	HU662DS	—	FactoryIncluded	—	20	—	50	—	60	—	—
	100	HU663AWK	HU663DS	RFK10	FactoryIncluded	—	50	—	75	—	75	—	—
	200	HU664AWK	HU664DS	HRK1020	FactoryIncluded	—	60	—	125	—	150	—	—

[11] For rainproof bolt-on hubs and water resistant hubs.
 [12] Factory Included to protect against inadvertent contact with live parts per UL 869A and NEC service entrance barrier requirements.
 [13] For switching dc, use two outside switching poles.
 [14] For 30-200 A two wire application use a three blade device.
 [15] Ground Lug Factory Included.
 [16] This catalog is shipped with HUB provision and knockouts.

3 SAFETY SWITCHES

UL Listed Maximum Short Circuit Current Ratings—AC only

NOTE: Consult the wiring diagram of the switch to verify the UL Listed short circuit current rating.

Table 3.19: Fusible Safety Switches

Heavy Duty Safety Switch Type	UL Listed Fuse Class	UL Listed Short Circuit Current Ratings
Fusible	H, K	10 kA
	R, J, L	200 kA [17]

Non-Fusible Safety Switches – Ratings

Systems equal or less than 10 kAIR SCCR—Any brand of circuit breaker or fuse not exceeding the ampere rating of the switch may be used in conjunction with a non-fusible safety switch.

Systems above 10 kAIR SCCR—The UL Listed short circuit current rating for Square D non-fusible switches is based upon the switch being used in conjunction with fuses or Square D circuit breakers or Mag-Gard motor circuit protectors.

Table 3.20: Non-Fusible Safety Switches [18] [19]

Switch Rating (A)	Fuse or Circuit Breaker Type [20]	3-Phase			250 Vdc / 600 Vdc
		240 Vac	480 Vac	600 Vac	
With Upstream Fuse Protection					
All	H, K	10 kA	10 kA	10 kA	Up to 10 kA
	R, T, J, L	200 kA	200 kA	200 kA	
With Upstream Circuit Breaker Protection					
All	Any brand circuit breaker	10 kA	10 kA	10 kA	Up to 10 kA
30–100	HD	25 kA	18 kA	14 kA	
30–100	HG	65 kA	35 kA	18 kA	
30–100	HJ	65 kA	35 kA	25 kA	
30–100	HL	65 kA	35 kA	35 kA	
30–100	HR	65 kA	35 kA	35 kA	
30–100	FA	14 kA	14 kA	14 kA	
30–100	FH	18 kA	18 kA	18 kA	
200	HD, JD	25 kA	18 kA	14 kA	
200	HG, JG	65 kA	35 kA	18 kA	
200	HJ, JJ	65 kA	35 kA	25 kA	
200	HL, JL	65 kA	35 kA	35 kA	
200	HR, JR	65 kA	35 kA	35 kA	
400	LA	22 kA	22 kA	22 kA	
400	LH	25 kA	25 kA	25 kA	
400–600	LD	25 kA	18 kA	14 kA	
400–600	LG	65 kA	35 kA	18 kA	
400–600	LJ	100 kA	65 kA	25 kA	
400–600	LL	100 kA	65 kA	50 kA	
400–600	LR	100 kA	65 kA	65 kA	

[17] On 600 V, 200 A switches, 100,000 A max. on corner grounded delta when using Class J or R fuses.

[18] For NEMA Type 4X Fiberglass Reinforced Polyester switches, see page 3-15.

[19] NEMA Type 7/9 SCCR 10 kAIR 600 Vac maximum.

[20] Ampere rating of fuse or circuit breaker not to exceed switch ampere rating.

Special Application Heavy Duty Safety Switches



VH361SSGL



H363DF



H361DX



VH361SSGL

316 Grade Stainless Steel—NEMA Type 3, 3R, 4, 4X, 5, 12

316 stainless steel enclosure safety switches offer superior corrosion resistance to a wider range of chemicals than 304 stainless switches. 316 better resists chloride and is often used in marine, waste treatment and transportation applications. Use water resistant hubs, see [Hubs, page 3-16](#). Equipment grounding lugs are supplied as standard through 200 A. See [Terminal Lug Data, page 3-21](#) for wire Termination data for grounding lugs.

For 304 stainless switches, see [240 Volt, page 3-10](#) and [600 Volt, page 3-11](#).

3

SAFETY SWITCHES

Table 3.21: 316 Grade Stainless Steel 3 Pole 600 Vac, 600 Vdc

System	Amperes	Cat. No	Line Side Barriers [21]	Horsepower Ratings— 3Ø				
				480 Vac [22]		600 Vac [22]		600 Vac [23]
				Std.	Max.	Std.	Max.	Max.
Fusible - 3 Wire (3 Blade and fuse holders) - 600 Vac 600 Vdc								
	30	VH361SSGL	Factory included	5	15	7-1/2	20	15
	60	VH362SSGL	Factory included	15	30	15	50	30
	100	VH363SSGL	Factory included	25	60	30	75	50
	200	VH364SSGL	Factory included	50	125	60	150	50
	400	H365SS	LSBG602	100	250	125	350	50
	600	H366SS	LSBG602	150	400	200	500	50
Non-Fusible - 3 Wire (3 Blades) - 600 Vac 600 Vdc								
	30	VHU361SSGL	Factory included	—	20	—	30	15
	60	VHU362SSGL	Factory included	—	50	—	60	30
	100	VHU363SSGL	Factory included	—	75	—	100	50
	200	VHU364SSGL	Factory included	—	125	—	150	50
	400	HU365SS	LSBG602	—	250	—	350	50
	600	HU366SS	LSBG602	—	400	—	500	50

[21] Factory included to protect against inadvertent contact with live parts per UL 869A and NEC service entrance barrier requirements.

[22] Std.—Using fast acting, one time fuses. Max.—Using dual element time delay fuses.

[23] For switching dc use two switching poles.



H363DF

Fiberglass Reinforced Polyester Enclosures—NEMA Type 4X

Fiberglass reinforced polyester enclosures are water resistant, corrosion resistant, and resists to windblown dust, rain, and splashing liquid. The molded fiberglass can withstand a wide range of operating temperatures and can withstand heavy impact. Switches are furnished with hubs, conduit provisions [Table 3.40 Conduit Provisions](#), [page 3-22](#), and equipment grounding lugs. See CAD drawings of the switch to verify the UL listed short circuit current rating or the enclosed safety switch catalog. UL Listed.

Table 3.22: Fiberglass Reinforced Polyester Enclosures NEMA Type 4X 3 Pole 600 Vac, 600 Vdc

System	Amperes	Cat. No.	Solid Neutral Assembly Kit	Class R Fuse Kits Cat. No.	Electrical Interlock Kits Field-Installed Cat. No.		Line Side Barriers Factory Included [24]	Horsepower Ratings—3Ø				Hubs [25]	
					1 NO/1 NC Contacts	2 NO/2 NC Contacts		480 Vac [26]		600 Vac [26]			
								Std.	Max.	Std.	Max.		
Fusible - 3 Wire (3 Blade and fuse holders) - 600 Vac 600 Vdc													
	30	H361DF	SN03	RFK06	9999TC10	9999TC20	Factory Included	5	15	7-1/2	20	15	3/4
	60	H362DF	SN03	RFK06H	9999TC10	9999TC20	Factory Included	15	30	15	50	30	1-1/4
	100	H363DF	SN0610	RFK10	9999TC10	9999TC20	Factory Included	25	60	30	75	50	2
	200	H364DF	—	HRK1020	9999R8	9999R9	Factory Included	50	125	60	150	50	2-1/2
Non-Fusible - 3 Wire (3 Blade) - 600 Vac 600 Vdc													
	30	HU361DF	SN03	—	9999TC10	9999TC20	Factory Included	—	20	—	30	15	3/4
	60	HU362DF	SN03	—	9999TC10	9999TC20	Factory Included	—	50	—	60	30	1-1/4
	100	HU363DF	SN0610	—	9999TC10	9999TC20	Factory Included	—	75	—	75	50	2
	200	HU364DF	—	—	9999R8	9999R9	Factory Included	—	125	—	150	50	2-1/2

Krydon™ Enclosures—NEMA Type 4X

Krydon enclosures are compression molded of fiberglass reinforced polyester, specially formulated to withstand attack from almost any corrosive atmosphere found in the toughest industrial application. Switches are furnished with water resistant hubs and equipment grounding lugs. See CAD drawing of the switch to verify the UL listed short circuit current rating or the enclosed safety switch catalog. UL Listed.



H361DX

Table 3.23: Krydon™ Enclosures — NEMA Type 4X 3 Pole 600 Vac, 600 Vdc

System	Amperes	Cat. No.	Solid Neutral Assembly Kit	Class R Fuse Kits Cat. No.	Electrical Interlock Kits Field-Installed Cat. No.		Line Side Barriers Factory Included [27]	Horsepower Ratings—3Ø				Hubs [25]	
					1 NO/1 NC Contact	2 NO/2 NC Contacts		480 Vac [28]		600 Vac [28]			600 Vdc [29]
								Std.	Max.	Std.	Max.		Max.
Fusible - 3 Wire (3 Blade and fuse holders) - 600 Vac 600 Vdc													
	30	H361DX	H60SN	RFK06	9999TC10	9999TC20	Factory Included	5	15	7-1/2	20	15	3/4
	60	H362DX	H60SN	RFK06H	9999TC10	9999TC20	Factory Included	15	30	15	50	30	1-1/4
	100	H363DX	SN0610	RFK10	9999TC10	9999TC20	Factory Included	25	60	30	75	50	2
Non-Fusible - 3 Wire (3 Blade) - 600 Vac 600 Vdc													
	30	HU361DX	H60SN	—	9999TC10	9999TC20	Factory Included	—	20	—	30	15	3/4
	60	HU362DX	H60SN	—	9999TC10	9999TC20	Factory Included	—	50	—	60	30	1-1/4
	100	HU363DX	SN0610	—	9999TC10	9999TC20	Factory Included	—	75	—	75	50	2

[24] Factory included to protect against inadvertent contact with live parts per UL 869A and NEC service entrance barrier requirements.

[25] Two hubs and hub drilling template are provided for field installation.

[26] Std.—Using fast acting, one time fuses. Max.—Using dual element time delay fuses.

[27] Factory included to protect against inadvertent contact with live parts per UL 869A and NEC service entrance barrier requirements.

[28] Std.—Using fast acting one time fuses. Max.—Using dual element time delay fuses.

[29] For switching dc, use two outside switching poles.

Heavy Duty Safety Switch Accessories

Square D by Schneider Electric brand heavy duty safety switches are UL listed for use with the following accessories:

Rainproof Bolt-On Hubs and Water Resistant Hubs

Rainproof Bolt-On Hubs



Rainproof Bolt-On Hubs

- UL Listed for indoor or rainproof applications
- Suitable for use with conduit having ANSI standard taper pipe thread
- NEMA Type 3R switches with catalog number ending in RB have a bolt-on closing cap factory installed
 - Accepts 3/4 in. through 2-1/2 in. bolt-on hubs
 - No gaskets required
- NEMA Type 3R switches with R suffix have blank top endwalls [30]
 - Accepts 3 in. through 4 in. bolt on hubs
 - Gaskets provided
 - Conduit entry holes must be cut in the field

Table 3.24: Rainproof Bolt-On Hubs [31]

Conduit Size	3/4	1	1-1/4	1-1/2	2	2-1/2	3	4	Closing Cap
Hub Cat. No	B075	B100	B125	B150	B200	B250	B300	B400	BCAP

Water Resistant Hubs

- UL Listed for dusty and wet applications
- Suitable for use with conduit having ANSI standard taper pipe thread
- Water resistant hubs are field installed on NEMA Type 4/4X/5 stainless steel and NEMA Type 12/3R and 12K enclosures
- Water resistant hubs are available in zinc or chrome plated finish
- Gaskets provided



H200 Zinc Plated



H050CP Chrome Plated

Table 3.25: Water Resistant Hubs [32]

Conduit Size	1/2	3/4	1	1-1/4	1-1/2	2	2-1/2	3	3-1/2	4
Standard-Zinc Hub Cat. No	H050	H075	H100	H125	H150	H200	H250	H300	H350	H400
Chrome Plated Hub Cat. No.	H050CP	H075CP	H100CP	H125CP	H150CP	H200CP	—	—	—	—

[30] 200 A Heavy Duty catalogs VH364NR, VH364R, VHU364R, VH224NR, VH324NR, and variants, comes with HUB provision and knockouts.

[31] Gaskets are provided on 3 in. and larger hubs.

[32] Gaskets are provided.



EIK1 Electrical Interlock Kit

Electrical Interlock Kits

Electrical interlocks for heavy duty safety switches 30 A through 1200 A are available as field installed kits, or on Type 12 or Type 4X enclosure factory installed. A pivot arm operates from the switch mechanism, breaking the control circuit before the main switch blades break. See supplemental digest section 2 for contact ratings. UL Listed for factory or field installation.

For factory installation catalog numbers available on Type 12 or 4X enclosures use the product configurator.

Table 3.26: Electrical Interlock Kit [33] [34]

Switch Amperes Rating	Series Number [35]	Electrical Interlock Kit Cat. No. [36]
30	F5-F8	EIK031
		EIK032
60 (600 V)	F5-F8	EIK1
		EIK2
60 (240 V)	F5-F8	EIK031
		EIK032
100-200	F5-F8	EIK1
		EIK2
30-100 Receptacle Switches	F5-F7	EIK1
		EIK2
30-200 Four- and Six-Pole Switches	F5-F6	EIK1
		EIK2
400-1200	E4-E5	EIK40601
		EIK40602

Table 3.27: Electrical Interlock Contact Ratings [37]

Interlock Type	AC 50 or 60Hz				DC		
	Volts	Make	Break	Cont.	Volts	Make / Break	Cont.
1 N. O. / 1 N. C. Contact (-1 Suffix [38])	120	40.00 A	15.00 A	15.00 A	115	0.50 A	15.00 A
	240	20.00 A	10.00 A	15.00 A	230	0.25 A	15.00 A
2 N. O. / 2 N. C. Contacts (-2 Suffix [39])	120	30.00 A	3.00 A	10.00 A	115	1.00 A	10.00 A
	240	15.00 A	1.5 A	10.00 A	230	0.30 A	10.00 A

Class R Fuse Rejection Kits

When installed, kit limits switch to Class R fuses only. Kits are available for field installation. Each kit supports one three pole switch.

Table 3.28: 240 Vac — Class R Fuse Kits [40]

Amperes	Series Number	Class R Fuse Kit Cat. No.
30	F5-F8	RFK03L
60	F5-F8	RFK03H
100	F5-F8	RFK10
200	F5-F8	HRK1020
400-600	E4-E5	HRK4060

Table 3.29: 600 Vac — Class R Fuse Kits [40] [41]

Amperes	Series Number	Class R Fuse Kit Cat. No.
30 [42]	F5-F8	RFK03H
30 A Receptacle Switches	F7	RFK06
30 A Four-Pole Switches	F5-F6	RFK06
60	F5-F8	RFK06H
100	F5-F8	RFK10
200	F5-F8	HRK1020
400-600	E4-E5	HRK4060

[33] For series not shown in table refer to the switch wiring diagram.

[34] Electrical interlocks for NEMA Type 4X fiberglass reinforced polyester and Krydon™ see Table 3.22 and Table 3.23 respectively.

[35] See page 3-22 and page 3-24 for safety switch series.

[36] Electrical interlock kit catalog numbers ending in 1 indicates one normally open and one normally closed contact. These kits use a 9007A01 industrial snap switch. Electrical interlock kit catalog numbers ending in 2 indicates two normally open and two normally closed contacts. These kits use a 9007C03 industrial snap switch.

[37] Single-pole single-throw interlock kits are rated 1/2 hp at 110 and 220 Vac.

[38] -1 Suffix uses a 9007A01 limit switch.

[39] -2 Suffix uses a 9007C03 limit switch.

[40] For series not shown in the table, refer to the switch wiring diagram.

[41] Class R Fuse Kits for Fiberglass Reinforced Polyester enclosures and Krydon™ enclosures see Table 3.22 Fiberglass Reinforced Polyester Enclosures NEMA Type 4X 3 Pole 600 Vac, 600 Vdc, page 3-15 and Table 3.23 Krydon™ Enclosures — NEMA Type 4X 3 Pole 600 Vac, 600 Vdc, page 3-15 respectively.

[42] H361-2, H361-2A, H361-2AWK and H361-2RB use RFK06.

Line Side Barrier Kits

The field instable line side barrier kits are required to meet National Electric Code (NFPA 70) for service entrance applications. Barrier kits protect against inadvertent contact with line side, uninsulated, ungrounded or service terminal live parts.

Table 3.30: Line Side Barrier Kits for Heavy Duty Safety Switch

Amperes	Voltage	Blades/Fuses	Catalog
30	600	2 or 3	LSBD602
30 / 60	240		LSBD202
60	600		LSBC02
100	240 / 600		LSBC02
200	240	2	LSBE202
	600	3	LSBE203
400 / 600	240	2	LSBE603
		3	LSBG202
	600	2 or 3	LSBG203
800 / 1200	240	2	LSBG602
		3	LSBF202
	600	2 or 3	LSBF203

Internal Barrier Kits

Internal barrier kits provide an additional barrier that helps prevent accidental contact with live parts. Field-installed transparent barriers do not restrict visual inspection of the switch. Barrier provides IEC529 IP2X protection when door of enclosed disconnect switch is open. Designed with convenient door for accessing fuses for replacement without removing barrier, and allows use of test probes.

Internal barrier kits are not designed to meet NEC2020 for service entrance applications, see [Table 3.30 Line Side Barrier Kits for Heavy Duty Safety Switch](#), page 3-18 for meeting this standard.

Table 3.31: Internal Barrier Kits for Heavy Duty

Amperes	Voltage	Barrier for	Cat. No.
30	600	Line and Load	SS03 [43]
60	240		SS03 [43]
	600		SS06 [43]
100	240 / 600		SS10 [43]
200		SS20 [43] [44]	
400 / 600		Line Side	SS4060LI
	Load Side	SS4060LO [45]	
800 / 1200	Line Side	SS80120LI	
	Load Side	SS80120LO [45]	



SS20

Solid Neutral Assembly Kits for Safety Switches

Table 3.32: Solid Neutral Assembly Kits [46] [47] [48] [49]

Amperes	Series Number [50]	Standard Neutral Kit Cat. No.	Terminal Data AWG/kcmil	Optional Copper Only Neutral Kit Cat. No.	Terminal Data AWG/kcmil
30	F5-F8	SN03 [51]	(2) 14-3 Al/Cu plus (1) 14-3 Al/Cu Svc Ground	SN03C [51]	(2) 14-6 Cu plus (1) 14-6 Cu Svc Ground
60	F5-F8, (600 V)	SN0610	(2) 14-1/0 Al/Cu plus (2) 14-6 Al/Cu Svc Ground	SN0610C	(2) 14-1/0 Cu plus (2) 14-6 Cu Svc Ground
	F5-F8 (240 V)	SN03	(2) 14-3 Al/Cu plus (1) 14-3 Al/Cu Svc Ground	SN03C	(2) 14-1/0 Cu plus (2) 14-6 Cu Svc Ground
100	F5-F8	SN0610	(2) 14-1/0 Al/Cu plus (2) 14-6 Al/Cu Svc Ground	SN0610C	(2) 14-1/0 Cu plus (2) 14-6 Cu Svc Ground
200 [52]	F5-F8	SN20A	(2) 6-250 Al/Cu plus (1) 14-10 Al/Cu Svc Ground	SN20C	(2) 6-250 Cu plus (1) 14-1/0 Cu Svc Ground
400 and 600	E4-E5	H600SN	(4) 1-750 Al/Cu plus (1) 4-300 Al/Cu Svc Ground	H600SNC	(2) 1-600 Cu and (2) 4-350 Cu plus (2) 6-250 Cu Svc Ground
800	E4	H800SNE4	(6) 3/0-750 Al/Cu plus (2) 6-350 Al/Cu Svc Ground	—	—
1200	E4	H1200SNE4	(8) 3/0-750 Al/Cu plus (2) 6-350 Al/Cu Svc Ground	—	—

[43] Can only be applied to F series.

[44] For 200 A 240 V devices is also needed to order line side barriers kits from table 3.29 LSBE202 or LSBE2023.

[45] Must buy line side also

[46] For series not shown in chart refer to the switch wiring diagram.

[47] For solid Neutral Assembly Kits for Krydon™ enclosure see [Table 3.23](#).

[48] For Solid Neutral Assembly Kits for Fiberglass Reinforced Polyester enclosures see [Table 3.22](#).

[49] Neutrals cannot be installed in 4 or 6 pole switches or receptacle switches.

[50] See [page 3-22](#) and [page 3-24](#) for safety switch series.

[51] The following 30 A Series F5-F6 switches use SN0610 or SN0610C: H3612, H3612RB, H3612A, H3612AWK, HU3612, HU3612RB, HU3612A and HU3612AWK.

[52] For 200% neutral, order (2) SN20A Neutral Kits and (1) SN20NI Neutral Jumper Kit.



Fuse Puller Kits

Fuse Puller Kits

Fuse Puller Kits are standard equipment on the following 30 A – 100 A switches: NEMA Type 12, Type 4/4X/5 stainless steel, Type 4X fiberglass reinforced polyester and Krydon™.

Fuse Puller Kit available for field installation on Type 1 and Type 3R, 30 A – 100 A switches. One Fuse Puller Kit required for a 3 pole fusible 240 V or 600 V heavy duty switch. Fuse Puller Kits can be field installed on switches manufactured since February 1980.

Table 3.33: Fuse Puller Kits for Heavy Duty Safety Switches

Amperes	Series Number [53]	Fuse Puller Kit Cat. No.
30	F5-F7	FPK03 [54]
60	F5-F7 (600 V)	FPK0610
60	F5 (240 V)	FPK03
100	F5-F7	FPK0610

Equipment Grounding Kits For Safety Switches

Equipment grounding kits are available for field installation.

Factory included ground lug comes as standard on heavy duty safety switches Type 12 and 4X enclosures.

Table 3.34: Equipment Grounding Kits and Terminal Data [55] [56]

Amperes	Series Number	Standard Cat. No.	Terminal Data AWG/kcmil	Optional Copper Only Cat. No.	Terminal Data AWG/kcmil
30	F5-F8	GTK03 [57]	(2) 14-4 Cu or (2) 12-4 Al or (4) 14-12 Cu or (4) 12-10 Al	GTK03C [57] [58]	(2) 14-6 Cu
60	F5-F8 (600 V)	GTK0610	(2) 14-1/0 Cu or (2) 12-1/0 Al and (2) 14-6 Cu or (2) 12-6 Al	GTK0610C	(2) 14-1/0 Cu and (2) 14-6 Cu
60	F5-F8 (240 V)	GTK03	(2) 14-4 Cu or (2) 12-4 Al or (4) 14-12 Cu or (4) 12-10 Al	GTK03C	(2) 14-6 Cu
100	F5-F8	GTK0610	(2) 14-1/0 Cu or (2) 12-1/0 Al and (2) 14-6 Cu or (2) 12-6 Al	GTK0610C	(2) 14-1/0 Cu and (2) 14-6 Cu
200	F5-F8	PKOGTA2	(2) 10-2/0 Cu or (2) 6-2/0 Al	PKOGTC2	(2) 14-4 Cu
400 and 600	E4-E5	PKOGTA2 [59]	(2) 10-2/0 Cu or (2) 6-2/0 Al	PKOGTC3	(4) 14-1/0 Cu
800	E4	PKOGTA7	(4) 4-350 Al/Cu	—	—
1200	E4	PKOGTA8	(8) 4-350 Al/Cu	—	—

Touch-Up Paint for Safety Switches

Description	Cat. No.
12 oz. Aerosol Paint Can, Square D ANSI-49 Gray Touch-Up Paint	PK49SP

NOTE: Standard package quantity is 6 cans.

Cover Viewing Window – Heavy Duty Single Throw Switches

Cover viewing window is positioned over the blades to allow visual verification of “ON/OFF” status.

- Available as standard on Heavy Duty Single Throw Safety Switches 30, 60, 100, and 200 AMP, Type 1, Type 3R, Type 12, and Type 4X Stainless Steel Enclosures.
- Units can be obtained without window on Type 12 and Type 4X stainless steel devices – shipped from factory.
- Available as factory modification on Type 12 and Type 4X enclosures – 400, 600, 800, and 1200 A.



[53] For series not shown in chart refer to the switch wiring diagram.

[54] 30 A 4 pole, H361-2 and H361-2RB Series F5, H361VA and H361WC Series F6 use FPK0610.

[55] For series not shown in table refer to the switch wiring diagram.

[56] Equipment Ground Kits (Al/Cu) are factory installed standard in 30-200 A Series F NEMA Type 4/4X/5 (stainless steel), 12. Equipment Ground Kits are standard factory installed on receptacle switches and Series F 30-200 A, 4 and 6 pole switches.

[57] H2212AWK accepts GTK03 or GTK03C. H3612A or AWK accepts GTK03C. H3612 and H3612RB accepts GTK0610 HU3612AWK accepts GTK03C. HU3612A accepts GTK0610C. HU3612RB accepts GTK0610 or GTK0610C.

[58] Optional copper equipment grounding kit for the 4 and 6 pole 30 A F Series: H461DS, H461AWK, HU461DS, HU661DS and HU661AWK accepts GTK03C HU461AWK accepts GTK0610C.

[59] Two required if equipment grounding conductors are run in parallel.

Lock OFF / Lock ON

Lock off provisions are standard on Heavy Duty Switches

Lock-on is also available as a factory modification on Type 12 and 304 Stainless Steel Type 4X enclosures. Obtain by selecting on product configurator.



Optional Lock-OFF Guard Kit Installed

Lock Off Guard Kits

For field installed kits, the lock off guard works by covering the lockout tagout openings whenever the switch is in the ON POSITION. This protects against a padlock from being inadvertently inserted into the switch lockplate. Available ONLY for use on Type 1, Type 3R, Type 12, Heavy Duty Safety Switches.

Table 3.35: Lock-Off Guard Kits for Heavy Duty Safety Switches

Switch Rating	Cat. No.
30 A	LOGK1
60 A 240 V	
60 A 600 V	LOGK2
100 and 200 A	

Key Interlock Systems

Factory installed only on heavy duty safety switches from 30 amp to 1200 amp, Type 12 and 304 stainless steel Type 4X.

The key interlock system is a simple and easy method of applying individual key interlock units and assemblies to the above equipment so as to require operation in a predetermined sequence. UL Listed.

Quoting: Contact Schneider Electric for catalog number, availability, and pricing prior to quoting a job. Detailed information is required before an order can be processed. Please see Supplemental Digest Section 2 for further information.

Use these suffixes on switch catalog numbers:

- KI = 1 lock per switch
- KI2 = 1 lock with 2 cylinders (2 keys) per switch
- KIKI = 2 separate locks per switch



Key Interlock System

Voltage Monitors for Safety Switches

Voltage monitors installed on safety switches indicate when voltage is present, helping to prevent hazards during maintenance work. Voltage monitors can be combined with other safety features such as Key Interlock, Viewing Windows or Lock-ON provisions.

- UL Listed
- Available on 30-1200 A Type 12 and 4X - 304 Stainless steel Heavy duty Safety Switches
- Obtain by selecting on product configurator [60]
- Not available on NEMA Type 7 and 9 and NEMA Type 4X Fiberglass and KrydonTM switches

NOTE: When voltage monitoring is required for 30 and 60 A application, a 100 A enclosure is used.



Safety Switch with Voltage Monitoring

Load Side Double Lug Kits

200 A heavy duty F-series switches are supplied standard with lugs suitable for one wire per phase. For two wires per phase and neutral, order the Double Lug Kit.

UL Recognized. Not included on switch wiring diagram as an accessory, available for Load Connections only. Lug can only be field installed on load side terminals. [61]



AL20DTF

Table 3.36: Double Lug Kits

Amperes	Cat. No. [62]	Lug Wire Range per Phase and Neutral AWG/kcmil	Wire Range Wire Bending Space per NEC Table 312.6 AWG/kcmil
200	AL20DTF	(2) 6–300 Cu/Al	(2) 6–250 Cu/Al

[60] For 30-60 A 240 Vac application, order 600 Vac heavy duty safety switch.
 [61] Double lug kit is a UL recognized component accessory kit consisting of UL listed lugs.
 [62] Kit contains 3 lugs. Order two kits for line and load lugs.

Copper Lug Kits

Lug kits that accept only copper wire are available for field installation:

- UL Listed
- UL Marine Listed
 - UL Marine listing is applicable ONLY to 30 - 200 A, NEMA Type 12/3R, NEMA Type 12K and NEMA Type 4/4X/5 stainless steel, safety switches
 - When copper only lugs kits are factory installed the switch will bear the UL Marine mark and be suitable for use on vessels over 65 feet long
 - When the copper only lugs kits are field installed the switch will not bear the UL Marine mark and would not be suitable for use on vessels over 65 feet long
- Not available for use on NEMA Type 4X Fiberglass, Krydon or NEMA Type 7 and 9 switches
- For field installation, order copper lug kits. See Table below
- For factory installation of copper lugs, add the suffix SLC to the standard catalog number

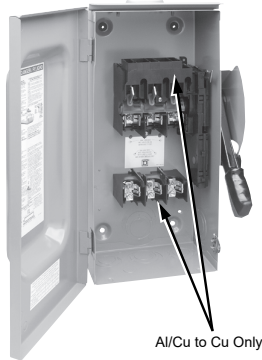

Table 3.37: Copper Lug Kits [63]

Amperes	Lug Kit Cat. No.	Lug Wire Range AWG/kcmil
30–60	CL0306F	(1) 14-8 Cu solid or 14-4 Cu stranded
100	CL10F	(1) 14-8 Cu solid or 14-1/0 Cu stranded
200	CL20F	(1) 6-250 Cu
400	CL40F	(1) 1-600 Cu plus (1) 6-250 Cu
600	CL60F	(1) 4-350 Cu
800	—	—
1200	—	—

Compression Lug Kits — 800 A and 1200 A Safety Switches

- UL Listed
- Compression Lug Kits available for field installation
- Compression Lug Kits contain VCEL07512H1 Versa-Crimp™ compression lugs
- Order one Compression Lug Kit per switching pole and/or neutral (see Table below)

Table 3.38: Compression Lug Kits

Amperes	Lug Kit Cat. No.	Conductors per Phase	Lug Wire Range kcmil
800	H8LKE2	(3) Line and (3) Load	500-750 kcmil (Al) or 500 kcmil (Cu)
1200	H12LKE2	(4) Line and (4) Load	500-750 kcmil (Al) or 500 kcmil (Cu)



Table 3.39: Terminal Lug Data [64]

Rating (A)	Wires Per Phase and Neutral	Wire Range Wire Bending Space per NEC Table 312.6 AWG/kcmil	Lug Wire Range AWG/kcmil	Optional [65] Compression Lug Field-Installed	Optional Copper Only [65] Compression Lug Field-Installed [66]
30	1	12–6 (Al) or 14–6 (Cu)	12–2 (Al) or 14–2 (Cu)	C10–14, [67] D8–14–SK, or E6–14	—
	2	12–10 (Al) or 14–10 (Cu)			
60 [68]	1	12–3 (Al) or 14–3 (Cu)	12–2 (Al) or 14–2 (Cu)	C10–14, [67] D8–14–SK, or E6–14	—
100 [69]	1	12–1/0 (Al) or 14–1/0 (Cu)	12–1/0 (Al) or 14–1/0 (Cu)	VCEL02114S1	VCELC02114S1
200 [70]	1	6–250 (Al/Cu)	6–300 (Al/Cu)	VCEL030516H1	VCELC030516H1
400 [71]	1	1/0–750 (Al/Cu) or 1/0–300 (Al/Cu)	1/0–750 (Al/Cu) or 1/0–300 (Al/Cu)	VCEL07512H1	VCELC07512H1
	2			or VCEL030516H1 [72] and VCEL05012H1	or VCELC030516H1 [73] and VCELC05012H1
600	2	3/0–500 (Al/Cu)	3/0–500 (Al/Cu)	VCEL05012H1	VCELC05012H1
800	3	3/0–750 (Al/Cu)	3/0–750 (Al/Cu)	H8LKE2 [74]	—
1200	4	3/0–750 (Al/Cu)	3/0–750 (Al/Cu)	H12LKE2 [74]	—

[63] One kit includes line/load lugs for a 3-pole switch. CL0306F, CL10F and CL20F includes six lugs. CL40F and CL60F includes twelve lugs.
 [64] 30–100 A switches suitable for 60°C or 75°C conductors. 200–1200 A switches suitable for 75°C conductors.
 [65] Hubbell Versa-Crimp™ unless otherwise noted.
 [66] For NEMA Type 1, 12/3R, 12K and 4/4X/5 stainless steel switches only.
 [67] Order from Thomas and Betts.
 [68] H60XFA and H60XFA1212 — use 75°C copper wire only. #6 AWG copper wire required for 60 A rating.
 [69] H100XFA and H100XFA1212 — use 75°C copper wire only. #3 AWG copper wire required for 100 A rating.
 [70] H225XJG and H225XJGAA — use 75°C copper wire only. Lug wire range is #3 AWG – 350 kcmil. Not UL Listed due to inadequate wire bending space (5" on ON end, 6" on OFF end).
 [71] Maximum wire bending space allows for (1) 600 kcmil or (2) 300 kcmil Al/Cu on NEMA Type 4/4X/5 stainless steel and NEMA Type 12 switches.
 [72] Order two PK516KN mounting kits when installing VCEL030516H1 lugs. Only one kit is required on 2 pole switches. PK516KN consists of (4) 5/16-18 Keps Nuts.
 [73] Order two PK516KN mounting kits when installing VCEL030516H1 or VCELC030516H1 lugs. Only one kit is required on 2 pole switches. PK516KN consists of (4) 5/16-18 Keps Nuts.
 [74] For 800 and 1200 A compression lug kits see Table 3.38 Compression Lug Kits, page 3-21 for additional information.

Table 3.40: Conduit Provisions

Amperes	Top and Bottom Endwall	
	NEMA Type 4X Fiberglass Reinforced Polyester and Krydron [75]	
30	3/4 in.	
60	1-1/4 in.	
100	2 in.	
200	2-1/2 in.	

Dimensions for VisiPac Type 1 and 3R Safety Switches

See Terminal Lug Data, page 3-21 for terminal lug data for the series switches listed in the dimension table below.

Table 3.41: Approximate Dimensions

Cat. No.	Series	H		W		D		W/H		Cat. No.	Series	H		W		D		W/H	
		in.	mm	in.	mm	in.	mm	in.	mm			in.	mm	in.	mm	in.	mm	in.	mm
VH221N	F8	14.57	370	6.36	162	5.11	130	7.48	190	VH221NRB	F8	14.84	377	6.63	168	5.05	128	7.60	193
VH321N	F8	14.57	370	6.36	162	5.11	130	7.48	190	VH321NRB	F8	14.84	377	6.63	168	5.05	128	7.60	193
VH361	F8	14.57	370	6.36	162	5.11	130	7.48	190	VH361RB	F8	14.84	377	6.63	168	5.05	128	7.60	193
VH361N	F8	14.57	370	6.36	162	5.11	130	7.48	190	VH361NRB	F8	14.84	377	6.63	168	5.05	128	7.60	193
VHU361	F8	14.57	370	6.36	162	5.11	130	7.48	190	VHU361RB	F8	14.84	377	6.63	168	5.05	128	7.60	193
VH222N	F8	14.57	370	6.36	162	5.11	130	7.48	190	VH222NRB	F8	14.84	377	6.63	168	5.05	128	7.60	193
VH322N	F8	14.57	370	6.36	162	5.11	130	7.48	190	VH322NRB	F8	14.84	377	6.63	168	5.05	128	7.60	193
VH362	F8	18.18	462	8.91	226	7.04	179	10.26	261	VH362RB	F8	18.40	467	9.08	231	6.98	177	10.39	264
VH362N	F8	18.18	462	8.91	226	7.04	179	10.26	261	VH362NRB	F8	18.40	467	9.08	231	6.98	177	10.39	264
VHU362	F8	18.18	462	8.91	226	7.04	179	10.26	261	VHU362RB	F8	18.40	467	9.08	231	6.98	177	10.39	264
VH223N	F8	21.84	555	8.91	226	7.04	179	10.28	261	VH223NRB	F8	22.10	561	9.08	231	7.02	178	10.42	265
VH323N	F8	21.84	555	8.91	226	7.04	179	10.28	261	VH323NRB	F8	22.10	561	9.08	231	7.02	178	10.42	265
VH363	F8	21.84	555	8.91	226	7.04	179	10.28	261	VH363RB	F8	22.10	561	9.08	231	7.02	178	10.42	265
VH363N	F8	21.84	555	8.91	226	7.04	179	10.28	261	VH363NRB	F8	22.10	561	9.08	231	7.02	178	10.42	265
VHU363	F8	21.84	555	8.91	226	7.04	179	10.28	261	VHU363RB	F8	22.10	561	9.08	231	7.02	178	10.42	265
VH224N	F8	28.00	711	16.61	422	8.51	216	18.55	471	VH224NRB	F8	28.94	735	17.02	432	8.51	216	18.36	466
VH324N	F8	28.00	711	16.61	422	8.51	216	18.55	471	VH324NRB	F8	28.94	735	17.02	432	8.51	216	18.36	466
VH364	F8	28.00	711	16.61	422	8.51	216	18.55	471	VH364RB	F8	28.94	735	17.02	432	8.51	216	18.36	466
VH364N	F8	28.00	711	16.61	422	8.51	216	18.55	471	VH364NRB	F8	28.94	735	17.02	432	8.51	216	18.36	466
VHU364	F8	28.00	711	16.61	422	8.51	216	18.55	471	VHU364RB	F8	28.94	735	17.02	432	8.51	216	18.36	466

Dimensions for NEMA Type 1 and 3R Safety Switches

See Terminal Lug Data, page 3-21 for terminal lug data for the series switches listed in the dimension table below.

Table 3.42: Approximate Dimensions

Cat. No.	Series	H		W		D		W/H		Cat. No.	Series	H		W		D		W/H	
		in.	mm	in.	mm	in.	mm	in.	mm			in.	mm	in.	mm	in.	mm	in.	mm
H225	E4	50.25	1276	27.63	702	10.13	257	27.63	702	H327NR	E4	69.13	1756	36.62	930	17.75	451	36.62	930
H225N	E4	50.25	1276	27.63	702	10.13	257	27.63	702	H328	E4	69.13	1756	36.62	930	17.75	451	36.62	930
H225NR	E5	50.31	1278	27.76	705	9.53	242	27.88	708	H328N	E4	69.13	1756	36.62	930	17.75	451	36.62	930
H225R	E5	50.31	1278	27.76	705	9.53	242	27.88	708	H328R	E4	69.13	1756	36.62	930	17.75	451	36.62	930
H226	E4	50.25	1276	27.63	702	10.13	257	27.63	702	H328NR	E4	69.13	1756	36.62	930	17.75	451	36.62	930
H226N	E4	50.25	1276	27.63	702	10.13	257	27.63	702	H365	E4	50.25	1276	27.63	702	10.13	257	27.63	702
H226NR	E5	50.31	1278	27.76	705	9.53	242	27.88	708	H365N	E4	50.25	1276	27.63	702	10.13	257	27.63	702
H226R	E5	50.31	1278	27.76	705	9.53	242	27.88	708	H365R	E5	50.31	1278	27.76	705	9.53	242	27.88	708
H227	E4	69.13	1756	36.62	930	17.75	451	36.62	930	H365NR	E5	50.31	1278	27.76	705	9.53	242	27.88	708
H227N	E4	69.13	1756	36.62	930	17.75	451	36.62	930	H366	E4	50.25	1276	27.63	702	10.13	257	27.63	702
H227NR	E4	69.13	1756	36.62	930	17.75	451	36.62	930	H366N	E4	50.25	1276	27.63	702	10.13	257	27.63	702
H227R	E4	69.13	1756	36.62	930	17.75	451	36.62	930	H366NR	E5	50.31	1278	27.76	705	9.53	242	27.88	708
H228	E4	69.13	1756	36.62	930	17.75	451	36.62	930	H366R	E5	50.31	1278	27.76	705	9.53	242	27.88	708
H228N	E4	69.13	1756	36.62	930	17.75	451	36.62	930	H367	E4	69.13	1756	36.62	930	17.75	451	36.62	930
H228NR	E4	69.13	1756	36.62	930	17.75	451	36.62	930	H367N	E4	69.13	1756	36.62	930	17.75	451	36.62	930
H228R	E4	69.13	1756	36.62	930	17.75	451	36.62	930	H367NR	E4	69.13	1756	36.62	930	17.75	451	36.62	930
H265	E4	50.25	1276	27.63	702	10.13	257	27.63	702	H367R	E4	69.13	1756	36.62	930	17.75	451	36.62	930
H265R	E5	50.31	1278	27.76	705	9.53	242	27.88	708	H368	E4	69.13	1756	36.62	930	17.75	451	36.62	930
H266	E4	50.25	1276	27.63	702	10.13	257	27.63	702	H368N	E4	69.13	1756	36.62	930	17.75	451	36.62	930
H266R	E5	50.31	1278	27.76	705	9.53	242	27.88	708	H368NR	E4	69.13	1756	36.62	930	17.75	451	36.62	930
H267	E4	69.13	1756	36.62	930	17.75	451	36.62	930	H368R	E4	69.13	1756	36.62	930	17.75	451	36.62	930
H267R	E4	69.13	1756	36.62	930	17.75	451	36.62	930	HU265	E4	50.25	1276	27.63	702	10.13	257	27.63	702
H268	E4	69.13	1756	36.62	930	17.75	451	36.62	930	HU265R	E5	50.31	1278	27.76	705	9.53	242	27.88	708
H268R	E4	69.13	1756	36.62	930	17.75	451	36.62	930	HU266	E4	50.25	1276	27.63	702	10.13	257	27.63	702
H321N	F5	14.60	371	6.50	165	4.88	124	7.55	192	HU266R	E5	50.31	1278	27.76	705	9.53	242	27.88	708
H321NRB	F5	14.88	378	6.63	168	4.88	124	7.55	192	HU267	E4	69.13	1756	36.62	930	17.75	451	36.62	930
H322N	F5	14.60	371	6.50	165	4.88	124	7.55	192	HU267R	E4	69.13	1756	36.62	930	17.75	451	36.62	930
H322NRB	F5	14.88	378	6.63	168	4.88	124	7.55	192	HU268	E4	69.13	1756	36.62	930	17.75	451	36.62	930
H323N	F5	21.25	540	8.50	216	6.38	162	10.50	267	HU268R	E4	69.13	1756	36.62	930	17.75	451	36.62	930
H323NRB	F5	21.25	540	8.50	216	6.38	162	10.50	267	HU365	E4	50.25	1276	27.63	702	10.13	257	27.63	702
H324N	F5	29.00	737	17.13	435	8.25	210	18.50	470	HU365R	E5	50.31	1278	27.76	705	9.53	242	27.88	708
H324NRB	F5	29.25	743	17.25	438	8.50	216	18.63	473	HU366	E4	50.25	1276	27.63	702	10.13	257	27.63	702
H325	E4	50.25	1276	27.88	708	10.13	257	27.88	708	HU366R	E5	50.31	1278	27.76	705	9.53	242	27.88	708
H325N	E4	50.25	1276	27.88	708	10.13	257	27.88	708	HU367	E4	69.13	1756	36.62	930	17.75	451	36.62	930
H325R	E5	50.31	1278	27.76	705	9.53	242	27.88	708	HU367R	E4	69.13	1756	36.62	930	17.75	451	36.62	930
H325NR	E5	50.31	1278	27.76	705	9.53	242	27.88	708	HU368	E4	69.13	1756	36.62	930	17.75	451	36.62	930
H326	E4	50.25	1276	27.63	702	10.13	257	27.63	702	HU368R	E4	69.13	1756	36.62	930	17.75	451	36.62	930
H326N	E4	50.25	1276	27.63	702	10.13	257	27.63	702	HU461	F5	20.50	521	14.75	375	6.85	174	16.13	410
H326R	E5	50.31	1278	27.76	705	9.53	242	27.88	708	HU462	F5	20.50	521	14.75	375	6.85	174	16.13	410
H326NR	E5	50.31	1278	27.76	705	9.53	242	27.88	708	HU463	F5	20.50	521	14.75	375	6.85	174	16.13	410
H327	E4	69.13	1756	36.62	930	17.75	451	36.62	930	HU464	F5	29.00	737	23.25	591	8.75	222	24.88	632
H327N	E4	69.13	1756	36.62	930	17.75	451	36.62	930	HU465	E4	50.25	1276						

Dimensions for VisiPacT Type 4X and 12 Safety Switches

See Terminal Lug Data, page 3-21 for terminal lug data for the series switches listed in the dimension table below.

Table 3.43: Approximate Dimensions

Cat. No.	Series	H		W		D		W/H		Cat. No.	Series	H		W		D		W/H	
		in.	mm	in.	mm	in.	mm	in.	mm			in.	mm	in.	mm	in.	mm	in.	mm
VH221DSGL	F8	14.93	379	7.91	201	5.40	137	8.40	213	VH364SSGL	F8	28.90	734	17.47	444	8.94	227	19.27	489
VH221NDSGL	F8	14.93	379	7.91	201	5.40	137	8.40	213	VHU364SSGL	F8	28.90	734	17.47	444	8.94	227	19.27	489
VH321DSGL	F8	14.93	379	7.91	201	5.40	137	8.40	213	VH221AWKGL	F8	14.57	370	6.48	165	5.25	133	7.67	195
VH321NDSGL	F8	14.93	379	7.91	201	5.40	137	8.40	213	VH221NAWKGL	F8	14.57	370	6.48	165	5.25	133	7.67	195
VH361DSGL	F8	14.93	379	7.91	201	5.40	137	8.40	213	VH321AWKGL	F8	14.57	370	6.48	165	5.25	133	7.67	195
VH361NDSGL	F8	14.93	379	7.91	201	5.40	137	8.40	213	VH321NAWKGL	F8	14.57	370	6.48	165	5.25	133	7.67	195
VHU361DSGL	F8	14.93	379	7.91	201	5.40	137	8.40	213	VH361AWKGL	F8	14.57	370	6.48	165	5.25	133	7.67	195
VHU361SSGL	F8	14.93	379	7.91	201	5.40	137	8.40	213	VH361NAWKGL	F8	14.57	370	6.48	165	5.25	133	7.67	195
VH222DSGL	F8	14.93	379	7.91	201	5.40	137	8.40	213	VHU361NAWKGL	F8	14.57	370	6.48	165	5.25	133	7.67	195
VH222NDSGL	F8	14.93	379	7.91	201	5.40	137	8.40	213	VH222AWKGL	F8	14.57	370	6.48	165	5.25	133	7.67	195
VH322DSGL	F8	14.93	379	7.91	201	5.40	137	8.40	213	VH222NAWKGL	F8	14.57	370	6.48	165	5.25	133	7.67	195
VH322NDSGL	F8	14.93	379	7.91	201	5.40	137	8.40	213	VH322AWKGL	F8	14.57	370	6.48	165	5.25	133	7.67	195
VH362DSGL	F8	16.93	430	8.90	226	7.26	184	10.71	272	VH322NAWKGL	F8	14.57	370	6.48	165	5.25	133	7.67	195
VH362NDSGL	F8	16.93	430	8.90	226	7.26	184	10.71	272	VH362AWKGL	F8	16.53	420	8.91	226	7.17	182	10.45	265
VU362DSGL	F8	16.93	430	8.90	226	7.26	184	10.71	272	VH362NAWKGL	F8	16.53	420	8.91	226	7.17	182	10.45	265
VH362SSGL	F8	16.93	430	8.90	226	7.26	184	10.71	272	VHU362AWKGL	F8	16.53	420	8.91	226	7.17	182	10.45	265
VHU362SSGL	F8	16.93	430	8.90	226	7.26	184	10.71	272	VHU362NAWKGL	F8	16.53	420	8.91	226	7.17	182	10.45	265
VH223DSGL	F8	20.73	527	9.34	237	7.20	183	11.15	283	VH223AWKGL	F8	20.49	520	8.92	227	7.15	182	10.44	265
VH223NDSGL	F8	20.73	527	9.34	237	7.20	183	11.15	283	VH223NAWKGL	F8	20.49	520	8.92	227	7.15	182	10.44	265
VH323DSGL	F8	20.73	527	9.34	237	7.20	183	11.15	283	VH323AWKGL	F8	20.49	520	8.92	227	7.15	182	10.44	265
VH323NDSGL	F8	20.73	527	9.34	237	7.20	183	11.15	283	VH323NAWKGL	F8	20.49	520	8.92	227	7.15	182	10.44	265
VH363DSGL	F8	20.73	527	9.34	237	7.20	183	11.15	283	VH363AWKGL	F8	20.49	520	8.92	227	7.15	182	10.44	265
VH363NDSGL	F8	20.73	527	9.34	237	7.20	183	11.15	283	VH363NAWKGL	F8	20.49	520	8.92	227	7.15	182	10.44	265
VU363DSGL	F8	20.73	527	9.34	237	7.20	183	11.15	283	VHU363AWKGL	F8	20.49	520	8.92	227	7.15	182	10.44	265
VH363SSGL	F8	20.73	527	9.34	237	7.20	183	11.15	283	VHU363NAWKGL	F8	20.49	520	8.92	227	7.15	182	10.44	265
VHU363SSGL	F8	20.73	527	9.34	237	7.20	183	11.15	283	VH224AWKGL	F8	28.93	735	17.01	432	9.02	229	18.58	472
VH224DSGL	F8	28.90	734	17.47	444	8.94	227	19.27	489	VH224NAWKGL	F8	28.93	735	17.01	432	9.02	229	18.58	472
VH224NDSGL	F8	28.90	734	17.47	444	8.94	227	19.27	489	VH324AWKGL	F8	28.93	735	17.01	432	9.02	229	18.58	472
VH324DSGL	F8	28.90	734	17.47	444	8.94	227	19.27	489	VH324NAWKGL	F8	28.93	735	17.01	432	9.02	229	18.58	472
VH324NDSGL	F8	28.90	734	17.47	444	8.94	227	19.27	489	VH364AWKGL	F8	28.93	735	17.01	432	9.02	229	18.58	472
VH364DSGL	F8	28.90	734	17.47	444	8.94	227	19.27	489	VH364NAWKGL	F8	28.93	735	17.01	432	9.02	229	18.58	472
VH364NDSGL	F8	28.90	734	17.47	444	8.94	227	19.27	489	VHU364AWKGL	F8	28.93	735	17.01	432	9.02	229	18.58	472
VU364DSGL	F8	28.90	734	17.47	444	8.94	227	19.27	489	VHU364NAWKGL	F8	28.93	735	17.01	432	9.02	229	18.58	472

Dimensions for NEMA Type 4, 4X, 5, 7, 9, and 12 Safety Switches
See [Terminal Lug Data](#), page 3-21 for terminal lug data for the series switches listed in the dimension table below.

Table 3.44: Approximate Dimensions

Cat. No.	Series	H		W		D		W/H		Cat. No.	Series	H		W		D		W/H	
		in.	mm	in.	mm	in.	mm	in.	mm			in.	mm	in.	mm	in.	mm	in.	mm
H225AWK	E4	46.25	1175	26.25	667	10.13	259	26.25	667	H461AWK	F6	20.50	521	14.75	375	6.80	173	16.13	410
H225NAWK	E4	46.25	1175	26.25	667	10.13	259	26.25	667	H461DS	F6	20.82	529	15.08	383	6.97	177	16.85	428
H225NDS	E4	46.25	1175	26.25	667	10.13	259	26.25	667	H462AWK	F6	20.50	521	14.75	375	6.80	173	16.13	410
H225JG	A1	22.56	573	10.88	276	7.75	197	10.88	276	H462DS	F6	20.82	529	15.08	383	6.97	177	16.85	428
H226AWK	E5	46.25	1175	26.25	667	10.13	259	26.25	667	H463AWK	F6	20.50	521	14.75	375	6.80	173	16.13	410
H226DS	E5	46.25	1175	26.25	667	10.13	259	26.25	667	H463DS	F6	20.82	529	15.08	383	6.97	177	16.85	428
H226NDS	E5	46.25	1175	26.25	667	10.13	259	26.25	667	H464AWK	F6	29.00	737	23.25	591	8.75	222	24.88	632
H26NAWK	E5	46.25	1175	26.25	667	10.13	259	26.25	667	H464DS	F6	29.00	737	23.75	603	8.88	226	25.25	641
H227AWK	E4	69.13	1756	36.62	930	17.75	451	36.62	930	H465AWK	E5	46.25	1175	32.50	826	10.13	259	32.50	826
H227NAWK	E4	69.13	1756	36.62	930	17.75	451	36.62	930	H465DS	F6	20.50	521	14.75	375	6.80	173	16.13	410
H228AWK	E4	69.13	1756	36.62	930	17.75	451	36.62	930	H663DS	F6	20.82	529	15.08	383	6.97	177	16.85	428
H228NAWK	E4	69.13	1756	36.62	930	17.75	451	36.62	930	H664AWK	F6	29.00	737	23.25	591	8.75	222	24.88	632
H265AWK	E5	46.25	1175	26.25	667	10.13	259	26.25	667	H664DS	F6	29.00	737	23.75	603	8.88	226	25.25	641
H265DS	E5	46.25	1175	26.25	667	10.13	259	26.25	667	HU265AWK	E5	46.25	1175	26.25	667	10.13	259	26.25	667
H266AWK	E5	46.25	1175	26.25	667	10.13	259	26.25	667	HU265DS	E5	46.25	1175	26.25	667	10.13	259	26.25	667
H266A	E5	46.25	1175	26.25	667	10.13	259	26.25	667	HU266AWK	E5	46.25	1175	26.25	667	10.13	259	26.25	667
H266DS	E5	46.25	1175	26.25	667	10.13	259	26.25	667	HU266DS	E5	46.25	1175	26.25	667	10.13	259	26.25	667
H267AWK	E4	69.13	1756	36.62	930	17.75	451	36.62	930	HU267AWK	E4	69.13	1756	36.62	930	17.75	451	36.62	930
H267NAWK	E4	69.13	1756	36.62	930	17.75	451	36.62	930	HU268AWK	E4	69.13	1756	36.62	930	17.75	451	36.62	930
H268AWK	E4	69.13	1756	36.62	930	17.75	451	36.62	930	HU361DF	F1	16.50	419	11.00	279	8.80	224	11.00	279
H268NAWK	E4	69.13	1756	36.62	930	17.75	451	36.62	930	HU361DX	F1	19.40	493	11.40	290	8.60	218	11.40	290
H325AWK	E5	46.25	1175	26.25	667	10.13	259	26.25	667	HU362DF	F1	16.50	419	11.00	279	8.80	224	11.00	279
H325DS	E5	46.25	1175	26.25	667	10.13	259	26.25	667	HU362DX	F1	19.40	493	11.40	290	8.60	218	11.40	290
H325NAWK	E5	46.25	1175	26.25	667	10.13	259	26.25	667	HU363DF	F1	24.80	630	13.70	348	12.00	305	13.70	348
H325NDS	E5	46.25	1175	26.25	667	10.13	259	26.25	667	HU363DX	F1	25.25	641	11.40	290	8.60	218	11.40	290
H326AWK	E5	46.25	1175	26.25	667	10.13	259	26.25	667	HU364DF	E1	31.30	795	26.30	668	11.80	300	26.30	668
H327AWK	E4	69.13	1756	36.62	930	17.75	451	36.62	930	HU364DX	E5	46.25	1175	26.25	667	10.13	259	26.25	667
H327NAWK	E4	69.13	1756	36.62	930	17.75	451	36.62	930	HU365DS	E5	46.25	1175	26.25	667	10.13	259	26.25	667
H328AWK	E4	69.13	1756	36.62	930	17.75	451	36.62	930	HU365SS	E5	46.25	1175	26.25	667	10.13	259	26.25	667
H328NAWK	E4	69.13	1756	36.62	930	17.75	451	36.62	930	HU366AWK	E5	46.25	1175	26.25	667	10.13	259	26.25	667
H361DF	F1	16.50	419	11.00	279	8.80	224	11.00	279	HU366DS	E5	46.25	1175	26.25	667	10.13	259	26.25	667
H361DX	F1	19.40	493	11.40	290	8.60	218	11.40	290	HU366SS	E5	46.25	1175	26.25	667	10.13	259	26.25	667
H362DF	F1	16.50	419	11.00	279	8.80	224	11.00	279	HU367AWK	E4	69.13	1756	36.62	930	17.75	451	36.62	930
H362DX	F1	19.40	493	11.40	290	8.60	218	11.40	290	HU368AWK	E4	69.13	1756	36.62	930	17.75	451	36.62	930
H363DF	F1	24.80	630	13.70	348	12.00	305	13.70	348	HU461AWK	F6	20.50	521	14.75	375	6.80	173	16.13	410
H363DX	F1	25.25	641	11.40	290	8.60	218	11.40	290	HU461DS	F6	20.82	529	15.08	383	6.97	177	16.85	428
H365SS	E5	46.25	1175	26.25	667	10.13	259	26.25	667	HU462AWK	F6	21.25	540	16.13	410	6.80	173	16.13	410
H364DF	E1	31.30	795	26.30	668	11.80	300	26.30	668	HU462DS	F6	20.82	529	15.08	383	6.97	177	16.85	428
H365AWK	E5	46.25	1175	26.25	667	10.13	259	26.25	667	HU463AWK	F6	20.50	521	14.75	375	6.80	173	16.13	410
H365DS	E5	46.25	1175	26.25	667	10.13	259	26.25	667	HU463DS	F6	20.82	529	15.08	383	6.97	177	16.85	428
H365NAWK	E5	46.25	1175	26.25	667	10.13	259	26.25	667	HU464AWK	F6	29.00	737	23.25	591	8.75	222	24.88	632
H365NDS	E5	46.25	1175	26.25	667	10.13	259	26.25	667	HU464DS	F6	29.00	737	23.75	603	8.88	226	25.25	641
H366AWK	E5	46.25	1175	26.25	667	10.13	259	26.25	667	HU465AWK	E5	46.25	1175	32.50	826	10.13	259	32.50	826
H366DS	E5	46.25	1175	26.25	667	10.13	259	26.25	667	HU661AWK	F6	20.50	521	14.75	375	6.80	173	16.13	410
H366NAWK	E5	46.25	1175	26.25	667	10.13	259	26.25	667	HU661DS	F6	20.82	529	15.08	383	6.97	177	16.85	428
H366NDS	E5	46.25	1175	26.25	667	10.13	259	26.25	667	HU662AWK	F6	20.50	521	14.75	375	6.80	173	16.13	410
H366SS	E5	46.25	1175	26.25	667	10.13	259	26.25	667	HU662DS	F6	20.82	529	15.08	383	6.97	177	16.85	428
H367AWK	E4	69.13	1756	36.62	930	17.75	451	36.62	930	HU663AWK	F6	20.50	521	14.75	375	6.80	173	16.13	410
H367NAWK	E4	69.13	1756	36.62	930	17.75	451	36.62	930	HU663DS	F6	20.82	529	15.08	383	6.97	177	16.85	428
H368AWK	E4	69.13	1756	36.62	930	17.75	451	36.62	930	HU664AWK	F6	29.00	737	23.25	591	8.75	222	24.88	632
H368NAWK	E4	69.13	1756	36.62	930	17.75	451	36.62	930	HU664DS	F6	29.00	737	23.75	603	8.88	226	25.25	641

SAFETY SWITCHES



30–100 A DT, DTU (Series F)
NEMA Type 1



82,000 Line
NEMA Type 1

30–100 A Types DT, DTU (Series F)

- Fusible (DT) and non-fusible (DTU) switches available
- Manually-operated switch suitable for use in accordance with article 702 of the NEC, ANSI/NFPA 70
- Standards: UL 98, Type KS1, CSA, and NOM
- Modular design—switch handle, lock-plate, switch mechanism; line and load bases are field replaceable
- UL Listed short circuit current ratings up to 200 kA (using with (fusible) or (non-fusible) Class R, J, or T fuses—see table for rating)
- Load make/break rated
- Horsepower rated
- Dual cover interlock
- May be padlocked ON (I) or OFF (O)
- Lock-off accepts up to three padlocks
- Side-opening door
- Quick make / quick break mechanism
- Meets NEMA requirements as heavy duty switch
- Field-installed electrical interlock kits
- Field-installed neutral assembly kits (2P and 3P switches)
- UL Listed as suitable for use as service equipment
- Supplied as standard for switching one load between two power sources, and may be field-converted to switch one power source between two loads.

30 (Series T4), 200–600 A Types 82,000 & 200 A DTU (Series E, A)

- Non-fusible
- Designed for manual transfer of one load between two power sources
- UL Listed switches are suitable for use in accordance with Article 702 of the National Electrical Code, ANSI / NFPA 70
- 82,000 and DTU double throw switches are continuous duty rated for their nameplate ampere rating
- The 82,000 and DTU (Series E, A) switches are load make/break rated
- UL Listed as suitable for use as service equipment
- Horsepower rated only as footnoted

Field-Installable Accessories

- Neutral
- Electrical Interlock
- Grounding Terminals

Double Throw Safety Switches (240 V)

Table 3.45: 240 V Double Throw Safety Switches

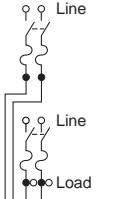
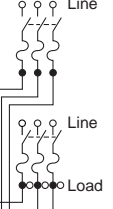
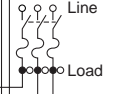
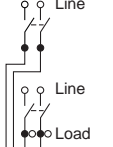
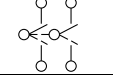
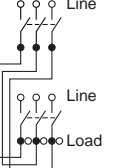
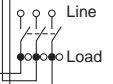
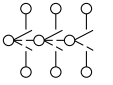
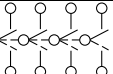
System	Amperes	Current Series	NEMA Type 1	NEMA Type 3R	NEMA Type 4,4X,5 304 Stainless Steel	NEMA Type 12 Gasketed	Horsepower Ratings [1] [2]				
			Cat. No.	Cat. No.	Cat. No.	Cat. No.	240 Vac		250 Vdc [3]		
							Std.	Max.	1Ø	3Ø	
Fusible—2P, 240 Vac—250 Vdc											
	100	F	DT223	DT223RB	—	—	7.5	15 [4]	15	30 [4]	20
Fusible—3P, 240 Vac—250 Vdc											
	30	F	DT321	DT321RB	—	—	1.5 [5]	3 [4]	3 [5]	7.5 [4]	5
	60	F	DT322	DT322RB	—	—	3 [5]	7.5 [4]	10 [5]	15 [4]	10
	100	F	DT323	DT323RB	—	—	7.5 [5]	15 [4]	15 [5]	30 [4]	20
Non-Fusible—2P, 240 Vac—250 Vdc											
	60	F	DTU222	—	—	—	—	—	10	—	10 [6]
	100	F	DTU223	DTU223RB	—	—	—	—	15	—	20 [6]
	30	T4	92251 [7]	—	—	—	—	—	—	—	—
	200	E	82254	DTU224NRB [7] [8]	—	H82254	15	—	—	—	—
	400	A	DTU225	DTU225R	—	—	—	—	—	—	50
Non-Fusible—3P, 240 Vac—250 Vdc											
	30	F	DTU321	—	—	—	—	3 [4]	5 [5]	10 [4]	5 [6]
	60	F	DTU322	—	—	—	—	—	10 [5]	15 [4]	10 [6]
	100	F	DTU323	DTU323RB	—	—	—	—	15 [5]	30 [4]	20 [6]
	30	T4	92351 [7]	—	—	—	—	—	—	—	—
	200	E	82354 [7]	—	—	H82354 [7]	15	—	—	—	—
	200	E	DTU324N [7] [8]	DTU324NRB [7] [8]	—	—	—	15	—	—	—
	400	A	DTU325	DTU325R	—	—	—	125	—	—	50
	600	A	DTU326	DTU326R	—	—	—	125	—	—	50
Non-Fusible—4P, 240 Vac											
	30	T4	92451 [7]	—	—	—	—	—	—	—	—
	600	A	DTU426	DTU426R	—	—	—	125	—	—	50

[1] The starting current of motors or more than standard horsepower may require the use of fuses with appropriate time delay characteristics.
 [2] Std.—Using fast acting one time fuses. Max.—Using dual element time delay fuses.
 [3] For switching dc, use two switching poles.
 [4] If used on corner grounded delta systems, install neutral and use outer switching pole for ungrounded conductors. See data bulletin 2700DB0202 for additional information.
 [5] Use outer switching poles.
 [6] Maximum rating.
 [7] 240 Vac only. Not Vdc rated.
 [8] Neutral included with device.

Double Throw Safety Switches (600 V)

Table 3.46: 600 V Double Throw Safety Switches

System	Amperes	Current Series	NEMA Type 1	NEMA Type 3R	NEMA Type 4, 4X, 5 304 Stainless Steel	NEMA Type 12 Gasketed	Horsepower Ratings [9] [10]							
							240 Vac		480 Vac		600 Vac		Vdc [11]	
							Std	Max	Std	Max	Std	Max	250	600
Cat. No.							3Ø	3Ø	3Ø [12]	3Ø [12]	3Ø	3Ø		
Fusible 3P, 600 Vac—600 Vdc														
	30	F	DT361	DT361RB	—	—	—	—	5 [13]	15 [13]	7.5	20	5	15 [14]
	60	F	DT362	DT362RB	—	—	—	—	15 [15]	30 [15]	15	50	—	30 [16]
	100	F	DT363	DT363RB	—	—	—	—	25 [17]	60 [17]	30	75	—	50 [18]
Non-Fusible 3P, 600 Vac—600 Vdc							1Ø [11]	3Ø [12]	1Ø [11]	3Ø [12]	1Ø [11]	3Ø [12]		
	30	F	DTU361	DTU361RB	—	—	5	10	7.5	20	10	30	5	15
	60	F	DTU362	DTU362RB	DTU362DS	DTU362AWK [20]	10	20 [21]	25	50 [22]	30	60 [23]	10	30
	100	F	DTU363	DTU363RB	DTU363DS	DTU363AWK [20]	20	40 [24]	40	75 [24]	40	100 [24]	20	50
	200	E	82344 [25]	82344RB [25]	82344DS [25] [26]	H82344 [25]	—	—	—	15 [27]	—	—	—	—
	400	A	DTU365	DTU365R	DTU365DS	DTU365AWK	—	125	—	250	—	350	50	—
	600	A	DTU366 [28]	DTU366R [28]	—	DTU366AWK [28]	—	125	—	250	—	350	50	—
Non-Fusible 4P, 600 Vac—600 Vdc							2Ø	3Ø	2Ø	3Ø	2Ø	3Ø		
	60	F	DTU462 [29]	Use NEMA Type 12	DTU462DS [29]	DTU462AWK [20] [29]	20	20	40	50	50	60	10	30
	100	F	DTU463 [29]		DTU463DS [29]	DTU463AWK [20] [29]	30	40	50	75	50	100	20	50
		400	A	DTU465 [28]	DTU465R [28]	—	—	—	125	—	250	—	350	50
600		A	DTU466 [28]	DTU466R [28]	—	—	—	125	—	250	—	350	50	—
Non-Fusible 6P, 600 Vac—600 Vdc							1Ø	3Ø	1Ø	3Ø	1Ø	3Ø		
	60	F	—	—	—	DTU662AWK [20] [29]	—	20	—	50	—	60	10	30
	100	F	—	—	—	DTU663AWK [20] [29]	—	40	—	75	—	100	20	50

[9] The starting current of motors of more than standard horsepower may require the use of fuses with appropriate time delay characteristics.
 [10] Std.—Using fast acting one time fuses. Max.—Using dual element time delay fuses. (Non-fusible switches have max rating unless noted.)
 [11] Use outer switching poles.
 [12] If used on corner grounded delta systems, install neutral and use outer switching pole for ungrounded conductors. See data bulletin 2700DB0202 for additional information.
 [13] 480 Vac 1 Phase HP = 3 Std, 7.5 Max
 [14] 10 Std, 15 Max
 [15] 480 Vac 1 Phase HP = 5 Std, 20 Max
 [16] 25 Std, 30 Max
 [17] 480 Vac 1 Phase HP = 10 Std, 30 Max
 [18] 40 Std, 50 Max
 [19] Maximum HP
 [20] Complete rating on switch is NEMA Type 3R, 5 or 12. For 3R applications, remove drain screw from bottom endwall.
 [21] Maximum HP is 15 for corner grounded delta systems.
 [22] Maximum HP is 30 for corner grounded delta systems.
 [23] Use 75°C #4 Cu or #2 Al conductors only on DTU362 and DTU362RB.
 [24] Use 75°C #1 Cu conductors only.
 [25] 480 Vac, 250 Vdc maximum
 [26] Not UL Listed.
 [27] Standard Hp rating.
 [28] 250 Vdc maximum.
 [29] Not suitable for use as service equipment.

Electrical Interlocks for Double Throw Safety Switches

Table 3.47: Electrical Interlocks (For Electrical Interlock Contact Ratings, see Supplemental Digest Section 2)

Switch	Field-Installed Electrical Interlock Kit Cat. No. [30]
30–100 A Type DT, DTU (Series F)	EIK1, EIK2 [31] [32]
200 A Type 82000 and DTU (Series E) [33]	[34]
400–600 A Type DTU (Series A)	DS200EK2D

Neutral Assemblies for Double Throw Safety Switches

Table 3.48: Neutral Assemblies

Switch	Field-Installed Standard Neutral Kit Cat. No.	Terminal Data AWG/kcmil	Field-Installed Copper only Neutral Kit Cat. No.	Terminal Data AWG/kcmil
30–100 A Type DT, DTU (Series F) (2- and 3-pole switches only)	SN0310	(3) 14-1/0 Al/Cu plus (2) 14-6 Al/Cu Svc Ground	SN0310C	(3) 14-1/0 Cu plus (2) 14-6 Cu Svc Ground
30 A (Series T4) (2- and 3-pole switches only)	DT30SN	(3) 14-4 Al/Cu plus (2) 14-4 Al/Cu Svc Ground	—	—
200 A Type 82000 (Series E) (2- and 3-pole switches only) [35]	[36]	(3) 6-300 Al/Cu plus (1) 6-2/0 Al or 10-2/0 Cu Svc Ground	—	—
200 A Type DTU (Series E)	Factory Installed	(3) 4-300 Al/Cu plus (1) 4-300 Al/Cu Svc Ground	—	—
400 A Type DTU (Series A)	DT400NKD	(1) 1/0-720 Al/Cu or (2) 1/0-300 Al/Cu plus (2) 6-250 Al/Cu Svc Ground	—	—
600 A Type DTU (Series A)	DT600NKD	(6) 250-500 Al/Cu plus (1) 6-250 Al/Cu Svc Ground	—	—

Service Grounding Kits for Double Throw Safety Switches

Table 3.49: Service Grounding Kits—Required for Service Equipment Use

Switch	Field-Installed Service Grounding Lug Kit Cat. No.	Terminal Data AWG/kcmil
30–60 A Type DT, DTU (Series F)	Included	(3) 14-2 Al/Cu or (6) 14-10 Al/Cu
100 A Type DT, DTU (Series F)	Included	(3) 14 - 1/0 Al/Cu
30 A Type 92,000 (Series T4)	DT30SG	(4) 14-4 Al/Cu
200 A Type 82000 and DTU (Series E)	DT100SG	(3) 14–1/0 Al/Cu
400–600 A Type DTU (Series A)	DS468GKD	(2) 6–250 Al/Cu [37]



Class R Fuse Rejection Kits

When properly installed, this kit accepts only Class R fuses. Kits are available for field installation.

Table 3.50: Class R Fuse Rejection Kits

Switch	Series Number	Class R Fuse Kit Cat. No.
Class R Fuse Kits—240 V (two kits per 3P switch)		
30 A	F5	RFK03
60 A	F5	RFK06
100 A	F5	RFK10
Class R Fuse Kits—600 V (two kits per 3P switch)		
30 A	F5	RFK06
60 A	F5	RFK06H
100 A	F5	RFK10



Viewing Windows for Double Throw Safety Switches

Accessory available on 30–100 A DT and DTU Series F switches only. Add the suffix **VW** to the catalog number.

Key Interlock Systems for Double Throw Safety Switches

For factory-installed key interlocks, refer to [page 3-20](#).

Lock-ON Provisions for Double Throw Safety Switches

Standard feature on 30–100 A type DT and DTU (Series F), and type 92000 switches. Feature available as factory installed option for Type 82000 (200 A only) and 200 A DTU (Series E) switches. Add the suffix **SPLO** to the catalog number.

[30] Electrical interlock kit catalog numbers with “1” suffix indicate one normally open and normally closed contact; “2” indicates two normally open and two normally closed contacts. See [Table 3.27 Electrical Interlock Contact Ratings](#), page 3-17

[31] 30–100 and 600 A Type DT, DTU (Series F) switches contain (2) separate switching mechanisms. Each mechanism will accept an electrical interlock. Some applications may therefore require (2) electrical interlocks.

[32] Double throw switches 92251, 92351, and 92451 are not available with factory or field installed electrical interlocks.

[33] Electrical interlock EK400DTU2 can be added to 200 A, 4-pole Type 82000 switches in the field.

[34] Type 82000 and DTU switches are available with electrical interlock factory-installed only. Not UL listed. Electrical interlocks are furnished with 2 N.O./N.C. contacts and are installed in both “ON” positions. To order, add suffix EI to standard switch catalog number.

[35] Neutral assembly catalog number DT200N can be added to 4P, 200 A, Type 82000 switches in the field.

[36] For 200 A Type 82000, a neutral assembly is available factory installed on 2P and 3P switches. Not UL Listed. To order, add suffix N to the standard catalog number. Neutral terminal lug data = (3) #4 - 250 kcmil Al/Cu wire and (1) #4 - 250 kcmil Al/Cu service ground.

[37] (3) 6-250 ground lugs are provided as standard. DS468GKD provides an additional (2) 6-250 ground lugs.



Rainproof Bolt-On Hubs for Double Throw Safety Switches

- UL Listed for indoor or rainproof applications
- Suitable for use with conduit having ANSI standard taper pipe thread
- NEMA Type 3R switches with catalog number ending in RB have a bolt-on closing cap factory installed
 - Accepts 3/4 in. through 2-1/2 in. bolt-on hubs
 - No gaskets required
- NEMA Type 3R switches with R suffix have blank top endwalls
 - Accepts 3 in. through 4 in. bolt on hubs
 - Gaskets provided
 - Conduit entry holes must be cut in the field

Table 3.51: Rainproof Bolt-On Hubs

Conduit Size	3/4	1	1-1/4	1-1/2	2	2-1/2	3	3-1/2	4	Closing Cap
Hub Cat. No.	B075	B100	B125	B150	B200	B250	B300	B350	B400	BCAP

Water Resistant Hubs for Double Throw Safety Switches

- UL Listed for dust resistant and water resistant applications
- Suitable for use with conduit having ANSI standard taper pipe thread
- Water resistant hubs are field installed on NEMA Type 4/4X/5 stainless steel and NEMA Type 12/3R and 12K enclosures
- Water resistant hubs are available in zinc or chrome plated finish
- Gaskets provided



H200 Zinc Plated



H050CP Chrome Plated

Table 3.52: Water Resistant Hubs [38]

Conduit Size	1/2	3/4	1	1-1/4	1-1/2	2	2-1/2	3	3-1/2	4
Standard-Zinc Hub Cat. No.	H050	H075	H100	H125	H150	H200	H250	H300	H350	H400
Chrome Plated Hub Cat. No.	H050CP	H075CP	H100CP	H125CP	H150CP	H200CP	—	—	—	—

[38] Gaskets are provided.

Terminal Lug Data for Double Throw Safety Switches

Table 3.53: Terminal Lug Data for Type DT, DTU (Series F) Double Throw Safety Switches [39]

Switch Type	Wires per Phase	NEMA Type 1, 3R, 4, 4X, 12			Optional Copper Only Lug
		Wire Range Wire Bending Space Per NEC Table 373-6 AWG/kcmil	Standard Lug Wire Range AWG/kcmil	Optional Compression Lug Field-Installed	
30–60 A Type DT, DTU (Series F)	1	12–2 Al or 14–2 Cu	12–2 Al or 14–2 Cu	C10-14, D8-14-SK, or E6-14 [40]	See Table 3.37 Copper Lug Kits, page 3-21 and Double Lug Kits, page 3-20 for appropriate kit. Order two kits per switch.
100 A Type DT, DTU (Series F)	1	12–1/0 Al or 14–1/0 Cu	12–1/0 Al or 14–1/0 Cu	VCEL02114S1 [41]	

Table 3.54: Terminal Lug Data for Types 82,000 and for A and E-Series DTU devices [39]

Amperes	Wires per Phase	Wire Range Wire Bending Space Per NEC Table 373-6 AWG/kcmil	Lug Wire Range AWG/kcmil	Optional Compression Lugs Field-Installed
30 A (Series T4)	1	14–8 Al/Cu	12–2 Al or 14–2 Cu	—
200	1	6–300 Al/Cu	6–300 Al/Cu	VCEL030516H1 [41]
400	1 or 2	1/0–600 Al/Cu or 1/0–300 Al/Cu	1/0 - 750 Al/Cu or 1/0 - 300 Al/Cu	—
600	2	250–500 Al/Cu	250–500 Al/Cu	—

Application Data for Double Throw Safety Switches
Situations Requiring Fuses

- 30–100 A Type DT (Series F):
Select DT switches from 240 Volt Double-Throw Safety Switches, page 3-26 and 600 Volt Double Throw Safety Switches, page 3-27 which have provisions for accepting fuses.
- 30 A, 200–600 A Type 82,000 (Series E, T4, A), DTU devices:
Use the non-fusible double throw switches from 240 Volt Double-Throw Safety Switches, page 3-26 and 600 Volt Double Throw Safety Switches, page 3-27 in conjunction with standard fusible devices, and install them according to diagram 1 or 2, below.

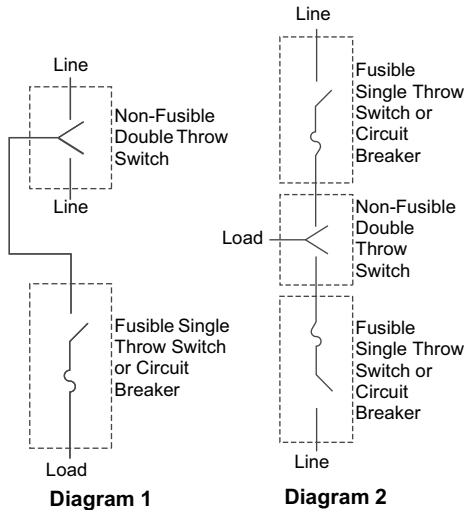

Table 3.55: UL Listed Short Circuit Current Ratings

Switch Type	Amperes	Voltage Rating	UL Listed Fuse Class	Short Circuit Current Rating [42] (A)
Type 92000	30 A	240 V	H, K	10,000 [43]
Type DT (Series F)	30–100 A	240 V or 600 V	H, K R, J	10,000 200,000
Type DTU [44] (Series F)	30–100 A	240 V or 600 V	H or K R, J or T	10,000 [43] 200,000
DTU224NRB and DTU324NRB (Series E)	200 A	240 V	H, K	10,000 [43]
DTU324N (Series E)	200 A	240 V	H, K R, J	10,000 [43] 100,000
Type 82,000	All	240 V or 600 V	H, J	10,000 [43]
Type DTU (Series A)	400–600 A	240 V or 600 V	H, K R, J, T	10,000 100,000

[39] 30-100 A switches suitable for 60° C or 75° C conductors. 200-600 A switches suitable for 75° C conductors.

[40] Order from Thomas and Betts

[41] Hubbell Versa-Crimp™ catalog numbers.

[42] Rating applies to AC only. The UL Listed short circuit current rating for non-fusible switches is based on the switch being used in conjunction with the corresponding fuse type. Evaluation of non-fusible switches in conjunction with molded case circuit breakers has not been performed.

[43] Any brand of circuit breaker or fuse not exceeding the ampere rating of the switch may be used ahead of a non-fusible safety switch when there is up to 10 kA short circuit current available.

[44] The DTU361 and DTU361RB are also suitable for use on a circuit capable of delivering not more than

(A) 18 kA, 600 Vac maximum when using Type FH circuit breaker rated 30 A maximum or
(B) 14 kA, 600 Vac maximum when using Type FA circuit breaker rated 30 A maximum.

Dimensions for DT/DTU (Series F) Safety Switches 30–100 A

Table 3.56: 30–100 A Type DT, DTU (Series F)—Approximate Dimensions

Cat. No.	Series	H		W		W/H		D	
		in.	mm	in.	mm	in.	mm	in.	mm
DT223	F5	38.00	965	9.88	251	11.13	283	6.75	171
DT223RB	F5	38.00	965	6.87	174	8.12	206	6.60	168
DT321	F5	38.00	965	10.25	260	11.50	292	6.75	171
DT321RB	F5	38.00	965	10.25	260	11.80	300	6.60	168
DT322	F5	38.00	965	10.25	260	11.50	292	6.75	171
DT322RB	F5	38.00	965	10.25	260	11.80	300	6.60	168
DT323	F5	38.00	965	9.88	251	11.13	283	6.75	171
DT323RB	F5	38.00	965	6.87	174	8.12	206	6.60	168
DT361	F5	38.00	965	10.25	260	11.50	292	6.75	171
DT361RB	F5	38.00	965	10.25	260	11.80	300	6.60	168
DT362	F5	38.00	965	10.25	260	11.50	292	6.75	171
DT362RB	F5	38.00	965	10.25	260	11.80	300	6.60	168
DT363	F5	38.00	965	9.88	251	11.13	283	6.75	171
DT363RB	F5	38.00	965	6.87	174	8.12	206	6.60	168
DTU222	F5	29.94	760	10.25	260	11.96	304	6.93	176
DTU223	F5	29.94	760	10.25	260	11.96	304	6.93	176
DTU223RB	F5	30.50	775	10.25	260	11.96	304	6.93	176
DTU321	F5	29.94	760	10.25	260	11.96	304	6.93	176
DTU322	F5	29.94	760	10.25	260	11.96	304	6.93	176
DTU323	F5	29.94	760	10.25	260	11.96	304	6.93	176
DTU323RB	F5	30.50	775	10.25	260	11.96	304	6.93	176
DTU361	F5	29.94	760	10.25	260	11.96	304	6.93	176
DTU361RB	F5	30.50	775	10.25	260	11.96	304	6.93	176
DTU362	F5	29.94	760	10.25	260	11.96	304	6.93	176
DTU362AWK	F6	29.94	760	10.25	260	11.96	304	6.93	176
DTU362DS	F6	30.26	769	10.25	260	11.50	292	7.12	181
DTU362RB	F5	30.50	775	10.25	260	11.96	304	6.93	176
DTU363	F5	29.94	760	10.25	260	11.96	304	6.93	176
DTU363AWK	F6	29.94	760	10.25	260	11.96	304	6.93	176
DTU363DS	F6	30.26	769	10.25	260	11.50	292	7.12	181
DTU363RB	F5	30.50	775	10.25	260	11.96	304	6.93	176
DTU462	F5	29.94	760	10.25	260	11.96	304	6.93	176
DTU462AWK	F6	30.26	769	15.50	394	16.75	425	7.12	181
DTU462DS	F6	30.26	769	15.50	394	16.75	425	7.12	181
DTU463	F5	29.94	760	10.25	260	11.96	304	6.93	176
DTU463AWK	F6	30.26	769	15.50	394	16.75	425	7.12	181
DTU463DS	F6	30.26	769	15.50	394	16.75	425	7.12	181
DTU662AWK	F6	30.26	769	15.50	394	16.75	425	7.12	181
DTU663AWK	F6	30.26	769	15.50	394	16.75	425	7.12	181

Dimensions for DTU (Series A E T4) Safety Switches 200–600 A

Table 3.57: 200–600 A Types 82,000 and E-Series DTU and 30 A devices—Approximate Dimensions

Cat. No.	Series	H		W		W/H		D	
		in.	mm	in.	mm	in.	mm	in.	mm
DTU224NRB	E1	32.50	826	20.63	524	24.00	610	10.63	270
82254	E1	30.88	784	15.75	400	19.63	499	9.75	248
82254NW	E1	30.88	784	20.00	508	23.88	607	11.75	298
82344	E2	30.88	784	20.00	508	23.88	607	11.75	298
82344RB	E1	32.50	826	20.63	524	24.00	610	10.63	270
82354	E1	30.88	784	20.00	508	23.88	607	11.75	298
92251	T4	10.00	254	8.00	203	9.75	248	4.75	121
82344DS	E1	30.88	784	20.00	508	23.88	607	11.75	298
DTU324N	E1	32.50	826	24.50	622	26.25	667	10.63	270
DTU324NRB	E1	32.50	826	24.50	622	26.25	667	10.63	270
H82344	E2	32.50	826	24.50	622	26.25	667	10.63	270
H82444	E2	32.50	826	30.21	767	33.61	854	10.63	270
H82454	E3	32.50	826	30.21	767	33.61	854	10.63	270
82454	E3	38.00	965	29.62	753	33.02	839	10.63	270
82444	E3	38.00	965	29.62	753	33.02	839	10.63	270
82454R	E3	38.00	965	29.62	753	33.02	839	10.63	270
82444R	E3	38.00	965	29.62	753	33.02	839	10.63	270
H82254	E3	32.50	826	24.50	622	26.25	667	10.63	270
H82354	E3	32.50	826	24.50	622	26.25	667	10.63	270
82444DS	E3	38.00	965	29.62	753	33.02	839	10.63	270
DTU326	A1	63.31	1608	23.66	601	24.46	621	8.88	226
DTU426	A1	63.31	1608	27.00	686	27.80	706	8.88	226
DTU366	A1	63.31	1608	23.66	601	24.46	621	8.88	226
DTU466	A1	63.31	1608	27.00	686	27.80	706	8.88	226
DTU326R	A1	63.76	1619	23.66	601	24.46	621	8.88	226
DTU426R	A1	63.76	1619	27.00	686	27.80	706	8.88	226
DTU366R	A1	63.76	1619	23.66	601	24.46	621	8.88	226
DTU466R	A1	63.76	1619	27.00	686	27.80	706	8.88	226
DTU366AWK	A1	63.76	1619	23.66	601	24.46	621	8.88	226
DTU225	A1	53.81	1367	23.13	588	23.88	607	7.25	184
DTU225R	A1	53.81	1367	23.13	588	23.88	607	7.25	184
DTU325	A1	53.81	1367	23.13	588	23.88	607	7.25	184
DTU325R	A1	53.81	1367	23.13	588	23.88	607	7.25	184
DTU365	A1	53.81	1367	23.13	588	23.88	607	7.25	184
DTU325R	A1	53.81	1367	23.13	588	23.88	607	7.25	184
DTU365AWK	A1	57.50	1461	23.00	584	23.75	603	7.25	184
DTU365DS	A1	57.50	1461	23.00	584	23.75	603	7.25	184
DTU465	A1	53.81	1367	23.13	588	23.88	607	7.25	184
DTU465R	A1	53.81	1367	23.13	588	23.88	607	7.25	184