

Section 2

Metering Equipment



Individual Meter Socket



MP Meter-Pak Metering Equipment



EZ Meter-Pak Metering Equipment

Meter Sockets	2-2
Ring and Ringless Type Individual Meter Sockets	2-2
Horizontal Ganged, Test Block Bypass Sockets and Accessories	2-3
Dimensions	2-5
MP Meter-Pak™ Meter Centers	2-6
Ring and Ringless Devices	2-6
Ring and Ringless Type Devices	2-6
Tenant Circuit Breakers	2-8
Accessories for MP Meter-Pak Meter Centers	2-8
Dimensions and Knockouts for MP Meter-Pak Meter Centers	2-9
EZ Meter-Pak™ Meter Centers	2-10
Indoor/Rainproof EZM General Information	2-10
Selection Information	2-12
1 Phase Main Devices	2-14
1 Phase Branch Devices	2-16
3 Phase Main Devices	2-17
3 Phase Branch Devices	2-19
3 Phase Main Devices (Busway Side Tap)	2-21
3 Phase Main Devices (Busway Center Tap)	2-22
Tenant Circuit Breakers and EZM Accessories	2-23
Dimensions	2-25

Individual Meter Sockets

This metering is generally utility specific. Always check with local utility company before installing. Contact your nearest Field Sales Office for additional catalog numbers, if required by utility.

- Available single or three phase, 600 Vac max., with and without horn or lever bypass, overhead and underground service feed.
- 10 kA short circuit current rating (or higher with utility approval).
- UL Listed, NEMA 3R enclosure.
- Units supplied with bonded neutral.
- Units supplied with hub opening in top endwall require the use of a bolt-on hub, or closing plate.
- Units supplied with solid top are for underground feed only.
- For accessories, refer to page 2-4.

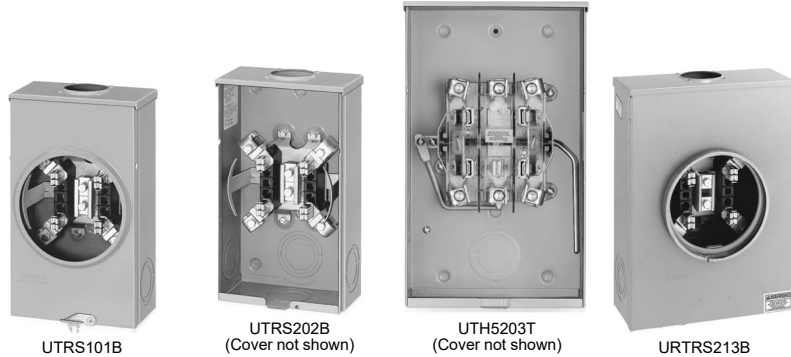

2 METERING EQUIPMENT

Table 2.1: Individual Meter Sockets

Ampere Rating [1]	Jaw Qty.	Service Type	Cat. No. [2]	Lug Wire Range (Al/Cu)			Enclosure Information			
				Line, Load, and Neutral (AWG/kcmil)	Wire Binding	Gnd. (AWG)	Material	Top Endwall Conf.		Box No. [3]
								Order Separately	Closing Plate [4]	
Ringless Type, 1Ø3W 600 Vac Max., Without Bypass or Jaw Release										
125	4	UG	UTZRS101A OBS[5]	8-2/0	1/2 in. Hex	14-2	Steel	Solid Top [5]	—	1R
125	4	OH	UTRS101B	8-2/0	Slotted	14-2	Steel	Series A	ACP	1R
125	4	OH	UATRS101B OBS	8-2/0	Slotted	14-2	Aluminum	Series A	ACPA	1R
125	4	OH	URS101BCPL	8-2/0	Slotted	14-2	Steel	Series A	ACP	1R
125	5	OH/UG	1003880A OBS[6]	8-2/0	Slotted	14-2	Steel	Series A	ACP	1R
125	4	OH/UG	UTZRS101CFL	8-2/0	1/2 in.	14-2	Steel	Series A	ACP [7]	1R
200	4	OH	UTRS202B	8-250	1/2 in. Hex	14-2	Steel	Series A	ACP	3R
200	4	OH	UATRS202B OBS	8-250	1/2 in. Hex	14-2	Aluminum	Series A	ACPA	3R
200	4	UG	UTRS213A [5]	1/0-350	1/2 in. Hex	14-2	Steel	Solid Top [5]	—	5R
200	4	OH/UG	UTRS213B [6]	1/0-350	1/2 in. Hex	14-2	Steel	Series A	ACP	5R
200	4	OH/UG	UATRS213B [6]	1/0-350	1/2 in. Hex	14-2	Aluminum	Series A	ACPA	5R
200	4	OH/UG	U92197CCCPL [8]	1/0-350	1/2 in. Hex	14-2	Steel	(2) Series A	(2) ACP [8]	7R
200	4	OH/UG	1004710E	8-250	1/2 in. Hex 5/16 Allen	None	Steel	Series A	ACP [7]	4R
200	4	OH/UG	UT92197CCFL	8-350	1/2 in. Hex 5/16 Allen	14-2	Steel	(2) Series A	(2) ACP [8]	7R
200	4	OH/UG	UTRS212C	8-250	1/2 in. Hex 5/16 Allen	14-2	Steel	Series A	ACP [7]	4R
200	4	OH/UG	UTRS213CFL	8-350	1/2 in. Hex 5/16 Allen	14-2	Steel	Series A	ACP [7]	5R
200	4	UG	UTRS220A OBS	3/8 in. Studs	9/16 in. Hex	14-2	Steel	Solid Top [9]	—	15.13x-13x5 inches
200	4	UG	UTRS223A	8-350	1/2 in. Hex 5/16 Allen	14-2	Steel	Solid Top [9]	—	2R
200	4	OH/UG	UTRS233C	8-350	1/2 in. Hex 5/16 Allen	14-2	Steel	Series A	ACP [7]	17.13x-13x5 inches
Ringless Type, 1Ø3W 600 Vac Max., With Test Switch										
20	8	UG	1007361C	#10 CU [10]	Studs	14-2	Steel	Solid Top [9]	—	16.5x1-4x3.5 inches
Ringless Type, 3Ø4W 600 Vac Max., With Test Switch										
20	13	UG	1007003C	#10 CU [10]	Studs	14-2	Steel	Solid Top [9]	—	16.5x1-4x3.5 inches
Ringless Type, 1Ø3W 600 Vac Max., With Horn Bypass, Without Jaw Release										
125	4	OH/UG	UHTRS101B	8-2/0	Slotted	14-2	Steel	Series A	ACP	1R
125	4	OH/UG	1004162A	8-2/0	Slotted	14-2	Steel	Series A	ACP	1R
125	4	OH/UG	UFHTRS101B	8-2/0	Slotted	14-2	Steel	Series A	ACP	1R
125	5	OH/UG	UGHTRS101B	8-2/0	Slotted	14-2	Steel	Series A	ACP	1R
125	5	OH	UGHTRS101L OBS[11]	8-2/0	Slotted	14-2	Steel	A125 [11]	—	1R
125	4	OH	URS101BDQ OBS[12]	8-2/0	1/2 in. Hex	None	Steel	Series A	ACP	1R
125	5	OH/UG	UGHTRS111C OBS[7]	8-2/0	Slotted	14-2	Steel	Series A	ACP [7]	4R
200	4	OH/UG	UBHMRS212B OBS[6]	8-250	1/2 in. Hex	None	Steel	Series A	ACP	4R
200	4	OH	UHTRS202B	8-250	1/2 in. Hex	14-2	Steel	Series A	ACP	3R
200	4	OH/UG	UHTRS212B [6]	8-250	1/2 in. Hex	14-2	Steel	Series A	ACP	4R
200	4	OH/UG	UHTRS213B [6]	1/0-350	1/2 in. Hex	14-2	Steel	Series A	ACP	5R

[1] Rating is continuous.
 [2] Device requires approval from the serving utility, consult your nearest Schneider Electric sales office.
 [3] For box dimensions, see page 2-5
 [4] Order appropriate bolt-on hub or closing plate separately and install on TOP endwall.
 [5] Device supplied with solid top endwall (without hub opening).
 [6] When unit is installed for underground feed, the appropriate closing plate must be ordered separately and installed over hub opening in TOP endwall of device.
 [7] Device supplied with closing plate ACP mounted on TOP endwall.
 [8] Device supplied with two closing plates ACP mounted in TOP endwall.
 [9] Device supplied with solid top endwall (without hub opening).[5]
 [10] Factory wiring is #12 CU. Field wiring can be up to #10.
 [11] Device supplied with 1-1/4 in. bolt-on hub (Cat. No. A125) mounted on TOP endwall.
 [12] Contains "Duquesne Light Co." approved label.

Table 2.1 Individual Meter Sockets (cont'd.)

Ampere Rating [13]	Jaw Qty.	Service Type	Cat. No. [14]	Lug Wire Range (Al/Cu)			Enclosure Information				Box No. [15]
				Line, Load, and Neutral (AWG/kcmil)	Wire Binding	Gnd. (AWG)	Material	Top Endwall Conf.			
								Hub Opening [16]	Closing Plate [16]		
200	4	UG	UHTRS223A [17]	1/0-350	1/2 in. Hex	14-2	Steel	Solid Top [17]	—	2R	
200	4	UG	URS212ADQ OBS [18]	8-250	1/2 in. Hex	None	Steel	Solid Top [17]	—	4R	
200	4	OH/UG	1004159A	8-350	1/2 in. Hex 5/16 Allen	14-2	Steel	Series A	ACP [19]	5R	
200	4	UG	1006388	Line 4/0 Comp Line Neut 2/0 Comp Load 6-250	9/16 in. Hex	(2) 14-2	Steel	Solid Top [20]	—	61x9x5 inches	
200	4	OH	1007665	8-250	1/2 in. Hex 5/16 Allen	14-2	Steel	Series A	ACP	3R	
200	5	OH/UG	UGHTRS213B	8-350	1/2 in. Hex 5/16 Allen	14-2	Steel	Series A	ACP	5R	
200	5	OH/UG	UGHTRS213C	8-350	1/2 in. Hex 5/16 Allen	14-2	Steel	Series A	ACP [19]	5R	
Ringless Type, 1Ø3W 600 Vac Max., With Lever Bypass and Jaw Release											
200	4	OH	UTH4203T OBS	6-350	1/2 in. Hex	14-2	Steel	Series A-L	ACPL	8R	
200	4	OH/UG	UTH4213T [21]	6-350	1/2 in. Hex	14-2	Steel	Series A-L	ACPL	9R	
200	5	OH	UTH5203T OBS	6-350	1/2 in. Hex	14-2	Steel	Series A-L	ACPL	8R	
200	5	OH/UG	UTH5213T [21]	6-350	1/2 in. Hex	14-2	Steel	Series A-L	ACPL	9R	
320	4	OH/UG	UTH4330T [22]	Studs Only	3/8 in. dia. studs	14-1/0	Steel	Series A-L	ACPL	11R	
320	4	OH/UG	1008068	Dual 6-350	5/16 in. Allen	14-1/0	Steel	Series A-L	ACPL [19]	34.5x1-6.44x6-5 inches	
200	5	OH/UG	1008801	6-350	1/2 in. Hex 5/16 Allen	14-2	Steel	Series A	ACP [19]	9R	
320	4	OH/UG	1009788A	3/8 in. Studs	9/16 in. Hex	None	Steel	Series A-L	ACPL [19]	34.5x1-3x5 inches	
320	4	OH/UG	UATH4330U	3/8 in. Studs	9/16 in. Hex	14-1/0	Aluminum	Series A-L	ACPL [19]	11R	
320	4	OH/UG	UTH43369T	Line 4-600 Load Dual 6-350	Line 1/2 in. Allen Load 5/16 in. Allen	14-1/0	Steel	Series A-L	ACPL	11R	
Ringless Type, 3Ø4W 600 Vac Max., With Lever Bypass and Jaw Release											
200	7	OH/UG	UTH7213T [21]	6-350	1/2 in. Hex	14-2	Steel	Series A-L	ACPL	9R	
320	7	OH	UTH7300T [22]	Studs Only	3/8 in. dia. studs	14-1/0	Steel	Series A-L	ACPL	10R	
200 A	7	OH/UG	UH7213C	6-350	1/2 in. Hex 5/16 Allen	None	Steel	Series A	ACP [19]	19x13-x5 inches	
Ringless Type, 3Ø4W 600 Vac Max., Bolt-On Socket Without Bypass											
400	7	OH/UG	UK7T OBS [22]	Studs Only	1/2 in.-20 dia. studs	1/2 in.-20 dia. studs	Steel	Series A-L	ACPL	12R	
400	7	OH/UG	UAK7T OBS [22]	Studs Only	1/2 in.-20 dia. studs	1/2 in.-20 dia. studs	Aluminum	Series A-L	ACPLA	12R	
Ring Type, 1Ø3W 600 Vac Max., Without Bypass or Jaw Release											
125	4	OH/UG	URTRS101B [21]	8-2/0	Slotted	14-2	Steel	Series A	ACP	1R	
200	4	OH/UG	URTRS213B [21]	1/0-350	1/2 in. Hex	14-2	Steel	Series A	ACP	5R	
125	5	OH	URS101BCR	8-2/0	Slotted	14-2	Steel	Series A	ACP	1R	
200	5	OH	URS202BCR	8-250	1/2 in. Hex 5/16 Allen	14-2	Steel	Series A	ACP	3R	

OBS - This product is obsolete.

Horizontal Ganged Meter Sockets



UT2R1121B

- 1Ø, 600 Vac max., main lugs only, 2 through 6 meter positions, with and without horn or lever bypass, end or center feed, overhead and underground service feeds.
- 10 kA short circuit current rating (or higher with utility approval).
- UL Listed, NEMA® 3R enclosure.
- Supplied with ground lugs.
- Supplied with hub opening in top endwall, requires the use of a bolt-on hub, or closing plate.

This metering is generally utility specific. Always check with local utility company before installing. Contact your nearest Field Sales Office for additional catalog numbers, if required by utility.

Table 2.2: Horizontal Ganged Meter Sockets

Branch Ratings				Mains Rating (A)	Cat. No.	Main Lugs Phase and Neutral Al/Cu (AWG/kcmil)	Branch Lugs Phase and Neutral Al/Cu (AWG)	Top Endwall [23]		Box No. [15]
Amperes [24]	No. of Positions	Socket Jaw Qty. [25]	Service Type					Hub Type (Order Separately)	Closing Plate (Order Separately)	
Ringless Type, 1Ø3W 600 Vac Max., Without Bypass or Jaw Release										
100	2	4	OH/UG	200	UT2R1121B	6-250	8-2/0	Series A	ACP	13R
	3			205	UT3R1121B OBS	6-250				13R1
	4			205	UT4R1131B OBS	6-350				14R
	5			250	UT5R1131B OBS	6-350				15R

[13] Rating is continuous.
 [14] Device requires approval from the serving utility, consult your nearest Schneider Electric sales office.
 [15] For box dimensions, see page 2-5
 [16] Order appropriate bolt-on hub or closing plate separately and install on TOP endwall.
 [17] Device supplied with solid top endwall (without hub opening).
 [18] Contains "Duquesne Light Co." approved label.
 [19] Device supplied with closing plate ACP mounted on TOP endwall. [10]
 [20] Device supplied with solid top endwall (without hub opening). [5]
 [21] When unit is installed for underground feed, the appropriate closing plate must be ordered separately and installed over hub opening in TOP endwall of device.
 [22] Order lugs separately, see page 2-4
 [23] For hubs and closing plates, see page 2-4.
 [24] Rating is continuous.
 [25] Fifth jaw kit available to convert 4-jaw socket to a 5-jaw socket. See page 2-4.

Table 2.2 Horizontal Ganged Meter Sockets (cont'd.)

Branch Ratings				Mains Rating (A)	Cat. No.	Main Lugs Phase and Neutral Al/Cu (AWG/kcmil)	Branch Lugs Phase and Neutral Al/Cu (AWG)	Top Endwall [26]		Box No. [27]
Amperes [28]	No. of Positions	Socket Jaw Qty. [29]	Service Type					Hub Type (Order Separately)	Closing Plate (Order Separately)	
200	6	4	OH/UG	300 CU / 250 AL	UT6R1131B OBS	6-350	8-250			16R
	2			205	UT2R2122B	6-250		Series A	ACP	17R
	4			360 CU / 310 AL	UT4R2352T	1/0-500		Series A-L	ACPL	18R
	5			500	UT5R2392TU	1/0-500 or (2)1/0-350		Series A-L	ACPL [26]	19R
	6			620	UT6R2392TU	1/0-500 or (2)1/0-350		Series A-L	ACPL [26]	20R
	3			300 CU / 250 AL	UT3R2332T	6-350		Series A-L	ACPL	14.13x32.4-x5.38 inches
	Ringless Type, 1Ø3W 600 Vac Max., With Horn Bypass, Without Jaw Release									
200	2	4	OH/UG	200	UHT2R1421C	6-250	8-2/0	Series A	ACP [27]	14.13x20.16-x5.38 inches

2 METERING EQUIPMENT



EMT3225CB



EMT1225CB Without Covers

Meter Mains with Test Block Bypass

Table 2.3: Ring Type, 1Ø3W and 3Ø4W, Meter Main with Test Block Bypass (Meets EUSERC Requirements)

System (Incoming and Service (Outgoing))	Meter Socket Type	Ampere Rating (Max.)	Short Circuit Current Rating	Cat. No. [27][28]	Main Circuit Breaker Type (Order Separately) [29]
120/240 Vac 1Ø3W	5-Jaw	225 A	100 kA max.	EMT1225CB	2P Type QB, QD, QG, QJ (QO, QO-VH, QOH) [30]
208Y/120 Vac 3Ø4W[31] or 240/120 Vac 3Ø4W Delta	7-Jaw	225 A	65 kA max.	EMT3225CB	3P Type QB, QD, QG or QJ

Table 2.4: EMT Terminal Wire Size [32]

Line Phase Lug	Line Neutral Lug	Service Ground Lug	Equipment Ground Lug	Load Neutral Lug
6 AWG-300 kcmil Al/Cu	6 AWG-350 kcmil Al/Cu	4 AWG-300 kcmil Al/Cu	6 AWG-300 kcmil Al/Cu	4 AWG-300 kcmil Al/Cu

Table 2.5: Adapter Plate, Lug Kits, and Sealing Rings

Accessory	Description	Cat. No.
Adapter Plate	To allow the use of a Series A Hub on a device that is setup for a series A-L Hub.	AAP
Lug Kits	For use on meter sockets supplied with Line, Load, and Neutral Studs only. Be sure to order enough lugs for each device (a typical 1Ø device requires 6 lugs).	
	Includes one, two-barrel lug (6-250 kcmil)	ARP00118 OBS
	Includes one, single barrel lug (4-600 kcmil)	ARP00129 OBS
	Includes three, two-barrel lugs (6-350 kcmil)	ARP00427
Sealing Ring	Snap-on Aluminum (Standard)	2920910001
	Snap-on Stainless Steel (Non-standard)	ARP00026
	Screw Type Aluminum (Non-standard)	29008W

OBS - This product is obsolete.

Meter Socket Accessories

Table 2.6: Fifth-Jaw Kit, Closing Plates, and Hubs

Accessory	Description	Cat. No.		
Fifth-Jaw Kit	Converts a 4-jaw meter socket to a 5-jaw meter socket. For use on meter sockets supplied without lever bypass or jaw release only.	A5J		
Closing Plates (to seal hub openings)	For Series A (steel)	ACP		
	For Series A (aluminum)	ACPA		
	For Series A-L (steel)	ACPL		
	For Series A-L (aluminum)	ACPLA OBS		
Hubs (listed by conduit size)	Series A	1.00 inch	A100	
		1.25 inch	A125	
		1.50 inch	A150	
		2.00 inch	A200	
		2.50 inch	A250	
		2.00 inch	A200L	
	Series A-L	2.50 inch	A250L	
		3.00 inch	A300L	
		3.50 inch	A350L OBS	
		4.00 inch	A400L	
		Series B	3.00 inch	B300

OBS - This product is obsolete.

[26] For hubs and closing plates, see page 2-4.

[27] For box dimensions, see page 2-5

[28] Rating is continuous.

[29] Fifth jaw kit available to convert 4-jaw socket to a 5-jaw socket. See page 2-4.

[26] Device supplied with 1 closing plate ACPL mounted in TOP endwall. A second closing plate needs to be ordered separately.

[27] Device supplied with two closing plates ACP mounted in TOP endwall.

[28] Supplied with bondable neutral, suitable for use as service equipment, suitable for overhead or underground service. UL Listed E6294.

[29] See page 2-23 to select main circuit breaker.

[30] Requires use of an EZM125QOA adapter (order separately), when using QO (40 A-125 A, 2-pole) 10 kA max. SCCR, QO-VH (40 A-60 A, 2-pole) 22 kA max. SCCR, or QOH (40 A-60 A, 2-pole) 42 kA max. SCCR.

[31] 100 kA max.

[32] Refer to circuit breaker listings for usable load lug wire sizes.

Table 2.7: Enclosure Dimensions

Dimensions (Inches)				
Box No.	H	W	D	Hub Opening (Max. Conduit Size) [33]
1R	10.88	8.00	3.50	Series A
2R	13.00	13.00	4.94	Solid Top
3R	14.00	8.00	4.38	Series A
4R	14.00	11.00	4.38	Series A
5R	15.00	11.00	4.38	Series A
6R	15.50	8.00	4.36	Series A
7R	17.13	13.00	4.94	(2) Series A
8R	19.00	10.50	4.94	Series A-L
9R	19.00	13.00	4.94	Series A-L
10R	34.50	15.00	5.68	Series A-L
11R	36.62	15.00	5.68	Series A-L
12R	43.00	20.25	6.00	Series A-L
13R	14.12	24.31	4.50	Series A
13R1	14.12	32.50	4.50	Series A
14R	14.12	40.62	4.50	Series A
15R	14.12	48.75	4.50	Series A
16R	14.12	57.00	4.50	Series A
17R	14.12	24.31	5.38	Series A
18R	14.12	40.62	5.38	Series A-L
19R	14.12	54.75	5.38	(2) Series A-L
20R	14.12	63.00	5.38	(2) Series A-L

Table 2.8: Knockout Information

Knockouts						
Symbol	S	A	B	C	D	
Conduit Size (in.)	5/16 [34]	1/2	3/4	1	1-1/4	
Symbol	E	F	G	H	I	J
Conduit Size (in.)	1-1/2	2	2-1/2	3	3-1/2	4

Dimensions and Knockouts for Meter Sockets

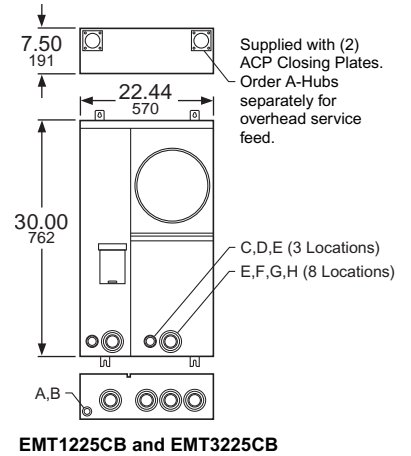
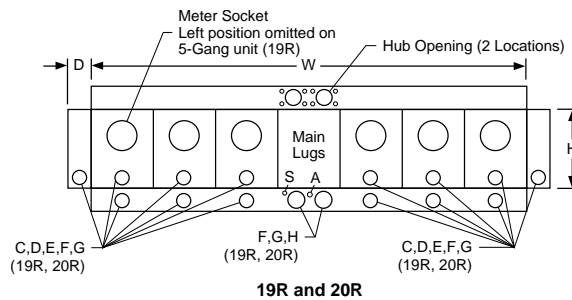
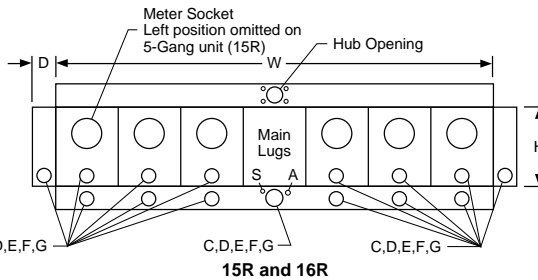
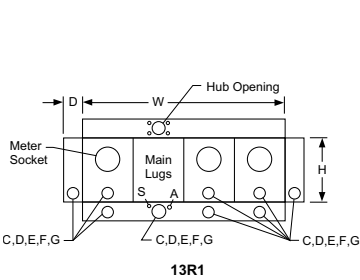
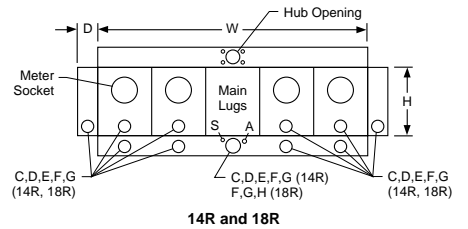
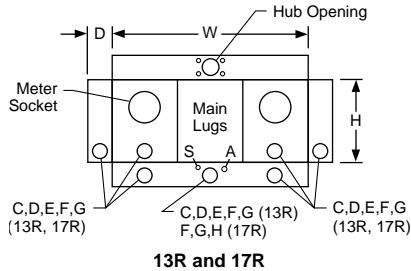
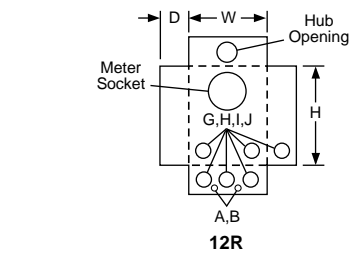
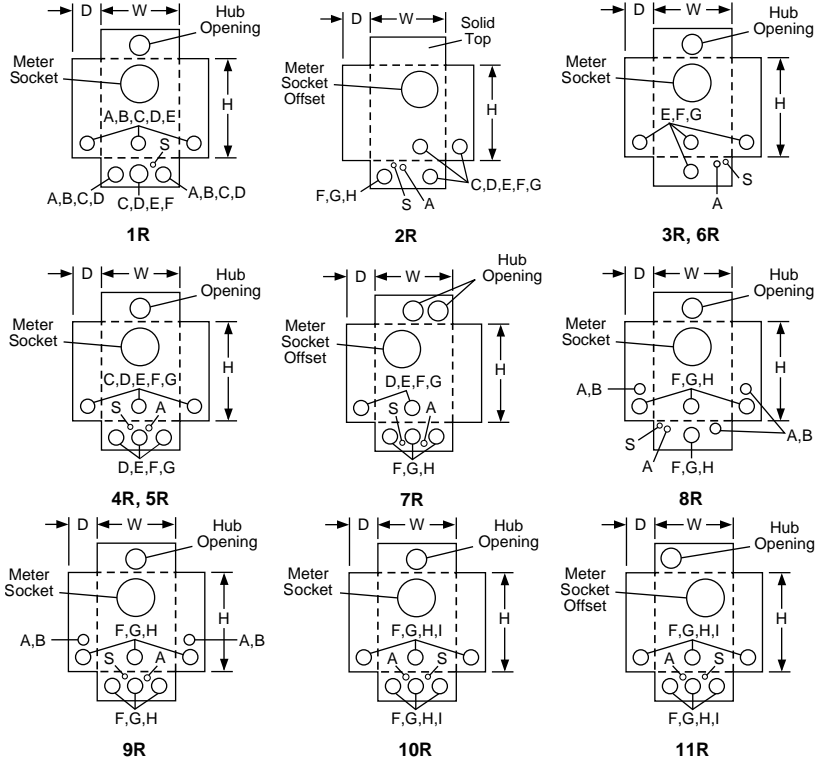

[33] Refer to page 2-4 for closing plates and hubs.
[34] Knockout for grounding conductor.



MP44125

Ring and Ringless Type Devices

- Consult local utility for approval before installation.
- 120/240 Vac 1Ø3W.
- Main lugs only—two to six meter sockets.
- Enclosures are indoor/rainproof NEMA 3R construction.
- Suitable only for use as service equipment.
- Swingable mounting feet supplied at bottom of device.
- Factory-installed mechanical lugs, alternate lugs and NEMA/EUSERC lug landing kits available.
- Surface mount, convertible to semi-flush with field installed flange kit.
- Ring type devices supplied with 4-jaw meter sockets (5th jaw kits available, order separately).
- Ringless type devices supplied with 5-jaw meter sockets, available with and without horn or lever bypass.
- Provisions for mounting 2-pole circuit breaker for each meter socket position (order circuit breakers separately).
- Mounting channel supplied, except for box 1R (125 A, 2-position).
- Combination overhead/underground feed.

Table 2.9: MP Catalog Number Description

Number Segment	Character	Description	MP	H	4	4	125
Device Name	MP	Meter-Pak Meter Center					
	Blank	Ring Type					
Socket/Bypass Type	R	Ringless Type with 5th Jaw					
	H	Ringless with Horn Bypass and 5th Jaw					
	L	Ringless with Lever Bypass, Jaw Release and 5th Jaw					
Bus Ampacity	2	200 A					
	3	300 A					
	4	400 A					
	5	500 A					
	6	600 A					
	8	800 A					
Number of Meter Sockets	2	2-Positions MP, MPH, MPL, and MPR					
	3	3-Positions MP, MPH, MPL, and MPR					
	4	4-Positions MP, MPH, MPL, and MPR					
	5	5-Positions MP, MPH and MPR					
Max. Tenant Circuit Breaker Amperage	125	125 A					
	200	200 A					
	225	225 A					

Table 2.10: Ring Type MP Meter-Pak Metering Equipment with 125 A (42 kA Maximum SCCR) or 200 A (22 kA Maximum SCCR) Meter Socket Positions

Amperes per Pos.	No. of Positions	Factory-Installed Main Lugs Ampacity (alternate lugs [1])	Main Bus Ampacity (A)	Cat. No.	Line Lug Wire Size Al/Cu AWG/kcmil	Circuit Breaker Type (2P)	Hub Prov. [2]	Semi-Flush Flange Kit	Wt Lbs	Box No.
125	2	200	200	MP22125 [3]	(1) 4-250	QO, QO-VH, QOH	A/B300	MPSF12	46	1R
	3	300	300	MP33125 [4]	(1) 1/0-600 or (2) 1/0-250		A-L	MPSF14	95	2R
	4	400	400	MP44125 [4]	(1) 1/0-600 or (2) 1/0-250		A-L	MPSF14	97	2R
	5	400 Al 500 Cu	500	MP55125 [4]	(1) 1/0-600 or (2) 1/0-250		(4) A-L	MPSF16	130	3R
	6	400 Al 500 Cu	600	MP66125 [4]	(1) 1/0-600 or (2) 1/0-250		(4) A-L	MPSF16	132	3R
200	2	400	400	MP42200 [4]	(1) 1/0-600 or (2) 1/0-250	QOM2-MM, QOM2-MVH	(4) A-L	MPSF23	99	4R
	3	400	400	MP43200 [4]	(1) 1/0-600 or (2) 1/0-250			MPSF23	99	4R
	4	400	600	MP64200 [4]	(1) 1/0-600 or (2) 1/0-250			MPSF24	135	5R
	5	600 Al, 750 Cu	800	MP85200 [4]	(2) 3/0-500			MPSF26	173	6R
	6	600 Al, 750 Cu	800	MP86200 [4]	(2) 3/0-500			MPSF26	173	6R

Table 2.11: Ringless Type MP Meter-Pak Metering Equipment with 125 A (42 kA Maximum SCCR) or 200 A Type MPR, MPH (22 kA Maximum SCCR) or 225 A Type MPL (100 kA Maximum SCCR) Meter Socket Positions

Amperes Per Pos.	No. of Pos.	Factory-Installed Main Lugs Ampacity (alternate lugs [1])	Main Bus Ampacity	No. Bypass Cat. No.	Horn Bypass Cat. No.	Lever Bypass Cat. No.	Line Lug Wire Size Al/Cu AWG/kcmil	Circuit Breaker Type (2P) [5]	Hub Prov. [2]	Semi-Flush Flange Kit	Wt Lbs	Box No.
125	2	200	200	MPR22125	MPH22125	—	(1) 4-250	QO, QO-VH, QOH	A/B300	MPSF12	46	1R
	3	300	300	MPR33125	MPH33125	—	(1) 1/0-600 or (2) 1/0-250		A-L	MPSF14	95	2R
	4	400	400	MPR44125	MPH44125	—	(1) 1/0-600 or (2) 1/0-250			MPSF14	97	2R
	5	400 Al 500 Cu	500	MPR55125	MPH55125	—	(1) 1/0-600 or (2) 1/0-250		(2) A-L	MPSF16	130	3R
	6	400 Al 500 Cu	600	MPR66125	MPH66125	—	(1) 1/0-600 or (2) 1/0-250			MPSF16	132	3R
200	2	400	400	MPR42200	MPH42200	—	(1) 1/0-600 or (2) 1/0-250	QOM2-MM, QOM2-MVH	(2) A-L	MPSF23	99	4R
	3	400	400	MPR43200	MPH43200					MPSF23	99	4R
	4	400	600	MPR64200	MPH64200					MPSF24	135	5R
225	2	350	350	—	—	MPL32225	(1) 1/0-600 or (2) 1/0-250	QBP-TM, QDP-TM, QGP-TM or QJ-TM QO [6], QO-VH [6] or QOH [6]	(2) A-L	N/A	105	7R
	3	400	500	—	—	MPL53225				N/A	147	8R
	4	400	600	—	—	MPL64225				N/A	200	9R
200	5	600 Al, 750 Cu	800	MPR85200	MPH85200	—	(2) 3/0-500	QOM2-MM, QOM2-MVH	(2) A-L	MPSF26	173	6R
	6	600 Al, 750 Cu	800	MPR86200	MPH86200	—	(2) 3/0-500			MPSF26	173	6R

NOTE: UL Listed short circuit current rating depends on lowest interrupting rating of circuit breaker installed.

[1] See page 2-8 for alternate lugs.
 [2] For A and A-L Hubs see page 2-3, for B Hubs see Digest Section 3.
 [3] Meets EUSERC standards.
 [4] Meets EUSERC standards with addition of lug landing kit, MMSK2.
 [5] See page 2-8
 [6] Requires use of EZM125QOA adapter (order separately).

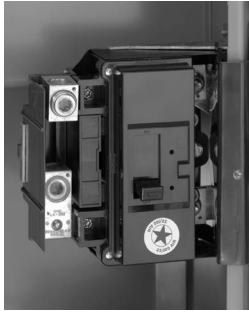

QOM2200MVH



QO2100VH
2P, Plug-on Type
Circuit Breaker



QDP22200TM
2P, Plug-on Type
Circuit Breaker



MMLK500

Tenant Circuit Breakers

UL Listed Short Circuit Current Rating depends on lowest interrupting rating of circuit breaker installed. (Refer to page 2-12 for Square D certified ratings for downstream panelboards and load centers.)

Table 2.12: Tenant Circuit Breakers

Amperes	10 k AIR 120/240 Vac	22 k AIR 120/240 Vac	42 k AIR 120/240 Vac	100 k AIR 120/240 Vac
For use in 125 A Max. Type MP, MPR and MPH Meter-Pak Metering Equipment				
40	QO240	QO240VH [7]	QOH240	—
50	QO250	QO250VH [7]	QOH250 [7]	—
60	QO260	QO260VH	QOH260 [7]	—
70	QO270	QO270VH	QOH270 [7]	—
80	QO280	QO280VH	QOH280 [7]	—
90	QO290	QO290VH	QOH290	—
100	QO2100	QO2100VH	QOH2100	—
125	QO2125	QO2125VH	QOH2125	—
For use in 200 A Max. Type MP, MPR and MPH Meter-Pak Metering Equipment				
100	QOM2100MM	QOM2100MVH	—	—
125	QOM2125MM	QOM2125MVH	—	—
150	QOM2150MM	QOM2150MVH	—	—
175	QOM2175MM	QOM2175MVH	—	—
200	QOM2200MM	QOM2200MVH	—	—
Amperes	10 k AIR 120/240 Vac	25 k AIR 120/240 Vac	65 k AIR 120/240 Vac	100 k AIR 120/240 Vac
For use in 225 A MPL Lever Bypass Meter-Pak Metering Equipment				
40	QO240 [8]	QO240VH [7] [9] [8]	QOH240 [10] [8]	—
50	QO250 [8]	QO250VH [7] [9] [8]	QOH250 [10] [7] [8]	—
60	QO260 [8]	QO260VH [7] [9] [8]	QOH260 [10] [7] [8]	—
70	QBP22070TM	QDP22070TM	QGP22070TM	QJP22070TM
80	QBP22080TM	QDP22080TM	QGP22080TM	QJP22080TM
90	QBP22090TM	QDP22090TM	QGP22090TM	QJP22090TM
100	QBP22100TM	QDP22100TM	QGP22100TM	QJP22100TM
110	QBP22110TM	QDP22110TM	QGP22110TM	QJP22110TM
125	QBP22125TM	QDP22125TM	QGP22125TM	QJP22125TM
150	QBP22150TM	QDP22150TM	QGP22150TM	QJP22150TM
175	QBP22175TM	QDP22175TM	QGP22175TM	QJP22175TM
200	QBP22200TM	QDP22200TM	QGP22200TM	QJP22200TM
225	QBP22225TM	QDP22225TM	QGP22225TM	QJP22225TM

Accessories for MP Meter-Pak Meter Centers

Table 2.13: Accessories

Accessory	Description	Cat. No.
Fifth Jaw Kit	Fifth Jaw Kit	5J
Horn Bypass Kit	For MPR and MPH only	MMHB
QO™ Adapter	For Bolt-on Q2M tenant circuit breakers (40–125 A, 2P)	EZM125QOA
Slider Type Manual Circuit Closing:	125 A Ring Style 2 Position Top Meter (Only) 125 and 200 A Ring Style	MM125MB [11] MM200MB [11]
Sealing Rings:	Snap-on Aluminum Screw Type Aluminum Snap-on Type Stainless Steel	2920910001 29008W ARP00026
Meter Cover-Lexan™	Meter Cover-Lexan™	29007
Optional Lug Kits:	(1) 1/0–600 AWG/kcmil or (2) 1/0–250 AWG/kcmil per phase (2) 3/0–500 AWG/kcmil per phase (2) 2–600 AWG/kcmil per phase	MMLK250 [12][13] MMLK500 [13] MMLK600 [13]
Semiflush Kits:	125 A 2 Position 125 A 3–4 Position 125 A 5–6 Position 200 A 2–3 Position 200 A 4 Position 200 A 5–6 Position	MPSF12 MPSF14 MPSF16 MPSF23 MPSF24 MPSF26
NEMA/EUSERC Lug Landing Kit:	For 3 through 6 position 125 A and 200 A devices. Each pad rated 600 A maximum and includes (2) 1/2-13 studs and mounting hardware.	MMSK2 [13]
NEMA Lug Landing Kit:	For use ONLY on MPL43225, MPL53225 and MPL64225 with optional lugs. See wiring diagram of each device for optional lugs.	MMSK4
MP Meter-Pak Wireway: (Wall Mount Pedestal)	125 A 2 Position ONLY 125 A 3–6 Position 200 A 2–6 Position MPL32-225 MPL53-225 MPL64-225	MP43X8PED MP43X11PED MP43X11PED MP35X11PED [14] MP43X11PED MP35X11PED [14]
MP Meter-Pak Wireway Extensions:	Used ONLY with MP43X8PED Used with MP43X11PED and MP35X11PED	MP12X8PEDEXT [14] MP12X11PEDEXT [14]

[7] Order only. Not stocked in PDS. Order Point: Lincoln.

[8] Requires use of EZM125QOA adapter (order separately).

[9] QO-VH tenant circuit breakers are rated 22 kAIR at 120/240 Vac.

[10] QOH tenant circuit breakers are rated 42 k AIR at 120/240 Vac.

[11] The meter center short circuit rating is 10 kA when manual circuit closing is used. Not rated for continuous duty.

[12] Standard lug for 3 through 6 position 125 A and 2 through 4 position 200 A devices.

[13] Cannot be installed on 2 position 125 A device.

[14] Order only. Not stocked in PDS. Order point: Lexington. For hubs and closing plates, see page 2-3.

Dimensions and Knockouts for MP Meter-Pak Meter Centers

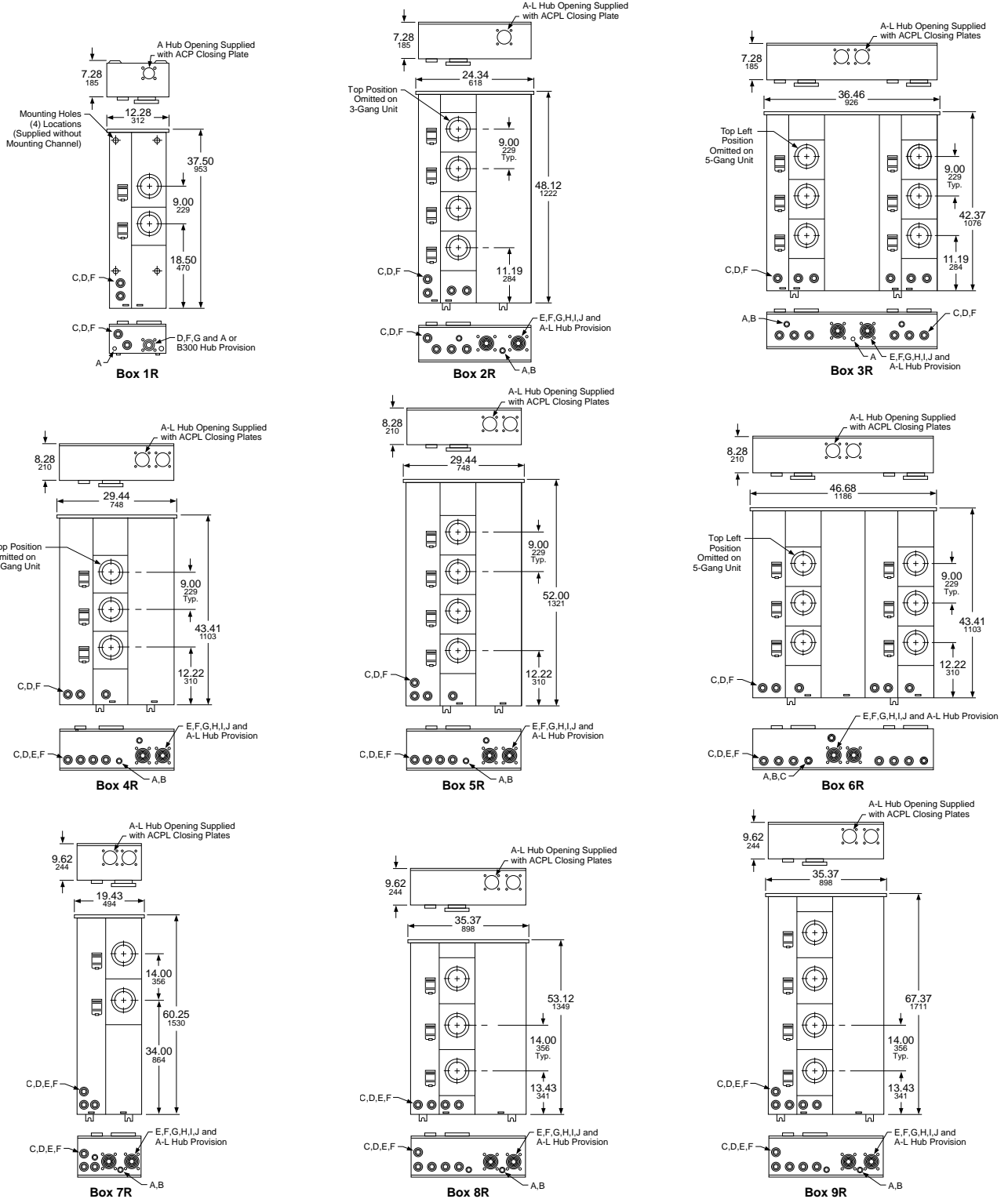

Knockouts										
Symbol	A	B	C	D	E	F	G	H	I	J
Conduit Size (in.)	1/2	3/4	1	1-1/4	1-1/2	2	2-1/2	3	3-1/2	4

NEMA 3R Construction

240 Vac Maximum, for use on AC systems, suitable for use as Service Equipment.

Utility Company Requirements Review local utility requirements to ensure that metering equipment meets their standards.

EZ Meter-Pak meter center enclosures meet NEC wire bending requirements, and are designed for wall mounting only (not suitable for floor mounting). All unmetrated conductor compartments may be sealed by the utility company.

EZ Meter-Pak meter centers have UL Listed short circuit current ratings up to 100 kA at 240 Vac when properly applied. For three-tier series ratings refer to Data Bulletin [4100DB0301](#).

Suitable incoming services for an EZM main device and available outgoing feeder(s) to downstream panelboards from EZM branch section(s)—

Incoming Service to Main Device 120/240 Vac, 1Ø3W

Available outgoing feeder(s) to downstream panelboards:

- 120/240 Vac, 1Ø3W (4-jaw ring type meter sockets, two-pole circuit breakers), (5-jaw ringless meter sockets, two-pole circuit breakers).

Incoming Service to Main Device 240/120 Vac, 3Ø4W Delta

Available outgoing feeder(s) to downstream panelboards:

- 120/240 Vac, 1Ø3W (Fed from transformer's "A-Phase" and "C-Phase" only.) NOTE: Connection to High-Leg "B-Phase" not permitted for this service (4-jaw ring type meter sockets, two-pole circuit breakers) (5-jaw ringless meter sockets, two-pole circuit breakers) Standard 3Ø IN/1Ø OUT branch units **are not suitable for use on this Delta System**. Special branch units are available for this System by adding suffix: "**CA**" to catalog number (Typical Examples: EZM313125XCA, EZM313125CUXCA, EZM314225CA, EZM314225XCA, EZM314225CUXCA, EZM315225CA, EZM314225CUCA, etc.).

- 240/120 Vac, 3Ø4W Delta (7-jaw meter sockets, three-pole circuit breakers).

Incoming Service to Main Device 208Y/120 Vac, 3Ø4W

Available outgoing feeder(s) to downstream panelboards:

- 120/208 Vac, 1Ø3W (5-jaw meter sockets, two-pole circuit breakers)
- 208Y/120 Vac, 3Ø4W (7-jaw meter sockets, three-pole circuit breakers).

EZM General Information

Main Devices

- 400, 600 and 800 A main disconnects may be end-mounted with branch units having 800 A or 1200 A continuous horizontal cross bus.
- 1000 and 1200 A main disconnect or terminal box **must be center mounted** when used with branch devices with main bus rated 800 A continuous.
- 1600 A main disconnect or terminal box **must be center mounted**.
- 2000 A main disconnect **must be center mounted** and requires use of branch units having 1200 A continuous horizontal cross bus.
- 400, 800 and 1200 A Type EZM-TBU terminal boxes supplied with lug landings to meet EUSERC requirements.

Main Circuit Breaker ratings: 400, 600, 800, 1000, 1200, 1600 and 2000 A

Main Fusible Switch ratings: 400, 600, 800, and 1200 A (1Ø3W only)

Main Lugs Terminal Box ratings: 225, 400, 600, 800, 1200, 1600, and 2000 A

Branch Units

- **125 and 225 A residential branch units** are available in ring type or ringless type construction and are supplied with 800 A continuous aluminum horizontal cross bus as standard (Example: EZM314125). For optional 1200 A continuous copper horizontal cross bus with aluminum vertical connectors, add suffix "**X**" to catalog number (Example: EZM314125X). For optional 1200 A continuous all-copper bussing, add suffix "**CUX**" to catalog number (Example: EZM314125CUX). NOTE: 5-gang 225 A EZM, EZMR and EZMH residential branch units are supplied with 1200 A continuous Cross Bus as standard, do not add suffix "X" or "CUX" to these units (Examples: EZMR315225 or EZMR315225CU). Plug-in style residential meter sockets are available as ring type **EZM** without bypass, ringless type **EZMR** without bypass, and ringless type **EZMH** with horn bypass. Tenant circuit breakers must be ordered separately for these branch units. 125 A max. units make use of Type QO, QO-VH or QO-H two-pole tenant circuit breakers (40–125 A). 225 A max. units make use of Type QDP-TM, QBP-TM, QGP-TM and QJP-TM two-pole tenant circuit breakers (70–225 A), and may also make use of two-pole Type QO (40–125 A at 10 kA max.), two-pole Type QO-VH (40–60 A at 100 kA max.), or two-pole Type QO-H (40–60 A at 100 kA max.) tenant circuit breakers.
- **225 A commercial branch units** are available in ring type or ringless type construction and are supplied with 1200 A copper horizontal cross bus with aluminum vertical connectors as standard (Example: EZML314225). For optional 1200 A continuous all-copper bussing, add suffix "**CU**" to catalog number (Example: EZML314225CU). Plug-in style commercial meter sockets are available as ring type **EZMT** with test block bypass (meets EUSERC requirements), ringless type **EZMR** without bypass, and ringless type **EZML** with lever bypass.

225 A max. units make use of type QDP-TM, QBP-TM, QGP-TM and QJP-TM two-pole or three-pole tenant circuit breakers (70–225 A), and may also make use of two-pole type QO (40–125 A at 10 kA max.), two-pole type QO-VH (40–60 A at 100 kA max.), or two-pole type QO-H (40–60 A at 100 kA max.) tenant circuit breakers.

Note: QO, QO-VH and QO-H tenant circuit breakers used in 225 A branch units require the use of adapter **EZM125QOA** (purchased separately).

- **400 A branch units** are available in ringless type construction only, and are supplied with 1200 A continuous all-copper bussing as standard (Example: EZML332400). These branch units are supplied with factory-installed type LJL tenant circuit breakers that have a field adjustable ampere rating trip setting from 125 A min. to 400 A max. A tamper-evident seal kit is available where needed, order seal kit **MICROTUSEAL** (refer to NEC 240-6 [c]). 400 A branch units are available as Type **EZML** with plug-in style lever bypass type meter sockets, or Type **EZMK** with bolt-on style with manual bypass type meter sockets.

- Units having **800 A continuous horizontal cross bus** WILL CONNECT with units having **1200 A continuous horizontal cross bus**.

- **Single phase units** (three bus bars in horizontal cross bus) WILL NOT CONNECT with **three phase units** (four bus bars in horizontal cross bus).

For Load Center Three-Tiered Series Ratings used downstream from Metering Equipment, refer to Data Bulletins: [4100DB0301](#) and [2700DB9901](#).

EZM Configuration Information

Table 2.14: EZM Mains Devices

Number Segment	Character	Description	EZM	1	1000	CB	U	CU
Device Name	EZM	EZ Meter-Pak Meter Center						
Service Feed	1	1Ph, 3W						
	3	3Ph, 4W						
Mains Rating		225 A						
		400 A						
		600 A						
		800 A						
		1000 A						
		1200 A						
		1600 A						
Main Type	CB	Main Circuit Breaker						
	FS	Main Fusible Switch						
	TB	Terminal Box						
	GCB	Main Circuit Breaker (65 kAIC)						
	JCB	Main Circuit Breaker (100 kAIC)						
Feed Direction	Blank	Overhead / Underground						
	C	Overhead / Underground						
	B	Underground Only						
	T	Overhead Only						
	U	Underground Only, Meets EUSERC Standards up to 1200 A max.						
	E	Underground Only, Meets EUSERC Standards up to 1200 A max.						
Special Construction	Blank	Aluminum Horizontal Cross Bus Bar up to 1000A max.						
	CU	Copper Horizontal Cross Bus Bar						
	MS	Includes Energy Reduction Maintenance Switch						

This table is for interpreting existing part numbers only. All possible combinations are not available.

Table 2.15: EZM Branch Devices

Number Segment	Character	Description	EZM	R	1	1	3	125	CU
Device Name	EZM	EZ Meter-Pak Meter Center							
Socket/Bypass Type	Blank	Ring Type							
	R	Ringless Type with 5th Jaw							
	H	Ringless with Horn Bypass and 5th Jaw							
	L	Lever Bypass with 5th Jaw, 7th Jaw if Three Phase							
	T	Ring Type Test-Block Bypass EUSERC							
	K	K-Base Bolt-On Type							
Service Feed	1	1Ph, 3W							
	3	3Ph, 4W							
Load Feed	1	1Ph, 3W							
	3	3Ph, 4W							
Number of Meter Sockets Available	Meter Sockets Available	1,2,3,4,5 or 6							
Maximum Tenant Circuit Breaker Amperage	125	125 A							
	225	225 A							
	400	400 A							
Special Construction	Blank	Aluminum Horizontal Cross Bus Bar							
	CA	For 240/120 Vac Delta Systems							
	CU	Copper Horizontal Cross Bus Bar							
	D	Removable Drip Hood with Indoor Top Endwall with Knockouts							
	M10	10-Inch Meter Centers							
X	1200A Copper Horizontal Cross Bus Bar								

2 METERING EQUIPMENT

Selection Information

- Review local utility requirements to ensure that metering equipment meets their standards.
- Check local utility to determine available fault current at the meter center.
- Using the SCCR table:
 - Select meter center configuration, main lugs only (Six Disconnect Rule), or remote main, main circuit breaker, or main fusible switch.
 - Read down to select SCCR equal to, or greater than desired rating.
 - Read across to select branch unit tenant circuit breaker type.
 - Continue reading across to select EZM main device type.

Table 2.16: UL Listed Meter Center Short-Circuit Current Ratings (SCCR) [1]

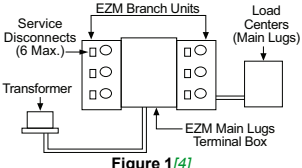
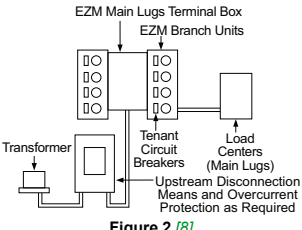
Figures	Short Circuit Current Rating (240 Vac Maximum) [2] [3]	EZM Meter Center Overcurrent Protection Devices	
		EZM Branch Unit Tenant Circuit Breaker Types Available (Branch Unit Amperes max., Number of Poles, Tenant Circuit Breaker Amperes Rating Range)	EZM Main Device with Integral Mounted Main, Remote Mounted Main or without an Upstream Mounted Main (Six Disconnect Rule)
 <p>Figure 1 [4]</p>	EZ Meter-Pak (Six Disconnect Rule Applications)—See Figure 1		
	10 kA	QO (125 A, 2P, 40–125 A) QO (225 A, 2P, 40–125 A) [5] QB (225 A, 2P or 3P, 70–225 A)	400–2000 A Main Lugs Terminal Box (Tenant Circuit Breakers used as Service Disconnects—6 maximum)
	22 kA	QO-VH (125 A, 2P, 40–125 A) QO-VH (225 A, 2P, 40–60 A) [5]	
	25 kA	QD (225 A, 2P or 3P, 70–225 A)	
	42 kA	QOH (125 A, 2P, 40–125 A) QOH (225 A, 2P, 40–60 A) [5]	
	65 kA	QG (225 A, 2P or 3P, 70–225 A)	
100 kA	QJ (225 A, 2P or 3P, 70–225 A) [6] LJL (125–400 A, 2P or 3P) [7]		
 <p>Figure 2 [8]</p>	EZ Meter-Pak 225–2000 A Main Lugs Terminal Box Applications Protected by Remote Main—See Figure 2		
	10 kA	QO (125 A, 2P, 40–125 A) QO (225 A, 2P, 40–125 A) [5] QB (225 A, 2P or 3P, 70–225 A) LJL (125–400 A, 2P or 3P) [7]	Must be protected by an upstream disconnecting means rated 10 k AIR minimum
	22 kA	QO-VH (125 A, 2P, 40–125 A) QO-VH (225 A, 2P, 40–60 A) [5] LJL (125–400 A, 2P or 3P) [7]	Must be protected by an upstream disconnecting means rated 22 k AIR minimum
	25 kA	QD (225 A, 2P or 3P, 70–225 A) LJL (125–400 A, 2P or 3P) [7]	Must be protected by an upstream disconnecting means rated 25 k AIR minimum
	42 kA	QOH (125 A, 2P, 40–125 A) QOH (225 A, 2P, 40–60 A) [5] LJL (125–400 A, 2P or 3P) [7]	Must be protected by an upstream disconnecting means rated 42 k AIR minimum
	65 kA	QO-VH (125 A, 2P, 40–125 A) QO-VH (225 A, 2P, 40–60 A) [5] QD (225 A, 2P or 3P, 70–225 A)	Must be protected by a Square D™ circuit breaker Type LA (400 A max.) or MA (1000 A max.) Rated 42 k AIR minimum
		QG (225 A, 2P or 3P, 70–225 A) LJL (125–400 A, 2P or 3P) [7]	Must be protected by an upstream disconnecting means rated 65 k AIR minimum
	100 kA	QJ (225 A, 2P or 3P, 70–225 A) [6] LJL (125–400 A, 2P or 3P) [7]	Must be protected by an upstream disconnecting means rated 100 k AIR minimum
		QO-VH (125 A, 2P, 40–125 A) QO-VH (225 A, 2P, 40–60 A) [5]	Must be protected by an upstream disconnection means with Class R (600 A max.); Class J (600 A max.); Class T6 (800 A max.); Class T3 (1200 A max.) or Class L (1200 A max.).
		QD (225 A, 2P only, 70–225 A) LJL (125–400 A, 2P or 3P) [7] QD (225 A, 3P only, 70–225 A) [6]	Must be protected by an upstream disconnection means with Class R (600 A max.); Class J (600 A max.); Class T6 (800 A max.); Class T3 (1200 A max.) or Class L (1200 A max.) fuses or by a Square D circuit breaker Type MJ (800 A max.); MHF (1000 A max.); PJ (1200 A max.); or RJ (2000 A max.) rated 100 k AIR minimum.
	EZ Meter-Pak—Main Circuit Breaker Applications—See Figure 3		
	10 kA	QO (125 A, 2P, 40–125 A) QO (225 A, 2P, 40–125 A) [5] QB (225 A, 2P or 3P, 70–225 A)	400–2000 A EZM Main Device with Type LH (400 A max.); MG or MJ (800 A max.); MH (1000 A max.); PG or PJ (1200 A max.); RG or RJ (2000 A max.)
65 kA			
100 kA	QO-VH (125 A, 2P, 40–125 A) QO-VH (225 A, 2P, 40–60 A) [5] QD (225 A, 2P or 3P, 70–225 A) LJL (125–400 A, 2P or 3P) [7]	1000 A Main Device with catalog number suffix "CBU" supplied with Type MHF circuit breaker.	
	100 kA	QD (225 A, 2P only, 70–225 A) QD (225 A, 3P only, 70–225 A) [6] LJL (125–400 A, 2P or 3P) [7]	800–2000 A EZM Main Device with Type MJ (800 A max.); MHF (1000 A max.); PJ (1200 A max.) or RJ (2000 A max.)
EZ Meter-Pak—Main Fusible Switch Applications—See Figure 3			
10 kA	QO (125 A, 2P, 40–125 A) QO (225 A, 2P, 40–125 A) [5] QB (225 A, 2P or 3P, 70–225 A)	400–1200 A EZM Main Device (1Ø or 3Ø) with Class T (300 Vac) fuses installed.	

[1] Tenant circuit breakers of same frame size having higher AIR values may replace tenant circuit breakers as listed in this table and maintain the series rating.
 [2] Meter center short circuit current rating is equal to the lowest short circuit current rating given in table for any circuit breaker installed in any meter panelboard in the meter center.
 [3] Short circuit current rating is measured at the LINE SIDE terminals of the integral mounted or remote mounted main providing overcurrent protection for the EZM metering equipment lineup.
 [4] For three-tier series ratings refer to Data Bulletin 4100DB0301.
 [5] Requires use of EZM125QQA adapter (order separately).
 [6] 3P only tenant circuit breaker(s) are limited to: 100 kA Max. at 208Y/120 Vac or 65 kA Max. at 240/120 Vac.
 [7] Supplied with factory-installed circuit breaker(s), with an adjustable trip range of 125–400 A.
 [8] For three-tier series ratings refer to Data Bulletin 4100DB0301.

Table 2.16 UL Listed Meter Center Short-Circuit Current Ratings (SCCR) [2.16] (cont'd.)

Figures	Short Circuit Current Rating (240 Vac Maximum) [9] [10]	EZM Meter Center Overcurrent Protection Devices	
		EZM Branch Unit Tenant Circuit Breaker Types Available (Branch Unit Amperes max., Number of Poles, Tenant Circuit Breaker Amperes Rating Range)	EZM Main Device with Integral Mounted Main, Remote Mounted Main or without an Upstream Mounted Main (Six Disconnect Rule)
	100 kA	QO-VH (125 A, 2P, 40–125 A) QO-VH (225 A, 2P, 40–60 A) [9] QD (225 A 2P only, 70–225 A) QD (225 A 3P only, 70–225 A) [10] LJL (125–400 A, 2P or 3P) [11]	400–1200 A EZM Main Device (1Ø or 3Ø) with Class T (300 Vac) fuses installed.

[9] Meter center short circuit current rating is equal to the lowest short circuit current rating given in table for any circuit breaker installed in any meter panelboard in the meter center.
 [10] Short circuit current rating is measured at the LINE SIDE terminals of the integral mounted or remote mounted main providing overcurrent protection for the EZM metering equipment lineup.
 [9] Requires use of EZM125QOA adapter (order separately).
 [10] 3P only tenant circuit breaker(s) are limited to: 100 kA Max. at 208Y/120 Vac or 65 kA Max at 240/120 Vac.
 [11] Supplied with factory-installed circuit breaker(s), with an adjustable trip range of 125–400 A.

1 phase, 3 wire 120/240 Vac EZ Meter-Pak™ Meter Centers
1 phase, Indoor/Rainproof, UL Listed

1200 A Main CB/Fusible Switch Devices come Standard with 2-STEP Removable Service Entrance Endwalls

Select EZM meter center short circuit current rating from [Table 2.16 UL Listed Meter Center Short Circuit Current Ratings \(SCCR\)](#), page 2-12. Using this table as a reference, make the following selections:

1. Select EZM 1Ø main device from [Table 2.17](#) or [Table 2.18](#), with an equal or higher short circuit rating than the application.
2. Select EZM 1Ø branch units from [Table 2.19](#), [Table 2.20](#) or [Table 2.21](#).
3. Select proper 2P type QO, QO-VH, QOH, QBP-TM, QDP-TM, QGP-TM or QJP-TM branch circuit breakers for use as tenant mains in branch unit from [Table 2.33](#) and [Table 2.34](#).
4. Select accessories as required from [Table 2.35](#).
5. Dimensions; see [page 2-25](#) and [page 2-26](#).

Select Main Devices—NEMA 3R Construction

Table 2.17: 1Ø Main Devices

Ampere Rating	Service Feed	Horizontal Cross Bus Rating and Bus Bar Material	Cat. No. [12]		Width (in.)	Factory-Installed Line Side Lug (Conductors per Phase and Neutral) Wire Size (AWG/kcmil)
Main Circuit Breaker (1Ø Incoming and 1Ø Outgoing)						
			65 kA	100 kA		
400	OH/UG	400 A, Al	EZM1400CB	—	18.66	(1) 1–600 or (2) 1–250
600	OH/UG	600 A, Al	EZM1600CB	—	18.66	(3) 3/0–500
800	OH/UG	800 A, Al	EZM1800CB	—	18.66	(3) 3/0–500
1000	OH/UG	1200 A, Cu	EZM11000CB	—	18.66	(3) 3/0–500
1200	OH	1200 A, Al	EZM11200GCBT [13]	EZM11200JCBT [13]	23.69	(4) 3/0–500
1200	UG	1200 A, Al	EZM11200GCBU [13][14]	EZM11200JCBU [13][14]	23.69	(4) 3/0–500
1600	UG	1200 A, Al/Cu	EZM11600GCBU [13][15]	EZM11600JCBU [13][15]	22.48	6 (Order Lugs Separately)
1600	OH/UG	1200 A, Al/Cu	EZM11600GCBC [13][15]	EZM11600JCBC [13][15]	30.19	(6) 1/0–750 or (12) 1/0–250
2000	OH/UG	1200 A, Al/Cu	—	EZM12000CB [15]	30.19	(6) 1/0–750 or (12) 1/0–250
2000	UG	1200 A, Al/Cu	—	EZM12000CBU [15]	30.19	6 (Order Lugs Separately)
Main Fusible Switches (1Ø Incoming and 1Ø Outgoing) Requires 300 Vac Class T Fuses (Order Separately)						
400	OH/UG	400 A, Al	—	EZM1400FS	18.66	(1) 1–600 or (2) 1–250
600	OH/UG	600 A, Al	—	EZM1600FS	18.50	(3) 3/0–500
600	UG	600 A, Al	—	EZM1600FSU	20.46	2 (Order Lugs Separately)
800	OH/UG	800 A, Al	—	EZM1800FS	18.50	(3) 3/0–500
800	UG	800 A, Al	—	EZM1800FSU	20.46	2 (Order Lugs Separately)
1200	OH	1200 A, Al	—	EZM11200FST	23.69	(4) 3/0–500
1200	UG	1200 A, Al	—	EZM11200FSB[14]	23.69	(4) 3/0–500
Main Lug Terminal Boxes (1Ø Incoming and 1Ø Outgoing)						
225	OH/UG	800 A, Al	—	EZM1225TB [16]	11.66	(1) 4–300
400	OH/UG	800 A, Al	—	EZM1400TB [17]	17.15	(2) 3/0–500
600	OH/UG	800 A, Al	—	EZM1600TB [17]	17.15	(2) 1/0–750 or (4) 1/0–300
800	OH/UG	800 A, Al	—	EZM1800TB [17]	18.66	(4) 3/0–500
800	OH/UG	800 A, Cu	—	EZM1800TBCU [17][18]	24.08	(4) 3/0–500
1600	OH/UG	1200 A, Al/Cu	—	EZM11600TB [17][18]	22.48	(6) 1/0–600 or (12) 1/0–300
2000	OH/UG	1200 A, Al/Cu	—	EZM12000TB [17][15]	30.19	6 (Order Lugs Separately)
Main Circuit Breaker (1Ø Incoming and 1Ø Outgoing) with Energy Reduction Maintenance (ERMS)						
1200	UG	1200 A, Al	EZM11200GCBUMS	EZM11200JCBUMS	26.39	(4) 3/0–500
1200	OH	1200 A, Cu	—	EZM11200JCBTMS	23.69	(4) 3/0–500
1600	OH/UG	1200 A, Cu	EZM11600GCBCMS	EZM11600JCBCMS	30.19	(6) 1/0–750 or (12) 1/0–250
1600	UG	1200 A, Al	EZM11600GCBUMS	EZM11600JCBUMS	30.19	6 (Order Lugs Separately)
2000	OH/UG	1200 A, Cu	EZM12000CBMS	—	30.19	(6) 1/0–750 or (12) 1/0–250
2000	UG	1200 A, Al	EZM12000CBUMS	—	30.19	6 (Order Lugs Separately)



[12] Does not meet EUSERC requirements.

[13] Ampere rating of the circuit breaker supplied with this device can be changed to a LOWER value in the field by changing the setting on the circuit breaker.

[14] For field installed Lug Landing Kit, order catalog number EZM1200ULL. Order lugs separately.

[15] Supplied with copper horizontal bus bars and aluminum vertical bus bars.

[16] 225 A terminal box supplied with isolated neutral that cannot be bonded NOT suitable for use on the LINE side of service equipment.

[17] Terminal box is suitable for use on LINE or LOAD side of service equipment. Supplied with isolated neutral and provided with neutral bonding kit for use as required. Refer to [page 2-12](#) for appropriate short circuit current ratings.

[18] Feed-thru lug kit available, see [page 2-23](#).

Table 2.18: 1Ø Main Devices, EUSERC

	Ampere Rating	Service Feed	Horizontal Cross Bus Rating and Bus Bar Material	Cat. No.		Width (in.)	Factory-Installed Lug Landings for use with Crimp-Type Lugs (2-Hole Mounting) Qty. per Phase and Neutral, except non-EUSERC. [19]
 <p>EZM11200GCBE</p>	Main Circuit Breakers (1Ø Incoming and 1Ø Outgoing)[19]						
				65 kA	100 kA		
	400	UG	400 A, Al	EZM1400CBU [20]	—	20.46	1 (Order Lugs Separately)
	600	UG	600 A, Al	EZM1600CBU [20]	—	26.19	2 (Order Lugs Separately)
	800	UG	800 A, Al	EZM1800CBU [20]	—	26.19	2 (Order Lugs Separately)
	1000	UG	1200 A, Cu	EZM11000CBU [21]	—	34.19	2 (Order Lugs Separately)
	1200	UG	1200 A, Al	EZM11200GCBE [22]	EZM11200JCBE [22]	32.39	3 (Order Lugs Separately)
	Main Fusible Switches (1Ø Incoming and 1Ø Outgoing) [19] Requires 300 Vac Class T Fuses (Order Separately)						
	400	UG	400 A, Al	—	EZM1400FSU	20.46	1 (Order Lugs Separately)
	600	UG	600 A, Al	—	EZM1600FSE	18.36	2 (Order Lugs Separately)
	1200	UG	1200 A, Al	—	EZM11200FSE	32.39	3 (Order Lugs Separately)
	Main Lug Terminal Boxes (1Ø Incoming and 1Ø Outgoing)						
	400	UG	800 A, Al	—	EZM1400TBU [23]	17.16	1 (Order Lugs Separately)
	800	UG	800 A, Al	—	EZM1800TBU [23]	25.16	2 (Order Lugs Separately)
	1200	UG	1200 A, Al/Cu	—	EZM11200TBU [23]	33.16	3 (Order Lugs Separately)
	Main Circuit Breaker (1Ø Incoming and 1Ø Outgoing) with Energy Reduction Maintenance Switch (ERMS)						
	1200	UG	1200 A, Al	EZM11200GCBEMS	EZM11200JCBEMS	32.39	3 (Order Lugs Separately)

[19] For mechanical lugs (3/0 AWG–600 kcmil) order kit CMEK4. Kit includes 4 lugs only. Multiple kits may be required, consult factory. For crimp-type lugs refer to Anderson Electrical Connector Products Catalog AEC-40R.

[20] Available by special order with main circuit breaker supplied with other standard ampere ratings, consult local Field Office (allow 6 weeks for delivery).

[21] Supplied with copper horizontal bus bars and aluminum vertical bus bars.

[22] Ampere rating of the circuit breaker supplied with this device can be changed to a LOWER value in the field by changing the setting on the circuit breaker.

[23] Terminal box is suitable for use on LINE or LOAD side of service equipment. Supplied with isolated neutral and provided with neutral bonding kit for use as required. Refer to page 2-12 for appropriate short circuit current ratings.

1 Phase Branch Devices—NEMA 3R Construction

Table 2.19: Branch Units—1Ø Incoming and 1Ø Outgoing



System Type	Number of Meter Sockets	Horizontal Cross Bus Rating and Bus Bar Material	Ring Type 4-Jaw Meter Socket without Bypass [24]		Ringless Type 5-Jaw Meter Socket without Bypass		Ringless Type 5-Jaw Meter Socket with Horn Bypass		Ringless Type 5-Jaw Meter Socket with Lever Bypass	
			Cat. No.	Width (in.)	Cat. No.	Width (in.)	Cat. No.	Width (in.)	Cat. No.	Width (in.)
125 A Maximum (Order Type QO, QO-VH or QOH Circuit Breakers Separately) [25][26]										
 EZMH114125	3	800 A Al	EZM113125 [27]	12.25	EZMR113125 [27]	12.25	EZMH113125 [27]	12.25	EZML113125 [27]	15.56
		1200 A Cu	—		—		—		—	
	4	800 A Al	EZM114125 [27]		EZMR114125 [27]		EZMH114125 [27]		EZML114125 [27]	
		1200 A Cu	EZM114125CUX		EZMR114125CUX		EZMH114125CUX		EZML114125CUX	
	5	800 A Al	EZM115125 [27]		EZMR115125 [27]		EZMH115125 [27]		EZML115125 [27]	
		1200 A Cu	EZM115125CUX		EZMR115125CUX		EZMH115125CUX		EZML115125CUX	
6	800 A Al	EZM116125 [27]	EZMR116125 [27]	EZMH116125 [27]	EZML116125 [27]					
1200 A Cu	EZM116125CUX	EZMR116125CUX	—	EZML116125CUX	—					
225 A Maximum Branch Units (Order Type QBP-TM, QDP-TM, QGP-TM or QJP-TM Circuit Breakers Separately) [28]										
 EZMT112225	2	800 A Al	EZM112225 [27]	17.38	EZMR112225 [27]	17.38	EZMH112225 [27]	17.38	—	—
		800 A Al	EZM113225 [27]		EZMR113225 [27]		EZMH113225 [27]		—	—
	1200 A Cu	EZM113225CUX	—		—		—		—	
	3	800 A Al	EZM114225 [27]		EZMR114225 [27]		EZMH114225 [27]		—	—
		1200 A Cu	EZM114225CUX		EZMR114225CUX		EZMH114225CUX		—	—
	4	1200 A Al/Cu	EZM115225		EZMR115225		EZMH115225		—	—
1200 A Cu		EZM115225CU	EZMR115225CU	—	—	—				
6	1200 A Cu	EZM116225	EZMR116225	EZMH116225	—	—				

Table 2.20: Branch Units—225 A Maximum Commercial (Order Type QBP-TM, QDP-TM, QGP-TM or QJP-TM Circuit Breakers Separately) [29]

System Type	Number of Meter Sockets	Horizontal Cross Bus Rating and Bus Bar Material	Ringless Type 5-Jaw Meter Socket with Lever Bypass and Jaw Release		Ringless Type 5-Jaw Meter Socket with Test Block Bypass. Meets EUSERC Requirements	
			Cat. No.	Width (in.)	Cat. No.	Width (in.)
 EZMT111225	1	1200 A Al/Cu	EZML112225	19.44	EZMT112225 [30]	22.42
		1200 A Al/Cu	EZML112225D [31]		—	—
	2	1200 A Al/Cu	EZML112225	19.44	EZMT112225 [30]	22.42
		1200 A Al/Cu	EZML112225D [31]		—	—
	3	1200 A Al/Cu	EZML113225	19.44	EZMT113225 [30][32]	22.42
		1200 A Al/Cu	EZML114225		—	—
4	1200 A Al/Cu	EZML114225CU	19.44	—	—	
	1200 A Al/Cu	EZML114225D [31]		—	—	

Table 2.21: Branch Units—400 A Maximum Commercial

System Type	Number of Meter Sockets	Main Cross Bus Rating and Bus Bar Material	Ringless Type 5-Jaw Meter Socket with Lever Bypass and Jaw Release. Includes Factory-Installed 400 A Type L.J.L. Circuit Breaker [33] [34]		Ringless Type K Bolt-on 4-Jaw Meter Socket with Manual Bypass. Includes Factory-Installed 400 A Type L.J.L. Circuit Breaker [34]	
			Cat. No.	Width (in.)	Cat. No.	Width (in.)
1Ø3W 120/240 Vac 2P Branch Circuit Breakers	1	1200 A Cu	EZML111400	23.21	EZMK111400	27.56
	2	1200 A Cu	EZML112400	23.21	—	27.56

[24] Snap-on aluminum sealing rings supplied as standard.
 [25] Supplied with removable drip hood and equipped with an indoor top endwall with knockouts provided.
 [26] Compatible with a branch terminal box accommodating a maximum conductor size of 300 kcmil when voltage drop calculations require sizes over 2/0, see Table 1.35: Accessories, page 2-23.
 [27] For 1200 A main cross bus add suffix "X" to catalog number (Example: EZM314125X). Allow 6 weeks for delivery.
 [28] Type QO, QO-VH and QOH branch circuit breakers (40–60 A) may be installed with use of EZM125QOA adapter kits, see page 2-23.
 [29] 2P Type QO (40–125 A, 10 kA max. meter center SCCR) or QO-VH and QO-H (40–60 A, 100 kA max. meter center SCCR) may be installed using EZM125QOA adapter kit, see page 2-23.
 [30] Supplied with bondable neutral, suitable for use as service equipment. Use main lugs terminal box type EZM-TBU for Six Disconnect Rule applications to feed this device. Supplied with copper horizontal bus bars and aluminum vertical bus bars.
 [31] Supplied with removable drip hood and equipped with an indoor top endwall with knockouts provided.
 [32] Does not meet EUSERC 48 in. minimum / 75 in. maximum meter height requirements for outdoor installations. The bottom meter socket is 37 inches above ground when the device is mounted with the top meter socket at 75 inches above ground. EUSERC indoor requirements are 36 in. minimum / 75 in. maximum.
 [33] Supplied with Class 320 lever bypass meter socket. Utilizes anti-inversion clip kit MMLRK, if required, refer to page 2-23.
 [34] L.J.L. circuit breaker has adjustable trip settings from 125-400 A. Use seal kit MICROTUSEAL, if required. L.J.L. circuit breaker terminal lug kit factory-installed and accommodates (2) 2/0-500 kcmil Cu-Al per phase. Alternate lug kit AL400L61K3 for L.J.L. circuit breaker is available, see page 2-23.

3Ø4W 208Y/120 Vac or 240/120 Vac Delta EZ Meter-Pak™ Meter Centers—3Ø Indoor/Rainproof, UL Listed

1200 A Main CB/Fusible Switch Devices come Standard with 2-STEP Removable Service Entrance Endwalls

Select EZM meter center short circuit current rating from Table 2.16. Using this table as a reference, make the following selections:

1. Select 3Ø EZM main device below with an equal or higher short circuit rating than the application from Table 2.22 and Table 2.23.
2. Select EZM 3Ø branch units from Table 2.24, Table 2.25, and Table 2.26.
3. Select proper 2P type QO, QO-VH, QOH, QBP-TM, QDP-TM, QGP-TM or QJP-TM or 3P QBP-TM, QDP-TM, QGP-TM or QJP-TM branch circuit breakers for use as tenant mains in branch unit; from Table 2.33 and Table 2.34.
4. Select accessories as required, from page 2-23.
5. Dimensions see page 2-25.

3 Phase Main Devices—NEMA 3R Construction

Table 2.22: 3Ø Main Devices

	Ampere Rating	Service Feed	Horizontal Cross Bus Rating and Bus Bar Material	Cat. No. [35]		Width (in.)	Factory-Installed Line Side Lug (Conductors per Phase and Neutral) Wire Size (AWG-kcmil)	
 <p>EZM31200FST</p>	Main Circuit Breakers (3Ø Incoming and 3Ø Outgoing)							
	65 kA Short Circuit Current Rating (400–1600 A Max.), 100 kA Short Circuit Current Rating (2000 A Max.)							
				Short Circuit Rating		65 kA	100 kA	
	400	OH/UG	400 A, Al	EZM3400CB	—	18.66	(1) 1–600 or (2) 1–250	
	600	OH/UG	600 A, Al	EZM3600CB	—	18.66	(3) 3/0–500	
	800	OH/UG	800 A, Al	EZM3800CB	—	18.66	(3) 3/0–500	
	1000	OH/UG	1200 A, Al	EZM31000CB	—	18.66	(3) 3/0–500	
	1200	OH	1200 A, Al	EZM31200GCBT [36]	—	23.69	(4) 3/0-500	
	1200	UG	1200 A, Al	EZM31200GCBU [37] [36]	EZM31200JCBU [37] [36]	23.69	(4) 3/0-500	
	1600	OH/UG	1200 A, Al/Cu	EZM31600GCBC [36] [38]	EZM31600JCBC [36] [38]	30.19	(6) 1/0–750 or (12) 1/0–250	
	1600	UG	1200 A, Al/Cu	EZM31600GCBU [36] [38]	EZM31600JCBU [36] [38]	30.19	6 (Order Lugs Separately)	
	2000	OH/UG	1200 A, Al/Cu	—	EZM32000CB [38]	30.19	(6) 1/0–750 or (12) 1/0–250	
	2000	UG	1200 A, Al/Cu	—	EZM32000CBU [38]	30.19	6 (Order Lugs Separately)	
	Main Fusible Switches (3Ø Incoming and 3Ø Outgoing) Requires 300 Vac Class T Fuses (Order Separately)							
	400	OH/UG	400 A, Al	—	EZM3400FS	18.66	(1) 1–600 or (2) 1–250	
	600	OH/UG	600 A, Al	—	EZM3600FS	18.66	(3) 3/0–500	
	800	OH/UG	800 A, Al	—	EZM3800FS	18.66	(3) 3/0–500	
	1200	OH	1200 A, Al	—	EZM31200FST	23.69	(4) 3/0–500	
	1200	UG	1200 A, Al	—	EZM31200FSB [37]	23.69	(4) 3/0-500	
	Main Lug Terminal Boxes (3Ø Incoming and 3Ø Outgoing)							
	225	OH/UG	800 A, Al	—	EZM3225TB [39]	11.66	(1) 4–300	
	400	OH/UG	800 A, Al	—	EZM3400TB [40]	17.15	(2) 3/0–500	
	600	OH/UG	800 A, Al	—	EZM3600TB [40]	17.15	(2) 1/0–750 or (4) 1/0–300	
	800	OH/UG	800 A, Al	—	EZM3800TB [40]	18.66	(4) 3/0–500	
	800	OH/UG	800 A, Cu	—	EZM3800TBCU [40] [41]	24.08	(4) 3/0–500	
	1600	OH/UG	1200 A, Al/Cu	—	EZM31600TB [38] [41] [40]	22.48	(6) 1/0-600 or (12) 1/0-300	
	2000	OH/UG	1200 A, Cu	—	EZM32000TB [40]	30.19	6 (Order Lugs Separately)	
	Main Circuit Breakers (3Ø Incoming and 3Ø Outgoing) with Energy Reduction Maintenance Switch (ERMS)							
1200	OH	1200 A, Cu	EZM31200GCBTMS	EZM31200JCBTMS	23.69	(4) 3/0–500		
1200	UG	1200 A, Cu	EZM31200GCBUMS	EZM31200JCBUMS	23.69	(4) 3/0–500		
1600	OH/UG	1200 A, Cu	EZM31600GCBCMS	EZM31600JCBCMS	30.19	(6) 1/0–750 or (12) 1/0–250		
1600	UG	1200 A, Cu	EZM31600GCBUMS	EZM31600JCBUMS	30.19	6 (Order Lugs Separately)		
2000	OH/UG	1200 A, Cu	EZM32000CBMS	—	30.19	(6) 1/0–750 or (12) 1/0–250		
2000	UG	1200 A, Cu	EZM32000CBUMS	—	30.19	6 (Order Lugs Separately)		

[35] Does not meet EUSERC requirements.

[36] Ampere rating of the circuit breaker supplied with this device can be changed to a LOWER value in the field by changing the setting on the circuit breaker.

[37] For field installed Lug Landing Kit order catalog number EZM1200ULL.

[38] Supplied with copper horizontal bus bars and aluminum vertical bus bars.

[39] 225 A terminal box supplied with isolated neutral that cannot be bonded.

[40] Terminal box is suitable for use on LINE or LOAD side of service equipment. Supplied with isolated neutral and provided with neutral bonding kit for use as required. Refer to page 2-12 for appropriate short circuit current ratings.

[41] Feed-thru lug kit available, see Table 2.35

Table 2.23: 3Ø Main Devices, EUSERC

	Ampere Rating	Service Feed	Horizontal Cross Bus Rating and Bus Bar Material	Cat. No.		Width (in.)	Factory-Installed Lug Landings For use with Crimp-Type Lugs (2-Hole Mounting) Qty. per Phase and Neutral, except non-EUSERC device. [42]
 <p>EZM31200GCBEMS</p>	Main Circuit Breakers (3Ø Incoming and 3Ø Outgoing)						
	Short Circuit Rating			65 kA	100 kA		
	400	UG	400 A, Al	EZM3400CBU [43]	—	20.46	1 (Order Lugs Separately)
	600	UG	600 A, Al	EZM3600CBU [43]	—	26.19	2 (Order Lugs Separately)
	800	UG	800 A, Al	EZM3800CBU [43]	—	26.19	2 (Order Lugs Separately)
	1000	UG	1200 A, Cu	EZM31000CBU	—	34.19	3 (Order Lugs Separately)
	1200	UG	1200 A, Al	EZM31200GCBE [44]	—	32.39	3 (Order Lugs Separately)
	Main Fusible Switches (3Ø Incoming and 3Ø Outgoing) Requires 300 Vac Class T Fuses (Order Separately)						
	400	UG	400 A, Al	—	EZM3400FSU	20.46	1 (Order Lugs Separately)
	600	UG	600 A, Al	—	EZM3600FSU	26.19	2 (Order Lugs Separately)
	800	UG	800 A, Al	—	EZM3800FSU	26.19	2 (Order Lugs Separately)
	1200	UG	1200 A, Al	—	EZM31200FSE	32.39	3 (Order Lugs Separately)
	Main Lugs Terminal Boxes (3Ø Incoming and 3Ø Outgoing)						
	400	UG	400 A, Al	—	EZM3400TBU [45]	17.16	1 (Order Lugs Separately)
	800	UG	800 A, Al	—	EZM3800TBU [45]	25.16	2 (Order Lugs Separately)
	1200	UG	1200 A, Cu	—	EZM31200TBU [45]	33.16	3 (Order Lugs Separately)
	Main Circuit Breaker (3Ø Incoming and 3Ø Outgoing) with Energy reduction Maintenance Switch (ERMS)						
	1200	UG	1200 A, Cu	EZM31200GCBEMS	EZM31200JCBEMS	32.39	3 (Order Lugs Separately)

2 METERING EQUIPMENT

[42] For mechanical lugs (3/0 AWG–600 kcmil) order kit CMEK4. Kit includes 4 lugs only. Multiple kits may be required, consult factory. For crimp-type lugs refer to Anderson Electrical Connector Products Catalog AEC-40R.

[43] Available by special order with main circuit breaker supplied with other standard ampere ratings, consult your nearest Field Sales Office (allow 6 weeks for delivery).

[44] Ampere rating of the circuit breaker supplied with this device can be changed to a LOWER value in the field by changing the setting on the circuit breaker.

[45] Terminal box is suitable for use on LINE or LOAD side of service equipment. Supplied with isolated neutral and provided with neutral bonding kit for use as required. Refer to page 2-12 for appropriate short circuit current ratings.



3 Phase Branch Devices—NEMA 3R Construction

Table 2.24: Branch Units—3Ø Incoming and 1Ø Outgoing

System Type	Number of Meter Sockets	Horizontal Cross Bus Rating [46] and Bus Bar Material	Ring Type 5-Jaw Meter Socket without Bypass [47]		Ringless Type 5-Jaw Meter Socket without Bypass		Ringless Type 5-Jaw Meter Socket with Horn Bypass		Ringless Type 5-Jaw Meter Socket with Lever Bypass	
			Cat. No	Width (in.)	Cat. No	Width (in.)	Cat. No	Width (in.)	Cat. No	Width (in.)
125 A Maximum (Order Type QO, QO-VH or QOH Circuit Breakers Separately) [48] [49]										
3Ø4W 208Y/120 Vac 5-Jaw-Meter Socket 2P Branch Circuit Breakers	3	800 A Al	EZM313125 [46]	12.25	EZMR313125 [46]	12.25	EZMH313125 [46]	12.25	EZML313125 [46]	15.56
		800 A Al	EZM313125M10 [50]		—		—		—	
		1200 A Cu	EZM313125CUX		EZMR313125CUX		EZMH313125CUX		EZML313125CUX	
	4	800 A Al	EZM314125 [46]		EZMR314125 [46]		EZMH314125 [46]		EZML314125 [46]	
		800 A Al	EZM314125M10 [50]		—		—		—	
		1200 A Cu	EZM314125CUX		EZMR314125CUX		EZMH314125CUX		EZML314125CUX	
	5	800 A Al	EZM315125 [46]		EZMR315125 [46]		EZMH315125 [46]		EZML315125 [46]	
		800 A Al	EZM315125M10 [50]		—		—		—	
		1200 A Cu	EZM315125CUX		EZMR315125CUX		EZMH315125CUX		EZML315125CUX	
	6	800 A Al	EZM316125 [46]		EZMR316125 [46]		EZMH316125 [46]		EZML316125 [46]	
		800 A Al	EZM316125M10 [50]		—		—		—	
		1200 A Cu	EZM316125CUX		EZMR316125CUX		EZMH316125CUX		EZML316125CUX	
225 A Maximum (Order Type QBP-TM, QDP-TM, QGP-TM or QJP-TM Circuit Breakers Separately) [51]										
3Ø4W 208Y/120 Vac 5-Jaw-Meter Socket 2P Branch Circuit Breakers	2	800 A Al	EZM312225 [46]	17.38	EZMR312225 [46]	17.38	EZMH312225 [46]	17.38	—	—
		800 A Al	EZM313225 [46]		—		—		—	
		1200 A Cu	EZM313225CUX		—		—		—	
	4	800 A Al	EZM314225 [46]		EZMR314225 [46]		EZMH314225 [46]		—	
		1200 A Cu	EZM314225CUX		EZMR314225CUX		EZMH314225CUX		—	
		1200 A Al/Cu	EZM315225		EZMR315225		EZMH315225		—	
	5	1200 A Cu	EZM315225CU		EZMR315225CU		EZMH315225CU		—	
		1200 A Al/Cu	EZM316225		EZMR316225		EZMH316225		—	
		1200 A Cu	EZM316225CU		EZMR316225CU		EZMH316225CU		—	
	6	1200 A Al/Cu	EZM316225CA		EZMR316225CA		EZMH316225CA		—	
		1200 A Al/Cu	EZM316225CA		EZMR316225CA		EZMH316225CA		—	
		1200 A Al/Cu	EZM316225CA		EZMR316225CA		EZMH316225CA		—	

METERING EQUIPMENT 2

Table 2.25: Branch Units—225 A Maximum Commercial

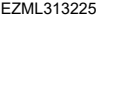
System Type	Number of Meter Sockets	Horizontal Cross Bus Rating and Bus Bar Material	Ringless Type Meter Socket without Bypass		Ringless Type Meter Socket with Lever Bypass and Jaw Release		Ring Type Meter Socket with Test Block Bypass. Meets EUSERC Requirements			
			Cat. No.	Width (in.)	Cat. No.	Width (in.)	Cat. No.	Width (in.)		
3Ø Incoming and 1Ø Outgoing [52] (Order Type QBP-TM, QDP-TM, QGP-TM or QJP-TM circuit breakers separately) [53]										
 EZMT311225	3Ø4W 208Y/120 Vac 5-Jaw Meter Sockets 2P Branch Circuit Breakers	1	1200 A Al/Cu	—	—	—	EZMT311225 [54]	22.42		
			1200 A Al/Cu	—	—	EZML312225	19.44	EZMT312225 [54]	22.42	
		2	1200 A Cu	—	—	EZML312225CU	19.44	—	—	
			1200 A Al/Cu	—	—	EZML312225D [48]	19.44	—	—	
	 EZML313225	3Ø4W 240/120 Vac Delta or 208Y/120 Vac 7-Jaw Meter Socket 3P Branch Circuit Breakers	3	1200 A Al/Cu	—	—	EZML313225	EZMT313225 [54][55]	22.42	
				1200 A Al/Cu	—	—	EZML313225D [48]	19.44	—	—
			4	1200 A Al/Cu	—	—	EZML314225	19.44	—	—
				1200 A Cu	—	—	EZML314225CU	19.44	—	—
3Ø Incoming and 3Ø Outgoing (Order QBP-TM, QDP-TM, QGP-TM or QJP-TM circuit breakers separately, see [53])										
 EZMT311225 Without Cover	3Ø4W 240/120 Vac Delta or 208Y/120 Vac 7-Jaw Meter Socket 3P Branch Circuit Breakers	1	1200 A Al/Cu	—	—	EZML331225	EZMT331225 [54]	22.42		
			1200 A Cu	—	—	EZML331225CU	19.44	—	—	
		2	1200 A Al/Cu	—	—	EZML331225D [48]	19.44	—	—	
			1200 A Al/Cu	EZMR332225	19.44	EZML332225	19.44	EZMT332225 [54]	22.42	
		3	1200 A Cu	—	—	EZML332225CU	19.44	—	—	
			1200 A Al/Cu	EZMR332225	19.44	EZML333225	19.44	EZMT333225 [54][55]	22.42	
	 EZML334225	3Ø4W 240/120 Vac Delta or 208Y/120 Vac 7-Jaw Meter Socket 3P Branch Circuit Breakers	4	1200 A Al/Cu	—	—	EZML333225CU	19.44	—	
				1200 A Al/Cu	EZMR334225	19.44	EZML334225	19.44	—	—
			4	1200 A Cu	—	—	EZML334225CU	19.44	—	—
				1200 A Al/Cu	—	—	EZML334225D [48]	19.44	—	—

[46] For 1200 A main cross bus, add suffix "X" to catalog number. Example: EZMR313125X.. Allow 6 weeks for delivery.
 [47] Snap-On aluminum sealing rings supplied as standard.
 [48] Supplied with removable drip hood and equipped with an indoor top endwall with knockouts provided.
 [49] Compatible with a branch terminal box accommodating a maximum conductor size of 300 kcmil when voltage drop calculations require sizes over 2/0, see Table 1.35: Accessories, page 2-23.
 [50] Distance between meter sockets as measured from centerline to centerline is 10 inches.
 [51] 2P Type QO (40–125 A, 10 kA max. meter center SCCR) or QO-VH and QO-H (40–60 A, 100 kA max. meter center SCCR) may be installed using EZM125QOA adapter kit, see page 2-23.
 [52] For 240/120 Vac Delta Systems add Suffix "CA" to catalog number (Example: EZM316125CA). All meter sockets are phased A and C only. Price remains the same as the base catalog number. Order only branch units, not stocked in PDS (6-week delivery).
 [53] 2P Type QO (40–125 A, 10 kA max. meter center SCCR) or QO-VH and QO-H (40–60 A, 100 kA max. meter center SCCR) may be installed using EZM125QOA adapter kit, refer to .
 [54] Supplied with bondable neutral, suitable for use as service equipment. Use main lugs terminal box type EZM-TBU for Six Disconnect Rule applications to feed this device. Supplied with copper horizontal bus bars and aluminum vertical bus bars.
 [55] Does not meet EUSERC 48 in. minimum / 75 in. maximum meter height requirements for outdoor installations. The bottom meter socket is 37 inches above ground when the device is mounted with the top meter socket at 75 inches above ground. EUSERC indoor requirements are 36 in. minimum / 75 in. maximum.
 For 400 A maximum Commercial Branch Units, see page 2-20.



Table 2.26: Branch Units—400 A Maximum Commercial

System Type	Number of Meter Sockets	Horizontal Cross Bus Rating	Ringless Type Meter Socket with Lever Bypass and Jaw Release—Includes Factory-Installed 400 A Type LJL Circuit Breaker. [56], [57]		Ringless Type K Bolt-on Meter Socket with Manual Bypass—Includes Factory-Installed 400 A Type LJL Circuit Breaker. [57]	
			Cat. No.	Width (in.)	Cat. No.	Width (in.)
3Ø Incoming and 1Ø Outgoing [58]						
3Ø4W 208Y/120 Vac 5-Jaw Meter Socket 2P Circuit Breakers	1	1200 A Cu	EZML311400	23.21	—	—
	2	1200 A Cu	EZML312400	23.21	—	—
3Ø Incoming and 3Ø Outgoing						
3Ø4W 240/120 Vac Delta or 208Y/120 Vac 7-Jaw Meter Socket 3P Circuit Breakers	1	1200 A Cu	EZML331400	23.21	EZMK331400	27.56
	2	1200 A Cu	EZML332400	23.21	EZMK332400	27.56

3Ø–1Ø OUT EZM Branch Unit Phase Balancing Flexibility

The major benefit of factory phase balancing is that most jobs will not require field phase balancing. To see if meter socket phase balancing in the field is required, do the following (refer to wiring diagram for complete instructions):

Starting Position	Possible Ending Position (By moving only one "Z" connector)	
AØ and BØ	can be changed to	AØ and CØ
AØ and CØ	can be changed to	AØ and BØ or BØ and CØ
BØ and CØ	can be changed to	AØ and CØ

- Determine if the load in amperes on each phase of the transformer using handle rating of tenant circuit breakers installed at each number of meter sockets. Use Phase Balancing Chart to determine total number of connections each meter socket makes on each phase of transformer.
- If phase balancing is required, determine which meter sockets should be changed to properly phase balance metering equipment lineup.
- Once meter socket(s) is selected to be phase balanced, remove individual meter socket cover from each meter socket to be phase balanced. The vertical bus bars running top to bottom in the branch unit behind each meter socket are phased: **AØ, BØ, CØ, left to right**.
- By moving only the line side meter socket "Z" shaped connectors per meter socket to be changed, phase balancing can easily be accomplished on-site:

Table 2.27: Example: To change an AØ and CØ meter socket to a BØ and CØ socket

<p>Starting Position Meter Socket Phasing: AØ and CØ</p>	<p>Step 2: Loosen hex nut from AØ line side meter socket jaw and slide "Z" connector down to free connector from stud.</p>	<p>Step 1: Remove hex nut from AØ line side connection to vertical bus.</p>
<p>Step 3: Rotate "Z" connector to right and align with stud on BØ vertical bus.</p>	<p>Step 4: Slide "Z" connector up to engage stud on BØ vertical bus. Torque hex nut of meter socket jaw to 75 lb-in (8 N·m).</p>	<p>Step 6: Replace hex nut (removed in Step 1) onto stud of BØ vertical bus and torque to 75 lb-in (9 N·m). Phase balancing of meter socket is complete: BØ and CØ.</p>

[56] Supplied with Class 320 lever bypass meter socket. Use anti-inversion clip kit, catalog number MMLRK, if required. See page 2-23.
 [57] LJL circuit breaker has adjustable trip settings from 125-400 A. Use seal kit MICROTUSEAL, if required. LJL circuit breaker terminal lug kit factory-installed and accommodates (2) 2/0-500 kcmil Cu-Al per phase. Alternate lug kit AL400L61K3 for LJL circuit breaker is available, see page 2-23.
 [58] For 240/120 Vac Delta Systems add Suffix "CA" to catalog number (Example: EZML311400CA). All meter sockets are phased A and C only. Price remains the same as the base catalog number. "Order only" branch units, not stocked in PDS (4-6 week delivery). Order point Lexington.

EZM Main with Busway Side Tap

EZ Meter-Pak™ metering equipment is available for use in high rise applications for connection to 800–5000 A I-Line™ or I-Line II plug-in busway installed as a vertical riser. Three phase only EZM main devices in the form of a main circuit breaker or main fusible switch are available with an integral busway tap extending from the right or left side of the main device and phased to align with the busway for either neutral front or neutral back installations.

Busway Mains, 3Ø only (Indoor only) ordering instructions:

- Step 1: Determine height to center line of busway plug-in opening, check local utility requirements for minimum and maximum meter socket heights.
- Step 2: Determine side of EZM main section for busway tap to extend from (busway tap is an integral part of the main and extends to the left or right on the EZM device as viewed from the front).
- Step 3: Check phasing of busway riser to insure that it matches phasing of busway tap on main section (indicated as neutral front or neutral back as viewed from the front).
- Step 4: Select Cat. No. from tables below.
- Step 5: Busway main devices are build to order specials and require 4 to 6 weeks for delivery.

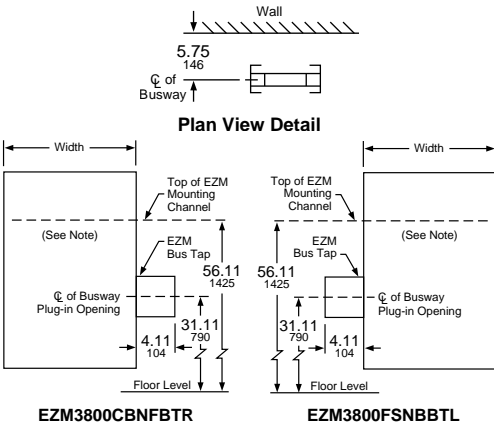

Table 2.28: EZM Busway Side Tap Mains Devices

Number Segment	Character	Description	EZM	3	800	CB	NF	BTR
Device Name	EZM	EZ Meter-Pak Meter Center						
Service Feed	3	3Ph, 4W						
Mains Rating	400 A							
	600 A							
	800 A							
	1000 A							
	1200 A							
Main Type	CB	Main Circuit Breaker						
	FS	Main Fusible Switch						
	GB	Main Circuit Breaker (65 kAIC)						
	JB	Main Circuit Breaker (100KAIC)						
Neutral Position	NF	Neutral Front						
	NB	Neutral Back						
Bus Tap Location	BTL	Bus Tap Left						
	BTR	Bus Tap Right						

This table is for interpreting existing part numbers only. All possible combinations are not available.

Table 2.29: 1200 A EZM Mains with Busway Side Tap (Three Phase Only—Note positioning left or right below)

Ampere Rating	Width (in.)	Horizontal Cross Bus Rating	Busway to LEFT of EZM Metering Equipment Lineup		Busway to RIGHT of EZM Metering Equipment Lineup	
			Neutral Front	Neutral Back	Neutral Front	Neutral Back
Main Circuit Breaker with Busway Tap						
65,000 RMS Symmetrical Amperes Maximum Short Circuit Current Rating						
400	18.66	400 A Al	EZM3400CBNFBTL	EZM3400CBNBBTL	EZM3400CBNFBTR	EZM3400CBNBBTR
600	18.66	600 A Al	EZM3600CBNFBTL	EZM3600CBNBBTL	EZM3600CBNFBTR	EZM3600CBNBBTR
800	18.66	800 A Al	EZM3800CBNFBTL	EZM3800CBNBBTL	EZM3800CBNFBTR	EZM3800CBNBBTR
1000	18.66	1000 A Al	EZM31000CBNFBTL [59]	EZM31000CBNBBTL [59]	EZM31000CBNFBTR [59]	EZM31000CBNBBTR [59]
1200	23.36	1200 A Cu	EZM31200GBNFBTL [59]	EZM31200GBNBBTL [59]	EZM31200GBNFBTR [59]	EZM31200GBNBBTR [59]
100,000 RMS Symmetrical Amperes Maximum Short Circuit Current Rating						
1200	23.36	1200 A Cu	EZM31200JBNFBTL [59]	EZM31200JBNBBTL [59]	EZM31200JBNFBTR [59]	EZM31200JBNBBTR [59]
Main Fusible Switch with Busway Tap Requires Class T (300 Vac) Fuses - Order Separately						
100,000 RMS Symmetrical Amperes Maximum Short Circuit Current Rating						
400	18.66	400 A Al	EZM3400FSNFBTL	EZM3400FSNBBTL	EZM3400FSNFBTR	EZM3400FSNBBTR
600	18.66	600 A Al	EZM3600FSNFBTL	EZM3600FSNBBTL	EZM3600FSNFBTR	EZM3600FSNBBTR
800	18.66	800 A Al	EZM3800FSNFBTL	EZM3800FSNBBTL	EZM3800FSNFBTR	EZM3800FSNBBTR
1200	22.36	1200 A Cu	EZM31200FSNFBTL [59]	EZM31200FSNBBTL [59]	EZM31200FSNFBTR [59]	EZM31200FSNBBTR [59]

NOTE: Dimensions shown position the centerline of top meter socket of a 125 A, 5-Gang or 6-Gang branch unit at 72" above floor level. Check with utility to meet local requirements.

Busway Transition Section

EZM busway transition section provides no overcurrent protection for the downstream EZM branch units.

Tenant main circuit breakers in these branch units must be selected as "fully rated" equipment. (Examples: QO for 10 kA, QO-VH for 22 kA or QOH for 42 kA.)

Table 2.30: EZM Busway Transition Sections (3Ø only)

Ampere Rating	I-Line™ Busway location	Neutral Front	Neutral Back	Width (in.)
1200	RIGHT of EZM Transition Section	EZM3BUSRF	EZM3BUSRB	12.00
1200	LEFT of EZM Transition Section	EZM3BUSLF	EZM3BUSLB	12.00

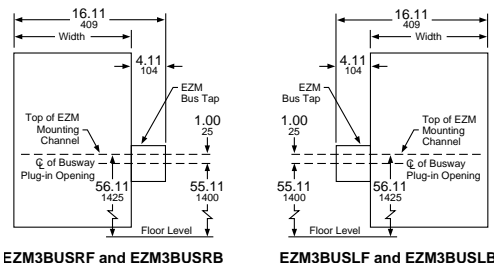

[59] Requires use of branch units supplied with 1200 A horizontal cross bus.



EZM Main with Center-Mounted Busway Tap

The EZM Main with center-mounted busway tap is a space-saving design for high rise applications that is installed as an integral component of the vertical riser busway and allows standard EZM branches to be mounted from both sides. See online digest updates for availability or contact your local field sales office for additional information

EZM Busway Center Tap Mains

The EZM Busway Center Tap mains offer provides a convenient space saving method for connecting EZM Branch Meter sections to I-Line II Busway in vertical riser applications. The mains are connected "inline" with the Busway column conserving precious electrical room space.

1. The Part Number Coding Table is to be used for interpreting existing part numbers only. All possible combinations are not available. Please contact product support for additional references needed.
2. Outgoing Feeder Bus Joint-Pak is included with each EZM CTM Section.
3. EZM Horizontal Cross Bus is 1200 A Copper Only
4. Busway Center Tap Mains are fully NEMA 3R Rated.
5. Mains Devices are fully sealable by utility.
6. EZM Branch units are installed using the mounting kit - EZMCTMKIT.
7. Short circuit current rating = 150,000 symmetrical amps.
8. EZM CTM is configured for neutral front only (G-> N-> C-> B->A-> G) as viewed front to rear.
9. Compatible with I-LINE II Busway rated 2000–5000 A.
10. Includes factory installed PowerPact M- and P-frame Circuit Breakers and Switches (Rated 600–1200 A.)
11. Fully compatible with all standard EZ Meter-Pak Branch Devices and Extenders.

Table 2.31: Part Number Coding

Number Segment	Character	Description	EZM	3	1000	JCB	C	20
Device Name	EZM	EZM Busway Center Tap Main						
System Connection (Phase Order: Front to Back)	3	3 Phase (N, C, B, A)						
Maximum Current of Main Service Disconnect	600	600 A						
	800	800 A						
	1000	1000 A						
	1200	1200 A						
Type of Main Service Disconnect (with AIC Rating)	GCB	65 kAIC Circuit Breaker						
	JCB	100 kAIC Circuit Breaker						
	FS	100 kAIC Fused Switch						
Material of I-Line II Busway	C	Copper						
	A	Aluminum						
Amperage of I-Line II Busway	20	2000 A						
	25	2500 A						
	30	3000 A						
	32	3200 A						
	40	4000 A						
	50	5000 A						

This table is for interpreting existing part numbers only. All possible combinations are not available.

Table 2.32: EZM Busway Center Tap Mains

	Main CB Ampere Rating (A)	I-Line II Busway Rating, Material	Cat. No.		Height (in.)	Width (in.)	Depth (in.)	MC [60] Height (in.)	
			3Ø Incoming	3Ø Outgoing					
	Main Circuit Breakers (3Ø Incoming and 3Ø Outgoing)								
			SCCR						
			65 kA		100 kA				
	600	2000A, Al	—	EZM3600JCBA20	—	43.08	22.70	14.78	56.11
		3000A, Al	—	EZM3600JCBA30	—	43.08	22.70	14.78	56.11
		4000A, Al	EZM3600GCBA40	EZM3600JCBA40	—	43.08	27.96	14.78	56.11
	800	2000A, Al	EZM3800GCBA20	—	—	43.08	22.70	14.78	56.11
		2500A, Al	EZM3800GCBA25	—	—	43.08	22.70	14.78	56.11
		3000A, Al	EZM3800GCBA30	EZM3800JCBA30	—	43.08	22.70	14.78	56.11
		4000A, Al	EZM3800GCBA40	EZM3800JCBA40	—	43.08	27.96	14.78	56.11
	1000	4000A, Al	—	EZM31000JCBA40	—	43.08	27.96	14.78	56.11
		3000A, Al	EZM31200GCBA30	—	—	43.08	22.70	14.78	56.11
	1200	4000A, Al	EZM31200GCBA40	EZM31200JCBA40	—	43.08	27.96	14.78	56.11

Tenant Circuit Breakers and EZM Accessories

Table 2.33: 125 A Max. EZM Branch Unit Tenant Circuit Breakers

	Poles	Ampere Rating	10 k AIR	22 k AIR	42 k AIR	100 k AIR
 <p>QO2100VH, Plug-on Type Circuit Breaker</p>	2	40	QO240	QO240VH	QOH240	—
		50	QO250	QO250VH	QOH250	—
		60	QO260	QO260VH	QOH260	—
		70	QO270	QO270VH	QOH270	—
		80	QO280	QO280VH	QOH280	—
		90	QO290	QO290VH	QOH290	—
	100	QO2100	QO2100VH	QOH2100	—	
	110	QO2110	QO2110VH	QOH2110	—	
	125	QO2125	QO2125VH	QOH2125	—	

Table 2.34: 225 A Max. EZM Branch Unit Tenant Circuit Breakers

	Poles	Ampere Rating	10 k AIR	25 k AIR	65 k AIR	100 k AIR
 <p>QDP22200TM</p>	2	40	QO240 [61]	QO240VH [61] [62]	QOH240 [61] [63]	—
		50	QO250 [61]	QO250VH [61] [62]	QOH250 [61] [63]	—
		60	QO260 [61]	QO260VH [61] [62]	QOH260 [61] [63]	—
		70	QBP22070TM	QDP22070TM	QGP22070TM	QJP22070TM
		80	QBP22080TM	QDP22080TM	QGP22080TM	QJP22080TM
		90	QBP22090TM	QDP22090TM	QGP22090TM	QJP22090TM
		100	QBP22100TM	QDP22100TM	QGP22100TM	QJP22100TM
		110	QBP22110TM	QDP22110TM	QGP22110TM	QJP22110TM
		125	QBP22125TM	QDP22125TM	QGP22125TM	QJP22125TM
		150	QBP22150TM	QDP22150TM	QGP22150TM	QJP22150TM
		175	QBP22175TM	QDP22175TM	QGP22175TM	QJP22175TM
		200	QBP22200TM	QDP22200TM	QGP22200TM	QJP22200TM
	225	QBP22225TM	QDP22225TM	QGP22225TM	QJP22225TM	
	3	70	QBP32070TM	QDP32070TM	QGP32070TM	QJP32070TM [64]
		80	QBP32080TM	QDP32080TM	QGP32080TM	QJP32080TM [64]
		90	QBP32090TM	QDP32090TM	QGP32090TM	QJP32090TM [64]
		100	QBP32100TM	QDP32100TM	QGP32100TM	QJP32100TM [64]
		110	QBP32110TM	QDP32110TM	QGP32110TM	QJP32110TM [64]
		125	QBP32125TM	QDP32125TM	QGP32125TM	QJP32125TM [64]
		150	QBP32150TM	QDP32150TM	QGP32150TM	QJP32150TM [64]
		175	QBP32175TM	QDP32175TM	QGP32175TM	QJP32175TM [64]
		200	QBP32200TM	QDP32200TM	QGP32200TM	QJP32200TM [64]
		225	QBP32225TM	QDP32225TM	QGP32225TM	QJP32225TM [64]

Table 2.35: Accessories

Accessory	Description	Cat. No.
1200 A Bus Extension (Indoor/ Outdoor Cu bus)	1Ø3W Bus Extension (6 in. wide) 1Ø3W Bus Extension (12 in. wide) 3Ø4W Bus Extension (6 in. wide) 3Ø4W Bus Extension (12 in. wide)	EZM1EXT6 EZM1EXT EZM3EXT6 EZM3EXT
1200 A Bussed Corner Sections (Indoor/Outdoor Cu bus only)	1Ø3W Inside Corner (14.75 in. wide) 1Ø3W Outside Corner (6.20 in. wide) 3Ø4W Inside Corner (14.75 in. wide) 3Ø4W Outside Corner (6.20 in. wide)	EZM1CORNER EZM1ELBOW EZM3CORNER EZM3ELBOW
1200 A Transition Sections—Old to New (10.7 in. wide Cu bus)	Add right of old style 1Ø EZM lineup Add right of old style 3Ø EZM lineup Add left of old style 1Ø EZM lineup Add left of old style 3Ø EZM lineup	EZM1TRANR EZM3TRANR EZM1TRANL EZM3TRANL
Mounting Channel	72" long	EZM72MC
Secondary Surge Arrester Mounting kit	For use with 1 or 2-SDSA1175 or 1-SDSA3650 (order surge arrester separately)	MMSAMK [65]
Stud Kit for EZM-TB 400–600 A terminal box	Includes (2) 1/2 in.-13 studs per pad and mounting hardware. Four pads per kit.	EZMSK2
Al/Cu Lug Kits (Each kit includes three, 2-barrel lugs.)	(1) 1/0–600 kcmil or (2) 1/0–250 kcmil per lug (2) 3/0–500 kcmil per lug (2) 2–600 kcmil per lug	MMLK250 MMLK500 MMLK600
Feed-Thru for EZM-TB 800 A Terminal Box	(4) 750 kcmil Al/Cu lugs per phase and neutral. Al wire 600 A max. Cu wire 800 A max.	EZM600FTLK3
Feed-Thru for EZM-TB 1600 A Terminal Box	(24) additional lugs, 600 kcmil Al/Cu, (6) per phase and neutral.	EZM1600FTLK3
EZM Mains Right Side Closure Cap	Replacement right side end cap for EZM Cross Bus Opening	EZMSCAP
EZM Mains Left Side Closure Cap	Replacement left side end cap for EZM Cross Bus Opening	EZMCAP
Fifth Jaw Kit	1 per kit	5J [66]
Horn Bypass Kit	Use with Type EZMR 1Ø meter socket only	MMHB
Slider Type Manual Circuit Closer	For (1) 125–225 A ring-type socket only—indoor/outdoor	MM200MB [67] [68]
Anti-inversion Clip	Rejects 100 A and 200 A watt-hour meters in Class 320 meter sockets in Type EZML branch units.	MMLRK
QO Adapter for bolt-on Q-frame tenant circuit breakers	For 2P Type QO (40–125 A, 10 kA max. meter center SCCR) or QO-VH and QOH (40–60 A, 100 kA max. meter center)	EZM125QOA
LJL Circuit Breaker Alternate Lug (DE2)	Kit includes (3) separate lugs for (1) #2 AWG - 500 kcmil Al or (1) #2 AWG - 600 kcmil Cu per lug.	AL400L61K3
LJL Circuit Breaker Seal Kit	Tamper-evident kit to seal LJL trip dial cover, (1) per circuit breaker, if required. Meets NEC 240-6 [c]	MICROTUSEAL
Meter Socket Closing Plates	Lexan Closing Plate—EZM, EZMR, EZMH, EZMT Metal Closing plate—EZMR, EZMH, EZML	29007 RSG4
Sealing Rings	Snap-on (Stainless Steel) Screw-Type (Aluminum) Latch-Type (Aluminum)—standard	ARP00026 29008W 2920910001
Barrel Lock Kit	For use on ringless EZM or MP branch unit covers, includes 6 each of head protectors, lock nuts and sealing caps. (Barrel lock not included)	MMBLC
Tenant Circuit Breaker Filler Plates	125 A Branches—2P Type QO (2 per opening) 225 A Branches—2P and 3P Q-Frame	QOFP

[61] Must use EZM125QOA adapter.

[62] QO-VH tenant circuit breaker is rated 22 k AIR max.

[63] QOH tenant circuit breaker is rated 42 k AIR max.

[64] 3-pole QJP tenant circuit breaker is rated 65 k AIR max. at 240/120 Vac, 3Ø4W High Leg Delta, or 100 k AIR max. at 208Y/120 Vac, 3Ø4W.

[65] Consult your nearest Schneider Electric sales office for details.

[66] All sockets include 5th Jaw factory-installed except EZM11__ devices.

[67] Meter center short circuit current rating is 10,000 RMS symmetrical amperes with manual circuit closers installed (bypass is not designed for use as continuous duty).

[68] For use on ring type meter sockets only.

Table 2.35 Accessories (cont'd.)

Accessory	Description	Cat. No.
Lug Landing Kit	For use with EZM 1200 A Mains suffix -CBU or -FSB. Order lugs separately	EZM1200ULL
Branch Section Mounting Kit for Riser Applications	This kit is needed when installing and connecting meter center branch sections to EZ-Meter Pak busway center tap mains in multi-floor riser applications (1 per branch section)	EZMCTMKIT
Branch Terminal Box	This device accommodates a maximum conductor size of 300 kcmil when voltage drop calculations require sizes over 2/0. The EZM3BTB accommodates oversizing conductors of up to 3 circuits, mounts above or below a 125 A EZM branch, and is rated NEMA 3R when below device, NEMA 1 when above device. The EZM6BTB accommodates oversizing conductors of up to 6 circuits, mounts above a 125 A EZM branch, and is rated NEMA 1.	EZM3BTB EZM6BTB
Load Center Main Lug Kit 125 A	125 A main lug kit for load centers, supporting larger wire sizes 6-4/0.	QOL125VD

2

METERING EQUIPMENT

Dimensions for EZ Meter-Pak Meter Centers

Table 2.36: Main Device Dimensions and Accessories (in.)

	Cat. No.	Height (H)	Width (W)	Depth (D)	MC Channel (MC)	Cat. No.	Height (H)	Width (W)	Depth (D)	MC Channel (MC)
<p>Main Device</p>	EZM11000CB	53.97	18.66	11.50	34.30	EZM1ELBOW [69] [70] [71]	19.50	14.52	8.01	11.85
	EZM11000CBU	66.27	32.39	13.70	47.28	EZM31000CB	53.97	18.66	11.50	34.30
	EZM11200G/JCBT	46.90	23.69	13.69	13.75	EZM31000CBU	66.27	32.39	13.70	47.28
	EZM11200G/JCBE	66.20	32.39	13.69	50.09	EZM31200G/JCBT	46.90	23.69	13.69	13.75
	EZM11200FST	46.90	23.69	13.69	13.75	EZM31200G/JCBE	66.20	32.39	13.69	50.09
	EZM11200FSE	66.20	32.39	13.69	50.09	EZM31200TBU	44.71	33.16	11.68	31.17
	EZM11200G/JCUBU	65.30	23.69	13.69	49.11	EZM31200G/JCUBU	65.30	23.69	13.69	49.11
	EZM11200FSB	65.30	23.69	13.69	49.11	EZM31200FSB	65.30	23.69	13.69	49.11
	EZM11200TBU	44.71	33.16	11.68	31.17	EZM31200FST	46.90	23.69	13.69	13.75
	EZM11200G/CBUMS	65.30	23.69	13.63	49.12	EZM31200FSE	66.20	32.39	13.69	51.09
	EZM11200G/CBEMS	66.27	32.39	13.70	50.09	EZM31200G/CBUMS	65.30	23.69	13.63	49.12
	EZM11200JCBUMS	65.30	23.69	13.63	49.12	EZM31200G/CBEMS	66.27	32.39	13.70	50.09
	EZM11200JCBEMS	66.27	32.39	13.70	50.09	EZM31200G/CBTMS	46.93	23.69	13.63	13.75
	EZM11200JCBTMS	46.93	23.69	13.63	13.75	EZM31200JCBUMS	65.30	23.69	13.63	49.12
	EZM11600G/JCBC	68.70	30.19	18.33	38.13	EZM31200JCBEMS	66.27	32.39	13.70	50.09
	EZM11600G/JCUBU	68.70	30.19	18.33	49.12	EZM31200JCBTMS	46.93	23.69	13.63	13.75
	EZM11600TB	55.09	22.48	13.00	27.92	EZM31600G/JCBC	68.70	30.19	18.33	38.13
	EZM11600G/CBUMS	68.91	30.19	18.31	44.50	EZM31600G/JCUBU	68.70	30.19	18.33	49.12
	EZM11600G/CBCMS	68.91	30.19	18.31	44.50	EZM31600TB	55.09	22.48	13.00	27.92
	EZM11600JCBUMS	68.91	30.19	18.31	44.50	EZM31600G/CBUMS	68.91	30.19	18.31	44.50
EZM11600JCBEMS	68.91	30.19	18.31	44.50	EZM31600G/CBCMS	68.91	30.19	18.31	44.50	
EZM12000CB	68.70	30.19	18.33	44.25	EZM31600JCBUMS	68.91	30.19	18.31	44.50	
EZM12000CBU	68.70	30.19	18.33	44.25	EZM31600JCBEMS	68.91	30.19	18.31	44.50	
EZM12000TB	71.09	30.19	21.46	37.62	EZM32000CB	68.70	30.19	18.33	44.25	
EZM12000CBMS	68.91	30.19	18.31	44.50	EZM32000CBU	68.70	30.19	18.33	44.25	
EZM12000CBUMS	68.91	30.19	18.31	44.50	EZM32000TB	71.09	30.19	21.46	37.62	
EZM1225TB [71]	21.81	11.66	6.37	13.00	EZM32000CBMS	68.91	30.19	18.31	44.50	
EZM1400CB	53.97	18.66	11.50	34.30	EZM32000CBUMS	68.91	30.19	18.31	44.50	
EZM1400CBU	69.03	20.46	11.50	49.37	EZM3225TB [71]	21.81	11.66	6.37	13.00	
EZM1400FS	53.97	18.66	11.50	34.30	EZM3400CB	53.97	18.66	11.50	34.30	
EZM1400FSU	69.03	20.46	11.50	49.37	EZM3400CBU	69.03	20.46	11.50	49.37	
EZM1400TB	30.46	17.15	7.09	16.29	EZM3400FS	53.97	18.66	11.50	34.30	
EZM1400TBU	35.71	17.16	8.00	27.17	EZM3400FSU	69.03	20.46	11.50	49.37	
EZM1600CB	53.97	18.66	11.50	34.30	EZM3400TB	30.46	17.15	7.09	16.29	
EZM1600CBU	69.03	20.46	11.50	49.37	EZM3400TBU	35.71	17.16	8.00	27.17	
EZM1600FS	53.97	18.66	11.50	34.30	EZM3600CB	53.97	18.66	11.50	34.30	
EZM1600FSU	69.03	20.46	11.50	49.37	EZM3600CBU	69.03	20.46	11.50	49.37	
EZM1600TB	30.46	17.15	7.09	16.29	EZM3600FS	53.97	18.66	11.50	34.30	
EZM1800CB	53.97	18.66	11.50	34.30	EZM3600FSU	69.03	20.46	11.50	49.37	
EZM1800CBU	69.03	20.46	11.50	49.37	EZM3600TB	30.46	17.15	7.09	16.29	
EZM1800FS	53.97	18.66	11.50	34.30	EZM3800CB	53.97	18.66	11.50	34.30	
EZM1800FSU	69.03	20.46	11.50	49.37	EZM3800CBU	69.03	20.46	11.50	49.37	
EZM1800TB	53.97	18.66	11.50	34.30	EZM3800FS	53.97	18.66	11.50	34.30	
EZM1800TBCU	51.76	22.48	7.09	28.01	EZM3800FSU	69.03	20.46	11.50	49.37	
EZM1800TBU	39.96	25.16	11.68	31.17	EZM3800TB	53.97	18.66	11.50	34.30	
EZM1EXT [71]	19.34	11.66	6.37	11.85	EZM3800TBCU	51.76	22.48	7.09	28.01	
EZM1EXT6 [71]	19.34	6.00	6.37	11.85	EZM3800TBU	39.96	25.16	11.68	31.17	
EZM1CORNER [69][71][72]	19.50	14.40	8.02	11.85	EZM3EXT [71]	19.34	11.66	6.37	11.85	
EZM3BTB [73]	19.31	12.25	8.43	—	EZM3EXT6 [71]	19.34	6.00	6.37	11.85	
EZM6BTB [69]	23.00	12.13	8.00	—	EZM3CORNER [69] [71] [72]	19.50	14.40	8.02	11.85	

2 METERING EQUIPMENT

[69] Indoor only.
 [70] Each leg of elbow section measures 6.17 in. corner of wall to start of next enclosure.
 [71] Device supplied without mounting channel, secure to wall by use of swingable mounting feet.
 [72] Each leg of this corner section measures 14.72 in. from wall to start of next enclosure.
 [73] Outdoor when mounted below branch device. Indoor only when mounted above branch device.

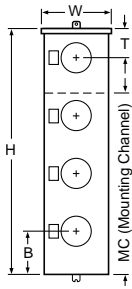

Branch Device

Table 2.37: Single Phase Branch Device Dimensions (in.) [74]

Cat. No. [available suffix]	Height (H)	Width (W)	Depth (D)	MC Channel (MC)	Top Meter (T)	Bottom Meter (B)	Cat. No. [available suffix]	Height (H)	Width (W)	Depth (D)	MC Channel (MC)	Top Meter (T)	Bottom Meter (B)
EZM112225 [X, CUX]	43.41	17.38	8.09	32.34	22.18	12.23	EZML112225 [CU]	39.06	19.44	9.44	25.51	11.67	13.39
EZM113125 [X, CUX]	42.37	12.25	7.09	31.30	13.18	11.19	EZML112225D	39.06	19.44	9.44	25.51	11.67	13.39
EZM113225 [X, CUX]	43.41	17.38	8.09	32.34	13.18	12.23	EZML112400	69.61	23.21	9.44	37.81	20.64	21.53
EZM114125 [X, CUX]	48.12	12.25	7.09	31.30	9.93	11.19	EZML113125 [X, CUX]	45.06	15.56	9.48	34.23	12.84	12.22
EZM114225 [X, CUX]	52.00	17.38	8.09	32.34	12.77	12.23	EZML113225 [CU]	53.06	19.44	9.44	39.51	11.67	13.39
EZM115125 [X, CUX]	57.12	12.25	7.09	31.30	9.93	11.19	EZML114125 [X, CUX]	55.06	15.56	9.48	34.29	12.84	12.22
EZM115225 [CU]	61.00	17.38	8.09	32.35	12.77	12.23	EZML114225 [CU]	67.06	19.44	9.44	39.51	11.67	13.39
EZM116125 [X, CUX]	66.12	12.25	7.09	40.30	9.93	11.19	EZML114225D	67.06	19.44	9.44	39.51	11.67	13.39
EZM16225	69.94	17.38	8.09	41.33	12.72	12.22	EZML115125 [X, CUX]	65.06	15.56	9.48	34.29	12.84	12.22
EZMH112225 [X, CUX]	43.41	17.38	8.09	32.34	22.18	12.23	EZML116125 [X, CUX]	75.06	15.56	9.48	44.29	12.84	12.25
EZMH113125 [X, CUX]	42.37	12.25	7.09	31.30	13.18	11.19	EZML112225 [X, CUX]	43.41	17.38	8.09	32.34	22.18	12.23
EZMH113225 [X, CUX]	43.41	17.38	8.09	32.34	13.18	12.23	EZMR113125 [X, CUX]	42.37	12.25	7.09	31.30	13.18	11.19
EZMH114125 [X, CUX]	48.12	12.25	7.09	31.30	9.93	11.19	EZMR113225 [X, CUX]	43.41	17.38	8.09	32.34	13.18	12.23
EZMH114225 [X, CUX]	52.00	17.38	8.09	32.34	12.77	12.23	EZMR114125 [X, CUX]	48.12	12.25	7.09	31.30	9.93	11.19
EZMH115125 [X, CUX]	57.12	12.25	7.09	31.30	9.93	11.19	EZMR114225 [X, CUX]	52.00	17.38	8.09	32.34	12.77	12.23
EZMH115225 [CU]	61.00	17.38	8.09	32.35	12.77	12.23	EZMR115125 [X, CUX]	57.12	12.25	7.09	31.30	9.93	11.19
EZMH116125 [X, CUX]	66.12	12.25	7.09	40.30	9.93	11.19	EZMR115225 [CU]	61.00	17.38	8.09	32.35	12.77	12.23
EZMH16225	69.94	17.37	8.09	41.33	12.72	12.22	EZMR116125 [X, CUX]	66.12	12.25	7.09	40.30	9.93	11.19
EZMK111400	45.55	27.56	9.74	37.81	24.51	21.04	EZMR16225	69.94	17.37	8.09	41.33	12.72	12.22
EZML111225 [CU]	39.06	19.44	9.44	25.51	25.67	13.39	EZMT112225	25.45	22.42	9.38	16.19	4.67	20.45
EZML11225D	39.06	19.44	9.44	25.51	25.67	13.39	EZMT112225	60.56	22.42	9.38	43.63	12.67	28.89
EZML111400	44.55	23.21	9.44	37.81	24.02	21.53	EZMT113225	79.56	22.42	9.38	48.25	12.67	28.89

Table 2.38: Three Phase Branch Device Dimensions (in.) [74]

Cat. No. [available suffix]	Height (H)	Width (W)	Depth (D)	MC Channel (MC)	Top Meter (T)	Bottom Meter (B)	Cat. No. [available suffix]	Height (H)	Width (W)	Depth (D)	MC Channel (MC)	Top Meter (T)	Bottom Meter (B)
EZM312225 [X, CUX, CA, XCA, CUXCA]	43.41	17.38	8.09	32.34	22.18	12.23	EZML314225 [CU, CA, CUCA]	67.06	19.44	9.44	39.51	11.67	13.39
EZM313125 [X, CUX, CA, XCA, CUXCA]	42.37	12.25	7.09	31.30	13.18	11.19	EZML315125 [X, CUX]	65.06	15.56	9.48	34.29	12.84	12.22
EZM313125M10	42.37	12.25	7.09	24.29	10.18	12.19	EZML316125 [X, CUX]	75.06	15.56	9.48	44.29	12.84	12.25
EZM313225 [X, CUX, CA, XCA, CUXCA]	43.41	17.38	8.09	32.34	13.18	12.23	EZML331225 [CU]	39.06	19.44	9.44	25.51	25.67	13.39
EZM314125 [X, CUX, CA, XCA, CUXCA]	48.12	12.25	7.09	31.30	9.93	11.19	EZML331225D	39.06	19.44	9.44	25.51	25.67	13.39
EZM314125M10	52.12	12.25	7.09	34.29	9.93	12.19	EZML331400	45.55	23.21	9.44	37.81	24.02	21.53
EZM314225 [X, CUX, CA, XCA, CUXCA]	52.00	17.38	8.09	32.34	12.77	12.23	EZML332225 [CU]	39.06	19.44	9.44	35.51	11.67	13.39
EZM315125 [X, CUX, CA, XCA, CUXCA]	57.12	12.25	7.09	31.30	9.93	11.19	EZML332225D	39.06	19.44	9.44	35.51	11.67	13.39
EZM315125M10	62.12	12.25	7.09	34.29	9.93	12.19	EZML332400 [CU]	69.61	23.21	9.44	37.82	20.64	21.53
EZM315225 [CU, CA, CUCA]	61.00	17.38	8.09	32.35	12.77	12.23	EZML333225 [CU]	53.06	19.44	9.44	39.51	11.67	13.39
EZM316125 [X, CUX, CA, XCA, CUXCA]	66.12	12.25	7.09	40.30	9.93	11.19	EZML333225D	53.06	19.44	9.44	39.51	11.67	13.39
EZM316225 [CU, CA]	69.94	17.37	8.09	41.33	12.72	12.22	EZML334225 [CU]	67.06	19.44	9.44	39.51	11.67	13.39
EZMH312225 [X, CUX, CA, XCA]	43.41	17.38	8.09	32.34	22.18	12.23	EZML334225D	67.06	19.44	9.44	39.51	11.67	13.39
EZMH313125 [X, CUX, CA, XCA]	42.37	12.25	7.09	31.30	13.18	11.19	EZMR312225 [X, CUX, CA, XCA]	43.41	17.38	8.09	32.34	22.18	12.23
EZMH313225 [X, CUX, CA, XCA]	43.41	17.38	8.09	32.34	13.18	12.23	EZMR313125 [X, CUX, CA, XCA]	42.37	12.25	8.09	31.30	13.18	11.19
EZMH314125 [X, CUX, CA, XCA]	48.12	12.25	7.09	31.30	9.93	11.19	EZMR313225 [X, CUX, CA, XCA]	43.41	17.38	8.09	32.34	13.18	12.23
EZMH314225 [X, CUX, CA, XCA]	52.00	17.38	8.09	32.34	12.77	12.23	EZMR314125 [X, CUX, CA, XCA]	48.12	12.25	7.09	31.30	9.93	11.19
EZMH315125 [X, CUX, CA, XCA]	57.12	12.25	7.09	31.30	9.93	11.19	EZMR314225 [X, CUX, CA, XCA]	52.00	17.38	8.09	32.34	12.77	12.23
EZMH315225 [CU, CA, CUCA]	61.00	17.38	8.09	32.35	12.77	12.23	EZMR315125 [X, CUX, CA, XCA]	57.12	12.25	7.09	31.30	9.93	11.19
EZMH316125 [X, CUX, CA, XCA]	66.12	12.25	7.09	40.30	9.93	11.19	EZMR315225 [CU, CA, CUXCA]	61.00	17.38	8.09	32.35	12.77	12.23
EZMH316225 [CU, CA]	69.94	17.37	8.09	41.33	12.72	12.22	EZMR316125 [X, CUX, CA, XCA]	66.12	12.25	7.09	40.30	9.93	11.19
EZMK331400	45.55	27.56	9.74	30.60	24.51	21.04	EZMR316225 [CU, CA]	69.94	17.37	8.09	41.33	12.72	12.22
EZMK332400	72.99	27.56	9.74	37.81	22.26	21.04	EZMR332225 [CU]	39.06	19.44	9.44	25.51	11.67	13.39
EZML311400 [CA]	45.55	23.21	9.44	37.81	24.02	21.53	EZMR333225 [CU]	53.06	19.44	9.44	39.51	11.67	13.39
EZML311225 [CU, CA, CUCA]	39.06	19.44	9.44	25.51	25.67	13.39	EZMR334225 [CU]	67.06	19.44	9.44	39.51	11.67	13.39
EZML312225 [CU, CA, CUCA]	39.06	19.44	9.44	25.51	11.67	13.39	EZMT311225 [CA]	25.45	22.42	9.38	16.19	4.67	20.45
EZML312225D [CA]	39.06	19.44	9.44	25.51	11.67	13.39	EZMT312225 [CA]	60.56	22.42	9.38	43.63	12.67	28.89
EZML312400 [CA]	69.61	23.21	9.44	37.82	20.64	21.53	EZMT313225 [CA]	79.56	22.42	9.38	48.25	12.67	28.89
EZML313125 [X, CUX]	45.06	15.56	9.48	34.23	12.84	12.22	EZMT331225	25.12	22.42	9.38	16.19	4.67	20.45
EZML313225 [CU, CA, CUCA]	53.06	19.44	9.44	39.51	11.67	13.39	EZMT332225	60.56	22.42	9.38	43.63	12.67	28.89
EZML313225D [CA]	53.06	19.44	9.44	39.51	11.67	13.39	EZMT333225	79.56	22.42	9.38	48.25	12.67	28.89
EZML314125 [X, CUX]	55.06	15.56	9.48	34.29	12.84	12.22							

[74] Standard branch units are available without suffix added.