

# 56 MW (IEC), OCP-compatible, indirect air cooling, 55000 m<sup>2</sup>

## DESIGN OVERVIEW

### Data Centre IT Capacity

Initial delivery of 9.36 MW  
Scalable to 56.16 MW

### Regional Voltage and Frequency

90-140kV, 10-15kV, 400V  
50Hz

### Redundancy Levels

Power: tri-redundant MV distribution, N generators, N LV distribution, N+1 OCP power supply units

Cooling: N+1 indirect air economiser

## INTRODUCTION

This reference design was developed for internet giant companies planning large data centres that are using Open Compute (OCP) style server and rack designs and who have IT application fault tolerance through virtualization and workload automation processes. These assumptions enable a more simplified approach in the electrical distribution architecture, thereby reducing CapEx and OpEx while maintaining high reliability overall. This design also puts an emphasis on reduced time to market (TTM) and scalability. It features prefabricated electrical substations installed and tested in the factory. The data centre would be built out in six increments of 9.36 MW data halls, which are evenly distributed between two buildings. Each data hall contains six IT rooms, which contain OCP racks with integrated power supplies and energy storage within the rack, along with an air-to-air cooling system serving each room. Together, these rooms and systems constitute the building blocks for the data centre. Each data centre expansion, therefore, is designed to occur in increments of 9360 kW of IT load.

## DESIGN HIGHLIGHTS

Supports OCP servers

Reduced TTM

High reliability

Scalable design

Minimized upfront CapEx

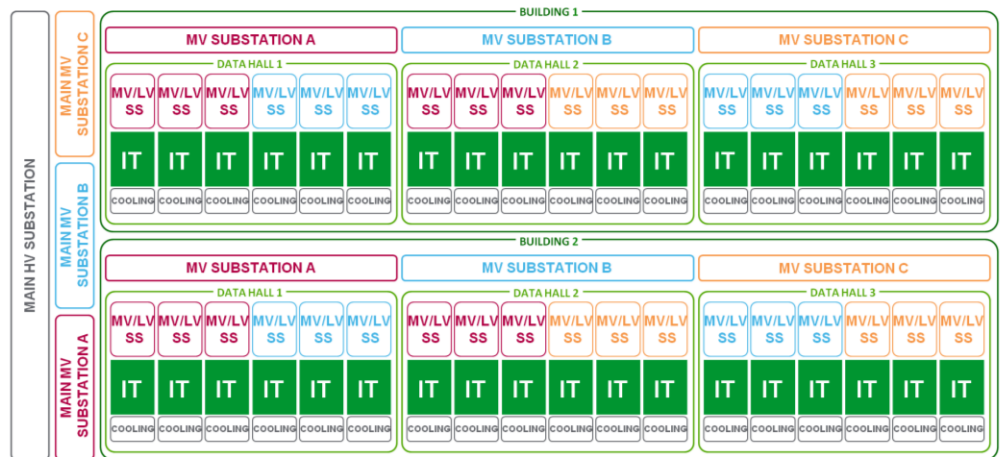

# Facility Power

## UTILITY CONNECTION

The data centre is designed for a maximum demand of 80 MVA, which requires a connection to the electric utility’s high voltage (HV) sub-transmission network. Depending on the country, the supply voltage can vary from 90 kV (e.g. France), to 110 kV (e.g. Finland), and up to 132 kV (e.g. UK). The utility company will be responsible for building the HV substation that provides metered power supplies “A” and “B”. Therefore, the change of ownership occurs after the metering point, which means that the data centre owner will specify and procure the HV/MV transformer.

## MAIN MEDIUM VOLTAGE (MV) SUBSTATION

Each building has a dedicated MV tri-redundant distribution system, which can be installed in three different pre-fabricated substations. Downstream of two HV utility incomers are three 40 MVA Minera power transformers with on-load tap changer (OLTC) that supply three Main MV substations, providing power to the six data halls. The MV distribution voltage can be chosen according to country practices (e.g. 10 kV in Finland, 11 kV in UK, plus 11 and 15 kV in Belgium). The short circuit impedance of the HV/MV transformer is chosen at 13% to avoid exceeding 25 kA short circuit current on the MV distribution network. The tri-redundant main MV distribution comprises three PIX air insulated switchgear lineups rated at 12 kV and 25 kA (3s) with a 2500 A busbar, ensuring better cost optimization. Each one of these PIX lineups feeds two MV substations in buildings 1 and 2 for A, B, and C-side distribution.

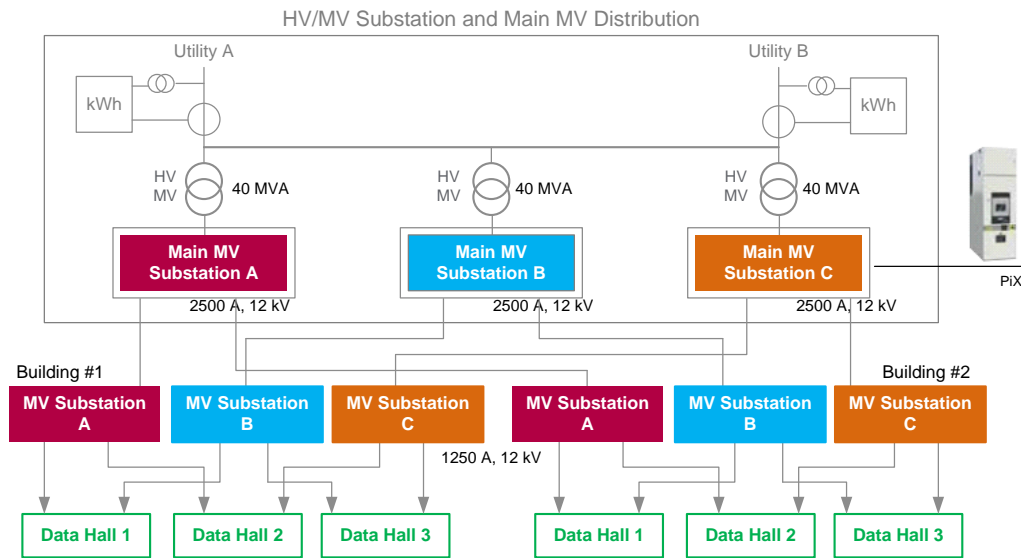

## FACILITY POWER HV/MV SUBSTATION ATTRIBUTES

Name	Value	Unit
Utility voltage	$90 < U_n < 140$	kV
Number of data halls supported	6	
Power path	Dual	
Quantity of HV/MV transformer(s)	3	
HV/MV transformer size	40	MVA
HV/MV transformer short circuit impedance	13	%
Quantity of main MV substation switchgear lineups	3	
Main MV substation bus amps	2500	A
Main MV substation bus voltage	$10 < U_n < 15$	kV
Main MV substation switchgear short time withstand current	25 (3)	kA (s)

# Facility Power

## MEDIUM VOLTAGE DISTRIBUTION PER BUILDING

Each MV Substation in an IT building supplies six MV/LV substations in two of the three data halls, resulting in dual path distribution to each data hall and therefore to each MV/LV substation. In fact, up to 12 MV/LV substations are connected to a single MV substation, where six are supplied in normal operation and up to nine in case of failure or maintenance. To optimise the MV distribution, the preferred MV source is connected to its MV switchboard by one dedicated cable and feeder, while the non-preferred (alternate) sources are connected in a daisy chain scheme, all in a group of three MV/LV substations. This configuration reduces footprint and costs of the MV switchgear, cabling and conduit, while maintaining an optimal performance in terms of safety and reliability.

Each of the MV substations consists of a *Premset* lineup rated at 12 kV and 25 kA (1s) with a 1250 A busbar that feeds two out of the three data halls per building, resulting in dual path distribution to each MV/LV substation or IT room in a tri-redundant architecture.

Each IT room within a data hall is supplied by a MV/LV substation that allows for 1N LV distribution, providing the best match with OCP IT equipment. MV/LV substations are comprised of MV transfer switchboard (MVTs) lineups which have two MV incomers and supply a single feeder, with one incomer as the preferred source. The MVTs are configured such that both A and B sources are the preferred source for three of the six MVTs.

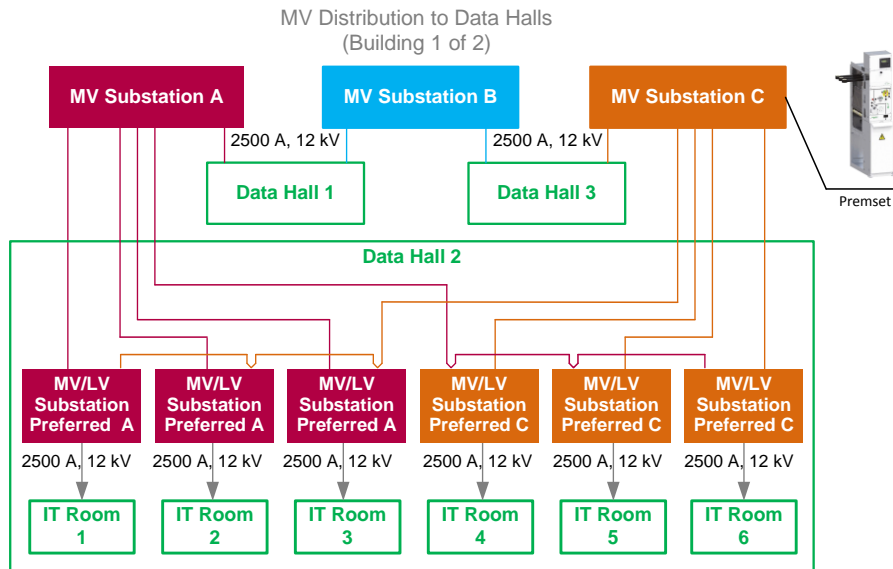

## FACILITY POWER MV DISTRIBUTION ATTRIBUTES

Name	Value	Unit
	Per data hall	
Number of MV substation switchgear lineups	3	
MV substation bus amps	1250	A
MV substation bus voltage	$10 < U_n < 15$	kV
MV substation switchgear short time withstand current	25 (1)	kA (s)

# Facility Power

## LOW VOLTAGE DISTRIBUTION

In this design, each of the 36 MV/LV substations houses a transformer, a generator, and the switchgear necessary to supply the IT load in a single room and the cooling for it, with 2N redundancy upstream of the substation. A total of 36 *Trihal* or *Minera* 2500 kVA transformers are used throughout the site to transform voltage from 12 kV to 400 V with 6% impedance. In addition, each of the 36 generators rated at 2500 kVA, 400 V provides backup power, simplifying the MV and LV distribution since a connection point between paths is not required. Every transformer and generator are coupled to the main LV switchboard with *Okken* LV switchgear rated at 400 V and 80 kA (1s) with a 4000 A bus, making up the complete LV distribution sub-system. This busbar nominal current rating is maximized to achieve cost-effectiveness and make the most of IT capacity.

Downstream of the main LV switchboard, an optimal combination of LV switchgear and *iBusway* systems with built-in intelligence feeds 1N power to N+1 power supplies located in the OCP rack. Additional redundancy is assumed at the IT process level, where IT loads would be transferred within the same data centre or to a different site in case of power failure or maintenance. This avoids unnecessary redundancy in the IT room, resulting in capital cost savings. Finally, the power train for a single room’s cooling system and auxiliaries is comprised of *Okken* LV switchgear lineups, rated at 1900 A, 400 V, providing distribution to the indirect air economisers, lighting, monitoring, security and automation systems, etc., while providing fault protection to the economisers through a 500 kVA *Galaxy 7000* UPS, rated at 400 V, to ensure continuous cooling.

The facility power system is designed to also support integrated peripheral devices like fire panels, access control systems, and environmental monitoring and control devices. Power meters in the electrical path monitor power quality and allow for predictive maintenance & diagnostics of the system. These meters also integrate with *StruxureWare Power Monitoring Expert*.

Every component in this Reference Design is built and tested to the applicable IEC standards. Further design details and schematics are available in the engineering package available upon request.

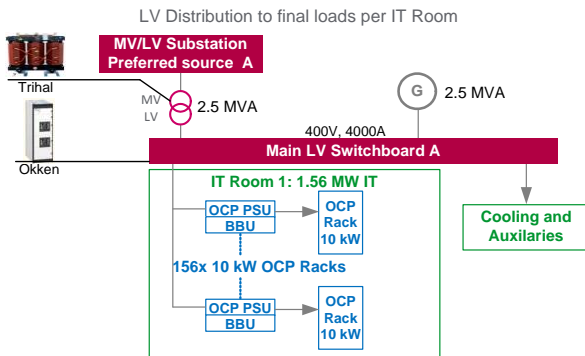

### DESIGN OPTIONS

This reference design can be modified as follows without a significant effect on the design’s performance attributes:

- Each LV generator can be connected to a mobile LV load bank, which enables generator testing.
- Add/change standby generator options:
  - Location
  - Tank size
  - Fuel type

### FACILITY POWER LV DISTRIBUTION ATTRIBUTES

Name	Value		Unit
	IT in each data hall	Cooling in each IT room	
Number of MV/LV transformer	6		
MV/LV transformer size	2.5		MVA
Generator redundancy	N		
Number of Generators	6		
Generator size	2500		kVA
Generator voltage	400		V
Number of LV critical switchgear	6	1	
LV critical bus amps	4000	1900	A
LV critical bus voltage	400	400	V
LV critical switchgear short time withstand current	80 (1)	50 (1)	kA (s)

# Facility Power

## POWER MONITORING

The power monitoring system is part of the DCIM (Data Centre Infrastructure Management System) system which measures, monitors tracks, and controls all aspects of the physical data centre in a real time. In addition, it optimizes planning, as well as continuous improvement in asset management to drive operational efficiency. Power monitoring system offers the following features:

**Preserve availability and reliability** of the Electrical Distribution system

Monitor quality of power

Reduce maintenance costs

**Quick diagnosis helps** reduce time to resolve issues

**Centralisation** in one or several places of all control and monitoring information for the electrical network

**Historic and archival data building** for analysis and capacity planning.

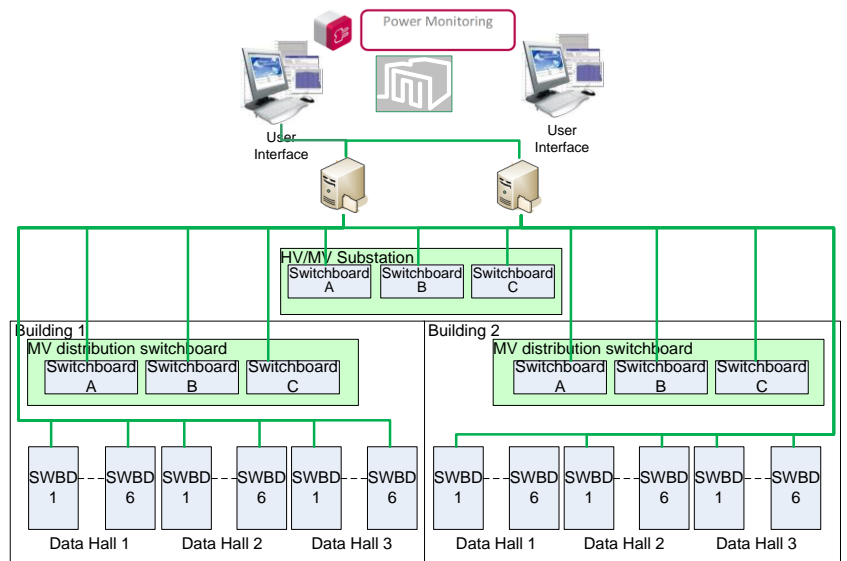

## POWER MONITORING SYSTEM MAIN FEATURES

Power Monitoring & Control <sup>1</sup>	
<p>Real-time power system status</p> <p>Critical power system alarm notification</p>	<p>Root cause analysis</p> <p>Power quality analysis</p>
Equipment Maintenance	Power Distribution Efficiency
<p>Simplify &amp; automate generator test reporting</p>	<p>Track PUE: in real-time and over time</p> <p>Quantify the cost of power system inefficiencies</p>
Power Loading & Balancing	Energy Billing Support
<p>Manage generator system power loading</p> <p>Manage UPS system power loading</p> <p>Manage IT branch circuit power loading</p>	<p>Branch circuit energy analysis</p> <p>Branch circuit energy data export</p>

# Facility Cooling

This facility cooling system is optimized for oceanic climates, in places like Dublin or San Francisco, with warm summers and cool winters, though it can be easily adapted to work in other types of climates.

The design is made up of 36 identical stand-alone cooling systems, one dedicated for each IT room. Each system comprises seven indirect air economisers that deliver clean and conditioned supply air to the data centre with an N+1 configuration at the room level. The economiser units are mounted on a side wall of the IT rooms, backing each unit against each other to save space, and each unit is individually connected to power and water.

Warm return air from the IT equipment is ducted to a common ceiling plenum, from which each economiser unit draws air, using an air-to-air heat exchange when ambient temperatures are favourable to supply the data centre with a flood of cool air through ventilation grilles at the perimeter of the IT room. Each chimney to the ceiling plenum uses a baffle that is manually tuned to balance the airflow.

When ambient temperatures are less favourable and an air-to-air heat exchange alone cannot sufficiently cool the data centre, the economiser units supplement the free cooling with indirect evaporative cooling, which removes heat from the IT air by evaporating water on the outside of the heat exchanger channels. In the case of a primary water supply failure, an optional water storage tank for each economiser unit can supply water to maintain evaporative cooling.

Regardless of which cooling mode is being used—air-to-air free cooling, or indirect evaporative—the economiser units always prevent the outside air from coming in contact with the data centre air.

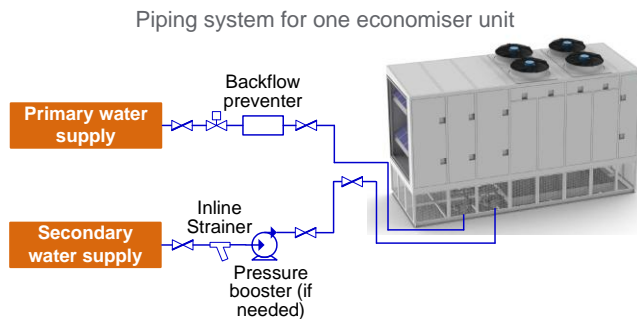

## DESIGN OPTIONS

This reference design can be modified as follows without a significant effect on the design’s performance attributes:

- Add *StruxureWare Building Operation*
- Eliminate secondary water supply tank size, or change its size
- Add a direct expansion system for supplemental cooling, with an optional water saving mode

## FACILITY COOLING ATTRIBUTES

Name	Value	Unit
Total facility cooling capacity	57.6	MW
	Each IT room	
Sub-system cooling capacity	1600	kW
Input voltage	400	V
Heat rejection medium	Air or water, depending on ambient conditions	
Number of cooling units	7	
Mechanical redundancy	N+1	
Outdoor heat exchange	Indirect evaporative cooling with economiser	
IT air supply temperature	25	°C
IT air return temperature	38.8	°C
Economiser type	Air-to-Air and Indirect Evaporative	

# IT Space

Six independent IT data halls can be built one by one to make up the IT space of this design. One data hall contains six IT rooms of 1560 kW apiece. Each room has 156 OCP racks at 10 kW each. Altogether, they constitute 56.16 MW of IT capacity.

In this design, each OCP V2 rack is fed by an *iBusway* system and has one OCP V2 PDU supplied in 400V/3ph, distributing power to two power shelves and batteries with 90 seconds of runtime. Each power shelf has three OCP V2 power supply units (PSUs) and three OCP V2 battery backup units (BBUs), at N+1 redundancy. OCP servers receive DC power from the power shelves through two 12 V busbars installed at the back of the rack.

This configuration with 400 vAC to 12 vDC conversion in the rack with local energy storage allows the server power supplies to be consolidated, so they are shared across several OCP servers. Moreover, energy storage can be scaled rack by rack, making the system highly adaptable. In addition, the PSU and BBU system is capable of performing self-monitoring for capacity management and notification if there is an issue.

Hot air containment is provisioned for each pair of IT rows to increase the cooling efficiency of the N+1 economiser units.

The security of the room is maintained at multiple points. At the rack level, access is controlled by a door lock and sensor. At the room level, security cameras are utilized for monitoring.

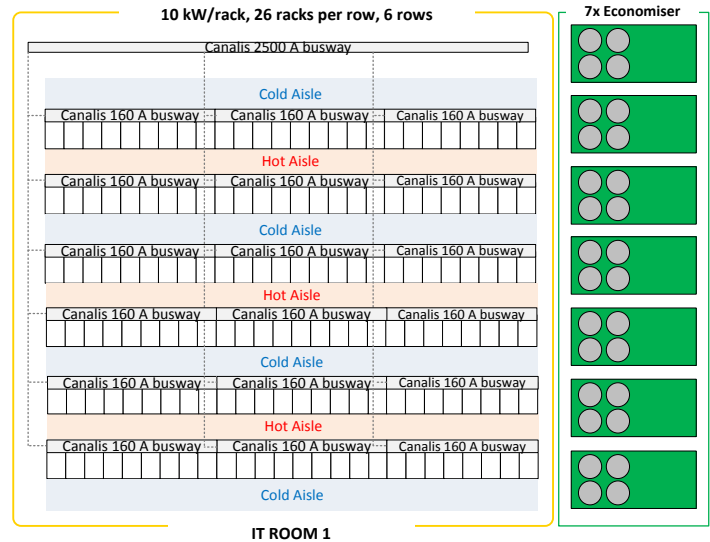

## DESIGN OPTIONS

This reference design can be modified as follows without a significant effect on the design's performance attributes:

- Add environmental and security management
- Add *StruxureWare Data Centre Expert*

## IT SPACE ATTRIBUTES

Name	Value	Unit
Total IT load	56.16	MW
Total number of data halls	6	
IT load per data hall	9360	kW
IT room per data hall	6	
IT load per room	1560	kW
IT floor space per room	600	m <sup>2</sup>
Supply voltage to IT	12	vDC
Average density	10	kW/rack
Number of racks per room	156	racks
Single or dual cord	Single	
CRAC/CRAH type	None	
CRAC/CRAH redundancy	N/A	
Containment type	Hot Aisle	

# Advantages of this Reference Design

- Open Compute Project compatible
- Meets Internet Giant business objectives such as IT equipment design, power density, scalability and sizing
- Highly reliable with predictable performance
- Reduces cost and complexity in electrical distribution by, in part, assuming automated IT workload mobility and software fault tolerance exists
- Simplifies the construction of extra-large sites minimizing risks and complexity
- Repeatable design worldwide that is compatible with IEC/ANSI, maximizing usage of Schneider Electric products globally available to minimize adaptation effort
- Highly efficient by minimizing electrical loss and needing only one conversion to feed IT electronics
- Highly efficient cooling solution with an indirect air economiser system with no compression (for most locations) maximizing the advantage provided in today's ASHRAE standard
- "End-to-end" solution considers constraints from utility to rack, for consistency and right sizing throughout the entire facility
- Chosen switchgear ratings are optimized to meet a balance between cost, efficiency, and high performance
- Optimize generator plant CapEx without compromising capacity nor availability
- Operating principles available to understand system dynamics, maintenance, and recovery situations
- High-end power monitoring system included to manage real time values, planning, and support optimization throughout the entire life cycle of the data centre

# Schneider Electric Life-Cycle Services

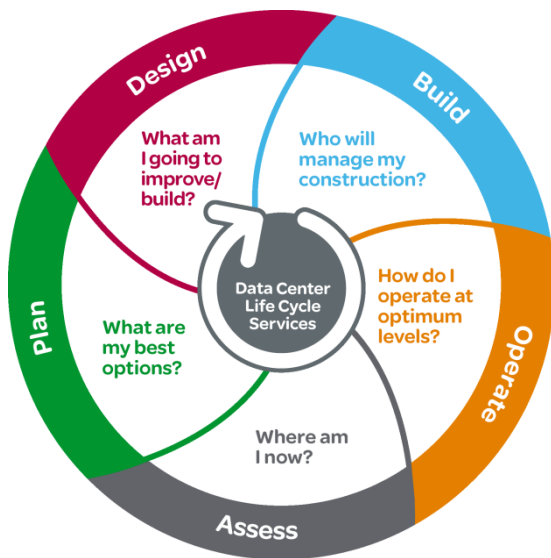

- 1** Team of **over 7,000 trained specialists** covering every phase and system in the data centre
- 2** Standardized, documented, and validated **methodology** leveraging automation tools and repeatable processes **developed over 45 years**
- 3** **Complete portfolio of services** to solve your technical or business challenge, simplify your life, and reduce costs

# Get more information on this design

Contact your Schneider Electric Account Manager to receive the Engineering Package for this design which contains the electrical one line diagrams, piping diagrams, dimensioned floor layouts, and equipment lists.