

# EasyLogic™ PM2225C

## User Manual

NVE3860702-09  
06/2024



# Legal Information

The information provided in this document contains general descriptions, technical characteristics and/or recommendations related to products/solutions.

This document is not intended as a substitute for a detailed study or operational and site-specific development or schematic plan. It is not to be used for determining suitability or reliability of the products/solutions for specific user applications. It is the duty of any such user to perform or have any professional expert of its choice (integrator, specifier or the like) perform the appropriate and comprehensive risk analysis, evaluation and testing of the products/solutions with respect to the relevant specific application or use thereof.

The Schneider Electric brand and any trademarks of Schneider Electric SE and its subsidiaries referred to in this document are the property of Schneider Electric SE or its subsidiaries. All other brands may be trademarks of their respective owner.

This document and its content are protected under applicable copyright laws and provided for informative use only. No part of this document may be reproduced or transmitted in any form or by any means (electronic, mechanical, photocopying, recording, or otherwise), for any purpose, without the prior written permission of Schneider Electric.

Schneider Electric does not grant any right or license for commercial use of the document or its content, except for a non-exclusive and personal license to consult it on an "as is" basis.

Schneider Electric reserves the right to make changes or updates with respect to or in the content of this document or the format thereof, at any time without notice.

**To the extent permitted by applicable law, no responsibility or liability is assumed by Schneider Electric and its subsidiaries for any errors or omissions in the informational content of this document, as well as any non-intended use or misuse of the content thereof.**

# Safety information

## Important information

Read these instructions carefully and look at the equipment to become familiar with the device before trying to install, operate, service, or maintain it. The following special messages may appear throughout this manual or on the equipment to warn of potential hazards or to call attention to information that clarifies or simplifies a procedure.



The addition of either symbol to a “Danger” or “Warning” safety label indicates that an electrical hazard exists which will result in personal injury if the instructions are not followed.



This is the safety alert symbol. It is used to alert you to potential personal injury hazards. Obey all safety messages that accompany this symbol to avoid possible injury or death.

### **DANGER**

**DANGER** indicates a hazardous situation which, if not avoided, **will result in** death or serious injury.

**Failure to follow these instructions will result in death or serious injury.**

### **WARNING**

**WARNING** indicates a hazardous situation which, if not avoided, **could result in** death or serious injury.

### **CAUTION**

**CAUTION** indicates a hazardous situation which, if not avoided, **could result in** minor or moderate injury.

### **NOTICE**



NOTICE is used to address practices not related to physical injury.

## Please note

Electrical equipment should be installed, operated, serviced and maintained in restricted access locations only by qualified personnel. No responsibility is assumed by Schneider Electric for any consequences arising out of the use of this equipment. A qualified person is one who has skills and knowledge related to the construction, installation, and operation of electrical equipment and has received safety training to recognize and avoid the hazards involved.

## Metering equipment symbols

The following IEC 60417 and ISO 7000 symbols may be used on the metering equipment:

Symbol	Reference	Description
	IEC 60417-5172	<b>Protective class II equipment</b> To identify equipment meeting the safety requirements specified for Class II equipment (double or reinforced insulation).
	ISO 7000-0434B	<b>Caution</b> To indicate that caution is necessary when operating the device or control close to where the symbol is placed. To indicate that the current situation needs operator awareness or operator action in order to avoid undesirable consequences.
	ISO 7000-1641	<b>Operator's manual; operating instructions</b> To identify the location where the operator's manual is stored or to identify information that relates to the operating instructions. To indicate operating instructions should be considered when operating the device or operating controls close to where the symbol is placed.

# Notices

## FCC

This equipment has been tested and found to comply with the limits for a Class A digital device, pursuant to Part 15 of the FCC rules. These limits are designed to provide reasonable protection against harmful interference when the equipment is operated in a commercial environment. This equipment generates, uses, and can radiate radio frequency energy and, if not installed and used in accordance with the instruction manual, may cause harmful interference to radio communications. Operation of this equipment in a residential area is likely to cause harmful interference in which case the user will be required to correct the interference at his own expense.

The user is cautioned that any changes or modifications not expressly approved by Schneider Electric could void the user's authority to operate the equipment.

This digital apparatus complies with CAN ICES-3 (A) /NMB-3(A).

## About this manual

This manual discusses features of the EasyLogic™ PM2225 power meter and provides installation and configuration instructions.

Throughout the manual, the term “meter” refers to all models of the PM2225. All differences between the models, such as a feature specific to one model, are indicated with the appropriate model number or description.

This manual assumes you have an understanding of power metering and are familiar with the equipment and power system in which your meter is installed.

This manual does not provide configuration information for advanced features where an expert user would perform advanced configuration. It also does not include instructions on how to incorporate meter data or perform meter configuration using energy management systems or software, other than ION Setup. ION Setup is a free configuration tool available for download from [www.se.com](http://www.se.com).

The most up-to-date documentation about your meter is available for download from [www.se.com](http://www.se.com).

### Related documents

Document	Number
PM2225 instruction sheet	NHA2778901

# Table of Contents

Safety precautions .....	11
Introduction .....	13
Meter overview .....	13
Meter features .....	13
Mounting adaptors .....	13
Feature summary .....	13
Measured parameters .....	15
Energy .....	15
Non Reset energy .....	15
Demand .....	16
Instantaneous .....	16
Power quality .....	16
Other measurements .....	16
Data display and analysis tools .....	17
Power Monitoring Expert .....	17
Power SCADA Operation .....	17
Meter configuration .....	17
Hardware references .....	18
PM2225C meter model .....	18
Supplemental information .....	18
Panel meter .....	18
Meter mounting .....	19
Meter wiring .....	19
Direct connect voltage limits .....	19
Balanced system considerations .....	21
Control power (auxiliary power) .....	22
Serial communications .....	22
RS-485 wiring .....	22
Meter Display .....	24
Display overview .....	24
LED indicators .....	24
Alarm / energy pulsing LED .....	24
Heartbeat / serial communications LED .....	25
Notification icons .....	25
Meter display language .....	25
Meter screen navigation .....	25
Navigation symbols .....	26
Meter screen menus overview .....	26
Setting up the display .....	27
Basic setup .....	28
Configuring basic setup parameters using the display .....	28
Configuring advanced setup parameters using the display .....	30
Setting up regional settings .....	31
Setting up the screen passwords .....	32
Lost password .....	32
Setting the clock .....	32
Retrofit .....	33

- Retrofit setting ..... 33
- Remote meter setup ..... 34**
  - Overview ..... 34
  - ION setup ..... 34
  - RS-485 port setup ..... 34
  - Meter setup through RS-485 ..... 34
  - Meter configuration using ION setup ..... 34
- Input / Output ..... 35**
  - PM2225C Analog input applications ..... 35
  - PM2225C Analog output applications ..... 37
  - PM2225C Status input (DI) applications ..... 39
  - PM2225C Digital output applications ..... 40
  - PM2225C Relay output applications ..... 41
  - IO LED Indicator ..... 43
- Alarms ..... 44**
  - Alarms overview ..... 44
  - Alarm types ..... 44
  - Unary alarms ..... 44
    - Available unary alarms ..... 44
  - Digital alarms ..... 44
    - Available digital alarms ..... 45
  - Standard alarms ..... 45
    - Example of over and under setpoint (standard) alarm operation ..... 45
    - Maximum allowable setpoint ..... 47
    - Available standard alarms ..... 47
  - Alarm priorities ..... 49
  - Alarm setup overview ..... 50
  - LED alarm indicator ..... 52
    - Configuring the LED for alarms using the display ..... 52
    - Configuring the LED for alarms using ION Setup ..... 52
  - Alarm display and notification ..... 53
  - Active alarms list and alarm history log ..... 53
  - Alarms counters ..... 54
  - Resetting alarms using ION Setup ..... 55
- Meter resets ..... 56**
  - Meter resets ..... 56
  - Meter initialization ..... 56
    - Performing resets using ION Setup ..... 56
- Measurements and calculations ..... 58**
  - Meter initialization ..... 58
  - Real-time readings ..... 58
  - Energy measurements ..... 58
  - Quadrant based VARh ..... 59
  - Min/max values ..... 59
  - Power demand ..... 59
    - Power demand calculation methods ..... 59
    - Block interval demand ..... 60
    - Synchronized demand ..... 61
    - Thermal demand ..... 61
  - Current demand ..... 61



Predicted demand.....	62
Peak demand .....	62
Timer.....	62
<b>Power quality .....</b>	<b>64</b>
Harmonics overview .....	64
Total harmonic distortion %.....	64
Harmonic content calculations .....	64
THD% calculations.....	64
thd calculations.....	64
Viewing THD/thd using the display .....	65
<b>Maintenance and upgrades.....</b>	<b>66</b>
Maintenance overview .....	66
Troubleshooting LED indicators .....	66
Meter memory .....	66
Meter battery.....	67
Viewing firmware version, model and serial number .....	67
Firmware upgrades.....	67
Technical assistance.....	67
<b>Verifying accuracy.....</b>	<b>68</b>
Overview of meter accuracy .....	68
Accuracy test requirements .....	68
Verifying accuracy test .....	69
Required pulses calculation for accuracy verification testing .....	70
Total power calculation for accuracy verification testing .....	71
Percentage error calculation for accuracy verification testing .....	71
Accuracy verification test points.....	71
Energy pulsing considerations .....	72
VT and CT considerations.....	72
Example calculations .....	73
Typical sources of test errors .....	74
<b>Power and power factor .....</b>	<b>75</b>
Power and power factor .....	75
Current phase shift from voltage .....	75
Real, reactive and apparent power (PQS).....	75
Power factor (PF) .....	76
Power factor sign convention .....	77
Power factor min/max convention.....	77
Power factor register format.....	77
<b>Specifications .....</b>	<b>80</b>
<b>China Standard Compliance .....</b>	<b>85</b>



# Safety precautions

Installation, wiring, testing and service must be performed in accordance with all local and national electrical codes.

 <b>DANGER</b>
<p><b>HAZARD OF ELECTRIC SHOCK, EXPLOSION, OR ARC FLASH</b></p> <ul style="list-style-type: none"> <li>• Apply appropriate Personal Protective Equipment (PPE) and follow safe electrical work practices. See NFPA 70E, CSA Z462 or other local standards.</li> <li>• Turn off all power supplying this device and the equipment in which it is installed before working on or in the equipment.</li> <li>• Always use a properly rated voltage sensing device to confirm that all power is off.</li> <li>• Follow guidelines in the Wiring section of the related Installation Sheet.</li> <li>• Assume communications and I/O wiring are hazardous live until determined otherwise.</li> <li>• Do not exceed the maximum ratings of this device.</li> <li>• Do not short secondary terminals of Voltage Transformer (VT).</li> <li>• Do not open secondary terminals of Current Transformer (CT).</li> <li>• Ground secondary circuit of CTs.</li> <li>• Do not use the data from the meter to confirm power is off.</li> <li>• Replace all devices, doors and covers before turning on power to this equipment.</li> <li>• Do not install CTs or LPCTs in equipment where they exceed 75% of the wiring space of any cross-sectional area in the equipment.</li> <li>• Do not install CTs or LPCTs in areas where ventilation openings may be blocked or in areas of breaker arc venting.</li> <li>• Secure CT or LPCT secondary conductors to ensure they do not contact live circuits.</li> <li>• Use copper conductors only.</li> <li>• Do not use water or any liquid material to clean the product. Use a cleaning cloth to remove dirt. If dirt cannot be removed, contact local Technical Support representative.</li> <li>• Before installation, verify the rating and the characteristics of the supply side over current protection devices. <b>DO NOT EXCEED</b> the maximum current or voltage rating of the meter.</li> </ul> <p><b>Failure to follow these instructions will result in death or serious injury.</b></p>

**NOTE:** See IEC 60950-1 for more information on communications and I/O wiring connected to multiple devices.

 <b>WARNING</b>
<p><b>UNINTENDED OPERATION</b></p> <ul style="list-style-type: none"> <li>• Do not use this device for critical control or protection of persons, animals, property or equipment.</li> </ul> <p><b>Failure to follow these instructions can result in death, serious injury, or equipment damage.</b></p>

**▲ WARNING****POTENTIAL COMPROMISE OF SYSTEM AVAILABILITY, INTEGRITY, AND CONFIDENTIALITY**

- Change default passwords/passcodes to help prevent unauthorized access to device settings and information.
- Disable unused ports/services and default accounts, where possible, to minimize pathways for malicious attacks.
- Place networked devices behind multiple layers of cyber defenses (such as firewalls, network segmentation, and network intrusion detection and protection).
- Use cybersecurity best practices (for example: least privilege, separation of duties) to help prevent unauthorized exposure, loss, modification of data and logs, interruption of services, or unintended operation.

**Failure to follow these instructions can result in death, serious injury, or equipment damage.**

# Introduction

## Meter overview

The PM2225C meter is a digital meter that offers comprehensive 3-phase electrical instrumentation and load management facilities in a compact and rugged package.

The meters offer value for the demanding needs of your energy monitoring and cost management applications. All meters in the PM2225C range comply with Class 1 or Class 0.5S accuracy standards and feature high quality, reliability and affordability in a compact and easy to install format.

## Meter features

The PM2225C meter supports many features, a few of the features are listed below:

- Self guided LCD display and navigation
- Energy accounting and balancing
- Measurement of both True PF and Displacement PF
- Active, reactive, and apparent energy readings
- Min/Max values of instantaneous parameters with timestamp.
- Cybersecurity: The meter supports the disabling of RS-485 port through front panel keys to prevent unauthorized access. Toggle the RTU devices in case of limited availability of nodes in software system.
- Suppression current: This is the minimum current at which the meter starts functioning. The meter can be configured to disregard the measurement of induced / auxiliary load current in the circuit. The suppression current selection can be done through the front display and through communication. The suppression current range is from 5 mA to 99 mA. The meter shows measurement if applied value is above the suppression value. The default suppression current is 5 mA.

You can use the meter as a stand-alone device, but its extensive capabilities are fully realized when used as part of an energy management system.

For applications, feature details and the most current and complete specifications of the PM2225C meters, see the EasyLogic PM2225C technical datasheet at [www.se.com](http://www.se.com)

## Mounting adaptors

There are different mounting adaptor accessories that can help when installing your meter in existing panels and cutouts where the default mounting hardware is not appropriate.

Mounting adaptor kits are ordered separately from the meter.

## Feature summary

Parameter	PM2225C
Accuracy Class for Wh	Class 1 or Class 0.5S
Accuracy Class for VARh	1.0

Parameter	PM2225C
Sampling rate per cycle	64
Current: <ul style="list-style-type: none"> <li>Per-phase and 3 phase average</li> <li>Calculated neutral current</li> </ul>	✓
Voltage: <ul style="list-style-type: none"> <li>V L-N - per-phase and 3 phase average</li> <li>V L-L - per-phase and 3 phase average</li> </ul>	✓
Power Factor <ul style="list-style-type: none"> <li>Per phase and 3 phase total</li> </ul>	True PF Displacement PF
Frequency	✓
Power: <ul style="list-style-type: none"> <li>Active power (kW) - Phase wise and total</li> <li>Apparent power (kVA) - Phase wise and total</li> <li>Reactive power (kVAR) - Phase wise and total</li> </ul>	✓
3 Phase unbalance	Current Voltage
Demand parameters (kW, kVA, kVAR, I) <ul style="list-style-type: none"> <li>Last demand</li> <li>Present demand</li> <li>Predictive demand</li> <li>Peak demand: Timestamp for peak demand <sup>1</sup></li> </ul>	✓
Energy: kWh, kVAh, kVARh (4 Quadrant) - Phase wise <sup>2</sup> and total <ul style="list-style-type: none"> <li>Delivered (Import / Forward)</li> <li>Received (Export / Reverse)</li> </ul>	Delivered (D) Received (R) Total (D+R) Net (D-R) Last cleared (Old) <sup>1</sup>
THD, thd: <ul style="list-style-type: none"> <li>Voltage L-N per phase</li> <li>Voltage L-L per phase</li> <li>Current per phase</li> </ul>	✓
Individual Harmonics	Up to 15th individual harmonics
Min / Max with timestamp <ul style="list-style-type: none"> <li>V L-L average</li> <li>V L-N average</li> <li>Current average</li> <li>Neutral current</li> <li>Frequency</li> <li>Active power, Total</li> <li>Apparent power, Total</li> <li>Reactive power, Total</li> <li>Power factor, Total</li> </ul>	✓
Communication	RS-485 Modbus RTU
Digital IO modules (2 inputs & 2 outputs)	METSEPM2225C and METSEPM2225CL05
Analog IO Modules (2 inputs & 2 outputs)	METSEPM2225C2AI2AO
Relay IO Modules (2 digital inputs and 2 relay outputs)	METSEPM2225C2DI2RO
Retrofit For configuring legacy communication data models	✓

1. Indicated features can be read through communication only.  
2. The Phase wise energy is applicable only for 3PH4W configurations.

## Measured parameters

### Energy

The meter provides bi-directional, 4-quadrant, Class 1 / Class 0.5S accurate energy metering.

The meter stores all accumulated active, reactive, and apparent energy parameters in nonvolatile memory:

The meter provides both per phase and total values of energy.

#### Total energy:

- kWh, kVARh, kVAh (delivered)
- kWh, kVARh, kVAh (received)
- kWh, kVARh, kVAh (delivered + received)
- kWh, kVARh, kVAh (delivered - received)

#### Per phase energy:

- kWh1, kWh2, kWh3, kVARh1, kVARh2, kVARh3, kVAh1, kVAh2, kVAh3 (delivered)
- kWh1, kWh2, kWh3, kVARh1, kVARh2, kVARh3, kVAh1, kVAh2, kVAh3 (received)
- kWh1, kWh2, kWh3, kVARh1, kVARh2, kVARh3, kVAh1, kVAh2, kVAh3 (delivered + received)
- kWh1, kWh2, kWh3, kVARh1, kVARh2, kVARh3, kVAh1, kVAh2, kVAh3 (delivered - received)

**NOTE:** Based on the energy scale selection, when kWh, kWh1, kWh2, kWh3, kVARh, kVARh1, kVARh2, kVARh3, kVAh, kVAh1, kVAh2, kVAh3 (delivered) or kWh, kWh1, kWh2, kWh3, kVARh, kVARh1, kVARh2, kVARh3, kVAh, kVAh1, kVAh2, kVAh3 (received) of the energy parameters overflow at 999.99 all energy parameter value resets.

**NOTE:** The energy per phase displays on the HMI for the 3PH4W configurations (3PH4W Opn Dlt Ctr Tp, 3PH4W Dlt Ctr Tp, 3PH4W Wye Ungnd, 3PH4W Wye Gnd, and 3PH4W Wye Res Gnd) only. For other configurations, the energy per phase is not displayed on HMI and obtains as "0" through communication.

### Non Reset energy

Non Reset energy parameters are Wh, VAh and VARh for both Del and Rec. Non Reset energy parameters are available on display in Diag page under Maintenance and through communication..

These parameter values cannot be reset either through display or communication. These Non Reset energy values will overflow automatically when they reach maximum value based on overflow limit.

Command	Accumulated energies	Non Reset energies	Old energies
Reset sub systems	Clear	No Clear	Clear
Initialization	Clear	No Clear	Clear
Reset all energies	Clear	No clear	No clear (update with Accumulated energies)
Reset all accumulated energies (total, per phase)	Clear	No clear	No clear (update with Accumulated energies)

## Demand

The meter provides last, present, predicted, and maximum (peak) demand values, and a timestamp when the maximum (peak) demand occurred.

The meter supports standard demand calculation methods, including sliding block, fixed block, rolling block, thermal and synchronized.

Peak demand registers can be reset manually (password protected).

Demand measurements include:

- W, VAR, VA demand total
- Amps demand average

## Instantaneous

The meter provides highly accurate 1-second measurements, average values, including true RMS, per phase and total for:

- Per phase and average voltage (line-to-line, line-to-neutral)
- Per phase and average current, and neutral current
  - NOTE:** Neutral current is calculated.
- Per phase and total power (VA, W, Var)
- Per phase and average for true and displacement power factor
- System frequency
- Per phase and maximum of all three for voltage unbalance and current unbalance

## Power quality

The meter provides complete harmonic distortion metering, recording, and real-time reporting, THD percentage for all voltage and current inputs.

The following power quality measurements are available:

- Total harmonic distortion (THD%) for current and voltage (displays line-to-line or line-to-neutral, based on selected system configuration)
- Individual odd harmonics up to 15th order (Voltage and current, per phase)

## Other measurements

Additional measurements recorded by the meter include several timers.

These timers include:

- I/O timer displays the powered ON duration of the input or output.
- Operating timer displays the powered ON duration of the meter.
- Active load timer displays the duration of the connected load, based on the specified minimum current for the load timer setpoint setting.



## Data display and analysis tools

### Power Monitoring Expert

EcoStruxure™ Power Monitoring Expert is a complete supervisory software package for power management applications.

The software collects and organizes data gathered from your facility's electrical network and presents it as meaningful, actionable information via an intuitive web interface.

Power Monitoring Expert communicates with devices on the network to provide:

- Real-time monitoring through a multi-user web portal
- Trend graphing and aggregation
- Power quality analysis and compliance monitoring
- Preconfigured and custom reporting

See the EcoStruxure™ Power Monitoring Expert online help for instructions on how to add your device into its system for data collection and analysis.

### Power SCADA Operation

EcoStruxure™ Power SCADA Operation is a complete real-time monitoring and control solution for large facility and critical infrastructure operations.

It communicates with your device for data acquisition and real-time control. You can use Power SCADA Operation for:

- System supervision
- Real-time and historical trending, event logging
- PC-based custom alarms

See the EcoStruxure™ Power SCADA Operation online help for instructions on how to add your device into its system for data collection and analysis.

## Meter configuration

Meter configuration can be performed through the display or PowerLogic™ ION Setup.

ION Setup is a meter configuration tool that can be downloaded for free at [www.se.com](http://www.se.com).

See the ION Setup online help or in the ION Setup device configuration guide. To download a copy, go to [www.se.com](http://www.se.com) and search for ION Setup device configuration guide.

## Hardware references

### PM2225C meter model

The meter is available in one model with optional accessories that provide various mounting options.

### Meter models

Model	Commercial reference	Description
PM2225C	METSEPM2225C	Front panel mount, 96 x 96 mm form factor, EasyLogic VAF Power and Energy meter with RS-485 communication and digital I/O capabilities. Complies with accuracy class 1.
	METSEPM2225CL05	Front panel mount, 96 x 96 mm form factor, EasyLogic VAF Power and Energy meter with RS-485 communication and digital I/O capabilities. Complies with accuracy class 0.5S.
	METSEPM2225C2AI2AO	Front panel mount, 96 x 96 mm form factor, EasyLogic VAF Power and Energy meter with RS-485 communication and analog I/O capabilities. Complies with accuracy class 0.5S.
	METSEPM2225C2DI2RO	Front panel mount, 96 x 96 mm form factor, EasyLogic VAF Power and Energy meter with RS-485 communication and relay output capabilities. Complies with accuracy class 0.5S.

### Supplemental information

This document is intended to be used in conjunction with the instruction sheet that comes in the box with your device and accessories.

See your device's instruction sheet for information related to installation.

See your product's catalog pages at [www.se.com](http://www.se.com) for information about your device, its options and accessories.

You can download updated documentation from [www.se.com](http://www.se.com) or contact your local Schneider Electric representative for the latest information about your product.

### Panel meter

The back of your meter supports various power system connections.

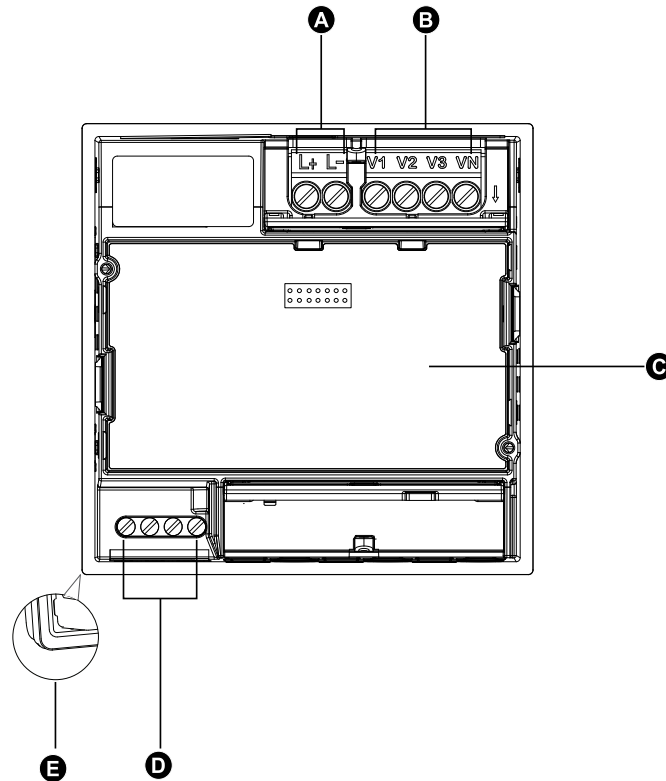

A	Auxiliary power supply (control power) terminals (L+, L-)
B	Input voltage terminals (V1, V2, V3, VN)
C	I/O card
D	RS-485 communications (D0, D1, SHLD, 0V)
E	Gasket

## Meter mounting

For mounting instructions and safety precautions, see the installation sheet that was shipped with your device

You can also download the latest copy at [www.se.com](http://www.se.com).

## Meter wiring

For wiring instructions and safety precautions, see the meter installation sheet that was shipped with your meter.

You can also download the latest copy at [www.se.com](http://www.se.com).

## Direct connect voltage limits

You can connect the meter's voltage inputs directly to the phase voltage lines of the power system if the power system's line-to-line or line-to-neutral voltages do not exceed the meter's direct connect maximum voltage limits.

The meter's voltage measurement inputs are rated by the manufacturer for up to 277 V L-N / 480 V L-L. However, the maximum voltage allowed for direct connection may be lower, depending on the local electrical codes and regulations.

As per installation category II the maximum voltage on the meter voltage measurement inputs should not exceed 277 V L-N / 480 V L-L for CAT III and 347 V L-N / 600 V L-L for CAT II.

If your system voltage is greater than the specified direct connect maximum voltage, you must use VTs (voltage transformers) to step down the voltages.

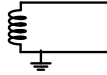
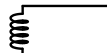
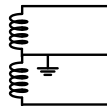
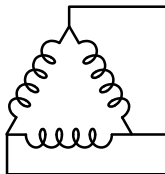
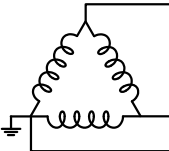
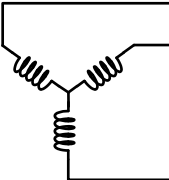
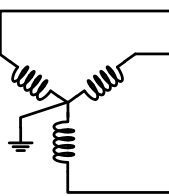
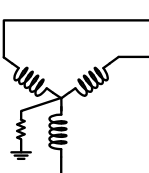
Power system description	Meter setting		Symbol	Direct connect maximum (UL / IEC)		# of VTs (if required)
	Display (meter)	Display (communication)		Installation category III	Installation category II	
Single-phase 2-wire line-to-neutral	1PH2W LN	1PH 2Wire L-N		≤ 277 V L-N	≤ 347 V L-N	1 VT
Single-phase 2-wire line-to-line	1PH2W LL	1PH 2Wire L-L		480 V L-L	600 V L-L	1 VT
Single-phase 3-wire line-to-line with neutral	1PH3W LL With N	1PH 3Wire L-L with N		≤ 277 V L-N / 480 V L-L	≤ 347 V L-N / 600 V L-L	2 VT
3-phase 3-wire Delta ungrounded	3PH3W Dlt Ungnd	3PH 3Wire Ungrounded Delta		480 V L-L	600 V L-L	2 VT
3-phase 3-wire Delta corner grounded	3PH3W Dlt Crnr Gnd	3PH 3Wire Corner Grounded Delta		240 V L-L	600 V L-L	2 VT
3-phase 3-wire Wye ungrounded	3PH3W Wye Ungnd	3PH 3Wire Ungrounded Wye		480 V L-L	600 V L-L	2 VT
3-phase 3-wire Wye grounded	3PH3W Wye Gnd	3PH 3Wire Grounded Wye		480 V L-L	600 V L-L	2 VT
3-phase 3-wire Wye resistance-grounded	3PH3W Wye Res Gnd	3PH 3Wire Resistance Grounded Wye		277 V L-N / 480 V L-L	347 V L-N / 600 V L-L	2 VT

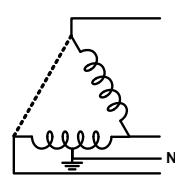
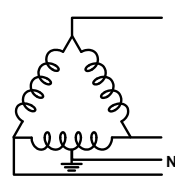
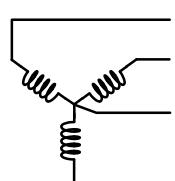
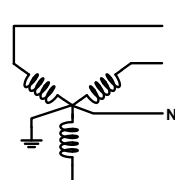
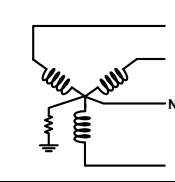
Power system description	Meter setting		Symbol	Direct connect maximum (UL / IEC)		# of VTs (if required)
	Display (meter)	Display (communication)		Installation category III	Installation category II	
3-phase 4-wire open Delta center-tapped	3PH4W Opn Dlt Ctr Tp	3PH 4Wire Center-Tapped Open Delta		173 V L-N / 347 V L-L	347 V L-N / 600 V L-L	3 VT
3-phase 4-wire Delta center-tapped	3PH4W Dlt Ctr Tp	3PH 4Wire Center-Tapped Delta		173 V L-N / 347 V L-L	347 V L-N / 600 V L-L	3 VT
3-phase 4-wire ungrounded Wye	3PH4W Wye Ungnd	3PH 4Wire Ungrounded Wye		≤ 277 V L-N / 480 V L-L	≤ 347 V L-N / 600 V L-L	3 VT or 2 VT
3-phase 4-wire grounded Wye	3PH4W Wye Gnd	3PH 4Wire Grounded Wye		≤ 277 V L-N / 480 V L-L	≤ 347 V L-N / 600 V L-L	3 VT or 2 VT
3-phase 4-wire resistance-grounded Wye	3PH4W Wye Res Gnd	3PH 4Wire Resistance Grounded Wye		≤ 277 V L-N / 480 V L-L	≤ 347 V L-N / 600 V L-L	3 VT or 2 VT

## Balanced system considerations

In situations where you are monitoring a balanced 3-phase load, you may choose to connect only one or two CTs on the phase(s) you want to measure, and then configure the meter so it calculates the current on the unconnected current input(s).

**NOTE:** For a balanced 4-wire Wye system, the meter’s calculations assume that there is no current flowing through the neutral conductor.

### Balanced 3-phase Wye system with 2 CTs

The current for the unconnected current input is calculated so that the vector sum for all three phases equal zero.

### Balanced 3-phase Wye or Delta system with 1CT

The currents for the unconnected current inputs are calculated so that their magnitude and phase angle are identical and equally distributed, and the vector sum for all three phase currents equal zero.

**NOTE:** You must always use 3 CTs for 3-phase 4-wire center-tapped Delta or center-tapped open Delta systems.

## Control power (auxiliary power)

	A	250 mA fuse
	<p>L+ and L- are non-polarized. If using an AC power supply with neutral, connect neutral to the meter's L- terminal.</p> <p>Always use a fuse on L+. Fuse L- when connecting an ungrounded neutral to the control power. If using a control power transformer, fuse both primary and secondary sides of the transformer. The fuses / circuit breakers must be rated for the installation voltage and sized for the available fault current.</p>	

## Serial communications

The meter supports serial communications through the RS-485 port. Up to 32 devices can be connected on a single RS-485 bus.

In an RS-485 network, there is one master device, typically an Ethernet to RS-485 gateway. It provides the means for RS-485 communications with multiple slave devices (for example, meters). For applications that require only one dedicated computer to communicate with the slave devices, an RS-232 to RS-485 converter can be used as the master device.

## RS-485 wiring

Connect the devices on the RS-485 bus in a point-to-point configuration, with the (+) and (-) terminals from one device connected to the corresponding (+) and (-) terminals on the next device.

## RS-485 cable

Use a shielded 2 twisted pair or 1.5 twisted pair RS-485 cable to wire the devices. Use one twisted pair to connect the (+) and (-) terminals, and use the other insulated wire to connect the C terminals

The total distance for devices connected on an RS-485 bus should not exceed 1000 m (3280 ft).

## RS-485 terminals

C	Common. This provides the voltage reference (zero volts) for the data plus and data minus signals
	Shield. Connect the bare wire to this terminal to help suppress signal noise that may be present. Ground the shield wiring at one end only (either at the master or the last slave device, but not both).
-	Data minus. This transmits/receives the inverting data signals.
+	Data plus. This transmits/receives the non-inverting data signals.

**NOTE:** If some devices in your RS-485 network do not have the C terminal, use the bare wire in the RS-485 cable to connect the C terminal from the meter to the shield terminal on the devices that do not have the C terminal.

# Meter Display

## Display overview

The display (integrated or remote) lets you use the meter to perform various tasks such as setting up the meter, displaying data screens, acknowledging alarms, or performing resets.

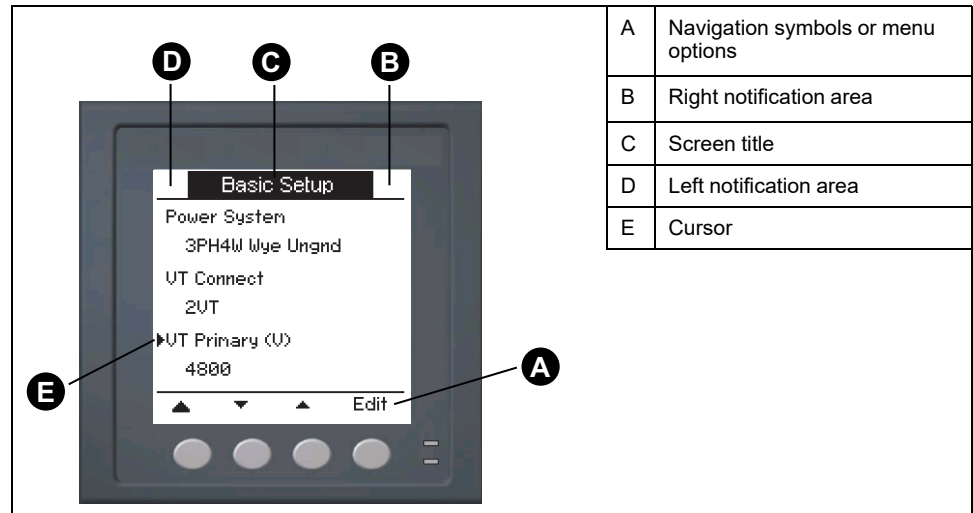

## LED indicators

The LED indicators alert or inform you of meter activity.

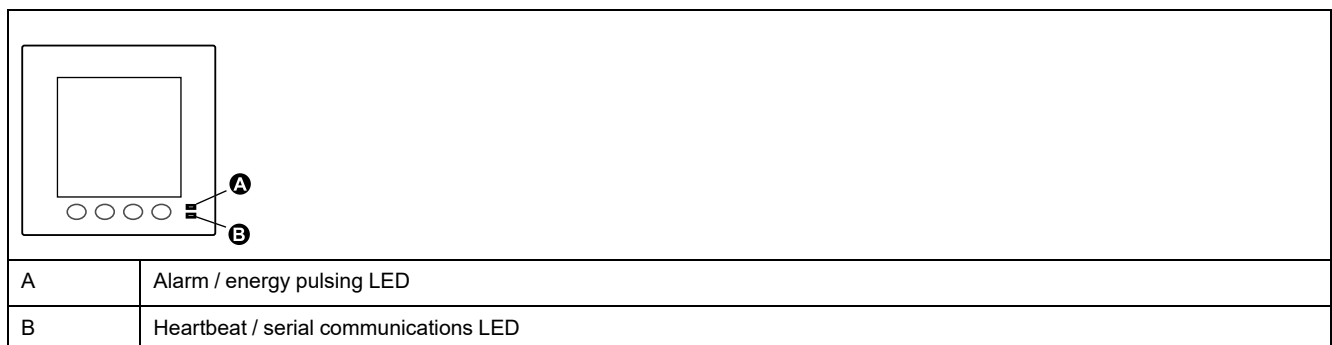

## Alarm / energy pulsing LED

The alarm / energy pulsing LED can be configured for alarm notification or energy pulsing.

When configured for alarm notification, this LED blinks every one second indicating that a high, medium or low priority alarm is tripped. The LED provides a visual indication of an active alarm condition or an inactive but unacknowledged high priority alarm.

When configured for energy pulsing, this LED flashes at a rate proportional to the amount of energy consumed. This is typically used to verify the power meter's accuracy.



## Heartbeat / serial communications LED

The heartbeat / serial communications LED blinks to indicate the meter's operation and serial Modbus communication status.



The LED blinks at a slow, steady rate to indicate the meter is operational. The LED flashes at a variable, faster rate when the meter is communicating over a Modbus serial communications port.

You cannot configure this LED for other purposes.

**NOTE:** A heartbeat LED that remains lit and does not blink (or flash) can indicate a technical problem. In this case, power down the meter and reapply power. If the LED still does not blink or flash, contact Technical Support.

## Notification icons

To alert you about meter state or events, notification icons appear at the top left or top right corner of the display screen.

Icon	Description
	The wrench icon indicates that the power meter is in an overvoltage condition or requires maintenance. It could also indicate that the energy LED is in an overrun state.
	The alarm icon indicates an alarm condition has occurred.

## Meter display language

If your meter is equipped with a display screen, you can configure the meter to display the measurements in one of several languages.

The following languages are available:

- English
- French
- Spanish
- German
- Portuguese
- Russian
- Chinese
- Turkish

## Meter screen navigation

The meter's buttons and display screen allow you to navigate data and setup screens, and to configure the meter's setup parameters.

A. Press the button below the appropriate menu to view that screen

B. Press the right arrow to view more screens

C. In setup mode, a small right arrow indicates the selected option

D. In setup mode, a small down arrow indicates that there are additional parameters to display. The down arrow disappears when there are no more parameters to display.

E. In setup mode, press the button under **Edit** to change that setting. If the item is read-only, cannot be configured with the meter's existing setup, or can only be configured using software, **Edit** disappears.

## Navigation symbols

Navigation symbols indicate the functions of the associated buttons on your meter's display.

Symbol	Description	Actions
▶	Right arrow	Scroll right and display more menu items or move cursor one character to the right
▲	Up arrow	Exit screen and go up one level
▼	Small down arrow	Move cursor down the list of options or display more items below
▲	Small up arrow	Move cursor up the list of items or display more items above
◀	Left arrow	Move cursor one character to the left
+	Plus sign	Increase the highlighted value or show the next item in the list.
-	Minus sign	Show the previous item in the list

When you reach the last screen, press the right arrow again to cycle through the screen menus.

## Meter screen menus overview

All meter screens are grouped logically, according to their function.

You can access any available meter screen by first selecting the Level 1 (top level) screen that contains it.

### Level 1 screen menus - IEEE title [IEC title]

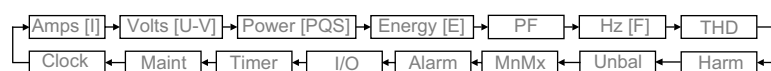

## Setting up the display

You can change the display screen's settings, such as contrast, backlight timeout, and screen timeout .

1. Navigate to **Maint > Setup**.
2. Enter the setup password (default is "0"), then press **OK**.
3. Navigate to **HMI > Disp**.
4. Move the cursor to point to the parameter you want to modify, then press **Edit**.
5. Modify the parameter as required, then press **OK**.
6. Move the cursor to point to the next parameter you want to modify, press **Edit**, make your changes, then press **OK**.
7. Press the up arrow to exit.
8. Press **Yes** to save your changes.

### Display settings available using the display

Parameter	Values	Description
Contrast	1 - 9	Increase or decrease the value to increase or decrease the display contrast.
Backlight Timeout (min)	0 - 60	Set how long backlight reduces its brightness after inactivity minutes. Default setting "0" disables the backlight timeout feature (i.e., backlight is always ON).
Screen Timeout (min)	0 - 60	Set how long the screen turns off after inactivity minutes. Default setting "0" disables the screen timeout feature (i.e., display is always ON).

To configure the display using ION Setup, see the "PM2000" topic in the ION Setup online help or in the ION Setup device configuration guide, available for download at [www.se.com](http://www.se.com).

# Basic setup

## Configuring basic setup parameters using the display

You can configure basic meter parameters using the display.

Proper configuration of the meter's basic setup parameters is essential for accurate measurement and calculations. Use the Basic Setup screen to define the electrical power system that the meter is monitoring.

If standard (1-sec) alarms have been configured and you make subsequent changes to the meter's basic setup, all alarms are disabled to prevent undesired alarm operation.

### **NOTICE**

#### **UNINTENDED EQUIPMENT OPERATION**

- Verify all standard alarms settings are correct and make adjustments as necessary.
- Re-enable all configured alarms.

**Failure to follow these instructions can result in equipment damage.**

After saving the changes, confirm all configured standard alarm settings are still valid, reconfigure them as required, and re-enable the alarms.

1. Navigate to **Maint > Setup**.
2. Enter the setup password (default is "0"), then press **OK**.
3. Navigate to **Meter > Basic**.
4. Move the cursor to point to the parameter you want to modify, then press **Edit**.
5. Modify the parameter as required, then press **OK**.
6. Move the cursor to point to the next parameter you want to modify, press **Edit**, make your changes, then press **OK**.

7. Press **Yes** to save your changes.

### Basic setup parameters available using the display

Values	Description
<b>Power System</b>	
Select the power system type (power transformer) the meter is wired to.	
1PH2W LN	Single-phase 2-wire line-to-neutral
1PH2W LL	Single-phase 2-wire line-to-line
1PH3W LL with N	Single-phase 3-wire line-to-line with neutral
3PH3W Dlt Ungnd	3-phase 3-wire ungrounded delta
3PH3W Dlt Crnr Gnd	3-phase 3-wire corner grounded delta
3PH3W Wye Ungnd	3-phase 3-wire ungrounded wye
3PH3W Wye Gnd	3-phase 3-wire grounded wye
3PH3W Wye Res Gnd	3-phase 3-wire resistance-grounded wye
3PH4W Opn Dlt Ctr Tp	3-phase 4-wire center-tapped open delta
3PH4W Dlt Ctr Tp	3-phase 4-wire center-tapped delta
3PH4W Wye Ungnd	3-phase 4-wire ungrounded wye
3PH4W Wye Gnd	3-phase 4-wire grounded wye
3PH4W Wye Res Gnd	3-phase 4-wire resistance-grounded wye
<b>VT Connect</b>	
Select how many voltage transformers (VT) are connected to the electrical power system.	
Direct Con	Direct connect; no VTs used
2VT	2 voltage transformers
3VT	3 voltage transformers
<b>VT Primary (V)</b>	
1 to 1,000,000	Enter the size of the VT primary, in Volts.
<b>VT Secondary (V)</b>	
100, 110, 115, 120	Select the size of the VT secondary, in Volts.
<b>CT on Terminal</b>	
Define how many current transformers (CT) are connected to the meter, and which terminals they are connected to.	
I1	1 CT connected to I1 terminal
I2	1 CT connected to I2 terminal
I3	1 CT connected to I3 terminal
I1 I2	2 CT connected to I1, I2 terminals
I2 I3	2 CT connected to I2, I3 terminals
I1 I3	2 CT connected to I1, I3 terminals
I1 I2 I3	3 CT connected to I1, I2, I3 terminals
<b>CT Primary (A)</b>	
1 to 32767	Enter the size of the CT primary, in Amps.
<b>CT Secondary (A)</b>	
1, 5	Select the size of the CT secondary, in Amps.
<b>Sys Frequency (Hz)</b>	
50, 60	Select the frequency of the electrical power system, in Hz.
<b>Phase Rotation</b>	
ABC, CBA	Select the phase rotation of the 3-phase system.

**Basic setup parameters available using the display (Continued)**

Values	Description
<b>A.Suppression</b> This is the minimum current at which the meter starts functioning. The meter can be configured to disregard the measurement of induced / auxiliary load current in the circuit.	
5 to 99	Select the Threshold Current (Suppression Current), in mA. <b>NOTE:</b> The default suppression current is 5 mA.
<b>CT Sequence</b> <sup>3</sup> Select the CT sequence based on the connection to the meter. <b>NOTE:</b> The default value of CT sequence is I1 I2 I3. <sup>4</sup>	
I1 I2 I3	3 CT connected in sequence of I1, I2, I3 terminals
I3 I2 I1	3 CT connected in sequence of I3, I2, I1 terminals
I3 I1 I2	3 CT connected in sequence of I3, I1, I2 terminals
I2 I3 I1	3 CT connected in sequence of I2, I3, I1 terminals
I2 I1 I3	3 CT connected in sequence of I2, I1, I3 terminals
I1 I3 I2	3 CT connected in sequence of I1, I3, I2 terminals
<b>CT Polarity Correction</b> <sup>5</sup> Select the CT for which the polarity is reversed. <b>NOTE:</b> The default value of CT Polarity Correction is None. <sup>4</sup>	
None	None of the CT polarity is reversed.
I1	Polarity reversed for the CT connected to the I1 terminal.
I2	Polarity reversed for the CT connected to the I2 terminal.
I3	Polarity reversed for the CT connected to the I3 terminal.
I1 I2	Polarity reversed for the CT connected to the I1 and I2 terminals.
I2 I3	Polarity reversed for the CT connected to the I2 and I3 terminals.
I1 I3	Polarity reversed for the CT connected to the I1 and I3 terminals.
I1 I2 I3	Polarity reversed for the CT connected to the I1, I2, and I3 terminals.

## Configuring advanced setup parameters using the display

You can configure a subset of advanced parameters using the display.

1. Navigate to **Maint > Setup**.
2. Enter the setup password (default is "0"), then press **OK**.
3. Navigate to **Meter > Advan**.
4. Move the cursor to point to the parameter you want to modify, then press **Edit**.
5. Modify the parameter as required, then press **OK**.
6. Move the cursor to point to the next parameter you want to modify, press **Edit**, make your changes, then press **OK**.

3. The CT sequence is applicable for 3PH3W and 3PH4W Power System Configurations and I1 I2 I3 CT on Terminal value. If you change the Power System Configurations or CT on Terminal value, then the CT sequence resets to the default value.

4. The device complies with the accuracy class only when CT sequence and CT polarity parameters are set to the default value.

5. The CT Polarity Correction parameters are available based on the selected Power System Configurations and CT on Terminal value. If you change the Power System Configurations or CT on Terminal value, then the CT Polarity Correction resets to the default value.

7. Press **Yes** to save your changes.

### Advanced setup parameters available using the display

Parameter	Values	Description
Label	—	This label identifies the device, e.g., “Power Meter”. You cannot use the display to edit this parameter. Use ION Setup to change the device label.
Load Timer Setpt (A)	0 - 18	Specifies the minimum average current at the load before the timer starts. The meter begins counting the number of seconds the load timer is on (i.e., whenever the readings are equal to or above this average current threshold).
Pk I dmd for TDD (A)	0 - 18	Specifies the minimum peak current demand at the load for inclusion in total demand distortion (TDD) calculations. If the load current is below the minimum peak current demand threshold, the meter does not use the readings to calculate TDD. Set this to “0” (zero) if you want the power meter to use the metered peak current demand for this calculation.

## Setting up regional settings

You can change the regional settings to localize the meter screens and display data in a different language, using local standards and conventions.

**NOTE:** In order to display a different language other than those listed in the Language setup parameter, you need to download the appropriate language file to the meter using the firmware upgrade process.

1. Navigate to **Maint > Setup**.
2. Enter the setup password (default is “0”), then press **OK**.
3. Navigate to **HMI > Region**.
4. Move the cursor to point to the parameter you want to modify, then press **Edit**.
5. Modify the parameter as required, then press **OK**.
6. Move the cursor to point to the next parameter you want to modify, press **Edit**, make your changes, then press **OK**.
7. Press the up arrow to exit.
8. Press **Yes** to save your changes.

### Regional settings available using the display

Parameter	Values	Description
Language	English US, French, Spanish, German, Portuguese, Chinese, Russian and Turkish	Select the language you want the meter to display.
Date Format	MM/DD/YY, YY/ MM/DD, DD/ MM/YY	Set how you want the date to be displayed, e.g., month/day/year.
Time Format	24Hr, AM/PM	Set how you want the time to be displayed, e.g., 17:00:00 or 5:00:00 PM.
HMI Mode	IEC, IEEE	Select the standards convention used to display menu names or meter data.

## Setting up the screen passwords

It is recommended that you change the default password in order to prevent unauthorized personnel from accessing password-protected screens such as the diagnostics and reset screens.

This can only be configured through the front panel. The factory-default setting for all passwords is “0” (zero).

1. Navigate to **Maint > Setup**.
2. Enter the setup password (default is “0”), then press **OK**.
3. Navigate to **HMI > Pass**.
4. Move the cursor to point to the parameter you want to modify, then press **Edit**.

Parameter	Values	Description
Setup	0000 - 9999	Sets the password for accessing the meter setup screens (Maint > Setup).
Energy Resets	0000 - 9999	Sets the password for resetting the meter's accumulated energy values.
Demand Resets	0000 - 9999	Sets the password for resetting the meter's recorded peak demand values.
Min/Max Resets	0000 - 9999	Sets the password for resetting the meter's recorded minimum and maximum values.

5. Modify the parameter as required, then press **OK**.
6. Move the cursor to point to the next parameter you want to modify, press **Edit**, make your changes, then press **OK**.
7. Press the up arrow to exit.
8. Press **Yes** to save your changes.

## Lost password

Visit [www.se.com](http://www.se.com) for support and assistance with lost passwords or other technical problems with the meter.

Make sure you include your meter's model, serial number and firmware version in your email or have it readily available if calling Technical Support.

## Setting the clock

The Clock setup screens allow you to set the meter's date and time.

1. Navigate to **Maint > Setup**.
2. Enter the setup password (default is “0”), then press **OK**.
3. Navigate to **Clock**.
4. Move the cursor to point to the parameter you want to modify, then press **Edit**.
5. Modify the parameter as required, then press **OK**.
6. Press **Yes** to save your changes.
7. Move the cursor to point to the next parameter you want to modify, press **Edit**, make your changes, then press **OK**.



8. Press the up arrow to exit.
9. Press **Yes** to save your changes.

Parameter	Values	Description
Date	DD/MM/YY, MM/DD/YY, YY/ MM/DD	Set the current date using the format displayed on screen, where DD = day, MM = month and YY = year.
Time	HH:MM:SS (24 hour format), HH:MM:SS AM or PM	Use the 24-hour format to set the current time in UTC (GMT).
Meter Time	GMT, Local	Select GMT to display the current time in UTC (Greenwich Mean Time zone). To display local time, set this parameter to Local, then use GMT Offset (h) to display local time in the proper time zone.

To configure the clock using ION Setup, see the “PM2000 series meter” topic in the ION Setup online help or in the ION Setup device configuration guide, available for download at [www.se.com](http://www.se.com).

## Retrofit

The retrofit communication mode in the meter provides you an option for configuring legacy data models to communicate with the new models. The retrofit register map selection can be configured using HMI.

## Retrofit setting

The following settings are required to enable the **Retrofit** communication mode in the meter.

1. Navigate to **Maint > Setup**.
2. Enter the setup password (default is “0”), then press **OK**.
3. Press **Comm**. The Serial Port screen appears.
4. Press **Edit** to select the **Accumulated** parameter.
5. Press - or + to scroll to **Retrofit**.
6. Press **OK** to select the **Retrofit** configuration.
7. Press **▲** to return to the setup screen.

**NOTE:** The existing configuration will be lost when you make new selection, so a confirmation screen appears.

- Press **Yes** to accept the changes and return to the Setup screen.
- Press **No** to keep the existing configuration and return to the Setup screen.

# Remote meter setup

## Overview

You can configure the meter's setup parameters through the meter's RS-485 communications port.

The meter is factory-configured with default RS-485 communications port settings. You must modify the default settings before connecting the meter to your RS-485 network. To configure the RS-485 port, you need:

- ION Setup

## ION setup

Go to [www.se.com](http://www.se.com) and search for ION Setup to download a copy of the installation file.

If you already have an existing installation of ION Setup, it is recommended that you upgrade to the latest version in order to access new features or enhancements and properly configure features available on your device.

Refer to the online help to learn how to use ION Setup.

## RS-485 port setup

The meter is factory-configured with default serial communications settings that you may need to modify before connecting the meter to the RS-485 bus.

The meter is factory-configured with the following default serial communications settings:

- Protocol = Modbus RTU
- Address = 1
- Baud rate = 19200
- Parity = Even

You can use a communications converter (USB to RS-485 or RS-232 to RS-485) device to connect to the meter.

## Meter setup through RS-485

After the meter's RS-485 port is configured and connected to the RS-485 network, you can use ION Setup to configure all other meter setup parameters.

## Meter configuration using ION setup

Start ION setup, create a site (or if applicable, use an existing site), then add your meter to the site.

See the "EasyLogic PM2000 Series Power Meter" topic in the ION setup online help or in the ION setup device configuration guide. To download a copy, go to [www.se.com](http://www.se.com) and search for ION setup device configuration guide.

# Input / Output

This section supplements the input and output installation and provides additional information regarding physical characteristics and capabilities

The input and output are available in the following variants:

- PM2225C two channel analog input and output
- PM2225C two channel digital input and output
- PM2225C two channel digital input and relay output

## PM2225C Analog input applications

The analog inputs interpret an incoming analog current signal from transducers. The analog I/O module can measure current using standard 4 - 20 mA analog transducers.

For analog input operation, the meter takes an analog input signal and provides the resulting scaled value. Analog inputs may show a value below zero scale if an open circuit is detected on the input port.

You can set the analog input's mode for current sensing.

### Wiring the analog input

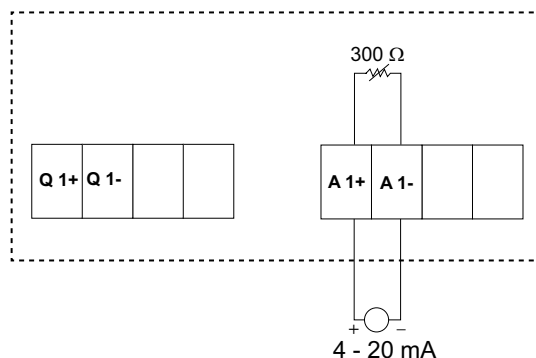

### Wiring the dual analog inputs

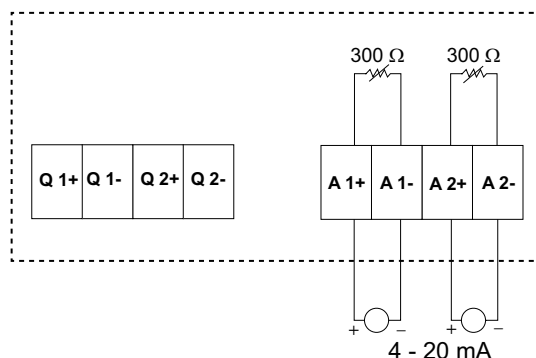

You can configure the following analog inputs on your meter:

Code	Unit	Description
0	–	No units
1	%	Percentage
2	°C	Degrees Celsius
3	°F	Degrees Fahrenheit

Code	Unit	Description
4	Deg	Degrees Angular
5	Hz	Hertz
6	A	Amperes
7	kA	Kilo Amperes
8	V	Volts
9	kV	Kilo Volts
10	MV	Mega Volts
11	W	Watts
12	kW	Kilowatts
13	MW	Megawatts
14	VAR	Volt-Ampere Reactive
15	kVAR	Kilo Volt-Ampere Reactive
16	MVAR	Mega Volt-Ampere Reactive
17	VA	Volt-Amperes
18	kVA	Kilo Volt-Amperes
19	MVA	Mega Volt-Amperes
20	WH	Watt-Hour
21	kWH	Kilowatt-Hour
22	MWH	Megawatt-Hour
23	VARH	Reactive Volt-Ampere Hour
24	kVARH	Reactive Kilo Volt-Ampere Hour
25	MVARH	Reactive Mega Volt-Ampere Hour
26	VAH	Volt-Ampere Hours
27	kVAH	Kilo Volt-Ampere Hours
28	MVAH	Mega Volt-Ampere Hours
29	Seconds	Seconds
30	Minutes	Minutes
31	Hours	Hours
32	Bytes (RAM)	Bytes
33	kBytes (RAM)	Kilobytes
34	\$	Dollars
35	gal	Gallons
36	gal/hr	Gallons/hour
37	gal/min	Gallons/minute
38	cfm	Cubic feet/min
39	PSI	PSI
40	BTU	BTU
41	L	Liters
42	ton-hours	Ton-hours
43	l/hr	Liters/hour
44	l/min	Liters/min
45	€	Euros
46	ms	Milliseconds
47	m <sup>3</sup>	Cubic-meters

Code	Unit	Description
48	m <sup>3</sup> /sec	Cubic-meters/sec
49	m <sup>3</sup> /min	Cubic-meters/min
50	m <sup>3</sup> /hr	Cubic-meters/hour
51	Pa	Pascals
52	Bars	Bar
53	RPM	Revolutions/min
55	BTU/hr	BTU/hour
56	PSIG	Pounds/square inch gauge
57	SCFM	Standard cubic feet/min
58	MCF	Thousand cubic feet
59	Therm	Therm
60	SCFH	Standard cubic feet/hour
61	PSIA	Pounds/square inch absolute
62	lbs	Pounds
63	kg	Kilogram
64	klbs	Kilopounds
65	lb/hr	Pound/hour
66	ton/hr	Ton/hour
67	kg/hr	Kilogram/hour
68	in. Hg	Inch of Mercury
69	kPa	KiloPascals
70	%RH	Percentage of relative humidity
71	MPH	Miles per hour
72	m/sec	Meters/sec
73	mV/cal/(cm <sup>2</sup> /min)	MilliVolts/calorie/(square centimeters/min)
74	in	Inches
75	mm	Millimeter
76	GWH	GigaWatt-Hour
77	GVARH	Reactive Giga Volt-Ampere Hour
78	GVAH	Giga Volt-Ampere Hours
79	AH	Ampere-Hours
80	kAH	Kiloamp-Hours
81	Therm/hr	Therm/hour

## PM2225C Analog output applications

The analog I/O module can send low current for standard 4 - 20 mA analog transducers.

For analog output operation, the meter takes an input value and scales it to the appropriate signal value to send out the physical analog output port.

**Wiring the analog output**

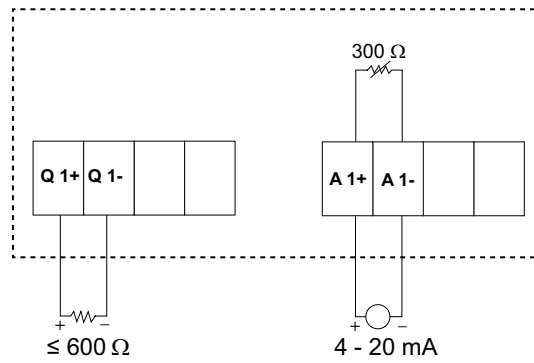

**Wiring the dual analog output**

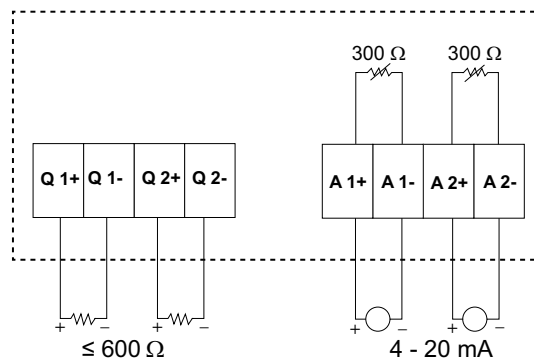

You can configure the following analog outputs on your meter:

Parameters	Description
Current	Current: Phase wise
	Current Average
	Current Unbalance: Phase wise
	Current Unbalance Worst
Voltage	Voltage L-L: Phase wise
	Voltage L-L Avg
	Voltage L-N: Phase wise
	Voltage L-N Avg
	Voltage Unbalance L-L: Phase wise
	Voltage Unbalance L-L Worst
	Voltage Unbalance L-N: Phase wise
	Voltage Unbalance L-N Worst
Power	Active Power: Phase wise
	Active Power Total
	Reactive Power: Phase wise
	Reactive Power Total
	Apparent Power: phase wise
	Apparent Power Total
PF	PF Total
Frequency	Frequency

# PM2225C Status input (DI) applications

Status inputs are typically used for monitoring the status of external contacts or circuit breakers.

The meter’s status inputs require either an external voltage source or whetting voltage (provided in the meter) to detect the status input’s ON/OFF state. The meter detects an ON state if the external voltage appearing at the status input is within its operating range.

### Wiring the status inputs

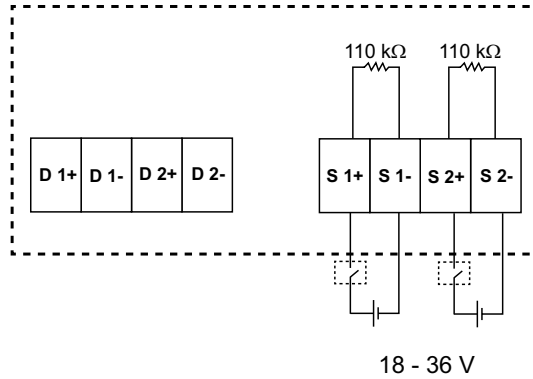

## Configuring status inputs using ION Setup

The status input ports (S1 and S2) can be configured using ION Setup.

1. Start ION Setup.
2. Connect to your meter.
3. Navigate to **I/O configuration > I/O Setup**.
4. Select a status input to configure and click **Edit**.  
The setup screen for that status input is displayed.
5. Enter a descriptive name for the status input’s **Label**.
6. Configure the other setup parameters as required.
7. Click **Send** to save your changes.

### Status input setup parameters available through ION Setup

Parameter	Values	Description
Label	—	Use this field to change the default label and assign a descriptive name to this status input.
Control Mode	Normal	This field displays how the status input functions. <ul style="list-style-type: none"> <li>• Normal: the status input is not associated with another meter function. The meter counts and records the number of incoming pulses normally.</li> </ul>
Debounce	0 to 9999	Debounce is the time delay that compensates for mechanical contact bounce. Use this field to set how long (in milliseconds) the external signal must remain in a certain state to be considered a valid state change.
Associations	—	This field displays additional information if the status input is already associated with another meter function.

## PM2225C Digital output applications

The meter is equipped with two digital output ports (D1, D2). You can configure the digital outputs for use in the following applications:

Switching applications, for example, to provide on/off control signals for switching capacitor banks, generators, and other external devices and equipment.

Energy pulsing applications, where a receiving device determines energy usage by counting the kWh pulses coming from the meter's digital output port.

Unary, digital and standard alarm configurations.

### Wiring the digital output

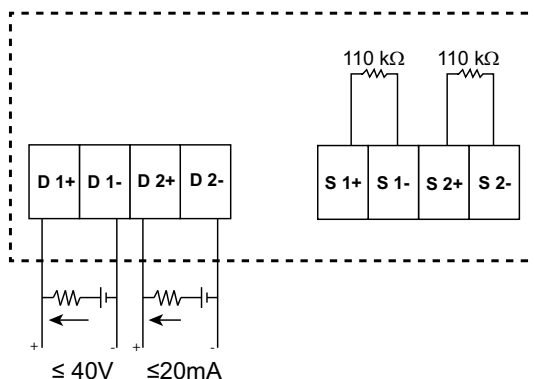

### Default digital output state

The default digital output state for I/O pin is high (switch closed). The digital output state for I/O pin can be changed through communication.

I/O pin state	External mode	Alarm	Display	Comm	Switch
Low	0	0	OFF	0	Open
	0	1	ON	1	Closed
	0	0	OFF	0	Open
	1	0	ON	1	Closed
High	0	0	OFF	0	Closed
	0	1	ON	1	Open
	0	0	OFF	0	Closed
	1	0	ON	1	Open

### Demand parameter for digital output

The associating demand parameters (Present demand (VA, W, VAR), Last demand (VA, W, VAR) and Predict demand (VA, W, VAR)) can be configured for digital output based on alarm events when exceeds the set upper limit. Only one demand parameter can be set at a given time.

**NOTE:** The alarm set up is done through communication using ION setup.

## Configuring digital outputs using ION Setup

You can use ION Setup to configure the digital outputs.



1. Start ION Setup.
2. Connect to your meter.
3. Navigate to **I/O configuration > I/O Setup**.
4. Select a digital output to configure and click **Edit**.  
The setup screen for that digital output is displayed.
5. Enter a descriptive name for the digital output in the **Label** field.
6. Configure the other setup parameters as required.
7. Click **Send** to save your changes.

**Digital output setup parameters available using ION Setup**

Parameter	Values	Description
Label	—	Use this field to change the default label and assign a descriptive name to this digital output.
Control Mode	External, Alarm, Energy	This field displays how the digital output functions. <ul style="list-style-type: none"> <li>• External: the digital output is controlled remotely either through software or by a PLC using commands sent through communications.</li> <li>• Alarm: the digital output is associated with the alarm system. The meter sends a pulse to the digital output port when the alarm is triggered.</li> <li>• Energy: The digital output is associated with energy pulsing. When this mode is selected, you can select the energy parameter and the set the pulse rate (pulses/kW).</li> </ul>
Behavior Mode	Normal, Timed, Coil Hold	<ul style="list-style-type: none"> <li>• Normal: this mode applies when control mode is set to External or Alarm. In the event of trigger for External mode, the digital output remains in the ON state until an OFF command is sent by the computer or PLC. In the event of trigger for Alarm mode, the digital output remains in the ON state until the drop out point is crossed.</li> <li>• Timed: the digital output remains ON for the period defined by the On Time setup register.</li> <li>• Coil Hold: this mode applies when control mode is set to External or Alarm. For a unary alarm that is associated with a digital output, you must set Behavior Mode to Coil Hold. The output turns on when the “energize” command is received and turns off when the “coil hold release” command is received. In the event of a control power loss, the output remembers and returns to the state it was in when control power was lost.</li> </ul>
On Time (s)	0 to 9999	This setting defines the pulse width (ON time) in seconds. <b>NOTE:</b> In energy mode, the digital output pulse ON time is fixed for 20 ms.
Select Alarms	All available alarms	Applies when Control Mode is set to Alarm. Select one or more alarms to monitor.
Associations	—	This field displays additional information if the digital output is already associated with another meter function.

## PM2225C Relay output applications

Relay outputs can be configured to be used in switching applications, for example, to provide on/off control signals for switching capacitor banks, generators, and other external devices and equipment.

### Wiring the two digital inputs and relay output

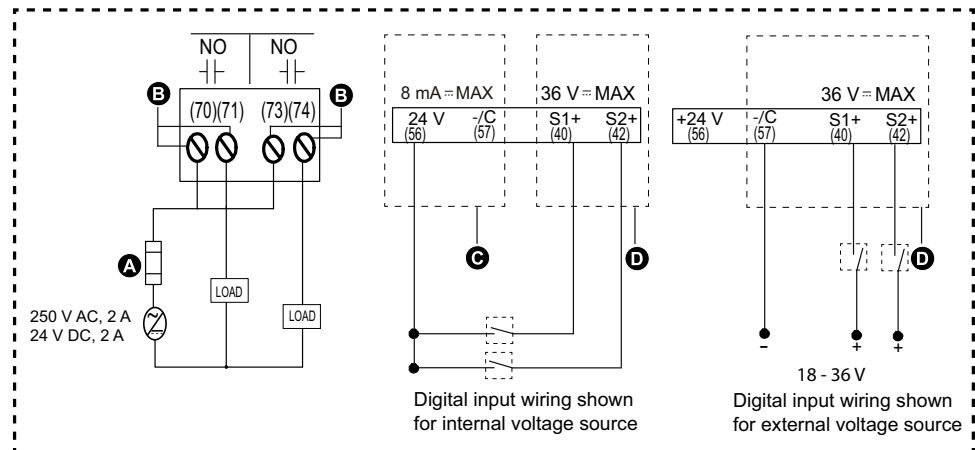

A	Overcurrent protective device
B	Relay 1 (70, 71), Relay 2 (73, 74)
C	Whetting output (56, 57)
D	Digital status inputs (40, 42, 57)

## Configuring relay outputs using ION Setup

You can use ION Setup to configure the relay output ports (Relay 1 and Relay 2).

1. Start ION Setup.
2. Connect to your meter.
3. Navigate to **I/O configuration > I/O Setup**.
4. Select a relay output to configure and click **Edit**.  
The setup screen for that relay output is displayed.
5. Enter a descriptive name for the relay output's **Label**.
6. Configure the other setup parameters as required.

7. Click **Send** to save your changes.

**Relay output setup parameters available through the ION Setup**

Parameter	Values	Description
Label	—	Use this field to change the default label and assign a descriptive name to this relay output.
Control Mode	External, Alarm	This field displays how the relay output functions. <ul style="list-style-type: none"> <li>External: the relay output is controlled remotely either through software or by a PLC using commands sent through communications.</li> <li>Alarm: the relay output is associated with the alarm system. The meter sends a pulse to the relay output port when the alarm is triggered.</li> </ul>
Behavior Mode	Normal, Timed, Coil Hold	<ul style="list-style-type: none"> <li>Normal: this mode applies when control mode is set to External or Alarm. In the event of trigger for External mode, the relay output remains in the closed state until an open command is sent by the computer or PLC. In the event of trigger for Alarm mode, the relay output remains in the closed state until the drop out point is crossed.</li> <li>Timed: the relay output remains ON for the period defined by the On Time setup register.</li> <li>Coil Hold: this mode applies when control mode is set to External or Alarm. For a unary alarm that is associated with a relay output, you must set Behavior Mode to Coil Hold. The output turns on when the “energize” command is received and turns off when the “coil hold release” command is received. In the event of a control power loss, the output remembers and returns to the state it was in when control power was lost.</li> </ul>
On Time (s)	0 to 9999	This setting defines the pulse width (ON time) in seconds.
Select Alarms	All available alarms	Applies when Control Mode is set to Alarm. Select one or more alarms to monitor.
Associations	—	This field displays additional information if the relay output is already associated with another meter function.

## IO LED Indicator

The IO LED indicator alerts or informs you of meters’ IO activities. The LED blinks at a constant pace when the IO module is attached to the meter.

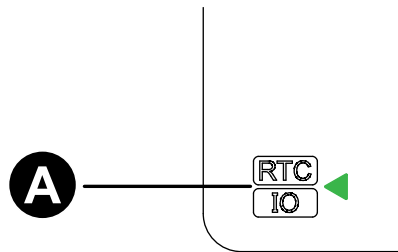

A	IO LED indicator (Green)
---	--------------------------

# Alarms

## Alarms overview

An alarm is the meter's means of notifying you when an alarm condition is detected, such as an error or an event that falls outside of normal operating conditions. Alarms are typically setpoint-driven and can be programmed to monitor certain behaviors, events or unwanted conditions in your electrical system.

You can configure your meter to generate and display high, medium and low priority alarms when predefined events are detected in the meter's measured values or operating states. Your meter also logs the alarm event information.

The meter ships with some alarms already enabled from the factory. Other alarms need to be configured before the meter can generate alarms.

Customize meter alarms as required, such as changing the priority. You can also create custom alarms using the advanced features of your meter.

## Alarm types

Your meters supports a number of different alarm types.

Type	METSEPM2225C2AI2AO	METSEPM2225C	METSEPM2225CL05	METSEPM2225C2DI2RO
Unary	4	4	4	4
Digital	—	2	2	2
Standard	23	23	23	23

## Unary alarms

A unary alarm is the simplest type of alarm — it monitors a single behavior, event or condition.

## Available unary alarms

Your meter has a set of 4 unary alarms.

Alarm label	Description
Meter Powerup	Meter powers on after losing control power.
Meter Reset	Meter resets for any reason.
Meter Diagnostic	Meter's self-diagnostic feature detects a problem.
Phase Reversal	Meter detects a phase rotation different than expected.

## Digital alarms

Digital alarms monitor the ON or OFF state of the meter's digital / status inputs.

## Digital alarm with setpoint delay

To prevent false triggers from erratic signals, you can set up pickup and dropout time delays for the digital alarm.

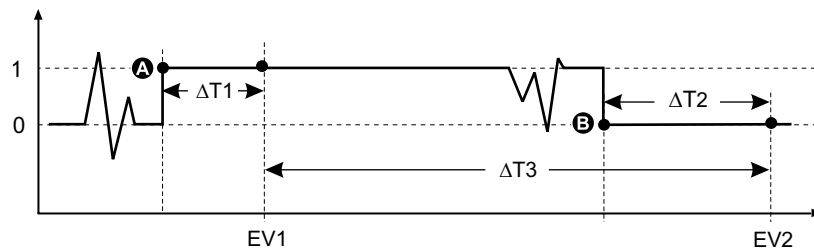

A	Pickup setpoint (1 = ON)	ΔT2	Dropout time delay (in seconds)
B	Dropout setpoint (0 = OFF)	EV2	End of alarm condition
ΔT1	Pickup time delay (in seconds)	ΔT3	Alarm duration (in seconds)
EV1	Start of alarm condition		

**NOTE:** To prevent filling the alarm log with nuisance alarm trips, the digital alarm is automatically disabled if the digital / status input changes state more than 4 times in one second or more than 10 times in ten seconds. In this case, you must re-enable the alarm using the display or ION Setup.

## Available digital alarms

Your meter has a set of 2 digital alarms.

Alarm label	Description
Digital Alarm S1	Digital input 1
Digital Alarm S2	Digital input 2

## Standard alarms

Standard alarms are setpoint-driven alarms which monitor certain behaviors, events or unwanted conditions in your electrical system.

Standard alarms have a detection rate equal to the 50/60 meter cycle, which is nominally 1 second if the meter’s frequency setting is configured to match the system frequency (50 or 60 Hz).

Many of the standard alarms are three-phase alarms. Alarm setpoints are evaluated for each of the three phases individually, but the alarm is reported as a single alarm. The alarm pickup occurs when the first phase exceeds the alarm pickup magnitude for the pickup time delay. The alarm is active as long as any phase remains in an alarm state. The alarm dropout occurs when the last phase drops below the dropout magnitude for the dropout time delay.

## Example of over and under setpoint (standard) alarm operation

The meter supports over and under setpoint conditions on standard alarms.

A setpoint condition occurs when the magnitude of the signal being monitored crosses the limit specified by the pickup setpoint setting and stays within that limit for a minimum time period specified by the pickup time delay setting.

The setpoint condition ends when the magnitude of the signal being monitored crosses the limit specified by dropout setpoint setting and stays within that limit for a minimum time period specified by dropout time delay setting.

## Over setpoint

When the value rises above the pickup setpoint setting and remains there long enough to satisfy the pickup time delay period ( $\Delta T1$ ), the alarm condition is set to ON. When the value falls below the dropout setpoint setting and remains there long enough to satisfy the dropout time delay period ( $\Delta T2$ ), the alarm condition is set to OFF.

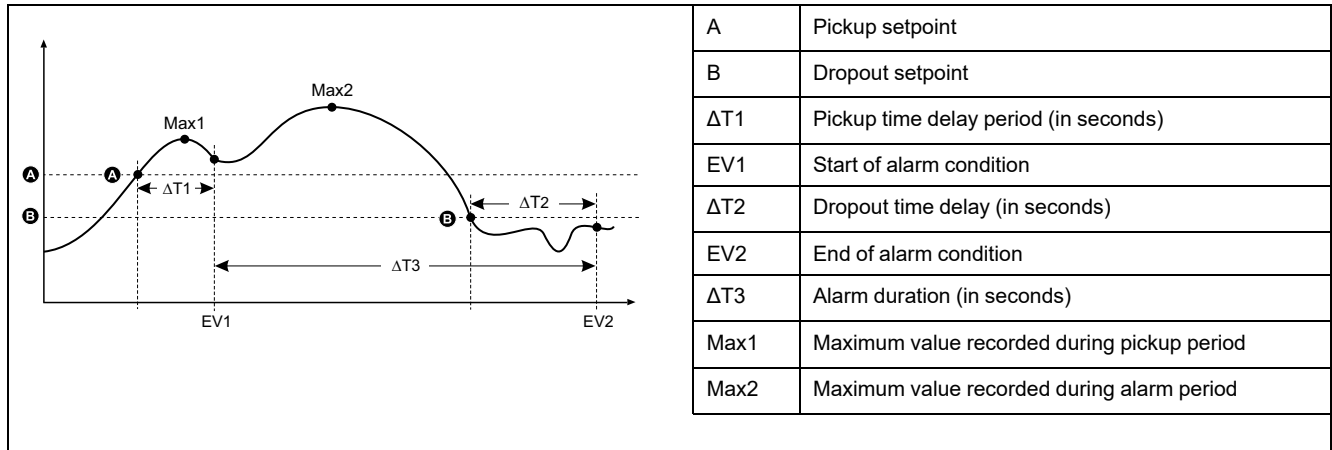

The meter records the date and time when the alarm event starts (EV1) and when it ends (EV2). The meter also performs any task assigned to the event, such as operating a digital output. The meter also records maximum values (Max1, Max2) before, during or after the alarm period.

## Under setpoint

When the value falls below the pickup setpoint setting and remains there long enough to satisfy the pickup time delay period ( $\Delta T1$ ), the alarm condition is set to ON. When the value rises above the dropout setpoint setting and remains there long enough to satisfy the dropout time delay period ( $\Delta T2$ ), the alarm condition is set to OFF.

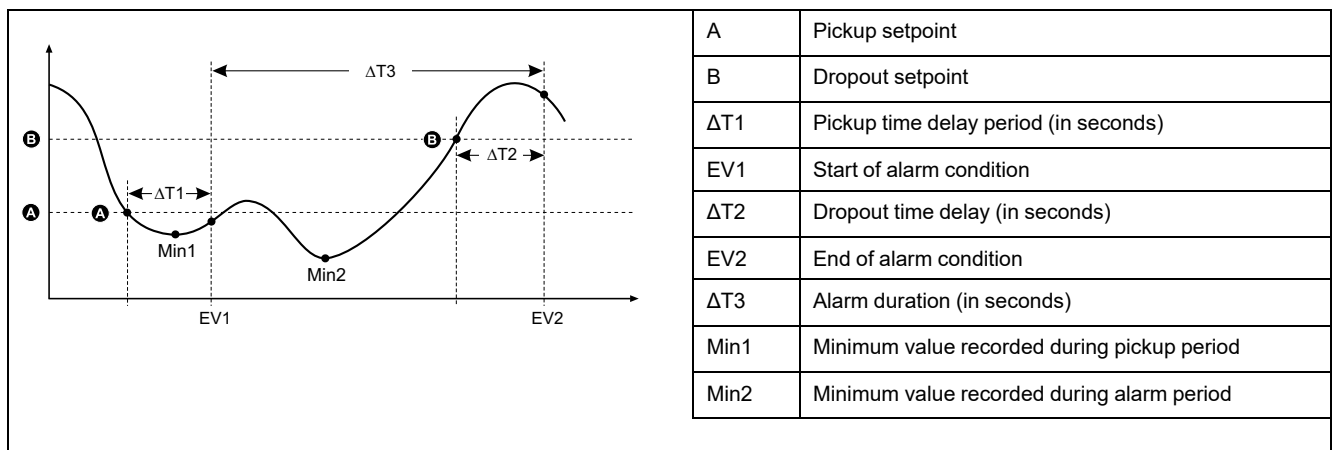

The meter records the date and time when the alarm event starts (EV1) and when it ends (EV2). The meter also performs any task assigned to the event, such as operating a digital output. The meter also records minimum values (Min1, Min2) before, during or after the alarm period.

## Maximum allowable setpoint

The meter is programmed to prevent user data entry errors, with set limits for the standard alarms.

The maximum setpoint value you can enter for some of the standard alarms depends on the voltage transformer ratio (VT ratio), current transformer ratio (CT ratio), system type (i.e., number of phases) and/or the maximum voltage and maximum current limits programmed at the factory.

**NOTE:** VT ratio is the VT primary divided by the VT secondary and CT ratio is the CT primary divided by the CT secondary.

Standard alarm	Maximum setpoint value
Over Phase Current	(maximum current) x (CT ratio)
Under Phase Current	(maximum current) x (CT ratio)
Under Voltage L-L	(maximum voltage) x (VT ratio)
Over Voltage L-N	(maximum voltage) x (VT ratio)
Under Voltage L-N	(maximum voltage) x (VT ratio)
Over Active Power	(maximum voltage) x (maximum current) x (number of phases)
Over Reactive Power	(maximum voltage) x (maximum current) x (number of phases)
Over Apparent Power	(maximum voltage) x (maximum current) x (number of phases)
Over Present Active Power Demand	(maximum voltage) x (maximum current) x (number of phases)
Over Last Active Power Demand	(maximum voltage) x (maximum current) x (number of phases)
Over Predicted Active Power Demand	(maximum voltage) x (maximum current) x (number of phases)
Over Present Reactive Power Demand	(maximum voltage) x (maximum current) x (number of phases)
Over Last Reactive Power Demand	(maximum voltage) x (maximum current) x (number of phases)
Over Predicted Reactive Power Demand	(maximum voltage) x (maximum current) x (number of phases)
Over Present Apparent Power Demand	(maximum voltage) x (maximum current) x (number of phases)
Over Last Apparent Power Demand	(maximum voltage) x (maximum current) x (number of phases)
Over Predicted Apparent Power Demand	(maximum voltage) x (maximum current) x (number of phases)

## Available standard alarms

Your meter has a set of standard alarms.

**NOTE:** Some alarms do not apply to all power system configurations. For example, line-to-neutral voltage alarms cannot be enabled on 3-phase delta systems. Some alarms use the system type and the VT or CT ratio to determine the maximum allowed setpoint.

Alarm label		Valid range and resolution		Units
ION Setup	Display	ION Setup	Display	
Over Phase Current	Over Current, Ph	0.000 to 99999.000	0 to 99999	A
Under Phase Current	Under Current, Ph	0.000 to 99999.000	0 to 99999	A
Over Voltage L-L	Over Voltage, L-L	0.00 to 999999.00	0 to 999999	V
Under Voltage L-L	Under Voltage, L-L	0.00 to 999999.00	0 to 9999999	V
Over Voltage L-N	Over Voltage, L-N	0.00 to 999999.00	0 to 9999999	V
Under Voltage L-N	Under Voltage L-N	0.00 to 999999.00	0 to 9999999	V
Over Active Power	Over kW	0.0 to 9999999.0	0 to 9999999	kW

Alarm label		Valid range and resolution		Units
ION Setup	Display	ION Setup	Display	
Over Reactive Power	Over kVAR	0.0 to 9999999.0	0 to 9999999	kVAR
Over Apparent Power	Over kVA	0.0 to 9999999.0	0 to 9999999	kVA
Leading True PF	Lead PF, True	-1.00 to -0.01 and 0.01 to 1.00		—
Lagging True PF	Lag PF, True	-1.00 to -0.01 and 0.01 to 1.00		—
Over Frequency	Over Frequency	0.000 to 99.000		Hz
Under Frequency	Under Frequency	0.000 to 99.000		Hz
Over Voltage THD	Over Voltage THD	0.000 to 99		%
Over Present Active Power Demand	Over kW Dmd, Pres	0.0 to 9999999.0	0 to 9999999	kW
Over Last Active Power Demand	Over kW Dmd, Last	0.0 to 9999999.0	0 to 9999999	kW
Over Predicted Active Power Demand	Over kW Dmd, Pred	0.0 to 9999999.0	0 to 9999999	kW
Over Present Reactive Power Demand	Over kVAR Dmd, Pres	0.0 to 9999999.0	0 to 9999999	kVAR
Over Last Reactive Power Demand	Over kVAR Dmd, Last	0.0 to 9999999.0	0 to 9999999	kVAR
Over Predicted Reactive Power Demand	Over kVAR Dmd, Pred	0.0 to 9999999.0	0 to 9999999	kVAR
Over Present Apparent Power Demand	Over kVA Dmd, Pres	0.0 to 9999999.0	0 to 9999999	kVA
Over Last Apparent Power Demand	Over kVA Dmd, Last	0.0 to 9999999.0	0 to 9999999	kVA
Over Predicted Apparent Power Demand	Over kVA Dmd, Pred	0.0 to 9999999.0	0 to 9999999	kVA

## Power factor (PF) alarms

You can set up a Leading PF or Lagging PF alarm to monitor when the circuit's power factor goes above or below the threshold you specify.

The Leading PF and Lagging PF alarms use the power factor quadrants as the values on the y-axis, with quadrant II on the lowest end of the scale, followed by quadrant III, quadrant I, and finally quadrant IV on the highest end of the scale.

Quadrant	PF values	Lead/Lag
II	0 to -1	Leading (capacitive)
III	-1 to 0	Lagging (inductive)
I	0 to 1	Lagging (inductive)
IV	1 to 0	Leading (capacitive)

## Leading PF alarm

The Leading PF alarm monitors an over setpoint condition.



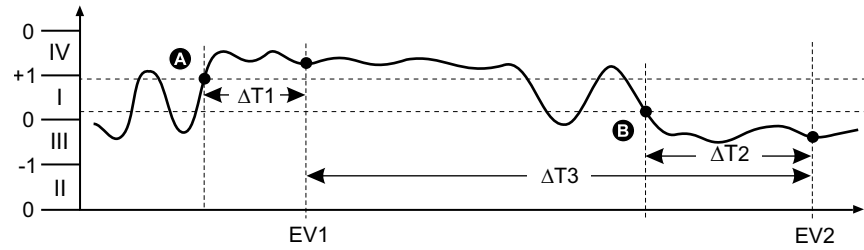

A	Pickup setpoint	$\Delta T2$	Dropout time delay (in seconds)
B	Dropout setpoint	EV2	End of alarm condition
$\Delta T1$	Pickup delay period (in seconds)	$\Delta T3$	Alarm duration (in seconds)
EV1	Start of alarm condition		

### Lagging PF alarm

The Lagging PF alarm monitors an under setpoint condition.

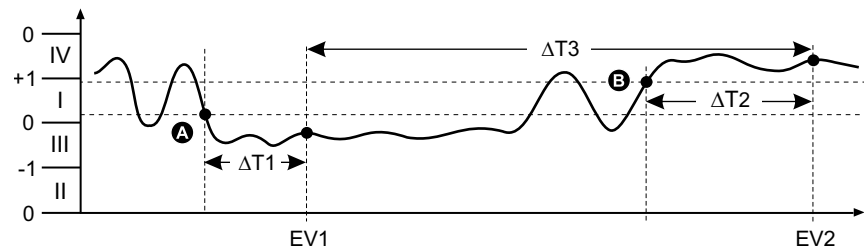

A	Pickup setpoint	$\Delta T2$	Dropout time delay (in seconds)
B	Dropout setpoint	EV2	End of alarm condition
$\Delta T1$	Pickup delay period (in seconds)	$\Delta T3$	Alarm duration (in seconds)
EV1	Start of alarm condition		

### Alarm priorities

Each alarm has a priority level that you can use to distinguish between events that require immediate action and those that do not require action.

Alarm priority	Alarm display notification and recording method			
	Alarm LED	Alarm icon	Alarm details	Alarm logging
High	Blinks while the alarm is active.	Blinks while the alarm is active. Alarm icon remains displayed until acknowledged.	Click <b>Details</b> to display what caused the alarm to pickup or drop off. Click <b>Ack</b> to acknowledge the alarm.	Recorded in alarm log.
Medium	Blinks while the alarm is active.	Blinks while the alarm is active.	Click <b>Details</b> to display what caused the alarm to pickup or drop off.	Recorded in alarm log.
Low	Blinks while the alarm is active.	Blinks while the alarm is active.	Click <b>Details</b> to display what caused the alarm to pickup or drop off.	Recorded in alarm log.
None	No activity	None	None	Recorded in event log only.

**NOTE:** The alarm LED notification only occurs if the alarm / energy pulsing LED is configured for alarming.

## Multiple alarm considerations

If multiple alarms with different priorities are active at the same time, the display shows the alarms in the order they occurred.

## Alarm setup overview

You can use ION Setup to configure unary, digital or standard (1-Sec) alarms.

If you make changes to the basic meter setup, all alarms are disabled to prevent undesired alarm operation.

### **NOTICE**

#### **UNINTENDED EQUIPMENT OPERATION**

- Verify all alarm settings are correct and make adjustments as necessary.
- Re-enable all configured alarms.

**Failure to follow these instructions can result in incorrect alarm functions.**

## Built-in error-checking

ION Setup dynamically checks incorrect setup combinations. When you enable an alarm, you must set up the pickup and dropout limits to acceptable values first in order to exit the setup screen.

## Setting up alarms using ION Setup

You can use ION Setup to create and set up alarms.

1. Start ION Setup and connect to your meter.
2. Open the **Alarming** screen.
3. Select the alarm you want to configure and click **Edit**.
4. Configure the setup parameters as explained in the different alarm setup sections.

See the ION Setup Device Configuration guide for more information.

## Unary alarm setup parameters

Configure the unary alarm setup parameters as required.

ION Setup controls are shown in parentheses.

Setting	Option or range	Description
Enable	Yes (checked) or No (cleared)	This enables or disables the alarm.
Priority	High, Medium, Low, None	This sets the alarm priority and notification options.

Setting	Option or range	Description
Select Dig Output (Outputs)	None Digital Output D1 Digital Output D2 Digital Output D1 & D2	Select the digital output(s) you want to control when the alarm is triggered.
Behaviour	Normal Timed Coil Hold	Select the required behaviour mode <b>NOTE:</b> When you select Normal value, Digital Output is not triggered

## Digital alarm setup parameters

Configure the digital alarm setup parameters as required.

ION Setup controls are shown in parentheses.

Setting	Option or range	Description
Enable	Yes (checked) or No (cleared)	This enables or disables the alarm.
Priority	High, Medium, Low, None	This sets the alarm priority and notification options.
Pickup Setpoint (Setpoint Pickup)	On, Off	Use this setting to control when to trip the alarm, based on the state of the digital input (On or Off).
Pickup Time Delay (Delay)	0 to 999999	This specifies the number of seconds the digital input must be in the alarm pickup state before the alarm is tripped.
Dropout Time Delay (Setpoint Dropout Delay)	0 to 999999	This specifies the number of seconds the digital input must be out of the alarm pickup state before the alarm turns off.
Select Dig Output (Outputs)	None Digital Output D1 Digital Output D2 Digital Output D1 & D2	Select the digital output(s) you want to control when the alarm is triggered.

## Standard (1-Sec) alarm setup parameters

Configure the standard alarm setup parameters as required.

ION Setup controls are shown in parentheses.

**NOTE:** It is recommended that you use ION Setup to configure standard (1-Sec) alarms. ION Setup supports a higher resolution to allow you to specify more decimal places when setting up the pickup setpoint and dropout setpoint values for certain measurements.

Setting	Option or range	Description
Enable	Yes (checked) or No (cleared)	This enables or disables the alarm.
Priority	High, Medium, Low, None	This sets the alarm priority and notification options.
Pickup Setpoint mA (Pickup Limit)	Varies depending on the standard alarm you are setting up	This is the value (magnitude) you define as the setpoint limit for triggering the alarm. For “over” conditions, this means the value has gone above the Pickup limit. For “under” conditions, this means the value has gone below the Pickup limit.

Setting	Option or range	Description
Pickup Time Delay (Delay)	0 to 999999	This specifies the number of seconds the signal must stay above the pickup setpoint (for "over" conditions), or below the pickup setpoint (for "under" conditions) before the alarm is tripped.
Dropout Setpoint mA (Dropout Limit)	Varies depending on the standard alarm you are setting up	This is the value (magnitude) you define as the limit for dropping out of the alarm condition. For "over" conditions, this means the value has gone below the Dropout limit. For "under" conditions, this means the value has gone above the Pickup limit.
Dropout Time Delay (Delay)	0 to 999999	This specifies the number of seconds the signal must stay below the dropout setpoint (for "over" conditions), or above the dropout setpoint (for "under" conditions) before the alarm condition is ended.
PU Set Point Lead/Lag (Lead, Lag)	Lead or Lag	Applies to PF (power factor) alarms only. Use this to set the PF value and quadrant to set the pickup setpoint for an over PF condition (PF Leading) or under PF condition (PF Lagging).
DO Set Point Lead/Lag (Lead, Lag)	Lead or Lag	Applies to PF (power factor) alarms only. Use this to set the PF value and quadrant to set the dropout setpoint for an over PF condition (PF Leading) or under PF condition (PF Lagging).
Select Dig Output (Outputs)	None Digital Output D1 Digital Output D2 Digital Output D1 & D2	Select the digital output(s) you want to control when the alarm is triggered.

## LED alarm indicator

You can use the meter's alarm / energy pulsing LED as an alarm indicator.

When set to detect alarms, the LED blinks to indicate an alarm condition.

## Configuring the LED for alarms using the display

You can use the meter display to configure the alarm / energy pulsing LED for alarming.

1. Navigate to the **Maint > Setup > LED**.
2. Set the mode to **Alarm**, then press **OK**.
3. Press the up arrow to exit. Press **Yes** to save your changes.

## Configuring the LED for alarms using ION Setup

You can use the ION Setup to configure your meter's LED for alarming.

1. Open ION Setup and connect to your meter. See the ION Setup Help for instructions.
2. Navigate to **Energy Pulsing**.
3. Select **Front Panel LED** and click **Edit**.
4. Set the control mode to **Alarm** and click **OK**.

5. Click **Send** to save your changes.

## Alarm display and notification

The meter notifies you when an alarm condition is detected.

### Alarm icon

When a low, medium or high priority alarm is tripped, this symbol appears at the top right corner of the display screen, indicating that an alarm is active:



For high priority alarms, the alarm icon remains displayed until you acknowledge the alarm.

### Alarm / energy pulsing LED

If configured for alarming, the alarm / energy pulsing LED also flashes to indicate the meter has detected an alarm condition.

### Alarm screens

If your meter is equipped with a display, you can use the buttons to navigate to the alarm setup or display screens.

### Active alarms

When a pickup event occurs, the active alarm list appears on the meter display's Active Alarms screen. Press **Detail** to see more event information.

### Alarm details

Details about the alarms can be viewed using:

- the active alarms (Active), alarm history (Hist), alarm counters (Count) and unacknowledged alarms (Unack) screens on the meter display, or

## Active alarms list and alarm history log

Each occurrence of a low, medium or high priority alarm is stored in the active alarms list and recorded in the alarm history log.

The active alarm list holds 40 entries at a time. The list works as a circular buffer, replacing old entries as new entries over 40 are entered into the active alarms list. The information in the active alarms list is volatile and reinitializes when the meter resets.

The alarm history log holds 40 entries. The log also works as a circular buffer, replacing old entries with new entries. The information in the alarm history log is nonvolatile and is retained when the meter resets.

## Viewing active alarm details using the display

When an alarm condition becomes true (alarm = ON), the alarm is displayed on the active alarms screen.

Alarms are displayed sequentially in the order of their occurrence, regardless of priority. The alarm details show the date and time of the alarm event, the type of event (for example, pickup or unary), which phase the alarm condition was detected on, and the value that caused the alarm condition.

**NOTE:** Alarm details are not available if the alarm priority is set to None.

The alarm details (for low, medium and high priority alarms) are also recorded in the alarm history log.

1. Navigate to **Alarm > Active**.
2. Select the alarm you want to view (the latest ones appear on top).
3. Press **Detail**.

**NOTE:** For unacknowledged high priority alarms, the Ack option appears on this screen. Press **Ack** to acknowledge the alarm, or return to the previous screen if you do not want to acknowledge the alarm.

## Viewing alarm history details using the display

The alarm history log keeps a record of active alarms and past alarms.

When an active alarm condition becomes false (alarm = OFF), the event is recorded in the alarm history log and alarm notification (alarm icon, alarm LED) is turned off.

Alarms are displayed sequentially in the order of their occurrence, regardless of priority. The alarm details show the date and time of the alarm event, the type of event (for example, dropout or unary), which phase the alarm condition was detected on, and the value that caused the alarm condition to turn ON or OFF.

**NOTE:** Alarm details are not available if the alarm priority is set to None.

1. Navigate to **Alarm > Hist**.
2. Select the alarm you want to view (the latest ones appear on top).
3. Press **Detail**.

**NOTE:** For unacknowledged high priority alarms, the **Ack** option appears on this screen. Press **Ack** to acknowledge the alarm, or return to the previous screen if you do not want to acknowledge the alarm.

## Alarms counters

Every occurrence of each type of alarm is counted and recorded in the meter.

## Alarms rollover value

The alarm counters roll over to zero after reaching the value 9999.

## Resetting alarms using ION Setup

Use ION Setup to reset alarms.

You can also reset alarms using the meter display.

1. Connect to your meter in ION Setup.
2. Open the **Meter Resets** screen.
3. Select the alarm parameters to clear and click **Reset**.

# Meter resets

## Meter resets

Resets allow you to clear various accumulated parameters stored on your meter or reinitialize the meter or meter accessories.

Meter resets clear your meter's onboard data and other related information. Resets are typically performed after you make changes to the meter's basic setup parameters (such as frequency, VT/PT or CT settings) to clear invalid or obsolete data in preparation for putting the meter into active service.

## Meter initialization

Meter Initialization is a special command that clears the meter's energy, power, demand values, and meter operation timer.

It is common practice to initialize the meter after its configuration is completed, before adding it to an energy management system.

After configuring all the meter setup parameters, navigate through the different meter display screens and make sure the displayed data is valid then perform meter initialization.

**NOTE:** You can perform meter initialization using ION setup and secured command interface.

## Performing resets using ION Setup

Resets allow you to clear all data of a particular type, such as all energy values or all minimum/maximum values.

1. Start ION Setup.
2. Connect to your meter.
3. Navigate to **Meter Resets**.



4. Select a parameter for reset and click **Reset**.

The selected parameter value gets cleared.

#### Reset parameters

Option	Description
Meter Initialization	Clears all data listed in this table.
Min/Max	Clears all the minimum and maximum registers.
Active Load Timer	Resets all active load timer logs.
Demands	Clears all the demand registers.
Peak Demands	Clears all the peak demand values.
Energies	Clears all accumulated energy values (kWh, kWh1, kWh2, kWh3, kVARh, kVARh1, kVARh2, kVARh3, kVAh, kVAh1, kVAh2, kVAh3), and Run hours.
Digital Outputs	Clears all digital output values.
Digital Output Counters	Clears all the digital output counters.
Digital Output On Times	Clears all the digital output on time logs.
Status Input Counters	Clears all the input counters.
Status Input On Times	Clears all the input on time logs.
Alarm Counters	Clears all the alarm counters and alarm logs.

# Measurements and calculations

## Meter initialization

Meter Initialization is a special command that clears the meter's energy, power, demand values, and meter operation timer.

It is common practice to initialize the meter after its configuration is completed, before adding it to an energy management system.

After configuring all the meter setup parameters, navigate through the different meter display screens and make sure the displayed data is valid then perform meter initialization.

**NOTE:** You can perform meter initialization using ION setup and secured command interface.

## Real-time readings

The meter measures currents and voltages, and reports in real time the RMS (Root Mean Squared) values for all three phases and neutral.

The voltage and current inputs are continuously monitored at a sampling rate of 64 samples per cycle. This amount of resolution helps enable the meter to provide reliable measurements and calculated electrical values for various commercial, buildings and industrial applications.

## Energy measurements

The meter provides fully bi-directional, 4-quadrant energy metering.

The meter stores all accumulated active, reactive and apparent energy measurements in nonvolatile memory:

The meter provides both per phase and total values of energy.

### Total energy:

- kWh, kVARh, kVAh (delivered)
- kWh, kVARh, kVAh (received)
- kWh, kVARh, kVAh (delivered + received)
- kWh, kVARh, kVAh (delivered - received)

### Per phase energy:

- kWh1, kWh2, kWh3, kVARh1, kVARh2, kVARh3, kVAh1, kVAh2, kVAh3 (delivered)
- kWh1, kWh2, kWh3, kVARh1, kVARh2, kVARh3, kVAh1, kVAh2, kVAh3 (received)
- kWh1, kWh2, kWh3, kVARh1, kVARh2, kVARh3, kVAh1, kVAh2, kVAh3 (delivered + received)
- kWh1, kWh2, kWh3, kVARh1, kVARh2, kVARh3, kVAh1, kVAh2, kVAh3 (delivered - received)

**NOTE:** Based on the energy scale selection, when kWh, kWh1, kWh2, kWh3, kVARh, kVARh1, kVARh2, kVARh3, kVAh, kVAh1, kVAh2, kVAh3 (delivered) or kWh, kWh1, kWh2, kWh3, kVARh, kVARh1, kVARh2, kVARh3, kVAh, kVAh1, kVAh2, kVAh3 (received) of the energy parameters overflow at 999.99 all energy parameter value resets.

**NOTE:** The energy per phase displays on the HMI for the 3PH4W configurations (3PH4W Opn Dlt Ctr Tp, 3PH4W Dlt Ctr Tp, 3PH4W Wye Ungnd, 3PH4W Wye Gnd, and 3PH4W Wye Res Gnd) only. For other configurations, the energy per phase is not displayed on HMI and obtains as "0" through communication.

## Quadrant based VARh

Quadrant based reactive energy values are available only on communication. These reactive energies are for Q1, Q2, Q3, and Q4 quadrants.

On communication quadrant based reactive energies will be recorded as follows:

- Q1 (00 to 90 Degree) = Q1 VARh , Del
- Q2 (90 to 180 Degree) = Q2 VARh , Del
- Q3 (180 to 270 degree) = Q3 VARh, Rec
- Q4 (270 to 360 degree) = Q4 VARh , Rec

If energy is cleared, all quadrant based VARhs will be cleared.

## Min/max values

When the readings reach their lowest or highest value, the meter updates and saves these min/max (minimum and maximum) quantities in non-volatile memory.

The meter's real-time readings are updated once every 50 cycles for 50 Hz systems, or once every 60 cycles for 60 Hz systems.

## Power demand

Power demand is a measure of average power consumption over a fixed time interval.

**NOTE:** If not specified, references to demand are assumed to mean power demand.

The meter measures instantaneous consumption and can calculate demand using various methods.

## Power demand calculation methods

Power demand is calculated by dividing the energy accumulated during a specified period by the length of that period.

How the meter performs this calculation depends on the method and time parameters you select (for example, timed rolling block demand with a 15-minute interval and 5-minute subinterval).

To be compatible with electric utility billing practices, the meter provides the following types of power demand calculations:

- Block interval demand
- Synchronized demand
- Thermal demand

You can configure the power demand calculation method from the display or software.

## Block interval demand

For block interval demand method types, you specify a period of time interval (or block) that the meter uses for the demand calculation.

Select/configure how the meter handles that interval from one of these different methods:

Type	Description
Timed Sliding Block	Select an interval from 1 to 60 minutes (in 1-minute increments). If the interval is between 1 and 15 minutes, the demand calculation <i>updates every 15 seconds</i> . If the interval is between 16 and 60 minutes, the demand calculation <i>updates every 60 seconds</i> . The meter displays the demand value for the last completed interval.
Timed Block	Select an interval from 1 to 60 minutes (in 1-minute increments). The meter calculates and updates the demand at the end of each interval.
Timed Rolling Block	Select an interval and a subinterval. The subinterval must divide evenly into the interval (for example, three 5-minute subintervals for a 15-minute interval). Demand is <i>updated at the end of each subinterval</i> . The meter displays the demand value for the last completed interval.

## Block interval demand example

The following illustration shows the different ways power demand is calculated using the block interval method. In this example, the interval is set to 15 minutes.

### Timed Sliding Block

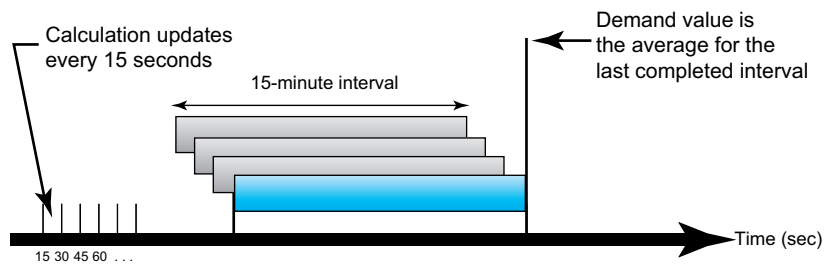

### Timed Block

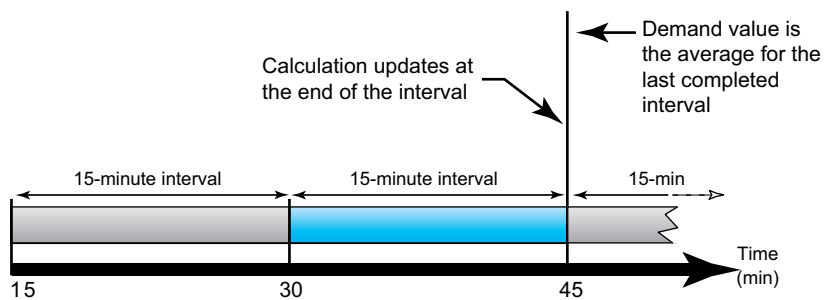

### Timed Rolling Block

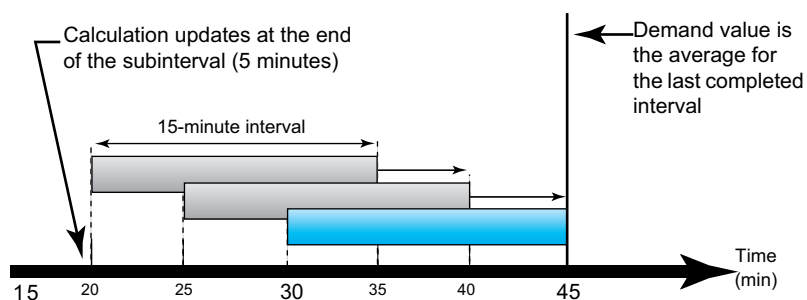

## Synchronized demand

You can configure the demand calculations to be synchronized using an external pulse input, a command sent over communications, or the device’s internal real-time clock.

Type	Description
Command synchronized demand	This method allows you to synchronize the demand intervals of multiple meters on a communications network. For example, if a programmable logic controller (PLC) input is monitoring a pulse at the end of a demand interval on a utility revenue meter, you can program the PLC to issue a command to multiple meters whenever the utility meter starts a new demand interval. Each time the command is issued, the demand readings of each meter are calculated for the same interval.
Clock synchronized demand	This method allows you to synchronize the demand interval to the meter’s internal real-time clock. This helps you synchronize the demand to a particular time, typically on the hour (for example, at 12:00 am). If you select another time of day when the demand intervals are to be synchronized, the time must be specified in minutes from midnight. For example, to synchronize at 8:00 am, select 480 minutes.

**NOTE:** For these demand types, you can choose block or rolling block options. If you select a rolling block demand option, you need to specify a subinterval.

## Thermal demand

Thermal demand calculates the demand based on a thermal response, which imitates the function of thermal demand meters.

The demand calculation updates at the end of each interval. You can set the demand interval from 1 to 60 minutes (in 1-minute increments).

### Thermal demand example

The following illustration shows the thermal demand calculation. In this example, the interval is set to 15 minutes. The interval is a window of time that moves across the timeline. The calculation updates at the end of each interval.

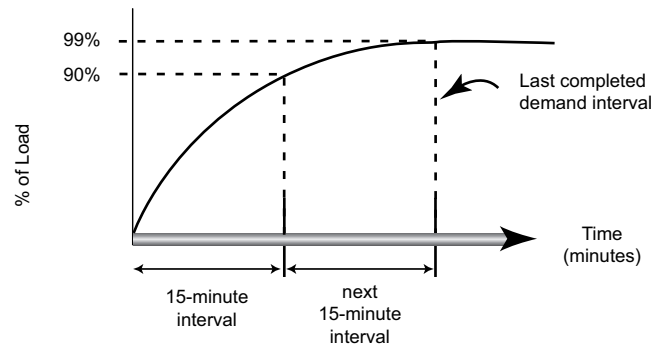

## Current demand

The meter calculates current demand using the block interval, synchronized or thermal demand methods.

You can set the demand interval from 1 to 60 minutes in 1 minute increments (for example, 15 minutes).

## Predicted demand

The meter calculates predicted demand for the end of the present interval for kW, kVAR, and kVA demand, taking into account the energy consumption so far within the present (partial) interval and the present rate of consumption.

Predicted demand is updated according to the update rate of your meter.

The following illustration shows how a change in load can affect predicted demand for the interval. In this example, the interval is set to 15 minutes.

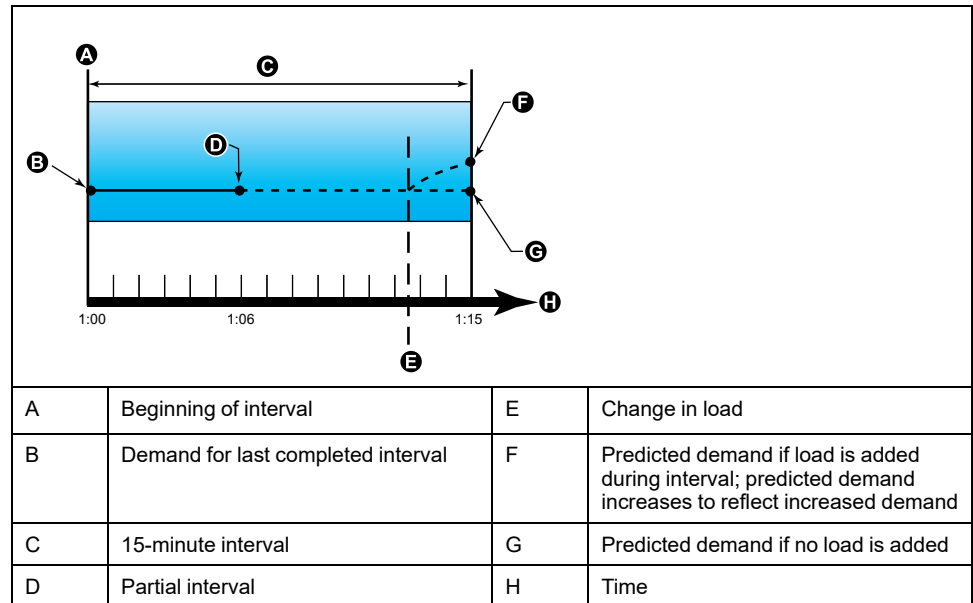

## Peak demand

The meter records the peak (or maximum) values for kW, kVAR, and kVA power (or peak demand).

The peak for each value is the highest average reading since the meter was last reset. These values are maintained in the meter's non-volatile memory.

The meter also stores the date and time when the peak demand occurred.

## Timer

The meter supports an active load timer, meter operation timer, and run time.

### Active load timer

Active load timer shows how much time a load has been running, based on the specified minimum current for the load timer setpoint setting.

### Meter operation timer

Meter operating timer shows how long the meter has been powered up.

## Run time

Run time shows how much time a load has been running, based on accumulated energy - received and delivered.

The run time can be read through communication only.

# Power quality

## Harmonics overview

This section describes the meter's power quality features and how to access power quality data. The meter measures voltage and current harmonics up to the 15th harmonic, and calculates Total Harmonic Distortion (THD%).

Harmonics are integer multiples of the fundamental frequency of the power system. Harmonics information is required for compliance to system power quality standards such as EN50160 and meter power quality standards such as IEC 61000-4-30.

The meter measures fundamental and higher harmonics relative to the fundamental frequency. The meter's power system setting defines which phases are present and determines how line-to-line or line-to-neutral voltage harmonics and current harmonics are calculated.

Harmonics are used to identify whether the supplied system power meets required power quality standards, or if non-linear loads are affecting your power system. Power system harmonics can cause current flow on the neutral conductor, and damage to equipment such as increased heating in electric motors. Power conditioners or harmonic filters can be used to minimize unwanted harmonics.

## Total harmonic distortion %

Total harmonic distortion (THD%) is a measure of the total per-phase voltage or current harmonic distortion present in the power system.

THD% provides a general indication of the quality of a waveform. THD% is calculated for each phase of both voltage and current.

## Harmonic content calculations

Harmonic content ( $H_C$ ) is equal to the RMS value of all the non-fundamental harmonic components in one phase of the power system.

The meter uses the following equation to calculate  $H_C$ :

$$H_C = \sqrt{(H_2)^2 + (H_3)^2 + (H_4)^2 \dots}$$

## THD% calculations

THD% is a quick measure of the total distortion present in a waveform and is the ratio of harmonic content ( $H_C$ ) to the fundamental harmonic ( $H_1$ ).

By default, the meter uses the following equation to calculate THD%:

$$THD = \frac{H_C}{H_1} \times 100\%$$

## thd calculations

thd is an alternate method for calculating total harmonic distortion that uses the RMS value for the total harmonic content rather than the fundamental content.

The meter uses the following equation to calculate thd:



$$\text{thd} = \frac{\text{HC}}{\sqrt{(\text{H1})^2 + (\text{HC})^2}} \times 100$$

## Viewing THD/thd using the display

You can view THD/thd data using the display.

**NOTE:** Your meter's Modbus map includes registers for total harmonic distortion data for integration into your power or energy management system.

1. Navigate to **THD** to view the **THD/thd Select** screen.
2. Press **THD** to display values that use the calculation method based on the fundamental harmonic or **thd** to display values that use the calculation method based on the RMS value of all harmonics in that phase (including the fundamental).

IEEE mode	IEC mode	Description
Amps	I	Total harmonic distortion data for per phase and neutral currents.
V L-L	U	Total harmonic distortion data line-to-line voltage.
V L-N	V	Total harmonic distortion data line-to-neutral voltage.

3. Press the current or voltage THD or thd values you want to view.  
The total harmonic distortion percentage values are displayed.
4. Press the up arrow to return to the main display screens.

# Maintenance and upgrades

## Maintenance overview

The meter does not contain any user-serviceable parts. If the meter requires service, contact your local Schneider Electric Technical Support representative.

<b>NOTICE</b>
<p><b>METER DAMAGE</b></p> <ul style="list-style-type: none"> <li>• Do not open the meter case.</li> <li>• Do not attempt to repair any components of the meter.</li> </ul> <p><b>Failure to follow these instructions can result in equipment damage.</b></p>

Do not open the meter. Opening the meter voids the warranty.

## Troubleshooting LED indicators

Abnormal heartbeat / serial communications LED behavior could mean potential problems with the meter.

<b>Problem</b>	<b>Probable causes</b>	<b>Possible solutions</b>
LED flash rate does not change when data is sent from the host computer.	Communications wiring	If using a serial-to-RS-485 converter, trace and check that all wiring from the computer to the meter is properly terminated.
	Internal hardware problem	Perform a hard reset: turn off control power to the meter, then re-apply power. If the problem persists, contact Technical Support.
Heartbeat / serial communications LED remains lit and does not flash ON and OFF	Internal hardware problem	Perform a hard reset: turn off control power to the meter, then re-apply power. If the problem persists, contact Technical Support.
Heartbeat / serial communications LED flashes, but the display is blank.	Display setup parameters incorrectly set	Review display parameter setup.

If the problem is not fixed after troubleshooting, contact Technical Support for help and ensure you have your meter’s firmware version, model and serial number information available.

## Meter memory

The meter stores configuration and logging information in non-volatile memory and a long-life memory chip.

The meter uses its non-volatile memory (NVRAM) to retain all data and metering configuration values.

## Meter battery

The internal battery in the meter keeps the meter's clock running when it is powered down to help maintain the meter time.

The life expectancy of the meter's internal battery is estimated to be over 10 years at 25 °C under typical operating conditions.

## Viewing firmware version, model and serial number

You can view the meter's firmware version, model and serial number from the display panel.

1. Navigate to **Maint > Diag**.
2. Press **Info** to view meter model, serial number, date of manufacturing, OS version, and RS version.
3. Press **St Edt** to view **Number of Edits**, **Date of Last Edit** and **Time of Last Edit**.
4. Press Up to exit.

## Firmware upgrades

There are a number of reasons why you may want to upgrade your meter's firmware.

- Improve meter performance (e.g., optimize processing speed)
- Enhance existing meter features and functions
- Add new functionality to the meter
- Achieve compliance to new industry standards

## Technical assistance

Visit [www.se.com](http://www.se.com) for support and assistance with lost passwords or other technical problems with the meter.

Make sure you include your meter's model, serial number and firmware version in your email or have it readily available if calling Technical Support.

# Verifying accuracy

## Overview of meter accuracy

All meters are tested and verified at the factory in accordance with International Electrotechnical Commission (IEC) and Institute of Electrical and Electronics Engineers (IEEE) standards.

Your meter typically does not require re-calibration. However, in some installations a final accuracy verification of the meters is required, especially if the meters will be used for revenue or billing applications.

## Accuracy test requirements

The most common method for testing meter accuracy is to apply test voltages and currents from a stable power source and compare the meter's readings with readings from a reference device or energy standard.

## Signal and power source

The meter maintains its accuracy during voltage and current signal source variations but its energy pulsing output needs a stable test signal to help produce accurate test pulses. The meter's energy pulsing mechanism needs approximately 10 seconds to stabilize after every source adjustment.

The meter must be connected to control power in order to conduct accuracy verification testing. Refer to your meter's installation documentation for power supply specifications.

### **DANGER**

#### **HAZARD OF ELECTRIC SHOCK, EXPLOSION, OR ARC FLASH**

Verify the device's power source meets the specifications for your device's power supply.

**Failure to follow these instructions will result in death or serious injury.**

## Control equipment

Control equipment is required for counting and timing the pulse outputs from an energy pulsing LED.

- Most standard test benches have an arm equipped with optical sensors to detect LED pulses (the photodiode circuitry converts detected light into a voltage signal).
- The reference device or energy standard typically has digital inputs that can detect and count pulses coming from an external source (i.e., the meter's pulse output).

**NOTE:** The optical sensors on the test bench can be disrupted by strong sources of ambient light (such as camera flashes, florescent tubes, sunlight reflections, floodlights, etc.). This can cause test errors. Use a hood, if necessary, to block out ambient light.

## Environment

The meter should be tested at the same temperature as the testing equipment. The ideal temperature is about 23 °C (73 °F). Make sure the meter is warmed up sufficiently before testing.

A warm-up time of 30 minutes is recommended before beginning energy accuracy verification testing. At the factory, the meters are warmed up to their typical operating temperature before calibration to help ensure that the meters will reach their optimal accuracy at operating temperature.

Most high precision electronic equipment requires a warm up time before it reaches its specified performance levels. Energy meter standards allow the manufacturers to specify meter accuracy derating due to ambient temperature changes and self-heating.

Your meter complies with and meets the requirements of these energy metering standards.

For a list of accuracy standards that your meter complies to, contact your local Schneider Electric representative or download the meter brochure from [www.se.com](http://www.se.com).

## Reference device or energy standard

To help ensure the accuracy of the test, it is recommended that you use a reference device or reference energy standard with a specified accuracy that is 6 to 10 times more accurate than the meter under test. Before you start testing, the reference device or energy standard should be warmed up as recommended by its manufacturer.

**NOTE:** Verify the accuracy and precision of all measurement equipment used in accuracy testing (for example, voltmeters, ammeters, power factor meters).

## Verifying accuracy test

The following tests are guidelines for accuracy testing your meter; your meter shop may have specific testing methods.

### **DANGER**

#### **HAZARD OF ELECTRIC SHOCK, EXPLOSION, OR ARC FLASH**

- Apply appropriate Personal Protective Equipment (PPE) and follow safe electrical work practices. See NFPA 70E, CSA Z462 or other local standards.
- Turn off all power supplying this device and the equipment in which it is installed before working on or in the equipment.
- Always use a properly rated voltage sensing device to confirm that all power is off.
- Do not exceed the maximum ratings of this device.
- Verify the device's power source meets the specifications for your device's power supply.

**Failure to follow these instructions will result in death or serious injury.**

1. Turn off all power supplying this device and the equipment in which it is installed before working on the device or equipment.
2. Use a properly rated voltage sensing device to confirm that all power is off.

3. Connect the test voltage and current source to the reference device or energy standard. Ensure all voltage inputs to the meter under test are connected in parallel and all current inputs are connected in series.

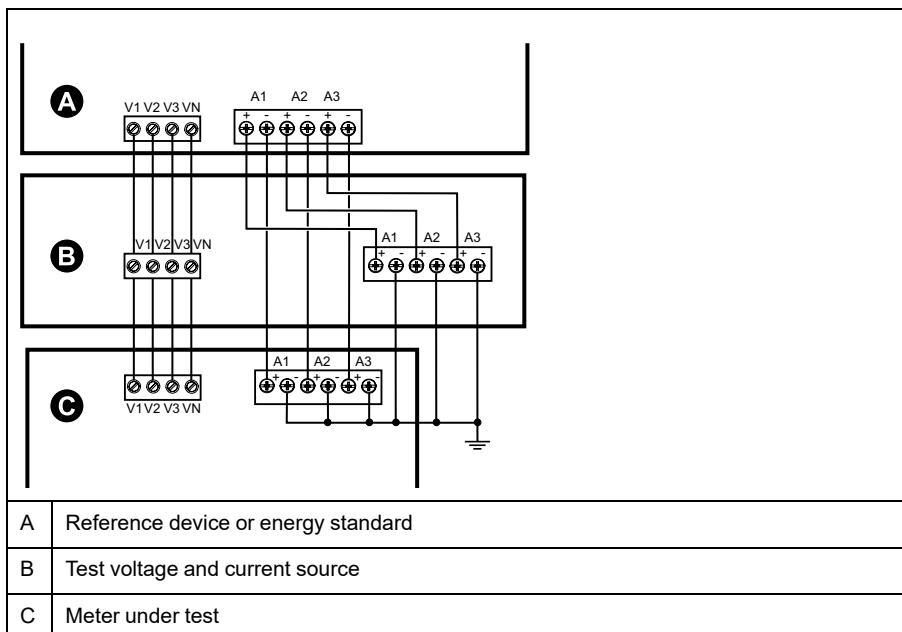

4. Connect the control equipment used for counting the standard output pulses using one of these methods:

Option	Description
Energy pulsing LED	Align the red light sensor on the standard test bench armature over the energy pulsing LED.
Pulse output	Connect the meter's pulse output to the standard test bench pulse counting connections.

**NOTE:** When selecting which method to use, be aware that energy pulsing LEDs and pulse outputs have different pulse rate limits.

5. Before performing the verification test, let the test equipment power up the meter and apply voltage for at least 30 seconds. This helps stabilize the internal circuitry of the meter.
6. Configure the meter's parameters for verifying accuracy testing.
7. Depending on the method selected for counting the energy pulses, configure the meter's energy pulsing LED or one of the pulse outputs to perform energy pulsing. Set the meter's energy pulse constant so it is in sync with the reference test equipment.
8. Perform accuracy verification on the test points. Run each test point for at least 30 seconds to allow the test bench equipment to read an adequate number of pulses. Allow 10 seconds of dwell time between test points.

## Required pulses calculation for accuracy verification testing

Accuracy verification test equipment typically requires you to specify the number of pulses for a specific test duration.

The reference test equipment typically requires you to specify the number of pulses required for a test duration of "t" seconds. Normally, the number of pulses required is at least 25 pulses, and the test duration is greater than 30 seconds.

Use the following formula to calculate the required number of pulses:

Number of pulses =  $P_{tot} \times K \times t / 3600$

Where:

- $P_{tot}$  = total instantaneous power in kilowatts (kW)
- $K$  = the meter's pulse constant setting, in pulses per kWh
- $t$  = test duration, in seconds (typically greater than 30 seconds)

## Total power calculation for accuracy verification testing

Accuracy verification testing supplies the same test signal (total power) to both the energy reference/standard and the meter under test.

Total power is calculated as follows, where:

- $P_{tot}$  = total instantaneous power in kilowatts (kW)
- $V_{LN}$  = test point line-to-neutral voltage in volts (V)
- $I$  = test point current in amps (A)
- $PF$  = power factor

The result of the calculation is rounded up to the nearest integer.

For a balanced 3-phase Wye system:

$P_{tot} = 3 \times V_{LN} \times I \times PF \times 1 \text{ kW}/1000 \text{ W}$

**NOTE:** A balanced 3-phase system assumes that the voltage, current and power factor values are the same for all phases.

For a single-phase system:

$P_{tot} = V_{LN} \times I \times PF \times 1 \text{ kW}/1000 \text{ W}$

## Percentage error calculation for accuracy verification testing

Accuracy verification testing requires you to calculate the percentage error between the meter being tested and the reference/standard.

Calculate the percentage error for every test point using the following formula:

Energy error =  $(EM - ES) / ES \times 100\%$

Where:

- $EM$  = energy measured by the meter under test
- $ES$  = energy measured by the reference device or energy standard.

**NOTE:** If accuracy verification reveals inaccuracies in your meter, they may be caused by typical sources of test errors. If there are no sources of test errors present, please contact your local Schneider Electric representative.

## Accuracy verification test points

The meter should be tested at full and light loads and at lagging (inductive) power factors to help ensure testing over the entire range of the meter.

The test amperage and voltage input rating are labeled on the meter. Refer to the installation sheet or data sheet for your meter's nominal current, voltage and frequency specifications.

Watt-hour test point	Sample accuracy verification test point
Full load	100% to 200% of the nominal current, 100% of the nominal voltage and nominal frequency at unity power factor or one (1).
Light load	10% of the nominal current, 100% of the nominal voltage and nominal frequency at unity power factor or one (1).
Inductive load (lagging power factor)	100% of the nominal current, 100% of the nominal voltage and nominal frequency at 0.50 lagging power factor (current lagging voltage by 60° phase angle).

VAR-hour test point	Sample accuracy verification test point
Full load	100% to 200% of the nominal current, 100% of the nominal voltage and nominal frequency at zero power factor (current lagging voltage by 90° phase angle).
Light load	10% of the nominal current, 100% of the nominal voltage and nominal frequency at zero power factor (current lagging voltage by 90° phase angle).
Inductive load (lagging power factor)	100% of the nominal current, 100% of the nominal voltage and nominal frequency at 0.87 lagging power factor (current lagging voltage by 30° phase angle).

## Energy pulsing considerations

The meter's energy pulsing LED and pulse outputs are capable of energy pulsing within specific limits.

Description	Energy pulsing LED	Pulse output
Maximum pulse frequency	35 Hz	20 Hz
Minimum pulse constant	1 pulse per k_h	
Maximum pulse constant	9,999,000 pulses per k_h	

The pulse rate depends on the voltage, current and PF of the input signal source, the number of phases, and the VT and CT ratios.

If P<sub>tot</sub> is the instantaneous power (in kW) and K is the pulse constant (in pulses per kWh), then the pulse period is:

$$\text{Pulse period (in seconds)} = \frac{3600}{K \times P_{\text{tot}}} = \frac{1}{\text{Pulse frequency (Hz)}}$$

## VT and CT considerations

Total power (P<sub>tot</sub>) is derived from the values of the voltage and current inputs at the secondary side, and takes into account the VT and CT ratios.

The test points are always taken at the secondary side, regardless of whether VTs or CTs are used.

If VTs and CTs are used, you must include their primary and secondary ratings in the equation. For example, in a balanced 3-phase Wye system with VTs and CTs:

$$P_{\text{tot}} = 3 \times V_{\text{LN}} \times \frac{V_{\text{T}_p}}{V_{\text{T}_s}} \times I \times \frac{C_{\text{T}_p}}{C_{\text{T}_s}} \times \text{PF} \times \frac{1 \text{ kW}}{1000 \text{ W}}$$

where P<sub>tot</sub> = total power, V<sub>T<sub>p</sub></sub> = VT primary, V<sub>T<sub>s</sub></sub> = VT secondary, C<sub>T<sub>p</sub></sub> = CT primary, C<sub>T<sub>s</sub></sub> = CT secondary and PF = power factor.



## Example calculations

This example calculation shows how to calculate power, pulse constants and maximum pulse frequency, and how to determine a pulse constant that reduces the maximum pulse frequency.

A balanced 3-phase Wye system uses 480:120 volt VTs and 120:5 amp CTs. The signals at the secondary side are 119 volts line-to-neutral and 5.31 amps, with a power factor of 0.85. The desired pulse output frequency is 20 Hz (20 pulses per second).

1. Calculate the typical total output power (P<sub>tot</sub>):

$$P_{tot} = 3 \times 119 \times \frac{480}{120} \times 5.31 \times \frac{120}{5} \times 0.85 \times \frac{1 \text{ kW}}{1000 \text{ W}} = 154.71 \text{ kW}$$

2. Calculate the pulse constant (K):

$$K = \frac{3600 \times (\text{pulse frequency})}{P_{tot}} = \frac{3600 \text{ seconds/hour} \times 20 \text{ pulses/second}}{154.71 \text{ kW}}$$

$$K = 465.5 \text{ pulses / kWh}$$

3. At full load (120% of nominal current = 6 A) and power factor (PF = 1), calculate the maximum total output power (P<sub>max</sub>):

$$P_{max} = 3 \times 119 \times \frac{480}{120} \times 6 \times \frac{100}{5} \times 1 \times \frac{1 \text{ kW}}{1000 \text{ W}} = 205.6 \text{ kW}$$

4. Calculate the maximum output pulse frequency at P<sub>max</sub>:

$$\text{Maximum pulse frequency} = \frac{K \times P_{max}}{3600} = \frac{465.5 \text{ pulses / kWh} \times 205.6 \text{ kW}}{3600 \text{ seconds/hour}}$$

$$\text{Maximum pulse frequency} = 26.6 \text{ pulses/second} = 26.6 \text{ Hz}$$

5. Check the maximum pulse frequency against the limits for the LED and pulse outputs:

- 26.6 Hz ≤ LED maximum pulse frequency (35 Hz)
- 26.6 Hz > pulse output maximum pulse frequency (20 Hz)

**NOTE:** The maximum pulse frequency is within the limits for LED energy pulsing. However, the maximum pulse frequency is greater than the limits for pulse output energy pulsing. Pulse output frequencies greater than 20 Hz will saturate the pulse output and cause it to stop pulsing. Therefore in this example, you can only use the LED for energy pulsing.

## Adjustments to allow energy pulsing at the pulse outputs

If you want to use the pulse output, you must reduce the output pulse frequency so it is within the limits.

Using the values from the above example, the maximum pulse constant for the pulse output is:

$$K_{max} = \frac{3600 \times (\text{pulse output maximum pulse frequency})}{P_{max}} = \frac{3600 \times 20}{205.6}$$

$$K_{max} = 350.14 \text{ pulses per kWh}$$

1. Set the pulse constant (K) to a value below Kmax, for example, 300 pulses/kWh. Calculate the new maximum output pulse frequency at Pmax:

$$\text{New maximum pulse frequency} = \frac{K \times P_{\text{max}}}{3600} = \frac{300 \text{ pulses/kWh} \times 205.6 \text{ kW}}{3600 \text{ seconds/hour}}$$

$$\text{New maximum pulse frequency} = 17.1 \text{ pulses/second} = 17.1 \text{ Hz}$$

2. Check the new maximum pulse frequency against the limits for the LED and pulse outputs:
  - $17.1 \text{ Hz} \leq \text{LED maximum pulse frequency (35 Hz)}$
  - $17.1 \text{ Hz} \leq \text{pulse output maximum frequency (20 Hz)}$

As expected, changing K to a value below Kmax allows you to use the pulse output for energy pulsing.

3. Set the new pulse constant (K) on your meter.

## Typical sources of test errors

If you see excessive errors during accuracy testing, examine your test setup and test procedures to eliminate typical sources of measurement errors.

Typical sources of accuracy verification testing errors include:

- Loose connections of voltage or current circuits, often caused by worn-out contacts or terminals. Inspect terminals of test equipment, cables, test harness and the meter under test.
- Meter ambient temperature is significantly different than 23 °C (73 °F).
- Floating (ungrounded) neutral voltage terminal in any configuration with unbalanced phase voltages.
- Inadequate meter control power, resulting in the meter resetting during the test procedure.
- Ambient light interference or sensitivity issues with the optical sensor.
- Unstable power source causing energy pulsing fluctuations.
- Incorrect test setup: not all phases connected to the reference device or the energy standard. All phases connected to the meter under test should also be connected to the reference meter/standard.
- Moisture (condensing humidity), debris or pollution present in the meter under test.

# Power and power factor

## Power and power factor

The sampled measurements taken at the meter’s voltage and current inputs provide data for calculating power and power factor.

In a balanced 3-phase alternating current (AC) power system source, the AC voltage waveforms on the current-carrying conductors are equal but offset by one-third of a period (a phase angle shift of 120 degrees between the three voltage waveforms).

## Current phase shift from voltage

Electrical current can lag, lead, or be in phase with the AC voltage waveform, and is typically associated with the type of load — inductive, capacitive or resistive.

For purely resistive loads, the current waveform is in phase with the voltage waveform. For capacitive loads, current leads voltage. For inductive loads, current lags voltage.

The following diagrams show how voltage and current waveforms shift based on load type under ideal (laboratory) conditions.

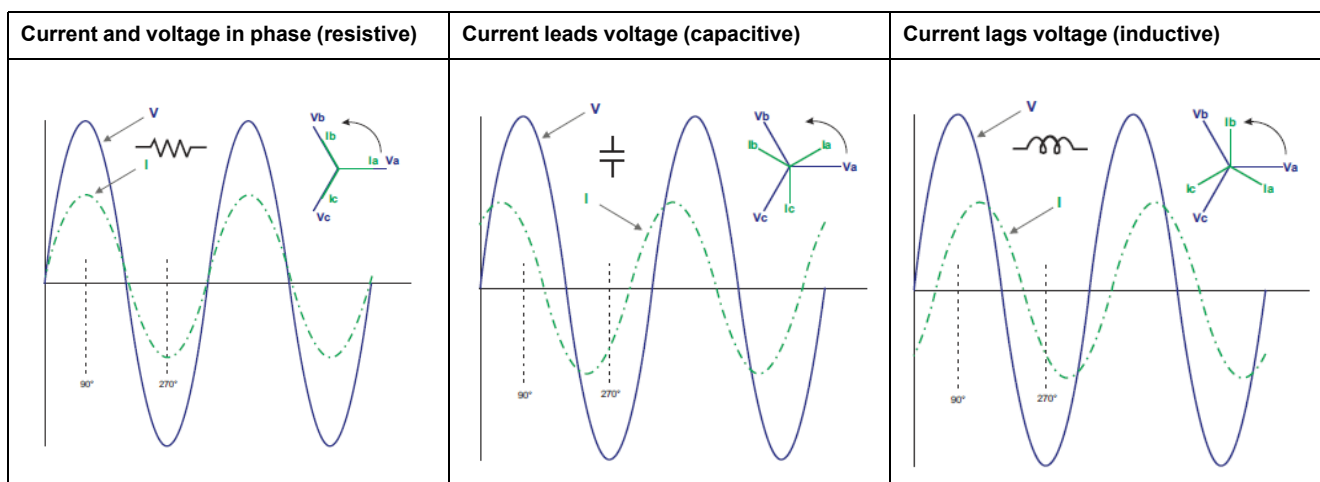

## Real, reactive and apparent power (PQS)

A typical AC electrical system load has both resistive and reactive (inductive or capacitive) components.

Real power, also known as active power (P) is consumed by resistive loads. Reactive power (Q) is either consumed by inductive loads or generated by capacitive loads.

Apparent power (S) is the capacity of your measured power system to provide real and reactive power.

The units for power are watts (W or kW) for real power P, vars (VAR or kVAR) for reactive power Q, and volt-amps (VA or kVA) for apparent power S.

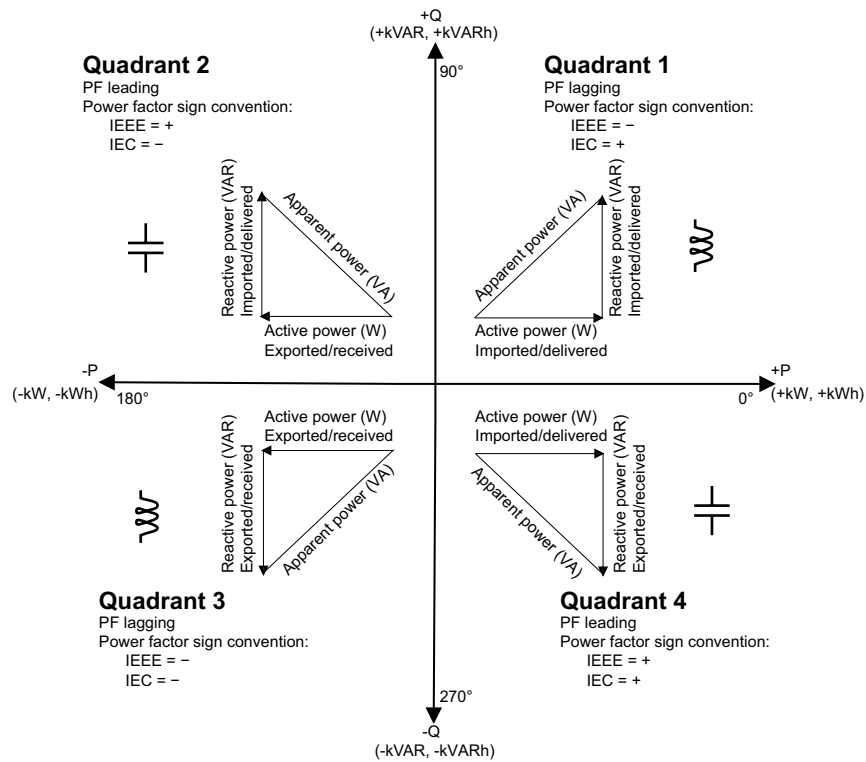

## Power flow

Positive real power P(+) flows from the power source to the load. Negative real power P(-) flows from the load to the power source.

## Power factor (PF)

Power factor (PF) is the ratio of real power (P) to apparent power (S).

PF is provided as a number between -1 and 1 or as a percentage from -100% to 100%, where the sign is determined by the convention.

$$PF = \frac{P}{S}$$

A purely resistive load has no reactive components, so its power factor is 1 (PF = 1, or unity power factor). Inductive or capacitive loads introduce a reactive power (Q) component to the circuit which causes the PF to become closer to zero.

## True PF and displacement PF

The meter supports true power factor and displacement power factor values:

- True power factor includes harmonic content.
- Displacement power factor only considers the fundamental frequency.

**NOTE:** Unless specified, the power factor displayed by the meter is true power factor.

## Power factor sign convention

Power factor sign (PF sign) can be positive or negative, and is defined by the conventions used by the IEEE or IEC standards.

You can set the power factor sign (PF sign) convention that is used on the display to either IEC or IEEE.

### PF sign convention: IEC

PF sign correlates with the direction of real power (kW) flow.

- Quadrant 1 and 4: Positive real power (+kW), the PF sign is positive (+).
- Quadrant 2 and 3: Negative real power (-kW), the PF sign is negative (-).

### PF sign convention: IEEE

PF sign is correlates with the PF lead/lag convention, in other words, the effective load type (inductive or capacitive):

- For a capacitive load (PF leading, quadrant 2 and 4), the PF sign is positive (+).
- For an inductive load (PF lagging, quadrant 1 and 3), the PF sign is negative (-).

## Power factor min/max convention

The meter uses a specific convention for determining the power factor minimum and maximum values.

- For negative PF readings, the minimum PF value is the measurement closest to -0 for PF readings between -0 to -1. For positive PF readings, the minimum PF value is the measurement closest to +1 for PF readings between +1 to +0.
- For negative PF readings, the maximum PF value is the measurement closest to -1 for PF readings between -0 to -1. For positive PF readings, the maximum PF value is the measurement closest to +0 for PF readings between +1 to +0.

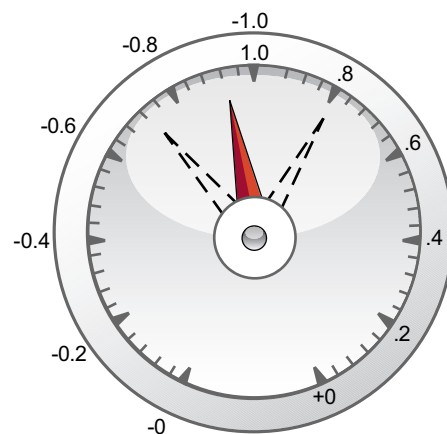

## Power factor register format

The meter performs a simple algorithm to the PF value then stores it in the PF register.

Each power factor value (PF value) occupies one floating point register for power factor (PF register). The meter and software interpret the PF register for all reporting or data entry fields according to the following diagram:

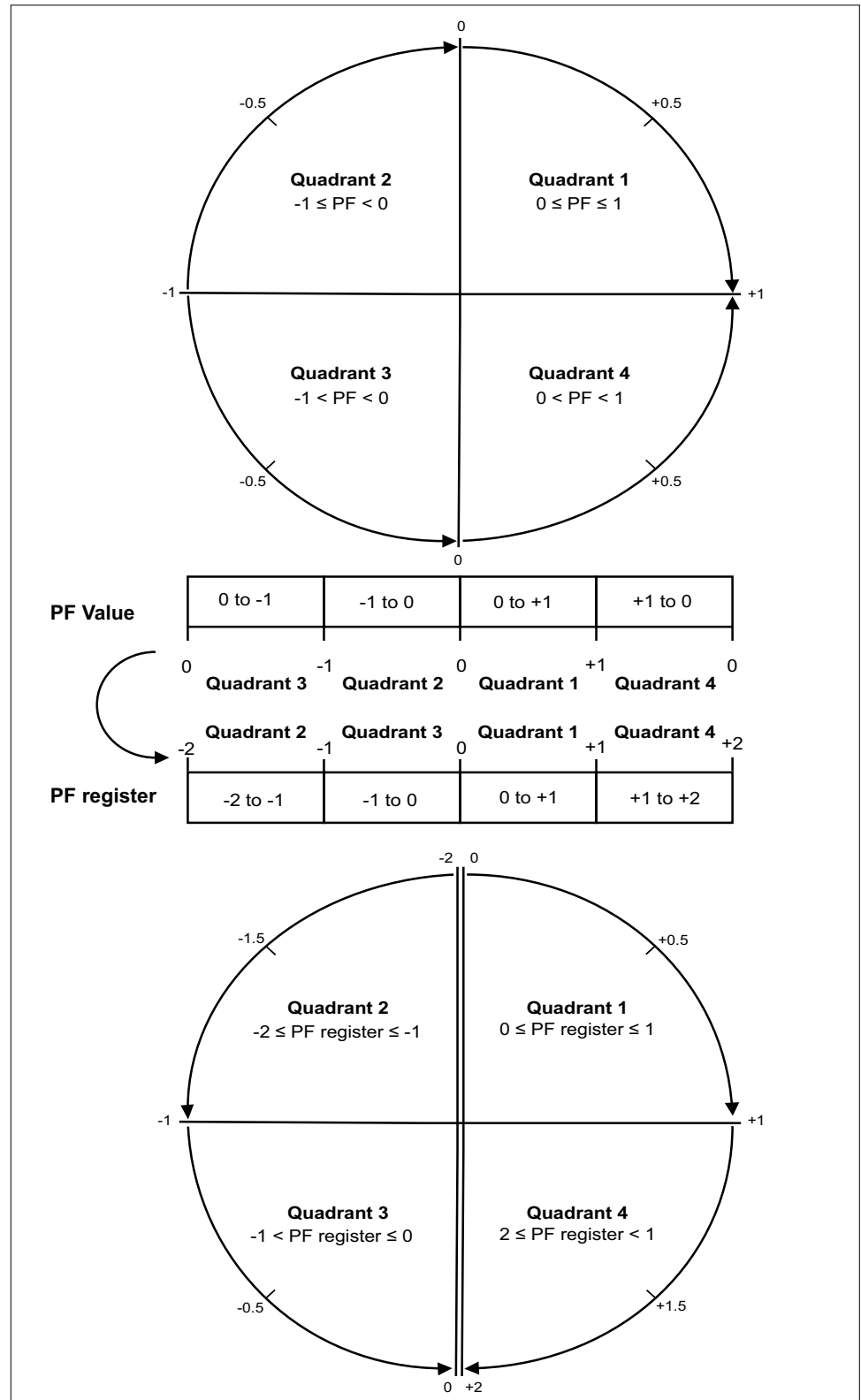

The PF value is calculated from the PF register value using the following formulae:

Quadrant	PF range	PF register range	PF formula
Quadrant 1	0 to +1	0 to +1	PF value = PF register value
Quadrant 2	-1 to 0	-2 to -1	PF value = (-2) - (PF register value)

<b>Quadrant</b>	<b>PF range</b>	<b>PF register range</b>	<b>PF formula</b>
Quadrant 3	0 to -1	-1 to 0	PF value = PF register value
Quadrant 4	+1 to 0	+1 to +2	PF value = (+2) - (PF register value)

## Specifications

The specifications contained in this section are subject to change without notice.  
For installation and wiring information, refer to the meter installation sheet.

## Mechanical characteristics

IP degree of protection (IEC 60529-1)	Front display: IP54 (Upgrade to IP65 with optional accessory kit METSEIP65OP96X96FF) Meter body: IP30
Panel thickness maximum	6.0 mm (0.25 in) maximum
Mounting position	Vertical
Display type	LCD display: Monochrome graphical LCD
Keypad	4 button with intuitive navigation
Front panel LED indicators	Green LED (heartbeat / serial communications activity) Amber LED (alarm / energy pulse output)
Weight	~ 300 gms
Dimensions W x H x D	96 x 96 x 73 mm max
Protection features	Password protected for set-up parameters

## Electrical characteristics

### Measurement accuracy

- IEC 61557-12<sup>6</sup>: 2021 PMD-II/[SD or SS]/K55/0.5

Parameter	Accuracy	Range
Current, Phase	Class 0.5 as per IEC 61557-12: 2021	10% I <sub>n</sub> to 120% I <sub>n</sub> , I <sub>n</sub> = 5 A
	± 0.2% <sup>7</sup>	
Voltage L-N	Class 0.5 as per IEC 61557-12: 2021	20 %U <sub>n</sub> to 120 %U <sub>n</sub> , U <sub>n</sub> = 230 V L-N, 240 V L-N
	± 0.2% <sup>8</sup>	
Power Factor	Class 0.5 as per IEC 61557-12: 2021	0.5 inductive to 0.8 capacitive
	± 0.01 count	
Active power	Class 0.5 as per IEC 61557-12: 2021	1% I <sub>n</sub> to 120% I <sub>n</sub> , I <sub>n</sub> = 5 A
		0.5 inductive to 0.8 capacitive
Apparent power	Class 0.5 as per IEC 61557-12: 2021	1% I <sub>n</sub> to 120% I <sub>n</sub> , I <sub>n</sub> = 5 A
		0.5 inductive to 0.8 capacitive
Reactive power	Class 1 as per IEC 61557-12: 2021	2% I <sub>n</sub> to 120% I <sub>n</sub> , I <sub>n</sub> = 5 A, Sin Θ, 0.25 inductive to 0.25 capacitive
Frequency	Class 0.5 as per IEC 61557-12: 2021	45 Hz to 65 Hz
	± 0.05%	
Active Energy	Class 0.5 as per IEC 61557-12: 2021	I <sub>n</sub> = 5 A nominal CT <sup>9</sup>

6. Power and Energy parameter accuracy at 240 V LN / 415 V LL system nominal

7. 250 mA to 6 A.

8. 100 V to 300 V

9. For 1 A CT nominal, additional error of ±1 % from 50 mA to 150 mA, ±2 % for current > 10 mA to < 50 mA. Partial standard compliance for Class 0.5S meter type (energy test clause only)



**Measurement accuracy (Continued)**

	Class 0.5S as per IEC 62053-22: 2020	
Apparent Energy	Class 0.5 as per IEC 61557-12: 2021	
	± 0.5%	
Reactive Energy	Class 2 as per IEC 62053-24: 2020	
	Class 1 as per IEC 61557-12: 2021	
THD and individual harmonics	Class 5 as per IEC 61557-12: 2021	
	± 5% of full scale	

**Voltage inputs**

VT primary	999 kV L-L max, starting voltage depends on VT ratio
V nominal	277 V L-N / 480 V L-L
Measured V with full range	35 - 480 V L-L (20 - 277 V L-N), CAT III 35 - 600 V L-L (20 - 347 V L-N), CAT II
Permanent overload	750 V AC L-L
Impedance	≥ 5 MΩ
Rated impulse voltage	6 kV for 1.2 μs
Frequency	50 / 60 Hz nominal ± 5%
VA burden	< 0.2 VA at 240 V AC L-N
Voltage terminal cable	0.20 - 5.26 mm <sup>2</sup> (24 - 10 AWG)

**Current inputs**

CT ratings	Primary adjustable 1 A to 32767 A Secondary 1 A or 5 A I-nominal
Measured current	5 mA to 6 A
Suppression current (to disregard negligible load)	5 mA to 99 mA
Withstand	Continuous 12 A; 50 A at 10 sec/hr, 500 A at 1 sec/hr
Impedance	< 0.3 mΩ
Frequency	50 / 60 Hz nominal
VA Burden	< 0.024 VA at 6 A
Current terminal cable	0.82 - 3.31 mm <sup>2</sup> (18 - 12 AWG)

**AC control power**

Operating range	80 - 277 V L-N ± 10%
Burden	< 8 VA at 277 V L-N
Frequency range	45 - 65 Hz
Ride-through time	50 ms at 120 V AC 250 ms at 230 V AC
Control power cable	0.20 - 5.26 mm <sup>2</sup> (24 - 10 AWG)

**DC control power**

Operating range	100 - 277 V DC ± 10%
Burden	< 3.3 W at 277 V DC
Ride-through time	50 ms at 125 V DC

**Displays update**

Instantaneous	1 s
Demand	15 s
Harmonics	5 s

**Wiring configuration**

User programmable	Configuration through both HMI and ION setup
	1ph 2W, L-N 1ph 2W, L-L 1ph 3W, L-L with N (2 phase) 3ph 3W, Delta, Ungrounded 3ph 4W, Wye Grounded 3ph 3W, Delta, Corner Grounded 3ph 3W, Wye, Ungrounded 3ph 3W, Wye Grounded 3ph 3W, Wye, Resistance Grounded 3ph 4W, Open Delta, Center-Tapped 3ph 4W, Delta, Center-Tapped 3ph 4W, Wye, Ungrounded 3ph 4W, Wye, Resistance Grounded

**Environmental characteristics**

Operating temperature	Meter: -25 to 70 °C (-13 to 158 °F) Display functions from -20 to -25 °C (-4 to -13 °F) with reduced performance
Storage temperature	-25 °C to +70 °C (-13 °F to 158 °F)
Humidity rating	5% to 95% RH at 50 °C (122 °F) (non-condensing)
Pollution degree	2
Altitude	≤ 2000 m (6562 ft) CAT-III / 3000 m (9842 ft) CAT-II
Location	For indoor use in a stationary panel Must be permanently connected and fixed Not suitable for wet locations
Product life	≥ 10 years, 45 °C (113 °F) 60% RH

**EMC (Electromagnetic Compatibility)<sup>+5</sup>**

Electrostatic discharge	IEC 61000-4-2
Immunity to radiated field	IEC 61000-4-3
Immunity to fast transients	IEC 61000-4-4
Immunity to impulse waves	IEC 61000-4-5
Conducted immunity	IEC 61000-4-6
Immunity to magnetic field	IEC 61000-4-8

Immunity to voltage dips	IEC 61000-4-11
Emissions (IEC61326-1)	Emissions FCC Part 15 Class A/CE

+5 Tested as per IEC 61326-1 standard for Emission.

## Safety

Europe	CE, as per IEC 61010-1: 2010 / AM1: 2016 and IEC 61326-1: 2020
US and Canada	cULus per UL 61010-1 Ed-3.1 CAN / CSA-C22.2 No. 61010-1 Ed-3.1, for 600 V AC
Measurement category (Voltage and Current inputs)	CAT III up to 480 V L-L CAT II up to 600 V L-L
Overvoltage category (Control power)	CAT III up to 300 V L-N
Dielectric	As per IEC / UL 61010-1 Ed-3.1
Protective Class	Protective Class II Double insulated for user-accessible parts
Other certification	RCM

## RS-485 communications

Number of ports	1
Maximum cable length	1000 m (3280 ft)
Maximum number of devices (unit loads)	Up to 32 devices on the same bus
Parity	Even, Odd, None (1 stop bit for Odd or Even parity; 2 stop bits for None)
Baud rate	4800, 9600, 19200, 38400
Isolation	2.5 kV RMS, double insulated
Cable type	0.13 - 1.30 mm <sup>2</sup> (26 - 16 AWG)

## Digital I/O

Isolation	2.5 kV RMS
<b>Digital (Status) Input</b>	
Voltage ratings	ON 18 to 36 V DC
	OFF 0 to 4 V DC
<b>Digital Output</b>	
Load voltage	≤ 40 V DC
Load current	≤ 20 mA
On resistance	≤ 50 Ω
Pulse duration for digital output <sup>10</sup>	[ 20, 25, 50, 100 ] ms

10. Indicates the feature is configurable through communication.

## Analog I/O

Update rate	1 s
<b>Analog Input</b>	
Measurement scale	4-20 mA
Maximum source impedance	> 500 $\Omega$
<b>Analog Output</b>	
Measurement scale	4-20 mA
Load impedance	$\leq$ 600 $\Omega$

## Relay

Relay Output	250 V L-N AC maximum / 2A
	24V DC / 2A
	2 Form A electro-mechanical relay
Output frequency	0.5 Hz maximum (1 second ON / 1 second OFF)
Contact resistance	50 m $\Omega$

## Whetting Output

24V DC / 8 mA maximum
-----------------------

## Real-time clock

Battery backup time	3 years <b>NOTE:</b> When date and time is configured and meter is in off state.
---------------------	---

# China Standard Compliance

This product complies with the following standard(s) in China:

## METSEPM2225C / METSEPM2225CL05

BS/ EN/ IEC/ UL 61010-1 Safety requirements for electrical equipment for measurement, control, and laboratory use - Part 1: General requirements

## METSEPM2225C2AI2AO / METSEPM2225C2DI2RO

BS/ EN/ IEC 61557-12 Electrical safety in low voltage distribution systems up to 1 000 V AC and 1 500 V DC - Equipment for testing, measuring or monitoring of protective measures - Part 12: Power metering and monitoring devices (PMD)

GB/T 17215.322-2008 交流电测量设备 特殊要求 第22部分：静止式有功电能表（0.2S级和0.5S级）

GB/T 17215.321-2008 交流电测量设备 特殊要求 第22部分：静止式有功电能表（1S级和2S级）

Schneider Electric  
35 rue Joseph Monier  
92500 Rueil Malmaison  
France

+ 33 (0) 1 41 29 70 00

[www.se.com](http://www.se.com)

As standards, specifications, and design change from time to time,  
please ask for confirmation of the information given in this publication.

© 2024 – Schneider Electric. All rights reserved.

NVE3860702-09