

Selectivity, Cascading and Coordination Guide

Guide - January 2024
Complementary Technical Information



Legal Information

The information provided in this Catalog contains description of Schneider Electric products, solutions and services ("Offer") with technical specifications and technical characteristics of the performance of the corresponding Offer.

The content of this document is subject to revision at any time without notice due to continued progress in methodology, design and manufacturing.

To the extent permitted by applicable law, no responsibility or liability is assumed by Schneider Electric and its subsidiaries for any type of damages arising out of or in connection with (i) informational content of this Catalog not conforming with or exceeding the technical specifications, or (ii) any error contained in this Catalog, or (iii) any use, decision, act or omission made or taken on basis of or in reliance on any information contained or referred to in this Catalog.

SCHNEIDER ELECTRIC MAKES NO WARRANTY OR REPRESENTATION OF ANY KIND, WHETHER EXPRESS OR IMPLIED, AS TO WHETHER THIS CATALOG OR ANY INFORMATION CONTAINED THEREIN SUCH AS PRODUCTS AND SERVICES WILL MEET REQUIREMENTS, EXPECTATIONS OR PURPOSE OF ANY PERSON MAKING USE THEREOF.

Schneider Electric brand and any trademarks of Schneider Electric and its subsidiaries referred to in this Catalog are property of Schneider Electric or its subsidiaries. All other brands are trademarks of their respective owners.

This Catalog and its content are protected under applicable copyright laws and provided for informative use only. No part of this Catalog may be reproduced or transmitted in any form or by any means (electronic, mechanical, photocopying, recording, or otherwise), for any purpose, without the prior written permission of Schneider Electric.

Copyright, intellectual, and all other proprietary rights in the content of this Catalog (including but not limited to software, audio, video, text, and photographs) rests with Schneider Electric or its licensors. All rights in such content not expressly granted herein are reserved. No rights of any kind are licensed or assigned or shall otherwise pass to persons accessing this information.

Trademarks

QR Code is a registered trademark of DENSO WAVE INCORPORATED in Japan and other countries.



Green Premium™



More than 75% of our product sales offer superior transparency on the material content, regulatory information and environmental impact of our products:

- RoHS compliance
- REACH substance information
- Industry leading # of PEP's*
- Circularity instructions



Discover what we mean by green
Check your products!

The Green Premium program stands for our commitment to deliver customer valued sustainable performance. It has been upgraded with recognized environmental claims and extended to cover all offers including Products, Services and Solutions.

CO₂ and P&L impact through... Resource Performance

Green Premium brings improved resource efficiency throughout an asset's lifecycle. This includes efficient use of energy and natural resources, along with the minimization of CO₂ emissions.

Cost of ownership optimization through... Circular Performance

We're helping our customers optimize the total cost of ownership of their assets. To do this, we provide IoT-enabled solutions, as well as upgrade, repair, retrofit, and remanufacture services.

Peace of mind through... Well-being Performance

Green Premium products are RoHS and REACH compliant. We're going beyond regulatory compliance with step-by-step substitution of certain materials and substances from our products.

Improved sales through... Differentiation

Green Premium delivers strong value propositions through third-party labels and services. By collaborating with third-party organizations we can support our customers in meeting their sustainability goals such as green building certifications.

*PEP: Product Environmental Profile (i.e. Environmental Product Declaration)

Design and selection of equipment for low voltage electrical installations requires to consider and check the behavior of all devices on the current path in fault situation. High short-circuit current can damage equipment by electrodynamical and thermal effects. Each device can individually withstand the worst effects, but it may require significant oversizing and, on occasion, may be impossible. So the protection of each device or equipment relies on upstream over-current protective device. In that case the proper "coordination" between the two devices shall be checked.

Lower amplitude faults such as overloads or some earth faults can also create disturbances by causing trips and power interruptions for larger sections of the installation than expected.

European Harmonization document HD60364-5-53 2015 for Low voltage electrical installation provides the following definition of coordination of electrical equipment:

530.3.5 Co-ordination of electrical equipment: *correct way of selecting electrical devices in series to ensure safety and continuity of service of the installation taking into account short-circuit protection and/or overload protection and/or selectivity*

This document is not intended as a substitute for and is not to be used for determining suitability or reliability of these devices for specific user applications. It is the duty of any such user or integrator to perform the appropriate and complete risk analysis, evaluation and testing of the devices with respect to the relevant specific application or use thereof.

Schneider Electric provides "co-ordination" performances for two or three low voltage devices in the following cases:

Coordination related to continuity of service

- Selectivity (also called discrimination)
- Selectivity enhanced by cascading
- Motor starter coordination type 2
- Circuit-breaker and LV/LV transformers

Coordination related to safety

- Cascading (also called group short-circuit protection, or back up protection)
- Motor starter coordination type 1
- Coordination between switch-disconnector and circuit breaker or fuses
- Coordination between circuit breaker and busbar trunking (busway) system

For coordination of Surge protection device with upstream overcurrent protection see the Design guide:



https://download.schneider-electric.com/files?p_Doc_Ref=CA903014E

General Content

Selectivity, Cascading and Coordination Guide

Coordination for Electrical Distribution

A

Coordination for Motor Circuits

B

Use of LV Switches and Transfer Switching Equipment

C

Protection of LV/LV Transformers and Capacitors

D

Coordination with Electrical Busbar Trunking

E

Link for downloading
this guide



Coordination for Electrical Distribution

Selectivity between Circuit Breakers.....	A-1
Introduction.....	A-1
Quick Access to the Tables	A-14
Ue ≤ 440 V AC	A-14
220-240/380-415 V AC	A-17
Ue = 690 V AC.....	A-114
Selectivity Tables for Direct Current Application	A-139
Ue: 24-48-60 V DC ^[3]	A-140
Ue: 110-125 V DC ^[3]	A-155
Ue: 220-250 V DC ^[3]	A-165
Selectivity with Fuses.....	A-173
Introduction.....	A-173
Selectivity Tables with Fuses	A-178
Introduction.....	A-178
Cascading (or Back-up Protection, or Combined Short-Circuit Protection).....	A-188
Introduction.....	A-188
Cascading Tables	A-191
Ue: 380-415 V AC (Ph/N 220-240 V AC).....	A-193
Ue: 440 V AC	A-198
Ue: 220-240 V AC.....	A-202
Motor Protection Cascading.....	A-206
Selectivity Enhanced by Cascading	A-209
Ue: 380-415 V AC (Ph/N 220-240 V AC).....	A-210
Ue: 440 V AC	A-223
Ue: 220-240 V AC (Ph/N 110-130 V AC).....	A-230

Coordination for Motor Circuits

Protection of Motor Circuit with Circuit Breaker.....	B-1
Using the circuit breaker/contactors coordination tables.....	B-6
Type 2 Coordination Table with Circuit-Breakers.....	B-10
Ue: 220-240 V AC.....	B-10
Ue: 380-400 V AC.....	B-12
Ue: 415 V AC.....	B-15
Ue: 440 V AC.....	B-18
Ue: 690 V AC.....	B-21
Type 1 Coordination Table with Circuit-Breakers.....	B-26
Type 1 Coordination Table with Circuit-Breakers for AC1 Utilisation Category: Non-Inductive or Slightly Inductive Loads	B-34
Protection of Motor Circuits with Fuses.....	B-35
Introduction.....	B-35
with NFC fuses.....	B-36
with DIN fuses.....	B-37
Type 2 Coordination Table with Fuses	B-38
Ue: 380-415 V AC.....	B-38
Ue: 660-690 V AC.....	B-40

Use of LV Switches

Use of LV Switches and Transfer Switching Equipment..	C-1
Choosing a Schneider Electric Switch-Disconnecter..	C-4
Circuit-Breaker/Switch-Disconnecter Coordination...	C-8
Fuses/TSE Coordination.....	C-14
Circuit Breaker/Switch-Disconnecter Coordination ..	C-15
Fuse/Switch-Disconnecter Coordination.....	C-36
Circuit-Breaker /TSE Coordination	C-40

Protection of LV/LV Transformers and Capacitors

Protection of LV/LV Transformers and Capacitors	D-1
---	-----

Coordination with Electrical Busbar Trunking

Coordination Tables between Circuit Breaker and Canalis Electrical Busbar Trunking	E-1
Ue: 220 or 240 V AC Ph/N.....	E-3
Ue: 380-415 V AC.....	E-4
Ue: 660-690 V AC.....	E-12

Selectivity between Circuit Breakers

Introduction



EO2487-37 eps

Selectivity of over-current protection is covered by Circuit Breakers standards: IEC/EN 60947-2 Annex A and IEC/EN 60898-1 Annex D. Selectivity of residual current protection is covered by IEC 60364 series and product standards IEC/EN 60947-2 Annex B and M, IEC/EN 61009-1.

Selectivity (Discrimination)

Selectivity is achieved by overcurrent and earth fault protective devices if a fault condition, occurring at any point in the installation, is cleared by the protective device located immediately upstream of the fault, while all the other protective devices remain unaffected.

Selectivity is required for installation supplying critical loads where one fault on one circuit shall not cause the interruption of the supply of other circuits. In the IEC 60364 series it is mandatory for installation supplying safety services (IEC60364-5-56 2009 560.7.4). Selectivity may also be required by some local regulations or for some special applications like:

- Medical location
- Marine
- High-rise building.

Selectivity is highly recommended when power availability and reliability is critical due to the nature of the loads such as:

- Data centers
- Infrastructure (tunnel, airport...)
- Critical processes.

From installation point of view: selectivity is achieved when the maximum short-circuit current at a point of installation is below selectivity limit of the circuit breakers supplying this point of installation. Selectivity shall be checked for all circuits supplied by one source and for all types of fault:

- Overload
- Short-circuit
- Earth fault.

When system can be supplied by different sources (Grid or Generator Set for instance) selectivity shall be checked in both cases.

According to the IEC 60364-5-53:535 2020 standard, selectivity between two circuit breakers can be:

- **Partial**: up to a specified value according to circuit breakers characteristics (I_s)
- **Full**: up to the maximum prospective short-circuit current (I_{sc_max}) on the load side of the downstream circuit breaker
- **Total**: up to the breaking capacity (I_{cu} or I_{cn}) of the downstream circuit breaker
- **Enhanced**: up to a value higher than the breaking capacity of the downstream circuit breaker when cascading is applied (see page A-209).

In an electrical installation, selectivity performance depends on the two circuit breakers characteristics and on the installation's maximum short-circuit current on the load side. The table below summarizes the different situations:

Selectivity in a given installation according to circuit breakers selectivity performance without or with cascading

	Selectivity characteristics of two circuit breakers	Short-circuit current on the load side versus the selectivity limit I_s of the two circuit breakers	Selectivity consequence for the electrical installation
Without cascading	Partial	$I_s \leq I_{sc_max} < I_{cu}$ (or I_{cn})	"Partial" (Example 1a) ☹️
		$I_{sc_max} < I_s < I_{cu}$ (or I_{cn})	"Full" (Example 1b) 😊
	Total	$I_{sc_max} \leq I_s = I_{cu}$ (or I_{cn})	"Total" (Example 2) 😊
With cascading	Partial	$I_s < I_{cu} < I_{sc_max}$	Partial (up to I_s) ☹️
	Total	$I_s = I_{cu} < I_{sc_max}$	Partial (up to I_{cu} but $< I_{sc_max}$) ☹️
	Enhanced	$I_{cu} < I_{sc_max} \leq I_{s_enhanced}$	Enhanced selectivity (up to $I_{s_enhanced}$) (Example 3) 😊

DB430717 eps

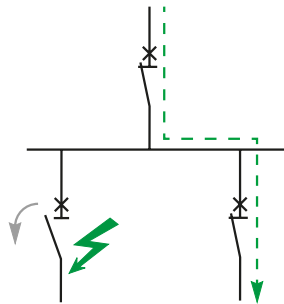

Selectivity is essential to ensure continuity of supply and fast fault localization.



Selectivity between Circuit Breakers

Introduction

A

From a designer perspective, a simple way of specifying selectivity in an electrical installation can be either:

- "Total or Full Selectivity between circuit breakers is required and cascading is forbidden"
- or
- "Total selectivity between circuit breakers is required. If cascading is applied, enhanced selectivity up to the maximum short-circuit current shall be ensured".

Practical examples :

- **Example 1: ComPacT NSX100F (Icu = 36 kA 400 V AC) TMD 100 A & iC60N C 32 A (Icu = 10 kA 400 V AC).**
 Selectivity limit Is = 1 kA (See table page A-66)
 - 1a: In a given circuit of an electrical installation where the maximum short-circuit current (Isc_max) downstream iC60N C 32 A is 5 kA the selectivity will be "partial".
 - 1b: In a given circuit of an electrical installation where the maximum short-circuit current (Isc_max) downstream iC60N C 32 A is 0.8 kA the selectivity will be "Full".
- **Example 2: ComPacT NSX100F (36 kA 400 V AC) MicroLogic 2.2 100 A & iC60N (10 kA 400 V AC) C 32 A.**
 Total selectivity (See table page A-65)
 - In a given circuit of an electrical installation where the maximum short-circuit current (Isc_max) downstream iC60N C 32 A is ≤ 10 kA the selectivity will be "Total".
- **Example 3: ComPacT NSX100F (36 kA 400 V AC) MicroLogic 100A & iC60N (10 kA 400 V AC) C 32 A.**
 Enhanced selectivity limit = 20 kA, Enhanced breaking capacity Icomb = 20 kA ("20/20" in table page A-65)
 - In a given circuit of an electrical installation where the maximum short-circuit current (Isc_max) downstream iC60N C 32 A is 10 kA < Isc_max ≤ 20 kA the selectivity will be "Enhanced".

Icu : breaking capacity of circuit-breaker according to IEC/EN 60947 series

Icn : breaking capacity of circuit-breaker according to IEC/EN 60898 or IEC/EN 61009 series

Principles of Selectivity

Different principles are involved to achieve selectivity based on:

- Current
- Time
- Energy
- Logic.

Current based selectivity

This method is implemented by setting successive tripping thresholds at stepped levels, from downstream circuits (lower settings) towards the source (higher settings). Selectivity is total or partial, depending on particular conditions, as noted above.

Time based selectivity

This method is implemented by adjusting the time-delayed tripping units, so that downstream relays have the shortest operating times, with progressively longer delays towards the source. In the two-level arrangement shown, upstream circuit breaker A is sufficiently delayed to ensure total selectivity with B (for example: MasterPacT with electronic trip unit).

Selectivity category B circuit breakers are designed for time based selectivity, the selectivity limit will be the upstream short time withstand value (Icw).

Selectivity based on a combination of the two previous methods

A time-delay added to a current level scheme can improve the overall selectivity performance.

The upstream CB has two magnetic tripping thresholds:

- Im A: delayed magnetic trip or short-delay electronic trip
- Ii: instantaneous trip

Selectivity is total if Isc B < Ii (instantaneous).

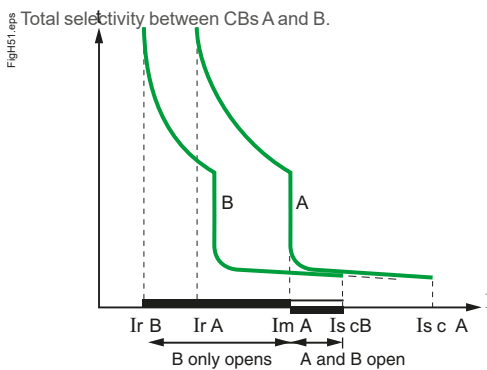
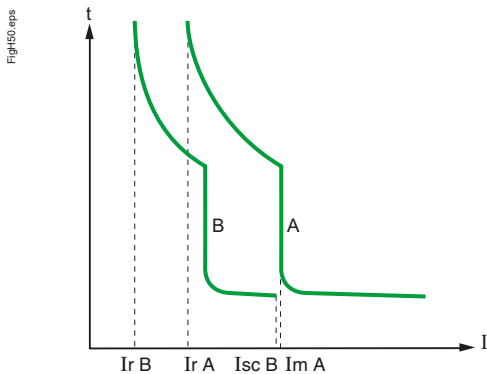

Partial selectivity between CBs A and B.

Selectivity between Circuit Breakers

Introduction

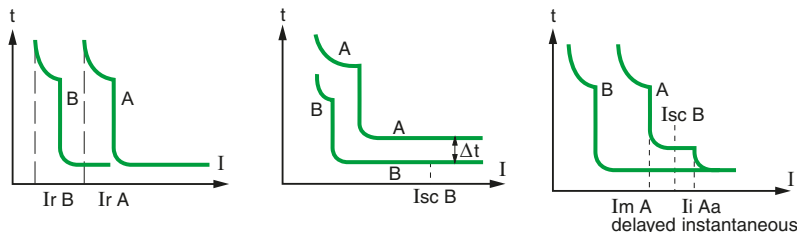

Current based selectivity, Time based selectivity, Combination of both

Protection against high level short-circuit currents: Selectivity based on arc-energy levels

Where time versus current curves are superposed, selectivity is possible with limiter circuit breaker when they are properly coordinated.

Principle: When a very high level short-circuit current is detected by the two circuit breakers A and B, their contacts open simultaneously. As a result, the current is highly limited.

- The very high arc-energy at level B induces the tripping of circuit breaker B
- Then, the arc-energy is limited at level A and is not sufficient to induce the tripping of A.

This approach requires an accurate coordination of limitation levels and tripping energy levels. It's implemented inside the ComPacT NSX range (current limiting circuit breaker), and between ComPacT NSX and Acti 9 range. This solution is the only one to achieve selectivity up to high short-circuit current with selectivity category A circuit breaker according to IEC/EN 60947-2.

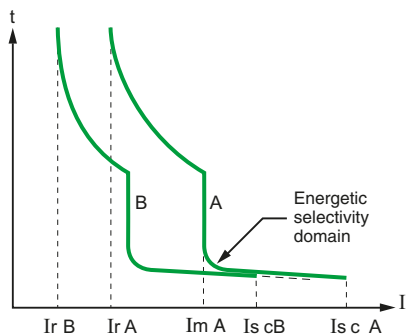

Energetic based selectivity.

Practical example of selectivity at several levels with Schneider Electric circuit breakers

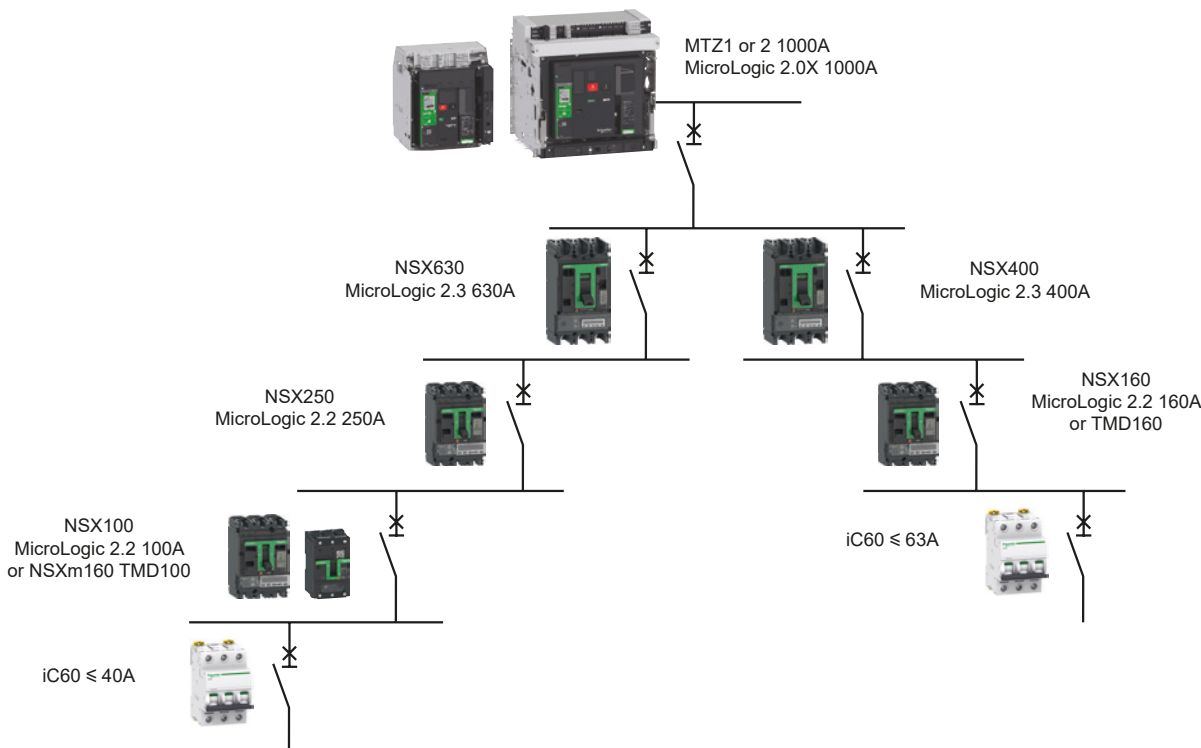

Selectivity between Circuit Breakers

Introduction

A

See Selectivity enhanced by cascading tables on page A-209

Selectivity enhanced by cascading

Cascading between 2 devices is normally achieved by using the tripping of the upstream circuit breaker A to help the downstream circuit breaker B to break the current.

In principle cascading is in contradiction with selectivity. But the energy selectivity technology implemented in ComPacT NSX circuit breakers allows to improve the breaking capacity of downstream circuit breakers and to keep a high selectivity performance at the same time.

The principle is as follows:

- The downstream limiting circuit breaker B sees a very high short-circuit current. The tripping is very fast (<1 ms) and then, the current is limited.
- The upstream circuit breaker A sees a limited short-circuit current compared to its breaking capability, but this current induces a repulsion of the contacts. As a result, the arcing voltage increases the current limitation. However, the arc energy is not high enough to induce the tripping of the circuit breaker. So, the circuit breaker A helps the circuit breaker B to limit and break the short-circuit current, without tripping itself. The selectivity limit can be higher than Icu B and the selectivity becomes total with a reduced cost of the devices.

Logic selectivity or “Zone Selective Interlocking – ZSI”

This type of selectivity can be achieved with circuit breakers equipped with specially designed electronic trip units (ComPacT, MasterPacT): only the Short Time Protection (Isd, Tsd) and Ground Fault Protection (GFP) functions of the controlled devices are managed by Logic Selectivity. In particular, the Instantaneous Protection function is not concerned.

The main benefit of this solution is to have a short tripping time wherever is located the fault with selectivity category B circuit breaker. Time based selectivity on multi level system implies long tripping time at the origin of the installation. ZSI does not increase the selectivity limit provided in the tables. In particular, for Selectivity category A circuit-breaker such as Compact NSX, ZSI will not change any performance above instantaneous threshold.

Settings of controlled Circuit Breakers

- Time delay: staging of the time delays is necessary at least for circuit breaker receiving a ZSI Input ($TsdD1 > \text{trip time with no delay of } D2$ and $TsdD2 > \text{trip time with no delay of } D3$).
- Thresholds: there are no threshold rules to be applied, but natural staging of the protection device ratings must be complied with ($IsdD1 > IsdD2 > IsdD3$).

Note: This technique provides selectivity even with circuit breakers of similar ratings.

Principles

Activation of the Logic Selectivity function is via transmission of information on the pilot wire:

- ZSI input:
 - Low level (no downstream faults): the Protection function is on standby with no time delay,
 - High level (presence of downstream faults): the relevant Protection function moves to the time delay status set on the device.
- ZSI output:
 - Low level: the trip unit detects no faults and sends no orders,
 - High level: the trip unit detects a fault and sends an order.

Operation

A pilot wire connects in cascading form the protection devices of an installation (see Fig. opposite). When a fault occurs, each circuit breaker upstream of the fault (detecting a fault) sends an order (high level output) and moves the upstream circuit breaker to its set time delay (high level input). The circuit breaker placed just above the fault does not receive any orders (low level input) and thus trips almost instantaneously.

Selectivity schemes based on logic techniques are possible, using CBs equipped with electronic tripping units designed for the purpose (ComPacT, MasterPacT) and interconnected with pilot wires

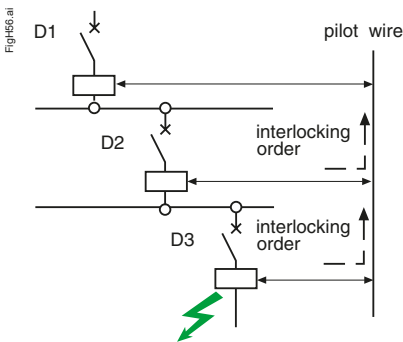

Logic selectivity

Selectivity between Circuit Breakers

Introduction



Selectivity between modular Circuit Breakers

We use two types of selectivity when these circuit breakers are combined:

- Current selectivity,
- Energy selectivity.

For selectivity to be ensured whatever the prospective fault current, 3 conditions have to be fulfilled:

- The upstream and downstream circuit breakers must have different ratings (ratio > 1.3),
- Their type of curve (B,C,D ...) shall be consistent to ensure D1 magnetic level > D2 magnetic level,
- The energy allowed to pass through the downstream circuit breaker when it cuts off must still be less than the operating energy of the upstream trip.

Example

Let us take the example of a single phase network where we have a 32 A curve D circuit breaker in series with a 10 A curve D circuit breaker:

- The 32 A circuit breaker protects the 6² cables and the 10 A circuit breaker protects the 1.5² cables. This combination allows selectivity, but up to what threshold?
- If current selectivity is considered ($t = f(I_p)$) it can be seen that the tripping curve of the downstream circuit breaker is well below the non-tripping curve of the upstream circuit breaker,
- Furthermore, each circuit breaker is well below the maximum stress permitted by the cables.

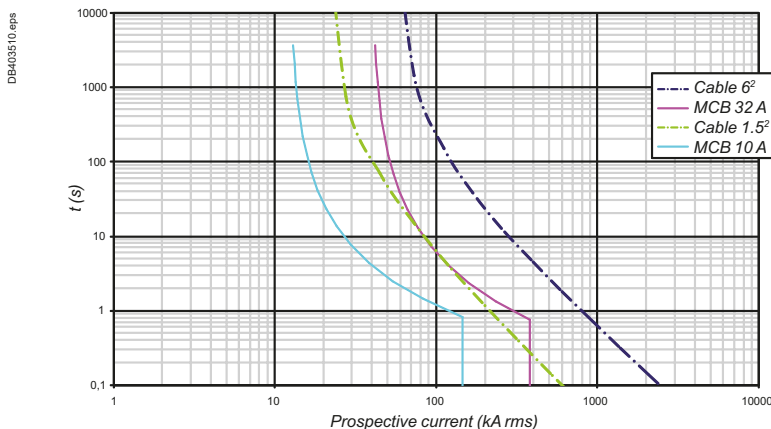
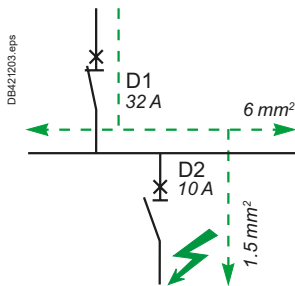

When considering energy selectivity, it is necessary to compare the maximum stresses characterized by the integrals I^2t relative to the development of the arc in the downstream device and by the sensitivity of the trip unit, still in I^2t , of the upstream device (curves $I^2t = f(I_p)$).

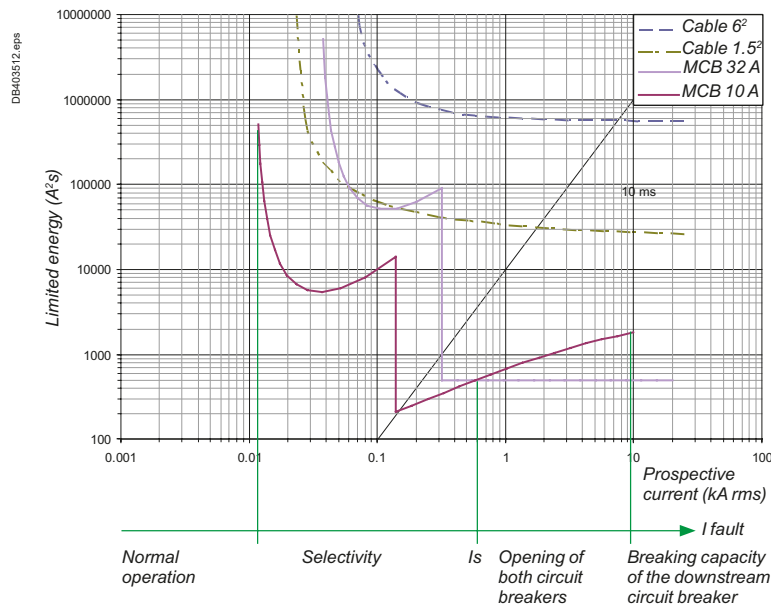

Selectivity between Circuit Breakers

Introduction

A

Selectivity between ComPacT NSX upstream and modular circuit breakers downstream

ComPacT NSX circuit breakers have been designed to provide total selectivity with Acti9 range.

- Total selectivity between ComPacT NSX 100 A with electronic trip unit and Acti9 circuit breaker up to 40 A.
- Total selectivity between ComPacT NSX ≥ 160 A with TMD trip unit ≥ 125 A or electronic trip unit and Acti9 up to 63 A.

Selectivity between ComPacT NSX circuit breakers

Thanks to the Roto-Active breaking principle in the ComPacT NSX, a combination of Schneider Electric circuit breakers provides an exceptional level of selectivity between protection devices.

This performance is due to the combination and optimization of 3 principles:

- Current selectivity,
- Energy selectivity,
- Time selectivity.

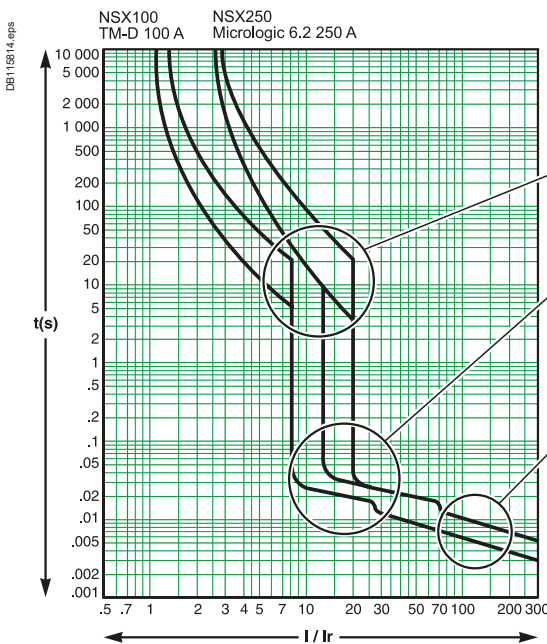

Protection against overloads: current selectivity

The protection is selective if the ratio between the setting thresholds is higher than 1.6 (in the case of two distribution circuit breakers).

Protection against weak short circuits: time selectivity

Tripping of the upstream device has a slight time delay; tripping of the downstream device is faster. The protection is selective if the ratio between the short-circuit protection thresholds is no less than 1.5.

Protection against high short circuits: energy selectivity

This principle combines the exceptional limiting power of the ComPacT NSX devices and reflex release, sensitive to the energy dissipated by the short circuit in the device. When a short circuit is high, if it is seen by two devices, the downstream device limits it greatly. The energy dissipated in the upstream device is insufficient to cause it to trip: there is selectivity whatever the value of the short circuit. The range has been designed to provide energy selectivity between NSX630/NSX250/NSX100 or NSX400/NSX160 with a trip unit with the same rating as the frame up to 440 V AC.

Selectivity between MasterPacT or ComPacT NS ≥ 630 A upstream and ComPacT NSX downstream

Thanks to their high-performance control units and a very innovative design, MasterPacT and ComPacT NS ≥ 630 A devices offer, as standard, a very high level of selectivity with downstream ComPacT NSX up to 630 A

Respect the basic rules of selectivity for overload and short-circuit, or check that curves do not overlap with EcoStruxure Power Design.

Check the selectivity limit in tables for high short-circuit current or when using limiter circuit breakers (MasterPacT MTZ1 L1 or ComPacT NS L or LB) upstream.

Selectivity between MasterPacT or ComPacT NS ≥ 630 A upstream and downstream

The selectivity category of these devices (excepted limiters ones) is B according to IEC/EN 60947 standard. Selectivity is obtained by a combination of current selectivity and time selectivity.

Respect the basic rules of selectivity for overload and short-circuit, or check that curves do not overlap with EcoStruxure Power Design.

Check the selectivity limit in tables for high short-circuit current or when using limiter circuit breakers (MasterPacT MTZ1 L1 or ComPacT NS L or LB).

Selectivity between Circuit Breakers

Introduction

Selectivity limits given in the selectivity tables are the best performance that can be achieved between two given circuit breakers. When the upstream circuit breaker is adjustable and its setting values are not specified, it is considered that it is set to its maximum values. Nevertheless, high selectivity performance is possible with lower settings.

How to use the tables

Basic rules of selectivity for overload and short-circuit

Requisite conditions

The values indicated in the tables (for 220, 380, 415 and 440 V AC 50/60Hz) are met if the following conditions are respected:

Upstream (D1)	Downstream (D2)	Thermal protection I _r up/I _r down	Magnetic protection I _m up/I _m down
TM	TM or MCB	1.6	2
	MicroLogic	1.6	1.5
	MA + Separate overload relay	3	2
	Thermal-magnetic motor circuit breaker	3	2
MicroLogic	TM or MCB	1.6	1.5
	MicroLogic	1.3	1.5
	MA + Separate overload relay	3	1.5
	Thermal-magnetic motor circuit breaker	3	1.5
TM-DC	TM TM-DC or MCB	3	2

Additional conditions for trip units with adjustable settings

Long time (tr)

The tables in the following pages show the limit of selectivity assuming the long time setting tr is set at the maximum value.

Different adjustment of tr may be used according to the following rules :

- $tr \geq 8$ for MicroLogic 5.X upstream a TM circuit breaker.
- $tr_{up} > tr_{down}$ for MicroLogic 5.X upstream another MicroLogic 5.X or check curves are not overlapping.

Short time trip pickup current (I_{sd})

The tables in the following pages show the limit of selectivity assuming the short time trip pickup current “I_{sd}” of upstream circuit breaker is equal to 10 x I_r.

- When the limit of selectivity indicated in the table is 10 x I_r, the limit of selectivity is in fact the upstream magnetic threshold I_{sd}.
- When selectivity is total, a different adjustment of I_{sd} (or I_m) may be used provided that the ratio between the magnetic thresholds indicated above is observed and the additional following rules are satisfied.

When downstream circuit breaker is a ComPacT NSX with MicroLogic 2.2 or 2.3:

- Upstream circuit breaker magnetic setting “I_{sd}” (or I_m) shall be higher than downstream fix instantaneous protection:

Downstream device trip unit	MicroLogic 2.2				MicroLogic 2.3	
MicroLogic Rating	40A	100A	160A	250A	400A	630A
I _{sd} (or I _m) minimum value for ComPacT NSX, ComPacT NS and MasterPacT MicroLogic upstream ComPacT NSX with Mic 2.x	600A	1500A	2400A	3000A	4800A	6900A

- Or upstream circuit breaker shall be equipped with MicroLogic type 5 with $I_{sd_{up}} \geq 1.5 I_{sd_{down}}$ and $T_{sd} \geq 0.1$

When downstream circuit breaker is a ComPacT NS or MasterPacT with MicroLogic 2.0, upstream circuit breaker shall be equipped with MicroLogic type 5, 6 or 7.0 with: $I_{sd_{up}} \geq 1.5 I_{sd_{down}}$ and $T_{sd} \geq 0.1$ s.

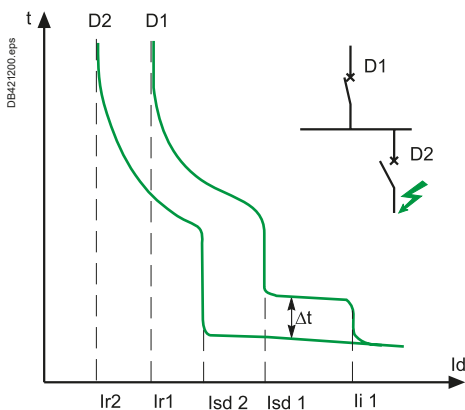

Selectivity between Circuit Breakers

Introduction

A

MasterPacT MTZ with MicroLogic X control unit offers two options for instantaneous trip: "Standard" and "Fast". Selectivity tables are provided with "Standard" setting.

See MicroLogic X User guide for setting guidelines.

Instantaneous trip pickup current (Ii)

The selectivity tables show the limit of selectivity assuming the instantaneous trip pickup current is set to its maximum value or it is inhibited (category B circuit breaker only).

- When the limit of selectivity indicated in the table is $15 \times I_n$ of the upstream device, the limit of selectivity is in fact the instantaneous trip pickup current of the upstream device. Consequently, if a lower instantaneous setting is applied a lower selectivity limit will be obtained.
- When selectivity is total ("T") with $I_i = 15 \times I_n$, a different adjustment of I_i may be used provided that the ratio between the magnetic thresholds indicated above is observed and the additional following rules are applied:

Downstream device trip unit:	MicroLogic 2/4/5/6/7 .2				MicroLogic 2/4/5/6/7.3	
MicroLogic Rating	40 A	100 A	160 A	250 A	400 A	630 A
Ii minimum value for ComPacT NSX, ComPacT NS and MasterPacT	2000 A	2250 A	2500 A	4000 A	6300 A	8000 A
MicroLogic upstream ComPacT NSX						

Short time tripping delay (Tsd)

When the upstream and downstream circuit breakers are fitted with a MicroLogic 5.x,6.x, 7.x trip unit, the minimum non-tripping time of the upstream device must be superior to the maximum tripping time of the downstream device. This is obtained by staging Tsd:

Tsd D1 > Tsd D2 (One band) & I2t Off

The tables show the limit of selectivity assuming function I2t OFF. If this is not the case, the user must verify that the curves do not overlap. Alternatively, ZSi can be wired between the MicroLogic of D1 and D2. In that case, Tsd D1 can be equal to Tsd D2.

Note that a MicroLogic 5/6/7.0* upstream with $I_i = \text{Off}$ and ZSi wired but not activated will operate as a MicroLogic 2.0*. So, the table of MicroLogic 2.0* shall be used for downstream devices not part of an ZSi system.

Ground Fault Protection (GFP) (Ig, Tg)

When the upstream and downstream circuit breakers are fitted with a MicroLogic 6.x trip unit, the user must verify current and time selectivity:

- The setting of the tripping threshold of the upstream GFP is greater than that of the downstream GFP.
- The intentional time-delay setting for the upstream GFP is higher than the opening time of the downstream protection device. Furthermore, it is essential that the intentional time-delay applied to the upstream protection device observes the maximum insulation fault elimination time defined by NEC § 230.95 (i.e. 1 s for 3000 A).

$I_g D1 \geq 1,3 I_g D2$ & $T_g D1 > T_g D2$ (One band).

Circuit Breaker with under-rated protection (MicroLogic trip unit with a lower rating than the frame)

ComPacT NSX, MasterPacT may be equipped with a MicroLogic with a rating lower than the frame (e.g. NSX250N MicroLogic 2.2 160 A).

Except when indicated differently, tables are given for a circuit breaker and a trip unit with the same rated current (e.g. NSX250N MicroLogic 2.2 250 A).

Performance of different configurations can be obtained, when not given in the tables with the following rules:

- For upstream circuit breaker: the column based on the MicroLogic trip unit rating shall be considered
- For downstream circuit breaker: the line based on the circuit breaker frame shall be considered.

Example

- Upstream: ComPacT NSX630F MicroLogic 2.3 400A
- Downstream: ComPacT NXS250N MicroLogic 2.2 160A.

Selectivity limit will be equal to NSX400F MicroLogic 400/NSX250N MicroLogic 250 $I_r = 160$ A.

So 4,8 kA according to table page A-66.

Selectivity between Circuit Breakers

Introduction



Example of Circuit Breaker with add-on module iC40 + Vigi.



Example of separate earth leakage relay RHU.

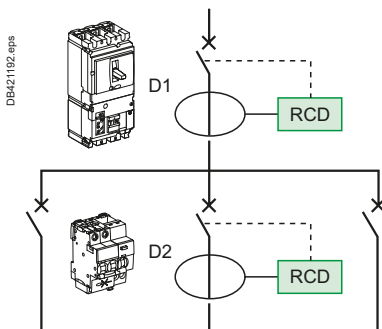

For more detail on RCD and selectivity of RCD see Electrical installation guide - wiki www.electrical-installation.org

Selectivity of RCDs

When Circuit Breakers are equipped with RCD function, selectivity tables are valid for short-circuit and earth fault with high amplitude current.

Residual Current Devices are by design very sensitive to fault and shall be coordinated properly to achieve total selectivity in addition to overcurrent protection.

Schneider Electric proposes a wide range of solutions with the RCD function:

- Circuit Breaker Add-On Residual Current Device (Vigi module)
- Circuit Breaker with integrated RCD function
 - Residual Current circuit breaker (RCBO) like iCV40,
 - Earth Leakage circuit breaker (ELCB) like ComPacT NSXm with MicroLogic 4.1, ComPacT NSX MicroLogic 4.x or 7.x, MasterPacT and ComPacT with MicroLogic 7.0* ,
- Circuit breaker with separate earth leakage relay (any circuit breaker with separated VigiPacT RH● range)
- Residual current circuit breaker (no overcurrent) like iID range.

All these devices from Schneider Electric are following by design the same rules for sensitivity and tripping time even if they are covered by different standard (IEC/EN 61009-1, IEC/EN 60947-2 Annex B or Annex M, IEC/EN 61008). So whatever the type of RCD is, the following rules apply:

- The sensitivity of the upstream residual current device must be at least equal to three times the sensitivity of the downstream residual current device
- The upstream residual current device must be:
 - Of the selective (S) type (or setting) if the downstream residual current device is an instantaneous type,
 - Of the delayed (R) type (or setting) if the downstream residual current device is a selective type. The minimum non-tripping time of the upstream device will therefore be greater than the maximum tripping time of the downstream device for all current values.

$$I\Delta n D1 \geq 3 \times I\Delta n D2 \ \& \ \Delta t (D1) > \Delta t (D2).$$

VigiPacT and MicroLogic Earth leakage protection accuracy is better than the minimum required by standard, allowing smaller ratio between thresholds. Selectivity between Schneider Electric RCDs is met if settings follow the following rules.

Upstream	Downstream	Ratio $I\Delta n_{up} / I\Delta n_{down}$	Time delay
ComPacT NS, NSX, NSxm & MasterPacT MicroLogic 4.* , 7.*	ComPacT NS, NSX, NSxm & MasterPacT MicroLogic 4.* , 7.*	2	$\Delta t_{upstream} > \text{Max break time downstream}$
	VigiPacT RH*	2	
	Other RCDs from Schneider Electric (Vigi Add on, RCCB and RCBO)	3	
VigiPacT RH*	MicroLogic 4.* , 7.* (ComPacT & MasterPacT)	1,5	
	Other RCDs from Schneider Electric (Vigi Add on, RCCB and RCBO)	1,25	
Other RCD from Schneider Electric (Vigi Add on, RCCB and RCBO)	VigiPacT RH*	1,5	
	Other RCDs from Schneider Electric (Vigi Add on, RCCB and RCBO)	2	
Other RCD from Schneider Electric (Vigi Add on, RCCB and RCBO)	VigiPacT RH*	3	
	Other RCDs from Schneider Electric (Vigi Add on, RCCB and RCBO)	3	

Table 1: Schneider Electric RCDs selectivity rules.

Note: IEC/EN 61008 and IEC/EN 61009-1 +IEC/EN 61009-2-1 devices are designed for household and similar uses. IEC/EN 60947-2 Annex B or M devices shall be installed only in parts of the installation accessible only to instructed persons (BA4) or skilled persons (BA5).



Selectivity between Circuit Breakers

Introduction

A



Example of Circuit Breakers with integrated earth leakage protection: ComPacT NSX with MicroLogic 7.2A, iCV40.

Overview of circuit breakers with integrated earth leakage protection ≤ 160 A

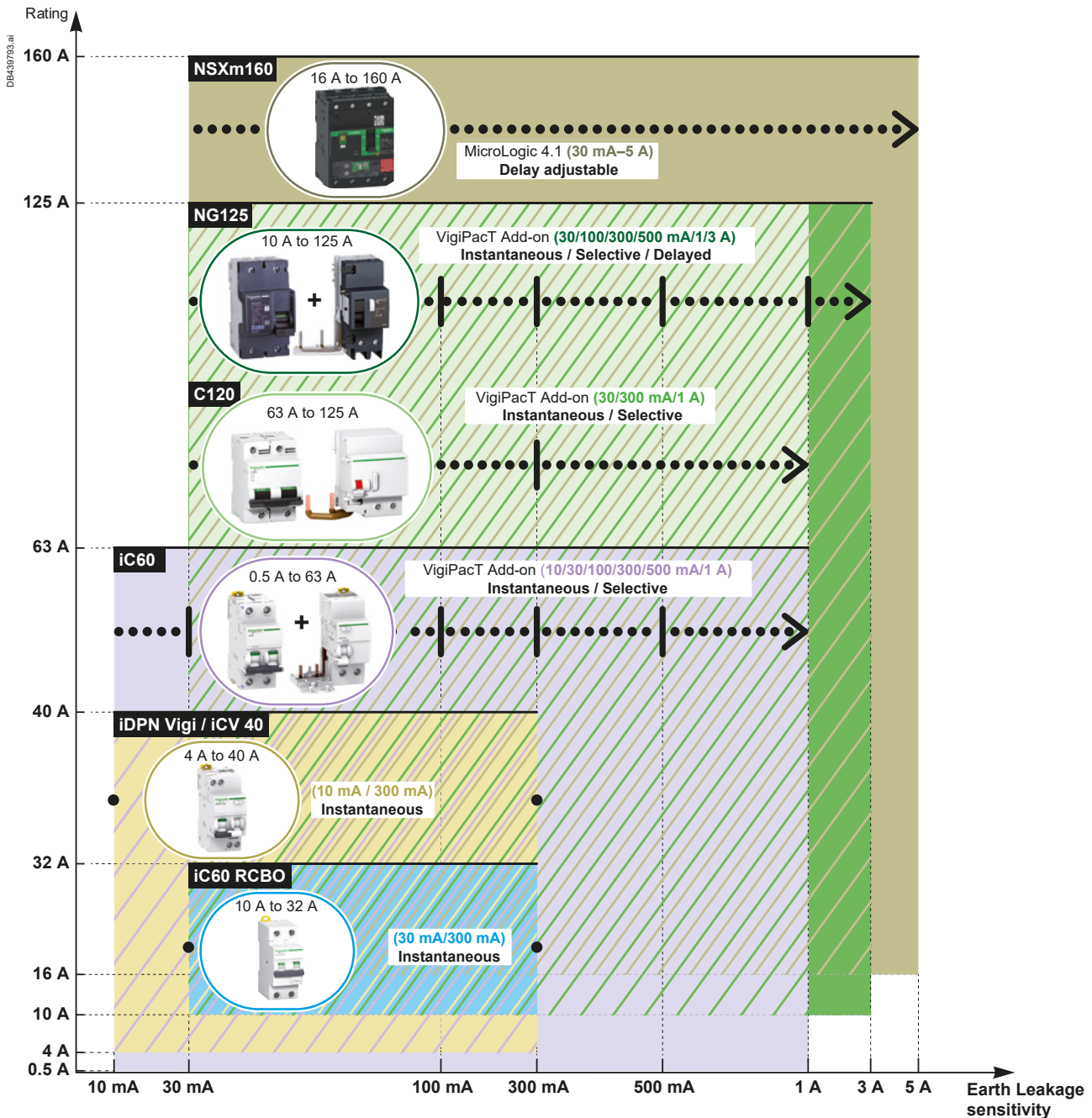

Selectivity between Circuit Breakers

Introduction

Overview of circuit breakers with separate earth leakage relay type A/AC

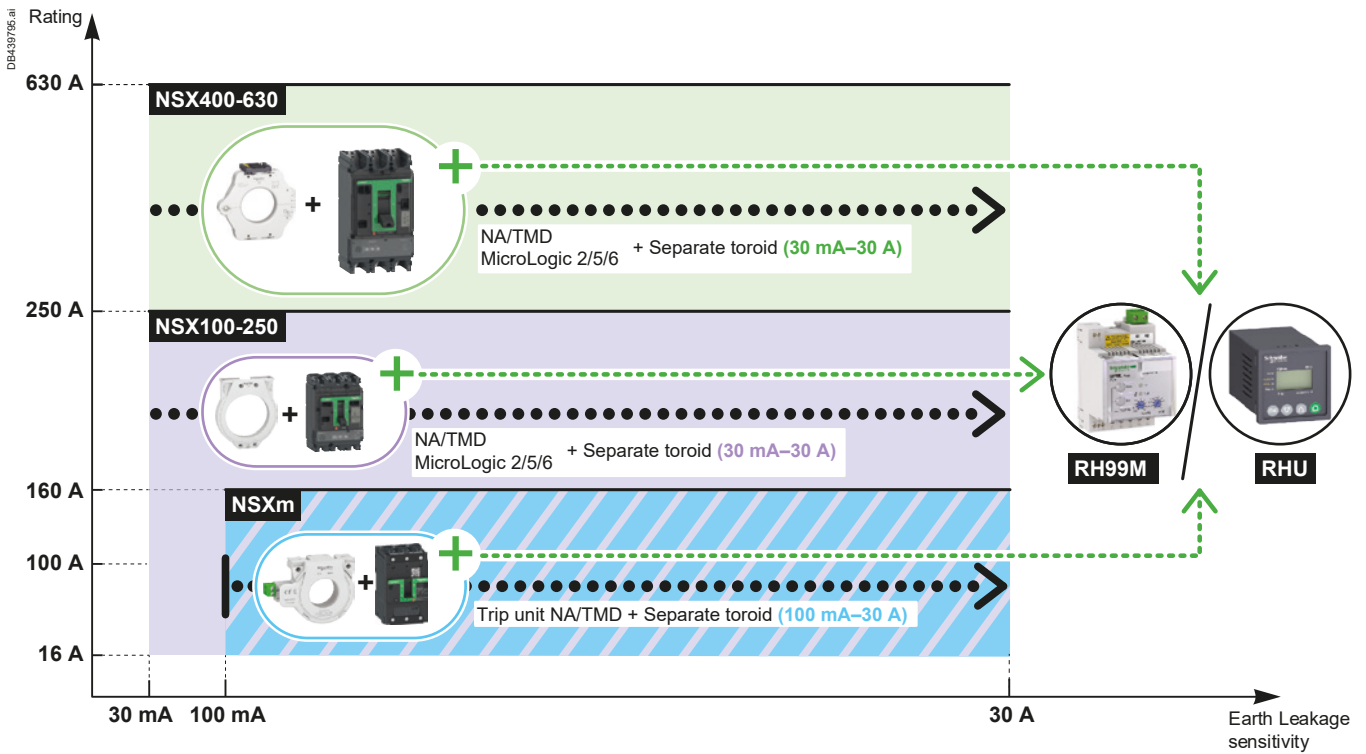

Overview of circuit breakers with separate earth leakage relay type B

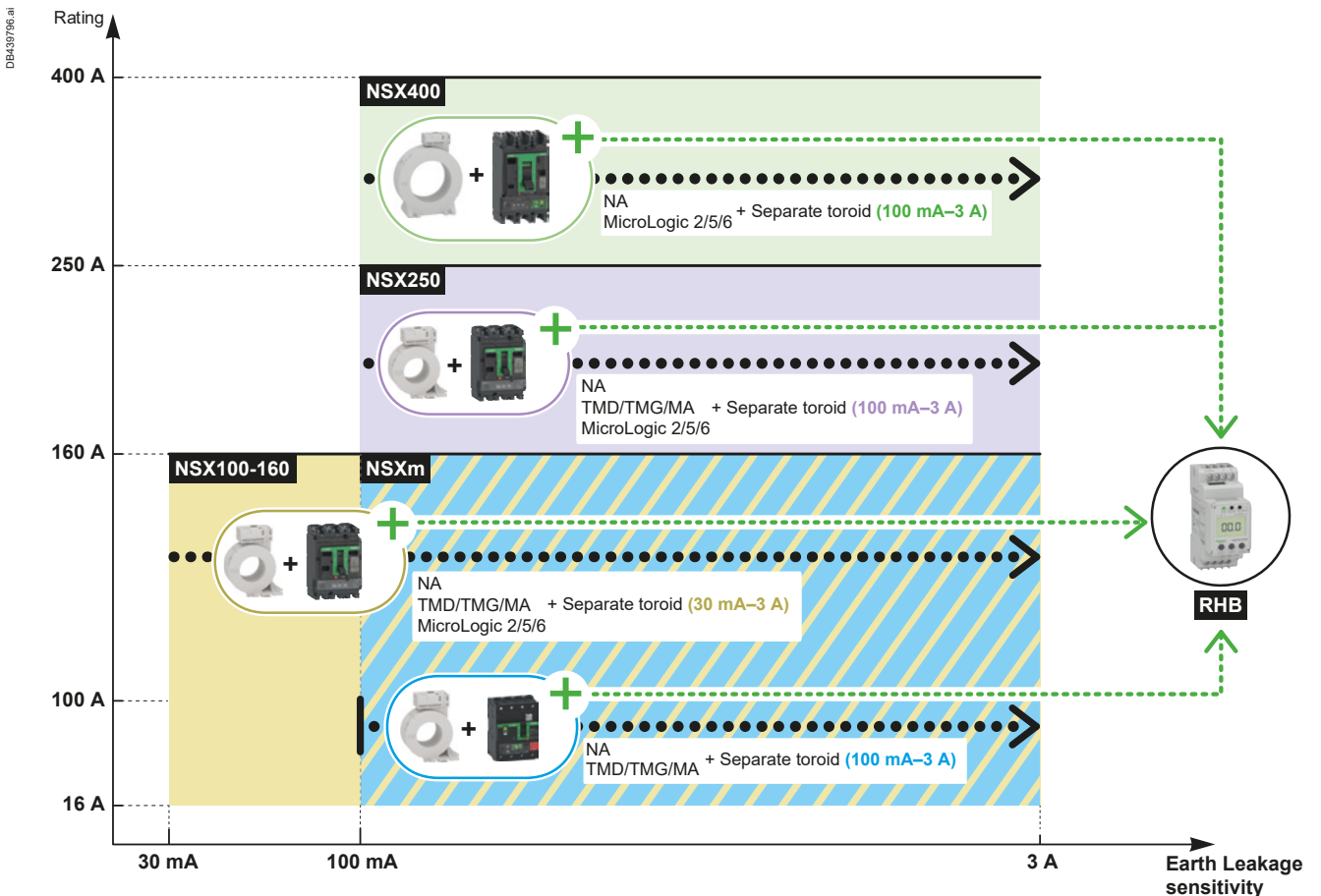

Selectivity between Circuit Breakers

Introduction

A

Using the selectivity tables for final distribution including single phase circuits

















Depending on the network and the type of downstream circuit breaker, the selection table below indicates which table should be consulted to find out the selectivity value.

The selectivity values are given in colour-coded tables.

■ For 220-240 V/380-415 V 50/60 Hz systems:

- In the case of a 2P downstream circuit breaker in a single-phase network (220-240 V), refer to the light green tables,
- In the case of 1P, 1P+N, 3P, 3P+N, 4P and 2P circuit breakers in a two-phase network (380-415 V), refer to the dark green tables.

Selection table

		Upstream network		
		L1 ————— N ————— <small>DBI23998.eps</small>	L1 ————— L2 ————— L3 ————— N ————— <small>DBI23998.eps</small>	L1 ————— L2 ————— L3 ————— <small>DBI23997.eps</small>
Type of Downstream network	Type of Downstream protection device	Ph/N 220-240 V	Ph/N 220-240 V Ph/Ph 380-415 V	Ph/Ph 380-415 V
N L1 <small>DBI24079.eps</small>	DBI23981.eps 2P			
	DBI124151.eps 1P			
	DBI23992.eps 1P+N			
L1 L2 <small>DBI24192.eps</small>	DBI23991.eps 2P			
L1 L2 L3 <small>DBI24080.eps</small>	DBI23993.eps 3P			
NL1 L2 L3 <small>DBI24081.eps</small>	DBI23994.eps 4P			
	DBI23993.eps 3P			
	DBI23995.eps 3P+N			

Note: This selection table shows you the colour.

By taking your downstream protection device, the type of upstream network and its voltage you can refer to the corresponding selectivity table.

Selectivity between Circuit Breakers

Introduction

Example: solution diagram

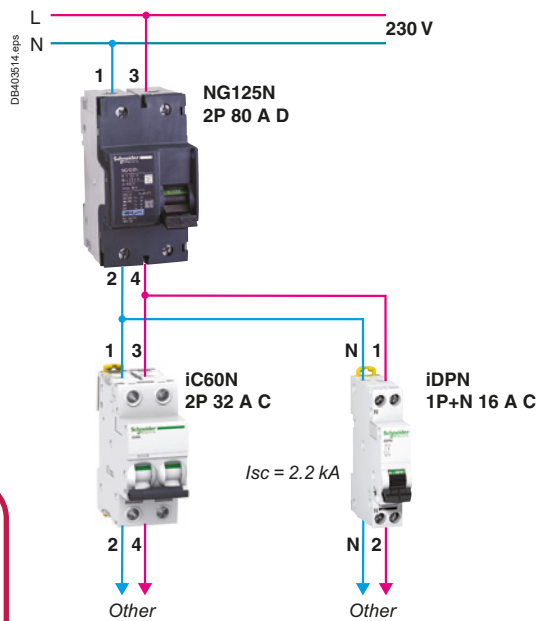

Upstream we have a NG 125N 80 A 2P curve D and downstream an iC60N 32 A 2P curve C. The network is 230 V between phase and neutral. By referring to the light green table on the selectivity page for NG125N curve D with iC60 downstream, we find 2200 A.

If the downstream product is replaced by an iDPN 1P+N curve C, you will use the dark green table for NG125N curve D and iDPN 1P+N downstream. The selectivity level is 2400 A for a 16 A.

Specifications

We want to achieve continuity of service in the event of a fault downstream of the NG125N 80 A. This circuit has an I_{sc} of 2.2 kA under a voltage of 230 V. By referring to the table for 230 V, 1P+N network, we find that for an upstream NG125N curve D with a rating of 80 A, we can have total selectivity up to 16 A if we use an iC60N 1P+N and up to 32 A with an iC60N 2P.

Upstream		NG125N/H/L Curve D										
In (A)		10	16	20	25	32	40	50	63	80	100	125
Downstream	2P (220-240 V) single-phase network											
Selectivity limit (A)												
iC60N/H/L	0.5	T	T	T	T	T	T	T	T	T	T	T
Curve C	1	T	T	T	T	T	T	T	T	T	T	T
	2	1200	T	T	T	T	T	T	T	T	T	T
	3	21	3400	3400	T	T	T	T	T	T	T	T
	4	18	1200	1300	5800	5600	T	T	T	T	T	T
	6	15	700	720	1900	1900	6000	11000	T	T	T	T
	10		22	480	1200	1200	2200	4200	10000	T	T	T
	13			28	51	900	1800	3000	7300	8000	T	T
	16				35	740	1300	2200	4700	5400	T	T
	20					46	88	1700	3500	3500	6900	T
	25						56	600	2500	2500	4600	6800
	32							80	2000	2200	3400	4400
	40								756	1900	2900	3500
	50									960	2300	2800
	63										2300	2800

4000 Selectivity limit = 4 kA.

T Total selectivity, up to the breaking capacity of the downstream circuit breaker.

No selectivity.

$I_s > I_{sc}$ Total selectivity

Selectivity between Circuit Breakers

Quick Access to the Tables

A

Contents

Downstream		Upstream								
Type		iC40, iC40N			iC60N/H/L			NG125N/H/L, C120N/H		
	Curve	B	C	D	B	C	D	B	C	D
iC40	B									
iC40N	C	page A-17	page A-18	page A-19	page A-23	page A-24	page A-25	page A-41	page A-42	page A-43
	D									
iCV40N	B	page A-20	page A-22	page A-22	page A-26	page A-27	page A-28	page A-41	page A-42	page A-43
	C									
iC60N/H/L	B	-	-	-	page A-29 page A-30	page A-31 page A-32	page A-33 page A-34	page A-44 page A-45	page A-46 page A-47	page A-48 page A-49
	C	-	-	-	page A-29 page A-30	page A-31 page A-32	page A-33 page A-34	page A-44 page A-45	page A-46 page A-47	page A-48 page A-49
	D	-	-	-	page A-29 page A-30	page A-31 page A-32	page A-33 page A-34	page A-44 page A-45	page A-46 page A-47	page A-48 page A-49
iC60 RCBO	B	-	-	-	page A-35 page A-36	page A-37 page A-38	page A-39 page A-40	page A-50 page A-51	page A-52 page A-53	page A-54 page A-55
	C	-	-	-	page A-35 page A-36	page A-37 page A-38	page A-39 page A-40	page A-50 page A-51	page A-52 page A-53	page A-54 page A-55
C120, NG125	B	-	-	-	-	-	-	page A-56 page A-57	page A-58 page A-59	page A-60 page A-61
	C	-	-	-	-	-	-	page A-56 page A-57	page A-58 page A-59	page A-60 page A-61
	D	-	-	-	-	-	-	page A-56 page A-57	page A-58 page A-59	page A-60 page A-61

Ue ≤ 440 V AC

Downstream	Upstream									
	NSXm		NSX100		NSX160		NSX250		NSX400	NSX630
Type	TM-D	MicroLogic	TM-D	MicroLogic	TM-D	MicroLogic	TM-D	MicroLogic	MicroLogic	MicroLogic
iC40										
iC40N										
iC60N/H/L	page A-62	page A-63	page A-64	page A-65	page A-64	page A-65	page A-64	page A-65		
C120, NG125										
ComPacT NSXm									page A-68	page A-68
ComPacT NSX100			page A-66	page A-67	page A-66	page A-67	page A-66	page A-67		
ComPacT NSX160	-	-								
ComPacT NSX250			-	-	-	-				
ComPacT NSX400							-	-		

Selectivity between Circuit Breakers

Quick Access to the Tables

440 V AC < U_e ≤ 690 V AC

Motor protection selectivity tables

See Introduction on page A-7 for condition of use of selectivity tables.

Contents

Upstream	ComPacT							
	NSXm	NSX				NS		
	16-160	100-250	100 -160	250	400-630	630b-1600	630b-1000	1600-3200
	All breaking capacities					N/H	L	N
Downstream	TM-D & MicroLogic 4.1	TMD	MicroLogic			MicroLogic		
	TeSys GV2 ME01...ME32	page A-98	page A-100	page A-102	page A-104	page A-99	page A-106	page A-107
TeSys GV2 P01...P32								
TeSys U LUB12 + LUC●6...12								
TeSys U LUB32 + LUC●6...32								
TeSys GV3 P13...P65								
TeSys GV4 P/PE/PEM 02-115								
ComPacT NSX100 F/N/H/S/L/R MicroLogic 2.2M 6.2M	page A-99	page A-101	page A-103	page A-105	page A-105	page A-106	page A-107	page A-108
ComPacT NSX160 F/N/H/S/L MicroLogic 2.2M 6.2M								
ComPacT NSX250 F/N/H/S/L/R MicroLogic 2.2M 6.2M								
ComPacT NSX400F/N/H/S/L/R MicroLogic 2.3 6.3M 320								
ComPacT NSX630F/N/H/S/L/R MicroLogic 2.3M 6.3M								
iC60 L MA1.6...MA40 + LRD	page A-99	page A-101	page A-103	page A-105	page A-105	page A-106	page A-107	page A-108
NG125L MA2.5...MA63 + LRD								
TeSys GV2 L03...L32 + LRD								
TeSys GV3 L25...L65 + LRD								
TeSys GV4 L/LE 02-115 +LRD								
ComPacT NSX100F/N/H/S/L MA 2.5...MA6.3 + LRD								
ComPacT NSX100F/N/H/S/L/R MA12.5...MA100 + LRD								
ComPacT NSX160F/N/H/S/L MA150 + LR9D/F								
ComPacT NSX250F/N/H/S/L/R MA220+LR9D/F								
ComPacT NSX400F/N/H/S/L/R 1.3M +LR9F								
ComPacT NSX630 F/N/H/S/L/R 1.3M +LR9F								



Selectivity between Circuit Breakers

Quick Access to the Tables

440 V AC < U_e ≤ 690 V AC

Contents

A

Upstream	MasterPact						
	MTZ1		MTZ2			MTZ3	
	06-16	06-10	08-20	25-40	25-40	40-63	40-63
	H1/H2/H3	L1	N1/H1/H2/L1	H1/H2	H3	H1	H2
Downstream	MicroLogic		MicroLogic			MicroLogic	
TeSys GV2 ME01...ME32							
TeSys GV2 P01...P32							
TeSys U LUB12 + LUC●6...12							
TeSys U LUB32 + LUC●6...32							
TeSys GV3 P13...P65							
TeSys GV4 P/PE/PEM 02-115							
ComPacT NSX100 F/N/H/S/L/R MicroLogic 2.2M 6.2M							
ComPacT NSX160 F/N/H/S/L MicroLogic 2.2M 6.2M							
ComPacT NSX250 F/N/H/S/L/R MicroLogic 2.2M 6.2M							
ComPacT NSX400F/N/H/S/L/R MicroLogic 2.3 6.3M 320							
ComPacT NSX630F/N/H/S/L/R MicroLogic 2.3M 6.3M	page A-109	page A-110	page A-111	page A-112	page A-113	page A-112	page A-113
iC60 L MA1.6...MA40 + LRD							
NG125L MA2.5...MA63 + LRD							
GV2 L03...L32 + LRD							
GV3 L25...L65 + LRD							
GV4 L/LE 02-115 +LRD							
ComPacT NSX100F/N/H/S/L MA 2.5...MA6.3 + LRD							
ComPacT NSX100F/N/H/S/L/R MA12.5...MA100 + LRD							
ComPacT NSX160F/N/H/S/L MA150 + LR9D/F							
ComPacT NSX250F/N/H/S/L/R MA220+LR9D/F							
ComPacT NSX400F/N/H/S/L/R 1.3M +LR9F							
ComPacT NSX630 F/N/H/S/L/R 1.3M +LR9F							

Motor protection cascading tables	
380...415 V AC	page A-210
440 V AC	page A-207
220...240 V AC	page A-208
Motor protection selectivity enhanced by cascading tables	
380...415 V AC	page A-210 to A-222
440 V AC	page A-223 to A-229
Protection of motor circuits with circuit-breakers	
Introduction	page B-1
Using the coordination tables	
Type 2 coordination tables with circuit-breaker	page B-10
Type 1 coordination tables with circuit-breaker	page B-26
Type 1 coordination table for AC1 utilisation category	
Non-inductive or slightly inductive loads	page B-34
Protection of motor circuits with fuses	
Introduction	page B-35
Type 2 coordination tables with fuses	page B-38

Selectivity Table

Upstream: iC40, iC40N Curve B

Downstream: iC40, iC40N Curves B, C, D

220-240/380-415 V AC



Upstream		iC40, iC40N										
		Curve B										
In (A)		1	2	3	4	6	10	16	20	25	32	40
Downstream												
1P+N												
3P, 3P+N												
Selectivity limit (A)												
iC40	2			12	16	30	60	110	180	240	340	450
iC40N	4					10	40	64	120	160	220	280
iC40N Arc	6						40	64	80	100	130	160
Curve B	10							64	80	100	130	160
[1]	13									100	130	160
	16									100	130	160
	20										130	160
	25											160
Selectivity limit (A)												
iC40	2				12	30	60	110	180	240	340	450
iC40N	4						32	64	120	160	220	280
iC40N Arc	6							51	80	100	130	160
Curve C	10								64	80	130	160
[1]	13										102	128
	16										102	128
	20											128
Selectivity limit (A)												
iC40	2					19	60	110	180	240	340	450
iC40N	4							51	120	160	220	280
iC40N Arc	6								64	80	130	160
Curve D	10										102	128
[1]	13											128
	16											128

[1] Arc iC40, VigiARC iC40, Arc iC40 active and VigiARC iC40 Active add-on can be added to iC40 without impacting the selectivity performance.

4000 Selectivity limit = 4 kA.

No selectivity.

Note: If you cannot find the combination needed, refer to the selection table on page A-12.

Selectivity Table

Upstream: iC40, iC40N Curve C

Downstream: iC40, iC40N Curves B, C, D

A

220-240/380-415 V AC

Upstream		iC40, iC40N										
		Curve C										
In (A)		1	2	3	4	6	10	16	20	25	32	40
Downstream												
1P+N												
3P, 3P+N												
Selectivity limit (A)												
iC40	2			24	32	48	140	270	350	510	820	830
iC40N	4					48	80	130	240	320	480	510
iC40N Arc	6						80	130	160	200	320	380
Curve B	10							130	160	200	260	320
[1]	13								160	200	260	320
	16								160	200	260	320
	20										260	320
	25											320
Selectivity limit (A)												
iC40	2			24	32	48	140	270	350	510	820	830
iC40N	4					10	80	130	240	320	480	510
iC40N Arc	6						80	130	160	200	320	380
Curve C	10							130	160	200	260	320
[1]	13								45	200	260	320
	16								45	200	260	320
	20										260	320
	25											320
Selectivity limit (A)												
iC40	2				25	48	140	270	350	510	820	830
iC40N	4						80	130	240	320	480	510
iC40N Arc	6							128	160	200	320	380
Curve D	10								128	200	260	320
[1]	13									141	153	320
	16									141	153	320
	20											256

[1] Arc iC40, VigiARC iC40, Arc iC40 active and VigiARC iC40 Active add-on can be added to iC40 without impacting the selectivity performance.

4000 Selectivity limit = 4 kA.

No selectivity.

Note: If you cannot find the combination needed, refer to the selection table on page A-12.

Selectivity Table

Upstream: iC40, iC40N Curve D

Downstream: iC40, iC40N Curves B, C, D

220-240/380-415 V AC



Upstream		iC40, iC40N										
		Curve D										
In (A)		1	2	3	4	6	10	16	20	25	32	40
Downstream 1P+N												
3P, 3P+N												
Selectivity limit (A)												
iC40	2			36	48	130	250	490	780	1100	1600	2300
iC40N	4					72	120	330	500	670	970	1400
iC40N Arc	6						120	190	390	520	740	1000
Curve B	10							190	240	300	580	810
[1]	13									300	380	480
	16									300	380	480
	20										380	480
	25											480
	32											480
Selectivity limit (A)												
iC40	2			36	48	130	250	490	780	1100	1600	2300
iC40N	4					10	120	330	500	670	970	1400
iC40N Arc	6							190	390	520	740	1000
Curve C	10							190	240	300	580	810
[1]	13									300	380	480
	16									300	380	480
	20										380	480
	25											480
Selectivity limit (A)												
iC40	2			36	48	130	250	490	780	1100	1600	2300
iC40N	4					10	120	330	500	670	970	1400
iC40N Arc	6						120	190	390	520	740	1000
Curve D	10							190	240	300	580	810
[1]	13									300	380	480
	16									300	380	480
	20										380	480
	25											480

[1] Arc iC40, VigiARC iC40, Arc iC40 active and VigiARC iC40 Active add-on can be added to iC40 without impacting the selectivity performance.

4000 Selectivity limit = 4 kA.

No selectivity.

Note: If you cannot find the combination needed, refer to the selection table on page A-12.

Selectivity Table

Upstream: iC40, iC40N Curve B

Downstream: iCV40N, iCV40H Curves B, C

A

220-240/380-415 V AC

Upstream		iC40, iC40N											
		Curve C											
In (A)		1	2	3	4	6	10	16	20	25	32	40	
Downstream													
1P+N													
3P, 3P+N													
Selectivity limit (A)													
iCV40N	2			12	16	30	60	110	180	240	340	450	
iCV40H	4					10	40	64	120	160	220	280	
iCV40N VigiArc	6						40	64	80	100	130	160	
iCV40H VigiArc	10							64	80	100	130	160	
Curve B	13									100	130	160	
[1]	16									100	130	160	
	20										130	160	
	25											160	
Selectivity limit (A)													
iCV40N	2				12	30	60	110	180	240	340	450	
iCV40H	4						32	64	120	160	220	280	
iCV40N VigiArc	6							51	80	100	130	160	
iCV40H VigiArc	10								64	80	130	160	
Curve B	13										102	128	
[1]	16										102	128	
	20											128	

[1] Arc iC40, VigiARC iC40, Arc iC40 active and VigiARC iC40 Active add-on can be added to iC40 without impacting the selectivity performance.

4000 Selectivity limit = 4 kA.

No selectivity.

Note: If you cannot find the combination needed, refer to the selection table on page A-12.

Selectivity Table

Upstream: iC40, iC40N Curve C

Downstream: iCV40N, iCV40H Curves B, C

220-240/380-415 V AC



Upstream		iC40, iC40N										
		Curve C										
In (A)		1	2	3	4	6	10	16	20	25	32	40
Downstream												
1P+N												
3P, 3P+N												
Selectivity limit (A)												
iCV40N	2			24	32	48	140	270	350	510	820	830
iCV40H	4					48	80	130	240	320	480	510
iCV40N VigiArc	6						80	130	160	200	320	380
iCV40H VigiArc	10							130	160	200	260	320
Curve B	13								160	200	260	320
[1]	16								160	200	260	320
	20										260	320
	25											320
Selectivity limit (A)												
iCV40N	2			24	32	48	140	270	350	510	820	830
iCV40H	4					10	80	130	240	320	480	510
iCV40N VigiArc	6						80	130	160	200	320	380
iCV40H VigiArc	10							130	160	200	260	320
Curve C	13								45	200	260	320
[1]	16								45	200	260	320
	20										260	320
	25											320

[1] Arc iC40, VigiARC iC40, Arc iC40 active and VigiARC iC40 Active add-on can be added to iC40 without impacting the selectivity performance.

4000 Selectivity limit = 4 kA.

No selectivity.

Note: If you cannot find the combination needed, refer to the selection table on page A-12.

Selectivity Table

Upstream: iC40, iC40N Curve D

Downstream: iCV40N, iCV40H Curves B, C

A

220-240/380-415 V AC

Upstream		iC40, iC40N										
		Curve D										
In (A)		1	2	3	4	6	10	16	20	25	32	40
Downstream												
1P+N												
3P, 3P+N												
Selectivity limit (A)												
iCV40N	2			36	48	130	250	490	780	1100	1600	2300
iCV40H	4					72	120	330	500	670	970	1400
iCV40N VigiArc	6						120	190	390	520	740	1000
iCV40H VigiArc	10							190	240	300	580	810
Curve B	13									300	380	480
[1]	16									300	380	480
	20										380	480
	25											480
	32											480
Selectivity limit (A)												
iCV40N	2			36	48	130	250	490	780	1100	1600	2300
iCV40H	4					10	120	330	500	670	970	1400
iCV40N VigiArc	6							190	390	520	740	1000
iCV40H VigiArc	10							190	240	300	580	810
Curve C	13									300	380	480
[1]	16									300	380	480
	20										380	480
	25											480

[1] Arc iC40, VigiARC iC40, Arc iC40 active and VigiARC iC40 Active add-on can be added to iC40 without impacting the selectivity performance.

4000 Selectivity limit = 4 kA.

No selectivity.

Note: If you cannot find the combination needed, refer to the selection table on page A-12.

Selectivity Table

Upstream: iC60N/H/L Curve B

Downstream: iC40, iC40N Curves B, C, D

220-240/380-415 V AC



Upstream	iC60N/H/L													
	Curve B													
In (A)	2	3	4	6	10	13	16	20	35	32	40	50	63	

Downstream	1P+N	3P, 3P+N
------------	------	----------

Selectivity limit (A)

iC40N	2		12	16	24	40	50	90	80	100	220	300	330	440
	iC40N Arc	4			14	40	50	64	80	100	190	270	300	380
Curve B	6					40	50	64	80	100	130	240	250	250
	10							64	80	100	130	160	200	250
	[1] 13									100	130	160	200	250
	16									100	130	160	200	250
	20										130	160	200	250
	25											160	200	250
	32												200	250
	40													250

Selectivity limit (A)

iC40N	2			5	24	40	50	90	80	100	220	300	330	440
	iC40N Arc	4				34	50	64	80	100	190	270	300	380
Curve C	6							47	80	100	130	240	250	250
	10								64	80	130	160	200	250
	[1] 13										102	128	200	250
	16										102	128	200	250
	20											128	160	250
	25												160	201
	32													201

Selectivity limit (A)

iC40N	2				19	40	50	90	80	100	220	300	330	440
	iC40N Arc	4						51	80	100	190	270	300	380
Curve D	6								59	78	130	240	250	250
	10										102	128	200	250
	[1] 16											128	160	201
	20												160	201
	25													201

[1] Arc iC40, VigiARC iC40, Arc iC40 active and VigiARC iC40 Active add-on can be added to iC40 without impacting the selectivity performance.

4000 Selectivity limit = 4 kA.

No selectivity.

Note: If you cannot find the combination needed, refer to the selection table on page A-12.

Selectivity Table

Upstream: iC60N/H/L Curve C

Downstream: iC40, iC40N Curves B, C, D

A

220-240/380-415 V AC

Upstream		iC60N/H/L												
		Curve C												
In (A)		2	3	4	6	10	13	16	20	35	32	40	50	63
Downstream														
1P+N														
3P, 3P+N														
Selectivity limit (A)														
iC40	2		24	32	48	80	100	130	160	300	410	540	910	930
iC40N	4				48	80	100	130	160	200	260	480	720	760
iC40N Arc	6					80	100	130	160	200	260	320	400	500
Curve B	10						100	130	160	200	260	320	400	500
[1]	13									200	260	320	400	500
	16									200	260	320	400	500
	20										260	320	400	500
	25											320	400	500
	32												400	500
	40													500
Selectivity limit (A)														
iC40	2		24	32	48	80	100	130	160	300	410	540	910	930
iC40N	4				14	80	100	130	160	200	260	480	720	760
iC40N Arc	6					80	100	130	160	200	260	320	400	500
Curve C	10							130	160	200	260	320	400	500
[1]	13									83	260	320	400	500
	16									83	260	320	400	500
	20										260	320	400	500
	25											124	400	500
	32												163	500
	40													186
Selectivity limit (A)														
iC40	2			25	48	80	100	130	160	300	410	540	910	930
iC40N	4					80	100	130	160	200	260	480	720	760
iC40N Arc	6						100	130	160	200	260	320	400	500
Curve D	10									200	260	320	400	500
[1]	13									83	165	320	400	500
	16									83	165	320	400	500
	20											151	400	500
	25												176	500
	32													255
	40													

[1] Arc iC40, VigiARC iC40, Arc iC40 active and VigiARC iC40 Active add-on can be added to iC40 without impacting the selectivity performance.

Selectivity limit = 4 kA.

No selectivity.

Note: If you cannot find the combination needed, refer to the selection table on page A-12.

Selectivity Table

Upstream: iC60N/H/L Curve D

Downstream: iC40, iC40N Curves B, C, D

220-240/380-415 V AC



Upstream	iC60N/H/L												
	Curve D												
In (A)	2	3	4	6	10	13	16	20	35	32	40	50	63

Downstream	1P+N													
	3P, 3P+N													

Selectivity limit (A)

iC40	2		36	48	72	120	160	190	390	510	700	960	1500	2000
iC40N	4				72	120	160	190	240	450	580	780	1100	1400
iC40N Arc	6					120	160	190	240	300	380	480	600	760
Curve B	10						160	190	240	300	380	480	600	760
[1]	13									300	380	480	600	760
	16									300	380	480	600	760
	20										380	480	600	760
	25											480	600	760
	32												600	760
	40													760

Selectivity limit (A)

iC40	2		36	48	72	120	160	190	390	510	700	960	1500	2000
iC40N	4				14	120	160	190	240	450	580	780	1100	1400
iC40N Arc	6					120	160	190	240	300	380	480	600	760
Curve C	10						34	190	240	300	380	480	600	760
[1]	13									300	380	480	600	760
	16									300	380	480	600	760
	20										380	480	600	760
	25											480	600	760
	32												600	760
	40													760

Selectivity limit (A)

iC40	2		36	48	72	120	160	190	390	510	700	960	1500	2000
iC40N	4				14	120	160	190	240	450	580	780	1100	1400
iC40N Arc	6					120	160	190	240	300	380	480	600	760
Curve D	10							57	240	300	380	480	600	760
[1]	13									83	380	480	600	760
	16									83	380	480	600	760
	20										155	151	600	760
	25											124	180	760
	32												163	760
	40													186

[1] Arc iC40, VigiARC iC40, Arc iC40 active and VigiARC iC40 Active add-on can be added to iC40 without impacting the selectivity performance.

4000 Selectivity limit = 4 kA.

No selectivity.

Note: If you cannot find the combination needed, refer to the selection table on page A-12.

Selectivity Table

Upstream: iC60N/H/L Curve B

Downstream: iCV40N, iCV40H Curves B, C

A

220-240/380-415 V AC

Upstream		iC60N/H/L													
		Curve B													
In (A)		2	3	4	6	10	13	16	20	35	32	40	50	63	
Downstream															
1P+N															
3P, 3P+N															
Selectivity limit (A)															
iCV40N	2		12	16	24	40	50	90	80	100	220	300	330	440	
iCV40H	4				14	40	50	64	80	100	190	270	300	380	
iCV40N VigiArc	6					40	50	64	80	100	130	240	250	250	
iCV40H VigiArc	10							64	80	100	130	160	200	250	
Curve B	13									100	130	160	200	250	
[1]	16									100	130	160	200	250	
	20										130	160	200	250	
	25											160	200	250	
	32												200	250	
Selectivity limit (A)															
iCV40N	2			5	24	40	50	90	80	100	220	300	330	440	
iCV40 H	4					34	50	64	80	100	190	270	300	380	
iCV40N VigiArc	6							47	80	100	130	240	250	250	
iCV40H VigiArc	10								64	80	130	160	200	250	
Curve C	13										102	128	200	250	
[1]	16										102	128	200	250	
	20											128	160	250	
	25												160	201	
	32													201	

[1] Arc iC40, Arc iC40 active add-on can be added to iCV40 without impacting the selectivity performance.

4000 Selectivity limit = 4 kA.

No selectivity.

Note: If you cannot find the combination needed, refer to the selection table on page A-12.

Selectivity Table

Upstream: iC60N/H/L Curve C

Downstream: iCV40N, iCV40H Curves B, C

220-240/380-415 V AC



Upstream	iC60N/H/L													
	Curve C													
In (A)	2	3	4	6	10	13	16	20	35	32	40	50	63	

Downstream	1P+N													
	3P, 3P+N													

Selectivity limit (A)														
iCV40N	2		24	32	48	80	100	130	160	300	410	540	910	930
iCV40H	4				48	80	100	130	160	200	260	480	720	760
iCV40N VigiArc	6					80	100	130	160	200	260	320	400	500
iCV40H VigiArc	10						100	130	160	200	260	320	400	500
Curve B	13									200	260	320	400	500
[1]	16									200	260	320	400	500
	20										260	320	400	500
	25											320	400	500
	32												400	500
Selectivity limit (A)														
iCV40N	2		24	32	48	80	100	130	160	300	410	540	910	930
iCV40H	4				14	80	100	130	160	200	260	480	720	760
iCV40N VigiArc	6					80	100	130	160	200	260	320	400	500
iCV40H VigiArc	10							130	160	200	260	320	400	500
Curve C	13									83	260	320	400	500
[1]	16									83	260	320	400	500
	20										260	320	400	500
	25											124	400	500
	32												163	500

[1] Arc iC40, Arc iC40 active add-on can be added to iCV40 without impacting the selectivity performance.

4000 Selectivity limit = 4 kA.

No selectivity.

Note: If you cannot find the combination needed, refer to the selection table on page A-12.

Selectivity Table

Upstream: iC60N/H/L Curve D

Downstream: iCV40N, iCV40H Curves B, C

A

220-240/380-415 V AC

Upstream		iC60N/H/L													
		Curve D													
In (A)		2	3	4	6	10	13	16	20	35	32	40	50	63	
Downstream															
1P+N															
3P, 3P+N															
Selectivity limit (A)															
iCV40N	2		36	48	72	120	160	190	390	510	700	960	1500	2000	
iCV40H	4				72	120	160	190	240	450	580	780	1100	1400	
iCV40N VigiArc	6					120	160	190	240	300	380	720	1000	1200	
iCV40H VigiArc	10						160	190	240	300	380	480	600	760	
Curve B	13									300	380	480	600	760	
[1]	16									300	380	480	600	760	
	20										380	480	600	760	
	25											480	600	760	
	32												600	760	
														760	
Selectivity limit (A)															
iCV40N	2		36	48	72	120	160	190	390	510	700	960	1500	2000	
iCV40H	4				14	120	160	190	240	450	580	780	1100	1400	
iCV40N VigiArc	6					120	160	190	240	300	380	720	1000	1200	
iCV40H VigiArc	10						34	190	240	300	380	480	600	760	
Curve C	13									300	380	480	600	760	
[1]	16									300	380	480	600	760	
	20										380	480	600	760	
	25											124	600	760	
	32												163	760	

[1] Arc iC40, Arc iC40 active add-on can be added to iCV40 without impacting the selectivity performance.

4000 Selectivity limit = 4 kA.

No selectivity.

Note: If you cannot find the combination needed, refer to the selection table on page A-12.

Selectivity Table

Upstream: iC60N/H/L Curve B

Downstream: iC60N/H/L Curves B, C, D

220-240/380-415 V AC



Upstream		iC60N/H/L													
		Curve B													
In (A)		1	2	3	4	6	10	13	16	20	25	32	40	50	63
Downstream		1P, 1P+N, 2P (380-415 V) two-phase network 3P, 3P+N, 4P													
Selectivity limit (A)															
iC60N/H/L	0.5	4	10	40	60	T	T	T	T	T	T	T	T	T	T
Curve B	1		10	12	16	40	70	120	170	210	300	780	1300	1700	4000
[1]	2			12	16	30	60	90	130	140	200	370	520	630	960
	3					30	40	70	90	120	150	250	380	460	670
	4					30	40	52	64	80	100	250	310	380	470
	6						40	52	64	80	100	190	290	300	440
	10								64	80	100	130	160	200	380
	13									80	100	130	160	200	250
	16										100	130	160	200	250
	20											130	160	200	250
	25												160	200	250
	32													200	250
	40														250
Selectivity limit (A)															
iC60N/H/L	0.5		10	40	60	T	T	T	T	T	T	T	T	T	T
Curve C	1				16	30	70	120	170	210	300	780	1300	1700	4000
[1]	2				16	18	60	90	130	160	200	370	520	630	960
	3					15	40	70	90	120	150	250	380	460	670
	4						27	52	64	80	100	250	310	380	470
	6								51	80	100	190	290	300	440
	10									64	80	130	160	200	250
	13											102	160	200	250
	16											102	128	200	250
	20												128	160	250
	25													160	200
	32														200
Selectivity limit (A)															
iC60 N/H/L	0.5			30	50	T	T	T	T	T	T	T	T	T	T
Curve D	1				12	30	60	120	170	210	300	780	1300	1700	4000
[1]	2					19	40	70	110	140	180	370	520	630	860
	3						31	41	90	120	150	250	380	460	670
	4								48	80	100	220	310	340	470
	6									64	80	190	240	300	380
	10											100	128	200	250
	13												128	160	250
	16												128	160	200
	20													160	200
	25														200

[1] Arc iC60, VigiARC iC60, Arc iC60 active and VigiARC iC60 Active add-on can be added to iC60 without impacting the selectivity performance. The breaking capacity being limited to 10kA.

4000 Selectivity limit = 4 kA.

T Total selectivity, up to the breaking capacity of the downstream circuit breaker.

No selectivity.

Note: If you cannot find the combination needed, refer to the selection table on page A-12.

Selectivity Table

Upstream: iC60N/H/L Curve B

Downstream: iC60N/H/L Curves B, C, D



220-240/380-415 V AC

Upstream		iC60N/H/L													
		Curve B													
In (A)		1	2	3	4	6	10	13	16	20	25	32	40	50	63
Downstream		2P (220-240 V) single-phase network													
Selectivity limit (A)															
iC60N/H/L	0.5	4	210	T	T	T	T	T	T	T	T	T	T	T	T
Curve B	1		10	20	20	60	110	260	530	790	2000	T	T	T	T
[1]	2			12	16	30	70	140	200	250	400	880	1700	2500	5300
	3					30	40	90	130	160	250	550	800	1100	1400
	4						40	70	110	120	180	370	520	630	960
	6						40	52	64	80	100	270	380	460	630
	10								64	80	100	190	290	300	440
	13									80	100	130	160	200	380
	16										100	130	160	200	250
	20											130	160	200	250
	25												160	200	250
	32													200	250
	40														250
Selectivity limit (A)															
iC60N/H/L	0.5		170	T	T	T	T	T	T	T	T	T	T	T	T
Curve C	1				20	60	110	260	530	790	2000	T	T	T	T
[1]	2				16	18	70	140	200	250	400	880	1700	2500	5300
	3					15	40	90	130	160	230	550	800	1100	1400
	4						27	70	90	120	180	370	520	630	860
	6								51	80	100	230	380	410	630
	10									64	80	130	240	300	440
	13											102	160	200	380
	16											102	128	200	250
	20												128	160	250
	25													160	200
	32														200
Selectivity limit (A)															
iC60N/H/L	0.5			T	T	T	T	T	T	T	T	T	T	T	T
Curve D	1				12	50	110	260	530	790	2000	T	T	T	T
[1]	2					19	60	120	200	250	350	1100	1700	2500	5300
	3						31	41	110	140	230	490	800	960	1400
	4								48	80	150	310	450	630	860
	6									64	80	230	330	410	500
	10											100	128	200	380
	13												128	160	250
	16												128	160	200
	20													160	200
	25														200

[1] Arc iC60, VigiARC iC60, Arc iC60 active and VigiARC iC60 Active add-on can be added to iC60 without impacting the selectivity performance. The breaking capacity being limited to 10kA.

- Selectivity limit = 4 kA.
- Total selectivity, up to the breaking capacity of the downstream circuit breaker.
- No selectivity.

Note: The selectivity limits given in the table must be compared to the phase/neutral fault current (Ik1). If the max. phase/earth fault current (If) is high, the selectivity of this fault current should also be verified by referring to the limits given in the table.

Selectivity Table

Upstream: iC60N/H/L Curve C

Downstream: iC60N/H/L Curves B, C, D

220-240/380-415 V AC

A

Upstream		iC60N/H/L													
		Curve C													
In (A)		1	2	3	4	6	10	13	16	20	25	32	40	50	63
Downstream		1P, 1P+N, 2P (380-415 V)													
		two-phase network													
		3P, 3P+N, 4P													
Selectivity limit (A)															
iC60N/H/L	0.5	8	60	T	T	T	T	T	T	T	T	T	T	T	T
Curve B	1		16	24	32	70	180	210	370	590	1100	2400	7000	T	T
[1]	2			24	32	48	140	160	220	310	460	780	1200	2000	2000
	3				5	48	120	104	190	280	380	580	820	1400	1400
	4					14	80	104	130	240	300	430	590	1000	1100
	6						80	104	130	160	200	380	480	770	850
	10							104	130	160	200	260	320	400	500
	13									160	200	260	320	400	500
	16										200	260	320	400	500
	20											260	320	400	500
	25												320	400	500
	32													400	500
	40														500
Selectivity limit (A)															
iC60N/H/L	0.5	8	50	T	T	T	T	T	T	T	T	T	T	T	T
Curve C	1		16	24	32	70	180	210	370	590	1100	2400	7900	T	T
[1]	2			24	32	48	120	160	220	310	460	780	1200	2000	2000
	3					16	80	104	190	280	380	480	820	1400	1400
	4					14	80	104	130	160	300	430	590	1000	1100
	6						80	104	130	160	200	380	480	770	850
	10								130	160	200	260	320	400	500
	13									55	200	260	320	400	500
	16										71	260	320	400	500
	20											260	320	400	500
	25												127	400	500
	32													168	500
	40														500
Selectivity limit (A)															
iC60N/H/L	0.5		50	T	T	T	T	T	T	T	T	T	T	T	T
Curve D	1			24	32	70	180	210	370	590	1100	2400	7900	T	T
[1]	2				25	48	120	160	220	310	460	680	1200	2000	2000
	3					15	80	104	130	240	380	480	710	1400	1400
	4						28	100	130	160	300	430	590	1000	1100
	6								130	160	200	260	480	770	850
	10									73	200	260	320	400	500
	13										79	260	320	400	500
	16										71	194	320	400	500
	20												135	400	500
	25													174	500
	32														277
	40														

[1] Arc iC60, VigiARC iC60, Arc iC60 active and VigiARC iC60 Active add-on can be added to iC60 without impacting the selectivity performance. The breaking capacity being limited to 10kA.

4000 Selectivity limit = 4 kA.

T Total selectivity, up to the breaking capacity of the downstream circuit breaker.

No selectivity.

Note: If you cannot find the combination needed, refer to the selection table on page A-12.

Selectivity Table

Upstream: iC60N/H/L Curve C

Downstream: iC60N/H/L Curves B, C, D

A

220-240/380-415 V AC

Upstream		iC60N/H/L													
		Curve C													
In (A)		1	2	3	4	6	10	13	16	20	25	32	40	50	63
Downstream		2P (220-240 V) single-phase network													
Selectivity limit (A)															
iC60N/H/L	0.5	20	T	T	T	T	T	T	T	T	T	T	T	T	T
Curve B	1		20	40	50	120	540	940	2700	T	T	T	T	T	T
[1]	2			24	32	70	210	260	430	800	1500	3600	7900	52000	53000
	3				5	48	140	180	250	450	710	1200	2100	11000	9800
	4					14	120	160	220	310	460	680	940	2000	2000
	6						80	104	130	240	350	510	770	1300	1100
	10							104	130	160	200	380	550	930	950
	13									160	200	260	480	680	760
	16										200	260	320	400	500
	20											260	320	400	500
	25												320	400	500
	32													400	500
	40														500
Selectivity limit (A)															
iC60N/H/L	0.5	20	T	T	T	T	T	T	T	T	T	T	T	T	T
Curve C	1		20	40	50	120	540	940	2700	T	T	T	T	T	T
[1]	2			24	32	70	210	260	430	660	1500	3600	7900	60000	53000
	3					16	140	180	250	380	710	1200	2100	11000	9800
	4					14	120	104	190	310	460	680	940	2000	2000
	6						80	104	130	160	350	510	620	1300	1100
	10								130	160	200	260	480	770	850
	13									55	200	260	480	680	760
	16										78	260	320	400	500
	20											260	320	400	500
	25												127	400	500
	32													168	500
	40														500
Selectivity limit (A)															
iC60N/H/L	0.5		T	T	T	T	T	T	T	T	T	T	T	T	T
Curve D	1			30	50	120	540	940	2700	T	T	T	T	T	T
[1]	2				25	48	210	260	430	800	1500	3600	7900	60000	53000
	3					15	120	160	250	380	630	1200	2100	11000	9800
	4						28	100	190	280	460	680	940	2000	2000
	6								130	160	300	450	620	1100	1100
	10									73	200	260	480	770	850
	13										79	260	320	680	760
	16											71	194	320	400
	20													135	400
	25														174
	32														
	40														

[1] Arc iC60, VigiARC iC60, Arc iC60 active and VigiARC iC60 Active add-on can be added to iC60 without impacting the selectivity performance. The breaking capacity being limited to 10kA.

- Selectivity limit = 4 kA.
- Total selectivity, up to the breaking capacity of the downstream circuit breaker.
- No selectivity.

Note: The selectivity limits given in the table must be compared to the phase/neutral fault current (Ik1). If the max. phase/earth fault current (If) is high, the selectivity of this fault current should also be verified by referring to the limits given in the table.

Selectivity Table

Upstream: iC60N/H/L Curve D

Downstream: iC60N/H/L Curves B, C, D

220-240/380-415 V AC



Upstream	iC60N/H/L													
	Curve D													
In (A)	1	2	3	4	6	10	13	16	20	25	32	40	50	63

Downstream	1P, 1P+N, 2P (380-415 V) two-phase network 3P, 3P+N, 4P
-------------------	--

Selectivity limit (A)															
iC60N/H/L	0.5	20	T	T	T	T	T	T	T	T	T	T	T	T	T
Curve B	1		30	50	70	150	290	510	770	2000	3900	T	T	T	T
[1]	2			36	48	110	210	300	450	730	890	1400	2300	5000	6800
	3				5	72	180	230	330	550	670	1100	1300	2800	4300
	4					72	120	160	290	410	560	840	1000	2000	2400
	6						120	160	190	360	450	660	910	1300	1600
	10							28	190	240	300	380	720	1100	1400
	13									240	300	380	480	900	1100
	16										300	380	480	900	1100
	20											380	480	600	760
	25												480	600	760
	32													600	760
	40													600	760

Selectivity limit (A)															
iC60N/H/L	0.5	20	T	T	T	T	T	T	T	T	T	T	T	T	T
Curve C	1		30	50	70	150	290	510	770	2000	3900	T	T	T	T
[1]	2			36	48	110	210	300	450	730	890	1600	2300	5000	6800
	3				5	15	120	230	330	550	670	1100	1300	2800	4300
	4					13	120	160	290	410	560	710	1000	2000	2400
	6						120	160	190	360	450	660	910	1300	1600
	10							28	49	240	300	380	720	1100	1100
	13									52	300	380	480	900	1100
	16										71	380	480	600	760
	20											380	480	600	760
	25												480	600	760
	32													105	760
	40													153	760

Selectivity limit (A)																
iC60N/H/L	0.5	20	T	T	T	T	T	T	T	T	T	T	T	T	T	
Curve D	1		30	50	70	150	290	510	770	2000	3900	T	T	T	T	
[1]	2			36	48	110	210	300	370	640	890	1600	2300	5000	6800	
	3					15	120	230	330	450	670	970	1300	2800	3800	
	4					13	28	160	190	410	560	710	1000	1600	2400	
	6						32	160	190	240	450	580	810	1300	1600	
	10								49	73	300	380	480	1100	1100	
	13									52	80	380	480	900	1100	
	16										71	380	480	600	760	
	20											105	135	600	760	
	25													105	760	
	32														153	
	40															245

[1] Arc iC60, VigiARC iC60, Arc iC60 active and VigiARC iC60 Active add-on can be added to iC60 without impacting the selectivity performance. The breaking capacity being limited to 10kA.

4000 Selectivity limit = 4 kA.

T Total selectivity, up to the breaking capacity of the downstream circuit breaker.

No selectivity.

Note: If you cannot find the combination needed, refer to the selection table on page A-12.

Selectivity Table

Upstream: iC60N/H/L Curve D

Downstream: iC60N/H/L Curves B, C, D

A

220-240/380-415 V AC

Upstream		iC60N/H/L													
		Curve D													
In (A)		1	2	3	4	6	10	13	16	20	25	32	40	50	63
Downstream 2P (220-240 V) single-phase network															
Selectivity limit (A)															
iC60N/H/L	0.5	T	T	T	T	T	T	T	T	T	T	T	T	T	T
Curve B	1		50	100	130	340	1600	10000	T	T	T	T	T	T	T
[1]	2			50	80	150	350	650	1100	2600	5800	16000	45000	T	T
	3				5	110	240	370	530	920	1600	3800	9500	T	T
	4					72	180	270	370	640	890	1400	2300	7100	12000
	6						120	160	290	480	590	900	1300	2200	2600
	10							28	190	360	450	660	910	1500	1900
	13									240	450	580	810	1300	1600
	16										300	380	720	1100	1400
	20											380	480	900	1100
	25												480	600	760
	32													600	760
	40														760
Selectivity limit (A)															
iC60N/H/L	0.5	T	T	T	T	T	T	T	T	T	T	T	T	T	T
Curve C	1		50	100	130	340	1600	10000	T	T	T	T	T	T	T
[1]	2			50	70	150	350	580	1100	2600	5800	16000	45000	T	T
	3				5	15	240	370	530	920	1600	3800	9500	T	T
	4					13	180	270	370	640	890	1400	1900	7100	12000
	6						120	160	290	480	590	900	1300	2200	2600
	10							28	190	360	450	660	910	1500	1900
	13									52	300	580	810	1300	1600
	16										71	380	720	1100	1400
	20											380	480	900	1100
	25												105	600	760
	32													153	760
	40														760
Selectivity limit (A)															
iC60N/H/L	0.5	T	T	T	T	T	T	T	T	T	T	T	T	T	T
Curve D	1		40	80	130	340	1600	10000	T	T	T	T	T	T	T
[1]	2			50	70	150	350	650	1200	2600	5800	16000	45000	T	T
	3					15	210	300	530	920	1600	3800	9500	T	T
	4					13	28	230	370	640	890	1400	1900	7100	12000
	6						32	160	190	420	590	900	1100	2200	2600
	10								49	73	450	660	910	1500	1900
	13									52	300	380	720	1300	1600
	16										71	380	480	1100	1400
	20											105	480	900	1100
	25												105	174	760
	32													153	760
	40														245

[1] Arc iC60, VigiARC iC60, Arc iC60 active and VigiARC iC60 Active add-on can be added to iC60 without impacting the selectivity performance. The breaking capacity being limited to 10kA.

4000 Selectivity limit = 4 kA.

T Total selectivity, up to the breaking capacity of the downstream circuit breaker.

No selectivity.

Note: The selectivity limits given in the table must be compared to the phase/neutral fault current (Ik1). If the max. phase/earth fault current (If) is high, the selectivity of this fault current should also be verified by referring to the table.

Selectivity Table

Upstream: iC60N/H/L Curve B

Downstream: iC60 RCBO Curves B, C (3P, 4P)

220-240/380-415 V AC



Upstream	iC60N/H/L													
	Curve B													
In (A)	1	2	3	4	6	10	13	16	20	25	32	40	50	63

Downstream		3P/4P 380-415 V AC														
Selectivity limit (A)																
iC60 RCBO Curve B	6							40	52	64	80	100	190	290	300	440
	10									64	80	100	130	240	200	380
	13										80	100	130	240	200	250
	16											100	130	160	200	250
	20												130	160	200	250
	25													160	200	250
	32														200	250
	40															250
Selectivity limit (A)																
iC60 RCBO Curve C	6									51	80	100	190	290	300	440
	10										64	80	130	240	200	250
	13												102	160	200	250
	16												102	128	200	250
	20													128	160	250
	25														160	200
	32															200

4000 Selectivity limit = 4 kA.
 No selectivity.

Note: If you cannot find the combination needed, refer to the selection table on page A-12.

Selectivity Table

Upstream: iC60N/H/L Curve B

Downstream: iC60 RCBO Curves B, C

A

220-240/380-415 V AC

Upstream		iC60N/H/L													
		Curve B													
In (A)		1	2	3	4	6	10	13	16	20	25	32	40	50	63
Downstream		2P (220-240 V AC), 2P (220-240 V AC Phase to Neutral) 3P (220-240 V AC Phase to Phase)													
Selectivity limit (A)															
iC60 RCBO Curve B	6						40	52	64	80	100	270	380	460	630
	10								64	80	100	190	290	300	440
	13									80	100	130	240	200	380
	16										100	130	240	200	250
	20											130	160	200	250
	25												160	200	250
	32													200	250
	40														200
Selectivity limit (A)															
iC60 RCBO Curve C	6								51	80	100	230	380	410	630
	10									64	80	130	240	300	440
	13											102	240	200	380
	16											102	128	200	250
	20												128	160	250
	25													160	200
	32														200

4000 Selectivity limit = 4 kA.

No selectivity.

Upstream		iC60N/H/L													
		Curve B													
In (A)		1	2	3	4	6	10	13	16	20	25	32	40	50	63
Downstream		2P or PN 230VAC Phase to Neutral													
Selectivity limit (A)															
iC60N/H/H2 RCBO VD Curve B	6						40	52	64	80	100	270	380	460	630
	10								64	80	100	190	290	300	440
	16										100	130	240	200	250
	20											130	160	200	250
	25												160	200	250
	32													200	250
	40														250
	45														
Selectivity limit (A)															
iC60/H/H2 RCBO VD Curve C	6								51	80	100	230	380	410	630
	10									64	80	130	240	300	440
	16											102	128	200	250
	20												128	160	250
	25													160	200
	32														200
	40														200
	45														

4000 Selectivity limit = 4 kA.

No selectivity.

VD: Voltage dependent RCBOs are RCBOs according to IEC 61009-2-2. These RCBOs are allowed only in some countries. See IEC 60364-5-53:2020 Annex F.

Note: The selectivity limits given in the table must be compared to the phase/neutral fault current (Ik1).

If the max. phase/earth fault current (If) is high, the selectivity of this fault current should also be verified by referring to the table.

Selectivity Table

Upstream: iC60N/H/L Curve C

Downstream: iC60 RCBO Curves B, C (3P, 4P)

220-240/380-415 V AC



Upstream	iC60N/H/L													
	Curve C													
In (A)	1	2	3	4	6	10	13	16	20	25	32	40	50	63

Downstream		3P/4P 380-415 V AC													
Selectivity limit (A)															
iC60 RCBO Curve B	6						80	104	130	160	200	380	480	770	850
	10							104	130	160	200	260	320	680	500
	13									160	200	260	320	600	500
	16										200	260	320	600	500
	20											260	320	400	500
	25												320	400	500
	32													400	500
	40														500
Selectivity limit (A)															
iC60 RCBO Curve C	6						80	104	130	160	200	380	480	770	850
	10								130	160	200	260	320	680	500
	13									55	200	260	320	600	500
	16										71	260	320	400	500
	20											260	320	400	500
	25												127	400	500
	32													168	500
	40														500

4000 Selectivity limit = 4 kA.

No selectivity.

Note: If you cannot find the combination needed, refer to the selection table on page A-12.

Selectivity Table

Upstream: iC60N/H/L Curve C

Downstream: iC60 RCBO Curves B, C

A

220-240/380-415 V AC

Upstream		iC60N/H/L													
		Curve C													
In (A)		1	2	3	4	6	10	13	16	20	25	32	40	50	63
Downstream		2P (220-240 V AC Phase to Neutral) 3P (220-240 V AC Phase to Phase)													
Selectivity limit (A)															
iC60 RCBO	6						80	104	130	240	350	510	770	1300	1100
VD	10							104	130	160	200	380	550	930	950
Curve B	13									160	200	260	480	770	760
	16										200	260	320	400	500
	20											260	320	400	500
	25												320	400	500
	32													400	500
	40														500
Selectivity limit (A)															
iC60 RCBO	6						80	104	130	160	350	510	620	1300	1100
Curve C	10								130	160	200	260	480	770	850
	13									55	200	260	480	770	760
	16										78	260	320	400	500
	20											260	320	400	500
	25												127	400	500
	32													168	500
	40														500

4000 Selectivity limit = 4 kA.

No selectivity.

Upstream		iC60N/H/L													
		Curve B													
In (A)		1	2	3	4	6	10	13	16	20	25	32	40	50	63
Downstream		2P or PN 230VAC Phase to Neutral													
Selectivity limit (A)															
iC60N/H/H2 RCBO	6						80	104	130	240	350	510	770	1300	1100
Curve B	10							104	130	160	200	380	550	930	950
	16										200	260	320	400	500
	20											260	320	400	500
	25												320	400	500
	32													400	500
	40														500
	45														500
Selectivity limit (A)															
iC60N/H/H2 RCBO	6						80	104	130	240	350	510	770	1300	1100
Curve C	10							104	130	160	200	380	550	930	950
	16										200	260	320	400	500
	20											260	320	400	500
	25												320	400	500
	32													400	500
	40														500
	45														500

4000 Selectivity limit = 4 kA.

No selectivity.

Note: The selectivity limits given in the table must be compared to the phase/neutral fault current (Ik1).
If the max. phase/earth fault current (If) is high, the selectivity of this fault current should also be verified by referring to the table.

Selectivity Table

Upstream: iC60N/H/L Curve D

Downstream: iC60 RCBO Curves B, C (3P, 4P)

220-240/380-415 V AC



Upstream	iC60N/H/L													
	Curve D													
In (A)	1	2	3	4	6	10	13	16	20	25	32	40	50	63

Downstream		3P/4P 380-415 V AC													
Selectivity limit (A)															
iC60 RCBO Curve B	6						120	160	190	360	450	660	910	1300	1600
	10							28	190	240	300	380	720	1100	1400
	13									240	300	380	480	900	1100
	16										300	380	480	900	1100
	20											380	480	600	760
	25												480	600	760
	32													600	760
	40														760
Selectivity limit (A)															
iC60 RCBO Curve C	6						120	160	190	360	450	660	910	1300	1600
	10							28	49	240	300	380	720	1100	1100
	13									52	300	380	480	900	1100
	16										71	380	480	900	760
	20											380	480	600	760
	25												105	600	760
	32													153	760
	40														760

4000 Selectivity limit = 4 kA.

No selectivity.

Note: If you cannot find the combination needed, refer to the selection table on page A-12.

Selectivity Table

Upstream: iC60N/H/L Curve D

Downstream: iC60 RCBO Curves B, C

A

220-240/380-415 V AC

Upstream		iC60N/H/L													
		Curve D													
In (A)		1	2	3	4	6	10	13	16	20	25	32	40	50	63
Downstream		2P (220-240 V AC Phase to Neutral)													
		3P (220-240 V AC Phase to Phase)													
Selectivity limit (A)															
iC60 RCBO Curve B	6						120	160	290	480	590	900	1300	2200	2600
	10							28	190	360	450	660	910	1500	1900
	13									240	450	580	810	1300	1600
	16										300	380	720	1100	1400
	20											380	480	900	1100
	25												480	900	760
	32													600	760
	40														760
Selectivity limit (A)															
iC60 RCBO Curve C	6						120	160	290	480	590	900	1300	2200	2600
	10							28	190	360	450	660	910	1500	1900
	13									52	300	580	810	1300	1600
	16										71	380	720	1100	1400
	20											380	480	900	1100
	25												105	600	760
	32													153	760
	40														760

4000 Selectivity limit = 4 kA.

No selectivity.

Upstream		iC60N/H/L													
		Curve D													
In (A)		1	2	3	4	6	10	13	16	20	25	32	40	50	63
Downstream		2P (220-240 V AC Phase to Neutral)													
Selectivity limit (A)															
iC60N/H/H2 RCBO VD Curve B	6						120	160	290	480	590	900	1300	2200	2600
	10							28	190	360	450	660	910	1500	1900
	16										300	380	720	1100	1400
	20											380	480	900	1100
	25												480	900	760
	32													600	760
	40														760
	45														760
Selectivity limit (A)															
iC60N/H/H2 RCBO VD Curve C	6						120	160	290	480	590	900	1300	2200	2600
	10							28	190	360	450	660	910	1500	1900
	16										300	380	720	1100	1400
	20											380	480	900	1100
	25												480	900	760
	32													600	760
	40														760
	45														760

4000 Selectivity limit = 4 kA.

No selectivity.

VD: Voltage dependent RCBOs are RCBOs according to IEC 61009-2-2. These RCBOs are allowed only in some countries. See IEC 60364-5-53:2020 Annex F.

Note: The selectivity limits given in the table must be compared to the phase/neutral fault current (Ik1).

If the max. phase/earth fault current (If) is high, the selectivity of this fault current should also be verified by referring to the limits given in the table.

Selectivity Table

Upstream: NG125N/H/L, C120N/H Curve B

Downstream: iC40, IC40N Curves B, C, D & iCV40N Curves B, C

220-240/380-415 V AC



Upstream	NG125N/H/L, C120N/H											
	Curve B											
In (A)	10	16	20	25	32	40	50	63	80	100	125	

Downstream	1P+N	3P, 3P+N
------------	------	----------

Selectivity limit (A)												
iC40 iC40N (1)	2	150	300	500	700	1000	1500	2000	T	T	T	T
iC40N Arc	4	40	64	80	400	500	700	800	3000	T	T	T
iCV40N/H	6	40	64	80	400	500	700	800	3000	T	T	T
iC40N/H VigiArc	10		64	80	100	130	500	600	1800	3000	T	T
Active iC40N VigiArc	13				100	130	160	200	1000	2000	3300	3750
Curve B	16				100	130	160	200	1000	2000	3300	3750
	20					52	160	200	1000	1600	2500	3700
	25						59	200	800	1300	2100	3700
	32							200	600	1000	1800	2700
	40								112	320	1600	2400
Selectivity limit (A)												
iC40 iC40N (1)	2	150	300	500	700	1000	1500	2000	T	T	T	T
iC40N Arc	4	40	64	80	400	500	700	800	3000	T	T	T
Active iC40N Arc	6		51	80	100	500	700	800	3000	T	T	T
iCV40N/H	10				80	130	500	600	1800	3000	4000	T
iC40N/H Vigi Arc	13					98	128	200	1000	2000	3300	3700
Active iC40N/H VigiArc	16					98	128	200	1000	2000	3300	3700
Curve C	20						128	160	1000	1600	2500	3700
	25							160	201	1300	2100	3700
	32								201	256	1800	2700
	40									255	320	2400
Selectivity limit (A)												
iC40	2	150	300	500	700	1000	1500	2000	T	T	T	T
iC40N	4			80	400	500	700	800	3000	T	T	T
Curve D	6					500	700	800	3000	T	T	T
	10							600	1800	3000	4000	T
	13								201	2000	3300	3700
[1]	16								201	2000	3300	3700
	20								201	256	2500	3700
	25								201	256	320	3700
	32									256	320	400
	40										320	400

[1] Arc iC40, VigiARC iC40, Arc iC40 active and VigiARC iC40 Active add-on can be added to iC40 without impacting the selectivity performance.

4000 Selectivity limit = 4 kA.

T Total selectivity, up to the breaking capacity of the downstream circuit breaker.

No selectivity.

Note: If you cannot find the combination needed, refer to the selection table on page A-12.

Selectivity Table

Upstream: NG125N/H/L, C120N/H Curve C

Downstream: iC40, IC40N Curves B, C, D & iCV40N Curves B, C

220-240/380-415 V AC

A

Upstream		NG125N/H/L, C120N/H										
		Curve C										
In (A)		10	16	20	25	32	40	50	63	80	100	125
Downstream												
1P+N												
3P, 3P+N												
Selectivity limit (A)												
iC40 iC40N (1)	2	150	300	500	700	1000	1500	T	T	T	T	T
iC40N Arc	4	80	130	170	400	500	700	800	3000	T	T	T
iCV40N/H	6	80	130	170	400	500	700	800	3000	T	T	T
iC40N/H VigiArc	10		130	160	200	350	500	600	1800	3000	T	T
Active iC40N VigiArc	13				200	270	340	450	1250	2000	3300	3700
Curve B	16				200	270	340	450	1250	2000	3300	3700
	20					52	320	400	1000	1600	2500	3700
	25						59	400	800	1300	2100	3700
	32							95	600	1000	1800	2700
	40								112	700	1600	2400
Selectivity limit (A)												
iC40 iC40N (1)	2	150	300	500	700	1000	1500	T	T	T	T	T
iC40N Arc	4	21	200	170	400	500	700	800	3000	4500	4500	T
Active iC40N Arc	6	18	200	170	400	500	700	800	3000	4500	4500	T
iCV40N/H	10		25	160	200	350	500	600	1800	3000	4500	4500
iC40N/H Vigi Arc	13				200	270	340	450	1250	2000	3300	3700
Active iC40N/H VigiArc	16				200	270	340	450	1250	2000	3300	3700
Curve C	20					52	320	400	1000	1600	2500	3700
	25						59	400	800	1300	2100	3700
	32							95	800	1000	1800	2700
	40								112	257	1600	2400
Selectivity limit (A)												
iC40	2	150	300	500	700	1000	1500	T	T	T	T	T
iC40N	4	21	200	170	400	500	700	800	3000	4500	4500	T
Curve D	6				400	500	700	800	3000	4500	4500	T
	10				200	450	500	600	1800	3000	4500	4500
	13							450	1000	2000	3300	3700
[1]	16							450	1000	2000	3300	3700
	20								1000	1600	2500	3700
	25								800	1300	2100	3700
	32										1800	2700
	40											2400

[1] Arc iC40, VigiARC iC40, Arc iC40 active and VigiARC iC40 Active add-on can be added to iC40 without impacting the selectivity performance.

4000 Selectivity limit = 4 kA.

T Total selectivity, up to the breaking capacity of the downstream circuit breaker.

No selectivity.

Note: If you cannot find the combination needed, refer to the selection table on page A-12.

Selectivity Table

Upstream: NG125N/H/L, C120N/H Curve D

Downstream: iC40, IC40N Curves B, C, D & iCV40N Curves B, C

220-240/380-415 V AC

A

Upstream		NG125N/H/L, C120N/H										
		Curve D										
In (A)		10	16	20	25	32	40	50	63	80	100	125
Downstream 1P+N												
3P, 3P+N												
Selectivity limit (A)												
iC40 iC40N (1)	2	240	770	830	2000	2200	4800	T	T	T	T	T
iC40N Arc	4	120	450	500	1000	1100	1900	4600	T	T	T	T
iCV40N/H	6	120	340	360	730	740	1200	2600	4700	T	T	T
iC40N/H VigiArc	10		192	240	550	580	860	1600	2800	3500	5600	T
Active iC40N VigiArc	13				300	380	480	1200	1900	2400	3600	4200
Curve B	16				300	380	480	1200	1900	2400	3600	4200
	20					380	480	1000	1500	2000	2900	3300
	25						59	950	1400	1700	2600	2900
	32							600	1100	1600	2200	2600
	40								756	1400	2100	2400
Selectivity limit (A)												
iC40 iC40N (1)	2	240	770	830	2000	2200	4800	T	T	T	T	T
iC40N Arc	4	120	450	500	1000	1100	1900	4600	T	T	T	T
Active iC40N Arc	6	18	192	360	730	740	1200	2600	4700	T	T	T
iCV40N/H	10		29	240	550	580	860	1600	2800	3500	5600	T
iC40N/H VigiArc	13				49	380	480	1200	1900	2400	3600	4200
Active iC40N/H VigiArc	16				49	380	480	1200	1900	2400	3600	4200
Curve C	20					52	480	1000	1500	2000	2900	3300
	25						59	600	1400	1700	2600	2900
	32							95	1100	1600	2200	2600
	40								756	960	2100	2400
Selectivity limit (A)												
iC40	2	240	770	830	2000	2200	4800	T	T	T	T	T
iC40N	4	21	450	500	1000	1100	1900	4600	T	T	T	T
Curve D	6	18	192	360	730	740	1200	2600	4700	T	T	T
	10		25	240	300	580	860	1600	2800	3500	5600	T
	13				49	380	480	1200	1900	2400	3600	4200
[1]	16				49	380	480	1200	1900	2400	3600	4200
	20					52	480	1000	1500	2000	2900	3300
	25						59	600	756	1700	2600	2900
	32							95	756	1600	2200	2600
	40								756	960	2100	2400

[1] Arc iC40, VigiARC iC40, Arc iC40 active and VigiARC iC40 Active add-on can be added to iC40 without impacting the selectivity performance.

4000 Selectivity limit = 4 kA.

T Total selectivity, up to the breaking capacity of the downstream circuit breaker.

No selectivity.

Note: If you cannot find the combination needed, refer to the selection table on page A-12.

Selectivity Table

Upstream: NG125N/H/L, C120N/H Curve B

Downstream: iC60N/H/L Curves B, C, D

A

220-240/380-415 V AC

Upstream		NG125N/H/L, C120N/H										
		Curve B										
In (A)		10	16	20	25	32	40	50	63	80	100	125

Downstream	1P, 1P+N, 2P (380-415 V) two-phase network 3P, 3P+N, 4P											
------------	---	--	--	--	--	--	--	--	--	--	--	--

Selectivity limit (A)												
iC60N/H/L	0.5	T	T	T	T	T	T	T	T	T	T	T
Curve B	1	70	150	210	350	550	2000	2500	T	T	T	T
	2	60	110	140	230	310	590	630	1200	2100	3900	9700
	3	40	90	120	180	220	380	460	770	1400	2000	5300
[1]	4	40	64	80	150	190	310	380	570	940	1400	2400
	6	15	64	80	100	130	290	300	440	620	930	1700
	10		22	80	100	130	200	200	380	550	770	1300
	13			28	100	130	160	200	380	480	680	1100
	16				35	130	160	200	250	320	600	940
	20					46	160	200	250	320	400	850
	25						56	200	250	320	400	750
	32							80	250	320	400	500
	40								250	320	400	500
	50									320	400	500
	63										400	500

Selectivity limit (A)												
iC60N/H/L	0.5	T	T	T	T	T	T	T	T	T	T	T
Curve C	1	70	150	210	350	550	2000	2500	T	T	T	T
	2	40	110	140	230	250	590	630	1200	2100	3900	9700
	3	30	64	120	180	220	380	460	770	1400	2000	5300
[1]	4		64	80	150	190	310	340	570	940	1400	2400
	6			80	100	130	290	300	440	620	930	1700
	10					130	160	200	380	550	770	1100
	13						160	200	250	480	680	940
	16							200	250	320	600	940
	20									320	400	850
	25									320	400	750
	32											500
	40											500

Selectivity limit (A)												
iC60N/H/L	0.5	T	T	T	T	T	T	T	T	T	T	T
Curve D	1	60	150	210	350	550	2000	2500	T	T	T	T
	2	40	90	140	200	250	520	630	1200	2100	3900	9700
	3		64	80	180	220	380	380	770	1200	2000	5300
[1]	4			80	150	190	310	340	570	820	1100	2400
	6					130	240	200	440	620	930	1700
	10							200	380	480	770	1100
	13								250	480	680	940
	16									320	600	940
	20										400	750
	25											500

[1] Arc iC60, VigiARC iC60, Arc iC60 active and VigiARC iC60 Active add-on can be added to iC60 without impacting the selectivity performance. The breaking capacity being limited to 10kA.

4000 Selectivity limit = 4 kA.

T Total selectivity, up to the breaking capacity of the downstream circuit breaker.

No selectivity.

Note: If you cannot find the combination needed, refer to the selection table on page A-12.

Selectivity Table

Upstream: NG125N/H/L, C120N/H Curve B

Downstream: iC60N/H/L Curves B, C, D

220-240/380-415 V AC



Upstream	NG125N/H/L, C120N/H										
	Curve B										
In (A)	10	16	20	25	32	40	50	63	80	100	125

Downstream	2P (220-240 V) single-phase network										
------------	-------------------------------------	--	--	--	--	--	--	--	--	--	--

Selectivity limit (A)

iC60N/H/L Curve B [1]	0.5	T	T	T	T	T	T	T	T	T	T	T
	1	120	490	T	T	T	T	T	T	T	T	T
	2	60	160	350	500	1200	4200	8100	T	T	T	T
	3	40	110	170	250	520	1300	1900	6700	T	T	T
	4	40	64	80	190	280	630	750	1400	2700	6200	T
	6	15	64	80	150	150	350	430	810	1400	2100	6100
	10		22	80	100	130	160	200	500	840	1300	2500
	13			28	100	130	240	200	440	770	1100	1900
	16				35	130	160	200	380	520	770	1400
	20					46	160	200	250	320	600	1000
	25						56	200	250	320	400	890
	32							80	250	320	400	840
	40								250	320	400	790
	50									320	400	750
	63											500

Selectivity limit (A)

iC60N/H/L Curve C [1]	0.5	T	T	T	T	T	T	T	T	T	T	T
	1	120	490	T	T	T	T	T	T	T	T	T
	2	60	160	350	500	1200	4200	8100	T	T	T	T
	3	30	110	170	250	520	1300	1900	6700	T	T	T
	4		64	80	190	280	630	750	1400	2700	6200	T
	6			80	150	150	350	430	810	1400	2100	6100
	10					130	160	200	500	840	1300	2500
	13						160	200	440	620	1100	1900
	16							200	380	520	770	1400
	20									320	600	1000
	25									320	400	890
	32											840
	40											500

Selectivity limit (A)

iC60N/H/L Curve D [1]	0.5	T	T	T	T	T	T	T	T	T	T	T
	1	120	490	T	T	T	T	T	T	T	T	T
	2	60	160	350	500	1200	4200	8100	T	T	T	T
	3		110	170	250	520	1300	1900	6700	T	T	T
	4			80	190	280	630	750	1400	2700	6200	T
	6					150	350	430	810	1400	2100	6100
	10							200	500	840	1300	2500
	13								380	620	930	1900
	16									520	770	1400
	20										600	1000
	25											890

[1] Arc iC60, VigiARC iC60, Arc iC60 active and VigiARC iC60 Active add-on can be added to iC60 without impacting the selectivity performance. The breaking capacity being limited to 10kA.

Selectivity limit = 4 kA.

Total selectivity, up to the breaking capacity of the downstream circuit breaker.

No selectivity.

Note: The selectivity limits given in the table must be compared to the phase/neutral fault current (Ik1).
If the max. phase/earth fault current (If) is high, the selectivity of this fault current should also be verified by referring to the limits given in the table.

Selectivity Table

Upstream: NG125N/H/L, C120N/H Curve C

Downstream: iC60N/H/L Curves B, C, D

A

220-240/380-415 V AC

Upstream		NG125N/H/L										
		Curve C										
In (A)		10	16	20	25	32	40	50	63	80	100	125
Downstream		1P, 1P+N, 2P (380-415 V) two-phase network 3P, 3P+N, 4P										
Selectivity limit (A)												
iC60N/H/L	0.5	T	T	T	T	T	T	T	T	T	T	T
Curve B	1	140	490	920	2300	T	T	T	T	T	T	T
	2	80	250	380	550	1800	2400	8800	10000	13000	T	T
	3	80	190	280	380	1200	1400	4600	8000	8500	14000	T
[1]	4	80	130	240	300	800	820	2000	2300	3400	7000	13000
	6	15	130	160	200	610	650	1400	2300	2300	3600	6400
	10		22	160	200	500	510	1100	1300	1600	2200	3600
	13			28	200	460	470	930	1100	1400	2000	2600
	16				35	380	430	770	950	1200	1700	2300
	20					46	320	680	850	960	1500	2100
	25						56	600	760	960	1200	1800
	32							80	500	640	1200	1500
	40								130	640	800	1500
	50									640	800	1500
	63										800	1000
Selectivity limit (A)												
iC60N/H/L	0.5	T	T	T	T	T	T	T	T	T	T	T
Curve C	1	140	490	920	2300	T	T	T	T	T	T	T
	2	80	250	380	550	2100	2400	8800	10000	13000	T	T
	3	80	190	280	380	1200	1400	4600	8000	8500	14000	T
[1]	4	18	130	160	300	800	820	2000	2300	3400	6000	13000
	6	15	130	160	200	610	650	1400	2300	2300	3600	5500
	10		22	160	200	500	510	930	1300	1400	2200	3100
	13			28	51	420	430	770	1100	1200	2000	2600
	16				35	256	400	770	950	1200	1700	2300
	20					46	320	680	850	960	1500	1800
	25						56	400	760	960	1200	1800
	32							80	500	640	1200	1500
	40								500	640	800	1500
	50									640	800	1000
	63										800	1000
Selectivity limit (A)												
iC60N/H/L	0.5	T	T	T	T	T	T	T	T	T	T	T
Curve D	1	140	490	920	2300	T	T	T	T	T	T	T
[1]	2	80	250	380	550	1800	2400	8800	10000	13000	T	T
	3	21	190	280	380	1200	1200	4600	8000	8500	14000	T
	4	18	130	160	300	740	740	2000	2300	3400	6000	13000
	6		130	160	200	570	600	1400	1900	2300	3600	5500
	10				200	450	480	930	1300	1400	2200	3100
	13					256	430	770	950	1200	1700	2600
	16						320	770	950	960	1500	2300
	20							400	760	960	1200	1800
	25									640	1200	1500
	32									640	800	1500
	40										800	1000

[1] Arc iC60, VigiARC iC60, Arc iC60 active and VigiARC iC60 Active add-on can be added to iC60 without impacting the selectivity performance. The breaking capacity being limited to 10kA.

4000 Selectivity limit = 4 kA.

T Total selectivity, up to the breaking capacity of the downstream circuit breaker.

No selectivity.

Note: If you cannot find the combination needed, refer to the selection table on page A-12.

Selectivity Table

Upstream: NG125N/H/L, C120N/H Curve C

Downstream: iC60N/H/L Curves B, C, D

220-240/380-415 V AC



Upstream		NG125N/H/L										
		Curve C										
In (A)		10	16	20	25	32	40	50	63	80	100	125

Downstream 2P (220-240 V) single-phase network

Selectivity limit (A)

iC60N/H/L Curve B	0.5	T	T	T	T	T	T	T	T	T	T	T
1	950	T	T	T	T	T	T	T	T	T	T	T
2	210	1900	4200	10000	T	T	T	T	T	T	T	T
3	120	780	1300	4700	T	T	T	T	T	T	T	T
4	80	310	590	1100	4000	13000	T	T	T	T	T	T
[1] 6	15	190	330	510	1500	2700	7200	9000	9000	9000	T	T
10		22	160	300	1000	1400	2700	3500	3500	7400	T	
13			28	200	760	910	2000	2700	2700	4900	8100	
16				35	620	620	1600	2700	2700	3600	5500	
20					46	480	1100	1600	1600	2200	3600	
25						56	930	1200	1200	2000	2600	
32							80	930	960	1700	2300	
40								130	960	1400	2000	
50									640	1200	1900	
63										1200	1700	

Selectivity limit (A)

iC60N/H/L Curve C	0.5	T	T	T	T	T	T	T	T	T	T	T
1	950	T	T	T	T	T	T	T	T	T	T	T
2	210	1900	3500	10000	T	T	T	T	T	T	T	T
3	80	670	1300	4700	T	T	T	T	T	T	T	T
4	18	310	590	1100	3600	13000	T	T	T	T	T	T
[1] 6	15	190	290	510	1500	2700	7200	9000	9000	9000	T	T
10		22	160	200	890	1200	2700	3700	3700	6600	T	
13			28	51	760	770	2000	2700	2700	4000	7200	
16				35	256	620	1600	2700	2700	3600	4600	
20					46	320	1100	1400	1400	2200	3600	
25						56	400	1100	1200	2000	2600	
32							80	500	960	1400	2300	
40								500	640	1200	2000	
50									640	800	1700	
63											1000	

Selectivity limit (A)

iC60N/H/L Curve D	0.5	T	T	T	T	T	T	T	T	T	T	T
1	950	T	T	T	T	T	T	T	T	T	T	T
[1] 2	210	1700	3500	10000	T	T	T	T	T	T	T	T
3	21	550	1300	4700	T	T	T	T	T	T	T	T
4	18	310	520	960	3600	13000	T	T	T	T	T	T
6		190	240	460	1500	2700	6400	9000	9000	9000	T	T
10				200	890	1100	2700	3700	3700	6600	T	
13					256	620	2000	2300	2300	4000	7200	
16						320	1400	2300	2300	3100	4600	
20							400	1400	1400	2200	3100	
25									960	1700	2600	
32									640	1400	2000	
40											1800	

[1] Arc iC60, VigiARC iC60, Arc iC60 active and VigiARC iC60 Active add-on can be added to iC60 without impacting the selectivity performance. The breaking capacity being limited to 10kA.

Selectivity limit = 4 kA.

Total selectivity, up to the breaking capacity of the downstream circuit breaker.

No selectivity.

Note: The selectivity limits given in the table must be compared to the phase/neutral fault current (Ik1). If the max. phase/earth fault current (If) is high, the selectivity of this fault current should also be verified by referring to the limits given in the table.

Selectivity Table

Upstream: NG125N/H/L, C120N/H Curve D

Downstream: iC60N/H/L Curves B, C, D

A

220-240/380-415 V AC

Upstream		NG125N/H/L, C120N/H										
		Curve D										
In (A)		10	16	20	25	32	40	50	63	80	100	125
Downstream		1P, 1P+N, 2P (380-415 V) two-phase network 3P, 3P+N, 4P										
Selectivity limit (A)												
iC60N/H/L	0.5	T	T	T	T	T	T	T	T	T	T	T
Curve B	1	410	3800	5200	T	T	T	T	T	T	T	T
	2	240	770	920	2600	2700	7400	14000	T	T	T	T
	3	180	610	640	1300	1600	3600	11000	T	T	T	T
[1]	4	120	450	450	890	1100	1900	4100	11000	13000	T	T
	6	15	340	360	730	740	1300	2600	4700	6200	T	T
	10		22	240	590	660	910	1700	2600	3500	T	T
	13			28	300	580	810	1500	2100	2500	4600	T
	16				35	380	720	1300	1900	2400	3600	T
	20					46	480	1100	1600	2000	3000	3600
	25						56	900	1400	1700	2400	2900
	32							83	1100	1700	2400	2600
	40								1100	1400	2100	2300
	50									1400	2000	2300
	63										2000	2300
Selectivity limit (A)												
iC60N/H/L	0.5	T	T	T	T	T	T	T	T	T	T	T
Curve C	1	410	3800	5200	T	T	T	T	T	T	T	T
	2	240	770	920	2600	2700	7400	T	T	T	T	T
	3	21	530	640	1300	1600	3600	11000	T	T	T	T
[1]	4	18	450	450	890	1100	1900	4100	11000	13000	T	T
	6	15	340	360	730	740	1300	2200	4700	6200	T	T
	10		22	240	590	580	910	1700	2600	3500	T	T
	13			28	51	580	720	1300	2100	2500	4100	T
	16				35	380	480	1100	1900	2400	3600	T
	20					46	88	1100	1600	2000	2700	2900
	25						56	600	1400	1700	2400	2900
	32							80	1100	1400	2400	2600
	40								756	1400	2100	2300
	50									960	2000	2300
	63										1800	2300
Selectivity limit (A)												
iC60N/H/L	0.5	T	T	T	T	T	T	T	T	T	T	T
Curve D	1	410	3800	5200	T	T	T	T	T	T	T	T
[1]	2	240	770	920	2600	2700	6300	T	T	T	T	T
	3	21	530	550	1300	1600	3600	11000	T	T	T	T
	4	18	370	450	890	970	1600	3700	11000	13000	T	T
	6	15	340	360	730	740	1100	2200	4700	5400	T	T
	10		22	240	520	580	810	1500	2600	3000	T	T
	13			28	51	380	720	1300	2100	2500	4100	T
	16				35	380	480	1100	1900	2400	3600	T
	20					46	480	900	1400	1700	2700	2900
	25						56	600	1400	1700	2400	2600
	32							80	1100	1400	2100	2600
	40								756	1400	2100	2300
	50									960	1800	1800
	63										1800	1800

[1] Arc iC60, VigiARC iC60, Arc iC60 active and VigiARC iC60 Active add-on can be added to iC60 without impacting the selectivity performance. The breaking capacity being limited to 10kA.

4000 Selectivity limit = 4 kA.

T Total selectivity, up to the breaking capacity of the downstream circuit breaker.

No selectivity.

Note: If you cannot find the combination needed, refer to the selection table on page A-12.

Selectivity Table

Upstream: NG125N/H/L, C120N/H Curve D

Downstream: iC60N/H/L Curves B, C, D

220-240/380-415 V AC



Upstream	NG125N/H/L, C120N/H										
	Curve D										
In (A)	10	16	20	25	32	40	50	63	80	100	125

Downstream	2P (220-240 V) single-phase network										
-------------------	--	--	--	--	--	--	--	--	--	--	--

Selectivity limit (A)

iC60N/H/L	0.5	T	T	T	T	T	T	T	T	T	T	T
Curve B	1	T	T	T	T	T	T	T	T	T	T	T
	2	1200	T	T	T	T	T	T	T	T	T	T
	3	520	3400	3400	T	T	T	T	T	T	T	T
	4	120	1200	1300	5800	5600	T	T	T	T	T	T
[1]	6	15	700	720	1900	1900	6000	11000	T	T	T	T
	10		22	540	1200	1200	2600	4200	10000	T	T	T
	13			28	300	900	1800	3400	7300	8000	T	T
	16				35	740	1500	2200	4700	5400	T	T
	20					46	910	1700	3500	3500	6900	T
	25						56	1500	2500	2500	5200	6800
	32							83	2000	2400	3400	4400
	40								1800	1900	2900	4000
	50									1900	2800	3300
	63										2300	2800

Selectivity limit (A)

iC60N/H/L	0.5	T	T	T	T	T	T	T	T	T	T	T
Curve C	1	T	T	T	T	T	T	T	T	T	T	T
	2	1200	T	T	T	T	T	T	T	T	T	T
	3	21	3400	3400	T	T	T	T	T	T	T	T
	4	18	1200	1300	5800	5600	T	T	T	T	T	T
[1]	6	15	700	720	1900	1900	6000	11000	T	T	T	T
	10		22	480	1200	1200	2200	4200	10000	T	T	T
	13			28	51	900	1800	3000	7300	8000	T	T
	16				35	740	1300	2200	4700	5400	T	T
	20					46	88	1700	3500	3500	6900	T
	25						56	600	2500	2500	4600	6800
	32							80	2000	2200	3400	4400
	40								756	1900	2900	3500
	50									960	2300	2800
	63										2300	2800

Selectivity limit (A)

iC60N/H/L	0.5	T	T	T	T	T	T	T	T	T	T	T
Curve D	1	T	T	T	T	T	T	T	T	T	T	T
[1]	2	1200	T	T	T	T	T	T	T	T	T	T
	3	21	3000	3400	T	T	T	T	T	T	T	T
	4	18	1100	1300	5800	4500	T	T	T	T	T	T
	6	15	600	600	1600	1600	5300	11000	T	T	T	T
	10		22	420	1000	1100	2200	3400	10000	T	T	T
	13			28	51	900	1700	2600	6400	7100	T	T
	16				35	380	1300	2200	3900	4500	T	T
	20					46	480	1500	3000	3500	6000	T
	25						56	600	2100	2500	4100	5900
	32							80	1800	2200	3400	4400
	40								756	1700	2400	2900
	50									960	2300	2800
	63										2000	2300

[1] Arc iC60, VigiARC iC60, Arc iC60 active and VigiARC iC60 Active add-on can be added to iC60 without impacting the selectivity performance. The breaking capacity being limited to 10kA.

4000 Selectivity limit = 4 kA.

T Total selectivity, up to the breaking capacity of the downstream circuit breaker.

No selectivity.

Note: The selectivity limits given in the table must be compared to the phase/neutral fault current (Ik1). If the max. phase/earth fault current (If) is high, the selectivity of this fault current should also be verified by referring to the table.

Selectivity Table

Upstream: NG125N/H/L, C120N/H Curve B

Downstream: iC60 RCBO Curves B, C

A

220-240/380-415 V AC

Upstream		NG125N/H/L, C120N/H										
		Curve B										
In (A)		10	16	20	25	32	40	50	63	80	100	125
Downstream 3P/4P 380-415 V AC												
Selectivity limit (A)												
iC60 RCBO Curve B	6	15	64	80	100	130	290	300	440	620	930	1700
	10		22	80	100	130	200	200	380	550	770	1300
	13			28	100	130	160	200	380	480	680	1100
	16				35	130	160	200	250	320	600	940
	20					46	160	200	250	320	400	850
	25						56	200	250	320	400	750
	32							80	250	320	400	500
Selectivity limit (A)												
iC60 RCBO Curve C	6			80	100	130	290	300	440	620	930	1700
	10					130	160	200	380	550	770	1100
	13						160	200	250	480	680	940
	16							200	250	320	600	940
	20									320	400	850
	25									320	400	750
	32											500

4000 Selectivity limit = 4 kA.

No selectivity.

Note: If you cannot find the combination needed, refer to the selection table on page A-12.

Selectivity Table

Upstream: NG125N/H/L, C120N/H Curve B

Downstream: iC60 RCBO Curves B, C

220-240/380-415 V AC

A

Upstream	NG125N/H/L, C120N/H										
	Curve B										
In (A)	10	16	20	25	32	40	50	63	80	100	125

Downstream	2P (220-240 V AC Phase to Neutral) 3P (220-240 V AC Phase to Phase)										
------------	--	--	--	--	--	--	--	--	--	--	--

Selectivity limit (A)												
iC60 RCBO Curve B	6	15	64	80	150	150	350	430	810	1400	2100	6100
	10		22	80	100	130	160	200	500	840	1300	2500
	13			28	100	130	240	200	440	770	1100	1900
	16				35	130	160	200	380	520	770	1400
	20					46	160	200	250	320	600	1000
	25						56	200	250	320	400	890
	32						80	250	320	400	840	
Selectivity limit (A)												
iC60 RCBO Curve C	6			80	150	150	350	430	810	1400	2100	6100
	10					130	160	200	500	840	1300	2500
	13						160	200	440	620	1100	1900
	16							200	380	520	770	1400
	20									320	600	1000
	25									320	400	890
	32										840	

4000 Selectivity limit = 4 kA.

No selectivity.

Upstream	NG125N/H/L, C120N/H										
	Curve B										
In (A)	10	16	20	25	32	40	50	63	80	100	125

Downstream	2P or PN 230VAC Phase to Neutral										
------------	----------------------------------	--	--	--	--	--	--	--	--	--	--

Selectivity limit (A)												
iC60N/H/H2 RCBO VD Curve B	6	15	64	80	150	150	350	430	810	1400	2100	6100
	10		22	80	100	130	160	200	500	840	1300	2500
	16				35	130	160	200	380	520	770	1400
	20					46	160	200	250	320	600	1000
	25						56	200	250	320	400	890
	32							80	250	320	400	840
	40							250	320	400	790	
	45										750	
Selectivity limit (A)												
iC60N/H/H2 RCBO VD Curve C	6			80	150	150	350	430	810	1400	2100	6100
	10					130	160	200	500	840	1300	2500
	16							200	380	520	770	1400
	20									320	600	1000
	25									320	400	890
	32											840
	40							250	320	400	500	
	45											

4000 Selectivity limit = 4 kA.

No selectivity.

VD: Voltage dependent RCBOs are RCBOs according to IEC 61009-2-2. These RCBOs are allowed only in some countries. See IEC 60364-5-53:2020 Annex F.

Note: The selectivity limits given in the table must be compared to the phase/neutral fault current (Ik1). If the max. phase/earth fault current (If) is high, the selectivity of this fault current should also be verified by referring to limits given in the table.

Selectivity Table

Upstream: NG125N/H/L, C120N/H Curve C

Downstream: iC60 RCBO Curves B, C (3,4P)

A

220-240/380-415 V AC

Upstream		NG125N/H/L										
		Curve C										
In (A)		10	16	20	25	32	40	50	63	80	100	125

Downstream		3P/4P 380-415 V AC										
Selectivity limit (A)												
iC60 RCBO Curve B	6	15	130	160	200	610	650	1400	2300	2300	3600	6400
	10		22	160	200	500	510	1100	1300	1600	2200	3600
	13			28	200	460	470	930	1100	1400	2000	2600
	16				35	380	430	770	950	1200	1700	2300
	20					46	320	680	850	960	1500	2100
	25						56	600	760	960	1200	1800
	32							80	500	640	1200	1500
Selectivity limit (A)												
iC60 RCBO Curve C	6	15	130	160	200	610	650	1400	2300	2300	3600	5500
	10		22	160	200	500	510	930	1300	1400	2200	3100
	13			28	51	420	430	770	1100	1200	2000	2600
	16				35	256	400	770	950	1200	1700	2300
	20					46	320	680	850	960	1500	1800
	25						56	400	760	960	1200	1800
	32							80	500	640	1200	1500

4000 Selectivity limit = 4 kA.

No selectivity.

Note: If you cannot find the combination needed, refer to the selection table on page A-12.

Selectivity Table

Upstream: NG125N/H/L, C120N/H Curve C

Downstream: iC60 RCBO Curves B, C

220-240/380-415 V AC



Upstream	NG125N/H/L										
	Curve C										
In (A)	10	16	20	25	32	40	50	63	80	100	125

Downstream	2P (220-240 V AC Phase to Neutral) 3P (220-240 V AC Phase to Phase)										
------------	--	--	--	--	--	--	--	--	--	--	--

Selectivity limit (A)												
iC60 RCBO Curve B	6	15	190	330	510	1500	2700	7200	9000	9000	T	T
	10		22	160	300	1000	1400	2700	3500	3500	7400	T
	13			28	200	760	910	2000	2700	2700	4900	8100
	16				35	620	620	1600	2700	2700	3600	5500
	20					46	480	1100	1600	1600	2200	3600
	25						56	930	1200	1200	2000	2600
	32							80	930	960	1700	2300

Selectivity limit (A)												
iC60 RCBO Curve C	6	15	190	290	510	1500	2700	7200	9000	9000	T	T
	10		22	160	200	890	1200	2700	3700	3700	6600	T
	13			28	51	760	770	2000	2700	2700	4000	7200
	16				35	256	620	1600	2700	2700	3600	4600
	20					46	320	1100	1400	1400	2200	3600
	25						56	400	1100	1200	2000	2600
	32							80	500	960	1400	2300

4000 Selectivity limit = 4 kA.

T Total selectivity, up to the breaking capacity of the downstream circuit breaker.

No selectivity.

Upstream	NG125N/H/L										
	Curve C										
In (A)	10	16	20	25	32	40	50	63	80	100	125

Downstream	2P (220-240 V AC Phase to Neutral)										
------------	------------------------------------	--	--	--	--	--	--	--	--	--	--

Selectivity limit (A)												
iC60N/H/H2 RCBO VD Curve B	6	15	190	330	510	1500	2700	7200	9000	9000	T	T
	10		22	160	300	1000	1400	2700	3500	3500	7400	T
	16				35	620	620	1600	2700	2700	3600	5500
	20					46	480	1100	1600	1600	2200	3600
	25						56	930	1200	1200	2000	2600
	32							80	930	960	1700	2300
	40								130	960	1400	2000
45									640	1200	1900	

Selectivity limit (A)												
iC60N/H/H2 RCBO VD Curve C	6	15	190	290	510	1500	2700	7200	9000	9000	T	T
	10		22	160	200	890	1200	2700	3700	3700	6600	T
	16				35	256	620	1600	2700	2700	3600	4600
	20					46	320	1100	1400	1400	2200	3600
	25						56	400	1100	1200	2000	2600
	32							80	500	960	1400	2300
	40								500	640	1200	2000
45									640	800	1700	

4000 Selectivity limit = 4 kA.

T Total selectivity, up to the breaking capacity of the downstream circuit breaker.

No selectivity.

VD: Voltage dependent RCBOs are RCBOs according to IEC 61009-2-2. These RCBOs are allowed only in some countries. See IEC 60364-5-53:2020 Annex F.

Note: The selectivity limits given in the table must be compared to the phase/neutral fault current (Ik1). If the max. phase/earth fault current (If) is high, the selectivity of this fault current should also be verified by referring to limits given in the table.

Selectivity Table

Upstream: NG125N/H/L, C120N/H Curve D

Downstream: iC60 RCBO Curves B, C

220-240/380-415 V AC

A

Upstream	NG125N/H/L, C120N/H										
	Curve D										
In (A)	10	16	20	25	32	40	50	63	80	100	125

Downstream		3P/4P 380-415 V AC										
Selectivity limit (A)												
iC60 RCBO Curve B	6	15	340	360	730	740	1300	2600	4700	6200	T	T
	10		22	240	590	660	910	1700	2600	3500	T	T
	13			28	300	580	810	1500	2100	2500	4600	T
	16				35	380	720	1300	1900	2400	3600	T
	20					46	480	1100	1600	2000	3000	3600
	25						56	900	1400	1700	2400	2900
	32							83	1100	1700	2400	2600
Selectivity limit (A)												
iC60 RCBO Curve C	6	15	340	360	730	740	1300	2200	4700	6200	T	T
	10		22	240	590	580	910	1700	2600	3500	T	T
	13			28	51	580	720	1300	2100	2500	4100	T
	16				35	380	480	1100	1900	2400	3600	T
	20					46	88	1100	1600	2000	2700	2900
	25						56	600	1400	1700	2400	2900
	32							80	1100	1400	2400	2600

4000 Selectivity limit = 4 kA.

T Total selectivity, up to the breaking capacity of the downstream circuit breaker.

No selectivity.

Note: If you cannot find the combination needed, refer to the selection table on page A-12.

Selectivity Table

Upstream: NG125N/H/L, C120N/H Curve D

Downstream: iC60 RCBO Curves B, C

220-240/380-415 V AC

A

Upstream		NG125N/H/L, C120N/H										
		Curve D										
In (A)		10	16	20	25	32	40	50	63	80	100	125

Downstream		2P (220-240 V AC Phase to Neutral) 3P (220-240 V AC Phase to Phase)										
------------	--	--	--	--	--	--	--	--	--	--	--	--

Selectivity limit (A)												
iC60 RCBO Curve B	6	15	700	720	1900	1900	6000	11000	T	T	T	T
	10		22	540	1200	1200	2600	4200	10000	T	T	T
	13			28	300	900	1800	3400	7300	8000	T	T
	16				35	740	1500	2200	4700	5400	T	T
	20					46	910	1700	3500	3500	6900	T
	25						56	1500	2500	2500	5200	6800
	32							83	2000	2400	3400	4400
Selectivity limit (A)												
iC60 RCBO Curve C	6	15	700	720	1900	1900	6000	11000	T	T	T	T
	10		22	480	1200	1200	2200	4200	10000	T	T	T
	13			28	51	900	1800	3000	7300	8000	T	T
	16				35	740	1300	2200	4700	5400	T	T
	20					46	88	1700	3500	3500	6900	T
	25						56	600	2500	2500	4600	6800
	32							80	2000	2200	3400	4400

4000 Selectivity limit = 4 kA.

T Total selectivity, up to the breaking capacity of the downstream circuit breaker.

No selectivity.

Upstream		NG125N/H/L, C120N/H										
		Curve D										
In (A)		10	16	20	25	32	40	50	63	80	100	125

Downstream		2P (220-240 V AC Phase to Neutral)										
------------	--	------------------------------------	--	--	--	--	--	--	--	--	--	--

Selectivity limit (A)												
iC60N/H/H2 RCBO VD Curve B	6	15	700	720	1900	1900	6000	11000	T	T	T	T
	10		22	540	1200	1200	2600	4200	10000	T	T	T
	16				35	740	1500	2200	4700	5400	T	T
	20					46	910	1700	3500	3500	6900	T
	25						56	1500	2500	2500	5200	6800
	32							83	2000	2400	3400	4400
	40								1800	1900	2900	4000
45									1900	2800	3300	
Selectivity limit (A)												
iC60N/H/H2 RCBO VD Curve C	6	15	700	720	1900	1900	6000	11000	T	T	T	T
	10		22	480	1200	1200	2200	4200	10000	T	T	T
	16				35	740	1300	2200	4700	5400	T	T
	20					46	88	1700	3500	3500	6900	T
	25						56	600	2500	2500	4600	6800
	32							80	2000	2200	3400	4400
	40								756	1900	2900	3500
45									960	2300	2800	

4000 Selectivity limit = 4 kA.

T Total selectivity, up to the breaking capacity of the downstream circuit breaker.

No selectivity.

VD: Voltage dependent RCBOs are RCBOs according to IEC 61009-2-2. These RCBOs are allowed only in some countries. See IEC 60364-5-53:2020 Annex F.

Note: The selectivity limits given in the table must be compared to the phase/neutral fault current (Ik1). If the max. phase/earth fault current (If) is high, the selectivity of this fault current should also be verified by referring to the limits given in the table.

Selectivity Table

Upstream: NG125N/H/L, C120N/H Curve B

Downstream: C120, NG125 Curves B, C, D

A

220-240/380-415 V AC

Upstream		NG125N/H/L, C120N/H										
		Curve B										
In (A)		10	16	20	25	32	40	50	63	80	100	125
Downstream		1P, 1P+N, 2P (380-415 V)										
		two-phase network										
		3P, 3P+N, 4P										
Selectivity limit (A)												
C120N/H	10			80	100	130	160	200	250	320	400	800
NG125N/H/L	16				100	130	160	200	250	320	400	750
Curve B	20					65	160	200	250	320	400	750
	25						160	200	250	320	400	500
	32							200	250	320	400	500
	40								250	320	400	500
	50									320	400	500
	63										400	500
	80											400
Selectivity limit (A)												
C120N/H	10					130	160	200	250	320	400	750
NG125N/H/L	16							200	250	320	400	500
Curve C	20								250	320	400	500
	25									320	400	500
	32										400	500
	40											500
Selectivity limit (A)												
C120N/H	10							200	250	320	400	750
NG125N/H/L	16									320	400	500
Curve D	20										400	500
	25											500

4000 Selectivity limit = 4 kA.

No selectivity.

Note: If you cannot find the combination needed, refer to the selection table on page A-12.

Selectivity Table

Upstream: NG125N/H/L, C120N/H Curve B

Downstream: C120, NG125 Curves B, C, D

220-240/380-415 V AC



Upstream	NG125N/H/L, C120N/H										
	Curve B										
In (A)	10	16	20	25	32	40	50	63	80	100	125

Downstream	2P (220-240 V) single-phase network											
Selectivity limit (A)												
C120N/H	10			80	100	130	260	200	400	540	670	1100
NG125N/H/L	16				100	130	240	200	250	480	630	910
Curve B	20					65	160	200	250	320	600	830
	25						160	200	250	320	400	830
	32							200	250	320	400	750
	40								250	320	400	750
	50									320	400	500
	63										400	500
	80											400
Selectivity limit (A)												
C120N/H	10					130	240	200	250	480	670	980
NG125N/H/L	16							200	250	320	400	830
Curve C	20								250	320	400	830
	25									320	400	750
	32										400	500
	40											500
Selectivity limit (A)												
C120N/H	10							200	250	320	630	980
NG125N/H/L	16									320	400	750
Curve D	20										400	750
	25											500

4000 Selectivity limit = 4 kA.

No selectivity.

Note: The selectivity limits given in the table must be compared to the phase/neutral fault current (Ik1).

If the max. phase/earth fault current (If) is high, the selectivity of this fault current should also be verified by referring to the limits given in the table.

Selectivity Table

Upstream: NG125N/H/L, C120N/H Curve C

Downstream: C120, NG125 Curves B, C, D

A

220-240/380-415 V AC

Upstream		NG125N/H/L, C120N/H										
		Curve C										
In (A)		10	16	20	25	32	40	50	63	80	100	125
Downstream		1P, 1P+N, 2P (380-415 V)										
		two-phase network										
		3P, 3P+N, 4P										
Selectivity limit (A)												
C120N/H	10		130	160	200	260	320	650	820	960	1300	1700
NG125N/H/L	16				200	260	320	600	760	800	900	1500
Curve B	20					65	320	400	500	640	800	1500
	25						320	400	500	640	800	1000
	32							400	500	640	800	1000
	40								500	640	800	1000
	50									640	800	1000
	63										800	1000
	80											1000
Selectivity limit (A)												
C120N/H	10		39	160	200	260	320	650	760	900	1200	1700
NG125N/H/L	16				70	110	320	400	500	640	800	1500
Curve C	20					65	124	400	500	640	800	1000
	25						89	149	500	640	800	1000
	32							123	240	640	800	1000
	40								181	269	800	1000
	50									227	800	1000
	63										800	1000
	80											1000
Selectivity limit (A)												
C120N/H	10					260	320	600	760	900	1200	1600
NG125N/H/L	16						320	400	500	640	800	1000
Curve D	20							400	500	640	800	1000
	25								500	640	800	1000
	32										800	1000
	40											1000

4000 Selectivity limit = 4 kA.

No selectivity.

Note: If you cannot find the combination needed, refer to the selection table on page A-12.

Selectivity Table

Upstream: NG125N/H/L, C120N/H Curve C

Downstream: C120, NG125 Curves B, C, D

220-240/380-415 V AC



Upstream		NG125N/H/L, C120N/H										
		Curve C										
In (A)		10	16	20	25	32	40	50	63	80	100	125
Downstream		2P (220-240 V) single-phase network										
Selectivity limit (A)												
C120N/H	10		130	160	200	480	510	930	1100	1200	1700	2500
NG125N/H/L	16				200	260	320	800	990	1100	1400	2000
Curve B	20					65	320	730	910	1100	1400	1900
	25						320	730	830	960	1200	1600
	32							400	830	960	1200	1600
	40								500	640	800	1500
	50									640	800	1500
	63										800	1000
	80											1000
Selectivity limit (A)												
C120N/H	10		39	160	200	260	480	870	1100	1200	1700	2500
NG125N/H/L	16				70	110	320	730	910	1100	1400	2000
Curve C	20					65	124	670	830	960	1300	1700
	25						89	149	500	640	1200	1600
	32							123	240	640	800	1500
	40								181	269	800	1000
	50									227	800	1000
	63										800	1000
	80											1000
Selectivity limit (A)												
C120N/H	10					260	320	800	1100	1100	1600	2200
NG125N/H/L	16						320	630	830	960	1300	1900
Curve D	20							400	760	960	1300	1700
	25								500	640	800	1500
	32										800	1500
	40											1000

Selectivity limit = 4 kA.

No selectivity.

Note: The selectivity limits given in the table must be compared to the phase/neutral fault current (Ik1).

If the max. phase/earth fault current (If) is high, the selectivity of this fault current should also be verified by referring to the limits given in the table.

Selectivity Table

Upstream: NG125N/H/L, C120N/H Curve D

Downstream: C120, NG125 Curves B, C, D

A

220-240/380-415 V AC

Upstream		NG125N/H/L, C120N/H										
		Curve D										
In (A)		10	16	20	25	32	40	50	63	80	100	125
Downstream		1P, 1P+N, 2P (380-415 V) two-phase network 3P, 3P+N, 4P										
Selectivity limit (A)												
C120N/H	10		190	240	300	380	480	970	1300	1600	2200	2500
NG125N/H/L	16				300	380	480	600	1100	1400	2000	2300
Curve B	20					65	480	600	1100	1400	2000	2300
	25						480	600	760	960	1200	1500
	32							600	760	960	1200	1500
	40								760	960	1200	1500
	50									960	1200	1500
	63										1200	1500
	80											1500
Selectivity limit (A)												
C120N/H	10		190	240	300	380	480	970	1300	1600	2200	2500
NG125N/H/L	16				70	110	480	600	1100	1400	2000	2300
Curve C	20					65	124	600	1100	1400	2000	2300
	25						89	149	760	960	1200	1500
	32							123	240	960	1200	1500
	40								181	269	1200	1500
	50									227	1200	1500
	63										1200	1500
	80											1500
Selectivity limit (A)												
C120N/H	10		39	240	300	380	480	970	1300	1600	2200	2500
NG125N/H/L	16				70	110	480	600	1100	1400	2000	2300
Curve D	20					65	124	193	1100	1400	2000	2300
	25						89	149	236	960	1200	1500
	32							123	240	960	1200	1500
	40								181	269	1200	1500
	50									227	1200	1500
	63										1200	1500
	80											1500

4000 Selectivity limit = 4 kA.

No selectivity.

Note: If you cannot find the combination needed, refer to the selection table on page A-12.

Selectivity Table

Upstream: NG125N/H/L, C120N/H Curve D

Downstream: C120, NG125 Curves B, C, D

220-240/380-415 V AC

A

Upstream	NG125N/H/L, C120N/H											
	Curve D											
In (A)	10	16	20	25	32	40	50	63	80	100	125	

Downstream 2P (220-240 V) single-phase network

Selectivity limit (A)

C120N/H NG125N/H/L Curve B	10		190	240	250	380	720	1300	2000	2400	3700	4800
	16				300	380	480	1100	1600	1900	2600	3200
	20					65	480	1100	1500	1800	2600	2900
	25						480	600	1200	1400	2100	2400
	32							600	1200	1400	2100	2400
	40								760	960	1200	1500
	50									960	1200	1500
	63										1200	1500
80											1500	

Selectivity limit (A)

C120N/H NG125N/H/L Curve C	10		190	240	250	380	720	1300	2000	2400	3700	4800
	16				70	110	480	1100	1600	1900	2600	3200
	20					65	124	1100	1500	1800	2600	2900
	25						89	149	1200	1400	2100	2400
	32							123	240	1400	2100	2400
	40								181	269	1200	1500
	50									227	1200	1500
	63										1200	1500
80											1500	

Selectivity limit (A)

C120N/H NG125N/H/L Curve D	10		39	240	250	380	720	1300	2000	2400	3700	4800
	16				70	110	480	1100	1600	1900	2600	3200
	20					65	124	193	1500	1800	2600	2900
	25						89	149	236	1400	2100	2400
	32							123	240	1400	2100	2400
	40								181	269	1200	1500
	50									227	1200	1500
	63										1200	1500
80											1500	

4000 Selectivity limit = 4 kA.

No selectivity.

Note: The selectivity limits given in the table must be compared to the phase/neutral fault current (Ik1).

If the max. phase/earth fault current (If) is high, the selectivity of this fault current should also be verified by referring to the limits given in the table.

Selectivity Table

Upstream: ComPacT NSXm E/B/F/N/H TM-D

Downstream: iC40, iC60, C120, NG125



Ue ≤ 440 V AC [1]

Upstream CB	NSXm63 E/B/F/N/H						NSXm160 E/B/F/N/H/TM-D			
Trip unit type	TM-D						TM-D			
Trip unit rating (A)	16	25	32	40	50	63	80	100	125	160
Setting Ir (A)	16	25	32	40	50	63	80	100	125	160

Downstream CB CB type	CB rating (A)	Selectivity limit (kA)									
		0.5	0.5	0.5	0.5	0.6	0.8	T	T	T	T
iC40 iC40N [2] iC40N Arc iCV40N/H (H≤32) iC40N/H VigiArc Active iC40N VigiArc All curves	≤ 10	0.5	0.5	0.5	0.5	0.6	0.8	T	T	T	T
	13-16			0.5	0.5	0.6	0.8	T	T	T	T
	20				0.6	0.6	0.8	T	T	T	T
	25					0.6	0.8	T	T	T	T
	32						0.8	3	T	T	T
	40							2	T	T	T
iC60N/H Curves B, C, D [3]	≤ 10	0.5	0.5	0.5	0.5	0.6	0.8	T	T	T	T
	13-16			0.5	0.5	0.6	0.8	T	T	T	T
	20				0.5	0.6	0.8	T	T	T	T
	25					0.6	0.8	10	T	T	T
	32						0.8	3	T	T	T
	40							2	T	T	T
	50								6	8	8
	63									8	8
iC60L Curves B, C, D, K, Z [3]	≤ 10	0.5	0.5	0.5	0.5	0.6	0.8	T	T	T	T
	13-16			0.5	0.5	0.6	0.8	T	T	T	T
	20				0.5	0.6	0.8	T	T	T	T
	25					0.6	0.8	10	T	T	T
	32						0.8	3	T	T	T
	40							2	16	16	16
	50								6	8	8
	63									8	8
iC60 RCBO Curves B, C	≤ 10	0.5	0.5	0.5	0.5	0.6	0.8	T	T	T	T
	13-16			0.5	0.5	0.6	0.8	T	T	T	T
	20				0.6	0.6	0.8	T	T	T	T
	25					0.6	0.8	T	T	T	T
	32						0.8	3	T	T	T
iC60N/H/H2 RCBO Curves B,C	≤ 10	0.5	0.5	0.5	0.5	0.6	0.8	T	T	T	T
	13-16			0.5	0.5	0.6	0.8	T	T	T	T
	20				0.6	0.6	0.8	T	T	T	T
	25					0.6	0.8	T	T	T	T
	32						0.8	3	T	T	T
	40							2	T	T	T
	45								6	8	8
C120N/H Curves B, C, D	63									1.25	1.25
	80										1.25
	100										1.25
	125										
NG125N/H/L Curves B, C, D	≤20				0.6	0.6	0.8	0.8	1	1.25	1.25
	25						0.8	0.8	1	1.25	1.25
	32						0.8	0.8	1	1.25	1.25
	40							0.8	1	1.25	1.25
	50							0.8	1	1.25	1.25
	63									1.25	1.25
	80										1.25
	100 (N)										1.25
125 (N)											

[1] 220-240 V AC/380-415 V for iCV40 and iC60 RCBO Ph-N.

[2] Arc iC40, Arc iC40 active add-on can be added to iCV40 without impacting the selectivity performance.

[3] Arc iC60, VigiARC iC60, Arc iC60 active and VigiARC iC60 Active add-on can be added to iC60 without impacting the selectivity performance. The breaking capacity being limited to 10kA.

4 Selectivity limit = 4 kA.

T Total selectivity, up to the breaking capacity of the downstream circuit breaker.

No selectivity.

Note: Respect the basic rules of selectivity, in terms of overload, short-circuit, ground fault and earth leakage when applicable see page A-1, or check curves with Schneider Electric online "Electrical calculation tools".

Selectivity Table

Upstream: ComPacT NSXm E/B/F/N/H MicroLogic 4.1

Downstream: iC40, iC60, C120, NG125

U_e ≤ 440 V AC ^[1]



Upstream CB		NSXm E/B/F/N/H										
Trip unit type		MicroLogic 4.1										
Trip unit rating (A)		25			50			100			160	
Setting I _r (A)		16	25	32	40	50	63	80	100	130	160	
Downstream CB		Selectivity limit (kA)										
CB type	CB rating (A)											
iC40 iC40N [2] iC40N Arc iCV40N/H (H≤32) iC40N/H VigiArc Active iC40N VigiArc All curves	≤ 10	0.37	0.37	0.75	0.75	0.75	T	T	T	T	T	
	13-16		0.37	0.75	0.75	0.75	T	T	T	T	T	
	20				0.75	0.75	T	T	T	T	T	
	25					0.75	T	T	T	T	T	
	32						T	T	T	T	T	
iC60N/H Curves B-C-D	≤ 10	0.37	0.37	1.5	1.5	1.5	T	T	T	T	T	
	13-16		0.37	0.75	0.75	0.75	T	T	T	T	T	
	20				0.75	0.75	T	T	T	T	T	
	25					0.75	T	T	T	T	T	
	32						T	T	T	T	T	
	40							T	T	T	T	
	50								8	8	8	
63									8	8		
iC60L Curves B-C-D-K-Z	≤ 10	0.37	0.37	1.5	1.5	1.5	T	T	T	T	T	
	13-16		0.37	0.75	0.75	0.75	T	T	T	T	T	
	20				0.75	0.75	T	T	T	T	T	
	25					0.75	T	T	T	T	T	
	32						T	T	T	T	T	
	40							16	16	16	16	
	50								8	8	8	
63									8	8		
iC60 RCBO Curves B, C	≤ 10	0.37	0.37	0.75	0.75	0.75	T	T	T	T	T	
	13-16		0.37	0.75	0.75	0.75	T	T	T	T	T	
	20				0.75	0.75	T	T	T	T	T	
	25					0.75	T	T	T	T	T	
	32						T	T	T	T	T	
iC60N/H/H2 RCBO Curves B,C	≤ 10	0.5	0.5	0.5	0.5	1.5	T	T	T	T	T	
	13-16		0.3	0.5	0.5	0.75	T	T	T	T	T	
	20				0.5	0.75	T	T	T	T	T	
	25					0.75	T	T	T	T	T	
	32						T	T	T	T	T	
	40						T	T	T	T	T	
	45								8	8	8	
C120N/H Curves B-C-D	63									2.4	2.4	
	80										2.4	
	100										2.4	
	125											
NG125N/H/L Curves B-C-D	≤ 20				0.75	0.75	1.5	1.5	1.5	2.4	2.4	
	25					0.75	1.5	1.5	1.5	2.4	2.4	
	32						1.5	1.5	1.5	2.4	2.4	
	40							1.5	1.5	2.4	2.4	
	50							1.5	1.5	2.4	2.4	
	63									2.4	2.4	
	80										2.4	
	100 (N)										2.4	
125 (N)												

[1] 220-240 V AC/380-415 V for iCV40 and iC60 RCBO Ph-N.

[2] Arc iC40, Arc iC40 active add-on can be added to iCV40 without impacting the selectivity performance.

[3] Arc iC60, VigiARC iC60, Arc iC60 active and VigiARC iC60 Active add-on can be added to iC60 without impacting the selectivity performance. The breaking capacity being limited to 10kA.

4 Selectivity limit = 4 kA.

T Total selectivity, up to the breaking capacity of the downstream circuit breaker.

No selectivity.

Note: When the upstream device is equipped with MicroLogic 4.1, the table provides selectivity limits for line to line or line to neutral short circuits, selectivity in earth fault condition shall be checked separately.

Selectivity Table

Upstream: ComPacT NSX100-250 TM-D (3P, 4P)

Downstream: iC40, iC60, C120, NG125, ComPacT NSXm

Ue ≤ 440 V AC [1]

A

Upstream CB		NSX100B/F/N/H/S/L/R (3P/4P)								NSX160B/F/N/H/S/L (3P/4P)				NSX250B/F/N/H/S/L/R (3P/4P)		
Trip unit type		TM-D								TM-D				TM-D		
Trip unit rating (A)		16	25	32	40	50	63	80	100	80	100	125	160	160	200	250
Setting Ir (A)		16	25	32	40	50	63	80	100	80	100	125	160	160	200	250
Downstream CB		Selectivity limit (kA)														
CB type	CB rating or Trip unit rating (A)															
iC40 iC40N [2] iC40N Arc iCV40N/H (H≤32) iC40N/H VigiArc Active iC40N VigiArc All curves	≤ 10	0.19	0.3	0.4	0.5	0.5	0.5	0.63	0.8	0.63	0.8	T	T	T	T	T
	13-16		0.3	0.4	0.5	0.5	0.5	0.63	0.8	0.63	0.8	T	T	T	T	T
	20			0.4	0.5	0.5	0.5	0.63	0.8	0.63	0.8	T	T	T	T	T
	25				0.5	0.5	0.5	0.63	0.8	0.63	0.8	T	T	T	T	T
	32					0.5	0.5	0.63	0.8	0.63	0.8	T	T	T	T	T
	40						0.5	0.63	0.8	0.63	0.8	T	T	T	T	T
iC60N/H Curves B, C, D [3]	≤ 10	0.19	0.3	0.4	0.5	0.5	0.5	1	2	1	2	T	T	T	T	T
	13-16		0.3	0.4	0.5	0.5	0.5	1	2	1	2	T	T	T	T	T
	20			0.4	0.5	0.5	0.5	0.63	1.5	0.63	1.5	T	T	T	T	T
	25				0.5	0.5	0.5	0.63	1.5	0.63	1.5	T	T	T	T	T
	32					0.5	0.63	1	0.63	1	0.63	T	T	T	T	T
	40						0.5	0.63	1	0.63	1	T	T	T	T	T
	50							0.63	0.8	0.63	0.8	T	T	T	T	T
63								0.8	0.8	0.8	T	T	T	T	T	
iC60L Curves B-C-D-K-Z [3]	≤ 10	0.19	0.3	0.4	0.5	0.5	0.5	1	2	1	2	T	T	T	T	T
	13-16		0.3	0.4	0.5	0.5	0.5	1	2	1	2	T	T	T	T	T
	20			0.4	0.5	0.5	0.5	0.63	1.5	0.63	1.5	T	T	T	T	T
	25				0.5	0.5	0.5	0.63	1.5	0.63	1.5	T	T	T	T	T
	32					0.5	0.63	1	0.63	1	0.63	T	T	T	T	T
	40						0.5	0.63	1	0.63	1	T	T	T	T	T
	50							0.63	0.8	0.63	0.8	T	T	T	T	T
63								0.8	0.8	0.8	T	T	T	T	T	
iC60 RCBO Curves B, C	≤ 10		0.3	0.4	0.5	0.5	0.5	1	2	1	2	T	T	T	T	T
	13-16		0.3	0.4	0.5	0.5	0.5	1	2	1	2	T	T	T	T	T
	20			0.4	0.5	0.5	0.5	0.63	1.5	0.63	1.5	T	T	T	T	T
	25				0.5	0.5	0.5	0.63	1.5	0.63	1.5	T	T	T	T	T
	32					0.5	0.63	1	0.63	1	0.63	T	T	T	T	T
iC60N/H/H2 RCBO Curves B,C	≤ 10	0.19	0.3	0.4	0.5	0.5	0.5	1	2	1	2	T	T	T	T	T
	13-16		0.3	0.4	0.5	0.5	0.5	1	2	1	2	T	T	T	T	T
	20			0.4	0.5	0.5	0.5	0.63	1.5	0.63	1.5	T	T	T	T	T
	25				0.5	0.5	0.5	0.63	1.5	0.63	1.5	T	T	T	T	T
	32					0.5	0.63	1	0.63	1	0.63	T	T	T	T	T
	40						0.5	0.63	1	0.63	1	T	T	T	T	T
C120N/H Curves B, C, D	63								0.8		0.8	2.4	2.4	2.4	T	T
	80											2.4	2.4	2.4	T	T
	100											2.4	2.4	2.4	T	T
	125												2.4	2.4	T	T
	125															T
NG125N/H/L Curves B, C, D	≤ 20			0.4	0.5	0.5	0.5	0.63	0.8	0.63	0.8	T	T	T	T	T
	25						0.5	0.63	0.8	0.63	0.8	2.4	2.4	2.4	T	T
	32						0.5	0.63	0.8	0.63	0.8	2.4	2.4	2.4	T	T
	40							0.63	0.8	0.63	0.8	2.4	2.4	2.4	T	T
	50								0.8	0.63	0.8	2.5	2.5	2.5	T	T
	63									0.8	0.8	2.5	2.5	2.5	T	T
	80										0.8	2.5	2.5	2.5	T	T
	100 (N)												2.5	2.5		T
125 (N)																T
ComPacT NSXm E/B/F/N/H TM-D	16			0.4	0.5	0.5	0.5	0.63	0.8	0.63	0.8	1.25	1.25	1.25	T	T
	25				0.5	0.5	0.5	0.63	0.8	0.63	0.8	1.25	1.25	1.25	T	T
	32						0.5	0.63	0.8	0.63	0.8	1.25	1.25	1.25	T	T
	40							0.63	0.8	0.63	0.8	1.25	1.25	1.25	T	T
	50							0.63	0.8	0.63	0.8	1.25	1.25	1.25	T	T
	63								0.8	0.63	0.8	1.25	1.25	1.25	T	T
	80										0.8	1.25	1.25	1.25	T	T
	100											1.25	1.25	1.25	T	T
	125												1.25	1.25		T
ComPacT NSXm E/B/F/N/H MicroLogic 4.1	25				0.5	0.5	0.5	0.63	0.8	0.63	0.8	1.25	1.25	1.25	T	T
	50							0.63	0.8	0.63	0.8	1.25	1.25	1.25	T	T
	100											1.25	1.25		T	T
	160															T

[1] 220-240 V AC/380-415 V for iCV40 and iC60 RCBO Ph-N.

[2] Arc iC40, Arc iC40 active add-on can be added to iCV40 without impacting the selectivity performance.

[3] Arc iC60, VigiARC iC60, Arc iC60 active and VigiARC iC60 Active add-on can be added to iC60 without impacting the selectivity performance. The breaking capacity being limited to 10kA.

4 Selectivity limit = 4 kA.

T Total selectivity, up to the breaking capacity of the downstream circuit breaker.

No selectivity.

Selectivity Table

Upstream: ComPacT NSX100-250 MicroLogic

Downstream: iC40, iC60, C120, NG125, ComPacT NSXm

U_e ≤ 440 V AC ^[1]



Upstream CB		NSX100B/F/N/H/S/L/R								NSX160B/F/N/H/S/L				NSX250B/F/N/H/S/L/R		
Trip unit type		MicroLogic ^[2]								MicroLogic ^[2]				MicroLogic ^[2]		
Trip unit rating (A)		40				100				160				250		
Setting I _r (A)		16	25	32	40	40	63	80	100	80	100	125	160	160	200	250
Downstream CB type	CB rating or Trip unit rating (A)	Selectivity limit (kA)														
iC40	≤ 10	T	T	T	T	T	T	T	T	T	T	T	T	T	T	T
iC40N ^[3]	13-16		T	T	T	T	T	T	T	T	T	T	T	T	T	T
iC40N Arc	20			T	T	T	T	T	T	T	T	T	T	T	T	T
iCV40N/H (H≤32)	25				T	T	T	T	T	T	T	T	T	T	T	T
iC40N/H VigiArc	32					T	T	T	T	T	T	T	T	T	T	T
Active iC40N VigiArc	40						T	T	T	T	T	T	T	T	T	T
All curves	40							T	T	T	T	T	T	T	T	T
iC60 N/H	≤ 10	T	T	T	T	T	T	T	T	T	T	T	T	T	T	T
Curves B, C, D	13-16		T	T	T	T	T	T	T	T	T	T	T	T	T	T
	20			T	T	T	T	T	T	T	T	T	T	T	T	T
	25				T	T	T	T	T	T	T	T	T	T	T	T
^[4]	32					T	T	T	T	T	T	T	T	T	T	T
	40						T	T	T	T	T	T	T	T	T	T
	50							6	6	T	T	T	T	T	T	T
	63								6	T	T	T	T	T	T	T
iC60L	≤ 10	T	T	T	T	T	T	T	T	T	T	T	T	T	T	T
Curves B-C-D-K-Z	16		T	T	T	T	T	T	T	T	T	T	T	T	T	T
	20			T	T	T	T	T	T	T	T	T	T	T	T	T
	25				T	T	T	T	T	T	T	T	T	T	T	T
	32					T	T	T	T	T	T	T	T	T	T	T
	40						T	T	T	T	T	T	T	T	T	T
	50							6	6	T	T	T	T	T	T	T
	63								6	T	T	T	T	T	T	T
iC60 RCBO	≤ 10	T	T	T	T	T	T	T	T	T	T	T	T	T	T	T
Curves B, C	16		T	T	T	T	T	T	T	T	T	T	T	T	T	T
	20			T	T	T	T	T	T	T	T	T	T	T	T	T
	25				T	T	T	T	T	T	T	T	T	T	T	T
	32					T	T	T	T	T	T	T	T	T	T	T
iC60N/H/H2 RCBO	≤ 10	T	T	T	T	T	T	T	T	T	T	T	T	T	T	T
Curves B,C	13-16		T	T	T	T	T	T	T	T	T	T	T	T	T	T
	20			T	T	T	T	T	T	T	T	T	T	T	T	T
	25				T	T	T	T	T	T	T	T	T	T	T	T
	32					T	T	T	T	T	T	T	T	T	T	T
	40						T	T	T	T	T	T	T	T	T	T
	45								6	6	T	T	T	T	T	T
C120N/H	63								1.5	2.4	2.4	2.4	2.4	T	T	T
Curves B, C, D	80										2.4	2.4	2.4	T	T	T
	100											2.4	2.4	T	T	T
	125												2.4	T	T	T
NG125N/H/L	≤ 20			0.6	0.6	1.5	1.5	1.5	1.5	T	T	T	T	T	T	T
Curves B, C, D	25					1.5	1.5	1.5	1.5	2.4	2.4	2.4	2.4	T	T	T
	32					1.5	1.5	1.5	1.5	2.4	2.4	2.4	2.4	T	T	T
	40					1.5	1.5	1.5	1.5	2.4	2.4	2.4	2.4	T	T	T
	50						1.5	1.5	1.5	2.4	2.4	2.4	2.4	T	T	T
	63							1.5	1.5	2.4	2.4	2.4	2.4	T	T	T
	80								1.5		2.4	2.4	2.4	T	T	T
	100 (N)										2.4	2.4	2.4	T	T	T
	125 (N)											2.4	2.4	T	T	T
ComPacT NSXm	16				0.6	1.5	1.5	1.5	1.5	2.4	2.4	2.4	2.4	T	T	T
E/B/F/N/H	25					1.5	1.5	1.5	1.5	2.4	2.4	2.4	2.4	T	T	T
TM-D	32						1.5	1.5	1.5	2.4	2.4	2.4	2.4	T	T	T
	40							1.5	1.5	2.4	2.4	2.4	2.4	T	T	T
	50								1.5	1.5	2.4	2.4	2.4	T	T	T
	63								1.5	1.5	2.4	2.4	2.4	T	T	T
	80									1.5	2.4	2.4	2.4	T	T	T
	100										2.4	2.4	2.4	T	T	T
	125											2.4	2.4	T	T	T
	160												2.4	T	T	T
ComPacT NSXm	25					1.5	1.5	1.5	1.5	2.4	2.4	2.4	2.4	T	T	T
E/B/F/N/H	50						1.5	1.5	1.5	2.4	2.4	2.4	2.4	T	T	T
MicroLogic 4.1	100									2.4	2.4	2.4	2.4	T	T	T
	160												2.4	T	T	T

^[1] 220-240/380-415 V AC for iCV40 and iC60 RCBO.
^[2] Applicable for all "Distribution" MicroLogic of ComPacT NSX range: 2.2 4.2, 5.2, 6.2, 7.2. For 4.2 and 7.2 selectivity rules for RCD apply in addition. Applicable for Generators and Service connection (G and AB type) MicroLogic of ComPacT NSX range but curves shall be checked. Not applicable for "Motor" MicroLogic of ComPacT NSX range ("M" type).
^[3] Arc iC40, Arc iC40 active add-on can be added to iCV40 without impacting the selectivity performance.
^[4] Arc iC60, VigiARC iC60, Arc iC60 active and VigiARC iC60 Active add-on can be added to iC60 without impacting the selectivity performance. The breaking capacity being limited to 10kA.

- 4 Selectivity limit = 4 kA.
- Total selectivity, up to the breaking capacity of the downstream circuit breaker.
- No selectivity.

Selectivity Table

Upstream: ComPacT NSX100-250 TM-D (3P, 4P)

Downstream: ComPacT NSX100-250 TM-D - MicroLogic

A

Ue ≤ 440 V AC

Upstream CB	NSX100B/F/N/H/S/L/R (3P/4P)								NSX160B/F/N/H/S/L (3P/4P)				NSX250B/F/N/H/S/L/R (3P/4P)		
Trip unit type	TM-D								TM-D				TM-D		
Trip unit rating (A)	16	25	32	40	50	63	80	100	80	100	125	160	160	200	250
Setting Ir (A)	16	25	32	40	50	63	80	100	80	100	125	160	160	200	250

Downstream CB			Selectivity limit (kA)														
CB type	Trip unit rating (A)	Trip unit setting Ir (A)															
Trip unit type																	
ComPacT NSX100 B/F TM-D, TM-G	16					0.5	0.5	0.5	0.63	0.8	0.63	0.8	1.25	1.25	1.25	T	T
	25						0.5	0.5	0.63	0.8	0.63	0.8	1.25	1.25	1.25	T	T
	32							0.5	0.63	0.8	0.63	0.8	1.25	1.25	1.25	T	T
	40								0.63	0.8	0.63	0.8	1.25	1.25	1.25	T	T
	50								0.63	0.8	0.63	0.8	1.25	1.25	1.25	T	T
	63									0.8		0.8	1.25	1.25	1.25	T	T
	80												1.25	1.25	1.25	T	T
100													1.25	1.25	T	T	
ComPacT NSX100 N/H/S/L/R TM-D, TM-G	16					0.5	0.5	0.5	0.63	0.8	0.63	0.8	1.25	1.25	1.25	T	T
	25						0.5	0.5	0.63	0.8	0.63	0.8	1.25	1.25	1.25	T	T
	32							0.5	0.63	0.8	0.63	0.8	1.25	1.25	1.25	36	36
	40								0.63	0.8	0.63	0.8	1.25	1.25	1.25	36	36
	50								0.63	0.8	0.63	0.8	1.25	1.25	1.25	36	36
	63									0.8		0.8	1.25	1.25	1.25	36	36
	80												1.25	1.25	1.25	36	36
100													1.25	1.25	36	36	
ComPacT NSX160 B/F/N/H/S/L TM-D, TM-G	≤ 63												1.25	1.25	1.25	4	5
	80												1.25	1.25	1.25	4	5
	100													1.25	1.25	4	5
	160																5
ComPacT NSX250 B/F/N/H/S/L/R TM-D, TM-G	≤ 100														1.25	2	2.5
	125															2	2.5
	160																2.5
	200																
ComPacT NSX100 B/F/N/H/S/L/R MicroLogic	40							0.5	0.63	0.8	0.63	0.8	1.25	1.25	1.25	2	2.5
	100													1.25	1.25	2	2.5
ComPacT NSX160 B/F/N/H/S/L MicroLogic	160	100												1.25	1.25	2	2.5
		160															2.5
ComPacT NSX250 B/F/N/H/S/L/R MicroLogic	250	≤ 100													1.25	2	2.5
		160															2.5
		250															

- 4 Selectivity limit = 4 kA.
- T Total selectivity, up to the breaking capacity of the downstream circuit breaker.
- No selectivity.

Note: Respect the basic rules of selectivity, in terms of overload, short-circuit, ground fault and earth leakage when applicable see page A-1, or check curves with Schneider Electric online "Electrical calculation tools".

Selectivity Table

Upstream: ComPacT NSX100-250 MicroLogic

Downstream: ComPacT NSX100-250 TM-D - MicroLogic

Ue ≤ 440 V AC



Upstream CB	NSX100B/F/N/H/S/L/R								NSX160B/F/N/H/S/L				NSX250B/F/N/H/S/L/R		
Trip unit type	MicroLogic ^[1]								MicroLogic ^[1]				MicroLogic ^[1]		
Trip unit rating (A)	40				100				160				250		
Setting Ir (A)	16	25	32	40	40	63	80	100	80	100	125	160	160	200	250

Downstream CB			Selectivity limit (kA)															
CB type	Trip unit rating (A)	Trip unit setting Ir (A)																
Trip unit type																		
ComPacT NSX100 B/F TM-D, TM-G	16						1.5	1.5	1.5	1.5	2.4	2.4	2.4	2.4	T	T	T	
	25						1.5	1.5	1.5	1.5	2.4	2.4	2.4	2.4	T	T	T	
	32							1.5	1.5	1.5	2.4	2.4	2.4	2.4	T	T	T	
	40								1.5	1.5	2.4	2.4	2.4	2.4	T	T	T	
	50									1.5	2.4	2.4	2.4	2.4	T	T	T	
	63											2.4	2.4	2.4	T	T	T	
	80												2.4	2.4	T	T	T	
100													2.4	T	T	T		
ComPacT NSX100 N/H/S/L/R TM-D, TM-G	16						1.5	1.5	1.5	1.5	2.4	2.4	2.4	2.4	T	T	T	
	25						1.5	1.5	1.5	1.5	2.4	2.4	2.4	2.4	T	T	T	
	32							1.5	1.5	1.5	2.4	2.4	2.4	2.4	36	36	36	
	40								1.5	1.5	2.4	2.4	2.4	2.4	36	36	36	
	50									1.5	2.4	2.4	2.4	2.4	36	36	36	
	63											2.4	2.4	2.4	36	36	36	
	80												2.4	2.4	36	36	36	
100													2.4	36	36	36		
ComPacT NSX160 B/F/N/H/S/L TM-D, TM-G	≤ 63												2.4	2.4	2.4	3	3	3
	80													2.4	2.4	3	3	3
	100														2.4	3	3	3
	160																	3
ComPacT NSX250 B/F/N/H/S/L/R TM-D, TM-G	≤ 100															3	3	3
	125																3	3
	160																	3
	200																	
ComPacT NSX100 B/F MicroLogic	40							1.5	1.5	1.5	2.4	2.4	2.4	2.4	T	T	T	
	100													2.4	T	T	T	
ComPacT NSX100 N/H/S/L/R MicroLogic	40							1.5	1.5	1.5	2.4	2.4	2.4	2.4	36	36	36	
	100													2.4	36	36	36	
ComPacT NSX160 B/F/N/H/S/L MicroLogic	160	100												2.4	3	3	3	
		160																3
ComPacT NSX250 B/F/N/H/S/L/R MicroLogic	250	≤ 100													3	3	3	
		160																3
		250																3

[1] Applicable for all "Distribution" MicroLogic of ComPacT NSX range: 2.2, 4.2, 5.2, 6.2, 7.2. For 4.2 and 7.2 selectivity rules for RCD apply in addition. Applicable for Generators and Service connection (G and AB type) MicroLogic of ComPacT NSX range but curves shall be checked. Not applicable for "Motor" MicroLogic of ComPacT NSX range ("M" type). When the upstream device is equipped with MicroLogic 4, 6 or 7, the table provides selectivity limits for line to line or line to neutral short circuits, selectivity in earth fault condition shall be checked separately.

- Selectivity limit = 4 kA.
- Total selectivity, up to the breaking capacity of the downstream circuit breaker.
- No selectivity.

Note: Respect the basic rules of selectivity, in terms of overload, short-circuit, ground fault and earth leakage when applicable see page A-1, or check curves with Schneider Electric online "Electrical calculation tools".

Selectivity Table

Upstream: ComPacT NSX400-630 MicroLogic

Downstream: iC40, iC60, C120, NG125, ComPacT NSXm, ComPacT NSX100-400

Ue ≤ 440 V AC

A

Upstream CB	NSX400F/N/H/S/L/R					NSX630F/N/H/S/L/R				
Trip unit type	MicroLogic ^[1]					MicroLogic ^[1]				
Trip unit rating (A)	250		400			630				
Setting Ir (A)	160	200	250	320	400	250	320	400	500	630

Downstream CB			Selectivity limit (kA)									
CB type	CB rating or Trip unit rating (A)	Trip unit setting Ir (A)										
Trip unit type												
iC40, iC40 N, iCV40 N, iCV40 H	[2]		T	T	T	T	T	T	T	T	T	T
iC60 N/H/L, iC60 RCBO, iC60N/H/H2 RCBO	[3]		T	T	T	T	T	T	T	T	T	T
C120N/H	≤ 80		T	T	T	T	T	T	T	T	T	T
	100			T	T	T	T	T	T	T	T	T
	125				T	T	T	T	T	T	T	T
NG125N/H/L	≤ 80		T	T	T	T	T	T	T	T	T	T
	100			T	T	T	T	T	T	T	T	T
	125				T	T	T	T	T	T	T	T
ComPacT NSXm E/B/F/N/H TM-D	≤ 100		T	T	T	T	T	T	T	T	T	T
	125			T	T	T	T	T	T	T	T	T
	160				T	T	T	T	T	T	T	T
ComPacT NSXm E/B/F/N/H MicroLogic 4.1	25		T	T	T	T	T	T	T	T	T	T
	50		T	T	T	T	T	T	T	T	T	T
	100		T	T	T	T	T	T	T	T	T	T
	160				T	T	T	T	T	T	T	T
ComPacT NSX100 B/F/N/H/S/L/R TM-D, TM-G	≤ 80		T	T	T	T	T	T	T	T	T	T
	100		T	T	T	T	T	T	T	T	T	T
ComPacT NSX160 B/F/N/H/S/L TM-D, TM-G	≤ 100		T	T	T	T	T	T	T	T	T	T
	125			T	T	T	T	T	T	T	T	T
	160				T	T	T	T	T	T	T	T
ComPacT NSX250 B/F/N/H/S/L/R TM-D, TM-G	≤ 100		4.8	4.8	4.8	4.8	4.8	T	T	T	T	T
	125			4.8	4.8	4.8	4.8	T	T	T	T	T
	160				4.8	4.8	4.8	T	T	T	T	T
	200					4.8	4.8		T	T	T	T
	250						4.8			T	T	T
ComPacT NSX100 B/F/N/H/S/L/R MicroLogic	40		T	T	T	T	T	T	T	T	T	T
	100		T	T	T	T	T	T	T	T	T	T
ComPacT NSX160 B/F/N/H/S/L MicroLogic	160	100	T	T	T	T	T	T	T	T	T	T
		160			T	T	T	T	T	T	T	T
ComPacT NSX250 B/F/N/H/S/L/R MicroLogic	250	≤ 100	4.8	4.8	4.8	4.8	4.8	T	T	T	T	T
		160			4.8	4.8	4.8	T	T	T	T	T
		250					4.8			T	T	T
ComPacT NSX400 F/N/H/S/L/R MicroLogic	400	160						6.9	6.9	6.9	6.9	6.9
		200							6.9	6.9	6.9	6.9
		250								6.9	6.9	6.9
		320									6.9	6.9
		400										6.9

[1] Applicable for all "Distribution" MicroLogic of ComPacT NSX range: 2.3, 4.3, 5.3, 6.3, 7.3. For 4.3 and 7.3 selectivity rules for RCD apply in addition.

[2] Applicable to iCV40 Arc, Active iCV40Arc. Arc iC40, Arc iC40 active add-on can be added to iCV40 without impacting the selectivity performance.

[3] Arc iC60, VigiARC iC60, Arc iC60 active and VigiARC iC60 Active add-on can be added to iC60 without impacting the selectivity performance. The breaking capacity being limited to 10kA.

Selectivity limit = 4 kA.

Total selectivity, up to the breaking capacity of the downstream circuit breaker.

No selectivity.

Note: Respect the basic rules of selectivity, in terms of overload, short-circuit, ground fault and earth leakage when applicable see page A-1, or check curves with Schneider Electric online "Electrical calculation tools".

Applicable for Generators and Service connection (G and AB type) MicroLogic of ComPacT NSX range but curves shall be checked.

Not applicable for "Motor" MicroLogic of ComPacT NSX range ("M" type).

When the upstream device is equipped with MicroLogic 4, 6 or 7, the table provides selectivity limits for line to line or line to neutral short circuits, selectivity in earth fault condition shall be checked separately.

Selectivity Table

Upstream: ComPacT NS630b-1600N/H MicroLogic

Downstream: iC40, iC60, C120, NG125, ComPacT NSXm, NSX100-630

Ue ≤ 440 V AC



Upstream CB	ComPacT NS630b/800/1000/1250/1600N/H																				
Trip unit type	MicroLogic 2.0 I _{sd} = 10 Ir								MicroLogic 5.0 - 6.0 - 7.0 Inst 15 In				MicroLogic 5.0 - 6.0 - 7.0 Inst OFF								
Trip unit rating In (A)	630		800		1000		1250		1600		630		800		1000		1250		1600		
Setting Ir (A)	250	400	630	800	1000	1250	1600	250	400	630	800	1000	1250	1600	250	400	630	800	1000	1250	1600

Downstream CB	CB type	CB rating or Trip unit rating (A)	Trip unit setting Ir (A)	Selectivity limit (kA)																	
CB type	Trip unit type	CB rating or Trip unit rating (A)	Trip unit setting Ir (A)	T	T	T	T	T	T	T	T	T	T	T	T	T	T	T	T	T	T
iC40, iC40 N, iCV40 N, iCV40 H		[2]		T	T	T	T	T	T	T	T	T	T	T	T	T	T	T	T	T	T
iC60 N/H/L, iC60 RCBO, iC60N/H/H2 RCBO		[3]		T	T	T	T	T	T	T	T	T	T	T	T	T	T	T	T	T	T
C120 N/H				T	T	T	T	T	T	T	T	T	T	T	T	T	T	T	T	T	T
NG125 N/H				T	T	T	T	T	T	T	T	T	T	T	T	T	T	T	T	T	T
NG125 L				T	T	T	T	T	T	T	T	T	T	T	T	T	T	T	T	T	T
ComPacT NSXm E/B/F/N/H				T	T	T	T	T	T	T	T	T	T	T	T	T	T	T	T	T	T
ComPacT NSX100 B/F/N/H/S/L/R TM-D, TM-G				T	T	T	T	T	T	T	T	T	T	T	T	T	T	T	T	T	T
ComPacT NSX160 B/F/N/H/S/L TM-D				T	T	T	T	T	T	T	T	T	T	T	T	T	T	T	T	T	T
ComPacT NSX250 B/F/N/H/S/L/R TM-D, TM-G	≤ 125			T	T	T	T	T	T	T	T	T	T	T	T	T	T	T	T	T	T
	160			T	T	T	T	T	T	T	T	T	T	T	T	T	T	T	T	T	T
	200					T	T	T	T	T	T	T	T	T	T	T	T	T	T	T	T
	250					T	T	T	T	T	T	T	T	T	T	T	T	T	T	T	T
ComPacT NSX100 B/F/N/H/S/L/R MicroLogic	40			T	T	T	T	T	T	T	T	T	T	T	T	T	T	T	T	T	T
	100			T	T	T	T	T	T	T	T	T	T	T	T	T	T	T	T	T	T
ComPacT NSX160 B/F/N/H/S/L MicroLogic	100			T	T	T	T	T	T	T	T	T	T	T	T	T	T	T	T	T	T
	160			T	T	T	T	T	T	T	T	T	T	T	T	T	T	T	T	T	T
ComPacT NSX250 B/F/N/H/S/L/R MicroLogic	≤ 100			T	T	T	T	T	T	T	T	T	T	T	T	T	T	T	T	T	T
	160			T	T	T	T	T	T	T	T	T	T	T	T	T	T	T	T	T	T
	250					T	T	T	T	T	T	T	T	T	T	T	T	T	T	T	T
ComPacT NSX400 F/N/H MicroLogic	400	160		T	T	T	T	T	T	T	T	T	T	T	T	T	T	T	T	T	T
		200				T	T	T	T	T	T	T	T	T	T	T	T	T	T	T	T
		250				T	T	T	T	T	T	T	T	T	T	T	T	T	T	T	T
		320				T	T	T	T	T	T	T	T	T	T	T	T	T	T	T	T
		400				T	T	T	T	T	T	T	T	T	T	T	T	T	T	T	T
ComPacT NSX400 S/L/R MicroLogic	400	160	90	90	90	90	90	90	90	90	90	90	90	90	90	90	90	90	90	90	90
		200		90	90	90	90	90	90	90	90	90	90	90	90	90	90	90	90	90	90
		250		90	90	90	90	90	90	90	90	90	90	90	90	90	90	90	90	90	90
		320		90	90	90	90	90	90	90	90	90	90	90	90	90	90	90	90	90	90
		400		90	90	90	90	90	90	90	90	90	90	90	90	90	90	90	90	90	90
ComPacT NSX630 F/N MicroLogic	630	250		T	T	T	T	T	T	T	T	T	T	T	T	T	T	T	T	T	T
		320		T	T	T	T	T	T	T	T	T	T	T	T	T	T	T	T	T	T
		400		T	T	T	T	T	T	T	T	T	T	T	T	T	T	T	T	T	T
		500				T	T	T	T	T	T	T	T	T	T	T	T	T	T	T	T
		630				T	T	T	T	T	T	T	T	T	T	T	T	T	T	T	T
ComPacT NSX630 H/S/L/R MicroLogic	630	250		65	65	65	65	65	65	65	65	65	65	65	65	65	65	65	65	65	65
		320		65	65	65	65	65	65	65	65	65	65	65	65	65	65	65	65	65	65
		400		65	65	65	65	65	65	65	65	65	65	65	65	65	65	65	65	65	65
		500		65	65	65	65	65	65	65	65	65	65	65	65	65	65	65	65	65	65
		630		65	65	65	65	65	65	65	65	65	65	65	65	65	65	65	65	65	65

[2] Applicable to iCV40 Arc, Active iCV40Arc. Arc iC40, Arc iC40 active add-on can be added to iCV40 without impacting the selectivity performance.
 [3] Arc iC60, VigiARC iC60, Arc iC60 active and VigiARC iC60 Active add-on can be added to iC60 without impacting the selectivity performance. The breaking capacity being limited to 10kA.

T Total selectivity, up to the breaking capacity of the downstream circuit breaker.

4 Selectivity limit = 4 kA.

No selectivity.

Note: Respect the basic rules of selectivity, in terms of overload, short-circuit, ground fault and earth leakage when applicable see page A-1, or check curves with Schneider Electric online "Electrical calculation tools".
 When the upstream device is equipped with MicroLogic 6 or 7, the table provides selectivity limits for line to line or line to neutral short circuits, selectivity in earth fault condition shall be checked separately.

Selectivity Table

Upstream: ComPacT NS630b-1600N/H MicroLogic

Downstream: ComPacT NS630b-1600

A

Ue ≤ 440 V AC

Upstream CB	ComPacT NS630b/800/1000/1250/1600N/H																	
Trip unit type	MicroLogic 2.0 I _{sd} = 10 I _r						MicroLogic 5.0 - 6.0 - 7.0 Inst 15 In						MicroLogic 5.0 - 6.0 - 7.0 Inst OFF					
	630	800	1000	1250	1600	630	800	1000	1250	1600	630	800	1000	1250	1600			
Trip unit rating I _n (A)	400	630	800	1000	1250	1600	400	630	800	1000	1250	1600	400	630	800	1000	1250	1600

Downstream CB		Selectivity limit (kA)																	
CB type	Trip unit setting I _r (A)																		
Trip unit type		4	6.3	8	10	12.5	16	9.4	9.4	12	15	18	18	18	18	18	18	18	18
ComPacT NS630b N/H MicroLogic	250	4	6.3	8	10	12.5	16	9.4	9.4	12	15	18	18	18	18	18	18	18	18
	320		6.3	8	10	12.5	16		9.4	12	15	18	18		18	18	18	18	18
	400		6.3	8	10	12.5	16		9.4	12	15	18	18		18	18	18	18	18
	500			8	10	12.5	16			12	15	18	18			18	18	18	18
	630				10	12.5	16				15	18	18				18	18	18
ComPacT NS800 N/H MicroLogic	320		6.3	8	10	12.5	16		9.4	12	15	18	18		18	18	18	18	18
	400		6.3	8	10	12.5	16		9.4	12	15	18	18		18	18	18	18	18
	500			8	10	12.5	16			12	15	18	18			18	18	18	18
	630				10	12.5	16				15	18	18			18	18	18	18
	800					12.5	16					18	18				18	18	18
ComPacT NS1000 N/H MicroLogic	400		6.3	8	10	12.5	16		9.4	12	15	18	18		18	18	18	18	18
	500			8	10	12.5	16			12	15	18	18			18	18	18	18
	630				10	12.5	16				15	18	18				18	18	18
	800					12.5	16					18	18					18	18
	1000						16						18						18
ComPacT NS1250 N/H MicroLogic	500			8	10	12.5	16			12	15	18	18			18	18	18	18
	630				10	12.5	16				15	18	18				18	18	18
	800					12.5	16					18	18					18	18
	1000						16						18						18
	1250																		
ComPacT NS1600 N/H MicroLogic	630				10	12.5	16				15	18	18				18	18	18
	800					12.5	16					18	18					18	18
	960						16						18						18
	1250																		
	1600																		
ComPacT NS630b L/LB MicroLogic	250	4	6.3	8	10	12.5	16	9.4	9.4	12	15	18.7	24	30	30	30	30	30	30
	320		6.3	8	10	12.5	16		9.4	12	15	18.7	24		30	30	30	30	30
	400		6.3	8	10	12.5	16		9.4	12	15	18.7	24		30	30	30	30	30
	500			8	10	12.5	16			12	15	18.7	24			30	30	30	30
	630				10	12.5	16				15	18.7	24				30	30	30
ComPacT NS800 L/LB MicroLogic	320		6.3	8	10	12.5	16		9.4	12	15	18.7	24		30	30	30	30	30
	400		6.3	8	10	12.5	16		9.4	12	15	18.7	24		30	30	30	30	30
	500			8	10	12.5	16			12	15	18.7	24			30	30	30	30
	630				10	12.5	16				15	18.7	24				30	30	30
	800					12.5	16					18.7	24					30	30
ComPacT NS1000 L MicroLogic	400		6.3	8	10	12.5	16		9.4	12	15	18.7	24		30	30	30	30	30
	500			8	10	12.5	16			12	15	18.7	24			30	30	30	30
	630				10	12.5	16				15	18.7	24				30	30	30
	800					12.5	16					18.7	24					30	30
	1000						16						24						30

4 Selectivity limit = 4 kA.

No selectivity.

Note: Respect the basic rules of selectivity, in terms of overload, short-circuit, ground fault and earth leakage when applicable see page A-1, or check curves with Schneider Electric online "Electrical calculation tools".
When the upstream device is equipped with MicroLogic 6 or 7, the table provides selectivity limits for line to line or line to neutral short circuits, selectivity in earth fault condition shall be checked separately.

Selectivity Table

Upstream: ComPacT NS1600b-3200N MicroLogic

Downstream: iC40, iC60, C120, NG125, ComPacT NSXm, NSX100-630, NS630b-3200

Ue ≤ 440 V AC



Upstream CB	ComPacT NS1600b/2000/2500/3200N											
Trip unit type	MicroLogic 2.0 Isd = 10 Ir				MicroLogic 5.0 - 6.0 - 7.0 Inst 15 In				MicroLogic 5.0 - 6.0 - 7.0 Inst OFF			
	1600	2000	2500	3200	1600	2000	2500	3200	1600	2000	2500	3200
Trip unit rating In (A)	1600	2000	2500	3200	1600	2000	2500	3200	1600	2000	2500	3200
Setting Ir (A)	1600	2000	2500	3200	1600	2000	2500	3200	1600	2000	2500	3200

Downstream CB CB type Trip unit type	CB rating or Trip unit rating (A)	Selectivity limit (kA)											
		T	T	T	T	T	T	T	T	T	T	T	T
iC40, iC40 N, iCV40 N, iCV40 H	[2]	T	T	T	T	T	T	T	T	T	T	T	T
iC60 N/H/L, iC60 RCBO, iC60N/H/H2 RCBO	[3]	T	T	T	T	T	T	T	T	T	T	T	T
C120 N/H		T	T	T	T	T	T	T	T	T	T	T	T
NG125 N/H		T	T	T	T	T	T	T	T	T	T	T	T
NG125 L		T	T	T	T	T	T	T	T	T	T	T	T
ComPacT NSXm E/B/F/N/H		T	T	T	T	T	T	T	T	T	T	T	T
ComPacT NSX B/F/N/H/S/L/R TM-D, TM-G	NSX100 NSX160 NSX250	T	T	T	T	T	T	T	T	T	T	T	T
ComPacT NSX B/F/N/H/S/L/R MicroLogic	NSX100 NSX160 NSX250	T	T	T	T	T	T	T	T	T	T	T	T
ComPacT NSX F/N/H/S/L/R	NSX400 NSX630	T	T	T	T	T	T	T	T	T	T	T	T
ComPacT NS N	NS630b NS800 NS1000 NS1250 NS1600	16 16 16 16 16	20 20 20 20 20	25 25 25 25 25	32 32 32 32 32	24 24 24 24 24	30 30 30 30 30	37.5 37.5 37.5 37.5 37.5	48 48 48 48 48	T T T T T	T T T T T	T T T T T	T T T T T
ComPacT NS H	NS630b NS800 NS1000 NS1250 NS1600	16 16 16 16 16	20 20 20 20 20	25 25 25 25 25	32 32 32 32 32	24 24 24 24 24	30 30 30 30 30	37.5 37.5 37.5 37.5 37.5	48 48 48 48 48	60 60 60 60 60	60 60 60 60 60	60 60 60 60 60	60 60 60 60 60
ComPacT NS N/H	NS1600b NS2000 NS2500 NS3200			25 25 25 25	32 32 32 32		37.5 37.5 37.5 37.5	48 48 48 48			60 60 60 60	60 60 60 60	
ComPacT NS L/LB	NS630bL/ LB NS800L/LB NS1000L	T T T T	T T T T	T T T T	T T T T	T T T T	T T T T	T T T T	T T T T	T T T T	T T T T	T T T T	T T T T

[2] Applicable to iCV40 Arc, Active iCV40Arc. Arc iC40, Arc iC40 active add-on can be added to iCV40 without impacting the selectivity performance.
 [3] Arc iC60, VigiARC iC60, Arc iC60 active and VigiARC iC60 Active add-on can be added to iC60 without impacting the selectivity performance. The breaking capacity being limited to 10kA.

Total selectivity, up to the breaking capacity of the downstream circuit breaker.

Selectivity limit = 4 kA.

No selectivity.

Note: Respect the basic rules of selectivity, in terms of overload, short-circuit, ground fault and earth leakage when applicable see page A-1, or check curves with Schneider Electric online "Electrical calculation tools".
 When the upstream device is equipped with MicroLogic 6 or 7, the table provides selectivity limits for line to line or line to neutral short circuits, selectivity in earth fault condition shall be checked separately.

Selectivity Table

Upstream: ComPacT NS1600b-3200H MicroLogic

Downstream: iC60, C120, NG125, NSX100-630, NS630b-3200

Ue ≤ 440 V AC

A

Upstream CB	ComPacT NS1600b/2000/2500/3200H											
Trip unit type	MicroLogic 2.0 Isd = 10 Ir				MicroLogic 5.0 - 6.0 - 7.0 Inst 15 In				MicroLogic 5.0 - 6.0 - 7.0 Inst OFF			
Trip unit rating In (A)	1600	2000	2500	3200	1600	2000	2500	3200	1600	2000	2500	3200
Setting Ir (A)	1600	2000	2500	3200	1600	2000	2500	3200	1600	2000	2500	3200

Downstream CB	CB rating or Trip unit rating (A)	Selectivity limit (kA)											
CB type	Trip unit type												
iC40, iC40 N, iCV40 N, iCV40 H	[2]	T	T	T	T	T	T	T	T	T	T	T	T
iC60 N/H/L, iC60 RCBO, iC60N/H/H2 RCBO	[3]	T	T	T	T	T	T	T	T	T	T	T	T
C120 N/H		T	T	T	T	T	T	T	T	T	T	T	T
NG125 N/H		T	T	T	T	T	T	T	T	T	T	T	T
NG125 L		T ^[1]	T ^[1]	T ^[1]	T ^[1]	T ^[1]	T ^[1]	T ^[1]	T ^[1]	T ^[1]	T ^[1]	T ^[1]	T ^[1]
ComPacT NSXm E/B/F		T	T	T	T	T	T	T	T	T	T	T	T
ComPacT NSXm N/H		T ^[1]	T ^[1]	T ^[1]	T ^[1]	T ^[1]	T ^[1]	T ^[1]	T ^[1]	T ^[1]	T ^[1]	T ^[1]	T ^[1]
ComPacT NSX B/F	NSX100	T	T	T	T	T	T	T	T	T	T	T	T
	NSX160	T	T	T	T	T	T	T	T	T	T	T	T
	NSX250	T	T	T	T	T	T	T	T	T	T	T	T
ComPacT NSX B/F	NSX100	T	T	T	T	T	T	T	T	T	T	T	T
	NSX160	T	T	T	T	T	T	T	T	T	T	T	T
	NSX250	T	T	T	T	T	T	T	T	T	T	T	T
ComPacT NSX F	NSX400	T	T	T	T	T	T	T	T	T	T	T	T
	NSX630	T	T	T	T	T	T	T	T	T	T	T	T
ComPacT NSX N/H/S/L/R	NSX100	T ^[1]	T ^[1]	T ^[1]	T ^[1]	T ^[1]	T ^[1]	T ^[1]	T ^[1]	T ^[1]	T ^[1]	T ^[1]	T ^[1]
	NSX250	T ^[1]	T ^[1]	T ^[1]	T ^[1]	T ^[1]	T ^[1]	T ^[1]	T ^[1]	T ^[1]	T ^[1]	T ^[1]	T ^[1]
ComPacT NSX N/H/S/L	NSX160	T ^[1]	T ^[1]	T ^[1]	T ^[1]	T ^[1]	T ^[1]	T ^[1]	T ^[1]	T ^[1]	T ^[1]	T ^[1]	T ^[1]
ComPacT NSX N/H/S/L/R	NSX100	T ^[1]	T ^[1]	T ^[1]	T ^[1]	T ^[1]	T ^[1]	T ^[1]	T ^[1]	T ^[1]	T ^[1]	T ^[1]	T ^[1]
	NSX250	T ^[1]	T ^[1]	T ^[1]	T ^[1]	T ^[1]	T ^[1]	T ^[1]	T ^[1]	T ^[1]	T ^[1]	T ^[1]	T ^[1]
ComPacT NSX N/H/S/L	NSX160	T ^[1]	T ^[1]	T ^[1]	T ^[1]	T ^[1]	T ^[1]	T ^[1]	T ^[1]	T ^[1]	T ^[1]	T ^[1]	T ^[1]
ComPacT NSX N/H/S/L/R	NSX400	T ^[1]	T ^[1]	T ^[1]	T ^[1]	T ^[1]	T ^[1]	T ^[1]	T ^[1]	T ^[1]	T ^[1]	T ^[1]	T ^[1]
	NSX630	T ^[1]	T ^[1]	T ^[1]	T ^[1]	T ^[1]	T ^[1]	T ^[1]	T ^[1]	T ^[1]	T ^[1]	T ^[1]	T ^[1]
ComPacT NS N	NS630b	16	20	25	32	24	30	37.5	42 ^[1]	42 ^[1]	42 ^[1]	42 ^[1]	42 ^[1]
	NS800	16	20	25	32	24	30	37.5	42 ^[1]	42 ^[1]	42 ^[1]	42 ^[1]	42 ^[1]
	NS1000	16	20	25	32	24	30	37.5	42 ^[1]	42 ^[1]	42 ^[1]	42 ^[1]	42 ^[1]
	NS1250		20	25	32		30	37.5	42 ^[1]	42 ^[1]	42 ^[1]	42 ^[1]	42 ^[1]
	NS1600			25	32			37.5	42 ^[1]		42 ^[1]	42 ^[1]	42 ^[1]
ComPacT NS H	NS630b	16	20	25	32	24	30	37.5	42 ^[1]	42 ^[1]	42 ^[1]	42 ^[1]	42 ^[1]
	NS800	16	20	25	32	24	30	37.5	42 ^[1]	42 ^[1]	42 ^[1]	42 ^[1]	42 ^[1]
	NS1000	16	20	25	32	24	30	37.5	42 ^[1]	42 ^[1]	42 ^[1]	42 ^[1]	42 ^[1]
	NS1250		20	25	32		30	37.5	42 ^[1]	42 ^[1]	42 ^[1]	42 ^[1]	42 ^[1]
	NS1600			25	32			37.5	42 ^[1]		42 ^[1]	42 ^[1]	42 ^[1]
ComPacT NS N/H	NS1600b			25	32			37.5	42 ^[1]		42 ^[1]	42 ^[1]	42 ^[1]
	NS2000				32				42 ^[1]			42 ^[1]	42 ^[1]
	NS2500												
	NS3200												
ComPacT NS L/LB	NS630bL/LB	T	T	T	T	T	T	T	T	T	T	T	T
	NS800L/LB	T	T	T	T	T	T	T	T	T	T	T	T
	NS1000L	T	T	T	T	T	T	T	T	T	T	T	T

[1] 40 kA for ComPacT NS1600b..3200H manufactured before 2015.

[2] Applicable to iCV40 Arc, Active iCV40Arc. Arc iC40, Arc iC40 active add-on can be added to iCV40 without impacting the selectivity performance.

[3] Arc iC60, VigiARC iC60, Arc iC60 active and VigiARC iC60 Active add-on can be added to iC60 without impacting the selectivity performance. The breaking capacity being limited to 10kA.

T Total selectivity, up to the breaking capacity of the downstream circuit breaker.

4 Selectivity limit = 4 kA.

No selectivity.

Note: Respect the basic rules of selectivity, in terms of overload, short-circuit, ground fault and earth leakage when applicable see page A-1, or check curves with Schneider Electric online "Electrical calculation tools".

When the upstream device is equipped with MicroLogic 6 or 7, the table provides selectivity limits for line to line or line to neutral short circuits, selectivity in earth fault condition shall be checked separately.

Selectivity Table

Upstream: ComPacT NS630b-1000L, ComPacT NS630b-800LB MicroLogic

Downstream: iC40, iC60, C120, NG125, ComPacT NSXm, NSX100-630

Ue ≤ 440 V AC



Upstream CB		ComPacT NS630b/800/1000L ComPacT NS630b/800LB																	
Trip unit type		MicroLogic 2.0 I _{sd} = 10 I _r					MicroLogic 5.0 - 6.0 - 7.0 Inst 15 In					MicroLogic 5.0 - 6.0 - 7.0 Inst OFF							
Trip unit rating In (A)		630		800		1000		630		800		1000		630		800		1000	
Setting I _r (A)		250	400	630	800	1000	250	400	630	800	1000	250	400	630	800	1000			

Downstream CB CB type Trip unit type	CB rating or Trip unit rating (A)	Trip unit setting I _r (A)	Selectivity limit (kA)																	
			T	T	T	T	T	T	T	T	T	T	T	T	T	T	T			
iC40, iC40 N, iCV40 N, iCV40 H	[2]		T	T	T	T	T	T	T	T	T	T	T	T	T	T	T	T	T	T
iC60 N/H/L, iC60 RCBO, iC60N/H/H2 RCBO	[3]		T	T	T	T	T	T	T	T	T	T	T	T	T	T	T	T	T	T
iC120 N/H			T	T	T	T	T	T	T	T	T	T	T	T	T	T	T	T	T	T
NG125 N/H			T	T	T	T	T	T	T	T	T	T	T	T	T	T	T	T	T	T
NG125 L			T	T	T	T	T	T	T	T	T	T	T	T	T	T	T	T	T	T
ComPacT NSXm E/B/F/N/H			T	T	T	T	T	T	T	T	T	T	T	T	T	T	T	T	T	T
ComPacT NSX100 B/F/N/H/S/L/R TM-D, TM-G			T	T	T	T	T	T	T	T	T	T	T	T	T	T	T	T	T	T
ComPacT NSX160 B/F			T	T	T	T	T	T	T	T	T	T	T	T	T	T	T	T	T	T
ComPacT NSX160 N/H/S/L TM-D, TM-G			36	36	36	T	T	36	36	36	T	T	36	36	36	T	T			
ComPacT NSX250 B/F/N/H/S/L/R TM-D, TM-G	≤ 125		20	20	20	T	T	20	20	20	T	T	20	20	20	T	T			
	160		20	20	20	T	T	20	20	20	T	T	20	20	20	T	T			
	200			20	20	T	T		20	20	T	T		20	20	T	T			
	250			20	20	T	T		20	20	T	T		20	20	T	T			
ComPacT NSX100 B/F/N/H/S/L/R MicroLogic	40		T	T	T	T	T	T	T	T	T	T	T	T	T	T	T	T	T	T
	100		T	T	T	T	T	T	T	T	T	T	T	T	T	T	T	T	T	T
ComPacT NSX160 B/F MicroLogic	160	100	T	T	T	T	T	T	T	T	T	T	T	T	T	T	T	T	T	T
		160	T	T	T	T	T	T	T	T	T	T	T	T	T	T	T	T	T	T
ComPacT NSX160 N/H/S/L MicroLogic	160	100	36	36	36	T	T	36	36	36	T	T	36	36	36	T	T			
		160	36	36	36	T	T	36	36	36	T	T	36	36	36	T	T			
ComPacT NSX250 B/F/N/H/S/L/R MicroLogic	250	≤ 100	20	20	20	T	T	20	20	20	T	T	20	20	20	T	T			
		160		20	20	T	T		20	20	T	T		20	20	T	T			
		250		20	20	T	T		20	20	T	T		20	20	T	T			
ComPacT NSX400 F/N/H/S/L/R MicroLogic	400	160	6.3	6.3	6.3	10	15	6.3	6.3	6.3	10	15	6.3	6.3	6.3	10	15			
		200		6.3	6.3	10	15		6.3	6.3	10	15		6.3	6.3	10	15			
		250		6.3	6.3	10	15		6.3	6.3	10	15		6.3	6.3	10	15			
		320		6.3	6.3	10	15			6.3	10	15			6.3	10	15			
		400			6.3	10	15			6.3	10	15				6.3	10	15		
ComPacT NSX630 F/N/H/S/L/R MicroLogic	630	250		6.3	6.3	8	10		6.3	6.3	8	10		6.3	6.3	8	10			
		320			6.3	8	10			6.3	8	10			6.3	8	10			
		400			6.3	8	10			6.3	8	10			6.3	8	10			
		500				8	10				8	10				8	10			
		630					10					10					10			

[2] Applicable to iCV40 Arc, Active iCV40Arc. Arc iC40, Arc iC40 active add-on can be added to iCV40 without impacting the selectivity performance.
 [3] Arc iC60, VigiARC iC60, Arc iC60 active and VigiARC iC60 Active add-on can be added to iC60 without impacting the selectivity performance. The breaking capacity being limited to 10kA.

Total selectivity, up to the breaking capacity of the downstream circuit breaker.

Selectivity limit = 4 kA.

No selectivity.

Note: Respect the basic rules of selectivity, in terms of overload, short-circuit, ground fault and earth leakage when applicable see page A-1, or check curves with Schneider Electric online "Electrical calculation tools".
 When the upstream device is equipped with MicroLogic 6 or 7, the table provides selectivity limits for line to line or line to neutral short circuits, selectivity in earth fault condition shall be checked separately.

Selectivity Table

Upstream: ComPacT NS630b-1000L, ComPacT NS630b-800LB MicroLogic

Downstream: ComPacT NS630b-1000



Ue ≤ 440 V AC

Upstream CB		ComPacT NS630b/800/1000L ComPacT NS630b/800LB														
Trip unit type		MicroLogic 2.0 I _{sd} = 10 I _r					MicroLogic 5.0 - 6.0 - 7.0 Inst 15 In					MicroLogic 5.0 - 6.0 - 7.0 Inst OFF				
Trip unit rating I _n (A)		630		800	1000	630		800	1000	630		800	1000			
Setting I _r (A)		250	400	630	800	1000	250	400	630	800	1000	250	400	630	800	1000

Downstream CB		Selectivity limit (kA)														
CB type	Trip unit setting I _r (A)															
CB type	Trip unit setting I _r (A)															
ComPacT NS630b N/H MicroLogic	250		6.3	6.3	8	10		6.3	6.3	8	10		6.3	6.3	8	10
	320			6.3	8	10			6.3	8	10			6.3	8	10
	400			6.3	8	10			6.3	8	10			6.3	8	10
	500				8	10				8	10				8	10
	630					10					10					10
ComPacT NS800 N/H MicroLogic	320			6.3	8	10			6.3	8	10			6.3	8	10
	400			6.3	8	10			6.3	8	10			6.3	8	10
	500				8	10				8	10				8	10
	630					10					10					10
	800															
ComPacT NS1000 N/H MicroLogic	400			6.3	8	10			6.3	8	10			6.3	8	10
	500				8	10				8	10				8	10
	630					10					10					10
	800															
	1000															
ComPacT NS630b L/LB MicroLogic	250		6.3	6.3	8	10		6.3	6.3	8	10		6.3	6.3	8	10
	320			6.3	8	10			6.3	8	10			6.3	8	10
	400			6.3	8	10			6.3	8	10			6.3	8	10
	500				8	10				8	10				8	10
	630					10					10					10
ComPacT NS800 L/LB MicroLogic	320			6.3	8	10			6.3	8	10			6.3	8	10
	400			6.3	8	10			6.3	8	10			6.3	8	10
	500				8	10				8	10				8	10
	630					10					10					10
	800															
ComPacT NS1000 L MicroLogic	400			6.3	8	10			6.3	8	10			6.3	8	10
	500				8	10				8	10				8	10
	630					10					10					10
	800															
	1000															

4 Selectivity limit = 4 kA.

No selectivity.

Note: Respect the basic rules of selectivity, in terms of overload, short-circuit, ground fault and earth leakage when applicable see page A-1, or check curves with Schneider Electric online "Electrical calculation tools".

When the upstream device is equipped with MicroLogic 6 or 7, the table provides selectivity limits for line to line or line to neutral short circuits, selectivity in earth fault condition shall be checked separately.

Selectivity Table

Upstream: MasterPacT MTZ1 06-16 H1/H2/H3 MicroLogic X

Downstream: iC40, iC60, C120, NG125, ComPacT NSXm, NSX100-630

Ue ≤ 440 V AC



Upstream CB	MasterPacT MTZ1 06/08/10/12/16 H1/H2/H3																				
Trip unit type	MicroLogic 2.0X Isd = 10 Ir								MicroLogic 5.0X - 6.0X - 7.0X Inst : 15 In Standard				MicroLogic 5.0X - 6.0X - 7.0X Inst : OFF								
Trip unit rating In (A)	630	800	1000	1250	1600	630	800	1000	1250	1600	630	800	1000	1250	1600	630	800	1000	1250	1600	
Setting Ir (A)	250	400	630	800	1000	1250	1600	250	400	630	800	1000	1250	1600	250	400	630	800	1000	1250	1600

Downstream CB	CB type	Trip unit type	CB rating or Trip unit rating (A)	Trip unit setting Ir (A)	Selectivity limit (kA)																			
					T	T	T	T	T	T	T	T	T	T	T	T	T	T	T	T	T	T	T	
iC40, iC40 N, iCV40 N, iCV40 H			[2]		T	T	T	T	T	T	T	T	T	T	T	T	T	T	T	T	T			
iC60 N/H/L, iC60 RCBO, iC60N/H/H2 RCBO			[3]		T	T	T	T	T	T	T	T	T	T	T	T	T	T	T	T	T			
C120 N/H					T	T	T	T	T	T	T	T	T	T	T	T	T	T	T	T	T			
NG125 N/H					T	T	T	T	T	T	T	T	T	T	T	T	T	T	T	T	T			
NG125 L					T	T	T	T	T	T	T	T	T	T	T	T	T	T	T	T	T			
NSXm E/B/F/N/H					T	T	T	T	T	T	T	T	T	T	T	T	T	T	T	T	T			
ComPacT NSX100 B/F/N/H/S/L/R TM-D, TM-G					T	T	T	T	T	T	T	T	T	T	T	T	T	T	T	T	T			
ComPacT NSX160 B/F/N/H/S/L TM-D, TM-G					T	T	T	T	T	T	T	T	T	T	T	T	T	T	T	T	T			
ComPacT NSX250 B/F/N/H/S/L/R TM-D, TM-G	≤ 125	160			T	T	T	T	T	T	T	T	T	T	T	T	T	T	T	T	T			
		200			T	T	T	T	T	T	T	T	T	T	T	T	T	T	T	T	T			
		250			T	T	T	T	T	T	T	T	T	T	T	T	T	T	T	T	T	T		
		400			T	T	T	T	T	T	T	T	T	T	T	T	T	T	T	T	T	T		
ComPacT NSX100 B/F/N/H/S/L/R MicroLogic	40	100			T	T	T	T	T	T	T	T	T	T	T	T	T	T	T	T	T			
		160			T	T	T	T	T	T	T	T	T	T	T	T	T	T	T	T	T	T		
ComPacT NSX160 B/F/N/H/S/L MicroLogic	40	100			T	T	T	T	T	T	T	T	T	T	T	T	T	T	T	T	T			
		160			T	T	T	T	T	T	T	T	T	T	T	T	T	T	T	T	T	T		
		250			T	T	T	T	T	T	T	T	T	T	T	T	T	T	T	T	T	T		
ComPacT NSX250 B/F/N/H/S/L/R MicroLogic	250	≤ 100			T	T	T	T	T	T	T	T	T	T	T	T	T	T	T	T	T			
		160			T	T	T	T	T	T	T	T	T	T	T	T	T	T	T	T	T	T		
		250			T	T	T	T	T	T	T	T	T	T	T	T	T	T	T	T	T	T		
		400			T	T	T	T	T	T	T	T	T	T	T	T	T	T	T	T	T	T	T	
ComPacT NSX400 F/N/H/S/L/R MicroLogic	400	160			T	T	T	T	T	T	T	T	T	T	T	T	T	T	T	T	T	T		
		200			T	T	T	T	T	T	T	T	T	T	T	T	T	T	T	T	T	T		
		250			T	T	T	T	T	T	T	T	T	T	T	T	T	T	T	T	T	T		
		320			T	T	T	T	T	T	T	T	T	T	T	T	T	T	T	T	T	T	T	
		400			T	T	T	T	T	T	T	T	T	T	T	T	T	T	T	T	T	T	T	
ComPacT NSX630 F/N/H/S/L/R MicroLogic	630	250			T	T	T	T	T	T	T	T	T	T	T	T	T	T	T	T	T	T		
		320			T	T	T	T	T	T	T	T	T	T	T	T	T	T	T	T	T	T		
		400			T	T	T	T	T	T	T	T	T	T	T	T	T	T	T	T	T	T		
		500			T	T	T	T	T	T	T	T	T	T	T	T	T	T	T	T	T	T	T	
		630			T	T	T	T	T	T	T	T	T	T	T	T	T	T	T	T	T	T	T	

[2] Applicable to iCV40 Arc, Active iCV40Arc. Arc iC40, Arc iC40 active add-on can be added to iCV40 without impacting the selectivity performance.
 [3] Arc iC60, VigiARC iC60, Arc iC60 active and VigiARC iC60 Active add-on can be added to iC60 without impacting the selectivity performance. The breaking capacity being limited to 10kA.

- Total selectivity, up to the breaking capacity of the downstream circuit breaker.
- Selectivity limit = 4 kA.
- No selectivity.

Note: Respect the basic rules of selectivity, in terms of overload, short-circuit, ground fault and earth leakage when applicable see page A-1, or check curves with Schneider Electric online "Electrical calculation tools".
 When the upstream device is equipped with MicroLogic 6 or 7, the table provides selectivity limits for line to line or line to neutral short circuits, selectivity in earth fault condition shall be checked separately.

Selectivity Table

Upstream: MasterPacT MTZ1 06-16 H1 MicroLogic X

Downstream: ComPacT NS630b-1600 MicroLogic A/E/P



Ue ≤ 440 V AC

Upstream CB		MasterPacT MTZ1 06/08/10/12/16 H1																	
Trip unit type		MicroLogic 2.0X I _{sd} = 10 I _r					MicroLogic 5.0X - 6.0X - 7.0X Inst: 15 I _n Standard					MicroLogic 5.0X - 6.0X - 7.0X Inst: OFF							
Trip unit rating I _n (A)		630	800	1000	1250	1600	630	800	1000	1250	1600	630	800	1000	1250	1600			
Setting I _r (A)		400	630	800	1000	1250	1600	400	630	800	1000	1250	1600	400	630	800	1000	1250	1600

Downstream CB		Selectivity limit (kA)																		
CB type	Trip unit type	Trip unit setting I _r (A)																		
ComPacT NS630b N/H MicroLogic	250	4	6.3	8	10	12.5	16	9.4	9.4	12	15	18.7	24	T	T	T	T	T	T	
	320		6.3	8	10	12.5	16		9.4	12	15	18.7	24		T	T	T	T	T	
	400		6.3	8	10	12.5	16		9.4	12	15	18.7	24		T	T	T	T	T	
	500			8	10	12.5	16			12	15	18.7	24			T	T	T	T	
	630				10	12.5	16				15	18.7	24				T	T	T	
ComPacT NS800 N/H MicroLogic	320		6.3	8	10	12.5	16		9.4	12	15	18.7	24		T	T	T	T	T	
	400		6.3	8	10	12.5	16		9.4	12	15	18.7	24		T	T	T	T	T	
	500			8	10	12.5	16			12	15	18.7	24			T	T	T	T	
	630				10	12.5	16				15	18.7	24			T	T	T	T	
	800					12.5	16					18.7	24				T	T	T	
ComPacT NS1000 N/H MicroLogic	400		6.3	8	10	12.5	16		9.4	12	15	18.7	24		T	T	T	T	T	
	500			8	10	12.5	16			12	15	18.7	24			T	T	T	T	
	630				10	12.5	16				15	18.7	24				T	T	T	
	800					12.5	16					18.7	24					T	T	
	1000						16						24						T	
ComPacT NS1250 N/H MicroLogic	500			8	10	12.5	16			12	15	18.7	24			T	T	T	T	
	630				10	12.5	16				15	18.7	24				T	T	T	
	800					12.5	16					18.7	24					T	T	
	1000						16						24						T	
	1250																		T	
ComPacT NS1600 N/H MicroLogic	630				10	12.5	16				15	18.7	24					T	T	
	800					12.5	16					18.7	24						T	
	960						16						24						T	
	1250																			
	1600																			
ComPacT NS630b L/LB MicroLogic	250	4	6.3	8	T	T	T	T	T	T	T	T	T	T	T	T	T	T	T	
	320		6.3	8	T	T	T	T	T	T	T	T	T	T	T	T	T	T	T	
	400		6.3	8	T	T	T	T	T	T	T	T	T	T	T	T	T	T	T	
	500			8	T	T	T	T	T	T	T	T	T	T	T	T	T	T	T	
	630				T	T	T	T	T	T	T	T	T	T	T	T	T	T	T	
ComPacT NS800 L/LB MicroLogic	320		6.3	8	10	T	T		9.4	T	T	T	T		T	T	T	T	T	
	400		6.3	8	10	T	T		9.4	T	T	T	T		T	T	T	T	T	
	500			8	10	T	T			T	T	T	T			T	T	T	T	
	630				10	T	T				T	T	T				T	T	T	
	800					12.5	T					T	T					T	T	
ComPacT NS1000 L MicroLogic	400		6.3	8	10	12.5	T		9.4	12	T	T	T		T	T	T	T	T	
	500			8	10	12.5	T			12	T	T	T			T	T	T	T	
	630				10	12.5	T				T	T	T				T	T	T	
	800					12.5	T					T	T					T	T	
	1000						T						T						T	

T Total selectivity, up to the breaking capacity of the downstream circuit breaker.

4 Selectivity limit = 4 kA.

No selectivity.

Note: Respect the basic rules of selectivity, in terms of overload, short-circuit, ground fault and earth leakage when applicable see page A-1, or check curves with Schneider Electric online "Electrical calculation tools".

When the upstream device is equipped with MicroLogic 6 or 7, the table provides selectivity limits for line to line or line to neutral short circuits, selectivity in earth fault condition shall be checked separately.

Selectivity table

Upstream: MasterPacT MTZ1 06-16 H1 MicroLogic X

Downstream: MasterPacT MTZ1 06-16

Ue ≤ 440 V AC



Upstream CB	MasterPacT MTZ1 06/08/10/12/16 H1																	
Trip unit type	MicroLogic 2.0X I _{sd} = 10 I _r						MicroLogic 5.0X - 6.0X - 7.0X Inst: 15 In Standard						MicroLogic 5.0X - 6.0X - 7.0X Inst: OFF					
	630	800	1000	1250	1600	630	800	1000	1250	1600	630	800	1000	1250	1600			
Trip unit rating I _n (A)	400	630	800	1000	1250	1600	400	630	800	1000	1250	1600	400	630	800	1000	1250	1600
Setting I _r (A)	400	630	800	1000	1250	1600	400	630	800	1000	1250	1600	400	630	800	1000	1250	1600

Downstream CB		Selectivity limit (kA)																		
CB type	Trip unit type	Trip unit setting I _r (A)																		
MasterPacT MTZ1 06 H1/H2/H3 MicroLogic	250	4	6.3	8	10	12.5	16	9.4	9.4	12	15	18.7	24	T	T	T	T	T	T	
	320		6.3	8	10	12.5	16		9.4	12	15	18.7	24		T	T	T	T	T	
	400		6.3	8	10	12.5	16		9.4	12	15	18.7	24		T	T	T	T	T	
	500			8	10	12.5	16			12	15	18.7	24			T	T	T	T	
	630				10	12.5	16				15	18.7	24				T	T	T	
MasterPacT MTZ1 08 H1/H2/H3 MicroLogic	320		6.3	8	10	12.5	16		9.4	12	15	18.7	24		T	T	T	T	T	
	400		6.3	8	10	12.5	16		9.4	12	15	18.7	24		T	T	T	T	T	
	500			8	10	12.5	16			12	15	18.7	24			T	T	T	T	
	630				10	12.5	16				15	18.7	24			T	T	T	T	
	800					12.5	16					18.7	24				T	T	T	
MasterPacT MTZ1 10 H1/H2/H3 MicroLogic	400		6.3	8	10	12.5	16		9.4	12	15	18.7	24		T	T	T	T	T	
	500			8	10	12.5	16			12	15	18.7	24			T	T	T	T	
	630				10	12.5	16				15	18.7	24				T	T	T	
	800					12.5	16					18.7	24					T	T	
	1000						16						24						T	
MasterPacT MTZ1 12 H1/H2/H3 MicroLogic	500			8	10	12.5	16			12	15	18.7	24			T	T	T	T	
	630				10	12.5	16				15	18.7	24				T	T	T	
	800					12.5	16					18.7	24					T	T	
	1000						16						24						T	
	1250																		T	
MasterPacT MTZ1 16 H1/H2/H3 MicroLogic	630				10	12.5	16				15	18.7	24				T	T	T	
	800					12.5	16					18.7	24					T	T	
	960						16						24						T	
	1250																		T	
	1600																		T	
MasterPacT MTZ1 06 L1 MicroLogic	250	4	6.3	8	T	T	T	T	T	T	T	T	T	T	T	T	T	T	T	
	320		6.3	8	T	T	T		T	T	T	T	T		T	T	T	T	T	
	400		6.3	8	T	T	T		T	T	T	T	T		T	T	T	T	T	
	500			8	T	T	T			T	T	T	T			T	T	T	T	
	630				T	T	T				T	T	T				T	T	T	
MasterPacT MTZ1 08 L1 MicroLogic	320		6.3	8	10	T	T		9.4	T	T	T	T		T	T	T	T	T	
	400		6.3	8	10	T	T		9.4	T	T	T	T		T	T	T	T	T	
	500			8	10	T	T			T	T	T	T			T	T	T	T	
	630				10	T	T					T	T				T	T	T	
	800					T	T						T					T	T	
MasterPacT MTZ1 10 L1 MicroLogic	400		6.3	8	10	12.5	T		9.4	12	T	T	T		T	T	T	T	T	
	500			8	10	12.5	T			12	T	T	T			T	T	T	T	
	630				10	12.5	T				T	T	T				T	T	T	
	800					12.5	T						T					T	T	
	1000						T												T	

- T Total selectivity, up to the breaking capacity of the downstream circuit breaker.
- 4 Selectivity limit = 4 kA.
- No selectivity.

Note: Respect the basic rules of selectivity, in terms of overload, short-circuit, ground fault and earth leakage when applicable see page A-1, or check curves with Schneider Electric online "Electrical calculation tools".
When the upstream device is equipped with MicroLogic 6 or 7, the table provides selectivity limits for line to line or line to neutral short circuits, selectivity in earth fault condition shall be checked separately.

Selectivity Table

Upstream: MasterPacT MTZ1 06-16 H2 MicroLogic X

Downstream: ComPacT NS630b-1600 MicroLogic A/E/P

Ue ≤ 440 V AC

A

Upstream CB		MasterPacT MTZ1 06/08/10/12/16 H2																	
Trip unit type		MicroLogic 2.0X Isd = 10 Ir					MicroLogic 5.0X - 6.0X - 7.0X Inst: 15 In Standard					MicroLogic 5.0X - 6.0X - 7.0X Inst: OFF							
Trip unit rating In (A)		630	630	800	1000	1250	1600	630	630	800	1000	1250	1600	630	630	800	1000	1250	1600
Setting Ir (A)		400	630	800	1000	1250	1600	400	630	800	1000	1250	1600	400	630	800	1000	1250	1600

Downstream CB		Selectivity limit (kA)																		
CB type	Trip unit type	Trip unit setting Ir (A)																		
ComPacT NS630b N/H MicroLogic	250	4	6.3	8	10	12.5	16	9.4	9.4	12	15	18.7	24	42	42	42	42	42	42	
	320		6.3	8	10	12.5	16		9.4	12	15	18.7	24		42	42	42	42	42	
	400		6.3	8	10	12.5	16		9.4	12	15	18.7	24		42	42	42	42	42	
	500			8	10	12.5	16			12	15	18.7	24			42	42	42	42	
	630				10	12.5	16				15	18.7	24				42	42	42	
ComPacT NS800 N/H MicroLogic	320		6.3	8	10	12.5	16		9.4	12	15	18.7	24		42	42	42	42	42	
	400		6.3	8	10	12.5	16		9.4	12	15	18.7	24		42	42	42	42	42	
	500			8	10	12.5	16			12	15	18.7	24			42	42	42	42	
	630				10	12.5	16				15	18.7	24			42	42	42	42	
	800					12.5	16					18.7	24				42	42	42	
ComPacT NS1000 N/H MicroLogic	400		6.3	8	10	12.5	16		9.4	12	15	18.7	24		42	42	42	42	42	
	500			8	10	12.5	16			12	15	18.7	24			42	42	42	42	
	630				10	12.5	16				15	18.7	24				42	42	42	
	800					12.5	16					18.7	24					42	42	
	1000						16						24						42	
ComPacT NS1250 N/H MicroLogic	500			8	10	12.5	16			12	15	18.7	24			42	42	42	42	
	630				10	12.5	16				15	18.7	24				42	42	42	
	800					12.5	16					18.7	24					42	42	
	1000						16						24						42	
	1250																		42	
ComPacT NS1600 N/H MicroLogic	630				10	12.5	16				15	18.7	24				42	42	42	
	800					12.5	16					18.7	24					42	42	
	960						16						24						42	
	1250																		42	
	1600																		42	
ComPacT NS630b L/LB MicroLogic	250	4	6.3	8	T	T	T	T	T	T	T	T	T	T	T	T	T	T	T	
	320		6.3	8	T	T	T		T	T	T	T	T		T	T	T	T	T	
	400		6.3	8	T	T	T		T	T	T	T	T		T	T	T	T	T	
	500			8	T	T	T			T	T	T	T			T	T	T	T	
	630				T	T	T				T	T	T				T	T	T	
ComPacT NS800 L/LB MicroLogic	320		6.3	8	10	T	T		9.4	T	T	T	T		T	T	T	T	T	
	400		6.3	8	10	T	T		9.4	T	T	T	T		T	T	T	T	T	
	500			8	10	T	T			T	T	T	T			T	T	T	T	
	630				10	T	T				T	T	T				T	T	T	
	800					T	T					T	T					T	T	
ComPacT NS1000 L MicroLogic	400		6.3	8	10	12.5	T		9.4	12	T	T	T		T	T	T	T	T	
	500			8	10	12.5	T			12	T	T	T			T	T	T	T	
	630				10	12.5	T				T	T	T				T	T	T	
	800					12.5	T					T	T					T	T	
	1000						T						T						T	

- T Total selectivity, up to the breaking capacity of the downstream circuit breaker.
- 4 Selectivity limit = 4 kA.
- No selectivity.

Note: Respect the basic rules of selectivity, in terms of overload, short-circuit, ground fault and earth leakage when applicable see page A-1, or check curves with Schneider Electric online "Electrical calculation tools".

When the upstream device is equipped with MicroLogic 6 or 7, the table provides selectivity limits for line to line or line to neutral short circuits, selectivity in earth fault condition shall be checked separately.

Selectivity Table

Upstream: MasterPacT MTZ1 06-16 H2 MicroLogic X

Downstream: MasterPacT MTZ1 06-16

Ue ≤ 440 V AC



Upstream CB		MasterPacT MTZ1 06/08/10/12/16 H2																	
Trip unit type		MicroLogic 2.0X Isd = 10 Ir					MicroLogic 5.0X - 6.0X - 7.0X Inst: 15 In Standard					MicroLogic 5.0X - 6.0X - 7.0X Inst: OFF							
Trip unit rating In (A)		630	630	800	1000	1250	1600	630	630	800	1000	1250	1600	630	630	800	1000	1250	1600
Setting Ir (A)		400	630	800	1000	1250	1600	400	630	800	1000	1250	1600	400	630	800	1000	1250	1600

Downstream CB		Selectivity limit (kA)																		
CB type	Trip unit type	Trip unit setting Ir (A)																		
MasterPacT MTZ1 06 H1/H2/H3 MicroLogic	250	4	6.3	8	10	12.5	16	9.4	9.4	12	15	18.7	24	42	42	42	42	42	42	
	320		6.3	8	10	12.5	16		9.4	12	15	18.7	24		42	42	42	42	42	
	400		6.3	8	10	12.5	16		9.4	12	15	18.7	24		42	42	42	42	42	
	500			8	10	12.5	16			12	15	18.7	24			42	42	42	42	
	630				10	12.5	16				15	18.7	24				42	42	42	
MasterPacT MTZ1 08 H1/H2/H3 MicroLogic	320		6.3	8	10	12.5	16		9.4	12	15	18.7	24		42	42	42	42	42	
	400		6.3	8	10	12.5	16		9.4	12	15	18.7	24		42	42	42	42	42	
	500			8	10	12.5	16			12	15	18.7	24			42	42	42	42	
	630				10	12.5	16				15	18.7	24			42	42	42	42	
	800					12.5	16					18.7	24				42	42	42	
MasterPacT MTZ1 10 H1/H2/H3 MicroLogic	400		6.3	8	10	12.5	16		9.4	12	15	18.7	24		42	42	42	42	42	
	500			8	10	12.5	16			12	15	18.7	24			42	42	42	42	
	630				10	12.5	16				15	18.7	24				42	42	42	
	800					12.5	16					18.7	24					42	42	
	1000						16						24						42	
MasterPacT MTZ1 12 H1/H2/H3 MicroLogic	500			8	10	12.5	16			12	15	18.7	24			42	42	42	42	
	630				10	12.5	16				15	18.7	24				42	42	42	
	800					12.5	16					18.7	24					42	42	
	1000						16						24						42	
	1250																			
MasterPacT MTZ1 16 H1/H2/H3 MicroLogic	630				10	12.5	16				15	18.7	24				42	42	42	
	800					12.5	16					18.7	24					42	42	
	960						16						24						42	
	1250																			
	1600																			
MasterPacT MTZ1 06 L1 MicroLogic	250	4	6.3	8	T	T	T	T	T	T	T	T	T	T	T	T	T	T	T	
	320		6.3	8	T	T	T		T	T	T	T	T		T	T	T	T	T	
	400		6.3	8	T	T	T		T	T	T	T	T		T	T	T	T	T	
	500			8	T	T	T			T	T	T	T			T	T	T	T	
	630				T	T	T				T	T	T				T	T	T	
MasterPacT MTZ1 08 L1 MicroLogic	320		6.3	8	10	T	T		9.4	T	T	T	T		T	T	T	T	T	
	400		6.3	8	10	T	T		9.4	T	T	T	T		T	T	T	T	T	
	500			8	10	T	T			T	T	T	T			T	T	T	T	
	630				10	T	T					T	T	T				T	T	
	800					T	T						T	T				T	T	
MasterPacT MTZ1 10 L1 MicroLogic	400		6.3	8	10	12.5	T		9.4	12	T	T	T		T	T	T	T	T	
	500			8	10	12.5	T			12	T	T	T			T	T	T	T	
	630				10	12.5	T				T	T	T				T	T	T	
	800					12.5	T						T					T	T	
	1000						T							T					T	

- T Total selectivity, up to the breaking capacity of the downstream circuit breaker.
- 4 Selectivity limit = 4 kA.
- No selectivity.

Note: Respect the basic rules of selectivity, in terms of overload, short-circuit, ground fault and earth leakage when applicable see page A-1, or check curves with Schneider Electric online "Electrical calculation tools".
When the upstream device is equipped with MicroLogic 6 or 7, the table provides selectivity limits for line to line or line to neutral short circuits, selectivity in earth fault condition shall be checked separately.

Selectivity Table

Upstream: MasterPacT MTZ1 06-16 H3 MicroLogic X

Downstream: ComPacT NS630b-1600 MicroLogic A/E/P



Ue ≤ 440 V AC

Upstream CB		MasterPacT MTZ1 06/08/10/12/16 H3																	
Trip unit type		MicroLogic 2.0X Isd = 10 Ir					MicroLogic 5.0X - 6.0X - 7.0X Inst: 15 In Standard					MicroLogic 5.0X - 6.0X - 7.0X Inst: OFF							
Trip unit rating In (A)		630	800	1000	1250	1600	630	800	1000	1250	1600	630	800	1000	1250	1600			
Setting Ir (A)		400	630	800	1000	1250	1600	400	630	800	1000	1250	1600	400	630	800	1000	1250	1600

Downstream CB		Selectivity limit (kA)																		
CB type	Trip unit type	Trip unit setting Ir (A)																		
ComPacT NS630b N/H MicroLogic	250	4	6.3	8	10	12.5	16	9.4	9.4	12	15	18.7	24	50	50	50	50	50	50	
	320		6.3	8	10	12.5	16		9.4	12	15	18.7	24		50	50	50	50	50	
	400		6.3	8	10	12.5	16		9.4	12	15	18.7	24		50	50	50	50	50	
	500			8	10	12.5	16			12	15	18.7	24			50	50	50	50	
	630				10	12.5	16				15	18.7	24				50	50	50	
ComPacT NS800 N/H MicroLogic	320		6.3	8	10	12.5	16		9.4	12	15	18.7	24		50	50	50	50	50	
	400		6.3	8	10	12.5	16		9.4	12	15	18.7	24		50	50	50	50	50	
	500			8	10	12.5	16			12	15	18.7	24			50	50	50	50	
	630				10	12.5	16				15	18.7	24			50	50	50	50	
	800					12.5	16					18.7	24				50	50	50	
ComPacT NS1000 N/H MicroLogic	400		6.3	8	10	12.5	16		9.4	12	15	18.7	24		50	50	50	50	50	
	500			8	10	12.5	16			12	15	18.7	24			50	50	50	50	
	630				10	12.5	16				15	18.7	24				50	50	50	
	800					12.5	16					18.7	24					50	50	
	1000						16						24						50	
ComPacT NS1250 N/H MicroLogic	500			8	10	12.5	16			12	15	18.7	24			50	50	50	50	
	630				10	12.5	16				15	18.7	24				50	50	50	
	800					12.5	16					18.7	24					50	50	
	1000						16						24						50	
	1250																		50	
ComPacT NS1600 N/H MicroLogic	630				10	12.5	16				15	18.7	24					50	50	
	800					12.5	16					18.7	24						50	
	960						16						24						50	
	1250																		50	
	1600																		50	
ComPacT NS630b L/LB MicroLogic	250	4	6.3	8	T	T	T	T	T	T	T	T	T	T	T	T	T	T	T	
	320		6.3	8	T	T	T		T	T	T	T	T		T	T	T	T	T	
	400		6.3	8	T	T	T		T	T	T	T	T		T	T	T	T	T	
	500			8	T	T	T			T	T	T	T			T	T	T	T	
	630				T	T	T				T	T	T				T	T	T	
ComPacT NS800 L/LB MicroLogic	320		6.3	8	10	T	T		9.4	T	T	T	T		T	T	T	T	T	
	400		6.3	8	10	T	T		9.4	T	T	T	T		T	T	T	T	T	
	500			8	10	T	T			T	T	T	T			T	T	T	T	
	630				10	T	T				T	T	T				T	T	T	
	800					T	T					T	T					T	T	
ComPacT NS1000 L MicroLogic	400		6.3	8	10	12.5	T		9.4	12	T	T	T		T	T	T	T	T	
	500			8	10	12.5	T			12	T	T	T			T	T	T	T	
	630				10	12.5	T				T	T	T				T	T	T	
	800					12.5	T					T	T					T	T	
	1000						T						T						T	

- T Total selectivity, up to the breaking capacity of the downstream circuit breaker.
- 4 Selectivity limit = 4 kA.
- No selectivity.

Note: Respect the basic rules of selectivity, in terms of overload, short-circuit, ground fault and earth leakage when applicable see page A-1, or check curves with Schneider Electric online "Electrical calculation tools".

When the upstream device is equipped with MicroLogic 6 or 7, the table provides selectivity limits for line to line or line to neutral short circuits, selectivity in earth fault condition shall be checked separately.

Selectivity Table

Upstream: MasterPacT MTZ1 06-16 H3 MicroLogic X

Downstream: MasterPacT MTZ1 06-16

Ue ≤ 440 V AC



Upstream CB		MasterPacT MTZ1 06/08/10/12/16 H3																	
Trip unit type		MicroLogic 2.0X Isd = 10 Ir					MicroLogic 5.0X - 6.0X - 7.0X Inst: 15 In Standard					MicroLogic 5.0X - 6.0X - 7.0X Inst: OFF							
Trip unit rating In (A)		630	800	1000	1250	1600	630	800	1000	1250	1600	630	800	1000	1250	1600			
Setting Ir (A)		400	630	800	1000	1250	1600	400	630	800	1000	1250	1600	400	630	800	1000	1250	1600

Downstream CB		Selectivity limit (kA)																		
CB type	Trip unit type	Trip unit setting Ir (A)																		
MasterPacT MTZ1 06 H1/H2/H3 MicroLogic	250	4	6.3	8	10	12.5	16	9.4	9.4	12	15	18.7	24	50	50	50	50	50	50	
	320		6.3	8	10	12.5	16	9.4	9.4	12	15	18.7	24	50	50	50	50	50	50	
	400		6.3	8	10	12.5	16	9.4	12	15	18.7	24	50	50	50	50	50	50		
	500			8	10	12.5	16	12	15	18.7	24	50	50	50	50	50	50			
	630				10	12.5	16	15	18.7	24	50	50	50	50	50	50				
MasterPacT MTZ1 08 H1/H2/H3 MicroLogic	320		6.3	8	10	12.5	16	9.4	12	15	18.7	24	50	50	50	50	50	50		
	400		6.3	8	10	12.5	16	9.4	12	15	18.7	24	50	50	50	50	50	50		
	500			8	10	12.5	16	12	15	18.7	24	50	50	50	50	50	50			
	630				10	12.5	16	15	18.7	24	50	50	50	50	50	50				
	800					12.5	16	18.7	24	50	50	50	50	50	50					
MasterPacT MTZ1 10 H1/H2/H3 MicroLogic	400		6.3	8	10	12.5	16	9.4	12	15	18.7	24	50	50	50	50	50	50		
	500			8	10	12.5	16	12	15	18.7	24	50	50	50	50	50	50			
	630				10	12.5	16	15	18.7	24	50	50	50	50	50	50				
	800					12.5	16	18.7	24	50	50	50	50	50	50					
	1000						16	24	50	50	50	50	50	50						
MasterPacT MTZ1 12 H1/H2/H3 MicroLogic	500			8	10	12.5	16	12	15	18.7	24	50	50	50	50	50	50			
	630				10	12.5	16	15	18.7	24	50	50	50	50	50	50				
	800					12.5	16	18.7	24	50	50	50	50	50	50					
	1000						16	24	50	50	50	50	50	50	50					
	1250							24	50	50	50	50	50	50	50					
MasterPacT MTZ1 16 H1/H2/H3 MicroLogic	630				10	12.5	16	15	18.7	24	50	50	50	50	50	50				
	800					12.5	16	18.7	24	50	50	50	50	50	50					
	960						16	24	50	50	50	50	50	50	50					
	1250							24	50	50	50	50	50	50	50					
	1600							24	50	50	50	50	50	50	50					
MasterPacT MTZ1 06 L1 MicroLogic	250	4	6.3	8	T	T	T	T	T	T	T	T	T	T	T	T	T	T	T	
	320		6.3	8	T	T	T	T	T	T	T	T	T	T	T	T	T	T	T	
	400		6.3	8	T	T	T	T	T	T	T	T	T	T	T	T	T	T	T	
	500			8	T	T	T	T	T	T	T	T	T	T	T	T	T	T	T	
	630				T	T	T	T	T	T	T	T	T	T	T	T	T	T	T	
MasterPacT MTZ1 08 L1 MicroLogic	320		6.3	8	10	T	T	9.4	T	T	T	T	T	T	T	T	T	T	T	
	400		6.3	8	10	T	T	9.4	T	T	T	T	T	T	T	T	T	T	T	
	500			8	10	T	T	T	T	T	T	T	T	T	T	T	T	T	T	
	630				10	T	T	T	T	T	T	T	T	T	T	T	T	T	T	
	800					T	T	T	T	T	T	T	T	T	T	T	T	T	T	
MasterPacT MTZ1 10 L1 MicroLogic	400		6.3	8	10	12.5	T	9.4	12	T	T	T	T	T	T	T	T	T	T	
	500			8	10	12.5	T	12	T	T	T	T	T	T	T	T	T	T	T	
	630				10	12.5	T	T	T	T	T	T	T	T	T	T	T	T	T	
	800					12.5	T	T	T	T	T	T	T	T	T	T	T	T	T	
	1000						T	T	T	T	T	T	T	T	T	T	T	T	T	

- T Total selectivity, up to the breaking capacity of the downstream circuit breaker.
- 4 Selectivity limit = 4 kA.
- No selectivity.

Note: Respect the basic rules of selectivity, in terms of overload, short-circuit, ground fault and earth leakage when applicable see page A-1, or check curves with Schneider Electric online "Electrical calculation tools".
When the upstream device is equipped with MicroLogic 6 or 7, the table provides selectivity limits for line to line or line to neutral short circuits, selectivity in earth fault condition shall be checked separately.

Selectivity Table

Upstream: MasterPacT MTZ1 06-10 L1 MicroLogic X

Downstream: iC40, iC60, C120, NG125, ComPacT NSXm, NSX100-630

Ue ≤ 440 V AC

A

Upstream CB		MasterPacT MTZ1 06/08/10 L1																	
Trip unit type		MicroLogic 2.0X I _{sd} = 10 I _r					MicroLogic 5.0X - 6.0X - 7.0X Inst : 15 In Standard					MicroLogic 5.0X - 6.0X - 7.0X Inst : OFF							
Trip unit rating I _n (A)		630		800		1000		630		800		1000		630		800		1000	
Setting I _r (A)		250	400	630	800	1000	250	400	630	800	1000	250	400	630	800	1000			

Downstream CB			Selectivity limit (kA)																
CB type	CB rating or Trip unit rating (A)	Trip unit setting I _r (A)																	
Trip unit type			T	T	T	T	T	T	T	T	T	T	T	T	T	T	T	T	T
iDPN, iDPN N			T	T	T	T	T	T	T	T	T	T	T	T	T	T	T	T	T
iC40, iC40 N, iCV40 N, iCV40 H			T	T	T	T	T	T	T	T	T	T	T	T	T	T	T	T	T
iC60 N/H/L, iC60 RCBO			T	T	T	T	T	T	T	T	T	T	T	T	T	T	T	T	T
C120 N/H			T	T	T	T	T	T	T	T	T	T	T	T	T	T	T	T	T
NG125 N/H			T	T	T	T	T	T	T	T	T	T	T	T	T	T	T	T	T
NG125 L			T	T	T	T	T	T	T	T	T	T	T	T	T	T	T	T	T
ComPacT NSXm E/B/F/N/H			T	T	T	T	T	T	T	T	T	T	T	T	T	T	T	T	T
ComPacT NSX100 B/FN/H/S/L/R TM-D			T	T	T	T	T	T	T	T	T	T	T	T	T	T	T	T	T
ComPacT NSX160 B/F TM-D			T	T	T	T	T	T	T	T	T	T	T	T	T	T	T	T	T
ComPacT NSX160 N/H/S/L TM-D			36	36	36	T	T	36	36	36	T	T	36	36	36	T	T		
ComPacT NSX250 B/F/N/H/S/L/R TM-D	≤ 125		20	20	20	T	T	20	20	20	T	T	20	20	20	T	T		
	160		20	20	20	T	T	20	20	20	T	T	20	20	20	T	T		
	200			20	20	T	T		20	20	T	T		20	20	T	T		
	250			20	20	T	T		20	20	T	T		20	20	T	T		
ComPacT NSX100 B/F/N/H/S/L/R MicroLogic	40		T	T	T	T	T	T	T	T	T	T	T	T	T	T	T	T	T
	100		T	T	T	T	T	T	T	T	T	T	T	T	T	T	T	T	T
ComPacT NSX160 B/F MicroLogic	40		T	T	T	T	T	T	T	T	T	T	T	T	T	T	T	T	T
	100		T	T	T	T	T	T	T	T	T	T	T	T	T	T	T	T	T
	160		T	T	T	T	T	T	T	T	T	T	T	T	T	T	T	T	T
ComPacT NSX160 N/H/S/L MicroLogic	40		36	36	36	T	T	36	36	36	T	T	36	36	36	T	T		
	100		36	36	36	T	T	36	36	36	T	T	36	36	36	T	T		
	160		36	36	36	T	T	36	36	36	T	T	36	36	36	T	T		
ComPacT NSX250 B/F/N/H/S/L/R MicroLogic	250	≤ 100	20	20	20	T	T	20	20	20	T	T	20	20	20	T	T		
		160		20	20	T	T		20	20	T	T		20	20	T	T		
		250		20	20	T	T		20	20	T	T		20	20	T	T		
ComPacT NSX400 F/N/H/S/L/R MicroLogic	400	160	6.3	6.3	6.3	10	15	6.3	6.3	6.3	10	15	6.3	6.3	6.3	10	15		
		200		6.3	6.3	10	15		6.3	6.3	10	15		6.3	6.3	10	15		
		250		6.3	6.3	10	15		6.3	6.3	10	15		6.3	6.3	10	15		
		320		6.3	6.3	10	15			6.3	10	15			6.3	10	15		
		400			6.3	10	15			6.3	10	15			6.3	10	15		
ComPacT NSX630 F/N/H/S/L/R MicroLogic	630	250		6.3	6.3	8	10		6.3	6.3	8	10		6.3	6.3	8	10		
		320			6.3	8	10			6.3	8	10			6.3	8	10		
		400			6.3	8	10			6.3	8	10			6.3	8	10		
		500				8	10				8	10				8	10		
		630					10					10					10		

- T Total selectivity, up to the breaking capacity of the downstream circuit breaker.
- 4 Selectivity limit = 4 kA.
- No selectivity.

Note: Respect the basic rules of selectivity, in terms of overload, short-circuit, ground fault and earth leakage when applicable see page A-1, or check curves with Schneider Electric online "Electrical calculation tools".
When the upstream device is equipped with MicroLogic 6 or 7, the table provides selectivity limits for line to line or line to neutral short circuits, selectivity in earth fault condition shall be checked separately.

Selectivity Table

Upstream: MasterPacT MTZ1 06-10 L1 MicroLogic X

Downstream: ComPacT NS630b-1000, MasterPacT MTZ1 06-10

Ue ≤ 440 V AC



Upstream CB		MasterPacT MTZ1 06/08/10 L1														
Trip unit type		MicroLogic 2.0X I _{sd} = 10 I _r					MicroLogic 5.0X - 6.0X - 7.0X Inst: 15 In Standard					MicroLogic 5.0X - 6.0X - 7.0X Inst: OFF				
Trip unit rating In (A)		630	800	1000	630	800	1000	630	800	1000	630	800	1000	630	800	1000
Setting I _r (A)		250	400	630	800	1000	250	400	630	800	1000	250	400	630	800	1000

Downstream CB		Selectivity limit (kA)															
CB type	Trip unit setting I _r (A)																
Trip unit type		6.3	6.3	8	10	6.3	6.3	8	10	6.3	6.3	8	10	6.3	6.3	8	10
ComPacT NS630b N/H/LB MicroLogic	250																
	320																
	400																
	500																
	630																
ComPacT NS800 N/H/LB MicroLogic	320																
	400																
	500																
	630																
	800																
ComPacT NS1000 N/H/L MicroLogic	400																
	500																
	630																
	800																
	1000																
MasterPacT MTZ1 06 H1/H2/H3/L1 MicroLogic	250																
	320																
	400																
	500																
	630																
MasterPacT MTZ1 08 H1/H2/H3/L1 MicroLogic	320																
	400																
	500																
	630																
	800																
MasterPacT MTZ1 10 H1/H2/H3/L1 MicroLogic	400																
	500																
	630																
	800																
	1000																

Selectivity limit = 4 kA.

No selectivity.

Note: Respect the basic rules of selectivity, in terms of overload, short-circuit, ground fault and earth leakage when applicable see page A-1, or check curves with Schneider Electric online "Electrical calculation tools".

When the upstream device is equipped with MicroLogic 6 or 7, the table provides selectivity limits for line to line or line to neutral short circuits, selectivity in earth fault condition shall be checked separately.

Selectivity Table

Upstream: MasterPacT MTZ2 08-20 N1/H1/H2/H2V/L1 MicroLogic X

Downstream: iC40, iC60, C120, NG125, ComPacT NSXm, NSX100-630

U_e ≤ 440 V AC

A

Upstream CB	MasterPacT MTZ2 08/10/12/16/20 N1/H1/H2/H2V/L1																				
Trip unit type	MicroLogic 2.0X I _{sd} = 10 I _r				MicroLogic 5.0X - 6.0X - 7.0X Inst: 15 I _n Standard				MicroLogic 5.0X - 6.0X - 7.0X Inst: OFF												
Trip unit rating I _n (A)	800	1000	1250	1600	2000	800	1000	1250	1600	2000	800	1000	1250	1600	2000						
Setting I _r (A)	320	630	800	1000	1250	1600	2000	320	630	800	1000	1250	1600	2000	320	630	800	1000	1250	1600	2000

Downstream CB			Selectivity limit (kA)																				
CB type	Trip unit type	CB rating or Trip unit rating (A)	Trip unit setting I _r (A)	T	T	T	T	T	T	T	T	T	T	T	T	T	T	T	T	T	T	T	
iC40, iC40 N, iCV40 N, iCV40 H				T	T	T	T	T	T	T	T	T	T	T	T	T	T	T	T	T	T	T	
iC60 N/H/L, iC60 RCBO				T	T	T	T	T	T	T	T	T	T	T	T	T	T	T	T	T	T	T	
iC120 N/H				T	T	T	T	T	T	T	T	T	T	T	T	T	T	T	T	T	T	T	
NG125 N/H				T	T	T	T	T	T	T	T	T	T	T	T	T	T	T	T	T	T	T	
NG125 L				T	T	T	T	T	T	T	T	T	T	T	T	T	T	T	T	T	T	T	
ComPacT NSXm E/B/F/N/H				T	T	T	T	T	T	T	T	T	T	T	T	T	T	T	T	T	T	T	
ComPacT NSX100 B/F/N/H/S/L/R TM-D, TM-G				T	T	T	T	T	T	T	T	T	T	T	T	T	T	T	T	T	T	T	
ComPacT NSX160 B/F/N/H/S/L TM-D, TM-G				T	T	T	T	T	T	T	T	T	T	T	T	T	T	T	T	T	T	T	
ComPacT NSX250 B/F/N/H/S/L/R TM-D, TM-G	≤ 125	160		T	T	T	T	T	T	T	T	T	T	T	T	T	T	T	T	T	T	T	
		200		T	T	T	T	T	T	T	T	T	T	T	T	T	T	T	T	T	T	T	
		250			T	T	T	T	T	T	T	T	T	T	T	T	T	T	T	T	T	T	T
		40		T	T	T	T	T	T	T	T	T	T	T	T	T	T	T	T	T	T	T	T
ComPacT NSX100 B/F/N/H/S/L/R MicroLogic	40	100		T	T	T	T	T	T	T	T	T	T	T	T	T	T	T	T	T	T	T	
		160		T	T	T	T	T	T	T	T	T	T	T	T	T	T	T	T	T	T	T	T
		160		T	T	T	T	T	T	T	T	T	T	T	T	T	T	T	T	T	T	T	T
ComPacT NSX250 B/F/N/H/S/L/R MicroLogic	250	≤ 100		T	T	T	T	T	T	T	T	T	T	T	T	T	T	T	T	T	T	T	
		160		T	T	T	T	T	T	T	T	T	T	T	T	T	T	T	T	T	T	T	T
		250			T	T	T	T	T	T	T	T	T	T	T	T	T	T	T	T	T	T	T
ComPacT NSX400 F/N/H/S/L/R MicroLogic	400	160		T	T	T	T	T	T	T	T	T	T	T	T	T	T	T	T	T	T	T	
		200		T	T	T	T	T	T	T	T	T	T	T	T	T	T	T	T	T	T	T	T
		250		T	T	T	T	T	T	T	T	T	T	T	T	T	T	T	T	T	T	T	T
		320			T	T	T	T	T	T	T	T	T	T	T	T	T	T	T	T	T	T	T
		400			T	T	T	T	T	T	T	T	T	T	T	T	T	T	T	T	T	T	T
ComPacT NSX630 F/N/H/S/L/R MicroLogic	630	250		T	T	T	T	T	T	T	T	T	T	T	T	T	T	T	T	T	T	T	
		320			T	T	T	T	T	T	T	T	T	T	T	T	T	T	T	T	T	T	T
		400			T	T	T	T	T	T	T	T	T	T	T	T	T	T	T	T	T	T	T
		500				T	T	T	T	T	T	T	T	T	T	T	T	T	T	T	T	T	T
		630				T	T	T	T	T	T	T	T	T	T	T	T	T	T	T	T	T	T

Total selectivity, up to the breaking capacity of the downstream circuit breaker.
 No selectivity.

Note: Respect the basic rules of selectivity, in terms of overload, short-circuit, ground fault and earth leakage when applicable see page A-1, or check curves with Schneider Electric online “Electrical calculation tools”.

When the upstream device is equipped with MicroLogic 6 or 7, the table provides selectivity limits for line to line or line to neutral short circuits, selectivity in earth fault condition shall be checked separately.

Selectivity Table

Upstream: MasterPacT MTZ2 08-20 N1/H1/H2/H2V MicroLogic X

Downstream: ComPacT NS630b-1600 MicroLogic A/E/P

Ue ≤ 440 V AC



Upstream CB	MasterPacT MTZ2 08/10/12/16/20 N1/H1/H2/H2V																	
Trip unit type	MicroLogic 2.0X Isd = 10 Ir						MicroLogic 5.0X - 6.0X - 7.0X Inst: 15 In Standard						MicroLogic 5.0X - 6.0X - 7.0X Inst: OFF					
Trip unit rating In (A)	800	1000	1250	1600	2000		800	1000	1250	1600	2000		800	1000	1250	1600	2000	
Setting Ir (A)	630	800	1000	1250	1600	2000	630	800	1000	1250	1600	2000	630	800	1000	1250	1600	2000

Downstream CB		Selectivity limit (kA)																	
CB type	Trip unit setting Ir (A)																		
ComPacT NS630bN/H MicroLogic	250	6.3	8	10	12.5	16	20	12	12	15	18.75	24	30	T	T	T	T	T	T
	320	6.3	8	10	12.5	16	20	12	12	15	18.75	24	30	T	T	T	T	T	T
	400	6.3	8	10	12.5	16	20	12	12	15	18.75	24	30	T	T	T	T	T	T
	500		8	10	12.5	16	20		12	15	18.75	24	30		T	T	T	T	T
	630			10	12.5	16	20			15	18.75	24	30			T	T	T	T
ComPacT NS800N/H MicroLogic	320	6.3	8	10	12.5	16	20	12	12	15	18.75	24	30	T	T	T	T	T	T
	400	6.3	8	10	12.5	16	20	12	12	15	18.75	24	30	T	T	T	T	T	T
	500		8	10	12.5	16	20		12	15	18.75	24	30		T	T	T	T	T
	630			10	12.5	16	20			15	18.75	24	30			T	T	T	T
	800				12.5	16	20				18.75	24	30				T	T	T
ComPacT NS1000N/H MicroLogic	400	6.3	8	10	12.5	16	20	12	12	15	18.75	24	30	T	T	T	T	T	T
	500		8	10	12.5	16	20		12	15	18.75	24	30		T	T	T	T	T
	630			10	12.5	16	20			15	18.75	24	30			T	T	T	T
	800				12.5	16	20				18.75	24	30				T	T	T
	1000					16	20					24	30					T	T
ComPacT NS1250N/H MicroLogic	500		8	10	12.5	16	20		12	15	18.75	24	30		T	T	T	T	T
	630			10	12.5	16	20			15	18.75	24	30			T	T	T	T
	800				12.5	16	20				18.75	24	30				T	T	T
	1000					16	20					24	30					T	T
	1250						20						30						T
ComPacT NS1600N/H MicroLogic	630			10	12.5	16	20			15	18.75	24	30			T	T	T	T
	800				12.5	16	20				18.75	24	30				T	T	T
	960					16	20					24	30					T	T
	1250						20						30						T
	1600													30					
ComPacT NS630bL/LB MicroLogic	250	6.3	8	T	T	T	T	T	T	T	T	T	T	T	T	T	T	T	T
	320	6.3	8	T	T	T	T	T	T	T	T	T	T	T	T	T	T	T	T
	400	6.3	8	T	T	T	T	T	T	T	T	T	T	T	T	T	T	T	T
	500		8	T	T	T	T		T	T	T	T	T		T	T	T	T	T
	630			T	T	T	T			T	T	T	T			T	T	T	T
ComPacT NS800 L/LB MicroLogic	320	6.3	8	10	T	T	T	T	T	T	T	T	T	T	T	T	T	T	T
	400	6.3	8	10	T	T	T	T	T	T	T	T	T	T	T	T	T	T	T
	500		8	10	T	T	T		T	T	T	T	T		T	T	T	T	T
	630			10	T	T	T			T	T	T	T			T	T	T	T
	800				T	T	T				T	T	T				T	T	T
ComPacT NS1000L MicroLogic	400	6.3	8	10	12.5	T	T	12	12	T	T	T	T	T	T	T	T	T	T
	500		8	10	12.5	T	T		12	T	T	T	T		T	T	T	T	T
	630			10	12.5	T	T			T	T	T	T			T	T	T	T
	800				12.5	T	T				T	T	T				T	T	T
	1000					T	T					T	T					T	T

- T Total selectivity, up to the breaking capacity of the downstream circuit breaker.
- 4 Selectivity limit = 4 kA.
- No selectivity.

Note: Respect the basic rules of selectivity, in terms of overload, short-circuit, ground fault and earth leakage when applicable see page A-1, or check curves with Schneider Electric online "Electrical calculation tools".
When the upstream device is equipped with MicroLogic 6 or 7, the table provides selectivity limits for line to line or line to neutral short circuits, selectivity in earth fault condition shall be checked separately.

Selectivity Table

Upstream: MasterPacT MTZ2 08-20 N1/H1/H2/H2V MicroLogic X

Downstream: MasterPacT MTZ1 06-16

Ue ≤ 440 V AC

A

Upstream CB	MasterPacT MTZ2 08/10/12/16/20 N1/H1/H2/H2V																	
Trip unit type	MicroLogic 2.0X I _{sd} = 10 I _r						MicroLogic 5.0X - 6.0X - 7.0X Inst : 15 I _n Standard						MicroLogic 5.0X - 6.0X - 7.0X Inst : OFF					
Trip unit rating I _n (A)	800	1000	1250	1600	2000	2000	800	1000	1250	1600	2000	2000	800	1000	1250	1600	2000	
Setting I _r (A)	630	800	1000	1250	1600	2000	630	800	1000	1250	1600	2000	630	800	1000	1250	1600	2000

Downstream CB		Selectivity limit (kA)																	
CB type	Trip unit setting I _r (A)																		
Trip unit type																			
MasterPacT MTZ1 06 H1/H2/H3 MicroLogic	250	6.3	8	10	12.5	16	20	12	12	15	18.75	24	30	T	T	T	T	T	T
	320	6.3	8	10	12.5	16	20	12	12	15	18.75	24	30	T	T	T	T	T	T
	400	6.3	8	10	12.5	16	20	12	12	15	18.75	24	30	T	T	T	T	T	T
	500		8	10	12.5	16	20		12	15	18.75	24	30		T	T	T	T	T
	630			10	12.5	16	20			15	18.75	24	30			T	T	T	T
MasterPacT MTZ1 08 H1/H2/H3 MicroLogic	320	6.3	8	10	12.5	16	20	12	12	15	18.75	24	30	T	T	T	T	T	T
	400	6.3	8	10	12.5	16	20	12	12	15	18.75	24	30	T	T	T	T	T	T
	500		8	10	12.5	16	20		12	15	18.75	24	30		T	T	T	T	T
	630			10	12.5	16	20			15	18.75	24	30			T	T	T	T
	800				12.5	16	20				18.75	24	30				T	T	T
MasterPacT MTZ1 10 H1/H2/H3 MicroLogic	400	6.3	8	10	12.5	16	20	12	12	15	18.75	24	30	T	T	T	T	T	T
	500		8	10	12.5	16	20		12	15	18.75	24	30		T	T	T	T	T
	630			10	12.5	16	20			15	18.75	24	30			T	T	T	T
	800				12.5	16	20				18.75	24	30				T	T	T
	1000					16	20					24	30					T	T
MasterPacT MTZ1 12 H1/H2/H3 MicroLogic	500		8	10	12.5	16	20		12	15	18.75	24	30		T	T	T	T	T
	630			10	12.5	16	20			15	18.75	24	30			T	T	T	T
	800				12.5	16	20				18.75	24	30				T	T	T
	1000					16	20					24	30					T	T
	1250						20						30						T
MasterPacT MTZ1 16 H1/H2/H3 MicroLogic	630			10	12.5	16	20			15	18.75	24	30			T	T	T	T
	800				12.5	16	20				18.75	24	30				T	T	T
	960					16	20					24	30					T	T
	1250						20						30						T
	1600																		
MasterPacT MTZ1 06 L1 MicroLogic	250	6.3	8	T	T	T	T	T	T	T	T	T	T	T	T	T	T	T	T
	320	6.3	8	T	T	T	T	T	T	T	T	T	T	T	T	T	T	T	T
	400	6.3	8	T	T	T	T	T	T	T	T	T	T	T	T	T	T	T	T
	500		8	T	T	T	T		T	T	T	T	T		T	T	T	T	T
	630			T	T	T	T			T	T	T	T			T	T	T	T
MasterPacT MTZ1 08 L1 MicroLogic	320	6.3	8	10	T	T	T	T	T	T	T	T	T	T	T	T	T	T	T
	400	6.3	8	10	T	T	T	T	T	T	T	T	T	T	T	T	T	T	T
	500		8	10	T	T	T		T	T	T	T	T		T	T	T	T	T
	630			10	T	T	T			T	T	T	T			T	T	T	T
	800				T	T	T				T	T	T				T	T	T
MasterPacT MTZ1 10 L1 MicroLogic	400	6.3	8	10	12.5	T	T	12	12	T	T	T	T	T	T	T	T	T	T
	500		8	10	12.5	T	T		12	T	T	T	T		T	T	T	T	T
	630			10	12.5	T	T			T	T	T	T			T	T	T	T
	800				12.5	T	T				T	T	T				T	T	T
	1000					T	T					T	T					T	T

- T Total selectivity, up to the breaking capacity of the downstream circuit breaker.
- 4 Selectivity limit = 4 kA.
- No selectivity.

Note: Respect the basic rules of selectivity, in terms of overload, short-circuit, ground fault and earth leakage when applicable see page A-1, or check curves with Schneider Electric online "Electrical calculation tools".

When the upstream device is equipped with MicroLogic 6 or 7, the table provides selectivity limits for line to line or line to neutral short circuits, selectivity in earth fault condition shall be checked separately.

Selectivity Table

Upstream: MasterPacT MTZ2 08-20 N1/H1 MicroLogic X

Downstream: MasterPacT MTZ2 08-20

Ue ≤ 440 V AC



Upstream CB	MasterPacT MTZ2 08/10/12/16/20 N1/H1																	
Trip unit type	MicroLogic 2.0X I _{sd} = 10 Ir						MicroLogic 5.0X - 6.0X - 7.0X Inst : 15 In Standard						MicroLogic 5.0X - 6.0X - 7.0X Inst : OFF					
	800	1000	1250	1600	2000	2000	800	1000	1250	1600	2000	2000	800	1000	1250	1600	2000	
Trip unit rating In (A)	630	800	1000	1250	1600	2000	630	800	1000	1250	1600	2000	630	800	1000	1250	1600	2000
Setting Ir (A)	630	800	1000	1250	1600	2000	630	800	1000	1250	1600	2000	630	800	1000	1250	1600	2000

Downstream CB		Selectivity limit (kA)																		
CB type	Trip unit type	Trip unit setting Ir (A)																		
MasterPacT MTZ2 08 N1/H1/L1 MicroLogic	320	6.3	8	10	12.5	16	20	12	12	15	18.75	24	30	T	T	T	T	T	T	
	400	6.3	8	10	12.5	16	20	12	12	15	18.75	24	30	T	T	T	T	T	T	
	500		8	10	12.5	16	20		12	15	18.75	24	30		T	T	T	T	T	
	630			10	12.5	16	20			15	18.75	24	30			T	T	T	T	
	800				12.5	16	20				18.75	24	30				T	T	T	
MasterPacT MTZ2 10 N1/H1/L1 MicroLogic	400	6.3	8	10	12.5	16	20	12	12	15	18.75	24	30	T	T	T	T	T	T	
	500		8	10	12.5	16	20		12	15	18.75	24	30		T	T	T	T	T	
	630			10	12.5	16	20			15	18.75	24	30			T	T	T	T	
	800				12.5	16	20				18.75	24	30				T	T	T	
	1000					16	20					24	30					T	T	
MasterPacT MTZ2 12 N1/H1/L1 MicroLogic	500		8	10	12.5	16	20		12	15	18.75	24	30		T	T	T	T	T	
	630			10	12.5	16	20			15	18.75	24	30			T	T	T	T	
	800				12.5	16	20				18.75	24	30				T	T	T	
	1000					16	20					24	30					T	T	
	1250						20						30						T	
MasterPacT MTZ2 16 N1/H1/L1 MicroLogic	630			10	12.5	16	20			15	18.75	24	30			T	T	T	T	
	800				12.5	16	20				18.75	24	30				T	T	T	
	960					16	20					24	30					T	T	
	1250						20						30						T	
	1600													30					T	
MasterPacT MTZ2 20 N1/H1/L1 MicroLogic	800				12.5	16	20				18.75	24	30				T	T	T	
	1000					16	20					24	30					T	T	
	1250						20						30						T	
	1600													30					T	
	MasterPacT MTZ2 08 H2/H2V MicroLogic	320	6.3	8	10	12.5	16	20	12	12	15	18.75	24	30	T	T	T	T	T	T
400	6.3	8	10	12.5	16	20	12	12	15	18.75	24	30	T	T	T	T	T	T		
500		8	10	12.5	16	20		12	15	18.75	24	30		T	T	T	T	T		
630			10	12.5	16	20			15	18.75	24	30			T	T	T	T		
800				12.5	16	20				18.75	24	30				T	T	T		
MasterPacT MTZ2 10 H2/H2V MicroLogic	400	6.3	8	10	12.5	16	20	12	12	15	18.75	24	30	T	T	T	T	T	T	
	500		8	10	12.5	16	20		12	15	18.75	24	30		T	T	T	T	T	
	630			10	12.5	16	20			15	18.75	24	30			T	T	T	T	
	800				12.5	16	20				18.75	24	30				T	T	T	
	1000					16	20					24	30					T	T	
MasterPacT MTZ2 12 H2/H2V MicroLogic	500		8	10	12.5	16	20		12	15	18.75	24	30		T	T	T	T	T	
	630			10	12.5	16	20			15	18.75	24	30			T	T	T	T	
	800				12.5	16	20				18.75	24	30				T	T	T	
	1000					16	20					24	30					T	T	
	1250						20						30						T	
MasterPacT MTZ2 16 H2/H2V MicroLogic	630			10	12.5	16	20			15	18.75	24	30			T	T	T	T	
	800				12.5	16	20				18.75	24	30				T	T	T	
	960					16	20					24	30					T	T	
	1250						20						30						T	
	1600													30					T	
MasterPacT MTZ2 20 H2/H2V MicroLogic	800				12.5	16	20				18.75	24	30				T	T	T	
	1000					16	20					24	30					T	T	
	1250						20						30						T	
	1600													30					T	

- T Total selectivity, up to the breaking capacity of the downstream circuit breaker.
- 4 Selectivity limit = 4 kA.
- No selectivity.

Note: Respect the basic rules of selectivity, in terms of overload, short-circuit, ground fault and earth leakage when applicable see page A-1, or check curves with Schneider Electric online "Electrical calculation tools".
When the upstream device is equipped with MicroLogic 6 or 7, the table provides selectivity limits for line to line or line to neutral short circuits, selectivity in earth fault condition shall be checked separately.

Selectivity Table

Upstream: MasterPacT MTZ2 08-20 H2 MicroLogic X

Downstream: MasterPacT MTZ2 08-20

Ue ≤ 440 V AC

A

Upstream CB	MasterPacT MTZ2 08/10/12/16/20 H2																	
Trip unit type	MicroLogic 2.0X I _{sd} = 10 I _r						MicroLogic 5.0X - 6.0X - 7.0X Inst: 15 In Standard				MicroLogic 5.0X - 6.0X - 7.0X Inst: OFF							
Trip unit rating I _n (A)	800	1000	1250	1600	2000	800	1000	1250	1600	2000	800	1000	1250	1600	2000			
Setting I _r (A)	630	800	1000	1250	1600	2000	630	800	1000	1250	1600	2000	630	800	1000	1250	1600	2000

Downstream CB		Selectivity limit (kA)																		
CB type	Trip unit type	Trip unit setting I _r (A)																		
MasterPacT MTZ2 08 N1/H1/L1 MicroLogic	320	6.3	8	10	12.5	16	20	12	12	15	18.75	24	30	T	T	T	T	T	T	
	400	6.3	8	10	12.5	16	20	12	12	15	18.75	24	30	T	T	T	T	T	T	
	500		8	10	12.5	16	20		12	15	18.75	24	30		T	T	T	T	T	
	630			10	12.5	16	20			15	18.75	24	30			T	T	T	T	
	800				12.5	16	20				18.75	24	30				T	T	T	
MasterPacT MTZ2 10 N1/H1/L1 MicroLogic	400	6.3	8	10	12.5	16	20	12	12	15	18.75	24	30	T	T	T	T	T	T	
	500		8	10	12.5	16	20		12	15	18.75	24	30		T	T	T	T	T	
	630			10	12.5	16	20			15	18.75	24	30			T	T	T	T	
	800				12.5	16	20				18.75	24	30				T	T	T	
	1000					16	20					24	30					T	T	
MasterPacT MTZ2 12 N1/H1/L1 MicroLogic	500		8	10	12.5	16	20		12	15	18.75	24	30		T	T	T	T	T	
	630			10	12.5	16	20			15	18.75	24	30			T	T	T	T	
	800				12.5	16	20				18.75	24	30				T	T	T	
	1000					16	20					24	30					T	T	
	1250						20						30						T	
MasterPacT MTZ2 16 N1/H1/L1 MicroLogic	630			10	12.5	16	20			15	18.75	24	30			T	T	T	T	
	800				12.5	16	20				18.75	24	30				T	T	T	
	960					16	20					24	30					T	T	
	1250						20						30						T	
	1600																		T	
MasterPacT MTZ2 20 N1/H1/L1 MicroLogic	800				12.5	16	20				18.75	24	30				T	T	T	
	1000					16	20					24	30					T	T	
	1250						20						30						T	
	1600																		T	
																				T
MasterPacT MTZ2 08 H2/H2V MicroLogic	320	6.3	8	10	12.5	16	20	12	12	15	18.75	24	30	85	85	85	85	85	85	
	400	6.3	8	10	12.5	16	20	12	12	15	18.75	24	30	85	85	85	85	85	85	
	500		8	10	12.5	16	20		12	15	18.75	24	30		85	85	85	85	85	
	630			10	12.5	16	20			15	18.75	24	30			85	85	85	85	
	800				12.5	16	20				18.75	24	30				85	85	85	
MasterPacT MTZ2 10 H2/H2V MicroLogic	400	6.3	8	10	12.5	16	20	12	12	15	18.75	24	30	85	85	85	85	85	85	
	500		8	10	12.5	16	20		12	15	18.75	24	30		85	85	85	85	85	
	630			10	12.5	16	20			15	18.75	24	30			85	85	85	85	
	800				12.5	16	20				18.75	24	30				85	85	85	
	1000					16	20					24	30					85	85	
MasterPacT MTZ2 12 H2/H2V MicroLogic	500		8	10	12.5	16	20		12	15	18.75	24	30		85	85	85	85	85	
	630			10	12.5	16	20			15	18.75	24	30			85	85	85	85	
	800				12.5	16	20				18.75	24	30				85	85	85	
	1000					16	20					24	30					85	85	
	1250						20						30						85	
MasterPacT MTZ2 16 H2/H2V MicroLogic	630			10	12.5	16	20			15	18.75	24	30		85	85	85	85	85	
	800				12.5	16	20				18.75	24	30			85	85	85	85	
	960					16	20					24	30				85	85	85	
	1250						20						30					85	85	
	1600																		85	
MasterPacT MTZ2 20 H2/H2V MicroLogic	800				12.5	16	20				18.75	24	30				85	85	85	
	1000					16	20					24	30					85	85	
	1250						20						30						85	
	1600																		85	

- T Total selectivity, up to the breaking capacity of the downstream circuit breaker.
- 4 Selectivity limit = 4 kA.
- No selectivity.

Note: Respect the basic rules of selectivity, in terms of overload, short-circuit, ground fault and earth leakage when applicable see page A-1, or check curves with Schneider Electric online "Electrical calculation tools".

When the upstream device is equipped with MicroLogic 6 or 7, the table provides selectivity limits for line to line or line to neutral short circuits, selectivity in earth fault condition shall be checked separately.

Selectivity Table

Upstream: MasterPacT MTZ2 08-20 H2V MicroLogic X

Downstream: MasterPacT MTZ2 08-20

Ue ≤ 440 V AC



Upstream CB	MasterPacT MTZ2 08/10/12/16/20 H2V																	
Trip unit type	MicroLogic 2.0X I _{sd} = 10 I _r						MicroLogic 5.0X - 6.0X - 7.0X Inst : 15 In Standard						MicroLogic 5.0X - 6.0X - 7.0X Inst : OFF					
Trip unit rating In (A)	800	1000	1250	1600	2000	800	1000	1250	1600	2000	800	1000	1250	1600	2000			
Setting I _r (A)	630	800	1000	1250	1600	2000	630	800	1000	1250	1600	2000	630	800	1000	1250	1600	2000

Downstream CB		Selectivity limit (kA)																		
CB type	Trip unit type	Trip unit setting I _r (A)																		
MasterPacT MTZ2 08 N1/H1/L1 MicroLogic	320	6.3	8	10	12.5	16	20	12	12	15	18.75	24	30	T	T	T	T	T	T	
	400	6.3	8	10	12.5	16	20	12	12	15	18.75	24	30	T	T	T	T	T	T	
	500		8	10	12.5	16	20		12	15	18.75	24	30		T	T	T	T	T	
	630			10	12.5	16	20			15	18.75	24	30			T	T	T	T	
	800				12.5	16	20				18.75	24	30				T	T	T	
MasterPacT MTZ2 10 N1/H1/L1 MicroLogic	400	6.3	8	10	12.5	16	20	12	12	15	18.75	24	30	T	T	T	T	T	T	
	500		8	10	12.5	16	20		12	15	18.75	24	30		T	T	T	T	T	
	630			10	12.5	16	20			15	18.75	24	30			T	T	T	T	
	800				12.5	16	20				18.75	24	30				T	T	T	
	1000					16	20					24	30					T	T	
MasterPacT MTZ2 12 N1/H1/L1 MicroLogic	500		8	10	12.5	16	20		12	15	18.75	24	30		T	T	T	T	T	
	630			10	12.5	16	20			15	18.75	24	30			T	T	T	T	
	800				12.5	16	20				18.75	24	30				T	T	T	
	1000					16	20					24	30					T	T	
	1250						20						30						T	
MasterPacT MTZ2 16 N1/H1/L1 MicroLogic	630			10	12.5	16	20			15	18.75	24	30			T	T	T	T	
	800				12.5	16	20				18.75	24	30				T	T	T	
	960					16	20					24	30					T	T	
	1250						20						30						T	
	1600													30						
MasterPacT MTZ2 20 N1/H1/L1 MicroLogic	800				12.5	16	20				18.75	24	30				T	T	T	
	1000					16	20					24	30					T	T	
	1250						20						30						T	
	1600																			
	2000																			
MasterPacT MTZ2 08 H2/H2V MicroLogic	320	6.3	8	10	12.5	16	20	12	12	15	18.75	24	30	T	T	T	T	T	T	
	400	6.3	8	10	12.5	16	20	12	12	15	18.75	24	30	T	T	T	T	T	T	
	500		8	10	12.5	16	20		12	15	18.75	24	30		T	T	T	T	T	
	630			10	12.5	16	20			15	18.75	24	30			T	T	T	T	
	800				12.5	16	20				18.75	24	30				T	T	T	
MasterPacT MTZ2 10 H2/H2V MicroLogic	400	6.3	8	10	12.5	16	20	12	12	15	18.75	24	30	T	T	T	T	T	T	
	500		8	10	12.5	16	20		12	15	18.75	24	30		T	T	T	T	T	
	630			10	12.5	16	20			15	18.75	24	30			T	T	T	T	
	800				12.5	16	20				18.75	24	30				T	T	T	
	1000					16	20					24	30					T	T	
MasterPacT MTZ2 12 H2/H2V MicroLogic	500		8	10	12.5	16	20		12	15	18.75	24	30		T	T	T	T	T	
	630			10	12.5	16	20			15	18.75	24	30			T	T	T	T	
	800				12.5	16	20				18.75	24	30				T	T	T	
	1000					16	20					24	30					T	T	
	1250						20						30						T	
MasterPacT MTZ2 16 H2/H2V MicroLogic	630			10	12.5	16	20			15	18.75	24	30			T	T	T	T	
	800				12.5	16	20				18.75	24	30				T	T	T	
	960					16	20					24	30					T	T	
	1250						20						30						T	
	1600													30						
MasterPacT MTZ2 20 H2/H2V MicroLogic	800				12.5	16	20				18.75	24	30				T	T	T	
	1000					16	20					24	30					T	T	
	1250						20						30						T	
	1600																			

- T Total selectivity, up to the breaking capacity of the downstream circuit breaker.
- 4 Selectivity limit = 4 kA.
- No selectivity.

Note: Respect the basic rules of selectivity, in terms of overload, short-circuit, ground fault and earth leakage when applicable see page A-1, or check curves with Schneider Electric online "Electrical calculation tools".
When the upstream device is equipped with MicroLogic 6 or 7, the table provides selectivity limits for line to line or line to neutral short circuits, selectivity in earth fault condition shall be checked separately.

Selectivity Table

Upstream: MasterPacT MTZ2 08-20 L1 MicroLogic X

Downstream: MasterPacT MTZ1 06 - 16 MicroLogic X

Ue ≤ 440 V AC

A

Upstream CB	MasterPacT MTZ2 08/10/12/16/20 L1																	
Trip unit type	MicroLogic 2.0X I _{sd} = 10 I _r						MicroLogic 5.0X - 6.0X - 7.0X Inst : 15 I _n Standard						MicroLogic 5.0X - 6.0X - 7.0X Inst : OFF					
	800	1000	1250	1600	2000	2000	800	1000	1250	1600	2000	2000	800	1000	1250	1600	2000	
Trip unit rating I _n (A)	630	800	1000	1250	1600	2000	630	800	1000	1250	1600	2000	630	800	1000	1250	1600	2000
Setting I _r (A)	630	800	1000	1250	1600	2000	630	800	1000	1250	1600	2000	630	800	1000	1250	1600	2000

Downstream CB		Selectivity limit (kA)																	
CB type	Trip unit setting I _r (A)																		
Trip unit type		6.3	8	10	12.5	16	20	12	12	15	18.75	24	30	37	37	37	37	37	37
MasterPacT MTZ1 06 H1/H2/H3 MicroLogic	250	6.3	8	10	12.5	16	20	12	12	15	18.75	24	30	37	37	37	37	37	37
	320	6.3	8	10	12.5	16	20	12	12	15	18.75	24	30	37	37	37	37	37	37
	400	6.3	8	10	12.5	16	20	12	12	15	18.75	24	30	37	37	37	37	37	37
	500		8	10	12.5	16	20		12	15	18.75	24	30		37	37	37	37	37
	630			10	12.5	16	20			15	18.75	24	30			37	37	37	37
MasterPacT MTZ1 08 H1/H2/H3 MicroLogic	320	6.3	8	10	12.5	16	20	12	12	15	18.75	24	30	37	37	37	37	37	37
	400	6.3	8	10	12.5	16	20	12	12	15	18.75	24	30	37	37	37	37	37	37
	500		8	10	12.5	16	20		12	15	18.75	24	30		37	37	37	37	37
	630			10	12.5	16	20			15	18.75	24	30			37	37	37	37
	800				12.5	16	20				18.75	24	30			37	37	37	37
MasterPacT MTZ1 10 H1/H2/H3 MicroLogic	400	6.3	8	10	12.5	16	20	12	12	15	18.75	24	30	37	37	37	37	37	37
	500		8	10	12.5	16	20		12	15	18.75	24	30		37	37	37	37	37
	630			10	12.5	16	20			15	18.75	24	30			37	37	37	37
	800				12.5	16	20				18.75	24	30				37	37	37
	1000					16	20					24	30					37	37
MasterPacT MTZ1 12 H1/H2/H3 MicroLogic	500		8	10	12.5	16	20		12	15	18.75	24	30		37	37	37	37	37
	630			10	12.5	16	20			15	18.75	24	30			37	37	37	37
	800				12.5	16	20				18.75	24	30				37	37	37
	1000					16	20					24	30					37	37
	1250						20					30							37
MasterPacT MTZ1 16 H1/H2/H3 MicroLogic	630			10	12.5	16	20			15	18.75	24	30			37	37	37	37
	800				12.5	16	20				18.75	24	30				37	37	37
	960					16	20					24	30					37	37
	1250						20						30						37
	1600												30						37
MasterPacT MTZ1 06 L1 MicroLogic	250	6.3	8	10	T	T	T	T	T	T	T	T	T	T	T	T	T	T	T
	320	6.3	8	10	T	T	T	T	T	T	T	T	T	T	T	T	T	T	T
	400	6.3	8	10	T	T	T	T	T	T	T	T	T	T	T	T	T	T	T
	500		8	10	T	T	T		T	T	T	T	T		T	T	T	T	T
	630			10	T	T			T	T	T	T			T	T	T	T	
MasterPacT MTZ1 08 L1 MicroLogic	320	6.3	8	10	12.5	T	T	12	12	T	T	T	T	T	T	T	T	T	T
	400	6.3	8	10	12.5	T	T	12	12	T	T	T	T	T	T	T	T	T	T
	500		8	10	12.5	T	T		12	T	T	T	T		T	T	T	T	T
	630			10	12.5	T	T			T	T	T	T			T	T	T	T
	800				12.5	T	T			T	T	T				T	T	T	
MasterPacT MTZ1 10 L1 MicroLogic	400	6.3	8	10	12.5	T	T	12	12	T	T	T	T	T	T	T	T	T	T
	500		8	10	12.5	T	T		12	T	T	T	T		T	T	T	T	T
	630			10	12.5	T	T			T	T	T	T			T	T	T	T
	800				12.5	T	T			T	T	T	T				T	T	T
	1000					T	T				T	T					T	T	

- T Total selectivity, up to the breaking capacity of the downstream circuit breaker.
- 4 Selectivity limit = 4 kA.
- No selectivity.

Note: Respect the basic rules of selectivity, in terms of overload, short-circuit, ground fault and earth leakage when applicable see page A-1, or check curves with Schneider Electric online "Electrical calculation tools".

When the upstream device is equipped with MicroLogic 6 or 7, the table provides selectivity limits for line to line or line to neutral short circuits, selectivity in earth fault condition shall be checked separately.

Selectivity Table

Upstream: MasterPacT MTZ2 08-20 L1 MicroLogic X

Downstream: ComPacT NS630b-1600 MicroLogic A/E/P

Ue ≤ 440 V AC



Upstream CB		MasterPacT MTZ2 08/10/12/16/20 L1																	
Trip unit type		MicroLogic 2.0X Isd = 10 Ir						MicroLogic 5.0X - 6.0X - 7.0X Inst: 15 In Standard						MicroLogic 5.0X - 6.0X - 7.0X Inst: OFF					
Trip unit rating In (A)		800	1000	1250	1600	2000	800	1000	1250	1600	2000	800	1000	1250	1600	2000			
Setting Ir (A)		630	800	1000	1250	1600	2000	630	800	1000	1250	1600	2000	630	800	1000	1250	1600	2000

Downstream CB		Selectivity limit (kA)																	
CB type	Trip unit setting Ir (A)																		
ComPacT NS630bN/H MicroLogic	250	6.3	8	10	12.5	16	20	12	12	15	18.75	24	30	37	37	37	37	37	37
	320	6.3	8	10	12.5	16	20	12	12	15	18.75	24	30	37	37	37	37	37	37
	400	6.3	8	10	12.5	16	20	12	12	15	18.75	24	30	37	37	37	37	37	37
	500		8	10	12.5	16	20		12	15	18.75	24	30		37	37	37	37	37
	630			10	12.5	16	20			15	18.75	24	30			37	37	37	37
ComPacT NS800N/H MicroLogic	320	6.3	8	10	12.5	16	20	12	12	15	18.75	24	30	37	37	37	37	37	37
	400	6.3	8	10	12.5	16	20	12	12	15	18.75	24	30	37	37	37	37	37	37
	500		8	10	12.5	16	20		12	15	18.75	24	30		37	37	37	37	37
	630			10	12.5	16	20			15	18.75	24	30			37	37	37	37
	800				12.5	16	20				18.75	24	30				37	37	37
ComPacT NS1000N/H MicroLogic	400	6.3	8	10	12.5	16	20	12	12	15	18.75	24	30	37	37	37	37	37	37
	500		8	10	12.5	16	20		12	15	18.75	24	30		37	37	37	37	37
	630			10	12.5	16	20			15	18.75	24	30			37	37	37	37
	800				12.5	16	20				18.75	24	30				37	37	37
	1000					16	20					24	30					37	37
ComPacT NS1250N/H MicroLogic	500		8	10	12.5	16	20		12	15	18.75	24	30		37	37	37	37	37
	630			10	12.5	16	20			15	18.75	24	30			37	37	37	37
	800				12.5	16	20				18.75	24	30				37	37	37
	1000					16	20					24	30					37	37
	1250						20						30						37
ComPacT NS1600N/H MicroLogic	630			10	12.5	16	20			15	18.75	24	30			37	37	37	37
	800				12.5	16	20				18.75	24	30				37	37	37
	960					16	20					24	30					37	37
	1250						20						30						37
	1600													30					37
ComPacT NS630bL/LB MicroLogic	250	6.3	8	10	T	T	T	T	T	T	T	T	T	T	T	T	T	T	T
	320	6.3	8	10	T	T	T	T	T	T	T	T	T	T	T	T	T	T	T
	400	6.3	8	10	T	T	T	T	T	T	T	T	T	T	T	T	T	T	T
	500		8	10	T	T	T		T	T	T	T	T		T	T	T	T	T
	630			10	T	T	T			T	T	T	T			T	T	T	T
ComPacT NS800L/LB MicroLogic	320	6.3	8	10	12.5	T	T	12	12	T	T	T	T	T	T	T	T	T	T
	400	6.3	8	10	12.5	T	T	12	12	T	T	T	T	T	T	T	T	T	T
	500		8	10	12.5	T	T		12	T	T	T	T		T	T	T	T	T
	630			10	12.5	T	T			T	T	T	T			T	T	T	T
	800				12.5	T	T				T	T	T				T	T	T
ComPacT NS1000L MicroLogic	400	6.3	8	10	12.5	T	T	12	12	T	T	T	T	T	T	T	T	T	T
	500		8	10	12.5	T	T		12	T	T	T	T		T	T	T	T	T
	630			10	12.5	T	T			T	T	T	T			T	T	T	T
	800				12.5	T	T				T	T	T				T	T	T
	1000					T	T					T	T					T	T

- T Total selectivity, up to the breaking capacity of the downstream circuit breaker.
- 4 Selectivity limit = 4 kA.
- No selectivity.

Note: Respect the basic rules of selectivity, in terms of overload, short-circuit, ground fault and earth leakage when applicable see page A-1, or check curves with Schneider Electric online "Electrical calculation tools".
When the upstream device is equipped with MicroLogic 6 or 7, the table provides selectivity limits for line to line or line to neutral short circuits, selectivity in earth fault condition shall be checked separately.

Selectivity Table

Upstream: MasterPacT MTZ2 25-40 H1/H2/H2V, MTZ3 40-63 H1/H2 MicroLogic X
Downstream: iC40, iCV40, iC60, C120, NG125, ComPacT NSXm, NSX100-630, NS630b-3200

Ue ≤ 440 V AC

A

Upstream CB	MasterPacT MTZ2 25/32/40 H1/H2/H2V						MasterPacT MTZ3 40/50/63 H1/H2						MasterPacT MTZ2 25/32/40 H1/H2/H2V						MasterPacT MTZ3 40/50/63 H1/H2					
Trip unit type	MicroLogic 2.0X I _{sd} = 10 I _r						MicroLogic 5.0X - 6.0X - 7.0X Inst : 15 In Standard						MicroLogic 5.0X - 6.0X - 7.0X Inst : OFF											
Trip unit rating In (A)	2500	3200	4000	4000	5000	6300	2500	3200	4000	4000	5000	6300	2500	3200	4000	4000	5000	6300	2500	3200	4000	4000	5000	6300
Setting Ir (A)	2500	3200	4000	4000	5000	6300	2500	3200	4000	4000	5000	6300	2500	3200	4000	4000	5000	6300	2500	3200	4000	4000	5000	6300

Downstream CB		Selectivity limit (kA)																				
CB type	CB rating (A)																					
iC40, iC40 N, iCV40 N, iCV40 H		T	T	T	T	T	T	T	T	T	T	T	T	T	T	T	T	T	T	T	T	T
		T	T	T	T	T	T	T	T	T	T	T	T	T	T	T	T	T	T	T	T	T
iC60 N/H/L, iC60 RCBO		T	T	T	T	T	T	T	T	T	T	T	T	T	T	T	T	T	T	T	T	T
		T	T	T	T	T	T	T	T	T	T	T	T	T	T	T	T	T	T	T	T	T
C120 N/H		T	T	T	T	T	T	T	T	T	T	T	T	T	T	T	T	T	T	T	T	T
		T	T	T	T	T	T	T	T	T	T	T	T	T	T	T	T	T	T	T	T	T
NG125 N/H/L		T	T	T	T	T	T	T	T	T	T	T	T	T	T	T	T	T	T	T	T	T
		T	T	T	T	T	T	T	T	T	T	T	T	T	T	T	T	T	T	T	T	T
ComPacT NSXm E/B/F/N/H		T	T	T	T	T	T	T	T	T	T	T	T	T	T	T	T	T	T	T	T	T
		T	T	T	T	T	T	T	T	T	T	T	T	T	T	T	T	T	T	T	T	T
ComPacT NSX B/F/H/N/S/L/R TM-D, TM-G	NSX100	T	T	T	T	T	T	T	T	T	T	T	T	T	T	T	T	T	T	T	T	T
	NSX160 ^[1]	T	T	T	T	T	T	T	T	T	T	T	T	T	T	T	T	T	T	T	T	T
	NSX250	T	T	T	T	T	T	T	T	T	T	T	T	T	T	T	T	T	T	T	T	T
	NSX400	T	T	T	T	T	T	T	T	T	T	T	T	T	T	T	T	T	T	T	T	T
ComPacT NSX B/F/H/N/S/L/R MicroLogic	NSX100	T	T	T	T	T	T	T	T	T	T	T	T	T	T	T	T	T	T	T	T	T
	NSX160 ^[1]	T	T	T	T	T	T	T	T	T	T	T	T	T	T	T	T	T	T	T	T	T
	NSX250	T	T	T	T	T	T	T	T	T	T	T	T	T	T	T	T	T	T	T	T	T
	NSX400	T	T	T	T	T	T	T	T	T	T	T	T	T	T	T	T	T	T	T	T	T
ComPacT NS N MicroLogic	NS630b	25	32	40	40	T	T	37.5	48	T	T	T	T	T	T	T	T	T	T	T	T	T
	NS800	25	32	40	40	T	T	37.5	48	T	T	T	T	T	T	T	T	T	T	T	T	T
	NS1000	25	32	40	40	T	T	37.5	48	T	T	T	T	T	T	T	T	T	T	T	T	T
	NS1250	25	32	40	40	T	T	37.5	48	T	T	T	T	T	T	T	T	T	T	T	T	T
ComPacT NS H MicroLogic	NS1600	25	32	40	40	T	T	37.5	48	T	T	T	T	T	T	T	T	T	T	T	T	T
	NS630b	25	32	40	40	50	63	37.5	48	60	60	T	T	T	T	T	T	T	T	T	T	T
	NS800	25	32	40	40	50	63	37.5	48	60	60	T	T	T	T	T	T	T	T	T	T	T
	NS1000	25	32	40	40	50	63	37.5	48	60	60	T	T	T	T	T	T	T	T	T	T	T
ComPacT NS N MicroLogic	NS1250	25	32	40	40	50	63	37.5	48	60	60	T	T	T	T	T	T	T	T	T	T	T
	NS1600	25	32	40	40	50	63	37.5	48	60	60	T	T	T	T	T	T	T	T	T	T	T
	NS1600b	25	32	40	40	50	63	37.5	48	60	60	T	T	T	T	T	T	T	T	T	T	T
	NS2000	25	32	40	40	50	63	37.5	48	60	60	T	T	T	T	T	T	T	T	T	T	T
ComPacT NS H MicroLogic	NS2500	25 ^[2]	32	40	40	50	63	37.5 ^[2]	48	60	60	T	T	T ^[2]	T	T	T	T	T	T	T	T
	NS3200		32 ^[2]	40	40	50	63		48 ^[2]	60	60	T	T		T ^[2]	T	T	T	T	T	T	T
	NS1600b	25	32	40	40	50	63	37.5	48	60	60	75	T	T	T	T	T	T	T	T	T	T
	NS2000	25	32	40	40	50	63	37.5	48	60	60	75	T	T	T	T	T	T	T	T	T	T
ComPacT NS L MicroLogic	NS2500	25 ^[2]	32	40	40	50	63	37.5 ^[2]	48	60	60	75	T	T ^[2]	T	T	T	T	T	T	T	T
	NS3200		32 ^[2]	40	40	50	63		48 ^[2]	60	60	75	T		T ^[2]	T	T	T	T	T	T	T
	NS630b	T	T	T	T	T	T	T	T	T	T	T	T	T	T	T	T	T	T	T	T	T
	NS800	T	T	T	T	T	T	T	T	T	T	T	T	T	T	T	T	T	T	T	T	T
ComPacT NS LB MicroLogic	NS1000	T	T	T	T	T	T	T	T	T	T	T	T	T	T	T	T	T	T	T	T	T
	NS630b	T	T	T	T	T	T	T	T	T	T	T	T	T	T	T	T	T	T	T	T	T
ComPacT NS LB MicroLogic	NS800	T	T	T	T	T	T	T	T	T	T	T	T	T	T	T	T	T	T	T	T	T
	NS800	T	T	T	T	T	T	T	T	T	T	T	T	T	T	T	T	T	T	T	T	T

[1] There is no R capacity for ComPacT NSX160.

[2] With I_r upstream > 1.3 I_r downstream.

T Total selectivity, up to the breaking capacity of the downstream circuit breaker.

4 Selectivity limit = 4 kA.

No selectivity.

Note: Respect the basic rules of selectivity, in terms of overload, short-circuit, ground fault and earth leakage when applicable see page A-1, or check curves with Schneider Electric online "Electrical calculation tools".

When the upstream device is equipped with MicroLogic 6 or 7, the table provides selectivity limits for line to line or line to neutral short circuits, selectivity in earth fault condition shall be checked separately.

Selectivity Table

Upstream: MasterPacT MTZ2 25-40 H1 MicroLogic X

Downstream: MasterPacT MTZ1 06-16, MTZ2 08-20

Ue ≤ 440 V AC



Upstream CB	MasterPacT MTZ2 25/32/40 H1								
Trip unit type	MicroLogic 2.0X I _{sd} = 10 I _r			MicroLogic 5.0X - 6.0X - 7.0X Inst: 15 In Standard			MicroLogic 5.0X - 6.0X - 7.0X Inst: OFF		
Trip unit rating I _n (A)	2500	3200	4000	2500	3200	4000	2500	3200	4000
Setting I _r (A)	2500	3200	4000	2500	3200	4000	2500	3200	4000

Downstream CB		Selectivity limit (kA)								
CB type	CB rating (A)									
MasterPacT MTZ1 H1 MicroLogic	MTZ1 06	25	32	40	37.5	T	T	T	T	T
	MTZ1 08	25	32	40	37.5	T	T	T	T	T
	MTZ1 10	25	32	40	37.5	T	T	T	T	T
	MTZ1 12	25	32	40	37.5	T	T	T	T	T
	MTZ1 16	25	32	40	37.5	T	T	T	T	T
MasterPacT MTZ1 H2 MicroLogic	MTZ1 06	25	32	40	37.5	48	T	T	T	T
	MTZ1 08	25	32	40	37.5	48	T	T	T	T
	MTZ1 10	25	32	40	37.5	48	T	T	T	T
	MTZ1 12	25	32	40	37.5	48	T	T	T	T
	MTZ1 16	25	32	40	37.5	48	T	T	T	T
MasterPacT MTZ1 H3 MicroLogic	MTZ1 06	25	32	40	37.5	48	60	T	T	T
	MTZ1 08	25	32	40	37.5	48	60	T	T	T
	MTZ1 10	25	32	40	37.5	48	60	T	T	T
	MTZ1 12	25	32	40	37.5	48	60	T	T	T
	MTZ1 16	25	32	40	37.5	48	60	T	T	T
MasterPacT MTZ2 N1 MicroLogic	MTZ2 08	25	32	40	37.5	T	T	T	T	T
	MTZ2 10	25	32	40	37.5	T	T	T	T	T
	MTZ2 12	25	32	40	37.5	T	T	T	T	T
	MTZ2 16	25	32	40	37.5	T	T	T	T	T
MasterPacT MTZ2 H1 MicroLogic	MTZ2 08	25	32	40	37.5	48	60	T	T	T
	MTZ2 10	25	32	40	37.5	48	60	T	T	T
	MTZ2 12	25	32	40	37.5	48	60	T	T	T
	MTZ2 16	25	32	40	37.5	48	60	T	T	T
	MTZ2 20	25	32	40	37.5	48	60	T	T	T
	MTZ2 25	25 ^[1]	32	40	37.5 ^[1]	48	60	T ^[1]	T	T
MasterPacT MTZ2 H2/H2V MicroLogic	MTZ2 08	25	32	40	37.5	48	60	T	T	T
	MTZ2 10	25	32	40	37.5	48	60	T	T	T
	MTZ2 12	25	32	40	37.5	48	60	T	T	T
	MTZ2 16	25	32	40	37.5	48	60	T	T	T
	MTZ2 20	25	32	40	37.5	48	60	T	T	T
	MTZ2 25	25 ^[1]	32	40	37.5 ^[1]	48	60	T ^[1]	T	T
MasterPacT MTZ2 H3 MicroLogic	MTZ2 20	25	32	40	37.5	48	60	T	T	T
	MTZ2 25	25 ^[1]	32	40	37.5 ^[1]	48	60	T ^[1]	T	T
	MTZ2 32		32 ^[1]	40		48 ^[1]	60		T ^[1]	T
MasterPacT MTZ1 L1 MicroLogic	MTZ1 06	T	T	T	T	T	T	T	T	T
	MTZ1 08	T	T	T	T	T	T	T	T	T
	MTZ1 10	T	T	T	T	T	T	T	T	T
MasterPacT MTZ2 L1 MicroLogic	MTZ2 08	25	32	40	37.5	48	60	T	T	T
	MTZ2 10	25	32	40	37.5	48	60	T	T	T
	MTZ2 12	25	32	40	37.5	48	60	T	T	T
	MTZ2 16	25	32	40	37.5	48	60	T	T	T
	MTZ2 20	25	32	40	37.5	48	60	T	T	T

[1] With I_r upstream > 1.3 I_r downstream.

T Total selectivity, up to the breaking capacity of the downstream circuit breaker.

4 Selectivity limit = 4 kA.

No selectivity.

Note: Respect the basic rules of selectivity, in terms of overload, short-circuit, ground fault and earth leakage when applicable see page A-1, or check curves with Schneider Electric online "Electrical calculation tools".

When the upstream device is equipped with MicroLogic 6 or 7, the table provides selectivity limits for line to line or line to neutral short circuits, selectivity in earth fault condition shall be checked separately.

Selectivity Table

Upstream: MasterPacT MTZ2 20/25/32/40 H2, MTZ3 40/50/63 H1 MicroLogic X

Downstream: MasterPacT MTZ1 06-16, MTZ2 08-40, MTZ3 40/50

$U_e \leq 440 \text{ V AC}$

A

Upstream CB		MasterPacT MTZ2 20/25/32/40 H2					MasterPacT MTZ3 40/50/63 H1					MasterPacT MTZ2 20/25/32/40 H2					MasterPacT MTZ3 40/50/63 H1														
Trip unit type		MicroLogic 2.0X I _{sd} = 10 Ir										MicroLogic 5.0X - 6.0X - 7.0X Inst: 15 In Standard										MicroLogic 5.0X - 6.0X - 7.0X Inst: OFF									
Trip unit rating In (A)		2500	3200	4000	4000	5000	6300	2500	3200	4000	4000	5000	6300	2500	3200	4000	4000	5000	6300	2500	3200	4000	4000	5000	6300						
Setting Ir (A)		2500	3200	4000	4000	5000	6300	2500	3200	4000	4000	5000	6300	2500	3200	4000	4000	5000	6300	2500	3200	4000	4000	5000	6300						
Downstream CB		Selectivity limit (kA)																													
CB type	CB rating (A)																														
MasterPacT MTZ1 H1 MicroLogic	MTZ1 06	25	32	40	40	T	T	37.5	T	T	T	T	T	T	T	T	T	T	T	T	T	T	T								
	MTZ1 08	25	32	40	40	T	T	37.5	T	T	T	T	T	T	T	T	T	T	T	T	T	T	T								
	MTZ1 10	25	32	40	40	T	T	37.5	T	T	T	T	T	T	T	T	T	T	T	T	T	T	T								
	MTZ1 12	25	32	40	40	T	T	37.5	T	T	T	T	T	T	T	T	T	T	T	T	T	T	T								
MasterPacT MTZ1 H2 MicroLogic	MTZ1 06	25	32	40	40	T	T	37.5	48	T	T	T	T	T	T	T	T	T	T	T	T	T	T								
	MTZ1 08	25	32	40	40	T	T	37.5	48	T	T	T	T	T	T	T	T	T	T	T	T	T	T								
	MTZ1 10	25	32	40	40	T	T	37.5	48	T	T	T	T	T	T	T	T	T	T	T	T	T	T								
	MTZ1 12	25	32	40	40	T	T	37.5	48	T	T	T	T	T	T	T	T	T	T	T	T	T	T								
MasterPacT MTZ1 H3 MicroLogic	MTZ1 06	25	32	40	40	50	63	37.5	48	60	60	T	T	T	T	T	T	T	T	T	T	T	T								
	MTZ1 08	25	32	40	40	50	63	37.5	48	60	60	T	T	T	T	T	T	T	T	T	T	T	T								
	MTZ1 10	25	32	40	40	50	63	37.5	48	60	60	T	T	T	T	T	T	T	T	T	T	T	T								
	MTZ1 12	25	32	40	40	50	63	37.5	48	60	60	T	T	T	T	T	T	T	T	T	T	T	T								
MasterPacT MTZ2 N1 MicroLogic	MTZ2 08	25	32	40	40	T	T	37.5	T	T	T	T	T	T	T	T	T	T	T	T	T	T	T								
	MTZ2 10	25	32	40	40	T	T	37.5	T	T	T	T	T	T	T	T	T	T	T	T	T	T	T								
	MTZ2 12	25	32	40	40	T	T	37.5	T	T	T	T	T	T	T	T	T	T	T	T	T	T	T								
	MTZ2 16	25	32	40	40	T	T	37.5	T	T	T	T	T	T	T	T	T	T	T	T	T	T	T								
MasterPacT MTZ2 H1 MicroLogic	MTZ2 08	25	32	40	40	50	63	37.5	48	60	60	T	T	T	T	T	T	T	T	T	T	T	T								
	MTZ2 10	25	32	40	40	50	63	37.5	48	60	60	T	T	T	T	T	T	T	T	T	T	T	T								
	MTZ2 12	25	32	40	40	50	63	37.5	48	60	60	T	T	T	T	T	T	T	T	T	T	T	T								
	MTZ2 16	25	32	40	40	50	63	37.5	48	60	60	T	T	T	T	T	T	T	T	T	T	T	T								
	MTZ2 20	25	32	40	40	50	63	37.5	48	60	60	T	T	T	T	T	T	T	T	T	T	T	T								
	MTZ2 25	25 ^[1]	32	40	40	50	63	37.5 ^[1]	48	60	60	T	T	T ^[1]	T	T	T	T	T	T	T	T	T	T							
MasterPacT MTZ2 H2/H2V MicroLogic	MTZ2 32		32 ^[1]	40	40	50	63		48 ^[1]	60	60	T	T		T ^[1]	T	T	T	T	T	T	T	T								
	MTZ2 40			40 ^[1]	40 ^[1]	50	63			60 ^[1]	60	T	T			T ^[1]	T ^[1]	T	T	T	T	T	T								
	MTZ2 08	25	32	40	40	50	63	37.5	48	60	60	75	94	85	85	85	T	T	T	T	T	T	T								
	MTZ2 10	25	32	40	40	50	63	37.5	48	60	60	75	94	85	85	85	T	T	T	T	T	T	T								
	MTZ2 12	25	32	40	40	50	63	37.5	48	60	60	75	94	85	85	85	T	T	T	T	T	T	T								
	MTZ2 16	25	32	40	40	50	63	37.5	48	60	60	75	94	85	85	85	T	T	T	T	T	T	T								
MasterPacT MTZ3 H1 MicroLogic	MTZ3 40			40 ^[1]	40 ^[1]	50	63			60 ^[1]	60 ^[1]	75	94			T ^[1]	T ^[1]	T	T	T	T	T	T								
	MTZ3 50				50 ^[1]	63					75 ^[1]	94				T ^[1]	T ^[1]	T	T	T	T	T	T								
	MTZ2 20	25	32	40	40	50	63	37.5	48	60	60	75	94	85	85	85	T	T	T	T	T	T	T								
	MTZ2 25	25 ^[1]	32	40	40	50	63	37.5 ^[1]	48	60	60	75	94	85 ^[1]	85	85	T	T	T	T	T	T	T								
	MTZ2 32		32 ^[1]	40	40	50	63		48 ^[1]	60	60	75	94		85 ^[1]	85	T	T	T	T	T	T	T								
	MTZ2 40			40 ^[1]	40 ^[1]	50	63			60 ^[1]	60 ^[1]	75	94		85 ^[1]	85	T ^[1]	T ^[1]	T	T	T	T	T								
MasterPacT MTZ3 H2 MicroLogic	MTZ3 40				40 ^[1]	50	63			60 ^[1]	60 ^[1]	75	94			T ^[1]	T ^[1]	T	T	T	T	T	T								
	MTZ3 50					50 ^[1]	63					75 ^[1]	94				T ^[1]	T ^[1]	T	T	T	T	T								
	MTZ1 06	T	T	T	T	T	T	T	T	T	T	T	T	T	T	T	T	T	T	T	T	T	T								
MasterPacT MTZ2 L1 MicroLogic	MTZ2 08	25	32	40	40	50	63	37.5	48	60	60	75	94	T	T	T	T	T	T	T	T	T	T								
	MTZ2 10	25	32	40	40	50	63	37.5	48	60	60	75	94	T	T	T	T	T	T	T	T	T	T								
	MTZ2 12	25	32	40	40	50	63	37.5	48	60	60	75	94	T	T	T	T	T	T	T	T	T	T								
MasterPacT MTZ2 L1 MicroLogic	MTZ2 16	25	32	40	40	50	63	37.5	48	60	60	75	94	T	T	T	T	T	T	T	T	T	T								
	MTZ2 20	25	32	40	40	50	63	37.5	48	60	60	75	94	T	T	T	T	T	T	T	T	T	T								

[1] With Ir upstream > 1.3 Ir downstream.

T Total selectivity, up to the breaking capacity of the downstream circuit breaker.

4 Selectivity limit = 4 kA.

No selectivity.

Note: Respect the basic rules of selectivity, in terms of overload, short-circuit, ground fault and earth leakage when applicable see page A-1, or check curves with Schneider Electric online "Electrical calculation tools".

When the upstream device is equipped with MicroLogic 6 or 7, the table provides selectivity limits for line to line or line to neutral short circuits, selectivity in earth fault condition shall be checked separately.

Selectivity Table

Upstream: MasterPacT MTZ2 25/32/40 H2V, MTZ3 40b/50/63 H1 MicroLogic X

Downstream: MasterPacT MTZ1 06-16, MTZ2 08-40, MTZ3 40b/50

Ue ≤ 440 V AC



Upstream CB	MasterPacT MTZ2 25/32/40 H2V						MasterPacT MTZ3 40b/50/63 H1						MasterPacT MTZ2 25/32/40 H2V						MasterPacT MTZ3 40b/50/63 H1											
Trip unit type	MicroLogic 2.0X I _{sd} = 10 Ir												MicroLogic 5.0X - 6.0X - 7.0X Inst: 15 In Standard												MicroLogic 5.0X - 6.0X - 7.0X Inst: OFF					
Trip unit rating In (A)	2500	3200	4000	4000	5000	6300	2500	3200	4000	4000	5000	6300	2500	3200	4000	4000	5000	6300	2500	3200	4000	4000	5000	6300						
Setting Ir (A)	2500	3200	4000	4000	5000	6300	2500	3200	4000	4000	5000	6300	2500	3200	4000	4000	5000	6300	2500	3200	4000	4000	5000	6300						

Downstream CB		Selectivity limit (kA)																							
CB type	CB rating (A)	25	32	40	40	50	63	37.5	48	60	60	75	94	25	32	40	40	50	63	37.5	48	60	60	75	94
MasterPacT MTZ1 H1 MicroLogic	MTZ1 06	T	T	T	T	T	T	T	T	T	T	T	T	T	T	T	T	T	T	T	T	T	T	T	T
	MTZ1 08	T	T	T	T	T	T	T	T	T	T	T	T	T	T	T	T	T	T	T	T	T	T	T	T
	MTZ1 10	T	T	T	T	T	T	T	T	T	T	T	T	T	T	T	T	T	T	T	T	T	T	T	T
	MTZ1 12	T	T	T	T	T	T	T	T	T	T	T	T	T	T	T	T	T	T	T	T	T	T	T	T
MasterPacT MTZ1 H2 MicroLogic	MTZ1 06	T	T	T	T	T	T	4	4	T	T	T	T	T	T	T	T	T	T	T	T	T	T	T	T
	MTZ1 08	T	T	T	T	T	T	4	4	T	T	T	T	T	T	T	T	T	T	T	T	T	T	T	T
	MTZ1 10	T	T	T	T	T	T	4	4	T	T	T	T	T	T	T	T	T	T	T	T	T	T	T	T
	MTZ1 12	T	T	T	T	T	T	4	4	T	T	T	T	T	T	T	T	T	T	T	T	T	T	T	T
MasterPacT MTZ1 H3 MicroLogic	MTZ1 06	T	T	T	T	50	63	37.5	48	60	60	T	T	T	T	T	T	T	T	T	T	T	T	T	T
	MTZ1 08	T	T	T	T	50	63	37.5	48	60	60	T	T	T	T	T	T	T	T	T	T	T	T	T	T
	MTZ1 10	T	T	T	T	50	63	37.5	48	60	60	T	T	T	T	T	T	T	T	T	T	T	T	T	T
	MTZ1 12	T	T	T	T	50	63	37.5	48	60	60	T	T	T	T	T	T	T	T	T	T	T	T	T	T
MasterPacT MTZ2 N1 MicroLogic	MTZ2 08	T	T	T	T	T	T	37.5	48	T	T	T	T	T	T	T	T	T	T	T	T	T	T	T	T
	MTZ2 10	T	T	T	T	T	T	37.5	48	T	T	T	T	T	T	T	T	T	T	T	T	T	T	T	T
	MTZ2 12	T	T	T	T	T	T	37.5	48	T	T	T	T	T	T	T	T	T	T	T	T	T	T	T	T
	MTZ2 16	T	T	T	T	T	T	37.5	48	T	T	T	T	T	T	T	T	T	T	T	T	T	T	T	T
MasterPacT MTZ2 H1 MicroLogic	MTZ2 08	T	T	T	T	50	63	37.5	48	60	60	T	T	T	T	T	T	T	T	T	T	T	T	T	T
	MTZ2 10	T	T	T	T	50	63	37.5	48	60	60	T	T	T	T	T	T	T	T	T	T	T	T	T	T
	MTZ2 12	T	T	T	T	50	63	37.5	48	60	60	T	T	T	T	T	T	T	T	T	T	T	T	T	T
	MTZ2 16	T	T	T	T	50	63	37.5	48	60	60	T	T	T	T	T	T	T	T	T	T	T	T	T	T
	MTZ2 20	T	T	T	T	50	63	37.5	48	60	60	T	T	T	T	T	T	T	T	T	T	T	T	T	T
	MTZ2 25	T ^[1]	T	T	T	50	63	37.5	48	60	60	T	T	T	T	T	T	T	T	T	T	T	T	T	T
MasterPacT MTZ2 H2/H2V MicroLogic	MTZ2 32	T	T ^[1]	T	T	50	63	48	48 ^[1]	60	60	T	T	T	T	T	T	T	T	T	T	T	T	T	T
	MTZ2 40	T	T	T	T ^[1]	50	63			60 ^[1]	60 ^[1]	T	T			T	T	T	T	T	T	T	T	T	
	MTZ2 08	T	T	T	T	50	63	37.5	48	60	60	75	94	T	T	T	T	T	T	T	T	T	T	T	T
	MTZ2 10	T	T	T	T	50	63	37.5	48	60	60	75	94	T	T	T	T	T	T	T	T	T	T	T	T
	MTZ2 12	T	T	T	T	50	63	37.5	48	60	60	75	94	T	T	T	T	T	T	T	T	T	T	T	T
	MTZ2 16	T	T	T	T	50	63	37.5	48	60	60	75	94	T	T	T	T	T	T	T	T	T	T	T	T
MasterPacT MTZ3 H1	MTZ3 40	T	T	T	T	50	63			60 ^[1]	60 ^[1]	75	94			T	T	T	T	T	T	T	T	T	
	MTZ3 50	T	T	T	T	50 ^[1]	63					75 ^[1]	94					T	T	T	T	T	T	T	
MasterPacT MTZ2 H3 MicroLogic	MTZ2 20	T	T	T	T	50	63	37.5	48	60	60	75	94	T	T	T	T	T	T	T	T	T	T	T	T
	MTZ2 25	T	T	T	T	50	63	37.5	48	60	60	75	94	T	T	T	T	T	T	T	T	T	T	T	T
	MTZ2 32	T	T	T	T	50	63	48	48 ^[1]	60	60	75	94			T	T	T	T	T	T	T	T	T	T
	MTZ2 40	T	T	T	T	50	63			60 ^[1]	60 ^[1]	75	94			T	T	T	T	T	T	T	T	T	T
MasterPacT MTZ3 H2	MTZ3 40	T	T	T	T	50	63			60 ^[1]	60 ^[1]	75	94			T	T	T	T	T	T	T	T	T	
	MTZ3 50	T	T	T	T	50 ^[1]	63					75 ^[1]	94					T	T	T	T	T	T	T	
MasterPacT MTZ1 L1 MicroLogic	MTZ1 06	T	T	T	T	T	T	T	T	T	T	T	T	T	T	T	T	T	T	T	T	T	T	T	T
	MTZ1 08	T	T	T	T	T	T	T	T	T	T	T	T	T	T	T	T	T	T	T	T	T	T	T	T
	MTZ1 10	T	T	T	T	T	T	T	T	T	T	T	T	T	T	T	T	T	T	T	T	T	T	T	T
MasterPacT MTZ2 L1 MicroLogic	MTZ2 08	T	T	T	T	50	63	37.5	48	60	60	75	94	T	T	T	T	T	T	T	T	T	T	T	T
	MTZ2 10	T	T	T	T	50	63	37.5	48	60	60	75	94	T	T	T	T	T	T	T	T	T	T	T	T
	MTZ2 12	T	T	T	T	50	63	37.5	48	60	60	75	94	T	T	T	T	T	T	T	T	T	T	T	T
	MTZ2 16	T	T	T	T	50	63	37.5	48	60	60	75	94	T	T	T	T	T	T	T	T	T	T	T	T
MTZ2 20	T	T	T	T	50	63	37.5	48	60	60	75	94	T	T	T	T	T	T	T	T	T	T	T	T	

[1] With Ir upstream > 1.3 Ir downstream.

T Total selectivity, up to the breaking capacity of the downstream circuit breaker.

4 Selectivity limit = 4 kA.

No selectivity.

Note: Respect the basic rules of selectivity, in terms of overload, short-circuit, ground fault and earth leakage when applicable see page A-1, or check curves with Schneider Electric online "Electrical calculation tools".

When the upstream device is equipped with MicroLogic 6 or 7, the table provides selectivity limits for line to line or line to neutral short circuits, selectivity in earth fault condition shall be checked separately.

Selectivity Table

Upstream: MasterPacT MTZ2 20/25/32/40 H3, MTZ3 40/50/63 H2 MicroLogic X
 Downstream: iC60, iC40, C120, NG125, ComPacT NSXm, NSX100-630, NS630b-3200

Ue ≤ 440 V AC

A

Upstream CB	MasterPacT MTZ2 20/25/32/40 H3				MasterPacT MTZ3 40/50/63 H2				MasterPacT MTZ2 20/25/32/40 H3				MasterPacT MTZ3 40/50/63 H2				MasterPacT MTZ2 20/25/32/40 H3				MasterPacT MTZ3 40/50/63 H2											
Trip unit type	MicroLogic 2.0X Isd = 10 Ir								MicroLogic 5.0X - 6.0X - 7.0X Inst: 15 In Standard								MicroLogic 5.0X - 6.0X - 7.0X Inst: OFF															
Trip unit rating In (A)	2000	2500	3200	4000	4000	5000	6300		2000	2500	3200	4000	4000	5000	6300		2000	2500	3200	4000	4000	5000	6300		2000	2500	3200	4000	4000	5000	6300	
Setting Ir (A)	2000	2500	3200	4000	4000	5000	6300		2000	2500	3200	4000	4000	5000	6300		2000	2500	3200	4000	4000	5000	6300		2000	2500	3200	4000	4000	5000	6300	

Downstream CB	CB type	CB rating (A)	Selectivity limit (kA)																			
			T	T	T	T	T	T	T	T	T	T	T	T	T	T	T	T	T	T	T	
iC40, iC40 N, iCV40 N, iCV40 H	(2)		T	T	T	T	T	T	T	T	T	T	T	T	T	T	T	T	T	T		
iC60 N/H/L, iC60 RCBO, iC60N/H2 RCBO	(3)		T	T	T	T	T	T	T	T	T	T	T	T	T	T	T	T	T	T		
C120 N/H			T	T	T	T	T	T	T	T	T	T	T	T	T	T	T	T	T	T		
NG125 N/H/L			T	T	T	T	T	T	T	T	T	T	T	T	T	T	T	T	T	T		
ComPacT NSXm E/B/F/N/H			T	T	T	T	T	T	T	T	T	T	T	T	T	T	T	T	T	T		
ComPacT B/F/H/N/S/L/R TM-D, TM-G	NSX100		T	T	T	T	T	T	T	T	T	T	T	T	T	T	T	T	T	T		
	NSX160 ^[1]		T	T	T	T	T	T	T	T	T	T	T	T	T	T	T	T	T	T		
	NSX250		T	T	T	T	T	T	T	T	T	T	T	T	T	T	T	T	T	T		
ComPacT B/F/H/N/S/L/R MicroLogic	NSX100		T	T	T	T	T	T	T	T	T	T	T	T	T	T	T	T	T	T		
	NSX160 ^[1]		T	T	T	T	T	T	T	T	T	T	T	T	T	T	T	T	T	T		
	NSX250		T	T	T	T	T	T	T	T	T	T	T	T	T	T	T	T	T	T		
ComPacT F/H/N/S/L/R	NSX400		T	T	T	T	T	T	T	T	T	T	T	T	T	T	T	T	T	T		
	NSX630		T	T	T	T	T	T	T	T	T	T	T	T	T	T	T	T	T	T		
ComPacT N MicroLogic	NS630b	20	25	32	40	40	T	T	30	37.5	48	T	T	T	T	T	T	T	T	T		
	NS800	20	25	32	40	40	T	T	30	37.5	48	T	T	T	T	T	T	T	T	T		
	NS1000	20	25	32	40	40	T	T	30	37.5	48	T	T	T	T	T	T	T	T	T		
	NS1250	20	25	32	40	40	T	T	30	37.5	48	T	T	T	T	T	T	T	T	T		
	NS1600	20	25	32	40	40	T	T	30	37.5	48	T	T	T	T	T	T	T	T	T		
ComPacT H MicroLogic	NS630b	20	25	32	40	40	50	63	30	37.5	48	60	60	T	T	65	65	65	65	T	T	T
	NS800	20	25	32	40	40	50	63	30	37.5	48	60	60	T	T	65	65	65	65	T	T	T
	NS1000	20	25	32	40	40	50	63	30	37.5	48	60	60	T	T	65	65	65	65	T	T	T
	NS1250	20	25	32	40	40	50	63	30	37.5	48	60	60	T	T	65	65	65	65	T	T	T
	NS1600	20	25	32	40	40	50	63	30	37.5	48	60	60	T	T	65	65	65	65	T	T	T
ComPacT N MicroLogic	NS1600b	20	25	32	40	40	50	63	30	37.5	48	60	60	T	T	65	65	65	65	T	T	T
	NS2000	20 ^[2]	25	32	40	40	50	63	30 ^[2]	37.5	48	60	60	T	T	65 ^[2]	65	65	65	T	T	T
	NS2500		25 ^[2]	32	40	40	50	63		37.5	48	60	60	T	T		65 ^[2]	65	65	T	T	T
	NS3200			32 ^[2]	40	40	50	63		48 ^[2]	60	60	T	T			65 ^[2]	65	65	T	T	T
ComPacT H MicroLogic	NS1600b	20	25	32	40	40	50	63	30	37.5	48	60	60	75	T	65	65	65	65	T	T	T
	NS2000	20 ^[2]	25	32	40	40	50	63	30 ^[2]	37.5	48	60	60	75	T	65 ^[2]	65	65	65	T	T	T
	NS2500		25 ^[2]	32	40	40	50	63		37.5	48	60	60	75	T		65 ^[2]	65	65	T	T	T
	NS3200			32 ^[2]	40	40	50	63		48 ^[2]	60	60	75	T			65 ^[2]	65	65	T	T	T
ComPacT L MicroLogic	NS630b		T	T	T	T	T	T	T	T	T	T	T	T	T	T	T	T	T	T		
	NS800		T	T	T	T	T	T	T	T	T	T	T	T	T	T	T	T	T	T		
	NS1000		T	T	T	T	T	T	T	T	T	T	T	T	T	T	T	T	T	T		
ComPacT LB MicroLogic	NS630b		T	T	T	T	T	T	T	T	T	T	T	T	T	T	T	T	T	T		
	NS800		T	T	T	T	T	T	T	T	T	T	T	T	T	T	T	T	T	T		

[1] There is no R capacity for ComPacT NSX160.
 [2] With Ir upstream > 1.3 Ir downstream.

T Total selectivity, up to the breaking capacity of the downstream circuit breaker.
4 Selectivity limit = 4 kA.
 No selectivity.

Note: Respect the basic rules of selectivity, in terms of overload, short-circuit, ground fault and earth leakage when applicable see page A-1, or check curves with Schneider Electric online "Electrical calculation tools".

When the upstream device is equipped with MicroLogic 6 or 7, the table provides selectivity limits for line to line or line to neutral short circuits, selectivity in earth fault condition shall be checked separately.

Selectivity Table

Upstream: MasterPacT MTZ2 20/25/32/40 H3, MTZ3 40/50/63 H2 MicroLogic X

Downstream: MasterPacT MTZ1 06-16, MTZ2 08-40 and MTZ3 40/50

Ue ≤ 440 V AC



Upstream CB	MasterPacT MTZ2 20/25/32/40 H3							MasterPacT MTZ3 40/50/63 H2							MasterPacT MTZ2 20/25/32/40 H3							MasterPacT MTZ3 40/50/63 H2																				
Trip unit type	MicroLogic 2.0X Isd = 10 Ir														MicroLogic 5.0X - 6.0X - 7.0X Inst: 15 In Standard														MicroLogic 5.0X - 6.0X - 7.0X Inst: OFF													
Trip unit rating In (A)	2000	2500	3200	4000	4000	5000	6300	2000	2500	3200	4000	4000	5000	6300	2000	2500	3200	4000	4000	5000	6300	2000	2500	3200	4000	4000	5000	6300	2000	2500	3200	4000	4000	5000	6300							
Setting Ir (A)	2000	2500	3200	4000	4000	5000	6300	2000	2500	3200	4000	4000	5000	6300	2000	2500	3200	4000	4000	5000	6300	2000	2500	3200	4000	4000	5000	6300	2000	2500	3200	4000	4000	5000	6300							

Downstream CB		Selectivity limit (kA)																						
CB type	CB rating (A)																							
MasterPacT MTZ1 H1 MicroLogic	MTZ1 06	20	25	32	40	40	T	T	30	37.5	T	T	T	T	T	T	T	T	T	T	T	T	T	T
	MTZ1 08	20	25	32	40	40	T	T	30	37.5	T	T	T	T	T	T	T	T	T	T	T	T	T	T
	MTZ1 10	20	25	32	40	40	T	T	30	37.5	T	T	T	T	T	T	T	T	T	T	T	T	T	T
	MTZ1 12	20	25	32	40	40	T	T	30	37.5	T	T	T	T	T	T	T	T	T	T	T	T	T	T
MasterPacT MTZ1 H2 MicroLogic	MTZ1 06	20	25	32	40	40	T	T	30	37.5	48	T	T	T	T	T	T	T	T	T	T	T	T	T
	MTZ1 08	20	25	32	40	40	T	T	30	37.5	48	T	T	T	T	T	T	T	T	T	T	T	T	T
	MTZ1 10	20	25	32	40	40	T	T	30	37.5	48	T	T	T	T	T	T	T	T	T	T	T	T	T
	MTZ1 12	20	25	32	40	40	T	T	30	37.5	48	T	T	T	T	T	T	T	T	T	T	T	T	T
MasterPacT MTZ1 H3 MicroLogic	MTZ1 06	20	25	32	40	40	50	63	30	37.5	48	60	60	T	T	T	T	T	T	T	T	T	T	T
	MTZ1 08	20	25	32	40	40	50	63	30	37.5	48	60	60	T	T	T	T	T	T	T	T	T	T	T
	MTZ1 10	20	25	32	40	40	50	63	30	37.5	48	60	60	T	T	T	T	T	T	T	T	T	T	T
	MTZ1 12	20	25	32	40	40	50	63	30	37.5	48	60	60	T	T	T	T	T	T	T	T	T	T	T
MasterPacT MTZ2 N1 MicroLogic	MTZ2 08	20	25	32	40	40	T	T	30	37.5	T	T	T	T	T	T	T	T	T	T	T	T	T	T
	MTZ2 10	20	25	32	40	40	T	T	30	37.5	T	T	T	T	T	T	T	T	T	T	T	T	T	T
	MTZ2 12	20	25	32	40	40	T	T	30	37.5	T	T	T	T	T	T	T	T	T	T	T	T	T	T
	MTZ2 16	20	25	32	40	40	T	T	30	37.5	T	T	T	T	T	T	T	T	T	T	T	T	T	T
MasterPacT MTZ2 H1 MicroLogic	MTZ2 08	20	25	32	40	40	50	63	30	37.5	48	60	60	T	T	T	T	T	T	T	T	T	T	T
	MTZ2 10	20	25	32	40	40	50	63	30	37.5	48	60	60	T	T	T	T	T	T	T	T	T	T	T
	MTZ2 12	20	25	32	40	40	50	63	30	37.5	48	60	60	T	T	T	T	T	T	T	T	T	T	T
	MTZ2 16	20	25	32	40	40	50	63	30	37.5	48	60	60	T	T	T	T	T	T	T	T	T	T	T
	MTZ2 20	20 ^[1]	25	32	40	40	50	63	30 ^[1]	37.5	48	60	60	T	T	T ^[1]	T	T	T	T	T	T	T	T
	MTZ2 25		25 ^[1]	32	40	40	50	63		37.5 ^[1]	48	60	60	T	T		T ^[1]	T	T	T	T	T	T	T
MasterPacT MTZ2 H2/H2V MicroLogic	MTZ2 32			32 ^[1]	40	40	50	63		48 ^[1]	60	60	T	T			T ^[1]	T	T	T	T	T	T	T
	MTZ2 40				40 ^[1]	40 ^[1]	50	63			60 ^[1]	60	T	T				T ^[1]	T ^[1]	T	T	T	T	T
	MTZ2 08	20	25	32	40	40	50	63	30	37.5	48	60	60	75	94	65	65	65	65	T	T	T	T	T
	MTZ2 10	20	25	32	40	40	50	63	30	37.5	48	60	60	75	94	65	65	65	65	T	T	T	T	T
	MTZ2 12	20	25	32	40	40	50	63	30	37.5	48	60	60	75	94	65	65	65	65	T	T	T	T	T
	MTZ2 16	20	25	32	40	40	50	63	30	37.5	48	60	60	75	94	65	65	65	65	T	T	T	T	T
MasterPacT MTZ3 H1	MTZ3 40				40 ^[1]	40 ^[1]	50	63				60 ^[1]	75	94	94				65 ^[1]	T ^[1]	T	T	T	T
	MTZ3 50					50 ^[1]	63					75 ^[1]	94	94						T ^[1]	T	T	T	T
	MTZ2 20	20 ^[1]	25	32	40	40	50	63	30 ^[1]	37.5	48	60	60	75	94	65 ^[1]	65	65	65	65	120	120	120	120
	MTZ2 25		25 ^[1]	32	40	40	50	63		37.5 ^[1]	48	60	60	75	94		65 ^[1]	65	65	65	120	120	120	120
MasterPacT MTZ3 H2	MTZ3 40				40 ^[1]	40 ^[1]	50	63			60 ^[1]	75	75	94				65 ^[1]	120 ^[1]	120	120	120	120	
	MTZ3 50					50 ^[1]	63				75 ^[1]	75	94						120 ^[1]	120	120	120	120	
MasterPacT MTZ1 L1 MicroLogic	MTZ1 06	T	T	T	T	T	T	T	T	T	T	T	T	T	T	T	T	T	T	T	T	T	T	T
	MTZ1 08	T	T	T	T	T	T	T	T	T	T	T	T	T	T	T	T	T	T	T	T	T	T	T
	MTZ1 10	T	T	T	T	T	T	T	T	T	T	T	T	T	T	T	T	T	T	T	T	T	T	T
MasterPacT MTZ2 L1 MicroLogic	MTZ2 08	20	25	32	40	40	50	63	30	37.5	48	60	60	75	94	100	100	100	100	T	T	T	T	T
	MTZ2 10	20	25	32	40	40	50	63	30	37.5	48	60	60	75	94	100	100	100	100	T	T	T	T	T
	MTZ2 12	20	25	32	40	40	50	63	30	37.5	48	60	60	75	94	100	100	100	100	T	T	T	T	T
	MTZ2 16	20	25	32	40	40	50	63	30	37.5	48	60	60	75	94	100	100	100	100	T	T	T	T	T
MTZ2 20	20	25	32	40	40	50	63		37.5	48	60	60	75	94	100	100	100	100	T	T	T	T	T	

[1] With Ir upstream > 1.3 Ir downstream.

T Total selectivity, up to the breaking capacity of the downstream circuit breaker.

4 Selectivity limit = 4 kA.

No selectivity.

Note: Respect the basic rules of selectivity, in terms of overload, short-circuit, ground fault and earth leakage when applicable see page A-1, or check curves with Schneider Electric online "Electrical calculation tools".

When the upstream device is equipped with MicroLogic 6 or 7, the table provides selectivity limits for line to line or line to neutral short circuits, selectivity in earth fault condition shall be checked separately.

Selectivity Table Motor Protection

Upstream: ComPacT NSXm TM-D, MicroLogic 4.1

Downstream: GV2ME/P, GV3P, GV4P/PE/PEM, LUB12, LUB32

≤ 440V AC

A

Upstream CB	NSXm E/B/F/N/H										NSXm E/B/F/N/H			
Trip unit type	TM-D										MicroLogic 4.1			
Trip unit rating (A)	16	25	32	40	50	63	80	100	125	160	25	50	100	160
Setting Ir (A)	16	25	32	40	50	63	80	100	125	160	23	50	100	160

Downstream CB			Selectivity limit (kA)													
CB type	CB rating (A)	Setting range (A)														
Trip unit type																
GV2 ME/P	01	0.1...0.16	T	T	T	T	T	T	T	T	T	T	T	T	T	
GV2 ME/P	02	0.16...0.25	T	T	T	T	T	T	T	T	T	T	T	T	T	
GV2 ME/P	03	0.25...0.40	T	T	T	T	T	T	T	T	T	T	T	T	T	
GV2 ME/P	04	0.40...0.63	T	T	T	T	T	T	T	T	T	T	T	T	T	
GV2 ME/P	05	0.63...1	T	T	T	T	T	T	T	T	T	T	T	T	T	
GV2 ME/P	06	1...1.6	0.5	T	T	T	T	T	T	T	T	0.38	0.75	T	T	
GV2 ME/P	07	1.6...2.5	0.5	0.5	0.5	T	T	T	T	T	T	0.38	0.75	T	T	
GV2 ME/P	08	2.5...4	0.5	0.5	0.5	0.5	0.6	0.8	T	T	T	0.38	0.75	T	T	
GV2 ME/P	10	4...6.3		0.5	0.5	0.5	0.6	0.8	T	T	T	0.38	0.75	T	T	
GV2 ME/P	14	06...10			0.5	0.5	0.6	0.8	8	8	10	10	0.38	0.75	T	T
GV2 ME/P	16	9...14					0.6	0.8	5	5	8	8		0.75	T	T
GV2 ME/P	20	13...18						0.8	4	4	7	7			T	T
GV2 ME/P	21	17...23						0.8	3	3	3	3			T	T
GV2 ME/P	22	20...25							3	3	3	3			T	T
GV2 ME/P	32	24...32								2	2	2			1.5	T
GV3 P	13	01...13					0.6	0.8	4	4	5	6		0.75	1.5	T
GV3 P	18	12...18						0.8	3	3	4	4			1.5	30
GV3 P	25	17...25							2	2	3	3			1.5	10
GV3 P	32	23...32								1	1.2	1.25				10
GV3 P	40	30...40									1.25	1.25				10
GV3 P	50	37...50										1.25				10
GV3 P	65	48...65														
GV4P/PE/PEM	02	0.8...2	0.5	0.5	0.5	0.5	0.6	T	T	T	T	T	0.38	T	T	T
GV4P/PE/PEM	03	1.4...3.5	0.5	0.5	0.5	0.5	0.6	5	T	T	T	T	0.38	3	3.5	T
GV4P/PE/PEM	07	2.9...7		0.5	0.5	0.5	0.6	0.8	3	4	4	4	0.38	2	2	4
GV4P/PE/PEM	12	5...12.5					0.6	0.8	1	1	3	3		0.75	1.5	2.4
GV4P/PE/PEM	25	10...25							1	1	1.25	1.25			1.5	2.4
GV4P/PE/PEM	50	20...50										1.25				2.4
GV4P/PE/PEM	80	40...80														
GV4P/PE/PEM	115	65...115														
LUB12 + LUC●	X6	0.15...0.6	0.5	0.5	0.5	0.5	0.6	0.8	36	36	36	36	0.25	0.75	1.5	36
LUB12 + LUC●	1X	0.35...1.4	0.5	0.5	0.5	0.5	0.6	0.8	36	36	36	36	0.25	0.75	1.5	36
LUB12 + LUC●	05	1.25...5	0.5	0.5	0.5	0.5	0.6	0.8	36	36	36	36	0.25	0.75	1.5	36
LUB12 + LUC●	12	3...12	0.5	0.5	0.5	0.5	0.6	0.8	36	36	36	36	0.25	0.75	1.5	36
LUB32 + LUC●	X6	0.15...0.6	0.5	0.5	0.5	0.5	0.6	0.8	1	1	1.25	1.25	0.25	0.75	1.5	20
LUB32 + LUC●	1X	0.35...1.4	0.5	0.5	0.5	0.5	0.6	0.8	1	1	1.25	1.25	0.25	0.75	1.5	20
LUB32 + LUC●	05	1.25...5	0.5	0.5	0.5	0.5	0.6	0.8	1	1	1.25	1.25	0.25	0.75	1.5	20
LUB32 + LUC●	12	3...12			0.5	0.5	0.6	0.8	1	1	1.25	1.25		0.75	1.5	20
LUB32 + LUC●	18	4.5...18						0.8	1	1	1.25	1.25			1.5	20
LUB32 + LUC●	32	8...32								1	1.25	1.25			1.5	20
LUB38 + LUC●	38	9.5...38									1.25	1.25				20

- T Total selectivity, up to the breaking capacity of the downstream circuit breaker.
- 4 Selectivity limit = 4 kA.
- No selectivity.

Selectivity Table Motor Protection

Upstream: ComPacT NSXm TM-D, MicroLogic 4.1

Downstream: IC60L MA, NG125L MA, GV2L/LE, GV3L, GV4L/LE

≤ 440V AC

Upstream CB Trip unit type	NSXm E/B/F/N/H										NSXm E/B/F/N/H			
	TM-D										MicroLogic 4.1			
Trip unit rating (A)	16	25	32	40	50	63	80	100	125	160	25	50	100	160
Setting I _r (A)	16	25	32	40	50	63	80	100	125	160	25	50	100	160



Downstream CB				Selectivity limit (kA)														
CB type	CB rating (A)	Th. OL Relay [1]	Setting range (A)															
IC60L MA	1.6	LRD6	1...1.6	0.5	T	T	T	T	T	T	T	T	T	T	5	5	T	T
IC60L MA	2.5	LRD7	1.6...2.5	0.5	0.5	0.5	T	T	T	T	T	T	T	0.375	0.75	T	T	
IC60L MA	4	LRD8	2.5...4	0.5	0.5	0.5	0.5	0.6	0.8	T	T	T	T	0.375	0.75	T	T	
IC60L MA	6.3	LRD10	4...6.3		0.5	0.5	0.5	0.6	0.8	1	1	1.25	1.25	0.38	0.75	1.5	T	
IC60L MA	10	LRD12	5.5...8		0.5	0.5	0.5	0.6	0.8	1	1	1.25	1.25	0.38	0.75	1.5	T	
IC60L MA	10	LRD14	07...10			0.5	0.5	0.6	0.8	1	1	1.25	1.25		0.75	1.5	T	
IC60L MA	12.5	LRD16	9...13				0.5	0.6	0.8	1	1	1.25	1.25		0.75	1.5	T	
IC60L MA	16	LRD21	12...18					0.6	0.8	1	1	1.25	1.25			1.5	T	
IC60L MA	25	LRD22	17...25							1	1	1.25	1.25			1.5	T	
IC60L MA	40	LRD32	23...32								1	1.25	1.25			1.5	T	
IC60L MA	40	LRD3355	30...40									1.25	1.25				T	
NG125L MA	40	LRD32	23...32								1	1.25	1.25			1.5	T	
NG125L MA	40	LRD3355	30...40									1.25	1.25				T	
NG125L MA	63	LRD3357	37...50										1.25				T	
NG125L MA	63	LRD3359	48...65														T	
GV2 L/LE	03	LRD3	0.25...0.40	T	T	T	T	T	T	T	T	T	T	T	T	T	T	
GV2 L/LE	04	LRD4	0.40...0.63	T	T	T	T	T	T	T	T	T	T	T	T	T	T	
GV2 L/LE	05	LRD5	0.63...1	T	T	T	T	T	T	T	T	T	T	T	T	T	T	
GV2 L/LE	06	LRD6	1...1.6	0.5	T	T	T	T	T	T	T	T	T	0.38	0.75	T	T	
GV2 L/LE	07	LRD7	1.6...2.5	0.5	0.5	0.5	T	T	T	T	T	T	T	0.38	0.75	T	T	
GV2 L/LE	08	LRD8	2.5...4	0.5	0.5	0.5	0.5	0.6	0.8	T	T	T	T	0.38	0.75	T	T	
GV2 L/LE	10	LRD10	4...6.3		0.5	0.5	0.5	0.6	0.8	T	T	T	T	0.38	0.75	T	T	
GV2 L/LE	14	LRD14	07...10			0.5	0.5	0.6	0.8	10	10	T	T	0.38	0.75	T	T	
GV2 L/LE	16	LRD16	9...13					0.6	0.8	7	7	10	10		0.75	T	T	
GV2 L/LE	20	LRD21	12...18						0.8	5	5	8	8			T	T	
GV2 L/LE	22	LRD22	17...25							3	3	3	3			T	T	
GV2 L/LE	32	LRD32	23...32								2	2	2			1.5	T	
GV3 L	25	LRD22	20...25							2	2	3	3			1.5	10	
GV3 L	32	LRD32	23...32								1	1.2	1.25			1.5	10	
GV3 L	40	LRD340	30...40									1.25	1.25				10	
GV3 L	50	LRD350	37...50										1.25				10	
GV3 L	65	LRD365	48...65															
GV4 L/LE	02	LRD-07	1.6...2.5	0.5	0.5	0.5	0.5	0.6	T	T	T	T	T	0.38	T	T	T	
GV4 L/LE	03	LRD-08	2.5...4	0.5	0.5	0.5	0.5	0.6	5	T	T	T	T	0.38	3	3.5	T	
GV4 L/LE	07	LRD-12	5.5...8		0.5	0.5	0.5	0.6	0.8	3	4	4	4	0.38	2	2	4	
GV4 L/LE	12	LRD-313	9...13					0.6	0.8	1	1	3	3			1.5	2.4	
GV4 L/LE	25	LRD-325	17...25							1	1	1.25	1.25			1.5	2.4	
GV4 L/LE	50	LRD-350	37...50										1.25				2.4	

[1] The selectivity limits given in the table apply also with GV "L" or "MA" type downstream circuit-breaker without overload relay for overcurrent higher than downstream magnetic threshold.

- T Total selectivity, up to the breaking capacity of the downstream circuit breaker.
- 4 Selectivity limit = 4 kA.
- No selectivity.

Selectivity Table Motor Protection

Upstream: ComPacT NSX100 to 250 TM-D

Downstream: GV2, GV3, GV4, LUB12, LUB32, Integral 63, ComPacT NSX100 to 250 ≤ 440V AC

A

Upstream CB	NSX100B/F/N/H/S/L/R								NSX160B/F/N/H/S/L				NSX250B/F/N/H/S/L/R			
Trip unit type	TM-D															
Trip unit rating (A)	16	25	32	40	50	63	80	100	80	100	125	160	160	200	250	
Setting I _r (A)	16	25	32	40	50	63	80	100	80	100	125	160	160	200	250	

Downstream CB			Selectivity limit (kA)															
CB type	CB rating (A) or Trip unit type	Setting range (A)																
GV2 ME/P	01	0.1...0.16	T	T	T	T	T	T	T	T	T	T	T	T	T	T	T	
GV2 ME/P	02	0.16...0.25	T	T	T	T	T	T	T	T	T	T	T	T	T	T	T	
GV2 ME/P	03	0.25...0.40	T	T	T	T	T	T	T	T	T	T	T	T	T	T	T	
GV2 ME/P	04	0.40...0.63	T	T	T	T	T	T	T	T	T	T	T	T	T	T	T	
GV2 ME/P	05	0.63...1	T	T	T	T	T	T	T	T	T	T	T	T	T	T	T	
GV2 ME/P	06	1...1.6	0.19	T	T	T	T	T	T	T	T	T	T	T	T	T	T	
GV2 ME/P	07	1.6...2.5	0.19	0.25	0.4	T	T	T	T	T	T	T	T	T	T	T	T	
GV2 ME/P	08	2.5...4	0.19	0.25	0.4	0.5	0.5	0.5	0.63	0.8	0.63	0.8	T	T	T	T	T	
GV2 ME/P	10	4...6.3		0.25	0.4	0.5	0.5	0.5	0.63	0.8	0.63	0.8	T	T	T	T	T	
GV2 ME/P	14	06...10			0.4	0.5	0.5	0.5	0.63	0.8	0.63	0.8	T	T	T	T	T	
GV2 ME/P	16	9...14				0.5	0.5	0.63	0.8	0.63	0.8	T	T	T	T	T	T	
GV2 ME/P	20	13...18						0.63	0.8	0.63	0.8	T	T	T	T	T	T	
GV2 ME/P	21	17...23						0.63	0.8	0.63	0.8	T	T	T	T	T	T	
GV2 ME/P	22	20...25						0.63	0.8	0.63	0.8	T	T	T	T	T	T	
GV2 ME/P	32	24...32						0.63	0.8	0.63	0.8	T	T	T	T	T	T	
GV3 P	13	01...13				0.5	0.5	0.5	0.63	0.8	0.63	0.8	1.25	1.25	1.25	T	T	
GV3 P	18	12...18					0.5	0.5	0.63	0.8	0.63	0.8	1.25	1.25	1.25	T	T	
GV3 P	25	17...25						0.5	0.63	0.8	0.63	0.8	1.25	1.25	1.25	T	T	
GV3 P	32	23...32							0.63	0.8	0.63	0.8	1.25	1.25	1.25	T	T	
GV3 P	40	30...40											1.25	1.25	1.25	T	T	
GV3 P	50	37...50											1.25	1.25		T	T	
GV3 P	65	48...65														T	T	
GV4P/PE/PEM	02	0.8...2	0.19	0.25	0.4	0.5	0.5	0.5	0.63	0.8	0.63	0.8	1.25	1.25	1.25	T	T	
GV4P/PE/PEM	03	1.4...3.5		0.25	0.4	0.5	0.5	0.5	0.63	0.8	0.63	0.8	1.25	1.25	1.25	T	T	
GV4P/PE/PEM	07	2.9...7		0.25	0.4	0.5	0.5	0.5	0.63	0.8	0.63	0.8	1.25	1.25	1.25	T	T	
GV4P/PE/PEM	12	5...12.5				0.5	0.5	0.5	0.63	0.8	0.63	0.8	1.25	1.25	1.25	T	T	
GV4P/PE/PEM	25	10...25							0.63	0.8	0.63	0.8	1.25	1.25	1.25	T	T	
GV4P/PE/PEM	50	20...50											1.25	1.25		T	T	
GV4P/PE/PEM	80	40...80														T	T	
GV4P/PE/PEM	115	65...115														T	T	
LUB12 + LUC	X6	0.15...0.6	0.19	0.3	0.4	0.5	0.5	0.5	0.63	0.8	0.63	0.8	T	T	T	T	T	
LUB12 + LUC	1X	0.35...1.4	0.19	0.3	0.4	0.5	0.5	0.5	0.63	0.8	0.63	0.8	T	T	T	T	T	
LUB12 + LUC	05	1.25...5	0.19	0.3	0.4	0.5	0.5	0.5	0.63	0.8	0.63	0.8	T	T	T	T	T	
LUB12 + LUC	12	3...12				0.5	0.5	0.5	0.63	0.8	0.63	0.8	T	T	T	T	T	
LUB32 + LUC	X6	0.15...0.6	0.19	0.3	0.4	0.5	0.5	0.5	0.63	0.8	0.63	0.8	5	5	5	T	T	
LUB32 + LUC	1X	0.35...1.4	0.19	0.3	0.4	0.5	0.5	0.5	0.63	0.8	0.63	0.8	5	5	5	T	T	
LUB32 + LUC	05	1.25...5	0.19	0.3	0.4	0.5	0.5	0.5	0.63	0.8	0.63	0.8	5	5	5	T	T	
LUB32 + LUC	12	3...12				0.5	0.5	0.5	0.63	0.8	0.63	0.8	5	5	5	T	T	
LUB32 + LUC	18	4.5...18						0.5	0.63	0.8	0.63	0.8	5	5	5	T	T	
LUB32 + LUC	32	8...32								0.8		0.8	5	5	5	T	T	
LUB38 + LUC	38	9.5...38											5	5	5	T	T	
Integral 63	LB1-LD03M16	1...13				0.5	0.5	0.5	0.63	0.8	0.63	0.8	1	1	1	T	T	
Integral 63	LB1-LD03M21	13...18						0.5	0.63	0.8	0.63	0.8	1	1	1	T	T	
Integral 63	LB1-LD03M22	18...25							0.63	0.8	0.63	0.8	1	1	1	T	T	
Integral 63	LB1-LD03M53	23...32								0.8	0.8	1	1	1	1	T	T	
Integral 63	LB1-LD03M55	28...40											1	1	1	T	T	
Integral 63	LB1-LD03M57	35...50											1	1	1	T	T	
GV5P150F/H		150															2.5	
GV5P220F/H		220															2.5	
NSX100 F/N/H/S/L/R	Mic. 2.2M or 6.2EM	25...50 100 (80)									0.8	0.8	1	1	1	36	36	
NSX160 F/N/H/S/L/R	Mic. 2.2M or 6.2EM	100 (80) 150											1	1	1	2	2.5	
NSX250 F/N/H/S/L/R	Mic. 2.2M or 6.2EM	150 220											1	1	1	2	2.5	

- T Total selectivity, up to the breaking capacity of the downstream circuit breaker.
- 4 Selectivity limit = 4 kA.
- No selectivity.

Note: Respect the basic rules of selectivity, in terms of overload, short-circuit, ground fault and earth leakage when applicable see page A-1, or check curves with Schneider Electric online "Electrical calculation tools".

Selectivity Table Motor Protection

Upstream: ComPacT NSX100 to 250 TM-D

Downstream: IC60L MA, NG125L MA, GV2, GV3, GV4, ComPacT NSX100
 ≤ 440V AC

Upstream CB				NSX100B/F/N/H/S/L/R						NSX160B/F/N/H/S/L				NSX250B/F/N/H/S/L/R					
Trip unit type				TM-D															
Trip unit rating (A)				16	25	32	40	50	63	80	100	80	100	125	160	160	200	250	
Setting Ir (A)				16	25	32	40	50	63	80	100	80	100	125	160	160	200	250	
Downstream CB				Selectivity limit (kA)															
CB type	CB rating (A)	Th. OL Relay [2]	Setting range (A)																
IC60L MA	1.6	LRD6	1...1.6	0.19	T	T	T	T	T	T	T	T	T	T	T	T	T	T	
IC60L MA	2.5	LRD7	1.6...2.5	0.19	0.3	0.4	T	T	T	T	T	T	T	T	T	T	T	T	
IC60L MA	4	LRD8	2.5...4	0.19	0.3	0.4	0.5	0.5	0.5	0.63	T	0.63	T	T	T	T	T	T	
IC60L MA	6.3	LRD10	4...6.3		0.3	0.4	0.5	0.5	0.5	0.63	5	0.63	5	T	T	T	T	T	
IC60L MA	10	LRD12	5.5...8		0.3	0.4	0.5	0.5	0.5	0.63	2	0.63	2	T	T	T	T	T	
IC60L MA	10	LRD14	07...10			0.4	0.5	0.5	0.5	0.63	0.8	0.63	0.8	T	T	T	T	T	
IC60L MA	12.5	LRD16	9...13				0.5	0.5	0.5	0.63	0.8	0.63	0.8	T	T	T	T	T	
IC60L MA	16	LRD21	12...18						0.5	0.63	0.8	0.63	0.8	T	T	T	T	T	
IC60L MA	25	LRD22	17...25							0.63	0.8	0.63	0.8	T	T	T	T	T	
IC60L MA	40	LRD32	23...32								0.8		0.8	T	T	T	T	T	
IC60L MA	40	LRD3355	30...40										0.8	T	T	T	T	T	
NG125L MA	1.6	LRD6	1...1.6	0.19	T	T	T	T	T	T	T	T	T	T	T	T	T	T	
NG125L MA	2.5	LRD7	1.6...2.5	0.19	0.3	0.4	T	T	T	T	T	T	T	T	T	T	T	T	
NG125L MA	4	LRD8	2.5...4	0.19	0.3	0.4	0.5	0.5	0.5	0.63	T	0.63	T	T	T	T	T	T	
NG125L MA	6.3	LRD10	4...6.3		0.3	0.4	0.5	0.5	0.5	0.63	5	0.63	5	T	T	T	T	T	
NG125L MA	10	LRD12	5.5...8		0.3	0.4	0.5	0.5	0.5	0.63	2	0.63	2	T	T	T	T	T	
NG125L MA	10	LRD14	07...10			0.4	0.5	0.5	0.5	0.63	0.8	0.63	0.8	T	T	T	T	T	
NG125L MA	12.5	LRD16	9...13				0.5	0.5	0.5	0.63	0.8	0.63	0.8	T	T	T	T	T	
NG125L MA	16	LRD21	12...18						0.5	0.63	0.8	0.63	0.8	T	T	T	T	T	
NG125L MA	25	LRD22	17...25							0.63	0.8	0.63	0.8	1.25	1.25	1.25	T	T	
NG125L MA	40	LRD32	23...32								0.8		0.8	1.25	1.25	1.25	T	T	
NG125L MA	40	LRD3355	30...40										0.8	1.25	1.25	1.25	T	T	
NG125L MA	63	LRD3357	37...50											1.25	1.25	1.25	T	T	
NG125L MA	63	LRD3359	48...65												1.25	1.25	T	T	
GV2 L/LE	03	LRD3	0.25...0.40	T	T	T	T	T	T	T	T	T	T	T	T	T	T	T	
GV2 L/LE	04	LRD4	0.40...0.63	T	T	T	T	T	T	T	T	T	T	T	T	T	T	T	
GV2 L/LE	05	LRD5	0.63...1	T	T	T	T	T	T	T	T	T	T	T	T	T	T	T	
GV2 L/LE	06	LRD6	1...1.6	0.19	T	T	T	T	T	T	T	T	T	T	T	T	T	T	
GV2 L/LE	07	LRD7	1.6...2.5	0.19	0.25	0.4	T	T	T	T	T	T	T	T	T	T	T	T	
GV2 L/LE	08	LRD8	2.5...4	0.19	0.25	0.4	0.5	0.5	0.5	0.63	0.8	0.63	0.8	T	T	T	T	T	
GV2 L/LE	10	LRD10	4...6.3		0.25	0.4	0.5	0.5	0.5	0.63	0.8	0.63	0.8	T	T	T	T	T	
GV2 L/LE	14	LRD14	07...10			0.4	0.5	0.5	0.5	0.63	0.8	0.63	0.8	T	T	T	T	T	
GV2 L/LE	16	LRD16	9...13				0.5	0.5	0.5	0.63	0.8	0.63	0.8	T	T	T	T	T	
GV2 L/LE	20	LRD21	12...18							0.63	0.8	0.63	0.8	T	T	T	T	T	
GV2 L/LE	22	LRD22	17...25							0.63	0.8	0.63	0.8	T	T	T	T	T	
GV2 L/LE	32	LRD32	23...32								0.8		0.8	T	T	T	T	T	
GV3 L	25	LRD22	20...25							0.63	0.8	0.63	0.8	1.25	1.25	1.25	T	T	
GV3 L	32	LRD32	23...32								0.8		0.8	1.25	1.25	1.25	T	T	
GV3 L	40	LRD340	30...40											1.25	1.25	1.25	T	T	
GV3 L	50	LRD350	37...50												1.25	1.25	T	T	
GV3 L	65	LRD365	48...65														T	T	
GV4 L/LE	02	LRD-07	1.6...2.5	0.19	0.25	0.4	0.5	0.5	0.5	0.63	0.8	0.63	0.8	1.25	1.25	1.25	T	T	
GV4 L/LE	03	LRD-08	2.5...4		0.25	0.4	0.5	0.5	0.5	0.63	0.8	0.63	0.8	1.25	1.25	1.25	T	T	
GV4 L/LE	07	LRD-12	5.5...8		0.25	0.4	0.5	0.5	0.5	0.63	0.8	0.63	0.8	1.25	1.25	1.25	T	T	
GV4 L/LE	12	LRD-313	9...13				0.5	0.5	0.5	0.63	0.8	0.63	0.8	1.25	1.25	1.25	T	T	
GV4 L/LE	25	LRD-325	17...25							0.63	0.8	0.63	0.8	1.25	1.25	1.25	T	T	
GV4 L/LE	50	LRD-350	37...50											1.25	1.25		T	T	
GV4 L/LE	80	LRD-33 63	63...80															T	
GV4 L/LE	115	LR9D-5369 LR9G115	90...150																
NSX100 [1]	MA2.5	LRD6	1...1.6	0.19	0.3	T	T	T	T	T	T	T	T	T	T	T	T	T	
NSX100 [1]	MA2.5	LRD7	1.6...2.5	0.19	0.3	0.4	0.5	0.5	0.5	T	T	T	T	T	T	T	T	T	
NSX100 [1]	MA6.3	LRD8	2.5...4	0.19	0.3	0.4	0.5	0.5	0.5	0.63	0.8	0.63	0.8	T	T	T	T	T	
NSX100 [1]	MA6.3	LRD10	4...6.3		0.3	0.4	0.5	0.5	0.5	0.63	0.8	0.63	0.8	T	T	T	T	T	
NSX100 [1]	MA12.5	LRD12	5.5...8		0.3	0.4	0.5	0.5	0.5	0.63	0.8	0.63	0.8	1	1	1	T	T	
NSX100 [1]	MA12.5	LRD14	9...13			0.4	0.5	0.5	0.5	0.63	0.8	0.63	0.8	1	1	1	T	T	
NSX100 [1]	MA12.5	LRD16	12...18				0.5	0.5	0.5	0.63	0.8	0.63	0.8	1	1	1	T	T	
NSX100 [1]	MA25	LRD21	17...25						0.5	0.63	0.8	0.63	0.8	1	1	1	T	T	
NSX100 [1]	MA25	LRD22	17...25							0.63	0.8	0.63	0.8	1	1	1	T	T	
NSX100 [1]	MA50	LRD32	23...32								0.8		0.8	1	1	1	36	36	
NSX100 [1]	MA50	LRD340	30...40											1	1	1	36	36	
NSX100 [1]	MA50	LRD350	37...50												1	1	36	36	
NSX100 [1]	MA100	LRD365	48...65														36	36	
NSX100 [1]	MA100	LRD3363	63...80														36	36	

[1] F/N/H/S/L/R

[2] The selectivity limits given in the table apply also with GV "L" or "MA" type downstream circuit-breaker without overload relay for overcurrent higher than downstream magnetic threshold.

T Total selectivity, up to the breaking capacity of the downstream circuit breaker.

4 Selectivity limit = 4 kA.

No selectivity.

Note: Respect the basic rules of selectivity, in terms of overload, short-circuit, ground fault and earth leakage when applicable see page A-1, or check curves with Schneider Electric online "Electrical calculation tools".

Version : 2.0 - 19/12/2023

548E4350

Selectivity Table Motor Protection

Upstream: ComPacT NSX100 to 160 MicroLogic

Downstream: GV2, GV3, GV4, LUB12, LUB32, Integral 63, ComPacT NSX100 to 250 ≤ 440V AC

A

Upstream CB	NSX100B/F/N/H/S/L/R							NSX160B/F/N/H/S/L				
Trip unit type	MicroLogic [1]											
Trip unit rating (A)	40			100				160				
Setting Ir (A)	16	25	40	40	63	80	100	63	80	100	125	160

Downstream CB			Selectivity limit (kA)											
CB type	CB rating (A) or Trip unit type	Setting range (A)												
GV2 ME/P	01	0.1...0.16	T	T	T	T	T	T	T	T	T	T	T	T
GV2 ME/P	02	0.16...0.25	T	T	T	T	T	T	T	T	T	T	T	T
GV2 ME/P	03	0.25...0.40	T	T	T	T	T	T	T	T	T	T	T	T
GV2 ME/P	04	0.40...0.63	T	T	T	T	T	T	T	T	T	T	T	T
GV2 ME/P	05	0.63...1	T	T	T	T	T	T	T	T	T	T	T	T
GV2 ME/P	06	1...1.6	0.6	0.6	0.6	T	T	T	T	T	T	T	T	T
GV2 ME/P	07	1.6...2.5	0.6	0.6	0.6	T	T	T	T	T	T	T	T	T
GV2 ME/P	08	2.5...4	0.6	0.6	0.6	T	T	T	T	T	T	T	T	T
GV2 ME/P	10	4...6.3		0.6	0.6	T	T	T	T	T	T	T	T	T
GV2 ME/P	14	06...10			0.6	T	T	T	T	T	T	T	T	T
GV2 ME/P	16	9...14				T	T	T	T	T	T	T	T	T
GV2 ME/P	20	13...18				T	T	T	T	T	T	T	T	T
GV2 ME/P	21	17...23					T	T	T	T	T	T	T	T
GV2 ME/P	22	20...25						T	T		T	T	T	T
GV2 ME/P	32	24...32							T			T	T	T
GV3 P	13	01...13			0.6	1.5	1.5	1.5	1.5	T	T	T	T	T
GV3 P	18	12...18					1.5	1.5	1.5	T	T	T	T	T
GV3 P	25	17...25							1.5	T	T	T	T	T
GV3 P	32	23...32									T	T	T	T
GV3 P	40	30...40											2.4	2.4
GV3 P	50	37...50												2.4
GV3 P	65	48...65												
GV4P/PE/PEM	02	0.8...2	T	T	T	T	T	T	T	T	T	T	T	T
GV4P/PE/PEM	03	1.4...3.5	25	25	25	T	T	T	T	T	T	T	T	T
GV4P/PE/PEM	07	2.9...7		2	2	2	2	2	2	4	4	4	4	4
GV4P/PE/PEM	12	5...12.5					1.5	1.5	1.5	2.4	2.4	2.4	2.4	2.4
GV4P/PE/PEM	25	10...25						1.5	1.5		2.4	2.4	2.4	2.4
GV4P/PE/PEM	50	20...50												2.4
GV4P/PE/PEM	80	40...80												
GV4P/PE/PEM	115	65...115												
LUB12 + LUC	X6	0.15...0.6	T	T	T	T	T	T	T	T	T	T	T	T
LUB12 + LUC	1X	0.35...1.4	T	T	T	T	T	T	T	T	T	T	T	T
LUB12 + LUC	05	1.25...5	T	T	T	T	T	T	T	T	T	T	T	T
LUB12 + LUC	12	3...12				T	T	T	T	T	T	T	T	T
LUB32 + LUC	X6	0.15...0.6	T	T	T	T	T	T	T	T	T	T	T	T
LUB32 + LUC	1X	0.35...1.4	T	T	T	T	T	T	T	T	T	T	T	T
LUB32 + LUC	05	1.25...5	T	T	T	T	T	T	T	T	T	T	T	T
LUB32 + LUC	12	3...12				T	T	T	T	T	T	T	T	T
LUB32 + LUC	18	4.5...18					T	T	T	T	T	T	T	T
LUB32 + LUC	32	8...32							T			T	T	T
LUB38 + LUC	38	9.5...38											T	T
Integral 63	LB1-LD03M16	1...13			0.6	1.5	1.5	1.5	1.5	2.4	2.4	2.4	2.4	2.4
Integral 63	LB1-LD03M21	13...18					1.5	1.5	1.5	2.4	2.4	2.4	2.4	2.4
Integral 63	LB1-LD03M22	18...25							1.5	1.5	2.4	2.4	2.4	2.4
Integral 63	LB1-LD03M53	23...32									1.5	2.4	2.4	2.4
Integral 63	LB1-LD03M55	28...40											2.4	2.4
Integral 63	LB1-LD03M57	35...50												2.4
Integral 63	LB1-LD03M61	45...63												
NSX100 F/N/H/S/L/R	Mic. 2.2M or 6.2EM	25...50							1.5			2.4	2.4	2.4
NSX160 F/N/H/S/L/R	Mic. 2.2M or 6.2EM	100										2.4	2.4	2.4
NSX250 F/N/H/S/L/R	Mic. 2.2M or 6.2EM	150												
NSX250 F/N/H/S/L/R	Mic. 2.2M or 6.2EM	220												

[1] Valid for all "Distribution" MicroLogic of ComPacT NSX: 2.2, 4.2, 5.2, 6.2, 7.2. Valid for Generators (and Service connection (G and AB type) MicroLogic of ComPacT NSX but curves shall be checked. Not Valid for "Motor" MicroLogic of ComPacT NSX ("M" type).

- T Total selectivity, up to the breaking capacity of the downstream circuit breaker.
- 4 Selectivity limit = 4 kA.
- No selectivity.

Note: Respect the basic rules of selectivity, in terms of overload, short-circuit, ground fault and earth leakage when applicable see page A-1, or check curves with Schneider Electric online "Electrical calculation tools".

Selectivity Table Motor Protection

Upstream: ComPacT NSX100 to 160, MicroLogic

Downstream: IC60L MA, NG125L MA, GV2, GV3, GV4, ComPacT NSX100

≤ 440V AC

Upstream CB				NSX100B/F/N/H/S/L/R								NSX160B/F/N/H/S/L						
Trip unit type				MicroLogic [1]														
Trip unit rating (A)				40				100				160						
Setting Ir (A)				16	25	40	40	63	80	100	63	80	100	125	160			
Downstream CB				Selectivity limit (kA)														
CB type	CB rating (A)	Th. OL Relay [2]	Setting range (A)															
IC60L MA	1.6	LRD6	1...1.6	T	T	T	T	T	T	T	T	T	T	T	T	T	T	T
IC60L MA	2.5	LRD7	1.6...2.5	1	1	1	T	T	T	T	T	T	T	T	T	T	T	T
IC60L MA	4	LRD8	2.5...4	0.6	0.6	0.6	T	T	T	T	T	T	T	T	T	T	T	T
IC60L MA	6.3	LRD10	4...6.3	0.6	0.6	0.6	5	5	5	5	T	T	T	T	T	T	T	T
IC60L MA	10	LRD12	5.5...8		0.6	0.6	2	2	2	2	T	T	T	T	T	T	T	T
IC60L MA	10	LRD14	07...10			0.6	1.5	1.5	1.5	1.5	T	T	T	T	T	T	T	T
IC60L MA	12.5	LRD16	9...13			0.6	1.5	1.5	1.5	1.5	T	T	T	T	T	T	T	T
IC60L MA	16	LRD21	12...18					1.5	1.5	1.5	T	T	T	T	T	T	T	T
IC60L MA	25	LRD22	17...25						1.5	1.5		T	T	T	T	T	T	T
IC60L MA	40	LRD32	23...32							1.5			T	T	T	T	T	T
IC60L MA	40	LRD3355	30...40											T	T	T	T	T
NG125L MA	1.6	LRD6	1...1.6	T	T	T	T	T	T	T	T	T	T	T	T	T	T	T
NG125L MA	2.5	LRD7	1.6...2.5	1	1	1	T	T	T	T	T	T	T	T	T	T	T	T
NG125L MA	4	LRD8	2.5...4	0.6	0.6	0.6	T	T	T	T	T	T	T	T	T	T	T	T
NG125L MA	6.3	LRD10	4...6.3	0.6	0.6	0.6	5	5	5	5	T	T	T	T	T	T	T	T
NG125L MA	10	LRD12	5.5...8		0.6	0.6	2	2	2	2	T	T	T	T	T	T	T	T
NG125L MA	10	LRD14	07...10			0.6	1.5	1.5	1.5	1.5	T	T	T	T	T	T	T	T
NG125L MA	12.5	LRD16	9...13			0.6	1.5	1.5	1.5	1.5	T	T	T	T	T	T	T	T
NG125L MA	16	LRD21	12...18					1.5	1.5	1.5	T	T	T	T	T	T	T	T
NG125L MA	25	LRD22	17...25						1.5	1.5		T	T	T	T	T	T	T
NG125L MA	40	LRD32	23...32							1.5				T	T	T	T	T
NG125L MA	40	LRD3355	30...40											T	T	T	T	T
NG125L MA	63	LRD3357	37...50												T	T	T	T
NG125L MA	63	LRD3359	48...65													T	T	T
GV2 L/LE	03	LRD3	0.25...0.40	T	T	T	T	T	T	T	T	T	T	T	T	T	T	T
GV2 L/LE	04	LRD4	0.40...0.63	T	T	T	T	T	T	T	T	T	T	T	T	T	T	T
GV2 L/LE	05	LRD5	0.63...1	T	T	T	T	T	T	T	T	T	T	T	T	T	T	T
GV2 L/LE	06	LRD6	1...1.6	0.6	0.6	0.6	T	T	T	T	T	T	T	T	T	T	T	T
GV2 L/LE	07	LRD7	1.6...2.5	0.6	0.6	0.6	T	T	T	T	T	T	T	T	T	T	T	T
GV2 L/LE	08	LRD8	2.5...4	0.6	0.6	0.6	T	T	T	T	T	T	T	T	T	T	T	T
GV2 L/LE	10	LRD10	4...6.3		0.6	0.6	T	T	T	T	T	T	T	T	T	T	T	T
GV2 L/LE	14	LRD14	07...10			0.6	T	T	T	T	T	T	T	T	T	T	T	T
GV2 L/LE	16	LRD16	9...13					T	T	T	T	T	T	T	T	T	T	T
GV2 L/LE	20	LRD21	12...18						T	T	T	T	T	T	T	T	T	T
GV2 L/LE	22	LRD22	17...25						T	T	T	T	T	T	T	T	T	T
GV2 L/LE	32	LRD32	23...32							T	T	T	T	T	T	T	T	T
GV3 L	25	LRD22	20...25							1.5	1.5							
GV3 L	32	LRD32	23...32										1.5					
GV3 L	40	LRD340	30...40												2.4	2.4		
GV3 L	50	LRD350	37...50														2.4	
GV3 L	65	LRD365	48...65															2.4
GV4 L/LE	02	LRD-07	1.6...2.5	T	T	T	T	T	T	T	T	T	T	T	T	T	T	T
GV4 L/LE	03	LRD-08	2.5...4	25	25	25	T	T	T	T	T	T	T	T	T	T	T	T
GV4 L/LE	07	LRD-12	5.5...8		2	2	2	2	2	2	4	4	4	4	4	4	4	4
GV4 L/LE	12	LRD-313	9...13					1.5	1.5	1.5	2.4	2.4	2.4	2.4	2.4	2.4	2.4	2.4
GV4 L/LE	25	LRD-325	17...25						1.5	1.5		2.4	2.4	2.4	2.4	2.4	2.4	2.4
GV4 L/LE	50	LRD-350	37...50							1.5								2.4
GV4 L/LE	80	LRD-33 63	63...80															
GV4 L/LE	115	LR9D-5369 LR9-F5369	90...150															
NSX100	MA2.5	LRD6	1...1.6	T	T	T	T	T	T	T	T	T	T	T	T	T	T	T
NSX100	MA2.5	LRD7	1.6...2.5	1	1	1	T	T	T	T	T	T	T	T	T	T	T	T
NSX100	MA6.3	LRD8	2.5...4	0.6	0.6	0.6	1.5	1.5	1.5	1.5	T	T	T	T	T	T	T	T
NSX100	MA6.3	LRD10	4...6.3		0.6	0.6	1.5	1.5	1.5	1.5	T	T	T	T	T	T	T	T
NSX100	MA12.5	LRD12	5.5...8		0.6	0.6	1.5	1.5	1.5	1.5	2.4	2.4	2.4	2.4	2.4	2.4	2.4	2.4
NSX100	MA12.5	LRD14	9...13			0.6	1.5	1.5	1.5	1.5	2.4	2.4	2.4	2.4	2.4	2.4	2.4	2.4
NSX100	MA12.5	LRD16	12...18			0.6	1.5	1.5	1.5	1.5	2.4	2.4	2.4	2.4	2.4	2.4	2.4	2.4
NSX100	MA25	LRD21	17...25					1.5	1.5	1.5	2.4	2.4	2.4	2.4	2.4	2.4	2.4	2.4
NSX100	MA25	LRD22	17...25						1.5	1.5		2.4	2.4	2.4	2.4	2.4	2.4	2.4
NSX100	MA50	LRD32	23...32							1.5				2.4	2.4	2.4	2.4	2.4
NSX100	MA50	LRD340	30...40												2.4	2.4	2.4	2.4
NSX100	MA50	LRD350	37...50													2.4	2.4	2.4
NSX100	MA100	LRD365	48...65															2.4
NSX100	MA100	LRD3363	63...80															2.4

[1] Valid for all "Distribution" MicroLogic of ComPacT NSX: 2.2, 4.2, 5.2, 6.2, 7.2. Valid for Generators (and Service connection (G and AB type) MicroLogic of ComPacT NSX but curves shall be checked. Not Valid for "Motor" MicroLogic of ComPacT NSX ("M" type).

[2] The selectivity limits given in the table apply also with GV "L" or "MA" type downstream circuit-breaker without overload relay for overcurrent higher than downstream magnetic threshold.

T Total selectivity, up to the breaking capacity of the downstream circuit breaker.

4 Selectivity limit = 4 kA.

No selectivity.

Note: Respect the basic rules of selectivity, in terms of overload, short-circuit, ground fault and earth leakage when applicable see page A-1, or check curves with Schneider Electric online "Electrical calculation tools".

Version : 2.0 - 19/12/2023

548E4350

Selectivity Table Motor Protection

Upstream: ComPacT NSX250 to 630 MicroLogic

Downstream: GV2, GV3, GV4, GV5, LUB12, LUB32, Integral 63, ComPacT NSX100 to 250
 ≤ 440V AC

A

Upstream CB	NSX250B/F/N/H/S/L/R					NSX400F/N/H/S/L/R					NSX630F/N/H/S/L/R				
Trip unit type	MicroLogic [1]														
Trip unit rating (A)	250					400					630				
Setting Ir (A)	100	125	160	200	250	160	200	250	320	400	250	320	400	500	630

Downstream CB			Selectivity limit (kA)														
CB type	CB rating (A)	Setting range (A)															
Trip unit type																	
GV2 ME/P	01	0.1...0.16	T	T	T	T	T	T	T	T	T	T	T	T	T	T	
GV2 ME/P	02	0.16...0.25	T	T	T	T	T	T	T	T	T	T	T	T	T	T	
GV2 ME/P	03	0.25...0.40	T	T	T	T	T	T	T	T	T	T	T	T	T	T	
GV2 ME/P	04	0.40...0.63	T	T	T	T	T	T	T	T	T	T	T	T	T	T	
GV2 ME/P	05	0.63...1	T	T	T	T	T	T	T	T	T	T	T	T	T	T	
GV2 ME/P	06	1...1.6	T	T	T	T	T	T	T	T	T	T	T	T	T	T	
GV2 ME/P	07	1.6...2.5	T	T	T	T	T	T	T	T	T	T	T	T	T	T	
GV2 ME/P	08	2.5...4	T	T	T	T	T	T	T	T	T	T	T	T	T	T	
GV2 ME/P	10	4...6.3	T	T	T	T	T	T	T	T	T	T	T	T	T	T	
GV2 ME/P	14	06...10	T	T	T	T	T	T	T	T	T	T	T	T	T	T	
GV2 ME/P	16	9...14	T	T	T	T	T	T	T	T	T	T	T	T	T	T	
GV2 ME/P	20	13...18	T	T	T	T	T	T	T	T	T	T	T	T	T	T	
GV2 ME/P	21	17...23	T	T	T	T	T	T	T	T	T	T	T	T	T	T	
GV2 ME/P	22	20...25	T	T	T	T	T	T	T	T	T	T	T	T	T	T	
GV2 ME/P	32	24...32	T	T	T	T	T	T	T	T	T	T	T	T	T	T	
GV3 P	13	01...13	T	T	T	T	T	T	T	T	T	T	T	T	T	T	
GV3 P	18	12...18	T	T	T	T	T	T	T	T	T	T	T	T	T	T	
GV3 P	25	17...25	T	T	T	T	T	T	T	T	T	T	T	T	T	T	
GV3 P	32	23...32	T	T	T	T	T	T	T	T	T	T	T	T	T	T	
GV3 P	40	30...40		T	T	T	T	T	T	T	T	T	T	T	T	T	
GV3 P	50	37...50			T	T	T	T	T	T	T	T	T	T	T	T	
GV3 P	65	48...65				T	T	T	T	T	T	T	T	T	T	T	
GV4P/PE/PEM	02	0.8...2	T	T	T	T	T	T	T	T	T	T	T	T	T	T	
GV4P/PE/PEM	03	1.4...3.5	T	T	T	T	T	T	T	T	T	T	T	T	T	T	
GV4P/PE/PEM	07	2.9...7	T	T	T	T	T	T	T	T	T	T	T	T	T	T	
GV4P/PE/PEM	12	5...12.5	T	T	T	T	T	T	T	T	T	T	T	T	T	T	
GV4P/PE/PEM	25	10...25	T	T	T	T	T	T	T	T	T	T	T	T	T	T	
GV4P/PE/PEM	50	20...50		T	T	T	T	T	T	T	T	T	T	T	T	T	
GV4P/PE/PEM	80	40...80				T	T	T	T	T	T	T	T	T	T	T	
GV4P/PE/PEM	115	65...115					T	T	T	T	T	T	T	T	T	T	
LUB12 + LUC	X6	0.15...0.6	T	T	T	T	T	T	T	T	T	T	T	T	T	T	
LUB12 + LUC	1X	0.35...1.4	T	T	T	T	T	T	T	T	T	T	T	T	T	T	
LUB12 + LUC	05	1.25...5	T	T	T	T	T	T	T	T	T	T	T	T	T	T	
LUB12 + LUC	12	3...12	T	T	T	T	T	T	T	T	T	T	T	T	T	T	
LUB32 + LUC	X6	0.15...0.6	T	T	T	T	T	T	T	T	T	T	T	T	T	T	
LUB32 + LUC	1X	0.35...1.4	T	T	T	T	T	T	T	T	T	T	T	T	T	T	
LUB32 + LUC	05	1.25...5	T	T	T	T	T	T	T	T	T	T	T	T	T	T	
LUB32 + LUC	12	3...12	T	T	T	T	T	T	T	T	T	T	T	T	T	T	
LUB32 + LUC	18	4.5...18	T	T	T	T	T	T	T	T	T	T	T	T	T	T	
LUB32 + LUC	32	8...32	T	T	T	T	T	T	T	T	T	T	T	T	T	T	
LUB38 + LUC	38	9,5...38	T	T	T	T	T	T	T	T	T	T	T	T	T	T	
Integral 63	LB1-LD03M16	1...13	T	T	T	T	T	T	T	T	T	T	T	T	T	T	
Integral 63	LB1-LD03M21	13...18	T	T	T	T	T	T	T	T	T	T	T	T	T	T	
Integral 63	LB1-LD03M22	18...25	T	T	T	T	T	T	T	T	T	T	T	T	T	T	
Integral 63	LB1-LD03M53	23...32	T	T	T	T	T	T	T	T	T	T	T	T	T	T	
Integral 63	LB1-LD03M55	28...40		T	T	T	T	T	T	T	T	T	T	T	T	T	
Integral 63	LB1-LD03M57	35...50			T	T	T	T	T	T	T	T	T	T	T	T	
Integral 63	LB1-LD03M61	45...63				T	T	T	T	T	T	T	T	T	T	T	
GV5P150F/N		150													T	T	
GV5P220F/N		220														T	
NSX100	Mic. 2.2M	25...50	36	36	36	36	36	T	T	T	T	T	T	T	T	T	
F/N/H/S/L/R	or 6.2EM	100								T	T	T	T	T	T	T	
NSX160	Mic. 2.2M	100					3			T	T	T	T	T	T	T	
F/N/H/S/L/R	or 6.2EM	150													T	T	
NSX250	Mic. 2.2M	150										4.8			T	T	
F/N/H/S/L/R	or 6.2EM	220														T	

[1] Valid for all "Distribution" MicroLogic of ComPacT NSX: 2.2/3, 4.2/3 5.2/3, 6.2/3, 7.2/3. Valid for Generators (and Service connection (G and AB type) MicroLogic of ComPacT NSX but curves shall be checked. Not Valid for "Motor" MicroLogic of ComPacT NSX ("M" type).

- T Total selectivity, up to the breaking capacity of the downstream circuit breaker.
- 4 Selectivity limit = 4 kA.
- No selectivity.

Note: Respect the basic rules of selectivity, in terms of overload, short-circuit, ground fault and earth leakage when applicable see page A-1, or check curves with Schneider Electric online "Electrical calculation tools".

Selectivity Table Motor Protection

Upstream: ComPacT NSX250 to 630 MicroLogic

Downstream: IC60L MA, NG125L MA, GV2, GV3, GV4, ComPacT NSX100 to 250 ≤ 440V AC

Upstream CB	NSX250B/F/N/H/S/L/R					NSX400F/N/H/S/L/R					NSX630F/N/H/S/L/R				
Trip unit type	MicroLogic [1]														
Trip unit rating (A)	250					400					630				
Setting Ir (A)	100	125	160	200	250	160	200	250	320	400	250	320	400	500	630



Downstream CB				Selectivity limit (kA)															
CB type	CB rating (A)	Th. OL Relay [2]	Setting range (A)																
IC60L MA	1.6	LRD6	1...1.6	T	T	T	T	T	T	T	T	T	T	T	T	T	T	T	T
IC60L MA	2.5	LRD7	1.6...2.5	T	T	T	T	T	T	T	T	T	T	T	T	T	T	T	T
IC60L MA	4	LRD8	2.5...4	T	T	T	T	T	T	T	T	T	T	T	T	T	T	T	T
IC60L MA	6.3	LRD10	4...6.3	T	T	T	T	T	T	T	T	T	T	T	T	T	T	T	T
IC60L MA	10	LRD12	5.5...8	T	T	T	T	T	T	T	T	T	T	T	T	T	T	T	T
IC60L MA	10	LRD14	07...10	T	T	T	T	T	T	T	T	T	T	T	T	T	T	T	T
IC60L MA	12.5	LRD16	9...13	T	T	T	T	T	T	T	T	T	T	T	T	T	T	T	T
IC60L MA	16	LRD21	12...18	T	T	T	T	T	T	T	T	T	T	T	T	T	T	T	T
IC60L MA	25	LRD22	17...25	T	T	T	T	T	T	T	T	T	T	T	T	T	T	T	T
IC60L MA	40	LRD32	23...32	T	T	T	T	T	T	T	T	T	T	T	T	T	T	T	T
IC60L MA	40	LRD3355	30...40																
NG125L MA	1.6	LRD6	1...1.6	T	T	T	T	T	T	T	T	T	T	T	T	T	T	T	T
NG125L MA	2.5	LRD7	1.6...2.5	T	T	T	T	T	T	T	T	T	T	T	T	T	T	T	T
NG125L MA	4	LRD8	2.5...4	T	T	T	T	T	T	T	T	T	T	T	T	T	T	T	T
NG125L MA	6.3	LRD10	4...6.3	T	T	T	T	T	T	T	T	T	T	T	T	T	T	T	T
NG125L MA	10	LRD12	5.5...8	T	T	T	T	T	T	T	T	T	T	T	T	T	T	T	T
NG125L MA	10	LRD14	07...10	T	T	T	T	T	T	T	T	T	T	T	T	T	T	T	T
NG125L MA	12.5	LRD16	9...13	T	T	T	T	T	T	T	T	T	T	T	T	T	T	T	T
NG125L MA	16	LRD21	12...18	T	T	T	T	T	T	T	T	T	T	T	T	T	T	T	T
NG125L MA	25	LRD22	17...25	T	T	T	T	T	T	T	T	T	T	T	T	T	T	T	T
NG125L MA	40	LRD32	23...32	T	T	T	T	T	T	T	T	T	T	T	T	T	T	T	T
NG125L MA	40	LRD3355	30...40																
NG125L MA	63	LRD3357	37...50																
NG125L MA	63	LRD3359	48...65																
GV2 L/LE	03	LRD3	0.25...0.40	T	T	T	T	T	T	T	T	T	T	T	T	T	T	T	T
GV2 L/LE	04	LRD4	0.40...0.63	T	T	T	T	T	T	T	T	T	T	T	T	T	T	T	T
GV2 L/LE	05	LRD5	0.63...1	T	T	T	T	T	T	T	T	T	T	T	T	T	T	T	T
GV2 L/LE	06	LRD6	1...1.6	T	T	T	T	T	T	T	T	T	T	T	T	T	T	T	T
GV2 L/LE	07	LRD7	1.6...2.5	T	T	T	T	T	T	T	T	T	T	T	T	T	T	T	T
GV2 L/LE	08	LRD8	2.5...4	T	T	T	T	T	T	T	T	T	T	T	T	T	T	T	T
GV2 L/LE	10	LRD10	4...6.3	T	T	T	T	T	T	T	T	T	T	T	T	T	T	T	T
GV2 L/LE	14	LRD14	07...10	T	T	T	T	T	T	T	T	T	T	T	T	T	T	T	T
GV2 L/LE	16	LRD16	9...13	T	T	T	T	T	T	T	T	T	T	T	T	T	T	T	T
GV2 L/LE	20	LRD21	12...18	T	T	T	T	T	T	T	T	T	T	T	T	T	T	T	T
GV2 L/LE	22	LRD22	17...25	T	T	T	T	T	T	T	T	T	T	T	T	T	T	T	T
GV2 L/LE	32	LRD32	23...32	T	T	T	T	T	T	T	T	T	T	T	T	T	T	T	T
GV3 L	25	LRD22	20...25	T	T	T	T	T	T	T	T	T	T	T	T	T	T	T	T
GV3 L	32	LRD32	23...32	T	T	T	T	T	T	T	T	T	T	T	T	T	T	T	T
GV3 L	40	LRD340	30...40																
GV3 L	50	LRD350	37...50																
GV3 L	65	LRD365	48...65																
GV4 L/LE	02	LRD-07	1.6...2.5	T	T	T	T	T	T	T	T	T	T	T	T	T	T	T	T
GV4 L/LE	03	LRD-08	2.5...4	T	T	T	T	T	T	T	T	T	T	T	T	T	T	T	T
GV4 L/LE	07	LRD-12	5.5...8	T	T	T	T	T	T	T	T	T	T	T	T	T	T	T	T
GV4 L/LE	12	LRD-313	9...13	T	T	T	T	T	T	T	T	T	T	T	T	T	T	T	T
GV4 L/LE	25	LRD-325	17...25	T	T	T	T	T	T	T	T	T	T	T	T	T	T	T	T
GV4 L/LE	50	LRD-350	37...50	T	T	T	T	T	T	T	T	T	T	T	T	T	T	T	T
GV4 L/LE	80	LRD-33 63	63...80																
GV4 L/LE	115	LR9/F-5369	90...150																
NSX100	MA2.5	LRD6	1...1.6	T	T	T	T	T	T	T	T	T	T	T	T	T	T	T	T
NSX100	MA2.5	LRD7	1.6...2.5	T	T	T	T	T	T	T	T	T	T	T	T	T	T	T	T
NSX100	MA6.3	LRD8	2.5...4	T	T	T	T	T	T	T	T	T	T	T	T	T	T	T	T
NSX100	MA6.3	LRD10	4...6.3	T	T	T	T	T	T	T	T	T	T	T	T	T	T	T	T
NSX100	MA12.5	LRD12	5.5...8	T	T	T	T	T	T	T	T	T	T	T	T	T	T	T	T
NSX100	MA12.5	LRD14	9...13	T	T	T	T	T	T	T	T	T	T	T	T	T	T	T	T
NSX100	MA12.5	LRD16	12...18	T	T	T	T	T	T	T	T	T	T	T	T	T	T	T	T
NSX100	MA25	LRD21	17...25	T	T	T	T	T	T	T	T	T	T	T	T	T	T	T	T
NSX100	MA25	LRD22	17...25	T	T	T	T	T	T	T	T	T	T	T	T	T	T	T	T
NSX100	MA50	LRD32	23...32																
NSX100	MA50	LRD340	30...40	36	36	36	36	36	36	36	36	36	36	36	36	36	36	36	36
NSX100	MA50	LRD350	37...50																
NSX100	MA100	LRD365	48...65																
NSX100	MA100	LRD3363	63...80																
NSX160	MA150	LR9D/F 5369	90...150																
NSX250	MA220	LR9D/F 5371	132...220																

[1] Valid for all "Distribution" MicroLogic of ComPacT NSX: 2.2/3, 4.2/3 5.2/3, 6.2/3, 7.2/3. Valid for Generators (and Service connection (G and AB type) MicroLogic of ComPacT NSX but curves shall be checked. Not Valid for "Motor" MicroLogic of ComPacT NSX ("M" type).

[2] The selectivity limits given in the table apply also with GV "L" or "MA" type downstream circuit-breaker without overload relay for overcurrent higher than downstream magnetic threshold.

Total selectivity, up to the breaking capacity of the downstream circuit breaker.

Selectivity limit = 4 kA.

No selectivity.

Note: Respect the basic rules of selectivity, in terms of overload, short-circuit, ground fault and earth leakage when applicable see page A-1, or check curves with Schneider Electric online "Electrical calculation tools".

Selectivity Table Motor Protection

Upstream: ComPacT NS630b to 1600 N/H

Downstream: IC60L MA, NG125L MA, LUB12, LUB32, GV2, GV3, GV4, GV5, GV6, ComPacT NSX100 to 630

≤ 440V AC

A

Upstream CB	NS630b 800 1000 1250 1600 N/H						NS630b 800 1000 1250 1600 N/H						NS630b 800 1000 1250 1600 N/H								
Trip unit type	MicroLogic 2.0						MicroLogic 5.0 - 6.0 - 7.0 Inst 15 In						MicroLogic 5.0 - 6.0 - 7.0 Inst OFF								
Trip unit rating In (A)	630		800	1000	1250	1600	630		800	1000	1250	1600	630		800	1000	1250	1600			
Setting Ir (A)	250	400	630	800	1000	1250	1600	250	400	630	800	1000	1250	1600	250	400	630	800	1000	1250	1600

Downstream CB	CB type	CB rating or Trip unit rating (A)	Selectivity limit (kA)																			
Trip unit type																						
IC60 L MA1.6...MA40 + LRD			T	T	T	T	T	T	T	T	T	T	T	T	T	T	T	T	T	T	T	
NG125L MA2.5...MA63 + LRD			T	T	T	T	T	T	T	T	T	T	T	T	T	T	T	T	T	T	T	
LUB12 + LUC•6..12			T	T	T	T	T	T	T	T	T	T	T	T	T	T	T	T	T	T	T	
LUB32 + LUC•6..32			T	T	T	T	T	T	T	T	T	T	T	T	T	T	T	T	T	T	T	
LUB38 + LUC•38			T	T	T	T	T	T	T	T	T	T	T	T	T	T	T	T	T	T	T	
GV2 ME01..ME32			T	T	T	T	T	T	T	T	T	T	T	T	T	T	T	T	T	T	T	
GV2 P01...P32			T	T	T	T	T	T	T	T	T	T	T	T	T	T	T	T	T	T	T	
GV2 L03..L32 + LRD			T	T	T	T	T	T	T	T	T	T	T	T	T	T	T	T	T	T	T	
GV3 P13...P65			T	T	T	T	T	T	T	T	T	T	T	T	T	T	T	T	T	T	T	
GV3 L25..L65 + LRD			T	T	T	T	T	T	T	T	T	T	T	T	T	T	T	T	T	T	T	
GV4 P/PE/PEM 02-115			T	T	T	T	T	T	T	T	T	T	T	T	T	T	T	T	T	T	T	
GV4 L/LE 02-115 +LRD			T	T	T	T	T	T	T	T	T	T	T	T	T	T	T	T	T	T	T	
GV5P150F/H	150		T	T	T	T	T	T	T	T	T	T	T	T	T	T	T	T	T	T	T	
GV5P220F/H	220			T	T	T	T	T		T	T	T	T	T		T	T	T	T	T	T	
GV6P320F/H	320				T	T	T				T	T	T					T	T	T	T	
GV6P500F/H	500					T						T									T	
NSX100 F/N/H/S/L MA 2.5...MA6.3 + LRD			T	T	T	T	T	T	T	T	T	T	T	T	T	T	T	T	T	T	T	
NSX100 F/N/H/S/L/R MA12.5...MA100 + LRD			T	T	T	T	T	T	T	T	T	T	T	T	T	T	T	T	T	T	T	
NSX160 F/N/H/S/L MA150 + LR9D/F	150		T	T	T	T	T	T	T	T	T	T	T	T	T	T	T	T	T	T	T	
NSX250 F/N/H/S/L/R MA220 + LR9D/F	220			T	T	T	T	T	T	T	T	T	T	T	T	T	T	T	T	T	T	
NSX400 F/N/H/S/L/R Mic. 1.3M +LR9F	320				T	T	T				T	T	T					T	T	T	T	
NSX630 F/N Mic. 1.3M +LR9F	500					T							T								T	
NSX630 H/S/L/R Mic. 1.3M +LR9F	500						65							65							65	
NSX100 F/N/H/S/L/R Mic. 2.2M 6.2M	25		T	T	T	T	T	T	T	T	T	T	T	T	T	T	T	T	T	T	T	
	50		T	T	T	T	T	T	T	T	T	T	T	T	T	T	T	T	T	T	T	
	100 (80)		T	T	T	T	T	T	T	T	T	T	T	T	T	T	T	T	T	T	T	
NSX160 F/N/H/S/L Mic. 2.2M 6.2M	≤ 100		T	T	T	T	T	T	T	T	T	T	T	T	T	T	T	T	T	T	T	
	150			T	T	T	T	T		T	T	T	T	T		T	T	T	T	T	T	
NSX250 F/N/H/S/L/R Mic. 2.2M 6.2M	≤ 150			T	T	T	T	T		T	T	T	T	T		T	T	T	T	T	T	
	220				T	T	T	T			T	T	T	T			T	T	T	T	T	
NSX400 F/N/H/S/L/R Mic. 2.3M 6.3M	320					T	T	T				T	T	T					T	T	T	
NSX630 F/N Mic. 2.3M 6.3M	500						T							T							T	
NSX630H/S/L/R Mic. 2.3M 6.3M	500							65							65						65	

- T Total selectivity, up to the breaking capacity of the downstream circuit breaker.
- 4 Selectivity limit = 4 kA.
- No selectivity.

Note: Respect the basic rules of selectivity, in terms of overload, short-circuit, ground fault and earth leakage when applicable see page A-1, or check curves with Schneider Electric online "Electrical calculation tools".

Selectivity Table Motor Protection

Upstream: ComPacT NS630b to 1000 L

Downstream: iC60L MA, NG125L MA, LUB12, LUB32, GV2, GV3, GV4, GV5, GV6, ComPacT NSX100 to 630

≤ 440V AC



Upstream CB		NS630b 800 1000 L														
Trip unit type		MicroLogic 2.0					MicroLogic 5.0 - 6.0 - 7.0 Inst 15 In					MicroLogic 5.0 - 6.0 - 7.0 Inst OFF				
Trip unit rating In (A)		630			800	1000	630			800	1000	630			800	1000
Setting Ir (A)		250	400	630	800	1000	250	400	630	800	1000	250	400	630	800	1000

Downstream CB		Selectivity limit (kA)																	
CB type	CB rating or Trip unit rating (A)																		
Trip unit type																			
iC60 L MA1.6 ... MA40 + LRD		T	T	T	T	T	T	T	T	T	T	T	T	T	T	T			
NG125L MA2.5 .. MA63 + LRD		T	T	T	T	T	T	T	T	T	T	T	T	T	T	T			
LUB12 + LUC●6..12		T	T	T	T	T	T	T	T	T	T	T	T	T	T	T			
LUB32 + LUC●6..32		T	T	T	T	T	T	T	T	T	T	T	T	T	T	T			
LUB38 + LUC●38		T	T	T	T	T	T	T	T	T	T	T	T	T	T	T			
GV2 ME01..ME32		T	T	T	T	T	T	T	T	T	T	T	T	T	T	T			
GV2 P01 .. P32		T	T	T	T	T	T	T	T	T	T	T	T	T	T	T			
GV2 L03..L32 + LRD		T	T	T	T	T	T	T	T	T	T	T	T	T	T	T			
GV3 P13 .. P65		T	T	T	T	T	T	T	T	T	T	T	T	T	T	T			
GV3 L25..L65 + LRD		T	T	T	T	T	T	T	T	T	T	T	T	T	T	T			
GV4 P/PE/PEM 02-115		T	T	T	T	T	T	T	T	T	T	T	T	T	T	T			
GV4 L/LE 02-115 +LRD		T	T	T	T	T	T	T	T	T	T	T	T	T	T	T			
GV5P150F/H	150		T	T	T	T		T	T	T		T	T	T	T				
GV5P220F/H	220			20	T	T			20	T	T			20	T	T			
GV6P320F/H	320				15	15				15	15				15	15			
GV6P500F/H	500					10					10					10			
NSX100 F/N/H/S/L MA 2.5 .. MA6.3 + LRD		T	T	T	T	T	T	T	T	T	T	T	T	T	T	T			
NSX100 F/N/H/S/L/R MA12.5 .. MA100 + LRD		T	T	T	T	T	T	T	T	T	T	T	T	T	T	T			
NSX160 F MA150 + LR9D/F	150		T	T	T	T	T	T	T	T	T	T	T	T	T	T			
NSX160N/H/S/L MA150 + LR9D/F	150		36	36	T	T		36	36	T	T		36	36	T	T			
NSX250 F/N/H/S/L/R MA220 + LR9D/F	220			20	T	T		20	20	20	T	T		20	20	T	T		
NSX400F/N/H/S/L/R MicroLogic 1.3M +LR9F	320					15										15			
NSX630 F/N/H/S/L/R MicroLogic 1.3M +LR9F	500					10										10			
NSX100 FN/H/S/L/R MicroLogic 2.2M 6.2M	25	T	T	T	T	T	T	T	T	T	T	T	T	T	T	T			
	50	T	T	T	T	T	T	T	T	T	T	T	T	T	T	T			
	100 (80)	T	T	T	T	T	T	T	T	T	T	T	T	T	T	T			
NSX160 F/N/H/S/L MicroLogic 2.2M 6.2M	≤ 100		36	36	36	T	T		36	36	36	T	T		36	36	T	T	
	150			36	36	T	T			36	36	T	T			36	36	T	T
NSX250 F/N/H/S/L/R MicroLogic 2.2M 6.2M	≤ 150			20	20	T	T			20	20	T	T			20	20	T	T
	220				20	T	T				20	T	T				20	T	T
NSX400F/N/H/S/L/R MicroLogic 2.3M 6.3M	320				15	15					15	15					15	15	
NSX630F/N/H/S/L/R MicroLogic 2.3M 6.3M	500					10						10						10	

- T Total selectivity, up to the breaking capacity of the downstream circuit breaker.
- 4 Selectivity limit = 4 kA.
- No selectivity.

Note: Respect the basic rules of selectivity, in terms of overload, short-circuit, ground fault and earth leakage when applicable see page A-1, or check curves with Schneider Electric online "Electrical calculation tools".

Selectivity Table Motor Protection

Upstream: ComPacT NS1600b - 3200 N

Downstream: IC60L MA, NG125L MA, LUB12, LUB32, GV2, GV3, GV4, GV5, GV6, ComPacT NSX100 to 630

≤ 440V AC

A

Upstream CB	NS1600 2000 2500 3200 N											
Trip unit type	MicroLogic 2.0				MicroLogic 5.0 - 6.0 - 7.0 Inst 15In				MicroLogic 5.0 - 6.0 - 7.0 Inst OFF			
Trip unit rating In (A)	1600	2000	2500	3200	1600	2000	2500	3200	1600	2000	2500	3200
Setting Ir (A)	1600	2000	2500	3200	1600	2000	2500	3200	1600	2000	2500	3200

Downstream CB	CB rating or Trip unit rating (A)	Selectivity limit (kA)											
CB type	Trip unit type												
IC60 L MA1.6 ... MA40 + LRD		T	T	T	T	T	T	T	T	T	T	T	T
NG125L MA2.5 .. MA63 + LRD		T	T	T	T	T	T	T	T	T	T	T	T
LUB12 + LUC●6..12		T	T	T	T	T	T	T	T	T	T	T	T
LUB32 + LUC●6..32		T	T	T	T	T	T	T	T	T	T	T	T
LUB38 + LUC●38		T	T	T	T	T	T	T	T	T	T	T	T
GV2 ME01..ME32		T	T	T	T	T	T	T	T	T	T	T	T
GV2 P01 .. P32		T	T	T	T	T	T	T	T	T	T	T	T
GV2 L03..L32 + LRD		T	T	T	T	T	T	T	T	T	T	T	T
GV3 P13 .. P65		T	T	T	T	T	T	T	T	T	T	T	T
GV3 L25..L65 + LRD		T	T	T	T	T	T	T	T	T	T	T	T
GV4 P/PE/PEM 02-115		T	T	T	T	T	T	T	T	T	T	T	T
GV4 L/LE 02-115 +LRD		T	T	T	T	T	T	T	T	T	T	T	T
GV5P150F/H	150	T	T	T	T	T	T	T	T	T	T	T	T
GV5P220F/H	220	T	T	T	T	T	T	T	T	T	T	T	T
GV6P320F/H	320	T	T	T	T	T	T	T	T	T	T	T	T
GV6P500F/H	500	T	T	T	T	T	T	T	T	T	T	T	T
NSX100 F/N/H/S/L MA 2.5 .. MA6.3 + LRD		T	T	T	T	T	T	T	T	T	T	T	T
NSX100 F/N/H/S/L/R MA12.5 .. MA100 + LRD		T	T	T	T	T	T	T	T	T	T	T	T
NSX160 F/N/H/S/L MA150 + LR9D/F	150	T	T	T	T	T	T	T	T	T	T	T	T
NSX250 F/N/H/S/L/R MA220 + LR9D/F	220	T	T	T	T	T	T	T	T	T	T	T	T
NSX400F/N/H/S/L/R MicroLogic 1.3M +LR9F	320	T	T	T	T	T	T	T	T	T	T	T	T
NSX630 F/N/H/S/L/R MicroLogic 1.3M +LR9F	500	T	T	T	T	T	T	T	T	T	T	T	T
NSX100 F/N/H/S/L/R MicroLogic 2.2M 6.2M	25-50	T	T	T	T	T	T	T	T	T	T	T	T
	100 (80)	T	T	T	T	T	T	T	T	T	T	T	T
NSX160 F/N/H/S/L MicroLogic 2.2M 6.2M	≤ 100	T	T	T	T	T	T	T	T	T	T	T	T
	150	T	T	T	T	T	T	T	T	T	T	T	T
NSX250 F/N/H/S/L/R MicroLogic 2.2M 6.2M	≤ 150	T	T	T	T	T	T	T	T	T	T	T	T
	220	T	T	T	T	T	T	T	T	T	T	T	T
NSX400 F/N/H/S/L/R MicroLogic 2.3M 6.3M	320	T	T	T	T	T	T	T	T	T	T	T	T
NSX630 F/N/H/S/L/R MicroLogic 2.3M 6.3M	320	T	T	T	T	T	T	T	T	T	T	T	T
	500	T	T	T	T	T	T	T	T	T	T	T	T

Total selectivity, up to the breaking capacity of the downstream circuit breaker.

No selectivity.

Note: Respect the basic rules of selectivity, in terms of overload, short-circuit, ground fault and earth leakage when applicable see page A-1, or check curves with Schneider Electric online "Electrical calculation tools".

Selectivity Table Motor Protection

Upstream: MasterPacT MTZ1 06-16 H1/H2/H3

Downstream: IC60L MA, NG125L MA, LUB12, LUB32, GV2, GV3, GV4, GV5, GV6, ComPacT NSX100 to 630

≤ 440V AC



Upstream CB	MasterPacT MTZ1 06/08/10/12/16 H1/H2/H3																				
Trip unit type	MicroLogic 2.0X								MicroLogic 5.0X - 6.0X - 7.0X Inst 15 In				MicroLogic 5.0X - 6.0X - 7.0X Inst OFF								
Trip unit rating In (A)	630		800		1000		1250		1600		630		800		1000		1250		1600		
Setting Ir (A)	250	400	630	800	1000	1250	1600	250	400	630	800	1000	1250	1600	250	400	630	800	1000	1250	1600

Downstream CB CB type Trip unit type	CB rating or Trip unit rating (A)	Selectivity limit (kA)																				
		250	400	630	800	1000	1250	1600	250	400	630	800	1000	1250	1600	250	400	630	800	1000	1250	1600
IC60 L MA1.6...MA40 + LRD		T	T	T	T	T	T	T	T	T	T	T	T	T	T	T	T	T	T	T	T	T
NG125L MA2.5...MA63 + LRD		T	T	T	T	T	T	T	T	T	T	T	T	T	T	T	T	T	T	T	T	T
LUB12 + LUC6...12		T	T	T	T	T	T	T	T	T	T	T	T	T	T	T	T	T	T	T	T	T
LUB32 + LUC6...32		T	T	T	T	T	T	T	T	T	T	T	T	T	T	T	T	T	T	T	T	T
LUB38 + LUC6...38		T	T	T	T	T	T	T	T	T	T	T	T	T	T	T	T	T	T	T	T	T
GV2 ME01...ME32 GV2 P01...P32 GV2 L03...L32 + LRD GV3 P13...P65 GV3 L25...L65 + LRD		T	T	T	T	T	T	T	T	T	T	T	T	T	T	T	T	T	T	T	T	T
GV4 P/PE/PEM 02-115 GV4 L/LE 02-115 +LRD GV5P150F/H			T	T	T	T	T	T	T	T	T	T	T	T	T	T	T	T	T	T	T	T
GV5P220F/H			T	T	T	T	T	T	T	T	T	T	T	T	T	T	T	T	T	T	T	T
GV6P320F/H						T	T						T	T						T	T	
GV6P500F/H							T							T								T
NSX100 F/N/H/S/L MA 2.5...MA6.3 + LRD NSX100 F/N/H/S/L/R MA12.5...MA100 + LRD		T	T	T	T	T	T	T	T	T	T	T	T	T	T	T	T	T	T	T	T	T
NSX160 F/N/H/S/L MA150 + LR9D/F	150		T	T	T	T	T	T	T	T	T	T	T	T	T	T	T	T	T	T	T	T
NSX250 F/N/H/S/L/R MA220 + LR9D/F	220			T	T	T	T	T		T	T	T	T	T			T	T	T	T	T	T
NSX400F/N/H/S/L/R MicroLogic 1.3M +LR9F	320				T	T	T					T	T	T						T	T	T
NSX630 F/N/H/S/L/R MicroLogic 1.3M +LR9F	500																					T
NSX100 FN/H/S/L/R MicroLogic 2.2M 6.2M	25	T	T	T	T	T	T	T	T	T	T	T	T	T	T	T	T	T	T	T	T	T
	50	T	T	T	T	T	T	T	T	T	T	T	T	T	T	T	T	T	T	T	T	T
	100 (80)		T	T	T	T	T	T		T	T	T	T	T			T	T	T	T	T	T
NSX160 F/N/H/S/L MicroLogic 2.2M 6.2M	≤ 100	T	T	T	T	T	T	T	T	T	T	T	T	T	T	T	T	T	T	T	T	T
	150		T	T	T	T	T	T		T	T	T	T	T			T	T	T	T	T	T
NSX250 F/N/H/S/L/R MicroLogic 2.2M 6.2M	≤ 150	T	T	T	T	T	T	T	T	T	T	T	T	T	T	T	T	T	T	T	T	T
	220		T	T	T	T	T	T		T	T	T	T	T			T	T	T	T	T	T
NSX400 F/N/H/S/L/R MicroLogic 2.3M 6.3M NSX630 F/N/H/S/L/R MicroLogic 2.3M 6.3M	320					T	T						T	T							T	T
	320					T	T						T	T							T	T
	500						T							T								T

- T Total selectivity, up to the breaking capacity of the downstream circuit breaker.
- 4 Selectivity limit = 4 kA.
- No selectivity.

Note: Respect the basic rules of selectivity, in terms of overload, short-circuit, ground fault and earth leakage when applicable see page A-1, or check curves with Schneider Electric online "Electrical calculation tools".

Selectivity Table Motor Protection

Upstream: MasterPacT MTZ1 06-10 L1

Downstream: IC60L MA, NG125L MA, LUB12, LUB32, GV2, GV3, GV4, GV5, GV6, ComPacT NSX100 to 630

≤ 440V AC

A

Upstream CB	MasterPacT MTZ1 06/08/10 L1														
Trip unit type	MicroLogic 2.0X					MicroLogic 5.0X - 6.0X - 7.0X Inst 15 In					MicroLogic 5.0X - 6.0X - 7.0X Inst OFF				
Trip unit rating In (A)	630			800	1000	630			800	1000	630			800	1000
Setting Ir (A)	250	400	630	800	1000	250	400	630	800	1000	250	400	630	800	1000

Downstream CB CB type Trip unit type	CB rating or Trip unit rating (A)	Selectivity limit (kA)														
		T	T	T	T	T	T	T	T	T	T	T	T	T	T	T
IC60 L MA1.6...MA40 + LRD		T	T	T	T	T	T	T	T	T	T	T	T	T	T	T
NG125L MA2.5...MA63 + LRD		T	T	T	T	T	T	T	T	T	T	T	T	T	T	T
LUB12 + LUC6...12		T	T	T	T	T	T	T	T	T	T	T	T	T	T	T
LUB32 + LUC6...32		T	T	T	T	T	T	T	T	T	T	T	T	T	T	T
LUB38 + LUC38		T	T	T	T	T	T	T	T	T	T	T	T	T	T	T
GV2 ME01...ME32 GV2 P01...P32 GV2 L03...L32 + LRD		T	T	T	T	T	T	T	T	T	T	T	T	T	T	T
GV3 P13...P65 GV3 L25...L65 + LRD		T	T	T	T	T	T	T	T	T	T	T	T	T	T	T
GV4 P/PE/PEM 02-115 GV4 L/LE 02-115 +LRD		T	T	T	T	T	T	T	T	T	T	T	T	T	T	T
GV5P150F/H			T	T	T	T		T	T	T	T		T	T	T	T
GV5P220F/H				20	T	T			20	T	T			20	T	T
GV6P320F/H					15	15				15	15				15	15
GV6P500F/H						10					10					10
NSX100 F/N/H/S/L MA 2.5...MA6.3 + LRD		T	T	T	T	T	T	T	T	T	T	T	T	T	T	T
NSX100 F/N/H/S/L/R MA12.5...MA100 + LRD		T	T	T	T	T	T	T	T	T	T	T	T	T	T	T
NSX160 F MA150 + LR9D/F	150		T	T	T	T	T	T	T	T	T	T	T	T	T	T
NSX160 N/H/S/L MA150 + LR9D/F	150		36	36	T	T		36	36	T	T		36	36	T	T
NSX250 F/N/H/S/L/R MA220 + LR9D/F	220			20	T	T			20	T	T			20	T	T
NSX400 F/N/H/S/L/R Mic. 1.3M + LR9F	320					15					15					15
NSX630 F/N/H/S/L/R Mic. 1.3M +LR9F	500															
NSX100 F/N/H/S/L/R Mic. 2.2M 6.2M	25/50	T	T	T	T	T	T	T	T	T	T	T	T	T	T	T
NSX160 F Mic. 2.2M 6.2M	100 (80)	T	T	T	T	T	T	T	T	T	T	T	T	T	T	T
	≤ 100	T	T	T	T	T	T	T	T	T	T	T	T	T	T	T
NSX160 N/H/S/L Mic. 2.2M 6.2M	150		T	T	T	T		T	T	T	T		T	T	T	T
	≤ 100	36	36	36	T	T		36	36	36	T	T		36	36	36
NSX250 F/N/H/S/L/R Mic. 2.2M 6.2M	150		36	36	T	T			36	36	T	T		36	36	T
	≤ 150		20	20	T	T			20	20	T	T		20	20	T
NSX400 F/N/H/S/L/R Mic. 2.3M 6.3M NSX630 F/N/H/S/L/R Mic. 2.3M 6.3M	220			20	T	T				20	T	T			20	T
	320				15	15					15	15				15
	500					10					10					10

- T Total selectivity, up to the breaking capacity of the downstream circuit breaker.
- 4 Selectivity limit = 4 kA.
- No selectivity.

Note: Respect the basic rules of selectivity, in terms of overload, short-circuit, ground fault and earth leakage when applicable see page A-1, or check curves with Schneider Electric online "Electrical calculation tools".

Selectivity Table Motor Protection

Upstream: MasterPacT MTZ2 08/10/12/16/20 N1/H1/H2/H2V/L1

Downstream: IC60L MA, NG125L MA, LUB12, LUB32, GV2, GV3, GV4, GV5, GV6, ComPacT NSX100 to 630

≤ 440V AC

Upstream CB	MasterPacT MTZ2 08/10/12/16/20 N1/H1/H2/H2V/L1																				
Trip unit type	MicroLogic 2.0X						MicroLogic 5.0X - 6.0X - 7.0X Inst 15 In						MicroLogic 5.0X - 6.0X - 7.0X Inst OFF								
Trip unit rating In (A)	800		1000	1250	1600	2000	800		1000	1250	1600	2000	800		1000	1250	1600	2000			
Setting Ir (A)	320	630	800	1000	1250	1600	2000	320	630	800	1000	1250	1600	2000	320	630	800	1000	1250	1600	2000



Downstream CB CB type Trip unit type	CB rating or Trip unit rating (A)	Selectivity limit (kA)																			
		T	T	T	T	T	T	T	T	T	T	T	T	T	T	T	T	T	T	T	T
IC60 L MA1.6...MA40 + LRD		T	T	T	T	T	T	T	T	T	T	T	T	T	T	T	T	T	T	T	T
NG125L MA2.5...MA63 + LRD		T	T	T	T	T	T	T	T	T	T	T	T	T	T	T	T	T	T	T	T
LUB12 + LUC6...12		T	T	T	T	T	T	T	T	T	T	T	T	T	T	T	T	T	T	T	T
LUB32 + LUC6...32		T	T	T	T	T	T	T	T	T	T	T	T	T	T	T	T	T	T	T	T
LUB38 + LUC6...38		T	T	T	T	T	T	T	T	T	T	T	T	T	T	T	T	T	T	T	T
GV2 ME01...ME32 GV2 P01...P32 GV2 L03...L32 + LRD		T	T	T	T	T	T	T	T	T	T	T	T	T	T	T	T	T	T	T	T
GV3 P13...P65 GV3 L25...L65 + LRD		T	T	T	T	T	T	T	T	T	T	T	T	T	T	T	T	T	T	T	T
GV4 P/PE/PEM 02-115 GV4 L/LE 02-115 +LRD		T	T	T	T	T	T	T	T	T	T	T	T	T	T	T	T	T	T	T	T
GV5P150F/H			T	T	T	T	T		T	T	T	T	T		T	T	T	T	T	T	T
GV5P220F/H			T	T	T	T	T		T	T	T	T	T		T	T	T	T	T	T	T
GV6P320F/H					T	T	T					T	T	T				T	T	T	T
GV6P500F/H						T	T						T	T						T	T
NSX100 F/N/H/S/L MA 2.5 .. MA6.3 + LRD		T	T	T	T	T	T	T	T	T	T	T	T	T	T	T	T	T	T	T	T
NSX100 F/N/H/S/L/R MA12.5 .. MA100 + LRD		T	T	T	T	T	T		T	T	T	T	T		T	T	T	T	T	T	T
NSX160 F/N/H/S/L MA150 + LR9D/F	150	T	T	T	T	T	T	T		T	T	T	T	T		T	T	T	T	T	T
NSX250 F/N/H/S/L/R MA220 + LR9D/F	220		T	T	T	T	T		T	T	T	T	T		T	T	T	T	T	T	T
NSX400F/N/H/S/L/R MicroLogic 1.3M +LR9F	320				T	T	T					T	T	T				T	T	T	T
NSX630 F/N/H/S/L/R MicroLogic 1.3M +LR9F	500					T	T						T	T						T	T
NSX100 FN/H/S/L/R MicroLogic 2.2M 6.2M	25/50	T	T	T	T	T	T	T	T	T	T	T	T	T	T	T	T	T	T	T	T
	100 (80)	T	T	T	T	T	T	T	T	T	T	T	T	T	T	T	T	T	T	T	T
NSX160 F/N/H/S/L MicroLogic 2.2M 6.2M	≤ 100	T	T	T	T	T	T	T		T	T	T	T	T		T	T	T	T	T	T
	150		T	T	T	T	T		T	T	T	T	T		T	T	T	T	T	T	T
NSX250 F/N/H/S/L/R MicroLogic 2.2M 6.2M	≤ 150		T	T	T	T	T		T	T	T	T	T		T	T	T	T	T	T	T
	220		T	T	T	T	T		T	T	T	T	T		T	T	T	T	T	T	T
NSX400F/N/H/S/L/R MicroLogic 2.3 6.3M	320				T	T	T					T	T	T				T	T	T	T
NSX630F/N/H/S/L/R MicroLogic 2.3 6.3M	500					T	T						T	T						T	T

- Total selectivity, up to the breaking capacity of the downstream circuit breaker.
- Selectivity limit = 4 kA.
- No selectivity.

Note: Respect the basic rules of selectivity, in terms of overload, short-circuit, ground fault and earth leakage when applicable see page A-1, or check curves with Schneider Electric online "Electrical calculation tools".

Selectivity Table Motor Protection

Upstream: MasterPacT MTZ2 25/32/40 H1/H2/H2V, MTZ3 40/50/63 H1
 Downstream: IC60L MA, NG125L MA, LUB12, LUB32, GV2, GV3, GV4, GV5, GV6, ComPacT NSX100 to 630

≤ 440V AC

A

Upstream CB	MTZ2 25/32/40 H1/H2/H2V			MTZ3 40/50/63 H1			MTZ2 25/32/40 H1/H2/H2V			MTZ3 40/50/63 H1			MTZ2 25/32/40 H1/H2/H2V			MTZ3 40/50/63 H1		
Trip unit type	MicroLogic 2.0X						MicroLogic 5.0X - 6.0X - 7.0X Inst 15 In						MicroLogic 5.0X - 6.0X - 7.0X Inst OFF					
Trip unit rating In (A)	2500	3200	4000	4000	5000	6300	2500	3200	4000	4000	5000	6300	2500	3200	4000	4000	5000	6300
Setting Ir (A)	2500	3200	4000	4000	5000	6300	2500	3200	4000	4000	5000	6300	2500	3200	4000	4000	5000	6300

Downstream CB	CB rating or Trip unit rating (A)	Selectivity limit (kA)																	
CB type Trip unit type		T	T	T	T	T	T	T	T	T	T	T	T	T	T	T	T	T	
IC60 L MA1.6...MA40 + LRD		T	T	T	T	T	T	T	T	T	T	T	T	T	T	T	T	T	
NG125L MA2.5...MA63 + LRD		T	T	T	T	T	T	T	T	T	T	T	T	T	T	T	T	T	
LUB12 + LUC6...12		T	T	T	T	T	T	T	T	T	T	T	T	T	T	T	T	T	
LUB32 + LUC6...32		T	T	T	T	T	T	T	T	T	T	T	T	T	T	T	T	T	
LUB38 + LUC6...38		T	T	T	T	T	T	T	T	T	T	T	T	T	T	T	T	T	
GV2 ME01...ME32 GV2 P01...P32 GV2 L03...L32 + LRD		T	T	T	T	T	T	T	T	T	T	T	T	T	T	T	T	T	
GV3 P13...P65 GV3 L25...L65 + LRD		T	T	T	T	T	T	T	T	T	T	T	T	T	T	T	T	T	
GV4 P/PE/PEM 02-115 GV4 L/LE 02-115 +LRD		T	T	T	T	T	T	T	T	T	T	T	T	T	T	T	T	T	
GV5P150F/H		T	T	T	T	T	T	T	T	T	T	T	T	T	T	T	T	T	
GV5P220F/H		T	T	T	T	T	T	T	T	T	T	T	T	T	T	T	T	T	
GV6P320F/H		T	T	T	T	T	T	T	T	T	T	T	T	T	T	T	T	T	
GV6P500F/H		T	T	T	T	T	T	T	T	T	T	T	T	T	T	T	T	T	
NSX100 F/N/H/S/L MA 2.5 .. MA6.3 + LRD		T	T	T	T	T	T	T	T	T	T	T	T	T	T	T	T	T	
NSX100 F/N/H/S/L/R MA12.5 .. MA100+LRD		T	T	T	T	T	T	T	T	T	T	T	T	T	T	T	T	T	
NSX160 F/N/H/S/L MA150 + LR9D/F	150	T	T	T	T	T	T	T	T	T	T	T	T	T	T	T	T	T	
NSX250 F/N/H/S/L/R MA220 + LR9D/F	220	T	T	T	T	T	T	T	T	T	T	T	T	T	T	T	T	T	
NSX400 F/N/H/S/L/R MicroLogic 1.3M+LR9F	320	T	T	T	T	T	T	T	T	T	T	T	T	T	T	T	T	T	
NSX630 F/N/H/S/L/R MicroLogic 1.3M+LR9F	500	T	T	T	T	T	T	T	T	T	T	T	T	T	T	T	T	T	
NSX100 FN/H/S/L/R MicroLogic 2.2M 6.2M	25/50/ 100	T	T	T	T	T	T	T	T	T	T	T	T	T	T	T	T	T	
NSX160 F/N/H/S/L MicroLogic 2.2M 6.2M	150	T	T	T	T	T	T	T	T	T	T	T	T	T	T	T	T	T	
NSX250 F/N/H/S/L/R MicroLogic 2.2M 6.2M	≤ 150	T	T	T	T	T	T	T	T	T	T	T	T	T	T	T	T	T	
	220	T	T	T	T	T	T	T	T	T	T	T	T	T	T	T	T	T	
NSX400 F/N/H/S/L/R MicroLogic 2.3 6.3M	320	T	T	T	T	T	T	T	T	T	T	T	T	T	T	T	T	T	
NSX630 F/N/H/S/L/R MicroLogic 2.3 6.3M	500	T	T	T	T	T	T	T	T	T	T	T	T	T	T	T	T	T	

T Total selectivity, up to the breaking capacity of the downstream circuit breaker.

Note: Respect the basic rules of selectivity, in terms of overload, short-circuit, ground fault and earth leakage when applicable see page A-1, or check curves with Schneider Electric online "Electrical calculation tools".

Selectivity Table Motor Protection

Upstream: MasterPacT MTZ2 20/25/32/40 H3, MTZ3 40/50/63 H2

Downstream: IC60L MA, NG125L MA, LUB12, LUB32, GV2, GV3, GV4, GV5, GV6, ComPacT NSX100 to 630

≤ 440V AC

Upstream CB	MTZ2 20/25/32/40				MTZ3 40/50/63				MTZ2 20/25/32/40				MTZ3 40/50/63											
	H3				H2				H3				H2											
Trip unit type	MicroLogic 2.0X								MicroLogic 5.0X - 6.0X - 7.0X Inst 15 In								MicroLogic 5.0X - 6.0X - 7.0X Inst OFF							
Trip unit rating In (A)	2000	2500	3200	4000	4000	5000	6300	6300	2000	2500	3200	4000	4000	5000	6300	6300	2000	2500	3200	4000	4000	5000	6300	6300
Setting Ir (A)	2000	2500	3200	4000	4000	5000	6300	6300	2000	2500	3200	4000	4000	5000	6300	6300	2000	2500	3200	4000	4000	5000	6300	6300



Downstream CB CB type Trip unit type	Selectivity limit (kA)																			
	T	T	T	T	T	T	T	T	T	T	T	T	T	T	T	T	T	T	T	T
IC60 L MA1.6...MA40 + LRD	T	T	T	T	T	T	T	T	T	T	T	T	T	T	T	T	T	T	T	T
NG125L MA2.5...MA63 + LRD	T	T	T	T	T	T	T	T	T	T	T	T	T	T	T	T	T	T	T	T
LUB12 + LUC6...12	T	T	T	T	T	T	T	T	T	T	T	T	T	T	T	T	T	T	T	T
LUB32 + LUC6...32	T	T	T	T	T	T	T	T	T	T	T	T	T	T	T	T	T	T	T	T
LUB38 + LUC6...38	T	T	T	T	T	T	T	T	T	T	T	T	T	T	T	T	T	T	T	T
GV2 ME01...ME32 GV2 P01...P32 GV2 L03...L32 + LRD	T	T	T	T	T	T	T	T	T	T	T	T	T	T	T	T	T	T	T	T
GV3 P13...P65 GV3 L25...L65 + LRD	T	T	T	T	T	T	T	T	T	T	T	T	T	T	T	T	T	T	T	T
GV4 P/PE/PEM 02-115 GV4 L/LE 02-115 +LRD	T	T	T	T	T	T	T	T	T	T	T	T	T	T	T	T	T	T	T	T
GV5P150F/H	T	T	T	T	T	T	T	T	T	T	T	T	T	T	T	T	T	T	T	T
GV5P220F/H	T	T	T	T	T	T	T	T	T	T	T	T	T	T	T	T	T	T	T	T
GV6P320F/H	T	T	T	T	T	T	T	T	T	T	T	T	T	T	T	T	T	T	T	T
GV6P500F/H	T	T	T	T	T	T	T	T	T	T	T	T	T	T	T	T	T	T	T	T
NSX100 F/N/H/S/L MA 2.5...MA6.3 + LRD	T	T	T	T	T	T	T	T	T	T	T	T	T	T	T	T	T	T	T	T
NSX100 F/N/H/S/L/R MA12.5...MA100 + LRD	T	T	T	T	T	T	T	T	T	T	T	T	T	T	T	T	T	T	T	T
NSX160 F/N/H/S/L MA150 + LR9D/G	T	T	T	T	T	T	T	T	T	T	T	T	T	T	T	T	T	T	T	T
NSX250 F/N/H/S/L/R MA220 + LR9D/G	T	T	T	T	T	T	T	T	T	T	T	T	T	T	T	T	T	T	T	T
NSX400 F/N/H/S/L/R MicroLogic 1.3M + LR9G	T	T	T	T	T	T	T	T	T	T	T	T	T	T	T	T	T	T	T	T
NSX630 F/N/H/S/L/R MicroLogic 1.3M + LR9G	T	T	T	T	T	T	T	T	T	T	T	T	T	T	T	T	T	T	T	T
NSX100 FN/H/S/L/R MicroLogic 2.2M 6.2M	T	T	T	T	T	T	T	T	T	T	T	T	T	T	T	T	T	T	T	T
NSX160 F/N/H/S/L MicroLogic 2.2M 6.2M	T	T	T	T	T	T	T	T	T	T	T	T	T	T	T	T	T	T	T	T
NSX250 F/N/H/S/L/R MicroLogic 2.2M 6.2M	T	T	T	T	T	T	T	T	T	T	T	T	T	T	T	T	T	T	T	T
NSX400 F/N/H/S/L/R MicroLogic 2.3 6.3M	T	T	T	T	T	T	T	T	T	T	T	T	T	T	T	T	T	T	T	T
NSX630 F/N/H/S/L/R MicroLogic 2.3 6.3M	T	T	T	T	T	T	T	T	T	T	T	T	T	T	T	T	T	T	T	T

- Total selectivity, up to the breaking capacity of the downstream circuit breaker.
- Selectivity limit = 4 kA.
- No selectivity.

Note: Respect the basic rules of selectivity, in terms of overload, short-circuit, ground fault and earth leakage when applicable see page A-1, or check curves with Schneider Electric online "Electrical calculation tools".

Selectivity Table 690 V AC

Upstream: ComPacT NSX100-250 TM-D

Downstream: TeSys GV2, GV3, TeSys U

Ue = 690 V AC

A

Upstream CB	NSX100L			NSX100L/R/HB1/HB2					NSX160L				NSX250L/R/HB1/HB2		
Trip unit type	TM-D			TM-D					TM-D				TM-D		
Trip unit rating (A)	16	25	32	40	50	63	80	100	80	100	125	160	160	200	250

Downstream CB	Icu 690 V AC	Th. OL Relay	Setting range (A)	Selectivity limit (kA)														
				T	T	T	T	T	T	T	T	T	T	T	T	T	T	T
GV2 L03	100 kA	LRD 03	0.25/0.40	T	T	T	T	T	T	T	T	T	T	T	T	T	T	T
GV2 L04	100 kA	LRD 04	0.40/0.63	T	T	T	T	T	T	T	T	T	T	T	T	T	T	T
GV2 L05	100 kA	LRD 05	0.63/1	T	T	T	T	T	T	T	T	T	T	T	T	T	T	T
GV2 L06	100 kA	LRD 06	1/1.6	T	T	T	T	T	T	T	T	T	T	T	T	T	T	T
GV2 L07 + LA9 LB920	50 kA	LRD 07	1.6/2.5	0.19	0.25	0.4	1	5	6	10	10	10	10	T	T	T	T	T
GV2 L08 + LA9 LB920	50 kA	LRD 08	2.5/4	0.19	0.25	0.4	0.5	0.5	0.5	1	1.5	1	1.5	T	T	36	T	T
GV2 L10 + LA9 LB920	50 kA	LRD 10	4/6.3		0.25	0.4	0.5	0.5	0.5	0.63	0.8	0.63	0.8	1.25	1.6	1.6	T	T
GV2 L14 + LA9 LB920	50 kA	LRD 14	7/10			0.4	0.5	0.5	0.5	0.63	0.8	0.63	0.8	1.25	1.6	1.6	T	T
GV2 L16 + LA9 LB920	50 kA	LRD 16	9/13					0.5	0.5	0.63	0.8	0.63	0.8	1.25	1.6	1.6	T	T
GV2 L20 + LA9 LB920	50 kA	LRD 21	12/18							0.63	0.8	0.63	0.8	1.25	1.6	1.6	T	T
GV2 L22 + LA9 LB920	50 kA	LRD 22	17/25							0.63	0.8	0.63	0.8	1.25	1.6	1.6	T	T
GV2 L32 + LA9 LB920	50 kA	LRD 32	23/32								0.8		0.8	1.25	1.6	1.6	T	T
GV3 P13	6 kA	Integrated	9/13					0.5	0.5	0.63	0.8	0.63	0.8	1	1.25	1.25	T	T
GV3 P18	6 kA	Integrated	12/18						0.5	0.63	0.8	0.63	0.8	1	1.25	1.25	T	T
GV3 P25	6 kA	Integrated	17/25							0.63	0.8	0.63	0.8	1	1.25	1.25	T	T
GV3 P32	6 kA	Integrated	23/32								0.8		0.8	1	1.25	1.25	T	T
GV3 P40	6 kA	Integrated	30/40											1.25	1.25	T	T	
GV3 P50	6 kA	Integrated	37/50													T	T	
GV3 P65	6 kA	Integrated	48/65														T	
GV3 L25	6 kA	LRD 22	20/25							0.63	0.8	0.63	0.8	1	1.25	1.25	T	T
GV3 L32	6 kA	LRD 32	23/32								0.8		0.8	1	1.25	1.25	T	T
GV3 L40	6 kA	LRD 340	30/40											1	1.25	1.25	T	T
GV3 L50	6 kA	LRD 350	37/50														T	T
GV3 L65	6 kA	LRD 365	48/65															T
LUB12 + LA9 LB20	35 kA	LUC*X6	0.15...0.6	0.19	0.3	0.4	0.5	0.5	0.5	0.63	0.8	0.7	0.8	1	1.6	1.6	T	T
		LUC*1X	0.35...1.4	0.19	0.3	0.4	0.5	0.5	0.5	0.63	0.8	0.7	0.8	1	1.6	1.6	T	T
		LUC*05	1.25...5	0.19	0.3	0.4	0.5	0.5	0.5	0.63	0.8	0.7	0.8	1	1.6	1.6	T	T
		LUC*12	3...12				0.5	0.5	0.5	0.63	0.8	0.7	0.8	1	1.6	1.6	T	T
LUB32 + LA9 LB20	35 kA	LUC*X6	0.15...0.6	0.19	0.3	0.4	0.5	0.5	0.5	0.63	0.8	0.7	0.8	1	1.6	1.6	T	T
		LUC*1X	0.35...1.4	0.19	0.3	0.4	0.5	0.5	0.5	0.63	0.8	0.7	0.8	1	1.6	1.6	T	T
		LUC*05	1.25...5	0.19	0.3	0.4	0.5	0.5	0.5	0.63	0.8	0.7	0.8	1	1.6	1.6	T	T
		LUC*12	3...12				0.5	0.5	0.5	0.63	0.8	0.7	0.8	1	1.6	1.6	T	T
		LUC*18	4.5...18						0.5	0.63	0.8	0.7	0.8	1	1.6	1.6	T	T
	LUC*32	8...32								0.8		0.8	1	1.6	1.6	T	T	
LUB12 + LUA LB1	70 kA	LUC*X6	0.15...0.6	0.19	0.3	0.4	0.5	0.5	0.5	0.63	0.8	0.7	0.8	1	1.6	1.6	T	T
		LUC*1X	0.35...1.4	0.19	0.3	0.4	0.5	0.5	0.5	0.63	0.8	0.7	0.8	1	1.6	1.6	T	T
		LUC*05	1.25...5	0.19	0.3	0.4	0.5	0.5	0.5	0.63	0.8	0.7	0.8	1	1.6	1.6	T	T
		LUC*12	3...12				0.5	0.5	0.5	0.63	0.8	0.7	0.8	1	1.6	1.6	T	T
LUB32 + LUA LB1	70 kA	LUC*X6	0.15...0.6	0.19	0.3	0.4	0.5	0.5	0.5	0.63	0.8	0.7	0.8	1	1.6	1.6	T	T
		LUC*1X	0.35...1.4	0.19	0.3	0.4	0.5	0.5	0.5	0.63	0.8	0.7	0.8	1	1.6	1.6	T	T
		LUC*05	1.25...5	0.19	0.3	0.4	0.5	0.5	0.5	0.63	0.8	0.7	0.8	1	1.6	1.6	T	T
		LUC*12	3...12				0.5	0.5	0.5	0.63	0.8	0.7	0.8	1	1.6	1.6	T	T
		LUC*18	4.5...18						0.5	0.63	0.8	0.7	0.8	1	1.6	1.6	T	T
	LUC*32	8...32								0.8		0.8	1	1.6	1.6	T	T	

T Total selectivity, up to the breaking capacity of the downstream circuit breaker.

4 Selectivity limit = 4 kA.

 No selectivity.

Note: Respect the basic rules of selectivity, for overload and short-circuit, see introduction or check curves.

Selectivity Table 690 V AC

Upstream: ComPacT NSX100-250 MicroLogic

Downstream: TeSys GV2, GV3, TeSys U

$U_e = 690 \text{ V AC}$



Upstream CB	NSX100L/R/HB1/HB2								NSX160L				NSX250L/R/HB1/HB2		
Trip unit type	MicroLogic ^[2]								MicroLogic ^[2]				MicroLogic ^[2]		
Trip unit rating (A)	40				100				160				250		
Setting I _r (A)	16	25	32	40	40	63	80	100	80	100	125	160	160	200	250

Downstream CB	Icu	Th. OL Relay	Setting range (A)	Selectivity limit (kA)																						
				0.25/0.40	0.40/0.63	0.63/1	1/1.6	1.6/2.5	2.5/4	4/6.3	7/10	9/13	12/18	17/25	23/32	0.6	1.5	1.5	1.5	1.5	4	4	4	4	T	T
GV2 L03	100 kA	LRD 03	0.25/0.40	T	T	T	T	T	T	T	T	T	T	T	T	T	T	T	T	T	T	T	T	T	T	T
GV2 L04	100 kA	LRD 04	0.40/0.63	T	T	T	T	T	T	T	T	T	T	T	T	T	T	T	T	T	T	T	T	T	T	T
GV2 L05	100 kA	LRD 05	0.63/1	T	T	T	T	T	T	T	T	T	T	T	T	T	T	T	T	T	T	T	T	T	T	T
GV2 L06	100 kA	LRD 06	1/1.6	T	T	T	T	T	T	T	T	T	T	T	T	T	T	T	T	T	T	T	T	T	T	T
GV2 L07 + LA9 LB920	50 kA	LRD 07	1.6/2.5	T ^[1]	T ^[1]	T ^[1]	T ^[1]	T ^[1]	T ^[1]	T ^[1]	T ^[1]	T ^[1]	T ^[1]	T	T	T	T	T	T	T	T	T	T	T	T	T
GV2 L08 + LA9 LB920	50 kA	LRD 08	2.5/4	T ^[1]	T ^[1]	T ^[1]	T ^[1]	T ^[1]	T ^[1]	T ^[1]	T ^[1]	T ^[1]	T ^[1]	T	T	T	T	T	T	T	T	T	T	T	T	T
GV2 L10 + LA9 LB920	50 kA	LRD 10	4/6.3			T ^[1]	T ^[1]	T ^[1]	T ^[1]	T ^[1]	T ^[1]	T ^[1]	T ^[1]	T	T	T	T	T	T	T	T	T	T	T	T	T
GV2 L14 + LA9 LB920	50 kA	LRD 14	7/10				T ^[1]	T ^[1]	T ^[1]	T ^[1]	T ^[1]	T ^[1]	T ^[1]	T	T	T	T	T	T	T	T	T	T	T	T	T
GV2 L16 + LA9 LB920	50 kA	LRD 16	9/13						T ^[1]	T ^[1]	T ^[1]	T ^[1]	T ^[1]	T	T	T	T	T	T	T	T	T	T	T	T	T
GV2 L20 + LA9 LB920	50 kA	LRD 21	12/18							T ^[1]	T ^[1]	T ^[1]	T ^[1]	T	T	T	T	T	T	T	T	T	T	T	T	T
GV2 L22 + LA9 LB920	50 kA	LRD 22	17/25								T ^[1]	T ^[1]	T ^[1]	T	T	T	T	T	T	T	T	T	T	T	T	T
GV2 L32 + LA9 LB920	50 kA	LRD 32	23/32									T ^[1]	T ^[1]	T	T	T	T	T	T	T	T	T	T	T	T	T
GV3 P13	6 kA	Integrated	9/13				0.6	1.5	1.5	1.5	1.5	4	4	4	4							T	T	T	T	T
GV3 P18	6 kA	Integrated	12/18						1.5	1.5	1.5	3.5	3.5	3.5	3.5							T	T	T	T	T
GV3 P25	6 kA	Integrated	17/25							1.5	1.5	3	3	3	3							T	T	T	T	T
GV3 P32	6 kA	Integrated	23/32								1.5			3	3							T	T	T	T	T
GV3 P40	6 kA	Integrated	30/40													2.4	2.4					T	T	T	T	T
GV3 P50	6 kA	Integrated	37/50														2.4							T	T	T
GV3 P65	6 kA	Integrated	48/65																							
GV3 L25	6 kA	LRD 22	20/25							1.5	1.5	3	3	3	3							T	T	T	T	T
GV3 L32	6 kA	LRD 32	23/32								1.5		3	3	3	3						T	T	T	T	T
GV3 L40	6 kA	LRD 340	30/40													2.4	2.4						T	T	T	T
GV3 L50	6 kA	LRD 350	37/50														2.4							T	T	T
GV3 L65	6 kA	LRD 365	48/65																							
LUB12 + LA9 LB20	35 kA	LUC*X6	0.15...0.6	T ^[1]	T ^[1]	T ^[1]	T ^[1]	T ^[1]	T ^[1]	T ^[1]	T ^[1]	T ^[1]	T ^[1]	T	T	T	T	T	T	T	T	T	T	T	T	T
		LUC*1X	0.35...1.4	T ^[1]	T ^[1]	T ^[1]	T ^[1]	T ^[1]	T ^[1]	T ^[1]	T ^[1]	T ^[1]	T ^[1]	T ^[1]	T	T	T	T	T	T	T	T	T	T	T	T
		LUC*05	1.25...5	T ^[1]	T ^[1]	T ^[1]	T ^[1]	T ^[1]	T ^[1]	T ^[1]	T ^[1]	T ^[1]	T ^[1]	T ^[1]	T	T	T	T	T	T	T	T	T	T	T	T
		LUC*12	3...12				T ^[1]	T ^[1]	T ^[1]	T ^[1]	T ^[1]	T ^[1]	T ^[1]	T ^[1]	T	T	T	T	T	T	T	T	T	T	T	T
LUB32 + LA9 LB20	35 kA	LUC*X6	0.15...0.6	T ^[1]	T ^[1]	T ^[1]	T ^[1]	T ^[1]	T ^[1]	T ^[1]	T ^[1]	T ^[1]	T ^[1]	T	T	T	T	T	T	T	T	T	T	T	T	T
		LUC*1X	0.35...1.4	T ^[1]	T ^[1]	T ^[1]	T ^[1]	T ^[1]	T ^[1]	T ^[1]	T ^[1]	T ^[1]	T ^[1]	T ^[1]	T	T	T	T	T	T	T	T	T	T	T	T
		LUC*05	1.25...5	T ^[1]	T ^[1]	T ^[1]	T ^[1]	T ^[1]	T ^[1]	T ^[1]	T ^[1]	T ^[1]	T ^[1]	T ^[1]	T	T	T	T	T	T	T	T	T	T	T	T
		LUC*12	3...12				T ^[1]	T ^[1]	T ^[1]	T ^[1]	T ^[1]	T ^[1]	T ^[1]	T ^[1]	T	T	T	T	T	T	T	T	T	T	T	T
		LUC*18	4.5...18									T ^[1]	T ^[1]	T ^[1]	T	T	T	T	T	T	T	T	T	T	T	T
LUC*32	8...32												T ^[1]		T	T	T	T	T	T	T	T	T	T	T	
LUB12 + LUA LB1	70 kA	LUC*X6	0.15...0.6	T	T	T	T	T	T	T	T	T	T	T	T	T	T	T	T	T	T	T	T	T	T	T
		LUC*1X	0.35...1.4	T	T	T	T	T	T	T	T	T	T	T	T	T	T	T	T	T	T	T	T	T	T	T
		LUC*05	1.25...5	T	T	T	T	T	T	T	T	T	T	T	T	T	T	T	T	T	T	T	T	T	T	T
		LUC*12	3...12				T	T	T	T	T	T	T	T	T	T	T	T	T	T	T	T	T	T	T	T
LUB32 + LUA LB1	70 kA	LUC*X6	0.15...0.6	T	T	T	T	T	T	T	T	T	T	T	T	T	T	T	T	T	T	T	T	T	T	T
		LUC*1X	0.35...1.4	T	T	T	T	T	T	T	T	T	T	T	T	T	T	T	T	T	T	T	T	T	T	T
		LUC*05	1.25...5	T	T	T	T	T	T	T	T	T	T	T	T	T	T	T	T	T	T	T	T	T	T	T
		LUC*12	3...12				T	T	T	T	T	T	T	T	T	T	T	T	T	T	T	T	T	T	T	T
		LUC*18	4.5...18							T	T	T	T	T	T	T	T	T	T	T	T	T	T	T	T	T
LUC*32	8...32												T		T	T	T	T	T	T	T	T	T	T	T	

[1] These combinations have been tested and selectivity is enhanced by cascading up to upstream ComPacT NSX circuit breaker (75 kA with HB1 and 100 kA with HB2). For example NSX100HB1 MicroLogic 2.2 + LA9LB920 + LUB12 can be used with a prospective short circuit up to 75 kA with total selectivity.
 [2] Applicable for all "Distribution" MicroLogic of ComPacT NSX range: 2.2, 5.2, 6.2. Not applicable for "Motor" MicroLogic of ComPacT NSX range ("M" type).

T Total selectivity, up to the breaking capacity of the downstream circuit breaker.
 4 Selectivity limit = 4 kA.
 No selectivity.

Note: Respect the basic rules of selectivity, for overload and short-circuit, see introduction or check curves.

Selectivity Table 690 V AC

Upstream: ComPacT NSX100-250 TM-D

Downstream: ComPacT NSX100-250 TM-D - MicroLogic - MA + LRD

Ue = 690 V AC

A

Upstream CB			NSX100L			NSX100L/R/HB1/HB2					NSX160L				NSX250L/R/HB1/HB2		
Trip unit type			TM-D			TM-D					TM-D				TM-D		
Trip unit rating (A)			16	25	32	40	50	63	80	100	80	100	125	160	160	200	250
Downstream CB	Th. OL Relay	Setting range (A)	Selectivity limit (kA)														
NSX100 L TM-D		16				0.5	0.5	0.5	0.63	0.8	0.63	0.8	1.25	1.25	1.25	2	2.5
		25					0.5	0.5	0.63	0.8	0.63	0.8	1.25	1.25	1.25	2	2.5
		32						0.5	0.63	0.8	0.63	0.8	1.25	1.25	1.25	2	2.5
NSX100 L/R/HB1/HB2 TM-D		40							0.63	0.8	0.63	0.8	1.25	1.25	1.25	2	2.5
		50							0.63	0.8	0.63	0.8	1.25	1.25	1.25	2	2.5
		63								0.8		0.8	1.25	1.25	1.25	2	2.5
		80											1.25	1.25	1.25	2	2.5
		100												1.25	1.25	2	2.5
NSX160 L TM-D		≤ 63											1.25	1.25	1.25	2	2.5
		80											1.25	1.25	1.25	2	2.5
		100												1.25	1.25	2	2.5
		160															2.5
NSX250 L/R/HB1/HB2 TM-D		≤ 100													1.25	2	2.5
		125														2	2.5
		160															2.5
		200															2.5
NSX100 L/R/HB1/HB2 MicroLogic		40						0.5	0.63	0.8	0.63	0.8	1.25	1.25	1.25	2	2.5
		100												1.25	1.25	2	2.5
NSX160 L MicroLogic		40						0.5	0.63	0.8	0.63	0.8	1.25	1.25	1.25	2	2.5
		100												1.25	1.25	2	2.5
		160															2.5
NSX250 L/R/HB1/HB2 MicroLogic		≤ 100													1.25	2	2.5
		160															2.5
		250															2.5
NSX100 L MA 2.5	LRD 06	1/1.6	0.19	0.3	0.4	0.5	0.5	0.5	0.63	0.8	0.63	0.8	1	1	1	20	20
NSX100 L MA 2.5	LRD 07	1.6/2.5	0.19	0.3	0.4	0.5	0.5	0.5	0.63	0.8	0.63	0.8	1	1	1	20	20
NSX100 L MA 6.3	LRD 08	2.5/4	0.19	0.3	0.4	0.5	0.5	0.5	0.63	0.8	0.63	0.8	1	1	1	20	20
NSX100 L MA 6.3	LRD 10	4/6.3		0.3	0.4	0.5	0.5	0.5	0.63	0.8	0.63	0.8	1	1	1	20	20
NSX100 L/R/HB1/HB2 MA 12.5	LRD 12	5.5/8		0.3	0.4	0.5	0.5	0.5	0.63	0.8	0.63	0.8	1	1	1	6	6
NSX100 L/R/HB1/HB2 MA 12.5	LRD 14	7/10			0.4	0.5	0.5	0.5	0.63	0.8	0.63	0.8	1	1	1	6	6
NSX100 L/R/HB1/HB2 MA 12.5	LRD 16	9/13				0.5	0.5	0.5	0.63	0.8	0.63	0.8	1	1	1	6	6
NSX100 L/R/HB1/HB2 MA 25	LRD 21	12/18						0.5	0.63	0.8	0.63	0.8	1	1	1	5	5
NSX100 L/R/HB1/HB2 MA 25	LRD 22	17/25							0.63	0.8	0.63	0.8	1	1	1	5	5
NSX100 L/R/HB1/HB2 MA 50	LRD 32	23/32								0.8		0.8	1	1	1	5	5
NSX100 L/R/HB1/HB2 MA 50	LRD 33 55	30/40											1	1	1	5	5
NSX100 L/R/HB1/HB2 MA 50	LRD 33 57	37/50												1	1	5	5
NSX100 L/R/HB1/HB2 MA 100	LRD 33 59	48/65														4	4
NSX100 L/R/HB1/HB2 MA 100	LRD 33 63	63/80															4
NSX100 L/R/HB1/HB2 MA 100	LRD 33 65 or 43 65	80/100															
NSX100 L/R/HB1/HB2 MicroLogic 2.2 M or 6.2 E-M		25/50										0.8	1	1	1	2	2.5
		100															2.5

Selectivity limit = 4 kA.

No selectivity.

Note: Respect the basic rules of selectivity, for overload and short-circuit, see introduction or check curves.

Selectivity Table 690 V AC

Upstream: ComPacT NSX100-250 MicroLogic

Downstream: ComPacT NSX100-250 TM-D - MicroLogic - MA

Ue = 690 V AC



Upstream CB	NSX100L/R/HB1/HB2								NSX160L				NSX250L/R/HB1/HB2		
Trip unit type	MicroLogic ^[1]								MicroLogic ^[1]				MicroLogic ^[1]		
Trip unit rating (A)	40				100				160				250		
Setting Ir (A)	16	25	32	40	40	63	80	100	80	100	125	160	160	200	250

Downstream CB	Th. OL Relay	Setting range (A)	Selectivity limit (kA)														
NSX100 L TM-D		16					1.5	1.5	1.5	1.5	2.4	2.4	2.4	2.4	3	3	3
		25					1.5	1.5	1.5	1.5	2.4	2.4	2.4	2.4	3	3	3
		32						1.5	1.5	1.5	2.4	2.4	2.4	2.4	3	3	3
NSX100 L/R/HB1/HB2		40							1.5	1.5	2.4	2.4	2.4	2.4	3	3	3
		50								1.5	2.4	2.4	2.4	2.4	3	3	3
		63										2.4	2.4	2.4	3	3	3
		80											2.4	2.4	3	3	3
		100												2.4	3	3	3
NSX160 L TM-D		≤ 63										2.4	2.4	2.4	3	3	3
		80											2.4	2.4	3	3	3
		100												2.4	3	3	3
		160															3
NSX250 L/R/HB1/HB2 TM-D		≤ 100													3	3	3
		125														3	3
		160															3
		200															
NSX100 L/R/HB1/HB2 MicroLogic		40					1.5	1.5	1.5	1.5	2.4	2.4	2.4	2.4	3	3	3
		100												2.4	3	3	3
NSX160 L MicroLogic		40									2.4	2.4	2.4	2.4	3	3	3
		100												2.4	3	3	3
		160															3
NSX250 L/R/HB1/HB2 MicroLogic		≤ 100													3	3	3
		160															3
		250															
NSX100 L MA 2.5	LRD 06	1/1.6	20	20	20	20	20	20	20	20	20	20	20	20	20	20	20
NSX100 L MA 2.5	LRD 07	1.6/2.5	20	20	20	20	20	20	20	20	20	20	20	20	20	20	20
NSX100 L MA 6.3	LRD 08	2.5/4	4	4	4	4	4	4	4	4	8	8	8	8	20	20	20
NSX100 L MA 6.3	LRD 10	4/6.3	4	4	4	4	4	4	4	4	8	8	8	8	20	20	20
NSX100 L/R/HB1/HB2 MA 12.5	LRD 12	5.5/8		2	2	2	2	2	2	2	2.4	2.4	2.4	2.4	20	20	20
NSX100 L/R/HB1/HB2 MA 12.5	LRD 14	7/10			2	2	2	2	2	2	2.4	2.4	2.4	2.4	20	20	20
NSX100 L/R/HB1/HB2 MA 12.5	LRD 16	9/13			2	2	2	2	2	2	2.4	2.4	2.4	2.4	20	20	20
NSX100 L/R/HB1/HB2 MA 25	LRD 21	12/18						2	2	2	2.4	2.4	2.4	2.4	13	13	13
NSX100 L/R/HB1/HB2 MA 25	LRD 22	17/25							2	2	2.4	2.4	2.4	2.4	13	13	13
NSX100 L/R/HB1/HB2 MA 50	LRD 32	23/32								1		2.4	2.4	2.4	11	11	11
NSX100 L/R/HB1/HB2 MA 50	LRD 33 55	30/40											2.4	2.4	11	11	11
NSX100 L/R/HB1/HB2 MA 50	LRD 33 57	37/50												2.4	11	11	11
NSX100 L/R/HB1/HB2 MA 100	LRD 33 59	48/65														10	10
NSX100 L/R/HB1/HB2 MA 100	LRD 33 63	63/80														10	10
NSX100 L/R/HB1/HB2 MA 100	LRD 33 65 or 43 65	80/100															10
NSX100 L/R/HB1/HB2 MicroLogic 2.2 M or 6.2 E-M		25/50								1.5	2.4	2.4	2.4	2.4	3	3	3
		100															3

[1] Applicable for all "Distribution" MicroLogic of ComPact NSX range: 2.2, 5.2, 6.2. Not applicable for "Motor" MicroLogic of ComPact NSX range ("M" type).

4 Selectivity limit = 4 kA.
 No selectivity.

Note: Respect the basic rules of selectivity, for overload and short-circuit, see introduction or check curves.

Selectivity Table 690 V AC

Upstream: ComPacT NSX400-630

Downstream: TeSys GV2, GV3, TeSys U



U_e = 690 V AC

Upstream CB	NSX400L/R/HB1/HB2				NSX400L/R/HB1/HB2					NSX630L/R/HB1/HB2				
Trip unit type	MicroLogic 2.3				MicroLogic 2.3 / 5.3 / 6.3					MicroLogic 2.3 / 5.3 / 6.3				
Trip unit rating (A)	250				400					630				
Setting I _r (A)	100	160	200	250	160	200	250	320	400	250	320	400	500	630

Downstream CB	I _{cu}	Th. OL Relay	Setting range (A)	Selectivity limit (kA)														
				T	T	T	T	T	T	T	T	T	T	T	T	T	T	
GV2 L03	100 kA	LRD 03	0.25/0.40	T	T	T	T	T	T	T	T	T	T	T	T	T	T	
GV2 L04	100 kA	LRD 04	0.40/0.63	T	T	T	T	T	T	T	T	T	T	T	T	T	T	
GV2 L05	100 kA	LRD 05	0.63/1	T	T	T	T	T	T	T	T	T	T	T	T	T	T	
GV2 L06	100 kA	LRD 06	1/1.6	T	T	T	T	T	T	T	T	T	T	T	T	T	T	
GV2 L07 + LA9 LB920	50 kA	LRD 07	1.6/2.5	T	T	T	T	T	T	T	T	T	T	T	T	T	T	
GV2 L08 + LA9 LB920	50 kA	LRD 08	2.5/4	T	T	T	T	T	T	T	T	T	T	T	T	T	T	
GV2 L10 + LA9 LB920	50 kA	LRD 10	4/6.3	T	T	T	T	T	T	T	T	T	T	T	T	T	T	
GV2 L14 + LA9 LB920	50 kA	LRD 14	7/10	T	T	T	T	T	T	T	T	T	T	T	T	T	T	
GV2 L16 + LA9 LB920	50 kA	LRD 16	9/13	T	T	T	T	T	T	T	T	T	T	T	T	T	T	
GV2 L20 + LA9 LB920	50 kA	LRD 21	12/18	T	T	T	T	T	T	T	T	T	T	T	T	T	T	
GV2 L22 + LA9 LB920	50 kA	LRD 22	17/25	T	T	T	T	T	T	T	T	T	T	T	T	T	T	
GV2 L32 + LA9 LB920	50 kA	LRD 32	23/32	T	T	T	T	T	T	T	T	T	T	T	T	T	T	
GV3 P13	6 kA	Integrated	9/13	T	T	T	T	T	T	T	T	T	T	T	T	T	T	
GV3 P18	6 kA	Integrated	12/18	T	T	T	T	T	T	T	T	T	T	T	T	T	T	
GV3 P25	6 kA	Integrated	17/25	T	T	T	T	T	T	T	T	T	T	T	T	T	T	
GV3 P32	6 kA	Integrated	23/32	T	T	T	T	T	T	T	T	T	T	T	T	T	T	
GV3 P40	6 kA	Integrated	30/40	T	T	T	T	T	T	T	T	T	T	T	T	T	T	
GV3 P50	6 kA	Integrated	37/50	T	T	T	T	T	T	T	T	T	T	T	T	T	T	
GV3 P65	6 kA	Integrated	48/65	T	T	T	T	T	T	T	T	T	T	T	T	T	T	
GV3 L25	6 kA	LRD 22	20/25	T	T	T	T	T	T	T	T	T	T	T	T	T	T	
GV3 L32	6 kA	LRD 32	23/32	T	T	T	T	T	T	T	T	T	T	T	T	T	T	
GV3 L40	6 kA	LRD 340	30/40	T	T	T	T	T	T	T	T	T	T	T	T	T	T	
GV3 L50	6 kA	LRD 350	37/50	T	T	T	T	T	T	T	T	T	T	T	T	T	T	
GV3 L65	6 kA	LRD 365	48/65	T	T	T	T	T	T	T	T	T	T	T	T	T	T	
LUB12 + LA9 LB20	35 kA	LUC*X6	0.15...0.6	T	T	T	T	T	T	T	T	T	T	T	T	T	T	
		LUC*1X	0.35...1.4	T	T	T	T	T	T	T	T	T	T	T	T	T	T	
		LUC*05	1.25...5	T	T	T	T	T	T	T	T	T	T	T	T	T	T	T
		LUC*12	3...12	T	T	T	T	T	T	T	T	T	T	T	T	T	T	T
LUB32 + LA9 LB20	35 kA	LUC*X6	0.15...0.6	T	T	T	T	T	T	T	T	T	T	T	T	T	T	
		LUC*1X	0.35...1.4	T	T	T	T	T	T	T	T	T	T	T	T	T	T	
		LUC*05	1.25...5	T	T	T	T	T	T	T	T	T	T	T	T	T	T	
		LUC*12	3...12	T	T	T	T	T	T	T	T	T	T	T	T	T	T	T
		LUC*18	4.5...18	T	T	T	T	T	T	T	T	T	T	T	T	T	T	T
LUC*32	8...32	T	T	T	T	T	T	T	T	T	T	T	T	T	T	T	T	
LUB12 + LUA LB1	70 kA	LUC*X6	0.15...0.6	T	T	T	T	T	T	T	T	T	T	T	T	T	T	
		LUC*1X	0.35...1.4	T	T	T	T	T	T	T	T	T	T	T	T	T	T	
		LUC*05	1.25...5	T	T	T	T	T	T	T	T	T	T	T	T	T	T	T
		LUC*12	3...12	T	T	T	T	T	T	T	T	T	T	T	T	T	T	T
LUB32 + LUA LB1	70 kA	LUC*X6	0.15...0.6	T	T	T	T	T	T	T	T	T	T	T	T	T	T	
		LUC*1X	0.35...1.4	T	T	T	T	T	T	T	T	T	T	T	T	T	T	T
		LUC*05	1.25...5	T	T	T	T	T	T	T	T	T	T	T	T	T	T	T
		LUC*12	3...12	T	T	T	T	T	T	T	T	T	T	T	T	T	T	T
		LUC*18	4.5...18	T	T	T	T	T	T	T	T	T	T	T	T	T	T	T
LUC*32	8...32	T	T	T	T	T	T	T	T	T	T	T	T	T	T	T	T	

T Total selectivity, up to the breaking capacity of the downstream circuit breaker.

Note: Respect the basic rules of selectivity, for overload and short-circuit, see introduction or check curves.

Selectivity Table 690 V AC

Upstream: ComPacT NSX400-630

Downstream: ComPacT NSX100-250 TM-D - MicroLogic - MA + LRD

Ue = 690 V AC



Upstream CB	NSX400L/R/HB1/HB2				NSX400L/R/HB1/HB2					NSX630L/R/HB1/HB2				
Trip unit type	MicroLogic ^[1]				MicroLogic ^[1]					MicroLogic ^[1]				
Trip unit rating (A)	250				400					630				
Setting Ir (A)	100	160	200	250	160	200	250	320	400	250	320	400	500	630

Downstream CB	Th. OL Relay	Setting range (A)	Selectivity limit (kA)												
NSX100 L TM-D		16	15	15	15	15	T	T	T	T	T	T	T	T	T
		25	15	15	15	15	T	T	T	T	T	T	T	T	T
		32	15	15	15	15	T	T	T	T	T	T	T	T	T
NSX100 L/R/HB1/HB2 TM-D		40	15	15	15	15	30	30	30	30	30	50	50	50	50
		50	15	15	15	15	30	30	30	30	30	50	50	50	50
		63	15	15	15	15	30	30	30	30	30	50	50	50	50
		80		15	15	15	30	30	30	30	30	50	50	50	50
		100		15	15	15	30	30	30	30	30	50	50	50	50
NSX100 R/HB1/HB2 MicroLogic		40	15	15	15	15	30	30	30	30	30	50	50	50	50
		100		15	15	15	30	30	30	30	30	50	50	50	50
NSX160 L TM-D		≤ 100		15	15	15	T	T	T	T	T	T	T	T	T
		125			15	15			T	T	T	T	T	T	T
		160				15			15	15	15	T	T	T	T
NSX160 L MicroLogic		40	15	15	15	15	T	T	T	T	T	T	T	T	T
		100		15	15	15	15	15	15	15	15	T	T	T	T
		160							15	15	15	T	T	T	T
NSX250 L/R/HB1/HB2 TM-D		200								8	8		12	12	12
		250									8			12	12
NSX250 L/R/HB1/HB2 MicroLogic		250									8			12	12
NSX100 L MA 2.5	LRD 06	1/1.6	T	T	T	T	T	T	T	T	T	T	T	T	T
NSX100 L MA 2.5	LRD 07	1.6/2.5	T	T	T	T	T	T	T	T	T	T	T	T	T
NSX100 L MA 6.3	LRD 08	2.5/4	T	T	T	T	T	T	T	T	T	T	T	T	T
NSX100 L MA 6.3	LRD 10	4/6.3	T	T	T	T	T	T	T	T	T	T	T	T	T
NSX100 L/R/HB1/HB2 MA 12.5	LRD 12	5.5/8	T	T	T	T	T	T	T	T	T	T	T	T	T
NSX100 L/R/HB1/HB2 MA 12.5	LRD 14	7/10	T	T	T	T	T	T	T	T	T	T	T	T	T
NSX100 L/R/HB1/HB2 MA 12.5	LRD 16	9/13	T	T	T	T	T	T	T	T	T	T	T	T	T
NSX100 L/R/HB1/HB2 MA 25	LRD 21	12/18	15	15	15	15	30	30	30	30	30	50	50	50	50
NSX100 L/R/HB1/HB2 MA 25	LRD 22	17/25	15	15	15	15	30	30	30	30	30	50	50	50	50
NSX100 L/R/HB1/HB2 MA 50	LRD 32	23/32	15	15	15	15	30	30	30	30	30	50	50	50	50
NSX100 L/R/HB1/HB2 MA 50	LRD 33 55	30/40		15	15	15	30	30	30	30	30	50	50	50	50
NSX100 L/R/HB1/HB2 MA 50	LRD 33 57	37/50		15	15	15	30	30	30	30	30	50	50	50	50
NSX100 L/R/HB1/HB2 MA 100	LRD 33 59	48/65			15	15		30	30	30	30	50	50	50	50
NSX100 L/R/HB1/HB2 MA 100	LRD 33 63	63/80				15			30	30	30	50	50	50	50
NSX100 L/R/HB1/HB2 MA 100	LRD 33 65 or 43 65	80/100								30	30		50	50	50
NSX160 L MA 150	LRD 43 67	95/150													T
NSX250 L/R/HB1/HB2 MA 220	LR9 F5371	132/220													12
NSX100 L/R/HB1/HB2 MicroLogic 2.2 M or 6.2 E-M		25/50		15	15	15	30	30	30	30	30	50	50	50	50
		100								15	15		50	50	50
NSX160 L MicroLogic 2.2 M or 6.2 E-M		25/50		12	12	12	T	T	T	T	T	T	T	T	T
		100								15	15		T	T	T
		150									15				T
NSX250 L/R/HB1/HB2 MicroLogic 2.2 M or 6.2 E-M		≤ 100								8	8			12	12
		150												12	12
		220													12

[1] Applicable for all "Distribution" MicroLogic of ComPact NSX range: 2.3, 5.3, 6.3. Not applicable for "Motor" MicroLogic of ComPact NSX range ("M" type).

- T Total selectivity, up to the breaking capacity of the downstream circuit breaker.
- 4 Selectivity limit = 4 kA or the breaking capacity of the downstream circuit breaker when lower.
- No selectivity.

Note: Respect the basic rules of selectivity, for overload and short-circuit, see introduction or check curves.

Selectivity Table 690 V AC

Upstream: ComPacT NS630b-1600N/H

Downstream: TeSys GV2, GV3, TeSys U, ComPacT NSX100-630



U_e = 690 V AC

Upstream CB	NS630b-1600N / H								NS630b-1600N / H								NS630b-1600N / H							
Trip unit type	MicroLogic 2.0								MicroLogic 5.0 - 6.0 Inst 15 In								MicroLogic 5.0 - 6.0 Inst OFF							
Trip unit rating (A)	630		800	1000	1250	1600	630		800	1000	1250	1600	630		800	1000	1250	1600						
Setting I _r (A)	250	400	630	800	1000	1250	1600	250	400	630	800	1000	1250	1600	250	400	630	800	1000	1250	1600			

Downstream CB	Setting range (A)	Selectivity limit (kA)																			
GV2 L03 - L06		T	T	T	T	T	T	T	T	T	T	T	T	T	T	T	T	T	T	T	T
GV2 L07 - L32 + LA9 LB920		T	T	T	T	T	T	T	T	T	T	T	T	T	T	T	T	T	T	T	T
LUB12 + LA9 LB20		T	T	T	T	T	T	T	T	T	T	T	T	T	T	T	T	T	T	T	T
LUB32 + LA9 LB20		T	T	T	T	T	T	T	T	T	T	T	T	T	T	T	T	T	T	T	T
LUB12 + LUA LB1		T	T	T	T	T	T	T	T	T	T	T	T	T	T	T	T	T	T	T	T
LUB32 + LUA LB1		T	T	T	T	T	T	T	T	T	T	T	T	T	T	T	T	T	T	T	T
GV3 32-65		T	T	T	T	T	T	T	T	T	T	T	T	T	T	T	T	T	T	T	T
NSX100 L/R/HB1/HB2 MA	≤ 100	T	T	T	T	T	T	T	T	T	T	T	T	T	T	T	T	T	T	T	T
NSX160 L MA	≤ 150	T	T	T	T	T	T	T	T	T	T	T	T	T	T	T	T	T	T	T	T
NSX250 L/R/HB1/HB2 MA	≤ 220	T	T	T	T	T	T	T	T	T	T	T	T	T	T	T	T	T	T	T	T
NSX100 L/R/HB1/HB2 TM-D	≤ 100	T	T	T	T	T	T	T	T	T	T	T	T	T	T	T	T	T	T	T	T
NSX160 L TM-D	≤ 160	T	T	T	T	T	T	T	T	T	T	T	T	T	T	T	T	T	T	T	T
NSX250 L/R/HB1/HB2 TM-D	≤ 125	T	T	T	T	T	T	T	T	T	T	T	T	T	T	T	T	T	T	T	T
	160	T	T	T	T	T	T	T	T	T	T	T	T	T	T	T	T	T	T	T	T
	200		T	T	T	T	T		T	T	T	T	T		T	T	T	T	T	T	T
	250		T	T	T	T	T		T	T	T	T	T		T	T	T	T	T	T	T
NSX100 L/R/HB1/HB2 MicroLogic	40	T	T	T	T	T	T	T	T	T	T	T	T	T	T	T	T	T	T	T	T
	100	T	T	T	T	T	T	T	T	T	T	T	T	T	T	T	T	T	T	T	T
NSX160 L MicroLogic	40	T	T	T	T	T	T	T	T	T	T	T	T	T	T	T	T	T	T	T	T
	100	T	T	T	T	T	T	T	T	T	T	T	T	T	T	T	T	T	T	T	T
	160	T	T	T	T	T	T	T	T	T	T	T	T	T	T	T	T	T	T	T	T
NSX250 L/R/HB1/HB2 MicroLogic	≤ 100	2.5	4	T	T	T	T	T	T	T	T	T	T	T	T	T	T	T	T	T	T
	160	2.5	4	T	T	T	T	T	T	T	T	T	T	T	T	T	T	T	T	T	T
	250	4	T	T	T	T	T	T	T	T	T	T	T	T		T	T	T	T	T	T
NSX400 S/L/R/HB1/HB2 1.3 M	320			T	T	T	T			T	T	T	T			T	T	T	T	T	T
NSX400 S/L/R/HB1/HB2 MicroLogic	160	2.5	4	T	T	T	T	T	T	T	T	T	T	T	T	T	T	T	T	T	T
	200		4	T	T	T	T			T	T	T	T	T		T	T	T	T	T	T
	250		4	T	T	T	T			T	T	T	T	T		T	T	T	T	T	T
	320			T	T	T	T			T	T	T	T	T			T	T	T	T	T
	400			T	T	T	T			T	T	T	T	T			T	T	T	T	T
NSX630 S/L/R/HB1/HB2 1.3 M	500				T	T	T				T	T	T	T				T	T	T	T
NSX630 S/L/R/HB1/HB2 MicroLogic	250		4	6.3	T	T	T	T		T	T	T	T	T			T	T	T	T	T
	320			6.3	T	T	T	T			T	T	T	T			T	T	T	T	T
	400			6.3	T	T	T	T			T	T	T	T			T	T	T	T	T
	500				T	T	T	T				T	T	T				T	T	T	T
	630				T	T	T	T				T	T	T				T	T	T	T

- T Total selectivity, up to the breaking capacity of the downstream circuit breaker.
- 4 Selectivity limit = 4 kA.
- No selectivity.

Note: Respect the basic rules of selectivity, for overload and short-circuit, see introduction or check curves.

Selectivity Table 690 V AC

Upstream: ComPacT NS630b-1600N/H

Downstream: ComPacT NS630b-1600

Ue = 690 V AC



Upstream CB	NS630b-1600N / H						NS630b-1600N / H						NS630b-1600N / H					
Trip unit type	MicroLogic 2.0						MicroLogic 5.0 - 6.0 Inst 15 In						MicroLogic 5.0 - 6.0 Inst position OFF					
Trip unit rating (A)	630	800	1000	1250	1600		630	800	1000	1250	1600		630	800	1000	1250	1600	
Setting Ir (A)	400	630	800	1000	1250	1600	400	630	800	1000	1250	1600	400	630	800	1000	1250	1600

Downstream CB	Setting range (A)	Selectivity limit (kA)																	
NS630b N/H MicroLogic	250	4	6.3	8	10	12.5	16	9.4	9.4	12	15	18	18	18	18	18	18	18	18
	320		6.3	8	10	12.5	16		9.4	12	15	18	18		18	18	18	18	18
	400		6.3	8	10	12.5	16		9.4	12	15	18	18		18	18	18	18	18
	500			8	10	12.5	16			12	15	18	18			18	18	18	18
	630				10	12.5	16				15	18	18				18	18	18
NS800 N/H MicroLogic	320		6.3	8	10	12.5	16		9.4	12	15	18	18		18	18	18	18	18
	400		6.3	8	10	12.5	16		9.4	12	15	18	18		18	18	18	18	18
	500			8	10	12.5	16			12	15	18	18			18	18	18	18
	630				10	12.5	16				15	18	18			18	18	18	18
	800					12.5	16					18	18				18	18	18
NS1000 N/H MicroLogic	400		6.3	8	10	12.5	16		9.4	12	15	18	18		18	18	18	18	18
	500			8	10	12.5	16			12	15	18	18			18	18	18	18
	630				10	12.5	16				15	18	18				18	18	18
	800					12.5	16					18	18					18	18
	1000						16						18						18
NS1250 N/H MicroLogic	500			8	10	12.5	16			12	15	18	18			18	18	18	18
	630				10	12.5	16				15	18	18				18	18	18
	800					12.5	16					18	18					18	18
	1000						16						18						18
	1250																		
NS1600 N/H MicroLogic	630				10	12.5	16				15	18	18				18	18	18
	800					12.5	16					18	18					18	18
	960						16						18						18
	1250																		
	1600																		
NS630b LB MicroLogic	250	4	6.3	8	10	12.5	30	9.4	9.4	12	15	18.7	30	30	30	30	30	30	30
	320		6.3	8	10	12.5	30		9.4	12	15	18.7	30		30	30	30	30	30
	400		6.3	8	10	12.5	30		9.4	12	15	18.7	30		30	30	30	30	30
	500			8	10	12.5	30			12	15	18.7	30			30	30	30	30
	630				10	12.5	30				15	18.7	30				30	30	30
NS800 LB MicroLogic	320		6.3	8	10	12.5	30		9.4	12	15	18.7	30		30	30	30	30	30
	400		6.3	8	10	12.5	30		9.4	12	15	18.7	30		30	30	30	30	30
	500			8	10	12.5	30			12	15	18.7	30			30	30	30	30
	630				10	12.5	30				15	18.7	30				30	30	30
	800					12.5	30					18.7	30					30	30

Selectivity limit = 4 kA.

No selectivity.

Note: Respect the basic rules of selectivity, for overload and short-circuit, see introduction or check curves.

Selectivity Table 690 V AC

Upstream: ComPacT NS1600b-3200N

Downstream: TeSys GV2, GV3, TeSys U, ComPacT NSX100-630, ComPacT NS630b-3200

Ue = 690 V AC

A

Upstream CB	NS1600-3200N				NS1600-3200N				NS1600-3200N			
Trip unit type	MicroLogic 2.0				MicroLogic 5.0 - 6.0 Inst 15 In				MicroLogic 5.0 - 6.0 Inst OFF			
Trip unit rating (A)	1600	2000	2500	3200	1600	2000	2500	3200	1600	2000	2500	3200

Downstream CB	Setting range (A)	Selectivity limit (kA)											
GV2 L03 - L06		T	T	T	T	T	T	T	T	T	T	T	T
GV2 L07 - L32 + LA9 LB920		T	T	T	T	T	T	T	T	T	T	T	T
LUB12 + LA9 LB20		T	T	T	T	T	T	T	T	T	T	T	T
LUB32 + LA9 LB20		T	T	T	T	T	T	T	T	T	T	T	T
LUB12 + LUA LB1		T	T	T	T	T	T	T	T	T	T	T	T
LUB32 + LUA LB1		T	T	T	T	T	T	T	T	T	T	T	T
GV3 32-65		T	T	T	T	T	T	T	T	T	T	T	T
ComPacT NSX L/R/HB1/HB2 TM-D / MA	NSX100	T	T	T	T	T	T	T	T	T	T	T	T
	NSX250	T	T	T	T	T	T	T	T	T	T	T	T
ComPacT NSX L TM-D / MA	NSX160	T	T	T	T	T	T	T	T	T	T	T	T
ComPacT NSX L/R/HB1/HB2 MicroLogic	NSX100	T	T	T	T	T	T	T	T	T	T	T	T
	NSX250	T	T	T	T	T	T	T	T	T	T	T	T
ComPacT NSX L MicroLogic	NSX160	T	T	T	T	T	T	T	T	T	T	T	T
ComPacT NSX L/R/HB1/HB2	NSX400	T	T	T	T	T	T	T	T	T	T	T	T
	NSX630	T	T	T	T	T	T	T	T	T	T	T	T
Compact NS N	NS630b	16	20	25	32	24	30	37.5	T	T	T	T	T
	NS800	16	20	25	32	24	30	37.5	T	T	T	T	T
	NS1000	16	20	25	32	24	30	37.5	T	T	T	T	T
	NS1250		20	25	32		30	37.5	T		T	T	T
	NS1600			25	32			37.5	T			T	T
Compact NS H	NS630b	16	20	25	32	24	30	37.5	48	T	T	T	T
	NS800	16	20	25	32	24	30	37.5	48	T	T	T	T
	NS1000	16	20	25	32	24	30	37.5	48	T	T	T	T
	NS1250		20	25	32		30	37.5	48		T	T	T
	NS1600			25	32			37.5	48			T	T
Compact NS N	NS1600b			25	32			37.5	48			60	60
	NS2000				32				48				60
	NS2500												
	NS3200												
Compact NS LB	NS630b LB	T	T	T	T	T	T	T	T	T	T	T	T
	NS800LB	T	T	T	T	T	T	T	T	T	T	T	T

- T Total selectivity, up to the breaking capacity of the downstream circuit breaker.
- 4 Selectivity limit = 4 kA or Total when Selectivity limit is higher than downstream device Icu.
- No selectivity.

Note: Respect the basic rules of selectivity, for overload and short-circuit, see introduction or check curves.

Selectivity Table 690 V AC

Upstream: NS630b-800LB

Downstream: TeSys GV2, GV3, TeSys U, ComPacT NSX100-630, ComPacT NS630b-800

Ue = 690 V AC



Upstream CB	NS630b-800LB					NS630b-800LB					NS630b-800LB				
Trip unit type	MicroLogic 2.0					MicroLogic 5.0 - 6.0 Inst 15 In					MicroLogic 5.0 - 6.0 Inst OFF				
Trip unit rating (A)	630		800			630		800			630		800		
Setting Ir (A)	250	400	630	630	800	250	400	630	630	800	250	400	630	630	800

Downstream CB	Setting range (A)	Selectivity limit (kA)														
GV2 L03 - L06		T	T	T	T	T	T	T	T	T	T	T	T	T	T	T
GV2 L07 - L32 + LA9 LB920		T	T	T	T	T	T	T	T	T	T	T	T	T	T	T
LUB12 + LA9 LB20		T	T	T	T	T	T	T	T	T	T	T	T	T	T	T
LUB32 + LA9 LB20		T	T	T	T	T	T	T	T	T	T	T	T	T	T	T
LUB12 + LUA LB1		T	T	T	T	T	T	T	T	T	T	T	T	T	T	T
LUB32 + LUA LB1		T	T	T	T	T	T	T	T	T	T	T	T	T	T	T
NSX100 L/R/HB1/HB2 MA	≤ 100	15	15	15	30	30	15	15	15	30	30	15	15	15	30	30
NSX160 L MA	≤ 150	10	10	10	30	30	10	10	10	30	30	10	10	10	30	30
NSX250 L/R/HB1/HB2 MA	≤ 220	10	10	10	10	10	10	10	10	10	10	10	10	10	10	10
NSX100 L TM-D	≤ 100	15	15	15	T	T	15	15	15	T	T	15	15	15	T	T
NSX100 R/HB1/HB2 TM-D	≤ 100	15	15	15	30	30	15	15	15	30	30	15	15	15	30	30
NSX160 L TM-D	≤ 160	10	10	10	T	T	10	10	10	T	T	10	10	10	T	T
NSX100 R/HB1/HB2 TM-D	≤ 160	10	10	10	30	30	10	10	10	30	30	10	10	10	30	30
NSX250 L TM-D	≤ 160	10	10	10	10	10	10	10	10	10	10	10	10	10	10	10
	200		10	10	10	10		10	10	10	10		10	10	10	10
	250		10	10	10	10		10	10	10	10		10	10	10	10
NSX100 L MicroLogic	40	15	15	15	T	T	15	15	15	T	T	15	15	15	T	T
	100	15	15	15	T	T	15	15	15	T	T	15	15	15	T	T
NSX100 R/HB1/HB2 MicroLogic	40	15	15	15	30	30	15	15	15	30	30	15	15	15	30	30
	100	15	15	15	30	30	15	15	15	30	30	15	15	15	30	30
NSX160 L MicroLogic	40-100	2.5	10	10	T	T	10	10	10	T	T	10	10	10	T	T
	160	2.5	10	10	T	T	10	10	10	T	T	10	10	10	T	T
NSX250 L/R/HB1/HB2 MicroLogic	≤ 160	2.5	4	10	15	15	10	10	10	15	15	10	10	10	15	15
	250		4	10	15	15		10	10	15	15		10	10	15	15
NSX400 S/L/R/HB1/HB2 MicroLogic	160	2.5	4	6.3	6.3	8	6.3	6.3	6.3	8	8	6.3	6.3	6.3	8	8
	200		4	6.3	6.3	8		6.3	6.3	8	8		6.3	6.3	8	8
	250		4	6.3	6.3	8		6.3	6.3	8	8		6.3	6.3	8	8
	320		4	6.3	6.3	8		6.3	6.3	8	8		6.3	6.3	8	8
	400			6.3	6.3	8			6.3	8	8			6.3	8	8
NSX630 S/L/R/HB1/HB2 MicroLogic	250		4	6.3	6.3	8		6.3	6.3	8	8		6.3	6.3	8	8
	320			6.3	6.3	8			6.3	8	8			6.3	8	8
	400			6.3	6.3	8			6.3	8	8			6.3	8	8
	500					8					8					8
	630															
NS630b N/H MicroLogic	250		4	6.3	6.3	8		6.3	6.3	8	8		6.3	6.3	8	8
	320			6.3	6.3	8			6.3	8	8			6.3	8	8
	400			6.3	6.3	8			6.3	8	8			6.3	8	8
	500					8					8					8
	630															
NS800 N/H MicroLogic	320			6.3	8	8			6.3	8	8			6.3	8	8
	400			6.3	8	8			6.3	8	8			6.3	8	8
	500					8					8					8
	≥ 630															
NS630b LB MicroLogic	250		4	6.3	6.3	8		6.3	6.3	8	8		6.3	6.3	8	8
	320			6.3	6.3	8			6.3	8	8			6.3	8	8
	400			6.3	6.3	8			6.3	8	8			6.3	8	8
	500					8					8					8
	630															
NS800 LB MicroLogic	320			6.3	6.3	8			6.3	8	8			6.3	8	8
	400			6.3	6.3	8			6.3	8	8			6.3	8	8
	500					8					8					8
	≥ 630															

- T** Total selectivity, up to the breaking capacity of the downstream circuit breaker.
- 4** Selectivity limit = 4 kA or the breaking capacity of the downstream circuit breaker when lower.
- No selectivity.

Note: Respect the basic rules of selectivity, for overload and short-circuit, see introduction or check curves.
Version : 2.0 - 19/12/2023
548E4360

Selectivity Table 690 V AC

Upstream: MasterPacT MTZ1 06-16H1/H2

Downstream: TeSys GV2, GV3, TeSys U, ComPacT NSX100-630

U_e = 690 V AC

A

Upstream CB	MasterPacT MTZ1 06-16H1/2								MasterPacT MTZ1 06-16H1/2								MasterPacT MTZ1 06-16H1/2							
Trip unit type	MicroLogic 2.0 X								MicroLogic 5.0 - 6.0 X Inst 15 In Standard								MicroLogic 5.0 - 6.0 X Inst OFF							
Trip unit rating (A)	630		800	1000	1250	1600		630		800	1000	1250	1600		630		800	1000	1250	1600				
Setting Ir (A)	250	400	630	800	1000	1250	1600	250	400	630	800	1000	1250	1600	250	400	630	800	1000	1250	1600			

Downstream CB	Setting range (A)	Selectivity limit (kA)																			
GV2 L03 - L06		T	T	T	T	T	T	T	T	T	T	T	T	T	T	T	T	T	T	T	T
GV2 L07 - L32 + LA9 LB920		T	T	T	T	T	T	T	T	T	T	T	T	T	T	T	T	T	T	T	T
LUB12 + LA9 LB20		T	T	T	T	T	T	T	T	T	T	T	T	T	T	T	T	T	T	T	T
LUB32 + LA9 LB20		T	T	T	T	T	T	T	T	T	T	T	T	T	T	T	T	T	T	T	T
LUB12 + LUA LB1		T	T	T	T	T	T	T	T	T	T	T	T	T	T	T	T	T	T	T	T
LUB32 + LUA LB1		T	T	T	T	T	T	T	T	T	T	T	T	T	T	T	T	T	T	T	T
GV3 32-65		T	T	T	T	T	T	T	T	T	T	T	T	T	T	T	T	T	T	T	T
NSX100 L/R/HB1/HB2 MA	≤ 100	T	T	T	T	T	T	T	T	T	T	T	T	T	T	T	T	T	T	T	T
NSX160 L MA	≤ 150	T	T	T	T	T	T	T	T	T	T	T	T	T	T	T	T	T	T	T	T
NSX250 L/R/HB1/HB2 MA	≤ 220	T	T	T	T	T	T	T	T	T	T	T	T	T	T	T	T	T	T	T	T
NSX100 L/R/HB1/HB2 TM-D		T	T	T	T	T	T	T	T	T	T	T	T	T	T	T	T	T	T	T	T
NSX160 L TM-D		T	T	T	T	T	T	T	T	T	T	T	T	T	T	T	T	T	T	T	T
NSX250 L/R/HB1/HB2 TM-D	≤ 125	T	T	T	T	T	T	T	T	T	T	T	T	T	T	T	T	T	T	T	T
	160	T	T	T	T	T	T	T	T	T	T	T	T	T	T	T	T	T	T	T	T
	200	T	T	T	T	T	T	T	T	T	T	T	T	T	T	T	T	T	T	T	T
	250	T	T	T	T	T	T	T	T	T	T	T	T	T	T	T	T	T	T	T	T
NSX100 L/R/HB1/HB2 MicroLogic	40	T	T	T	T	T	T	T	T	T	T	T	T	T	T	T	T	T	T	T	T
	100	T	T	T	T	T	T	T	T	T	T	T	T	T	T	T	T	T	T	T	T
NSX160 L MicroLogic	40	T	T	T	T	T	T	T	T	T	T	T	T	T	T	T	T	T	T	T	T
	100	T	T	T	T	T	T	T	T	T	T	T	T	T	T	T	T	T	T	T	T
	160	T	T	T	T	T	T	T	T	T	T	T	T	T	T	T	T	T	T	T	T
NSX250 L/R/HB1/HB2 MicroLogic	≤ 100	2.5	4	T	T	T	T	T	T	T	T	T	T	T	T	T	T	T	T	T	T
	160	2.5	4	T	T	T	T	T	T	T	T	T	T	T	T	T	T	T	T	T	T
	250	4	T	T	T	T	T	T	T	T	T	T	T	T	T	T	T	T	T	T	T
NSX400 S/L/R/HB1/HB2 1.3 M	320			T	T	T	T	T			T	T	T	T	T			T	T	T	T
NSX400 S/L/R/HB1/HB2 MicroLogic	160	2.5	4	T	T	T	T	T	T	T	T	T	T	T	T	T	T	T	T	T	T
	200	4	T	T	T	T	T	T	T	T	T	T	T	T	T	T	T	T	T	T	T
	250	4	T	T	T	T	T	T	T	T	T	T	T	T	T	T	T	T	T	T	T
	320			T	T	T	T	T			T	T	T	T	T			T	T	T	T
	400			T	T	T	T	T			T	T	T	T	T			T	T	T	T
NSX630 S/L/R/HB1/HB2 1.3 M	500			T	T	T	T	T			T	T	T	T	T			T	T	T	T
NSX630 S/L/R/HB1/HB2 MicroLogic	250	4	6.3	T	T	T	T	T	T	T	T	T	T	T	T	T	T	T	T	T	T
	320		6.3	T	T	T	T	T			T	T	T	T	T			T	T	T	T
	400		6.3	T	T	T	T	T			T	T	T	T	T			T	T	T	T
	500			T	T	T	T	T			T	T	T	T	T			T	T	T	T
	630			T	T	T	T	T			T	T	T	T	T			T	T	T	T

- T Total selectivity, up to the breaking capacity of the downstream circuit breaker.
- 4 Selectivity limit = 4 kA.
- No selectivity.

Note: Respect the basic rules of selectivity, for overload and short-circuit, see introduction or check curves.

Selectivity Table 690 V AC

Upstream: MasterPacT MTZ1 06-16H1/H2

Downstream: ComPacT NS630b-1600

U_e = 690 V AC



Upstream CB	MasterPacT MTZ1 06-16H1/2					MasterPacT MTZ1 06-16H1/2					MasterPacT MTZ1 06-16H1/2							
Trip unit type	MicroLogic 2.0 X					MicroLogic 5.0 - 6.0 X Inst 15 In Standard					MicroLogic 5.0 - 6.0 X Inst OFF							
Trip unit rating (A)	630	800	1000	1250	1600	630	800	1000	1250	1600	630	800	1000	1250	1600			
Setting I _r (A)	400	630	800	1000	1250	1600	400	630	800	1000	1250	1600	400	630	800	1000	1250	1600

Downstream CB	Setting range (A)	Selectivity limit (kA)																	
NS630b N/H MicroLogic	250	4	6.3	8	10	12.5	16	9.4	9.4	12	15	18.7	24	T	T	T	T	T	T
	320		6.3	8	10	12.5	16		9.4	12	15	18.7	24		T	T	T	T	T
	400		6.3	8	10	12.5	16		9.4	12	15	18.7	24		T	T	T	T	T
	500			8	10	12.5	16			12	15	18.7	24			T	T	T	T
	630				10	12.5	16				15	18.7	24				T	T	T
NS800 N/H MicroLogic	320		6.3	8	10	12.5	16		9.4	12	15	18.7	24		T	T	T	T	T
	400		6.3	8	10	12.5	16		9.4	12	15	18.7	24		T	T	T	T	T
	500			8	10	12.5	16			12	15	18.7	24			T	T	T	T
	630				10	12.5	16				15	18.7	24			T	T	T	T
	800					12.5	16					18.7	24				T	T	T
NS1000 N/H MicroLogic	400		6.3	8	10	12.5	16		9.4	12	15	18.7	24		T	T	T	T	T
	500			8	10	12.5	16			12	15	18.7	24			T	T	T	T
	630				10	12.5	16				15	18.7	24				T	T	T
	800					12.5	16					18.7	24					T	T
	1000						16						24						T
NS1250 N/H MicroLogic	500			8	10	12.5	16			12	15	18.7	24			T	T	T	T
	630				10	12.5	16				15	18.7	24				T	T	T
	800					12.5	16					18.7	24					T	T
	1000						16						24						T
	1250																		
NS1600 N/H MicroLogic	630				10	12.5	16				15	18.7	24				T	T	T
	800					12.5	16					18.7	24					T	T
	960						16						24						T
	1250																		
	1600																		
NS630b L/LB MicroLogic	250	4	6.3	8	10	12.5	T	9.4	9.4	12	15	18.7	T	T	T	T	T	T	T
	320		6.3	8	10	12.5	T		9.4	12	15	18.7	T	T	T	T	T	T	T
	400		6.3	8	10	12.5	T		9.4	12	15	18.7	T	T	T	T	T	T	T
	500			8	10	12.5	T			12	15	18.7	T		T	T	T	T	T
	630				10	12.5	T				15	18.7	T			T	T	T	T
NS800 L/LB MicroLogic	320		6.3	8	10	12.5	T		9.4	12	15	18.7	T	T	T	T	T	T	T
	400		6.3	8	10	12.5	T		9.4	12	15	18.7	T	T	T	T	T	T	T
	500			8	10	12.5	T			12	15	18.7	T		T	T	T	T	T
	630				10	12.5	T				15	18.7	T			T	T	T	T
	800					12.5	T					18.7	T				T	T	T
NS1000 L MicroLogic	400		6.3	8	10	12.5	T		9.4	12	15	18.7	T	T	T	T	T	T	T
	500			8	10	12.5	T			12	15	18.7	T		T	T	T	T	T
	630				10	12.5	T				15	18.7	T			T	T	T	T
	800					12.5	T					18.7	T				T	T	T
	1000						T						T						T

- T Total selectivity, up to the breaking capacity of the downstream circuit breaker.
- 4 Selectivity limit = 4 kA.
- No selectivity.

Note: Respect the basic rules of selectivity, for overload and short-circuit, see introduction or check curves.

Selectivity Table 690 V AC

Upstream: MasterPacT MTZ1 06-16H1/H2

Downstream: MasterPacT MTZ1 06-16



Ue = 690 V AC

Upstream CB	MasterPacT MTZ1 06-16H1/2						MasterPacT MTZ1 06-16H1/2						MasterPacT MTZ1 06-16H1/2							
Trip unit type	MicroLogic 2.0 X						MicroLogic 5.0 - 6.0 X Inst 15 In Standard						MicroLogic 5.0 - 6.0 X Inst OFF							
Trip unit rating (A)	630	800	1000	1250	1600	630	800	1000	1250	1600	630	800	1000	1250	1600	630	800	1000	1250	1600
Setting Ir (A)	400	630	800	1000	1250	1600	400	630	800	1000	1250	1600	400	630	800	1000	1250	1600		

Downstream CB	Setting range (A)	Selectivity limit (kA)																	
MTZ1 06 H1/H2 MicroLogic X	250	4	6.3	8	10	12.5	16	9.4	9.4	12	15	18.7	24	T	T	T	T	T	T
	320		6.3	8	10	12.5	16		9.4	12	15	18.7	24		T	T	T	T	T
	400		6.3	8	10	12.5	16		9.4	12	15	18.7	24		T	T	T	T	T
	500			8	10	12.5	16			12	15	18.7	24			T	T	T	T
	630				10	12.5	16				15	18.7	24				T	T	T
MTZ1 08 H1/H2 MicroLogic	320		6.3	8	10	12.5	16		9.4	12	15	18.7	24		T	T	T	T	T
	400		6.3	8	10	12.5	16		9.4	12	15	18.7	24		T	T	T	T	T
	500			8	10	12.5	16			12	15	18.7	24			T	T	T	T
	630				10	12.5	16				15	18.7	24			T	T	T	T
	800					12.5	16					18.7	24				T	T	T
MTZ1 10 H1/H2 MicroLogic X	400		6.3	8	10	12.5	16		9.4	12	15	18.7	24		T	T	T	T	T
	500			8	10	12.5	16			12	15	18.7	24			T	T	T	T
	630				10	12.5	16				15	18.7	24				T	T	T
	800					12.5	16					18.7	24					T	T
	1000						16						24						T
MTZ1 12 H1/H2 MicroLogic X	500			8	10	12.5	16			12	15	18.7	24			T	T	T	T
	630				10	12.5	16				15	18.7	24				T	T	T
	800					12.5	16					18.7	24					T	T
	1000						16						24						T
	1250																		
MTZ1 16 H1/H2 MicroLogic X	630				10	12.5	16				15	18.7	24				T	T	T
	800					12.5	16					18.7	24					T	T
	960						16						24						T
	1250																		
	1600																		
MTZ1 06 L1 MicroLogic X	250	4	6.3	8	10	12.5	T	9.4	9.4	12	15	T	T	T	T	T	T	T	T
	320		6.3	8	10	12.5	T		9.4	12	15	T	T		T	T	T	T	T
	400		6.3	8	10	12.5	T		9.4	12	15	T	T		T	T	T	T	T
	500			8	10	12.5	T			12	15	T	T			T	T	T	T
	630				10	12.5	T				15	T	T				T	T	T
MTZ1 08 L1 MicroLogic X	320		6.3	8	10	12.5	T		9.4	12	15	T	T		T	T	T	T	T
	400		6.3	8	10	12.5	T		9.4	12	15	T	T		T	T	T	T	T
	500			8	10	12.5	T			12	15	T	T			T	T	T	T
	630				10	12.5	T				15	T	T				T	T	T
	800					12.5	T					T	T					T	T
MTZ1 10 L1 MicroLogic X	400		6.3	8	10	12.5	T		9.4	12	15	T	T		T	T	T	T	T
	500			8	10	12.5	T			12	15	T	T			T	T	T	T
	630				10	12.5	T				15	T	T				T	T	T
	800					12.5	T					T	T					T	T
	1000						T						T						T

- T Total selectivity, up to the breaking capacity of the downstream circuit breaker.
- 4 Selectivity limit = 4 kA.
- No selectivity.

Note: Respect the basic rules of selectivity, for overload and short-circuit, see introduction or check curves.

Selectivity Table 690 V AC

Upstream: MasterPacT MTZ2 08-20N1/H1/H2/L1

Downstream: TeSys GV2, GV3, TeSys U, ComPacT NSX100-630

Ue = 690 V AC



Upstream CB	MasterPacT MTZ2 08-20N1 (42 kA) / H1 / H2 / L1								MasterPacT MTZ2 08-20N1 (42 kA) / H1 / H2 / L1								MasterPacT MTZ2 08-20N1 (42 kA) / H1 / H2 / L1							
Trip unit type	MicroLogic 2.0 X								MicroLogic 5.0 - 6.0 X Inst 15 In Standard								MicroLogic 5.0 - 6.0 X Inst OFF							
Trip unit rating (A)	800		1000	1250	1600	2000	800		1000	1250	1600	2000	800		1000	1250	1600	2000						
Setting Ir (A)	320	630	800	1000	1250	1600	2000	320	630	800	1000	1250	1600	2000	320	630	800	1000	1250	1600	2000			

Downstream CB	Setting range (A)	Selectivity limit (kA)																			
GV2 L03 - L06		T	T	T	T	T	T	T	T	T	T	T	T	T	T	T	T	T	T	T	T
GV2 L07 - L32 + LA9 LB920		T	T	T	T	T	T	T	T	T	T	T	T	T	T	T	T	T	T	T	T
LUB12 + LA9 LB20		T	T	T	T	T	T	T	T	T	T	T	T	T	T	T	T	T	T	T	T
LUB32 + LA9 LB20		T	T	T	T	T	T	T	T	T	T	T	T	T	T	T	T	T	T	T	T
LUB12 + LUA LB1		T	T	T	T	T	T	T	T	T	T	T	T	T	T	T	T	T	T	T	T
LUB32 + LUA LB1		T	T	T	T	T	T	T	T	T	T	T	T	T	T	T	T	T	T	T	T
GV3 32-65		T	T	T	T	T	T	T	T	T	T	T	T	T	T	T	T	T	T	T	T
NSX100 L/R/HB1/HB2 ≤ 100 MA < 100		T	T	T	T	T	T	T	T	T	T	T	T	T	T	T	T	T	T	T	T
NSX160 L MA < 150	≤ 150	T	T	T	T	T	T	T	T	T	T	T	T	T	T	T	T	T	T	T	T
NSX250 L/R/HB1/HB2 ≤ 220 MA < 220	≤ 220	T	T	T	T	T	T	T	T	T	T	T	T	T	T	T	T	T	T	T	T
NSX100 L/R/HB1/HB2 TM-D		T	T	T	T	T	T	T	T	T	T	T	T	T	T	T	T	T	T	T	T
NSX160 L TM-D		T	T	T	T	T	T	T	T	T	T	T	T	T	T	T	T	T	T	T	T
NSX250 L/R/HB1/HB2 TM-D	≤ 125	T	T	T	T	T	T	T	T	T	T	T	T	T	T	T	T	T	T	T	T
	160	T	T	T	T	T	T	T	T	T	T	T	T	T	T	T	T	T	T	T	T
	200	3.2	T	T	T	T	T	T	T	T	T	T	T	T	T	T	T	T	T	T	T
	250		T	T	T	T	T	T	T	T	T	T	T	T	T	T	T	T	T	T	T
NSX100 L/R/HB1/HB2 MicroLogic	40	T	T	T	T	T	T	T	T	T	T	T	T	T	T	T	T	T	T	T	T
	100	T	T	T	T	T	T	T	T	T	T	T	T	T	T	T	T	T	T	T	T
NSX160 L MicroLogic	40	T	T	T	T	T	T	T	T	T	T	T	T	T	T	T	T	T	T	T	T
	100	T	T	T	T	T	T	T	T	T	T	T	T	T	T	T	T	T	T	T	T
	160	T	T	T	T	T	T	T	T	T	T	T	T	T	T	T	T	T	T	T	T
NSX250 L/R/HB1/HB2 MicroLogic	≤ 100	T	T	T	T	T	T	T	T	T	T	T	T	T	T	T	T	T	T	T	T
	160	T	T	T	T	T	T	T	T	T	T	T	T	T	T	T	T	T	T	T	T
	250		T	T	T	T	T	T	T	T	T	T	T	T	T	T	T	T	T	T	T
NSX400 S/L/R/HB1/HB2 1.3 M	320		T	T	T	T	T	T	T	T	T	T	T	T	T	T	T	T	T	T	T
NSX400 S/L/R/HB1/HB2 MicroLogic	160	3.2	T	T	T	T	T	T	T	T	T	T	T	T	T	T	T	T	T	T	T
	200	3.2	T	T	T	T	T	T	T	T	T	T	T	T	T	T	T	T	T	T	T
	250	3.2	T	T	T	T	T	T	T	T	T	T	T	T	T	T	T	T	T	T	T
	320		T	T	T	T	T	T	T	T	T	T	T	T	T	T	T	T	T	T	T
400		T	T	T	T	T	T	T	T	T	T	T	T	T	T	T	T	T	T	T	T
NSX630 S/L/R/HB1/HB2 1.3 M	500		T	T	T	T	T	T	T	T	T	T	T	T	T	T	T	T	T	T	T
NSX630 S/L/R/HB1/HB2 MicroLogic	250	3.2	6.3	T	T	T	T	T	T	T	T	T	T	T	T	T	T	T	T	T	T
	320		6.3	T	T	T	T	T	T	T	T	T	T	T	T	T	T	T	T	T	T
	400		6.3	T	T	T	T	T	T	T	T	T	T	T	T	T	T	T	T	T	T
	500			T	T	T	T	T	T	T	T	T	T	T	T	T	T	T	T	T	T
	630			T	T	T	T	T	T	T	T	T	T	T	T	T	T	T	T	T	T

- T Total selectivity, up to the breaking capacity of the downstream circuit breaker.
- 4 Selectivity limit = 4 kA.
- No selectivity.

Note: Respect the basic rules of selectivity, for overload and short-circuit, see introduction or check curves.

Selectivity Table 690 V AC

Upstream: MasterPacT MTZ2 08-20N1/H1/H2

Downstream: ComPacT NS630b-1600



Ue = 690 V AC

Upstream CB	MasterPacT MTZ2 08-20N1 (42 kA) / H1 / H2 / L1						MasterPacT MTZ2 08-20N1 (42 kA) / H1 / H2 / L1						MasterPacT MTZ2 08-20N1 (42 kA) / H1 / H2 / L1					
Trip unit type	MicroLogic 2.0 X						MicroLogic 5.0 - 6.0 X Inst 15 In Standard						MicroLogic 5.0 - 6.0 X Inst OFF					
Trip unit rating (A)	800	1000	1250	1600	2000	2000	800	1000	1250	1600	2000	2000	800	1000	1250	1600	2000	
Setting Ir (A)	630	800	1000	1250	1600	2000	630	800	1000	1250	1600	2000	630	800	1000	1250	1600	2000

Downstream CB	Setting range (A)	Selectivity limit (kA)																	
		6.3	8	10	12.5	16	20	12	12	15	18.75	24	30	T	T	T	T	T	T
NS630b N/H MicroLogic	250	6.3	8	10	12.5	16	20	12	12	15	18.75	24	30	T	T	T	T	T	T
	320	6.3	8	10	12.5	16	20	12	12	15	18.75	24	30	T	T	T	T	T	T
	400	6.3	8	10	12.5	16	20	12	12	15	18.75	24	30	T	T	T	T	T	T
	500		8	10	12.5	16	20		12	15	18.75	24	30		T	T	T	T	T
	630			10	12.5	16	20			15	18.75	24	30			T	T	T	T
NS800 N/H MicroLogic	320	6.3	8	10	12.5	16	20	12	12	15	18.75	24	30	T	T	T	T	T	T
	400	6.3	8	10	12.5	16	20	12	12	15	18.75	24	30	T	T	T	T	T	T
	500		8	10	12.5	16	20		12	15	18.75	24	30		T	T	T	T	T
	630			10	12.5	16	20			15	18.75	24	30			T	T	T	T
	800				12.5	16	20				18.75	24	30				T	T	T
NS1000 N/H MicroLogic	400	6.3	8	10	12.5	16	20	12	12	15	18.75	24	30	T	T	T	T	T	T
	500		8	10	12.5	16	20		12	15	18.75	24	30		T	T	T	T	T
	630			10	12.5	16	20			15	18.75	24	30			T	T	T	T
	800				12.5	16	20				18.75	24	30				T	T	T
	1000					16	20					24	30					T	T
NS1250 N/H MicroLogic	500		8	10	12.5	16	20		12	15	18.75	24	30		T	T	T	T	T
	630			10	12.5	16	20			15	18.75	24	30			T	T	T	T
	800				12.5	16	20				18.75	24	30				T	T	T
	1000					16	20					24	30					T	T
	1250						20						30						T
NS1600 N/H MicroLogic	630			10	12.5	16	20			15	18.75	24	30			T	T	T	T
	800				12.5	16	20				18.75	24	30				T	T	T
	960					16	20					24	30					T	T
	1250						20						30						T
	1600													30					
NS630b LB MicroLogic	250	6.3	8	10	12.5	T	T	12	12	15	T	T	T	T	T	T	T	T	
	320	6.3	8	10	12.5	T	T	12	12	15	T	T	T	T	T	T	T	T	
	400	6.3	8	10	12.5	T	T	12	12	15	T	T	T	T	T	T	T	T	
	500		8	10	12.5	T	T		12	15	T	T	T		T	T	T	T	
	630			10	12.5	T	T			15	T	T	T		T	T	T	T	
NS800 LB MicroLogic	320	6.3	8	10	12.5	T	T	12	12	15	T	T	T	T	T	T	T	T	
	400	6.3	8	10	12.5	T	T	12	12	15	T	T	T	T	T	T	T	T	
	500		8	10	12.5	T	T		12	15	T	T	T		T	T	T	T	
	630			10	12.5	T	T			15	T	T	T		T	T	T	T	
	800				12.5	T	T				T	T	T			T	T	T	

- T Total selectivity, up to the breaking capacity of the downstream circuit breaker.
- 4 Selectivity limit = 4 kA.
- No selectivity.

Note: Respect the basic rules of selectivity, for overload and short-circuit, see introduction or check curves.

Selectivity Table 690 V AC

Upstream: MasterPacT MTZ2 08-20N1/H1/H2

Downstream: MasterPacT MTZ1 06-16

U_e = 690 V AC



Upstream CB	MasterPacT MTZ2 08-20N1 (42 kA) / H1 / H2						MasterPacT MTZ2 08-20N1 (42 kA) / H1 / H2						MasterPacT MTZ2 08-20N1 (42 kA) / H1 / H2							
Trip unit type	MicroLogic 2.0 X						MicroLogic 5.0 - 6.0 X Inst 15 In Standard						MicroLogic 5.0 - 6.0 X Inst OFF							
Trip unit rating (A)	800	1000	1250	1600	2000	800	1000	1250	1600	2000	800	1000	1250	1600	2000	800	1000	1250	1600	2000
Setting I _r (A)	630	800	1000	1250	1600	2000	630	800	1000	1250	1600	2000	630	800	1000	1250	1600	2000		

Downstream CB	Setting range (A)	Selectivity limit (kA)																	
		6.3	8	10	12.5	16	20	12	12	15	18.75	24	30	T	T	T	T	T	T
MTZ1 06 H1/H2 MicroLogic X	250	6.3	8	10	12.5	16	20	12	12	15	18.75	24	30	T	T	T	T	T	T
	320	6.3	8	10	12.5	16	20	12	12	15	18.75	24	30	T	T	T	T	T	T
	400	6.3	8	10	12.5	16	20	12	12	15	18.75	24	30	T	T	T	T	T	T
	500		8	10	12.5	16	20		12	15	18.75	24	30		T	T	T	T	T
	630			10	12.5	16	20			15	18.75	24	30				T	T	T
MTZ1 08 H1/H2 MicroLogic X	320	6.3	8	10	12.5	16	20	12	12	15	18.75	24	30	T	T	T	T	T	T
	400	6.3	8	10	12.5	16	20	12	12	15	18.75	24	30	T	T	T	T	T	T
	500		8	10	12.5	16	20		12	15	18.75	24	30		T	T	T	T	T
	630			10	12.5	16	20			15	18.75	24	30				T	T	T
	800				12.5	16	20				18.75	24	30					T	T
MTZ1 10 H1/H2 MicroLogic X	400	6.3	8	10	12.5	16	20	12	12	15	18.75	24	30	T	T	T	T	T	T
	500		8	10	12.5	16	20		12	15	18.75	24	30		T	T	T	T	T
	630			10	12.5	16	20			15	18.75	24	30				T	T	T
	800				12.5	16	20				18.75	24	30					T	T
	1000					16	20					24	30						T
MTZ1 12 H1/H2 MicroLogic X	500		8	10	12.5	16	20		12	15	18.75	24	30		T	T	T	T	T
	630			10	12.5	16	20			15	18.75	24	30			T	T	T	T
	800				12.5	16	20				18.75	24	30				T	T	T
	1000					16	20					24	30					T	T
	1250						20						30						T
MTZ1 16 H1/H2 MicroLogic X	630			10	12.5	16	20			15	18.75	24	30			T	T	T	T
	800				12.5	16	20				18.75	24	30				T	T	T
	960					16	20					24	30					T	T
	1250						20						30						T
	1600													30					

- T Total selectivity, up to the breaking capacity of the downstream circuit breaker.
- 4 Selectivity limit = 4 kA.
- No selectivity.

Note: Respect the basic rules of selectivity, for overload and short-circuit, see introduction or check curves.

Selectivity Table 690 V AC

Upstream: MasterPacT MTZ2 08-20N1/H1

Downstream: MasterPacT MTZ2 08-20

Ue = 690 V AC

A

Upstream CB	MasterPacT MTZ2 08-20N1 / H1					MasterPacT MTZ2 08-20N1 / H1					MasterPacT MTZ2 08-20N1 / H1							
Trip unit type	MicroLogic 2.0 X					MicroLogic 5.0 - 6.0 X Inst 15 In Standard					MicroLogic 5.0 - 6.0 X Inst OFF							
Trip unit rating (A)	800	1000	1250	1600	2000	800	1000	1250	1600	2000	800	1000	1250	1600	2000			
Setting Ir (A)	630	800	1000	1250	1600	2000	630	800	1000	1250	1600	2000	630	800	1000	1250	1600	2000

Downstream CB	Setting range (A)	Selectivity limit (kA)																	
MTZ2 08 N1/H1/L1 MicroLogic X	320	6.3	8	10	12.5	16	20	12	12	15	18.75	24	30	T	T	T	T	T	T
	400	6.3	8	10	12.5	16	20	12	12	15	18.75	24	30	T	T	T	T	T	T
	500		8	10	12.5	16	20		12	15	18.75	24	30		T	T	T	T	T
	630			10	12.5	16	20			15	18.75	24	30			T	T	T	T
	800				12.5	16	20				18.75	24	30				T	T	T
MTZ2 10 N1/H1/L1 MicroLogic	400	6.3	8	10	12.5	16	20	12	12	15	18.75	24	30	T	T	T	T	T	T
	500		8	10	12.5	16	20		12	15	18.75	24	30		T	T	T	T	T
	630			10	12.5	16	20			15	18.75	24	30			T	T	T	T
	800				12.5	16	20				18.75	24	30				T	T	T
	1000					16	20					24	30					T	T
MTZ2 12 N1/H1/L1 MicroLogic X	500		8	10	12.5	16	20		12	15	18.75	24	30		T	T	T	T	T
	630			10	12.5	16	20			15	18.75	24	30			T	T	T	T
	800				12.5	16	20				18.75	24	30				T	T	T
	1000					16	20					24	30					T	T
	1250						20						30						T
MTZ2 16 N1/H1/L1 MicroLogic X	630			10	12.5	16	20			15	18.75	24	30			T	T	T	T
	800				12.5	16	20				18.75	24	30				T	T	T
	960					16	20					24	30					T	T
	1250						20						30						T
	1600																		
MTZ2 20 N1/H1/L1 MicroLogic X	800				12.5	16	20				18.75	24	30				T	T	T
	1000					16	20					24	30					T	T
	1250						20						30						T
	1600																		
MTZ2 08 H2 MicroLogic X	320	6.3	8	10	12.5	16	20	12	12	15	18.75	24	30	T	T	T	T	T	T
	400	6.3	8	10	12.5	16	20	12	12	15	18.75	24	30	T	T	T	T	T	T
	500		8	10	12.5	16	20		12	15	18.75	24	30		T	T	T	T	T
	630			10	12.5	16	20			15	18.75	24	30			T	T	T	T
	800				12.5	16	20				18.75	24	30				T	T	T
MTZ2 10 H2 MicroLogic X	400	6.3	8	10	12.5	16	20	12	12	15	18.75	24	30	T	T	T	T	T	T
	500		8	10	12.5	16	20		12	15	18.75	24	30		T	T	T	T	T
	630			10	12.5	16	20			15	18.75	24	30			T	T	T	T
	800				12.5	16	20				18.75	24	30				T	T	T
	1000					16	20					24	30					T	T
MTZ2 12 H2 MicroLogic X	500		8	10	12.5	16	20		12	15	18.75	24	30		T	T	T	T	T
	630			10	12.5	16	20			15	18.75	24	30			T	T	T	T
	800				12.5	16	20				18.75	24	30				T	T	T
	1000					16	20					24	30					T	T
	1250						20						30						T
MTZ2 16 H2 MicroLogic X	630			10	12.5	16	20			15	18.75	24	30			T	T	T	T
	800				12.5	16	20				18.75	24	30				T	T	T
	960					16	20					24	30					T	T
	1250						20						30						T
	1600																		
MTZ2 20 H2 MicroLogic X	800				12.5	16	20				18.75	24	30				T	T	T
	1000					16	20					24	30					T	T
	1250						20						30						T
	1600																		

T Total selectivity, up to the breaking capacity of the downstream circuit breaker.

4 Selectivity limit = 4 kA.

No selectivity.

Note: Respect the basic rules of selectivity, for overload and short-circuit, see introduction or check curves.

Selectivity Table 690 V AC

Upstream: MasterPacT MTZ2 08-20H2

Downstream: MasterPacT MTZ2 08-20

Ue = 690 V AC



Upstream CB	MasterPacT MTZ2 08-20H2					MasterPacT MTZ2 08-20H2					MasterPacT MTZ2 08-20H2							
Trip unit type	MicroLogic 2.0 X					MicroLogic 5.0 - 6.0 X Inst 15 In Standard					MicroLogic 5.0 - 6.0 X Inst OFF							
Trip unit rating (A)	800	1000	1250	1600	2000	800	1000	1250	1600	2000	800	1000	1250	1600	2000			
Setting Ir (A)	630	800	1000	1250	1600	2000	630	800	1000	1250	1600	2000	630	800	1000	1250	1600	2000

Downstream CB	Setting range (A)	Selectivity limit (kA)																	
MTZ2 08 N1/H1/L1 MicroLogic X	320	6.3	8	10	12.5	16	20	12	12	15	18.75	24	30	T	T	T	T	T	T
	400	6.3	8	10	12.5	16	20	12	12	15	18.75	24	30	T	T	T	T	T	T
	500		8	10	12.5	16	20		12	15	18.75	24	30		T	T	T	T	T
	630			10	12.5	16	20			15	18.75	24	30			T	T	T	T
	800				12.5	16	20				18.75	24	30				T	T	T
MTZ2 10 N1/H1/L1 MicroLogic X	400	6.3	8	10	12.5	16	20	12	12	15	18.75	24	30	T	T	T	T	T	T
	500		8	10	12.5	16	20		12	15	18.75	24	30		T	T	T	T	T
	630			10	12.5	16	20			15	18.75	24	30			T	T	T	T
	800				12.5	16	20				18.75	24	30				T	T	T
	1000					16	20					24	30					T	T
MTZ2 12 N1/H1/L1 MicroLogic X	500		8	10	12.5	16	20		12	15	18.75	24	30		T	T	T	T	T
	630			10	12.5	16	20			15	18.75	24	30			T	T	T	T
	800				12.5	16	20				18.75	24	30				T	T	T
	1000					16	20					24	30					T	T
	1250						20						30						T
MTZ2 16 N1/H1/L1 MicroLogic X	630			10	12.5	16	20			15	18.75	24	30			T	T	T	T
	800				12.5	16	20				18.75	24	30				T	T	T
	960					16	20					24	30					T	T
	1250						20						30						T
	1600																		
MTZ2 20 N1/H1/L1 MicroLogic X	800				12.5	16	20				18.75	24	30				T	T	T
	1000					16	20					24	30					T	T
	1250						20						30						T
	1600																		
MTZ2 08 H2 MicroLogic X	320	6.3	8	10	12.5	16	20	12	12	15	18.75	24	30	82	82	82	82	82	82
	400	6.3	8	10	12.5	16	20	12	12	15	18.75	24	30	82	82	82	82	82	82
	500		8	10	12.5	16	20		12	15	18.75	24	30		82	82	82	82	82
	630			10	12.5	16	20			15	18.75	24	30			82	82	82	82
	800				12.5	16	20				18.75	24	30				82	82	82
MTZ2 10 H2 MicroLogic X	400	6.3	8	10	12.5	16	20	12	12	15	18.75	24	30	82	82	82	82	82	82
	500		8	10	12.5	16	20		12	15	18.75	24	30		82	82	82	82	82
	630			10	12.5	16	20			15	18.75	24	30			82	82	82	82
	800				12.5	16	20				18.75	24	30				82	82	82
	1000					16	20					24	30					82	82
MTZ2 12 H2 MicroLogic X	500		8	10	12.5	16	20		12	15	18.75	24	30		82	82	82	82	82
	630			10	12.5	16	20			15	18.75	24	30			82	82	82	82
	800				12.5	16	20				18.75	24	30				82	82	82
	1000					16	20					24	30					82	82
	1250						20						30						82
MTZ2 16 H2 MicroLogic X	630			10	12.5	16	20			15	18.75	24	30		82	82	82	82	82
	800				12.5	16	20				18.75	24	30			82	82	82	82
	960					16	20					24	30					82	82
	1250						20						30						82
	1600																		
MTZ2 20 H2 MicroLogic X	800				12.5	16	20				18.75	24	30				82	82	82
	1000					16	20					24	30					82	82
	1250						20						30						82
	1600																		

T Total selectivity, up to the breaking capacity of the downstream circuit breaker.

4 Selectivity limit = 4 kA.

No selectivity.

Note: Respect the basic rules of selectivity, for overload and short-circuit, see introduction or check curves.

Version : 2.0 - 19/12/2023
548E4360

Selectivity Table 690 V AC

Upstream: MasterPacT MTZ2 08-20L1

Downstream: ComPacT NS630b-1600



Ue = 690 V AC

Upstream CB	MasterPacT MTZ2 08-20L1					MasterPacT MTZ2 08-20L1					MasterPacT MTZ2 08-20L1							
Trip unit type	MicroLogic 2.0 X					MicroLogic 5.0 - 6.0 X Inst 15 In Standard					MicroLogic 5.0 - 6.0 X Inst OFF							
Trip unit rating (A)	800	1000	1250	1600	2000	800	1000	1250	1600	2000	800	1000	1250	1600	2000			
Setting Ir (A)	630	800	1000	1250	1600	2000	630	800	1000	1250	1600	2000	630	800	1000	1250	1600	2000

Downstream CB	Setting range (A)	Selectivity limit (kA)																	
NS630b N/H MicroLogic	250	6.3	8	10	12.5	16	20	12	12	15	18.75	24	30	37	37	37	37	37	37
	320	6.3	8	10	12.5	16	20	12	12	15	18.75	24	30	37	37	37	37	37	37
	400	6.3	8	10	12.5	16	20	12	12	15	18.75	24	30	37	37	37	37	37	37
	500		8	10	12.5	16	20		12	15	18.75	24	30		37	37	37	37	37
	630			10	12.5	16	20			15	18.75	24	30			37	37	37	37
NS800 N/H MicroLogic	320	6.3	8	10	12.5	16	20	12	12	15	18.75	24	30	37	37	37	37	37	37
	400	6.3	8	10	12.5	16	20	12	12	15	18.75	24	30	37	37	37	37	37	37
	500		8	10	12.5	16	20		12	15	18.75	24	30		37	37	37	37	37
	630			10	12.5	16	20			15	18.75	24	30			37	37	37	37
	800				12.5	16	20				18.75	24	30				37	37	37
NS1000 N/H MicroLogic	400	6.3	8	10	12.5	16	20	12	12	15	18.75	24	30	37	37	37	37	37	37
	500		8	10	12.5	16	20		12	15	18.75	24	30		37	37	37	37	37
	630			10	12.5	16	20			15	18.75	24	30			37	37	37	37
	800				12.5	16	20				18.75	24	30				37	37	37
	1000					16	20					24	30					37	37
NS1250 N/H MicroLogic	500		8	10	12.5	16	20		12	15	18.75	24	30		37	37	37	37	37
	630			10	12.5	16	20			15	18.75	24	30			37	37	37	37
	800				12.5	16	20				18.75	24	30				37	37	37
	1000					16	20					24	30					37	37
	1250						20						30						37
NS1600 N/H MicroLogic	630			10	12.5	16	20			15	18.75	24	30			37	37	37	37
	800				12.5	16	20				18.75	24	30				37	37	37
	960					16	20					24	30					37	37
	1250						20						30						37
	1600																		37
NS630b LB MicroLogic	250	6.3	8	10	12.5	T	T	12	12	15	T	T	T	T	T	T	T	T	T
	320	6.3	8	10	12.5	T	T	12	12	15	T	T	T	T	T	T	T	T	T
	400	6.3	8	10	12.5	T	T	12	12	15	T	T	T	T	T	T	T	T	T
	500		8	10	12.5	T	T		12	15	T	T	T		T	T	T	T	T
	630			10	12.5	T	T			15	T	T	T			T	T	T	T
NS800 LB MicroLogic	320	6.3	8	10	12.5	T	T	12	12	15	T	T	T	T	T	T	T	T	T
	400	6.3	8	10	12.5	T	T	12	12	15	T	T	T	T	T	T	T	T	T
	500		8	10	12.5	T	T		12	15	T	T	T		T	T	T	T	T
	630			10	12.5	T	T			15	T	T	T			T	T	T	T
	800				12.5	T	T				T	T	T				T	T	T

T Total selectivity, up to the breaking capacity of the downstream circuit breaker.

4 Selectivity limit = 4 kA.

No selectivity.

Note: Respect the basic rules of selectivity, for overload and short-circuit, see introduction or check curves.

Selectivity Table 690 V AC

Upstream: MasterPacT MTZ2 08-20L1

Downstream: MasterPacT MTZ1 06-16

U_e = 690 V AC



Upstream CB	MasterPacT MTZ2 08-20L1					MasterPacT MTZ2 08-20L1					MasterPacT MTZ2 08-20L1							
Trip unit type	MicroLogic 2.0 X					MicroLogic 5.0 - 6.0 X Inst 15 In Standard					MicroLogic 5.0 - 6.0 X Inst OFF							
Trip unit rating (A)	800	1000	1250	1600	2000	800	1000	1250	1600	2000	800	1000	1250	1600	2000			
Setting I _r (A)	630	800	1000	1250	1600	2000	630	800	1000	1250	1600	2000	630	800	1000	1250	1600	2000

Downstream CB	Setting range (A)	Selectivity limit (kA)																
MTZ1 06 H1/H2 MicroLogic X	250	6.3	8	10	12.5	16	20	12	12	15	18.75	24	30	37	37	37	37	37
	320	6.3	8	10	12.5	16	20	12	12	15	18.75	24	30	37	37	37	37	37
	400	6.3	8	10	12.5	16	20	12	15	18.75	24	30	37	37	37	37	37	37
	500		8	10	12.5	16	20		12	15	18.75	24	30		37	37	37	37
	630			10	12.5	16	20			15	18.75	24	30			37	37	37
MTZ1 08 H1/H2 MicroLogic X	320	6.3	8	10	12.5	16	20	12	12	15	18.75	24	30	37	37	37	37	37
	400	6.3	8	10	12.5	16	20	12	12	15	18.75	24	30	37	37	37	37	37
	500		8	10	12.5	16	20		12	15	18.75	24	30		37	37	37	37
	630			10	12.5	16	20			15	18.75	24	30			37	37	37
	800				12.5	16	20				18.75	24	30				37	37
MTZ1 10 H1/H2 MicroLogic X	400	6.3	8	10	12.5	16	20	12	12	15	18.75	24	30	37	37	37	37	37
	500		8	10	12.5	16	20		12	15	18.75	24	30		37	37	37	37
	630			10	12.5	16	20			15	18.75	24	30			37	37	37
	800				12.5	16	20				18.75	24	30				37	37
	1000					16	20					24	30					37
MTZ1 12 H1/H2 MicroLogic X	500		8	10	12.5	16	20		12	15	18.75	24	30		37	37	37	37
	630			10	12.5	16	20			15	18.75	24	30			37	37	37
	800				12.5	16	20				18.75	24	30				37	37
	1000					16	20					24	30					37
	1250						20						30					37
MTZ1 16 H1/H2 MicroLogic X	630			10	12.5	16	20			15	18.75	24	30			37	37	37
	800				12.5	16	20				18.75	24	30				37	37
	960					16	20					24	30					37
	1250						20						30					37
	1600																	37

Selectivity limit = 4 kA.

No selectivity.

Note: Respect the basic rules of selectivity, for overload and short-circuit, see introduction or check curves.

Selectivity Table 690 V AC

Upstream: MasterPacT MTZ2 08-20L1

Downstream: MaserPacT MTZ2 08-20

Ue = 690 V AC

A

Upstream CB	MasterPacT MTZ2 08-20L1						MasterPacT MTZ2 08-20L1						MasterPacT MTZ2 08-20L1							
Trip unit type	MicroLogic 2.0 X						MicroLogic 5.0 - 6.0 X Inst 15 In Standard						MicroLogic 5.0 - 6.0 X Inst OFF							
Trip unit rating (A)	800		1000		1250		1600		2000		800		1000		1250		1600		2000	
Setting Ir (A)	630	800	1000	1250	1600	2000	630	800	1000	1250	1600	2000	630	800	1000	1250	1600	2000		

Downstream CB	Setting range (A)	Selectivity limit (kA)																	
MasterPacT MTZ2 08 N1/H1/H2 MicroLogic X	320	6.3	8	10	12.5	16	20	12	12	15	18.75	24	30	37	37	37	37	37	37
	400	6.3	8	10	12.5	16	20	12	12	15	18.75	24	30	37	37	37	37	37	37
	500		8	10	12.5	16	20		12	15	18.75	24	30		37	37	37	37	37
	630			10	12.5	16	20			15	18.75	24	30			37	37	37	37
	800				12.5	16	20				18.75	24	30				37	37	37
MasterPacT MTZ2 10 N1/H1/H2 MicroLogic X	400	6.3	8	10	12.5	16	20	12	12	15	18.75	24	30	37	37	37	37	37	37
	500		8	10	12.5	16	20		12	15	18.75	24	30		37	37	37	37	37
	630			10	12.5	16	20			15	18.75	24	30			37	37	37	37
	800				12.5	16	20				18.75	24	30				37	37	37
	1000					16	20					24	30					37	37
MasterPacT MTZ2 12 N1/H1/H2 MicroLogic X	500		8	10	12.5	16	20		12	15	18.75	24	30		37	37	37	37	37
	630			10	12.5	16	20			15	18.75	24	30			37	37	37	37
	800				12.5	16	20				18.75	24	30				37	37	37
	1000					16	20					24	30					37	37
	1250						20						30						37
MasterPacT MTZ2 16 N1/H1/H2 MicroLogic X	630			10	12.5	16	20			15	18.75	24	30			37	37	37	37
	800				12.5	16	20				18.75	24	30				37	37	37
	960					16	20					24	30					37	37
	1250						20						30						37
	1600																		
MasterPacT MTZ2 20 N1/H1/H2 MicroLogic X	800				12.5	16	20				18.75	24	30				37	37	37
	1000					16	20					24	30					37	37
	1250						20						30						37
	1600																		
MasterPacT MTZ2 08 L1 MicroLogic X	320	6.3	8	10	12.5	16	20	12	12	15	18.75	24	30	37	37	37	37	37	37
	400	6.3	8	10	12.5	16	20	12	12	15	18.75	24	30	37	37	37	37	37	37
	500		8	10	12.5	16	20		12	15	18.75	24	30		37	37	37	37	37
	630			10	12.5	16	20			15	18.75	24	30			37	37	37	37
	800				12.5	16	20				18.75	24	30				37	37	37
MasterPacT MTZ2 10 L1 MicroLogic X	400	6.3	8	10	12.5	16	20	12	12	15	18.75	24	30	37	37	37	37	37	37
	500		8	10	12.5	16	20		12	15	18.75	24	30		37	37	37	37	37
	630			10	12.5	16	20			15	18.75	24	30			37	37	37	37
	800				12.5	16	20				18.75	24	30				37	37	37
	1000					16	20					24	30					37	37
MasterPacT MTZ2 12 L1 MicroLogic X	500		8	10	12.5	16	20		12	15	18.75	24	30		37	37	37	37	37
	630			10	12.5	16	20			15	18.75	24	30			37	37	37	37
	800				12.5	16	20				18.75	24	30				37	37	37
	1000					16	20					24	30					37	37
	1250						20						30						37
MasterPacT MTZ2 16 L1 MicroLogic X	630			10	12.5	16	20			15	18.75	24	30		37	37	37	37	37
	800				12.5	16	20				18.75	24	30			37	37	37	37
	960					16	20					24	30					37	37
	1250						20						30						37
	1600																		
MasterPacT MTZ2 20 L1 MicroLogic X	800				12.5	16	20				18.75	24	30				37	37	37
	1000					16	20					24	30					37	37
	1250						20						30						37
	1600																		

Selectivity limit = 4 kA.

No selectivity.

Note: Respect the basic rules of selectivity, for overload and short-circuit, see introduction or check curves.

Selectivity Table 690 V AC

Upstream: MasterPacT MTZ2 25-40H1/H2/H3, MTZ3 40b-63H1/H2

Downstream: TeSys GV2, GV3, TeSys U,
ComPacT NSX100-630, ComPacT NS630b-3200

Ue = 690 V AC



Upstream CB	MTZ2 25-40 H1/H2/H3			MTZ3 H1/H2			MTZ2 25-40 H1/H2/H3			MTZ3 H1/H2			MTZ2 25-40 H1/H2/H3			MTZ3 H1/H2		
Trip unit type	MicroLogic 2.0 X						MicroLogic 5.0 - 6.0 X Inst 15 In Standard						MicroLogic 5.0 - 6.0 X Inst OFF					
Trip unit rating (A)	2500	3200	4000	4000	5000	6300	2500	3200	4000	4000	5000	6300	2500	3200	4000	4000	5000	6300

Downstream CB	Setting range (A)	Selectivity limit (kA)																	
		25	32	40	40	50	63	25	32	40	40	50	63	25	32	40	40	50	63
GV2 L03 - L06		T	T	T	T	T	T	T	T	T	T	T	T	T	T	T	T	T	T
GV2 L07 - L32 + LA9 LB920		T	T	T	T	T	T	T	T	T	T	T	T	T	T	T	T	T	T
LUB12 + LA9 LB20		T	T	T	T	T	T	T	T	T	T	T	T	T	T	T	T	T	T
LUB32 + LA9 LB20		T	T	T	T	T	T	T	T	T	T	T	T	T	T	T	T	T	T
LUB12 + LUA LB1		T	T	T	T	T	T	T	T	T	T	T	T	T	T	T	T	T	T
LUB32 + LUA LB1		T	T	T	T	T	T	T	T	T	T	T	T	T	T	T	T	T	T
NSX100 L/R/HB1/HB2 MA	≤ 100	T	T	T	T	T	T	T	T	T	T	T	T	T	T	T	T	T	T
NSX160 L MA	≤ 150	T	T	T	T	T	T	T	T	T	T	T	T	T	T	T	T	T	T
NSX250 L/R/HB1/HB2 MA	≤ 220	T	T	T	T	T	T	T	T	T	T	T	T	T	T	T	T	T	T
ComPacT NSX L/R/HB1/HB2 TM-D	NSX100	T	T	T	T	T	T	T	T	T	T	T	T	T	T	T	T	T	T
	NSX250	T	T	T	T	T	T	T	T	T	T	T	T	T	T	T	T	T	T
ComPacT NSX L TM-D	NSX160	T	T	T	T	T	T	T	T	T	T	T	T	T	T	T	T	T	T
ComPacT NSX L/R/HB1/HB2 MicroLogic	NSX100	T	T	T	T	T	T	T	T	T	T	T	T	T	T	T	T	T	T
	NSX250	T	T	T	T	T	T	T	T	T	T	T	T	T	T	T	T	T	T
ComPacT NSX L MicroLogic	NSX160	T	T	T	T	T	T	T	T	T	T	T	T	T	T	T	T	T	T
ComPacT NSX S/L/R/HB1/HB2	NSX400	T	T	T	T	T	T	T	T	T	T	T	T	T	T	T	T	T	T
	NSX630	T	T	T	T	T	T	T	T	T	T	T	T	T	T	T	T	T	T
Compact NS N MicroLogic	NS630b	25	32	40	T	T	T	T	T	T	T	T	T	T	T	T	T	T	T
	NS800	25	32	40	T	T	T	T	T	T	T	T	T	T	T	T	T	T	T
	NS1000	25	32	40	T	T	T	T	T	T	T	T	T	T	T	T	T	T	T
	NS1250	25	32	40	T	T	T	T	T	T	T	T	T	T	T	T	T	T	T
	NS1600	25	32	40	T	T	T	T	T	T	T	T	T	T	T	T	T	T	T
Compact NS H MicroLogic	NS630b	25	32	40	40	T	T	37.5	48	T	T	T	T	T	T	T	T	T	T
	NS800	25	32	40	40	T	T	37.5	48	T	T	T	T	T	T	T	T	T	T
	NS1000	25	32	40	40	T	T	37.5	48	T	T	T	T	T	T	T	T	T	T
	NS1250	25	32	40	40	T	T	37.5	48	T	T	T	T	T	T	T	T	T	T
	NS1600	25	32	40	40	T	T	37.5	48	T	T	T	T	T	T	T	T	T	T
Compact NS N MicroLogic	NS1600b	25	32	40	40	50	63	37.5	48	60	60	T	T	T	T	T	T	T	T
	NS2000	25	32	40	40	50	63	37.5	48	60	60	T	T	T	T	T	T	T	T
	NS2500		32	40	40	50	63		48	60	60	T	T		T	T	T	T	
	NS3200			40	40	50	63			60	60	T	T			T	T	T	
Compact NS LB MicroLogic	NS630b	T	T	T	T	T	T	T	T	T	T	T	T	T	T	T	T	T	T
	NS800	T	T	T	T	T	T	T	T	T	T	T	T	T	T	T	T	T	T

- T Total selectivity, up to the breaking capacity of the downstream circuit breaker.
- 4 Selectivity limit = 4 kA or Total when Selectivity limit is higher than downstream device Icu.
- No selectivity.

Note: Respect the basic rules of selectivity, for overload and short-circuit, see introduction or check curves.

Selectivity Table 690 V AC

Upstream: MasterPacT MTZ2 25-40H1

Downstream: MasterPacT MTZ1 06-16, MTZ2 08-20



Ue = 690 V AC

Upstream CB	MTZ2 H1 25-40			MTZ2 H1 25-40			MTZ2 H1 25-40		
Trip unit type	MicroLogic 2.0 X			MicroLogic 5.0 - 6.0 X Inst 15In Standard			MicroLogic 5.0 - 6.0 X Inst OFF		
Trip unit rating (A)	2500	3200	4000	2500	3200	4000	2500	3200	4000

Downstream CB	Setting range (A)	Selectivity limit (kA)								
MasterPacT MTZ1 H1/H2	MTZ1 06	25	32	40	37.5	T	T	T	T	T
	MTZ1 08	25	32	40	37.5	T	T	T	T	T
	MTZ1 10	25	32	40	37.5	T	T	T	T	T
	MTZ1 12	25	32	40	37.5	T	T	T	T	T
	MTZ1 16	25	32	40	37.5	T	T	T	T	T
MasterPacT MTZ2 N1	MTZ2 08	25	32	40	37.5	T	T	T	T	T
	MTZ2 10	25	32	40	37.5	T	T	T	T	T
	MTZ2 12	25	32	40	37.5	T	T	T	T	T
	MTZ2 16	25	32	40	37.5	T	T	T	T	T
MasterPacT MTZ2 H1	MTZ2 08	25	32	40	37.5	48	60	T	T	T
	MTZ2 10	25	32	40	37.5	48	60	T	T	T
	MTZ2 12	25	32	40	37.5	48	60	T	T	T
	MTZ2 16	25	32	40	37.5	48	60	T	T	T
	MTZ2 20	25	32	40	37.5	48	60	T	T	T
	MTZ2 32		32	40		48	60		T	T
MasterPacT MTZ2 H2	MTZ2 08	25	32	40	37.5	48	60	T	T	T
	MTZ2 10	25	32	40	37.5	48	60	T	T	T
	MTZ2 12	25	32	40	37.5	48	60	T	T	T
	MTZ2 16	25	32	40	37.5	48	60	T	T	T
	MTZ2 20	25	32	40	37.5	48	60	T	T	T
	MTZ2 32		32	40		48	60		T	T
MasterPacT MTZ2 H3	MTZ2 20	25	32	40	37.5	48	60	T	T	T
	MTZ2 25		32	40		48	60		T	T
	MTZ2 32			40			60			T
MasterPacT MTZ2 L1	MTZ2 08	25	32	40	37.5	48	60	T	T	T
	MTZ2 10	25	32	40	37.5	48	60	T	T	T
	MTZ2 12	25	32	40	37.5	48	60	T	T	T
	MTZ2 16	25	32	40	37.5	48	60	T	T	T
	MTZ2 20	25	32	40	37.5	48	60	T	T	T

Total selectivity, up to the breaking capacity of the downstream circuit breaker.

Selectivity limit = 4 kA.

No selectivity.

Note: Respect the basic rules of selectivity, for overload and short-circuit, see introduction or check curves.

Selectivity Table 690 V AC

Upstream: MasterPacT MTZ2 25-40H2, MTZ3 40b-63H1

Downstream: MasterPacT MTZ1 06-16, MTZ2 08-40, MTZ3 40b-50

U_e = 690 V AC



Upstream CB	MTZ2 H2			MTZ3 H1			MTZ2 H2			MTZ3 H1			MTZ2 H2			MTZ3 H1		
Trip unit type	MicroLogic 2.0 X						MicroLogic 5.0 - 6.0 X Inst 15 In Standard						MicroLogic 5.0 - 6.0 X Inst OFF					
Trip unit rating (A)	2500	3200	4000	4000	5000	6300	2500	3200	4000	4000	5000	6300	2500	3200	4000	4000	5000	6300

Downstream CB	Setting range (A)	Selectivity limit (kA)																	
MasterPacT MTZ1 H1/H2 MicroLogic X	MTZ1 06	25	32	40	37.5	T	T	T	T	T	T	T	T	T	T	T	T	T	T
	MTZ1 08	25	32	40	40	T	T	37.5	T	T	T	T	T	T	T	T	T	T	T
	MTZ1 10	25	32	40	40	T	T	37.5	T	T	T	T	T	T	T	T	T	T	T
	MTZ1 12	25	32	40	40	T	T	37.5	T	T	T	T	T	T	T	T	T	T	T
MasterPacT MTZ2 N1 MicroLogic X	MTZ2 08	25	32	40	40	T	T	37.5	T	T	T	T	T	T	T	T	T	T	T
	MTZ2 10	25	32	40	40	T	T	37.5	T	T	T	T	T	T	T	T	T	T	T
	MTZ2 12	25	32	40	40	T	T	37.5	T	T	T	T	T	T	T	T	T	T	T
	MTZ2 16	25	32	40	40	T	T	37.5	T	T	T	T	T	T	T	T	T	T	T
MasterPacT MTZ2 H1 MicroLogic X	MTZ2 08	25	32	40	40	50	63	37.5	48	60	60	T	T	T	T	T	T	T	T
	MTZ2 10	25	32	40	40	50	63	37.5	48	60	60	T	T	T	T	T	T	T	T
	MTZ2 12	25	32	40	40	50	63	37.5	48	60	60	T	T	T	T	T	T	T	T
	MTZ2 16	25	32	40	40	50	63	37.5	48	60	60	T	T	T	T	T	T	T	T
	MTZ2 20	25	32	40	40	50	63	37.5	48	60	60	T	T	T	T	T	T	T	T
	MTZ2 25		32	40	40	50	63		48	60	60	T	T		T	T	T	T	T
	MTZ2 32			40	40	50	63			60	60	T	T			T	T	T	T
MasterPacT MTZ2 H2 MicroLogic X	MTZ2 08	25	32	40	40	50	63	37.5	48	60	60	75	T	82	82	82	T	T	T
	MTZ2 10	25	32	40	40	50	63	37.5	48	60	60	75	T	82	82	82	T	T	T
	MTZ2 12	25	32	40	40	50	63	37.5	48	60	60	75	T	82	82	82	T	T	T
	MTZ2 16	25	32	40	40	50	63	37.5	48	60	60	75	T	82	82	82	T	T	T
	MTZ2 20	25	32	40	40	50	63	37.5	48	60	60	75	T	82	82	82	T	T	T
	MTZ2 25		32	40	40	50	63		48	60	60	75	T		82	82	82	T	T
MasterPacT MTZ3 H1	MTZ3 40b					50	63					75	94					T	T
	MTZ3 50						63						94						T
	MTZ3 63																		
MasterPacT MTZ2 H3 MicroLogic X	MTZ2 20	25	32	40	40	50	63	37.5	48	60	60	75	94	82	82	82	T	T	T
	MTZ2 25		32	40	40	50	63		48	60	60	75	94		82	82	T	T	T
	MTZ2 32			40	40	50	63			60	60	75	94			82	T	T	T
	MTZ2 40					50	63					75	94					T	T
MasterPacT MTZ3 H2	MTZ3 40b					50	63					75	94					T	T
	MTZ3 50						63						94						T
MasterPacT MTZ2 L1 MicroLogic X	MTZ2 08	25	32	40	40	50	63	37.5	48	60	60	75	94	T	T	T	T	T	T
	MTZ2 10	25	32	40	40	50	63	37.5	48	60	60	75	94	T	T	T	T	T	T
	MTZ2 12	25	32	40	40	50	63	37.5	48	60	60	75	94	T	T	T	T	T	T
	MTZ2 16	25	32	40	40	50	63	37.5	48	60	60	75	94	T	T	T	T	T	T
	MTZ2 20	25	32	40	40	50	63	37.5	48	60	60	75	94	T	T	T	T	T	T

T Total selectivity, up to the breaking capacity of the downstream circuit breaker.

4 Selectivity limit = 4 kA.

No selectivity.

Note: Respect the basic rules of selectivity, for overload and short-circuit, see introduction or check curves.

Selectivity Table 690 V AC

Upstream: MasterPacT MTZ2 20-40H3, MTZ3 40b-63H2

Downstream: MasterPacT MTZ1 06-16, MTZ2 08-40, MTZ3 40b-50



U_e = 690 V AC

Upstream CB		MTZ2 H3						MTZ3 H2				MTZ2 H3						MTZ3 H2				
Trip unit type		MicroLogic 2.0 X						MicroLogic 5.0 - 6.0 X Inst 15 In Standard						MicroLogic 5.0 - 6.0 X Inst OFF								
Trip unit rating (A)		2000	2500	3200	4000	4000	5000	6300	2000	2500	3200	4000	4000	5000	6300	2000	2500	3200	4000	4000	5000	6300
Downstream CB	Setting range (A)	Selectivity limit (kA)																				
MasterPacT MTZ1 H1/H2 MicroLogic X	MTZ1 06	20	25	32	40	40	T	T	30	37.5	T	T	T	T	T	T	T	T	T	T	T	
	MTZ1 08	20	25	32	40	40	T	T	30	37.5	T	T	T	T	T	T	T	T	T	T	T	
	MTZ1 10	20	25	32	40	40	T	T	30	37.5	T	T	T	T	T	T	T	T	T	T	T	
	MTZ1 12	20	25	32	40	40	T	T	30	37.5	T	T	T	T	T	T	T	T	T	T	T	
MasterPacT MTZ2 N1 MicroLogic X	MTZ1 16	20	25	32	40	40	T	T	30	37.5	T	T	T	T	T	T	T	T	T	T	T	
	MTZ2 08	20	25	32	40	40	T	T	30	37.5	T	T	T	T	T	T	T	T	T	T	T	
	MTZ2 10	20	25	32	40	40	T	T	30	37.5	T	T	T	T	T	T	T	T	T	T	T	
	MTZ2 12	20	25	32	40	40	T	T	30	37.5	T	T	T	T	T	T	T	T	T	T	T	
MasterPacT MTZ2 H1 MicroLogic X	MTZ2 16	20	25	32	40	40	T	T	30	37.5	T	T	T	T	T	T	T	T	T	T	T	
	MTZ2 08	20	25	32	40	40	50	63	30	37.5	48	60	60	T	T	T	T	T	T	T	T	
	MTZ2 10	20	25	32	40	40	50	63	30	37.5	48	60	60	T	T	T	T	T	T	T	T	
	MTZ2 12	20	25	32	40	40	50	63	30	37.5	48	60	60	T	T	T	T	T	T	T	T	
	MTZ2 16	20	25	32	40	40	50	63	30	37.5	48	60	60	T	T	T	T	T	T	T	T	
	MTZ2 20	20	25	32	40	40	50	63		37.5	48	60	60	T	T		T	T	T	T	T	
	MTZ2 25			32	40	40	50	63			48	60	60	T	T			T	T	T	T	
MasterPacT MTZ2 H2 MicroLogic X	MTZ2 32				40	40	50	63				60	60	T	T			T	T	T	T	
	MTZ2 40					50	63				60	60	T	T					T	T	T	
	MTZ2 08	20	25	32	40	40	50	63	30	37.5	48	60	60	75	T	65	65	65	65	T	T	T
	MTZ2 10	20	25	32	40	40	50	63	30	37.5	48	60	60	75	T	65	65	65	65	T	T	T
	MTZ2 12	20	25	32	40	40	50	63	30	37.5	48	60	60	75	T	65	65	65	65	T	T	T
	MTZ2 16	20	25	32	40	40	50	63	30	37.5	48	60	60	75	T	65	65	65	65	T	T	T
	MTZ2 20		25	32	40	40	50	63		37.5	48	60	60	75	T		65	65	65	T	T	T
MasterPacT MTZ3 H1	MTZ2 25			32	40	40	50	63			48	60	60	75	T		65	65	65	T	T	T
	MTZ3 40b						50	63					75	94							T	T
MasterPacT MTZ2 H3 MicroLogic X	MTZ3 50						63							94							T	
	MTZ2 20	20	25	32	40	40	50	63		37.5	48	60	60	75	94		65	65	65	T	T	T
	MTZ2 25			32	40	40	50	63			48	60	60	75	94			65	65	T	T	T
	MTZ2 32				40	40	50	63				60	60	75	94				65	T	T	T
MasterPacT MTZ3 H2	MTZ2 40					50	63						75	94							T	T
	MTZ3 50						63							94								T
MasterPacT MTZ2 L1 MicroLogic X	MTZ2 08	20	25	32	40	40	50	63	30	37.5	48	60	60	75	94	65	65	65	65	T	T	T
	MTZ2 10	20	25	32	40	40	50	63	30	37.5	48	60	60	75	94	65	65	65	65	T	T	T
	MTZ2 12	20	25	32	40	40	50	63	30	37.5	48	60	60	75	94	65	65	65	65	T	T	T
	MTZ2 16	20	25	32	40	40	50	63	30	37.5	48	60	60	75	94	65	65	65	65	T	T	T
	MTZ2 20	20	25	32	40	40	50	63		37.5	48	60	60	75	94		65	65	65	T	T	T

- T Total selectivity, up to the breaking capacity of the downstream circuit breaker.
- 4 Selectivity limit = 4 kA.
- No selectivity.

Note: Respect the basic rules of selectivity, for overload and short-circuit, see introduction or check curves.

Selectivity Tables for Direct Current Application



How to use the tables:

In the following pages are provided selectivity tables for the following system:

- 24-48 60 Vdc
- 110-125 Vdc
- 220-250 Vdc

With time constant from 1.5 to 25 ms

Suitability of circuit breakers according to voltage and earthing system shall be checked before using these tables. Selection of devices in DC can be challenging due to the diversity of voltage levels and earthing system. See product catalog or guides for DC application.

In this document we will consider the following cases:

IT	TN		
<p>Isolated from earth + and - conductors protected and disconnected</p> <p>Case 1</p>	<p>- (or +) earthed '+ and - conductors protected and disconnected</p> <p>Case 2</p>	<p>Midpoint earthed (not distributed) + and - conductors protected and disconnected</p> <p>Case 3</p>	<p>- (or +) earthed '+ (or -) conductors protected and disconnected</p> <p>Case 4</p>

For one given voltage the selectivity table is applicable for Case 1, Case 2, Case 3, Case 4 with this voltage between + and – for all types of fault. (In IT, Case 1, circuit breaker will not trip during first fault to earth)

For one given voltage selectivity limits in the table can also apply to system with higher voltage (up to 2 times) for all type of fault in Case 3 and for + to – fault only (Fault "B") in Case 1 if the same circuit breakers with same number of poles can be used at this higher voltage.

Selectivity Table

Upstream: iC60 Curve B

Downstream: iC60 Curves B, C, D, C60H-DC Curve C



Ue: 24-48-60 V DC ^[3]

Time constant: 1.5 ms - 25 ms

Upstream	iC60N/H/L, 1P or 2P ^[1]										
	Curve B										
In (A)	3	4	6	10	16	20	25	32	40	50	63

Downstream			Selectivity limit (A) ^[2]										
Circuit breaker	Curve	Rating (A)	3	4	6	10	16	20	25	32	40	50	63
iC60N/H/L 1P or 2P ^[1]	B	≤ 1		T	T	T	T	T	T	T	T	T	T
		2				T	T	T	T	T	T	T	T
		3				150	1200	T	T	T	T	T	T
		4						500	900	T	T	T	T
		6							300	700	1000	1800	4000
		≥ 16								400	500	800	1000
	C	≤ 1		T	T	T	T	T	T	T	T	T	T
		2				T	T	T	T	T	T	T	T
		3				150	1200	T	T	T	T	T	T
		4						400	900	T	T	T	T
		6							300	700	1000	1800	3000
		≥ 16								300	500	700	800
	D	≤ 1			T	T	T	T	T	T	T	T	T
		2				1600	T	T	T	T	T	T	T
		3					900	11000	T	T	T	T	T
		4							700	T	T	T	T
		6								500	800	1800	3000
		≥ 16									400	600	800
C60H-DC 1P or 2P ^[1]	C	≤ 1		T	T	T	T	T	T	T	T	T	
		2				T	T	T	T	T	T	T	
		3				150	1200	T	T	T	T	T	
		4						400	900	T	T	T	
		6							300	700	1000	1800	3000
		≥ 16								300	500	700	800

[1] Type of circuit breaker depend on earthing system and circuit breaker ranges (see Distribution guide direct current CA908061).

[2] According to the voltage and number of pole used, the breaking capacity can be changed. Selectivity limit is the minimum of the value indicated in the table and the breaking capacity of downstream circuit breaker.

[3] This table is applicable for Case 1, Case 2, Case 3, Case 4 defined in introduction with this voltage between + and - Selectivity limits in this table for Case 1 and Case 3 can also apply to system with higher voltage (up to 2 times) for the same circuit breaker (same number of poles used).

Total selectivity, up to the breaking capacity of the downstream circuit breaker.

Selectivity limit = 700 A.

No selectivity.

Selectivity Table

Upstream: iC60 Curve C

Downstream: iC60 Curves B, C, D, C60H-DC Curve C

Ue: 24-48-60 V DC^[3]

Time constant: 1.5 ms - 25 ms



Upstream	iC60N/H/L, 1P or 2P ^[1]											
	Curve C											
In (A)	3	4	6	10	16	20	25	32	40	50	63	

Downstream			Selectivity limit (A) ^[2]											
Circuit breaker	Curve	Rating (A)	3	4	6	10	16	20	25	32	40	50	63	
iC60N/H/L 1P or 2P ^[1]	B	≤ 1	T	T	T	T	T	T	T	T	T	T	T	
		2			700	T	T	T	T	T	T	T	T	
		3				900	T	T	T	T	T	T	T	
		4					900	8000	T	T	T	T	T	
		6							900	1800	3200	T	T	
		10								700	800	1500	2000	
		16										1000	1200	
		≥ 20												
	C	≤ 1	T	T	T	T	T	T	T	T	T	T	T	T
		2			500	T	T	T	T	T	T	T	T	
		3				900	T	T	T	T	T	T	T	
		4					900	6700	T	T	T	T	T	
		6							700	1400	3200	T	T	
		10								700	800	1500	2000	
		16										1000	1200	
		≥ 20												
	D	≤ 1	T	T	T	T	T	T	T	T	T	T	T	T
		2			350	T	T	T	T	T	T	T	T	
		3				700	T	T	T	T	T	T	T	
		4					700	4000	T	T	T	T	T	
		6							700	1400	3200	T	T	
		10								500	800	1500	1800	
		16										1000	1200	
		≥ 20												
C60H-DC 1P or 2P ^[1]	C	≤ 1	T	T	T	T	T	T	T	T	T	T	T	
		2			500	T	T	T	T	T	T	T	T	
		3				900	T	T	T	T	T	T	T	
		4					900	6700	T	T	T	T	T	
		6							700	1400	3200	T	T	
		10								700	800	1500	2000	
		16										1000	1200	
		≥ 20												

[1] Type of circuit breaker depend on earthing system and circuit breaker ranges (see Distribution guide direct current CA908061).

[2] According to the voltage and number of pole used, the breaking capacity can be changed.

Selectivity limit is the minimum of the value indicated in the table and the breaking capacity of downstream circuit breaker.

[3] This table is applicable for Case 1, Case 2, Case 3, Case 4 defined in introduction with this voltage between + and -
Selectivity limits in this table for Case 1 and Case 3 can also apply to system with higher voltage (up to 2 times) for the same circuit breaker (same number of poles used).

T Total selectivity, up to the breaking capacity of the downstream circuit breaker.

700 Selectivity limit = 700 A.

No selectivity.

Compliance of circuit breakers according to voltage and earthing system shall be checked before using this table.

Selectivity Table

Upstream: iC60 Curve D

Downstream: iC60 Curves B, C, D, C60H-DC Curve C

Ue: 24-48-60 V DC^[3]

Time constant: 1.5 ms - 25 ms

A

Upstream			iC60N/H/L, 1P or 2P ^[1]											
			Curve D											
In (A)			3	4	6	10	16	20	25	32	40	50	63	
Downstream			Selectivity limit (A) ^[2]											
Circuit breaker	Curve	Rating (A)												
iC60N/H/L 1P or 2P ^[1]	B	≤ 1	T	T	T	T	T	T	T	T	T	T	T	T
		2		1500	T	T	T	T	T	T	T	T	T	T
		3			400	T	T	T	T	T	T	T	T	T
		4				700	T	T	T	T	T	T	T	T
		6					700	1000	2500	700	1400	1600	3600	9000
		10								900	1000	1900	2700	
		16												
		≥ 20												
		C	≤ 1	T	T	T	T	T	T	T	T	T	T	T
	2			1000	T	T	T	T	T	T	T	T	T	T
	3				350	T	T	T	T	T	T	T	T	T
	4					700	T	T	T	T	T	T	T	T
	6						700	1000	2000	T	T	T	T	
	10								700	1400	1600	3600	9000	
	16									900	1000	1500	2100	
	≥ 20													
	D		≤ 1	T	T	T	T	T	T	T	T	T	T	T
		2		700	T	T	T	T	T	T	T	T	T	T
		3			350	T	T	T	T	T	T	T	T	
		4				700	T	T	T	T	T	T	T	
		6					700	1000	2000	T	T	T	T	
		10							700	1400	1600	3600	7400	
		16								900	1000	1500	2100	
		≥ 20												
		C60H-DC 1P or 2P ^[1]	C	≤ 1	T	T	T	T	T	T	T	T	T	T
	2				1000	T	T	T	T	T	T	T	T	T
	3					350	T	T	T	T	T	T	T	T
4						700	T	T	T	T	T	T	T	
6							700	1000	2000	T	T	T	T	
10									700	1400	1600	3600	9000	
16										900	1000	1500	2100	
≥ 20														

[1] Type of circuit breaker depend on earthing system and circuit breaker ranges (see Distribution guide direct current CA908061).

[2] According to the voltage and number of pole used, the breaking capacity can be changed. Selectivity limit is the minimum of the value indicated in the table and the breaking capacity of downstream circuit breaker.

[3] This table is applicable for Case 1, Case 2, Case 3, Case 4 defined in introduction with this voltage between + and - Selectivity limits in this table for Case 1 and Case 3 can also apply to system with higher voltage (up to 2 times) for the same circuit breaker (same number of poles used).

Total selectivity, up to the breaking capacity of the downstream circuit breaker.

Selectivity limit = 700 A.

No selectivity.

Compliance of circuit breakers according to voltage and earthing system shall be checked before using this table.

Selectivity Table

Upstream: C60H-DC Curve C

Downstream: iC60 Curves B, C, D, C60H-DC Curve C

Ue: 24-48-60 V DC ^[3]

Time constant: 1.5 ms - 25 ms



Upstream	C60H-DC, 1P or 2P ^[1]										
	Curve C										
In (A)	3	4	6	10	16	20	25	32	40	50	63

Downstream			Selectivity limit (A) ^[2]										
Circuit breaker	Curve	Rating (A)											
iC60N/H/L 1P or 2P ^[1]	B	≤ 1		T	T	T	T	T	T	T	T	T	T
		2			150	T	T	T	T	T	T	T	T
		3				300	1200	T	T	T	T	T	T
		4					500	800	1500	T	T	T	T
		6						370	450	900	1600	3600	7300
		10								400	800	1200	1800
		≥ 16											
	C	≤ 1		T	T	T	T	T	T	T	T	T	T
		2			150	T	T	T	T	T	T	T	T
		3				300	1200	T	T	T	T	T	T
		4					400	600	1500	T	T	T	T
		6						300	450	900	1600	3600	6000
		10								400	800	1200	1450
		≥ 16											
	D	≤ 1		T	T	T	T	T	T	T	T	T	T
		2			150	T	T	T	T	T	T	T	T
		3				200	900	T	T	T	T	T	T
		4					400	600	1500	T	T	T	T
		6						300	450	900	1600	3600	6000
		10								400	700	1200	1450
		≥ 16											
C60H-DC 1P or 2P ^[1]	C	≤ 1		T	T	T	T	T	T	T	T	T	
		2			150	T	T	T	T	T	T	T	
		3				300	1200	T	T	T	T	T	
		4					500	800	1500	T	T	T	
		6						370	450	900	1600	3600	7300
		10								400	800	1200	1800
		≥ 16											

[1] Type of circuit breaker depend on earthing system and circuit breaker ranges (see Distribution guide direct current CA908061).

[2] According to the voltage and number of pole used, the breaking capacity can be changed. Selectivity limit is the minimum of the value indicated in the table and the breaking capacity of downstream circuit breaker.

[3] This table is applicable for Case 1, Case 2, Case 3, Case 4 defined in introduction with this voltage between + and - Selectivity limits in this table for Case 1 and Case 3 can also apply to system with higher voltage (up to 2 times) for the same circuit breaker (same number of poles used).

T Total selectivity, up to the breaking capacity of the downstream circuit breaker.

700 Selectivity limit = 700 A.

 No selectivity.

Compliance of circuit breakers according to voltage and earthing system shall be checked before using this table.

Selectivity Table

Upstream: C120, NG125 Curve B

Downstream: iC60 Curves B, C, D, C60H-DC Curve C

Ue: 24-48-60 V DC ^[3]

Time constant: 1.5 ms - 25 ms

A

Upstream			C120N/H/L, NG125N/H/L, 1P or 2P ^[1]											
			Curve B											
In (A)			10	16	20	25	32	40	50	63	80	100	125	
Downstream			Selectivity limit (A) ^[2]											
Circuit breaker	Curve	Rating (A)												
iC60N/H/L 1P or 2P ^[1]	B	≤ 2	T	T	T	T	T	T	T	T	T	T	T	
		3	150	T	T	T	T	T	T	T	T	T	T	
		4		300	500	1000	1250	T	T	T	T	T	T	
		6			300	500	600	1800	2000	5500	T	T	T	
		10						700	700	1900	5000	9500	T	
		16									2000	3500	8500	
		20										2000	4200	
		≥ 25												
	C	≤ 2	T	T	T	T	T	T	T	T	T	T	T	T
		3	120	T	T	T	T	T	T	T	T	T	T	T
		4		250	900	1100	1300	T	T	T	T	T	T	
		6				500	500	1400	2000	4500	T	T	T	
		10						500	600	1500	5000	9000	T	
		16									1800	3000	7000	
		20										2000	3500	
		≥ 25												
	D	≤ 1	T	T	T	T	T	T	T	T	T	T	T	T
		2	5000	T	T	T	T	T	T	T	T	T	T	
		3		600	T	T	T	T	T	T	T	T	T	
		4			500	800	1000	T	T	T	T	T	T	
		6				300	300	1100	1600	3500	T	T	T	
		10						400	400	1200	4000	8000	T	
		16							250	400	1400	2500	6000	
		20									600	1400	3500	
≥ 25														
C60H-DC 1P or 2P ^[1]	C	≤ 2	T	T	T	T	T	T	T	T	T	T	T	
		3	120	T	T	T	T	T	T	T	T	T	T	
		4		250	900	1100	1300	T	T	T	T	T	T	
		6				500	500	1400	2000	4500	T	T	T	
		10						500	600	1500	5000	9000	T	
		16									1800	3000	7000	
		20										2000	3500	
		≥ 25												

[1] Type of circuit breaker depend on earthing system and circuit breaker ranges (see Distribution guide direct current CA908061).

[2] According to the voltage and number of pole used, the breaking capacity can be changed. Selectivity limit is the minimum of the value indicated in the table and the breaking capacity of downstream circuit breaker.

[3] This table is applicable for Case 1, Case 2, Case 3, Case 4 defined in introduction with this voltage between + and - Selectivity limits in this table for Case 1 and Case 3 can also apply to system with higher voltage (up to 2 times) for the same circuit breaker (same number of poles used).

T Total selectivity, up to the breaking capacity of the downstream circuit breaker.

700 Selectivity limit = 700 A.

No selectivity.

Compliance of circuit breakers according to voltage and earthing system shall be checked before using this table.

Selectivity Table

Upstream: C120, NG125 Curve C

Downstream: iC60 Curves B, C, D, C60H-DC Curve C

Ue: 24-48-60 V DC ^[3]

Time constant: 1.5 ms - 25 ms



Upstream	C120N/H/L, NG125N/H/L, 1P or 2P ^[1]										
	Curve C										
In (A)	10	16	20	25	32	40	50	63	80	100	125

Downstream			Selectivity limit (A) ^[2]										
Circuit breaker	Curve	Rating (A)											
iC60N/H/L 1P or 2P ^[1]	B	≤ 2	T	T	T	T	T	T	T	T	T	T	T
		3	5000	T	T	T	T	T	T	T	T	T	T
		4		1500	2000	T	T	T	T	T	T	T	T
		6			400	1500	3000	T	T	T	T	T	T
		10						1800	3000	8000	T	T	T
		16						1000	1400	2500	15000	T	T
		20									6500	11500	T
		25									4500	8500	15000
		32										5000	8000
	≥ 40												
	C	≤ 2	T	T	T	T	T	T	T	T	T	T	T
		3	5000	T	T	T	T	T	T	T	T	T	T
		4		1000	1400	T	T	T	T	T	T	T	T
		6			400	1000	2400	T	T	T	T	T	T
		10					800	1500	3000	8500	T	T	T
		16						800	1400	3000	15000	T	T
		20								1700	6500	11000	T
		25									4500	8500	12000
		32									3000	5000	7000
	≥ 40												
	D	≤ 2	T	T	T	T	T	T	T	T	T	T	T
		3	4000	T	T	T	T	T	T	T	T	T	T
		4		500	1000	T	T	T	T	T	T	T	T
		6				800	1900	T	T	T	T	T	T
		10					600	1200	2500	7000	T	T	T
		16						500	1000	2500	12000	T	T
		20								1400	5500	9000	T
25										3500	7500	11000	
32											3500	6000	
≥ 40													
C60H-DC 1P or 2P ^[1]	C	≤ 2	T	T	T	T	T	T	T	T	T	T	
		3	5000	T	T	T	T	T	T	T	T	T	
		4		1000	1400	T	T	T	T	T	T	T	
		6			400	1000	2400	T	T	T	T	T	
		10					800	1500	3000	8500	T	T	
		16						800	1400	3000	15000	T	
		20								1700	6500	11000	
		25									4500	8500	12000
		32									3000	5000	7000
≥ 40													

[1] Type of circuit breaker depend on earthing system and circuit breaker ranges (see Distribution guide direct current CA908061).

[2] According to the voltage and number of pole used, the breaking capacity can be changed. Selectivity limit is the minimum of the value indicated in the table and the breaking capacity of downstream circuit breaker.

[3] This table is applicable for Case 1, Case 2, Case 3, Case 4 defined in introduction with this voltage between + and - Selectivity limits in this table for Case 1 and Case 3 can also apply to system with higher voltage (up to 2 times) for the same circuit breaker (same number of poles used).

T Total selectivity, up to the breaking capacity of the downstream circuit breaker.

700 Selectivity limit = 700 A.

No selectivity.

Compliance of circuit breakers according to voltage and earthing system shall be checked before using this table.

Selectivity Table

Upstream: C120, NG125 Curve D

Downstream: iC60 Curves B, C, D, C60H-DC Curve C

Ue: 24-48-60 V DC [3]

Time constant: 1.5 ms - 25 ms

A

Upstream	C120N/H/L, NG125N/H/L, 1P or 2P [1]										
	Curve D										
In (A)	10	16	20	25	32	40	50	63	80	100	125

Downstream			Selectivity limit (A) [2]												
Circuit breaker	Curve	Rating (A)													
iC60N/H/L 1P or 2P [1]	B	≤ 3	T	T	T	T	T	T	T	T	T	T	T	T	T
		4	5000	T	T	T	T	T	T	T	T	T	T	T	T
		6		1000	2000	T	T	T	T	T	T	T	T	T	T
		10			1000	9000	1400	3500	5000	T	T	T	T	T	T
		16						1500	2500	6000	T	T	T	T	T
		20							2000	3500	T	T	T	T	T
		25									15000	T	T	T	T
		32									9000	T	T	T	T
		40									7000	10000	T	T	T
		50													10000
	63													5000	
	C	≤ 3	T	T	T	T	T	T	T	T	T	T	T	T	T
		4	5000	T	T	T	T	T	T	T	T	T	T	T	T
		6		1000	2000	T	T	T	T	T	T	T	T	T	T
		10			1000	9000	1400	3000	4000	15000	T	T	T	T	T
		16						1500	2000	6000	T	T	T	T	T
		20								3000	T	T	T	T	T
		25									12000	T	T	T	T
		32									8000	T	T	T	T
		40									5000	9000	T	T	T
		50													9000
	63													4000	
	D	≤ 3	T	T	T	T	T	T	T	T	T	T	T	T	T
		4	5000	T	T	T	T	T	T	T	T	T	T	T	T
		6		1000	2000	T	T	T	T	T	T	T	T	T	T
		10			1000	9000	1400	3000	4000	12000	T	T	T	T	T
		16						1200	2000	5000	T	T	T	T	T
		20									T	T	T	T	T
		25									10000	T	T	T	T
		32									6000	12000	T	T	T
40											5000	9000	T	T	
50														10000	
63													5000		
C60H-DC 1P or 2P [1]	C	≤ 3	T	T	T	T	T	T	T	T	T	T	T	T	
		4	5000	T	T	T	T	T	T	T	T	T	T	T	
		6		1000	2000	T	T	T	T	T	T	T	T	T	
		10			1000	9000	1400	3000	4000	15000	T	T	T	T	
		16						1500	2000	6000	T	T	T	T	
		20								3000	T	T	T	T	
		25									12000	T	T	T	
		32									8000	T	T	T	
		40									5000	9000	T	T	
		50													9000
63													4000		

[1] Type of circuit breaker depend on earthing system and circuit breaker ranges (see Distribution guide direct current CA908061).

[2] According to the voltage and number of pole used, the breaking capacity can be changed.

Selectivity limit is the minimum of the value indicated in the table and the breaking capacity of downstream circuit breaker.

[3] This table is applicable for Case 1, Case 2, Case 3, Case 4 defined in introduction with this voltage between + and -
Selectivity limits in this table for Case 1 and Case 3 can also apply to system with higher voltage (up to 2 times) for the same circuit breaker (same number of poles used).

T Total selectivity, up to the breaking capacity of the downstream circuit breaker.

5000 Selectivity limit = 5000 A.

No selectivity.

Compliance of circuit breakers according to voltage and earthing system shall be checked before using this table.

Selectivity Table

Upstream: ComPacT NSX100/160/250 DC TM-D, TM-DC

Downstream: iC60, C120, NG125. C60H-DC

Ue: 24-48-60 V DC [3]

Time constant: 1.5 ms - 25 ms



Upstream CB	NSX100DC								NSX160DC				NSX250 DC			
	1P1D 2P2D F/N/M/S 3P3D F/S [1]															
Trip unit type	TMD, TM-DC								TMD, TM-DC				TM-DC			
Trip unit rating (A)	16	25	32	40	50	63	80	100	100	125	160	160	200	250		
Im	fixed	fixed	fixed	fixed	fixed	fixed	fixed	fixed	fixed	fixed	fixed	fixed	Mini	Maxi	Mini	Maxi
	260	400	550	700	700	700	800	800	800	1250	1250	1250	1000	2000	1250	2500

Downstream Rating	Selectivity limit (kA) [2]															
iC60 N/H	0.5	T	T	T	T	T	T	T	T	T	T	T	T	T	T	T
B-C-D curves	1	T	T	T	T	T	T	T	T	T	T	T	T	T	T	T
	2	10	T	T	T	T	T	T	T	T	T	T	T	T	T	T
iC60 L	3	5	10	T	T	T	T	T	T	T	T	T	T	T	T	T
B-C-D curves	4	0.26	5	10	T	T	T	T	T	T	T	T	T	T	T	T
	5		0.4	5	10	T	T	T	T	T	T	T	T	T	T	T
1P1D or 2P2D	6			0.55	5	10	T	T	T	T	T	T	T	T	T	T
[1]	10				0.7	5	T	T	T	T	T	T	T	T	T	T
	13					0.7	T	T	T	T	T	T	T	T	T	T
	15-16						5	T	T	T	T	T	T	T	T	T
	20						0.7	10	10	10	T	T	T	T	T	T
	25							5	10	10	T	T	T	T	T	T
	32							0.8	10	10	T	T	T	10	T	T
	40								5	5	10	T	T	5	T	T
	50								0.8	0.8	10	10	10		10	T
	63										5	5	5		5	T
C60H-DC	0.5	T	T	T	T	T	T	T	T	T	T	T	T	T	T	T
C curves	1	T	T	T	T	T	T	T	T	T	T	T	T	T	T	T
	2	10	T	T	T	T	T	T	T	T	T	T	T	T	T	T
1P1D or 2P2D	3	5	10	T	T	T	T	T	T	T	T	T	T	T	T	T
[1]	4	0.26	5	10	T	T	T	T	T	T	T	T	T	T	T	T
	5		0.4	5	10	T	T	T	T	T	T	T	T	T	T	T
	6			0.55	5	10	T	T	T	T	T	T	T	T	T	T
	10				0.7	5	T	T	T	T	T	T	T	T	T	T
	13					0.7	T	T	T	T	T	T	T	T	T	T
	15-16						5	T	T	T	T	T	T	T	T	T
	20						0.7	10	10	10	T	T	T	T	T	T
	25							5	10	10	T	T	T	T	T	T
	30-32							0.8	10	10	T	T	T	10	T	T
	40								5	5	10	T	T	5	T	T
	50								0.8	0.8	10	10	10		10	T
	63										5	5	5		5	T
C120 N/H	63										1.25	5	5		5	T
B-C-D curves	80														5	T
1P1D or 2P2D	100														5	T
[1]	125															T
NG125 N/H/L	10		0.4	0.5	0.7	0.7	0.7	5	5	5	10	10	10	T	T	T
B-C-D curves	16			0.5	0.7	0.7	0.7	0.8	5	5	10	10	10	10	T	T
1P1D or 2P2D	20				0.7	0.7	0.7	0.8	0.8	0.8	10	10	10	5	T	T
[1]	25					0.7	0.7	0.8	0.8	0.8	10	10	10	5	T	T
	32							0.8	0.8	0.8	5	10	10	1	T	T
	40								0.8	0.8	5	10	10	1	T	T
	50										1.25	5	5	1	10	T
	63										1.25	5	5		5	T
	80														5	T
	100 (N)														5	T
	125 (N)															T

[1] Type of circuit breaker depend on earthing system and circuit breaker ranges (see Distribution guide direct current CA908061).

[2] According to the voltage and number of pole used, the breaking capacity can be changed.

Selectivity limit is the minimum of the value indicated in the table and the breaking capacity of downstream circuit breaker.

[3] This table is applicable for Case 1, Case 2, Case 3, Case 4 defined in introduction with this voltage between + and -

Selectivity limits in this table for Case 1 and Case 3 can also apply to system with higher voltage (up to 2 times) for the same circuit breaker (same number of poles used).

Compliance of circuit breakers according to voltage and earthing system shall be checked before using this table.

Selectivity Table

Upstream: ComPacT NSX100/160/250 DC with Parallel Connection of Poles

Downstream: iC60, C60H-DC, C120, NG125

Ue: 24-48-60 V DC [3]

Time constant: 1.5 ms - 25 ms

A

Upstream CB	NSX 100DC F				NSX 160DC F		NSX 250 DC F			NSX 100DC F				NSX 160DC F		NSX 250DC F		
	2P2D				3P3D		2P used			4P4D				Parallel connection for + or -		Parallel connection for + or -		2 poles with parallel connection for + and - [2]
Trip unit type	TM-D, TM-DC				TM-DC		TM-DC			TM-D, TM-DC				TM-DC				
Trip unit rating (A)	50	63	80	125	160	200	50	63	80	125	160	200	50	63	80	125	160	200
Equivalent rated current	125	158	200	313	400	500	115	145	184	288	368	460	115	145	184	288	368	460
Im	fixed		fixed	fixed	fixed	fixed	Mini	Maxi	fixed	fixed	fixed	fixed	fixed	Mini	Maxi	fixed	Mini	Maxi
	1400	1400	1600	2500	2500	2000	4000	1400	1400	1600	2500	2500	2000	4000	1400	1400	1600	2500

Downstream	Rating	Selectivity limit (kA) [2]																	
iC60 N / H B-C-D Curves	0.5	T	T	T	T	T	T	T	T	T	T	T	T	T	T	T	T	T	
	1	T	T	T	T	T	T	T	T	T	T	T	T	T	T	T	T	T	
iC60 L B-C-D-curves	2	T	T	T	T	T	T	T	T	T	T	T	T	T	T	T	T	T	
	3	T	T	T	T	T	T	T	T	T	T	T	T	T	T	T	T	T	
1P1D or 2P2D [1]	4	T	T	T	T	T	T	T	T	T	T	T	T	T	T	T	T	T	
	5	T	T	T	T	T	T	T	T	T	T	T	T	T	T	T	T	T	
	6	T	T	T	T	T	T	T	T	T	T	T	T	T	T	T	T	T	
	10	T	T	T	T	T	T	T	T	T	T	T	T	T	T	T	T	T	
	13	T	T	T	T	T	T	T	T	T	T	T	T	T	T	T	T	T	
	15-16	T	T	T	T	T	T	T	T	T	T	T	T	T	T	T	T	T	
	20	10	T	T	T	T	T	T	T	T	T	T	T	T	T	T	T	T	
	25	5	T	T	T	T	T	T	T	5	T	T	T	T	T	T	T	T	
	32	0.8	T	T	T	T	T	T	T	0.8	T	T	T	T	T	T	T	T	
	40		10	T	T	T	T	T	T		10	T	T	T	T	T	T	T	
C60H-DC C Curves	50		10	10	T	T	10	T		10	10	T	T	10	T	T	10	T	
	63		5	5	T	T	5	T		5	5	T	T	5	T	T	5	T	
	0.5	T	T	T	T	T	T	T	T	T	T	T	T	T	T	T	T	T	
	1	T	T	T	T	T	T	T	T	T	T	T	T	T	T	T	T	T	
	2	T	T	T	T	T	T	T	T	T	T	T	T	T	T	T	T	T	
	3	T	T	T	T	T	T	T	T	T	T	T	T	T	T	T	T	T	
	4	T	T	T	T	T	T	T	T	T	T	T	T	T	T	T	T	T	
	5	T	T	T	T	T	T	T	T	T	T	T	T	T	T	T	T	T	
	6	T	T	T	T	T	T	T	T	T	T	T	T	T	T	T	T	T	
	10	T	T	T	T	T	T	T	T	T	T	T	T	T	T	T	T	T	
1P1D or 2P2D [1]	13	T	T	T	T	T	T	T	T	T	T	T	T	T	T	T	T	T	
	15-16	T	T	T	T	T	T	T	T	T	T	T	T	T	T	T	T	T	
	20	10	T	T	T	T	T	T	10	T	T	T	T	T	T	T	T	T	
	25	5	T	T	T	T	T	T	5	T	T	T	T	T	T	T	T	T	
	30-32	0.8	T	T	T	T	T	T	0.8	T	T	T	T	T	T	T	T	T	
	40		10	T	T	T	T	T		10	T	T	T	T	T	T	T	T	
	50		10	10	T	T	10	T		10	10	T	T	10	T	T	10	T	
	63		5	5	T	T	5	T		5	5	T	T	5	T	T	5	T	
	C120 N/H B-C-D Curves	63		1.25	5	T	T	T			1.25	5	T	T	T	T	T	T	T
		80				T	T	T					T	T	T	T	T	T	T
100					T	T	T					T	T	T	T	T	T	T	
125					T	T	T					T	T	T	T	T	T	T	
NG125 N/H/L B-C-D Curves	10	5	10	10	T	T	T	5	10	10	T	T	T	T	T	T	T	T	
	16	0.8	10	10	T	T	T	0.8	10	10	T	T	T	T	T	T	T	T	
	20	0.8	10	10	T	T	T	0.8	10	10	T	T	T	T	T	T	T	T	
	25	0.8	10	10	T	T	T	0.8	10	10	T	T	T	T	T	T	T	T	
	32	0.8	5	10	T	T	T	0.8	5	10	T	T	T	T	T	T	T	T	
	40		5	10	T	T	T		5	10	T	T	T	T	T	T	T	T	
	50		1.25	5	T	T	T		1.25	5	T	T	T	T	T	T	T	T	
	63		1.25	5	T	T	T		1.25	5	T	T	T	T	T	T	T	T	
	80				T	T	T				T	T	T	T	T	T	T	T	
	100 (N)				T	T	T				T	T	T	T	T	T	T	T	
125 (N)				T	T	T				T	T	T	T	T	T	T	T		

[1] Type of circuit breaker (1P1D, 2P2D) depend on earthing system and circuit breaker ranges.
For voltage up to 60Vdc one single pole of iC60 C120 NG125 NSX range is enough to break the current.
For ranges with 3P or 4P breakers only (NSX250 for example), one or two poles only are used of a 3P circuit breaker.

[2] According to the voltage and nb of pole used, the breaking capacity can be changed.
Selectivity limit is the minimum of the value indicated in the table and the breaking capacity of downstream circuit breaker.

[3] This table is applicable for Case 1, Case 2, Case 3, Case 4 defined in introduction with this voltage between + and -.
Selectivity limits in this table for case 1 and Case 3 can also apply to system with higher voltage (up to 2 times) for the same circuit breaker (same number of poles used).

Compliance of circuit breakers according to voltage and earthing system shall be checked before using this table.

Selectivity Table

Upstream: ComPacT NSX100/160/250 DC TM-G

Downstream: iC60, C60H-DC, C120, NG125

Ue: 24-48-60 V DC [3]

Time constant: 1.5 ms - 25 ms



Upstream CB	NSX100DC						NSX160DC			NSX250 DC		
	3P3D (1 or 2 P used) F/S [1]											
Trip unit type	TM-G						TM-G			TM-G		
Trip unit rating (A)	16	25	40	63	80	100	100	125	160	160	200	250
Im	80	100	100	150	250	400	400	530	530	530	530	625

Downstream	In	Selectivity limit (kA) [2]											
iC60 N/H/L	0.5	10	10	10	T	T	T	T	T	T	T	T	T
	B-C-D Curves	1	5	5	5	T	T	T	T	T	T	T	T
1P1D or 2P2D [1]	2	0.08	0.1	0.1	10	T	T	T	T	T	T	T	T
	3			0.1	5	10	T	T	T	T	T	T	T
	4				0.15	5	10	10	T	T	T	T	T
	5					0.25	5	5	T	T	T	T	T
	6						0.4	0.4	T	T	T	T	T
	10								10	10	10	10	T
	13								5	5	5	5	10
	15-16								5	5	5	5	5
	20								0.5	0.5	0.5	0.5	5
	25												0.6
	32												
	40												
	50												
63													
C60H-DC	0.5	10	10	10	T	T	T	T	T	T	T	T	T
	C Curves	1	5	5	5	T	T	T	T	T	T	T	T
1P1D or 2P2D [1]	2	0.08	0.1	0.1	10	T	T	T	T	T	T	T	T
	3			0.1	5	10	T	T	T	T	T	T	T
	4				0.15	5	10	10	T	T	T	T	T
	5					0.25	5	5	T	T	T	T	T
	6						0.4	0.4	T	T	T	T	T
	10								10	10	10	10	T
	13								5	5	5	5	10
	15-16								5	5	5	5	5
	20								5	5	5	5	5
	25								0.5	0.5	0.5	0.5	5
	30-32												0.6
	40												
	50												
63													
NG125 N/H/L	10					0.25	0.4	0.4	0.5	0.5	0.5	0.5	0.6
	B-C-D Curves	16					0.4	0.5	0.5	0.5	0.5	0.5	0.6
1P1D or 2P2D [1]	20								0.5	0.5	0.5	0.5	0.6
	25												0.6
	32												
	40												

[1] Type of circuit breaker (1P1D, 2P2D) depend on earthing system and circuit breaker ranges.
 For voltage up to 60Vdc one single pole of iC60 C120 NG125 NSX range is enough to break the current.
 For ranges with 3P or 4P breakers only (NSX250 for example), one or two poles only are used of a 3P circuit breaker.

[2] According to the voltage and nb of pole used, the breaking capacity can be changed.
 Selectivity limit is the minimum of the value indicated in the table and the breaking capacity of downstream circuit breaker.

[3] This table is applicable for Case 1, Case 2, Case 3, Case 4 defined in introduction with this voltage between + and -.
 Selectivity limits in this table for case 1 and Case 3 can also apply to system with higher voltage (up to 2 times) for the same circuit breaker (same number of poles used).

Compliance of circuit breakers according to voltage and earthing system shall be checked before using this table.

Selectivity Table

Upstream: ComPacT NSX100/160/250 DC TM-D, TM-DC

Downstream: ComPacT NSX100/160 DC TM-D, TM-DC, TM-G

Ue: 24-48-60 V DC ^[3]

Time constant: 1.5 ms - 25 ms

A

Upstream CB	NSX100 DC								NSX160 DC			NSX250 DC				
	1P1D 2P2D F/N/M/S (3P3D F/S) ^[1]											3P3D (1 or 2 P Used) F/S ^[1]				
Trip unit type	TM-D								TM-D, TM-DC			TM-DC				
Trip unit rating (A)	16	25	32	40	50	63	80	100	100	125	160	160	200	250		
Im	fixed	fixed	fixed	fixed	fixed	fixed	fixed	fixed	fixed	fixed	fixed	fixed	Mini	Maxi	Mini	Maxi
	260	400	550	700	700	700	640	800	800	1250	1250	1250	1000	2000	1250	2500

Downstream Rating Im CB	Selectivity limit (kA) ^[2]																			
NSX100DC TM-D (TM-DC) 1P1D or 2P2PD (3P3D) ^[1]	16	260			0.5	0.7	0.7	0.7	0.7	0.7	0.8	0.8	1.25	1.25	1.25	1	2	1.25	5	
	25	400				0.7	0.7	0.7	0.7	0.8	0.8	1.25	1.25	1.25	1.25	1	2	1.25	5	
	32	400							0.7	0.7	0.8	0.8	1.25	1.25	1.25	1	2	1.25	5	
	40	700								0.7	0.8	0.8	1.25	1.25	1.25	1	2	1.25	5	
	50	700									0.7	0.8	0.8	1.25	1.25	1.25	1	2	1.25	2.5
	63	700										0.8	0.8	1.25	1.25	1.25	1	2	1.25	2.5
	80	800												1.25	1.25	1.25	1	2	1.25	2.5
100	1000												1.25	1.25	1.25	1	2	1.25	2.5	
NSX100DC TM-G 3P3D ^[1]	16	80			0.5	0.7	0.7	0.7	0.7	0.8	0.8	1.25	1.25	1.25	1	2	1.25	10		
	25	100				0.7	0.7	0.7	0.7	0.8	0.8	1.25	1.25	1.25	1	2	1.25	5		
	40	100								0.7	0.8	0.8	1.25	1.25	1.25	1	2	1.25	5	
	63	150								0.7	0.8	0.8	1.25	1.25	1.25	1	2	1.25	5	
	80	250									0.8		1.25	1.25	1.25	1	2	1.25	2.5	
100	400											1.25	1.25	1.25	1	2	1.25	2.5		
NSX160DC 1P1D or 2P2D 3P2D ^[1] NSX160DC TM-G 3P3D ^[1]	100	1000										1.25	1.25	1.25	1	2	1.25	2.5		
	125	1200																1.25	2.5	
	160	1250																		
	125	530																1.25	2.5	
160	530																			

[1] Type of circuit breaker (1P1D, 2P2D) depend on earthing system and circuit breaker ranges.
 For voltage up to 60Vdc one single pole of iC60 C120 NG125 NSX range is enough to break the current.
 For ranges with 3P or 4P breakers only (NSX250 for example), one or two poles only are used of a 3P circuit breaker.

[2] According to the voltage and nb of pole used, the breaking capacity can be changed.
 Selectivity limit is the minimum of the value indicated in the table and the breaking capacity of downstream circuit breaker.

[3] This table is applicable for Case 1, Case 2, Case 3, Case 4 defined in introduction with this voltage between + and -.
 Selectivity limits in this table for case 1 and Case 3 can also apply to system with higher voltage (up to 2 times) for the same circuit breaker (same number of poles used).

Compliance of circuit breakers according to voltage and earthing system shall be checked before using this table.

Selectivity Table

Upstream: ComPacT NSX400/630/1200 DC TM-DC

Downstream: iC60, C60H-DC, C120, NG125

Ue: 24-48-60 V DC [3]

Time constant: 1.5 ms - 25 ms



Upstream CB	NSX400DC F/S						NSX630DC F/S				NSX1200DC N							
	3P3D (1 or 2 P Used) [1]										2P2D							
Trip unit type	TM-DC						TM-DC				TM-DC							
Trip unit rating (A)	250		320		400		500		600		630		800		1000		1200	
Im	min	max	min	max	min	max	min	max	min	max	min	max	min	max	min	max	min	max
	625	1250	800	1600	1000	2000	1250	2500	1500	3000	1575	3150	2000	4000	2500	5000	3000	6000

Downstream Rating	Selectivity limit (kA) [2]																		
iC60 N/H/L	0.5	T	T	T	T	T	T	T	T	T	T	T	T	T	T	T	T	T	T
B-C-D Curves	1	T	T	T	T	T	T	T	T	T	T	T	T	T	T	T	T	T	T
	2	T	T	T	T	T	T	T	T	T	T	T	T	T	T	T	T	T	T
	3	T	T	T	T	T	T	T	T	T	T	T	T	T	T	T	T	T	T
	4	T	T	T	T	T	T	T	T	T	T	T	T	T	T	T	T	T	T
1P1D or 2P2D	5	T	T	T	T	T	T	T	T	T	T	T	T	T	T	T	T	T	T
[1]	6	T	T	T	T	T	T	T	T	T	T	T	T	T	T	T	T	T	T
	10	10	T	10	T	T	T	T	T	T	T	T	T	T	T	T	T	T	T
	13	5	T	10	T	T	T	T	T	T	T	T	T	T	T	T	T	T	T
	15-16	0.6	T	5	T	10	T	T	T	T	T	T	T	T	T	T	T	T	T
	20		10	5	T	5	T	T	T	T	T	T	T	T	T	T	T	T	T
	25		5	0.8	10	5	T	T	T	T	T	T	T	T	T	T	T	T	T
	32		1.25	0.8	10	1	10	T	T	T	T	T	T	T	T	T	T	T	T
	40				10		10	T	T	T	T	T	T	T	T	T	T	T	T
	50				5		5	T	T	T	T	T	T	T	T	T	T	T	T
	63				5		2	T	T	T	T	T	T	T	T	T	T	T	T
C60H-DC	0.5	T	T	T	T	T	T	T	T	T	T	T	T	T	T	T	T	T	T
C Curves	1	T	T	T	T	T	T	T	T	T	T	T	T	T	T	T	T	T	T
	2	T	T	T	T	T	T	T	T	T	T	T	T	T	T	T	T	T	T
1P1D or 2P2D	3	T	T	T	T	T	T	T	T	T	T	T	T	T	T	T	T	T	T
[1]	4	T	T	T	T	T	T	T	T	T	T	T	T	T	T	T	T	T	T
	5	T	T	T	T	T	T	T	T	T	T	T	T	T	T	T	T	T	T
	6	T	T	T	T	T	T	T	T	T	T	T	T	T	T	T	T	T	T
	10	10	T	10	T	T	T	T	T	T	T	T	T	T	T	T	T	T	T
	13	5	T	10	T	T	T	T	T	T	T	T	T	T	T	T	T	T	T
	15-16	0.6	T	5	T	10	T	T	T	T	T	T	T	T	T	T	T	T	T
	20		10	5	T	5	T	T	T	T	T	T	T	T	T	T	T	T	T
	25		5	0.8	10	5	T	T	T	T	T	T	T	T	T	T	T	T	T
	30-32		1.25	0.8	10	1	10	T	T	T	T	T	T	T	T	T	T	T	T
	40				10		10	T	T	T	T	T	T	T	T	T	T	T	T
	50				5		5	T	T	T	T	T	T	T	T	T	T	T	T
	63				5		2	T	T	T	T	T	T	T	T	T	T	T	T
C120 N/H	63							T	1.5	T	1.5	T	5	T	T	T	T	T	T
	80							T		T		2	T	T	T	T	T	T	T
1P1D or 2P2D	100 (N)							T		T			T	T	T	T	T	T	T
[1]	125 (N)							5		T			T	5	T	T	T	T	T
NG125 N/H/L	10	0.625	5	5	10	5	10	T	T	T	T	T	T	T	T	T	T	T	T
B-C-D Curves	16		1.25	0.8	10	5	10	T	T	T	T	T	T	T	T	T	T	T	T
	20				5	1	10	T	T	T	T	T	T	T	T	T	T	T	T
1P1D or 2P2D	25				5	1	5	10	T	T	T	T	T	T	T	T	T	T	T
[1]	32				1.6	1	5	5	T	10	T	10	T	T	T	T	T	T	T
	40						2	5	T	5	T	5	T	T	T	T	T	T	T
	50							1.25	T	5	T	5	T	10	T	T	T	T	T
	63								T	1.5	T	1.5	T	5	T	T	T	T	T
	80								T		T		2	T	T	T	T	T	T
	100 (N)								T		T			T	T	T	T	T	T
	125 (N)							5		T				T	5	T	T	T	T

[1] Type of circuit breaker (1P1D, 2P2D) depend on earthing system and circuit breaker ranges.
 For voltage up to 60Vdc one single pole of iC60 C120 NG125 NSX range is enough to break the current.
 For ranges with 3P or 4P breakers only (NSX250 for example), one or two poles only are used of a 3P circuit breaker.

[2] According to the voltage and nb of pole used, the breaking capacity can be changed.
 Selectivity limit is the minimum of the value indicated in the table and the breaking capacity of downstream circuit breaker.

[3] This table is applicable for Case 1, Case 2, Case 3, Case 4 defined in introduction with this voltage between + and -.
 Selectivity limits in this table for case 1 and Case 3 can also apply to system with higher voltage (up to 2 times) for the same circuit breaker (same number of poles used).

Compliance of circuit breakers according to voltage and earthing system shall be checked before using this table.

Selectivity Table

Upstream: ComPacT NSX400/630/1200 DC TM-DC

Downstream: ComPacT NSX100/160/250 DC TM-D, TM-DC, TM-G

Ue: 24-48-60 V DC ^[3]

Time constant: 1.5 ms - 25 ms

A

Upstream CB	NSX400DC F/S						NSX630DC F/S				NSX1200DC N							
	3P3D (1 or 2 P Used) ^[1]												2P2D					
Trip unit type	TM-DC						TM-DC				TM-DC							
Trip unit rating (A)	250		320		400		500		600		630		800		1000		1200	
I _m	min	max	min	max	min	max	min	max	min	max	min	max	min	max	min	max	min	max
I _m	625	1250	800	1600	1000	2000	1250	2500	1500	3000	1575	3150	2000	4000	2500	5000	3000	6000

Downstream CB	Rating	I _m	Selectivity limit (kA) ^[2]																		
NSX100DC	16	260	0.63	1.25	0.8	1.6	1	2	1.25	2.5	1.5	3	1.5	3.1	2	4	2.5	5	3	T	
	TM-D	25	400		1.25	0.8	1.6	1	2	1.25	2.5	1.5	3	1.5	3.1	2	4	2.5	5	3	10
		(TM-DC)	32	400			1.6	1	2	1.25	2.5	1.5	3	1.5	3.1	2	4	2.5	5	3	6
	1P1D or 2P2PD (3P3D)	40	700				1.6	1	2	1.25	2.5	1.5	3	1.5	3.1	2	4	2.5	5	3	6
		50	700				1.6	1	2	1.25	2.5	1.5	3	1.5	3.1	2	4	2.5	5	3	6
	^[1]	63	700				1.6	1	2	1.25	2.5	1.5	3	1.5	3.1	2	4	2.5	5	3	6
		80	800					1	2		2.5		3	1.5	3.1	2	4	2.5	5	3	6
		100	1000						2		2.5		3		3.1	2	4	2.5	5	3	6
NSX100DC	16	80	0.63	1.25	0.8	1.6	1	2	1.25	2.5	1.5	3	1.5	3.1	2	4	2.5	5	3	T	
	TM-G	25	100	0.63	1.25	0.8	1.6	1	2	1.25	2.5	1.5	3	1.5	3.1	2	4	2.5	5	3	10
	3P3P	40	100	0.63	1.25	0.8	1.6	1	2	1.25	2.5	1.5	3	1.5	3.1	2	4	2.5	5	3	6
	^[1]	63	150	0.63	1.25	0.8	1.6	1	2	1.25	2.5	1.5	3	1.5	3.1	2	4	2.5	5	3	6
		80	250	0.63	1.25	0.8	1.6	1	2		2.5		3	1.5	3.1	2	4	2.5	5	3	6
		100	400			0.8	1.6	1	2		2.5		3	1.5	3.1	2	4	2.5	5	3	6
NSX160DC	100	1000						2		2.5		3	1.5	3.1	2	4	2.5	5	3	6	
TM-DC	125	1200								2.5		3		3.1		4	2.5	5	3	6	
1P1D or 2P2PD	160	1250								2.5		3		3.1		4	2.5	5	3	6	
NSX160DC	125	530								2.5	1.5	3	1.5	3.1	2	4	2.5	5	3	6	
TM-G 3P3D	160	530								2.5	1.5	3	1.5	3.1	2	4	2.5	5	3	6	
NSX250DC	200	1000								2.5	1.5	3	1.5	3.1	2	4	2.5	5	3	6	
TM-DC		2000										3		3.1		4	2.5	5	3	6	
3P3D ^[1]	250	1250												3.1		4	2.5	5	3	6	
		2500													3.1		4		5	3	6
NSX250DC	200	530							1.25	2.5	1.5	3	1.5	3.1	2	4	2.5	5	3	6	
TM-G 3P3D	250	625							1.25	2.5	1.5	3	1.5	3.1	2	4	2.5	5	3	6	

[1] Type of circuit breaker (1P1D, 2P2D) depend on earthing system and circuit breaker ranges.
 For voltage up to 60Vdc one single pole of iC60 C120 NG125 NSX range is enough to break the current.
 For ranges with 3P or 4P breakers only (NSX250 for example), one or two poles only are used of a 3P circuit breaker.

[2] According to the voltage and nb of pole used, the breaking capacity can be changed.
 Selectivity limit is the minimum of the value indicated in the table and the breaking capacity of downstream circuit breaker.

[3] This table is applicable for Case 1, Case 2, Case 3, Case 4 defined in introduction with this voltage between + and -.
 Selectivity limits in this table for case 1 and Case 3 can also apply to system with higher voltage (up to 2 times) for the same circuit breaker (same number of poles used).

Compliance of circuit breakers according to voltage and earthing system shall be checked before using this table.

Selectivity Table

Upstream: MasterPacT NW DC

Downstream: iC60, C60H-DC, C120, NG125. ComPacT NSX100/160/250

Ue: 24-48-60 V DC^[3]

Time constant: 1.5 ms - 25 ms



Upstream CB	NW10DC -C N/H					NW10DC -C N/H					NW10DC -C N/H				
						NW20DC -C N/H					NW20DC -C N/H				
											NW40DC-C N/H				
2P2D															
Trip unit type	MicroLogic 1.0 DC														
	Range 1250/2500A					Range 2500/5400A					Range 5000/11000A				
Type	A	B	C	D	E	A	B	C	D	E	A	B	C	D	E
Setting	1250	1500	1600	2000	2500	2500	3300	4000	5000	5400	5000	8000	10000	11000	11000

Downstream	Rating	Im	Selectivity limit (kA) ^[2]													
iC60 N / H	0.5-63		T	T	T	T	T	T	T	T	T	T	T	T	T	T
C60H-DC	0.5-63		T	T	T	T	T	T	T	T	T	T	T	T	T	T
C120 N/H	63		T	T	T	T	T	T	T	T	T	T	T	T	T	T
	80		1.25	T	T	T	T	T	T	T	T	T	T	T	T	T
	100		1.25	1.5	T	T	T	T	T	T	T	T	T	T	T	T
	125		1.25	1.5	1.6	T	T	T	T	T	T	T	T	T	T	T
NG125 N/H/L B-C-D Curves	10-50		T	T	T	T	T	T	T	T	T	T	T	T	T	T
	63		T	T	T	T	T	T	T	T	T	T	T	T	T	T
	80		1.25	T	T	T	T	T	T	T	T	T	T	T	T	T
	100 (N)		1.25	1.5	T	T	T	T	T	T	T	T	T	T	T	T
	125 (N)		1.25	1.5	1.6	T	T	T	T	T	T	T	T	T	T	T
NSX100DC N/H TM-D	16	260	1.25	1.5	1.6	10	T	T	T	T	T	T	T	T	T	T
	25	400	1.25	1.5	1.6	5	10	10	T	T	T	T	T	T	T	T
	32	400	1.25	1.5	1.6	2	5	5	T	T	T	T	T	T	T	T
	40	700		1.5	1.6	2	2.5	2.5	10	T	T	T	T	T	T	T
	50	700		1.5	1.6	2	2.5	2.5	5	T	T	T	T	T	T	T
	63	700		1.5	1.6	2	2.5	2.5	3.3	T	T	T	T	T	T	T
TM-DC	80	800		1.5	1.6	2	2.5	2.5	3.3	4	T	T	T	T	T	T
	100	1000				2	2.5	2.5	3.3	4	5	T	T	T	T	T
NSX100DC TM-G	16	80	1.25	1.5	1.6	10	T	T	T	T	T	T	T	T	T	T
	25	100	1.25	1.5	1.6	5	10	10	T	T	T	T	T	T	T	T
	40	100		1.5	1.6	2	2.5	2.5	10	T	T	T	T	T	T	T
	63	150		1.5	1.6	2	2.5	2.5	3.3	T	T	T	T	T	T	T
	80	250		1.5	1.6	2	2.5	2.5	3.3	4	T	T	T	T	T	T
	100	400				2	2.5	2.5	3.3	4	5	T	T	T	T	T
NSX160DC TM-DC	100	1000				2	2.5	2.5	5	T	T	T	T	T	T	T
	125	1200					2.5	2.5	3.3	10	T	T	T	T	T	T
	160	1250					2.5	2.5	3.3	5	10	T	T	T	T	T
NSX160DC TM-G	125	530	1.25	1.5	1.6	2	2.5	2.5	3.3	10	T	T	T	T	T	T
	160	530	1.25	1.5	1.6	2	2.5	2.5	3.3	5	10	T	T	T	T	T
NSX250DC TM-DC	200	1000				2	2.5	2.5	5	T	T	T	T	T	T	T
		2000								5	T	T	T	T	T	T
	250	1250					2.5	2.5	3.3	5	10	T	T	T	T	T
		2500					2.5	3.3	4	5	T	T	T	T	T	T
NSX250DC TM-G	200	530	1.25	1.5	1.6	2	2.5	2.5	5	T	T	T	T	T	T	T
	250	625		1.5	1.6	2	2.5	2.5	3.3	5	10	T	T	T	T	T

- [1] Type of circuit breaker (1P1D, 2P2D) depend on earthing system and circuit breaker ranges.
For voltage up to 60Vdc one single pole of iC60 C120 NG125 NSX range is enough to break the current.
For ranges with 3P or 4P breakers only (NSX250 for example), one or two poles only are used of a 3P circuit breaker.
- [2] According to the voltage and nb of pole used, the breaking capacity can be changed.
Selectivity limit is the minimum of the value indicated in the table and the breaking capacity of downstream circuit breaker.
- [3] This table is applicable for Case 1, Case 2, Case 3, Case 4 defined in introduction with this voltage between + and -.
Selectivity limits in this table for case 1 and Case 3 can also apply to system with higher voltage (up to 2 times) for the same circuit breaker (same number of poles used).

Compliance of circuit breakers according to voltage and earthing system shall be checked before using this table.

Selectivity Table

Upstream: MasterPacT NW DC

Downstream: ComPacT NSX400/630/1200 DC, MasterPacT NW DC



Ue: 24-48-60 V DC ^[3]

Time constant: 1.5 ms - 25 ms

Upstream CB	NW10DC -C N/H					NW10DC -C N/H					NW10DC -C N/H				
						NW20DC -C N/H					NW20DC -C N/H				
											NW40DC-C N/H				
	2P2D														
Trip unit type	MicroLogic 1.0 DC														
	Range 1250/2500A					Range 2500/5400A					Range 5000/11000A				
Type	A	B	C	D	E	A	B	C	D	E	A	B	C	D	E
Setting	1250	1500	1600	2000	2500	2500	3300	4000	5000	5400	5000	8000	10000	11000	11000

Downstream CB	Rating	Im	Selectivity limit (kA) ^[2]															
NSX400DC	250	635	1.25	1.5	1.6	2	2.5	2.5	3.3	4	5	5.4	5	T	T	T	T	
	TM-DC	1250					2.5	2.5	3.3	4	5	5.4	5	T	T	T	T	
	3P3D ^[1]	320	800			1.6	2	2.5	2.5	3.3	4	5	5.4	5	T	T	T	T
			1600							3.3	4	5	5.4	5	10	T	T	T
		400	1000				2	2.5	2.5	3.3	4	5	5.4	5	10	T	T	T
	2000								4	5	5.4	5	10	T	T	T		
NSX630DC	500	1250						2.5	3.3	4	5	5.4	5	T	T	T	T	
	TM-DC	2500								5	5.4	5	10	T	T	T	T	
	3P3D ^[1]	600	1500							3.3	4	5	5.4	5	10	T	T	T
		3000											10	T	T	T	T	
NSX1200DC	630	1575							3.3	4	5	5.4	5	8	10	11	11	
	TM-DC	3150											8	10	11	11	11	
	3P3D ^[1]	800	2000								4	5	5.4	5	8	10	11	11
			4000											8	10	11	11	11
		1000	2500										5	8	10	11	11	11
			5000												10	11	11	11
		1200	3000											8	10	11	11	11
	6000														11	11	11	
NW DC-C	1000	1250							3.3	4	5	5.4	5	8	10	11	11	
		2500									5	5.4	5	8	10	11	11	
	1000/2000	2500									5	5.4	5	8	10	11	11	11
		5400													10	11	11	11
	1000/2000/4000	5000												10	11	11	11	
	11000																	

- [1] Type of circuit breaker (1P1D, 2P2D) depend on earthing system and circuit breaker ranges.
For voltage up to 60Vdc one single pole of iC60 C120 NG125 NSX range is enough to break the current.
For ranges with 3P or 4P breakers only (NSX250 for example), one or two poles only are used of a 3P circuit breaker.
- [2] According to the voltage and nb of pole used, the breaking capacity can changed.
Selectivity limit is the minimum of the value indicated in the table and the breaking capacity of downstream circuit breaker.
- [3] This table is applicable for Case 1, Case 2, Case 3, Case 4 defined in introduction with this voltage between + and -.
Selectivity limits in this table for case 1 and Case 3 can also apply to system with higher voltage (up to 2 times) for the same circuit breaker (same number of poles used).

Compliance of circuit breakers according to voltage and earthing system shall be checked before using this table.

Selectivity Table

Upstream: C60H-DC Curve C

Downstream: C60H-DC Curve C

Ue: 110-125 V DC [3]

Time constant: 1.5 ms - 25 ms



Upstream	C60H-DC, 1P or 2P [1]												
	Curve C												
In (A)	1	2	3	4	6	10	16	20	25	32	40	50	63

Downstream Circuit breaker	Curve	Rating (A)	Selectivity limit (A) [2]												
			1	2	3	4	6	10	16	20	25	32	40	50	63
C60H-DC 1P or 2P [1]	C	0.5	T	T	T	T	T	T	T	T	T	T	T	T	T
		1					250	T	T	T	T	T	T	T	T
		2						250	900	1800	11000	T	T	T	T
		3							300	500	700	1800	5000	T	T
		4										900	1300	3000	6000
		6												1200	1800
		≥ 10													

- [1] Type of circuit breaker (1P1D, 2P2D) depend on earthing system and circuit breaker ranges.
For voltage up to 60Vdc one single pole of iC60 C120 NG125 NSX range is enough to break the current.
For ranges with 3P or 4P breakers only (NSX250 for example), one or two poles only are used of a 3P circuit breaker.
- [2] According to the voltage and nb of pole used, the breaking capacity can be changed.
Selectivity limit is the minimum of the value indicated in the table and the breaking capacity of downstream circuit breaker.
- [3] This table is applicable for Case 1, Case 2, Case 3, Case 4 defined in introduction with this voltage between + and -.
Selectivity limits in this table for case 1 and Case 3 can also apply to system with higher voltage (up to 2 times) for the same circuit breaker (same number of poles used).

- T Total selectivity, up to the breaking capacity of the downstream circuit breaker.
- 500 Selectivity limit = 500 A.
- No selectivity.

Compliance of circuit breakers according to voltage and earthing system shall be checked before using this table.

Selectivity Table

Upstream: C120, NG125 Curves B, C, D

Downstream: C60H-DC Curve C

Ue: 110-125 V DC ^[3]

Time constant: 1.5 ms - 25 ms

A

Upstream		C120N/H/L, NG125N/H/L, 1P or 2P ^[1]										
		Curve B										
In (A)		10	16	20	25	32	40	50	63	80	100	125

Downstream Circuit breaker	Curve	Rating (A)	Selectivity limit (A) ^[2]										
C60H-DC 1P or 2P ^[1]	C	0.5	500	T	T	T	T	T	T	T	T	T	T
		1		450	T	T	T	T	T	T	T	T	T
		2			500	800	2500	T	T	T	T	T	T
		3						2400	4000	5000	T	T	T
		4						800	1000	1500	5000	T	T
		6									1800	3000	7000
		10										1500	3500
		16											2500
		≥ 20											

Upstream		C120N/H/L, NG125N/H/L, 1P or 2P ^[1]										
		Curve C										
In (A)		10	16	20	25	32	40	50	63	80	100	125

Downstream Circuit breaker	Curve	Rating (A)	Selectivity limit (A) ^[2]										
C60H-DC 1P or 2P ^[1]	C	0.5	T	T	T	T	T	T	T	T	T	T	T
		1	1000	T	T	T	T	T	T	T	T	T	T
		2		5000	T	T	T	T	T	T	T	T	T
		3			1800	T	T	T	T	T	T	T	T
		4				1300	5500	12000	T	T	T	T	T
		6					2400	3000	6000	7000	12000	T	T
		10								3500	5500	8500	T
		16										5500	9000
		20											6000
		≥ 25											5000

Upstream		C120N/H/L, NG125N/H/L, 1P or 2P ^[1]										
		Curve D										
In (A)		10	16	20	25	32	40	50	63	80	100	125

Downstream Circuit breaker	Curve	Rating (A)	Selectivity limit (A) ^[2]										
C60H-DC 1P or 2P ^[1]	C	≤ 1	T	T	T	T	T	T	T	T	T	T	T
		2	2500	6000	T	T	T	T	T	T	T	T	T
		3	700	1500	7000	T	T	T	T	T	T	T	T
		4			1800	10000	12000	T	T	T	T	T	T
		6				2500	3000	4000	6000	7000	T	T	T
		10							2000	3000	T	T	T
		16									9000	T	T
		20									5000	T	T
		25										10000	T
		32										5000	12000
40											6000		
≥ 50													

[1] Type of circuit breaker depend on earthing system and circuit breaker ranges (see Distribution guide direct current CA908061).
 [2] According to the voltage and number of pole used, the breaking capacity can be changed. Selectivity limit is the minimum of the value indicated in the table and the breaking capacity of downstream circuit breaker.
 [3] This table is applicable for Case 1, Case 2, Case 3, Case 4 defined in introduction with this voltage between + and - Selectivity limits in this table for Case 1 and Case 3 can also apply to system with higher voltage (up to 2 times) for the same circuit breaker (same number of poles used).

- T Total selectivity, up to the breaking capacity of the downstream circuit breaker.
- 500 Selectivity limit = 500 A.
- No selectivity.

Compliance of circuit breakers according to voltage and earthing system shall be checked before using this table.

Selectivity Table

Upstream: ComPacT NSX100/160/250 DC TM-DC

Downstream: iC60, C60H-DC, C120, NG125

Ue: 110-125 V DC [3]

Time constant: 1.5 ms - 25 ms



Upstream CB	NSX100DC								NSX160DC			NSX250 DC				
	1P1D 2P2D F/N/M/S 3P3D F/S [1]											3P3D (1 or 2 P used) F/S [1]				
Trip unit type	TMD, TM-DC								TMD, TM-DC			TM-DC				
Trip unit rating (A)	16	25	32	40	50	63	80	100	100	125	160	160	200		250	
Im	fixed	fixed	fixed	fixed	fixed	fixed	fixed	fixed	fixed	fixed	fixed	fixed	Mini	Maxi	Mini	Maxi
	260	400	550	700	700	700	800	800	800	1250	1250	1250	1000	2000	1250	2500

Downstream	Rating	Selectivity limit (kA) [2]															
iC60 N/H/L B-C-D Curves	0.5	T	T	T	T	T	T	T	T	T	T	T	T	T	T	T	T
	1	T	T	T	T	T	T	T	T	T	T	T	T	T	T	T	T
	2	10	T	T	T	T	T	T	T	T	T	T	T	T	T	T	T
	3	5	10	T	T	T	T	T	T	T	T	T	T	T	T	T	T
	4	0.26	5	T	T	T	T	T	T	T	T	T	T	T	T	T	T
	5		0.4	10	10	T	T	T	T	T	T	T	T	T	T	T	T
	6			5	5	10	T	T	T	T	T	T	T	T	T	T	T
	10			0.55	0.7	5	T	T	T	T	T	T	T	T	T	T	T
	2x (1P1D or 2P2D) [1] (2 Poles in serie)	13				0.7	T	T	T	T	T	T	T	T	T	T	T
		15-16					5	T	T	T	T	T	T	T	T	T	T
		20					0.7	10	10	10	T	T	T	T	T	T	T
		25						5	10	10	T	T	T	T	T	T	T
		32							0.8	10	10	T	T	T	10	T	T
		40								5	5	10	T	T	5	T	T
50									0.8	0.8	10	10	10		T	10	
63											5	10	5		T	5	
C60H-DC C Curves	0.5	5	T	T	T	T	T	T	T	T	T	T	T	T	T	T	
	1	5	10	T	T	T	T	T	T	T	T	T	T	T	T	T	
	2	0.26	5	10	T	T	T	T	T	T	T	T	T	T	T	T	
	1P1D or 2P2D [1]	3		0.4	5	10	T	T	T	T	T	T	T	T	T	T	T
		4			0.5	5	10	T	T	T	T	T	T	T	T	T	T
	5				0.7	5	T	T	T	T	T	T	T	T	T	T	
	6					5	10	T	T	T	T	T	T	T	T	T	
	10					0.7	5	10	T	T	T	T	T	T	T	T	
	13						0.7	5	10	10	T	T	T	10	T	T	
	15-16							0.8	10	10	T	T	T	10	T	T	
	20								5	5	T	T	T	5	T	T	
	25								0.8	0.8	10	T	T	0.8	T	T	
	30-32										5	10	10		T	10	
	40											5	5		T	5	
50														10	T		
63														5	T		
C120 N/H B-C-D Curves	63										1.25	1.25		5	10	T	
	80													2		T	
	1P1D or 2P2D [1]	100													2		T
		125															T
NG125 N/H/L B-C-D Curves	10		0.4	0.5	0.7	0.7	0.7	0.8	0.8	0.8	10	10	10	5	T	T	
	1P1D or 2P2D [1]	16			0.5	0.7	0.7	0.7	0.8	0.8	0.8	10	10	10	1	T	T
		20				0.7	0.7	0.7	0.8	0.8	0.8	10	10	10	1	T	T
	25						0.7	0.8	0.8	0.8	5	10	10	1	T	T	
	32							0.8	0.8	0.8	0.8	1.25	5	5	1	T	
	40								0.8	0.8	1.25	1.25	1.25	1	10	T	
	50										1.25	1.25	1.25	1	5	T	
	63											1.25	1.25		5	10	
	80														2	T	
	100 (N)														2	T	
	125 (N)															T	

[1] Type of circuit breaker (1P1D, 2P2D) depend on earthing system and circuit breaker ranges.
 For voltage up to 60Vdc one single pole of iC60 C120 NG125 NSX range is enough to break the current.
 For ranges with 3P or 4P breakers only (NSX250 for example), one or two poles only are used of a 3P circuit breaker.

[2] According to the voltage and nb of pole used, the breaking capacity can changed.
 Selectivity limit is the minimum of the value indicated in the table and the breaking capacity of downstream circuit breaker.

[3] This table is applicable for Case 1, Case 2, Case 3, Case 4 defined in introduction with this voltage between + and -.
 Selectivity limits in this table for case 1 and Case 3 can also apply to system with higher voltage (up to 2 times) for the same circuit breaker (same number of poles used).

Compliance of circuit breakers according to voltage and earthing system shall be checked before using this table.

Selectivity Table

Upstream: ComPacT NSX100/160/250 DC with Parallel Connection of Poles

Downstream: iC60, C60H-DC, C120, NG125

Ue: 110-125 V DC [3]

Time constant: 1.5 ms - 25 ms

A

Upstream CB	NSX 100DC F				NSX 160DC F		NSX 250 DC F		NSX 100DC F			NSX 160DC F		NSX 250 DC F			
	2P2D				3P3D 2P used				4P4D								
	Parallel connection for + or -						Parallel connection for + or -		2 poles with parallel connection for + and - [2]								
Trip unit type	TM-D, TM-DC				TM-DC				TM-D, TM-DC				TM-DC				
Trip unit rating (A)	50	63	80	125	160	200	50	63	80	125	160	200	50	63	80	125	
Equivalent rated current	125	158	200	313	400	500	115	145	184	288	368	460	115	145	184	288	
Im	fixed	fixed	fixed	fixed	fixed	Mini	Maxi	fixed	fixed	fixed	fixed	fixed	Mini	Maxi	fixed	Mini	Maxi
	1400	1400	1600	2500	2500	2000	4000	1400	1400	1600	2500	2500	2000	4000	1400	1400	1600

Downstream	Rating	Selectivity limit (kA) [2]															
iC60 N/H/L B-C-D Curves	0.5	T	T	T	T	T	T	T	T	T	T	T	T	T	T	T	
	1	T	T	T	T	T	T	T	T	T	T	T	T	T	T	T	
	2	T	T	T	T	T	T	T	T	T	T	T	T	T	T	T	
	3	T	T	T	T	T	T	T	T	T	T	T	T	T	T	T	
	4	T	T	T	T	T	T	T	T	T	T	T	T	T	T	T	
	5	T	T	T	T	T	T	T	T	T	T	T	T	T	T	T	
	6	T	T	T	T	T	T	T	T	T	T	T	T	T	T	T	
	10	T	T	T	T	T	T	T	T	T	T	T	T	T	T	T	
	2x (1P1D or 2P2D) [1] (2 Poles in serie)	13	T	T	T	T	T	T	T	T	T	T	T	T	T	T	T
		15-16	T	T	T	T	T	T	T	v	T	T	T	T	T	T	T
		20	10	T	T	T	T	T	T	10	T	T	T	T	T	T	T
		25	5	T	T	T	T	T	T	5	T	T	T	T	T	T	T
		32	0.8	T	T	T	T	T	T	0.8	T	T	T	T	T	T	T
40			10	T	T	T	T	T		10	T	T	T	T	T	T	
50			10	10	T	T	10	T		10	10	T	T	10	T	T	
63		5	10	T	T	5	T		5	10	T	T	5	10	T		
C60H-DC C Curves	0.5	T	T	T	T	T	T	T	T	T	T	T	T	T	T	T	
	1	T	T	T	T	T	T	T	T	T	T	T	T	T	T	T	
	2	T	T	T	T	T	T	T	T	T	T	T	T	T	T	T	
	1P1D or 2P2D [1]	3	T	T	T	T	T	T	T	T	T	T	T	T	T	T	T
		4	T	T	T	T	T	T	T	T	T	T	T	T	T	T	T
	5	T	T	T	T	T	T	T	T	T	T	T	T	T	T	T	
	6	T	T	T	T	T	T	T	T	T	T	T	T	T	T	T	
	10	10	T	T	T	T	T	T	10	T	T	T	T	T	T	T	
	13	5	T	T	T	T	T	T	5	T	T	T	T	T	T	T	
	15-16	0.8	T	T	T	T	T	T	0.8	T	T	T	T	T	T	T	
	20		T	T	T	T	T	T		T	T	T	T	T	T	T	
	25		10	T	T	T	T	T		10	T	T	T	T	T	T	
	30-32		5	10	T	T	10	T		5	10	T	T	10	T	T	
40			5	T	T	5	T			5	T	T	5	T	T		
50				10	T	T	T				10	T	T	T	T		
63				5	T	T	T				5	T	T	T	T		
C120 N/H B-C-D Curves	63			1.25	T	T	10	T			1.25	T	T	10	T	T	
	80				T	T	T	T				T	T	T	T	T	
	100				T	T	T	T				T	T	T	T	T	
	125				T	T	T	T				T	T	T	T	T	
NG125 N/H/L B-C-D Curves	10	0.8	10	10	T	T	T	T	0.8	10	10	T	T	T	T	T	
	16	0.8	10	10	T	T	T	T	0.8	10	10	T	T	T	T	T	
	20	0.8	10	10	T	T	T	T	0.8	10	10	T	T	T	T	T	
	25	0.8	5	10	T	T	T	T	0.8	5	10	T	T	T	T	T	
	32	0.8	1.25	5	T	T	T	T	0.8	1.25	5	T	T	T	T	T	
	40		1.25	1.25	T	T	T	T		1.25	1.25	T	T	T	T	T	
	50		1.25	1.25	T	T	T	T		1.25	1.25	T	T	T	T	T	
	63			1.25	T	T	10	T			1.25	T	T	10	T	T	
	80				T	T	T	T				T	T	T	T	T	
	100 (N)				T	T	T	T				T	T	T	T	T	
	125 (N)				T	T	T	T				T	T	T	T	T	

[1] Type of circuit breaker (1P1D, 2P2D) depend on earthing system and circuit breaker ranges.
 For voltage up to 60Vdc one single pole of iC60 C120 NG125 NSX range is enough to break the current.
 For ranges with 3P or 4P breakers only (NSX250 for example), one or two poles only are used of a 3P circuit breaker.

[2] According to the voltage and nb of pole used, the breaking capacity can be changed.
 Selectivity limit is the minimum of the value indicated in the table and the breaking capacity of downstream circuit breaker.

[3] This table is applicable for Case 1, Case 2, Case 3, Case 4 defined in introduction with this voltage between + and -.
 Selectivity limits in this table for case 1 and Case 3 can also apply to system with higher voltage (up to 2 times) for the same circuit breaker (same number of poles used).

Compliance of circuit breakers according to voltage and earthing system shall be checked before using this table.

Selectivity Table

Upstream: ComPacT NSX100/160/250DC TM-G

Downstream: iC60, C60H-DC, NG125

Ue: 110-125 V DC [3]

Time constant: 1.5 ms - 25 ms



Upstream CB	NSX100DC						NSX160DC			NSX250 DC		
	3P3D (1 or 2 P used) F/S [1]											
Trip unit type	TM-G						TM-G			TM-G		
Trip unit rating	16	25	40	63	80	100	100	125	160	160	200	250
Im	80	100	100	150	250	400	400	530	530	530	530	625

Downstream	In	Selectivity limit (kA) [2]												
iC60 N/H/L B-C-D Curves	0.5	10	10	10	T	T	T	T	T	T	T	T	T	
	1	5	5	5	T	T	T	T	T	T	T	T	T	
	2	0.08	0.1	0.1	10	T	T	T	T	T	T	T	T	
	3			0.1	5	10	T	T	T	T	T	T	T	
	4				0.15	5	10	10	T	T	T	T	T	
	2x(1P1D or 2P2D) [1]	5				0.25	5	5	T	T	T	T	T	
		6					0.4	0.4	T	T	T	T	T	
		(2 Poles in serie)	10							10	10	10	10	T
			13							5	5	5	5	10
			15-16							5	5	5	5	5
			20							5	5	5	5	5
			25							0.5	0.5	0.5	0.5	5
			32											0.6
			40											
50														
63														
C60H-DC C Curves	0.5	5	5	5	10	T	T	T	T	T	T	T	T	
	1	0.08	0.1	0.1	5	10	T	T	T	T	T	T	T	
	2		0.1	0.1	0.15	5	10	10	T	T	T	T	T	
	3			0.1	0.15	0.25	5	5	T	T	T	T	T	
	4				0.15	0.25	0.4	0.4	T	T	T	T	T	
	5					0.25	0.4	0.4	T	T	T	T	T	
	6						0.4	0.4	10	10	10	10	T	
	10								10	10	10	10	10	
	13								5	5	5	5	10	
	15-16								0.5	0.5	0.5	0.5	5	
	20								0.5	0.5	0.5	0.5	0.6	
	25									0.5	0.5	0.5	0.6	
	30-32												0.6	
	40													
50														
63														
NG125 N/H/L B-C-D Curves	10					0.25	0.4	0.4	0.5	0.5	0.5	0.5	0.6	
	16						0.4	0.5	0.5	0.5	0.5	0.5	0.6	
	1P1D or 2P2D [1]	20								0.5	0.5	0.5	0.5	0.6
		25												0.6
		32												
		40												

[1] Type of circuit breaker (1P1D, 2P2D) depend on earthing system and circuit breaker ranges.
 For voltage up to 60Vdc one single pole of iC60 C120 NG125 NSX range is enough to break the current.
 For ranges with 3P or 4P breakers only (NSX250 for example), one or two poles only are used of a 3P circuit breaker.

[2] According to the voltage and nb of pole used, the breaking capacity can changed.
 Selectivity limit is the minimum of the value indicated in the table and the breaking capacity of downstream circuit breaker.

[3] This table is applicable for Case 1, Case 2, Case 3, Case 4 defined in introduction with this voltage between + and -.
 Selectivity limits in this table for case 1 and Case 3 can also apply to system with higher voltage (up to 2 times) for the same circuit breaker (same number of poles used).

Compliance of circuit breakers according to voltage and earthing system shall be checked before using this table.

Selectivity Table

Upstream: ComPacT NSX100/160/250 DC TM-D, TM-DC

Downstream: ComPacT NSX100/160 DC TM-D, TM-DC, TM-G

Ue: 110-125 V DC ^[3]

Time constant: 1.5 ms - 25 ms

A

Upstream CB	NSX100 DC								NSX160 DC				NSX250 DC				
	1P1D 2P2D F/N/M/S (3P3D F/S) ^[1]												3P3D (1 or 2 P Used) F/S ^[1]				
Trip unit type	TM-D								TM-D, TM-DC				TM-DC				
Trip unit rating (A)	16	25	32	40	50	63	80	100	80	100	125	160	160	200		250	
	fixed	fixed	fixed	fixed	fixed	fixed	fixed	fixed	fixed	fixed	fixed	fixed	fixed	Mini	Maxi	Mini	Maxi
I _m	260	400	550	700	700	700	640	800	640	800	1250	1250	1250	1000	2000	1250	2500

Downstream Rating I _m CB			Selectivity limit (kA) ^[2]																	
NSX100DC TM-D (TM-DC) 1P1D or 2P2D (3P3D) ^[1]	16	260			0.5	0.7	0.7	0.7	0.7	0.8	0.7	0.8	1.25	1.25	1.25	1	2	1.25	5	
	25	400				0.7	0.7	0.7	0.7	0.8	0.7	0.8	1.25	1.25	1.25	1	2	1.25	5	
	32	400						0.7	0.7	0.8	0.7	0.8	1.25	1.25	1.25	1	2	1.25	5	
	40	700							0.7	0.8	0.7	0.8	1.25	1.25	1.25	1	2	1.25	2.5	
	50	700								0.7	0.8	0.7	0.8	1.25	1.25	1.25	1	2	1.25	2.5
	63	700									0.8		0.8	1.25	1.25	1.25	1	2	1.25	2.5
	80	800												1.25	1.25	1.25	1	2	1.25	2.5
	100	1000											1.25	1.25	1.25	1	2	1.25	2.5	
NSX100DC TM-G 3P3D ^[1]	16	80			0.5	0.7	0.7	0.7	0.7	0.8	0.7	0.8	1.25	1.25	1.25	1	2	1.25	10	
	25	100				0.7	0.7	0.7	0.7	0.8	0.7	0.8	1.25	1.25	1.25	1	2	1.25	5	
	40	100							0.7	0.8	0.7	0.8	1.25	1.25	1.25	1	2	1.25	5	
	63	150								0.7	0.8		0.8	1.25	1.25	1.25	1	2	1.25	5
	80	250									0.8			1.25	1.25	1.25	1	2	1.25	2.5
	100	400											1.25	1.25	1.25	1	2	1.25	2.5	
NSX160DC 1P1D or 2P2D 3P2D ^[1]	100	1000											1.25	1.25	1.25	1	2	1.25	2.5	
	125	1200																1.25	2.5	
	160	1250																		
NSX160DC	125	530																1.25	2.5	
TM-G 3P3D ^[1]	160	530																		

[1] Type of circuit breaker (1P1D, 2P2D) depend on earthing system and circuit breaker ranges.
 For voltage up to 60Vdc one single pole of iC60 C120 NG125 NSX range is enough to break the current.
 For ranges with 3P or 4P breakers only (NSX250 for example), one or two poles only are used of a 3P circuit breaker.

[2] According to the voltage and nb of pole used, the breaking capacity can be changed.
 Selectivity limit is the minimum of the value indicated in the table and the breaking capacity of downstream circuit breaker.

[3] This table is applicable for Case 1, Case 2, Case 3, Case 4 defined in introduction with this voltage between + and -.
 Selectivity limits in this table for Case 1 and Case 3 can also apply to system with higher voltage (up to 2 times) for the same circuit breaker (same number of poles used).

Compliance of circuit breakers according to voltage and earthing system shall be checked before using this table.

Selectivity Table

Upstream: ComPacT NSX400/630/1200 DC TM-DC

Downstream: iC60, C60H-DC, C120, NG125

Ue: 110-125 V DC [3]

Time constant: 1.5 ms - 25 ms



Upstream CB	NSX400DC F/S						NSX630DC F/S				NSX1200DC N							
	3P3D (1 or 2 P Used) [1]										2P2D							
Trip unit type	TM-DC						TM-DC				TM-DC							
Trip unit rating (A)	250		320		400		500		600		630		800		1000		1200	
	min	max	min	max	min	max	min	max	min	max	min	max	min	max	min	max	min	max
Im	625	1250	800	1600	1000	2000	1250	2500	1500	3000	1575	3150	2000	4000	2500	5000	3000	6000

Downstream	Rating	Selectivity limit (kA) [2]																	
iC60 N/H/L B-C-D Curves 2x (1P1D or 2P2D) [1]	0.5	T	T	T	T	T	T	T	T	T	T	T	T	T	T	T	T	T	T
	1	T	T	T	T	T	T	T	T	T	T	T	T	T	T	T	T	T	T
	2	T	T	T	T	T	T	T	T	T	T	T	T	T	T	T	T	T	T
	3	T	T	T	T	T	T	T	T	T	T	T	T	T	T	T	T	T	T
	4	T	T	T	T	T	T	T	T	T	T	T	T	T	T	T	T	T	T
	5	T	T	T	T	T	T	T	T	T	T	T	T	T	T	T	T	T	T
	6	T	T	T	T	T	T	T	T	T	T	T	T	T	T	T	T	T	T
	10	10	T	10	T	T	T	T	T	T	T	T	T	T	T	T	T	T	T
	13	5	T	10	T	T	T	T	T	T	T	T	T	T	T	T	T	T	T
	15-16	0.6	T	5	T	10	T	T	T	T	T	T	T	T	T	T	T	T	T
	20		10	5	T	5	T	T	T	T	T	T	T	T	T	T	T	T	T
	25		5	0.8	10	5	T	T	T	T	T	T	T	T	T	T	T	T	T
	32		1.25	0.8	10	1	10	T	T	T	T	T	T	T	T	T	T	T	T
	40				10		10	T	T	T	T	T	T	T	T	T	T	T	T
	50				5		5	T	T	T	T	T	T	T	T	T	T	T	T
63				5		2	T	T	T	T	T	T	T	T	T	T	T	T	
C60H-DC C Curve 1P1D or 2P2D [1]	0.5	T	T	T	T	T	T	T	T	T	T	T	T	T	T	T	T	T	T
	1	T	T	T	T	T	T	T	T	T	T	T	T	T	T	T	T	T	T
	2	T	T	T	T	T	T	T	T	T	T	T	T	T	T	T	T	T	T
	3	T	T	T	T	T	T	T	T	T	T	T	T	T	T	T	T	T	T
	4	15	T	T	T	T	T	T	T	T	T	T	T	T	T	T	T	T	T
	5	10	T	T	T	T	T	T	T	T	T	T	T	T	T	T	T	T	T
	6	5	T	15	T	15	T	T	T	T	T	T	T	T	T	T	T	T	T
	10	0.6	T	10	T	10	T	T	T	T	T	T	T	T	T	T	T	T	T
	13		15	5	T	5	T	T	T	T	T	T	T	T	T	T	T	T	T
	15-16		5	0.8	15	5	15	T	T	T	T	T	T	T	T	T	T	T	T
	20		1.25		10	5	10	T	T	T	T	T	T	T	T	T	T	T	T
	25				10	1	10	T	T	T	T	T	T	T	T	T	T	T	T
	30-32				5	1	10	T	T	T	T	T	T	T	T	T	T	T	T
	40				5	1	5	T	T	T	T	T	T	T	T	T	T	T	T
	50				5	1	5	10	T	T	T	T	T	T	T	T	T	T	T
63				5	1	5	10	T	T	T	T	T	T	T	T	T	T	T	
C120 N/H B-C-D Curves 1P1D or 2P2D [1]	63									T		T		T		2.5	T	T	T
	80							5		T		T		T			T	T	T
	100 (N)							5		10		10		10			T	T	T
125 (N)							5		5		5		5			T	T	T	
NG125 N/H/L B-C-D Curves 1P1D or 2P2D [1]	10	0.625	1.25	0.8	1.6	1	5	T	T	10	T	10	T	T	T	T	T	T	T
	16				1.6	1	2	5	T	5	T	5	T	T	T	T	T	T	T
	20						2	1.25	T	1.5	T	1.5	T	T	T	T	T	T	T
	25								T		T		T	10	T	T	T	T	T
	32								T		T		T	5	T	10	T	T	T
	40								T		T		T	2	T	5	T	T	T
	50								T		T		T	2	T	2.5	T	T	T
	63								T		T		T		T	2.5	T	T	T
	80								5		T		T		T		T	T	T
	100 (N)								5		10		10		10		T	T	T
	125 (N)								5		5		5		5		T	T	T

[1] Type of circuit breaker (1P1D, 2P2D) depend on earthing system and circuit breaker ranges.
 For voltage up to 60Vdc one single pole of iC60 C-120 NG125 NSX range is enough to break the current.
 For ranges with 3P or 4P breakers only (NSX250 for example), one or two poles only are used of a 3P circuit breaker.

[2] According to the voltage and nb of pole used, the breaking capacity can be changed.
 Selectivity limit is the minimum of the value indicated in the table and the breaking capacity of downstream circuit breaker.

[3] This table is applicable for Case 1, Case 2, Case 3, Case 4 defined in introduction with this voltage between + and -.
 Selectivity limits in this table for case 1 and Case 3 can also apply to system with higher voltage (up to 2 times) for the same circuit breaker (same number of poles used).

Compliance of circuit breakers according to voltage and earthing system shall be checked before using this table.

Selectivity Table

Upstream: ComPacT NSX400/630/1200 DC TM-DC

Downstream: ComPacT NSX100/160/250 DC, TM-D, TM-DC, TM-G

U_e: 110-125 V DC ^[3]

Time constant: 1.5 ms - 25 ms

A

Upstream CB	NSX400DC F/S						NSX630DC F/S				NSX1200DC N							
Trip unit type	TM-DC						TM-DC				TM-DC							
Trip unit rating (A)	250		320		400		500		600		630		800		1000		1200	
	min	max	min	max	min	max	min	max	min	max	min	max	min	max	min	max	min	max
I _m	625	1250	800	1600	1000	2000	1250	2500	1500	3000	1575	3150	2000	4000	2500	5000	3000	6000

Downstream Rating CB	Selectivity limit (kA) ^[2]																			
NSX100DC	16	260	0.63	1.25	0.8	1.6	1	2	1.25	2.5	1.5	3	1.5	3.1	2	4	2.5	5	3	T
TM-D	25	400	0.63	1.25	0.8	1.6	1	2	1.25	2.5	1.5	3	1.5	3.1	2	4	2.5	5	3	10
(TM-DC)	32	400		1.25	0.8	1.6	1	2	1.25	2.5	1.5	3	1.5	3.1	2	4	2.5	5	3	6
1P1D or 2P2PD	40	700			0.8	1.6	1	2	1.25	2.5	1.5	3	1.5	3.1	2	4	2.5	5	3	6
(3P3D)	50	700				1.6	1	2	1.25	2.5	1.5	3	1.5	3.1	2	4	2.5	5	3	6
^[1]	63	700					1	2	1.25	2.5	1.5	3	1.5	3.1	2	4	2.5	5	3	6
	80	800						2		2.5		3	1.5	3.1	2	4	2.5	5	3	6
	100	1000						2		2.5		3		3.1	2	4	2.5	5	3	6
NSX100DC	16	80	0.63	1.25	0.8	1.6	1	2	1.25	2.5	1.5	3	1.5	3.1	2	4	2.5	5	3	T
TM-G	25	100	0.63	1.25	0.8	1.6	1	2	1.25	2.5	1.5	3	1.5	3.1	2	4	2.5	5	3	10
3P3P	40	100			0.8	1.6	1	2	1.25	2.5	1.5	3	1.5	3.1	2	4	2.5	5	3	6
^[1]	63	150					1	2	1.25	2.5	1.5	3	1.5	3.1	2	4	2.5	5	3	6
	80	250						2		2.5		3	1.5	3.1	2	4	2.5	5	3	6
	100	400						2		2.5		3	1.5	3.1	2	4	2.5	5	3	6
NSX160DC	100	1000						2		2.5		3	1.5	3.1	2	4	2.5	5	3	6
TM-DC	125	1200								2.5		3		3.1		4	2.5	4	3	6
1P1D or 2P2PD	160	1250								2.5		3		3.1		4	2.5	4	3	6
NSX160DC	125	530								2.5	1.5	3	1.5	3.1	2	4	2.5	4	3	6
TM-G 3P3D	160	530								2.5	1.5	3	1.5	3.1	2	4	2.5	4	3	6
NSX250DC	200	1000								2.5	1.5	3	1.5	3.1	2	4	2.5	4	3	6
TM-DC		2000										3		3.1		4	2.5	4	3	6
3P3D ^[1]	250	1250												3.1		4	2.5	4	3	6
		2500												3.1		4		4	3	6
NSX250DC	200	530							1.25	2.5	1.5	3	1.5	3.1	2	4	2.5	4	3	6
TM-G 3P3D	250	625							1.25	2.5	1.5	3	1.5	3.1	2	4	2.5	4	3	6

[1] Type of circuit breaker (1P1D, 2P2D) depend on earthing system and circuit breaker ranges.
 For voltage up to 60Vdc one single pole of iC60 C120 NG125 NSX range is enough to break the current.
 For ranges with 3P or 4P breakers only (NSX250 for example), one or two poles only are used of a 3P circuit breaker.

[2] According to the voltage and nb of pole used, the breaking capacity can changed.
 Selectivity limit is the minimum of the value indicated in the table and the breaking capacity of downstream circuit breaker.

[3] This table is applicable for Case 1, Case 2, Case 3, Case 4 defined in introduction with this voltage between + and -.
 Selectivity limits in this table for case 1 and Case 3 can also apply to system with higher voltage (up to 2 times) for the same circuit breaker (same number of poles used).

Compliance of circuit breakers according to voltage and earthing system shall be checked before using this table.

Selectivity Table

Upstream: MasterPacT NW DC

Downstream: iC60, C60H-DC, C120, NG125. ComPacT NSX100/160/250

Ue: 110-125 V DC ^[3]

Time constant: 1.5 ms - 25 ms



Upstream CB	NW10DC -C N/H					NW10DC -C N/H					NW10DC -C N/H				
	NW20DC -C N/H										NW20DC -C N/H				
	NW40DC-C N/H														
2P2D															
Trip unit type	MicroLogic 1.0 DC														
	Range 1250/2500A					Range 2500/5400A					Range 5000/11000A				
Type	A	B	C	D	E	A	B	C	D	E	A	B	C	D	E
Setting	1250	1500	1600	2000	2500	2500	3300	4000	5000	5400	5kA	8kA	10kA	11kA	11kA

Downstream	Rating	Im	Selectivity limit (kA) ^[2]														
iC60 N/H/L 2x (1P1D or 2P2D) ^[1]	0.5-63		T	T	T	T	T	T	T	T	T	T	T	T	T	T	
C60H-DC ^[1]	0.5-63		T	T	T	T	T	T	T	T	T	T	T	T	T	T	
C120 N/H	63		T	T	T	T	T	T	T	T	T	T	T	T	T	T	
1P1D or 2P2D ^[1]	80		1.25	T	T	T	T	T	T	T	T	T	T	T	T	T	
	100		1.25	1.5	T	T	T	T	T	T	T	T	T	T	T	T	
	125		1.25	1.5	1.6	T	T	T	T	T	T	T	T	T	T	T	
NG125 N/H/L B-C-D Curves	10-50		T	T	T	T	T	T	T	T	T	T	T	T	T	T	
	63		T	T	T	T	T	T	T	T	T	T	T	T	T	T	
	80		1.25	T	T	T	T	T	T	T	T	T	T	T	T	T	
	100 (N)		1.25	1.5	T	T	T	T	T	T	T	T	T	T	T	T	
1P1D or 2P2D ^[1]	125 (N)		1.25	1.5	1.6	T	T	T	T	T	T	T	T	T	T	T	
	16	260	1.25	1.5	1.6	10	T	T	T	T	T	T	T	T	T	T	
	TM-D	25	400	1.25	1.5	1.6	5	10	10	T	T	T	T	T	T	T	T
		32	400	1.25	1.5	1.6	2	5	5	T	T	T	T	T	T	T	T
40		700		1.5	1.6	2	2.5	2.5	10	T	T	T	T	T	T	T	
50		700		1.5	1.6	2	2.5	2.5	5	T	T	T	T	T	T	T	
TM-DC	63	700		1.5	1.6	2	2.5	2.5	3.3	T	T	T	T	T	T	T	
	80	800		1.5	1.6	2	2.5	2.5	3.3	4	T	T	T	T	T	T	
	100	1000				2	2.5	2.5	3.3	4	5	T	T	T	T	T	
NSX100DC TM-G	16	80	1.25	1.5	1.6	10	T	T	T	T	T	T	T	T	T	T	
	25	100	1.25	1.5	1.6	5	10	10	T	T	T	T	T	T	T	T	
	40	100		1.5	1.6	2	2.5	2.5	10	T	T	T	T	T	T	T	
	63	150		1.5	1.6	2	2.5	2.5	3.3	T	T	T	T	T	T	T	
	80	250		1.5	1.6	2	2.5	2.5	3.3	4	T	T	T	T	T	T	
NSX160DC TM-DC	100	400				2	2.5	2.5	3.3	4	5	T	T	T	T	T	
	100	1000				2	2.5	2.5	5	T	T	T	T	T	T	T	
	125	1200					2.5	2.5	3.3	10	T	T	T	T	T	T	
NSX160DC TM-G	160	1250					2.5	2.5	3.3	5	10	T	T	T	T	T	
	125	530	1.25	1.5	1.6	2	2.5	2.5	3.3	10	T	T	T	T	T	T	
	160	530	1.25	1.5	1.6	2	2.5	2.5	3.3	5	10	T	T	T	T	T	
NSX250DC TM-DC	200	1000				2	2.5	2.5	5	T	T	T	T	T	T	T	
		2000								4	5	T	T	T	T	T	
	250	1250					2.5	2.5	3.3	5	10	T	T	T	T	T	
NSX250DC TM-G	250	2500								2.5	3.3	4	5	T	T	T	
	200	530	1.25	1.5	1.6	2	2.5	2.5	5	T	T	T	T	T	T	T	
250	625		1.5	1.6	2	2.5	2.5	3.3	5	10	T	T	T	T	T		

- [1] Type of circuit breaker (1P1D, 2P2D) depend on earthing system and circuit breaker ranges.
For voltage up to 60Vdc one single pole of iC60 C120 NG125 NSX range is enough to break the current.
For ranges with 3P or 4P breakers only (NSX250 for example), one or two poles only are used of a 3P circuit breaker.
- [2] According to the voltage and nb of pole used, the breaking capacity can be changed.
Selectivity limit is the minimum of the value indicated in the table and the breaking capacity of downstream circuit breaker.
- [3] This table is applicable for Case 1, Case 2, Case 3, Case 4 defined in introduction with this voltage between + and -.
Selectivity limits in this table for case 1 and Case 3 can also apply to system with higher voltage (up to 2 times) for the same circuit breaker (same number of poles used).

Compliance of circuit breakers according to voltage and earthing system shall be checked before using this table.

Selectivity Table

Upstream: MasterPacT NW DC

Downstream: ComPacT NSX400/630/1200 DC, MasterPacT NW DC

Ue: 110-125 V DC ^[3]

Time constant: 1.5 ms - 25 ms

A

Upstream CB	NW10DC -C N/H					NW10DC -C N/H					NW10DC -C N/H				
						NW20DC -C N/H					NW20DC -C N/H				
											NW40DC-C N/H				
	2P2D														
Trip unit type	MicroLogic 1.0 DC														
	Range 1250/2500A					Range 2500/5400A					Range 5000/11000A				
Type	A	B	C	D	E	A	B	C	D	E	A	B	C	D	E
Setting	1250	1500	1600	2000	2500	2500	3300	4000	5000	5400	5000	8000	10000	11000	11000

Downstream Rating CB	Rating	Im	Selectivity limit (kA) ^[2]														
NSX400DC TM-DC 3P3D ^[1]	250	635	1.25	1.5	1.6	2	2.5	2.5	3.3	4	5	5.4	5	T	T	T	T
		1250					2.5	2.5	3.3	4	5	5.4	5	T	T	T	T
	320	800			1.6	2	2.5	2.5	3.3	4	5	5.4	5	T	T	T	T
		1600							3.3	4	5	5.4	5	10	T	T	T
	400	1000				2	2.5	2.5	3.3	4	5	5.4	5	10	T	T	T
	2000								4	5	5.4	5	10	T	T	T	
NSX630DC TM-DC 3P3D ^[1]	500	1250						2.5	3.3	4	5	5.4	5	T	T	T	T
		2500								5	5.4	5	10	T	T	T	
	600	1500							3.3	4	5	5.4	5	10	T	T	T
		3000											10	T	T	T	
NSX1200DC TM-DC 3P3D ^[1]	630	1575							3.3	4	5	5.4	5	8	10	11	11
		3150											8	10	11	11	
	800	2000								4	5	5.4	5	8	10	11	11
		4000											8	10	11	11	
	1000	2500										5	8	10	11	11	
		5000												10	11	11	
	1200	3000											8	10	11	11	
	6000													11	11		
NW DC-C	1000	1250							3.3	4	5	5.4	5	8	10	11	11
		2500									5	5.4	5	8	10	11	11
	1000/2000	2500									5	5.4	5	8	10	11	11
		5400												10	11	11	
	1000/2000/4000	5000												10	11	11	
		11000														11	

[1] Type of circuit breaker (1P1D, 2P2D) depend on earthing system and circuit breaker ranges.
 For voltage up to 60Vdc one single pole of iC60 C120 NG125 NSX range is enough to break the current.
 For ranges with 3P or 4P breakers only (NSX250 for example), one or two poles only are used of a 3P circuit breaker.

[2] According to the voltage and nb of pole used, the breaking capacity can changed.
 Selectivity limit is the minimum of the value indicated in the table and the breaking capacity of downstream circuit breaker.

[3] This table is applicable for Case 1, Case 2, Case 3, Case 4 defined in introduction with this voltage between + and -.
 Selectivity limits in this table for case 1 and Case 3 can also apply to system with higher voltage (up to 2 times) for the same circuit breaker (same number of poles used).

Compliance of circuit breakers according to voltage and earthing system shall be checked before using this table.

Selectivity Table

Upstream: C120, NG125 Curves B, C, D

Downstream: C60H-DC Curve C

Ue: 220-250 V DC [3]

Time constant (L/R): 1.5 ms to 25 ms



Upstream		C120N/H/L, NG125N/H/L, 2P, 3P or 4P [1]										
		Curve B										
In (A)		10	16	20	25	32	40	50	63	80	100	125

Downstream	Rating (A)	Selectivity limit (A) [2]											
C60H-DC 1P or 2P [1] C Curves	0.5	500	T	T	T	T	T	T	T	T	T	T	T
	1		250	500	750	1500	T	T	T	T	T	T	T
	2				600	900	2000	3000	3500	5500	T	T	T
	3						1300	1500	1800	3000	5000	T	T
	4							1000	1200	1700	2800	5000	T
	6									1400	2000	3200	T
	10										1400	2300	T
	16											2000	T
≥ 20												2000	

Upstream		C120N/H/L, NG125N/H/L, 2P, 3P or 4P [1]										
		Curve C										
In (A)		10	16	20	25	32	40	50	63	80	100	125

Downstream	Rating (A)	Selectivity limit (A) [2]											
C60H-DC 1P or 2P [1] C Curves	0.5	T	T	T	T	T	T	T	T	T	T	T	T
	1	300	1700	6000	T	T	T	T	T	T	T	T	T
	2		1000	1600	6000	T	T	T	T	T	T	T	T
	3			1000	3000	4000	5000	T	T	T	T	T	T
	4					2500	3500	2500	4500	T	T	T	T
	6							1000	2500	T	T	T	T
	10								1700	4000	6000	8000	T
	16								1000	2500	4500	6000	T
	20									2000	3500	4500	T
	25										3000	4000	T
	≥ 32												4000

Upstream		C120N/H/L, NG125N/H/L, 2P, 3P or 4P [1]										
		Curve D										
In (A)		10	16	20	25	32	40	50	63	80	100	125

Downstream	Rating (A)	Selectivity limit (A) [2]											
Circuit breaker C60H-DC 1P or 2P [1] C Curves	0.5	T	T	T	T	T	T	T	T	T	T	T	T
	1	1400	T	T	T	T	T	T	T	T	T	T	T
	2	800	3000	6000	T	T	T	T	T	T	T	T	T
	3			3500	5000	T	T	T	T	T	T	T	T
	4			1000	3000	5000	6000	T	T	T	T	T	T
	6					2000	2500	3500	4500	T	T	T	T
	10							2000	2500	8000	T	T	T
	16									6500	T	T	T
	20									4000	6000	T	T
	25										5500	7500	T
	32											5000	T
	≥ 40												5000

[1] Type of circuit breaker depend on earthing system and circuit breaker ranges (see Distribution guide direct current CA908061).

[2] According to the voltage and number of pole used, the breaking capacity can be changed. Selectivity limit is the minimum of the value indicated in the table and the breaking capacity of downstream circuit breaker.

[3] This table is applicable for Case 1, Case 2, Case 3, Case 4 defined in introduction with this voltage between + and - Selectivity limits in this table for Case 1 and Case 3 can also apply to system with higher voltage (up to 2 times) for the same circuit breaker (same number of poles used).

T Total selectivity, up to the breaking capacity of the downstream circuit breaker.

500 Selectivity limit = 500 A.

No selectivity.

Compliance of circuit breakers according to voltage and earthing system shall be checked before using this table.

Selectivity Table

Upstream: ComPacT NSX100/160/250 TM-D, TM-DC

Downstream: C60H-DC, C120, NG125

Ue: 220-250 V DC ^[3]

Time constant: 1.5 ms - 25 ms

A

Upstream CB	NSX100DC								NSX160DC			NSX250 DC				
	1P1D 2P2D F/N/M/S 3P3D F/S ^[1]											3P3D (1 or 2 P used) F/S ^[1]				
Trip unit type	TMD, TM-DC								TMD, TM-DC			TM-DC				
Trip unit rating (A)	16	25	32	40	50	63	80	100	100	125	160	160	200	250		
	fixed	fixed	fixed	fixed	fixed	fixed	fixed	fixed	fixed	fixed	fixed	fixed	Mini	Maxi	Mini	Maxi
Im	260	400	550	700	700	700	800	800	800	1250	1250	1250	1000	2000	1250	2500

Downstream	Rating	Selectivity limit (kA) ^[2]															
C60H-DC	0.5	5	10	10	10	T	T	T	T	T	T	T	T	T	T	T	
	1	5	5	5	5	10	T	T	T	T	T	T	T	T	T	T	
C Curves	2	0.26	0.4	0.55	0.7	5	T	T	T	T	T	T	T	T	T	T	
	3		0.4	0.55	0.7	0.7	T	T	T	T	T	T	T	T	T	T	
1P1D or 2P2D ^[1]	4			0.55	0.7	0.7	10	T	T	T	T	T	T	T	T	T	
	5				0.7	0.7	10	10	T	T	T	T	T	T	T	T	
	6					0.7	5	10	10	10	T	T	T	T	T	T	
	10					0.7	5	5	5	5	T	T	T	T	T	T	
	13						0.7	0.8	5	5	10	T	T	10	T	T	
	15-16							0.8	0.8	5	10	10	10	5	T	T	
	20								0.8	0.8	5	5	5	1	T	T	
	25									0.8	0.8	5	5	5	1	T	T
	30-32										5	5	5		T	10	
	40											5	5		T	5	
	50														10		
	63														5		
	C120 N/H	63										1.25	1.25		5	10	
80														2			
B-C-D Curves	80																
	100													2			
2P2D or 4P4D ^[1]	100																
	125																
NG125 N/H/L	10		0.4	0.5	0.7	0.7	0.7	0.8	0.8	0.8	10	10	10	5	T	T	
	16			0.5	0.7	0.7	0.7	0.8	0.8	0.8	10	10	10	1	T	T	
B-C-D Curves	20				0.7	0.7	0.7	0.8	0.8	0.8	10	10	10	1	T	T	
	25						0.7	0.8	0.8	0.8	5	10	10	1	T	T	
	32							0.8	0.8	0.8	1.25	5	5	1	T	T	
	40								0.8	0.8	1.25	1.25	1.25	1	10	T	
	50										1.25	1.25	1.25	1	5	T	
	63											1.25	1.25		5	10	
	80														2		
	100 (N)														2		
	125 (N)																

[1] Type of circuit breaker (1P1D, 2P2D) depend on earthing system and circuit breaker ranges.
 For voltage up to 60Vdc one single pole of iC60 C120 NG125 NSX range is enough to break the current.
 For ranges with 3P or 4P breakers only (NSX250 for example), one or two poles only are used of a 3P circuit breaker.

[2] According to the voltage and nb of pole used, the breaking capacity can be changed.
 Selectivity limit is the minimum of the value indicated in the table and the breaking capacity of downstream circuit breaker.

[3] This table is applicable for Case 1, Case 2, Case 3, Case 4 defined in introduction with this voltage between + and -.
 Selectivity limits in this table for case 1 and Case 3 can also apply to system with higher voltage (up to 2 times) for the same circuit breaker (same number of poles used).

Compliance of circuit breakers according to voltage and earthing system shall be checked before using this table.

Selectivity Table

Upstream: ComPacT NSX100/160/250 DC TM-G

Downstream: C60H-DC, NG125

Ue: 220-250 V DC [3]

Time constant: 1.5 ms - 25 ms



Upstream CB	NSX100DC						NSX160DC			NSX250 DC		
	3P3D (1 or 2 P used) F/S [1]											
Trip unit type	TM-G						TM-G			TM-G		
Trip unit rating (A)	16	25	40	63	80	100	100	125	160	160	200	250
I _m	80	100	100	150	250	400	400	530	530	530	530	625

Downstream	In	Selectivity limit (kA) [2]											
C60H-DC	0.5	5	5	5	5	5	5	5	T	T	T	T	T
C Curves	1	0.08	0.1	0.1	0.15	0.25	5	5	10	T	T	T	T
1P1D or 2P2D	2		0.1	0.1	0.15	0.25	0.4	0.4	10	10	10	T	T
[1]	3			0.1	0.15	0.25	0.4	0.4	5	10	10	10	T
	4				0.15	0.25	0.4	0.4	0.53	5	5	5	10
	5					0.25	0.4	0.4	0.53	0.53	0.53	0.53	5
	6						0.4	0.4	0.53	0.53	0.53	0.53	0.63
	10								0.53	0.53	0.53	0.53	0.63
	13								0.53	0.53	0.53	0.53	0.63
	15-16								0.53	0.53	0.53	0.53	0.63
	20								0.53	0.53	0.53	0.53	0.63
	25									0.53	0.53	0.53	0.63
	30-32												0.63
	40												
	50												
	63												
NG125 N/H/L	10												
B-C-D Curves	16												
2P2D or 4P4D	20												
[1]	25												
	32												
	40												

- [1] Type of circuit breaker (1P1D, 2P2D) depend on earthing system and circuit breaker ranges.
For voltage up to 60Vdc one single pole of iC60 C120 NG125 NSX range is enough to break the current.
For ranges with 3P or 4P breakers only (NSX250 for example), one or two poles only are used of a 3P circuit breaker.
- [2] According to the voltage and nb of pole used, the breaking capacity can be changed.
Selectivity limit is the minimum of the value indicated in the table and the breaking capacity of downstream circuit breaker.
- [3] This table is applicable for Case 1, Case 2, Case 3, Case 4 defined in introduction with this voltage between + and -.
Selectivity limits in this table for case 1 and Case 3 can also apply to system with higher voltage (up to 2 times) for the same circuit breaker (same number of poles used).

Compliance of circuit breakers according to voltage and earthing system shall be checked before using this table.

Selectivity Table

Upstream: ComPacT NSX100 - 250 DC TMD

Downstream: ComPacT NSX100 - 160 DC TMD, TMG



Ue: 220-250 V DC [3]

Time constant: 1.5 ms - 25 ms

Upstream CB	NSX100 DC								NSX160 DC				NSX250 DC				
	1P1D 2P2D F/N/M/S (3P3D F/S) [1]												3P3D (1 or 2 P Used) F/S [1]				
Trip unit type	TM-D								TM-D, TM-DC				TM-DC				
Trip unit rating (A)	16	25	32	40	50	63	80	100	80	100	125	160	160	200	250		
	fixed	fixed	fixed	fixed	fixed	fixed	fixed	fixed	fixed	fixed	fixed	fixed	fixed	Mini	Maxi	Mini	Maxi
Im	260	400	550	700	700	700	640	800	640	800	1250	1250	1250	1000	2000	1250	2500

Downstream Rating Im CB	Selectivity limit (kA) [2]																				
NSX100DC TM-D (TM-DC) 1P1D or 2P2PD (3P3D) [1]	16	260			0.5	0.7	0.7	0.7	0.7	0.8	0.8	0.8	1.25	1.25	1.25	1	2	1.25	5		
	25	400				0.7	0.7	0.7	0.7	0.8	0.8	0.8	1.25	1.25	1.25	1	2	1.25	5		
	32	400							0.7	0.7	0.8	0.8	0.8	1.25	1.25	1.25	1	2	1.25	5	
	40	700								0.7	0.8	0.8	0.8	1.25	1.25	1.25	1	2	1.25	2.5	
	50	700									0.7	0.8	0.8	0.8	1.25	1.25	1.25	1	2	1.25	2.5
	63	700										0.8	0.8	0.8	1.25	1.25	1.25	1	2	1.25	2.5
80	800													1.25	1.25	1.25	1	2	1.25	2.5	
100	1000													1.25	1.25	1.25	1	2	1.25	2.5	
NSX100DC TM-G 3P3D [1]	16	80			0.5	0.7	0.7	0.7	0.7	0.8	0.8	0.8	1.25	1.25	1.25	1	2	1.25	10		
	25	100				0.7	0.7	0.7	0.7	0.8	0.8	0.8	1.25	1.25	1.25	1	2	1.25	5		
	40	100								0.7	0.8	0.8	0.8	1.25	1.25	1.25	1	2	1.25	5	
	63	150									0.7	0.8	0.8	0.8	1.25	1.25	1.25	1	2	1.25	5
	80	250										0.8	0.8	0.8	1.25	1.25	1.25	1	2	1.25	2.5
100	400													1.25	1.25	1.25	1	2	1.25	2.5	
NSX160DC TM-DC 1P1D or 2P2PD 3P2D [1]	100	1000												1.25	1.25	1.25	1	2	1.25	2.5	
	125	1200																	1.25	2.5	
	160	1250																			
NSX160DC	125	530																		1.25	2.5
TM-G 3P3D [1]	160	530																			

- [1] Type of circuit breaker (1P1D, 2P2D) depend on earthing system and circuit breaker ranges.
For voltage up to 60Vdc one single pole of iC60 C120 NG125 NSX range is enough to break the current.
For ranges with 3P or 4P breakers only (NSX250 for example), one or two poles only are used of a 3P circuit breaker.
- [2] According to the voltage and nb of pole used, the breaking capacity can be changed.
Selectivity limit is the minimum of the value indicated in the table and the breaking capacity of downstream circuit breaker.
- [3] This table is applicable for Case 1, Case 2, Case 3, Case 4 defined in introduction with this voltage between + and -.
Selectivity limits in this table for case 1 and Case 3 can also apply to system with higher voltage (up to 2 times) for the same circuit breaker (same number of poles used).

Compliance of circuit breakers according to voltage and earthing system shall be checked before using this table.

Selectivity Table

Upstream: ComPacT NSX400/630/1200 DC TM-DC

Downstream: C60H-DC, C120, NG125

Ue: 220-250 V DC [3]

Time constant: 1.5 ms - 25 ms



Upstream CB	NSX400DC F/S						NSX630DC F/S				NSX1200DC N							
	3P3D (1 or 2 P Used) [1]										2P2D							
Trip unit type	TM-DC						TM-DC				TM-DC							
Trip unit rating (A)	250		320		400		500		600		630		800		1000		1200	
	min	max	min	max	min	max	min	max	min	max	min	max	min	max	min	max	min	max
Im	625	1250	800	1600	1000	2000	1250	2500	1500	3000	1575	3150	2000	4000	2500	5000	3000	6000

Downstream In	Selectivity limit (kA) [2]																	
C60H-DC	0.5	T	T	T	T	T	T	T	T	T	T	T	T	T	T	T	T	T
C Curve	1	T	T	T	T	T	T	T	T	T	T	T	T	T	T	T	T	T
1P1D or 2P2D	2	T	T	T	T	T	T	T	T	T	T	T	T	T	T	T	T	T
[1]	3	T	T	T	T	T	T	T	T	T	T	T	T	T	T	T	T	T
	4	15	T	T	T	T	T	T	T	T	T	T	T	T	T	T	T	T
	5	10	T	T	T	10	T	T	T	T	T	T	T	T	T	T	T	T
	6	5	T	15	T	5	T	T	T	T	T	T	T	T	T	T	T	T
	10	0.6	T	10	T	1	T	T	T	T	T	T	T	T	T	T	T	T
	13		10	5	10		10	10	T	10	T	10	T	10	T	T	T	T
	15-16		5	0.8	5		5	5	T	5	T	5	T	5	T	T	T	T
	20		1.25		1.6		5	1.25	T	1.5	T	1.5	T	5	T	T	T	T
	25						2		T		T		2	T	T	T	T	T
	30-32								T		T			T	T	T	T	T
	40								T		T			T	T	T	T	T
	50								T		T			T	T	T	T	T
	63								T		T			T	T	T	T	T
NG125 N/H/L	10	0.625	1.25	0.8	1.6	1	5	T	T	10	T	10	T	T	T	T	T	T
B-C-D Curves	16				1.6	1	2	5	T	5	T	5	T	T	T	T	T	T
2P2D or 4P4D	20						2	1.25	T	1.5	T	1.5	T	T	T	T	T	T
[1]	25								T		T			T	T	T	T	T
	32								T		T			T	10	T	T	T
	40								T		T			T	10	T	T	T
	50								T		T			T	5	T	T	T
	63								T		T			T		5	T	T
	80								5		T			T			T	T
	100 (N)								5		10			10			T	T
	125 (N)								5		5			5			T	T
C120 N/H	63								T		T			T		5	T	T
B-C-D Curves	80								5		T			T			T	T
2P2D or 4P4D	100								5		10			10			T	T
[1]	125								5		5			5			T	T

[1] Type of circuit breaker (1P1D, 2P2D) depend on earthing system and circuit breaker ranges.
 For voltage up to 60Vdc one single pole of iC60 C120 NG125 NSX range is enough to break the current.
 For ranges with 3P or 4P breakers only (NSX250 for example), one or two poles only are used of a 3P circuit breaker.

[2] According to the voltage and nb of pole used, the breaking capacity can be changed.
 Selectivity limit is the minimum of the value indicated in the table and the breaking capacity of downstream circuit breaker.

[3] This table is applicable for Case 1, Case 2, Case 3, Case 4 defined in introduction with this voltage between + and -.
 Selectivity limits in this table for case 1 and Case 3 can also apply to system with higher voltage (up to 2 times) for the same circuit breaker (same number of poles used).

Compliance of circuit breakers according to voltage and earthing system shall be checked before using this table.

Selectivity Table

Upstream: ComPacT NSX400/630/1200 DC TM-DC

Downstream: ComPacT NSX100/160 DC TM-D, TM-DC, TM-G

Ue: 220-250 V DC ^[3]

Time constant: 1.5 ms - 25 ms

A

Upstream CB	NSX400DC F/S						NSX630DC F/S				NSX1200DC N							
Trip unit type	TM-DC						TM-DC				TM-DC							
Trip unit rating (A)	250		320		400		500		600		630		800		1000		1200	
	min	max	min	max	min	max	min	max	min	max	min	max	min	max	min	max	min	max
I _m	625	1250	800	1600	1000	2000	1250	2500	1500	3000	1575	3150	2000	4000	2500	5000	3000	6000

Downstream Rating Im CB	Selectivity limit (kA) ^[2]																			
NSX100DC	16	260	0.63	1.25	0.8	1.6	1	2	1.25	2.5	1.5	3	1.5	3.1	2	4	2.5	5	3	T
TM-D	25	400	0.63	1.25	1	1.6	1	2	1.25	2.5	1.5	3	1.5	3.1	2	4	2.5	5	3	10
(TM-DC)	32	400		1.25	1	1.6	1	2	1.25	2.5	1.5	3	1.5	3.1	2	4	2.5	5	3	6
1P1D or 2P2PD (3P3D)	40	700			1	1.6	1	2	1.25	2.5	1.5	3	1.5	3.1	2	4	2.5	5	3	6
^[1]	50	700				1.6	1	2	1.25	2.5	1.5	3	1.5	3.1	2	4	2.5	5	3	6
	63	700					1	2	1.25	2.5	1.5	3	1.5	3.1	2	4	2.5	5	3	6
	80	800						2		2.5		3	1.5	3.1	2	4	2.5	5	3	6
	100	1000						2		2.5		3		3.1	2	4	2.5	5	3	6
NSX100DC	16	80	0.63	1.25	0.8	1.6	1	2	1.25	2.5	1.5	3	1.5	3.1	2	4	2.5	5	3	T
TM-G	25	100	0.63	1.25	1	1.6	1	2	1.25	2.5	1.5	3	1.5	3.1	2	4	2.5	5	3	10
3P3D ^[1]	40	100			1	1.6	1	2	1.25	2.5	1.5	3	1.5	3.1	2	4	2.5	5	3	6
	63	150					1	2	1.25	2.5	1.5	3	1.5	3.1	2	4	2.5	5	3	6
	80	250						2		2.5		3	1.5	3.1	2	4	2.5	5	3	6
	100	400						2		2.5		3	1.5	3.1	2	4	2.5	5	3	6
NSX160DC	100	1000						2		2.5		3	1.5	3.1	2	4	2.5	5	3	6
TM-DC	125	1200								2.5		3		3.1		4	2.5	4	3	6
1P1D or 2P2PD	160	1250								2.5		3		3.1		4	2.5	4	3	6
NSX160DC	125	530								2.5	1.5	3	1.5	3.1	2	4	2.5	4	3	6
TM-G 3P3D	160	530								2.5	1.5	3	1.5	3.1	2	4	2.5	4	3	6
NSX250DC	200	1000								2.5	1.5	3	1.5	3.1	2	4	2.5	4	3	6
TM-DC		2000										3		3.1		4	2.5	4	3	6
3P3D ^[1]	250	1250												3.1		4	2.5	4	3	6
		2500												3.1		4		4	3	6
NSX250DC	200	530							1.25	2.5	1.5	3	1.5	3.1	2	4	2.5	4	3	6
TM-G 3P3D	250	625							1.25	2.5	1.5	3	1.5	3.1	2	4	2.5	4	3	6

[1] Type of circuit breaker (1P1D, 2P2D) depend on earthing system and circuit breaker ranges.

For voltage up to 60Vdc one single pole of iC60 C120 NG125 NSX range is enough to break the current.

For ranges with 3P or 4P breakers only (NSX250 for example), one or two poles only are used of a 3P circuit breaker.

[2] According to the voltage and nb of pole used, the breaking capacity can changed.

Selectivity limit is the minimum of the value indicated in the table and the breaking capacity of downstream circuit breaker.

[3] This table is applicable for Case 1, Case 2, Case 3, Case 4 defined in introduction with this voltage between + and -.

Selectivity limits in this table for case 1 and Case 3 can also apply to system with higher voltage (up to 2 times) for the same circuit breaker (same number of poles used).

Selectivity Table

Upstream: MasterPacT NW DC

Downstream: C60H-DC, C120, NG125. ComPacT NSX100/160/250 DC

Ue: 220-250 V DC [3]

Time constant: 1.5 ms - 25 ms



Upstream CB	NW10DC -C N/H					NW10DC -C N/H					NW10DC -C N/H				
						NW20DC -C N/H					NW20DC -C N/H				
											NW40DC-C N/H				
2P2D															
Trip unit type	MicroLogic 1.0 DC														
	Range 1250/2500A					Range 2500/5400A					Range 5000/11000A				
Type	A	B	C	D	E	A	B	C	D	E	A	B	C	D	E
Setting	1250	1500	1600	2000	2500	2500	3300	4000	5000	5400	5kA	8kA	10kA	11kA	11kA

Downstream	Rating	Im	Selectivity limit (kA) [2]													
C60H-DC [1]	0.5-63		T	T	T	T	T	T	T	T	T	T	T	T	T	T
C120 N/H	63		T	T	T	T	T	T	T	T	T	T	T	T	T	T
2P/2P or 4P4D [1]	80		1.25	T	T	T	T	T	T	T	T	T	T	T	T	T
	100		1.25	1.5	T	T	T	T	T	T	T	T	T	T	T	T
	125		1.25	1.5	1.6	T	T	T	T	T	T	T	T	T	T	T
NG125 N/H/L B-C-D Curves	10-50		T	T	T	T	T	T	T	T	T	T	T	T	T	T
	63		T	T	T	T	T	T	T	T	T	T	T	T	T	T
	80		1.25	T	T	T	T	T	T	T	T	T	T	T	T	T
2P/2P or 4P4D [1]	100 (N)		1.25	1.5	T	T	T	T	T	T	T	T	T	T	T	T
	125 (N)		1.25	1.5	1.6	T	T	T	T	T	T	T	T	T	T	T
NSX100DC N/H	16	260	1.25	1.5	1.6	2	2.5	2.5	10	T	T	T	T	T	T	T
	25	400	1.25	1.5	1.6	2	2.5	2.5	5	T	T	T	T	T	T	T
TM-D	32	400	1.25	1.5	1.6	2	2.5	2.5	3.3	10	T	T	T	T	T	T
1P1D or 2P2D [1]	40	700		1.5	1.6	2	2.5	2.5	3.3	5	10	T	10	T	T	T
	50	700		1.5	1.6	2	2.5	2.5	3.3	4	5	T	5	T	T	T
	63	700		1.5	1.6	2	2.5	2.5	3.3	4	5	10	5	T	T	T
TM-DC [1]	80	800		1.5	1.6	2	2.5	2.5	3.3	4	5	5.4	5	T	T	T
	100	1000				2	2.5	2.5	3.3	4	5	5.4	5	T	T	T
NSX100DC	16	80	1.25	1.5	1.6	2	2.5	2.5	10	T	T	T	T	T	T	T
TM-G [1]	25	100	1.25	1.5	1.6	2	2.5	2.5	5	T	T	T	T	T	T	T
	40	100		1.5	1.6	2	2.5	2.5	3.3	5	10	T	10	T	T	T
3P3D	63	150		1.5	1.6	2	2.5	2.5	3.3	4	5	10	5	T	T	T
	80	250		1.5	1.6	2	2.5	2.5	3.3	4	5	5.4	5	T	T	T
	100	400				2	2.5	2.5	3.3	4	5	5.4	5	T	T	T
NSX160DC	100	1000				2	2.5	2.5	3.3	4	5	5.4	5	T	T	T
TM-DC 1P1D or 2P2D [1]	125	1200					2.5	2.5	3.3	4	5	5.4	5	T	T	T
	160	1250					2.5	2.5	3.3	4	5	5.4	5	T	T	T
NSX160DC	125	530	1.25	1.5	1.6	2	2.5	2.5	3.3	4	5	5.4	5	T	T	T
TM-G 3P3D	160	530	1.25	1.5	1.6	2	2.5	2.5	3.3	4	5	5.4	5	T	T	T
NSX250DC	200	1000				2	2.5	2.5	5	4	5	5.4	5	T	T	T
TM-DC [1]		2000								4	5	5.4	5	T	T	T
	250	1250					2.5	2.5	3.3	4	5	5.4	5	T	T	T
3P3D		2500					2.5	3.3	4	5	5.4	5	T	T	T	
NSX250DC	200	530	1.25	1.5	1.6	2	2.5	2.5	5	4	5	5.4	5	T	T	T
TM-G	250	625		1.5	1.6	2	2.5	2.5	3.3	4	5	5.4	5	T	T	T

[1] Type of circuit breaker (1P1D, 2P2D) depend on earthing system and circuit breaker ranges.

For voltage up to 60Vdc one single pole of iC60 C120 NG125 NSX range is enough to break the current.

For ranges with 3P or 4P breakers only (NSX250 for example), one or two poles only are used of a 3P circuit breaker.

[2] According to the voltage and nb of pole used, the breaking capacity can changed.

Selectivity limit is the minimum of the value indicated in the table and the breaking capacity of downstream circuit breaker.

[3] This table is applicable for Case 1, Case 2, Case 3, Case 4 defined in introduction with this voltage between + and -.

Selectivity limits in this table for case 1 and Case 3 can also apply to system with higher voltage (up to 2 times) for the same circuit breaker (same number of poles used).

Compliance of circuit breakers according to voltage and earthing system shall be checked before using this table.

Selectivity Table

Upstream: MasterPacT NW DC

Downstream: ComPacT NSX400/630/1200 DC, MasterPacT NW DC

Ue: 220-250 V DC ^[3]

Time constant: 1.5 ms - 25 ms

A

Upstream CB	NW10DC -C N/H					NW10DC -C N/H					NW10DC -C N/H				
						NW20DC -C N/H					NW20DC -C N/H				
											NW40DC-C N/H				
2P2D															
Trip unit type	MicroLogic 1.0 DC														
	Range 1250/2500A					Range 2500/5400A					Range 5000/11000A				
Type	A	B	C	D	E	A	B	C	D	E	A	B	C	D	E
Setting	1250	1500	1600	2000	2500	2500	3300	4000	5000	5400	5000	8000	10000	11000	11000

Downstream CB	Rating	Im	Selectivity limit (kA) ^[2]														
NSX400DC TM-DC 3P3D ^[1]	250	635	1.25	1.5	1.6	2	2.5	2.5	3.3	4	5	5.4	5	T	T	T	T
		1250					2.5	2.5	3.3	4	5	5.4	5	T	T	T	T
		800			1.6	2	2.5	2.5	3.3	4	5	5.4	5	T	T	T	T
		1600							3.3	4	5	5.4	5	10	T	T	T
		400	1000				2	2.5	2.5	3.3	4	5	5.4	5	10	T	T
		2000							4	5	5.4	5	10	10	11	11	
NSX630DC TM-DC 3P3D ^[1]	500	1250					2.5	3.3	4	5	5.4	5	10	10	11	11	
		2500								5	5.4	5	10	10	11	11	
		1500						3.3	4	5	5.4	5	10	10	11	11	
		3000											10	10	11	11	
NSX1200DC TM-DC 3P3D ^[1]	630	1575						3.3	4	5	5.4	5	8	10	11	11	
		3150											8	10	11	11	
		2000							4	5	5.4	5	8	10	11	11	
		4000											8	10	11	11	
		1000	2500									5	8	10	11	11	
		5000												10	11	11	
		1200	3000										8	10	11	11	
		6000													11	11	
MasterPacT NW DC-C	1000	1250						3.3	4	5	5.4	5	8	10	11	11	
		2500								5	5.4	5	8	10	11	11	
		2500								5	5.4	5	8	10	11	11	
		5400												10	11	11	
		1000/2000/4000	5000											10	11	11	
		11000															

- [1] Type of circuit breaker (1P1D, 2P2D) depend on earthing system and circuit breaker ranges.
For voltage up to 60Vdc one single pole of iC60 C120 NG125 NSX range is enough to break the current.
For ranges with 3P or 4P breakers only (NSX250 for example), one or two poles only are used of a 3P circuit breaker.
- [2] According to the voltage and nb of pole used, the breaking capacity can be changed.
Selectivity limit is the minimum of the value indicated in the table and the breaking capacity of downstream circuit breaker.
- [3] This table is applicable for Case 1, Case 2, Case 3, Case 4 defined in introduction with this voltage between + and -.
Selectivity limits in this table for case 1 and Case 3 can also apply to system with higher voltage (up to 2 times) for the same circuit breaker (same number of poles used).

Compliance of circuit breakers according to voltage and earthing system shall be checked before using this table.

Selectivity with Fuses

Introduction

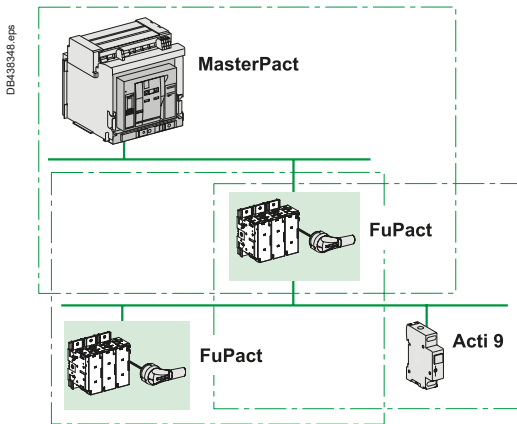

Principle

Schneider Electric offers a coordinated protection system

In an electrical installation, protection fuses are never used alone and must always be integrated in a system comprising circuit breakers.

Coordination is required between:

- Upstream and downstream fuses
- Upstream circuit breakers and downstream fuses
- Upstream fuses and downstream circuit breakers.

Upstream fuse / Downstream fuse

Selectivity is obtained when

Total energy of downstream fuse (E_{tav}) < Pre-arcing energy of upstream fuse (E_{pam})

Note: If E_{tav} is higher than 80 % of E_{pam} , the upstream fuse may be derated.

■ Upstream gG fuse-link / downstream gG fuse-link

Standard IEC/EN 60269-2-1 indicates limit values for pre-arcing and total energies for operation of gG and gM fuse-links, where the operating current is approximately 30 In.

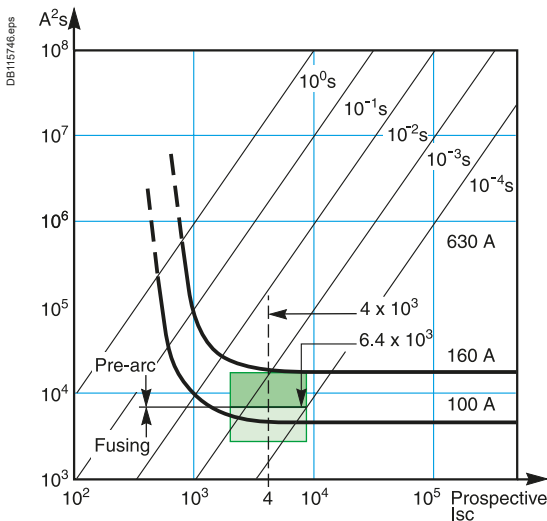

Curves $E = f(I)$ superimposed.

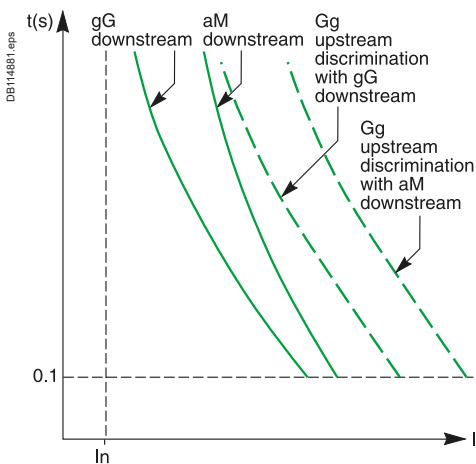

$I = f(t)$ curves.

I^2t limit and test currents for verification of selectivity

I_n (A)	Minimum values of pre-arcing I^2t		Maximum values of operating I^2t	
	Rms values of I prospective (kA)	I^2t (A²s)	Rms values of I prospective (kA)	I^2t (A²s)
16	0.27	291	0.55	1 210
20	0.40	640	0.79	2 500
25	0.55	1 210	1.00	4 000
32	0.79	2 500	1.20	5 750
40	1.00	4 000	1.50	9 000
50	1.20	5 750	1.85	13 700
63	1.50	9 000	2.30	21 200
80	1.85	13 700	3.00	36 000
100	2.30	21 200	4.00	64 000
125	3.00	36 000	5.10	104 000
160	4.00	64 000	6.80	185 000
200	5.10	104 000	8.70	302 000
250	6.80	185 000	11.80	557 000
315	8.70	302 000	15.00	900 000
400	11.80	557 000	20.00	1 600 000
500	15.00	900 000	26.00	2 700 000
630	20.00	1 600 000	37.00	5 470 000
800	26.00	2 700 000	50.00	10 000 000
1000	37.00	5 470 000	66.00	17 400 000
1250	50.00	10 000 000	90.00	33 100 000

■ Upstream gG fuse-link / downstream aM fuse-link

The $I = f(t)$ curve for an aM fuse-link is steeper. aM fuse-links are just as fast as gG fuse-links for short-circuit currents, but slower for low overloads.

That is why the selectivity ratio between gG and aM fuse-links is approximately 2.5 to 4.

A

DB125651.eps

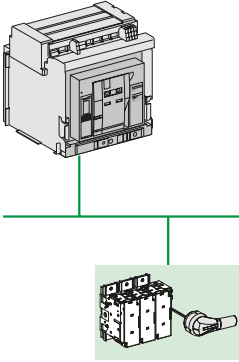

Upstream circuit breaker / Downstream fuse

Upstream circuit breaker with delayed ST (short time) protection function
 This is the situation for a MLVS (main low-voltage switchboard) or sub-distribution switchboard protected by an incoming circuit breaker. The upstream circuit breaker has an electrodynamic withstand capacity I_{cw} and provides time selectivity.

Rule

Examination of selectivity at the critical points on the LT (long time) and ST (short time) curves results in a selectivity table. Analysis of the LT critical point indicates whether selectivity between the protection devices is possible or not. Analysis of the ST (or I_{cw}) critical point indicates whether the selectivity limit is greater than or equal to the ST (or I_{cw}) value.

Note:

- The LT critical point is the most restrictive
- For circuit breakers with a I_{cw} value that is high and/or equal to I_{cu} , the ST critical point is almost never a problem, i.e. selectivity is total.

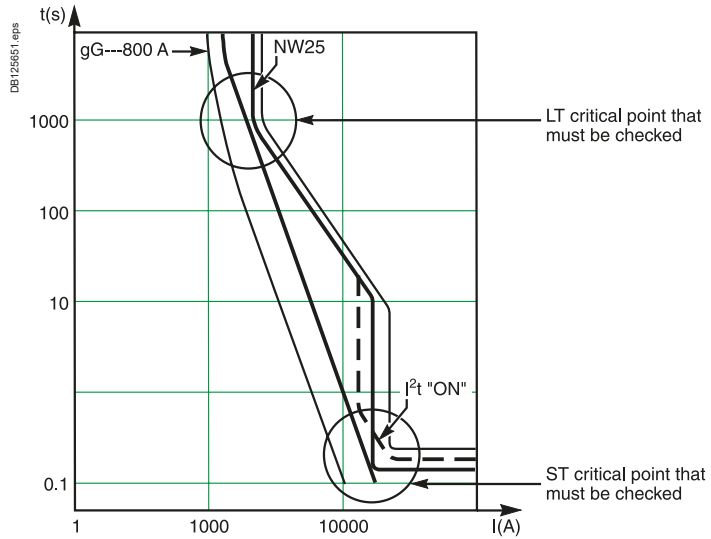

Time-current curves and critical points that must be checked.

DB125653.eps

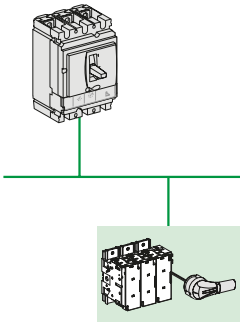

Upstream circuit breaker with non-delayed ST (short time) protection and/or current-limiting function

For checking that the ST critical point is OK, it is necessary to compare:

- The energy curves of the protection devices
- The non-tripping curves of the upstream circuit breaker and the fusing curves of the downstream fuse, and to run tests for the critical values.

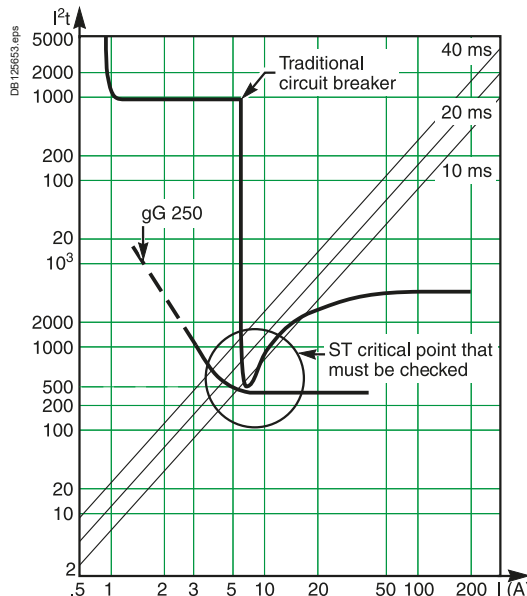

Energy curves and critical points that must be checked.



I²t ON setting

To significantly limit the stresses exerted on the installation (cables installed on trays, power supplied by an engine generator set, etc.), it may be necessary to set the ST protection function to a low value.

The I²t ON function, a constant-energy tripping curve, maintains the level of selectivity performance and facilitates total selectivity.

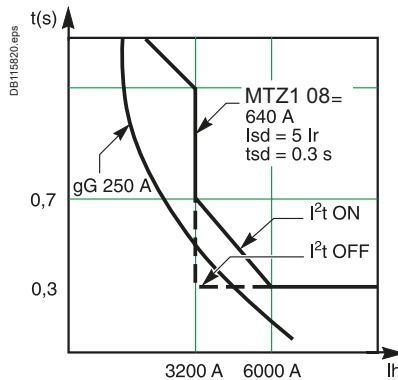

I²t ON curve.

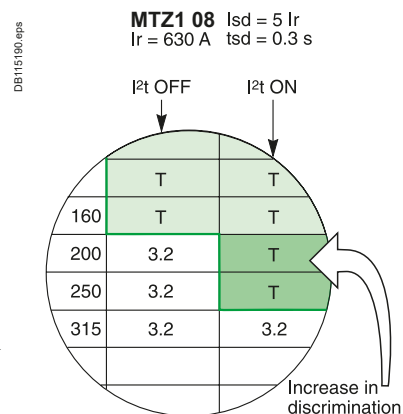

Increase in the selectivity limit.

A

DB43850 eps

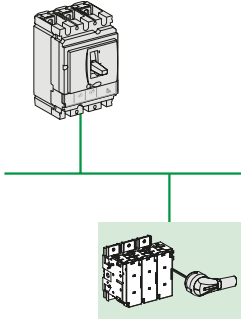

ComPacT NSX upstream of gG or aM fuse-links

ComPacT NSX is a current-limiting circuit breaker. Even without an ST (short time) delay setting, selectivity at the ST critical point is significantly improved because ComPacT NSX has a mini-delay that considerably increases curve values at the ST critical point.

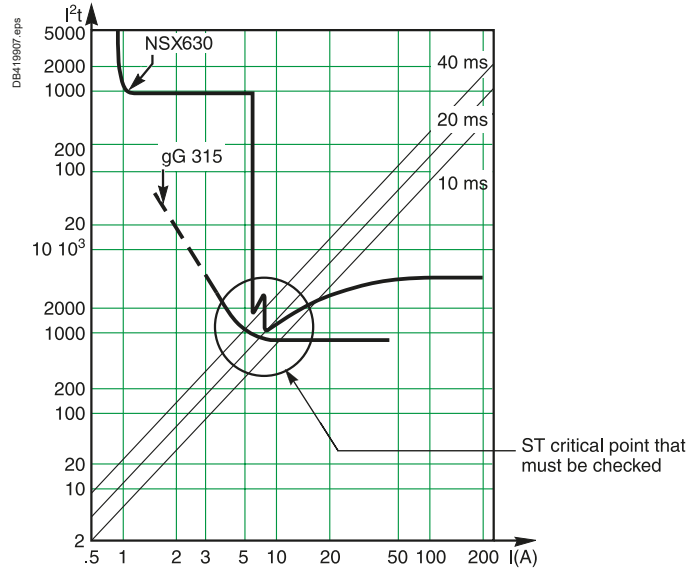

I^2t curve for ComPacT NSX and a fuse.

See pages A-180 and A-187 for the selectivity tables.

DB438413 eps

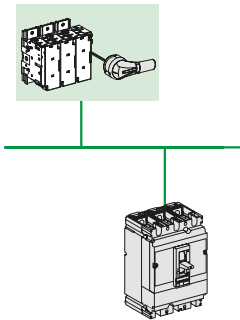

ComPacT NSX downstream of gG or aM fuse-links

ComPacT NSX offers an extremely high level of current-limiting performance due to the piston-based reflex tripping system. Again, selectivity is significantly improved with an upstream fuse.

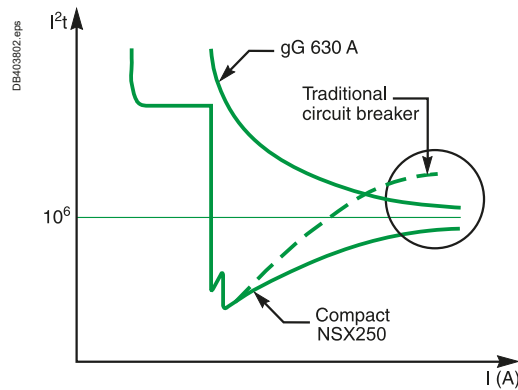

See page A-187 for the selectivity tables.

Selectivity with Fuses - Introduction

Upstream: FuPacT (GG Fuse-Link)

Downstream: FuPacT (GG or AM Fuse-Link)

DB-438351_epps

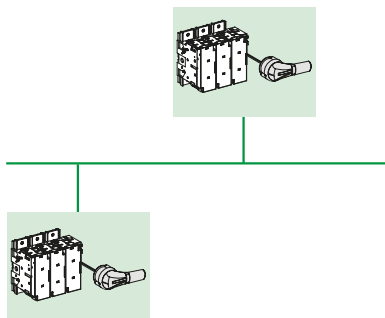

The tables below indicate the necessary ratings for the upstream and downstream fuse-links to achieve **total selectivity**. They take into account the standardised values stipulated in IEC/EN 60269-1 and IEC/EN 60269-2-1 for:

- The pre-arcing energies of the upstream fuse-links
- The total fusing energies of the downstream fuse-links.

Upstream fuse-link gG (In) / gM (Ich)	Downstream fuse-link gG (In) / gM (Ich)	aM (In)
Rating (A)		
16	6	4
20	10	6
25	16	8
32	20	10
40	25	12
50	32	16
63	40	20
80	50	25
100	63	32
125	80	40
160	100	63
200	125	80
250	160	125
315	200	125
400	250	160
500	315	200
630	400	250
800	500	315
1000	630	400
1250	800	500

Examples:

- An upstream 125 A gG fuse-link provides total selectivity with an 80 A gG fuse-link and/or a 40 A aM fuse-link situated downstream
- An upstream 125 A gG fuse-link provides total selectivity with a 63 A gG 63M80 fuse-link (with an 80 A characteristic) situated downstream.



Selectivity Tables with Fuses

Introduction

Upstream: MasterPacT MTZ

Downstream: FuPacT (GG or AM Fuse-Link)

Ue ≤ 440 V AC

A

DB439349 eps

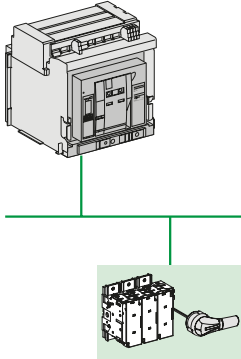

MicroLogic settings:
 ■ LT setting: Tr = 24 seconds.
 ■ ST setting: instantaneous OFF / Isd = 10 Ir / Tsd = 0.4 seconds.

Upstream CB	MasterPacT MTZ																	
	MicroLogic 5.0 X - 6.0 X - 7.0 X																	
	MTZ1	MTZ1	MTZ1	MTZ1	MTZ1	MTZ1	MTZ1	MTZ1	MTZ1	MTZ1	MTZ1	MTZ2	MTZ2	MTZ2	MTZ2	MTZ3	MTZ3	
	08 H1	08 H1	08 H1	08 H1	08 H1	08 H1	08 H1	08 H1	10 H1	12 H1	16 H1	MTZ2	MTZ2	MTZ2	MTZ2	MTZ3	MTZ3	
	08	08	08	08	08	08	08	08	10	12	16	20	25	32	40	50	63	
	N1	N1	N1	N1	N1	N1	N1	N1	N1	N1	N1	H1/H2	H1/H2	H1/H2	H1/H2	H1/H2	H1/H2	
	H1/H2	H1/H2	H1/H2	H1/H2	H1/H2	H1/H2	H1/H2	H1/H2	H1/H2	H1/H2	H1/H2	H3	H3	H3	H3	H3	H3	
Down-stream	Rating (A)	400	400	400	630	800	800	800	800	1000	1200	1600	2000	2500	3200	4000	5000	6300
	Ir setting	160	200	240	315	400	480	630	800	1000	1200	1600	2000	2500	3200	4000	5000	6300
gG/aM ^[1]	32	T	T	T	T	T	T	T	T	T	T	T	T	T	T	T	T	T
Fuse-link	40	T	T	T	T	T	T	T	T	T	T	T	T	T	T	T	T	T
	50	T	T	T	T	T	T	T	T	T	T	T	T	T	T	T	T	T
	63	T	T	T	T	T	T	T	T	T	T	T	T	T	T	T	T	T
	80	T	T	T	T	T	T	T	T	T	T	T	T	T	T	T	T	T
	100	T	T	T	T	T	T	T	T	T	T	T	T	T	T	T	T	T
	125		T	T	T	T	T	T	T	T	T	T	T	T	T	T	T	T
	160			T	T	T	T	T	T	T	T	T	T	T	T	T	T	T
	200				T	T	T	T	T	T	T	T	T	T	T	T	T	T
	250					T	T	T	T	T	T	T	T	T	T	T	T	T
	315						5	T	T	T	T	T	T	T	T	T	T	T
	355							T	T	T	T	T	T	T	T	T	T	T
	400							6	T	T	T	T	T	T	T	T	T	T
	500								8	T	T	T	T	T	T	T	T	T
	630									T	T	T	T	T	T	T	T	T
	800										12	T	T	T	T	T	T	T
	1000											16	T	T	T	T	T	T
	1250												20	T	T	T	T	T

[1] According to IEC/EN 60269-1 a "XMY" gM fuses have the same conventional time and pre-arcing time as "Y" rated gG fuse. Tables for gG fuse can be used for gM fuse using the second number of gM for the gG equivalent rating.

- 16 Selectivity limit in kA
- T Total selectivity, up to the breaking capacity of the downstream circuit breaker.
- No selectivity.

Note: Respect the basic rules of selectivity, in terms of overcurrent, short-circuit, see page A-1, or check curves with curve direct software.

Selectivity Tables with Fuses - Introduction

Upstream: ComPacT NS630b to 3200

Downstream: FuPacT (GG Fuse-Link)

$U_e \leq 440 \text{ V AC}$

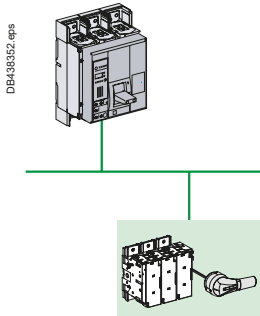

MicroLogic settings:
 ■ LT setting: $T_r = 24$ seconds.
 ■ ST setting: instantaneous OFF / $I_{sd} = 10 I_r$ / $T_{sd} = 0.4$ seconds.

Upstream CB		ComPacT NS L MicroLogic 5.0-6.0-7.0								
		NS630b	NS630b	NS630b	NS630b	NS630b	NS630b	NS630b	NS800	NS1000
Down-stream	Rating (A)	400	400	400	630	630	630	630	800	1000
	I_r setting	160	200	240	315	400	500	630	800	1000
gG^[1]	32	T	T	T	T	T	T	T	T	T
Fuse-link	40	T	T	T	T	T	T	T	T	T
	50	T	T	T	T	T	T	T	T	T
	63	T	T	T	T	T	T	T	T	T
	80	T	T	T	T	T	T	T	T	T
	100		74	74	74	74	74	74	74	74
	125			41	41	41	41	41	41	41
	160				16	16	16	16	16	16
	200					10	10	10	10	10
	250						10	10	10	10
	315								10	10
	355								10	10
	400									10
	500									
	630									
	800									
	1000									
	1250									

Upstream CB		ComPacT NS N/H MicroLogic 5.0-6.0-7.0														
		NS630b	NS630b	NS630b	NS630b	NS630b	NS630b	NS630b	NS800	NS1000	NS1250	NS1600	NS1600b	NS2000	NS2500	NS3200
Down-stream	Rating (A)	400	400	400	630	630	630	630	800	1000	1200	1600	1600	2000	2500	3200
	I_r setting	160	200	240	315	400	500	630	800	1000	1200	1600	1600	2000	2500	3200
gG^[1]	32	T	T	T	T	T	T	T	T	T	T	T	T	T	T	T
Fuse-link	40	T	T	T	T	T	T	T	T	T	T	T	T	T	T	T
	50	T	T	T	T	T	T	T	T	T	T	T	T	T	T	T
	63	T	T	T	T	T	T	T	T	T	T	T	T	T	T	T
	80	T	T	T	T	T	T	T	T	T	T	T	T	T	T	T
	100		T	T	T	T	T	T	T	T	T	T	T	T	T	T
	125			T	T	T	T	T	T	T	T	T	T	T	T	T
	160				T	T	T	T	T	T	T	T	T	T	T	T
	200					T	T	T	T	T	T	T	T	T	T	T
	250						T	T	T	T	T	T	T	T	T	T
	315								T	T	T	T	T	T	T	T
	355							44	44	44	44	T	T	T	T	T
	400								35	35	35	T	T	T	T	T
	500									25	25	T	T	T	T	T
	630										25	40	40	40	40	40
	800												40	40	40	40
	1000													40	40	40
	1250														40	40

[1] According to IEC/EN 60269-1 a "XMY" gM fuses have the same conventional time and pre-arcing time as "Y" rated gG fuse. Tables for gG fuse can be used for gM fuse using the second number of gM or the gG equivalent rating.

- 41 Selectivity limit in kA
- T Total selectivity, up to the breaking capacity of the downstream circuit breaker.
- No selectivity.

Selectivity Tables with Fuses - Introduction

Upstream: ComPacT NSX100 to 630

Downstream: FuPacT (GG Fuse-Link)

A

Ue ≤ 440 V AC

DB49354.eps

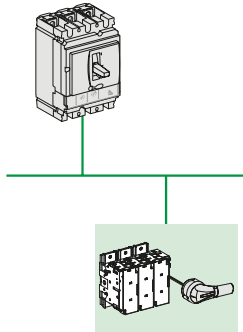

Upstream CB		NSX100B/F/N/H/S/L								NSX160B/F/N/H/S/L				NSX250B/F/N/H/S/L			
Trip unit type		TM-D								TM-D				TM-D			
Down-stream	Rating (A)	100								160				250			
	I _r setting	16	25	32	40	50	63	80	100	80	100	125	160	160	200	250	
	I _m (kA)	0.19	0.3	0.4	0.5	0.5	0.5	0.63	0.8	1	1	1	1	1	2	2.5	
gG ^[1] Fuse-link	2	T	T	T	T	T	T	T	T	T	T	T	T	T	T	T	
	4	T	T	T	T	T	T	T	T	T	T	T	T	T	T	T	
	6	T	T	T	T	T	T	T	T	T	T	T	T	T	T	T	
	10	T	T	T	T	T	T	T	T	T	T	T	T	T	T	T	
	16				T	T	T	T	T	T	T	T	T	T	T	T	
	20				T	T	T	T	T	T	T	T	T	T	T	T	
	25				T	T	T	T	T	T	T	T	T	T	T	T	
	32					T	T	T	T	T	T	T	T	T	T	T	
	35						T	T	T			T	T	T	T	T	
	40							T	T			T	T	T	T	T	
	50								T	T			T	T	T	T	T
	63									T	T			T	T	T	
	80														T	T	
	100															T	
	125																T
160																	

Upstream CB		NSX100B/F/N/H/S/L				NSX160B/F/N/H/S/L				NSX250B/F/N/H/S/L			NSX400F/N/H/S/L			NSX630F/N/H/S/L					
Trip unit type		MicroLogic 2, 5, 6 I _{sd} = 10 I _r				MicroLogic 2, 5, 6 I _{sd} = 10 I _r				MicroLogic 2, 5, 6 I _{sd} = 10 I _r			MicroLogic 2, 5, 6 I _{sd} = 10 I _r			MicroLogic 2, 5, 6 I _{sd} = 10 I _r					
Down-stream	Rating (A)	40				100				160			250			400			630		
	I _r setting	18	25	40	40	63	80	100	100	125	160	160	200	250	250	320	400	400	500	630	
	I _m (kA)	0.25		0.4	0.4	0.63	0.8	1	1	1.25	1.6	1.6	2	2.5	2.5	3.2	4	4	5	6.3	
gG ^[1] Fuse-link	2	T	T	T	T	T	T	T	T	T	T	T	T	T	T	T	T	T	T	T	
	4	T	T	T	T	T	T	T	T	T	T	T	T	T	T	T	T	T	T	T	
	6	T	T	T	T	T	T	T	T	T	T	T	T	T	T	T	T	T	T	T	
	10		T	T	T	T	T	T	T	T	T	T	T	T	T	T	T	T	T	T	
	16			T	T	T	T	T	T	T	T	T	T	T	T	T	T	T	T	T	
	20				T	T	T	T	T	T	T	T	T	T	T	T	T	T	T	T	
	25				T	T	T	T	T	T	T	T	T	T	T	T	T	T	T	T	
	32					T	T	T	T	T	T	T	T	T	T	T	T	T	T	T	
	35						T	T	T	T	T	T	T	T	T	T	T	T	T	T	
	40							T	T	T	T	T	T	T	T	T	T	T	T	T	
	50								T	T	T	T	T	T	T	T	T	T	T	T	
	63									T	T	T	T	T	T	T	T	T	T	T	
	80										T	T	T	T	T	T	T	T	T		
	100											T	T	T	T	T	T	T	T		
	125												T	T	T	T	T	T	T		
160													T	T	T	T	T	T			
200														T	T	T	T	T			
250															T	T	T	T			

[1] According to IEC/EN 60269-1 a "XMY" gM fuses have the same conventional time and pre-arcing time as "Y" rated gG fuse. Tables for gG fuse can be used for gM fuse using the second number of gM for the gG equivalent rating.

Selectivity Tables with Fuses - Introduction

Upstream: ComPacT NSX100 to 630

Downstream: FuPacT (AM Fuse-Link)

$U_e \leq 440 \text{ V AC}$

DB438365.eps

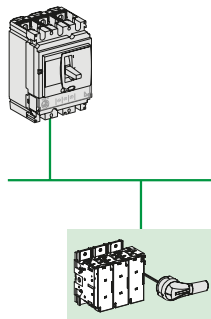

Upstream CB		NSX100B/F/N/H/S/L							NSX160B/F/N/H/S/L				NSX250B/F/N/H/S/L			
Trip unit type		TM-D							TM-D				TM-D			
Down-stream	Rating (A)	16	25	32	40	50	63	80	100	80	100	125	160	160	200	250
	I_m (kA)	0.19	0.3	0.4	0.5	0.5	0.5	0.63	0.8	1	1	1	1	1	2	2.5
aM Fuse-link	2	T	T	T	T	T	T	T	T	T	T	T	T	T	T	T
	4	T	T	T	T	T	T	T	T	T	T	T	T	T	T	T
	6	T	T	T	T	T	T	T	T	T	T	T	T	T	T	T
	10				T	T	T	T	T	T	T	T	T	T	T	T
	16						T	T	T	T	T	T	T	T	T	T
	20							T	T	T	T	T	T	T	T	T
	32								T	T	T	T	T	T	T	T
	35											T	T	T	T	T
	40												T	T	T	T
	50													T	T	T
	63													T	T	T

Upstream CB		NSX100B/F/N/H/S/L							NSX160B/F/N/H/S/L					NSX250B/F/N/H/S/L				
Trip unit type		MicroLogic							MicroLogic					MicroLogic				
Down-stream	Rating (A)	40		100			160			250								
	I_m (kA)	18	25	40	40	63	80	100	63	80	100	125	160	100	125	160	200	250
aM Fuse-link	2	T	T	T	T	T	T	T	T	T	T	T	T	T	T	T	T	T
	4	T	T	T	T	T	T	T	T	T	T	T	T	T	T	T	T	T
	6		T	T	T	T	T	T	T	T	T	T	T	T	T	T	T	T
	10			T	T	T	T	T	T	T	T	T	T	T	T	T	T	T
	16					T	T	T	T	T	T	T	T	T	T	T	T	T
	20						T	T	T	T	T	T	T	T	T	T	T	T
	32										T	T			T	T	T	
	35															T	T	
	40															T	T	
	50															T	T	
	63															T	T	

Upstream CB		NSX400F/N/H/S/L						NSX630F/N/H/S/L				
Trip unit type		MicroLogic						MicroLogic				
Down-stream	Rating (A)	400		250		320		630		500		
	I_m (kA)	160	200	250	320	400	250	320	400	500	630	
aM Fuse-link	2	T	T	T	T	T	T	T	T	T	T	
	4	T	T	T	T	T	T	T	T	T	T	
	6	T	T	T	T	T	T	T	T	T	T	
	10	T	T	T	T	T	T	T	T	T	T	
	16	T	T	T	T	T	T	T	T	T	T	
	20	T	T	T	T	T	T	T	T	T	T	
	32	T	T	T	T	T	T	T	T	T	T	
	35	T	T	T	T	T	T	T	T	T	T	
	40	T	T	T	T	T	T	T	T	T	T	
	50		T	T	T	T	T	T	T	T	T	
	63			T	T	T	T	T	T	T	T	

Selectivity Tables with Fuses - Introduction

Upstream: ComPacT NSXm MicroLogic, TM-D

Downstream: GG & AM Fuses



Ue: 380-415 V AC

Upstream CB		ComPacT NSXm E/B/F/N/H									
Trip unit type		TM-D									
Downstream	Rating (A)	16	25	32	40	50	63	80	100	125	160
	I _r (A)	16	25	32	40	50	63	80	100	125	160
gG fuse ^[1]	2	T	T	T	T	T	T	T	T	T	T
	4	T	T	T	T	T	T	T	T	T	T
	6	T	T	T	T	T	T	T	T	T	T
	10	T	T	T	T	T	T	T	T	T	T
	16				T	T	T	T	T	T	T
	20				T	T	T	T	T	T	T
	25				T	T	T	T	T	T	T
	32							T	T	T	T
	35									T	T
	40									T	T
	50									T	T
	63									T	T
	80										T

Upstream CB		ComPacT NSXm E/B/F/N/H															
Trip unit type		MicroLogic 4.1															
Downstream	Rating (A)	25				50					100				160		
		10	16	20	25	20	25	32	40	50	50	63	80	100	100	125	160
gG fuse ^[1]	2	T	T	T	T	T	T	T	T	T	T	T	T	T	T	T	T
	4	T	T	T	T	T	T	T	T	T	T	T	T	T	T	T	T
	6																
	10		0.2	0.2	0.3	0.2	0.3	0.3	0.4	0.5	T	T	T	T	T	T	T
	16								0.4	0.5	T	T	T	T	T	T	T
	20								0.4	0.5	T	T	T	T	T	T	T
	25								0.4	0.5	T	T	T	T	T	T	T
	32												T	T	T	T	T
	35															T	T
	40															T	T
	50															T	T
	63															T	T
	80																T

Upstream CB		ComPacT NSXm E/B/F/N/H									
Trip unit type		TM-D									
Downstream	Rating (A)	16	25	32	40	50	63	80	100	125	160
	I _r (A)	16	25	32	40	50	63	80	100	125	160
aM fuse	2	T	T	T	T	T	T	T	T	T	T
	4	T	T	T	T	T	T	T	T	T	T
	6	T	T	T	T	T	T	T	T	T	T
	10				T	T	T	T	T	T	T
	16						T	T	T	T	T
	20							T	T	T	T
	32									T	T
	40										T

Upstream CB		ComPacT NSXm E/B/F/N/H															
Trip unit type		MicroLogic 4.1															
Downstream	Rating (A)	25				50					100				160		
		10	16	20	25	20	25	32	40	50	50	63	80	100	100	125	160
aM fuse	2	T	T	T	T	T	T	T	T	T	T	T	T	T	T	T	T
	4		T	T	T	T	T	T	T	T	T	T	T	T	T	T	T
	6			0.2	0.3	0.2	0.3	0.3	0.4	0.5	T	T	T	T	T	T	T
	10							0.3	0.4	0.5	T	T	T	T	T	T	T
	16											T	T	T	T	T	T
	20												T	T	T	T	T
	32														T	T	T
	40															T	T

[1] According to IEC/EN 60269-1 a "XMY" gM fuses have the same conventional time and pre-arcing time as "Y" rated gG fuse. Tables for gG fuse can be used for gM fuse using the second number of gM for the gG equivalent rating.

Selectivity Tables with Fuses - Introduction

Upstream: Fuses NH000/NH00/NH0/NH1

Downstream: iC60N/H/L Curve B, C, D

U_e: 380-415 V AC Ph/Ph
(220-240 V AC Ph/N)

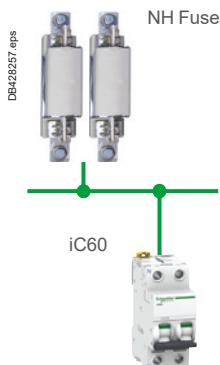

Upstream		NH000/NH00/NH0/NH1													
In (A)		16	20	25	32	35	40	50	63	80	100	125	160	200	250
Downstream Rating (A)															
		Selectivity limit (kA)													
iC60N/H/L Curve B	0.5	T	T	T	T	T	T	T	T	T	T	T	T	T	T
	1	1.6	4.5	T	T	T	T	T	T	T	T	T	T	T	T
	1.6	0.8	1.7	5	T	T	T	T	T	T	T	T	T	T	T
	2	0.65	1.2	2.7	5.1	7.5	15	T	T	T	T	T	T	T	T
	3		1	1.9	3.3	4.5	8	T	T	T	T	T	T	T	T
	4		0.75	1	2	2.7	4	7.5	9.5	T	T	T	T	T	T
	6			0.8	1.5	2	2.7	4.5	7.2	8.5	T	T	T	T	T
	10			0.6	1.1	1.5	1.9	2.9	5.4	5	12	13	T	T	T
	13			0.55	0.9	1.4	1.7	2.5	3.5	4.2	9.5	9.9	T	T	T
	16				0.8	1.2	1.5	2.2	3	3.6	7.8	8	T	T	T
	20					1	1.3	1.8	2.5	3.1	6	6.5	T	T	T
	25						1	1.7	2.2	2.8	5.4	5.7	15	T	T
	32							1.5	2	2.6	4.5	4.9	11.7	T	T
	40								1.9	2.4	4	4.6	10.2	T	T
50									2.3	3.7	4.4	9.7	T	T	
63										3.5	4.2	9	T	T	
iC60N/H/L Curve C	0.5	T	T	T	T	T	T	T	T	T	T	T	T	T	T
	1	1.6	4.5	T	T	T	T	T	T	T	T	T	T	T	T
	1.6	0.8	1.7	5	T	T	T	T	T	T	T	T	T	T	T
	2	0.65	1.2	2.7	5.1	7.5	15	T	T	T	T	T	T	T	T
	3		1	1.9	3.3	4.5	8	T	T	T	T	T	T	T	T
	4		0.75	1	2	2.7	4	7.5	9.5	T	T	T	T	T	T
	6			0.8	1.5	2	2.7	4.5	7.2	8.5	T	T	T	T	T
	10			0.6	1.1	1.5	1.9	2.9	5.4	5	12	13	T	T	T
	13			0.55	0.9	1.4	1.7	2.5	3.5	4.2	9.5	9.9	T	T	T
	16				0.8	1.2	1.5	2.2	3	3.6	7.8	8	T	T	T
	20					1	1.3	1.8	2.5	3.1	6	6.5	T	T	T
	25						1	1.7	2.2	2.8	5.4	5.7	15	T	T
	32							1.5	2	2.6	4.5	4.9	11.7	T	T
	40								1.9	2.4	4	4.6	10.2	T	T
50									2.3	3.7	4.4	9.7	T	T	
63										3.5	4.2	9	T	T	
iC60N/H/L Curve D	0.5	T	T	T	T	T	T	T	T	T	T	T	T	T	T
	1	1.5	4.4	T	T	T	T	T	T	T	T	T	T	T	T
	1.6	0.7	1.7	4.9	T	T	T	T	T	T	T	T	T	T	T
	2	0.6	1.2	2.7	5	7.3	14.8	T	T	T	T	T	T	T	T
	3		0.9	1.9	3.3	4.5	8	T	T	T	T	T	T	T	T
	4		0.75	1	2	2.7	4	7.5	9.5	T	T	T	T	T	T
	6			0.8	1.5	2	2.7	4.5	7.2	8.5	T	T	T	T	T
	10			0.6	1.1	1.5	1.9	2.9	5.4	5	12	13	T	T	T
	13				0.9	1.4	1.7	2.5	3.5	4.2	9.5	9.9	T	T	T
	16					1.2	1.5	2.2	3	3.6	7.8	8	T	T	T
	20						1.3	1.8	2.5	3.1	6	6.5	T	T	T
	25							1.7	2.2	2.8	5.4	5.7	15	T	T
	32								2	2.6	4.5	4.9	11.7	T	T
	40									2.4	4	4.6	10.2	T	T
50										3.7	4.4	9.7	T	T	
63										4.2	4.2	9	T	T	

1.7 Selectivity limit (kA) = 1.7 kA.

T Total selectivity, up to the breaking capacity of the downstream circuit breaker.

No selectivity.

See also guide CA908036 for Acti9 and fuses coordination.



Selectivity Tables with Fuses - Introduction

Upstream: Fuses NH000/NH00/NH0/NH1

Downstream: iC60 RCBO Curve B, C

A

Ue: 380-415 V Ph/Ph
(220-240 V Ph/N)

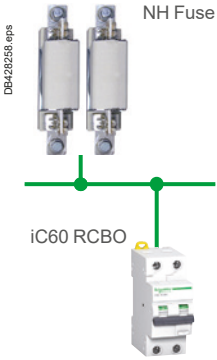

Upstream		NH000/NH00/NH0/NH1													
In (A)		16	20	25	32	35	40	50	63	80	100	125	160	200	250
Downstream	Selectivity limit (kA)														
	Rating (A)														
iC60N/H/H2 RCBO Curve B	0.5	T	T	T	T	T	T	T	T	T	T	T	T	T	T
	1	1.6	4.5	T	T	T	T	T	T	T	T	T	T	T	T
	1.6	0.8	1.7	5	T	T	T	T	T	T	T	T	T	T	T
	2	0.65	1.2	2.7	5.1	7.5	15	T	T	T	T	T	T	T	T
	3		1	1.9	3.3	4.5	8	T	T	T	T	T	T	T	T
	4		0.75	1	2	2.7	4	7.5	9.5	T	T	T	T	T	T
	6			0.8	1.5	2	2.7	4.5	7.2	8.5	T	T	T	T	T
	10			0.6	1.1	1.5	1.9	2.9	5.4	5	12	13	T	T	T
	13			0.55	0.9	1.4	1.7	2.5	3.5	4.2	9.5	9.9	T	T	T
	16				0.8	1.2	1.5	2.2	3	3.6	7.8	8	T	T	T
	20					1	1.3	1.8	2.5	3.1	6	6.5	T	T	T
	25						1	1.7	2.2	2.8	5.4	5.7	15	T	T
	32							1.5	2	2.6	4.5	4.9	11.7	T	T
	40								1.9	2.4	4	4.6	10.2	T	T
	45									2.3	3.7	4.4	9.7	T	T
iC60N/H/H2 RCBO Curve C	6			0.8	1.5	2	2.7	4.5	7.2	8.5	T	T	T	T	T
	10			0.6	1.1	1.5	1.9	2.9	5.4	5	12	13	T	T	T
	13			0.55	0.9	1.4	1.7	2.5	3.5	4.2	9.5	9.9	T	T	T
	16				0.8	1.2	1.5	2.2	3	3.6	7.8	8	T	T	T
	20					1.3	1.8	2.5	3.1	6	6.5	T	T	T	
	25						1.7	2.2	2.8	5.4	5.7	15	T	T	
	32							2	2.6	4.5	4.9	11.7	T	T	
	40								2.4	4	4.6	10.2	T	T	
	45									3.7	4.4	9.7	T	T	

1.7 Selectivity limit (kA) = 1.7 kA.

T Total selectivity, up to the breaking capacity of the downstream circuit breaker.

No selectivity.

See also guide CA908036 for Acti9 and fuses coordination.

Selectivity Tables with Fuses - Introduction

Upstream: Fuses NH000/NH00/NH0/NH1

Downstream: Acti9 iC40, IC40N, iCV40, ICV40N/H

Ue: 380-415 V Ph/Ph
(220-240 V Ph/N)

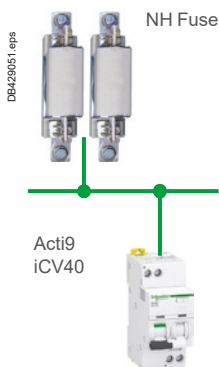

Upstream		NH000/NH00/NH0/NH1													
In (A)		16	20	25	32	35	40	50	63	80	100	125	160	200	250
Downstream	Selectivity limit (kA)														
	Rating (A)														
iC40 iC40N (1) iC40N Arc iCV40N/H iC40N/H VigiArc Active iC40N VigiArc Curve B	1	2	T	T	T	T	T	T	T	T	T	T	T	T	T
	2	0.5	0.8	2.5	T	T	T	T	T	T	T	T	T	T	T
	3		0.6	1.2	2.6	5	T	T	T	T	T	T	T	T	T
	4		0.5	1.05	2	4	5	T	T	T	T	T	T	T	T
	6			1	1.4	2.5	3.5	4.7	8.5	T	T	T	T	T	T
	10			0.75	1.1	2	2.5	3.1	3.6	5.4	T	T	T	T	T
	13			0.7	1	1.8	2	2.7	3	5	T	T	T	T	T
	16			0.6	0.9	1.55	1.7	2.2	3	4.4	T	T	T	T	T
	20				0.8	1.4	1.6	2	2.45	3.5	T	T	T	T	T
	25					1.2	1.4	1.7	2.35	3.3	8	T	T	T	T
32										7.5	T	T	T	T	
40								1.5	2.3	3.2	7.5	T	T	T	
iC40 iC40N (1) iC40N Arc Active iC40N Arc3 iCV40N/H iC40N/H VigiArc Active iC40N/H VigiArc Curve C	1	2	T	T	T	T	T	T	T	T	T	T	T	T	T
	2	0.5	0.8	2.5	T	T	T	T	T	T	T	T	T	T	T
	3		0.6	1.2	2.6	5	T	T	T	T	T	T	T	T	T
	4		0.5	1.05	2	4	5	T	T	T	T	T	T	T	T
	6			0.9	1.4	2.5	3.5	4.65	8.5	T	T	T	T	T	T
	10			0.375	1.025	1.8	2.5	2.8	3.6	5.4	T	T	T	T	T
	13					1.5	2	2.2	3	5	T	T	T	T	T
	16					0.775	1.7	2	3	4.4	T	T	T	T	T
	20						1.6	1.875	2.45	3.5	T	T	T	T	T
	25							0.85	2.35	3.3	8	T	T	T	T
32										7.5	T	T	T	T	
40										6.6	T	T	T	T	
Acti9 iC40 Acti9 iC40 N Curve D	1	2	T	T	T	T	T	T	T	T	T	T	T	T	T
	2	0.5	0.8	2.5	T	T	T	T	T	T	T	T	T	T	T
	3		0.6	1.2	2.6	5	T	T	T	T	T	T	T	T	T
	4		0.5	1.05	2	4	5	T	T	T	T	T	T	T	T
	6			0.8	1.4	2.5	3.5	4.6	8.5	T	T	T	T	T	T
	10				0.95	1.6	2.5	2.5	3.6	5.4	T	T	T	T	T
	13						2	2.1	3	5	T	T	T	T	T
	16						1.7	1.8	3	4.4	T	T	T	T	T
	20							1.75	2.45	3.5	T	T	T	T	T
	25								2.35	3.3	8	T	T	T	T
32									3.2	7.5	T	T	T	T	
40										6.6	T	T	T	T	

2.6 Selectivity limit (kA) = 2.6 kA.

T Total selectivity, up to the breaking capacity of the downstream circuit breaker.

No selectivity.

See also guide CA908036 for Acti9 and fuses coordination.

Selectivity Tables with Fuses - Introduction

Upstream: Fuses NH000/NH00/NH0/NH1

Downstream: C120N/H and NG125N/H/L Curve B, C, D

A

Ue: 380-415 V Ph/Ph
(220-240 V Ph/N)

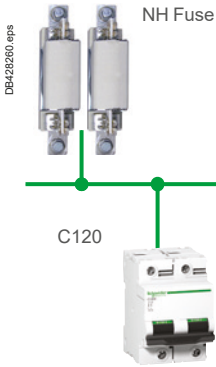

Upstream		NH000/NH00/NH0/NH1											
In (A)		25	32	35	40	50	63	80	100	125	160	200	250
Downstream		Selectivity limit (kA)											
Rating (A)													
C120N/H NG125N/H/L Curve B	10		0.75	0.95	1.1	1.6	1.9	2.7	5.5	7.5	18.5	T	T
	16		0.55	0.8	0.95	1.4	1.7	2.3	4.6	7	12.5	T	T
	20				0.9	1.35	1.65	2.2	4.5	6.5	12	22.5	T
	25					1.15	1.45	2.05	3.8	5.8	9.5	13.5	T
	32					1.1	1.4	2	3.7	5	9	13	T
	40						1.35	1.85	3.4	4.8	7.6	10.5	T
	50								3.25	4.7	7.2	9.5	T
	63								3	4.5	7	9.3	T
	80									4.2	6.2	8.2	T
	100											7.7	T
125											7.5	T	
C120N/H NG125N/H/L Curve C	10		0.75	0.95	1.1	1.6	1.9	2.7	5.5	7.5	18.5	T	T
	16		0.55	0.8	0.95	1.4	1.7	2.3	4.6	7	12.5	T	T
	20				0.9	1.35	1.65	2.2	4.5	6.5	12	22.5	T
	25					1.15	1.45	2.05	3.8	5.8	9.5	13.5	T
	32						1.4	2	3.7	5	9	13	T
	40							1.85	3.4	4.8	7.6	10.5	T
	50								3.25	4.7	7.2	9.5	T
	63									4.5	7	9.3	T
	80											8.2	T
	100											7.7	T
125												T	
C120N/H NG125N/H/L Curve D	10		0.75	0.95	1.1	1.6	1.9	2.7	5.5	7.5	18.5	T	T
	16				0.95	1.4	1.7	2.3	4.6	7	12.5	T	T
	20					1.35	1.65	2.2	4.5	6.5	12	22.5	T
	25						1.45	2.05	3.8	5.8	9.5	13.5	T
	32							2	3.7	5	9	13	T
	40								3.4	4.8	7.6	10.5	T
	50									4.7	7.2	9.5	T
	63										7	9.3	T
	80											8.2	T
	100												T
125												T	

- 1.4 Selectivity limit (kA) = 1.4 kA.
- T Total selectivity, up to the breaking capacity of the downstream circuit breaker.
- No selectivity.

See also guide CA908036 for Acti9 and fuses coordination.

Selectivity Tables with Fuses - Introduction

Upstream: FuPacT (GG Fuse-Link)

Downstream: ComPacT NSXm, NSX100 to 630

Ue ≤ 440 V AC

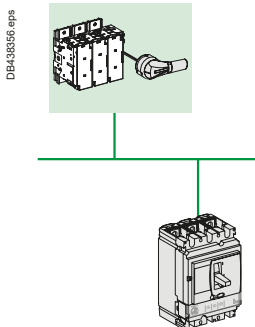

Upstream		gG fuse															
Downstream CB	Rating (A)	160	200	250	315	355	400	450	500	560	630	670	710	750	800	1000	1250
ComPacT NSXm E/B/F/N/H TM-D	16	0.5	5	T	T	T	T	T	T	T	T	T	T	T	T	T	T
	25	0.5	5	30	T	T	T	T	T	T	T	T	T	T	T	T	T
	32	0.5	5	20	T	T	T	T	T	T	T	T	T	T	T	T	T
	40	0.5	5	20	30	T	T	T	T	T	T	T	T	T	T	T	T
	50	0.5	5	15	30	T	T	T	T	T	T	T	T	T	T	T	T
	63	0.5	5	10	30	T	T	T	T	T	T	T	T	T	T	T	T
	80		5	10	25	T	T	T	T	T	T	T	T	T	T	T	T
	100			7	20	T	T	T	T	T	T	T	T	T	T	T	T
	125					T	T	T	T	T	T	T	T	T	T	T	T
160					T	T	T	T	T	T	T	T	T	T	T	T	
ComPacT NSXm E/B/F/N/H MicroLogic 4.1	25	0.375	5	20	30	T	T	T	T	T	T	T	T	T	T	T	T
	50	0.375	5	15	30	T	T	T	T	T	T	T	T	T	T	T	T
	100			10	30	T	T	T	T	T	T	T	T	T	T	T	T
	160					T	T	T	T	T	T	T	T	T	T	T	T
ComPacT NSX100 TM-D	16	2.5	4	7	15	T	T	T	T	T	T	T	T	T	T	T	T
	25	2.5	4	7	15	T	T	T	T	T	T	T	T	T	T	T	T
	32	2.5	4	7	15	T	T	T	T	T	T	T	T	T	T	T	T
	40	2.5	4	7	15	T	T	T	T	T	T	T	T	T	T	T	T
	50	2.5	4	7	15	T	T	T	T	T	T	T	T	T	T	T	T
	63	2.5	4	7	15	T	T	T	T	T	T	T	T	T	T	T	T
	80		4	7	15	T	T	T	T	T	T	T	T	T	T	T	T
	100			7	15	T	T	T	T	T	T	T	T	T	T	T	T
	125					T	T	T	T	T	T	T	T	T	T	T	T
ComPacT NSX250 TM-D	≤ 100						T	T	T	T	T	T	T	T	T	T	T
	125						T	T	T	T	T	T	T	T	T	T	T
	160						T	T	T	T	T	T	T	T	T	T	T
	200						T	T	T	T	T	T	T	T	T	T	T
	250						T	T	T	T	T	T	T	T	T	T	T
ComPacT NSX100 MicroLogic	40			4	10	T	T	T	T	T	T	T	T	T	T	T	T
	100			4	10	T	T	T	T	T	T	T	T	T	T	T	T
ComPacT NSX160 MicroLogic	40				7	8	T	T	T	T	T	T	T	T	T	T	T
	100				7	8	T	T	T	T	T	T	T	T	T	T	T
	160				7	8	T	T	T	T	T	T	T	T	T	T	T
ComPacTNSX250 MicroLogic	100							10	T	T	T	T	T	T	T	T	T
	160							10	T	T	T	T	T	T	T	T	T
	250								T	T	T	T	T	T	T	T	T
ComPacT NSX400 MicroLogic	160								6	7	9	10	T	T	T	T	T
	200								6	7	9	10	T	T	T	T	T
	250								6	7	9	10	T	T	T	T	T
	320								6	7	9	10	T	T	T	T	T
	400								6	7	9	10	T	T	T	T	T
ComPacT NSX630 MicroLogic	400												12	15	30	T	T
	630												12	15	30	T	T

- 16 Selectivity limit in kA
- T Total selectivity, up to the breaking capacity of the downstream circuit breaker.
- No selectivity.

Cascading (or Back-up Protection, or Combined Short-Circuit Protection)

Introduction

A

Cascading is the legacy name used by Schneider Electric.

Product standards such as IEC/EN 60947, 60898, 61009-1 call this performance of two circuit-breakers "back-up protection".

Low voltage Electrical installation standard IEC 60364 serie and in particular IEC 60364-5-53 (2019) Clause 535.5 use the wording "Combined short-circuit protection".

In this document we'll keep "Cascading" but the three wordings are equivalent.

In North America and UL standards this performance is known as "Series rating".

IEC/EN 60947-2, Annex A IEC 60364-4-43 (2008) § 434.5.1

What is cascading?

Cascading is the use of the current limiting capacity of circuit breakers at a given point to permit installation of lower-rated and therefore lower-cost circuit breakers downstream.

The upstream ComPacT circuit breakers acts as a barrier against short-circuit currents. In this way, downstream circuit breakers with lower breaking capacities than the prospective short-circuit (at their point of installation) operate under their normal breaking conditions.

Since the current is limited throughout the circuit controlled by the limiting circuit breaker, cascading applies to all switchgear downstream. It is not restricted to two consecutive devices.

General use of cascading

With cascading, the devices can be installed in different switchboards. Thus, in general, cascading refers to any combination of circuit breakers where a circuit breaker with a breaking capacity less than the prospective Isc at its point of installation can be used. Of course, the breaking capacity of the upstream circuit breaker must be greater than or equal to the prospective short-circuit current at its point of installation.

The combination of two circuit breakers in cascading configuration is covered by the following standards of:

- Product standard such as IEC/EN 60947, 60898, 61009-1
- Low voltage electrical installation.

Coordination between circuit breakers

The use of a protective device possessing a breaking capacity less than the prospective short-circuit current at its installation point is permitted as long as another device is installed upstream with at least the necessary breaking capacity. In this case, the characteristics of the two devices must be coordinated in such a way that the energy let through by the upstream device is not more than that which can be withstood by the downstream device and the cables protected by these devices without damage.

Cascading can only be checked by laboratory tests and the possible combinations can be specified only by the circuit breaker manufacturer.

Cascading and selectivity

In cascading configurations, due to the Roto-active breaking technique, selectivity is maintained and, in some cases, even enhanced. Consult the enhanced selectivity tables on page A-209 for data on selectivity limits.

Cascading tables

Schneider Electric cascading tables are:

- Drawn up on the basis of calculations (comparison between the energy limited by the upstream device and the maximum permissible thermal stress for the downstream device)
- Verified experimentally in accordance with IEC/EN standard 60947-2. For 50/60 Hz distribution systems with 220-240 V, 380-415 V and 440 V between phases, the tables of the following pages indicate cascading possibilities between upstream ComPacT and downstream Acti 9 and ComPacT circuit breakers as well as between upstream MasterPact and downstream ComPacT circuit breakers.

How to use the table

The reinforced breaking capacity given in the table shall be compared to the presumed short-circuit current (rms value) at the point of installation without taking in consideration the limitation effect of the upstream circuit-breaker.

Circuit breaker with Vigi module (Add-On Residual Current Device - RCD):

When circuit breakers are equipped with Vigi module, the following cascading tables are still applicable.

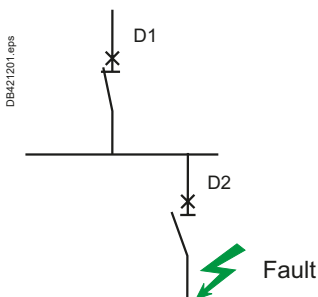
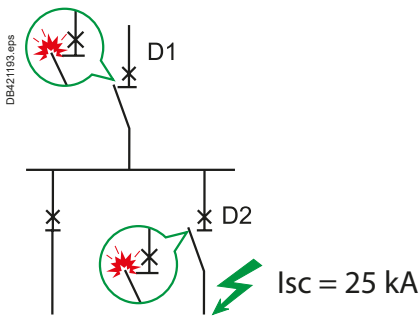

D1 and D2 in series.

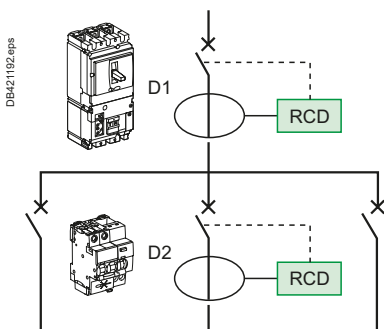



Using the cascading tables

The following cascading tables takes in account all types of faults: between phases, phase and neutral, phase and earth in all earthing systems. In IT the following cascading tables can not be used to evaluate performances in case of "double fault" between two different phases and earth in two different locations of the installation. Each breaker shall comply to IEC/EN 60947-2 Annex H to be used in such a system. Depending on the network and the type of downstream circuit breaker, the selection table below indicates which table should be consulted to find out the reinforced breaking capacity thanks to cascading.

Selection table

		Upstream network					
		DB123996.eps L1 _____ N _____		DB123998.eps L1 _____ L2 _____ L3 _____ N _____		DB123997.eps L1 _____ L2 _____ L3 _____	
Type of Downstream network	Type of Downstream protection device	Type of circuit breaker upstream device: 1P, 2P, 3P or 4P circuit breaker					
		Ph/N 110-130 V	Ph/N 220-240 V	Ph/N 110-130 V Ph/Ph 220-240 V	Ph/N 220-240 V Ph/Ph 380-415 V	Ph/Ph 220-240 V	Ph/Ph 380-415 V
DB124079.eps N L1	DB123991.eps 2P		[1]		[1]		
	DB124191.eps 1P	DB123992.eps 1P + N		[1]		[1]	
DB124192.eps L1 L2	DB123991.eps 2P			See table Ue: 220-240 V	See table Ue: 380-415 V	See table Ue: 220-240 V	See table Ue: 380-415 V
DB124080.eps L1 L2 L3	DB123993.eps 3P			See table Ue: 220-240 V	See table Ue: 380-415 V	See table Ue: 220-240 V	See table Ue: 380-415 V
DB124081.eps NL1 L2 L3	DB123994.eps 4P			See table Ue: 220-240 V	See table Ue: 380-415 V		
	DB123995.eps 3P+N			See table Ue: 220-240 V	See table Ue: 380-415 V		

[1] Values provided in Tables Ue: 220-240 V AC can be used to check reinforced breaking capacity of a circuit-breaker protecting 220-240 V AC single phase circuit in case of Line to Neutral fault (i.e: Reinforced breaking capacity from table Ue: 220-240 V AC \geq Ik1) provided that:

- Upstream circuit-breaker is a 4P or 2P or Acti9 iC60 1P+N, and
- Downstream circuit-breaker is a 2P or an Acti9 iC60 1P+N

In all cases for 220-240 V AC Single phase application, tables Ue: 380-415 V AC shall be used to check breaking capacity in case of line to earth Fault (i.e. Reinforced breaking capacity Ue: 380-415 V AC \geq If).

See the difference between the Line to Earth fault and Line to Neutral fault below.

A

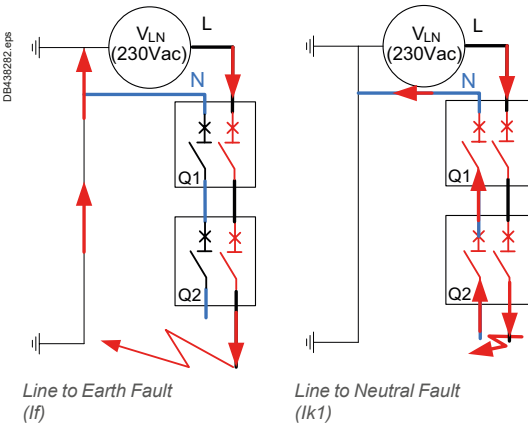

Difference between Line to Neutral and Line to earth fault regarding cascading

The number of poles breaking the current is different in case of line to neutral fault and line to earth fault.

The reinforced breaking capacity published in tables for a given "Line to Line" system voltage apply to all type of faults including line to earth.

Application of cascading

Both "Industrial" circuit-breaker standard (IEC/EN 60947) and "residential" circuit-breaker standards (IEC/EN 60898 & 61009) define and provide test method for this "cascading" performance.

Anyway Schneider Electric doesn't recommend to apply cascading in installation used by un instructed persons. The following tables are therefore providing a "reinforced breaking capacity" according to IEC/EN 60947-2 Annex A.

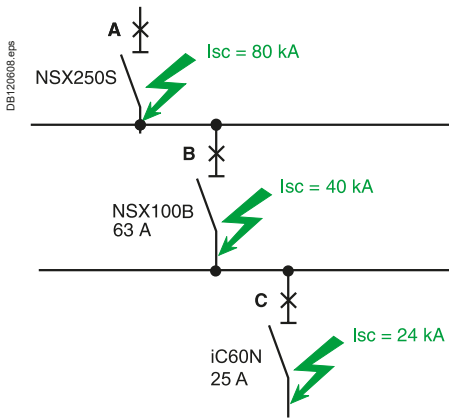

Three level cascading

Consider three circuit breakers A, B and C connected in series. The criteria for cascading are fulfilled in the following two cases:

- The upstream device A is coordinated for cascading with both devices B and C (even if the cascading criteria are not fulfilled between B and C). It is simply necessary to check that the combinations A + B and A + C have the required breaking capacity
- Each pair of successive devices is coordinated, i.e. A with B and B with C (even if the cascading criteria are not fulfilled between A and C). It is simply necessary to check that the combinations A + B and B + C have the required breaking capacity.

Example: the upstream breaker A is a NSX250S (breaking capacity 100 kA) for a prospective Isc of 80 kA across its output terminals.

A NSX100B (breaking capacity 25 kA) can be used for circuit breaker B for a prospective Isc of 40 kA across its output terminals, since the "reinforced" breaking capacity provided by cascading with the upstream NSX250S is 50 kA.

A iC60N (breaking capacity 10 kA) can be used for circuit breaker C for a prospective Isc of 24 kA across its output terminals since the "reinforced" breaking capacity provided by cascading with the upstream NSX250S is 30 kA.

Note that the "reinforced" breaking capacity of the iC60N with the NSX100B upstream is only 20 kA, but:

- A + B = 50 kA
- A + C = 30 kA.

Cascading Tables

Quick Access to the Tables



Downstream	Upstream							
Type	iC40	iC60	C120	NG125	ComPacT NSXm	ComPacT NSX100	ComPacT NSX160	ComPacT NSX250
380-415 V (Ph/N 220-240 V)								
iC40	page A-193	page A-193	page A-193	page A-193	page A-194	page A-194	page A-195	page A-195
iC60								
C120								
NG125								
ComPacT NSXm	-	-	-	-	-	-	-	-
ComPacT NSX100								
ComPacT NSX160							page A-196	page A-196
ComPacT NSX250							-	-
440 V								
iC60		page A-198		page A-198	page A-198	page A-198	page A-199	-
NG125								
ComPacT NSXm	-	-	-	-	-	-	-	-
ComPacT NSX100								page A-199
ComPacT NSX160								
ComPacT NSX250								
220-240 V (Ph/N 110-130 V)								
iDPN		page A-202	page A-202	page A-202	page A-202	page A-202	page A-203	page A-203
iC60								
C120								
NG125								
ComPacT NSXm	-	-	-	-	-	-	-	-
ComPacT NSX100								
ComPacT NSX160								
ComPacT NSX250								

Selectivity enhanced by cascading

Downstream	Upstream			
Type	ComPacT NSXm	ComPacT NSX100	ComPacT NSX160	ComPacT NSX250
380-415 V (Ph/N 220-240 V)				
iC60	page A-210	page A-211	page A-212 to A-213	page A-212 to A-213
C120	-	-	-	page A-212 to A-213
NG125	-	-	-	page A-212 to A-213
ComPacT NSXm	-	-	-	page A-212 to A-213
ComPacT NSX100	-	-	-	page A-212 to A-213
440 V				
ComPacT NSXm	-	-	-	page A-225 to A-226
iC60	page A-223	page A-224	page A-225 to A-226	-
NG125	-	-	page A-225 to A-226	page A-225 to A-226
ComPacT NSX100	-	-	-	page A-225 to A-226
220-240 V (Ph/N 110-130 V)				
iC60	-	page A-232	page A-230 to A-232	page A-230 to A-232
C120	-	-	-	page A-230 to A-232
NG125	-	-	page A-230	page A-230 to A-232
ComPacT NSXm	-	-	-	page A-233 to A-234
ComPacT NSX100	-	-	-	page A-233 to A-234

Cascading Tables

Quick Access to the Tables

A

Downstream	Upstream				
Type	ComPacT NSX400	ComPacT NSX630	ComPacT NS630b-1600	ComPacT NS1600-3200	MasterPacT MTZ
380-415 V (Ph/N 220-240 V)					
ComPacT NSXm				-	-
ComPacT NSX100	page A-196	page A-196			
ComPacT NSX160					
ComPacT NSX250					
ComPacT NSX400			page A-197	page A-197	page A-197
ComPacT NSX630					
ComPacT NS630b					
ComPacT NS800					
ComPacT NS1000	-	-			
ComPacT NS1250					
ComPacT NS1600					
440 V					
ComPacT NSXm			-	-	-
ComPacT NSX100	page A-200	page A-200			
ComPacT NSX160					
ComPacT NSX250					
ComPacT NSX400					
ComPacT NSX630			page A-201	page A-201	page A-201
ComPacT NS630b					
ComPacT NS800	-	-			
ComPacT NS1000					
ComPacT NS1250					
ComPacT NS1600					
220-240 V (Ph/N 110-130 V)					
ComPacT NSXm			-	-	-
ComPacT NSX100	page A-204	page A-204			
ComPacT NSX160					
ComPacT NSX250					
ComPacT NSX400			page A-205	page A-205	page A-205
ComPacT NSX630					
ComPacT NSX630b	-	-			

Selectivity enhanced by cascading

Downstream	Upstream					
Type	ComPacT NSX400	ComPacT NSX630	ComPacT NS800	ComPacT NS1000	ComPacT NS1250	ComPacT NS1600
380-415 V (Ph/N 220-240 V)						
ComPacT NSXm			-	-	-	-
ComPacT NSX100	page A-214	page A-214				
ComPacT NSX160						
ComPacT NSX250			page A-215	page A-215	page A-215	page A-215
ComPacT NSX400	-	-				
ComPacT NSX630						
440 V						
ComPacT NSXm			-	-	-	-
ComPacT NSX100	page A-227	page A-227				
ComPacT NSX160						
ComPacT NSX250			page A-228	page A-228	page A-228	page A-228
ComPacT NSX400	-	-				
ComPacT NSX630						
220-240 V (Ph/N 110-130 V)						
ComPacT NSXm	-	-	-	-		
ComPacT NSX100	page A-234	page A-234	page A-234	page A-234		
ComPacT NSX160						
ComPacT NSX250						
ComPacT NSX400	-	-	-			
ComPacT NSX630						

Cascading

Upstream: iC40, iC60, C120, NG125

Downstream: iC40, iCV40, iC60, C120, NG125

U_e: 380-415 V AC
(Ph/N 220-240 V AC)



Upstream CB	iDPN N	iC40 N	iC60			C120			NG125			
			N	H	L	N	H	L	N	H	L	
Icu (kA)	10	10	10	15	≤ 25 A	32/40 A	50/63 A	10	15	25	36	50

Downstream CB	Rating (A)	Icu (kA) (Icn (A))	Reinforced breaking capacity (kA) according to IEC/EN 60947-2 Annex A										
			iDPN N	iC40 N	iC60 N	iC60 H	iC60 L	C120 N	C120 H	C120 L	NG125 N	NG125 H	NG125 L
iC40 ^[1]	2-16	6/4500	10	10	10	10	20	15	10	10	10	16	20
	20-40		10	10	10	10	15	10	10	10	10	16	16
iC40N ^[1]	2-16	10/6000				15	25	20	15		15	20	25
	20-40					15	20	15		15	16	16	20
iCV40N ^[1]	6-16	6000	10	10	10	15	25	20	15		15	20	25
	20-40		10	10	10	15	20	15		15	16	16	20
iC40N ARC ^[1]	6-16	10/6000				15	25	20	15		15	20	25
iC40N+ARC iC40 ^[1]	20-40					15	20	15		15	16	16	20
iC40N+VigiARC iC40 ^[1]	20-40				15	20	15		15	16	16	20	
iCV40N VigiARC ^[1]	6-16	10000				15	25	20	15		15	20	25
iC40H ^[1]	20-32					15	20	15		15	16	16	20
iCV40H ^[1]	20-32				15	20	15		15	16	16	20	
iC40H+ARC iC40 ^[1]	6-16	10000				15	25	20	15		15	20	25
iC40H+VigiARC iC40 ^[1]	20-32					15	20	15		15	16	16	20
iCV40H VigiARC ^[1]	20-32				15	20	15		15	16	16	20	
iC60N	0.5-25	10				15	25	20	15		15	25	25
	32-40					15	20	15		15	25	25	
	50-63					15	20	15		15	25	25	
iC60N+ARC iC60 ^[1]	0.5-25	10				15	25	20	15		15	25	25
iC60N+VigiARC iC60 ^[1]	32-40					15	20	15		15	25	25	
iC60H	0.5-25					25	20			25	36	36	
iC60H	32-40	15						20			25	36	36
	50-63									25	36	36	
	iC60H+ARC iC60 ^[1]					25	20			25	36	36	
iC60H+VigiARC iC60 ^[1]	32-40						20			25	36	36	
iC60L	0.5-25	25										36	50
	32-40										36	50	
	50-63										25	36	36
iC60L+ARC iC60 ^[1]	0.5-25	25										36	36
iC60L+VigiARC iC60 ^[1]	32-40										25	36	36
iC60 RCBO 2P/3P 400V ^[1]	10-32		6000	10	10	15	25	20	15	10	15	25	25
iC60 RCBO 2P (PN) 230V ^[1]	10-32	10000	10	10	15	25	20	15	10	15	25	25	
iC60N RCBO (VD)	6-45	6000	10	10	15	25	20	15	10	15	25	25	
iC60H RCBO (VD)	6-45	10000			15	25	20	15		15	25	36	36
iC60H2 RCBO (VD)	10-32	10000			15	25	20	15		15	25	36	36
C120N	63-125	10								15	25	25	36
C120H	63-125	15									25	25	36
NG125N	10-125	25										36	36
NG125H	10-125	36											50

[1] U_e = 380-400 V AC (Ph/N 220-230 V AC)

VD: Voltage dependent RCBOs are RCBOs according to IEC 61009-2-2. These RCBOs are allowed only in some countries. See IEC 60364-5-53:2020 Annex F.

Cascading

Upstream: ComPacT NSXm, NSX100

Downstream: iC40, iCV40, iC60, C120, NG125, ComPacT NSXm, NSX100

A

Ue: 380-415 V AC
(Ph/N 220-240 V AC)

Upstream CB			NSXm					NSX100					
			E	B	F	N	H	B	F	N	H	S	L
Icu (kA)			16	25	36	50	70	25	36	50	70	100	150
Downstream CB			Reinforced breaking capacity (kA) according to IEC/EN 60947-2 Annex A										
	Rating (A)	Icu (kA) (Icn (A))											
iC40 ^[1]	2-40	6/4500	10	10	10	10	10	10	10	10	10	10	10
iC40N ^[1]	2-16	10/6000	16	20	20	20	20	20	20	20	20	20	20
	20-40		16	16	16	16	16	16	16	16	16	16	16
iCV40N ^[1]	6-16	6000	16	20	20	20	20	20	20	20	20	20	20
	20-40		16	16	16	16	16	16	16	16	16	16	16
iC40N ARC ^[1]	6-16	10/6000	16	20	20	20	20	20	20	20	20	20	20
iC40N+ARC iC40 ^[1]	20-40		16	16	16	16	16	16	16	16	16	16	16
iC40N+VigiARC iC40 ^[1]	20-40	10000	16	20	20	20	20	20	20	20	20	20	20
iCV40N VigiARC ^[1]													
iC40H ^[1]	6-16	10000	16	20	20	20	20	20	20	20	20	20	20
iCV40H ^[1]	20-32		16	16	16	16	16	16	16	16	16	16	16
iC40H+ARC iC40 ^[1]	6-16	10000	16	20	20	20	20	20	20	20	20	20	20
iC40H+VigiARC iC40 ^[1]													
iCV40H VigiARC ^[1]	20-32	16	16	16	16	16	16	16	16	16	16	16	
iC60N	0.5-40	10	16	20	25	30	30	20	25	30	30	30	30
	50-63		16	20	25	30	30	20	25	30	30	30	30
iC60N+ARC iC60 ^[1]	0.5-40	10	16	20	25	30	30	20	25	30	30	30	30
iC60N+VigiARC iC60 ^[1]													
iC60H	0.5-40	15	16	25	36	36	36	25	36	40	40	40	40
	50-63		16	25	36	36	36	25	36	40	40	40	40
iC60H+ARC iC60 ^[1]	0.5-40	15	16	25	36	36	36	25	36	40	40	40	40
iC60H+VigiARC iC60 ^[1]													
iC60L	0.5-25	25			36	36	36		36	40	40	40	40
	32-40		20		25	36	36	36	25	36	40	40	40
	50-63	15	16	25	36	36	36	25	36	40	40	40	40
iC60L+ARC iC60 ^[1]	0.5-25	25			36	36	36		36	40	40	40	40
iC60L+VigiARC iC60 ^[1]													
iC60 RCBO 2P/3P 400V ^[1]	10-32	6000	16	20	20	20	20	20	20	20	20	20	20
iC60 RCBO 2P/3P (PN) 230V ^[1]	10-32	10000	16	20	20	20	20	20	20	20	20	20	20
iC60N RCBO (VD)	6-20	6000	16	20	25	30	30	20	25	30	30	30	30
	32-45		16	20	25	25	25	20	25	25	25	25	25
iC60H RCBO (VD)	6-20	10000	16	25	36	36	36	25	36	40	40	40	40
	32-45		16	25	25	25	25	25	25	25	25	25	25
iC60H2 RCBO (VD)	10-20	10000	16	25	36	36	36	25	36	40	40	40	40
	32		16	25	25	25	25	25	25	25	25	25	25
C120N	63-125	10	16	25	25	25	25	25	25	25	25	25	25
C120H	63-125	15	16	25	25	25	25	25	25	25	25	25	25
NG125N	10-125	25		36	36	36		36	36	36	50	70	
NG125H	10-125	36			40	50			40	50	70	100	
NG125L	10-80	50				70				70	100	150	
NSXm E	16-160	16		25	30	30	30	25	25	30	30	30	30
NSXm B	16-160	25		36	36	50	50	36	36	50	50	50	50
NSXm F	16-160	36			50	70	70		50	70	70	70	70
NSXm N	16-160	50				70				70	70	70	70
NSXm H	16-160	70											
NSX100 B	16-100	25						36	36	50	50	50	50
NSX100 F	16-100	36							50	70	100	150	150
NSX100 N	16-100	50								70	100	150	150
NSX100 H	16-100	70									100	150	150
NSX100 S	16-100	100										100	150

[1] Ue = 380-400 V AC (Ph/N 220-230 V AC)

Cascading Table

Upstream: ComPacT NSX160, NSX250

Downstream: iC40, iCV40, iC60, C120, NG125, ComPacT NSXm, NSX100

Ue: 380-415 V AC
(Ph/N 220-240 V AC)



Upstream CB	NSX160						NSX250					
	B	F	N	H	S	L	B	F	N	H	S	L
Icu (kA)	25	36	50	70	100	150	25	36	50	70	100	150

Downstream CB			Reinforced breaking capacity (kA) according to IEC/EN 60947-2 Annex A											
	Rating (A)	Icu (kA)	B	F	N	H	S	L	B	F	N	H	S	L
iC40 ^[1]	2-40	6/4500	10	10	10	10	10	10	10	10	10	10	10	10
iC40N ^[1]	2-16	10/6000	20	20	20	20	20	20	20	20	20	20	20	20
	20-40		16	16	16	16	16	16	16	16	16	16	16	16
iCV40N ^[1]	6-16	6000	20	20	20	20	20	20	20	20	20	20	20	20
	20-40		16	16	16	16	16	16	16	16	16	16	16	16
iC40N ARC ^[1]	6-16	10/6000	20	20	20	20	20	20	20	20	20	20	20	20
iC40N+ARC iC40 ^[1]	20-40		16	16	16	16	16	16	16	16	16	16	16	16
iC40N+VigiARC iC40 ^[1]			16	16	16	16	16	16	16	16	16	16	16	16
iC40H ^[1]	6-16	10000	20	20	20	20	20	20	20	20	20	20	20	20
iCV40H ^[1]	20-32		16	16	16	16	16	16	16	16	16	16	16	16
iC40H+ARC iC40 ^[1]	6-16	10000	20	20	20	20	20	20	20	20	20	20	20	20
iC40H+VigiARC iC40 ^[1]	20-32		16	16	16	16	16	16	16	16	16	16	16	16
iCV40H+VigiARC ^[1]			16	16	16	16	16	16	16	16	16	16	16	16
iC60N	0.5-40	10	20	25	30	30	30	30	20	25	30	30	30	30
	50-63		20	25	30	30	30	30	20	25	25	25	25	25
iC60N+ARC iC60 ^[1]	0.5-40	10	20	25	30	30	30	30	20	25	30	30	30	30
iC60N+VigiARC iC60 ^[1]	0.5-40	10	20	25	30	30	30	30	20	25	30	30	30	30
iC60H	0.5-40	15	25	36	40	40	40	40	25	30	30	30	30	30
	50-63		25	36	36	36	36	36	25	25	25	25	25	25
iC60H+ARC iC60 ^[1]	0.5-40	15	25	36	40	40	40	40	25	30	30	30	30	30
iC60H+VigiARC iC60 ^[1]	0.5-40	15	25	36	40	40	40	40	25	30	30	30	30	30
iC60L	0.5-25	25	25	36	40	40	40	40	25	30	30	30	30	30
	32-40	20	25	36	40	40	40	40	25	30	30	30	30	30
	50-63	15	25	36	36	36	36	36	25	25	25	25	25	25
iC60L+ARC iC60 ^[1]	0.5-25	25	25	36	40	40	40	40	25	30	30	30	30	30
iC60L+VigiARC iC60 ^[1]	32-40	20	25	36	40	40	40	40	25	30	30	30	30	30
iC60 RCBO 2P/3P 400V ^[1]	10-20	6000	20	20	20	20	20	20	20	20	20	20	20	20
	25-32		20	20	20	20	20	20	16	16	16	16	16	16
iC60 RCBO 2P/3P (PN) 230V ^[1]	10-20	10000	20	20	20	20	20	20	20	20	20	20	20	20
	25-32		20	20	20	20	20	20	16	16	16	16	16	16
iC60N RCBO (VD)	6-20	6000	20	25	30	30	30	30	20	25	30	30	30	30
	32-45		20	25	25	25	25	25	20	25	25	25	25	25
iC60H RCBO (VD)	6-20	10000	25	36	40	40	40	40	25	30	30	30	30	30
	32-45		25	25	25	25	25	25	25	25	25	25	25	25
iC60H2 RCBO (VD)	6-20	10000	25	36	40	40	40	40	25	30	30	30	30	30
	32		25	25	25	25	25	25	25	25	25	25	25	25
C120N	63-125	10	25	25	25	25	25	25	25	25	25	25	25	25
C120H	63-125	15	25	25	25	25	25	25	25	25	25	25	25	25
NG125N	10-125	25		36	36	36	50	70		36	36	36	50	70
NG125H	10-125	36			40	50	70	100			40	50	70	100
NG125L	10-80	50			50	70	100	150			50	70	100	150
NSXm E	16-160	16	25	25	30	30	30	30	25	25	30	30	30	30
NSXm B	16-160	25		36	36	50	50	50		36	36	50	50	50
NSXm F	16-160	36			50	70	70	70			50	70	70	70
NSXm N	16-160	50				70	70	70				70	70	70
NSXm H	16-160	70												
NSX100 B	16-100	25		36	36	50	50	50		36	36	50	50	50
NSX100 F	16-100	36			50	70	100	150			50	70	100	150
NSX100 N	16-100	50				70	100	150				70	100	150
NSX100 H	16-100	70					100	150					100	150
NSX100 S	16-100	100						150						150

[1] Ue = 380-400 V AC (Ph/N 220-230 V AC)

VD: Voltage dependent RCBOs are RCBOs according to IEC 61009-2-2. These RCBOs are allowed only in some countries. See IEC 60364-5-53:2020 Annex F.

Cascading

Upstream: ComPacT NSX160, NSX250, NSX400, NSX630

Downstream: ComPacT NSXm, NSX100, NSX160, NSX250, NSX400, NSX630



Ue: 380-415 V AC
(Ph/N 220-240 V AC)

Upstream CB	NSX160						NSX250					
	B	F	N	H	S	L	B	F	N	H	S	L
Icu (kA)	25	36	50	70	100	150	25	36	50	70	100	150

Downstream CB			Reinforced breaking capacity (kA) according to IEC/EN 60947-2 Annex A											
	Rating (A)	Icu (kA)												
NSX160 B	16-160	25		36	36	50	50	50		36	36	50	50	50
NSX160 F	16-160	36			50	70	100	150			50	70	100	150
NSX160 N	16-160	50				70	100	150				70	100	150
NSX160 H	16-160	70					100	150					100	150
NSX160 S	16-160	100						150						150
NSX250 B	16-250	25								36	36	50	50	50
NSX250 F	16-250	36									50	70	100	150
NSX250 N	16-250	50										70	100	150
NSX250 H	16-250	70											100	150
NSX250 S	16-250	100												150

Upstream CB	NSX400					NSX630				
	F	N	H	S	L	F	N	H	S	L
Icu (kA)	36	50	70	100	150	36	50	70	100	150

Downstream CB			Reinforced breaking capacity (kA) according to IEC/EN 60947-2 Annex A										
	Rating (A)	Icu (kA)											
NSXm E	16-160	16	25	30	30	30	30	25	30	30	30	30	30
NSXm B	16-160	25	36	36	50	50	50	36	36	50	50	50	50
NSXm F	16-160	36		50	70	70	70		50	70	70	70	70
NSXm N	16-160	50			70	70	70			70	70	70	70
NSXm H	16-160	70											
NSX100 B	16-100	25	36	36	50	50	50	36	36	50	50	50	50
NSX100 F	16-100	36		50	70	100	150		50	70	100	150	150
NSX100 N	16-100	50			70	100	150			70	100	150	150
NSX100 H	16-100	70				100	150				100	150	150
NSX100 S	16-100	100					150						150
NSX100 L	16-100	150											
NSX160 B	16-160	25	36	36	50	50	50	36	36	50	50	50	50
NSX160 F	16-160	36		50	70	100	150		50	70	100	150	150
NSX160 N	16-160	50			70	100	150			70	100	150	150
NSX160 H	16-160	70				100	150				100	150	150
NSX160 S	16-160	100					150						150
NSX160 L	16-160	150											
NSX250 B	16-250	25	36	36	50	50	50	36	36	50	50	50	50
NSX250 F	16-250	36		50	70	100	150		50	70	100	150	150
NSX250 N	16-250	50			70	100	150			70	100	150	150
NSX250 H	16-250	70				100	150				100	150	150
NSX250 S	16-250	100					150						150
NSX250 L	16-250	150											
NSX400 F	250-400	36		50	70	100	150		50	70	100	150	150
NSX400 N	250-400	50			70	100	150			70	100	150	150
NSX400 H	250-400	70				100	150				100	150	150
NSX400 S	250-400	100					150						150
NSX400 L	250-400	150											
NSX630 F	250-630	36							50	70	100	150	150
NSX630 N	250-630	50								70	100	150	150
NSX630 H	250-630	70									100	150	150
NSX630 S	250-630	100											150
NSX630 L	250-630	150											

Cascading

Upstream: ComPacT NS630b-1600, ComPacT NS1600-3200, MasterPact MTZ

Downstream: ComPacT NSX, ComPacT NS630b-1600

Ue: 380-415 V AC
(Ph/N 220-240 V AC)



Upstream CB	NS630b-1600				NS1600-3200		MTZ1	MTZ2
	N	H	L ^[1]	LB ^[2]	N	H	L1	L1
Icu (kA)	50	70	150	200	70	85	150	150

Downstream CB	Rating (A)	Icu (kA)	Reinforced breaking capacity (kA) according to IEC/EN 60947-2 Annex A							
NSX100 B	16-100	25	50	50	50	50			50	
NSX100 F	16-100	36	50	70	150	150			150	
NSX100 N	16-100	50		70	150	150			150	
NSX100 H	16-100	70			150	150			150	
NSX100 S	16-100	100			150	200			150	
NSX100 L	16-100	150				200				
NSX160 B	16-160	25	50	50	50	50			50	
NSX160 F	16-160	36	50	70	150	150			150	
NSX160 N	16-160	50		70	150	150			150	
NSX160 H	16-160	70			150	150			150	
NSX160 S	16-160	100			150	200			150	
NSX160 L	16-160	150				200				
NSX250 B	16-250	25	50	50	50	50			50	
NSX250 F	16-250	36	50	70	150	150			150	
NSX250 N	16-250	50		70	150	150			150	
NSX250 H	16-250	70			150	150			150	
NSX250 S	16-250	100			150	200			150	
NSX250 L	16-250	150				200				
NSX400 F	250-400	36	50	70	150	150			150	
NSX400 N	250-400	50		70	150	150			150	
NSX400 H	250-400	70			150	150			150	
NSX400 S	250-400	100			150	200			150	
NSX400 L	250-400	150				200				
NSX630 F	250-630	36	50	70	150	150			150	
NSX630 N	250-630	50		70	150	150			150	
NSX630 H	250-630	70			150	150			150	
NSX630S	250-630	100			150	200			150	
NSX630 L	250-630	150				200				
NS630b-1600 N	630-1600	50		70	150	200	70	70	150	65
NS630b-1600 H	630-1600	70			150	200			150	

[1] ComPacT NS630bL, NS800L, NS1000L

[2] ComPacT NS630bLB, NS800LB

Cascading

Upstream: iC60, NG125, ComPacT NSXm, NSX100

Downstream: iC60, NG125, ComPacT NSXm, NSX100

A

Ue: 440 V AC

Upstream CB	iC60					NG125		
	N	H	L			N	H	L
	≤ 25 A			32-40 A	50-63 A			
Icu (kA)	6	10	20	15	10	20	30	40

Downstream CB			Reinforced breaking capacity (kA) according to IEC/EN 60947-2 Annex A							
	Rating (A)	Icu (kA)								
iC60 N	0.5-63	6		10	20	15	10	20	20	20
iC60 H	0.5-63	10			20	15		20	25	25
iC60 L	0.5-25	20							30	40
	32-40	15						20	30	30
	50-63	10						20	25	25
NG125 N	1-125	20							30	40
NG125 H	1-125	30								40

Upstream CB	NSXm					NSX100					
	E	B	F	N	H	B	F	N	H	S	L
Icu (kA)	15	20	35	50	65	20	35	50	65	90	130

Downstream CB			Reinforced breaking capacity (kA) according to IEC/EN 60947-2 Annex A										
	Rating (A)	Icu (kA)											
iC60 N	0.5-63	6	10	15	15	20	20	15	15	20	20	20	20
iC60 H	0.5-63	10		20	20	25	25	20	20	25	25	25	25
iC60 L	0.5-25	20				25	25			25	25	25	25
	32-40	15		20	20	25	25	20	20	25	25	25	25
	50-63	10		20	20	25	25	20	20	25	25	25	25
NG125 N	1-125	20			35	35	35		35	35	35	50	65
NG125 H	1-125	30			35	40	50		35	40	50	65	90
NG125 L	1-80	40				50	65			50	65	90	130
NSXm E	16-160	15		20	30	30	30	20	20	30	30	30	30
NSXm B	16-160	20			35	35	50		35	35	50	50	50
NSXm F	16-160	35				50	65			50	65	65	65
NSXm N	16-160	50					65				65	65	65
NSXm H	16-160	65											
NSX100 B	16-100	20							35	35	50	50	50
NSX100 F	16-100	35								50	65	90	130
NSX100 N	16-100	50									65	90	130
NSX100 H	16-100	65										90	130
NSX100 S	16-100	90											130

Cascading

Upstream: ComPacT NSX160, NSX250

Downstream: iC60, NG125, ComPacT NSXm, NSX100, NSX160, NSX250

Ue: 440 V AC



Upstream CB	NSX160						NSX250					
	B	F	N	H	S	L	B	F	N	H	S	L
Icu (kA)	20	35	50	65	90	130	20	35	50	65	90	130

Downstream CB			Reinforced breaking capacity (kA) according to IEC/EN 60947-2 Annex A											
	Rating (A)	Icu (kA)												
iC60 N	0.5-63	6	15	15	20	20	20							
iC60 H	0.5-63	10	20	20	25	25	25							
iC60 L	0.5-25	20			25	25	25							
	32-40	15	20	20	25	25	25							
	50-63	10	20	20	25	25	25							
NG125 N	1-125	20		35	35	35	50	65		35	35	35	50	65
NG125 H	1-125	30		35	40	50	65	90		35	40	50	65	90
NG125 L	1-80	40			50	65	90	130			50	65	90	130
NSXm E	16-160	15	20	20	30	30	30	30	20	20	30	30	30	30
NSXm B	16-160	20		35	35	50	50	50		35	35	50	50	50
NSXm F	16-160	35			50	65	65	65			50	65	65	65
NSXm N	16-160	50				65	65	65				65	65	65
NSXm H	16-160	65										65	65	65
NSX100 B	16-100	20		35	35	50	50	50		35	35	50	50	50
NSX100 F	16-100	35			50	65	90	130			50	65	90	130
NSX100 N	16-100	50				65	90	130				65	90	130
NSX100 H	16-100	65					90	130					90	130
NSX100 S	16-100	90						130						130
NSX100 L	16-100	130												
NSX160 B	16-160	20		35	35	50	50	50		35	35	50	50	50
NSX160 F	16-160	35			50	65	90	130			50	65	90	130
NSX160 N	16-160	50				65	90	130				65	90	130
NSX160 H	16-160	65					90	130					90	130
NSX160 S	16-160	90						130						130
NSX160 L	16-160	130												
NSX250 B	16-250	20								35	35	50	50	50
NSX250 F	16-250	35									50	65	90	130
NSX250 N	16-250	50										65	90	130
NSX250 H	16-250	65											90	130
NSX250 S	16-250	90												130
NSX250 L	16-250	130												

Cascading

Upstream: ComPacT NSX400, NSX630

Downstream: ComPacT NSXm, NSX100, NSX160, NSX250, NSX400, NSX630

Ue: 440 V AC

A

Upstream CB	NSX400					NSX630				
	F	N	H	S	L	F	N	H	S	L
Icu (kA)	30	42	65	90	130	30	42	65	90	130

Downstream CB			Reinforced breaking capacity (kA) according to IEC/EN 60947-2 Annex A									
	Rating (A)	Icu (kA)										
NSXm E	16-160	10	20	30	30	30	30	20	30	30	30	30
NSXm B	16-160	20	30	30	50	50	50	30	30	50	50	50
NSXm F	16-160	35		42	65	65	65		42	65	65	65
NSXm N	16-160	50			65	65	65			65	65	65
NSXm H	16-160	65										
NSX100 B	16-100	20	30	30	50	50	50	30	30	50	50	50
NSX100 F	16-100	35		42	65	90	130		42	65	90	130
NSX100 N	16-100	50			65	90	130			65	90	130
NSX100 H	16-100	65				90	130				90	130
NSX100 S	16-100	90					130					130
NSX100 L	16-100	130										
NSX160 B	16-160	20	30	30	50	50	50	30	30	50	50	50
NSX160 F	16-160	35		42	65	90	130		42	65	90	130
NSX160 N	16-160	50			65	90	130			65	90	130
NSX160 H	16-160	65				90	130				90	130
NSX160 S	16-160	90					130					130
NSX160 L	16-160	130										
NSX250 B	16-250	20	30	30	50	50	50	30	30	50	50	50
NSX250 F	16-250	35		42	65	90	130		42	65	90	130
NSX250 N	16-250	50			65	90	130			65	90	130
NSX250 H	16-250	65				90	130				90	130
NSX250 S	16-250	90					130					130
NSX250 L	16-250	130										
NSX400 F	250-400	30		42	65	90	130		42	65	90	130
NSX400 N	250-400	42			65	90	130			65	90	130
NSX400 H	250-400	65				90	130				90	130
NSX400 S	250-400	90					130					130
NSX400 L	250-400	130										
NSX630 F	250-630	30							42	65	90	130
NSX630 N	250-630	42								65	90	130
NSX630 H	250-630	65									90	130
NSX630 S	250-630	90										130
NSX630 L	250-630	130										

Cascading

Upstream: ComPacT NS630b-1600, ComPacT NS1600-3200, MasterPact MTZ

Downstream: ComPacT NSX, ComPacT NS630b-1600

Ue: 440 V AC



Upstream CB	NS630b-1600				NS1600-3200		MTZ1	MTZ2
	N	H	L ^[1]	LB ^[2]	N	H	L1	L1
Icu (kA)	50	65	130	200	65	85	130	150

Downstream CB			Reinforced breaking capacity (kA) according to IEC/EN 60947-2 Annex A							
	Rating (A)	Icu (kA)								
NSX100 B	16-100	20	50	50	50	50				50
NSX100 F	16-100	35	50	65	130	130				130
NSX100 N	16-100	50		65	130	130				130
NSX100 H	16-100	65			130	130				130
NSX100 S	16-100	90			130	200				130
NSX100 L	16-100	130				200				
NSX160 B	16-160	20	50	50	50	50				50
NSX160 F	16-160	35	50	65	130	130				130
NSX160 N	16-160	50		65	130	130				130
NSX160 H	16-160	65			130	130				130
NSX160 S	16-160	90			130	200				130
NSX160 L	16-160	130				200				
NSX250 B	16-250	20	50	50	50	50				50
NSX250 F	16-250	35	50	65	130	130				130
NSX250 N	16-250	50		65	130	130				130
NSX250 H	16-250	65			130	130				130
NSX250 S	16-250	90			130	200				130
NSX250 L	16-250	130				200				
NSX400 F	250-400	30	50	65	130	130				130
NSX400 N	250-400	42		65	130	130				130
NSX400 H	250-400	65			130	130				130
NSX400 S	250-400	90			130	200				130
NSX400 L	250-400	130				200				
NSX630 F	250-630	30	50	65	130	130				130
NSX630 N	250-630	42		65	130	130				130
NSX630 H	250-630	65			130	130				130
NSX630 S	250-630	90			130	200				130
NSX630 L	250-630	130				200				
NS630b-1600 N	630-1600	50		65	130	200	65	65	130	65
NS630b-1600 H	630-1600	65			130	200			130	

[1] ComPacT NS630bL, NS800L, NS1000L
 [2] ComPacT NS630bLB, NS800LB

Cascading

Upstream: iC60, C120, NG125, ComPacT NSXm, NSX100

Downstream: iC60, C120, NG125, ComPacT NSXm, NSX100

A

Ue: 220-240 V AC
(Ph/N 110-130 V AC)

Upstream CB		iC60					C120		NG125		
		N	H	L		N	H	N	H	L	
Icu (kA)		20	30	50	36	30	20	30	50	70	100

Downstream CB			Reinforced breaking capacity (kA) according to IEC/EN 60947-2 Annex A									
	Rating (A)	Icu (kA)										
iC60 N	0.5-25	20		30	50	36	30		30	50	50	50
	32-40	20		30		36	30		30	50	50	50
	50-63	20		30			30		30	50	50	50
iC60 H	0.5-25	30			50	36				50	70	70
	32-40	30				36				50	70	70
	50-63	30								50	70	70
iC60 L	0.5-25	50									70	100
	32-40	36								50	70	100
	50-63	30								50	70	100
C120 N	63-125	20								50	70	70
C120 H	63-125	30						30		50	70	70
NG125 N	1-125	50									70	70
NG125 H	1-125	70										100

Upstream CB		NSXm					NSX100					
		E	B	F	N	H	B	F	N	H	S	L
Icu (kA)		25	50	85	90	100	40	85	90	100	120	150

Downstream CB			Reinforced breaking capacity (kA) according to IEC/EN 60947-2 Annex A										
	Rating (A)	Icu (kA)											
iC60 N	0.5-63	20	25	40	60	60	60	40	40	60	60	60	60
iC60 H	0.5-63	30		50	80	80	80	40	50	80	80	80	80
iC60 L	0.5-25	50			80	80	80		65	80	80	80	80
	32-40	36		50	80	80	80	40	65	80	80	80	80
	50-63	30		50	80	80	80	40	65	80	80	80	80
C120 N	63-125	20	25	50	50	50	50	40	40	50	50	70	70
C120 H	63-125	30		50	50	50	50	40	40	50	50	70	70
NG125 N	1-125	50			60	70	70		60	70	70	85	85
NG125 H	1-125	70			85	85	85		85	85	85	85	85
NG125 L	1-80	100											
NSXm E	16-160	25		50	85	85	85	40	85	85	85	85	85
NSXm B	16-160	50			85	90	100		85	90	100	100	100
NSXm F	16-160	85				90	100			90	100	100	100
NSXm N	16-160	90					100				100	100	100
NSXm H	16-160	100											
NSX100 B	16-100	40							85	90	90	100	100
NSX100 F	16-100	85								90	100	120	120
NSX100 N	16-100	90									100	120	150
NSX100 H	16-100	100										120	150
NSX100 S	16-100	120											150

Cascading

Upstream: ComPacT NSX160, NSX250

Downstream: IDPN, iC60, C120, NG125, ComPacT NSXm, NSX100, NSX160, NSX250

Ue: 220-240 V AC
(Ph/N 110-130 V AC)



Upstream CB	NSX160						NSX250					
	B	F	N	H	S	L	B	F	N	H	S	L
Icu (kA)	40	85	90	100	120	150	40	85	90	100	120	150

Downstream CB			Reinforced breaking capacity (kA) according to IEC/EN 60947-2 Annex A												
	Rating (A)	Icu (kA)													
iC60 N	0.5-40	20	40	40	60	60	60	60	60	40	40	60	60	60	60
	50-63	20	40	40	60	60	60	60	60	40	40	60	60	60	60
iC60 H	0.5-40	30	40	50	80	80	80	80	80	40	50	65	65	65	65
	50-63	30	40	50	80	80	80	80	80	40	50	65	65	65	65
iC60 L	0.5-25	50		65	80	80	80	80		65	80	80	80	80	80
	32-40	36	40	65	80	80	80	80	40	65	80	80	80	80	80
	50-63	30	40	65	80	80	80	80	40	50	65	65	65	65	65
C120 N	63-125	20	40	40	50	50	70	70	40	40	50	50	70	70	
C120 H	63-125	30	40	40	50	50	70	70	40	40	50	50	70	70	
NG125 N	1-125	50		60	70	70	85	85		60	70	70	85	85	
NG125 H	1-125	70		85	85	85	85	85		85	85	85	85	85	
NG125 L	1-80	100													
NSXm E	16-160	25	40	85	85	85	85	85	40	85	85	85	85	85	
NSXm B	16-160	50		85	90	100	100	100		85	90	100	100	100	
NSXm F	16-160	85			90	100	100	100			90	100	100	100	
NSXm N	16-160	90				100	100	100				100	100	100	
NSXm H	16-160	100											100	100	
NSX100 B	16-100	40		85	90	90	100	100		85	90	90	100	100	
NSX100 F	16-100	85			90	100	120	120			90	100	120	120	
NSX100 N	16-100	90				100	120	150				100	120	150	
NSX100 H	16-100	100					120	150					120	150	
NSX100 S	16-100	120						150						150	
NSX100 L	16-100	150													
NSX160 B	16-160	40		85	90	90	100	100		85	90	90	100	100	
NSX160 F	16-160	85			90	100	120	120			90	100	120	120	
NSX160 N	16-160	90				100	120	150				100	120	150	
NSX160 H	16-160	100					120	150					120	150	
NSX160 S	16-160	120						150						150	
NSX160 L	16-160	150													
NSX250 B	16-250	40								85	90	90	100	100	
NSX250 F	16-250	85									90	100	120	120	
NSX250 N	16-250	90										100	120	150	
NSX250 H	16-250	100											120	150	
NSX250 S	16-250	120												150	
NSX250 L	16-250	150													

Cascading

Upstream: ComPacT NSX400, NSX630

Downstream: ComPacT NSX100, NSX160, NSX250, NSX400, NSX630

A

Ue: 220-240 V AC
(Ph/N 110-130 V AC)

Upstream CB	NSX400					NSX630				
	F	N	H	S	L	F	N	H	S	L
Icu (kA)	40	85	100	120	150	40	85	100	120	150

Downstream CB			Reinforced breaking capacity (kA) according to IEC/EN 60947-2 Annex A										
	Rating (A)	Icu (kA)											
NSX100 B	16-100	40		85	90	100	100		85	90	100	100	
NSX100 F	16-100	85			100	120	150			100	120	150	
NSX100 N	16-100	90			100	120	150			100	120	150	
NSX100 H	16-100	100				120	150				120	150	
NSX100 S	16-100	120					150					150	
NSX100 L	16-100	150											150
NSX160 B	16-160	40		85	90	100	100		85	90	100	100	
NSX160 F	16-160	85			100	120	150			100	120	150	
NSX160 N	16-160	90			100	120	150			100	120	150	
NSX160 H	16-160	100				120	150				120	150	
NSX160 S	16-160	120					150					150	
NSX160 L	16-160	150											150
NSX250 B	16-250	40		85	90	100	100		85	90	100	100	
NSX250 F	16-250	85			100	120	150			100	120	150	
NSX250 N	16-250	90			100	120	150			100	120	150	
NSX250 H	16-250	100				120	150				120	150	
NSX250 S	16-250	120					150					150	
NSX250 L	16-250	150											150
NSX400 F	250-400	40		85	100	120	150		85	100	120	150	
NSX400 N	250-400	85			100	120	150			100	120	150	
NSX400 H	250-400	100				120	150			100	120	150	
NSX400 S	250-400	120					150				120	150	
NSX400 L	250-400	150											150
NSX630 F	250-630	40							85	100	120	150	
NSX630 N	250-630	85								100	120	150	
NSX630 H	250-630	100								100	120	150	
NSX630 S	250-630	120									120	150	
NSX630 L	250-630	150											150

Cascading

Upstream: ComPacT NS630b-1600, MasterPact MTZ

Downstream: ComPacT NSX, ComPacT NS630b-1600

Ue: 220-240 V AC
(Ph/N 110-130 V AC)



Upstream CB	NS630b-1600				MTZ1	MTZ2
	N	H	L ^[1]	LB ^[2]	L1	L1
Icu (kA)	50	70	150	200	150	150

Downstream CB			Reinforced breaking capacity (kA) according to IEC/EN 60947-2 Annex A				
	Rating (A)	Icu (kA)					
NSX100 B	16-100	40	50		50	50	
NSX100 F	16-100	85			150	150	
NSX100 N	16-100	90			150	150	
NSX100 H	16-100	100			150	150	
NSX100 S	16-100	120			150	200	150
NSX100 L	16-100	150				200	
NSX160 B	16-160	40	50	50	50	50	50
NSX160 F	16-160	85			150	150	150
NSX160 N	16-160	90			150	150	150
NSX160 H	16-160	100			150	150	150
NSX160 S	16-160	120			150	200	150
NSX160 L	16-160	150				200	
NSX250 B	16-250	40	50	50	50	50	50
NSX250 F	16-250	85			150	150	150
NSX250 N	16-250	90			150	150	150
NSX250 H	16-250	100			150	150	150
NSX250 S	16-250	120			150	200	150
NSX250 L	16-250	150				200	
NSX400 F	250-400	40	50	50	150	150	150
NSX400 N	250-400	85			150	150	150
NSX400 H	250-400	100			150	150	150
NSX400 S	250-400	120			150	200	150
NSX400 L	250-400	150				200	
NSX630 F	250-630	40	50	50	150	150	150
NSX630 N	250-630	85			150	150	150
NSX630 H	250-630	100			150	150	150
NSX630 S	250-630	120			150	200	150
NSX630 L	250-630	150				200	
NS630b-1600 N	630-1600	50		70			70

[1] ComPacT NS630bL, NS800L, NS1000L

[2] ComPacT NS630bLB, NS800LB

Motor Protection Cascading

Upstream: NG125, ComPacT NSXm, NSX100, NSX160, NSX250, NSX400, NSX630

Downstream: IC60L MA, NG125L MA, LUB12, LUB32, GV2, GV3, GV4, GV5

Ue ≤ 380-415 V AC

Ph/N 220/240 V AC

A

Upstream CB			NG125			NSXm					NSX100					
			N	H	L	E	B	F	N	H	B	F	N	H	S	L
Icu (kA)			25	36	50	16	25	36	50	70	25	36	50	70	100	150

Downstream CB			Reinforced breaking capacity (kA)													
CB type	Rating (A)	Icu (kA)														
iC60L MA	1.6-16	20	25	36	50		25	36	36	36	25	36	40	40	40	40
	25-60	15	25	36	36	16	25	30	30	30	25	30	30	30	30	30
NG125L MA	1.6-80	50										70		70	100	150
	01-14	100														
GV2 ME	16-22	15				25	36	40	50	50	25	36	40	50	50	50
	32	10				25	36	40	50	50	25	36	40	50	50	50
	01-16	100								70				70	100	150
GV2 P	20-32	50														
	01-16	100								70				70	100	150
GV2 L	20-32	50														
	01-16	100								70				70	100	150
GV3 P	40-65	50								70				70	100	150
GV3 L	40-65	50								70				70	100	150
LUB12	0.15-12	50								70				70	100	150
LUB32	0.15-32	50								70				70	100	150
GV4L & LE B	2-115	25						36	36	50		36	36	50	50	50
GV4L & LE N	2-115	50								70				70	100	100
GV4L & LE S	2-115	100														150
GV4P, PE, PEM B	2-115	25						36	36	50		36	36	50	50	50
GV4P, PE, PEM N	2-115	50								70				70	100	100
GV4P, PE, PEM S	2-115	100														150

Upstream CB			NSX160					NSX250						
			B	F	N	H	S	L	B	F	N	H	S	L
Icu (kA)			25	36	50	70	100	150	25	36	50	70	100	150

Downstream CB			Reinforced breaking capacity (kA)													
CB type	Rating (A)	Icu (kA)														
iC60L MA	1.6-16	20	25	36	40	40	40	40	25	30	30	30	30	30	30	
	25-60	15	25	30	30	30	30	30	25	25	25	25	25	25	25	
NG125L MA	1.6-80	50				70	100	150				70	100	150		
	01-14	100														
GV2 ME	16-32	15	25	36	40	50	50	50	25	36	40	50	50	50		
	01-16	100														
	20-32	50				70	100	150				70	100	150		
GV2 L	01-16	100														
	20-32	50				70	100	150				70	100	150		
GV3 P	40-65	50				70	100	150				70	100	150		
GV3 L	40-65	50				70	100	150				70	100	150		
LUB12	0.15-12	50				70	100	150				70	100	150		
LUB32	0.15-32	50				70	100	150				70	100	150		
GV4L & LE B	2-115	25		36	36	50	50	50		36	36	50	50	50		
GV4L & LE N	2-115	50				70	100	100				70	100	100		
GV4L & LE S	2-115	100						150						150		
GV4P, PE, PEM B	2-115	25		36	36	50	50	50		36	36	50	50	50		
GV4P, PE, PEM N	2-115	50				70	100	100				70	100	100		
GV4P, PE, PEM S	2-115	100						150						150		

Upstream CB			NSX400					NSX630				
			F	N	H	S	L	F	N	H	S	L
Icu (kA)			25	36	50	70	100	150	25	36	100	150

Downstream CB			Reinforced breaking capacity (kA)									
CB type	Rating (A)	Icu (kA)										
GV4L & LE B	2-115	25	36	36	50	50	50	36	36	50	50	50
GV4L & LE N	2-115	50			70	100	100			70	100	100
GV4L & LE S	2-115	100					150					150
GV4P, PE, PEM B	2-115	25	36	36	50	50	50	36	36	50	50	50
GV4P, PE, PEM N	2-115	50			70	100	100			70	100	100
GV4P, PE, PEM S	2-115	100					150					150
GV5P150F	150	36		50	70	100	100		50	70	100	100
GV5P150H	150	70				100	150				100	150

Note: For ComPacT NSX with motor trip unit downstream: use Electrical distribution tables.

Motor Protection Cascading

Upstream: ComPacT NSXm, NSX100, NSX160, NSX250, NSX400, NSX630

Downstream: GV4, GV5

$U_e \leq 440 \text{ V AC}$

A

Upstream CB			NSXm					NSX100					
			E	B	F	N	H	B	F	N	H	S	L
Icu (kA)			10	20	35	50	65	20	35	50	65	90	130

Downstream CB			Reinforced breaking capacity (kA)										
CB type	Rating (A)	Icu (kA)											
GV4L, LE B	2-115	20			35	35	50		35	35	50	50	50
GV4L, LE N	2-115	50					65				65	90	100
GV4L, LE S	2-115	70										90	130
GV4P, PE, PEM B	2-115	20			35	35	50		35	35	50	50	50
GV4P, PE, PEM N	2-115	50					65				65	90	100
GV4P, PE, PEM S	2-115	70										90	130

Upstream CB			NSX160					NSX250						
			B	F	N	H	S	L	B	F	N	H	S	L
Icu (kA)			20	35	50	65	90	130	20	35	50	65	90	130

Downstream CB			Reinforced breaking capacity (kA)											
CB type	Rating (A)	Icu (kA)												
GV4L, LE B	2-115	20		35	35	50	50	50		35	35	50	50	50
GV4L, LE N	2-115	50				65	90	100				65	90	100
GV4L, LE S	2-115	70					90	130				90	130	
GV4P, PE, PEM B	2-115	20		35	35	50	50	50		35	35	50	50	50
GV4P, PE, PEM N	2-115	50				65	90	100				65	90	100
GV4P, PE, PEM S	2-115	70					90	130				90	130	

Upstream CB			NSX400					NSX630				
			F	N	H	S	L	F	N	H	S	L
Icu (kA)			35	50	65	90	130	35	50	65	90	130

Downstream CB			Reinforced breaking capacity (kA)									
CB type	Rating (A)	Icu (kA)										
GV4L, LE B	2-115	20	35	35	50	50	50	35	35	50	50	50
GV4L, LE N	2-115	50			65	90	100			65	90	100
GV4L, LE S	2-115	70				90	130				90	130
GV4P, PE, PEM B	2-115	20	35	35	50	50	50	35	35	50	50	50
GV4P, PE, PEM N	2-115	50			65	90	100			65	90	100
GV4P, PE, PEM S	2-115	70				90	130				90	130
GV5P150F	150	35		50	65	100	100		50	65	100	100
GV5P150H	150	65				100	150				100	150

Note: For ComPacT NSX with motor trip unit downstream: use Electrical distribution tables.

Motor Protection Cascading

Upstream: NG125, ComPacT NSXm, NSX100, NSX160, NSX250, NSX400, NSX630

Downstream: IC60L MA, NG125L MA, LUB12, LUB32, GV2, GV3, GV4

Ue ≤ 220-240 V AC

Ph/N 110-130 V AC

A

Upstream CB	NG125			NSXm					NSX100					
	N	H	L	E	B	F	N	H	B	F	N	H	S	L
Icu (kA)	50	70	100	25	50	85	90	100	40	85	90	100	120	150

Downstream CB			Reinforced breaking capacity (kA)													
CB type	Rating (A)	Icu (kA)														
iC60L MA	1.6-16	40	50	70	100							65	80	80	80	80
	25-60	30	50	70	70					40	80	80	80	80	80	80
NG125L MA	1.6-80	100													120	150
	01-14	100														
GV2 ME	16-32	50									85	90	100	100	100	100
	01-16	100														
GV2 P	20-32	100														
	01-16	100														
GV2 L	20-32	50					85	85	100		85	90	100	100	100	100
	01-16	100														
GV3 P	13-65	100														
	13-65	100														
LUB12	0.15-12	50					85	85	100						120	150
	0.15-32	50					85	85	100						120	150
GV4L, LE B	2-115A	50					85	85	100		85	85	100	100	100	100
	2-115A	100													120	150
GV4L, LE S	2-115A	120														150
	2-115A	50					85	85	100		85	85	100	100	100	100
GV4P, PE, PEM B	2-115A	100													120	150
	2-115A	120													120	150
GV4P, PE, PEM S	2-115A	50					85	85	100		85	85	100	100	100	100
	2-115A	100													120	150
GV4P, PE, PEM S	2-115A	120													120	150
	2-115A	120													120	150

Upstream CB	NSX160						NSX250					
	B	F	N	H	S	L	B	F	N	H	S	L
Icu (kA)	40	85	90	100	120	150	40	85	90	100	120	150

Downstream CB			Reinforced breaking capacity (kA)													
CB type	Rating (A)	Icu (kA)														
iC60L MA	1.6-16	40		65	80	80	80	80	80	40	65	80	80	80	80	80
	25-60	30	40	80	80	80	80	80	80	40	50	65	65	65	65	65
NG125L MA	1.6-80	100													120	150
	01-14	100														
GV2 ME	16-32	50		85	90	100	100	100		85	90	100	100	100	100	100
	01-16	100														
GV2 P	20-32	100														
	01-16	100														
GV2 L	20-32	50		85	90	100	100	100		85	90	100	100	100	100	100
	01-16	100														
GV3 P	40-65	100														
	40-65	100														
LUB12	0.15-12	50		85	85	100	100	100		85	85	100	100	100	100	100
	0.15-32	50						120	150						120	150
GV4L, LE B	2-115	50														150
	2-115	100		85	85	100	100	100		85	85	100	100	100	100	100
GV4L, LE S	2-115	120						120	150						120	150
	2-115	50		85	85	100	100	100		85	85	100	100	100	100	100
GV4P, PE, PEM B	2-115	100						120	150						120	150
	2-115	120						120	150						120	150
GV4P, PE, PEM S	2-115	50		85	85	100	100	100		85	85	100	100	100	100	100
	2-115	100						120	150						120	150
GV4P, PE, PEM S	2-115	120						120	150						120	150
	2-115	120						120	150						120	150

Upstream CB	NSX400					NSX630				
	F	N	H	S	L	F	N	H	S	L
Icu (kA)	40	85	100	120	150	40	85	100	120	150

Downstream CB			Reinforced breaking capacity (kA)										
CB type	Rating (A)	Icu (kA)											
GV4L, LE B	2-115	50		85	100	100	100		85	100	100	100	100
	2-115	100					120	150				120	150
GV4L, LE S	2-115	120						150					150
	2-115	50		85	100	100	100		85	100	100	100	100
GV4P, PE, PEM B	2-115	100						120	150				150
	2-115	100						120	150				150

Note: For ComPacT NSX with motor trip unit downstream: use Electrical distribution tables.



With traditional circuit breakers, cascading between two devices generally results in the loss of selectivity.

With ComPacT circuit breakers, the selectivity characteristics in the tables remain applicable and are in some cases even enhanced. Protection selectivity is obtained for short-circuit currents greater than the rated breaking capacity of the circuit breaker and even, in some cases, for its enhanced breaking capacity. In the later case, **protection selectivity is total**, i.e. only the downstream device trips for any and all possible faults at its point in the installation.

Example

Consider a combination between:

- A ComPacT NSX250H with trip unit TM250D
- A ComPacT NSX100F with trip unit TM25D.

The selectivity tables indicate total selectivity. Protection selectivity is therefore obtained up to the breaking capacity of the NSX100F, i.e. **36 kA**.

The cascading tables indicate an enhanced breaking capacity of **70 kA**.

The enhanced selectivity tables indicate that in a cascading configuration, selectivity is obtained up to **70 kA**, i.e. for any and all possible faults at that point in the installation.

Enhanced selectivity tables - 380-415 V

For each combination of two circuit breakers, the tables indicate the:

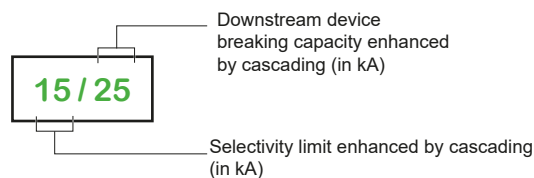

In a table, a box containing two equal values indicates that selectivity is provided up to the reinforced breaking capacity of the downstream device.

These tables apply only to cases with combined selectivity and cascading between two devices. For all other cases, refer to the normal cascading and selectivity tables.

Technical principle

Enhanced selectivity is the result of the exclusive ComPacT NSX Roto-active breaking technique which operates as follows:

- Due to the short-circuit current (electrodynamic forces), the contacts in both devices simultaneously separate. The result is major limitation of the short-circuit current
- The dissipated energy provokes the reflex tripping of the downstream device, but is insufficient to trip the upstream device.

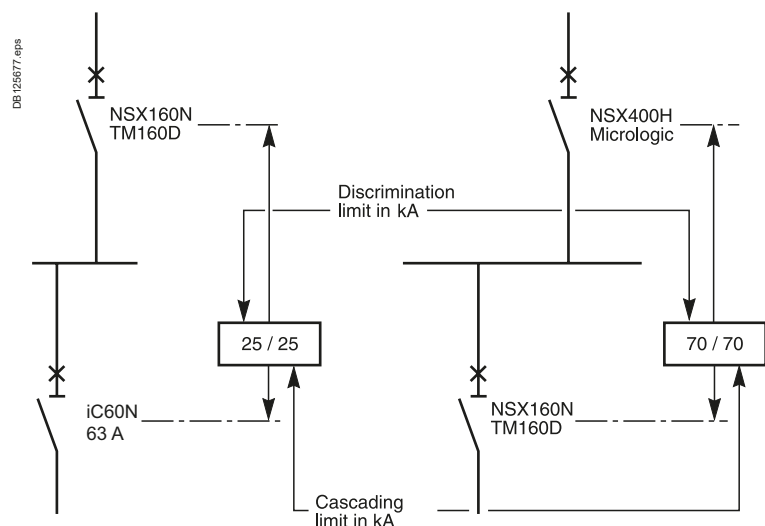

Note: Respect the basic rules of selectivity, in terms of overload, short-circuit, see page A-1 and A-14.

Selectivity Enhanced by Cascading

Upstream: ComPacT NSXm, MicroLogic 4.1, TM-D

Downstream: iC60

A

Ue: 380-415 V AC
(Ph/N 220-240 V AC)

Upstream CB		NSXm					F					N/H				
		B														
Icu (kA)		25					36					50/70				
Trip unit		MicroLogic 4.1														
Rating (A)		100			160		100			160		100			160	
Setting Ir (A)		63	80	100	125	160	63	80	100	125	160	63	80	100	125	160

Downstream CB			Selectivity limit (kA) / Breaking capacity enhanced by cascading (kA)														
CB type	Rating (A)	Icu (kA)															
iC60N	≤ 16	10	20/20	20/20	20/20	20/20	20/20	25/25	25/25	25/25	25/25	25/25	25/30	25/30	25/30	25/30	25/30
	20	10	20/20	20/20	20/20	20/20	20/20	25/25	25/25	25/25	25/25	25/25	25/30	25/30	25/30	25/30	25/30
	25	10		20/20	20/20	20/20	20/20		25/25	25/25	25/25	25/25		25/30	25/30	25/30	25/30
	32	10		20/20	20/20	20/20	20/20		25/25	25/25	25/25	25/25		25/30	25/30	25/30	25/30
	40	10		16/20	16/20	16/20	16/20		16/25	16/25	16/25	16/25		16/30	16/30	16/30	16/30
	50	10			8/20	8/20	8/20				8/25	8/25			8/30	8/30	8/30
	63	10				8/20	8/20					8/25	8/25			8/30	8/30
iC60H	≤ 16	15	25/25	25/25	25/25	25/25	25/25	25/36	25/36	25/36	25/36	25/36	25/36	25/36	25/36	25/36	25/36
	20	15	25/25	25/25	25/25	25/25	25/25	25/36	25/36	25/36	25/36	25/36	25/36	25/36	25/36	25/36	25/36
	25	15		25/25	25/25	25/25	25/25		25/36	25/36	25/36	25/36		25/36	25/36	25/36	25/36
	32	15		25/25	25/25	25/25	25/25		25/36	25/36	25/36	25/36		25/36	25/36	25/36	25/36
	40	15		16/25	16/25	16/25	16/25		16/36	16/36	16/36	16/36		16/36	16/36	16/36	16/36
	50	15			8/25	8/25	8/25			8/36	8/36	8/36		8/36	8/36	8/36	
	63	15				8/25	8/25				8/36	8/36			8/36	8/36	
iC60	≤ 16	25	25/25	25/25	25/25	25/25	25/25	25/36	25/36	25/36	25/36	25/36	25/36	25/36	25/36	25/36	25/36
	20	25	25/25	25/25	25/25	25/25	25/25	25/36	25/36	25/36	25/36	25/36	25/36	25/36	25/36	25/36	25/36
	25	25		25/25	25/25	25/25	25/25		25/36	25/36	25/36	25/36		25/36	25/36	25/36	25/36
	32	20		25/25	25/25	25/25	25/25		25/36	25/36	25/36	25/36		25/36	25/36	25/36	25/36
	40	20		16/25	16/25	16/25	16/25		16/36	16/36	16/36	16/36		16/36	16/36	16/36	16/36
	50	15			8/25	8/25	8/25			8/36	8/36	8/36		8/36	8/36	8/36	
	63	15				8/25	8/25				8/36	8/36			8/36	8/36	

Upstream CB		NSXm					F					N/H				
		B														
Icu (kA)		25					36					50/70				
Trip unit		TM-D														
Rating (A)		≤ 63	80	100	125	160	≤ 63	80	100	125	160	≤ 63	80	100	125	160

Downstream CB			Selectivity limit (kA) / Breaking capacity enhanced by cascading (kA)														
CB type	Rating (A)	Icu (kA)															
iC60N	≤ 16	10	-/20	20/20	20/20	20/20	20/20	-/25	25/25	25/25	25/25	25/25	-/30	25/30	25/30	25/30	25/30
	20	10	-/20	20/20	20/20	20/20	20/20	-/25	25/25	25/25	25/25	25/25	-/30	25/30	25/30	25/30	25/30
	25	10		10/20	20/20	20/20	20/20		10/25	25/25	25/25	25/25		10/30	25/30	25/30	25/30
	32	10		3/20	20/20	20/20	20/20		3/25	25/25	25/25	25/25		3/30	25/30	25/30	25/30
	40	10		2/20	16/20	16/20	16/20		2/25	16/25	16/25	16/25		2/30	16/30	16/30	16/30
	50	10			6/20	8/20	8/20			6/25	8/25	8/25			6/30	8/30	8/30
	63	10				8/20	8/20				8/25	8/25			8/30	8/30	
iC60H	≤ 16	15	-/25	25/25	25/25	25/25	25/25	-/36	25/36	25/36	25/36	25/36	-/36	25/36	25/36	25/36	25/36
	20	15	-/25	25/25	25/25	25/25	25/25	-/36	25/36	25/36	25/36	25/36	-/36	25/36	25/36	25/36	25/36
	25	15		10/25	25/25	25/25	25/25		10/36	25/36	25/36	25/36		10/36	25/36	25/36	25/36
	32	15		3/25	25/25	25/25	25/25		3/36	25/36	25/36	25/36		3/36	25/36	25/36	25/36
	40	15		2/25	16/25	16/25	16/25		2/36	16/36	16/36	16/36		2/36	16/36	16/36	16/36
	50	15			6/25	8/25	8/25			6/36	8/36	8/36		6/36	8/36	8/36	
	63	15				8/25	8/25				8/36	8/36			8/36	8/36	
iC60L	≤ 16	25	-/25	25/25	25/25	25/25	25/25	-/36	25/36	25/36	25/36	25/36	-/36	25/36	25/36	25/36	25/36
	20	25	-/25	25/25	25/25	25/25	25/25	-/36	25/36	25/36	25/36	25/36	-/36	25/36	25/36	25/36	25/36
	25	25		10/25	25/25	25/25	25/25		10/36	25/36	25/36	25/36		10/36	25/36	25/36	25/36
	32	20		3/25	25/25	25/25	25/25		3/36	25/36	25/36	25/36		3/36	25/36	25/36	25/36
	40	20		2/25	16/25	16/25	16/25		2/36	16/36	16/36	16/36		2/36	16/36	16/36	16/36
	50	15			6/25	8/25	8/25			6/36	8/36	8/36		6/36	8/36	8/36	
	63	15				8/25	8/25				8/36	8/36			8/36	8/36	

Note: Respect the basic rules of selectivity, in terms of overload, short-circuit, ground fault and earth leakage when applicable see page A-1, or check curves with Schneider Electric online "Electrical calculation tools".

Selectivity Enhanced by Cascading

Upstream: ComPacT NSX100, MicroLogic

Downstream: iC60

Ue: 380-415 V
(Ph/N 220-240 V AC)



Upstream CB		NSX100												
		B	F				N				H		S	L
Icu (kA)	25	36				50				70		100	150	
Trip unit	MicroLogic ^[1]													
Rating (A)	40	100	40	100	40	100	40	100	40	100	40	100	40	100

Downstream CB			Selectivity limit (kA) / Breaking capacity enhanced by cascading (kA)											
CB type	Rating (A)	Icu (kA)												
iC60N	≤ 20	10	20/20	20/20	25/25	25/25	30/30	30/30	30/30	30/30	30/30	30/30	30/30	30/30
	25	10	20/20	20/20	25/25	25/25	30/30	30/30	30/30	30/30	30/30	30/30	30/30	30/30
	32	10		20/20		25/25		30/30		30/30		30/30		30/30
	40	10		20/20		25/25		30/30		30/30		30/30		30/30
	50	10		6/20		6/25		6/30		6/30		6/30		6/30
	63	10		6/20		6/25		6/30		6/30		6/30		6/30
iC60H	≤ 20	15	25/25	25/25	36/36	36/36	40/40	40/40	40/40	40/40	40/40	40/40	40/40	40/40
	25	15	25/25	25/25	36/36	36/36	40/40	40/40	40/40	40/40	40/40	40/40	40/40	40/40
	32	15		25/25		36/36		40/40		40/40		40/40		40/40
	40	15		25/25		36/36		40/40		40/40		40/40		40/40
	50	15		6/25		6/36		6/40		6/40		6/40		6/40
	63	15		6/25		6/36		6/40		6/40		6/40		6/40
iC60L	≤ 20	25	25/25	25/25	36/36	36/36	40/40	40/40	40/40	40/40	40/40	40/40	40/40	40/40
	25	25	25/25	25/25	36/36	36/36	40/40	40/40	40/40	40/40	40/40	40/40	40/40	40/40
	32	20		25/25		36/36		40/40		40/40		40/40		40/40
	40	20		25/25		36/36		40/40		40/40		40/40		40/40
	50	15		6/25		6/36		6/40		6/40		6/40		6/40
	63	15		6/25		6/36		6/40		6/40		6/40		6/40

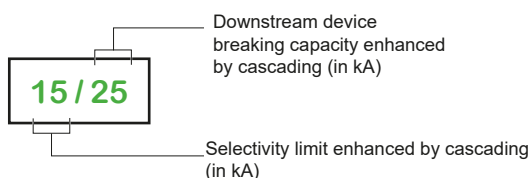

[1] Applicable for all "Distribution" MicroLogic of ComPacT NSX range: 2.2, 4.2, 5.2, 6.2, 7.2. For 4.2 and 7.2 selectivity rules for RCD apply in addition. Applicable for Generators and Service connection (G and AB type) MicroLogic of ComPacT NSX range but curves shall be checked. Not applicable for "Motor" MicroLogic of ComPacT NSX range ("M" type).

Note: Respect the basic rules of selectivity, in terms of overload, short-circuit, ground fault and earth leakage when applicable see page A-1, or check curves with Schneider Electric online "Electrical calculation tools".

Selectivity Enhanced by Cascading

Upstream: ComPacT NSX160, NSX250, MicroLogic

Downstream: iC60, C120, NG125, ComPacT NSXm, NSX100

A

Ue: 380-415 V AC
(Ph/N 220-240 V AC)

Upstream CB		NSX160												
		B	F				N		H		S		L	
Icu (kA)		25	36				50		70		100		150	
Trip unit		MicroLogic ^[1]												
Rating (A)		100	160	100	160	100	160	100	160	100	160	100	160	

Downstream CB			Selectivity limit (kA) / Breaking capacity enhanced by cascading (kA)											
CB type	Rating (A)	Icu (kA)												
iC60N	≤ 20	10	20/20	20/20	25/25	25/25	30/30	30/30	30/30	30/30	30/30	30/30	30/30	30/30
	25	10	20/20	20/20	25/25	25/25	30/30	30/30	30/30	30/30	30/30	30/30	30/30	30/30
	32	10	20/20	20/20	25/25	25/25	30/30	30/30	30/30	30/30	30/30	30/30	30/30	30/30
	40	10	20/20	20/20	25/25	25/25	30/30	30/30	30/30	30/30	30/30	30/30	30/30	30/30
	50	10	6/20	20/20	6/25	25/25	6/30	30/30	6/30	30/30	6/30	30/30	6/30	30/30
	63	10	6/20	20/20	6/25	25/25	6/30	30/30	6/30	30/30	6/30	30/30	6/30	30/30
iC60H	≤ 20	15	25/25	25/25	36/36	36/36	40/40	40/40	40/40	40/40	40/40	40/40	40/40	40/40
	25	15	25/25	25/25	36/36	36/36	40/40	40/40	40/40	40/40	40/40	40/40	40/40	40/40
	32	15	25/25	25/25	36/36	36/36	40/40	40/40	40/40	40/40	40/40	40/40	40/40	40/40
	40	15	25/25	25/25	36/36	36/36	40/40	40/40	40/40	40/40	40/40	40/40	40/40	40/40
	50	15	6/25	25/25	6/36	36/36	6/36	36/36	6/36	36/36	6/36	36/36	6/36	36/36
	63	15	6/25	25/25	6/36	36/36	6/36	36/36	6/36	36/36	6/36	36/36	6/36	36/36
iC60L	≤ 20	25	25/25	25/25	36/36	36/36	40/40	40/40	40/40	40/40	40/40	40/40	40/40	40/40
	25	25	25/25	25/25	36/36	36/36	40/40	40/40	40/40	40/40	40/40	40/40	40/40	40/40
	32	20	25/25	25/25	36/36	36/36	40/40	40/40	40/40	40/40	40/40	40/40	40/40	40/40
	40	20	25/25	25/25	36/36	36/36	40/40	40/40	40/40	40/40	40/40	40/40	40/40	40/40
	50	15	6/25	25/25	6/36	36/36	6/36	36/36	6/36	36/36	6/36	36/36	6/36	36/36
	63	15	6/25	25/25	6/36	36/36	6/36	36/36	6/36	36/36	6/36	36/36	6/36	36/36

Upstream CB		NSX250												
		B	F				N		H		S		L	
Icu (kA)		25	36				50		70		100		150	
Trip unit		MicroLogic ^[1]												
Rating (A)		250	250				250		250		250		250	

Downstream CB			Selectivity limit (kA) / Breaking capacity enhanced by cascading (kA)												
CB type	Rating (A)	Icu (kA)													
iC60N	≤ 40	10	20/20	25/25				30/30		30/30		30/30		30/30	
	50-63A	10	20/20	25/25				25/25		25/25		25/25		25/25	
iC60H	≤ 40	15	25/25	30/30				30/30		30/30		30/30		30/30	
	50-63A	15	25/25	25/25				25/25		25/25		25/25		25/25	
iC60L	≤ 25	25	25/25	30/30				30/30		30/30		30/30		30/30	
	32-40	20	25/25	30/30				30/30		30/30		30/30		30/30	
	50-63	15	25/25	25/25				25/25		25/25		25/25		25/25	
C120 N		10	25/25	25/25				25/25		25/25		25/25		25/25	
C120 H		15	25/25	25/25				25/25		25/25		25/25		25/25	
NG125 N		25		36/36				36/36		50/50		70/70		70/70	
NG125 H		36						40/40		50/50		70/70		100/100	
NG125 L		50								70/70		100/100		150/150	
NSXm E		16	25/25	25/25				30/30		30/30		30/30		30/30	
NSXm B		25		36/36				36/36		50/50		50/50		50/50	
NSXm F		36						50/50		70/70		70/70		70/70	
NSXm N		50						50/50		70/70		70/70		70/70	
NSX100 B	≤ 25	25		36/36				36/36		50/50		50/50		50/50	
TM-D	40-100	25		36/36				36/36		36/50		36/50		36/50	
NSX100 F	≤ 25	36						50/50		70/70		100/100		150/150	
TM-D	40-100	36						36/50		36/70		36/100		36/150	
NSX100 N	≤ 25	50								70/70		100/100		150/150	
TM-D	40-100	50								36/70		36/100		36/150	
NSX100 H	≤ 25	70										100/100		150/150	
TM-D	40-100	70										36/100		36/150	
NSX100 S	≤ 25	100												150/150	
TM-D	40-100	100												36/150	
NSX100 B		25		36/36				36/50		36/50		36/50		36/50	
MicroLogic NSX100 F		36								36/70		36/100		36/150	
MicroLogic NSX100 N		50								36/70		36/100		36/150	
MicroLogic NSX100 H		70										36/100		36/150	
MicroLogic NSX100 S		100												36/150	
MicroLogic															

[1] Applicable for all "Distribution" MicroLogic of ComPacT NSX range: 2.2 4.2, 5.2, 6.2, 7.2. For 4.2 and 7.2 selectivity rules for RCD apply in addition. Applicable for Generators and Service connection (G and AB type) MicroLogic of ComPacT NSX range but curves shall be checked. Not applicable for "Motor" MicroLogic of ComPacT NSX range ("M" type).

Note: Respect the basic rules of selectivity, in terms of overload, short-circuit, ground fault and earth leakage when applicable see page A-1, or check curves with Schneider Electric online "Electrical calculation tools".

Selectivity Enhanced by Cascading

Upstream: ComPacT NSX160, NSX250, TM-D

Downstream: iC60, C120, NG125, ComPacT NSXm, NSX100

Ue: 380-415 V AC
(Ph/N 220-240 V AC)



Upstream CB		NSX160					
		B	F	N	H	S	L
Icu (kA)		25	36	50	70	100	150
Trip unit		TM-D					
Rating (A)		≤ 100	125-160	≤ 100	125-160	≤ 100	125-160

Downstream CB			Selectivity limit (kA) / Breaking capacity enhanced by cascading (kA)											
CB type	Rating (A)	Icu (kA)												
iC60N	≤ 20	10	-/20	20/20	-/25	25/25	-/30	30/30	-/30	30/30	-/30	30/30	-/30	30/30
	25	10	-/20	20/20	-/25	25/25	-/30	30/30	-/30	30/30	-/30	30/30	-/30	30/30
	32	10	-/20	20/20	-/25	25/25	-/30	30/30	-/30	30/30	-/30	30/30	-/30	30/30
	40	10	-/20	20/20	-/25	25/25	-/30	30/30	-/30	30/30	-/30	30/30	-/30	30/30
	50	10	-/20	20/20	-/25	25/25	-/30	30/30	-/30	30/30	-/30	30/30	-/30	30/30
	63	10	-/20	20/20	-/25	25/25	-/30	30/30	-/30	30/30	-/30	30/30	-/30	30/30
iC60H	≤ 20	15	-/25	25/25	-/36	36/36	-/40	40/40	-/40	40/40	-/40	40/40	-/40	40/40
	25	15	-/25	25/25	-/36	36/36	-/40	40/40	-/40	40/40	-/40	40/40	-/40	40/40
	32	15	-/25	25/25	-/36	36/36	-/40	40/40	-/40	40/40	-/40	40/40	-/40	40/40
	40	15	-/25	25/25	-/36	36/36	-/40	40/40	-/40	40/40	-/40	40/40	-/40	40/40
	50	15	-/25	25/25	-/36	36/36	-/40	40/40	-/40	40/40	-/40	40/40	-/40	40/40
	63	15	-/25	25/25	-/36	36/36	-/40	40/40	-/40	40/40	-/40	40/40	-/40	40/40
iC60L	≤ 20	25	-/25	25/25	-/36	36/36	-/40	40/40	-/40	40/40	-/40	40/40	-/40	40/40
	25	25	-/25	25/25	-/36	36/36	-/40	40/40	-/40	40/40	-/40	40/40	-/40	40/40
	32	20	-/25	25/25	-/36	36/36	-/40	40/40	-/40	40/40	-/40	40/40	-/40	40/40
	40	20	-/25	25/25	-/36	36/36	-/40	40/40	-/40	40/40	-/40	40/40	-/40	40/40
	50	15	-/25	25/25	-/36	36/36	-/40	40/40	-/40	40/40	-/40	40/40	-/40	40/40
	63	15	-/25	25/25	-/36	36/36	-/40	40/40	-/40	40/40	-/40	40/40	-/40	40/40

Upstream CB		NSX250					
		B	F	N	H	S	L
Icu (kA)		25	36	50	70	100	130
Trip unit		TM-D					
Rating (A)		200-250	200-250	200-250	200-250	200-250	200-250

Downstream CB			Selectivity limit (kA) / Breaking capacity enhanced by cascading (kA)										
CB type	Rating (A)	Icu (kA)											
iC60N	≤ 40	10	20/20	25/25	30/30	30/30	30/30	30/30	30/30	30/30	30/30	30/30	30/30
	50-63	10	20/20	25/25	25/25	25/25	25/25	25/25	25/25	25/25	25/25	25/25	25/25
iC60H	≤ 40	15	25/25	30/30	30/30	30/30	30/30	30/30	30/30	30/30	30/30	30/30	30/30
	50-63	15	25/25	25/25	25/25	25/25	25/25	25/25	25/25	25/25	25/25	25/25	25/25
iC60L	≤ 25	25	25/25	30/30	30/30	30/30	30/30	30/30	30/30	30/30	30/30	30/30	30/30
	32-40	20	25/25	30/30	30/30	30/30	30/30	30/30	30/30	30/30	30/30	30/30	30/30
	50-63	15	25/25	25/25	25/25	25/25	25/25	25/25	25/25	25/25	25/25	25/25	25/25
C120N		10	25/25	25/25	25/25	25/25	25/25	25/25	25/25	25/25	25/25	25/25	25/25
C120H		15	25/25	25/25	25/25	25/25	25/25	25/25	25/25	25/25	25/25	25/25	25/25
NG125 N		25		36/36	36/36	50/50	50/50	70/70	70/70	100/100	150/150	150/150	
NG125 H		36			40/40	50/50	50/50	70/70	70/70	100/100	150/150	150/150	
NG125 L		50				70/70	70/70	100/100	100/100	150/150	150/150	150/150	
NSXm E	≤ 125	16	25/25	25/25	30/30	30/30	30/30	30/30	30/30	30/30	30/30	30/30	
NSXm B	≤ 125	25		36/36	36/36	50/50	50/50	50/50	50/50	50/50	50/50	50/50	
NSXm F	≤ 125	36			50/50	70/70	70/70	70/70	70/70	70/70	70/70	70/70	
NSXm N	≤ 125	50				70/70	70/70	70/70	70/70	70/70	70/70	70/70	
NSX100 B	≤ 25	25		36/36	36/36	50/50	50/50	50/50	50/50	50/50	50/50	50/50	
TM-D	40 - 100	25		36/36	36/36	36/50	36/50	36/50	36/50	36/50	36/50	36/50	
NSX100 F	≤ 25	36			50/50	70/70	70/70	100/100	100/100	150/150	150/150	150/150	
TM-D	40 - 100	36			36/50	36/70	36/70	36/100	36/100	36/150	36/150	36/150	
NSX100 N	≤ 25	50				70/70	70/70	100/100	100/100	150/150	150/150	150/150	
TM-D	40 - 100	50				36/70	36/70	36/100	36/100	36/150	36/150	36/150	
NSX100 H	≤ 25	70						100/100	100/100	150/150	150/150	150/150	
TM-D	40 - 100	70						36/100	36/100	36/150	36/150	36/150	
NSX100S	≤ 25	100								150/150	150/150	150/150	
TM-D	40 - 100	70								36/150	36/150	36/150	
NSX100 B		25		2/36	2/36	2/50	2/50	2/50	2/50	2/50	2/50	2/50	
MicroLogic													
NSX100 F		36			2/50	2/70	2/70	2/100	2/100	2/150	2/150	2/150	
MicroLogic													
NSX100 N		50				2/70	2/70	2/100	2/100	2/150	2/150	2/150	
MicroLogic													
NSX100 H		70						2/100	2/100	2/150	2/150	2/150	
MicroLogic													
NSX100 S		100								2/150	2/150	2/150	
MicroLogic													

Note: Respect the basic rules of selectivity, in terms of overload, short-circuit, ground fault and earth leakage when applicable see page A-1, or check curves with Schneider Electric online "Electrical calculation tools".

Selectivity Enhanced by Cascading

Upstream: ComPacT NSX400, NSX630, MicroLogic

Downstream: ComPacT NSXm, NSX100, NSX160, NSX250

A

Ue: 380-415 V AC
(Ph/N 220-240 V AC)

Upstream CB	NSX400					NSX630				
	F	N	H	S	L	F	N	H	S	L
Icu (kA)	36	50	70	100	150	36	50	70	100	150
Trip unit	MicroLogic ^[1]									
Rating (A)	400	400	400	400	400	630	630	630	630	630

Downstream CB			Selectivity limit (kA) / Breaking capacity enhanced by cascading (kA)									
CB type	Trip unit	Icu (kA)										
NSXm E	TM-D	16	25/25	30/30	30/30	30/30	30/30	25/25	30/30	30/30	30/30	30/30
NSXm B	TM-D	25	36/36	36/36	50/50	50/50	50/50	36/36	36/36	50/50	50/50	50/50
NSXm F	TM-D	36		50/50	70/70	70/70	70/70		50/50	70/70	70/70	70/70
NSXm N	TM-D	50			70/70	70/70	70/70			70/70	70/70	70/70
NSXm E	MicroLogic	16	25/25	30/30	30/30	30/30	30/30	25/25	30/30	30/30	30/30	30/30
NSXm B	MicroLogic	25	36/36	36/36	50/50	50/50	50/50	36/36	36/36	50/50	50/50	50/50
NSXm F	MicroLogic	36		50/50	70/70	70/70	70/70		50/50	70/70	70/70	70/70
NSXm N	MicroLogic	50			70/70	70/70	70/70			70/70	70/70	70/70
NSX100 B	TM-D	25	36/36	36/36	50/50	50/50	50/50	36/36	36/36	50/50	50/50	50/50
NSX100 F	TM-D	36		50/50	70/70	100/100	150/150		50/50	70/70	100/100	150/150
NSX100 N	TM-D	50			70/70	100/100	150/150			70/70	100/100	150/150
NSX100 H	TM-D	70				100/100	150/150				100/100	150/150
NSX100 S	TM-D	100					150/150					150/150
NSX160 B	TM-D	25	36/36	36/36	50/50	50/50	50/50	36/36	36/36	50/50	50/50	50/50
NSX160 F	TM-D	36		50/50	70/70	100/100	150/150		50/50	70/70	100/100	150/150
NSX160 N	TM-D	50			70/70	100/100	150/150			70/70	100/100	150/150
NSX160 H	TM-D	70				100/100	150/150				100/100	150/150
NSX160 S	TM-D	100					150/150					150/150
NSX250 B	TM-D	25						36/36	36/36	50/50	50/50	50/50
NSX250 F	TM-D	36							50/50	70/70	100/100	150/150
NSX250 N	TM-D	50								70/70	100/100	150/150
NSX250 H	TM-D	70									100/100	150/150
NSX250 S	TM-D	100										150/150
NSX100 B	MicroLogic	25	36/36	36/36	50/50	50/50	50/50	36/36	36/36	50/50	50/50	50/50
NSX100 F	MicroLogic	36		50/50	70/70	100/100	150/150		50/50	70/70	100/100	150/150
NSX100 N	MicroLogic	50			70/70	100/100	150/150			70/70	100/100	150/150
NSX100 H	MicroLogic	70				100/100	150/150				100/100	150/150
NSX100 S	MicroLogic	100					150/150					150/150
NSX160 B	MicroLogic	25	36/36	36/36	50/50	50/50	50/50	36/36	36/36	50/50	50/50	50/50
NSX160 F	MicroLogic	36		50/50	70/70	100/100	150/150		50/50	70/70	100/100	150/150
NSX160 N	MicroLogic	50			70/70	100/100	150/150			70/70	100/100	150/150
NSX160 H	MicroLogic	70				100/100	150/150				100/100	150/150
NSX160 S	MicroLogic	100					150/150					150/150
NSX250 B	MicroLogic	25						36/36	36/36	50/50	50/50	50/50
NSX250 F	MicroLogic	36							50/50	70/70	100/100	150/150
NSX250 N	MicroLogic	50								70/70	100/100	150/150
NSX250 H	MicroLogic	70									100/100	150/150
NSX250 S	MicroLogic	100										150/150

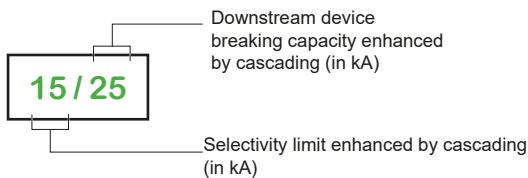

[1] Applicable for all "Distribution" MicroLogic of ComPacT NSX range: 2.3, 4.3, 5.3, 6.3, 7.3. For 4.3 and 7.3 selectivity rules for RCD apply in addition. Applicable for Generators and Service connection (G and AB type) MicroLogic of ComPacT NSX range but curves shall be checked. Not applicable for "Motor" MicroLogic of ComPacT NSX range ("M" type).

Note: Respect the basic rules of selectivity, in terms of overload, short-circuit, ground fault and earth leakage when applicable see page A-1, or check curves with Schneider Electric online "Electrical calculation tools".

Selectivity Enhanced by Cascading

Upstream: ComPacT NS800, NS1000, NS1250, NS1600, MicroLogic

Downstream: ComPacT NSX100, NSX160, NSX250, NSX400, NSX630

Ue: 380-415 V AC
(Ph/N 220-240 V AC)



Upstream CB		NS800				NS1000			NS1250		NS1600	
		N	H	L	LB	N	H	L	N	H	N	H
	Icu (kA)	50	70	150	200	50	70	150	50	70	50	70
	Trip unit	MicroLogic										
	Rating (A)	800	800	800	800	1000	1000	1000	1250	1250	1600	1600

Downstream CB			Selectivity limit (kA) / Breaking capacity enhanced by cascading (kA)										
CB type	Trip unit	Icu (kA)											
NSX100 B	TM-D / MicroLogic	25	50/50	50/50	50/50	50/50	50/50	50/50	50/50	50/50	50/50	50/50	50/50
NSX100 F	TM-D / MicroLogic	36	50/50	70/70	150/150	150/150	50/50	70/70	150/150	50/50	70/70	50/50	70/70
NSX100 N	TM-D / MicroLogic	50		70/70	150/150	150/150		70/70	150/150		70/70		70/70
NSX100 H	TM-D / MicroLogic	70			150/150	150/150			150/150				
NSX100 S	TM-D / MicroLogic	100			150/150	200/200			150/150				
NSX100 L	TM-D / MicroLogic	150				200/200							
NSX160 B	TM-D / MicroLogic	25	50/50	50/50	50/50	50/50	50/50	50/50	50/50	50/50	50/50	50/50	50/50
NSX160 F	TM-D / MicroLogic	36	50/50	70/70	150/150	150/150	50/50	70/70	150/150	50/50	70/70	50/50	70/70
NSX160 N	TM-D / MicroLogic	50		70/70	150/150	150/150		70/70	150/150		70/70		70/70
NSX160 H	TM-D / MicroLogic	70			150/150	150/150			150/150				
NSX160 S	TM-D / MicroLogic	100			150/150	200/200			150/150				
NSX160 L	TM-D / MicroLogic	150				200/200							
NSX250 B	TM-D / MicroLogic	25	50/50	50/50	50/50	50/50	50/50	50/50	50/50	50/50	50/50	50/50	50/50
NSX250 F	TM-D / MicroLogic	36	50/50	70/70	150/150	150/150	50/50	70/70	150/150	50/50	70/70	50/50	70/70
NSX250 N	TM-D / MicroLogic	50		70/70	150/150	150/150		70/70	150/150		70/70		70/70
NSX250 H	TM-D / MicroLogic	70			150/150	150/150			150/150				
NSX250 S	TM-D / MicroLogic	100			150/150	200/200			150/150				
NSX250 L	TM-D / MicroLogic	150				200/200							
NSX400 F	MicroLogic	36	50/50	70/70	10/150	10/150	50/50	70/70	15/150	50/50	70/70	50/50	70/70
NSX400 N	MicroLogic	50		70/70	10/150	10/150		70/70	15/150		70/70		70/70
NSX400 H	MicroLogic	70			10/150	10/150			15/150				
NSX400 S	MicroLogic	100			10/150	10/200			15/150				
NSX400 L	MicroLogic	150				10/200							
NSX630 F	MicroLogic	36					50/50	65/70	10/150	50/50	65/70	50/50	65/70
NSX630 N	MicroLogic	50						65/70	10/150		65/70		65/70
NSX630 H	MicroLogic	70							10/150				
NSX630 S	MicroLogic	100							10/150				

Note: Respect the basic rules of selectivity, in terms of overload, short-circuit, ground fault and earth leakage when applicable see page A-7, or check curves with Schneider Electric online "Electrical calculation tools".

Selectivity Enhanced by Cascading

Upstream: NSX100 Micrologic

Downstream: iC60 RCBO

Ue: 380-415 V AC
(Ph/N 220-240 V AC)

A

Upstream	NSX100											
	B		F		N		H		S		L	
Icu (kA)	25		36		50		70		100		150	
Trip unit	Micrologic		Micrologic		Micrologic		Micrologic		Micrologic		Micrologic	
Rating (A)	40	100	40	100	40	100	40	100	40	100	40	100

Downstream															
	Icn (A)	In (A)	Selectivity/Breaking capacity enhanced limits (kA)												
iC60 RCBO	6000 3/4P	≤ 20	20/20	20/20	20/20	20/20	20/20	20/20	20/20	20/20	20/20	20/20	20/20	20/20	20/20
		25	20/20	20/20	20/20	20/20	20/20	20/20	20/20	20/20	20/20	20/20	20/20	20/20	20/20
		32		20/20		20/20		20/20		20/20		20/20		20/20	20/20
	10000 2P	≤ 20	20/20	20/20	20/20	20/20	20/20	20/20	20/20	20/20	20/20	20/20	20/20	20/20	20/20
		25	20/20	20/20	20/20	20/20	20/20	20/20	20/20	20/20	20/20	20/20	20/20	20/20	20/20
		32		20/20		20/20		20/20		20/20		20/20		20/20	20/20
iC60N RCBO VD	6000	≤ 20	20/20	20/20	25/25	25/25	30/30	30/30	30/30	30/30	30/30	30/30	30/30	30/30	30/30
		25	20/20	20/20	25/25	25/25	25/25	25/25	25/25	25/25	25/25	25/25	25/25	25/25	25/25
		32		20/20		25/25		25/25		25/25		25/25		25/25	25/25
		40		20/20		25/25		25/25		25/25		25/25		25/25	25/25
		45		6/20		6/25		6/25		6/25		6/25		6/25	6/25
iC60H RCBO VD	10000	≤ 20	25/25	25/25	36/36	36/36	40/40	40/40	40/40	40/40	40/40	40/40	40/40	40/40	40/40
		25	25/25	25/25	25/25	25/25	25/25	25/25	25/25	25/25	25/25	25/25	25/25	25/25	25/25
		32		25/25		25/25		25/25		25/25		25/25		25/25	25/25
		40		25/25		25/25		25/25		25/25		25/25		25/25	25/25
		45		6/25		6/25		6/25		6/25		6/25		6/25	6/25
iC60H2 RCBO VD	10000	≤ 20	25/25	25/25	36/36	25/36	40/40	40/40	40/40	40/40	40/40	40/40	40/40	40/40	
		25	25/25	25/25	25/25	25/25	25/25	25/25	25/25	25/25	25/25	25/25	25/25	25/25	
		32		25/25		25/25		25/25		25/25		25/25		25/25	25/25

VD: Voltage dependent RCBOs are RCBOs according to IEC 61009-2-2. These RCBOs are allowed only in some countries. See IEC 60364-5-53:2020 Annex F.

Selectivity Enhanced by Cascading (cont.)

Upstream: NSX160, NSX250 Micrologic

Downstream: iC60 RCBO

U_e: 380-415 V AC
(Ph/N 220-240 V AC)



Upstream	NSX160											
	B		F		N		H		S		L	
Icu (kA)	25		36		50		70		100		150	
Trip unit	Micrologic		Micrologic		Micrologic		Micrologic		Micrologic		Micrologic	
Rating (A)	100	160	100	160	100	160	100	160	100	160	100	160

Downstream														
	Icn (A)	In (A)	Selectivity/Breaking capacity enhanced limits (kA)											
iC60 RCBO	6000 3/4P	≤ 20	20/20	20/20	20/20	20/20	20/20	20/20	20/20	20/20	20/20	20/20	20/20	20/20
		25-32	20/20	20/20	20/20	20/20	20/20	20/20	20/20	20/20	20/20	20/20	20/20	20/20
	10000 2P	≤ 20	20/20	20/20	20/20	20/20	20/20	20/20	20/20	20/20	20/20	20/20	20/20	20/20
iC60N RCBO VD	6000	≤ 20	20/20	20/20	25/25	25/25	30/30	30/30	30/30	30/30	30/30	30/30	30/30	30/30
		25	20/20	20/20	25/25	25/25	25/25	25/25	25/25	25/25	25/25	25/25	25/25	
		32	20/20	20/20	25/25	25/25	25/25	25/25	25/25	25/25	25/25	25/25	25/25	
		40	20/20	20/20	25/25	25/25	25/25	25/25	25/25	25/25	25/25	25/25	25/25	
iC60H RCBO VD	10000	≤ 20	25/25	25/25	36/36	36/36	40/40	40/40	40/40	40/40	40/40	40/40	40/40	
		25	25/25	25/25	25/25	25/25	25/25	25/25	25/25	25/25	25/25	25/25	25/25	
		32	25/25	25/25	25/25	25/25	25/25	25/25	25/25	25/25	25/25	25/25	25/25	
		40	25/25	25/25	25/25	25/25	25/25	25/25	25/25	25/25	25/25	25/25	25/25	
iC60H2 RCBO VD	10000	≤ 20	25/25	25/25	36/36	36/36	40/40	40/40	40/40	40/40	40/40	40/40	40/40	
		25	25/25	25/25	25/25	25/25	25/25	25/25	25/25	25/25	25/25	25/25	25/25	
		32	25/25	25/25	25/25	25/25	25/25	25/25	25/25	25/25	25/25	25/25	25/25	
		45	6/20	20/20	6/25	25/25	6/25	25/25	6/25	25/25	6/25	25/25	6/25	

Upstream	NSX250											
	B		F		N		H		S		L	
Icu (kA)	25		36		50		70		100		150	
Trip unit	Micrologic		Micrologic		Micrologic		Micrologic		Micrologic		Micrologic	
Rating (A)	250		250		250		250		250		250	

Downstream														
	Icn (A)	In (A)	Selectivity/Breaking capacity enhanced limits (kA)											
iC60 RCBO	6000 3/4P	≤ 20	20/20	20/20	20/20	20/20	20/20	20/20	20/20	20/20	20/20	20/20	20/20	
		25-32	16/16	16/16	16/16	16/16	16/16	16/16	16/16	16/16	16/16	16/16	16/16	
	10000 2P	≤ 20	20/20	20/20	20/20	20/20	20/20	20/20	20/20	20/20	20/20	20/20	20/20	
iC60N RCBO VD	6000	≤ 20	20/20	25/25	30/30	30/30	30/30	30/30	30/30	30/30	30/30	30/30	30/30	
		25-45	20/20	25/25	25/25	25/25	25/25	25/25	25/25	25/25	25/25	25/25		
iC60H RCBO VD	10000	≤ 20	25/25	30/30	30/30	30/30	30/30	30/30	30/30	30/30	30/30	30/30	30/30	
		25-45	25/25	25/25	25/25	25/25	25/25	25/25	25/25	25/25	25/25	25/25		
iC60H2 RCBO VD	10000	≤ 20	25/25	30/30	30/30	30/30	30/30	30/30	30/30	30/30	30/30	30/30	30/30	
		25-32	25/25	25/25	25/25	25/25	25/25	25/25	25/25	25/25	25/25	25/25		

VD: Voltage dependent RCBOs are RCBOs according to IEC 61009-2-2. These RCBOs are allowed only in some countries. See IEC 60364-5-53:2020 Annex F.

Selectivity Enhanced by Cascading

Upstream: NSXm, NSX160, NSX250 TM-D

Downstream: iC60 RCBO

Ue: 380-415 V AC
(Ph/N 220-240 V AC)

A

Upstream	NSXm B					NSXm F					NSXm N/H				
Icu (kA)	25					36					50/70				
Rating (A)	≤ 63	80	100	125	160	≤ 63	80	100	125	160	≤ 63	80	100	125	160

Downstream																		
	Icn (A)	In (A)	Selectivity/Breaking capacity enhanced limits (kA)															
iC60 RCBO	6000 3/4P	≤ 20	-/20	20/20	20/20	20/20	20/20	20/20	-/20	20/20	20/20	20/20	20/20	20/20	20/20	20/20	20/20	
		25		3/20	20/20	20/20	20/20	20/20		3/20	20/20	20/20	20/20	20/20	20/20	20/20	20/20	
		32		2/20	20/20	20/20	20/20		2/20	20/20	20/20	20/20		2/20	20/20	20/20	20/20	
	10000 2P	≤ 20	-/20	20/20	20/20	20/20	20/20	20/20	-/20	20/20	20/20	20/20	20/20	20/20	-/20	20/20	20/20	20/20
		25		3/20	20/20	20/20	20/20	20/20		3/20	20/20	20/20	20/20		3/20	20/20	20/20	20/20
		32		2/20	20/20	20/20	20/20		2/20	20/20	20/20	20/20		2/20	20/20	20/20	20/20	
iC60N RCBO VD	6000	≤ 20	-/20	20/20	20/20	20/20	20/20	-/25	25/25	25/25	25/25	25/25	-/30	25/30	25/30	25/30	25/30	
		25		8/20	20/20	20/20	20/20		8/25	25/25	25/25	25/25		8/25	25/25	25/25	25/25	
		32		3/20	20/20	20/20	20/20		3/25	25/25	25/25	25/25		3/25	25/25	25/25	25/25	
		40		2/20	16/20	16/20	16/20		2/25	16/25	16/25	16/25		2/25	16/25	16/25	16/25	
		45			6/20	8/20	8/20			6/25	8/25	8/25			6/25	8/25	8/25	
iC60H RCBO VD	10000	≤ 20	-/25	25/25	25/25	25/25	25/25	-/36	25/36	25/36	25/36	25/36	-/36	25/36	25/36	25/36	25/36	
		25		8/25	25/25	25/25	25/25		8/25	25/25	25/25	25/25		8/25	25/25	25/25	25/25	
		32		3/25	25/25	25/25	25/25		3/25	25/25	25/25	25/25		3/25	25/25	25/25	25/25	
		40		2/25	16/25	16/25	16/25		2/25	16/25	16/25	16/25		2/25	16/25	16/25	16/25	
		45			6/25	8/25	8/25			6/25	8/25	8/25			6/25	8/25	8/25	
iC60H2 RCBO VD	10000	≤ 20	-/25	25/25	25/25	25/25	25/25	-/36	25/36	25/36	25/36	25/36	-/36	25/36	25/36	25/36	25/36	
		25		8/25	25/25	25/25	25/25		8/25	25/25	25/25	25/25		8/25	25/25	25/25	25/25	
		32		3/25	25/25	25/25	25/25		3/25	25/25	25/25	25/25		3/25	25/25	25/25	25/25	

Upstream	NSX160													
	B				F		N		H		S		L	
Icu (kA)	25				36		50		70		100		150	
Trip unit	TM-D				TM-D		TM-D		TM-D		TM-D		TM-D	
Rating (A)	≤ 100	125-160			≤ 100	125-160	≤ 100	125-160	≤ 100	125-160	≤ 100	125-160	≤ 100	125-160

Downstream															
	Icn (A)	In (A)	Selectivity/Breaking capacity enhanced limits (kA)												
iC60 RCBO	6000 3/4P	≤ 20	-/20	20/20	-/20	20/20	-/20	20/20	-/20	20/20	-/20	20/20	-/20	20/20	20/20
		25-32	-/20	20/20	-/20	20/20	-/20	20/20	-/20	20/20	-/20	20/20	-/20	20/20	20/20
	10000 2P	≤ 20	-/20	20/20	-/20	20/20	-/20	20/20	-/20	20/20	-/20	20/20	-/20	20/20	20/20
		25-32	-/20	20/20	-/20	20/20	-/20	20/20	-/20	20/20	-/20	20/20	-/20	20/20	20/20
iC60N RCBO VD	6000	≤ 20	-/20	20/20	-/25	25/25	-/30	30/30	-/30	30/30	-/30	30/30	-/30	30/30	30/30
		25-45	-/20	20/20	-/25	25/25	-/25	25/25	-/25	25/25	-/25	25/25	-/25	25/25	25/25
iC60H RCBO VD	10000	≤ 20	-/25	25/25	-/36	36/36	-/40	40/40	-/40	40/40	-/40	40/40	-/40	40/40	40/40
		25-45	-/25	25/25	-/25	25/25	-/25	25/25	-/25	25/25	-/25	25/25	-/25	25/25	25/25
iC60H2 RCBO VD	10000	≤ 20	-/25	25/25	-/36	36/36	-/40	40/40	-/40	40/40	-/40	40/40	-/40	40/40	40/40
		25-32	-/25	25/25	-/25	25/25	-/25	25/25	-/25	25/25	-/25	25/25	-/25	25/25	25/25

Upstream	NSX250													
	B				F		N		H		S		L	
Icu (kA)	25				36		50		70		100		150	
Trip unit	TM-D				TM-D		TM-D		TM-D		TM-D		TM-D	
Rating (A)	200-250				200-250		200-250		200-250		200-250		200-250	

Downstream									
	Icn (A)	In (A)	Selectivity/Breaking capacity enhanced limits (kA)						
iC60 RCBO	6000 3/4P	≤ 20	20/20	20/20	20/20	20/20	20/20	20/20	20/20
		25-32	16/16	16/16	16/16	16/16	16/16	16/16	16/16
	10000 2P	≤ 20	20/20	20/20	20/20	20/20	20/20	20/20	20/20
		25-32	16/16	16/16	16/16	16/16	16/16	16/16	16/16
iC60N RCBO VD	6000	≤ 20	20/20	25/25	30/30	30/30	30/30	30/30	30/30
		25-45	20/20	25/25	25/25	25/25	25/25	25/25	25/25
iC60H RCBO VD	10000	≤ 20	25/25	30/30	30/30	30/30	30/30	30/30	30/30
		25-45	25/25	25/25	25/25	25/25	25/25	25/25	25/25
iC60H2 RCBO VD	10000	≤ 20	25/25	30/30	30/30	30/30	30/30	30/30	30/30
		25-32	25/25	25/25	25/25	25/25	25/25	25/25	25/25

VD: Voltage dependent RCBOs are RCBOs according to IEC 61009-2-2. These RCBOs are allowed only in some countries. See IEC 60364-5-53:2020 Annex F.

Selectivity Enhanced by Cascading

Upstream: ComPacT NSX160, NSX250, NSX400

Downstream: LUB12, LUB32, Integral 63

Ue: 380-415 V AC



Upstream CB		NSX160H	NSX160S	NSX160L	NSX250H	NSX250S	NSX250L
	Icu (kA)	70 kA	100 kA	150 kA	70 kA	100 kA	150 kA
	Trip unit	TM-D					
	Rating (A)	80/100	125/160	80/100	125/160	80/100	125/160

Downstream CB			Selectivity limit (kA) / Breaking capacity enhanced by cascading (kA)											
CB type	Trip unit type	Rating (A)												
LUB12	LUC●X6	0.15-0.6		70/70		100/100		150/150	70/70	70/70	100/100	100/100	100/100	100/100
	LUC●1X	0.35-1.4		70/70		100/100		150/150	70/70	70/70	100/100	100/100	100/100	100/100
	LUC●05	1.25-5		70/70		100/100		150/150	70/70	70/70	100/100	100/100	100/100	100/100
	LUC●12	3-12		70/70		100/100		150/150	70/70	70/70	100/100	100/100	100/100	100/100
LUB32	LUC●X6	0.15-0.6		5/70		5/100		5/150	5/70	70/70	5/100	100/100	5/100	100/100
	LUC●1X	0.35-1.4		5/70		5/100		5/150	5/70	70/70	5/100	100/100	5/100	100/100
	LUC●05	1.25-5		5/70		5/100		5/150	5/70	70/70	5/100	100/100	5/100	100/100
	LUC●12	3-12		5/70		5/100		5/150	5/70	70/70	5/100	100/100	5/100	100/100
	LUC●18	4.5-18		5/70		5/100		5/150	5/70	70/70	5/100	100/100	5/100	100/100
	LUC●32	8-32		5/70		5/100		5/150	5/70	70/70	5/100	100/100	5/100	100/100
Integral 63	LB1-LD03M16	10-13							70/70		100/100		150/150	
LD1-LD030	LB1-LD03M21	11-18							70/70		100/100		150/150	
LD4-LD130	LB1-LD03M22	18-25							70/70		100/100		150/150	
LD4-LD030	LB1-LD03M53	23-32							70/70		100/100		150/150	
	LB1-LD03M55	28-40							70/70		100/100		150/150	
	LB1-LD03M57	35-50							70/70		100/100		150/150	
	LB1-LD03M61	45-63							70/70		100/100		150/150	

Upstream CB		NSX160H	NSX160L	NSX160L	NSX250H	NSX250S	NSX250L	NSX400H	NSX400S	NSX400L
	Icu (kA)	70 kA	100 kA	150 kA	70 kA	100 kA	150 kA	70 kA	100 kA	150 kA
	Trip unit	MicroLogic								
	Rating (A)	160	160	160	250	250	250	400	400	400

Downstream CB			Selectivity limit (kA) / Breaking capacity enhanced by cascading (kA)										
CB type	Trip unit type	Rating (A)											
LUB12	LUC●X6	0.15-0.6	70/70	100/100	150/150	70/70	100/100	100/100					
	LUC●1X	0.35-1.4	70/70	100/100	150/150	70/70	100/100	100/100					
	LUC●05	1.25-5	70/70	100/100	150/150	70/70	100/100	100/100					
	LUC●12	3-12	70/70	100/100	150/150	70/70	100/100	100/100					
LUB32	LUC●X6	0.15-0.6	5/70	5/100	5/150	70/70	100/100	100/100					
	LUC●1X	0.35-1.4	5/70	5/100	5/150	70/70	100/100	100/100					
	LUC●05	1.25-5	5/70	5/100	5/150	70/70	100/100	100/100					
	LUC●12	3-12	5/70	5/100	5/150	70/70	100/100	100/100					
	LUC●18	4.5-18	5/70	5/100	5/150	70/70	100/100	100/100					
	LUC●32	8-32	5/70	5/100	5/150	70/70	100/100	100/100					
Integral 63	LB1-LD03M16	10-13	70/70	100/100	150/150	70/70	100/100	150/150	70/70	100/100	150/150		
LD1-LD030	LB1-LD03M21	11-18				70/70	100/100	150/150	70/70	100/100	150/150		
LD4-LD130	LB1-LD03M22	18-25				70/70	100/100	150/150	70/70	100/100	150/150		
LD4-LD030	LB1-LD03M53	23-32				70/70	100/100	150/150	70/70	100/100	150/150		
	LB1-LD03M55	28-40				70/70	100/100	150/150	70/70	100/100	150/150		
	LB1-LD03M57	35-50				70/70	100/100	150/150	70/70	100/100	150/150		
	LB1-LD03M61	45-63				70/70	100/100	150/150	70/70	100/100	150/150		

Note: Respect the basic rules of selectivity, in terms of overload, short-circuit, ground fault and earth leakage when applicable see page A-7, or check curves with Schneider Electric online "Electrical calculation tools".

Selectivity Enhanced by Cascading

Upstream: ComPacT NSX160

Downstream: GV2 ME

Ue: 380-415 V AC

A

Upstream CB			NSX160B								NSX160F							
	Icu (kA)		25 kA								36 kA							
	Trip unit		TM-D															
	Rating (A)		16	25	40	63	80	100	125	160	16	25	32	40/50	63	80	100	125

Downstream CB			Selectivity limit (kA) / Breaking capacity enhanced by cascading (kA)																
CB type	Thermal relay	Rating (A)																	
GV2 ME01	Integrated	0.1-0.16	25/25	25/25	25/25	25/25	25/25	25/25	25/25	25/25	25/25	25/25	36/36	36/36	36/36	36/36	36/36	36/36	36/36
GV2 ME02	Integrated	0.16-0.25	25/25	25/25	25/25	25/25	25/25	25/25	25/25	25/25	25/25	25/25	36/36	36/36	36/36	36/36	36/36	36/36	36/36
GV2 ME03	Integrated	0.25-0.40	25/25	25/25	25/25	25/25	25/25	25/25	25/25	25/25	25/25	25/25	36/36	36/36	36/36	36/36	36/36	36/36	36/36
GV2 ME04	Integrated	0.40-0.63	25/25	25/25	25/25	25/25	25/25	25/25	25/25	25/25	25/25	25/25	36/36	36/36	36/36	36/36	36/36	36/36	36/36
GV2 ME05	Integrated	0.63-1	25/25	25/25	25/25	25/25	25/25	25/25	25/25	25/25	25/25	25/25	36/36	36/36	36/36	36/36	36/36	36/36	36/36
GV2 ME06	Integrated	1-1.6	25/25	25/25	25/25	25/25	25/25	25/25	25/25	25/25	25/25	25/25	36/36	36/36	36/36	36/36	36/36	36/36	36/36
GV2 ME07	Integrated	1.6-2.5	25/25	25/25	25/25	25/25	25/25	25/25	25/25	25/25	25/25	25/25	36/36	36/36	36/36	36/36	36/36	36/36	36/36
GV2 ME08	Integrated	2.5-4								25/25	25/25							36/36	36/36
GV2 ME10	Integrated	4-6.3								25/25	25/25							36/36	36/36
GV2 ME14	Integrated	6-10								25/25	25/25							36/36	36/36
GV2 ME16	Integrated	9-14								25/25	25/25							36/36	36/36
GV2 ME20	Integrated	13-18								25/25	25/25							36/36	36/36
GV2 ME21	Integrated	17-23								25/25	25/25							36/36	36/36
GV2 ME22	Integrated	20-25								25/25	25/25							36/36	36/36
GV2 ME32	Integrated	24-32								25/25	25/25							36/36	36/36

Upstream CB			NSX160N/H/S/L										
	Icu (kA)		50/70/100/150 kA										
	Trip unit		TM-D										
	Rating (A)		16	25	32	40	50	63	80	100	125	160	

Downstream CB			Selectivity limit (kA) / Breaking capacity enhanced by cascading (kA)										
CB type	Thermal relay	Rating (A)											
GV2 ME01	Integrated	0.1-0.16	50/50	50/50	50/50	50/50	50/50	50/50	50/50	50/50	50/50	50/50	50/50
GV2 ME02	Integrated	0.16-0.25	50/50	50/50	50/50	50/50	50/50	50/50	50/50	50/50	50/50	50/50	50/50
GV2 ME03	Integrated	0.25-0.40	50/50	50/50	50/50	50/50	50/50	50/50	50/50	50/50	50/50	50/50	50/50
GV2 ME04	Integrated	0.40-0.63	50/50	50/50	50/50	50/50	50/50	50/50	50/50	50/50	50/50	50/50	50/50
GV2 ME05	Integrated	0.63-1	50/50	50/50	50/50	50/50	50/50	50/50	50/50	50/50	50/50	50/50	50/50
GV2 ME06	Integrated	1-1.6		50/50	50/50	50/50	50/50	50/50	50/50	50/50	50/50	50/50	50/50
GV2 ME07	Integrated	1.6-2.5			50/50	50/50	50/50	50/50	50/50	50/50	50/50	50/50	50/50
GV2 ME08	Integrated	2.5-4										50/50	50/50
GV2 ME10	Integrated	4-6.3										50/50	50/50
GV2 ME14	Integrated	6-10										50/50	50/50
GV2 ME16	Integrated	9-14										50/50	50/50
GV2 ME20	Integrated	13-18										50/50	50/50
GV2 ME21	Integrated	17-23										50/50	50/50
GV2 ME22	Integrated	20-25										50/50	50/50
GV2 ME32	Integrated	24-32										50/50	50/50

Upstream CB			NSX160B				NSX160F				NSX160F			
	Icu (kA)		25 kA				36 kA				50/70/100/150 kA			
	Trip unit		MicroLogic											
	Rating (A)		160				160				160			

Downstream CB			Selectivity limit (kA) / Breaking capacity enhanced by cascading (kA)								
CB type	Thermal relay	Rating (A)									
GV2 ME01	Integrated	0.1-0.16	25/25				36/36				50/50
GV2 ME02	Integrated	0.16-0.25	25/25				36/36				50/50
GV2 ME03	Integrated	0.25-0.40	25/25				36/36				50/50
GV2 ME04	Integrated	0.40-0.63	25/25				36/36				50/50
GV2 ME05	Integrated	0.63-1	25/25				36/36				50/50
GV2 ME06	Integrated	1-1.6	25/25				36/36				50/50
GV2 ME07	Integrated	1.6-2.5	25/25				36/36				50/50
GV2 ME08	Integrated	2.5-4	25/25				36/36				50/50
GV2 ME10	Integrated	4-6.3	25/25				36/36				50/50
GV2 ME14	Integrated	6-10	25/25				36/36				50/50
GV2 ME16	Integrated	9-14	25/25				36/36				50/50
GV2 ME20	Integrated	13-18	25/25				36/36				50/50
GV2 ME21	Integrated	17-23	25/25				36/36				50/50
GV2 ME22	Integrated	20-25	25/25				36/36				50/50
GV2 ME32	Integrated	24-32	25/25				36/36				50/50

Note: Respect the basic rules of selectivity, in terms of overload, short-circuit, ground fault and earth leakage when applicable see page A-7, or check curves with Schneider Electric online "Electrical calculation tools".

Selectivity Enhanced by Cascading

Upstream: ComPacT NSX160

Downstream: GV2 P

Ue: 380-415 V AC



Upstream CB		NSX160H				NSX160S			
	Icu (kA)	70 kA				100 kA			
	Trip unit	TM-D							
	Rating (A)	80	100	125	160	80	100	125	160

Downstream CB			Selectivity limit (kA) / Breaking capacity enhanced by cascading (kA)							
CB type	Thermal relay	Rating (A)								
GV2 P01	Integrated	0.1-0.16	70/70	70/70	70/70	70/70	100/100	100/100	100/100	100/100
GV2 P02	Integrated	0.16-0.25	70/70	70/70	70/70	70/70	100/100	100/100	100/100	100/100
GV2 P03	Integrated	0.25-0.40	70/70	70/70	70/70	70/70	100/100	100/100	100/100	100/100
GV2 P04	Integrated	0.40-0.63	70/70	70/70	70/70	70/70	100/100	100/100	100/100	100/100
GV2 P05	Integrated	0.63-1	70/70	70/70	70/70	70/70	100/100	100/100	100/100	100/100
GV2 P06	Integrated	1-1.6	70/70	70/70	70/70	70/70	100/100	100/100	100/100	100/100
GV2 P07	Integrated	1.6-2.5	70/70	70/70	70/70	70/70	100/100	100/100	100/100	100/100
GV2 P08	Integrated	2.5-4			70/70	70/70	100/100	100/100	100/100	100/100
GV2 P10	Integrated	4-6.3			70/70	70/70	100/100	100/100	100/100	100/100
GV2 P14	Integrated	6-10			70/70	70/70	100/100	100/100	100/100	100/100
GV2 P16	Integrated	9-14			70/70	70/70	100/100	100/100	100/100	100/100
GV2 P20	Integrated	13-18			70/70	70/70	100/100	100/100	100/100	100/100
GV2 P21	Integrated	17-23			70/70	70/70	100/100	100/100	100/100	100/100
GV2 P22	Integrated	20-25			70/70	70/70	100/100	100/100	100/100	100/100

Upstream CB		NSX160L				NSX160H	NSX160S	NSX160L
	Icu (kA)	150 kA				70 kA	100 kA	150 kA
	Trip unit	TM-D				MicroLogic		
	Rating (A)	80	100	125	160	160	160	160

Downstream CB			Selectivity limit (kA) / Breaking capacity enhanced by cascading (kA)							
CB type	Thermal relay	Rating (A)								
GV2 P01	Integrated	0.1-0.16	150/150	150/150	150/150	150/150	70/70	100/100	150/150	
GV2 P02	Integrated	0.16-0.25	150/150	150/150	150/150	150/150	70/70	100/100	150/150	
GV2 P03	Integrated	0.25-0.40	150/150	150/150	150/150	150/150	70/70	100/100	150/150	
GV2 P04	Integrated	0.40-0.63	150/150	150/150	150/150	150/150	70/70	100/100	150/150	
GV2 P05	Integrated	0.63-1	150/150	150/150	150/150	150/150	70/70	100/100	150/150	
GV2 P06	Integrated	1-1.6	150/150	150/150	150/150	150/150	70/70	100/100	150/150	
GV2 P07	Integrated	1.6-2.5	150/150	150/150	150/150	150/150	70/70	100/100	150/150	
GV2 P08	Integrated	2.5-4			150/150	150/150	70/70	100/100	150/150	
GV2 P10	Integrated	4-6.3			150/150	150/150	70/70	100/100	150/150	
GV2 P14	Integrated	6-10			150/150	150/150	70/70	100/100	150/150	
GV2 P16	Integrated	9-14			150/150	150/150	70/70	100/100	150/150	
GV2 P20	Integrated	13-18			150/150	150/150	70/70	100/100	150/150	
GV2 P21	Integrated	17-23			150/150	150/150	70/70	100/100	150/150	
GV2 P22	Integrated	20-25			150/150	150/150	70/70	100/100	150/150	

Note: Respect the basic rules of selectivity, in terms of overload, short-circuit, ground fault and earth leakage when applicable see page A-7, or check curves with Schneider Electric online "Electrical calculation tools".

Selectivity Enhanced by Cascading

Upstream: ComPacT NSX160

Downstream: GV2 L

A

Ue: 380-415 V AC

Upstream CB		NSX160H				NSX160S			
	Icu (kA)	70 kA				100 kA			
	Trip unit	TM-D							
	Rating (A)	80	100	125	160	80	100	125	160

Downstream CB			Selectivity limit (kA) / Breaking capacity enhanced by cascading (kA)							
CB type	Thermal relay	Rating (A)								
GV2 L03	LR2 D13 03	0.25-0.40	70/70	70/70	70/70	70/70	100/100	100/100	100/100	100/100
GV2 L04	LR2 D13 04	0.40-0.63	70/70	70/70	70/70	70/70	100/100	100/100	100/100	100/100
GV2 L05	LR2 D13 05	0.63-1	70/70	70/70	70/70	70/70	100/100	100/100	100/100	100/100
GV2 L06	LR2 D13 06	1-1.6	70/70	70/70	70/70	70/70	100/100	100/100	100/100	100/100
GV2 L07	LR2 D13 07	1.6-2.5	70/70	70/70	70/70	70/70	100/100	100/100	100/100	100/100
GV2 L08	LR2 D13 08	2.5-4			70/70	70/70	100/100	100/100	100/100	100/100
GV2 L10	LR2 D13 10	4-6.3			70/70	70/70	100/100	100/100	100/100	100/100
GV2 L14	LR2 D13 14	7-10			70/70	70/70	100/100	100/100	100/100	100/100
GV2 L16	LR2 D13 16	9-13			70/70	70/70	100/100	100/100	100/100	100/100
GV2 L20	LR2 D13 21	12-18			70/70	70/70	100/100	100/100	100/100	100/100
GV2 L22	LR2 D13 22	17-25			70/70	70/70	100/100	100/100	100/100	100/100

Upstream CB		NSX160L				NSX160H	NSX160S	NSX160L	
	Icu (kA)	150 kA				70 kA	100 kA	150 kA	
	Trip unit	MicroLogic							
	Rating (A)	80	100	125	160	160	160	160	

Downstream CB			Selectivity limit (kA) / Breaking capacity enhanced by cascading (kA)							
CB type	Thermal relay	Rating (A)								
GV2 L03	LR2 D13 03	0.25-0.40	150/150	150/150	150/150	150/150	70/70	100/100	150/150	
GV2 L04	LR2 D13 04	0.40-0.63	150/150	150/150	150/150	150/150	70/70	100/100	150/150	
GV2 L05	LR2 D13 05	0.63-1	150/150	150/150	150/150	150/150	70/70	100/100	150/150	
GV2 L06	LR2 D13 06	1-1.6	150/150	150/150	150/150	150/150	70/70	100/100	150/150	
GV2 L07	LR2 D13 07	1.6-2.5	150/150	150/150	150/150	150/150	70/70	100/100	150/150	
GV2 L08	LR2 D13 08	2.5-4			150/150	150/150	70/70	100/100	150/150	
GV2 L10	LR2 D13 10	4-6.3			150/150	150/150	70/70	100/100	150/150	
GV2 L14	LR2 D13 14	7-10			150/150	150/150	70/70	100/100	150/150	
GV2 L16	LR2 D13 16	9-13			150/150	150/150	70/70	100/100	150/150	
GV2 L20	LR2 D13 21	12-18			150/150	150/150	70/70	100/100	150/150	
GV2 L22	LR2 D13 22	17-25			150/150	150/150	70/70	100/100	150/150	

Note: Respect the basic rules of selectivity, in terms of overload, short-circuit, ground fault and earth leakage when applicable see page A-7, or check curves with Schneider Electric online "Electrical calculation tools".

Selectivity Enhanced by Cascading

Upstream: ComPacT NSXm, MicroLogic, TM-D

Downstream: iC60

Ue: 440 V AC



Upstream CB		NSXm B					F					N/H					
Icu (kA)		20					35					50/65					
Trip unit		MicroLogic 4.1															
Rating (A)		100	160			100			160			100			160		
Setting Ir (A)		63	80	100	125	160	63	80	100	125	160	63	80	100	125	160	

Downstream CB			Selectivity limit (kA) / Breaking capacity enhanced by cascading (kA)																			
CB type	Rating (A)	Icu (kA)																				
iC60N	≤ 16	6	15/15	15/15	15/15	15/15	15/15	15/15	15/15	15/15	15/15	15/15	15/15	15/15	15/15	15/15	20/20	20/20	20/20	20/20	20/20	20/20
	20	6	15/15	15/15	15/15	15/15	15/15	15/15	15/15	15/15	15/15	15/15	15/15	15/15	15/15	15/15	20/20	20/20	20/20	20/20	20/20	20/20
	25	6		15/15	15/15	15/15	15/15	15/15	15/15	15/15	15/15	15/15	15/15	15/15	15/15		20/20	20/20	20/20	20/20	20/20	20/20
	32	6		15/15	15/15	15/15	15/15	15/15	15/15	15/15	15/15	15/15	15/15	15/15	15/15		20/20	20/20	20/20	20/20	20/20	20/20
	40	6		15/15	15/15	15/15	15/15	15/15	15/15	15/15	15/15	15/15	15/15	15/15	15/15		16/20	16/20	16/20	16/20	16/20	16/20
	50	6				8/15	8/15	8/15	8/15	8/15	8/15	8/15	8/15	8/15	8/15			8/20	8/20	8/20	8/20	8/20
63	6					8/15	8/15					8/15	8/15	8/15				8/20	8/20	8/20	8/20	8/20
iC60H	≤ 16	10	20/20	20/20	20/20	20/20	20/20	20/20	20/20	20/20	20/20	20/20	20/20	20/20	20/20	25/25	25/25	25/25	25/25	25/25	25/25	25/25
	20	10	20/20	20/20	20/20	20/20	20/20	20/20	20/20	20/20	20/20	20/20	20/20	20/20	20/20	25/25	25/25	25/25	25/25	25/25	25/25	25/25
	25	10		20/20	20/20	20/20	20/20	20/20	20/20	20/20	20/20	20/20	20/20	20/20	20/20		25/25	25/25	25/25	25/25	25/25	25/25
	32	10		20/20	20/20	20/20	20/20	20/20	20/20	20/20	20/20	20/20	20/20	20/20	20/20		25/25	25/25	25/25	25/25	25/25	25/25
	40	10		16/20	16/20	16/20	16/20	16/20	16/20	16/20	16/20	16/20	16/20	16/20	16/20		16/25	16/25	16/25	16/25	16/25	16/25
	50	10				8/20	8/20	8/20	8/20	8/20	8/20	8/20	8/20	8/20	8/20			8/25	8/25	8/25	8/25	8/25
63	10					8/20	8/20					8/20	8/20	8/20				8/25	8/25	8/25	8/25	8/25
iC60L	≤ 16	20	20/20	20/20	20/20	20/20	20/20	20/20	20/20	20/20	20/20	20/20	20/20	20/20	25/25	25/25	25/25	25/25	25/25	25/25	25/25	25/25
	20	20	20/20	20/20	20/20	20/20	20/20	20/20	20/20	20/20	20/20	20/20	20/20	20/20	25/25	25/25	25/25	25/25	25/25	25/25	25/25	25/25
	25	20		20/20	20/20	20/20	20/20	20/20	20/20	20/20	20/20	20/20	20/20	20/20		25/25	25/25	25/25	25/25	25/25	25/25	25/25
	32	15		20/20	20/20	20/20	20/20	20/20	20/20	20/20	20/20	20/20	20/20	20/20		25/25	25/25	25/25	25/25	25/25	25/25	25/25
	40	15		16/20	16/20	16/20	16/20	16/20	16/20	16/20	16/20	16/20	16/20	16/20		16/25	16/25	16/25	16/25	16/25	16/25	16/25
	50	10				8/20	8/20	8/20	8/20	8/20	8/20	8/20	8/20	8/20			8/25	8/25	8/25	8/25	8/25	8/25
63	10					8/20	8/20					8/20	8/20	8/20				8/25	8/25	8/25	8/25	8/25

Upstream CB		NSXm B					F					N / H				
Icu (kA)		20					35					50 / 65				
Trip unit		TM-D														
Rating (A)		≤ 63	80	100	125	160	≤ 63	80	100	125	160	≤ 63	80	100	125	160

Downstream CB			Selectivity limit (kA) / Breaking capacity enhanced by cascading (kA)																			
CB type	Rating (A)	Icu (kA)																				
iC60N	≤ 16	6	-/15	15/15	15/15	15/15	15/15	-/15	15/15	15/15	15/15	15/15	15/15	15/15	-/20	20/20	20/20	20/20	20/20	20/20	20/20	20/20
	20	6	-/15	15/15	15/15	15/15	15/15	-/15	15/15	15/15	15/15	15/15	15/15	15/15	-/20	20/20	20/20	20/20	20/20	20/20	20/20	20/20
	25	6		8/15	15/15	15/15	15/15		8/15	15/15	15/15	15/15	15/15		8/20	20/20	20/20	20/20	20/20	20/20	20/20	
	32	6		3/15	15/15	15/15	15/15		3/15	15/15	15/15	15/15	15/15		3/20	20/20	20/20	20/20	20/20	20/20	20/20	20/20
	40	6		2/15	15/15	15/15	15/15		2/15	15/15	15/15	15/15	15/15		2/20	16/20	16/20	16/20	16/20	16/20	16/20	16/20
	50	6				6/15	8/15	8/15		6/15	8/15	8/15	8/15			6/20	8/20	8/20	8/20	8/20	8/20	8/20
63	6					8/15	8/15					8/15	8/15				8/20	8/20	8/20	8/20	8/20	8/20
iC60H	≤ 16	10	-/20	20/20	20/20	20/20	20/20	-/20	20/20	20/20	20/20	20/20	20/20	-/25	25/25	25/25	25/25	25/25	25/25	25/25	25/25	25/25
	20	10	-/20	20/20	20/20	20/20	20/20	-/20	20/20	20/20	20/20	20/20	20/20	-/25	25/25	25/25	25/25	25/25	25/25	25/25	25/25	25/25
	25	10		8/20	20/20	20/20	20/20		8/20	20/20	20/20	20/20	20/20		8/25	25/25	25/25	25/25	25/25	25/25	25/25	25/25
	32	10		3/20	20/20	20/20	20/20		3/20	20/20	20/20	20/20	20/20		3/25	25/25	25/25	25/25	25/25	25/25	25/25	25/25
	40	10		2/20	16/20	16/20	16/20		2/20	16/20	16/20	16/20	16/20		2/25	16/25	16/25	16/25	16/25	16/25	16/25	16/25
	50	10				6/20	8/20	8/20		6/20	8/20	8/20	8/20			6/25	8/25	8/25	8/25	8/25	8/25	8/25
63	10					8/20	8/20					8/20	8/20				8/25	8/25	8/25	8/25	8/25	8/25
iC60L	≤ 16	20	-/20	20/20	20/20	20/20	20/20	-/20	20/20	20/20	20/20	20/20	20/20	-/25	25/25	25/25	25/25	25/25	25/25	25/25	25/25	25/25
	20	20	-/20	20/20	20/20	20/20	20/20	-/20	20/20	20/20	20/20	20/20	20/20	-/25	25/25	25/25	25/25	25/25	25/25	25/25	25/25	25/25
	25	20		8/20	20/20	20/20	20/20		8/20	20/20	20/20	20/20	20/20		8/25	25/25	25/25	25/25	25/25	25/25	25/25	25/25
	32	15		3/20	20/20	20/20	20/20		3/20	20/20	20/20	20/20	20/20		3/25	25/25	25/25	25/25	25/25	25/25	25/25	25/25
	40	15		2/20	16/20	16/20	16/20		2/20	16/20	16/20	16/20	16/20		2/25	16/25	16/25	16/25	16/25	16/25	16/25	16/25
	50	10				6/20	8/20	8/20		6/20	8/20	8/20	8/20			6/25	8/25	8/25	8/25	8/25	8/25	8/25
63	10					8/20	8/20					8/20	8/20				8/25	8/25	8/25	8/25	8/25	8/25

Note: Respect the basic rules of selectivity, in terms of overload, short-circuit, ground fault and earth leakage when applicable see page A-1, or check curves with Schneider Electric online "Electrical calculation tools".

Selectivity Enhanced by Cascading

Upstream: ComPacT NSX100, MicroLogic

Downstream: iC60



Ue: 440 V AC

Upstream CB		NSX100															
		B			F			N			H			S		L	
Icu (kA)		20			35			50			65			90		130	
Trip unit		MicroLogic ^[1]															
Rating (A)		40	100	40	100	40	100	40	100	40	100	40	100	40	100	40	100

Downstream CB			Selectivity limit (kA) / Breaking capacity enhanced by cascading (kA)														
CB type	Rating (A)	Icu (kA)															
iC60N	≤ 20	6	15/15	15/15	15/15	15/15	20/20	20/20	20/20	20/20	20/20	20/20	20/20	20/20	20/20	20/20	20/20
	25	6	15/15	15/15	15/15	15/15	20/20	20/20	20/20	20/20	20/20	20/20	20/20	20/20	20/20	20/20	20/20
	32	6		15/15		15/15		20/20		20/20		20/20		20/20		20/20	20/20
	40	6		15/15		15/15		20/20		20/20		20/20		20/20		20/20	20/20
	50	6		6/15		6/15		6/20		6/20		6/20		6/20		6/20	6/20
	63	6		6/15		6/15		6/20		6/20		6/20		6/20		6/20	6/20
iC60H	≤ 20	10	20/20	20/20	20/20	20/20	25/25	25/25	25/25	25/25	25/25	25/25	25/25	25/25	25/25	25/25	25/25
	25	10	20/20	20/20	20/20	20/20	25/25	25/25	25/25	25/25	25/25	25/25	25/25	25/25	25/25	25/25	25/25
	32	10		20/20		20/20		25/25		25/25		25/25		25/25		25/25	25/25
	40	10		20/20		20/20		25/25		25/25		25/25		25/25		25/25	25/25
	50	10		6/20		6/20		6/25		6/25		6/25		6/25		6/25	6/25
	63	10		6/20		6/20		6/25		6/25		6/25		6/25		6/25	6/25
iC60L	≤ 20	20	20/20	20/20	20/20	20/20	25/25	25/25	25/25	25/25	25/25	25/25	25/25	25/25	25/25	25/25	25/25
	25	20	20/20	20/20	20/20	20/20	25/25	25/25	25/25	25/25	25/25	25/25	25/25	25/25	25/25	25/25	25/25
	32	15		20/20		20/20		25/25		25/25		25/25		25/25		25/25	25/25
	40	15		20/20		20/20		25/25		25/25		25/25		25/25		25/25	25/25
	50	10		6/20		6/20		6/25		6/25		6/25		6/25		6/25	6/25
	63	10		6/20		6/20		6/25		6/25		6/25		6/25		6/25	6/25

[1] Applicable for all "Distribution" MicroLogic of ComPacT NSX range: 2.2 4.2, 5.2, 6.2, 7.2. For 4.2 and 7.2 selectivity rules for RCD apply in addition. Applicable for Generators and Service connection (G and AB type) MicroLogic of ComPacT NSX range but curves shall be checked. Not applicable for "Motor" MicroLogic of ComPacT NSX range ("M" type).

Note: Respect the basic rules of selectivity, in terms of overload, short-circuit, ground fault and earth leakage when applicable see page A-1, or check curves with Schneider Electric online "Electrical calculation tools".

Selectivity Enhanced by Cascading

Upstream: ComPacT NSX160, NSX250, MicroLogic

Downstream: iC60, NG125, ComPacT NSXm, NSX100

Ue: 440 V AC



Upstream CB		NSX160											
		B		F		N		H		S		L	
Icu (kA)		20		35		50		65		90		130	
Trip unit		MicroLogic [1]											
Rating (A)		100	160	100	160	100	160	100	160	100	160	100	160

Downstream CB			Selectivity limit (kA) / Breaking capacity enhanced by cascading (kA)											
CB type	Rating (A)	Icu (kA)												
iC60N	≤ 20	6	15/15	15/15	15/15	15/15	20/20	20/20	20/20	20/20	20/20	20/20	20/20	20/20
	25	6	15/15	15/15	15/15	15/15	20/20	20/20	20/20	20/20	20/20	20/20	20/20	20/20
	32	6	15/15	15/15	15/15	15/15	20/20	20/20	20/20	20/20	20/20	20/20	20/20	20/20
	40	6	15/15	15/15	15/15	15/15	20/20	20/20	20/20	20/20	20/20	20/20	20/20	20/20
	50	6	6/15	15/15	6/15	15/15	6/20	20/20	6/20	20/20	6/20	20/20	6/20	20/20
	63	6	6/15	15/15	6/15	15/15	6/20	20/20	6/20	20/20	6/20	20/20	6/20	20/20
iC60H	20	10	20/20	20/20	20/20	20/20	25/25	25/25	25/25	25/25	25/25	25/25	25/25	25/25
	25	10	20/20	20/20	20/20	20/20	25/25	25/25	25/25	25/25	25/25	25/25	25/25	25/25
	32	10	20/20	20/20	20/20	20/20	25/25	25/25	25/25	25/25	25/25	25/25	25/25	25/25
	40	10	20/20	20/20	20/20	20/20	25/25	25/25	25/25	25/25	25/25	25/25	25/25	25/25
	50	10	6/20	20/20	6/20	20/20	6/25	25/25	6/25	25/25	6/25	25/25	6/25	25/25
	63	10	6/20	20/20	6/20	20/20	6/25	25/25	6/25	25/25	6/25	25/25	6/25	25/25
iC60L	≤ 20	20	20/20	20/20	20/20	20/20	25/25	25/25	25/25	25/25	25/25	25/25	25/25	25/25
	25	20	20/20	20/20	20/20	20/20	25/25	25/25	25/25	25/25	25/25	25/25	25/25	25/25
	32	15	20/20	20/20	20/20	20/20	25/25	25/25	25/25	25/25	25/25	25/25	25/25	25/25
	40	15	20/20	20/20	20/20	20/20	25/25	25/25	25/25	25/25	25/25	25/25	25/25	25/25
	50	10	6/20	20/20	6/20	20/20	6/25	25/25	6/25	25/25	6/25	25/25	6/25	25/25
	63	10	6/20	20/20	6/20	20/20	6/25	25/25	6/25	25/25	6/25	25/25	6/25	25/25
NG125 N	≤ 20	20				35/35		35/35		35/35		50/50	65/65	
NG125 H	≤ 20	30						40/40		50/50		65/65	90/90	
NG125 L	≤ 20	40						50/50		65/65		90/90	130/130	

Upstream CB		NSX250											
		B		F		N		H		S		L	
Icu (kA)		20		35		50		65		90		130	
Trip unit		MicroLogic [1]											
Rating (A)		250		250		250		250		250		250	

Downstream CB			Selectivity limit (kA) / Breaking capacity enhanced by cascading (kA)											
CB type	Rating (A)	Icu (kA)												
NG125 N		20					35/35		35/35		35/35		50/50	65/65
NG125 H		30							40/40		50/50		65/65	90/90
NG125 L		40									65/65		90/90	130/130
NSXm E		15	20/20		20/20		30/30		30/30		30/30		30/30	30/30
NSXm B		20			35/35		35/35		50/50		50/50		50/50	50/50
NSXm F		35					50/50		65/65		65/65		65/65	65/65
NSXm N		50							65/65		65/65		65/65	65/65
NSX100 B TM-D	≤ 25				35/35		35/35		50/50		50/50		50/50	50/50
	40 - 100				35/35		35/35		36/50		36/50		36/50	36/50
NSX100 F TM-D	≤ 25						50/50		65/65		90/90		130/130	130/130
	40 - 100						36/50		36/65		36/90		36/130	36/130
NSX100 N TM-D	≤ 25								65/65		90/90		130/130	130/130
	40 - 100								36/65		36/90		36/130	36/130
NSX100 H TM-D	≤ 25										90/90		130/130	130/130
	40 - 100										36/90		36/130	36/130
NSX100 S TM-D	≤ 25												130/130	130/130
	40 - 100												36/130	36/130
NSX100 B MicroLogic		20			35/35		35/35		35/50		35/50		35/50	
NSX100 F MicroLogic		35					35/50		35/50		35/90		35/130	35/130
NSX100 N MicroLogic		50							35/65		35/90		35/130	35/130
NSX100 H MicroLogic		65									35/90		35/130	35/130
NSX100 S MicroLogic		90											35/130	35/130

[1] Applicable for all "Distribution" MicroLogic of ComPacT NSX range: 2.2 4.2, 5.2, 6.2, 7.2. For 4.2 and 7.2 selectivity rules for RCD apply in addition. Applicable for Generators and Service connection (G and AB type) MicroLogic of ComPacT NSX range but curves shall be checked. Not applicable for "Motor" MicroLogic of ComPacT NSX range ("M" type).

Note: Respect the basic rules of selectivity, in terms of overload, short-circuit, ground fault and earth leakage when applicable see page A-1, or check curves with Schneider Electric online "Electrical calculation tools".

Selectivity Enhanced by Cascading

Upstream: ComPacT NSX160, NSX250, TM-D

Downstream: iC60, NG125, ComPacT NSXm, NSX100

Ue: 440 V AC

A

Upstream CB		NSX160											
		B		F		N		H		S		L	
Icu (kA)		20		35		50		65		90		130	
Trip unit		TM-D											
Rating (A)		≤ 100	125-160	≤ 100	125-160	≤ 100	125-160	≤ 100	125-160	≤ 100	125-160	≤ 100	125-160

Downstream CB			Selectivity limit (kA) / Breaking capacity enhanced by cascading (kA)											
CB type	Rating (A)	Icu (kA)												
iC60N	20	6	-/15	15/15	-/15	15/15	-/20	20/20	-/20	20/20	-/20	20/20	-/20	20/20
	25	6	-/15	15/15	-/15	15/15	-/20	20/20	-/20	20/20	-/20	20/20	-/20	20/20
	32	6	-/15	15/15	-/15	15/15	-/20	20/20	-/20	20/20	-/20	20/20	-/20	20/20
	40	6	-/15	15/15	-/15	15/15	-/20	20/20	-/20	20/20	-/20	20/20	-/20	20/20
	50	6	-/15	15/15	-/15	15/15	-/20	20/20	-/20	20/20	-/20	20/20	-/20	20/20
	63	6	-/15	15/15	-/15	15/15	-/20	20/20	-/20	20/20	-/20	20/20	-/20	20/20
iC60H	≤ 20	10	-/20	20/20	-/20	20/20	-/25	25/25	-/25	25/25	-/25	25/25	-/25	25/25
	25	10	-/20	20/20	-/20	20/20	-/25	25/25	-/25	25/25	-/25	25/25	-/25	25/25
	32	10	-/20	20/20	-/20	20/20	-/25	25/25	-/25	25/25	-/25	25/25	-/25	25/25
	40	10	-/20	20/20	-/20	20/20	-/25	25/25	-/25	25/25	-/25	25/25	-/25	25/25
	50	10	-/20	20/20	-/20	20/20	-/25	25/25	-/25	25/25	-/25	25/25	-/25	25/25
	63	10	-/20	20/20	-/20	20/20	-/25	25/25	-/25	25/25	-/25	25/25	-/25	25/25
iC60L	≤ 20	20	-/20	20/20	-/20	20/20	-/25	25/25	-/25	25/25	-/25	25/25	-/25	25/25
	25	20	-/20	20/20	-/20	20/20	-/25	25/25	-/25	25/25	-/25	25/25	-/25	25/25
	32	15	-/20	20/20	-/20	20/20	-/25	25/25	-/25	25/25	-/25	25/25	-/25	25/25
	40	15	-/20	20/20	-/20	20/20	-/25	25/25	-/25	25/25	-/25	25/25	-/25	25/25
	50	10	-/20	20/20	-/20	20/20	-/25	25/25	-/25	25/25	-/25	25/25	-/25	25/25
	63	10	-/20	20/20	-/20	20/20	-/25	25/25	-/25	25/25	-/25	25/25	-/25	25/25
NG125 N	≤ 20	20				35/35		35/35		35/35		50/50		65/65
NG125 H	≤ 20	30				35/35		40/40		50/50		65/65		90/90
NG125 L	≤ 20	40						50/50		65/65		90/90		130/130

Upstream CB		NSX250											
		B		F		N		H		S		L	
Icu (kA)		20		35		50		65		90		130	
Trip unit		TM-D											
Rating (A)		200-250		200-250		200-250		200-250		200-250		200-250	

Downstream CB			Selectivity limit (kA) / Breaking capacity enhanced by cascading (kA)											
CB type	Rating (A)	Icu (kA)												
NG125 N		20				35/35		35/35		35/35		50/50		65/65
NG125 H		30						40/40		50/50		65/65		90/90
NG125 L		40								65/65		90/90		130/130
NSXm E	≤ 125	10	20/20			20/20		30/30		30/30		30/30		30/30
NSXm B	≤ 125	20				35/35		35/35		50/50		50/50		50/50
NSXm F	≤ 125	35						50/50		65/65		65/65		65/65
NSXm N	≤ 125	50								65/65		65/65		65/65
NSX100 B	≤ 25	25				35/35		35/35		50/50		50/50		50/50
TM-D	40 - 100					35/35		35/35		36/50		36/50		36/50
NSX100 F	≤ 25	36						50/50		65/65		90/90		130/130
TM-D	40 - 100							36/50		36/65		36/90		36/130
NSX100 N	≤ 25	50								65/65		90/90		130/130
TM-D	40 - 100									36/65		36/90		36/130
NSX100 H	≤ 25	70										90/90		130/130
TM-D	40 - 100											36/90		36/130
NSX100 S	≤ 25	100												130/130
TM-D	40 - 100													36/130
NSX100 B		25				2/35		2/35		2/50		2/50		2/50
MicroLogic														
NSX100 F		36						2/50		2/50		2/90		2/130
MicroLogic														
NSX100 N		50								2/65		2/90		2/130
MicroLogic														
NSX100 H		70										2/90		2/130
MicroLogic														
NSX100 S		100												2/130
MicroLogic														

Note: Respect the basic rules of selectivity, in terms of overload, short-circuit, ground fault and earth leakage when applicable see page A-1, or check curves with Schneider Electric online "Electrical calculation tools".

Selectivity Enhanced by Cascading

Upstream: ComPacT NSX400, NSX630, MicroLogic

Downstream: ComPacT NSXm, NSX100, NSX160, NSX250

Ue: 440 V AC



Upstream CB			NSX400					NSX630				
			F	N	H	S	L	F	N	H	S	L
	Icu (kA)		30	42	65	90	130	30	42	65	90	130
	Trip unit		MicroLogic ^[1]									
	Rating (A)		400	400	400	400	400	630	630	630	630	630

Downstream CB			Selectivity limit (kA) / Breaking capacity enhanced by cascading (kA)										
CB type	Trip unit	Icu (kA)											
NSXm E	TM-D	10	20/20	30/30	30/30	30/30	30/30	30/30	20/20	30/30	30/30	30/30	30/30
NSXm B	TM-D	20	30/30	30/30	50/50	50/50	50/50	30/30	30/30	50/50	50/50	50/50	50/50
NSXm F	TM-D	35		42/42	65/65	65/65	65/65		42/42	65/65	65/65	65/65	65/65
NSXm N	TM-D	50			65/65	65/65	65/65			65/65	65/65	65/65	65/65
NSXm E	MicroLogic	10	20/20	30/30	30/30	30/30	30/30	20/20	30/30	30/30	30/30	30/30	30/30
NSXm B	MicroLogic	20	30/30	30/30	50/50	50/50	50/50	30/30	30/30	50/50	50/50	50/50	50/50
NSXm F	MicroLogic	35		42/42	65/65	65/65	65/65		42/42	65/65	65/65	65/65	65/65
NSXm N	MicroLogic	50			65/65	65/65	65/65			65/65	65/65	65/65	65/65
NSX100 B	TM-D	20	30/30	30/30	50/50	50/50	50/50	30/30	30/30	50/50	50/50	50/50	50/50
NSX100 F	TM-D	35		42/42	65/65	90/90	130/130		42/42	65/65	90/90	130/130	130/130
NSX100 N	TM-D	50			65/65	90/90	130/130			65/65	90/90	130/130	130/130
NSX100 H	TM-D	65				90/90	130/130				90/90	130/130	130/130
NSX100 S	TM-D	90					130/130					130/130	130/130
NSX160 B	TM-D	20	30/30	30/30	50/50	50/50	50/50	30/30	30/30	50/50	50/50	50/50	50/50
NSX160 F	TM-D	35		42/42	65/65	90/90	130/130		42/42	65/65	90/90	130/130	130/130
NSX160 N	TM-D	50			65/65	90/90	130/130			65/65	90/90	130/130	130/130
NSX160 H	TM-D	65				90/90	130/130				90/90	130/130	130/130
NSX160 S	TM-D	90					130/130					130/130	130/130
NSX250 B	TM-D	20						30/30	30/30	50/50	50/50	50/50	50/50
NSX250 F	TM-D	35							42/42	65/65	90/90	130/130	130/130
NSX250 N	TM-D	50								65/65	90/90	130/130	130/130
NSX250 H	TM-D	65									90/90	130/130	130/130
NSX250 S	TM-D	90										130/130	130/130
NSX100 B	MicroLogic	20	30/30	30/30	50/50	50/50	50/50	30/30	30/30	50/50	50/50	50/50	50/50
NSX100 F	MicroLogic	35		42/42	65/65	90/90	130/130		42/42	65/65	90/90	130/130	130/130
NSX100 N	MicroLogic	50			65/65	90/90	130/130			65/65	90/90	130/130	130/130
NSX100 H	MicroLogic	65				90/90	130/130				90/90	130/130	130/130
NSX100 S	MicroLogic	90					130/130					130/130	130/130
NSX160 B	MicroLogic	20	30/30	30/30	50/50	50/50	50/50	30/30	30/30	50/50	50/50	50/50	50/50
NSX160 F	MicroLogic	35		42/42	65/65	90/90	130/130		42/42	65/65	90/90	130/130	130/130
NSX160 N	MicroLogic	50			65/65	90/90	130/130			65/65	90/90	130/130	130/130
NSX160 H	MicroLogic	65				90/90	130/130				90/90	130/130	130/130
NSX160 S	MicroLogic	90					130/130					130/130	130/130
NSX250 B	MicroLogic	20						30/30	30/30	50/50	50/50	50/50	50/50
NSX250 F	MicroLogic	35							42/42	65/65	90/90	130/130	130/130
NSX250 N	MicroLogic	50								65/65	90/90	130/130	130/130
NSX250 H	MicroLogic	65									90/90	130/130	130/130
NSX250 S	MicroLogic	90										130/130	130/130

[1] Applicable for all "Distribution" MicroLogic of ComPacT NSX range: 2.3 4.3, 5.3, 6.3, 7.3. For 4.3 and 7.3 selectivity rules for RCD apply in addition. Applicable for Generators and Service connection (G and AB type) MicroLogic of ComPacT NSX range but curves shall be checked Not applicable for "Motor" MicroLogic of ComPacT NSX range ("M" type).

Note: respect the basic rules of selectivity, in terms of overload, short-circuit, ground fault and earth leakage when applicable see page A-1, or check curves with Schneider Electric online "Electrical calculation tools".

Selectivity Enhanced by Cascading

Upstream: ComPacT NS800, NS1000, NS1250, NS1600, MicroLogic

Downstream: ComPacT NSX100, NSX160, NSX250, NSX400, NSX630



Ue: 440 V AC

Upstream CB		NS800				NS1000			NS1250		NS1600	
		N	H	L	LB	N	H	L	N	H	N	H
	Icu (kA)	50	65	130	200	50	65	130	50	65	50	65
	Trip unit	MicroLogic										
	Rating (A)	800	800	800	800	1000	1000	1000	1250	1250	1600	1600

Downstream CB			Selectivity limit (kA) / Breaking capacity enhanced by cascading (kA)										
CB type	Trip unit	Icu (kA)											
NSX100 B	TM-D / MicroLogic	20	50/50	50/50	50/50	50/50	50/50	50/50	50/50	50/50	50/50	50/50	50/50
NSX100 F	TM-D / MicroLogic	35	50/50	65/65	130/130	130/130	50/50	65/65	130/130	50/50	65/65	50/50	65/65
NSX100 N	TM-D / MicroLogic	50		65/65	130/130	130/130		65/65	130/130		65/65		65/65
NSX100 H	TM-D / MicroLogic	65			130/130	130/130			130/130				
NSX100 S	TM-D / MicroLogic	90			130/130	200/200			130/130				
NSX100 L	TM-D / MicroLogic	130				200/200							
NSX160 B	TM-D / MicroLogic	20	50/50	50/50	50/50	50/50	50/50	50/50	50/50	50/50	50/50	50/50	50/50
NSX160 F	TM-D / MicroLogic	35	50/50	65/65	130/130	130/130	50/50	65/65	130/130	50/50	65/65	50/50	65/65
NSX160 N	TM-D / MicroLogic	50		65/65	130/130	130/130		65/65	130/130		65/65		65/65
NSX160 H	TM-D / MicroLogic	65			130/130	130/130			130/130				
NSX160 S	TM-D / MicroLogic	90			130/130	200/200			130/130				
NSX160 L	TM-D / MicroLogic	130				200/200							
NSX250 B	TM-D / MicroLogic	20	50/50	50/50	50/50	50/50	50/50	50/50	50/50	50/50	50/50	50/50	50/50
NSX250 F	TM-D / MicroLogic	35	50/50	65/65	130/130	130/130	50/50	65/65	130/130	50/50	65/65	50/50	65/65
NSX250 N	TM-D / MicroLogic	50		65/65	130/130	130/130		65/65	130/130		65/65		65/65
NSX250 H	TM-D / MicroLogic	65			130/130	130/130			130/130				
NSX250 S	TM-D / MicroLogic	90			130/130	200/200			130/130				
NSX250 L	TM-D / MicroLogic	130				200/200							
NSX400 F	MicroLogic	30	50/50	65/65	10/130	10/130	50/50	65/65	15/130	50/50	65/65	50/50	65/65
NSX400 N	MicroLogic	42		65/65	10/130	10/130		65/65	15/130		65/65		65/65
NSX400 H	MicroLogic	65			10/130	10/130			15/130				
NSX400 S	MicroLogic	90			10/130	10/200			15/130				
NSX400 L	MicroLogic	130				10/200							
NSX630 F	MicroLogic	30					50/50	65/65	10/130	50/50	65/65	50/50	65/65
NSX630 N	MicroLogic	42						65/65	10/130		65/65		65/65
NSX630 H	MicroLogic	65							10/130				
NSX630 S	MicroLogic	90							10/130				

Note: Respect the basic rules of selectivity, in terms of overload, short-circuit, ground fault and earth leakage when applicable see page A-1, or check curves with Schneider Electric online "Electrical calculation tools".

Selectivity Enhanced by Cascading

Upstream: ComPacT NSX160, NSX250, NSX400

Downstream: LUB12, LUB32

Ue: 440 V AC



Upstream CB		NSX160H	NSX160S		NSX160L		NSX250H		NSX250S		NSX250L		
	Icu (kA)	65 kA	90 kA		130 kA		65 kA		90 kA		130 kA		
	Trip unit	TM-D											
	Rating (A)	80/100	125/160	80/100	125/160	80/100	125/160	160	200/250	160	200/250	160	200/250

Downstream CB			Selectivity limit (kA) / Breaking capacity enhanced by cascading (kA)											
CB type	Trip unit type	Rating (A)												
LUB12	LUC \bullet X6	0.15-0.6		65/65		90/90		130/130	65/65	65/65	90/90	90/90	100/100	100/100
	LUC \bullet 1X	0.35-1.4		65/65		90/90		130/130	65/65	65/65	90/90	90/90	100/100	100/100
	LUC \bullet 05	1.25-5		65/65		90/90		130/130	65/65	65/65	90/90	90/90	100/100	100/100
	LUC \bullet 12	3-12		65/65		90/90		130/130	65/65	65/65	90/90	90/90	100/100	100/100
LUB32	LUC \bullet X6	0.15-0.6		5/65		5/90		5/130	5/65	65/65	5/90	90/90	5/100	100/100
	LUC \bullet 1X	0.35-1.4		5/65		5/90		5/130	5/65	65/65	5/90	90/90	5/100	100/100
	LUC \bullet 05	1.25-5		5/65		5/90		5/130	5/65	65/65	5/90	90/90	5/100	100/100
	LUC \bullet 12	3-12		5/65		5/90		5/130	5/65	65/65	5/90	90/90	5/100	100/100
	LUC \bullet 18	4.5-18		5/65		5/90		5/130	5/65	65/65	5/90	90/90	5/100	100/100
	LUC \bullet 32	8-32		5/65		5/90		5/130	5/65	65/65	5/90	90/90	5/100	100/100

Upstream CB		NSX160H	NSX160S	NSX160L	NSX250H	NSX250S	NSX250L	NSX400H	NSX400L
	Icu (kA)	65 kA	90 kA	130 kA	65 kA	90 kA	130 kA	65 kA	90 kA
	Trip unit	MicroLogic							
	Rating (A)	160	160	160	250	250	250	400	400

Downstream CB			Selectivity limit (kA) / Breaking capacity enhanced by cascading (kA)						
CB type	Trip unit type	Rating (A)							
LUB12	LUC \bullet X6	0.15-0.6	65/65	90/90	130/130	65/65	90/90	100/100	
	LUC \bullet 1X	0.35-1.4	65/65	90/90	130/130	65/65	90/90	100/100	
	LUC \bullet 05	1.25-5	65/65	90/90	130/130	65/65	90/90	100/100	
	LUC \bullet 12	3-12	65/65	90/90	130/130	65/65	90/90	100/100	
LUB32	LUC \bullet X6	0.15-0.6	50/65	50/90	50/130	65/65	90/90	100/100	
	LUC \bullet 1X	0.35-1.4	50/65	50/90	50/130	65/65	90/90	100/100	
	LUC \bullet 05	1.25-5	50/65	50/90	50/130	65/65	90/90	100/100	
	LUC \bullet 12	3-12	50/65	50/90	50/130	65/65	90/90	100/100	
	LUC \bullet 18	4.5-18	50/65	50/90	50/130	65/65	90/90	100/100	
	LUC \bullet 32	8-32	50/65	50/90	50/130	65/65	90/90	100/100	

Selectivity Enhanced by Cascading

Upstream: ComPacT NSX160, NSX250, TM-D

Downstream: iC60, C120, NG125

Ue: 220-240 V AC
(Ph/N 110-130 V AC)

A

Upstream CB		NSX160											
		B		F		N		H		S		L	
Icu (kA)		40		85		90		100		120		150	
Trip unit		TM-D											
Rating (A)		80-100	125-160	80-100	125-160	80-100	125-160	80-100	125-160	80-100	125-160	80-100	125-160

Downstream CB			Selectivity limit (kA) / Breaking capacity enhanced by cascading (kA)											
CB type	Rating (A)	Icu (kA)	B		F		N		H		S		L	
iC60N		20	30/30	40/40	60/60	60/60	60/60	60/60	60/60	60/60	60/60	60/60	60/60	60/60
iC60H		30	40/40	50/50	80/80	80/80	80/80	80/80	80/80	80/80	80/80	80/80	80/80	80/80
iC60L	≤ 25	50		65/65	80/80	80/80	80/80	80/80	80/80	80/80	80/80	80/80	80/80	80/80
	32-40	36	40/40	65/65	80/80	80/80	80/80	80/80	80/80	80/80	80/80	80/80	80/80	80/80
	50-63	30	40/40	65/65	80/80	80/80	80/80	80/80	80/80	80/80	80/80	80/80	80/80	80/80
NG125 N	≤ 20	50		60/60	70/70	70/70	70/70	70/70	70/70	70/70	70/70	70/70	70/70	70/70
	25 to 125	50												
NG125 H	≤ 20	70		85/85	85/85	85/85	85/85	85/85	85/85	85/85	85/85	85/85	85/85	85/85
	25 to 80	70												

Upstream CB		NSX250											
		B		F		N		H		S		L	
Icu (kA)		40		85		90		100		120		150	
Trip unit		TM-D											
Rating (A)		200-250	200-250	200-250	200-250	200-250	200-250	200-250	200-250	200-250	200-250	200-250	200-250

Downstream CB			Selectivity limit (kA) / Breaking capacity enhanced by cascading (kA)											
CB type	Rating (A)	Icu (kA)	B		F		N		H		S		L	
iC60N		20	30/30	40/40	60/60	60/60	60/60	60/60	60/60	60/60	60/60	60/60	60/60	60/60
iC60H		30	40/40	50/50	65/65	65/65	65/65	65/65	65/65	65/65	65/65	65/65	65/65	65/65
iC60L	≤ 25	50		65/65	80/80	80/80	80/80	80/80	80/80	80/80	80/80	80/80	80/80	80/80
	32-40	36	40/40	65/65	80/80	80/80	80/80	80/80	80/80	80/80	80/80	80/80	80/80	80/80
	50-63	30	40/40	40/40	65/65	65/65	65/65	65/65	65/65	65/65	65/65	65/65	65/65	65/65
C120 N/H		20/30	40/40	40/40	50/50	50/50	50/50	50/50	50/50	70/70	70/70	70/70	70/70	70/70
NG125 N		50		60/60	70/70	70/70	70/70	70/70	70/70	85/85	85/85	85/85	85/85	85/85
NG125 H		70		85/85	85/85	85/85	85/85	85/85	85/85	100/100	100/100	100/100	100/100	100/100

Note: Respect the basic rules of selectivity, in terms of overload, short-circuit, ground fault and earth leakage when applicable see page A-1, or check curves with Schneider Electric online "Electrical calculation tools".

Selectivity Enhanced by Cascading

Upstream: NSX100, NSX160, NSX250 Micrologic

Downstream: iC60 RCBO

Ue: 220-240 V AC
(Ph/N 110-130 V AC)



Upstream	NSX100											
	B		F		N		H		S		L	
Icu (kA)	40		85		90		100		120		150	
Trip unit	Micrologic		Micrologic		Micrologic		Micrologic		Micrologic		Micrologic	
Rating (A)	40	100	40	100	40	100	40	100	40	100	40	100

Downstream														
	Icn (A)	In (A)	Selectivity/Breaking capacity enhanced limits (kA)											
iC60 RCBO	10000	≤ 25	25/25	25/25	25/25	25/25	25/25	25/25	25/25	25/25	25/25	25/25	25/25	25/25
		32		25/25		25/25		25/25		25/25		25/25		25/25
iC60H RCBO	10000	≤ 20	25/25	25/25	36/36	36/36	40/40	40/40	40/40	40/40	40/40	40/40	40/40	40/40
		25	25/25	25/25	25/25	25/25	30/30	30/30	30/30	30/30	30/30	30/30	30/30	30/30
		32		25/25		25/25		30/30		30/30		30/30		30/30
		40		25/25		25/25		30/30		30/30		30/30		30/30
iC60H2 RCBO	10000	≤ 20	25/25	25/25	36/36	36/36	40/40	40/40	40/40	40/40	40/40	40/40	40/40	
		25	25/25	25/25	30/30	30/30	30/30	30/30	30/30	30/30	30/30	30/30	30/30	
		32		25/25		25/25		30/30		30/30		30/30		30/30

Upstream	NSX160											
	B		F		N		H		S		L	
Icu (kA)	40		85		90		100		120		150	
Trip unit	Micrologic		Micrologic		Micrologic		Micrologic		Micrologic		Micrologic	
Rating (A)	100	160	100	160	100	160	100	160	100	160	100	160

Downstream														
	Icn (A)	In (A)	Selectivity/Breaking capacity enhanced limits (kA)											
iC60 RCBO	10000	≤ 32	25/25	25/25	25/25	25/25	25/25	25/25	25/25	25/25	25/25	20/20	20/20	20/20
iC60H RCBO	10000	≤ 20	25/25	25/25	36/36	36/36	40/40	40/40	40/40	40/40	40/40	40/40	40/40	40/40
		25	25/25	25/25	25/25	25/25	30/30	30/30	30/30	30/30	30/30	30/30	30/30	30/30
		32	25/25	25/25	25/25	25/25	30/30	30/30	30/30	30/30	30/30	30/30	30/30	30/30
		40	25/25	25/25	25/25	25/25	30/30	30/30	30/30	30/30	30/30	30/30	30/30	30/30
iC60H2 RCBO	10000	≤ 20	25/25	25/25	36/36	36/36	40/40	40/40	40/40	40/40	40/40	40/40	40/40	
		25	25/25	25/25	25/25	25/25	30/30	30/30	30/30	30/30	30/30	30/30	30/30	
		32	25/25	25/25	25/25	25/25	30/30	30/30	30/30	30/30	30/30	30/30	30/30	

Upstream	NSX250											
	B		F		N		H		S		L	
Icu (kA)	40		85		90		100		120		150	
Trip unit	Micrologic		Micrologic		Micrologic		Micrologic		Micrologic		Micrologic	
Rating (A)	250		250		250		250		250		250	

Downstream													
	Icn (A)	In (A)	Selectivity/Breaking capacity enhanced limits (kA)										
iC60 RCBO	10000	≤ 32	25/25		25/25		25/25		25/25		25/25		25/25
iC60H RCBO	10000	≤ 20	25/25		30/30		30/30		30/30		30/30		30/30
		25-45	25/25		25/25		25/25		25/25		25/25		25/25
iC60H2 RCBO	10000	≤ 20	25/25		30/30		30/30		30/30		30/30		30/30
		25-32	25/25		25/25		25/25		25/25		25/25		25/25

Selectivity Enhanced by Cascading

Upstream: ComPacT NSX100, NSX160, NSX250, MicroLogic

Downstream: iC60, C120, NG125

A

Ue: 220-240 V AC
(Ph/N 110-130 V AC)

Upstream CB		NSX100													
		B			F			N			H		S		L
Icu (kA)		40			85			90			100		120		150
Trip unit		MicroLogic ^[1]													
Rating (A)		40	100	40	100	40	100	40	100	40	100	40	100	40	100

Downstream CB			Selectivity limit (kA) / Breaking capacity enhanced by cascading (kA)												
CB type	Rating (A)	Icu (kA)													
iC60N	≤ 25	20	40/40	40/40	40/40	40/40	60/60	60/60	60/60	60/60	60/60	60/60	60/60	60/60	60/60
	32-40	20		40/40		40/40		60/60		60/60		60/60		60/60	
	50-63	20													
iC60H	≤ 25	30	40/40	40/40	50/50	50/50	80/80	80/80	80/80	80/80	80/80	80/80	80/80	80/80	
	32-40	30		40/40		50/50		80/80		80/80		80/80		80/80	
	50-63	30													
iC60L	≤ 25	50			65/65	65/65	80/80	80/80	80/80	80/80	80/80	80/80	80/80	80/80	
	32-40	36				65/65		80/80		80/80		80/80		80/80	
	50-63	30													

Upstream CB		NSX160													
		B			F			N			H		S		L
Icu (kA)		40			85			90			100		120		150
Trip unit		MicroLogic ^[1]													
Rating (A)		80	160	80	160	80	160	80	160	80	160	80	160	80	160

Downstream CB			Selectivity limit (kA) / Breaking capacity enhanced by cascading (kA)											
CB type	Rating (A)	Icu (kA)												
iC60N	≤ 50	20	40/40	40/40	40/40	40/40	60/60	60/60	60/60	60/60	60/60	60/60	60/60	60/60
	63	20		40/40		40/40		60/60		60/60		60/60		60/60
iC60H	≤ 50	30	40/40	40/40	50/50	50/50	80/80	80/80	80/80	80/80	80/80	80/80	80/80	80/80
	63	30		40/40		50/50		80/80		80/80		80/80		80/80
iC60L	≤ 40	36			65/65	65/65	80/80	80/80	80/80	80/80	80/80	80/80	80/80	80/80
	50	30	40/40	40/40	65/65	65/65	80/80	80/80	80/80	80/80	80/80	80/80	80/80	
	63	30		40/40		65/65		80/80		80/80		80/80		

Upstream CB		NSX250													
		B			F			N			H		S		L
Icu (kA)		40			85			90			100		120		150
Trip unit		MicroLogic ^[1]													
Rating (A)		250			250			250			250		250		250

Downstream CB			Selectivity limit (kA) / Breaking capacity enhanced by cascading (kA)											
CB type	Rating (A)	Icu (kA)												
iC60N		20	40/40		40/40		60/60		60/60		60/60		60/60	
iC60H		30	40/40		50/50		65/65		65/65		65/65		65/65	
iC60L	≤ 25	50			65/65		80/80		80/80		80/80		80/80	
	32-40	36			65/65		80/80		80/80		80/80		80/80	
	50-63	30	40/40		65/65		65/65		65/65		65/65		65/65	
C120 N/H		20/30	40/40		40/40		50/50		50/50		70/70		70/70	
NG125 N		50			60/60		70/70		70/70		85/85		85/85	
NG125 H		70			85/85		85/85		85/85		100/100		100/100	

[1] Applicable for all "Distribution" MicroLogic of ComPacT NSX range: 2.2 4.2, 5.2, 6.2, 7.2. For 4.2 and 7.2 selectivity rules for RCD apply in addition. Applicable for Generators and Service connection (G and AB type) MicroLogic of ComPacT NSX range but curves shall be checked. Not applicable for "Motor" MicroLogic of ComPacT NSX range ("M" type).

Note: Respect the basic rules of selectivity, in terms of overload, short-circuit, ground fault and earth leakage when applicable see page A-1, or check curves with Schneider Electric online "Electrical calculation tools".

Selectivity Enhanced by Cascading

Upstream: ComPacT NSX250, TM-D, MicroLogic

Downstream: ComPacT NSXm, NSX100

Ue: 220-240 V AC
(Ph/N 110-130 V AC)



Upstream CB		NSX250					
		B	F	N	H	S	L
	Icu (kA)	40	85	90	100	120	150
	Trip unit	TM-D					
	Rating (A)	200-250	200-250	200-250	200-250	200-250	200-250

Downstream CB			Selectivity limit (kA) / Breaking capacity enhanced by cascading (kA)					
CB type	Rating (A)	Icu (kA)						
NSXm E		25	40/40	85/85	85/85	85/85	85/85	85/85
NSXm B		50		85/85	90/90	100/100	100/100	100/100
NSXm F		85			90/90	100/100	100/100	100/100
NSXm N		90				100/100	100/100	100/100
NSX100 B	≤ 25	40		85/85	90/90	100/100	100/100	100/100
TM-D	40 - 100			36/85	36/90	36/100	36/100	36/100
NSX100 F	≤ 25	85			90/90	100/100	120/120	150/150
TM-D	40 - 100				36/90	36/100	36/120	36/150
NSX100 N	≤ 25	90				100/100	120/120	150/150
TM-D	40 - 100					36/100	36/120	36/150
NSX100 H	≤ 25	100					120/120	150/150
TM-D	40 - 100						36/120	36/150
NSX100 S	≤ 25	120						150/150
TM-D	40 - 100							36/150
NSX100 B		40		2/85	2/90	2/100	2/100	2/100
MicroLogic								
NSX100 F		85			2/90	2/100	2/120	2/150
MicroLogic								
NSX100 N		90				2/100	2/120	2/150
MicroLogic								
NSX100 H		100					2/120	2/150
MicroLogic								
NSX100 S		120						2/150
MicroLogic								

Upstream CB		NSX250					
		B	F	N	H	S	L
	Icu (kA)	40	85	90	100	120	150
	Trip unit	MicroLogic [1]					
	Rating (A)	200-250	200-250	200-250	200-250	200-250	200-250

Downstream CB			Selectivity limit (kA) / Breaking capacity enhanced by cascading (kA)					
CB type	Rating (A)	Icu (kA)						
NSXm E	≤ 125	25	40/40	85/85	85/85	85/85	85/85	85/85
NSXm B	≤ 125	50		85/85	90/90	100/100	100/100	100/100
NSXm F	≤ 125	85			90/90	100/100	100/100	100/100
NSXm N	≤ 125	90				100/100	100/100	100/100
NSX100 B	≤ 25	40		85/85	90/90	100/100	100/100	100/100
TM-D	40-100			36/85	36/90	36/100	36/100	36/100
NSX100 F	≤ 25	85			90/90	100/100	120/120	150/150
TM-D	40-100				36/90	36/100	36/120	36/150
NSX100 N	≤ 25	90				100/100	120/120	150/150
TM-D	40-100					36/100	36/120	36/150
NSX100 H	≤ 25	100					120/120	150/150
TM-D	40-100						36/120	36/150
NSX100 S	≤ 25	120						150/150
TM-D	40-100							36/150
NSX100 B		40		36/85	36/90	36/100	36/100	36/100
MicroLogic								
NSX100 F		85			36/90	36/100	36/120	36/150
MicroLogic								
NSX100 N		90				36/100	36/120	36/150
MicroLogic								
NSX100 H		100					36/120	36/150
MicroLogic								
NSX100 S	120	120						36/150

[1] Applicable for all "Distribution" MicroLogic of ComPacT NSX range: 2.2 4.2, 5.2, 6.2, 7.2. For 4.2 and 7.2 selectivity rules for RCD apply in addition. Applicable for Generators and Service connection (G and AB type) MicroLogic of ComPacT NSX range but curves shall be checked. Not applicable for "Motor" MicroLogic of ComPacT NSX range ("M" type).

Note: Respect the basic rules of selectivity, in terms of overload, short-circuit, ground fault and earth leakage when applicable see page A-1, or check curves with Schneider Electric online "Electrical calculation tools".

Selectivity Enhanced by Cascading

Upstream: ComPacT NSX400, NSX630, NS800L, NS800LB, NS1000L, MicroLogic

Downstream: ComPacT NSX100, NSX160, NSX250, NSX400, NSX630



Ue: 220-240 V AC
(Ph/N 110-130 V AC)

Upstream CB	NSX400				NSX630				NS800		NS1000
	N	H	S	L	N	H	S	L	L	LB	L
Icu (kA)	85	100	120	150	85	100	120	150	150	200	150
Trip unit	MicroLogic ^[1]										
Rating (A)	400	400	400	400	630	630	630	630	800		1000

Downstream CB			Selectivity limit (kA) / Breaking capacity enhanced by cascading (kA)										
CB type	Trip unit	Icu (kA)											
NSX100 B	TM-D	40	85/85	90/90	100/100	100/100	85/85	90/90	100/100	100/100	50/50	50/50	50/50
NSX100 F	TM-D	85		90/90	120/120	150/150		90/90	120/120	150/150	150/150	150/150	150/150
NSX100 N	TM-D	90		100/100	120/120	150/150		100/100	120/120	150/150	150/150	150/150	150/150
NSX100 H	TM-D	100			120/120	150/150			120/120	150/150	150/150	150/150	150/150
NSX100 S	TM-D	120				150/150				150/150	150/150	200/200	150/150
NSX100 L	TM-D	150										200/200	
NSX160 B	TM-D	40	85/85	90/90	100/100	100/100	85/85	90/90	100/100	100/100	50/50	50/50	50/50
NSX160 F	TM-D	85		90/90	120/120	150/150		90/90	120/120	150/150	150/150	150/150	150/150
NSX160 N	TM-D	90		100/100	120/120	150/150		100/100	120/120	150/150	150/150	150/150	150/150
NSX160 H	TM-D	100			120/120	150/150			120/120	150/150	150/150	150/150	150/150
NSX160 S	TM-D	120				150/150				150/150	150/150	200/200	150/150
NSX160 L	TM-D	150										200/200	
NSX250 B	TM-D	40					85/85	90/90	100/100	100/100	50/50	50/50	50/50
NSX250 F	TM-D	85						90/90	120/120	150/150	150/150	150/150	150/150
NSX250 N	TM-D	90						100/100	120/120	150/150	150/150	150/150	150/150
NSX250 H	TM-D	100							120/120	150/150	150/150	150/150	150/150
NSX250 S	TM-D	120								150/150	150/150	200/200	150/150
NSX250 L	TM-D	150										200/200	
NSX100 B	MicroLogic	40	85/85	90/90	100/100	100/100	85/85	90/90	100/100	100/100	50/50	50/50	50/50
NSX100 F	MicroLogic	85		90/90	120/120	150/150		90/90	120/120	150/150	150/150	150/150	150/150
NSX100 N	MicroLogic	90		100/100	120/120	150/150		100/100	120/120	150/150	150/150	150/150	150/150
NSX100 H	MicroLogic	100			120/120	150/150			120/120	150/150	150/150	150/150	150/150
NSX100 S	MicroLogic	120				150/150				150/150	150/150	200/200	150/150
NSX100 L	MicroLogic	150										200/200	
NSX160 B	MicroLogic	40	85/85	90/90	100/100	100/100	85/85	90/90	100/100	100/100	50/50	50/50	50/50
NSX160 F	MicroLogic	85		90/90	120/120	150/150		90/90	120/120	150/150	150/150	150/150	150/150
NSX160 N	MicroLogic	90		100/100	120/120	150/150		100/100	120/120	150/150	150/150	150/150	150/150
NSX160 H	MicroLogic	100			120/120	150/150			120/120	150/150	150/150	150/150	150/150
NSX160 S	MicroLogic	120				150/150				150/150	150/150	200/200	150/150
NSX160 L	MicroLogic	150										200/200	
NSX250 B	MicroLogic	40					85/85	90/90	100/100	100/100	50/50	50/50	50/50
NSX250 F	MicroLogic	85						90/90	120/120	150/150	150/150	150/150	150/150
NSX250 N	MicroLogic	90						100/100	120/120	150/150	150/150	150/150	150/150
NSX250 H	MicroLogic	100							120/120	150/150	150/150	150/150	150/150
NSX250 S	MicroLogic	120								150/150	150/150	200/200	150/150
NSX250 L	MicroLogic	150										200/200	
NSX400 F	MicroLogic	40									10/150	10/150	15/150
NSX400 N	MicroLogic	85									10/150	10/150	15/150
NSX400 H	MicroLogic	100									10/150	10/150	15/150
NSX400 S	MicroLogic	120									10/150	10/200	15/150
NSX400 L	MicroLogic	150										10/200	
NSX630 F	MicroLogic	40											10/150
NSX630 N	MicroLogic	85											10/150
NSX630 H	MicroLogic	100											10/150
NSX630 S	MicroLogic	120											10/150

[1] Applicable for all "Distribution" MicroLogic of ComPacT NSX range: 2.3 4.3, 5.3, 6.3, 7.3. For 4.3 and 7.3 selectivity rules for RCD apply in addition. Applicable for Generators and Service connection (G and AB type) MicroLogic of ComPacT NSX range but curves shall be checked Not applicable for "Motor" MicroLogic of ComPacT NSX range ("M" type).

Note: Respect the basic rules of selectivity, in terms of overload, short-circuit, ground fault and earth leakage when applicable see page A-1, or check curves with Schneider Electric online "Electrical calculation tools".

Protection of Motor Circuit with Circuit Breaker

Introduction

Introduction

A circuit supplying a motor may include one, two, three or four switchgear or controlgear devices fulfilling one or more functions.

When a number of devices are used, they must be coordinated for providing optimum operation of the motor.

Protection of a motor circuit involves a number of parameters that depend on:

- The application (type of machine driven, starting frequency, etc.)
- The level of service continuity imposed by the load or the application
- The applicable standards to ensure protection of life and property.

The necessary electrical functions are of very different natures:

- Protection (motor-dedicated for overloads)
- Control (generally with high endurance levels)
- Isolation.

Protection functions

Disconnection functions:

- Isolate a motor circuit prior to maintenance operations.

Short-circuit protection:

Protect the starter and the cables against major overcurrents ($> 10 I_n$).

Control:

Start and stop the motor, and, if applicable:

- Gradual acceleration
- Speed control.

Overload protection:

Protect the starter and the cables against minor overcurrents ($< 10 I_n$).

Additional specific protection:

- Limitative fault protection (while the motor is running)
- Preventive fault protection (monitoring of motor insulation with motor off).

Overloads ($I < 10 I_n$).

An overload may be caused by:

- An electrical problem, for instance on the mains (loss of a phase, voltage outside tolerances, etc.)
- A mechanical problem, for instance excessive torque due to abnormally high demands by the process or motor damage (bearing vibrations, etc.)

A further consequence of these two origins is excessively long starting.

Impedant short-circuit ($10 < I < 50 I_n$)

Deterioration of motor-winding insulation is the primary cause.

Short-circuit ($I > 50 I_n$)

This type of fault is relatively rare. A possible cause may be a connection error during maintenance.

Overload protection

Thermal relays provide protection against this type of fault. They may be:

- Integrated in the short-circuit protective device
- Separate.

Short-circuit protection

This type of protection is provided by a circuit breaker.

Protection against insulation faults

This type of protection may be provided by:

- A residual current device (RCD)
- An insulation monitoring device (IMD).

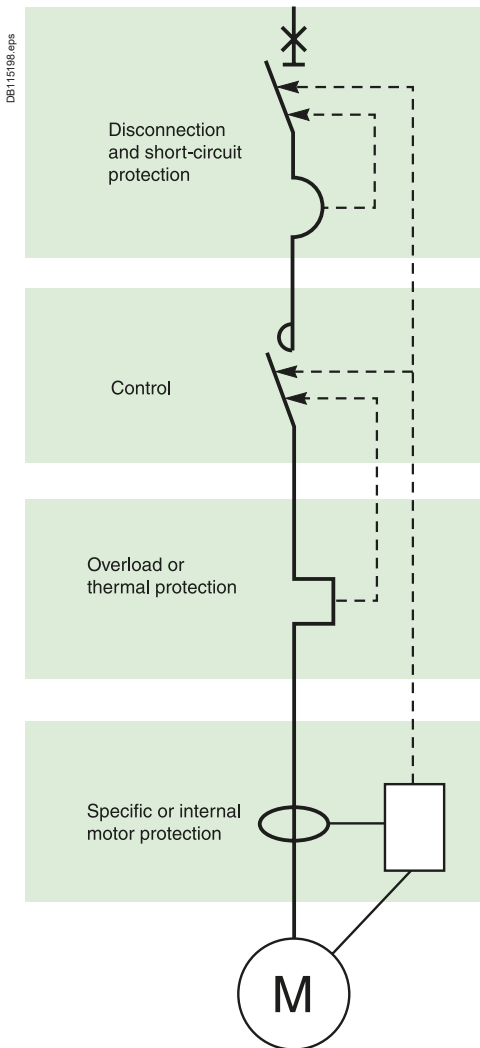

Protection of Motor Circuit with Circuit Breaker

Introduction

B

Applicable standards

A circuit supplying a motor must comply with the general rules set out in IEC standard 60947-4-1 and in particular with those concerning contactors, motor starters and their protection as stipulated in IEC/EN 60947-4-1, notably:

- Coordination of the components of the motor circuit
- Trip class for thermal relays
- Contactor utilisation categories
- Coordination of insulation.

Coordination of the components of the motor circuit

Two types of coordination

The standard defines tests at different current levels. The purpose of these tests is to place the switchgear and controlgear in extreme conditions. Depending on the state of the components following the tests, the standard defines two types of coordination:

■ Type 1:

Deterioration of the contactor and the relay is acceptable under two conditions:

- No danger to operating personnel
- No danger to any components other than the contactor and the relay

■ Type 2:

Only minor welding of the contactor or starter contacts is permissible and the contacts must be easily separated.

- Following type-2 coordination tests, the switchgear and controlgear functions must be fully operational.

Which type of coordination is needed?

Selection of a type of coordination depends on the operating conditions encountered.

The goal is to achieve the best balance between the user's needs and the cost of the installation.

■ Type 1:

- Qualified maintenance service
- Low cost of switchgear and controlgear
- Continuity of service is not imperative or may be obtained by simply replacing the faulty motor drawer

■ Type 2:

- Continuity of service is imperative
- Limited maintenance service
- Specifications stipulating type 2.

Protection of motor circuit with circuit breaker

Introduction

The different test currents

"Ic", "r" and "Iq" test currents

To qualify for type-2 coordination, the standard requires three fault-current tests to check that the switchgear and controlgear operates correctly under overload and short-circuit conditions.

"Ic" current (overload $I < 10 I_n$)

The thermal relay provides protection against this type of fault, up to the I_c value (a function of I_m or I_{sd}) defined by the manufacturer.

IEC/EN standard 60947-4-1 stipulates two tests that must be carried out to guarantee coordination between the thermal relay and the short-circuit protective device:

- At $0.75 I_c$, only the thermal relay reacts
- At $1.25 I_c$, the short-circuit protective device reacts.

Following the tests at 0.75 and $1.25 I_c$, the trip characteristics of the thermal relay must be unchanged. Type-2 coordination thus enhances continuity of service. The contactor may be closed automatically following clearing of the fault.

"r" current

(Impedant short-circuit $10 < I < 50 I_n$)

The primary cause of this type of fault is the deterioration of insulation. IEC/EN standard 60947-4-1 defines an intermediate short-circuit current "r". This test current is used to check that the protective device provides protection against impedant short-circuits.

There must be no modification in the original characteristics of the contactor and the thermal relay following the test.

The circuit breaker must trip in ≤ 10 ms for a fault current $\geq 15 I_n$.

Operational current I_e (AC3) of the motor (in A)	"r" current (kA)
$I_e \leq 16$	1
$16 < I_e \leq 63$	3
$63 < I_e \leq 125$	5
$125 < I_e \leq 315$	10
$315 < I_e < 630$	18

"Iq" current

(short-circuit $I > 50 I_n$)

This type of fault is relatively rare. A possible cause may be a connection error during maintenance.

Short-circuit protection is provided by devices that open quickly.

IEC/EN standard 60947-4-1 defines the "Iq" current as generally ≥ 50 kA.

The "Iq" current is used to check the coordination of the switchgear and controlgear installed on a motor supply circuit.

Following this test under extreme conditions, all the coordinated switchgear and controlgear must remain operational.

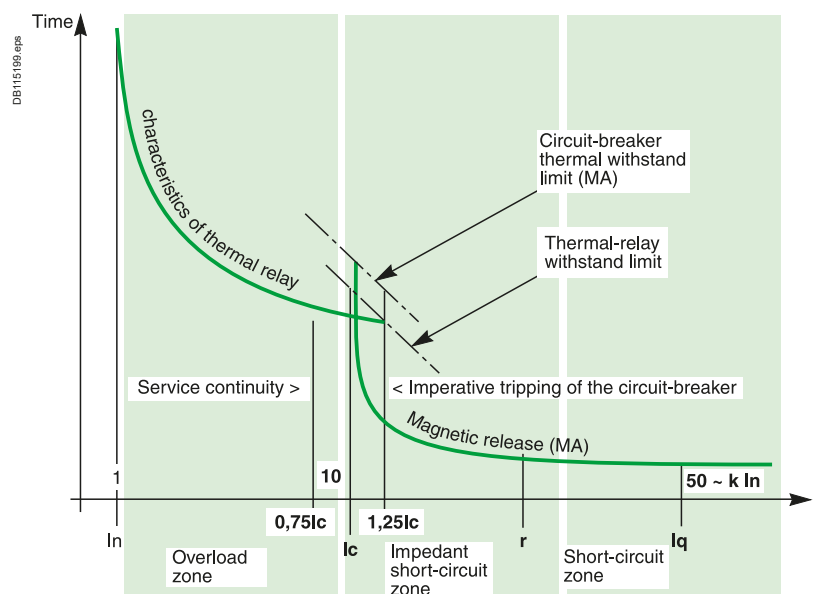

Protection of Motor Circuit with Circuit Breaker

Introduction

B

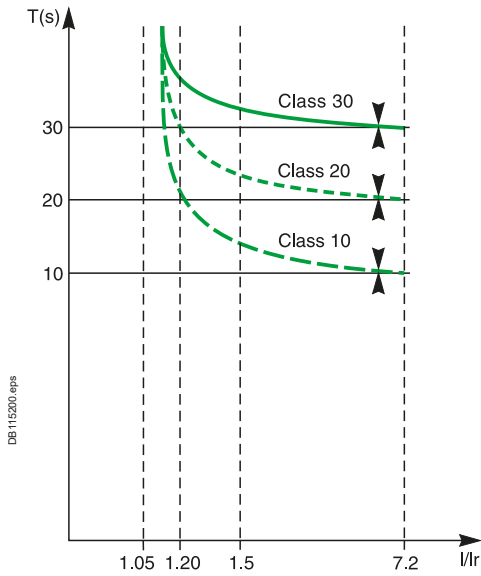

Trip class of a thermal relay.

Trip class of a thermal relay

The four trip class of a thermal relay are 10 A, 10, 20 and 30 (maximum tripping times at 7.2 Ir).

Classes 10 and 10 A are the most commonly used. Classes 20 and 30 are reserved for motors with difficult starting conditions.

The diagram and the table opposite can be used to select a thermal relay suited to the motor starting time.

Class	1.05 Ir	1.2 Ir	1.5 Ir	7.2 Ir
10 A	t > 2 h	t < 2 h	t < 2 min.	2 ≤ t ≤ 10 s
10	t > 2 h	t < 2 h	t < 4 min.	4 ≤ t ≤ 10 s
20	t > 2 h	t < 2 h	t < 8 min.	6 ≤ t ≤ 20 s
30	t > 2 h	t < 2 h	t < 12 min.	9 ≤ t ≤ 30 s

Protection of Motor Circuit with Circuit Breaker

Introduction

The four utilisation categories of contactors (AC1 to AC4)

The four utilisation categories of contactors (AC1 to AC4) determine the operating frequency and endurance of a contactor. The category depends on the type of load. If the load is a motor, the category also depends on the service classification.

Main characteristics of the controlled electrical circuits and applications

Category	Type of load	Contactor usage	Typical applications
AC1	No-inductive ($\cos \phi 0.8$)	Energisation	Heating, distribution
AC2	Slip-ring motors ($\cos \phi 0.65$)	Starting Switching off during running Regenerative braking Inching	Wire drawing machines
AC3	Squirrel-cage motors ($\cos \phi 0.45$ for $I_e \leq 100A$) ($\cos \phi 0.35$ for $I_e > 100A$)	Starting Switching off during running	Compressors, lifts, mixing Pumps, escalators, fans, Conveyers, air-conditioning
AC4	Squirrel-cage motors ($\cos \phi 0.45$ for $I_e \leq 100A$) ($\cos \phi 0.35$ for $I_e > 100A$)	Starting Switching off during running Regenerative braking Plugging Inching	Printing machines, wire

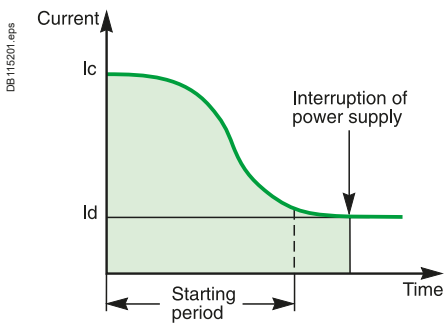

AC3 utilisation category. The contactor interrupts the rated current of the motor.

AC3 utilisation category

This category covers asynchronous squirrel-cage motors that are switched off during running. This is the most common situation (85 % of all cases).

The control device establishes the starting current and interrupts the rated current at a voltage equal to approximately one-sixth of the rated value.

Current interruption is carried out with no difficulty.

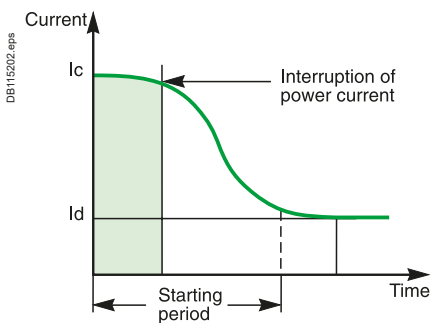

AC4 utilisation category. The contactor must be capable of interrupting the starting current I_d .

AC4 utilisation category

This category covers asynchronous squirrel-cage or slip-ring motors capable of operating under regenerative-braking or inching (jogging) conditions.

The control device establishes the starting current and is capable of interrupting the starting current at a voltage that may be equal to that of the mains.

Such difficult conditions require oversizing of the control and protective devices with respect to category AC3.

Protection of Motor Circuit with Circuit Breaker

Using the Circuit Breaker/Contactor Coordination Tables

B

Subtransient phenomena related to direct on-line starting of asynchronous motors

Subtransient phenomena occurring when starting squirrel-cage motors:
A squirrel-cage motor draws a high inrush current during starting. This current is related to the combined influence of two parameters:

- The high inductance of the copper stator winding
- The magnetisation of the iron core of the stator.

I_n motor: current drawn by the motor at full rated load (in A rms)

I_d : current drawn by the motor during starting (in A rms)

I_d'' : subtransient current generated by the motor when it is energised.
This very short subtransient phenomenon is expressed as $k \times I_d \times r^2$ (in A peak).

t_d : motor starting time, from 0.5 to 30 seconds depending on the application.

t_d'' : duration of the subtransient current, from 0.010 to 0.015 seconds when the motor is energised.

I_{rm} : magnetic setting of the circuit breakers.

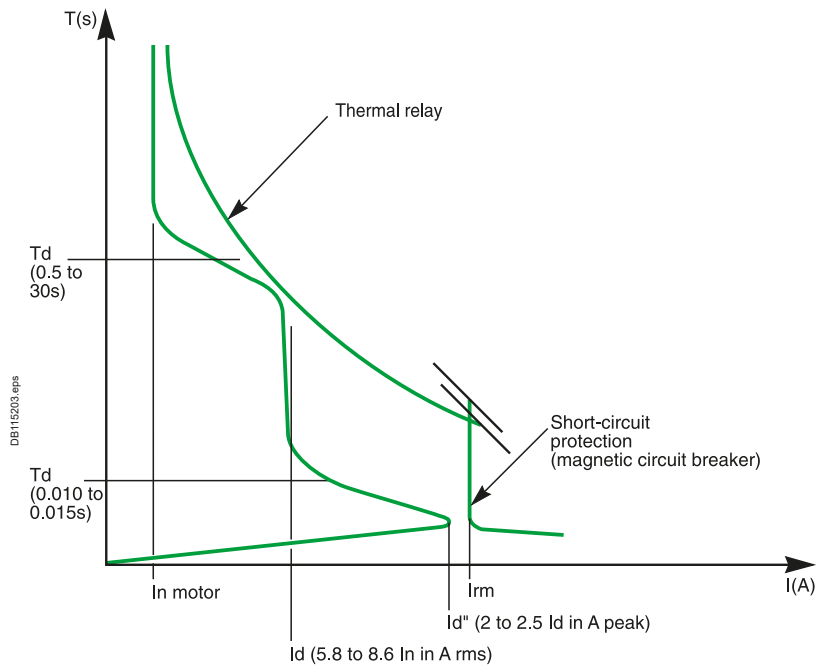

Typical upper and lower limits for these subtransient currents:

These values, not covered by standards, also depend on the type of motor technology used:

- Ordinary motors $I_d'' = 2 I_d$ to $2.1 I_d$ (in A peak)
- High-efficiency motors $I_d'' = 2.2 I_d$ to $2.5 I_d$ (in A peak).
- Variation of I_d'' as a function of I_d :

Type of motor	I_d (in A rms)	I_d'' (in A peak)
Ordinary motor	5.8 to 8.6 I_n motor	$I_d'' = 2 I_d = 11.5 I_n$ (A peak) to $I_d'' = 2.1 I_d = 18 I_n$ (A peak)
High-efficiency motor	5.8 to 8.6 I_n motor	$I_d'' = 2.2 I_d = 12.5 I_n$ (A peak) to $I_d'' = 2.5 I_d = 21.5 I_n$ (A peak)

Example: Upon energisation, a high-efficiency motor with an I_d of 7.5 I_n produces a subtransient current with a value between (depending on its characteristics):

- Minimum = $16.5 I_n$ (in A peak)
- Maximum = $18.8 I_n$ (in A peak).

Protection of Motor Circuit with Circuit Breaker

Using the Circuit Breaker/Contactor Coordination Tables

B

Subtransient currents and protection settings:

- As illustrated in the above table, subtransient currents can be very high.
- If they approach their upper limits, they can trip short-circuit protection devices (nuisance tripping)
- Circuit breakers are rated to provide optimum short-circuit protection for motor starters (type 2 coordination with thermal relay and contactor)
- Combinations made up of circuit breakers and contactors and thermal relays are designed to allow starting of motors generating high subtransient currents (up to $19 I_n$ motor peak)
- The tripping of short-circuit protective devices when starting with a combination listed in the coordination tables means:
 - The limits of certain devices may be reached
 - The use of the starter under type 2 coordination conditions on the given motor may lead to premature wear of one of the components of the combination.

In event of such a problem, the ratings of the starter and the associated protective devices must be redesigned.

European regulation EC640 has been introduced in January 2015 to enforce usage of premium efficiency motor classified as IE3.

One consequence of the improvement of induction motor's efficiency may be an increase of starting current value.

TeSys and **ComPact** ranges can handle IE3 motor higher inrush and starting current. However, due to the spread of starting current values of the motors on the market, it's recommended to check the value of subtransient starting current in Direct-On-Line application when $I_{start} > 7.5 I_n$ or I_{peak} inrush $> 19 \times I_n$.

Using the coordination tables for circuit breaker and contactors:

Ordinary motor:

The starter components can be selected directly from the coordination tables, whatever the values of the starting current (I_d from 5.8 to $8.6 I_n$) and the subtransient current

High-efficiency motors with $I_d \leq 7.5 I_n$:

The starter components can be selected directly from the coordination tables, whatever the values of the starting current and the subtransient current

High-efficiency motors with $I_d > 7.5 I_n$:

When circuit breakers are used for motor currents in the neighbourhood of their rated current, they are set to provide minimum short-circuit protection at **19 I_n motor (A peak)**.

There are two possibilities:

- The subtransient starting current is known (indicated by the motor manufacturer) and is less than **19 I_n motor (A peak)**.
In this case, the starter components can be selected directly from the coordination tables, whatever the value of the starting current (for $I_d > 7.5 I_n$).
Example: for a 110 kW 380-415 V 3-phase motor, the selected components are: NSX250-MA220/LC1G225 + LR9G225.
- The subtransient starting current is unknown or greater than **19 I_n motor (A peak)**.
In this case, the value used for the motor power in the coordination tables should be increased by 20 % to satisfy optimum starting and coordination conditions.
Example: for a 110 kW 380-415 V 3-phase motor, the selected components are those for a motor power of $110 + 20\% = 132$ kW:
NSX400 MicroLogic 1.3M/LC1G265 + LR9G500

Reversing starters and coordination

The starter components can be selected using the tables for direct-on-line starting. Replace contactors LC1 by LC2.

Star-delta starting and coordination

- The components should be sized according to the current flowing in the motor windings
- The mounting locations and connections of the various components of star-delta starters should be selected according to the type of coordination required and the protective devices implemented.

Protection of Motor Circuit with Circuit Breaker

Using the Circuit Breaker/Contactor Coordination Tables

B

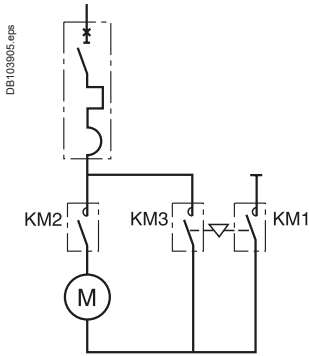

Solution with thermal-magnetic motor circuit breaker.

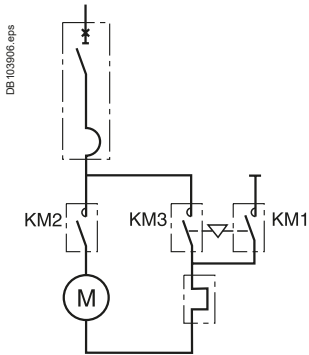

Solution with magnetic motor circuit breaker.

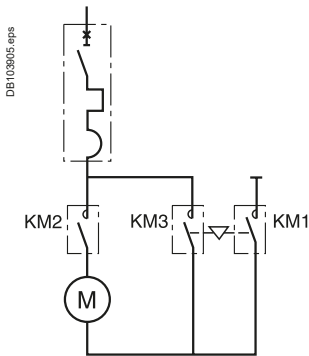

Solution with thermal-magnetic motor circuit breaker.

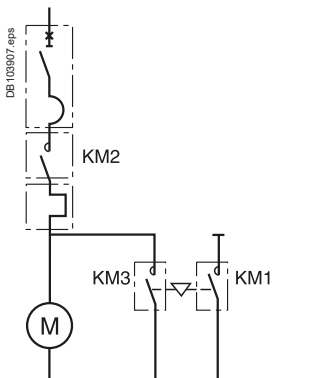

Solution with magnetic motor circuit breaker.

Star-delta starting and type 1 coordination

Contactors KM2 and KM3 are sized for the line current divided by 1.732 KM1 can be sized for the line current divided by 3, however, for the sake of homogeneity, it is often identical to contactors KM2 and KM3.

The starter components are selected from the special star-delta type 1 coordination tables.

Example: consider the following case:

- 45 kW motor supplied at 380 V
- Star-delta starting
- Separate thermal relay
- Short-circuit current of 20 kA at the starter
- Type 1 coordination.

The starter components are selected using the table on page 557E4505.indd/8:

- Circuit breaker: NSX100N-MA 100
- Contactor: LC3-D50
- Thermal relay: LR2-D3357.

Star-delta starting and type 2 coordination

Contactors KM1, KM2 and KM3 are sized for the line current.

The starter components are selected from the direct-on-line type 2 coordination tables.

Example: consider the following case:

- 55 kW motor supplied at 415 V
- Star-delta starting
- Thermal protection built into the circuit breaker providing short-circuit protection
- Short-circuit current of 45 kA at the starter
- Type 2 coordination.

The starter components are selected using the table on page 189:

- Circuit breaker: GV4P/PE or PEM 115
- Starter: LC1-D115 to be replaced by LC3-D115.

Note: Electronic relay TeSys T can be selected according to the line current divided by sqrt(3) and mounted downstream KM3. KM1 KM2 KM3 being selected as described before.

Protection of Motor Circuit with Circuit Breaker

Using the Circuit Breaker/Contactor Coordination Tables

Starting class and thermal relays

The following tables correspond to "normal" motor starting times. The associated thermal relays are either class 10 or 10 A (tripping time < 10 s).

- For motors with long starting times, the class 10 or 10 A thermal relays must be replaced with class 20 thermal relays as indicated in the correspondence table opposite (for type 1 and type 2 coordination)
- Long starting times requiring a class 30 relay:
Apply a derating coefficient (K = 0.8) to the circuit breaker and the contactor
- Coordination tables with the multifunction protective relay LT6-P
Three types of multifunction relays (see the corresponding catalog for detailed characteristics) are available. They may be connected:
 - directly to the motor power supply line
 - to the secondary winding of the current transformer.



The characteristics of the current transformers are the following (as defined by IEC/EN 44-1/44-3):

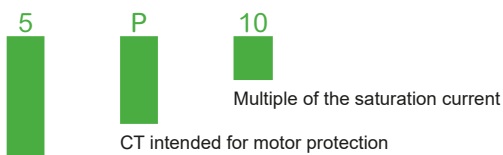

Accuracy class (5 %)

The current transformer ratings must be 5 VA per phase.

Relay		Rating Direct	Connecting Using current trans.
LTM R08	0.4 to 8 A	■	■
LTM R27	1.35 to 27 A	■	
LTM R100	5 to 100 A	■	

Correspondence table class 10 A and class 20 relay			
Contactor series D	Thermal relay Class10/10 A	Class 20	Setting range
LC1-D09-D38	LRD 05	LRD 05L	0.63...1
	LRD 06	LRD 06L	1...1.6
	LRD 07	LRD 07L	1.6...2.5
	LRD 08	LRD 08L	2.5...4
	LRD 10	LRD 10L	4...6
	LRD 12	LRD 12L	5.5...8
LC1-D12-D38	LRD 14	LRD 14L	7...10
	LRD 16	LRD 16L	9...13
LC1-D18-D38	LRD 21	LRD 21L	12...18
LC1-D25-D38	LRD 22	LRD 22L	17...25
	LRD 32	LRD 32L	23...32
LC1-D32-D38	LRD 35		30...38
D40A - D65A	LRD 313	LRD 313L	9... 13
	LRD 318	LRD 318L	12... 18
	LRD 325	LRD 325L	17... 25
	LRD 332	LRD 332L	23... 32
	LRD 340	LRD 340L	30... 40
	LRD 350	LRD 350L	37... 50
D80 - D95	LRD 365	LRD 365L	38... 65
	LRD 3322	LR2 D3522	17... 25
	LRD 3353	LR2 D3553	23... 32
	LRD 3355	LR2 D3555	30... 40
	LRD 3357	LR2 D3557	37... 50
	LRD 3359	LR2 D3559	48... 65
D115-D150	LRD 3361	LR2 D3561	55... 70
	LRD 3363	LR2 D3563	63... 80
D115-D150	LRD 3365		80... 104
	LR9 D5367	LR9D 5567	60... 100
G115 - G225	LR9 D5369	LR9D 5569	90... 150
	Class5E...30E		Setting range
G265 - G500	LR9G115		28...115
	LR9G225		57...225
G630	LR9G500		125...500
	LR9G630		160...630

Type 2 Coordination Table with Circuit-Breakers

U_e: 220-240 V AC

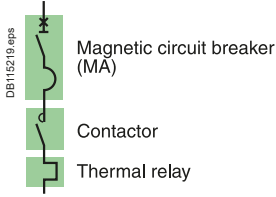

Circuit breakers, contactors and thermal relays

Performance "Iq" (kA): U_e = 220-240 V AC (IEC/EN 60947-4-1)

Circuit breaker	B	F	N	H	S	L
GV4L & LE 02 - 12	-	-	100	-	120 ^[4]	-
GV4L & LE 25 - 115	50	-	100	-	120 ^[4]	-
NSX100/160/250-MA	-	85	90	100	120	150
NSX400/630-MicroLogic 1.3M	-	85	90	100	120	150
NS800L/NS1000L micrologic 5.0	-	-	-	-	-	150

Starting^[1]: normal^[1] LRD class 10A, LR9 class 10, LR9G 5E/10E/20E/30E^[5]

Motors P (kW)	Guide values of operational current in amps at :				Circuit breakers			Contactors ^[2]		Thermal o/l relays	
	220 V (A)	230 V (A)	240 V (A)	I _e max (A)	Type	rat(A)	I _{rm} (A)	Type	Type	Irth ^[1]	
0.09	0.54	0.52	0.50	1	GV4L or GV4LE	2	14	LC1-D09	LRD-05	0.63/1	
0.12	0.73	0.7	0.67	1	GV4L or GV4LE	2	14	LC1-D09	LRD-05	0.63/1	
0.18	1.05	1	0.96	1.6	GV4L or GV4LE	2	22	LC1-D09	LRD-06	1/1.6	
0.25	1.57	1.5	1.44	1.6	GV4L or GV4LE	2	22	LC1-D09	LRD-06	1/1.6	
0.37	2.0	1.9	1.82	2.5	GV4L or GV4LE	3.5	35	LC1-D09	LRD-07	1.6/2.5	
0.55	2.7	2.6	2.5	3	GV4L or GV4LE	3.5	42	LC1-D32	LRD-08	2.5/4	
0.75	3.5	3.3	3.2	4	GV4L or GV4LE	7	56	LC1-D32	LRD-08	2.5/4	
1.1	4.9	4.7	4.5	6	GV4L or GV4LE	7	84	LC1-D32	LRD-10	4/6	
1.5	6.6	6.3	6.0	7	GV4L or GV4LE	7	91	LC1-D40A	LRD-12 ^[3]	5.5/8	
2.2	8.9	8.5	8.1	10	GV4L or GV4LE	12.5	138	LC1-D40A	LRD-14 ^[3]	7 / 10	
3	11.8	11.3	10.8	12.5	GV4L or GV4LE	12.5	163	LC1-D40A	LRD313	9/13	
4	15.7	15	14.4	18	GV4L or GV4LE	25	250	LC1-D40A	LRD318	12/18	
					NSX100-MA	25	250	LC1-D80	LRD 3321	12/18	
5.5	20.9	20	19.2	25	GV4L or GV4LE	25	325	LC1-D40A	LRD325	17/25	
					NSX100-MA	25	325	LC1-D80	LRD 3322	17/25	
7.5	28.2	27	25.9	32	GV4L or GV4LE	50	450	LC1-D40A	LRD332	23/32	
					NSX100-MA	50	450	LC1-D80	LRD-33 53	23/32	
10	36.1	35	33.1	40	GV4L or GV4LE	50	550	LC1-D50A	LRD340	30/40	
					NSX100-MA	50	550	LC1-D80	LRD-33 55	30/40	
11	40	38	36	50	GV4L or GV4LE	50	650	LC1-D50A	LRD350	37/50	
				40	NSX100-MA	50	550	LC1-D80	LRD-33 55	30/40	
15	53	51	49	65	GV4L or GV4LE	80	880	LC1-D65A	LRD365	48/65	
				63	NSX100-MA	100	700	LC1-D80	LRD-33 59	48/65	
18.5	64	61	58	65	GV4L or GV4LE	80	880	LC1-D65A	LRD365	48/65	
				63	NSX100-MA	100	900	LC1-D80	LRD-33 59	48/65	
22	75	72	69	80	GV4L or GV4LE	80	1040	LC1-D80	LRD-33 63	63/80	
					NSX100-MA	100	1100	LC1-D80	LRD-33 63	63/80	
30	100	96	92	100	NSX100-MA	100	1300	LC1-D115	LR9-D53 67	60/100	
								LC1G115	LR9G115	28/115	
37	120	115	110	150	NSX160-MA	150	1950	LC1-D150	LR9-D53 69	90/150	
								LC1G150	LR9G225	57/225	
45	146	140	134	150	NSX160-MA	150	1950	LC1-D150	LR9-D53 69	90/150	
								LC1G150	LR9G225	57/225	
55	177	169	162	185	NSX250-MA	220	2420	LC1G185	LR9G225	57/225	
				220	NSX400 - MicroLogic 1.3M	320	3520	LC1G265	LR9G500	125/500	
75	240	230	220	265	NSX400 - MicroLogic 1.3M	320	3520	LC1G265	LR9G500	125/500	
90	291	278	266	320	NSX400 - MicroLogic 1.3M	320	3840	LC1G330	LR9G500	125/500	
110	355	340	326	400	NSX630 - MicroLogic 1.3M	500	5500	LC1G400	LR9G500	125/500	
132	418	400	383	500	NSX630 - MicroLogic 1.3M	500	6500	LC1G500	LR9G500	125/500	
150	477	457	438	500	NSX630 - MicroLogic 1.3M	500	6500	LC1G500	LR9G500	125/500	
160	509	487	467	630	NS800L - MicroLogic 5.0 - LR off	800	8000	LC1G630	LR9G630	160/630	
200	637	609	584	630	NS800L - MicroLogic 5.0 - LR off	800	8000	LC1G630	LR9G630	160/630	
220	700	658	631	700	NS800L - MicroLogic 5.0 - LR off	800	9600	LC1-F780 or LC1F1000	TC800/5 + LRD10	500/800	
250	782	748	717	800	NS1000L - MicroLogic 5.0 - LR off	1000	10000	LC1-F780 or LC1F1000	TC800/5 + LRD10	500/800	

[1] For long starting (class 20), see the correspondence table for thermal relay page B-9.

[2] Reversers: replace LC1 with LC2 ; start-delta starter : replace LC1 with LC3 for TeSys D, see TeSys G catalog for TeSys G.

[3] Separate overload relay.

[4] GV4LE only, for GV4 "S" performance with rotary handle, order GV4LE "S" & rotary handle separately.

[5] For installations with a class 30 relay, a derating of 20% applies on circuit-breakers and the contacteur rating shall be checked according to 30s thermal withstand.

> Discover Schneider Electric
TeSys Catalog



MKTED210011EN

Type 2 Coordination Table with Circuit-Breakers

Ue: 220-240 V AC

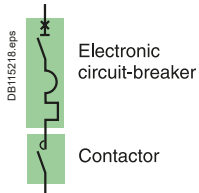

Circuit breakers, and contactors

Performance "Iq" (kA): Ue = 220-240 V AC (IEC/EN 60947-4-1)						
Circuit breakers	B	F	N	H	S	L
GV4 P, PE & PEM 02 - 12	-	-	100	-	120 [4]	-
GV4 P, PE & PEM 25 - 115	50	-	100	-	120 [4]	-
NSX100/160/250 MicroLogic 2.2M/6.2M	-	85	90	100	120	150
NSX400/630 MicroLogic 2.3M/6.3M	-	85	90	100	120	150
NS800L/NS1000L MicroLogic 5.0	-	-	-	-	-	150

Starting [1] Standard IEC/EN 60947-4-1				
Trip unit normal (classe) long (classe)	GV4P, PE or PEM	MicroLogic 2.2M/2.3M 5. 10	MicroLogic 6.2M/6.3M 5. 10	Micrologic 5.0 10
normal (classe)	10	5. 10	5. 10	10
long (classe)	20	20	20. 30 [1]	20

Motors P (kW)	Guide values of operational current in amps at :				Circuit breakers			Contactors [2]	Thermal o/l relays
	220 V (A)	230 V (A)	240 V (A)	Ie max (A)	Type	trip unit	I _{rt} (A)	I _{rm} (A) [3]	Type
0.09	0.54	0.52	0.50	1	GV4P, PE or PEM	2	0.8/2	14	LC1-D25
0.12	0.73	0.7	0.67	1	GV4P, PE or PEM	2	0.8/2	14	LC1-D25
0.18	1.05	1	0.96	1.6	GV4P, PE or PEM	2	0.8/2	22	LC1-D25
0.25	1.57	1.5	1.44	1.6	GV4P, PE or PEM	2	0.8/2	22	LC1-D25
0.37	2.0	1.9	1.82	2.5	GV4P, PE or PEM	3.5	1.4/3.5	42	LC1-D32
0.55	2.7	2.6	2.5	3	GV4P, PE or PEM	3.5	1.4/3.5	42	LC1-D32
0.75	3.5	3.3	3.2	4	GV4P, PE or PEM	7	2.9/7	56	LC1-D50A
1.1	4.9	4.7	4.5	6	GV4P, PE or PEM	7	2.9/7	84	LC1-D50A
1.5	6.6	6.3	6.0	7	GV4P, PE or PEM	7	2.9/7	91	LC1-D50A
2.2	8.9	8.5	8.1	10	GV4P, PE or PEM	12.5	5/12.5	138	LC1-D50A
3	11.8	11.3	10.8	12.5	GV4P, PE or PEM	12.5	5/12.5	163	LC1-D50A
4	15.7	15	14.4	25	NSX100	MicroLogic 2.2M or 6.2M	12/25	13I _{rt}	LC1-D80
					GV4P, PE or PEM	25	10/25	250	LC1-D65A
					NSX100	MicroLogic 2.2M or 6.2M	12/25	13I _{rt}	LC1-D80
5.5	20.9	20	19.2	25	GV4P, PE or PEM	25	10/25	250	LC1-D65A
					NSX100	MicroLogic 2.2M or 6.2M	12/25	13I _{rt}	LC1-D80
					GV4P, PE or PEM	50	20/50	13I _{rt}	LC1-D65A
7.5	28.2	27	25.9	50	NSX100	MicroLogic 2.2M or 6.2M	25/50	13I _{rt}	LC1-D80
					NSX100	MicroLogic 2.2M or 6.2M	25/50	13I _{rt}	LC1-D80
					NSX100	MicroLogic 2.2M or 6.2M	25/50	13I _{rt}	LC1-D80
10	36.1	35	33.1	50	GV4P, PE or PEM	50	20/50	13I _{rt}	LC1-D65A
					NSX100	MicroLogic 2.2M or 6.2M	25/50	13I _{rt}	LC1-D80
					NSX100	MicroLogic 2.2M or 6.2M	25/50	13I _{rt}	LC1-D80
11	40	38	36	50	GV4P, PE or PEM	50	20/50	13I _{rt}	LC1-D65A
					NSX100	MicroLogic 2.2M or 6.2M	25/50	13I _{rt}	LC1-D80
					NSX100	MicroLogic 2.2M or 6.2M	25/50	13I _{rt}	LC1-D80
15	53	51	49	80	GV4P, PE or PEM	80	40/80	13I _{rt}	LC1-D65A
					NSX100	MicroLogic 2.2M or 6.2M	50/100	13I _{rt}	LC1-D80
					NSX100	MicroLogic 2.2M or 6.2M	50/100	13I _{rt}	LC1-D80
18.5	64	61	58	80	GV4P, PE or PEM	80	40/80	13I _{rt}	LC1-D80
					NSX100	MicroLogic 2.2M or 6.2M	50/100	13I _{rt}	LC1-D80
					NSX100	MicroLogic 2.2M or 6.2M	50/100	13I _{rt}	LC1-D80
22	75	72	69	115	GV4P, PE or PEM	115	65/115	13I _{rt}	LC1D115 or LC1G115
					NSX100	MicroLogic 2.2M or 6.2M	50/100 (80)	13I _{rt}	LC1D115 or LC1G115
					NSX100	MicroLogic 2.2M or 6.2M	50/100	13I _{rt}	LC1D115 or LC1G115
30	100	96	92	100	GV4P, PE or PEM	115	65/115	13I _{rt}	LC1D115 or LC1G115
					NSX100	MicroLogic 2.2M	50/100	13I _{rt}	LC1D115 or LC1G115
					NSX160	MicroLogic 2.2M or 6.2M	70/150	13I _{rt}	LC1D150 or LC1G150
37	120	115	110	150	NSX160	MicroLogic 2.2M or 6.2M	70/150	13I _{rt}	LC1D150 or LC1G150
					NSX160	MicroLogic 2.2M or 6.2M	70/150	13I _{rt}	LC1D150 or LC1G150
					NSX250	MicroLogic 2.2M or 6.2M	100/220	13I _{rt}	LC1G185
45	146	140	134	150	NSX400	MicroLogic 2.3M or 6.3M	160/320	13I _{rt}	LC1G185
					NSX400	MicroLogic 2.3M or 6.3M	160/320	13I _{rt}	LC1G265
					NSX400	MicroLogic 2.3M or 6.3M	160/320	13I _{rt}	LC1G330
90	291	278	266	320	NSX630	MicroLogic 2.3M or 6.3M	250/500	13I _{rt}	LC1G400
					NSX630	MicroLogic 2.3M or 6.3M	250/500	13I _{rt}	LC1G500
					NSX630	MicroLogic 2.3M or 6.3M	250/500	13I _{rt}	LC1G500
110	355	340	326	400	NS800L	MicroLogic 5.0	320/800	8000	LC1G630
					NS800L	MicroLogic 5.0	320/800	8000	LC1G630
					NS800L	MicroLogic 5.0	320/800	8000	LC1G630
132	418	400	383	500	NS800L	MicroLogic 5.0	320/800	8000	LC1-F780 or LC1F1000
					NS800L	MicroLogic 5.0	320/800	8000	LC1-F780 or LC1F1000
					NS800L	MicroLogic 5.0	320/800	8000	LC1-F780 or LC1F1000
150	448	429	411	500	NS1000L	MicroLogic 5.0	400/1000	10000	LC1-F780 or LC1F1000
					NS1000L	MicroLogic 5.0	400/1000	10000	LC1-F780 or LC1F1000
					NS1000L	MicroLogic 5.0	400/1000	10000	LC1-F780 or LC1F1000

[1] For class 30 the contactor rating shall be checked according to 30s thermal withstand.
 [2] Reversers: replace LC1 with LC2 ; start-delta starter : replace LC1 with LC3 for TeSys D, see TeSys G.
 [3] li for MicroLogic 5.0 control unit.
 [4] GV4PE and PEM only, for GV4 "S" performance with rotary handle, order GV4PE, PEM "S" & rotary handle separately.

> Discover Schneider Electric TeSys Catalog



MKTED210011EN

Type 2 Coordination Table with Circuit-Breakers

Ue: 380-400 V AC

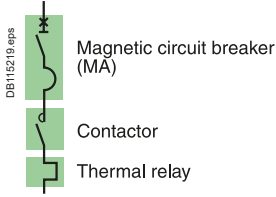

Circuit breakers, contactors and thermal relays

Performance "Iq" (kA): Ue = 380-400 V AC (IEC/EN 60947-4-1)

Circuit breaker	B	F	N	H	S	L
GV4L & LE 02 - 12	-	-	50	-	100 [4]	-
GV4L & LE 25 - 115	25	-	50	-	100 [4]	-
NSX100/160/250-MA	-	36	50	70	100	130
NSX400/630-MicroLogic 1.3M	-	36	50	70	100	130
NS800L/NS1000L MicroLogic 5.0	-	-	-	-	-	130

Starting [1]: normal LRD class 10 A, LR9 class 10.

Motors Rated power P(kW)	Guide values of operational current in amps at :			Circuit breakers			Contactors [2]		Thermal o/l relays	
	380 V	400 V	Ie max	Type	rat(A)	Irm(A) [3]	Type	Type	Irth [1]	
0.18	0.63	0.6	1	GV4L or GV4LE	2	14	LC1-D09	LRD-05	0.63/1	
0.25	0.89	0.85	1	GV4L or GV4LE	2	14	LC1-D09	LRD-05	0.63/1	
0.37	1.16	1.1	1.6	GV4L or GV4LE	2	22	LC1-D09	LRD-06	1/1.6	
0.55	1.58	1.5	2	GV4L or GV4LE	2	26	LC1-D09	LRD-06	1.6/2.5	
0.75	2.00	1.9	2	GV4L or GV4LE	2	26	LC1-D09	LRD-06	1.6/2.5	
1.1	2.8	2.7	3.5	GV4L or GV4LE	3.5	46	LC1-D25	LRD-08	2.5/4	
1.5	3.8	3.6	4	GV4L or GV4LE	7	56	LC1-D32A + GV1L3 [5]	LRD-08	2.5/4	
2.2	5.2	4.9	6	GV4L or GV4LE	7	84	LC1-D32A + GV1L3 [5]	LRD-10	4/6	
3	6.8	6.5	7	GV4L or GV4LE	7	91	LC1-D40A	LRD-12 [5]	5.5/8	
4	8.9	8.5	10	GV4L or GV4LE	12.5	138	LC1-D65A	LRD-14 [5]	7 / 10	
5.5	12.1	11.5	12.5	GV4L or GV4LE	12.5	163	LC1-D65A	LRD-313	9/13	
7.5	16.3	15.5	18	GV4L or GV4LE	25	250	LC1-D65A	LRD-318	12/18	
10	20	19	25	NSX100-MA	25	250	LC1-D80	LRD 3321	12/18	
				GV4L or GV4LE	25	325	LC1-D65A	LRD-325	17/25	
11	23	22	25	NSX100-MA	25	325	LC1-D80	LRD 3322	17/25	
				GV4L or GV4LE	25	325	LC1-D65A	LRD-325	17/25	
15	31	29	32	NSX100-MA	25	450	LC1-D80	LRD 3322	17/25	
				GV4L or GV4LE	50	450	LC1-D65A	LRD-332	23/32	
18.5	37	35	40	NSX100-MA	50	450	LC1-D80	LRD-33 53	23/32	
				GV4L or GV4LE	50	550	LC1-D65A	LRD-340	30/40	
22	43	41	50	NSX100-MA	50	550	LC1-D80	LRD-33 55	30/40	
				GV4L or GV4LE	50	650	LC1-D65A	LRD-350	37/50	
30	58	55	65	NSX100-MA	50	650	LC1-D80	LRD-33 57	37/50	
				GV4L or GV4LE	80	880	LC1-D65A	LRD-365	48/65	
37	69	66	80	NSX100-MA	100	900	LC1-D80	LRD-33 59	48/65	
				GV4L or GV4LE	80	1040	LC1-D80	LRD-33 63	63/80	
45	84	80	100	NSX100-MA	100	1100	LC1-D80	LRD-33 63	63/80	
				GV4L or GV4LE	115	1380	LC1-D115	LR9D-5367	60/100	
55	102	97	115	NSX100-MA	100	1300	LC1G115	LR9G115	28/115	
				GV4L or GV4LE	115	1495	LC1-D115	LR9D-5369	90/150	
75	139	132	150	NSX160-MA	150	1950	LC1-D115	LR9G115	28/115	
				NSX160-MA	150	1950	LC1-D150	LR9D-53 69	90/150	
90	168	160	185	NSX250-MA	220	2640	LC1G115	LR9G115	28/115	
110	205	195	220	NSX250-MA	220	2640	LC1-D150	LR9D-53 69	90/150	
				NSX400-MicroLogic 1.3M	320	3520	LC1G150	LR9G225	57/225	
132	242	230	265	NSX400-MicroLogic 1.3M	320	3520	LC1G185	LR9G225	57/225	
160	295	280	320	NSX400-MicroLogic 1.3M	320	3840	LC1G265	LR9G500	125/500	
200	368	350	400	NSX630-MicroLogic 1.3M	500	5500	LC1G265	LR9G500	125/500	
220	400	380	500	NSX630-MicroLogic 1.3M	500	6000	LC1G330	LR9G500	125/500	
250	453	430	500	NSX630-MicroLogic 1.3M	500	6500	LC1G400	LR9G500	125/500	
300	526	500	630	NS800L - MicroLogic 5.0 - LR off	800	8000	LC1G500	LR9G500	125/500	
315	568	540	630	NS800L - MicroLogic 5.0 - LR off	800	8000	LC1G630	LR9G630	160/630	
355	642	610	780	NS1000L - MicroLogic 5.0 - LR off	1000	10000	LC1G630	LR9G630	160/630	
400	726	690	780	NS1000L - MicroLogic 5.0 - LR off	1000	10000	LC1-F780 or LC1 F1000	TC800/1 + LRD-05	500/800	
450	789	750	780	NS1000L - MicroLogic 5.0 - LR off	1000	10000	LC1-F780 or LC1 F1000	TC800/1 + LRD-05	500/800	
500	895	850	900	NS1000L - MicroLogic 5.0 - LR off	1000	10000	LC1-F1000	TC1000/1 + LRD-05	600/1000	

[1] Heavy starting (class 20), see thermal O/L chart of equivalence page B-9.

[2] Reversers: replace LC1 with LC2 ; start-delta starter : replace LC1 with LC3 for TeSys D, see TeSys G catalog for TeSys G.

[3] li for MicroLogic 5.0 control unit.

[4] GV4LE only, for GV4 "S" performance with rotary handle, order GV4LE "S" & rotary handle separately.

[5] Separate overload Relay, use terminal block LAD7B106.

[6] GV1L3 to be mounted directly on supply side of the contactor.

> Discover Schneider Electric
TeSys Catalog



MKTED210011EN

Type 2 Coordination Table with Circuit-Breakers

Ue: 380-400 V AC

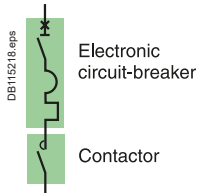

Circuit breakers, and contactors

Performance "Iq" (kA): Ue = 380-400 V AC (IEC/EN 60947-4-1)

Circuit breaker	B	F	N	H	S	L
GV4 P, PE & PEM 02 - 12	-	-	50	-	100 [4]	-
GV4 P, PE & PEM 25 - 115	25	-	50	-	100 [4]	-
NSX100/160/250 MicroLogic 2.2M/6.2M	-	36	50	70	100	130
NSX400/630 MicroLogic 2.3M/6.3M	-	36	50	70	100	130
NS800L/NS1000L MicroLogic 5.0	-	-	-	-	-	130

Starting [1] Standard IEC/EN 60947-4-1

Trip unit normal (classe) long (classe)	GV4P, PE or PEM	MicroLogic 2.2M/2.3M	MicroLogic 6.2M/6.3M	Mircologic 5.0
10	5. 10	5. 10	5. 10	10
20	20	20	20. 30 [1]	20

Motors Rated power P(kW)	Guide values of operational current in amps at :			Circuit breakers			Contactors [2]	
	380 V	400 V	Ie max	Type	trip unit	I _{rt} (A)	I _{rm} (A) [3]	Type
0.18	0.63	0.6	2	GV4P, PE or PEM	2	0.8/2	34	LC1-D25
0.25	0.89	0.85	2	GV4P, PE or PEM	2	0.8/2	34	LC1-D25
0.37	1.16	1.1	2	GV4P, PE or PEM	2	0.8/2	34	LC1-D25
0.55	1.58	1.5	2	GV4P, PE or PEM	2	0.8/2	34	LC1-D25
0.75	2.00	1.9	2	GV4P, PE or PEM	2	0.8/2	34	LC1-D25
1.1	2.8	2.7	3.5	GV4P, PE or PEM	3.5	1.4/3.5	60	LC1-D32
1.5	3.8	3.6	7	GV4P, PE or PEM	7	2.9/7	119	LC1-D50A
2.2	5.2	4.9	7	GV4P, PE or PEM	7	2.9/7	119	LC1-D50A
3	6.8	6.5	7	GV4P, PE or PEM	7	2.9/7	119	LC1-D50A
4	8.9	8.5	12.5	GV4P, PE or PEM	12.5	5/12.5	213	LC1-D50A
5.5	12.1	11.5	12.5	GV4P, PE or PEM	12.5	5/12.5	213	LC1-D50A
7.5	16.3	15.5	25	GV4P, PE or PEM	25	10/25	425	LC1-D65A
10	20	19	25	NSX100	MicroLogic 2.2M or 6.2M	12/25	13I _{rt}	LC1-D80
				GV4P, PE or PEM	25	10/25	425	LC1-D65A
11	23	22	25	NSX100	MicroLogic 2.2M or 6.2M	12/25	13I _{rt}	LC1-D80
				GV4P, PE or PEM	25	10/25	425	LC1-D65A
15	31	29	50	NSX100	MicroLogic 2.2M or 6.2M	12/25	13I _{rt}	LC1-D80
				GV4P, PE or PEM	50	20/50	850	LC1-D65A
18.5	37	35	50	NSX100	MicroLogic 2.2M or 6.2M	25/50	13I _{rt}	LC1-D80
				GV4P, PE or PEM	50	20/50	850	LC1-D65A
22	43	41	50	NSX100	MicroLogic 2.2M or 6.2M	25/50	13I _{rt}	LC1-D80
				GV4P, PE or PEM	50	20/50	850	LC1-D65A
30	58	55	65	NSX100	MicroLogic 2.2M or 6.2M	25/50	13I _{rt}	LC1-D80
				GV4P, PE or PEM	80	40/80	1360	LC1-D65A
37	69	66	80	NSX100	MicroLogic 2.2M or 6.2M	50/100(80)	13I _{rt}	LC1-D80
				GV4P, PE or PEM	80	40/80	1360	LC1-D80
45	84	80	100	NSX100	MicroLogic 2.2M or 6.2M	50/100(80)	13I _{rt}	LC1-D80
				GV4P, PE or PEM	115	65/115	1955	LC1D115 or LC1G115
55	102	97	115	NSX100	MicroLogic 2.2M	50/100	13I _{rt}	LC1D115 or LC1G115
				GV4P, PE or PEM	115	65/115	1955	LC1D115 or LC1G115
75	139	132	150	NSX160	MicroLogic 2.2M or 6.2M	70/150	13I _{rt}	LC1D150 or LC1G115
				NSX250	MicroLogic 2.2M or 6.2M	100/220	13I _{rt}	LC1G185
90	168	160	185	NSX250	MicroLogic 2.2M or 6.2M	100/220	13I _{rt}	LC1G225
				NSX400	MicroLogic 2.3M or 6.3M	160/320	13I _{rt}	LC1G265
110	205	195	265	NSX400	MicroLogic 2.3M or 6.3M	160/320	13I _{rt}	LC1G265
				NSX400	MicroLogic 2.3M or 6.3M	160/320	13I _{rt}	LC1G330
160	295	280	320	NSX400	MicroLogic 2.3M or 6.3M	160/320	13I _{rt}	LC1G400
200	368	350	400	NSX630	MicroLogic 2.3M or 6.3M	250/500	13I _{rt}	LC1G500
220	400	380	500	NSX630	MicroLogic 2.3M or 6.3M	250/500	13I _{rt}	LC1G500
250	453	430	500	NSX630	MicroLogic 2.3M or 6.3M	250/500	13I _{rt}	LC1G630
300	526	500	630	NS800L	MicroLogic 5.0	320/800	8000	LC1F780 or LC1F1000
315	568	540	630	NS800L	MicroLogic 5.0	320/800	8000	LC1F780 or LC1F1000
355	642	610	780/900	NS1000L	MicroLogic 5.0	400/1000	10 000	LC1F780 or LC1F1000
400	726	690	780/900	NS1000L	MicroLogic 5.0	400/1000	10 000	LC1F780 or LC1F1000
450	789	750	780/900	NS1000L	MicroLogic 5.0	400/1000	10 000	LC1F780 or LC1F1000
500	895	850	900	NS1000L	MicroLogic 5.0	400/1000	10 000	LC1F780 or LC1F1000

[1] For class 30 the contacteur rating shall be checked according to 30s thermal withstand.

[2] Reversers : replace LC1 with LC2 ; start-delta starter : replace LC1 with LC3 for TeSys D, see TeSys G catalog for TeSys G.

[3] Ii for MicroLogic 5.0 control unit.

[4] GV4PE and PEM only, for GV4 "S" performance with rotary handle, order GV4PE, PEM "S" & rotary handle separately.

> Discover Schneider Electric TeSys Catalog



MKTED210011EN

Type 2 Coordination Table with Circuit-Breakers

Ue: 380-400 V AC

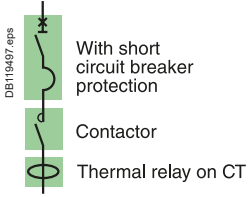

Circuit breakers, contactors and thermal relays

Performance "Iq" (kA): Ue = 380-400 V AC (IEC/EN 60947-4-1)

Circuit breaker	B	F	N	H	S	L
GV4L & LE 02 - 12	-	-	50	-	100 [4]	-
GV4L & LE 25 - 115	25	-	50	-	100 [4]	-
NSX100/160/250-MA	-	36	50	70	100	130
NSX400/630-MA	-	36	50	70	100	130
NS800L/NS1000L MicroLogic 5.0	-	-	-	-	-	130

Starting [1]: adjustable class 10 A to 30.

B

Motors Rated power P(kW)	Guide values of operational current in amps at :			Circuit breakers		Contactors [2]	Thermal o/l relays Adj. class 10A to 30		
	380 V	400 V	le max	Type	rat(A)		Irm(A)	Type	Irth [1]
0.18	0.63	0.6	2	GV4L or GV4LE	2	26	LC1-D32	LTM R08	0.4/8
0.25	0.89	0.85	2	GV4L or GV4LE	2	26	LC1-D32	LTM R08	0.4/8
0.37	1.16	1.1	2	GV4L or GV4LE	2	26	LC1-D32	LTM R08	0.4/8
0.55	1.58	1.5	2	GV4L or GV4LE	2	26	LC1-D32	LTM R08	0.4/8
0.75	2.00	1.9	2	GV4L or GV4LE	2	26	LC1-D32	LTM R08	0.4/8
1.1	2.8	2.7	3.5	GV4L or GV4LE	3.5	46	LC1-D40A	LTM R08	0.4/8
1.5	3.8	3.6	7	GV4L or GV4LE	7	91	LC1-D40A	LTM R08	0.4/8
2.2	5.2	4.9	7	GV4L or GV4LE	7	91	LC1-D40A	LTM R08	0.4/8
3	6.8	6.5	7	GV4L or GV4LE	7	91	LC1-D40A	LTM R08	0.4/8
4	8.9	8.5	10	GV4L or GV4LE	12.5	138	LC1-D65A	LTM R27	1.35/27
			12.5	NSX100-MA	12.5	163	LC1-D80	LTM R27	1.35/27
5.5	12.1	11.5	12.5	GV4L or GV4LE	12.5	163	LC1-D65A	LTM R27	1.35/27
				NSX100-MA	12.5	163	LC1-D80	LTM R27	1.35/27
7.5	16.3	15.5	25	GV4L or GV4LE	25	325	LC1-D65A	LTM R27	1.35/27
				NSX100-MA	25	325	LC1-D80	LTM R27	1.35/27
10	20	19	25	GV4L or GV4LE	25	325	LC1-D65A	LTM R27	1.35/27
				NSX100-MA	25	325	LC1-D80	LTM R27	1.35/27
11	23	22	25	GV4L or GV4LE	25	325	LC1-D65A	LTM R27	1.35/27
				NSX100-MA	25	325	LC1-D80	LTM R27	1.35/27
15	31	29	32	GV4L or GV4LE	50	550	LC1-D65A	LTM R100	5/100
			32	NSX100-MA	50	550	LC1-D80	LTM R100	5/100
18.5	37	35	40	GV4L or GV4LE	50	550	LC1-D65A	LTM R100	5/100
			50	NSX100-MA	50	550	LC1-D80	LTM R100	5/100
22	43	41	50	GV4L or GV4LE	50	650	LC1-D65A	LTM R100	5/100
				NSX100-MA	50	550	LC1-D80	LTM R100	5/100
30	58	55	65	GV4L or GV4LE	80	880	LC1-D65A	LTM R100	5/100
			80	NSX100-MA	100	1100	LC1-D80	LTM R100	5/100
37	69	66	80	GV4L or GV4LE	80	1040	LC1-D80	LTM R100	5/100
				NSX100-MA	100	1100	LC1-D80	LTM R100	5/100
45	84	80	92	GV4L or GV4LE	115	1265	LC1D115 or G115	LTM R100	5/100
			100	NSX100-MA	150	1300	LC1D115 or G115	LTM R100	5/100
55	102	97	110	GV4L or GV4LE	115	1265	LC1D115 or G115	LTM R08	on CT
			115	NSX160-MA	150	1500	LC1D115 or G115	LTM R08	on CT
75	139	132	150	NSX160-MA	150	1600	LC1D150 or G150	LTM R08	on CT
90	168	160	185	NSX250-MA	220	2640	LC1G185	LTM R08	on CT
110	205	195	220	NSX250-MA	220	2640	LC1G225	LTM R08	on CT
			265	NSX400 1.3M	320	3520	LC1G265	LTM R08	on CT
132	242	230	265	NSX400 1.3M	320	3520	LC1G265	LTM R08	on CT
160	295	280	320	NSX400 1.3M	320	3840	LC1G330	LTM R08	on CT
200	368	350	500	NSX630 1.3M	500	5500	LC1G400	LTM R08	on CT
220	400	380	500	NSX630-1.3M	500	6500	LC1G500	LTM R08	on CT
250	453	430	500	NSX630-1.3M	500	6000	LC1G500	LTM R08	on CT
300	526	500	630	NS800L - MicroLogic 5.0 - LR off	800	8800	LC1G630	LTM R08	on CT
315	568	540	630	NS800L - MicroLogic 5.0 - LR off	800	9600	LC1G630	LTM R08	on CT
355	642	610	630	NS800L - MicroLogic 5.0 - LR off	800	9600	LC1G630	LTM R08	on CT
400	726	690	780	NS1000L - MicroLogic 5.0 - LR off	1000	10000	LC1-F780 or LC1F1000	LTM R08	on CT
450	789	750	780	NS1000L - MicroLogic 5.0 - LR off	1000	10000	LC1-F780 or LC1F1000	LTM R08	on CT
500	895	850	780	NS1000L - MicroLogic 5.0 - LR off	1000	10000	LC1-F780 or LC1F1000	LTM R08	on CT
500		850	900.00	NS1000L - MicroLogic 5.0 - LR off	1000	10000	LC1-F1000	LTM R08	on CT

[1] For installations with a class 30 relay, a derating of 20% must be apply on circuit-breakers and the contacteur rating shall be checked according to 30s thermal withstand.

[2] Reversers : replace LC1 with LC2 ; start-delta starter : replace LC1 with LC3 for TeSys D, see TeSys G catalog for TeSys G.

[3] li for MicroLogic 5.0 control unit.

[4] GV4LE only, for GV4 "S" performance with rotary handle, order GV4LE "S" & rotary handle separately.

> Discover Schneider Electric TeSys Catalog



MKTED210011EN

Version : 2.0 - 19/12/2023

548E4505

Type 2 Coordination Table with Circuit-Breakers

Ue: 415 V AC

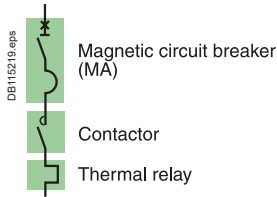

Circuit breakers, contactors and thermal relays

Performance "Iq" (kA): Ue = 415 V AC (IEC/EN 60947-4-1)

Circuit breaker	B	F	N	H	S	L
GV4L & LE 02 - 12	-	-	50	-	100 [4]	-
GV4L & LE 25 - 115	25	-	50	-	100 [4]	-
NSX100/160/250-MA	-	36	50	70	100	130
NSX400/630-MicroLogic 1.3M	-	36	50	70	100	130
NS800L/NS1000L MicroLogic 5.0	-	-	-	-	-	130

Starting [1]: normal LRD class 10 A, LR9 class 10.



Motors Rated power P(kW)	Guide values of operational current in amps at : 415 V		Circuit breakers			Contactors [2]		Thermal o/l relays	
	le max		Type L/LE	rat(A)	Irm(A) [3]	Type	Type	Irth [1]	
0.18	0.58	1	GV4L or GV4LE	2	14	LC1-D09	LRD-05	0.63/1	
0.25	0.82	1	GV4L or GV4LE	2	14	LC1-D09	LRD-05	0.63/1	
0.37	1.06	1.6	GV4L or GV4LE	2	22	LC1-D09	LRD-06	1/1.6	
0.55	1.45	2	GV4L or GV4LE	2	26	LC1-D09	LRD-06	1.6/2.5	
0.75	1.83	2	GV4L or GV4LE	2	26	LC1-D09	LRD-06	1.6/2.5	
1.1	2.60	3.5	GV4L or GV4LE	3.5	46	LC1-D25	LRD-08	2.5/4	
1.5	3.5	4	GV4L or GV4LE	7	56	LC1-D32 + GV1L3 [6]	LRD-08	2.5/4	
2.2	4.7	6	GV4L or GV4LE	7	84	LC1-D32 + GV1L3 [6]	LRD-10	4/6	
3	6.3	7	GV4L or GV4LE	7	91	LC1-D40A	LRD-12 [5]	5.5/8	
4	8.2	10	GV4L or GV4LE	12.5	138	LC1-D65A	LRD-14 [5]	7 /10	
5.5	11.1	12.5	GV4L or GV4LE	12.5	163	LC1-D65A	LRD-313	9/13	
7.5	14.9	18	GV4L or GV4LE	25	250	LC1-D65A	LRD-318	12/18	
10	18.3	25	NSX100-MA	25	250	LC1-D80	LRD 3321	12/18	
			GV4L or GV4LE	25	325	LC1-D65A	LRD-325	17/25	
11	21.2	25	NSX100-MA	25	325	LC1-D80	LRD 3322	17/25	
			GV4L or GV4LE	25	325	LC1-D65A	LRD-325	17/25	
15	28.0	32	NSX100-MA	50	450	LC1-D65A	LRD-332	23/32	
			GV4L or GV4LE	50	450	LC1-D80	LRD-33 53	23/32	
18.5	33.7	40	NSX100-MA	50	550	LC1-D65A	LRD-340	30/40	
			GV4L or GV4LE	50	550	LC1-D80	LRD-33 55	30/40	
22	39.5	50	NSX100-MA	50	650	LC1-D65A	LRD-350	37/50	
			GV4L or GV4LE	50	650	LC1-D80	LRD-33 55	30/40	
30	53.0	63	NSX100-MA	80	880	LC1-D65A	LRD-365	48/65	
			GV4L or GV4LE	100	1100	LC1-D80	LRD-33 59	48/65	
37	63.6	80	NSX100-MA	80	1040	LC1-D80	LRD-33 63	63/80	
			GV4L or GV4LE	100	1100	LC1-D80	LRD-33 63	63/80	
45	77.1	80	NSX100-MA	80	1040	LC1-D80	LRD-33 63	63/80	
			GV4L or GV4LE	100	1100	LC1-D80	LRD-33 63	63/80	
55	93.5	115	NSX100-MA	115	1495	LC1-D115	LR9D-5369	90/150	
			GV4L or GV4LE	150	1950	LC1G115	LR9G115	28/115	
75	127.2	150	NSX160-MA	150	1950	LC1-D150	LR9-D53 69	90/150	
			NSX160-MA	150	1950	LC1G115	LR9G115	28/115	
90	154.2	185	NSX250-MA	220	2420	LC1-D150	LR9-D53 69	90/150	
110	188.0	220	NSX250-MA	220	2860	LC1G150	LR9G225	57/225	
132	221.7	265	NSX400-MicroLogic 1.3M	320	3500	LC1G185	LR9G225	57/225	
160	269.9	320	NSX400-MicroLogic 1.3M	320	4160	LC1G225	LR9G225	57/225	
200	337.3	500	NSX630-MicroLogic 1.3M	500	5500	LC1G265	LR9G500	125/500	
220	366.3	500	NSX630-MicroLogic 1.3M	500	6500	LC1G330	LR9G500	125/500	
250	414.5	500	NSX630-MicroLogic 1.3M	500	6500	LC1G400	LR9G500	125/500	
300	481.9	630	NS800L - MicroLogic 5.0 - LR off	800	8000	LC1G400	LR9G500	125/500	
315	520.5	630	NS800L - MicroLogic 5.0 - LR off	800	8000	LC1G630	LR9G630	160/630	
355	588.0	630	NS800L - MicroLogic 5.0 - LR off	800	8000	LC1G630	LR9G630	160/630	
400	665.1	780	NS1000L - MicroLogic 5.0 - LR off	1000	9600	LC1G630	LR9G630	160/630	
450	722.9	780	NS1000L - MicroLogic 5.0 - LR off	1000	10000	LC1-F780/ LC1F1000	TC800/1 + LRD-05	500/800	
			NS1000L - MicroLogic 5.0 - LR off	1000	10000	LC1-F780/ LC1F1000	TC800/1 + LRD-05	500/800	
500	819.3	850	NS1000L - MicroLogic 5.0 - LR off	1000	10000	LC1-F1000	TC1000/1 + LRD-05	500/1000	

[1] For long starting (class 20), see the correspondence table for thermal relay page B-9.

[2] Reversers: replace LC1 with LC2 ; start-delta starter : replace LC1 with LC3 for TeSys D, see TeSys G catalog for TeSys G.

[3] ii for MicroLogic 5.0 control unit.

[4] GV4LE only, for GV4 "S" performance with rotary handle, order GV4LE "S" & rotary handle separately.

[5] Separate overload Relay.

[6] GV1L3 to be mounted directly on supply side of the contactor.

> Discover Schneider Electric
TeSys Catalog



MKTED210011EN

Type 2 Coordination Table with Circuit-Breakers

Ue: 415 V AC

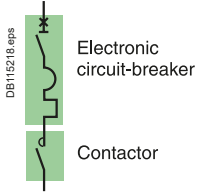

Circuit breakers, contactors

Performance "Iq" (kA): Ue = 415 V AC (IEC/EN 60947-4-1)

Circuit breaker	B	F	N	H	S	L
GV4 P, PE & PEM 02 - 12	-	-	50	-	100 ^[4]	-
GV4 P, PE & PEM 25 - 115	25	-	50	-	100 ^[4]	-
NSX100/160/250 MicroLogic 2.2M/6.2M	-	36	50	70	100	130
NSX400/630 MicroLogic 2.3M/6.3M	-	36	50	70	100	130
NS800L/NS1000L MicroLogic 5.0	-	-	-	-	-	130

Starting^[1] Standard IEC/EN 60947-4-1

Trip unit normal (classe)	GV4P, PE or PEM	MicroLogic 2.2M/2.3M	MicroLogic 6.2M/6.3M	Mircologic 5.0
long (classe)	10	5. 10	5. 10	10
long (classe)	20	20	20. 30 ^[1]	20

Motors Rated power P(kW)	Guide values of operational current in amps at : 415 V		Circuit breakers				Contactors ^[2]
	le max		Type	trip unit	Irth(A)	Irm(A) ^[3]	Type
0.18	0.58	2	GV4P, PE or PEM	2	0.8/2	34	LC1-D25
0.25	0.82	2	GV4P, PE or PEM	2	0.8/2	34	LC1-D25
0.37	1.06	2	GV4P, PE or PEM	2	0.8/2	34	LC1-D25
0.55	1.45	2	GV4P, PE or PEM	2	0.8/2	34	LC1-D25
0.75	1.83	2	GV4P, PE or PEM	2	0.8/2	34	LC1-D25
1.1	2.60	3.5	GV4P, PE or PEM	3.5	1.4/3.5	60	LC1-D32
1.5	3.5	7	GV4P, PE or PEM	7	2.9/7	119	LC1-D50A
2.2	4.7	7	GV4P, PE or PEM	7	2.9/7	119	LC1-D50A
3	6.3	7	GV4P, PE or PEM	7	2.9/7	119	LC1-D50A
4	8.2	12.5	GV4P, PE or PEM	12.5	5/12.5	213	LC1-D50A
5.5	11	12.5	GV4P, PE or PEM	12.5	5/12.5	213	LC1-D50A
7.5	15	25	GV4P, PE or PEM	25	10/25	425	LC1-D65A
10	18	25	NSX100	MicroLogic 2.2M or 6.2M	12/25	13Irth	LC1-D80
			GV4P, PE or PEM	25	10/25	425	LC1-D65A
11	21	25	NSX100	MicroLogic 2.2M or 6.2M	12/25	13Irth	LC1-D80
			GV4P, PE or PEM	25	10/25	425	LC1-D65A
15	28	50	NSX100	MicroLogic 2.2M or 6.2M	12/25	13Irth	LC1-D80
			GV4P, PE or PEM	50	10/25	850	LC1-D65A
18.5	34	50	NSX100	MicroLogic 2.2M or 6.2M	25/50	13Irth	LC1-D80
			GV4P, PE or PEM	50	20/50	850	LC1-D65A
22	40	50	NSX100	MicroLogic 2.2M or 6.2M	25/50	13Irth	LC1-D80
			GV4P, PE or PEM	50	20/50	850	LC1-D65A
30	53	65	NSX100	MicroLogic 2.2M or 6.2M	25/50	13Irth	LC1-D80
			GV4P, PE or PEM	80	40/80	1360	LC1-D65A
37	64	80	NSX100	MicroLogic 2.2M or 6.2M	50/100(80)	13Irth	LC1-D80
			GV4P, PE or PEM	80	40/80	1360	LC1-D80
45	77	115	NSX100	MicroLogic 2.2M or 6.2M	50/100(80)	13Irth	LC1-D80
			GV4P, PE or PEM	115	65/115	1955	LC1-D115 or LC1-F115
55	93	115	NSX100	MicroLogic 2.2M	50/100	13Irth	LC1D115 or LC1G115
			GV4P, PE or PEM	115	65/115	1955	LC1D115 or LC1G115
75	127	150	NSX160	MicroLogic 2.2M or 6.2M	70/150	13Irth	LC1D150 or LC1G115
			NSX160	MicroLogic 2.2M or 6.2M	70/150	13Irth	LC1D150 or LC1G150
90	154	185	NSX250	MicroLogic 2.2M or 6.2M	100/220	13Irth	LC1G185
110	188	220	NSX250	MicroLogic 2.2M or 6.2M	100/220	13Irth	LC1G225
132	222	265	NSX400	MicroLogic 2.3M or 6.3M	160/320	13Irth	LC1G265
160	270	320	NSX400	MicroLogic 2.3M or 6.3M	160/320	13Irth	LC1G330
200	337	500	NSX630	MicroLogic 2.3M or 6.3M	250/500	13Irth	LC1G400
220	366	500	NSX630	MicroLogic 2.3M or 6.3M	250/500	13Irth	LC1G400
250	414	500	NSX630	MicroLogic 2.3M or 6.3M	250/500	13Irth	LC1G500
300	482	630	NS800L	MicroLogic 5.0	320/800	8800	LC1G630
315	520	630	NS800L	MicroLogic 5.0	320/800	9600	LC1G630
355	588	780	NS1000L	MicroLogic 5.0	400/1000	10000	LC1-F780 or LC1F1000
400	665	780	NS1000L	MicroLogic 5.0	400/1000	10000	LC1-F780 or LC1F1000
450	723	780	NS1000L	MicroLogic 5.0	400/1000	10000	LC1-F780 or LC1F1000
500	819	850	NS1000L	MicroLogic 5.0	400/1000	10000	LC1F1000

[1] For class 30 the contactor rating shall be checked according to 30s thermal withstand.

[2] Reversers: replace LC1 with LC2 ; start-delta starter : replace LC1 with LC3 for TeSys D, see TeSys G catalog for TeSys G.

[3] li for MicroLogic 5.0 control unit.

[4] GV4PE and PEM only, for GV4 "S" performance with rotary handle, order GV4PE, PEM "S" & rotary handle separately

> Discover Schneider Electric TeSys Catalog



MKTED210011EN

Type 2 Coordination Table with Circuit-Breakers

Ue: 415 V AC

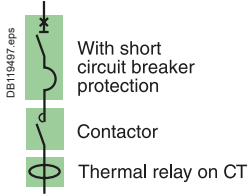

Circuit breakers, contactors and thermal relays

Performance "Iq" (kA): Ue = 415 V AC (IEC/EN 60947-4-1)						
Circuit breakers	B	F	N	H	S	L
GV4 L & LE 02 - 12	-	-	50	-	100 [4]	-
GV4 L & LE 25 - 115	25	-	50	-	100 [4]	-
NSX100/160/250-MA	-	36	50	70	100	130
NSX400/630-MA	-	36	50	70	100	130
NS800L/NS1000L MicroLogic 5.0	-	-	-	-	-	130

Starting [1]: adjustable class 10 A to 30.



Motors Rated power P(kW)	Guide values of operational current in amps at :		Circuit breakers			Contactors [2]		Thermal o/l relays	
	415 V	Ie max	Type	rat(A)	Irm(A)	Type	Adj. class 10A to 30		
0.18	0.58	2	GV4L or GV4LE	2	26	LC1-D32	LTM R08	0.4/8	
0.25	0.82	2	GV4L or GV4LE	2	26	LC1-D32	LTM R08	0.4/8	
0.37	1.06	2	GV4L or GV4LE	2	26	LC1-D32	LTM R08	0.4/8	
0.55	1.45	2	GV4L or GV4LE	2	26	LC1-D32	LTM R08	0.4/8	
0.75	1.83	2	GV4L or GV4LE	2	26	LC1-D32	LTM R08	0.4/8	
1.1	2.60	3.5	GV4L or GV4LE	3.5	46	LC1-D40A	LTM R08	0.4/8	
1.5	3.5	7	GV4L or GV4LE	7	91	LC1-D40A	LTM R08	0.4/8	
2.2	4.7	7	GV4L or GV4LE	7	91	LC1-D40A	LTM R08	0.4/8	
3	6.3	7	GV4L or GV4LE	7	91	LC1-D40A	LTM R08	0.4/8	
4	8.2	10	GV4L or GV4LE	12.5	138	LC1-D65A	LTM R27	1.35/27	
		12.5	NSX100-MA	12.5	163	LC1-D80	LTM R27	1.35/27	
5.5	11.1	12.5	GV4L or GV4LE	12.5	163	LC1-D65A	LTM R27	1.35/27	
			NSX100-MA	12.5	163	LC1-D80	LTM R27	1.35/27	
7.5	15	25	GV4L or GV4LE	25	325	LC1-D65A	LTM R27	1.35/27	
			NSX100-MA	25	325	LC1-D80	LTM R27	1.35/27	
10	18	25	GV4L or GV4LE	25	325	LC1-D65A	LTM R27	1.35/27	
			NSX100-MA	25	325	LC1-D80	LTM R27	1.35/27	
11	21	25	GV4L or GV4LE	25	325	LC1-D65A	LTM R27	1.35/27	
			NSX100-MA	25	325	LC1-D80	LTM R27	1.35/27	
15	28	32	GV4L or GV4LE	50	550	LC1-D65A	LTM R100	5/100	
		32	NSX100-MA	50	650	LC1-D80	LTM R100	5/100	
18.5	34	40	GV4L or GV4LE	50	550	LC1-D65A	LTM R100	5/100	
		50	NSX100-MA	50	650	LC1-D80	LTM R100	5/100	
22	40	50	GV4L or GV4LE	50	650	LC1-D65A	LTM R100	5/100	
			NSX100-MA	50	650	LC1-D80	LTM R100	5/100	
30	53	65	GV4L or GV4LE	80	880	LC1-D65A	LTM R100	5/100	
		80	NSX100-MA	100	1100	LC1-D80	LTM R100	5/100	
37	64	80	GV4L or GV4LE	80	1040	LC1-D80	LTM R100	5/100	
			NSX100-MA	100	1100	LC1-D80	LTM R100	5/100	
45	77	115	GV4L or GV4LE	115	1265	LC1D115 or LC1G115	LTM R100	5/100	
		100	NSX100-MA	100	1100	LC1D115 or LC1G115	LTM R100	5/100	
55	93	115	GV4L or GV4LE	115	1495	LC1D115 or LC1G115	LTM R08	sur TC/on CT	
		150	NSX160-MA	150	1950	LC1D150 or LC1G115	LTM R08	sur TC/on CT	
75	127	150	NSX160-MA	150	1950	LC1D150 or LC1G150	LTM R08	sur TC/on CT	
90	154	185	NSX250-MA	220	2420	LC1G185	LTM R08	sur TC/on CT	
110	188	220	NSX250-MA	220	2860	LC1G225	LTM R08	sur TC/on CT	
132	222	265	NSX400 1.3M	320	3500	LC1G265			
160	270	320	NSX400 1.3M	320	4000	LC1G265	LTM R08	sur TC/on CT	
200	337	400	NSX630-1.3M	500	5500	LC1G400	LTM R08	sur TC/on CT	
		500							
220	366	400	NSX630-1.3M	500	5500	LC1G400	LTM R08	sur TC/on CT	
		500							
250	414	500	NSX630-1.3M	500	6300	LC1G500	LTM R08	sur TC/on CT	
300	482	630	NS800L - MicroLogic 5.0 - LR off	800	8000	LC1G630	LTM R08	sur TC/on CT	
315	520	630	NS800L - MicroLogic 5.0 - LR off	800	8000	LC1G630	LTM R08	sur TC/on CT	
355	588	780	NS1000L - MicroLogic 5.0 - LR off	1000	10000	LC1-F780 or LC1F1000	LTM R08	sur TC/on CT	
400	665	780	NS1000L - MicroLogic 5.0 - LR off	1000	10000	LC1-F780 or LC1F1000	LTM R08	sur TC/on CT	
450	723	780	NS1000L - MicroLogic 5.0 - LR off	1000	10000	LC1-F780 or LC1F1000	LTM R08	sur TC/on CT	
500	819	900	NS1000L - MicroLogic 5.0 - LR off	1000	10000	LC1F1000	LTM R08	sur TC/on CT	

[1] For installations with a class 30 relay, a derating of 20% must be applied on circuit-breakers and the contactor rating shall be checked according to 30s thermal withstand.

[2] Reversers: replace LC1 with LC2 ; start-delta starter : replace LC1 with LC3 for TeSys D, see TeSys G catalog for TeSys G.

[3] li for MicroLogic 5.0 control unit.

[4] GV4LE only, for GV4 "S" performance with rotary handle, order GV4LE "S" & rotary handle separately.

> Discover Schneider Electric TeSys Catalog



MKTED210011EN

Type 2 Coordination Table with Circuit-Breakers

Ue: 440 V AC

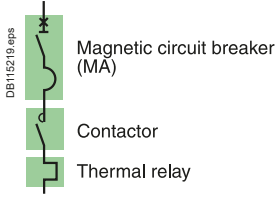

Circuit Breakers, contactors and thermal relays

Performance "Iq" (kA): Ue = 440 VAC (IEC/EN 60947-4-1) [2]						
Circuit breakers	B	F	N	H	S	L
GV4L & LE 02 - 12	-	-	50	-	70 [4]	-
GV4L & LE 25 - 115	20	-	50	-	70 [4]	-
NSX100/160/250-MA	-	35	50	65	90	130
NSX400/630-MicroLogic 1.3M	-	30	42	65	90	130
NS630bL/NS800L/NS1000L MicroLogic 5.0	-	-	-	-	-	130

Starting [1]: normal LRD class 10 A, LR9 class 10.

Motors Rated power P(kW)	Guide values of operational current in amps at : 440 V (A)		Circuit breakers			Contactors [3]		Thermal o/l relays	
	le max		Type	rat(A)	Irm(A) [4]	Type	Type	Irrth [1]	
0.18	0.55	1	GV4L or GV4LE	2	14	LC1-D09	LRD-05	0.63/1	
0.25	0.77	1	GV4L or GV4LE	2	14	LC1-D09	LRD-05	0.63/1	
0.37	1	1.6	GV4L or GV4LE	2	22	LC1-D09	LRD-06	1/1.6	
0.55	1.36	1.6	GV4L or GV4LE	2	22	LC1-D09	LRD-06	1/1.6	
0.75	1.7	2	GV4L or GV4LE	2	26	LC1-D09	LRD-07	1.6/2.5	
1.1	2.4	2.5	GV4L or GV4LE	3.5	35	LC1-D25 + GV1L3 [3]	LR9D07	1.6/2.5	
1.5	3.3	3.5	GV4L or GV4LE	3.5	46	LC1-D32 + GV1L3 [3]	LR9D08	2.5/4	
2.2	4.5	5	GV4L or GV4LE	7	70	LC1-D32 + GV1L3 [3]	LR9D10	4/6	
3	5.9	7	GV4L or GV4LE	7	91	LC1-D40A	LRD-12 [5]	5.5/8	
4	7.7	8	GV4L or GV4LE	12.5	113	LC1-D65A	LRD-12 [5]	5.5/8	
5.5	10.5	12.5	GV4L or GV4LE	12.5	163	LC1-D65A	LRD-313	9/13	
7.5	14	16	GV4L or GV4LE	25	225	LC1-D65A	LRD-318	12/18	
10	18.2	18	NSX100-MA	25	250	LC1-D80	LRD 3321	12/18	
		25	GV4L or GV4LE	25	325	LC1-D65A	LRD-325	17/25	
11	20	25	NSX100-MA	25	325	LC1-D80	LRD 3322	17/25	
		25	GV4L or GV4LE	25	325	LC1-D65A	LRD-325	17/25	
15	26	32	NSX100-MA	25	325	LC1-D80	LRD 3322	17/25	
		32	GV4L or GV4LE	50	450	LC1-D65A	LRD-332	23/32	
18.5	32	40	NSX100-MA	50	450	LC1-D80	LRD-3353	23/32	
		40	GV4L or GV4LE	50	550	LC1-D65A	LRD-340	30/40	
22	38	40	NSX100-MA	50	550	LC1-D80	LRD-3355	30/40	
		40	GV4L or GV4LE	50	550	LC1-D65A	LRD-340	30/40	
30	50	65	NSX100-MA	50	550	LC1-D80	LRD-3355	30/40	
		63	GV4L or GV4LE	80	880	LC1-D65A	LRD-365	48/65	
37	60	65	NSX100-MA	100	900	LC1-D80	LRD-3359	48/65	
		63	GV4L or GV4LE	80	880	LC1-D65A	LRD-365	48/65	
45	73	80	NSX100-MA	100	900	LC1-D80	LRD-3359	48/65	
		80	GV4L or GV4LE	80	1040	LC1-D80	LRD-33 63	63/80	
55	88	100	NSX100-MA	100	1100	LC1-D80	LRD-3363	63/80	
		100	GV4L or GV4LE	115	1150	LC1D115	LR9D5367	60/100	
75	120	150	NSX100-MA	100	1500	LC1G115	LR9G115	28/115	
		150	NSX160-MA	150	1800	LC1D150	LR9D5367	60/100	
90	145	150	NSX160-MA	150	1800	LC1D150	LR9D5369	90/150	
		150	NSX160-MA	150	1950	LC1G150	LR9G225	57/225	
110	177	185	NSX250-MA	220	2640	LC1G150	LR9D5369	90/150	
132	209	265	NSX400-MicroLogic 1.3M	320	3520	LC1G185	LR9G225	57/225	
160	255	265	NSX400 MicroLogic 1.3M	320	3520	LC1G265	LR9G225	57/225	
200	318	320	NSX400 MicroLogic 1.3M	320	4160	LC1G265	LR9G500	125/500	
220	343	400	NSX400 MicroLogic 1.3M	320	4160	LC1G330	LR9G500	125/500	
250	390	500	NSX630-MicroLogic 1.3M	500	5500	LC1G400	LR9G500	125/500	
300	466	500	NSX630-MicroLogic 1.3M	500	5500	LC1G400	LR9G500	125/500	
315	490	630	NSX630-MicroLogic 1.3M	500	6500	LC1G500	LR9G500	125/500	
355	554	630	NS800L - MicroLogic 5.0 - LR off	800	8000	LC1G630	LR9G500	125/500	
375	587	630	NS800L - MicroLogic 5.0 - LR off	800	8000	LC1G630	LR9G630	160/630	
400	627	720	NS800L - MicroLogic 5.0 - LR off	800	9600	LC1G630	LR9G630	160/630	
450	695	720	NS800L - MicroLogic 5.0 - LR off	800	9600	LC1F780 or	TC800/1 + LRD05	500/800	
						LC1F1000			
500	772	800	NS1000L - MicroLogic 5.0 - LR off	1000	10000	LC1F780 or	TC800/1 + LRD05	500/800	
						LC1F1000			
560	863	900	NS1000L - MicroLogic 5.0 - LR off	1000	10000	LC1F1000	TC1000/1 + LRD05	600/1000	

[1] For long starting (class 20), see the correspondence table for thermal relay page B-9.

[2] For 480V, consult Schneider Electric.

[3] Reversers: replace LC1 with LC2 ; start-delta starter : replace LC1 with LC3 for TeSys D, see TeSys G catalog for TeSys G.

[4] GV4LE only, for GV4 "S" performance with rotary handle, order GV4LE "S" & rotary handle separately.

[5] Separate overload Relay, use terminal block LAD7B106.

[6] GV1L3 to be mounted directly on supply side of the contactor.

> Discover Schneider Electric
TeSys Catalog



MKTED210011EN

Type 2 Coordination Table with Circuit-Breakers

Ue: 440 V AC

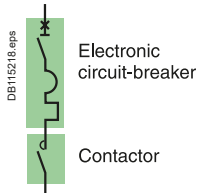

Circuit Breakers, and contactors

Performance "Iq" (kA): Ue = 440 VAC (IEC/EN 60947-4-1) [2]

Circuit breaker	B	F	N	H	S	L
GV4 P, PE & PEM 02 - 12	-	-	50	-	70 [5]	-
GV4 P, PE & PEM 25 - 115	20	-	50	-	70 [5]	-
NSX100/160/250-MA	-	35	42	65	90	130
NSX400/630-MA	-	30	42	65	90	130
NS630bL/NS800L/NS1000L MicroLogic 5.0	-	-	-	-	-	130

Starting [1] Standard IEC/EN 60947-4-1

Trip unit normal (classe)	GV4P, PE or PEM	MicroLogic 2.2M/2.3M	MicroLogic 6.2M/6.3M	Mircologic 5.0
long (classe)	10	5. 10	5. 10	10
long (classe)	20	20	20. 30 [1]	20

Motors Rated power P(kW)	Guide values of operational current in amps at : 440 V (A)		Circuit breakers				Contactors [2]
	Ie max (A)		Type	trip unit	I _{rt} (A)	I _{rm} (A) [4]	Type
0.18	0.55	2	GV4P, PE or PEM	2	0.8/2	34	LC1-D25
0.25	0.77	2	GV4P, PE or PEM	2	0.8/2	34	LC1-D25
0.37	1	2	GV4P, PE or PEM	2	0.8/2	34	LC1-D25
0.55	1.36	2	GV4P, PE or PEM	2	0.8/2	34	LC1-D25
0.75	1.7	2	GV4P, PE or PEM	2	0.8/2	34	LC1-D25
1.1	2.4	2.5	GV4P, PE or PEM	3.5	1.4/3.5	60	LC1-D32
1.5	3.3	3.5	GV4P, PE or PEM	3.5	1.4/3.5	60	LC1-D32
2.2	4.5	7	GV4P, PE or PEM	7	2.9/7	119	LC1-D65A
3	5.9	7	GV4P, PE or PEM	7	2.9/7	119	LC1-D65A
4	7.7	12.5	GV4P, PE or PEM	12.5	5/12.5	213	LC1-D65A
5.5	10.5	12.5	GV4P, PE or PEM	12.5	5/12.5	213	LC1-D65A
7.5	14	25	GV4P, PE or PEM	25	10/25	425	LC1-D65A
10	18.2	25	NSX100	MicroLogic 2.2M/6.2M	12/20	13I _{rt}	LC1-D80
			GV4P, PE or PEM	25	10/25	425	LC1-D65A
11	20	25	NSX100	MicroLogic 2.2M/6.2M	15/25	13I _{rt}	LC1-D80
			GV4P, PE or PEM	25	10/25	425	LC1-D65A
15	26	50	NSX100	MicroLogic 2.2M/6.2M	15/25	13I _{rt}	LC1-D80
			GV4P, PE or PEM	50	20/50	850	LC1-D65A
18.5	32	50	NSX100	MicroLogic 2.2M/6.2M	24/40	13I _{rt}	LC1-D80
			GV4P, PE or PEM	50	20/50	850	LC1-D65A
22	38	50	NSX100	MicroLogic 2.2M/6.2M	24/40	13I _{rt}	LC1-D80
			GV4P, PE or PEM	50	20/50	850	LC1-D65A
30	50	63	NSX100	MicroLogic 2.2M/6.2M	24/40	13I _{rt}	LC1-D80
			GV4P, PE or PEM	80	40/80	1360	LC1-D65A
37	60	63	NSX100	MicroLogic 2.2M/6.2M	48/80	13I _{rt}	LC1-D80
			GV4P, PE or PEM	80	40/80	1360	LC1-D65A
45	73	80	NSX100	MicroLogic 2.2M/6.2M	48/80	13I _{rt}	LC1-D80
			GV4P, PE or PEM	80	40/80	1360	LC1-D80
55	88	100	NSX100	MicroLogic 2.2M/6.2M	48/80	13I _{rt}	LC1-D80
			GV4P, PE or PEM	115	65/115	1955	LC1-D115 or LC1-F115
75	120	150	NSX100	MicroLogic 2.2M/6.2M	60/100	13I _{rt}	LC1D115 or LC1G115
			NSX160	MicroLogic 2.2M/6.2M	90/150	13I _{rt}	LC1D150 or LC1G150
90	145	150	NSX160	MicroLogic 2.2M/6.2M	90/150	13I _{rt}	LC1D150 or LC1G150
110	177	185	NSX250	MicroLogic 2.2M/6.2M	131/220	13I _{rt}	LC1G185
132	209	265	NSX400	MicroLogic 2.3M/6.3M	160/320	13I _{rt}	LC1G265
160	255	265	NSX400	MicroLogic 2.3M/6.3M	160/320	13I _{rt}	LC1G265
200	318	320	NSX400	MicroLogic 2.3M/6.3M	160/320	13I _{rt}	LC1G330
220	343	400	NSX630	MicroLogic 2.3M/6.3M	250/500	13I _{rt}	LC1G400
250	390	400	NSX630	MicroLogic 2.3M/6.3M	250/500	13I _{rt}	LC1G400
300	466	500	NSX630	MicroLogic 2.3M/6.3M	250/500	13I _{rt}	LC1G500
315	490	630	NS800L	MicroLogic 5.0	320/800	8800	LC1G630
355	554	630	NS800L	MicroLogic 5.0	320/800	9600	LC1G630
375	587	630	NS800L	MicroLogic 5.0	320/800	9600	LC1G630
400	627	720	NS800L	MicroLogic 5.0	320/800	9600	LC1-F780 or LC1F1000
450	695	720	NS800L	MicroLogic 5.0	320/800	9600	LC1-F780 or LC1F1000
500	772	800	NS1000L	MicroLogic 5.0	400/1000	10000	LC1-F1000
560	863	900	NS1000L	MicroLogic 5.0	400/1000	10000	LC1-F1000

[1] For class 30 the contacteur rating shall be checked according to 30s thermal withstand.

[2] For 480V, consult Schneider Electric.

[3] Reversers: replace LC1 with LC2; start-delta starter: replace LC1 with LC3 for TeSys D, see TeSys G catalog for TeSys G.

[4] Ii for MicroLogic 5.0 control unit.

[5] GV4PE only, for GV4 "S" performance with rotary handle, order GV4PE "S" & rotary handle separately.

> Discover Schneider Electric TeSys Catalog



MKTED210011EN

Type 2 Coordination Table with Circuit-Breakers

U_e: 440 V AC

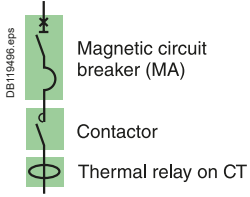

Circuit breakers, contactors and thermal relays

Performance "Iq" (kA): U _e = 440 VAC (IEC/EN 60947-4-1) ^[1]						
Circuit breakers	B	F	N	H	S	L
GV4 L & LE 02 - 12	-	-	50	-	70 ^[4]	-
GV4 L & LE 25 - 115	20	-	50	-	70 ^[4]	-
NSX100/160/250-MA	-	35	42	65	90	130
NSX400/630-MicroLogic 1.3M	-	30	42	65	90	130
NS630bL/NS800L/NS1000L MicroLogic 5.0	-	-	-	-	-	130

Starting ^[1]: normal LRD class 10 A, LR9 class 10.

Motors Rated power P(kW)	Guide values of operational current in amps at :		Circuit breakers			Contactors ^[2]		Thermal o/l relays Adj. class 10A to 30	
	440 V (A)	I _e max	Type	rat(A)	I _{rm} (A) ^[4]	Type	Type	I _{rt} h ^[1]	
0.18	0.55	2	GV4L or GV4LE	2	26	LC1-D32	LTM R08	0.4/8	
0.25	0.77	2	GV4L or GV4LE	2	26	LC1-D32	LTM R08	0.4/8	
0.37	1	2	GV4L or GV4LE	2	26	LC1-D32	LTM R08	0.4/8	
0.55	1.36	2	GV4L or GV4LE	2	26	LC1-D32	LTM R08	0.4/8	
0.75	1.7	2	GV4L or GV4LE	2	26	LC1-D32	LTM R08	0.4/8	
1.1	2.4	3.5	GV4L or GV4LE	3.5	46	LC1-D40A	LTM R08	0.4/8	
1.5	3.3	3.5	GV4L or GV4LE	3.5	46	LC1-D40A	LTM R08	0.4/8	
2.2	4.5	7	GV4L or GV4LE	7	91	LC1-D40A	LTM R08	0.4/8	
3	5.9	7	GV4L or GV4LE	7	91	LC1-D40A	LTM R08	0.4/8	
4	7.7	10	GV4L or GV4LE	12.5	138	LC1-D65A	LTM R27	1.35/27	
		12.5	NSX100-MA	12.5	163	LC1-D80	LTM R27	1.35/27	
5.5	10.5	12.5	GV4L or GV4LE	12.5	163	LC1-D65A	LTM R27	1.35/27	
			NSX100-MA	12.5	163	LC1-D80	LTM R27	1.35/27	
7.5	14	25	GV4L or GV4LE	25	325	LC1-D65A	LTM R27	1.35/27	
			NSX100-MA	25	325	LC1-D80	LTM R27	1.35/27	
10	18.2	25	GV4L or GV4LE	25	325	LC1-D65A	LTM R27	1.35/27	
			NSX100-MA	25	325	LC1-D80	LTM R27	1.35/27	
11	20	25	GV4L or GV4LE	25	325	LC1-D65A	LTM R27	1.35/27	
			NSX100-MA	25	325	LC1-D80	LTM R27	1.35/27	
15	26	32	GV4L or GV4LE	50	550	LC1-D65A	LTM R100	5/100	
		32	NSX100-MA	50	550	LC1-D80	LTM R100	5/100	
18.5	32	40	GV4L or GV4LE	50	550	LC1-D65A	LTM R100	5/100	
		50	NSX100-MA	50	550	LC1-D80	LTM R100	5/100	
22	38	50	GV4L or GV4LE	50	650	LC1-D65A	LTM R100	5/100	
			NSX100-MA	50	650	LC1-D80	LTM R100	5/100	
30	50	65	GV4L or GV4LE	80	880	LC1-D65A	LTM R100	5/100	
		80	NSX100-MA	100	1100	LC1-D80	LTM R100	5/100	
37	60	65	GV4L or GV4LE	80	880	LC1-D65A	LTM R100	5/100	
		80	NSX100-MA	100	1100	LC1-D80	LTM R100	5/100	
45	73	80	GV4L or GV4LE	80	1040	LC1-D80	LTM R100	5/100	
			NSX100-MA	100	1100	LC1-D80	LTM R100	5/100	
55	88	100	GV4L or GV4LE	115	1150	LC1D115	LTM R100	5/100	
			NSX100-MA	100	1300	LC1G115	LTM R100	5/100	
75	120	150	NSX160-MA	150	1800	LC1D115 or G115	LTM R100	5/100	
90	145	150	NSX160-MA	150	1950	LC1D150 or G150	LTM R08	on CT	
110	177	185	NSX250-MA	220	2640	LC1G185	LTM R08	on CT	
132	209	265	NSX400-MicroLogic 1.3M	320	3520	LC1G265	LTM R08	on CT	
160	255	265	NSX400-MicroLogic 1.3M	320	3520	LC1G265	LTM R08	on CT	
200	318	320	NSX400-MicroLogic 1.3M	320	4160	LC1G330	LTM R08	on CT	
220	343	400	NSX630-MicroLogic 1.3M	500	5500	LC1G400	LTM R08	on CT	
250	390	500	NSX630-MicroLogic 1.3M	500	5500	LC1G400	LTM R08	on CT	
300	466	500	NSX630-MicroLogic 1.3M	500	6500	LC1G500	LTM R08	on CT	
315	490	630	NS800L - MicroLogic 5.0 - LR off	800	8000	LC1G630	LTM R08	on CT	
355	554	630	NS800L - MicroLogic 5.0 - LR off	800	9600	LC1G630	LTM R08	on CT	
375	587	630	NS800L - MicroLogic 5.0 - LR off	800	9600	LC1G630	LTM R08	on CT	
400	627	720	NS800L - MicroLogic 5.0 - LR off	800	9600	LC1-F780 or LC1-F1000	LTM R08	on CT	
450	695	720	NS800L - MicroLogic 5.0 - LR off	800	9600	LC1-F780 or LC1-F1000	LTM R08	on CT	
500	772	800	NS1000L -MicroLogic 5.0 - LR off	1000	10000	LC1-F1000	LTM R08	on CT	
560	863	900	NS1000L -MicroLogic 5.0 - LR off	1000	10000	LC1-F1000	LTM R08	on CT	

[1] For 480V, consult Schneider Electric.

[2] For installations with a class 30 relay, a derating of 20% must be apply on circuit-breakers and the contacteur rating shall be checked according to 30s thermal withstand

[3] Reversers: replace LC1 with LC2; start-delta starter: replace LC1 with LC3 for TeSys D, see TeSys G catalog for TeSys G

[4] GV4LE only, for GV4 "S" performance with rotary handle, order GV4LE "S" & rotary handle separately.

> Discover Schneider Electric
TeSys Catalog



MKTED210011EN

Type 2 Coordination Table with Circuit-Breakers

Ue: 690 V AC

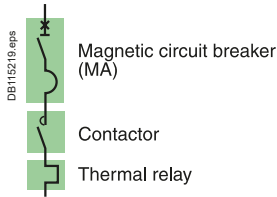

Circuit Breakers, contactors and thermal relays

Performance "Iq" (kA) : Ue = 690 VAC (IEC/EN 60947-4-1)

Circuit breaker	Iq
GV2 < L06 or GV2 ≥ L07 + LA9 LB920	50 kA
GV2 < P06 or GV2 ≥ P07 + LA9 LB920	50 kA

Starting [1]: normal LRD class 10 A.

GV2L										
Motors			Circuit breaker				Contactors [3]		Thermal o/l relays	
P (kW)	I (A) 690 V	Ie max	Iq (kA)	Type	Rating (A)	Irm (A)	Type	Type	Irth [1]	
0.37	0.64	0.64	100	GV2L05	1	13	LC1D09	LRD05	0.63...1	
0.55	0.87	1	100	GV2L05	1	13	LC1D09	LRD05	0.63...1	
0.75	1.1	1.6	100	GV2L06	1.6	21	LC1D09	LRD06	1...1.6	
1.1	1.6	2.5	100	GV2L06	1.6	21	LC1D09	LRD06	1...1.6	
1.5	2.1	2.5	65	LA9LB920 [2] + GV2-L07	2.5	33	LC1-D25	LRD07	1.6...2.5	
2.2	2.8	4	65	LA9LB920 [2] + GV2-L08	4	52	LC1-D25	LRD08	2.5...4	
3	3.8	4	65	LA9LB920 [2] + GV2-L08	4	52	LC1-D25	LRD08	2.5...4	
4	4.9	6	65	LA9LB920 [2] + GV2-L10	6.3	82	LC1-D25	LRD10	4...6	
5.5	6.7	8	65	LA9LB920 [2] + GV2-L14	10	130	LC1D32	LRD12	5.5...8	
7.5	8.9	10	65	LA9LB920 [2] + GV2-L14	10	130	LC1D32	LRD14	7...10	
10	11.5	13	65	LA9LB920 [2] + GV2-L16	14	182	LC1D32	LRD16	9...13	
11	12.8	13	65	LA9LB920 (2) + GV2L16	14	182	LC1D32	LRD16	9...13	
15	17	18	65	LA9LB920 [2] + GV2-L20	18	234	LC1D32	LRD21	12..18	
18.5	21	21	65	LA9LB920 [2] + GV2-L22	25	325	LC1D32	LRD22	16..24	
22	24	32	65	LA9LB920 [2] + GV2-L32	32	416	LC1D32	LRD32	23..32	
							LC1-D40A	LRD332	23..32	

GV2P							
Motors			Circuit breaker			Contactors [3]	
P (kW)	I (A) 690 V	Ie max	Iq (kA)	Type	Irth (A)	Irm (A)	Type
0.37	0.63	0.63	100	GV2-P05	1	13	LC1-D09
0.55	0.87	1	100	GV2-P05	1	13	LC1-D09
0.75	1.1	1.6	100	GV2-P06	1.6	22.5	LC1-D09
1.1	1.6	2.5	65	LA9LB920 [2] + GV2-P07	2.5	33.5	LC1-D25
1.5	2.1	2.5	65	LA9LB920 [2] + GV2-P07	2.5	33.5	LC1-D25
2.2	2.8	4	65	LA9LB920 [2] + GV2-P08	4	51	LC1-D25
3	3.8	4	65	LA9LB920 [2] + GV2-P08	4	51	LC1-D25
4	4.9	6.3	65	LA9LB920 [2] + GV2-P10	6.3	78	LC1-D25
5.5	6.7	10	65	LA9LB920 [2] + GV2-P14	10	138	LC1-D25
7.5	8.9	10	65	LA9LB920 [2] + GV2-P14	10	138	LC1-D25
10	12	14	65	LA9LB920 [2] + GV2-P16	14	170	LC1-D25
11	12.8	14	65	LA9LB920 [2] + GV2-P16	14	170	LC1-D25
15	17	18	65	LA9LB920 [2] + GV2-P20	18	223	LC1-D25
18.5	21	23	65	LA9LB920 [2] + GV2-P21	23	327	LC1-D32
22	24	32	65	LA9LB920 [2] + GV2-P32	32	416	LC1-D40A

Starting: adjustable									
Motors			Circuit breaker			Contactors [3]		Thermal o/l relays	
P (kW)	I (A) 690 V	Ie max	Type	Rating (A)	Irm (A)	Type	Type	Irth [1]	
0.37	0.64	0.64	GV2-L05	1	13	LC1-D09	LTM R08	0.4/8	
0.55	0.87	1	GV2-L05	1	13	LC1-D09	LTM R08	0.4/8	
0.75	1.1	1.6	GV2-L06	1.6	21	LC1-D09	LTM R08	0.4/8	
1.1	1.6	2.5	GV2-L06	1.6	21	LC1-D25	LTM R08	0.4/8	
1.5	2.1	2.5	LA9LB920 [2] + GV2-L07	2.5	33	LC1-D25	LTM R08	0.4/8	
2.2	2.8	4	LA9LB920 [2] + GV2-L08	4	52	LC1-D25	LTM R08	0.4/8	
3	3.8	4	LA9LB920 [2] + GV2-L08	4	52	LC1-D25	LTM R08	0.4/8	
4	4.9	6	LA9LB920 [2] + GV2-L10	6.3	82	LC1-D25	LTM R08	0.4/8	
5.5	6.7	8	LA9LB920 [2] + GV2-L14	10	130	LC1-D25	LTM R08	0.4/8	
7.5	8.9	10	LA9LB920 [2] + GV2-L14	10	130	LC1-D25	LTM R27	1.35/27	
11	12.8	14	LA9LB920 [2] + GV2-L16	14	182	LC1-D25	LTM R27	1.35/27	
15	17	18	LA9LB920 [2] + GV2-L20	18	234	LC1-D32	LTM R27	1.35/27	
18.5	21	21	LA9LB920 [2] + GV2-L22	25	325	LC1-D32	LTM R27	1.35/27	
22	24	27	LA9LB920 [2] + GV2-L32	32	416	LC1-D40A	LTM R27	1.35/27	

[1] For long starting (class 20), see the correspondence table for thermal relay.
 [2] One LA9LB920 limiter (on the supply side of the breaker) can be used for several starter up to 32 A.
 Connections between limiter and GV2 breaker shall be done in such a way to minimize the risk of short circuit.
 [3] Reversers: replace LC1 with LC2; start-delta starter: replace LC1 with LC3.

> Discover Schneider Electric TeSys Catalog



MKTED210011EN

Type 2 Coordination Table with Circuit-Breakers

U_e: 690 V AC

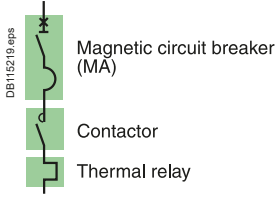

Circuit Breakers, contactors and thermal relays

Performance "Iq" (kA) : U_e = 690 VAC (IEC/EN 60947-4-1)

Circuit breaker	Iq
LUALB1	70 kA
LA9LB920	35 kA

Starting : adjustable.

B

Motors P (kW)	I (A)	I _e max	TeSys U		Limiter	Control unit	
			Type ^[2]	I _m		Type ^[1]	I _{rth}
0.37	0.64	0.64	LUB12	14.2 In	LUALB1	LUC●01	0.35...1.4
			LUB12	14.2 In	LA9LB920	LUC●01	0.35...1.4
0.55	0.87	1	LUB12	14.2 In	LUALB1	LUC●01	0.35...1.4
			LUB12	14.2 In	LA9LB920	LUC●01	0.35...1.4
0.75	1.1	1.6	LUB12	14.2 In	LUALB1	LUC●01	0.35...1.4
			LUB12	14.2 In	LA9LB920	LUC●01	0.35...1.4
1.1	1.6	2.5	LUB12	14.2 In	LUALB1	LUC●05	1.25...5
			LUB12	14.2 In	LA9LB920	LUC●05	1.25...5
1.5	2.1	2.5	LUB12	14.2 In	LUALB1	LUC●05	1.25...5
			LUB12	14.2 In	LA9LB920	LUC●05	1.25...5
2.2	2.8	4	LUB12	14.2 In	LUALB1	LUC●05	1.25...5
			LUB12	14.2 In	LA9LB920	LUC●05	1.25...5
3	3.8	4	LUB12	14.2 In	LUALB1	LUC●05	1.25...5
			LUB12	14.2 In	LA9LB920	LUC●05	1.25...5
4	4.9	6	LUB12	14.2 In	LUALB1	LUC●12	3...12
			LUB12	14.2 In	LA9LB920	LUC●12	3...12
5.5	6.7	8	LUB12	14.2 In	LUALB1	LUC●12	3...12
			LUB12	14.2 In	LA9LB920	LUC●12	3...12
7.5	8.9	10	LUB12	14.2 In	LUALB1	LUC●12	3...12
			LUB12	14.2 In	LA9LB920	LUC●12	3...12
11	12.8	18	LUB32	14.2 In	LUALB1	LUC●18	4.5...18
			LUB32	14.2 In	LA9LB920	LUC●18	4.5...18
15	17	18	LUB32	14.2 In	LUALB1	LUC●18	4.5...18
			LUB32	14.2 In	LA9LB920	LUC●18	4.5...18
18.5	21	25	LUB32	14.2 In	LUALB1	LUC●32	8...32
			LUB32	14.2 In	LA9LB920	LUC●32	8...32

[1] To be replaced by A, B, D or CM according to protection and monitoring needs.

[2] For Reversing: replace LUB12 by LU2B12 and LUB32 by LU2B32.

Type 2 Coordination Table with Circuit-Breakers

Ue: 690 V AC

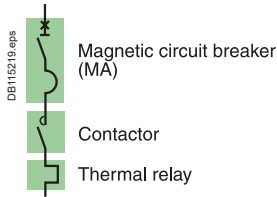

Circuit Breakers, contactors and thermal relays

Performance "Iq" (kA) : Ue = 690 VAC (IEC/EN 60947-4-1)			
Circuit breakers	HB1	HB2	LB
NSX100/250 MA	75 kA	100 kA	-
NSX400/630 MicroLogic 1.3M	75 kA	100 kA	-
NS800 MicroLogic 5.0x	-	-	75 kA

Starting ^[1]: normal LRD class 10 A, LR9 class 10.

Motors Rated power P(kW)	Guide values of operational current in amps at :		Circuit breakers			Contactors ^[2]		Thermal o/l relays ^[1]	
	690 V (A)	Ie max	Type	rat(A)	Irm(A) ^[3]	Type	Type	IrtH	
0.37	0.64	1	NSX100-MA	12.5	75	LC1-D80	CT 1A + LRD05	0.63..1	
0.55	0.87	1	NSX100-MA	12.5	75	LC1-D80	CT 1A + LRD05	0.63..1	
0.75	1.1	1.5	NSX100-MA	12.5	75	LC1-D80	CT 1.5A + LRD05	0.95..1.5	
1.1	1.6	2.5	NSX100-MA	12.5	75	LC1-D80	CT 2A + LRD05	1.26..2	
1.5	2.1	2.5	NSX100-MA	12.5	75	LC1-D80	CT 2.5A + LRD05	1.6..2.5	
2.2	2.8	4	NSX100-MA	12.5	75	LC1-D80	CT 4A + LRD05	2.5..4	
3	3.8	4	NSX100-MA	12.5	75	LC1-D80	CT 4A + LRD05	2.5..4	
4	4.9	6	NSX100-MA	12.5	112	LC1-D80	CT 6A + LRD05	3.8..6	
5.5	6.7	7.5	NSX100-MA	12.5	112	LC1-D80	CT 7.5A + LRD05	4.7..7.5	
7.5	8.9	12.5	NSX100-MA	12.5	162	LC1-D80	CT 10A + LRD05	6.3..10	
10	11.5	12.5	NSX100-MA	12.5	162	LC1-D80	CT 12.5A + LRD05	7.8..12.5	
11	12.8	20	NSX100-MA	25	162	LC1-D80	CT 20A + LRD05	12.6..20	
15	17	20	NSX100-MA	25	300	LC1-D80	CT 20A + LRD05	12.6..20	
18.5	21	25	NSX100-MA	25	325	LC1-D80	CT 24A + LRD05	15.24	
22	24	25	NSX100-MA	25	325	LC1-D80	CT 30A + LRD05	19..30	
30	32	40	NSX100-MA	50	550	LC1-D150	CT 40A + LRD05	25..40	
37	39	50	NSX100-MA	50	550	LC1G115	LR9G115 (or CT 40A + LRD05)	25..115	
					650	LC1D150	CT 50A + LRD05	31.5..50	
45	47	50	NSX100-MA	50	650	LC1G115	LR9G115 (or CT 50A + LRD05)	25..115	
					650	LC1D150	CT 50A + LRD05	31.5..50	
55	57	63	NSX100-MA	100	900	LC1D150	CT 50A + LRD05	48..80	
					1100	LC1G115	LR9G115 (or CT 80A + LRD05)	48..80	
75	77	80	NSX100-MA	100	1100	LC1D150	CT 100A + LRD05	48..80	
					1650	LC1G115	LR9G225	57..225	
90	93	100	NSX250-MA	150	1650	LC1G150	LR9G225 (or CT+ LRD05)	57..225	
110	113	115	NSX250-MA	150	1650	LC1G185	LR9G225 (or CT+ LRD05)	57..225	
132	134	150	NSX250-MA	150	1800	LC1G225	LR9G225 (or CT+ LRD05)	57..225	
160	162	220	NSX250-MA	220	2420	LC1G225	LR9G500 (or CT+ LRD05)	125..500	
200	203	220	NSX250-MA	220	2640	LC1G265	LR9G500 (or CT+ LRD05)	125..500	
220	220	225	NSX400-MicroLogic 1.3M	320	3520	LC1G330	LR9G500 (or CT+ LRD05)	125..500	
250	250	280	NSX400-MicroLogic 1.3M	320	3520	LC1G400	LR9G500 (or CT+ LRD05)	125..500	
315	313	330	NSX630-MicroLogic 1.3M	500	5500	LC1G400	LR9G500 (or CT+ LRD05)	125..500	
335	335	340	NSX630-MicroLogic 1.3M	500	5500	LC1G500	LR9G500 (or CT+ LRD05)	125..500	
355	354	500	NSX630-MicroLogic 1.3M	500	5500	LC1G500	LR9G500 (or CT+ LRD05)	125..500	
375	374	500	NSX630-MicroLogic 1.3M	500	5500	LC1G630	LR9G630 (or CT+ LRD05)	160..630	
400	400	500	NSX630-MicroLogic 1.3M	500	5500	LC1G630	LR9G630 (or CT+ LRD05)	160..630	
450	455	500	NSX630-MicroLogic 1.3M	500	6000	LC1G630	LR9G630 (or CT+ LRD05)	160..630	
475	475	500	NSX630 MicroLogic 1.3M ^[4]	500	6500	LC1G630	LR9G630 (or CT+ LRD05)	160..630	
500	495	500	NSX630-MicroLogic 1.3M ^[4]	500	6500	LC1G630	LR9G630 (or CT+ LRD05)	160..630	
500	495	560	NS800LB MicroLogic 5 LR Off	800	8000	LC1F780/ LC1G800	LR9G630 (or CT+ LRD05)	160..630	

[1] CT: Current transformer for motor thermal relay, for instance S11 range from RS ISOLSEC. > Discover Schneider Electric TeSys Catalog

[2] Reversers: replace LC1 with LC2; start-delta starter: replace LC1 with LC3 for TeSys D, see TeSys G catalog for TeSys G.

[3] ii for MicroLogic 5.0 control unit.

[4] Check compatibility with starting current I Peak < 8,8kA peak.



Type 2 Coordination Table with Circuit-Breakers

U_e: 690 V AC

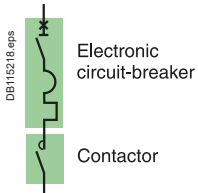

Circuit Breakers, contactors

Performance "I _q " (kA) : U _e = 690 VAC (IEC/EN 60947-4-1)			
Circuit breakers	HB1	HB2	LB
NSX100/160/250 MicroLogic 2.2 M/6.2 M	75 kA	100 kA	-
NSX400/630 MicroLogic 2.2 M/6.2 M	75 kA	100 kA	-
NS800 MicroLogic 5.0x	-	-	75 kA

Starting	Standard IEC/EN 60947-4-1		
MicroLogic	2.2 M/2.3 M	6.2 M/6.3 M	5.0
Normal (class)	5. 10	5. 10	10
Long (class)	20	20. 30	20

Motors			Circuit breakers				Contactors ^[1]
P (kW)	I (A) 690 V	I _e max	Type	Trip unit	I _{rth} (A)	I _{rm} (A) ^[2]	Type
10	11.6	25	NSX100	MicroLogic 2.2 M or 6.2 M	12/25	13 I _{rth}	LC1 D80
11	12.8	25	NSX100	MicroLogic 2.2 M or 6.2 M	12/25	13 I _{rth}	LC1 D80
15	17	25	NSX100	MicroLogic 2.2 M or 6.2 M	12/25	13 I _{rth}	LC1 D80
18.5	22	25	NSX100	MicroLogic 2.2 M or 6.2 M	12/25	13 I _{rth}	LC1 D80
22	24	25	NSX100	MicroLogic 2.2 M or 6.2 M	12/25	13 I _{rth}	LC1 D80
30	32	50	NSX100	MicroLogic 2.2 M or 6.2 M	25/50	13 I _{rth}	LC1D150/G115
37	39	50	NSX100	MicroLogic 2.2 M or 6.2 M	25/50	13 I _{rth}	LC1D150/G115
45	47	50	NSX100	MicroLogic 2.2 M or 6.2 M	25/50	13 I _{rth}	LC1D150/G115
55	57	63	NSX100	MicroLogic 2.2 M or 6.2 M	50/100	13 I _{rth}	LC1D150/G115
75	77	80	NSX100	MicroLogic 2.2 M or 6.2 M	50/100	13 I _{rth}	LC1D150/G115
90	93	100	NSX250	MicroLogic 2.2 M or 6.2 M	70/150	13 I _{rth}	LC1G150
110	113	125	NSX250	MicroLogic 2.2 M or 6.2 M	70/150	13 I _{rth}	LC1G185
132	134	150	NSX250	MicroLogic 2.2 M or 6.2 M	70/150	13 I _{rth}	LC1G225
160	162	220	NSX250	MicroLogic 2.2 M or 6.2 M	100/220	13 I _{rth}	LC1G225
200	203	220	NSX250	MicroLogic 2.2 M or 6.2 M	100/220	13 I _{rth}	LC1G265
220	223	280	NSX400	MicroLogic 2.3 M or 6.3 M	160/320	13 I _{rth}	LC1G330
250	250	280	NSX400	MicroLogic 2.3 M or 6.3 M	160/320	13 I _{rth}	LC1G400
315	313	340	NSX630	MicroLogic 2.3 M or 6.3 M	250/500	13 I _{rth}	LC1G400
335	335	340	NSX630	MicroLogic 2.3 M or 6.3 M	250/500	13 I _{rth}	LC1G500
355	354	460	NSX630	MicroLogic 2.3 M or 6.3 M	250/500	13 I _{rth}	LC1G500
375	374	460	NSX630	MicroLogic 2.3 M or 6.3 M	250/500	13 I _{rth}	LC1G630
400	400	460	NSX630	MicroLogic 2.3 M or 6.3 M	250/500	13 I _{rth}	LC1G630
450	455	460	NSX630	MicroLogic 2.3 M or 6.3 M	250/500	13 I _{rth}	LC1G630
475	475	480	NSX630 ^[3]	MicroLogic 2.3 M or 6.3 M	250/500	13 I _{rth}	LC1G630
500	500	500	NSX630 ^[3]	MicroLogic 2.3 M or 6.3 M	250/500	13 I _{rth}	LC1G630
500	500	580	NS800LB	MicroLogic 5.0 /E	320/800	13 I _{rth}	LC1F780/LC1G800

[1] Reversers: replace LC1 with LC2; start-delta starter: replace LC1 with LC3.

[2] I_i for MicroLogic 5.0 control unit.

[3] Check compatibility with starting current I_{Peak} < 8,8kA peak.

Type 2 Coordination Table with Circuit-Breakers

Ue: 690 V AC

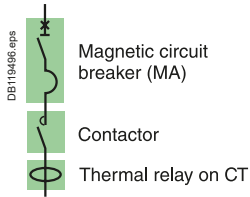

Circuit Breakers, contactors

Performance "Iq" (kA): Ue = 690 VAC (IEC/EN 60947-4-1)			
Circuit breakers	HB1	HB2	LB
NSX100/250 MA	75 kA	100 kA	-
NSX400/630 MicroLogic 1.3 M	75 kA	100 kA	-
NS800 MicroLogic 5.0x	-	-	75 kA

Starting: adjustable.

Motors P (kW)	I (A) 690 V	Ie max	Circuit breakers			Contactors ^[2]		Thermal o/l relays	
			Type	Rating (A)	Irm (A)	Type	Type	Irth ^[1]	
0.37	0.64	8	NSX100-MA	12.5	75	LC1-D80	LTM R08	0.4/8	
0.55	0.87	8	NSX100-MA	12.5	75	LC1-D80	LTM R08	0.4/8	
0.75	1.1	8	NSX100-MA	12.5	75	LC1-D80	LTM R08	0.4/8	
1.1	1.6	8	NSX100-MA	12.5	75	LC1-D80	LTM R08	0.4/8	
1.5	2.1	8	NSX100-MA	12.5	75	LC1-D80	LTM R08	0.4/8	
2.2	2.8	8	NSX100-MA	12.5	75	LC1-D80	LTM R08	0.4/8	
3	3.8	8	NSX100-MA	12.5	75	LC1-D80	LTM R08	0.4/8	
4	4.9	8	NSX100-MA	12.5	112	LC1-D80	LTM R08	0.4/8	
5.5	6.7	8	NSX100-MA	12.5	112	LC1-D80	LTM R08	0.4/8	
7.5	8.9	12.5	NSX100-MA	12.5	162	LC1-D80	LTM R27	1.35/27	
11	12.8	25	NSX100-MA	25	325	LC1-D80	LTM R27	1.35/27	
15	17	25	NSX100-MA	25	325	LC1-D80	LTM R27	1.35/27	
18.5	21	25	NSX100-MA	25	325	LC1-D80	LTM R27	1.35/27	
22	24	25	NSX100-MA	25	400	LC1-D80	LTM R27	1.35/27	
30	32	50	NSX100-MA	50	650	LC1D150/G115	LTM R100	5/100	
37	39	50	NSX100-MA	50	650	LC1D150/G115	LTM R100	5/100	
45	47	50	NSX100-MA	50	650	LC1D150/G115	LTM R100	5/100	
55	57	63	NSX100-MA	100	1100	LC1D150/G115	LTM R100	5/100	
75	77	80	NSX100-MA	100	1100	LC1-D150/G115	LTM R100	5/100	
90	93	100	NSX250-MA	150	1650	LC1G150	LTM R100	5/100	
110	113	115	NSX250-MA	150	1650	LC1G185	LTM R08	on TC	
132	134	150	NSX250-MA	150	1800	LC1G225	LTM R08	on TC	
160	162	220	NSX250-MA	220	2420	LC1G225	LTM R08	on TC	
200	203	220	NSX250-MA	220	2640	LC1G265	LTM R08	on TC	
220	223	225	NSX400-MicroLogic 1.3M	320	3520	LC1G330	LTM R08	on TC	
250	250	280	NSX400-MicroLogic 1.3M	320	3520	LC1G400	LTM R08	on TC	
315	313	340	NSX630-MicroLogic 1.3M	500	5500	LC1G400	LTM R08	on TC	
335	335	340	NSX630-MicroLogic 1.3M	500	5500	LC1G500	LTM R08	on TC	
355	354	500	NSX630-MicroLogic 1.3M	500	5500	LC1G500	LTM R08	on TC	
375	374	500	NSX630-MicroLogic 1.3M	500	5500	LC1G630	LTM R08	on TC	
400	400	500	NSX630-MicroLogic 1.3M	500	5500	LC1G630	LTM R08	on TC	
450	455	500	NSX630-MicroLogic 1.3M	500	6000	LC1G630	LTM R08	on TC	
475	475	500	NSX630-MicroLogic 1.3M ^[3]	500	6500	LC1G630	LTM R08	on TC	
500	500	500	NSX630-MicroLogic 1.3M ^[3]	500	6500	LC1G630	LTM R08	on CT	
500	500	560	NS800LB MicroLogic 5 LR Off	800	8000	LC1F780/G800	LTM R08	on CT	

[1] Check contactor and circuit breaker thermal withstand for installations with a class 30 relay.
 [2] Reversers: replace LC1 with LC2; start-delta starter: replace LC1 with LC3 for TeSys D, see TeSys G catalog for TeSys G.
 [3] Check compatibility with starting current I Peak < 8,8kA peak.

Type 1 Coordination Table with Circuit-Breakers

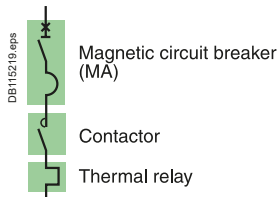

GV4L Circuit Breaker, contactor and Overload relay

Direct-on-line starting

Reverser

"Iq" breaking performance: equal to the breaking capacity of the circuit breaker alone.

Starting [1]: Direct on line normal start Class 10A/10.

B

Motors												Circuit breakers		Contactors [3]		Thermal relays [1]	
220/230 V		380 V		415 V		440 V		500-525 V		660-690 V		Type	cal (A)	Type	Type	I _{rth} (A)	
P (kW)	I (A)	P (kW)	I (A)	P (kW)	I (A)	P (kW)	I (A)	P (kW)	I (A)	P (kW)	I (A)						
0.37	1.8	0.37	1.2	0.37	1.1	0.37	1	0.55	1.2	0.75	1.2	GV4L or LE	2	LC1-D09	LRD 06	1/1.6	
		0.55	1.6	0.55	1.5	0.55	1.4	0.75	1.5	1	1.5	GV4L or LE	2	LC1-D09	LRD 06	1/1.6	
		0.75	2	0.75	1.8	0.75	1.7	1.1	2	1.5	2	GV4L or LE	2	LC1-D09	LRD 07	1.6/2.5	
0.55	2.8	1.1	2.8	1.1	2.6			1.5	2.6	2.2	2.8	GV4L or LE	3.5	LC1-D09	LRD 08	2.5/4	
		1.5	3.8	1.5	3.5	1.5	3.3			3	3.8	GV4L or LE	7	LC1-D09	LRD 08	2.5/4	
1.1	4.4	2.2	5.2	2.2	4.7	2.2	4.5	3	5	4	4.9	GV4L or LE	7	LC1-D09	LRD 10	4/6	
1.5	6.1	3	6.6	3	6.5	3	5.8	4	6.5	5.5	6.6	GV4L or LE	7	LC1-D09	LRD 12	5.5/8	
2.2	8.7	4	8.5	4	8.2	4	7.9	5.5	9	7.5	8.9	GV4L or LE	12.5	LC1-D09	LRD 14	7/10	
												GV4L or LE	12.5	LC1-D12	LRD 14	7/10	
3	11.5	5.5	11.5	5.5	11.1	5.5	10.5	7.5	12	10	11.5	GV4L or LE	12.5	LC1-D12	LRD 16	9/13	
												GV4L or LE	25	LC1-D18	LRD 21	12/18	
4	14.5	7.5	16	7.5	15	7.5	14	9	14	10	15	GV4L or LE	25	LC1-D18	LRD 21	12/18	
												GV4L or LE	25	LC1-D18	LRD 16	9/13	
5.5	20	11	23	11	21	11	20	11	18.4	18.5	21.3	GV4L or LE	25	LC1-D25	LRD 22	16/24	
												GV4L or LE	25	LC1-D25	LRD 21	12/18	
7.5	28	15	30	15	28	15	26.5	18.5	28.5	30	34.6	GV4L or LE	25	LC1-D32	LRD 22	16/24	
												GV4L or LE	50	LC1-D32	LRD 32	23/32	
11	39	18.5	37	18.5	35	22	37			22	33	GV4L or LE	50	LC1-D40A	LRD 340	30/40	
		22	44	22	40			30	45	33	39	GV4L or LE	50	LC1-D40A	LRD 350	37/50	
15	52					30	50			37	42	GV4L or LE	50	LC1-D50A	LRD 350	37/50	
												GV4L or LE	50	LC1-D65A	LRD 365	48/65	
18.5	64	30	58	30	53	37	60	37	55	45	47	GV4L or LE	50	LC1-D65A	LRD 350	37/50	
												GV4L or LE	80	LC1-D65A	LRD 365	48/65	
22	75	37	69	45	77	45	73	55	80	55	57	GV4L or LE	80	LC1-D80	LRD 3361	55/70	
												GV4L or LE	80	LC1-D80	LRD 3361	55/70	
		45	80							55	77	GV4L or LE	80	LC1-D80	LRD 3363	63/80	
												GV4L or LE	115	LC1-D95	LRD 3365	80/104	
30	95	55	97	55	93	55	90	75	106	90	93	GV4L or LE	80	LC1-D115	LRD 3361	55/70	
												GV4L or LE	80	LC1-D115	LR9D5367	60/100	
										90	93	GV4L or LE	115	LC1-D115	LR9D5369	90/150	

[1] For long starting (class 20), see the correspondence table for thermal relay.

[2] For 480V applications, consult Schneider Electric.

[3] Reversers: replace LC1 with LC2.

Type 1 Coordination Table with Circuit-Breakers

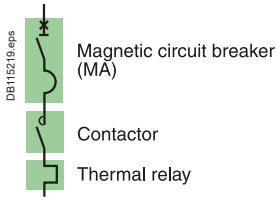

NSX100 Circuit bBreakers, contactors and thermal relays

Direct-on-line starting

Reverser

"Iq" breaking performance: equal to the breaking capacity of the circuit breaker alone.

Starting [1]: normal class 10A/10.



Motors												Circuit breakers		Contactors [3]	Thermal relays [1]	
220/230 V		380 V		415 V		440 V [2]		500-525 V		660-690 V		Type	cal (A)	Type	Type	lrth (A)
P (kW)	I (A)	P (kW)	I (A)	P (kW)	I (A)	P (kW)	I (A)	P (kW)	I (A)	P (kW)	I (A)	Type	cal (A)	Type	Type	lrth (A)
0.37	1.8	0.37	1.2	0.37	1.1	0.37	1	0.55	1.2	0.75	1.2	NSX100B/F/N/H/S/L MA	2.5	LC1-D09	LRD 06	1/1.6
		0.55	1.6	0.55	1.5	0.55	1.4	0.75	1.5	1	1.5	NSX100B/F/N/H/S/L MA	2.5	LC1-D09	LRD 06	1/1.6
0.55	2.8	0.75	2	0.75	1.8	0.75	1.7					NSX100B/F/N/H/S/L MA	2.5	LC1-D09	LRD 07	1.6/2.5
						1.1	2.4	1.1	2	1.5	2	NSX100B/F/N/H/S/L MA	2.5	LC1-D09	LRD 07	1.6/2.5
1.1	4.4	1.1	2.8	1.1	2.5			1.5	2.6	2.2	2.8	NSX100B/F/N/H/S/L MA	6.3	LC1-D09	LRD 08	2.5/4
		1.5	3.7	1.5	3.5	1.5	3.1			3	3.8	NSX100B/F/N/H/S/L MA	6.3	LC1-D09	LRD 08	2.5/4
1.5	6.1	2.2	5	2.2	4.8	2.2	4.5	3	5	4	4.9	NSX100B/F/N/H/S/L MA	6.3	LC1-D09	LRD 10	4/6
		3	6.6	3	6.5	3	5.8	4	6.5	5.5	6.6	NSX100B/F/N/H/S/L MA	12.5	LC1-D09	LRD 12	5.5/8
2.2	8.7	4	8.5	4	8.2	4	7.9	5.5	9			NSX100B/F/N/H/S/L MA	12.5	LC1-D09	LRD 14	7/10
										7.5	8.9	NSX100B/F/N/H/S/L MA	12.5	LC1-D12	LRD 14	7/10
3	11.5									7.5	8.9	NSX100HB1/HB2 MA	12.5	LC1-D40A	LRD 14	7/10
		5.5	11.5	5.5	11	5.5	10.4	7.5	12			NSX100B/F/N/H/S/L MA	12.5	LC1-D12	LRD 16	9/13
4	14.5	7.5	15.5	7.5	14	7.5	13.7	9	14			NSX100B/F/N/H/S/L MA	25	LC1-D18	LRD 21	12/18
				9	17	9	16.9	10	15			NSX100B/F/N/H/S/L MA	25	LC1-D18	LRD 21	12/18
5.5	20									10	11.5	NSX100B/F/N/H/S/L MA	25	LC1-D18	LRD 16	9/13
										10	11.5	NSX100HB1/HB2 MA	25	LC1-D40A	LRD313	9/13
7.5	28	11	22	11	21	11	20.1	11	18.4			NSX100B/F/N/H/S/L MA	25	LC1-D25	LRD 22	17/25
										15	17	NSX100B/F/N/H/S/L MA	25	LC1-D25	LRD 21	12/18
11	39									18.5	21.3	NSX100B/F/N/H/S/L MA	25	LC1-D32	LRD 22	17/25
										18.5	21.3	NSX100HB1/HB2 MA	25	LC1-D40A	LRD325	17/25
15	52	15	30	15	28	15	26.5	18.5	28.5			NSX100B/F/N/H/S/L MA	50	LC1-D32	LRD 32	23/32
								22	33	30	34.6	NSX100B/F/N/H/S/L MA	50	LC1-D40A	LRD340	30/40
18.5	64									30	34.6	NSX100HB1/HB2 MA	50	LC1-D80	LRD3355	30/40
										30	34.6	NSX100B/F/N/H/S/L MA	50	LC1-D40A	LRD350	37/50
22	75											NSX100B/F/N/H/S/L MA	50	LC1-D50A	LRD350	37/50
										37	42	NSX100B/F/N/H/S/L MA	50	LC1-D65A	LRD350	37/50
25	85									37	42	NSX100HB1/HB2 MA	50	LC1-D80	LRD3357	37/50
										37	42	NSX100B/F/N/H/S/L MA	100	LC1-D65A	LRD365	48/65
30	100															
										45	49	NSX100B/F/N/H/S/L/ HB1/HB2 MA	100	LC1-D80	LRD3357	37/50
												NSX100B/F/N/H/S/L MA	100	LC1-D80	LRD3363	63/80
												NSX100B/F/N/H/S/L MA	100	LC1-D95	LRD3365	80/104
										55	57	NSX100B/F/N/H/S/L/ HB1/HB2 MA	100	LC1-D115	LRD3361	55/70
										75	77	NSX100B/F/N/H/S/L/ HB1/HB2 MA	100	LC1-D115	LR9-D53 67	60/100

[1] For long starting (class 20), see the correspondence table for thermal relay.

[2] For 480V applications, consult Schneider Electric.

[3] Reversers: replace LC1 with LC2.

Type 1 Coordination Table with Circuit-Breakers

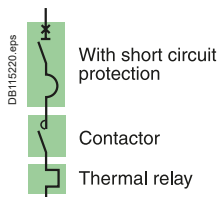

NSX160 to NS1250 circuit breaker, contactor and thermal relay

Direct-on-line starting

Reverser

"Iq" breaking performance: equal to the breaking capacity of the circuit breaker alone.

Starting^[1]: normal, class 10.

Motors												Circuit breakers		Contactors ^[3]		Thermal relays ^[1]	
220/230 V		380 V		415 V		440 V ^[2]		500-525 V		660-690 V		Type	cal (A)	Type	Type	I _{rt} (A)	
P (kW)	I (A)	P (kW)	I (A)	P (kW)	I (A)	P (kW)	I (A)	P (kW)	I (A)	P (kW)	I (A)						
37	125	55	105	75	135	75	124	75	110	90	100	NSX160B/F/N/H/S/L MA	150	LC1D-150	LR9-D53 69	90/150	
45	150	75	140					90	130			NSX250HB1/HB2 MA		LC1G150	LR9G225	27/225	
55	180	90	170	90	160	90	156	110	156	110	120	NSX 250B/F/N/H/S/L/HB1/HB2 MA	220	LC1G185	LR9G225	27/225	
		110	210	110	200	132	215					NSX 250B/F/N/H/S/L/HB1/HB2 MA	220	LC1G225	LR9G225	27/225	
								132	190	132	140	NSX 250B/F/N/H/S/L/HB1/HB2 MA	220	LC1G265	LR9G225	27/225	
75	250	132	250	132	230	160	256	160	228			NSX400F/N/H/S/L/HB1/HB2 MicroLogic 1.3M	320	LC1G265	LR9G500	125/500	
90	312	160	300	160	270			200	281	200	220	NSX400F/N/H/S/L/HB1/HB2 MicroLogic 1.3M	320	LC1G330	LR9G500	125/500	
110	360	200	380	220	380	220	360	220	310			NSX630F/N/H/S/L/HB1/HB2 MicroLogic 1.3M	500	LC1G400	LR9G500	125/500	
										250	270	NSX630F/N/H/S/L/HB1/HB2 MicroLogic 1.3M	500	LC1G400	LR9G500	125/500	
		220	420			250	401			335	335	NSX630F/N/H/S/L/HB1/HB2 MicroLogic 1.3M	500	LC1G500	LR9G500	125/500	
150	480	250	480	250	430			315	445			NSX630F/N/H/S/L/HB1/HB2 MicroLogic 1.3M	500	LC1G500	LR9G500	125/500	
						300	480			375	400	NSX630F/N/H/S/L/HB1/HB2 MicroLogic 1.3M	500	LC1G630	LR9G630	160/630	
160	520	300	570	300	510	335	540	355	500			NS800N/H MicroLogic 5.0 - LR off li ON	800	LC1G630	LR9G630	160/630	
								375	530			NS1000L MicroLogic 5.0 - LR off li ON	1000				
200	630	335	630	335	580	375	590	450	630			NS800N/H MicroLogic 5.0 - LR off li ON	800	LC1G630	LR9G630	160/630	
												NS1000L MicroLogic 5.0 - LR off li ON	1000				
220	700	375	700	375	650	400	650					NS800N/H MicroLogic 5.0 - LR off li ON	800	LC1G800	TC800/1 + LRD05		
												NS1000L MicroLogic 5.0 - LR off li ON	1000				
		400	750	400	690	450	720					NS800N/H MicroLogic 5.0 - LR off li ON	800	LC1G800	TC800/1 + LRD05		
												NS1000L MicroLogic 5.0 - LR off li ON	1000	LC1-BL33			
										500	530	NS800N/H MicroLogic 5.0 - LR off li ON	800	LC1-BL33	TC800/1 + LRD05		
										560	580	NS1000L MicroLogic 5.0 - LR off li ON	1000				
250	800	450	800	450	750			500	700			NS1000N/H MicroLogic 5.0 - LR off - li ON	1000	LC1-BM33	TC800/1 + LRD05		
								560	760			NS1000N/H MicroLogic 5.0 - LR off - li ON	1000	LC1-BM33	TC1000/1 + LRD05		
		500	900	500	830	500	800	600	830			NS1250N/H MicroLogic 5.0 - LR off - li ON	1250	LC1-BP33	TC1000/1 + LRD05		
300	970	560	1000	560	920	600	960	670	920			NS1250N/H MicroLogic 5.0 - LR off - li ON					
		600	1100	600	1000	670	1080	750	1020								

[1] For long starting (class 20), see the correspondence table for thermal relay.

[2] For 480V applications, consult Schneider Electric.

[3] Reversers: replace LC1 with LC2.

Type 1 Coordination Table with Circuit-Breakers

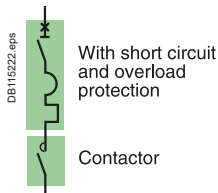

GV4P Circuit Breaker and contactor

Direct-on-line starting

Reverser

"Iq" breaking performance: equal to the breaking capacity of the circuit breaker alone.

Starting^[1]: Direct on line normal start Class 10A/10.



Motors												Circuit breakers		Contactors ^[3]		Thermal relay ^[1]	
220/230 V		380 V		415 V		440 V		500-525 V		660-690 V		Type	cal (A)	Type	Type	I _{rt} h (A)	
P (kW)	I (A)	P (kW)	I (A)	P (kW)	I (A)	P (kW)	I (A)	P (kW)	I (A)	P (kW)	I (A)						
0.37	1.8	0.37	1.2	0.37	1.1	0.37	1	0.55	1.2	0.75	1.2	GV4P, PE or PEM	2	LC1-D09		0.8/2	
		0.55	1.6	0.55	1.5	0.55	1.4	0.75	1.5	1	1.5	GV4P, PE or PEM	2	LC1-D09		0.8/2	
		0.75	2	0.75	1.8	0.75	1.7	1.1	2.4	1.1	2	1.5	2	GV4P, PE or PEM	2	LC1-D09	
0.55	2.8	1.1	2.8	1.1	2.6			1.5	2.6	2.2	2.8	GV4P, PE or PEM	3.5	LC1-D09		1.4/3.5	
		1.5	3.8	1.5	3.5	1.5	3.3			3	3.8	GV4P, PE or PEM	7	LC1-D09		2.9/7	
1.1	4.4	2.2	5.2	2.2	4.7	2.2	4.5	3	5	4	4.9	GV4P, PE or PEM	7	LC1-D09		2.9/7	
1.5	6.1	3	6.6	3	6.5	3	5.8	4	6.5	5.5	6.6	GV4P, PE or PEM	7	LC1-D09		2.9/7	
2.2	8.7	4	8.5	4	8.2	4	7.9	5.5	9	7.5	8.9	GV4P, PE or PEM	12.5	LC1-D25		5/12.5	
												GV4P, PE or PEM	12.5	LC1-D25		5/12.5	
3	11.5	5.5	11.5	5.5	11.1	5.5	10.5	7.5	12			GV4P, PE or PEM	12.5	LC1-D25		5/12.5	
4	14.5	7.5	16	7.5	15	7.5	14	9	14	10	15						
												9	17	9	16.9	10	15
												GV4P, PE or PEM	25	LC1-D25		10/25	
5.5	20	11	23	11	21	11	20	11	18.4			GV4P, PE or PEM	25	LC1-D25		10/25	
												GV4P, PE or PEM	25	LC1-D25		10/25	
7.5	28	15	30	15	28	15	26.5	18.5	28.5			GV4P, PE or PEM	50	LC1-D40A		20/50	
								22	33	30	34.6	GV4P, PE or PEM	50	LC1-D40A		20/50	
11	39	18.5	37	18.5	35	22	37			30	34.6	GV4P, PE or PEM	50	LC1-D40A		20/50	
		22	44	22	40			30	45	33	39	GV4P, PE or PEM	50	LC1-D50A		20/50	
15	52					30	50					GV4P, PE or PEM	50	LC1-D65A		20/50	
										37	42	GV4P, PE or PEM	50	LC1-D65A		20/50	
18.5	64	30	58	30	53	37	60	37	55			GV4P, PE or PEM	80	LC1-D65A		40/80	
				37	64							GV4P, PE or PEM	80	LC1-D65A		40/80	
										45	47	GV4P, PE or PEM	80	LC1-D80		40/80	
22	75	37	69	45	77	45	73	55	80			GV4P, PE or PEM	80	LC1-D80		40/80	
		45	80									GV4P, PE or PEM	115	LC1-D95		65/115	
										55	57	GV4P, PE or PEM	80	LC1-D115		40/80	
										75	77	GV4P, PE or PEM	80	LC1-D115		40/80	
30	95	55	97	55	93	55	90	75	106	90	93	GV4P, PE or PEM	115	LC1-D115		65/115	

[1] For long starting (class 20), see the correspondence table for thermal relay.

[2] For 480V applications, consult Schneider Electric.

[3] Reversers: replace LC1 with LC2.

Type 1 Coordination Table with Circuit-Breakers

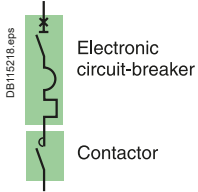

NSX100 to NS1250 circuit breakers

Direct-on-line starting

Reverser

"Iq" breaking performance: equal to the breaking capacity of the circuit breaker alone.

Starting	Standard IEC/EN 60947-4-1		
	2.2 M/2.3 M	6.2 M/6.3 M	5.0
Normal (class)	5, 10	5, 10	10
Long (class)	20	20, 30 ^[3]	20

B

Motors												Circuit breakers		Contactors ^[2]		
220/230 V		380 V		415 V		440 V ^[1]		500-525 V		660-690 V		Type	Trip unit	Irth (A)	Type	
P (kW)	I (A)	P (kW)	I (A)	P (kW)	I (A)	P (kW)	I (A)	P (kW)	I (A)	P (kW)	I (A)					
7.5	28	15	30	15	28	15	26.5	18.5	28.5			NSX100B/F/N/H/S/L	MicroLogic 2.2 or 6.2	25/50	LC1-D32	
11	39	18.5	37	22	40	22	39	22	33	30	34.6	NSX100B/F/N/H/S/L/HB1/HB2	MicroLogic 2.2 or 6.2	25/50	LC1-D40A	
		22	44	25	47			30	45	33	39	NSX100B/F/N/H/S/L/HB1/HB2	MicroLogic 2.2 or 6.2	25/50	LC1-D50A	
15	52	30	59	30	55	30	51.5					NSX100B/F/N/H/S/L	MicroLogic 2.2 or 6.2	48/80	LC1-D65A	
										37	42	NSX100HB1/HB2	MicroLogic 2.2 or 6.2	48/80	LC1-D80	
18.5	64					37	64	37	55			NSX100B/F/N/H/S/L	MicroLogic 2.2 or 6.2	48/80	LC1-D65A	
22	75	37	72	37	72	45	76	55	80	45	49	NSX100B/F/N/H/S/L/HB1/HB2	MicroLogic 2.2 or 6.2	48/80	LC1-D80	
25	85	45	85									NSX100B/F/N/H/S/L/HB1/HB2	MicroLogic 2.2 or 6.2	50/100	LC1-D95	
										55	60	NSX100B/F/N/H/S/L/HB1/HB2	MicroLogic 2.2 or 6.2	50/100	LC1-D80	
30	100			55	100	55	96			75	80	NSX100B/F/N/H/S/L/HB1/HB2	MicroLogic 2.2 or 6.2	50/100	LC1D115 or LC1G115	
37	125	55	105	75	135	75	124	75	110	90	100	NSX160B/F/N/H/S/L	MicroLogic 2.2 or 6.2	70/150	LC1D150 or LC1G150	
45	150	75	140					90	130			NSX250HB1/HB2				
		90	170	90	160	90	156	110	156	110	120	NSX 250B/F/N/H/S/L/HB1/HB2	MicroLogic 2.2 or 6.2	100/220	LC1G185	
		110	210	110	200	132	215					NSX 250B/F/N/H/S/L/HB1/HB2	MicroLogic 2.2 or 6.2	100/220	LC1G225	
								132	190	132	140	NSX 250B/F/N/H/S/L/HB1/HB2	MicroLogic 2.2 or 6.2	100/220	LC1G265	
										160	175					
75	250	132	250	132	230	160	256	160	228			NSX400F/N/H/S/L/HB1/HB2	MicroLogic 2.3 or 6.3	160/320	LC1G265	
90	312	160	300	160	270			200	281	200	220	NSX400F/N/H/S/L/HB1/HB2	MicroLogic 2.3 or 6.3	160/320	LC1G330	
								220	240	220	240					
110	360	200	380	220	380	220	360	220	310	250	270	NSX630F/N/H/S/L/HB1/HB2	MicroLogic 2.3 or 6.3	250/500	LC1G400	
		220	420			250	401	315	445	335	335	NSX630F/N/H/S/L/HB1/HB2	MicroLogic 2.3 or 6.3	250/500	LC1G500	
150	480	250	480	250	430			335	460			NSX630F/N/H/S/L/HB1/HB2	MicroLogic 2.3 or 6.3	250/500	LC1G500	
						300	480	355	500	375	530	450	480	NSX630F/N/H/S/L/HB1/HB2	MicroLogic 2.3 or 6.3	250/500
160	520	300	570	300	510	335	540	400	570			NS800N/H NS1000L	MicroLogic 5.0 li ON	320/800 400/1000	LC1G630	
200	630	335	630	335	580	375	590	450	630			NS800N/H NS1000L	MicroLogic 5.0 li ON	320/800 400/1000	LC1G630	
220	700	375	700	375	650	400	650					NS800N/H NS1000L	MicroLogic 5.0 li ON	320/800 400/1000	LC1G800	
										400	750	400	690	450	720	
										500	530	NS800N/H NS1000L	MicroLogic 5.0 li ON	320/800 400/1000	LC1-BL33	
										560	580					
250	800	450	800	450	750			500	700			NS1000N/H	MicroLogic 5.0 li ON	400/1000	LC1-BM33	
								560	760							
		500	900	500	830	500	800	600	830			NS1000N/H	MicroLogic 5.0 li ON	400/1000	LC1-BM33	
						560	900									
300	970	560	1000	560	920	600	960	670	920			NS1250N/H	MicroLogic 5.0 li ON	630/1250	LC1-BP33	
		600	1100	600	1000	670	1080	750	1020			NS1250N/H	MicroLogic 5.0 li ON	630/1250	LC1-BP33	

[1] For 480V applications, consult Schneider Electric.

[2] Reversers: replace LC1 with LC2.

[3] For class 30 the contacteur rating shall be checked according to 30s thermal withstand (F range).

Type 1 Coordination Table with Circuit-Breakers

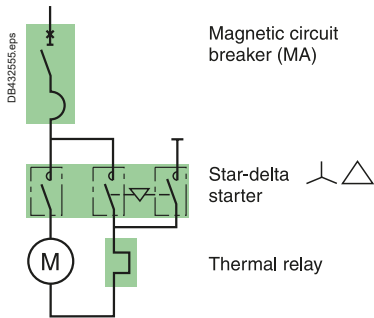

GV4L/LE and NSX100 circuit breaker

Star-delta starting

"Iq" breaking performance: equal to the breaking capacity of the circuit breaker alone.

Starting: normal.



Motors								Circuit breakers		Contactors		Thermal relays	
220/230 V		380 V		415 V		440 V ^[1]		Type	cal (A)	Type	Type	I _{rt} h (A)	
P (kW)	I (A)	P (kW)	I (A)	P (kW)	I (A)	P (kW)	I (A)						
0.55	2.8	1.1	2.8	1.1	2.6	1.5	3.1	GV4L or LE	3.5	LC3-D09	LRD 07	1.6/2.5	
		1.5	3.8	1.5	3.5			GV4L or LE	7	LC3-D09	LRD 07	1.6/2.5	
1.1	4.4	2.2	5.2	2.2	4.7	2.2	4.5	GV4L or LE	7	LC3-D09	LRD 08	2.5/4	
1.5	6.1	3	6.6	3	6.5	3	5.8	GV4L or LE	12.5	LC3-D09	LRD 08	2.5/4	
2.2	8.7	4	8.5	4	8.2	4	7.9	GV4L or LE	12.5	LC3-D09	LRD 10	4/6	
3	11.5	5.5	11.5	5.5	11.1	5.5	10.4	GV4L or LE	12.5	LC3-D09	LRD 12	5.5/8	
4	14.5	7.5	16	7.5	15	7.5	13.7	GV4L or LE	25.0	LC3-D09	LRD 14	7/10	
5.5	20			9	17	9	16.9	GV4L or LE	25.0	LC3-D12	LRD 16	9/13	
		11	23	11	21	11	20	GV4L or LE	25.0	LC3-D12	LRD 16	9/13	
7.5	28	15	30	15	28	15	26.5	GV4L or LE	50.0	LC3-D18	LRD 21	12/18	
11	39	18.5	37	22	40	22	37	GV4L or LE	50.0	LC3-D18	LRD 22	17/25	
		22	44	25	47			GV4L or LE	50.0	LC3-D32	LRD 32	23/32	
15	52					30	50	GV4L or LE	80.0	LC3-D32	LRD 32	23/32	
				30	53			GV4L or LE	80.0	LC3-D32	LRD 32	23/32	
18.5	64	30	58	37	64	37	60	GV4L or LE	80.0	3xLC1-D40A	LRD 340	30/40	
		37	69					GV4L or LE	80.0	3xLC1-D40A	LRD 350	37/50	
22	75	45	80	45	77	45	73	GV4L or LE	80.0	2xLC1-D50A + 1 xLC1D40A	LRD 350	37/50	
30	95	45	80	55	93	55	90	GV4L or LE	80.0	2xLC1-D65A + 1 xLC1D40A	LRD 365	48/65	
30	95	55	97	55	93	55	90	GV4L or LE	115	2xLC1-D65A + 1 xLC1D40A	LRD 365	48/65	
0.55	2.8	1.5	3.8	1.5	3.5	1.5	3.1	NSX100B/F/N/H/S/L MA	6.3	LC3-D09	LRD 07	1.6/2.5	
1.1	4.4	2.2	5.2	2.2	4.7	2.2	4.5	NSX100B/F/N/H/S/L MA	6.3	LC3-D09	LRD 08	2.5/4	
1.5	6.1	3	6.6	3	6.5	3	5.8	NSX100B/F/N/H/S/L MA	12.5	LC3-D09	LRD 08	2.5/4	
2.2	8.7	4	8.5	4	8.2	4	7.9	NSX100B/F/N/H/S/L MA	12.5	LC3-D09	LRD 10	4/6	
3	11.5	5.5	11.5	5.5	11.1	5.5	10.4	NSX100B/F/N/H/S/L MA	12.5	LC3-D09	LRD 12	5.5/8	
4	14.5	7.5	16	7.5	15	7.5	13.7	NSX100B/F/N/H/S/L MA	25	LC3-D09	LRD 14	7/10	
5.5	20			9	17	9	16.9	NSX100B/F/N/H/S/L MA	25	LC3-D12	LRD 16	9/13	
		11	23	11	21	11	20	NSX100B/F/N/H/S/L MA	25	LC3-D12	LRD 16	9/13	
7.5	28	15	30	15	28	15	26.5	NSX100B/F/N/H/S/L MA	50	LC3-D18	LRD 21	12/18	
11	39	18.5	37	22	40	22	37	NSX100B/F/N/H/S/L MA	50	LC3-D18	LRD 22	17/25	
		22	44	25	47			NSX100B/F/N/H/S/L MA	100	LC3-D32	LRD 32	23/32	
15	52					30	50	NSX100B/F/N/H/S/L MA	100	LC3-D32	LRD 32	23/32	
				30	53			NSX100B/F/N/H/S/L MA	100	LC3-D32	LRD 32	23/32	
18.5	64	30	58	37	64	37	60	NSX100B/F/N/H/S/L MA	100	3xLC1-D40A	LRD 340	30/40	
		37	69					NSX100B/F/N/H/S/L MA	100	3xLC1-D40A	LRD 350	37/50	
22	75	45	80	45	77	45	73	NSX100B/F/N/H/S/L MA	100	2xLC1-D50A + 1 xLC1D40A	LRD 350	37/50	
30	100			55	100	55	96	NSX100B/F/N/H/S/L MA	100	2xLC1-D65A + 1 xLC1D40A	LRD 365	48/65	

[1] For 480V applications, consult Schneider Electric.

Type 1 Coordination Table with Circuit-Breakers

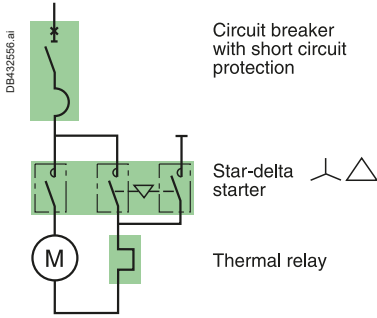

NSX160 to NS1000 circuit breakers

Star-delta starting

"Iq" breaking performance: equal to the breaking capacity of the circuit breaker alone.

Starting: normal.

Motors								Circuit breakers		Contactors		Thermal relays	
220/230 V		380 V		415 V		440 V ^[1]		Type	cal (A)	Type	Type	Irth (A)	
P (kW)	I (A)	P (kW)	I (A)	P (kW)	I (A)	P (kW)	I (A)						
37	125	55	105	75	135	75	124	NSX160B/F/N/H/S/L MA	150	LC3-D80	LRD 3359	48/65	
45	150	75	140					NSX160B/F/N/H/S/L MA	150	LC3-D80	LRD 3363	63/80	
		90	170	90	160	90	156	NSX160B/F/N/H/S/L MA	150	LC3D115	LR9D 5367	60/100	
								NSX250B/F/N/H/S/L MA	220	2xLC1G115+LC1D65A	LR9G115	28/115	
55	180					110	180	NSX250B/F/N/H/S/L MA	220	LC3D115	LR9D 5367	60/100	
		110	210	110	200			NSX250B/F/N/H/S/L MA	220	2xLC1G115+LC1D65A	LR9G115	28/115	
						132	215	NSX250B/F/N/H/S/L MA	220	LC3D115	LR9D 5369	90/150	
								NSX250B/F/N/H/S/L MA	220	2xLC1G150+LC1D80	LR9G225	57/225	
75	250	132	250	132	230			NSX400F/N/H/S/L MicroLogic 1.3M	320	LC3D150	LR9D 5369	90/150	
								NSX400F/N/H/S/L MicroLogic 1.3M	320	2xLC1G150+LC1D80	LR9G225	57/225	
90	312	160	300	160	270	160	256	NSX400F/N/H/S/L MicroLogic 1.3M	320	2xLC1G185+LC1G115	LR9G225	57/225	
110	360	200	380	220	380	220	360	NSX630F/N/H/S/L MicroLogic 1.3M	500	2xLC1G225+LC1G150	LR9G225	57/225	
		220	420			250	401	NSX630F/N/H/S/L MicroLogic 1.3M	500	2xLC1G265+LC1G150	LR9G500	125/500	
150	480	250	480	250	430			NSX630F/N/H/S/L MicroLogic 1.3M	500	2xLC1G265+LC1G150	LR9G500	125/500	
						300	480	NSX630F/N/H/S/L MicroLogic 1.3M	500	2xLC1G330+LC1G185	LR9G500	125/500	
160	520	300	570	300	510	335	540	NS800N/H MicroLogic 5.0 - LR off li ON	800	2xLC1G330+LC1G185	LR9G500	125/500	
								NS1000L MicroLogic 5.0 - LR off li ON	1000				
				335	580	375	590	NS800N/H MicroLogic 5.0 - LR off li ON	800	2xLC1G400+LC1G225	LR9G500	125/500	
								NS1000L MicroLogic 5.0 - LR off li ON	1000				

[1] For 480V applications, consult Schneider Electric.

Type 1 Coordination Table with Circuit-Breakers

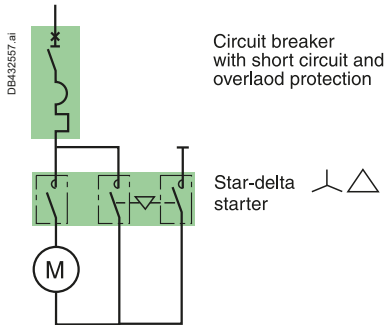

GV4P/PE/PEM, NSX100 to NS1000 circuit breakers, contactors

Star-delta starting

"Iq" breaking performance: equal to the breaking capacity of the circuit breaker alone.
Starting: normal.



Motors								Circuit breakers			Contactors
220/230 V		380 V		415 V		440 V ^[1]		Type	Trip unit	Irth (A)	Type
P (kW)	I (A)	P (kW)	I (A)	P (kW)	I (A)	P (kW)	I (A)				
0.37	1.8	0.37	1.2	0.37	1.1	0.37	1	GV4P, PE or PEM	2	0.8/2	LC3-D09
		0.55	1.6	0.55	1.5	0.55	1.4	GV4P, PE or PEM	2	0.8/2	LC3-D09
0.55	2.8	0.75	2	0.75	1.8	0.75	1.7	GV4P, PE or PEM	2	0.8/2	LC3-D09
		1.1	2.8	1.1	2.6	1.1	2.4	GV4P, PE or PEM	3.5	1.4/3.5	LC3-D09
1.1	4.4	1.5	3.8	1.5	3.5	1.5	3.3	GV4P, PE or PEM	3.5	1.4/3.5	LC3-D09
		2.2	5.2	2.2	4.7	2.2	4.5	GV4P, PE or PEM	7	2.9/7	LC3-D09
1.5	6.1	3	6.6	3	6.5	3	5.8	GV4P, PE or PEM	7	2.9/7	LC3-D09
		4	8.5	4	8.2	4	7.9	GV4P, PE or PEM	7	2.9/7	LC3-D09
2.2	8.7	4	8.5	4	8.2	4	7.9	GV4P, PE or PEM	12.5	5/12.5	LC3-D09
		5.5	11.5	5.5	11.1	5.5	10.5	GV4P, PE or PEM	12.5	5/12.5	LC3-D09
3	11.5	7.5	16	7.5	15	7.5	14	GV4P, PE or PEM	25	10/25	LC3-D12
		9	17	9	16.9	9	16.9	GV4P, PE or PEM	25	10/25	LC3-D12
5.5	20	11	23	11	21	11	20	GV4P, PE or PEM	25	10/25	LC3-D18
		15	30	15	28	15	26.5	GV4P, PE or PEM	50	20/50	LC3-D18
7.5	28	15	30	15	28	15	26.5	GV4P, PE or PEM	50	20/50	LC3-D18
		18.5	37	18.5	35	22	37	GV4P, PE or PEM	50	20/50	LC3-D18
11	39	18.5	37	18.5	35	22	37	GV4P, PE or PEM	50	20/50	LC3-D18
		22	44	22	40	22	40	GV4P, PE or PEM	50	20/50	LC3-D18
15	52	30	53	30	50	30	50	GV4P, PE or PEM	50	20/50	LC3-D32
		37	64	37	64	37	60	GV4P, PE or PEM	80	40/80	3xLC1-D40A
18.5	64	30	58	37	64	37	60	GV4P, PE or PEM	80	40/80	3xLC1-D40A
		37	69	45	77	45	73	GV4P, PE or PEM	80	40/80	3xLC1-D40A
22	75	45	80					GV4P, PE or PEM	115	65/115	2xLC1-D50A + 1xLC1D40A
		55	97	55	93	55	90	GV4P, PE or PEM	115	65/115	2xLC1-D50A + 1xLC1D40A
7.5	28	15	30	15	28	15	26.5	NSX100B/F/N/H/S/L	MicroLogic 2.2M or 6.2E-M	25/50	LC3-D18
		11	39	18.5	37	22	40	22	39	NSX100B/F/N/H/S/L	MicroLogic 2.2M or 6.2E-M
15	52	22	44	25	47			NSX100B/F/N/H/S/L	MicroLogic 2.2M or 6.2E-M	25/50	LC3-D18
		30	55	30	51.5			NSX100B/F/N/H/S/L	MicroLogic 2.2M or 6.2E-M	50/100	LC3-D32
18.5	64	30	59	30	55			NSX100B/F/N/H/S/L	MicroLogic 2.2M or 6.2E-M	50/100	LC3-D32
		37	72	37	66	37	64	NSX100B/F/N/H/S/L	MicroLogic 2.2M or 6.2E-M	50/100	3xLC1-D40A
22	75			45	80	45	76	NSX100B/F/N/H/S/L	MicroLogic 2.2M or 6.2E-M	50/100	2xLC1-D50A + 1xLC1D40A
								NSX100B/F/N/H/S/L	MicroLogic 2.2M or 6.2E-M	50/100	2xLC1-D50A + 1xLC1D40A
30	100			55	100	55	96	NSX100B/F/N/H/S/L	MicroLogic 2.2M or 6.2E-M	50/100	2xLC1-D50A + 1xLC1D40A
								NSX100B/F/N/H/S/L	MicroLogic 2.2M or 6.2E-M	50/100	2xLC1-D65A + 1xLC1D40A
37	125	55	105					NSX160B/F/N/H/S/L	MicroLogic 2.2M or 6.2E-M	70/150	LC3-D80
		75	140	75	135	75	124	NSX160B/F/N/H/S/L	MicroLogic 2.2M or 6.2E-M	70/150	LC3-D80
45	150	75	140					NSX160B/F/N/H/S/L	MicroLogic 2.2M or 6.2E-M	70/150	LC3-D80
		90	170	90	160	90	156	NSX 250B/F/N/H/S/L	MicroLogic 2.2M or 6.2E-M	100/220	LC3-D115 or 2xLC1G115+D65A
55	180	110	210	110	200	110	180	NSX 250B/F/N/H/S/L	MicroLogic 2.2M or 6.2E-M	100/220	LC3-D115 or 2xLC1G115+D65A
		132	250	132	230			NSX400F/N/H/S/L	MicroLogic 2.3M or 6.3E-M	160/320	LC3-D150 or 2xLC1G150+D80
75	250					160	256	NSX400F/N/H/S/L	MicroLogic 2.3M or 6.3E-M	160/320	2xLC1G185+LC1D95
								NSX400F/N/H/S/L	MicroLogic 2.3M or 6.3E-M	160/320	2xLC1G185+LC1G115
90	312	160	300	160	270			NSX400F/N/H/S/L	MicroLogic 2.3M or 6.3E-M	160/320	2xLC1G225+LC1G115
						200	320	NSX400F/N/H/S/L	MicroLogic 2.3M or 6.3E-M	160/320	2xLC1G225+LC1G115
110	360					220	340	NSX630F/N/H/S/L	MicroLogic 2.3M or 6.3E-M	250/500	2xLC1G225+LC1G150
								NSX630F/N/H/S/L	MicroLogic 2.3M or 6.3E-M	250/500	2xLC1G265+LC1G150
150	480	200	380	220	380	250	401	NSX630F/N/H/S/L	MicroLogic 2.3M or 6.3E-M	250/500	2xLC1G265+LC1G150
		250	480	250	430			NSX630F/N/H/S/L	MicroLogic 2.3M or 6.3E-M	250/500	2xLC1G265+LC1G150
160	520					300	480	NSX630F/N/H/S/L	MicroLogic 2.3M or 6.3E-M	250/500	2xLC1G330+LC1G185
		300	570	300	510	335	540	NS800N/H	MicroLogic 5.0	320/800	2xLC1G330+LC1G185
				335	580	375	590	NS1000L		400/1000	
								NS800N/H	MicroLogic 5.0	320/800	2xLC1G400+LC1G225
								NS1000L		400/1000	

[1] For 480V applications, consult Schneider Electric.

Type 1 Coordination Table with Circuit-Breakers for AC1 Utilisation Category: Non-Inductive or Slightly Inductive Loads

$U_e \leq 440 \text{ V AC}$

"Iq" performance: equal to the breaking capacity of the circuit breaker alone.

Ie max ^[1] 40°	Circuit breakers Type	Iq 440V (kA)				Contactor
		According to circuit breaker breaking capacity	Trip unit	Rating (A)	Ir (A)	
40	ComPacT NSX100 B/F/N	25/35/50	MicroLogic 2.2/5.2	40	18..40	LC1D40A
80	ComPacT NSX100 B/F/N	25/35/50	MicroLogic 2.2/5.2	100	40..100	LC1D50A or 65A
100	ComPacT NSX100 B/F/N	25/35/50	MicroLogic 2.2/5.2	100	40..100	LC1D80
160	ComPacT NSX160 B/F/N	25/35/50	MicroLogic 2.2/5.2	160	63..160	LC1D80 LC1D115
250	ComPacT NSX250 B/F/N	35/50	MicroLogic 2.3/5.3	250	100..250	LC1D115
275	ComPacT NSX400 F/N	35/50	MicroLogic 2.3/5.3	400	160..400	LC1G150
315	ComPacT NSX400 F/N	35/50	MicroLogic 2.3/5.3	400	160..400	LC1G185
350	ComPacT NSX400 F/N	35/50	MicroLogic 2.3/5.3	400	160..400	LC1G225
400	ComPacT NSX400 F/N	35/50	MicroLogic 2.3/5.3	400	160..400	LC1G265
500	ComPacT NSX630 F/N	35/50	MicroLogic 2.3/5.3	630	150..630	LC1G330
630	ComPacT NSX630 F/N	35/50	MicroLogic 2.3/5.3	630	150..630	LC1G400
800	ComPacT NS800L	130	MicroLogic 2.0/5.0/6.0/7.0	800	320..800	LC1G500
1000	ComPacT NS1000L	130	MicroLogic 2.0/5.0/6.0/7.0	1000	400..1000	LC1G630 LC1F1250
1250	MasterPact MTZ1 12 H1/H2/H3	42/50/50	MicroLogic 5/6/7.0X li "fast"	1250	500..1250	LC1F1400
1400	MasterPact MTZ1 16 H1/H2/H3	42/50/50	MicroLogic 5/6/7.0X li "fast"	1600	630..1600	LC1F1400
1600	MasterPact MTZ1 16 H1/H2/H3 MasterPact MTZ2 16 N1/H1/H2	42/50/50	MicroLogic 5/6/7.0X li "fast"	1600	630..1600	LC1F1700
1700	MasterPact MTZ2 20 N1/H1/H2	42/50/50	MicroLogic 5/6/7.0X li "fast"	2000	800..2000	LC1F1700
2000	MasterPact MTZ2 20 N1/H1/H2	42/50/50	MicroLogic 5/6/7.0X li "fast"	2000	800..2000	LC1F1700
2100	MasterPact MTZ2 25 N1/H1/H2	42/50/50	MicroLogic 5/6/7.0X li "fast"	2500	1000..2500	LC1F2100

[1] Values for Fix circuit breaker with IEC/EN 60947-1 Tables 9 & 10 cross section of conductors. Check derating of circuit breaker and contactor according to ambient temperature and installation.

Protection of Motor Circuits with Fuses

Introduction

Fuse size table

The table below indicates the minimum and maximum fuse sizes depending on the rating of the switch and the applicable reference standard.

	BS			DIN NH	
	min.	max.		min.	max.
GSB32	A1	A1	GSD63	000	000
GSB63	A2	A3	GSD125	00	00
GSB100	A4	A4	GSD160	00	00
GSB160	A4	A4	GSD250	1	1
GSB200	B1	B2	GSD400	2	2
GSB250	B1	B3	GSD630	3	3
GSB400	B1	B4	GSD800	3	3
GSB630	C2	C2	GSD1250	4	4
GSB800	C3	C3			
GSB1250	D1	D1			
	NFC				
GSC32	10x38		ISFT100N	000	000
GSC50	14x51		ISFT100	000	000
GSC125	22X58		ISF.160	000	00
			ISF.250	1	1
			ISF.400	2	2
			ISF.630	3	3

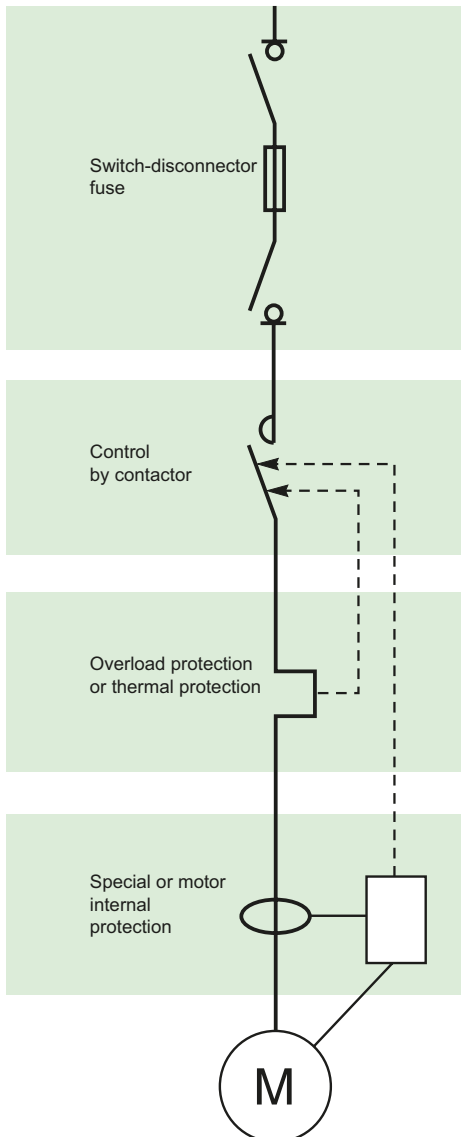

Protection of motor feeders

A motor feeder is generally made up of:

- A control contactor
- A thermal relay for overcurrent protection
- A short-circuit protection device
- A disconnection device capable of interrupting load currents.

FuPact switch-disconnector fuses are ideally suited to perform the last two functions in the list. What is more, FuPact devices are totally compatible with the IEC/EN 60204 machine directive.

Additional specific protection:

- Fault limiting protection (while the motor is running)
- Fault prevention (monitoring of motor insulation with motor off).

FuPact characteristics

The local emergency-off switch must have the AC23 characteristic for the rated motor current.

Motor starting characteristics are the following:

- Peak current: 8 to 10 I_n
- Duration of peak current: 20 to 30 ms
- Starting current I_d: 4 to 8 I_n
- Starting time t_d: 2 to 4 seconds.

Short-circuit protection of motors is done by aM or gM^[1] fuse-links that are sized to take into account the above characteristics.

FuPact offers a wide range of fuse utilisations, whatever the applicable reference standard.

[1] A gM fuse-link is in fact simply a derated gG fuse-link.

Coordination of devices on the motor feeder

Thermal protection of:

- Motor
- Conductors
- Switch
- Fuse

is done by the thermal relay on the contactor.

Overload (or short-circuit) protection of:

- Motor
- Conductors
- Switch
- Thermal relay

is done by the fuse.

To obtain a high level of operational quality, it is important to check **coordination of the devices** on the motor feeder in compliance with standard IEC/EN 60947-4.

NOTE : Proposed fuses are based on 4 poles winding 50 Hz induction motors direct on line start with starting current I_d/I_n ≤ 7 and starting time t_d ≤ 10 sec.

The choice of fuses and overload relay shall be checked according to the actual motor's characteristics, particularly for high efficiency motors that may have higher starting current.

Protection of Motor Circuits

with NFC Fuses

Selection tables for FuPact devices and associated NFC fuse-links

Example:

A 30 kW motor supplied at 690 V is protected by:

- 80 A gG fuse-links
- 32 A aM fuse-links.

Both types of fuse-links may be mounted on a FuPact INFC63^[1] or higher.

See the grey section in the table on following page.

B

380 - 400 V AC						
P(kW)	(HP)	In (A)	FuPact	gG	FuPact	aM
0,37	0,49	1,1	GSC32	4	GSC32	2
0,55	0,73	1,6	GSC32	6	GSC32	2
0,75	1,0	2,2	GSC32	10	GSC32	4
1,1	1,5	2,7	GSC32	10	GSC32	4
1,5	2,0	3,8	GSC32	16	GSC32	4
2,2	2,9	5,5	GSC32	16	GSC32	6
3,0	4,0	7,1	GSC32	20	GSC32	8
4,0	5,3	9,2	GSC32	25	GSC32	10
5,5	7,3	12,0	GSC32	32	GSC32	12
7,5	10	16	GSC50	40	GSC32	16
11	15	23	GSC50	50	GSC32	25
15	20	31	GSC125	80	GSC32	32
19	25	38	GSC125	80	GSC50	40
22	29	45	GSC125	100	GSC50	50
30	40	60	GSC125	125	GSC125	63
37	49	75	NA	160	GSC125	80
45	60	87	NA	200	GSC125	100
55	73	107	NA	200	GSC125	125

415 V AC						
P(kW)	(HP)	In (A)	FuPact	gG	FuPact	aM
0,37	0,49	1,1	GSC32	4	GSC32	2
0,55	0,73	1,5	GSC32	6	GSC32	2
0,75	1,0	2,0	GSC32	6	GSC32	2
1,1	1,5	2,5	GSC32	10	GSC32	4
1,5	2,0	3,5	GSC32	16	GSC32	4
2,2	2,9	5,0	GSC32	16	GSC32	6
3,0	4,0	6,5	GSC32	20	GSC32	8
4,0	5,3	8,4	GSC32	25	GSC32	10
5,5	7,3	11,0	GSC32	32	GSC32	12
7,5	10	14	GSC50	40	GSC32	16
11	15	21	GSC50	50	GSC32	25
15	20	28	GSC125	63	GSC32	32
19	25	35	GSC125	80	GSC50	40
22	29	41	GSC125	80	GSC50	50
30	40	55	GSC125	100	GSC125	63
37	49	69	NA	160	GSC125	80
45	60	80	NA	160	GSC125	80
55	73	98	NA	200	GSC125	100

660 - 690 V AC						
P(kW)	(HP)	In (A)	FuPact	gG	FuPact	aM
0,37	0,49	0,7	GSC50	2	GSC50	2
0,55	0,73	0,9	GSC50	4	GSC50	2
0,75	1,0	1,1	GSC50	4	GSC50	2
1,1	1,5	1,6	GSC50	6	GSC50	2
1,5	2,0	2,2	GSC50	6	GSC50	4
2,2	2,9	2,8	GSC50	10	GSC50	4
3,0	4,0	3,8	GSC50	10	GSC50	6
4,0	5,3	4,9	GSC50	16	GSC50	6
5,5	7,3	6,7	GSC50	20	GSC50	8
7,5	10	9	GSC50	25	GSC50	10
11	15	13	GSC125	32	GSC50	16
15	20	17	GSC125	40	GSC50	20
19	25	22	GSC125	50	GSC50	25
22	29	24	GSC125	50	GSC50	25
30	40	32	GSC125	80	GSC125	32
37	49	39	GSC125	80	GSC125	40
45	60	47	NA	100	GSC125	50
55	73	57	NA	125	GSC125	63
75	100	77	NA	160	GSC125	80
90	120	93	NA	200	NA	100
110	147	113	NA	250	NA	125

[1] FuPact is designed to allow overrated protection.

Protection of Motor Circuits

with DIN Fuses

Selection tables for FuPact devices and associated DIN fuse-links

Example:

A 37 kW motor supplied at 400 V is protected by:

■ 160 A gG fuse-links

■ 80 A aM fuse-links.

Both types of fuse-links may be mounted on a FuPact GSD125 or higher.

See the grey section in the table below.

380 - 400 V AC							415 V AC						
P(kW)	(HP)	In (A)	FuPact	gG	FuPact	aM	P(kW)	(HP)	In (A)	FuPact	gG	FuPact	aM
0,37	0,49	1,1	GSD63	4	GSD63	2	0,37	0,49	1,1	GSD63	4	GSD63	2
0,55	0,73	1,6	GSD63	6	GSD63	2	0,55	0,73	1,5	GSD63	6	GSD63	2
0,75	1,0	2,2	GSD63	10	GSD63	4	0,75	1,0	2,0	GSD63	6	GSD63	2
1,1	1,5	2,7	GSD63	10	GSD63	4	1,1	1,5	2,5	GSD63	10	GSD63	4
1,5	2,0	3,8	GSD63	16	GSD63	4	1,5	2,0	3,5	GSD63	16	GSD63	4
2,2	2,9	5,5	GSD63	16	GSD63	6	2,2	2,9	5,0	GSD63	16	GSD63	6
3,0	4,0	7,1	GSD63	20	GSD63	8	3,0	4,0	6,5	GSD63	20	GSD63	8
4,0	5,3	9,2	GSD63	25	GSD63	10	4,0	5,3	8,4	GSD63	25	GSD63	10
5,5	7,3	12,0	GSD63	32	GSD63	16	5,5	7,3	11,0	GSD63	32	GSD63	16
7,5	10	16	GSD63	40	GSD63	16	7,5	10	14	GSD63	40	GSD63	16
11	15	23	GSD63	50	GSD63	25	11	15	21	GSD63	50	GSD63	25
15	20	31	GSD63	80	GSD63	32	15	20	28	GSD63	63	GSD63	32
19	25	38	GSD63	80	GSD63	40	19	25	35	GSD63	80	GSD63	40
22	29	45	GSD125	100	GSD63	50	22	29	41	GSD63	80	GSD63	50
30	40	60	GSD125	125	GSD63	63	30	40	55	GSD125	100	GSD63	63
37	49	75	GSD125	160	GSD125	80	37	49	69	GSD125	160	GSD125	80
45	60	87	GSD250	200	GSD125	100	45	60	80	GSD125	160	GSD125	80
55	73	107	GSD250	200	GSD125	125	55	73	98	GSD250	200	GSD125	100
75	100	149	GSD250	250	GSD160	160	75	100	136	GSD250	250	GSD160	160
90	120	179	GSD400	355	GSD250	200	90	120	164	GSD400	315	GSD250	200
110	147	214	GSD400	400	GSD250	250	110	147	196	GSD400	355	GSD250	200
132	176	247	GSD630	450	GSD250	250	132	176	226	GSD400	400	GSD250	250
150	200	293	GSD630	500	GSD400	315	150	200	268	GSD630	450	GSD400	315
160	213	300	GSD630	630	GSD400	315	160	213	275	GSD630	500	GSD400	315
200	267	391	GSD630	800	GSD630	400	200	267	358	GSD630	630	GSD400	400

660 - 690 V AC						
PkW	HP	In (A)	FuPact	gG	FuPact	aM
0,37	0,49	0,7	GSD63	2	GSD63	2
0,55	0,73	0,9	GSD63	4	GSD63	2
0,75	1,0	1,1	GSD63	4	GSD63	2
1,1	1,5	1,6	GSD63	6	GSD63	2
1,5	2,0	2,2	GSD63	6	GSD63	4
2,2	2,9	2,8	GSD63	10	GSD63	4
3,0	4,0	3,8	GSD63	10	GSD63	6
4,0	5,3	4,9	GSD63	16	GSD63	6
5,5	7,3	6,7	GSD63	20	GSD63	8
7,5	10	9	GSD63	25	GSD63	10
11	15	13	GSD63	32	GSD63	16
15	20	17	GSD63	40	GSD63	20
18.5	25	22	GSD63	50	GSD63	25
22	29	24	GSD63	50	GSD63	25
30	40	32	GSD125	80	GSD63	32
37	49	39	GSD125	80	GSD63	40
45	60	47	GSD125	100	GSD63	50
55	73	57	GSD125	125	GSD63	63
75	100	77	GSD250	160	GSD125	80
90	120	93	GSD250	200	GSD125	100
110	147	113	GSD400	250	GSD125	125
132	176	134	GSD400	250	GSD250	160
150	200	152	GSD400	315	GSD250	160
160	213	162	GSD400	315	GSD250	160
200	267	203	GSD630	400	GSD250	200



Selectivity, Cascading and Coordination Guide

Type 2 Coordination Table with Fuses

Ue: 380-415 V AC

Schneider Electric switch-disconnector fuses and contactors

Performance: Ue = 380-415 V - "Iq" 50 kA (IEC/EN 60947-4-1)

Starting Class 10 A/10

B

Motors P (kW)	I (A) 380 V	I (A) 415 V	Ie Max (A)	Switch-fuse ^[1]	Fuse-link type		Contactors ^[2]	Thermal relays	
				Type	gG rating (A)	aM rating (A)	Type	Type	I _{rt} h (A)
0.37	1.2	1.1	1.6	GSC32/GSD63	4	2	LC1D09	LRD 06	1/1.6
0.55	1.6	1.5	1.6	GSC32/GSD63	6	2	LC1D09	LRD 06	1/1.6
0.75	2	1.8	2.5	GSC32/GSD63	10	4	LC1D09	LRD 07	1.6/2.5
1.1	2.8	2.6	2.5	GSC32/GSD63	10	4	LC1D09	LRD 07	1.6/2.5
1.5	3.7	3.4	4	GSC32/GSD63	16	4	LC1D09	LRD 08	2.5/4
2.2	5.3	4.8	6	GSC32/GSD63	16	6	LC1D09	LRD 10	4/6
3	7	6.5	8	GSC32/GSD63	20	8	LC1D09	LRD 12	5.5/8
4	9	8.2	10	GSC32/GSD63	25	10	LC1D12	LRD 14	7/10
5.5	12	11	12	GSC32/GSD63	32	16	LC1D12	LRD 16	9/13
7.5	16	14	16	GSC32/GSD63	-	16	LC1D18	LRD 21	12/18
10	21	19	24	GSC50/GSD63	40	-			
				GSC32/GSD63	-	25	LC1D25	LRD 22	16/24
11	23	21	24	GSC50/GSD63	50	-			
				GSC32/GSD63	-	25	LC1D25	LRD 22	16/24
15	30	28	32	GSC50/GSD63	50	-			
				GSC32/GSD63	-	32	LC1D32	LRD 32	23/32
18.5	37	34	40	GSC125/GSD63	63	-			
				GSC50/GSD63	-	40	LC1D40A	LRD 340	30/40
22	43	40	50	GSC125/GSD63	80	-			
				GSD50/GSD63	-	50	LC1D50A	LRD 350	37/50
30	59	55	63	GSC125/GSD63	100	-			
				GSD125/GSD63	-	63	LC1D65A	LRD 365	48/65
37	72	66	80	GSD125	125	-			
				GSD125	160	-	LC1D80	LRD 3363	63/80
45	85	80	100	GSC125/GSD125	-	80			
				GSD125	-	100	LC1D115	LR9 D53 67	60/100
55	105	100	115	GSD250	200	-			
				GSC125/GSD125	-	125	LC1D115	LR9 D53 69	90/150
75	140	135	150	GSD250	200	-			
				GSD160	-	160	LC1D150	LR9 D53 69	90/150
90	170	160	185	GSD250	250	-			
				GSD250	-	200	LC1G185	LC1 G225	27/225
110	210	200	220	GSD400	355	-			
				GSD250	-	250	LC1G225	LR9 G225	27/225
132	250	230	250	GSD400	400	-			
				GSD250	-	315	LC1G330	LR9 G500	125/500
160	300	270	265	GSD630	450	-			
				LC1G400	-	-	LC1G400	LR9 G500	125/500
200	380	361	400	GSD400	-	315/400			
				LC1G400	-	-	LC1G400	LR9 G500	125/500
250	460	430	500	GSD630	630	-			
				GSD630	800	-	LC1G500	LR9 G500	125/500
280	520	475	630	GSD630	800	500	LC1G500	LR9 G500	125/500
300	565	500	630	GSD630	800	630	LC1G630	LR9 G630	160/630
335	610	560	630	GSD630	-	630	LC1G630	LR9 G630	160/630
355	630	590	630	GSD630	-	630	LC1G630	LR9 G630	160/630
				GSD630	-	800	LC1G630	LR9 G630	160/630

[1] GSC for NFC cylindrical fuse-link/GSD for NH DIN type fuse-link.
 [2] Reversers: replace LC1 by LC2; star-delta starter: replace LC1 by LC3.

Selectivity, Cascading and Coordination Guide

Type 2 Coordination Table with Fuses

Ue: 380-415 V AC

Schneider Electric switch-disconnector fuses and contactors

Performance: Ue = 380-415 V - "Iq" 50 kA (IEC/EN 60947-4-1)

Starting

Adjustable class 10 A to 30 ^[4]

Motors P (kW)	I (A) 380 V	I (A) 415 V	Ie Max (A)	Switch-fuse ^[1]	Fuse-link type		Contactors ^[2]	Thermal relays	
				Type	gG rating (A)	aM rating (A)	Type	Type	Irth (A)
0.37	1.2	1.1	2	GSC32/GSD63	4	2	LC1D09	LTM R08	0.4/8 ^[3]
0.55	1.6	1.5	2	GSC32/GSD63	6	2	LC1D09	LTM R08	0.4/8 ^[3]
0.75	2	1.8	4	GSC32/GSD63	10	4	LC1D09	LTM R08	0.4/8 ^[3]
1.1	2.8	2.6	4	GSC32/GSD63	10	4	LC1D09	LTM R08	0.4/8 ^[3]
1.5	3.7	3.4	4	GSC32/GSD63	16	4	LC1D09	LTM R08	0.4/8 ^[3]
2.2	5.3	4.8	6	GSC32/GSD63	16	6	LC1D09	LTM R08	0.4/8 ^[3]
3	7	6.5	8	GSC32/GSD63	20	8	LC1D09	LTM R08	0.4/8 ^[3]
4	9	8.2	10	GSC32/GSD63	25	10	LC1D12	LTM R27	1.35/27 ^[3]
5.5	12	11	12	GSC32/GSD63	32	16	LC1D18	LTM R27	1.35/27 ^[3]
7.5	16	14	16	GSC32/GSD63	-	16	LC1D25	LTM R27	1.35/27 ^[3]
10	21	19	25	GSC50/GSD63	40	-			
				GSC32/GSD63	-	25	LC1D32	LTM R27	1.35/27 ^[3]
11	23	21	25	GSC50/GSD63	50	-			
				GSC32/GSD63	-	25	LC1D32	LTM R27	1.35/27 ^[3]
15	30	28	32	GSC50/GSD63	50	-			
				GSC32/GSD63	-	32	LC1D40A	LTM R100	5/100 ^[3]
18.5	37	34	40	GSC125/GSD63	80	-			
				GSC50/GSD63	-	40	LC1D40A	LTM R100	5/100 ^[3]
22	43	40	50	GSC125/GSD63	80	-			
				GSC125/GSD63	80	-			
30	59	55	63	GSC50/GSD63	-	50	LC1D50A	LTM R100	5/100 ^[3]
				GSC125/GSD63	100	-			
37	72	66	80	GSC125/GSD125	125	-			
				GSD125	-	80	LC1D80	LTM R100	5/100 ^[3]
45	85	80	80	GSC125/GSD125	160	-			
				GSD125	-	100	LC1D115	LTM R100	5/100 ^[3]
55	105	100	115	GSD250	200	-			
				GSC125/GSD125	-	125	LC1D115	LTM R08	On CT
75	140	135	150	GSD250	200	-			
				GSD160	-	160	LC1D150	LTM R08	On CT
90	170	160	185	GSD250	250	-			
				GSD250	-	200	LC1G185	LTM R08	On CT
110	210	200	225	GSD400	355	-			
				GSD250	-	250	LC1G225	LTM R08	On CT
132	250	230	250	GSD400	400	-			
				GSD250	-	315	LC1G265	LTM R08	On CT
160	300	270	315	GSD630	450	-			
				GSD400	-	315/400	LC1G330	LTM R08	On CT
200	380	361	400	GSD630	630	-			
				GSD400	-	400/500	LC1G400	LTM R08	On CT
250	460	430	500	GSD630	800	-			
				GSD630	800	500	LC1G500	LTM R08	On CT
280	520	475	630	GSD630	800	630	LC1G630	LTM R08	On CT
300	565	500	630	GSD630	-	630	LC1G630	LTM R08	On CT
335	610	560	630	GSD630	-	630	LC1G630	LTM R08	On CT
355	630	590	630	GSD630	-	800	LC1G630	LTM R08	On CT

[1] GSC for NFC cylindrical fuse-link/GSD for NH DIN type fuse-link

[2] Reversers: replace LC1 by LC2; star-delta starter: replace LC1 by LC3.

[3] Currents transformers built-in electronic relays.

[4] For use with overload relay setted in class 20 and 30, apply respectively a derating of 20 % and 37 %.

Selectivity, Cascading and Coordination Guide

Type 2 Coordination Table with Fuses

Ue: 660-690 V AC

Schneider Electric switch-disconnector fuses and contactors

Performance: Ue = 660-690 V - "Iq" 50 kA (IEC/EN 60947-4-1)

Starting

Class 10 A/10

Motors P (kW)	I (A) 690 V	Ie Max (A)	Switch-fuse ^[1]	Fuse-link type		Contactors ^[2]	Thermal relays	
			Type	gG rating (A)	aM rating (A)	Type	Type	I _{rt} h (A)
0.75	1.1	1.6	GSC50/GSCD63	4	2	LC1D09	LRD 06	1/1.6
1	1.6	1.6	GSC50/GSCD63	6	2	LC1D09	LRD 06	1/1.6
1.5	2.2	2.5	GSC50/GSCD63	6	4	LC1D09	LRD 07	1.6/2.5
2.2	2.8	4	GSC50/GSCD63	10	4	LC1D09	LRD 08	2.5/4
3	3.8	4	GSC50/GSCD63	10	6	LC1D09	LRD 08	2.5/4
4	4.9	6	GSC50/GSCD63	16	6	LC1D09	LRD 10	4/6
5.5	6.7	8	GSC50/GSCD63	20	8	LC1D09	LRD 12	5.5/8
7.5	8.9	10	GSC50/GSCD63	25	10	LC1D25	LRD 16	9/13
11	12.8	13	GSC50/GSCD63	-	16	LC1D25	LRD 16	9/13
15	17	20	GSC125/GSD63	32	-			
			GSC50/GSD63	-	20	LC1D25	LRD 22	16/24
18.5	22	24	GSC125/GSD63	40	-			
			GSC50/GSD63	-	25	LC1D32	LRD 22	16/24
22	24	32	GSC125/GSD63	50	-			
			GSC50/GSD63	-	25	LC1D40A	LRD 332	23/32
30	32	32	GSC125/GSD63	50	-			
			GSC50/GSD63	-	32	LC1D40A	LRD 340	30/40
37	39	40	GSC125/GSD125	80	-			
			GSC125/GSD63	-	40	LC1D65A	LRD 365	37/50
45	47	50	GSC125/GSD125	80	-			
			GSC125/GSD63	-	50	LC1D80	LRD 3357	37/50
55	57	63	GSD125	100	-			
			GSC125/GSD63	-	63	LC1D115	LRD 3359	48/65
75	77	80	GSD125	125	-			
			GSD250	160	-	LC1D115	LRD 3363	63/80
90	93	100	GSD125	-	100	LC1D150	LR9 D53 69	90/150
			GSD250	200	-			
110	113	125	GSD125	-	125	LC1G185	LR9 G225	27/225
			GSD400	250	-			
132	134	160	GSD250	-	160	LC1G265	LR9 G225	25/125
			GSD400	250	-			
160	162	160	GSD250	-	160	LC1G265	LR9 G225	27/225
			GSD400	315	-			
200	203	200	GSD250	-	200	LC1G330	LR9 G500	125/500
			GSD630	400	-			
220	223	250	GSD250	-	250	LC1G400	LR9 G500	125/500
			GSD630	450	-			
250	253	315	GSD400	-	315	LC1G400	LR9 G500	125/500
			GSD630	500	-			
315	320	355	GSD400	-	355	LC1G500	LR9 G500	125/500
355	354	400	GSD400	-	400	LC1G630	LR9 G630	160/630
400	400	450	GSD630	-	450	LC1G630	LR9 G630	160/630
450	455	500	GSD630	-	500	LC1G630	LR9 G630	160/630

[1] GSC for NFC cylindrical fuse-link/GSD for NH DIN type fuse-link.

[2] Reversers: replace LC1 by LC2; star-delta starter: replace LC1 by LC3.

Selectivity, Cascading and Coordination Guide

Type 2 Coordination Table with Fuses

U_e: 660-690 V

Schneider Electric switch-disconnector fuses and contactors

Performance: U_e = 660-690 V - "I_q" 50 kA (IEC/EN 60947-4-1)

Starting

Adjustable class 10 A to 30 ^[3]

Motors			Switch-fuse ^[1]	Fuse-link type		Contactors ^[2]	Thermal relays	
P (kW)	I (A) 690 V	I _e Max (A)		Type	gG rating (A)		aM rating (A)	Type
0.75	1.1	2	GSC50/GSCD63	4	2	LC1D09	LTM R08	0.4/8 ^[4]
1	1.6	2	GSC50/GSCD63	6	2	LC1D09	LTM R08	0.4/8 ^[4]
1.5	2.2	4	GSC50/GSCD63	6	4	LC1D09	LTM R08	0.4/8 ^[4]
2.2	2.8	4	GSC50/GSCD63	10	4	LC1D09	LTM R08	0.4/8 ^[4]
3	3.8	6	GSC50/GSCD63	10	6	LC1D09	LTM R08	0.4/8 ^[4]
4	4.9	6	GSC50/GSCD63	16	6	LC1D09	LTM R08	0.4/8 ^[4]
5.5	6.7	8	GSC50/GSCD63	20	8	LC1D09	LTM R08	0.4/8 ^[4]
7.5	8.9	10	GSC50/GSCD63	25	10	LC1D25	LTM R27	1.35/27 ^[4]
11	12.8	16	GSC50/GSCD63	-	16	LC1D25	LTM R27	1.35/27 ^[4]
			GSC125/GSD63	32	-			
15	17	20	GSC50/GSD63	-	20	LC1D25	LTM R27	1.35/27 ^[4]
			GSC125/GSD63	40	-			
18.5	22	25	GSC50/GSD63	-	25	LC1D32	LTM R27	1.35/27 ^[4]
			GSC125/GSD63	50	-			
22	24	25	GSC50/GSD63	-	25	LC1D40A	LTM R27	1.35/27 ^[4]
			GSC125/GSD63	50	-			
30	32	32	GSC125/GSD63	-	32	LC1D40A	LTM R100	5/100 ^[4]
			GSC125/GSD125	80	-			
37	39	40	GSC125/GSD63	80	40	LC1D65A	LTM R100	5/100 ^[4]
			GSC125/GSD125	-	-			
45	47	50	GSC125/GSD63	-	50	LC1D80	LTM R100	5/100 ^[4]
			GSD125	100	-			
55	57	63	GSC125/GSD63	-	63	LC1D115	LTM R100	5/100 ^[4]
			GSD125	125	-			
75	77	80	GSD125	-	80	LC1D115	LTM R100	5/100 ^[4]
			GSD250	160	-			
90	93	100	GSD125	-	100	LC1D150	LTM R100	5/100 ^[4]
			GSD250	200	-			
110	113	125	GSD125	-	125	LC1G185	LTM R08	On CT
			GSD400	250	-			
132	134	160	GSD250	-	160	LC1G265	LTM R08	On CT
			GSD400	250	-			
160	162	160	GSD250	-	160	LC1G265	LTM R08	On CT
			GSD400	315	-			
200	203	200	GSD250	-	200	LC1G330	LTM R08	On CT
			GSD630	400	-			
220	223	250	GSD250	-	250	LC1G400	LTM R08	On CT
			GSD630	450	-			
250	253	315	GSD400	-	315	LC1G400	LTM R08	On CT
			GSD630	500	-			
315	320	355	GSD400	-	355	LC1G500	LTM R08	On CT
355	354	400	GSD400	-	400	LC1G630	LTM R08	On CT
400	400	450	GSD630	-	450	LC1G630	LTM R08	On CT
450	455	500	GSD630	-	500	LC1G630	LTM R08	On CT

[1] GSC for NFC cylindrical fuse-link/GSD for NH DIN type fuse-link.

[2] Reversers: replace LC1 by LC2; star-delta starter: replace LC1 by LC3.

[3] For use with overload relay setted in class 20 and 30, apply respectively a derating of 20 % and 37 %.

[4] Currents transformers built-in electronic relays.



Use of LV Switches and Transfer Switching Equipment

Presentation

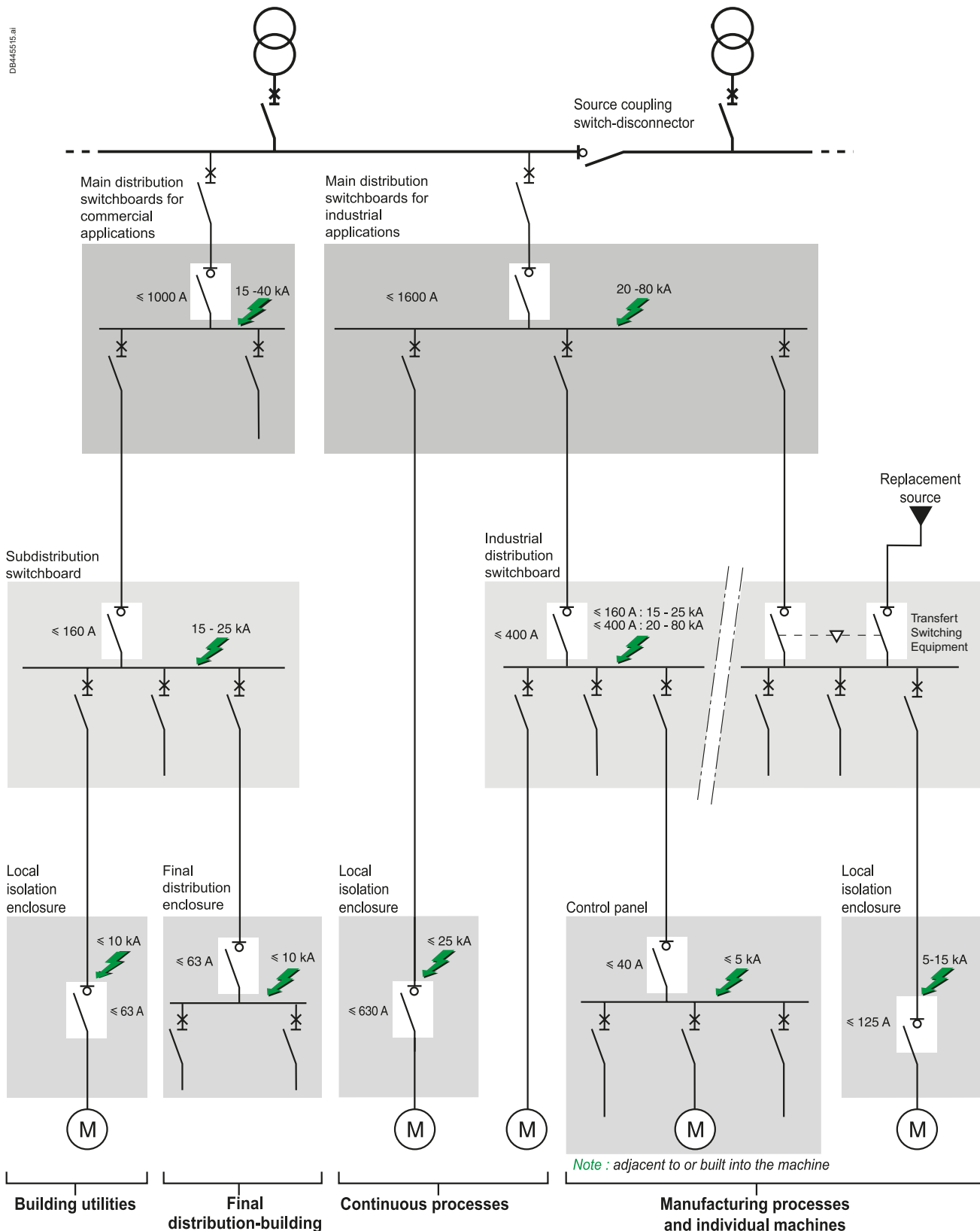

Use of LV Switches and Transfer Switching Equipment

Presentation

Functions and positions of LV switches

Switches are necessary in different level of low voltage installation for the following main applications :

- Functional switching
- Supplying installation from different sources (transfert-switching equipment)
- Starting stopping equipments
- Emergency switching
- Switching off and disconnection for isolation of one circuit or switchboard for maintenance.

IEC 60364-5-53 Electrical installations of buildings – Part 5-53: Selection and erection of electrical equipment

Isolation, switching and control standard provides requirement for isolation of circuits, functional switching, and emergency switching.

IEC/EN 60204-1 Safety of machinery - Electrical equipment of machines - Part 1: General requirements

standard provides requirements for disconnection of machines.

“Suitability for isolation” is necessary to ensure people safety in open position.

Suitable for isolation

Switch-disconnector

“Isolation” function i.e disconnection from supply is required for all circuits or equipment in order to guarantee the safety of people during repairs or maintenance.

Low voltage electrical installation standards (IEC 60364 series for example) provide requirements to ensure properly this function:

Device for isolation shall:

- Isolate all live conductors (including neutral but not PEN)
- Withstand specified impulse voltage in open position
- Have a leakage current below specified values in open position
- Be lockable in the “open” position so as to prevent any risk of involuntary reclosing
- Ensure that the isolating distance between open contacts of the device is visible or be clearly and reliably indicated by “off” or “open” marking.

These requirements are totally covered with devices compliant to IEC/EN 60947-1/2/3 suitable for isolation.

This characteristics is clearly marked on product by the symbol of switch-disconnector.



DB414421.eps

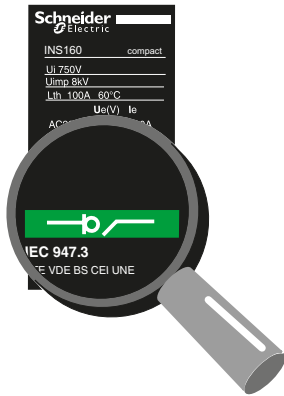

Use of LV Switches and Transfer Switching Equipment

Switch-disconnector standards and characteristics

IEC/EN 60947-3 Low-voltage switchgear and controlgear – Part 3:

Switches, disconnectors and fuse-combination units specifies the performances and test of switch-disconnector. The main characteristics of an industrial switch-disconnector are:

- Rated and limiting values for the main circuit: voltage, current, short time withstand in case of short circuit, making current in case of switch on-to short-circuit, rated conditional short-circuit with a specified short-circuit protection.
- Utilization category (for a switching device or a fuse) is a “combination of specified requirements related to the conditions in which the switching device or the fuse fulfils its purpose, selected to represent a characteristic group of practical applications” [IEV 441-17-19]

This characteristic (alphanumerical code) defines requirement linked to a type of load, such as making and breaking current for durability test, minimum number of operation, power factor of the current to make and break.

See example below.

- Control circuits: opening/closing Coils and auxiliaries allowing remote opening and/or closing if any.
- Auxiliary circuits: O/C Contacts for remote signaling.

Example:

A switch with a rating of 125 A, from the AC23 category must be able to:

- Make a 10 In (1250 A) current with a $\cos \phi$ of 0.35
- Break a 8 In (1000 A) current with a $\cos \phi$ of 0.35.

Its other characteristics are:

- To withstand a 12 In - 1 s short-circuit current, which defines the $I_{cw} = 1500$ A r.m.s. thermal withstand during 1 s.

Utilization category		Characteristic applications
Frequent operations	Non frequent operations	
AC-21A	AC-21B	Resistive loads including moderate overloads ($\cos \phi = 0.95$)
AC-22A	AC-22B	Mixed resistive and inductive loads including moderate overloads ($\cos \phi = 0.65$)
AC-23A	AC-23B	Motors with cage winding or other loads which are highly inductive ($\cos \phi = 0.45$ or 0.35)

Choosing a Schneider Electric Switch-Disconnecter

The switch must be chosen according to:

- The characteristics of the network on which it is installed,
- The location and the application,
- Coordination with the upstream protection devices (in particular overload and short-circuit).

Choice criteria

Network characteristics

Nominal voltage, nominal frequency and nominal current are determined in the same way as for a circuit breaker:

- Nominal voltage = nominal voltage of the network
- Frequency = network frequency
- Nominal current = rated current of a value immediately higher than the downstream load current. Note that the rated current is defined for a given ambient temperature and that a derating may have to be taken into account.

Location and application

This determines the type and characteristics or main functions that the switch must possess. There are 3 function levels (see table opposite):

- Basic functions, virtually common to all switch types:
 - Isolation, control, padlocking, safety.
- Additional characteristic functions
 - Direct formulation of the needs of the user and of the switch environment, i.e.:
 - Industrial type performance
 - Need for emergency stopping
 - Isc level
 - Type of interlocking
 - Type of control
 - Utilization category
 - Mounting system.
- Specific functions
 - Linked to operation and to installation requirements, i.e.:
 - Earth leakage protection
 - Motor mechanisms
 - Remote opening ("emergency stop" function)
 - Withdrawability.

See table K (see page C-5) and M (page C-7) for more characteristics per ranges.

Coordination

All switches must be protected by an overcurrent protection device placed upstream.

For switch disconnector according to IEC/EN 60947-3, the ability of the equipment to make, carry and break short-circuit currents is stated in terms of one or more of the following ratings.

- a) Rated short-time withstand current
- b) Rated short-circuit making capacity
- c) Rated conditional short-circuit current

Rated short-time withstand current and rated short-circuit making capacity are characteristics of the switch disconnector alone. These characteristics can be used to check that upstream overcurrent protection clearing time and peak let through current are consistent with the switch-disconnector electrodynamic withstand, short-time and permanent withstand.

Rated conditional short-circuit current : It is the value of short-circuit current the switch-disconnector can withstand in coordination with this given overcurrent protection.

The tables below provide for each switch-disconnector of main Schneider Electric ranges the circuit-breakers that will ensure protection in case of an overload, and short-circuit.

The performance given in the table can be

- "T - total coordination" : meaning the Switch-disconnector is protected up to the breaking capacity (I_{cu}/I_{cn}) of the circuit breaker installed on the supply side.
- a value of a rated conditional short-circuit current (given in RMS and related peak value) : meaning the Switch-disconnector is protected up to this maximum short-circuit current with the specified circuit breaker installed on the supply side.

Transfert Switching Equipment (TSE)

Coordination between overcurrent protections and automatic transfert switching equipment (TSE) shall be checked as for switch-disconnectors (see IEC/EN 60947-6-1).

- For transfert switching equipment based on MasterPact, ComPacT NS and NSX switch disconnectors, the related following coordination tables apply.
- For TransfertPact TA series, dedicated coordination tables are provided. See C-14 to C-19.

Choosing a Schneider Electric Switch-Disconnecter

Switch-disconnector characteristics according to application

		Main distribution switchboards	Industrial distribution switchboard	Subdistribution switchboards	Final distribution enclosures	Control panel	Local isolation enclosures
Current range		400 to 6300 A	40 to 630 A	≤ 160 A	≤ 125 A	≤ 40/125 A	10 to 630 A
LV switch basic functions							
making and breaking load current		■	■	■	■	■	■
Isolation ^[1]		■	■	■	■	■	■
Padlocking		■	■	■	■	■	■
Characteristics							
Maximum short-circuit level ^[2]		20 to 80 kA	■ I ≤ 160 A: 15 to 25 kA ■ I ≤ 630 A: 20 to 80 kA	■ I ≤ 63 A: 15 kA ■ I ≤ 160 A: 25 kA	10 kA	3 to 5 kA	■ I ≤ 63 A: 10 kA ■ I ≤ 630 A: 25 kA
Utilization category	AC21A AC22A AC23 AC3	■	■ □	■ □	■ □	■	■ ■ I ≤ 63 A
Handle	Rotary Direct front Front extended Side extended	■ ■ □ □	■ □ □ □	■ ■ □ □	□ ■ □ □	■ ■ □ □	■ □ ■ ■
Mounting	On plate Symmetrical rail (45 mm tip)	■ □	□ ■	□ ■	□ ■	■ □	□ □
Specific functions							
Earth leakage protection		□	□	□	□		
Other	Draw-out, auxiliary switches, auxiliary releases, remote control Emergency stop	■ □	■ □	□ □			□ □

Table K

■ compulsory
□ possible

[1] with positive break indication or visible isolation.

[2] values are indicative. Maximum presumed short-circuit current shall be calculated for each installation.



Choosing a Schneider Electric Switch-Disconnecter

The switches available in the Schneider Electric offer

Schneider Electric offers its customers several ranges of switches.

Choice depends on:

- The application
- The additional functions to be implemented (accessories, installation, residual current protection, etc.).

The following table summarizes the possibilities offered by all the Schneider Electric ranges according to the applications described above.

Applications Products	Incoming switches for					Local isolation switches Local isolation enclosures
	Main distribution switchboards 400-6300 A	Industrial distribution switchboards 400-630 A	Subdistribution switchboards ≤ 160 A	Final distribution enclosures ≤ 125 A	Control panels ≤ 40/125 A	
Vario					■	■
Acti 9 iSW/iID (modular profile)				■		□
Acti 9 iSW-NA (modular profile)				□		■
ComPacT INS ≤ 160 (modular profile)		■	■	■		■
NG125 NA (modular profile)			■	■		■
ComPacT INS (industrial)	■	■				■
ComPacT NSXm NA (Modular/Industrial)			■	□		□
ComPacT NSX-NA (industrial)	□	■	□			■
MasterPact NA/HA/HF (industrial)	■					

Table L

- very common
- fairly common



Choosing a Schneider Electric Switch-Disconnecter

Switch-disconnector range technical data

Table M below lists the main technical data of the switches in the Schneider Electric ranges.

Range	Vario	Acti 9 iSW	iSW NA	iID	Multi 9 NG125 NA	ComPacT INS	INV	NSXm NA	NSX NA	NS NA	MasterPact NA	HA	HF
Clip-on on rail		■	■	■	■	■ ^[3]	■ ^[3]	■	■	■			
Main functions	Isolation	■	■ ^[5]	■	■	■	■	■	■	■	■	■	■
	Positive break indication	■	■	■	■	■	■	■	■	■	■	■	■
	Visible isolation						■						
Emergency stop	Manual ^[7]	■			■	■ ^[4]	■ ^[4]	■ ^[4]	■	■	■	■	■
	Remote (MN coil)			■ ^[6]	■ ^[6]	■ ^[6]		■ ^[6]	■ ^[6]	■ ^[6]	■ ^[6]	■ ^[6]	■ ^[6]
Other functions	Residual current			■	■ ^[8]				■ ^[8]		■	■	■
	Remote opening (MX)			■	■			■	■	■	■	■	■
	Remote control (Open Close)								■	■ ^[9]	■	■	■
Fixed/drawout	Fixed	■	■	■	■	■	■	■	■	■	■	■	■
	Drawout								■	■ ^[9]	■	■	■
On/Off indication contact	■	■	■	■ ^[1]	■ ^[1]	■ ^[2]	■ ^[2]	■	■	■	■	■	■
Ratings (A)	12	■											
	16			■									
	20	■											
	25	■		■									
	32	■											
	40	■	■	■	■	■							
	50							■					
	63	■	■	■	■	■	■						
	80	■		■	■	■	■						
	100		■	■	■	■	■	■	■				
	125	■	■			■	■						
	160	■				■	■	■	■				
	175	■											
	250						■	■	■				
	320						■	■					
	400						■	■	■				
	500						■	■					
	630						■	■		■		■	■
	800						■	■		■	■	■	■
	1000						■	■		■	■	■	■
1250						■	■		■	■	■	■	
1600						■	■		■	■	■	■	
2000						■	■		■	■	■	■	
2500						■	■		■	■	■	■	
3200									■		■	■	
4000											■	■	
5000											■	■	
6300											■	■	

Table M

- [1] SD auxiliary contact available on iID.
- [2] OF contact and CAO or CAF.
- [3] Only 40 to 160 A (modular profile).
- [4] Specific INS/INV emergency stop switches.
- [5] Only on ratings 40/63/100/125. iSW 20 and 32 are switch without isolation function according to IEC/EN 60669-1.
- [6] With MN auxiliaries.
- [7] Yellow front plate/red handle.
- [8] Associated Vigi bloc.
- [9] Option available up to 1600 A.

Circuit-Breaker/Switch-Disconnecter Coordination

Upstream: Acti9 iC40, iC60, C120, NG125

Downstream: Acti9 iID40, iID, RCCB ID B type

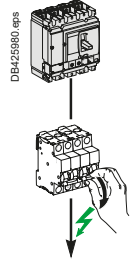

Ue: 380-415 V AC

Downstream	Switch-disconnector	iID40					iID ^{[1] [2]}					RCCB ID				
		Rating (A)	25	40	63	25	40	63	80	100	25	40	63	100	125	
		I _{cw} (A)	500	800	1260	500	800	1260	1200	1500	500	500	630	800	1250	
		I _{cm} (kA)	5	5	5	5	5	5	5	5	5	5	5	5	5	

Upstream Circuit breaker	Rating (A)	I _{cu} (kA) 415 V	Switch disconnector conditionnal short-circuit current and related making capacity:													
			25	40	63	80	100	125	150	160	170	180	200	250	300	
iC40	≤ 25	10	T	T	T	T	T	T	T	T	T	T	T	T	T	
B, C, D curves	32 to 40	10	T	T	T	T	T	T	T	T	T	T	T	T	T	
iC40N	≤ 25	10	T	T	T	T	T	T	T	T	T	T	T	T	T	
B, C, D curves	32 to 40	10	T	T	T	T	T	T	T	T	T	T	T	T	T	
iC60N	≤ 25	10	T	T	T	T	T	T	T	T	T	T	T	T	T	
B, C, D curves	32	10	T	T	T	T	T	T	T	T	T	T	T	T	T	
	40	10	T	T	T	T	T	T	T	T	T	T	T	T	T	
	50 to 63	10	T	T	T	T	T	T	T	T	T	T	T	T	T	
iC60H	≤ 25	15	T	T	T	T	T	T	T	T	T	T	T	T	T	
B, C, D curves	32	15	T	T	T	T	T	T	T	T	T	T	T	T	T	
	40	15	T	T	T	T	T	T	T	T	T	T	T	T	T	
	50 to 63	15	T	T	T	T	T	T	T	T	T	T	T	T	T	
iC60L	≤ 25	25	T	T	T	T	T	T	T	T	T	T	T	T	T	
B, C, D, K, Z curves	32	20	T	T	T	T	T	T	T	T	T	T	T	T	T	
	40	20	T	T	T	T	T	T	T	T	T	T	T	T	T	
	50 to 63	15	T	T	T	T	T	T	T	T	T	T	T	T	T	
C120N	63	10			T			T	T	T			7/11	7/11	7/11	
B, C, D curves	80	10						10/17	10/17				7/11	7/11		
	100	10							10/17				5/8	5/8		
	125	10											5/8	5/8		
C120H	63	20			T			T	T	T			7/11	7/11	7/11	
B, C, D curves	80	20			10/17			10/17	10/17	10/17			7/11	7/11		
	100	20							10/17				5/8	5/8		
	125	20											5/8	5/8		
NG125N	≤ 40	25	16/27	16/27	16/27		16/27	16/27	16/27	16/27		15/25	15/25	15/25	15/25	
B, C, D curves	50 to 63	25			16/27			16/27	16/27	16/27		15/25	15/25	15/25	15/25	
	80	25						10/17	10/17				10/17	10/17		
	100	25							10/17				10/17	10/17		
	125	25											10/17	10/17		
NG125H	≤ 40	36	16/27	16/27	16/27		16/27	16/27	16/27	16/27		15/25	15/25	15/25	15/25	
C curves	50 to 63	36			16/27			16/27	16/27	16/27		15/25	15/25	15/25	15/25	
	80	36						10/17	10/17				10/17	10/17		
NG125L	≤ 40	50	16/27	16/27	16/27		16/27	16/27	16/27	16/27		15/25	15/25	15/25	15/25	
B, C, D curves	50 to 63	50			16/27			16/27	16/27	16/27		15/25	15/25	15/25	15/25	
	80	50			10/17			10/17	10/17	10/17		10/17	10/17	10/17	10/17	

[1] Include Acti9 iID AC type, A type, ASI type and B-SI type.

[2] For Acti9 iID B type EV, please contact Schneider Electric.

T Switch-disconnector is totally coordinated up to the I_{cu} of the circuit breaker installed on supply side.

16/27 Switch-disconnector is protected up to 16 kA rms / 27 kA peak.

Protection of the switch-disconnector is not ensured.

Circuit-Breaker/Switch-Disconnecter Coordination

Upstream: ComPacT NSXm, NSX100, NSX160

Downstream: Acti9 iID40, iID, RCCB ID B type

Ue: 380-415 V AC

Downstream	Switch-disconnector	iID40			iID ^{[1] [2]}					RCCB ID					
		Rating (A)	25	40	63	25	40	63	80	100	25	40	63	100	125
		Icw (A)	500	800	1260	500	800	1260	1200	1500	500	500	630	800	1250
		Icm (kA)	5	5	5	5	5	5	5	5	5	5	5	5	5

Upstream Circuit breaker	Rating (A)	Switch disconnector conditional short-circuit current and related making capacity:													
NSXm Icu 415V: E/B/F/N/H 16/25/36/50/70	≤ 25	-	5/7.65	5/7.65	5/7.65	5/7.65	5/7.65	5/7.65	5/7.65	5/7.65	5/7.65	5/7.65	5/7.65	5/7.65	5/7.65
	32	-		5/7.65	5/7.65		5/7.65	5/7.65	5/7.65	5/7.65		5/7.65	5/7.65	5/7.65	5/7.65
	40	-		5/7.65	5/7.65		5/7.65	5/7.65	5/7.65	5/7.65		5/7.65	5/7.65	5/7.65	
	50	-			5/7.65			5/7.65	5/7.65	5/7.65			5/7.65	5/7.65	
	63	-				5/7.65			5/7.65	5/7.65			5/7.65	5/7.65	
	80	-							5/7.65	5/7.65			5/7.65	5/7.65	
	100	-								5/7.65				5/7.65	
NSX100 Icu 415V: B/F/N/H/S/L 25/36/50/70/100/150	≤ 25	-	5/7.65	5/7.65	5/7.65	5/7.65	5/7.65	5/7.65	5/7.65	5/7.65	5/7.65	5/7.65	5/7.65	5/7.65	
	32	-		5/7.65	5/7.65		5/7.65	5/7.65	5/7.65	5/7.65		5/7.65	5/7.65		
	40	-		5/7.65	5/7.65		5/7.65	5/7.65	5/7.65	5/7.65		5/7.65	5/7.65		
	50	-			5/7.65			5/7.65	5/7.65	5/7.65			5/7.65		
	63	-				5/7.65			5/7.65	5/7.65			5/7.65		
	80	-							5/7.65	5/7.65			5/7.65		
NSX160 B/F/N/H/S/L	125	-								5/7.65					
	160	-											5/7.65		

[1] Include Acti9 iID AC type, A type, ASI type and B-SI type.

[2] For Acti9 iID B type EV, please contact Schneider Electric.

5/7.65 Switch-disconnector is protected up to 5 kA rms / 7.65 kA peak.

Protection of the switch-disconnector is not ensured.

Circuit-Breaker/Switch-Disconnecter Coordination

Upstream: Acti9 iC40, iC60, C120, NG125

Downstream: Acti9 iSW-NA, iSW, NG125NA

Ue: 380-415 V AC

Downstream	Switch-disconnector	iSW-NA				iSW				NG125NA				
		Rating (A)	40	63	80	100	40	63	100	125	63	80	100	125
		Icw (A)	800	1260	1600	2000	1.5	1.5	1.5	1.5	1.5	1.5	1.5	1.5
		Icm (kA)	5	5	5	5	5	5	5	5	2	2	2	2

Upstream Circuit breaker	Rating (A)	Icu (kA) 415 V	Switch disconnector conditional short-circuit current and related making capacity:													
iC40 B, C, D curves	≤ 25	10	T	T	T	T	T	T	T	T	T	T	T	T	T	T
	32 to 40	10	T	T	T	T	T	T	T	T	T	T	T	T	T	T
iC40N B, C, D curves	≤ 25	10	T	T	T	T	T	T	T	T	T	T	T	T	T	T
	32 to 40	10	T	T	T	T	T	T	T	T	T	T	T	T	T	T
iC60N/H/L All curves	≤ 25	10/15/25	T	T	T	T	T	T	T	T	T	T	T	T	T	T
	32	10/15/20	T	T	T	T	T	T	T	T	T	T	T	T	T	T
	40	10/15/20	T	T	T	T	T	T	T	T	T	T	T	T	T	T
	50	10/15/15		T	T	T		T	T	T	T	T	T	T	T	T
C120N B, C, D curves	63	10														
	80	10		10/17	10/17	10/17		10/17	10/17	10/17						
	100	10				10/17			10/17	10/17						
	125	10							10/17	10/17						
C120H B, C, D curves	63	20														
	80	20		15/25	15/25	15/25		15/25	15/25	15/25	T	T	T	T	T	T
	100	20				10/17			10/17	10/17						
	125	20							10/17	10/17						
NG125N B, C, D curves	≤ 40	25	16/27	16/27	16/27	16/27	16/27	16/27	16/27	16/27	T	T	T	T	T	T
	50 to 63	25		16/27	16/27	16/27		16/27	16/27	16/27	T	T	T	T	T	T
	80	25				10/17			10/17	10/17						
	100	25				10/17			10/17	10/17						
	125	25							10/17	10/17						
NG125H C curves	≤ 40	36	16/27	16/27	16/27	16/27	16/27	16/27	16/27	16/27	T	T	T	T	T	T
	50 to 63	36		16/27	16/27	16/27		16/27	16/27	16/27	T	T	T	T	T	T
	63	36				10/17			10/17	10/17	T	T	T	T	T	T
	80	36				10/17			10/17	10/17						
NG125L B, C, D curves	≤ 40	50	20/40	20/40	20/40	20/40	20/40	20/40	20/40	20/40	T	T	T	T	T	T
	50	50		16/27	16/27	16/27		16/27	16/27	16/27	T	T	T	T	T	T
	63	50		16/27	16/27	16/27		16/27	16/27	16/27	T	T	T	T	T	T
	80	50				10/17			10/17	10/17						

[1] Include Acti9 iID AC type, A type, ASI type and B-SI type.
 [2] For Acti9 iID B type EV, please contact Schneider Electric.

- T Switch-disconnector is totally coordinated up to the Icu of the circuit breaker installed on supply side.
- 116/27 Switch-disconnector is protected up to 16 kA rms / 27 kA peak.
- Protection of the switch-disconnector is not ensured.

Circuit-Breaker/Switch-Disconnecter Coordination

Upstream: iC40/iDPN, iC60, C120, NG125, ComPacT NSXm, NSX100, NSX160

Downstream: iSW, NG125NA, ComPacT NSXm NA

Ue ≤ 415 V AC

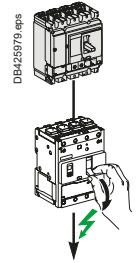

Downstream	Switch-disconnector Rating (A)	iSW				NG125NA				NSXm NA			
		40	63	100	125	63	80	100	125	50	100	160	
		Icw (kA)	1.5	1.5	1.5	1.5	1.5	1.5	1.5	1.5	0.9	1.5	1.5
		Icm (kA)	5	5	5	5	2	2	2	2	1.38	2.13	2.13

Upstream Circuit breaker	Rating or setting	Icu (kA) 415 V	Switch-disconnector conditional short-circuit current and related making capacity										
			iSW 40	iSW 63	iSW 100	iSW 125	NG125NA 63	NG125NA 80	NG125NA 100	NG125NA 125	NSXm NA 50	NSXm NA 100	NSXm NA 160
iC40/iDPN All curves	≤ 25	6	T	T	T	T	T	T	T	T	T	T	T
	32	6	T	T	T	T	T	T	T	T	T	T	T
	40	6	T	T	T	T	T	T	T	T	T	T	T
iC40N/iDPNN All curves	≤ 25	10	T	T	T	T	T	T	T	T	T	T	T
	32	10	T	T	T	T	T	T	T	T	T	T	T
	40	10	T	T	T	T	T	T	T	T	T	T	T
iC60N/H/L All Curves	≤ 25	10/15/25	T	T	T	T	T	T	T	T	T	T	T
	32-40	10/15/20	T	T	T	T	T	T	T	T	T	T	T
	50	10/15/15		T	T	T	T	T	T	T	T	T	T
	63	10/15/15		T	T	T	T	T	T	T	T	T	T
C120N/H All curves	63	10/15		T	T	T			T	T	T	T	T
	80	10/15				10/17	10/17			T	T	T	T
	100	10/15								T	T	T	T
	125	10/15								T	T	T	T
NG125N B-C-D Curves	≤ 40	25	16/27	16/27	16/27	16/27	T	T	T	T	T	T	T
	50	25		16/27	16/27	16/27		T	T	T	T	T	T
	63	25		16/27	16/27	16/27		T	T	T	T	T	T
	80	25			10/17	10/17			T	T	T	T	T
	100	25				10/17			T	T	T	T	T
NG125H C Curve	≤ 40	36	16/27	16/27	16/27	16/27	T	T	T	T	T	T	T
	50	36		16/27	16/27	16/27	T	T	T	T	T	T	T
	63	36		16/27	16/27	16/27	T	T	T	T	T	T	T
	80	36			10/17	10/17		T	T	T	T	T	T
NG125L B-C-D Curves	≤ 40	50	20/40	20/40	20/40	20/40	T	T	T	T	T	T	T
	50	50		16/27	16/27	16/27		T	T	T	T	T	T
	63	50		16/27	16/27	16/27			T	T	T	T	T
	80	50			10/17	10/17			T	T	T	T	T
NSXm Icu 415V: E/B/F/N/H 16/25/36/50/70	≤ 40	*	5/7,65	5/7,65	5/7,65	5/7,65	T	T	T	T	T	T	T
	50	*		5/7,65	5/7,65	5/7,65	T	T	T	T	T	T	T
	63	*		5/7,65	5/7,65	5/7,65	T	T	T	T	T	T	T
	80	*			5/7,65	5/7,65		T	T	T	T	T	T
	100	*			5/7,65	5/7,65			T	T	T	T	T
	125	*				5/7,65				T	T	T	T
NSX100 Icu 415V: B/F 25/36	≤ 40	*	5/7,65	5/7,65	5/7,65	5/7,65	T	T	T	T	T	T	T
	50	*		5/7,65	5/7,65	5/7,65	T	T	T	T	T	T	T
	63	*		5/7,65	5/7,65	5/7,65	T	T	T	T	T	T	T
	80	*			5/7,65	5/7,65		T	T	T	T	T	T
NSX160 B/F	125	*				5/7,65				T			T
	160	*				5/7,65				T			T
NSX100 Icu 415V: N/H 50/70	≤ 40	*	5/7,65	5/7,65	5/7,65	5/7,65	36/75	36/75	36/75	36/75	T	T	T
	50	*		5/7,65	5/7,65	5/7,65	36/75	36/75	36/75	36/75	T	T	T
	63	*		5/7,65	5/7,65	5/7,65	36/75	36/75	36/75	36/75		T	T
	80	*			5/7,65	5/7,65		36/75	36/75	36/75		T	T
NSX160 N/H	125	*				5/7,65				36/75			T
	160	*				5/7,65				36/75			T
NSX100 Icu 415V: S/L 100/150	≤ 40	*	5/7,65	5/7,65	5/7,65	5/7,65	36/75	36/75	36/75	36/75	70/150	70/150	70/150
	50	*		5/7,65	5/7,65	5/7,65	36/75	36/75	36/75	36/75	70/150	70/150	70/150
	63	*		5/7,65	5/7,65	5/7,65	36/75	36/75	36/75	36/75	70/150	70/150	70/150
	80	*			5/7,65	5/7,65		36/75	36/75	36/75	70/150	70/150	70/150
NSX160 S/L	125	*				5/7,65				36/75			70/150
	160	*				5/7,65				36/75			70/150

T Switch-disconnector is totally coordinated up to the Icu of the circuit breaker installed on supply side.

36/75 Switch-disconnector is protected up to 36 kA rms / 75 kA.

Protection of the switch-disconnector is not ensured.

Circuit-Breaker/Switch-Disconnecter Coordination

Upstream: iC60, C120, NG125

Downstream: ComPacT INS40 to INS250, INV100 to INV250

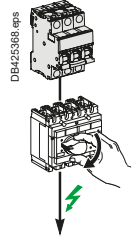

Ue ≤ 415 V AC

Downstream	Switch-disconnector	INS40	INS63	INS80	INS100	INS 250-100 INV100	INS125	INS160	INS 250-160 INV160	INS 250-200 INV200	INS250 INV250
	Ith (A) 60°	40	63	80	100	100	125	160	160	250	250
	Icw (kA)	3	3	3	5.5	8.5	5.5	5.5	8.5	8.5	8.5
	Icm (kA)	15	15	15	20	30	20	20	30	30	30

Upstream	Rating	Icu (kA)	Switch-disconnector conditional short-circuit current and related making capacity										
Circuit breaker	415 V	415 V											
iC60N B-C-D Curves	≤ 32	10	T	T	T	T	T	T	T	T	T	T	T
	40	10	T	T	T	T	T	T	T	T	T	T	T
	50	10		T	T	T	T	T	T	T	T	T	T
	63	10		T	T	T	T	T	T	T	T	T	T
iC60H B-C-D Curves	≤ 32	15	T	T	T	T	T	T	T	T	T	T	T
	40	15	T	T	T	T	T	T	T	T	T	T	T
	50	15		T	T	T	T	T	T	T	T	T	T
	63	15		T	T	T	T	T	T	T	T	T	T
iC60L B-C-D-K-Z Curves	≤ 25	25	T	T	T	T	T	T	T	T	T	T	T
	32	20	T	T	T	T	T	T	T	T	T	T	T
	40	20		T	T	T	T	T	T	T	T	T	T
	50	15		T	T	T	T	T	T	T	T	T	T
	63	15		T	T	T	T	T	T	T	T	T	T
C120N B-C-D Curves	63	10		T	T	T	T	T	T	T	T	T	T
	80	10			T	T	T	T	T	T	T	T	T
	100	10				T	T	T	T	T	T	T	T
	2, 3, 4P 415 V	125	10					T	T	T	T	T	T
C120H B-C-D Curves	63	15		T	T	T	T	T	T	T	T	T	T
	80	15			T	T	T	T	T	T	T	T	T
	100	15				T	T	T	T	T	T	T	T
	2, 3, 4P 415 V	125	15					T	T	T	T	T	T
NG125N B-C-D Curves	≤ 40	25	T	T	T	T	T	T	T	T	T	T	T
	63	25		T	T	T	T	T	T	T	T	T	T
	80	25			T	T	T	T	T	T	T	T	T
	100	25				T	T	T	T	T	T	T	T
NG125H C Curve	≤ 40	36	T	T	T	T	T	T	T	T	T	T	T
	63	36		T	T	T	T	T	T	T	T	T	T
	80	36			T	T	T	T	T	T	T	T	T
NG125L C Curve	≤ 40	50	T	T	T	T	T	T	T	T	T	T	T
	63	50		T	T	T	T	T	T	T	T	T	T
	80	50			T	T	T	T	T	T	T	T	T

- T Switch-disconnector is totally coordinated up to the Icu of the circuit breaker installed on supply side.
- 36/75 Switch-disconnector is protected up to 36 kA rms / 75 kA.
- Protection of the switch-disconnector is not ensured.

Circuit-Breaker/Switch-Disconnecter Coordination

Upstream: ComPacT NSXm

Downstream: ComPacT INS40 to 250, ComPacT INV100 to 250

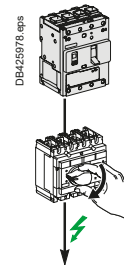

Ue ≤ 440 V AC

Downstream	Switch-disconnector	INS40	INS63	INS80	INS100	INS250-100 INV100	INS125	INS160	INS250-160 INV160	INS250-200 INV200	INS250 INV250
	Ith A 60°	40	63	80	100	100	125	160	160	200	200
	Icw (kA)	3	3	3	5.5	8.5	5.5	5.5	8.5	8.5	8.5
	Icm (kA)	15	15	15	20	30	20	20	30	30	30

Upstream	Icu (kA)	Ir	Switch-disconnector conditional short-circuit current and related making capacity											
Circuit breaker: 415 V	440 V													
NSXm E TMD, MicroLogic	16	10	Ir ≤ 40	T	T	T	T	T	T	T	T	T	T	T
			Ir ≤ 50		T	T	T	T	T	T	T	T	T	T
			Ir ≤ 63		T	T	T	T	T	T	T	T	T	T
			Ir ≤ 80			T	T	T	T	T	T	T	T	T
			Ir ≤ 100				T	T	T	T	T	T	T	T
			Ir ≤ 125							T	T	T	T	T
			Ir ≤ 160								T	T	T	T
NSXm B TMD, MicroLogic	25	20	Ir ≤ 40	T	T	T	T	T	T	T	T	T	T	
			Ir ≤ 50		T	T	T	T	T	T	T	T	T	
			Ir ≤ 63		T	T	T	T	T	T	T	T	T	
			Ir ≤ 80			T	T	T	T	T	T	T	T	
			Ir ≤ 100				T	T	T	T	T	T	T	
			Ir ≤ 125							T	T	T	T	
			Ir ≤ 160								T	T	T	
NSXm F TMD, MicroLogic	36	35	Ir ≤ 40	T	T	T	T	T	T	T	T	T	T	
			Ir ≤ 50		T	T	T	T	T	T	T	T	T	
			Ir ≤ 63		T	T	T	T	T	T	T	T	T	
			Ir ≤ 80			T	T	T	T	T	T	T	T	
			Ir ≤ 100				T	T	T	T	T	T	T	
			Ir ≤ 125							T	T	T	T	
			Ir ≤ 160								T	T	T	
NSXm N TMD, MicroLogic	50	50	Ir ≤ 40	36/75	36/75	36/75	T	T	T	T	T	T	T	
			Ir ≤ 50		36/75	36/75	T	T	T	T	T	T	T	
			Ir ≤ 63		36/75	36/75	T	T	T	T	T	T	T	
			Ir ≤ 80			36/75	T	T	T	T	T	T	T	
			Ir ≤ 100				T	T	T	T	T	T	T	
			Ir ≤ 125							T	T	T	T	
			Ir ≤ 160								T	T	T	
NSXm H TMD, MicroLogic	70	65	Ir ≤ 40	36/75	36/75	36/75	T	T	T	T	T	T	T	
			Ir ≤ 50		36/75	36/75	T	T	T	T	T	T	T	
			Ir ≤ 63		36/75	36/75	T	T	T	T	T	T	T	
			Ir ≤ 80			36/75	T	T	T	T	T	T	T	
			Ir ≤ 100				T	T	T	T	T	T	T	
			Ir ≤ 125							T	T	T	T	
			Ir ≤ 160								T	T	T	

T Switch-disconnector is totally coordinated up to the Icu of the circuit breaker installed on supply side.

36/75 Switch-disconnector is protected up to 36 kA rms / 75 kA.

Protection of the switch-disconnector is not ensured.

Fuses/TSE Coordination

Upstream: gG Fuse

Downstream: TransferPacT 32-160A (TA10D●●03 .. 06●●, TA16D●●08 .. 16●●)

Downstream: TransferPacT Automatic TA25, TA63, TransferPacT Remote TA25, TA63

Ue ≤ 440 V AC

Downstream	TSE	TA10D●●03..06●●						TA16D●●08..16●●			
	Ith (A) 60°		32	40	50	63	80	100	80	100	125
Icw (kA)		3	3	3	3	3	3	5.5	5.5	5.5	5.5
Icm (kAp)		15	15	15	15	15	15	20	20	20	20

Upstream Fuse type	Rating	TSE conditionnal short-circuit current and related making capacity:										
gG fuse link without other overload protection	25	T	T	T	T	T	T	T	T	T	T	
	32		T	T	T	T	T	T	T	T	T	
	40			T	T	T	T	T	T	T	T	
	50				T	T	T	T	T	T	T	
	63						T		T	T	T	
	80						T		T	T	T	
	100									T	T	
	125										T	
gG fuse link for protection against short-circuit only O/L protection ensured by external relay or other means	160										T	
	≤50	T	T	T	T	T	T	T	T	T	T	
	63	T	T	T	T	T	T	T	T	T	T	
	80		T	T	T	T	T	T	T	T	T	
	100			T	T	T	T	T	T	T	T	
	125				80/176	80/176	80/176	80/176	T	T	T	T
	160					36/75	36/75	36/75	50/105	50/105	50/105	50/105
200									36/75	36/75	36/75	

T TSE is Totally coordinated up to the breaking capacity of the fuse installed on supply side.

36/75 TSE is protected up to 36 kA rms / 75 kA.

Protection of the TSE is not ensured.

Ue ≤ 440 V AC

Downstream	TSE	TA25, TR25				TA63, TR63			
	Ith (A) 60°	100	160	200	250	320	400	500	630
Icw (kA)	15/0.1s 10/0.5s 8/1s	15/0.1s 10/0.5s 8/1s	15/0.1s 10/0.5s 8/1s	15/0.1s 10/0.5s 8/1s	25/0.1s 20/0.5s 15/1s	25/0.1s 20/0.5s 15/1s	25/0.1s 20/0.5s 15/1s	25/0.1s 20/0.5s 15/1s	
Icm (kAp)	30	30	30	30	40	40	40	40	

Upstream Fuse type	Rating	TSE conditionnal short-circuit current and related making capacity:							
gG fuse	80	T	T	T	T	T	T	T	T
	100		T	T	T	T	T	T	T
	160			T	T	T	T	T	T
	200				T	T	T	T	T
	250					T	T	T	T
	320						T	T	T
	400							T	T
	500								T
	630								
	gG fuse for protection against short-circuit only O/L protection ensured by external relay or other means	100	T	T	T	T	T	T	T
160			T	T	T	T	T	T	T
200				T	T	T	T	T	T
250					T	T	T	T	T
320						T	T	T	T
400							T	T	T
500								T	T
630								T	

T TSE is Totally coordinated up to the Icu of the circuit breaker installed on supply side.

Protection of the TSE is not ensured.

Circuit Breaker/Switch-Disconnecter Coordination

Upstream: ComPacT NSX100 to 250

Downstream: ComPacT INS40 to INS250, INV100 to INV250

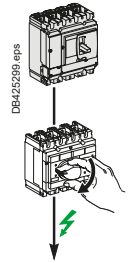

Ue ≤ 440 V AC

Downstream	Switch-disconnector	INS40	INS63	INS80	INS100	INS250-100 INV100	INS125	INS160	INS250-160 INV160	INS250-200 INV200	INS250 INV250	
		Ith A 60°	40	63	80	100	100	125	160	160	200	250
		Icw (kA)	3	3	3	5.5	8.5	5.5	5.5	8.5	8.5	8.5
		Icm (kA)	15	15	15	20	30	20	20	30	30	30

Upstream circuit breaker	Icu (kA)			Ir	Switch-disconnector conditional short-circuit current and related making capacity										
	415V	440V													
NSX100B NSX160B TMD/TMG/ MicroLogic	25	20	Ir ≤ 40	T	T	T	T	T	T	T	T	T	T	T	
			Ir ≤ 63		T	T	T	T	T	T	T	T	T	T	
			Ir ≤ 80			T	T	T	T	T	T	T	T	T	T
			Ir ≤ 100				T	T	T	T	T	T	T	T	T
			Ir ≤ 125							T	T	T	T	T	T
NSX250B TMD/TMG/ MicroLogic	25	20	Ir ≤ 40	T	T	T	T	T	T	T	T	T	T	T	
			Ir ≤ 63		T	T	T	T	T	T	T	T	T	T	
			Ir ≤ 80			T	T	T	T	T	T	T	T	T	
			Ir ≤ 100				T	T	T	T	T	T	T	T	
			Ir ≤ 125							T	T	T	T	T	
NSX100F NSX160F TMD/TMG/ MicroLogic	36	35	Ir ≤ 40	T	T	T	T	T	T	T	T	T	T		
			Ir ≤ 63		T	T	T	T	T	T	T	T	T		
			Ir ≤ 80			T	T	T	T	T	T	T	T		
			Ir ≤ 100				T	T	T	T	T	T	T		
			Ir ≤ 125							T	T	T	T		
NSX250F TMD/TMG/ MicroLogic	36	35	Ir ≤ 40	25/52	25/52	25/52	T	T	T	T	T	T	T		
			Ir ≤ 63		25/52	25/52	T	T	T	T	T	T	T		
			Ir ≤ 80			25/52	T	T	T	T	T	T	T		
			Ir ≤ 100				T	T	T	T	T	T	T		
			Ir ≤ 125							T	T	T	T		
NSX100N/H NSX160N/H TMD/TMG/ MicroLogic	50/70	50/65	Ir ≤ 40	36/75	36/75	36/75	T	T	T	T	T	T	T		
			Ir ≤ 63		36/75	36/75	T	T	T	T	T	T	T		
			Ir ≤ 80			36/75	T	T	T	T	T	T	T		
			Ir ≤ 100				T	T	T	T	T	T	T		
			Ir ≤ 125							T	T	T	T		
NSX250N/H TMD/TMG/ MicroLogic	50/70	50/65	Ir ≤ 40	25/52	25/52	25/52	T	T	T	T	T	T	T		
			Ir ≤ 63		25/52	25/52	T	T	T	T	T	T	T		
			Ir ≤ 80			25/52	T	T	T	T	T	T	T		
			Ir ≤ 100				T	T	T	T	T	T	T		
			Ir ≤ 125							T	T	T	T		
NSX100S/L/R TMD/TMG/ MicroLogic	100/ 150/ 200	90/ 130/ 200	Ir ≤ 40	36/75	36/75	36/75	65/143	T	65/143	65/143	T	T	T		
			Ir ≤ 63		36/75	36/75	65/143	T	65/143	65/143	T	T	T		
			Ir ≤ 80			36/75	65/143	T	65/143	65/143	T	T	T		
			Ir ≤ 100				65/143	T	65/143	65/143	T	T	T		
			Ir ≤ 125							65/143	65/143	T	T		
NSX160S/L TMD/TMG/ MicroLogic	100/ 150	90/ 130	Ir ≤ 40	36/75	36/75	36/75	65/143	T	65/143	65/143	T	T	T		
			Ir ≤ 63		36/75	36/75	65/143	T	65/143	65/143	T	T	T		
			Ir ≤ 80			36/75	65/143	T	65/143	65/143	T	T	T		
			Ir ≤ 100				65/143	T	65/143	65/143	T	T	T		
			Ir ≤ 125							65/143	65/143	T	T		
NSX250S/L/R TMD/TMG/ MicroLogic	100/ 150/ 200	90/ 130/ 200	Ir ≤ 40	25/52	25/52	25/52	65/143	T	65/143	65/143	T	T	T		
			Ir ≤ 63		25/52	25/52	65/143	T	65/143	65/143	T	T	T		
			Ir ≤ 80			25/52	65/143	T	65/143	65/143	T	T	T		
			Ir ≤ 100				65/143	T	65/143	65/143	T	T	T		
			Ir ≤ 125							65/143	65/143	T	T		

T Switch-disconnector is totally coordinated up to the Icu of the circuit breaker installed on supply side.

36/75 Switch-disconnector is protected up to 36 kA rms / 75 kA.

Protection of the switch-disconnector is not ensured.

Circuit Breaker/Switch-Disconnecter Coordination

Upstream: ComPacT NSX100 to 630

Downstream: ComPacT NSX100 to 630 NA

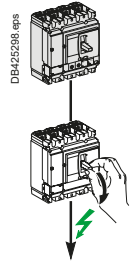

Ue ≤ 440 V AC

Downstream	Switch-disconnector	NSX100NA	NSX160NA	NSX250NA	NSX400NA	NSX630NA
	Ith A 60°	100	160	250	400	630
	Icw (kA)	1.8	2.5	3.5	5	6
	Icm (kA)	2.6	3.6	4.9	7.1	8.5

Upstream Circuit breaker	Icu (kA) 415 V	440 V	Ir	Switch-disconnector conditional short-circuit current and related making capacity				
NSX100B	25	20	Ir ≤ 100	T	T	T	T	T
NSX160B			Ir ≤ 160		T	T	T	T
NSX250B			Ir ≤ 200			T	T	T
TMD/TMG/MicroLogic			Ir ≤ 250			T	T	T
NSX100F	36	35	Ir ≤ 100	T	T	T	T	T
NSX160F			Ir ≤ 160		T	T	T	T
NSX250F			Ir ≤ 200			T	T	T
TMD/TMG/MicroLogic			Ir ≤ 250			T	T	T
NSX400F	36	30	Ir = 100 [1]	T	T	T	T	T
NSX630F			Ir ≤ 160		T	T	T	T
MicroLogic			Ir ≤ 250			T	T	T
			Ir ≤ 400				T	T
			Ir ≤ 630					T
NSX100N	50	50	Ir ≤ 100	T	T	T	T	T
NSX160N			Ir ≤ 160		T	T	T	T
NSX250N			Ir ≤ 200			T	T	T
TMD/TMG/MicroLogic			Ir ≤ 250			T	T	T
NSX400N	50	42	Ir = 100 [1]	T	T	T	T	T
NSX630N			Ir ≤ 160		T	T	T	T
MicroLogic			Ir ≤ 250			T	T	T
			Ir ≤ 400				T	T
			Ir ≤ 630					T
NSX100H	70	65	Ir ≤ 100	T	T	T	T	T
NSX160H			Ir ≤ 160		T	T	T	T
NSX250H			Ir ≤ 200			T	T	T
TMD/TMG/MicroLogic			Ir ≤ 250			T	T	T
NSX400H	70	65	Ir = 100 [1]	T	T	T	T	T
NSX630H			Ir ≤ 160		T	T	T	T
MicroLogic			Ir ≤ 250			T	T	T
			Ir ≤ 400				T	T
			Ir ≤ 630					T
NSX100S	100	90	Ir ≤ 100	T	T	T	T	T
NSX160S			Ir ≤ 160		T	T	T	T
NSX250S			Ir ≤ 200			T	T	T
TMD/TMG/MicroLogic			Ir ≤ 250			T	T	T
NSX400S	100	90	Ir = 100 [1]	T	T	T	T	T
NSX630S			Ir ≤ 160		T	T	T	T
MicroLogic			Ir ≤ 250			T	T	T
			Ir ≤ 400				T	T
			Ir ≤ 630					T
NSX100L	150	130	Ir ≤ 100	T	T	T	T	T
NSX160L			Ir ≤ 160		T	T	T	T
NSX250L			Ir ≤ 200			T	T	T
TMD/TMG/MicroLogic			Ir ≤ 250			T	T	T
NSX400L	150	130	Ir = 100 [1]	T	T	T	T	T
NSX630L			Ir ≤ 160		T	T	T	T
MicroLogic			Ir ≤ 250			T	T	T
			Ir ≤ 400				T	T
			Ir ≤ 630					T
NSX100R	200	200	Ir ≤ 100	T	T	T	T	T
NSX250R			Ir ≤ 160		T	T	T	T
TMD/TMG/MicroLogic			Ir ≤ 200			T	T	T
			Ir ≤ 250			T	T	T
NSX400R	200	200	Ir = 100 [1]	T	T	T	T	T
NSX630R			Ir ≤ 160		T	T	T	T
MicroLogic			Ir ≤ 250			T	T	T
			Ir ≤ 400				T	T
			Ir ≤ 630					T

[1] NSX400 with MicroLogic 250 A can be set down to 100 A.

T Switch-disconnector is totally coordinated up to the Icu of the circuit breaker installed on supply side.

Protection of the switch-disconnector is not ensured.

Circuit Breaker/Switch-Disconnecter Coordination

Upstream: ComPacT NSX400 to 630

Downstream: ComPacT INS/INV100 to 630

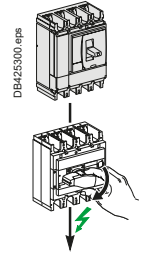

Ue ≤ 440 V AC

Downstream	Switch-disconnector	INS100	INS250-100 INV100	INS125	INS160	INS250-160 INV160	INS250-200 INV200	INS250 INV250	INS320 INV320	INS400 INV400	INS500 INV500	INS630 INV630	INS630b INV630b
		Ith A 60°	100	125	160	160	200	250	320	400	500	630	630
	Icw (kA)	5.5	8.5	5.5	5.5	8.5	8.5	8.5	20	20	20	20	35
	Icm (kA)	20	30	20	20	30	30	30	50	50	50	50	75

Upstream Circuit breaker	Icu (kA)		Setting Ir	Switch-disconnector conditional short-circuit current and related making capacity											
	415 V	440 V		16/32	T	16/32	16/32	T	T	T	T	T	T	T	T
NSX400F NSX630F MicroLogic	36	30	Ir = 100 [1]	16/32	T	16/32	16/32	T	T	T	T	T	T	T	
			Ir ≤ 160			16/32	T	T	T	T	T	T	T	T	
			Ir ≤ 200					T	T	T	T	T	T	T	
			Ir ≤ 250						T	T	T	T	T	T	
			Ir ≤ 320								T	T	T	T	
			Ir ≤ 400									T	T	T	
			Ir ≤ 500										T	T	
NSX400N NSX630N MicroLogic	50	42	Ir = 100 [1]	16/32	36/75	16/32	16/32	36/75	36/75	36/75	T	T	T	T	
			Ir ≤ 160			16/32	36/75	36/75	36/75	T	T	T	T		
			Ir ≤ 200					36/75	36/75	T	T	T	T		
			Ir ≤ 250						36/75	T	T	T	T		
			Ir ≤ 320							T	T	T	T		
			Ir ≤ 400								T	T	T		
			Ir ≤ 500									T	T		
NSX400H NSX630H MicroLogic	70	65	Ir = 100 [1]	16/32	36/75	16/32	16/32	36/75	36/75	36/75	T	T	T	T	
			Ir ≤ 160			16/32	36/75	36/75	36/75	T	T	T	T		
			Ir ≤ 200					36/75	36/75	T	T	T	T		
			Ir ≤ 250						36/75	T	T	T	T		
			Ir ≤ 320							T	T	T	T		
			Ir ≤ 400								T	T	T		
			Ir ≤ 500									T	T		
NSX400S NSX630S MicroLogic	100	90	Ir = 100 [1]	16/32	36/75	16/32	16/32	36/75	36/75	36/75	T	T	T	T	
			Ir ≤ 160			16/32	36/75	36/75	36/75	T	T	T	T		
			Ir ≤ 200					36/75	36/75	T	T	T	T		
			Ir ≤ 250						36/75	T	T	T	T		
			Ir ≤ 320							T	T	T	T		
			Ir ≤ 400								T	T	T		
			Ir ≤ 500									T	T		
NSX400L NSX630L MicroLogic	150	130	Ir = 100 [1]	16/32	36/75	16/32	16/32	36/75	36/75	36/75	T	T	T	T	
			Ir ≤ 160			16/32	36/75	36/75	36/75	T	T	T	T		
			Ir ≤ 200					36/75	36/75	T	T	T	T		
			Ir ≤ 250						36/75	T	T	T	T		
			Ir ≤ 320							T	T	T	T		
			Ir ≤ 400								T	T	T		
			Ir ≤ 500									T	T		
NSX400R NSX630R MicroLogic	200	200	Ir = 100 [1]	16/32	36/75	16/32	16/32	36/75	36/75	36/75	150/330	150/330	150/330	150/330	
			Ir ≤ 160			16/32	36/75	36/75	36/75	150/330	150/330	150/330	150/330		
			Ir ≤ 200					36/75	36/75	150/330	150/330	150/330	150/330		
			Ir ≤ 250						36/75	150/330	150/330	150/330	150/330		
			Ir ≤ 320							150/330	150/330	150/330	150/330		
			Ir ≤ 400								150/330	150/330	150/330		
			Ir ≤ 500									150/330	150/330		
Ir ≤ 630										150/330					

[1] NSX400 with MicroLogic 250 A can be set down to 100 A.

- T Switch-disconnector is totally coordinated up to the Icu of the circuit breaker installed on supply side.
- 36/75 Switch-disconnector is protected up to 36 kA rms / 75 kA.
- Protection of the switch-disconnector is not ensured.

Circuit Breaker/Switch-Disconnecter Coordination

Upstream: ComPacT NS630b to 3200, MasterPact MTZ1

Downstream: ComPacT INS/INV500 to 2500

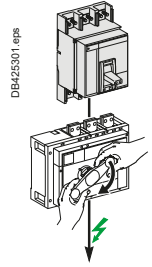

Ue ≤ 440 V AC

Downstream	Switch-disconnector	INS500	INS630	INS630b	INS800	INS1000	INS1250	INS1600	INS2000	INS2500	
		INV500	INV630	INV630b	INV800	INV1000	INV1250	INV1600	INV2000	INV2500	
		Ith A 60°	500	630	630	800	1000	1250	1600	2000	2500
		Icw (kA)	20	20	35	35	35	35	35	50	50
Icm (kA)	50	50	75	75	75	75	75	105	105		

Upstream Circuit breaker	Icu (kA)		Setting Ir	Switch-disconnector conditionnal short-circuit current and related making capacity									
	415 V	440 V		20/50	20/50	35/75	35/75	35/75	35/75	35/75	35/75	T	T
NS630bN	50	50	Ir ≤ 500	20/50	20/50	35/75	35/75	35/75	35/75	35/75	35/75	T	T
NS800N			Ir ≤ 630		20/50	35/75	35/75	35/75	35/75	35/75	35/75	T	T
NS1000N			Ir ≤ 800				35/75	35/75	35/75	35/75	35/75	T	T
NS1250N			Ir ≤ 1000					35/75	35/75	35/75	35/75	T	T
NS1600N			Ir ≤ 1250						35/75	35/75	35/75	T	T
			Ir ≤ 1600							35/75	35/75	T	T
NS630bH	70	65	Ir ≤ 500	20/50	20/50	35/75	35/75	35/75	35/75	35/75	50/105	50/105	
NS800H			Ir ≤ 630		20/50	35/75	35/75	35/75	35/75	35/75	50/105	50/105	
NS1000H			Ir ≤ 800				35/75	35/75	35/75	35/75	50/105	50/105	
NS1250H			Ir ≤ 1000					35/75	35/75	35/75	50/105	50/105	
NS1600H			Ir ≤ 1250						35/75	35/75	50/105	50/105	
			Ir ≤ 1600							35/75	50/105	50/105	
NS630bL	150	130	Ir ≤ 500	50/105	50/105	T	T	T	T	T	T	T	
NS800L			Ir ≤ 630		50/105	T	T	T	T	T	T	T	
NS1000L			Ir ≤ 800				T	T	T	T	T	T	
			Ir ≤ 1000					T	T	T	T	T	
NS630bLB	200	200	Ir ≤ 500	90/200	90/200	T	T	T	T	T	T	T	
NS800LB			Ir ≤ 630		90/200	T	T	T	T	T	T	T	
			Ir ≤ 800				T	T	T	T	T	T	
NS1600bN	70	65	Ir ≤ 1250						35/75	35/75	50/105	50/105	
NS2000N			Ir ≤ 1600							35/75	50/105	50/105	
NS2500N			Ir ≤ 2000								50/105	50/105	
NS3200N			Ir ≤ 2500									50/105	
NS1600bH	85	85	Ir ≤ 1250						35/75	35/75	50/105	50/105	
NS2000H			Ir ≤ 1600							35/75	50/105	50/105	
NS2500H			Ir ≤ 2000								50/105	50/105	
NS3200H			Ir ≤ 2500									50/105	
MTZ1 06H1	42	42	Ir ≤ 500	20/50	20/50	35/75	35/75	35/75	35/75	35/75	T	T	
MTZ1 08H1			Ir ≤ 630		20/50	35/75	35/75	35/75	35/75	35/75	T	T	
MTZ1 10H1			Ir ≤ 800				35/75	35/75	35/75	35/75	T	T	
MTZ1 12H1			Ir ≤ 1000					35/75	35/75	35/75	T	T	
MTZ1 16H1			Ir ≤ 1250						35/75	35/75	T	T	
			Ir ≤ 1600							35/75	T	T	
MTZ1 06H2	50	50	Ir ≤ 500	20/50	20/50	35/75	35/75	35/75	35/75	35/75	T	T	
MTZ1 08H2			Ir ≤ 630		20/50	35/75	35/75	35/75	35/75	35/75	T	T	
MTZ1 10H2			Ir ≤ 800				35/75	35/75	35/75	35/75	T	T	
MTZ1 12H2			Ir ≤ 1000					35/75	35/75	35/75	T	T	
MTZ1 16H2			Ir ≤ 1250						35/75	35/75	T	T	
			Ir ≤ 1600							35/75	T	T	
MTZ1 06H3	66	66	Ir ≤ 500	20/50	20/50	35/75	35/75	35/75	35/75	35/75	50/105	50/105	
MTZ1 08H3			Ir ≤ 630		20/50	35/75	35/75	35/75	35/75	35/75	50/105	50/105	
MTZ1 10H3			Ir ≤ 800				35/75	35/75	35/75	35/75	50/105	50/105	
MTZ1 12H3			Ir ≤ 1000					35/75	35/75	35/75	50/105	50/105	
MTZ1 16H3			Ir ≤ 1250						35/75	35/75	50/105	50/105	
			Ir ≤ 1600							35/75	50/105	50/105	
MTZ1 06L1	150	130	Ir ≤ 500	50/105	50/105	100/220	100/220	100/220	100/220	100/220	100/220	100/220	
MTZ1 08L1			Ir ≤ 630		50/105	100/220	100/220	100/220	100/220	100/220	100/220	100/220	
MTZ1 10L1			Ir ≤ 800				100/220	100/220	100/220	100/220	100/220	100/220	
			Ir ≤ 1000					100/220	100/220	100/220	100/220	100/220	

- T Switch-disconnector is totally coordinated up to the Icu of the circuit breaker installed on supply side.
- 36/75 Switch-disconnector is protected up to 36 kA rms / 75 kA.
- Protection of the switch-disconnector is not ensured.

Circuit Breaker/Switch-Disconnecter Coordination

Upstream: ComPacT NS630b to 3200, MasterPact MTZ1

Downstream: ComPacT NS630b to 3200 NA

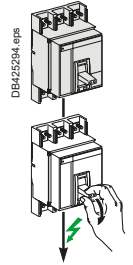

Ue ≤ 440 V AC

Downstream	Switch-disconnector	NS630b NA	NS800 NA	NS1000 NA	NS1250 NA	NS1600 NA	NS1600b NA	NS2000 NA	NS2500 NA	NS3200 NA
	Ith A 60°	630	800	1000	1250	1600	1600	2000	2500	3200
	Icw (kA)	25 (0.5s)	25 (0.5s)	25 (0.5s)	25 (0.5s)	25 (0.5s)	32 (3s)	32 (3s)	32 (3s)	32 (3s)
	Icm (kA)	52	52	52	52	52	135	135	135	135

Upstream Circuit breaker	Icu (kA)		Setting	Switch-disconnector conditional short-circuit current and related making capacity									
	415 V	440 V Ir		NS630b NA	NS800 NA	NS1000 NA	NS1250 NA	NS1600 NA	NS1600b NA	NS2000 NA	NS2500 NA	NS3200 NA	
NS630bN	50	50	Ir ≤ 630	T	T	T	T	T	T	T	T	T	T
NS800N			Ir ≤ 800		T	T	T	T	T	T	T	T	T
NS1000N			Ir ≤ 1000			T	T	T	T	T	T	T	T
NS1250N			Ir ≤ 1250				T	T	T	T	T	T	T
NS1600N			Ir ≤ 1600					T	T	T	T	T	T
NS630bH	70	65	Ir ≤ 630	T	T	T	T	T	T	T	T	T	T
NS800H			Ir ≤ 800		T	T	T	T	T	T	T	T	T
NS1000H			Ir ≤ 1000			T	T	T	T	T	T	T	T
NS1250H			Ir ≤ 1250				T	T	T	T	T	T	T
NS1600H			Ir ≤ 1600					T	T	T	T	T	T
NS630bL	150	130	Ir ≤ 630	T	T	T	T	T	T	T	T	T	T
NS800L			Ir ≤ 800		T	T	T	T	T	T	T	T	T
NS1000L			Ir ≤ 1000			T	T	T	T	T	T	T	T
NS630bLB	200	200	Ir ≤ 630	T	T	T	T	T	T	T	T	T	T
NS800LB			Ir ≤ 800		T	T	T	T	T	T	T	T	T
NS1600bN	70	65	Ir ≤ 1600						T	T	T	T	T
NS2000N			Ir ≤ 2000							T	T	T	T
NS2500N			Ir ≤ 2500								T	T	T
NS3200N			Ir ≤ 3200									T	T
NS1600bH	85	85	Ir ≤ 1600						T	T	T	T	T
NS2000H			Ir ≤ 2000							T	T	T	T
NS2500H			Ir ≤ 2500								T	T	T
NS3200H			Ir ≤ 3200									T	T
MTZ1 06H1	42	42	Ir ≤ 630	25/52	25/52	25/52	25/52	25/52	T	T	T	T	T
MTZ1 08H1			Ir ≤ 800		25/52	25/52	25/52	25/52	T	T	T	T	T
MTZ1 10H1			Ir ≤ 1000			25/52	25/52	25/52	T	T	T	T	T
MTZ1 12H1			Ir ≤ 1250				25/52	25/52	T	T	T	T	T
MTZ1 16H1			Ir ≤ 1600					25/52	T	T	T	T	T
MTZ1 06H2	50	50	Ir ≤ 630	25/52	25/52	25/52	25/52	25/52	T	T	T	T	T
MTZ1 08H2			Ir ≤ 800		25/52	25/52	25/52	25/52	T	T	T	T	T
MTZ1 10H2			Ir ≤ 1000			25/52	25/52	25/52	T	T	T	T	T
MTZ1 12H2			Ir ≤ 1250				25/52	25/52	T	T	T	T	T
MTZ1 16H2			Ir ≤ 1600					25/52	T	T	T	T	T
MTZ1 06H3	66	66	Ir ≤ 630	25/52	25/52	25/52	25/52	25/52	T	T	T	T	T
MTZ1 08H3			Ir ≤ 800		25/52	25/52	25/52	25/52	T	T	T	T	T
MTZ1 10H3			Ir ≤ 1000			25/52	25/52	25/52	T	T	T	T	T
MTZ1 12H3			Ir ≤ 1250				25/52	25/52	T	T	T	T	T
MTZ1 16H3			Ir ≤ 1600					25/52	T	T	T	T	T
MTZ1 06L1	150	130	Ir ≤ 630	T	T	T	T	T	T	T	T	T	T
MTZ1 08L1			Ir ≤ 800		T	T	T	T	T	T	T	T	T
MTZ1 10L1			Ir ≤ 1000			T	T	T	T	T	T	T	T

Switch-disconnector is totally coordinated up to the Icu of the circuit breaker installed on supply side.

36/75 Switch-disconnector is protected up to 36 kA rms / 75 kA.

Protection of the switch-disconnector is not ensured.

Circuit Breaker/Switch-Disconnecter Coordination

Upstream: MasterPacT MTZ2

Downstream: ComPacT INS/INV500 to 2500

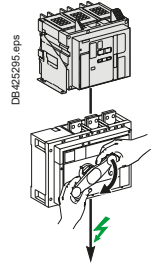

U_e ≤ 440 V AC

Downstream	Switch-disconnector	INS500 INV500	INS630 INV630	INS630b INV630b	INS800 INV800	INS1000 INV1000	INS1250 INV1250	INS1600 INV1600	INS2000 INV2000	INS2500 INV2500
	I _{th} A 60°	500	630	630	800	1000	1250	1600	2000	2500
	I _{cw} (kA)	20	20	35	35	35	35	35	50	50
	I _{cm} (kA)	50	50	75	75	75	75	75	105	105

Upstream	I _{cu} (kA)	Setting	Switch-disconnector conditional short-circuit current and related making capacity										
Circuit breaker	415 V 440 V I _r												
MTZ2 08N1	42	42	I _r ≤ 500	20/50	20/50	35/75	35/75	35/75	35/75	35/75	35/75	T	T
MTZ2 10N1			I _r ≤ 630		20/50	35/75	35/75	35/75	35/75	35/75	35/75	T	T
MTZ2 12N1			I _r ≤ 800				35/75	35/75	35/75	35/75	35/75	T	T
MTZ2 16N1			I _r ≤ 1000					35/75	35/75	35/75	35/75	T	T
MTZ2 20N1			I _r ≤ 1250						35/75	35/75	35/75	T	T
			I _r ≤ 1600							35/75	35/75	T	T
			I _r ≤ 2000								35/75	T	T
MTZ2 08H1	66	66	I _r ≤ 500	20/50	20/50	35/75	35/75	35/75	35/75	35/75	50/105	50/105	
MTZ2 10H1			I _r ≤ 630		20/50	35/75	35/75	35/75	35/75	35/75	50/105	50/105	
MTZ2 12H1			I _r ≤ 800				35/75	35/75	35/75	35/75	50/105	50/105	
MTZ2 16H1			I _r ≤ 1000					35/75	35/75	35/75	50/105	50/105	
MTZ2 20H1			I _r ≤ 1250						35/75	35/75	50/105	50/105	
MTZ2 25H1			I _r ≤ 1600							35/75	35/75	50/105	50/105
			I _r ≤ 2000								50/105	50/105	
			I _r ≤ 2500									50/105	
MTZ2 08H2/H2V	100	100	I _r ≤ 500	20/50	20/50	35/75	35/75	35/75	35/75	35/75	50/105	50/105	
MTZ2 10H2/H2V			I _r ≤ 630		20/50	35/75	35/75	35/75	35/75	35/75	50/105	50/105	
MTZ2 12H2/H2V			I _r ≤ 800				35/75	35/75	35/75	35/75	50/105	50/105	
MTZ2 16H2/H2V			I _r ≤ 1000					35/75	35/75	35/75	50/105	50/105	
MTZ2 20H2/H2V			I _r ≤ 1250						35/75	35/75	50/105	50/105	
MTZ2 25H2/H2V			I _r ≤ 1600							35/75	35/75	50/105	
MTZ2 08L1	150	150	I _r ≤ 500	20/50	20/50	35/75	35/75	35/75	35/75	35/75	50/105	50/105	
MTZ2 10L1			I _r ≤ 630		20/50	35/75	35/75	35/75	35/75	35/75	50/105	50/105	
MTZ2 12L1			I _r ≤ 800				35/75	35/75	35/75	35/75	50/105	50/105	
MTZ2 16L1			I _r ≤ 1000					35/75	35/75	35/75	50/105	50/105	
MTZ2 20L1			I _r ≤ 1250						35/75	35/75	50/105	50/105	
MTZ2 20H3	150	150	I _r ≤ 2000								50/105	50/105	
MTZ2 25H3			I _r ≤ 2500									50/105	

T Switch-disconnector is totally coordinated up to the I_{cu} of the circuit breaker installed on supply side.

36/75 Switch-disconnector is protected up to 36 kA rms / 75 kA.

Protection of the switch-disconnector is not ensured.

Circuit Breaker/Switch-Disconnecter Coordination

Upstream: ComPacT NS630b -1600, MasterPact MTZ1, MTZ2

Downstream: MasterPacT MTZ1 HA, MasterPact MTZ2 NA

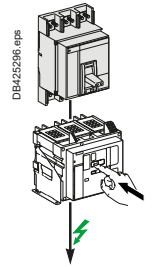

Ue ≤ 440 V AC

Downstream	Switch-disconnector	MTZ1	MTZ1	MTZ1	MTZ1	MTZ1	MTZ2	MTZ2	MTZ2	MTZ2	
		06HA	08HA	10HA	12HA	16HA	08NA	10NA	12NA	16NA	
		Ith A 60°	630	800	1000	1250	1600	800	1000	1250	1600
		Icw (kA)	36	36	36	36	36	42	42	42	42
Icm (kA)	75	75	75	75	75	88	88	88	88		

Upstream Circuit breaker	Icu (kA)		Setting	Switch-disconnector conditional short-circuit current and related making capacity									
	415 V	440 V Ir											
NS630bN	50	50	Ir ≤ 630	T	T	T	T	T	T	T	T	T	T
NS800N			Ir ≤ 800		T	T	T	T	T	T	T	T	T
NS1000N			Ir ≤ 1000			T	T	T		T	T	T	T
NS1250N			Ir ≤ 1250				T	T			T	T	T
NS1600N			Ir ≤ 1600					T				T	T
NS630bH	70	65	Ir ≤ 630	50/105	50/105	50/105	50/105	50/105	50/105	50/105	50/105	50/105	50/105
NS800H			Ir ≤ 800		50/105	50/105	50/105	50/105	50/105	50/105	50/105	50/105	50/105
NS1000H			Ir ≤ 1000			50/105	50/105	50/105		50/105	50/105	50/105	50/105
NS1250H			Ir ≤ 1250				50/105	50/105			50/105	50/105	50/105
NS1600H			Ir ≤ 1600					50/105				50/105	50/105
NS630bL	150	130	Ir ≤ 630	T	T	T	T	T	T	T	T	T	T
NS800L			Ir ≤ 800		T	T	T	T	T	T	T	T	T
NS1000L			Ir ≤ 1000			T	T	T		T	T	T	T
NS630bLB	200	200	Ir ≤ 630	T	T	T	T	T	T	T	T	T	T
NS800LB			Ir ≤ 800		T	T	T	T	T	T	T	T	T
MTZ1 06H1	42	42	Ir ≤ 630	36/75	36/75	36/75	36/75	36/75	42/88	42/88	42/88	42/88	42/88
MTZ1 08H1			Ir ≤ 800		36/75	36/75	36/75	36/75	42/88	42/88	42/88	42/88	42/88
MTZ1 10H1			Ir ≤ 1000			36/75	36/75	36/75		42/88	42/88	42/88	42/88
MTZ1 12H1			Ir ≤ 1250				36/75	36/75			42/88	42/88	42/88
MTZ1 16H1			Ir ≤ 1600					36/75				42/88	42/88
MTZ1 06H2	50	50	Ir ≤ 630	36/75	36/75	36/75	36/75	36/75	42/88	42/88	42/88	42/88	42/88
MTZ1 08H2			Ir ≤ 800		36/75	36/75	36/75	36/75	42/88	42/88	42/88	42/88	42/88
MTZ1 10H2			Ir ≤ 1000			36/75	36/75	36/75		42/88	42/88	42/88	42/88
MTZ1 12H2			Ir ≤ 1250				36/75	36/75			42/88	42/88	42/88
MTZ1 16H2			Ir ≤ 1600					36/75				42/88	42/88
MTZ1 06H3	66	66	Ir ≤ 630	36/75	36/75	36/75	36/75	36/75	42/88	42/88	42/88	42/88	42/88
MTZ1 08H3			Ir ≤ 800		36/75	36/75	36/75	36/75	42/88	42/88	42/88	42/88	42/88
MTZ1 10H3			Ir ≤ 1000			36/75	36/75	36/75		42/88	42/88	42/88	42/88
MTZ1 12H3			Ir ≤ 1250				36/75	36/75			42/88	42/88	42/88
MTZ1 16H3			Ir ≤ 1600					36/75				42/88	42/88
MTZ1 06L1	150	130	Ir ≤ 630	T	T	T	T	T	T	T	T	T	T
MTZ1 08L1			Ir ≤ 800		T	T	T	T	T	T	T	T	T
MTZ1 10L1			Ir ≤ 1000			T	T	T		T	T	T	T
MTZ2 08N1	42	42	Ir ≤ 800		36/75	36/75	36/75	36/75	42/88	42/88	42/88	42/88	42/88
MTZ2 10N1			Ir ≤ 1000			36/75	36/75	36/75		42/88	42/88	42/88	42/88
MTZ2 12N1			Ir ≤ 1250				36/75	36/75			42/88	42/88	42/88
MTZ2 16N1			Ir ≤ 1600					36/75				42/88	42/88
MTZ2 20N1													
MTZ2 08H1	66	66	Ir ≤ 800		36/75	36/75	36/75	36/75	42/88	42/88	42/88	42/88	42/88
MTZ2 10H1			Ir ≤ 1000			36/75	36/75	36/75		42/88	42/88	42/88	42/88
MTZ2 12H1			Ir ≤ 1250				36/75	36/75			42/88	42/88	42/88
MTZ2 16H1			Ir ≤ 1600					36/75				42/88	42/88

T Switch-disconnector is totally coordinated up to the Icu of the circuit breaker installed on supply side.

36/75 Switch-disconnector is protected up to 36 kA rms / 75 kA.

Protection of the switch-disconnector is not ensured.

Circuit Breaker/Switch-Disconnecter Coordination

Upstream: MasterPact MTZ2, MTZ3

Downstream: MasterPact MTZ2 HA, MTZ3 HA

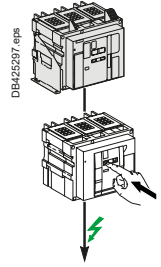

Ue ≤ 440 V AC

Downstream	Switch-disconnector	MTZ2 08 HA	MTZ2 10 HA	MTZ2 12 HA	MTZ2 16 HA	MTZ2 20 HA	MTZ2 25 HA	MTZ2 32 HA	MTZ2 40 HA	MTZ3 40 HA	MTZ3 50 HA	MTZ3 63 HA
	Ith A 60°	800	1000	1250	1600	2000	2500	3200	4000	4000	5000	6300
	Icw (kA)	66	66	66	66	66	66	66	66	85	85	85
	Icm (kA)	145	145	145	145	145	145	145	145	187	187	187

Upstream Circuit breaker	Icu (kA)		Setting Ir	Switch-disconnector conditionnal short-circuit current and related making capacity											
	415 V	440 V		MTZ2 08 HA	MTZ2 10 HA	MTZ2 12 HA	MTZ2 16 HA	MTZ2 20 HA	MTZ2 25 HA	MTZ2 32 HA	MTZ2 40 HA	MTZ3 40 HA	MTZ3 50 HA	MTZ3 63 HA	
MTZ2 08N1	42	42	Ir ≤ 800	T	T	T	T	T	T	T	T	T	T	T	
			Ir ≤ 1000		T	T	T	T	T	T	T	T	T	T	
			Ir ≤ 1250			T	T	T	T	T	T	T	T	T	
			Ir ≤ 1600				T	T	T	T	T	T	T	T	
			Ir ≤ 2000					T	T	T	T	T	T	T	
MTZ2 08H1	66	66	Ir ≤ 800	T	T	T	T	T	T	T	T	T	T		
			Ir ≤ 1000		T	T	T	T	T	T	T	T	T		
			Ir ≤ 1250			T	T	T	T	T	T	T	T		
			Ir ≤ 1600				T	T	T	T	T	T	T		
			Ir ≤ 2000					T	T	T	T	T	T		
			Ir ≤ 2500						T	T	T	T	T		
			Ir ≤ 3200							T	T	T	T		
MTZ2 40H1			Ir ≤ 4000								T	T	T		
			Ir ≤ 5000									T	T		
			Ir ≤ 6300										T	T	
			Ir ≤ 800	66/145	66/145	66/145	66/145	66/145	66/145	66/145	66/145	66/145	85/187	85/187	
			Ir ≤ 1000		66/145	66/145	66/145	66/145	66/145	66/145	66/145	66/145	85/187	85/187	
MTZ2 12H2/H2V			Ir ≤ 1250			66/145	66/145	66/145	66/145	66/145	66/145	85/187	85/187		
			Ir ≤ 1600				66/145	66/145	66/145	66/145	66/145	85/187	85/187		
			Ir ≤ 2000					66/145	66/145	66/145	66/145	85/187	85/187		
			Ir ≤ 2500						66/145	66/145	66/145	85/187	85/187		
			Ir ≤ 3200							66/145	66/145	85/187	85/187		
			Ir ≤ 4000								66/145	66/145	85/187	85/187	
			Ir ≤ 800	66/145	66/145	66/145	66/145	66/145	66/145	66/145	66/145	66/145	85/187	85/187	
MTZ2 10L1			Ir ≤ 1000		66/145	66/145	66/145	66/145	66/145	66/145	66/145	85/187	85/187		
			Ir ≤ 1250			66/145	66/145	66/145	66/145	66/145	66/145	85/187	85/187		
			Ir ≤ 1600				66/145	66/145	66/145	66/145	66/145	85/187	85/187		
			Ir ≤ 2000					66/145	66/145	66/145	66/145	85/187	85/187		
			Ir ≤ 2500						66/145	66/145	66/145	85/187	85/187		
			Ir ≤ 3200							66/145	66/145	85/187	85/187		
			Ir ≤ 4000								66/145	66/145	85/187		
			Ir ≤ 4000	66/145	66/145	66/145	66/145	66/145	66/145	66/145	66/145	85/187	85/187		
			Ir ≤ 5000									66/145	85/187	85/187	
MTZ3 63H2			Ir ≤ 6300									85/187	85/187		

T Switch-disconnector is totally coordinated up to the Icu of the circuit breaker installed on supply side.

36/75 Switch-disconnector is protected up to 36 kA rms / 75 kA.

Protection of the switch-disconnector is not ensured.

Circuit Breaker/Switch-Disconnecter Coordination

Upstream: MasterPact MTZ2, MasterPact MTZ3

Downstream: MasterPact MTZ2 HF

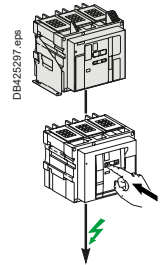

Ue ≤ 440 V AC

Downstream	Switch-disconnector	MTZ2 08 HF	MTZ2 10 HF	MTZ2 12 HF	MTZ2 16 HF	MTZ2 20 HF	MTZ2 25 HF	MTZ2 32 HF	MTZ2 40 HF
	Ith A 60°	800	1000	1250	1600	2000	2500	3200	4000
	Icw (kA)	85	85	85	85	85	85	85	85
	Icm (kA)	187	187	187	187	187	187	187	187

Upstream Circuit breaker	Icu (kA)		Setting	Switch-disconnector conditionnal short-circuit current and related making capacity								
	415 V	440 V Ir										
MTZ2 08N1	42	42	Ir ≤ 800	T	T	T	T	T	T	T	T	T
MTZ2 10N1			Ir ≤ 1000		T	T	T	T	T	T	T	T
MTZ2 12N1			Ir ≤ 1250			T	T	T	T	T	T	T
MTZ2 16N1			Ir ≤ 1600				T	T	T	T	T	T
MTZ2 20N1			Ir ≤ 2000					T	T	T	T	T
MTZ2 08H1	66	66	Ir ≤ 800	T	T	T	T	T	T	T	T	T
MTZ2 10H1			Ir ≤ 1000		T	T	T	T	T	T	T	T
MTZ2 12H1			Ir ≤ 1250			T	T	T	T	T	T	T
MTZ2 16H1			Ir ≤ 1600				T	T	T	T	T	T
MTZ2 20H1			Ir ≤ 2000					T	T	T	T	T
MTZ2 25H1			Ir ≤ 2500						T	T	T	T
MTZ2 32H1			Ir ≤ 3200							T	T	T
MTZ2 40H1			Ir ≤ 4000								T	T
MTZ3 40H1	100	100	Ir ≤ 2500						85/187	85/187	85/187	85/187
MTZ3 50H1			Ir ≤ 3200							85/187	85/187	85/187
MTZ3 63H1			Ir ≤ 4000								85/187	85/187
MTZ2 08H2/H2V	100	100	Ir ≤ 800	100/220	100/220	100/220	100/220	100/220	100/220	100/220	100/220	100/220
MTZ2 10H2/H2V			Ir ≤ 1000		100/220	100/220	100/220	100/220	100/220	100/220	100/220	100/220
MTZ2 12H2/H2V			Ir ≤ 1250			100/220	100/220	100/220	100/220	100/220	100/220	100/220
MTZ2 16H2/H2V			Ir ≤ 1600				100/220	100/220	100/220	100/220	100/220	100/220
MTZ2 20H2/H2V			Ir ≤ 2000					100/220	100/220	100/220	100/220	100/220
MTZ2 25H2/H2V			Ir ≤ 2500						100/220	100/220	100/220	100/220
MTZ2 32H2/H2V			Ir ≤ 3200							100/220	100/220	100/220
MTZ2 40H2/H2V			Ir ≤ 4000								100/220	100/220
MTZ2 08L1	150	150	Ir ≤ 800	100/220	100/220	100/220	100/220	100/220	100/220	100/220	100/220	100/220
MTZ2 10L1			Ir ≤ 1000		100/220	100/220	100/220	100/220	100/220	100/220	100/220	100/220
MTZ2 12L1			Ir ≤ 1250			100/220	100/220	100/220	100/220	100/220	100/220	100/220
MTZ2 16L1			Ir ≤ 1600				100/220	100/220	100/220	100/220	100/220	100/220
MTZ2 20L1			Ir ≤ 2000					100/220	100/220	100/220	100/220	100/220
MTZ2 20H3	150	150	Ir ≤ 2000					85/187	85/187	85/187	85/187	85/187
MTZ2 25H3			Ir ≤ 2500						85/187	85/187	85/187	85/187
MTZ2 32H3			Ir ≤ 3200							85/187	85/187	85/187
MTZ2 40H3			Ir ≤ 4000								85/187	85/187
MTZ3 40H2	150	150	Ir ≤ 2500						85/187	85/187	85/187	85/187
MTZ3 50H2			Ir ≤ 3200							85/187	85/187	85/187
MTZ3 63H2			Ir ≤ 4000								85/187	85/187

T Switch-disconnector is totally coordinated up to the Icu of the circuit breaker installed on supply side.

36/75 Switch-disconnector is protected up to 36 kA rms / 75 kA.

Protection of the switch-disconnector is not ensured.

Circuit Breaker/Switch-Disconnecter Coordination

Upstream: MasterPact MTZ2, MasterPact MTZ3

Downstream: MasterPact MTZ2 HH, MasterPact NW40b/50/63 HH

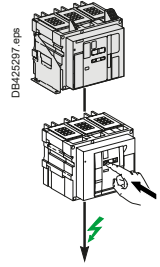

Ue ≤ 440 V AC

Downstream	Switch-disconnector	MTZ2 20 HH	MTZ2 25 HH	MTZ2 32 HH	MTZ2 40 HH	NW40b HH	NW50 HH	NW63 HH
	Ith A 60°	2000	2500	3200	4000	4000	5000	6300
	Icw (kA)	100	100	100	100	100	100	100
	Icm (kA)	220	220	220	220	220	220	220

Upstream Circuit breaker	Icu (kA)		Setting	Switch-disconnector conditional short-circuit current and related making capacity						
	415 V	440 V Ir								
MTZ2 08N1	42	42	Ir ≤ 800	T	T	T	T	T	T	T
MTZ2 10N1			Ir ≤ 1000	T	T	T	T	T	T	T
MTZ2 12N1			Ir ≤ 1250	T	T	T	T	T	T	T
MTZ2 16N1			Ir ≤ 1600	T	T	T	T	T	T	T
MTZ2 20N1			Ir ≤ 2000	T	T	T	T	T	T	T
MTZ2 08H1	66	66	Ir ≤ 800	T	T	T	T	T	T	T
MTZ2 10H1			Ir ≤ 1000	T	T	T	T	T	T	T
MTZ2 12H1			Ir ≤ 1250	T	T	T	T	T	T	T
MTZ2 16H1			Ir ≤ 1600	T	T	T	T	T	T	T
MTZ2 20H1			Ir ≤ 2000	T	T	T	T	T	T	T
MTZ2 25H1			Ir ≤ 2500		T	T	T	T	T	T
MTZ2 32H1			Ir ≤ 3200			T	T	T	T	T
MTZ2 40H1			Ir ≤ 4000				T	T	T	T
MTZ3 40H1	100	100	Ir ≤ 2500		T	T	T	T	T	T
MTZ3 50H1			Ir ≤ 3200			T	T	T	T	T
MTZ3 63H1			Ir ≤ 4000				T	T	T	T
			Ir ≤ 5000					T	T	T
			Ir ≤ 6300						T	T
MTZ2 08H2/H2V	100	100	Ir ≤ 800	T	T	T	T	T	T	T
MTZ2 10H2/H2V			Ir ≤ 1000	T	T	T	T	T	T	T
MTZ2 12H2/H2V			Ir ≤ 1250	T	T	T	T	T	T	T
MTZ2 16H2/H2V			Ir ≤ 1600	T	T	T	T	T	T	T
MTZ2 20H2/H2V			Ir ≤ 2000	T	T	T	T	T	T	T
MTZ2 25H2/H2V			Ir ≤ 2500		T	T	T	T	T	T
MTZ2 32H2/H2V			Ir ≤ 3200			T	T	T	T	T
MTZ2 40H2/H2V			Ir ≤ 4000				T	T	T	T
MTZ2 08L1	150	150	Ir ≤ 800	100/220	100/220	100/220	100/220	100/220	100/220	100/220
MTZ2 10L1			Ir ≤ 1000	100/220	100/220	100/220	100/220	100/220	100/220	100/220
MTZ2 12L1			Ir ≤ 1250	100/220	100/220	100/220	100/220	100/220	100/220	100/220
MTZ2 16L1			Ir ≤ 1600	100/220	100/220	100/220	100/220	100/220	100/220	100/220
MTZ2 20L1			Ir ≤ 2000	100/220	100/220	100/220	100/220	100/220	100/220	100/220
MTZ2 20H3	150	150	Ir ≤ 2000	100/220	100/220	100/220	100/220	100/220	100/220	100/220
MTZ2 25H3			Ir ≤ 2500		100/220	100/220	100/220	100/220	100/220	100/220
MTZ2 32H3			Ir ≤ 3200			100/220	100/220	100/220	100/220	100/220
MTZ2 40H3			Ir ≤ 4000				100/220	100/220	100/220	100/220
MTZ3 40H2	150	150	Ir ≤ 2500		100/220	100/220	100/220	100/220	100/220	100/220
MTZ3 50H2			Ir ≤ 3200			100/220	100/220	100/220	100/220	100/220
MTZ3 63H2			Ir ≤ 4000				100/220	100/220	100/220	100/220
			Ir ≤ 5000					100/220	100/220	100/220
			Ir ≤ 6300						100/220	100/220

T Switch-disconnector is totally coordinated up to the Icu of the circuit breaker installed on supply side.

36/75 Switch-disconnector is protected up to 36 kA rms / 75 kA.

Protection of the switch-disconnector is not ensured.

Circuit-Breaker/Switch-Disconnecter Coordination

Upstream: ComPacT NSXm, ComPacT NSX100 to 250

Downstream: ComPacT INS100 to 250, ComPacT INV100 to 250

Ue: 500-525 V AC

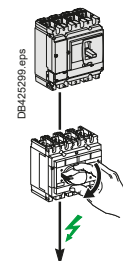

Downstream	Switch-disconnector	INS100	INS250-100 INV100	INS125	INS160	INS250-160 INV160	INS250-200 INV200	INS250 INV250
		Ith A 60°	100	100	125	160	160	200
Icw (kA)		5.5	8.5	5.5	5.5	8.5	8.5	8.5
Icm (kA)		20	30	20	20	30	30	30

Upstream Circuit breaker	Icu (kA)		Ir	Switch-disconnector conditional short-circuit current and related making capacity							
	500 V	525 V									
NSXm E/B TMD	8/10	-	Ir ≤ 40	T	T	T	T	T	T	T	T
			Ir ≤ 50	T	T	T	T	T	T	T	T
			Ir ≤ 63	T	T	T	T	T	T	T	T
NSXm F TMD	15	10	Ir ≤ 40	T	T	T	T	T	T	T	T
			Ir ≤ 50	T	T	T	T	T	T	T	T
			Ir ≤ 63	T	T	T	T	T	T	T	T
NSXm N TMD	25	15	Ir ≤ 40	T	T	T	T	T	T	T	T
			Ir ≤ 50	T	T	T	T	T	T	T	T
			Ir ≤ 63	T	T	T	T	T	T	T	T
NSXm H TMD	30	22	Ir ≤ 40	T	T	T	T	T	T	T	T
			Ir ≤ 50	T	T	T	T	T	T	T	T
			Ir ≤ 63	T	T	T	T	T	T	T	T
NSX100B NSX160B NSX250B TMD/TMG/ MicroLogic	15	-	Ir ≤ 100	T	T	T	T	T	T	T	T
			Ir ≤ 125			T	T	T	T	T	T
			Ir ≤ 160				T	T	T	T	T
			Ir ≤ 200					T	T	T	T
			Ir ≤ 250							T	T
NSX100F NSX160F NSX250F TMD/TMG/ MicroLogic	25	22	Ir ≤ 100	T	T	T	T	T	T	T	T
			Ir ≤ 125			T	T	T	T	T	T
			Ir ≤ 160				T	T	T	T	T
			Ir ≤ 200					T	T	T	T
			Ir ≤ 250							T	T
NSX100N NSX160N NSX250N TMD/TMG/ MicroLogic	36	35	Ir ≤ 100	22/46	T	22/46	T	T	T	T	T
			Ir ≤ 125			22/46	T	T	T	T	T
			Ir ≤ 160				T	T	T	T	T
			Ir ≤ 200					T	T	T	T
			Ir ≤ 250							T	T
NSX100H NSX160H NSX250H TMD/TMG/ MicroLogic	50	35	Ir ≤ 100	22/46	T	22/46	T	T	T	T	T
			Ir ≤ 125			22/46	T	T	T	T	T
			Ir ≤ 160				T	T	T	T	T
			Ir ≤ 200					T	T	T	T
			Ir ≤ 250							T	T
NSX100S NSX160S NSX250S TMD/TMG/ MicroLogic	65	40	Ir ≤ 100	22/46	T	22/46	T	T	T	T	T
			Ir ≤ 125			22/46	T	T	T	T	T
			Ir ≤ 160				T	T	T	T	T
			Ir ≤ 200					T	T	T	T
			Ir ≤ 250							T	T
NSX100L NSX160L NSX250L TMD/TMG/ MicroLogic	70	50	Ir ≤ 100	22/46	T	22/46	T	T	T	T	T
			Ir ≤ 125			22/46	T	T	T	T	T
			Ir ≤ 160				T	T	T	T	T
			Ir ≤ 200					T	T	T	T
			Ir ≤ 250							T	T
NSX100R NSX250R TMD/TMG/ MicroLogic	80	65	Ir ≤ 100	22/46	T	22/46	T	T	T	T	T
			Ir ≤ 125			22/46	T	T	T	T	T
			Ir ≤ 160				T	T	T	T	T
			Ir ≤ 200					T	T	T	T
			Ir ≤ 250							T	T

- T Switch-disconnector is totally coordinated up to the Icu of the circuit breaker installed on supply side.
- 36/75 Switch-disconnector is protected up to 36 kA rms / 75 kA.
- Protection of the switch-disconnector is not ensured.

Circuit-Breaker/Switch-Disconnecter Coordination

Upstream: ComPacT NSX400 to 630

Downstream: ComPacT INS/INV100 to 630

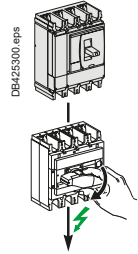

Ue: 500-525 V AC

Downstream	Switch-Disconnecter	INS250-100 INV100	INS250-160 INV160	INS250-200 INV200	INS250 INV250	INS320 INV320	INS400 INV400	INS500 INV500	INS630 INV630	INS630b INV630b
		Ith A 60°	100	160	200	250	320	400	500	630
	Icw (kA)	8.5	8.5	8.5	8.5	20	20	20	20	35
	Icm (kA)	30	30	30	30	50	50	50	50	75

Upstream	Icu (kA)			Ir	Switch-disconnector conditionnal short-circuit current and related making capacity									
	Circuit breaker	500 V	525 V		INS250-100 INV100	INS250-160 INV160	INS250-200 INV200	INS250 INV250	INS320 INV320	INS400 INV400	INS500 INV500	INS630 INV630	INS630b INV630b	
NSX400F NSX630F MicroLogic	25	20	Ir = 100 ^[1]	T	T	T	T	T	T	T	T	T	T	
			Ir ≤ 160		T	T	T	T	T	T	T	T	T	
			Ir ≤ 200			T	T	T	T	T	T	T	T	
			Ir ≤ 250				T	T	T	T	T	T	T	
			Ir ≤ 320						T	T	T	T	T	
			Ir ≤ 400							T	T	T	T	
			Ir ≤ 500								T	T	T	
NSX400N NSX630N MicroLogic	30	22	Ir = 100 ^[1]	25/52	25/52	25/52	25/52	T	T	T	T	T		
			Ir ≤ 160		25/52	25/52	25/52	T	T	T	T	T		
			Ir ≤ 200			25/52	25/52	T	T	T	T	T		
			Ir ≤ 250				25/52	T	T	T	T	T		
			Ir ≤ 320					T	T	T	T	T		
			Ir ≤ 400						T	T	T	T		
			Ir ≤ 500							T	T	T		
NSX400H NSX630H MicroLogic	50	35	Ir = 100 ^[1]	25/52	25/52	25/52	25/52	T	T	T	T	T		
			Ir ≤ 160		25/52	25/52	25/52	T	T	T	T	T		
			Ir ≤ 200			25/52	25/52	T	T	T	T	T		
			Ir ≤ 250				25/52	T	T	T	T	T		
			Ir ≤ 320					T	T	T	T	T		
			Ir ≤ 400						T	T	T	T		
			Ir ≤ 500							T	T	T		
NSX400S NSX630S MicroLogic	65	40	Ir = 100 ^[1]	25/52	25/52	25/52	25/52	T	T	T	T	T		
			Ir ≤ 160		25/52	25/52	25/52	T	T	T	T	T		
			Ir ≤ 200			25/52	25/52	T	T	T	T	T		
			Ir ≤ 250				25/52	T	T	T	T	T		
			Ir ≤ 320					T	T	T	T	T		
			Ir ≤ 400						T	T	T	T		
			Ir ≤ 500							T	T	T		
NSX400L NSX630L MicroLogic	70	50	Ir = 100 ^[1]	25/52	25/52	25/52	25/52	T	T	T	T	T		
			Ir ≤ 160		25/52	25/52	25/52	T	T	T	T	T		
			Ir ≤ 200			25/52	25/52	T	T	T	T	T		
			Ir ≤ 250				25/52	T	T	T	T	T		
			Ir ≤ 320					T	T	T	T	T		
			Ir ≤ 400						T	T	T	T		
			Ir ≤ 500							T	T	T		
NSX400R NSX630R MicroLogic	80	65	Ir = 100 ^[1]	25/52	25/52	25/52	25/52	T	T	T	T	T		
			Ir ≤ 160		25/52	25/52	25/52	T	T	T	T	T		
			Ir ≤ 200			25/52	25/52	T	T	T	T	T		
			Ir ≤ 250				25/52	T	T	T	T	T		
			Ir ≤ 320					T	T	T	T	T		
			Ir ≤ 400						T	T	T	T		
			Ir ≤ 500							T	T	T		

[1] NSX400 with MicroLogic 250 A can be set down to 100 A.

T Switch-disconnector is totally coordinated up to the Icu of the circuit breaker installed on supply side.

36/75 Switch-disconnector is protected up to 36 kA rms / 75 kA.

Protection of the switch-disconnector is not ensured.

Circuit-Breaker/Switch-Disconnecter Coordination

Upstream: ComPacT NS630b to 3200, MasterPact MTZ1/2

Downstream: ComPacT INS/INV500 to 2500

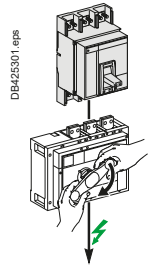

Ue: 500-525 V AC

Downstream	Switch-disconnector	INS500 INV500	INS630 INV630	INS630b INV630b	INS800 INV800	INS1000 INV1000	INS1250 INV1250	INS1600 INV1600	INS2000 INV2000	INS2500 INV2500
	Ith A 60°	500	630	630	800	1000	1250	1600	2000	2500
	Icw (kA)	20	20	35	35	35	35	35	50	50
	Icm (kA)	50	50	75	75	75	75	75	105	105

Upstream Circuit breaker	Icu (kA) 500-525 V	Ir	Switch-disconnector conditional short-circuit current and related making capacity								
			INS500 INV500	INS630 INV630	INS630b INV630b	INS800 INV800	INS1000 INV1000	INS1250 INV1250	INS1600 INV1600	INS2000 INV2000	INS2500 INV2500
NS630bN NS800N NS1000N NS1250N NS1600N	40	Ir ≤ 500	20/50	20/50	35/75	35/75	35/75	35/75	35/75	T	T
		Ir ≤ 630		20/50	35/75	35/75	35/75	35/75	35/75	T	T
		Ir ≤ 800				35/75	35/75	35/75	35/75	T	T
		Ir ≤ 1000					35/75	35/75	35/75	T	T
		Ir ≤ 1250						35/75	35/75	T	T
NS630bH NS800H NS1000H NS1250H NS1600H	50	Ir ≤ 500	20/50	20/50	35/75	35/75	35/75	35/75	35/75	T	T
		Ir ≤ 630		20/50	35/75	35/75	35/75	35/75	35/75	T	T
		Ir ≤ 800				35/75	35/75	35/75	35/75	T	T
		Ir ≤ 1000					35/75	35/75	35/75	T	T
		Ir ≤ 1250						35/75	35/75	T	T
NS630bL NS800L NS1000L	100	Ir ≤ 500	36/75	36/75	T	T	T	T	T	T	T
		Ir ≤ 630		36/75	T	T	T	T	T	T	T
		Ir ≤ 800				T	T	T	T	T	T
		Ir ≤ 1000					T	T	T	T	T
NS630bLB NS800LB	100	Ir ≤ 500	70/154	70/154	T	T	T	T	T	T	T
		Ir ≤ 630		70/154	T	T	T	T	T	T	T
		Ir ≤ 800				T	T	T	T	T	T
NS1600bN NS2000N NS2500N NS3200N	65	Ir ≤ 1250						35/75	35/75	50/105	50/105
		Ir ≤ 1600							35/75	50/105	50/105
		Ir ≤ 2000								50/105	50/105
		Ir ≤ 2500									50/105
MTZ1 06H1/H2 MTZ1 08H1/2 MTZ1 10H1/2 MTZ1 12H1/2 MTZ1 16H1/2	42	Ir ≤ 500	20/50	20/50	35/75	35/75	35/75	35/75	35/75	T	T
		Ir ≤ 630		20/50	35/75	35/75	35/75	35/75	35/75	T	T
		Ir ≤ 800				35/75	35/75	35/75	35/75	T	T
		Ir ≤ 1000					35/75	35/75	35/75	T	T
		Ir ≤ 1250						35/75	35/75	T	T
MTZ1 06L1 MTZ1 08L1 MTZ1 10L1	100	Ir ≤ 500	36/75	36/75	T	T	T	T	T	T	T
		Ir ≤ 630		36/75	T	T	T	T	T	T	T
		Ir ≤ 800				T	T	T	T	T	T
		Ir ≤ 1000					T	T	T	T	T
MTZ2 08N1 MTZ2 10N1 MTZ2 12N1 MTZ2 16N1 MTZ2 20N1	42	Ir ≤ 500	20/50	20/50	35/75	35/75	35/75	35/75	35/75	T	T
		Ir ≤ 630		20/50	35/75	35/75	35/75	35/75	35/75	T	T
		Ir ≤ 800				35/75	35/75	35/75	35/75	T	T
		Ir ≤ 1000					35/75	35/75	35/75	T	T
		Ir ≤ 1250						35/75	35/75	T	T
		Ir ≤ 1600							35/75	T	T
MTZ2 08 MTZ2 10 MTZ2 12 MTZ2 16 MTZ2 20 MTZ2 25 MTZ2 32 MTZ2 40	H1/H/H3/L1 66/85/130	Ir ≤ 500	20/50	20/50	35/75	35/75	35/75	35/75	35/75	50/105	50/105
		Ir ≤ 630		20/50	35/75	35/75	35/75	35/75	35/75	50/105	50/105
		Ir ≤ 800				35/75	35/75	35/75	35/75	50/105	50/105
		Ir ≤ 1000					35/75	35/75	35/75	50/105	50/105
		Ir ≤ 1250						35/75	35/75	50/105	50/105
		Ir ≤ 1600							35/75	50/105	50/105
		Ir ≤ 2000								50/105	50/105
		Ir ≤ 2500									50/105

T Switch-disconnector is totally coordinated up to the Icu of the circuit breaker installed on supply side.

36/75 Switch-disconnector is protected up to 36 kA rms / 75 kA.

Protection of the switch-disconnector is not ensured.

Circuit-Breaker/Switch-Disconnecter Coordination

Upstream: ComPacT NSXm, ComPacT NSX100 to 250

Downstream: ComPacT INS100 to 250, ComPacT INV100 to 250

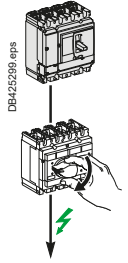

Ue: 690 V AC

Downstream	Switch-disconnector	INS100	INS250-100 INV100	INS125	INS160	INS250-160 INV160	INS250-200 INV200	INS250 INV250
		Ith A 60°	100	100	125	160	160	200
Icw (kA)		5.5	8.5	5.5	5.5	8.5	8.5	8.5
Icm (kA)		20	30	20	20	30	30	30

Upstream Circuit breaker	Icu (kA) 690 V	Ir	Switch-disconnector conditional short-circuit current and related making capacity						
NSXm N TMD	10	I _r ≤ 40	T	T	T	T	T	T	T
		I _r ≤ 50	T	T	T	T	T	T	T
		I _r ≤ 63	T	T	T	T	T	T	T
NSXm H TMD	10	I _r ≤ 40	T	T	T	T	T	T	T
		I _r ≤ 50	T	T	T	T	T	T	T
		I _r ≤ 63	T	T	T	T	T	T	T
NSX100F NSX160F NSX250F TMD/TMG/ MicroLogic	8	I _r ≤ 100	T	T	T	T	T	T	T
		I _r ≤ 125			T	T	T	T	T
		I _r ≤ 160				T	T	T	T
		I _r ≤ 200						T	T
NSX100N NSX160N NSX250N TMD/TMG/ MicroLogic	10	I _r ≤ 100	T	T	T	T	T	T	T
		I _r ≤ 125			T	T	T	T	T
		I _r ≤ 160				T	T	T	T
		I _r ≤ 200						T	T
NSX100H NSX160H NSX250H TMD/TMG/ MicroLogic	10	I _r ≤ 100	T	T	T	T	T	T	T
		I _r ≤ 125			T	T	T	T	T
		I _r ≤ 160				T	T	T	T
		I _r ≤ 200						T	T
NSX100S NSX160S NSX250S TMD/TMG/ MicroLogic	15	I _r ≤ 100	T	T	T	T	T	T	T
		I _r ≤ 125			T	T	T	T	T
		I _r ≤ 160				T	T	T	T
		I _r ≤ 200						T	T
NSX100L NSX160L NSX250L TMD/TMG/ MicroLogic	20	I _r ≤ 100	T	T	T	T	T	T	T
		I _r ≤ 125			T	T	T	T	T
		I _r ≤ 160				T	T	T	T
		I _r ≤ 200						T	T
NSX100R NSX250R TMD/TMG/ MicroLogic	45	I _r ≤ 100	20/40	T	20/40	20/40	T	T	T
		I _r ≤ 125			20/40	20/40	T	T	T
		I _r ≤ 160				20/40	T	T	T
		I _r ≤ 200						T	T
		I _r ≤ 250						T	

T Switch-disconnector is totally coordinated up to the I_{cu} of the circuit breaker installed on supply side.

36/75 Switch-disconnector is protected up to 36 kA rms / 75 kA.

Protection of the switch-disconnector is not ensured.

Circuit-Breaker/Switch-Disconnecter Coordination

Upstream: ComPacT NSX400 to 630

Downstream: ComPacT INS/INV500 to 2500

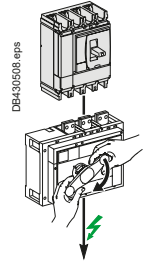

Ue: 690 V AC

Downstream	Switch-disconnector	INS500 INV500	INS630 INV630	INS630b INV630b	INS800 INV800	INS1000 INV1000	INS1250 INV1250	INS1600 INV1600	INS2000 INV2000	INS2500 INV2500
	Ith A 60°	630	630	630	800	1000	1250	1600	2000	2500
	Icw (kA)	20	20	35	35	35	35	35	50	50
	Icm (kA)	50	50	75	75	75	75	75	105	105

Upstream Circuit breaker	Icu (kA) 690 V	Ir	Switch-disconnector conditional short-circuit current and related making capacity								
			INS500 INV500	INS630 INV630	INS630b INV630b	INS800 INV800	INS1000 INV1000	INS1250 INV1250	INS1600 INV1600	INS2000 INV2000	INS2500 INV2500
NSX400F NSX630F MicroLogic	10	Ir = 100 ^[1]	T	T	T	T	T	T	T	T	T
		Ir ≤ 160		T	T	T	T	T	T	T	T
		Ir ≤ 200			T	T	T	T	T	T	T
		Ir ≤ 250				T	T	T	T	T	T
		Ir ≤ 320					T	T	T	T	T
		Ir ≤ 400						T	T	T	T
		Ir ≤ 500							T	T	T
NSX400N NSX630N MicroLogic	10	Ir = 100 ^[1]	T	T	T	T	T	T	T	T	T
		Ir ≤ 160		T	T	T	T	T	T	T	T
		Ir ≤ 200			T	T	T	T	T	T	T
		Ir ≤ 250				T	T	T	T	T	T
		Ir ≤ 320					T	T	T	T	T
		Ir ≤ 400						T	T	T	T
		Ir ≤ 500							T	T	T
NSX400H NSX630H MicroLogic	20	Ir = 100 ^[1]	T	T	T	T	T	T	T	T	T
		Ir ≤ 160		T	T	T	T	T	T	T	T
		Ir ≤ 200			T	T	T	T	T	T	T
		Ir ≤ 250				T	T	T	T	T	T
		Ir ≤ 320					T	T	T	T	T
		Ir ≤ 400						T	T	T	T
		Ir ≤ 500							T	T	T
NSX400S NSX630S MicroLogic	25	Ir = 100 ^[1]	T	T	T	T	T	T	T	T	T
		Ir ≤ 160		T	T	T	T	T	T	T	T
		Ir ≤ 200			T	T	T	T	T	T	T
		Ir ≤ 250				T	T	T	T	T	T
		Ir ≤ 320					T	T	T	T	T
		Ir ≤ 400						T	T	T	T
		Ir ≤ 500							T	T	T
NSX400L NSX630L MicroLogic	35	Ir = 100 ^[1]	25/52	25/52	25/52	25/52	T	T	T	T	T
		Ir ≤ 160		25/52	25/52	25/52	T	T	T	T	T
		Ir ≤ 200			25/52	25/52	T	T	T	T	T
		Ir ≤ 250				25/52	T	T	T	T	T
		Ir ≤ 320					T	T	T	T	T
		Ir ≤ 400						T	T	T	T
		Ir ≤ 500							T	T	T
NSX400R NSX630R MicroLogic	45	Ir = 100 ^[1]	25/52	25/52	25/52	25/52	T	T	T	T	T
		Ir ≤ 160		25/52	25/52	25/52	T	T	T	T	T
		Ir ≤ 200			25/52	25/52	T	T	T	T	T
		Ir ≤ 250				25/52	T	T	T	T	T
		Ir ≤ 320					T	T	T	T	T
		Ir ≤ 400						T	T	T	T
		Ir ≤ 500							T	T	T

[1] NSX400 with MicroLogic 250 A can be set down to 100 A.

T Switch-disconnector is totally coordinated up to the Icu of the circuit breaker installed on supply side.

36/75 Switch-disconnector is protected up to 36 kA rms / 75 kA.

Protection of the switch-disconnector is not ensured.

Circuit-Breaker/Switch-Disconnecter Coordination

Upstream: ComPacT NS630b to 3200, MasterPact MTZ1/2

Downstream: ComPacT INS/INV500 to 2500

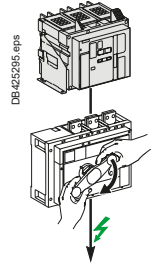

Ue: 690 V AC

Downstream	Switch-disconnector	INS500 INV500	INS630 INV630	INS630b INV630b	INS800 INV800	INS1000 INV1000	INS1250 INV1250	INS1600 INV1600	INS2000 INV2000	INS2500 INV2500
	Ith A 60°	630	630	630	800	1000	1250	1600	2000	2500
	Icw (kA)	20	20	35	35	35	35	35	50	50
	Icm (kA)	50	50	75	75	75	75	75	105	105

Upstream Circuit breaker	Icu (kA) 690 V	Ir	Switch-disconnector conditional short-circuit current and related making capacity								
			INS500 INV500	INS630 INV630	INS630b INV630b	INS800 INV800	INS1000 INV1000	INS1250 INV1250	INS1600 INV1600	INS2000 INV2000	INS2500 INV2500
NS630bN NS800N NS1000N NS1250N NS1600N	30	Ir ≤ 500	20/50	20/50	35/75	35/75	35/75	35/75	35/75	T	T
		Ir ≤ 630		20/50	35/75	35/75	35/75	35/75	35/75	T	T
		Ir ≤ 800				35/75	35/75	35/75	35/75	T	T
		Ir ≤ 1000					35/75	35/75	35/75	T	T
		Ir ≤ 1250						35/75	35/75	T	T
NS630bH NS800H NS1000H NS1250H NS1600H	42	Ir ≤ 500	20/50	20/50	35/75	35/75	35/75	35/75	35/75	50/105	50/105
		Ir ≤ 630		20/50	35/75	35/75	35/75	35/75	35/75	50/105	50/105
		Ir ≤ 800				35/75	35/75	35/75	35/75	50/105	50/105
		Ir ≤ 1000					35/75	35/75	35/75	50/105	50/105
		Ir ≤ 1250						35/75	35/75	50/105	50/105
NS630bLB NS800LB	75	Ir ≤ 500	70/154	70/154	T	T	T	T	T	T	T
		Ir ≤ 630		70/154	T	T	T	T	T	T	T
		Ir ≤ 800			T	T	T	T	T	T	T
NS1600bN NS2000N NS2500N NS3200N	65	Ir ≤ 1250						35/75	35/75	50/105	50/105
		Ir ≤ 1600							35/75	50/105	50/105
		Ir ≤ 2000								50/105	50/105
		Ir ≤ 2500									50/105
MTZ1 06H1/H2 MTZ1 08H1/2 MTZ1 10H1/2 MTZ1 12H1/2 MTZ1 16H1/2	42	Ir ≤ 500	20/50	20/50	35/75	35/75	35/75	35/75	35/75	T	T
		Ir ≤ 630		20/50	35/75	35/75	35/75	35/75	35/75	T	T
		Ir ≤ 800				35/75	35/75	35/75	35/75	T	T
		Ir ≤ 1000					35/75	35/75	35/75	T	T
		Ir ≤ 1250						35/75	35/75	T	T
MTZ1 06L1 MTZ1 08L1 MTZ1 10L1	25	Ir ≤ 500	T	T	T	T	T	T	T	T	T
		Ir ≤ 630		T	T	T	T	T	T	T	T
		Ir ≤ 800				T	T	T	T	T	T
		Ir ≤ 1000					T	T	T	T	T
MTZ2 08N1 MTZ2 10N1 MTZ2 12N1 MTZ2 16N1 MTZ2 20N1	42	Ir ≤ 500	20/50	20/50	35/75	35/75	35/75	35/75	35/75	T	T
		Ir ≤ 630		20/50	35/75	35/75	35/75	35/75	35/75	T	T
		Ir ≤ 800				35/75	35/75	35/75	35/75	T	T
		Ir ≤ 1000					35/75	35/75	35/75	T	T
		Ir ≤ 1250						35/75	35/75	T	T
		Ir ≤ 1600							35/75	T	T
MTZ2 08 MTZ2 10 MTZ2 12 MTZ2 16 MTZ2 20 MTZ2 25 MTZ2 32 MTZ2 40	H1/H2/H3/L1 66/85/100/100	Ir ≤ 500	20/50	20/50	35/75	35/75	35/75	35/75	35/75	50/105	50/105
		Ir ≤ 630		20/50	35/75	35/75	35/75	35/75	35/75	50/105	50/105
		Ir ≤ 800				35/75	35/75	35/75	35/75	50/105	50/105
		Ir ≤ 1000					35/75	35/75	35/75	50/105	50/105
		Ir ≤ 1250						35/75	35/75	50/105	50/105
		Ir ≤ 1600							35/75	50/105	50/105
		Ir ≤ 2000								50/105	50/105
		Ir ≤ 2500									50/105

T Switch-disconnector is totally coordinated up to the Icu of the circuit breaker installed on supply side.

36/75 Switch-disconnector is protected up to 36 kA rms / 75 kA.

Protection of the switch-disconnector is not ensured.

Circuit-Breaker/Switch-Disconnecter Coordination

Upstream: ComPacT NSX100 to 630

Downstream: ComPacT NSX100NA to 630NA

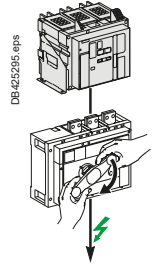

Ue: 500-525 V AC

Ue: 690 V AC

Downstream	Switch-disconnector	NSX100NA	NSX160NA	NSX250NA	NSX400NA	NSX630NA
	Ith A 60°	100	160	250	400	630
	Icw (kA)	1.8	2.5	3.5	5	6
	Icm (kA)	2.6	3.6	4.9	7.1	8.5

Upstream Circuit breaker	Icu (kA)			I _r	Switch-disconnector conditional short-circuit current and related making capacity				
	500 V	525 V	690 V						
NSX100B NSX160B NSX250B TMD/TMG/ MicroLogic	15	-	-	I _r ≤ 50	T	T	T	T	T
				I _r ≤ 100	T	T	T	T	T
				I _r ≤ 160		T	T	T	T
				I _r ≤ 250			T	T	T
NSX100F NSX160F NSX250F TMD/TMG/ MicroLogic	25	22	8	I _r ≤ 50	T	T	T	T	T
				I _r ≤ 100	T	T	T	T	T
				I _r ≤ 160		T	T	T	T
				I _r ≤ 250			T	T	T
NSX400F NSX630F MicroLogic	25	20	10	I _r = 100 ^[1]	T	T	T	T	T
				I _r ≤ 160		T	T	T	T
				I _r ≤ 250			T	T	T
				I _r ≤ 400				T	T
				I _r ≤ 630					T
NSX100N NSX160N NSX250N TMD/TMG/ MicroLogic	36	35	10	I _r ≤ 50	T	T	T	T	T
				I _r ≤ 100	T	T	T	T	T
				I _r ≤ 160		T	T	T	T
				I _r ≤ 250			T	T	T
NSX400N NSX630N MicroLogic	30	22	10	I _r = 100 ^[1]	T	T	T	T	T
				I _r ≤ 160		T	T	T	T
				I _r ≤ 250			T	T	T
				I _r ≤ 400				T	T
				I _r ≤ 630					T
NSX100H NSX160H NSX250H TMD/TMG/ MicroLogic	50	35	10	I _r ≤ 50	T	T	T	T	T
				I _r ≤ 100	T	T	T	T	T
				I _r ≤ 160		T	T	T	T
				I _r ≤ 250			T	T	T
NSX400H NSX630H MicroLogic	50	35	20	I _r = 100 ^[1]	T	T	T	T	T
				I _r ≤ 160		T	T	T	T
				I _r ≤ 250			T	T	T
				I _r ≤ 400				T	T
				I _r ≤ 630					T
NSX100S NSX160S NSX250S TMD/TMG/ MicroLogic	65	40	15	I _r ≤ 50	T	T	T	T	T
				I _r ≤ 100	T	T	T	T	T
				I _r ≤ 160		T	T	T	T
				I _r ≤ 250			T	T	T
NSX400S NSX630S MicroLogic	65	40	25	I _r = 100 ^[1]	T	T	T	T	T
				I _r ≤ 160		T	T	T	T
				I _r ≤ 250			T	T	T
				I _r ≤ 400				T	T
				I _r ≤ 630					T
NSX100L NSX160L NSX250L TMD/TMG/ MicroLogic	70	50	20	I _r ≤ 50	T	T	T	T	T
				I _r ≤ 100	T	T	T	T	T
				I _r ≤ 160		T	T	T	T
				I _r ≤ 250			T	T	T
NSX400L NSX630L MicroLogic	70	50	35	I _r = 100 ^[1]	T	T	T	T	T
				I _r ≤ 160		T	T	T	T
				I _r ≤ 250			T	T	T
				I _r ≤ 400				T	T
				I _r ≤ 630					T

[1] NSX400 with MicroLogic 250 A can be set down to 100 A.

Switch-disconnector is totally coordinated up to the Icu of the circuit breaker installed on supply side.

Protection of the switch-disconnector is not ensured.

Circuit-Breaker/Switch-Disconnecter Coordination

Upstream: ComPacT NS630b to 3200, MasterPact MTZ1

Downstream: ComPacT NS630b to 3200 NA

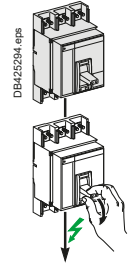

Ue: 500-525 V AC

Ue: 690 V AC

Downstream	Switch-disconnector	NS630b NA	NS800 NA	NS1000 NA	NS1250 NA	NS1600 NA	NS1600b NA	NS2000 NA	NS2500 NA	NS3200 NA
	Ith A 60°	630	800	1000	1250	1600	1600	2000	2500	3200
	Icw (kA)	25 (0.5s)	25 (0.5s)	25 (0.5s)	25 (0.5s)	25 (0.5s)	32 (3s)	32 (3s)	32 (3s)	32 (3s)
	Icm (kA)	52	52	52	52	52	135	135	135	135

Upstream	Icu (kA)	Setting	Switch-disconnector conditional short-circuit current and related making capacity										
Circuit breaker 500-525 V 690 V	Ir												
NS630bN	40	30	Ir ≤ 630	T	T	T	T	T	T	T	T	T	T
NS800N			Ir ≤ 800		T	T	T	T	T	T	T	T	T
NS1000N			Ir ≤ 1000			T	T	T	T	T	T	T	T
NS1250N			Ir ≤ 1250				T	T	T	T	T	T	T
NS1600N			Ir ≤ 1600					T	T	T	T	T	T
NS630bH	50	42	Ir ≤ 630	T	T	T	T	T	T	T	T	T	T
NS800H			Ir ≤ 800		T	T	T	T	T	T	T	T	T
NS1000H			Ir ≤ 1000			T	T	T	T	T	T	T	T
NS1250H			Ir ≤ 1250				T	T	T	T	T	T	T
NS1600H			Ir ≤ 1600					T	T	T	T	T	T
NS630bL	100	-	Ir ≤ 630	T	T	T	T	T	T	T	T	T	T
NS800L			Ir ≤ 800		T	T	T	T	T	T	T	T	T
NS1000L			Ir ≤ 1000			T	T	T	T	T	T	T	T
NS630bLB	100	75	Ir ≤ 630	T	T	T	T	T	T	T	T	T	T
NS800LB			Ir ≤ 800		T	T	T	T	T	T	T	T	T
NS1600bN	65	65	Ir ≤ 1600						T	T	T	T	T
NS2000N			Ir ≤ 2000						T	T	T	T	T
NS2500N			Ir ≤ 2500							T	T	T	T
NS3200N			Ir ≤ 3200								T	T	T
MTZ1 06H1	42	42	Ir ≤ 630	25/52	25/52	25/52	25/52	25/52	T	T	T	T	T
MTZ1 08H1			Ir ≤ 800		25/52	25/52	25/52	25/52	T	T	T	T	T
MTZ1 10H1			Ir ≤ 1000			25/52	25/52	25/52	T	T	T	T	T
MTZ1 12H1			Ir ≤ 1250				25/52	25/52	T	T	T	T	T
MTZ1 16H1			Ir ≤ 1600					25/52	T	T	T	T	T
MTZ1 06L1	100	25	Ir ≤ 630	T	T	T	T	T	T	T	T	T	T
MTZ1 08L1			Ir ≤ 800		T	T	T	T	T	T	T	T	T
MTZ1 10L1			Ir ≤ 1000			T	T	T	T	T	T	T	T

T Switch-disconnector is totally coordinated up to the Icu of the circuit breaker installed on supply side.

36/75 Switch-disconnector is protected up to 36 kA rms / 75 kA.

Protection of the switch-disconnector is not ensured.

Circuit-Breaker/Switch-Disconnecter Coordination

Upstream: ComPacT NS630b to1600, MasterPact MTZ1, MTZ2

Downstream: MasterPact MTZ1 HA, MasterPact MTZ2 NA

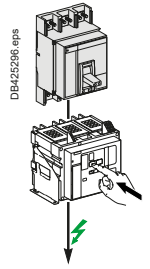

Ue: 500-525 V AC

Ue: 690 V AC

Downstream	Switch-disconnector	MTZ1 06HA	MTZ1 08HA	MTZ1 10HA	MTZ1 12HA	MTZ1 16HA	MTZ2 08NA	MTZ2 10NA	MTZ2 12NA	MTZ2 16NA
	Ith A 60°	630	800	1000	1250	1600	800	1000	1250	1600
	Icw (kA)	36	36	36	36	36	42	42	42	42
	Icm (kA)	75	75	75	75	75	88	88	88	88

Upstream	Icu (kA)	Setting		Switch-disconnector conditional short-circuit current and related making capacity								
Circuit breaker 500-525 V 690 V	Ir											
NS630bN	40	30	Ir ≤ 630	T	T	T	T	T	T	T	T	T
NS800N			Ir ≤ 800		T	T	T	T	T	T	T	T
NS1000N			Ir ≤ 1000			T	T	T		T	T	T
NS1250N			Ir ≤ 1250				T	T			T	T
NS1600N			Ir ≤ 1600					T				T
NS630bH	50	42	Ir ≤ 630	T	T	T	T	T	T	T	T	T
NS800H			Ir ≤ 800		T	T	T	T	T	T	T	T
NS1000H			Ir ≤ 1000			T	T	T		T	T	T
NS1250H			Ir ≤ 1250				T	T			T	T
NS1600H			Ir ≤ 1600					T				T
NS630bL	100	-	Ir ≤ 630	T	T	T	T	T	T	T	T	T
NS800L			Ir ≤ 800		T	T	T	T	T	T	T	T
NS1000L			Ir ≤ 1000			T	T	T		T	T	T
NS630bLB	100	75	Ir ≤ 630	T	T	T	T	T	T	T	T	T
NS800LB			Ir ≤ 800		T	T	T	T	T	T	T	T
MTZ1 06H1/2	42	42	Ir ≤ 630	36/75	36/75	36/75	36/75	36/75	T	T	T	T
MTZ1 08H1/2			Ir ≤ 800		36/75	36/75	36/75	36/75	T	T	T	T
MTZ1 10H1/2			Ir ≤ 1000			36/75	36/75	36/75		T	T	T
MTZ1 12H1/2			Ir ≤ 1250				36/75	36/75			T	T
MTZ1 16H1/2			Ir ≤ 1600					36/75				T
MTZ1 06L1	100	25	Ir ≤ 630	T	T	T	T	T	T	T	T	T
MTZ1 08L1			Ir ≤ 800		T	T	T	T	T	T	T	T
MTZ1 10L1			Ir ≤ 1000			T	T	T		T	T	T
MTZ2 08N1	42	42	Ir ≤ 800		36/75	36/75	36/75	36/75	T	T	T	T
MTZ2 10N1			Ir ≤ 1000			36/75	36/75	36/75		T	T	T
MTZ2 12N1			Ir ≤ 1250				36/75	36/75			T	T
MTZ2 16N1			Ir ≤ 1600					36/75				T
MTZ2 20N1												
MTZ2 08H1	66	66	Ir ≤ 800		36/75	36/75	36/75	36/75	42/88	42/88	42/88	42/88
MTZ2 10H1			Ir ≤ 1000			36/75	36/75	36/75		42/88	42/88	42/88
MTZ2 12H1			Ir ≤ 1250				36/75	36/75			42/88	42/88
MTZ2 16H1			Ir ≤ 1600					36/75				42/88
MTZ2 20H1												

T Switch-disconnector is totally coordinated up to the Icu of the circuit breaker installed on supply side.

36/75 Switch-disconnector is protected up to 36 kA rms / 75 kA.

Protection of the switch-disconnector is not ensured.

Circuit-Breaker/Switch-Disconnecter Coordination

Upstream: MasterPact MTZ2, MTZ3

Downstream: MasterPact MTZ2 HA, MTZ3 HA

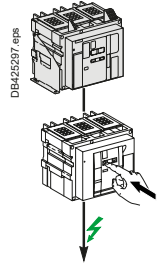

Ue: 500-525 V AC

Ue: 690 V AC

Downstream	Switch-disconnector	MTZ2 08 HA	MTZ2 10 HA	MTZ2 12 HA	MTZ2 16 HA	MTZ2 20 HA	MTZ2 25 HA	MTZ2 32 HA	MTZ2 40 HA	MTZ3 40 HA	MTZ3 50 HA	MTZ3 63 HA
	Ith A 60°		800	1000	1250	1600	2000	2500	3200	4000	4000	5000
Icw (kA)		66	66	66	66	66	66	66	66	85	85	85
Icm (kA)		145	145	145	145	145	145	145	145	187	187	187

Upstream	Circuit breaker	Icu (kA)	500-525 V	690 V	Setting	Switch-disconnector conditional short-circuit current and related making capacity														
						Ir	MTZ2 08 HA	MTZ2 10 HA	MTZ2 12 HA	MTZ2 16 HA	MTZ2 20 HA	MTZ2 25 HA	MTZ2 32 HA	MTZ2 40 HA	MTZ3 40 HA	MTZ3 50 HA	MTZ3 63 HA			
MTZ2 08N1		42	42	Ir ≤ 800	T	T	T	T	T	T	T	T	T	T	T	T				
					Ir ≤ 1000		T	T	T	T	T	T	T	T	T	T				
					Ir ≤ 1250			T	T	T	T	T	T	T	T	T				
					Ir ≤ 1600				T	T	T	T	T	T	T	T				
					Ir ≤ 2000						T	T	T	T	T	T				
MTZ2 08H1		66	66	Ir ≤ 800	T	T	T	T	T	T	T	T	T	T	T	T				
					Ir ≤ 1000		T	T	T	T	T	T	T	T	T	T				
					Ir ≤ 1250			T	T	T	T	T	T	T	T	T				
					Ir ≤ 1600				T	T	T	T	T	T	T	T				
					Ir ≤ 2000						T	T	T	T	T	T				
					Ir ≤ 2500							T	T	T	T	T				
					Ir ≤ 3200								T	T	T	T				
					Ir ≤ 4000									T	T	T				
					MTZ3 40H1		100	100	Ir ≤ 4000								66/145	85/187	85/187	85/187
										Ir ≤ 5000									85/187	85/187
Ir ≤ 6300															85/187					
MTZ2 08H2		85	85	Ir ≤ 800	66/145	66/145	66/145	66/145	66/145	66/145	66/145	66/145	66/145	T	T	T				
					Ir ≤ 1000		66/145	66/145	66/145	66/145	66/145	66/145	66/145	66/145	66/145	T	T	T		
					Ir ≤ 1250			66/145	66/145	66/145	66/145	66/145	66/145	66/145	66/145	T	T	T		
					Ir ≤ 1600				66/145	66/145	66/145	66/145	66/145	66/145	66/145	T	T	T		
					Ir ≤ 2000					66/145	66/145	66/145	66/145	66/145	66/145	T	T	T		
					Ir ≤ 2500						66/145	66/145	66/145	66/145	66/145	T	T	T		
					Ir ≤ 3200							66/145	66/145	66/145	66/145	T	T	T		
					Ir ≤ 4000								66/145	66/145	66/145	T	T	T		
					MTZ2 08L1		130	100	Ir ≤ 800	66/145	66/145	66/145	66/145	66/145	66/145	66/145	66/145	66/145	85/187	85/187
Ir ≤ 1000		66/145	66/145	66/145						66/145	66/145	66/145	66/145	66/145	85/187	85/187	85/187			
Ir ≤ 1250			66/145	66/145						66/145	66/145	66/145	66/145	66/145	85/187	85/187	85/187			
Ir ≤ 1600				66/145						66/145	66/145	66/145	66/145	66/145	85/187	85/187	85/187			
Ir ≤ 2000										66/145	66/145	66/145	66/145	66/145	85/187	85/187	85/187			
MTZ2 20H3		130	100	Ir ≤ 2000					66/145	66/145	66/145	66/145	85/187	85/187	85/187					
					Ir ≤ 2500					66/145	66/145	66/145	85/187	85/187	85/187					
					Ir ≤ 3200						66/145	66/145	85/187	85/187	85/187					
					Ir ≤ 4000							66/145	85/187	85/187	85/187					
MTZ3 40H2		130	100	Ir ≤ 4000								66/145	85/187	85/187	85/187					
					Ir ≤ 5000									85/187	85/187					
					Ir ≤ 6300										85/187					

T Switch-disconnector is totally coordinated up to the Icu of the circuit breaker installed on supply side.

36/75 Switch-disconnector is protected up to 36 kA rms / 75 kA.

Protection of the switch-disconnector is not ensured.

Circuit-Breaker/Switch-Disconnecter Coordination

Upstream: MasterPact MTZ2, MTZ3

Downstream: MasterPact MTZ2 HF, MasterPact NW 40b/50/63 HH

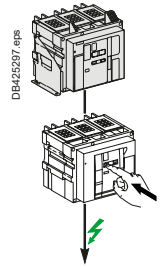

Ue: 500-525 V AC

Ue: 690 V AC

Downstream	Switch-disconnector	MTZ2	MTZ2	MTZ2	MTZ2	MTZ2	MTZ2	MTZ2	MTZ2	MTZ2	NW40b	NW50	NW63
		08 HF	10 HF	12 HF	16 HF	20 HF	25 HF	32 HF	40 HF	HH	HH	HH	
	Ith A 60°	800	1000	1250	1600	2000	2500	3200	4000	4000	5000	6300	
	Icw (kA)	85	85	85	85	85	85	85	85	100	100	100	
	Icm (kA)	187	187	187	187	187	187	187	187	220	220	220	

Upstream	Icu (kA)		Setting	Switch-disconnector conditionnal short-circuit current and related making capacity											
	525 V	690 V		Ir	08 HF	10 HF	12 HF	16 HF	20 HF	25 HF	32 HF	40 HF	HH	HH	
MTZ2 08N1	42	42	Ir ≤ 800	T	T	T	T	T	T	T	T	T	T	T	
MTZ2 10N1			Ir ≤ 1000		T	T	T	T	T	T	T	T	T	T	
MTZ2 12N1			Ir ≤ 1250			T	T	T	T	T	T	T	T	T	
MTZ2 16N1			Ir ≤ 1600				T	T	T	T	T	T	T	T	
MTZ2 20N1			Ir ≤ 2000					T	T	T	T	T	T	T	
MTZ2 08H1	66	66	Ir ≤ 800	T	T	T	T	T	T	T	T	T	T	T	
MTZ2 10H1			Ir ≤ 1000		T	T	T	T	T	T	T	T	T	T	
MTZ2 12H1			Ir ≤ 1250			T	T	T	T	T	T	T	T	T	
MTZ2 16H1			Ir ≤ 1600				T	T	T	T	T	T	T	T	
MTZ2 20H1			Ir ≤ 2000					T	T	T	T	T	T	T	
MTZ2 25H1			Ir ≤ 2500						T	T	T	T	T	T	
MTZ2 32H1			Ir ≤ 3200							T	T	T	T	T	
MTZ2 40H1			Ir ≤ 4000								T	T	T	T	
MTZ3 40H1	100	100	Ir ≤ 2500						85/187	85/187	85/187	T	T	T	
MTZ3 50H1			Ir ≤ 3200							85/187	85/187	T	T	T	
MTZ3 63H1			Ir ≤ 4000								85/187	T	T	T	
			Ir ≤ 5000										T	T	
			Ir ≤ 6300											T	
MTZ2 08H2	85	85	Ir ≤ 800	T	T	T	T	T	T	T	T	T	T	T	
MTZ2 10H2			Ir ≤ 1000		T	T	T	T	T	T	T	T	T	T	
MTZ2 12H2			Ir ≤ 1250			T	T	T	T	T	T	T	T	T	
MTZ2 16H2			Ir ≤ 1600				T	T	T	T	T	T	T	T	
MTZ2 20H2			Ir ≤ 2000					T	T	T	T	T	T	T	
MTZ2 25H2			Ir ≤ 2500						T	T	T	T	T	T	
MTZ2 32H2			Ir ≤ 3200							T	T	T	T	T	
MTZ2 40H2			Ir ≤ 4000								T	T	T	T	
MTZ2 08L1	130	100	Ir ≤ 800	85/187	85/187	85/187	85/187	85/187	85/187	85/187	85/187	100/220	100/220	100/220	
MTZ2 10L1			Ir ≤ 1000		85/187	85/187	85/187	85/187	85/187	85/187	85/187	100/220	100/220	100/220	
MTZ2 12L1			Ir ≤ 1250			85/187	85/187	85/187	85/187	85/187	85/187	100/220	100/220	100/220	
MTZ2 16L1			Ir ≤ 1600				85/187	85/187	85/187	85/187	85/187	100/220	100/220	100/220	
MTZ2 20L1			Ir ≤ 2000					85/187	85/187	85/187	85/187	100/220	100/220	100/220	
MTZ2 20H3	130	100	Ir ≤ 2000					85/187	85/187	85/187	85/187	100/220	100/220	100/220	
MTZ2 25H3			Ir ≤ 2500						85/187	85/187	85/187	100/220	100/220	100/220	
MTZ2 32H3			Ir ≤ 3200							85/187	85/187	100/220	100/220	100/220	
MTZ2 40H3			Ir ≤ 4000								85/187	100/220	100/220	100/220	
MTZ3 40H2	130	100	Ir ≤ 2500						85/187	85/187	85/187	100/220	100/220	100/220	
MTZ3 50H2			Ir ≤ 3200							85/187	85/187	100/220	100/220	100/220	
MTZ3 63H2			Ir ≤ 4000								85/187	100/220	100/220	100/220	
			Ir ≤ 5000									100/220	100/220	100/220	
			Ir ≤ 6300										100/220	100/220	

T Switch-disconnector is totally coordinated up to the Icu of the circuit breaker installed on supply side.

36/75 Switch-disconnector is protected up to 36 kA rms / 75 kA.

Protection of the switch-disconnector is not ensured.

Fuse/Switch-Disconnecter Coordination

Upstream: gG Fuse

Downstream: iSW-NA, iID, iSW, NG125NA

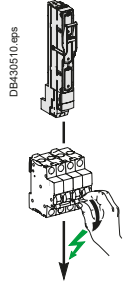

Ue ≤ 415 V AC

Downstream	Switch-disconnector	iSW-NA				iID [1]				
		Rating (A)	40	63	80	100	25	40	63	100
	I _{cw} (kA)	800	1260	1600	2000	500	800	1260	1200	1500
	I _{cm} (kA)	5	5	5	5	5	5	5	5	5

Upstream		Switch-disconnector conditionnal short-circuit current and related making capacity								
Fuse type	Rating (A)									
gG fuse link without overload relay	16	T	T	T	T	T	T	T	T	T
	20	T	T	T	T		T	T	T	T
	25	T	T	T	T		T	T	T	T
	32		80/176	80/176	80/176			80/176	80/176	80/176
	40		80/176	80/176	80/176			80/176	80/176	80/176
	50			30/63	30/63				30/63	30/63
	63				30/63					30/63

Downstream	Switch-disconnector	iSW				NG125NA			
		Rating (A)	40	63	100	125	63	80	100
	I _{cw} (kA)	1.5	1.5	1.5	1.5	1.5	1.5	1.5	1.5
	I _{cm} (kA)	5	5	5	5	2	2	2	2

Upstream		Switch-disconnector conditionnal short-circuit current and related making capacity								
Fuse type	Rating (A)									
gG fuse link without overload relay	16	60/132	60/132	60/132	60/132	T	T	T	T	T
	20	40/84	40/84	40/84	40/84	T	T	T	T	T
	25	25/52	25/52	25/52	25/52	T	T	T	T	T
	32		20/40	20/40	20/40	80/176	80/176	80/176	80/176	80/176
	40		10/17	10/17	10/17	80/176	80/176	80/176	80/176	80/176
	50			10/17	10/17		50/105	50/105	50/105	50/105
	63			10/17	10/17			50/105	50/105	50/105
80				10/17				50/105	50/105	

[1] See Guide CA908023 for additional information.

- T Switch-disconnector is totally coordinated up to the I_{cu} of the circuit breaker installed on supply side.
- 36/75 Switch-disconnector is protected up to 36 kA rms / 75 kA.
- Protection of the switch-disconnector is not ensured.

Without overload relay : The proposed fuse ensures protection of the switch-disconnector against overload and short-circuit
 With overload relay : The proposed fuse ensures protection of the switch-disconnector against short-circuit only. Overload protection needs to be provided by another means.

Note: Current limitation characteristics can be significantly different from one manufacturer to another. This table can not dispense to check selected fuse characteristics.

Fuse/Switch-Disconnecter Coordination

Upstream: gG, aM, BS fuses

Downstream: ComPacT INS40 to 630, INV100 to 360

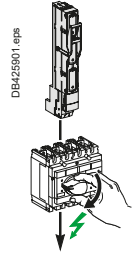

Ue ≤ 500 V AC

Downstream	Switch-Disconnecter Ith (A) 60°	ComPacT INS 40 - 160						ComPacT INS250 ComPacT INV				ComPacT INS ComPacT INV			
		40	63	80	100	125	160	100	160	200	250	320	400	500	630
	Icw (kA)	3	3	3	5.5	5.5	5.5	8.5	8.5	8.5	8.5	20	20	20	20
	Icm (kA)	15	15	15	20	20	20	30	30	30	30	50	50	50	50

Upstream	Fuse type	Rating	Switch-disconnector conditionnal short-circuit current and related making capacity													
gG fuse link without overload relay	25	T	T	T	T	T	T	T	T	T	T	T	T	T	T	
	32	T	T	T	T	T	T	T	T	T	T	T	T	T	T	
	40		T	T	T	T	T	T	T	T	T	T	T	T	T	
	50		T	T	T	T	T	T	T	T	T	T	T	T	T	
	63				T	T	T	T	T	T	T	T	T	T	T	
	80				T	T	T	T	T	T	T	T	T	T	T	
	100					T	T	T	T	T	T	T	T	T	T	
	125						T	T	T	T	T	T	T	T	T	
	160							T	T	T	T	T	T	T	T	
	200								T	T	T	T	T	T	T	
	225-250									T	T	T	T	T	T	
	300-315										T	T	T	T	T	
	355											T	T	T	T	
	400												T	T	T	
	450													T	T	
500														T		
gG fuse link with overload relay	40	T	T	T	T	T	T	T	T	T	T	T	T	T	T	
	50-63	T	T	T	T	T	T	T	T	T	T	T	T	T	T	
	80	T	T	T	T	T	T	T	T	T	T	T	T	T	T	
	100	T	T	T	T	T	T	T	T	T	T	T	T	T	T	
	125	80/176	80/176	80/176	T	T	T	T	T	T	T	T	T	T	T	
	160	36/75	36/75	36/75	50/105	50/105	50/105	T	T	T	T	T	T	T	T	
	200				36/75	36/75	36/75	T	T	T	T	T	T	T	T	
	225-250							T	T	T	T	T	T	T	T	
	300							T	T	T	T	T	T	T	T	
	315							T	T	T	T	T	T	T	T	
	355							50/105	50/105	50/105	50/105	T	T	T	T	
	400-450											T	T	T	T	
500											T	T	T	T		
630											50/105	50/105	50/105	50/105		
800														50/105		
aM Fuse link with overload relay	40	T	T	T	T	T	T	T	T	T	T	T	T	T	T	
	50 - 63	T	T	T	T	T	T	T	T	T	T	T	T	T	T	
	80	80/176	80/176	80/176	T	T	T	T	T	T	T	T	T	T	T	
	100	50/105	50/105	50/105	T	T	T	T	T	T	T	T	T	T	T	
	125				T	T	T	T	T	T	T	T	T	T	T	
	160				50/105	50/105	50/105	T	T	T	T	T	T	T	T	
	200				36/75	36/75	36/75	T	T	T	T	T	T	T	T	
	225							80/176	80/176	80/176	80/176	T	T	T	T	
	250							50/105	50/105	50/105	50/105	T	T	T	T	
	300-315											T	T	T	T	
	355-400											T	T	T	T	
	450											50/105	50/105	50/105	50/105	
	500											50/105	50/105	50/105	50/105	
630											30/63	30/63	30/63	30/63		
BS Fuse link with overload relay	32M63	T	T	T	T	T	T	T	T	T	T	T	T	T	T	
	63M80	T	T	T	T	T	T	T	T	T	T	T	T	T	T	
	63M100	T	T	T	T	T	T	T	T	T	T	T	T	T	T	
	100M125	50/105	50/105	50/105	T	T	T	T	T	T	T	T	T	T	T	
	100M160				50/105	50/105	50/105	T	T	T	T	T	T	T	T	
	100M200							T	T	T	T	T	T	T	T	
	200M250							T	T	T	T	T	T	T	T	
	200M315											T	T	T	T	
	315M400											50/105	50/105	50/105	50/105	
	400M500											40/84	40/84	40/84	40/84	

- T Switch-disconnector is totally coordinated up to the Icu of the circuit breaker installed on supply side.
- 36/75 Switch-disconnector is protected up to 36 kA rms / 75 kA.
- Protection of the switch-disconnector is not ensured.

Note: Current limitation characteristics can be significantly different from one manufacturer to another. This table can not dispense to check selected fuse characteristics

Fuse/Switch-Disconnecter Coordination

Upstream: gG, aM, BS fuses

Downstream: ComPacT NSXm50 to 160NA, NSX100 to 630NA

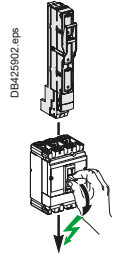

$U_e \leq 500 \text{ V AC}$

Downstream	Switch-Disconnecter	NSXm50NA	NSXm100NA	NSXm160NA	NSX100NA	NSX160NA	NSX250NA	NSX400NA	NSX630NA
	Ith (A) 60°	50	100	160	100	160	250	400	630
	Icw (kA)	50	100	160	1.8	2.5	3.5	5	6
	Icm (kA)	0.9	1.5	1.5	2.6	3.6	4.9	7.1	8.5
		1.38	2.13	2.13					

Upstream		Switch-disconnector conditional short-circuit current and related making capacity							
Fuse type	Rating								
gG fuse link without overload relay	40	T	T	T	T	T	T	T	T
	50-63		T	T	T	T	T	T	T
	80		T	T	T	T	T	T	T
	100			T		T	T	T	T
	125			T		T	T	T	T
	160					T	T	T	T
	200						T	T	T
	225-250							T	T
	300-315							T	T
	355								T
	400-450								T
500								T	
gG fuse link with overload relay	40	T	T	T	T	T	T	T	T
	50-63	T	T	T	T	T	T	T	T
	80	T	T	T	T	T	T	T	T
	100		T	T	T	T	T	T	T
	125		T	T	T	T	T	T	T
	160			T		T	T	T	T
	200			T		T	T	T	T
	225-250						T	T	T
	300-315							T	T
	355								T
	400-450								T
500								T	
630								T	
aM Fuse link with overload relay	40	T	T	T	T	T	T	T	T
	50 - 63	T	T	T	T	T	T	T	T
	80		T	T	T	T	T	T	T
	100		T	T	T	T	T	T	T
	125			T		T	T	T	T
	160			T		T	T	T	T
	200						T	T	T
	225-250							T	T
	300-315								T
	355								T
	400-450								T
500								T	
630								T	
BS Fuse link with overload relay	32M63	T	T	T	T	T	T	T	T
	63M80		T	T	T	T	T	T	T
	63M100		T	T	T	T	T	T	T
	100M125		T	T	T	T	T	T	T
	100M160		T	T	T	T	T	T	T
	100M200						T	T	T
	200M250							T	T
	200M315								T
	315M400								T
	400M500								T

Switch-disconnector is totally coordinated up to the Icu of the circuit breaker installed on supply side.

Protection of the switch-disconnector is not ensured.

Without overload relay : The proposed fuse ensures protection of the switch-disconnector against overload and short-circuit

With overload relay : The proposed fuse ensures protection of the switch-disconnector against short-circuit only. Overload protection needs to be provided by another means.

Note: Current limitation characteristics can be significantly different from one manufacturer to another. This table can not dispense to check selected fuse characteristics

Fuse/Switch-Disconnecter Coordination

Upstream: gG, aM, BS fuses

Downstream: ComPacT INS40 to 630, INV100 to 630

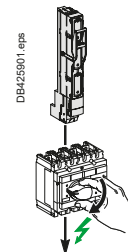

U_e ≤ 690 V AC

Downstream	Switch-Disconnecter	ComPacT INS 40 - 160			ComPacT INS250 ComPacT INV				ComPacT INS ComPacT INV			
		100	125	160	100	160	200	250	320	400	500	630
	I _{th} (A) 60°	100	125	160	100	160	200	250	320	400	500	630
	I _{cw} (kA)	5.5	5.5	5.5	8.5	8.5	8.5	8.5	20	20	20	20
	I _{cm} (kA)	20	20	20	30	30	30	30	50	50	50	50

Upstream												
Fuse type	Rating											
gG fuse link without overload relay	25	T	T	T	T	T	T	T	T	T	T	T
	32	T	T	T	T	T	T	T	T	T	T	T
	40	T	T	T	T	T	T	T	T	T	T	T
	50	T	T	T	T	T	T	T	T	T	T	T
	63	T	T	T	T	T	T	T	T	T	T	T
	80	T	T	T	T	T	T	T	T	T	T	T
	100	T	T	T	T	T	T	T	T	T	T	T
	125		T		T	T	T	T	T	T	T	T
	160					T	T	T	T	T	T	T
	200						T	T	T	T	T	T
	225-250							T	T	T	T	T
	300-315								T	T	T	T
	355									T	T	T
	400									T	T	T
	450										T	T
500										T	T	
gG fuse link with overload relay	40	T	T	T	T	T	T	T	T	T	T	T
	50-63	T	T	T	T	T	T	T	T	T	T	T
	80	T	T	T	T	T	T	T	T	T	T	T
	100	T	T	T	T	T	T	T	T	T	T	T
	125	T	T	T	T	T	T	T	T	T	T	T
	160			T	T	T	T	T	T	T	T	T
	200			T	T	T	T	T	T	T	T	T
	225-250							T	T	T	T	T
	300								T	T	T	T
	315									T	T	T
	355									T	T	T
	400-450									T	T	T
	500									T	T	T
	630								50/105	50/105	50/105	50/105
	800											
aM Fuse link with overload relay	40	T	T	T	T	T	T	T	T	T	T	T
	50 - 63	T	T	T	T	T	T	T	T	T	T	T
	80	T	T	T	T	T	T	T	T	T	T	T
	100	T	T	T	T	T	T	T	T	T	T	T
	125			T	T	T	T	T	T	T	T	T
	160			T	T	T	T	T	T	T	T	T
	200			T	T	T	T	T	T	T	T	T
	225				50/105	50/105	50/105	50/105		T	T	T
	250									T	T	T
	300-315									T	T	T
	355-400									T	T	T
	450									50/105	50/105	50/105
	500									50/105	50/105	50/105
	630											30/63

T Switch-disconnector is totally coordinated up to the I_{cu} of the circuit breaker installed on supply side.

36/75 Switch-disconnector is protected up to 36 kA rms / 75 kA.

Protection of the switch-disconnector is not ensured.

Note: Current limitation characteristics can be significantly different from one manufacturer to another. This table can not dispense to check selected fuse characteristics.

Circuit-Breaker/TSE Coordination

Upstream: Acti9 iC60, C120, NG125

Downstream: TransferPacT TA10D●●03..06●●, TA16D●●08..16●●

Ue ≤ 415 V AC

Downstream	TSE	TA10D●●03..06●●						TA16D●●08..16●●			
	I _{th} (A) 60°	32	40	50	63	80	100	80	100	125	160
	I _{cm} (kA)	3	3	3	3	3	3	5.5	5.5	5.5	5.5
	I _{cu}	15	15	15	15	15	15	20	20	20	20

Upstream Circuit breaker	Rating	I _{cu} (415 V AC)	TSE conditionnal short-circuit current and related making capacity:									
			T	T	T	T	T	T	T	T	T	T
iC60N B-C-D Curves	≤ 32	10	T	T	T	T	T	T	T	T	T	T
	40	10	T	T	T	T	T	T	T	T	T	T
	50	10		T	T	T	T	T	T	T	T	T
	63	10			T	T	T	T	T	T	T	T
iC60H B-C-D Curves	≤ 32	15	T	T	T	T	T	T	T	T	T	T
	40	15	T	T	T	T	T	T	T	T	T	T
	50	15		T	T	T	T	T	T	T	T	T
	63	15			T	T	T	T	T	T	T	T
iC60L B-C-D-K-Z Curves	≤ 25	25	T	T	T	T	T	T	T	T	T	T
	32	20	T	T	T	T	T	T	T	T	T	T
	40	20		T	T	T	T	T	T	T	T	T
	50	15			T	T	T	T	T	T	T	T
C120N B-C-D Curves 1P 240 V 2,3,4P 415 V	63	10			T	T	T	T	T	T	T	T
	80	10				T	T	T	T	T	T	T
	100	10							T	T	T	T
	125	10								T	T	T
C120H B-C-D Curves 1P 240 V 2,3,4P 415 V	63	15			T	T	T	T	T	T	T	T
	80	15				T	T	T	T	T	T	T
	100	15							T	T	T	T
	125	15								T	T	T
NG125N B-C-D curves	≤ 32	25	T	T	T	T	T	T	T	T	T	T
	40	25		T	T	T	T	T	T	T	T	T
	50	25			T	T	T	T	T	T	T	T
	63	25				T	T	T	T	T	T	T
	80	25					T	T	T	T	T	T
	100	25							T	T	T	T
NG125H C- Curve	≤ 32	36	T	T	T	T	T	T	T	T	T	T
	40	36		T	T	T	T	T	T	T	T	T
	50	36			T	T	T	T	T	T	T	T
	63	36				T	T	T	T	T	T	T
	80	36					T	T	T	T	T	T
NG125L C- Curve	≤ 32	50	T	T	T	T	T	T	T	T	T	T
	40	50		T	T	T	T	T	T	T	T	T
	50	50			T	T	T	T	T	T	T	T
	63	50				T	T	T	T	T	T	T
	80	50					T	T	T	T	T	T

T TSE is totally coordinated up to the I_{cu} of the circuit breaker installed on supply side.

36/75 TSE is protected up to 36 kA rms / 75 kA.

Protection of the TSE is not ensured.

Circuit-Breaker/TSE Coordination

Upstream: ComPacT NSXm

Downstream: TransferPacT 32-160A (TA10D●●03 .. 06●●, TA16D●●08 .. 16●●)

Ue ≤ 440 V AC

Downstream	TSE	TA10D●●03..06●●						TA16D●●08..16●●			
	I _{th} (A) 60°	32	40	50	63	80	100	80	100	125	160
	I _{cw} (kA)	3	3	3	3	3	3	5.5	5.5	5.5	5.5
	I _{cm} (kAp)	15	15	15	15	15	15	20	20	20	20

Upstream Circuit breaker	Icu		Setting	TSE conditional short-circuit current and related making capacity:										
	415 V AC	440 V AC												
NSXm E TMD Micrologic 4.1	16	10	I _r ≤32	T	T	T	T	T	T	T	T	T	T	T
			I _r ≤40		T	T	T	T	T	T	T	T	T	T
			I _r ≤50			T	T	T	T	T	T	T	T	T
			I _r ≤63				T	T	T	T	T	T	T	T
			I _r ≤80						T	T	T	T	T	T
			I _r ≤100							T	T	T	T	T
			I _r ≤125									T	T	T
			I _r ≤160											T
NSXm B TMD Micrologic 4.1	25	20	I _r ≤32	T	T	T	T	T	T	T	T	T	T	T
			I _r ≤40		T	T	T	T	T	T	T	T	T	
			I _r ≤50			T	T	T	T	T	T	T	T	
			I _r ≤63				T	T	T	T	T	T	T	
			I _r ≤80						T	T	T	T	T	
			I _r ≤100							T	T	T	T	
			I _r ≤125									T	T	
			I _r ≤160										T	
NSXm F TMD Micrologic 4.1	36	35	I _r ≤32	T	T	T	T	T	T	T	T	T	T	
			I _r ≤40		T	T	T	T	T	T	T	T		
			I _r ≤50			T	T	T	T	T	T	T		
			I _r ≤63				T	T	T	T	T	T		
			I _r ≤80						T	T	T	T		
			I _r ≤100							T	T	T		
			I _r ≤125									T		
			I _r ≤160										T	
NSXm n TMD Micrologic 4.1	50	50	I _r ≤32	36/75	36/75	36/75	36/75	36/75	36/75	T	T	T	T	
			I _r ≤40		36/75	36/75	36/75	36/75	36/75	T	T	T		
			I _r ≤50			36/75	36/75	36/75	36/75	T	T	T		
			I _r ≤63				36/75	36/75	36/75	T	T	T		
			I _r ≤80					36/75	36/75	T	T	T		
			I _r ≤100						36/75	T	T	T		
			I _r ≤125									T		
			I _r ≤160										T	
NSXm H TMD Micrologic 4.1	70	65	I _r ≤32	36/75	36/75	36/75	36/75	36/75	36/75	T	T	T	T	
			I _r ≤40		36/75	36/75	36/75	36/75	36/75	T	T	T		
			I _r ≤50			36/75	36/75	36/75	36/75	T	T	T		
			I _r ≤63				36/75	36/75	36/75	T	T	T		
			I _r ≤80					36/75	36/75	T	T	T		
			I _r ≤100						36/75	T	T	T		
			I _r ≤125									T		
			I _r ≤160										T	

T TSE is totally coordinated up to the Icu of the circuit breaker installed on supply side.

36/75 TSE is protected up to 36 kA rms / 75 kA.

Protection of the TSE is not ensured.

Circuit-Breaker/TSE Coordination

Upstream: ComPacT NSX100-250

Downstream: TransferPacT 32-160A (TA10D●●03..06●●, TA16D●●08..16●●)

Ue ≤ 440 V AC

Downstream	TSE	TA10D●●03..06●●						TA16D●●08..16●●			
	Ith (A) 60°	32	40	50	63	80	100	80	100	125	160
	Icw (kA)	3	3	3	3	3	3	5.5	5.5	5.5	5.5
	Icm (kAp)	15	15	15	15	15	15	20	20	20	20

Upstream Circuit breaker	Icu		Setting	TSE conditionnal short-circuit current and related making capacity:																	
	415 V AC	440 V AC		Irs≤32	Irs≤40	Irs≤50	Irs≤63	Irs≤80	Irs≤100	Irs≤125	Irs≤160	Irs≤32	Irs≤40	Irs≤50	Irs≤63	Irs≤80	Irs≤100	Irs≤125	Irs≤160		
NSX100B NSX160B TMD/TMG / MicroLogic	25	20	Irs≤32	T	T	T	T	T	T	T	T	T	T	T	T	T	T	T	T		
			Irs≤40		T	T	T	T	T	T	T	T	T	T	T	T	T	T	T	T	
			Irs≤50			T	T	T	T	T	T	T	T	T	T	T	T	T	T	T	T
			Irs≤63				T	T	T	T	T	T	T	T	T	T	T	T	T	T	T
			Irs≤80								T	T	T	T	T	T	T	T	T	T	T
			Irs≤100								T		T	T	T	T	T	T	T	T	T
			Irs≤125																T	T	T
			Irs≤160																		T
NSX250B TMD/TMG / MicroLogic	25	20	Irs≤32	T	T	T	T	T	T	T	T	T	T	T	T	T	T	T	T		
			Irs≤40		T	T	T	T	T	T	T	T	T	T	T	T	T	T	T	T	
			Irs≤50			T	T	T	T	T	T	T	T	T	T	T	T	T	T	T	T
			Irs≤63				T	T	T	T	T	T	T	T	T	T	T	T	T	T	T
			Irs≤80								T	T	T	T	T	T	T	T	T	T	T
			Irs≤100								T		T	T	T	T	T	T	T	T	T
			Irs≤125																T	T	T
			Irs≤160																		T
NSX100F NSX160F TMD/TMG / MicroLogic	36	35	Irs≤32	T	T	T	T	T	T	T	T	T	T	T	T	T	T	T	T		
			Irs≤40		T	T	T	T	T	T	T	T	T	T	T	T	T	T	T	T	
			Irs≤50			T	T	T	T	T	T	T	T	T	T	T	T	T	T	T	T
			Irs≤63				T	T	T	T	T	T	T	T	T	T	T	T	T	T	T
			Irs≤80								T	T	T	T	T	T	T	T	T	T	T
			Irs≤100								T		T	T	T	T	T	T	T	T	T
			Irs≤125																T	T	T
			Irs≤160																		T
NSX250F TMD/TMG / MicroLogic	36	35	Irs≤32	25/52	25/52	25/52	25/52	25/52	25/52	25/52	25/52	T	T	T	T	T	T	T	T		
			Irs≤40		25/52	25/52	25/52	25/52	25/52	25/52	T	T	T	T	T	T	T	T	T	T	
			Irs≤50			25/52	25/52	25/52	25/52	25/52	T	T	T	T	T	T	T	T	T	T	T
			Irs≤63				25/52	25/52	25/52	25/52	T	T	T	T	T	T	T	T	T	T	T
			Irs≤80						25/52	25/52	25/52	T	T	T	T	T	T	T	T	T	T
			Irs≤100							25/52		T	T	T	T	T	T	T	T	T	T
			Irs≤125																T	T	T
			Irs≤160																		T

T Switch-disconnector is totally coordinated up to the Icu of the circuit breaker installed on supply side.

36/75 Switch-disconnector is protected up to 36 kA rms / 75 kA.

Protection of the switch-disconnector is not ensured.

Circuit-Breaker/TSE Coordination

Upstream: ComPacT NSX100-250

Downstream: TransferPacT 32-160A (TA10D●●03 .. 06●●, TA16D●●08 .. 16●●)

Ue ≤ 440 V AC

Downstream	TSE	TA10D●●03..06●●						TA16D●●08..16●●			
	Ith (A) 60°	32	40	50	63	80	100	80	100	125	160
	Icw (kA)	3	3	3	3	3	3	5.5	5.5	5.5	5.5
	Icm (kAp)	15	15	15	15	15	15	20	20	20	20

Upstream Circuit breaker	Icu		Setting	TSE conditionnal short-circuit current and related making capacity:											
	415 V AC	440 V AC													
NSX100N/H NSX160N/H TMD/TMG / Micrologic	50/70	50/65	Ir≤32	36/75	36/75	36/75	36/75	36/75	36/75	36/75	36/75	T	T	T	T
			Ir≤40		36/75	36/75	36/75	36/75	36/75	36/75	T	T	T	T	
			Ir≤50			36/75	36/75	36/75	36/75	36/75	T	T	T	T	
			Ir≤63				36/75	36/75	36/75	36/75	T	T	T	T	
			Ir≤80					36/75	36/75	36/75	T	T	T	T	
			Ir≤100						36/75	36/75	T	T	T	T	
			Ir≤125										T	T	
NSX250N/H TMD/TMG / Micrologic	50/70	50/65	Ir≤32	25/52	25/52	25/52					T	T	T	T	
			Ir≤40		25/52	25/52	25/52	25/52	25/52	25/52	T	T	T	T	
			Ir≤50			25/52	25/52	25/52	25/52	25/52	T	T	T	T	
			Ir≤63				25/52	25/52	25/52	25/52	T	T	T	T	
			Ir≤80					25/52	25/52	25/52	T	T	T	T	
			Ir≤100						25/52	25/52		T	T	T	
			Ir≤125										T	T	
NSX100S/L/R NSX160S/L TMD/TMG / MicroLogic	100/150 /200	90/150 /200	Ir≤32	36/75	36/75	36/75	36/75	36/75	36/75	36/75	65/143	65/143	65/143	65/143	
			Ir≤40		36/75	36/75	36/75	36/75	36/75	36/75	65/143	65/143	65/143	65/143	
			Ir≤50			36/75	36/75	36/75	36/75	36/75	65/143	65/143	65/143	65/143	
			Ir≤63				36/75	36/75	36/75	36/75	65/143	65/143	65/143	65/143	
			Ir≤80					36/75	36/75	36/75	65/143	65/143	65/143	65/143	
			Ir≤100						36/75	36/75	65/143	65/143	65/143	65/143	
			Ir≤125										65/143	65/143	
NSX250S/L/R TMD/TMG / MicroLogic	100/150 /200	90/150 /200	Ir≤32	25/52	25/52	25/52	25/52	25/52	25/52	25/52	65/143	65/143	65/143	65/143	
			Ir≤40		25/52	25/52	25/52	25/52	25/52	25/52	65/143	65/143	65/143	65/143	
			Ir≤50			25/52	25/52	25/52	25/52	25/52	65/143	65/143	65/143	65/143	
			Ir≤63				25/52	25/52	25/52	25/52	65/143	65/143	65/143	65/143	
			Ir≤80					25/52	25/52	25/52	65/143	65/143	65/143	65/143	
			Ir≤100						25/52	25/52	65/143	65/143	65/143	65/143	
			Ir≤125										65/143	65/143	

T Switch-disconnector is totally coordinated up to the Icu of the circuit breaker installed on supply side.

36/75 Switch-disconnector is protected up to 36 kA rms / 75 kA.

Protection of the switch-disconnector is not ensured.

Circuit-Breaker/TSE Coordination

Upstream: ComPacT NSX100-630 NS630b

Downstream: TransferPacT Automatic TA25, TA63, TransferPacT Remote TA25, TA63

Ue ≤ 440 V AC

Downstream	TSE	TA25, TR25				TA63, TR63			
	lth (A) 60°		100	160	200	250	320	400	500
Icw (kA)		15/0.1s	15/0.1s	15/0.1s	15/0.1s	25/0.1s	25/0.1s	25/0.1s	25/0.1s
		10/0.5s 8/1s	10/0.5s 8/1s	10/0.5s 8/1s	10/0.5s 8/1s	20/0.5s 15/1s	20/0.5s 15/1s	20/0.5s 15/1s	20/0.5s 15/1s
Icm (kAp)		30	30	30	30	40	40	40	40

Upstream	Icu		Setting	TSE conditionnal short-circuit current and related making capacity:								
Circuit breaker	415 V AC	440 V AC										
NSX100B/F/N/H/S/L NSX160B/F/N/H/S/L NSX250B/F/N/H/S/L TMD/TMG/Micrologic	25/36/ 50/70/ 100/150	25/35/ 50/65/ 90/130	I _r ≤100	T	T	T	T	T	T	T	T	T
			I _r ≤160		T	T	T	T	T	T	T	T
			I _r ≤200			T	T	T	T	T	T	T
			I _r ≤250				T	T	T	T	T	T
NSX100R NSX250R TMD/TMG/Micrologic	200	200	I _r ≤100	T	T	T	T	T	T	T	T	T
			I _r ≤160		T	T	T	T	T	T	T	T
			I _r ≤200			T	T	T	T	T	T	T
			I _r ≤250				T	T	T	T	T	T
NSX400F/N/H/S/L NSX630F/N/H/S/L Micrologic Note: Min. In 100 A Max. In 570A	36/50/ 70/100/ 150	30/42/ 65/90/ 130	I _r ≤100	T	T	T	T	T	T	T	T	T
			I _r ≤160		T	T	T	T	T	T	T	T
			I _r ≤200			T	T	T	T	T	T	T
			I _r ≤250				T	T	T	T	T	T
			I _r ≤320					T	T	T	T	T
			I _r ≤400						T	T	T	T
			I _r ≤500							T	T	T
NSX400R NSX630R Micrologic Note: Min. In 100 A Max. In 570A	200	200	I _r ≤100	150/330	150/330	150/330	150/330	T	T	T	T	T
			I _r ≤160		150/330	150/330	150/330	T	T	T	T	T
			I _r ≤200			150/330	150/330	T	T	T	T	T
			I _r ≤250				150/330	T	T	T	T	T
			I _r ≤320					T	T	T	T	T
			I _r ≤400						T	T	T	T
			I _r ≤500							T	T	T
NS630b/800 N	50	50	I _r ≤320					20/50	20/50	20/50	20/50	20/50
			I _r ≤400						20/50	20/50	20/50	20/50
			I _r ≤500							20/50	20/50	20/50
			I _r ≤630								20/50	20/50
NS630b/800H	70	65	I _r ≤320					20/50	20/50	20/50	20/50	
			I _r ≤400						20/50	20/50	20/50	
			I _r ≤500							20/50	20/50	
			I _r ≤630								20/50	
NS630b/800 L	150	130	I _r ≤320					T	T	T	T	
			I _r ≤400						T	T	T	
			I _r ≤500							T	T	
			I _r ≤630								T	

T Switch-disconnector is totally coordinated up to the Icu of the circuit breaker installed on supply side.

150/330 Switch-disconnector is protected up to 36 kA rms / 75 kA.

Protection of the switch-disconnector is not ensured.

Protection of LV/LV Transformers and Capacitors

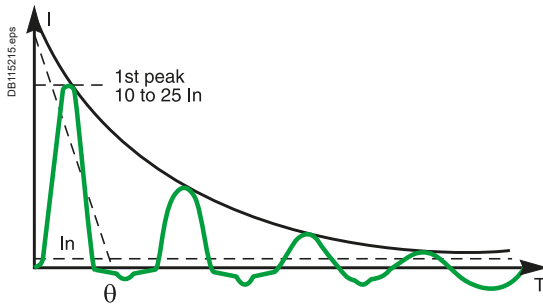

Inrush currents

When LV/LV transformers are switched on, very high inrush currents are produced which must be taken into account when choosing overcurrent protection devices. The peak value of the first current wave often reaches 10 to 15 times the rated rms current of the transformer and may reach values of 20 to 25 times the rated current even for transformers rated less than 50 kVA.

Selecting the protection

The values in the tables have been calculated for a crest factor of 25.

These tables indicate the circuit breaker and trip unit to be used depending on:

- The primary supply voltage (230 V or 400 V)
- The type of transformer (single-phase or three-phase).

They correspond to the most frequent case of step down-transformer in which the primary is wound externally ^[1] with no de-rating for harmonics (K-factor = 1).

The type of circuit breaker to be used (i.e. N, H or L) depends on the breaking capacity required at the point of installation.

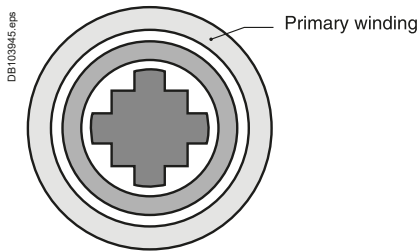

Transformer Power rating (kVA)			Circuit breaker		
230-240V 1-ph	230-240V 3-ph 400-415V 1-ph	400-415V 3-ph	Type	Curve	Rating
0.05	0.09	0.16	iC60	D or K	0.5
0.11	0.18	0.32	iC60	D or K	1
0.21	0.36	0.63	iC60	D or K	2
0.33	0.58	1.0	iC60	D or K	3
0.67	1.2	2.0	iC60	D or K	6
1.1	1.8	3.2	iC60,NG125	D or K	10
1.7	2.9	5.0	iC60,NG125	D or K	16
2.1	3.6	6.3	iC60,NG125	D or K	20
2.7	4.6	8.0	iC60,NG125	D or K	25
3.3	5.8	10	iC60,NG125	D or K	32
4.2	7.2	13	iC60,NG125	D or K	40
5.3	9.2	16	iC60,NG125	D or K	50
6.7	12	20	iC60,NG125	D or K	63
8.3	14	25	C120,NG125	D or K	80
11	18	32	C120,NG125	D or K	100
13	23	40	C120,NG125	D or K	125

Protection using a ComPacT circuit breaker (1st peak ≤ 25 In)

ComPacT NSX100 to NSX250 equipped with TM-D thermal-magnetic trip unit			Protective device		
Transformer rating (kVA)			Circuit breakers		
230/240 V 1-phase	230/240 V 3-phases 400/415 V 1-phase	400/415 V 3-phases		Trip unit	Ir max setting
3	5 to 6	9 to 12	NSX100B/F/N/H/S/L	TM16D	1
5	8 to 9	14 to 16	NSX100B/F/N/H/S/L	TM25D	1
7 to 9	13 to 16	22 to 28	NSX100B/F/N/H/S/L/R	TM40D	1
12 to 15	20 to 25	35 to 44	NSX100B/F/N/H/S/L/R	TM63D	1
16 to 19	26 to 32	45 to 56	NSX100B/F/N/H/S/L/R	TM80D	1
18 to 23	32 to 40	55 to 69	NSX160B/F/N/H/S/L	TM100D	1
23 to 29	40 to 50	69 to 87	NSX160B/F/N/H/S/L	TM125D	1
29 to 37	51 to 64	89 to 111	NSX250B/F/N/H/S/L/R	TM160D	1
37 to 46	64 to 80	111 to 139	NSX250B/F/N/H/S/L/R	TM200D	1

ComPacT NSX100 to NS1600/MasterPact equipped with MicroLogic trip unit

Transformer rating (kVA)		Protective device			
230/240 V 1-phase	230/240 V 3-phases 400/415 V 1-phase	400/415 V 3-phases	Circuit breakers	Trip unit	Ir max setting
4 to 7	6 to 13	11 to 22	NSX100B/F/N/H/S/L/R	MicroLogic 2.2, 4.2, 5.2, 6.2, 7.2 40	0.8
9 to 19	16 to 30	27 to 56	NSX100B/F/N/H/S/L/R	MicroLogic 2.2, 4.2, 5.2, 6.2, 7.2 100	0.8
15 to 30	05 to 50	44 to 90	NSX160B/F/N/H/S/L	MicroLogic 2.2, 4.2, 5.2, 6.2, 7.2 160	0.8
23 to 46	40 to 80	70 to 139	NSX250B/F/N/H/S/L/R	MicroLogic 2.2, 4.2, 5.2, 6.2, 7.2 250	0.8
37 to 65	64 to 112	111 to 195	NSX400F/N/H/S/L/R	MicroLogic 2.3, 4.3, 5.3, 6.3, 7.3 400	0.7
58 to 83	100 to 144	175 to 250	NSX630F/N/H/S/L/R	MicroLogic 2.3, 4.3, 5.3, 6.3, 7.3 630	0.6
58 to 150	100 to 250	175 to 436	NS630bN/bH-NT06H1	MicroLogic 5.0/6.0/7.0	1
74 to 184	107 to 319	222 to 554	NS800N/H-MTZ108H1-MTZ208N1/H1	MicroLogic 5.0/6.0/7.0	1
90 to 230	159 to 398	277 to 693	NS1000N/H-MTZ110H1-MTZ210N1/H1	MicroLogic 5.0/6.0/7.0	1
115 to 288	200 to 498	346 to 866	NS1250N/H-MTZ112H1-MTZ212N1/H1	MicroLogic 5.0/6.0/7.0	1
147 to 368	256 to 640	443 to 1108	NS1600N/H-MTZ116H1-MTZ216N1/H1	MicroLogic 5.0/6.0/7.0	1
184 to 460	320 to 800	554 to 1385	MTZ220N1/H1	MicroLogic 5.0/6.0/7.0	1
230 to 575	400 to 1000	690 to 1730	MTZ225H2/H3	MicroLogic 5.0/6.0/7.0	1
294 to 736	510 to 1280	886 to 2217	MTZ232H2/H3	MicroLogic 5.0/6.0/7.0	1

[1] For other windings or special applications, please consult Schneider Electric.

If a circuit breaker upstream of a transformer with a transformation ratio of 1 and a rated power of less than 5 kVA is subject to nuisance tripping, before choosing a circuit breaker with a higher rating, invert the input and the output of the transformer (the inrush current may be doubled if the primary is wound internally rather than externally).

NS630b L, LB, NS800 L LB, NS1000L, MTZ1 06 08 10 L1 cannot be used without checking the inrush current is below their fast tripping characteristics, consult Schneider Electric.

Protection of LV/LV Transformers and Capacitors

DB115216.eps

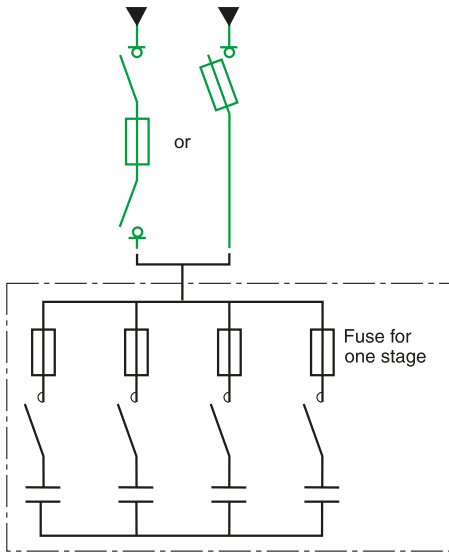

Capacitor-bank protection.

056639A-30.eps



Rectimat 2 capacitor bank.

Protection of capacitors

It is necessary to take into account:

- Permissible variations in the fundamental voltage and in harmonic content
The increase in the current rating for the protection device may reach 30 %.
- Variations due to capacitor tolerances.

The increase in the current rating for the protection device may reach 15 % (but only 5 % for Rectiphase capacitors).

Given the above, the generally required correction factor ranges from 1.6 to 2.

For Rectiphase capacitor banks, an optimized factor of only 1.4 may be used for standard banks.

Protection table for fixed or automatic capacitor banks

400/415 V		
Capacitor (kVAR)	gG fuse-link rating	FuPact
10 kVAR	20 A	GS●32/GSD63
20 kVAR	40 A	GSC50/GSB63/GSD63
30 kVAR	63 A	GSC125/GSB63/GSD63
50 kVAR	100 A	GSC125/GSB100/GSD125
60 kVAR	125 A	GSC125/GSB160/GSD125
80 kVAR	160 A	GSB160/GSD160
105 kVAR	250 A	GSB250/GSD250
150 kVAR	315 A	GSB400/GSD400
210 kVAR	450 A	GSB630/GSD630
315 kVAR	670 A	GSB800/GSD800

690 V		
Capacitor (kVAR)	gG fuse-link rating	FuPact
10 kVAR	16 A	GS●32/GSD63
20 kVAR	32 A	GS●32/GSD63
30 kVAR	40 A	GSC40/GS●63
50 kVAR	63 A	GS●63/GSC125
60 kVAR	80 A	GS●125/GSB100
80 kVAR	100 A	GS●125/GSDB160
105 kVAR	125 A	GS●160
150 kVAR	200 A	GS●250
210 kVAR	250 A	GS●400
315 kVAR	400 A	GS●400
405 kVAR	500 A	GS●630
450 kVAR	560 A	GS●630
495 kVAR	630 A	GS●800
540 kVAR	670 A	GS●800

Coordination Tables between Circuit Breaker and Canalis Electrical Busbar Trunking

When choosing a circuit breaker to protect a busbar trunking system, it is necessary to take into account:

- The usual rules concerning the circuit breaker current settings:
 - $I_b \leq I_r \leq I_{nc}$ where:
 - I_b = maximum load current
 - I_r = circuit breaker current setting
 - I_{nc} = current rating of the busbar trunking
- The electrodynamic withstand of the busbar trunking: the peak current \hat{I} limited by the circuit breaker must be less than the electrodynamic withstand capacity (or rated peak current) of the busbar trunking.

The following tables provide maximum prospective short-circuit current where busbar trunking systems can be installed in coordination with specified circuit breaker.

Different coordination tables are provided for 400V AC and 690V AC systems

How to read the table

Example Canalis KSA630 Ue: 400V AC.

Type of Canalis busbar trunking KSA630		≤ 32 kA	36 kA	50 kA	70 kA	100 kA	150 kA
Type of circuit breaker	ComPacT NSX	NSX400F/N/H/S/L NSX630F/N/H/S/L		NSX400N/H/S/L NSX630N/H/S/L	NSX400H/S/L NSX630H/S/L	NSX400S/L NSX630S/L	NSX400L NSX630L
	ComPacT NS	NS630b N/H/L/LB NS800N/H/L/LB		NS630b L/LB NS800L/LB			NS630b LB NS800LB
	MasterPact MTZ1	MTZ1 06 H1/H2/H3/L1 MTZ1 08 H1/H2/H3/L1		MTZ1 06 L1 MTZ1 08 L1			
Family of circuit breaker		For a presumed short-circuit current of 65 kA NSX400H/S/L, NSX630H/S/L, NS630b L/LB, NS800 L/LB, MTZ1 06L1 08L1 can be used to protect the canalis. The bold line is the optimized solution.					



Coordination Tables between Circuit Breaker and Canalis Electrical Busbar Trunking

Example

Consider two 630 kVA/400 V transformer (Usc 4 %) supplying a main LV switchboard for which the prospective short-circuit current on the busbars is 44 kA.

From the switchboard, a 30-metre long Canalis KSA630 transmission electrical busbar trunking system (630 A) supplies a Canalis KSA630 trunking system (630A) for distribution with high-density tap-offs.

A tap-off on the KSA630 trunking supplies a Canalis KSA160 trunking system.

The short-circuit level are respectively:

- 44 kA downstream of circuit breaker CB1 and at the upstream connection of the KSA630 trunking
- 33 kA at the junction between the KSA630 transmission trunking and the KSA630 trunking for high-density tap-offs.

What circuit breakers should be chosen for CB1 and CB2 to protect the installation against short-circuits?

	CB1	CB2
Prospective Isc	44 kA	33 kA
Circuit breakers	NSX630N (50 kA breaking capacity)	NSX160F (36 kA breaking capacity)
Isc protection level for KSA630 trunking	50 kA	
Isc protection level for KSA160 trunking		35 kA

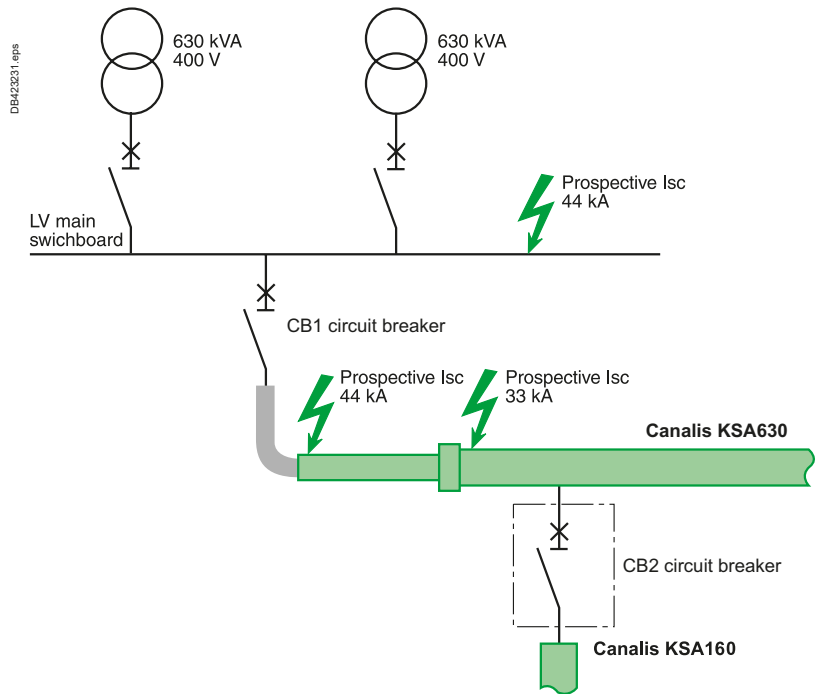

Coordination Tables between Circuit Breaker and Canalis Electrical Busbar Trunking

Canalis KDP KBA KBB L+N+PE

Ue: 220 or 240 V AC Ph/N

Type of Canalis busbar trunking KDP20 L + N + PE						
Isc max. in kA rms		10 kA	15 kA	20 kA		
Type of circuit breaker	iC60	iC60N 10/16/20	iC60H 10/16/20	iC60L 10/16/20		
Isc max. in kA rms	NG	NG125N 10/16/20				
Type of Canalis busbar trunking KBA25 L + N + PE						
Isc max. in kA rms		10 kA	15 kA	20 kA	25 kA	
Type of circuit breaker	iC60	iC60N 10/.../25	iC60H 10/.../25	iC60L 10/.../25	iC60L 10/.../25	
Isc max. in kA rms	NG	NG125N 10/.../25				
Type of Canalis busbar trunking KBB25 L + N + PE						
Isc max. in kA rms		10 kA	15 kA	20 kA	25 kA	
Type of circuit breaker	iC60	iC60N 10/.../25	iC60H 10/.../25	iC60L 10/.../25	iC60L 10/.../25	
Isc max. in kA rms	NG	NG125N 10/.../25				
Type of Canalis busbar trunking KBA40 L + N + PE						
Isc max. in kA rms		10 kA	15 kA	20 kA	25 kA	50 kA
Type of circuit breaker	iC60	iC60N 10/.../40	iC60H 10/.../40	iC60L 40	iC60L 10/.../25	
Isc max. in kA rms	NG	NG125N 10/.../40	NG125N 10/.../40	NG125N 10/.../40	NG125N 10/.../40	NG125L 10/.../40
Type of Canalis busbar trunking KBB40 L + N + PE						
Isc max. in kA rms		10 kA	15 kA	20 kA	25 kA	50 kA
Type of circuit breaker	iC60	iC60N 10/.../40	iC60H 10/.../40	iC60L 40	iC60L 10/.../25	
Isc max. in kA rms	NG	NG125N 10/.../40	NG125N 10/.../40	NG125N 10/.../40	NG125N 10/.../40	NG125L 10/.../40



Coordination Tables between Circuit Breaker and Canalis Electrical Busbar Trunking

Canalis KDP KBA KBB 3L+N+PE, KNA
 Ue: 380-415 V AC

Type of Canalis busbar trunking KDP20 3L+N+PE						
Isc max. in kA rms	10 kA		15 kA	20 kA		
Type of circuit breaker	iC60	iC60N 10/16/20	iC60H 10/16/20	iC60L 10/16/20		
	NG125	NG125N 10/16/20				

Type of Canalis busbar trunking KBA25 3L+N+PE					
Isc max. in kA rms	10 kA		15 kA	20 kA	25 kA
Type of circuit breaker	iC60	iC60N 10/.../25	iC60H 10/.../25	iC60L 10/.../25	iC60L 10/.../25
	NG125	NG125N 10/.../25			

Type of Canalis busbar trunking KBB25 3L+N+PE					
Isc max. in kA rms	10 kA		15 kA	20 kA	25 kA
Type of circuit breaker	iC60	iC60N 10/.../25	iC60H 10/.../25	iC60L 10/.../25	iC60L 10/.../25
	NG125	NG125N 10/.../25			

Type of Canalis busbar trunking KBA40 3L+N+PE							
Isc max. in kA rms	10 kA		15 kA	20 kA	25 kA	36 kA	50 kA
Type of circuit breaker	iC60	iC60N 10/.../40	iC60H 10/.../40	iC60L 40	iC60L 10/.../25		
	NG125	NG125N 10/.../40	NG125N 10/.../40	NG125N 10/.../40	NG125N 10/.../40	NG125H 10/.../40	NG125L 10/.../40

Type of Canalis busbar trunking KBB40 3L+N+PE							
Isc max. in kA rms	10 kA		15 kA	20 kA	25 kA	36 kA	50 kA
Type of circuit breaker	iC60	iC60N 10/.../40	iC60H 10/.../40	iC60L 40	iC60L 10/.../25		
	NG125	NG125N 10/.../40	NG125N 10/.../40	NG125N 10/.../40	NG125N 10/.../40	NG125H 10/.../40	NG125L 10/.../40

E

Type of Canalis busbar trunking KNA40					
Isc max. in kA rms	10 kA		15 kA	20 kA	25 kA
Type of circuit breaker	iC60	iC60N 40	iC60H 40	iC60L 40	
	NG125	NG125N/H/L 40			
	ComPacT	NSXm E/B/F/N/H 40A		NSXm B/F/N/H 40A	
	NSXm				
	ComPacT NSX	NSX100B/F/N/H/S/L 40A			

Type of Canalis busbar trunking KNA63							
Isc max. in kA rms	10 kA		15 kA	20 kA	25 kA	36 kA	50 kA
Type of circuit breaker	iC60	iC60N 63	iC60H 63				
	C120	C120N 63	C120H 63				
	NG125	NG125N/H/L 63			NG125H 63	NG125L 63	
	ComPacT	NSXm E/B/F/N/H 63A		NSXm B/F/N/H 63A			
	NSXm						
	ComPacT NSX	NSX100B/F/N/H/S/L 63A					

Type of Canalis busbar trunking KNA100							
Isc max. in kA rms	10 kA		15 kA	20 kA	25 kA	36 kA	50 kA
Type of circuit breaker	C120	C120N 100A	C120H 100A				
	NG125	NG125N/H/L 100			NG125H/L 80	NG125L 80	
	ComPacT	NSXm E/B/F/N/H 100A		NSXm B/F/N/H 100A			
	NSXm						
	ComPacT NSX	NSX100B/F/N/H/S/L NSX160B/F/N/H/S/L					

Type of Canalis busbar trunking KNA160							
Isc max. in kA rms	10 kA		15 kA	20 kA	25 kA	36 kA	50 kA
Type of circuit breaker	NG125	NG125N125					
	ComPacT	NSXm E/B/F/N/H 160		NSXm B/F/N/H 160A		NSXm F/N/H 160A	NSXm N/H 160A
	NSXm						
	ComPacT NSX	NSX100B/F/N/H/S/L NSX160B/F/N/H/S/L NSX250B/F/N/H/S/L		NSX100F/N/H/S/L NSX160F/N/H/S/L NSX250F/N/H/S/L		NSX100N/H/S/L NSX160N/H/S/L NSX250N/H/S/L	

Coordination Tables between Circuit Breaker and Canalis Electrical Busbar Trunking

Canalis KSA
Ue: 380-415 V AC

Type of Canalis busbar trunking KSA100							
Isc max. in kA rms		25 kA	36 kA	50 kA			
Type of circuit breaker	NG125	NG125N100	NG125H80	NG125L 80			
	ComPacT NSXm	NSXm B/F/N/H 100	NSXm F/N/H 100				
	ComPacT NSX	NSX100B/F/N/H/S/L					

Type of Canalis busbar trunking KSA160							
Isc max. in kA rms		25 kA	36 kA	50 kA	70 kA	90 kA	
Type of circuit breaker	ComPacT NSXm	NSXm B/F/N/H 160	NSXm F/N/H 160	NSXm N/H 160	NSXm H 160		
	ComPacT NSX	NSX100B/F/N/H/S/L	NSX100F/N/H/S/L	NSX100N/H/S/L	NSX100H/S/L	NSX100S/L	
		NSX160B/F/N/H/S/L	NSX160F/N/H/S/L	NSX160N/H/S/L	NSX160H/S/L		
		NSX250B/F/N/H/S/L	NSX250F/N/H/S/L	NSX250N/H/S/L			

Type of Canalis busbar trunking KSA250							
Isc max. in kA rms		25 kA	36 kA	50 kA	70 kA	100 kA	150 kA
Type of circuit breaker	ComPacT NSX	NSX160B/F/N/H/S/L	NSX160F/N/H/S/L	NSX160N/H/S/L	NSX160H/S/L	NSX160S/L	NSX160L
		NSX250B/F/N/H/S/L	NSX250F/N/H/S/L	NSX250N/H/S/L	NSX250H/S/L	NSX250S/L	NSX250L
		NSX400F/N/H/S/L	NSX400F/N/H/S/L	NSX400N/H/S/L			

Type of Canalis busbar trunking KSA400							
Isc max. in kA rms		25 kA	36 kA	50 kA	70 kA	100 kA	150 kA
Type of circuit breaker	ComPacT NSX	NSX250B/F/N/H/S/L	NSX250F/N/H/S/L	NSX250N/H/S/L	NSX250H/S/L	NSX250S/L	NSX250L
		NSX400F/N/H/S/L	NSX400F/N/H/S/L	NSX400N/H/S/L	NSX400H/S/L	NSX400S/L	NSX400L
		NSX630F/N/H/S/L	NSX630F/N/H/S/L	NSX630N/H/S/L	NSX630H/S/L	NSX630S/L	NSX630L
	ComPacT NS	NS630b N/H/L/LB	NS630b L/LB	NS630b L/LB	NS630b LB		

Type of Canalis busbar trunking KSA500							
Isc max. in kA rms		25 kA	36 kA	50 kA	70 kA	100 kA	150 kA
Type of circuit breaker	ComPacT NSX	NSX400F/N/H/S/L	NSX400F/N/H/S/L	NSX400N/H/S/L	NSX400H/S/L	NSX400S/L	NSX400L
		NSX630F/N/H/S/L	NSX630F/N/H/S/L	NSX630N/H/S/L	NSX630H/S/L	NSX630S/L	NSX630L
	ComPacT NS	NS630b N/H/L/LB		NS630b L/LB	NS630b LB		

Type of Canalis busbar trunking KSA630							
Isc max. in kA rms		≤ 32 kA	36 kA	50 kA	70 kA	100 kA	150 kA
Type of circuit breaker	ComPacT NSX	NSX400F/N/H/S/L		NSX400N/H/S/L	NSX400H/S/L	NSX400S/L	NSX400L
		NSX630F/N/H/S/L		NSX630N/H/S/L	NSX630H/S/L	NSX630S/L	NSX630L
	ComPacT NS	NS630b N/H/L/LB		NS630b L/LB			NS630b LB
		NS800N/H/L/LB		NS800L/LB			NS800LB
	MasterPact MTZ1	MTZ1 06 H1/H2/H3/L1		MTZ1 06 L1			
		MTZ1 08 H1/H2/H3/L1		MTZ1 08 L1			
		MTZ1 10 H1/H2/H3/L1		MTZ1 10 L1			

Type of Canalis busbar trunking KSA800							
Isc max. in kA rms		25 kA	36 kA	50 kA	70 kA	100 kA	150 kA
Type of circuit breaker	ComPacT NSX	NSX630F/N/H/S/L		NSX630N/H/S/L	NSX630H/S/L	NSX630S/L	NSX630L
	ComPacT NS	NS630b N/H/L/LB			NS630b L/LB		
		NS800N/H/L/LB			NS800L/LB		
		NS1000N/H/L			NS1000L		
	MasterPact MTZ1	MTZ1 06 H1/H2/H3/L1			MTZ1 06 L1		
		MTZ1 08 H1/H2/H3/L1			MTZ1 08 L1		
		MTZ1 10 H1/H2/H3/L1			MTZ1 10 L1		

Type of Canalis busbar trunking KSA1000							
Isc max. in kA rms		25 kA	36 kA	50 kA	70 kA	100 kA	150 kA
Type of circuit breaker	ComPacT NS	NS800N/H/L/LB			NS800L/LB		
		NS1000N/H/L			NS1000L		
		NS1250N/H					
	MasterPact MTZ1	MTZ1 08 H1/H2/H3/L1			MTZ1 08 L1		
		MTZ1 10 H1/H2/H3/L1			MTZ1 10 L1		
		MTZ1 12 H1/H2/H3					



Coordination Tables between Circuit Breaker and Canalis Electrical Busbar Trunking

Canalis KTA/KTC
Ue: 380-415 V AC

Type of Canalis busbar trunking KTA0800							
Isc max. in kA rms		≤ 30 kA	50 kA	65 kA	85 kA	100 kA	150 kA
Type of circuit breaker	ComPacT NSX	NSX630F/NH/S/L	NSX630N/H/S/L	NSX630H/S/L	NSX630S/L	NSX630S/L	NSX630L
	ComPacT NS	NS630b N/H/L/LB NS800N/H/L/LB NS1000N/H/L/LB		NS630b L/LB NS800L/LB NS1000L			NS630b LB NS800LB
	MasterPact MTZ1	MTZ1 06 H1/H2/H3/L1 MTZ1 08 H1/H2/H3/L1 MTZ1 10 H1/H2/H3/L1		MTZ1 06 L1 MTZ1 08 L1 MTZ1 10 L1			
	MasterPact MTZ2 [1]	MTZ2 08 N1/H1/H2/L1 MTZ2 10 N1/H1/H2/L1					
Type of Canalis busbar trunking KTA0800 reinforced short-circuit level							
Isc max. in kA rms		≤ 30 kA	50 kA	65 kA	85 kA	100 kA	150 kA
Type of circuit breaker	ComPacT NSX	NSX630F/NH/S/L	NSX630N/H/S/L	NSX630H/S/L	NSX630S/L	NSX630S/L	NSX630L
	ComPacT NS	NS630b N/H/L/LB NS800N/H/L/LB NS1000N/H/L/LB		NS630b L/LB NS800L/LB NS1000L			NS630b LB NS800LB
	MasterPact MTZ1	MTZ1 06 H1/H2/H3/L1 MTZ1 08 H1/H2/H3/L1 MTZ1 10 H1/H2/H3/L1		MTZ1 06 L1 MTZ1 08 L1 MTZ1 10 L1			
	MasterPact MTZ2 [1]	MTZ2 08 N1/H1/H2/L1 MTZ2 10 N1/H1/H2/L1					
Type of Canalis busbar trunking KTA1000/KTC1000							
Isc max. in kA rms		42 kA	50 kA	65 kA	85 kA	100 kA	150 kA
Type of circuit breaker	ComPacT NS	NS800N/H/L/LB NS1000N/H/L NS1250N/H			NS800L/LB NS1000L		
	MasterPact MTZ1	MTZ1 08 H1/H2/H3/L1 MTZ1 10 H1/H2/H3/L1 MTZ1 12 H1/H2/H3	MTZ1 08 H2/H3/L1 MTZ1 10 H2/H3/L1 MTZ1 12 H2/H3		MTZ1 08 L1 MTZ1 10 L1		
	MasterPact MTZ2 [1]	MTZ2 08 N1/H1/H2/L1 MTZ2 10 N1/H1/H2/L1 MTZ2 12 N1/H1/H2/L1	MTZ2 08 H1/H2/L1 MTZ2 10 H1/H2/L1 MTZ2 12 H1/H2/L1				
Type of Canalis busbar trunking KTA1000/KTC1000 reinforced short-circuit level							
Isc max. in kA rms		42 kA	50 kA	65 kA	85 kA	100 kA	150 kA
Type of circuit breaker	ComPacT NS	NS800N/H/L/LB NS1000N/H/L NS1250N/H		NS800H/L/LB NS1000H/L NS1250H		NS800L NS1000L	
	MasterPact MTZ1	MTZ1 08 H1/H2/H3/L1 MTZ1 10 H1/H2/H3/L1 MTZ1 12 H1/H2/H3	MTZ1 08 H2/H3/L1 MTZ1 10 H2/H3/L1 MTZ1 12 H2/H3	MTZ1 08 H3/L1 MTZ1 10 H3/L1 MTZ1 12 H3		MTZ1 08 L1 MTZ1 10 L1	
	MasterPact MTZ2 [1]	MTZ2 08 N1/H1/H2/L1 MTZ2 10 N1/H1/H2/L1 MTZ2 12 N1/H1/H2/L1	MTZ2 08 H1/H2/L1 MTZ2 10 H1/H2/L1 MTZ2 12 H1/H2/L1	MTZ2 08 L1 MTZ2 10 L1 MTZ2 12 L1			
Type of Canalis busbar trunking KTA1250/KTC1350							
Isc max. in kA rms		42 kA	50 kA	65 kA	85 kA	100 kA	150 kA
Type of circuit breaker	ComPacT NS	NS1000N/H NS1250N/H NS1600N/H			NS1000L		
	MasterPact MTZ1	MTZ1 10 H1/H2/H3/L1 MTZ1 12 H1/H2/H3 MTZ1 16 H1/H2/H3	MTZ1 10 H2/H3/L1 MTZ1 12 H2/H3 MTZ1 16 H2/H3		MTZ1 10 L1		
	MasterPact MTZ2 [1]	MTZ2 10 N1/H1/H2/L1 MTZ2 12 N1/H1/H2/L1 MTZ2 16 N1/H1/H2/L1	MTZ2 10 H1/H2/L1 MTZ2 12 H1/H2/L1 MTZ2 16 H1/H2/L1				
Type of Canalis busbar trunking KTA1250/KTC1350 reinforced short-circuit level							
Isc max. in kA rms		42 kA	50 kA	65 kA	85 kA	100 kA	150 kA
Type of circuit breaker	ComPacT NS	NS1000N/H/L NS1250N/H NS1600N/H		NS1000H/L NS1250H NS1600H		NS1000L	
	MasterPact MTZ1	MTZ1 10 H1/H2/H3/L1 MTZ1 12 H1/H2/H3 MTZ1 16 H1/H2/H3	MTZ1 10 H2/H3/L1 MTZ1 12 H2/H3 MTZ1 16 H2/H3	MTZ1 10 H3/L1 MTZ1 12 H3 MTZ1 16 H3		MTZ1 10 L1	
	MasterPact MTZ2 [1]	MTZ2 10 N1/H1/H2/L1 MTZ2 12 N1/H1/H2/L1 MTZ2 16 N1/H1/H2/L1	MTZ2 10 H1/H2/L1 MTZ2 12 H1/H2/L1 MTZ2 16 H1/H2/L1	MTZ2 10 L1 MTZ2 12 L1 MTZ2 16 L1			
Type of Canalis busbar trunking KTA1600/KTC1600							
Isc max. in kA rms		42 kA	50 kA	65 kA	85 kA	100 kA	150 kA
Type of circuit breaker	ComPacT NS	NS1250N/H NS1600N/H		NS1250H NS1600H			
	MasterPact MTZ1	MTZ1 12 H1/H2/H3 MTZ1 16 H1/H2/H3	MTZ1 12 H2/H3 MTZ1 16 H2/H3	MTZ1 12 H3 MTZ1 16 H3			
	MasterPact MTZ2 [1]	MTZ2 12 N1/H1/H2/L1 MTZ2 16 N1/H1/H2/L1 MTZ2 20 N1/H1/H2/H3/L1	MTZ2 12 H1/H2/L1 MTZ2 16 H1/H2/L1 MTZ2 20 H1/H2/H3/L1	MTZ2 12 L1 MTZ2 16 L1 MTZ2 20 L1			

[1] MTZ2 H2 cover MTZ2 H2 and H2V.

Coordination Tables between Circuit Breaker and Canalis Electrical Busbar Trunking

Canalis KTA/KTC
Ue: 380-415 V AC

Type of Canalis busbar trunking KTA1600/KTC1600 reinforced short-circuit level							
Isc max. in kA rms		42 kA	50 kA	65 kA	85 kA	100 kA	150 kA
Type of circuit breaker	ComPacT NS	NS1250N/H NS1600N/H		NS1250H NS1600H			
		NS1600b N/H NS2000N/H			NS1600b H NS2000H		
	MasterPact MTZ1	MTZ1 12 H1/H2/H3 MTZ1 16 H1/H2/H3	MTZ1 12 H2/H3 MTZ1 16 H2/H3	MTZ1 12 H3 MTZ1 16 H3			
	MasterPact MTZ2 [1]	MTZ2 12 N1/H1/H2/L1 MTZ2 16 N1/H1/H2/L1 MTZ2 20 N1/H1/H2/H3/L1	MTZ2 12 H1/H2/L1 MTZ2 16 H1/H2/L1 MTZ2 20 H1/H2/H3/L1		MTZ2 12 H2/L1 MTZ2 16 H2/L1 MTZ2 20 H2/H3/L1		MTZ2 12 L1 MTZ2 16 L1 MTZ2 20 L1
Type of Canalis busbar trunking KTA2000/KTC2000							
Isc max. in kA rms		42 kA	50 kA	65 kA	85 kA	100 kA	150 kA
Type of circuit breaker	ComPacT NS	NS1600b N/H NS2000N/H NS2500N/H					
	MasterPact MTZ1	MTZ1 16 H1/H2/H3	MTZ1 16 H2/H3	MTZ1 16 H3			
	MasterPact MTZ2 [1]	MTZ2 16 N1/H1/H2/L1 MTZ2 20 N1/H1/H2/H3/L1	MTZ2 16 H1/H2/L1 MTZ2 20 H1/H2/H3/L1		MTZ2 16 L1 MTZ2 20 L1		
		MTZ2 25 H1/H2/H3					
Type of Canalis busbar trunking KTA2000/KTC2000 reinforced short-circuit level							
Isc max. in kA rms		42 kA	50 kA	65 kA	85 kA	100 kA	150 kA
Type of circuit breaker	ComPacT NS	NS1600b N/H NS2000N/H			NS1600b H NS2000H		
	MasterPact MTZ1	MTZ1 16 H1/H2/H3	MTZ1 16 H2/H3	MTZ1 16 H3			
	MasterPact MTZ2 [1]	MTZ2 16 N1/H1/H2/L1 MTZ2 20 N1/H1/H2/H3/L1	MTZ2 16 H1/H2/L1 MTZ2 20 H1/H2/H3/L1		MTZ2 16 H2/L1 MTZ2 20 H2/H3/L1		MTZ2 16 L1 MTZ2 20 L1
		MTZ2 25 H1/H2/H3					
Type of Canalis busbar trunking KTA2500/KTC2500							
Isc max. in kA rms		42 kA	50 kA	65 kA	80 kA	100 kA	150 kA
Type of circuit breaker	MasterPact MTZ2 [1]	MTZ2 20 H1/H2/H3/L1 MTZ2 25 H1/H2/H3 MTZ2 32 H1/H2/H3			MTZ2 20 H2/H3/L1 MTZ2 25 H2/H3 MTZ2 32 H2/H3	MTZ2 20 L1	MTZ2 20 L1
Type of Canalis busbar trunking KTA2500/KTC2500 reinforced short-circuit level							
Isc max. in kA rms		42 kA	50 kA	65 kA	80 kA	100 kA	110 kA
Type of circuit breaker	MasterPact MTZ2 [1]	MTZ2 20 H1/H2/H3/L1 MTZ2 25 H1/H2/H3 MTZ2 32 H1/H2/H3			MTZ2 20 H2/H3/L1 MTZ2 25 H2/H3 MTZ2 32 H2/H3		MTZ2 20 H3/L1 [2] MTZ2 25 H3 MTZ2 32 H3
Type of Canalis busbar trunking KTA3200/KTC3200							
Isc max. in kA rms		42 kA	50 kA	65 kA	85 kA	100 kA	110 kA
Type of circuit breaker	MasterPact MTZ2 [1]	MTZ2 25 H1/H2/H3 MTZ2 32 H1/H2/H3 MTZ2 40 H1/H2/H3			MTZ2 25 H2/H3 MTZ2 32 H2/H3 MTZ2 40 H2/H3		
	MasterPact MTZ3	MTZ3 40 H1/H2					
Type of Canalis busbar trunking KTA3200/KTC3200 reinforced short-circuit level							
Isc max. in kA rms		42 kA	50 kA	65 kA	85 kA	100 kA	110 kA
Type of circuit breaker	MasterPact MTZ2 [1]	MTZ2 25 H1/H2/H3 MTZ2 32 H1/H2/H3 MTZ2 40 H1/H2/H3			MTZ2 25 H2/H3 MTZ2 32 H2/H3 MTZ2 40 H2/H3		MTZ2 25 H3 MTZ2 32 H3 MTZ2 40 H3
	MasterPact MTZ3	MTZ3 40 H1/H2					
Type of Canalis busbar trunking KTA4000/KTC4000							
Isc max. in kA rms		42 kA	50 kA	65 kA	90 kA	100 kA	110 kA
Type of circuit breaker	MasterPact MTZ2 [1]	MTZ2 32 H1/H2/H3 MTZ2 40 H1/H2/H3			MTZ2 32 H2/H3 MTZ2 40 H2/H3		
	MasterPact MTZ3	MTZ3 40 H1/H2 MTZ3 50 H1/H2					
Type of Canalis busbar trunking KTA4000/KTC4000 reinforced short-circuit level							
Isc max. in kA rms		42 kA	50 kA	65 kA	90 kA	100 kA	120 kA
Type of circuit breaker	MasterPact MTZ2 [1]	MTZ2 32 H1/H2/H3 MTZ2 40 H1/H2/H3			MTZ2 32 H2/H3 MTZ2 40 H2/H3		MTZ2 32 H3 MTZ2 40 H3
	MasterPact MTZ3	MTZ3 40 H1/H2 MTZ3 50 H1/H2			MTZ3 40 H2 MTZ3 50 H2		
Type of Canalis busbar trunking KTA5000/KTA 5000 Reinforced short-circuit level							
Isc max. in kA rms		42 kA	50 kA	65 kA	90 kA	100 kA	120 kA
Type of circuit breaker	MasterPact MTZ2 [1]	MTZ2 32 H1/H2/H3 MTZ2 40 H1/H2/H3			MTZ2 32 H2/H3 MTZ2 40 H2/H3		MTZ2 32 H3 MTZ2 40 H3
	MasterPact MTZ3	MTZ3 40 H1/H2 MTZ3 50 H1/H2 MTZ3 63 H1/H2			MTZ3 40 H2 MTZ3 50 H2 MTZ3 63 H2		
Type of Canalis busbar trunking KTC5000							
Isc max. in kA rms		42 kA	50 kA	65 kA	95 kA	100 kA	110 kA
Type of circuit breaker	MasterPact MTZ2 [1]	MTZ2 32 H1/H2/H3 MTZ2 40 H1/H2/H3			MTZ2 32 H2/H3 MTZ2 40 H2/H3		
	MasterPact MTZ3	MTZ3 40 H1/H2 MTZ3 50 H1/H2 MTZ3 63 H1/H2					

[1] MTZ2 H2 cover MTZ2 H2 and H2V. [2] L1 up to 150kA.

Coordination Tables between Circuit Breaker and Canalis Electrical Busbar Trunking

Canalis KTA/KTC
Ue: 380-415 V AC

Type of Canalis busbar trunking KTC5000 reinforced short-circuit level							
Isc max. in kA rms		42 kA	50 kA	65 kA	90 kA	100 kA	120 kA
Type of circuit breaker	MasterPact MTZ2 ^[1]	MTZ2 32 H1/H2/H3 MTZ2 40 H1/H2/H3			MTZ2 32H2/H3 MTZ2 40H2/H3		MTZ2 32 H3 MTZ2 40 H3
	MasterPact MTZ3		MTZ3 40 H1/H2 MTZ3 50 H1/H2 MTZ3 63 H1/H2				MTZ3 40 H2 MTZ3 50 H2 MTZ3 63 H2
Type of Canalis busbar trunking KTC6300/KTC6300 Reinforced short-circuit level							
Isc max. in kA rms		42 kA	50 kA	65 kA	90 kA	100 kA	120 kA
Type of circuit breaker	MasterPact MTZ2 ^[1]		MTZ2 32 H1/H2/H3 MTZ2 40 H1/H2/H3			MTZ2 32 H2/H3 MTZ2 40 H2/H3	MTZ2 32 H3 MTZ2 40 H3
	MasterPact MTZ3			MTZ3 40 H1/H2 MTZ3 50 H1/H2 MTZ3 63 H1/H2			MTZ3 40 H2 MTZ3 50 H2 MTZ3 63 H2

[1] MTZ2 H2 cover MTZ2 H2 and H2V.



Coordination Tables between Circuit Breaker and Canalis Electrical Busbar Trunking

Canalis KRA Ue: 380-415 V AC

Type of Canalis busbar trunking KRA0800							
Isc max. in kA rms		≤ 25 kA	50 kA	60 kA	70 kA	100 kA	150 kA
Type of circuit breaker	ComPacT NSX	NSX400B/F/N/H/S/L NSX630B/F/N/H/S/L	NSX400N/H/S/L NSX630N/H/S/L		NSX400H/S/L NSX630H/S/L	NSX400S/L NSX630S/L	NSX400L NSX630L
	ComPacT NS	NS630b N/H/L/LB NS800N/H/L/LB NS1000N/H/L		NS630b L/LB NS800L/LB NS1000L		NS630b LB NS800LB	
	MasterPact MTZ1	MTZ1 06 H1/H2/H3/L1 MTZ1 08 H1/H2/H3/L1 MTZ1 10 H1/H2/H3/L1		MTZ1 06 L1 MTZ1 08 L1 MTZ1 10 L1			
	MasterPact MTZ2 ^[1]	MTZ2 08 N1/H1/H2/L1 MTZ2 10 N1/H1/H2/L1					
Type of Canalis busbar trunking KRA1000							
Isc max. in kA rms		≤ 25 kA	50 kA	60 kA	70 kA	100 kA	150 kA
Type of circuit breaker	ComPacT NSX	NSX400B/F/N/H/S/L NSX630B/F/N/H/S/L	NSX400N/H/S/L NSX630N/H/S/L		NSX400H/S/L NSX630H/S/L	NSX400S/L NSX630S/L	NSX400L NSX630L
	ComPacT NS	NS800N/H/L/LB NS1000N/H/L NS1250N/H		NS800L/LB NS1000L		NS800LB	
	MasterPact MTZ1	MTZ1 08 H1/H2/H3/L1 MTZ1 10 H1/H2/H3/L1 MTZ1 12 H1/H2/H3		MTZ1 08 L1 MTZ1 10 L1			
	MasterPact MTZ2 ^[1]	MTZ2 08 N1/H1/H2/L1 MTZ2 10 N1/H1/H2/L1 MTZ2 12 N1/H1/H2/L1					
Type of Canalis busbar trunking KRA1250							
Isc max. in kA rms		≤ 42 kA	50 kA	60 kA	70 kA	100 kA	150 kA
Type of circuit breaker	ComPacT NSX	NSX630B/F/N/H/S/L	NSX630N/H/S/L	NSX630H/S/L		NSX630S/L	NSX630L
	ComPacT NS		NS1000N/H/L NS1250N/H NS1600N/H			NS1000L	
	MasterPact MTZ1	MTZ1 10H1/H2/H3/L1 MTZ1 12H1/H2/H3 MTZ1 16H1/H2/H3	MTZ1 10 H2/H3/L1 MTZ1 12 H2/H3 MTZ1 16 H2/H3			MTZ1 10 L1	
	MasterPact MTZ2 ^[1]	MTZ2 10 N1/H1/H2/L1 MTZ2 12 N1/H1/H2/L1 MTZ2 16 N1/H1/H2/L1	MTZ2 10 H1/H2/L1 MTZ2 12 H1/H2/L1 MTZ2 16 H1/H2/L1	MTZ2 10 L1 MTZ2 12 L1 MTZ2 16 L1			
Type of Canalis busbar trunking KRA1600							
Isc max. in kA rms		42 kA	50 kA	60 kA	70 kA	100 kA	150 kA
Type of circuit breaker	ComPacT NS ≤ 1600		NS1250N/H NS1600N/H				
	ComPacT NS ≥ 1600b		NS1600b N/H NS2000N/H				
	MasterPact MTZ1	MTZ1 12 H1/H2/H3 MTZ1 16 H1/H2/H3	MTZ1 12 H2/H3 MTZ1 16 H2/H3				
	MasterPact MTZ2 ^[1]	MTZ2 10 N1/H1/H2/L1 MTZ2 12 N1/H1/H2/L1 MTZ2 16 N1/H1/H2/L1	MTZ2 10 H1/H2/L1 MTZ2 12 H1/H2/L1 MTZ2 16 H1/H2/L1	MTZ2 10 L1 MTZ2 12 L1 MTZ2 16 L1			
Type of Canalis busbar trunking KRA2000							
Isc max. in kA rms		42 kA	50 kA	65 kA	85 kA	100 kA	150 kA
Type of circuit breaker	ComPacT NS ≤ 1600		NS1600N/H	NS1600H			
	ComPacT NS ≥ 1600b		NS1600b N/H NS2000N/H NS2500N/H				
	MasterPact MTZ1	MTZ1 16 H1/H2/H3	MTZ1 16 H2/H3	MTZ1 16 H3			
	MasterPact MTZ2 ^[1]	MTZ2 16 N1/H1/H2/L1 MTZ2 20 N1 MTZ2 25 H1/H2/H3	MTZ2 16 H1/H2/L1 MTZ2 20 H1/H2/L1 MTZ2 25 H1/H2/H3	MTZ2 16 L1 MTZ2 20 L1			
Type of Canalis busbar trunking KRA2500							
Isc max. in kA rms		42 kA	50 kA	65 kA	80 kA	100 kA	150 kA
Type of circuit breaker	ComPacT NS ≥ 1600b		NS2000N/H NS2500N/H NS3200N/H		NS2000H NS2500H NS3200H		
	MasterPact MTZ2 ^[1]	MTZ2 20 N1	MTZ2 20 H1/H2/H3/L1		MTZ2 20 H2/H3/L1 MTZ2 25 H2/H3 MTZ2 32 H2/H3		MTZ2 20 L1
Type of Canalis busbar trunking KRA3200							
Isc max. in kA rms		42 kA	50 kA	65 kA	85 kA	100 kA	150 kA
Type of circuit breaker	ComPacT NS ≥ 1600b		NS2500N/H NS3200N/H		NS2500H NS3200H		
	MasterPact MTZ2 ^[1]		MTZ2 25 H1/H2/H3 MTZ2 32 H1/H2/H3 MTZ2 40 H1/H2/H3		MTZ2 25 H2/H3 MTZ2 32 H2/H3 MTZ2 40 H2/H3		
	MasterPact MTZ3			MTZ3 40 H1/H2			
Type of Canalis busbar trunking KRA4000							
Isc max. in kA rms		42 kA	50 kA	65 kA	85 kA	100 kA	150 kA
Type of circuit breaker	ComPacT NS		NS3200N/H		NS3200H		
	MasterPact MTZ2 ^[1]		MTZ2 32 H1/H2/H3 MTZ2 40 H1/H2/H3		MTZ2 32 H2/H3 MTZ2 40 H2/H3		
	MasterPact MTZ3			MTZ3 40 H1/H2 MTZ3 50 H1/H2			
Type of Canalis busbar trunking KRA5000							
Isc max. in kA rms		42 kA	50 kA	65 kA	85 kA	100 kA	150 kA
	MasterPact MTZ2 ^[1]		MTZ2 40 H1/H2/H3		MTZ2 40 H2/H3		
	MasterPact MTZ3			MTZ3 40 H1/H2 MTZ3 50 H1/H2 MTZ3 63 H1/H2			

[1] MTZ2 H2 cover MTZ2 H2 and H2V.

Coordination Tables between Circuit Breaker and Canalis Electrical Busbar Trunking

Canalis KRC
Ue: 380-415 V AC

MasterPact MTZ2 ^[1]							
Isc max. in kA rms		≤ 36 kA	50 kA	60 kA	70 kA	100 kA	150 kA
Type of circuit breaker	ComPacT NSX	NSX400B/F/N/H/S/L NSX630B/F/N/H/S/L	NSX400N/H/S/L NSX630N/H/S/L		NSX400H/S/L NSX630H/S/L	NSX400S/L NSX630S/L	NSX400L NSX630L
	ComPacT NS	NS800N/H/L/LB NS1000N/H/L NS1250N/H			NS800L/LB NS1000L		
	MasterPact MTZ1	MTZ1 08 H1/H2/H3/L1 MTZ1 10 H1/H2/H3/L1 MTZ1 12 H1/H2/H3			MTZ1 08 L1 MTZ1 10 L1		
	MasterPact MTZ2 ^[1]	MTZ2 08 N1/H1/H2/L1 MTZ2 10 N1/H1/H2/L1 MTZ2 12 N1/H1/H2/L1					
Type of Canalis busbar trunking KRC1350							
Isc max. in kA rms		≤ 36 kA	50 kA	60 kA	70 kA	100 kA	150 kA
Type of circuit breaker	ComPacT NSX	NSX630B/F/N/H/S/L	NSX630N/H/S/L	NSX630H/S/L		NSX630S/L	NSX630L
	ComPacT NS	NS1000N/H/L NS1250N/H NS1600N/H				NS1000L	
	MasterPact MTZ1	MTZ1 10 H1/H2/H3/L1 MTZ1 12 H1/H2/H3 MTZ1 16 H1/H2/H3			MTZ1 10 L1		
	MasterPact MTZ2 ^[1]	MTZ2 10 N1/H1/H2/L1 MTZ2 12 N1/H1/H2/L1 MTZ2 16 N1/H1/H2/L1					
Type of Canalis busbar trunking KRC1600							
Isc max. in kA rms		42 kA	50 kA	65 kA	85 kA	100 kA	150 kA
Type of circuit breaker	ComPacT NS ≤ 1600		NS1250N/H NS1600N/H	NS1250H NS1600H			
	ComPacT NS ≥ 1600b		NS1600b N/H NS2000N/H				
	MasterPact MTZ1	MTZ1 12 H1 MTZ1 16 H1	MTZ1 12 H2 MTZ1 16 H2	MTZ1 12 H3 MTZ1 16 H3			
	MasterPact MTZ2 ^[1]	MTZ2 12 N1 MTZ2 16 N1 MTZ2 20 N1		MTZ2 12 H1 MTZ2 16 H1 MTZ2 20 H1	MTZ2 12 L1 MTZ2 16 L1 MTZ2 20 L1		
Type of Canalis busbar trunking KRC2000							
Isc max. in kA rms		42 kA	50 kA	65 kA	80 kA	100 kA	150 kA
Type of circuit breaker	ComPacT NS ≤ 1600		NS1600N/H	NS1600H			
	ComPacT NS ≥ 1600b		NS1600b N NS2000N NS2500N		NS1600b H NS2000H NS2500H		
	MasterPact MTZ1	MTZ1 16 H1/H2/H3	MTZ1 16 H2/H3	MTZ1 16 H3			
	MasterPact MTZ2 ^[1]	MTZ2 16 N1/H1/H2/L1 MTZ2 20 N1/H1/H2/H3/L1 MTZ2 25 H1/H2/H3		MTZ2 16 H1/H2/L1 MTZ2 20 H1/H2/H3/L1 MTZ2 25 H1/H2/H3	MTZ2 16 H2/L1 MTZ2 20 H2/H3/L1 MTZ2 25 H2/H3		MTZ2 16 L1 MTZ2 20 L1
Type of Canalis busbar trunking KRC2500							
Isc max. in kA rms		42 kA	50 kA	65 kA	80 kA	100 kA	150 kA
Type of circuit breaker	ComPacT NS ≥ 1600b		NS2000N/H NS2500N/H NS3200N/H		NS2000H NS2500H NS3200H		
	MasterPact MTZ2 ^[1]	MTZ2 20 N1	MTZ2 20 H1/H2/H3/L1 MTZ2 25 H1/H2/H3 MTZ2 32 H1/H2/H3		MTZ2 20 H2/H3/L1 MTZ2 25 H2/H3 MTZ2 32 H2/H3		MTZ2 20 L1
Type of Canalis busbar trunking KRC3200							
Isc max. in kA rms		42 kA	50 kA	65 kA	85 kA	100 kA	150 kA
Type of circuit breaker	ComPacT NS ≥ 1600b		NS2500N/H NS3200N/H		NS2500H NS3200H		
	MasterPact MTZ2 ^[1]		MTZ2 25 H1/H2/H3 MTZ2 32 H1/H2/H3 MTZ2 40 H1/H2/H3		MTZ2 25 H2/H3 MTZ2 32 H2/H3 MTZ2 40 H2/H3		
	MasterPact MTZ3				MTZ3 40 H1/H2		
Type of Canalis busbar trunking KRC4000							
Isc max. in kA rms		42 kA	50 kA	65 kA	85 kA	100 kA	150 kA
Type of circuit breaker	ComPacT NS		NS3200N/H		NS3200H		
	MasterPact MTZ2 ^[1]		MTZ2 32 H1/H2/H3 MTZ2 40 H1/H2/H3		MTZ2 32 H2/H3 MTZ2 40 H2/H3		
	MasterPact MTZ3				MTZ3 40 H1/H2 MTZ3 50 H1/H2		
Type of Canalis busbar trunking KRC5000							
Isc max. in kA rms		42 kA	50 kA	65 kA	85 kA	100 kA	125 kA
Type of circuit breaker	MasterPact MTZ2 ^[1]		MTZ2 40 H1/H2/H3		MTZ2 40 H2/H3		MTZ2 40 H3
	MasterPact MTZ3			MTZ3 40 H1/H2 MTZ3 50 H1/H2 MTZ3 63 H1/H2			MTZ3 40 H2 MTZ3 50 H2 MTZ3 63 H2
Type of Canalis busbar trunking KRC6300							
Isc max. in kA rms		42 kA	50 kA	65 kA	85 kA	100 kA	125 kA
Type of circuit breaker	MasterPact MTZ2 ^[1]		MTZ2 40 H1/H2/H3		MTZ2 40 H2/H3		MTZ2 40 H3
	MasterPact MTZ3			MTZ3 40 H1/H2 MTZ3 50 H1/H2 MTZ3 63 H1/H2			MTZ3 40 H2 MTZ3 50 H2 MTZ3 63 H2

[1] MTZ2 H2 cover MTZ2 H2 and H2V.

Coordination Tables between Circuit Breaker and Canalis Electrical Busbar Trunking

Canalis KSA
Ue: 660-690 V AC

Type of Canalis busbar trunking KSA100								
Isc max. in kA rms		10 kA	15 kA	20 kA	25 kA	45 kA	75 kA	100 kA
Type of circuit breaker	ComPacT NSX	NSX100N/H/S/L NSX160N/H/S/L NSX250N/H/S/L	NSX100S/L NSX160S/L NSX250S/L	NSX100L				
Type of Canalis busbar trunking KSA160								
Isc max. in kA rms		10 kA	15 kA	20 kA	25 kA	45 kA	75 kA	100 kA
Type of circuit breaker	ComPacT NSX	NSX100N/H/S/L NSX160N/H/S/L NSX250N/H/S/L	NSX100S/L NSX160S/L NSX250S/L	NSX100L NSX160L NSX250L	NSX100R			
Type of Canalis busbar trunking KSA250								
Isc max. in kA rms		10 kA	15 kA	20 kA	25 kA	45kA	75 kA	100 kA
Type of circuit breaker	ComPacT NSX	NSX160N/H/S/L NSX250N/H/S/L NSX400F/N/H/S/L	NSX160S/L NSX250S/L NSX400H/S/L	NSX160L NSX250L NSX400H/S/L		NSX250R	NSX250HB1	NSX250HB2
Type of Canalis busbar trunking KSA400								
Isc max. in kA rms		10 kA	15 kA	20 kA	25 kA	45kA	75 kA	100 kA
Type of circuit breaker	ComPacT NSX	NSX250N/H/S/L	NSX250S/L	NSX250L	NSX250R		NSX250HB1	NSX250HB2
		NSX400F/N/H/S/L NSX630F/N/H/S/L		NSX400H/S/L NSX630H/S/L	NSX400S/L NSX630S/L	NSX400R NSX630R	NSX400HB1	NSX400HB2
	ComPacT NS	NS630b N/H/LB			NS630b LB			
Type of Canalis busbar trunking KSA500								
Isc max. in kA rms		10 kA	15 kA	20 kA	25 kA	45 kA	75 kA	100 kA
Type of circuit breaker	ComPacT NSX	NSX400F/N/H/S/L NSX400H/S/L		NSX400H/S/L NSX630H/S/L	NSX400S/L NSX630S/L	NSX400R NSX630R	NSX400HB1	NSX400HB2
	ComPacT NS	NS630b N/H/LB NS800N/H/LB				NS630b LB NS800LB		
Type of Canalis busbar trunking KSA630								
Isc max. in kA rms		10 kA	15 kA	20 kA	25 kA	45 kA	75 kA	100 kA
Type of circuit breaker	ComPacT NSX	NSX400F/N/H/S/L NSX630F/N/H/S/L	NSX400H/S/L NSX630H/S/L	NSX400H/S/L NSX630H/S/L	NSX400S/L NSX630S/L	NSX400R NSX630R	NSX400HB1	NSX400HB2
	ComPacT NS	NS630b N/H/LB NS800N/H/LB				NS630b LB NS800LB		
Type of Canalis busbar trunking KSA800								
Isc max. in kA rms		25 kA	30 kA	35 kA	45 kA	65 kA	75 kA	100 kA
Type of circuit breaker	ComPacT NSX	NSX400S/L/R/HB1/HB2 NSX630S/L/R/HB1/HB2	NSX400L/R/HB1/HB2 NSX630L/R/HB1/HB2	NSX400R/HB1/HB2 NSX630R/HB1/HB2		NSX400HB1/HB2 NSX630HB1/HB2		NSX400HB2 NSX630HB2
	ComPacT NS	NS630b N/H/LB NS800N/H/LB NS1000N/H		NS630b H/LB NS800H/LB NS1000H	NS630b LB NS800LB			
	MasterPact MTZ1	MTZ1 06 H1/H2/L1 MTZ1 08 H1/H2/L1 MTZ1 10 H1/H2/L1	MTZ1 06 H1/H2 MTZ1 08 H1/H2 MTZ1 10 H1/H2					
	MasterPact MTZ2	MTZ2 08 N1/H1/H2/L1 MTZ2 10 N1/H1/H2/L1						
Type of Canalis busbar trunking KSA1000								
Isc max. in kA rms		25 kA	30 kA	35 kA	45 kA	65 kA	75 kA	100 kA
Type of circuit breaker	ComPacT NSX	NSX400S/L/R/HB1/HB2 NSX630S/L/R/HB1/HB2	NSX400L/R/HB1/HB2 NSX630L/R/HB1/HB2	NSX400R/HB1/HB2 NSX630R/HB1/HB2		NSX400HB1/HB2 NSX630HB1/HB2		NSX400HB2 NSX630HB2
	ComPacT NS	NS630b N/H/LB NS800N/H/LB NS1000N/H		NS630b H/LB NS800H/LB NS1000H	NS630b LB NS800LB			
	MasterPact MTZ1	MTZ1 08 H1/H2/L1 MTZ1 10 H1/H2/L1	MTZ1 08 H1/H2 MTZ1 10 H1/H2					
	MasterPact MTZ2	MTZ1 12 H1/H2 MTZ2 08 N1/H1/H2/L1 MTZ2 10 N1/H1/H2/L1 MTZ2 12 N1/H1/H2/L1						



Coordination Tables between Circuit Breaker and Canalis Electrical Busbar Trunking

Canalis KTA, KTC
Ue: 660-690 V AC

Type of Canalis busbar trunking KTA1000/KTC1000									
Isc max. in kA rms		25 kA	30 kA	42 kA	50 kA	65 kA	75 kA	100 kA	
Type of circuit breaker	ComPacT NSX	NSX400S/L/R/HB1/HB2 NSX630S/L/R/HB1/HB2	NSX400L/R/HB1/HB2 NSX630L/R/HB1/HB2	NSX400R/HB1/HB2 NSX630R/HB1/HB2		NSX400HB1/HB2 NSX630HB1/HB2		NSX400HB2 NSX630HB2	
	ComPacT NS	NS630b N/H/LB NS800N/H/LB NS1000N/H		NS630b H/LB NS800H/LB NS1000H		NS630b LB NS800LB			
	MasterPact MTZ1	MTZ1 08 H1/H2/L1 MTZ1 10 H1/H2/L1	MTZ1 08 H1/H2 MTZ1 10 H1/H2						
	MasterPact MTZ2	MTZ2 08 N1/H1/H2/L1 MTZ2 10 N1/H1/H2/L1 MTZ2 12 N1/H1/H2/L1			MTZ2 08 H1/H2/L1 MTZ2 10 H1/H2/L1 MTZ2 12 H1/H2/L1				
Type of Canalis busbar trunking KTA1000/KTC1000 reinforced short-circuit level									
Isc max. in kA rms		25 kA	30 kA	42 kA	50 kA	65 kA	75 kA	100 kA	
Type of circuit breaker	ComPacT NSX	NSX400S/L/R/HB1/HB2 NSX630S/L/R/HB1/HB2	NSX400L/R/HB1/HB2 NSX630L/R/HB1/HB2	NSX400R/HB1/HB2 NSX630R/HB1/HB2		NSX400HB1/HB2 NSX630HB1/HB2		NSX400HB2 NSX630HB2	
	ComPacT NS	NS800N/H/LB NS1000N/H NS1250N/H		NS800H/LB NS1000H NS1250H		NS800LB			
	MasterPact MTZ1	MTZ1 08 H1/H2/L1 MTZ1 10 H1/H2/L1	MTZ1 08 H1/H2 MTZ1 10 H1/H2						
	MasterPact MTZ2	MTZ2 08 N1/H1/H2/L1 MTZ2 10 N1/H1/H2/L1 MTZ2 12 N1/H1/H2/L1			MTZ2 08 H1/H2/L1 MTZ2 10 H1/H2/L1 MTZ2 12 H1/H2/L1				
Type of Canalis busbar trunking KTA1250/KTC1350									
Isc max. in kA rms		25 kA	30 kA	42 kA	50 kA	65 kA	75 kA	100 kA	
Type of circuit breaker	ComPacT NS	NS800N/H/LB NS1000N/H NS1250N/H NS1600N/H		NS800H/LB NS1000H NS1250H NS1600H		NS800LB			
	ComPacT NS > 1600b	NS1600b N							
	MasterPact MTZ1	MTZ1 08 H1/H2/L1	MTZ1 08 H1/H2						
	MasterPact MTZ2	MTZ2 10 N1/H1/H2/L1 MTZ2 12 N1/H1/H2/L1 MTZ2 16 N1/H1/H2/L1			MTZ2 10 H1/H2/L1 MTZ2 12 H1/H2/L1 MTZ2 16 H1/H2/L1				
Type of Canalis busbar trunking KTA1250/KTC1350 reinforced short-circuit level									
Isc max. in kA rms		25 kA	30 kA	42 kA	50 kA	65 kA	75 kA	100 kA	
Type of circuit breaker	ComPacT NS	NS800N/H/LB NS1000N/H NS1250N/H NS1600N/H		NS800H/LB NS1000H NS1250H NS1600H		NS800LB			
	ComPacT NS > 1600b	NS1600b N							
	MasterPact MTZ1	MTZ1 08 H1/H2/L1	MTZ1 08 H1/H2						
	MasterPact MTZ2	MTZ2 10 N1/H1/H2/L1 MTZ2 12 N1/H1/H2/L1 MTZ2 16 N1/H1/H2/L1			MTZ2 10 H1/H2/L1 MTZ2 12 H1/H2/L1 MTZ2 16 H1/H2/L1				
Type of Canalis busbar trunking KTA1600/KTC1600									
Isc max. in kA rms		25 kA	30 kA	42 kA	50 kA	65 kA	85 kA	100 kA	
Type of circuit breaker	ComPacT NS	NS1250N/H NS1600N/H		NS1250H NS1600H					
	ComPacT NS > 1600b	NS1600b N NS2000N							
	MasterPact MTZ1	MTZ1 12 H1/H2 MTZ1 16 H1/H2							
	MasterPact MTZ2	MTZ2 12 N1/H1/H2/L1 MTZ2 16 N1/H1/H2/L1 MTZ2 20 N1/H1/H2/H3/L1			MTZ2 12 H1/H2/L1 MTZ2 16 H1/H2/L1 MTZ2 20 H1/H2/H3/L1				
Type of Canalis busbar trunking KTA1600/KTC1600 reinforced short-circuit level									
Isc max. in kA rms		25 kA	30 kA	42 kA	50 kA	65 kA	85 kA	100 kA	
Type of circuit breaker	ComPacT NS	NS1250N/H NS1600N/H		NS1250H NS1600H					
	ComPacT NS > 1600b	NS1600b N NS2000N							
	MasterPact MTZ1	MTZ1 12 H1/H2 MTZ1 16 H1/H2							
	MasterPact MTZ2	MTZ2 12 N1/H1/H2/L1 MTZ2 16 N1/H1/H2/L1 MTZ2 20 N1/H1/H2/H3/L1			MTZ2 12 H1/H2/L1 MTZ2 16 H1/H2/L1 MTZ2 20 H1/H2/H3/L1				

E

Coordination Tables between Circuit Breaker and Canalis Electrical Busbar Trunking

Canalis KTA, KTC
Ue: 660-690 V AC

Type of Canalis busbar trunking KTA2000 / KTC2000								
Isc max. in kA rms	25 kA	30 kA	42 kA	50 kA	65 kA	85 kA	100 kA	
Type of circuit breaker	ComPacT NS	NS1600N/H		NS1600H				
	ComPacT NS > 1600b			NS1600b N NS2000N NS2500N				
	MasterPact MTZ1	MTZ1 16 H1/H2						
	MasterPact MTZ2	MTZ2 16 N1/H1/H2/L1 MTZ2 20 N1/H1/H2/H3/L1		MTZ2 16 H1/H2/L1 MTZ2 20 H1/H2/H3/L1		MTZ2 16 L1 MTZ2 20 L1		
		MTZ2 25 H1/H2/H3						
Type of Canalis busbar trunking KTA2000 / KTC2000 reinforced short-circuit level								
Isc max. in kA rms	25 kA	30 kA	42 kA	50 kA	65 kA	85 kA	100 kA	
Type of circuit breaker	ComPacT NS	NS1600N/H		NS1600H				
	ComPacT NS > 1600b			NS1600b N NS2000N NS2500N				
	MasterPact MTZ1	MTZ1 16 H1/H2						
	MasterPact MTZ2	MTZ2 16 N1/H1/H2/L1 MTZ2 20 N1/H1/H2/H3/L1		MTZ2 16 H1/H2/L1 MTZ2 20 H1/H2/H3/L1		MTZ2 16L1	MTZ2 16 L1	
		MTZ2 25 H1/H2/H3				MTZ2 20 H2/H3/L1	MTZ2 20 H3/L1	
						MTZ2 25 H2/H3	MTZ2 25 H3	
Type of Canalis busbar trunking KTA2500 / KTC2500								
Isc max. in kA rms	25 kA	30 kA	42 kA	50 kA	65 kA	80 kA	100 kA	
Type of circuit breaker	ComPacT NS	NS1600N/H		NS1600H				
	ComPacT NS > 1600b			NS2000N NS2500N NS3200N				
	MasterPact MTZ1	MTZ1 16 H1/H2						
	MasterPact MTZ2	MTZ2 20 N1/H1/H2/H3/L1		MTZ2 20 H1/H2/H3/L1		MTZ2 20 H2/H3/L1	MTZ2 20 L1	
		MTZ2 25 H1/H2/H3				MTZ2 25 H2/H3		
		MTZ2 32 H1/H2/H3				MTZ2 32 H2/H3		
Type of Canalis busbar trunking KTA2500 / KTC2500 reinforced short-circuit level								
Isc max. in kA rms	25 kA	30 kA	42 kA	50 kA	65 kA	85 kA	100 kA	
Type of circuit breaker	ComPacT NS	NS1600N/H		NS1600H				
	ComPacT NS > 1600b			NS2000N NS2500N NS3200N				
	MasterPact MTZ1	MTZ1 16 H1/H2						
	MasterPact MTZ2	MTZ2 20 N1/H1/H2/H3/L1		MTZ2 20 H1/H2/H3/L1		MTZ2 20 H2/H3/L1	MTZ2 20 L1	
		MTZ2 25 H1/H2/H3				MTZ2 25 H2/H3		
		MTZ2 32 H1/H2/H3				MTZ2 32 H2/H3		
Type of Canalis busbar trunking KTA3200 / KTC3200								
Isc max. in kA rms	25 kA	30 kA	42 kA	50 kA	65 kA	85 kA	100 kA	
Type of circuit breaker	ComPacT NS			NS2000N NS3200N				
	MasterPact MTZ2	MTZ2 32 H1/H2/H3		MTZ2 40 H1/H2/H3		MTZ2 32 H2/H3	MTZ2 40 H2/H3	
	MasterPact MTZ3	MTZ3 40 H1/H2						
Type of Canalis busbar trunking KTA3200 / KTC3200 reinforced short-circuit level								
Isc max. in kA rms	25 kA	30 kA	42 kA	50 kA	65 kA	85 kA	100 kA	
Type of circuit breaker	ComPacT NS			NS2000N NS3200N				
	MasterPact MTZ2	MTZ2 32 H1/H2/H3		MTZ2 40 H1/H2/H3		MTZ2 32 H2/H3	MTZ2 32 H3	
	MasterPact MTZ3	MTZ3 40 H1/H2				MTZ2 40 H2/H3	MTZ2 40 H3	
Type of Canalis busbar trunking KTA4000 / KTC4000								
Isc max. in kA rms	25 kA	30 kA	42 kA	50 kA	65 kA	85 kA	100 kA	
Type of circuit breaker	ComPacT NS			NS3200N				
	MasterPact MTZ2	MTZ2 32 H1/H2/H3		MTZ2 40 H1/H2/H3		MTZ2 32 H2/H3	MTZ2 40 H2/H3	
	MasterPact MTZ3	MTZ3 40 H1/H2		MTZ3 50 H1/H2				
Type of Canalis busbar trunking KTA4000 / KTC4000 reinforced short-circuit level								
Isc max. in kA rms	25 kA	30 kA	42 kA	50 kA	65 kA	85 kA	95 kA	100 kA
Type of circuit breaker	ComPacT NS			NS3200N				
	MasterPact MTZ2	MTZ2 32 H1/H2/H3		MTZ2 40 H1/H2/H3		MTZ2 32 H2/H3	MTZ2 32 H3	
	MasterPact MTZ3	MTZ3 40 H1/H2		MTZ3 50 H1/H2		MTZ2 40 H2/H3	MTZ2 40 H3	



Coordination Tables between Circuit Breaker and Canalis Electrical Busbar Trunking

Canalis KTA, KTC
Ue: 660-690 V AC

Type of Canalis busbar trunking KTC5000				
Isc max. in kA rms		65 kA	85 kA	95 kA
Type of circuit breaker	MasterPact MTZ2	MTZ2 32 H1/H2/H3 MTZ2 40 H1/H2/H3	MTZ2 32 H2/H3 MTZ2 40 H2/H3	MTZ2 32 H3 MTZ2 40 H3
	MasterPact MTZ3		MTZ3 40 H1/H2 MTZ3 50 H1/H2 MTZ3 63 H1/H2	
Type of Canalis busbar trunking KTA5000 / KTC5000 Reinforced short-circuit				
Isc max. in kA rms		65 kA	85 kA	100 kA
Type of circuit breaker	MasterPact MTZ2	MTZ2 32 H1/H2/H3 MTZ2 40 H1/H2/H3	MTZ2 32 H2/H3 MTZ2 40 H2/H3	MTZ2 32 H3 MTZ2 40 H3
	MasterPact MTZ3		MTZ3 40 H1/H2 MTZ3 50 H1/H2 MTZ3 63 H1/H2	
Type of Canalis busbar trunking KTC6300				
Isc max. in kA rms		65 kA	85 kA	100 kA
Type of circuit breaker	MasterPact MTZ2	MTZ2 40 H1/H2/H3	MTZ2 40 H2/H3	MTZ2 40 H3
	MasterPact MTZ3		MTZ3 40 H1/H2 MTZ3 50 H1/H2 MTZ3 63 H1/H2	

Coordination Tables between Circuit Breaker and Canalys Electrical Busbar Trunking

Canalis KRA
Ue: 660-690 V AC

Type of Canalis busbar trunking KRA0800							
Isc max. in kA rms	25 kA	30 kA	36 kA	45 kA	65 kA	75 kA	100 kA
Type of circuit breaker	ComPacT NSX	NSX400S/L/R/HB1/HB2 NSX630S/L/R/HB1/HB2	NSX400L/R/HB1/HB2 NSX630L/R/HB1/HB2	NSX400R/HB1/HB2 NSX630R/HB1/HB2		NSX400HB1/HB2 NSX630HB1/HB2	NSX400HB2 NSX630HB2
	ComPacT NS	NS630b N/H/LB NS800N/H/LB NS1000N/H			NS630b LB NS800LB		
	MasterPact MTZ1	MTZ1 06 H1/H2/L1 MTZ1 08 H1/H2/L1 MTZ1 10 H1/H2/L1					
	MasterPact MTZ2	MTZ2 08N1/H1/H2/L1 MTZ2 10N1/H1/H2/L1					

Type of Canalis busbar trunking KRA1000							
Isc max. in kA rms	25 kA	30 kA	36 kA	45 kA	65 kA	75 kA	100 kA
Type of circuit breaker	ComPacT NSX	NSX400S/L/R/HB1/HB2 NSX630S/L/R/HB1/HB2	NSX400L/R/HB1/HB2 NSX630L/R/HB1/HB2	NSX400R/HB1/HB2 NSX630R/HB1/HB2		NSX400HB1/HB2 NSX630HB1/HB2	NSX400HB2 NSX630HB2
	ComPacT NS	NS800N/H/LB NS1000N/H NS1250N/H			NS800LB		
	MasterPact MTZ1	MTZ1 08 H1/H2/L1 MTZ1 10 H1/H2/L1 MTZ1 12 H1/H2					
	MasterPact MTZ2	MTZ2 08 N1/H1/H2/L1 MTZ2 10 N1/H1/H2/L1 MTZ2 12 N1/H1/H2/L1					

Type of Canalis busbar trunking KRA1250							
Isc max. in kA rms	25 kA	30 kA	35 kA	42 kA	50 kA	75 kA	100 kA
Type of circuit breaker	ComPacT NSX	NSX630H/S/L	NSX630S/L/R/HB1/HB2	NSX630L/R/HB1/HB2	NSX630R/HB1/HB2	NSX630HB1/HB2	NSX630HB2
	ComPacT NS		NS1000N/H NS1250N/H NS1600N/H		NS1000H NS1250H NS1600H	NS800LB	
	MasterPact MTZ1	MTZ1 10 H1/H2/L1		MTZ1 10 H1/H2			
	MasterPact MTZ2		MTZ1 12 H1/H2 MTZ1 16 H1/H2			MTZ2 10 H1/H2/L1 MTZ2 12 H1/H2/L1 MTZ2 16 H1/H2/L1	

Type of Canalis busbar trunking KRA1600							
Isc max. in kA rms	25 kA	30 kA	42 kA	50 kA	65 kA	75 kA	100 kA
Type of circuit breaker	ComPacT NS	NS1250N/H NS1600N/H	NS1250H NS1600H				
	ComPacT NS ≥ 1600b		NS1600b N NS2000N				
	MasterPact MTZ1		MTZ1 12 H1/H2 MTZ1 16 H1/H2				
	MasterPact MTZ2		MTZ2 12 N1/H1/H2/L1 MTZ2 16 N1/H1/H2/L1 MTZ2 20 N1/H1/H2/H3/L1		MTZ2 12 H1/H2/L1 MTZ2 16 H1/H2/L1 MTZ2 20 H1/H2/H3/L1		

Type of Canalis busbar trunking KRA2000							
Isc max. in kA rms	25 kA	30 kA	42 kA	50 kA	65 kA	80 kA	100 kA
Type of circuit breaker	ComPacT NS	NS1600N/H	NS1600H				
	ComPacT NS ≥ 1600b		NS1600b N NS2000N NS2500N				
	MasterPact MTZ1		MTZ1 16 H1/H2				
	MasterPact MTZ2		MTZ2 16 N1/H1/H2/L1 MTZ2 20 N1/H1/H2/H3/L1 MTZ2 25 H1/H2/H3		MTZ2 16 H1/H2/L1 MTZ2 20 H1/H2/H3/L1 MTZ2 25 H1/H2/H3	MTZ2 16 L1 MTZ2 20 L1	

Type of Canalis busbar trunking KRA2500							
Isc max. in kA rms	25 kA	30 kA	42 kA	50 kA	65 kA	80 kA	100 kA
Type of circuit breaker	ComPacT NS ≥ 1600b		NS2000N NS2500N NS3200N				
	MasterPact MTZ2		MTZ2 20 N1/H1/H2/H3/L1		MTZ2 20 H1/H2/H3/L1	MTZ2 20 H2/H3 MTZ2 20 L1	
			MTZ2 25 H1/H2/H3 MTZ2 32 H1/H2/H3			MTZ2 25 H2/H3 MTZ2 32 H2/H3	

Type of Canalis busbar trunking KRA3200							
Isc max. in kA rms	25 kA	30 kA	42 kA	50 kA	65 kA	85 kA	100 kA
Type of circuit breaker	ComPacT NS > 1600b		NS2500N NS3200N				
	MasterPact MTZ2		MTZ2 25 H1/H2/H3 MTZ2 32 H1/H2/H3 MTZ2 40 H1/H2/H3			MTZ2 25 H2/H3 MTZ2 32 H2/H3 MTZ2 40 H2/H3	MTZ2 25 H3 MTZ2 32 H3 MTZ2 40 H3
	MasterPact MTZ3			MTZ3 40 H1/H2			

Coordination Tables between Circuit Breaker and Canalis Electrical Busbar Trunking

Canalis KRA, KRC
Ue: 660-690 V AC

Type of Canalis busbar trunking KRA4000									
Isc max. in kA rms	25 kA	30 kA	42 kA	50 kA	65 kA	85 kA	100 kA		
Type of circuit breaker	ComPact NS $\geq 1600b$	NS3200N							
	MasterPact MTZ2	MTZ2 32 H1/H2/H3 MTZ2 40 H1/H2/H3				MTZ2 32 H2/H3 MTZ2 40 H2/H3	MTZ2 32 H3 MTZ2 40 H3		
	MasterPact MTZ3	MTZ2 40 H1/H2/H3 MTZ3 50 H1/H2							
Type of Canalis busbar trunking KRA5000									
Isc max. in kA rms	25 kA	30 kA	42 kA	50 kA	65 kA	85 kA	100 kA		
Type of circuit breaker	MasterPact MTZ1	MTZ2 32 H1/H2/H3 MTZ2 40 H1/H2/H3				MTZ2 32 H2/H3 MTZ2 40 H2/H3	MTZ2 32 H3 MTZ2 40 H3		
	MasterPact MTZ2	MTZ3 40 H1/H2 MTZ3 50 H1/H2 MTZ3 63 H1/H2							
Type of Canalis busbar trunking KRC1000									
Isc max. in kA rms	25 kA	30 kA	36 kA	45 kA	65 kA	75 kA	100 kA		
Type of circuit breaker	ComPact NSX	NSX400S/L/R/HB1/HB2 NSX630S/L/R/HB1/HB2	NSX400S/L/R/HB1/HB2 NSX630S/L/R/HB1/HB2	NSX400R/HB1/HB2 NSX630R/HB1/HB2	NSX400HB1/HB2 NSX630HB1/HB2	NSX400HB2 NSX630HB2	NSX400HB2 NSX630HB2		
	ComPact NS	NS800N/H/LB NS1000N/H NS1250N/H	NS800N/H/LB NS1000N/H NS1250N/H	NS800H/LB NS1000H NS1250H	NS800LB				
	MasterPact MTZ1	MTZ1 08 H1/H2/L1 MTZ1 10H1/H2/L1	MTZ1 08 H1/H2 MTZ1 10 H1/H2						
	MasterPact MTZ2	MTZ1 12 H1/H2 MTZ2 08 N1/H1/H2/L1 MTZ2 10 N1/H1/H2/L1 MTZ2 12 N1/H1/H2/L1							
Type of Canalis busbar trunking KRC1350									
Isc max. in kA rms	25 kA	30 kA	35 kA	45 kA	65 kA	75 kA	100 kA		
Type of circuit breaker	ComPact NSX	NSX630H/S/L	NSX630S/L/R/HB1/HB2	NSX630L/R/HB1/HB2	NSX630R/HB1/HB2	NSX630HB1/HB2	NSX630HB2		
	ComPact NS	NS1000N/H NS1250N/H NS1600N/H	NS1000H NS1250H NS1600H	NS800LB					
	MasterPact MTZ1	MTZ1 10 H1/H2/L1	MTZ1 10 H1/H2						
	MasterPact MTZ2	MTZ1 12 H1/H2 MTZ1 16 H1/H2 MTZ2 10 N1/H1/H2/L1 MTZ2 12 N1/H1/H2/L1 MTZ2 16 N1/H1/H2/L1							
Type of Canalis busbar trunking KRC1600									
Isc max. in kA rms	25 kA	30 kA	42 kA	50 kA	65 kA	75 kA	100 kA		
Type of circuit breaker	ComPact NS	NS1250N/H NS1600N/H	NS1250H NS1600H	NS1600b N NS2000N					
	ComPact NS $\geq 1600b$								
	MasterPact MTZ1	MTZ1 12 H1/H2 MTZ1 16 H1/H2							
	MasterPact MTZ2	MTZ2 12 N1/H1/H2/L1 MTZ2 16 N1/H1/H2/L1 MTZ2 20 N1/H1/H2/H3/L1		MTZ2 12 H1/H2/L1 MTZ2 16 H1/H2/L1 MTZ2 20 H1/H2/H3/L1	MTZ2 12 L1 MTZ2 16 L1 MTZ2 20 L1				
Type of Canalis busbar trunking KRC2000									
Isc max. in kA rms	25 kA	30 kA	42 kA	50 kA	65 kA	80 kA	100 kA		
Type of circuit breaker	ComPact NS	NS1600N/H	NS1600H						
	ComPact NS $\geq 1600b$	NS1600b N NS2000N NS2500N							
	MasterPact MTZ1	MTZ1 16 H1/H2							
	MasterPact MTZ2	MTZ2 16 N1/H1/H2/L1 MTZ2 20 N1/H1/H2/H3/L1 MTZ2 25 H1/H2/H3		MTZ2 16 H1/H2/L1 MTZ2 20 H1/H2/H3/L1 MTZ2 25 H1/H2/H3	MTZ2 16 H2/H3 MTZ2 20 H2/H3 MTZ2 25 H2/H3	MTZ2 16 L1 MTZ2 20 L1			
Type of Canalis busbar trunking KRC2500									
Isc max. in kA rms	25 kA	30 kA	42 kA	50 kA	65 kA	80 kA	100 kA		
Type of circuit breaker	ComPact NS $\geq 1600b$	NS2000N NS2500N NS3200N							
	MasterPact MTZ2	MTZ2 20 N1/H1/H2/H3/L1		MTZ2 20 H1/H2/H3/L1	MTZ2 20 H2/H3 MTZ2 25 H2/H3	MTZ2 20 L1			
		MTZ2 25 H1/H2/H3 MTZ2 32 H1/H2/H3							



Coordination Tables between Circuit Breaker and Canalis Electrical Busbar Trunking

Canalis KRC

Ue: 660-690 V AC

Type of Canalis busbar trunking KRC3200									
Isc max. in kA rms		25 kA	30 kA	42 kA	50 kA	65 kA	85 kA	100 kA	
Type of circuit breaker	ComPacT NS ≥ 1600b	NS2500N NS3200N							
	MasterPact MTZ2	MTZ2 25 H1/H2/H3 MTZ2 32 H1/H2/H3 MTZ2 40 H1/H2/H3				MTZ2 25 H2/H3 MTZ2 32 H2/H3 MTZ2 40 H2/H3	MTZ2 25 H3 MTZ2 32 H3 MTZ2 40 H3		
	MasterPact MTZ3	MTZ3 40 H1/H2							
Type of Canalis busbar trunking KRC4000									
Isc max. in kA rms		25 kA	30 kA	42 kA	50 kA	65 kA	85 kA	100 kA	
Type of circuit breaker	ComPacT NS ≥ 1600b	NS3200N							
	MasterPact MTZ2	MTZ2 32 H1/H2/H3 MTZ2 40 H1/H2/H3				MTZ2 32 H2/H3 MTZ2 40 H2/H3	MTZ2 32 H3 MTZ2 40 H3		
	MasterPact MTZ3	MTZ3 40 H1/H2 MTZ3 50 H1/H2							
Type of Canalis busbar trunking KRC5000									
Isc max. in kA rms		25 kA	30 kA	42 kA	50 kA	65 kA	85 kA	100 kA	
Type of circuit breaker	MasterPact MTZ1	MTZ2 32 H1/H2/H3 MTZ2 40 H1/H2/H3				MTZ2 32 H2/H3 MTZ2 40 H2/H3	MTZ2 32 H3 MTZ2 40 H3		
	MasterPact MTZ2	MTZ3 40 H1/H2 MTZ3 50 H1/H2 MTZ3 63 H1/H2							
Type of Canalis busbar trunking KRC6300									
Isc max. in kA rms		25 kA	30 kA	42 kA	50 kA	65 kA	85 kA	100 kA	
Type of circuit breaker	MasterPact MTZ1	MTZ2 40 H1/H2/H3				MTZ2 40 H2/H3	MTZ2 40 H3		
	MasterPact MTZ2	MTZ3 40 H1/H2 MTZ3 50 H1/H2 MTZ3 63 H1/H2							



Life Is On | **Schneider**
Electric

Schneider Electric Industries SAS

35, rue Joseph Monier
CS 30323
92506 Rueil Malmaison Cedex
France

RCS Nanterre 954 503 439
Capital social 896 313 776 €
www.se.com

01/2024

© 2024- Schneider Electric. All Rights Reserved.
All trademarks are owned by Schneider Electric Industries SAS or its affiliated companies.
Document reference: LVPED318033EN

This document has been
printed on recycled paper

