

VARC 931

Arc flash protection simulator unit

Publication version: VARC931/EN M/A001

User manual



Table of Contents

1. General	4
1.1. Simulator components	4
2. Settings before simulation	5
2.1. Programming switches in I/O units.....	5
2.2. Example settings for I/O units dipswitches.....	9
2.3. Programming of the VAMP 321	10
3. Fault simulation	13
3.1. Trip signals in VARC 931	13
3.2. Fault simulation in VARC 931	14

1. General

This is user's guide for VARC 931 arc protection simulator. This guide describes the simple procedures which will help to use VARC 931 arc protection simulator.

1.1. Simulator components

This simulator has one arc master unit (VAMP 321) and total number of three I/O units (VAM 12L, VAM 3L, VAM 4C).

There are installed two arc sensors in VAM 12L, one fiber loop in VAM 3L and three current sensors in VAM 4C. One arc sensor is also installed to master unit VAMP 321.

Following figure shows, how simulator components are connected.

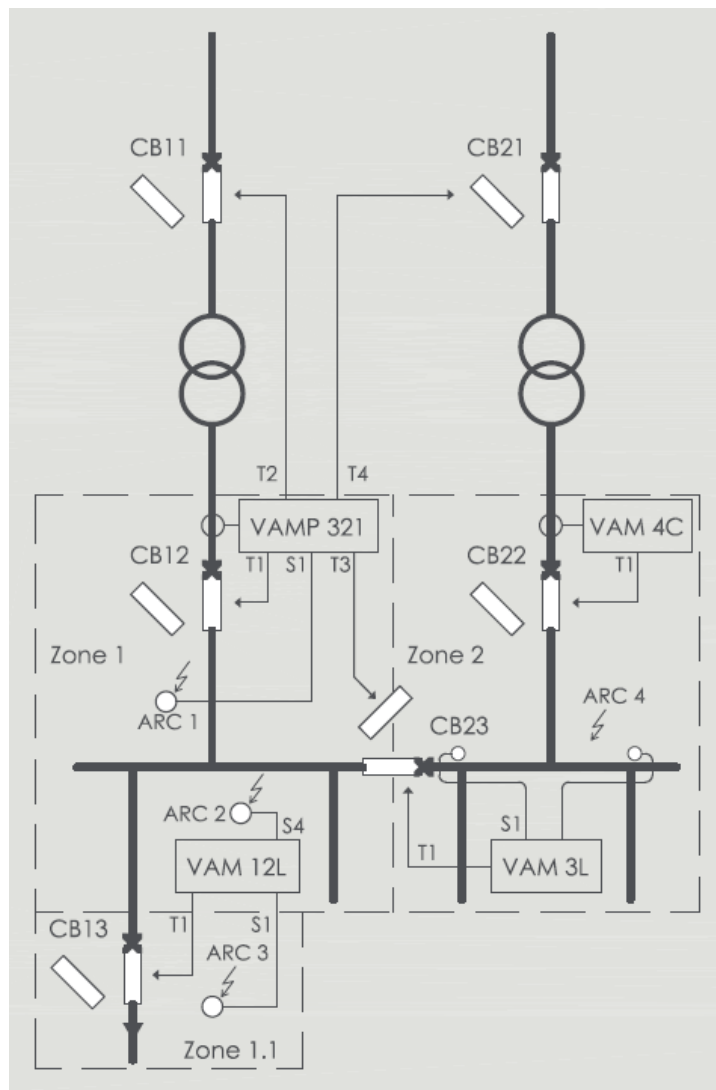

Figure 1.1-1 Connections in simulator VARC 931

There are two arc sensors in zone 1. These sensors are connected to VAMP 321 S1 and VAM 12L S4. One fiber loop is in zone 2. This loop is connected to VAM 3L S1. One arc sensor is connected to VAM 12L S1. This sensor will trip only CB13.

This simulator overcurrent criteria measuring in zone 1 is done by VAMP 321 and in zone 2 by VAM 4C. While default settings are used, tripping of the breakers needs to have both overcurrent and light criteria enabled.

2. Settings before simulation

Able to use this simulator, you need to have power cable, and three VX001 modular cables, for powering up the devices. Typically these cables are included in the simulator transportation box.

2.1. Programming switches in I/O units

Before system implementation, check the positions of the programming switches in accordance with the following principles:

- Each I/O unit connected to the communication bus has its own address (each I/O unit have a unique address).
- Set the programming switches before connecting the supply voltage if it's possible
- System must be always re-installed when address of I/O units are changed. (Installation is done in VAMP 321 arc-menu, or from local panel by pressing F2)
- Selected address must be in right protection zone

Each protection zone has eight addresses which can be used.

- Zone 1 addresses 0...7
- Zone 2 addresses 8...15
- Zone 3 addresses 16...23
- Zone 4 addresses 24...31

The programming switches in I/O units have different weight factors. To create an address for the I/O unit, turn switches with different values to the ON position and calculate the sum of their weight factors. The following table shows the weight factors of each programming switch for VAM 10L and VAM 3L.

Programming switch weight factors for VAM 12L and VAM 3L

Switch No.	Weight factor
8	1
7	2
6	4
5	8
4	16

In this simulator VAM 12L - I/O unit is in zone 1. So the selected address must be between 0...7.

VAM 3L – I/O unit is in zone 2, so the selected address for VAM 3L must be between 8...15 in this simulator.

Current I/O unit VAM 4C have a different kind of weight factors. Following table shows weight factor for VAM 4C.

Dipswitch weight factors for VAM 4C

Switch No.	Weight factor
8	1
7	2
6	4
5	8

Current I/O unit VAM 4C address counting begins always in 32. To determine the address of a current I/O unit, add the sum of the weight factors to 32 (for example, programming switch values total is 7, then the address of the current I/O unit is $32+7=39$). If the address 32 is selected, then VAM 4C is set to be master mode. Therefore the using of address 32 is not recommended in this simulator.

When the addresses for I/O units are selected, next step is to determine other functions for I/O units.

Explanations for for I/O units VAM 12L and VAM 3L dipswitches are as follows.

Switch 1 determines which light activation activates the arc stage. When the switch position is ON, the arc stage only activates the light information provided by the units own sensors. In OFF position the arc stage activates on the light information received from any unit in the same protection zone.

Switch 2 determines the trip relay latch. When the switch is in ON position the trip relay remains engaged after the arc trip until the fault is acknowledged at the master units panel.

Switch 3 determines the arc trip criteria. When the switch is in ON position the trip is based on light information only. In OFF position both fault current and light information are required.

Switches 4...8 determines the address of I/O unit.

VAM 12L / VAM 12LD

When the L>ext/int DIP switch is in “L>int” position, the output relays are only activated by dedicated sensors.

SENSOR 1 activates T1.

SENSOR 2 activates T2.

SENSOR 3 activates T3.

SENSORS 4 to 10 are normally sending light information to system according to zone setting.

If the switch is in “L>ext” position, all output relays are also controlled by the selected zone information. This activation source can be any sensor channel 4 to 10 or from an external I/O unit configured to the same zone.

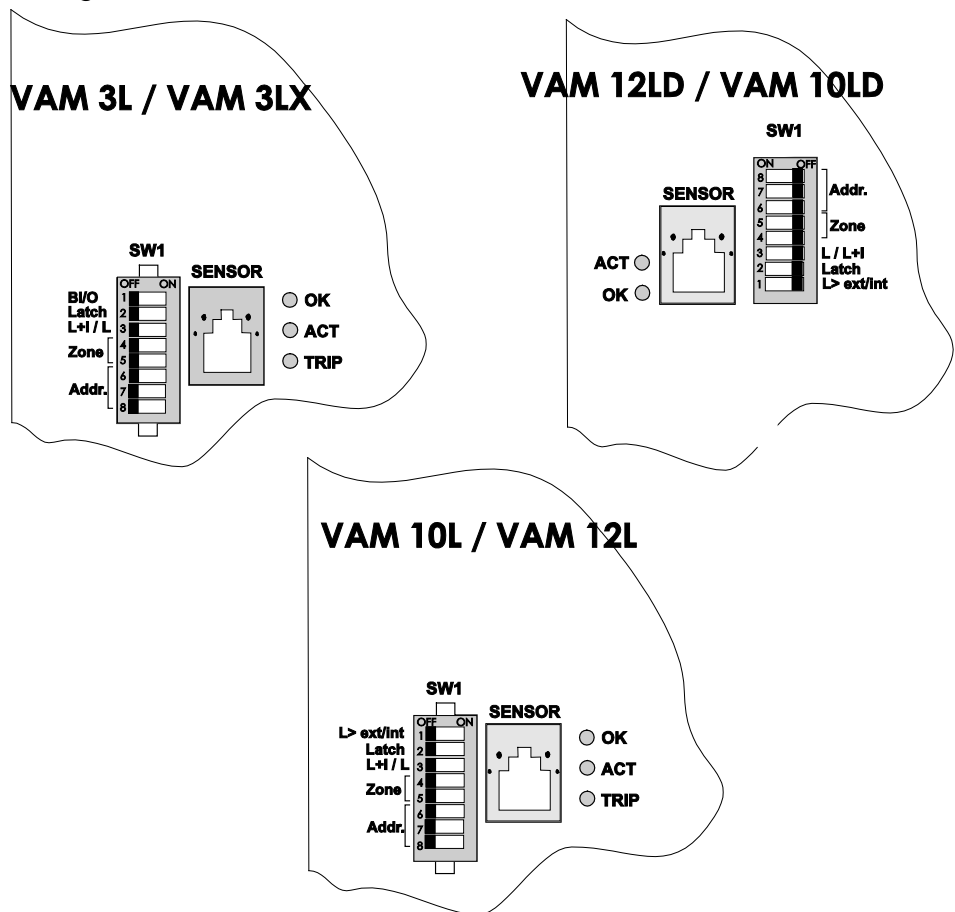

VAM3L/VAM3LX, VAM10L/VAM10LD, VAM12L/VAM12LD dips

Figure 2.1-1 Programming switches for VAM 12L, VAM 10L and VAM 3L

Explanations for VAM 4C dipswitches are as follows:

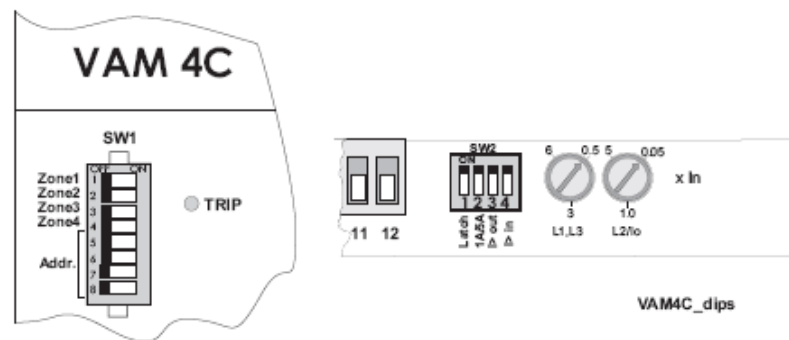

Figure 2.1-2 Programming switches for VAM 4C

VAM 4C SW1 switch settings

Switch	Definition	Description
1	Zone 1	System operating zone 1 (light information)
2	Zone 2	System operating zone 2 (light information)
3	Zone 3	System operating zone 3 (light information)
4	Zone 4	System operating zone 4 (light information)
5	Addr	Address weighting coefficient 8
6	Addr	Address weighting coefficient 4
7	Addr	Address weighting coefficient 2
8	Addr	Address weighting coefficient 1

VAM 4C SW2 switch settings

Switch	Definition	Description
1	Latch	Position "0" (switch down): trip relay is only operational while the protection is activated Position "1" (switch up): trip relay changes to latching status after trip
2	1A / 5A *	Position "0" (switch down): rated secondary current of the current transformer is 1 A Position "1" (switch up): rated secondary current of the current transformer is 5 A
3	I> out	Position "0" (switch down): unit does not transmit the current criteria to other units Position "1" (switch up): unit transmits the current criteria to other units
4	I> in	Position "0" (switch down): unit does not receive the current criteria from other units Position "1" (switch up): unit receives the current criteria from other units

*) As in CT

2.2. Example settings for I/O units dipswitches

Here is an example how I/O units dipswitches can be adjusted while simulator is working properly and reasonable way.

With following dipswitch settings, the addresses of I/O units are:

VAM 12L address is 5

VAM 3L address is 10

VAM 4C address is 35

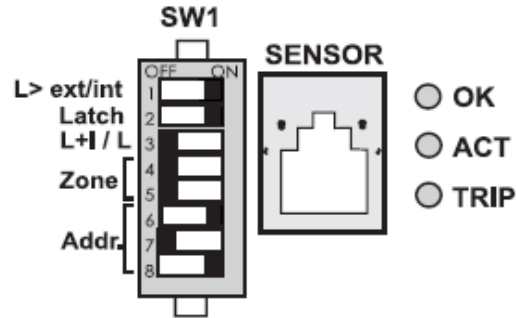

Figure 2.2-1 Example dipswitch settings for VAM 12L

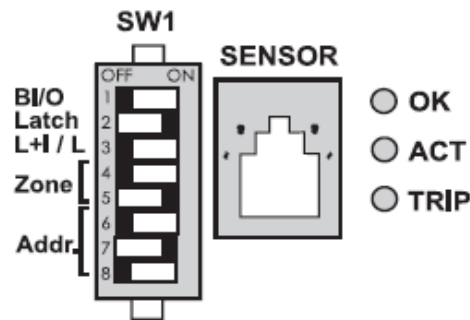

Figure 2.2-2 Example dipswitch settings for VAM 3L

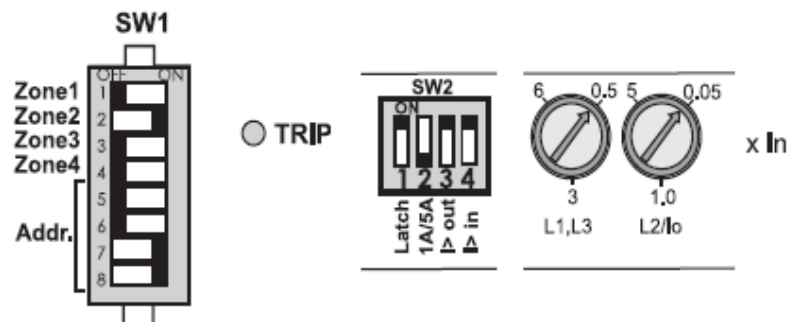

Figure 2.2-3 Example dipswitch settings for VAM 4C

2.3. Programming of the VAMP 321

Programming of the VAMP 321 requires VAMPSET software, and connection between PC and relay. VAMPSET software can be downloaded from following link:

<http://www.schneider-electric.com/products/ww/en/2300-ied-user-software/2320-vamp-user-software/62050-vamp-software/>

USB-connection cable type is VX052.

In the basic programming, there are used four menus from the VAMPSET. “Arc protection” – menu. “Arc matrix – current”. “Arc matrix – light”, and “arc matrix – output”.

Settings in the “Arc protection”-menu:

DEVICE INFO
 MEASUREMENTS
 CURRENT HARMONICS
ARC PROTECTION
 ARC MATRIX - CURRENT
 ARC MATRIX - LIGHT
 ARC MATRIX - OUTPUT
 ARC EVENT ENABLING
 VOLTAGE HARMONICS
 PHASOR DIAGRAM
 RMS MEASURING
 MONTH MAX
 CURRENT MINIMUMS and MAXIMUMS
 + DEMAND VALUES...
 + VIRTUAL INPUTS...
 + RELAYS...
 + VIRTUAL OUTPUTS...
 LED NAMES
 FUNCTION BUTTONS
 EVENT BUFFER
 DISTURBANCE RECORDER
 + PROGRAMMABLE STAGE...
 OBJECTS
 RELEASE OUTPUT MATRIX LATCHES
 + MATRIX...
 LOGIC...
 MIMIC
 + LOCAL...
 SCALING
 EVENT MASKS for OBJECTS
 DI EVENT TEXTS
 LOGIC EVENT ENABLING
 SYSTEM CLOCK
 CLOCK SYNC
 SLOT INFO
 PROTOCOL CONFIGURATION
 DIAGNOSIS

Settings

I>int. pick-up setting	250 A
I>int. pick-up setting	0.50 xIn
Io>int. pick-up setting	60 A
Io>int. pick-up setting	1.20 xIn
Communication mode	Master
Install arc sensors & I/O units	-
Installation state	Ready
Release arc latches	-
Clear I/O units' registers	-
Forward I>int. to I>ext.	<input type="checkbox"/>
Forward Io>int. to I>ext.	<input type="checkbox"/>
Link Arc selfdiag to SF relay	<input checked="" type="checkbox"/>

Current measurement states

Measurement	State
I>int.	0
Io>int.	0
I>ext.	0

Arc Stages

Stage	Stage Enabled	Trip delay [ms]	State	DI to block stage
1	On	0	0	-
2	On	50	0	-
3	On	0	0	-
4	On	50	0	-
5	Off	0	0	-
6	Off	0	0	-
7	Off	0	0	-
8	Off	0	0	-

Zones

Zone	State
1	0
2	0
3	0
4	0

Installed arc sensors

Sensor	Arc sensor status
1	OK

Installed I/O units

I/O unit Address	Zone / I>ext.	Connected sensors	Activated sensors	Sensor error	Clear registers
5	Zone 1	{2}1,4	-	-	-
10	Zone 2	{1}1	-	-	-

Figure 2.3-1. Settings in the “Arc protection”-menu

From this menu arc sensors can be installed. Also releasing of the latches and clearing of the I/O-unit registers are done from this menu. However, these functions can be also done from the push buttons F1 and F2.

In this menu there is also selected which Arc-stages are enabled, and which are the trip delays for these arc stages. 0 ms delay means instant trip. Arc stages 2 and 4 are used for 50 ms delayed trip, because these stages are set to open transformer incomer circuit breakers CB11 and CB21 within 50 ms, if the fault continues.

Arc protection-menu shows also VAMP 321 own connected arc sensors and installed I/O-units.

Settings in “arc matrix – current”-menu:

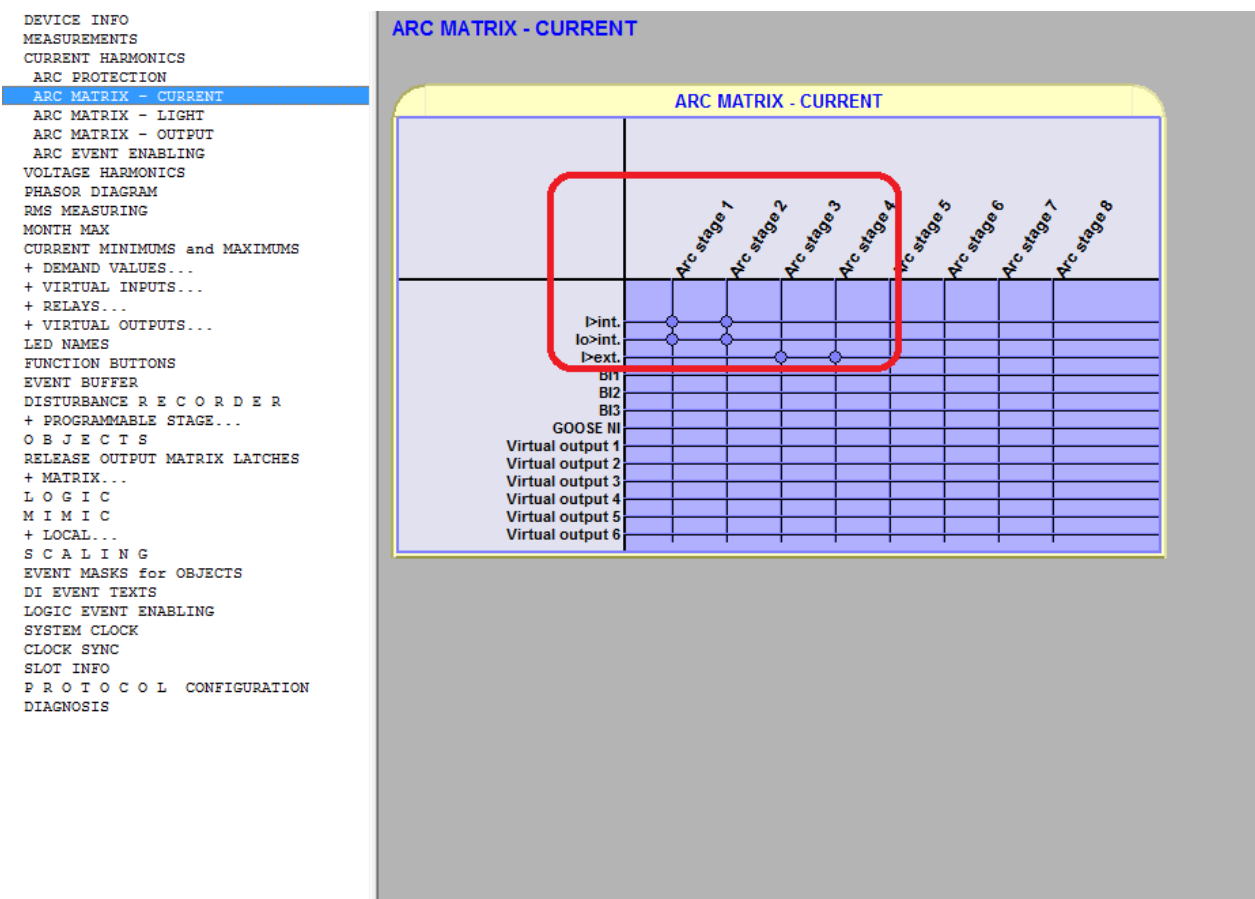

Figure 2.3-2. Settings in the “arc matrix – current”-menu

In this menu, there are selected current criteria for each of the arc stages. Arc stages 1 and 2 are using VAMP 321 internal overcurrent information. Arc stages 3 and 4 are using VAM 4C external overcurrent information.

If device needs to be set to operate with “light only”-criteria, then this matrix has to be left empty.

Settings in the “arc matrix – light”-menu:

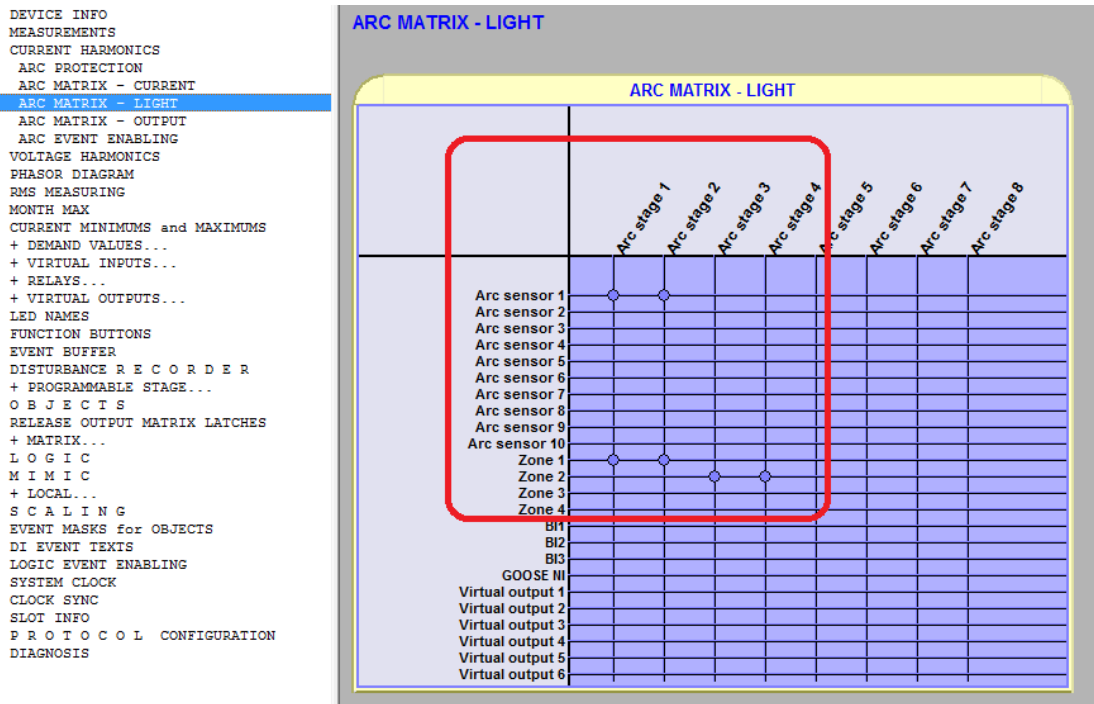

Figure 2.3-3. Settings in the “arc matrix – light”-menu

In this menu, there are selected light criteria for each of the arc stages. Zone 1 and VAMP 321 internal arc sensor light information, are used for Arc stage 1 and 2. Zone 2 light information and used for Arc stage 3 and 4.

Settings in the “arc matrix – output”-menu:

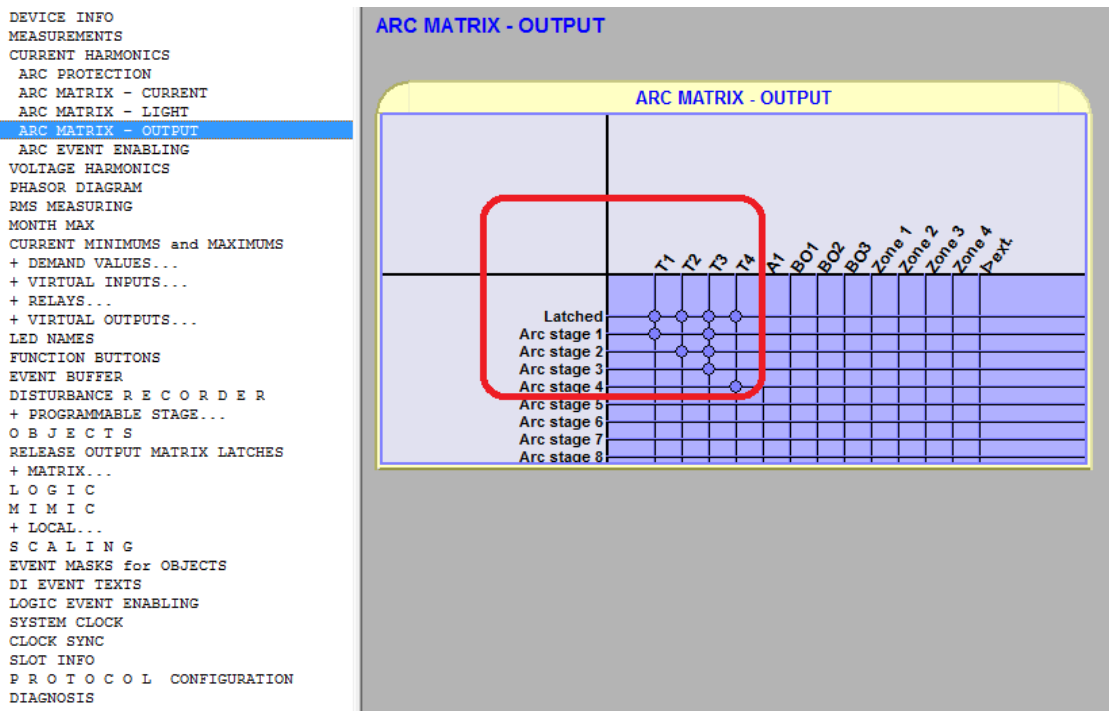

Figure 2.3-4. Settings in the “arc matrix – output”-menu

In this menu, there are selected tripping criteria for each of the arc stages. Stage 1 will trip CB12 and CB23. If the fault continues, stage 2 will trip CB11 after 50ms.

Stage 3 will trip CB23 and VAM 4C will trip CB22. If the fault continues stage 4 will trip CB21 after 50ms.

3. Fault simulation

3.1. Trip signals in VARC 931

Arc protection system in this simulator trips the circuit breakers as follows:

VAMP 321 shall trip CB12 (T1) and CB23 (T3) in zone 1 fault. If the fault in the zone1 continues over 50ms, VAMP 321 shall trip CB11 (T2).

VAM 12L shall trip CB13 (T1), when the fault is detected by sensor 1.

VAM 4C shall trip CB22 (T1), when the fault is in the zone 2. If the fault in the zone2 continues over 50ms, VAMP 321 shall trip CB21 (T4).

VAM 3L shall trip CB23 when the fault is in zone 2.

VARC 931

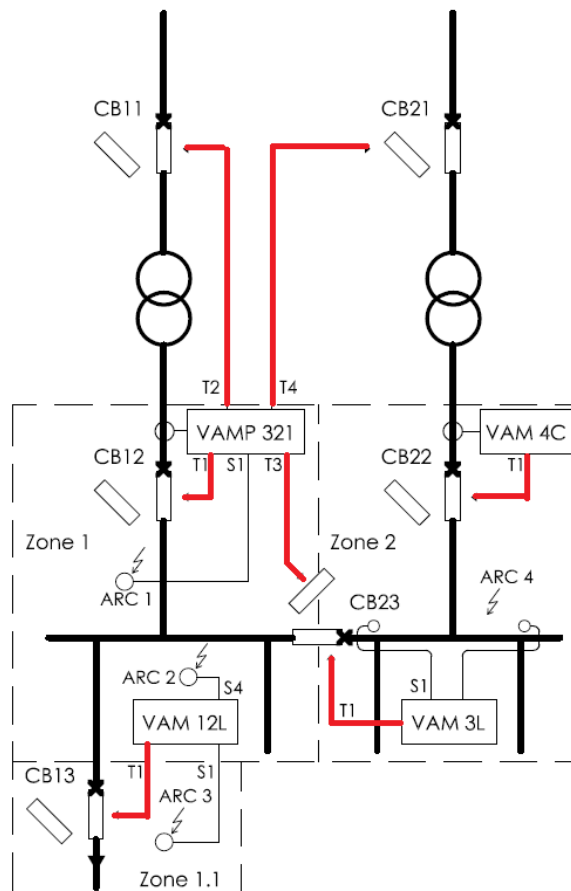

Figure 3.1-1. Tripping signals in red

3.2. Fault simulation in VARC 931

In this simulator, there can be created arc fault in the four different places. Also there is possibility to select is the overcurrent information enabled or disabled.

There are switches for circuit breaker failure selection, and for manual opening of the circuit breakers.

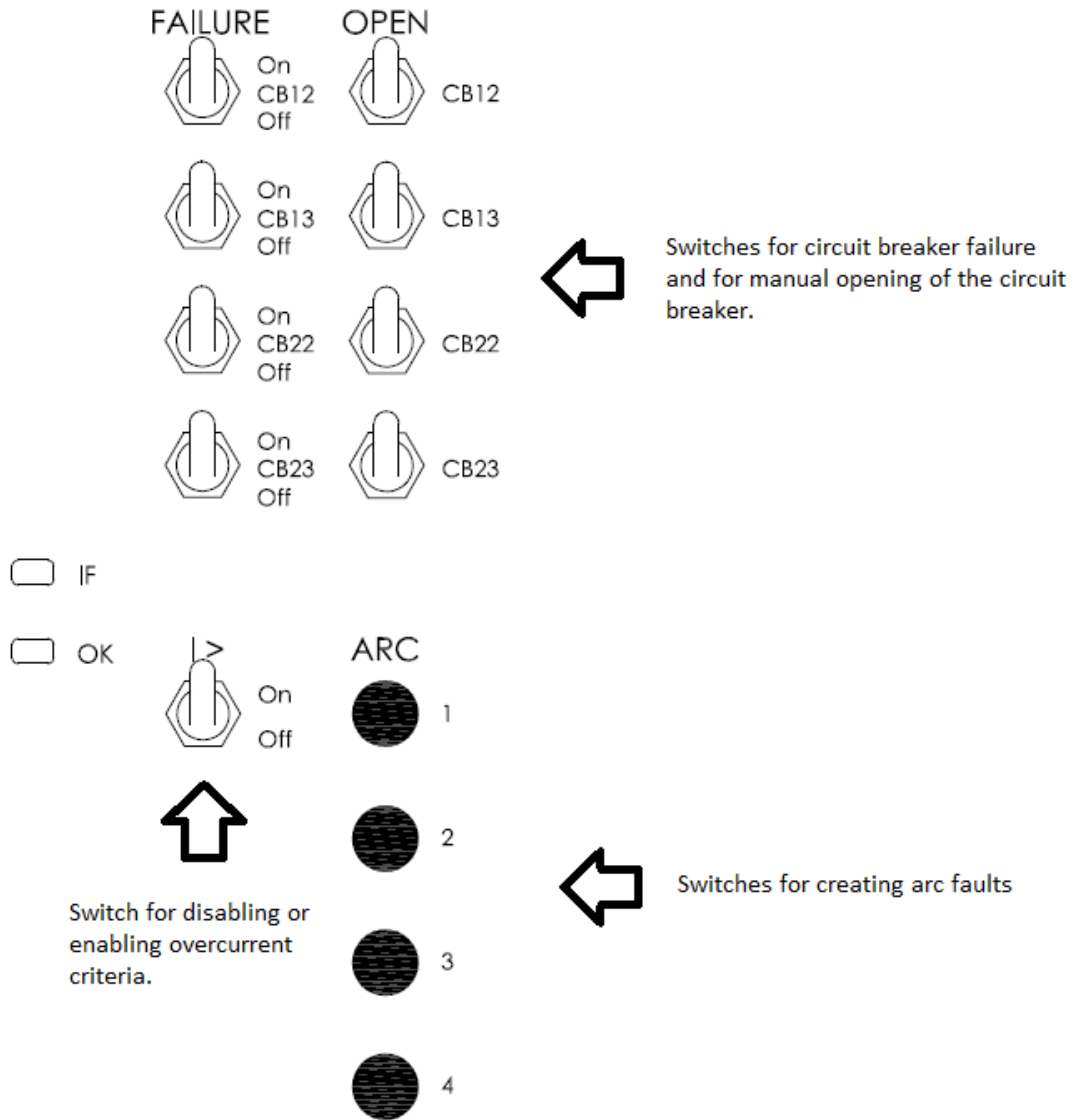

Figure 3.2-1. Fault simulation switches

ARC 1 button will create fault to Zone 1. This fault sensor is connected to VAMP 321 sensor channel 1. This fault will trip CB12 and CB23. If the ARC 1 button is pressed more than 50ms, CB11 will be also tripped.

ARC 2 button will create fault to Zone 1. This fault sensor is connected to VAM 12L sensor channel 4. This fault will trip CB12 and CB23. If the ARC 2 button is pressed more than 50ms, CB11 will be also tripped.

ARC 3 button will create fault to VAM 12L sensor channel 1, and this channel will trip CB13.

ARC 4 button will create fault to Zone 2. This fault sensor is connected to VAM 3L sensor channel 1. This fault will trip CB22 and CB23. If the ARC 4 button are pressed more than 50ms, CB21 will be also tripped.

When default settings are used, arc system will not trip if the overcurrent criteria is disabled.

If more information about VAMP 321 system is needed, please see the VAMP 321 manual. It is available from the following link:
<http://www.schneider-electric.com/download/ww/en/results/0/0/28764990-Vamp-Arc-Protection-current/0/>



Customers Care Center

<http://www.schneider-electric.com/cc>

Schneider Electric

35 rue Joseph Monier
92506 Rueil-Malmaison
FRANCE
Phone: +33 (0) 1 41 29 70 00
Fax: +33 (0) 1 41 29 71 00

www.schneider-electric.com

Publication version: VARC931/EN M/A001

Publishing: Schneider Electric
02/2016