

MZ18A

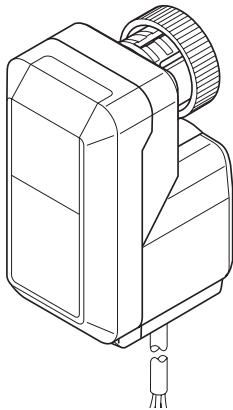

Modulating Valve Actuator

The MZ18A actuator is specifically designed to provide modulating control together with the VZ22, VZ32 and VZ42 series of small linear valves.

The MZ18A is used in fan-coil-units, induction units, small reheaters and recoolers, and for zone control applications. The actuator is compatible with controllers providing 0–10V or 2–10V output signals.

Reliable longtime operation is ensured due to the fact that no mechanical feedback potentiometer and no mechanical endswitches are needed. Due to an automatic synchro-nization function the close-off point is self-adjusting.

Based on a running time of 150 s, valve positioning and flow adjustment is very exact.

SPECIFICATIONS

Part number845-5100
Input voltage.	24 VAC, ± 15%, 50/60 Hz
Power consumption	1,4 VA
Input signal.	modulating 0-10 V, 2-10 V adjustable <0,1 mA
Operation	direct/reverse (adjustable)
Stroke	6,5 mm
Running time	150 s at 50 Hz 120 s at 60 Hz
Stem force	180 N (for valves DN 15–20)
Protection class IP 40 in accordance with EN 60529	
Insulation class.	III in accordance with EN 60730
Connection cable	1,5 m
Coupling ring	M 30 x 1,5
Ambient operating temperature limits	0 – +55 °C
Weight	0,4 kg
Suitable valves	see table on last page

DIMENSIONS mm (in)

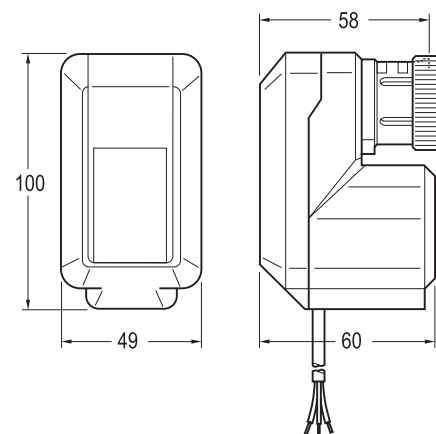

FUNCTION

The movement of the electric actuator is produced by a screw spindle which is driven in both directions by a synchronous motor through a set of gears. A magnetic clutch limits the torque of the gear assembly and the driving force of the actuator.

The actuator is fixed to the valve body by means of a coupling ring requiring no tools for mounting.

The actuator is maintenance-free and supplied completely with a ready-to-wire connecting cable.

A microprocessor-based high performance positioner guarantees accurate control.

The close-off position is self adjusting by means of an automatic synchronization function.

Synchronization is carried out when power is switched on and each time the stem reaches 0 % or 100 % of its travel. As long as the synchronization is active the input signal is ignored!

The movement of the actuator stem indicates whether the valve is opening or closing. (Fig. 1)

MOUNTING

Mounting Position

The actuator may only be mounted beside or above the valve. Adjust the valve in the right position before mounting the actuator. (Fig. 2)

Mounting

Before the actuator is fixed to the valve, the adjustment cap must be removed. Make sure that the actuator is in the open position (factory supplied position) before fixing the actuator to the valve body. (Fig. 3)

The actuator must be mounted by hand. Don't use tools or additional forces, because actuator and valve may be damaged.

CONNECTIONS

The electrical installation must comply with the wiring diagram shown in Fig 4.

A functional check of the valve actuator can be carried out by changing the Y input signal.

FUNCTION

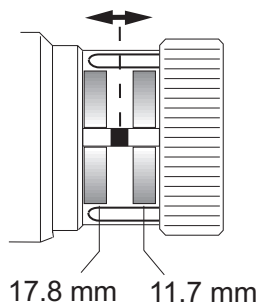

Fig. 1

MOUNTING

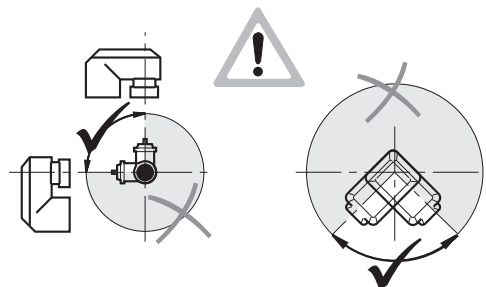

Fig. 2

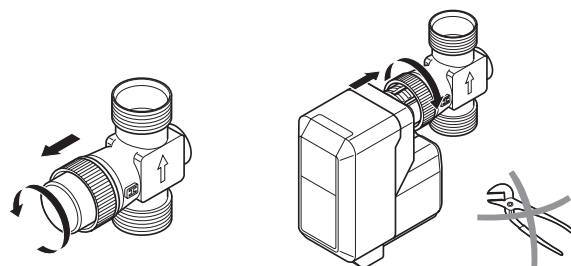

Fig. 3

CONNECTIONS

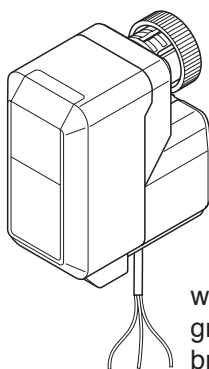

Fig. 4

SWITCH SELECTION

The built-in selector switches must be set according to the valve type (2-way or 3-way), valve size, and the controller output signal (0–10V or 2–10V), see Fig 5.

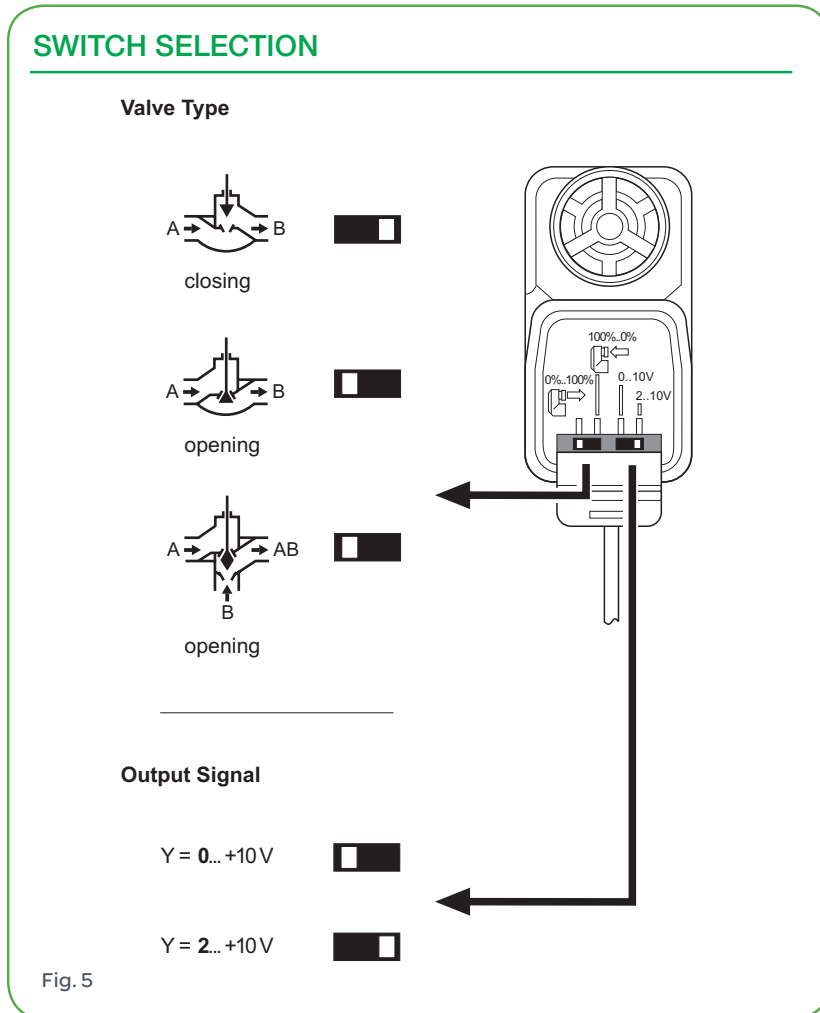

Fig. 5

FLOW CAPACITIES AND CLOSE OFF PRESSURE RATINGS

Two-way valves, VZ22

DN	Valve		Close-Off Pressure (kPa) with Actuators MZ18A, MZ18B, MZ18L (180 N)
	k_{vs}	TAC Part no.	
15	0.16	721-0702	1600
15	0.25	721-0706	1600
15	0.40	721-0710	1600
15	0.63	721-0714	1600
15	1.00	721-0718	1200
15	1.60	721-0722	1200
20	2.50	721-0726	400
20	4.00	721-0730	400

Three-way valves, VZ32

DN	Valve			Close-Off Pressure (kPa) with Actuators MZ18A, MZ18B, MZ18L (180 N)
	k_{vs} A-AB	B-AB	TAC Part no.	
15	0.25	0.16	731-0706	800
15	0.40	0.25	731-0710	800
15	0.63	0.40	731-0714	800
15	1.00	0.63	731-0718	250
15	1.60	1.00	731-0722	250
20	2.50	1.60	731-0726	240
20	4.00	2.50	731-0730	240

Three-way valves, VZ42

DN	Valve			Close-Off Pressure (kPa) with Actuators MZ18A, MZ18B, MZ18L (180 N)
	k_{vs} A-AB	B-AB	TAC Part no.	
15	0.40	0.25	741-0710	800
15	0.63	0.40	741-0714	800
15	1.00	0.63	741-0718	250
15	1.60	1.00	741-0722	250
20	2.50	1.60	741-0726	240
20	4.00	2.50	741-0730	240