

# Andover Continuum™

## I/O Modules

The Andover Continuum intelligent building system allows you to mix and match various combinations of DIN rail-mounted modules – flexible I/O, CPU and power supply, and your choice of several user interface modules – in a single controller location to meet your building's control and monitoring needs.



# Andover Continuum I/O Modules Features



With the Andover Continuum system, as your network grows, simply add or replace I/O modules as needed.

The Andover Continuum I/O modules feature a sleek, lightweight casing designed for natural convection cooling, and a 3-position front cover for easy access. Built-in quick-release fasteners at the back of each I/O module are provided for DIN rail mounting — no tools required. These fasteners also snap into a locked position for panel mounting. Input and output connectors are located at the bottom of each I/O module and are removable for easy field access and maintenance. All Andover Continuum modules are designed for mounting in an optional NEMA 1-style Andover Continuum enclosure.



## PRODUCT AT A GLANCE

- Flexible, Modular Design Fits Every Application
- User-Configurable I/O Selection to Meet Specific Control Needs
- DIN Rail Mounting Provides Easy Installation and System Expansion
- NEMA 1-Style Enclosure Available
- Three-Position Front Cover for Easy Access
- Built-in Quick-Release Fasteners— No Tools Required!
- Removable Input/Output Connectors for Easy Installation
- Slide-Together Power/Communications Connections
- Optional Remote Mounting
- Push-Button Network Commissioning
- Choice of RS-485 or FTT-10A Media

The Andover Continuum I/O modules communicate with the Andover Continuum NetController CPU module using Andover LON communications. Like all Andover Continuum modules, the I/O modules slide together via built-in connectors on either side so network expansion is quick and easy. Both power transmission and communication signals feed through these connectors. For added convenience, in applications such as door control or lighting control, a single module or groups of I/O modules can be remotely located and connected using approved cable, and powered from a local power supply. Each I/O module features its own push-button for quick and easy network commissioning.

# Andover Continuum I/O Modules

## Features (continued)

### Communication Choices

All Andover Continuum modules are available in either the standard RS-485 or the Free Topology (FTT-10A) media interface. RS-485 is perfect for local mounting applications and is a lower cost media choice. FTT-10A provides increased flexibility and reliability. FTT modules are connected using a twisted-pair cable and can be wired in a bus, star, distributed star, or even a ring topology for added resilience. Note: You cannot mix and match both media types on the same I/O bus.

### Dimension Drawings

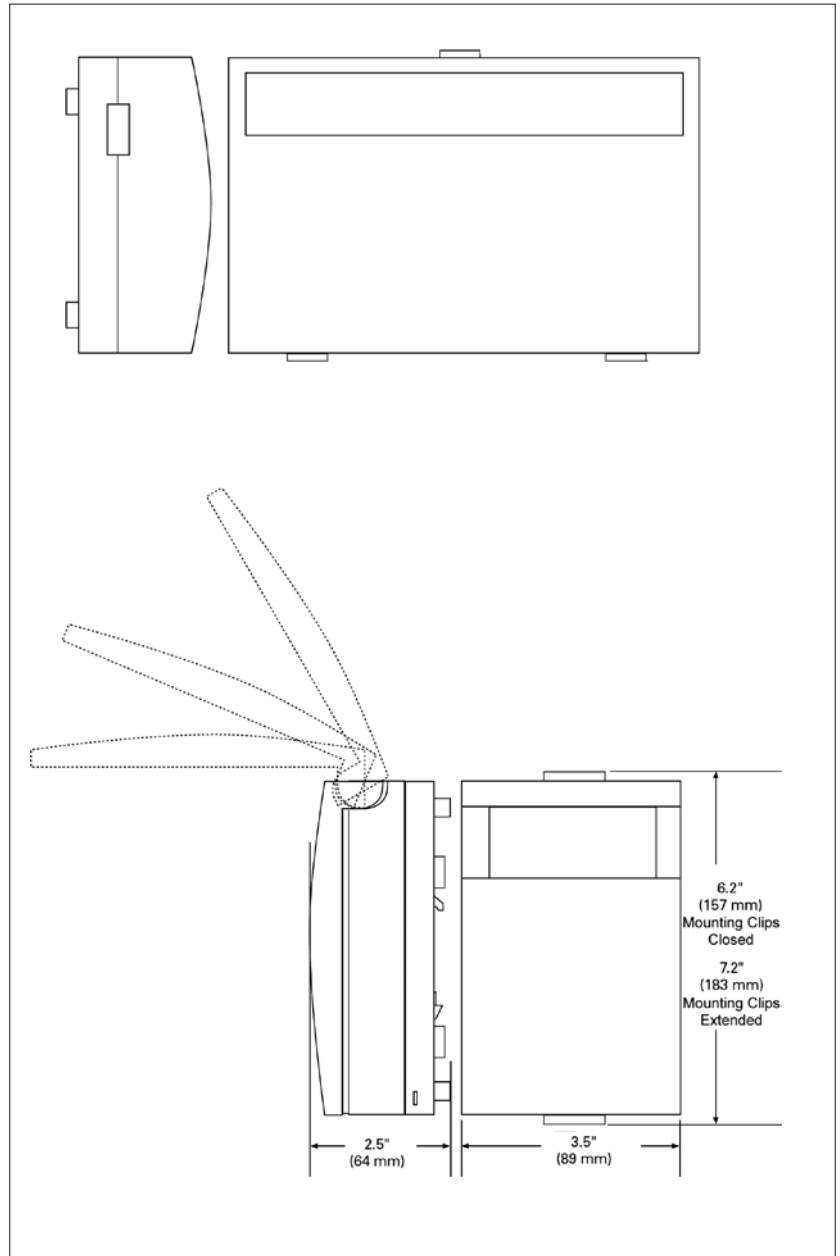

# Andover Continuum I/O Modules Specifications



LISTED  
5882  
OPEN ENERGY  
MANAGEMENT EQUIPMENT

## I/O Modules

### Mechanical

#### Operating Environment

32–120°F (0 to 49°C),  
10–95%RH (non-condensing)

#### Size\*

3.8" W (96.5mm) including connectors

7.2" H (182.88mm) with mounting  
clips extended

6.2" H (157.48mm) with mounting  
clips closed

2.5" D (96.5 x 170.2 x 63.5mm)

*\*With the exception of the VS-8-4 models –  
9.0" W x 7.2" H (6.2" H closed) x 2.5" D  
(228.7 x 182.88mm (157.48 mm closed)  
x 63.5mm)*

#### Weight\*

.75 lbs (0.34kg)

*\*With the exception of the VS-8-4 models –  
1.32lbs (0.60kg)*

#### Enclosure Type

UL open class,  
flammability rating of UL94-5V, IP 10

#### Mounting

Mount on DIN rail or wall-mount  
using attached clips.

Andover Continuum NEMA 1-style  
enclosure available

### Battery Backup

Via Andover Continuum  
UPS power supply

### Communications

#### Communications Interface:

TAC-LON communications with  
Andover Continuum CPU module  
Choice of RS-485 or FTT-10A interface

#### Comm. Error Checking

International Standard CRC 16

#### RS-485

Communications Speed: 39k baud

Bus Length: 2,000 ft. (610m)

Bus Media: Shielded, twisted pair cable

120v termination required at both ends  
of the ACC-LON network (when modules  
are mounted remotely)

#### FTT-10A

Communications Speed: 78k baud

Bus Length: Up to 8858 ft. (2700m) –  
bus topology

Up to 1640 ft (500m) – free topology

Repeater required for longer distances

Bus Media: Refer to FTT-10A

documentation in Andover Continuum  
I/O System Reference Guide

(P/N: 30-3001-4999--Rev D or higher)

#### Power/Communications Connections

5-position plug-in connectors on left and  
right sides allow Andover Continuum mod-  
ules to be directly connected to each other  
or remotely connected via approved cable

### CPU

3120E2 MCU with internal ROM,  
EEPROM, and SRAM

Except VT-1 and AC-1Plus:

3150BFU1 with internal EEPROM  
and external FLASH and SRAM

### Agency Listings

UL/CUL 916, FCC CFR 47 Part 15,  
ICES-003, EN55022,

AS/NZS 3548, and VCCI Class A,  
CE UL 864 - (UI-8-10-S, DI-8-S, MI-6-S,

AO-4-8-S, DO-6-TR-S, DO-4-R-S,  
DM-20-S, DO-4-R-O-S, UI-8-10-10V-S,  
and AO-4-8-0-S only)

UL 294 - (UI-8-10, DI-8, DO-4-R, DM-20,  
AC-1, AC-1Plus, AC-1A, UI-8-10-10V,  
DO-4-R-O, VS-8-4, and VS-8-4-T only)

UL-1076 - (UI-8-10, UI-8-10-10V, DO-4-R,  
DO-4-R-O, AC-1, AC-1a, and AC-1Plus only)

# UI-8-10

## I/O Module

The UI-8-10, Andover Continuum’s universal input module, provides 8 universal inputs, software configurable as voltage, thermistor, digital, or counter point types. Each point can also be configured as a supervised input for security monitoring, providing separate indication of alarm and trouble conditions. This module is a perfect choice for any mix of temperature, pressure, flow, status points, and

similar inputs in a control system, with a 0–5 volt input range and 10-bit A/D conversion.

A UI-8-10-10V model is also available for 0–10 volt applications. It provides the identical point type selection, but is equipped with individual voltage divider DIP switches on each input, allowing each to be configured for a 0-10 volt range.

### Specifications



**Electrical**

**Power Consumption**

0.7 W @ 10-28VDC max.

**Overload Protection**

0.5 A resettable fuse with transient voltage suppressor (TVS) and reverse polarity protection.

**Inputs**

**Number of Inputs**

8 Universal inputs; 10 bit resolution

**Input Types**

Voltage, Thermistor, Digital, Counter, and Supervised

**Input Protection**

24 V AC/DC allowed to any single input (40V TVS on each input – UI-8-10-10V model only)

**Input Impedance**

UI-8-10 (0–5V): 5 MW w/pullup disabled; 10 KW w/pullup enabled

UI-8-10-10V (0–10V): 4.4 KW

**Input Connections**

Two-piece, 13-position removable terminal block

**Voltage**

UI-8-10 (0–5V)

Range: 0–5 V

Resolution: 5 mV

Accuracy: ±15 mV (±0.3% FSR)

UI-8-10-10V (0–10V)

Range: 0–10 V

Resolution: 10 mV

Accuracy: ±15 mV V (±0.4% FSR)

**Thermistor**

UI-8-10 (0–5V)

Type: 10 KW, Type III Thermistor

Range: -30 to 230°F (-34 to 110°C)

Resolution: 40 to 100°F range (4 to 38°C)

Accuracy: 40 to 100°F range (4 to 38°C)

UI-8-10-10V (0–10V)

Type: 10 KW, Type III Thermistor

Range: -30 to 230°F (-34 to 110°C)

Resolution: 0.20°F typical (0.11°C typical)

Accuracy: ±1.0°F (±0.55°C)

**Digital & Counter**

Input Type: Contact Closure

Frequency: 4 Hz (max.)

Pulse Width: 125 ms ( min.)

(Digital pulse widths are based on Scan Time.)

**Supervised**

Input Type: Single or Double Resistor Supervision, Parallel or Series Circuit

**User LEDs/Switches**

**Status Indicator LEDs**

Power Power Indicator

Comm TD Indicator

Status Service/Wink Indicator

**Push-Button Switches**

Commission Reset

**Models**

**UI-8-10**

8 Universal inputs; 0-5 Volt input range

**UI-8-10-10V**

8 Universal inputs; 0-10 Volt input range

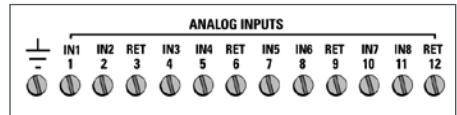

# DI-8

## I/O Module

The DI-8, Andover Continuum’s digital input module, is used for cost-effective sensing of multiple dry digital inputs in applications such as equipment status monitoring or alarm point monitoring. The DI-8 has eight digital inputs—each can be software configured to accept a digital (contact closure or 0–5 volt input) or counter signal. Counter frequency is 10 Hz on all eight inputs. In addition, high speed counting up to 10KHz max. is available (via a DIP

switch) on Channels 1 and 2 for high-speed metering and industrial applications.

40 V bipolar transorbs on all eight inputs protect against high voltage short duration transient events. The DI-8 is designed to accept dry contact inputs or 0-5 volts, but can withstand up to 24 VAC/VDC continuous voltage on four channels.

### Specifications



#### Electrical

##### Power Consumption

0.8 W @ 10–28 VDC max.

##### Overload Protection

0.5 A resettable fuse with transient voltage suppressor (TVS) and reverse polarity protection

#### Inputs

##### Number of Inputs:

8 Digital inputs

##### Input Types

Digital or Counter, software selectable

##### Input Protection

24 V AC/DC applied to 4 channels max. (40V TVS on each input)

##### Input Impedance

10KW pull-up resistor referenced to +5 VDC

##### Inputs Connections

Two-piece, 13-position removable terminal block

##### Digital

Input Type: Contact closure or 0–5V input

Pulse Width: 50 ms ( min.)

Current: 0.5mA (max.)

#### Counter:

Input Type: Contact closure or 0–5 VDC input

Channels 1 and 2 in HI-speed mode (selectable via dip switch):

Frequency: 10kHz (max.)

Pulse Width: 50 μS (min.)

Current: 0.5 mA

Channels 3 through 8; and Channel 1 and 2 in LO-speed mode:

Frequency: 10 Hz (max.)

Pulse Width: 50 mS (min.)

Current: 0.5 mA

#### User leads/Switches

##### Status Indicator LEDs

Power Power Indicator

Comm TD Indicator

Status Service/Wink Indicator

Input Status 1–8 Input Status Indicator (Closed circuit=ON)

##### Switches

Commission

Reset

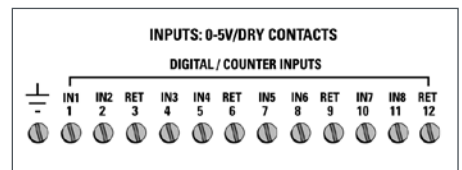

# DI-6-AC

## I/O Module

The DI-6-AC, Andover Continuum’s digital AC input module, has six digital (“wet”) AC inputs for cost-effective ON-OFF status indication of fan motor starters, solenoid valves, control relays, or external power supplies, and similar applications that require a quick and easy way to detect voltage. The DI-6-AC monitors the absence or presence of AC or DC voltage levels directly, with no interposing relays

needed. The DI-6-AC can monitor voltages from 24–120V.

A DI-6-AC-HV model is also available for sensing higher voltages—120–240V. Both models can also accept DC voltages. All inputs are optically coupled with 2500V isolation on each input for noise-free operation.

### Specifications



#### Electrical

##### Power Consumption

0.7 W @ 24 VDC (max.); when provided by Andover Continuum power supply module

##### Overload Protection

0.5 A re-settable fuse with transient voltage suppressor (TVS) and reverse polarity protection

#### Inputs

##### Number of Inputs

6 Digital AC or DC voltage inputs

##### Input Protection

2500 V isolation on each input. Each input has a 270 V metal oxide varistor (MOV.)

#### Input Connections

Two-piece, 13-position removable terminal block

##### DI-6-AC

AC Inputs

AC Input Range: 20–132 Vrms

AC Input Current: 5 mA (max.)

AC Voltage “ON” Threshold: 16 Vrms

(Above this voltage is considered “ON”)

AC Voltage “OFF” Threshold: 8 Vrms

(Below this voltage is considered “OFF”)

Input Resistance (±5%): 30KW

Maximum Turn ON Time: 20 ms

Maximum Turn OFF Time: 60 ms

DC Input Voltage Range: 20–132 V

DC Input Current: 5 mA (max.)

DC Voltage “ON” Threshold: 20 V

(Above this voltage is considered “ON”)

DC Voltage “OFF” Threshold: 12 V

(Below this voltage is considered “OFF”)

##### DI-6-AC-HV

AC Inputs:

AC Input Range: 90–250 Vrms

AC Input Current: 2 mA (max.)

AC Voltage “ON” Threshold: 75 Vrms

(Above this voltage is considered “ON”)

AC Voltage “OFF” Threshold: 30 Vrms

(Below this voltage is considered “OFF”)

Input Resistance (±5%): 200KW

Maximum Turn ON Time: 20 ms

Maximum Turn OFF Time: 60 ms

DC Input Voltage Range: 90–250 V

DC Input Current: 2 mA (max.)

DC Voltage “ON” Threshold: 90 V

(Above this voltage is considered “ON”)

DC Voltage “OFF” Threshold: 45 V

(Below this voltage is considered “OFF”)

#### User leads/Switches

##### Status Indicator LEDs

Power Power Indicator

Comm TD Indicator

Status Service/Wink

Indicator

Input Status 1–6 Input Status Indicator

(Above voltage

threshold = ON)

#### Switches

Commission

Reset

#### Models

##### DI-6-AC

6 Digital AC Inputs, 24–120 V input signal

##### DI-6-AC-HV

6 Digital AC Inputs, 120–240 V input signal

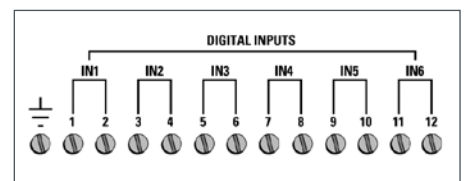

# MI-6

## I/O Module

The MI-6, Andover Continuum's milliamp input module, allows for a direct connection of a 2-wire 0–20mA or 4–20mA sensor to any of the module's six inputs. The need for an external resistor and an external power supply is eliminated. The MI-6 module is a perfect match for temperature

transmitters, humidity and pressure transducers, gas monitors, and other industry-standard sensors with either a 0–20mA or 4–20mA output. The six inputs on the MI-6 module have a 0-20mA range and 10 bit A/D conversion.

### Specifications



#### Electrical

##### Power Consumption

3.8 W @ 24 VDC max.  
(Including up to 20mA sensor power for each input)

##### Overload Protection

0.5 A resettable fuse with transient voltage suppressor (TVS) and reverse polarity protection

#### Inputs

##### Number of Inputs

6 Milliamp inputs

##### Input Range

0–20 mA

##### Resolution

20  $\mu$ A

##### Accuracy

$\pm$ 80  $\mu$ A (max.)

##### Drift

$\pm$ 50ppm/DegC (max.)

##### Input Resistance

249W, 0.1%

##### Maximum Input Current

$\pm$ 30 mA

##### Voltage Supply to Sensors

19–26 VDC

##### Input Protection

Each input: A transient voltage suppressor (TVS) and a resettable fuse.

Sensor voltage output: TVS and resettable fuse

##### Input Connections

Two-piece, 13-position removable terminal block

#### User Leads/Switches

##### Status Indicator LEDs

- Power    Power Indicator
- Comm    TD Indicator
- Status    Service/Wink Indicator

##### Switches

- Commission
- Reset

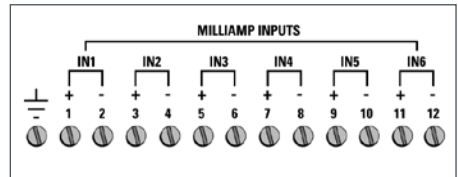



# AO-4-8

## I/O Module

The DI-8, Andover Continuum’s digital input module, is used for cost-effective sensing of multiple dry digital inputs in applications such as equipment status monitoring or alarm point monitoring. The DI-8 has eight digital inputs—each can be software configured to accept a digital (contact closure or 0–5 volt input) or counter signal. Counter frequency is 10 Hz on all eight inputs. In addition, high speed counting up to 10KHz max. is available (via a DIP switch) on Channel The AO-4-8, Andover Continuum’s analog output module, has four analog outputs with eight-bit resolution, which can be

configured as either voltage (0–10 VDC) or current (0–20 mA) outputs. The AO-4-8 is the perfect choice for valves, dampers, variable speed drives, and similar equipment that demand high control accuracy.

An AO-4-8-O model with full override capabilities is also available. Each output contains a three-position manual override switch and override potentiometer. In addition, the AO-4-8-O provides software override feedback to the Andover Plain English programming language for each output.

### Specifications



#### Electrical

##### Power Consumption

3.8 W @ 24 VDC max.

##### Overload Protection

0.5 A resettable fuse with transient voltage suppressor (TVS) and reverse polarity protection

#### Outputs

##### AO-4-8

4 Analog outputs; 8 bit resolution

##### AO-4-8-O

4 Analog outputs with overrides; 8 bit resolution

#### Output Protection

1/8 pico fuse per channel (40V TVS on each output—AO-4-8-O model only)

#### Output Connections

Two-piece, 13-position removable terminal block

#### Output Types

Voltage or current

#### Voltage

Range: 0–10 VDC  
Resolution: 0.05 V  
Accuracy: ±0.10V (1%FSR)  
Output Current: +5 mA (sourcing) -1 mA (sinking)  
Load Resistance: 2KW .(sourcing, min.)

#### Current

Range: 0–20 mA  
Resolution: 0.1 mA  
Accuracy: ±0.2 mA  
Load Resistance: 650W (max.)

#### Output Overrides

3-position manual override switch and override potentiometer on each output, with software feedback. LED override status indicator. (AO-4-8-O only)

#### User Leads/Switches

##### Status Indicator LEDs

- Power            Power Indicator
- Comm            TD Indicator
- Override        Common Override Indicator
- Status           Service/Wink Indicator

##### Switches

- Commission
- Reset

#### Models

##### AO-4-8

4 Analog outputs

##### AO-4-8-O

4 Analog outputs with overrides

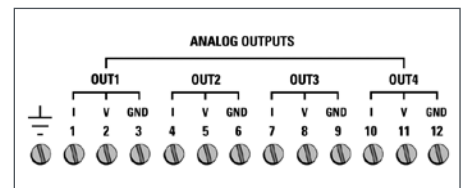

# DO-6-TR

## I/O Module

The DO-6-TR, Andover Continuum's triac output module, has six Form A triac-based outputs, rated at 0.5 A @ 24 VAC, for cost-effective on/off or pulse-width modulation (PWM) control of lighting, heat, and fan units. The PWM feature permits the modulation of valves and dampers to 0.1 second resolution. Adjacent outputs can also be configured in pairs to

provide up to three Form K, Tri-state outputs for bi-directional control of dampers and valves.

Metal oxide varistors and optocouplers on the DO-6-TR provide 2500V isolation on each output, ensure noise-free operation, and, in most cases, eliminate the need to install MOVs in the field.

### Specifications



#### Electrical

##### Power Consumption

1.1 W @ 24 VDC max.

##### Overload Protection

0.5 A resettable fuse with transient voltage suppressor (TVS) and reverse polarity protection

#### Outputs

##### Output Type

6 Form A optically isolated triac outputs (can be configured up to 3 Form K Tri-State outputs)

##### Output Rating

0.5 A @ 24 VAC  
(Cannot switch DC loads)

##### Output Accuracy

0.1 sec. for Pulse Width Modulation (PWM) control

##### Output Protection

2,500 V optical isolation  
Metal oxide varistor and snubber on each output

##### Output Connections

Two-piece, 13-position removable terminal block

#### User LEDs/Switches

##### Status Indicator LEDs

Power	Power Indicator
Comm	TD Indicator
Status	Service/Wink Indicator
Out1-Out6	Six Output Status Indicators

##### Switches

Commission  
Reset

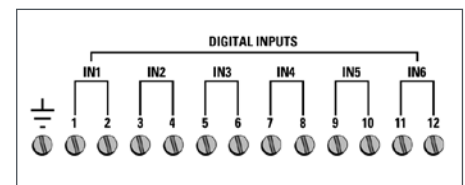

# DO-4-R

## I/O Module

The DO-4-R, Andover Continuum's digital output module, has four Form C relay outputs, rated at 5 A @ 240 VAC. These versatile outputs make the DO-4-R an excellent choice for switching motor starters and other inductive loads up to 240 VAC, with either two position (on/off) or pulse-width modulation (PWM) control. The PWM feature permits the modulation of valves and dampers to 0.1 second resolution. Two adjacent Form C relay outputs can be combined in software to provide a Tri-state output, for bi-directional control of valves and dampers and other end devices. Metal oxide

varistors and 5,000 V isolation on each output ensures reliable noise-free operation.

A DO-4-R-O model with full override capability is also available. Each output has a local hand-off-auto switch, which enables service personnel to override the output. The switch also provides override feedback of the output value for use in troubleshooting or test conditions. A local indicator light for each output displays relay status. Another LED provides override status.

## Specifications



### Electrical

#### Power Consumption

2.8 W @ 10--28 VDC max.

#### Overload Protection

0.5 A resettable fuse with transient voltage suppressor (TVS) and reverse polarity protection

### Outputs

#### DO-4-R

4 Form C relay outputs

#### DO-4-R-O

4 Form C relay outputs with overrides

#### Output Rating

5 A @ 240 VAC; 5 A @ 30 VDC

#### Output Resolution

0.1 sec. For Pulse Width Modulation (PWM) control

#### Output Protection

270 V varistors across contacts.  
5000 Vrms isolation @ 60 Hz between relay contacts and relay coil

#### Output Overrides

3-position manual override switch on each output, with software feedback.

LED override status indicator (DO-4-R-O only)

#### Override Feedback

Override detection and feedback provided for each output

#### Output Connections

Two-piece, 13-position removable terminal block

### User LEDs/Switches

#### Status Indicator LEDs

Power	Power Indicator
Comm	TD Indicator
Override	Common Override Indicator
Status	Service/Wink Indicator
Out1-Out4	Four Output Status Indicators

#### Switches

Commission  
Reset

### Models

#### DO-4-R

4 Form C relay outputs

#### DO-4-R-O

4 Form C relay outputs with overrides

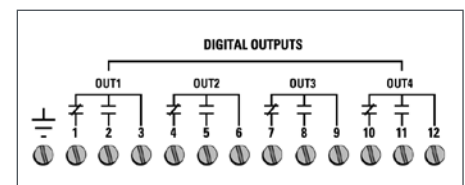

# DM-20

## I/O Module

The DM-20, Andover Continuum's Digital Input and Output module, provides high density, versatile I/O for many control applications. The DM-20 can control any combination of 20 inputs and outputs.

When coupled with the optional DIO-20 Expansion Board, the DM-20 allows you to mix and match up to 20\* digital inputs and outputs using standard off-the-shelf digital I/O blocks to meet a wide range of applications, including ON-OFF or pulse-width

modulation (PWM) control of equipment and for switching inductive loads up to 240VAC. The DM-20 provides 24 VDC power to the DIO-20 via a three-position cable assembly.

\* Actual number of modules depends on the mix of inputs/outputs used. See Andover Continuum I/O System Reference Manual (Rev D or higher) for more information.

## Specifications



### Electrical

#### Power Consumption

0.5 W @ 24VDC max.

Up to 9 W @ 24 VDC when the DIO-20 is powered from the DM-20

#### External Power Connector

Three-position removable connector

#### Overload Protection

0.5 A resettable fuse with transient voltage suppressor (TVS) and reverse polarity protection for both DM-20 power and DIO-20 power

#### LED Power Supply

Customer-provided external 5 V power supply when using the DM-20 to drive LEDs

### Inputs/Outputs

20 total points; user-selectable channel-by-channel as inputs or outputs

#### w/o DIO-20

Input Type: Digital 0–5 VDC

Pulse Width: 125 ms ( min.)

(Digital pulse widths are based on Scan Time.)

Current: 10 $\mu$ A

Output Type: Digital

Open-collector transistor with series 330 ohm 1/8 W resistor; 15 mA (max.) @ 5 V DC

#### w/DIO-20

Input Type: 24 VDC logic voltage

(DIO-20). Input rating depends on input module(s) selected

Pulse Width: 125 ms ( min.)

(Digital pulse widths are based on Scan Time.)

Current: N/A

Output Type: 5 VDC logic voltage.

Output range depends on output module selected

Output Resolution: 0.1 sec. For Pulse Width Modulation (PWM) control

Output Protection: Transient voltage suppressor (TVS) and current limiting resistor on each channel

Input/Output

Connections: One female 25-pin D-subminiature connector

### User LEDs/Switches

#### Status Indicator LEDs

Power Power Indicator

Comm TD Indicator

Status Service/Wink Indicator

#### Switches

Commission

Reset

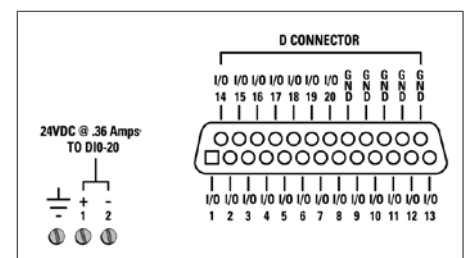

# AC-1 Family

## Family of Access Control Modules



TAC<sup>®</sup> offers three access control modules to meet the demands of different access requirements:

### AC-1:

Use the AC-1 when powering modules from a Andover Continuum power supply. (AC-1 has a 24VDC power input only.) The AC-1 supports Wiegand/Prox cards and 5 V/12 V reader power (switch-selectable).

### AC-1A:

Use the AC-1A if you are powering modules from a local 12VDC power supply. The AC-1A offers an extended 10-28VDC power input. (Power supply can also power any 12 V prox readers you may be using.) The AC-1A supports Wiegand/Prox cards, and 5 V reader power only.

### AC-1PLUS:

The enhanced version. Use the AC-1Plus when using mag stripe or Cardkey readers, ADA sequences that require extra inputs, special door unlock/door ajar times for disabled persons, and jobs that require reader tamper detection. The AC-1Plus offers an extended 10-28VDC power input (power supply can also power 12 V prox readers), and supports 5 V reader power only.

# AC-1

## I/O Module

The AC-1 provides full I/O for an access controlled door or portal in one compact module. The AC-1 can be located near an access controlled door for localized control and reduced wiring costs; or several AC-1 modules can be grouped together and DIN rail-mounted for centralized control.

The AC-1 provides a Wiegand card input for Wiegand swipe and proximity type cards, reading up to 64 bits per card. Reader power is switch-selectable between 5V and 12V to meet most card reader power requirements.

The AC-1 has two 5 A, Form C relays—one for the door lock and a second for local alarm annunciation. Each output has an integral hand-off-auto switch for manual operation, and software feedback of the switch position.

Up to three supervised alarm inputs can be used for door status contacts, request-to-exit devices, a cabinet tamper switch, or any other two-state or three-state (on/off/trouble) alarm device.

### Keypad Control

The AC-1 supports Wiegand output keypads. To simplify installation and reduce wiring costs, the keypad data comes into the module via the reader data lines.

### Access Control

During normal operation of the AC-1, access decisions are made in the Andover Continuum NetController CPU, which provides storage for up to 75,000 “local” personnel records. In addition, the NetController’s event buffer is software-configurable to allow for the most optimized memory usage. If network communications are interrupted, the AC-1 will revert to a programmable degrade mode of operation, providing uninterrupted card access using site codes and other degrade mode parameters stored in non-volatile EEPROM in each AC-1 module.

A door can be configured to operate based on site code only, site code plus card, card plus personal ID number (PIN), or keypad only. The door’s operating mode can even be changed based on time-of-day or other events for optimum flexibility through TAC’s easy-to-use Andover Plain English programming language. Each keypad can also permit entry of a duress alarm code that can initiate an alarm sequence at any AC-1 controller or at the Andover Continuum workstation.

Time-based anti-passback and entry/egress anti-passback are available to prevent tailgating. Entry/egress anti-passback is system-wide and can be performed by readers located on different AC-1 controllers across the network.

Using Andover Plain English, the AC-1 can also be used for custom access control sequences such as two-man rule, optical turnstile control, and man trap configurations.

# AC-1 Specifications

## AC-1



### Electrical

#### Power Consumption

2.6 W plus reader power consumption at 24VDC max.

#### Overload Protection

0.5 A resettable fuse with transient voltage suppressor (TVS) and reverse polarity protection

### Inputs

#### Card Readers

1

#### Card Reader Type

Supports Wiegand swipe and proximity readers

#### Maximum Number of bits/Card

64

#### Card Reader Power

5 VDC or 12 VDC (switch selectable)

Switch Setting: +5 V

Output Voltage: +5.20 V  $\pm$ 0.05 V

Output Current: 120 mA (max.)

Switch Setting: +12 V

Output Voltage: +12.0 V  $\pm$ 5%

Output Current: 180 mA (max.)

#### Distance, Card Reader to AC-1

500 ft. max. using 18-ga. wire

200 ft. max. using 22-ga. wire

#### Alarm Inputs

Up to 3 supervised inputs. Single or double resistor supervision, series or parallel

#### Input Protection

Transient voltage suppressor (TVS) on each input

### Outputs

#### Door Outputs

2 Form C relays

#### Output Rating

5 A @ 24 V AC/DC

#### Output Protection

5,000 V isolation

270 V metal oxide varistors (MOVs)

on each output

#### Overrides

3-position manual override switch on each output for manual control of relay.

LED override status indicator

#### Override Feedback

Override detection and software feedback provided for each output

#### Reader LED Output

Open collector; up to 50 mA

#### Inputs/Output Connections

Two-piece, 16-position removable terminal block

### User LEDs/Switches

#### Status Indicator LEDs

Power	Power Indicator
Comm	TD Indicator
Override	Common Override Indicator
Status	Service/Wink Indicator
Out1 - Out2	Two Output Status Indicators
+5 V Reader Power	5 V Reader Power Indicator
+12 V Reader Power	12 V Reader Power Indicator

#### Switches

Commission

Reset

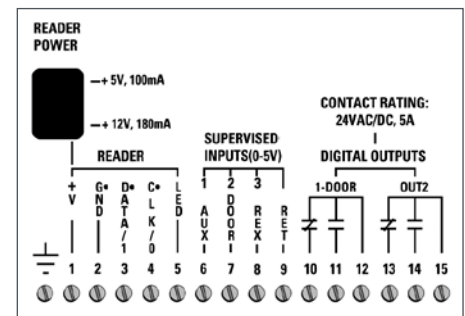

# AC-1A

## I/O Module

The AC-1Plus, Andover Continuum's full-feature access control module, provides full I/O for an access controlled door or portal in one compact module. The AC-1Plus supports multiple card formats, ADA (Alternate Door Access) doors, and multiple reader LED patterns. In addition, built-in reader supervision is provided—one LED will periodically check for voltage, absence of voltage, or shorts, and expose any of these conditions to the user for security purposes. The AC-1Plus can be located near an access controlled door for localized control and reduced wiring costs; or several AC-1Plus modules can be grouped together and DIN rail-mounted for centralized control.

The AC-1Plus provides a Wiegand card input for Wiegand swipe and proximity type cards, reading up to 64 bits per card. The AC-1Plus also supports CardKey cards, reading up to 34 bits per card, and ABA card readers. Card reader power is 50 mA at 5V .

The AC-1Plus has two 5 A, Form C relays — one for the door lock and an auxiliary output for local alarm annunciation, for example. Each output has an integral hand-off-auto switch and software feedback of the switch position.

The AC-1Plus provides five supervised input channels, configurable as an exit request, door switch sensor, ADA exit request, bond sensor, or as a general purpose supervised input point.

### Keypad Control

The AC-1Plus supports Wiegand or ABA output keypads. To simplify installation and reduce wiring costs, a combination Wiegand (or ABA) output reader/keypad may be used. In this case, the keypad data comes into the module via the reader data lines. In addition, the AC-1Plus allows separate wiring of both a Wiegand (or ABA) output keypad and reader.

### Access Control

During normal operation of the AC-1A, access decisions are made in the Andover Continuum NetController CPU , which provides storage for up to 75,000 "local" personnel records. In addition, the NetController's event buffer is software-configurable to allow for the most optimized memory usage. If network communications are interrupted, the AC-1A will revert to a programmable degrade mode of operation, providing uninterrupted card access using site codes and other degrade mode parameters stored in non-volatile EEPROM in each AC-1A module.

A door can be configured to operate based on site code only, site code plus card, card plus personal ID number (PIN), or keypad only. The door's operating mode can even be changed based on time-of-day or other events for optimum flexibility through TAC's easy-to-use Andover Plain English™ programming language. Each keypad can also permit entry of a duress alarm code that can initiate an alarm sequence at any AC-1A controller or at the Andover Continuum workstation.

Time-based anti-passback and entry/egress anti-passback are available to prevent tailgating. Entry/egress anti-passback is system-wide and can be performed by readers located on different AC-1A controllers across the network.

Using Andover Plain English, the AC-1A can also be used for custom access control sequences such as two-man rule, optical turnstile control, and man trap configurations.



# AC-1A I/O Module Specifications

## AC-1A



### Electrical

#### Power Consumption

2.0 W at 10-28VDC plus reader power consumption

#### Overload Protection

0.5 A resettable fuse with transient voltage suppressor (TVS) and reverse polarity protection

### Inputs

#### Card Readers

1

#### Card Reader Type

Supports Wiegand swipe and proximity readers

#### Maximum Number of bits/Card

64

#### Card Reader Power

5 VDC,  $\pm 3\%$ , 50 mA, Current Limited

#### Distance, Card Reader to AC-1A

500 ft. max. using 18-ga. wire

200 ft. max. using 22-ga. wire

### Alarm Inputs

Up to 3 supervised inputs. Single or double resistor supervision, series or parallel

### Input Protection

Transient voltage suppressor (TVS) on each input

### Outputs

#### Door Outputs

2 Form C relays

#### Output Rating

5 A @ 24 V AC/DC

#### Output Protection

5,000 V isolation

270 V metal oxide varistors

(MOVs) on each output

#### Overrides

3-position manual override switch on each output for manual control of relay. LED override status indicator

#### Override Feedback

Override detection and software feedback provided for each output.

#### Reader LED Output

Open collector; up to 100 mA

#### Inputs/Output Connections

Two-piece, 18-position removable terminal block

### User LEDs/Switches

#### Status Indicator LEDs

Power	Power Indicator
Comm	TD Indicator
Override	Common Override Indicator
Status	Service/Wink Indicator
Out1 - Out2	Two Output Status Indicators
+5 V Reader Power	5 V Reader Power Indicator

#### Switches

Commission

Reset

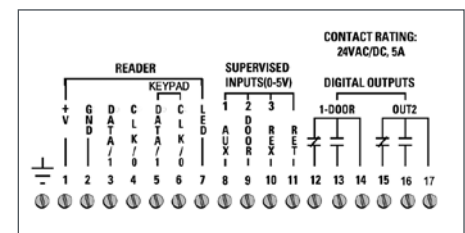

# AC-1Plus

## I/O Module

The AC-1Plus, Andover Continuum's full-feature access control module, provides full I/O for an access controlled door or portal in one compact module. The AC-1Plus supports multiple card formats, ADA (Alternate Door Access) doors, and multiple reader LED patterns. In addition, built-in reader supervision is provided—one LED will periodically check for voltage, absence of voltage, or shorts, and expose any of these conditions to the user for security purposes. The AC-1Plus can be located near an access controlled door for localized control and reduced wiring costs; or several AC-1Plus modules can be grouped together and DIN rail-mounted for centralized control.

The AC-1Plus provides a Wiegand card input for Wiegand swipe and proximity type cards, reading up to 64 bits per card. The AC-1Plus also supports CardKey cards, reading up to 34 bits per card, and ABA card readers. Card reader power is 50 mA at 5V.

The AC-1Plus has two 5 A, Form C relays — one for the door lock and an auxiliary output for local alarm annunciation, for example. Each output has an integral hand-off-auto switch and software feedback of the switch position.

The AC-1Plus provides five supervised input channels, configurable as an exit request, door switch sensor, ADA exit request, bond sensor, or as a general purpose supervised input point.

### Keypad Control

The AC-1Plus supports Wiegand or ABA output keypads. To simplify installation and reduce wiring costs, a combination Wiegand (or ABA) output reader/keypad may be used. In this case, the keypad data comes into the module via the reader data lines. In addition, the AC-1Plus allows separate wiring of both a Wiegand (or ABA) output keypad and reader.

### Access Control

During normal operation of the AC-1Plus, access decisions are made in the Andover Continuum NetController CPU, which provides storage for up to 75,000 "local" personnel records. In addition, the NetController's event buffer is software-configurable to allow for the most optimized memory usage. If network communications are interrupted, the AC-1Plus will revert to a programmable degrade mode of operation, providing uninterrupted card access using site codes, card formats, and other degrade mode parameters stored in non-volatile EEPROM such as multiple card types (including custom format) and four site codes per each card type. ADA doors are also supported in degrade mode.

A door can be configured to operate based on site code only, site code plus card, card only, card plus personal ID number (PIN), or keypad only. The door's operating mode can even be changed based on time-of-day or other events for optimum flexibility through TAC's easy-to-use Andover Plain English programming language. Each keypad can also permit entry of a duress alarm code that can initiate an alarm sequence at any AC-1Plus controller or at the Andover Continuum workstation.

Time-based anti-passback and entry/egress anti-passback are available to prevent tailgating. Entry/egress anti-passback is system-wide and can be performed by readers located on different AC-1Plus controllers across the network.

Using Andover Plain English, the AC-1Plus can also be used for custom access control sequences such as two-man rule, optical turnstile control, and man trap configurations.

# AC-1Plus I/O Module Specifications

## AC-1Plus



### Electrical

#### Power Consumption

2.2 W at 10-28VDC plus reader power consumption

#### Overload Protection

0.5 A resettable fuse with transient voltage suppressor (TVS) and reverse polarity protection

### Inputs

#### Card Readers

1

#### Card Reader Type

Supports Wiegand, Proximity, CardKey, and ABA readers

#### Maximum Number of bits/Card

64 for Wiegand and Proximity;  
34 for CardKey

#### Card Reader Power

5 VDC,  $\pm 3\%$ , 50 mA, Current Limited

#### Distance, Card Reader to AC-1Plus

500 ft. max. using 18-ga. wire

200 ft. max. using 22-ga. wire

#### Alarm Inputs

5 supervised inputs. Single or double resistor supervision, series or parallel

#### Input Protection

Transient voltage suppressor (TVS) on each input

### Outputs

#### Door Outputs

2 Form C relays

#### Output Rating

5 A @ 24 V AC/DC

#### Output Protection

5,000 V isolation  
270 V metal oxide varistors (MOVs) on each output

#### Overrides

3-position manual override switch on each output. LED override status indicator

#### Override Feedback

Override detection and software feedback provided for each output

#### Reader LED Outputs

2 open collector; up to 100 mA.

Choice of 3 LED patterns

#### Inputs/Output Connections

Removable terminal blocks:

(2) 8-position; (1) 6-position

### User LEDs/Switches

#### Status Indicator LEDs

Power	Power Indicator
Comm	TD Indicator
Override	Common Override Indicator
Status	Service/Wink Indicator
Out1 - Out2	Two Output Status Indicators
+5 V Reader Power	5 V Reader Power Indicator

#### Switches:

Commission

Reset

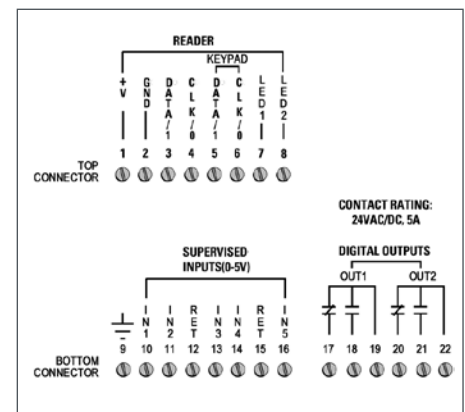

# LO-2

## I/O Module

The LO-2, Andover Continuum's lighting control module, can control 2 high voltage lighting circuits, using externally mounted GE RR7 or RR9 lighting relays, rated for 20 A @ 277 VAC (347 VAC option for Canada). These relays are connected to the LO-2 via two three foot, 5-conductor wires provided. The RR9 relay provides status feedback of the relay position, using a built-in pilot contact. The RR7 relay provides control of the circuit with no feedback. An on-board status LED for each output is provided when RR9 relays are used, as well as pilot light voltage for wall switches that have status indication. External 28 VAC is required to power the GE relays. This same transformer can power the LO-2 when the module is located remotely.

An LO-2-O model, with on-board momentary override toggle switches, is also available.

### External Override Capabilities

Two Class II low voltage manual override inputs, one for each relay output, are provided for override capabilities. These inputs directly control the lighting relays, independent of any schedule or program. Wall switches, occupancy sensors, or a combination of both may be wired to these inputs.

### Lighting Control

The LO-2 can be coupled with Andover Continuum's programmable input modules to provide flexible lighting control strategies such as:

- Outdoor Lighting Control with a Photocell
- Daylight Control
- After-Hours Lighting Usage with Card Swipe Readers
- Adjustable Override Time with Flick Warning
- Cleaning Crew Override
- Data Logging and Reporting
- Run time Analysis, including Accumulated On-Time and Percentage On-Time
- Tenant Billing Reports
- Custom Control Strategies

These programs can be easily modified to fit the exact needs of your project.

# LO-2 I/O Module Specifications

## LO-2



### Electrical

#### Power Consumption

0.4 W @ 24 VDC max. Consumes no DC power when external AC power is present

#### External AC Power

28 VAC powers both module and lighting relays; can also power the LO-2 module when mounted remotely

#### External Transformer

40 VA transformer provides power for up to 5 LO-2 modules (10 GE relays and associated devices)

#### Overload Protection

DC: 0.5 A resettable fuse with transient voltage suppressor (TVS) and reverse polarity protection. AC: 0.5 A resettable fuse with MOV

### Inputs/Outputs

#### Inputs

2 Class II Low Voltage override inputs, providing direct control of lighting relays

#### Input Protection

Transient voltage suppressors (TVS) with reverse polarity protection

#### Outputs

##### Output Type

2 pulsed lighting control outputs compatible with externally mounted GE RR7 or RR9 relays

##### Output Rating (Lighting Relay)

Lamp Load – 20 A Tungsten Filament @125 VAC  
Resistive Load – 20 A ballast @ 277 VAC (@347 VAC, Canada)  
Motor Load – 0.5 HP @ 110-125 VAC  
0.5 HP @ 220-277 VAC  
(0.5 HP @ 347 VAC, Canada)

##### Pilot Contact Rating (RR9 only)

1 A @ 24 VAC, isolated

##### Output Feedback

RR9 relays have LED status indication and software feedback for relay status

##### Output Protection

Transient voltage suppressors (TVS) on outputs. GE relays provide isolation

##### Overrides

Momentary override toggle switches (LO-2-O model only)

##### AC Power/External Override

##### Input Connections

Two-piece, 12-position removable terminal block

### Lighting Relay Connections

5-position male connector accepts standard GE female plug-in connector.

(Two 3-foot, 5-conductor wires with female connectors provided. Wires color-coded to match GE relays.)

### User LEDs/Switches

#### Status Indicator LEDs

Power	Power Indicator
Comm	TD Indicator
Status	Service/Wink Indicator
Out1-Out2	Two Output Status Indicators (RR-9 only)
24 VAC	External 24-30 VAC Indicator

#### Switches

Commission  
Reset

### Models

#### LO-2

2 pulsed lighting control outputs

#### LO-2-O

2 pulsed lighting control outputs with overrides

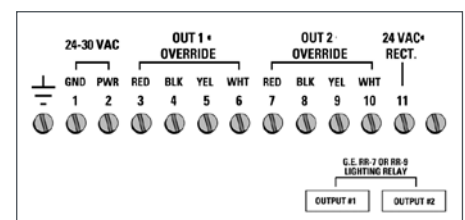

# VS-8-4

## I/O Module

The VS-8-4, Andover Continuum’s video switch module, integrates low-cost, high quality video security directly into your Andover Continuum system. The VS-8-4 switches eight video signal inputs and four high-speed, buffered outputs. Any one of the eight input lines can be connected to any of the four outputs. Each output has a voltage gain of two and is capable of driving 75W back-terminated lines. Up to eight surveillance cameras

and four video monitors or VCRs can be connected to a single VS-8-4 module.

The VS-8-4 can be ordered with optional date/time and caption display. Captions are selectable, allowing different displays based on events or alarms.

Both models can be ordered to support either the PAL or NTSC standard.

### Specifications

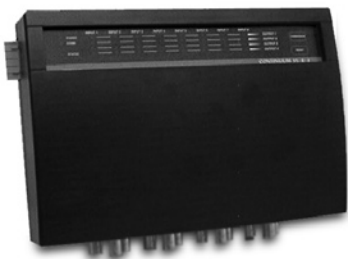

#### Electrical

##### Power Consumption

2 W @ 10-28VDC max.

##### Overload Protection

0.5 A resettable fuse with transient voltage suppressor (TVS) and reverse polarity protection

#### Inputs/Outputs

##### Inputs

8 Video inputs

##### Input Impedance

75W

##### Bandwidth (-3dB)

>75MHz (R<sub>load</sub>=150W)

##### Single Channel Crosstalk

>-60dB@10MHz

##### All Channel Crosstalk

>-55dB@10MHz

##### All Channel Off Isolation

>-55dB@10MHz

##### Outputs

4 Video outputs

##### Output Impedance

75W

##### Signal

1 V peak-peak when terminated into 75W

##### Input/Output Connections

75W BNC connectors

##### Input/Output Protection

ESD protection provided

#### User LEDs/Switches

##### Status Indicator LEDs

Power	Power Indicator
Comm	TD Indicator
Status	Service/Wink Indicator
Input Status 1-8	Input Status Indicator (4 LEDs per input)

##### Switches

- Commission
- Reset

#### Models

##### VS-8-4

8 Video inputs; 4 Video outputs, NTSC or PAL video inputs

##### VS-8-4-TN

8 Video inputs; 4 Video outputs with date/time- and text-stamping for NTSC video inputs

##### VS-8-4-TP

8 Video inputs; 4 Video outputs with date/time- and text-stamping for PAL video inputs

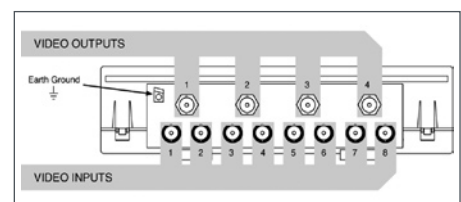

# VT-1

## I/O Module

The Andover Continuum VT-1 Interactive Voice Response (IVR) module provides users with easy-to-use remote data entry capabilities for their Andover Continuum system using the familiar touch-tone keypad on any North American standard or cellular telephone. The VT-1 also allows spoken messages to be pre-recorded to inform the user of current system conditions and/or to prompt the user for additional input.

The VT-1 can be used, for example, to change building setpoints or schedules; arm or disarm

alarms; unlock doors; request status or determine operating conditions of equipment; and to report alarm or event conditions or history.

The VT-1 provides 10 built-in prompt messages and 50 pre-recorded vocabulary words, which can be used individually or combined to form phrases and sentences. In addition, up to 50 custom messages (up to 3.5 minutes total) can be pre-recorded, played, and erased in the VT-1's Message Management Mode—all over the telephone!

### Specifications



#### Electrical

##### Power Consumption

1.5 W @ 24 VDC max.

##### Overload Protection

0.5 A resettable fuse with transient voltage suppressor (TVS) and reverse polarity protection

#### Inputs/Outputs

##### Phone Line Connections

1 RJ-11 connector with SIDAC and resettable telecom fuses

#### User LEDs/Switches

##### Status LEDs

- Power
- Communications
- Service/Wink indicator
- Record mode
- Play mode
- Erase mode
- Ring
- Off-hook

##### Switches

- Commission
- Reset

**Note: VT-1 approved for use in North American phone systems only.**

All brand names, trademarks and registered trademarks are the property of their respective owners. Information contained within this document is subject to change without notice.

On October 1st, 2009, TAC became the Buildings Business of its parent company Schneider Electric. This document reflects the visual identity of Schneider Electric, however there remains references to TAC as a corporate brand in the body copy. As each document is updated, the body copy will be changed to reflect appropriate corporate brand changes.