

Cam selector / Commutateur à cames / Nockenschalter / Conmutador de levos / Commutatore a camme / Comutador de

Installation / Mise en œuvre / Einstellung / Instalación / Messa in opera / Instalação

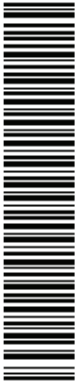

Tightening torque
Couple de serrage
Anzugsdrehmoment
Par de apriete
Coppia di serraggio
Binário de aperto
K10 : 5 lb-in. 0,6 Nm

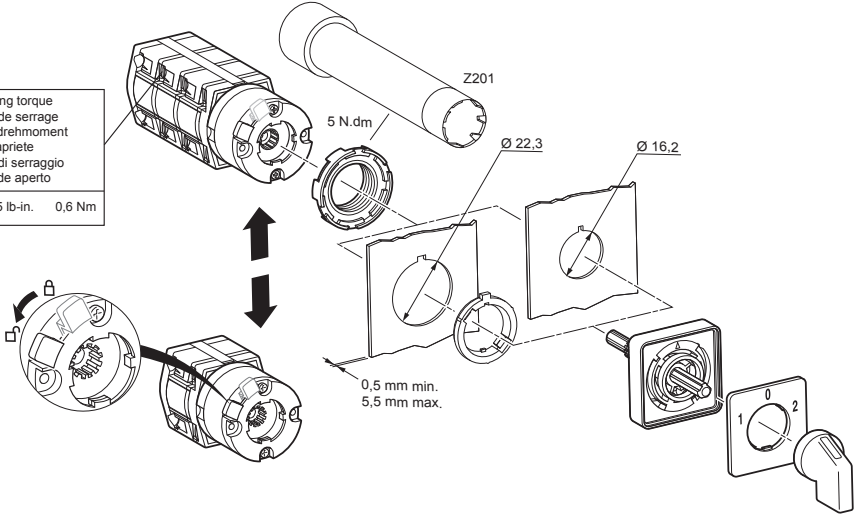

Single hole mounting / Percage fixation / Einlochbefestigung / Montaje en perforación única / Montaggio in singolo / Montagem simples

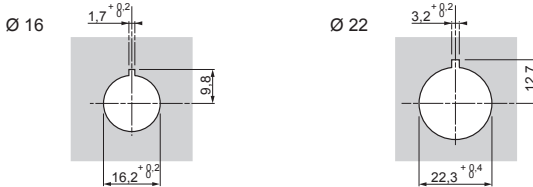

Characteristics / Caractéristiques / Kenndaten / Características / Caratteristiche / Características

Per UL and CSA certifications / Suivant certifications UL et CSA / Gemäß UL- und CSA-Zertifizierungen / Según certificaciones UL y CSA / Secondo le certificazioni UL e CSA / Segundo certificações UL e CSA

K10

Rated Voltage / Tension nominale / Nennspannung / Tensión nominal / Tensione nominale di esercizio / Voltagem nominal	V.A.C.	300
Ampere Rating / Ampérage / Stromstärke / Rango del amperaje / Potenza nominale in ampere / Amperagem	A	10
Standard motor load / Charge normale du moteur / Standard-Motorlast / Carga del motor estándar / Carico forza motrice standard / Carga normal do motor	3 phase - 3 pole / Triphasé - Tripolaire 3 phase - 3-pole / 3 fases - 3 polos trifase - tripolare / 3 fases - 3 polos	110 V - 120 V 220 V - 240 V
DOL-Rating / Capacité DOL / DOL-Wert / Rango DOL / Potenza nominale-DOL / Capacidade DOL	1 phase - 2 pole / Monophasé - Bipolaire 1-phase - 2-pole / 1 fase - 2 polos monofase - bipolare / 1 fase - 2 polos	110 V - 120 V 220 V - 240 V 277 V
Pilot Duty / Service pilote / Hauptsächl. Einsatz / Carga piloto / Lavoro motore pilota / Serviço piloto	Heavy / Intensif / Hochleistung Pesado / Pesante / Intensivo	A300
Type of copper wire / Type de fil en cuivre / Drahttyp aus Kupfer / Tipo de alambre en cobre / Tipo di filo in rame / Tipo de cabo de cobre	Use copper wire only	mm ²
Temperature rating of wire (A: 60 °C for max. 80A, 75 °C for max. 100A - B: 60 °C for max. 125A, 75 °C for max. 150A) / Température limite du fil (A: 60 °C pour 80 A maxi, 75 °C pour 100 A maxi - B: 60 °C pour 125 A maxi, 75 °C pour 150 A maxi) / Drahttemperatur (A: 60 °C bei max. 80 A, 75 °C bei max. 100 A - B: 60 °C bei max. 125 A, 75 °C bei max. 150 A) / Rango de temperatura del alambre (A: 60 °C para máx. 80A, 75 °C para máx. 100A - B: 60 °C para máx. 125A, 75 °C para máx. 150A) / Temperatura massima del filo (A: 60 °C per max. 80 A, 75 °C per max. 100 A - B: 60 °C per max. 125 A, 75 °C per max. 150 A) / Temperatura limite do cabo (A: 60 °C para 80A máx., 75 °C para 100A máx. - B: 60 °C para 125A máx., 75 °C para 150A máx.)	°C	60/75

These devices are suitable for use on circuits capable of delivering not more than 5 kA rms symmetrical amperes, 600V AC max. when protected by Class RK1 fuses / Ces dispositifs sont adaptés aux utilisations sur des circuits susceptibles de délivrer au plus 5 kA alternatifs efficaces, 600V AC maxi., avec protection par fusibles RK1 / Diese Geräte sind zur Verwendung an Stromkreisen mit Nennspannungen bis max. 600V AC geeignet, deren symmetrischer Kurzschlussstrom 5 kA eff nicht übersteigt und für die als Kurzschlusschutz "Type RK1" Sicherungen vorgesehen sind / Estos dispositivos se adaptan a las utilizations sobre circuitos capaces de entregar al máximo 5 kA alternativos eficaces, 600V CA máximo, con protección por fusibles RK1 / Questi dispositivi sono adattati agli utilizzi su circuiti capaci di consegnare tutt'al più 5 kA alternativi efficaci, 600V AC maxi., con protezione per fusibili RK1 / Estes dispositivos são adaptados para utilizações sobre circuitos capazes de emitir aos mais 5 kA alternativos eficazes, 600V AC maxi., com protecção por fusíveis RK1

Cam selector / Commutateur à cames / Nockenschalter / Conmutador de levas / Commutatore a camme / Comutador de cames

Switches / Interrupteurs / Schalter / Interruptores / Interruttori / Interruptores

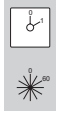
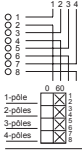

K10-A001ACH
K10-B002ACH
K10-C003ACH
K10-D004ACH

Single-pole stepped selectors with zero position /
 Sélectionneurs à gradins unipolaires avec position zéro /
 Einpolige Stufenwähler mit Nullposition /
 Selectores graduales unipolares con posición cero /
 Selettori a gradini unipolari con posizione zero /
 Selectores de degraus unipolares com posição zero

Two-pole stepped selectors with zero position /
 Sélectionneurs à gradins bipolaires avec position zéro /
 Zweipolige Stufenwähler mit Nullposition /
 Selectores graduales bipolares con posición cero /
 Selettori a gradini bipolari con posizione zero /
 Selectores de degraus bipolares com posição zero

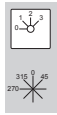
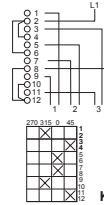
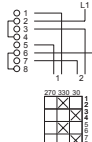
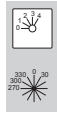
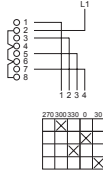
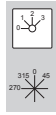
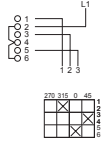
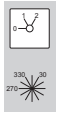
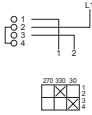

K10-B002QCH

K10-C003QCH

K10-D004QCH

K10-D012QCH

K10-F013QCH

Single-pole stepped selectors without zero position /
 Sélectionneurs à gradins unipolaires sans position zéro /
 Einpolige Stufenwähler ohne Nullposition /
 Selectores graduales unipolares sin posición cero /
 Selettori a gradini unipolari senza posizione zero /
 Selectores de degraus unipolares sem posição zero

Two-pole stepped selectors without zero position /
 Sélectionneurs à gradins bipolaires sans position zéro /
 Zweipolige Stufenwähler ohne Nullposition /
 Selectores graduales bipolares sin posición cero /
 Selettori a gradini bipolari senza posizione zero /
 Selectores de degraus bipolares sem posição zero

Spring-loaded two-way switch /
 Inverseur à rappel /
 Rückstellungsumschalter /
 Comutador de retroceso /
 Invertitore a richiamo /
 Comutador de mola

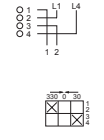
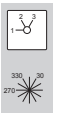
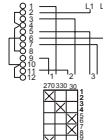
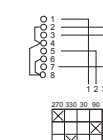
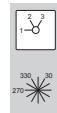
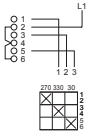

K10-C003NCH

K10-D004NCH

K10-F013NCH

K10-B006TCH

Two-way switches with zero position / Inverseurs avec position zéro /
 Umschalter mit Nullposition / Conmutadores con posición cero /
 Invertitori con posizione zero / Comutadores com posição zero

Two-way switches without zero position / Inverseurs sans position zéro /
 Umschalter ohne Nullposition / Conmutadores sin posición cero /
 Invertitori senza posizione zero / Comutadores sem posição zero

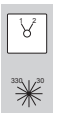
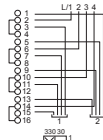
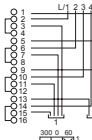

K10-B001UCH
K10-D002UCH
K10-F003UCH
K10-H004UCH

K10-B011UCH
K10-D012UCH
K10-F013UCH
K10-H014UCH

Voltmeter selectors / Sélectionneurs de voltmètre /
 Voltmeterwähler / Selectores de voltmetro /
 Selettori di voltmetro / Selectores de voltímetro

Amperemeter selectors / Sélectionneurs d'ampèremètre /
 Amperemeterwähler / Selectores de amperímetro /
 Selettori di amperometro / Selectores de amperímetro

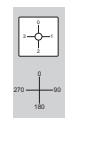
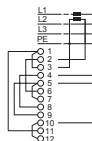
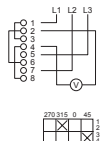
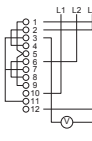

K10-F027MCH

K10-D024MCH

K10-F003MCH