

Mounting / Montage / Montage / Montaje / Montaggio / Montagem

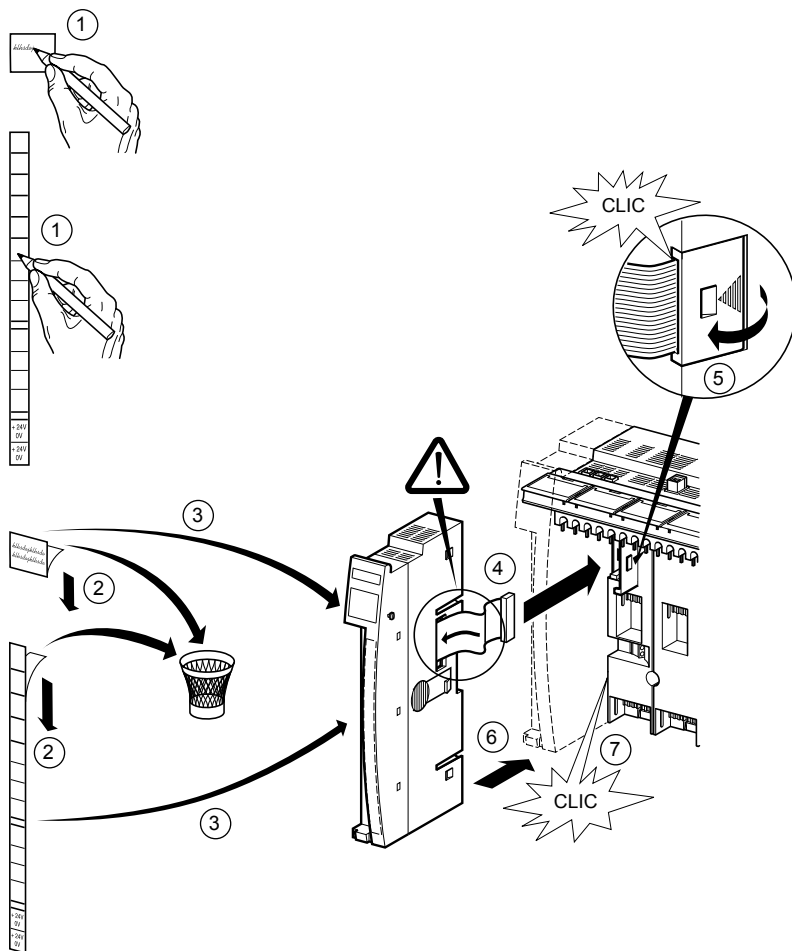

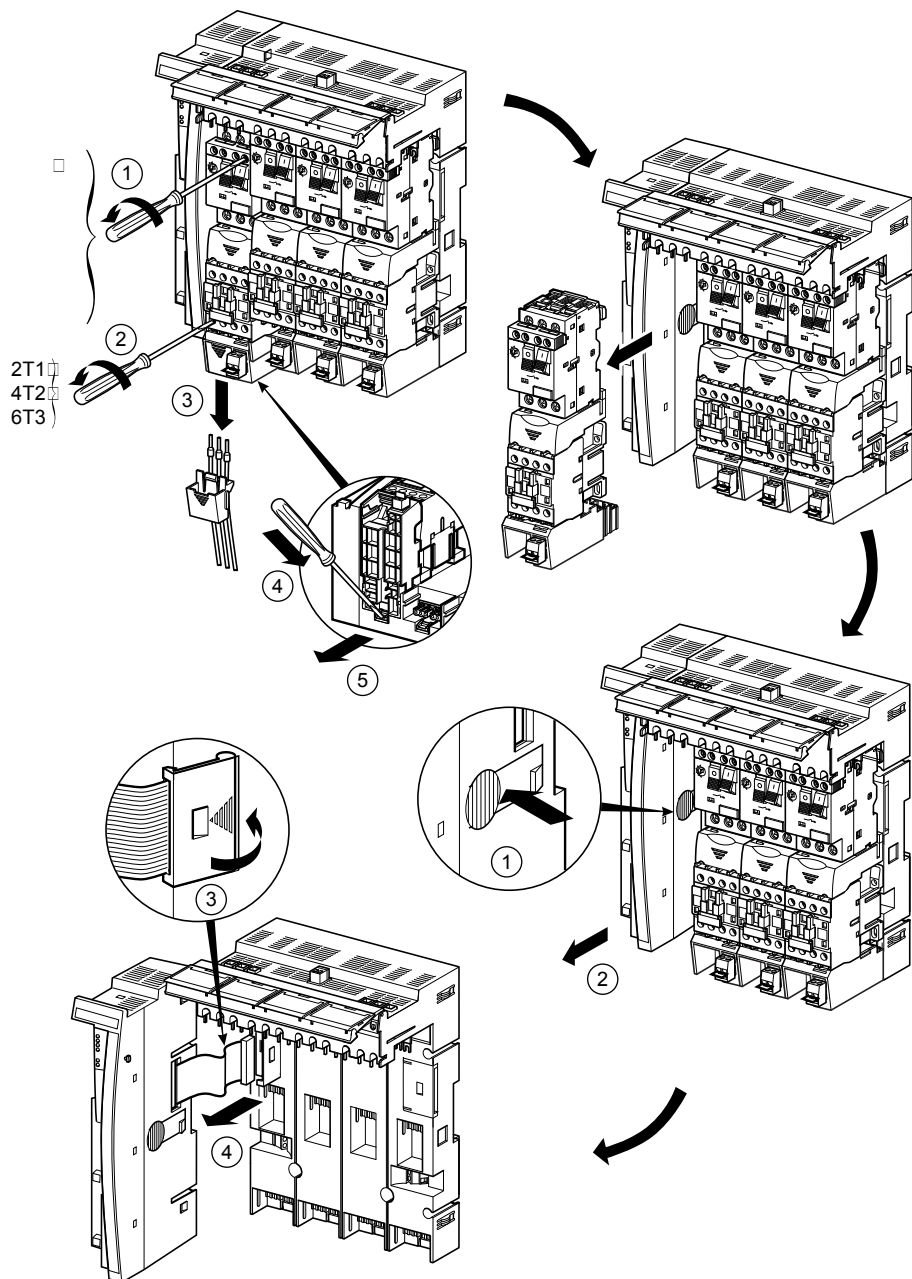



Removal / Démontage / Demontage / Desmontaje / Smontaggio / Desmontagem

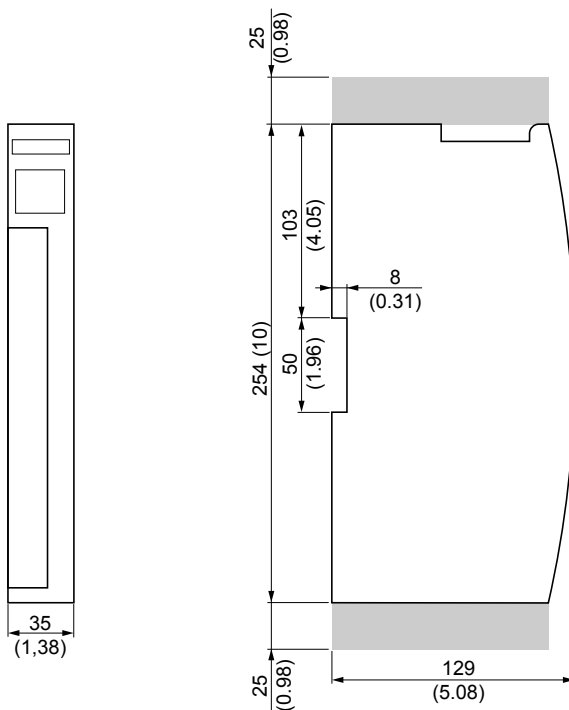

Overall dimensions / Encombrements / Abmessungen / Dimensiones / Ingombri / Dimensões



			
[mm ²]	[mm ²]	[N.m]	[Ø mm]
1,5	2,5	0,8	3
AWG 16	AWG 14	In.bl 7.1	

Display of presence of voltage on inputs / outputs
 Visualisation présence tension sur entrées / sorties
 Spannungskontrollanzeige an den Ein- und Ausgängen
 Visualización de presencia de tensión en entradas / salidas
 Visualizzazione presenza tensione su entrate / uscite
 Visualização presença de tensão nas entradas / saídas

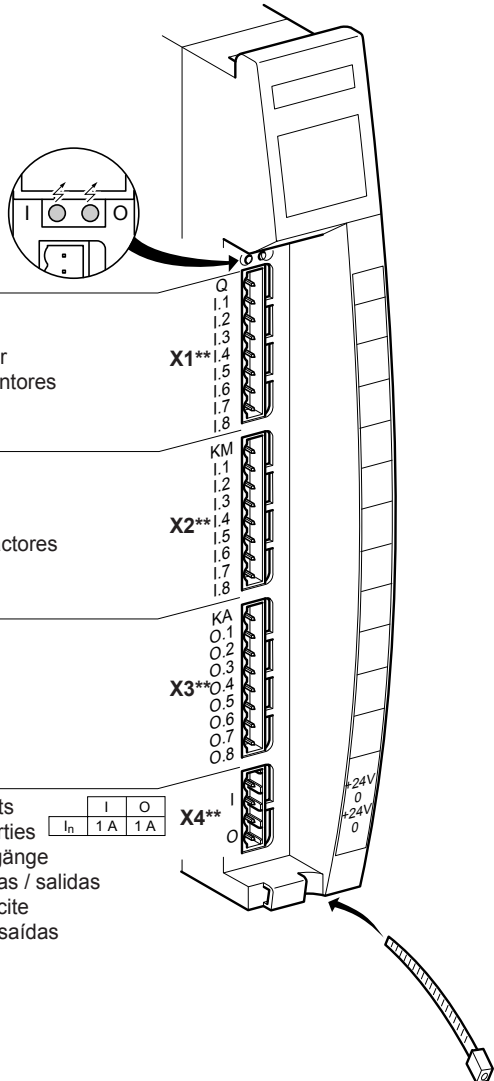

X1 Circuit-breaker status information
 Information d'état des disjoncteurs
 Zustandsinformation der Überlastschalter
 Información sobre el estado de los disyuntores
 Informazione di stato dei disgiuntori
 Informação de estado dos disjuntores

X2 Contactor status information
 Information d'état des contacteurs
 Zustandsinformation der Schütze
 Información sobre el estado de los contactores
 Informazione di stato dei contattori
 Informação de estado dos contactores

X3 Commands (relay coils)
 Commandes bobines des relais
 Steuerung (Relaisspulen)
 Comandos (bobinas de los relés)
 Comandi bobine dei relé
 Comandos bobinas dos relés

X4 Separate power supplies of inputs/outputs
 Alimentations séparées des entrées / sorties
 Getrennte Versorgung der Ein- und Ausgänge
 Alimentaciones separadas de las entradas / salidas
 Alimentazioni separate delle entrate / uscite
 Alimentações separadas das entradas / saídas

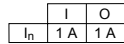

(**) Voir page suivante
 See next page
 siehe nachfolgende Seite
 Vedere pagina seguente
 Ver la siguiente página
 Ver página seguinte

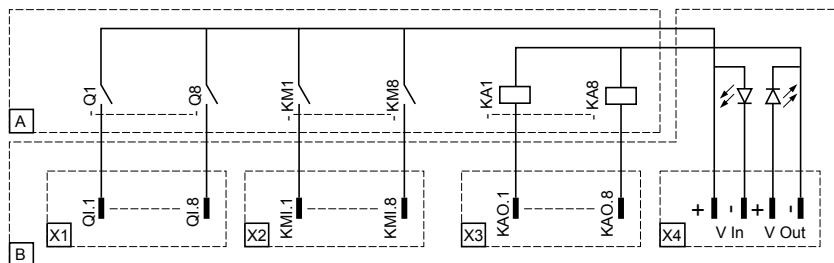

24 V power supply
V In : for inputs
V Out : for outputs

Alimentation 24 V :
V In : des entrées
V Out : des sorties

Energieversorgung 24 V
V In: Versorgung der Eingänge
V Out: Versorgung der Ausgänge

- A: Tego Power receptacle
B: Communication coupler

- X1: Withdrawable terminal block for connection of contacts of circuit-breakers 1 to 8 (terminals QI.1 to QI.8)
X2: Withdrawable terminal block for connection of contacts of contactors 1 to 8 (terminals KMI.1 to KMI.8)
X3: Withdrawable terminal block for connection of interface relays 1 to 8 (terminals KAO.1 to KAO.8)
X4: Withdrawable terminal block for 24V power supply of inputs and outputs.

It is essential to connect:

- to the coupler: the 24 V IN and 24 V OUT,
- to the sub-base: the Uc contactor coil supply.



When control of contactor coils is 24 V --- (not relayed) connect 24 V OUT / 0 V to Uc+ / Uc- on the sub-base.

- A: Embase Tego Power.
B: Coupleur de communication.

- X1: Bornier débrochable pour le raccordement des contacts des disjoncteurs 1 à 8 (bornes QI.1 à QI.8)
X2: Bornier débrochable pour le raccordement des contacts des contacteurs 1 à 8 (bornes KMI.1 à KMI.8).
X3: Bornier débrochable pour le raccordement des relais d'interface 1 à 8 (bornes KAO.1 à KAO.8).
X4: Bornier débrochable pour l'alimentation 24 V des entrées et des sorties.

Il est impératif de connecter :

- sur le coupleur les alimentations 24 V IN et 24 V OUT,
- sur l'embase l'alimentation Uc des bobines de contacteurs.



Lorsque la commande des bobines de contacteurs est de 24 V --- (non relayé) relier le 24 V OUT / 0 V à Uc+ / Uc- sur l'embase.

- A: Tego Power Anschlußleiste
B: Kommunikationskoppler

- X1: Ausziehbare Klemmenleiste zum Anschluß der Kontakte der Überlastschalter 1 bis 8
(Klemmen QI.1 bis QI.8)
X2: Ausziehbare Klemmenleiste zum Anschluß der Kontakte der Schütze 1 bis 8 (Klemmen KMI.1 bis KMI.8)
X3: Ausziehbare Klemmenleiste zum Anschluß der Schnittstellenrelais 1 bis 8 (Klemmen KAO.1 bis KAO.8)
X4: Ausziehbare Klemmenleiste zur 24 V-Versorgung der Ein- und Ausgänge.

Folgende Anschlüsse sind unerlässlich:

- am Koppler: Spannungsversorgung 24V IN und 24V OUT
- auf der Anschlußleiste: Uc-Spannungsversorgung der Schaltschützspulen.



Wenn die Ansteuerung der Schaltschützspulen mit 24V --- (ohne Relais) erfolgt, die 24V OUT / 0V auf der Anschlußleiste an Uc+ / Uc- anschließen

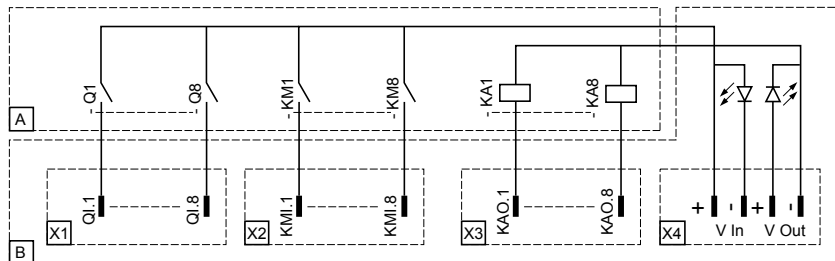

Alimentación 24 V
V In: de las entradas
V Out: de las salidas

Alimentazione 24 V
V In : entrate
V Out : uscite

Alimentação 24 V
V In: das entradas
V Out: das saídas

A: Soporte Tego Power

B: Acoplador de comunicación

X1: Regleta de terminales retirable para la conexión de los contactos de los disyuntores 1 a 8
 (bornes QI.1 a QI.8).

X2: Regleta de terminales retirable para la conexión de los contactos de los contactores 1 a 8
 (bornes KMI.1 a KMI.8).

X3: Regleta de terminales retirable para la conexión de los relés de interfaz 1 a 8
 (bornes KAO.1 a KAO.8).

X4: Regleta de terminales retirable para la alimentación 24 V de las entradas y las salidas.

Es imperativo conectar:

- **Sobre el acoplador, las alimentaciones 24 V IN y 24 V OUT.**

- **Sobre la placa de conexión, la alimentación Uc de las bobinas de contactores.**



Quando el comando de las bobinas de contactores es de 24 V --- (sin relé) conectar el 24 V OUT / 0 V a Uc+ / Uc- sobre la placa de conexión.

A: Piastra di basamento Tego Power

B: Accoppiatore di comunicazione

X1: Morsetti sfilabile per il collegamento dei contatti dei disgiuntori 1 a 8 (morsetti QI.1 a QI.8)

X2: Morsetti sfilabile per il collegamento dei contatti dei contactori 1 a 8 (morsetti KMI.1 a KMI.8)

X3: Morsetti sfilabile per il collegamento dei relé d'interfaccia 1 a 8 (morsetti KAO.1 a KAO.8)

X4: Morsetti sfilabile per l'alimentazione 24 V delle entrate e delle uscite.

È imperativo collegare :

- **sull'accoppiatore, le alimentazioni 24 V IN e 24 V OUT**

- **sulla piastra di basamento, l'alimentazione Uc delle bobine di contattori**



Quando il comando delle bobine di contattori è di 24 V --- (senza relé), collegare il 24 V OUT / 0 V a UC+ / Uc- sulla piastra di basamento.

A: Base Tego Power

B: Acoplador de comunicação

X1: Caixa de terminais desencaixável para a ligação dos contactos dos disjuntores 1 a 8
 (terminais QI.1 a QI.8).

X2: Caixa de terminais desencaixável para a ligação dos contactos dos contactores 1 a 8
 (terminais KMI.1 a KMI.8).

X3: Caixa de terminais desencaixável para a ligação dos relés de interface 1 a 8
 (terminais KAO.1 a KAO.8).

X4: Caixa de terminais desencaixável para a alimentação 24 V das entradas e saídas.

É imperativo conectar:

- **no acoplador as alimentações 24 V IN e 24 V OUT,**

- **na ficha, a alimentação Uc das bobinas de contactores.**



Quando o comando das bobinas de contactores for de 24 V --- (sem relé) ligar o 24 V Out / 0 V a Uc+ / Uc- na ficha.