

REVISIONS				
ZONE	REV.	DESCRIPTION	DATE	APPROVED
	01	RELEASE FOR PRODUCTION	26 JAN 16	KMS
	02	RESIZED ELE PANEL, WAS 900W; SH8 A2 - ADDED 42U STD, C4 - 13 WAS 14	18 MAR 16	KMS

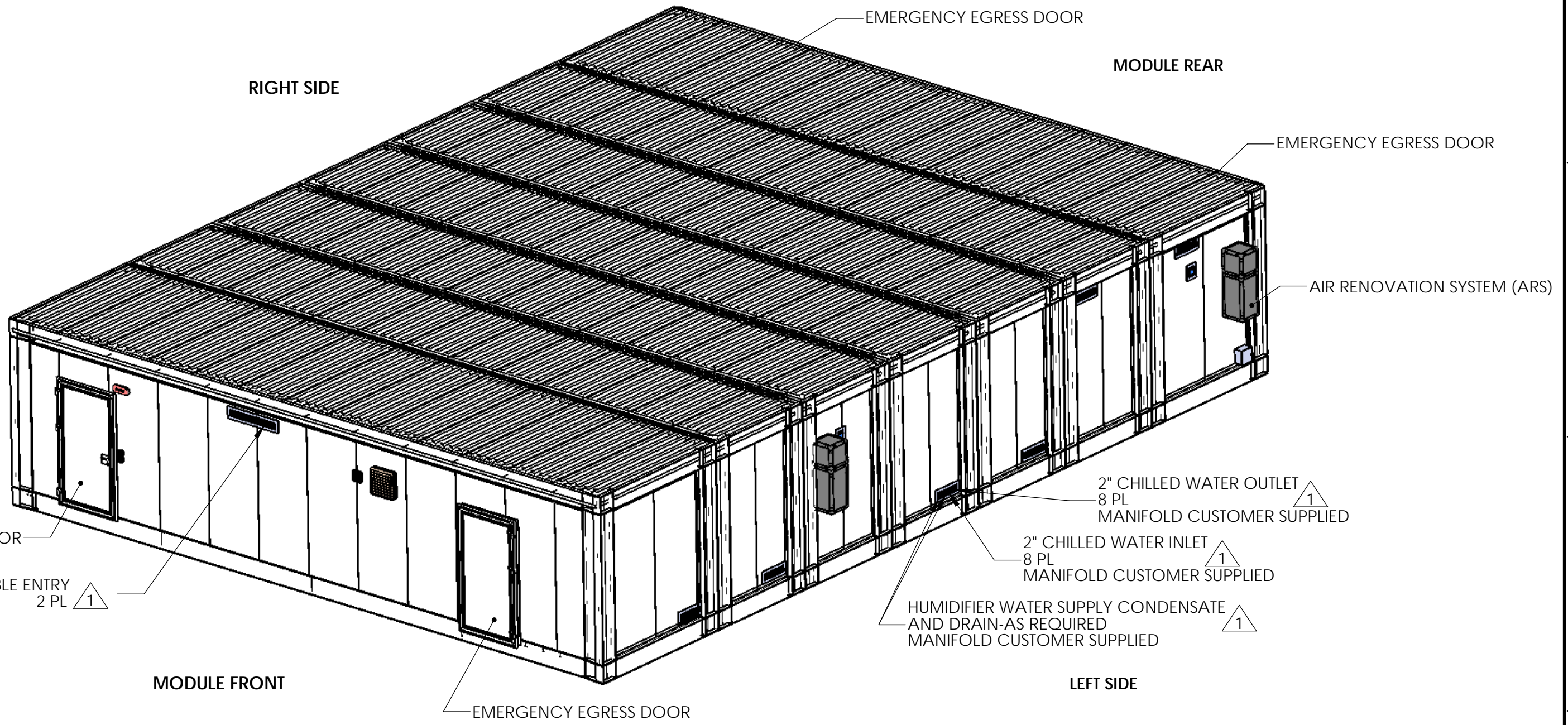

NOTES, UNLESS OTHERWISE SPECIFIED:

- ALL DATA CABLE, POWER CABLE, AND COOLING PIPING INTERFACES ARE THROUGH ROXTEC CABLE ENTRY SEALS (OR SCHNEIDER ELECTRIC ENGINEERING APPROVED IP54, IP 66/67 EQUIVALENT).
- MATERIAL: SEE INDIVIDUAL COMPONENTS LISTED IN BOM.

THIS DRAWING AND SPECIFICATIONS HEREIN ARE THE PROPERTY OF SCHNEIDER ELECTRIC AND SHALL NOT BE COPIED, REPRODUCED OR USED IN WHOLE OR IN PART, AS THE BASIS FOR THE MANUFACTURE OR SALE OF ITEMS WITHOUT WRITTEN PERMISSION FROM SCHNEIDER ELECTRIC. THIS DRAWING IS BASED UPON LATEST AVAILABLE INFORMATION AND IS SUBJECT TO CHANGE WITHOUT NOTICE.

CONSULT USER MANUAL FOR COMPLETE INSTALLATION AND OPERATING INSTRUCTIONS

UNLESS NOTED, DIMENSIONS IN MILLIMETERS & TOLERANCES ARE:

XXXX.	± 25	mm
XXX.	± 10	mm
XX.	± 5	mm
X.	± 1	mm
X.X	± 0.5	mm
X.XX	± 0.30	mm

X* +1*
X.X* +0.5*

BRACKETED DIMENSIONS ARE IN INCHES & ARE FOR REFERENCE ONLY

SHEET DESCRIPTION: ISOMETRIC VIEW

SCALE: 1:75

THIRD ANGLE PROJECTION



DESCRIPTION: SMARTSHELTER DATA HALL; EXTERNAL FRAME; WITH PERIMETER COOLING; BUSWAY; 400V/50HZ

PRODUCT: PREFAB SOLUTIONS

DRAWING: PFMIEG500C2E098B-001		REV: 02
DRAWN: K SCHALLER	7 JAN 2016	SIZE: B
APPROVED: B STEWART	26 JAN 2016	
ENGINEER: K SCHALLER	SHEET 1 OF 9	

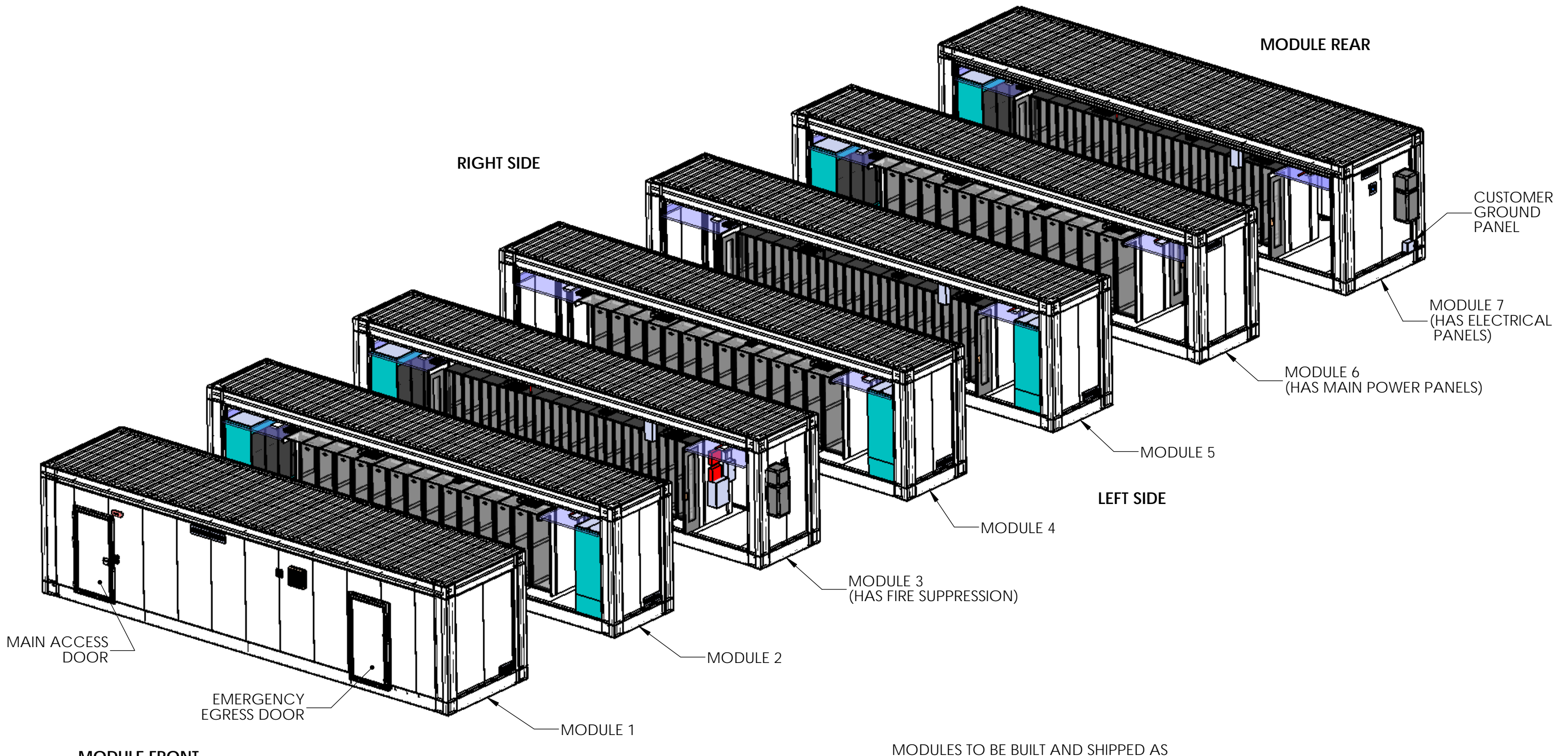

MODULES TO BE BUILT AND SHIPPED AS DISCRETE MODULES AND JOINED ON SITE. SEE INSTALLATION MANUAL FOR ADDITIONAL DETAIL

THIS DRAWING AND SPECIFICATIONS HEREIN ARE THE PROPERTY OF SCHNEIDER ELECTRIC AND SHALL NOT BE COPIED, REPRODUCED OR USED IN WHOLE OR IN PART, AS THE BASIS FOR THE MANUFACTURE OR SALE OF ITEMS WITHOUT WRITTEN PERMISSION FROM SCHNEIDER ELECTRIC. THIS DRAWING IS BASED UPON LATEST AVAILABLE INFORMATION AND IS SUBJECT TO CHANGE WITHOUT NOTICE.

UNLESS NOTED, DIMENSIONS IN MILLIMETERS & TOLERANCES ARE:
 XXXX. ± 25 mm
 XXX. ± 10 mm
 XX. ± 5 mm
 X. ± 1 mm
 X.X ± 0.5 mm
 X.XX ± 0.30 mm
 X* + 1*
 X.X* + 0.5*

SHEET DESCRIPTION
EXPLODED VIEW
 SCALE: AS NOTED OR 1:100
 THIRD ANGLE PROJECTION

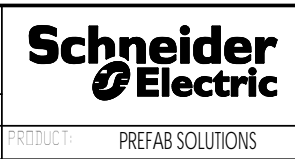

DESCRIPTION
 SMARTSHELTER DATA HALL; EXTERNAL FRAME;
 WITH PERIMETER COOLING; BUSWAY;
 400V/50HZ

DRAWING		PFMIEG500C2E098B-001	
DRAWN:	K SCHALLER	7 JAN 2016	REV 02
APPROVED:	B STEWART	26 JAN 2016	SIZE B
ENGINEER:	K SCHALLER	SHEET 2 OF 9	

CONSULT USER MANUAL FOR COMPLETE INSTALLATION AND OPERATING INSTRUCTIONS

BRACKETED DIMENSIONS ARE IN INCHES & ARE FOR REFERENCE ONLY

THIRD ANGLE PROJECTION

PRODUCT: PREFAB SOLUTIONS

FILE ID: PFMIEG500C2E098B-001 Non-ISO, EMEA Perimeter Busway

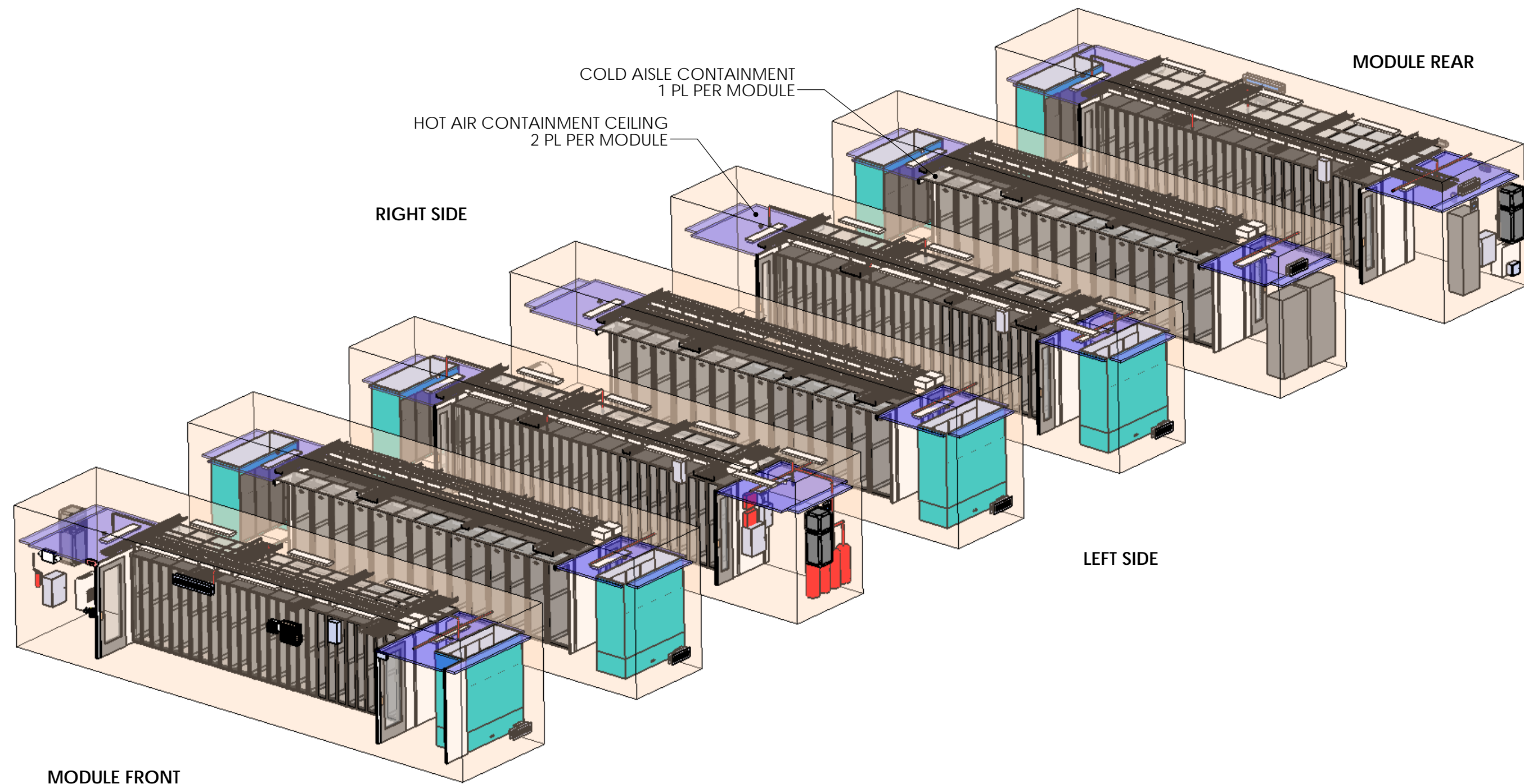

EXPLODED VIEW OF
INTERIOR OF MODULES
STRUCTURE REMOVED FOR CLARITY

THIS DRAWING AND SPECIFICATIONS HEREIN ARE THE PROPERTY OF SCHNEIDER ELECTRIC AND SHALL NOT BE COPIED, REPRODUCED OR USED IN WHOLE OR IN PART, AS THE BASIS FOR THE MANUFACTURE OR SALE OF ITEMS WITHOUT WRITTEN PERMISSION FROM SCHNEIDER ELECTRIC. THIS DRAWING IS BASED UPON LATEST AVAILABLE INFORMATION AND IS SUBJECT TO CHANGE WITHOUT NOTICE.

CONSULT USER MANUAL FOR COMPLETE INSTALLATION AND OPERATING INSTRUCTIONS

UNLESS NOTED, DIMENSIONS IN MILLIMETERS & TOLERANCES ARE:

XXXX.	± 25	mm
XXX.	± 10	mm
XX.	± 5	mm
X.	± 1	mm
X.X	± 0.5	mm
X.XX	± 0.30	mm

BRACKETED DIMENSIONS ARE IN INCHES & ARE FOR REFERENCE ONLY

SHEET DESCRIPTION
INTERIOR EXPLODED VIEW

SCALE: 1:100
THIRD ANGLE PROJECTION



DESCRIPTION
SMARTSHELTER DATA HALL; EXTERNAL FRAME;
WITH PERIMETER COOLING; BUSWAY;
400V/50HZ

PRODUCT: PREFAB SOLUTIONS

DRAWING	PFMIEG500C2E098B-001		
DRAWN:	K SCHALLER	7 JAN 2016	REV 02
APPROVED:	B STEWART	26 JAN 2016	SIZE B
ENGINEER:	K SCHALLER	SHEET 3 OF 9	

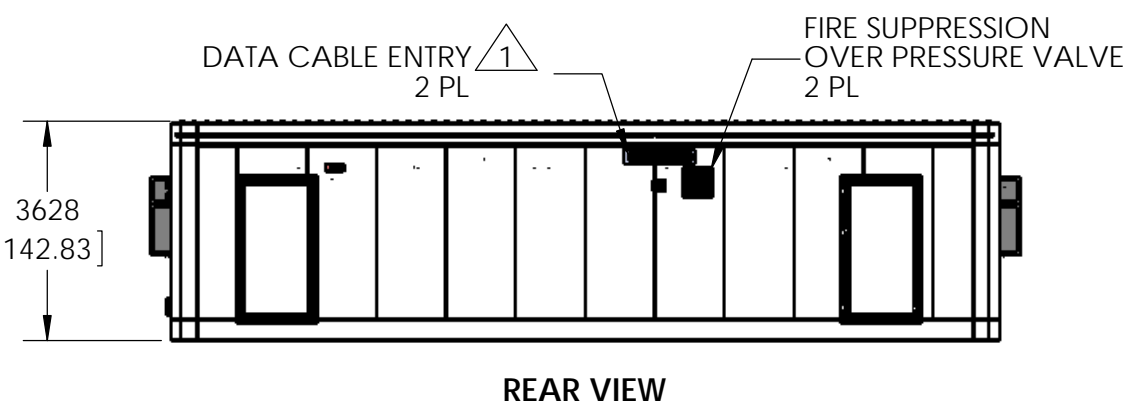
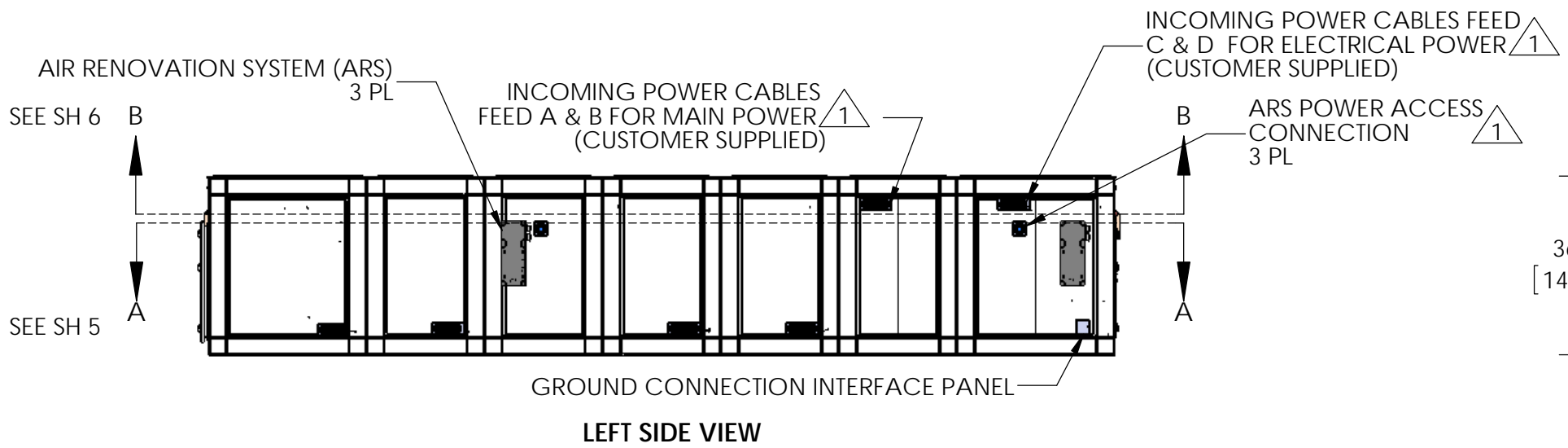
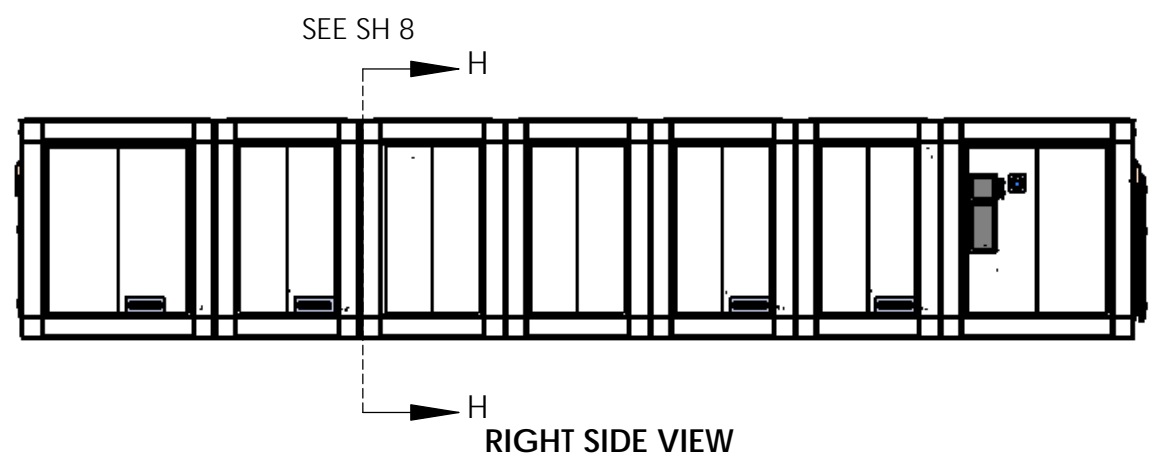
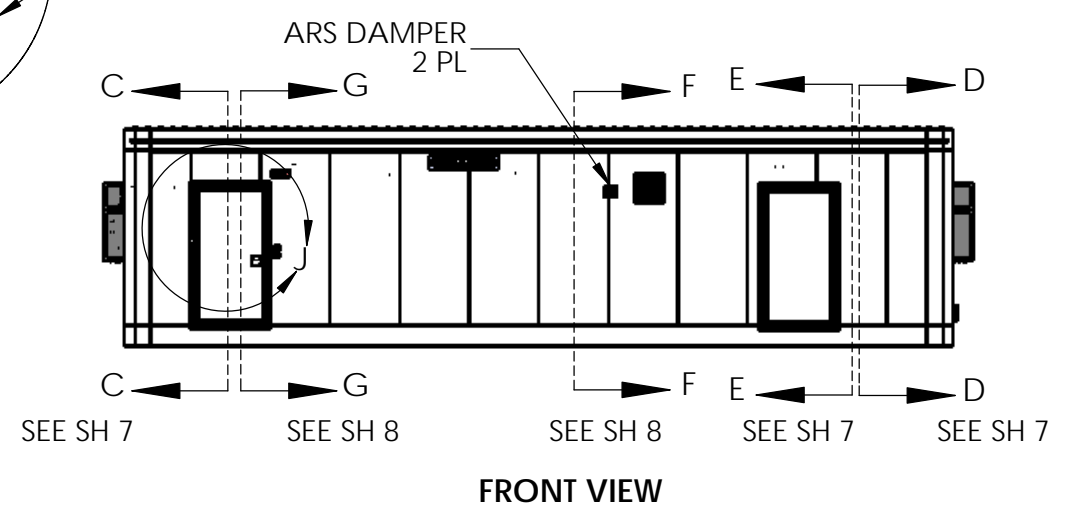
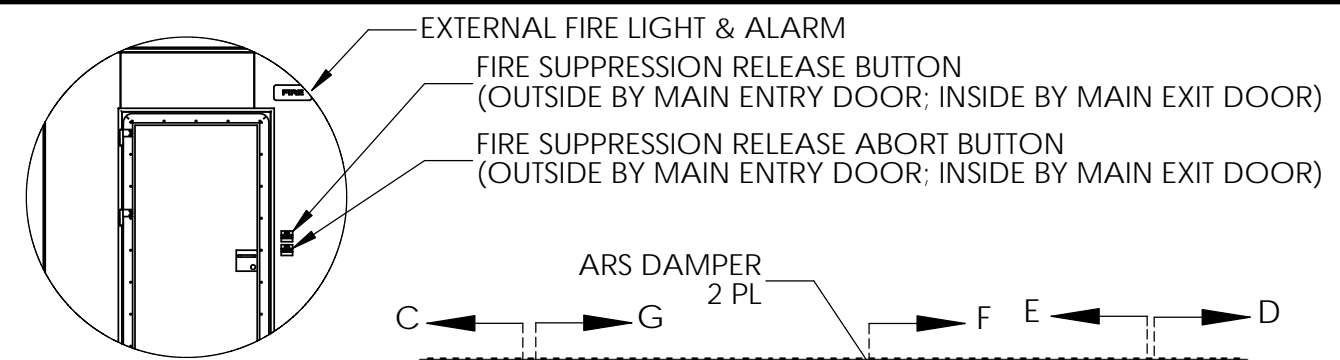
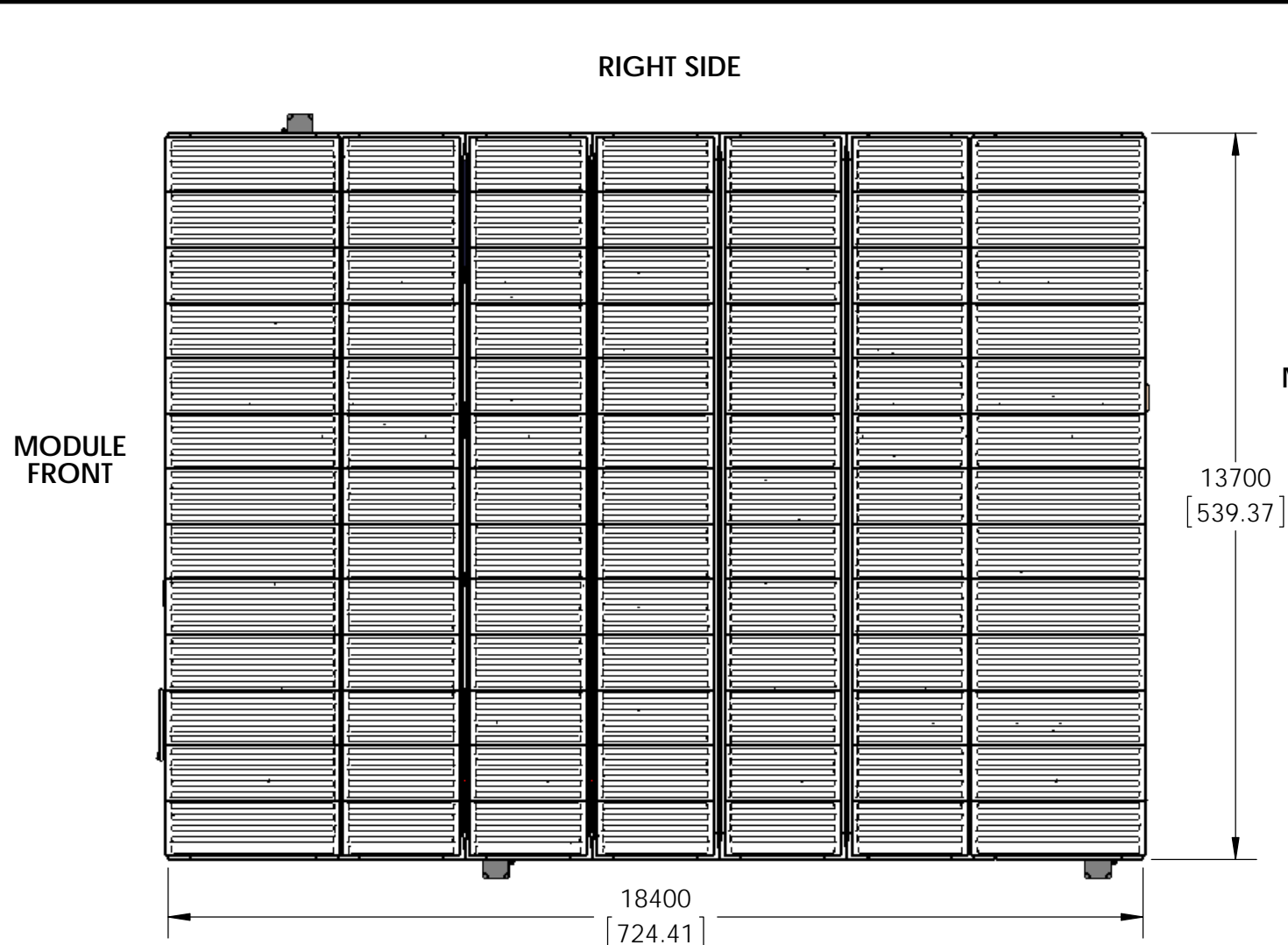

THIS DRAWING AND SPECIFICATIONS HEREIN ARE THE PROPERTY OF SCHNEIDER ELECTRIC AND SHALL NOT BE COPIED, REPRODUCED OR USED IN WHOLE OR IN PART, AS THE BASIS FOR THE MANUFACTURE OR SALE OF ITEMS WITHOUT WRITTEN PERMISSION FROM SCHNEIDER ELECTRIC. THIS DRAWING IS BASED UPON LATEST AVAILABLE INFORMATION AND IS SUBJECT TO CHANGE WITHOUT NOTICE.	UNLESS NOTED, DIMENSIONS IN MILLIMETERS & TOLERANCES ARE: XXX. ± 25 mm XXX. ± 10 mm XX. ± 5 mm X. ± 1 mm X.X ± 0.5 mm X.XX ± 0.30 mm	SHEET DESCRIPTION OVERALL DIM	Schneider Electric	DESCRIPTION SMARTSHELTER DATA HALL; EXTERNAL FRAME; WITH PERIMETER COOLING; BUSWAY; 400V/50HZ	DRAWING PFMIEG500C2E098B-001		
					CONSULT USER MANUAL FOR COMPLETE INSTALLATION AND OPERATING INSTRUCTIONS	BRACKETED DIMENSIONS ARE IN INCHES & ARE FOR REFERENCE ONLY	THIRD ANGLE PROJECTION
				PRODUCT: PREFAB SOLUTIONS	DRAWN: K.SCHALLER	7 JAN 2016	REV 02
					APPROVED: B.STEWART	26 JAN 2016	SIZE B

RIGHT SIDE

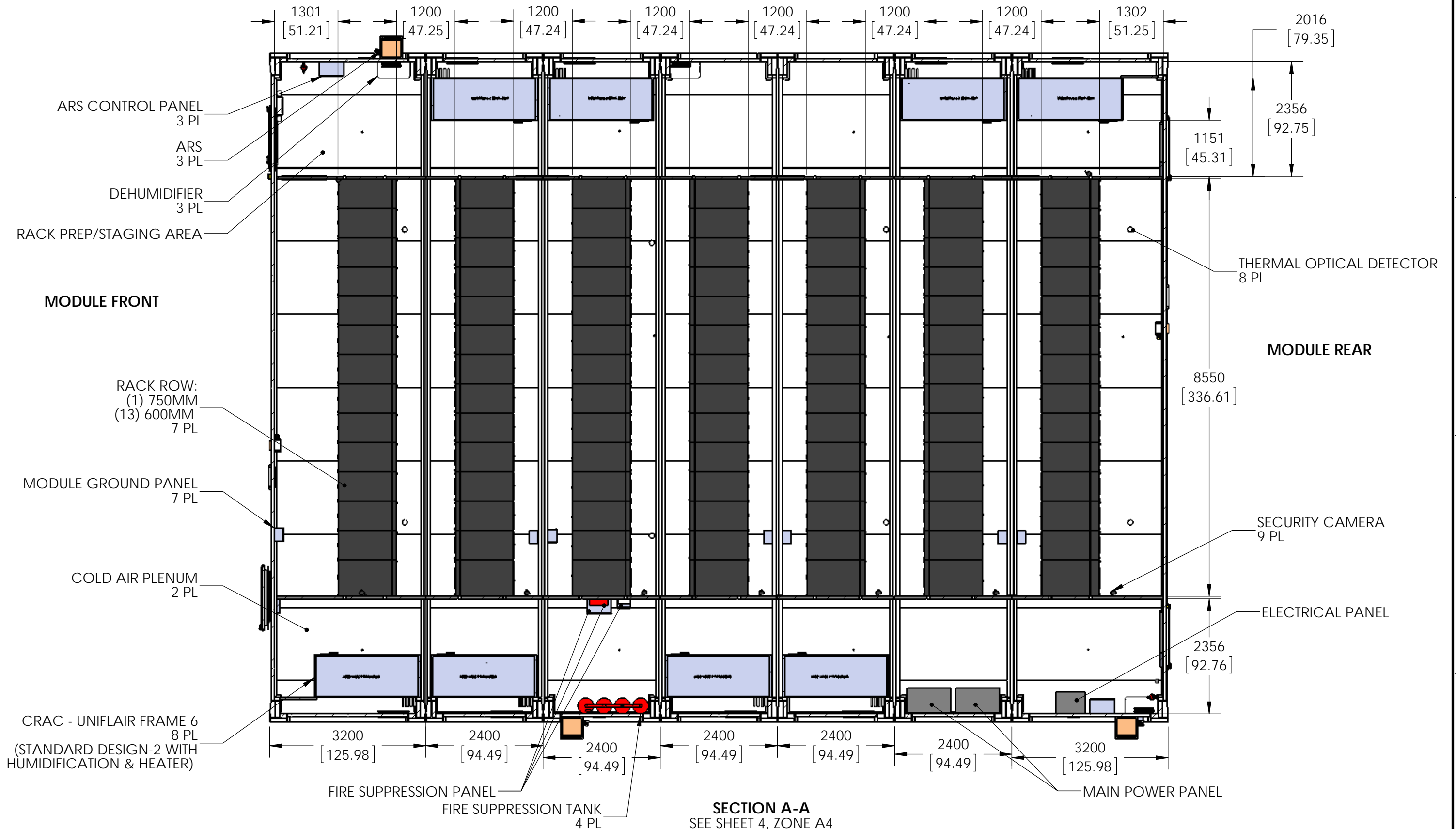

SECTION A-A
SEE SHEET 4, ZONE A4

<p>THIS DRAWING AND SPECIFICATIONS HEREIN ARE THE PROPERTY OF SCHNEIDER ELECTRIC AND SHALL NOT BE COPIED, REPRODUCED OR USED IN WHOLE OR IN PART, AS THE BASIS FOR THE MANUFACTURE OR SALE OF ITEMS WITHOUT WRITTEN PERMISSION FROM SCHNEIDER ELECTRIC. THIS DRAWING IS BASED UPON LATEST AVAILABLE INFORMATION AND IS SUBJECT TO CHANGE WITHOUT NOTICE.</p> <p>CONSULT USER MANUAL FOR COMPLETE INSTALLATION AND OPERATING INSTRUCTIONS</p>	<p>UNLESS NOTED, DIMENSIONS IN MILLIMETERS & TOLERANCES ARE:</p> <p>X* ± 1* X.X* ± 0.5*</p> <p>BRACKETED DIMENSIONS ARE IN INCHES & ARE FOR REFERENCE ONLY</p>	<p>XXXX ± 25 mm XXX ± 10 mm XX ± 5 mm X ± 1 mm X.X ± 0.5 mm X.XX ± 0.30 mm</p>	<p>SHEET DESCRIPTION: INTERNAL DIM - SECT A</p> <p>SCALE: AS NOTED OR 1:75 THIRD ANGLE PROJECTION</p>		<p>DESCRIPTION: SMARTSHELTER DATA HALL; EXTERNAL FRAME; WITH PERIMETER COOLING; BUSWAY; 400V/50HZ</p> <p>PRODUCT: PREFAB SOLUTIONS</p>	DRAWING PFMIEG500C2E098B-001		
						DRAWN: K SCHALLER 7 JAN 2016 REV 02	APPROVED: B STEWART 26 JAN 2016	ENGINEER: K SCHALLER SHEET 5 OF 9

A B C D E F G H

LEFT SIDE

FIRE SUPPRESSANT PIPING

BUSWAY POWER PANEL
14 PL

MODULE DATA CABLE TRAY

POWER CABLE TRAY
(BUSWAY, CRAC)

AUX CABLE TRAY

MODULE FRONT

MODULE REAR

FIRE SUPPRESSION NOZZLE
24 PL

DATA CABLE TRAY

FLUORESCENT LIGHT
38 PL

BUSWAY TAPOFF
196 PL

CRAC POWER CABLE TRAY

THERMAL OPTICAL
DETECTOR
38 PL

SECTION B-B
LOOKING UP
SEE SHEET 4, ZONE A3

THIS DRAWING AND SPECIFICATIONS HEREIN ARE THE PROPERTY OF SCHNEIDER ELECTRIC AND SHALL NOT BE COPIED, REPRODUCED OR USED IN WHOLE OR IN PART, AS THE BASIS FOR THE MANUFACTURE OR SALE OF ITEMS WITHOUT WRITTEN PERMISSION FROM SCHNEIDER ELECTRIC. THIS DRAWING IS BASED UPON LATEST AVAILABLE INFORMATION AND IS SUBJECT TO CHANGE WITHOUT NOTICE.

UNLESS NOTED, DIMENSIONS IN MILLIMETERS & TOLERANCES ARE:
 XXXX. ± 25 mm
 XXX. ± 10 mm
 XX. ± 5 mm
 X. ± 1 mm
 X.X ± 0.5 mm
 X.XX ± 0.30 mm
 X° ± 1°
 X.X° ± 0.5°

SHEET DESCRIPTION
INTERNAL COMPONENTS - SECT B
 SCALE: AS NOTED OR 1:70
 THIRD ANGLE PROJECTION



DESCRIPTION
SMARTSHELTER DATA HALL; EXTERNAL FRAME; WITH PERIMETER COOLING; BUSWAY; 400V/50HZ

DRAWING		PFMIEG500C2E098B-001	
DRAWN:	K SCHALLER	7 JAN 2016	REV 02
APPROVED:	B STEWART	26 JAN 2016	SIZE B
ENGINEER:	K SCHALLER	SHEET 6 OF 9	

CONSULT USER MANUAL FOR COMPLETE INSTALLATION AND OPERATING INSTRUCTIONS

BRACKETED DIMENSIONS ARE IN INCHES & ARE FOR REFERENCE ONLY

PRODUCT: PREFAB SOLUTIONS

FILE ID: PFMIEG500C2E098B-001 Non-ISO, EMEA Perimeter Busway

A B C D E F G H

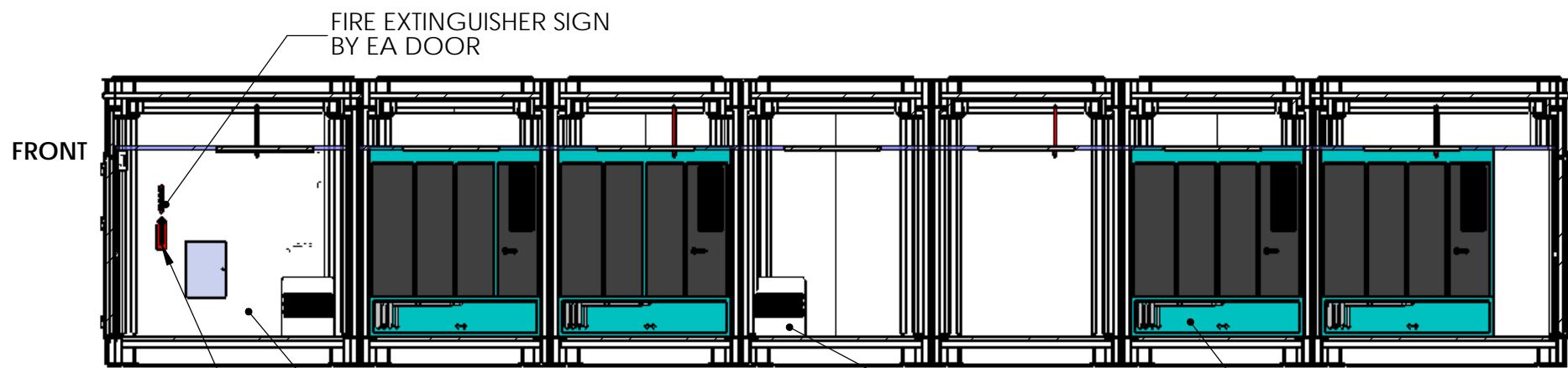

SECTION C-C
SEE SHEET 4, ZONE F2

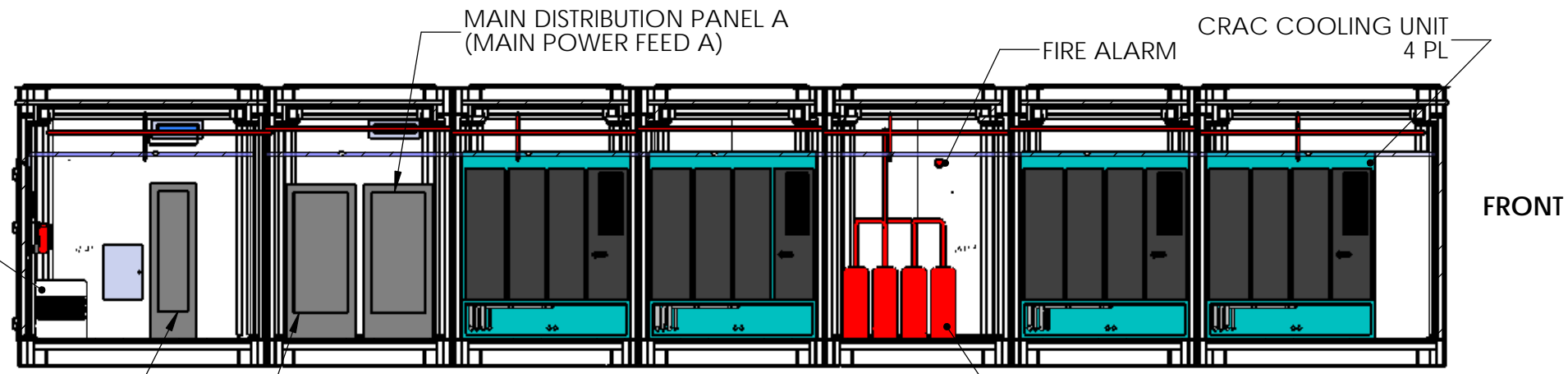

SECTION D-D
SEE SHEET 4, ZONE H2

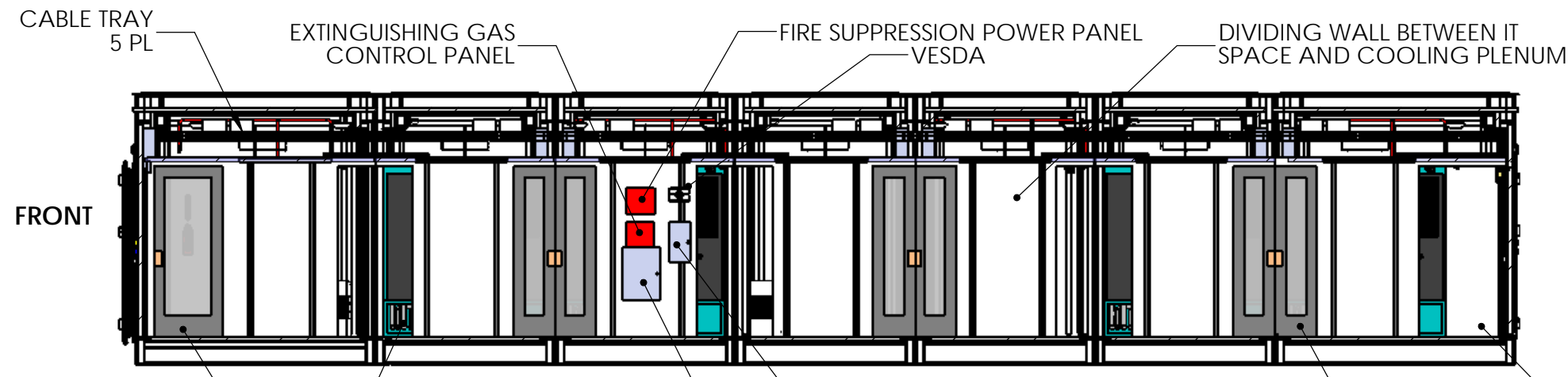

SECTION E-E
SEE SHEET 4, ZONE H2

FOR ADDITIONAL DETAIL SEE:
 FIRE SUPPRESSION DRAWING - PFMIEX500E-FS
 ELECTRICAL PANEL DRAWING - PFMIEX500E-EL
 LIGHTING DRAWING - PFMIEX500E-LT
 MONITORING DRAWING - PFMIEXXXXXXXXXX_MONITORING
 GROUNDING DRAWING - PFMIEXXXXXXXXXX_GROUNDING
 ELECTRICAL ONELINE DRW - PFMIEG500C2E098B_ELE_ONELINE

THIS DRAWING AND SPECIFICATIONS HEREIN ARE THE PROPERTY OF SCHNEIDER ELECTRIC AND SHALL NOT BE COPIED, REPRODUCED OR USED IN WHOLE OR IN PART, AS THE BASIS FOR THE MANUFACTURE OR SALE OF ITEMS WITHOUT WRITTEN PERMISSION FROM SCHNEIDER ELECTRIC. THIS DRAWING IS BASED UPON LATEST AVAILABLE INFORMATION AND IS SUBJECT TO CHANGE WITHOUT NOTICE.

CONSULT USER MANUAL FOR COMPLETE INSTALLATION AND OPERATING INSTRUCTIONS

UNLESS NOTED, DIMENSIONS IN MILLIMETERS & TOLERANCES ARE:
 XXXX ± 25 mm
 XXX ± 10 mm
 XX ± 5 mm
 X ± 1 mm
 X.X ± 0.5 mm
 X.XX ± 0.30 mm

BRACKETED DIMENSIONS ARE IN INCHES & ARE FOR REFERENCE ONLY

SHEET DESCRIPTION
SECTION C-E

SCALE: AS NOTED OR 1:80

THIRD ANGLE PROJECTION



DESCRIPTION
SMARTSHELTER DATA HALL; EXTERNAL FRAME; WITH PERIMETER COOLING; BUSWAY; 400V/50HZ

PRODUCT: PREFAB SOLUTIONS

DRAWING		PFMIEG500C2E098B-001	
DRAWN:	K SCHALLER	7 JAN 2016	REV 02
APPROVED:	B STEWART	26 JAN 2016	SIZE
ENGINEER:	K SCHALLER	SHEET 7 OF 9	B

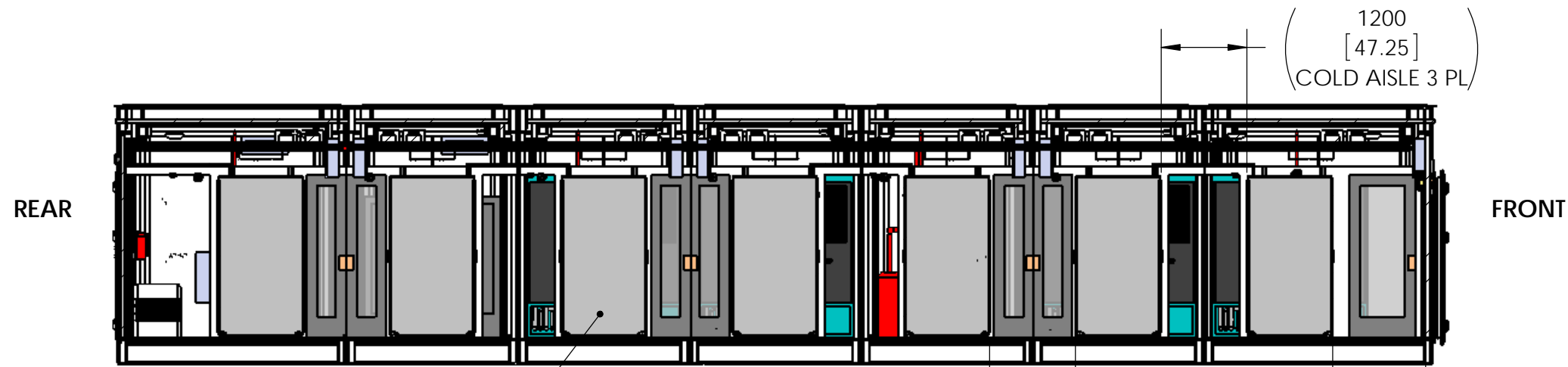

RACK - 48U, 600MM, 1200MM SHOWN
42U, 600MM, 1200MM STANDARD SIZE
1 ROW PER MODULE

SECTION F-F
SEE SHEET 4, ZONE G2

1200
[47.24]
HOT AISLE 3 PL

1300
[51.17]
OUTBOARD AISLE
1 HOT; 1 COLD

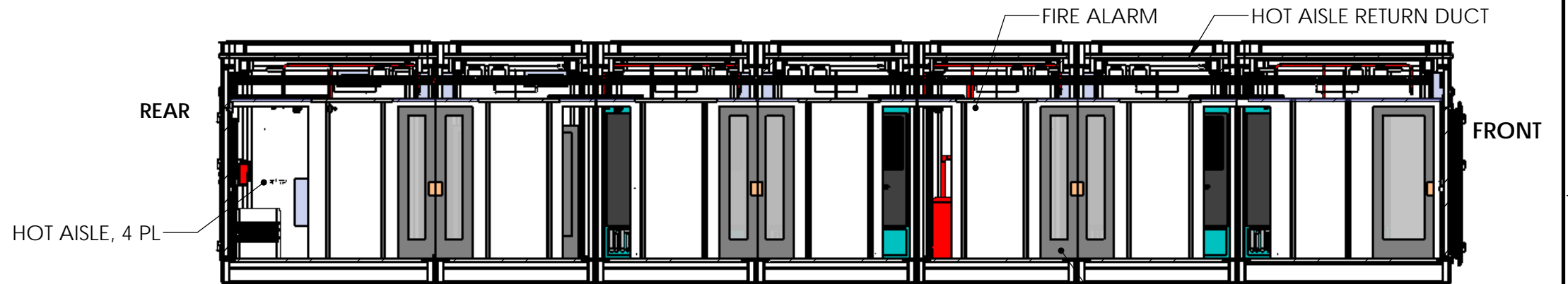

HOT AISLE, 4 PL

SECTION G-G
SEE SHEET 4, ZONE F2

COLD AISLE
w/ DUAL DOORS, 3PL
w/ SINGLE DOOR, 1 PL

LEFT SIDE
FIRE SUPPRESSION CONTROL PANEL
FIRE SUPPRESSION POWER PANEL

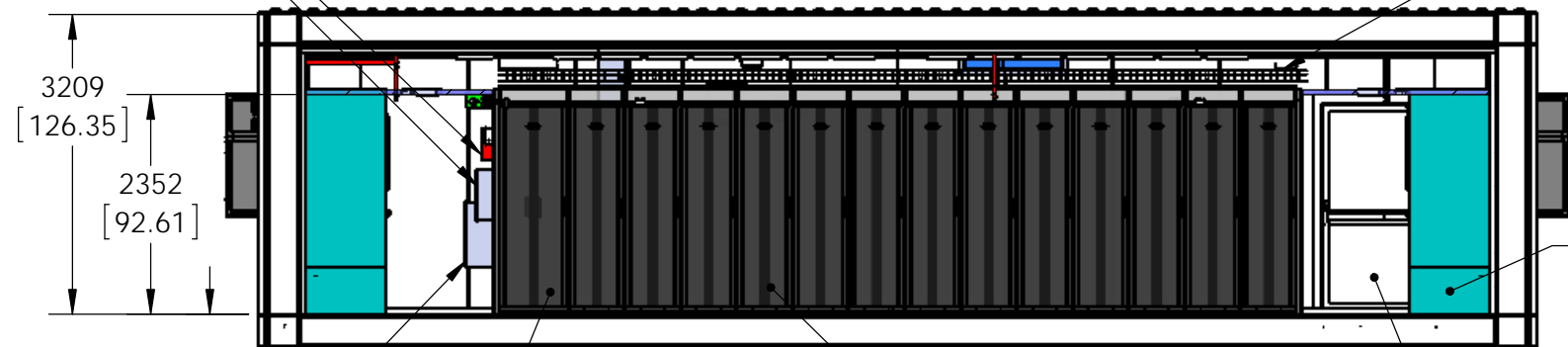

SECTION H-H
SEE SHEET 4, ZONE F2

360
[14.17]

750MM RACK
ARS CONTROL PANEL

600MM RACK
13 PL

DOOR
2 PL

CRAC, 2 PL

CABLE TRAY
4 PL

THIS DRAWING AND SPECIFICATIONS HEREIN ARE THE PROPERTY OF SCHNEIDER ELECTRIC AND SHALL NOT BE COPIED, REPRODUCED OR USED IN WHOLE OR IN PART, AS THE BASIS FOR THE MANUFACTURE OR SALE OF ITEMS WITHOUT WRITTEN PERMISSION FROM SCHNEIDER ELECTRIC. THIS DRAWING IS BASED UPON LATEST AVAILABLE INFORMATION AND IS SUBJECT TO CHANGE WITHOUT NOTICE.

UNLESS NOTED, DIMENSIONS IN MILLIMETERS & TOLERANCES ARE:
XXXX ± 25 mm
XXX ± 10 mm
XX ± 5 mm
X ± 1 mm
X.X ± 0.5 mm
X.XX ± 0.30 mm
X* + 1*
X.X* + 0.5*

SHEET DESCRIPTION
SECTION F-F
SCALE: AS NOTED OR 1:80
THIRD ANGLE PROJECTION



DESCRIPTION
SMARTSHELTER DATA HALL; EXTERNAL FRAME;
WITH PERIMETER COOLING; BUSWAY;
400V/50HZ

DRAWING		PFMIEG500C2E098B-001	
DRAWN:	K SCHALLER	7 JAN 2016	REV 02
APPROVED:	B STEWART	26 JAN 2016	SIZE B
ENGINEER:	K SCHALLER	SHEET 8 OF 9	

CONSULT USER MANUAL FOR COMPLETE INSTALLATION AND OPERATING INSTRUCTIONS

BRACKETED DIMENSIONS ARE IN INCHES & ARE FOR REFERENCE ONLY

PRODUCT: PREFAB SOLUTIONS

FILE ID: PFMIEG500C2E098B-001 Non-ISO, EMEA Perimeter Busway

A B C D E F G H

LEFT SIDE

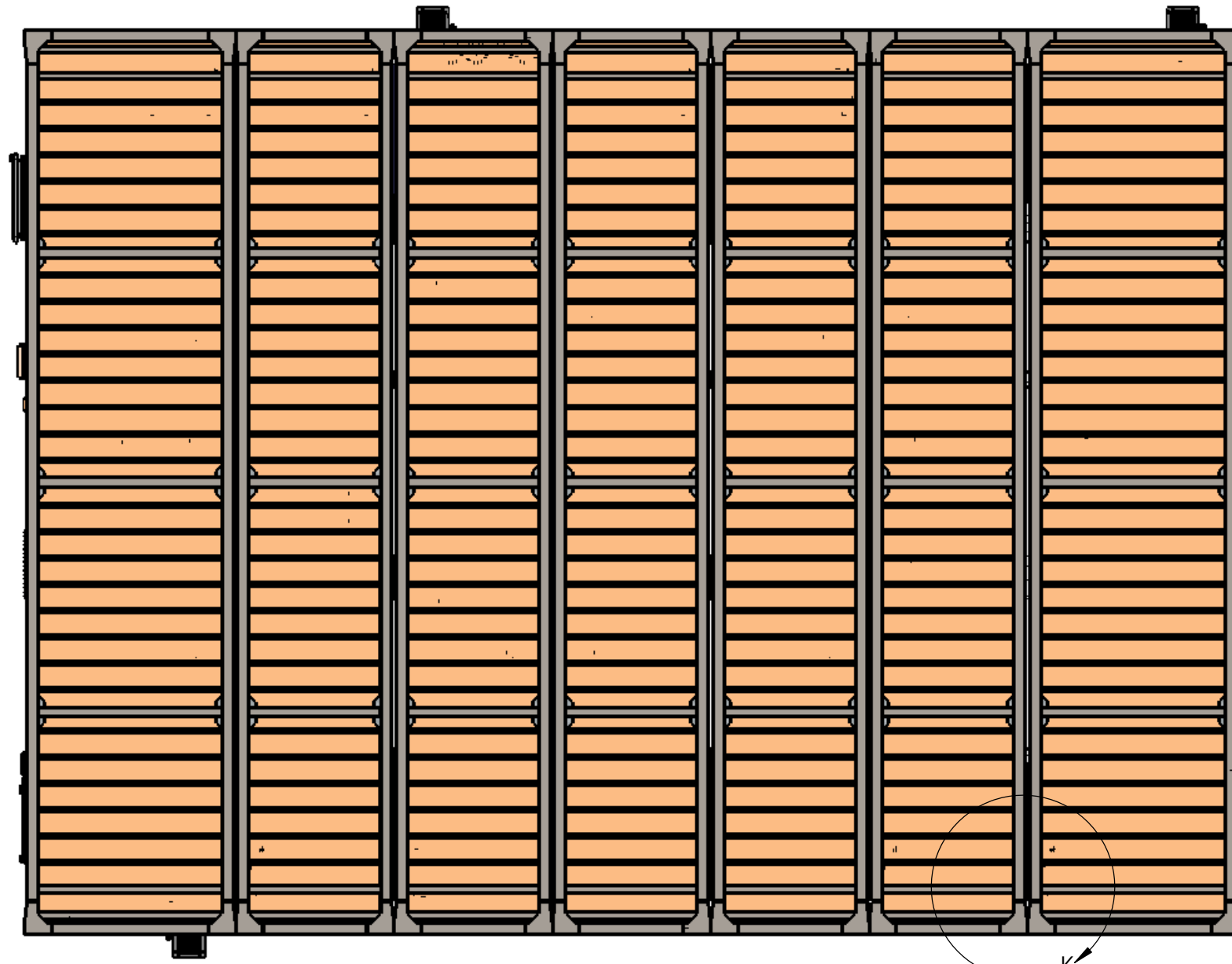

MODULE FRONT

MODULE REAR

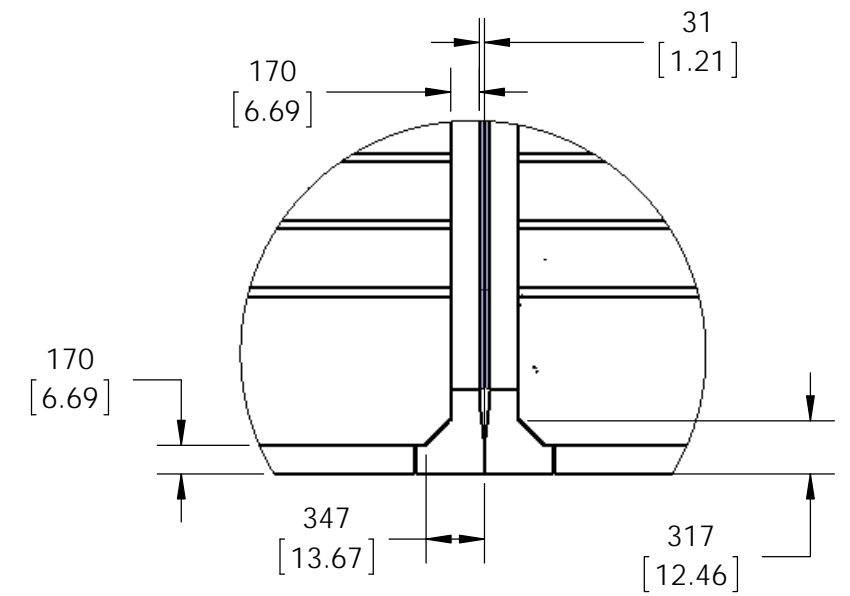

DETAIL K
SCALE 1 : 45

BOTTOM VIEW

THIS DRAWING AND SPECIFICATIONS HEREIN ARE THE PROPERTY OF SCHNEIDER ELECTRIC AND SHALL NOT BE COPIED, REPRODUCED OR USED IN WHOLE OR IN PART, AS THE BASIS FOR THE MANUFACTURE OR SALE OF ITEMS WITHOUT WRITTEN PERMISSION FROM SCHNEIDER ELECTRIC. THIS DRAWING IS BASED UPON LATEST AVAILABLE INFORMATION AND IS SUBJECT TO CHANGE WITHOUT NOTICE.

UNLESS NOTED, DIMENSIONS IN MILLIMETERS & TOLERANCES ARE:
 XXXX. ± 25 mm
 XXX. ± 10 mm
 XX. ± 5 mm
 X. ± 1 mm
 X.X ± 0.5 mm
 X.XX ± 0.30 mm
 X° + 1°
 X.X° + 0.5°

SHEET DESCRIPTION
BOTTOM VIEW
 SCALE: TO NOT SCALE DRW 1:90
 THIRD ANGLE PROJECTION



DESCRIPTION
 SMARTSHELTER DATA HALL; EXTERNAL FRAME;
 WITH PERIMETER COOLING; BUSWAY;
 400V/50HZ

DRAWING		PFMIEG500C2E098B-001	
DRAWN:	K SCHALLER	7 JAN 2016	REV 02
APPROVED:	B STEWART	26 JAN 2016	SIZE B
ENGINEER:	K SCHALLER	SHEET 9 OF 9	

CONSULT USER MANUAL FOR COMPLETE INSTALLATION AND OPERATING INSTRUCTIONS

BRACKETED DIMENSIONS ARE IN INCHES & ARE FOR REFERENCE ONLY

THIRD ANGLE PROJECTION

PRODUCT: PREFAB SOLUTIONS

FILE ID: PFMIEG500C2E098B-001 Non-ISO, EMEA Perimeter Busway

A B C D E F G H