



EVlink

Catalog 2020

Electric vehicle charging solutions



se.com

Life Is On

Schneider
Electric



Green Premium™

An industry leading portfolio of offers delivering sustainable value



More than 75% of our product sales offer superior transparency on the material content, regulatory information and environmental impact of our products:

- RoHS compliance
- REACH substance information
- Industry leading # of PEP's*
- Circularity instructions



Discover what we mean by green
Check your products!

The Green Premium program stands for our commitment to deliver customer valued sustainable performance. It has been upgraded with recognized environmental claims and extended to cover all offers including Products, Services and Solutions.

CO₂ and P&L impact through... Resource Performance

Green Premium brings improved resource efficiency throughout an asset's lifecycle. This includes efficient use of energy and natural resources, along with the minimization of CO₂ emissions.

Cost of ownership optimization through... Circular Performance

We're helping our customers optimize the total cost of ownership of their assets. To do this, we provide IoT-enabled solutions, as well as upgrade, repair, retrofit, and remanufacture services.

Peace of mind through... Well-being Performance

Green Premium products are RoHS and REACH compliant. We're going beyond regulatory compliance with step-by-step substitution of certain materials and substances from our products.

Improved sales through... Differentiation

Green Premium delivers strong value propositions through third-party labels and services. By collaborating with third-party organizations we can support our customers in meeting their sustainability goals such as green building certifications.

*PEP: Product Environmental Profile (i.e. Environmental Product Declaration)

Contents

| | |
|--|--------------|
| Presentation | |
| EVlink charging solutions: giving confidence in the future | p. 4 |
| How it Works | p. 7 |
| The electric vehicle | p. 8 |
| Where to charge | p. 9 |
| Charging | p. 10 |
| The EVlink Product Range | p. 13 |
| 9 selection criteria for charging station | p. 14 |
| Energy management | p. 16 |
| Communicating charging stations | p. 18 |
| Overview of EVlink offer | p. 20 |
| EVlink Wallbox | p. 22 |
| EVlink Smart Wallbox | p. 28 |
| EVlink Parking | p. 34 |
| EVlink DC Fast Charge | p. 42 |
| EVlink AC charging station testing tool | p. 44 |
| EVlink cables | p. 46 |
| Managing the Charging Station Energy | p. 49 |
| EVlink Load Management System | p. 50 |
| Typical load management architectures | p. 54 |
| IT network possible topologies | p. 57 |
| Metering solutions | p. 58 |
| EVlink Electrical distribution | p. 61 |
| Electrical distribution | p. 62 |
| Solutions for Your Project | p. 65 |
| Solutions for your project | p. 66 |
| "Turnkey" project | p. 67 |
| Services for contractors | p. 68 |
| Services for operators | p. 69 |
| List of References | p. 71 |

EVlink charging solutions:



IEC standards compliance



Worldwide customer support



Network of installation and service partners

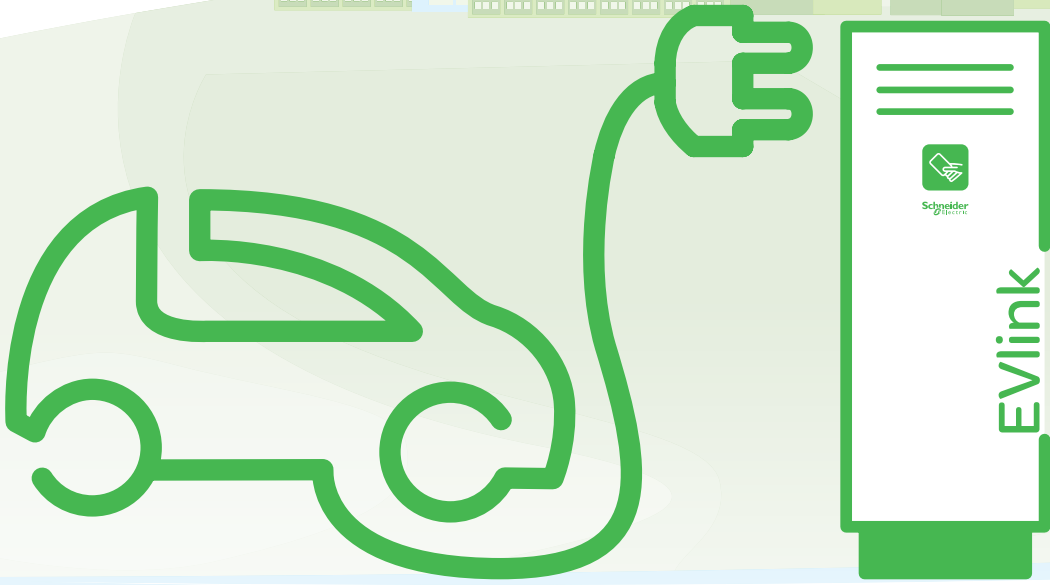

giving confidence in the future



125,000 stations in 50 countries

“ Worldwide availability of our charging station and service offers is the best proof of our long-term engagement ”





Ladestasjon for elbil
Pay Parken Charge & Drive

1. Velg betalingsmetode
2. Start lading og følg instruksene på display

2340

Ladefakt

2,50

Schneider Electric

EVlink

How it Works

The electric vehicle

4 major items:

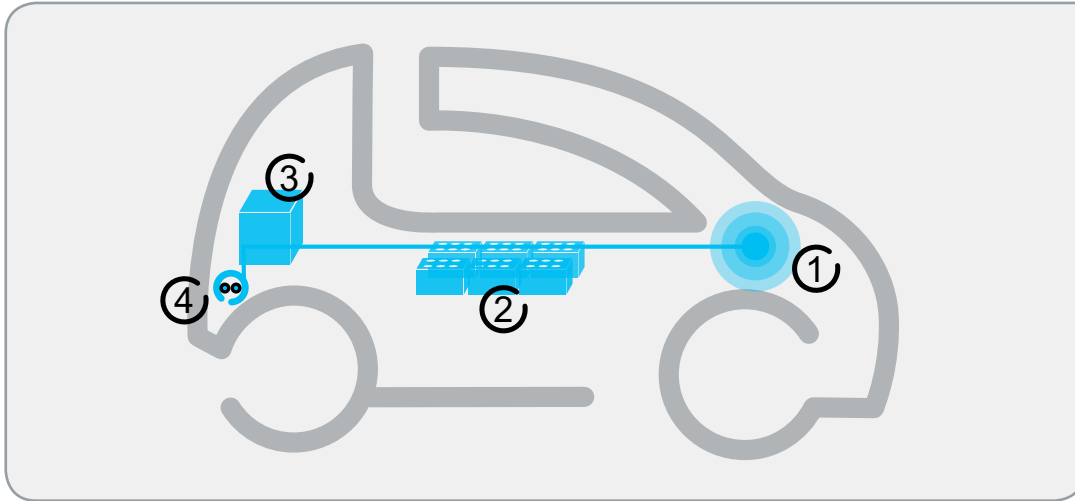

① Motor

The vehicle has one or more motors. Depending on size and performance, the total power ranges between 15 and 200 kW.

Example: 48 kW (65 hp) for a small 4-seater sedan.

② Batteries

Battery technology has made very significant progress in recent years. Lead has gradually been replaced by other, more efficient compounds. Research continues with a view to improving capacity and reducing weight.

The most common technology at present is lithium-ion.

These new batteries have no memory effect and can therefore be charged without having to be completely empty beforehand. They are present in telephones, laptop computers, and some aircraft, as well as in electric vehicles.

③ On-board charger

The vehicle is fitted with one battery charger supplied in AC by the charging station that defines the maximum charging current available. In some vehicles the battery charger may also be supplied in DC by the charging station.

④ Charging inlet

The vehicle is fitted with at least one inlet for AC charging. In some vehicles the inlet can also be used for DC fast charging or is completed by a second inlet for DC fast charging.



Where to charge



At home

A charging station for private use installed in the garage.



At home — condominium

A charging station for indoor or outdoor use, installed in a private parking place.

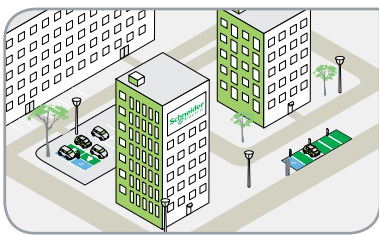

At work

More and more companies have installed charging stations in their own parking areas. They have a choice of whether users can charge their batteries for free or pay a fee.

Municipal fleets and the fleets of delivery services, as well as government departments generally have parking areas fully equipped to charge their electric vehicles.

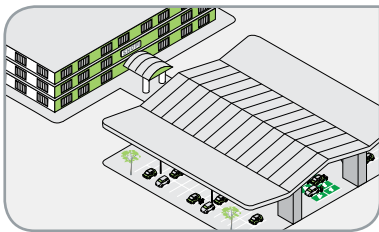

In private parking area

To meet new customer demands, the operators of public and semi-public parking areas (for instance, commercial buildings, shopping malls, restaurants, hotels, hospitals, etc.), frequently offer EV charging services. Charging stations can generally be accessed with a badge or a mobile app based on various commercial conditions.

Municipalities and car park managers are now developing these services.



On street

Involved in new green mobility deployment, municipalities are giving access to a network of charging stations located on the street or in public parking areas. Charging stations can generally be accessed with a badge or thanks to a Smartphone App., based on various commercial conditions.

Electric car sharing is another service offer that municipalities now promote. Charging station networks allow combined use by car-sharing services and electric vehicle drivers.

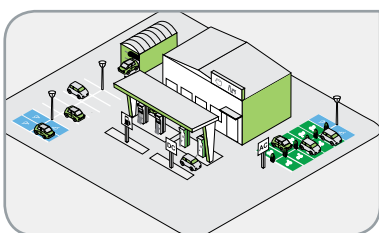

At service station

Service stations equipped for fast charging are appearing at test locations in some countries. Customers use the less than 30 minutes charging time to take a break or shop in the supermarket.

Charging

➤ The charging mode determines the protection level

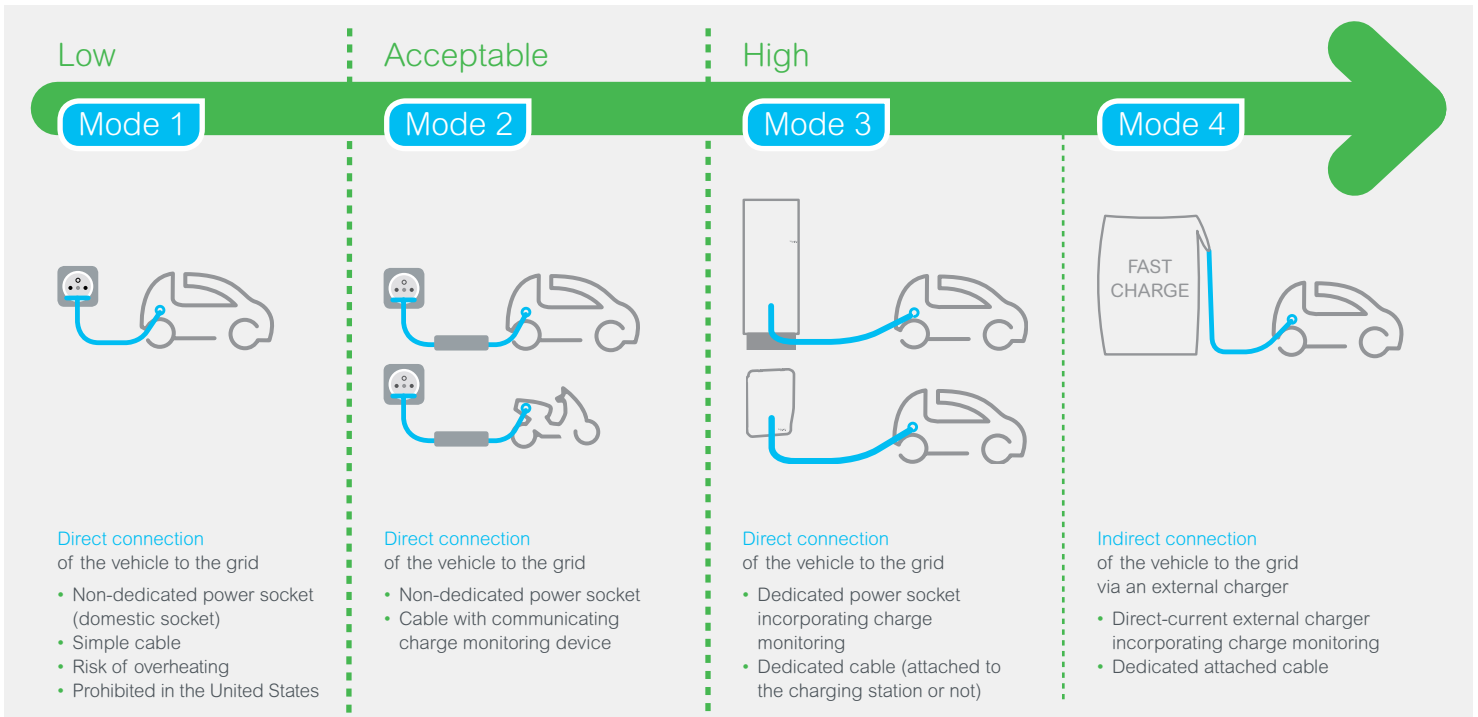

➤ Mode 2, Mode 3 or Mode 4 determines the type of charging connectors

Mode 2

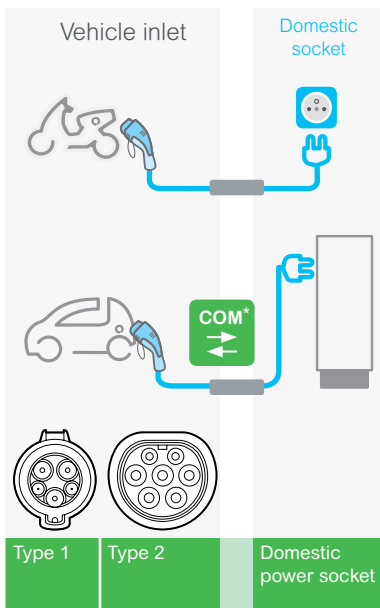

Mode 3

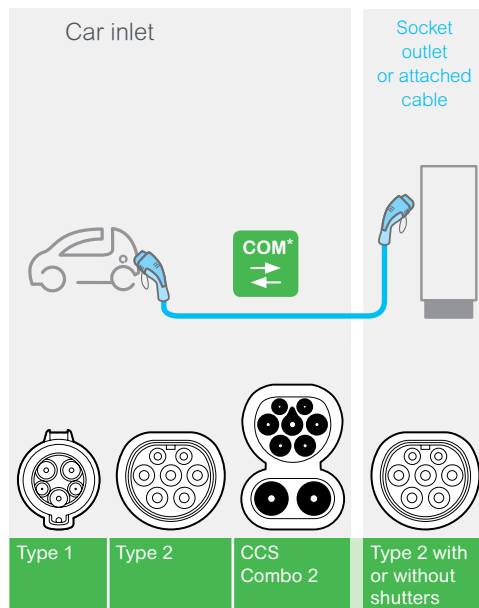

Mode 4

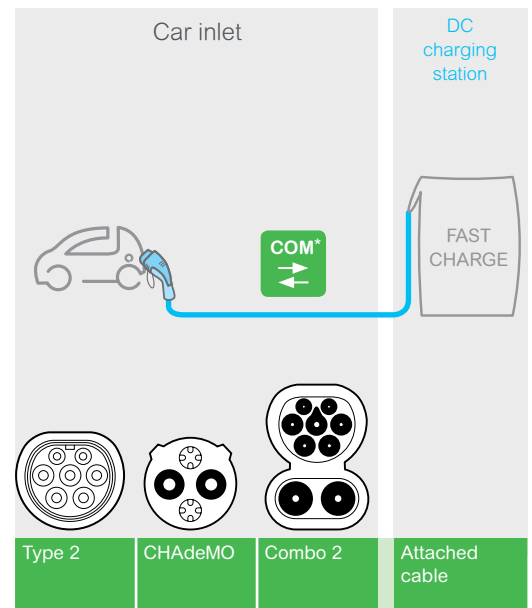







***Focus on technology**

Charging cable

A "COM" wire allows data communication between the vehicle and the charging station. The charging process starts only if the following information is OK:









- Vehicle earthing
- Indication of the charging cable rating.

➤ The effective charging capacity is that of the weakest "link", for example:

| Vehicle charger | Cable/charging mode | Charging point | Effective charging capacity |
|---|--|---|-----------------------------|
|  7 kW |  2.3 kW (Mode 2) |  Domestic power socket 2.3 kW (Mode 2) | 2.3 kW |
|  7 kW |  7.4 kW (Mode 3) |  Charging station 22 kW | 7.4 kW |

➤ The power of the source determines the charging speed*

Example: for a vehicle with a 40 kWh battery:

| Source used | Domestic power socket | Dedicated AC power socket | | Dedicated DC power socket |
|-------------------------------|---|--|---|---|
| Power | Single-phase: 2.3 kW | Single-phase: 7.4 kW | Three-phase: 22 kW | Three-phase: 24 kW |
| Time to "fill up" |  18 h |  7 h |  2h30 min |  2h |
| % of charge reached in 30 min |  3% |  7% |  20% |  25% |

(*) Subject to the use of a suitable cable.

Focus on technology

Electrical distribution architecture

Standalone

One or several charging stations can be connected to the same protection panel. The protection could also be installed in the Parking station floor base (see chapter page 34). Each charging station operates independently. They are protected upstream and their consumption can be measured. The charging stations can be connected to a supervision.

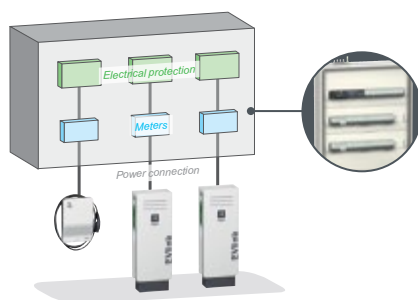

Clustered

An alternative way is to manage energy availability: [EVlink Load Management System](#). It makes it possible to consider various needs related to the use of the vehicles that will be charged. A cluster consists of charging stations, from 3 to 1000 charging stations, controlled by EVlink Load Management System, power meter, 3G/4G modem, etc., that can be connected to a supervision.

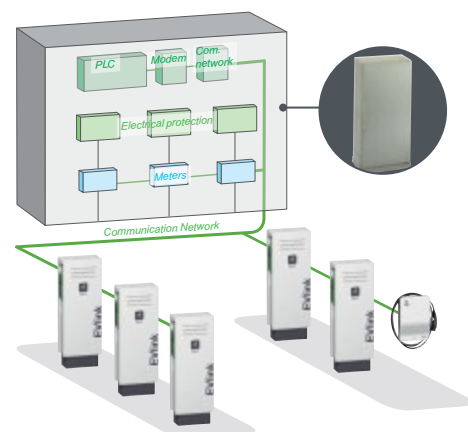



The EVlink Product Range

Electric vehicle charging stations

9 selection criteria for charging station

Electrical



| | | | | |
|-------------------------|---|--|---|-----------------------------------|
| Power per socket | 3.7 kW - 7.4 kW ▲ Single-phase main supply. | 11 kW - 22 kW ▲ Three-phase main supply. | 22 kW (AC) - 24 kW (DC) | |
| Charging mode | Mode 2 ▲ Use of charging cable equipped with its control interface. | Mode 3 ▲ Advanced charging control with communication between station and vehicle. Use of direct charging cable. | Mode 4 ▲ Advanced charging control with communication between station and vehicle for DC charging mode. | |
| Socket outlet | Domestic ▲ Up to 2.3 kW | Type 2 ▲ Up to 22 kW | Attached cable type 1 Attached cable type 2 ▲ AC type 1: up to 7.4 kW ▲ AC type 2: up to 22 kW | Combo 2 CHAdeMO ▲ 24 kW |

Usage





| | | | | |
|-----------------------------|---|--|---|--|
| Socket outlet access | Free access | Key ▲ Key lock. | Authentication ▲ Access with RFID badge or via Smartphone apps for connected stations. Function depending whether connected station or not. | |
| Load management | Optimized Cost & Service continuity ▲ C1-type: 'Optimized cost' > delayed start or temporary current limitation. ▲ C2-type: 'Opt. cost + Service continuity' > delayed start or temporary current limitation > real-time max charging current control. | Optimized charging time ▲ For not connected charging station. Remaining available power is split between the 2 cars, giving priority to the one with less energy or time already allocated, to prevent tripping. | Optimized charging station management ▲ For charging station cluster connected to a facility network. A global energy management is provided (facility network + stations) in order to preserve site or building services availability and optimize vehicle charging. | |
| Connectivity | Yes - No ▲ Enabling communication (wired, 3G/4G modem) to the cloud-based supervision. | | | |

Installation



| | | | | |
|-------------------|---|---|--|--|
| Mounting | On Wall ▲ Cabinet fixed on wall. | | On Floor ▲ Cabinet with integrated or separate pole. | |
| Protection | Electrical ▲ D-type: built-in DC fault current detection (RDC-DD) ▲ I-type: protection devices can be installed on pedestal; ▲ F-type: factory mounted protection device. | Mechanical IP54 ▲ Protection from dust, splashing water. Outdoor use is possible. | Mechanical IK10 ▲ Resistance to pendulum shock: mass of 5 kg, 40 cm string. | |
| Aspect | Stylish ▲ White resistant plastic casing. | Robust ▲ Metallic casing. | Robust + ▲ Antivandalism features. Metallic casing, extra keyboard protection. | |

For eligible countries

| | EVlink Wallbox | | EVlink Smart Wallbox | EVlink Parking | EVlink DC Fast Charge |
|---|---------------------|-----------------|---|--|---|
| | 'Standard' | 'Plus' |  Cloud-connectable |  Cloud-connectable |  Cloud-connectable |
| Charging power (kW) | 3.7 11 | 7.4 22 | 7.4 22 | 7.4 22 | 22 (AC) 24 (DC) |
| Charging mode | 3 | 3 | 2 3 | 2 3 | 3 4 |
| 2 Mode 2 3 Mode 3 4 Mode 4 | | | | | |
| Socket outlet Attached cable | T2 ACT1 ACT2 | T2 ACT1 ACT2 | T2 T2+D ACT1 ACT2 | T2 T2+D T2+T2 | ACT CHAdemo ACT Combo 2 T2 22 kW (AC) |
| D Domestic ACT1 Att. cable with plug Type 1 ACT2 Att. cable with plug Type 2 T2 Plug type 2 (optional shutter) | | | | | |
| Charging access | F K | F K | F K A | F A | F A |
| F Free access K Key lock A Authentication | | | | | |
| Load management | C1 | C2 | C1+M | C1+T+M | M |
| C1 Optimized Cost C2 Opt. Cost + Service Continuity T Opt. Charging Time M Opt. Station Management | | | | | |
| Connectivity | N | N | N Y | N Y | N Y |
| Y Yes (ready to connectivity) N No | | | | | |
| Mounting | W F | W F | W F | W F | W F |
| W Wall F Floor | | | | | |
| Protection | Elec IP IK 54/10 | D 54/10 | I 54/10 | I 54/10 | F 54/10 |
| D Built-in DC filter I Possible on-site mounting F Factory-mounted 54 Dust + splashing water 10 5 kg shock | | | | | |
| Aspect | S | S | S | R | R+ |
| S Stylish R Robust R+ Robust + | | | | | |

Energy management

How to optimize the impact of consumption of a charging solution on an electrical installation

> The problem

Initial situation

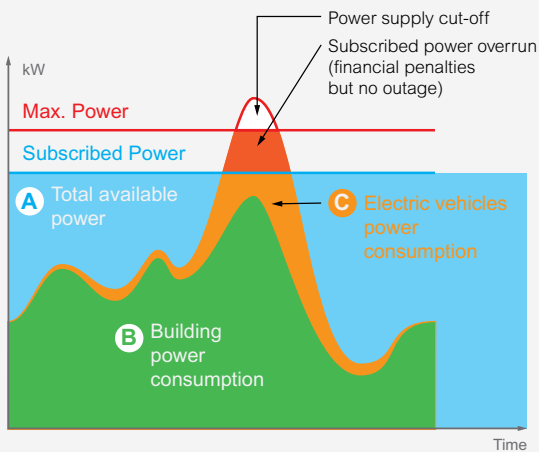

The installation of charging stations in an existing electrical installation can have a significant impact due to the power level required by electric vehicles to charge.

> Solution without energy management

Increase of subscribed power

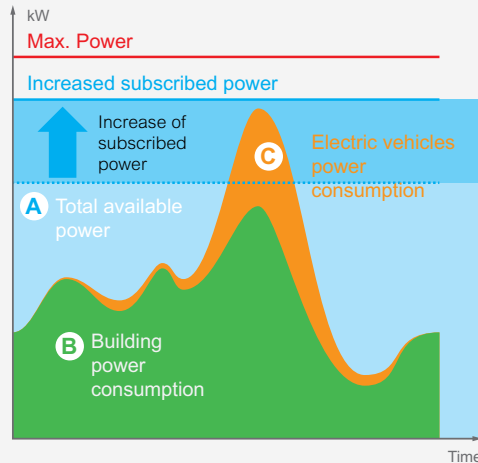

This solution consists of increasing the power subscribed to the energy supplier to maintain the same consumption model. It implies an increase in the cost of the subscription and does not guarantee that the trigger threshold will never be exceeded. Thus the continuity of service of the building is not guaranteed.

Electrical installation without energy management

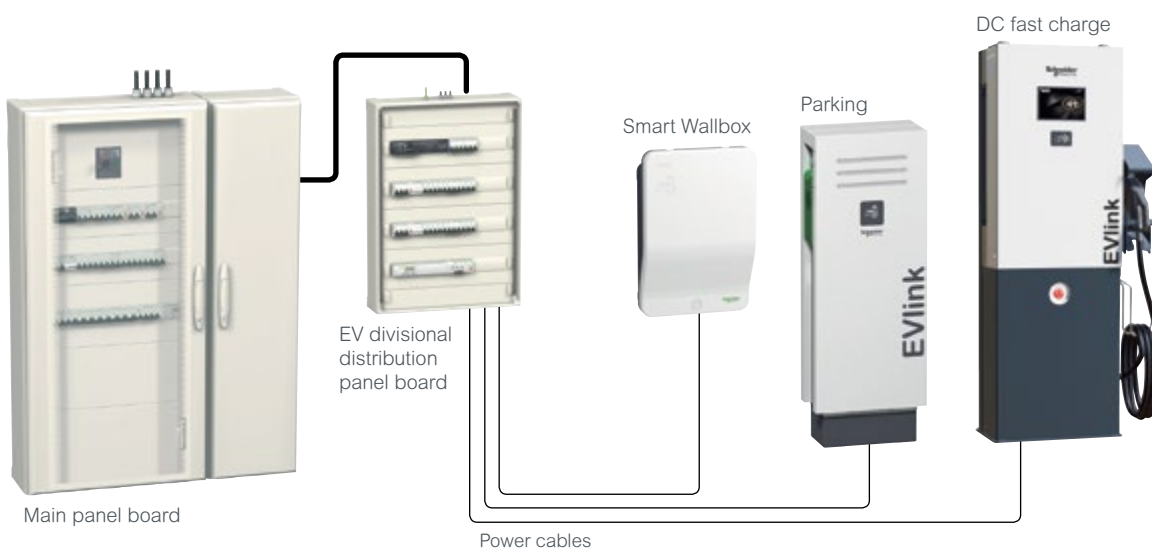

> Schneider Electric solutions

Static energy management

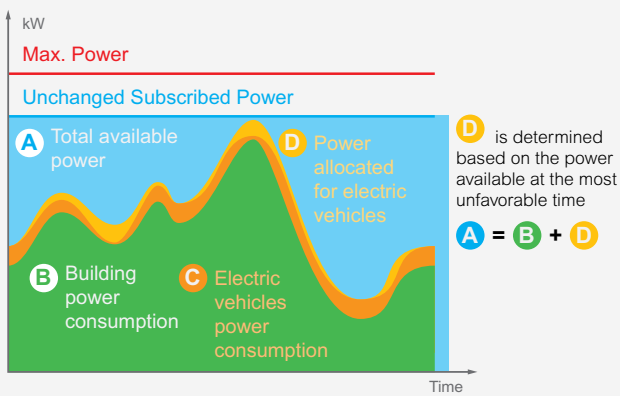

Setpoint "D" is fixed. The power is distributed between all connected vehicles.

Dynamic energy management

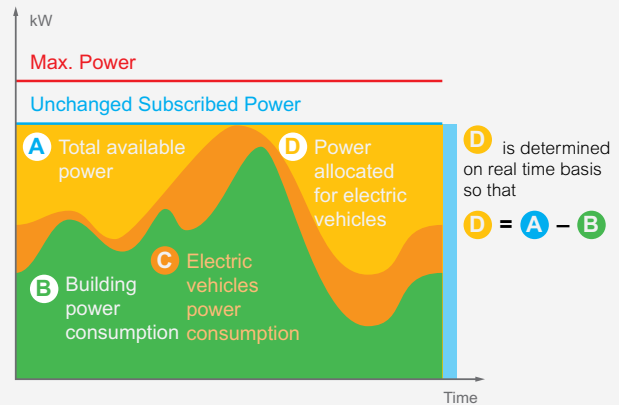

Setpoint "D" is adjusted in real time according to the consumption of the rest of loads in the building, to maximize the power allocated to charging electric vehicles.

Electrical installation with energy management

From 1 to 1000 charging stations depending on the EVlink LMS (Load Management System) model selected.

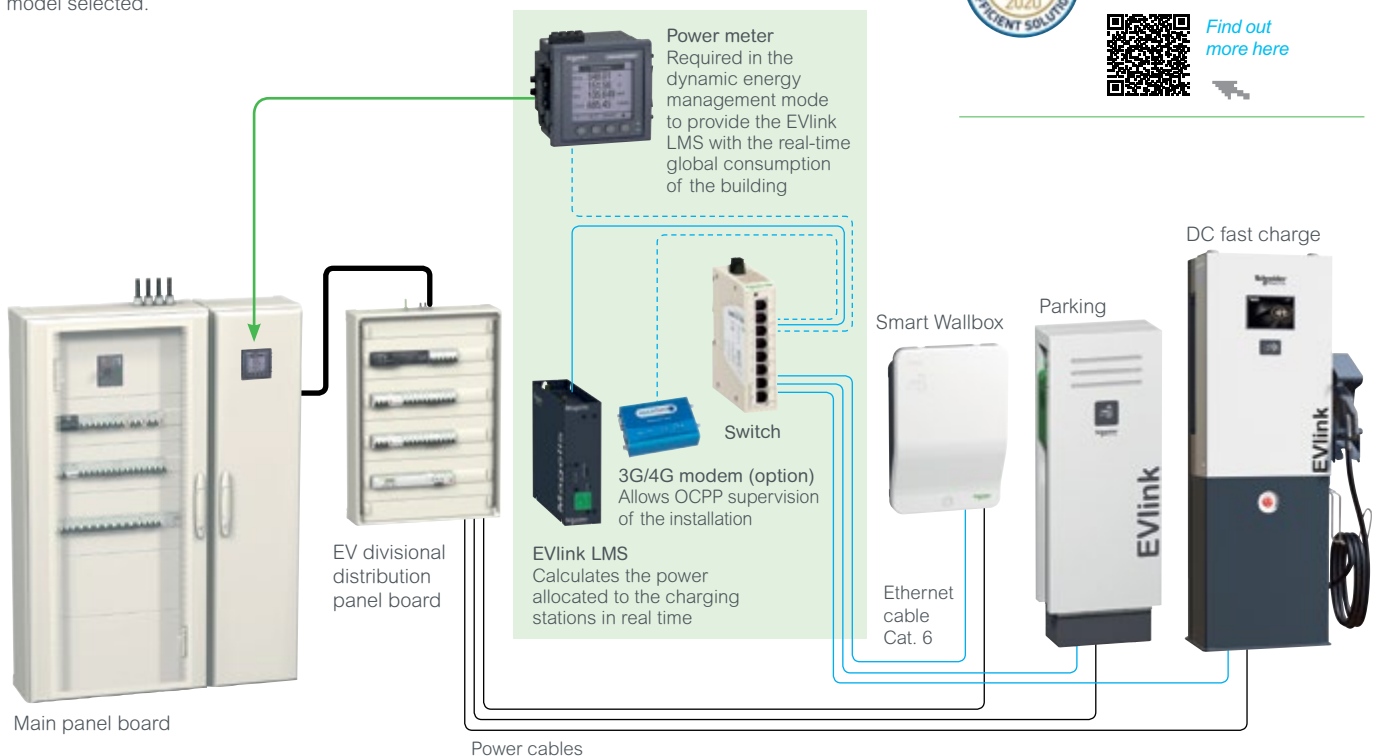

EVlink Load Management System has been awarded with the prestigious "Solar impulse Efficient Solution" label.



Find out more here

Communicating charging stations

Charging station connectivity

EVlink Parking and EVlink Smart Wallbox charging stations are fitted with Ethernet ports (cable).

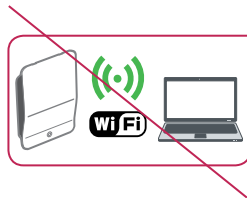
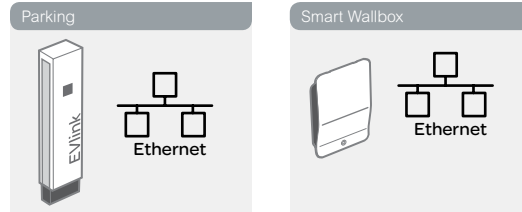

Communication for commissioning purpose

Charging stations settings are customized during the commissioning phase. Their Ethernet port must be connected to a standard PC for this purpose. No WiFi connection available at this stage.

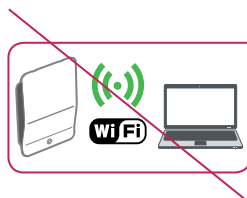
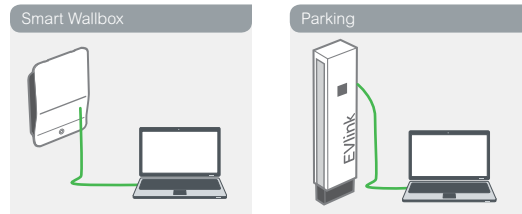

Communication for maintenance purpose

Later changes of charging stations settings are sometime requested. They can be achieved by either:

- direct connection to charging station Ethernet port,
- or connection via a LAN, avoiding to open/close the charging station.

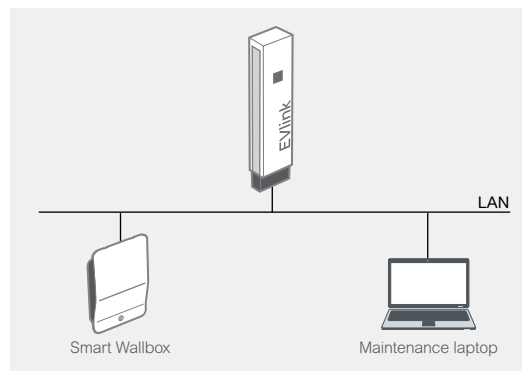
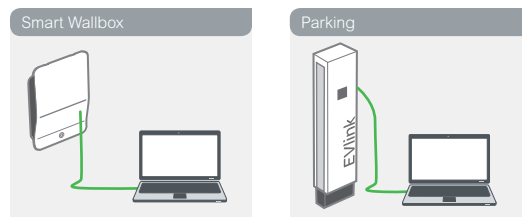



Communication for Cloud supervision

EVlink Parking and EVlink Smart Wallbox access to the Cloud is available with 3G/4G or DSL technologies, and OCPP protocol.

Examples of possible Supervision services:

- User Access Management
- Getting Charge Details Records
- Reporting
- Asset management.

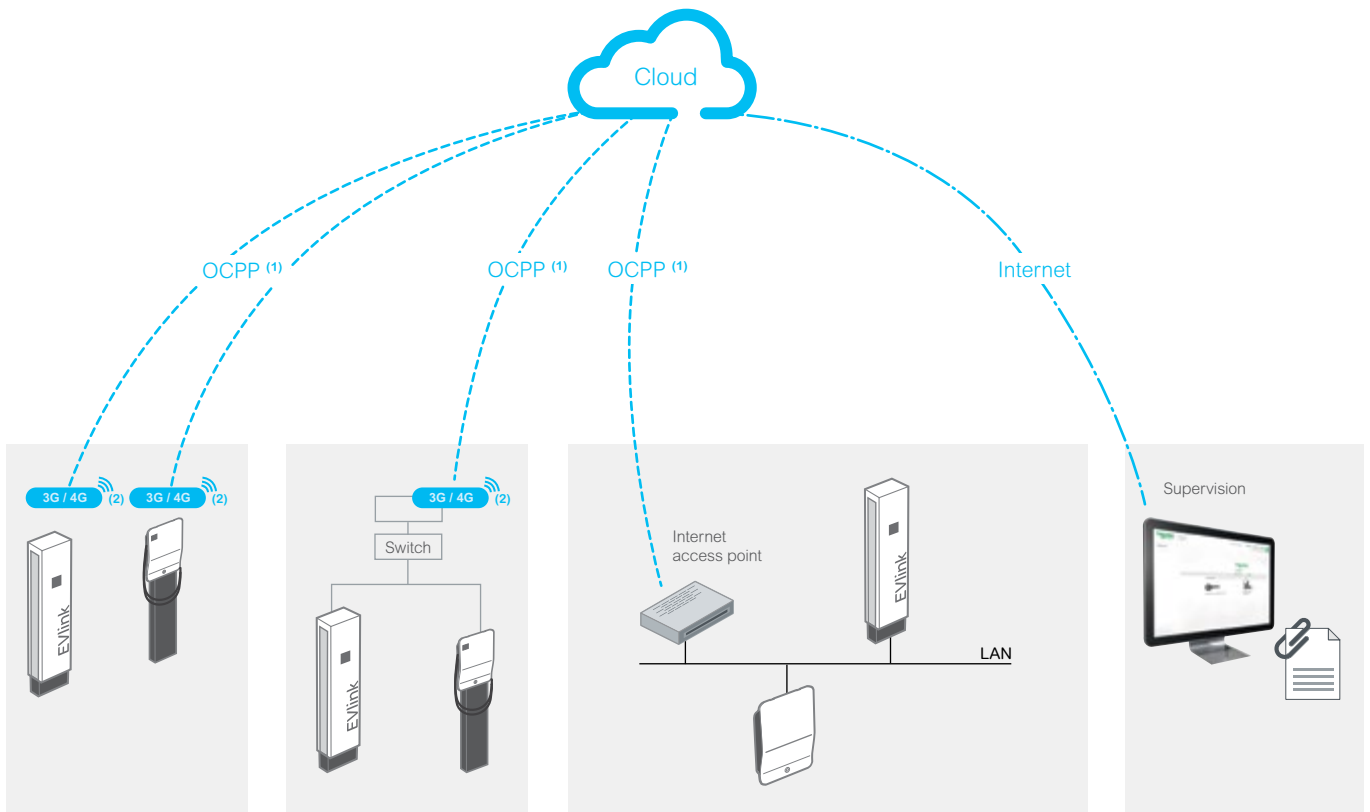

⁽¹⁾ OCPP: Open Charge Point Protocol standard.

⁽²⁾ 4G modem: switches to 3G if no 4G covering.

Overview of EVlink offer

EVlink Wallbox



page 22

Wallbox 'Standard'

- Outdoor or indoor use
- Wall-mounted or floor-standing*
- Power range: 3.7 to 22 kW
- T2 socket outlet (with or without shutters) or attached cable with T1 or T2 connector
- Key lock to prevent cable theft and to prevent starting and stopping a charging session
- Delayed start or temporary current limitation capability

Wallbox 'Plus'

Same features as Wallbox 'Standard'

Additional functions:

- Built-in protection against residual direct current
- TIC interface with French utility meters to avoid the risk of tripping of connection to the grid.

(*) Pole as an accessory.

How to use an EVlink Wallbox



Scan or click on QR code

EVlink Smart Wallbox



page 28

- Outdoor or Indoor installation
- Wall-mounted or floor standing*
- Power Range: 7.4 kW or 22 kW with permanent derating option
- Socket outlet (T2/T2S) + domestic socket option (TE) or attached cable (T2/T1)
- Key lock to prevent cable theft and to prevent starting and stopping a charging session
- RFID badge authentication
- Energy metering capacity
- Optional communication module (3G/4G) or Ethernet to connect to a Supervision.

(*) Pole as an accessory.

How to use an EVlink Smart Wallbox



Scan or click on QR code

EVlink Parking



page 34

- Outdoor or Indoor installation
- Wall-mounted or floor standing
- Power Range: 7.4 kW to 22 kW with permanent derating option
- 1 or 2 socket outlet (T2/T2S) + domestic socket option (TE)
- Free access or RFID badge authentication
- Energy metering capacity with automatic load balancing through commissioning
- Optional communication module (3G/4G) or Ethernet to connect to a Supervision.

How to use an EVlink Parking charging station



Scan or click on QR code

EVlink Load Management System for load management and supervision

Energy management functions

- Avoid penalties for exceeding subscribed power
- Avoid power outages due to EV charging
- Reduce energy costs
- Monitor and control your installation locally
- Increase EV charger user satisfaction by providing fair EV charging services.



Site management, supervision

- EV charging usage analysis
- Access and user authorization management
- Charging transactions data registering
- Maintenance & logs data registering.

EVlink Load Management System: see page 50



EVlink DC fast charge*



page 42

- Outdoor or Indoor installation
- Floor Standing
- Wall-mounted or floor standing with pedestal*
- Max DC output power: 24 kW
- **4 wallmounted charging stations**
 - 2 x mono-standard charging stations:
 - either with 'CHAdeMO' socket,
 - or with 'CCS Combo 2' socket
 - 1 x bi-standard charging station with 'CHAdeMO' socket + 'CCS Combo 2' socket
 - 1 x tri-standard charging station with 'CHAdeMO' socket + 'CCS Combo 2' socket + 'AC 22kW T2' socket.
- Free access or RFID badge authentication.

(*) Pedestal to be ordered separately.



EVlink accessories & spare parts



- Floor standing and wall mounted bases
- Socket outlets, charging cables, cable holder
- Caps, covers
- Pack of 10 RFID badges
- AC Charging Station testing tool
- Key lock
- 3G/4G modem.

EVlink Services

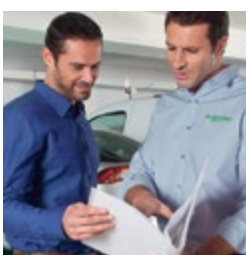

EVlink Services: Solutions for your projects

As an energy management specialist, Schneider Electric offers the following services:

- Installation audit and commissioning by trained engineers or certified installers
- Warranty extension (on standard 24 months warranty)
- Training of your staff
- Spare parts offer for all EVlink charging stations.

EVlink Wallbox

In short



Product QR code
'FLASH ME'



EVlink Wallbox, a range made of Wallbox 'Standard' and Wallbox 'Plus'

Extensive choice

Wallbox 'Standard' and Wallbox 'Plus' are each available in 14 versions:

- Rated charging power: 3.7, 7.4, 11 or 22 kW
- T2 socket outlet (with or without shutter) or attached cable (with T1 or T2 connector)

Charging station QR Code

- To get the product datasheet or to join Customer Care Center with "mySchneider" app, flash the QR Code with your usual QR Code reader
- To access cloud-based EcoStruxure™ Facility Expert app maintenance organizer: charging station registration, maintenance reports, (see page 25)

Robustness

- Highly robust to mechanical impact: IK10
- Suitable for outdoor use: IP54
- Heavy duty T2 socket outlet with silver plated contacts avoiding overheating

Easy to use

- "Plug and charge"
- One-touch stop/restart
- Attached cable rolled up around the Wallbox
- 1 or 2 charging stations mounted on the same pole

Energy management options

Only one option to be selected at once, or none

- Delayed start to charge only in off-peak hours
- Temporary current limitation from 16 A (3.7 and 11 kW) to 10 A, or from 32 A (7.4 and 22 kW) to 16 A, to cut the risk of electric overload
- Permanently adjust the maximum charging current available for the vehicle, to avoid tripping (utility meter or incoming circuit-breaker) when the overall consumption of the home is close to the subscribed power

The first two options are activated by closing an external contact (off-peak switch, load-shedding device, etc) hardwired to the single digital input. The third option is only available in Wallbox Plus when using the TIC ("Télé-Information Client") interface of French utility meters (single-phase residential only with Linky and former electronics meters)

Protection against earth leakage current (Wallbox Plus only)

Wallbox Plus is fitted with a built-in protection against residual direct current (RDC-DD, as "Residual Direct Current Detecting Device"). This makes it possible to use an upstream type A protection against residual current (RCD) both in single-phase and three-phase, in accordance with the CENELEC HD 60364-7-722:2016 electrical installation standard.

Please note that despite the mandatory application of this new standard since February 2019, some countries may have not yet updated their national standard accordingly. National standards and codes prevail and the use of a RCD type A combined with a RDC-DD may be prohibited in three-phase.

At home



At home — condominium

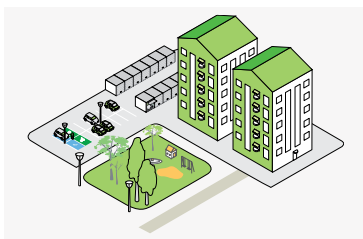

In private parking area

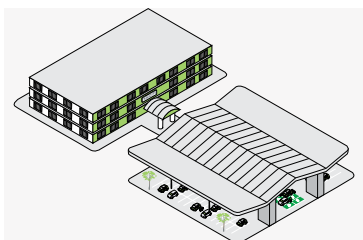

Application

EVlink Wallbox 'Standard' and EVlink Wallbox 'Plus'

Wallbox Standard and Wallbox Plus are recommended for homes, as well as tougher environments (condominium, corporate car park, hotel, etc.), because of their weatherproof and robust design.

Discovery



Charging station with attached cable

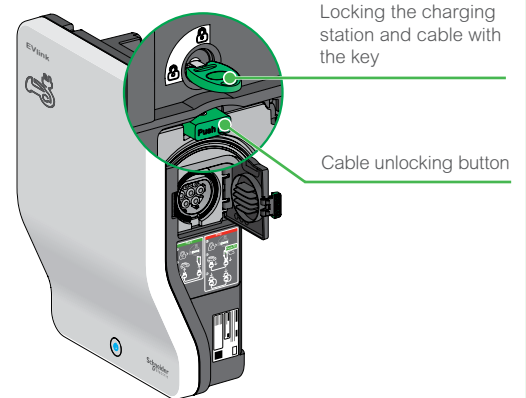
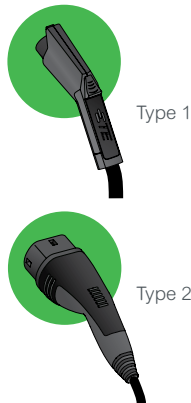

Charging station with socket outlet

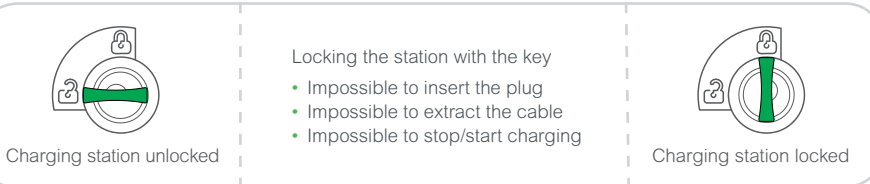
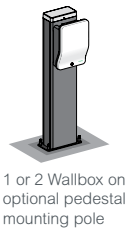

Easy to install

Installation by a single technician in less than 30 minutes;
no special tools required
Top, bottom or back side wiring
Immediate commissioning

What's inside an EVlink Wallbox



Scan or click on QR code

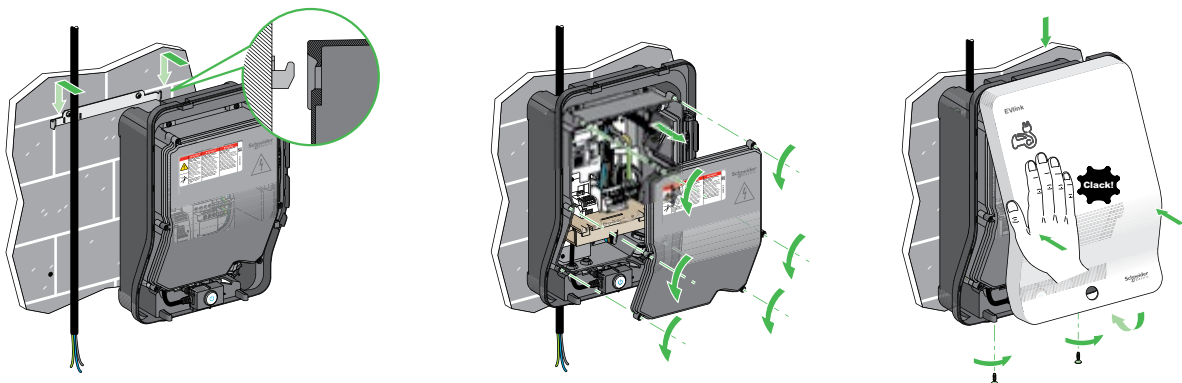

EVlink Wallbox

Characteristics



Z.E. READY*



> ROHS compliant
> Reach compliant
> EoLi: End Of Life Process
> Product Environmental Profile compliant

Certification

EVlink Wallbox has obtained the CB test certificate issued by the LCIE test laboratory, establishing compliance with the IEC 61851-1 and IEC 61851-22 standards.

(*) Granted to Wallbox Standard, planned for Wallbox Plus.

EVlink Wallbox 'Standard' and EVlink Wallbox 'Plus'

Power supply network

- 220 - 240 V single-phase – 50/60 Hz for 3.7 and 7.4 kW charging stations
- 380 - 415 V three-phase – 50/60 Hz for 11 and 22 kW charging stations
- Suitable earthing systems:
 - TT, TN-S, TN-C-S
 - IT (may require the addition of an isolating transformer to make it possible to charge certain vehicles)

Mechanical and environmental characteristics

- Ingress protection code: IP54
- Impact protection code: IK10
- Operating temperature: -30°C to +50°C
- Storage temperature: -40°C to +80°C
- Attached cable length: 4 m
- Energy management exclusive options: delayed charging start, temporary current limitation, real time maximum charging current control (Wallbox Plus only, combined with TIC interface of French utility meters)

Access control modes

- Free access
- Control by key lock, including charging cable locking

Warranty

- 24 months for the entire EVlink range

Standards

- IEC/EN 61851-1 ed 2.0
- IEC/EN 61851-22 ed 1.0
- IEC/EN 62196-1 ed 2.0
- IEC/EN 62196-2 ed 1.0.

Charging station references

EVlink Wallbox



| Description | Socket outlet or connector type | Power (kW) Phases | References | |
|--|---------------------------------|---|--------------------|--------------------|
| | | | Wallbox Standard | Wallbox Plus |
| With socket outlet on right side ⁽¹⁾ - Silver-plated contacts | | | | |
| T2 | | 3.7 (1P - 16 A) | EVH2S3P02K | EVH3S3P02K |
| | | 7.4 (1P - 32 A) | EVH2S7P02K | EVH3S7P02K |
| | | 11 (3P - 16 A) | EVH2S11P02K | EVH3S11P02K |
| T2 with shutters | | 22 (3P - 32 A) | EVH2S22P02K | EVH3S22P02K |
| | | 3.7 (1P - 16 A) | EVH2S3P04K | EVH3S3P04K |
| | | 7.4 (1P - 32 A) | EVH2S7P04K | EVH3S7P04K |
| | | 11 (3P - 16 A) | EVH2S11P04K | EVH3S11P04K |
| | | 22 (3P - 32 A) | EVH2S22P04K | EVH3S22P04K |
| | | With attached cable 4 m, on right side - Silver-plated contacts | | |
| T1 | | 3.7 (1P - 16 A) | EVH2S3P0AK | EVH3S3P0AK |
| | | 7.4 (1P - 32 A) | EVH2S7P0AK | EVH3S7P0AK |
| T2 | | 3.7 (1P - 16 A) | EVH2S3P0CK | EVH3S3P0CK |
| | | 7.4 (1P - 32 A) | EVH2S7P0CK | EVH3S7P0CK |
| | | 11 (3P - 16 A) | EVH2S11P0CK | EVH3S11P0CK |
| | | 22 (3P - 32 A) | EVH2S22P0CK | EVH3S22P0CK |

⁽¹⁾ Cable available as an accessory.

Protections and options with Wallbox Standard

| Description | | Single-phase | | Three-phase | |
|--|--|---|--|---|--|
| Charging | | 3.7 kW - 16 A | | 11 kW - 16 A | |
| Rated Power - Current | | 7.4 kW - 32 A | | 22 kW - 32 A | |
| Protection | | 20 A Curve C | | 40 A Curve C | |
| Circuit breaker (overcurrent) ⁽¹⁾ | | 40 A Curve C | | 20 A Curve C | |
| RCD (residual current) ⁽¹⁾ | | 30 mA B Type for EV ⁽²⁾ : A9Z51225 | | 30 mA B Type for EV: A9Z51425 | |
| | | 30 mA B-SI Type ⁽²⁾ : A9Z61225 | | 30 mA B-SI Type: A9Z61425 | |
| Under voltage tripping auxiliary | | with iC60 A9A26969 (optional) | | with DT40 A9N26969 (optional) | |
| Delayed start | | A9A26969 (optional) | | A9N26969 (optional) | |
| Relay | | With normally open contact | | With normally open contact | |
| Temporary current limitation | | With normally open contact | | With normally open contact | |
| Relay | | With normally open contact | | With normally open contact | |

Protections and options with Wallbox Plus

| Description | | Single-phase | | Three-phase | |
|--|--|----------------------------------|--|----------------------------------|--|
| Charging | | 3.7 kW - 16 A | | 11 kW - 16 A | |
| Rated Power - Current | | 7.4 kW - 32 A | | 22 kW - 32 A | |
| Protection | | 20 A Curve C | | 40 A Curve C | |
| Circuit breaker (overcurrent) ⁽¹⁾ | | 40 A Curve C | | 20 A Curve C | |
| RCD (residual current) ⁽¹⁾ | | 30 mA A-SI Type ⁽²⁾ | | 30 mA A-SI Type ⁽²⁾ | |
| Under voltage tripping auxiliary | | with iC60 A9A26969 (4) | | with DT40 A9N26969 (4) | |
| Delayed start | | A9A26969 (3)(4) | | A9N26969 (3)(4) | |
| Relay | | With normally open contact | | With normally open contact | |
| Temporary current limitation | | With normally open contact | | With normally open contact | |
| Relay | | With normally open contact | | With normally open contact | |

⁽¹⁾ References to be defined and local availability to be checked by Schneider Electric front offices.

⁽²⁾ In accordance with the electrical installation standard HD 60364-7-722:2016. Refer to local regulation.

⁽³⁾ Necessary to meet EV Ready requirements.

⁽⁴⁾ Mandatory for safety in case of charging station damage further to a short-circuit created by the vehicle.

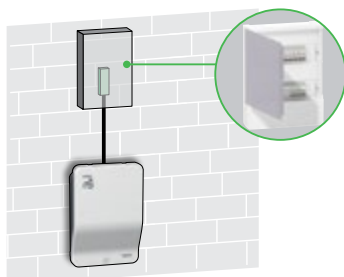

The charging station operates autonomously. It has a dedicated protective device.

- > Installation: by an electrician
- > Location: residential, private usage

EVlink Wallbox

Accessory references

EVlink Cable

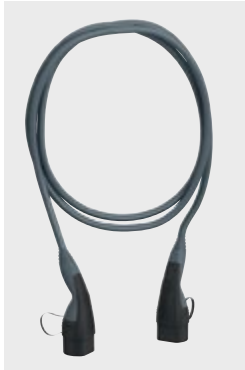

To connect the car to the charging station. Available with a T1 or T2 connector.

Please refer to page 46

AC charging station testing tool



Enables an operating check in the field of the charging station and charging cable. Reference: **EVA1SADS**

Pedestal mounting pole



Floor standing:
 • for 1 Wallbox, Reference **EVP2PBSSG1**
 • for 2 Wallbox, Reference **EVP2PBSSG2**
 Available 4th quarter of 2020

Spare part references

Front panel



Reference
EVP1HCWN

Socket outlet

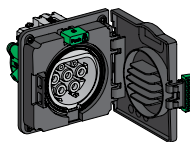

| | References |
|------------------|------------------|
| T2S single-phase | EVP1HSM41 |
| T2 single-phase | EVP1HSM21 |
| T2S three-phase | EVP1HSM43 |
| T2 three-phase | EVP1HSM23 |

Key lock



| | References |
|--------------------------------|-----------------|
| Key lock Random ⁽¹⁾ | EVP1HLSR |
| Key lock Single ⁽¹⁾ | EVP1HLSS |

⁽¹⁾ Example:
 - If you order one EVP1HLSR: you will receive 1 lock + 2 keys with same code.
 - If you order one EVP1HLSS: you will receive 10 locks + 20 keys with same code for all keys.

Attached cable

T1 charging connector



| | References |
|-------------------|---------------------|
| 16 A single-phase | EVP2CNS161A4 |
| 32 A single-phase | EVP2CNS321A4 |

T2 charging connector



| | References |
|-------------------|---------------------|
| 16 A single-phase | EVP2CNS161C4 |
| 32 A single-phase | EVP2CNS321C4 |



| | References |
|------------------|---------------------|
| 16 A three-phase | EVP2CNS163C4 |
| 32 A three-phase | EVP2CNS323C4 |

Practical information

➤ Dimensions (mm)

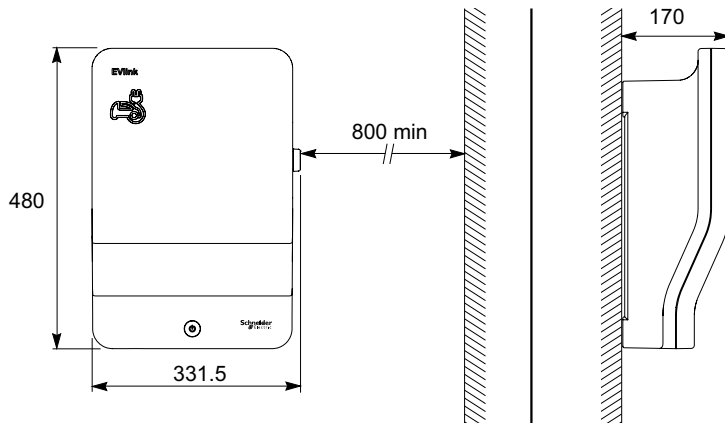

5.6 kg (Wallbox Standard)
6.3 kg (Wallbox Plus)



7.5 kg (Wallbox Standard with attached cable)
7.9 kg (Wallbox Plus with attached cable)

EcoStruxure™ Facility Expert

Register your charging station and improve your maintenance efficiency now with EcoStruxure™ Facility Expert.

- EcoStruxure™ Facility Expert is a simple, cloud-based tool that helps you organize maintenance records, follow-up on preventive maintenance, access log histories, create reports, and integrate remote alarming from your equipment.
- Let EcoStruxure™ Facility Expert help you optimize your maintenance activities. Download it for free on your PC or for your smart device at the Apple or Google Play store.
- You are ready to flash the product QR code with the EcoStruxure™ Facility Expert reader.



Additional information for Wallbox Standard

| Technical document | Language | References |
|----------------------------|---|---|
| With socket outlet | | |
| Quick start guide | EN/ES/FR/DE ⁽¹⁾ IT/NL/PL/PT | NHA31789 NHA31790 |
| Instruction sheet | EN/ES/FR/DE ⁽¹⁾ IT/NL/PL/PT NO/SV/FI | NHA31778 NHA31779 QGH34400 |
| With attached cable | | |
| Quick start guide | EN/ES/FR/DE ⁽¹⁾ IT/NL/PL/PT | NHA31783 NHA31784 |
| Instruction sheet | EN/ES/FR/DE ⁽¹⁾ IT/NL/PL/PT NO/SV/FI | NHA31787 NHA31788 QGH34396 |

Additional information for Wallbox Plus

| Technical document | Language | References |
|----------------------------|---|------------------------------------|
| With socket outlet | | |
| Instruction sheet | EN/FR/DE/NO ⁽¹⁾ SV/ES/NL/IT | PHA92084 PHA92086 |
| With attached cable | | |
| Instruction sheet | EN/FR/DE/NO ⁽¹⁾ SV/ES/NL/IT | PHA92085 PHA92087 |

⁽¹⁾ Delivered with the Wallbox.

To download the above documents, do a search by reference on www.schneider-electric.com

EVlink Smart Wallbox

In short



Product QR code
'FLASH ME'



Cloud-connectable



Schneider Electric supports OCPP and is an active member of OCA (Open Charge Alliance).

Extensive choice

Charging station offer:

- Maximum charging power: 7.4 kW or 22 kW with a single-phase or three-phase power supply
- Maximum charging current can be adjusted from 8 A to 32 A
- T2 socket outlet with or without shutter
- T2 socket outlet with shutters + type E domestic socket outlet
- Attached cable with T1 or T2 connector
- Key locking or RFID user authentication

Charging station QR Code

- To get the product datasheet or to join Customer Care Center with "mySchneider" app, flash the QR Code with your usual QR Code reader.
- To access cloud-based EcoStruxure™ Facility Expert app maintenance organizer: charging station registration, maintenance reports, (see page 31)

Robustness

- Heavy duty socket outlet with silver plated contacts avoiding overheating
- High protection against mechanical impacts: IK10
- Suitable for outdoor use: IP54

Easy to install and commission

- Wall mounting or floor standing
- 1 or 2 charging stations on the same pole
- Easy wiring
- Integrated measuring of the apparent power
- Interface with an external MID energy meter
- Parameters setting through a web server embedded in the charging station

Energy management

- Delayed charging locally controlled by a wired contact to postpone charging to off-peak hours
- Temporary current limitation to a set value, controlled by a wired contact, to reduce the overall facility consumption and reduce the risk of power outage.
- Delayed charging and current limitation can also be controlled by the EV Load Management System, the supervision (over OCPP) or by the building management system (over Modbus)

Versatile connection to a supervision

- Wired Ethernet: 3 ports
- 3G/4G modem as an accessory
- OCPP 1.5 or OCPP 1.6 interface

Services offer

- Worldwide network of certified installers providing on-site installation, on-site commissioning, maintenance plan and on-demand repair and asset management contracts
- Worldwide customer care center

Optimized architecture

- Standalone or clustered architecture
- Connected or not to a supervision (through OCPP 1.5 or OCPP 1.6 communication protocols).

Fleet car at home



Condominium



Corporate and semi-public car parks

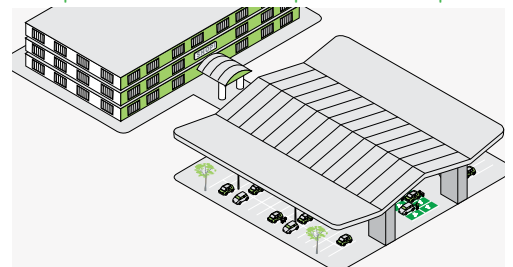

Application

Smart Wallbox is recommended for all private and semi-public areas whenever there are needs of user authentication, charging sessions monitoring or charging assets management.

Discovery

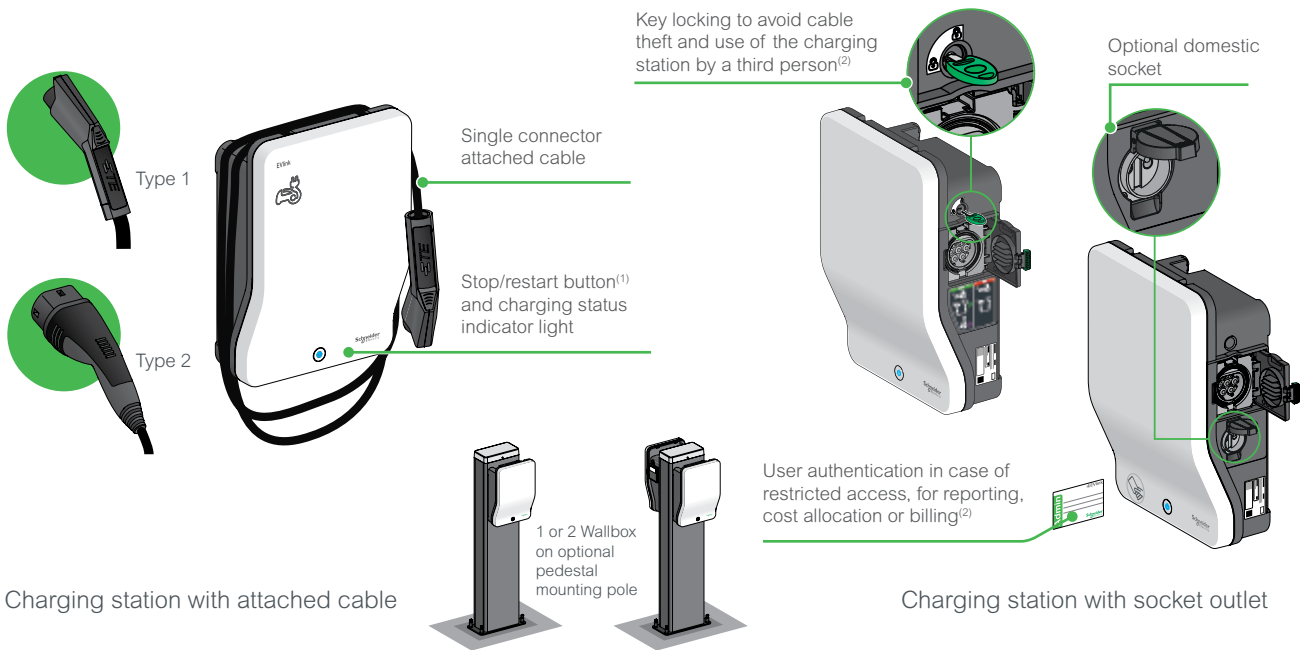

⁽¹⁾: also available with EVlink Smart Wallbox with attached cable.
⁽²⁾: function can be deactivated with commissioning tool.

Easy to install and commission

Installation by a single technician in less than 30 minutes; no special tools required

Top, bottom or back side wiring

Easy commissioning with a laptop connected to the embedded webserver

What's inside an EVlink Smart Wallbox



Scan or click on QR code

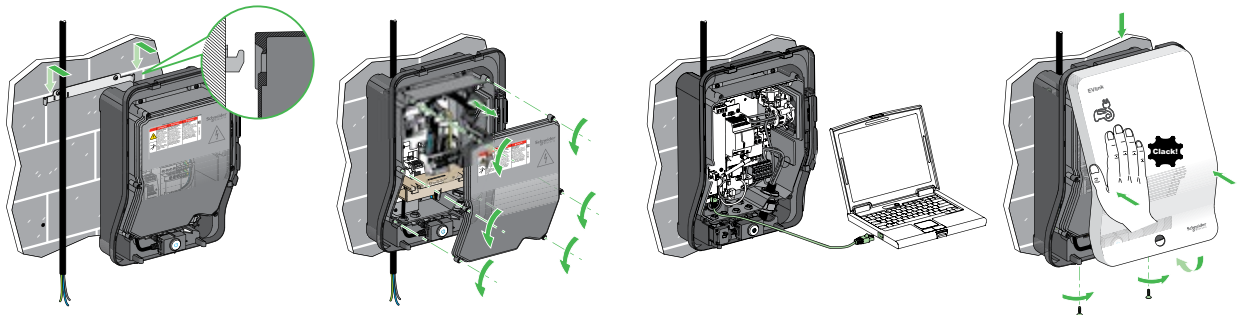

For example, you can:

- configure RFID badges. All RFID badges are accepted by default (factory setting)
- amend the maximum current values per socket
- activate the functions: load shedding
- produce maintenance reports
- set up access to supervision
- ...

EVlink Smart Wallbox

Characteristics



Z.E. READY



> ROHS compliant
> Reach compliant
> EoL: End Of Life Process
> Product Environmental Profile compliant

Certification

EVlink Smart Wallbox has obtained the CB test certificate issued by the LCIE test laboratory, establishing compliance with the IEC 61851-1 and IEC 61851-22 standards.

Power supply

- Smart Wallbox can be supplied either in single-phase or in three-phase
- 220-240 V single-phase - 50/60 Hz
- 380-415 V three-phase - 50/60 Hz

Rated charging current

- T2/T2S socket-outlet: 8 A to 32 A (factory setting 32 A)
- TE socket-outlet: 10 A

Power consumption

- Power consumption of each conditional input (limitation and deferred start): 5 mA 24 V DC

Diagram of the earthing system

- TT, TN-S, TN-C-S
- IT (may require the addition of an isolating transformer for charging of certain vehicles)

Mechanical and environmental characteristics

- Ingress protection code: IP54
- Impact protection code: IK10
- Operating temperature: -30°C to +50°C
- Storage temperature: -40°C to +80°C
- Attached cable length: 4.5 m

Charging access

- Key locking
 - User authentication through a RFID badge. Remote authentication by supervision or local setting of authorized badges
 - 13.56 MHz RFID reader for badges with chips Mifare Ultralight, Mifare Classic 1K / 4K, I Code SLI, Tag-it HFI, EM4135 ... (under ISO/IEC 14443 A&B, ISO/IEC 15693 protocols)
- Notes: RFID badges available on the market and standard are modified very often, so we advice to carry out prior test on our charging station to check compatibility
- 10 RFID badges provided with every RFID-type charging station

Warranty

- 24 months for the entire EVlink range

Standards

- IEC/EN 61851-1 ed 2.0
- IEC/EN 61851-22 ed 1.0
- IEC/EN 62196-1 ed 2.0
- IEC/EN 62196-2 ed 1.0

Connectivity

- Wired Ethernet: 3 ports
 - Port 1: LAN
 - Port 2: 3G/4G
 - Port 3: connection to PC for commissioning
- 3G/4G modem as an accessory
- OCPP 1.5 or OCPP 1.6 interface

Energy metering

- Integrated measuring of the apparent power
- Interface with an external MID energy meter

Commissioning

- Parameters setting through a web server embedded in the charging station.

Charging station references

EVlink Smart Wallbox



| Description | Socket outlet or connector type | Charging access | Power (kW) ⁽¹⁾ Phases | References |
|--|---------------------------------|---------------------|-------------------------------------|---------------------|
| With socket outlet on right side - Silver plated contacts | | | | |
| T2 | | Key | 7.4 (1P) / 22 (3P) | EVB1A22P2KI |
| | | RFID ⁽²⁾ | 7.4 (1P) / 22 (3P) | EVB1A22P2RI |
| T2 with shutter | | Key | 7.4 (1P) / 22 (3P) | EVB1A22P4KI |
| | | RFID ⁽²⁾ | 7.4 (1P) / 22 (3P) | EVB1A22P4RI |
| T2 with shutter and TE (domestic) | | Key | 7.4 (1P) / 22 (3P) | EVB1A22P4EKI |
| | | RFID ⁽²⁾ | 7.4 (1P) / 22 (3P) | EVB1A22P4ERI |
| With attached cable 4.5 m, on right side - Silver plated contacts | | | | |
| T1 | | Key | 7.4 (1P) | EVB1A7PAKI |
| | | RFID ⁽²⁾ | 7.4 (1P) | EVB1A7PARI |
| T2 | | Key | 7.4 (1P) | EVB1A7PCKI |
| | | RFID ⁽²⁾ | 7.4 (1P) | EVB1A7PCRI |
| T2 | | Key | 22 (3P) | EVB1A22PCKI |
| | | RFID ⁽²⁾ | 22 (3P) | EVB1A22PCRI |

⁽¹⁾ Factory setting: 32 A - and all RFID badges validated. Can be replaced by customer setting (16 A, list of RFID badges...) using a PC via embedded webserver (see commissioning guide DOCA0060).

⁽²⁾ Includes 10 RFID badges.

Protective devices and optional equipment

New installation: supply line and protection devices must be defined for the highest power setting.

| Description | | Single-phase | Three-phase |
|--|-----------|--|---|
| Charging | | | |
| Rated Power - Current | | 7.4 kW - 32 A ⁽⁴⁾ | 22 kW - 32 A ⁽⁴⁾ |
| Protection | | | |
| Circuit breaker (overcurrent) ⁽¹⁾ | | 40 A Curve C | 40 A Curve C |
| RCD (residual current) ⁽¹⁾ | | 30 mA B Type for EV ⁽²⁾ : A9Z51240 | 30 mA B Type for EV: A9Z51440 |
| | | 30 mA B-SI Type ⁽²⁾ : A9Z61240 | 30 mA B-SI type for EV: A9Z61440 |
| Under voltage tripping auxiliary | with iC60 | A9A26969 ⁽³⁾ | A9A26969 ⁽³⁾ |
| | with DT40 | A9N26969 ⁽³⁾ | A9N26969 ⁽³⁾ |
| Deferred start | | | |
| Relay | | With normally open contact ⁽⁵⁾ | |
| Load-shedding | | | |
| Relay | | With normally open contact ⁽⁵⁾ | |

⁽¹⁾ References to be defined and local availability to be checked by Schneider Electric front offices.

⁽²⁾ In accordance with the electrical installation standard HD 60364-7-722:2016. Refer to local regulation.

⁽³⁾ Necessary to meet EV Ready requirements.

⁽⁴⁾ Without or with domestic socket.

⁽⁵⁾ Smart Wallbox setting can be changed to "normally closed" if necessary, with commissioning tool.

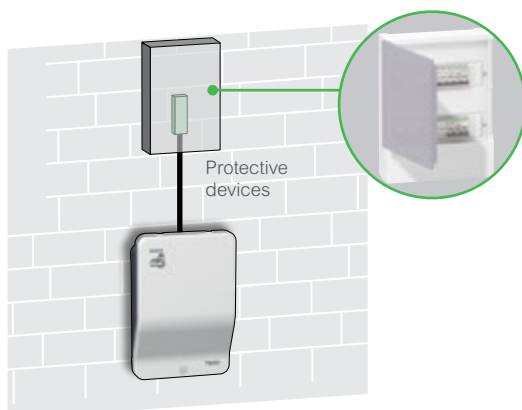

The charging station operates autonomously. It has a dedicated protective device.

➤ Installation: by an electrician

➤ Location: residential, private usage

EVlink Smart Wallbox

Accessory references

EVlink Cable

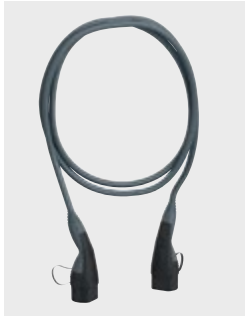

Available with T1 or T2 connector.

Please refer to page 46

AC charging station testing tool



Enables operating check of the charging station and charging cable.
Reference: **EVA1SADS**

Pedestal mounting pole



Floor standing:
• for 1 Wallbox, Reference **EVP2PBSSG1**
• for 2 Wallbox, Reference **EVP2PBSSG2**
Available 4th quarter of 2020

Modem



Modems to be mounted inside the Smart Wallbox.
3G/4G Modem
Reference: **EVP3MM**

Pack of 10 RFID badges

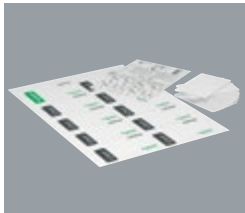

For charging stations equipped with an RFID reader. The badges are supplied blank, ready to be programmed to identify an administrator or user. Sheet of adhesive labels for badges: 1 administrator + 9 users.
Reference: **EVP1BNS**

Antenna for Smart Wallbox GPRS/3G/4G modem





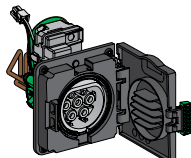

Antenna must be ordered separately:
Ethernet cable 0.3 m included.
To be mounted inside the Smart Wallbox
Reference: **EVP2MX**

Spare part references

| Front panel | Reference |
|---|-----------------|
|  | EVP1HCWN |

| Socket outlet | References |
|---|----------------------|
|  | T2S EVP1BSE43 |
| | T2 EVP1BSE23 |
| | TE EVP1BSSE |

| Key lock | References |
|---|--|
|  | Key lock Random ⁽¹⁾ EVP1HLSR |
| | Key lock Single ⁽¹⁾ EVP1HLSS |

| Attached cable | References |
|---|--|
| T1 charging connector | |
|  | 32 A single-phase EVP1CBS321A45 |
| T2 charging connector | |
|  | 32 A single-phase EVP1CBS321C45 |
|  | 32 A three-phase EVP1CBS323C45 |

⁽¹⁾ Example:
- If you order one EVP1HLSR: you will receive 1 lock + 2 keys with same code.
- If you order one EVP1HLSS: you will receive 10 locks + 20 keys with same code for all keys.

Practical information

> Dimensions (mm)

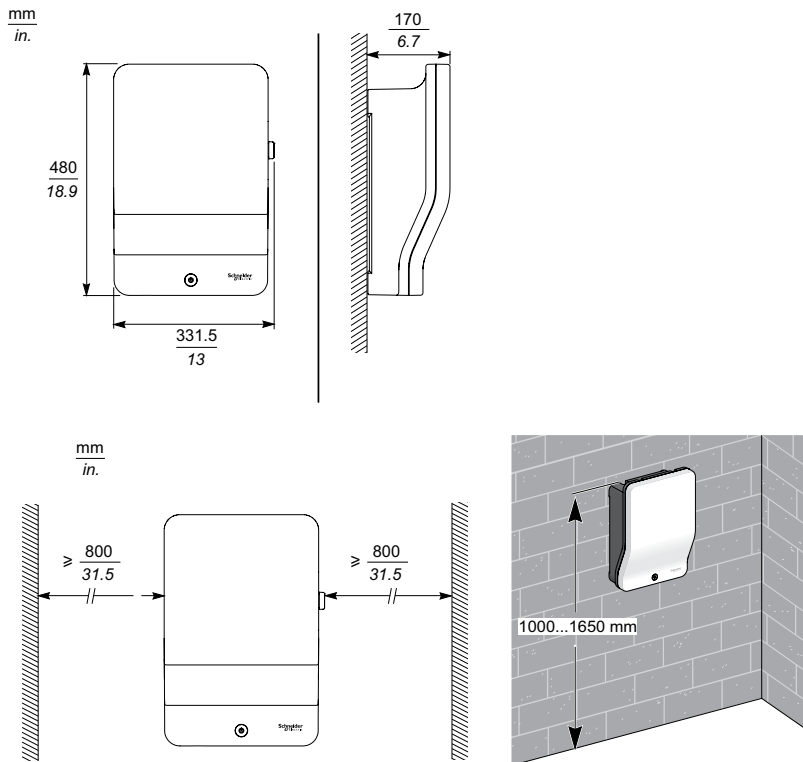



With socket outlets

 **6.2 kg (13.66 lb) - T2/T2S**

 **6.6 kg (14.55 lb) - T2/T2S + TE**

With attached cable

 **7.7 kg (15.43 lb) - 7.4 kW**

 **8.3 kg (17.63 lb) - 22.1 kW**

Additional information

| Charging station technical document | Language | References |
|--|-------------------|-------------------|
| Installation Guide ⁽¹⁾ (model with socket outlet) | EN / FR / ES / IT | NHA95005 |
| | DE / NL / NO / SV | NHA95006 |
| Installation Guide ⁽¹⁾ (model with attached cable) | EN / FR / ES / IT | NHA95018 |
| | DE / NL / NO / SV | NHA95021 |
| User guide ⁽¹⁾ | EN / FR / ES / IT | NHA95096 |
| | DE / NL / NO / SV | NHA95097 |
| Commissioning Guide ⁽²⁾ (standalone charging station) | FR | DOCA0060FR |
| | EN | DOCA0060EN |

⁽¹⁾ Delivered with the product.

⁽²⁾ To be downloaded.

To download the above documents, do a search by reference on www.se.com

EcoStruxure™ Facility Expert

Register your charging station and improve your maintenance efficiency now with EcoStruxure™ Facility Expert.

- EcoStruxure™ Facility Expert is a simple, cloud-based tool that helps you organize maintenance records, follow-up on preventive maintenance, access log histories, create reports, and integrate remote alarming from your equipment.
- Let EcoStruxure™ Facility Expert help you optimize your maintenance activities. Download it for free on your PC or for your smart device at the Apple or Google Play store.
- You are ready to flash the product QR code with the EcoStruxure™ Facility Expert reader.



EVlink Parking

In short



Extensive choice

Charging station offer

- Compliant with power supply network: 220-240 V / 380-415 V
- 7.4 kW or 22 kW (32 A for 230 / 400 V) and settable from 6 A to 32 A
- High robustness of Socket outlet (Type 2 or Type 2 with shutters) thanks to silver plated contact avoiding overheat
- Multiple configurations: user identification, one or two sockets outlets, floor-standing or wall-mounted

Charging station QR Code

- To get the product datasheet or to join Customer Care Center with "mySchneider" app, flash the QR Code with your usual QR Code reader.
- To access cloud-based EcoStruxure™ Facility Expert app maintenance organizer: charging station registration, maintenance reports, (see page 41)

Options

- Ethernet communication with supervision system via 3G/4G modem

Accessories offer

- Cables, RFID badges, cable holder, modem, etc.

Spare parts offer

- Floor base, wall base, socket outlet, caps, flap, etc.

Services offer

- Worldwide network of certified installers providing on-site installation, on-site commissioning, maintenance plan and on-demand repair and asset management contracts
- Worldwide customer care center

Optimized architecture

- Standalone or clustered architecture
- Connected or not to a supervision (through OCPP 1.5 or OCPP 1.6 communication protocole)
- Electrical protection devices in external cabinet or in the parking station floor base.



Easy commissioning with a laptop connected to the embedded webserver

For example, you can:

- configure RFID badges. All RFID badges are accepted by default (factory setting)
- amend the maximum current values per socket
- authorize the permanently attached cable (cable which remains attached permanently to the station)
- activate the functions: load shedding and conditional outgoing line per socket
- balance the charging powers (for 2-socket stations)
- produce maintenance reports
- set up access to supervision
- ...

At home - condominium



At work

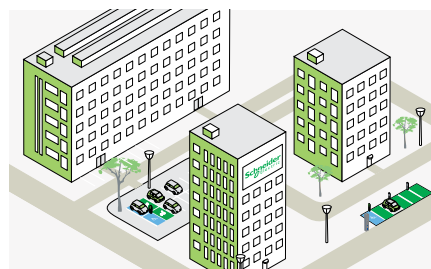

Corporate and semi-public car parks

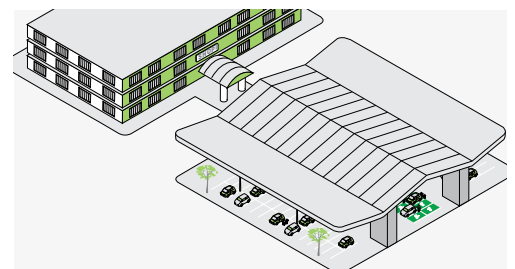

In short



Provide optimum flexibility

The maximum power can be set:

- Through the embedded Web server. This setting can be changed at any time with a few clicks.
- Remotely, via
 - a back-end Charge Point Operator, through OCPP
 - a Building Management System, an load management system, or any other local system through Modbus

The setting can be either a permanent or dynamic value.

Enhanced features

Benefit from advanced features and configure your charging station thanks to the EVlink embedded Web server.

- Adapt the charging station power demand to your electrical distribution:
 - configure load management per socket outlet or for the charging station
 - set automated load balancing between socket outlets for dual charging stations*
 - set other related energy management features: load shedding, circuit breaker status, and postponed charge
- Select the relevant power-metering solution:
 - with current transformers already included in the cabinet
 - with additional power meters for higher metering precision, MID-compliant or not
- Adapt the charging station to your application:
 - activate or deactivate RFID badge reader
 - select to allow the cable to remain permanently plugged in the charging station
 - configure IP address and network parameters
 - visualize Charge Detail Record (3000 history)

Diagnosis and maintenance

- Perform diagnosis thanks to charging station front face LEDs or through the embedded Web server
- Restore factory default settings without a computer
- Upgrade the charging station with the latest firmware and benefit from additional features

Supervision capability

- Operate and maintain your charging infrastructure:
 - connect to supervision through OCPP 1.5 or OCPP 1.6 protocol
 - connect to local management system, such as Building Management System, through modbus TCP/IP.

(*) This feature allows vehicles to recharge as quickly as possible, with the station also limiting the power delivered to its maximum set value.



Schneider Electric supports OCPP and is an active member of OCA (Open Charge Alliance).

In private parking area

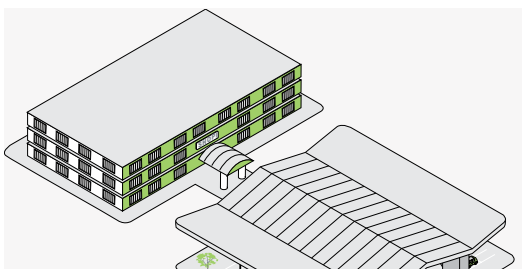

On street



EVlink Parking

Characteristics



The appearance may be customized on request.

Please do not hesitate to contact your Schneider Electric representative to assist you in this project.



> RoHS compliant
> Reach compliant
> EoL: End Of Life Process
> Product Environmental Profile compliant



Z.E. READY

Power supply network

- Earthing system: TT, TN-S, TN-C-S
 - IT (may require the addition of an isolating transformer for charging of certain vehicles)
- Frequency: 50 Hz or 60 Hz
- Socket outlet supply circuit (1 circuit per socket outlet):
 - 220/240 V 1P+N *or*
 - 380/415 V 3P+N
- Control circuit voltage (for charging station):
 - 220/240 V 1P+N

Charging modes

- Mode 2 with:
 - 10 A / Type E (FR standard) domestic socket
 - 10 A / Type F (DE standard) domestic socket
- Mode 3 with T2 socket outlet (with or without shutter)
- Communication between charging station and vehicle via charging cable as per IEC 61851

Charging access

User authentication through a RFID badge. Remote authentication by supervision or local setting of authorized badges

- 13.56 MHz RFID reader for badges with chips Mifare Ultralight, Mifare Classic 1K / 4K, I Code SLI, Tag-it HFI, EM4135 ... (under ISO/IEC 14443 A&B, ISO/IEC 15693 protocols)

Notes: RFID badges available on the market and standard are modified very often, so we advice to carry out prior test on our charging station to check compatibility

- 10 RFID badges provided with every RFID-type charging station

Mechanical and environmental

- Painted steel body, anti-corrosion treatment
- Protection: IP54 (IEC 60529), IK10 (IEC 62262)
- Operating temperature: -25°C to +40°C for Mode 2 / Mode 3 charging station
- Operating temperature: -25°C to +50°C for Mode 3 only charging station

IT Network connection

- TCP/IP
- FTP, SMTP or HTTP data retrieval
- Operations:
 - remote user authentication
 - retrieve data for Charging Data Record
 - charging station status monitoring
 - get remote commands

Certification

- CE and CB scheme (IEC 61851-1 and IEC 61851-22 standards)
- EV and ZE ready

Warranty

- 24 months for the entire EVlink range.

Charging station references

> Floor standing



Without
RFID reader

With
RFID reader



Mode 3

| Charging station type | No. of chargepoints | Socket outlet type Silver-plated contacts | Power per socket outlet / Phases | | |
|---------------------------------------|---------------------|--|----------------------------------|-------------------|-------------|
| | | | 7.4 kW (1P - 32 A) | 22 kW (3P - 32 A) | |
| Plug and charge - without RFID reader | | | | | |
| | 1 ⁽¹⁾ | T2 | | EVF2S7P02 | EVF2S22P02 |
| | | T2 with shutters | | EVF2S7P04 | EVF2S22P04 |
| | 2 | T2 | | EVF2S7P22 | EVF2S22P22 |
| | | T2 with shutters | | EVF2S7P44 | EVF2S22P44 |
| With RFID reader ⁽²⁾ | | | | | |
| | 1 ⁽¹⁾ | T2 | | EVF2S7P02R | EVF2S22P02R |
| | | T2 with shutters | | EVF2S7P04R | EVF2S22P04R |
| | 2 | T2 | | EVF2S7P22R | EVF2S22P22R |
| | | T2 with shutters | | EVF2S7P44R | EVF2S22P44R |

⁽¹⁾ On the right side of the charging station.

⁽²⁾ Includes 10 RFID badges.

Mode 3/Mode 2

| Charging station type | No. of chargepoints | Socket outlet type Silver-plated contacts | Power per socket outlet / Phases | | |
|---------------------------------------|---------------------|--|--|---|-------------|
| | | | 7.4 kW (1P - 32 A) 2.3 kW (1P - 10 A) | 22 kW (3P - 32 A) 2.3 kW (1P - 10 A) | |
| Plug and charge - without RFID reader | | | | | |
| | 1 | T2 - TF | | EVF2S7P2F | EVF2S22P2F |
| | | T2 with shutters - TE | | EVF2S7P4E | EVF2S22P4E |
| With RFID reader ⁽¹⁾ | | | | | |
| | 1 | T2 - TF | | EVF2S7P2FR | EVF2S22P2FR |
| | | T2 with shutters - TE | | EVF2S7P4ER | EVF2S22P4ER |

⁽¹⁾ Includes 10 RFID badges.

> Wall mounted



Without
RFID reader

With
RFID reader

Mode 3

| Charging station type | No. of chargepoints | Socket outlet type Silver-plated contacts | Power per socket outlet / Phases | | |
|---------------------------------------|---------------------|--|----------------------------------|-------------------|-------------|
| | | | 7.4 kW (1P - 32 A) | 22 kW (3P - 32 A) | |
| Plug and charge - without RFID reader | | | | | |
| | 1 ⁽¹⁾ | T2 | | EVW2S7P02 | EVW2S22P02 |
| | | T2 with shutters | | EVW2S7P04 | EVW2S22P04 |
| | 2 | T2 | | EVW2S7P22 | EVW2S22P22 |
| | | T2 with shutters | | EVW2S7P44 | EVW2S22P44 |
| With RFID reader ⁽²⁾ | | | | | |
| | 1 ⁽¹⁾ | T2 | | EVW2S7P02R | EVW2S22P02R |
| | | T2 with shutters | | EVW2S7 P04R | EVW2S22P04R |
| | 2 | T2 | | EVW2S7P22R | EVW2S22P22R |
| | | T2 with shutters | | EVW2S7P44R | EVW2S22P44R |

⁽¹⁾ On the right side of the charging station.

⁽²⁾ Includes 10 RFID badges.

EVlink Parking

Accessory references

AC charging station testing tool

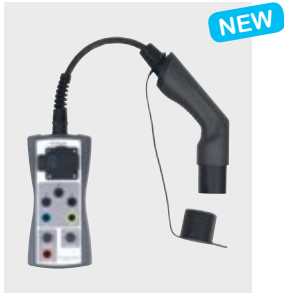

Enables an operating check in the field of the charging station and charging cable.
Reference: [EVA1SADS](#)

Modem



Modems to be mounted inside- external cabinet- Floor standing base, with EVP1FKC (Din rail mounting kit)
3G/4G Modem
Reference: [EVP3MM](#)

Antenna for Parking 3G/4G modem



Antenna must be ordered separately:
Ethernet cable 1 m included.
Antenna to be mounted on the Floor base EVP2FBS (hole diam 22 mm)
Reference: [EVP2MP](#)

Pack of 10 RFID badges

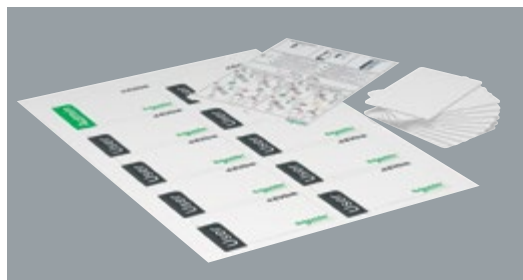

For charging stations equipped with an RFID reader.
The badges are supplied blank, ready to be programmed to identify an administrator or user.
Sheet of adhesive labels for badges: 1 administrator + 9 users.
Reference: [EVP1BNS](#)

Protective cover



For wall-mounted charging stations.
Blocks user access to cable sockets used for wiring.
Degree of protection: IK10
Reference: [EVP1WPSC](#)

Cable holder

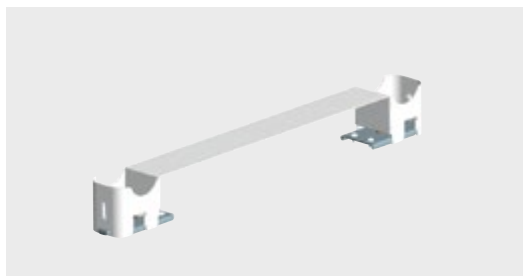

For floor-standing and wall-mounted EVlink Parking charging stations, (also compatible with EVF1....., EVW1..... and EVlink Parking charging stations.)
Allows the cable to be wound up for easy storage and locked on the holder.
Reference: [EVP1PH](#)

DIN rail mounting kit



For using the floor standing charging station as an electrical enclosure.
Compatible only with floor standing charging station (ref. EVF2) and floor standing base (ref. EVP2FBS).
Reference: [EVP1FKC](#)

EVlink Cable

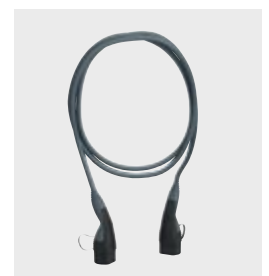

Several vehicle connector/ plug combinations are available for charging stations.

Please refer to page 41

Please refer to page 46

Spare part references

Base

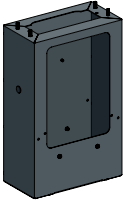

Floor-standing base.
Reference: [EVP2FBS](#)
See page 41

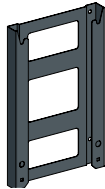

Wall-mounted base.
Reference: [EVP1WBS](#)

Enclosure

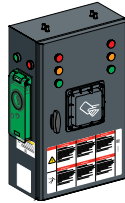

| Characteristics | References |
|--------------------|-----------------------------|
| 7.4 kW 1XT2 | EVP2PE702 |
| 7.4 kW 1XT2 RFID | EVP2PE702R |
| 7.4 kW 1XT2S | EVP2PE704 |
| 7.4 kW 1XT2S RFID | EVP2PE704R |
| 7.4 kW 2XT2 | EVP2PE722 |
| 7.4 kW 2XT2 RFID | EVP2PE722R |
| 7.4 kW 2XT2S | EVP2PE744 |
| 7.4 kW 2XT2S RFID | EVP2PE744R |
| 7.4 kW T2S-TE | EVP2PE74E |
| 7.4 kW T2S-TE RFID | EVP2PE74ER |
| 7.4 kW T2-TF | EVP2PE72F |
| 7.4 kW T2-TF RFID | EVP2PE72FR |
| 22 kW 1XT2 | EVP2PE2202 |
| 22 kW 1XT2 RFID | EVP2PE2202R |
| 22 kW 1XT2S | EVP2PE2204 |
| 22 kW 1XT2S RFID | EVP2PE2204R |
| 22 kW 2XT2 | EVP2PE2222 |
| 22 kW 2XT2 RFID | EVP2PE2222R |
| 22 kW 2XT2S | EVP2PE2244 |
| 22 kW 2XT2S RFID | EVP2PE2244R |
| 22 kW T2-TF | EVP2PE222F |
| 22 kW T2-TF RFID | EVP2PE222FR |
| 22 kW T2S-TE | EVP2PE224E |
| 22 kW T2S-TE RFID | EVP2PE224ER |

Cap

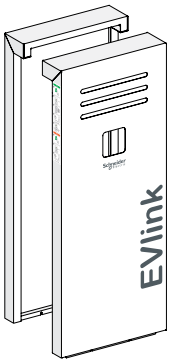

Floor standing.
Reference: [EVP2FCG](#)

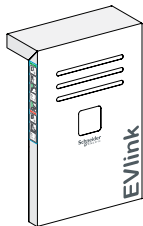

Wall mounted.
Reference: [EVP2WCG](#)

Socket outlet



Green socket outlet T2.
Reference: [EVP1PSS2](#)

Green socket outlet
T2 with shutters.
Reference: [EVP1PSS4](#)



Green socket outlet TE.
Reference: [EVP1PSSE](#)

Green socket outlet TF.
Reference: [EVP1PSSF](#)

EVlink Parking

Practical information

➤ Content - Only one person required

Only one person is required to handle and install the floor-standing or wall-mounted charging station. This is possible thanks to delivery in three packages weighing less than 20 Kg each.

➤ Package contents and weight indication

Floor-standing charging station

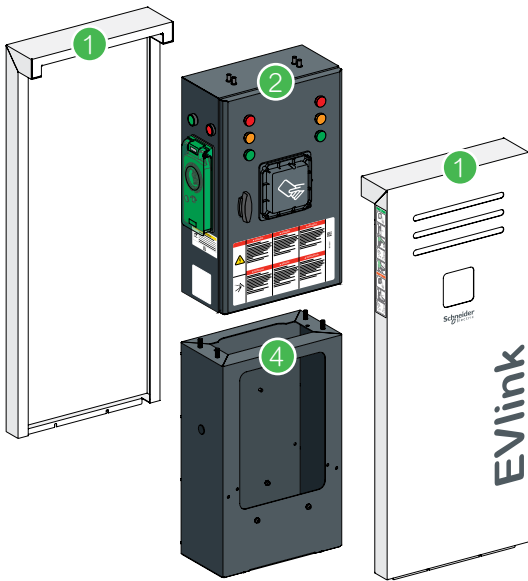

Wall-mounted charging station

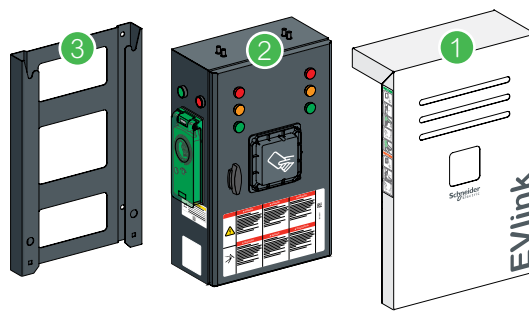

- 1 Cap
- 2 Enclosure
- 3 Wall base
- 4 Floor base

| Charging station type | | Floor-standing | Wall-mounted |
|-----------------------|-------------|----------------|--------------|
| Package | Composition | Weight | Weight |
| 1 | Cap | 17 Kg | 8 Kg |
| 2 | Enclosure | 20 Kg | 20 Kg |
| 3 | Wall base | - | 5 Kg |
| 4 | Floor base | 13 Kg | - |

➤ Dimensions (mm)

Floor-standing charging station

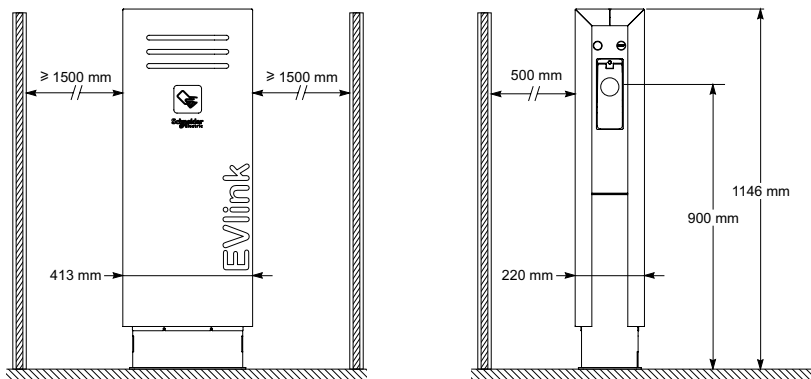

Wall-mounted charging station

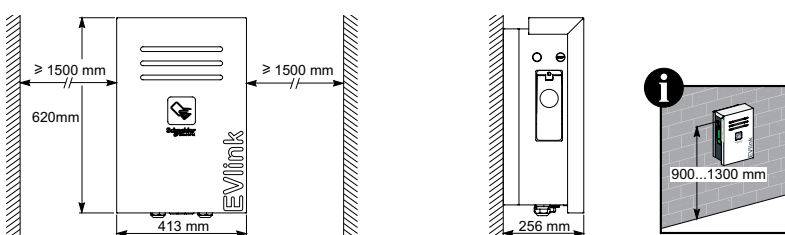

Additional information

| Technical document | Language | References |
|---|-----------------------------|--------------------------------------|
| Installation guide | EN / FR | NHA47410_EN_FR ⁽¹⁾ |
| | DE / RU | NHA47410_DE_RU ⁽²⁾ |
| | IT / ES | NHA47410_IT_ES ⁽²⁾ |
| | NO / SV | QGH34417 ⁽²⁾ |
| EVlink Parking: Electrical diagram | ES / DE / IT / RU / EN / FR | NHA81498 ⁽¹⁾ |
| EVlink Commissioning Guide EVlink Parking | EN | DOCA0060EN ⁽²⁾ |

⁽¹⁾ Delivered with the product.
⁽²⁾ To be downloaded.

To download the above documents, do a search by reference on www.se.com

Practical information

➤ Recommended protective devices per charging station circuit

| Electrical circuit protection - Specifications / Recommendation | | | | |
|---|--|--------------------------------------|--------------------------------|-------------------|
| Powered device | 1P - T2 outlet | 3P T2 outlet | 1P+N Dom. socket | 1P+N Ctrl circuit |
| Rated Power - Current | 7.4 kW - 32 A | 22 kW - 32 A | 2.3 kW - 10 A | 100 W max. |
| Protective devices | | | | |
| Circuit breaker (overcurrent) ⁽¹⁾ | 40 A curve C | 40 A curve C | 16 A curve C | 10 A curve C |
| RCD (residual current) ⁽¹⁾ | 30 mA B Type for EV ⁽²⁾ : A9Z51240 | 30 mA B Type for EV: A9Z51440 | 30 mA A-SI Type | 30 mA A-SI Type |
| | 30 mA B-SI Type ⁽²⁾ : A9Z61240 | 30 mA B-SI Type: A9Z61440 | | |
| Under voltage tripping auxiliary | with iC60 | A9A26969 ⁽³⁾ | A9A26969 ⁽³⁾ | - |
| | with DT40 | A9N26969 ⁽³⁾ | A9N26969 ⁽³⁾ | - |

⁽¹⁾ References to be defined and local availability to be checked by Schneider Electric front offices.

⁽²⁾ In accordance with the electrical installation standard HD 60364-7-722:2016. Refer to local regulation.

⁽³⁾ Necessary to meet EV Ready requirements.

➤ Easy installation with DIN rail mounting kit ref.: EVP1FKC compatible with floor standing charging station ref.: EVF2 and floor standing base EVP2FBS

Thanks to a modular floor base, installers can prepare wiring of protection devices at their workshops. This accessory allows to power the charging station with only one power cable, even for 2 plug-charging stations.



EcoStruxure™ Facility Expert

Register your charging station and improve your maintenance efficiency now with EcoStruxure™ Facility Expert.

- EcoStruxure™ Facility Expert is a simple, cloud-based tool that helps you organize maintenance records, follow-up on preventive maintenance, access log histories, create reports, and integrate remote alarming from your equipment.
- Let EcoStruxure™ Facility Expert help you optimize your maintenance activities. Download it for free on your PC or for your smart device at the Apple or Google Play store.
- You are ready to flash the product QR code with the EcoStruxure™ Facility Expert reader.

Step 1:

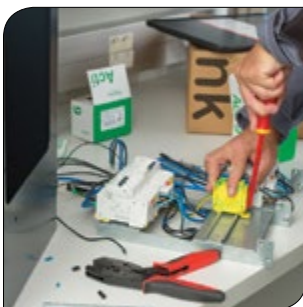

Wire protection devices on the adapted rail.

Step 2:



Insert wired protection kit in the floor base.

Step 3:



Finish the wiring.

Step 4:



Install the prewired floor base on site.

What's inside an EVlink Parking charging station



Scan or click on QR code



EVlink DC Fast Charge

In short



DC 24 kW - 1 connector / single standard DC 24 kW - 2 or 3 connectors / multiple standards

DC 24 kW stations are able to charge an electric vehicle in less than 1 hour. The range covers a large variety of needs with a choice of either, per station:

- 1 connector, CHAdeMO or CCS Combo 2
- 2 connectors, CHAdeMO + CCS Combo 2
- 3 connectors, CHAdeMO + CCS Combo 2 + AC Type 2 (front socket outlet with shutter, for AC current)

Communication with dual modem for separate operation & maintenance supervision

Installation

- Indoor or outdoor
- Wall mounted, floor mounted with additional pedestal
- Installation in less than 2 hours (when supply cable is already installed)

Maintenance

- Reduced maintenance as there is no air filter to replace and a robust design (IP54, IK10) for uptime optimization.

Application

EVlink Fast Charge stations are designed to charge a vehicle rapidly: **80% of capacity charged in less than 1 hour.**

DC 24 kW - 1 connector / single standard

Communication with dual modem for separate operation & maintenance supervision

DC 24 kW - 2 or 3 connectors / multiple standards

Charging stations are ideal solutions for shopping centers, restaurants, parking areas or for any work place or shared buildings.

Characteristics



EVD1S24T0H



EVD1S24T0H + EVP1DB1LG



EVD1S24THB



EVD1S24THB + EVP1DB2LG



EVD1S24THB2



EVD1S24THB2 + EVP1DB2LG

Mechanical and environmental features

- Degree of protection: IP54 (except cordsets)
- Degree of mechanical protection: IK10
- Operating temperature: -25°C / +50°C (with derating above 35°C)
- Storage temperature: -20°C to 45°C
- Operating altitude: 2000 m max.
- Relative humidity: 10% to 95%

Power supply network and charging mode

- Power supply: 380 - 480 V, 3P + N + Earth, 50 - 60 Hz
- Nominal supply current: 37 A

Direct current charging (all charging stations)

- Charging in Mode 4 (IEC 61851-23)
- Charging power: 24 kW
- Charging voltage/current: 150 to 530 V DC / 1.5 to 65 A with CHAdeMO, CCS Combo 2 sockets
- Protected against short circuit, overload; Residual Current Device on DC output; protected against overheating, temperature regulated
- Cable length: 3.25 m

Alternating current charging (3-socket charging station only)

- Charging in Mode 3 (IEC 61851-22)
- Charging power: 22 kW
- Protected against short circuit, overload; protected against overheating, temperature regulated
- Charging voltage/current: 400 V ± 10% AC, 3P + N + Earth, 32 A max., with the front AC Type 2 socket outlet

Communication

- Wireless 3G modem
- OCPP 1.6
- LAN/TCP IP protocol

User interfaces

- 7-inch touch screen
- RFID card reader

Dimensions (cabinet without socket / cable)

- Wall mounted (mm): H 860 x L 507 x W 250
- Mono-standard on pedestal (mm): H 1533 x L 536 x W 336
- Multi-standard on pedestal (mm): H 1835 x L 536 x W 336.

Charging station references

Standard compliance

- EV international standard: EN 61851 Ed. 2
- Immunity for industrial environment: EN 61000-6-2 - sept. 2015
- Emission for industrial environment: EN 61000-6-4 - 2017 + A1: 2011
- EMC for industrial environment: Class A.

| EVlink DC Fast Chargers | | | |
|-----------------------------|-----------------------------------|-------------|-------------|
| Power | Connector(s) | References | Weight (kg) |
| 24 kW DC | CHAdeMO | EVD1S24T0H | 66 |
| | CCS Combo 2 | EVD1S24T0B | 66 |
| | CHAdeMO + CCS Combo 2 | EVD1S24THB | 85 |
| 24 kW DC/22 kW AC | CHAdeMO + CCS Combo 2 + AC Type 2 | EVD1S24THB2 | 85 |
| Pedestals | | | |
| For EVlink DC fast chargers | | References | Weight (kg) |
| For EVD1S24T0H, EVD1S24T0B | | EVP1DB1LG | 51 |
| For EVD1S24THB, EVD1S24THB2 | | EVP1DB2LG | 53 |

EVlink AC charging station testing tool

NEW

In short



Reference: EVA1SADS



Tool for trained electricians

This tool permits to check correct operation of an AC charging station:

- EVlink Wallbox
- EVlink Smart Wallbox
- EVlink Parking
- EVlink City
- Any charging station complying with IEC 61851-1, by simulation of a vehicle during charging

Easy to carry

- Weight Approx. 795 g

Compatibility

- Accepts any cable fitted with a T2 connector
- Single-phase or three-phase alternating current charging
- Cable to be ordered separately; [please refer to page 46](#).

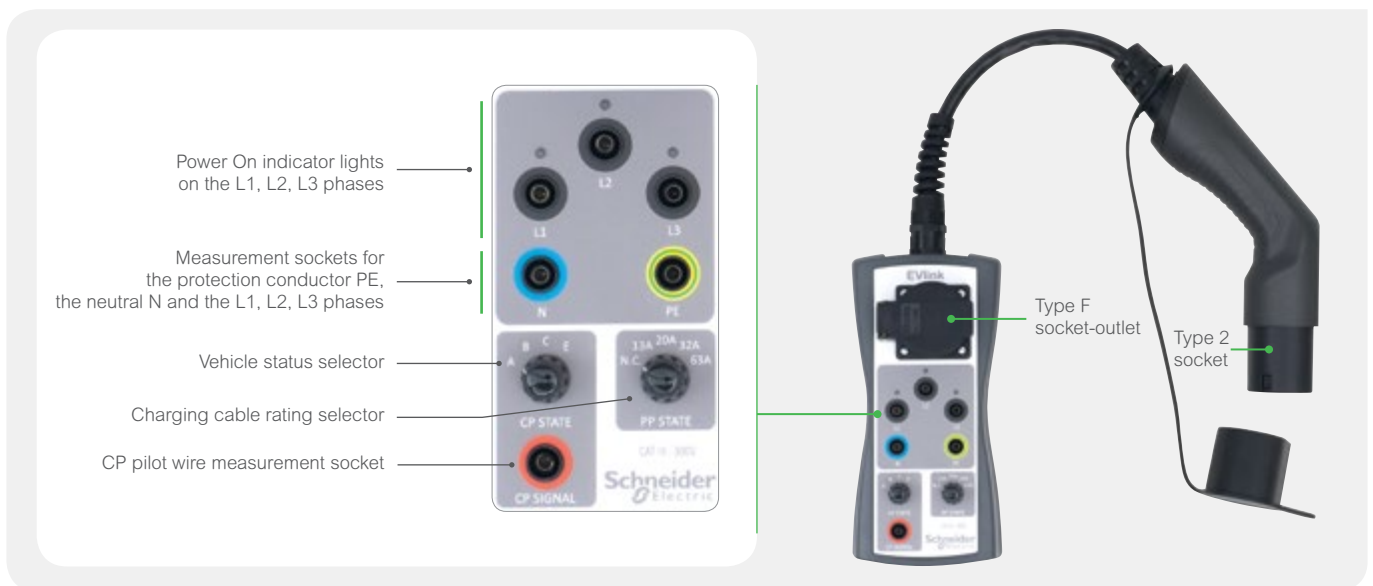

Perfectly simple...

Once the testing tool is connected to the charging station, charging is started thanks to a button. A few minutes is all that's needed to check correct charging station operation

... and standalone

Power supply via the charging cable. No internal battery, so unlimited time for servicing operations and for you peace of mind

Possible Checks and measurements

- Check voltage presence on each phase
- Measure the voltage between phases, between phase and neutral, between neutral and ground
- Check the ground continuity
- Test the ground fault circuit interruption capacity of the charging station
- Measure the voltage between the CP pilot wire and the ground
- Observe the signals transmitted on the CP pilot wire.

Characteristics

Characteristics of the power supply network

- The testing tool is powered via the charging current
- Network frequency: 50 Hz
- Earthing system: TT or TN (do not use in IT)
- Voltage: 400 V \sim on type 2 connector
- Power: test consumer Max. 2.9 kVA (no continuous operation!)

Mechanical and environmental characteristics

- Degree of protection (as per IEC 60529): IP20
- Dimensions (HxLxD): complete with connector plug: 105 x 750 x 62 mm
- Weight: approx. 795 g
- Connector: Type 2 inlet • IEC 62196 type 2-II • U: 400V3 \sim • F: 50 Hz
- Storage temperature: -25°C / +60°C
- Operating temperature: -10°C / +45°C
- Risk of mechanical damage to the testing tool if dropped at a temperature < -2°C
- Relative humidity rate (RH): < Max. 80%, condensation ruled out

Accessories and documents included

- Instruction guide
- Detailed user manual (to be downloaded from the Web)

Certification

The AC charging station testing tool complies with standards IEC 61010-1 and IEC 61851-1

Recommended measuring instruments for additional tests

- Operations b, c, d, e, f, require the use of measuring instruments (multimeter, ground fault circuit interrupter tester, oscilloscope) not supplied with the EVlink testing tool
- For observation of signals during the electric vehicle status simulation test (signals in accordance with the IEC 61851 standard).

EVlink cables

Characteristics

EVlink cable for charging stations:

Mobility within arm's reach



Type 1 (T1) Type 2 (T2)

+

- Tested and certified product: Third-part laboratory CB certification (LCIE) complies with applicable standard IEC 62196
- High protection, fast charging (Mode 3)
- High-strength cable

Characteristics

- Length: available in 5, 7 and 10 m
- Max. current: 32 A
- Operating temperature: -30°C to +50°C
- Degree of protection: IP44.

Two good reasons to have a second EVlink cable in your electric vehicle

1

To take advantage of the charging capacity of public charging stations: by having an appropriate EVlink cable for the charging stations used, you obtain fast charging with high protection.

2



To have a fallback solution.

E.g.: charging cable damaged or misplaced, help out another electric vehicle user.

Which EVlink cable

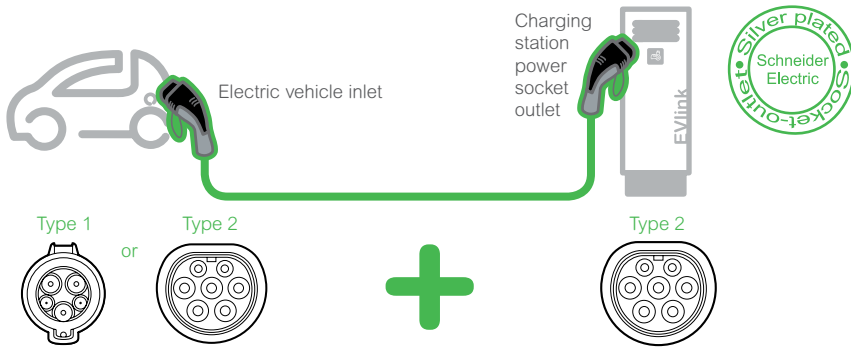
for which electric vehicle?

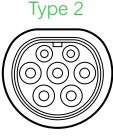

| | References | No. of phases | | Charging power accepted (kW) | | | | Cable length (m) |
|---|--------------|---------------|---|------------------------------|-----|----|----|------------------|
| | | 1 | 3 | 3.7 | 7.4 | 11 | 22 | |
|  +  | EVP1CNS32121 | ● | | ● | ● | | | 5 |
| | EVP1CNL32121 | ● | | ● | ● | | | 7 |
| | EVP1CNX32121 | ● | | ● | ● | | | 10 |
|  +  | EVP1CNS32122 | ● | | ● | ● | | | 5 |
| | EVP1CNL32122 | ● | | ● | ● | | | 7 |
| | EVP1CNX32122 | ● | | ● | ● | | | 10 |
| | EVP1CNS32322 | | ● | ● | ● | ● | ● | 5 |
| | EVP1CNL32322 | | ● | ● | ● | ● | ● | 7 |
| | EVP1CNX32322 | | ● | ● | ● | ● | ● | 10 |





EVlink

Managing the Charging Station Energy

EVlink Load Management System

EVlink Load Management System

EVlink LMS Load Management System for EVlink Smart Wallbox, EVlink Parking and EVlink DC Fast Charge



EVlink Load Management System has been awarded with the prestigious "Solar impulse Efficient Solution" label.



[Find out more here](#)



EVlink Load Management System (EVlink LMS) allows to monitor, control and maximize EV charging based on the real-time available power in the building. It ensures the respect of cost and energy efficiency constraints of a set of charging stations by controlling their operation. The controller runs its management program according to the selected parameters and data received from the charging stations.

Characteristics

- PLC type: Magelis iPC IIoT Edge Box Core
- Operating system: Linux Yocto
- Supply voltage: 12...24 V DC
- Inrush current: 0.43 A
- Consumption: 16 W
- Dimensions: 150 x 46 x 157 mm
- Protection class: IP40
- Compliance with directives:
 - 2014/30/EU (electromagnetic compatibility)
 - 2014/35/EU (Low Voltage Directive)
 - Class A EN 55022 (electromagnetic compatibility, conducted and radiated emissions)
- Connections: 2 x USB 2.0, 1 x HDMI, 2 x Ethernet (10/100/1000 Mb/s), 1 x COM RS-232 (default), RS-232/422/485 (non-isolated), 1 ground connection, 1 x GPIO, 1 power supply connector 24 V DC

Functions

- Calculates the power allocated to the charging stations
- Ensures the centralization and availability of data for each station

Connection to the charging stations

- Directly to the Ethernet LAN via a switch

External network connection

- Directly to the Ethernet LAN or remotely via a 3G or 4G modem
- Communication under OCPP 1.6 JSON (possible upgrade to OCPP 2.0)

User interface

EVlink LMS provides access to an ergonomic and intuitive user interface (web server) allowing to:

- remote start / stop of a charging session
- reset or reboot a charging station
- visualize a dashboard indicating in real time the status of each charging station
- manage badges (local addition, import or export badges list) and user rights
- access and download the history of charging data by station, by badge or aggregated for the infrastructure
- consult and download maintenance data.



Current charging sessions



Charging history of electric vehicles

To download the latest release of the EVlink Load Management System software, please scan or click on the following QR code:



EVlink LMS references

| | | EVlink LMS with Static mode (dynamic load management with STATIC current setpoint) | | | EVlink LMS with Dynamic & Static modes (dynamic load management with DYNAMIC current setpoint, or STATIC current setpoint) | | | NEW |
|---------------------------|--|---|-----------------|-----------------|---|-----------------|-----------------|---------------------|
| References ⁽²⁾ | | HMIBSCEA53D1ESS | HMIBSCEA53D1ESM | HMIBSCEA53D1EDB | HMIBSCEA53D1EDS | HMIBSCEA53D1EDM | HMIBSCEA53D1EDL | HMIBSCEA53D1EML |
| Features | | | | | | | | |
| Capacity | Number of EVlink charging stations | 15 | 50 | 5 | 15 | 50 | 100 | 1000 ⁽¹⁾ |
| Power management | Dynamic, with a STATIC current setpoint | ● | ● | ● | ● | ● | ● | ● |
| | Dynamic, with a DYNAMIC current setpoint | | | ● | ● | ● | ● | ● |
| | Time of use | | ● | | ● | ● | ● | ● |
| Multi zone | Maximum number of zones | 1 | 10 | 2 | 2 | 10 | 20 | 200 |
| | Maximum number of zones levels | 1 | 3 | 2 | 2 | 3 | 3 | 4 |
| Other loads | Power consumption reporting on other feeders | | ● | | | ● | ● | ● |
| Badge management | VIP privilege user badge | | ● | | | ● | ● | ● |
| Stations management | VIP privilege charging station | | ● | | | ● | ● | ● |

⁽¹⁾ Via the management of up to 9 slave EVlink Load Management System

⁽²⁾ To upgrade from a current commercial reference to a higher-level one, please consult us.

Functions performed by all commercial references of EVlink LMS

| Access Management | Commissioning | Operation | Connectivity |
|---|---|---|---|
| <p>▼</p> <p>Add, modify, delete, supervise badges</p> | <p>▼</p> <p>Commissioning all charging stations directly from EVlink LMS</p> <p>Save & restore commissioned configuration</p> | <p>▼</p> <p>Supervision through real time dashboard and remote actions on charging stations</p> <p>Charge data report export</p> <p>Maintenance report export</p> | <p>▼</p> <p>Connection with CPO supervision (OCPP 1.6 Json)</p> <p>Connection with EcoStruxure supervision (web services)⁽¹⁾</p> <p>Optional: 3G/4G modem</p> <p>Commissioning by Ethernet cable</p> |

⁽¹⁾ May require specific development

Dimensions

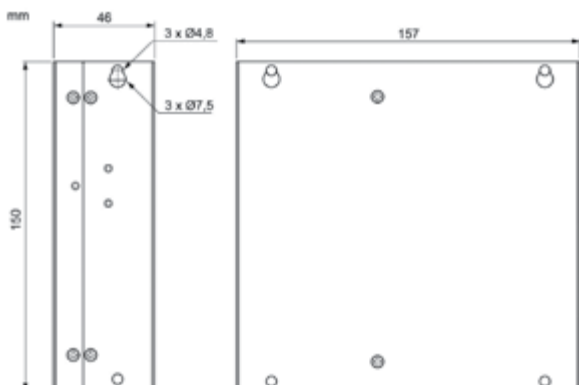

Rear view

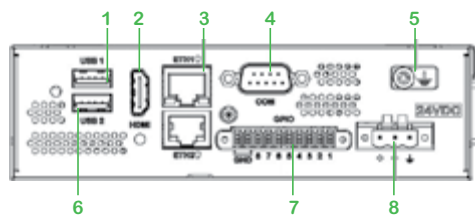

- 1- USB1 (USB 2.0)
- 2- HDMI port
- 3- ETH1 (10/100/1000 Mbits/s)
- 4- COM port RS-232/422/485
- 5- Ground connection pin
- 6- USB2 (USB 2.0)
- 7- GPIO
- 8- DC power connector

EVlink Load Management System

› Benefits

Simplified, decentralized, flexible installation architecture

- The EVlink Load Management System manages and controls **up to 100 charging stations from one same controller** and user interface dashboard
- With a decentralized and flexible architecture to maximize service continuity, offers the possibility to manage up to **1000 charging stations with a master/slave architecture**, with supervision and control in one only user interface dashboard for the entire system
- Is available in different versions to adapt to the specific customer needs, whether it is less than 5 charging stations, to up to 1000
- Allows to manage several parking zones, each one with its own power metering for dynamic load management, and all of it from a single controller
- It is scalable, and allows the installation to be upgraded easily from a current model to a more sophisticated one if the customer EV charging needs evolve
- Operates with open protocols (OCPP 1.6J) facilitating integration to other systems
- Allows the execution of installations in compliance with "EV/ZE Ready" standards
- Is available at most distributors.

Designed to be easily installed and commissioned by an installer

- Protection and control components to be installed in a Prisma panel or equivalent
- The webserver includes a configuration assistant that walks the installer through the different steps to configure the system
- Automatic scan and configuration of charging stations, all in parallel to save time
- Easy firmware updates, with most recent firmware release available on se.com.

Multiple functionalities for efficient operation and trouble-free maintenance

- Integrates in a single product the local supervision of charging stations and their power management
- Includes an intuitive dashboard interface to manage and control the installation
- Maximizes building continuity of service all while providing the highest possible EV charging capabilities in real-time
- Distributes energy equitably among all electric vehicles while maximizing the power delivered to the charging stations and the number of vehicles that charge simultaneously
- Provides time-of-use electricity tariff scheduling to limit EV charging when electricity price is high, and to maximize it when it is low (depending on the selected model)
- Reassures the electric vehicle driver who can see that the charging of his car is active before leaving it (a new vehicle is always actively charging when just connected), prioritized even when all the available power is already distributed to other vehicles being there for a longer time
- Allows the management of user badges without having to subscribe to a complementary supervision system
- Allows to define priority (VIP) user badges or charging stations, that will not be load-shed, or just when strictly necessary to ensure building power continuity (depending on the selected model)
- Registers all historic data related to the EV charging transactions for analytics, cost allocation or invoicing
- Does not generate any subscription cost (if the services of a Charge Point Operator are needed, EVlink LMS is compatible with a CPO backend (OCPP 1.6J protocol)
- Offers integration capabilities as it communicates with the Building Management System (BMS) via a webservice (may require specific development)
- Offers the guarantee of a major international manufacturer and world leader in eMobility.

➤ Operation

Description example to illustrate load reduction and load-shedding operation

- EVlink LMS controls the EV charging infrastructure
- It allows to limit the instantaneous power drawn by the entire set of connected electric vehicles, and manages the energy allocated to each one of them
- In real time, it transmits a setpoint to each charging station, which transfers it to the vehicles
- If the setpoint is exceeded, a decrease in energy is applied in the same way to all charge points (51% in the example with 17 kW of available power)
- Output reduction is done only on electrical phases in need of it.

| Available power in the building allocated to EV charging | Delivered charging power | Description |
|--|--|---|
| 33.1 kW ➤ | <p>Nominal powers: 3.7 kW, 3.7 kW, 3.7 kW, 22 kW</p> | The full available energy is delivered. |
| 17 kW ➤ | <p>Nominal powers: 3.7 kW, 3.7 kW, 3.7 kW, 22 kW</p> | The energy will be delivered according to an equal percentage, in this example: 51%. Details $17 \text{ kW} / 33.1 \text{ kW} = 51\%$. |
| 12 kW ➤ | <p>Nominal powers: 3.7 kW, 3.7 kW, 3.7 kW, 22 kW</p> | When reaching the minimum current setpoint of a charge point, its current level will be maintained so that the EV keeps charging. Details Min. current for an EV to charge (according to IEC 61851) = 6 A, representing 1.4 kW of a 3.7 kW charging station. $12 - (3 \times 1.4 \text{ kW}) = 7.8 \text{ kW}$, that are provided by the 22 kW charging station. |
| 7.5 kW ➤ | <p>Nominal powers: 3.7 kW, 3.7 kW, 3.7 kW, 22 kW</p> | If there is not enough power to feed all the charging stations, charge point load shedding will be triggered, following the load shedding rules. Details With 6 A (1.4 kW) per active charging station (IEC 61851 minimum current), the 7.5 kW of charging power are respected by switching off 1 charging station. $7.5 - (2 \times 1.4 \text{ kW}) = 4.7 \text{ kW}$, that are provided by the 22 kW charging station. |

➤ Principle of load balancing between vehicles

When the load shedding is triggered, the algorithm allows to distribute the available energy according to 2 strategies (depending on the settings):

- **Based on the energy already consumed:** the system interrupts the charging of the vehicles that have obtained the highest amount of kWh since the start of their charging, favoring new vehicles.
- **Based on the connection time:** the system interrupts the charging of the vehicles with the longest charging time favoring those last arrived.

In both cases, the system rechecks and updates the situation every 15 minutes.

Typical load management architectures

➤ Static energy management: Dynamic load management below a fixed current setpoint

Single-zone

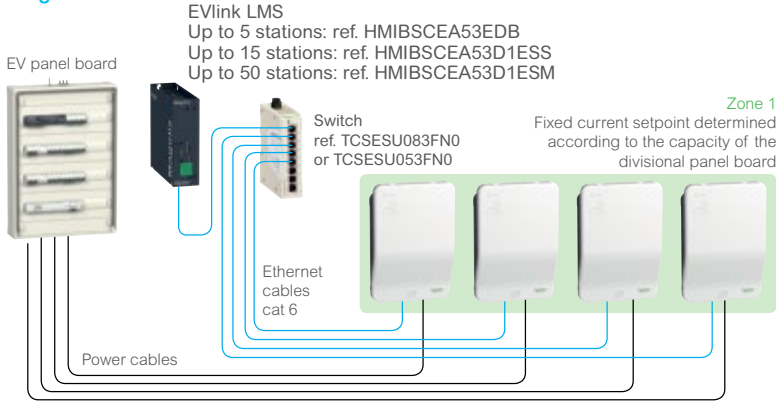

To select the right EVlink LMS commercial reference based on all available features, please check the selection table on page 51.

Multi-zone (multiple switchboards)

EVlink LMS
From 1 to 5 stations in total, in maximum 2 zones: ref. HMIBSCEA53D1EDB
From 1 to 15 stations in total in 1 same zone: ref. HMIBSCEA53D1ESS
From 1 to 15 stations in total, in maximum 2 zones: ref. HMIBSCEA53D1EDS
From 1 to 50 stations in total, in maximum 10 zones: ref. HMIBSCEA53D1ESM

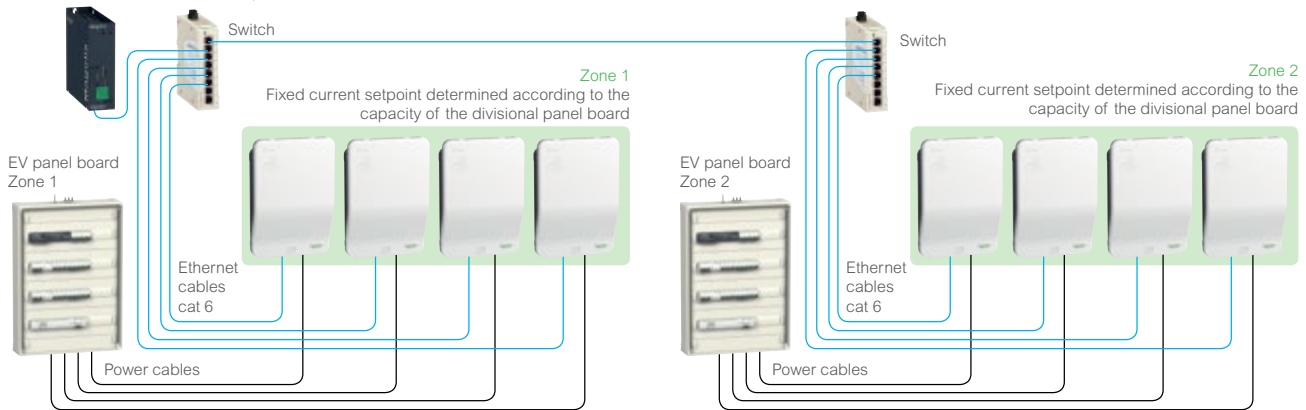

➤ Dynamic load management from a dynamic current setpoint

Multi zone⁽¹⁾

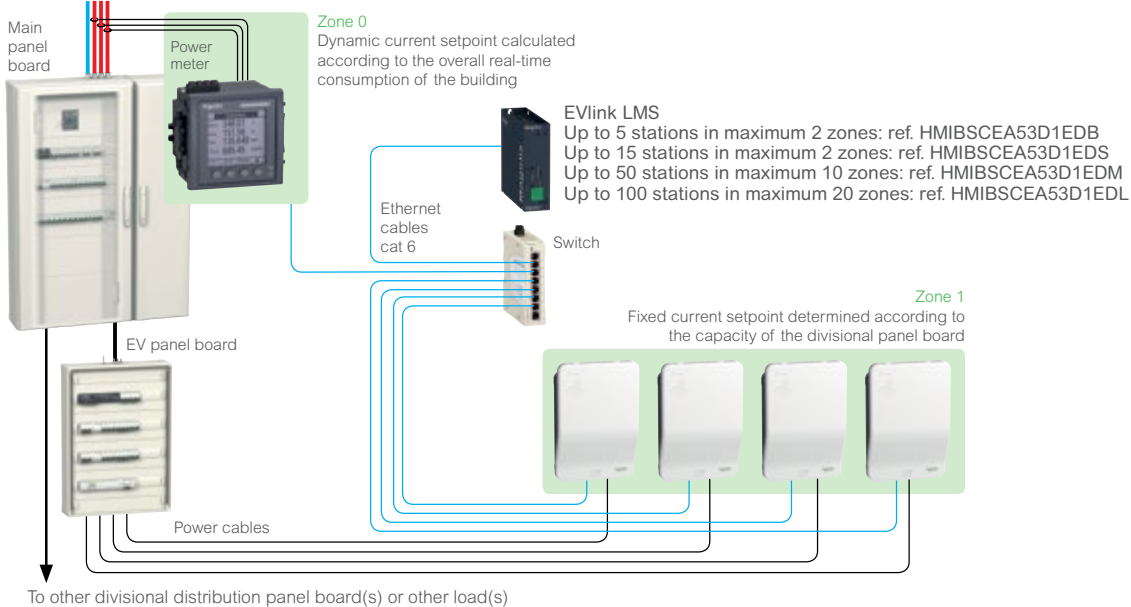

Multi zone⁽¹⁾

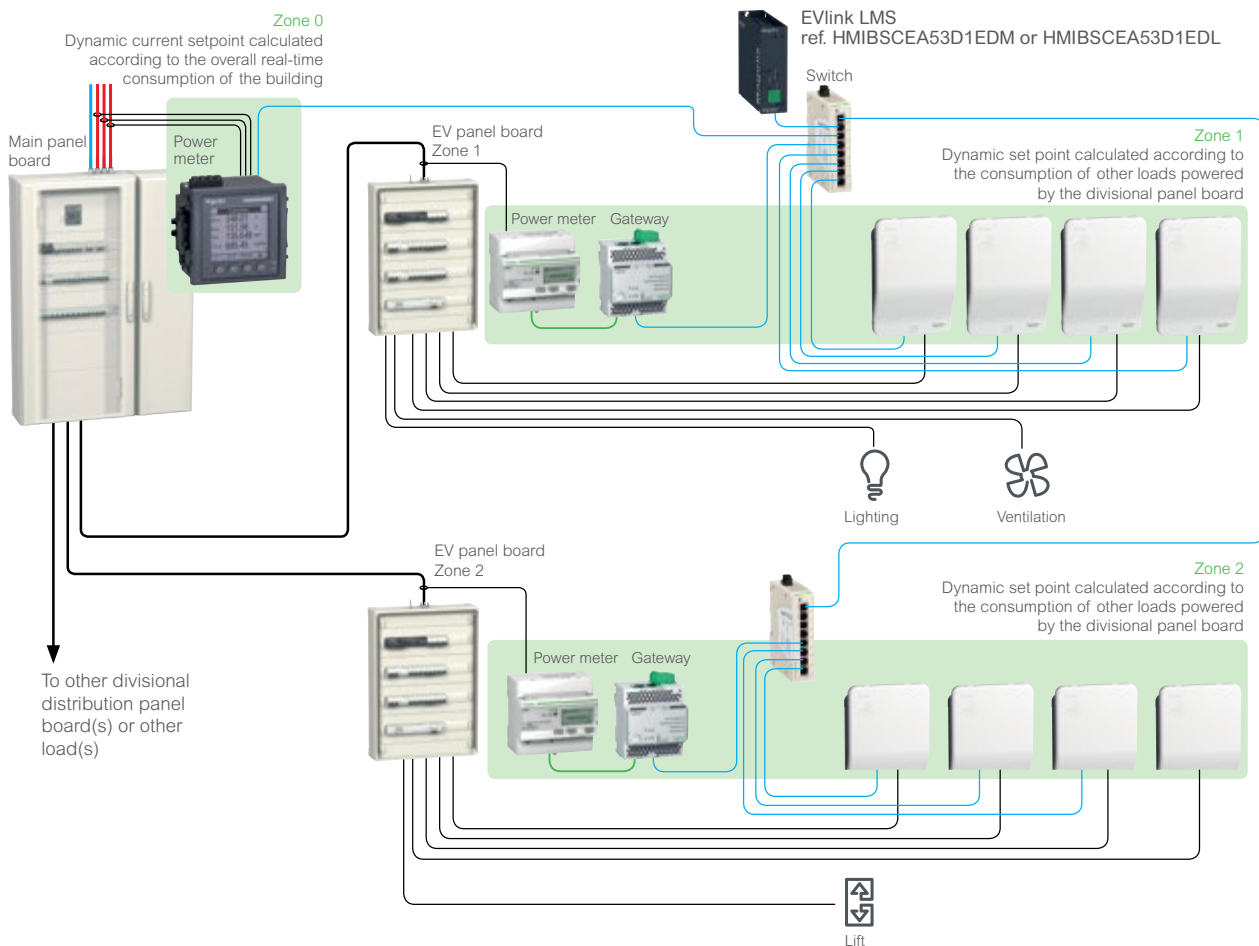
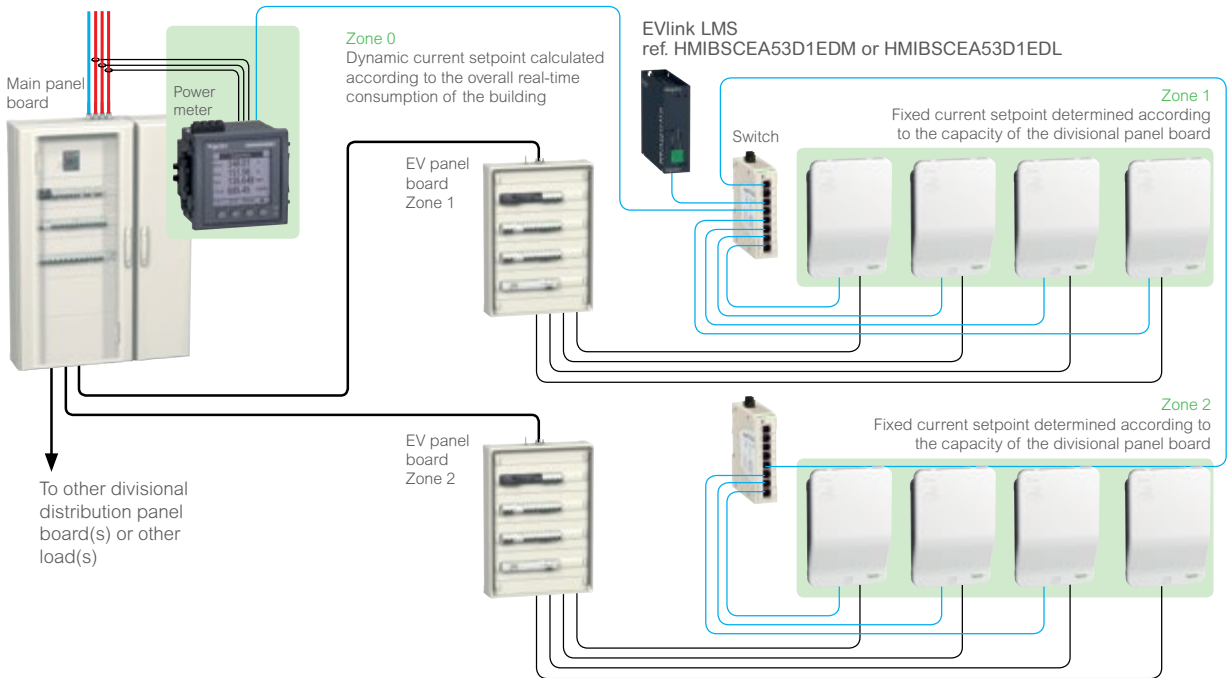

⁽¹⁾ No more than 3 cascaded zones. Otherwise, a EVlink LMS Master/Slave architecture is required (see next page)

Typical load management architectures

EVlink LMS Master/Slave architecture

For more than 100 charging stations with dynamic or static load management

- An EVlink LMS Master can manage up to 9 EVlink LMS Slaves and up to 100 charging stations by itself. The total number of charging stations managed can therefore be up to 1000, distributed in up to 200 electrical zones
- Load management is implemented for the full scope of the system, and the supervision and control of it is aggregated in one only user interface dashboard for the entire system
- An EVlink LMS Master can manage any commercial reference as a slave. Those shall be selected based on the number of stations to be managed by slave
- The EVlink LMS Master includes a specific configuration assistant to ease the entire system configuration.

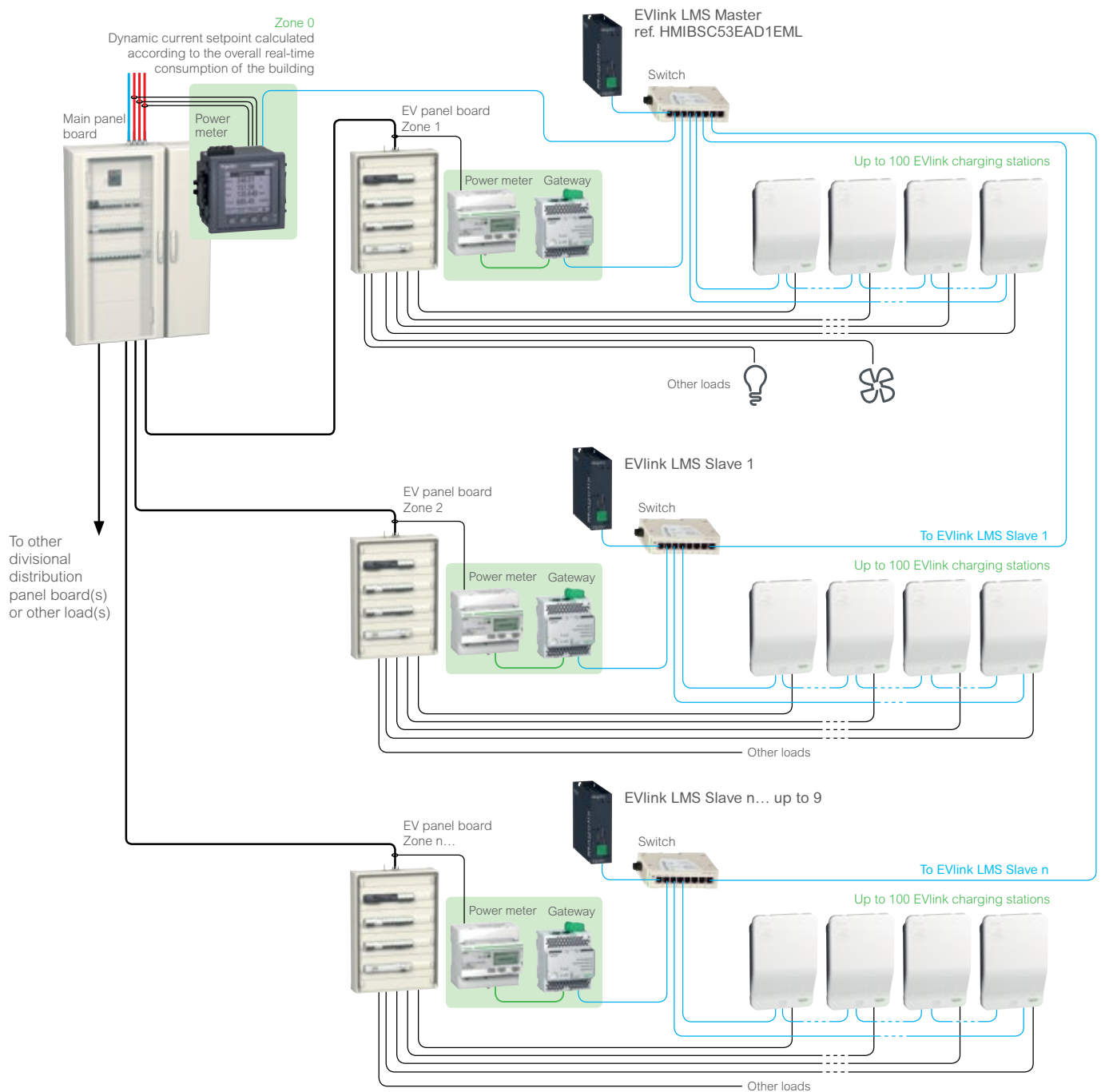

IT network possible topologies

➤ Star topology

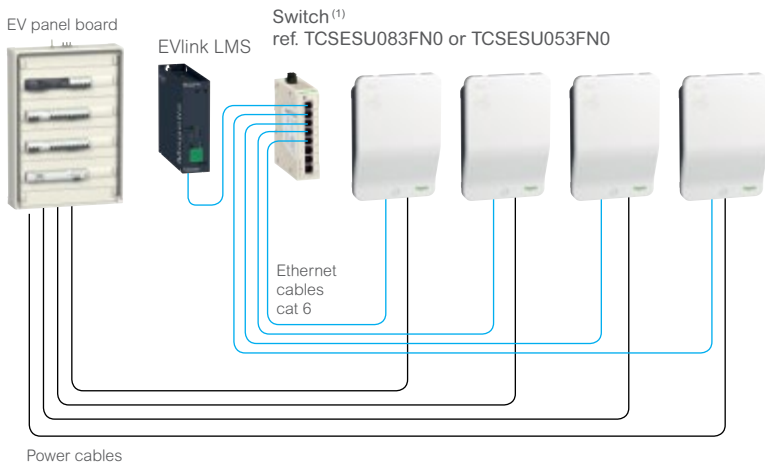

➤ Ring topology

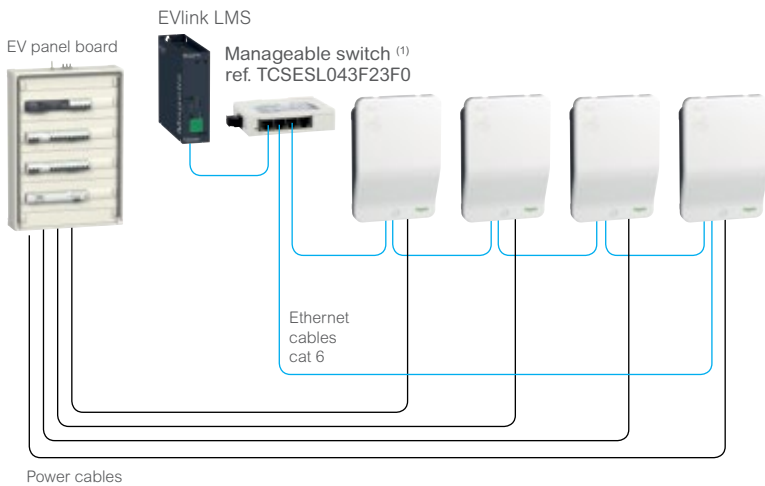

➤ Daisy chain topology⁽²⁾

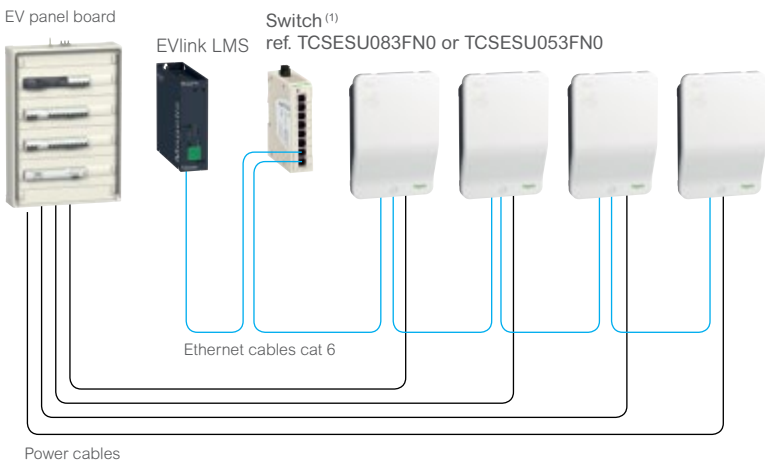

⁽¹⁾ Provide 3 available ports on the switch for a computer (settings and maintenance), a modem, the customer network, etc.

⁽²⁾ This topology does not ensure optimum continuity of service.

Metering solutions

➤ Standalone meters with external current transformers



METSEPM5320

PowerLogic Power meter

| Commercial reference | METSEPM5320 |
|-------------------------------------|--|
| Communication | 1 Ethernet port |
| Accuracy class | 0.5 S |
| Dimensions | 96 x 96 x 72 mm (H x W x D) |
| Consumption | 130 mA / 24 V DC - 65 mA / PoE 48 V DC |
| To be completed with (not provided) | <ul style="list-style-type: none"> • a closed Current Transformer • a cut-off device • a short-circuiting block |



A9MEM3255



A9MEM3555

iEM Energy meters

| Commercial reference | A9MEM3255 | A9MEM3555 |
|-------------------------------------|---|-------------------------------|
| Allocation of costs | MID class C | - |
| Communication | Modbus | Modbus |
| Class of accuracy | 0.5 S with TI 5 A, 1 with TI 1 A | 0.5 S |
| Width | 5 x 18 mm modules | 5 x 18 mm modules |
| To be completed with (not provided) | Closed current transformers a cut-off device a short-circuiting block a Link 150 gateway | Rogowski current transformers |



EGX150

Modbus – Ethernet Link 150 gateway

| Commercial reference | EGX150 |
|------------------------|---|
| Ethernet communication | 2 Ethernet ports type 10/100 Base TX protocol: HTTP, Modbus TCP/IP, FTP, SNMP |
| Serial communication | 2 serial ports (RS232 or RS485, 2 or 4 wires) Modbus serial protocol Max. no. of devices: 32 directly (or 247 indirectly) |
| Power supply | 24 V DC or PoE (15 W class 3) |
| Consumption | 130 mA / 24 V DC - 65 mA / PoE 48 V DC |
| Width | 8 x 9 mm modules |
| Operating temperature | -25°C to +70°C |

➤ Circuit breakers with embedded metering



Enerlin'X IFE
LV434002

ComPact NSX

Enerlin'X IFE switchboard server, ComPact NSX circuit breaker

Commercial reference LV434002

Enerlin'X IFE provides an Ethernet interface to a ComPact NSX circuit breaker when it embeds a metering module

Electrical distribution 3-P, 4-P

Communication Modbus TCP with circuit breaker

Metering charging stations energy consumption



MasterPact MTZ with Micrologic Control unit and Enerlin'X EIFE
LV851001

Enerlin'X EIFE Embedded Ethernet interface for draw out Masterpact MTZ

Commercial reference LV851001

Enerlin'X EIFE provides an embedded Ethernet interface to a MasterPact circuit breaker whose Micrologic Control unit can perform the charging stations metering

Electrical distribution 3-P, 4-P

Communication Modbus TCP with circuit breaker

Metering charging stations energy consumption



EVlink Electrical Distribution

Canalis busbar trunking system

Canalis KN, Canalis KS preassembled protection kits for EV chargers

Electrical distribution

➤ Canalis busbar trunking system

Experience the decentralized electrical distribution with Canalis busbar trunking system.

Save space and cost in your LV Switchboard, benefit from installation in half the time in comparison with cables, better reliability and personal safety. Canalis is scalable, flexible and future-proof solution for your EV installation, well adapted to indoor car parks / garages.

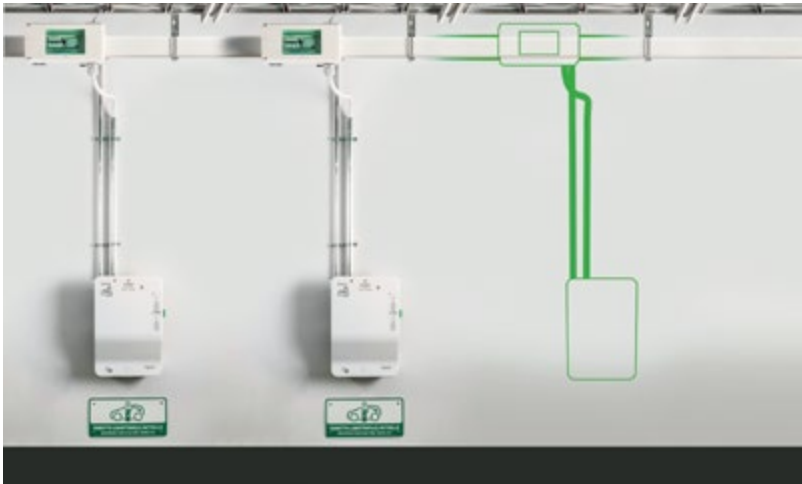

A reliable, scalable and pluggable electrical distribution solution is provided by the Canalis busbar trunking system.

This solution is well adapted to indoor car parks, company garages...

- Canalis KN, distribution from 40 to 160 A, Tap-off units from 16 to 63 A
- Canalis KS, distribution from 100 to 1000 A, Tap-off units from 16 to 400 A.

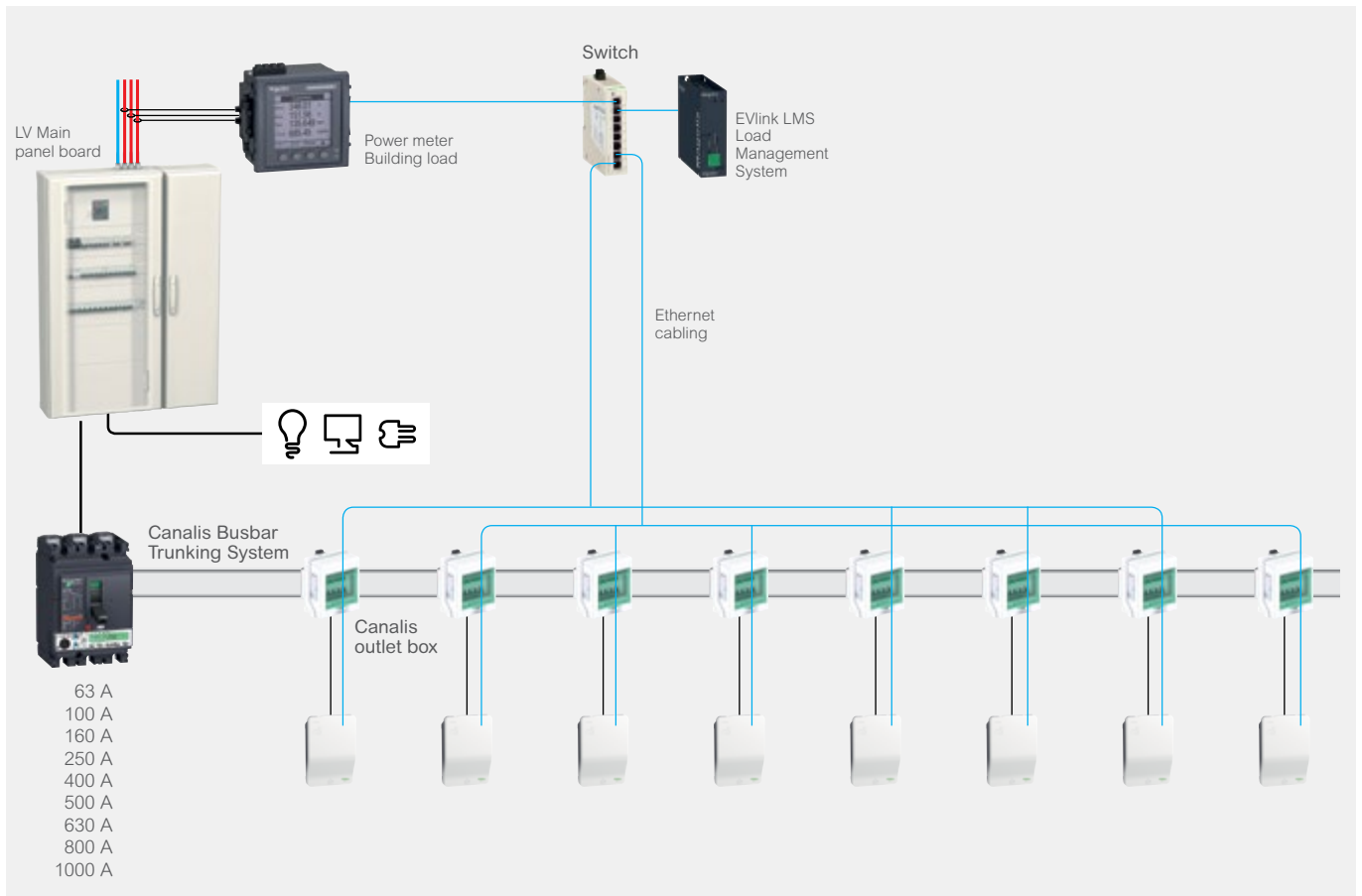

➤ Canalis KN, Canalis KS preassembled protection kits for EV chargers*



NEW



- **2-pole and 4-pole pre-assembled and pre-cabled kits for Canalis KN up to 160 A integrating:**
 - 1 x 8-module tap-off unit
 - 1 x circuit breaker
 - 1 x RCD B-type for electric vehicle applications

| Charging station power kW | Description of the kit | Included | | | Kit reference |
|------------------------------|---|--------------|----------|----------|--------------------|
| | | Tap-off unit | MCB | RCD | |
| 3.7 | Protection kit Canalis KN 8 mod. 2P MCB 25 A RCD B EV | KNB63SM48 | A9F04220 | A9Z51225 | EVK8KN2PB25 |
| 7.4 | Protection kit Canalis KN 8 mod. 2P MCB 40 A RCD B EV | | A9F04240 | A9Z51240 | EVK8KN2PB40 |
| 11 | Protection kit Canalis KN 8 mod. 4P MCB 25 A RCD B EV | | A9F04420 | A9Z61425 | EVK8KN4PB25 |
| 22 | Protection kit Canalis KN 8 mod. 4P MCB 40 A RCD B EV | | A9F04440 | A9Z51440 | EVK8KN4PB40 |



NEW



- **2-pole and 4-pole pre-assembled and pre-cabled kits for Canalis KS up to 250 A integrating:**
 - 1 x 8-module tap-off unit
 - 1 x circuit breaker
 - 1 x RCD B-type for electric vehicle applications

| Charging station power kW | Description of the kit | Included | | | Kit reference |
|------------------------------|---|--------------|----------|----------|--------------------|
| | | Tap-off unit | MCB | RCD | |
| 3.7 | Protection kit Canalis KS 8 mod. 2P MCB 25 A RCD B EV | KSB63SM48 | A9F04220 | A9Z51225 | EVK8KS2PB25 |
| 7.4 | Protection kit Canalis KS 8 mod. 2P MCB 40 A RCD B EV | | A9F04240 | A9Z51240 | EVK8KS2PB40 |
| 11 | Protection kit Canalis KS 8 mod. 4P MCB 25 A RCD B EV | | A9F04420 | A9Z61425 | EVK8KS4PB25 |
| 22 | Protection kit Canalis KS 8 mod. 4P MCB 40 A RCD B EV | | A9F04440 | A9Z51440 | EVK8KS4PB40 |

* Check availability in your country.



EVlink

Solutions for Your Project

"Turnkey" project

Services for contractors

Services for operators

Solutions for your project



Listen Understand Propose

Your Schneider Electric correspondent is a professional, specialized in the charging infrastructure solution.

Based on the technical and economic data of your charging station project, he or she will propose the appropriate solution:

- "Turnkey" charging station project performed by Schneider Electric
- Sale of charging stations and services with possible support at start-up.

Preliminary technical audit

To contract the optimum solution.

For example, this service is essential when the charging station consumption could jeopardize the electrical infrastructure of an existing facility.

"Turnkey" project

The charging station project is proposed to you in a contractual document

It specifies the following information:

- Precise characteristics of the structure
- Schedule of the various project phases and a delivery date
- Technical documents submitted for operation and maintenance
- Conditions of support services

On the agreed date, Schneider Electric will deliver the complete solution in operating conditions and allowing on-site training of operating personnel.



➤ The project is managed entirely by the eMobility Center of Expertise.

A single contact for the project team, whatever the subject, commercial or technical.

Energy management and supervision are key to the expertise of project teams



Solutions

Our comprehensive energy management solutions are generally included in "turnkey" projects.

Services for contractors



Designers, installers ...
Develop new competencies, get support from our specialists
to make your business more efficient



Training on regulations, electrical and communication architectures, **setup, tests and maintenance for contractors**

- Charging station design principles.
- Learning about and mastering Schneider Electric standard architectures, charging stations, components, and monitoring services.
- Training in assembly, operating tests and maintenance procedures.



Technical support during projects

If necessary, priority access to our specialists is provided through a hotline or on-site as a paying service.

Services for operators



Private or public parking operators, fleet managers ...

Schneider Electric helps you save time and preserves your peace of mind through maintenance of your charging station infrastructure.



Maintenance:
preserving availability

Schneider Electric has trained a network of local installer-partners.

They perform routine maintenance of your charging stations and perform repairs if necessary. They are supported by our Customer Care Centers.



List of references

Link for mySchneider App download

eMobility news on the website

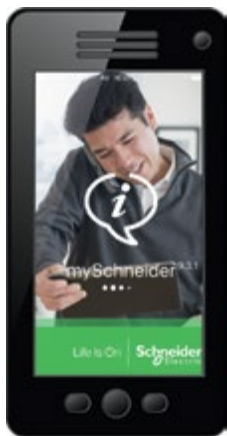

Scan or click on QR code

mySchneider app gives access to

- Customer Care Center
- On line Schneider-electric catalogues
- Green Premium information
- ...



- Information
- Advice
- Charging solutions and much more!



Scan or click on QR code

EVlink

EVlink Wallbox charging stations

| Characteristics | References | |
|---|------------------|--------------|
| | Wallbox Standard | Wallbox Plus |
| Charging stations with socket outlet | | |
| 3.7 kW – T2 | EVH2S3P02K | EVH3S3P02K |
| 7.4 kW – T2 | EVH2S7P02K | EVH3S7P02K |
| 11 kW – T2 | EVH2S11P02K | EVH3S11P02K |
| 22 kW – T2 | EVH2S22P02K | EVH3S22P02K |
| 3.7 kW – T2 with shutters | EVH2S3P04K | EVH3S3P04K |
| 7.4 kW – T2 with shutters | EVH2S7P04K | EVH3S7P04K |
| 11 kW – T2 with shutters | EVH2S11P04K | EVH3S11P04K |
| 22 kW – T2 with shutters | EVH2S22P04K | EVH3S22P04K |
| Charging stations with 4 m attached cable | | |
| 3.7 kW – T1 | EVH2S3P0AK | EVH3S3P0AK |
| 7.4 kW – T1 | EVH2S7P0AK | EVH3S7P0AK |
| 3.7 kW – T2 | EVH2S3P0CK | EVH3S3P0CK |
| 7.4 kW – T2 | EVH2S7P0CK | EVH3S7P0CK |
| 11 kW – T2 | EVH2S11P0CK | EVH3S11P0CK |
| 22 kW – T2 | EVH2S22P0CK | EVH3S22P0CK |

| Spare parts | References |
|--|--------------|
| Key lock | |
| Key lock random (1 lock + 2 keys) | EVP1HLSR |
| Key lock single (10 locks + 20 identical keys) | EVP1HLSS |
| Front panel | |
| Front panel | EVP1HCWN |
| Socket outlet | |
| T2S single-phase | EVP1HSM41 |
| T2 single-phase | EVP1HSM21 |
| T2S three-phase | EVP1HSM43 |
| T2 three-phase | EVP1HSM23 |
| Attached cable | |
| Attached cable T1 - 16 A single-phase | EVP2CNS161A4 |
| Attached cable T1 - 32 A single-phase | EVP2CNS321A4 |
| Attached cable T2 - 16 A single-phase | EVP2CNS161C4 |
| Attached cable T2 - 32 A single-phase | EVP2CNS321C4 |
| Attached cable T2 - 16 A three-phase | EVP2CNS163C4 |
| Attached cable T2 - 32 A three-phase | EVP2CNS323C4 |

| Accessories | Reference |
|--|------------|
| Pedestal for 1 EVlink Wallbox NEW Available 4 th quarter of 2020 | EVP2PBSSG1 |
| Pedestal for 2 EVlink Wallbox NEW Available 4 th quarter of 2020 | EVP2PBSSG2 |
| Kit to update pedestal for 1 EVlink Wallbox to 2 EVlink Wallbox | EVP2PBSSGC |

Additional offer

| Test tool | Reference |
|---|-----------|
| AC charging station testing tool NEW | EVA1SADS |

EVlink Smart Wallbox charging stations

| Characteristics | References |
|---|--------------|
| Charging stations with socket outlet | |
| 7.4 / 22 kW – T2 - Key lock | EVB1A22P2KI |
| 7.4 / 22 kW – T2 - RFID | EVB1A22P2RI |
| 7.4 / 22 kW – T2 shutter - Key lock | EVB1A22P4KI |
| 7.4 / 22 kW – T2 shutter - RFID | EVB1A22P4RI |
| 7.4 / 22 kW – T2 shutter + TE - Key lock | EVB1A22P4EKI |
| 7.4 / 22 kW – T2 shutter + TE - RFID | EVB1A22P4ERI |
| Charging stations with 4.5 m attached cable | |
| 7.4 kW – T1 - Key lock | EVB1A7PAKI |
| 7.4 kW – T1 - RFID | EVB1A7PARI |
| 7.4 kW – T2 - Key lock | EVB1A7PCKI |
| 7.4 kW – T2 - RFID | EVB1A7PCRI |
| 22 kW – T2 - Key lock | EVB1A22PCKI |
| 22 kW – T2 - RFID | EVB1A22PCRI |

| Spare parts | References |
|--|---------------|
| Key lock | |
| Key lock random (1 lock + 2 keys) | EVP1HLSR |
| Key lock single (10 locks + 20 identical keys) | EVP1HLSS |
| Front panel | |
| Front panel | EVP1HCWN |
| Socket outlet | |
| Socket outlet T2S three-phase | EVP1BSE43 |
| Socket outlet T2 three-phase | EVP1BSE23 |
| Domestic socket outlet TE | EVP1BSSE |
| Attached cable | |
| Attached cable T1 - 32A single-phase | EVP1CBS321A45 |
| Attached cable T2 - 32A single-phase | EVP1CBS321C45 |
| Attached cable T2 - 32A three-phase | EVP1CBS323C45 |

| Accessories | References |
|--|------------|
| Pack of 10 RFID badges | EVP1BNS |
| Pedestal for 1 EVlink Wallbox NEW Available 4 th quarter of 2020 | EVP2PBSSG1 |
| Pedestal for 2 EVlink Wallbox NEW Available 4 th quarter of 2020 | EVP2PBSSG2 |
| Kit to update pedestal for 1 EVlink Wallbox to 2 EVlink Wallbox NEW Available 4 th quarter of 2020 | EVP2PBSSGC |
| Communication interfaces | |
| 3G/4G modem NEW | EVP3MM |
| 3G/4G modem antenna (for EVlink Smart Wallbox only) | EVP2MX |

Additional offer

| Test tool | Reference |
|---|-----------|
| AC charging station testing tool NEW | EVA1SADS |

EVlink

EVlink Parking charging stations

| Characteristics ⁽¹⁾ | References |
|---|-------------|
| Floor-standing charging stations | |
| 7.4 kW – 1 x T2 | EVF2S7P02 |
| 7.4 kW – 1 x T2 – RFID | EVF2S7P02R |
| 7.4 kW – 1 x T2 with shutters | EVF2S7P04 |
| 7.4 kW – 1 x T2 with shutters – RFID | EVF2S7P04R |
| 7.4 kW – 2 x T2 | EVF2S7P22 |
| 7.4 kW – 2 x T2 – RFID | EVF2S7P22R |
| 7.4 kW – 2 x T2 with shutters | EVF2S7P44 |
| 7.4 kW – 2 x T2 with shutters – RFID | EVF2S7P44R |
| 7.4 / 2.3 kW – T2 / TF | EVF2S7P2F |
| 7.4 / 2.3 kW – T2 / TF – RFID | EVF2S7P2FR |
| 7.4 / 2.3 kW – T2 with shutters / TE | EVF2S7P4E |
| 7.4 / 2.3 kW – T2 with shutters / TE – RFID | EVF2S7P4ER |
| 22 kW – 1 x T2 | EVF2S22P02 |
| 22 kW – 1 x T2 – RFID | EVF2S22P02R |
| 22 kW – 1 x T2 with shutters | EVF2S22P04 |
| 22 kW – 1 x T2 with shutters – RFID | EVF2S22P04R |
| 22 kW – 2 x T2 | EVF2S22P22 |
| 22 kW – 2 x T2 – RFID | EVF2S22P22R |
| 22 kW – 2 x T2 with shutters | EVF2S22P44 |
| 22 kW – 2 x T2 with shutters – RFID | EVF2S22P44R |
| 22 / 2.3 kW – T2 / TF | EVF2S22P2F |
| 22 / 2.3 kW – T2 / TF – RFID | EVF2S22P2FR |
| 22 / 2.3 kW – T2 with shutters / TE | EVF2S22P4E |
| 22 / 2.3 kW – T2 with shutters / TE – RFID | EVF2S22P4ER |
| Wall-mounted charging stations | |
| 7.4 kW – 1 x T2 | EVW2S7P02 |
| 7.4 kW – 1 x T2 – RFID | EVW2S7P02R |
| 7.4 kW – 1 x T2 with shutters | EVW2S7P04 |
| 7.4 kW – 1 x T2 with shutters - RFID | EVW2S7P04R |
| 7.4 kW – 2 x T2 | EVW2S7P22 |
| 7.4 kW – 2 x T2 – RFID | EVW2S7P22R |
| 7.4 kW – 2 x T2 with shutters | EVW2S7P44 |
| 7.4 kW – 2 x T2 with shutters - RFID | EVW2S7P44R |
| 22 kW – 1 x T2 | EVW2S22P02 |
| 22 kW – 1 x T2 – RFID | EVW2S22P02R |
| 22 kW – 1 x T2 with shutters | EVW2S22P04 |
| 22 kW – 1 x T2 with shutters - RFID | EVW2S22P04R |
| 22 kW – 2 x T2 | EVW2S22P22 |
| 22 kW – 2 x T2 – RFID | EVW2S22P22R |
| 22 kW – 2 x T2 with shutters | EVW2S22P44 |
| 22 kW – 2 x T2 with shutters - RFID | EVW2S22P44R |

⁽¹⁾ Charging stations characteristics = Power – Number x type of socket outlet – RFID: badge reader.

| Accessories | |
|---|----------|
| Pack of 10 RFID badges | EVP1BNS |
| Cable holder | EVP1PH |
| DIN rail mounting kit | EVP1FKC |
| Protective cover – only for wall-mounted charging station | EVP1WPSC |
| Communication interfaces | |
| 3G/4G modem NEW | EVP3MM |
| 3G/4G modem antenna (for EVlink Parking only) | EVP2MP |

EVlink Parking charging stations

| Spare parts | References |
|---|-------------|
| Enclosure | |
| 7.4 kW – 1 x T2 | EVP2PE702 |
| 7.4 kW – 1 x T2 – RFID | EVP2PE702R |
| 7.4 kW – 1 x T2 with shutters | EVP2PE704 |
| 7.4 kW – 1 x T2 with shutters – RFID | EVP2PE704R |
| 7.4 kW – 2 x T2 | EVP2PE722 |
| 7.4 kW – 2 x T2 – RFID | EVP2PE722R |
| 7.4 kW – 2 x T2 with shutters | EVP2PE744 |
| 7.4 kW – 2 x T2 with shutters – RFID | EVP2PE744R |
| 7.4 / 2.3 kW – T2/TF | EVP2PE72F |
| 7.4 / 2.3 kW – T2/TF – RFID | EVP2PE72FR |
| 7.4 / 2.3 kW – T2 with shutters/TE | EVP2PE74E |
| 7.4 / 2.3 kW – T2 with shutters/TE – RFID | EVP2PE74ER |
| 22 kW – 1 x T2 | EVP2PE2202 |
| 22 kW – 1 x T2 – RFID | EVP2PE2202R |
| 22 kW – 1 x T2 with shutters | EVP2PE2204 |
| 22 kW – 1 x T2 with shutters – RFID | EVP2PE2204R |
| 22 kW – 2 x T2 | EVP2PE2222 |
| 22 kW – 2 x T2 – RFID | EVP2PE2222R |
| 22 kW – 2 x T2 with shutters | EVP2PE2244 |
| 22 kW – 2 x T2 with shutters – RFID | EVP2PE2244R |
| 22 / 2.3 kW – T2/TF | EVP2PE222F |
| 22 / 2.3 kW – T2/TF – RFID | EVP2PE222FR |
| 22 / 2.3 kW – T2 with shutters/TE | EVP2PE224E |
| 22 / 2.3 kW – T2 with shutters/TE – RFID | EVP2PE224ER |
| Base | |
| Floor-standing base | EVP2FBS |
| Wall-mounted base | EVP1WBS |
| Cap | |
| Floor standing | EVP2FCG |
| Wall mounted | EVP2WCG |
| Socket outlet | |
| Green socket outlet T2 | EVP1PSS2 |
| Green socket outlet T2S | EVP1PSS4 |
| Green socket outlet TE | EVP1PSSE |
| Green socket outlet TF | EVP1PSSF |

Additional offer

| Test tool | Reference |
|---|-----------|
| AC charging station testing tool NEW | EVA1SADS |

EVlink

EVlink DC Fast Charge

| Characteristics | | References |
|---------------------------------------|---|--------------------|
| DCFC 24 kW with 3.25 m attached cable | | |
| EVlink 24 kW DC Charger | CHAdeMO single | EVD1S24T0H |
| | CCS Combo 2 single | EVD1S24T0B |
| | CHAdeMO - CCS Combo 2 bi-standard | EVD1S24THB |
| EVlink 24/22 kW DC/AC Charger | CHAdeMO - CCS Combo 2 Type 2 tri-standard | EVD1S24THB2 |
| Accessories | | References |
| Pedestal for EVlink 24 kW DC Charger | Single | EVP1DB1LG |
| | Multi | EVP1DB2LG |

EVlink Load Management System

| Characteristics ⁽¹⁾ | References ⁽²⁾ | |
|--------------------------------|---|-----------------------------------|
| EVlink Load Management System | up to 5 charging stations dynamic or static setpoint | HMIBSCEA53D1EDB |
| | up to 15 charging stations dynamic or static setpoint | HMIBSCEA53D1EDS |
| | up to 50 charging stations dynamic or static setpoint | HMIBSCEA53D1EDM |
| | up to 100 charging stations dynamic or static setpoint | HMIBSCEA53D1EDL |
| | up to 15 charging stations static setpoint | HMIBSCEA53D1ESS |
| | up to 50 charging stations static setpoint | HMIBSCEA53D1ESM |
| | up to 1000 charging stations, Master/Slave architecture | HMIBSCEA53D1EML NEW |

⁽¹⁾ To upgrade from a current commercial reference to a higher-level one, please consult us.

⁽²⁾ To select the right commercial reference based on all available features, please consult the selection table on page 51.

Canalis kits

| Charging station power | Description | References |
|------------------------|--------------------------------|-------------------------------|
| Canalis KN | | |
| 3.7 kW | KN 8 mod. 2P MCB 25 A RCD B EV | EVK8KN2PB25 NEW |
| 7.4 kW | KN 8 mod. 2P MCB 40 A RCD B EV | EVK8KN2PB40 NEW |
| 11 kW | KN 8 mod. 4P MCB 25 A RCD B EV | EVK8KN4PB25 NEW |
| 22 kW | KN 8 mod. 4P MCB 40 A RCD B EV | EVK8KN4PB40 NEW |
| Canalis KS | | |
| 3.7 kW | KS 8 mod. 2P MCB 25 A RCD B EV | EVK8KS2PB25 NEW |
| 7.4 kW | KS 8 mod. 2P MCB 40 A RCD B EV | EVK8KS2PB40 NEW |
| 11 kW | KS 8 mod. 4P MCB 25 A RCD B EV | EVK8KS4PB25 NEW |
| 22 kW | KS 8 mod. 4P MCB 40 A RCD B EV | EVK8KS4PB40 NEW |

Charging cables

| EVlink charging cable | | | | References |
|-----------------------|---------------|-------|--------|---------------------|
| Plug-Connector | Rated current | Phase | Length | |
| T2-T1 | 32 A | 1 | 5 m | EVP1CNS32121 |
| | | | 7 m | EVP1CNL32121 |
| | | | 10 m | EVP1CNX32121 |
| T2-T2 | 32 A | 1 | 5 m | EVP1CNS32122 |
| | | | 7 m | EVP1CNL32122 |
| | | | 10 m | EVP1CNX32122 |
| | 32 A | 3 | 5 m | EVP1CNS32322 |
| | | | 7 m | EVP1CNL32322 |
| | | | 10 m | EVP1CNX32322 |



Note

Life Is On

Schneider
Electric

Schneider Electric SE

35, rue Joseph Monier
CS 30323
92506 Rueil Malmaison Cedex
France

RCS Nanterre 542 048 574
Capital social 2 268 274 220 €
www.se.com

September, 2020
Document Number COM-POWER-VE-CA3-EN

© 2020 - Schneider Electric. All Rights Reserved.
All trademarks are owned by Schneider Electric SE or its affiliated companies.

This document has been
printed on recycled paper 