

# MiCOM

# P120/P121/P122/P123

Overcurrent Relays

P12x/EN T/Eb6\_

Software Version: P120 V11  
P121, P122 & P123 V12

Technical Guide



# MiCOM P120/P121/P122 & P123 OVERCURRENT RELAYS TECHNICAL GUIDE

## CONTENTS

Safety Instructions	Pxxxx/EN SS/G11
Introduction	P12x/EN IT/Eb6
Handling, Installation and Case Dimensions	P12x/EN IN/Eb6
User Guide	P12x/EN FT/Eb6
Menu Content Tables	P12x/EN HI/Eb6
Technical Data and Curve Characteristics	P12x/EN TD/Eb6
Getting Started	P12x/EN GS/Eb6
Application Guide	P12x/EN AP/Eb6
Communication Database	P12x/EN CT/Eb6
Commissioning and Maintenance Guide	P12x/EN CM/Eb6
Connection Diagrams	P12x/EN CO/Eb6
Commissioning Test and Setting Records Sheets	P12x/EN RS/Eb6
Hardware/Software Version History and Compatibility	P12x/EN VC/Eb6
Additional Documentation for MiCOM P120R	P12x/ EN AD/Eb6

**BLANK PAGE**

# **SAFETY SECTION**



# **STANDARD SAFETY STATEMENTS AND EXTERNAL LABEL INFORMATION FOR SCHNEIDER ELECTRIC EQUIPMENT**

<b>1.</b>	<b>INTRODUCTION</b>	<b>3</b>
<b>2.</b>	<b>HEALTH AND SAFETY</b>	<b>3</b>
<b>3.</b>	<b>SYMBOLS AND EXTERNAL LABELS ON THE EQUIPMENT</b>	<b>4</b>
3.1	Symbols	4
3.2	Labels	4
<b>4.</b>	<b>INSTALLING, COMMISSIONING AND SERVICING</b>	<b>4</b>
<b>5.</b>	<b>DECOMMISSIONING AND DISPOSAL</b>	<b>7</b>
<b>6.</b>	<b>TECHNICAL SPECIFICATIONS FOR SAFETY</b>	<b>8</b>
6.1	Protective fuse rating	8
6.2	Protective Class	8
6.3	Installation Category	8
6.4	Environment	8

**BLANK PAGE**



---

## 1. INTRODUCTION

This guide and the relevant equipment documentation provide full information on safe handling, commissioning and testing of this equipment. This Safety Guide also includes descriptions of equipment label markings.

Documentation for equipment ordered from Schneider Electric is despatched separately from manufactured goods and may not be received at the same time. Therefore this guide is provided to ensure that printed information which may be present on the equipment is fully understood by the recipient.

The technical data in this safety guide is typical only, see the technical data section of the relevant product publication(s) for data specific to a particular equipment.



Before carrying out any work on the equipment the user should be familiar with the contents of this Safety Guide and the ratings on the equipment's rating label.

Reference should be made to the external connection diagram before the equipment is installed, commissioned or serviced.

Language specific, self-adhesive User Interface labels are provided in a bag for some equipment.

---

## 2. HEALTH AND SAFETY

The information in the Safety Section of the equipment documentation is intended to ensure that equipment is properly installed and handled in order to maintain it in a safe condition.

It is assumed that everyone who will be associated with the equipment will be familiar with the contents of that Safety Section, or this Safety Guide.

When electrical equipment is in operation, dangerous voltages will be present in certain parts of the equipment. Failure to observe warning notices, incorrect use, or improper use may endanger personnel and equipment and also cause personal injury or physical damage.

Before working in the terminal strip area, the equipment must be isolated.

Proper and safe operation of the equipment depends on appropriate shipping and handling, proper storage, installation and commissioning, and on careful operation, maintenance and servicing. For this reason only qualified personnel may work on or operate the equipment.

Qualified personnel are individuals who:





- Are familiar with the installation, commissioning, and operation of the equipment and of the system to which it is being connected;
- Are able to safely perform switching operations in accordance with accepted safety engineering practices and are authorised to energize and de-energize equipment and to isolate, ground, and label it;
- Are trained in the care and use of safety apparatus in accordance with safety engineering practices;
- Are trained in emergency procedures (first aid).

The equipment documentation gives instructions for its installation, commissioning, and operation. However, the manual cannot cover all conceivable circumstances or include detailed information on all topics. In the event of questions or specific problems, do not take any action without proper authorization. Contact the appropriate Schneider Electric technical sales office and request the necessary information.

### 3. SYMBOLS AND EXTERNAL LABELS ON THE EQUIPMENT

For safety reasons the following symbols and external labels, which may be used on the equipment or referred to in the equipment documentation, should be understood before the equipment is installed or commissioned.

#### 3.1 Symbols

 Caution: refer to equipment documentation	 Caution: risk of electric shock
 Protective Conductor (*Earth) terminal	 Functional/Protective Conductor (*Earth) terminal. Note: This symbol may also be used for a Protective Conductor (Earth) Terminal if that terminal is part of a terminal block or sub-assembly e.g. power supply.

\*NOTE: THE TERM EARTH USED THROUGHOUT THIS GUIDE IS THE DIRECT EQUIVALENT OF THE NORTH AMERICAN TERM GROUND.

#### 3.2 Labels

See Safety Guide (SFTY/4L M/G11) for equipment labelling information.

### 4. INSTALLING, COMMISSIONING AND SERVICING



#### Equipment connections

Personnel undertaking installation, commissioning or servicing work for this equipment should be aware of the correct working procedures to ensure safety.

The equipment documentation should be consulted before installing, commissioning, or servicing the equipment.

Terminals exposed during installation, commissioning and maintenance may present a hazardous voltage unless the equipment is electrically isolated.

The clamping screws of all terminal block connectors, for field wiring, using M4 screws shall be tightened to a nominal torque of 1.3 Nm.

Equipment intended for rack or panel mounting is for use on a flat surface of a Type 1 enclosure, as defined by Underwriters Laboratories (UL).

Any disassembly of the equipment may expose parts at hazardous voltage, also electronic parts may be damaged if suitable electrostatic voltage discharge (ESD) precautions are not taken.

If there is unlocked access to the rear of the equipment, care should be taken by all personnel to avoid electric shock or energy hazards.

Voltage and current connections shall be made using insulated crimp terminations to ensure that terminal block insulation requirements are maintained for safety.

Watchdog (self-monitoring) contacts are provided in numerical relays to indicate the health of the device. Schneider Electric strongly recommends that these contacts are hardwired into the substation's automation system, for alarm purposes.

To ensure that wires are correctly terminated the correct crimp terminal and tool for the wire size should be used.

The equipment must be connected in accordance with the appropriate connection diagram.

#### Protection Class I Equipment

- Before energizing the equipment it must be earthed using the protective conductor terminal, if provided, or the appropriate termination of the supply plug in the case of plug connected equipment.
- The protective conductor (earth) connection must not be removed since the protection against electric shock provided by the equipment would be lost.
- When the protective (earth) conductor terminal (PCT) is also used to terminate cable screens, etc., it is essential that the integrity of the protective (earth) conductor is checked after the addition or removal of such functional earth connections. For M4 stud PCTs the integrity of the protective (earth) connections should be ensured by use of a locknut or similar.

The recommended minimum protective conductor (earth) wire size is 2.5 mm<sup>2</sup> (3.3 mm<sup>2</sup> for North America) unless otherwise stated in the technical data section of the equipment documentation, or otherwise required by local or country wiring regulations.

The protective conductor (earth) connection must be low-inductance and as short as possible.

All connections to the equipment must have a defined potential. Connections that are pre-wired, but not used, should preferably be grounded when binary inputs and output relays are isolated. When binary inputs and output relays are connected to common potential, the pre-wired but unused connections should be connected to the common potential of the grouped connections.

Before energizing the equipment, the following should be checked:

- Voltage rating/polarity (rating label/equipment documentation),
- CT circuit rating (rating label) and integrity of connections,
- Protective fuse rating,
- Integrity of the protective conductor (earth) connection (where applicable),
- Voltage and current rating of external wiring, applicable to the application.



#### **Accidental touching of exposed terminals**

If working in an area of restricted space, such as a cubicle, where there is a risk of electric shock due to accidental touching of terminals which do not comply with IP20 rating, then a suitable protective barrier should be provided.



#### **Equipment use**

If the equipment is used in a manner not specified by the manufacturer, the protection provided by the equipment may be impaired.



#### **Removal of the equipment front panel/cover**

Removal of the equipment front panel/cover may expose hazardous live parts, which must not be touched until the electrical power is removed.

**UL and CSA/CUL Listed or Recognized equipment**

To maintain UL and CSA/CUL Listing/Recognized status for North America the equipment should be installed using UL or CSA Listed or Recognized parts for the following items: connection cables, protective fuses/fuseholders or circuit breakers, insulation crimp terminals and replacement internal battery, as specified in the equipment documentation.

For external protective fuses a UL or CSA Listed fuse shall be used. The Listed type shall be a Class J time delay fuse, with a maximum current rating of 15 A and a minimum d.c. rating of 250 Vd.c., for example type AJT15.

Where UL or CSA Listing of the equipment is not required, a high rupture capacity (HRC) fuse type with a maximum current rating of 16 Amps and a minimum d.c. rating of 250 Vd.c. may be used, for example Red Spot type NIT or TIA.

**Equipment operating conditions**

The equipment should be operated within the specified electrical and environmental limits.

**Current transformer circuits**

Do not open the secondary circuit of a live CT since the high voltage produced may be lethal to personnel and could damage insulation. Generally, for safety, the secondary of the line CT must be shorted before opening any connections to it.

For most equipment with ring-terminal connections, the threaded terminal block for current transformer termination has automatic CT shorting on removal of the module. Therefore external shorting of the CTs may not be required, the equipment documentation should be checked to see if this applies.

For equipment with pin-terminal connections, the threaded terminal block for current transformer termination does NOT have automatic CT shorting on removal of the module.

**External resistors, including voltage dependent resistors (VDRs)**

Where external resistors, including voltage dependent resistors (VDRs), are fitted to the equipment, these may present a risk of electric shock or burns, if touched.

**Battery replacement**

Where internal batteries are fitted they should be replaced with the recommended type and be installed with the correct polarity to avoid possible damage to the equipment, buildings and persons.

**Insulation and dielectric strength testing**

Insulation testing may leave capacitors charged up to a hazardous voltage. At the end of each part of the test, the voltage should be gradually reduced to zero, to discharge capacitors, before the test leads are disconnected.

**Insertion of modules and pcb cards**

Modules and PCB cards must not be inserted into or withdrawn from the equipment whilst it is energized, since this may result in damage.

**Insertion and withdrawal of extender cards**

Extender cards are available for some equipment. If an extender card is used, this should not be inserted or withdrawn from the equipment whilst it is energized. This is to avoid possible shock or damage hazards. Hazardous live voltages may be accessible on the extender card.



### External test blocks and test plugs

Great care should be taken when using external test blocks and test plugs such as the MMLG, MMLB and MiCOM P990 types, hazardous voltages may be accessible when using these. \*CT shorting links must be in place before the insertion or removal of MMLB test plugs, to avoid potentially lethal voltages.

\*Note: When a MiCOM P992 Test Plug is inserted into the MiCOM P991 Test Block, the secondaries of the line CTs are automatically shorted, making them safe.



### Fiber optic communication

Where fiber optic communication devices are fitted, these should not be viewed directly. Optical power meters should be used to determine the operation or signal level of the device.



### Cleaning

The equipment may be cleaned using a lint free cloth dampened with clean water, when no connections are energized. Contact fingers of test plugs are normally protected by petroleum jelly, which should not be removed.

## 5. DECOMMISSIONING AND DISPOSAL



### De-commissioning

The supply input (auxiliary) for the equipment may include capacitors across the supply or to earth. To avoid electric shock or energy hazards, after completely isolating the supplies to the equipment (both poles of any dc supply), the capacitors should be safely discharged via the external terminals prior to de-commissioning.



### Disposal

It is recommended that incineration and disposal to water courses is avoided. The equipment should be disposed of in a safe manner. Any equipment containing batteries should have them removed before disposal, taking precautions to avoid short circuits. Particular regulations within the country of operation, may apply to the disposal of the equipment.

## 6. TECHNICAL SPECIFICATIONS FOR SAFETY

Unless otherwise stated in the equipment technical manual, the following data is applicable.

### 6.1 Protective fuse rating

The recommended maximum rating of the external protective fuse for equipments is 16A, high rupture capacity (HRC) Red Spot type NIT, or TIA, or equivalent. Unless otherwise stated in equipment technical manual, the following data is applicable. The protective fuse should be located as close to the unit as possible.



**CAUTION - CTs must NOT be fused since open circuiting them may produce lethal hazardous voltages.**

### 6.2 Protective Class

IEC 60255-27: 2005  
EN 60255-27: 2006

Class I (unless otherwise specified in the equipment documentation). This equipment requires a protective conductor (earth) connection to ensure user safety.

### 6.3 Installation Category

IEC 60255-27: 2005  
EN 60255-27: 2006

Installation Category III (Overvoltage Category III):  
Distribution level, fixed installation.

Equipment in this category is qualification tested at 5 kV peak, 1.2/50  $\mu$ s, 500  $\Omega$ , 0.5 J, between all supply circuits and earth and also between independent circuits.

### 6.4 Environment

The equipment is intended for indoor installation and use only. If it is required for use in an outdoor environment then it must be mounted in a specific cabinet or housing which will enable it to meet the requirements of IEC 60529 with the classification of degree of protection IP54 (dust and splashing water protected).

Pollution Degree - Pollution Degree 2  
Altitude - Operation up to 2000m

Compliance is demonstrated by reference to safety standards.

IEC 60255-27:2005  
EN 60255-27: 2006

# **INTRODUCTION**





## **CONTENTS**

---

<b>1.</b>	<b>INTRODUCTION</b>	<b>3</b>
<hr/>		
<b>2.</b>	<b>HOW TO USE THIS MANUAL</b>	<b>4</b>
<hr/>		
<b>3.</b>	<b>INTRODUCTION TO THE MiCOM RANGE</b>	<b>5</b>
<hr/>		
<b>4.</b>	<b>INTRODUCTION TO THE MiCOM P120, P121, P122 &amp; P123 RELAYS</b>	<b>6</b>
<hr/>		
<b>5.</b>	<b>MAIN FUNCTIONS</b>	<b>7</b>
<b>5.1</b>	<b>Main functions</b>	<b>7</b>
<b>5.2</b>	<b>General functions</b>	<b>8</b>

**BLANK PAGE**

## 1. INTRODUCTION

The overcurrent relays of the **MiCOM P120 range** are Schneider Electric universal overcurrent relays. **MiCOM P120, P121, P122** and **P123** relays have been designed to control, protect and monitor industrial installations, public distribution networks and substations, and to be used as back-up protection for EHV and HV transmission networks.

## 2. HOW TO USE THIS MANUAL

This manual provides a description of **MiCOM P120**, **P121**, **P122** and **P123** functions and settings. The goal of this manual is to allow the user to become familiar with the application, installation, setting and commissioning of these relays.

This manual has the following format:

<i>P12x/EN IT</i>	<i>Introduction</i>
	The introduction presents the documentation structure and a brief presentation of the relay, including functions.
<i>P12x/EN IN</i>	<i>Handling, installation and case dimensions</i>
	This section provides logistics general instructions for handling, installing and stocking..
<i>P12x/EN FT</i>	<i>User Guide of <b>MiCOM P120</b>, <b>P121</b>, <b>P122</b> and <b>P123</b> relays</i>
	This section provides relay settings with a brief explanation of each setting and detailed description. It also provides recording and measurements functions including the configuration of the event and disturbance recorder and measurement functions.
<i>P12x/EN HI</i>	<i>Menu content tables</i>
	This section shows the menu structure of the relays, with a complete list of all of the menu settings.
<i>P12x/EN AP</i>	<i>Application Notes</i>
	This section includes a description of common power system applications of the relay, calculation of suitable settings, some typical worked examples, and how to apply the settings to the relay.
<i>P12x/EN TD</i>	<i>Technical data and curve characteristics</i>
	This section provides technical data including setting ranges, accuracy limits, recommended operating conditions, ratings and performance data. Compliance with norms and international standards is quoted where appropriate.
<i>P12x/EN CT</i>	<i>Communication mapping data bases</i>
	This section provides an overview regarding the communication interfaces of the relay. Detailed protocol mappings, semantics, profiles and interoperability tables are not provided within this manual. Separate documents are available per protocol, available for download from our website.
<i>P12x/EN CM</i>	<i>Commissioning and Maintenance Guide</i>
	Instructions on how to commission the relay, comprising checks on the calibration and functionality of the relay.
<i>P12x/EN CO</i>	<i>Connection diagrams for <b>MiCOM P120/P121</b> and <b>P122/P123</b></i>
	This section provides the mechanical and electrical description. External wiring connections to the relay are indicated.
<i>P12x/EN RS</i>	<i>Commissioning test records</i>
	This section contains checks on the calibration and functionality of the relay.
<i>P12x/EN VC</i>	<i>Hardware/Software version history</i>
	History of all hardware and software releases for the product.
<i>P12x/EN AD</i>	<i>ADDENDUM documentation MiCOM P120 R</i>
	This section gives information about P120R specific relay.

---

### 3. INTRODUCTION TO THE MiCOM RANGE

MiCOM is a comprehensive solution capable of meeting all electricity supply requirements. It comprises of a range of components, systems and services from Schneider Electric. Flexibility is central to the MiCOM concept.

MiCOM provides the ability to define an application solution and, through extensive communication capabilities, to integrate this solution with your power supply control system.

The components within MiCOM are:

- **P** range protection relays
- **C** range control products
- **M** range measurement products for accurate metering and monitoring
- **S** range versatile PC support and substation control packages

MiCOM products include extensive facilities for recording information on the state and behaviour of a power system, using disturbance and fault records.

They can also provide measurements of the power system at regular intervals to a control centre enabling remote monitoring and control to take place.

For up-to-date information on any MiCOM product, refer to the technical publications, which can be obtained from: Schneider Electric or your local sales office; alternatively visit our web site.

#### 4. INTRODUCTION TO THE MiCOM P120, P121, P122 & P123 RELAYS

The range of **MiCOM** protection relays is built on the success of the MIDOS, K and MODN ranges by incorporating the last changes in digital technology. Relays from the MiCOM P120 range are fully compatible and use the same modular box concept.

**MiCOM P120, P121, P122** and **P123** relays provide comprehensive overcurrent phase and earth fault protection for utilities networks, industrial plants and networks as well as for other applications where overcurrent protection is required. The earth fault protection is sensitive enough to be applied in electrical networks where the earth fault current is low.

In addition to its protective functions, each relay offers control and recording features. They can be fully integrated to a control system so protection, control, data acquisition and recording of faults, events and disturbances can be made available.

The relays are equipped on the front panel with a liquid crystal display (LCD) with 2 x 16 back-lit alphanumerical characters, a tactile 7 button keypad (to access all settings, clear alarms and read measurements) and 8 LEDs that indicate the status of **MiCOM P120, P121, P122** and **P123** relays.

In addition, the use of the RS485 communication port makes it possible to read, reinitialise and change the settings of the relays, if required, from a local or remote PC computer loaded with MiCOM S1 software.

Its flexibility of use, reduced maintenance requirements and ease of integration allow the MiCOM P120 range to provide an adaptable solution for the problems of the protection of electric networks.

## 5. MAIN FUNCTIONS

### 5.1 Main functions

The following table shows the functions available for the different models of the **MiCOM P120 range** of relays.

ANSI CODES	FEATURES	P120	P121	P122	P123
50/51 or 50N/51N	Single-phase overcurrent	●			
50/51	Three-phase overcurrent		●	●	●
50N/51N	Earth fault overcurrent		●	●	●
64N	Restricted Earth fault		●	●	●
49	Thermal overload (True RMS)			●	●
37	Undercurrent			●	●
46	Negative sequence overcurrent			●	●
	Broken conductor detection			●	●
	Cold load pickup			●	●
	Instantaneous/start contact	●	●	●	●
86	Latching output contacts	●	●	●	●
	Setting groups	1	1	2	2
50BF	Circuit breaker failure detection			●	●
	Trip circuit supervision			●	●
	Circuit Breaker monitoring and control			●	●
	Blocking logic	●	●	●	●
	Inrush Blocking			●	●
	Selective relay scheme logic			●	●
	Logic equations		●	●	●
	Auxiliary Timers	2	2	3	5
79	Multi-shot autoreclose				●
	Clockwise and anti-clockwise phase rotation			●	●
	Switch on to fault (SOTF)				●
	Test of output relays (maintenance)			●	●
	CB control Local/Remote				●

## 5.2 General functions

The following table shows the general features available.

GENERAL FEATURES		P120	P121	P122	P123
Number of digital inputs		2	2	3	5
Total number of outputs relays		4	4	6	8
Events recording		250	0	250	250
Fault recording		25	0	25	25
Disturbance recording		5	0	5	5
Setting group		1	1	2	2
Auxiliary timers		2	2	3	5
Communication	IEC60870-5-103, DNP 3.0 & Modbus RTU	•	•	•	•
	Courier	•	•	•	•
Time synchronisation	Via rear communication port (DCS)	•		•	•
	Via digital input (external clock)	•		•	•
Settings software	MiCOM S1 using RS232 front port	•	•	•	•
Logic equation	AND, OR and NOT gates (8 equations)		•	•	•
Measurements	RMS currents values & frequency	•	•	•	•
	Peak and rolling currents values			•	•
	Max and average currents values			•	•



# **HANDLING, INSTALLATION AND CASE DIMENSIONS**



# CONTENTS

---

<b>1.</b>	<b>GENERAL CONSIDERATIONS</b>	<b>3</b>
1.1	Receipt of relays	3
1.2	Electrostatic discharge (ESD)	3
<b>2.</b>	<b>HANDLING OF ELECTRONIC EQUIPMENT</b>	<b>4</b>
<b>3.</b>	<b>RELAY MOUNTING</b>	<b>5</b>
<b>4.</b>	<b>UNPACKING</b>	<b>6</b>
<b>5.</b>	<b>STORAGE</b>	<b>7</b>
<b>6.</b>	<b>DIMENSIONS</b>	<b>8</b>
6.1	Connection of power terminals, and Signals terminals	8
6.2	Communication port RS485	9
6.3	Earthing	9
<b>7.</b>	<b>CASE DIMENSIONS</b>	<b>10</b>

---

**BLANK PAGE**

---

## 1. GENERAL CONSIDERATIONS



BEFORE CARRYING OUT ANY WORK ON THE EQUIPMENT, THE USER SHOULD BE FAMILIAR WITH THE CONTENTS OF THE SAFETY GUIDE SFTY/4LM/E11 OR LATER ISSUE, OR THE SAFETY AND TECHNICAL DATA SECTIONS OF THE TECHNICAL MANUAL AND ALSO THE RATINGS ON THE EQUIPMENT RATING LABEL.

### 1.1 Receipt of relays

Protective relays, although generally of robust construction, require careful treatment prior to installation on site. Upon receipt, relays should be examined immediately to ensure no damage has been sustained in transit. If damage has been sustained during transit a claim should be made to the transport contractor and Schneider Electric should be promptly notified.

Relays that are supplied unmounted and not intended to be installed immediately should be returned with their protective polythene bags.

### 1.2 Electrostatic discharge (ESD)

The relays use components that are sensitive to electrostatic discharges.

The electronic circuits are well protected by the metal case and the internal module should not be withdrawn unnecessarily. When handling the module outside its case, care should be taken to avoid contact with components and electrical connections. If removed from the case for storage, the module should be placed in an electrically conducting antistatic bag.

There are no setting adjustments within the module and it is advised that it is not unnecessarily disassembled. Although the printed circuit boards are plugged together, the connectors are a manufacturing aid and not intended for frequent dismantling; in fact considerable effort may be required to separate them. Touching the printed circuit board should be avoided, since complementary metal oxide semiconductors (CMOS) are used, which can be damaged by static electricity discharged from the body.

---

## 2. HANDLING OF ELECTRONIC EQUIPMENT

A person's normal movements can easily generate electrostatic potentials of several thousand volts. Discharge of these voltages into semiconductor devices when handling electronic circuits can cause serious damage, which often may not be immediately apparent but the reliability of the circuit will have been reduced.

The electronic circuits are completely safe from electrostatic discharge when housed in the case. Do not expose them to risk of damage by withdrawing modules unnecessarily.

Each module incorporates the highest practicable protection for its semiconductor devices. However, if it becomes necessary to withdraw a module, the following precautions should be taken to preserve the high reliability and long life for which the equipment has been designed and manufactured.

1. Before removing a module, ensure that you are at the same electrostatic potential as the equipment by touching the case.
2. Handle the module by its frontplate, frame or edges of the printed circuit board. Avoid touching the electronic components, printed circuit track or connectors.
3. Do not pass the module to another person without first ensuring you are both at the same electrostatic potential. Shaking hands achieves equipotential.
4. Place the module on an antistatic surface, or on a conducting surface which is at the same potential as yourself.
5. Store or transport the module in a conductive bag.

If you are making measurements on the internal electronic circuitry of an equipment in service, it is preferable that you are earthed to the case with a conductive wrist strap. Wrist straps should have a resistance to ground between  $500\text{k}\Omega$  –  $10\text{M}\Omega$ .

If a wrist strap is not available you should maintain regular contact with the case to prevent a build-up of static. Instrumentation which may be used for making measurements should be earthed to the case whenever possible.

More information on safe working procedures for all electronic equipment can be found in BS5783 and IEC 147-OF. It is strongly recommended that detailed investigations on electronic circuitry or modification work should be carried out in a special handling area such as described in the above-mentioned BS and IEC documents.

### **3. RELAY MOUNTING**

Relays are dispatched either individually or as part of a panel/rack assembly.

If an MMLG test block is to be included it should be positioned at the right-hand side of the assembly (viewed from the front). Modules should remain protected by their metal case during assembly into a panel or rack.

For individually mounted relays an outline diagram is supplied in section 6 of this chapter showing the panel cut-outs and hole centres.

#### **4. UNPACKING**

Care must be taken when unpacking and installing the relays so that none of the parts is damaged or the settings altered. Relays must only be handled by skilled personnel. The installation should be clean, dry and reasonably free from dust and excessive vibration. The site should be well lit to facilitate inspection. Relays that have been removed from their cases should not be left in situations where they are exposed to dust or damp. This particularly applies to installations which are being carried out at the same time as construction work.



## 5. STORAGE

If relays are not to be installed immediately upon receipt they should be stored in a place free from dust and moisture in their original cartons. Where de-humidifier bags have been included in the packing they should be retained. The action of the de-humidifier crystals will be impaired if the bag has been exposed to ambient conditions and may be restored by gently heating the bag for about an hour, prior to replacing it in the carton.

Dust which collects on a carton may, on subsequent unpacking, find its way into the relay; in damp conditions the carton and packing may become impregnated with moisture and the de-humidifier will lose its efficiency.

Storage temperature:  $-25^{\circ}\text{C}$  to  $+70^{\circ}\text{C}$ .

## 6. DIMENSIONS

### 6.1 Connection of power terminals, and Signals terminals

The individual equipment are delivered with sufficient M4 screws to connect the relay via annular terminals, with a maximum recommended of two annular terminals per contact.

If necessary, Schneider Electric can provide annular terminals to crimp. 5 references exist according to the section of the wire (see below). Each reference corresponds to a sachet of 100 terminals.

Push-on connector 4.8 x 0.8 (wire size 0.75 - 1.5mm<sup>2</sup>)  
Schneider Electric reference: ZB9128 015



Push-on connector 4.8 x 0.8mm (wire size 1.5 - 2.5mm<sup>2</sup>)  
Schneider Electric reference: ZB9128 016



P0166ENc

M4 90° Ring Tongue terminal (wire size 0.25 - 1.65mm<sup>2</sup>)  
Schneider Electric reference, Stafford part number ZB9124 901



M4 90° Ring Tongue terminal (wire size 1.5 - 2.5mm<sup>2</sup>)  
Schneider Electric reference, Stafford part number ZB9124 900



P0167ENc



## 7. CASE DIMENSIONS

MiCOM P120, P121, P122 and P123 relays are available in a 4U metal case for panel or flush mounting.

Weight: 1.7 to 2.1 Kg

<u>External size:</u>	Height	case	152 mm
		front panel	177 mm
	Width	case	97 mm
		front panel	103 mm
	Depth	case	226 mm
		front panel + case	252 mm

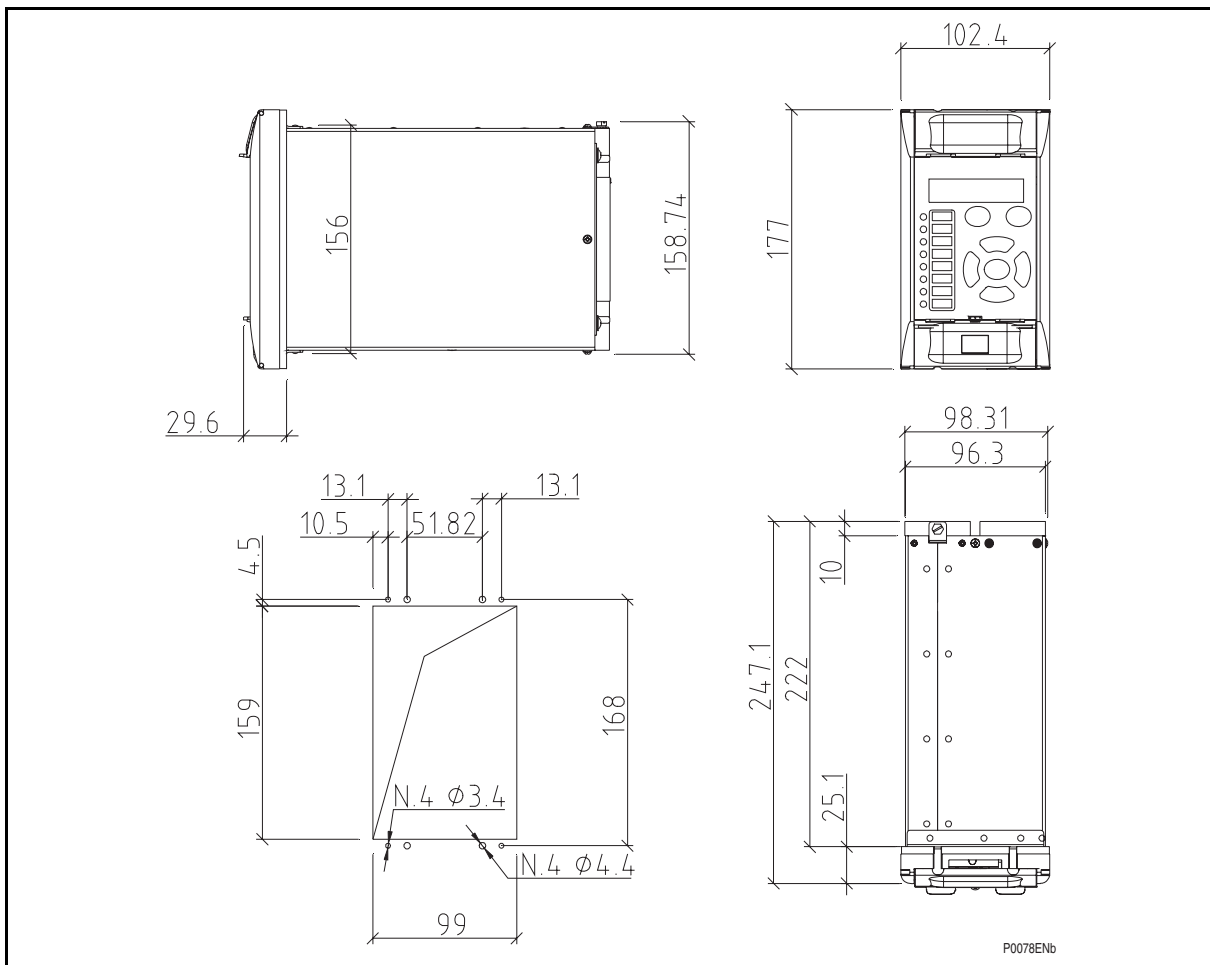

MiCOM P120, P121, P122 AND P123 RELAYS CASE DIMENSIONS

**NOTE:** The chassis is normally secured in the case by four screws (Self tap screws 6x1,4), to ensure good seating. The fixing screws should be fitted in normal service (do not add washers). Do not discard these screws.

# **USER GUIDE**



# CONTENTS

<b>1.</b>	<b>PRESENTATION OF MiCOM P120, P121, P122 AND P123 RELAYS</b>	<b>3</b>
<b>1.1</b>	<b>USER INTERFACE</b>	<b>4</b>
1.1.1	Relay Overview	4
1.1.2	Front panel description	4
1.1.3	LCD display and keypad description	5
1.1.4	LEDs	6
1.1.5	Description of the two areas under the top and bottom flaps	7
1.1.6	The USB/RS232 cable (to power and set the relay)	7
<b>1.2</b>	<b>Menu structure</b>	<b>8</b>
<b>1.3</b>	<b>PASSWORD</b>	<b>8</b>
1.3.1	Password protection	8
1.3.2	Password entry	8
1.3.3	Changing the password	9
1.3.4	Change of setting invalidation	9
<b>1.4</b>	<b>Displays of Alarm &amp; Warning Messages</b>	<b>9</b>
1.4.1	Electrical Network Alarms	9
1.4.2	Relay Hardware or Software Warning Messages	11
<b>2.</b>	<b>MENUS</b>	<b>13</b>
<b>2.1</b>	<b>Default display</b>	<b>13</b>
<b>2.2</b>	<b>Menu contents description</b>	<b>13</b>
<b>2.3</b>	<b>OP PARAMETERS Menu</b>	<b>14</b>
<b>2.4</b>	<b>ORDERS menu (P122 and P123 Only)</b>	<b>15</b>
<b>2.5</b>	<b>CONFIGURATION menu</b>	<b>15</b>
2.5.1	Submenu DISPLAY	16
2.5.2	Submenu CT RATIO	16
2.5.3	Submenus LED 5 to 8	16
2.5.4	Submenu GROUP SELECT (P122 & P123 only)	19
2.5.5	Submenu ALARMS (P121, P122 and P123 only)	19
2.5.6	Submenu CONFIGURATION INPUTS (P122 & P123 only)	20
2.5.7	Submenu OUTPUT RELAYS (P121, P122 and P123 only)	21
2.5.8	Submenu PHASE ROTATION (P122 & P123 only)	21
<b>2.6</b>	<b>MEASUREMENTS Menu</b>	<b>21</b>
<b>2.7</b>	<b>COMMUNICATION Menu</b>	<b>23</b>
2.7.1	MODBUS COMMUNICATION Menu	23
2.7.2	Courier COMMUNICATION Menu	24
2.7.3	IEC 60870-5-103 COMMUNICATION Menu	24
2.7.4	DNP3 COMMUNICATION Menu	24

<b>2.8</b>	<b>PROTECTION Menu</b>	<b>25</b>
2.8.1	Submenu [50/51] PHASE OC	25
2.8.2	Submenu [50N/51N] EARTH OC (P121 - P122 - P123 only)	28
2.8.3	Submenu [46] NEGATIVE Phase SEQUENCE I <sub>2</sub> > (P122 & P123 only)	31
2.8.4	Submenu [49] Therm OL (P122 & P123 only)	33
2.8.5	Submenu [37] UNDERCURRENT I <sub>&lt;</sub> (P122 & P123 only)	34
2.8.6	Submenu [79] AUTORECLOSE (P123 only)	34
<b>2.9</b>	<b>AUTOMAT. CTRL Menu</b>	<b>38</b>
2.9.1	Submenu Trip Commands	38
2.9.2	Submenu Latch of trip output relay by Function	39
2.9.3	Submenu Blocking Logic	41
2.9.4	Inrush Blocking Logic submenu (P122 and P123 only)	42
2.9.5	Submenus Logic Select (P122 & P123 only)	43
2.9.6	Outputs Relays submenu	43
2.9.7	Latch of the auxiliary output relays (RL2 to RL8)	46
2.9.8	Inputs submenu	47
2.9.9	BROKEN CONDUCTOR submenu (P122 & P123 only)	49
2.9.10	COLD LOAD PICK-UP submenu (P122 & P123 only)	49
2.9.11	CIRCUIT BREAKER FAILURE submenu (P122 & P123 only)	50
2.9.12	CIRCUIT BREAKER SUPERVISION sub-menu (P122 & P123 only)	51
2.9.13	Submenu SOTF (Switch on to Fault) (P123 only)	52
2.9.14	Submenu Logic Equations (P121, P122 & P123 only)	53
<b>2.10</b>	<b>RECORDS Menu (P120, P122 and P123 only)</b>	<b>56</b>
2.10.1	CB MONITORING submenu (P122, P123 only)	56
2.10.2	Fault Record submenu	57
2.10.3	INSTANTANEOUS submenu	57
2.10.4	DISTURBANCE RECORD submenu	58
2.10.5	Time PEAK VALUE submenu (P122, P123 only)	58
2.10.6	ROLLING DEMAND submenu (P122, P123 only)	59
<b>3.</b>	<b>WIRING</b>	<b>60</b>
<b>3.1</b>	<b>Auxiliary supply</b>	<b>60</b>
<b>3.2</b>	<b>Current measurement inputs</b>	<b>60</b>
<b>3.3</b>	<b>Logic inputs</b>	<b>60</b>
<b>3.4</b>	<b>Output relays</b>	<b>60</b>
<b>3.5</b>	<b>Communication</b>	<b>61</b>
3.5.1	RS485 rear communication port	61
3.5.2	RS232 front communication port (P120, P121, P122, P123)	61



---

## 1. PRESENTATION OF MiCOM P120, P121, P122 AND P123 RELAYS

**MiCOM P120, P121 P122** and **P123** are fully numerical relays designed to perform electrical protection and control functions.

The following section describes the MiCOM P120 range and the main differences between the different models.

MiCOM relays are powered either from a DC (2 voltage ranges) or an AC auxiliary power supply.

Using the front panel, the user can easily navigate through the menu and access data, change settings, read measurements, etc.

Eight LEDs situated in the front panel help the user to quickly know the status of the relay and the presence of alarms. Alarms that have been detected are stored and can be displayed on the back-lit LCD.

Any short time voltage interruption (<50ms) is filtered and regulated through the auxiliary power supply.

Regarding current inputs, **MiCOM P120** has 2 current inputs available, one for 1A and one for 5A rated CTs.

**MiCOM P121, P122 & P123** have 3 phase and 1 earth current inputs available for 1 and 5 Amps rated CTs. On each one of these relays, it is possible to combine 1 and 5 Amp current inputs together (i-e a mix between 1A for earth fault and 5A for phase connections).

**MiCOM 120, P121, P122** and **P123** relays continuously measure phase and earth currents (P120 makes a single measurement) and take into account the true RMS current value up to 10th harmonic (at 50 Hz).

Output relays are freely configurable and can be activated by any of the control or protection functions available in the relay. Logic inputs can also be assigned to various control functions.

On their rear terminals **MiCOM P120, P121 P122** and **P123** have a standard RS485 port available. When ordering, the user can choose between the following communication protocol: ModBus RTU, IEC 60870-5-103, Courier or DNP3.0.

Using RS485 communication channel, all stored information (measurements, alarms, and parameters) can be read and settings can be modified when the chosen protocol allows it.

Reading and modification of this data can be carried out on site with a standard PC loaded with Schneider Electric setting software.

Thanks to its RS485 based communication, **MiCOM P120, P121, P122** and **P123** relays can be connected directly to a digital control system. All the available data can then be gathered by a substation control system and be processed either locally or remotely.

**1.1 USER INTERFACE**

**1.1.1 Relay Overview**

The next figures show the MiCOM P120, P121, P122 and P123 relays.



The table shows the case size for the relays.

Height	Depth	Width
4U (177mm)	226mm	20 TE

The hinged covers at the top and bottom of the relay are shown closed. Extra physical protection for the front panel can be provided by an optional transparent front cover; this allows read only access to the relays settings and data but does not affect the relays IP rating. When full access to the relay keypad is required to edit the settings, the transparent cover can be unclipped and removed when the top and bottom hinged covers are open.

**1.1.2 Front panel description**

**MiCOM P120, P121, P122 and P123** relay front panel allows the user to easily enter relay settings, display measured values and alarms and to clearly display the status of the relay.

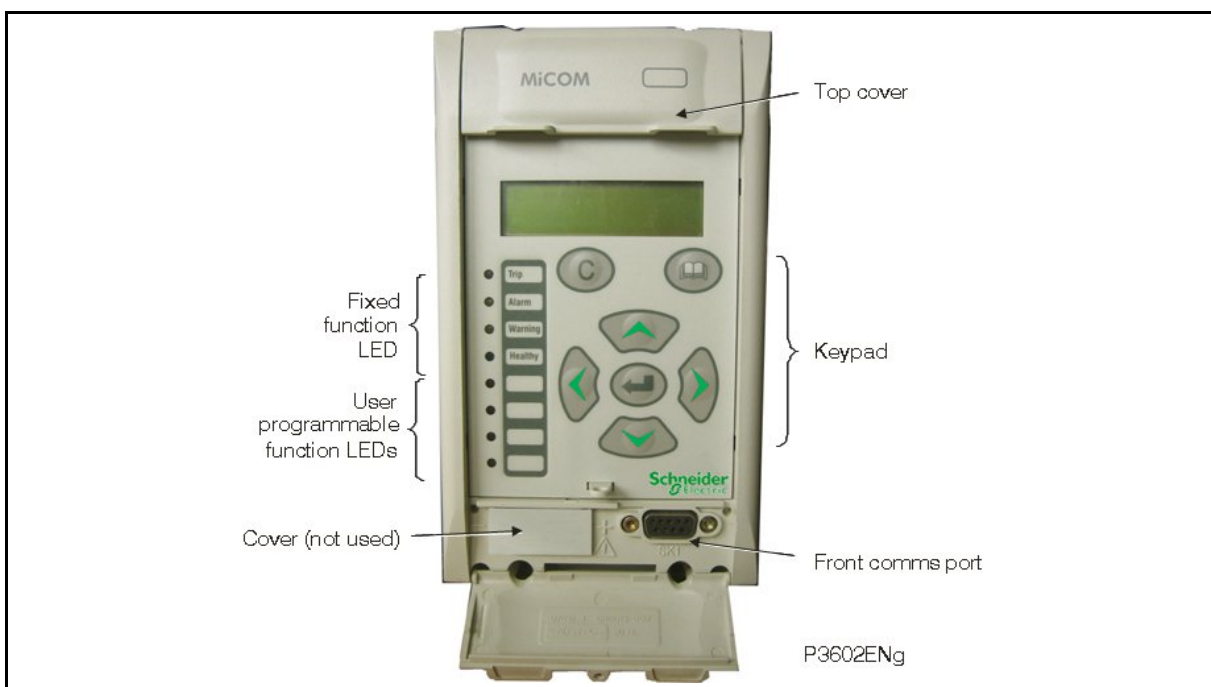

**FIGURE 1: MiCOM P120, P121, P122 AND P123 FRONT PANEL DESCRIPTION**

The front panel of the relay has three separate sections:

1. The LCD display and the keypad,
2. The LEDs
3. The two zones under the upper and lower flaps.

**NOTE:** Starting from Hardware 5, there is no need of battery in the front of the relay. Indeed, disturbance, fault and event records are stored on a flash memory card that doesn't need to be backed up by a battery. The compartment is fitted with a blanking cover.

### 1.1.3 1.1.3 LCD display and keypad description

The front panel components are shown below. The front panel functionality is identical for the P120, P121, P122 & P123 relays.

#### 1.1.3.1 LCD display

In the front panel, a liquid crystal display (LCD) displays settings, measured values and alarms. Data is accessed through a menu structure.



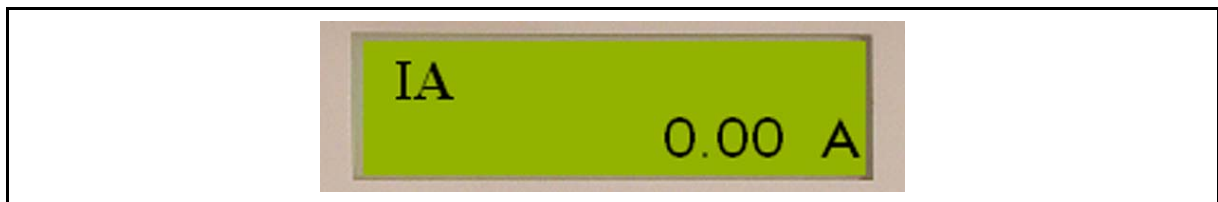

The LCD has two lines, with sixteen characters each. A back-light is activated when a key is pressed and will remain lit for five minutes after the last key press. This allows the user to be able to read the display in most lighting conditions.



#### 1.1.3.2 Keypad

The keypad has seven keys divided into two groups:

- Two keys located just under the screen (keys  and ).

Keys  and  are used to read and acknowledge alarms. To display successive alarms, press key . Alarms are displayed in reverse order of their detection (the most recent alarm first, the oldest alarm last). To acknowledge the alarms, the user can either acknowledge each alarm using  or go to the end of the ALARM menu and acknowledge all the alarms at the same time.

When navigating through submenus, key  is also used to come back to the head line of the corresponding menu.

**NOTE:** To acknowledge a relay latched refer to the corresponding submenu section.

- Four main keys , , ,  located in the middle of the front panel.

They are used to navigate through the different menus and submenus and to do the setting of the relay.

The key  is used to validate a choice or a value (modification of settings).

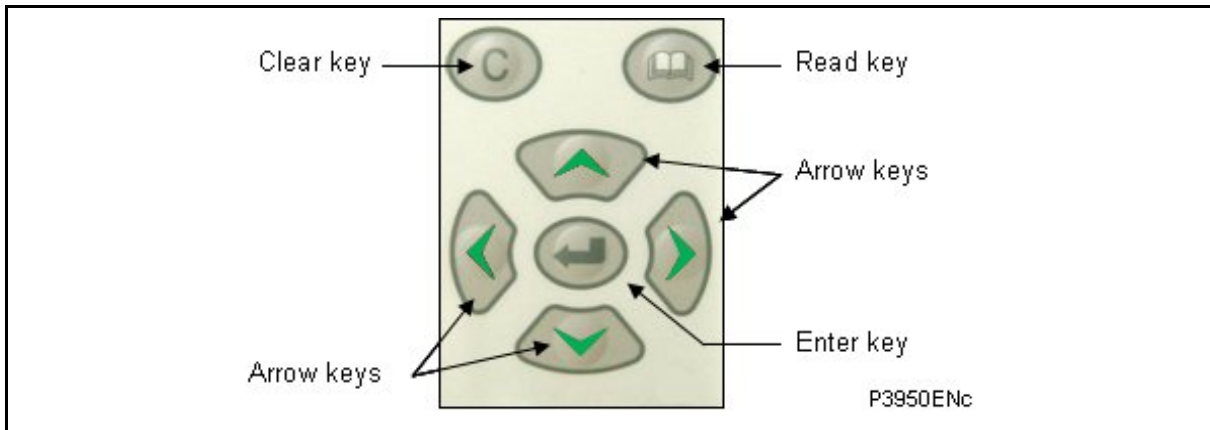

### 1.1.4 LEDs

The LED labels on the front panel are by default written in English, however the user has self-adhesive labels available with **MiCOM** relays on which it is possible to write using a ball point pen.

The top four LEDs indicate the status of the relay (Trip condition, alarm LED, equipment failure, auxiliary supply).

The four lower LEDs are freely programmable by the user and can be assigned to display a threshold crossing for example (available for all models) or to show the status of the logic inputs (P122 & P123 ONLY). The description of each one of these eight LEDs located in the left side of the front view is given hereafter (numbered from the top to bottom from 1 to 8):

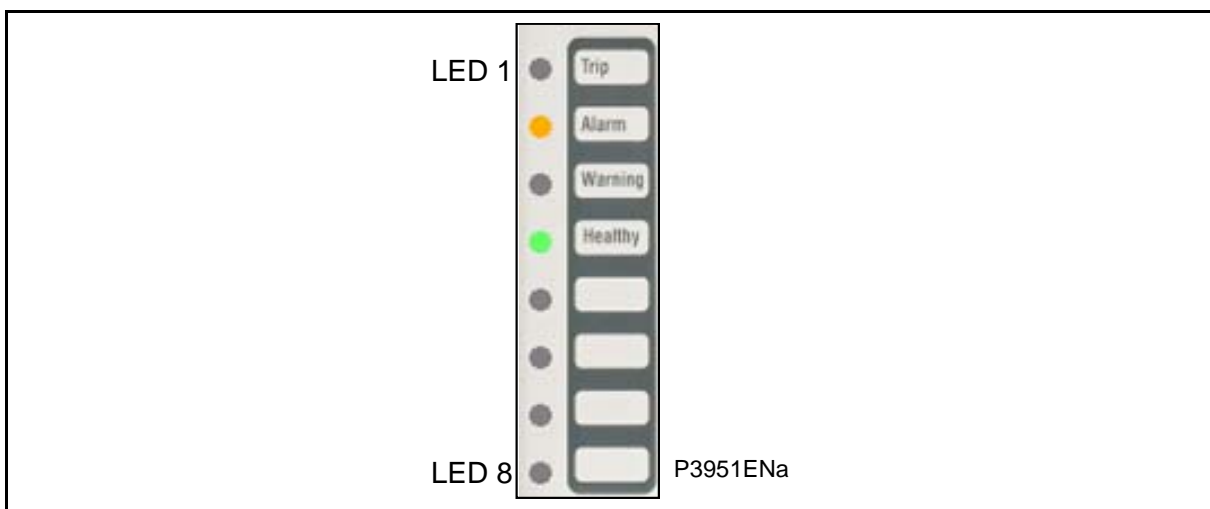

**LED 1** **Colour: RED** **Label: Trip**

LED 1 indicates that the relay has issued a trip order to the cut-off element (circuit breaker, contactor). This LED recopies the trip order issued to the Trip logic output. Its normal state is unlit. As soon as a triggering order is issued, the LED lights up. It is cleared when the associated alarm is acknowledged either through the front panel, or by a remote command, a digital input, or by a new fault (CONFIGURATION/Alarms menu).

**LED 2** **Colour: ORANGE** **Label: ALARM**

LED 2 indicates that the relay has detected an alarm. This alarm can either be a threshold crossing (instantaneous), or a trip order (time delayed). As soon as an alarm is detected, the LED starts blinking. After all the alarms have been read, the LED lights up continuously.

After acknowledgement of all the alarms, the LED is extinguished.

**NOTE:** It is possible to configure the instantaneous alarms to be self reset or not by choosing Yes or No in the CONFIGURATION/Alarms Menu.

The alarm LED can be reset either through the front panel, or by remote command, by a digital input, or by a new fault (CONFIGURATION/Alarms menu).

**LED 3** **Colour: ORANGE** **Label: Warning**

LED 3 indicates internal alarms of the relay. When the relay detects a « non critical » internal alarm (typically a communication failure), the LED starts blinking continuously. When the relay detects a fault that is considered as « critical », the LED lights up continuously. Only the disappearance of the cause of the fault can clear this LED (repair of the module, clearance of the Fault).

**LED 4** **Colour: GREEN** **Label: Healthy**

LED 4 indicates that the relay is powered by an auxiliary source at the nominal range.

**LED 5 to 8** **Colour: RED** **Label: Aux.1 to 4.**

These LEDs are user programmable and can be set to display information about instantaneous and time-delayed thresholds as well as the status of the logic inputs (for P122 & P123 only). Under the CONFIGURATION/LED menu of the relay, the user can select the information he wishes to associate with each LED. He can affect more than one function to one LED. The LED will then light up when at least one of the associated information is valid (OR gate). The LED is cleared when all the associated alarms are acknowledged.

#### 1.1.5 Description of the two areas under the top and bottom flaps

##### 1.1.5.1 Relay Identification

Under the upper flap, a label identifies the relay according to its model number (order number) and its serial number. This information defines the product in a way that is unique. In all your requests, please make reference to these two numbers.

Under the model and serial number, you will find information about the level of voltage of the auxiliary supply and the nominal earth current value.

##### 1.1.5.2 Lower flap

Under the lower flap, a RS232 port is available in all MiCOM relays. It can be used either to download a new version of the application software version into the relay flash memory or to download/retrieve settings plugging a laptop loaded with MiCOM S1 setting software. Note that on older hardware, the downloading/retrieval of settings was not possible on P120 and P121 relays.

To withdraw more easily the active part of the MiCOM relay (i-e the chassis) from its case, open the two flaps, then with a 3mm screwdriver, turn the extractor located under the upper flap, and pull it out of its case pulling the flaps towards you.

#### 1.1.6 The USB/RS232 cable (to power and set the relay)

The USB/RS232 cable is able to perform the following functions:

1. It is able to power the relay from its front port. This allows the user to view or modify data on the relay even when the auxiliary power supply of the relay has failed or when the relay is not connected to any power supply. The USB port of the PC supplies the power necessary to energize the relay. This lasts as long as the battery of the PC can last.
2. It provides an USB / RS 232 interface between the MiCOM relay and the PC. This allows the user to be able to change the setting of the relay using a PC with its USB port.

It eases the use of the relay allowing the retrieval of records and disturbance files for example when the auxiliary supply has failed or is not available.

The associated driver (supplied with the relay) needs to be installed in the PC. For more information, refer to MiCOM E2 User Guide.

### 1.2 Menu structure

The relay's menu is arranged in a tabular structure. Each setting in the menu is referred to as a cell, and each cell in the menu may be accessed by reference to a row and column address. The settings are arranged so that each column contains related settings, for example all of the disturbance recorder settings are contained within the same column. As shown in the figure, the top row of each column contains the heading that describes the settings contained within that column. Movement between the columns of the menu can only be made at the column heading level. A complete list of all of the menu settings is given in the Menu Content tables (P12x/EH HI section).

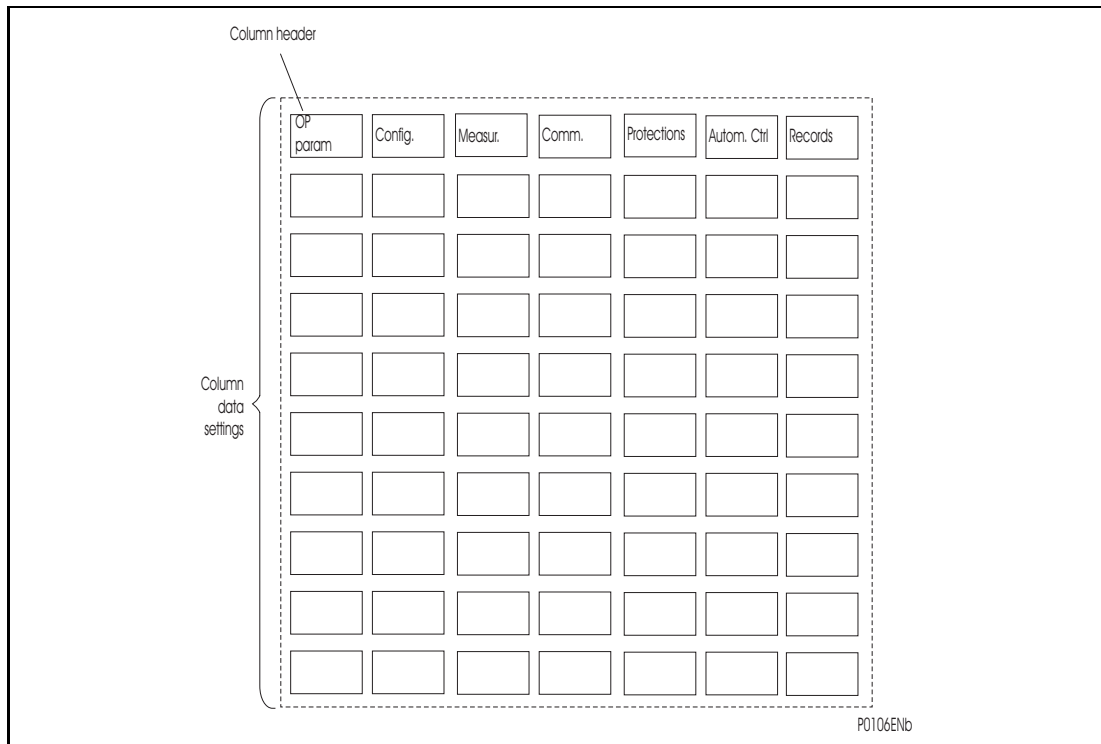

MENU STRUCTURE

### 1.3 PASSWORD

#### 1.3.1 Password protection

A password is required for relay settings, especially when changing the various thresholds, time delays, communication parameters, allocation of inputs and outputs relays.

The password consists of four capital characters. When leaving factory, the password is set to **AAAA**. The user can define his own combination of four characters.

Should the password be lost or forgotten, the modification of the stored parameters is blocked. It is then necessary to contact the manufacturer or his representative and a stand-by password specific to the relay may be obtained.

The programming mode is indicated with the letter "P" on the right hand side of the display on each menu heading. The letter "P" remains present as long as the password is active (**5 minutes** if there is no action on the keypad).



#### 1.3.2 Password entry

The input of the password is requested as soon as a modification of a parameter is made for any one of the six/eight menus and the submenus. The user enters each one of the 4 characters and then validates the entire password with **↵**.

After 5 seconds, the display returns to the point of the preceding menu.

If no key is pressed inside of 5 minutes, the password is deactivated. A new password request is associated with any subsequent parameter modification.

### 1.3.3 Changing the password

To change an active password, go to the OP. PARAMETERS menu and then to the Password submenu. Enter the current password and validate it. Then press  and enter the new password character by character and validate the new password using .

The message NEW PASSWORD OK is displayed to indicate that the new password has been accepted.

### 1.3.4 Change of setting invalidation

The procedure to modify a setting is described in the following sections of this manual.

If there is a need to get back to the old setting push key  before validating the setting change. The following message will then appear on the LCD for a few seconds and the old setting will remain unchanged.

<p><b>UPGRADE</b> <b>CANCEL</b></p>
---

## 1.4 Displays of Alarm & Warning Messages

Alarm messages are displayed directly on the front panel LCD. They have priority over the default display presenting measured current values. As soon as the relay detects an alarm condition (crossing of a threshold for example), the associated message is displayed on the front panel LCD and the LED Alarm (LED 2) lights up.

We distinguish two types of alarm and warning messages:

- Alarm messages generated by the electrical power network.
- Warning messages caused by hardware or software faults from the relay.

### 1.4.1 Electrical Network Alarms

Any crossing of a threshold (instantaneous or time delay) generates an "electrical network alarm". The involved threshold is indicated. Regarding the phase thresholds, the phase designation (A, B or C) is also displayed.

If several alarms are triggered, they are all stored in their order of appearance and presented on the LCD in reverse order of their detection (the most recent alarm first, the oldest alarm last). Each alarm message is numbered and the total number of alarm messages is displayed.

The user can read all the alarm messages pressing .

The user acknowledges and clears the alarm messages from the LCD pressing .

The user can acknowledge each alarm message one by one or all by going to the end of the list to acknowledge, and clear, all the alarm messages pressing .

The control of the ALARM LED (LED 2) is directly assigned to the status of the alarm messages stored in the memory.

If one or several messages are NOT READ and NOT ACKNOWLEDGED, the ALARM LED (LED 2) flashes.

If all the messages have been READ but NOT ACKNOWLEDGED, the ALARM LED (LED 2) lights up continuously.

If all the messages have been ACKNOWLEDGED, and cleared, if the cause that generated the alarm disappears, the ALARM LED (LED 2) is extinguished.

The different electrical system alarms are listed below:

le>	1 <sup>st</sup> stage earth fault threshold
le>>	2 <sup>nd</sup> stage earth fault threshold
le>>>	3 <sup>rd</sup> stage earth fault threshold

I> PHASE	1 <sup>st</sup> stage overcurrent threshold
I>> PHASE	2 <sup>nd</sup> stage overcurrent threshold
I>>> PHASE	3 <sup>rd</sup> stage overcurrent threshold
tIe>	1 <sup>st</sup> stage earth fault time-out
tIe>>	2 <sup>nd</sup> stage earth fault time-out
tIe>>>	3 <sup>rd</sup> stage earth fault time-out
tI> PHASE	1 <sup>st</sup> stage overcurrent time-out
tI>> PHASE	2 <sup>nd</sup> stage overcurrent time-out
tI>>> PHASE	3 <sup>rd</sup> stage overcurrent time-out
THERMAL ALARM	thermal alarm threshold
THERMAL TRIP	thermal trip threshold
I<	undercurrent element threshold
tI< PHASE	undercurrent fault time-out
BRKN COND.	broken conductor indication. I2/I1 ratio exceeded for a period of time that is higher than tBC can be set under the AUTOMAT. CTRL/Broken cond. menu.
t AUX 1	t AUX1 time-out
t AUX 2	t AUX2 time-out
t AUX 3	t AUX3 time-out
t AUX 4	t AUX4 time-out
t AUX 5	t AUX5 time-out
CB FAIL	circuit breaker failure indication (the CB does not trip on tBF time. tBF can be set under the AUTOMAT. CTRL/CB Fail menu).
I2>	negative sequence current threshold (1 <sup>st</sup> stage)
tI2>	negative sequence current threshold time-out (1 <sup>st</sup> stage)
I2>>	negative sequence current threshold (2 <sup>nd</sup> stage)
tI2>>	negative sequence current threshold time-out (2 <sup>nd</sup> stage)
SPRING CHARGE FAIL	Faulty circuit breaker indication given by a logic input that has been assigned (under the AUTOMAT. CTRL/Inputs menu).
T operating CB	Operating (or tripping) time of the circuit breaker longer than the value set in the AUTOMAT. CTRL/CB Supervision menu.
CB OPEN NB	Number of circuit breaker operation higher than the value set in the AUTOMAT. CTRL/CB Supervision menu.
ΣAmps(n)	Total measured current broken by CB is higher than the value set in AUTOMAT. CTRL/CB Supervision menu.
TRIP CIRCUIT	Circuit breaker trip circuit failure longer than the supervision timer t SUP (that can be set under the AUTOMAT. CTRL/CB Supervision menu or RL1 energised (trip circuit supervision not enabled).
LATCH RELAY	At least one output relay is latched.
LATCH RELAY TRIP	The relay trip is latched.
CB CLOSE FAILURE	Circuit breaker closing time longer than the value set in the AUTOMAT. CTRL/CB Supervision menu.



RECLOSER SUCCESSFUL	Successful reclose signal. Indicates that when the fault has been cleared upon circuit breaker reclosure, and has not re-appeared before expiry of the reclaim time.
RECLOSER BLOCKED	<p>Recloser blocking signal. Generated by:</p> <ul style="list-style-type: none"> <li>- auxiliary power supply failure during dead time (definitive trip).</li> <li>- external blocking signal. External blocking can be set by the user in the PROTECTION G1 / [79] AUTORECLOSE/Ext Block menu. This blocking signal is provided via a logic input assigned to the Block_79 function in the AUTOMAT. CTRL/Inputs menu.</li> <li>- definitive trip.</li> <li>- remote trip command during the reclaim time.</li> <li>- pick-up of I2&gt; or thermal trip during dead time.</li> <li>- breaker failure (circuit breaker failure to trip on expiry of tBF).</li> <li>- breaker operating time (or tripping time) longer than the set time.</li> </ul>
RECLOSER CONFLICT	<p>Configuration conflict of the re-close function. This signal is generated by:</p> <ul style="list-style-type: none"> <li>- O/O Interlock not assigned to a logic input or assigned but not wired to the input.</li> <li>- no output relay assigned to the CB CLOSE function (AUTOMAT. CTRL/Output Relays menu ).</li> <li>- trip contact latched.</li> <li>- no re-close cycle assigned to the protection functions (PROTECTION/ [79] Autoreclose menu ).</li> </ul>
MAINTENANCE MODE	The relay is in maintenance mode.

#### 1.4.2 Relay Hardware or Software Warning Messages

Any software or hardware fault internal to MiCOM relay generates a "hardware/software alarm" that is stored in memory as a "Hardware Alarm". If several hardware alarms are detected they are all stored in their order of appearance. The warning messages are presented on the LCD in reverse order of their detection (the most recent first and the oldest last). Each warning message is numbered and the total stored is shown.

The user can read all warning messages pressing , without entering the password.

It is not possible to acknowledge and clear warning messages caused by internal relay hardware or software failure. This message can only be cleared once the cause of the hardware or software failure has been removed.

The control of the WARNING LED (LED 3) is directly assigned to the status of the warning messages stored in the memory.

If the internal hardware or software failure is major (i.e. the relay cannot perform protection functions), the WARNING LED (LED 3) lights up continuously.

- major fault: Protection and automation functions of the equipment are blocked. In this condition, the protection relay detects the corresponding fault and activates RL0 Watch Dog relay (35-36 terminals contact is closed).

For instance: the "DEF. ANA" fault (fault in the analog circuit channel) is considered as a major fault because the protection functions will not operate correctly.

- minor fault: Protection and automation functions of the relay operate. A minor fault will not activate RL0 Watch Dog relay (35-36 terminals contact is closed, 36-37 terminals is open). This fault causes a LED alarm and is displayed on the LCD panel.

The Watch Dog relay controls the correct operation of the protection and automation function. This relay fault "RL0 relay" is activated if the following functions or checks are faulty:

- microprocessor operation,
- power supply check,
- reconstituted internal power supply check,
- heating of a circuit board component monitoring,
- analog channel monitoring (acquisition sampling),
- programm execution monitoring,
- communication ports monitoring.

If the internal hardware or software failure is minor (like a communication failure that has no influence on the protection and automation functions), the WARNING LED (LED 3) will flash.

Possible Hardware or Software alarm messages are:

Major fault:

The protection and automation functions are stopped.  
The RL0 watchdog relay is de-energised (35-36 contact closed).

<< CALIBRATION ERROR.>>: Calibration zone failure

<< CT ERROR >>: Analog channel failure

<< DEFAULT SETTINGS (\*) >>

<< SETTING ERROR (\*\*) >>

**(\*) DEFAULT SETTINGS:** Each time the relay is powered ON it will check its memory contents to determine whether the settings are set to the factory defaults. If the relay detects that the default settings are loaded an alarm is raised. The **ALARM LED (YELLOW)** will light up and the Watch Dog contact will be activated.

Only one parameter in the relay's menu needs to be changed to suppress these messages and to reset the watch dog. This alarm is only an indication to the user that the relay has its default settings applied.

**(\*\*) SETTING ERROR:** Each time the relay is powered ON it will check the coherence of the setting data. If the relay detects a problem with the settings, a "**HARDWARE**" **ALARM** will appear on the LCD display followed by "**SETTING ERROR**" message (when pushing on the button).. The **ALARM LED (YELLOW)** will light up and the Watch Dog contact will be activated. To reset this alarm it is necessary to power **ON** and **OFF** the relay. Following this, the last unsuccessful setting change will then need to be re-applied. If the alarm persists, i.e. the "**SETTING ERROR**" alarm is still displayed, please contact Schneider Electric Customer Care Center for advice and assistance.

Minor fault:

The MiCOM relay is fully operational.  
The RL0 watchdog relay is energised (35-36 contact open, 36-37 contact closed).

<< COMM.ERROR >>: Communication failure

<< CLOCK ERROR >>: Time tag failure

<< STATS RESET >>: Statistical data recorded (like CB supervision statistics (Number of CB opening, etc) have been reset.

## 2. MENUS

The menu of MiCOM P120, P121, P122 and P123 relays is divided into main menus and submenus. The available content depends on the model of the relay.

### 2.1 Default display

By default, the LCD displays the current value measured (selected phase or earth). As soon as an alarm is detected by the relay, that information is considered as more important and the alarm message is then displayed instead of the default value.

The user can configure the information he wants to display by default going under the CONFIGURATION/Display menu.

### 2.2 Menu contents description

The menu of MiCOM P122 & P123 relays is divided into main sections. To access to these menus from the default display, press  $\odot$ . To return to the default display from these menus or sub-menus press  $\odot$ .

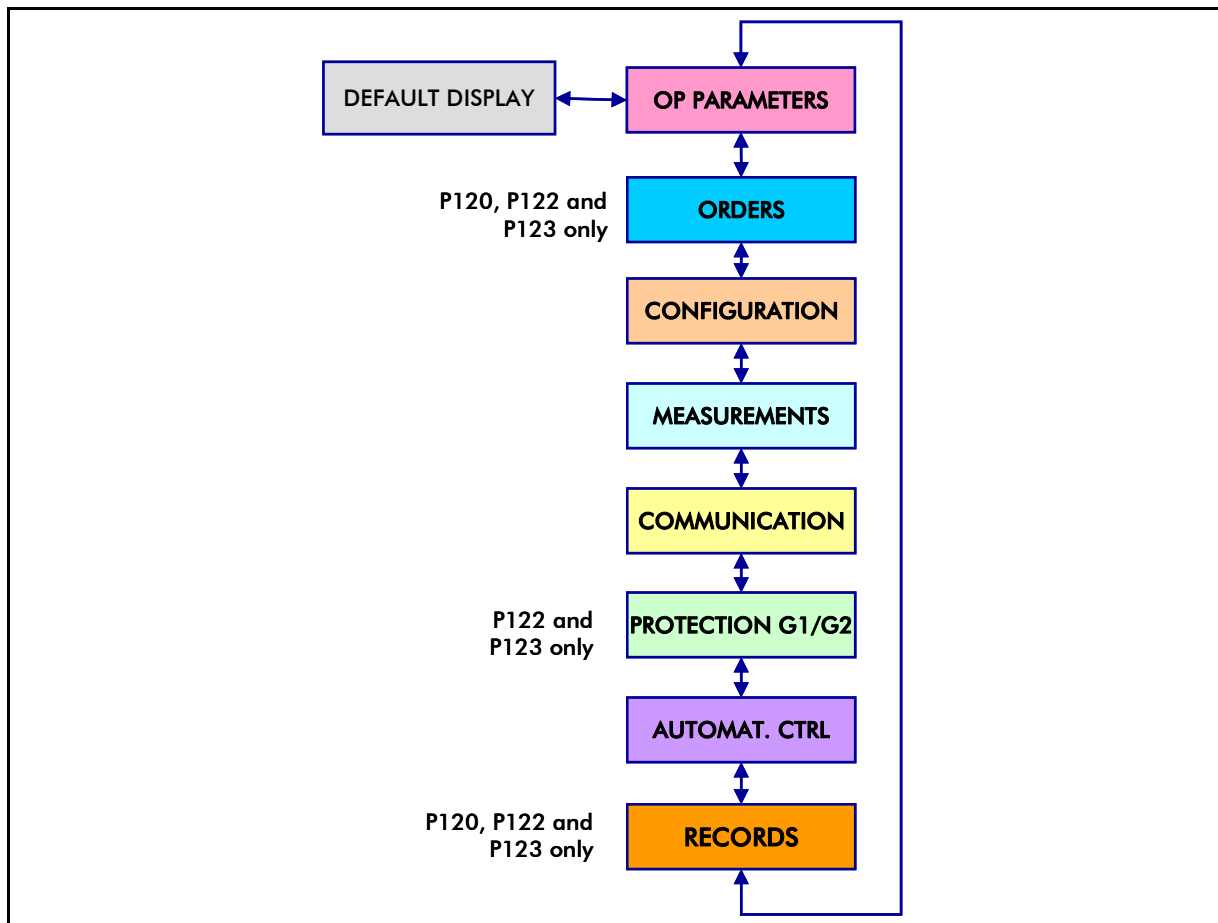



FIGURE 2: ORGANIZATION OF MiCOM P12x MAIN MENU

**NOTE:** The content of the menu is presented in the document P12x/EN HI. This table helps the user to navigate through the different menus and submenus. For MiCOM P121, P122 and P123, while navigating between submenu points, the user can press the key  $\odot$  to go back to the corresponding head menu.

Using MiCOM S1 Studio, the menu is displayed with a tree structure. A click on the “+” sign (or a double click on the menu title) opens the corresponding submenu.

The second column displays the corresponding value for each parameter.

**2.3 OP PARAMETERS Menu**

On the P12x front panel, press  to access the menu OP PARAMETERS from the default display.





**OP PARAMETERS**

Heading of the OP PARAMETERS menu  
Press  to access the menu content.

**Password**                   \* \* \* \*

Password entry. This password is required when modifying relay settings and parameters (see § 1.3).

**Password**                   AAAA

To enter a password, enter it letter by letter using   to go up or down in the alphabet.  
After each letter, press  to enter the following letter.  
At the end, press  to validate the password. If the password is correct, the message « PASSWORD OK » is displayed on the screen.  
NOTE: The password is initially set in factory to AAAA.

**WARNING: NO SETTING CHANGES DONE EITHER LOCALLY (THROUGH RS232) OR REMOTELY (THROUGH RS485) WILL BE ALLOWED DURING THE 5 FIRST MINUTES FOLLOWING A CHANGE OF PASSWORD.**

**Language**                   ENGLISH

Indicates the language used in the display.

**Description**               Pxxx

Indicates the type of relay

**Reference**                 MiCOM

Displays the reference number that lists the equipment associated with the relay.

**Software version**       XX

Displays the version of the software (P121, P122 and P123 only)

**Frequency**               50 Hz

Nominal value of the network frequency. Select either 50 or 60 Hz.

**Active Group**            1

Displays the active protection and automation group. This value can be either 1 or 2. (P121, P122 and P123 only)

**Input Status**           54321  
                              10110

Displays the status of the logic Inputs  
Logic Inputs are numbered from 1 to 5 for P123, 1 to 3 for P122 and 1 to 2 for P120 and P121.  
When the status of one input is:  
- state 0: it means that the input is de-energised  
- state 1: it means that the input is energised

**Relay Status**           87654321  
                              01011101

Displays the status of the logic outputs.  
Logic Outputs are numbered from 1 to 8 for P123, 1 to 6 for P122 and 1 to 4 for P120 and P121.  
When The state of each output is:  
- state 0: it means that the output relay is activated  
- state 1: it means that the output relay is not activated  
To activate an unlatching operation, the password is requested.  
NOTE: The Watch-dog output (RL0) is not displayed in the output status menu.

**Date**                       12/08/02

Displays the date (12/08/02 = 12 August 2002).

**Time**                      13:57:44

Displays the time (13:57:44 = 1:57:44 pm).

## 2.4 ORDERS menu (P120, P122 and P123 Only)

This menu gives the possibility:

- To send open or close orders to the Circuit Breakers from the front panel (MiCOM P122 and P123). Open and close orders are written in the event file. This action generates a "Control Trip" alarm, which can be inhibited. If inhibited, the "trip" LED and the "Alarm" LED are not lit if the relay RL1 is ordered by a control trip information (affected to an input in the "configuration/inputs" submenu).
- To reset locally alarms and LEDs, and to clear records when a fault is acknowledged (P120 only),
- To start a disturbance recording from the protection relay.

**ORDERS**

Heading of the ORDERS menu

**Open Order** No

P122 and P123 only,

Sends manually an open order from the local control panel. This order is permanently assigned to the Trip output relay (selected with "automatic control/output relay" menu .

Setting range: No, Yes.

To apply the control, enter the password (if necessary). In the "confirmation ?" cell, select Yes to apply the order.

**Close Order** No

P122 and P123 only,

Sends manually a close order from the local control panel: RL2 to RL8 (if configured)

Setting range: No, Yes (the "confirmation ?" cell will be displayed after setting change)

**General Reset** No

P120 only,

When a fault drops out, this command resets locally alarms and LEDs (except hardware alarms), and clears disturbance records, fault records and event records.

Setting range: No, Yes

To apply the control, enter the password (if necessary). In the "confirmation ?" cell, select Yes to apply the order.

**Disturb rec start** No

Trigs a disturbance recording from the front panel.

Setting range: No, Yes (the "confirmation ?" cell will be displayed after setting change).

## 2.5 CONFIGURATION menu

Under this menu, the different submenus are:

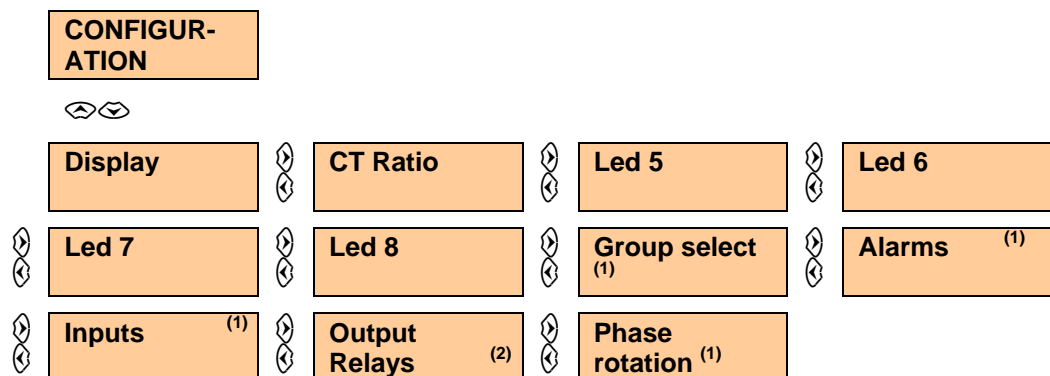

- ⇒ (1) P122 & P123 only
- (2) P121, P122 & P123 only

Press to access the CONFIGURATION menu from the default display, then until the desired submenu header is displayed.

2.5.1 Submenu DISPLAY

<b>CONFIGURATION</b>	Heading of the CONFIGURATION menu.
<b>Display</b>	Heading of the DISPLAY submenu.
<b>Default Display</b> IL1,2,3,N	Displays the default current value (Phase A, Phase B , Phase C, Earth N or the four values simultaneously can be chosen).
<b>Phase A Text</b> L1	Choose a label (displayed with the associated measurement value ) for phase A. Possible choices: A, L1, or R (modified after entering the password)
<b>Phase B Text</b> L2	As above for phase B Possible choices are B, L2, or S.
<b>Phase C Text</b> L3	As above for phase C Possible choices are C, L3, or T.
<b>E/Gnd Text</b> E	As above for earth phase Possible choices are N, E, or G.

**WARNING:** This DISPLAY submenu does not exist in MiCOM P121. The default display is IA and A,B, C, N for the label of the different phases.

2.5.2 Submenu CT RATIO

<b>CONFIGURATION</b>	
<b>CT Ratio</b>	Heading of the CT RATIO submenu.
<b>Line CT primary</b> 1000	Choose the rated primary current of the line CT. Setting range: from 1 to 9999 – step 1.000
<b>Line CT sec</b> 1	Choose the rated secondary current of the line CT. Setting value: either 1 or 5.
<b>E/Gnd CT primary</b> 1000	Choose the rated primary current of the earth CT. Setting range: from 1 to 9999 – step 1.0000
<b>E/Gnd CT sec</b> 1	Choose the rated secondary current of the earth CT. Setting value: 1 or 5.

2.5.3 Submenus LED 5 to 8

The LED 5 to LED 8 configuration submenu is used to assignate to a LED a protection function (the LED lights up when the protection function is active).

The following table lists the protection functions that can be assigned to the LEDs (5 to 8) for each model of relay.

Function	P120	P121	P122	P123	Information
I>	X	X	X	X	Instantaneous first phase overcurrent threshold
tl>	X	X	X	X	Time delayed first phase overcurrent threshold
I>>	X	X	X	X	Instantaneous second phase overcurrent threshold

Function	P120	P121	P122	P123	Information
tl>>	X	X	X	X	Time delayed second phase overcurrent threshold
l>>>	X	X	X	X	Instantaneous third phase overcurrent threshold
tl>>>	X	X	X	X	Time delayed third phase overcurrent threshold
le>	X	X	X	X	Instantaneous first earth overcurrent threshold
tle>	X	X	X	X	Time delayed first earth overcurrent threshold
le>>	X	X	X	X	Instantaneous second overcurrent earth threshold
tle>>	X	X	X	X	Time delayed second earth overcurrent threshold
le>>>	X	X	X	X	Instantaneous third earth overcurrent threshold
tle>>>	X	X	X	X	Time delayed third earth threshold
le>>>>			X	X	Instantaneous derived earth overcurrent threshold
tle>>>>			X	X	Time delayed derived earth overcurrent threshold
l<			X	X	Alarm threshold undercurrent
tl<			X	X	Time delayed undercurrent threshold
Therm Trip			X	X	Trip on Thermal overload
Brkn Cond.			X	X	Broken conductor detection
CB Fail			X	X	Detection of a Circuit Breaker failure (CB not open at the end of tBF timer)
tl2>			X	X	Time delayed first negative phase sequence overcurrent threshold
tl2>>			X	X	Time delayed second negative phase sequence overcurrent threshold.
Input 1	X	X	X	X	Copy of the status of the Logic Input n°1 ("automat ctrl/inputs" menu)
Input 2	X	X	X	X	Copy of the status of the Logic Input n°2
Input 3			X	X	Copy of the status of the Logic Input n°3
Input 4				X	Copy of the status of the Logic Input n°4
Input 5				X	Copy of the status of the Logic Input n°5
Recloser Run				X	Signal that Autoreclose cycle is working ("Autoreclose in progress" signal)
Recloser int Blk				X	Autoreclose lock activated by the internal process of the autoreclose
Recloser Ext Blk				X	Autoreclose lock activated by the input "block 79"
t Aux 1	X	X	X	X	Copy of Aux1 Logic Input delayed by Aux1 time time (Aux1 logic input and aux1 time are set with "automat ctrl/inputs" menu)
t Aux 2	X	X	X	X	Copy of Aux2 Logic Input delayed by Aux 2 time
t Aux 3			X	X	Copy of Aux3 Logic Input delayed by Aux3 time

Function	P120	P121	P122	P123	Information
t Aux 4				X	Copy of Aux4 Logic Input delayed by Aux4 time
t Aux 5				X	Copy of Aux5 Logic Input delayed by Aux 5 time
SOTF				X	Switch on to fault timer expired
tIA>				X	Time delayed first threshold trip on phase A
tIB>				X	Time delayed first threshold trip on phase B
tIC>				X	Time delayed first threshold trip on phase C
Equation A		X	X	X	Output of Boolean Equation A
Equation B		X	X	X	Output of Boolean Equation B
Equation C		X	X	X	Output of Boolean Equation C
Equation D		X	X	X	Output of Boolean Equation D
Equation E		X	X	X	Output of Boolean Equation E
Equation F		X	X	X	Output of Boolean Equation F
Equation G		X	X	X	Output of Boolean Equation G
Equation H		X	X	X	Output of Boolean Equation H



NOTES: ⇒ Each parameter can be assigned to one or more LED's.  
 ⇒ One or more parameters (OR logic) can provoke each LED to light up.

MiCOM S1 Studio setting:

The LED 5 (6, 7 or 8) submenu contains up to 3 lines parameter settings. In the value column, each line represents a setting value. State "1" means that the corresponding parameter is associated to the LED.

The corresponding parameters are displayed in the setting panel: from 00 (last digit) up to 0D (first digit).

P12x Front panel setting:

Press  to access the LED 5 CONFIGURATION submenu, then  twice (press  to access to others LEDs CONFIGURATION submenus).

Select "Yes" to assignate a LED to a function.

<b>CONFIGURATION</b>	
<b>Led 5</b>	
<b>Led 5 Function</b>	<b>No</b>

Heading LED 5 submenu.

Activate (select choice "Yes" or inhibit ("No") LED 5 operation when:  
 - an alarm is exceeded,  
 - a threshold time delay has elapsed.

Refer to previous tables for protection functions list.



2.5.4 Submenu GROUP SELECT (P122 & P123 only)

The submenu "GROUP SELECT" is used to select the active protection group

**CONFIGURATION**

**Group Select**

Heading of the "GROUP SELECT" sub-menu.

**Change Group  
Input = INPUT**

Setting choice : MENU or INPUT

MENU is used to change settings group via HMI and/or RS485 port.

If MENU is selected, the following menu is displayed:

**Setting Group**  
**1**

Select active setting protection group 1 or 2.

2.5.5 Submenu ALARMS (P121, P122 and P123 only)

**CONFIGURATION**

**Alarms**

Heading of the Alarms submenu.

Setting choices: Yes or No.

**Inst. Self-reset ?**  
**No**

Setting choice Yes: the alarms that are instantaneous will be self reset when they come back to a normal value (below the threshold).

Setting choice No: the alarms that are instantaneous will be need to be acknowledged by the user to be reset <sup>(1)</sup>.

MiCOM S1 label: Self-acknowledge instantly"

**Reset led on  
fault ?** **No**

Yes: the LED associated with an old alarm will be automatically reset when a new fault occurs. This is done to avoid a display of numerous alarms that are not active any more.

No: the appearance of a new fault will not automatically reset LEDs associated with an old fault <sup>(1)</sup>.

MiCOM S1 label: "LED Acknowledge on Fault"

**INH Alarm tAux1**  
**No**

Yes: auxiliary timer 1 output will not raise an alarm. Alarm LED stays OFF, no message will be displayed on the HMI.

No: I< threshold will raise an alarm.

**INH Alarm tAux2**  
**No**

As above with timer 2.

**INH Alarm tAux3**  
**Yes**

As above with timer 3 <sup>(1)</sup>.

**INH Alarm tAux4**  
**Yes**

As above with timer 4 <sup>(2)</sup>.

**INH Alarm tAux5**  
**Yes**

As above with timer 5 <sup>(2)</sup>.

**INH Alarm Ctrl Trip**  
Yes

Control trip function assigned to the input. The default value is Yes. The next table summarises the behaviour of control trip function when a control trip function is received by the relay.

Case				
RL1 assigned to "Ctrl Trip"	No	No	Yes	Yes
"Ctrl trip" alarm inhibited	No	Yes	No	Yes
Result:				
LED trip	Off	Off	On	Off
LED Alarm	blinking	Off	blinking	Off
Alarm message on display	Yes	No	Yes	No
Event "EVT_TC_TRIP_X1" generated in the event file	Yes	Yes	Yes	Yes
Default recorded in the records/faul record menu	No	No	Yes	Yes
RL1 activated	No	No	Yes	Yes

**INH Alarm [79] Ext Block**  
No

As above for the autorecloser blocking by a logical input (external blocking) <sup>(2)</sup>.

**INH Alarm I<**  
No

As above for the I< threshold.

**INH Alarm Equ. A**  
No

.../...

As above for the logical equations (from A to H).

**INH Alarm Equ. H**  
No

(1) P122 and P123 only

(2) P123 only

2.5.6 Submenu CONFIGURATION INPUTS (P122 & P123 only)

A digital input can be configured to be activated either on low level or on high level. Low level (or high level) depends of the application of the digital inputs.

The user has to set under the Menu CONFIGURATION the auxiliary voltage (AC or DC) for the digital inputs. This setting is necessary because of the time filtering which is different in DC and AC. The inversion of the logic input in this menu inverts its allocated function status in the logic inputs allocation (AUTOMAT CTRL/INPUTS menu). For example: if EL 2 logic input is 1, then tAux1 = 0 when logic input is 1 and tAux1 = 1 when logic input is 0.

**CONFIGURATION**

**Inputs**

Heading of the CONFIGURATION INPUTS submenu.

**Inputs**      5 4 3 2 1  
                  1 0 1 1 0

P122 (3 inputs) and P123 only.  
This menu is used to assign active high or low functionality to each logic input.  
0 = active low, 1 = active high

MiCOM S1 label: "Rising Edge / High Level"

**Voltage input**  
DC

Setting choice: AC or DC power supply for the digital input. The power supply for any input is the same as the power supply of the relay.

2.5.7 Submenu OUTPUT RELAYS (P121, P122 and P123 only)

**CONFIGURATION**

**Output Relays**

Heading of the CONFIGURATION RELAYS MAINTENANCE submenu.

**Fail Safe R.      87654321  
                          0000000**

P121 (4 relays), P123 (6 relays) and P123 (8 relays)  
This menu allows the user to invert each of the output relay contacts for the de-energised state.  
1 = relay activated when driving signal is not active  
0 = relay not activated when driving signal is not active

**Maintenance Mode  
                          No**

P122 and P123 only  
Choose if you want to activate the MAINTENANCE MODE of the relay. If Yes is selected, output relays are disconnected from the protection and automation functions.

**Relays CMD    8765W4321  
                          000000000**

P122 (6 relays + watchdog) and P123 (8 relays + Watchdog) only  
If the MAINTENANCE MODE is activated (set to Yes), this menu allows the user to activate each one of the output relay (from RL1 to RL8, W = Watchdog)  
1 = relay activated  
0 = relay not activated

2.5.8 Submenu PHASE ROTATION (P122 & P123 only)

**CONFIGURATION**

**PHASE ROTATION**



Heading of the PHASE ROTATION sub-menu.

**PHASE ROTATION  
                          A-B-C**

Choose the phase rotation between either A-B-C or A-C-B.

2.6 MEASUREMENTS Menu

Under the MEASUREMENTS menu, the user can read the various measurement values.

To access the MEASUREMENTS menu from the default display, press  then  2 times.

**MEASUREMENTS**

Heading of the MEASUREMENTS menu.

**Frequency            50.10 Hz**

Displays the network frequency calculated from phase currents

**IL1                    640.10 A**

Displays the current value of phase A (True RMS value) taking into account the phase CT ratio (CONFIGURATION/CT RATIO submenu).

**IL2                    629.00 A**

As above for phase B.

**IL3                    634.50 A**

As above for phase C.

**I N                    3.15 A**

As above for current value.

<b>le&gt;&gt;&gt;&gt;</b> <b>0.00A</b>	Displays the derived earth overcurrent threshold <sup>(1)</sup> .
<b>I1</b> <b>103A</b>	Displays the positive sequence component <sup>(1)</sup> .
<b>I2</b> <b>50A</b>	Displays the negative sequence component <sup>(1)</sup> .
<b>RATIO I2/I1</b> <b>50%</b>	Displays the ratio of I2/I1. This derived measurement is used by the Broken Conductor detection function (menu AUTOMAT. CTRL) <sup>(1)</sup> .
<b>In - fn</b> <b>RST = [C] 0.0A</b>	Displays the earth current In (True RMS value) minus the current value at the fundamental frequency (value of the harmonics). Press <b>⊙</b> to clear the value (password required) <sup>(1)</sup> .
<b>Thermal θ</b> <b>RST = [C] 67%</b>	Displays the % thermal state based on true RMS values. Press <b>⊙</b> to clear the % values (password required) <sup>(1)</sup> .
<b>Max &amp; Average I</b> <b>RST = [C]</b>	Allows the user to clear the maximum (peak) and average (rolling) memorised values of the current. Press <b>⊙</b> to clear these values (password required) <sup>(1)</sup> .
<b>Max IL1 Rms</b> <b>127.36 A</b>	Displays the peak value for phase A. The value is the true RMS maximum value <sup>(1)</sup> .
<b>Max IL2 Rms</b> <b>156.28 A</b>	As above for phase B <sup>(1)</sup> .
<b>Max IL3 Rms</b> <b>139.01 A</b>	As above for phase C <sup>(1)</sup> .
<b>Average IL1 Rms</b> <b>98.25 A</b>	Displays the rolling value for phase A. The value is the true RMS average value <sup>(1)</sup> .
<b>Average IL2 Rms</b> <b>97.88 A</b>	As above for phase B <sup>(1)</sup> .
<b>Average IL3 Rms</b> <b>99.02 A</b>	As above for phase C <sup>(1)</sup> .
<b>MAX. SUBPERIOD</b> <b>RST = [C]</b>	Allows the user to clear the maximum subperiod values of the 3 currents <sup>(1)</sup> .
<b>MAX. SUBPERIOD</b> <b>IL1 Rms = 245A</b>	Displays the IA peak value demand. The value is the true RMS maximum value on a subperiod <sup>(1)</sup> .
<b>MAX. SUBPERIOD</b> <b>IL2 Rms = 240A</b>	As above for IB peak <sup>(1)</sup> .
<b>MAX. SUBPERIOD</b> <b>IL3 Rms = 250A</b>	As above for IC peak <sup>(1)</sup> .
<b>ROLLING AVERAGE</b> <b>RST = [C]</b>	Allows the user to clear the rolling average values of the 3 currents <sup>(1)</sup> .
<b>ROLLING AVERAGE</b> <b>IL1 Rms = 0A</b>	Displays the IA average value demand. The value is the true RMS average value on a number of subperiod set in Record menu <sup>(1)</sup> .
<b>ROLLING AVERAGE</b> <b>IL2 Rms = 0A</b>	As above for IB average value <sup>(1)</sup> .
<b>ROLLING AVERAGE</b> <b>IL3 Rms = 0A</b>	As above for IC average value <sup>(1)</sup> .

<b>Reclose Stats</b> RST = [C]	Allows the user to clear the statistics stored for the autoreclose function. Press $\odot$ to clear these values <sup>(2)</sup> .
<b>Total Recloses</b> 16	Displays the total number of reclosings <sup>(2)</sup> .
<b>Cycle 1 Recloses</b> 1	Displays the total number of reclosings for cycle 1 <sup>(2)</sup> .
<b>Cycle 2 Recloses</b> 7	Displays the total number of reclosings for cycle 2 <sup>(2)</sup> .
<b>Cycle 3 Recloses</b> 5	Displays the total number of reclosings for cycle 3 <sup>(2)</sup> .
<b>Cycle 4 Recloses</b> 3	Displays the total number of reclosings for cycle 4.
<b>Total Trip &amp; Lockout</b> 2	Displays the total number of definitive trips (including autoreclose function for P123).  When 52a input is connected, only the trip number increases when its logic state changes.  When 52a input is not connected, every control trip order increases the trip number.  The control trip orders are RL1 trip (fault), HMI opening order, MiCOM S1 opening order, rear com opening order and digital input opening order.

(1) P122 and P123 only.

## 2.7 COMMUNICATION Menu

The COMMUNICATION menu content depends on the communication protocol of the relay. Four protocols are available: MODBUS, Courier, IEC 60870-5-103 and DNP3.0.

### 2.7.1 MODBUS COMMUNICATION Menu

<b>COMMUNICATION</b>	Heading of the COMMUNICATION menu.
<b>Communication ?</b> Yes	Activates or deactivates MODBUS RTU communication via the RS485 port on the rear terminals of the relay.
<b>Baud Rate</b> 9600 bd	Choose the baud rate of ModBus transmission. Select from: 300, 600, 1200, 2400, 4800, 9600, 19200 or 38400 bd.
<b>Parity</b> None	Choose the parity in the ModBus data frame. Select parity: "Even", "Odd" or "None".
<b>Stop Bits</b> 1	Choose the number of stop bits in the ModBus data frame. Select stop bit: 0 or 1.
<b>Relay Address</b> 29	This cell sets the unique address for the relay such that only one relay is accessed by master station software. Select an address from 1 to 255.
<b>Date format</b> Private	Choose the format of the date, either PRIVATE or IEC protocol.

**WARNING: A MODBUS NETWORK IS LIMITED TO 31 RELAY + 1 RELAY MASTER ADDRESSES ON THE SAME MODBUS SUB-LAN.**

## 2.7.2 Courier COMMUNICATION Menu

<b>COMMUNICATION</b>	Heading of the COMMUNICATION menu.
<b>Communication ?</b> Yes	Activates Courier communication via the RS485 port on the rear terminals of the relay.
<b>Relay Address</b> 12	This cell sets the unique address for the relay such that only one relay is accessed by master station software. Select an address from 1 to 255.

## 2.7.3 IEC 60870-5-103 COMMUNICATION Menu

<b>COMMUNICATION</b>	Heading of the COMMUNICATION menu.
<b>Communication ?</b> Yes	Activates IEC 60870-5-103 communication via the RS485 port on the rear terminals of the relay.
<b>Data Bits</b> 9600 bd	Choose the baud rate of IEC 60870-5-103 transmission. Select from: 300, 600, 1200, 2400, 4800, 9600, 19200, 38400 bauds.
<b>Relay Address</b> 29	This cell sets the unique address for the relay such that only one relay is accessed by master station software. Select from 1 to 255 using $\leftarrow$ . Press $\rightarrow$ to validate your choice.

## 2.7.4 DNP3 COMMUNICATION Menu

<b>COMMUNICATION</b>	Heading of the COMMUNICATION menu.
<b>Communication ?</b> Yes	Activates MODBUS RTU communication via the RS485 port on the rear terminals of the relay.
<b>Baud Rate</b> 9600 bd	This cell controls the communication speed between relay and master station. It is important that both relay and master station are set at the same speed setting. Select from: 300, 600, 1200, 2400, 4800, 9600, 19200, 38400 bauds.
<b>Parity</b> None	Choose the parity in the MODBUS frame. Select Even, Odd or None.
<b>Stop Bits</b> 1	Choose the number of stop bits in the MODBUS frame. Select 0 or 1.
<b>Relay Address</b> 29	This cell sets the unique address for the relay such that only one relay is accessed by master station software. Select from 1 to 255.

## 2.8 PROTECTION Menu

The protection menu is divided into two groups for **MiCOM P122 and P123**: PROTECTION G1 for the first setting group and PROTECTION G2 for the second setting group.

The different submenus are:

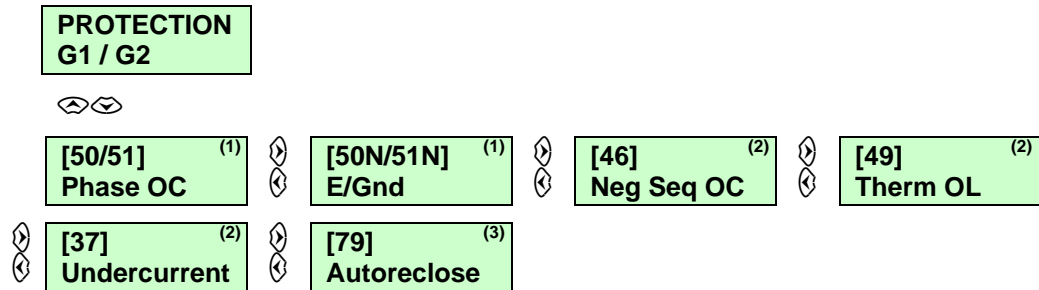

- (1) one submenu for P120
- (2) P122 and P123 only
- (3) P123 only

Under this PROTECTION menu, the user can program the parameters of the different phase or earth protection functions and define their associated setting (thresholds, time delay).

### 2.8.1 Submenu [50/51] PHASE OC

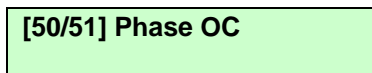
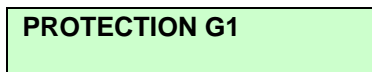

Heading of the phase overcurrent protection submenu (“[50/51] PHASE OVERCURRENT”).

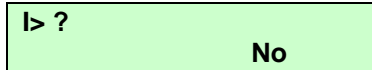

Setting choice: Yes or No  
 Yes: the first phase overcurrent threshold (I>) protection is enabled. The first phase overcurrent threshold protection submenu (see § 2.8.1.1) is displayed.  
 No: the first phase threshold (I>) is not enabled, and the next menu is the “I>> ?” menu.

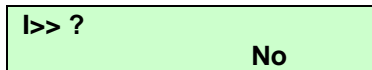

Setting choice Yes or No  
 Yes: the second phase overcurrent threshold (I>>) protection is enabled. The second phase overcurrent threshold protection submenu (see § 2.8.1.2) is displayed.  
 No: the second phase overcurrent threshold (I>>) protection is not enabled, and the next menu is the “I>>> ?” menu.

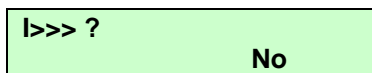

Setting choice Yes or No  
 Yes: the third phase overcurrent threshold (I>>>) protection is enabled. The third phase overcurrent threshold protection submenu (see § 2.8.1.3) is displayed.  
 No: the third phase overcurrent threshold (I>>>) protection is not enabled.

2.8.1.1 Submenu First phase overcurrent threshold (I>) protection

<b>I&gt; ?</b> <b>Yes</b>	“Yes” option is selected. The first phase overcurrent threshold (I>) protection is enabled.
<b>I&gt;</b> <b>4 In</b>	Sets the value for the overcurrent threshold I>. The threshold setting range is from 0.1 to 25In.
<b>Delay Type</b> <b>DMT</b>	Selects the time delay type associated with I>. Setting choices are: - “DMT” (definite minimum time): see section a, - “IDMT” (inverse definite minimum time): section b, - “RI” (electromechanical inverse time curve): section c.

a) Delay type = Definite Minimum Time

<b>Delay Type</b> <b>DMT</b>	“DMT” is selected
<b>tI &gt;</b> <b>40ms</b>	Sets the time delay associated with I>. The setting range is from 0.040 to 150.0s (step 10ms).
<b>t Reset</b> <b>0 ms</b>	P122 and P123 only, Sets the reset time value from 0 to 600s (step 10ms)

b) Delay type = Inverse Definite Minimum Time

<b>Delay Type</b> <b>IDMT</b>	“IDMT” is selected
<b>Idmt</b> <b>IEC SI</b>	Selects the type of curve. Select choice from: - IEC SI, IEC STI, IEC VI, IEC EI, IEC LTI (IEC curve), - ICO2, IEEE MI, CO8, IEEE VI, IEEE EI (IEEE/ANSI curve).
<b>Tms</b> <b>0,025</b>	Sets the Time Multiplier Setting (TMS) value for the curve. The setting range is from 0.025 to 1.500 (step 0.001)
<b>Reset Delay Type</b> <b>DMT</b>	P122 and P123 only, if “Idmt” = IEEE/ANSI or COx curve is selected only. Selects the reset delay time type. Select between DMT (Definitive Time) and IDMT (Inverse Time).
<b>Rtms</b> <b>0.025</b>	P122 and P123 only, if “Reset Delay Type” = IDMT is selected. Sets the Reverse Time Multiplier Setting (RTMS) value associated with the IDMT reset time choice from 0.025 to 1.5 (step 0.001)
<b>t Reset</b> <b>0 ms</b>	P122 and P123 only, Sets the reset time value from 0 to 600 s (step 10 ms)
<b>I&gt; &gt;&gt; &gt;&gt;&gt;</b> <b>Interlock</b> <b>Yes</b>	Interlock of first threshold by the second and third thresholds, but only if first threshold trip is set to IDMT (if I>> or I>>> activated, I> submenu only). Setting choice: No, Yes



c) Delay type = RI - electromechanical inverse time curve

<b>Delay Type</b> RI	Display of the I> inverse time delay (electromechanical RI curve).
<b>K</b> 2.500	Selects the RI curve K value from 0.100 to 10 (step 0.100)
<b>t Reset</b> 60 ms	P122 and P123 only, Sets the reset time value from 0 to 600 s (step 10 ms)

### 2.8.1.2 Submenu Second phase overcurrent threshold (I>>) protection

This section presents the main specific points for this submenu (I>> = Yes). Refer to § 2.8.1.1 for details (setting ranges, setting choices and availabilities).

<b>I&gt;&gt; ?</b> Yes	“Yes” option is selected. The second phase overcurrent threshold (I>>) protection is enabled.
<b>I&gt;&gt;</b> 4 In	Sets the value for the overcurrent threshold I>>, The threshold setting range is from 0.1 to 40 In (step 0.01) In.
<b>Delay Type</b> DMT	Selects the time delay type associated with I>>. Setting choices “DMT”: see a, “IDMT”: see b, “RI”: see c.

a) Delay type = Definite Minimum Time

<b>Delay Type</b> DMT	“DMT” is selected
<b>tl &gt;&gt;</b> 0.040	Set the value for the time delay associated with I>>.
<b>t Reset</b> 0 ms	Reset time value.

b) Delay type = Inverse Definite Minimum Time

Identical to § 2.8.1.1, section b).

c) Delay type = RI - electromechanical inverse time curve

Identical to § 2.8.1.1, section c).

### 2.8.1.3 Submenu Third phase overcurrent threshold (I>>>) protection

<b>I&gt;&gt;&gt; ?</b> Yes	Yes” option is selected. The third phase overcurrent threshold (I>>>) protection is enabled.
<b>I&gt;&gt;&gt; Sample</b> No	P122 and P123 only Select the mode of operation of the third threshold. I>>> operates on current sample base if you select (YES), or on Discrete Fourier Transformation base if you select (NO)
<b>I&gt;&gt;&gt;</b> 10 In	Set the value for the third overcurrent threshold I>>> The threshold setting range is from 0.5 to 40 In (step 0.010 In)
<b>tl &gt;&gt;&gt;</b> 100 ms	Set the time delay associated with I>>>. The setting range is from 0 to 150.0s (step 0.010s).

2.8.2 Submenu [50N/51N] E/GND (P121 - P122 - P123 only)

**PROTECTION G1**

**[50N/51N] E/Gnd**

Heading of the earth overcurrent protection submenu.

**le> ?**  
**No**

Setting choice: Yes or No  
 Yes: the first earth overcurrent threshold (le>) protection is enabled. The first earth overcurrent threshold protection submenu (see § 2.8.2.1) is displayed.  
 No: the first earth overcurrent threshold (le>) protection is not enabled, and the next menu is the “le>> ?” menu.

**le>> ?**  
**No**

Setting choice Yes or No  
 Yes: the second earth overcurrent threshold (le>>) protection is enabled. The second earth overcurrent threshold submenu (see § 2.8.2.2) is displayed.  
 No: the second earth overcurrent threshold (le>>) protection is not enabled, and the next menu is the “le>>> ?” menu.

**le>>> ?**  
**No**

Setting choice Yes or No  
 Yes: the third earth overcurrent threshold (le>>>) protection is enabled. The third earth overcurrent threshold protection submenu (see § 2.8.2.3) is displayed.  
 No: the third earth overcurrent threshold (le>>>) protection is not enabled, and the next menu is the “le >>>>?” submenu.

**le >>>>?**  
**Yes/No**

P122-P123 only.  
 Setting choice Yes or No  
 Yes: the derived earth overcurrent threshold (see § 2.8.2.4) is enabled.  
 No: the derived earth overcurrent threshold is disabled.

2.8.2.1 Submenu First earth overcurrent threshold (le>) protection

**le> ?**  
**Yes**

“Yes” option is selected.  
 The first earth overcurrent threshold (le>) protection is enabled.

**le>**  
**0.05 len**

Sets the value for the earth overcurrent current threshold le>. The threshold setting range is from 0.002 to 1len (Cortec code C), from 0.01 to 8 len (Cortec code B) and from 0.1 to 40 len (Cortec code A).

**Delay Type**  
**DMT**

Selects the time delay type associated with le>.  
 Setting choices are:  
 - “DMT” (definite minimum time): see section a,  
 - “IDMT” (inverse definite minimum time): section b,  
 - “RI” (electromechanical inverse time curve): section c,  
 - “RXIDG” for Netmanagements curves (available for 0.01 to 8 len range only): section d.

## a) Delay type = Definite Minimum Time

<b>Delay Type</b>	<b>DMT</b>
-------------------	------------

"DMT" is selected

<b>tle &gt;</b>	<b>100 ms</b>
-----------------	---------------

Sets the time delay associated with le>. The setting range is from 0 to 150.0 s (step 10 ms).

<b>t Reset</b>	<b>0 ms</b>
----------------	-------------

P122 and P123 only,  
Sets the reset time value from 0 to 600 s (step 10 ms)

## b) Delay type = Inverse Definite Minimum Time

<b>Delay Type</b>	<b>IDMT</b>
-------------------	-------------

"IDMT" is selected

<b>Idmt</b>	<b>IEC SI</b>
-------------	---------------

Selects the type of curve. Select choice from:  
- IEC SI, IEC STI, IEC VI, IEC EI, IEC LTI (IEC curve),  
- ICO2, IEEE MI, CO8, IEEE VI, IEEE EI (IEEE/ANSI curve), BPN EDF.

<b>Tms</b>	<b>0,025</b>
------------	--------------

Sets the Time Multiplier Setting (TMS) value for the curve from 0.025 to 1.500 (step 0.001)

<b>Reset Delay Type</b>	<b>DMT</b>
-------------------------	------------

P122 and P123 only, if "Idmt" = IEEE/ANSI curve is selected.  
Selects the reset delay time type. Select between DMT (Definitive Time) and IDMT (Inverse Time).

<b>Rtms</b>	<b>0.025</b>
-------------	--------------

P122 and P123 only, if "Reset Delay Type" = IDMT is selected.  
Sets the Reverse Time Multiplier Setting (RTMS) value associated with the IDMT reset time choice from 0.025 to 1.5 (step 0.001)

<b>t Reset</b>	<b>0 ms</b>
----------------	-------------

P122 and P123 only,  
Sets the reset time value from 0 to 600 s (step 10 ms)

<b>le&gt; &gt;&gt; &gt;&gt;&gt;</b>	<b>Yes</b>
<b>Interlock</b>	

Interlock of first threshold by the second and third thresholds, but only if first threshold trip is set to IDMT (if le>> or le>>> activated, le> submenu only).  
Setting choice: No, Yes

## c) Delay type = RI - electromechanical inverse time curve

<b>Delay Type</b>	<b>RI</b>
-------------------	-----------

Display of the I> inverse time delay (electromechanical RI curve).

<b>K</b>	<b>2.500</b>
----------	--------------

Selects the RI curve K value from 0.100 to 10 (step 0.100)

<b>t Reset</b>	<b>60 ms</b>
----------------	--------------

P122 and P123 only,  
Sets the reset time value from 0 to 600 s (step 10 ms)

## d) Delay type = RXIDG for Netmanagements curves (P122 and P123, cortec B only)

<b>Delay type</b>	<b>RXIDG</b>
-------------------	--------------

Displays the le> inverse time delay (RXIDG curve).

<b>K</b>	<b>0.3</b>
----------	------------

Set the value for the coefficient k associated to the RXIDG curve. The setting range is from 0.3 to 1 (step 0.1).

<b>t Reset</b>	<b>60 ms</b>
----------------	--------------

Set the value for the time reset from 0 to 600 s.

2.8.2.2 Submenu Second earth overcurrent threshold ( $I_{e>>}$ ) protection

This section presents the main specific points for this submenu ( $I_{e>>} = \text{Yes}$ ). Refer to § 2.8.2.1 for details (setting ranges, setting choices and availabilities).

<b><math>I_{e&gt;&gt;}</math> ?</b> Yes	“Yes” option is selected. The second earth overcurrent threshold ( $I_{e>>}$ ) protection is enabled.
<b><math>I_{e&gt;&gt;}</math></b> 0.002 $I_{en}$	Sets the value for the second earth fault threshold $I_{e>>}$ .
<b>Delay Type</b> DMT	Selects the time delay type associated with $I_{e>>}$ . Setting choices “DMT”: see a, “IDMT”: see b, “RI”: see c, “RXIDG”, see d.

## a) Delay type = Definite Minimum Time

<b>Delay Type</b> DMT	“DMT” is selected
<b><math>t_{le &gt;&gt;}</math></b> 0.040 s	Set the value for the time delay associated with $I_{e>>}$ .
<b>t Reset</b> 0 ms	Reset time value.

## b) Delay type = Inverse Definite Minimum Time

Identical to § 2.8.2.1, section b).

## c) Delay type = RI - electromechanical inverse time curve

Identical to § 2.8.2.1, section c).

## d) Delay type = RXIDG for Netmanagements curves (P122 and P123, cortec B only)

Identical to § 2.8.2.1, section d).

2.8.2.3 Submenu Third earth overcurrent threshold ( $I_{e>>>}$ ) protection

<b><math>I_{e&gt;&gt;&gt;}</math> ?</b> Yes	Yes” option is selected. The third earth overcurrent threshold ( $I_{e>>>}$ ) protection is enabled.
<b><math>I_{e&gt;&gt;&gt;}</math> Sample</b> No	P122 and P123 only Select the mode of operation of the third earth threshold. $I_{e>>>}$ operates on current sample base if you select (YES), or on Discrete Fourier Transformation base if you select (NO)
<b><math>I_{e&gt;&gt;&gt;}</math></b> 10 $I_{en}$	Set the value for the third earth fault threshold $I_{e>>>}$ . The threshold setting range is from 0.002 to 1 $I_{n}$ (step 0.001 $I_{n}$ )
<b><math>t_{le &gt;&gt;&gt;}</math></b> 100 ms	Set the time delay associated with $I_{e>>>}$ . The setting range is from 0 to 150.0s (step 0.010s).

2.8.2.4 Submenu derived earth overcurrent threshold ( $I_{e>>>>}$ ) protection

This section presents the main specific points for this submenu ( $I_{e>>>>} = \text{Yes}$ ).  $I_{e>>>>}$  represents the vectorial sum of the three phases. Refer to § 2.8.2.1 for details (setting ranges, setting choices and availabilities).

$I_{e>>>>} ?$	<b>Yes</b>
---------------	------------

“Yes” option is selected.  
The derived earth overcurrent threshold ( $I_{e>>>>}$ ) protection is enabled.

$I_{e>>>>}$	<b>0.002 <math>I_{en}</math></b>
-------------	----------------------------------

Sets the value for the derived earth overcurrent  $I_{e>>>>}$ .

Delay Type	<b>DMT</b>
------------	------------

Selects the time delay type associated with  $I_{e>>>>}$ .  
Setting choices “DMT”: see a, “IDMT”: see b, “RI”: see c.

## a) Delay type = Definite Minimum Time

Delay Type	<b>DMT</b>
------------	------------

“DMT” is selected

$t_{I_{e>>>>}}$	<b>0.040 s</b>
-----------------	----------------

Set the value for the time delay associated with  $I_{e>>>>}$ .

t Reset	<b>0 ms</b>
---------	-------------

Reset time value.

## b) Delay type = Inverse Definite Minimum Time

Identical to § 2.8.2.1, section b).

## c) Delay type = RI - electromechanical inverse time curve

Identical to § 2.8.2.1, section c).

## d) Delay type = RXIDG for Netmanagements curves (P122 and P123, cortec B only)

Identical to § 2.8.2.1, section d).

## 2.8.3 Submenu [46] NEG SEQ (P122 &amp; P123 only)

<b>PROTECTION G1</b>
----------------------

<b>[46] Neg Seq OC</b>
------------------------

Heading of the negative phase sequence overcurrent threshold ( $I_{2>}$ ) protection submenu.

$I_{2>} ?$	<b>No</b>
------------	-----------

Setting choice: Yes or No  
Yes: the first negative phase sequence overcurrent threshold ( $I_{2>}$ ) protection is enabled. The first negative phase sequence overcurrent threshold submenu (see § 2.8.3.1) is displayed.  
No: the first negative phase sequence overcurrent threshold ( $I_{2>}$ ) is not enabled, and the next menu is the “ $I_{2>>} ?$ ” menu.

$I_{2>>} ?$	<b>No</b>
-------------	-----------

Setting choice Yes or No  
Yes: the second negative phase sequence overcurrent threshold ( $I_{2>>}$ ) is enabled. The second negative phase sequence overcurrent threshold submenu (see § 2.8.1.2) is displayed.  
No: the second negative phase sequence overcurrent threshold ( $I_{2>>}$ ) is not enabled.

2.8.3.1 Submenu First negative phase sequence overcurrent threshold (I2>) protection

<b>I2&gt; ?</b> <b>Yes</b>	“Yes” option is selected. The first negative phase sequence overcurrent threshold (I2>) is enabled.
<b>I2&gt;</b> <b>0.1 In</b>	Sets the value for the first negative phase sequence overcurrent threshold I2>. The threshold setting range is from 0.1 to 40In (step 0.1In).
<b>Delay Type</b> <b>DMT</b>	Selects the time delay type associated with I2>. Setting choices are: - “DMT” (definite minimum time): see section a, - “IDMT” (inverse definite minimum time): see section b, - “RI” (electromechanical inverse time curve): section c.

a) Delay type = Definite Minimum Time

<b>Delay Type</b> <b>DMT</b>	“DMT” is selected
<b>tI2&gt;</b> <b>0.040</b>	Sets the time delay associated with I2>. The setting range is from 0 to 150.0 s (step 10 ms).
<b>t Reset</b> <b>0 ms</b>	Sets the reset time value from 0 to 600 s (step 10 ms)

b) Delay type = Inverse Definite Minimum Time

<b>Delay Type</b> <b>IDMT</b>	“IDMT” is selected
<b>Curve</b> <b>IEC SI</b>	Selects the type of curve. Select choice from: - IEC SI, IEC STI, IEC VI, IEC EI, IEC LTI (IEC curve), - ICO2, IEEE MI, CO8, IEEE VI, IEEE EI (IEEE/ANSI curve).
<b>Tms</b> <b>0,025</b>	Sets the Time Multiplier Setting (TMS) value for the curve. The setting range is from 0.025 to 1.500 (step 0.001)
<b>t Reset</b> <b>0 ms</b>	Sets the reset time value from 0 to 600 s (step 10 ms)

c) Delay type = RI - electromechanical inverse time curve

<b>Delay Type</b> <b>RI</b>	Display of the I2> inverse time delay (electromechanical RI curve).
<b>K</b> <b>2.500</b>	Selects the RI curve K value from 0.100 to 10 (step 0.100)
<b>t Reset</b> <b>60 ms</b>	P122 and P123 only, Sets the reset time value from 0 to 600 s (step 10 ms)

## 2.8.3.2 Submenu I2&gt;&gt; threshold

I2>> ?	Yes
--------	-----

“Yes” option is selected.  
second threshold of the negative phase sequence overcurrent I2>> is enabled

I2>>	1 In
------	------

Set the value for the second threshold of the negative phase sequence overcurrent I2>>. 0.1 to 40 In (step 0.01 In).

tI2>>	150 ms
-------	--------

Set the time delay associated with I2>> from 0 to 150 s (step 10 ms).

## 2.8.4 Submenu [49] Therm OL (P122 &amp; P123 only)

PROTECTION G1
---------------

[49] Therm OL
---------------

Heading of the [49] Therm OL (Thermal Overload) submenu.

Therm OL ?	Yes
------------	-----

Setting choice Yes or No  
Yes: the thermal overload function is enabled. Then the following menu is displayed.  
No: the thermal overload function is not enabled, and no menu content is displayed.

I $\theta$ >	0.5 In
--------------	--------

Sets the value for the thermal current threshold I $\theta$ > from 0.1 to 3.2In (step 0.01In).

Te	10 mn
----	-------

Sets value for the Te thermal time constant associated with the thermal overload formula from 1 min to 200mn (step 1mn).

k	1.01
---	------

Sets the value for the k factor associated with the thermal overload function, from 1 to 1.5 (step 0.01).

$\theta$ Trip	110 %
---------------	-------

Set the percentage applicable to the thermal overload trip threshold, from 50% to 200% (step 1%).

$\theta$ Alarm ?	Yes
------------------	-----

Setting choice Yes or No.  
Yes: the thermal overload alarm function is enabled. Then the following menu is displayed.  
No: the thermal overload function is not enabled and the next menu is not activated.

$\theta$ Alarm	90 %
----------------	------

Sets the percentage applicable to the thermal overload alarm threshold, from 50% to 200% (step 1%).

2.8.5 Submenu [37] UNDERCURRENT Protection (P122 & P123 only)

Undercurrent function will:

- start as soon as the current of one phase is below  $I_{<}$  threshold value (**OR** of the 3 phases current)
- trip if the current of one phase - at least - remains below this threshold during more than  $t_{I<}$ .

$I_{<}$  starting could be inhibited when CB is open (52a)

Function $I_{<}$	Yes
$I_{<}$	0.20 $I_n$
$t_{I<}$	0.00 s
Inhibition by 52A	Yes

**PROTECTION G1**

**[37] Under Current**

Heading of the [37] undercurrent submenu

$I_{<}$  ?  
Yes

Setting choice Yes or No  
Yes: the first undercurrent threshold ( $I_{<}$ ) protection is enabled. Then the following menu is displayed.  
No: the first undercurrent threshold ( $I_{<}$ ) protection is not enabled, and the next menu is not activated.

$I_{<}$   
0.2  $I_n$

Sets the value for the undercurrent threshold  $I_{<}$ , from 0.02 to  $1 I_n$  (step  $0.01 I_n$ ).

$t_{I<}$   
200 ms

Sets the time delay associated with  $I_{<}$ , from 0 to 150 s (step 10ms).

Inhibition  $I_{<}$  on 52A  
Yes

This function inhibits undercurrent protection on circuit breaker (52A) trip. Setting choice Yes or No.

2.8.6 Submenu [79] AUTORECLOSE (P123 only)

The autoreclose function provides the ability to automatically control the autorecloser, with two, three, or four shot cycles. Each cycle implements a dead time and a reclaim time.

During the autorecloser cycle, if the relay receives an order to change setting group, this order is kept in memory, and will only be executed after the timer has elapsed.

Autoreclose function is available if:

- a logical input is assigned to 52a state,
- and trip output relay is not latched to the earth and/or phase protection.

In addition to these settings, the user can fully link the autoreclose function to the protection function using the menus "PROTECTION G1 / Phase OC" and "PROTECTION/ E/Gnd".

**PROTECTION G1**

**[79] Autoreclose**

Heading of the [79] AUTORECLOSER submenu.



<b>Autoreclose ?</b> <b>Yes</b>
------------------------------------

Setting choice Yes or No

Yes: the autoreclose function is enabled. Then the "Ext CB Fail ?" menu is displayed.

Immediately could appear the message: "Conflict Recloser".

Do not worry, you are hardly beginning to set your ARC and some settings must be worked out.

No: the autoreclose function is not enabled, and no menu is activated.

<b>Ext CB Fail ?</b> <b>Yes</b>
------------------------------------

Allows the use of a dedicated input (CB FLT) to inform the autoreclose function of the state of the CB (failed or operational). This signal has to be assigned to a digital input by the Automatic Control inputs submenu  
Setting choice Yes or No.

Yes: The CB will be declared fault and the autoreclose will move in the locked status when the Ext. CB Fail time will be elapsed and the Ext CB Fail will stand active.

No: the Ext Block submenu is activated.

<b>Ext CB Fail Time</b> <b>.0.1 s</b>
--

If "Ext CB Fail"=Yes option is selected only.

Set the value for the external CB failure time delay tCFE. The Ext. CB Fail timer will start when the tD will be expired. If during this time the signal Ext CB Fail will disappear, the ARC will continue with its programmed cycles. Once this set time has elapsed, the information Ext CB Fail is validated. Setting range is from 10ms to 600s (step 10ms).

<b>Ext Block ?</b> <b>Yes</b>
----------------------------------

Setting choice: Yes or No

Allows the use of a dedicated input (Block\_79) to block the autoreclose function.

If you set this item to Yes to make it active you have to assign to a digital input the function Block 79 by the inputs submenu in Automatic control function. With the Ext. Block activated (the relevant digital input supplied) the autoreclose will move to the locked status after a protection trip involved in the sequences matrix of the ARC.

<b>Rolling demand ?</b> <b>Yes</b>
---------------------------------------

Setting choice: Yes or No

Yes: activates the trip activity supervision. At the first trip order generated, the relay starts a temporization during which, if the current trip number reaches the programmed max trips number, the relay stops the pending autoreclose cycle (definitive trip).

<b>Max cycles nb</b> <b>10</b>
-----------------------------------

Setting range from 2 to 100 (step 1).

Sets the programmed maximum trip number.

<b>Time period</b> <b>10 mn</b>
------------------------------------

Setting range from 10 mn to 24 h (step 10mn).

Sets the temporization for trip activity supervision.

The dead time (tD1, tD2, tD3 and tD4) starts when the digital input connected to the 52a, auxiliary contact of the CB, is de-energised and the involved protection threshold reset. It means that CB has tripped. If on trip protection the CB opening signal (52a) is lacking, after a fixed time out of 2.00 s at 50 Hz or 1.67 s at 60 Hz, the ARC resets to the initial status. If on trip protection the 52a signal changes status but the protection threshold trip stands the tD timer will start when the protection trip threshold will disappear. In the above case NONE TIME OUT IS FORECASTED.

The 52a signal has to assigned to a digital input by by the inputs submenu in Automatic control function. The 52a signal is in accordance with the CB status.

Auxiliary Contact status		CB Status
52A	52B	-----
Active	Inactive	Circuit Breaker open
Inactive	Active	Circuit Breaker closed

Within the tD a further time window is active. This time window starts together to the tD. It expires after 50ms.

If within this time window a threshold involved in the trip of the CB and in the ARC cycle is intermittent the ARC will be lock.

**Dead Time**  
tD1            50 ms

Sets the value for the First Cycle Dead Time (tD1). The Dead Time starts at the CB trip, when 52a input has disappeared.  
Setting range is from 50ms to 300s (step 10ms).

**Dead Time**  
tD2            50 ms

As above for the second Cycle Dead Time (tD2)  
Setting range is from 50ms to 300s (step 10ms).

**Dead Time**  
tD3            50 ms

As above for the third Cycle Dead Time (tD3)  
Setting range is from 50ms to 600s (step 10ms).

**Dead Time**  
tD4            50 ms

As above for the fourth Cycle Dead Time (tD4)  
Setting range is from 50ms to 600s (step 10ms).

**Min Dropoff Time**  
tI>            50 ms

Sets the value after a first trip This drop off time is used with an IDMT electromagnetic relay, and starts when the CB opens. The induction disk returns to its initial position during this additional time  
Setting range is from 50ms to 600s (step 10ms).

**Min Dropoff Time**  
tI>>           50 ms

As above for I>>  
Setting range is from 50ms to 600s (step 10ms).

**Min Dropoff Time**  
tI>>>           50 ms

As above for I>>>  
Setting range is from 50ms to 600s (step 10ms).

**Min Dropoff Time**  
tIE>            50 ms

As above for IE>  
Setting range is from 50ms to 600s (step 10ms).

**Min Dropoff Time**  
tIE>>           50 ms

As above for IE>>  
Setting range is from 50ms to 600s (step 10ms).

**Min Dropoff Time**  
tIE>>>           50 ms

As above for IE>>>  
Setting range is from 50ms to 600s (step 10ms).

**Reclaim Time**  
tR            0.02 s

Set the Reclaimer time value (tR). The reclaim time , starts when the CB has closed. Setting range is from 20ms to 600s (step 10ms).  
After the reclaim time, if the circuit breaker does not trip again, the autoreclose function resets; otherwise, the relay either advances to the next shot that is programmed in the autoreclose cycle, or, if all the programmed reclose attempts have been accomplished, it locks out.  
If the protection element operates during the reclaim time following the final reclose attempt, the relay will lockout and the autoreclose function is disabled until the lockout condition resets.

<b>Inhib Time</b>	
<b>tl</b>	<b>0.02 s</b>

Set the value for the Inhibit Time (tl). The "Inhib Time tl" timer is used to block the autoreclose being initiated after the CB is manually closed onto a fault. The lockout condition can reset by a manual closing after the "Inhib Time tl". Setting range is from 20ms to 600s (step 10ms).

<b>Phase Cycles</b>	
	<b>0</b>

Select the number of cycles associated with the phase autoreclose function, from 0 to 4 (step 1).

<b>E/Gnd Cycles</b>	
	<b>0</b>

Select the number of cycles associated with the earth autoreclose function, from 0 to 4 (step 1).

<b>CYCLES</b>	<b>4321</b>
<b>tl&gt;</b>	<b>1201</b>

4321 are the cycles associated to the trip on tl> pick up  
1201 are the actions to be executed after the tl> time delay has elapsed:  
0 = no action on autorecloser: definitive trip (autoreclose will move in the lock status),  
1 = trip on tl> pick-up, followed by reclosing cycle  
2 = no trip on tl> pick-up: and this whatever the setting is in the "AUTOMAT. CRTL/Trip commands/Trip tl>" menu.  
3 = autoreclose without trip (trip order is inhibited and no trip is performed from autoreclose function).

<b>CYCLES</b>	<b>4321</b>
<b>tl&gt;&gt;</b>	<b>1211</b>

As above for tl>>.

<b>CYCLES</b>	<b>4321</b>
<b>tl&gt;&gt;&gt;</b>	<b>1110</b>

As above for tl>>>.

<b>CYCLES</b>	<b>4321</b>
<b>tle&gt;</b>	<b>0111</b>

As above for tle>.

<b>CYCLES</b>	<b>4321</b>
<b>tle&gt;&gt;</b>	<b>1121</b>

As above for tle>>.

<b>CYCLES</b>	<b>4321</b>
<b>tle&gt;&gt;&gt;</b>	<b>1111</b>

As above for tle>>>.

<b>CYCLES</b>	<b>4321</b>
<b>tAux1&gt;</b>	<b>1112</b>

As above for tAux1>.

<b>CYCLES</b>	<b>4321</b>
<b>tAux2</b>	<b>0111</b>
<b>tAux3</b>	<b>1111</b>
<b>tAux4</b>	<b>1111</b>
<b>tAux5</b>	<b>1111</b>

As above for tAux2, tAux3, tAux4 and tAux5

### 2.9 AUTOMAT. CTRL Menu

Under the AUTOMAT. CTRL Menu, the user can program the different automation functions available in the MiCOM P120, P121, P122 and P123.

The different submenus are:

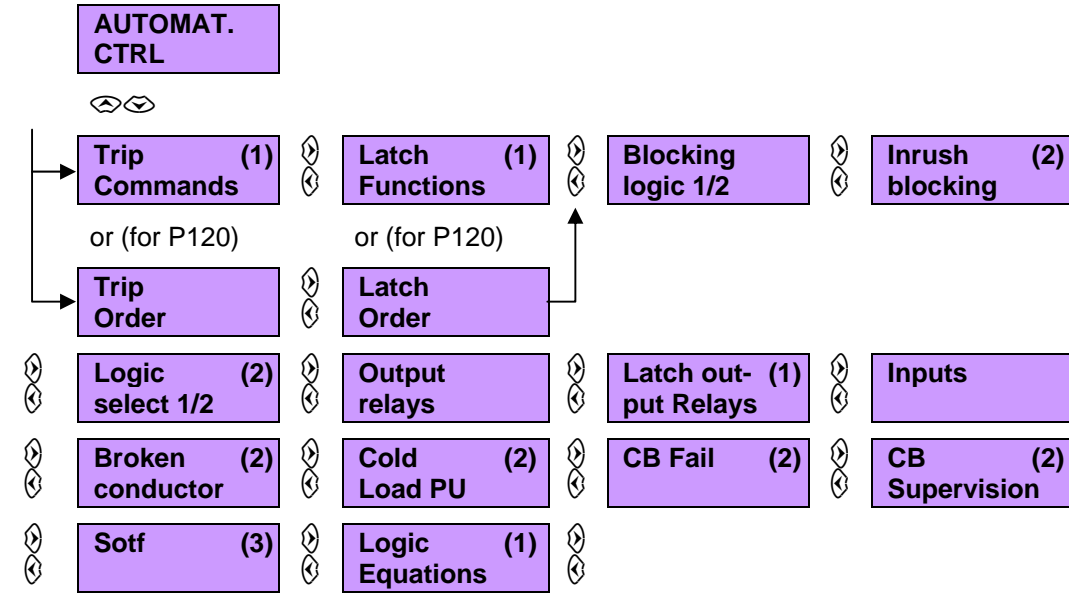

- (1) P121, P122 and P123 only
- (2) P122 and P123 only
- (3) P123 only

To access the AUTOMAT. CTRL Menu, press then until the menu is reached.

#### 2.9.1 Submenu Trip Commands

This submenu makes it possible to assign some or all the selected following thresholds to the trip output relay.

Function	P120	P121	P122	P123	INFORMATION and COMMENTS
Trip tl>	X	X	X	X	Time delayed first phase overcurrent threshold trip
Trip tl>>	X	X	X	X	Time delayed second phase overcurrent threshold trip
Trip tl>>>	X	X	X	X	Time delayed third phase overcurrent threshold trip
Trip tle>	X	X	X	X	Time delayed first earth overcurrent threshold trip
Trip tle>>	X	X	X	X	Time delayed second earth overcurrent threshold trip
Trip tle>>>				X	Time delayed third earth overcurrent threshold trip
Trip tle>>>>			X	X	Time delayed derived earth overcurrent threshold trip.
Trip tl <			X	X	Time delayed undercurrent threshold (tl<) trip. This information is generated in less than a cycle of the network frequency (50 or 60 Hz).
Trip tl2 >			X	X	Time delayed first negative phase sequence overcurrent threshold (tl2>) trip.

Function	P120	P121	P122	P123	INFORMATION and COMMENTS
Trip tI2 >>			X	X	Time delayed second negative phase sequence overcurrent threshold (tI2>>) trip.
Trip Thermal $\theta$			X	X	Thermal overload trip threshold ( $\theta$ Trip).
Trip Brkn.Cond			X	X	Broken conductor detection signal.
Trip t Aux 1		X	X	X	Time delayed auxiliary input Aux 1.
Trip t Aux 2		X	X	X	Time delayed auxiliary input Aux 2.
Trip t Aux 3			X	X	Time delayed auxiliary input Aux 3.
Trip t Aux 4				X	Time delayed auxiliary input Aux 4.
Trip t Aux 5				X	Time delayed auxiliary input Aux 5.
Trip SOTF				X	SOTF function to the trip output. When the tSOTF has elapsed, the trip command is ordered.
Ctrl Trip				X	Control Trip function to the trip output relay RL1.
Trip CB Fail				X	CB Fail function.
Trip Equ A		X	X	X	Logical output of Boolean Equation A.
Trip Equ B		X	X	X	Logical output of Boolean Equation B.
Trip Equ C		X	X	X	Logical output of Boolean Equation C.
Trip Equ D		X	X	X	Logical output of Boolean Equation D.
Trip Equ E		X	X	X	Logical output of Boolean Equation E.
Trip Equ F		X	X	X	Logical output of Boolean Equation F.
Trip Equ G		X	X	X	Logical output of Boolean Equation G.
Trip Equ H		X	X	X	Logical output of Boolean Equation H.

**AUTOMAT. CTRL**

Heading of the AUTOMAT.CTRL

**Trip Commands**

Heading of the Trip ORDER sub-menu.

**Trip Order**P120 Only  
Heading of the P120 submenu.**Function****Yes / No**

Setting choice Yes: Assign the corresponding time delay or function to the trip output relay RL1. Then the trip output relay (RL1) will be activated at the end of the corresponding time delay.

Setting choice No: the trip output relay (RL1) will never be activated, even at the end of the corresponding time delay or function.

Refer to previous table for protection functions list and comments.

## 2.9.2 Submenu Latch of trip output relay by Function

With this submenu the user can program the trip output relay associated with one or many thresholds so that it stays latched after the cause for activating these functions has disappeared.

Function	P120	P121	P122	P123	INFORMATION and COMMENTS
Latch tl>	X	X	X	X	Time delayed first phase overcurrent threshold
Latch tl>>	X	X	X	X	Time delayed second phase overcurrent threshold
Latch tl>>>	X	X	X	X	Time delayed third phase overcurrent threshold
Latch tle>		X	X	X	Time delayed first earth overcurrent threshold
Latch tle>>		X	X	X	Time delayed second earth overcurrent threshold
Latch tle>>>		X	X	X	Time delayed third earth overcurrent threshold
Latch tle>>>>			X	X	Time delay of derived earth overcurrent threshold.
Latch tl <			X	X	Time delayed undercurrent threshold
Latch tl2 >			X	X	Time delayed first negative phase sequence overcurrent threshold.
Latch tl2 >>			X	X	Time delayed second negative phase sequence overcurrent threshold
Latch Thermal $\theta$			X	X	Thermal overload information.
Latch Brkn.Cond			X	X	Broken conductor function.
Latch t Aux 1		X	X	X	Aux1 delayed by Aux1 time
Latch t Aux 2		X	X	X	Aux2 delayed by Aux2 time
Latch t Aux 3			X	X	Aux3 delayed by Aux 3 time
Latch t Aux 4				X	Aux4 delayed by Aux 4 time
Latch t Aux 5				X	Aux5 delayed by Aux 5 time (option)
Latch SOTF				X	SOTF function.
Latch CB Fail				X	CB Fail function.

**AUTOMAT. CTRL**

Heading of the AUTOMAT. CTRL menu.

**Latch Functions**

Heading of the submenu.

**Latch Order**

P120 only  
Heading of the P120 submenu.

**Function**  
**Yes**

Setting choice Yes: Latch the trip output relay associated with the corresponding protection function. The relay will be remain latched after the fault has disappeared.

Setting choice No: The trip output relay will be active when the relevant command is active. The relay will not be active if the relevant command is reset.

Refer to previous table for protection functions list and comments.

NOTE: To reset the latched output relay:

P120	P121	P122 & P123
<p>To reset the latched relays with MiCOM P120: When a relay associated to a time delay overcurrent threshold is latched, no dedicated alarm signalling that the relay has been latched is displayed. The latched output can be reset by acknowledging the alarm message pressing keys <math>\text{Ⓢ}</math> and <math>\text{Ⓢ}</math>. The latched relay can also be reset either by an opto input or by a remote command.</p>	<p>The active relay latched can be reset by:</p> <ul style="list-style-type: none"> <li>- Either by resetting of the alarm "tl&gt; PHASE"* from the front panel by pushing <math>\text{Ⓢ}</math>.</li> <li>- or by a logic input assigned to this function</li> <li>- or by remote command.</li> </ul> <p>Note: No alarm dedicated to the latch of RL1</p>	<p>The active relay latched can be reset by:</p> <ul style="list-style-type: none"> <li>- Either by resetting of the alarm "LATCH RELAY TRIP" from the front panel by pushing <math>\text{Ⓢ}</math>.</li> <li>- or by a logic input assigned to this function</li> <li>- or by remote command.</li> </ul> <p>Note: The alarm "LATCH RELAY TRIP" is dedicated to the latch of RL1</p>

\*: tl> or other function presented in the "AUTOMAT. CTRL/Latch functions" menu

### 2.9.3 Submenu Blocking Logic

Through the Blocking Logic submenu, the user can block each delayed threshold using a "Block Logic" input (refer to Inputs menu). **MiCOM P122 & P123** relays have the submenu Blocking Logic 1 and Blocking Logic 2 available for setting.

It is possible to enable or disable the "blocking" of most protection functions even if a logic input has been assigned to that function.

Function	P120	P121	P122	P123	INFORMATION and COMMENTS
tl>	X	X	X	X	Time delayed first phase overcurrent threshold
tl>>	X	X	X	X	Time delayed second phase overcurrent threshold
tl>>>	X	X	X	X	Time delayed third phase overcurrent threshold
tle>	X	X	X	X	Time delayed first earth overcurrent threshold
tle>>	X	X	X	X	Time delayed second earth overcurrent threshold
tle>>>	X	X	X	X	Time delayed third earth overcurrent threshold
tle>>>>			X	X	Time delayed of derived earth overcurrent threshold.
tl2 >			X	X	Time delayed first negative phase sequence overcurrent threshold
tl2 >>			X	X	Time delayed second negative phase sequence overcurrent threshold.
Thermal $\theta$			X	X	Trip threshold for thermal overload.
Brkn.Cond			X	X	Broken Conductor trip signal.
tAux 1		X	X	X	Aux1 Logic Input delayed by Aux1 time
tAux 2		X	X	X	Aux2 Logic Input delayed by Aux2 time
tAux 3			X	X	Aux3 Logic Input delayed by Aux3 time
tAux 4				X	Aux4 Logic Input delayed by Aux4 time
tAux 5				X	Aux5 Logic Input delayed by Aux5 time

**AUTOMAT. CTRL**

**Blocking Logic**

Heading of the Blocking Logic submenu.

**Block Function**  
**No**

Enables or disables blocking logic of the function on the level (logic state =1) of logic input "Block Logic"

Refer to previous table for protection functions list.

2.9.4 Inrush Blocking Logic submenu (P122 and P123 only)

Through the Inrush Blocking Logic submenu, the user can set a 2<sup>nd</sup> harmonic blocking threshold and block each delayed overcurrent threshold by setting . MiCOM P122 & P123 relays have the submenu Inrush Blocking available for setting.

It is possible to enable or disable the "blocking" of most protection functions even if a logic input has been assigned to that function. Blocking of a protection function can be prevented if "No" is selected in the relevant window (see below). Blocking of a protection function can be enabled if "Yes" is selected in the relevant window.

Function	P122	P123	INFORMATION and COMMENTS
I>	X	X	Instantaneous first phase overcurrent threshold
I>>	X	X	Instantaneous second phase overcurrent threshold
I>>>	X	X	Instantaneous third phase overcurrent threshold
Ie>	X	X	Instantaneous first earth overcurrent threshold
Ie>>	X	X	Instantaneous second earth overcurrent threshold
Ie>>>	X	X	Instantaneous third earth overcurrent threshold
Ie>>>>	X	X	Instantaneous derived earth overcurrent threshold.
I2>	X	X	Instantaneous first negative phase sequence overcurrent threshold
I2>>	X	X	Instantaneous second negative phase sequence overcurrent threshold

**AUTOMAT. CTRL**

**Blocking Inrush**

Heading of the Inrush Blocking logic submenu.

**Blocking Inrush**  
**Yes**



Setting choice Yes: The crossing of the Harmonic H2 ratio threshold on any phase activates the Inrush Blocking Logic function instantaneously.  
Setting choice No: The crossing of the Harmonic H2 ratio threshold doesn't activate the Inrush Blocking logic function.

**Inr. Harmonic 2 Ratio =**  
**20%**

Set the value for the 2<sup>nd</sup> harmonic threshold ratio calculated as a percentage of the fundamental component from 10 to 35% (step 0.1%). Press  to validate your choice.



**T Inrush reset =**  
**0 ms**

Set the value for the Inrush tReset time. This provides a reset delay of the Inrush Blocking signal (logic state=1) once the 2<sup>nd</sup> harmonic level falls below the set threshold. The setting range is from 0.0s to 2 s (step 10ms). Use  to change setting and press  to validate your choice.

**Blocking Inrush Function**  
**No**

Enables or disables Inrush blocking for the function. Refer to previous tables for protection functions list.

2.9.5 Submenus Logic Select (P122 & P123 only)

With the submenu Logic Select. 1 or Logic Select. 2, the user can assign each time delay threshold to the "Log Sel" input (refer to Inputs menu).

Setting Yes or No enables or disables Logic Selectivity 1 of the following protection functions:

**AUTOMAT. CTRL**

**Logic Select. 1**

Heading of the Logic Select. 1 submenu.

**Sel1 tl>>**  
**Yes/No**

Time delayed second phase overcurrent threshold (tl>>).

**Sel1 tl>>>**  
**Yes/No**

Time delayed third phase overcurrent threshold (tl>>>).

**Sel1 tle>>**  
**Yes/No**

Second earth fault time delay overcurrent threshold (tle>>).

**Sel1 tle>>>**  
**Yes/No**

Third earth fault time delay overcurrent threshold (tle>>>).

**Sel1 tle>>>>**  
**Yes/No**

Derived earth overcurrent threshold (tle>>>>).

**t Sel1**  
**20 ms**

Set the selective scheme logic time delay t Sel1, from 0s to 150s (step 10ms).

2.9.6 Outputs Relays submenu

This submenu makes it possible to assign various alarm and trip thresholds (instantaneous and/or time delay) to a logic output. Setting choice: 1 assigns the output relay; 0 no assignment, i.e. output signal trip (RL1) in the following list is assigned to output 3 (RL3), 7 (RL7) and 8 (RL8).

Excepted from this option are the Watchdog (RL0) and the Tripping (RL1) outputs (refer to Trip Commands submenu).

The total number of programmable logic outputs for the four relay models is listed in the table:

Model	P120	P121	P122	P123
Output relays	3	3	5	7

RL2 relay is a change over relay. The others RL3 to RL8 are normally open relays.

The following protection functions can be assigned to output relays using this submenu.

Function	P120	P121	P122	P123	INFORMATION and COMMENTS
Trip	X	X	X	X	Output signal Trip (RL1).
I>	X	X	X	X	Instantaneous first phase overcurrent threshold (I>).
tl>	X	X	X	X	Time delayed first phase overcurrent threshold (tl>).
I>>	X	X	X	X	Instantaneous second phase overcurrent threshold (I>>).
tl>>	X	X	X	X	Time delayed second phase overcurrent threshold (tl>>).
I>>>	X	X	X	X	Instantaneous third phase overcurrent threshold (I>>>).
tl>>>	X	X	X	X	Time delayed third phase overcurrent threshold (I>>>).
Ie>	X	X	X	X	Instantaneous first earth overcurrent threshold (Ie>).
tle>	X	X	X	X	Time delayed first earth overcurrent threshold (tle>).
Ie>>	X	X	X	X	Instantaneous second earth fault overcurrent threshold (Ie>>).
tle>>	X	X	X	X	Time delayed second earth fault overcurrent threshold (tle>>).
Ie>>>	X	X	X	X	Instantaneous third earth fault overcurrent threshold (Ie>>>).
tle>>>	X	X	X	X	Time delayed third earth fault time delay overcurrent threshold (tle>>>).
Ie>>>>			X	X	Derived earth overcurrent threshold.
tle>>>>			X	X	Time delayed threshold of derived earth overcurrent.
tl<			X	X	Time delayed undercurrent threshold
tl2>			X	X	Time delayed first negative phase sequence overcurrent threshold
tl2>>			X	X	Time delayed second negative phase sequence overcurrent threshold
Therm.			X	X	Thermal alarm threshold to the output relays.
Therm. Trip			X	X	Thermal trip threshold to the output relays.
CB Alarm			X	X	Circuit Breaker Alarm function signal (CB Open NB, Sum Amps(n), CB Open Time and CB Close Time).
52 Fail			X	X	Trip circuit supervision (TCS) failure function signal.
Brkn. Cond			X	X	Broken conductor function signal
CB Fail			X	X	Circuit breaker failure function signal
CB Close P120 / P121	X	X			Circuit breaker closing order: Communication front face and rear port control of output relays (RL2 – RL3)

Function	P120	P121	P122	P123	INFORMATION and COMMENTS
CB Close P122			X		Circuit breaker closing order: "Ctrl Close" logic input, HMI, communication front face and rear port control of output relays (RL2 – RL5)
CB Close P123				X	Circuit breaker closing order: Only "autoreclose" function controls relays RL2 to RL7 (see also "CONTROL close" function).
t Aux 1		X	X	X	Aux1 auxiliary input delayed by tAux1 time.
t Aux 2		X	X	X	Aux2 auxiliary input delayed by tAux2 time.
t Aux 3			X	X	Aux3 auxiliary input delayed by tAux3 time.
t Aux 4				X	Aux4 auxiliary input delayed by tAux4 time.
t Aux 5				X	Aux5 auxiliary input delayed by tAux5 time.
79 Run				X	Signal that Autoreclose cycle is working ("Autorecloser in progress" signal).
79 Trip				X	Autoreclose final trip function.
79 Int block				X	Autoreclose lock activated by the internal process of the autoreclose
79 Ext block				X	Autoreclose lock activated by the input "block 79"
Order 1Comm.			X	X	Remote command 1
Order 2Comm.			X	X	Remote command 2.
Order 3Comm.			X	X	Remote command 3.
Order 4 Comm.			X	X	Remote command 4.
Active Group			X	X	Active Group indication.
SOTF				X	SOTF functionality – when the tSOTF has elapsed the assigned relay is activated.
CONTROL Trip				X	Control trip command.
CONTROL Close				X	Control close command. Logic input, HMI, communication front face and rear port control the affected relay (1 to 8). Refer to "CB Close (P123)" function to see autoreclose control operation.
Input1	X	X	X	X	Opto input 1.
Input2	X	X	X	X	Opto input 2.
Input3			X	X	Opto input 3 status.
Input4				X	Opto input 4 status.
Input5				X	Opto input 5 status.
tIA>				X	First delayed threshold for phase A (tIA>)
tIB>				X	First delayed threshold for phase B (tIB>).
tIC>				X	First delayed threshold for phase C (tIC>).
EQU. A		X	X	X	Logic output of Boolean Equation A.
EQU. B		X	X	X	Logic output of Boolean Equation B.
EQU. C		X	X	X	Logic output of Boolean Equation C.
EQU D		X	X	X	Logic output of Boolean Equation D.

Function	P120	P121	P122	P123	INFORMATION and COMMENTS
EQU E		X	X	X	Logic output of Boolean Equation E.
EQU. F		X	X	X	Logic output of Boolean Equation F.
EQU. G		X	X	X	Logic output of Boolean Equation G.
EQU. H		X	X	X	Logic output of Boolean Equation H.

**AUTOMAT. CTRL**

**Output Relays**

Heading of the Output Relays submenu.

**Function 8765432  
1100010**

Assigning the corresponding protection function to the output relays; i.e. to output 3 (RL3)  
Setting choice: 1 assigns the output relay; 0 no assignment  
Refer to previous table for protection functions list.

**Function 65432  
00010**

Submenu for P122.

**Function 432  
010**

Submenu for P120 and P121.

2.9.7 Latch of the auxiliary output relays (RL2 to RL8)

This submenu (not available in P120 menu) makes it possible to latch the auxiliary output relays, relay by relay.

**AUTOMAT. CTRL**

**Latch Output Relays**

Heading of the Latch Output Relays submenu.

**Output 2  
No**

Latch the auxiliary output relay RL2.

**Output 3  
Yes**

Latch the auxiliary output relay RL3.

**Output 4  
Yes**

Latch the auxiliary output relay RL4.

**Output 5  
Yes**

P122 and P123 only  
Latch the auxiliary output relay RL5.

**Output 6  
No**

P122 and P123 only  
Latch the auxiliary output relay RL6.

**Output 7  
Yes**

P123 only  
Latch the auxiliary output relay RL7.

**Output 8  
No**

P123 only  
Latch the auxiliary output relay RL8.

NOTE: To reset the latched auxiliary relays:

	P121	P122 & P123
The auxiliary output latched can be reset by:	<ul style="list-style-type: none"> <li>- Either by resetting of the "OP PARAMETERS/Relay Status" from the front panel by pushing ☺.</li> <li>- or by a logic input assigned to this function</li> <li>- or by remote command.</li> </ul> <p>Note: No alarm dedicated to the latch of the auxiliary output relay</p>	<ul style="list-style-type: none"> <li>- Either by resetting of the alarm "LATCH RELAY TRIP" from the front panel by pushing ☺.</li> <li>- or by a logic input assigned to this function</li> <li>- or by remote command.</li> </ul> <p>Note: The alarm "LATCH RELAY TRIP" is dedicated to the latch of RL1</p>

### 2.9.8 Inputs submenu

This submenu makes it possible to assign a single function or multiple automation functions to each logic input. The following functions are available for mapping to a logic input:

Label	P120	P121	P122	P123	Function
None	X	X	X	X	No link/assignment
Unlatch	X	X	X	X	Unlocks latched output relays
52 a	X	X	X	X	Position of the circuit breaker (open)
52 b	X	X	X	X	Position of the circuit breaker (close)
CB FLT	X	X	X	X	External failure information from the CB
Aux 1	X	X	X	X	Assign external information to input Aux1
Aux 2	X	X	X	X	Assign external information to input Aux2
Aux 3			X	X	Assign the input the external information Aux 3
Aux 4				X	Assign the input the external information Aux 4
Aux 5				X	Assign the input the external information Aux 5
Block Logic 1 Or Blk Log 1	X	X	X	X	Blocking logic 1
Block Logic 2			X	X	Blocking logic 2
Start Disturb			X	X	Starting of the disturbance recording function
Cold Load PU			X	X	Assign cold load pick up
Logic Select 1			X	X	Logic selectivity 1
Logic Select 2			X	X	Logic selectivity 2
Change setting			X	X	Change of setting group (default setting group 1)
Block [79]				X	Blocking of the autorecloser function [79]
θ Reset			X	X	Reset of the thermal state
Trip Circuit			X	X	Trip circuit supervision input
Strt tBF			X	X	Starting of the Breaker Fail Timer
Reset Leds			X	X	Reset of the "Trip" & "Alarm" leds

Label	P120	P121	P122	P123	Function
Maint. Mode			X	X	Maintenance Mode ON/OFF change
SOTF				X	Switch on to fault (SOTF) logical input.
Local Mode				X	Local mode condition (if activated, any remote command to the output relays is forbidden)
Synchro			X	X	Assign a Time synchronisation input
Ctrl Trip			X	X	Assign a control trip function to the input. When activated, it is possible to order output relay(s) affected to the control trip function (P122: RL1 only, P123: RL1 to RL8).
Ctrl Close			X	X	Assign a control close function to the input. When activated, it is possible to order output relays affected to the CB Close (P122) or control close (P123) function. For P123, this input can be started by the SOTF feature.

NOTE: For P120:  
 The external information Aux1 and Aux2 is used only for signalisation on the communication network.  
 T Aux1 and t Aux2 are fixed and equal to 0 ms.  
 Only one blocking logic function.

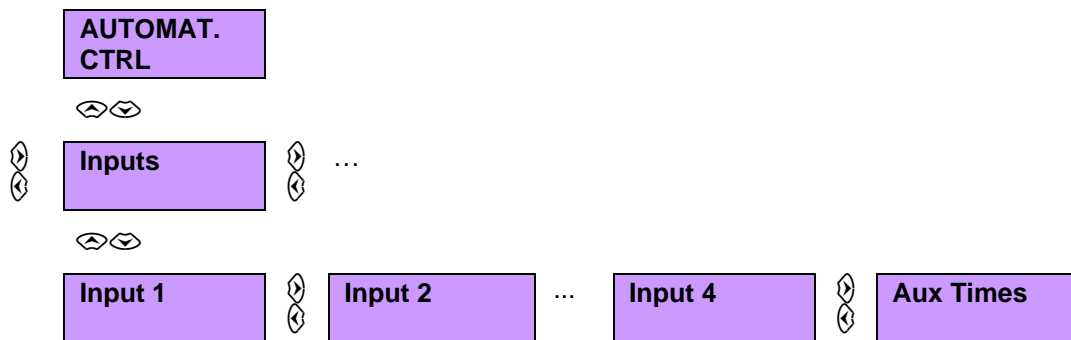

2.9.8.1 Function assignement to a logic input

<b>AUTOMAT. CTRL</b>	
<b>Inputs</b>	Heading of the Inputs sub-menu.
<b>Input 1</b> 52a	Assigning label 52a to logic input 1. See the previous table for input choices.
<b>Input 2</b> 52b	Assigning label 52b to logic input 2. See the previous table for input choices.
<b>Input 3</b> Aux1	Assigning label Aux1 to logic input 3. See the previous table for input choices.
<b>Input 4</b> Log Sel 1	Assigning label Log Sel 1 to logic input 4. See the previous table for input choices.
<b>Aux1 Time</b> t Aux1 10s	Displays setting value of timer assigned to logic input Aux1, from 0ms to 200s (steps of 10ms).
<b>Aux2 Time</b> t Aux2 10s	As above for Aux2.

**AUTOMAT. CTRL**

**Inputs**

Heading of the Inputs sub-menu.

**Aux3 Time  
t Aux3                    10s**

P122 and P123 only  
A above for Aux3.

**Aux4 Time  
t Aux4                    10s**

P123 only  
A above for Aux4.

**Aux5 Time  
t Aux5                    10s**

P123 only  
A above for Aux5.

2.9.9 BROKEN CONDUCTOR submenu (P122 & P123 only)

**AUTOMAT. CTRL**

**Broken Cond.**

Heading of Broken Conductor detector submenu.

**Brkn. Cond. ?  
                                  No**

Selection of the Broken Conductor function.  
If Yes is selected, the broken conductor detection is activated and the following menu is displayed:  
If No is selected, the Broken Conductor function is inactive.

**Brkn. Cond Time  
tBC                        1 s**

Displays delay timer setting (tBC) for the Broken Conductor function. When sensitive settings are used, it is probable that the element will operate for any unbalance condition occurring on the system (for example, during a single pole autoreclose cycle). A long time delay is necessary to ensure co-ordination with other protective devices. It is common to set the time delay to 60 seconds.

Setting range from 0 to 14400s (steps of 1s).

**Ratio I2/I1  
                                  20 %**

Displays value, in percent, for the Broken Conductor threshold to tolerate some margin and load variations, This threshold is the ratio between negative and positive phase sequence current. it is typical to set this value at 200% above this value.

Setting range is from 20 to 100% by, in steps of 1%.

2.9.10 COLD LOAD PICK-UP submenu (P122 & P123 only)

The Cold Load PU (CLP) submenu allows the user to enable the cold load pick-up function. Selected threshold values can temporary be raised.

TEXT	P122	P123	INFORMATION and COMMENTS
tl> ?	X	X	Time delayed l> threshold.
tl>> ?	X	X	Time delayed l>> threshold.
tl>>> ?	X	X	Time delayed tl>>> threshold.
tle> ?	X	X	Time delayed tle> threshold.
tle>> ?	X	X	Time delayed tle>> threshold.
tle>>> ?	X	X	Time delayed tle>>> threshold.
tl2> ?	X	X	Time delayed tl2> threshold.
tl2>> ?	X	X	Time delayed tl2>> threshold.
t Therm. ?	X	X	Time delayed Thermal overload threshold

**AUTOMAT. CTRL**

**Cold Load PU**

Heading of the Cold Load PU submenu.

**Cold Load PU ?**  
**Yes**

Selection of the cold load pick-up function.  
If Yes is selected, the following menu is displayed:  
If No is selected, the cold load pick-up function is inactive.

**CLPU Start Input**  
**Yes**

If "start input" is selected, the CLP will be started by digital input 52A (selected using the following menus),  
Setting choice: Yes or No

**CLPU Start auto**  
**No**

Selects the cold load pickup activation.  
If "Start auto" is selected, the CLP will start if the 3-phases current grows from less than 5% In to more than In in less than 20 ms,  
Setting choice: Yes or No

Note:-If "start Input" + "Start auto" is selected, both modes are activated.

**Cold Load PU level**  
**200 %**

Displays scaling value, in percent, for the cold load pick up assigned to the selected thresholds. This value is the amount by which the selected threshold is increased or decreased.  
Setting range is from 20% to 800%, in steps of 1%.

**Cold Load PU tCL =**  
**400 ms**

Displays delay timer setting (tCL) for the Cold Load Pick-up function from 0.1 to 3600s (step 10ms).  
The timer tCL controls the time for which the protections elements are altered. When tCL has elapsed, settings revert back to their original values.  
tCL is initiated thanks to a dedicated input signal (refer to "Automat. Ctrl/Inputs" menu), generated by connecting an auxiliary contact from the CB (52a or 52b) or starting device to the logic relevant input.

2.9.11 CIRCUIT BREAKER FAILURE submenu (P122 & P123 only)

With the CB Fail submenu, circuit breaker failure can be detected and associated parameters can be set.

**AUTOMAT. CTRL**

**CB Fail**

Heading of the CB Fail submenu.

**CB Fail ?**  
**Yes**

Selection of the circuit breaker failure function.  
If Yes is selected, the following menu is displayed:  
If No is selected, the CB Fail function is inactive.

**I<=**  
**0.1 In**

Selection of the under current threshold associated to the CB failure detection function, from 0.02In to 1In (step 0.01In).

**CB Fail Time tBF**  
**40 ms**

Selection of the circuit breaker failure time delay from 10ms to 10s (step 10ms).

**Block I> ?**  
**No**

Select the possibility to block the instantaneous signal I> in case of circuit breaker failure detection.

**Block Ie> ?**  
**Yes**

Select the possibility to block the instantaneous signal Ie> in case of circuit breaker failure detection.



2.9.12 CIRCUIT BREAKER SUPERVISION sub-menu (P122 & P123 only)

With the CB Supervision submenu circuit breakers can be supervised and monitored, and associated parameters can be set.

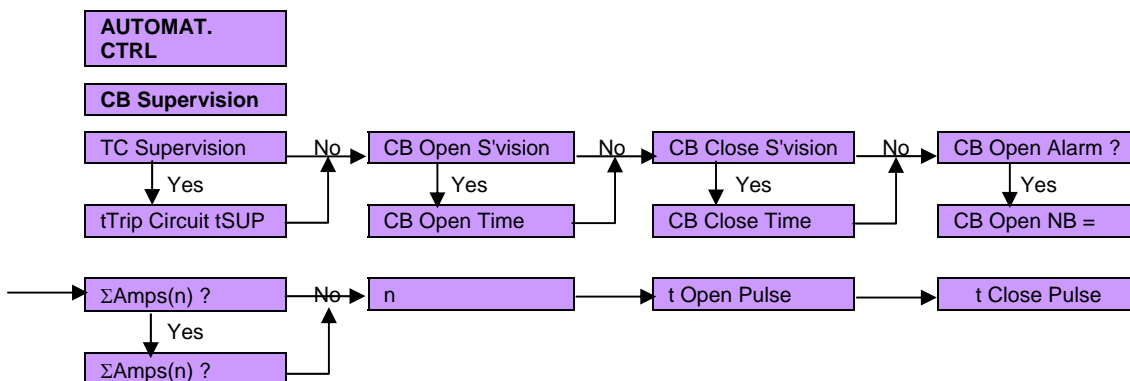

**AUTOMAT. CTRL**

**CB Supervision**

Heading of the CB Supervision submenu.

**TC Supervision**  
Yes

Selection of the trip circuit supervision function. If Yes is selected, the "t Trip Circuit t SUP" menu is displayed.

**t Trip Circuit t SUP**  
200 ms

Displays the delay timer setting (tSUP) for TC supervision, from 0.1 to 10s (step 10ms).

**CB Open S'vision**  
Yes

Selection of the time monitoring function of CB open operations. If Yes is selected, the "CB Open Time" menu is displayed.

**CB Open Time**  
100 ms

Displays monitoring time for CB open operations. from 0.05 to 1.0s (step 10ms).

**CB Close S'vision**  
Yes

Selection of the time monitoring function of CB close operations. If Yes is selected, "CB Close" window is displayed: If No is selected the next window is CB Open Alarm.

**CB Close Time**  
100 ms

Displays monitoring time for CB close operations, from 0.050 to 1.0s (steps of 10 ms).

**CB Open Alarm ?**  
Yes

Selection of the monitor function for maximum count of CB operations. If Yes is selected, the "CB Open NB" window is displayed.

**CB Open NB =**  
0

Displays alarm threshold for CB open count from 0 to 50000 (step 1).

**ΣAmps(n) ?**  
Yes

Selection of the monitoring function that continuously sums the current (in Amps or square Amps) interrupted by the CB. Setting choice: Yes, No.

If Yes is selected, "ΣAmps(n) ?" window is displayed.

**ΣAmps(n) ?**  
1000 E6

Displays alarm threshold for the summation of the current (in Amps or square Amps) interrupted by the CB, from 0 to 4000 E6 A (or A<sup>2</sup>) (step 1 E6). (E6 = 10<sup>6</sup>)

**n**  
1

Displays the exponent for the summation (I A or I<sup>2</sup> A<sup>2</sup>). Setting choice for n: 1 or 2

<b>t Open Pulse</b> 100 ms	Displays and sets the tripping pulse time, from 0.1 to 5s, (step 10ms).
<b>t Close Pulse</b> 100 ms	Displays and sets the closing pulse time, from 0.1 to 5s (step 10ms).

2.9.13 Submenu SOTF (Switch on to Fault) (P123 only)

With the Switch On To Fault (SOTF) submenu, it is possible to shorten the time to trip when for example the relay has detected a fault that is still present on a feeder after energising.

Using this menu, when SOTF function is activated, it is possible to choose the origin of the circuit breaker closing command which will start the SOTF feature. One or several origins can be selected.

The SOTF function can be set using “Automatic Ctrl” menu, “Trip Command”, “Output relays” and “Inputs” submenus.

<b>AUTOMAT. CTRL</b>	
<b>SOTF</b>	Heading of SOTF submenu.
<b>Sotf?</b> Yes/No	Enables/Disables the SOTF function. If Yes is selected, the following menu is displayed. If No is selected, the SOTF submenu is not activated.
<b>t Sotf</b> 0.10 s	Set the time delay value (tSotf) associated to the SOTF function , from 0 to 500ms (step 10ms).  The SOTF/TOR tripping time delay is useful for some cases of serious transient or when three poles don't close at the same time, or when the CB doesn't close instantaneously.
<b>I&gt;&gt;?</b> No	Setting choice Yes: The crossing of the I>> threshold activates the SOTF function. The timer t Sotf starts its countdown on crossing of the I>> threshold, and once elapsed, the relay issues a trip order.  Setting choice No: The crossing of the I>> threshold doesn't activate the SOTF function.
<b>I&gt;&gt;&gt;?</b> No	As above for I>>> threshold.
<b>Ctrl close input</b> Yes/No	Enables/disables the possibility to start the SOTF function by the dedicated logic input “Ctrl Close”. This “Ctrl Close” input should be assigned to input 1, 2, 3 or 4 using “Automat. ctrl/Inputs” menu.
<b>SOTF Input</b> Yes/No	Enables/disables the option to start the SOTF function by the dedicated logic input “SOTF”. This “SOTF” input should be assigned to input 1, 2, 3 or 4 using “Automat. ctrl/Inputs” menu.
<b>HMI closing order:</b> Yes/No	Enables/disables the possibility to start the SOTF function by a user's manual closing order, using interface.
<b>[79] closing</b> Yes/No	Enables/disables the possibility to start the SOTF function by an internal autoreclose order.
<b>Front comm. order</b> Yes/No	Enables/disables the possibility to start the SOTF function by a front port communication order.
<b>Rear comm. order</b> Yes/No	Enables/disables the possibility to start the SOTF function with an order sent to the rear port communication.

## 2.9.14 Submenu Logic Equations (P121, P122 &amp; P123 only)

## 2.9.14.1 Parameters

With the Logic Equations submenu, it is possible to form complex Boolean functions using NOT, AND and OR operators (indicated from highest to lowest priority). Up to 16 operands can be used in any single equation. The following logic signals are available for mapping to an equation:

Function	P121	P122	P123	Information
<b>Null</b>	X	X	X	the condition is null (low level)
<b>Not Null</b>	X	X	X	the condition is not null (high level)
<b>I&gt;</b>	X	X	X	Instantaneous first phase overcurrent threshold
<b>tl&gt;&gt;</b>	X	X	X	Time delayed second phase overcurrent threshold
<b>I&gt;&gt;</b>	X	X	X	Instantaneous second phase overcurrent threshold
<b>tl&gt;</b>	X	X	X	Time delayed first phase overcurrent threshold
<b>I&gt;&gt;&gt;</b>	X	X	X	Instantaneous third phase overcurrent threshold
<b>tl&gt;&gt;&gt;</b>	X	X	X	Time delayed third phase overcurrent threshold
<b>le&gt;</b>	X	X	X	Instantaneous first earth overcurrent threshold
<b>tle&gt;</b>	X	X	X	Time delayed first earth overcurrent threshold
<b>le&gt;&gt;</b>	X	X	X	Instantaneous second earth overcurrent threshold
<b>tle&gt;&gt;</b>	X	X	X	Time delayed second earth overcurrent threshold
<b>le&gt;&gt;&gt;</b>	X	X	X	Instantaneous third earth overcurrent threshold
<b>tle&gt;&gt;&gt;</b>	X	X	X	Time delayed third earth threshold
<b>I2&gt;</b>		X	X	Instantaneous first phase negative sequence threshold
<b>tl2&gt;</b>		X	X	Time delayed negative phase sequence (1 <sup>st</sup> threshold)
<b>I2&gt;&gt;</b>		X	X	Instantaneous second phase negative sequence threshold
<b>tl2&gt;&gt;</b>		X	X	Time delayed negative phase sequence (2 <sup>nd</sup> threshold)
<b>Th. Al.</b>		X	X	Thermal alarm output signal (thermal alarm)
<b>Th. Tr.</b>		X	X	Trip on Thermal overload (thermal trip)
<b>I&lt;</b>		X	X	Instantaneous undercurrent threshold
<b>tl&lt;</b>		X	X	Time delayed undercurrent
<b>Brk Co.</b>		X	X	broken conductor.
<b>Reclos.</b>			X	Autoreclose final trip
<b>tAux 1</b>	X	X	X	Copy of the status of the Logic Input tAux 1
<b>tAux 2</b>	X	X	X	Copy of the status of the Logic Input tAux 2
<b>tAux 3</b>		X	X	Copy of the status of the Logic Input tAux 3
<b>tAux 4</b>			X	Copy of the status of the Logic Input tAux 4
<b>tAux 5</b>			X	Copy of the status of the Logic Input tAux 5
<b>Input 1</b>	X	X	X	Instantaneous digital input 1
<b>Input 2</b>	X	X	X	Instantaneous digital input 2
<b>Input 3</b>	X	X	X	Instantaneous digital input 3

Function	P121	P122	P123	Information
Input 4	X	X	X	Instantaneous digital input 4
Input 5	X	X	X	Instantaneous digital input 5
79 e. bl			X	Autoreclose lock activated by the input "block 79" (External Blocking)
79 I bl			X	Autoreclose lock activated by the internal process of the autoreclose (Internal Blocking)
le>>>>		X	X	Derived earth overcurrent threshold.
tle>>>>		X	X	Time delayed derived earth overcurrent threshold.

2.9.14.2 Interface

The Logic equation has the following structure:

- "Equation A.00" to "Equation A.15" views are accessible using and keys,
- Pressing key will open "T Operate" menu.

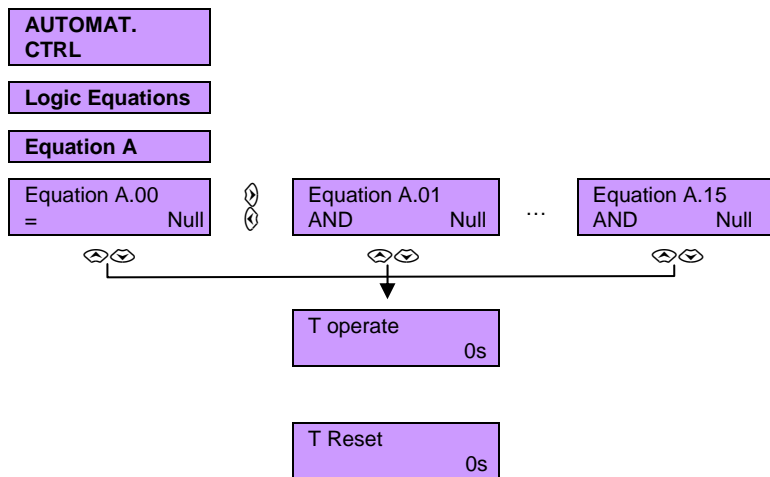

In order to modify an "Equation A.xx" menu:

- Press key to access to the menu (if necessary, enter password).

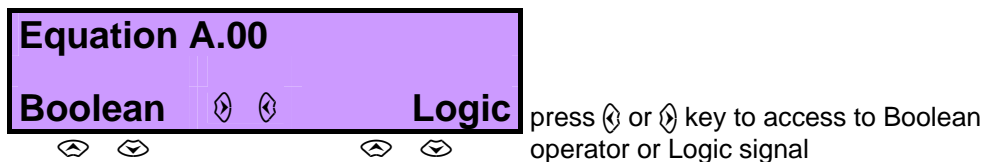

press or key to modify the corresponding value.

- Press to validate or to cancel the setting.

**AUTOMAT. CTRL**

**Logic Equations**

**Equation A**

Heading of Equation A submenu.

The following submenu is identical from A.01 to A.15.

**Equation A.00**  
= **Null**

Boolean function (left lower part of the LED panel): selects the Boolean function associated to the logic signal. Presence or not presence of the corresponding logic signal can be selected and combined to the previous equation with an OR or AND condition.

Setting choices:

- for A.00: "=", "= Not"

- for A.01 to A.15: "OR", "OR NOT", "AND" or "AND NOT",

Note: AND operator has priority to OR operator (refer to the following note)

**Equation A.00**  
= **Null**

Logic signal (right lower part): Is used to select the logic signal corresponding to the Boolean equation. Refer to the previous table to see the text corresponding to each signal.

Setting Choice: Null and logic signals.

**T Operate**  
**0s**

The time of operation setting is used to set the minimum time of truth of the selected conditions before validating the truth of the logic operation.

Setting choice: from 0 to 600s, step 10ms

**T Reset**  
**0s**

The reset time sets a minimum time before the logic operation is not true when at least one condition is not true. Setting choice: from 0 to 600s, step 10ms

Example of Equation A settings:

Equation A.00 "= not" "tAux 1" + Equation A.01 "and not" "tAux 2" means not tAux 1 and not tAux 2.

Note: AND operator has priority on OR operator:

- "A or B and C" means "A or (B and C)".
- To obtain "A and (B or C)", select "A and B or A and C".

**2.10 RECORDS Menu (P120, P122 and P123 only)**

Through the RECORDS menu, stored data, events, disturbances and monitoring information can be displayed and read.

The different submenus are:

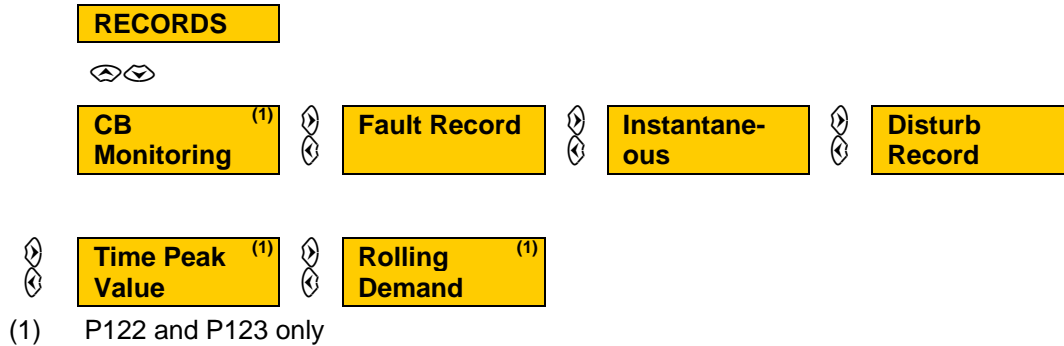

**2.10.1 CB MONITORING submenu (P122, P123 only)**

Through the CB Monitoring submenu, it is possible to read and clear counter values associated with the circuit breaker.

NOTE: The following counters may be reset to zero, for example, following a maintenance inspection and overhaul.

<b>RECORD</b>	Heading the RECORD menu.
<b>CB Monitoring</b>	Heading the CB Monitoring submenu.
<b>CB Opening Time</b> 95 ms	Displays the circuit breaker opening time (ms), measured between the trip command (Trip output relay) and the change of position of O/O (52a).
<b>CB Closing Time</b> 115 ms	Displays the circuit breaker closing time (ms), measured between the closing command (output auxiliary relay) and the change of position of O/O (52a).
<b>CB Operations</b> RST = [C] 5489	Displays the number of opening commands executed by the circuit breaker. To clear these values, press $\odot$ .
<b><math>\Sigma</math> Amps (n)</b> RST = [C]	Displays the summation of the current (in Amps or square Amps) interrupted by the CB. Stored current values for all 3 phases are cleared together. To clear these values, press $\odot$ .
<b><math>\Sigma</math> Amps (n) IA</b> 4 E4	Displays the summation value of the current (in Amps or square Amps) for phase A interrupted by the circuit breaker.
<b><math>\Sigma</math> Amps (n) IB</b> 2 E4	As above for phase B.
<b><math>\Sigma</math> Amps (n) IC</b> 8 E3	As above for phase C.

## 2.10.2 Fault Record submenu

The Fault Record submenu makes it possible to read up to twenty five stored fault records. Information about a fault is recorded when a threshold is crossed.

<b>RECORD</b>	
<b>fault Record</b>	Heading of the fault Record submenu.
<b>Record Number</b> 2	Selection of the fault record number to be displayed (select either 1, 2, 3, 4 or 5).
<b>fault Time</b> 12:05:23:42	Displays the time when the fault was recorded. The format of the time is hh:mm:ss. In this example the fault was recorded at 12:05:23 pm (and 420ms).
<b>fault Date</b> 12/11/99	Displays the date when the fault was recorded. The format of the Date is DD/MM/YY. In this example, the fault was recorded on November 12th 1999.
<b>Active Set Group</b> 1	Displays the active setting group (1 or 2).
<b>Faulted Phase</b> Phase A	Displays the phase, where a fault occurred, for the chosen fault record. (NONE, phase A, B, C, EARTH, AB, AC, BC, or ABC).
<b>Threshold</b> I>>	Displays the origin of the fault that generated the trip order.
<b>Magnitude</b> 1200 A	Displays the magnitude value of the fault: Voltage, current, earth power. The value is based on the amplitude at 50 or 60 Hz.
<b>IA Magnitude</b> 1200 A	Displays the magnitude value of the phase A current at the time of the fault.
<b>IB Magnitude</b> 500 A	As above for phase B.
<b>IC Magnitude</b> 480 A	As above for phase C.
<b>In Magnitude</b> 103 A	As above for earth current.

## 2.10.3 INSTANTANEOUS submenu

Through the INSTANANEOUS submenu, it is possible to read recorded values associated with the crossing of a threshold (start information).

<b>RECORDS</b>	
<b>Instantaneous</b>	Heading of the Instantaneous submenu.
<b>Number</b> 5	Select the number of Instantaneous records to be displayed (maximum 5).

<b>Hour</b> 13:07:15:53	Displays the time when the instantaneous record was recorded. The format of the time is hh:mm:ss: ms. In this example the fault was recorded at 1:07:15 pm and 530 ms.
<b>Date</b> 12/11/01	Displays the date when the instantaneous record was recorded. The format of the Date is DD/MM/YY. In this example, the fault was recorded on November 12th 2001.
<b>Origin</b> le>	Displays which threshold has been crossed.
<b>Length</b> 57 ms	Displays the period of time during which the threshold has been exceeded.
<b>Trip</b> No	Displays if a trip followed the crossing of the threshold or not.

2.10.4 DISTURBANCE RECORD submenu

The Disturb Record submenu makes it possible to set and read disturbance records. Each disturbance record consists of analog and digital data. Up to 9 seconds disturbance record(s) duration can be stored (5 x 3s, 4 x 3s, 3 x 5s, 2 x 7s or 1 x 9s). The beginning of the record can be adjusted with a selected pre-time.

<b>RECORD</b>	
<b>Disturb Record</b>	Heading of the Disturb Record submenu.
<b>Records number ?</b> 5	Setting choices: 1, 2, 3, 4 or 5. Sets the disturbance record length. This setting choice adjusts the number of records according to the record length. Setting choice allows 5 records of 3 seconds, 4 records of 3 seconds, 3 records of 5 seconds, 2 records of 7 seconds or 1 record of 9 seconds. (P122 and P123 only)
<b>Pre-Time</b> 0.2 s	Set the disturbance record pre-time, from 100ms to 3s (step 100ms). The pre-time adjusts the beginning of the disturbance record: In this example, the record starts 200ms before the disturbance. Its length is fixed (except P120).
<b>Post-Time</b> 0.2 s	P120 only: Set the disturbance record post-time, from 100 ms to 3s (step 100ms). The total disturbance recording time is 3 seconds (pre-time + post-time).
<b>Disturb Rec Trig</b> ON INST.	Select which criteria will start the disturbance record function. Setting choices are ON INST. (starts recording on instantaneous thresholds) or ON TRIP (starts recording after a trip happened).

2.10.5 Time PEAK VALUE submenu (P122, P123 only)

The Time PEAK VALUE submenu makes it possible to set parameters associated to this function. (Peak and Average values displayed in the Measurements menu)

<b>RECORD</b>	
<b>Time Peak Value</b>	Heading of the Time Peak Value submenu.
<b>Time Window</b> 5 mn	Set the value for the time window during which peak and average values are stored, Select choice: 5mn, 10mn, 15mn, 30mn, or 60mn.



## 2.10.6 ROLLING DEMAND submenu (P122, P123 only)

The Rolling Demand submenu makes it possible to set the values for rolling sub-period and number of the sub-period used for the calculation of the 3 phase Rolling Average and peak demand values, available in the Measurement menu.

**RECORDS**

**Rolling Demand**

Heading of the Rolling Demand submenu.

**Sub period**

**1 mn**

Set the window of time of the subperiod used to calculate rolling average values, from 1mn to 60mn (step 1mn)

**Num of Sub Per**

**1**

Select the number of sub-period used for the calculation of the average of these average values.

### 3. WIRING

**MiCOM P120** range of relays have the same terminal layout for common elements. The wiring diagram for each model is provided in Appendix 1 of the Technical Guide.

#### 3.1 Auxiliary supply

The auxiliary power supply for the **MiCOM P120, P121, P122 & P123** relays can be either direct current with a voltage range of 24-60 VDC, 48-250 VDC, or alternative current with a voltage range of 48-250 VAC/ 50-60 Hz or 24-250Vdc/24-240Vac. The voltage range (Ua) is specified on the adhesive paper label under the top hinged cover on the front of the relay.

**The auxiliary power supply must be connected only to terminals 33 and 34.**

#### 3.2 Current measurement inputs

**MiCOM P120, P121, P122 and P123** have 3 phase and 1 earth current inputs available for 1 and 5 Amps rated CTs. On each one of these relays, it is possible to combine 1 and 5 Amp current inputs together (i-e a mix between 1A for earth fault and 5A for phase connections) (refer to the wiring diagram).

NOTE: All phase inputs must have the same rating (1 or 5 Amps).

#### 3.3 Logic inputs

The number of logic inputs depends on the relay model. The relays have programmable opto-isolated logic inputs, which can be assigned to any available label or function.

Logic inputs for each relay model:

Model	P120	P121	P122	P123
Logic outputs	2	2	3	5

On the same MiCOM **P12x** relay, the user can mix different voltage levels as logic inputs are fully independent (e.g. Uaux = 48-250 Vdc, Input 1= 48 Vdc, Input 2-5= 110 Vdc).

If the user sets the supply of the logic input as AC they are active from 24 to 240Vac.

The automation functions that can be assigned to these logic inputs can be selected from the AUTOMAT. CTRL Menu.

NOTE: Do not forget to select in the CONFIGURATION/Configuration Inputs Menu whether the voltage input is "AC" or "DC".

#### 3.4 Output relays

The number of logic outputs depends on the relay model. The relays have configurable logic outputs, which can be assigned to any available function.

The number of logic outputs available for each relay model is presented in the following table:

Model	P120	P121	P122	P123
Logic outputs	5	5	7	9

The first logic output (RL0) is dedicated to indicate a relay fault (Watchdog, WD) and is not part of this table.

The normally closed (NC) contact of the Watchdog (RL0) can not be configured. The other contacts can be configured to be activated on activation of the different functions available in the relay. A basic output matrix is included in the relay.

Some logic outputs have changeover contacts (RL1 and RL2). The other relays (RL3, to RL 9) are normally open contacts.

The protection and control functions that can be assigned to these output relays can be selected from the AUTOMAT. CTRL Menu.

### 3.5 Communication

#### 3.5.1 RS485 rear communication port

All MiCOM relays have an RS485 rear communication port.

The terminals 29-30-31-32 are dedicated to the RS485 communication port. See wiring diagrams in chapter P12y/EN CO of the Technical Guide.

#### 3.5.2 RS232 front communication port (P120, P121, P122, P123)

**MiCOM P120, P121, P122 and P123** relays provide a RS 232 communication port. This port is dedicated to Setting software MiCOM S1.

The cable between the **relay** and the PC is a standard RS 232 shielded-cable.

The relay requires a RS232 cable with a 9-pin male connector.

The RS232 cable has to be wired as indicated below:

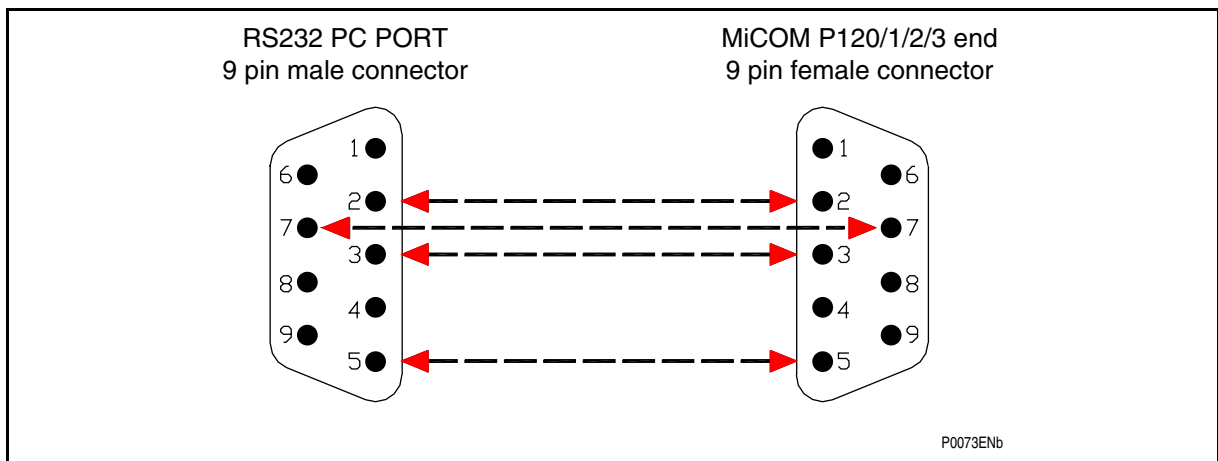

FIGURE 3: FRONT PANEL PORT COMMUNICATION RS232 CABLE WIRING

A USB/RS232 cable can also be used to communicate to the relay.

**BLANK PAGE**

# **MENU CONTENT TABLES**



## **CONTENTS**

---

<b>1.</b>	<b>MiCOM P120 – V11 SOFTWARE</b>	<b>3</b>
<b>2.</b>	<b>MiCOM P121 – V12 SOFTWARE</b>	<b>5</b>
<b>3.</b>	<b>MiCOM P122 – V12 SOFTWARE</b>	<b>8</b>
<b>4.</b>	<b>MiCOM P123 – V12 SOFTWARE</b>	<b>16</b>

**BLANK PAGE**



1. MiCOM P120 – V11 SOFTWARE

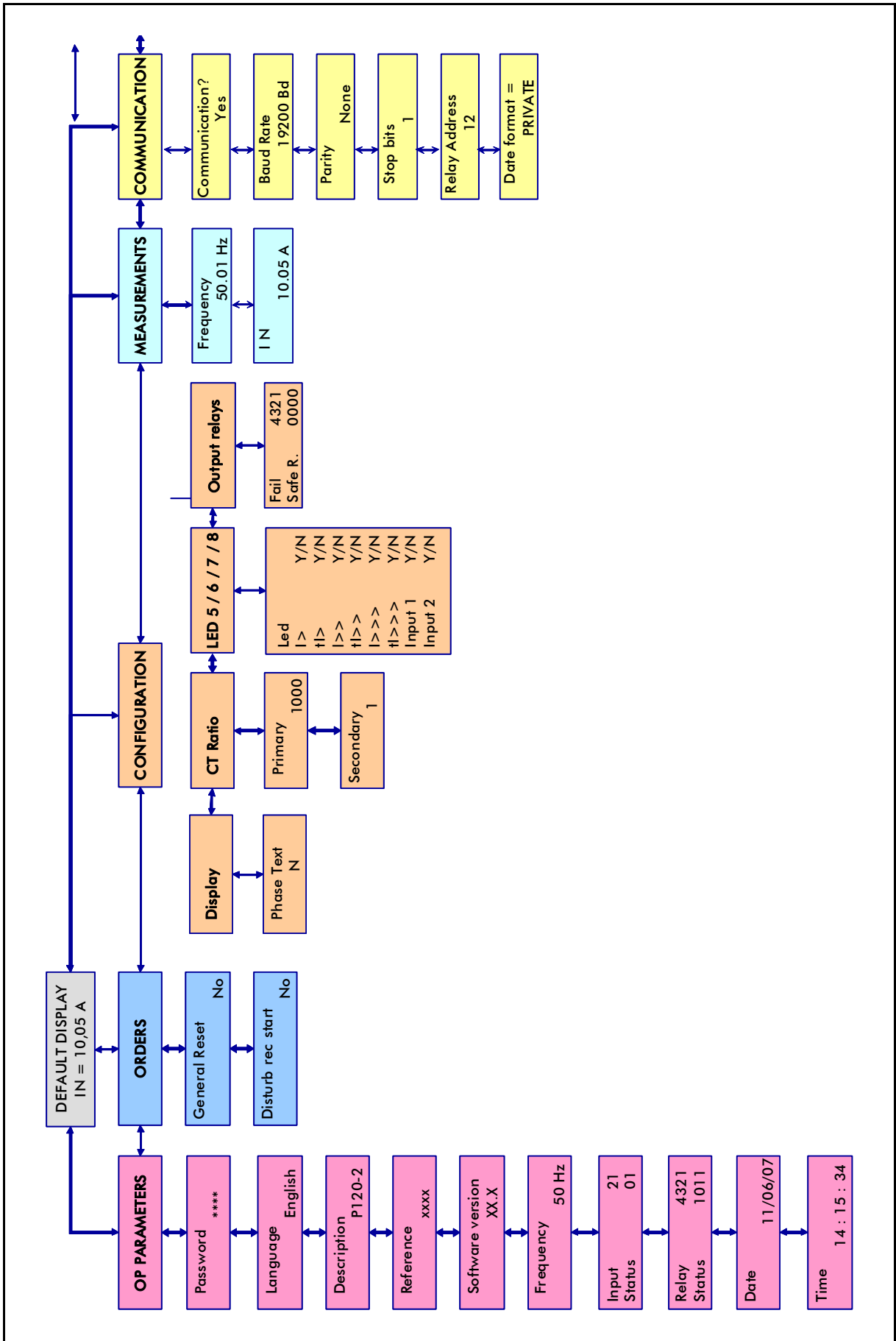

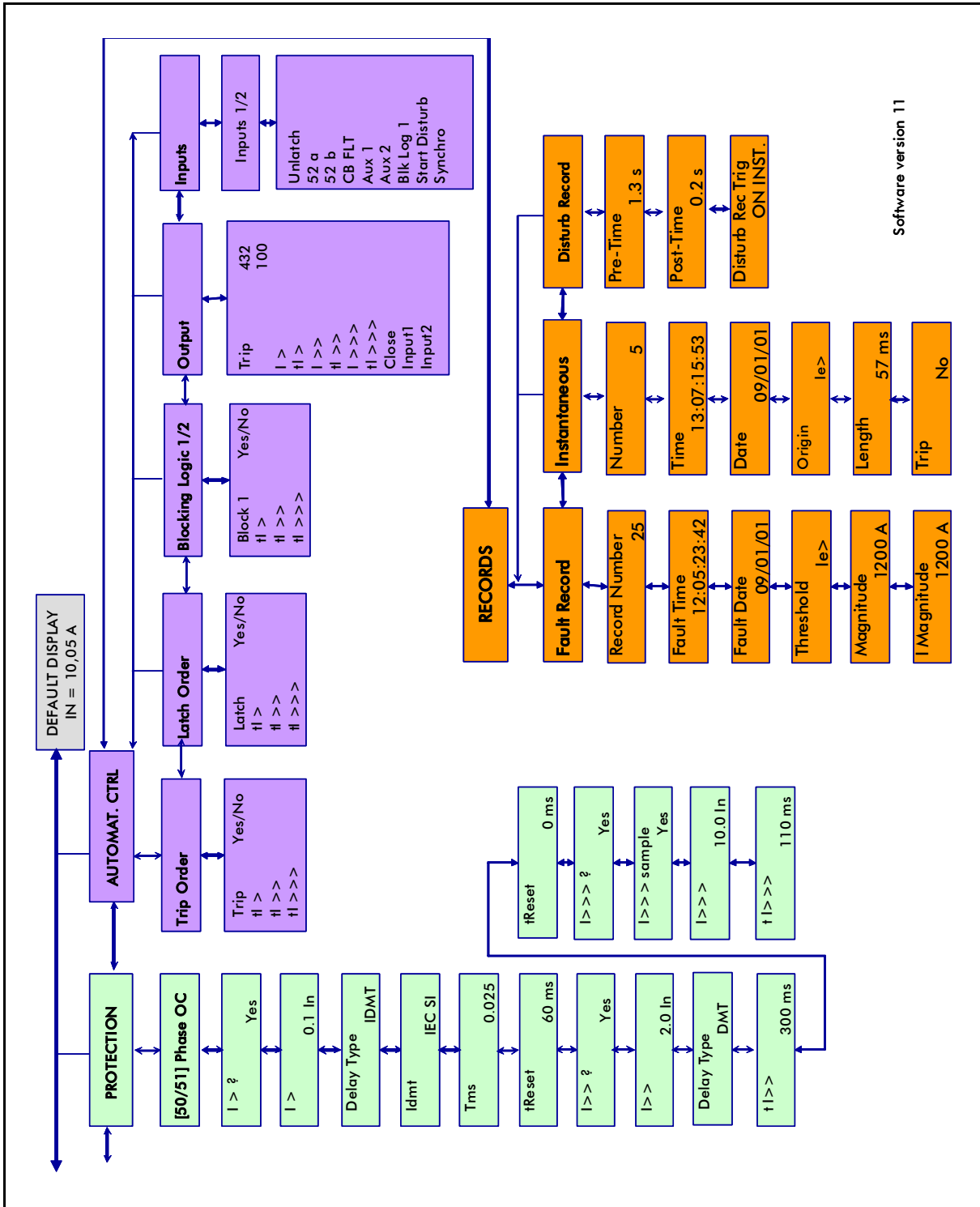

2. MiCOM P121 – V12 SOFTWARE

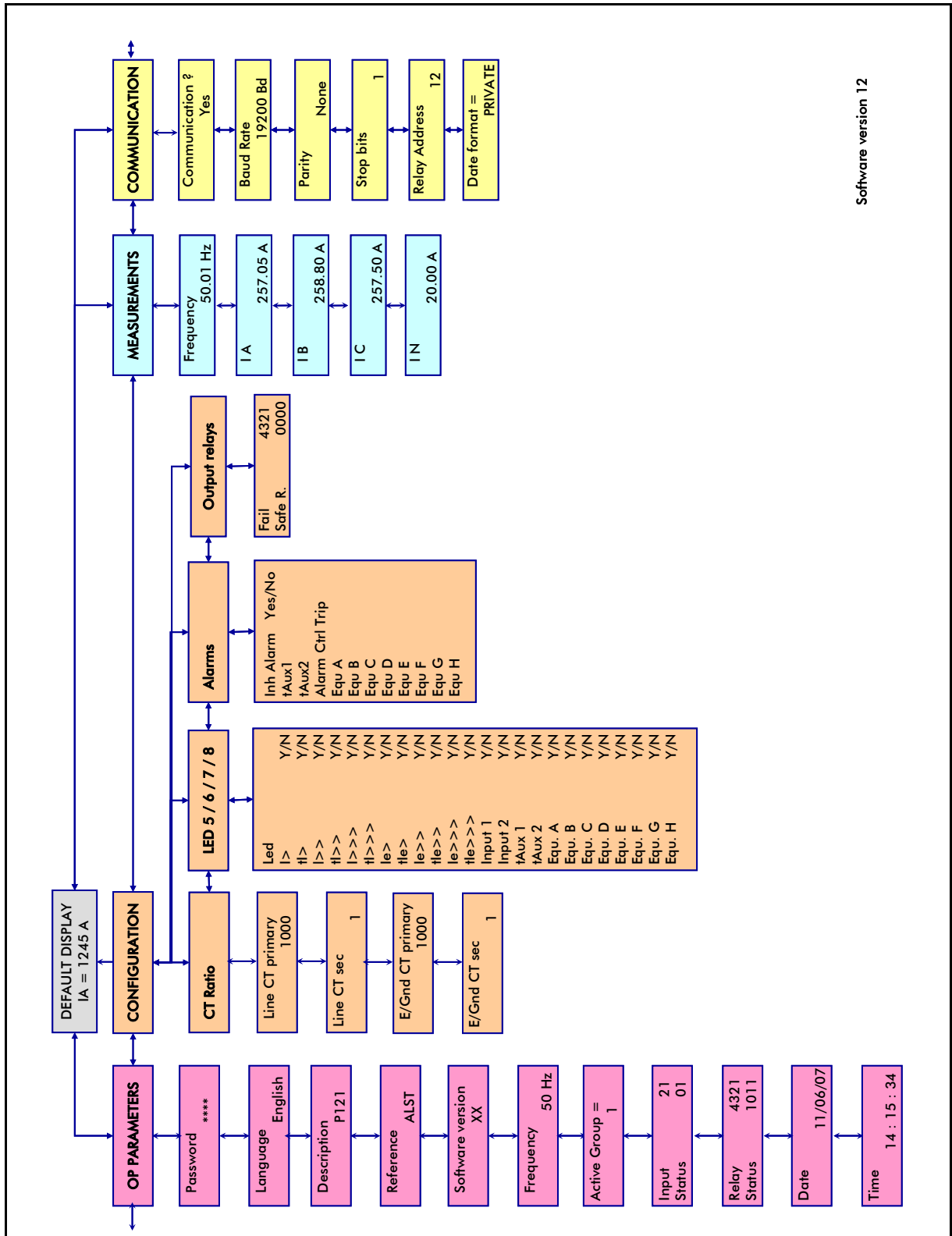

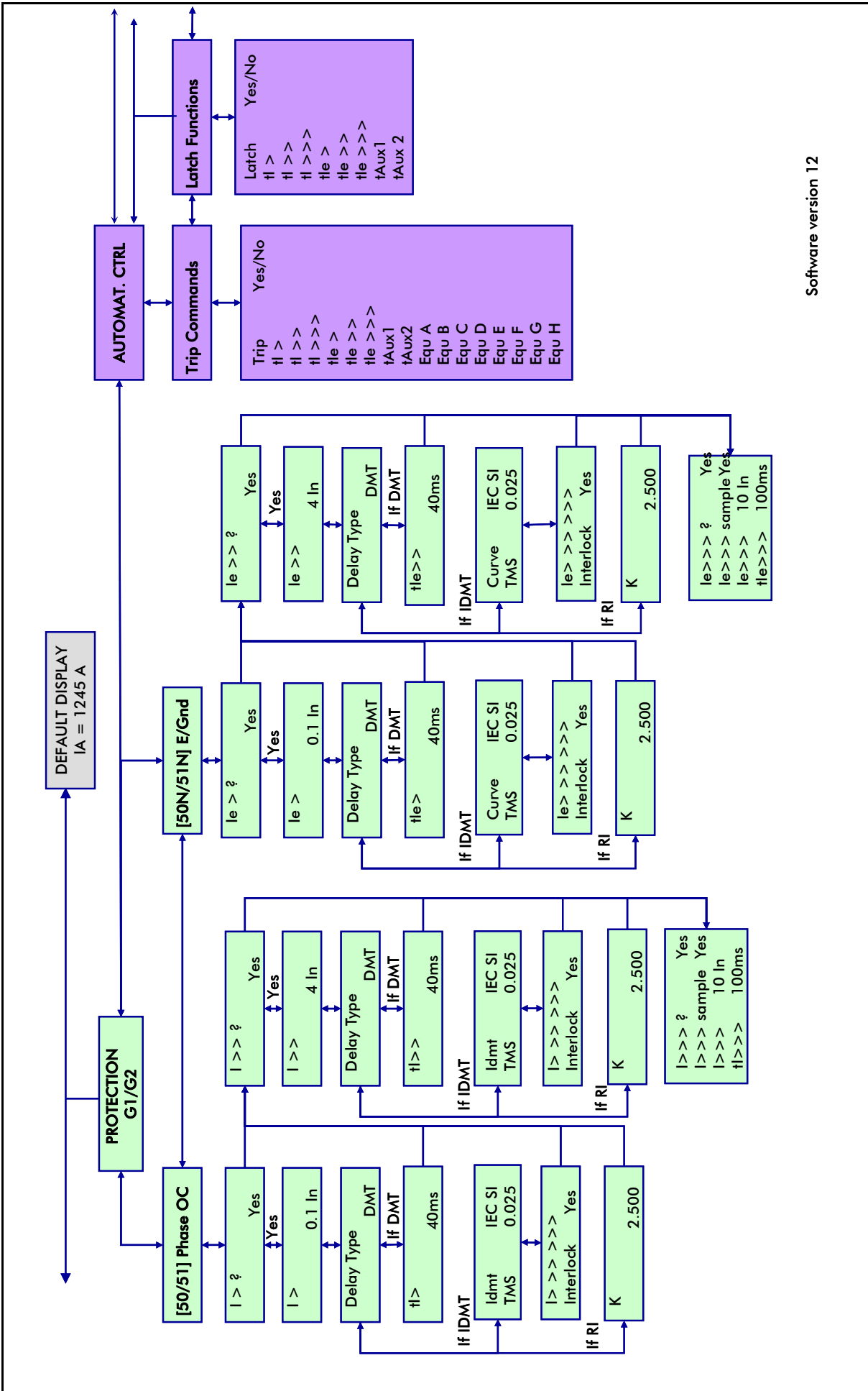

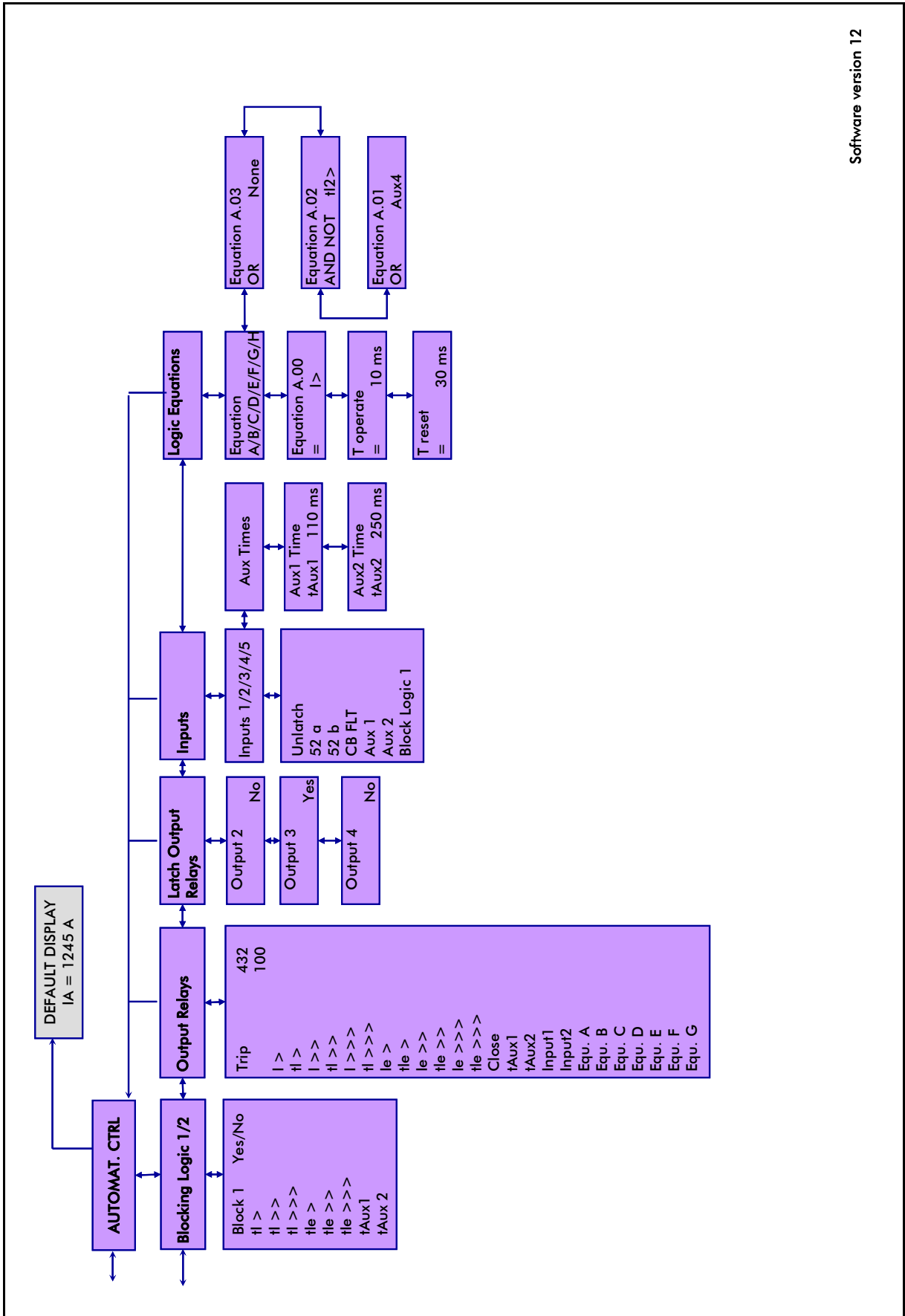

### 3. MiCOM P122 – V12 SOFTWARE

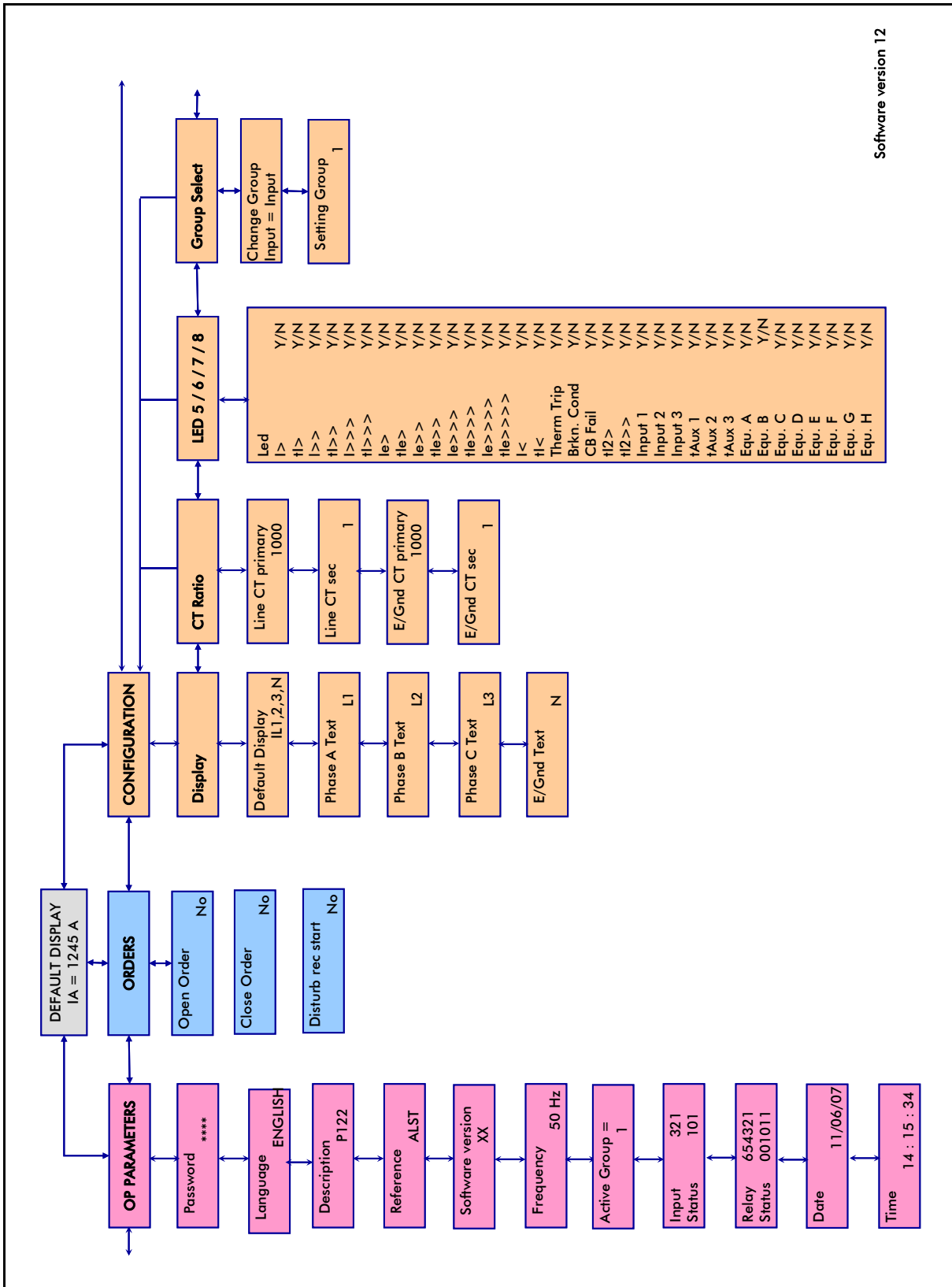

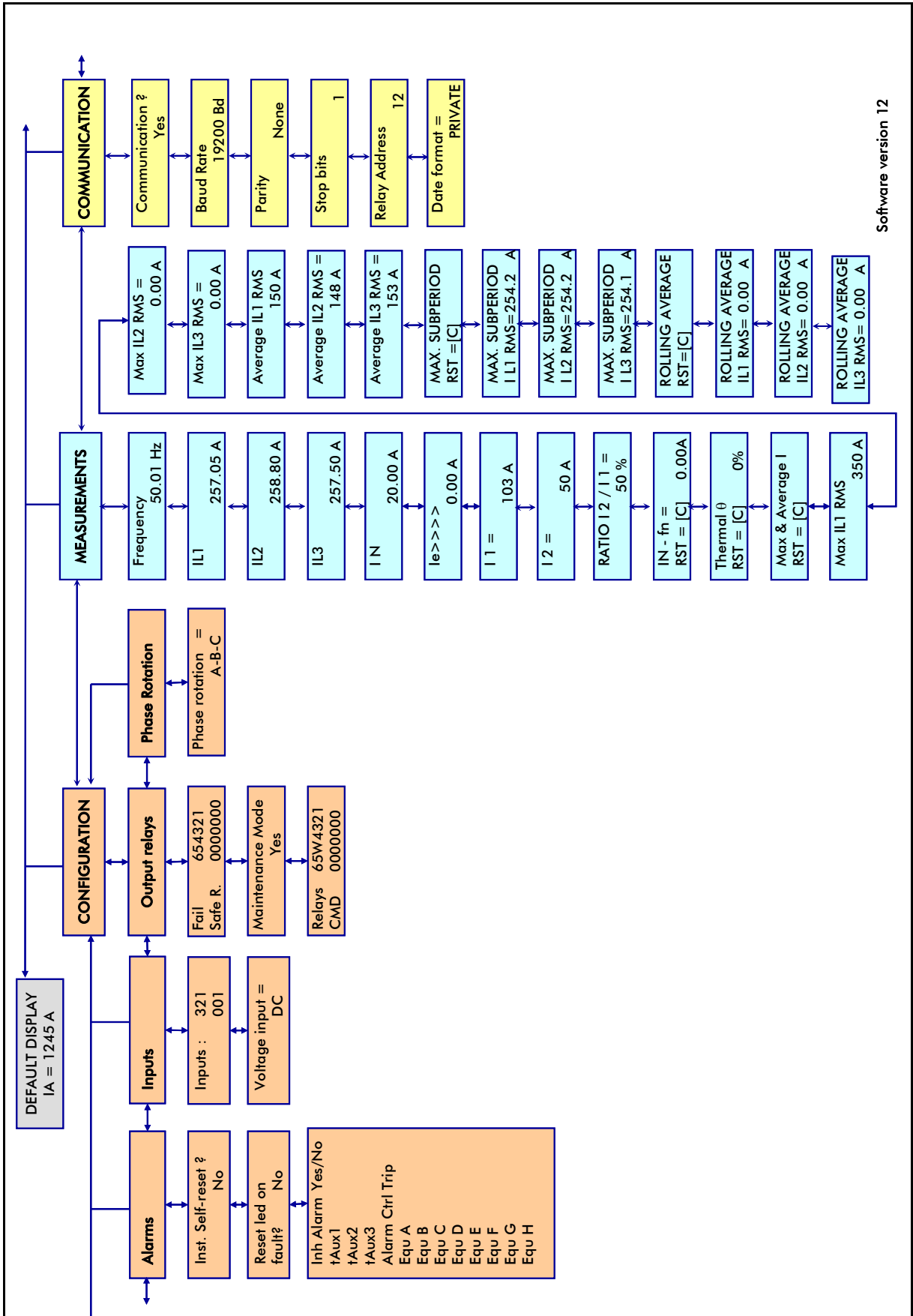

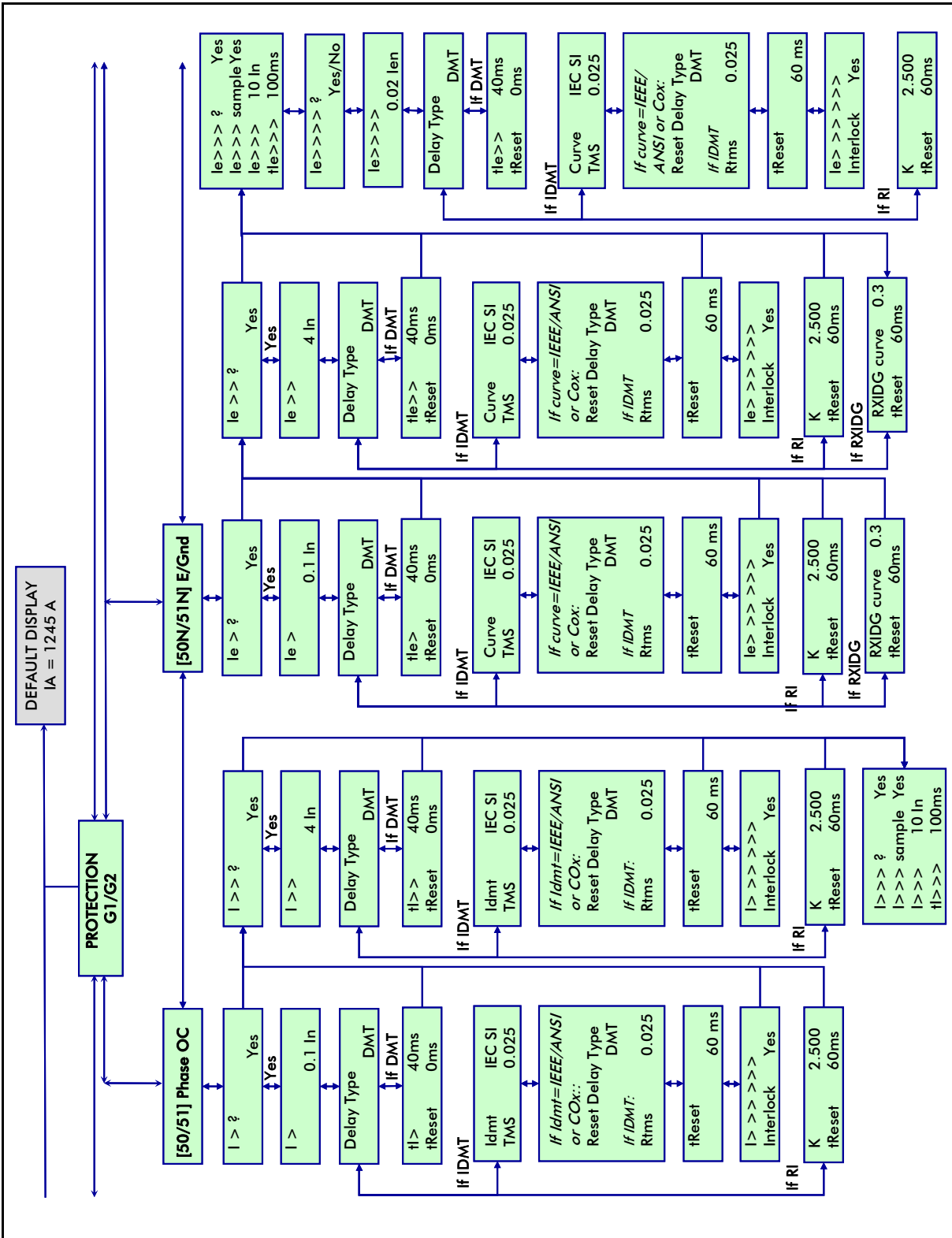



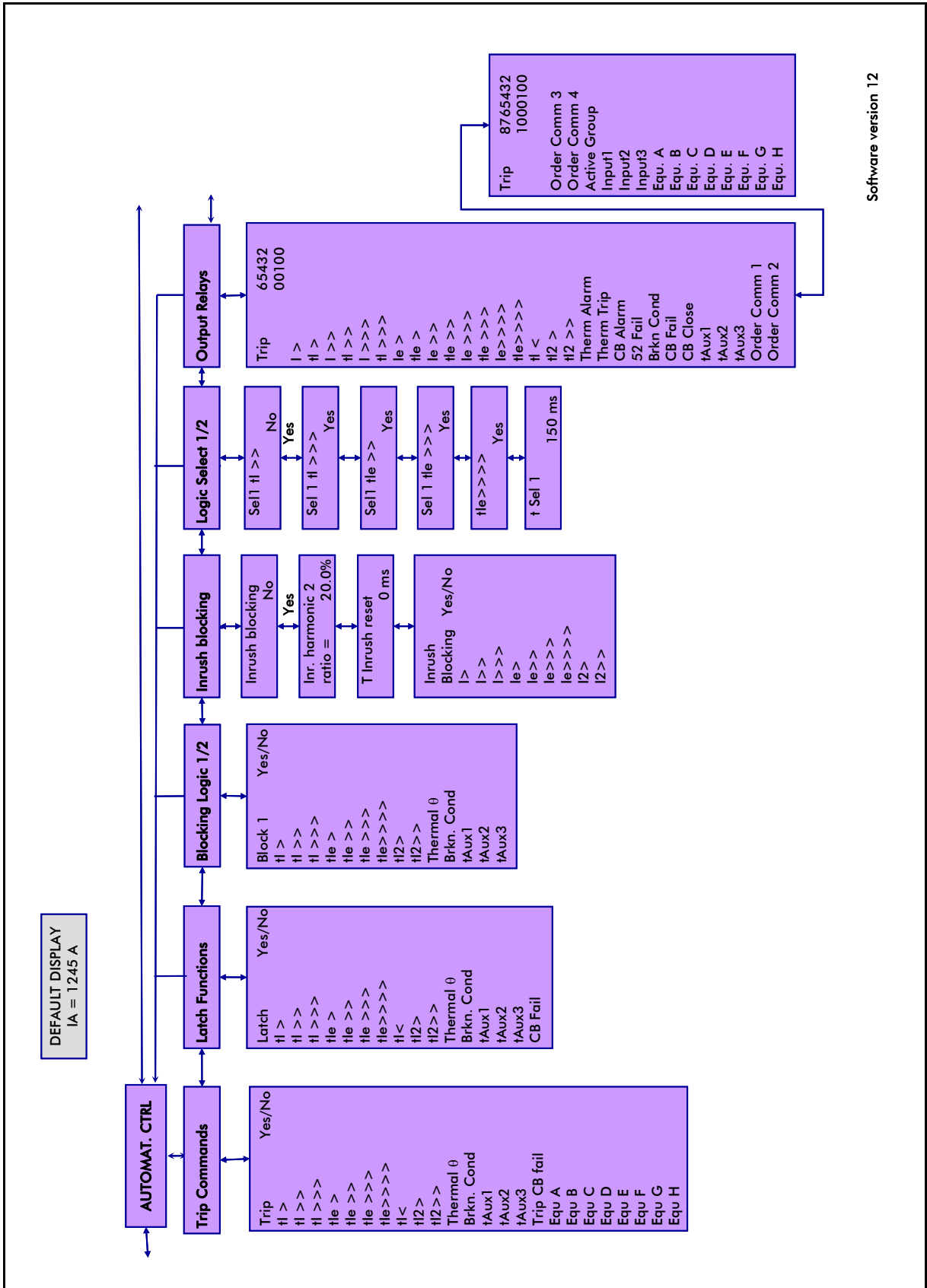

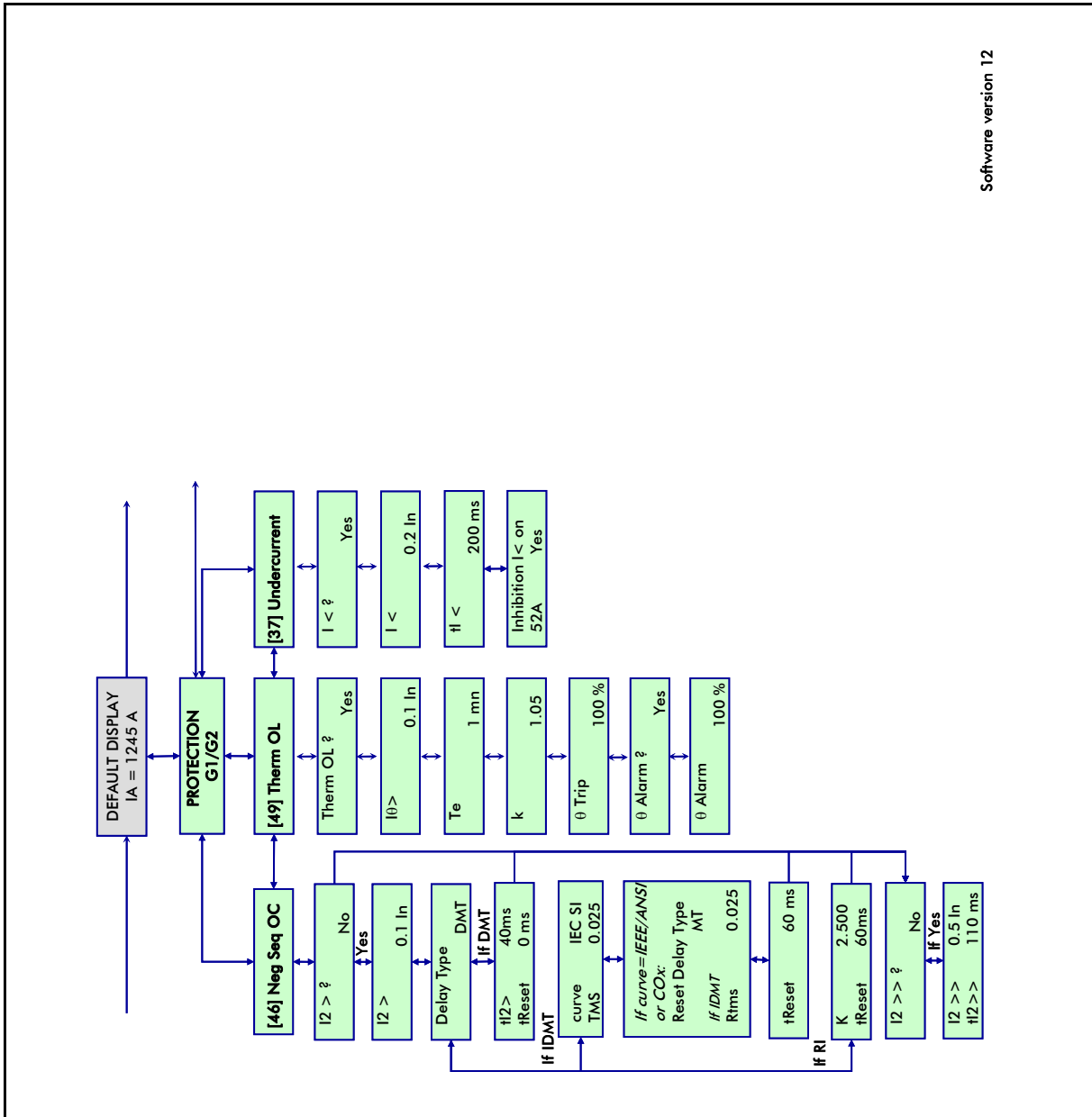

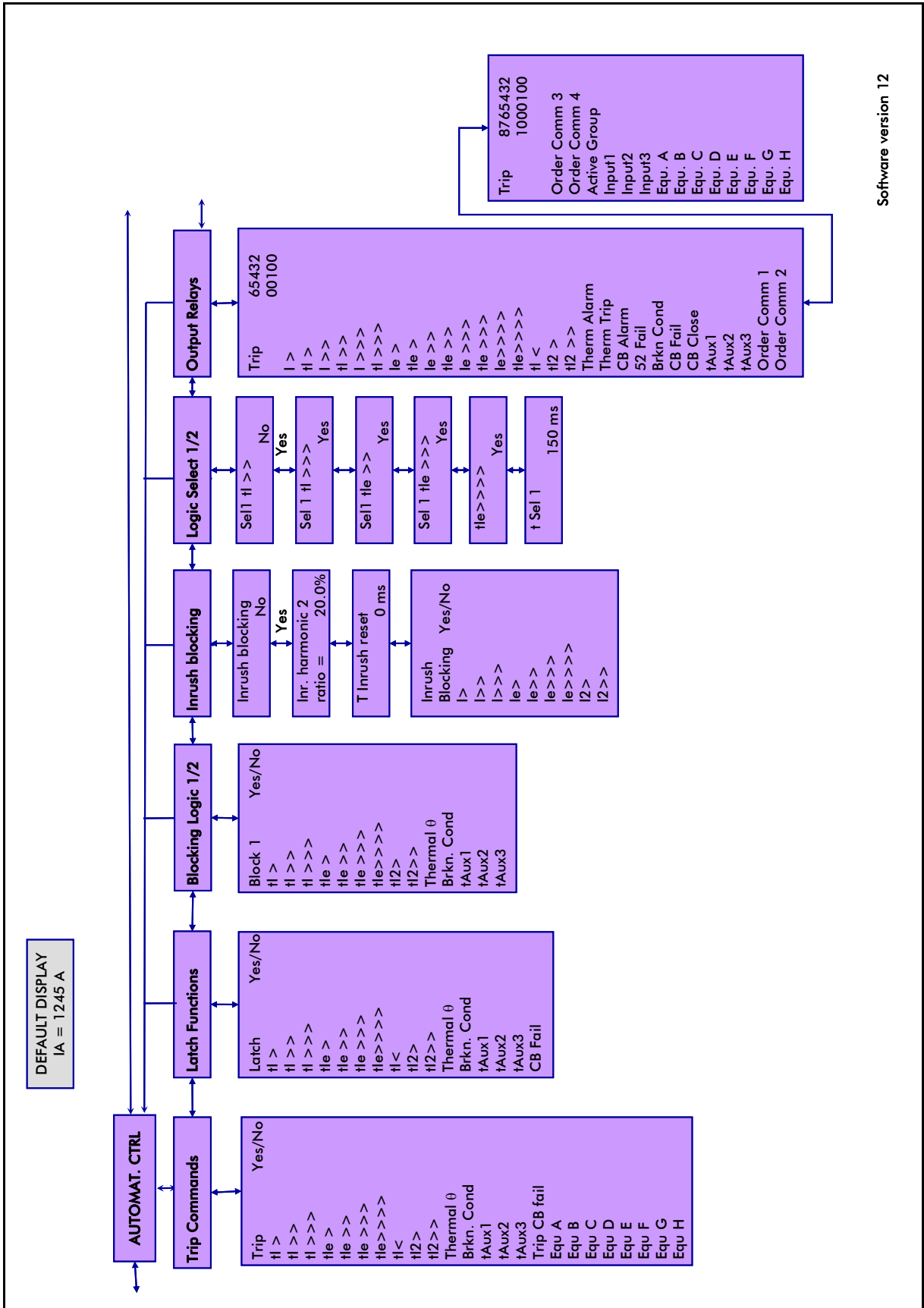

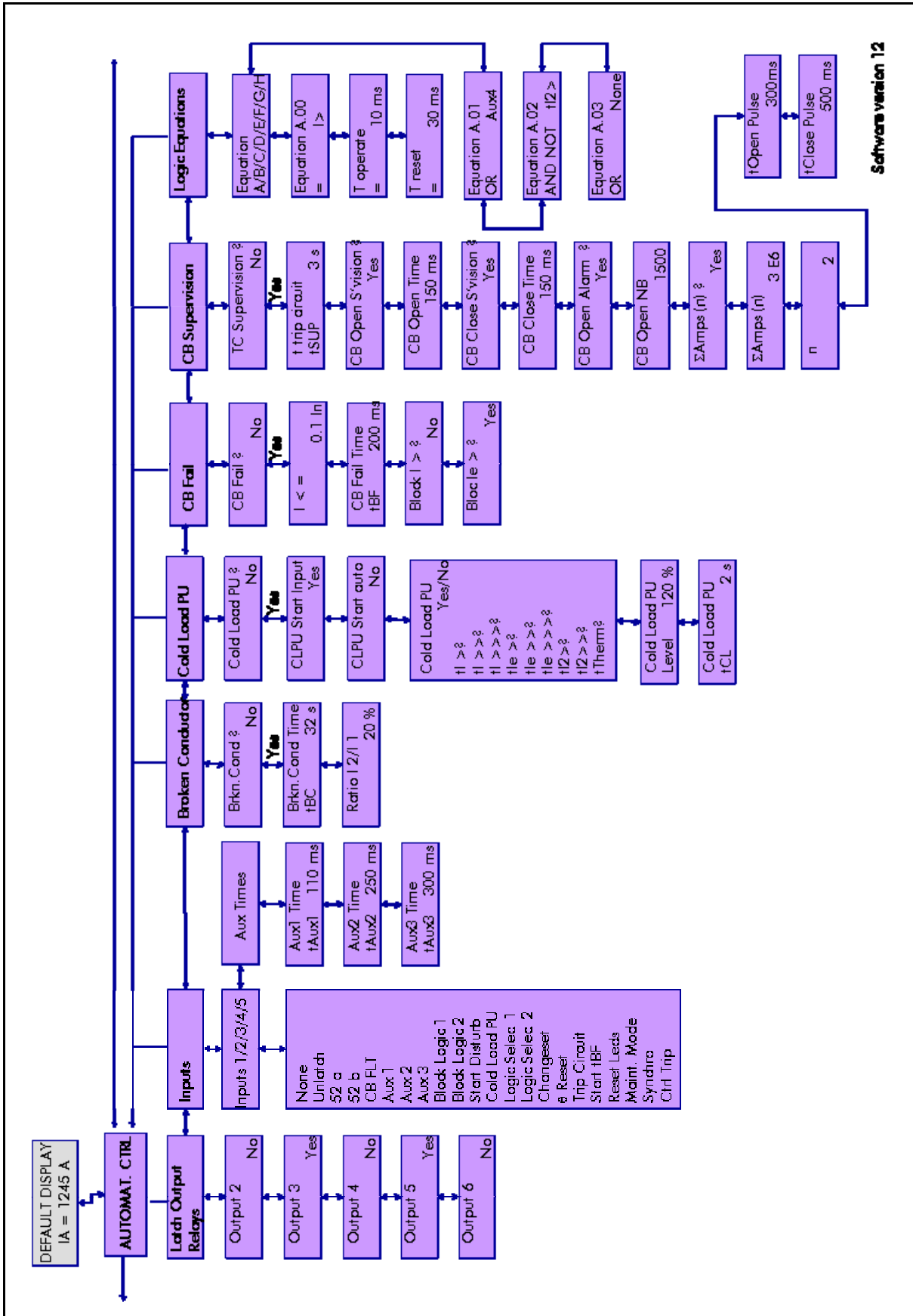

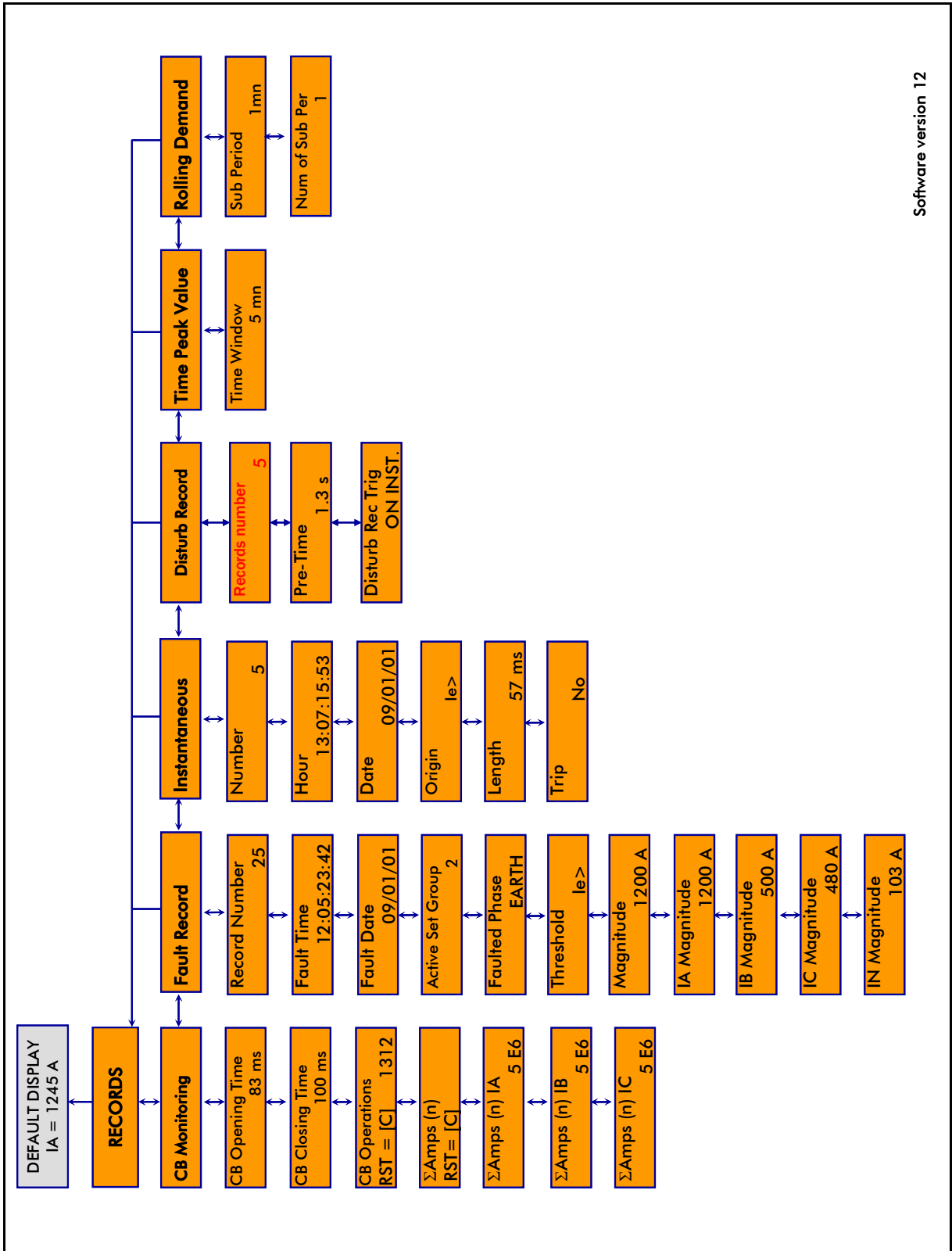

4. MiCOM P123 – V12 SOFTWARE

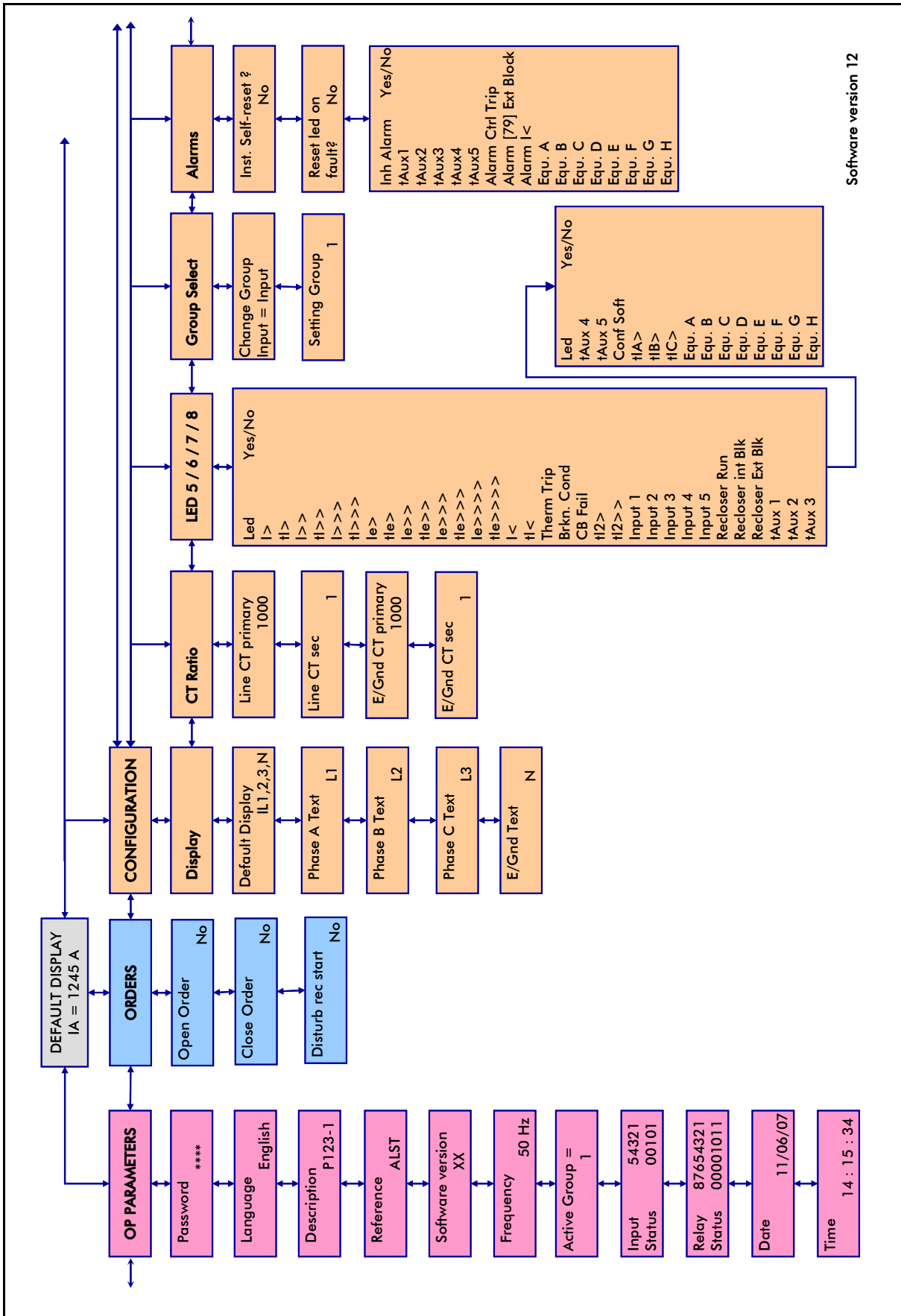

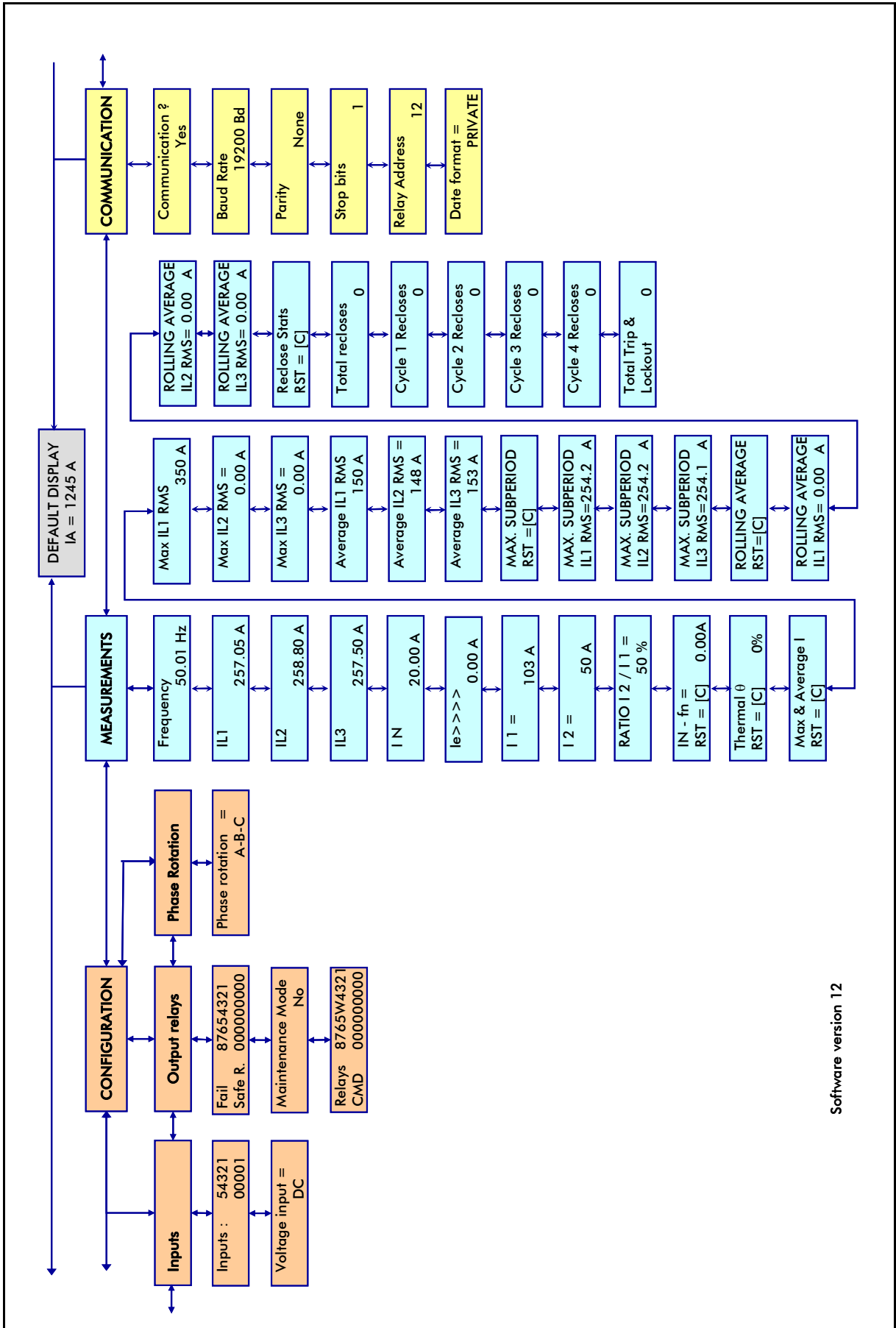

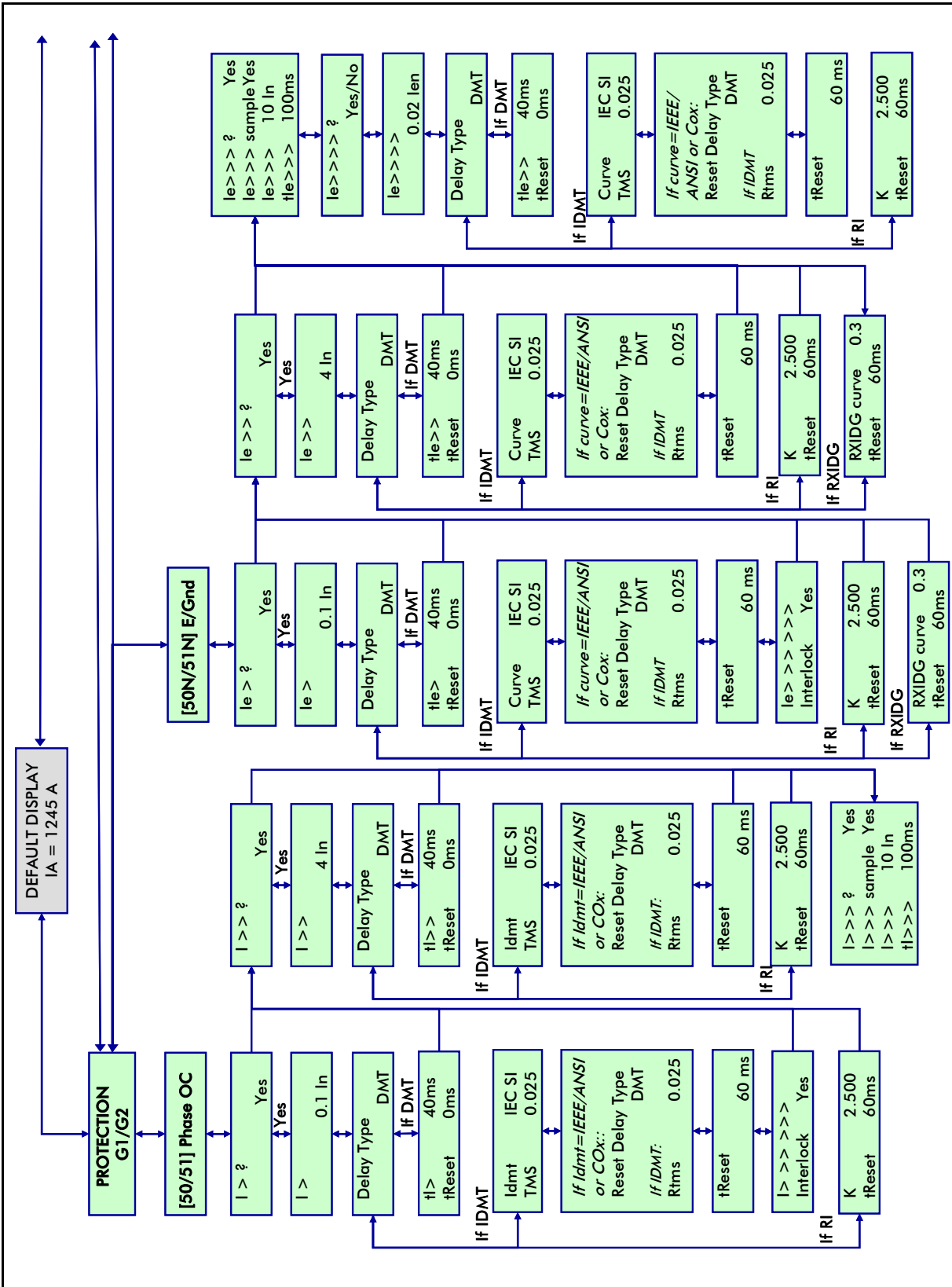



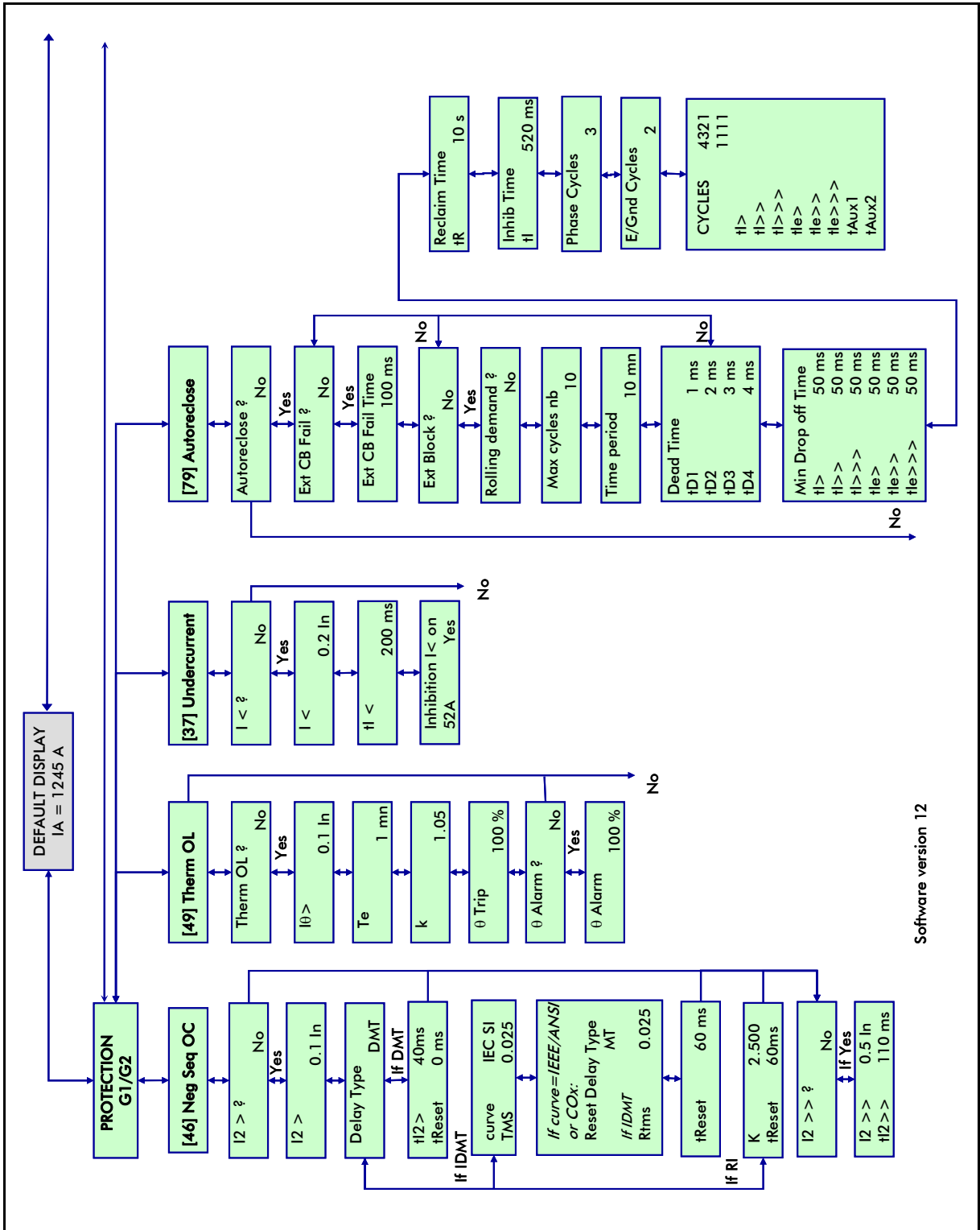

Software version 12

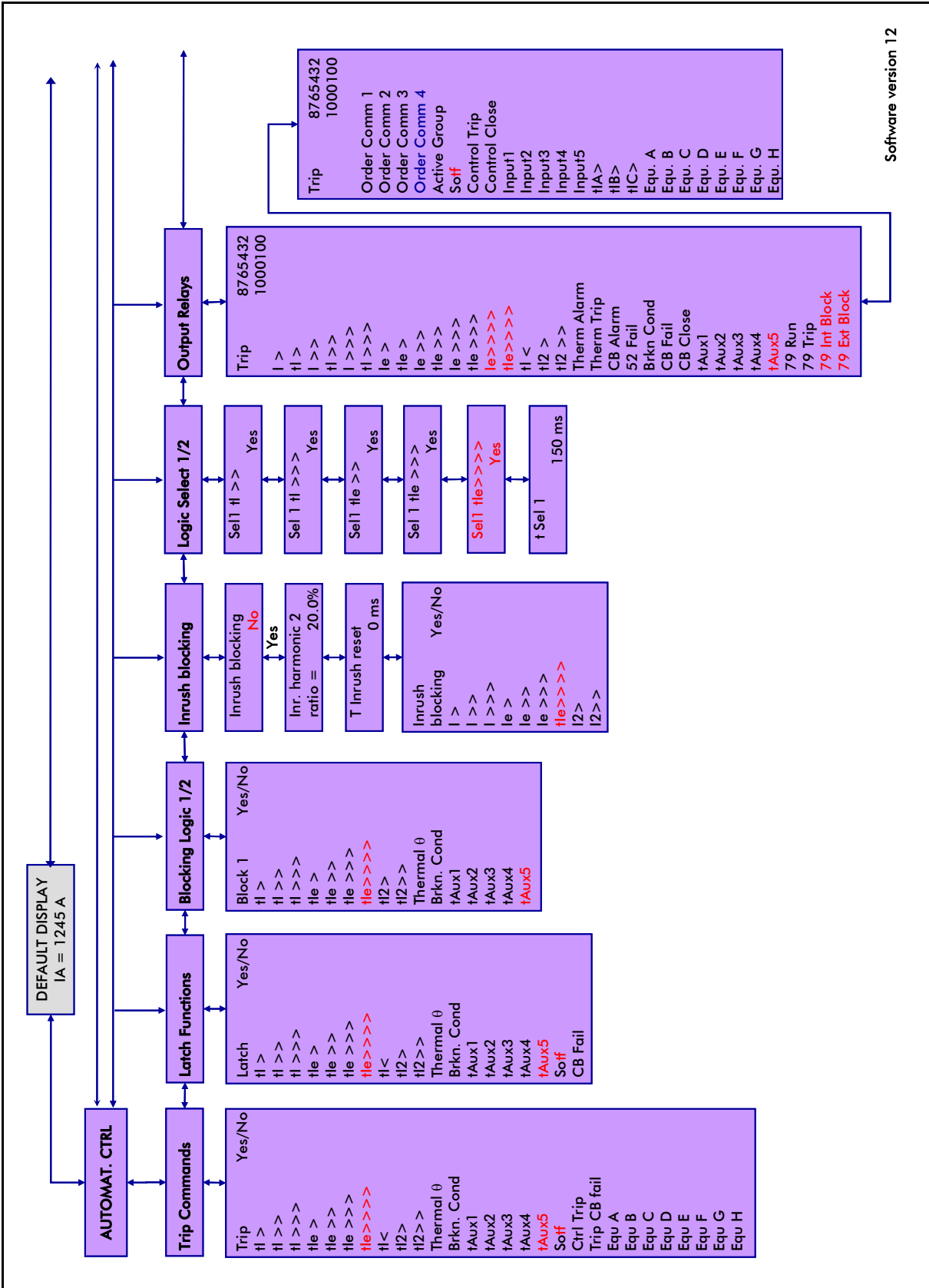

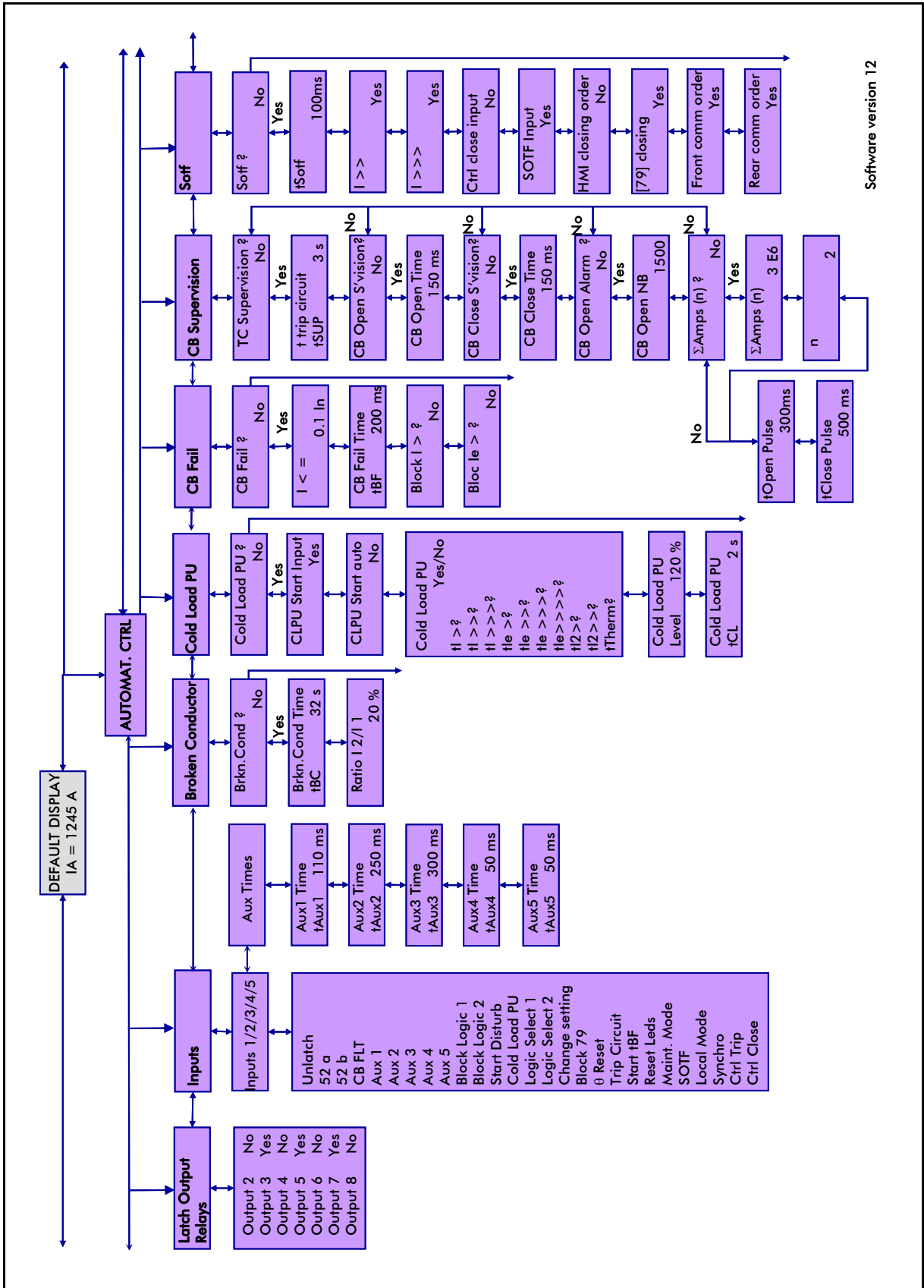

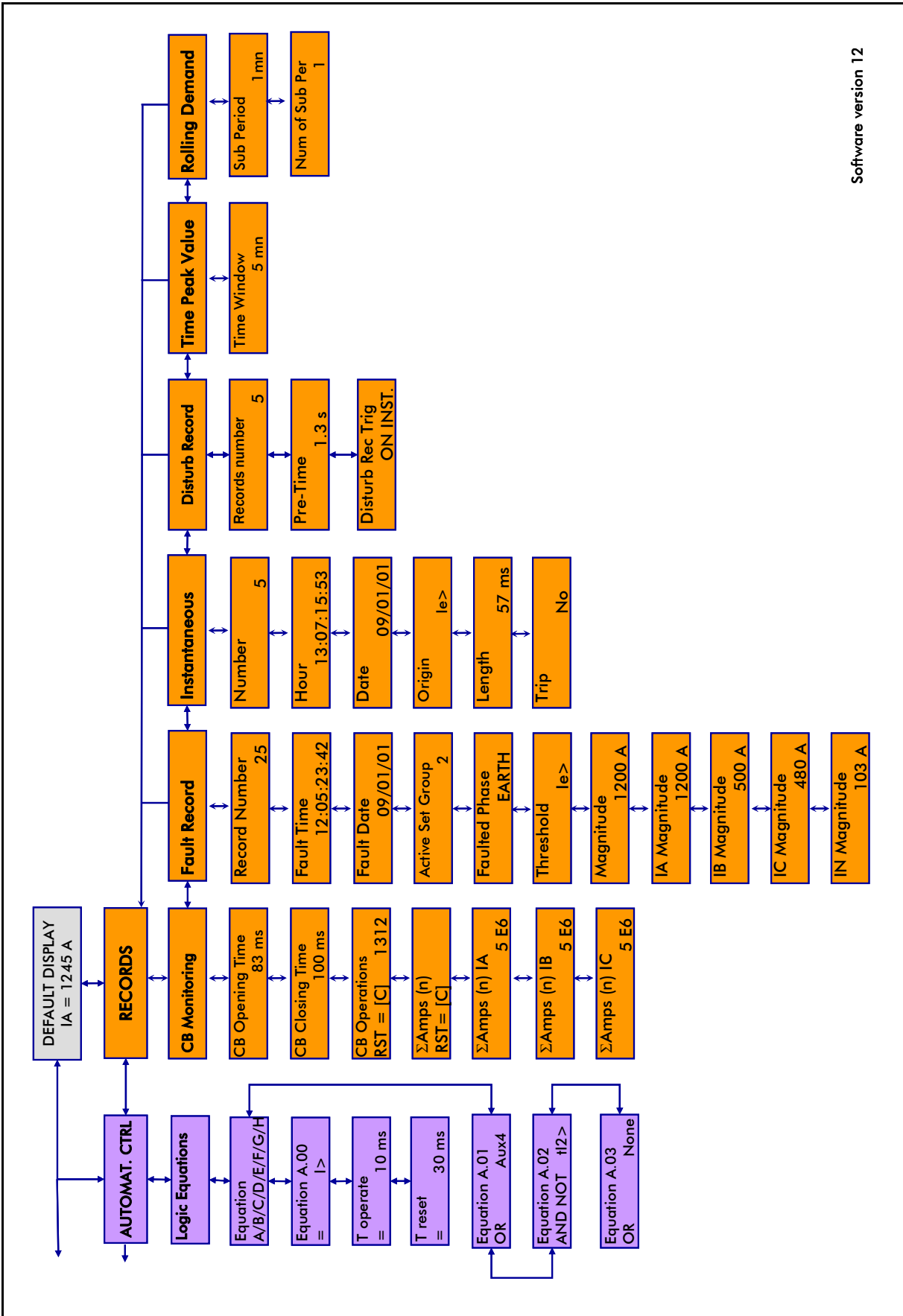

# **TECHNICAL DATA AND CHARACTERISTIC CURVES**



# CONTENT

<b>1.</b>	<b>RATINGS</b>	<b>7</b>
1.1	Power Supply	7
1.2	Frequency	7
1.3	Current Inputs	7
1.4	Phase and earth current transformers consumption	7
1.4.1	P12x phase CT consumption	7
1.4.2	P12x earth CT consumption	8
1.5	Logic Inputs	8
1.5.1	Supply	8
1.6	Output Relay Characteristic	9
<b>2.</b>	<b>INSULATION</b>	<b>10</b>
<b>3.</b>	<b>EMC TESTS</b>	<b>11</b>
<b>4.</b>	<b>ENVIRONMENT</b>	<b>12</b>
<b>5.</b>	<b>EU DIRECTIVE</b>	<b>13</b>
5.1	EMC compliance	13
5.2	Product safety	13
<b>6.</b>	<b>DEVIATION OF PROTECTION ELEMENTS</b>	<b>14</b>
<b>7.</b>	<b>DEVIATION OF AUTOMATION FUNCTIONS TIMERS</b>	<b>14</b>
<b>8.</b>	<b>DEVIATION OF MEASUREMENTS</b>	<b>14</b>
<b>9.</b>	<b>PROTECTION SETTING RANGES</b>	<b>15</b>
9.1	[50/51] Phase Overcurrent (P120, P121, P122 & P123)	15
9.1.1	Protection Setting Ranges	15
9.2	[50N/51N] Earth fault protection (P121, P122 & P123)	15
9.2.1	Protection Setting Ranges	16
9.3	Negative Sequence Overcurrent Protection (P122 & P123)	17
9.3.1	Protection Setting Ranges	17
9.4	Thermal Overload Protection (P122 & P123)	18
9.4.1	Protection Setting Ranges	18
9.5	Undercurrent Protection (P122 & P123)	18
9.5.1	Protection Setting Ranges	18

<b>9.6</b>	<b>Multishot Autoreclose Function (P123)</b>	<b>18</b>
9.6.1	Multishot Autoreclose Settings	19
9.6.2	Further timing	20
<hr/>		
<b>10.</b>	<b>AUTOMATION CONTROL FUNCTIONS</b>	<b>21</b>
10.1	Trip commands	21
10.2	Latch functions	21
10.3	Blocking logic (P122 & P123)	21
10.4	Second Inrush blocking logic (P122 & P123)	21
10.5	Logic select (P122 & P123)	22
10.6	Output relays	22
10.7	Latch of the auxiliary output relays (P121, P122 & P123)	22
10.8	Inputs	22
10.8.1	Inputs assignation	22
10.8.2	Auxiliary times	23
10.9	Broken Conductor Detection (P122 & P123)	23
10.9.1	Broken Conductor Detection Setting Ranges	23
10.10	Cold Load Pickup (P122 & P123)	23
10.11	Circuit Breaker Failure (P122 & P123)	23
10.11.1	CB Fail Setting Ranges	23
10.12	Trip Circuit Supervision (P122 & P123)	24
10.12.1	Trip Circuit Supervision Setting Ranges	24
10.13	Circuit Breaker Control and Monitoring (P122 & P123)	24
10.13.1	Setting Ranges	24
10.14	SOTF/TOR Switch on to fault / Trip on reclose (P123)	24
10.14.1	Setting Ranges	24
10.15	Logic Equation (P121, P122 & P123)	25
10.15.1	Timer Setting Ranges	25
10.15.2	Available logical gates	25
10.15.3	Available signals	26
<hr/>		
<b>11.</b>	<b>RECORDING FUNCTIONS (P120, P121, P122 &amp; P123)</b>	<b>28</b>
11.1	Event Records	28
11.2	Fault Records	28
11.3	Instantaneous recorder	28
11.4	Disturbance Records	28
11.4.1	Triggers; Data; Setting Ranges	28
<hr/>		
<b>12.</b>	<b>COMMUNICATION</b>	<b>29</b>



---

<b>13.</b>	<b>CURVES</b>	<b>30</b>
<b>13.1</b>	<b>General</b>	<b>30</b>
13.1.1	Inverse Time Curves:	30
13.1.2	RXIDG Curves (P122/P123 only):	31
13.1.3	Reset Timer	31
<b>13.2</b>	<b>Thermal Overload Curves</b>	<b>33</b>
<b>13.3</b>	<b>IEC Curves</b>	<b>34</b>
<b>13.4</b>	<b>RI Curves</b>	<b>40</b>
<b>13.5</b>	<b>IEEE/ANSI &amp; CO Curves</b>	<b>41</b>
<b>13.6</b>	<b>Rectifier protection curve</b>	<b>47</b>
<b>13.7</b>	<b>RXIDG curve</b>	<b>48</b>
<b>13.8</b>	<b>Thermal overload curves</b>	<b>49</b>

**BLANK PAGE**

Information required with order (P120)

Information required with order														
Versions	Order - No.													
	1	2	3	4	5	6	7	8	9	10	11	12	13	14
MiCOM P12x – Overcurrent protection	P12	0	*	0	0	*	*	*	*	2	*	*	*	*
<b>Variant</b>														
Earth or single Phase overcurrent	0													
<b>Earth current input</b>														
0.1 to 40 I <sub>on</sub>	A													
0.01 to 8 I <sub>on</sub>	B													
0.002 to 1 I <sub>on</sub>	C													
<b>Auxiliary voltage</b>														
48 - 250 Vdc / 48 - 240 Vac	H													
48 - 250 Vdc / 48 - 240 Vac	T													
48 - 250 Vdc / 48 - 240 Vac	V													
48 - 250 Vdc / 48 - 240 Vac	W													
24 - 250 Vdc / 24 - 240 Vac	Z													
<b>Digital input voltage</b>														
105 - 145 Vdc	H													
24 - 250 Vdc (Special option for ENA UK)	T													
110 Vdc -30% / +20%	V													
220 Vdc -30% / +20%	W													
24-250Vdc / 24-240Vdc	Z													
<b>Communication interface</b>														
Modbus	1													
KBus / Courier	2													
IEC 60870-5-103	3													
DNP3	4													
<b>Language</b>														
French	0													
English / American	1													
Spanish	2													
German	3													
Italian	4													
Russian	5													
Polish	6													
Turkish	E													
<b>Latest Major Software release</b>														
V XX.X <sup>(2)</sup>	?													
<b>Latest Minor Software release</b>														
V XX.X <sup>(2)</sup>	?													
<b>Mounting option</b>														
None (default) <sup>(3)</sup>	0													
Pre-fixed HMI (no withdrawability)	1													
Sealed cover <sup>(3)</sup>	2													
Pre-fixed with sealed cover	3													

(1) Available only with larger LCD  
 (2) Unless specified, the latest version will be delivered  
 (3) Not available with "Auxiliary voltage – Digital input voltage code T"

Information required with order (P121, P122 & P123)

Information required with order		Order - No.													
Versions		1	2	3	4	5	6	7	8	9	10	11	12	13	14
MiCOM P12x – Overcurrent protection		P	1	2	0	0	*	*	*	*	*	*	*	*	*
<b>Variant</b>															
3 Phase and Earth overcurrent	1														
Advanced – 3 Phase and Earth overcurrent	2														
Expert – 3 Phase and Earth overcurrent	3														
<b>Earth current input</b>															
0.1 to 40 I <sub>on</sub>	A														
0.01 to 8 I <sub>on</sub>	B														
0.002 to 1 I <sub>on</sub>	C														
<b>Voltage Input</b>															
57 – 130 V	A														
220 – 480 V	B														
<b>Auxiliary voltage</b>															
48 - 250 Vdc / 48 - 240 Vac									H						
48 - 250 Vdc / 48 - 240 Vac									T						
48 - 250 Vdc / 48 - 240 Vac									V						
48 - 250 Vdc / 48 - 240 Vac									W						
24 - 250 Vdc / 24 - 240 Vac									Z						
<b>Digital input voltage</b>															
105 - 145 Vdc															
24 - 250 Vdc (Special option for ENA UK)															
110 Vdc -30% / +20%															
220 Vdc -30% / +20%															
24-250Vdc / 24-240Vdc															
<b>Communication interface</b>															
Modbus										1					
KBus / Courier										2					
IEC 60870-5-103										3					
DNP3										4					
<b>Language</b>															
French										0					
English / American										1					
Spanish										2					
German										3					
Italian										4					
Russian										5					
Polish										6					
Portuguese										7					
Dutch										8					
Czech										A					
Hungarian										B					
Greek										C					
Chinese (only available in phase II hardware with larger LCD display)										D					
Turkish										E					
<b>Hardware version</b>															
Text display											2				
Larger LCD display											3				
<b>Latest Major Software release</b>															
V XX.X <sup>(2)</sup>													?		
<b>Latest Minor Software release</b>															
V XX.X <sup>(2)</sup>														?	
<b>Mounting option</b>															
None (default) <sup>(3)</sup>															0
Pre-fixed HMI (no withdrawability)															1
Sealed cover <sup>(3)</sup>															2
Pre-fixed with sealed cover															3

(1) Available only with larger LCD  
 (2) Unless specified, the latest version will be delivered  
 (3) Not available with "Auxiliary voltage – Digital input voltage code T"

## 1. RATINGS

### 1.1 Power Supply

Nominal auxiliary voltage Vx	24-60Vdc; 48 -250Vdc/ 48-250 Vac
Operating range	DC: ± 20% of Vx AC: - 20%, +10% of Vx
Residual ripple	Up to 12%
Stored energy time	≥50 ms for interruption of Vx
Burden	Stand by: <3W DC or <8VA AC Max: <6W DC or <14VA AC

### 1.2 Frequency

Frequency protection functions	From 45 to 65Hz
Nominal frequency	50/60Hz

### 1.3 Current Inputs

Phase current inputs	1 and 5A by connection
Earth current inputs	1 and 5A by connection
Operating range	Selected at order (Cortec)
Burden Phase Current	< 0.025 VA (1A) < 0.3 VA (5A)
Burden Earth Current	< 0.08 VA (1A) < 0.42 VA (5A)
Thermal withstand	1s @ 100 x rated current 2s @ 40 x rated current continuous @ 4 x rated current

### 1.4 Phase and earth current transformers consumption

#### 1.4.1 P12x phase CT consumption

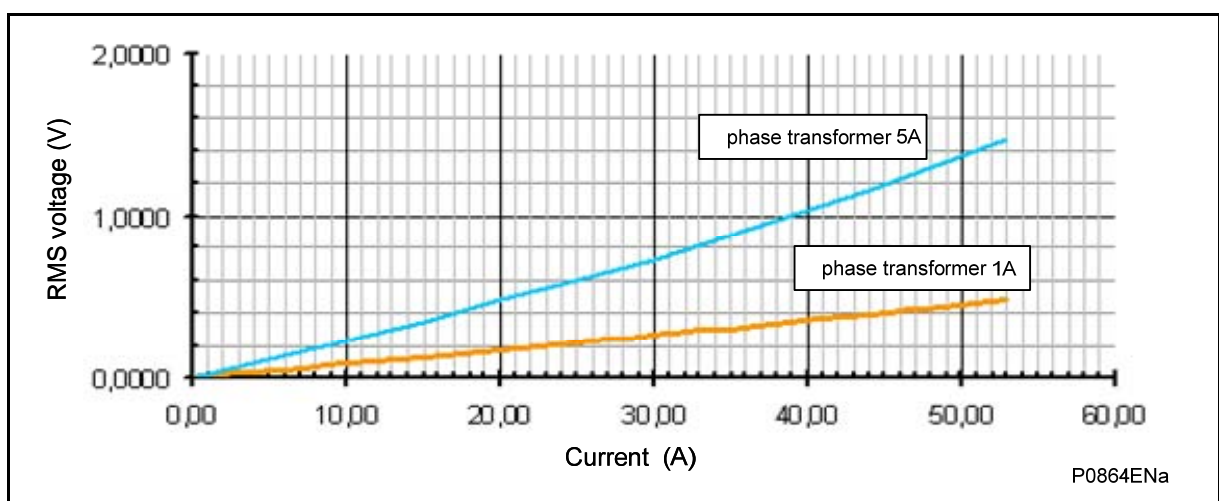

1.4.2 P12x earth CT consumption

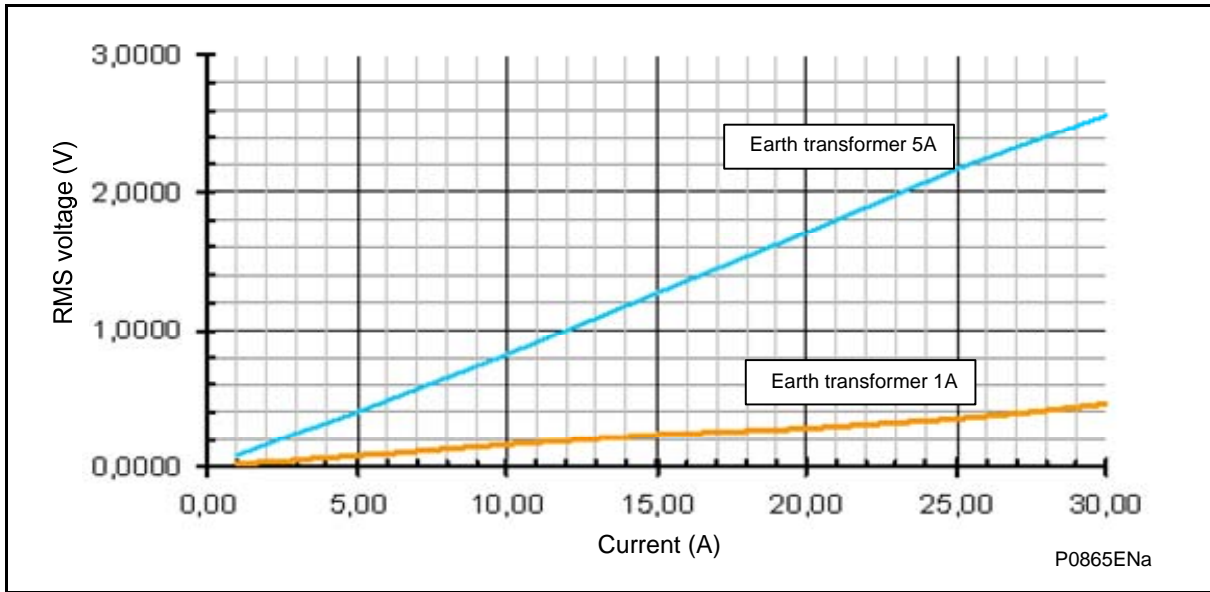

1.5 Logic Inputs

Logic input type	Independent optically insulated
Logic input burden	< 10 mAmps per input
Logic input recognition time	< 5ms

1.5.1 Supply

Ordering Code	Relay auxiliary power supply		Logic Inputs				
	Nominal voltage range Vx	Operating voltage range	Nominal Voltage range	Minimal polarisation voltage	Maximum polarisation current	Holding current after 2 ms	Maximum continuous withstand
A	24 - 60 Vdc	19,2 – 76 Vdc	24 – 250 Vdc 24 – 240 Vac	19,2 Vdc 19,2 Vac	35 mA	2.3 mA	300 Vdc 264 Vac
F	48 – 250 Vdc 48 – 240 Vac	38.4 – 300 Vdc 38.4 – 264 Vac					
T	48 – 250 Vdc 48 – 240 Vac Special EA (**)	38.4 – 300 Vdc 38.4 – 264 Vac	24 – 250 Vdc 24 – 240 Vac	19,2 Vdc 19,2 Vac	35 mA	2.3 mA	300 Vdc 264 Vac
H	48 – 250 Vdc 48 – 240 Vac	38.4 – 300 Vdc 38.4 – 264 Vac	129 Vdc	105 Vdc	3.0 mA @ 129 Vdc		145 Vdc
V	48 – 250 Vdc 48 – 240 Vac	38.4 – 300 Vdc 38.4 – 264 Vac	110 Vdc	77 Vdc	7.3 mA @ 110 Vdc		132 Vdc
W	48 – 250 Vdc 48 – 240 Vac	38.4 – 300 Vdc 38.4 – 264 Vac	220 Vdc	154 Vdc	3.4 mA @ 220 Vdc		262 Vdc

(\*\*) Logic input recognition time for EA approval. Dedicated filtering on 24 samples (15 ms at 50 Hz)

**1.6 Output Relay Characteristic**

<b>Contact rating</b>	
Contact relay	Dry contact Ag Ni
Make current	Max. 30A and carry for 3s
Carry capacity	5A continuous
Rated Voltage	250Vac
<b>Breaking characteristic</b>	
Breaking capacity AC	1500 VA resistive 1500 VA inductive (P.F. = 0.5) 220 Vac, 5A ( $\cos \varphi = 0.6$ )
Breaking capacity DC	135 Vdc, 0.3A (L/R = 30 ms) 250 Vdc, 50W resistive or 25W inductive (L/R=40ms)
Operation time	<7ms
Durability	
Loaded contact	10000 operation minimum
Unloaded contact	100000 operation minimum

**2. INSULATION**

Dielectric withstand	IEC 60255-5 : 2000	2 kV common mode 1 kV differential mode
	ANSI/IEEE C37.90-1989 (reaffirmed 1994)	1.5 kV rms AC for 1 minute, across normally open contacts.
Impulse voltage	IEC 60255-5 : 2000	5 kV common mode 1 kV differential mode
Insulation resistance	IEC 60255-5 : 2000	> 1000 M $\Omega$



### 3. EMC TESTS

High Frequency Disturbance

IEC 60255-22-1:1988	2.5kV common mode, Class III 1kV differential mode, Class III
---------------------	--

Electrostatic Discharge

EN 61000-4-2: 1995 and IEC 60255-22-2: 1996	8kV contact discharge, Class 4 15kV air discharge, Class 4
---	---

Fast Transient

IEC 60255-22-4:2002, Class A	2kV 5kHz, terminal block comms. 4kV 2.5kHz, all circuits excluding comms.
------------------------------	--

EN 61000-4-4:1995, Level 4	4kV 5kHz, power supply 2kV 5kHz, all circuits excluding power supply.
----------------------------	--

Surge

EN 61000-4-5:1995 and IEC 60255-22-5:2002	4kV common mode, Level 4 2kV differential mode, Level 4
---	--

#### Conducted Emissions

EN 55022: 1998	0.15 - 0.5MHz, 79dBµV (quasi peak) 66dBµV (average) 0.5 - 30MHz, 73dBµV (quasi peak) 60dBµV (average).
----------------	---

Radiated Emissions

EN 55022: 1998	30 - 230MHz, 40dBµV/m at 10m measurement distance 230 - 1GHz, 47dBµV/m at 10m measurement distance.
----------------	--

Conducted Immunity

EN 61000-4-6:1996	Level 3, 10V rms @ 1kHz 80% am, 150kHz to 80MHz
-------------------	---

Radiated Immunity

EN 61000-4-3:2002 ANSI/IEEE C37.90.2:2004	Level 3, 10V/m 80MHz to 1GHz @ 1kHz 80% am 35V/m 80MHz to 1GHz @ 1kHz 80% am 35V/m 80MHz to 1GHz @ 100% pulse modulated front face only.
--	--

#### Radiated immunity from digital telephones

EN 61000-4-3:2002	Level 4, 30V/m 800MHz to 960MHz and 1.4GHz to 2GHz @ 1kHz 80% am
-------------------	--

ANSI Surge Withstand Capability

IEEE/ANSI C37.90.1: 2002	4kV fast transient and 2.5kV oscillatory applied common mode and differential mode
--------------------------	--

Magnetic Field Immunity

IEC 61000-4-8: 1994	Level 5, 100A/m applied continuously, 1000A/m for 3s.
IEC 61000-4-9: 1993	Level 5, 1000A/m.
IEC 61000-4-10: 1993	Level 5, 100A/m at 100kHz and 1MHz.

#### 4. ENVIRONMENT

Temperature	IEC 60068-2-1 : 1993 IEC 60068-2-2: 1993	Storage      –25 °C to +70 °C Operation:   –25 °C to + 55 °C –25°C to 70° (*) (* ) The upper limit is permissible for a single 6 hour duration within any 24 hour period.
Humidity dam heat	IEC 60068-2-78:2001	56 days at 93% RH and 40 °C
Enclosure protection	IEC 60-529: 2001	Dust IP50 (whole case), Front IP 52, Back IP 10
Sinusoidal Vibrations	IEC 60255-21-1:1998	Response and endurance, class 2
Shocks	IEC 60255-21-2:1998	Response and withstand, class 2
Shock withstand & Bump	IEC 60255-21-2:1998	Response and withstand, class 1
Seismic	IEC 60255-21-3:1993	Class 2

##### Corrosive Environments :

Per IEC 60068-2-60: 1995, Part 2, Test Ke, Method (class) 3

Industrial corrosive environment/poor environmental control, mixed gas flow test.

21 days at 75% relative humidity and +30°C

Exposure to elevated concentrations of H<sub>2</sub>S, NO<sub>2</sub>, Cl<sub>2</sub> and SO<sub>2</sub>.

---

## 5. EU DIRECTIVE

### 5.1 EMC compliance



89/336/EEC

93/31/EEC

Compliance with European Commission EMC Directive.

Generic standards were used to establish conformity:

EN50081-2: 1994

EN60952-2: 1995

### 5.2 Product safety



2006/95/EC

(replacing 73/23/EEC from  
01/2007)

Compliance with European Commission Low Voltage Directive. Compliance is demonstrated by reference to generic safety standards:

– EN61010-1: 1993/A2: 1995

– EN60950: 1992/A11: 1997

## 6. DEVIATION OF PROTECTION ELEMENTS

### Glossary

I	:	Phase current
I <sub>s</sub>	:	I <sub>&gt;</sub> , I <sub>&gt;&gt;</sub> , I <sub>&gt;&gt;&gt;</sub> & I <sub>&lt;</sub>
I <sub>2s</sub>	:	I <sub>2&gt;</sub> , I <sub>2&gt;&gt;</sub> & I <sub>2&gt;&gt;&gt;</sub>
I <sub>es</sub>	:	I <sub>e&gt;</sub> , I <sub>e&gt;&gt;</sub> & I <sub>e&gt;&gt;&gt;</sub>
DT	:	Definite time
IDMT	:	Inverse definite minimum time

Element	Range	Deviation	Trigger	Reset	Time deviation
Phase overcurrent elements I <sub>&gt;</sub> & I <sub>&gt;&gt;</sub> & I <sub>&gt;&gt;&gt;</sub>	0.1 to 40 I <sub>n</sub>	± 2%	DT: I <sub>s</sub> ± 2% IDMT: 1.1I <sub>s</sub> ± 2%	0.95 I <sub>s</sub> ± 2% 1.05 I <sub>s</sub> ± 2%	±2% +30...50ms ±5% +30...50ms
Earth fault overcurrent elements I <sub>e&gt;</sub> & I <sub>e&gt;&gt;</sub> & I <sub>e&gt;&gt;&gt;</sub>	0.002 to 1 I <sub>en</sub> 0.01 to 8 I <sub>en</sub> 0.1 to 40 I <sub>en</sub>	± 2%	DT: I <sub>es</sub> ± 2% IDMT: 1.1I <sub>es</sub> ± 2%	0.95 I <sub>es</sub> ± 2% 1.05 I <sub>es</sub> ± 2%	±2% +30...50ms ±5% +30...50ms
Negative sequence phase overcurrent elements I <sub>2&gt;</sub> , I <sub>2&gt;&gt;</sub> & I <sub>2&gt;&gt;&gt;</sub>	0.1 to 40 I <sub>n</sub>	± 2%	DT: I <sub>2s</sub> ± 2% IDMT: 1.1I <sub>2s</sub> ± 2%	0.95 I <sub>2s</sub> ± 2% 1.05 I <sub>2s</sub> ± 2%	±2% +30...50ms ±5% +30...50ms
Phase undercurrent element I <sub>&lt;</sub>	0.02 to 1 I <sub>n</sub>	± 2%	DT: I <sub>&lt;</sub> ± 2%	0.95 I <sub>&lt;</sub> ± 2%	±2% +30...50ms
Broken conductor [I <sub>2</sub> /I <sub>1</sub> ]	20 to 100%	± 3%	DT: I <sub>2</sub> /I <sub>1</sub> ± 3%	0.95 I <sub>2</sub> /I <sub>1</sub> ± 3%	±2% +30...50ms
Thermal overload I <sub>θ&gt;</sub> , θ Alarm, θ Trip	0.10 to 3.2 I <sub>n</sub>	± 3%	IDMT: I <sub>θ&gt;</sub> ± 3%	0.97 I <sub>θ&gt;</sub> ± 3%	-5% +30...50ms (ref. IEC 60255-8)

## 7. DEVIATION OF AUTOMATION FUNCTIONS TIMERS

Autoreclose timers t <sub>Ds</sub> , t <sub>R</sub> , t <sub>I</sub>	±2% +10...30ms
CB fail & CB monitoring timers	±2% +10...30ms
Auxiliary timers t <sub>AUX1</sub> , t <sub>AUX2</sub> , t <sub>AUX3</sub> , t <sub>AUX4</sub> , t <sub>AUX5</sub>	±2% +10...30ms
Cold load pickup	±2% +20...40ms
SOTF/TOR	±2% +20...40ms

## 8. DEVIATION OF MEASUREMENTS

Measurement	Range	Deviation
Phase current	0.1 to 40 I <sub>n</sub>	Typical ±0.5% at I <sub>n</sub>
Earth current	0.002 to 1 I <sub>en</sub>	Typical ±0.5% at I <sub>en</sub>
	0.01 to 8 I <sub>en</sub>	Typical ±0.5% at I <sub>en</sub>
	0.1 to 40 I <sub>en</sub>	Typical ±0.5% at I <sub>en</sub>

## 9. PROTECTION SETTING RANGES

### 9.1 [50/51] Phase Overcurrent (P120, P121, P122 & P123)

- Phase current Fundamental only

NOTE : When I> or I>> is associated to an IDMT curve, the maximum setting recommended should be 2In.

#### 9.1.1 Protection Setting Ranges

[51] Phase OC	Setting Range		
	Min	Max	Step
I> ?	No or Yes		
I>	0.1 In	25 In	0.01 In
Delay type	DT or IDMT (IEC_STI, IEC_SI, IEC_VI, IEC_EI, IEC_LTI, C02, C08, IEEE_MI, IEEE_VI, IEEE_EI, RI, RECT curve)		
tI>	0 s	150 s	0.01 s
I> TMS	0.025	1.5	0.001
I> Reset Delay Type	DT or IDMT		
I> RTMS	0.025	1.5	0.001
I> tReset	0.00 s	600 s	0.01 s
K (RI)	0.1	10	0.1
I> >> >>> interlock	No or Yes		
I>> ?	No or Yes		
I>>	0.5 In	40 In	0.01 In
Delay type	DT or IDMT (IEC_STI, IEC_SI, IEC_VI, IEC_EI, IEC_LTI, C02, C08, IEEE_MI, IEEE_VI, IEEE_EI, RI, RECT curve)		
tI>>	0 s	150 s	0.01 s
I>> TMS	0.025	1.5	0.001
I>> Reset Delay Type	DT or IDMT		
I>> RTMS	0.025	1.5	0.025
I>> tReset	0.00 s	600 s	0.01 s
K (RI)	0.1	10	0.1
I>>> ?	No or Yes or Peak		
I>>> Sample	No or Yes		
I>>>	0.5 In	40 In	0.01 In
tI>>>	0 s	150 s	0.01 s

### 9.2 [50N/51N] Earth fault protection (P121, P122 & P123)

- Earth fault current Fundamental only
- Earth fault current ranges See following table

NOTE : When Ie> or Ie>> are associated to an IDMT curve, the maximum setting recommended should be the maximum of the range divided by 20.

## 9.2.1 Protection Setting Ranges

[Earth] OC	Setting Range		
	Min	Max	Step
<b>High sensitivity current set</b>	Cortec code <b>P12-C-X---X</b>		
le>	0.002 len	1 len	0.001 len
le>>	0.002 len	1 len	0.001 len
le>>>	0.002 len	1 len	0.001 len
<b>Med. sensitivity current set</b>	Cortec code <b>P12-B-X---X</b>		
le>	0.01 len	2 len	0.005 len
le>>	0.01 len	8 len	0.005 len
le>>>	0.01 len	8 len	0.005 len
<b>Low sensitivity current set</b>	Cortec code <b>P12-A-X---X</b>		
le>	0.1 len	25 len	0.1 len
le>>	0.5 len	40 len	0.1 len
le>>>	0.5 len	40 len	0.1 len
le> ?	No or Yes		
Delay type	DT or IDMT (IEC_STI, IEC_SI, IEC_VI, IEC_EI, IEC_LTI, C02, C08, IEEE_MI, IIEEE_VI, IEEE_EI, RI, RECT curve) or RXIDG (only for Cortec code P12-B-X---X)		
tle>	0 s	150 s	0.01 s
Interlock le> >> >>>	No or Yes		
K (RI)	0.1	10	0.1
le> TMS	0.025	1.5	0.001
le> Reset Delay Type	DT or IDMT		
le> RTMS	0.025	3.2	0.001
le> tReset	0.00 s	600 s	0.01 s
le>> ?	No or Yes		
Delay type	DT or IDMT (IEC_STI, IEC_SI, IEC_VI, IEC_EI, IEC_LTI, C02, C08, IEEE_MI, IIEEE_VI, IEEE_EI, RI, RECT curve) or RXIDG (only for Cortec code P12-B-X---X)		
tle>>	0 s	150 s	0.01 s
K (RI)	0.1	10	0.1
le>> TMS	0.025	1.5	0.001
le>> Reset Delay Type	DT or IDMT		
le>> RTMS	0.025	3.2	0.001
le>> tReset	0.04 s	600 s	0.01 s
tle>>>	0 s	150	0.01 s
le>>> ?	No or Yes		
le>>> Sample	No or Yes		

[Earth] OC	Setting Range		
	Min	Max	Step
tIe>>>	0 s	150 s	0.01 s
Ie>>>> ?	No or Yes		
Ie>>>>	0.1 I <sub>n</sub>	40 I <sub>n</sub>	0.5 I <sub>n</sub>
Delay type	DT or IDMT (IEC_STI, IEC_SI, IEC_VI, IEC_EI, IEC_LTI, C02, C08, IEEE_MI, IEEE_VI, IEEE_EI, RI, RECT curve) or RXIDG (only for Cortec code P12-B-X---X)		
tIe>>>>	0 s	100 s	0.01 s
K (RI)	0.1	10	0.1
Ie>>>> TMS	0.025	1.5	0.001
Ie>>>> Reset Delay Type	DT or IDMT		
Ie>>>> RTMS	0.025	3.2	0.001
Ie>>>> tReset	0.04 s	600 s	0.01 s
tIe>>>>	0 s	150	0.01 s

**9.3 Negative Sequence Overcurrent Protection (P122 & P123)**

– Phase current: Fundamental only

NOTE : When I<sub>2></sub> is associated to an IDMT curve, the maximum setting recommended should be 2I<sub>n</sub>.

**9.3.1 Protection Setting Ranges**

[46] Neg.Seq. OC	Setting ranges		
	Min	Max	Step
I <sub>2&gt;</sub> ?	No or Yes		
I <sub>2&gt;</sub>	0.1 I <sub>n</sub>	40 I <sub>n</sub>	0.01 I <sub>n</sub>
Delay Type	DT or IDMT (IEC_STI, IEC_SI, IEC_VI, IEC_EI, IEC_LTI, C02, C08, IEEE_MI, IEEE_VI, IEEE_EI, RI, RECT curve)		
tI <sub>2&gt;</sub>	0 s	150s	0.01s
I <sub>2&gt;</sub> TMS	0.025	1.5	0.001
I <sub>2&gt;</sub> Reset Delay Type	DT or IDMT		
I <sub>2&gt;</sub> RTMS	0.025	1.5	0.025
I <sub>2&gt;</sub> tReset	0.04 s	100 s	0.01 s
I <sub>2&gt;&gt;</sub> ?	No or Yes		
I <sub>2&gt;&gt;</sub>	0.1 I <sub>n</sub>	40 I <sub>n</sub>	0.01 I <sub>n</sub>
tI <sub>2&gt;&gt;</sub>	0 s	150s	0.01s

## 9.4 Thermal Overload Protection (P122 & P123)

– Phase Current: RMS

### 9.4.1 Protection Setting Ranges

[49] Therm. OL	Setting ranges		
Therm. OL ?	No or Yes		
$I_{\theta}$	0.1 In	3.2 In	0.01
$T_e$	1 mn	200 mn	1mn
K	1	1,5	0.01
$\theta$ Trip	50%	200%	1%
$\theta$ Alarm ?	No or Yes		
$\theta$ Alarm	50%	200%	1%

## 9.5 Undercurrent Protection (P122 & P123)

– Undercurrent: Fundamental only

– Phase current: Fundamental only

### 9.5.1 Protection Setting Ranges

[37] Under Current	Setting ranges		
	Min	Max	Step
$I_{<}$ ?	Yes or No		
$I_{<}$	0.2 In	1 In	0.01 In
$t_{I<}$	0 s	150 s	0.01 s
Inhibition $I_{<}$ on 52A	Yes or No		

## 9.6 Multishot Autoreclose Function (P123)

**Main shots:** 4 independent shots.

**External logic inputs:** 4 inputs (external CB fail, phase start, earth start, blocking order).

Internal programmable trigger from phase and earth fault on all re-closing cycles.

External trigger from logic input.

Programmable dead times and reclaim time setting.



9.6.1 Multishot Autoreclose Settings

[79] Autoreclose	Setting range		
	Min	Max	Step
Autoreclose ?	Yes or No		
Ext. CB Fail ?	Yes or No		
Ext. CB Fail time	0.01 s	600 s	0.01 s
Ext Block ?	Yes or No		
Rolling demand ?	Yes or No		
Maximum cycle number	2	100	1
Time period	10mn	24h	10mn
<b>Dead time</b>			
tD1	0.01 s	300 s	0.01 s
tD2	0.01 s	300 s	0.01 s
tD3	0.01 s	600 s	0.01 s
tD4	0.01 s	600 s	0.01 s
<b>Minimum drop off time</b>			
tl>	50ms	600s	10ms
tl>>	50ms	600s	10ms
tl>>>	50ms	600s	10ms
tle>	50ms	600s	10ms
tle>>	50ms	600s	10ms
tle>>>	50ms	600s	10ms
Reclaim Time tR	0.02 s	600 s	0.01 s
Inhib time			
Phase Cycles	0	4	1
E/Gnd Cycles	0	4	1
<b>Cycles</b>	<b>4 3 2 1</b>	<b>Settings</b>	
tl>	1 1 1 1	0 or 1 or 2 or 3	
tl>>	1 1 1 1	0 or 1 or 2 or 3	
tl>>>	1 1 1 1	0 or 1 or 2 or 3	
tle>	1 1 1 1	0 or 1 or 2 or 3	
tle>>	1 1 1 1	0 or 1 or 2 or 3	
tle>>>	1 1 1 1	0 or 1 or 2 or 3	
tAux1	1 1 1 1	0 or 1 or 2 or 3	
tAux2	1 1 1 1	0 or 1 or 2 or 3	

0 = no action on autorecloser : definitive trip  
 1 = trip on pick up of the protection element, followed by reclosing cycle  
 2 = no trip on pick up of the protection element also if this has been set in the *CRTL/Trip commands/Trip* menu.  
 3 = autoreclose without trip (trip order inhibited, no trip order from autoreclose function).



## 10. AUTOMATION CONTROL FUNCTIONS

### 10.1 Trip commands

Assignment of the following thresholds to trip output relay:

- all models: tl>, tl>>, tl>>>, tle>, tle>> ,
- P121, P122 & P123 additional functions: t Aux 1, t Aux 2, Equ A, Equ B, Equ C, Equ D, Equ E, Equ F, Equ G, Equ H,
- P122 & P123 additional functions: tle>>>>, tl < , tl2 >, tl2 >>, Thermal  $\theta$ , Brkn.Cond, t Aux 3,
- P123 additional functions: tle>>>, t Aux 4, t Aux 5, SOTF, Ctrl , CB Fail.

### 10.2 Latch functions

Trip output relay programmable with one or many thresholds:

- all models: tl>, tl>>, tl>>> ,
- P121, P122 & P123 additional functions: tle>, tle>>, tle>>>, tAux1 and tAux2
- P122 & P123 additional functions: tle>>>>, tl <, tl2 >, tl2 >>, Thermal  $\theta$ , Brkn.Cond and t Aux 3
- P123 additional functions: tAux 4, tAux 5, SOTF, CB Fail.

### 10.3 Blocking logic (P122 & P123)

Possibility to block the following delayed thresholds:

- all models: tl>, tl>>, tl>>>, tle>, tle>>, tle>>> ,
- P121, P122 & P123 additional functions: tAux1 and tAux2
- P122 & P123 additional functions: tle>>>>, tl2 >, tl2 >>, Thermal  $\theta$ , Brkn.Cond and t Aux 3,
- P123 additional functions: tAux 4, tAux 5.

### 10.4 Second Inrush blocking logic (P122 & P123)

Possibility to set a second harmonic blocking threshold and to block each delayed overcurrent threshold

Blocking Inrush	Setting range		
	Min	Max	Step
Blocking inrush	Yes or No		
Inrush harmonic ratio	10%	35%	0.1%
Inrush tReset time	0s	2s	10ms

Thresholds: tl>, tl>>, tl>>>, tle>, tle>>, tle>>>, le>>>>, I2> and I2>>

## 10.5 Logic select (P122 & P123)

Logic selectivity 1 and logic selectivity 2: this function is used to assign each time delay to threshold to the “Log Sel” input.

Blocking Inrush	Setting range		
	Min	Max	Step
Sel1 tl>>	Yes or No		
Sel1 tl>>>	Yes or No		
Sel1 tle>>	Yes or No		
Sel1 tle>>>	Yes or No		
Sel1 tle>>>>	Yes or No		
T Sel1	0s	500s	10ms

## 10.6 Output relays

Alarm and trip threshold assignation to a logic output: 3 relays (P120, P121), 5 relays (P122) and 7 relays (P123).

Assignable functions:

- all models: Output signal trip (RL1), l>, tl>, l>>, tl>>, l>>>, tl>>>, le>, tle>, le>>, tle>>, le>>>, tle>>>, CB Close, Input 1 and input 2
- P121, P122 & P123 additional functions: t Aux 1, t Aux 2, Equation A, B, C, D, E, F, G and H,
- P122 & P123 additional functions: le>>>>, tle>>>>, tl<, tl2>, tl2>>, Therm., Therm. Trip, CB Alarm, 52 Fail, Brkn. Cond, CB Fail, t Aux 3, Order 1Comm. Order 2Comm, Order 3Comm., Order 4 Comm., Active Group, Input3, CTS,
- P123 additional functions: t Aux 4, t Aux 5, 79 Run, 79 Trip, 79 Locked, 79 Int block, 79 Ext block, SOTF Group, CONTROL Trip, CONTROL Close, Input4, Input5, tIA>, tIB> and tIC>.

## 10.7 Latch of the auxiliary output relays (P121, P122 & P123)

Possibility to latch output relays:

- P121: Output 2 to 4,
- P122: Output 2 to 6,
- P123: Output 2 to 8.

## 10.8 Inputs

### 10.8.1 Inputs assignation

Single function or multiple automation functions assignable to 4 logic inputs:

- all models: None, Unlatch, 52 a, 52 b, CB FLT, Aux 1, Aux 2, Block Logic 1,
- P122 & P123 additional functions: Aux 3, Block Logic 2, Start Disturb, Cold Load PU, Logic Select 1, Logic Select 2, Change setting,  $\theta$  Reset, Trip Circuit, Strt tBF, Reset Leds, Maint. Mode, Synchro, Ctrl Trip, Ctrl Close
- P123 additional functions: Aux 3, Aux 4, Block [79], SOTF and local mode

10.8.2 Auxiliary times

Auxiliary timers	Setting range		
	Min	Max	Step
Aux1 time tAux1	0	200s	10ms
Aux2 time tAux2	0	200s	10ms
Aux3 time tAux3	0	200s	10ms
Aux4 time tAux4	0	200s	10ms
Aux5 time tAux5	0	200s	10ms

10.9 Broken Conductor Detection (P122 & P123)

Principle used: I2/I1

Functionality available for: (IA or IB or IC) > 10% In

10.9.1 Broken Conductor Detection Setting Ranges

Broken Conductor	Setting range		
	Min	Max	Step
Brkn.Cond ?	Yes or No		
Ratio I2/I1	20%	100%	1%
Brkn.Cond Time tBC	1s	14400s	1s

10.10 Cold Load Pickup (P122 & P123)

Cold Load PU	Setting range		
	Min	Max	Step
Cold Load PU ?	Yes or No		
CLPU Start input	Yes or No		
CLPU Start auto	Yes or No		
Cold load PU level	20%	800%	1%
Cold load PU tCL	100ms	3600s	10ms

10.11 Circuit Breaker Failure (P122 & P123)

10.11.1 CB Fail Setting Ranges

CB Fail	Setting range		
	Min	Max	Step
CB Fail ?	Yes or No		
I<	0.02 In	1In	0.01 In
CB Fail Time tBF	10 ms	10 s	0.01 s
Block I>	No	Yes	Yes or No
Block Ie>	No	Yes	Yes or No

**10.12 Trip Circuit Supervision (P122 & P123)**

## 10.12.1 Trip Circuit Supervision Setting Ranges

TC Supervision	Setting range		
	Min	Max	Step
TC Supervision ?	Yes or No		
t trip circuit tSUP	0.1 s	10 s	0.05 s

**10.13 Circuit Breaker Control and Monitoring (P122 & P123)**

## 10.13.1 Setting Ranges

CB Supervision	Setting range		
	Min	Max	Step
CB Open S'vision?	Yes or No		
CB Open time	0.05 s	1 s	0.01 s
CB Close S'vision?	Yes or No		
CB Close time	0.05 s	1 s	0.01 s
CB Open Alarm ?	Yes or No		
CB Open NB	0	50000	1
$\Sigma$ Amps(n) ?	Yes or No		
$\Sigma$ Amps(n)	0 E6 A	4000 E6 A	1E6 A
N	1	2	1
tOpen Pulse(*)	0.10 s	5 s	0.01 s
tClose Pulse(*)	0.10 s	5 s	0.01 s

(\*)Note: The tOpen/Close Pulse is available in the P123 for the Local /Remote functionality

**10.14 SOTF/TOR Switch on to fault / Trip on reclose (P123)**

## 10.14.1 Setting Ranges

SOTF	Setting range		
	Min	Max	Step
SOTF?	Yes or No		
t SOTF	0 ms	500 ms	10ms
I>>	Yes or No		
I>>>	Yes or No		
Ctrl close input	Yes or No		
SOTF input	Yes or No		
HMI closing order	Yes or No		
[79] closing	Yes or No		
Front comm. order	Yes or No		
Rear comm. order	Yes or No		

**10.15 Logic Equation (P121, P122 & P123)**

The MiCOM P121, P122 and P123 relays integrate complete logic equations to allow customization of the product based on customer application.

Up to 8 independent Boolean equations can be used (from A to H). Every result of equation can be time delayed and assigned to any output relays, trip, trip latching and/or HMI LEDs.

Up to 16 operands can be used (from 00 to 15). Within operands, there are two parts:

- (1/2) : **logical gates** (NOT, OR, AND, NOT AND, NOT OR)
- (2/2) : **signals** (I>, tl>>, Input1 ...etc)

**10.15.1 Timer Setting Ranges**

Logic equat T delay	Setting range		
	Min	Max	Step
EQU. A Toperat	0 s	600 s	0.01 s
EQU. A Treset	0 s	600 s	0.01 s
EQU. B Toperat	0 s	600 s	0.01 s
EQU. B Treset	0 s	600 s	0.01 s
EQU. C Toperat	0 s	600 s	0.01 s
EQU. C Treset	0 s	600 s	0.01 s
EQU. D Toperat	0 s	600 s	0.01 s
EQU. D Treset	0 s	600 s	0.01 s
EQU. E Toperat	0 s	600 s	0.01 s
EQU. E Treset	0 s	600 s	0.01 s
EQU. F Toperat	0 s	600 s	0.01 s
EQU. F Treset	0 s	600 s	0.01 s
EQU. G Toperat	0 s	600 s	0.01 s
EQU. G Treset	0 s	600 s	0.01 s
EQU. H Toperat	0 s	600 s	0.01 s
EQU. H Treset	0 s	600 s	0.01 s

**10.15.2 Available logical gates**

Logical gates	Availability (1/2)
NOT	A00 B00 C00 D00 E00 F00 G00 H00
OR (by default) AND AND NOT OR NOT	A01 to A15 B01 to B15 C01 to C15 D01 to D15 E01 to E15 F01 to F15 G01 to G15 H01 to H15

## 10.15.3 Available signals

With the Logic Equations submenu, 16 operands can be used in any single equation. The following logic signals are available for mapping to an equation:

TEXT	Signals (2/2)
Null	Condition is Null
Not Null	Condition is not Null
I>	Instantaneous first phase threshold
I>>	Instantaneous second phase threshold
I>>>	Instantaneous third phase threshold
tI>	Time delayed first phase threshold
tI>>	Time delayed second phase threshold
tI>>>	Time delayed third phase threshold
Ie>	Instantaneous first earth threshold
Ie>>	Instantaneous second earth threshold
Ie>>>	Instantaneous third earth threshold
tIe>	Time delayed first earth threshold
tIe>>	Time delayed second earth threshold
tIe>>>	Time delayed third earth threshold
Aux 1	Copy of the status of the Logic Input Aux 1
Aux 2	Copy of the status of the Logic Input Aux 2
Aux 3	Copy of the status of the Logic Input Aux 3
Aux 4	Copy of the status of the Logic Input Aux 4
Aux 5	Copy of the status of the Logic Input Aux 5
I2>	Instantaneous first phase negative sequence threshold
I2>>	Instantaneous second phase negative sequence threshold
tI2>	Time delayed negative phase sequence (1st threshold)
tI2>>	Time delayed negative phase sequence (2nd threshold)
Thermal Alarm	Thermal alarm output signal
Therm Trip	Trip on Thermal overload
I<	Instantaneous undercurrent threshold
tI<	Time delayed undercurrent
Brk Co.	broken conductor.
Reclos.	Autoreclose final trip
Aux 1	Copy of the status of the Logic Input Aux 1
Aux 2	Copy of the status of the Logic Input Aux 2
Aux 3	Copy of the status of the Logic Input Aux 3
Aux 4	Copy of the status of the Logic Input Aux 4
Aux 5	Copy of the status of the Logic Input Aux 5
Input 1	Instantaneous digital input 1
Input 2	Instantaneous digital input 2
Input 3	Instantaneous digital input 3



TEXT	Signals (2/2)
Input 4	Instantaneous digital input 4
Input 5	Instantaneous digital input 5
79 e. b1	Autoreclose lock activated by the input "block 79" (External Blocking 1)
79 l b1	Autoreclose lock activated by the internal process of the autoreclose (Internal Blocking)
le>>>>	Derived earth overcurrent threshold.
tle>>>>	Time delayed derived earth overcurrent threshold.

## 11. RECORDING FUNCTIONS (P120, P121, P122 & P123)

### 11.1 Event Records

Capacity	250 events
Time-tag	1 millisecond
Triggers	Any selected protection alarm and threshold Logic input change of state Setting changes Self test events

### 11.2 Fault Records

Capacity	25 faults
Time-tag	1 millisecond
Triggers	Any selected protection alarm and threshold
Data	Fault date Protection thresholds Setting Group AC inputs measurements (RMS) Fault measurements

### 11.3 Instantaneous recorder

Capacity	5 starting informations (instantaneous)
Time-tag	1 millisecond
Triggers	Any selected protection alarm and threshold
Data	date, hour origin (any protection alarm) length (duration of the instantaneous trip yes or no)

### 11.4 Disturbance Records

#### 11.4.1 Triggers; Data; Setting Ranges

Disturbance Records	P120, P122, P123			
Triggers	Any selected protection alarm and threshold, logic input, remote command			
Data	AC input channels digital input and output states frequency value			
	<b>Default value</b>	<b>Setting range</b>		
		<b>Min</b>	<b>Max</b>	<b>Step</b>
Records number	5	1	5	1
Pre-Time	0.1s	0.1s	2.9 / 4.9 / 6.9 or 8.9	0.1
Post-Time (P120 only)	0.1	0.1	3	0.1
Disturb rec Trig	ON TRIP	ON TRIP or ON INST.		
Trigger	Any selected protection alarm and threshold Logic input Remote command			

---

**12. COMMUNICATION**

Type Port	Relay position	Physical Link	Connectors	Data Rate	Protocol
RS485	Rear port	Screened twister pair	Screws or snap-on	300 to 38400 baud (programmable)	ModBus RTU, Courier, IEC60870-5-103, DNP3.0
RS232	Front port (P120, P121, P122 & P123)	Screened twister pair	Sub-D 9 pin female connector	300 to 38400 baud (programmable)	ModBus RTU

## 13. CURVES

### 13.1 General

Although the curves tend towards infinite when the current approaches  $I_s$  (general threshold), the minimum guaranteed value of the operating current for all the curves with the inverse time characteristic is 1.1 $I_s$  (with a tolerance of  $\pm 0.05I_s$ ).

#### 13.1.1 Inverse Time Curves:

The first stage thresholds for phase (earth) overcurrent can be selected with an inverse definite minimum time (IDMT) characteristic. The time delay is calculated with a mathematical formula.

In all, there are eleven IDMT characteristics available.

The mathematical formula applicable to the first ten curves is:

$$t = T \times \left( \frac{K}{\left( I / I_s \right)^\alpha - 1} + L \right)$$

Where:

- t Operation time
- K Factor (see table)
- I Value of measured current
- $I_s$  Value of the programmed threshold (pick-up value)
- $\alpha$  Factor (see table)
- L ANSI/IEEE constant (zero for IEC and RECT curves)
- T Time multiplier setting from 0.025 to 1.5

Type of curve	Standard	K factor	$\alpha$ factor	L factor
Short time inverse	Schneider Electric	0.05	0.04	0
Standard inverse	IEC	0.14	0.02	0
Very inverse	IEC	13.5	1	0
Extremely inverse	IEC	80	2	0
Long time inverse	Schneider Electric	120	1	0
Short time inverse	C02	0.02394	0.02	0.01694
Moderately Inverse	ANSI/IEEE	0.0515	0.02	0.114
Long time inverse	C08	5.95	2	0.18
Very inverse	ANSI/IEEE	19.61	2	0.491
Extremely inverse	ANSI/IEEE	28.2	2	0.1217
Rectifier protection	RECT	45900	5.6	0

The RI curve has the following definition:

$$t = K \cdot \frac{1}{0.339 - \frac{0.236}{\left( I / I_s \right)}}$$

K setting is from 0.10 to 10 in steps of 0.05.

The equation is valid for  $1.1 \leq I/I_s \leq 20$ .

13.1.2 RXIDG Curves (P122/P123 only):

RXIDG curves can be selected on P122 & P123 with medium earth current sensitivity (corresponding to Cortec model number P12-B-X---X).

The first and second earth thresholds can be selected with dedicated RXIDG curves.

The curves available follow the formula :

$$t = 5.8 - 1.35 * \ln ( 1/ (k * Is/I))$$

Where:

- t = tripping time
- k = coefficient (from 0.3 to 1, by steps of 0.1)
- IS = value of the programmed threshold (Pick-up value)
- I = value of measured current

In order to be compliant with the Netmanagement specifications the relay must be used with :

- An earth current range 0.01 Ion to 8 Ion
- A rated current wiring 1A
- A core balanced CT with a ratio 25/1.

13.1.3 Reset Timer

The first stage threshold for phase and earth overcurrent protection is provided with a timer hold facility "t Reset".

The value that is set for this reset timer corresponds to the minimum time during which the current value needs to be lower than 95% of the phase (or earth) threshold before the corresponding phase (or earth) time delay is reset.

NOTE: There is an exception to this rule when the protection triggers. In fact, in this case, the time delays (tl> and tle>) are immediately reset.

The value of the Reset Timer depends on the type of timer associated to the pick up first phase (or earth) threshold.

Type of timer associated to the first & second phase (earth) threshold	Reset Timer	
	P120, P121	P122, P123
DMT	0 ms	0 ms
Rectifier, IDMT IEC or RI	50 ms	Settable from 0 to 600 ms
RXIDG (*)	-	Settable from 0 to 600 ms
IDMT IEEE or CO	50 ms	Settable from 0 to 600 ms or Inverse Time (choice of 5 IEEE curves)

(\*) first and second earth threshold only

Reset timer on P122 & P123 relays:

The first stage threshold for phase and earth overcurrent protection, negative sequence overcurrent on P122 and P123 are provided with a timer hold facility "t Reset".

It may be set to a definite time value or to an inverse definite minimum time characteristic (IEEE/ANSI curves only). This may be useful in certain applications, for example when grading with upstream electromechanical overcurrent relays that have inherent reset time delays.

The second and third stage thresholds for the earth fault overcurrent protection only have a definite time reset.

A possible situation where the reset timer may be used is to reduce fault clearance times where intermittent faults occur.

An example may occur in a cable with plastic insulation. In this application it is possible that the fault energy melts the cable insulation, which then reseals after clearance, thereby eliminating the cause for the fault. This process repeats itself to give a succession of fault current pulses, each of increasing duration with reducing intervals between the pulses, until the fault becomes permanent.

When the reset time of the overcurrent relay is set to minimum the relay will be repeatedly reset and will not be able to trip until the fault becomes permanent. By using the reset timer hold function the relay will integrate the fault current pulses, thereby reducing fault clearance time.

The mathematical formula applicable to the five curves is:

$$t = T \times \left( \frac{K}{1 - (I / I_s)^\alpha} \right)$$

Where:

- t     Reset time
- K     Factor (see table)
- I     Value of the measured current
- I<sub>s</sub>   Value of the programmed threshold (pick-up value)
- α     Factor (see table)
- T     Reset time multiplier (RTMS) setting between 0.025 and 1.5.

Type of curve	Standard	K factor	α factor
Short time inverse	C02	2.261	2
Moderately inverse	ANSI/IEEE	4.850	2
Long time inverse	C08	5.950	2
Very inverse	ANSI/IEEE	21.600	2
Extremely Inverse	ANSI/IEEE	29.100	2

**13.2 Thermal Overload Curves**

The thermal time characteristic is given by:

$$e^{\left(\frac{-t}{\tau}\right)} = \frac{(I^2 - (kX/FLC)^2)}{(I^2 - I_p^2)}$$

Where:

- t = Time to trip, following application of the overload current, I
- τ = Heating and cooling time constant of the protected plant equipment
- I = Largest phase current
- I<sub>FLC</sub> = Full load current rating (relay setting 'Thermal Trip')
- k = 1.05 constant, allows continuous operation up to < 1.05 I<sub>FLC</sub>
- I<sub>p</sub> = Steady state pre-loading current before application of the overload

The time to trip varies depending on the load current carried before application of the overload, i.e. whether the overload was applied from "hot" or "cold".

Curves of the thermal overload time characteristic are given in Technical Data.

The mathematical formula applicable to MiCOM Relays is the following

$$t \text{ Trip} = T_e \ln \left( \frac{|K^2 - \theta|}{|K^2 - \theta_{trip}|} \right)$$

Where :

- t Trip = Time to trip (in seconds)
- T<sub>e</sub> = Thermal time constant of the equipment to be protected (in seconds)
- K = Thermal overload equal to I<sub>eq</sub>/k I<sub>θ</sub> with:
  - I<sub>eq</sub> = Equivalent current corresponding to the RMS value of the largest phase current
  - I<sub>θ</sub> = Full load current rating given by the national standard or by the supplier
- k = Factor associated to the thermal state formula
- θ alarm = Initial thermal state. If the initial thermal state = 30% then θ = 0.3
- θ trip = Trip thermal state. If the trip thermal state is set at 100%, then θ trip = 1

The settings of these parameters are available in the various menus. The calculation of the thermal state is given by the following formula:

$$\Theta_{\tau+1} = \left( \frac{I_{eq}}{kX I_{\theta}} \right)^2 \left[ 1 - e^{\left(\frac{-t}{T_e}\right)} \right] + \Theta_{\tau} e^{\left(\frac{-t}{T_e}\right)}$$

θ being calculated every 20ms.

The following curves are given for indication only.

### 13.3 IEC Curves

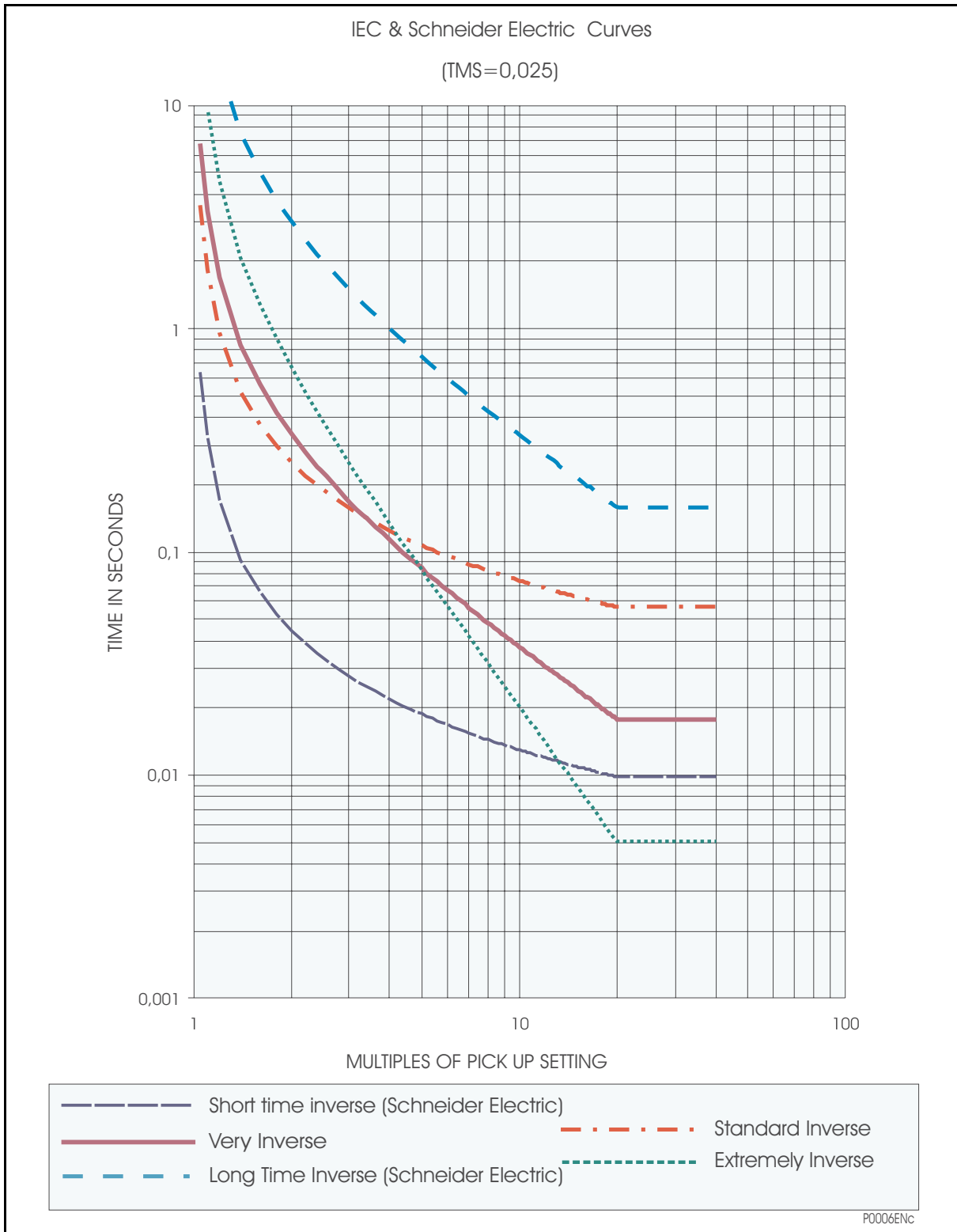



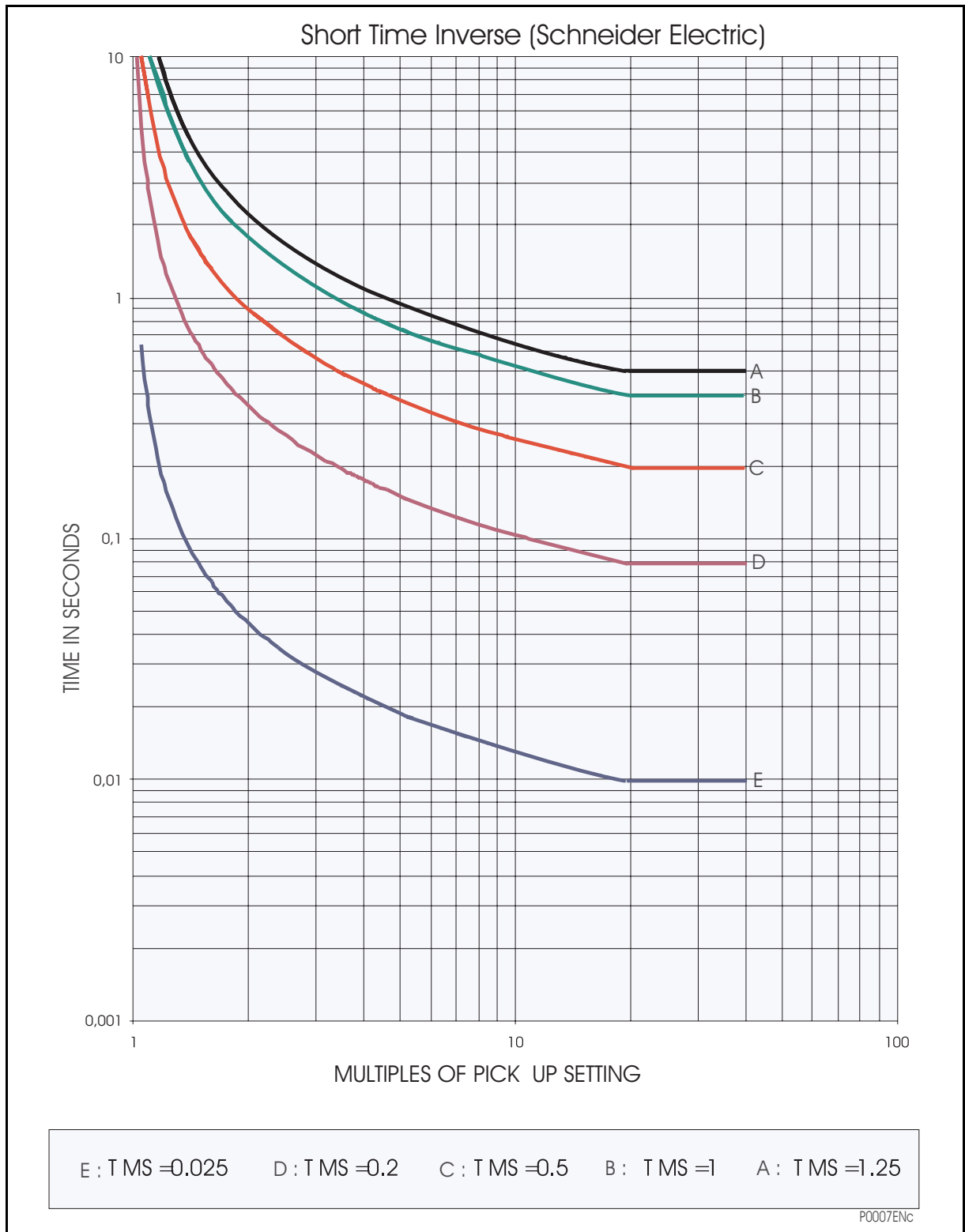

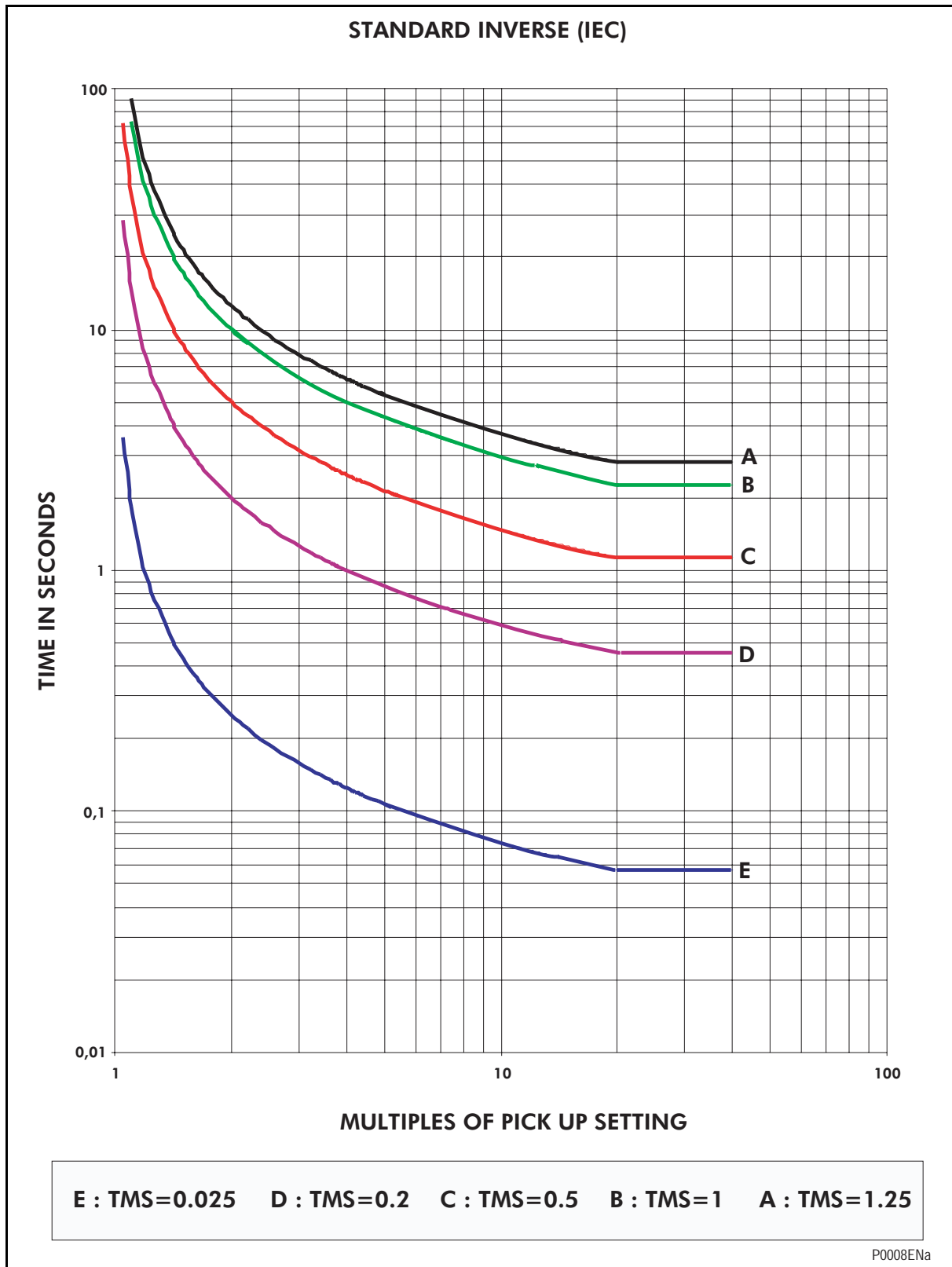

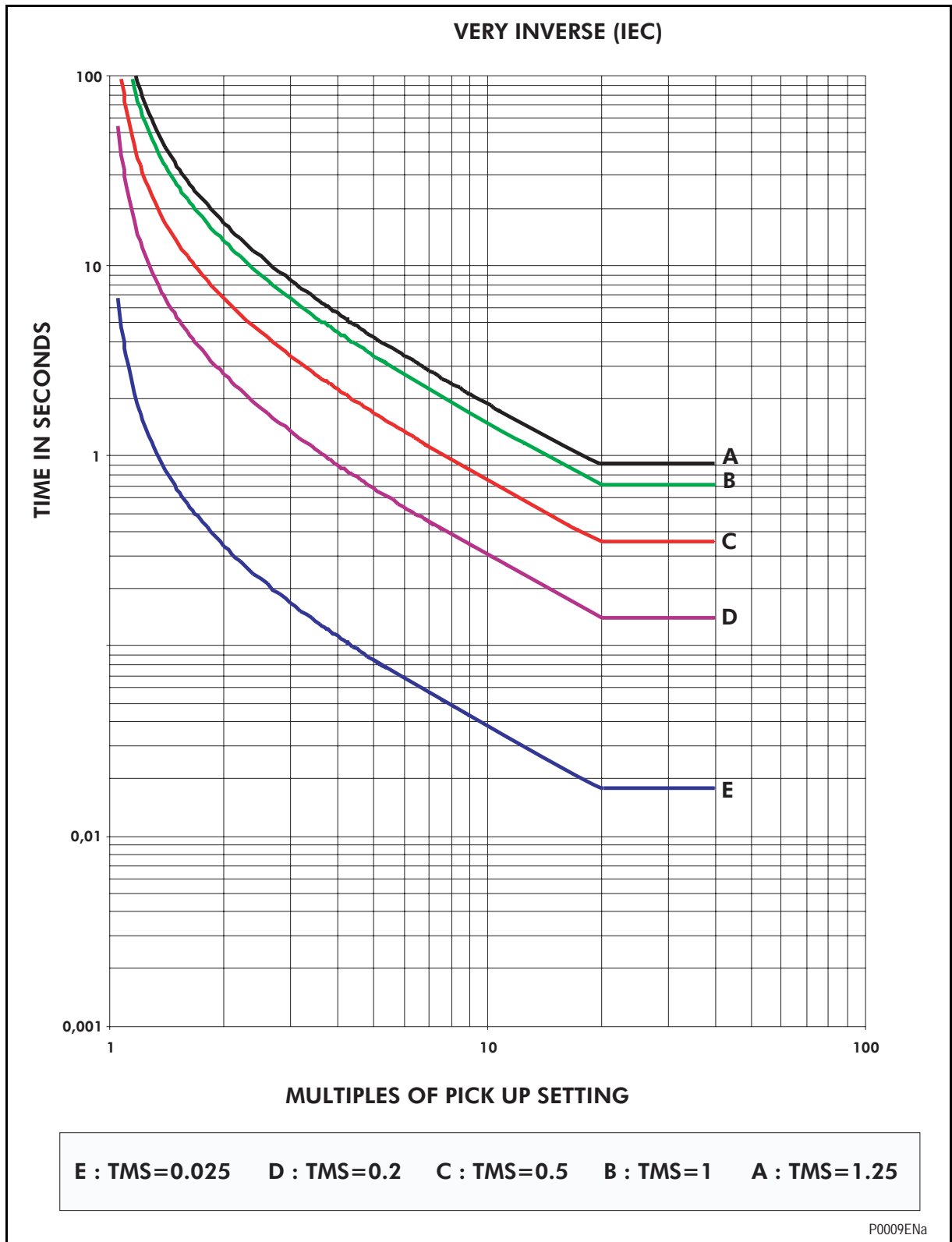

### EXTREMELY INVERSE (IEC)

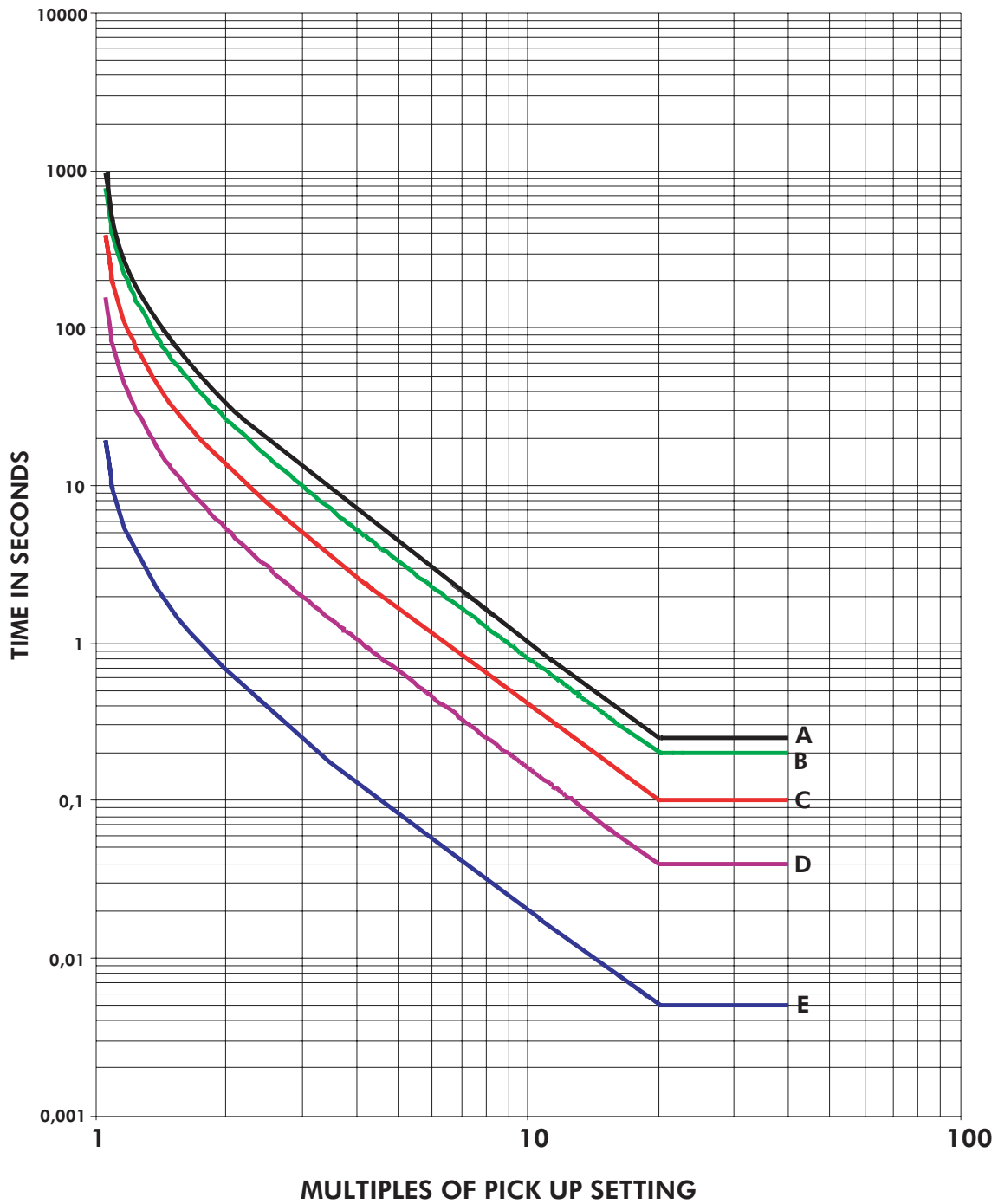

E : TMS=0.025    D : TMS=0.2    C : TMS=0.5    B : TMS=1    A : TMS=1.25

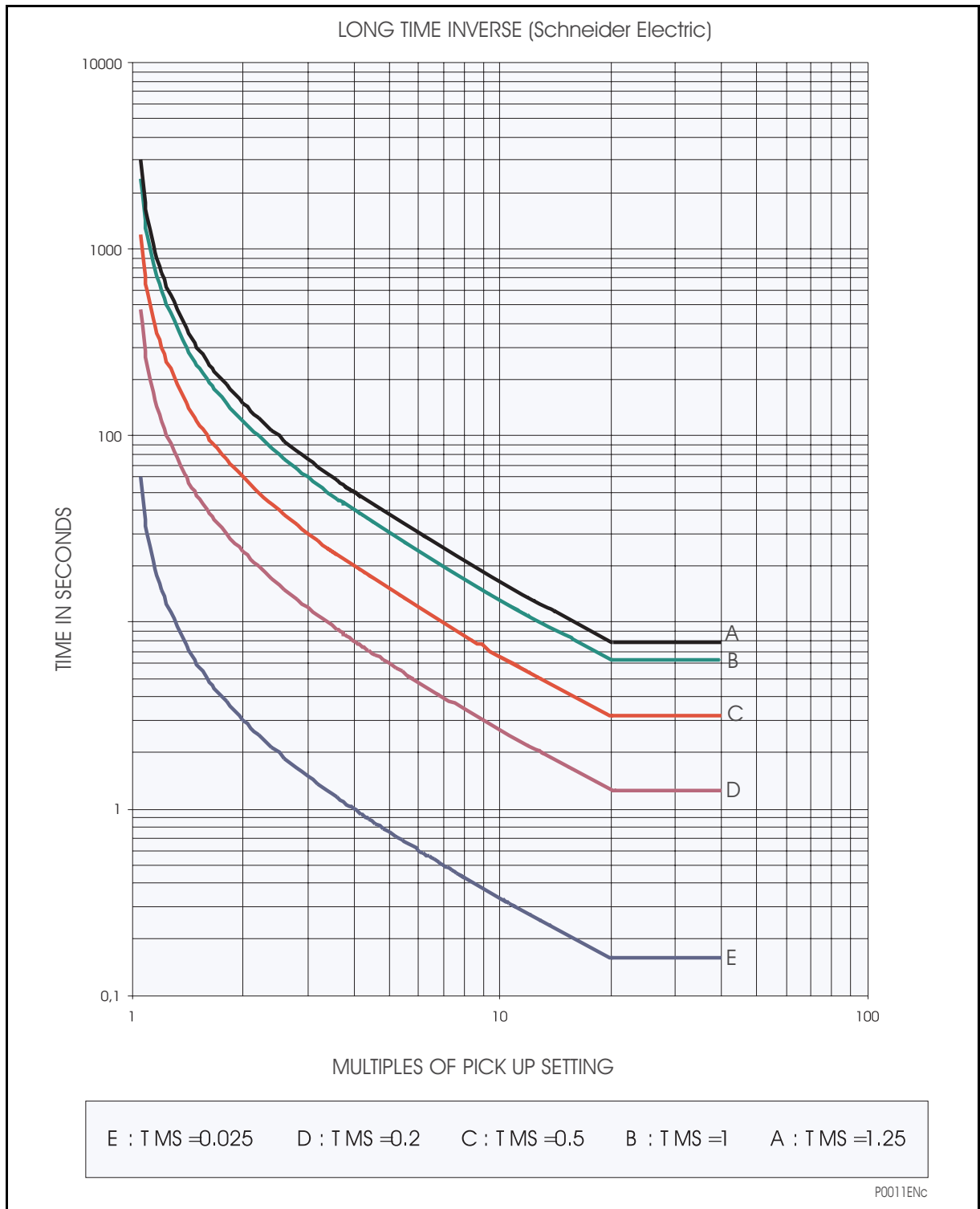

13.4 RI Curves

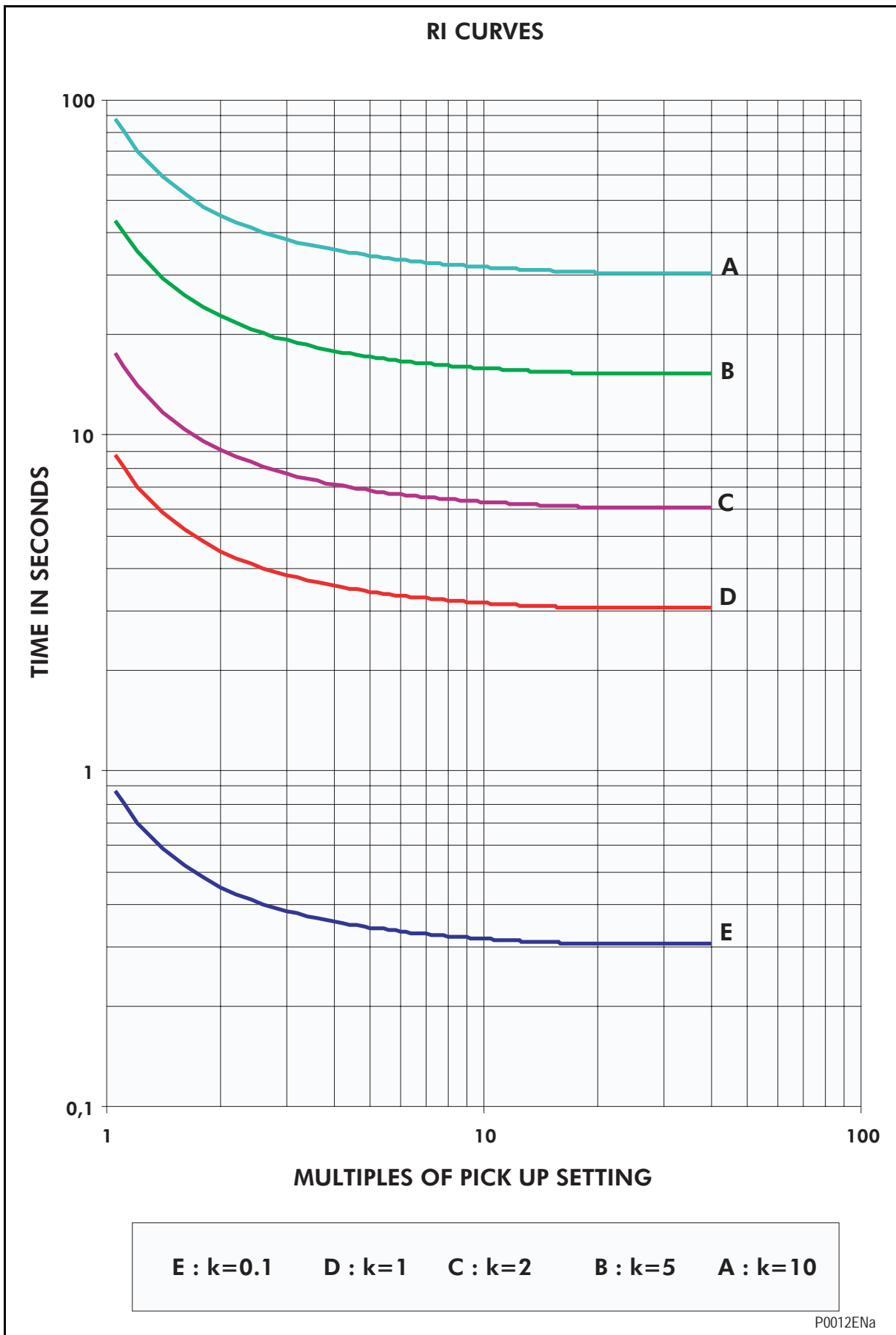

13.5 IEEE/ANSI & CO Curves

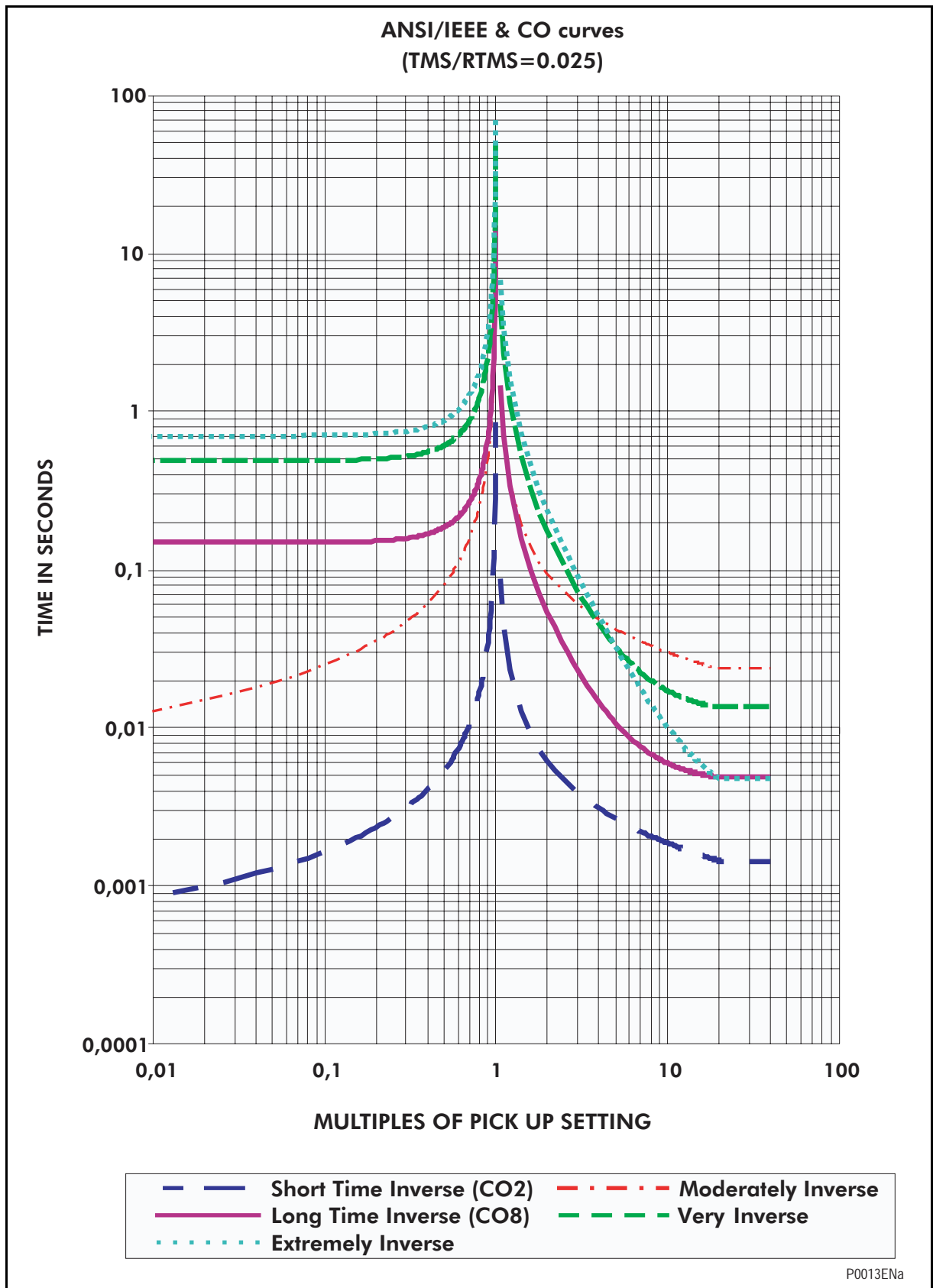

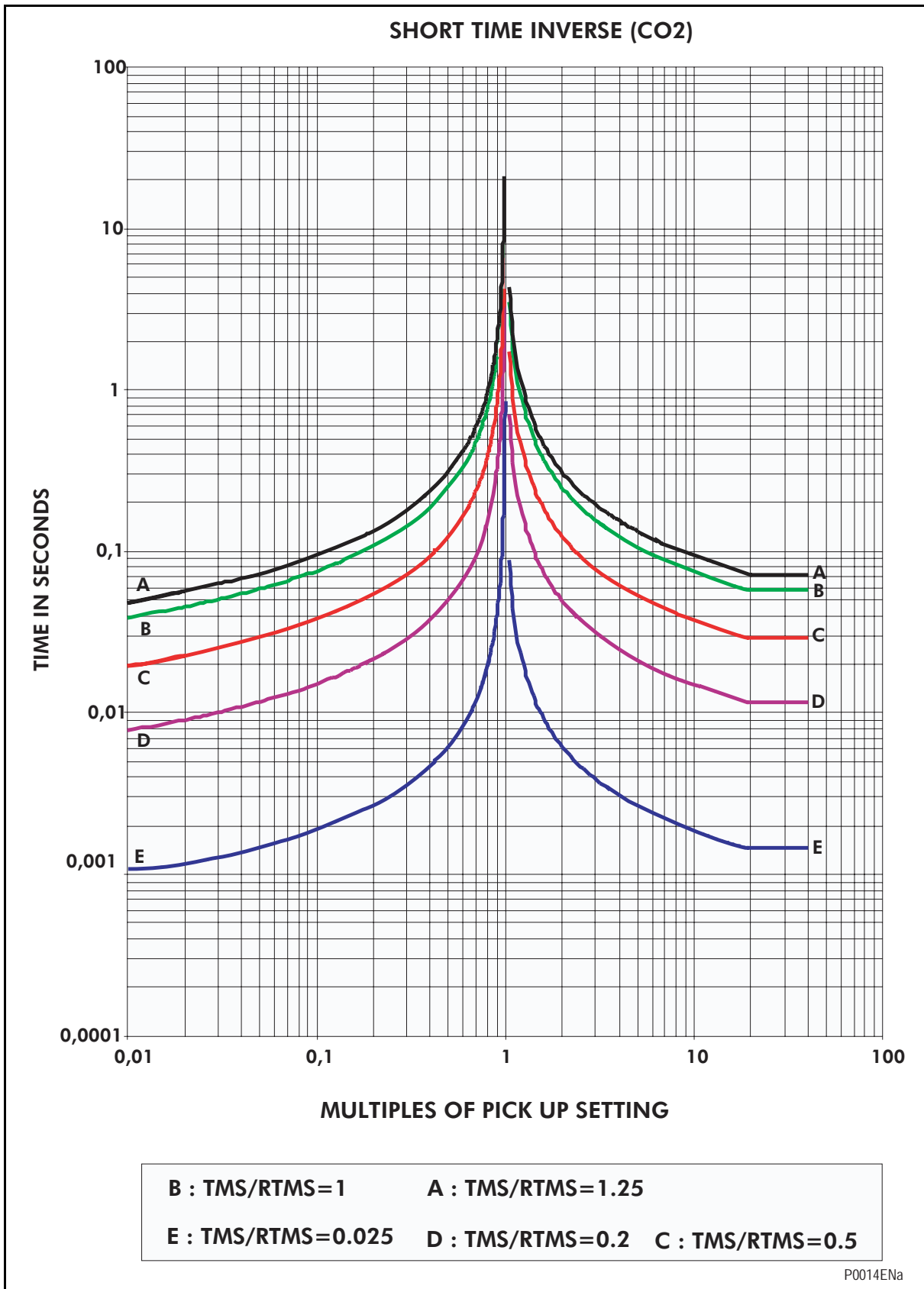



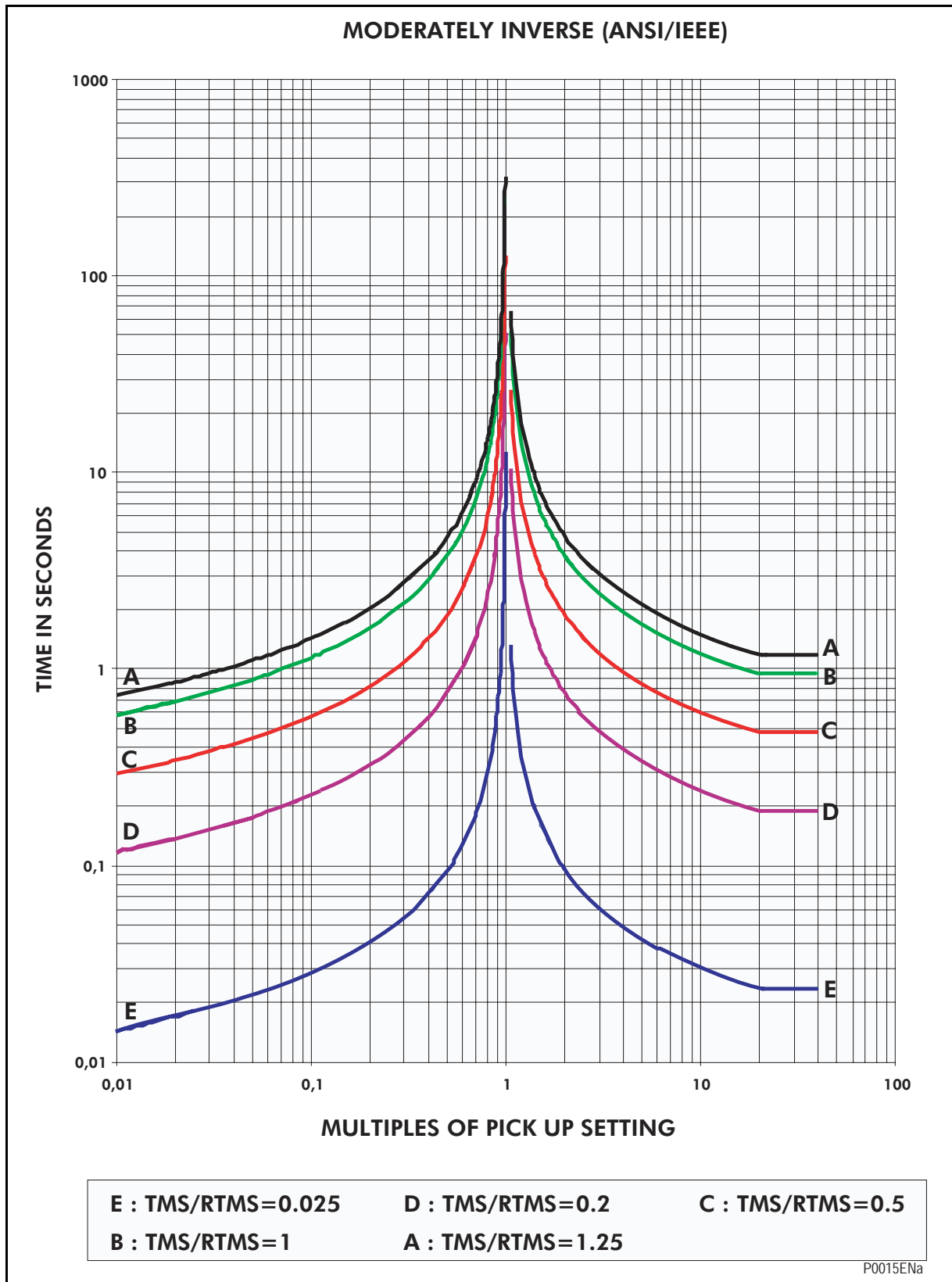

### LONG TIME INVERSE (CO8)

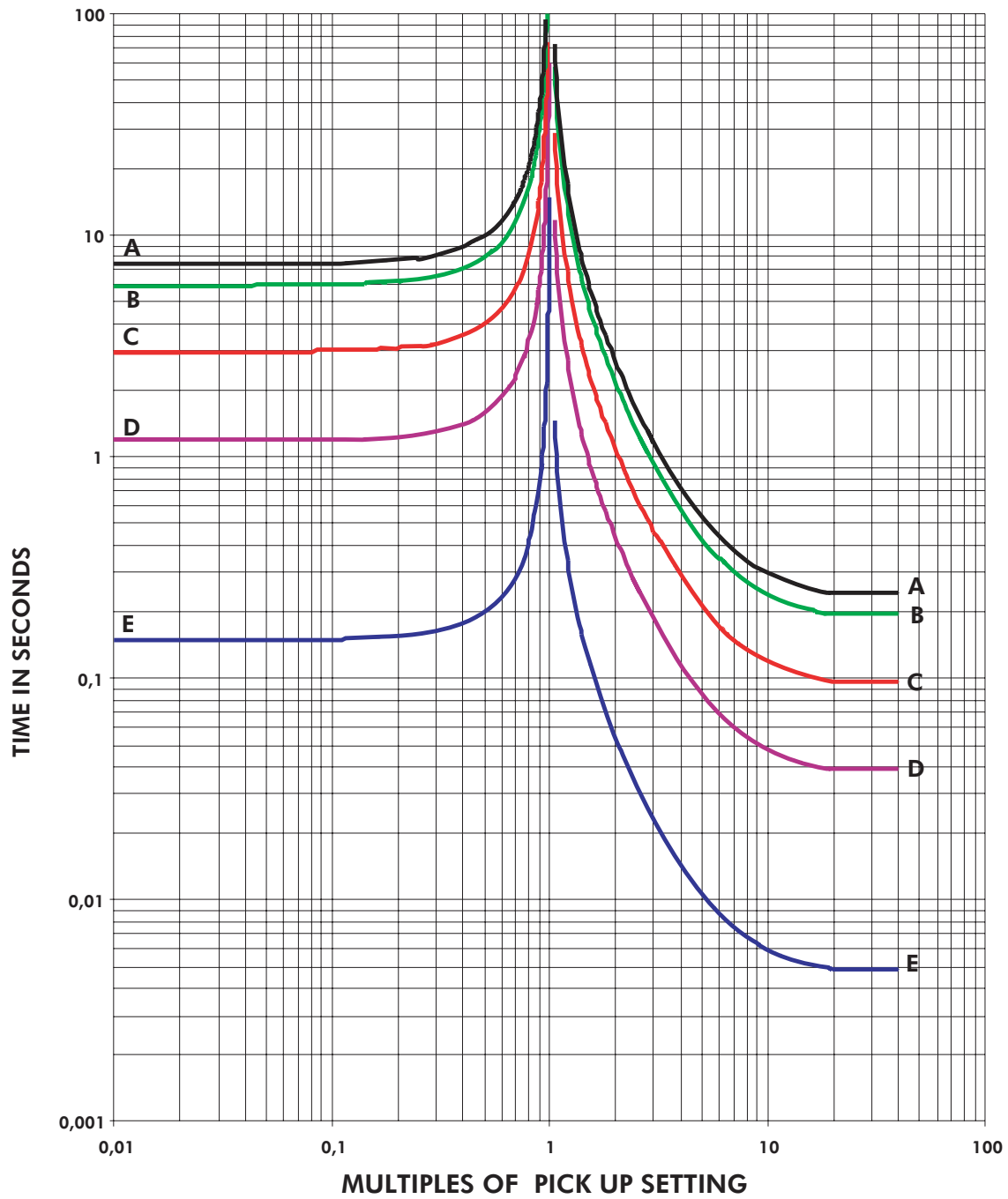

<b>E : TMS/RTMS=0.025</b>	<b>D : TMS/RTMS=0.2</b>	<b>C : TMS/RTMS=0.5</b>
<b>B : TMS/RTMS=1</b>	<b>A : TMS/RTMS=1.25</b>	

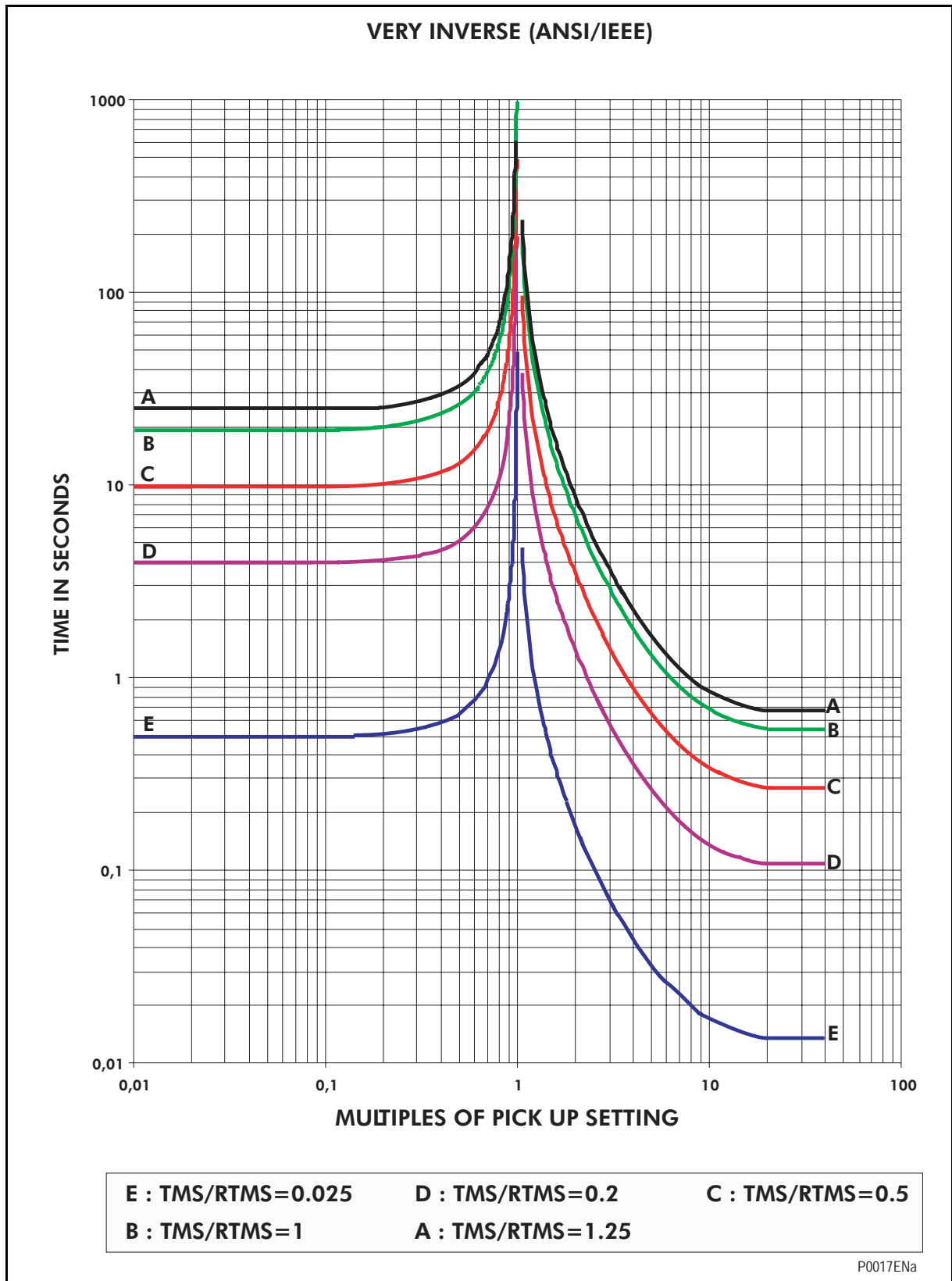

### EXTREMELY INVERSE (ANSI/IEEE)

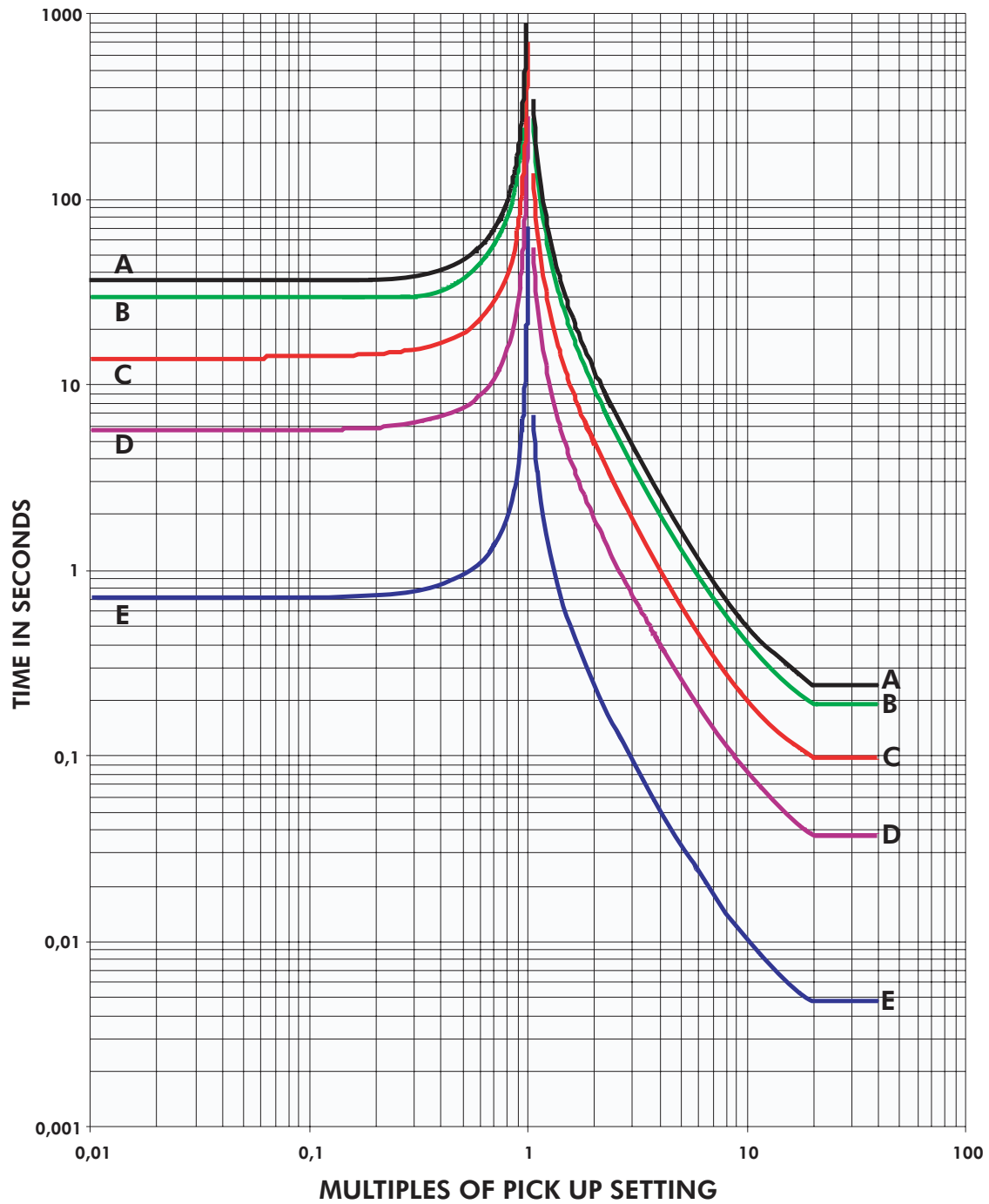

E : TMS/RTMS=0.025	D : TMS/RTMS=0.2	C : TMS/RTMS=0.5
B : TMS/RTMS=1	A : TMS/RTMS=1.25	

13.6 Rectifier protection curve

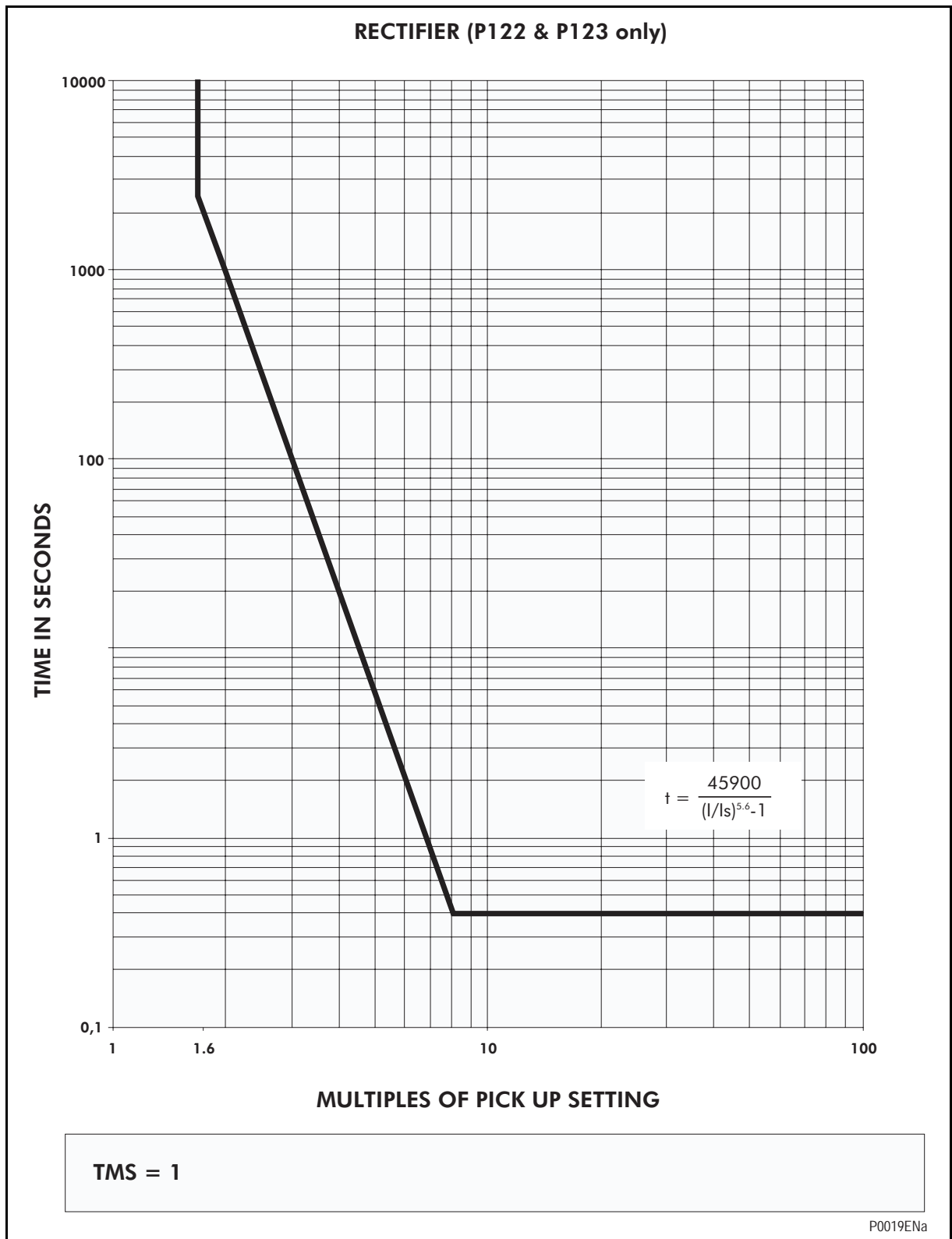

13.7 RXIDG curve

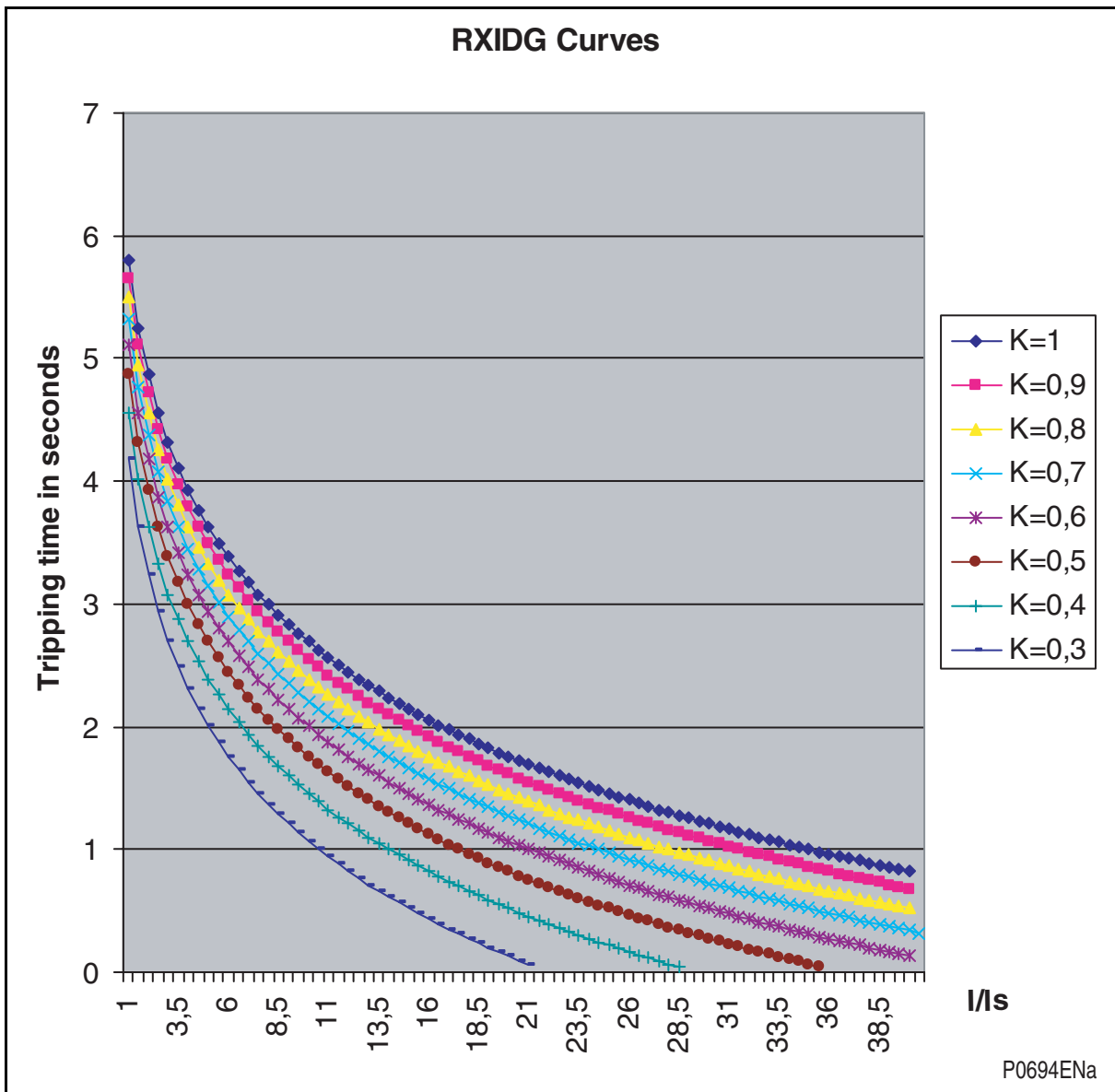

13.8 Thermal overload curves

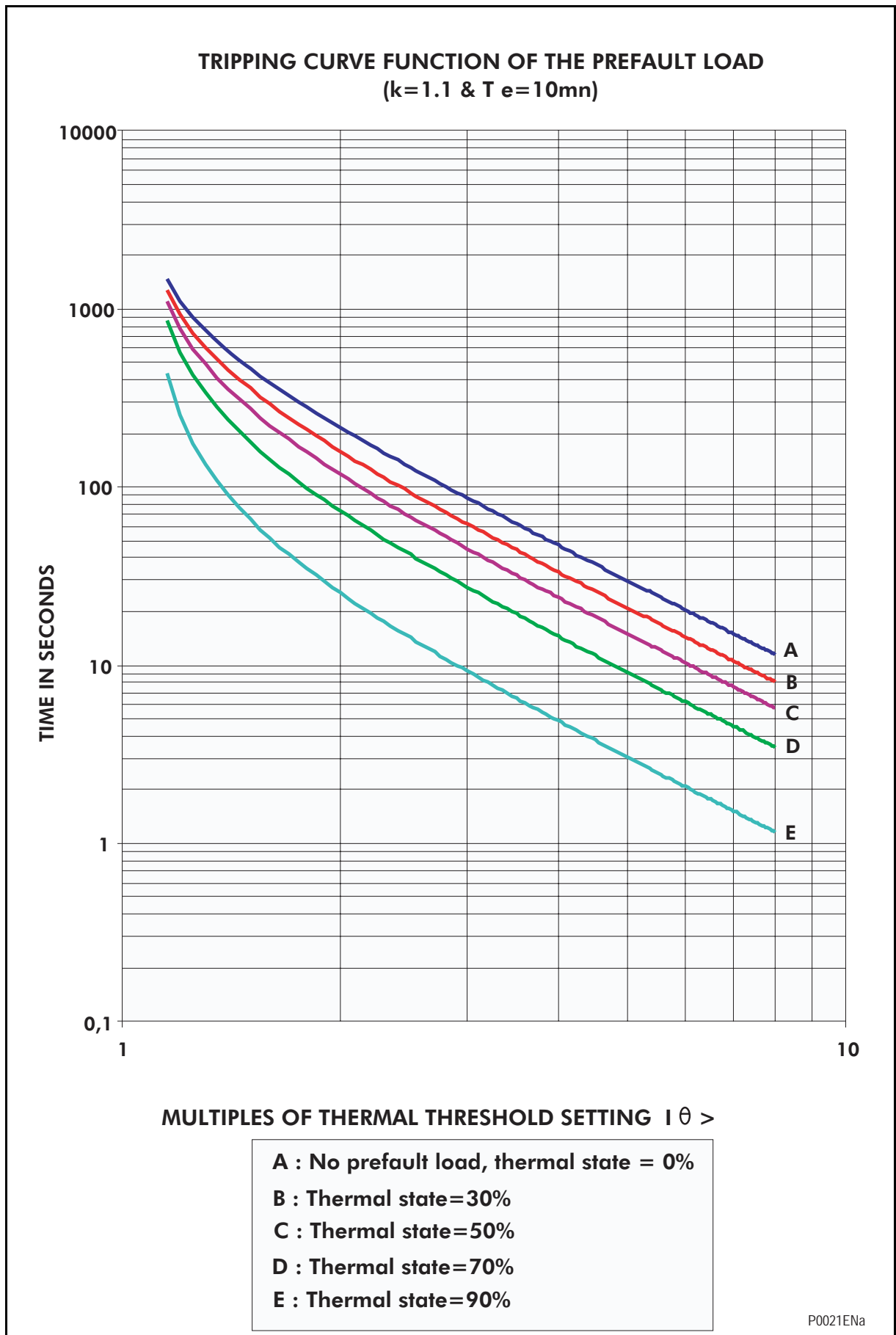

**BLANK PAGE**



# GETTING STARTED



# CONTENT

<b>1.</b>	<b>ENERGISING THE RELAY</b>	<b>3</b>
1.1	System Connections	3
1.2	Auxiliary Power Supply Connections	3
<b>2.</b>	<b>USER INTERFACE AND MENU STRUCTURE</b>	<b>4</b>
2.1	User interfaces and menu structure	4
2.1.1	“Default settings” alarm	4
2.1.2	Password protection	4
2.1.3	Setting the language	5
2.1.4	Setting Date and time	5
2.1.5	Menu navigation	5
2.2	Menu structure	6
<b>3.</b>	<b>LOCAL CONNECTION TO A PC</b>	<b>7</b>
3.1	Configuration	7
3.1.1	REMOTE connection	7
3.2	Products plugged in the same panel	8
3.3	Communication between distant products	8
3.4	MiCOM S1 and MiCOM S1 Studio relay communications basics	9
3.5	MiCOM S1 Studio	9
3.5.1	Data Model Management	9
3.5.2	“Quick Connection” to the relay using MiCOM S1 Studio	12
3.5.3	Create a system	15
3.5.4	Create a new substation	16
3.5.5	Create a new voltage level	17
3.5.6	Create a new bay	17
3.5.7	Create a new device	18
3.5.8	Open Settings File	19
3.6	MiCOM S1	21
3.6.1	Starting MiCOM S1	21
3.6.2	Open communication link with relay	23
3.6.3	Off-line use of MiCOM S1	25
3.6.4	MiCOM monitoring	25
3.7	Presentation and analysis of disturbance	27
<b>4.</b>	<b>WITHDRAWING MODULE FROM CASE</b>	<b>28</b>
<b>5.</b>	<b>COMPANY CONTACT INFORMATION</b>	<b>30</b>

**BLANK PAGE**

## 1. ENERGISING THE RELAY

To energise the relay correctly, follow the following instructions carefully.

### 1.1 System Connections

1. Check the wiring scheme of your installation.
2. Check that the contacts of output relay **RL1** are included in your trip circuit.

### 1.2 Auxiliary Power Supply Connections

Connect a DC or AC (according to nominal supply rating  $U_a$ ) voltage power supply.



**POSITIVE Vaux TO TERMINAL 33**  
**NEGATIVE Vaux TO TERMINAL 34**  
**DO NOT FORGET TO CONNECT THE EARTH REFERENCE TO**  
**TERMINAL 29!**

Turn on the auxiliary power supply and set to approximately rated voltage as shown on the front panel of the relay.

The display should show:

<b>IA</b> <b>1.00 A</b>
----------------------------

Displays the A phase current (true RMS value) taking into account the phase CT ratio (CONFIGURATION/CT RATIO submenu).

**LEDs** should be in the following configuration:

- Green LED L3 "Healthy" (Vaux) is illuminated
- All the other LEDs should be off.

## 2. USER INTERFACE AND MENU STRUCTURE



Before carrying out any work on the equipment, the user should be familiar with the contents of the safety section/safety guide SFTY/4LM/D11 or later issue, the technical data section and the ratings on the equipment rating label.

Refer to “GETTING STARTED” (GS) section for the description of the following procedures (interfaces and menu).

Before the initial operation of the relay, some of the parameter settings must be checked or modified (otherwise, “Setting alarm” is displayed).

Lift the upper and lower hinged covers and remove the transparent cover over the front panel. When the keypad is exposed, it provides full access to the menu options of the relay. The relevant information is displayed on the LCD.

### 2.1 User interfaces and menu structure

The settings and functions of the MiCOM relay can be accessed both from the front panel keypad and LCD, and via the front and rear communication ports. Information on each of these methods is given in this section to describe how to start using the relay.

The front panel of the relay includes a keypad, a 16-character alphanumeric liquid crystal display (LCD) and 8 LEDs.

#### 2.1.1 “Default settings” alarm

When the relay is powered ON, it checks its memory contents. If the default settings are loaded, an alarm is raised and The ALARM yellow LED lights up.

To suppress this message and to reset the watch dog, change one parameter in the relay's menu:

- Press the button,
- Modify, for instance, the password or the language (“OP parameters” menu).

#### 2.1.2 Password protection

Password protection is applicable to most of the relay parameter settings, especially to the selection of the various thresholds, time delays, communication parameters, allocation of logic inputs and logic outputs.

The password consists of four capital characters. When leaving the factory, the password is set to **AAAA**. The user can define any combination of four characters.

Should the password be lost or forgotten, the modification of stored parameters is blocked. It is then necessary to contact the manufacturer or his agent and by specifying the serial number of the relay, a stand-by password specific to the relay concerned may be obtained.

**NOTE:** The programming mode is indicated with the letter “P” on the right hand side of the display on each menu heading. The letter “P” remains present as long as the password is active (**5 minutes** if there is no action on the keypad).









- Go to the “OP. Parameters” menu by pressing and then to the “password” menu by pressing ,
- Enter the current password (default password = “AAAA”) and validate with (this operation is not necessary if the password has been entered some minutes ago),
- Enter the new password character by character, using and arrows to change a letter (maintain the key pressed to scroll through the letter in the alphabet). Use and arrows to select another character: a flashing cursor will indicate which character field of the password may be entered.,
- Validate using or cancel using . If the password is correct, the following message is displayed on the LCD: PASSWORD OK

As soon as the password has been entered, no setting change will be accepted via the remote or local communication port (RS485 or RS232).







Alternatively, the password can be entered by using the **Password** window in the **OP.PARAMETERS** menu. This password entry procedure is the same as above.

**NOTE:** In case of loss of password a back up password can be provided contacting Schneider Electric Customer Care Center.





### 2.1.3 Setting the language

- Go to the “OP. Parameters” menu by pressing  and then to the “Language” menu by pressing , ,
- If necessary, enter the current password and validate with ,
- Select the language using  or  arrows, and validate with ,
- Validate using  or cancel using .

### 2.1.4 Setting Date and time

- Go to the “OP. Parameters” menu by pressing  and then to the “Date” menu by pressing  (x9),
- If necessary, enter the current password and validate with ,
- Set the date using  or  arrow, and validate with  (10/11/08 means November 10th 2008),













**NOTE:** When you modify the date, the first digit for the day or the month can be selected according to the second digit. For instance, if 13/09/08 is displayed, you cannot select 33 for the day, or 29 for the month.

- Validate using  or cancel using .
- Select the “Time ” menu by pressing 2 key,
- Set the date using  or  arrow, and validate with  (14:21:42 means 2:21:42 pm)

### 2.1.5 Menu navigation

A simple menu structure (refer to chapter GS) allows setting and reading of parameters and functionality.

The keypad provides full access to the menu options, with informations displayed on the LCD.

- Press , ,  and  keys for menu navigation:
  - Press  or  keys to navigate from a menu heading to another menu heading (refer to the figure below),
  - Press  key to access to a sub menu, then navigate using  or  keys.
- Maintain these keys pressed to scroll through the menu,
- If necessary, modify a parameter by pressing  key.
  - Modify the corresponding parameter using arrows,
  - Validate using , or cancel using .

**2.2 Menu structure**

The menu structure is shown below.

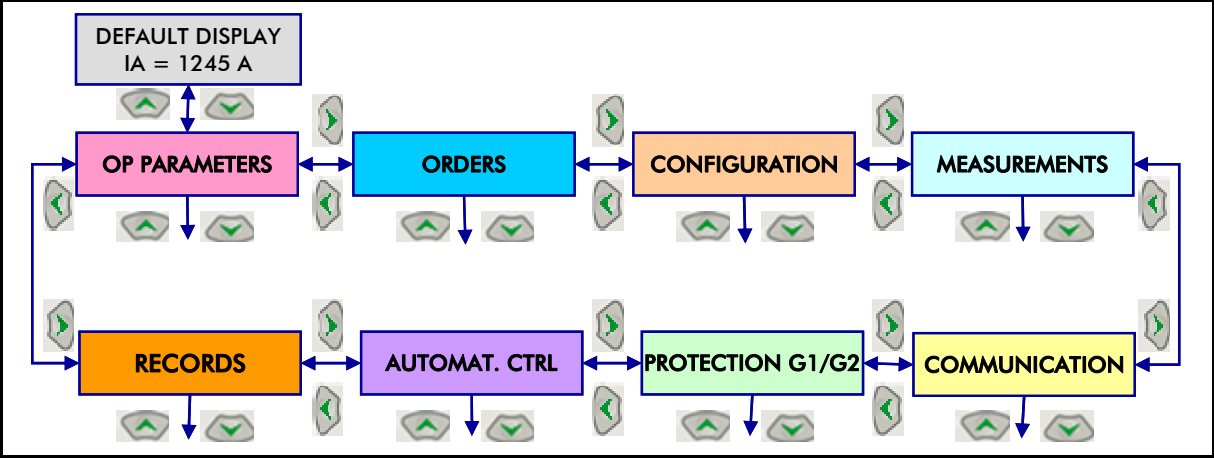

Refer to chapter HI for the menu details.



### 3. LOCAL CONNECTION TO A PC

#### 3.1 Configuration

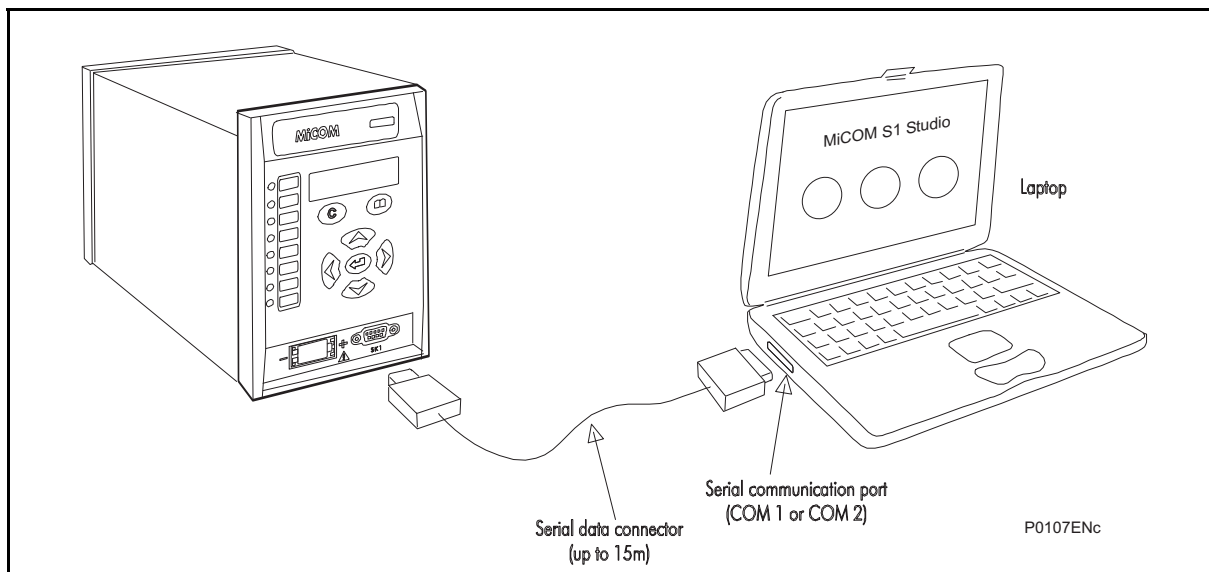

For a local connection between a PC and the relay, a serial cable with metallic shield should be used.

The wiring of the RS232 cable must be as shown in the following drawing.

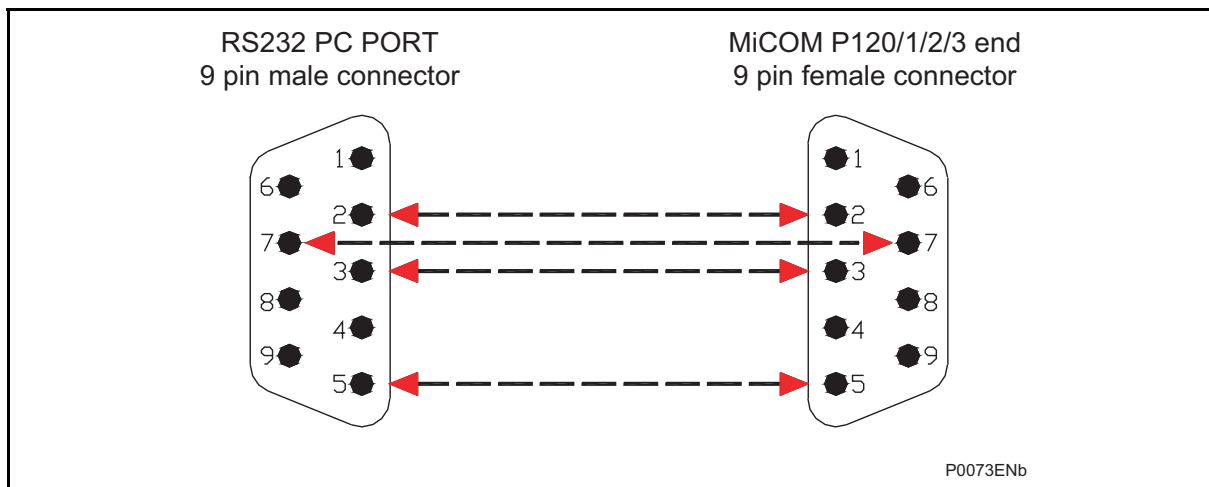

A USB/RS232 cable can also be used to communicate to the relay

#### 3.1.1 REMOTE connection

The figure shows the recommended way to connect a RS485 cable to the relay to build a local network.

### 3.2 Products plugged in the same panel

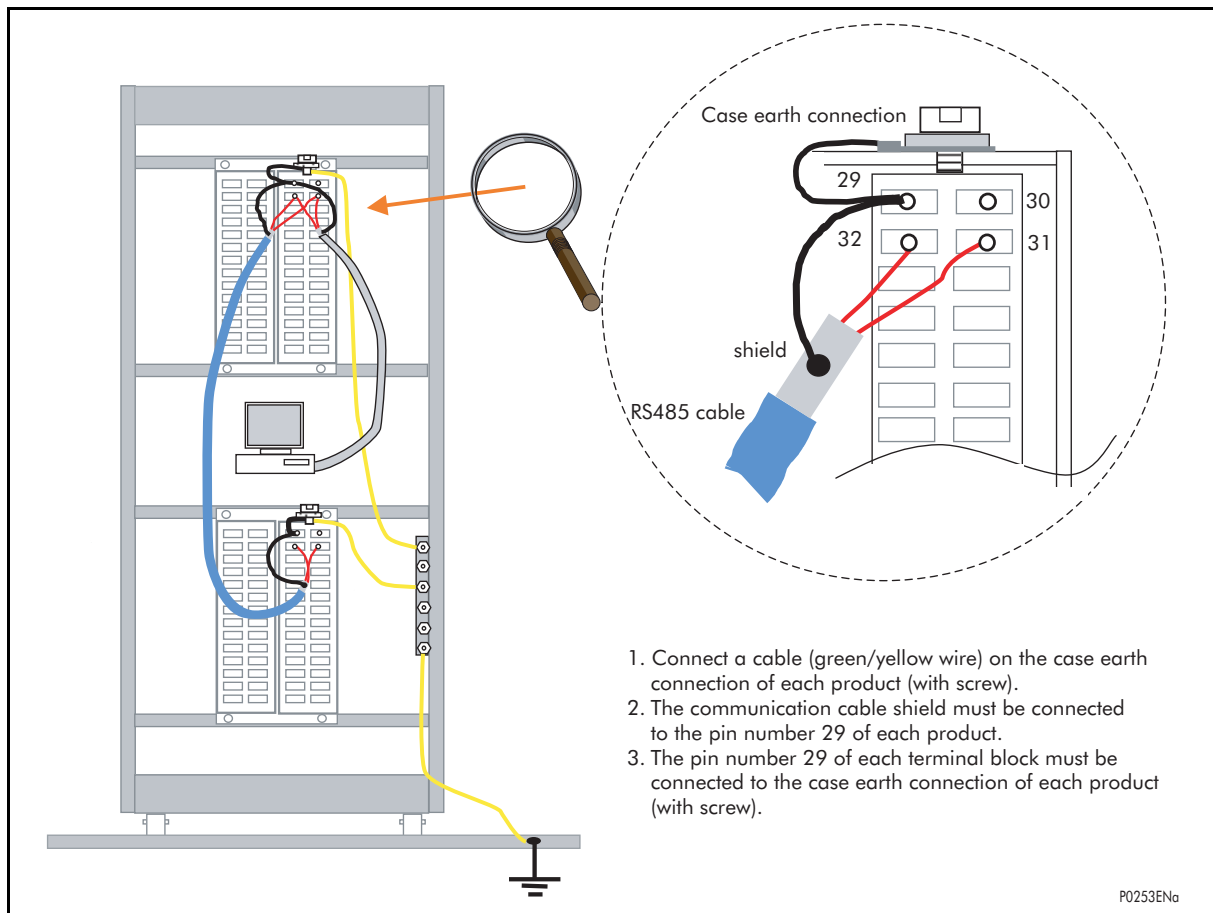

### 3.3 Communication between distant products

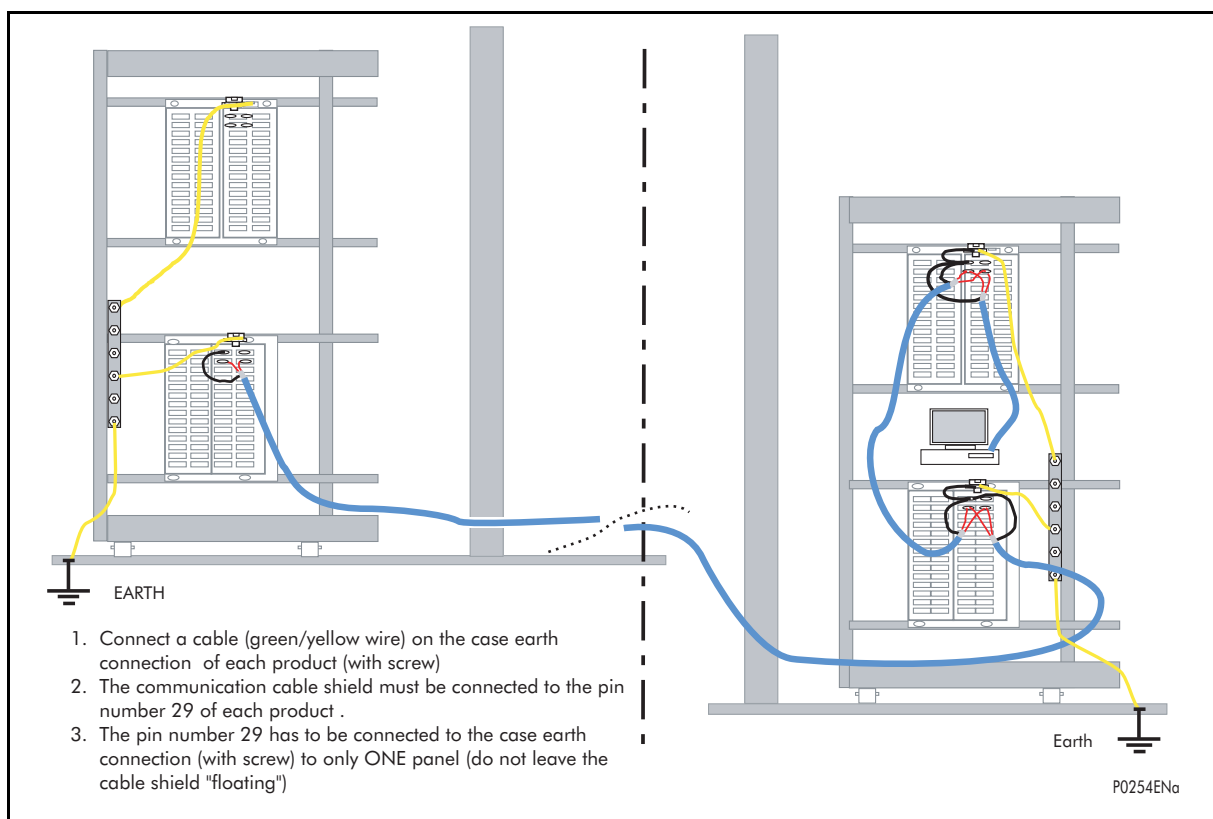

### 3.4 MiCOM S1 and MiCOM S1 Studio relay communications basics

MiCOM S1 and MiCOM S1 Studio are the universal MiCOM IED Support Softwares and provide users a direct and convenient access to all stored data in any MiCOM IED using the EIA(RS)232 front communication port.

MiCOM S1 Studio provide full access to MiCOM Px20, Px30, Px40 relays and others IED,

The following sections give the main procedures to connect and to use MiCOM S1 and MiCOM S1 Studio.

Before starting, verify that the EIA(RS)232 serial cable is properly connected to the EIA(RS)232 port on the front panel of the relay. Please follow the instructions in section 3.1 to ensure a proper connection is made between the PC and the relay before attempting to communicate with the relay.

This section is intended as a quick start guide to using MiCOM S1 and MiCOM S1 Studio, and assumes you have a copy of MiCOM S1 or MiCOM S1 Studio installed on your PC. Please refer to the MiCOM S1 or MiCOM S1 Studio User Manual for more detailed information.

### 3.5 MiCOM S1 Studio

#### 3.5.1 Data Model Management

The settings and parameters of the protection relay can be extracted from the relay or loaded using Data Model manager. The Data Model Manager can load any model from Local file, CD ROM or Internet server (if connected).

The Data Model Manager is used to add or to remove data models, to export and to import data model files.

It is necessary to close MiCOM S1 Studio when the Data Model Manager is opened.

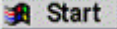
To Open Data Model manager, click on the icon: , select "MiCOM S1 Studio" then "Data Model Manager" in the "Programs" menu.

The following panel is displayed:

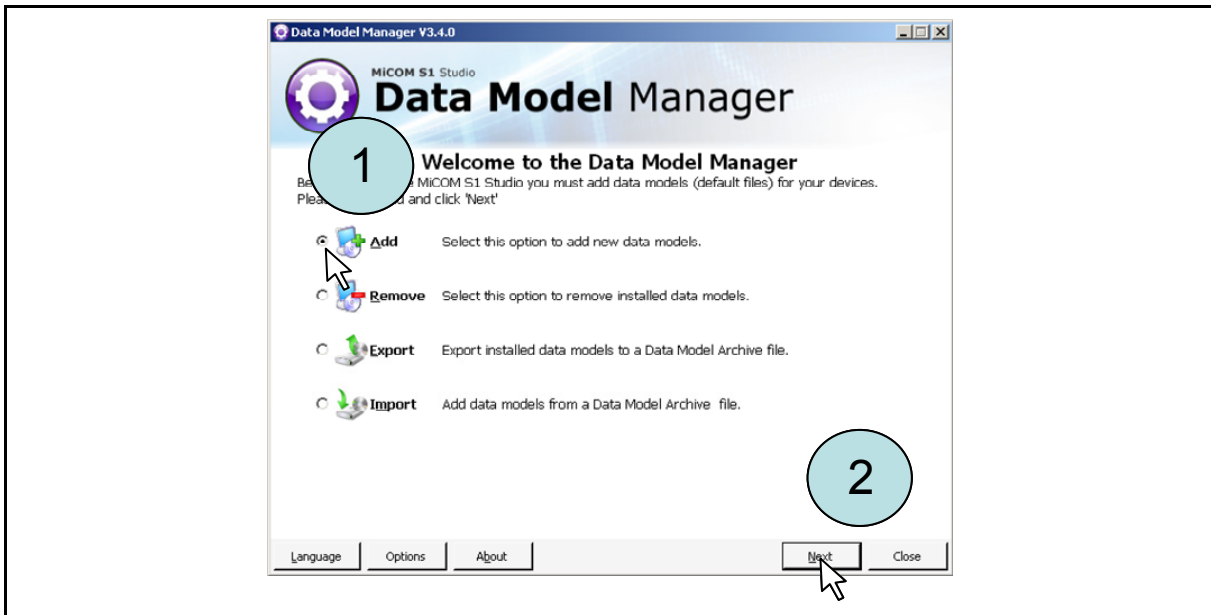

Select the “Add” option to add the new data model then click on the “Next” button.

The next panel is used to select the model source (CD ROM, local folder or Schneider Electric FTP server [DEFAULT FTP]). Select the model source and click on the “next” button.

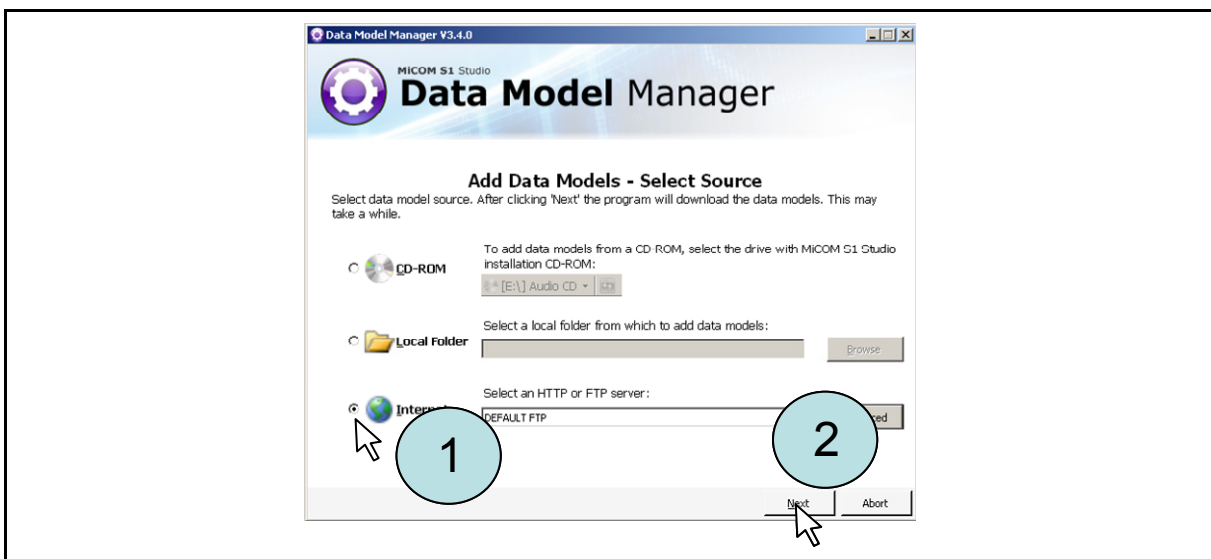

NOTE: the following procedure is given with FTP server selected.

The Data Model Manager loads data models details, and then displays automatically the language selection option panel. Select the menu language(s) and click on the “Next” button.

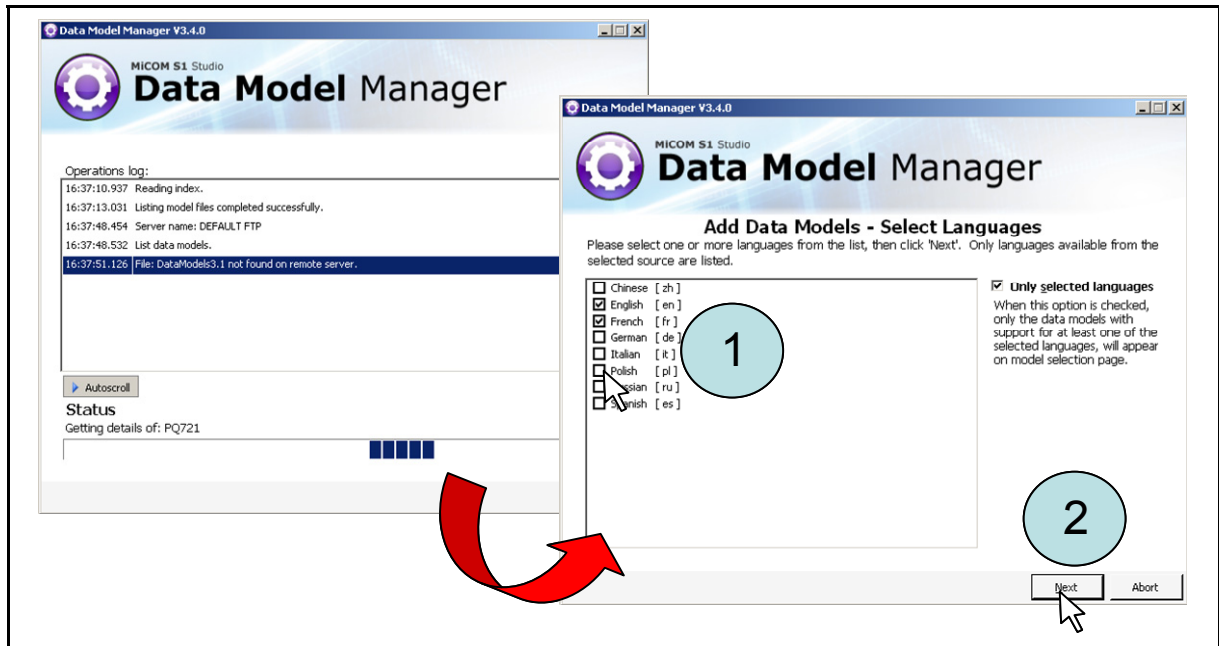

The data models panel is displayed. Select the data model for your product (for instance, to download P12x data models, open the “Px10/Px20/Px20C/M/Modulex” sub-menu (click on “+” then select data model according to your product). When data models are selected, the Data Model Manager panel displays the selected models size to download.

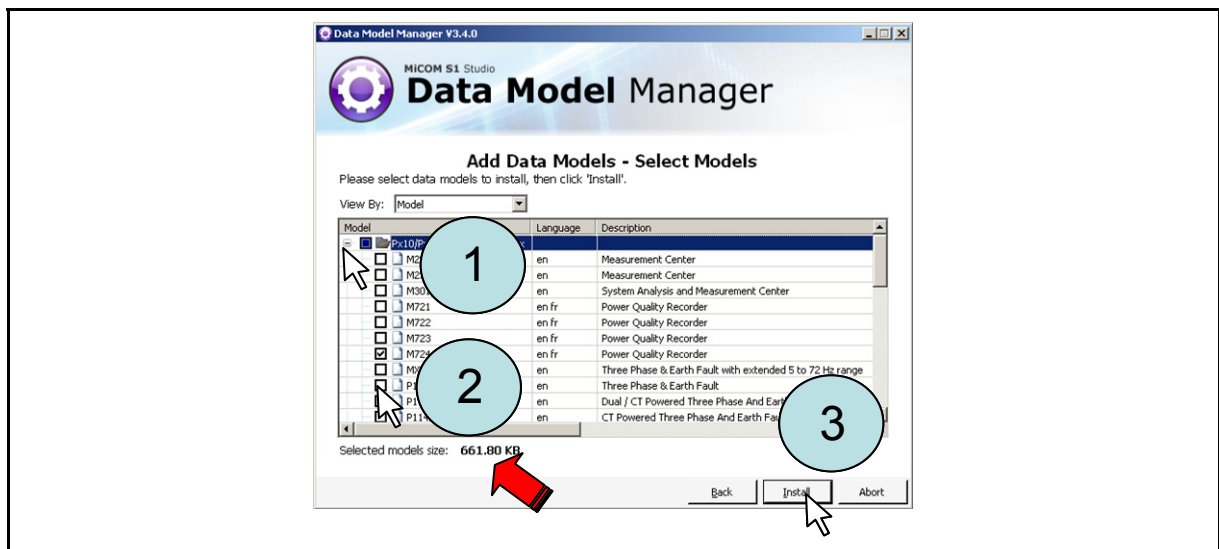

Click on “Install button”. The model files are downloaded and updated in the system.

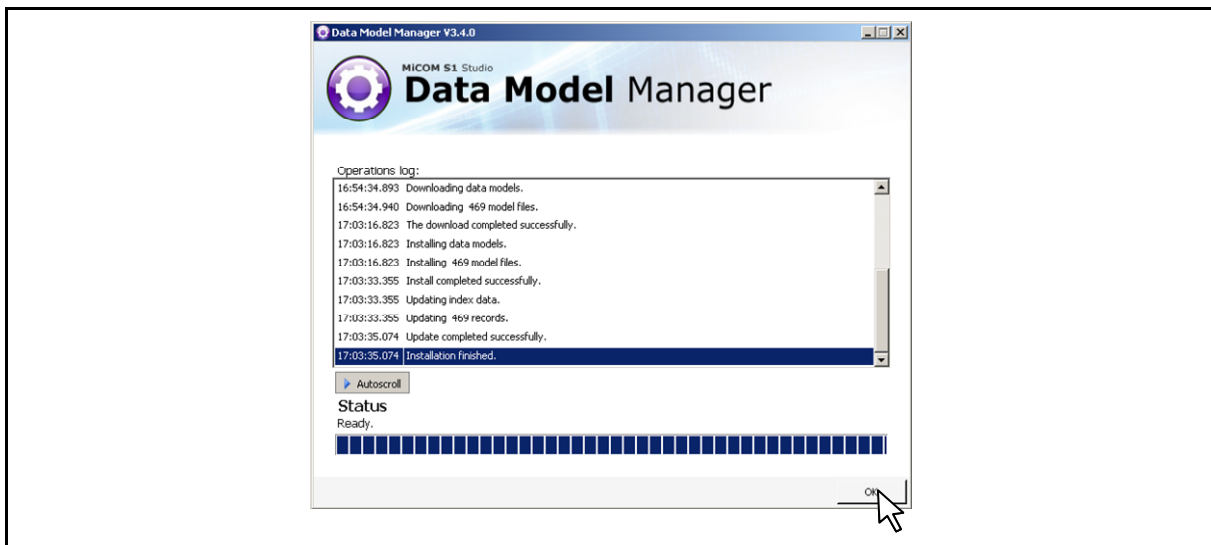

When installation has been completed, close the Data Model Manager. This Data Model is used with MiCOM S1 Studio when a system is opened or created. To open this default setting file, refer to § 3.5.8.

### 3.5.2 “Quick Connection” to the relay using MiCOM S1 Studio

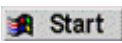
To start MiCOM S1 Studio, click on the icon: 

In the "Programs" menu, select "MiCOM S1 Studio".

The MiCOM S1 Studio launcher screen is displayed:

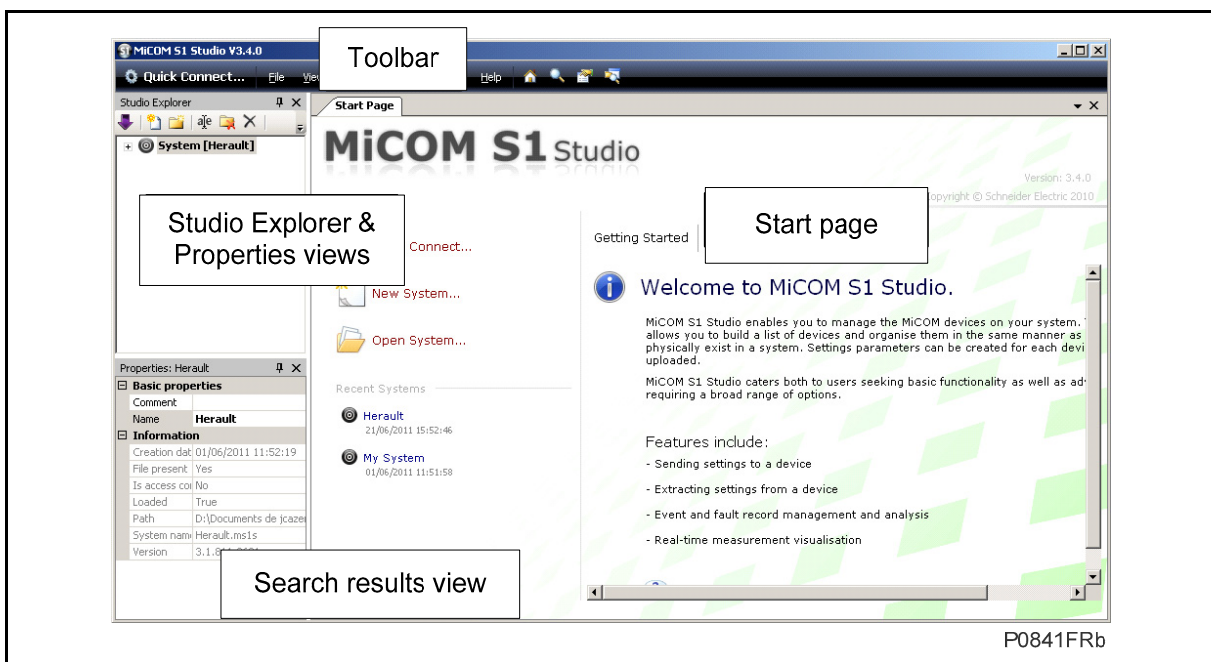

Click on the “Quick Connect” button at the top left of the application:



Create a new system (see § 3.5.3) or open an existing one:

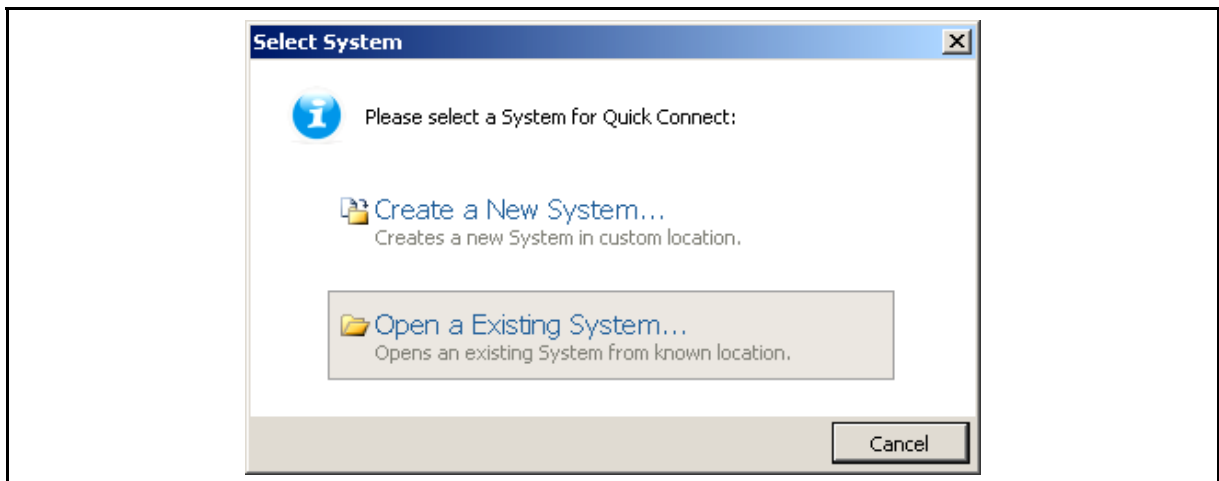

When a system is opened (or created), the following “device type” window is displayed.

Select "Px20 Series" from the presented options:



Select a port from the presented options:

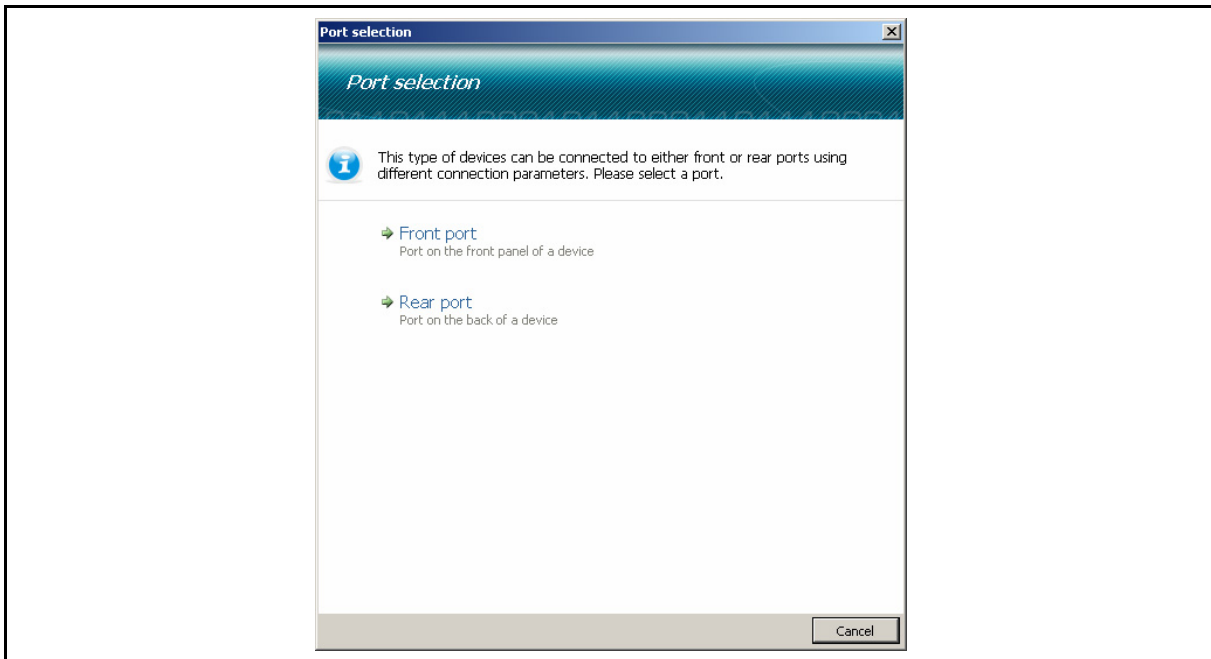

Upon a successful connection, a dialog will be displayed showing device type, model number and plant reference. Options for language, device name and comment are also available.

The device is displayed in the Studio Explorer panel.



### 3.5.3 Create a system

In MiCOM S1 Studio, a System provides a root node in the Studio Explorer from which all subsequent nodes are created.

Substations, bays, voltage levels and devices are added to the system. If a system is no longer needed, It can be deleted using the delete command.

The use of Quick Connect will automatically create a default system, if one does not already exist. Systems are not opened automatically, unless “Reopen last System at start-up” is selected in “Options / Preferences...” menu.

To create a new system:

- By default, the window displays the message “create new or open existing system”: click on “new” to create a new system.
- If a system is loaded in the “Studio Explorer” window, right-click on the panel background and select New System or select the corresponding icon on Studio Explorer's toolbar.

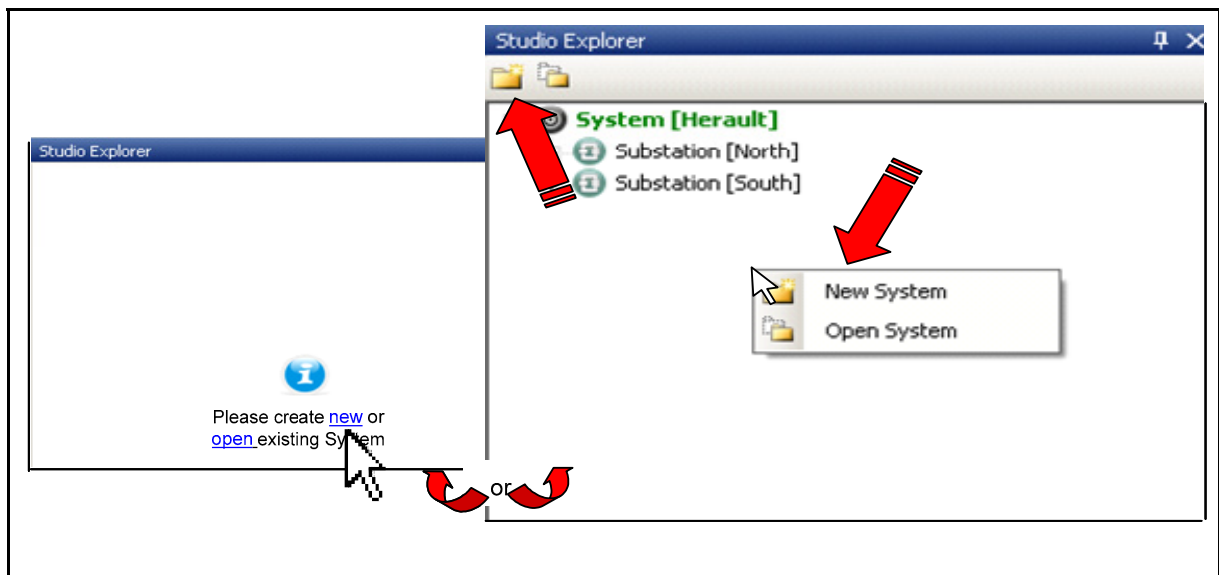

The following window is displayed: Enter the name of the system, and the path to save the system file.

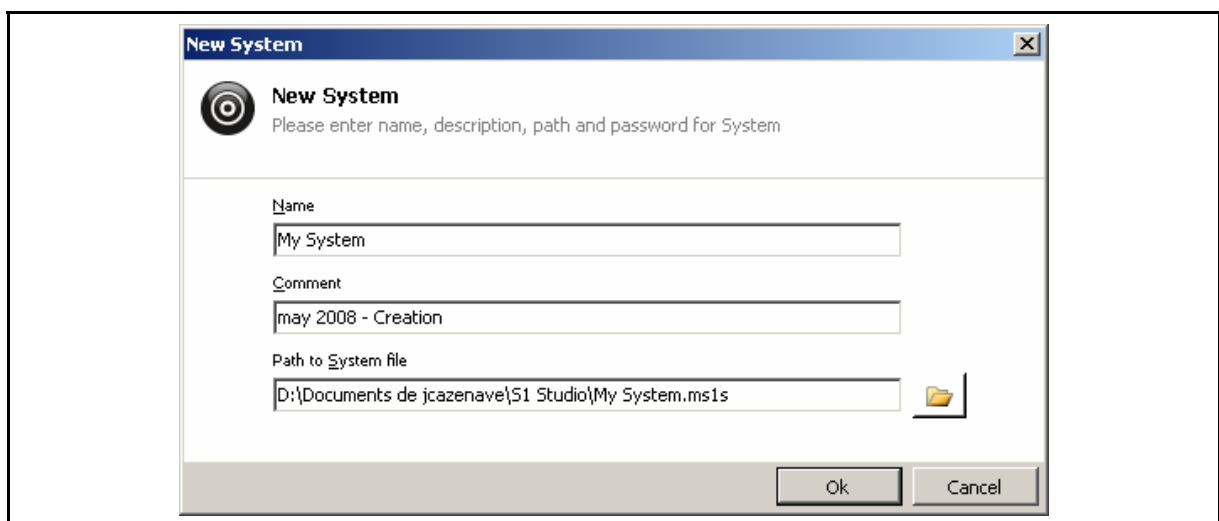

The new System is displayed in the Studio Explorer panel:

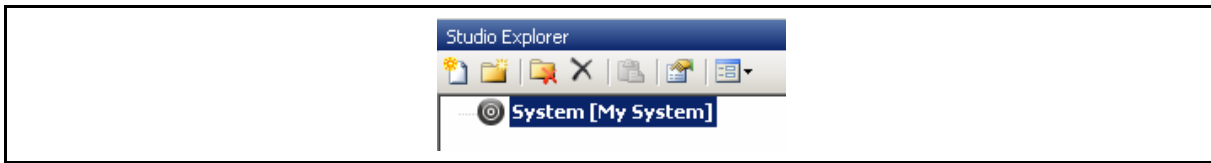

**NOTE:** In the Studio Explorer panel, if an item is selected, its properties are displayed in the “Properties” panel

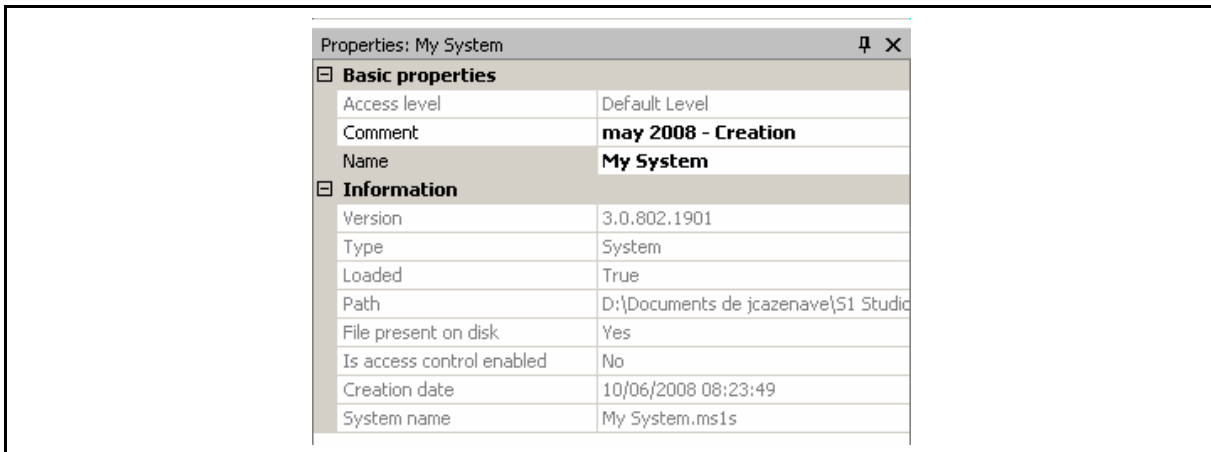

### 3.5.4 Create a new substation

Select the system: the menu bar is updated with “new device”, “new substation”, “close”, “delete”, “paste”, “properties” and “options” icons.

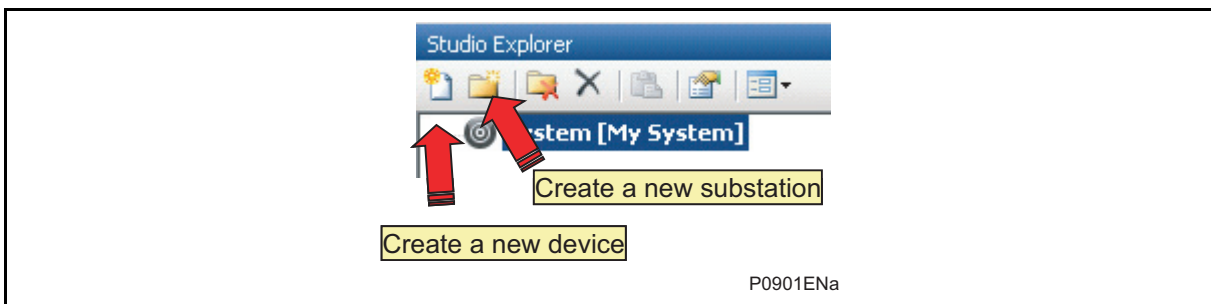

Click on “new substation” icon (or select the menu using right-click). The following window is displayed:

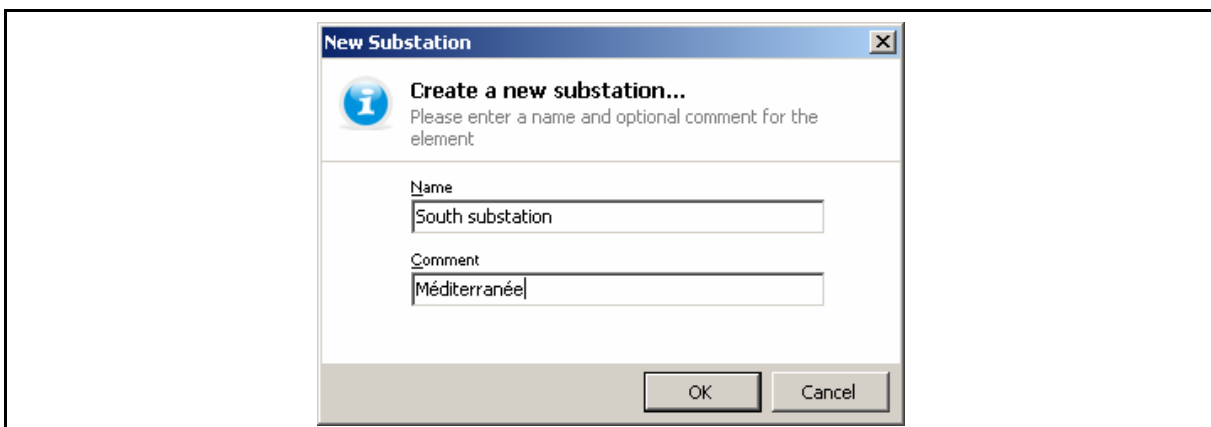

The new substation is displayed and the menu bar is updated when a substation is selected:

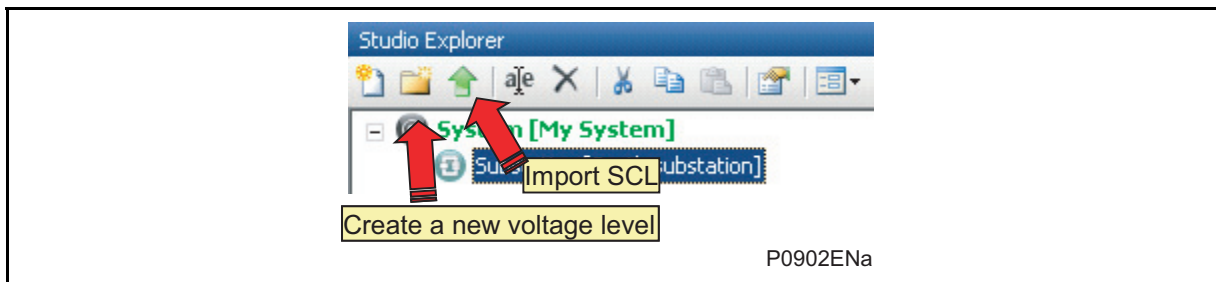

Click on “Import SCL” button to import a Substation Configuration File.

To create a substation configuration, click on “new voltage level” button.

### 3.5.5 Create a new voltage level

Select the substation and click on “new station level” button (or select the menu using right-click).

In the “Create a new voltage level”, enter the voltage level of the station.

The “new voltage level” is displayed and the “new bay” icon is displayed.

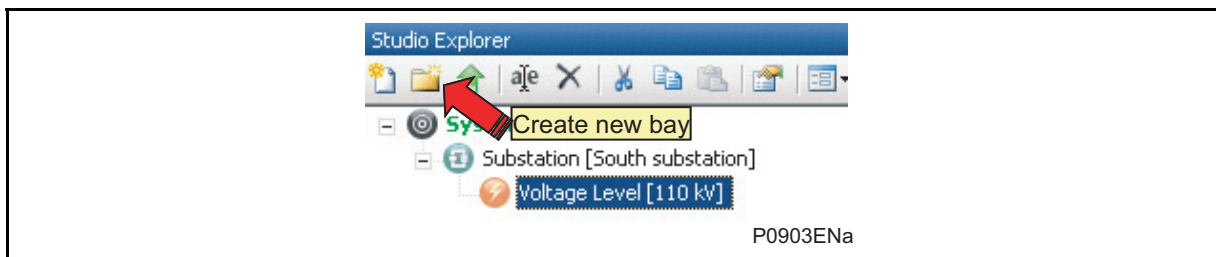

### 3.5.6 Create a new bay

Select the substation and click on “new bay” button (or select the menu using right-click).

In the “Create new bay...” window, enter the bay indication,

The new bay is displayed.

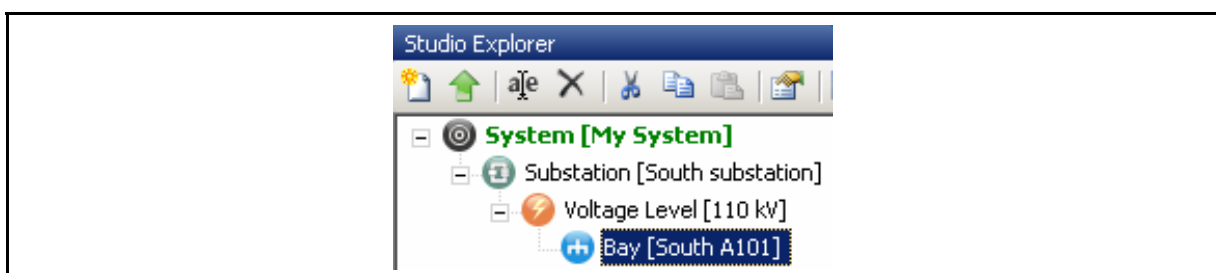

### 3.5.7 Create a new device

Click on “new device” button (or select the menu using right-click).

Select the device type and, if necessary, the communications protocol mode that will be used to send the file to the device.

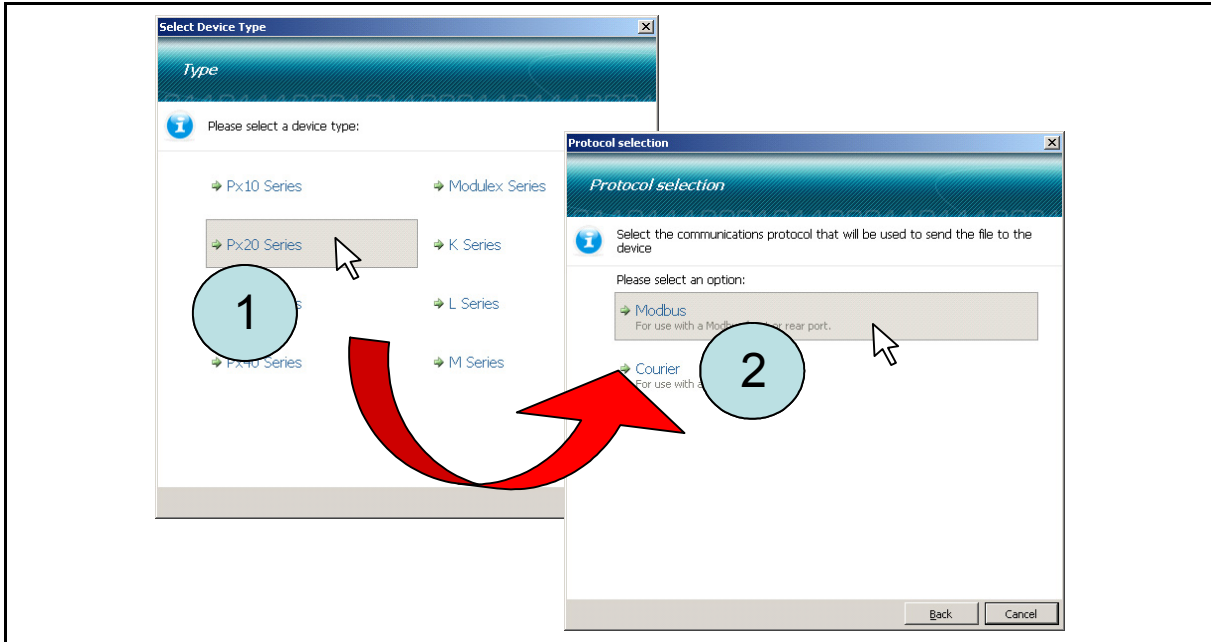

Select the device type, click “Next” button.

Select the model and click “Next” button.

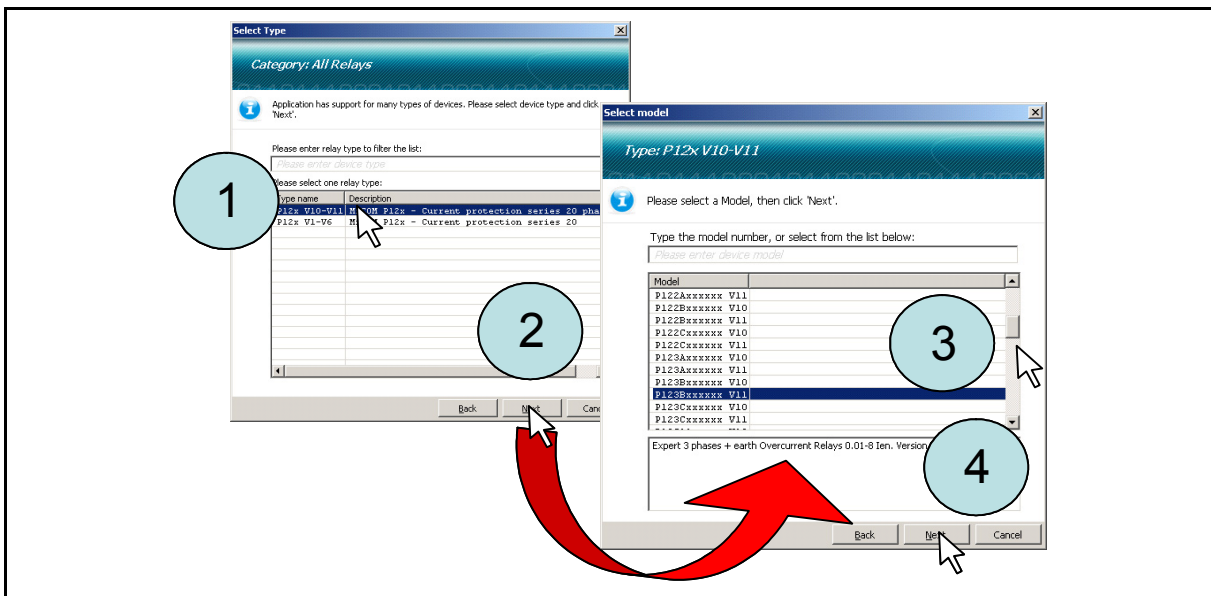

Enter the name and add a description of the device:

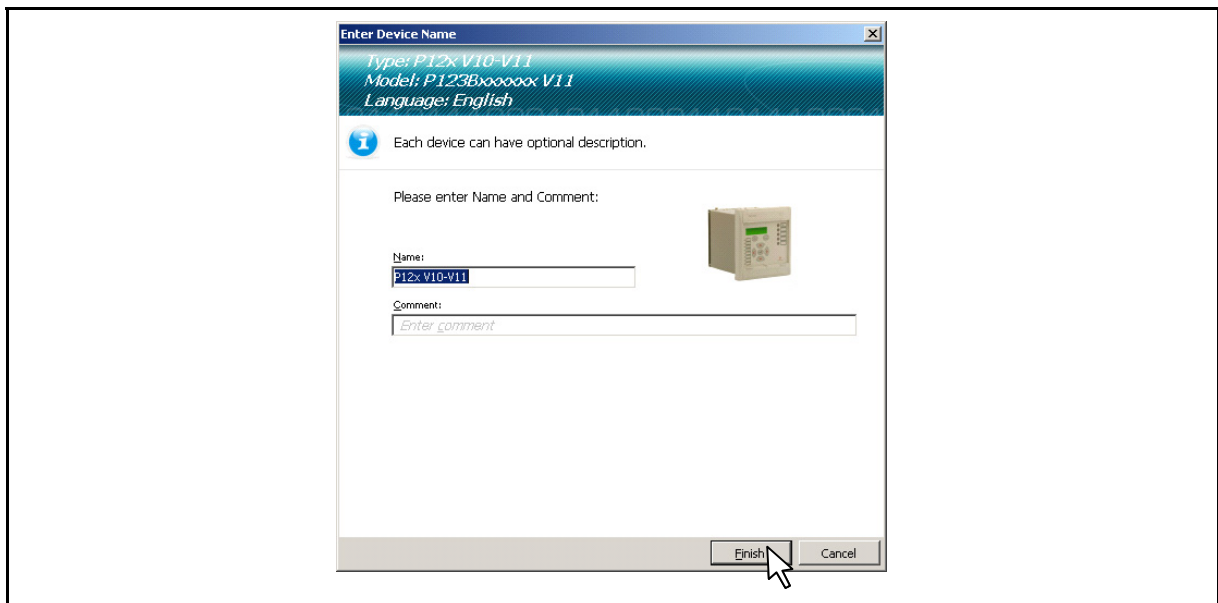

The new device is created and displayed.

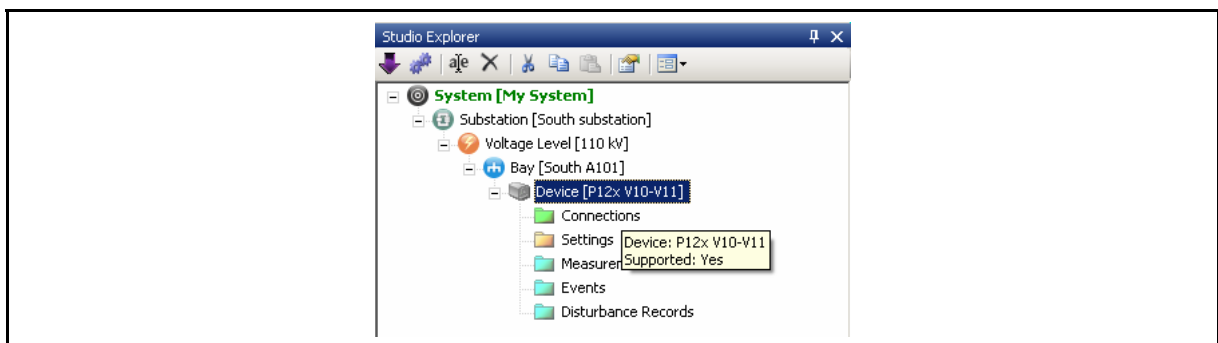

### 3.5.8 Open Settings File

To open an existing file:

- If the file is saved or if the relay is not connected: open the Settings folder and open the Settings file,
- If the relay is connected, extract the settings from the relay: click on the “Extract Settings” command or right click on the Settings folder.

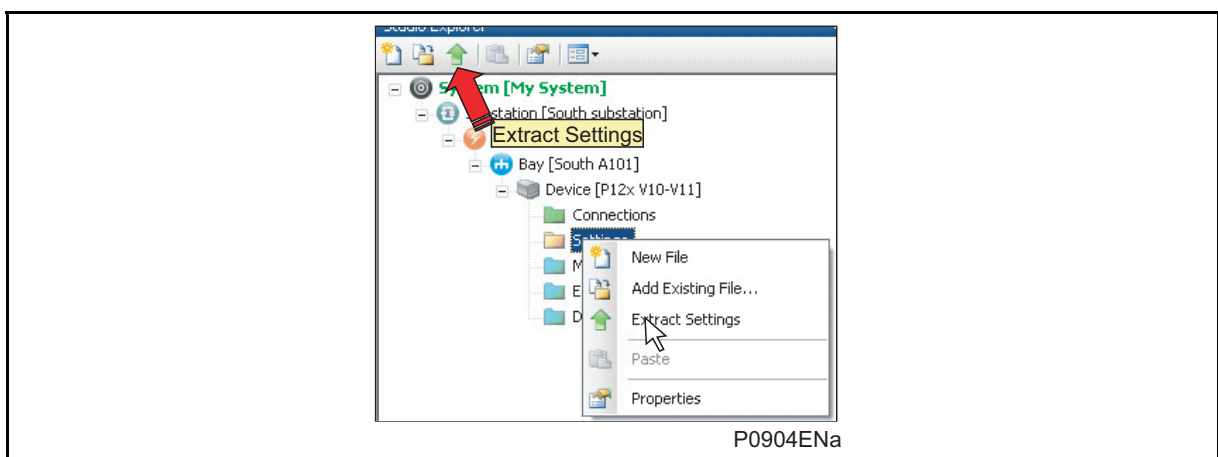

To open default settings:

- Click on “Open Default Settings File” Option in the File menu.
- Select the device type then the communication protocol.
- Select the device type and click on the “Next” button:

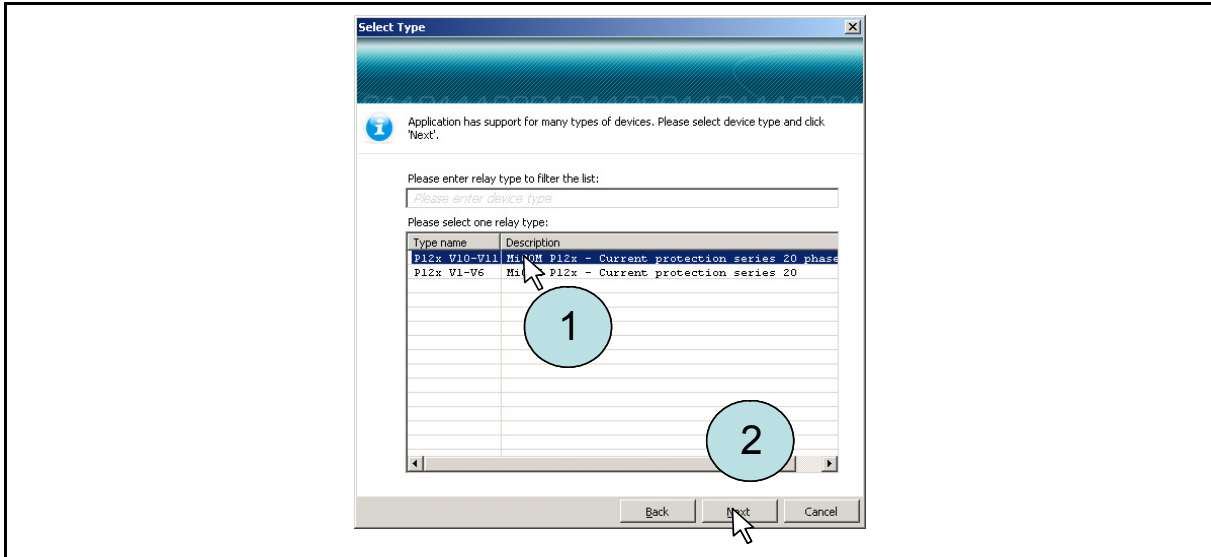

- Select the Model and click on the “Finish” button. The default settings are displayed.

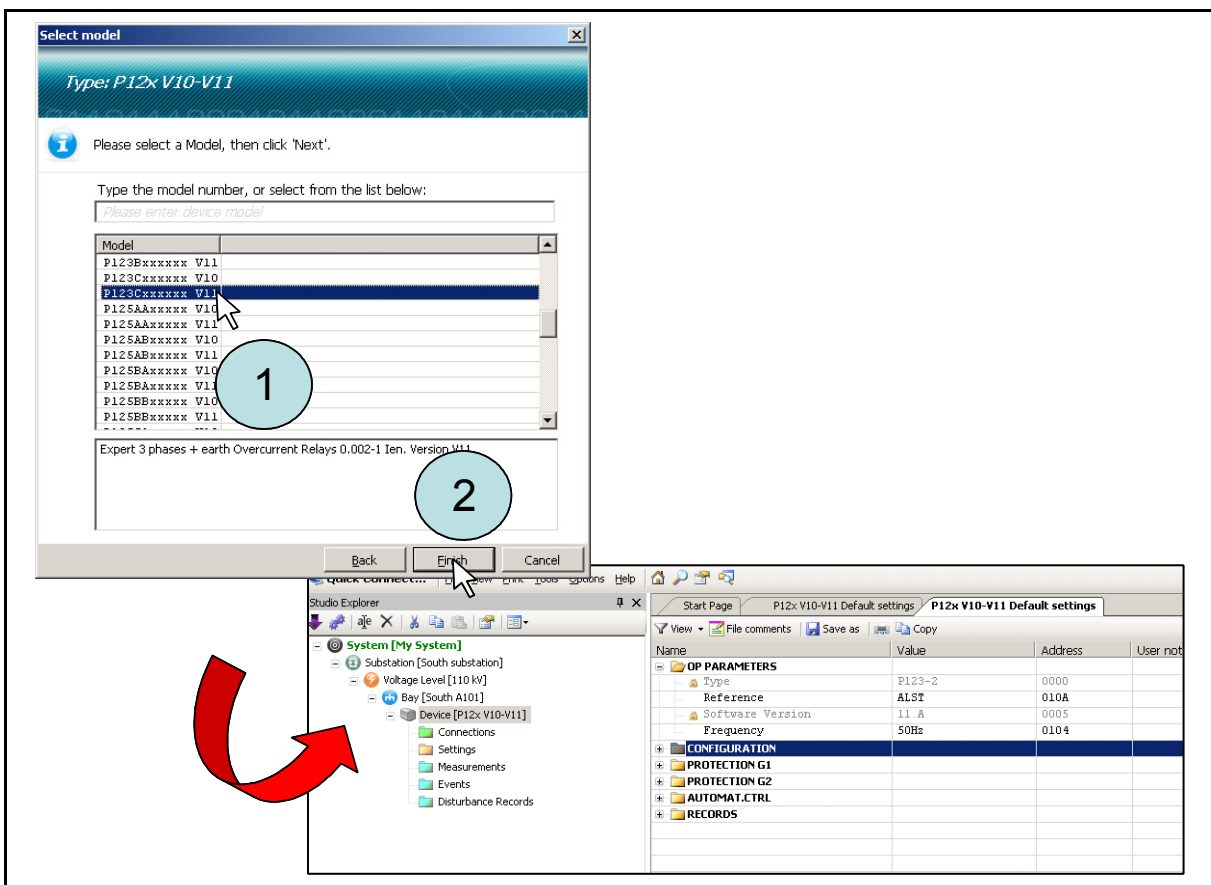

### 3.6 MiCOM S1

#### 3.6.1 Starting MiCOM S1

To start MiCOM S1 Studio, click on the icon: .

In the "Programs" menu, select "MiCOM S1" then "MiCOM S1".

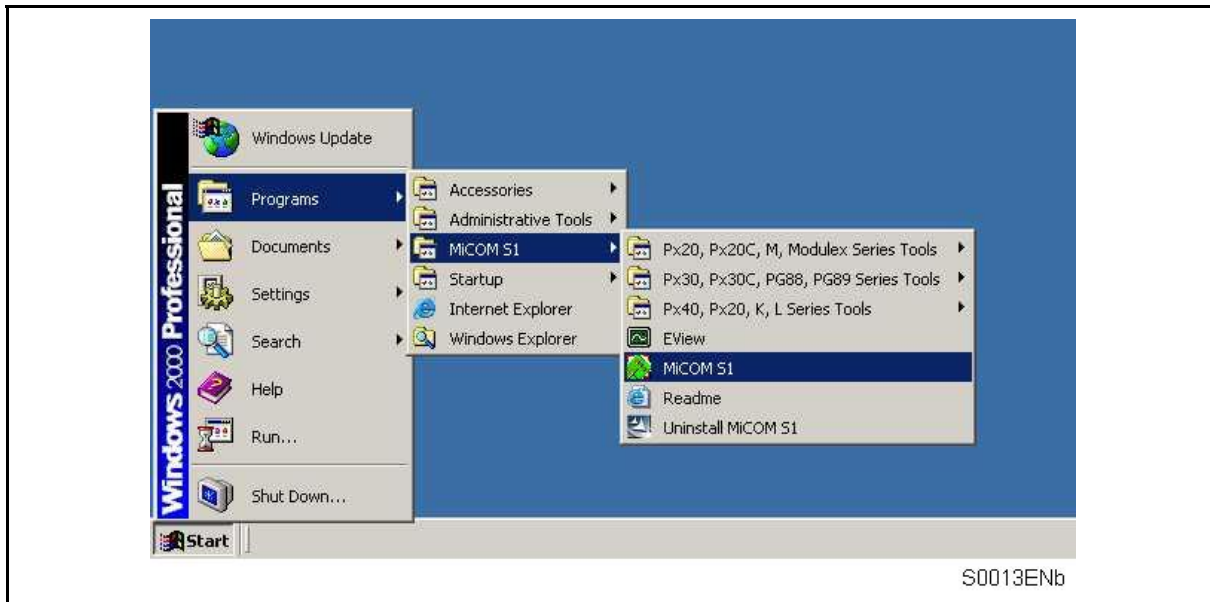

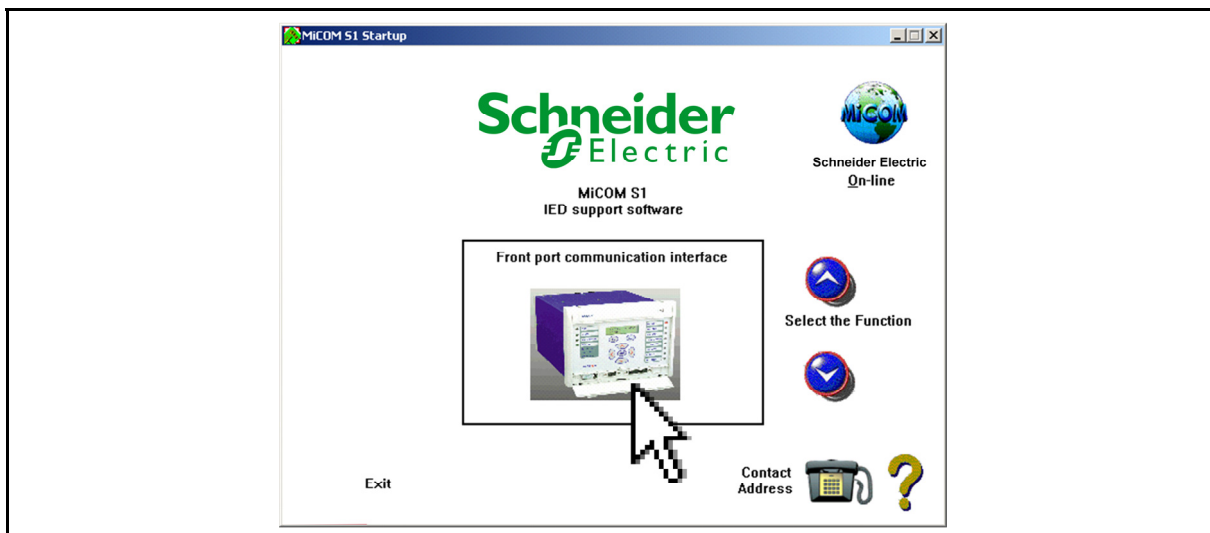

**WARNING: CLICKING ON "UNINSTALL MiCOM S1", WILL UNINSTALL MiCOM S1, AND ALL DATA AND RECORDS USED IN MiCOM S1.**

You access the MiCOM S1 launcher screen.

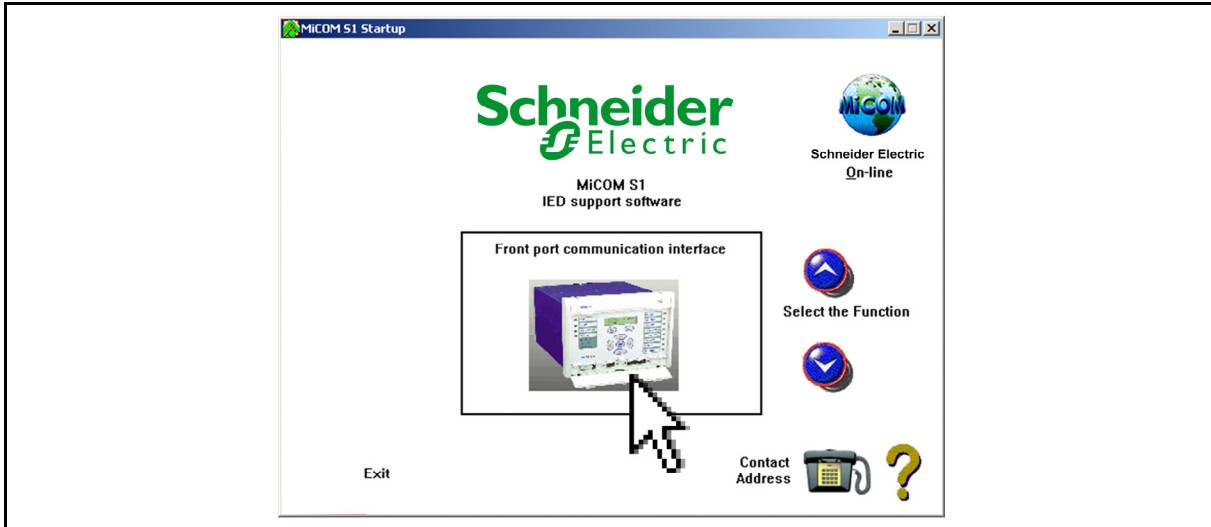

- Select the Px20 product: If necessary, click on the blue arrows (   ).



Select the Setup button: 

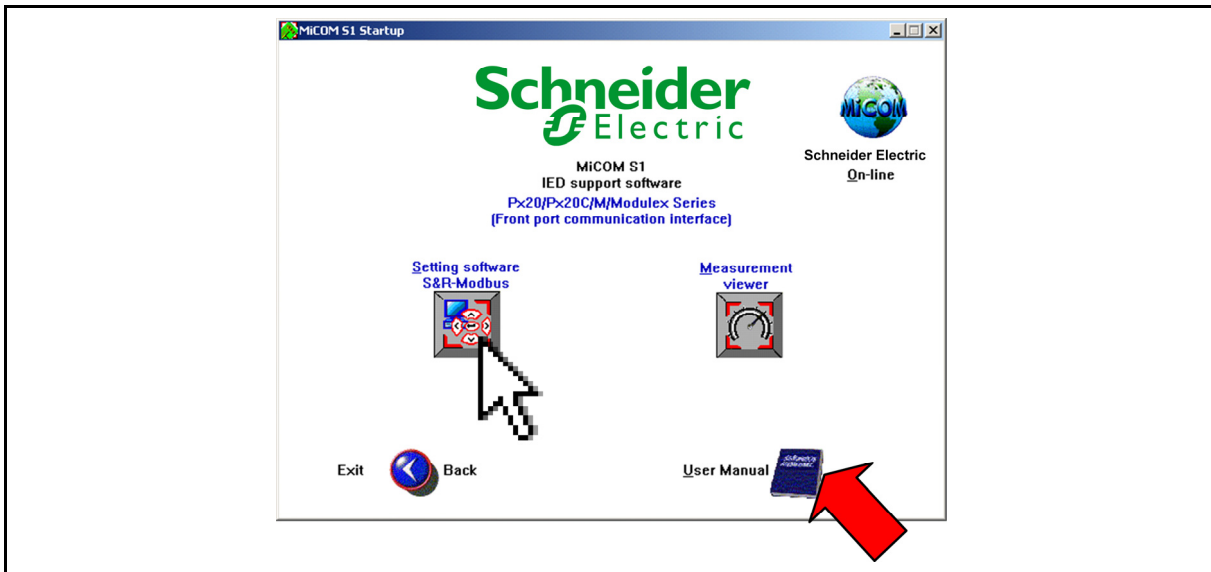

NOTE: Select the "User Manual" button to read "setting & records" and "Measurement Viewer" description and operating procedures.



3.6.2 Open communication link with relay

To open the communications link from S1 to the relay, follow the following procedure.

First, if necessary, the communication setup must be adjusted. In the "Device" menu, select "Communications Setup..."

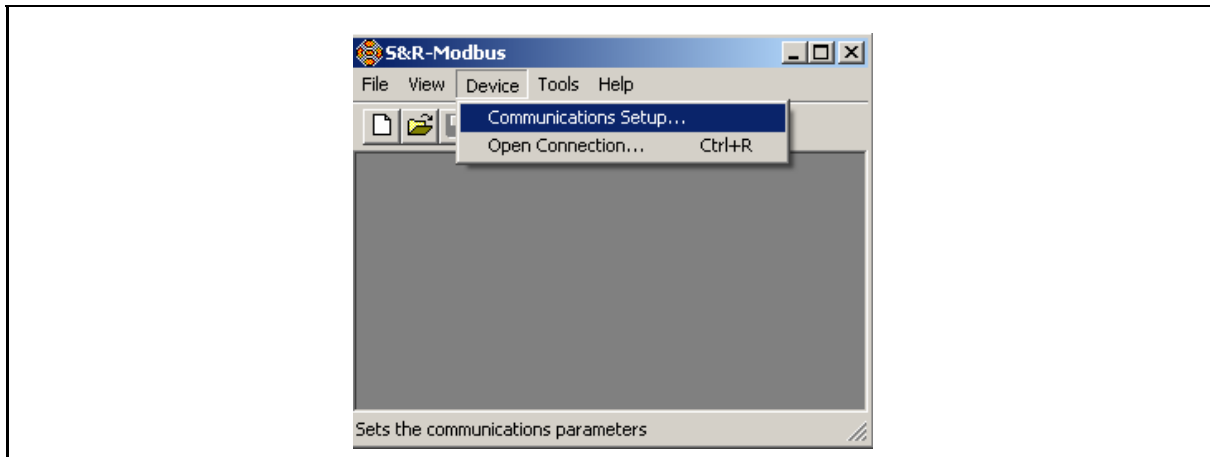

This brings up the following screen:

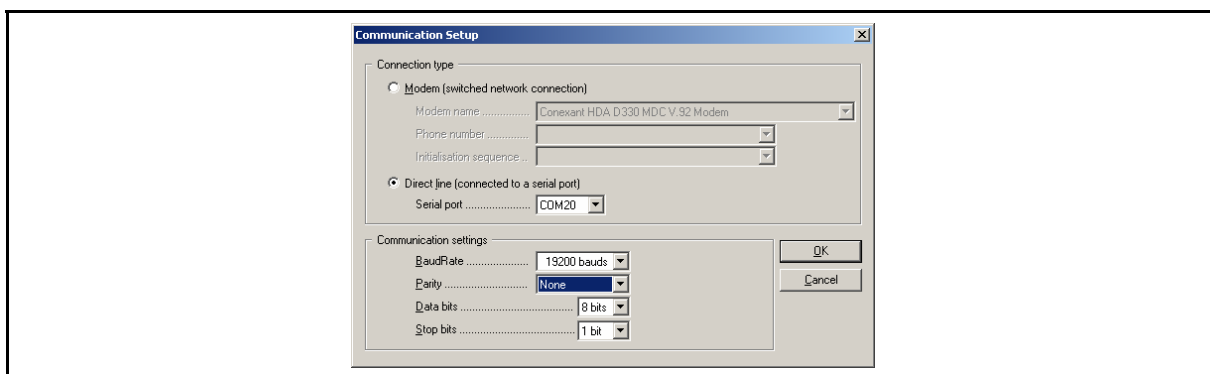

**COMMUNICATION SET-UP SCREEN**



When the communications setup is correct, the link with the relay can be initialized. In the "Device" menu, select "Open Connection..."

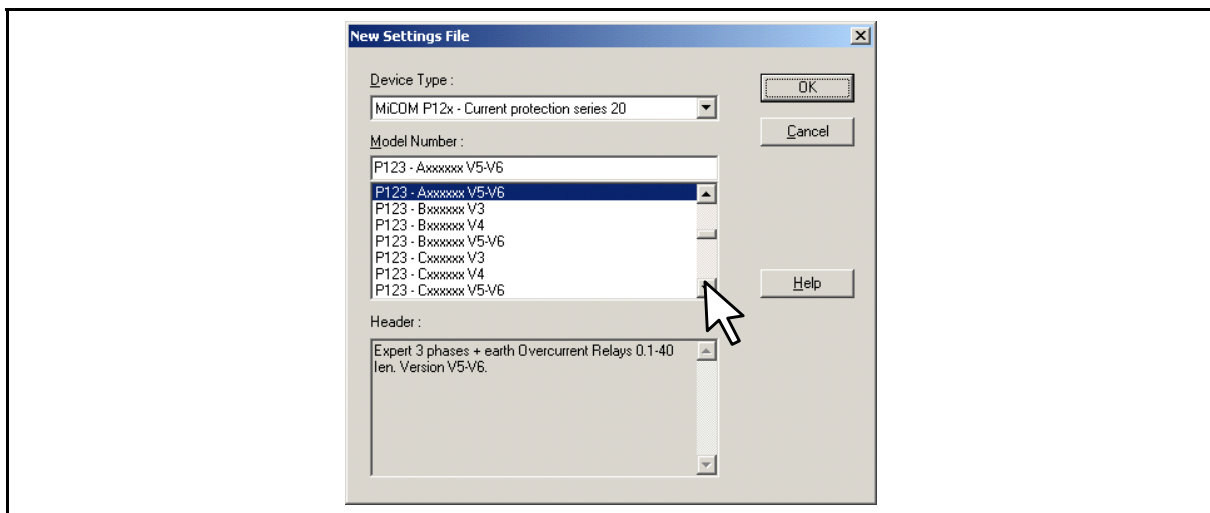

This brings up a prompt for the address of the relay to be interrogated.

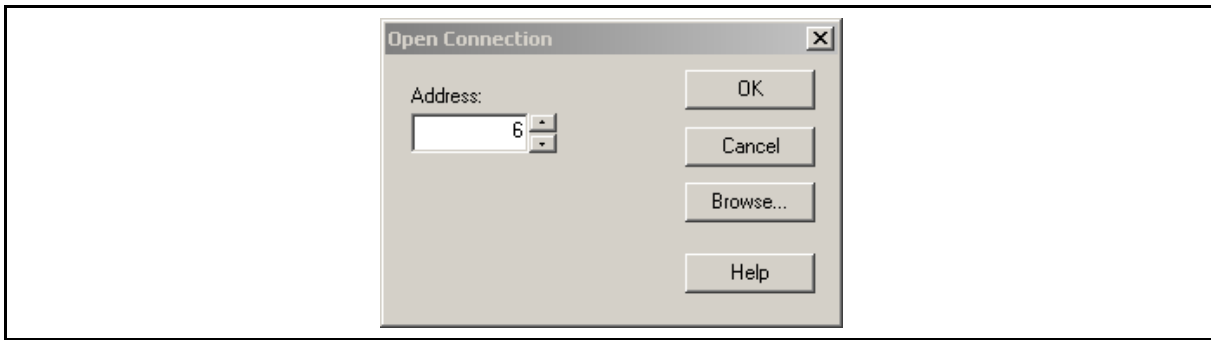

When this has been entered, a prompt for the password appears.

When these have been entered satisfactorily the relay is then able to communicate with MiCOM S1. When a communication link has been established between the PC and a MiCOM IED, both are said to be online. Data and information can be directly transferred from and to the IED using the menu available under the "DEVICE" menu.

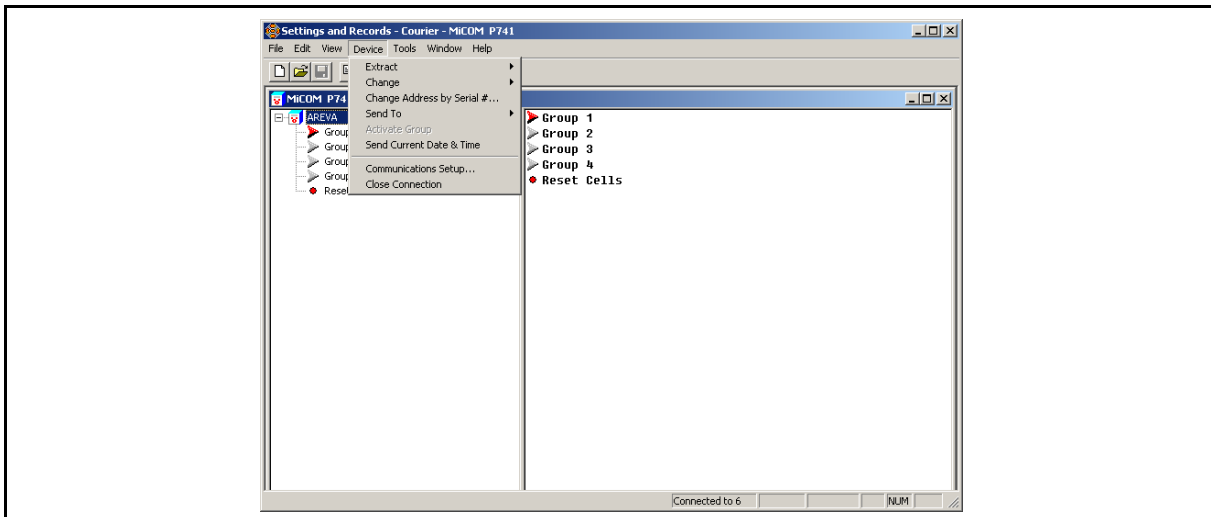

For further instruction on how to extract, download and modify settings files, please refer to the MiCOM S1 User Manual.

Select the main function in the right hand window.

To modify a setting value, double click the corresponding line in the left hand window. It opens a setting window.

A red star (\*) indicates that a setting value is modified.

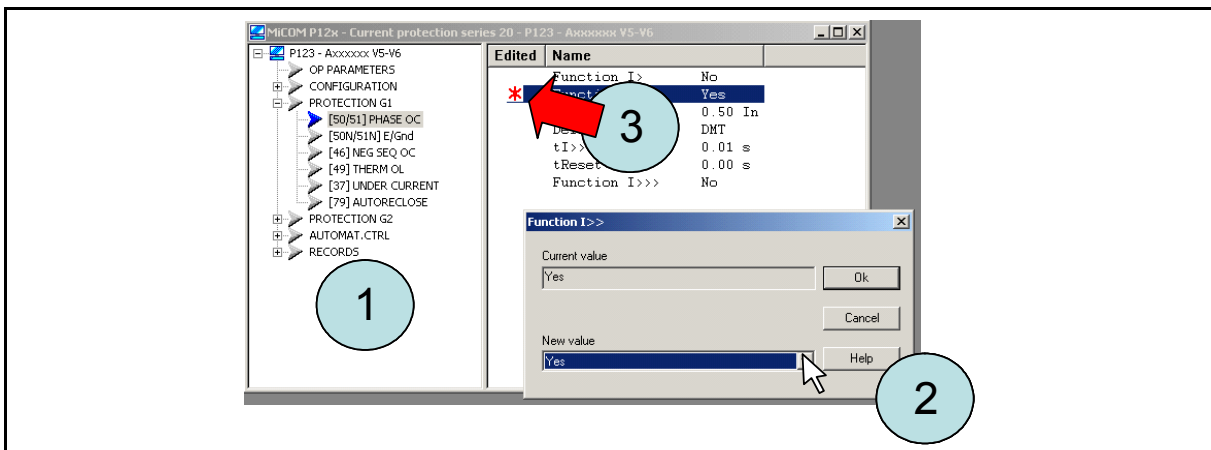

### 3.6.3 Off-line use of MiCOM S1

As well as being used for the on-line editing of settings, MiCOM S1 can also be used as an off-line tool to prepare settings without access to the relay. In order to open a default setting file for modification, in the “File” menu, select “New” and then “Settings File...”

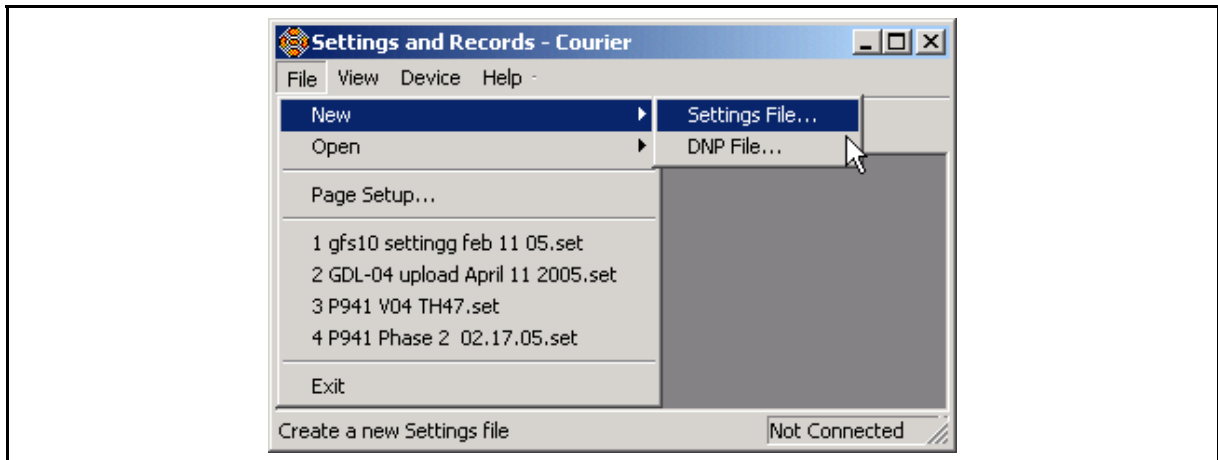

This brings up a prompt for the relay model type where you can select the correct relay for your application:

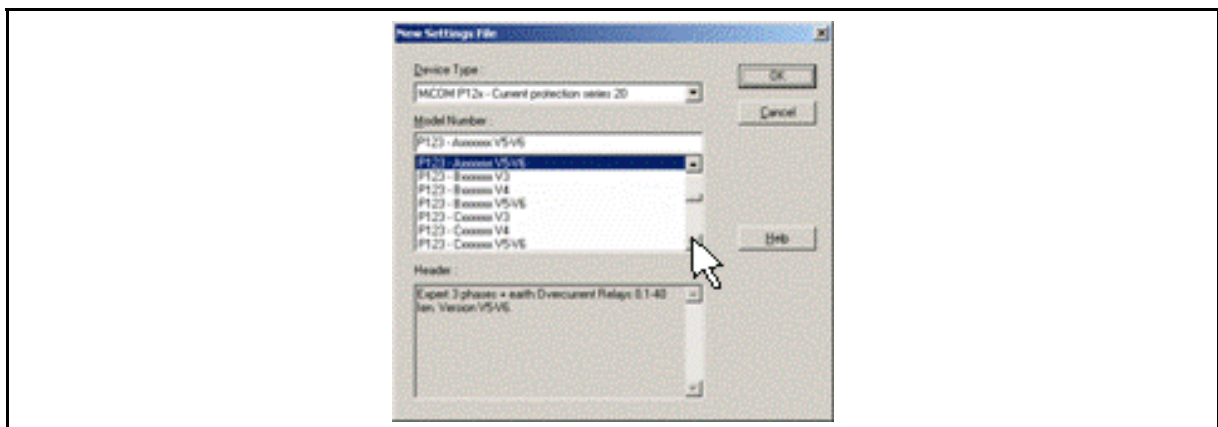

Clicking on “OK” will open the default file and you can start to edit settings. For further instruction on how to extract, download and modify settings files, please refer to the MiCOM S1 User Manual.

### 3.6.4 MiCOM monitoring

The monitoring module enables to connect to the front port, retrieve and monitor its measurements.



Click on the monitoring button:

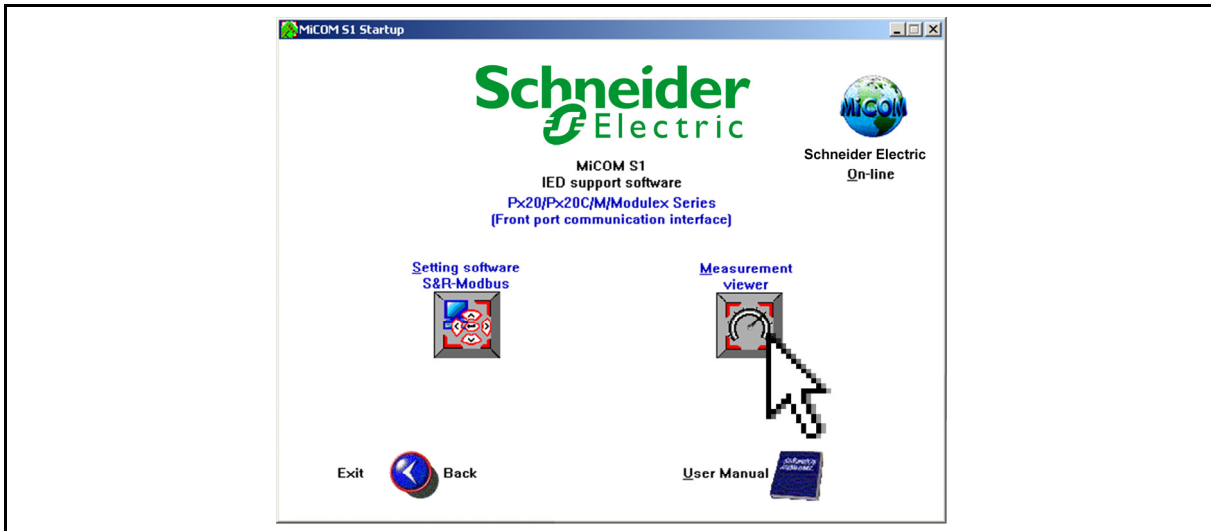

The monitoring module is displayed.

Use the “Device” menu to configure the communication:

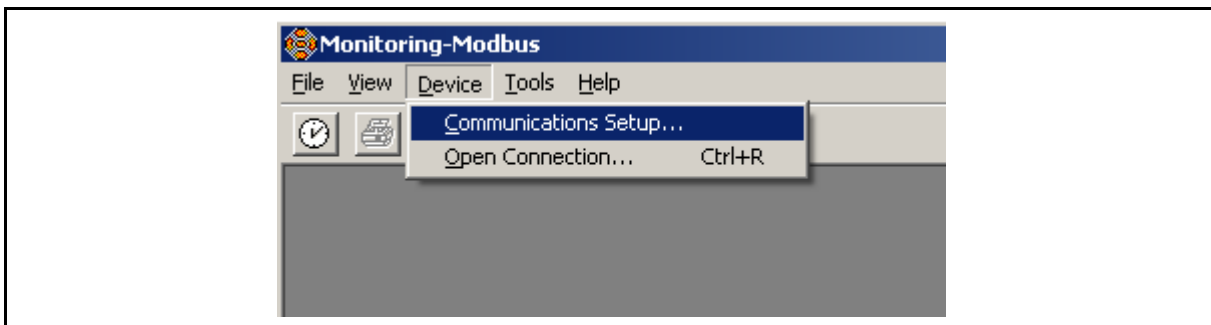

The “Communications setup...” menu enables to select or to setup the communication settings. The “Open Connection...” menu enables the PC to retrieve data from the online device.

### 3.7 Presentation and analysis of disturbance

The reading and analysis of disturbance is performed using Wavewin.

To open Wavewin with MiCOM S1:

- In the main page, select the function using the blue arrows (↶↷),
- Click on the “presentation and Analysis of Disturbance Recording Data with “Wavewin” window.

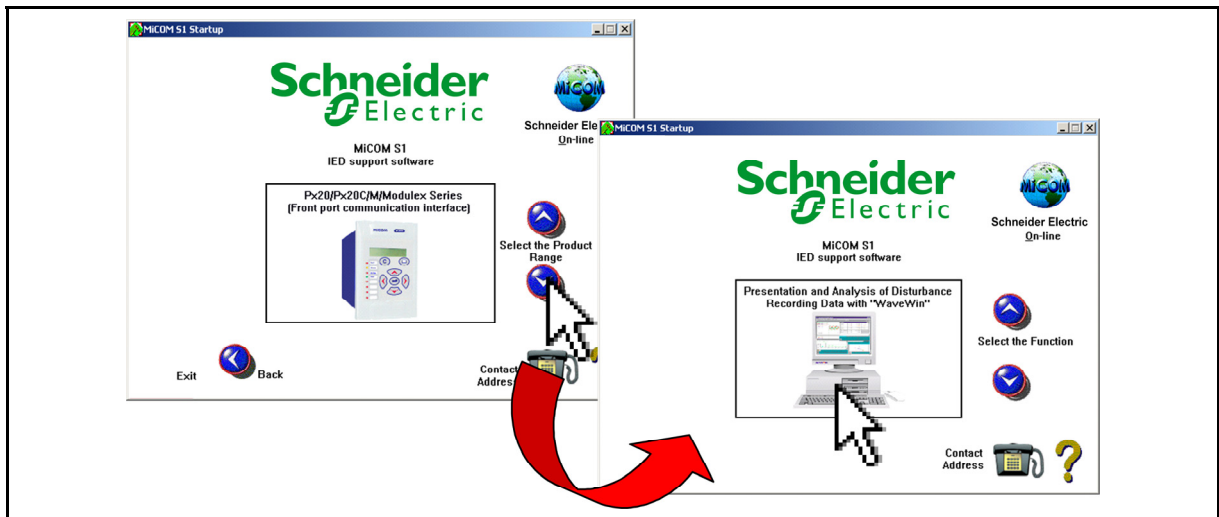

Using MiCOM S1 Studio, open Wavewin using “Tools” menu.

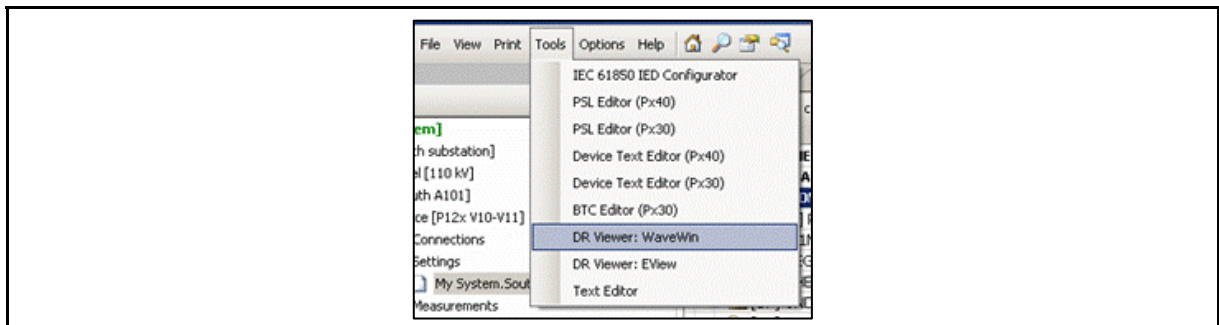

The Wavewin File Manager is displayed (refer to the Wavewin User’s guide to operate Wavewin).

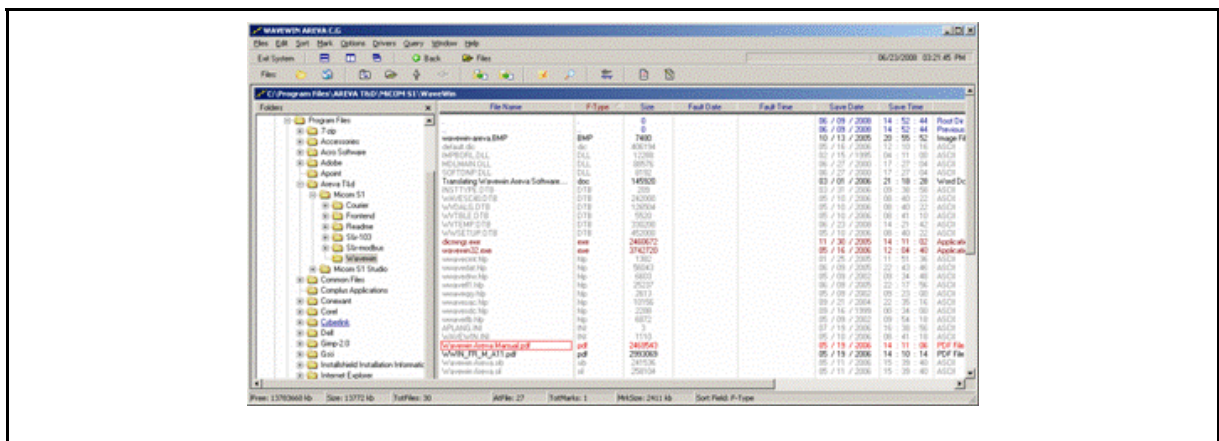

#### 4. WITHDRAWING MODULE FROM CASE

Remove the top and bottom hinged covers:

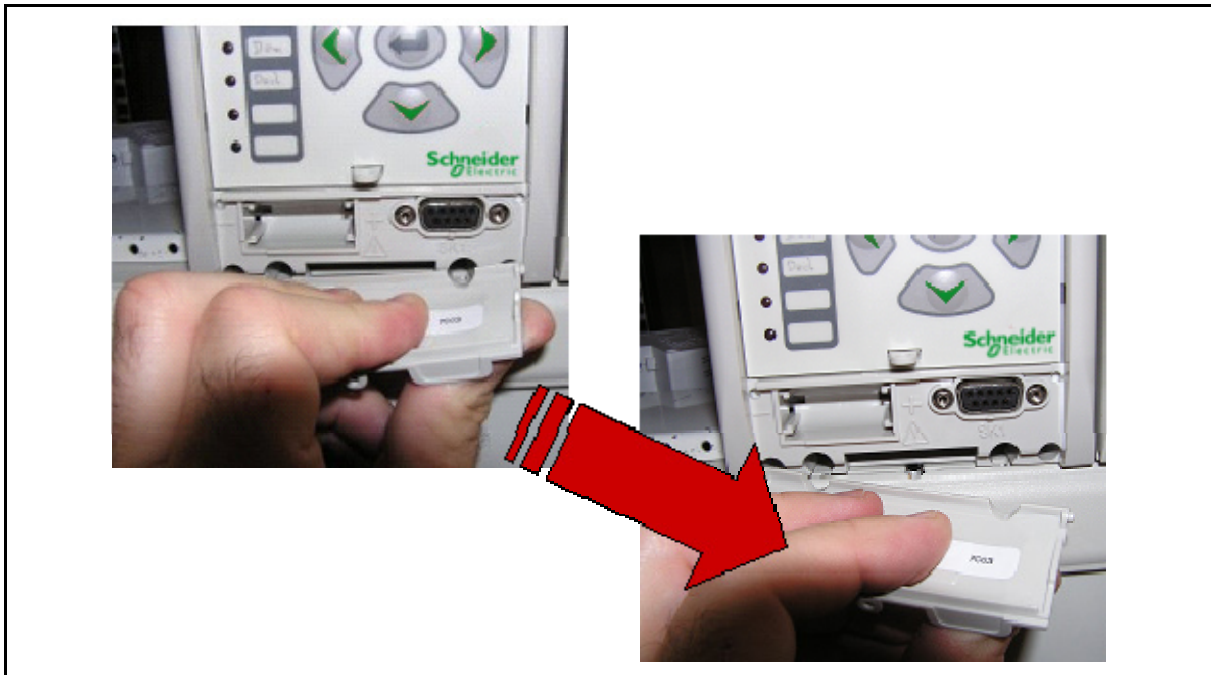

Depose the four retaining screws in the top and the bottom side of the relay. These screws retain the relay to the case.

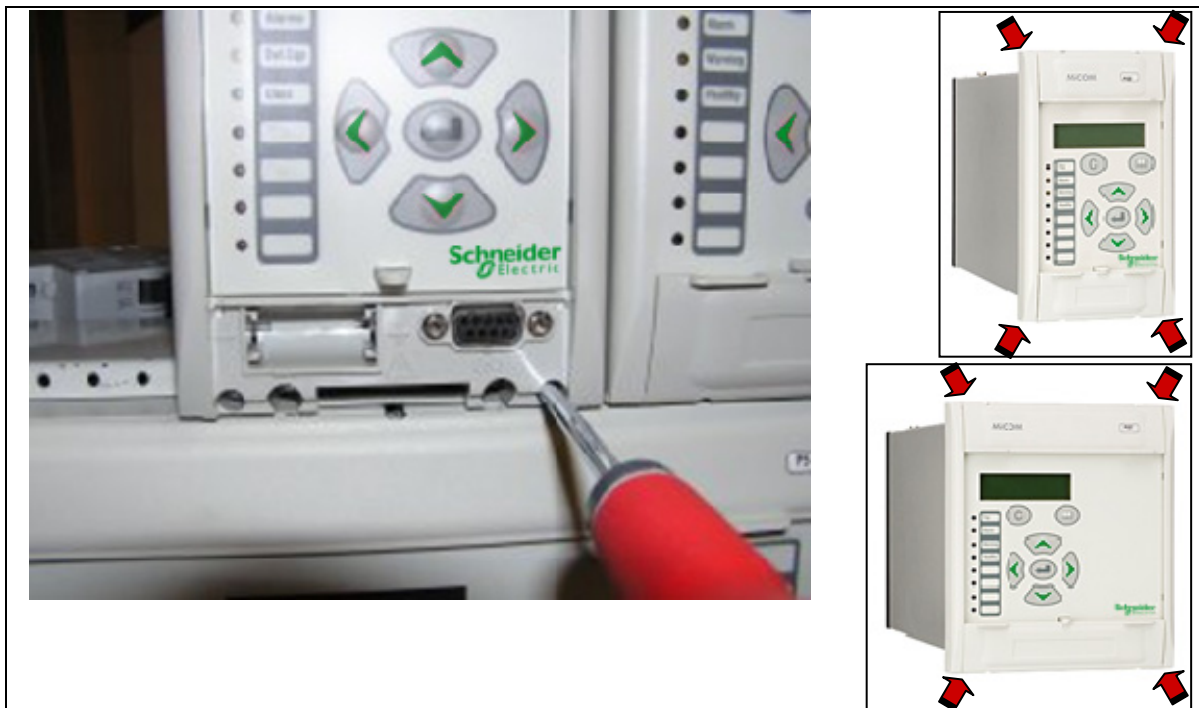

Insert a 3mm screwdriver into the hole situated under the upper hinged cover above the LCD:

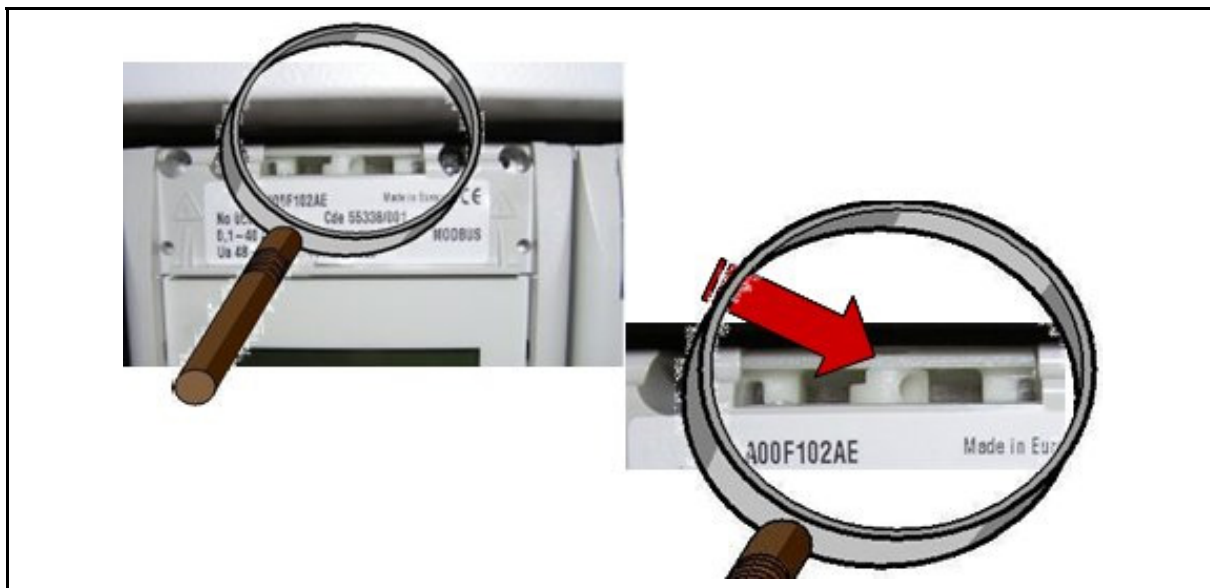

Turn the lock pin 90° to the left:

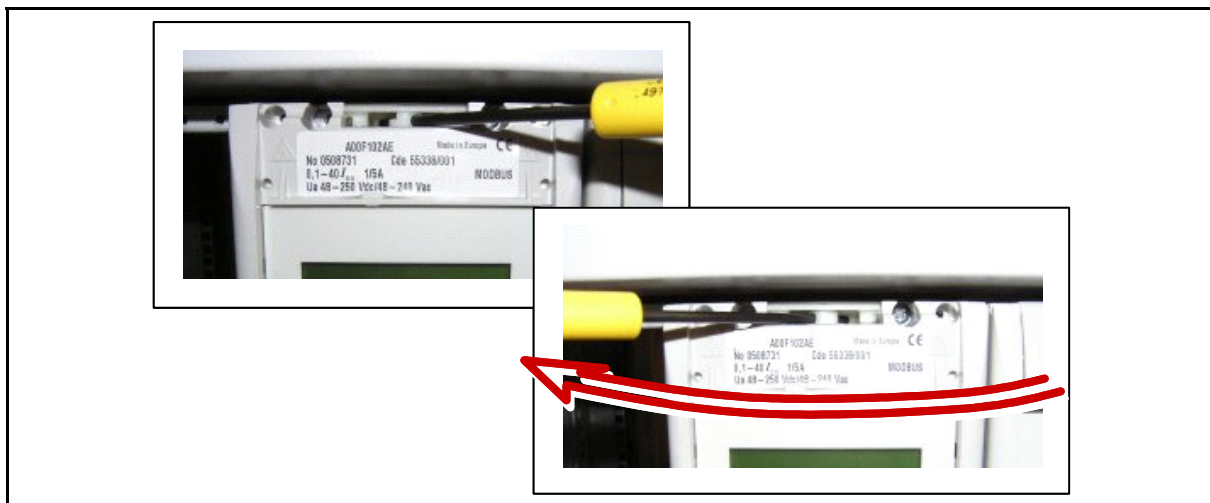

Insert the screwdriver into the second hole under the lower hinged cover, and the lower lock pin is turned 90° to the right.

By this turning action, push slightly forward the module and extract it by pulling on both sides of the front panel.



## 5. COMPANY CONTACT INFORMATION

If you need information pertaining to the operation of this MiCOM product that you have purchased, please contact your local Schneider Electric agent or the Customer Care Center ([www.schneider-electric.com/cc](http://www.schneider-electric.com/cc)). Do not forget to give the serial number and reference of the MiCOM product.

The MiCOM product reference and serial numbers are documented under the upper hinged cover on the front of the relay. For more precise information, refer to the section "Relay Identification" in this chapter.

### **PLEASE GIVE THE FOLLOWING DATA WHEN MAKING A CALL TO Schneider Electric:**

- CORTEC code of the MiCOM relay
- Serial number of the MiCOM relay
- Order reference
- Operator reference



# **APPLICATION GUIDE**



# CONTENTS

<b>1.</b>	<b>INTRODUCTION</b>	<b>5</b>
1.1	Protection of Underground and Overhead Lines	5
<b>2.</b>	<b>EARTH AND PHASE CURRENT OVERCURRENT FUNCTIONS</b>	<b>6</b>
2.1	Instantaneous function (50/50N) (P122 and P123 relays)	7
2.2	Derived earth overcurrent threshold ( $I_{e>>>>}$ , P122 and P123 only)	7
2.3	$I_{e>...I_{e>>>>...I_{e>>>>}}$ Interlock	8
2.4	DMT thresholds	8
2.5	IDMT thresholds	8
2.5.1	Inverse time curves	8
2.5.2	RXIDG curves	9
2.6	Reset timer	10
2.6.1	Reset timer (P122 & P123 only)	10
2.7	Time graded protection	11
<b>3.</b>	<b>TRANSFORMER INRUSH CURRENT (P122 &amp; P123 ONLY)</b>	<b>12</b>
3.1	Overview	12
3.2	Operation	12
3.2.1	Principle	15
<b>4.</b>	<b>BUSBAR PROTECTION ON RADIAL SYSTEMS</b>	<b>16</b>
<b>5.</b>	<b>BLOCKING LOGIC FUNCTION (BLOCKED OVERCURRENT PROTECTION)</b>	<b>17</b>
<b>6.</b>	<b>RESTRICTED EARTH FAULT</b>	<b>18</b>
6.1	Introduction	18
6.2	High impedance principle	19
6.3	Setting guide	20
6.3.1	CT requirements for High Impedance Restricted Earth Fault Protection	21
6.4	Use of METROSIL non linear resistors	21
6.4.1	Metrosil units for relays with 1A CT	22
6.4.2	Metrosil units for relays with 5A CT	23
<b>7.</b>	<b>RECTIFIER PROTECTION</b>	<b>24</b>
<b>8.</b>	<b>BACK-UP DIAGRAM USING « TRANSFERRED SELECTIVE TRIPPING »</b>	<b>26</b>
<b>9.</b>	<b>REMOTE PROTECTION STAND-BY DIAGRAM</b>	<b>28</b>
<b>10.</b>	<b>1 ½ BREAKER SCHEME</b>	<b>29</b>

<b>11.</b>	<b>THERMAL OVERLOAD PROTECTION (P122 &amp; P123 ONLY)</b>	<b>30</b>
11.1	Time Constant Characteristic	30
11.2	Setting Guidelines	32
<b>12.</b>	<b>COLD LOAD PICK-UP (P122 &amp; P123 ONLY)</b>	<b>33</b>
12.1	Exemple of application for earth Fault Protection applied to Transformers	34
<b>13.</b>	<b>SWITCH ON TO FAULT / TRIP ON RECLOSE PROTECTION (P123 ONLY)</b>	<b>35</b>
13.1	General	35
13.2	SOTF/ TOR description	35
<b>14.</b>	<b>LOCAL / REMOTE MODE (P123 ONLY)</b>	<b>37</b>
14.1	General	37
14.2	Setting	37
<b>15.</b>	<b>AUXILIARY TIMERS (P121, P122 &amp; P123 ONLY)</b>	<b>38</b>
<b>16.</b>	<b>SETTING GROUP SELECTION (P122 &amp; P123 ONLY)</b>	<b>39</b>
<b>17.</b>	<b>MAINTENANCE MODE</b>	<b>41</b>
<b>18.</b>	<b>SELECTIVE SCHEME LOGIC (P122 &amp; P123 ONLY)</b>	<b>42</b>
<b>19.</b>	<b>LOGIC EQUATIONS (P121, P122 &amp; P123 ONLY)</b>	<b>43</b>
<b>20.</b>	<b>NEGATIVE SEQUENCE OVERCURRENT PROTECTION (P122 &amp; P123 ONLY)</b>	<b>44</b>
20.1	I2> and I2>> Setting Guidelines	44
<b>21.</b>	<b>BROKEN CONDUCTOR DETECTION (P122 &amp; P123 ONLY)</b>	<b>46</b>
21.1	Example of Setting	47
<b>22.</b>	<b>DESCRIPTION AND SETTING GUIDE OF THE AUTORECLOSE FUNCTION (P123 ONLY)</b>	<b>48</b>
22.1	Introduction	48
22.2	Description of the function	49
22.2.1	Autorecloser activation	49
22.2.2	Logic Inputs	49
22.2.3	Autoreclose Logic Outputs	50
22.2.4	Autoreclose logic description	50
22.2.5	Autoreclose Inhibit Following Manual Close	51
22.2.6	Recloser lockout	51
22.2.7	Setting group change lockout	51
22.2.8	Rolling demand	51

<b>22.3</b>	<b>Setting Guidelines</b>	<b>51</b>
22.3.1	Number Of Shots	51
22.3.2	Dead Timer Setting	52
22.3.3	Minimum drop-off time setting	52
22.3.4	Reclaim Timer Setting	54
22.3.5	Autoreclose setting guideline	55
<b>23.</b>	<b>CIRCUIT BREAKER STATE MONITORING</b>	<b>60</b>
<b>24.</b>	<b>CIRCUIT BREAKER CONDITION MONITORING (P122 &amp; P123 ONLY)</b>	<b>61</b>
<b>24.1</b>	<b>Circuit Breaker Condition Monitoring Features</b>	<b>61</b>
<b>24.2</b>	<b>Setting guidelines</b>	<b>61</b>
24.2.1	Setting the $\Sigma I^n$ Thresholds	61
24.2.2	Setting the Number of Operations Thresholds	62
24.2.3	Setting the Operating Time Thresholds	62
<b>25.</b>	<b>UNDERCURRENT PROTECTION FUNCTION (P122 &amp; P123 ONLY)</b>	<b>63</b>
<b>26.</b>	<b>CIRCUIT BREAKER FAILURE PROTECTION: CBF (P122 &amp; P123 ONLY)</b>	<b>64</b>
<b>26.1</b>	<b>Circuit Breaker Failure Protection mechanism</b>	<b>64</b>
<b>26.2</b>	<b>Typical settings</b>	<b>67</b>
26.2.1	Breaker Fail Timer Settings	67
26.2.2	Breaker Fail Undercurrent Settings	67
<b>27.</b>	<b>TRIP CIRCUIT SUPERVISION (P122 &amp; P123 ONLY)</b>	<b>68</b>
<b>27.1</b>	<b>Trip Circuit Supervision mechanism</b>	<b>68</b>
<b>27.2</b>	<b>External resistor R1 calculation</b>	<b>71</b>
<b>28.</b>	<b>REAL TIME CLOCK SYNCHRONISATION VIA OPTO-INPUTS</b>	<b>73</b>
<b>29.</b>	<b>EVENT RECORDS</b>	<b>73</b>
<b>30.</b>	<b>FAULT RECORDS</b>	<b>73</b>
<b>31.</b>	<b>INSTANTANEOUS RECORDER</b>	<b>73</b>
<b>32.</b>	<b>DISTURBANCE RECORDER</b>	<b>74</b>
<b>33.</b>	<b>ROLLING AND PEAK VALUE DEMANDS (P122 &amp; P123 ONLY)</b>	<b>75</b>
<b>33.1</b>	<b>Rolling demand</b>	<b>75</b>
<b>33.2</b>	<b>Peak value demand</b>	<b>76</b>

---

<b>34.</b>	<b>CT REQUIREMENTS</b>	<b>77</b>
34.1	Definite time / IDMT overcurrent & earth fault protection	77
34.2	Instantaneous overcurrent & earth fault protection	77
34.3	Definite time / IDMT sensitive earth fault (SEF) protection	77
34.4	High Impedance Restricted Earth Fault Protection	78

---

## 1. INTRODUCTION

### 1.1 Protection of Underground and Overhead Lines

The secure and reliable transmission and distribution of power within a network is heavily dependent upon the integrity of underground cables and overhead lines, which link the various sections of the network together. Therefore the associated protection system must also provide both secure and reliable operation.

The most common fault conditions, on underground cables and overhead lines, are short circuit faults. These faults may occur between the phase conductors but will most often involve one or more phase conductor becoming short-circuited to earth.

Faults caused by short circuits require the fastest faulted conductor clearance times but at the same time allowing for suitable co-ordination with other downstream protection devices.

Fault sensitivity is an issue common to all voltage levels. For transmission systems, tower-footing resistance can be high. Also, high resistance faults might be prevalent where lines pass over sandy or rocky terrain. Fast, discriminative faulted conductor clearance is required for these fault conditions.

The effect of fault resistance is more pronounced on lower voltage systems, resulting in potentially lower fault currents, which in turn increases the difficulty in the detection of high resistance faults. In addition, many distribution systems use earthing arrangements designed to limit the passage of earth fault current.

Earthed methods as such as using resistance, Petersen coil or insulated systems make the detection of earth faults arduous. Special protection equipment is often used to overcome these problems.

Nowadays, the supply continuity in the energy distribution is of paramount importance.

On overhead lines most of faults are transient or semi-permanent in nature.

In order to increase system availability multi-shot autoreclose cycles are commonly used in conjunction with instantaneous tripping elements. For permanent faults it is essential that only the faulted section of the network is isolated. High-speed, discriminative fault clearance is therefore a fundamental requirement of any protection scheme on a distribution network.

Power transformers are installed at all system voltage levels and have their own specific requirements with regard to protection. In order to limit the damage incurred by a transformer under fault conditions, fast clearance of the windings with phase to phase and phase to earth faults is a primary requirement.

Damage to electrical plant equipment such as transformers, cables and lines may also be incurred by excessive loading conditions, which leads directly to overheating of the equipment and subsequent degradation of their insulation. To protect against such fault conditions, protective devices require thermal characteristics too.

Uncleared faults, arising either from the failure of the associated protection system or of the switchgear itself, must also be considered. The protection devices concerned should be fitted with logic to deal with breaker failure and relays located upstream must be able to provide adequate back-up protection for such fault conditions.

Other situations may arise on overhead lines, such as broken phase conductors. Traditionally, a series fault has been difficult to detect.

With today's digital technology, it is now possible to design elements, which are responsive to such unbalanced system, conditions and to subsequently issue alarm and trip signals.

On large networks, time co-ordination of the overcurrent and earth fault protection relays can often lead to problematic grading situations or, as is often the case, excessive fault clearance times. Such problems can be overcome by relays operating in blocked overcurrent schemes.

## 2. EARTH AND PHASE CURRENT OVERCURRENT FUNCTIONS

MiCOM P120 range of relays provide definite and independent time delay overcurrent protection.

Each phase current and earth current input has three thresholds.

The first and second thresholds can be set as definite delay time or inverse delay time using the IEC, IEEE/ANSI, CO, RI and RECT curves. Their parameters are shown in the Technical Data chapter of this Technical Guide.

The third threshold can be set as definite delay time only, but can be set to work on the peak of the current measured.

In a similar way, the earth fault elements has three different thresholds, that besides can be set independently of the settings chosen for the phases.

The instantaneous thresholds are represented by the symbol “I>” for the first threshold, “I>>” and “I>>>” for the second and third instantaneous thresholds (“Ie>”, “Ie>>” and “Ie>>>” for earth thresholds, and Ie>>>> for derived earth current).

The time delayed thresholds are represented by the symbol “tI>” for the first threshold, “tI>>” and “tI>>>” for the second and third time delay thresholds (“tIe>”, “tIe>>” and “tIe>>>” for the time delay earth fault thresholds, and tIe>>>> for time delayed derived earth current).

The protection elements trip when the following conditions are realized:

- The phase current exceeds the set overcurrent threshold.
- The time delay has elapsed.
- The blocking logic (if used) is not activated.

The following diagrams show the functionality for each threshold.

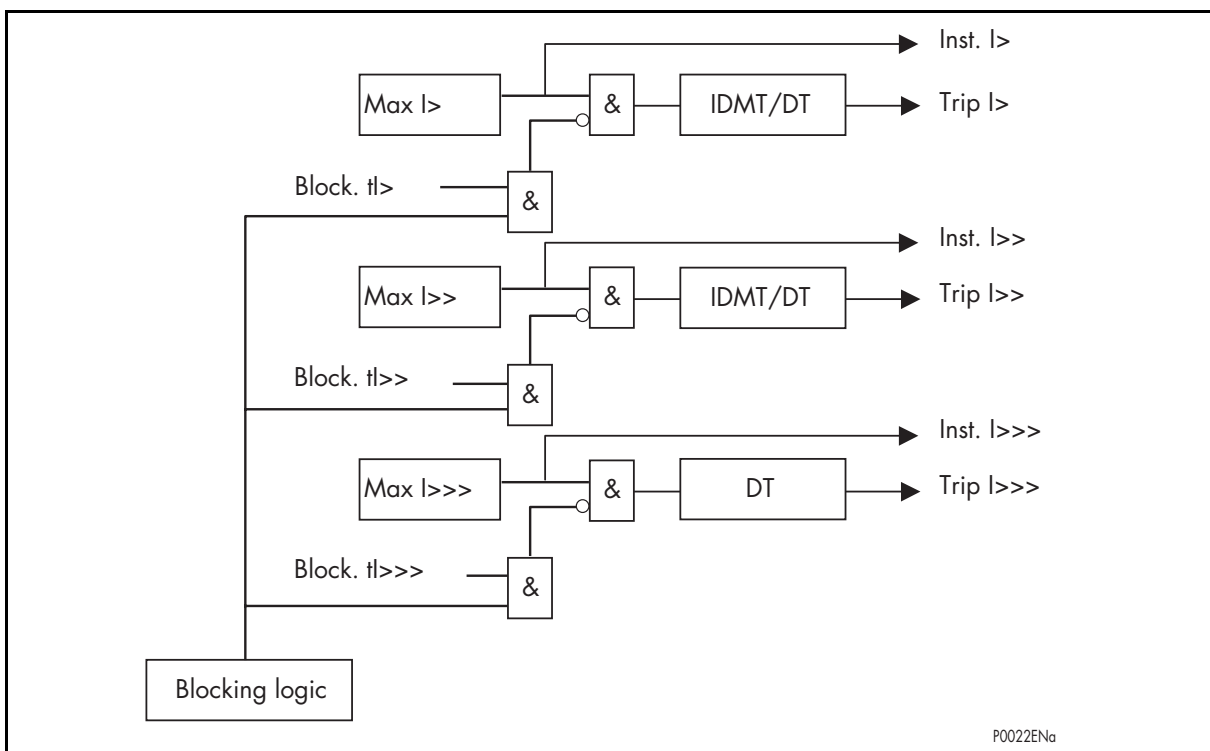

FIGURE 1: LOGIC OF PHASE THRESHOLDS I>, I>> AND I>>>

- With:
- Max I> = [IA>] OR [IB>] OR [IC>]
  - Max I>> = [IA>>] OR [IB>>] OR [IC>>]
  - Max I>>> = [IA>>>] OR [IB>>>] OR [IC>>>]



The logic associated to the earth fault threshold is identical to the one described above. The different thresholds  $I>$  &  $tI>$ ,  $I>>$  &  $tI>>$  and  $I>>>$  &  $tI>>>$  are respectively replaced by thresholds  $Ie>$  &  $tIe>$ ,  $Ie>>$  &  $tIe>>$ ,  $Ie>>>$  &  $tIe>>>$ . and  $Ie>>>>$  &  $tIe>>>>$ .

Thanks to the «Blocking Logic» function, it is possible to freeze the timer as long as the "Block Logic" signal is active.

As soon as the blocking "Block Logic" signal disappears, if the overcurrent value is still over the set threshold, the time delay resumes its countdown considering the value prior to the activation of the blocking function as its new initial value. This allows a faster clearance of the fault after a reset of the "Block Logic" signal.

## 2.1 Instantaneous function (50/50N) (P122 and P123 relays)

In order to ensure fast tripping on highly saturated current signal, it has been decided that  $I>>>$  and  $Ie>>>$  should operate on a current sample base in addition to the Discrete Fourier transformation bases (see User Guide chapter). Both algorithms can operate on a highly saturated current signal. However with a high X/R ratio, it is recommended to use the sample base method.

As soon as a phase (or earth) threshold is running, the instantaneous output associated with this threshold is activated. This output indicates that the protection element has detected a phase (or earth) fault and that the time delay associated with the threshold has started. This time delay can be blocked via the logic input "Block Logic" associated with this threshold. If this blocking input is activated by an output contact of a downstream relay, the logic that will lead to the trip command is then blocked only if the relay that is the closest to the fault can see and therefore eliminate the fault. This principle is known as «Blocking logic» or «Blocking». It is described in more detail in this document.

## 2.2 Derived earth overcurrent threshold ( $Ie>>>>$ , P122 and P123 only)

The derived earth current ( $Ie>>>>$ ) is the vectorial summation:  $\vec{I}\bar{A} + \vec{I}\bar{B} + \vec{I}\bar{C}$ :  
 $\vec{I}\bar{A} + \vec{I}\bar{B} + \vec{I}\bar{C} = Ie>>>>$ .

The  $Ie>>>>$  can be set as definite delay time or inverse delay time using the IEC, IEEE/ANSI, CO, RI and RECT curves. Their parameters are shown in the Technical Data chapter of this Technical Guide.

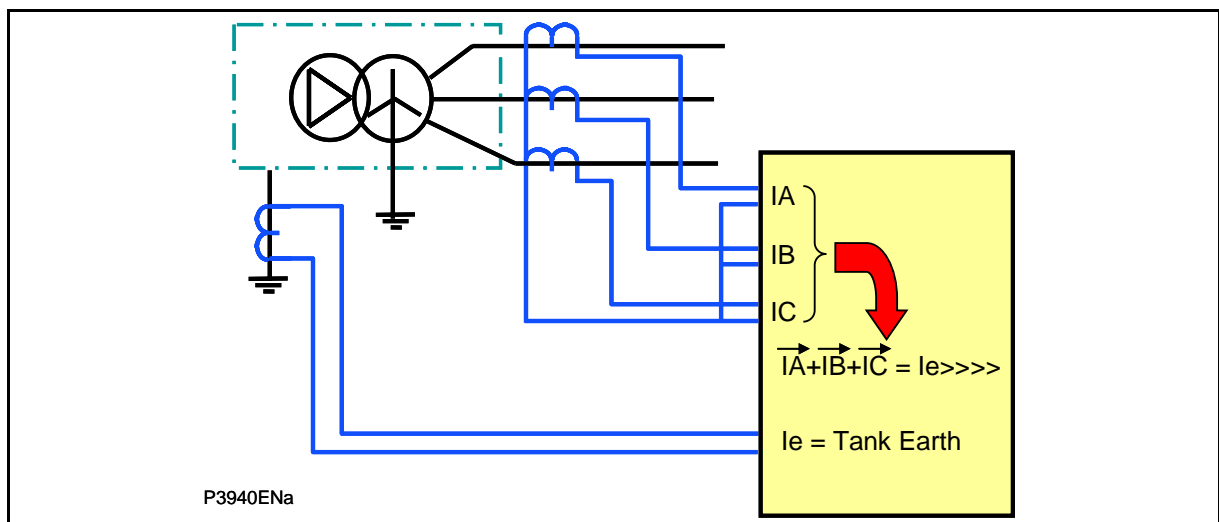

As soon as  $Ie>>>>$  threshold is running, the instantaneous output associated with this threshold is activated. This output indicates that the protection element has detected an earth fault and that the time delay associated with the threshold has started. This time delay can be blocked via the logic input "Block Logic" associated with this threshold. If this blocking input is activated by an output contact of a downstream relay, the logic that will lead to the trip command is then blocked only if the relay that is the closest to the fault can see and therefore eliminate the fault. This principle is known as «Blocking logic» or «Blocking». It is described in more detail in this document.

**2.3 le>...le>>...le>>> Interlock**

For P122 and P123 relays:

The choice of this functionality is available when the IDMT delay trip time is selected for the first earth threshold.

The following figures show the window where this functionality can be or not to be activated. The 2<sup>nd</sup> and 3<sup>rd</sup> threshold pickup can suspend 1<sup>st</sup> threshold output control to save selectivity. Below the trend of the delay trip time of the first threshold is shown for both cases Yes or No.

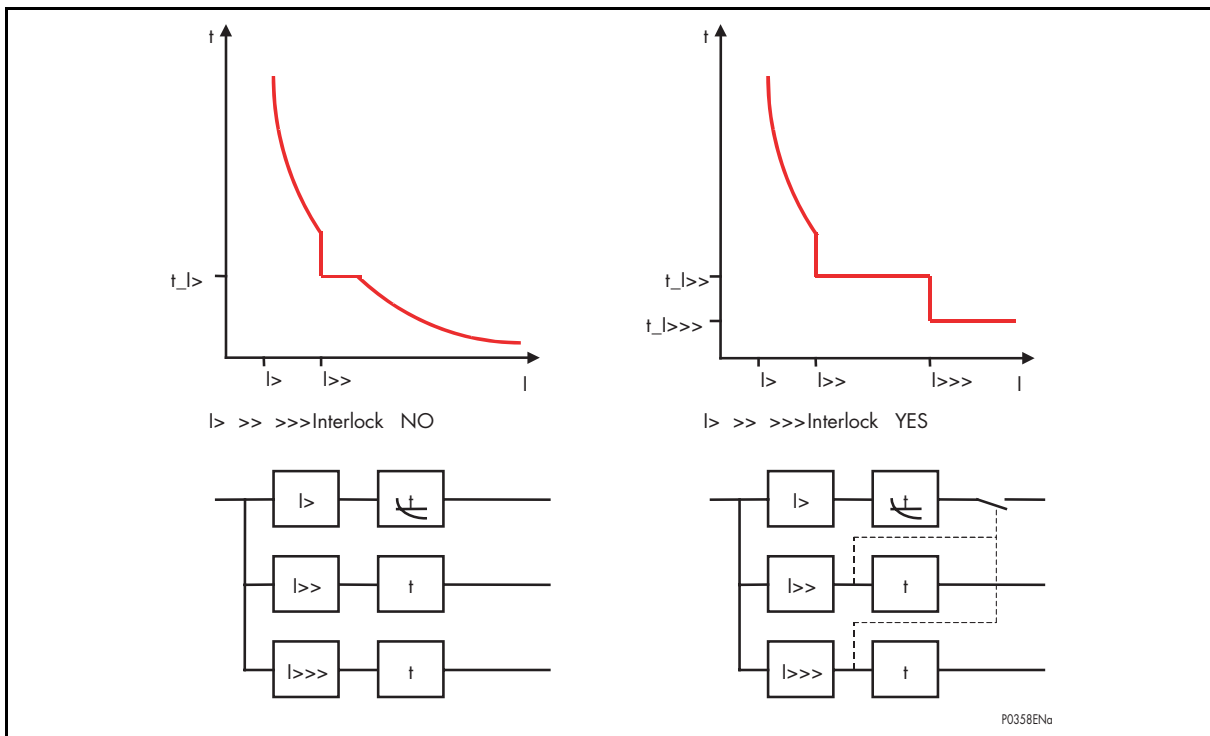

**2.4 DMT thresholds**

The three phase (earth) overcurrent thresholds can be selected with a time constant delay. The time to operate is equal to the time delay set, plus the time for the output contact to operate (typically about 20 to 30 ms ; 20ms for a current exceeding or equal to 2 times the threshold) and the time required to detect the overcurrent state (maximum 20ms at 50Hz).

For DMT curves, a reset timer "tReset" is associated with the first and second thresholds (phase and earth elements).

**2.5 IDMT thresholds**

**2.5.1 Inverse time curves**

The first and second phases (earth) overcurrent threshold can be selected with a dependent time characteristic. The time delay is calculated with a mathematical formula.

There are eleven inverse time characteristics available.

The mathematical formula applicable to the first ten curves is:

$$t = T \times \left( \frac{K}{(I/I_s)^\alpha - 1} + L \right)$$

Where:

- t = Tripping time  
 K = Coefficient (see table)  
 I = Value of measured current  
 I<sub>s</sub> = Value of the programmed threshold (Pick-up value)  
 α = Coefficient (see table)  
 L = ANSI/IEEE coefficient (zero for IEC curves)  
 T = Time multiplier between 0.025 and 1.5

Type of curve	Standard	K factor	α factor	L factor
Short Time Inverse	Schneider Electric	0.05	0.04	0
Standard inverse	IEC	0.14	0.02	0
Very inverse	IEC	13.5	1	0
Extremely inverse	IEC	80	2	0
Long time inverse	Schneider Electric	120	1	0
Short Time Inverse	C02	0.02394	0.02	0.01694
Moderately Inverse	ANSI/IEEE	0.0515	0.02	0.114
Long Time Inverse	C08	5.95	2	0.18
Very Inverse	ANSI/IEEE	19.61	2	0.491
Extremely Inverse	ANSI/IEEE	28.2	2	0.1215
Rectifier Protection		45900	5.6	0

The RI curve (electromechanical) is given by the following formula:

$$t = K \times \left( \frac{1}{0.339 - 0.236 / (I / I_s)} \right)$$

With K that can be adjusted from 0.10 to 10 in steps of 0.05.

This equation is valid for  $1.1 \leq (I/I_s) \leq 20$ .

Although the curves tend towards infinite when the current approaches I<sub>s</sub>, the minimum guaranteed value of the operating current for all the curves with the inverse time characteristic is 1.1I<sub>s</sub> (with a tolerance of ± 0,05I<sub>s</sub>), except rectifier protection curve for which the minimum value is 1.6 I<sub>s</sub> ± 0.05 I<sub>s</sub>.

## 2.5.2 RXIDG curves

RXIDG curves can be selected on P122 & P123 with medium earth current sensitivity (corresponding to Cortec model number P12-B-X---X).

The first and second earth thresholds can be selected with dedicated RXIDG curves.

The curves available follow the formula:

$$t = 5.8 - 1.35 * \ln ( 1 / (k * I_s/I))$$

Where:

- t = tripping time  
 k = coefficient (from 0.3 to 1, by steps of 0.1)  
 I<sub>S</sub> = value of the programmed threshold (Pick-up value)  
 I = value of measured current

In order to be compliant with the Netmanagement specifications the relay must be used with:

- An earth current range 0.01 I<sub>on</sub> to 8 I<sub>on</sub>
- A rated current wiring 1A
- A core balanced CT with a ratio 25/1.

## 2.6 Reset timer

The first phase overcurrent threshold [ $I_{>}/t_{I>}$ ] ( $[I_{e>}/t_{Ie>}]$ ) for the earth has a reset timer.

The value that is set for this reset timer corresponds to the minimum time during which the current value needs to be lower than 95% of the phase (or earth) threshold before the corresponding phase (or earth) time delay is reset.

NOTE: This rule doesn't apply when the protection triggers. When the protection triggers, the time delay  $t_{I>}$  (or  $t_{Ie>}$ ) is immediately reset.

The value of this reset timer depends on the type of timer associated with the first phase (Earth) threshold.

Type of timer associated with the first & second phase (earth) threshold	Reset Timer	
	P120, P121	P122, P123
DMT (see note below)	0 ms	0 ms to 600 s
Rectifier, IDMT IEC or RI	50 ms	Setting range from 0 to 600 s
RXIDG	-	Setting range from 0 to 600 s
IDMT IEEE or CO	50 ms	Setting range from 0 to 600 s or Inverse Time (Choice of 5 IEEE curves)

(\*) first and second earth threshold only

### 2.6.1 Reset timer (P122 & P123 only)

For the first phase and earth overcurrent stages, MiCOM P122 and P123 have a timer hold facility "tReset", which can be set to a definite time value or to an inverse time characteristic (IEEE/ANSI curves only). This may be useful for some applications, for example when grading with upstream electromechanical overcurrent relays which have inherent reset time delays.

This timer hold facility used to reduce the time to clear a fault is also useful in situations where intermittent faults occur. This may occur for example in a plastic insulated cable. In this case, the fault energy may provoke the cable insulation to melt and reseal, thereby extinguishing the fault. This process repeats itself a couple of times giving a succession of fault current pulses, each one of increasing duration with reducing intervals between the pulses, until the fault becomes permanent.

When the reset time of the overcurrent relay is minimum the relay will be repeatedly reset and not be able to trip until the fault becomes permanent. By using the Timer Hold facility, the relay will integrate the fault current pulses, thereby reducing fault clearance time.

The reset timer "tReset" for MiCOM P122 & P123 can be found in the following menu:

- If the first phase (earth) threshold is selected with an IDMT IEC or RI curve, the reset timer "tReset" with DMT characteristic can be set under the menu:
  - Protection / [50/51] Phase OC/tReset for the phase.
  - Protection / [50N/51N] E/Gnd/tReset for the earth.
- If the first phase (earth) threshold is selected with an IDMT IEEE or CO curve, the reset timer "tReset" with a DMT or IDMT characteristic can be set under the menu:
  - Protection / [50/51] Phase OC/Type Tempo Reset for the phase
  - Protection / [50N/51N] E/Gnd/Type Tempo Reset for the earth.

Reset Time "tReset" with an IDMT characteristic:

The mathematical formula applicable to the five curves is:

$$t = T \times \left( \frac{K}{1 - (I/I_s)^\alpha} \right)$$

Where:

- t = Reset time
- K = Coefficient (see table)
- I = Value of the measured current
- I<sub>s</sub> = Value of the programmed threshold (pick-up value)
- α = Coefficient (see table)
- T = Reset Time Multiplier (Rtms) between 0.025 and 3.2

Type of curves	Standard	K factor	α factor
Short time inverse	C02	2.261	2
Moderately Inverse	ANSI/IEEE	4.85	2
Long time Inverse	C08	5.95	2
Very inverse	ANSI/IEEE	21.6	2
Extremely inverse	ANSI/IEEE	29.1	2

## 2.7 Time graded protection

Inverse definite minimum time relays are time graded in such a way that the relay closer to the fault operates faster than the upstream relays. This is referred to as relay co-ordination because if the relay nearest to the fault does not operate, the next relay will trip in a slightly longer time. The time grading steps are typically 400 ms, the operation times becoming progressively longer with each stage.

When difficulty is experienced in arranging the required time grading steps, the use of a blocked overcurrent scheme should be considered (described in a later section).

**NOTE:** The dynamic range of measurement is typically 1000 times minimum setting.

### 3. TRANSFORMER INRUSH CURRENT (P122 & P123 only)

The inrush blocking function assumes stability protection during transformer energising based on harmonic 2 presence.

In applications where the sensitivity of overcurrent thresholds need to be set below the prospective peak inrush current, the inrush block function can be used to block the overcurrent, earth fault and negative sequence overcurrent stages. During transformer inrush conditions, the second harmonic component of the inrush current may be as high as 70%. In practice, the second harmonic level may not be the same for all phases during inrush and therefore the relay will provide an Inrush Blocking signal for any phase above the set threshold. In general, a setting of 15% to 20% for the Inrush harmonic 2 ratio can be applied in most cases taking care that setting it too high, inrush blocking may not operate for low levels of second harmonic current which may result in the O/C element tripping during transformer energization. Similarly applying a too low a setting, inrush blocking may prevent tripping during some internal transformer faults with significant second harmonic current.

#### 3.1 Overview

Inrush Blocking function operates by measuring ratio of second to fundamental harmonic current. It could be used as “blocking logic” of I >, I >>, I >>>, I0 >, I0 >>, I0 >>>, Ie >>>>, I2 >, I2 >> or I2 >>> in case the harmonic 2 ratio is higher than the settable threshold. Indeed, inrush blocking functions will reset selected protection function starting.

The minimum duration of overcurrent threshold inhibition (tReset) can be also set. This value depends on the transformer power transient inrush duration: between 0.1 second (for a 100kVA transformer) to 1.0 second (for a large unit). It is used to avoid any maloperation during a fixed duration in case of too sensitive setting.

#### 3.2 Operation

For each of the three phases currents (IA, IB, IC), the harmonic restraint function compares the ratio of harmonic 2 to fundamental with the setting ratio (adjustable from Harmonic 2 / Fundamental = 10 % up to 35 % step 1%).

Minimum fundamental current value required for operation of Inrush Blocking function. There is  $0.2I_n$ , and there is no upper limit to disable this feature. However, in transformer protection, the high set overcurrent stage shall not be controlled by this Inrush Blocking feature; this enables detection of all high current faults without inrush blocking.

Inrush Blocking feature will block selected protection stages, any time inrush conditions occurs on the line (Ratio of 2nd Harmonics measured > Inrush H2 settings ratio), and will be at least active during tReset.

Operating Inrush current is settable from 10% to 35% of fundamental current.

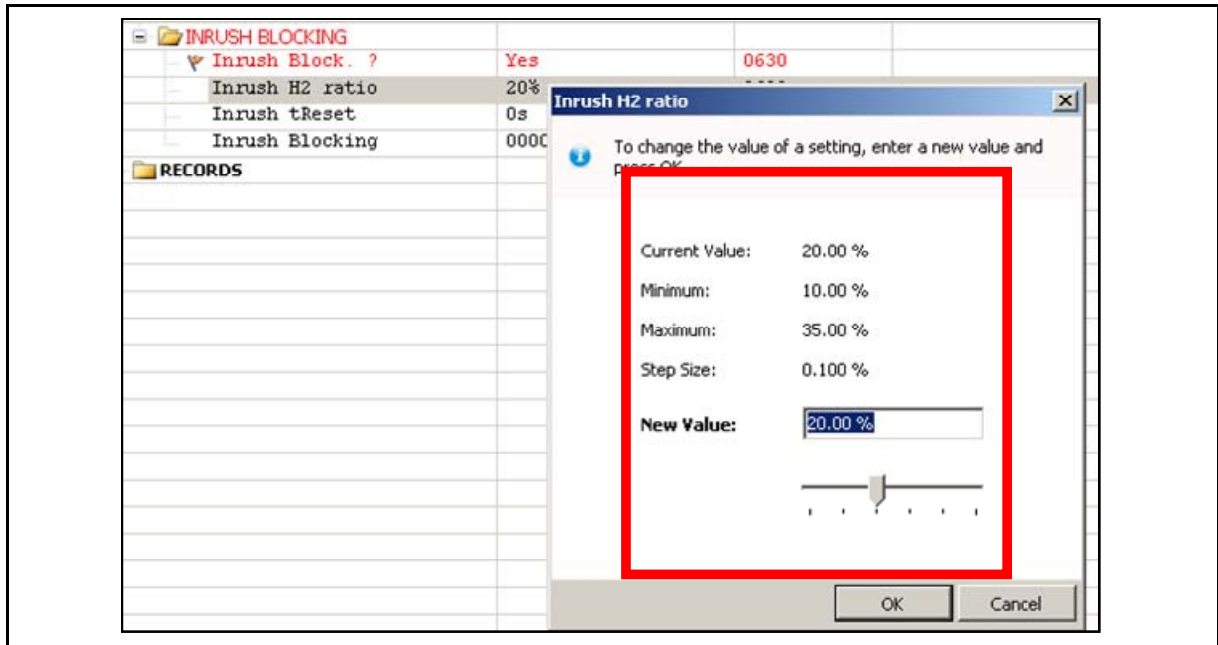

tReset timer defines the minimum duration of overcurrent threshold inhibition (0-2s, settable). This timer starts as soon as operating inrush current threshold picks up:

- If inrush condition duration is smaller than tReset setting value, selected overcurrent function will remain inhibited during tReset.
- If inrush condition duration is longer than tReset setting value, selected overcurrent function will be inhibited as long as inrush condition remains valid.

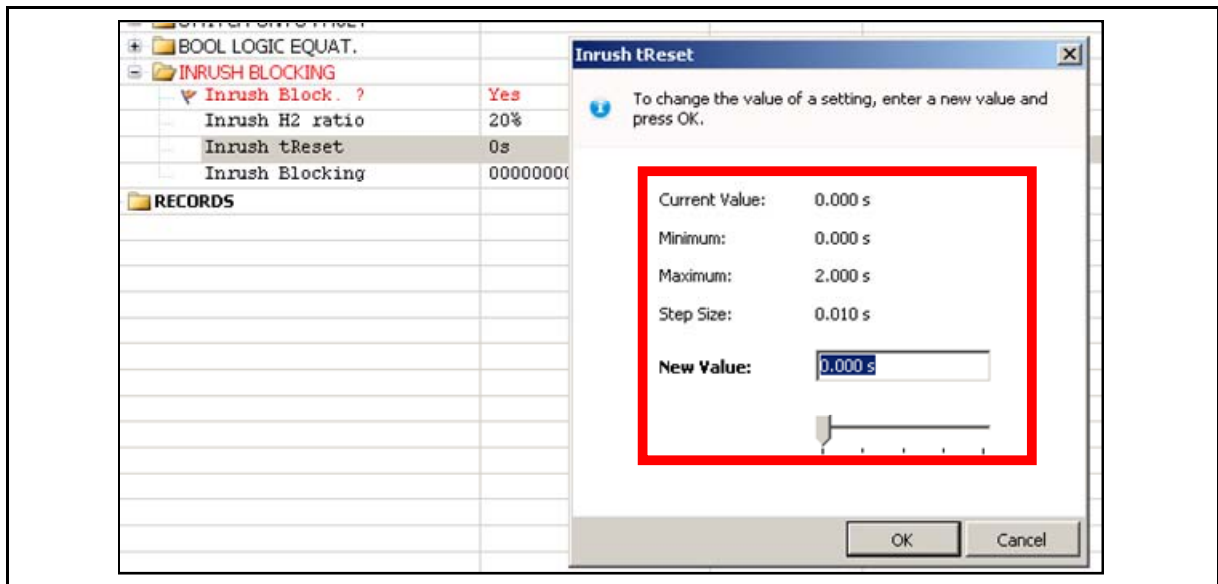

Under inrush condition, the following selectable protection stages will be blocked:

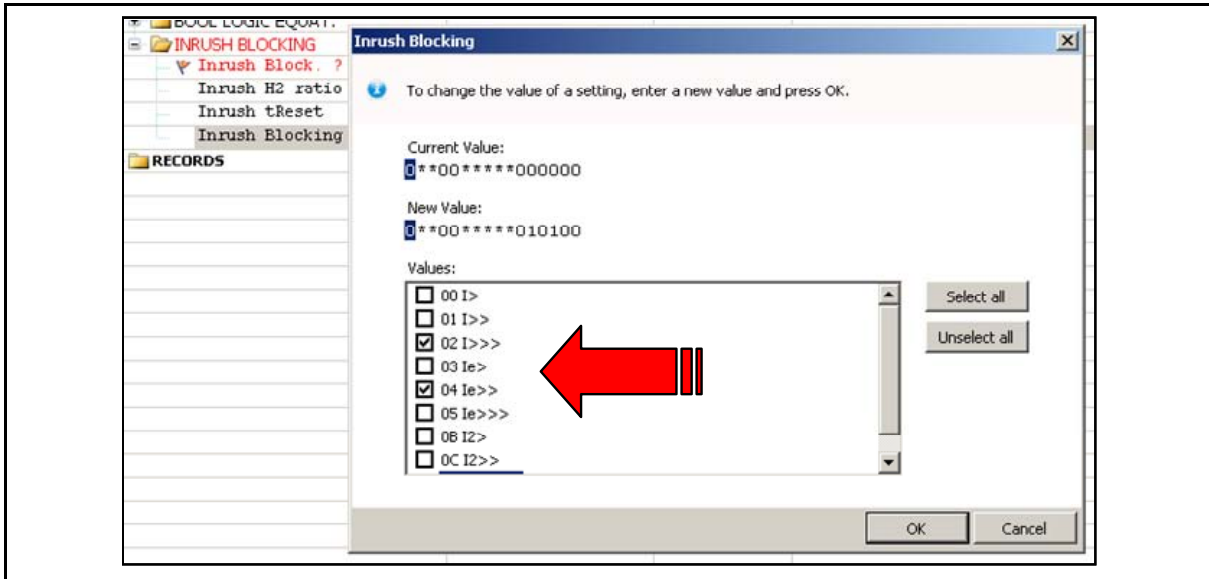

NOTE: Inrush Blocking in P122 and P123 relays is not phase selective. On occurrence of inrush condition, in any phase, selected protection stages in all 3 phases will be blocked.



3.2.1 Principle

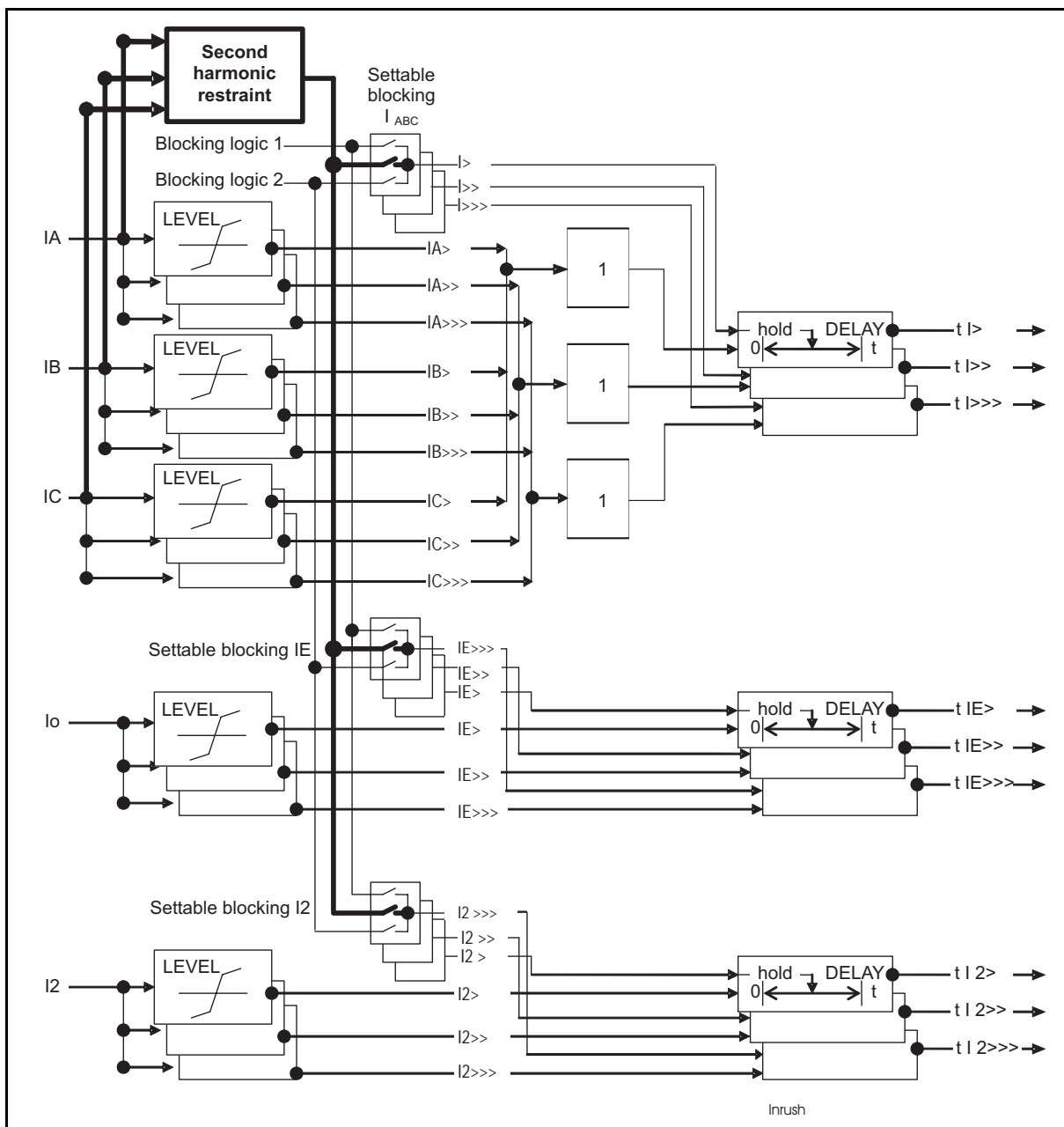

#### 4. BUSBAR PROTECTION ON RADIAL SYSTEMS

The use of non-directional overcurrent relays to protect a busbar is based on the following hypotheses:

- The network is a radial system,
- The incoming and outgoing feeders are clearly defined, the incomers being always considered as suppliers of energy and feeders as loads.

Under these circumstances, the busbar is effectively protected using the interlocking principle (Figure 2).

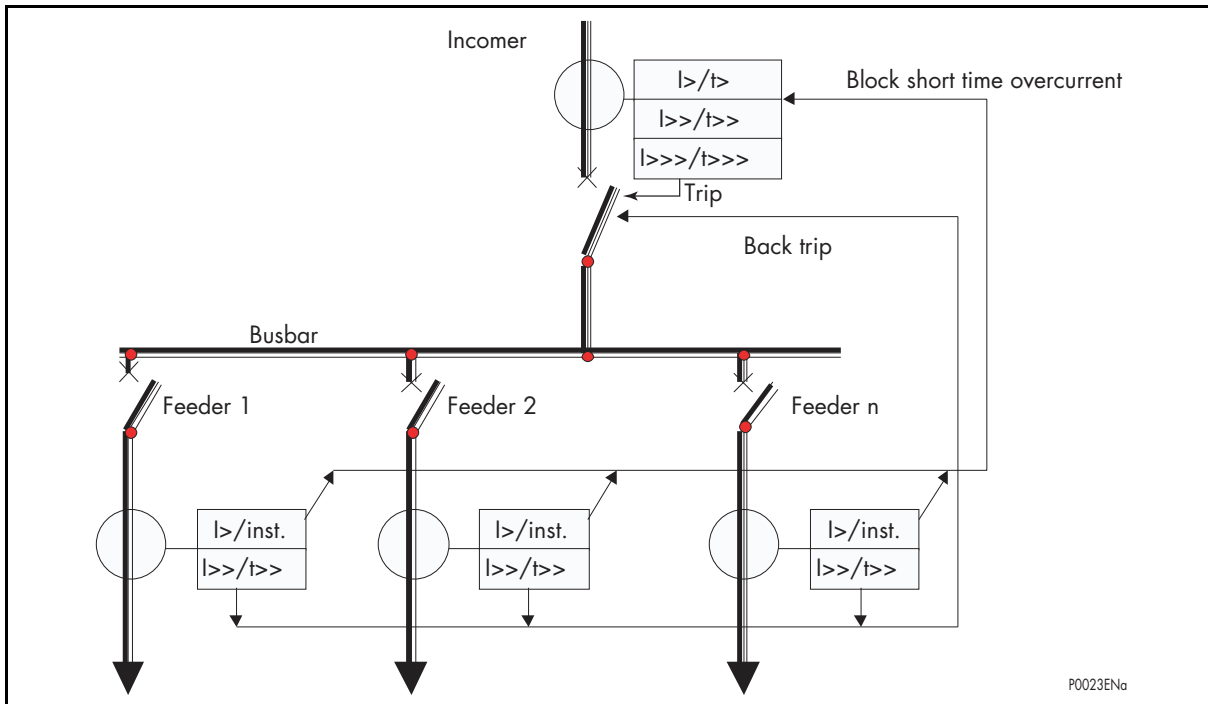

FIGURE 2: BLOCKED OVERCURRENT FOR BUSBAR PROTECTION

The instantaneous overcurrent signals of the feeders protection are grouped together and wired to the « Blocking logic » logic input of the relay protecting the incomer. The blocking function is programmed to inhibit either the first or first two thresholds. The third  $I_{>>>}$  threshold picks up at a high value ( $>10 I_n$ ) with a short time delay ( $<60$  ms).

If a fault appears on the network, the relay protecting the associated feeder will immediately (in less than 30 ms) send a blocking order to the relay protecting the incomer. After the fault has been cleared (by opening the circuit breaker), the blocking order is removed and the relay protecting the incomer is unblocked. As the fault current is no longer present, the timer is reinitialised.

If the fault appears on the busbar, the fault current exceeds by far the value of the third threshold ( $I_{>>>}$ ). As this third threshold is not blocked by the blocking logic of relays protecting the incomers, the trip order is sent in less than 60 ms and the busbar is de-energised.

## 5. BLOCKING LOGIC FUNCTION (BLOCKED OVERCURRENT PROTECTION)

This type of protection can be applied to radial feeder circuits where there is little or no back feed. For parallel feeders, ring circuits or where there can be a back feed from generators, directional relays should be considered.

The blocking logic function allows the upstream IDMT relay to be blocked by the start output of a downstream relay that has detected the presence of fault current above its threshold. Thus both upstream and downstream relays can have the same current and time settings, and the blocking feature will automatically provide grading. If the breaker fail protection is active, the blocking order on the upstream relay will be removed if the down-stream circuit breaker fails to trip.

Thus for a fault downstream from relay C, the start output from relay C will prevent relay B from operating and the start output of relay B will prevent relay A from operating. Thus all 3 relays could have the same time and current threshold settings and the grading would be obtained by the blocking signal received from a relay closer to the fault. This gives a constant, close time grading, but there will be no back-up protection in the event of pilots being short circuited.

However, in practice it is recommended to set the upstream relay to a value that is 10% higher than the downstream relay setting. This ensures that the downstream relay successfully blocks the upstream relay when required.

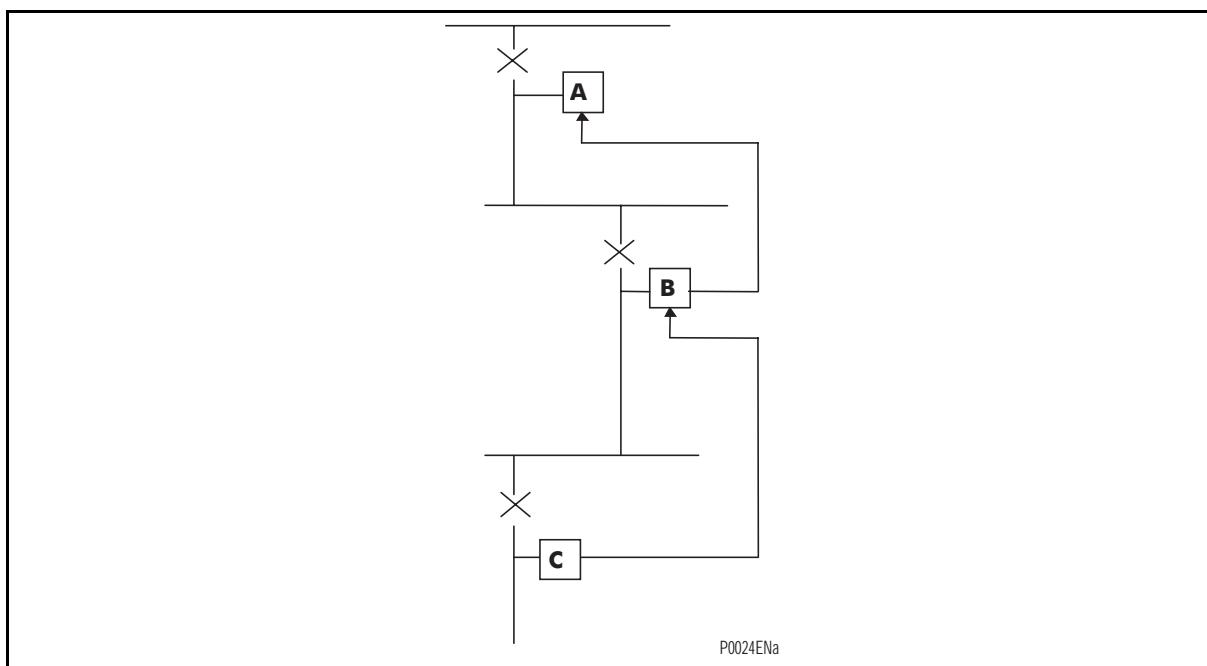

FIGURE 3: BLOCKING LOGIC

To assign the "Blocking Logic" functions, go under the AUTOMAT CTRL/Blocking Logic menu.

MiCOM P120 & P121 relays have only one blocking logic function.

MiCOM P122 & P123 relays have two blocking functions, which can be used to block the Earth and Phase thresholds.

## 6. RESTRICTED EARTH FAULT

MiCOM P120, P121, P122 and P123 provide Restricted Earth Fault protection. It should be noted that:

The algorithms implemented in P120 and P121 for the first and second thresholds ( $I_{>}$ ,  $I_{0>}$  and  $I_{>>}$ ,  $I_{0>>}$ ) are similar to the ones implemented in the P122 and P123 for the same thresholds. However the algorithm of the third threshold ( $I_{>>>}$  and  $I_{0>>>}$ ) of P120 and P121 is different to the one of P122 and P123.

In fact, the algorithm of the third threshold of the P122 and P123 is based on a current sample base in addition to the Discrete Fourier Transformation base. This implementation allows to trip faster on highly saturated current signals. The third threshold of P120 and P121- as it is for the first and second threshold of P120, P121, P122 and P123 products - is based on the Fourier transformation;

This explains the outstanding results obtained by the third threshold of P122 and P123 compared to the other thresholds regarding the high impedance restricted earth fault application. So for:

- P122 and P123: The user can use all the thresholds for REF application. Note that the results of the third threshold will be greater due to the fact that a sample base algorithm is used.
- P120 and P121: The user can use all the threshold for REF application. The results of the third threshold will be similar to one of the first and second threshold (since all the thresholds are based on Discrete Fourier Transformation).

NOTE: For P122 and P123, the maximum internal fault level for the third threshold (for the 0.002 to  $1I_n$  range) must not exceed  $20I_n$ .

### 6.1 Introduction

The restricted earth fault relay is a high impedance differential scheme which balances zero sequence current flowing in the transformer neutral against zero sequence current flowing in the transformer phase windings. Any unbalance for in-zone fault will result in an increasing voltage on the CT secondary and thus will activate the REF protection.

This scheme is very sensitive and can then protect against low levels of fault current in resistance grounded systems where the earthing impedance and the fault voltage limit the fault current.

In addition, this scheme can be used in a solidly grounded system. It provides a more sensitive protection, even though the overall differential scheme provides a protection for faults over most of the windings.

The high impedance differential technique ensures that the impedance of the circuit is of sufficiently high impedance such that the differential voltage that may occur under external fault conditions is lower than the voltage required to drive setting current through the relay. This ensures stability against external fault conditions and then the relay will operate only for faults occurring inside the protected zone.

## 6.2 High impedance principle

High impedance schemes are used in a differential configuration where one current transformer is completely saturated and the other CTs are healthy.

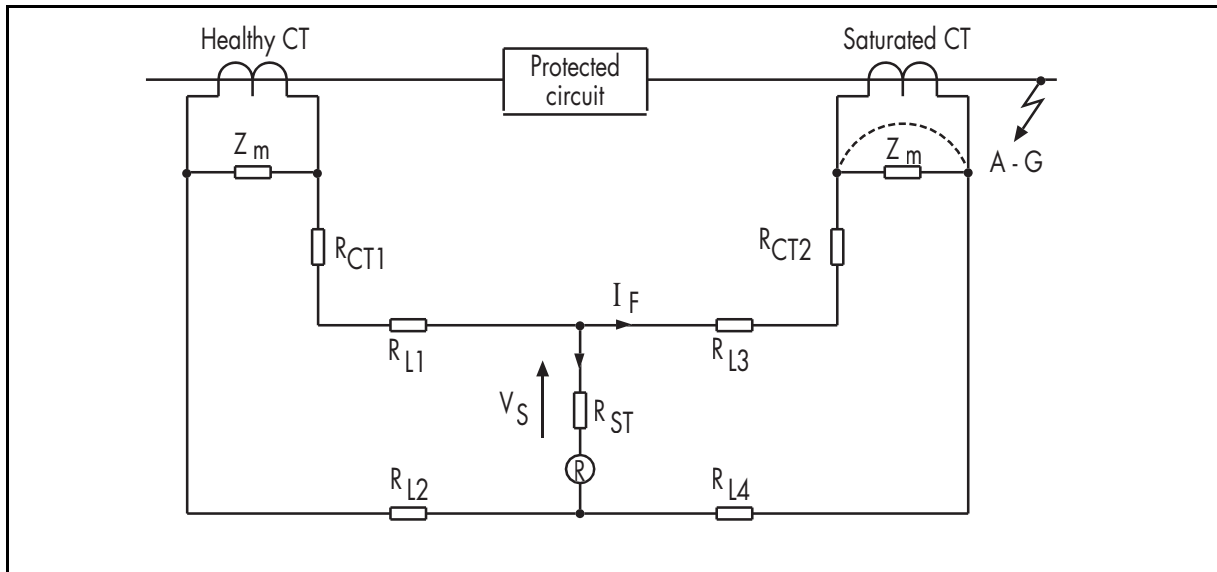

FIGURE 4: HIGH IMPEDANCE SCHEME PRINCIPLE

The voltage applied across the relay is:

$$V_r = I_f (R_{CT} + 2R_L)$$

$I_f$  : Maximum secondary external fault current.

$R_{CT}$  : Resistance of the Current transformer secondary winding.

$R_L$  : Resistance of a single wire from the relay to the CT.

A stabilizing resistor  $R_{ST}$  can be used in series with the relay circuit in order to improve the stability of the relay under external fault conditions. This resistor will limit the spill current under  $I_s$ .

$$V_s = I_s (R_{ST})$$

$I_s$ : Current relay setting

$V_s$ : Stability Voltage setting

Note that the relay consumption has been taken into account.

The general stability conditions can be obtained when:

$$V_s > K \cdot I_f (R_{CT} + 2R_L)$$

Where  $K$  is the stability factor.

This stability factor is influenced by the ratio  $V_k/V_s$  which in turns governs the stability of the REF protection element for through faults .

$V_k$  = The Knee point voltage of the CT.

To obtain a high speed operation for internal faults, the Knee point voltage  $V_k$  of the CT must be significantly higher than the stability voltage  $V_s$  . A ratio of 4 or 5 would be appropriate.

For MiCOM P121, P122 and P123, we found the following results:

$K = 1$  for  $V_k/V_s$  less or equal to 16 and

$K = 1.2$  for  $V_k/V_s > 16$ .

NOTE: The maximum internal fault level for stage 3 of 0.002 to 1In board must not exceed 20In.

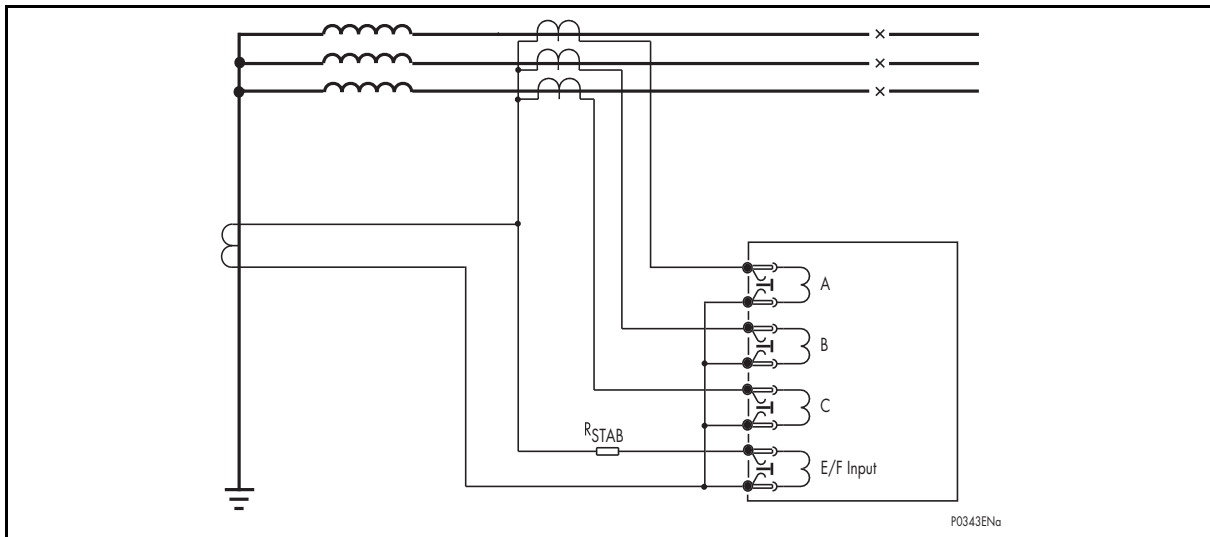

FIGURE 5: CT CONNECTION DIAGRAM FOR HIGH IMPEDANCE REF APPLICATION

### 6.3 Setting guide

The characteristics of the relay and the value of K influence the stability of the scheme as explained here above.

The typical setting values shall be chosen to provide a primary operating current less than 30 % of the minimum earth fault level for a resistance earthed system. For a solidly earthed system, the typical setting shall provide an operating current between 10 and 60 % of the rated current.

The primary operating current, at the secondary, depends on the following factors:

- Current Transformer ratio
  - Relay operating current  $I_s$
  - Number of CT in parallel with the relay element (n)
  - The inrush current of each CT ( $I_e$ ) at the stability voltage
- $$I_{op} = CT_{Ratio} \cdot (I_s + n \cdot I_e)$$

Current setting should be selected for a high impedance element so that the primary current reaches its nominal current with a given CT, according to the following equation:

$$I_s < \{(I_{op} / CT_{Ratio}) - n \cdot I_e\}$$

It is also possible to determine the maximum inrush current of the CT to reach a specific primary operating current with a given relay setting.

The setting of the stabilising resistor must be calculated according to the above formula, where the setting depends on the required stability voltage setting  $V_s$  and the relay setting  $I_s$

$$\frac{V_s}{I_s} = \frac{k I_f (R_{CT} + 2R_L)}{I_s}$$

For MiCOM P12x,  $I_s$  is equivalent to  $I_{e>}$ , so the above equation becomes:

$$\frac{V_s}{I_{e>}} = \frac{k I_f (R_{CT} + 2R_L)}{I_{e>}}$$

with

$K = 1$  for  $V_k/V_s$  less or equal to 16 and

$K = 1.2$  for  $V_k/V_s > 16$ .

So

$$R_{ST} = \frac{k I_f (R_{CT} + 2R_L)}{I_{e>}}$$

with  $V_k \geq 4 \cdot I_s \cdot R_{ST}$  (A typical value to ensure the high speed operation for an internal fault).

#### 6.3.1 CT requirements for High Impedance Restricted Earth Fault Protection

The High Impedance Restricted Earth Fault element shall remain stable for through faults and operate in less than 40ms for internal faults provided that the following equations are met in determining CT requirements and the value of the associated stabilising resistor:

$$R_s = [k \cdot (I_f) \cdot (R_{CT} + 2R_L)] / I_s$$

$$V_k \geq 4 \cdot I_s \cdot R_s$$

with

$K = 1$  for  $V_k/V_s$  less or equal to 16 and

$K = 1.2$  for  $V_k/V_s > 16$ .

#### 6.4 Use of METROSIL non linear resistors

Metrosils are used to limit the peak voltage developed by the current transformers under internal fault conditions, to a value below the insulation level of the current transformers, relay and interconnecting leads, which are normally able to withstand 3KV peak.

The following formula should be used to estimate the peak transient voltage that could be induced by an internal fault. This peak voltage depends on:

- CT Knee point ( $V_k$ )
- Voltage that would be induced by an internal fault if CT doesn't saturate ( $V_f$ )

This prospective voltage itself depends on:

- Maximum internal fault secondary current
- CT ratio
- CT secondary winding resistance
- CT lead resistance to the common point
- Relay lead resistance
- Stability resistor value

- $V_p = 2 \sqrt{\{2 \cdot V_k (V_f - V_k)\}}$

$$V_f = I'_f \cdot (R_{ct} + 2R_L + R_{ST})$$

Where

- $V_p$ : peak voltage developed by the CT under internal fault conditions
- $V_f$ : maximum voltage that would be produced if CT saturation did not occur
- $V_k$ : current transformer Knee point voltage
- $I'_f$ : is the maximum internal secondary fault current
- $R_{ct}$ : current transformer secondary winding transformer
- $R_L$ : maximum lead burden from CT to relay
- $R_{ST}$ : Relay stabilising resistor.

When the value given by the formula is greater than 3KV peak, it is necessary to use Metrosils. They are connected across the relay circuit and they allow to shunt the secondary current output of the current transformer from the relay in order to prevent very high secondary voltages.

Metrosils are externally mounted and have annular discs shape.

Their operating characteristics is according to the formula:

$$V = C.I^{0.25}$$

Where

- V: Instantaneous voltage applied to the non-linear resistor (Metrosil)
- C: Constant of the non-linear resistor (Metrosil)
- I: Instantaneous current through the non-linear resistor (Metrosil)

With the sinusoidal voltage applied across the Metrosil, the RMS current would be approximately 0.25 times the peak current. This current value can be calculated as follows:

$$I_{rms} = 0.52 \left\{ \frac{V_s(rms) \cdot \sqrt{2}}{C} \right\}^4$$

Where

- Vs(rms): RMS value of the sinusoidal voltage applied across the Metrosil.

This is due to the fact that the current waveform through the Metrosil is not sinusoidal but appreciably distorted.

For satisfactory application of the non-linear resistor (Metrosil), its characteristics should comply with the following requirements:

- At the relay voltage setting, the non-linear resistor (Metrosil) current should be as low as possible, but no greater than approximately 30mA rms for 1A current transformers and approximately 100mA rms for 5A current transformer.
- At the maximum secondary current, the non-linear resistor (Metrosil) should limit the voltage to 1500V rms or 2120V peak for 0.25 second. At higher relay voltage settings, it is not always possible to limit the fault voltage to 1500V rms, so higher fault voltage may have to be tolerated.

The following tables show the typical types of Metrosil that will be required, depending on relay current rating, REF voltage setting etc.

#### 6.4.1 Metrosil units for relays with 1A CT

The Metrosil units with 1A CTs have been designed to comply with the following restrictions:

- At the relay voltage setting, the Metrosil current should be less than 30mA rms.
- At the maximum secondary internal fault current, the Metrosil unit should limit the voltage to 1500V rms if possible.

The Metrosil units normally recommended to be used with 1Amp CTs are shown in the following table:

Relay Voltage setting	Nominal Characteristics		Recommended Metrosil Type	
	C	$\beta$	Single pole Relay	Triple pole relay
Up to 125V rms	450	0.25	600A/S1/S256	600A/S3/1/S802
125 to 300V rms	900	0.25	600A/S1/S1088	600A/S3/1/S1195

NOTE: Single pole Relay Metrosil Units are normally supplied without mounting brackets unless otherwise specified by the customer.



## 6.4.2 Metrosil units for relays with 5A CT

These Metrosil units have been designed to comply with the following requirements:

- At the relay voltage setting, the Metrosil current should be less than 100mA rms (the actual maximum currents passed by the units shown below their type description)
- At the maximum secondary internal fault current the Metrosil unit should limit the voltage to 1500V rms for 0.25 second. At the higher relay settings, it is not possible to limit the fault voltage to 1500V rms, hence higher voltage have to be tolerated ( indicated by \* , \*\* , \*\*\* ).

The Metrosil units normally recommended for the used with 5 Amps CTs and single pole relays are shown in the following table:

Secondary Internal fault current	Recommended Metrosil Type			
	Relay Voltage Setting			
Amps rms 50A	Up to 200V rms 600A/S1/S1213 C= 540/640 35mA rms	250V rms 600A/S1/S1214 C= 670/800 40mA rms	275V rms 600A/S1/S1214 C= 670/800 50mA rms	300V rms 600A/S1/S1223 C= 740/870* 50mA rms
100A	600A/S2/P/S1217 C= 470/540 35mA rms	600A/S2/P/S1215 C= 570/670 75mA rms	600A/S2/P/S1215 C= 570/670 100mA rms	600A/S2/P/S1196 C= 620/740* 100mA rms
150A	600A/S3/P/S1219 C= 430/500 100mA rms	600A/S3/P/S1220 C= 520/620 100mA rms	600A/S3/P/S1221 C= 570/670** 100mA rms	600A/S3/P/S1222 C= 620/740*** 100mA rms

NOTE: \* 2400V peak  
\*\* 2200V peak  
\*\*\* 2600V peak

In some cases, single disc assemblies may be acceptable, contact Schneider Electric for detailed information.

The Metrosil units used with 5 Amps CTs can also be used with triple pole relays and consist of three single pole units mounted on the same central stud but electrically insulated from each other. To order these units please specify "Triple pole Metrosil type", followed by the single pole type reference.

## 7. RECTIFIER PROTECTION

Rectifiers require a specific inverse time protection curve.

Protecting a rectifier is different from protecting conventional overcurrent applications. In fact, a large number of rectifiers can withstand relatively long periods of overcharge without being damaged. To give an idea, they can generally withstand 150 % of the load for 2 hours and 300 % for 1 minute.

A typical application is shown on the diagram below.

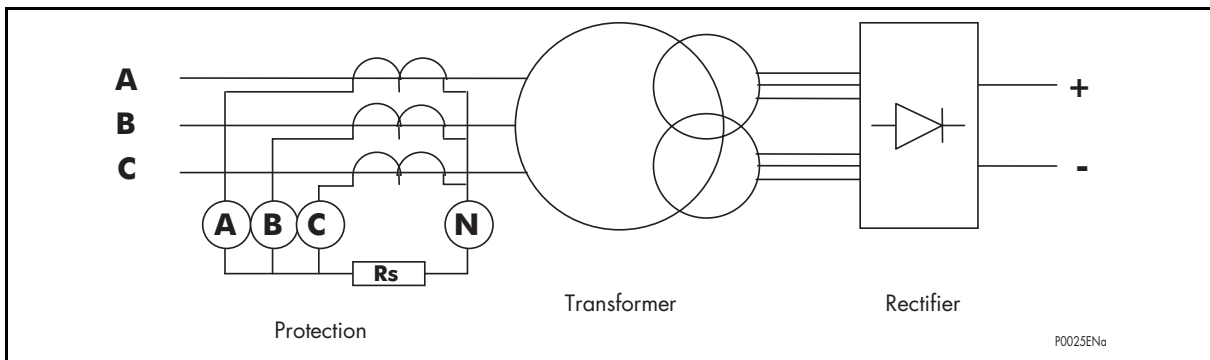

FIGURE 6: PROTECTION FOR SILICON RECTIFIERS

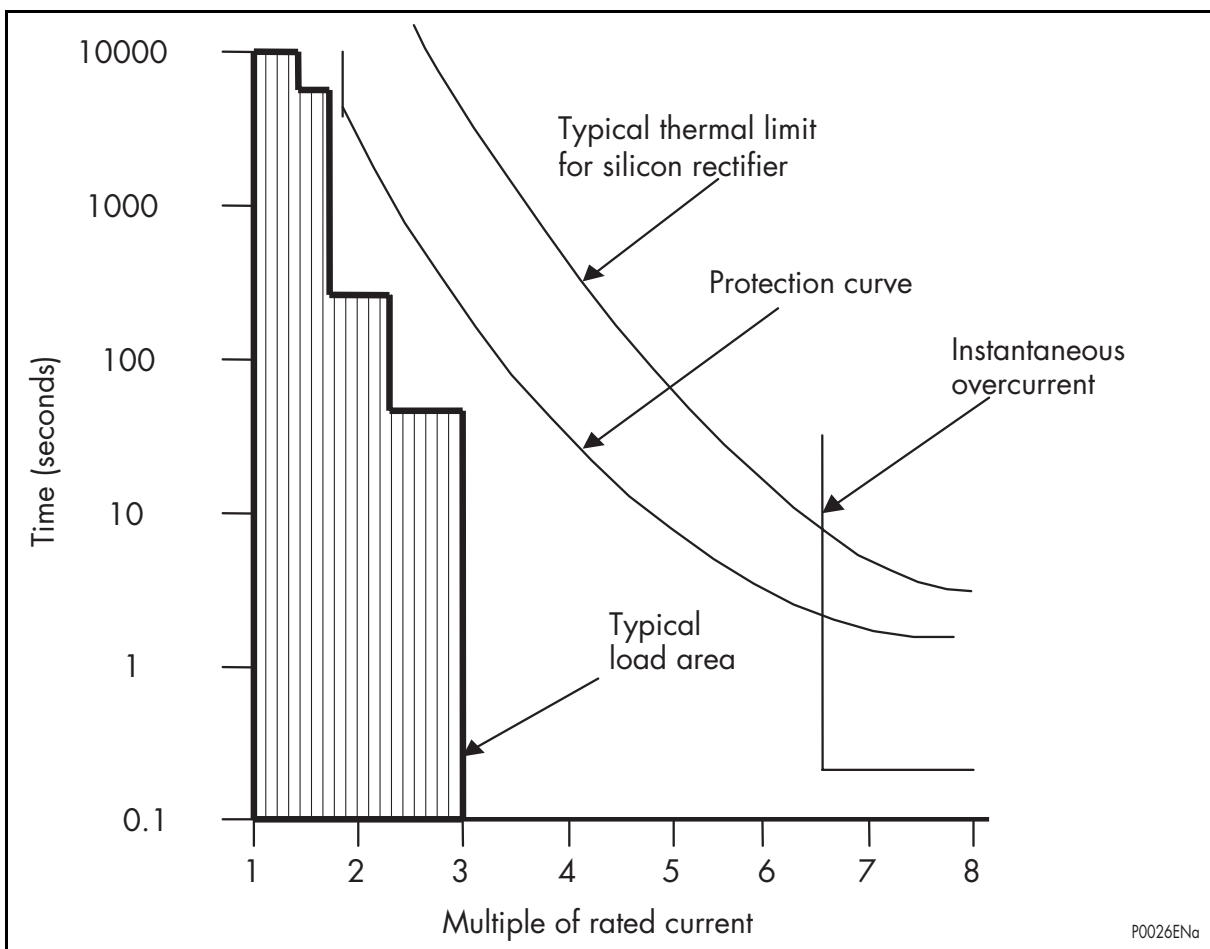

FIGURE 7: MATCHING CURVE TO LOAD AND THERMAL LIMIT OF RECTIFIER

The current threshold  $I>$  should be set to the rated rms value of the current that flows into the transformer when the rectifier is delivering its rated load. The relay will give a start indication when the current exceeds this setting but this is of no consequence because this function is not used in this application. The rectifier curve should be an inverse time curve and should cut-off currents below 1.6 times allowing the rectifier to carry 150% overload for long periods. If this is not acceptable, the  $I>$  setting can be adjusted to move the cut-off point relative to the current scale. The operation time can be modified by adjusting the time multiplier setting (TMS) so that the time lies between limiting characteristic of the rectifier and the tolerated load area.

Typical settings for the TMS area:

Light industrial service	TMS = 0.025
Medium duty service	TMS = 0.1
Heavy duty traction	TMS = 0.8

The high set is typically set at 8 times the rated current as this ensures HV AC protection will discriminate with faults covered by the LV protection. However, the high set could be set to 4 or 5 times the rated current if the AC protection is not trustworthy.

Use of the thermal element to provide protection between 70% and 160% of rated current could enhance the protection. It is also common practice to provide restricted earth fault protection for the transformer feeding the rectifier. Refer to the corresponding section dealing with restricted earth fault protection.

## 8. BACK-UP DIAGRAM USING « TRANSFERRED SELECTIVE TRIPPING »

In this application, the relay protecting the incomer can trip the circuit breaker of the faulty feeder via the watchdog contact of the relay protecting the faulty feeder.

Figure 8 illustrates this example:

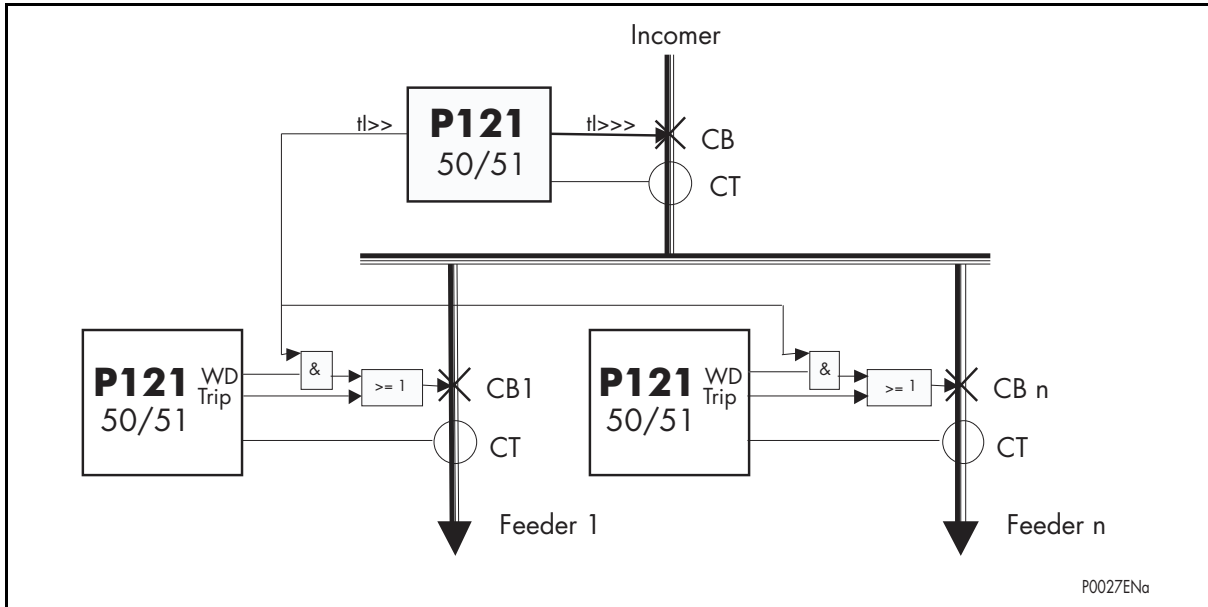

FIGURE 8: EXAMPLE OF A BACK-UP DIAGRAM USING " TRANSFERRED SELECTIVE TRIP"

Thus, a fault occurring on a feeder can be cleared tripping the circuit breaker of the faulty feeder, even if the relay protecting this feeder failed to operate. Without this function, the fault would normally be cleared by the opening of the circuit breaker of the incomer. This would lead to a total loss of operation on the affected busbar.

The relay protecting the incomer has two time delay output contacts available (among others):

- 3rd threshold:  $tl>>>$  time delay at 60ms (active threshold for the high phase faults)
- 2nd threshold:  $tl>>$  time delay selectively greater than for the third threshold, i.e. 360ms.

The output contact associated with the 2nd threshold is wired in serie with the watchdog contact of the downstream relays, so that it can activate the trip coil of the circuit breakers of the feeders. Regarding the output contact associated with the 2nd and 3rd threshold, this contact is directly wired to the trip coil of the incomer circuit breaker.

Case n°1 → all relays operate normally:

In this case, watchdog contacts of all the relays are open.

Thus, for a phase fault on the busbar, threshold  $tl>>$  or  $tl>>>$  of the P121 located on the incomer will clear the fault.

For a phase fault on one of the feeder, the thresholds  $tl>>$  and  $tl>>>$  of the relay located on the incomer being selectively set to higher values than the ones set for the phase thresholds of downstream relays, the fault shall be cleared selectively by the relay of the faulty feeder (selectivity between the relay of the incomer and relays of the feeders is ensured thanks to intervals of selectivity correctly chosen, or thanks to a suitable blocking diagram).

Case n°2 → the relay supervising one of the feeders is faulty:

In this case, the watchdog contact of this relay is closed.

Thus, for a phase fault on the busbar, thresholds  $t_{l>>}$  and  $t_{l>>>}$  activate their associated output contact. However, threshold  $t_{l>>}$  will clear the fault as this threshold has been set to a lower value than the threshold  $t_{l>>>}$ .

For a phase fault on one of the 'healthy' feeders, thresholds  $t_{l>>}$  and  $t_{l>>>}$  of the relay located on the incomer being selectively set to higher values than the ones set for the phase thresholds of the downstream relays, the fault shall be cleared selectively by the relay of the faulty feeder (selectivity between the relay of the incomer and relays of the feeders is ensured thanks to intervals of selectivity correctly chosen or thanks to a suitable blocking diagram).

For a phase fault on the feeder of the failed relay, the threshold  $t_{l>>}$  of the relay located on the incomer operates via the watchdog contact of the faulty relay on the trip coil of the circuit breaker of the faulty feeder. This threshold being selectively set to a value lower than the threshold  $t_{l>>>}$  (which operates directly on the coil of the incomer circuit breaker), the fault is therefore selectively cleared.

### 9. REMOTE PROTECTION STAND-BY DIAGRAM

MiCOM P121, P122 and P123 relays can be used as a HV distance back-up protection (Figure 9). Depending on the type of selectivity required, 51/51N function of P121, P122 and P123 needs to be set either as time constant or as time dependent. The value of the time delay of  $I>/I_e$  is set to a value that is compatible with thresholds Z2 or Z3 (2nd and 3rd distance protection zone).

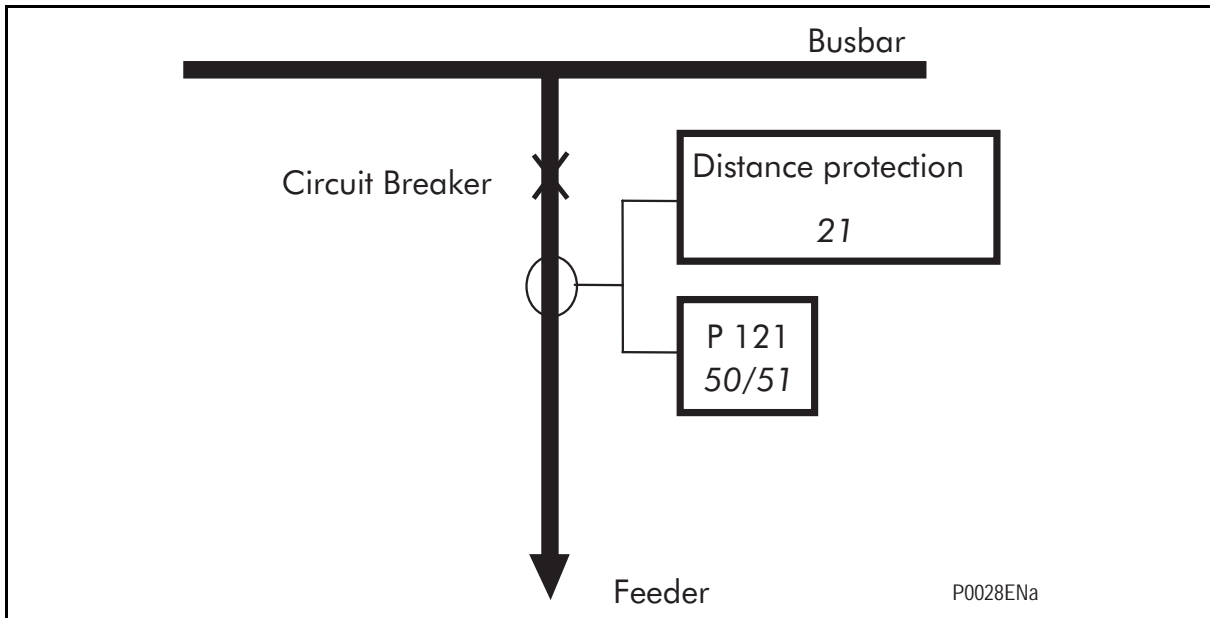

FIGURE 9: ASSISTANCE OF REMOTE PROTECTION BY A MiCOM P121 PROTECTION

The «Equipment default » contact of the distance protection (case of a numerical protection) can be wired to a MiCOM P121, P122 and P123 relays to optimise the time to trip.

### 10. 1 ½ BREAKER SCHEME

For HV/EHV stations with a 1 ½ circuit breaker scheme (Figure 10), the zone between the two circuit breakers and the switch section needs to be protected with a standard ANSI 50 protection.

The time to trip is an essential criteria to be considered when choosing this protection. MiCOM P121, P122 or P123 relays are perfectly suited for this application. The time delay of the first threshold (tI>) is set to a low value (typically 100 ms above the circuit breaker failure time). This will allow the relay to be blocked by the close contact of the associated switch.

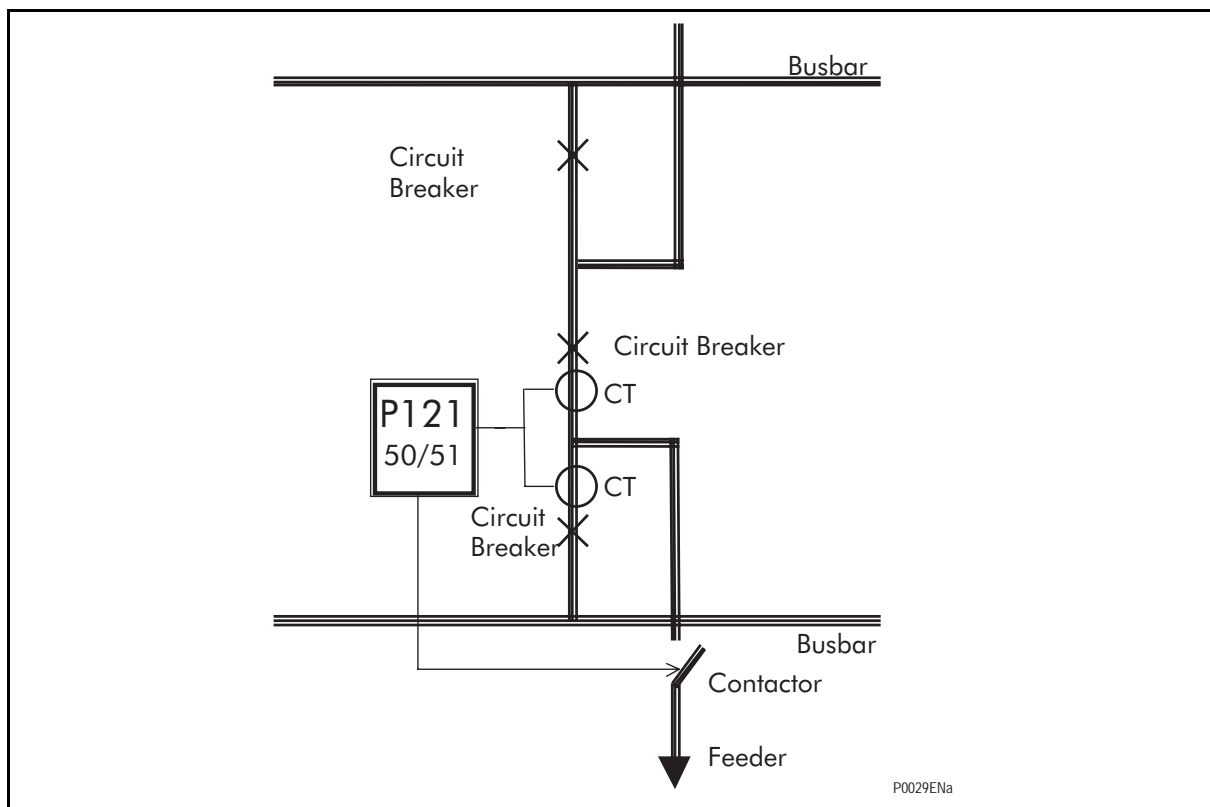

FIGURE 10: 1 ½ BREAKER SCHEME

## 11. THERMAL OVERLOAD PROTECTION (P122 & P123 ONLY)

Thermal overload protection can be applied to prevent damages to the equipment of the electrical plant when operating at temperatures that are above the values designed for maximum withstand. A prolonged overloading causes excessive heating, which may result in premature deterioration of the insulation, or in extreme cases, insulation failure.

MiCOM P122 & P123 relays incorporate a current based thermal replica, using load current to reproduce the heating and cooling of the equipment to be protected. The element thermal overload protection can be set with both alarm and trip stages.

The heating within any plant equipment, such as cables or transformers, is of resistive type ( $I^2R \times t$ ). Thus, the quantity of heat generated is directly proportional to the current squared ( $I^2$ ). The thermal time characteristic used in the relay is based on current squared, integrated over time.

MiCOM P122 & P123 relays automatically use the highest phase current as input information for the thermal model.

Protection equipment is designed to operate continuously at a temperature corresponding to its full load rating, where heat generated is balanced with heat dissipated by radiation etc. Over-temperature conditions therefore occur when currents in excess of rating are allowed to flow for a certain period of time. It can be shown that temperatures during heating follow exponential time constants and a similar exponential decrease of temperature occurs during cooling.

In order to apply this protection element, the thermal time constant ( $T_e$ ) of the plant equipment to be protected is therefore required.

The following sections will show that different plant equipment possesses different thermal characteristics, due to the nature of their construction.

### 11.1 Time Constant Characteristic

This characteristic is used to protect cables, dry type transformers (e.g. type AN), and capacitor banks.

The thermal time characteristic is given by:

$$e^{\left(\frac{-t}{\tau}\right)} = \frac{\left(I^2 - (k \times I_{FLC})^2\right)}{\left(I^2 - I_p^2\right)}$$

Where:

- t = Time to trip, following application of the overload current, I
- $\tau$  = Heating and cooling time constant of the protected plant equipment
- I = Largest phase current
- $I_{FLC}$  = Full load current rating (relay setting 'Thermal Trip')
- k = 1.05 constant, allows continuous operation up to  $< 1.05 I_{FLC}$
- $I_p$  = Steady state pre-loading current before application of the overload

The time to trip varies depending on the load current carried before application of the overload, i.e. whether the overload was applied from "hot" or "cold".

Curves of the thermal overload time characteristic are presented in the chapter P12x/EN TD/C55 of the Technical Guide.



**Mathematical formula applicable to the MiCOM Relays:**

The calculation of the Time to Trip is given by:

$$T_{trip} = T_e \ln \left( \frac{|K^2 - \theta|}{|K^2 - \theta_{trip}|} \right)$$

With:

$T_{trip}$  = Time to trip (in seconds)

$T_e$  = Thermal time constant of the protected element (in seconds)

$K$  = Thermal overload equal to  $I_{eq}/k I_{\theta >}$

$I_{eq}$  = Equivalent current corresponding to the RMS value of the largest phase current.

$I_{\theta >}$  = Full load current rating given by the national standard or by the supplier.

$k$  = Factor associated to the thermal state formula.

$\theta$  = Initial thermal state. If the initial thermal state = 30% then  $\theta = 0.3$

$\theta_{trip}$  = Trip thermal state. If the trip thermal state is set at 100%, then  $\theta_{trip} = 1$

The settings of these parameters are available in the menus:

PROTECTION G1/ [49] Therm OL

PROTECTION G2/ [49] Therm OL

**The calculation of the thermal state is given by the following formula:**

$$\Theta_{\tau+1} = \left( \frac{I_{eq}}{k \times I_{\theta >}} \right)^2 \left[ 1 - e^{\left( \frac{-t}{T_e} \right)} \right] + \Theta_{\tau} e^{\left( \frac{-t}{T_e} \right)}$$

$\theta$  being calculated every 20ms.

## 11.2 Setting Guidelines

The current setting is calculated as:

Thermal Trip ( $\theta_{trip}$ ) = Permissible continuous loading of the plant equipment / CT ratio.  
Typical time constant values are given in the following tables. The 'Time Constant' parameter is given in minutes.

Paper insulated lead sheathed cables or polyethylene insulated cables are placed above the ground or in conduits. The table shows  $\tau$  in minutes, for different cable rated voltages and conductor cross-sectional areas:

CSA mm <sup>2</sup>	6 -11 kV	22 kV	33 kV	66 kV
25 - 50	10	15	40	-
70 - 120	15	25	40	60
150	25	40	40	60
185	25	40	60	60
240	40	40	60	60
300	40	60	60	90
	Time constant $\tau$ (minutes)			

Other plant items:

	Time constant $\tau$ (minutes)	Limits
Dry-type transformers	40 60 - 90	Rating < 400 kVA Rating 400 - 800 kVA
Air-core reactors	40	
Capacitor banks	10	
Overhead lines	10	Cross section $\geq 100 \text{ mm}^2$ Cu or $150 \text{ mm}^2$ Al
Busbars	60	

An alarm can be raised when reaching a thermal state corresponding to a percentage of the trip threshold. A typical setting might be 'Thermal Trip' = 70% of thermal capacity.

## 12. COLD LOAD PICK-UP (P122 & P123 ONLY)

The Cold Load Pick-up feature allows selected settings of MiCOM P122 and P123 relays to be changed to react to temporary overload conditions that may occur during cold starts. This condition may happen by switching on large heating loads after a sufficient cooling period, or loads that draw high initial starting currents.

When a feeder is energised, the current levels that flow for a period of time following energising may differ greatly from the normal load levels. Consequently, overcurrent settings that have been applied to give short circuit protection may not be suitable during this period.

The Cold Load Pick-up (CLP) logic raises the settings of selected stages for a set duration (tCL). This allows the protection settings to be set closer to the load profile. Cold load pick-up cannot restart until the end of tCL duration. The CLP logic provides stability, without compromising protection performance during starting.

The CLP can be started by digital logic Input 52A and/or internal threshold detection by (Not I< & I>) and/or internal threshold detection by (Not I0< & I0>).

If the CB positions are not available, to detect the Cold Load Pick-up start, a new internal threshold is created named autostart.

To detect the Cold Load Pick-up, the three phases current should be under 5% of  $I_n$ . When the current grows up to  $I_n$  or more, with a time of less than 200 ms, an internal edge detection is created.

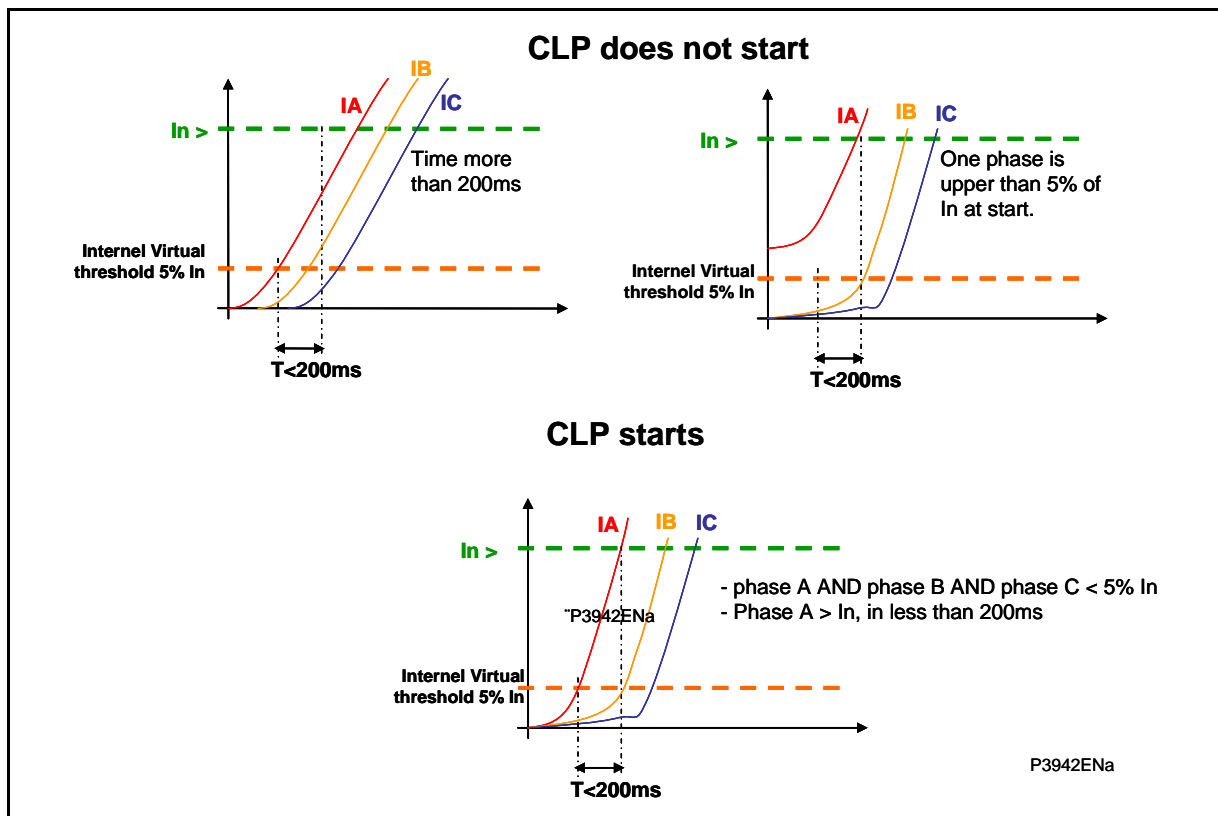

The following diagram shows the logic start of CLP

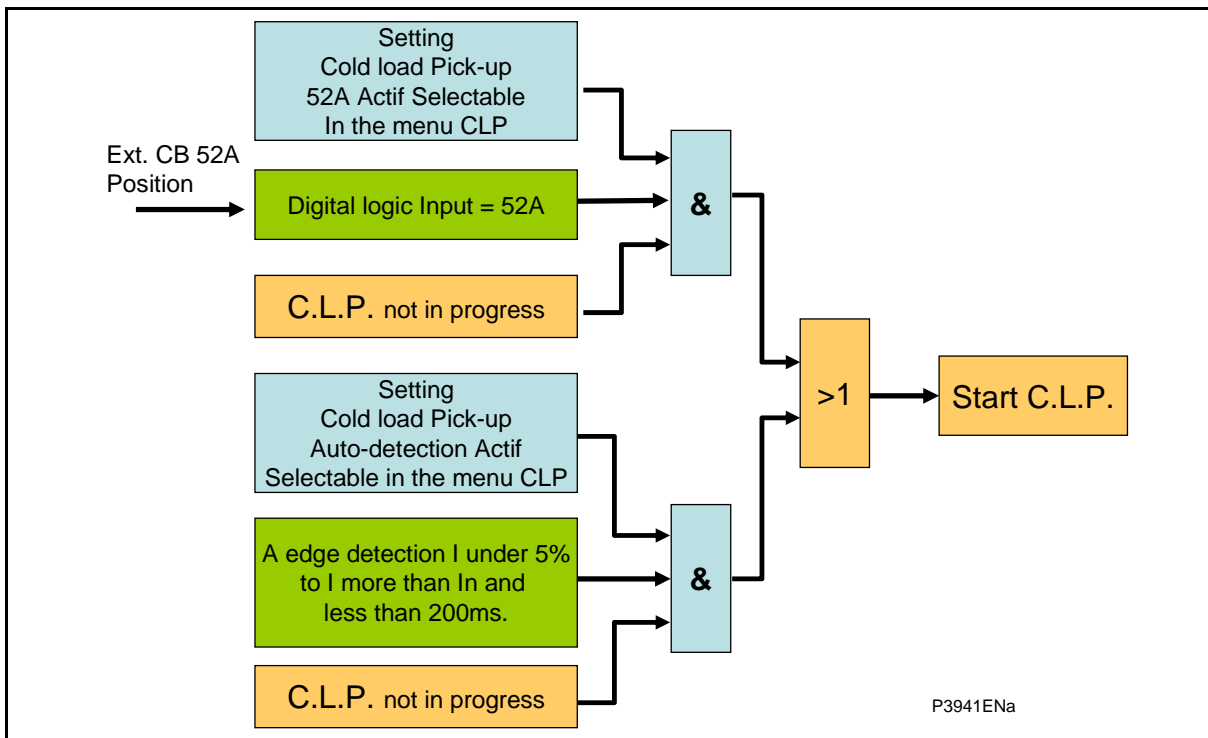

### 12.1 Exemple of application for earth Fault Protection applied to Transformers

Where an earth fault relay is residually connected on the primary side of a delta-star transformer, no time delay is required for co-ordination purposes, due to the presence of the delta winding. However, a nominal time delay or stabilising resistor is recommended, to ensure transient stability during transformer energising.

The CLP logic may be used in a similar manner to that previously described for the motor application.

This method will not provide stability in the event of asymmetric CT saturation (as a result of an unbalanced fault condition). In this case, use a stabilising resistor.

### 13. SWITCH ON TO FAULT / TRIP ON RECLOSE PROTECTION (P123 ONLY)

#### 13.1 General

In some feeder applications, fast tripping may be required if a fault is still present on the feeder after the reclose of the circuit breaker (Close on to fault).

Some faults may not be cleared after a reclose due to the fact that the conditions that led to the fault have not been removed from the feeder after a reclosing cycle or a manual trip, or due to earthing clamps left on after a maintenance visit. In these cases, it may be desirable to clear the fault condition in a quicker time, rather than to wait for the trip delay time DMT or IDMT associated with the involved protection to elapse.

In the case of a CB being manually closed, a switch on to an existing fault may occur. This situation is particularly critical because the overcurrent protection would not clear the fault until the set time delay has elapsed. It is then desirable to clear the fault as fast as possible.

Activation and setting of the SOTF/TOR (Switch On To Fault/ Trip On Reclose) function can be done under the AUTOMATIC CTRL/SOTF submenu.

The crossing of I>> and I>>> thresholds initiate the SOTF function.

#### 13.2 SOTF/ TOR description

The following signals can activate the SOTF/TOR function:

- "Ctrl close" logical input,
- manual closing ordered by HMI,
- command generated by a digital input labelled "SOTF",
- front communication order,
- rear communication order,
- close ordered by autorecloser,

The following diagram illustrates this functionality.

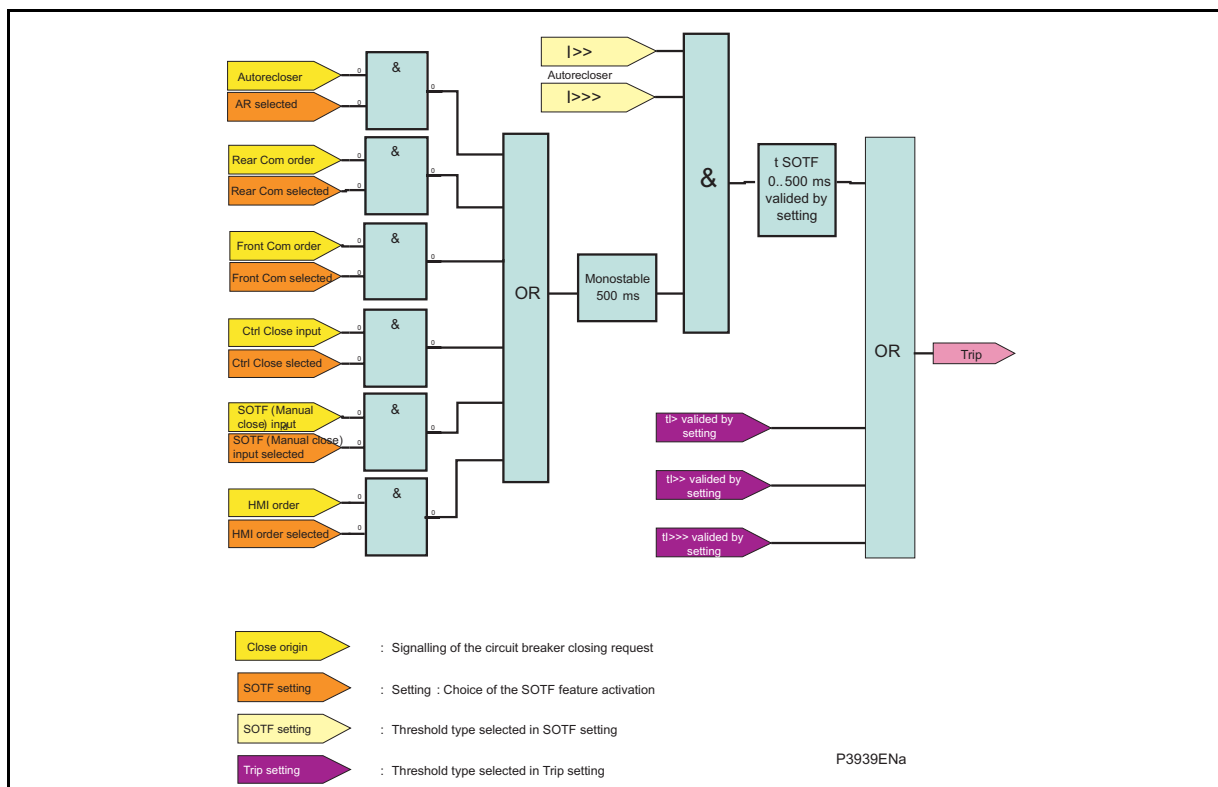

FIGURE 11: LOGIC DIAGRAM OF THE SOTF

When at least one of the selected signals has been detected, a fixed timer starts and lasts 500ms.

Once this fixed timer has elapsed and  $I_{>>}$  or  $I_{>>>}$  thresholds have been crossed, the configurable timer named "tSotf" starts. This configurable timer is particularly useful in applications where selectivity for fault occurring in stage two or three is requested.

This timer is also useful for cases where serious transient happen, where the three poles of the CB do not close at the same time and in cases where the CB may not instantaneously close.

This "tSotf" can also be considered a trip delay time that substitutes the trip timer of the threshold that has been crossed so that the time to trip is accelerated.

If a trip due to switch on to fault occurs during the reclaim time of the ARC, the trip will be definitive and the ARC will be locked.

If the  $I_{>>}$  and  $I_{>>>}$  reset during the settable timer "tSotf", the SOTF/TOR function is reset.

## 14. LOCAL / REMOTE MODE (P123 ONLY)

### 14.1 General

The goal of this feature is to be able to block commands sent remotely through communication networks (like setting parameters, control command, etc.), to prevent any accidents or maloperation during maintenance work performed on site.

A digital input labelled “LOCAL MODE” is assigned to this feature. In Local mode, only the synchronising time signal is allowed.

Commands sent remotely (CTRL TRIP and CTRL CLOSE) as well as commands sent by the autoreclose function (CB Close) can be set to activate their own dedicated output relay (and not necessarily the same output relay as the protection trip output RL1).

### 14.2 Setting

In the “AUTOMATIC CTRL/Trip Commands” menu, TC item uses the “CTRL TRIP” function to open the CB.

In the “AUTOMATIC CTRL/Output relays” menu, the “CTRL TRIP” and “CTRL CLOSE” functions are assigned to remotely open and close the CB.

The “CB CLOSE” relay is assigned to close the CB by Autoreclose.

In order to keep the functionality of previous firmware versions, the user will have to assign both “TRIP” and “CTRL TRIP” information to relay RL1, and to assign both “CTRL CLOSE” and “CB CLOSE” information to the same auxiliary relay.

Here is an example of application.

In the following scheme, the user may assign the different signals to different relays: “TRIP” signal may be assigned to the trip relay RL1, the “CTRL TRIP” signal to the auxiliary relay number 2, the “CB CLOSE” signal to the auxiliary relay number 3 and the “CTRL CLOSE” to the auxiliary relay number 4.

When the “Local” input is energised, all remote commands are blocked. When the “Local” input is de-energised, remote control commands can be issued.

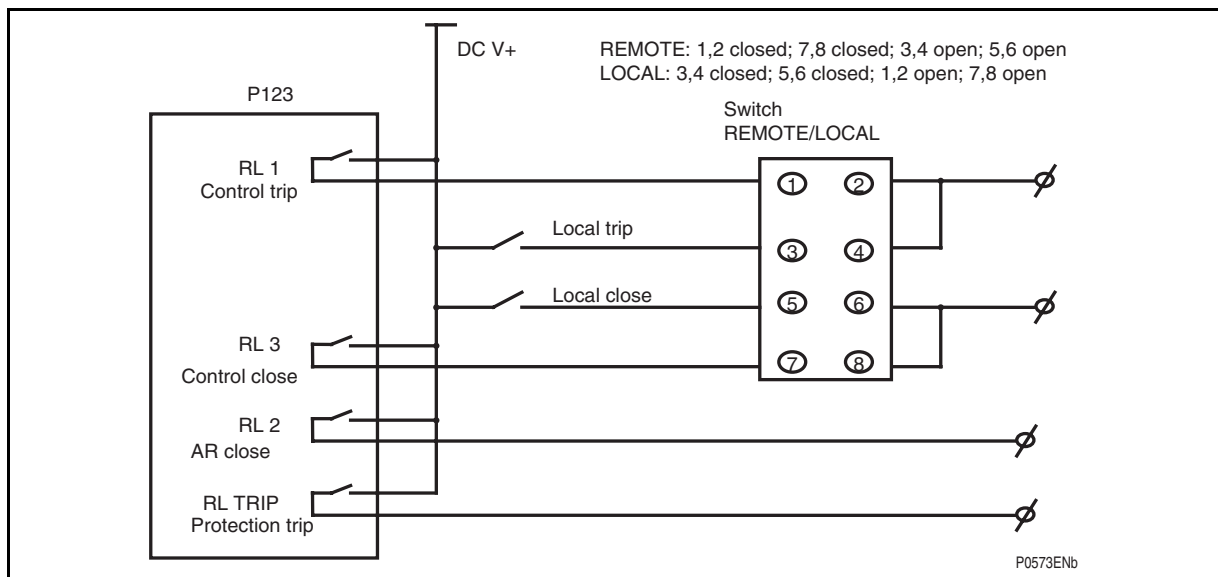

FIGURE 12: EXAMPLE OF LOCAL/REMOTE APPLICATION

## 15. AUXILIARY TIMERS (P121, P122 & P123 ONLY)

Five auxiliary timers tAux1, tAux2, tAux3 (P122/P123 only), tAux4 and tAux5 (P123 only) are available and associated to Aux1, Aux2, Aux3, Aux4 and Aux5 logic inputs (refer to "AUTOMAT. CRTL/INPUTS" menu). When these inputs are energised, the associated timers start and, when the set time has elapsed, the associated output relays close (refer to "AUTOMAT. CRTL/OUTPUTS" menu). Time delays can be independently set from 0 ms to 200 s.

**NOTE:** It is possible to allocate logic inputs of the MiCOM P120 to the external information Aux1 and Aux2. Therefore, these inputs cannot command output relays. Moreover, the tAux1 and tAux2 timers are fixed and equal to 0. Thus the Aux1 and Aux2 inputs can only be used for indication on the communication network.



---

## 16. SETTING GROUP SELECTION (P122 & P123 ONLY)

MiCOM P122 and P123 relays have two setting groups associated to the protection functions named PROTECTION G1 and PROTECTION G2. Only one group is active.

Switching between the groups can be done via:

- the relay front panel interface (CONFIGURATION/GROUP SELECT/ SETTING GROUP 1 or 2),
- a dedicated logic input (AUTOMAT. CTRL/INPUT X/CHANGE SET) where X is the chosen logic input,
- through the communications port (refer to Mapping Database for detailed information).

To avoid any false trip, the change of setting group is only carried out when no protection function is running (except the thermal overload function).

If a setting group change is received during any protection or automation function, it is stored and executed after the last timer has elapsed.

The user can check which one of the active group is active looking under the OP PARAMETERS menu.

The user can also assign the active group to an output relay. Using a normally open contact, this means that:

- an open contact will indicate that the active group is Group 1
- a close contact will indicate that the active group is Group 2

### Change of setting group done by a digital input

It is possible to change the setting group via the activation of a digital input (on level).

Warning: if the digital input that has been assigned to the change of setting group operates on level (low or high), it is not possible to change the setting group via remote communication or front panel.

### SWITCH BETWEEN ACTIVE GROUPS:

When powering on the relay, the group selected (Group 1 or Group 2) corresponds to the state of the logic input. This means:

#### A - With a Logic input configuration = 0

Group 1 = logic Input is not active

Group 2 = logic Input is active

If the programmed logic input is supplied with +V, then the active group will be G1.

If the programmed logic input is not supplied with +V, then the active group will be G2.

#### B - With a Logic input configuration = 1

Group 1 = logic Input is not active

Group 2 = logic Input is active

If the set logic input is energized with +V, then the active group will be G2.

If the set logic input is not energized with +V, then the active group will be G1.

**Priority**

When changing parameters through the front panel, the priority is given to the user that takes local control of the relay when entering a password. Change of setting group done via a remote command is not allowed for as long as the password is active (5mn).

<b>ORIGIN OF THE ORDER</b>	<b>PRIORITY LEVEL</b>
FRONT PANEL	MAXIMUM
LOGIC INPUT	MEDIUM
REMOTE COMMUNICATIONS	MINIMUM

---

## 17. MAINTENANCE MODE

This menu allows the user to verify the operation of the protection functions without actually sending any external command (Tripping or signalling).

The selection of the maintenance mode is possible by logic input, control command (rear or front port), or by front panel interface. The end of maintenance mode is done by logic input, by control command or on the front panel interface time out (5 minutes) and by turning off the power supply.

Maintenance Mode
YES

When this menu is activated (set to YES), the Alarm led will start to flash and the alarm message "MAINTENANCE MODE" will be displayed. In this case, all the output contacts are blocked, and no command can be issued to these contacts, even if a protection threshold associated to one of these output contacts has been crossed.

(If a protection threshold is crossed, all associated LEDs will be ON, even the TRIP LED, if the threshold is associated to the RL1).

RELAYS	8765W4321
CMD	00000000

This window allows the user to verify the external wiring to the relay output contacts. To do this, the user just has to assign a 1 to any of the output contacts, and this will close the contact and the continuity of the wiring can be verified.

## 18. SELECTIVE SCHEME LOGIC (P122 & P123 ONLY)

The following figure describes the use of non-cascade protection schemes using the start contacts from downstream relays to block operation of upstream relays.

In the case of Selective Overcurrent Logic (SOL), the start contacts are used to increase the time delays of upstream relays, instead of blocking them. This provides an alternative approach to achieving a non-cascade type of overcurrent scheme. It may be more familiar to some utilities than the blocked overcurrent arrangement.

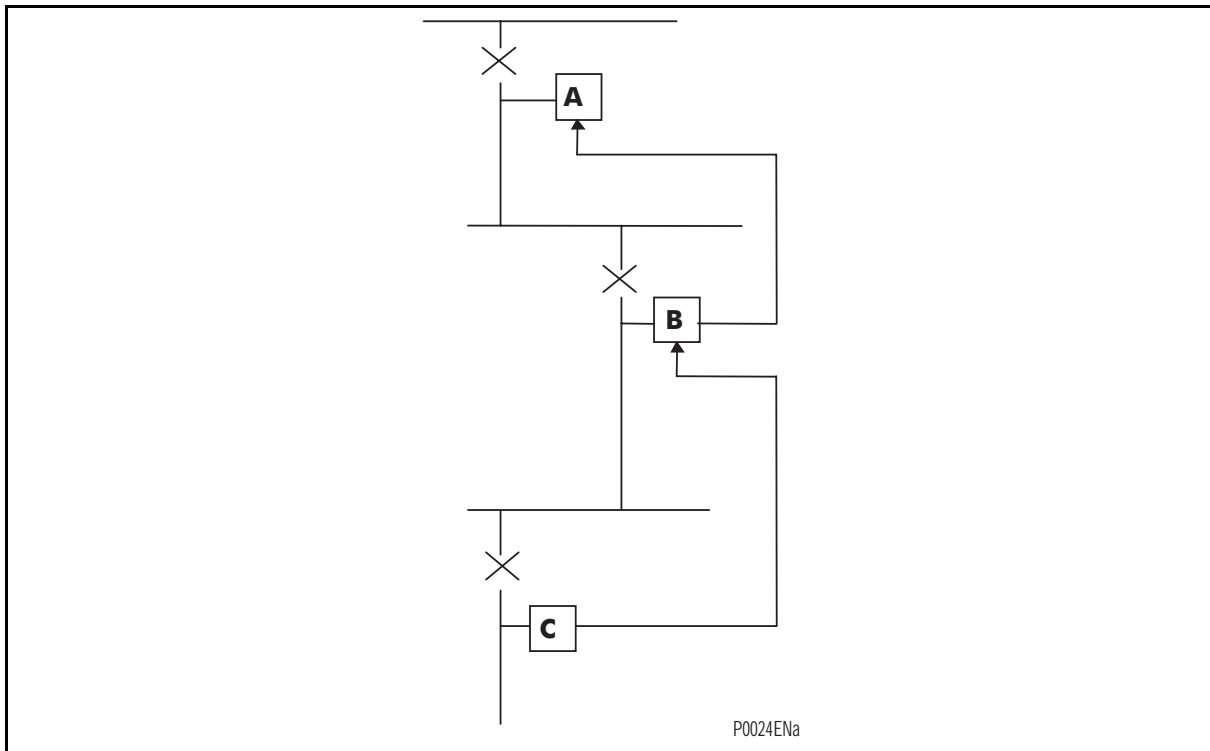

FIGURE 13: TYPICAL SCHEME LOGIC

The SOL function temporarily increase the time delay settings of the second and third stages of phase overcurrent, derived and measured earth fault and sensitive earth fault protection elements. This logic is initiated by energising the appropriate logic input (Log Sel1 or Log Sel2) as selected in AUTOMAT.CRTL/INPUTS menu.

To allow time for a start contact to initiate a change of setting, the time settings of the second and third stages should include a nominal delay. Guidelines for minimum time settings are identical to those given for blocked overcurrent schemes.

The tSel1 and tSel2 timers can be independently set from 0 to 150 s.

### 19. LOGIC EQUATIONS (P121, P122 & P123 ONLY)

The logic equations can be used to construct complex Boolean logic using the following operators: AND NOT, OR NOT, AND, OR.

An example logic implementation using Equation A is shown below:

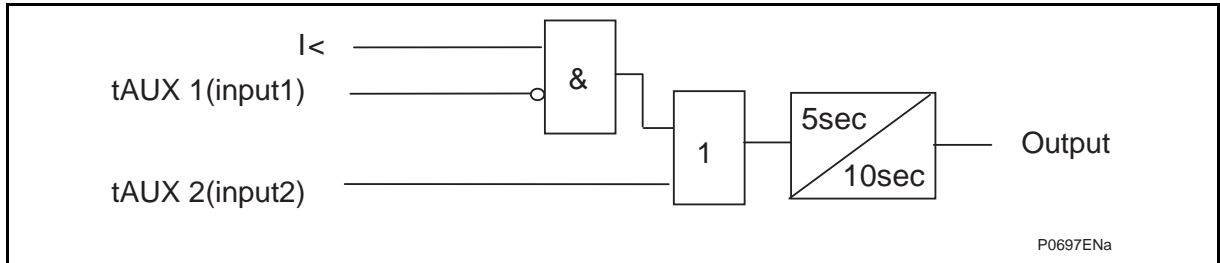

The time of operation ( $t_{Operation}$ ) setting sets the minimum time of truth of a condition before validating the truth of the logic operation.

The reset time ( $t_{Reset}$ ) sets a minimum time before the logic operation is not true when at least one condition is not true.

The following logic diagram illustrates the  $t_{Operation}$  and  $t_{Reset}$  operation with the following equation:

Equation A.00 “= not” “tAux 1” + Equation A.01 “and not” “tAux 2”  
 this equation means not tAux 1 and not tAux 2.

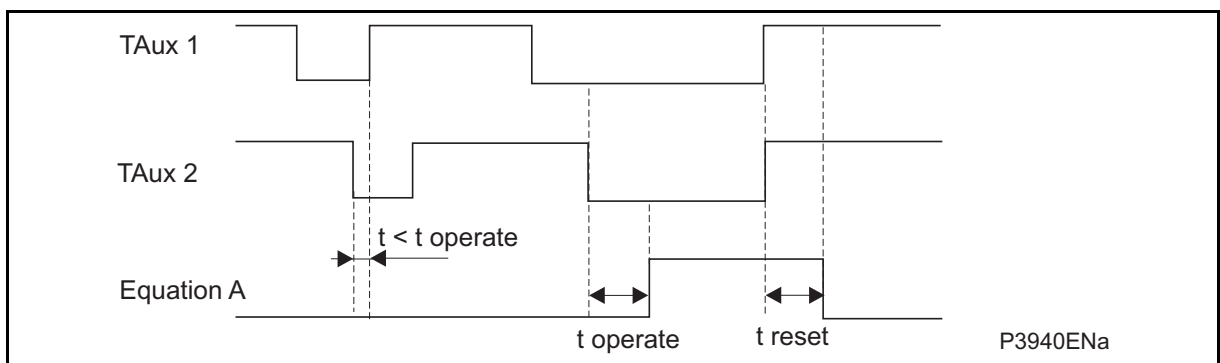

## 20. NEGATIVE SEQUENCE OVERCURRENT PROTECTION (P122 & P123 ONLY)

In traditional phase overcurrent protection schemes, overcurrent thresholds must be set above maximum load current levels. This limits the sensibility of the relay. Most protection schemes also use an earth fault element using residual current, which improves sensitivity for earth faults. However, it can happen that some faults occur and stay undetected by such schemes.

Any unbalanced fault condition will produce negative sequence current. Thus, a negative phase sequence overcurrent element can detect both phase-to-phase and phase to earth faults.

This section describes how negative phase sequence overcurrent protection may be applied in conjunction with standard overcurrent and earth fault protection in order to solve some problems of application.

- Negative phase sequence overcurrent elements is more sensitive to resistive phase-to-phase faults, whereas phase overcurrent elements may not operate.
- In some applications, an earth fault relay may not be able to detect a residual current because of the configuration of the network. For example, an earth fault relay connected on the delta side of a delta-star transformer is unable to detect earth faults on the star side. However, negative sequence current will be present on both sides of the transformer in any fault condition, independently of the transformer configuration. Therefore, negative phase sequence overcurrent element may be used to provide time-delayed back-up protection for any uncleared asymmetrical faults.
- Where fuses are used to protect motors on rotating machines, a blown fuse produces a large amount of negative sequence current. This is a dangerous condition for the machine because negative phase sequence current generates overheating. Then, a negative phase sequence overcurrent element may be used to back-up motor protection relays.
- It may also be required to trigger an alarm to announce the presence of negative phase sequence currents in the system. Operators are then prompted to investigate the cause of the unbalance.

The negative phase sequence overcurrent elements have a current pick up settings  $I_{2>}$  and  $I_{2>>}$ , and can be time-delayed using configurable timers  $t_{I_{2>}}$  and  $t_{I_{2>>}}$ .

### 20.1 $I_{2>}$ and $I_{2>>}$ Setting Guidelines

$I_{2>}$  and  $I_{2>>}$  thresholds can be set under the PROTECTION G1 (2)/[46] Neg Seg 0C menu.

The current pick-up threshold  $I_{2>}$  must be set to a value that is higher than the normal negative phase sequence current because of the normal unbalance conditions on the network. This can be done practically during the commissioning, using the MEASUREMENTS menu of the relay to display the negative phase sequence current value. Then, this value has to be increased by 20%.

Where negative phase sequence element is used to clear particular cases of uncleared asymmetric faults, the threshold setting have to be calculated based on a fault analysis of that particular system, due to the complexities involved. However, to ensure that the protection element will operate, the current pick-up value has to be set to approximately 20% below the lowest calculated negative phase sequence fault current for a specific remote fault.

It is essential to set correctly the time delay associated to this function. It should also be noted that this element is used primarily as a back-up protection to other protective devices or to provide an alarm. Therefore, this function is usually set with a long time delay.

Care must be made to ensure that the time delay is set above the operating time of any other protection device (at minimum fault level) present on the system and that may react to unbalanced faults, such as:

- Phase overcurrent elements
- Earth fault elements
- Broken conductor elements
- Negative phase sequence influenced thermal protection elements

tI2> and tI2>> timers associated to I2 threshold can be set under the menu PROTECTION 7G1(2)/[46] Neg Seg OC.

## 21. BROKEN CONDUCTOR DETECTION (P122 & P123 ONLY)

Most of the faults that affect a power system occur between one phase and the earth or between two phases and the earth. These faults are shunt faults and are caused by lightning discharges and other overvoltages generating flashovers. They may also arise from birds on overhead lines or mechanical damage on underground cables, etc.

Such faults lead the current to increase appreciably and therefore they can easily be detected in most applications. Open circuit faults are a different type of faults that can happen in electrical networks. These faults can be caused by broken conductors, blown fuses or misoperation of a pole of a circuit-breaker.

Series faults will not lead to an increase in phase current and therefore they can not be easily detected by common overcurrent relays. However, this type of faults produce an unbalance that creates negative phase sequence current, which can be detected.

The use of negative phase sequence overcurrent is then recommended to detect such faulty conditions. However, on lightly loaded lines, the value of the negative sequence current caused by a faulty condition may be very close to, or even inferior, to the full load steady state unbalance generated by CT errors, load unbalance, etc. As a consequence, a negative sequence protection element would not work for low level of loads.

As a solution, MiCOM P122 and P123 have a protection element that measures the ratio between the negative and the positive phase sequence current ( $I_2/I_1$ ). Using this ratio instead of the measure of  $I_2$  only, the relay will be able to detect a faulty condition independently on the level of load on the network, since the ratio is approximately constant with variations in load current. It is then possible to get a more sensitive setting.

**NOTE:** the Broken conductor function is inhibited if the current value flowing in each one of the three phases is inferior to 10% of the nominal current.

### Setting Guidelines

On single point earthed power systems, there is a low zero sequence current flow and the ratio  $I_2/I_1$  that flows is close to 100%. On multiple earthed power systems, (assuming that the impedances in each sequence network are equals), the ratio  $I_2/I_1$  will be equal to 50%.

It is possible to calculate the ratio of  $I_2/I_1$  corresponding to various system impedances, according to the following equations:

$$I_{1F} = \frac{E_g(Z_2+Z_0)}{Z_1Z_2+Z_1Z_0+Z_2Z_0}$$

$$I_{2F} = \frac{-E_gZ_0}{Z_1Z_2+Z_1Z_0+Z_2Z_0}$$

Where:

$E_g$  = System Voltage  
 $Z_0$  = Zero sequence impedance  
 $Z_1$  = Positive sequence impedance  
 $Z_2$  = Negative sequence impedance

Therefore:

$$\frac{I_{2F}}{I_{1F}} = \frac{Z_0}{Z_0+Z_2}$$

As a consequence, for an open circuit in a particular part of the system,  $I_2/I_1$  can be determined from the ratio between the zero sequence and the negative sequence impedance. It must be noted however, that this ratio may vary depending on the location of the fault. It is therefore desirable to apply a setting that is as sensitive as possible. Practically, the levels of standing negative phase sequence current present on the system guide the choice of this minimum setting. A system study, or the use of measurement data of the relay during commissioning stage are two ways to determine this minimum setting. If the latter method is chosen, it is important to take measurements during maximum load conditions, to be sure that all single phase loads are taken into account.



A time delay (tBC) is necessary to ensure co-ordination with other protective devices.

### 21.1 Example of Setting

The following information comes from a the relay commissioning report;

$$I_{\text{full load}} = 500\text{A}$$

$$I_2 = 50\text{A}$$

Then:

$$I_2/I_1 = 50/500 = 0.1$$

To tolerate some margin and load variations, it is typical to set this value at 200% above this value: Therefore, RATIO I2/I1 = 20%

Set tBC at 60s to allow short circuits to be cleared by time delayed protections.

## 22. DESCRIPTION AND SETTING GUIDE OF THE AUTORECLOSE FUNCTION (P123 ONLY)

### 22.1 Introduction

An analysis of faults on overhead line network has shown that:

- 80-90% are transient in nature,
- the remaining 10-20% of faults are either non-permanent (arcing fault) or permanent.

A transient fault is a self clearing 'non-damage' fault. This type of fault can be isolated and cleared by the immediate tripping of one or more circuit breakers, and does not reappear when the line is re-energised. The most common cause of transient faults are lightning, insulator flashover, clashing conductors and debris blown by the wind.

The immediate trip will not clear a non-permanent or permanent fault, and the use of the recloser may be necessary to clear it. A small tree branch falling on the line could cause a non-permanent fault. Permanent faults could be caused by broken conductors, transformer faults, cable faults or machine faults which must be located and repaired before the supply can be restored.

Most of the time, if the faulty line is immediately tripped, and the fault arc has sufficient time to de-ionise, reclose of the circuit breakers will result in the line being successfully re-energised. Autoreclose schemes are used to automatically reclose a switching device once a time delay has elapsed and starting after the CB has opened.

On HV/MV distribution networks, the autoreclose function is used mainly for radial feeders where system stability problems do not generally arise. Using the autoreclose minimises time of interruption and reduces operating costs.

Automatic autorecloser allows a substation to operate unattended: the number of visits to manually reclose a circuit breaker is substantially reduced. This feature constitutes therefore an important advantage for substations supervised remotely.

On circuits using time graded protection, the automatic autorecloser allows the use of instantaneous protection to give a high speed first trip. With fast tripping, the duration of the power arc resulting from an overhead line fault is reduced to a minimum, thus lessening the chance of damage and to develop the transient fault into a permanent fault.

Using short time delay protection prevents blowing of fuses and reduces circuit breaker maintenance by eliminating pre-arc heating when clearing transient faults.

The next figure shows an example of 4 autoreclose cycles (maximum numbers of allowed cycles) to the final trip ( $td_1$ ,  $td_2$ ,  $td_3$ ,  $td_4$  = dead time 1, 2, 3 and 4 timers,  $tr$  = Reclaim time, O = CB open and C = CB closed).

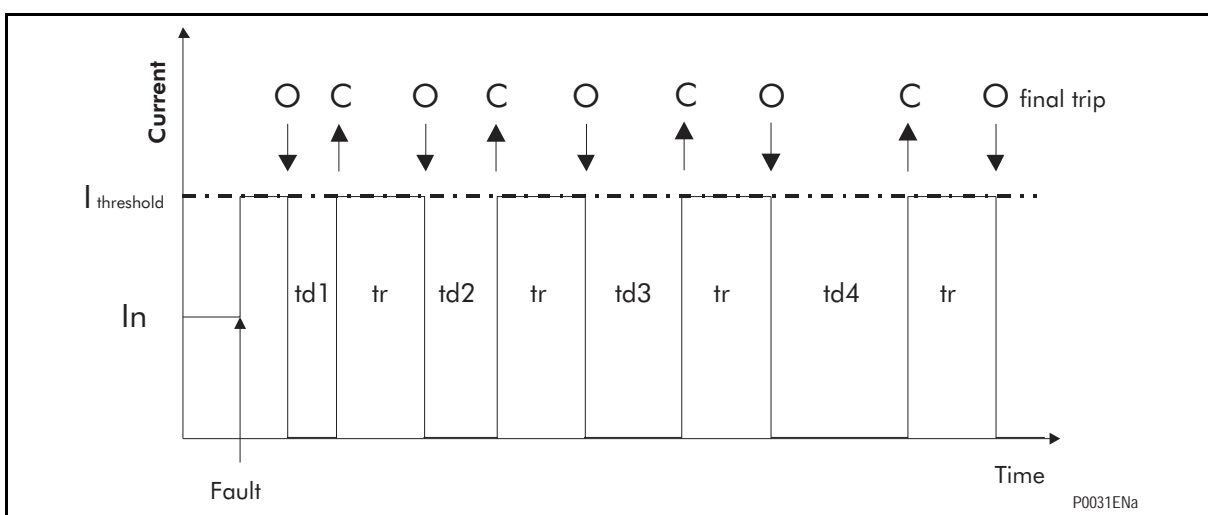

FIGURE 14: TYPICAL AUTORECLOSE CYCLES

When short time delay protection is used with autoreclose, the scheme is normally arranged to block the instantaneous protection after the first trip. Therefore, if the fault persists after re-closing, time graded protection will give discriminative tripping with fuses or other protection devices, resulting in the isolation of the faulted section. However, for certain applications, where the majority of the faults are likely to be transient, it is not uncommon to allow more than one instantaneous trip before the instantaneous protection is blocked.

Some schemes allow a number of re-closings and time graded trips after the first instantaneous trip, which may result in the burning out and clearance of non-permanent faults. Such an approach may also be used to allow fuses to operate in teed feeders where the fault current is low.

Any decision to apply the autoreclose function would be influenced by all data known on the frequency of transient faults (for instance feeders which consist partly of overhead lines and partly of underground cables). When a significant proportion of the faults are permanent, the advantages of the autoreclose are small, particularly since re-closing on to a faulty cable is likely to aggravate the damage.

## 22.2 Description of the function

### 22.2.1 Autorecloser activation

The autoreclose function is activated using “AUTOMAT. CTRL/ PROTECTION G1” menu. The same settings apply for the Menu PROTECTION G2.

The autoreclose function of the MiCOM P123 is available only if the following conditions are verified:

- The auxiliary contact of the CB status 52a must be connected to the relay.  
Refer to the “AUTOMAT. CTRL/Inputs” menu
- The trip output relay RL1 must not be latched to the earth and/or phase protection function.  
Refer to the “AUTOMAT. CTRL/Latch functions” menu

NOTE: If the auxiliary supply is lost during an autoreclose cycle, the autoreclose function is totally disabled.

In addition to Autoreclose settings, the user will be able to fully link the autoreclose function to the protection function using the menus “PROTECTION G1/Phase OC” and “PROTECTION/E/Gnd”.

### 22.2.2 Logic Inputs

The autoreclose function has four inputs that can be assigned to the autoreclose logic. These inputs can be opto-isolated inputs configured for that under the “AUTOMAT. CTRL” menu. External contacts can then be wired to be used as an input and influence the autorecloser scheme. These 4 inputs are :

- one external CB fail,
- two external starting orders,
- one external blocking order.

The following table gives the “AUTOMAT.CTRL/Inputs” menu assigned to the autoreclose logic input. The second column presents the menu disabling the function if not assigned in the “PROTECTION G1/Autoreclose” menu (Setting = No).

	“Inputs” menu	Enabled with:
External CB Fail	CB FLT	EXT CB FLT
External starting orders	Aux 1 Aux 2	CYCLES tAux1 * CYCLES tAux2 *
External blocking order	Block-79	Ext Block ?

\* These two external orders can be independently disabled.

### 22.2.2.1 External CB fail

Most of circuit breakers provide one trip-close-trip cycle. A delay time is necessary to return to the nominal state of the CB (for example, the spring that allows the circuit breaker to close should be fully charged). The state of the CB can be checked using an input assigned to the "CB FLT" function. If on completion of the "Ext CB Fail time" (tCFE), the "CB FLT" indicates a failed state of the CB, a lockout occur and the CB remains open.

### 22.2.2.2 External starting orders

Two independent and programmable inputs (Aux 1 and Aux 2) can be used to initiate the autorecloser function from an external device (such as an existing overcurrent relay). These logic inputs may be used independently and also in parallel with the MiCOM P123 Overcurrent settings.

### 22.2.2.3 Internal and external blocking orders

The autoreclose can be blocked by an internal or an external control. It can be used when a protection is needed without requiring the use of the autorecloser function.

The external block is the "Block 79" input.

The internal block can be a final trip, a number of A/R rolling demand valid or an A/R conflict.

A typical example is on a transformer feeder, where the autoreclose may be initiated from the feeder protection but need to be blocked from the transformer protection side.

### 22.2.3 Autoreclose Logic Outputs

The following output signals can be assigned to a LED (see "CONFIGURATION / Led" menu) or to the output relays (see "AUTOMAT.CTRL/Output Relays" menu) to provide information about the status of the autoreclose cycle.

- Autoreclose in progress
- Final Trip.

The following table gives the "CONFIGURATION/Led" and the "AUTOMAT.CTRL/Output Relays" menus used to assign the autoreclose output signal.

	LED menu	Output relays menu
Autoreclose in progress	Recloser Run	79 run
Final Trip	Recloser Blocked	79 Locked

#### 22.2.3.1 Autoreclose in progress

The "Autoreclose in progress" signal is present during the complete reclose cycles from protection initiation to the end of the reclaim time or lockout.

#### 22.2.3.2 Final trip

The "Final trip" signal indicates that a complete autoreclose cycle has been completed and that the fault has been cleared.

The "Final trip" signal can be reset after a manual closing of the CB after the settable "inhibit time (tl)".

#### 22.2.4 Autoreclose logic description

The autoreclose function provides the ability to automatically control the autorecloser (two, three or four shot cycle, settable using "Phase Cycles" and "E/Gnd Cycles" menu). Dead times for all the shots (reclose attempts) can be independently adjusted.

The number of shots is directly related to the type of faults likely to occur on the system and the voltage level of the system (for instance medium voltage networks).

The Dead Time (tD1, tD2, tD3 and tD4) and the minimum drop-off time start when the CB has tripped (when the 52a input has disappeared). Dead Time is adjusted to start autoreclose when circuit breaker is closed.

At the end of the relevant dead time, "CB FLT" input is sent (see § 22.2.2.1).

The reclaim time (tR) starts when the CB has closed. If the circuit breaker does not trip again, the autoreclose function resets at the end of the reclaim time.

If the protection operates during the reclaim time, the relay either advances to the next shot that is programmed in the autoreclose cycle, or it locks out (see § 22.2.6).

The total number of reclosures is displayed under the "MEASUREMENTS/Reclose Stats" menu.

#### 22.2.5 Autoreclose Inhibit Following Manual Close

The "Inhib Time tI" timer can be used to block the autoreclose being initiated after the CB is manually closed onto a fault. The Autoreclose is blocked during the "Inhib Time tI" following manual CB Closure.

#### 22.2.6 Recloser lockout

If the protection element operates during the reclaim time, following the final reclose attempt, the relay will lockout and the autoreclose function is disabled until the lockout condition resets.

The lockout condition can reset by a manual closing after the "Inhib Time tI".

The Autoreclose can also be locked out using a "CB FLT" input. This information can be issued from the "not charged" or "Low gas pressure" indications of CB springs.

Note that Autoreclose can also be locked by:

- The fact that the CB doesn't open after tBf delay (CB Fail)
- An operating time that is above programmed thresholds.

#### 22.2.7 Setting group change lockout

The change of setting groups on MiCOM P122 and P123 is only possible if there are no protection or automation functions running (except the thermal overload function). During the autorecloser cycle, if the relay receives an order to change setting groups, this order is kept in memory, and will only be executed after the timer has elapsed.

#### 22.2.8 Rolling demand

This specific counter avoids a frequent operation of a CB in case of frequent intermittent fault. The numbers of shoot can be adjusted from 1 to 100 in the cell "Max cycles nb", settable in a time period from 10min to 24 hours.

The rolling demand is used when a definite number of successfully recloses are made on a definite time.

### 22.3 Setting Guidelines

#### 22.3.1 Number Of Shots

There is no perfect rule to define the number of shots for a particular application.

For medium voltage systems it is common to use two or three autoreclose shots, and, for specific applications, four shots. Using four shots, final dead time can be set for a time long enough to allow thunderstorms to stop before definitive final reclose. This scheme prevents unnecessary lockout caused by consecutive transient faults.

Typically, the first trip, and sometimes the second, are caused by the instantaneous protection. Since 80% of faults are transient, the following trips will be time delayed, and all will have increasing dead times to clear non-permanent faults.

In order to determine the number of shots required; the first factor is the ability for the circuit breaker to perform several trip-close operations in a short time and, the effect of these operations on the maintenance period.

If a moderate percentage of non-permanent faults is present in a system, two or more shots are justified. If fused 'tees' are used and the fault level is low, the timer of the fuses may not discriminate with the main IDMT relay: several shots are usefull. This would not warm up the fuse to a such extent that it would eventually blow before the main protection operated.

22.3.2 Dead Timer Setting

Load, circuit breaker, fault de-ionising time and protection reset are taken into consideration when setting the dead timer.

22.3.3 Minimum drop-off time setting

If an electromagnetic relay is used (working on the principle of disc in the electromagnetic field due to eddy current generated in the disc), an additional dead time (Min Drop-off Time), depending of the tripping cause, is settable,

This function includes the choice to select an IDMT curve on the relay reset time, setting the drop-off time on phase and neutral autoreclose cycles.

This drop-off time blocks the next cycle if this one not elapsed.

A next cycle can be start if the dead time is elapsed and treset elapsed to.

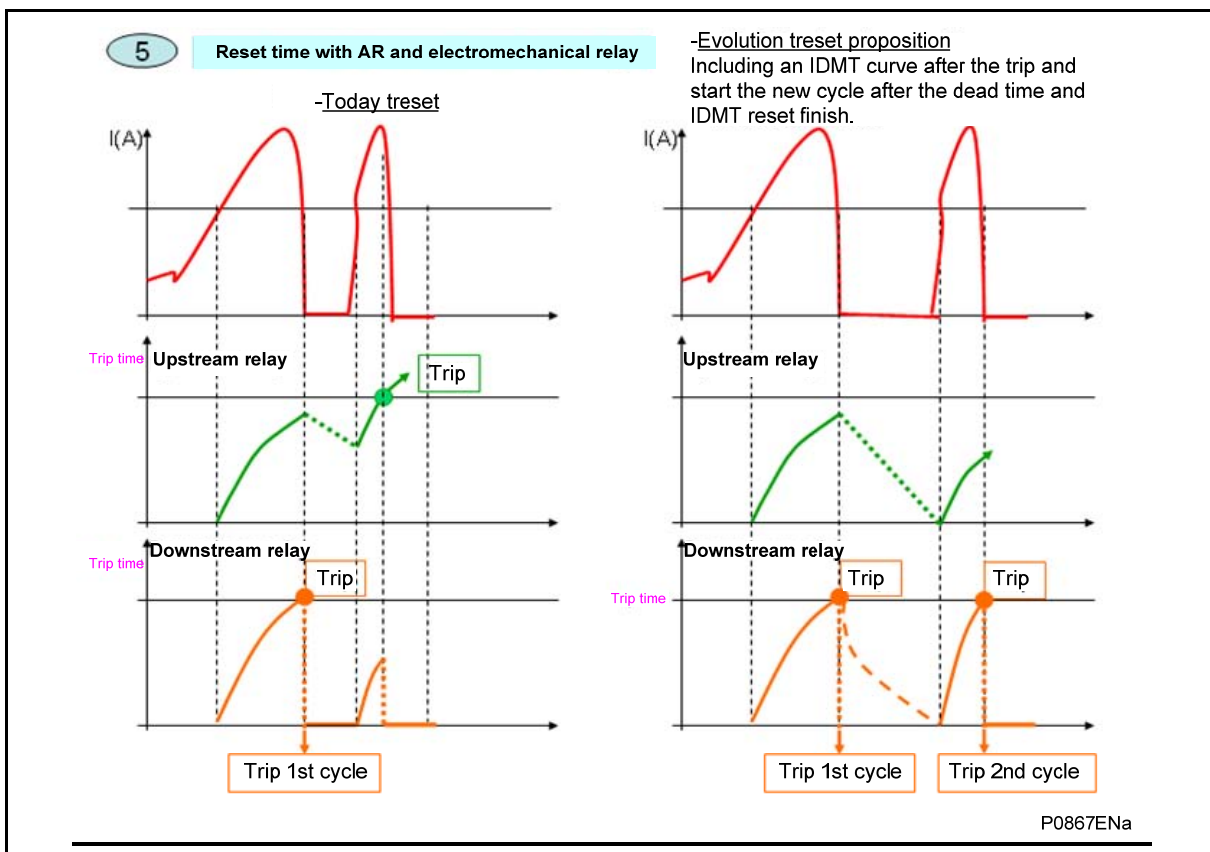

NOTE: this function is currently used with IDMT curve.  
 If dead time > Drop-off time, the relay will close the CB at the end of dead time.  
 If dead time < Drop-off time, the relay will close the CB at the end of dropp-off time.

### 22.3.3.1 Load

It is very difficult to optimize the dead time due to the great diversity of load on a system. However, it is possible to study each type of load separately and thereby be able to define a typical dead time.

The most common types of loads are synchronous or induction motors and lighting circuits.

Synchronous motors tolerate only extremely short interruptions of supply without loss of synchronism. In practice, the dead time should be sufficient to allow the motor no-volt device to operate. Typically, a minimum dead time of 0.2-0.3 seconds is recommended.

Induction motors, on the other hand, can withstand supply interruptions, up to a maximum of 0.5 seconds and re-accelerate successfully. In general dead times of 3-10 seconds are normally satisfactory, but there may be special cases for which additional time is required to allow the reset of manual controls and safety devices.

Loss of supply of lighting circuits, such as street lighting, can lead to important safety problems (car circulation). Regarding domestic customers, the main consideration is linked to the inconvenience caused.

The number of minutes lost per year to customers will be reduced on feeders using the autorecloser and will also be affected by the dead time settings used.

### 22.3.3.2 Circuit Breaker

For high speed autoreclose, the minimum dead time of the power system depends on the minimum time delay imposed by the circuit breaker during a trip and reclose operation.

Since a circuit breaker is a mechanical device, it has an inherent contact separation time. This operating time for a modern circuit breaker is usually within the 50-100ms range, but could be longer with older designs.

**NOTE:** The closing pulse time delay (adjusted using 'AUTOMAT. CTRL / CB Supervision / tClose Pulse' setting) should be higher than the time delay necessary to close the CB (mechanical closing and CB Closing loop). In the same way, the opening pulse time delay ('AUTOMAT. CTRL / CB Supervision / tOpen Pulse' setting) should be higher than the time delay necessary to open the CB. Otherwise, the autorecloser can be locked.

After a trip, the mechanism need some time to reset before applying a close pulse. This reset time varies depending on the circuit breaker, but lasts typically 0.1 seconds.

Once the circuit breaker has reset, the breaker can start to close. The period of time between the energisation of the closing mechanism and the making of the contacts is called closing time. Because of the time constant of a solenoid closing mechanism and the inertia of the plunger, a solenoid closing mechanism may take 0.3s. A spring operated breaker, on the other hand, can close in less than 0.2 seconds.

Where high speed reclosing is required, for the majority of medium voltage applications, the circuit breaker mechanism dictates itself the minimum dead time. However, the fault de-ionising time may also have to be considered.

High speed autoreclose may be required to maintain stability on a network that has two or more power sources. For high speed autoreclose, the system disturbance time should be minimised using fast protection, <50 ms, such as distance or feeder differential protection and fast circuit breakers < 100 ms. Fast fault clearance can reduce the time for the fault arc to de-ionise.

To ensure stability between two sources, a dead time of <300 ms is typically required. Considering only the CB, this minimum time corresponds to the reset time of the the mechanism plus the CB closing time. Thus, a solenoid mechanism is not adapted for high speed autoreclose due to the fact that the closing time is generally too long.

### 22.3.3.3 Fault De-ionising Time

For high speed autoreclose, the time to de-ionise faults may be the factor the most important when considering the dead time. This is the time required for the ionised air to disperse around the fault position so that the insulation level of the air is restored. This time may be around the following value:

De-ionising time =  $(10.5 + ((\text{system voltage in kV})/34.5)) / \text{frequency}$

For 66 kV = 0.25 s (50Hz)

For 132 kV = 0.29 s (50 Hz)

### 22.3.3.4 Protection Reset

It is essential that the protection fully resets during the dead time, so that correct time discrimination is maintained after reclose on to a fault. For high speed autoreclose, instantaneous reset of protection is required.

Typical 11/33kV dead time settings in the UK are as follow:

1st dead time = 5 - 10 seconds

2nd dead time = 30 seconds

3rd dead time = 60 - 100 seconds

4th dead time (uncommon in the UK, however used in South Africa) = 60 - 100 seconds

### 22.3.4 Reclaim Timer Setting

The following factors influence the choice of the reclaim timer:

- Supply continuity - Large reclaim times can result in unnecessary lockout for transient faults.
- Fault incidence/Past experience - Small reclaim times may be required where there is a high incidence of lightning strikes to prevent unnecessary lockout for transient faults.
- Charging time of the spring or resetting of electromagnetic induction disk relay - For high speed autoreclose, the reclaim time may be set longer than the spring charging time to ensure that there is sufficient energy in the circuit breaker to perform a trip-close-trip cycle. For delayed autoreclose, this setting is of no need as the dead time can be extended by an extra CB healthy check window time if there is insufficient energy in the CB. If there is insufficient energy after the check window time the relay will lockout.
- Switchgear Maintenance - Excessive operation resulting from short reclaim times can mean shorter maintenance periods. A minimum reclaim time of 5s may be needed to give sufficient time to the CB to recover after a trip and close before it can perform another trip-close-trip cycle.

The reclaim time must be long enough to allow any time delayed protection leading to autoreclose to operate. Failure to do so can cause the autoreclose scheme to reset too soon and the reactivation of the instantaneous protection.

If that were the case, a permanent fault would look like some transient faults, caused by continuous autorecloses. Applying a protection against excessive fault frequency lockout is an additional precaution that can solve this problem.

It is possible to obtain short reclaim times to obtain less lockouts of the CB by blocking the reclaim time from the protection start signals. If short reclaim times are to be used, then the switchgear rating may dictate the minimum reclaim time.

Sensitive earth fault protection is used to detect high resistance earth faults. The time delay of such protections is usually a long time delay, typically about 10-15s. If autoreclose is generated by the SEF protection, this timer must be taken into account when deciding the value of the reclaim time, if the reclaim time is not blocked by an SEF protection start signal. Sensitive earth faults, caused by a broken overhead conductor in contact with dry ground or a wood fence are rarely transient faults and may be dangerous to people.



It is therefore common practice to block the autoreclose using the sensitive earth fault protection and lockout the circuit breaker.

Where motor-wound spring closed circuit breakers are used, the reclaim time must be at least as long as the spring winding time for high speed autoreclose to ensure that the breaker can perform a trip-close-trip cycle.

A typical 11/33kV reclaim time is 3-10 seconds, this prevents unnecessary lockout during thunderstorms. However, times up to 60-180 seconds maybe used.

22.3.5 Autoreclose setting guideline

22.3.5.1 General setting

SETTING CONDITION FOR THE ARC FUNCTIONALITY		
<b>"PROTECTION Gx / [79] AUTORECLOSE"</b>		
"Autoreclose"	Yes	
"Phase Cycles" or/and "E/GND Cycles"	At least 1	If the cycle = 0 none autoreclose available
"Cycles xxxx"	1234 0111	Max number cycle: max. 4 cycles
<b>"AUTOMA. CTRL / INPUTS"</b>		
One of the digital inputs. The relevant input must be configured as Active High	52a	This input must be in accordance with the CB position: HIGH with CB close, LOW with CB opened.

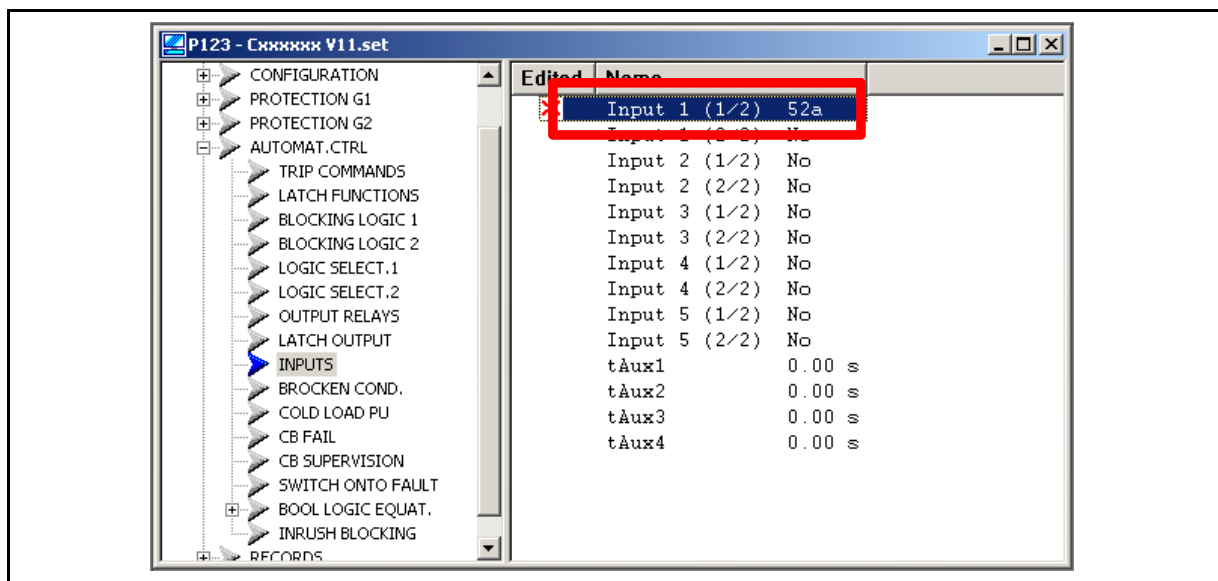

<b>"AUTOMA. CTRL / OUTPUTS RELAYS"</b>		
"CB Close & SOTF"	CB Close	This relay must be only assigned to this function.
One of the relays from 2 to 8		

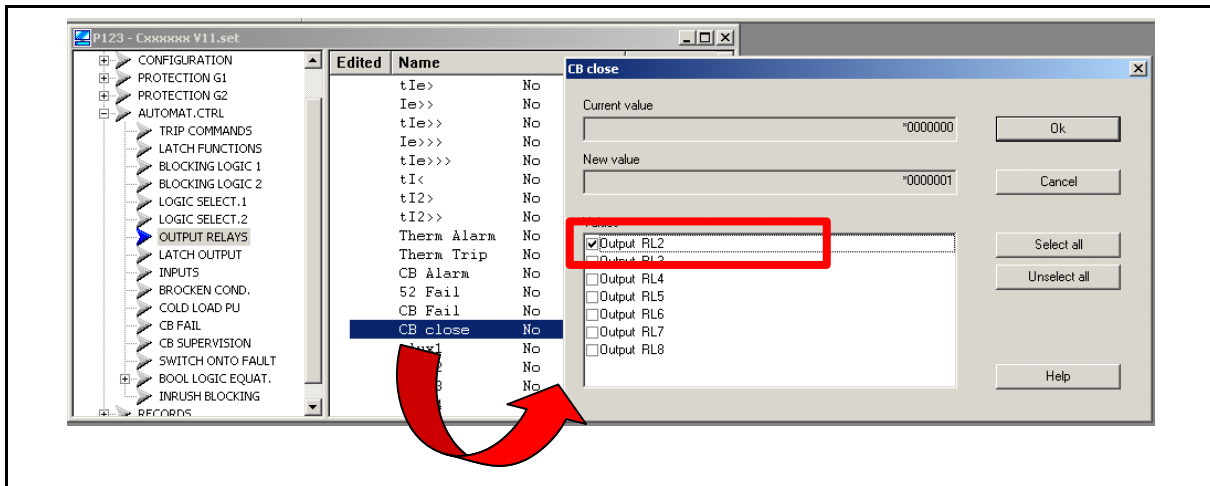

22.3.5.2 Trip and reclose (normal operation)

Autoreclose starts only if tripping order (RL1) has been performed (Trip & Start).

Red LED of trip will always come whenever autoreclose starts.

"PROTECTION Gx / [79] AUTORECLOSE"		
"Autoreclose"	Yes	
"Phase Cycles" or/and "E/GND Cycles"	At least 1	If the cycle = 0 none autoreclose available
Cycles tI>, tI>>, tI>>>, tIe>, tIe>>, tIe>>>, tPe/leCos>, tPe/leCos>>	1234 0111	Max number cycle: max. 4 cycles

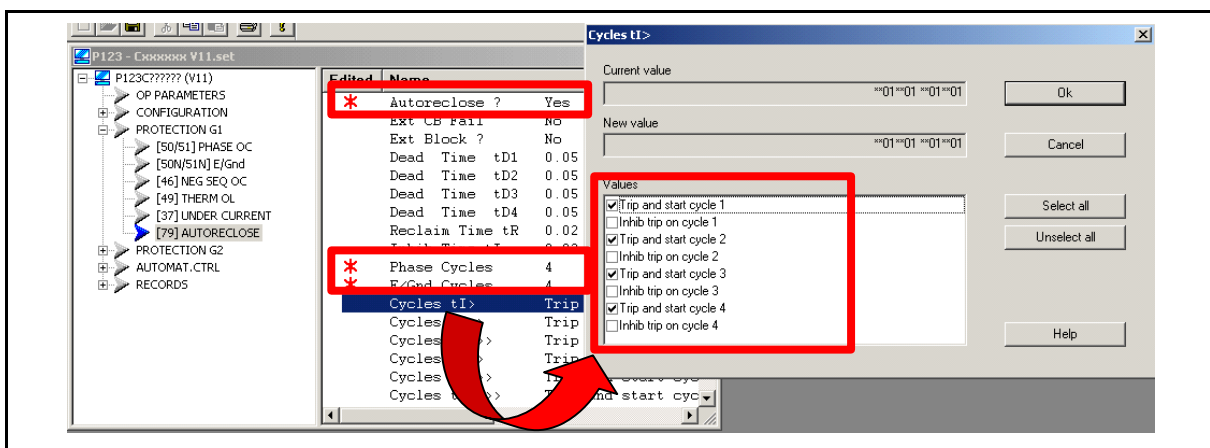

"AUTOMA. CTRL / TRIP COMMANDS"		
Trip Commands	At least a trip command.	Overcurrent and/or earth fault overcurrent trip thresholds (One of them is enough)

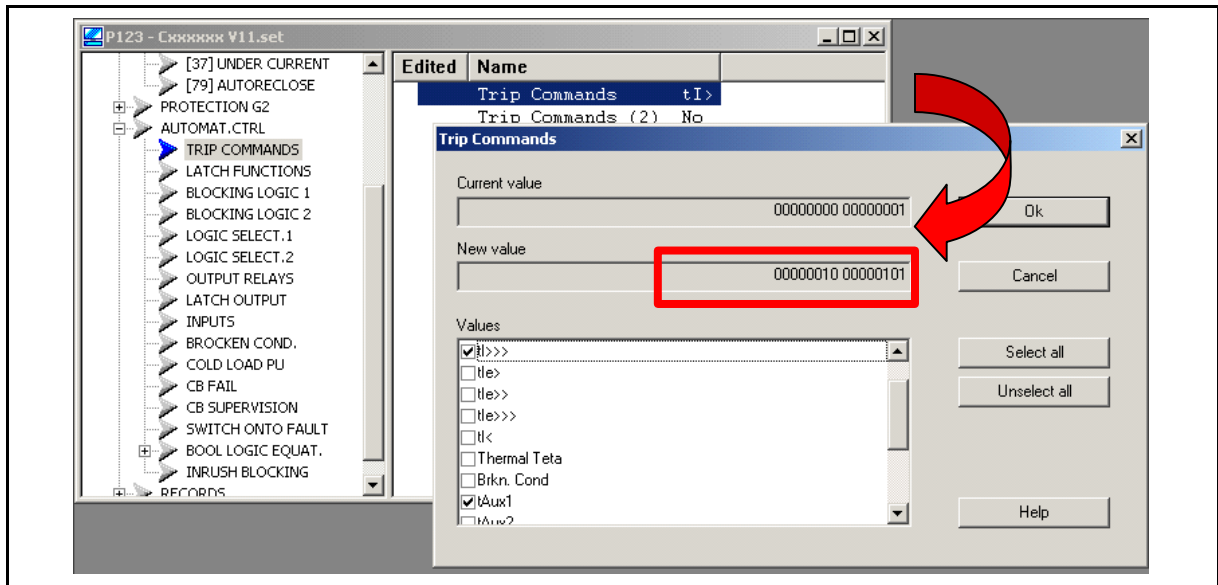

22.3.5.3 Autoreclose only (external trip)

Since v11.B version, it is now possible to inhibit trip order (tick Trip & Inhib trip) in the settings file to work like a standalone autorecloser (see the next figure).

In the following configuration :

- tAux is removed from Trip commands,
- No trip is performed from autoreclose function,
- Trip LED will remain OFF.

"PROTECTION Gx / [79] AUTORECLOSE"		
"Autoreclose"	Yes	
"Phase Cycles" or/and "E/GND Cycles"	At least 1	If the cycle = 0 none autoreclose available
"Cycles tAux1" "Cycles tAux2"		For each cycle used, enable "trip and start cycle" <b>AND</b> "Inhib trip on cycle"

To achieve "autoreclose only" setting, external start should be wired on a digital input. This digital input should be assigned to tAux1 and/or tAux2.

"AUTOMA. CTRL / INPUTS"		
Automat control inputs	Aux	Select on Automat control input Aux

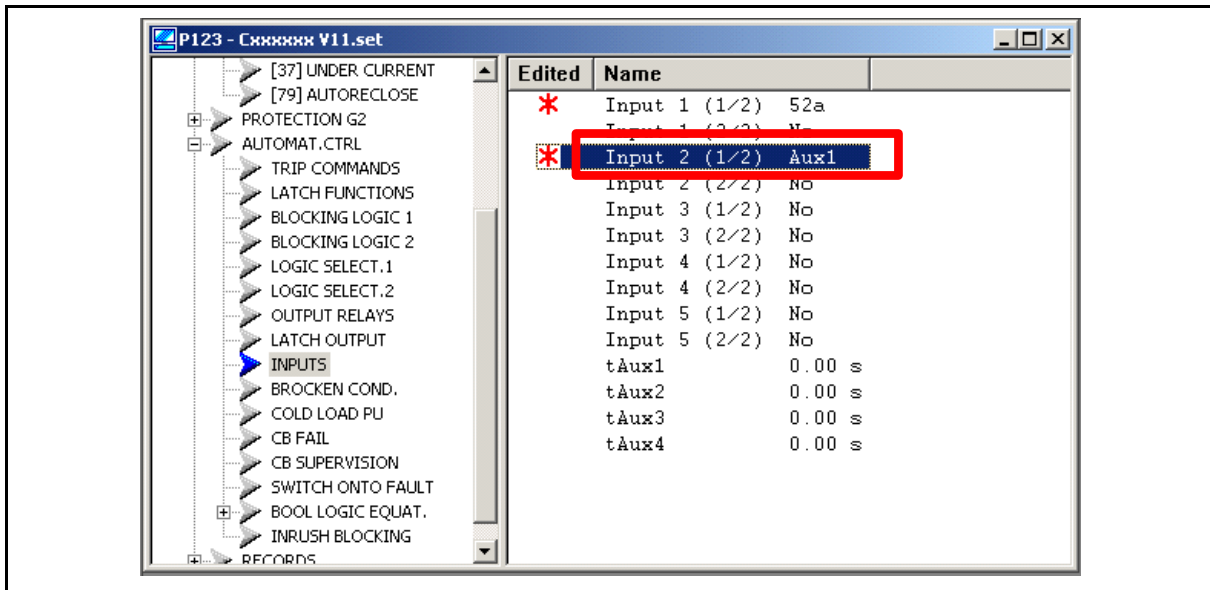

Within Autorecloser menu, both “strip and start” and “inhib trip” should be selected for tAux1 and/or tAux2

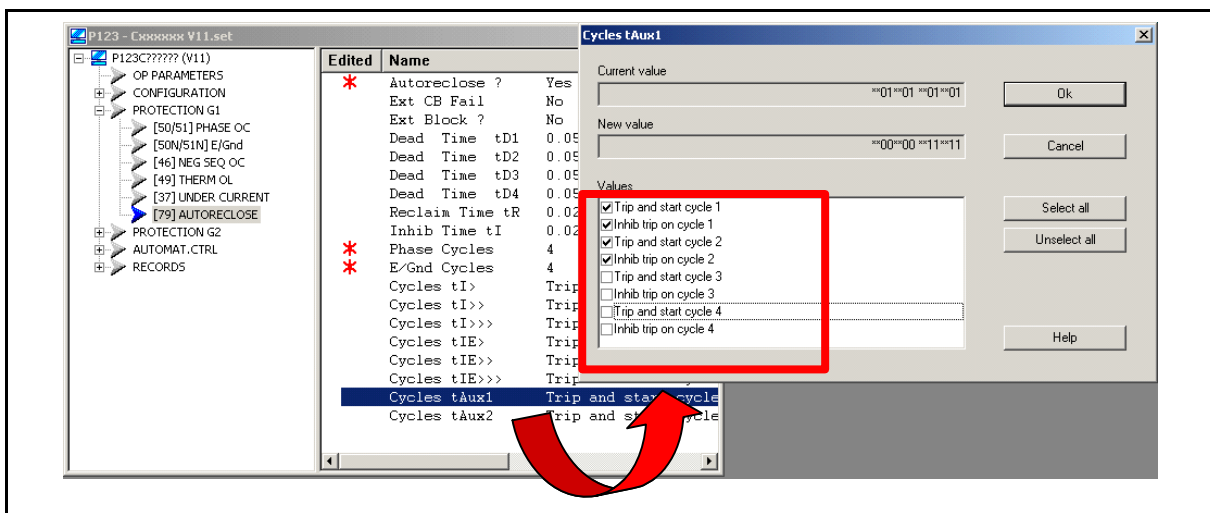

To avoid any trip when tAux is ON, ensure that tAux is not selected in trip command menu.

“AUTOMA. CTRL / TRIP COMMANDS”		
Trip Commands	Trip command without tAux	Untick the corresponding tAux

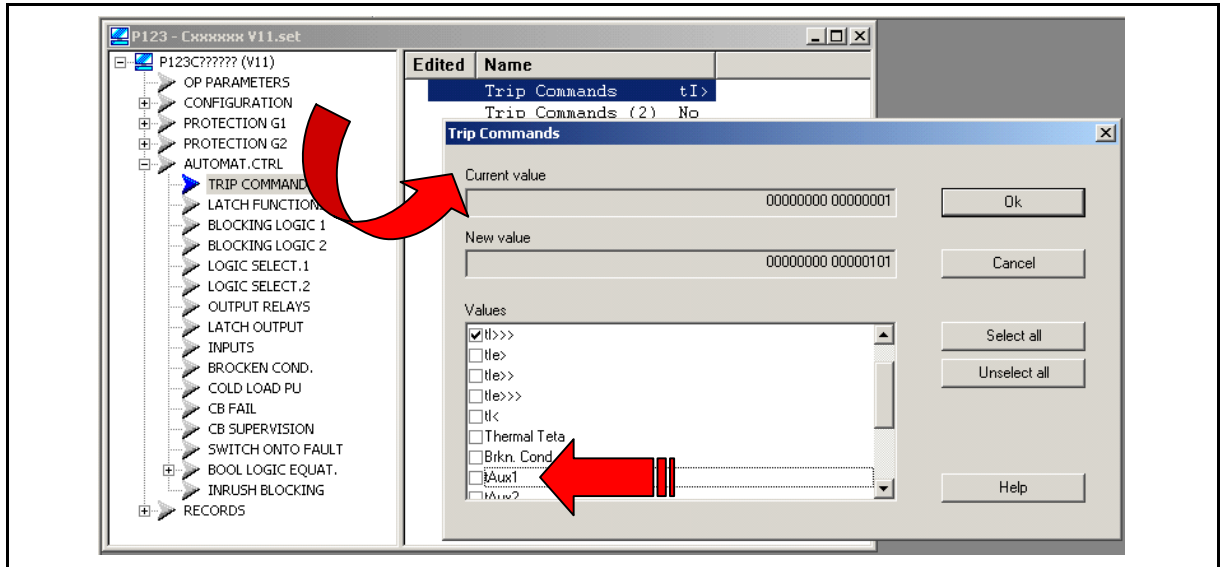

## **23. CIRCUIT BREAKER STATE MONITORING**

An operator at a remote location requires a reliable indication of the state of the switchgear. Without an indication that each circuit breaker is either open or closed, the operator has insufficient information to decide on switching operations. The MiCOM P120/P121/P122/P123 relays incorporate a circuit breaker state monitoring, giving an indication of the position of the circuit breaker.

This indication is available either on the relay front panel (P122 - P123 only) or via the communication network.

The positions of the CB can be selected under the "AUTOMAT.CTRL/Inputs" and "CONFIGURATION/Led menu".

Further, the MiCOM P122 and P123 relays are able to inform the operator that the CB has not opened following a remote trip command (refer section "CB FAIL protection").

---

## 24. CIRCUIT BREAKER CONDITION MONITORING (P122 & P123 ONLY)

Periodic maintenance of circuit breakers is generally based on a fixed time interval, or a fixed number of fault current interruptions.

The relays record the following controls and statistics related to each circuit breaker trip operation:

- delay timer setting,
- monitoring time for CB open and close operations,
- CB open count,
- summation of the current interrupted by the CB,
- exponent for the summation,
- tripping and closing pulse time

### 24.1 Circuit Breaker Condition Monitoring Features

For each circuit breaker trip operation the relay records statistics as shown in the following table taken from the relay menu. The “RECORDS/CB Monitoring” menu cells shown are counter values only.

The circuit breaker condition monitoring counter increases when it receives:

- the digital input 52A switches (RL1 trip),
- an HMI (or MiCOM S1) opening order
- a rear com opening order,
- a digital input opening order.

In cases where the breaker is tripped by an external protection device it is also possible to update the CB condition monitoring. This is achieved by allocating one of the logic inputs or via the communication to accept a trigger from an external device.

### 24.2 Setting guidelines

#### 24.2.1 Setting the $\Sigma I^n$ Thresholds

Where overhead lines are prone to frequent faults and are protected by oil circuit breakers (OCB's), oil changes account for a large proportion of the life cycle cost of the switchgear. Generally, oil changes are performed at a fixed interval of circuit breaker fault operations. However, this may result in premature maintenance where fault currents tend to be low, and hence oil degradation is slower than expected.

The  $\Sigma I^n$  counter monitors the cumulative severity of the duty placed on the interrupter allowing a more accurate assessment of the circuit breaker condition to be made.

For OCB's, the dielectric withstand of the oil generally decreases as a function of  $\Sigma I^2t$ . This is where 'I' is the fault current broken, and 't' is the arcing time within the interrupter tank (not the interrupting time). As the arcing time cannot be determined accurately, the relay would normally be set to monitor the sum of the broken current squared, by setting  $n = 2$ .

For other types of circuit breaker, especially those operating on higher voltage systems, practical evidence suggests that the value of  $n = 2$  may be inappropriate. In such applications  $n$  may be set to 1.

An alarm in this instance may be indicative of the need for gas/vacuum interrupter HV pressure testing, for example.

It is imperative that any maintenance programme must be fully compliant with the switchgear manufacturer's instructions.

#### 24.2.2 Setting the Number of Operations Thresholds

Every operation of a circuit breaker results in some degree of wear for its components. Thus, routine maintenance, such as oiling of mechanisms, may be based upon the number of operations. Suitable setting of the maintenance threshold will allow an alarm to be raised, indicating when preventative maintenance is due.

Should maintenance not be carried out, the relay can be set to lockout the autoreclose function on reaching a operations threshold. This prevents further reclosure when the circuit breaker has not been maintained to the standard demanded by the switchgear manufacturer's maintenance instructions.

Certain circuit breakers, such as oil circuit breakers (OCB's) can only perform a certain number of fault interruptions before requiring maintenance attention. This is because each fault interruption causes carbonising of the oil, degrading its dielectric properties.

#### 24.2.3 Setting the Operating Time Thresholds

Slow CB operation is also indicative of the need for mechanism maintenance. Therefore, alarm is provided and is settable in the range of 100 ms to 5 s. This time is set in relation to the specified interrupting time of the circuit breaker.



## 25. UNDERCURRENT PROTECTION FUNCTION (P122 & P123 ONLY)

MiCOM P122 & P123 relays include 2 undercurrent elements. One is dedicated for the CB fail detection (see CB failure protection section).

The other one can be used to provide additional protective functions to prevent damage/further damage to the power system. This function allows typical applications such as loss of load.

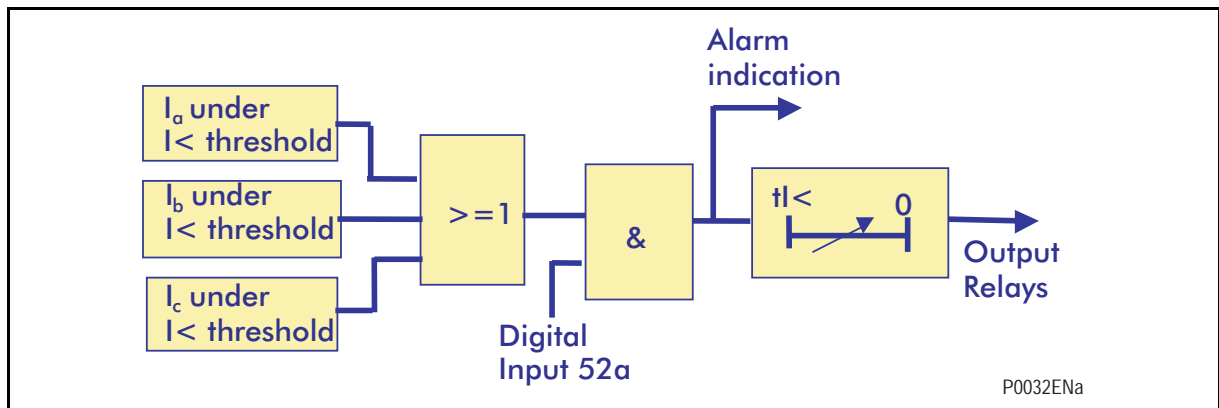

FIGURE 15: UNDERCURRENT PROTECTION LOGIC

The undercurrent protection function is available only if the auxiliary contact of the CB status is connected to the relay. A logic input should be energised via the 52a contact of the CB.

In this way a logic input (1 to 5 for P123, 1 to 3 for P122) is allocated to the 52a function. See the **AUTOMAT. CTRL/ Inputs x** menu.

An alarm is given when:

- at least one of the 3 phase current is detected under the threshold  $I <$
- and the CB is closed.

When the alarm condition is present and lasts longer than the set time  $tI <$ , one or more output relay can be energised.

See the **AUTOMAT. CTRL/trip commands/Trip  $tI <$**  menu to assign  $tI <$  to the trip output relay RL1.

See the **AUTOMAT. CTRL/Output Relays/  $tI <$**  menu to assign  $tI <$  to the auxiliary output relay RL2 to RL8 (to RL6 for P122).

$I <$  threshold can be set under the **PROTECTION G1(2)/Undercurrent/  $I <$**  menu from 2% to 100% of the rated current  $I_n$ .

$tI <$  time can be set under the **PROTECTION G1(2)/Undercurrent/  $tI <$**  menu from 0 to 150s.

## 26. CIRCUIT BREAKER FAILURE PROTECTION: CBF (P122 & P123 ONLY)

When a fault is detected, one or more main protection elements will issue a trip order to the associated circuit breaker(s). To isolate the fault, and prevent (heavier) damage on the power system it is essential that the circuit breaker operates correctly.

On power systems, a fault that is not clear quickly enough threatens the stability of the system. It is therefore common practice to install circuit breaker failure protection, which monitors that the circuit breaker has opened within a reasonable period of time. If the fault current has not been eliminated after the set time delay, the breaker failure protection (CBF) will send a signal.

The CBF protection can be used to back-trip upstream circuit breakers to ensure that the fault is correctly isolated. The CBF protection can also eliminate all blocking orders associated to logic selectivity.

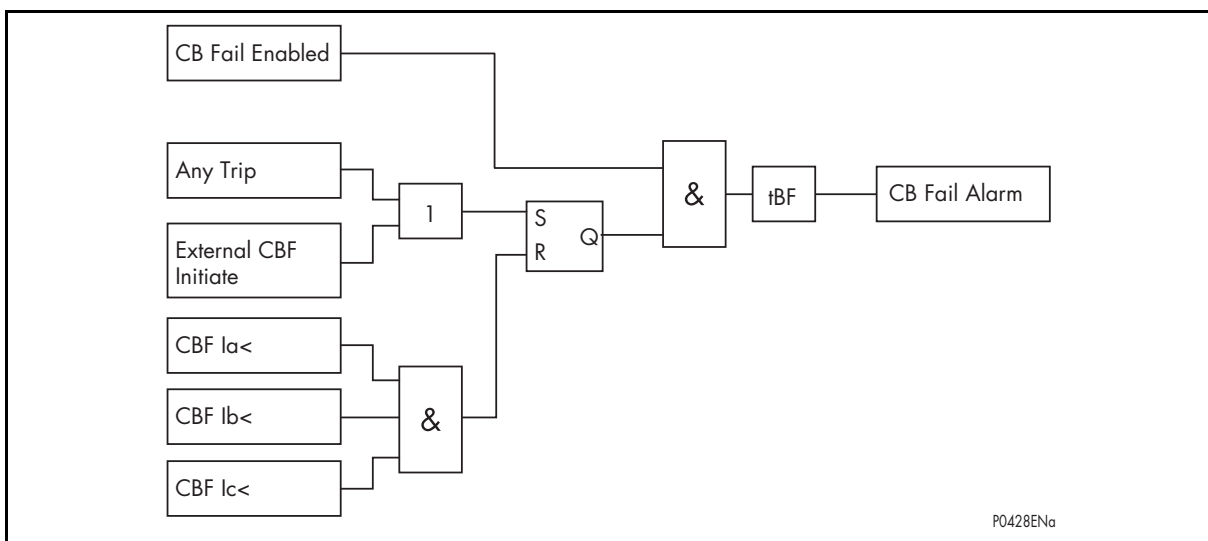

FIGURE 16: CB FAIL PRINCIPLE

### 26.1 Circuit Breaker Failure Protection mechanism

Hereafter is described how the CB failure protection available in MiCOM P122 & P123 relays works.

The t BF timer is initiated when a trip order is given to the output relay **RL1**. Note that the trip order can be issued either by a protection element, or by a logic input. Then the relay monitors the current signal of each phase and compares each phase current signal with the bandzone made by the undercurrent  $I_{<}$  threshold. This threshold value can be set under the AUTOMAT. CTRL/CB FAIL menu.

Once the t BF timer has been initiated, the relay detects the first time that the current goes out of the  $I_{<}$  bandzone. When the relay detects this transition, it initiates another timer. This timer is of fixed duration and equivalent to 20 samples.

The relay sampling rate being 32 samples by cycle, this timer is of 12,5 ms duration for system at 50 Hz and 10,4 ms for a system at 60 Hz. During this period of time, the relay is checking if the current goes out the  $I_{<}$  bandzone again. In case that the current is not eliminated, the current signal should again go out the  $I_{<}$  bandzone, and this after half a cycle, i-e 16 samples (10ms at 50Hz).

Each time the relay detects that the current goes out the  $I_{<}$  bandzone, the relay re-initiates again the timer ( of a 20 samples). In this 20 samples time window, the relay checks that the current signal going out the  $I_{<}$  bandzone is in opposite way than the first one.

- If there is no current signal going out in opposite way compared to the first one, the relay considers that there is an opened CB pole condition. The « CB pole open » internal signal is initiated.

- If there is a current signal going out in opposite way compared to the first one, the relay considers that the pole of the CB is not yet open. The « CB pole closed » internal signal is maintained.

Once the  $t_{BF}$  time delay has elapsed, the relay checks the internal state of each pole of the circuit breaker. If one or several internal poles are not opened, the relay then declares that the CB has failed. The "CB FAIL" message is displayed.

Note that it is possible to initiate the CB fail detection function by a digital input without having any trip order being given by the relay. In this case, the  $t_{BF}$  timer starts its countdown when receiving this digital input signal. If the CB is not opened (by an another protection relay) once the  $t_{BF}$  has elapsed, the relay declares that the CB has failed.

The user can associate the digital input to the "CB Fail detection" under the AUTOMAT. CTRL/Inputs menu.

Figure 17 hereafter shows the start of the CB Fail detection after a trip order was sent:

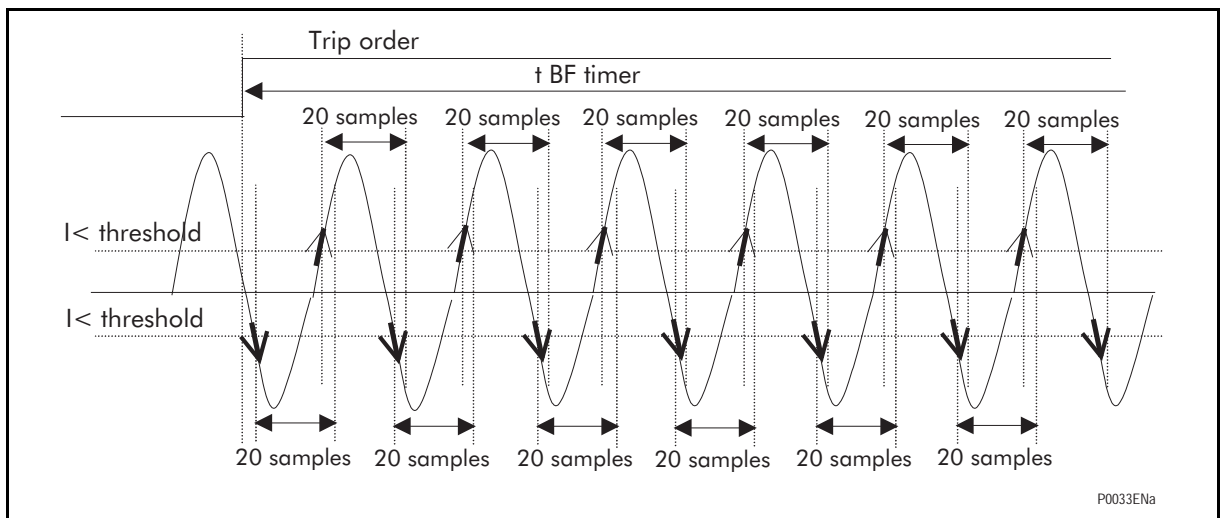

FIGURE 17: CB FAIL DETECTION PRINCIPLE

Figure 18 hereafter shows the normal opening of the CB before  $t_{BF}$  has elapsed. In this case, no CB fail alarm is given.

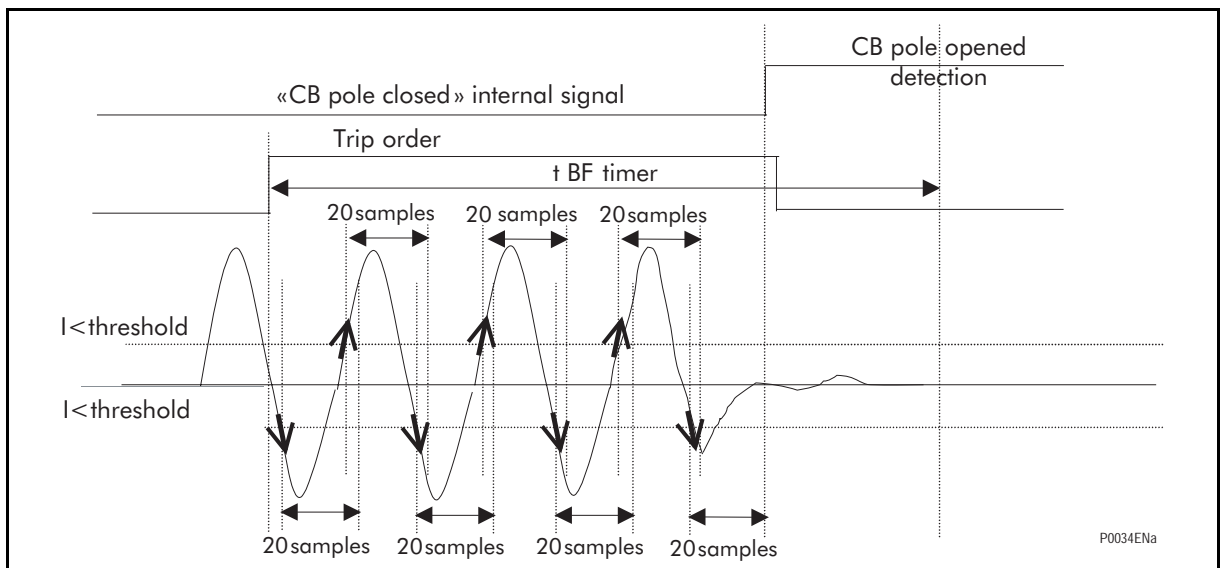

FIGURE 18: CB OPEN BEFORE  $t_{BF}$  EXPIRED

Figure 19 hereafter shows a CB failure condition. After the  $t_{BF}$  timer elapses, the relay doesn't detect the opening of the CB pole. Therefore, a CB FAIL signal is given.

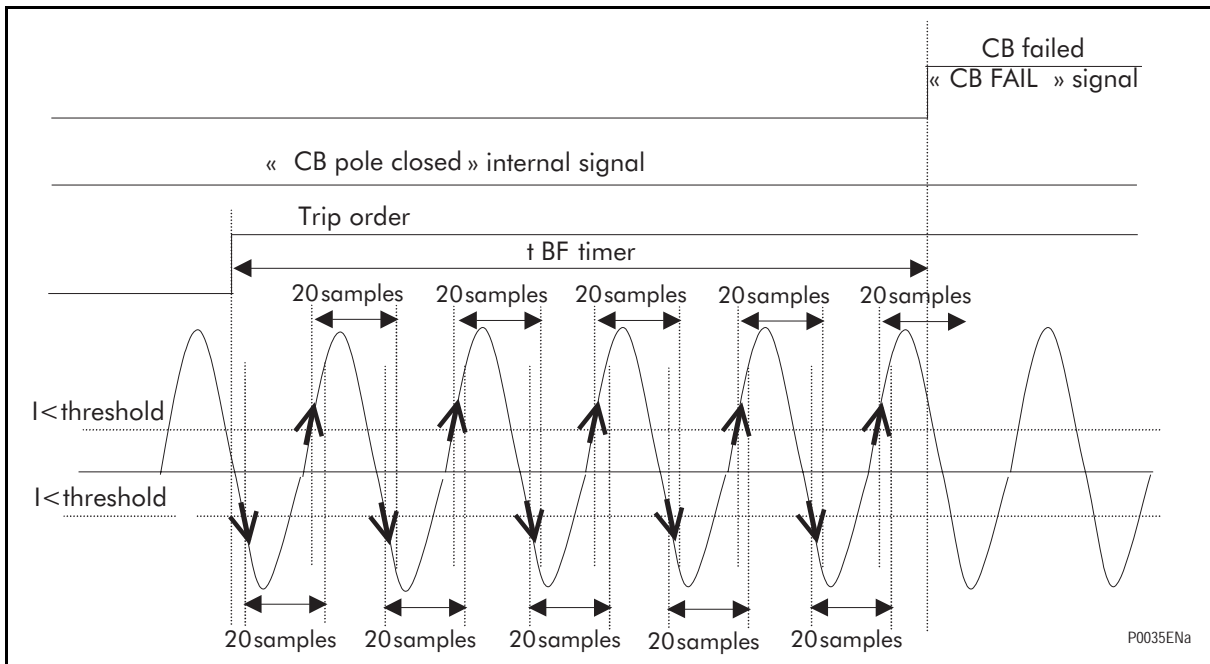

FIGURE 19: CB NOT YET OPEN BEFORE  $t_{BF}$  EXPIRED

Figure 20 hereafter shows an other case of normal CB operation. Once the fault is cleared, the phase current signal takes time to decrease due to the de-magnetisation of the phase CT. It is a typical case for TPY class CTs which are built with air gap in their magnetic core. Before the drop off of the  $t_{BF}$  timer, the relay has detected an opening of the CB pole, thus no CB failure signal is given as it is required. A basic Breaker Failure element based on an simple undercurrent element would detect a false CB failure condition as the current signal value is outside the  $I <$  bandzone at the  $t_{BF}$  timer drop off.

NOTE: Both « CB pole closed » and « CB pole opened » internal signals mentioned in the above diagrams are derived from the Circuit Breaker Failure function algorithm. They are not affected by the status of the relay opto-inputs wired to the 52a and 52b CB auxiliary contacts.

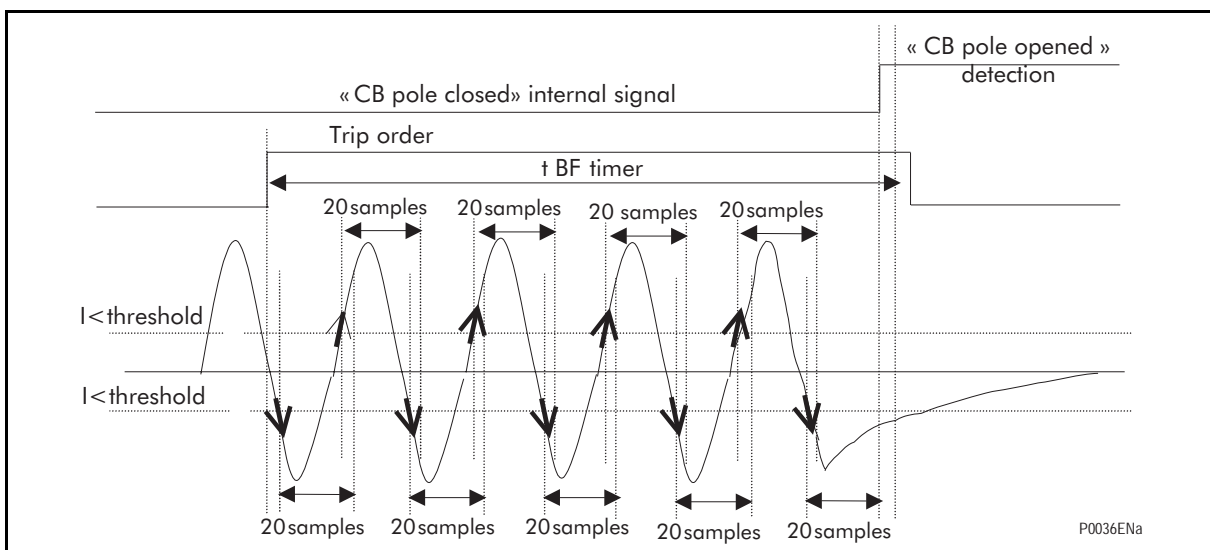

FIGURE 20: DE-ENERGIZATION OF THE CT PHASE

The selection in the relay menu is grouped as follows:

MENU TEXT	SETTING RANGE		STEP SIZE
	MIN	MAX	
CB Fail ?	No	Yes	
tBF	0.03 s	10 s	10 ms
I<	0.02 I <sub>n</sub>	I <sub>n</sub>	0.01 I <sub>n</sub>

## 26.2 Typical settings

### 26.2.1 Breaker Fail Timer Settings

A typical timer setting used with a 2 ½ cycle circuit breaker is around 150 ms.

### 26.2.2 Breaker Fail Undercurrent Settings

The phase undercurrent settings (I<) must be set to a value that is under the load current, to ensure that I< operation indicates that the circuit breaker pole is open. A typical setting for overhead line or cable circuits is 20% I<sub>n</sub>, with 5% I<sub>n</sub> common for generator circuit breaker CBF.

NOTE: The reset time of P122 and P123 is around 15 ms.

## 27. TRIP CIRCUIT SUPERVISION (P122 & P123 ONLY)

The trip circuit extends beyond the relay enclosure and passes through more components, such as fuse, wires, relay contacts, auxiliary switch contact and so on.

These complications, coupled with the importance of the circuit, have directed attention to its supervision.

The simplest arrangement for trip circuit supervision contains a healthy trip lamp in series with a resistance placed in parallel with a trip output relay contacts of the protection device.

However, this solution has limitations as no alarm can be generated. Following paragraphs describe typical application examples.

### 27.1 Trip Circuit Supervision mechanism

The Trip Circuit Supervision function included in the **MiCOM P122** and **P123** relays is described below:

**WARNING 1: SINCE HARDWARE 5 (NAMED ALSO PHASE II), THE VALUES USED IN THE CALCULATION OF THE EXTERNAL RESISTOR NEEDED FOR THE TRIP CIRCUIT SUPERVISION HAVE CHANGED.**

**WARNING 2: THE POLARISATION CURRENT OF THE LOGIC INPUT MUST BE 3.5mA DURING 2ms (MINIMUM). THE HOLDING CURRENT AFTER THESE 2ms SHOULD BE 2.3mA (SEE P12x/EN TD CHAPTER FOR SPECIFIC POLARISATION RANGES ACCORDING TO NOMINAL RANGE).**

A logic input is programmed to the **AUTOMAT. CTRL/CB Supervision/TC Supervision** function. The logic input is associated to the label **Trip Circ** within the **AUTOMAT. CTRL/Inputs** menu. Then, this logic input is wired in the trip circuit according to one of the typical application diagrams shown in the following example.

When the function TC Supervision is set to "Yes" under the **CB Supervision** sub-menu, the relay checks continuously on trip circuit continuity whatever the CB status is CB opened or CB closed. The function **TC Supervision** is enabled when the trip logic output (**RL1**) is not energised. The function **TC Supervision** is not enabled when the trip logic output (**RL1**) is energised.

**NOTE:** If RL1 is energised, the "Trip Circuit Super" alarm message is displayed in order to inform that the TC Supervision is not enabled.

A **52 Fail** (trip circuit failure) signal is generated if the logic input detects no voltage signal during a time longer than the settable timer **tSUP**. See Chapter P12x/EN FT (User Guide) and Chapter P12x/EN TD (Technical Data) for the settings.

As this function is disabled when the trip logic output (**RL1**) is energised, this function is suitable for use with the enabled relay latching logic.

The tSUP timer can be set according to the following table:

MENU TEXT	SETTING RANGE		STEP SIZE
	MIN	MAX	
TC Supervision ?	Yes	No	
tSUP	100ms	10s	50ms

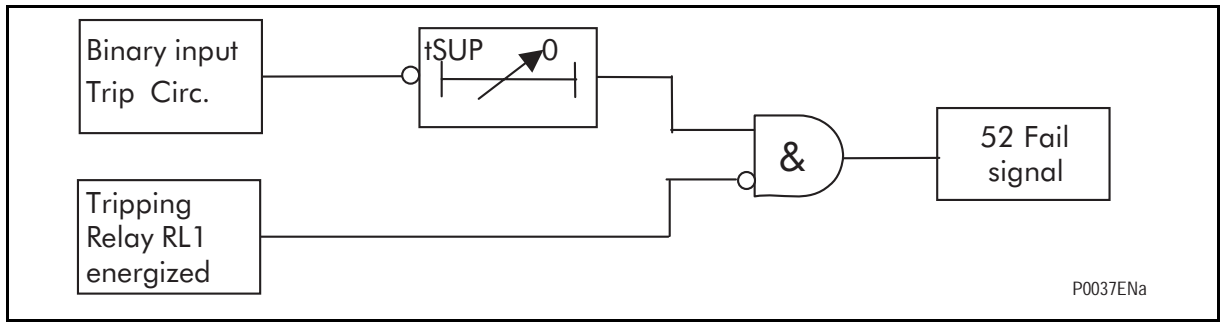

FIGURE 21: TRIP CIRCUIT SUPERVISION PRINCIPLE DIAGRAM

Three examples of application are given below.

Example 1

In this example only the 52a auxiliary contact is available, the MiCOM relay monitors the trip coil whatever the CB status is (CB open or CB closed ).

However, this configuration is not recommended because the 52a contact and associated circuit is not monitored.

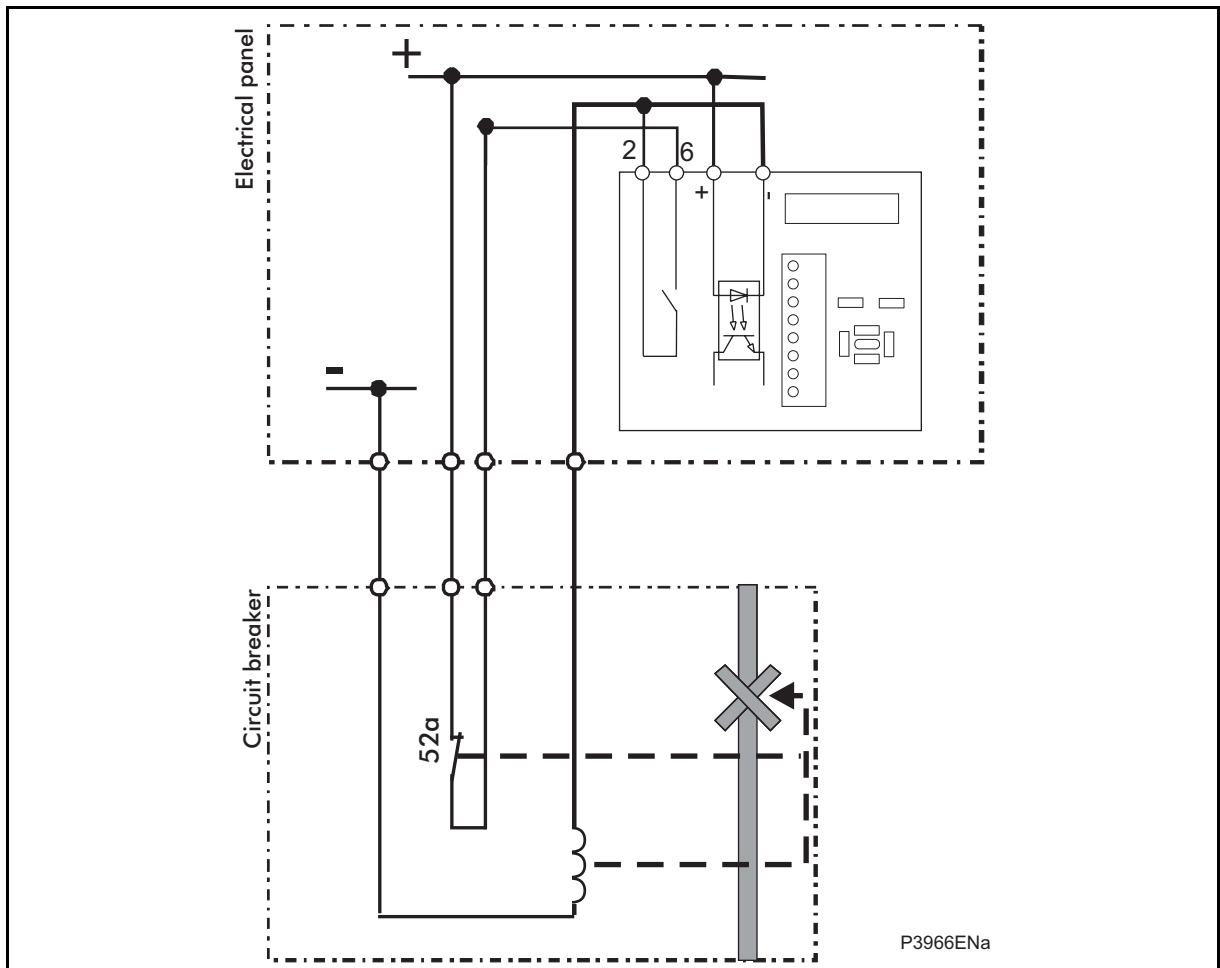

FIGURE 22: TRIP COIL MONITORING

Example 2

In this example both 52a and 52b auxiliary contacts are available; the MiCOM P122 and P123 relays monitor the complete trip circuit when the CB is closed and a part of the trip circuit when the CB is open.

In this case it is necessary to insert a resistor R1 in series with 52b, if either the output (**RL1**) trip is latched or it stays involuntarily closed, or a long time trip pulse is programmed (See

section 27.2 for R1 calculation). Otherwise, a short circuit of DC trip supply would occur during tripping sequence.

In this example, the protection is limited: the coil is only monitored when CB is closed.

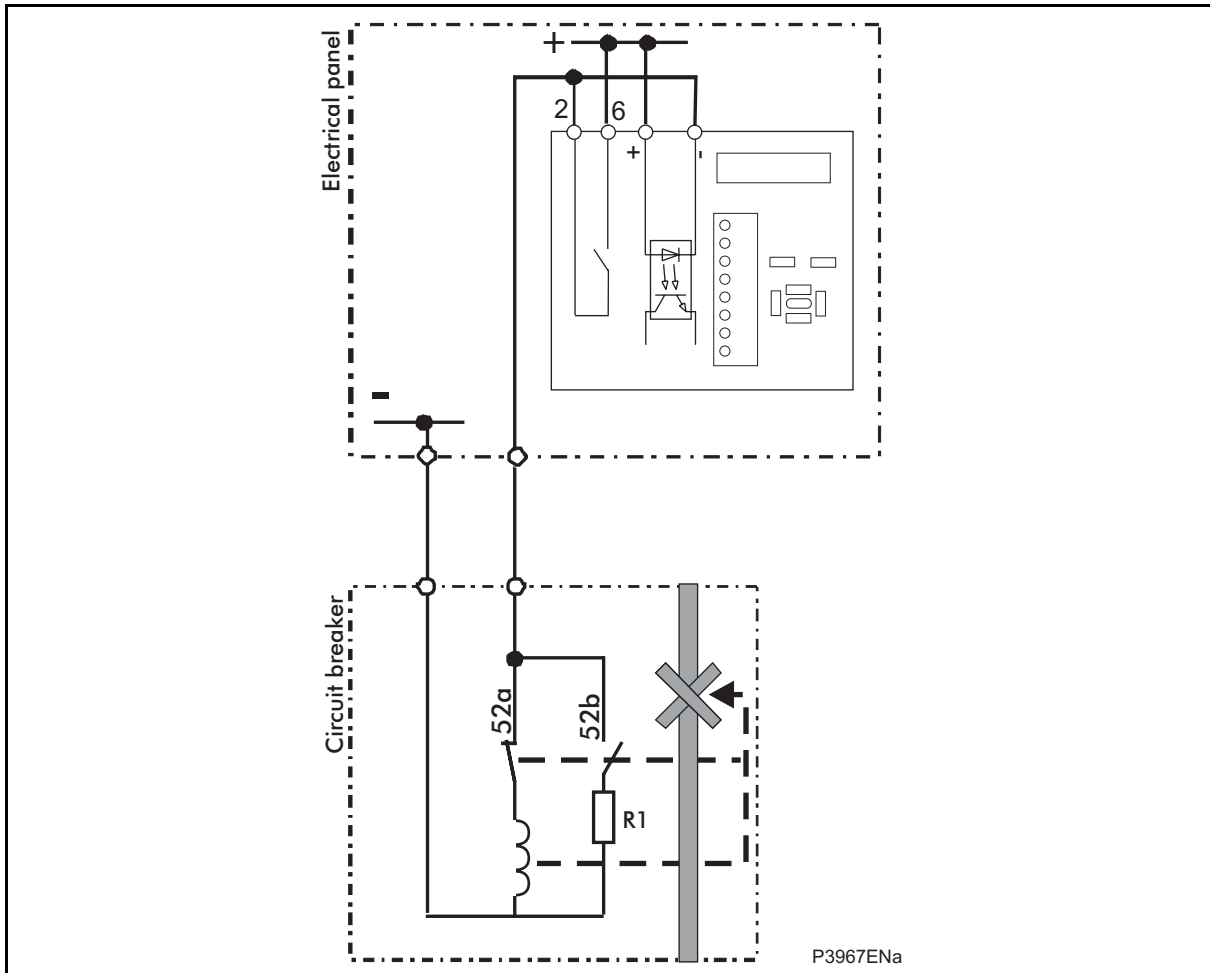

FIGURE 23: TRIP COIL AND AUXILIARY CONTACTS MONITORING

Example 3

In this example both 52a and 52b auxiliary contacts are available, the MiCOM P122 and P123 relays monitor the complete trip circuit whatever the CB status (CB open or CB closed).

In this case it is necessary to insert a R1, if either the output (**RL1**) trip is latched, or it stays involuntarily closed, or a long time trip pulse is programmed (See section 27.2 for R1 calculation). Otherwise, a short circuit of DC trip supply would occur during tripping sequence.



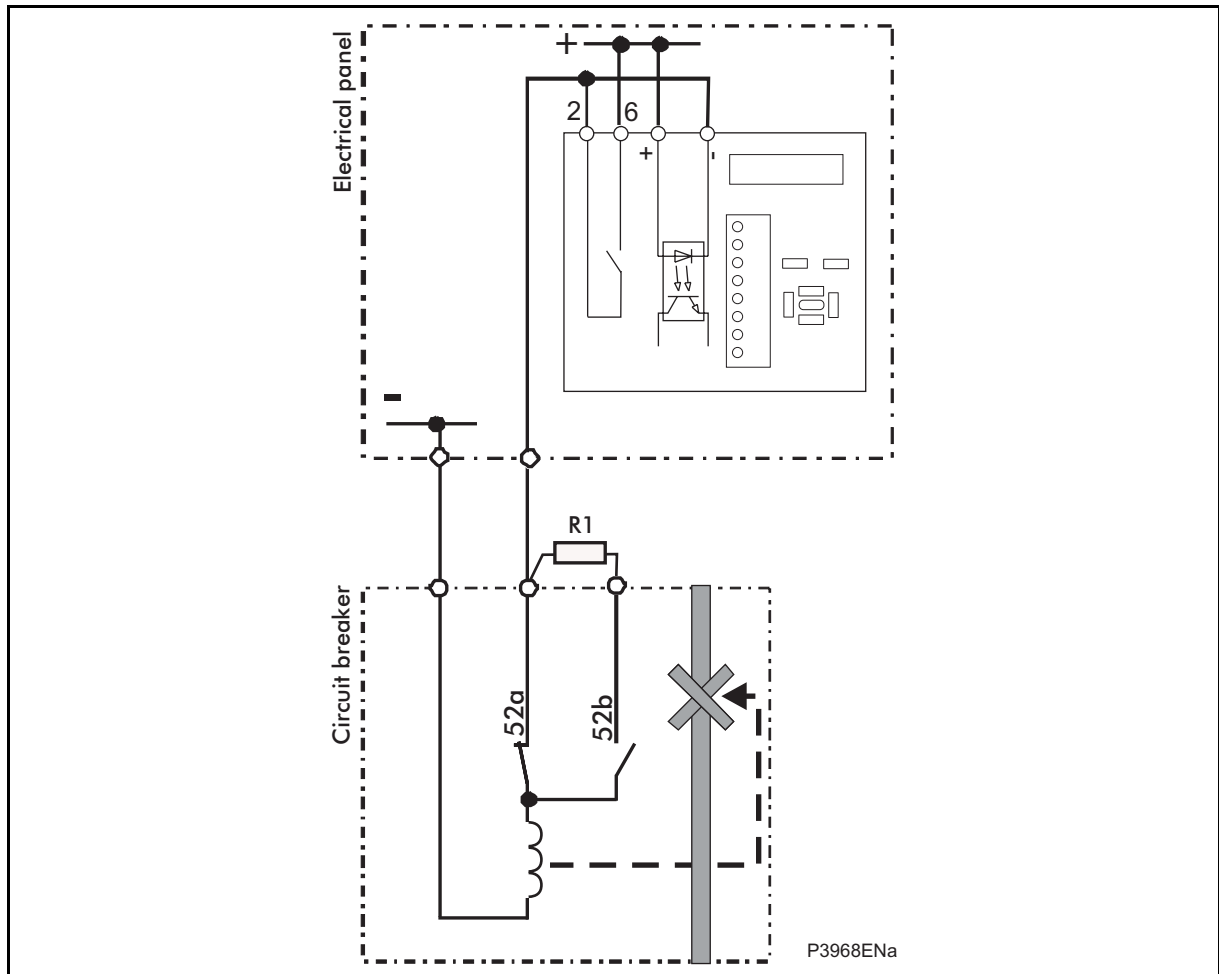

FIGURE 24: TRIP COIL AND AUXILIARY CONTACTS MONITORING WHATEVER THE POSITION OF THE CB

**27.2 External resistor R1 calculation**

The calculation of the R1 resistor value will take into account that a minimum current is flowing through the logic input. This minimum current value is a function of the relay auxiliary voltage range (Ua).

- Remarks:
- The presence of auxiliary relays, such as an anti-pumping system for instance, in the trip circuit must be taken into account for the R1 resistance values specification.
  - It is assumed the maximum variations of the auxiliary voltage value are  $\pm 20\%$ .

Ordering Code	Relay auxiliary power supply		Logic Inputs				
	Nominal voltage range Vx	Operating voltage range	Nominal Voltage range	Minimal polarisation voltage	Maximum polarisation current	Holding current after 2 ms	Maximum continuous withstand
T	48 – 250 Vdc 48 – 240 Vac Special EA (**)	38.4 – 300 Vdc 38.4 – 264 Vac	24 – 250 Vdc 24 – 240 Vac	19,2 Vdc 19,2 Vac	35 mA	2.3 mA	300 Vdc 264 Vac
H	48 – 250 Vdc 48 – 240 Vac	38.4 – 300 Vdc 38.4 – 264 Vac	129 Vdc	105 Vdc	3.0 mA @ 129 Vdc		145 Vdc
V	48 – 250 Vdc 48 – 240 Vac	38.4 – 300 Vdc 38.4 – 264 Vac	110 Vdc	77 Vdc	7.3 mA @ 110 Vdc		132 Vdc
W	48 – 250 Vdc 48 – 240 Vac	38.4 – 300 Vdc 38.4 – 264 Vac	220 Vdc	154 Vdc	3.4 mA @ 220 Vdc		262 Vdc

(\*\*) Logic input recognition time for EA approval. Dedicated filtering on 24 samples (15 ms at 50 Hz)

1 - Case of example No 2:

The R1 resistor maximum value (in Ohm) is defined by the following formula:

$$R1 < \frac{0,8 \times U_a - U_{\min}}{I_{\min}} [\text{Ohm}]$$

Where:

Ua = auxiliary voltage value (in this case a DC voltage; range is given on label under the top hinged cover).

Umin = internal minimum voltage value needed for the opto logic input to operate.

Imin = minimum current value needed for the opto logic input to operate.

The R1 resistor withstand value (in Watt) is defined below:

$$P_{R1} > 2 \times \frac{(1,2 \times U_a)^2}{R1} [\text{W}]$$

2 - Case of example No 3:

The R1 resistor maximum value (in Ohm) is defined by the following formula:

$$R1 < \frac{0,8 \times U_a - U_{\min}}{I_{\min}} - R_{\text{Coil}} [\text{Ohm}]$$

Where:

Ua = auxiliary voltage value (in this case a DC voltage; range is given on label under the top hinged cover).

Umin = internal minimum voltage value needed for the opto logic input to operate.

Imin = minimum current value needed for the opto logic input to operate.

Rcoil = Trip coil resistance value.

The R1 resistor withstand value (in Watt) is defined below:

$$P_{R1} > 2 \times \frac{(1,2 \times U_a)^2}{(R1 + R_{\text{Coil}})} [\text{W}]$$

If the trip contact is latched or temporarily by-passed, the continuous current through the tripping coil is:

$$I_{\text{CONTINUOUS}} = \frac{(1,2 \times U_a)}{R1 + R_{\text{COIL}}}$$

If the value is above admissible continuous current through the tripping coil, trip contact latching must not be made and by-passing trip contact should never be made.

---

## 28. REAL TIME CLOCK SYNCHRONISATION VIA OPTO-INPUTS

In modern protective schemes it is often desirable to synchronize the relay's real time clock so that events from different relays can be placed in chronological order. This can be done using the communication interface connected to the substation control system or via an opto-input. Any of the available opto-inputs on the P12x relay can be selected for synchronization. Pulsing this input will result in the real time clock snapping to the nearest minute. The recommended pulse duration is 20ms to be repeated no more than once per minute. An example of the time synchronization function is shown.

Time of "Sync. Pulse"	Corrected Time
19:47:00.000 to 19:47:29.999	19:47:00.000
19:47:30.000 to 19:47:59.999	19:48:00.000

NOTE: The above assumes a time format of hh:mm:ss

---

## 29. EVENT RECORDS

The relay records and time tags up to 250 events and stores them in a non-volatile (flash) memory. This allows the system operator to analyse the sequence of events that occurred within the relay after a particular power system condition, or switching sequence, etc. When the available space is exhausted, the new fault automatically overwrites the oldest fault.

The real time clock within the relay times tag each event, with a resolution of 1ms.

The user can view event records either via the front panel interface, via the EIA (RS) 232 port, or remotely, via the rear EIA (RS) 485 port.

---

## 30. FAULT RECORDS

Each time any of the programmed thresholds are crossed, a fault record is created and stored in memory. The fault record tags up to 25 faults and stores them in a non-volatile (flash) memory. This allows the system operator to identify and analyse network failures. When the available memory space is exhausted, the new fault automatically overwrites the oldest fault.

The user can view actual fault record under the **RECORD/Fault Record** menu, where he can select to display up to 25 stored records. These records are fault flags, fault measurements, etc. Also note that the time stamp displayed in the fault record itself will be more accurate than the corresponding time stamp given in the event record. This is due to the fact that events are logged some time after the actual fault record happens.

The user can view event records either via the front panel interface, via the EIA (RS) 232 port, or remotely, via the rear EIA (RS) 485 port.

---

## 31. INSTANTANEOUS RECORDER

Each time any of programmed thresholds are crossed, an instantaneous record is created and displayed under the RECORDS/Instantaneous menu. The last five starting information with the duration of the information are available.

The following information is displayed under the RECORDS/Fault Record menu: number of faults, hour, date, origin (crossing of I>, I>>, I>>> or le>, le>> or le>>> thresholds), duration of the instantaneous, and if the crossing of the threshold lead to a trip or not.

## **32. DISTURBANCE RECORDER**

The integral disturbance recorder has a memory space specifically dedicated for storage of disturbance records. The disturbance records that may be stored are 3, 5, 7 or 9 seconds length each. When the available memory space is exhausted, the new record automatically overwrites the oldest record.

The recorder stores actual samples that are taken at a rate of 32 samples per cycle.

Each disturbance record consists of analogue and digital channels. (Note that the relevant CT ratios for the analogue channels are also extracted to enable scaling to primary quantities).

The total disturbance recording time is 5 records of 3 seconds, or 4 × 3s, or 3 × 5s, or 2 × 7s or 1 × 9s. The disturbance record starts with the disturbance. If the pre-time time is set to 100ms, the record starts 100 ms before the disturbance.

### 33. ROLLING AND PEAK VALUE DEMANDS (P122 & P123 ONLY)

MiCOM P122 and P123 relays can store the 3 phases rolling average and maximum subperiod values. The description and principle of calculation are presented hereafter.

#### 33.1 Rolling demand

Calculation of the rolling demand value for IA, Ib and IC currents is done the following way:

- Calculation of the average of the RMS values on a "Rolling Sub Period" period.

The width of the period "Rolling Sub Period" can be set under the "RECORDS/Rolling Demand/Sub Period" menu.

Setting range: from 1 to 60 minutes.

- Storage of these values in a sliding window.

Calculation of the average of these average values (sliding window values) on the number of "Num of Sub Periods" periods.

The number of Sub Period "Num of Sub Periods" can be set under the "RECORDS/Rolling Demand/Num of Sub Per" menu.

Setting range: from 1 to 24.

- Display of the first result under the MEASUREMENTS menu only after the storage of "Num of Sub Periods" periods. The 3 phases Rolling average value are displayed:

Rolling Average IA RMS  
Rolling Average IB RMS  
Rolling Average IC RMS

- The calculation is reset either via the front operator interface (Key c) without entering a password, or by a remote command.

**NOTE:** In case of loss of power supply the rolling demand are not stored. A modification of the settings (either "Rolling Sub Period" or "Num of Sub Periods" parameter) reset the calculation.

Example:

Sub Period = 5 mn  
Num of Sub Period = 2

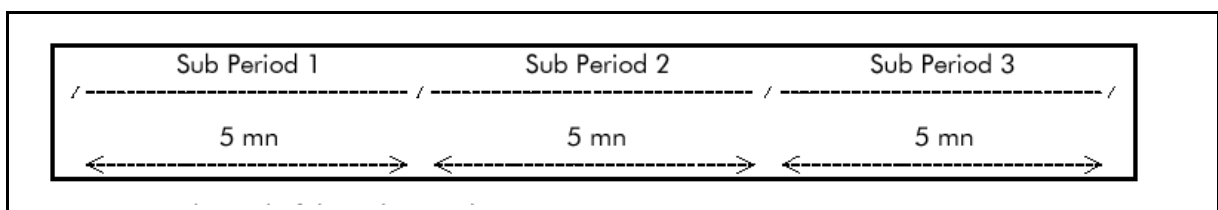

At the end of the Sub Period 2:

Rolling average value = (average value 1 + average value 2)/2

At the end of the Sub Period 3:

New Rolling average value = (average value 2 + average value 3)/2

### 33.2 Peak value demand

The principle of calculation of the Peak value demand for IA, IB and IC currents is the following:

For every "Rolling Sub Period", a new average value is compared with the previous value calculated at the previous "Rolling Sub Period". If this new value is greater than the previous value already stored, then this new value is stored instead of the previous one.

In the other way, if this new value is lower than the previous value already stored, then the previous value is stored.

This way the average peak value will be refreshed each Sub Period;

There is no dedicated setting for this calculation. The setting of the Sub Period in the RECORDS menu is used.

The 3 phase Peak value demand are displayed in the MEASUREMENTS menu:

MAX SUBPERIOD IA RMS  
MAX SUBPERIOD IB RMS  
MAX SUBPERIOD IC RMS

- The calculation is reset either by pushing key  $\odot$  without using a password, or by remote command.

NOTE: In case of loss of power supply, Peak average values are stored. A modification of the "Rolling Sub Period" parameter reset the calculation.

## 34. CT REQUIREMENTS

Hereafter are presented the CT requirements for MiCOM P12x Overcurrent. Current transformer requirements are based on a potential maximum fault current that is 50 times the relay rated current ( $I_n$ ) and on the setting of the instantaneous at 25 times rated current ( $I_n$ ). The current transformer requirements are designed to provide operation of all protection elements.

When the criteria for a specific application are higher than the criteria described above, or when the actual lead resistance exceeds the limiting value recommended, it may be desirable to increase the CT requirements according to the following formula.

Nominal Rating	Nominal Output	Accuracy Class	Accuracy Limit Factor	Limiting lead resistance
1A	2.5VA	10P	20	1.3 ohms
5A	7.5VA	10P	20	0.11 ohms

The following table gives the resistance of current transformer ( $R_{CT}$ ) secondary winding:

	$R_{CT} (R = U/I)$	
	1A	5A
Current transformer (30A)	$0.75V / 30A = 25m\Omega$	$0.25A / 30A = 8m\Omega$
Earth transformer (30A)	$2.6A / 30A = 87m\Omega$	$0.45V / 30A = 15m\Omega$

### 34.1 Definite time / IDMT overcurrent & earth fault protection

Time-delayed Phase overcurrent elements:

$$V_K \geq I_{cp}/2 * (R_{CT} + R_L + R_{rp})$$

Time-delayed Earth Fault overcurrent elements:

$$V_K \geq I_{cn}/2 * (R_{CT} + 2R_L + R_{rp} + R_m)$$

### 34.2 Instantaneous overcurrent & earth fault protection

CT requirements for instantaneous phase overcurrent elements:

$$V_K \geq I_{sp} * (R_{CT} + R_L + R_{rp})$$

CT requirements for instantaneous earth fault overcurrent elements:

$$V_K \geq I_{sn} * (R_{CT} + 2R_L + R_{rp} + R_m)$$

### 34.3 Definite time / IDMT sensitive earth fault (SEF) protection

Time delay SEF protection:

$$V_K \geq I_{cn}/2 * (R_{CT} + 2R_L + R_{rp} + R_m)$$

SEF Protection - as fed from a core-balance CT:

The type of current transformers that are required are core balance type and with metering class accuracy and with a limiting secondary voltage that follows the following formula:

Time Delayed element:

$$V_K \geq I_{cn}/2 * (R_{CT} + 2R_L + R_{rp} + R_m)$$

Instantaneous element:

$$V_K \geq I_{fn}/2 * (R_{CT} + 2R_L + R_{rp} + R_m)$$

In addition, note that phase error of the applied core balance current transformer should be less than 90 minutes at 10% of rated current and less than 150 minutes at 1% of rated current.

Abbreviations used in the previous formula are explained below:

Where:

- VK = Required CT knee-point voltage (volts),
- I<sub>fn</sub> = Maximum prospective secondary earth fault current (amps),
- I<sub>fp</sub> = Maximum prospective secondary phase fault current (amps),
- I<sub>cn</sub> = Maximum prospective secondary earth fault current or 31 times I<sub>o</sub> setting (whichever is lower) (amps),
- I<sub>cp</sub> = Maximum prospective secondary phase fault current or 31 times I<sub>o</sub> setting (whichever is lower) (amps),
- I<sub>sn</sub> = Stage 2 & 3 Earth Fault setting (amps),
- I<sub>sp</sub> = Stage 2 and 3 setting (amps),
- R<sub>CT</sub> = Resistance of current transformer secondary winding (ohms)
- R<sub>rp</sub> = Impedance of relay phase current input at 30I<sub>n</sub>
- R<sub>L</sub> = Resistance of a single lead from relay to current transformer (ohms),
- R<sub>rp</sub> = Impedance of relay phase current input at 30I<sub>n</sub> (ohms),
- R<sub>rn</sub> = Impedance of the relay neutral current input at 30I<sub>n</sub> (ohms).

#### 34.4 High Impedance Restricted Earth Fault Protection

The High Impedance Restricted Earth Fault element shall remain stable for through faults and shall operate in less than 40ms for internal faults provided that following equations are met when determining CT requirements and the value of the associated stabilising resistor:

$$R_s = [K * (I_f) * (R_{CT} + 2R_L)] / I_s$$

$$V_K \geq 4 * I_s * R_s$$

- K = 1 for V<sub>k</sub>/V<sub>s</sub> less or equal to 16
- K = 1.2 for V<sub>k</sub>/V<sub>s</sub> greater than 16

Where:

- V<sub>K</sub> = Required CT knee-point voltage (volts),
- R<sub>s</sub> = Value of Stabilising resistor (ohms),
- I<sub>f</sub> = Maximum through fault current level (amps).
- V<sub>K</sub> = CT knee point voltage (volts),
- I<sub>s</sub> = Current setting of REF element (amps),
- R<sub>CT</sub> = Resistance of current transformer secondary winding (ohms),
- R<sub>L</sub> = Resistance of a single lead from relay to current transformer (ohms).



**MODBUS DATABASE  
COURIER DATABASE  
IEC 60870-5-103  
DNP 3.0 DATABASE**

**BLANK PAGE**

MiCOM P120/P121/P122/P123

# **MODBUS DATABASE**

**BLANK PAGE**

# CONTENT

<b>1.</b>	<b>INTRODUCTION</b>	<b>3</b>
1.1	Purpose of this document	3
1.2	Glossary	3
<b>2.</b>	<b>MODBUS PROTOCOL</b>	<b>4</b>
2.1	Technical characteristics of the MODBUS connection	4
2.1.1	Parameters of the MODBUS connection	4
2.1.2	Synchronisation of exchanges messages	4
2.1.3	Message validity check	4
2.1.4	Address of the MiCOM relays	4
2.2	MODBUS functions of the MiCOM relays	5
2.3	Presentation of the MODBUS protocol	5
2.3.1	Frame size received by the protection device (slave)	5
2.3.2	Format of frames sent by the MiCOM relays	6
2.3.3	Messages validity check	6
<b>3.</b>	<b>MiCOM P120, P121, P122 AND P123 RELAY DATABASE ORGANISATION</b>	<b>7</b>
3.1	Description of the application mapping	7
3.1.1	Settings	7
3.1.2	Disturbance records (P122, P123)	7
3.1.3	Event records (P122, P123)	8
3.1.4	Fault records (P122, P123)	8
3.1.5	Characteristics	9
3.2	Page 0h (Read access only)	9
3.3	Page 1h	12
3.4	Page 2h (Access in reading and in writing)	17
3.5	Page 3h (Access in reading and in writing)	20
3.6	Page 4h Access in writing	20
3.7	Page 5h	21
3.7.1	For P121 P122 and P123	21
3.7.2	For P120	26
3.8	Page 6h	27
3.9	Page 7h	28
3.10	Page 8h (P122, P123)	29
3.11	Pages 9h to 21h	30
3.11.1	Meaning of each value channel	30
3.11.2	Calculation formula for phase current values	30
3.11.3	Calculation formula for earth current values	31
3.12	Page 22h	32

<b>3.13</b>	<b>Page 35h</b>	<b>32</b>
<b>3.14</b>	<b>Page 36h</b>	<b>36</b>
<b>3.15</b>	<b>Page 37h</b>	<b>36</b>
3.15.1	Calculation formula for phase current values	37
3.15.2	Calculation formula for earth current values	37
<b>3.16</b>	<b>Page 3Eh</b>	<b>37</b>
<b>3.17</b>	<b>Pages 38h to 3Ch</b>	<b>38</b>
3.17.1	Calculation formula for phase current values	39
3.17.2	Calculation formula for earth current values	39
<b>3.18</b>	<b>Pages 3Dh</b>	<b>40</b>
<b>4.</b>	<b>DESCRIPTION OF THE MAPPING FORMAT, MICOM P122 AND P123</b>	<b>42</b>
<b>4.1</b>	<b>Disturbance record additional information</b>	<b>56</b>
4.1.1	MODBUS request definition used for disturbance record	56
4.1.2	Request to know the number of disturbance records in SRAM	56
4.1.3	Service requests	56
4.1.4	Disturbance record upload request	56
4.1.5	Index frame upload request	57
4.1.6	Request to retrieve the oldest non-acknowledge event	57
4.1.7	Request to retrieve a dedicated event	57
4.1.8	Modbus request definition used to retrieve the fault records	57
4.1.9	Request to retrieve the oldest non-acknowledge fault record	58
4.1.10	Request to retrieve a dedicated fault record	58

## 1. INTRODUCTION

### 1.1 Purpose of this document

This document describes the characteristics of the different communication protocol of **MiCOM P120, P121, P122** and **P123** relays.

The available communication protocols on the relay are listed below:

- MODBUS
- IEC 60870-5-103
- K-BUS/Courier (not available)
- DNP3

### 1.2 Glossary

$I_r, I_s, I_t$  : currents measured on the concerned phases (r, s, t)

$I_E$  : residual current measured by earth input (= 3.I zero sequence)

pf : soft weight of a word of 16 bits

PF : heavy weight of a word of 16 bits

## 2. MODBUS PROTOCOL

MiCOM P120, P121, P122 and P123 relays can communicate by a RS 485 link behind the unit following the MODBUS RTU protocol.

### 2.1 Technical characteristics of the MODBUS connection

#### 2.1.1 Parameters of the MODBUS connection

The different parameters of the MODBUS connection are as follows:

- Isolated two-point RS485 connection (2kV 50Hz),
- MODBUS line protocol in RTU mode

Communication speed can be configured by an operator dialog in the front panel of the relay:

Baud rate (dec)
300
600
1200
2400
4800
9600
19200
38400

Transmission mode of the configured characters by operator dialog.

Mode
1 start / 8 bits / 1 stop: total 10 bits
1 start / 8 bits / even parity / 1 stop: total 11 bits
1 start / 8 bits / odd parity / 1 stop: total 11 bits
1 start / 8 bits / 2 stop: total 11 bits

#### 2.1.2 Synchronisation of exchanges messages

All character received after a silence on the line with more or equal to a transmission time of 3 characters is considered as a firm start.

#### 2.1.3 Message validity check

The frame validity is working with a cyclical redundancy code CRC with 16 bits. The generator polynomial is:

$$1 + x^2 + x^{15} + x^{16} = 1010\ 0000\ 0000\ 0001\ \text{binary} = A001\text{h}$$

#### 2.1.4 Address of the MiCOM relays

The address of the MiCOM relay on a same MODBUS network is situated between 1 and 255. The address 0 is reserved for the broadcast messages



**2.2 MODBUS functions of the MiCOM relays**

Protection device data may be read or modified by using function codes. Following are the available function codes. Function codes to read from or write into parameter cells in the protection device are described in the listed following table.

Function Nr.	Data Read	Data Write	Data Format & Type
1	X		N bits
2	X		N bits
3	X		N words
4	X		N words
5		X	1 bit
6		X	1 word
7	Fast		8 bits
8	X		Diagnostics counter
11	X		Event counter
15		X	N bits
16		X	N words

**2.3 Presentation of the MODBUS protocol**

Master slave protocol, all exchange understands a master query and a slave response

Frame size received from **MiCOM P120, P121, P122 and P123** relays

2.3.1 Frame size received by the protection device (slave)

Frame transmitted by the master ( query):

Slave number	Function code	Information	CRC16
1 byte	1 byte	n bytes	2 bytes
0 à FFh	1 à 10h		

Slave number:

The slave number is situated between 1 and 255.

A frame transmitted with a slave number 0 is globally addressed to all pieces of equipment (broadcast frame )

Function code:

Requested MODBUS function (1 to 16)

Information:

Contains the parameters of the selected function.

CRC16:

Value of the CRC16 calculated by the master.

NOTE: The MiCOM relay does not respond to globally broadcast frames sent out by the master.

2.3.2 Format of frames sent by the MiCOM relays

Frame sent by the MiCOM relay (response)

Slave number	Function code	Data	CRC16
1 byte	1 byte	n bytes	2 bytes
1 à FFh	1 à 10h		

Slave number:

The slave number is situated between 1 and 255.

Function code:

Processed MODBUS function (1 to 16).

Data:

Contains reply data to master query .

CRC 16:

Value of the CRC 16 calculated by the slave.

2.3.3 Messages validity check

When **MiCOM P120, P121, P122** and **P123** relays receive a master query, it validates the frame:

If the CRC is false, the frame is invalid. **MiCOM P120, P121, P122** and **P123** relays do not reply to the query. The master must retransmit its query. Excepting a broadcast message, this is the only case of non-reply by **MiCOM P120, P121, P122** and **P123** relays to a master query.

If the CRC is good but the MiCOM relay can not process the query, it sends an exception response.

Warning frame sent by the MiCOM relay (response)

Slave number	Function code	Warning code	CRC16
1 byte	1 byte	1 byte	2 bytes
1 to FFh	81h or 83h or 8Ah or 8Bh		pf ... PF

Slave number:

The slave number is situated between 1 and 255.

Function code:

The function code returned by the MiCOM relay in the warning frame is the code in which the most significant bit (b7) is forced to 1.

Warning code:

On the 8 warning codes of the MODBUS protocol, the MiCOM relay manages two of them:

- code 01: function code unauthorised or unknown.
- code 03: a value in the data field is unauthorised ( incorrect data ).
  - Control of pages being read
  - Control of pages being written
  - Control of addresses in pages
  - Length of request messages

CRC16:

Value of the CRC16 calculated by the slave.

### 3. MiCOM P120, P121, P122 AND P123 RELAY DATABASE ORGANISATION

#### 3.1 Description of the application mapping

##### 3.1.1 Settings

MiCOM P122 and P123 application mapping has 9 pages of parameters.

Parameters are organized in pages.

MiCOM P12y application mapping has 7 pages of parameters.

The characteristics are the following:

Page	Data type	Read permission	Write permission
0h	Product information, remote signalling, measurements	Through communication	
1h	General remote parameters	X	X
2h	Setting group 1 remote parameters	X	X
3h	Setting group 2 remote parameters	X	X
4h	Remote controls	X	X
5h	Boolean equations	X	X
6h	General remote parameters (part 2)	X	X
7h	Quick reading byte	Fast	
8h	Time synchronisation (only for P122, P123)	X	X

They are completely listed below.

##### 3.1.2 Disturbance records (P122, P123)

Before uploading any disturbance record, a service request must be send to select the record number to be uploaded.

The answer following this request contain the following information:

1. Numbers of samples (pre and post time)
2. Phase CT ratio
3. Earth CT ratio
4. Internal phase and earth ratios
5. Number of the last disturbance mapping page
6. Number of samples in this last disturbance mapping page

**The mapping pages used for this service request are from 38h to 3Ch.**

**Pages 9h to 21h:** Contain the disturbance data (25 pages)

A disturbance mapping page contains 250 words:

0900 à 09FAh: 250 disturbance data words

0A00 à 0AFAh: 250 disturbance data words

0B00 à 0BFAh: 250 disturbance data words

2100 à 21FAh: 250 disturbance data words

**The disturbance data pages contain the sample of a single channel from a record.**

**Page 22h:** contains the index of the disturbance

**Page 38h à 3Ch:** Selection of the disturbance record and channel

**Page 3Dh:** A dedicated request allows to know the number of disturbance records stored in SRAM.

### 3.1.3 Event records (P122, P123)

To upload the event records two requests are allowed:

**Page 35h:** Request to upload an event record without acknowledge of this event.

Used addresses:

3500h:	EVENT 1
...	
354Ah:	EVENT 75
...	
35F9h	EVENT 250

**Page 36h:** Request to upload the non-acknowledged oldest stored event record. Two modes are available for the acknowledgement: automatic acknowledgement or manual acknowledgement

The mode depends of the state of bit 12 of telecommand word (address 400 h).

If this bit is set, then the acknowledgement is manual else the acknowledgement is automatic.

In automatic mode, the reading of the event acknowledges the event.

In manual mode, it is necessary to write a specific command to acknowledge the oldest event.

(set the bit 13 of control word 400 h )

### 3.1.4 Fault records (P122, P123)

**Page 37h:** Page dedicated to upload fault record

Used addresses:

3700h:	FAULT 1
3701h:	FAULT 2
...	
3718h:	FAULT 25

**Page 3Eh:** Request to upload the non-acknowledged oldest stored fault record.

Two modes are available for the acknowledgement: automatic acknowledgement or manual acknowledgement

The mode depends of the state of bit 12 of telecommand word (address 400 h).

If this bit is set, then the acknowledgement is manual else the acknowledgement is automatic.

In automatic mode, the reading of the fault acknowledges automatically the event.

In manual mode, it is necessary to write a specific command to acknowledge the oldest fault.

(set the bit 14 of control word 400 h )

MiCOM P120/P121/P122/P123

3.1.5 Characteristics

Page 0h can only be read through communication.

Pages 1h, 2h, 3h and 4h can be read and write.

Page 7h can be access in quick reading only.

Page 8h can be write (P122, P123 only).

They are describe more precisely in the following chapters.

3.2 Page 0h (Read access only)

Read access only.

Legend:       Reserved:       Free for future use  
               Obsolete:       Do not use (reserved for old versions)

Address	Group	Description	Values range	Step	Unit	Format	Fault Value	Range
0000	Product Information	Relay description characters 1 and 2	32-127	1		F10		P120 to P123
0001		Relay description characters 3 and 4	32-127	1		F10	P1	P120 to P123
0002		Relay description characters 5 and 6	32-127	1		F10	23	P120 to P123
0003		Unit reference characters 1 and 2	32-127	1		F10	AL	P120 to P123
0004		Unit reference characters 3 and 4	32-127	1		F10	ST	P120 to P123
0005		Software version	10-xx	1		F21		P120 to P123
0006		Communication description	0-3	1		F41		P120 to P123
0007		Internal phase ratio	800			F1	800	P122-P123
0008		Internal earth ratio : 0.1 to 40 lon range 0.01 to 8 lon range 0.002 to 1 lon range	800 3277 32700			F1	800 3277 32700	P120 to P123
0009		General start info.	0-1	1		F1		P120 to P123
000A to 000B		Reserved						P120 to P123
000C		LED Status	0-255			F73		P120 to P123
000D		Real Active Setting Group (after taking into account the protection flags)	1-2			F1		P122-P123
000E		Password active				F24	0	P120 to P123
000F		Device status				F45		P120 to P123
0010	Remote signalling	Logical inputs	0 to 7 or to 31	1		F12		P120 to P123
0011		Logical data status Part 1/2	0 to FFFF	2 <sup>n</sup>		F20a		P120 to P123
0012		Trip status	0 to FFFF	2 <sup>n</sup>		F22		P120 to P123
0013		Output contacts	0 to 127 or to 511	1		F13		P120 to P123
0014		Status information l>	0 to FFFF	1		F17		P121 to P123
0015		Status information l>>	0 to FFFF	1		F17		P121 to P123
0016		Status information l>>>	0 to FFFF	1		F17		P121 to P123
0017		Status information lE>	0 to FFFF	1		F16		P120 to P123
0018		Status information lE>>	0 to FFFF	1		F16		P120 to P123
0019		Status information lE>>>	0 to FFFF	1		F16		P120 to P123
001A		l> memorisation	0 to FFFF	1		F17		P121 to P123
001B		l>> memorisation	0 to FFFF	1		F17		P121 to P123
001C		l>>> memorisation	0 to FFFF	1		F17		P121 to P123
001D		tl> memorisation	0 to FFFF	1		F17		P121 to P123
001E		tl>> memorisation	0 to FFFF	1		F17		P121 to P123
001F		tl>>> memorisation	0 to FFFF	1		F17		P121 to P123
0020		Thermal state information	0 to 1	1		F37		P122-P123
0021		Status information l<	0 to FFFF	1		F17		P122-P123
0022		Status information l2>	0 to FFFF	1		F16		P122-P123
0023		Output information Part 1/2	0 to FFFF	1		F38		P121 to P123
0024		tl< memorisation	0 to FFFF	1		F17		P122-P123

Address	Group	Description	Values range	Step	Unit	Format	Fault Value	Range
0025		Memorised flags for non acknowledged alarms Part 1/3				F36a		P122-P123
0026		Number of disturbance records available	0 to 5	1		F31		P122-P123
0027		Tripping status (RL1) Fault origin	0 to 1 0 to 28	1 1		F1 F81		P120-P121 P122-P123
0028		CB supervision flag				F43		P122-P123
0029		Memorised flags for non acknowledged alarms Part 2/3				F44		P122-P123
002A		Logical data status Part 2/2	0 to FFFF	2n		F20b		P120 to P123
002B		Status information I2>>	0 to FFFF	1		F16		P122-P123
002C		Memorised flags for non acknowledged alarms Part 3/3				F36b		P122 P123
002D		Reserved						P120 to P123
002E		Memorised latched relays	0 to 127 or to 511	1		F13		P120 to P123
002F		Reserved						P120 to P123
0030	Remote measurements	Phase A current RMS value	0 to 600000	1	1/100 A	F18		P121 to P123
0032		Phase B current RMS value	0 to 600000	1	1/100 A	F18		P121 to P123
0034		Phase C current RMS value	0 to 600000	1	1/100 A	F18		P121 to P123
0036		Earth current RMS value	0 to 600000	1	1/100 A	F18		P120 to P123
0038 to 0039		Reserved						P120 to P123
003A		Thermal state (saved)			%	F1		P122-P123
003B		Frequency	4500 to 6500	1	1/100 Hz	F1		P120 to P123
003C		Max RMS value phase A	0 to 600000	1	1/100 A	F18		P122-P123
003E		Max RMS value phase B	0 to 600000	1	1/100 A	F18		P122-P123
0040		Max RMS value phase C	0 to 600000	1	1/100 A	F18		P122-P123
0042		Average RMS value Phase A	0 to 600000	1	1/100 A	F18		P122-P123
0044		Average RMS value Phase B	0 to 600000	1	1/100 A	F18		P122-P123
0046		Average RMS value Phase C	0 to 600000	1	1/100 A	F18		P122-P123
0048		Harmonic IE	0 to 600000	1	1/100 A	F18		P122-P123
004A		I2 current fundamental value	0 to 600000	1	1/100 A	F18		P122-P123
004C		I1 current fundamental value	0 to 600000	1	1/100 A	F18		P122-P123
004E		I2/I1 ratio			%	F1		P122-P123
004F		Reserved						P120 to P123
0050	Fourier Module	Module IA		1	CAN	F1		P121 to P123
0051		Module IB		1	CAN	F1		P121 to P123
0052		Module IC		1	CAN	F1		P121 to P123
0053		Module IE		1	CAN	F1		P120 to P123
0054	Fourier Argument	Argument IA		°		F1		P121 to P123
0055		Argument IB		°		F1		P121 to P123
0056		Argument IC		°		F1		P121 to P123
0057		Argument IE		°		F1		P120 to P123
0058		Module I2		°		F1		P122-P123
0059		Module I1		°		F1		P122-P123
005A	Recloser statistics	Cycle total number				F1		P123
005B		Cycle 1 number				F1		P123
005C		Cycle 2 number				F1		P123
005D		Cycle 3 number				F1		P123
005E		Cycle 4 number				F1		P123
005F		Definitive tripping number				F1		P123
0060		Closing order number				F1		P123
0061	Rolling Demand	Average sliding time window- RMS IA	0 to 600000	1	1/100 A	F18		P122-P123
0063		Average sliding time window- RMS IB	0 to 600000	1	1/100 A	F18		P122-P123
0065		Average sliding time window- RMS IC	0 to 600000	1	1/100 A	F18		P122-P123

MiCOM P120/P121/P122/P123

Address	Group	Description	Values range	Step	Unit	Format	Fault Value	Range
0067		Maximum of the sub period average value RMS phase A	0 to 600000	1	1/100 A	F18		P122-P123
0069		Maximum of the sub period average value RMS phase B	0 to 600000	1	1/100 A	F18		P122-P123
006B		Maximum of the sub period average value RMS phase C	0 to 600000	1	1/100 A	F18		P122-P123
006D to 006F		Reserved						P122-P123
0070		Output information SOTF	0 to FFFF	1		F54		P123
0071	Boolean equations	Boolean equation status				F61		P121 to P123
0072	Remote signalling	Output information part 2/2	0 to FFFF	1		F79		P121 to P123
0073	Remote signaling	Output information IE derived	0 to FFFF	1		F16		P122 - P123
0074	Fourier module	Module IE derived				F1		P122 - P123
0075	Fourier Argument	Argument calculated IE				F1		P121 to P123
0076	Closing origin	Closing origin status	0 - 63	1		F75		P123
0077	CB monitoring measurements	CB Operations number / time		1		F1	0	P123

**3.3 Page 1h**

Read and write access

Address	Group	Description	Values range	Step	Unit	Format	Fault Value	Range
0100	Remote settings	Address of front/rear port: MODBUS IEC 60870-5-103	1 - 255 1 - 255	1		F1	1	P120 to P123
0101		Reserved						
0102		Password (characters 1 and 2)	32 -127	1		F10	AA	P120 to P123
0103		Password (characters 3 and 4)	32 -127	1		F10	AA	P120 to P123
0104		Frequency	50-60	10	Hz	F1	50	P120 to P123
0105		Phase A label	L1-A-R	VTA		F25	A	P121 to P123
0106		Phase B label	L2-B-S	VTA		F25	B	P121 to P123
0107		Phase C label	L3-C-T	VTA		F25	C	P121 to P123
0108		Earth label	N-G-E	VTA		F25	N	P120 to P123
0109		By default display	1-4	1		F26	1	P120 to P123
010A		User reference (characters 1 and 2)	32-127	1		F10	AL	P120 to P123
010B		User reference (characters 3 and 4)	32-127	1		F10	ST	P120 to P123
010C		Faults number to be displayed by default	1-25	1		F31	5	P122-P123
010D		Level signalisation of logic inputs	0-31	31		F12	0	P122-P123
010E		Instantaneous fault number to be displayed	1-5	1		F31	5	P122-P123
010F		Voltage Type applied to the logic inputs	0-1	1		F50	0	P122-P123
0110	CB monitoring measurements	Operations number		1		F1		P122-P123
0111		CB Operating time		1	1/100 s	F1		P122-P123
0112-0113		Switched square Amps phase A sum			An	F18		P122-P123
0114-0115		Switched square Amps phase B sum			An	F18		P122-P123
0116-0117		Switched square Amps phase C sum			An	F18		P122-P123
0118		CB Closing time			1/100 s	F1		P122-P123
0119 to 011D		Reserved						P120 to P123
011E		Maintenance mode						P122-P123
011F		Relays Latching				F14		P121 to P123
0120	Ratio	Primary phase CT value	1 to 50000	1		F1	1000	P121 to P123
0121		Secondary phase CT value	1 to 5	4		F1	1	P121 to P123
0122		Primary earth CT value	1 to 50000	1		F1	1000	P120 to P123
0123		Secondary earth CT value	1 to 5	4		F1	1	P120 to P123
0124 to 012D		Reserved						P120 to P123
012E		Fail safe and inversion relays		1		F60	0	P120 to P123
012F		Rotation phase sequence	0 to 1	1		F51	0	P121 to P123
0130	Communication	Speed	0 to 7	1		F4	6 = 19200 bds	P120 to P123
0131		Parity	0 to 2	1		F5	0 = without	P120 to P123



MiCOM P120/P121/P122/P123

Address	Group	Description	Values range	Step	Unit	Format	Fault Value	Range
0132		Data bits	0 to 1	1		F28	1 = 8 bits	P120 to P123
0133		Stop bit	0 to 1	1		F29	0 = 1 stop bit	P120 to P123
0134		COM available	0 to 1	1		F30	1=COM available	P120 to P123
0135		Date Format	0 to 1	1		F48	0= Private	P120-P122-P123
0136		IEC870-5-103 Private messages option	0 to 1	1		F56	0= Public	P120 to P123
0137		Address of rear port: COURIER DNP3	1 - 255 1 - 59999				255 1	P120 to P123
0138 to 013F		Reserved					0	P120 to P123
0140	Configuration	Setting group	1 to 2	1		F1	1	P122-P123
0141		Validation of instantaneous alarms auto reset	0 to 1	1		F1	0	P122-P123
0142		Configuration of change of group selection	0 to 1	1		F47	1	P122-P123
0143		Reserved						
0144		Configuration of LED reset on fault	0 to 1	1		F1	0	P122-P123
0145 to 0149		Reserved					0	P120 to P123
014A	Output Relays allocation	Max I2>>	0 to 31	1		F14	0	P122-P123
014B to 014F		Reserved						
0150	LEDs allocation	Led 5 Part 1/3		1		F19a	4	P120 to P123
0151		Led 6 Part 1/3		1		F19a	16	P120 to P123
0152		Led 7 Part 1/3		1		F19a	32	P120 to P123
0153		Led 8 Part 1/3		1		F19a	64	P120 to P123
0154		Led 5 Part 2/3		1		F19b	0	P120 to P123
0155		Led 6 Part 2/3		1		F19b	0	P120 to P123
0156		Led 7 Part 2/3		1		F19b	0	P120 to P123
0157		Led 8 Part 2/3		1		F19b	0	P120 to P123
0158 to 015A		Reserved						P120 to P123
015B	Logic input allocation	Logic input 1 Part 2/2				F15b	0	P122-P123
015C		Logic input 2 Part 2/2				F15b	0	P122-P123
015D		Logic input 3 Part 2/2				F15b	0	P122-P123
015E		Logic input 4 Part 2/2				F15b	0	P123
015F		Logic input 5 Part 2/2				F15b	0	P123
0160	Logic input allocation	Logic input 1 Part 1/2				F15a	0	P120 to P123
0161		Logic input 2 Part 1/2				F15a	0	P120 to P123
0162		Logic input 3 Part 1/2				F15a	0	P122-P123
0163		Logic input 4 Part 1/2				F15a	0	P123
0164		Logic input 5 Part 1/2				F15a	0	P123
0165	Output relays allocation	Broken conductor detection	0-31	1		F14	0	P122-P123
0166		CB failure	0 - 31	1		F14	0	P122-P123

Address	Group	Description	Values range	Step	Unit	Format	Fault Value	Range
0167		tI<	0 - 31	1		F14	0	P122-P123
0168		I2>	0 - 31	1		F14	0	P122-P123
0169		Thermal overload alarm	0 - 31	1		F14	0	P122-P123
016A		Thermal overload trip	0-31	1		F14	0	P122-P123
016B		CB close	0-31	1		F14	0	P121 to P123
016C		tAUX1	0-31	1		F14	0	P120 to P123
016D		tAUX2	0-31	1		F14	0	P120 to P123
016E		CB alarms	0-31	1		F14	0	P122-P123
016F		Trip circuit	0-31	1		F14	0	P123
0170		Active setting group 2	0 - 31	1		F14	0	P122-P123
0171		Trip	0 - 31	1		F14	1	P120 to P123
0172		tI>	0 - 31	1		F14	0	P121 to P123
0173		tI>>	0 - 31	1		F14	0	P121 to P123
0174		tI>>>	0 - 31	1		F14	0	P121 to P123
0175		tIE>	0 - 31	1		F14	0	P120 to P123
0176		tIE>>	0 - 31	1		F14	0	P120 to P123
0177		tIE>>>	0 - 31	1		F14	0	P120 to P123
0178		I>	0 - 31	1		F14	0	P121 to P123
0179		I>>	0 - 31	1		F14	0	P121 to P123
017A		I>>>	0 - 31	1		F14	0	P121 to P123
017B		IE>	0 - 31	1		F14	0	P120 to P123
017C		IE>>	0 - 31	1		F14	0	P120 to P123
017D		IE>>>	0 - 31	1		F14	0	P120 to P123
017E		Recloser running	0 - 31	1		F14	0	P123
017F		Recloser final trip	0 - 31	1		F14	0	P123
0180	Automation	Tripping configuration Part 1/2	0 to 65535	1		F6a	1	P120 to P123
0181		Latching function configuration part 1/2	0 to 65535	1		F7a	0	P120 to P123
0182		Blocking logic 1 Part 1/2	0 to 65535	1		F8a	0	P120 to P123
0183		Blocking logic 2 Part 1/2	0 to 65535	1		F8a	0	P122-P123
0184		Broken conductor detection	0 - 1	1		F24	0	P122-P123
0185		tBC	0 to 14400	1		F1	0	P122-P123
0186		Cold load pick-up activation	0 - 1	1		F24	0	P122-P123
0187		Cold load pick-up sources	0 to 255	1		F33	0	P122-P123
0188		Cold load pick-up level (%)	20 to 800	1		F1	50	P122-P123
0189		Cold load pick-up start delay	1 to 36000*	1	1/10 s	F1	10	P122-P123
018A		CB failure	0 - 1	1		F24	0	P122-P123
018B		tBF	0 to 1000	1	1/100 s	F1	10	P122-P123
018C		Logic Selectivity1	0 to 31	1		F40	0	P122-P123
018D		tSEL1	0 to 15000	1	1/100 s	F1	0	P122-P123
018E		Logic Selectivity2	0 to 31	1		F40	0	P122-P123
018F		tSEL2	0 to 15000	1	1/100 s	F1	0	P122-P123

MiCOM P120/P121/P122/P123

Address	Group	Description	Values range	Step	Unit	Format	Fault Value	Range
0190	Disturbance	Pre-time	1 to 29 1 to 36 1 to 49 1 to 74 1 to 149	1	1/10 s	F1	1	P122-P123
0191		Do not use						
0192		Disturbance starting condition	0 - 1	1		F32	0	P122-P123
0193	CB supervision	Operating time supervision	0 - 1	1		F24	0	P122-P123
0194		Operating time threshold	5 to 100	5	1/100 s	F1	5	P122-P123
0195		Operations number supervision	0 - 1	1		F24	0	P122-P123
0196		Operations number threshold	0 - 50000	1		F1	0	P122-P123
0197		CB switched Amps sum supervision (Power n)	0 - 1	1		F24	0	P122-P123
0198		CB switched Amps sum threshold	0 to 4000		10E6 An			P122-P123
0199		Amps or square Amps	1 - 2	1		F1	1	P122-P123
019A		Closing time threshold	5 to 100	5	1/100 s	F1	0	P122-P123
019B	Aux inputs	Auxiliary timer 1	0 to 20000	1	1/100 s	F1	0	P120 to P123
019C		Auxiliary timer 2	0 to 20000	1	1/100 s	F1	0	P120 to P123
019D	Max. & average measurement	Peak value	5 to 60		min	F42	5	P122-P123
019E	Broken conductor	I2 / I1 threshold	20 to 100	1	%	F1	20	P122-P123
019F	CB supervision	Tripping time	10 to 500	5	1/100 s	F1	10	P122-P123
01A0		Closing time	10 to 500	5	1/100 s	F1	10	P122-P123
01A1		Closing time threshold supervision	0 - 1	1		F24	0	P122-P123
01A2	CB Fail	Trip circuit supervision	0 - 1	1		F24	0	P122-P123
01A3		t SUP	10 to 1000	5	1/100 s	F1	10	P122-P123
01A4		I< threshold CB failure	10 - 100	1	%In	F1	10	P122-P123
01A5		Instantaneous phase blocking if CB failure	0 - 1	1		F24	0	P122-P123
01A6		Instantaneous earth blocking if CB failure	0 - 1	1		F24	0	P122-P123
01A7	Rolling Demand	Sub period	0 - 60	1	min	F1		P122-P123
01A8		Sub period number	0 - 24	1		F1		P122-P123
01A9	Output relays allocation	Communication Order 1	0 - 31	1		F14	0	P122-P123
01AA		Communication Order 2	0 - 31	1		F14	0	P122-P123
01AB		Communication Order 3	0 - 31	1		F14	0	P122-P123
01AC		Communication Order 4	0 - 31	1		F14	0	P122-P123
01AD		T comm 1	10 - 60000	5	1/100s	F1	10	P122-P123
01AE		T comm 2	10 - 60000	5	1/100s	F1	10	P122-P123
01AF		T comm 3	10 - 60000	5	1/100s	F1	10	P122-P123
01B0		T comm 4	10 - 60000	5	1/100s	F1	10	P122-P123
01B1		tAux3	0 - 31	1		F14	0	P122-P123
01B2		tAux4	0 - 31	1		F14	0	P123
01B3		Auxiliary timer3	0 - 20000	1	1/100s	F1	0	P122-P123
01B4		Auxiliary timer4	0 - 20000	1	1/100s	F1	0	P123
01B5 - 01BC	Courier	Courier Description	32-127	1		F10	P1	P120 to P123

Address	Group	Description	Values range	Step	Unit	Format	Fault Value	Range
01BD	Automation	Cold Load start detection	0 to 3	1		F76	1	P122 – P123
01BE – 01F5		Reserved						
01F6	Output relays allocation	Remote trip	0 – 31	1		F14	0	P121 - P123
01F7		Remote close	0 – 31	1		F14	0	P121 - P123
01F8	Automatisms	SOTF function	0 – 1	1		F24	0	P123
01F9		SOTF timer	0 - 500	1	1/1000s	F1	0	P123
01FA		SOTF parameter l>> or l>>>	0 - 3	1		F53	0	P123
01FB		Tripping configuration Part 2/2	0 to 4095	1		F6b	0	P121 to P123
01FC		Latching function configuration part 2/2	0 to 4095	1		F7b	0	P122- P123
01FD	Output relays allocation	SOTF	0 - 31	1		F14	0	P123
01FE		Internal blocked recloser	0 - 31	1		F14	0	P123
01FF		reserved						

NOTE: this needs to be corrected in the next comms database to:

- (1) SOTF function
- (2) SOTF timer,
- (3) SOTF parameter l>> or l>>>,
- (3) SOTF

MiCOM P120/P121/P122/P123

3.4 Page 2h (Access in reading and in writing)

Access in reading and in writing

Address	Group	Description	Values range	Step	Unit	Format	Fault Value	Range
0200	[50/51] Phase Overcurrent Protection	l> activation	0-1	1		F24	0	P121 to P123
0201		l> threshold	10 to 2500	1	1/100 In	F1	10	P121 to P123
0202		l> time delay type	0 to 2	1		F27a	0	P121 to P123
0203		l> IDMT Curve Type	0 to 10	1		F3a	1	P121 to P123
0204		l> TMS value	25 to 1500	1	1/1000	F1	25	P121 to P123
0205		l> K value (RI curve)	100 to 10000	5	1/1000	F1	100	P121 to P123
0206		tl> value	0 to 15000	1	1/100 s	F1	4	P121 to P123
0207		l> Reset type	0 - 1	1		F27a	0	P122-P123
0208		l> RTMS value	25 to 3200	1	1/1000	F1	25	P122-P123
0209		l> tRESET value	0 to 60000	1	1/100 s	F1	0	P122-P123
020A		l> Interlock	0-1	1		F24	0	P121 to P123
020B to 020F		Reserved					0	P120 to P123
0210		l>> activation	0-1	1		F24	0	P121 to P123
0211		l>> Threshold	50 to 4000	5	1/100 In	F1	50	P121 to P123
0212		tl>> value	0 to 15000	1	1/100 s	F1	1	P121 to P123
0213		l>> time delay type	0 – 2	1		F27a	0	P122-P123
0214		l>> IDMT curve type	0 – 10	1		F3a	1	P122-P123
0215		l>> TMS value	25 – 1500	1	1/1000	F1	25	P122-P123
0216		K value (RI curve)	100 – 10000	5	1/1000	F1	100	P122-P123
0217		l>> Reset Type	0 – 1	1		F27a	0	P122-P123
0218		l>> RTMS value	25 – 3200	1	1/1000	F1	25	P122-P123
0219		l>> tRESET value	0 to 60000	1	1/100 s	F1	0	P122-P123
021A to 021F		Reserved					0	P120 to P123
0220		l>>> activation	0-1	1		F24	0	P121 to P123
0221		l>>> Threshold	50 to 4000	5	1/100 In	F1	50	P121 to P123
0222		tl>>> value	0 to 15000	1	1/100 s	F1	1	P121 to P123
0223		"l>>> on sample" activation	0 – 1	1		F24	0	P120-P122-P123
0223 to 022F		Reserved					0	P120 to P123
0230	[50N/51N] Earth Overcurrent Protection	IE> activation	0-1	1		F24	0	P120 to P123
0231		IE> Threshold Low sensitivity	10 to 2500	1	1/100 IEn	F1	10	P120 to P123
		Med. sensitivity	10 to 2000	5	1/1000 IEn		10	
		High sensitivity	2 to 1000	1	1/1000 IEn		2	
0232		IE> time delay type	0 to 3	1		F27b	0	P120 to P123
0233		IE> IDMT curve type	0 to 11	1		F3a	1	P120 to P123
0234		IE> TMS value	25 to 1500	1	1/1000	F1	25	P120 to P123

Address	Group	Description	Values range	Step	Unit	Format	Fault Value	Range
0235		IE> K value (RI curve)	100 to 10000	5	1/1000	F1	100	P120 to P123
0236		tIE> value	0 to 15000	1	1/100 s	F1	4	P120 to P123
0237		IE> reset type	0 - 1	1		F27a	0	P122-P123
0238		IE> RTMS value	25 to 3200	1	1/1000	F1	25	P122-P123
0239		IE> tRESET value	0 to 60000	1	1/100 s	F1	0	P122-P123
023A		IE> RXIDG curve (Belgium)	0 to 7	0	1	F3b	0	P122-P123
023B		IE> Interlock	0-1	1		F24	0	P121 to P123
023C to 023F		Reserved						P120 to P123
0240		IE>> activation	0-1	1		F24	0	P120 to P123
0241		IE>> Threshold				F1		P120 to P123
		Low sensitivity	50 to 4000	1	1/100 IEn		50	
		Med. sensitivity	10 to 8000	5	1/1000 IEn		10	
		High sensitivity	2 to 1000	1	1/1000 IEn		2	
0242		tIE>> value	0 to 15000	1	1/100 s	F1	1	P120 to P123
0243		IE>> time delay type	0 to 3	1		F27b	0	P122-P123
0244		IE>> IDMT curve type	0 to 11	1		F3a	1	P122-P123
0245		IE>> TMS value	25 to 1500	1	1/1000	F1	25	P122-P123
0246		IE>> K value (RI curve)	100 to 10000	5	1/1000	F1	100	P122-P123
0247		IE>> Reset Type	0 - 1	1		F27a	0	P122-P123
0248		IE>> RTMS value	25 - 3200	1	1/1000	F1	25	P122-P123
0249		IE>> tRESET value	0 to 60000	1	1/100 s	F1	0	P122-P123
024A		IE>> RXIDG curve (Belgium)	0 to 7	0	1	F3b	0	P122-P123
024B to 024E		Reserved					0	P120 to P123
024F		"IE>>> on sample" activation	0 - 1	1		F24	0	P122-P123
0250		IE>>>	0-1	1		F24	0	P120 to P123
0251		IE>>> Threshold				F1		P120 to P123
		Low sensitivity	50 to 4000	1	1/100 IEn		50	
		Med. sensitivity	10 to 8000	5	1/1000 IEn		10	
		High sensitivity	2 to 1000	1	1/1000 IEn		2	
0252		tIE>>>value	0 to 15000	1	1/100 s	F1	1	P120 to P123
0253	[49] Thermal Overload Protection	lth> activation	0 - 1	1		F24	0	P122-P123
0254		lth> Threshold	10 to 320	5	1/100	F1	8	P122-P123
0255		lth> k value	100 to 150	1	1/100	F1	105	P122-P123
0256		lth> trip threshold	50 to 200	1	%	F1	100	P122-P123
0257		lth> alarm activation	0 - 1	1		F24	0	P122-P123
0258		lth> alarm threshold	50 to 200	1	%	F1	90	P122-P123
0259		Thermal overload time constant	1 to 200	1	mn	F1	1	P122-P123
025A	[37] Phase Undercurrent Protection	lc activation	0-1	1		F24	0	P122-P123

MiCOM P120/P121/P122/P123

Address	Group	Description	Values range	Step	Unit	Format	Fault Value	Range
025B		I< threshold	0 to 100	1	% In	F1	20	P122-P123
025C	[46] Negative Sequence Protection	I2> activation	0-1	1		F24	0	P122-P123
025D		I2> threshold	10 to 4000	1	1/100 In	F1	10	P122-P123
025E		I2> time delay type	0 to 2	1		F27a	0	P122-P123
025F		I2> IDMT type	0 to 9	1		F3a	1	P122-P123
0260		I2> TMS value	25 to 1500	1	1/1000	F1	25	P122-P123
0261		I2> K value (RI)	100 to 10000	5	1/1000	F1	100	P122-P123
0262		tI2> value	0 to 15000	1	1/100 s	F1		P122-P123
0263		I2> Reset type	0 - 1	1		F27a	0	P122-P123
0264		I2> RTMS value	25 to 3200	1	1/1000	F1	25	P122-P123
0265		I2> tRESET value	4 to 10000	1	1/100 s	F1	4	P122-P123
0266		I2>> activation	0 - 1	1		F24	0	P122-P123
0267		I2>> Threshold	10 - 4000	1	1/100 In	F1	10	P122-P123
0268		t2>> value	0 to 15000	1	1/100 s	F1		P122-P123
0269 to 026D		Reserved					0	P120 to P123
026E	Next... [37] I<	Inhibition of I< on 52A	0-1	1		F24	0	P122 P123
026F		tI< value	0 to 15000	1	1/100 s	F1		P122-P123
0270	[79] Autoreclose	Recloser activation	0 - 1	1		F24	0	P123
0271		CB position active	0 - 1	1		F1	0	P123
0272-0273		Supervision window	1 to 60000	1	1/100 s	F18	1	P123
0274		External blocking input	0 - 1	1		F24	0	P123
0275 - 0276		Reserved					0	P120 to P123
0277		Dead time 1	5 to 30000	1	1/100 s	F1	5	P123
0278		Dead time 2	5 to 30000	1	1/100 s	F1	5	P123
0279-027A		Dead time 3	5 to 60000	1	1/100 s	F18	5	P123
027B-027C		Dead time 4	5 to 60000	1	1/100 s	F18	5	P123
027D-027E		Reclaim time	2 to 60000	1	1/100 s	F18	2	P123
027F-0280		Inhibit time	2 to 60000	1	1/100 s	F18	2	P123
0281		Recloser cycles for phase faults	0 to 4	1		F1	0	P123
0282		Recloser cycles for earth faults	0 to 4	1		F1	0	P123
0283		I> Phase cycle configuration	0 - 2222	1		F49	0	P123
0284		I>> Phase cycle configuration	0 - 2222	1		F49	0	P123
0285		I>>> Phase cycle configuration	0 - 2222	1		F49	0	P123
0286		IE> Phase cycle configuration	0 - 2222	1		F49	0	P123
0287		IE>> Phase cycle configuration	0 - 2222	1		F49	0	P123
0288		IE>>> Phase cycle configuration	0 - 2222	1		F49	0	P123
0289		TAUX1 cycle configuration (phase group)	0 - 3333	1		F49	0	P123
028A		TAUX2 cycle configuration (earth group)	0 - 3333	1		F49	0	P123
028B		Trips nb / time blocks AR (function activation)	0-1	1		F24	0	P123

Address	Group	Description	Values range	Step	Unit	Format	Fault Value	Range
028C		CB Operations number / time threshold	2 - 100	1		F1	10	P123
028D		Period for CB Operations number / time	10 to 1440	10	mn	F1	10	P123
028E-028F		Minimum Dead Time for tI>	5 to 60000	1	1/100 s	F18	5	P123
0290-0291		Minimum Dead Time for tI>>	5 to 60000	1	1/100 s	F18	5	P123
0292-0293		Minimum Dead Time for tI>>>	5 to 60000	1	1/100 s	F18	5	P123
0294-0295		Minimum Dead Time for tIE>	5 to 60000	1	1/100 s	F18	5	P123
0296-0297		Minimum Dead Time for tIE>>	5 to 60000	1	1/100 s	F18	5	P123
0298-0299		Minimum Dead Time for tIE>>>	5 to 60000	1	1/100 s	F18	5	P123
029A-029F		Reserved						
02A0	[50N/51N] le>>>>	le>>>> activation	0-1	1		F24	0	P122-P123
02A1		le>>>> Threshold	10 to 4000	1	1/100 IEn	F1	10	P122-P123
02A2		le>>>> time delay type	0 to 1	1		F27a	0	P122-P123
02A3		le>>>> IDMT curve type	0 to 11	1		F3a	1	P122-P123
02A4		le>>>> TMS value	25 to 1500	1	1/1000	F1	25	P122-P123
02A5		le>>>> K value (RI curve)	100 to 10000	5	1/1000	F1	100	P122-P123
02A6		tIe>>>> value	0 to 15000	1	1/100 s	F1	4	P122-P123
02A7		le>>>> reset type	0 - 1	1		F27a	0	P122-P123
02A8		le>>>> RTMS value	25 to 3200	1	1/1000	F1	25	P122-P123
02A9		le>>>> tRESET value	0 to 60000	1	1/100 s	F1	0	P122-P123
02AA		le>>>> RXIDG curve (Belgium)	0 to 7	0	1	F3b	0	P122-P123
02AB to 02AF		Reserved					0	P120 to P123

### 3.5 Page 3h (Access in reading and in writing)

The same as page 2H except addresses are 03XX instead of 02XX.

### 3.6 Page 4h Access in writing

Address	Group	Description	Values range	Step	Unit	Format	Fault Value	Range
0400	Remote control	Remote control Part 1/2	0 to 31	1		F9a	0	P120 to P123
0401		Reserved					0	P120 to P123
0402		Remote contro of output relays in maintenance mode	0 to 511	1		F39	0	P122-P123
0403		Remote control Part 2/2	0 to 1	1		F9b	0	P122-P123



MiCOM P120/P121/P122/P123

**3.7 Page 5h**

3.7.1 For P121 P122 and P123

Address (hex)	Group	Description	Values range	Step	Unit	Format	Def. Value
0500	<b>Bool Equations</b>	Equation A.00 operator	0 - 1	1		F70	0
0501		Equation A.00 operand	0 - 36	1		F72	0
0502		Equation A.01 operator	0 - 3	1		F71	0
0503		Equation A.01 operand	0 - 36	1		F72	0
0504		Equation A.02 operator	0 - 3	1		F71	0
0505		Equation A.02 operand	0 - 36	1		F72	0
0506		Equation A.03 operator	0 - 3	1		F71	0
0507		Equation A.03 operand	0 - 36	1		F72	0
0508		Equation A.04 operator	0 - 3	1		F71	0
0509		Equation A.04 operand	0 - 36	1		F72	0
050A		Equation A.05 operator	0 - 3	1		F71	0
050B		Equation A.05 operand	0 - 36	1		F72	0
050C		Equation A.06 operator	0 - 3	1		F71	0
050D		Equation A.06 operand	0 - 36	1		F72	0
050E		Equation A.07 operator	0 - 3	1		F71	0
050F		Equation A.07 operand	0 - 36	1		F72	0
0510		Equation A.08 operator	0 - 3	1		F71	0
0511		Equation A.08 operand	0 - 36	1		F72	0
0512		Equation A.09 operator	0 - 3	1		F71	0
0513		Equation A.09 operand	0 - 36	1		F72	0
0514		Equation A.10 operator	0 - 3	1		F71	0
0515		Equation A.10 operand	0 - 36	1		F72	0
0516		Equation A.11 operator	0 - 3	1		F71	0
0517		Equation A.11 operand	0 - 36	1		F72	0
0518		Equation A.12 operator	0 - 3	1		F71	0
0519		Equation A.12 operand	0 - 36	1		F72	0
051A		Equation A.13 operator	0 - 3	1		F71	0
051B		Equation A.13 operand	0 - 36	1		F72	0
051C		Equation A.14 operator	0 - 3	1		F71	0
051D		Equation A.14 operand	0 - 36	1		F72	0
051E		Equation A.15 operator	0 - 3	1		F71	0
051F		Equation A.15 operand	0 - 36	1		F72	0
0520		Equation B.00 operator	0 - 1	1		F70	0
0521		Equation B.00 operand	0 - 36	1		F72	0
0522		Equation B.01 operator	0 - 3	1		F71	0
0523		Equation B.01 operand	0 - 36	1		F72	0
0524		Equation B.02 operator	0 - 3	1		F71	0
0525		Equation B.02 operand	0 - 36	1		F72	0
0526		Equation B.03 operator	0 - 3	1		F71	0
0527		Equation B.03 operand	0 - 36	1		F72	0
0528		Equation B.04 operator	0 - 3	1		F71	0
0529		Equation B.04 operand	0 - 36	1		F72	0
052A		Equation B.05 operator	0 - 3	1		F71	0

Address (hex)	Group	Description	Values range	Step	Unit	Format	Def. Value
052B		Equation B.05 operand	0 - 36	1		F72	0
052C		Equation B.06 operator	0 - 3	1		F71	0
052D		Equation B.06 operand	0 - 36	1		F72	0
052E		Equation B.07 operator	0 - 3	1		F71	0
052F		Equation B.07 operand	0 - 36	1		F72	0
0530		Equation B.08 operator	0 - 3	1		F71	0
0531		Equation B.08 operand	0 - 36	1		F72	0
0532		Equation B.09 operator	0 - 3	1		F71	0
0533		Equation B.09 operand	0 - 36	1		F72	0
0534		Equation B.10 operator	0 - 3	1		F71	0
0535		Equation B.10 operand	0 - 36	1		F72	0
0536		Equation B.11 operator	0 - 3	1		F71	0
0537		Equation B.11 operand	0 - 36	1		F72	0
0538		Equation B.12 operator	0 - 3	1		F71	0
0539		Equation B.12 operand	0 - 36	1		F72	0
053A		Equation B.13 operator	0 - 3	1		F71	0
053B		Equation B.13 operand	0 - 36	1		F72	0
053C		Equation B.14 operator	0 - 3	1		F71	0
053D		Equation B.14 operand	0 - 36	1		F72	0
053E		Equation B.15 operator	0 - 3	1		F71	0
053F		Equation B.15 operand	0 - 36	1		F72	0
0540		Equation C.00 operator	0 - 1	1		F70	0
0541		Equation C.00 operand	0 - 36	1		F72	0
0542		Equation C.01 operator	0 - 3	1		F71	0
0543		Equation C.01 operand	0 - 36	1		F72	0
0544		Equation C.02 operator	0 - 3	1		F71	0
0545		Equation C.02 operand	0 - 36	1		F72	0
0546		Equation C.03 operator	0 - 3	1		F71	0
0547		Equation C.03 operand	0 - 36	1		F72	0
0548		Equation C.04 operator	0 - 3	1		F71	0
0549		Equation C.04 operand	0 - 36	1		F72	0
054A		Equation C.05 operator	0 - 3	1		F71	0
054B		Equation C.05 operand	0 - 36	1		F72	0
054C		Equation C.06 operator	0 - 3	1		F71	0
054D		Equation C.06 operand	0 - 36	1		F72	0
054E		Equation C.07 operator	0 - 3	1		F71	0
054F		Equation C.07 operand	0 - 36	1		F72	0
0550		Equation C.08 operator	0 - 3	1		F71	0
0551		Equation C.08 operand	0 - 36	1		F72	0
0552		Equation C.09 operator	0 - 3	1		F71	0
0553		Equation C.09 operand	0 - 36	1		F72	0
0554		Equation C.10 operator	0 - 3	1		F71	0
0555		Equation C.10 operand	0 - 36	1		F72	0
0556		Equation C.11 operator	0 - 3	1		F71	0
0557		Equation C.11 operand	0 - 36	1		F72	0

MiCOM P120/P121/P122/P123

Address (hex)	Group	Description	Values range	Step	Unit	Format	Def. Value
0558		Equation C.12 operator	0 - 3	1		F71	0
0559		Equation C.12 operand	0 - 36	1		F72	0
055A		Equation C.13 operator	0 - 3	1		F71	0
055B		Equation C.13 operand	0 - 36	1		F72	0
055C		Equation C.14 operator	0 - 3	1		F71	0
055D		Equation C.14 operand	0 - 36	1		F72	0
055E		Equation C.15 operator	0 - 3	1		F71	0
055F		Equation C.15 operand	0 - 36	1		F72	0
0560		Equation D.00 operator	0 - 1	1		F70	0
0561		Equation D.00 operand	0 - 36	1		F72	0
0562		Equation D.01 operator	0 - 3	1		F71	0
0563		Equation D.01 operand	0 - 36	1		F72	0
0564		Equation D.02 operator	0 - 3	1		F71	0
0565		Equation D.02 operand	0 - 36	1		F72	0
0566		Equation D.03 operator	0 - 3	1		F71	0
0567		Equation D.03 operand	0 - 36	1		F72	0
0568		Equation D.04 operator	0 - 3	1		F71	0
0569		Equation D.04 operand	0 - 36	1		F72	0
056A		Equation D.05 operator	0 - 3	1		F71	0
056B		Equation D.05 operand	0 - 36	1		F72	0
056C		Equation D.06 operator	0 - 3	1		F71	0
056D		Equation D.06 operand	0 - 36	1		F72	0
056E		Equation D.07 operator	0 - 3	1		F71	0
056F		Equation D.07 operand	0 - 36	1		F72	0
0570		Equation D.08 operator	0 - 3	1		F71	0
0571		Equation D.08 operand	0 - 36	1		F72	0
0572		Equation D.09 operator	0 - 3	1		F71	0
0573		Equation D.09 operand	0 - 36	1		F72	0
0574		Equation D.10 operator	0 - 3	1		F71	0
0575		Equation D.10 operand	0 - 36	1		F72	0
0576		Equation D.11 operator	0 - 3	1		F71	0
0577		Equation D.11 operand	0 - 36	1		F72	0
0578		Equation D.12 operator	0 - 3	1		F71	0
0579		Equation D.12 operand	0 - 36	1		F72	0
057A		Equation D.13 operator	0 - 3	1		F71	0
057B		Equation D.13 operand	0 - 36	1		F72	0
057C		Equation D.14 operator	0 - 3	1		F71	0
057D		Equation D.14 operand	0 - 36	1		F72	0
057E		Equation D.15 operator	0 - 3	1		F71	0
057F		Equation D.15 operand	0 - 36	1		F72	0
0580		Equation E.00 operator	0 - 1	1		F70	0
0581		Equation E.00 operand	0 - 36	1		F72	0
0582		Equation E.01 operator	0 - 3	1		F71	0
0583		Equation E.01 operand	0 - 36	1		F72	0
0584		Equation E.02 operator	0 - 3	1		F71	0

Address (hex)	Group	Description	Values range	Step	Unit	Format	Def. Value
0585		Equation E.02 operand	0 - 36	1		F72	0
0586		Equation E.03 operator	0 - 3	1		F71	0
0587		Equation E.03 operand	0 - 36	1		F72	0
0588		Equation E.04 operator	0 - 3	1		F71	0
0589		Equation E.04 operand	0 - 36	1		F72	0
058A		Equation E.05 operator	0 - 3	1		F71	0
058B		Equation E.05 operand	0 - 36	1		F72	0
058C		Equation E.06 operator	0 - 3	1		F71	0
058D		Equation E.06 operand	0 - 36	1		F72	0
058E		Equation E.07 operator	0 - 3	1		F71	0
058F		Equation E.07 operand	0 - 36	1		F72	0
0590		Equation E.08 operator	0 - 3	1		F71	0
0591		Equation E.08 operand	0 - 36	1		F72	0
0592		Equation E.09 operator	0 - 3	1		F71	0
0593		Equation E.09 operand	0 - 36	1		F72	0
0594		Equation E.10 operator	0 - 3	1		F71	0
0595		Equation E.10 operand	0 - 36	1		F72	0
0596		Equation E.11 operator	0 - 3	1		F71	0
0597		Equation E.11 operand	0 - 36	1		F72	0
0598		Equation E.12 operator	0 - 3	1		F71	0
0599		Equation E.12 operand	0 - 36	1		F72	0
059A		Equation E.13 operator	0 - 3	1		F71	0
059B		Equation E.13 operand	0 - 36	1		F72	0
059C		Equation E.14 operator	0 - 3	1		F71	0
059D		Equation E.14 operand	0 - 36	1		F72	0
059E		Equation E.15 operator	0 - 3	1		F71	0
059F		Equation E.15 operand	0 - 36	1		F72	0
05A0		Equation F.00 operator	0 - 1	1		F70	0
05A1		Equation F.00 operand	0 - 36	1		F72	0
05A2		Equation F.01 operator	0 - 3	1		F71	0
05A3		Equation F.01 operand	0 - 36	1		F72	0
05A4		Equation F.02 operator	0 - 3	1		F71	0
05A5		Equation F.02 operand	0 - 36	1		F72	0
05A6		Equation F.03 operator	0 - 3	1		F71	0
05A7		Equation F.03 operand	0 - 36	1		F72	0
05A8		Equation F.04 operator	0 - 3	1		F71	0
05A9		Equation F.04 operand	0 - 36	1		F72	0
05AA		Equation F.05 operator	0 - 3	1		F71	0
05AB		Equation F.05 operand	0 - 36	1		F72	0
05AC		Equation F.06 operator	0 - 3	1		F71	0
05AD		Equation F.06 operand	0 - 36	1		F72	0
05AE		Equation F.07 operator	0 - 3	1		F71	0
05AF		Equation F.07 operand	0 - 36	1		F72	0
05B0		Equation F.08 operator	0 - 3	1		F71	0
05B1		Equation F.08 operand	0 - 36	1		F72	0

MiCOM P120/P121/P122/P123

Address (hex)	Group	Description	Values range	Step	Unit	Format	Def. Value
05B2		Equation F.09 operator	0 - 3	1		F71	0
05B3		Equation F.09 operand	0 - 36	1		F72	0
05B4		Equation F.10 operator	0 - 3	1		F71	0
05B5		Equation F.10 operand	0 - 36	1		F72	0
05B6		Equation F.11 operator	0 - 3	1		F71	0
05B7		Equation F.11 operand	0 - 36	1		F72	0
05B8		Equation F.12 operator	0 - 3	1		F71	0
05B9		Equation F.12 operand	0 - 36	1		F72	0
05BA		Equation F.13 operator	0 - 3	1		F71	0
05BB		Equation F.13 operand	0 - 36	1		F72	0
05BC		Equation F.14 operator	0 - 3	1		F71	0
05BD		Equation F.14 operand	0 - 36	1		F72	0
05BE		Equation F.15 operator	0 - 3	1		F71	0
05BF		Equation F.15 operand	0 - 36	1		F72	0
05C0		Equation G.00 operator	0 - 1	1		F70	0
05C1		Equation G.00 operand	0 - 36	1		F72	0
05C2		Equation G.01 operator	0 - 3	1		F71	0
05C3		Equation G.01 operand	0 - 36	1		F72	0
05C4		Equation G.02 operator	0 - 3	1		F71	0
05C5		Equation G.02 operand	0 - 36	1		F72	0
05C6		Equation G.03 operator	0 - 3	1		F71	0
05C7		Equation G.03 operand	0 - 36	1		F72	0
05C8		Equation G.04 operator	0 - 3	1		F71	0
05C9		Equation G.04 operand	0 - 36	1		F72	0
05CA		Equation G.05 operator	0 - 3	1		F71	0
05CB		Equation G.05 operand	0 - 36	1		F72	0
05CC		Equation G.06 operator	0 - 3	1		F71	0
05CD		Equation G.06 operand	0 - 36	1		F72	0
05CE		Equation G.07 operator	0 - 3	1		F71	0
05CF		Equation G.07 operand	0 - 36	1		F72	0
05D0		Equation G.08 operator	0 - 3	1		F71	0
05D1		Equation G.08 operand	0 - 36	1		F72	0
05D2		Equation G.09 operator	0 - 3	1		F71	0
05D3		Equation G.09 operand	0 - 36	1		F72	0
05D4		Equation G.10 operator	0 - 3	1		F71	0
05D5		Equation G.10 operand	0 - 36	1		F72	0
05D6		Equation G.11 operator	0 - 3	1		F71	0
05D7		Equation G.11 operand	0 - 36	1		F72	0
05D8		Equation G.12 operator	0 - 3	1		F71	0
05D9		Equation G.12 operand	0 - 36	1		F72	0
05DA		Equation G.13 operator	0 - 3	1		F71	0
05DB		Equation G.13 operand	0 - 36	1		F72	0
05DC		Equation G.14 operator	0 - 3	1		F71	0
05DD		Equation G.14 operand	0 - 36	1		F72	0
05DE		Equation G.15 operator	0 - 3	1		F71	0

Address (hex)	Group	Description	Values range	Step	Unit	Format	Def. Value
05DF		Equation G.15 operand	0 - 36	1		F72	0
05E0		Equation H.00 operator	0 - 1	1		F70	0
05E1		Equation H.00 operand	0 - 36	1		F72	0
05E2		Equation H.01 operator	0 - 3	1		F71	0
05E3		Equation H.01 operand	0 - 36	1		F72	0
05E4		Equation H.02 operator	0 - 3	1		F71	0
05E5		Equation H.02 operand	0 - 36	1		F72	0
05E6		Equation H.03 operator	0 - 3	1		F71	0
05E7		Equation H.03 operand	0 - 36	1		F72	0
05E8		Equation H.04 operator	0 - 3	1		F71	0
05E9		Equation H.04 operand	0 - 36	1		F72	0
05EA		Equation H.05 operator	0 - 3	1		F71	0
05EB		Equation H.05 operand	0 - 36	1		F72	0
05EC		Equation H.06 operator	0 - 3	1		F71	0
05ED		Equation H.06 operand	0 - 36	1		F72	0
05EE		Equation H.07 operator	0 - 3	1		F71	0
05EF		Equation H.07 operand	0 - 36	1		F72	0
05F0		Equation H.08 operator	0 - 3	1		F71	0
05F1		Equation H.08 operand	0 - 36	1		F72	0
05F2		Equation H.09 operator	0 - 3	1		F71	0
05F3		Equation H.09 operand	0 - 36	1		F72	0
05F4		Equation H.10 operator	0 - 3	1		F71	0
05F5		Equation H.10 operand	0 - 36	1		F72	0
05F6		Equation H.11 operator	0 - 3	1		F71	0
05F7		Equation H.11 operand	0 - 36	1		F72	0
05F8		Equation H.12 operator	0 - 3	1		F71	0
05F9		Equation H.12 operand	0 - 36	1		F72	0
05FA		Equation H.13 operator	0 - 3	1		F71	0
05FB		Equation H.13 operand	0 - 36	1		F72	0
05FC		Equation H.14 operator	0 - 3	1		F71	0
05FD		Equation H.14 operand	0 - 36	1		F72	0
05FE		Equation H.15 operator	0 - 3	1		F71	0
05FF		Equation H.15 operand	0 - 36	1		F72	0

3.7.2 For P120  
 Reserved

3.8 Page 6h

Read and write access

Address	Group	Description	Values range	Step	Unit	Format	Fault Value	Range
0600		Alarms inhibition				F59		P120 to P123
0601 to 061F		Reserved						
0620	Output relays allocation	Input 1		1		F14	0	P120 to P123
0621		Input 2		1		F14	0	P120 to P123
0622		Input 3		1		F14	0	P120 to P123
0623		Input 4		1		F14	0	P120 to P123
0624		Input 5		1		F14	0	P120 to P123
0625		Input 6		1		F14	0	P120 to P123
0626		Input 7		1		F14	0	P120 to P123
0627		tl> phase A		1		F14	0	P120 to P123
0628		tl> phase B		1		F14	0	P120 to P123
0629		tl> phase C		1		F14	0	P120 to P123
062A		Do not use		1		F14	0	P122 - P123
062B		le>>>>		1		F14	0	P122 - P123
062C		tle>>>>		1		F14	0	P122 - P123
062D		[79] ext locked		1		F14	0	P123
062E		tAux5	0-31	1		F14	0	P123
062F		Free						P120 to 0123
0630	Automation Inrush	Inrush activation				F24	0	P122-P123
0631		Inrush blocking selection				F8c	0	P122-P123
0632		Inrush harmonic 2 ratio	100-350	1	0.1%	F1	200	P122-P123
0633		tlrush_reset	0 - 200	10	1/100 s	F1	0	P122-P123
0634 to 063F		Free for automation					0	
0640	Equation tempos	Equation A rising tempo	0 - 60000	1	1/100 s	F1	0	P121 to 123
0641		Equation A falling tempo	0 - 60000	1	1/100 s	F1	0	P121 to 123
0642		Equation B rising tempo	0 - 60000	1	1/100 s	F1	0	P121 to 123
0643		Equation B falling tempo	0 - 60000	1	1/100 s	F1	0	P121 to 123
0644		Equation C rising tempo	0 - 60000	1	1/100 s	F1	0	P121 to 123
0645		Equation C falling tempo	0 - 60000	1	1/100 s	F1	0	P121 to 123
0646		Equation D rising tempo	0 - 60000	1	1/100 s	F1	0	P121 to 123
0647		Equation D falling tempo	0 - 60000	1	1/100 s	F1	0	P121 to P123
0648		Equation E rising tempo	0 - 60000	1	1/100 s	F1	0	P121 to P123
0649		Equation E falling tempo	0 - 60000	1	1/100 s	F1	0	P121 to P123
064A		Equation F rising tempo	0 - 60000	1	1/100 s	F1	0	P121 to P123
064B		Equation F falling tempo	0 - 60000	1	1/100 s	F1	0	P121 to P123
064C		Equation G rising tempo	0 - 60000	1	1/100 s	F1	0	P121 to P123
064D		Equation G falling tempo	0 - 60000	1	1/100 s	F1	0	P121 to P123
064E		Equation H rising tempo	0 - 60000	1	1/100 s	F1	0	P121 to P123

Address	Group	Description	Values range	Step	Unit	Format	Fault Value	Range
064F		Equation H falling tempo	0 - 60000	1	1/100 s	F1	0	P121 to P123
0650	Output relay allocation	Equation A assignation to outputs		1		F14	0	P121 to P123
0651		Equation B assignation to outputs		1		F14	0	P121 to P123
0652		Equation C assignation to outputs		1		F14	0	P121 to P123
0653		Equation D assignation to outputs		1		F14	0	P121 to P123
0654		Equation E assignation to outputs		1		F14	0	P121 to P123
0655		Equation F assignation to outputs		1		F14	0	P121 to P123
0656		Equation G assignation to outputs		1		F14	0	P121 to P123
0657		Equation H assignation to outputs		1		F14	0	P121 to P123
0658	LEDs allocation	Led 5 Part 3/3		1		F19c	0	
0659		Led 6 Part 3/3		1		F19c	0	
065A		Led 7 Part 3/3		1		F19c	0	
065B		Led 8 Part 3/3		1		F19c	0	
065C to 066F		Free					0	
0670 to 0674	Do not use	Do not use						
0675	Records	Dist. records number	1 to 5	1	1	F1	5	P122-P123
0676	Output relays allocation	I<	0 - 31	1		F14	0	P122-P123
0677	Aux inputs	Auxiliary timer 5	0 – 20000	1	1/100s	F1	0	P123
0678	Automation	Blocking logic 1 Part 2/2	0 to 1	1		F8b	0	P123
0679		Blocking logic 2 Part 2/2	0 to 1	1		F8b	0	P123
067A	Automation / SOTF	SOTF source activation	0 – 63	1		F75	0	P123
067B to 06FF		Free					0	

### 3.9 Page 7h

Access in quick reading only (MODBUS 07 function)

Address	Group	Description	Values range	Step	Unit	Format	Fault Value
0700	Quick reading byte	relay status		1	-	F23	0



**3.10 Page 8h (P122, P123)**

Time synchronisation: access in writing for n words (function 16). The time synchronisation format is based on 8 bits (4 words).

If date Format (0135h) is private date then format is:

Timer	Address (hex)	Nb bytes	Mask (hex)	Values range	Unit
Year	0800	2	FFFF	1994-2093	Years
Month	0801	1 (Hi)	FF	1 -12	Months
Day		1 (Lo)	FF	1 - 31	Days
Hour	0802	1 (Hi)	FF	0 - 23	Hours
Minute		1 (Lo)	FF	0 - 59	Minutes
Milliseconds	0803	2	FFFF	0 - 59999	ms

Else format is ( Inverted IEC 870-5-4 CP56Time2a):

Timer	Address (hex)	Nb bytes	Mask (hex)	Values range	Unit
	0800	1 (Hi)			
Year		1 (Lo)	7F	94-99 (1994-1999) 0-93 (2000-2093)	Years
Month	0801	1 (Hi)	0F	1 - 12	Months
Day of the week		1 (Lo)	E0	1 – 7 (Monday – Sunday)	Days
Day of the month		1 (Lo)	1F	1 - 31	Days
Season	0802	1 (Hi)	80	0 - 1 (summer – winter)	
Hour		1 (Hi)	1F	0 - 23	Hours
Date validity		1 (Lo)	80	0 - 1 (valid – invalid)	
Minute		1 (Lo)	3F	0 - 59	Minutes
Milliseconds	0803	2	FFFF	0 - 59999	ms

### 3.11 Pages 9h to 21h

Disturbance record data (25 pages). Access in words writing (**function 03**)

Each disturbance mapping page contain 250 words.

Addresses	Contents
0900h to 09FAh	250 disturbance data words
0A00h to 0AFAh	250 disturbance data words
0B00h to 0BFAh	250 disturbance data words
0C00h to 0CFAh	250 disturbance data words
0D00h to 0DFAh	250 disturbance data words
0E00h to 0EFAh	250 disturbance data words
0F00h to 0FFAh	250 disturbance data words
1000h to 10FAh	250 disturbance data words
1100h to 11FAh	250 disturbance data words
1200h to 12FAh	250 disturbance data words
1300h to 13FAh	250 disturbance data words
1400h to 14FAh	250 disturbance data words
1500h to 15FAh	250 disturbance data words
1600h to 16FAh	250 disturbance data words
1700h to 17FAh	250 disturbance data words
1800h to 18FAh	250 disturbance data words
1900h to 19FAh	250 disturbance data words
1A00h to 1AFAh	250 disturbance data words
1B00h to 1BFAh	250 disturbance data words
1C00h to 1CFAh	250 disturbance data words
1D00h to 1DFAh	250 disturbance data words
1E00h to 1EFAh	250 disturbance data words
1F00h to 1FFAh	250 disturbance data words
2000h to 20FAh	250 disturbance data words
2100h to 21FAh	250 disturbance data words

NOTE: The disturbance data pages contain values of one channel from one given disturbance record.

#### 3.11.1 Meaning of each value channel

- IA, IB, IC and I<sub>o</sub> channels:

The value is an signed 16 bits word equivalent to the ADC value

#### 3.11.2 Calculation formula for phase current values

Line phase current value (primary value) = phase sampled value x phase primary CT / phase internal CT ratio (mapping address 0007 = 800) x  $\sqrt{2}$

MiCOM P120/P121/P122/P123

3.11.3 Calculation formula for earth current values

The formula depends of nominal earth current:

**0.1 to 40 I<sub>on</sub> range**

Line earth current value (primary value) = earth sampled value x earth primary CT / earth internal CT ratio (mapping address 0008 = 800) x  $\sqrt{2}$

**0.01 to 8 I<sub>on</sub> range**

Line earth current value (primary value) = earth sampled value x earth primary CT / earth internal CT ratio (mapping address 0008 = 3277) x  $\sqrt{2}$

**0.002 to 1 I<sub>on</sub> range**

Line earth current value (primary value) = earth sampled value x earth primary CT / earth internal CT ratio (mapping address 0008 = 32700) x  $\sqrt{2}$

- Frequency channel:

Time between two samples in microseconds

- Logic channels:

Logic channel	MODBUS, COURIER & DNP 3.0	IEC 61870-5-103
Bit 0	Trip relay (RL1)	Earth Starting
Bit 1	Output relay 2	General Starting
Bit 2	Output relay 3	CB Fail
Bit 3	Output relay 4	General Trip
Bit 4	Watch-dog relay	tI>
Bit 5	Output relay 5	tI>>
Bit 6	Output relay 6	tI>>>
Bit 7	Output relay 7	tIE>
Bit 8	Output relay 8	tIE>>
Bit 9	Reserved	tIE>>>
Bit 10	Logic input 1	Logic input 1
Bit 11	Logic input 2	Logic input 2
Bit 12	Logic input 3	Logic input 3
Bit 13	Logic input 4	Logic input 4
Bit 14	Logic input 5	Logic input 5
Bit 15	Reserved	Reserved

**3.12 Page 22h**

Disturbance record index frame (7 to 9 Words)

Access in word reading (**function 03**)

Addresses	Contents
2200h	Disturbance data index frame

Disturbance record index frame

Word	Contents
n° 1	Disturbance record number
n° 2	Disturbance record finish date (second)
n° 3	Disturbance record finish date (second)
n° 4	Disturbance record finish date (millisecond)
n° 5	Disturbance record finish date (millisecond)
n° 6	Disturbance record starting condition: 1: tripping command (RL1) 2: instantaneous 3: remote command 4: logic input
n° 7	Frequency at the post-time beginning
n° 8	(=0) Optional
n° 9	(=0) Optional

**3.13 Page 35h**

Addresses 3500h to 35FAh.

Event record data (9 words)

Word n° 1: Event meaning

Word n° 2: MODBUS associated value

Word n° 3: MODBUS address

Word n° 4: COURIER Cell address

Words n° 5 & 6 if data format is private:

Event date (second) number of seconds since 01/01/94

Words n° 7 & 8 if data format is private:

Event date (millisecond)

Words N°5, 6, 7, 8, if data format is Inverted IEC 870-5-4 CP56Time2a:

See format § 0

Address	Group	Description	Values range	Step	Unit	Format	Fault Value
0700	Quick reading byte	relay status		1	-	F23	0

Page 8h (P122, P123)

Word n° 9:

Acknowledge

0=event non acknowledged

1= event acknowledged

Code	Meaning of the event	Type	MODBUS address	COURIER Cell
00	No event			
01	Control close order (remote & HMI)	F9a	013h	021
02	Control trip order (remote & HMI)	F9a	013h	021
03	Disturbance recording start	F74		-
04	Trip output delatch	F9a	013h	021
05	Setting change	Address		-
06	Remote thermal reset	F9a		-
07	Maintenance Mode	F9a ↑ ↓	0400h	-
08	Control relay in maintenance mode	F39 ↑ ↓	013h	-
09	l>	F17 ↑ ↓	014h	023
10	l>>	F17 ↑ ↓	015h	023
11	l>>>	F17 ↑ ↓	016h	023
12	lE>	F16 ↑ ↓	017h	023
13	lE>>	F16 ↑ ↓	018h	023
14	lE>>>	F16 ↑ ↓	019h	023
15	Thermal overload alarm	F37 ↑ ↓	020h	023
16	Thermal overload threshold	F37 ↑ ↓	020h	023
17	tl>	F17 ↑ ↓	014h	023
18	tl>>	F17 ↑ ↓	015h	023
19	tl>>>	F17 ↑ ↓	016h	023
20	tlE>	F16 ↑ ↓	017h	023
21	tlE>>	F16 ↑ ↓	018h	023
22	tlE>>>	F16 ↑ ↓	019h	023
23	tl<	F16 ↑ ↓	021h	023
24	Broken conductor	F38 ↑ ↓	023h	024
25	tAux 1	F38 ↑ ↓	023h	024
26	tAux 2	F38 ↑ ↓	023h	024
27	CB failure	F38 ↑ ↓	023h	024
28	Selective logic 1	F20a ↑ ↓	011h	020
29	Selective logic 2	F20a ↑ ↓	011h	020
30	Blocking logic 1	F20a ↑ ↓	011h	020
31	Blocking logic 2	F20a ↑ ↓	011h	020
32	Setting group change	1 or 2	011h	020
33	52a	F20a ↑ ↓	011h	020
34	52b	F20a ↑ ↓	011h	020
35	Acknowledgement of the output relay latched, by logic input,	F20a ↑ ↓	011h	020
36	SF6	F20a ↑ ↓	011h	020

Code	Meaning of the event	Type	MODBUS address	COURIER Cell
37	Cold load start	F20a ↑ ↓	011h	020
38	Change of input logic state	F12 ↑ ↓	010h	020
39	Thermal overload trip	F37	013h	021
40	tI> trip	F13	013h	021
41	tI>> trip	F13	013h	021
42	tI>>> trip	F13	013h	021
43	tIE> trip	F13	013h	021
44	tIE>> trip	F13	013h	021
45	tIE>>> trip	F13	013h	021
46	tI< trip	F13	013h	021
47	Broken conductor trip	F13	013h	021
48	tAux 1 trip	F13	013h	021
49	tAux 2 trip	F13	013h	021
50	Output relays command	F39 ↑ ↓	013h	021
51	Front panel single alarm acknowl.			
52	Front panel all alarms acknowledge			
53	Remote single alarm acknowledge			
54	Remote all alarms acknowledge			
55	Major material alarm	F45 ↑ ↓	00Fh	022
56	Minor material alarm	F45 ↑ ↓	00Fh	022
57	I2>	F16 ↑ ↓	022h	024
58	tI2>	F16 ↑ ↓	022h	024
59	Operation time	F43 ↑ ↓	028h	024
60	Operation numbers	F43 ↑ ↓	028h	024
61	Sum of switched square amps	F43 ↑ ↓	028h	024
62	Trip circuit supervision	F43 ↑ ↓	028h	024
63	Closing time	F43 ↑ ↓	028h	024
64	Reclose successful	F43 ↑ ↓	028h	024
65	Recloser final trip	F43 ↑ ↓	028h	025
66	Recloser settings error or configuration error	F43 ↑ ↓	028h	024
67	I2> trip	F13	013h	021
68	General Starting (IEC103)	F1 ↑ ↓	009h	
69	Recloser active (IEC103)	F43 ↑ ↓	028h	
70	CB Closed by autoreclosure (IEC103)			
71	Relays latching	F13	02Eh	
72	External CB failure	F20b ↑ ↓	02Ah	020

Code	Meaning of the event	Type	MODBUS address	COURIER Cell
73	I<	F16 ↑ ↓	021h	023
74	I2>>	F16 ↑ ↓	022h	024
75	tI2>>	F16 ↑ ↓	022h	024
76	I2>> Trip	F16 ↑ ↓	013h	021
77	Reserved			
78	Latching Trip Relay (RL1)	F22		
79	tAux 3	F38	023h	025
80	tAux 3 trip	F13	013h	021
81	tAux 4	F38	023h	025
82	tAux 4 trip	F13	013h	021
83	t Reset I>	F17 ↑ ↓	014h	025
84	t Reset I>>	F17 ↑ ↓	015h	025
85	t Reset IE>	F16 ↑ ↓	017h	025
86	t Reset IE>>	F16 ↑ ↓	018h	025
87	t Reset I2>	F16 ↑ ↓	022h	025
88	TRIP Breaker Failure	F13	013h	021
89	t BF / Ext. Breaker Failure	F38	023h	025
90	Manual Close (input)	F20b ↑ ↓	02Ah	020
91	t SOTF	F54	070h	025
92	t SOTF trip	F13	013h	021
93	Local Mode (IEC 103)	F20b ↑ ↓	02Ah	020
94	Reset leds (IEC103)			
95	Recloser internal locked	F43 ↑ ↓	028h	024
96	Recloser in progress	F43 ↑ ↓	028h	025
97	Synchronization > 10s	F23		
98	Inrush blocking	F38 ↑ ↓		
99	tEquation A	F61 ↑ ↓	071h	
100	tEquation B	F61 ↑ ↓	071h	
101	tEquation C	F61 ↑ ↓	071h	
102	tEquation D	F61 ↑ ↓	071h	
103	tEquation E	F61 ↑ ↓	071h	
104	tEquation F	F61 ↑ ↓	071h	
105	tEquation G	F61 ↑ ↓	071h	
106	tEquation H	F61 ↑ ↓	071h	
107	tEquation A trip	F13		
108	tEquation B trip	F13		
109	tEquation C trip	F13		
110	tEquation D trip	F13		

Code	Meaning of the event	Type	MODBUS address	COURIER Cell
111	tEquation E trip	F13		
112	tEquation F trip	F13		
113	tEquation G trip	F13		
114	tEquation H trip	F13		
115	CB activity Operation time	F43 ↑ ↓	028h	024 ??
116	le>>>>	F16 ↑ ↓	073h	023 ??
117	tle>>>>	F16 ↑ ↓	073h	023 ??
118	tle>>>> trip	F13	013h	021 ??
119	t Reset le>>>>	F16 ↑ ↓	073h	025 ??
120	tAux 5	F38 ↑ ↓	023h	024 ??
121	tAux 5 trip	F13	013h	021
122	Do not use			
123	Recloser external locked	F43 ↑ ↓	028h	024

NOTE: The double arrow ↑ ↓ means the event is generated on event occurrence (↑) and on event disappearance (↓).  
 On event occurrence, the corresponding bit of the associated format is set to « 1 ».  
 On event disappearance, the corresponding bit of the associated format is set to « 0 ».

### 3.14 Page 36h

Most older event data

Access in word reading (**function 03**)

Addresses	Contents
3600h	Most older event data

### 3.15 Page 37h

Fault record value data

Access in word reading (**function 03**)

Addresses	Contents
3700h	Fault value record n°1
3701h	Fault value record n°2
3702h	Fault value record n°3
...	...
3718h	Fault value record n°25



Each record is made up of 15 words:

Word Nr.	Contents
1	Fault number
PRIVATE FORMAT: 2 & 3	Fault date (number of seconds since 01/01/94)
PRIVATE FORMAT: 4 & 5	Fault date (milli-seconds)
IEC FORMAT: 2 to 5	Fault date (see format of time synchronisation, address 0800h)
6	Fault date (season) 0= winter 1= summer 2= undefined
7	Active setting group during the fault (1 or 2)
8	Fault type origin (format F80)
9	Fault protection origin (format F81)
10	Fault amplitude value (Fourier module)
11	Phase A current value (Fourier module)
12	Phase B current value (Fourier module)
13	Phase C current value (Fourier module)
14	Earth current value (Fourier module)
15	Acknowledgement: 0 = fault not acknowledged 1 = fault acknowledged

3.15.1 Calculation formula for phase current values

Line phase current value (primary value) = phase sampled value (e.g. word 10, 11, 12 or 13) x phase primary CT / phase internal CT ratio (mapping address 0007 = 800)

3.15.2 Calculation formula for earth current values

The formula depends of nominal earth current:

**0.1 to 40 I<sub>on</sub> range**

Line earth current value (primary value) = earth sampled value (word 10 or 14) x earth primary CT ratio/ earth internal CT ratio (mapping address 0008 = 800)

**0.01 to 8 I<sub>on</sub> range**

Line earth current value (primary value) = earth sampled value (e.g. word 10 or 14) x earth primary CT ratio/ earth internal CT ratio (mapping address 0008 = 3277)

**0.002 to 1 I<sub>on</sub> range**

Line earth current value (primary value) = earth sampled value (e.g. word 10 or 14) x earth primary CT ratio/ earth internal CT ratio (mapping address 0008 = 32700)

3.16 Page 3Eh

Most older Fault record value data

Access in word reading (**function 03**)

Addresses	Contents
3E00h	Most older Fault record

**3.17 Pages 38h to 3Ch**

Selection of the disturbance record and channel (11 to 13 words are uploaded for each address reading)

Access in word reading (**function 03**)

Address	Disturbance record number	Format
38x0h	1	IA
38x1h	1	IB
38x2h	1	IC
38x3h	1	IE
38x4h	1	Frequency
38x5h	1	Logic input and outputs
39x0h	2	IA
39x1h	2	IB
39x2h	2	IC
39x3h	2	IE
39x4h	2	Frequency
39x5h	2	Logic input and outputs
3Ax0h	3	IA
3Ax1h	3	IB
3Ax2h	3	IC
3Ax3h	3	IE
3Ax4h	3	Frequency
3Ax5h	3	Logic input and outputs
3Bx0h	4	IA
3Bx1h	4	IB
3Bx2h	4	IC
3Bx3h	4	IE
3Bx4h	4	Frequency
3Bx5h	4	Logic input and outputs
3Cx0h	1	IA
3Cx1h	1	IB
3Cx2h	1	IC
3Cx3h	1	IE
3Cx4h	1	Frequency
3Cx5h	1	Logic input and outputs

If x = 0 then the first 6250 word are selected, if x=1 the following 6250 word are selected, and so on...

- Word n° 1:           Number of samples included in the mapping
- Word n° 2:           Sample number in pre-time
- Word n° 3:           Sample number in post-time

## MiCOM P120/P121/P122/P123

Word n° 4:	Phase primary CT ratio
Word n° 5:	Phase secondary CT ratio
Word n° 6:	Earth primary CT ratio
Word n° 7:	Earth secondary CT ratio
Word n° 8:	Phase internal CT ratio
Word n° 9:	Earth internal CT ratio
Word n° 10:	Mapping last page number
Word n° 11:	Number of words in the mapping last page
Word n° 12:	Coefficient of samples conversion (=1) (Optional)
Word n° 13:	Reference of samples conversion (=1) (Optional)

## 3.17.1 Calculation formula for phase current values

Line phase current value (primary value) = phase sampled value (e.g. address 3800h, 3801h or 3802h) x phase primary CT x (1 / internal phase ratio\*) x  $\sqrt{2}$

(\*) Mapping address 0007 = 800

## 3.17.2 Calculation formula for earth current values

Line earth current value (primary value) = earth sampled value (e.g. address 3803h) x earth primary CT x (1 / internal earth ratio\*) x  $\sqrt{2}$

(\*) The internal earth ratio depends of nominal earth current:

**0.1 to 40 I<sub>on</sub> range**

Mapping address 0008 = 800

**0.01 to 8 I<sub>on</sub> range**

Mapping address 0008 = 3277

**0.002 to 1 I<sub>on</sub> range**

Mapping address 0008 = 32700

**3.18 Pages 3Dh**

Number of disturbance records available

Access in word reading (**function 03**)

Addresses	Contents
3D00h	Number of disturbance records available

- Word n° 1: Number of disturbance records available
- Word n° 2: Oldest disturbance record number (n)
- Words n° 3 & 4: Oldest disturbance record date (second)
- Words n° 5 & 6: Oldest disturbance record date (millisecond)
- Word n° 7: Disturbance record starting origin  
 1= trip relay (RL1)  
 2= instantaneous threshold  
 3= remote command  
 4= logic input
- Word n° 8: Acknowledge
- Word n° 9: Number of Previous Disturbance record (n+1)
- Words n° 10 & 11: Previous disturbance record date (second)
- Words n° 12 & 13: Previous disturbance record date (millisecond)
- Word n° 14: Disturbance record starting origin  
 1= trip relay (RL1)  
 2= instantaneous threshold  
 3= remote command  
 4= logic input
- Word n° 15: Acknowledge
- Word n° 16: Number of Previous Disturbance record (n+2)
- Words n° 17 & 18: Previous disturbance record date (second)
- Words n° 19 & 20: Previous disturbance record date (millisecond)
- Word n° 21: Disturbance record starting origin  
 1= trip relay (RL1)  
 2= instantaneous threshold  
 3= remote command  
 4= logic input
- Word n° 22: Acknowledge
- Word n° 23: Number of Previous Disturbance record (n+3)
- Words n° 24 & 25: Previous disturbance record date (second)
- Words n° 26 & 27: Previous disturbance record date (millisecond)
- Word n° 28: Disturbance record starting origin  
 1= trip relay (RL1)  
 2= instantaneous threshold  
 3= remote command  
 4= logic input
- Word n° 29: Acknowledge
- Word n° 30: Number of Previous Disturbance record (n+4)
- Words n° 31 & 32: Previous disturbance record date (second)

## MiCOM P120/P121/P122/P123

Words n° 33 & 34:	Previous disturbance record date (millisecond)
Word n° 35:	Disturbance record starting origin 1= trip relay (RL1) 2= instantaneous threshold 3= remote command 4= logic input
Word n° 36:	Acknowledge

#### 4. DESCRIPTION OF THE MAPPING FORMAT, MiCOM P122 AND P123

CODE	DESCRIPTION
F1	Unsigned integer – numerical data: 0 to 65535
F2	Signed integer – numerical data: -32768 to 32767
F3a	Unsigned integer – curves type 0: STI (IEC) 1: SI (IEC) 2: VI (IEC) 3: EI (IEC) 4: LTI (IEC) 5: STI (C02) 6: MI (ANSI) 7: LTI (CO8) 8: VI (ANSI) 9: EI (ANSI) 10: RC (IEC) Rectifier curve 11: BPN (EDF)
F3b	Unsigned integer – RXIDG curve type 0 : curve 1 (K = 0.3) 1 : curve 2 (K = 0.4) 2 : curve 3 (K= 0.5) 3 : curve 4 (K = 0.6) 4 : curve 5 (K = 0.7) 5 : curve 6 (K = 0.8) 6 : curve 7 (K = 0.9) 7 : curve 8 (K = 1.0)
F4	Unsigned integer: MODBUS speed 0: 300 1: 600 2: 1200 3: 2400 4: 4800 5: 9600 6: 19200 7: 38400
F5	Unsigned integer: parity 0: without 1: even 2: odd

CODE	DESCRIPTION
F6a	Unsigned integer: Tripping configuration Part 1/2  bit 0: tl> bit 1: tl>> bit 2: tl>>> bit 3: tIE> bit 4: tIE>> bit 5: tIE>>> bit 6: l< bit 7: tlth> bit 8: Broken conductor detection bit 9: tAux 1 bit 10: tAux 2 bit 11: tl2> bit 12: tl2>> bit 13: tAux 3 bit 14: tAux 4 bit 15: Breaker Failure
F6b	Tripping configuration Part 2/2  Bit 0: SOFT Bit 1: Control Trip (remote or HMI) Bit 2: t Boolean equation A Bit 3: t Boolean equation B Bit 4: t Boolean equation C Bit 5: t Boolean equation D Bit 6: t Boolean equation E Bit 7: t Boolean equation F Bit 8: t Boolean equation G Bit 9: t Boolean equation H Bit 10: tle>>>> Bit 11: tAux5 Bit 12 to 15: Free
F7a	Latching function configuration part 1/2  bit 0: l> latching bit 1: l>> bit 2: l>>> bit 3: lE> bit 4: lE>> bit 5: lE>>> bit 6: l< bit 7: tlth> bit 8: Broken conductor detection bit 9: tAux 1 bit 10: tAux 2 bit 11: tl2> bit 12: tl2>> bit 13: tAux 3 bit 14: tAux 4 bit 15: Breaker Failure
F7b	Latching functions configuration part 2/2  bit 0: SOTF bit 1 to 9: Reserved bit 10: le>>>> bit 11: tAux5 bit 12 to 15: Reserved

CODE	DESCRIPTION
F8a	Blocking logic configuration Part 1/2 bit 0: I> bit 1: I>> bit 2: I>>> bit 3: IE> bit 4: IE>> bit 5: IE>>> bit 6: reserved bit 7: tlth> bit 8: Broken conductor detection bit 9: tAux 1 bit 10: tAux 2 bit 11: tI2> bit 12: tI2>> bit 13: tAux 3 bit 14: tAux 4 bit 15: le>>>>
F8b	Blocking logic configuration Part 2/2 bit 0: tAux 5
F8c	Inrush blocking configuration bit 0: I> bit 1: I>> bit 2: I>>> bit 3: IE> bit 4: IE>> bit 5: IE>>> bit 6: reserved bit 7: reserved bit 8: reserved bit 9: reserved bit 10: reserved bit 11: I2> bit 12: I2>> bit 13: Do not use bit 14: reserved bit 15: le>>>>
F9a	Remote controls Part 1/2 bit 0: Tripping contact delatched bit 1: 1 <sup>st</sup> alarm acknowledge bit 2: All alarms acknowledge bit 3: Control trip order bit 4: Control close order bit 5: Setting group change bit 6: Thermal state reset bit 7: Peak And Rolling Value Reset Bit 8: Disturbance Record Starting Order Bit 9: Maintenance Mode Bit 10: Recloser Counter Reset Bit 11: Recloser Reset Bit 12: Local Manual Acknowledge Bit 13: Oldest Event Acknowledge Bit 14: Oldest Fault Acknowledge Bit 15: Hardware "Stat Reset" Alarm Acknowledge



MiCOM P120/P121/P122/P123

CODE	DESCRIPTION
F9b	Remote controls Part 2/2 Bit 0: Launching I <sub>0</sub> harmonic calculation bit 1: Internally reserved for delatching of tripping relay only (RL1), and not like bit 0 in F9a. Bit 2: Acknowledgement of the oldest disturbance record bit 3: End of maintenance mode bit 4: Reset of Rolling Demands Data (average avlues and timers) bit 5: Reset of maximum values of the averages in sub period bit 6: leds reset bit 7: Internal reset of non latched tripping LED bit 8: communication Order 1 bit 9: communication Order 2 bit 10: communication Order 3 bit 11: communication Order 4 bit 12: Reset of SA <sup>2</sup> counter bit 13: Reset of trips counter bit 15: Reserved (R&D feature only)
F10	2 characters ASCII 32 –127 = ASCII character1 32 – 127 = ASCII character 2
F11	Reserved
F12	Unsigned integer: Logic input status bit 0: logic input number 1 bit 1: logic input number 2 bit 2: logic input number 3 bit 3: logic input number 4 bit 4: logic input number 5 bits 5 to 15: reserved
F13	Unsigned integer: logic outputs status bit 0: logic output number RL1 (tripping) bit 1: logic output number RL2 bit 2: logic output number RL3 bit 3: logic output number RL4 bit 4: logic output number RL0 (watchdog) bit 5: logic output number RL5 bit 6: logic output number RL6 bit 7: logic output number RL7 bit 8: logic output number RL8 bits 9 to 15: reserved
F14	Unsigned integer: logic outputs configuration bit 0: selection logic output number RL2 bit 1: selection logic output number RL3 bit 2: selection logic output number RL4 bit 3: selection logic output number RL5 bit 4: selection logic output number RL6 bit 5: selection logic output number RL7 bit 6: selection logic output number RL8

CODE	DESCRIPTION
F15a	Logical inputs allocation part 1/2 bit 0: Unlatch bit 1: 52 a bit 2: 52 b bit 3: CB fault (Lack of SF6) bit 4: tAux1 bit 5: tAux2 bit 6: Blocking logic 1 bit 7: Blocking logic 2 bit 8: Disturbance start bit 9: Cold load pick up bit 10: Logic selectivity 1 bit 11: Logic selectivity 2i bit 12: Setting group change bit 13: Autorecloser locking bit 14: Termal state reset bit 15: Trip circuit supervision
F15b	Logical inputs allocation part 2/2 bit 0: Circuit Breaker Failure bit 1: Alarm LED reset bit 2: Maintenance mode bit 3: tAux3 bit 4: tAux4 bit 5: SOTF bit 6: Local mode bit 7: Synchronization bit 8: Control Trip bit 9: Control Close bit 10: tAux5 bit 11 to 15: reserved
F16	threshold earth information status bit 0: information threshold exceeded (IE> or IE>> or IE>>> or le>>>>) bit 1: reserved bit 2: reserved bit 3: reserved bit 4: reserved bit 5: Instantaneous information (IE> or IE>> or IE>>> or le>>>>) bit 6: Tripping information (tIE> or tIE>> or tIE>>> or tle>>>>) bits 7 to 15: reserved
F17	Unsigned integer: threshold phase information status bit 0: information thresold exceeded (I>, I>>, I>>>) bit 1: Instantaneous IA bit 2: Instantaneous IB bit 3: Instantaneous IC bit 4: Interlock bit 5: Instantaneous information I> or I>> or I>>> or I< bit 6: Tripping information tI> or tI>> or tI>>> or tI< bits 7 to 15: reserved
F18	Long integer

CODE	DESCRIPTION
F19a	Unsigned integer: LEDs allocation (1/3)  bit 0: l> bit 1: tl> bit 2: l>> bit 3: tl>> bit 4: l>>> bit 5: tl>>> bit 6: lE> bit 7: tlE> bit 8: lE>> bit 9: tlE>> bit 10: lE>>> bit 11: tlE>>> bit 12: Thermal overload trip bit 13: tl2> bit 14: Broken conductor trip bit 15: CB failure
F19b	Unsigned integer: LEDs allocation (2/3)  bit 0: Logic input 1 bit 1: Logic input 2 bit 2: Logic input 3 bit 3: Logic input 4 bit 4: Logic input 5 bit 5: Recloser running bit 6: Recloser internal blocked bit 7: tAUX1 bit 8: tAUX2 bit 9: tl2>> bit 10: SOFT bit 11: tAux3 bit 12: tAux4 bit 13: t l > phase A bit 14: t l > phase B bit 15: t l > phase C
F19c	LEDs allocation (3/3)  bit 0: Equation A bit 1: Equation B bit 2: Equation C bit 3: Equation D bit 4: Equation E bit 5: Equation F bit 6: Equation G bit 7: Equation H bit 8: le>>>> bit 9: tle>>>> bit 10: Do not use bit 11: l< bit 12: tl< bit 13: tAux5 bit 14: [79] external blocked

CODE	DESCRIPTION
F20a	Logical data status Part 1/2 bit 0: Selective scheme logic 1 bit 1: Selective scheme logic 2 bit 2: Relay delatch bit 3: CB position (52 a) bit 4: CB position (52 b) bit 5: Lack of SF6 bit 6: External Aux1 bit 7: External Aux2 bit 8: Blocking logic 1 bit 9: Blocking logic 2 bit 10: Disturbance record start bit 11: Cold load start bit 12: Setting group change bit 13: Recloser locked bit 14: Thermal state reset bit 15: Trip circuit supervision
F20b	Logical data status Part 2/2 bit 0: CB Failure by external signalisation bit 1: LEDs alarms reset bit 2: Maintenance mode bit 3: External Aux3 bit 4: External Aux4 bit 5: Manual Close (SOFT/TOR) --> New name = "SOTF" bit 6: Local Mode bit 7: Synchronisation bit 8: Control Trip bit 9: Control Close bit 10: External Aux5
F21	Unsigned integer: software version 10: Version 1.A 11: Version 1.B 20: Version 2.A
F22	Unsigned integer: Trip status bit 0: Trip output relay RL1 latched bit 1: Memorization of trip information bit 2 to bit 15: free
F23	Unsigned integer: relay status bit 0: Relay status bit 1: Minor material alarm bit 2: Presence of non-acknowledged event bit 3: Synchronisation state bit 4: Presence of non-acknowledged disturbance record bit 5: Presence of non-acknowledged fault record bit 6: reserved bit 7: reserved
F24	Status of the relay functions 0: Disabled 1: Enabled
F25	2 ASCII characters

MiCOM P120/P121/P122/P123

CODE	DESCRIPTION
F26	By default display 1: IA measurement display (True RMS) 2: IB measurement display (True RMS) 3: IC measurement display (True RMS) 4: IN measurement display (True RMS)
F27a	Type delay time 0: DMT time delay 1: IDMT time delay 2: RI time delay
F27b	Type time delay with RXIDG curves 0: DMT time delay 1: IDMT time delay 2: RI time delay 3: RXIDG curves
F28	Communication data bits 0: 7 data bits 1: 8 data bits
F29	Communication stop bits 0: 1 stop bit 1: 2 stop bits
F30	Communication availability 0: Communication non-available 1: Communication available
F31	Unsigned integer: Number of available event records 0: None 1: 1 event record available 2: 2 event records available 3: 3 event records available 4: 4 event records available 5: 5 event records available
F32	Disturbance record start condition on: 0: INSTANTANEOUS 1: TRIPPING
F33	Cold load pick-up sources bit 0: t1> bit 1: t1>> bit 2: t1>>> bit 3: t1E> bit 4: t1E>> bit 5: t1E>>> bit 6: Thermal overload trip bit 7: t12> bit 8: t12>> bit 9: t1E>>>> bit 10 to 15: reserved
F34	Reserved
F35	Disturbance record upload running 0: No 1: Yes

CODE	DESCRIPTION
F36a	Memorised flags of non acknowledged alarms Part 1/3  bit 0: IE> bit 1: tIE> bit 2: IE>> bit 3: tIE>> bit 4: IE>>> bit 5: tIE>>> bit 6: Thermal overload alarm bit 7: Thermal overload trip bit 8: Broken conductor bit 9: CB failure bit 10: I2>> bit 11: I2> bit 12: tI2> bit 13: tAux 1 bit 14: tAux 2 bit 15: tI2>>
F36b	Memorised flags of non acknowledged alarms Part 3/3  Bit 0: t Boolean Equation A Bit 1: t Boolean Equation B Bit 2: t Boolean Equation C Bit 3: t Boolean Equation D Bit 4: t Boolean Equation E Bit 5: t Boolean Equation F Bit 6: t Boolean Equation G Bit 7: t Boolean Equation H
F37	Thermal overload information  bit 0: Thermal overload alarm bit 1: Thermal overload trip
F38	Output information part 1/2  bit 0: reserved bit 1: CB failure bit 2: Pole A opening bit 3: Pole B opening bit 4: Pole C opening bit 5: Broken conductor bit 6: tAux 1 bit 7: tAux 2 bit 8: Broken conductor time delay bit 9: CB failure time delay bit 10: "Cold load pick up" temporization started bit 11: CB alarms or bits 0,1,2,4 of F43 bit 12: tAux 3 bit 13: tAux 4 bit 14: Inrush blocking bit 15: tAux 5
F39	Output relays command  bit 0: RL1 (trip) bit 1: RL2 bit 2: RL3 bit 3: RL0 (watch-dog) bit 4: RL4 bit 5: RL5 bit 6: RL6 bit 7: RL7 bit 8: RL8

CODE	DESCRIPTION
F40	Selective scheme logic configuration bit 0: tl>> bit 1: tl>>> bit 2: tIE>> bit 3: tIE>>> bit 4: tle>>>>
F41	Communication description 0: Front and rear MODBUS communication 1: Front MODBUS and rear Courier communication 2: Front MODBUS and rear IEC103 communication 3: Front MODBUS and rear DNP3 communication
F42	Peak value of max. & average measurement 5, 10, 15, 30 or 60 minutes
F43	CB supervision flags bit 0: CB operating time overreach bit 1: CB operation number overreach bit 2: Square Amps sum overreach bit 3: Trip circuit self-test bit 4: CB closing time overreach bit 5: Recloser int locked bit 6: Recloser successful bit 7: Recloser in progress bit 8: Closing command issued from recloser cycle bit 9: Recloser configuration error bit 10: Recloser in service bit 11: Recloser final trip bit 12: "CB operations number / time" overreach bit 13: Recloser external locked bit 14: Recloser reinitialized
F44	Memorised flags of non acknowledged alarms Part 2/3 bit 0: CB, operating time overreach bit 1: CB operation number overreach bit 2: Square Amps sum overreach bit 3: Trip circuit self-test bit 4: CB closing time overreach bit 5: tAux 3 bit 6: tAux 4 bit 7: External CB failure bit 8: SOFT bit 9: le>>>> bit 10: tle>>>> bit 11: tAux5 bit 12: Do not use bit 13: Control trip bit 14: Autorecloser internal blocking bit 15: Autorecloser external blocking

CODE	DESCRIPTION
F45	Device status bit 0: Watchdog bit 1: Communication failure bit 2: EEPROM data failure bit 3: Analogue failure bit 4: Datation failure bit 5: EEPROM calibration failure bit 6: SRAM failure bit 7: Battery failure bit 8: Reserved bit 9: Default settings alarm bit 10 to 15: reserved
F46	Remote controls Part 2/2 See format F9b
F47	Configuration of change of group selection. Setting group change 0: either by communication, or of the relay front (MENU) 1: on LEVEL (High or Low) of digital input.
F48	Date Format 0: Private Format Date 1: IEC Format Date
F49	Recloser cycle configuration bit 0: Cycle 1 configuration ( trip and initialise the reclosure) bit 1: Cycle 1 configuration ( block the tripping on cycle ) bit 2, 3: reserved bit 4: Cycle 2 configuration ( trip and initialise the reclosure) bit 5: Cycle 2 configuration ( block the tripping on cycle ) bit 6, 7: reserved bit 8: Cycle 3 configuration ( trip and initialise the reclosure) bit 9: Cycle 3 configuration ( block the tripping on cycle ) bit 10, 11: reserved bit 12: Cycle 4 configuration ( trip and initialise the reclosure) bit 13: Cycle 4 configuration ( block the tripping on cycle )
F50	Voltage Type applied to the logic inputs 0: DC Voltage 1: AC Voltage
F51	Rotation phase sequence 0: Direct phase rotation ABC 1: Inverse phase rotation ACB
F52	Reserved
F53	SOTF parameters 0: Start I>> 1: Start I>>>
F54	Output information SOTF Bit 0: SOTF in progress Bit 1: Instantaneous information Bit 2: Tripping information
F56	IEC870-5-103 messages option for non-standard protections 0 : Public messages 1 : Private messages.
F58	Reserved



CODE	DESCRIPTION
F59	Alarms inhibition Bit 0: tAux1 Bit 1: tAux2 Bit 2: tAux3 Bit 3: tAux4 Bit 4: tAux5 Bit 5: Equation A Bit 6: Equation B Bit 7: Equation C Bit 8: Equation D Bit 9: Equation E Bit 10: Equation F Bit 11: Equation G Bit 12: Equation H Bit 13: Control trip Bit 14: Autorecloser blocked by input Bit 15: I<
F60	Fail safe and inversion relays bit x = 0 : relay normally de-energized. bit x = 1 : relay normally energized. bit 0 : Fail safe logic output number RL1 (tripping) bit 1 : Fail safe logic output number RL2 bit 2 : Inversion logic output number RL3 bit 3 : Inversion logic output number RL4 bit 4 : Inversion logic output number RL5 bit 5 : Inversion logic output number RL6 bit 6 : Inversion logic output number RL7 bit 7 : Inversion logic output number RL8 bits 8 à 15 : Reserved
F61	Boolean Equation Status Bit 0: Reserved Bit 1: t Boolean Equation A Bit 2: t Boolean Equation B Bit 3: t Boolean Equation C Bit 4: t Boolean Equation D Bit 5: Temporisation A, B,... or H active Bit 6: t Boolean Equation E Bit 7: t Boolean Equation F Bit 8: t Boolean Equation G Bit 9: t Boolean Equation H Bits 10 to 15: Reserved
F70	1st Operator for Boolean equations 0 : Nothing 1 : NOT
F71	Other than 1st Operator for Boolean equations 0 : OR 1 : OR NOT 2 : AND 3 : AND NOT

CODE	DESCRIPTION
F72	Equations operands 0: NULL 1: l> 2: tl> 3: l>> 4: tl>> 5: l>>> 6: tl>>> 7: IE> 8: tIE> 9: IE>> 10: tIE>> 11: IE>>> 12: tIE>>> 13: l2> 14: tl2> 15: l2>> 16: tl2>> 17: Thermal alarm 18: Thermal tripping 19: l< 20: tl< 21: Tripping BRK 22: Tripping 79 23: tAux 1 24: tAux 2 25: tAux 3 26: tAux 4 27: tAux 5 28: Logical Input 1 29: Logical Input 2 30: Logical Input 3 31: Logical Input 4 32: Logical Input 5 33: le>>>> 34: tle>>>> 35: [79] Recloser internal locked 36: [79] Recloser external locked 37: Do not use
F73	LED status (bit = 0 if LED inactive) Bit 0 – Trip LED Bit 1 – Alarm LED Bit 2 – Warning LED Bit 3 – Healthy LED (always active) Bit 4 – LED 5 Bit 5 – LED 6 Bit 6 – LED 7 Bit 7 – LED 8
F74	Measurements transmission enabling for IEC870-5-103 communication 0 : None 1 : On trip protection 2 : On instantaneous protection 3 : On communication order 4 : On logic input order 5 : No disturbance 6 : On HMI order

CODE	DESCRIPTION
F75	SOTF parameters: Closing orders types for SOTF starting Bit 0: Front port communication order Bit 1: Rear port communication order Bit 2: "Ctrl Close" logical input Bit 3: "SOTF" logical input Bit 4: Reclosing ordered by Autorecloser Bit 5: Reclosing ordered by HMI
F76	Cold Load start detection Bit 0: Detection with 52a input Bit 1: Automatic detection (Detection from important current growth, from 0.05 In to In in 200 ms max)
F77	Do not use
F78	Do not use
F79	Output information part 2/2 bit 0: Do not use
F80	Fault type origin 0 = None 1 = Phase A 2 = Phase B 3 = Phase C 4 = Phases A-B 5 = Phases A-C 6 = Phases B-C 7 = Phases A-B-C 8 = Earth
F81	Fault protection origin 0 = None 1 = Remote tripping 2 = Thermal overload 4 = tl>> 5 = tl>>> 6 = tlE> 7 = tlE>> 8 = tlE>>> 9 = tl< 10 = Broken conductor 11 = tAux1 12 = tAux2 13 = tl2> 14 = tl2>> 15 = tAux3 16 = tAux4 17 = CB Fail 18 = SOTF 19 = tEquation A 20 = tEquation B 21 = tEquation C 22 = tEquation D 23 = tEquation E 24 = tEquation F 25 = tEquation G 26 = tEquation H 27 = tAux5 28 = tle>>>>

CODE	DESCRIPTION
F82	Unsigned integer: Number of disturbances records 0: 1 1: 2 2: 3 3: 5

#### 4.1 Disturbance record additional information

##### 4.1.1 MODBUS request definition used for disturbance record

To upload a disturbance record, the following requests must be done in the exact given order:

- (optional): Send a request to know the number of disturbance records available in SRAM.
- (compulsory): Send a request with the record number and the channel number.
- (compulsory): Send one or several requests to upload the disturbance record data. It depends of the number of samples.
- (compulsory): Send a request to upload the index frame.

##### 4.1.2 Request to know the number of disturbance records in SRAM

Slave number	Function code	Word address	Word number	CRC
xx	03h	3Dh 00	00 24h	xx xx

This request may be answered an error message with the error code:

EVT\_NOK(OF): No record available

NOTE: If there is less than 5 records available, the answer will contains zero in the non-used words.

##### 4.1.3 Service requests

This request must be send before uploading the disturbance record channel samples. It allows to know the record number and the channel number to upload. It allows also to know the number of samples in the channel.

Slave number	Function code	Word address	Word number	CRC
xx	03h	Refer to mapping	00 0Bh	xx xx

This request may be answered an error message with two different error codes:

CODE\_DEF\_RAM(02): SRAM failure

CODE\_EVT\_NOK(03): No disturbance record available in SRAM

##### 4.1.4 Disturbance record upload request

Slave number	Function code	Word address	Word number	CRC
xx	03h	Refer to mapping	01 to 7Dh	xx xx

This request may be answered an error message with two different error codes:

CODE\_DEP\_DATA(04): The required disturbance data number is greater than the memorised number.

CODE\_SERV\_NOK(05): The service request for disturbance record and channel number has not been send.

MiCOM P120/P121/P122/P123

4.1.5 Index frame upload request

Slave number	Function code	Word address	Word number	CRC
xx	03h	22h 00	00 07h	xx xx

This request may be answered an error message with an error code:

CODE\_SERV\_NOK(05): The service request for disturbance record and channel number has not been send.

Two ways can be followed to retrieve an event record:

- Send a request to retrieve the oldest non-acknowledge event.
- Send a request to retrieve a dedicated event.

4.1.6 Request to retrieve the oldest non-acknowledge event

Slave number	Function code	Word address	Word number	CRC
xx	03h	36h 00	00 09h	xx xx

This event request may be answered an error message with the error code:

EVT\_EN\_COURS\_ECRIT (5): An event is being written into the saved RAM.

NOTE: On event retrieval, two possibilities exist regarding the event record acknowledgement:  
 a) Automatic event record acknowledgement on event retrieval.  
 b) Non automatic event record acknowledgement on event retrieval.

a) Automatic event record acknowledgement on event retrieval:

The bit12 of the remote order frame (format F9 – mapping address 0400h) shall be set to 0. On event retrieval, this event record is acknowledged.

b) Non automatic event record acknowledgement on event retrieval:

The bit12 of the remote order frame (format F9 – mapping address 0400h) shall be set to 1. On event retrieval, this event record is not acknowledged.

To acknowledge this event, an other remote order shall be sent to the relay. The bit 13 of this frame (format F9 – mapping address 0400h) shall be set to 1.

4.1.7 Request to retrieve a dedicated event

Slave number	Function code	Word address	Word number	CRC
xx	03h	Refer to mapping	00 09h	xx xx

This event request may be answered an error message with the error code:

EVT\_EN\_COURS\_ECRIT (5): An event is being written into the saved RAM.

NOTE: This event retrieval does not acknowledge this event.

4.1.8 Modbus request definition used to retrieve the fault records

Two ways can be followed to retrieve a fault record:

Send a request to retrieve the oldest non-acknowledge fault record.

Send a request to retrieve a dedicated fault record.

4.1.9 Request to retrieve the oldest non-acknowledge fault record

Slave number	Function code	Word address	Word number	CRC
xx	03h	3Eh 00	00 0Fh	xx xx

NOTE: On fault retrieval, two possibilities exist regarding the fault record acknowledgement:

- a) Automatic fault record acknowledgement on event retrieval.
- b) Non automatic fault record acknowledgement on event retrieval.

a) Automatic fault record acknowledgement on fault retrieval:

The bit12 of the remote order frame (format F9 – mapping address 0400h) shall be set to 0. On fault retrieval, this fault record is acknowledged.

b) Non automatic fault record acknowledgement on fault retrieval:

The bit12 of the remote order frame (format F9 – mapping address 0400h) shall be set to 1. On fault retrieval, this fault record is not acknowledged.

To acknowledge this fault, an other remote order shall be sent to the relay. The bit 14 of this frame (format F9 – mapping address 0400h) shall be set to 1.

4.1.10 Request to retrieve a dedicated fault record

Slave number	Function code	Word address	Word number	CRC
xx	03h	Refer to mapping	00 0Fh	xx xx

NOTE: This fault value retrieval does not acknowledge this fault record.

MiCOM P120/P121/P122/P123

# **COURIER DATABASE**

**BLANK PAGE**



# CONTENT

<b>1.</b>	<b>K-BUS PROTOCOL AND COURIER LANGUAGE</b>	<b>3</b>
<b>1.1</b>	<b>K-BUS</b>	<b>3</b>
1.1.1	K-Bus transmission layer	3
1.1.2	K-Bus connection	3
1.1.3	Auxiliary equipment	3
<b>1.2</b>	<b>Relay courier database</b>	<b>4</b>
<b>1.3</b>	<b>Setting changes</b>	<b>4</b>
<b>1.4</b>	<b>Systems integration data</b>	<b>4</b>
1.4.1	Address of the relay	4
1.4.2	Measured values	4
1.4.3	Status word	5
1.4.4	Unit status word	5
1.4.5	Control status word	5
1.4.6	Logic input status word	5
1.4.7	Output relay status word	5
1.4.8	Control information	6
1.4.9	Protection Indication	6
1.4.10	Measurement control	8
1.4.11	Change of remote measurements	8
<b>1.5</b>	<b>Event extraction</b>	<b>9</b>
1.5.1	Automatic event extraction	9
1.5.2	Event types	9
1.5.3	Event format	9
1.5.4	Manual record extraction	10
<b>1.6</b>	<b>Disturbance record extraction (P120, P122, P123 only)</b>	<b>10</b>
<b>2.</b>	<b>LIST OF EVENTS CREATED BY THE RELAY</b>	<b>11</b>
<b>3.</b>	<b>COURIER DATABASE ORGANISATION P120</b>	<b>14</b>
<b>4.</b>	<b>COURIER DATABASE ORGANISATION P121</b>	<b>23</b>
<b>5.</b>	<b>COURIER DATABASE ORGANISATION P122, P123</b>	<b>51</b>

**BLANK PAGE**

## 1. K-BUS PROTOCOL AND COURIER LANGUAGE

The serial communications are transmitted on K-Bus, a multi-drop network proposing an instantaneous interface with IEC 870 - 5 - FT1.2 standards. The language and the communication protocol used are Courier. This concept permits especially to the generic programmes of the principal units to access to a high number of different relay types without need to change permanently the principal unit program for each relay type. The relays forms a distributed database in which the principal workstation proceeds to a selective call of the slave relays in order to know all necessary information.

Courier has a concept for the functions with a selective call system which allows not a slave periphery to communicate directly with the central unit when one shall informs another about a particular event. The slave workstation has to wait that the principal workstation asks for the information. With Courier each information is given into a box with a code of the length and the database type. In knowing the database format the reception periphery can read them.

### 1.1 K-BUS

K-Bus is a communication system developed for connecting the slave peripheries in remoting on the central unit, permitting them to execute all remote monitoring and remote control functions using the appropriated communication language. K-Bus is not able to permit a direct communication between the slave peripheries. Only a communication between the central unit and the slave peripheries can be established. The principal characteristics of the K-Bus are his profitability, his high security level, his installation facility and his user friendliness.

#### 1.1.1 K-Bus transmission layer

The communication port is supported on the reception levels and the voltage transmission RS485 with galvanic isolation assured by a transformer. A selective call protocol is used. No relay unit is allowed to transmit before having received a validation message without any error detection. The transmission is synchronous on a pair of isolated waves. The data are coded FM0 with a clock signal for eliminate all CC-component, allows the signal to cross the transformers.

With the exception of the central units, each network node is passive. No defective unit from the system can interfere with the communications established with the other units. The message format is HDLC. The data transmission speed is 64 kbits/s.

#### 1.1.2 K-Bus connection

The connection on the K-Bus port is realised by screwed terminals of 4 mm of MIDOS standards or by FASTON-connectors. A cabled pair is sufficient to realise the connection, knowing that the polarity is not important. It is recommended to use an external screen earth linked at the end of the principal workstation only. The screen has to be fixed with a M4 screw following the wiring scheme (cf. TG: P12X/EN T). The functioning of the K-BUS network is guaranteed for 32 units connected on 1000 meters of cables. Thanks to the data code method, the polarity of the Bus cable connection is not important.

**NOTE:** The K-Bus network has to finish with a 150 ohms resistance on each end of the Bus. The principal workstation can be placed anywhere on the network. This command point has to be unique.

#### 1.1.3 Auxiliary equipment

For communication with the relay it is necessary to have at least one converter case K-Bus/IEC870-5 of the type KITZ and a computer suitable software, an interconnection cable RS232 for connecting the KITZ to the computer and a software conform to the specification of the Courier protocol.

## 1.2 Relay courier database

The Courier database is two dimensional structure with each cell in the database being referenced by a row and column address. Both the column and the row can take a range from 0 to 255. Addresses in the database are specified as hexadecimal values, eg 0A02 is column 0A (10 decimal) row 02. Associated settings/data will be part of the same column, row zero of the column contains a text string to identify the contents of the column.

This data base is given in paragraph 1, 4, 5.

## 1.3 Setting changes

This uses a combination of three commands to perform a settings change:

Enter Setting Mode - checks that the cell is settable and returns the limits

Pre-load Setting - Places a new value in the cell, this value is echoed to ensure that setting corruption has not taken place, the validity of the setting is not checked by this action.

Execute Setting - Confirms the setting change, if the change is valid then a positive response will be returned, if the setting change fails then an error response will be returned.

Abort Setting - This command can be used to abandon the setting change.

This is the most secure method and is ideally suitable for on-line editors as the setting limits are taken from the relay before the setting change is made. However this method can be slow if many settings are to be changed as three commands are required for each change.

## 1.4 Systems integration data

### 1.4.1 Address of the relay

The relays can have any address between 1 and 254 included. The address 255 corresponds to the global address to which all relays and all the other slave peripheries are responding. The Courier protocol specifies that no response can be resent from a slave periphery to a global message. This permits to avoid that all peripheries respond at the same time creating by this way user conflict on the Bus.

Each relay has an address settled on 255 in order to guarantee that in case of his connection to the operating network, its address cannot create any conflict with the address of another periphery already running. In order to permit to a new periphery to get entirely operational, its address has to be settled. The address can be modified manually by capturing the password, than by following the method of the setting change through the user interface on the front plate of the relay.

The same, if the network functioning on a computer takes in charge the auto-addressing, the relay address can be settled on 0 to active the characteristic of auto-addressing of the computer software. The relay receives then the next valid address on the Bus.

If the address is 255 or it is unknown, it can be modified by sending a new address, with a global message, to a periphery possessing a particular serial number. This method is used for those peripheries which do not have any user interface for reading or for changing the address in process.

### 1.4.2 Measured values

Each measured value can be periodically extracted by a selective call of **MiCOM P120, P121, P122 and P123** relays.

## MiCOM P120/P121/P122/P123

## 1.4.3 Status word

Each response of a slave periphery contains an octet of status. This octet is resent by the relay at the beginning of each message for signalling important data. The principal workstation can be design for responding automatically to these important data.

The contained indications are the following:

Bit 0 - 1 =	Recording of disturbance available for retrieval
Bit 1 - 1 =	Change of the Unit status word
Bit 2 - 1 =	Change of the control status word
Bit 3 - 1 =	Relay busy, no response possible in time
Bit 4 - 1 =	Relay out of service
Bit 5 - 1 =	Recording of events available for retrieval
Bit 6 - 1 =	Switched alarm indicator
Bit 7 - 1 =	Switched tripping indicator

Only bits 3,4 and 7 are used for version **P121**.

Bits 1, 3 4, 5 and 7 are used for versions **P120, P122, P123**.

## 1.4.4 Unit status word

The unit status word is located in the menu **000C**.

Each bits pair of the Unit status word serves to indicate the status (position) of the unit elements checked through the relay.

This functionality is not supported on **MiCOM P120, P121, P122** and **P123** relays.

## 1.4.5 Control status word

The Control status word is located in the cell of the menu **000D**.

It is used for transmitting the control information of the slave periphery to the central unit.

Nevertheless, the relays described in this manual are protection relays, which are not using this control characteristic.

## 1.4.6 Logic input status word

The logic control input status can be observed in proceeding to a selective call from the cell of menu **0020**. The 2 bits inferior of the returned value indicating the status of each of the 2 logic inputs. This cell is accessible only in reading.

Bit 0:	logic input 1
Bit 1:	logic input 2
Bit 2:	logic input 3
Bit 3:	logic input 4
Bit 4:	logic input 5

## 1.4.7 Output relay status word

The output relay status can be observed in proceeding to a selective call from the cell of menu **0021**. The 8 bits inferior of the returned value indicating the status of each of the 5 output relays. This cell is accessible only in reading.

Bit 0:	relay 1 (TRIP)
Bit 1,2,3:	programmable relays n° 2,3,4
Bit 4:	Watchdog
Bit 5,6,7,8:	programmable relays n° 5,6,7,8

1.4.8 Control information

The status of internal controls triggered by the auto-control program of the relays can be observed in proceeding to a selective call of the cell of menu **0022**.

The bits 0 to 6 indicate the material controls of the product.

Bit 0	Analogue Output error
Bit 1	Communication error
Bit 2	EEPROM data error
Bit 3	Analogue fault
Bit 4	Clock error
Bit 5	EEPROM calibration error
Bit 6	RAM error
Bit 7	Battery error
Bit 8	Reserved
Bit 9	Default settings
Bit 10 to 15	Reserved

1.4.9 Protection Indication

The protection indications gives the status of different protection elements in the relay. The fault indications are generated with these indications.

They are transmitted in the events recordings, in case of a fault recording.

This is the only way to access to these indications.

The status of internal protection indication of the relays can be observed in proceeding to a selective call of the cell of menu **0023** and **0024**.

The following table presents the list of the protection indications of the cell 0023:

Bit position	Function of the protection
0	I>
1	I>>
2	I>>>
3	IE>
4	IE>>
5	IE>>>
6	tI>
7	tI>>
8	tI>>>
9	tIE>
10	tIE>>
11	tIE>>>
12	Thermal alarm
13	Thermal overload
14	tI<
15	reserved

## MiCOM P120/P121/P122/P123

The following table presents the list of the protection indications of the cell 0024:

Bit position	Function of the protection
0	Broken conductor
1	t Aux 1
2	t Aux 2
3	Breaker failure
4	I2>
5	tI2>
6	Open operating time
7	Trip operation number
8	SA 2n
9	Trip circuit Supervision
10	Close operating time
11	Successful autoreclose
12	Locked autorecloser
13	Autorecloser configuration fail
14	I2>>
15	tI2>>

The following table presents the list of the protection indications of the cell 0025:

Bit position	Function of the protection
0	t Aux 3
1	t Aux 4
2	t Reset I>
3	t Reset I>>
4	t Reset IE>
5	t Reset IE>>
6	t Reset I2>
7	t BF
8	t SOTF
9	Final Trip
10	Autoreclos. In progress
11	Reserved
12	Reserved
13	Reserved
14	Reserved
15	Reserved

The following table presents the list of the protection indications of the cell 0026 :

Bit position	Function of the protection
0	t Equation A
1	t Equation B
2	t Equation C
3	t Equation D
4	t Equation E
5	t Equation F
6	t Equation G
7	t Equation H
8	Blocking Inrush
9	Reserved
10	Reserved
11	Reserved
12	Reserved
13	Reserved
14	Reserved
15	Reserved

#### 1.4.10 Measurement control

The control functions through a relay of the **MiCOM P12x** range can be executed on a serial link. These functions are supported in particular on the changes of the individual relay settings, on the changes of the setting groups, on the remote control of the circuit breaker, as well as on the functions and the locking of the selected output relays.

The remote control is limited in the control functions selected in the table of the relays menu. The CRC and the controls of the message length are used on each received message. No response is given for messages received with an error detection. The principal unit can be re-initialised in order to resent an order as often as wanted if he is not receiving any response or if he receives a response with an error detection.

NOTE: The control commands are generally materialised by the change of the cell value. They dispose the same inherent security. No response is allowed for the global orders to avoid any user conflict of the Bus. For this type of order, a double start is used for the verification of the message by the relay. The relay transmits then a confirmation indicating that the control order or the change of setting has been accepted. If this is not the case, the relay is sending an error message.

#### 1.4.11 Change of remote measurements

The relay is only responding to the orders of a setting change through the serial port if the SD0 link = 1 is selected. The selection of the SD0 link = 1 is blocking all the changes of remote setting with the exception of the SC logical links and the password capture. When the SD0 link = 0 is selected, the remote setting are protected by the password.

For changing the remote links, the password has to be first remote captured and the SD and SD0 function links have to be settled on 1.



## 1.5 Event extraction

Events can be extracted either automatically or manually. For automatic extraction all events are extracted in sequential order using the standard Courier mechanism, this includes fault. The manual approach allows the user to select randomly an event, or a fault from the stored records.

### 1.5.1 Automatic event extraction

This method is intended for continuous extraction of event and fault information as it is produced via the rear port.

When new event information is created the Event bit is set within the Status byte, this indicates to the Master device that event information is available. The oldest, unextracted event can be extracted from the relay using the Send Event command. The relay will respond with the event data, which will be either a Courier Type 0 or Type 3 event. The Type 3 event is used for fault records.

Once an event is extracted from the relay the Accept Event can be used to confirm that the event has been successfully extracted. If all events have been extracted then the event bit will reset, if there are more events still to be extracted the next event can be accessed using the Send Event command as before.

### 1.5.2 Event types

Events will be created by the relay under the following circumstances:

- Change of state of output contact
- Change of state of opto input
- Protection element operation
- Alarm condition
- Setting Change
- Fault Record (Type 3 Courier Event)

### 1.5.3 Event format

The Send Event command results in the following fields being returned by the relay:

- Cell Reference
- Timestamp
- Cell Text
- Cell Value

Paragraph 2 contains a table of the events created by the relay and indicates how the contents of the above fields are interpreted. Fault records will return a Courier Type 3 event which contains the above fields together with two additional fields:

- Event extraction column
- Event number

These events contain additional information which is extracted from the relay using the referenced extraction column. Row 01 of the extraction column contains a setting which allows the fault record to be selected. This setting should be set to the event number value returned within the record, the extended data can be extracted from the relay by uploading the text and data from the column.

#### 1.5.4 Manual record extraction

Column 02 of the database can be used for manual viewing fault records. The contents of this column will depend of the nature of the record selected. It is possible to select directly a fault record.

Fault Record Selection (Row 01) - This cell can be used to directly select a fault record using a value between 0 and 4 to select one of up to five stored fault records (0 will be the most recent fault and 4 will be the oldest). The column will then contain the details of the fault record selected (row 02 to 0A)

It should be noted that if this column is used to extract event information from the relay the number associated with a particular record will change when a new fault occurs.

#### 1.6 Disturbance record extraction (P120, P122, P123 only)

The stored disturbance records within the relay are accessible via the Courier interface.

Select Record Number (Row 01) - This cell can be used to select the record to be extracted. Record 0 will be the oldest un-extracted record, older records will be assigned positive values, and negative values will be used for more recent records. To facilitate automatic extraction via the rear port the Disturbance bit of the Status byte is set by the relay whenever there are un-extracted disturbance records.

Once a record has been selected, using the above cell, the time and date of the record can be read from cell 02. The disturbance record itself can be extracted using the block transfer mechanism from cell B00B.

As has been stated the rear Courier port can be used to automatically extract disturbance records as they occur. This operates using the standard Courier mechanism defined in Chapter 8 of the Courier User Guide.

**2. LIST OF EVENTS CREATED BY THE RELAY**

Code	Cell text	Cell reference	Availability
00	UNKNOWN EVENT	-	
01	REMOTE CB CLOSING	0	P120-P122-P123
02	CB TRIP	0	P120-P122-P123
03	DIST TRIG	0	P120-P122-P123
04	UNLOCK TRIP	0	P120-P122-P123
05	SET. CHANGE	0	P120-P122-P123
06	RESET THERM	0	P122-P123
07	SET MAINT MODE	0	P122-P123
08	SET RELAY MAINT MODE	0021	P122-P123
09	I>	0023	P122-P123
10	I>>	0023	P122-P123
11	I>>>	0023	P122-P123
12	IE>	0023	P120-P122-P123
13	IE>>	0023	P120-P122-P123
14	IE>>>	0023	P120-P122-P123
15	TH. ALARM	0023	P122-P123
16	TH OVERLOAD	0023	P122-P123
17	tl>	0023	P122-P123
18	tl>>	0023	P122-P123
19	tl>>>	0023	P122-P123
20	tlE>	0023	P120-P122-P123
21	tlE>>	0023	P120-P122-P123
22	tlE>>>	0023	P120-P122-P123
23	tl<	0023	P122-P123
24	BROKEN CONDUCTOR	0024	P122-P123
25	t Aux1	0024	P122-P123
26	t Aux2	0024	P122-P123
27	BREAKER FAILURE	0024	P122-P123
28	Logic Sel. 1	0020	P122-P123
29	Logic Sel. 2	0020	P122-P123
30	Blocking Logic 1	0020	P120-P122-P123
31	Blocking Logic 2	0020	P122-P123
32	Setting group change	0020	P122-P123
33	52 a	0020	P120-P122-P123
34	52 b	0020	P120-P122-P123
35	ACK ALL ALAR	0020	P120-P122-P123
36	SF6	0020	P122-P123
37	COLD LOAD PICKUP	0020	P122-P123
38	TS Change	0020	P120-P122-P123
39	TRIP: TH OVERLOAD	0021	P122-P123
40	TRIP: tl>	0021	P122-P123

Code	Cell text	Cell reference	Availability
41	TRIP: tI>>	0021	P122-P123
42	TRIP: tI>>>	0021	P122-P123
43	TRIP: tIE>	0021	P120-P122-P123
44	TRIP: tIE>>	0021	P120-P122-P123
45	TRIP: tIE>>>	0021	P120-P122-P123
46	TRIP: tI<	0021	P122-P123
47	TRIP: BROKEN CONDUCTOR	0021	P122-P123
48	TRIP: t Aux 1	0021	P122-P123
49	TRIP: t Aux 2	0021	P122-P123
50	AUX Relays	0021	P120-P122-P123
51	ACK 1 AL (FRONT)	0	P120-P122-P123
52	ACK ALAR (FRONT)	0	P120-P122-P123
53	ACK 1 ALARM (COM)	0	P120-P122-P123
54	ACK ALAR (COM)	0	P120-P122-P123
55	Hard Maj Alarm	0022	P120-P122-P123
56	Hard min Alarm	0022	P120-P122-P123
57	I2 >	0024	P122-P123
58	t 2 >	0024	P122-P123
59	OPEN OPERATING TIME	0024	P122-P123
60	TRIP OPERATION Nb	0024	P122-P123
61	SA2N	0024	P122-P123
62	SW TRIP CIRCUIT	0024	P122-P123
63	CLOSE OPERATING TIME	0024	P122-P123
64	SUCCESS AUTORECLOSE	0024	P123
65	AUTORECLOSER FINAL TRIP	0025	P123
66	AUTORECLOSER CONF. FAIL	0024	P123
67	TRIP: t I2 >	0021	P122-P123
68	Reserved		
69	Reserved		
70	Reserved		
71	LATCHED RELAYS	-	P122-P123
72	EXT BREAKER FAILURE	0020	P122-P123
73	I<	0023	P122-P123
74	I2>>	0024	P122-P123
75	tI2>>	0024	P122-P123
76	TRIP: tI2>>	0021	P122-P123
77	Reserved		
78	LATCHED RELAY TRIP	-	P122-P123
79	t AUX3	0025	P122-P123
80	TRIP: t AUX3	0021	P122-P123
81	t AUX4	0025	P123
82	TRIP: t AUX4	0021	P123

MiCOM P120/P121/P122/P123

Code	Cell text	Cell reference	Availability
83	t Reset l>	0025	P122-P123
84	t Reset l>>	0025	P122-P123
85	t Reset IE>	0025	P122-P123
86	t Reset IE>>	0025	P122-P123
87	t Reset l2>	0025	P122-P123
88	TRIP Breaker Failure	0021	P122-P123
89	t BF /Ext. Breaker Failure	0025	P122-P123
90	MANUAL CLOSE (Inp)	0020	P123
91	t SOTF	0025	P123
92	TRIP t SOTF	0021	P123
93	LOCAL MODE	0020	P123
94	Reserved		
95	LOCKED AUTORECLOSER	0024	P123
96	AUTORECLOS. IN PROGRESS	0025	P123
97	TIME SYNCHRO	-	P122-P123
98	INRUSH BLOCKING	00XX	P122-P123
99	t Equation A	0026	P122-P123
100	t Equation B	0025	P122-P123
101	t Equation C	0026	P122-P123
102	t Equation D	0025	P122-P123
103	t Equation E	0026	P122-P123
104	t Equation F	0025	P122-P123
105	t Equation G	0026	P122-P123
106	t Equation H	0025	P122-P123
107	TRIP: t Equation A	0021	P122-P123
108	TRIP: t Equation B	0021	P122-P123
109	TRIP: t Equation C	0021	P122-P123
110	TRIP: t Equation D	0021	P122-P123
111	TRIP: t Equation E	0021	P122-P123
112	TRIP: t Equation F	0021	P122-P123
113	TRIP: t Equation G	0021	P122-P123
114	TRIP: t Equation H	0021	P122-P123
	GEN. SET. CHANGE		P120-P122-P123

NOTE: When the cell reference is different of zero this means that the event is generated on event occurrence and another is generated on event disappearance.

When the cell reference is equal to zero, only the event on edging edge is generated.

Twelve bits are available in the string of characters to describe the contain of the Courier cell:

On event occurrence, the corresponding bit of the associated format is set to « 1 ».

On event disappearance, the corresponding bit of the associated format is set to « 0 ».

### 3. COURIER DATABASE ORGANISATION P120

Col	Row	Menu Text	Data Type	Ind	Values (*: default)	Depend	Cell Type	Min/Max/Step
<b>00</b>	<b>00</b>	<b>SYSTEM DATA</b>						
	01	Language	Ver>: Indexed String	0 1 2 3	Lang1 (French) Lang2 (English) * Lang3 (German) Lang4 (Spanish)		Setting	0/3/1
	02	Password	ASCII Password(4 bytes)		AAAA		Setting	32/127/1
	03	<i>Flinks: NOT IMPLEMENTED</i>						
	04	Description	ASCII Text (6 bytes)		" P120 "**		Setting	32/127/1
	05	Plant Reference	ASCII Text (4 bytes)		" Pref "		Setting	32/127/1
	06	Model Number	ASCII Text (16 bytes)		" Model Number "		Data	
	07	Firmware Number	ASCII Text (16 bytes)		" Firmware Number "		Data	
	08	Serial Number	ASCII Text (16 bytes)		" Serial Number "		Data	
	09	Frequency	Unsigned Integer (2 bytes)		XXXX Hz		Setting	50/60/10
	0A	Communication Level	Unsigned Integer (2 bytes)		1		Data	
	0B	Address	Unsigned Integer (2 bytes)		1*		Setting	1/255/1
	0C	<i>Plant Status Word: NOT IMPLEMENTED</i>						
	0D	<i>Control Status Word: NOT IMPLEMENTED</i>						
	0E	Setting Group	Unsigned Integer				Data	Always = 1
	0F	<i>Load shed Stage: NOT IMPLEMENTED</i>						
	10	Circuit Breaker Control	Binary flag (3 bits)		0: No operation 1: Trip 2: Close		Data	
	11	Software Reference	ASCII Text (16 characters)				Data	
	12-1F	<i>Unused, reserved</i>						
	20	Logic Input Status	Binary flag (3 bits)		0: log input 1 1: log input 2		Data	

MiCOM P120-P121-P122-P123

Col	Row	Menu Text	Data Type	Ind	Values (*: default)	Depend	Cell Type	Min/Max/Step
	21	Relay Output Status	Binary flag (5 bits)		0: relay 1 (trip) 1: relay 2 2: relay 3 3: relay 4 4: watchdog relay		Data	
	22	Alarm	Binary flag (16 bits)		0: Ana output err 1: Comm err 2: Eeprom err data 3: Ct error 4: reserved 5: Eeprom err calib 6: reserved 7: reserved 8: reserved 9: Default settings 10 to 15: reserved		Data	
	23	Pseudo Logic Input Status group 1	Binary flag (12 bits)		3: IE> 4: IE>> 5: IE>>> 9: t IE> 10: t IE>> 11: t IE>>>		Data	
	24	Pseudo Logic Input Status group 2	Binary flag (3 bits)		0: Reserved 1: tAux 1 2: tAux 2		Data	
<b>01</b>	<b>00</b>	<b>USER CONTROL</b>						
	01	Remote control 1	Binary flag (9 bits)		0: Unlock trip cont.* 1: Ack first alarm 2: Ack all alarms 3: TRIP 4: CLOSE 5 to 7: Reserved 8: Dist. Rec. Trig 9 to 15: Reserved		Setting	0/511/1
<b>02</b>	<b>00</b>	<b>VIEW RECORDS</b>						
	01	Record number	Unsigned Integer (2 bytes)			5 *	Setting	1/5/1
	02	Occur date	Unsigned Integer (2 bytes)					
	03	Active set group	Unsigned Integer (2 bytes)					
	04	Phase in fault	ASCII Text					

Col	Row	Menu Text	Data Type	Ind	Values (*: default)	Depend	Cell Type	Min/Max/Step
	05	Fault Id	ASCII Text					
	06	Magnitude	Courier floating point number					
	0A	In magnitude	Courier floating point number					
<b>03</b>	<b>00</b>	<b>MEASUREMENTS</b>						
	01	I0 RMS	Courier floating point number				Data	
	09	FREQUENCY	Courier floating point number				Data	Starting from V5.F
<b>0E</b>	<b>00</b>	<b>CT RATIOS</b>						
	01	CT Primary	Unsigned Integer (2 bytes)		1000 *		Setting	1/3000/1
	02	CT Secondary	Unsigned Integer (2 bytes)		1 *		Setting	1/5/4
		<i>Protection Group n° 1</i>						
<b>21</b>	<b>00</b>	<b>EARTH FAULT</b>						
	<b>01</b>	<b>Stage 1 Overcurrent</b>	(Sub Heading)					
	02	Max I>	Binary (1 bit)	0	Disabled * / Enabled		Setting	0/1/1
	03	Threshold I>	Courier floating point number		0.01 IEn*	2102=1	Setting	0.01/1.0/0.005
	04	Tempo Type I>	Indexed String	0 1 2 3	0: definite time * 1: inverse time 2: RI curve 3: Laborelec curves	2102=1	Setting	0/3/1
	05	Curve Type I>	Indexed String	0 1 2 3 4 5 6 7 8 9 10	STI (CEI) * SI (CEI) VI (CEI) EI (CEI) LTI (CEI) STI (CO2) MI (ANSI) LTI (CO8) VI (ANSI) EI (ANSI) RC (CEI)	2104=1	Setting	0/10/1
	07	TMS I>	Courier floating point number		0.025 *	2104=1	Setting	0.025/1.5/0.025
	08	K I>	Courier floating point number		0.1 *	2104=2	Setting	0.1/10.0/0.005
	09	Tempo I>	Courier floating point number		0.01 s *	2104=0	Setting	0 /150.0/0.01
	0C-0F	<i>Reserved</i>						



MiCOM P120-P121-P122-P123

Col	Row	Menu Text	Data Type	Ind	Values (*: default)	Depend	Cell Type	Min/Max/Step
	<b>10</b>	<b>Stage 2 Overcurrent</b>	(Sub Heading)					
	11	Max I>>	Binary (1 bit)	0	Disabled * / Enabled		Setting	0/1/1
	12	Threshold I>>	Courier floating point number		0.01 IEn*	2111=1	Setting	0.01/8.0/0.005
	18	Tempo I>>	Courier floating point number		0.01 s *	2113=0	Setting	0 /150.0/0.01
	1C-1F	<i>Reserved</i>						
	<b>20</b>	<b>Stage 3 Overcurrent</b>	(Sub Heading)					
	21	Max I>>>	Binary (1 bit)	0	Disabled * / Enabled		Setting	0/1/1
	22	Threshold I>>>	Courier floating point number		0.01 IEn *	2121=1	Setting	0.01/8.0/0.005
	23	Tempo I>>>	Courier floating point number		0.01 s *	2121=1	Setting	0 /150.0/0.01
<b>60</b>	<b>00</b>	<b>AUTOMATISM</b>						
	01	Trip Configuration	Binary (11 bits)		0: t I> 1: t I>> 2: t I>>> 3: reserved 4: reserved 5: reserved 6: reserved 7: reserved 8: reserved 9: tAux1 10: tAux2		Setting	0 / 2047 / 1
	02	Latched Configuration	Binary (11 bits)		0: Latch I> 1: Latch I>> 2: Latch I>>> 3: reserved 4: reserved 5: reserved 6: reserved 7: reserved. 8: reserved 9: Latch Aux1 10: Latch Aux2		Setting	0 / 2047 / 1

Col	Row	Menu Text	Data Type	Ind	Values (*: default)	Depend	Cell Type	Min/Max/Step
	03	Blocking Configuration	Binary (11 bits)		0: Blocking t l> 1: Blocking t l>> 2: Blocking t l>>> 3: reserved 4: reserved 5: reserved 6: reserved 7: reserved 8: reserved 9: Blocking tAux1 10: Blocking tAux2		Setting	0 / 2047 / 1
<b>61</b>	<b>00</b>	<b>TS SETTINGS</b>						
	06	Timer aux 1	Courier floating point number		0 *		Setting	0 / 200.0 / 0.01
	07	Timer aux 2	Courier floating point number		0 *		Setting	0 / 200.0 / 0.01
	10	Logical input 1 allocation (1/2)	Binary (9 bits)	0 1 2 3 4 5 6 7 8	0: delatch 1: 52 a 2: 52 b 3: CB failure 4: External input 1 5: External input 2 6: Logic blocking 7: Reserved 8: Disturbance start		Setting	0/511/1
	11	Logical input 2 allocation (1/2)	Binary (9 bits)	0 1 2 3 4 5 6 7 8	0: delatch 1: 52 a 2: 52 b 3: CB failure 4: External input 1 5: External input 2 6: Logic blocking 7: Reserved 8: Disturbance start		Setting	0/511/1
	15	Logical input 1 allocation (2/2)	Binary (8 bits)	0 1 2 3 4 5 6 7	0: Reserved 1: Reserved 2: Reserved 3: Reserved 4: Reserved 5: Reserved 6: Reserved 7: Synchronisation		Setting	0/255/ 1

MiCOM P120-P121-P122-P123

Col	Row	Menu Text	Data Type	Ind	Values (*: default)	Depend	Cell Type	Min/Max/Step
	16	Logical input 2 allocation (2/2)	Binary (8 bits)	0 1 2 3 4 5 6 7	0: Reserved 1: Reserved 2: Reserved 3: Reserved 4: Reserved 5: Reserved 6: Reserved 7: Synchronisation		Setting	0/255/ 1
<b>62</b>	<b>00</b>	<b>TC SETTINGS</b>						
	01	GENERAL TRIP	Binary (3 bits)		000 *		Setting	0/7/1
	02	l>	Binary (3 bits)		000 *		Setting	0/7/1
	03	tl>	Binary (3 bits)		000 *		Setting	0/7/1
	04	l>>	Binary (3 bits)		000 *		Setting	0/7/1
	05	t l>>	Binary (3 bits)		000 *		Setting	0/7/1
	06	l>>>	Binary (3 bits)		000 *		Setting	0/7/1
	07	t l>>>	Binary (3 bits)		000 *		Setting	0/7/1
	15	Reclosing	Binary (3 bits)		000 *		Setting	0/7/1
	16	tAux 1	Binary (3 bits)		000 *		Setting	0/7/1
	17	tAux 2	Binary (3 bits)		000 *		Setting	0/7/1
	28	Logical input 1	Binary (3 bits)		000 *		Setting	0/7/1
	29	Logical input 2	Binary (3 bits)		000 *		Setting	0/7/1
<b>63</b>	<b>00</b>	<b>LEDS SETTINGS</b>						
	01	Led 5 1/2	Binary (6 bits)	1 *	0: l> * 1: t l> 2: l>> 3: t l>> 4: l>>> 5: t l>>>		Setting	0/63/1
	02	Led 6 1/2	Binary (6 bits)	2 *	0: l> 1: t l> * 2: l>> 3: t l>> 4: l>>> 5: t l>>>		Setting	0/63/1
	03	Led 7 1/2	Binary (6 bits)	4 *	0: l>		Setting	0/63/1

Col	Row	Menu Text	Data Type	Ind	Values (*: default)	Depend	Cell Type	Min/Max/Step
					1: t l> 2: l>> * 3: t l>>> 4: l>>>> 5: t l>>>>			
	04	Led 8 1/2	Binary (6 bits)	16 *	0: l> 1: t l> 2: l>> 3: t l>>> 4: l>>>> * 5: t l>>>>		Setting	0/63/1
	05	Led 5 2/2	Binary (9 bits)	0 *	0: Input 1 1: Input 2 2: Reserved 3: Reserved 4: Reserved 5: Reserved 6: Reserved 7: tAux1 8: tAux2		Setting	0/511/1
	06	Led 6 2/2	Binary (9 bits)	0 *	0: Input 1 1: Input 2 2: Reserved 3: Reserved 4: Reserved 5: Reserved 6: Reserved 7: tAux1 8: tAux2		Setting	0/511/1
	07	Led 7 2/2	Binary (9 bits)	0 *	0: Input 1 1: Input 2 2: Reserved 3: Reserved 4: Reserved 5: Reserved 6: Reserved 7: tAux1 8: tAux2		Setting	0/511/1

MiCOM P120-P121-P122-P123

Col	Row	Menu Text	Data Type	Ind	Values (*: default)	Depend	Cell Type	Min/Max/Step
	08	Led 8 2/2	Binary (9 bits)	0 *	0: Input 1 1: Input 2 2: Reserved 3: Reserved 4: Reserved 5: Reserved 6: Reserved 7: tAux1 8: tAux2		Setting	0/511/1
<b>64</b>	<b>00</b>	<b>ALARMS</b>						
	10	Inhib. Alarms tAux	Binary (2 bits)	0 0	0: Alarm tAux1 1: Alarm tAux2		Setting	0/3/1
<b>70</b>	<b>00</b>	<b>RECORDER CONTROL</b>						
	01	Start/Trigger recorder	Indexed String	0 1 2	Stopped Triggerred Running *		Setting	1/2/1
	02	Recorder Source	Indexed String	0	Samples *		Data	
	20	Pretemps	Courier floating point number		0.1 secondes		Setting	0.1/3.0/0.1
	21	Postemps	Courier floating point number		0.1 secondes		Setting	0.1/3.0/0.1
	22	Trigger	Indexed String	0	On Inst* / On Trig		Setting	0/1/1
<b>80</b>	<b>00</b>	<b>DISTURBANCE REC</b>						
	01	Record Number	Unsigned integer (1 byte)		0*		Setting	0/5/1 (selon contexte)
	02	Trigger Time	IEC870 Time & Date		dd/mm/yy hh:mm		Data	
	03	Available Channel Bit Mask	Binary Flag Indexed String	0 1	11 " IO " " Inputs/Outputs "		Data	
	04	Channel Types	Binary Flag 0: digital, 1: analogue		01		Data	
	05	Channel Offsets	Repeated group of Courier numbers		Upload Offsets		Data	
	06	Scaling Factors	Repeated group of Courier numbers		Upload Scal. Factors		Data	
	07-0F	NOT IMPLEMENTED – reserved						
	10	Record Length	Integer (2 bytes)				Data	

Col	Row	Menu Text	Data Type	Ind	Values (*: default)	Depend	Cell Type	Min/Max/Step
	11	Trigger position	Integer (2 bytes)				Data	
	12	Time Base	Courier floating point number				Data	
	13	NOT IMPLEMENTED – reserved						
	14	Upload Timer	Repeated group of Integers				Data	
	15-1F	NOT IMPLEMENTED – reserved						
	20	Upload Channel 0	Repeated group of Integers				Data	
	21	Upload Channel Inputs/Outputs	Repeated group of Integer/Bin. flags				Data	
<b>90</b>	<b>00</b>	<b>AUTOMAT. FLT</b>						
	01	Record number	Unsigned Integer (2 bytes)				Setting (automatic)	
	02	Occur fault date	Unsigned Integer (2 bytes)				Data	
	03	Active set group	Unsigned Integer (2 bytes)		1		Data	
	04	Phase in fault	ASCII Text (10 bytes)		“ PHASE A ”		Data	
	05	Fault Id	ASCII Text (18 bytes)		“   >> ”		Data	
	06	Magnitude	Courier floating point number		12.34 A		Data	
	0A	In Magnitude	Courier floating point number		12.34 A		Data	
<b>BF</b>	<b>00</b>	<b>COMM SYSTEM DATA</b>						
	01	Dist Record Cntrl Ref	Menu Cell (2)		0x7000		Data	
	02	Dist Record Extract Ref	Menu Cell (2)		0x8000		Data	
	03	Setting Transfert					Setting	0/1/1
	04	<i>Reset Demand Timers</i>	<i>NOT IMPLEMENTED</i>					
	05	<i>Reset Event Report</i>	<i>NOT IMPLEMENTED</i>					

**4. COURIER DATABASE ORGANISATION P121**

Col	Row	Menu Text	Data Type	Ind	Values (*: default)	Depend	Cell Type	Min/Max/Step
<b>00</b>	<b>00</b>	<b>SYSTEM DATA</b>						
	01	Language	Ver>: Indexed String	0 1 2 3	Lang1 (French) Lang2 (English) * Lang3 (German) Lang4 (Spanish)		Setting	0/3/1
	02	Password	ASCII Password (4 bytes)		AAAA		Setting	32/127/1
	03	<i>Fnlinks: NOT IMPLEMENTED</i>						
	04	Description	ASCII Text (6 bytes)		" P121 "**		Setting	32/127/1
	05	Plant Reference	ASCII Text (4 bytes)		" Pref "		Setting	32/127/1
	06	Model Number	ASCII Text (16 bytes)		" Model Number "		Data	
	07	Firmware Number	ASCII Text (16 bytes)		" Firmware Number "		Data	
	08	Serial Number	ASCII Text (16 bytes)		" Serial Number "		Data	
	09	Frequency	Unsigned Integer (2 bytes)		XXXX Hz		Setting	50/60/10
	0A	Communication Level	Unsigned Integer (2 bytes)		1		Data	
	0B	Address	Unsigned Integer (2 bytes)		1*		Setting	1/255/1
	0C	<i>Plant Status Word: NOT IMPLEMENTED</i>						
	0D	<i>Control Status Word: NOT IMPLEMENTED</i>						
	0E	Setting Group	Unsigned Integer				Data	
	0F	<i>Load shed Stage: NOT IMPLEMENTED</i>						
	10	Circuit Breaker Control	Binary flag (3 bits)		0: No operation 1: Trip 2: Close		Data	
	11	Software Reference	ASCII Text (16 characters)				Data	
	12-1F	<i>Unused, reserved</i>						

Col	Row	Menu Text	Data Type	Ind	Values (*: default)	Depend	Cell Type	Min/Max/Step
	20	Logic Input Status	Binary flag (3 bits)		0: log input 1 1: log input 2 2: log input 3		Data	
	21	Relay Output Status	Binary flag (5 bits)		0: relay 1 (trip) 1: relay 2 2: relay 3 3: relay 4 4: watchdog relay		Data	
	22	Alarm	Binary flag (16 bits)		0: Ana output err 1: Comm err 2: Eeprom err data 3: Ct error 4: reserved 5: Eeprom err calib 6: reserved 7: reserved 8: reserved 9: Default settings 10 to 15: reserved		Data	
	23	Pseudo Logic Input Status group 1	Binary flag (12 bits)		0: l> 1: l>> 2: l>>> 3: IE> 4: IE>> 5: IE>>> 6: t l> 7: t l>> 8: t l>>> 9: t IE> 10: t IE>> 11: t IE>>>		Data	
	24	Pseudo Logic Input Status group 2	Binary flag (3 bits)		0: Reserved 1: tAux 1 2: tAux 2		Data	
	26	Pseudo Logic Input Status group 4	Binary flag (8 bits)		0: t Equation A 1: t Equation B 2: t Equation C 3: t Equation D 4: t Equation E 5: t Equation F 6: t Equation G 7: t Equation H		Data	



MiCOM P120-P121-P122-P123

Col	Row	Menu Text	Data Type	Ind	Values (*: default)	Depend	Cell Type	Min/Max/Step
<b>01</b>	<b>00</b>	<b>USER CONTROL</b>						
	01	Remote control 1	Binary flag (5 bits)		0: Unlock trip cont.* 1: Ack first alarm 2: Ack all alarms 3: TRIP 4: CLOSE 5 to 15: Reserved		Setting	0/ 31/1
<b>03</b>	<b>00</b>	<b>MEASUREMENTS</b>						
	01	IA RMS	Courier floating point number				Data	
	02	IB RMS	Courier floating point number				Data	
	03	IC RMS	Courier floating point number				Data	
	04	I0 RMS	Courier floating point number				Data	
	09	FREQUENCY	Courier floating point number				Data	
<b>0C</b>	<b>00</b>	<b>FAIL-SAFE RELAYS SETTINGS</b>						
	01	Fail-safe relays	Binary flag (4 bits)		0: relay 1 (trip) 1: relay 2 2: relay 3 3: relay 4		Setting	0 / 15 / 1
<b>0D</b>	<b>00</b>	<b>GENERAL SETTING</b>						
	01	Phase rotation sense	Indexed string		0: Direct (A/B/C) 1: Inverse (A/B/C)		Setting	0 (A/B/C) 1 (A/B/C)
<b>0E</b>	<b>00</b>	<b>CT RATIOS</b>						
	01	Phase CT Primary	Unsigned Integer (2 bytes)		1000 *		Setting	1/3000/1
	02	Phase CT Secondary	Unsigned Integer (2 bytes)		1 *		Setting	1/5/4
	03	Neutral CT Primary	Unsigned Integer (2 bytes)		1000 *		Setting	1/3000/1
	04	Neutral CT Secondary	Unsigned Integer (2 bytes)		1 *		Setting	1/5/4
		<i>Protection Group n° 1</i>						
<b>20</b>	<b>00</b>	<b>PHASE OVERCURRENT</b>						
	01	Stage 1 Overcurrent	(Sub Heading)					
	02	Max I>	Binary (1 bit)	0	Disabled * / Enabled		Setting	0/1/1
	03	Threshold I>	Courier floating point number		0.1 In *	2002=1	Setting	0.1/25.0/0.1

Col	Row	Menu Text	Data Type	Ind	Values (*: default)	Depend	Cell Type	Min/Max/Step
	04	Temporisation Type l>	Indexed String	0 1 2	0: definite time * 1: inverse time 2: RI curve	2002=1	Setting	0/2/1
	05	Curve type l>	Indexed String	0 1 2 3 4 5 6 7 8 9 10	STI (CEI) * SI (CEI) VI (CEI) EI (CEI) LTI (CEI) STI (CO2) MI (ANSI) LTI (CO8) VI (ANSI) EI (ANSI) RC (CEI)	2004=1	Setting	0/10/1
	06	TMS l>	Courier floating point number		0.025 *	2004=1	Setting	0.025/1.5/0.001
	07	K l>	Courier floating point number		0.1 *	2004=2	Setting	0.1/10.0/0.005
	08	Tempo l>	Courier floating point number		0.01 s *	2004=0	Setting	0 /150.0/0.01
	0C-0F	<i>Reserved</i>						
	10	Stage 2 Overcurrent	(Sub Heading)					
	11	Max l>>	Binary (1 bit)	0	Disabled * / Enabled		Setting	0/1/1
	12	Threshold l>>	Courier floating point number		0.50 In *	2011=1	Setting	0.5/40.0/0.05
	13	Temporisation Type l>>	Indexed String	0 1 2	0: definite time * 1: inverse time 2: RI curve	2011=1	Setting	0/2/1
	14	Curve type l>>	Indexed String	0 1 2 3 4 5 6 7 8 9 10	STI (CEI) * SI (CEI) VI (CEI) EI (CEI) LTI (CEI) STI (CO2) MI (ANSI) LTI (CO8) VI (ANSI) EI (ANSI) RC (CEI)	2013=1	Setting	0/10/1
	15	TMS l>>	Courier floating point number		0.025 *	2013=1	Setting	0.025/1.5/0.001
	16	K l>>	Courier floating point number		0.1 *	2013=2	Setting	0.1/10.0/0.005
	17	Tempo l>>	Courier floating point number		0.01 s *	2013=0	Setting	0 /150/0.01

MiCOM P120-P121-P122-P123

Col	Row	Menu Text	Data Type	Ind	Values (*: default)	Depend	Cell Type	Min/Max/Step
	1B-1F	Reserved						
	20	Stage 3 Overcurrent	(Sub Heading)					
	21	Max I>>>	Binary (1 bit)	0	Disabled * / Enabled		Setting	0/1/1
	22	Threshold I>>>	Courier floating point number		0.50 In *	2021=1	Setting	0.5/40.0/0.05
	23	Tempo I>>>	Courier floating point number		0.01 s *	2021=1	Setting	0 /150/0.01
21	00	EARTH FAULT						
	01	Stage 1 Overcurrent	(Sub Heading)					
	02	Max IE>	Binary (1 bit)	0	Disabled * / Enabled		Setting	0/1/1
	03	Threshold IE>	Courier floating point number		0.01 IEn*	2102=1	Setting	0.01/1.0/0.005
	04	Tempo Type IE>	Indexed String	0 1 2	0: definite time * 1: inverse time 2: RI curve	2102=1	Setting	0/2/1
	05	Curve Type IE>	Indexed String	0 1 2 3 4 5 6 7 8 9 10	STI (CEI) * SI (CEI) VI (CEI) EI (CEI) LTI (CEI) STI (CO2) MI (ANSI) LTI (CO8) VI (ANSI) EI (ANSI) RC (CEI)	2104=1	Setting	0/10/1
	07	TMS IE>	Courier floating point number		0.025 *	2104=1	Setting	0.025/1.5/0.001
	08	K IE>	Courier floating point number		0.1 *	2104=2	Setting	0.1/10.0/0.005
	09	Tempo IE>	Courier floating point number		0.01 s *	2104=0	Setting	0 /150.0/0.01
	0C-0F	Reserved						
	10	Stage 2 Overcurrent	(Sub Heading)					
	11	Max IE>>	Binary (1 bit)	0	Disabled * / Enabled		Setting	0/1/1
	12	Threshold IE>>	Courier floating point number		0.01 IEn*	2111=1	Setting	0.01/8.0/0.005
	13	Tempo Type IE>>	Indexed String	0 1 2	0: definite time * 1: inverse time 2: RI curve	2111=1	Setting	0/3/1

Col	Row	Menu Text	Data Type	Ind	Values (*: default)	Depend	Cell Type	Min/Max/Step
	14	Curve Type IE>>	Indexed String	0 1 2 3 4 5 6 7 8 9 10	STI (CEI) * SI (CEI) VI (CEI) EI (CEI) LTI (CEI) STI (CO2) MI (ANSI) LTI (CO8) VI (ANSI) EI (ANSI) RC (CEI)	2113=1	Setting	0/10/1
	16	TMS IE>>	Courier floating point number		0.025 *	2113=1	Setting	0.025/1.5/0.001
	17	K IE>>	Courier floating point number		0.1 *	2113=2	Setting	0.1/10.0/0.005
	18	Tempo IE>>	Courier floating point number		0.01 s *	2113=0	Setting	0 /150.0/0.01
	1C-1F	<i>Reserved</i>						
	20	Stage 3 Overcurrent	(Sub Heading)					
	21	Max IE>>>	Binary (1 bit)	0	Disabled * / Enabled		Setting	0/1/1
	22	Threshold IE>>>	Courier floating point number		0.01 IEn *	2121=1	Setting	0.01/8.0/0.005
	23	Tempo IE>>>	Courier floating point number		0.01 s *	2121=1	Setting	0 /150.0/0.01
60	00	AUTOMATISM						
	01	Trip Configuration 1/2	Binary (11 bits)		0: t l> * 1: t l>> 2: t l>>> 3: t IE> 4: t IE>> 5: t IE>>> 6: reserved 7: reserved 8: reserved 9: tAux1 10: tAux2		Setting	0 / 2047 / 1

MiCOM P120-P121-P122-P123

Col	Row	Menu Text	Data Type	Ind	Values (*: default)	Depend	Cell Type	Min/Max/Step
	02	Latched Configuration	Binary (11 bits)		0: Latch l> 1: Latch l>> 2: Latch l>>> 3: Latch lE> 4: Latch lE>> 5: Latch lE>>> 6: reserved 7: reserved. 8: reserved 9: Latch Aux1 10: Latch Aux2		Setting	0 / 2047 / 1
	03	Blocking 1 Configuration	Binary (11 bits)		0: Blocking t l> 1: Blocking t l>> 2: Blocking t l>>> 3: Blocking t lE> 4: Blocking t lE>> 5: Blocking t lE>>> 6: reserved 7: reserved 8: reserved 9: Blocking tAux1 10: Blocking tAux2		Setting	0 / 2047 / 1
	15	Trip Configuration 2/2	Binary (10 bits)	0 *	0: Reserved 1: Reserved 2: Trip Equation A 3: Trip Equation B 4: Trip Equation C 5: Trip Equation D 6: Trip Equation E 7: Trip Equation F 8: Trip Equation G 9: Trip Equation H		Setting	0 / 4095 / 1
<b>61</b>	<b>00</b>	<b>TS SETTINGS</b>						
	06	Timer aux 1	Courier floating point number		0 *		Setting	0 / 200.0 / 0.01
	07	Timer aux 2	Courier floating point number		0 *		Setting	0 / 200.0 / 0.01

Col	Row	Menu Text	Data Type	Ind	Values (*: default)	Depend	Cell Type	Min/Max/Step
	10	Logical input allocation 1	Binary (7 bits)		0: delatch 1: 52 a 2: 52 b 3: CB failure 4: External input 1 5: External input 2 6: Logic blocking		Setting	0 / 127 / 1
	11	Logical input allocation 2	Binary (7 bits)		0: delatch 1: 52 a 2: 52 b 3: CB failure 4: External input 1 5: External input 2 6: Logic blocking		Setting	0 / 127 / 1
<b>62</b>	<b>00</b>	<b>TC SETTINGS</b>						
	01	GENERAL TRIP	Binary (3 bits)		000 *		Setting	0/7/1
	02	l>	Binary (3 bits)		000 *		Setting	0/7/1
	03	t l>	Binary (3 bits)		000 *		Setting	0/7/1
	04	l>>	Binary (3 bits)		000 *		Setting	0/7/1
	05	t l>>	Binary (3 bits)		000 *		Setting	0/7/1
	06	l>>>	Binary (3 bits)		000 *		Setting	0/7/1
	07	t l>>>	Binary (3 bits)		000 *		Setting	0/7/1
	08	IE>	Binary (3 bits)		000 *		Setting	0/7/1
	09	t IE>	Binary (3 bits)		000 *		Setting	0/7/1
	0A	IE>>	Binary (3 bits)		000 *		Setting	0/7/1
	0B	t IE>>	Binary (3 bits)		000 *		Setting	0/7/1
	0C	IE>>>	Binary (3 bits)		000 *		Setting	0/7/1
	0D	t IE>>>	Binary (3 bits)		000 *		Setting	0/7/1
	15	Reclosing	Binary (3 bits)		000 *		Setting	0/7/1
	16	tAux1	Binary (3 bits)		000 *		Setting	0/7/1
	17	tAux2	Binary (3 bits)		000 *		Setting	0/7/1
	1D	TC lock setting	Binary (3 bits)		000 * bit 0 to 2 =1: TC Locked		Setting	0/7/1

MiCOM P120-P121-P122-P123

Col	Row	Menu Text	Data Type	Ind	Values (*: default)	Depend	Cell Type	Min/Max/Step
	28	Logical input 1	Binary (3 bits)		000 *		Setting	0/7/1
	29	Logical input 2	Binary (3 bits)		000 *		Setting	0/7/1
	30	t Equation A	Binary (3 bits)		000 *		Setting	0/7/1
	31	t Equation B	Binary (3 bits)		000 *		Setting	0/7/1
	32	t Equation C	Binary (3 bits)		000 *		Setting	0/7/1
	33	t Equation D	Binary (3 bits)		000 *		Setting	0/7/1
	34	t Equation E	Binary (3 bits)		000 *		Setting	0/7/1
	35	t Equation F	Binary (3 bits)		000 *		Setting	0/7/1
	36	t Equation G	Binary (3 bits)		000 *		Setting	0/7/1
	37	t Equation H	Binary (3 bits)		000 *		Setting	0/7/1
63	00	LEDS SETTINGS						
	01	Led 5 1/3	Binary (16 bits)		0: l> 1: t l> 2: l>> * 3: t l>> 4: l>>> 5: t l>>> 6: IE> 7: t IE> 8: IE>> 9: t IE>> 10: IE>>> 11: t IE>>> 12 to 15: Reserved		Setting	0/65535/1
	02	Led 6 1/3	Binary (16 bits)		0: l> 1: t l> 2: l>> 3: t l>> 4: l>>> * 5: t l>>> 6: IE> 7: t IE> 8: IE>> 9: t IE>> 10: IE>>> 11: t IE>>> 12 to 15: Reserved		Setting	0/65535/1
	03	Led 7 1/3	Binary (16 bits)		0: l>		Setting	0/65535/1

Col	Row	Menu Text	Data Type	Ind	Values (*: default)	Depend	Cell Type	Min/Max/Step
					1: t l> 2: l>> 3: t l>> 4: l>>> 5: t l>>> * 6: IE> 7: t IE> 8: IE>> 9: t IE>> 10: IE>>> 11: t IE>>> 12 to 15: Reserved			
	04	Led 8 1/3	Binary (16 bits)		0: l> 1: t l> 2: l>> 3: t l>> 4: l>>> 5: t l>>> * 6: IE> 7: t IE> 8: IE>> 9: t IE>> 10: IE>>> 11: t IE>>> 12 to 15: Reserved		Setting	0/65535/1
	05	Led 5 2/3	Binary (9 bits)	0 *	0: Input 1 1: Input 2 2: Reserved 3: Reserved 4: Reserved 5: Reserved 6: Reserved 7: tAux1 8: tAux2		Setting	0/511/1
	06	Led 6 2/3	Binary (9 bits)	0 *	0: Input 1 1: Input 2 2: Reserved 3: Reserved 4: Reserved 5: Reserved 6: Reserved 7: tAux1 8: tAux2		Setting	0/511/1



MiCOM P120-P121-P122-P123

Col	Row	Menu Text	Data Type	Ind	Values (*: default)	Depend	Cell Type	Min/Max/Step
	07	Led 7 2/3	Binary (9 bits)	0 *	0: Input 1 1: Input 2 2: Reserved 3: Reserved 4: Reserved 5: Reserved 6: Reserved 7: tAux1 8: tAux2		Setting	0/511/1
	08	Led 8 2/3	Binary (9 bits)	0 *	0: Input 1 1: Input 2 2: Reserved 3: Reserved 4: Reserved 5: Reserved 6: Reserved 7: tAux1 8: tAux2		Setting	0/511/1
	09	Led 5 3/3	Binary (8 bits)	0 *	0: Equation A 1: Equation B 2: Equation C 3: Equation D 4: Equation E 5: Equation F 6: Equation G 7: Equation H		Setting	0/255/1
	0A	Led 6 3/3	Binary (8 bits)	0 *	0: Equation A 1: Equation B 2: Equation C 3: Equation D 4: Equation E 5: Equation F 6: Equation G 7: Equation H		Setting	0/255/1
	0B	Led 7 3/3	Binary (8 bits)	0 *	0: Equation A 1: Equation B 2: Equation C 3: Equation D 4: Equation E 5: Equation F 6: Equation G 7: Equation H		Setting	0/255/1

Col	Row	Menu Text	Data Type	Ind	Values (*: default)	Depend	Cell Type	Min/Max/Step
	0C	Led 8 3/3	Binary (8 bits)	0 *	0: Equation A 1: Equation B 2: Equation C 3: Equation D 4: Equation E 5: Equation F 6: Equation G 7: Equation H		Setting	0/255/1
<b>64</b>	<b>00</b>	<b>ALARMS</b>						
	10	Inhib. Alarms tAux	Binary (2 bits)	0 *	0: Alarm tAux1 1: Alarm tAux2		Setting	0/3/1
<b>6C</b>	<b>00</b>	<b>BOOLEAN EQUATIONS 1/2</b>						
	10	EQUATION A						
	11	Operator 00	Indexed String	0 * 1	* (Space) NOT		Setting	0/1/1
	12	Operand 00	Indexed String	0 * 1 2 3 4 5 6 7 8 9 10 11 12 25 26	NULL *  > t  >  >> t  >>  >>> t  >>> IE> t IE> IE>> t IE>> IE>>> t IE>>> tAux1 tAux2		Setting	0/26/1
	13	Operator 01	Indexed String	0 * 1 2 3	OR * OR NOT AND AND NOT		Setting	0/3/1

MiCOM P120-P121-P122-P123

Col	Row	Menu Text	Data Type	Ind	Values (*: default)	Depend	Cell Type	Min/Max/Step
	14	Operand 00	Indexed String	0 * 1 2 3 4 5 6 7 8 9 10 11 12 25 26	NULL *  > t  >  >> t  >>  >>> t  >>> IE> t IE> IE>> t IE>> IE>>> t IE>>> tAux1 tAux2		Setting	0/26/1
	15	Operator 02	Indexed String	0 * 1 2 3	OR * OR NOT AND AND NOT		Setting	0/3/1
	16	Operand 02	Indexed String	0 * 1 2 3 4 5 6 7 8 9 10 11 12 25 26	NULL *  > t  >  >> t  >>  >>> t  >>> IE> t IE> IE>> t IE>> IE>>> t IE>>> tAux1 tAux2		Setting	0/26/1
	17	Operator 03	Indexed String	0 * 1 2 3	OR * OR NOT AND AND NOT		Setting	0/3/1

Col	Row	Menu Text	Data Type	Ind	Values (*: default)	Depend	Cell Type	Min/Max/Step
	18	Operand 03	Indexed String	0 * 1 2 3 4 5 6 7 8 9 10 11 12 25 26	NULL *  > t  >  >> t  >>  >>> t  >>> IE> t IE> IE>> t IE>> IE>>> t IE>>> tAux1 tAux2		Setting	0/26/1
	19	Operator 04	Indexed String	0 * 1 2 3	OR * OR NOT AND AND NOT		Setting	0/3/1
	1A	Operand 04	Indexed String	0 * 1 2 3 4 5 6 7 8 9 10 11 12 25 26	NULL *  > t  >  >> t  >>  >>> t  >>> IE> t IE> IE>> t IE>> IE>>> t IE>>> tAux1 tAux2		Setting	0/26/1
	1B	Operator 05	Indexed String	0 * 1 2 3	OR * OR NOT AND AND NOT		Setting	0/3/1

MiCOM P120-P121-P122-P123

Col	Row	Menu Text	Data Type	Ind	Values (*: default)	Depend	Cell Type	Min/Max/Step
	1C	Operand 05	Indexed String	0 * 1 2 3 4 5 6 7 8 9 10 11 12 25 26	NULL *  > t  >  >> t  >>  >>> t  >>> IE> t IE> IE>> t IE>> IE>>> t IE>>> tAux1 tAux2		Setting	0/26/1
	1D	Operator 06	Indexed String	0 * 1 2 3	OR * OR NOT AND AND NOT		Setting	0/3/1
	1E	Operand 06	Indexed String	0 * 1 2 3 4 5 6 7 8 9 10 11 12 25 26	NULL *  > t  >  >> t  >>  >>> t  >>> IE> t IE> IE>> t IE>> IE>>> t IE>>> tAux1 tAux2		Setting	0/26/1
	1F	Operator 07	Indexed String	0 * 1 2 3	OR * OR NOT AND AND NOT		Setting	0/3/1

Col	Row	Menu Text	Data Type	Ind	Values (*: default)	Depend	Cell Type	Min/Max/Step
	20	Operand 07	Indexed String	0 * 1 2 3 4 5 6 7 8 9 10 11 12 25 26	NULL *  > t  >  >> t  >>  >>> t  >>> IE> t IE> IE>> t IE>> IE>>> t IE>>> tAux1 tAux2		Setting	0/26/1
	21	Operator 08	Indexed String	0 * 1 2 3	OR * OR NOT AND AND NOT		Setting	0/3/1
	22	Operand 08	Indexed String	0 * 1 2 3 4 5 6 7 8 9 10 11 12 25 26	NULL *  > t  >  >> t  >>  >>> t  >>> IE> t IE> IE>> t IE>> IE>>> t IE>>> tAux1 tAux2		Setting	0/26/1
	23	Operator 09	Indexed String	0 * 1 2 3	OR * OR NOT AND AND NOT		Setting	0/3/1

MiCOM P120-P121-P122-P123

Col	Row	Menu Text	Data Type	Ind	Values (*: default)	Depend	Cell Type	Min/Max/Step
	24	Operand 09	Indexed String	0 * 1 2 3 4 5 6 7 8 9 10 11 12 25 26	NULL *  > t  >  >> t  >>  >>> t  >>> IE> t IE> IE>> t IE>> IE>>> t IE>>> tAux1 tAux2		Setting	0/26/1
	25	Operator 10	Indexed String	0 * 1 2 3	OR * OR NOT AND AND NOT		Setting	0/3/1
	26	Operand 10	Indexed String	0 * 1 2 3 4 5 6 7 8 9 10 11 12 25 26	NULL *  > t  >  >> t  >>  >>> t  >>> IE> t IE> IE>> t IE>> IE>>> t IE>>> tAux1 tAux2		Setting	0/26/1
	27	Operator 11	Indexed String	0 * 1 2 3	OR * OR NOT AND AND NOT		Setting	0/3/1

Col	Row	Menu Text	Data Type	Ind	Values (*: default)	Depend	Cell Type	Min/Max/Step
	28	Operand 11	Indexed String	0 * 1 2 3 4 5 6 7 8 9 10 11 12 25 26	NULL *  > t  >  >> t  >>  >>> t  >>> IE> t IE> IE>> t IE>> IE>>> t IE>>> tAux1 tAux2		Setting	0/26/1
	29	Operator 12	Indexed String	0 * 1 2 3	OR * OR NOT AND AND NOT		Setting	0/3/1
	2A	Operand 12	Indexed String	0 * 1 2 3 4 5 6 7 8 9 10 11 12 25 26	NULL *  > t  >  >> t  >>  >>> t  >>> IE> t IE> IE>> t IE>> IE>>> t IE>>> tAux1 tAux2		Setting	0/26/1
	2B	Operator 13	Indexed String	0 * 1 2 3	OR * OR NOT AND AND NOT		Setting	0/3/1



MiCOM P120-P121-P122-P123

Col	Row	Menu Text	Data Type	Ind	Values (*: default)	Depend	Cell Type	Min/Max/Step
	2C	Operand 13	Indexed String	0 * 1 2 3 4 5 6 7 8 9 10 11 12 25 26	NULL *  > t  >  >> t  >>  >>> t  >>> IE> t IE> IE>> t IE>> IE>>> t IE>>> tAux1 tAux2		Setting	0/26/1
	2D	Operator 14	Indexed String	0 * 1 2 3	OR * OR NOT AND AND NOT		Setting	0/3/1
	2E	Operand 14	Indexed String	0 * 1 2 3 4 5 6 7 8 9 10 11 12 25 26	NULL *  > t  >  >> t  >>  >>> t  >>> IE> t IE> IE>> t IE>> IE>>> t IE>>> tAux1 tAux2		Setting	0/26/1
	2F	Operator 15	Indexed String	0 * 1 2 3	OR * OR NOT AND AND NOT		Setting	0/3/1

Col	Row	Menu Text	Data Type	Ind	Values (*: default)	Depend	Cell Type	Min/Max/Step
	30	Operand 15	Indexed String	0 * 1 2 3 4 5 6 7 8 9 10 11 12 25 26	NULL *  > t  >  >> t  >>  >>> t  >>> IE> t IE> IE>> t IE>> IE>>> t IE>>> tAux1 tAux2		Setting	0/26/1
<b>6C</b>	<b>40</b>	<b>EQUATION B</b>						
	41	Operator 00	Indexed String	0 * 1	* (Space) NOT		Setting	0/1/1
	42	Operand 00	Indexed String	0 * 1 2 3 4 5 6 7 8 9 10 11 12 25 26	NULL *  > t  >  >> t  >>  >>> t  >>> IE> t IE> IE>> t IE>> IE>>> t IE>>> tAux1 tAux2		Setting	0/26/1
	43	Operator 01	Indexed String	0 * 1 2 3	OR * OR NOT AND AND NOT		Setting	0/3/1
	.....	.....	.....	...	.....		.....	.....

MiCOM P120-P121-P122-P123

Col	Row	Menu Text	Data Type	Ind	Values (*: default)	Depend	Cell Type	Min/Max/Step
	60	Operand 15	Indexed String	0 * 1 2 3 4 5 6 7 8 9 10 11 12 25 26	NULL *  > t  >  >> t  >>  >>> t  >>> IE> t IE> IE>> t IE>> IE>>> t IE>>> tAux1 tAux2		Setting	0/26/1
<b>6C</b>	<b>70</b>	<b>EQUATION C</b>						
	71	Operator 00	Indexed String	0 * 1	* (Space) NOT		Setting	0/1/1
	72	Operand 00	Indexed String	0 * 1 2 3 4 5 6 7 8 9 10 11 12 25 26	NULL *  > t  >  >> t  >>  >>> t  >>> IE> t IE> IE>> t IE>> IE>>> t IE>>> tAux1 tAux2		Setting	0/26/1
	73	Operator 01	Indexed String	0 * 1 2 3	OR * OR NOT AND AND NOT		Setting	0/3/1
	.....	.....	.....	...	.....		.....	.....

Col	Row	Menu Text	Data Type	Ind	Values (*: default)	Depend	Cell Type	Min/Max/Step
	90	Operand 15	Indexed String	0 * 1 2 3 4 5 6 7 8 9 10 11 12 25 26	NULL *  > t  >  >> t  >>  >>> t  >>> IE> t IE> IE>> t IE>> IE>>> t IE>>> tAux1 tAux2		Setting	0/26/1
<b>6C</b>	<b>A0</b>	<b>EQUATION D</b>						
	A1	Operator 00	Indexed String	0 * 1	* (Space) NOT		Setting	0/1/1
	A2	Operand 00	Indexed String	0 * 1 2 3 4 5 6 7 8 9 10 11 12 25 26	NULL *  > t  >  >> t  >>  >>> t  >>> IE> t IE> IE>> t IE>> IE>>> t IE>>> tAux1 tAux2		Setting	0/26/1
	A3	Operator 01	Indexed String	0 * 1 2 3	OR * OR NOT AND AND NOT		Setting	0/3/1
	.....	.....	.....	...	.....		.....	.....

MiCOM P120-P121-P122-P123

Col	Row	Menu Text	Data Type	Ind	Values (*: default)	Depend	Cell Type	Min/Max/Step
	C0	Operand 15	Indexed String	0 * 1 2 3 4 5 6 7 8 9 10 11 12 25 26	NULL *  > t  >  >> t  >>  >>> t  >>> IE> t IE> IE>> t IE>> IE>>> t IE>>> tAux1 tAux2		Setting	0/26/1
<b>6D</b>	<b>00</b>	<b>BOOLEAN EQUATIONS 2/2</b>						
	10	EQUATION E						
	11	Operator 00	Indexed String	0 * 1	* (Space) NOT		Setting	0/1/1
	12	Operand 00	Indexed String	0 * 1 2 3 4 5 6 7 8 9 10 11 12 25 26	NULL *  > t  >  >> t  >>  >>> t  >>> IE> t IE> IE>> t IE>> IE>>> t IE>>> tAux1 tAux2		Setting	0/26/1
	13	Operator 01	Indexed String	0 * 1 2 3	OR * OR NOT AND AND NOT		Setting	0/3/1
	.....	.....	.....	...	.....		.....	.....

Col	Row	Menu Text	Data Type	Ind	Values (*: default)	Depend	Cell Type	Min/Max/Step
	30	Operand 15	Indexed String	0 * 1 2 3 4 5 6 7 8 9 10 11 12 25 26	NULL *  > t  >  >> t  >>  >>> t  >>> IE> t IE> IE>> t IE>> IE>>> t IE>>> tAux1 tAux2		Setting	0/26/1
<b>6E</b>	<b>40</b>	<b>EQUATION F</b>						
	41	Operator 00	Indexed String	0 * 1	* (Space) NOT		Setting	0/1/1
	42	Operand 00	Indexed String	0 * 1 2 3 4 5 6 7 8 9 10 11 12 25 26	NULL *  > t  >  >> t  >>  >>> t  >>> IE> t IE> IE>> t IE>> IE>>> t IE>>> tAux1 tAux2		Setting	0/26/1
	43	Operator 01	Indexed String	0 * 1 2 3	OR * OR NOT AND AND NOT		Setting	0/3/1
	.....	.....	.....	...	.....		.....	.....

MiCOM P120-P121-P122-P123

Col	Row	Menu Text	Data Type	Ind	Values (*: default)	Depend	Cell Type	Min/Max/Step
	60	Operand 15	Indexed String	0 * 1 2 3 4 5 6 7 8 9 10 11 12 25 26	NULL *  > t  >  >> t  >>  >>> t  >>> IE> t IE> IE>> t IE>> IE>>> t IE>>> tAux1 tAux2		Setting	0/26/1
<b>6E</b>	<b>70</b>	<b>EQUATION G</b>						
	71	Operator 00	Indexed String	0 * 1	* (Space) NOT		Setting	0/1/1
	72	Operand 00	Indexed String	0 * 1 2 3 4 5 6 7 8 9 10 11 12 25 26	NULL *  > t  >  >> t  >>  >>> t  >>> IE> t IE> IE>> t IE>> IE>>> t IE>>> tAux1 tAux2		Setting	0/26/1
	73	Operator 01	Indexed String	0 * 1 2 3	OR * OR NOT AND AND NOT		Setting	0/3/1
	.....	.....	.....	...	.....		.....	.....

Col	Row	Menu Text	Data Type	Ind	Values (*: default)	Depend	Cell Type	Min/Max/Step
	90	Operand 15	Indexed String	0 * 1 2 3 4 5 6 7 8 9 10 11 12 25 26	NULL *  > t  >  >> t  >>  >>> t  >>> IE> t IE> IE>> t IE>> IE>>> t IE>>> tAux1 tAux2		Setting	0/26/1
<b>6E</b>	<b>A0</b>	<b>EQUATION H</b>						
	A1	Operator 00	Indexed String	0 * 1	* (Space) NOT		Setting	0/1/1
	A2	Operand 00	Indexed String	0 * 1 2 3 4 5 6 7 8 9 10 11 12 25 26	NULL *  > t  >  >> t  >>  >>> t  >>> IE> t IE> IE>> t IE>> IE>>> t IE>>> tAux1 tAux2		Setting	0/26/1
	A3	Operator 01	Indexed String	0 * 1 2 3	OR * OR NOT AND AND NOT		Setting	0/3/1
	.....	.....	.....	...	.....		.....	.....



MiCOM P120-P121-P122-P123

Col	Row	Menu Text	Data Type	Ind	Values (*: default)	Depend	Cell Type	Min/Max/Step
	C0	Operand 15	Indexed String	0 * 1 2 3 4 5 6 7 8 9 10 11 12 25 26	NULL * l> t l> l>> t l>> l>>> t l>>> lE> t lE> lE>> t lE>> lE>>> t lE>>> tAux1 tAux2		Setting	0/26/1
<b>6E</b>	<b>00</b>	<b>BOOLEAN EQUATIONS DELAYS</b>						
	01	Equation A operation delay	Courier floating point number		0 *		Setting	0/ 600.0/ 0.01 s
	02	Equation A reset delay	Courier floating point number		0 *		Setting	0/ 600.0/ 0.01 s
	03	Equation B operation delay	Courier floating point number		0 *		Setting	0/ 600.0/ 0.01 s
	04	Equation B reset delay	Courier floating point number		0 *		Setting	0/ 600.0/ 0.01 s
	05	Equation C operation delay	Courier floating point number		0 *		Setting	0/ 600.0/ 0.01 s
	06	Equation C reset delay	Courier floating point number		0 *		Setting	0/ 600.0/ 0.01 s
	07	Equation D operation delay	Courier floating point number		0 *		Setting	0/ 600.0/ 0.01 s
	08	Equation D reset delay	Courier floating point number		0 *		Setting	0/ 600.0/ 0.01 s
	09	Equation E operation delay	Courier floating point number		0 *		Setting	0/ 600.0/ 0.01 s
	0A	Equation E reset delay	Courier floating point number		0 *		Setting	0/ 600.0/ 0.01 s
	0B	Equation F operation delay	Courier floating point number		0 *		Setting	0/ 600.0/ 0.01 s
	0C	Equation F reset delay	Courier floating point number		0 *		Setting	0/ 600.0/ 0.01 s
	0D	Equation G operation delay	Courier floating point number		0 *		Setting	0/ 600.0/ 0.01 s
	0E	Equation G reset delay	Courier floating point number		0 *		Setting	0/ 600.0/ 0.01 s
	0F	Equation H operation delay	Courier floating point number		0 *		Setting	0/ 600.0/ 0.01 s
	10	Equation H reset delay	Courier floating point number		0 *		Setting	0/ 600.0/ 0.01 s

Col	Row	Menu Text	Data Type	Ind	Values (*: default)	Depend	Cell Type	Min/Max/Step
<b>BF</b>	<b>00</b>	<b>COMM SYSTEM DATA</b>						
	01		NOT IMPLEMENTED				Data	
	02		NOT IMPLEMENTED				Data	
	03	Setting Transfert					Setting	0/ 1/ 1
	04	Reset Demand Timers	NOT IMPLEMENTED					
	05	Reset Event Report	NOT IMPLEMENTED					
<b>BF</b>	<b>00</b>	<b>COMM SYSTEM DATA</b>						
	01	Dist Record Cntrl Ref	Menu Cell (2)		0x7000		Data	
	02	Dist Record Extract Ref	Menu Cell (2)		0x8000		Data	
	03	Setting Transfert						

## 5. COURIER DATABASE ORGANISATION P122, P123

This Database organisation is common for both products, except for the Autorecloser function, the SOTF function (with Control Trip and Control Close outputs). Items specific to P123 are set in *Italic*.

Col	Row	Menu Text	Data Type	Ind	Values (*: default)	Depend	Cell Type	Min/Max/Step
<b>00</b>	<b>00</b>	<b>SYSTEM DATA</b>						
	01	Language	Ver>: Indexed String	0 1 2 3	Lang1 (French) Lang2 (English)* Lang3 (German) Lang4 (Spanish)		Setting	0/3/1
	02	Password	ASCII Password (4 bytes)		AAAA		Setting	32/127/1
	03	Fnlinks: NOT IMPLEMENTED						
	04	Description	ASCII Text (6 bytes)		" P123 "**		Setting	32/127/1
	05	Plant Reference	ASCII Text (4 bytes)		" Pref "		Setting	32/127/1
	06	Model Number	ASCII Text (16 bytes)		" Model Number "		Data	
	07	Firmware Number	ASCII Text (16 bytes)		" Firmware Number "		Data	
	08	Serial Number	ASCII Text (16 bytes)		" Serial Number "		Data	
	09	Frequency	Unsigned Integer (2 bytes)		XXXX Hz		Setting	50/60/10
	0A	Communication Level	Unsigned Integer (2 bytes)		1		Data	
	0B	Address	Unsigned Integer (2 bytes)		1*		Setting	1/255/1
	0C	Plant Status Word: NOT IMPLEMENTED						
	0D	Control Status Word: NOT IMPLEMENTED						
	0E	Setting Group	Unsigned Integer				Data	
	0F	Load shed Stage: NOT IMPLEMENTED						
	10	Circuit Breaker Control	Indexed String		0*: No operation 1: Trip 2: Close		Setting	0/2/1
	11	Software Reference	ASCII Text (16 characters)				Data	
	12-1F	Unused, reserved						

Col	Row	Menu Text	Data Type	Ind	Values (*: default)	Depend	Cell Type	Min/Max/Step
	20	Logic Input Status	Binary flag (5 bits / 3 bits)		0: log input 1 1: log input 2 2: log input 3 3: <i>log input 4</i> 4: <i>log input 5</i>		Data	
	21	Relay Output Status	Binary flag (9 bits / 7 bits)		0: relay 1 (trip) 1: relay 2 2: relay 3 3: relay 4 4: watchdog relay 5: relay 5 6: relay 6 7: <i>relay 7</i> 8: <i>relay 8</i>		Data	
	22	Alarm	Binary flag (16 bits)		0: Ana output err 1: Comm err 2: Eeprom err data 3: Ct error 4: Clock error 5: Eeprom err calib 6: Ram error 7: Battery error 8: reserved 9: Default settings 10 to 15: reserved		Data	
	23	Pseudo Logic Input Status group 1	Binary flag (16 bits)		0: I> 1: I>> 2: I>>> 3: IE> 4: IE>> 5: IE>>> 6: t I> 7: t I>> 8: t I>>> 9: t IE> 10: t IE>> 11: t IE>>> 12: Thermal Alarm 13: Therm. Overload 14: t I< 15: I<		Data	

MiCOM P120/P121/P122/P123

Col	Row	Menu Text	Data Type	Ind	Values (*: default)	Depend	Cell Type	Min/Max/Step
	24	Pseudo Logic Input Status group 2	Binary flag (16 bits)		0: Broken Conductor 1: tAux 1 2: tAux 2 3: Breaker Fail. 4: I2 > 5: t I2> 6: Open operating time 7: Trip operation Nb 8: SA 2 n 9: SW Trip Circuit 10: Close operating time 11: <i>Successful autoreclose</i> 12: <i>Locked autorecloser</i> 13: <i>Autorecloser conf. fail</i> 14: I2>> 15: t I2>>		Data	
	25	Pseudo Logic Input Status group 3	Binary flag (16 bits)		0: tAux 3 1: tAux 4 2: t Reset I> 3: t Reset I>> 4: t Reset IE> 5: t Reset IE>> 6: t Reset I2> 7: t BF 8: t SOTF 9: <i>Final Trip</i> 10: <i>Autoreclos. in progress</i> 11 à 15: reserved		Data	
	26	Pseudo Logic Input Status group 4	Binary flag (9 bits)		0: t Equation A 1: t Equation B 2: t Equation C 3: t Equation D 4: t Equation E 5: t Equation F 6: t Equation G 7: t Equation H 8: Blocking Inrush		Data	

Col	Row	Menu Text	Data Type	Ind	Values (*: default)	Depend	Cell Type	Min/Max/Step
01	00	USER CONTROL						
	01	Remote control 1	Binary flag (16 bits)		0: Unlock trip cont.* 1: Ack first alarm 2: Ack all alarms 3: TRIP 4: CLOSE 5: Setting Change 6: Th. State Reset 7: RMS aver&max Reset 8: Dist. Rec. Trig 9: Maintenance Start 10: Recloser timer Reset 11: Recloser Reset 12: Reserved 13: Reserved 14: Reserved 15: SRAM def . ack		Setting	0/65535/1
	02	Remote control 2	Binary flag (9 bits)		0: Relay 0: TRIP* 1: Relay 1 2: Relay 2 3: Relay 3 4: Watchdog Relay 5: Relay 4 6: Relay 5 7: Relay 6 8: Relay 7		Setting	0/511/1
	03	Remote control 3	Binary flag (6 bits)		0: Reset I0 Harmonic 1: Reserved 2: Reserved 3: Maintenance stop 4: Reset rolling averages 5: Reset sub-period average peaks.		Setting	0/63/1
02	00	VIEW RECORDS						
	01	Record number	Unsigned Integer (2 bytes)			5 *	Setting	1/5/1
	02	Occur date	Unsigned Integer (2 bytes)					
	03	Active set group	Unsigned Integer (2 bytes)					
	04	Phase in fault	ASCII Text					
	05	Fault Id	ASCII Text					
	06	Magnitude	Courier floating point number					

MiCOM P120/P121/P122/P123

Col	Row	Menu Text	Data Type	Ind	Values (*: default)	Depend	Cell Type	Min/Max/Step
	07	Ia magnitude	Courier floating point number					
	08	Ib magnitude	Courier floating point number					
	09	Ic magnitude	Courier floating point number					
	0A	In magnitude	Courier floating point number					
<b>03</b>	<b>00</b>	<b>MEASUREMENTS</b>						
	01	IA RMS	Courier floating point number				Data	
	02	IB RMS	Courier floating point number				Data	
	03	IC RMS	Courier floating point number				Data	
	04	I0 RMS	Courier floating point number				Data	
	05	I <sub>direct</sub>	Courier floating point number				Data	
	06	IINV	Courier floating point number				Data	
	07	Ratio I <sub>dir</sub> / I <sub>2</sub>	Courier floating point number				Data	
	08	THERMAL STATE (Rst)	Unsigned Integer (2 bytes) (%)				Data	
	09	FREQUENCY	Courier floating point number				Data	
	0A	RST RMS MAX & AVERAGE						
	0B	MAX RMS IA	Courier floating point number				Data	
	0C	MAX RMS IB	Courier floating point number				Data	
	0D	MAX RMS IC	Courier floating point number				Data	
	0E	IA RMS AVERAGE	Courier floating point number				Data	
	0F	IB RMS AVERAGE	Courier floating point number				Data	
	10	IC RMS AVERAGE	Courier floating point number				Data	
	11	IN – F <sub>n</sub> (Rst)	Courier floating point number				Data	
	20	RST Sub-period average Peaks						
	21	IA RMS Sub-period average Peak	Courier floating point number				Data	
	22	IB RMS Sub-period average Peak	Courier floating point number				Data	
	23	IC RMS Sub-period average	Courier floating point number				Data	

Col	Row	Menu Text	Data Type	Ind	Values (*: default)	Depend	Cell Type	Min/Max/Step
		Peak						
	24	RST Rolling Averages						
	25	IA RMS Rolling Average	Courier floating point number				Data	
	26	IB RMS Rolling Average	Courier floating point number				Data	
	27	IC RMS Rolling Average	Courier floating point number				Data	
<b>04</b>	<b>00</b>	<b>RECLOSER STATISTICS (Rst)</b>						
	01	TOTAL CYCLE NUMBER	Unsigned Integer (2 bytes)				Data	
	02	CYCLE 1 NUMBER	Unsigned Integer (2 bytes)				Data	
	03	CYCLE 2 NUMBER	Unsigned Integer (2 bytes)				Data	
	04	CYCLE 3 NUMBER	Unsigned Integer (2 bytes)				Data	
	05	CYCLE 4 NUMBER	Unsigned Integer (2 bytes)				Data	
	06	DEFINITIVE TRIP NUMBER	Unsigned Integer (2 bytes)				Data	
	07	RECLOSE ORDER NUMBER	Unsigned Integer (2 bytes)				Data	
<b>06</b>	<b>00</b>	<b>SW MONITORING</b>						
	01	RST SAn Ix						
	02	SAn IA	Courier floating point number				Data	
	03	SAn IB	Courier floating point number				Data	
	04	SAn IC	Courier floating point number				Data	
	05	SW operation nb (Rst)	Unsigned Integer (2 bytes)				Data	
	06	SW operation time	Courier floating point number		0.0 s		Data	
	07	SW Closing time	Courier floating point number				Data	
<b>08</b>	<b>00</b>	<b>TIME:</b>						
	01	Date/Time	IEC870 Time & Date				Data	
	02	Date Format (IEC/no)	Indexed String		0: Private * 1: IEC		Setting	0 (Private) / 1 (IEC)



MiCOM P120/P121/P122/P123

Col	Row	Menu Text	Data Type	Ind	Values (*: default)	Depend	Cell Type	Min/Max/Step
<b>0C</b>	<b>00</b>	<b>FAIL-SAFE RELAYS SETTINGS</b>						
	01	Fail-safe relays	Binary flag (8 bits / 6 bits)		0: relay 1 (trip) 1: relay 2 2: relay 3 3: relay 4 4: relay 5 5: relay 6 6: relay 7 7: relay 8		Setting	1/255/1
<b>0D</b>	<b>00</b>	<b>GENERAL SETTING</b>						
	01	Phase Rotation sense	Indexed String		0: Direct (A/B/C) * 1: Inverse (A/C/B)		Setting	0 (A/B/C) / 1 (A/C/B)
<b>0E</b>	<b>00</b>	<b>CT RATIOS</b>						
	01	Phase CT Primary	Unsigned Integer (2 bytes)		1000 *		Setting	1/50000/1
	02	Phase CT Secondary	Unsigned Integer (2 bytes)		1 *		Setting	1/5/4
	03	Neutral CT Primary	Unsigned Integer (2 bytes)		1000 *		Setting	1/50000/1
	04	Neutral CT Secondary	Unsigned Integer (2 bytes)		1 *		Setting	1/5/4
<b>0F</b>	<b>00</b>	<b>SETTING GROUPS</b>						
	01	Setting group toggle	Indexed String		0: Menu * 1: Input		Setting	0 (Menu) / 1 (Input)
	02	Select setting group	Unsigned Integer (2 bytes)		1*	0F01=0	Setting	1/2
	03	Group 1 visible	Indexed String		0: YES * 1: NO		Setting	0 (YES) / 1 (NO)
	04	Group 2 visible	Indexed String		0: YES 1: NO *		Setting	0 (YES) / 1 (NO)
		Protection Group n° 1						
<b>20</b>	<b>00</b>	<b>PHASE OVERCURRENT</b>						
	01	Stage 1 Overcurrent	(Sub Heading)					
	02	Max I>	Binary (1 bit)	0	Disabled * / Enabled		Setting	0/1/1
	03	Threshold I>	Courier floating point number		0.1 In *	2002=1	Setting	0.1/25.0/0.1

Col	Row	Menu Text	Data Type	Ind	Values (*: default)	Depend	Cell Type	Min/Max/Step
	04	Temporisation Type I>	Indexed String	0 1 2	0: definite time * 1: inverse time 2: RI curve	2002=1	Setting	0/2/1
	05	Curve type I>	Indexed String	0 1 2 3 4 5 6 7 8 9 10	STI (CEI) * SI (CEI) VI (CEI) EI (CEI) LTI (CEI) STI (CO2) MI (ANSI) LTI (CO8) VI (ANSI) EI (ANSI) RC (CEI)	2004=1	Setting	0/10/1
	06	TMS I>	Courier floating point number		0.025 *	2004=1	Setting	0.025/1.5/0.001
	07	K I>	Courier floating point number		0.1 *	2004=2	Setting	0.1/10.0/0.005
	08	Tempo I>	Courier floating point number		0.01 s *	2004=0	Setting	0 /150.0/0.01
	09	Tempo reset type I>	Indexed String		0: definite time 1: inverse time	2004=1 & 2005>= 5 & 2005 <=9	Setting	0/1
	0A	RTMS I>	Courier floating point number		0.025	2009 = 1	Setting	0.025/3.2/0.001
	0B	T RESET I>	Courier floating point number		0.04	2009 = 0 or 2004 =0 or 2004 =2 or (2004=1 & 2005 < 5 & 2005 > 9)	Setting	0/600.0/0.01
	0C-0F	Reserved						
	10	Stage 2 Overcurrent	(Sub Heading)					
	11	Max I>>	Binary (1 bit)	0	Disabled * / Enabled		Setting	0/1/1
	12	Threshold I>>	Courier floating point number		0.50 ln *	2011=1	Setting	0.5/40.0/0.05
	13	Temporisation Type I>>	Indexed String	0 1 2	0: definite time * 1: inverse time 2: RI curve	2011=1	Setting	0/2/1

MiCOM P120/P121/P122/P123

Col	Row	Menu Text	Data Type	Ind	Values (*: default)	Depend	Cell Type	Min/Max/Step
	14	Curve type I>>	Indexed String	0 1 2 3 4 5 6 7 8 9 10	STI (CEI) * SI (CEI) VI (CEI) EI (CEI) LTI (CEI) STI (CO2) MI (ANSI) LTI (CO8) VI (ANSI) EI (ANSI) RC (CEI)	2013=1	Setting	0/10/1
	15	TMS I>>	Courier floating point number		0.025 *	2013=1	Setting	0.025/1.5/0.001
	16	K I>>	Courier floating point number		0.1 *	2013=2	Setting	0.1/10.0/0.005
	17	Tempo I>>	Courier floating point number		0.01 s *	2013=0	Setting	0 /150/0.01
	18	Tempo reset type I>>	Indexed String		0: definite time 1: inverse time	2013=1 & 2014>= 5 & 2014 <=9	Setting	0/1
	19	RTMS I>>	Courier floating point number		0.025	2018 = 1	Setting	0.025/3.2/0.001
	1A	T RESET I>>	Courier floating point number		0.04	2018 = 0 or 2013 = 0 or 2013 =2 or (2013=1 & 2014 < 5 & 2014 > 9)	Setting	0/600.0/0.01
	1B-1F	Reserved						
	20	Stage 3 Overcurrent	(Sub Heading)					
	21	Max I>>>	Binary (1 bit)	0	Disabled * / Enabled		Setting	0/1/1
	22	Threshold I>>>	Courier floating point number		0.50 In *	2021=1	Setting	0.5/40.0/0.05
	23	Tempo I>>>	Courier floating point number		0.01 s *	2021=1	Setting	0 /150/0.01
	24	Sample I>>>	Binary (1 bit)	0	Disabled * / Enabled	2021=1	Setting	0/1/1
<b>21</b>	<b>00</b>	<b>EARTH FAULT</b>						
	01	Stage 1 Overcurrent	(Sub Heading)					
	02	Max IE>	Binary (1 bit)	0	Disabled * / Enabled		Setting	0/1/1

Col	Row	Menu Text	Data Type	Ind	Values (*: default)	Depend	Cell Type	Min/Max/Step
	03	Threshold IE>	Courier floating point number		0.01 IEn* or 0.002 IEn* if great sensitivity	2102=1	Setting	0.01/2.0/0.005 or 0.1/25.0/0.01 if normal sensitivity or 0.002/1.0/0.001 if great sensitivity
	04	Tempo Type IE>	Indexed String	0 1 2 3	0: definite time * 1: inverse time 2: RI curve 3: RXIDG curves	2102=1	Setting	0/3/1
	05	Curve Type IE>	Indexed String	0 1 2 3 4 5 6 7 8 9 10	STI (CEI) * SI (CEI) VI (CEI) EI (CEI) LTI (CEI) STI (CO2) MI (ANSI) LTI (CO8) VI (ANSI) EI (ANSI) RC (CEI)	2104=1	Setting	0/10/1
	06	Curve Type 2 (RXIDG) IE>	Indexed String	0 1 2 3 4 5 6 7	K = 0.3 * K = 0.4 K = 0.5 K = 0.6 K = 0.7 K = 0.8 K = 0.9 K = 1.0.	2104=3	Setting	0/7/1
	07	TMS IE>	Courier floating point number		0.025 *	2104=1	Setting	0.025/1.5/0.001
	08	K IE>	Courier floating point number		0.1 *	2104=2	Setting	0.1/10.0/0.005
	09	Tempo IE>	Courier floating point number		0.01 s *	2104=0	Setting	0 /150.0/0.01
	0A	Tempo reset Type IE>	Indexed String		0: definite time 1: inverse time	2104=1 & 2105>= 5 & 2105 <=9	Setting	0/1
	0B	RTMS IE>	Courier floating point number		0.025	210A = 1	Setting	0.025/3.2/0.001

MiCOM P120/P121/P122/P123

Col	Row	Menu Text	Data Type	Ind	Values (*: default)	Depend	Cell Type	Min/Max/Step
	0C	T RESET IE>	Courier floating point number		0.04	210A = 0 or 2104 = 0 or 2104 =2 or 2104 =3 or (2104=1 & 2105 < 5 & 2105 > 9)	Setting	0/600.0/0.01
	0D	Interlock IE>	Binary (1 bit)	0	Disabled * / Enabled	(2104 =3 or 2104=1) & (2111=1 or 2121=1)	Setting	0/1/1
	0E-0F	Reserved						
	10	Stage 2 Overcurrent	(Sub Heading)					
	11	Max IE>>	Binary (1 bit)	0	Disabled * / Enabled		Setting	0/1/1
	12	Threshold IE>>	Courier floating point number		0.01 IEn* or 0.50 IEn* if normal sensitivity or 0.002 IEn* if great sensitivity	2111=1	Setting	0.01/8.0/0.005 or 0.50/40.0/0.01 if normal sensitivity or 0.002/1.0/0.001 if great sensitivity
	13	Tempo Type IE>>	Indexed String	0 1 2 3	0: definite time * 1: inverse time 2: RI curve 3: RXIDG curves	2111=1	Setting	0/3/1
	14	Curve Type IE>>	Indexed String	0 1 2 3 4 5 6 7 8 9 10	STI (CEI) * SI (CEI) VI (CEI) EI (CEI) LTI (CEI) STI (CO2) MI (ANSI) LTI (CO8) VI (ANSI) EI (ANSI) RC (CEI)	2113=1	Setting	0/10/1

Col	Row	Menu Text	Data Type	Ind	Values (*: default)	Depend	Cell Type	Min/Max/Step
	15	Curve Type 2 (RXIDG) IE>>	Indexed String	0 1 2 3 4 5 6 7	K = 0.3 * K = 0.4 K = 0.5 K = 0.6 K = 0.7 K = 0.8 K = 0.9 K = 1.0.	2113=3	Setting	0/7/1
	16	TMS IE>>	Courier floating point number		0.025 *	2113=1	Setting	0.025/1.5/0.001
	17	K IE>>	Courier floating point number		0.1 *	2113=2	Setting	0.1/10.0/0.005
	18	Tempo IE>>	Courier floating point number		0.01 s *	2113=0	Setting	0 /150.0/0.01
	19	Tempo reset Type IE>>	Indexed String		0: definite time 1: inverse time	2113=1 & 2114>= 5 & 2114 <=9	Setting	0/1
	1A	RTMS IE>>	Courier floating point number		0.025	2119 = 1	Setting	0.025/3.2/0.001
	1B	T RESET IE>>	Courier floating point number		0.04	2119 = 0 or 2113 = 0 or 2113 =2 or 2113 =3 or (2113=1 & 2114 < 5 & 2114 > 9)	Setting	0/600.0/0.01
	1C-1F	Reserved						
	20	Stage 3 Overcurrent	(Sub Heading)					
	21	Max IE>>>	Binary (1 bit)	0	Disabled * / Enabled		Setting	0/1/1
	22	Threshold IE>>>	Courier floating point number		0.01 IEn* or 0.50 IEn* if normal sensitivity or 0.002 IEn* if great sensitivity	2121=1	Setting	0.01/8.0/0.005 or 0.50/40.0/0.01 if normal sensitivity or 0.002/1.0/0.001 if great sensitivity
	23	Tempo IE>>>	Courier floating point number		0.01 s *	2121=1	Setting	0 /150.0/0.01
	24	Sample IE>>>	Binary (1 bit)	0	Disabled * / Enabled	2121=1	Setting	0/1/1
<b>22</b>	<b>00</b>	<b>THERMAL OVERLOAD</b>						
	01	Ith>	Binary (1 bit)	0	Disabled * / Enabled		Setting	0/1/1
	02	Threshold Ith>	Courier floating point number		0.10 Ith*	2201=1	Setting	0.01/3.2/0.01

MiCOM P120/P121/P122/P123

Col	Row	Menu Text	Data Type	Ind	Values (*: default)	Depend	Cell Type	Min/Max/Step
	03	K lth>	Courier floating point number		1.05 *	2201=1	Setting	1.0/1.50/0.01 ln
	04	θ TRIP	Unsigned Integer (2 bytes)		100 % *	2201=1	Setting	50 / 200/ 1 %
	05	θ ALARM ?	Binary (1 bit)	0	Disabled * / Enabled	2201=1	Setting	0/1/1
	06	θ ALARM	Unsigned Integer (2 bytes)		90 % *	2205 =1	Setting	50 / 200/ 1 %
	07	Thermal constant	Unsigned Integer (2 bytes)		1 *	2201=1	Setting	1/ 200 / 1 mn
<b>23</b>	<b>00</b>	<b>MIN I&lt;</b>						
	01	I<	Binary (1 bit)	0	Disabled * / Enabled		Setting	0/1/1
	02	Threshold I<	Unsigned Integer (2 bytes)		20 %ln *	2301=1	Setting	2 / 100 / 1 %ln
	03	Tempo I <	Courier floating point number		0.01 s *	2301=1	Setting	0 /150.0/0.01
	04	Inhib. I< by 52a	Binary (1 bit)	0	Disabled * / Enabled	2301=1	Setting	0/1/1
<b>24</b>	<b>00</b>	<b>NEGATIVE CURRENT</b>						
	01	I2>	Binary (1 bit)	0	Disabled * / Enabled		Setting	0/1/1
	02	Threshold I2>	Courier floating point number		0.1 ln *	2401 = 1	Setting	0.1/40.0/0.01 ln
	03	Temporisation Type	Indexed String	0 1 2	0: definite time * 1: inverse time 2: RI curve	2401 = 1	Setting	0/2/1
	04	Curve type	Indexed String	0 1 2 3 4 5 6 7 8 9	STI (CEI) * SI (CEI) VI (CEI) EI (CEI) LTI (CEI) STI (CO2) MI (ANSI) LTI (CO8) VI (ANSI) EI (ANSI)	2403 = 1	Setting	0/9/1
	05	TMS	Courier floating point number		0.025 *	2403=1	Setting	0.025/1.5/0.001
	06	K (RI)	Courier floating point number		0.1 *	2403=2	Setting	0.1/10.0/0.005
	07	Tempo I2>	Courier floating point number		0.01 s *	2403=0	Setting	0 /150.0/1.0
	08	Reset tempo type	Indexed String		0: definite time 1: inverse time	2403=1 & 2404>= 5 & 2404 <=9	Setting	0/1/1
	09	RTMS	Courier floating point number		0.025 *	2408 = 1	Setting	0.025/3.2/0.001

Col	Row	Menu Text	Data Type	Ind	Values (*: default)	Depend	Cell Type	Min/Max/Step
	0A	T RESET	Courier floating point number		0.04 *	2408 = 0 or 2403 =2 or (2403=1 & 2404 < 5 & 2404 > 9)	Setting	0.04/100/0.01
	10	I2>>	Binary (1 bit)	0	Disabled * / Enabled		Setting	0/1/1
	11	Threshold I2>>	Courier floating point number		0.1 In *	2410 = 1	Setting	0.1/40.0/0.01 In
	12	Tempo I2>>	Courier floating point number		0.01 s *	2410 = 1	Setting	0 /150.0/1.0
<b>25</b>	<b>00</b>	<b>AUTORECLOSER</b>						
	01	Autorecloser	Binary (1 bit)	0	Disabled * / Enabled		Setting	0/1/1
	02	State circuit breaker	Binary (1 bit)		Disabled * / Enabled	2501 = 1	Setting	0/1/1
	03	Control window	Courier floating point number		0.01 s *	2502 = 1	Setting	0.01 / 600.00 / 0.01 s
	04	External blocking	Binary (1 bit)		Disabled * / Enabled	2501 = 1	Setting	0/1/1
	07	Temporisation cycle 1	Courier floating point number		0.05 s *	2501 = 1	Setting	0.05 / 300.00 / 0.01 s
	08	Temporisation cycle 2	Courier floating point number		0.05 s *	2501 = 1	Setting	0.05 / 300.00 / 0.01 s
	09	Temporisation cycle 3	Courier floating point number		0.05 s *	2501 = 1	Setting	0.05 / 600.00 / 0.01 s
	0A	Temporisation cycle 4	Courier floating point number		0.05 s *	2501 = 1	Setting	0.05 / 600.00 / 0.01 s
	0B	Reclaim TIME	Courier floating point number		0.02 s *	2501 = 1	Setting	0.02 / 600.00 / 0.01 s
	0C	Inhibition time	Courier floating point number		0.02 s *	2501 = 1	Setting	0.02 / 600.00 / 0.01 s
	0D	Number of short circuit cycle	Unsigned Integer (2 bytes)		0 *	2501 = 1	Setting	0 / 4 / 1
	0E	Number of earth fault cycle	Unsigned Integer (2 bytes)		0 *	2501 = 1	Setting	0 / 4 / 1
	0F	Cycles tI> configuration	Unsigned Integer (2 bytes)		0x1111 *	2501 = 1	Setting	0/2/1 on each 4 bit group
	10	Cycles tI>> configuration	Unsigned Integer (2 bytes)		0x1111 *	2501 = 1	Setting	0/2/1 on each 4 bit group
	11	Cycles tI>>> configuration	Unsigned Integer (2 bytes)		0x1111 *	2501 = 1	Setting	0/2/1 on each 4 bit group
	12	Cycles tIE> configuration	Unsigned Integer (2 bytes)		0x1111 *	2501 = 1	Setting	0/2/1 on each 4 bit group
	13	Cycles tIE>> configuration	Unsigned Integer (2 bytes)		0x1111 *	2501 = 1	Setting	0/2/1 on each 4 bit group



MiCOM P120/P121/P122/P123

Col	Row	Menu Text	Data Type	Ind	Values (*: default)	Depend	Cell Type	Min/Max/Step
	14	Cycles tIE>>> configuration	Unsigned Integer (2 bytes)		0x1111 *	2501 = 1	Setting	0/2/1 on each 4 bit group
	15	Cycles tAux1> configuration	Unsigned Integer (2 bytes)		0x1111 *	2501 = 1	Setting	0/2/1 on each 4 bit group
	16	Cycles tAux2> configuration	Unsigned Integer (2 bytes)		0x1111 *	2501 = 1	Setting	0/2/1 on each 4 bit group
		Protection Group n° 2						
<b>40</b>	<b>00</b>	<b>PHASE OVERCURRENT</b>						
	01	Stage 1 Overcurrent	(Sub Heading)					
	02	Max I>	Binary (1 bit)	0	Disabled * / Enabled		Setting	0/1/1
	03	Threshold I>	Courier floating point number		0.1 In *	4002=1	Setting	0.1/25.0/0.1
	04	Tempo Type I>	Indexed String	0 1 2	0: definite time * 1: inverse time 2: RI curve	4002=1	Setting	0/2/1
	05	Curve Type I>	Indexed String	0 1 2 3 4 5 6 7 8 9 10	STI (CEI) * SI (CEI) VI (CEI) EI (CEI) LTI (CEI) STI (CO2) MI (ANSI) LTI (CO8) VI (ANSI) EI (ANSI) RC (CEI)	4004=1	Setting	0/10/1
	06	TMS I>	Courier floating point number		0.025 *	4004=1	Setting	0.025/1.5/0.001
	07	K I>	Courier floating point number		0.1 *	4004=2	Setting	0.1/10.0/0.005
	08	Tempo I>	Courier floating point number		0.01 s *	4004=0	Setting	0.01/150.0/1.0
	09	Reset tempo type I>	Indexed String		0: definite time 1: inverse time	4004=1 & 4005>= 5 & 4005 <=9	Setting	0/1
	0A	RTMS I>	Courier floating point number		0.025	4009 = 1	Setting	0.025/3.2/0.001

Col	Row	Menu Text	Data Type	Ind	Values (*: default)	Depend	Cell Type	Min/Max/Step
	0B	T RESET I>	Courier floating point number		0.04	4009 = 0 or 4004 =0 or 4004 =2 or (4004=1 & 4005 < 5 & 4005 > 9)	Setting	0/600.0/0.01
	0C-0F	Reserved						
	10	Stage 2 Overcurrent	(Sub Heading)					
	11	Max I>>	Binary (1 bit)	0	Disabled * / Enabled		Setting	0/1/1
	12	Threshold I>>	Courier floating point number		0.50 In *	4011=1	Setting	0.5/40.0/0.05
	13	Tempo Type I>>	Indexed String	0 1 2	0: definite time * 1: inverse time 2: RI curve	4011=1	Setting	0/2/1
	14	Curve Type I>>	Indexed String	0 1 2 3 4 5 6 7 8 9 10	STI (CEI) * SI (CEI) VI (CEI) EI (CEI) LTI (CEI) STI (CO2) MI (ANSI) LTI (CO8) VI (ANSI) EI (ANSI) RC (CEI)	4013=1	Setting	0/10/1
	15	TMS I>>	Courier floating point number		0.025 *	4013=1	Setting	0.025/1.5/0.001
	16	K I>>	Courier floating point number		0.1 *	4013=2	Setting	0.1/10.0/0.005
	17	Tempo I>>	Courier floating point number		0.01 s *	4013=0	Setting	0 /150/0.01
	18	Reset tempo type I>>	Indexed String		0: definite time 1: inverse time	4013=1 & 4014>= 5 & 4014 <=9	Setting	0/1
	19	RTMS I>>	Courier floating point number		0.025	4018 = 1	Setting	0.025/3.2/0.001
	1A	T RESET I>>	Courier floating point number		0.04	4018 = 0 or 4013 =0 or 4013 =2 or (4013=1 & 4014 < 5 & 4014 > 9)	Setting	0/600.0/0.01
	1B-1F	Reserved						

MiCOM P120/P121/P122/P123

Col	Row	Menu Text	Data Type	Ind	Values (*: default)	Depend	Cell Type	Min/Max/Step
	20	Stage 3 Overcurrent	(Sub Heading)					
	21	Max I>>>	Binary (1 bit)	0	Disabled * / Enabled		Setting	0/1/1
	22	Threshold I>>>	Courier floating point number		0.50 In *	4021=1	Setting	0.5/40.0/0.05
	23	Tempo I>>>	Courier floating point number		0.01 s *	4021=1	Setting	0 /150/0.01
	24	Sample I>>>	Binary (1 bit)	0	Disabled * / Enabled	4021=1	Setting	0/1/1
<b>41</b>	<b>00</b>	<b>EARTH FAULT</b>						
	01	Stage 1 Overcurrent	(Sub Heading)					
	02	Max IE>	Binary (1 bit)	0	Disabled * / Enabled		Setting	0/1/1
	03	Threshold IE>	Courier floating point number		0.01 IEn* or 0.002 IEn* if great sensitivity	4102=1	Setting	0.01/2.0/0.005 or 0.1/25.0/0.01 if normal sensitivity or 0.002/1.0/0.001 if great sensitivity
	04	Temporisation Type IE>	Indexed String	0 1 2 3	0: definite time * 1: inverse time 2: RI curve 3: RXIDG curve	4102=1	Setting	0/3/1
	05	Curve type IE>	Indexed String	0 1 2 3 4 5 6 7 8 9 10	STI (CEI) * SI (CEI) VI (CEI) EI (CEI) LTI (CEI) STI (CO2) MI (ANSI) LTI (CO8) VI (ANSI) EI (ANSI) RC (CEI)	4104=1	Setting	0/10/1
	06	Curve Type 2 (RXIDG) IE>	Indexed String	0 1 2 3 4 5 6 7	K = 0.3 * K = 0.4 K = 0.5 K = 0.6 K = 0.7 K = 0.8 K = 0.9 K = 1.0.	2104=3	Setting	0/7/1
	07	TMS IE>	Courier floating point number		0.025 *	4104=1	Setting	0.025/1.5/0.001
	08	K IE>	Courier floating point number		0.1 *	4104=2	Setting	0.1/10.0/0.005

Col	Row	Menu Text	Data Type	Ind	Values (*: default)	Depend	Cell Type	Min/Max/Step
	09	Tempo IE>	Courier floating point number		0.01 s *	4104=0	Setting	0/150.0/0.01
	0A	Tempo reset Type IE>	Indexed String		0: definite time 1: inverse time	4104=1 & 4105>= 5 & 4105 <=9	Setting	0/1
	0B	RTMS IE>	Courier floating point number		0.025	4109 = 1	Setting	0.025/3.2/0.001
	0C	T RESET IE>	Courier floating point number		0.04	4109 = 0 or 4104 =0 or 4104 =2 or 4104 =3 or (4104=1 & 4105 < 5 & 4105 > 9)	Setting	0/600.0/0.01
	0D	Interlock IE>	Binary (1 bit)	0	Disabled * / Enabled	(4104 =3 or 4104=1) & (4111=1 or 4121=1)	Setting	0/1/1
	0E-0F	Reserved						
	10	Stage 2 Overcurrent	(Sub Heading)					
	11	Max IE>>	Binary (1 bit)	0	Disabled * / Enabled		Setting	0/1/1
	12	Threshold IE>>	Courier floating point number		IEn* or 0.50 IEn* if normal sensitivity or 0.002 IEn* if great sensitivity	4111=1	Setting	0.01/8.0/0.005 or 0.50/40.0/0.01 if normal sensitivity or 0.002/1.0/0.001 if great sensitivity
	13	Temporisation Type IE>>	Indexed String	0 1 2 3	0: definite time * 1: inverse time 2: RI curve 3: RXIDG curve	4111=1	Setting	0/3/1
	14	Curve type IE>>	Indexed String	0 1 2 3 4 5 6 7 8 9 10	STI (CEI) * SI (CEI) VI (CEI) EI (CEI) LTI (CEI) STI (CO2) MI (ANSI) LTI (CO8) VI (ANSI) EI (ANSI) RC (CEI)	4113=1	Setting	0/10/1
	15	Curve Type 2 (RXIDG) IE>	Indexed String	0	K = 0.3 *	4113=3	Setting	0/7/1

MiCOM P120/P121/P122/P123

Col	Row	Menu Text	Data Type	Ind	Values (*: default)	Depend	Cell Type	Min/Max/Step
				1 2 3 4 5 6 7	K = 0.4 K = 0.5 K = 0.6 K = 0.7 K = 0.8 K = 0.9 K = 1.0.			
	16	TMS IE>>	Courier floating point number		0.025 *	4113=1	Setting	0.025/1.5/0.001
	17	K IE>>	Courier floating point number		0.1 *	4113=2	Setting	0.1/10.0/0.005
	18	Tempo IE>>	Courier floating point number		0.01 s *	4113=0	Setting	0 /150.0/0.01
	19	Tempo reset Type IE>>	Indexed String		0: definite time 1: inverse time	4113=1 & 4114 >= 5 & 4114 <=9	Setting	0/1
	1A	RTMS IE>>	Courier floating point number		0.025	4119 = 1	Setting	0.025/3.2/0.001
	1B	T RESET IE>>	Courier floating point number		0.04	4119 = 0 or 4113 =0 or 4113 =2 or 4113 =3 or (4113=1 & 4114 < 5 & 4114 > 9)	Setting	0/600.0/0.01
	1C-1F	Reserved						
	20	Stage 3 Overcurrent	(Sub Heading)					
	21	Max IE>>>	Binary (1 bit)	0	Disabled * / Enabled		Setting	0/1/1
	22	Threshold IE>>>	Courier floating point number		IEn* or 0.50 IEn* if normal sensitivity or 0.002 IEn* if great sensitivity	4121=1	Setting	0.01/8.0/0.005 or 0.50/40.0/0.01 if normal sensitivity or 0.002/1.0/0.001 if great sensitivity
	23	Tempo IE>>>	Courier floating point number		0.01 s *	4121=1	Setting	0 /150.0/0.01
	24	Sample IE>>>	Binary (1 bit)	0	Disabled * / Enabled	4121=1	Setting	0/1/1
<b>42</b>	<b>00</b>	<b>THERMAL OVERLOAD</b>						
	01	Ith>	Binary (1 bit)	0	Disabled * / Enabled		Setting	0/1/1
	02	Threshold Ith>	Courier floating point number		0.10 Ith*	4201=1	Setting	0.01/3.2/0.01
	03	K Ith>	Courier floating point number		1.05 *	4201=1	Setting	1.0/1.50/0.01 In

Col	Row	Menu Text	Data Type	Ind	Values (*: default)	Depend	Cell Type	Min/Max/Step
	04	0 TRIP	Unsigned Integer (2 bytes)		100 % *	4201=1	Setting	50 / 200 / 1 %
	05	0 ALARM ?	Binary (1 bit)	0	Disabled * / Enabled	4201=1	Setting	0/1/1
	06	0 ALARM	Unsigned Integer (2 bytes)		90 % *	4205 =1	Setting	50 / 200 / 1 %
	07	Thermal constant	Unsigned Integer (2 bytes)		1 *	4201=1	Setting	1/ 200 / 1 mn
<b>43</b>	<b>00</b>	<b>MIN I&lt;</b>						
	01	I<	Binary (1 bit)	0	Disabled * / Enabled		Setting	0/1/1
	02	Threshold I<	Unsigned Integer (2 bytes)		20 %In *	4301=1	Setting	2 / 100 / 1 %In
	03	Tempo I <	Courier floating point number		0.01 s *	4301=1	Setting	0 /150.0/0.01
	04	Inhib. I< by 52a	Binary (1 bit)	0	Disabled * / Enabled	4301=1	Setting	0/1/1
<b>44</b>	<b>00</b>	<b>NEGATIVE CURRENT</b>						
	01	I2>	Binary (1 bit)	0	Disabled * / Enabled		Setting	0/1/1
	02	Threshold I2>	Courier floating point number		0.1 In *	4401 = 1	Setting	0.1/40.0/0.01 In
	03	Temporisation type		0 1 2	0: definite time * 1: inverse time 2: RI curve	4401 = 1	Setting	0/2/1
	04	Curve Type	Indexed String	0 1 2 3 4 5 6 7 8 9	STI (CEI) * SI (CEI) VI (CEI) EI (CEI) LTI (CEI) STI (CO2) MI (ANSI) LTI (CO8) VI (ANSI) EI (ANSI)	4401 = 1	Setting	0/9/1
	05	TMS	Courier floating point number		0.025 *	4403=1	Setting	0.025/1.5/0.001
	06	K (RI)	Courier floating point number		0.1 *	4403=2	Setting	0.1/10.0/0.005
	07	Tempo I2>	Courier floating point number		0.01 s *	4403=0	Setting	0 /150.0/1.0
	08	Temporisation reset type	Indexed String		0: definite time 1: inverse time	4403=1 & 4404>= 5 & 4404 <=9	Setting	0/1/1
	09	RTMS	Courier floating point number		0.025 *	4408 = 1	Setting	0.025/3.2/0.001
	0A	T RESET	Courier floating point number		0.04 *	4408 = 0 or	Setting	0.04/100/0.01

MiCOM P120/P121/P122/P123

Col	Row	Menu Text	Data Type	Ind	Values (*: default)	Depend	Cell Type	Min/Max/Step
						4403 =2 or (4403=1 & 4404 < 5 & 4404 > 9)		
	10	I2>>	Binary (1 bit)	0	Disabled * / Enabled		Setting	0/1/1
	11	Threshold I2>>	Courier floating point number		0.1 ln *	4410 = 1	Setting	0.1/40.0/0.01 ln
	12	Tempo I2>>	Courier floating point number		0.01 s *	4410 = 1	Setting	0 /150.0/1.0
<b>45</b>	<b>00</b>	<b>AUTORECLOSER</b>						
	01	Autorecloser	Binary (1 bit)	0	Disabled * / Enabled		Setting	0/1/1
	02	State circuit breaker	Binary (1 bit)		Disabled * / Enabled	4501 = 1	Setting	0/1/1
	03	Control window	Courier floating point number		0.01 s *	4502 = 1	Setting	0.01 / 600.00 / 0.01 s
	04	External blocking	Binary (1 bit)		Disabled * / Enabled	4501 = 1	Setting	0/1/1
	07	Temporisation cycle 1	Courier floating point number		0.05 s *	4501 = 1	Setting	0.05 / 300.00 / 0.01 s
	08	Temporisation cycle 2	Courier floating point number		0.05 s *	4501 = 1	Setting	0.05 / 300.00 / 0.01 s
	09	Temporisation cycle 3	Courier floating point number		0.05 s *	4501 = 1	Setting	0.05 / 600.00 / 0.01 s
	0A	Temporisation cycle 4	Courier floating point number		0.05 s *	4501 = 1	Setting	0.05 / 600.00 / 0.01 s
	0B	Reclaim TIME	Courier floating point number		0.02 s *	4501 = 1	Setting	0.02 / 600.00 / 0.01 s
	0C	Inhibition time	Courier floating point number		0.02 s *	4501 = 1	Setting	0.02 / 600.00 / 0.01 s
	0D	Number of short circuit cycle	Unsigned Integer (2 bytes)		0 *	4501 = 1	Setting	0 / 4 / 1
	0E	Number of earth fault cycle	Unsigned Integer (2 bytes)		0 *	4501 = 1	Setting	0 / 4 / 1
	0F	Cycles tI> configuration	Unsigned Integer (2 bytes)		0x1111 *	4501 = 1	Setting	0/2/1 on each 4 bit group
	10	Cycles tI>> configuration	Unsigned Integer (2 bytes)		0x1111 *	4501 = 1	Setting	0/2/1 on each 4 bit group
	11	Cycles tI>>> configuration	Unsigned Integer (2 bytes)		0x1111 *	4501 = 1	Setting	0/2/1 on each 4 bit group
	12	Cycles tIE> configuration	Unsigned Integer (2 bytes)		0x1111 *	4501 = 1	Setting	0/2/1 on each 4 bit group
	13	Cycles tIE>> configuration	Unsigned Integer (2 bytes)		0x1111 *	4501 = 1	Setting	0/2/1 on each 4 bit group
	14	Cycles tIE>>> configuration	Unsigned Integer (2 bytes)		0x1111 *	4501 = 1	Setting	0/2/1 on each 4 bit group

Col	Row	Menu Text	Data Type	Ind	Values (*: default)	Depend	Cell Type	Min/Max/Step
	15	Cycles tAux1> configuration	Unsigned Integer (2 bytes)		0x1111 *	4501 = 1	Setting	0/2/1 on each 4 bit group
	16	Cycles tAux2> configuration	Unsigned Integer (2 bytes)		0x1111 *	4501 = 1	Setting	0/2/1 on each 4 bit group
<b>60</b>	<b>00</b>	<b>AUTOMATISM</b>						
	01	Trip Configuration	Binary (15 bits)	1 *	0: t l> * 1: t l>> 2: t l>>> 3: t lE> 4: t lE>> 5: t lE>>> 6: t l< 7: t Therm 8: Broken Conductor 9: tAux1 10: tAux2 11: t l2> 12: t l2>> 13: tAux3 14: tAux4 15: Breaker Fail		Setting	0 / 65535 / 1
	02	Latch Configuration	Binary (15 bits)	0 *	0: Latch l> 1: Latch l>> 2: Latch l>>> 3: Latch lE> 4: Latch lE>> 5: Latch lE>>> 6: Latch l< 7: Latch Therm. Ov. 8: Latch Broken Conductor 9: Latch Aux1 10: Latch Aux2 11: Latch l2> 12: Latch l2>> 13: Latch Aux3 14: Latch Aux4 15: Latch Breaker Fail		Setting	0 / 65535 / 1
	03	Blocking 1 Configuration	Binary (16 bits)	0 *	0: Blocking t l> 1: Blocking t l>> 2: Blocking t l>>> 3: Blocking t lE> 4: Blocking t lE>> 5: Blocking t lE>>> 6: Blocking t l<		Setting	0 / 65535 / 1



MiCOM P120/P121/P122/P123

Col	Row	Menu Text	Data Type	Ind	Values (*: default)	Depend	Cell Type	Min/Max/Step
					7: Blocking t Therm 8: Blocking Broken Conductor 9: Blocking tAux1 10: Blocking tAux2 11: Blocking t I2> 12: Blocking t I2>> 13: Blocking tAux3 14: Blocking tAux4 15: reserved			
	04	Blocking 2 Configuration	Binary (16 bits)	0 *	0: Blocking t I> 1: Blocking t I>> 2: Blocking t I>>> 3: Blocking t IE> 4: Blocking t IE>> 5: Blocking t IE>>> 6: Blocking t I< 7: Blocking t Therm 8: Blocking Broken Conductor 9: Blocking tAux1 10: Blocking tAux2 11: Blocking t I2> 12: Blocking t I2>> 13: Blocking tAux3 14: Blocking tAux4 15: reserved		Setting	0 / 65535 / 1
	05	Broken conductor detection	Binary (1 bit)		Disabled * / Enabled		Setting	0 / 1 / 1
	06	Tempo tBC	Unsigned Integer (2 bytes)		0 *	6005 = 1	Setting	0 / 144.0 / 0.01 s
	07	Threshold mod iinv/irect in %	Courier floating point number		20 % *	6005 = 1	Setting	20 / 100 / 1 %
	08	Cold load start	Binary (1 bit)		Disabled * / Enabled		Setting	0 / 1 / 1
	09	Threshold of cold load start	Binary (9 bits)	0 *	0: Desens t I> 1: Desens t I>> 2: Desens t I>>> 3: Desens t IE> 4: Desens t IE>> 5: Desens t IE>>> 6: Desens t Therm 7: Desens t I2> 8: Desens t I2>>	6008 = 1	Setting	0 / 511 / 1
	0A	% of cold load start	Unsigned Integer (2 bytes)		50 % *	6008 = 1	Setting	20 / 500 / 1
	0B	Cold load start Tempo	Courier floating point number		1.0 s *	6008 = 1	Setting	0.1 / 3600.0 / 0.1 s
	0C	Breaker failure	Binary (1 bit)		Disabled * / Enabled		Setting	0 / 1 / 1

Col	Row	Menu Text	Data Type	Ind	Values (*: default)	Depend	Cell Type	Min/Max/Step
	0D	I< Threshold for Breaker failure	Courier floating point number		10 % *	600C = 1	Setting	2 / 100/ 1 %
	0E	Tempo tBF	Unsigned Integer (2 bytes)		0.1 s *	600C = 1	Setting	0.03 / 10.0 / 0.01 s
	0F	Phase instant blocking	Binary (1 bit)		Disabled * / Enabled	600C = 1	Setting	0 / 1/ 1
	10	Earth instant blocking	Binary (1 bit)		Disabled * / Enabled	600C = 1	Setting	0 / 1/ 1
	11	Logic selectivity 1	Binary (4 bits)	0 *	0: t I>> 1: t I>>> 2: t IE>> 3: t IE>>>		Setting	0 / 15/ 1
	12	Tempo selectivity1	Courier floating point number		0 *	6011 <> 0	Setting	0 / 150.0 / 0.01 s
	13	Logic selectivity 2	Binary (4 bits)	0 *	0: t I>> 1: t I>>> 2: t IE>> 3: t IE>>>		Setting	0 / 15 / 1
	14	Tempo selectivity 2	Courier floating point number		0 *	6013 <> 1	Setting	0 / 150.0 / 0.01 s
	15	Trip Configuration 2/2	Binary (10 bits)	0 *	0: Trip SOTF 1: Control TRIP 2: Trip Equation A 3: Trip Equation B 4: Trip Equation C 5: Trip Equation D 6: Trip Equation E 7: Trip Equation F 8: Trip Equation G 9: Trip Equation H		Setting	0 / 4095 / 1
	16	Latch Configuration 2/2	Binary (2 bits)	0 *	0: Latch SOTF 1: Reserved		Setting	0 / 3 / 1
	20	Blocking Inrush detection	Binary (1 bit)		Disabled * / Enabled		Setting	0 / 1 / 1
	21	Inrush harmonic 2 ratio in %	Courier floating point number		20.0 % *	6020 = 1	Setting	10.0 / 35.0 / 0.01%
	22	Inrush Reset tempo	Courier floating point number		0 *	6020 = 1	Setting	0 / 2.00 / 0.01 s
	23	Inrush blocking selection	Binary (13 bits)		0: t I> 1: t I>> 2: t I>>> 3: t IE> 4: t IE>> 5: t IE>>> 6: Reserved 7: Reserved	6020 = 1	Setting	0 / 8191 / 1

MiCOM P120/P121/P122/P123

Col	Row	Menu Text	Data Type	Ind	Values (*: default)	Depend	Cell Type	Min/Max/Step
					8: Reserved 9: Reserved 10: Reserved 11: t I2> 12: t I2>>			
<b>61</b>	<b>00</b>	<b>TS SETTINGS</b>						
	06	Timer aux 1	Courier floating point number		0 *		Setting	0 / 200.0 / 0.01
	07	Timer aux 2	Courier floating point number		0 *		Setting	0 / 200.0 / 0.01
	08	TS setting (Edge type)	Binary (5 bits)		Bit 0 to 4 = 0: Rising edge Bit 0 to 4 = 1: Falling edge		Setting	0 / 31 / 1
	09	TS voltage	Indexed String		0 * = DC 1 = AC		Setting	0 / 1 / 1
	0A	Timer aux 3	Courier floating point number		0 *		Setting	0 / 200.0 / 0.01
	0B	Timer aux 4	Courier floating point number		0 *		Setting	0 / 200.0 / 0.01
	10	Logical input 1 allocation (1/2)	Binary (16 bits)	0 1 2 3 4 5 6 7 8 9 10 11 12 13 14 15	0: delatch 1: 52 a 2: 52 b 3: CB failure 4: External input 1 5: External input 2 6: Logic blocking 1 7: Logic blocking 2 8: Disturbance start 9: Cold load start 10: Log Selectivity 1 11: Log Selectivity 2 12: Change of group 13: Recloser locked 14: Thermal reset 15: Trip circuit supervision		Setting	0 / 65535 / 1
	11	Logical input 2 allocation (1/2)	Binary (16 bits)	0 1 2 3 4 5 6 7 8 9 10	0: delatch 1: 52 a 2: 52 b 3: CB failure 4: External input 1 5: External input 2 6: Logic blocking 1 7: Logic blocking 2 8: Disturbance start 9: Cold load start 10: Log Selectivity 1		Setting	0 / 65535 / 1

Col	Row	Menu Text	Data Type	Ind	Values (*: default)	Depend	Cell Type	Min/Max/Step
				11 12 13 14 15	11: Log Selectivity 2 12: Change of group 13: <i>Recloser locked</i> 14: Thermal reset 15: Trip circuit supervision			
	12	Logical input 3 allocation (1/2)	Binary (16 bits)	0 1 2 3 4 5 6 7 8 9 10 11 12 13 14 15	0: delatch 1: 52 a 2: 52 b 3: CB failure 4: External input 1 5: External input 2 6: Logic blocking 1 7: Logic blocking 2 8: Disturbance start 9: Cold load start 10: Log Selectivity 1 11: Log Selectivity 2 12: Change of group 13: <i>Recloser locked</i> 14: Thermal reset 15: Trip circuit supervision		Setting	0 / 65535 / 1
	13	<i>Logical input 4 allocation (1/2)</i>	<i>Binary (16 bits)</i>	0 1 2 3 4 5 6 7 8 9 10 11 12 13 14 15	0: <i>delatch</i> 1: <i>52 a</i> 2: <i>52 b</i> 3: <i>CB failure</i> 4: <i>External input 1</i> 5: <i>External input 2</i> 6: <i>Logic blocking 1</i> 7: <i>Logic blocking 2</i> 8: <i>Disturbance start</i> 9: <i>Cold load start</i> 10: <i>Log Selectivity 1</i> 11: <i>Log Selectivity 2</i> 12: <i>Change of group</i> 13: <i>Recloser locked</i> 14: <i>Thermal reset</i> 15: <i>Trip circuit supervision</i>		<i>Setting</i>	<i>0 / 65535 / 1</i>

MiCOM P120/P121/P122/P123

Col	Row	Menu Text	Data Type	Ind	Values (*: default)	Depend	Cell Type	Min/Max/Step
	14	Logical input 5 allocation (1/2)	Binary (16 bits)	0 1 2 3 4 5 6 7 8 9 10 11 12 13 14 15	0: delatch 1: 52 a 2: 52 b 3: CB failure 4: External input 1 5: External input 2 6: Logic blocking 1 7: Logic blocking 2 8: Disturbance start 9: Cold load start 10: Log Selectivity 1 11: Log Selectivity 2 12: Change of group 13: Recloser locked 14: Thermal reset 15: Trip circuit supervision		Setting	0 / 65535 / 1
	15	Logical input 1 allocation (2/2)	Binary (8 bits)	0 1 2 3 4 5 6 7	0: external CB failure 1: Leds reset 2: Maintenance mode 3: External input 3 4: External input 4 5: Manual Close 6: Local Mode 7: Synchronisation		Setting	0/255/ 1
	16	Logical input 2 allocation (2/2)	Binary (8 bits)	0 1 2 3 4 5 6 7	0: external CB failure 1: Leds reset 2: Maintenance mode 3: External input 3 4: External input 4 5: Manual Close 6: Local Mode 7: Synchronisation		Setting	0/255/ 1
	17	Logical input 3 allocation (2/2)	Binary (8 bits)	0 1 2 3 4 5 6 7	0: external CB failure 1: Leds reset 2: Maintenance mode 3: External input 3 4: External input 4 5: Manual Close 6: Local Mode 7: Synchronisation		Setting	0/255/ 1

Col	Row	Menu Text	Data Type	Ind	Values (*: default)	Depend	Cell Type	Min/Max/Step
	18	Logical input 4 allocation (2/2)	Binary (8 bits)	0 1 2 3 4 5 6 7	0: external CB failure 1: Leds reset 2: Maintenance mode 3: External input 3 4: External input 4 5: Manual Close 6: Local Mode 7: Synchronisation		Setting	0/255/ 1
	19	Logical input 5 allocation (2/2)	Binary (8 bits)	0 1 2 3 4 5 6 7	0: external CB failure 1: Leds reset 2: Maintenance mode 3: External input 3 4: External input 4 5: Manual Close 6: Local Mode 7: Synchronisation		Setting	0/255/ 1
<b>62</b>	<b>00</b>	<b>TC SETTINGS</b>						
	01	GENERAL TRIP	Binary (7 bits/ 5 bits)		0000000 * / 00000 *		Setting	0/127/1 or 0/31/1
	02	l>	Binary (7 bits/ 5 bits)		0000000 * / 00000 *		Setting	0/127/1 or 0/31/1
	03	tl>	Binary (7 bits/ 5 bits)		0000000 * / 00000 *		Setting	0/127/1 or 0/31/1
	04	l>>	Binary (7 bits/ 5 bits)		0000000 * / 00000 *		Setting	0/127/1 or 0/31/1
	05	t l>>	Binary (7 bits/ 5 bits)		0000000 * / 00000 *		Setting	0/127/1 or 0/31/1
	06	l>>>	Binary (7 bits/ 5 bits)		0000000 * / 00000 *		Setting	0/127/1 or 0/31/1
	07	t l>>>	Binary (7 bits/ 5 bits)		0000000 * / 00000 *		Setting	0/127/1 or 0/31/1
	08	lE>	Binary (7 bits/ 5 bits)		0000000 * / 00000 *		Setting	0/127/1 or 0/31/1
	09	t lE>	Binary (7 bits/ 5 bits)		0000000 * / 00000 *		Setting	0/127/1 or 0/31/1
	0A	lE>>	Binary (7 bits/ 5 bits)		0000000 * / 00000 *		Setting	0/127/1 or 0/31/1
	0B	t lE>>	Binary (7 bits/ 5 bits)		0000000 * / 00000 *		Setting	0/127/1 or 0/31/1
	0C	lE>>>	Binary (7 bits/ 5 bits)		0000000 * / 00000 *		Setting	0/127/1 or 0/31/1
	0D	t lE>>>	Binary (7 bits/ 5 bits)		0000000 * / 00000 *		Setting	0/127/1 or 0/31/1
	0E	Broken conductor	Binary (7 bits/ 5 bits)		0000000 * / 00000 *		Setting	0/127/1 or 0/31/1
	0F	Breaker failure	Binary (7 bits/ 5 bits)		0000000 * / 00000 *		Setting	0/127/1 or 0/31/1
	10	t l<	Binary (7 bits/ 5 bits)		0000000 * / 00000 *		Setting	0/127/1 or 0/31/1

MiCOM P120/P121/P122/P123

Col	Row	Menu Text	Data Type	Ind	Values (*: default)	Depend	Cell Type	Min/Max/Step
	11	t I2>	Binary (7 bits/ 5 bits)		0000000 * / 00000 *		Setting	0/127/1 or 0/31/1
	12	t I2>>	Binary (7 bits/ 5 bits)		0000000 * / 00000 *		Setting	0/127/1 or 0/31/1
	13	Thermal alarm	Binary (7 bits/ 5 bits)		0000000 * / 00000 *		Setting	0/127/1 or 0/31/1
	14	Thermal trip	Binary (7 bits/ 5 bits)		0000000 * / 00000 *		Setting	0/127/1 or 0/31/1
	15	Reclosing	Binary (7 bits/ 5 bits)		0000000 * / 00000 *		Setting	0/127/1 or 0/31/1
	16	tAux 1	Binary (7 bits/ 5 bits)		0000000 * / 00000 *		Setting	0/127/1 or 0/31/1
	17	tAux 2	Binary (7 bits/ 5 bits)		0000000 * / 00000 *		Setting	0/127/1 or 0/31/1
	18	Breaker alarm	Binary (7 bits/ 5 bits)		0000000 * / 00000 *		Setting	0/127/1 or 0/31/1
	19	Trip circuit alarm	Binary (7 bits/ 5 bits)		0000000 * / 00000 *		Setting	0/127/1 or 0/31/1
	1A	<i>Autoreclose in progress</i>	<i>Binary (7 bits)</i>		0000000 *		Setting	0/127/1
	1B	<i>Definitive trip</i>	<i>Binary (7 bits)</i>		0000000 *		Setting	0/127/1
	1C	TC Active Setting Group	Binary (7 bits/ 5 bits)		0000000 * / 00000 * bit 0 to 6 =0: Group 1 bit 0 to 6 =1: Group 2		Setting	0/127/1 or 0/31/1
	1D	TC lock setting	Binary (7 bits/ 5 bits)		0000000 * / 00000 *		Setting	0/127/1 or 0/31/1
	1E	tAux 3	Binary (7 bits/ 5 bits)		0000000 * / 00000 *		Setting	0/127/1 or 0/31/1
	1F	<i>tAux 4</i>	<i>Binary (7 bits)</i>		0000000 *		Setting	0/127/1
	20	tCOMM1	Binary (7 bits/ 5 bits)		0000000 * / 00000 *		Setting	0/127/1 or 0/31/1
	21	tCOMM2	Binary (7 bits/ 5 bits)		0000000 * / 00000 *		Setting	0/127/1 or 0/31/1
	22	tCOMM3	Binary (7 bits/ 5 bits)		0000000 * / 00000 *		Setting	0/127/1 or 0/31/1
	23	tCOMM4	Binary (7 bits/ 5 bits)		0000000 * / 00000 *		Setting	0/127/1 or 0/31/1
	24	<i>SOTF</i>	<i>Binary (7 bits)</i>		0000000 *		Setting	0/127/1
	25	<i>CONTROL TRIP</i>	<i>Binary (7 bits)</i>		0000000 *		Setting	0/127/1
	26	<i>CONTROL CLOSE</i>	<i>Binary (7 bits)</i>		0000000 *		Setting	0/127/1
	27	<i>Locked Autorecloser</i>	<i>Binary (7 bits)</i>		0000000 *		Setting	0/127/1
	28	Logical input 1	Binary (7 bits/ 5 bits)		0000000 * / 00000 *		Setting	0/127/1 or 0/31/1
	29	Logical input 2	Binary (7 bits/ 5 bits)		0000000 * / 00000 *		Setting	0/127/1 or 0/31/1
	2A	Logical input 3	Binary (7 bits/ 5 bits)		0000000 * / 00000 *		Setting	0/127/1 or 0/31/1

Col	Row	Menu Text	Data Type	Ind	Values (*: default)	Depend	Cell Type	Min/Max/Step
	2B	Logical input 4	Binary (7 bits)		0000000 *		Setting	0/127/1
	2C	Logical input 5	Binary (7 bits)		0000000 *		Setting	0/127/1
	30	Equation A	Binary (7 bits/ 5 bits)		0000000 * / 00000 *		Setting	0/127/1 or 0/31/1
	31	Equation B	Binary (7 bits/ 5 bits)		0000000 * / 00000 *		Setting	0/127/1 or 0/31/1
	32	Equation C	Binary (7 bits/ 5 bits)		0000000 * / 00000 *		Setting	0/127/1 or 0/31/1
	33	Equation D	Binary (7 bits/ 5 bits)		0000000 * / 00000 *		Setting	0/127/1 or 0/31/1
	34	Equation E	Binary (7 bits/ 5 bits)		0000000 * / 00000 *		Setting	0/127/1 or 0/31/1
	35	Equation F	Binary (7 bits/ 5 bits)		0000000 * / 00000 *		Setting	0/127/1 or 0/31/1
	36	Equation G	Binary (7 bits/ 5 bits)		0000000 * / 00000 *		Setting	0/127/1 or 0/31/1
	37	Equation H	Binary (7 bits/ 5 bits)		0000000 * / 00000 *		Setting	0/127/1 or 0/31/1
<b>63</b>	<b>00</b>	<b>LEDS SETTINGS</b>						
	01	Led 5 1/3	Binary (16 bits)	4 *	0: l> 1: t l> 2: l>> * 3: t l>>> 4: l>>>> 5: t l>>>> 6: lE> 7: t lE> 8: lE>> 9: t lE>>> 10: lE>>>> 11: t lE>>>> 12: Thermal Overload 13: t l2> 14: Broken Conductor 15: Breaker Failure		Setting	0/65535/1



MiCOM P120/P121/P122/P123

Col	Row	Menu Text	Data Type	Ind	Values (*: default)	Depend	Cell Type	Min/Max/Step
	02	Led 6 1/3	Binary (16 bits)	16 *	0: l> 1: t l> 2: l>> 3: t l>> 4: l>>> * 5: t l>>> 6: IE> 7: t IE> 8: IE>> 9: t IE>> 10: IE>>> 11: t IE>>> 12: Thermal Overload 13: t l2> 14: Broken Conductor 15: Breaker Failure		Setting	0/65535/1
	03	Led 7 1/3	Binary (16 bits)	32 *	0: l> 1: t l> 2: l>> 3: t l>> 4: l>>> 5: t l>>> * 6: IE> 7: t IE> 8: IE>> 9: t IE>> 10: IE>>> 11: t IE>>> 12: Thermal Overload 13: t l2> 14: Broken Conductor 15: Breaker Failure		Setting	0/65535/1

Col	Row	Menu Text	Data Type	Ind	Values (*: default)	Depend	Cell Type	Min/Max/Step
	04	Led 8 1/3	Binary (16 bits)	64 *	0: l> 1: t l> 2: l>> 3: t l>> 4: l>>> 5: t l>>> 6: lE> * 7: t lE> 8: lE>> 9: t lE>> 10: lE>>> 11: t lE>>> 12: Thermal Overload 13: t l2> 14: Broken Conductor 15: Breaker Failure		Setting	0/65535/1
	05	Led 5 2/3	Binary (11 bits)	0 *	0: Input 1 1: Input 2 2: Input 3 3: <i>Input 4</i> 4: <i>Input 5</i> 5: <i>Locked Autorecloser</i> 6: <i>Autorecloser in progress</i> 7: tAux1 8: tAux2 9: t l2>> 10: SOTF		Setting	0/2047/1
	06	Led 6 2/3	Binary (11 bits)	0 *	0: Input 1 1: Input 2 2: Input 3 3: <i>Input 4</i> 4: <i>Input 5</i> 5: <i>Locked Autorecloser</i> 6: <i>Autorecloser in progress</i> 7: tAux1 8: tAux2 9: t l2>> 10: SOTF		Setting	0/2047/1

MiCOM P120/P121/P122/P123

Col	Row	Menu Text	Data Type	Ind	Values (*: default)	Depend	Cell Type	Min/Max/Step
	07	Led 7 2/3	Binary (11 bits)	0 *	0: Input 1 1: Input 2 2: Input 3 3: <i>Input 4</i> 4: <i>Input 5</i> 5: <i>Locked Autorecloser</i> 6: <i>Autorecloser in progress</i> 7: tAux1 8: tAux2 9: t I2>> 10: SOTF		Setting	0/2047/1
	08	Led 8 2/3	Binary (11 bits)	0 *	0: Input 1 1: Input 2 2: Input 3 3: <i>Input 4</i> 4: <i>Input 5</i> 5: <i>Locked Autorecloser</i> 6: <i>Autorecloser in progress</i> 7: tAux1 8: tAux2 9: t I2>> 10: SOTF		Setting	0/2047/1
	09	Led 5 3/3	Binary (8 bits)	0 *	0: Equation A 1: Equation B 2: Equation C 3: Equation D 4: Equation E 5: Equation F 6: Equation G 7: Equation H		Setting	0/255/1
	0A	Led 6 3/3	Binary (8 bits)	0 *	0: Equation A 1: Equation B 2: Equation C 3: Equation D 4: Equation E 5: Equation F 6: Equation G 7: Equation H		Setting	0/255/1

Col	Row	Menu Text	Data Type	Ind	Values (*: default)	Depend	Cell Type	Min/Max/Step
	0B	Led 7 3/3	Binary (8 bits)	0 *	0: Equation A 1: Equation B 2: Equation C 3: Equation D 4: Equation E 5: Equation F 6: Equation G 7: Equation H		Setting	0/255/1
	0C	Led 8 3/3	Binary (8 bits)	0 *	0: Equation A 1: Equation B 2: Equation C 3: Equation D 4: Equation E 5: Equation F 6: Equation G 7: Equation H		Setting	0/255/1
<b>64</b>	<b>00</b>	<b>ALARMS</b>						
	01	Instant. alarm self-reset	Binary (1 bits)		Disabled * / Enabled		Setting	0/1/1
	02	Reset leds on Fault	Binary (1 bits)		Disabled * / Enabled		Setting	0/1/1
	10	Inhib. Alarms tAux	Binary (4 bits / 3 bits)	0 0 1 1	0: Alarm tAux1 1: Alarm tAux2 2: Alarm tAux3 3: Alarm tAux4		Setting	0/15/1 or 0/7/1
<b>69</b>	<b>00</b>	<b>SW SUPERVISION</b>						
	01	Trip circuit supervision ?	Binary (1 bit)	0	Disabled * / Enabled		Setting	0/1/1
	02	Trip circuit time ?	Courier floating point number		0.1 s *	6901 = 1	Setting	0.1/10.0/0.05 s
	03	SW Operating time?	Binary (1 bit)	0	Disabled * / Enabled		Setting	0/1/1
	04	SW Operating time	Courier floating point number		0.05 s*	6903 = 1	Setting	0.05/1.0/0.05 s
	05	SW Operating number?	Binary (1 bit)	0	Disabled * / Enabled		Setting	0/1/1
	06	SW Closing time ?	Courier floating point number		0.05 s*	6905 = 1	Setting	0.05/1.0/0.05 s
	07	SW Closing time	Binary (1 bit)	0	Disabled * / Enabled		Setting	0/1/1
	08	SW Operating number	Unsigned Integer (2 bytes)		0 *	6907 = 1	Setting	0/50000/1
	09	SA2n?	Binary (1 bit)	0	Disabled * / Enabled		Setting	0/1/1
	0A	SA2n	Courier floating point number		0 exp+06 A <sup>2</sup> *	6909 = 1	Setting	0/4000/1 (*exp+06)
	0B	N	Unsigned Integer (2 bytes)		1 *		Setting	1/2/1

MiCOM P120/P121/P122/P123

Col	Row	Menu Text	Data Type	Ind	Values (*: default)	Depend	Cell Type	Min/Max/Step
	0C	TRIP t	Courier floating point number		0.1 s*		Setting	0.1/5.0/0.05 s
	0D	CLOSE t	Courier floating point number		0.1 s*		Setting	0.1/5.0/0.05 s
<b>6A</b>	<b>00</b>	<b>COMM ORDER LATCH TIMES</b>						
	01	t COMM1	Courier floating point number		0.1 s*	6220 != 0	Setting	0.1/600.0/0.05 s
	02	t COMM2	Courier floating point number		0.1 s*	6221 != 0	Setting	0.1/600.0/0.05 s
	03	t COMM3	Courier floating point number		0.1 s*	6222 != 0	Setting	0.1/600.0/0.05 s
	04	t COMM4	Courier floating point number		0.1 s*	6223 != 0	Setting	0.1/600.0/0.05 s
<b>6B</b>	<b>00</b>	<b>SWITCH ON TO FAULT</b>						
	01	SOTF function ?	Binary (1 bit)	0	Disabled * / Enabled		Setting	0/1/1
	02	TManual close	Courier floating point number		0.1 s*	6B01 = 1	Setting	0/0.50/0.01 s
	03	Start l>> / l>>>	Binary (2 bit)	0 1	0*: Start l>> 1: Start l>>>	6B01 = 1	Setting	0/3/1
<b>6C</b>	<b>00</b>	<b>BOOLEAN EQUATIONS 1/2</b>						
	10	EQUATION A	(Sub Heading)					
	11	Operator 00	Indexed String	0 * 1	* (Space) NOT		Setting	0/1/1

Col	Row	Menu Text	Data Type	Ind	Values (*: default)	Depend	Cell Type	Min/Max/Step
	12	Operand 00	Indexed String	0 * 1 2 3 4 5 6 7 8 9 10 11 12 13 14 15 16 17 18 19 20 21 22 23 24 25 26	NULL * I> t I> I>> t I>> I>>> t I>>> IE> t IE> IE>> t IE>> IE>>> t IE>>> I2> t I2> I2>> t I2>> Thermal Alarm Thermal Trip I< t I< CB Fail <i>Recloser</i> tAux1 tAux2 tAux3 tAux4		Setting	0/28/1 or 0/27/1
	13	Operator 01	Indexed String	0 * 1 2 3	OR * OR NOT AND AND NOT		Setting	0/3/1

MiCOM P120/P121/P122/P123

Col	Row	Menu Text	Data Type	Ind	Values (*: default)	Depend	Cell Type	Min/Max/Step
	14	Operand 01	Indexed String	0 * 1 2 3 4 5 6 7 8 9 10 11 12 13 14 15 16 17 18 19 20 21 22 23 24 25 26	NULL * I> t I> I>> t I>> I>>> t I>>> IE> t IE> IE>> t IE>> IE>>> t IE>>> I2> t I2> I2>> t I2>> Thermal Alarm Thermal Trip I< t I< CB Fail <i>Recloser</i> tAux1 tAux2 tAux3 tAux4		Setting	0/28/1 or 0/27/1
	15	Operator 02	Indexed String	0 * 1 2 3	OR * OR NOT AND AND NOT		Setting	0/3/1

Col	Row	Menu Text	Data Type	Ind	Values (*: default)	Depend	Cell Type	Min/Max/Step
	16	Operand 02	Indexed String	0 * 1 2 3 4 5 6 7 8 9 10 11 12 13 14 15 16 17 18 19 20 21 22 23 24 25 26	NULL * I> t I> I>> t I>> I>>> t I>>> IE> t IE> IE>> t IE>> IE>>> t IE>>> I2> t I2> I2>> t I2>> Thermal Alarm Thermal Trip I< t I< CB Fail <i>Recloser</i> tAux1 tAux2 tAux3 tAux4		Setting	0/28/1 or 0/27/1
	17	Operator 03	Indexed String	0 * 1 2 3	OR * OR NOT AND AND NOT		Setting	0/3/1



MiCOM P120/P121/P122/P123

Col	Row	Menu Text	Data Type	Ind	Values (*: default)	Depend	Cell Type	Min/Max/Step
	18	Operand 03	Indexed String	0 * 1 2 3 4 5 6 7 8 9 10 11 12 13 14 15 16 17 18 19 20 21 22 23 24 25 26	NULL * I> t I> I>> t I>> I>>> t I>>> IE> t IE> IE>> t IE>> IE>>> t IE>>> I2> t I2> I2>> t I2>> Thermal Alarm Thermal Trip I< t I< CB Fail <i>Recloser</i> tAux1 tAux2 tAux3 tAux4		Setting	0/28/1 or 0/27/1
	19	Operator 04	Indexed String	0 * 1 2 3	OR * OR NOT AND AND NOT		Setting	0/3/1

Col	Row	Menu Text	Data Type	Ind	Values (*: default)	Depend	Cell Type	Min/Max/Step
	1A	Operand 04	Indexed String	0 * 1 2 3 4 5 6 7 8 9 10 11 12 13 14 15 16 17 18 19 20 21 22 23 24 25 26	NULL * I> t I> I>> t I>> I>>> t I>>> IE> t IE> IE>> t IE>> IE>>> t IE>>> I2> t I2> I2>> t I2>> Thermal Alarm Thermal Trip I< t I< CB Fail <i>Recloser</i> tAux1 tAux2 tAux3 tAux4		Setting	0/28/1 or 0/27/1
	1B	Operator 05	Indexed String	0 * 1 2 3	OR * OR NOT AND AND NOT		Setting	0/3/1

MiCOM P120/P121/P122/P123

Col	Row	Menu Text	Data Type	Ind	Values (*: default)	Depend	Cell Type	Min/Max/Step
	1C	Operand 05	Indexed String	0 * 1 2 3 4 5 6 7 8 9 10 11 12 13 14 15 16 17 18 19 20 21 22 23 24 25 26	NULL * I> t I> I>> t I>> I>>> t I>>> IE> t IE> IE>> t IE>> IE>>> t IE>>> I2> t I2> I2>> t I2>> Thermal Alarm Thermal Trip I< t I< CB Fail <i>Recloser</i> tAux1 tAux2 tAux3 tAux4		Setting	0/28/1 or 0/27/1
	1D	Operator 06	Indexed String	0 * 1 2 3	OR * OR NOT AND AND NOT		Setting	0/3/1

Col	Row	Menu Text	Data Type	Ind	Values (*: default)	Depend	Cell Type	Min/Max/Step
	1E	Operand 06	Indexed String	0 * 1 2 3 4 5 6 7 8 9 10 11 12 13 14 15 16 17 18 19 20 21 22 23 24 25 26	NULL * I> t I> I>> t I>> I>>> t I>>> IE> t IE> IE>> t IE>> IE>>> t IE>>> I2> t I2> I2>> t I2>> Thermal Alarm Thermal Trip I< t I< CB Fail <i>Recloser</i> tAux1 tAux2 tAux3 tAux4		Setting	0/28/1 or 0/27/1
	1F	Operator 07	Indexed String	0 * 1 2 3	OR * OR NOT AND AND NOT		Setting	0/3/1

MiCOM P120/P121/P122/P123

Col	Row	Menu Text	Data Type	Ind	Values (*: default)	Depend	Cell Type	Min/Max/Step
	20	Operand 07	Indexed String	0 * 1 2 3 4 5 6 7 8 9 10 11 12 13 14 15 16 17 18 19 20 21 22 23 24 25 26	NULL * I> t I> I>> t I>> I>>> t I>>> IE> t IE> IE>> t IE>> IE>>> t IE>>> I2> t I2> I2>> t I2>> Thermal Alarm Thermal Trip I< t I< CB Fail <i>Recloser</i> tAux1 tAux2 tAux3 tAux4		Setting	0/28/1 or 0/27/1
	21	Operator 08	Indexed String	0 * 1 2 3	OR * OR NOT AND AND NOT		Setting	0/3/1

Col	Row	Menu Text	Data Type	Ind	Values (*: default)	Depend	Cell Type	Min/Max/Step
	22	Operand 08	Indexed String	0 * 1 2 3 4 5 6 7 8 9 10 11 12 13 14 15 16 17 18 19 20 21 22 23 24 25 26	NULL * I> t I> I>> t I>> I>>> t I>>> IE> t IE> IE>> t IE>> IE>>> t IE>>> I2> t I2> I2>> t I2>> Thermal Alarm Thermal Trip I< t I< CB Fail <i>Recloser</i> tAux1 tAux2 tAux3 tAux4		Setting	0/28/1 or 0/27/1
	23	Operator 09	Indexed String	0 * 1 2 3	OR * OR NOT AND AND NOT		Setting	0/3/1

MiCOM P120/P121/P122/P123

Col	Row	Menu Text	Data Type	Ind	Values (*: default)	Depend	Cell Type	Min/Max/Step
	24	Operand 09	Indexed String	0 * 1 2 3 4 5 6 7 8 9 10 11 12 13 14 15 16 17 18 19 20 21 22 23 24 25 26	NULL * I> t I> I>> t I>> I>>> t I>>> IE> t IE> IE>> t IE>> IE>>> t IE>>> I2> t I2> I2>> t I2>> Thermal Alarm Thermal Trip I< t I< CB Fail <i>Recloser</i> tAux1 tAux2 tAux3 tAux4		Setting	0/28/1 or 0/27/1
	25	Operator 10	Indexed String	0 * 1 2 3	OR * OR NOT AND AND NOT		Setting	0/3/1

Col	Row	Menu Text	Data Type	Ind	Values (*: default)	Depend	Cell Type	Min/Max/Step
	26	Operand 10	Indexed String	0 * 1 2 3 4 5 6 7 8 9 10 11 12 13 14 15 16 17 18 19 20 21 22 23 24 25 26	NULL * I> t I> I>> t I>> I>>> t I>>> IE> t IE> IE>> t IE>> IE>>> t IE>>> I2> t I2> I2>> t I2>> Thermal Alarm Thermal Trip I< t I< CB Fail <i>Recloser</i> tAux1 tAux2 tAux3 tAux4		Setting	0/28/1 or 0/27/1
	27	Operator 11	Indexed String	0 * 1 2 3	OR * OR NOT AND AND NOT		Setting	0/3/1



MiCOM P120/P121/P122/P123

Col	Row	Menu Text	Data Type	Ind	Values (*: default)	Depend	Cell Type	Min/Max/Step
	28	Operand 11	Indexed String	0 * 1 2 3 4 5 6 7 8 9 10 11 12 13 14 15 16 17 18 19 20 21 22 23 24 25 26	NULL * I> t I> I>> t I>> I>>> t I>>> IE> t IE> IE>> t IE>> IE>>> t IE>>> I2> t I2> I2>> t I2>> Thermal Alarm Thermal Trip I< t I< CB Fail <i>Recloser</i> tAux1 tAux2 tAux3 tAux4		Setting	0/28/1 or 0/27/1
	29	Operator 12	Indexed String	0 * 1 2 3	OR * OR NOT AND AND NOT		Setting	0/3/1

Col	Row	Menu Text	Data Type	Ind	Values (*: default)	Depend	Cell Type	Min/Max/Step
	2A	Operand 12	Indexed String	0 * 1 2 3 4 5 6 7 8 9 10 11 12 13 14 15 16 17 18 19 20 21 22 23 24 25 26	NULL * I> t I> I>> t I>> I>>> t I>>> IE> t IE> IE>> t IE>> IE>>> t IE>>> I2> t I2> I2>> t I2>> Thermal Alarm Thermal Trip I< t I< CB Fail <i>Recloser</i> tAux1 tAux2 tAux3 tAux4		Setting	0/28/1 or 0/27/1
	2B	Operator 13	Indexed String	0 * 1 2 3	OR * OR NOT AND AND NOT		Setting	0/3/1

MiCOM P120/P121/P122/P123

Col	Row	Menu Text	Data Type	Ind	Values (*: default)	Depend	Cell Type	Min/Max/Step
	2C	Operand 13	Indexed String	0 * 1 2 3 4 5 6 7 8 9 10 11 12 13 14 15 16 17 18 19 20 21 22 23 24 25 26	NULL * I> t I> I>> t I>> I>>> t I>>> IE> t IE> IE>> t IE>> IE>>> t IE>>> I2> t I2> I2>> t I2>> Thermal Alarm Thermal Trip I< t I< CB Fail <i>Recloser</i> tAux1 tAux2 tAux3 tAux4		Setting	0/28/1 or 0/27/1
	2D	Operator 14	Indexed String	0 * 1 2 3	OR * OR NOT AND AND NOT		Setting	0/3/1

Col	Row	Menu Text	Data Type	Ind	Values (*: default)	Depend	Cell Type	Min/Max/Step
	2E	Operand 14	Indexed String	0 * 1 2 3 4 5 6 7 8 9 10 11 12 13 14 15 16 17 18 19 20 21 22 23 24 25 26	NULL * I> t I> I>> t I>> I>>> t I>>> IE> t IE> IE>> t IE>> IE>>> t IE>>> I2> t I2> I2>> t I2>> Thermal Alarm Thermal Trip I< t I< CB Fail <i>Recloser</i> tAux1 tAux2 tAux3 tAux4		Setting	0/28/1 or 0/27/1
	2F	Operator 15	Indexed String	0 * 1 2 3	OR * OR NOT AND AND NOT		Setting	0/3/1

MiCOM P120/P121/P122/P123

Col	Row	Menu Text	Data Type	Ind	Values (*: default)	Depend	Cell Type	Min/Max/Step
	30	Operand 15	Indexed String	0 * 1 2 3 4 5 6 7 8 9 10 11 12 13 14 15 16 17 18 19 20 21 22 23 24 25 26	NULL * l> t l> l>> t l>> l>>> t l>>> IE> t IE> IE>> t IE>> IE>>> t IE>>> l2> t l2> l2>> t l2>> Thermal Alarm Thermal Trip l< t l< CB Fail <i>Recloser</i> tAux1 tAux2 tAux3 tAux4		Setting	0/28/1 or 0/27/1
<b>6C</b>	<b>40</b>	<b>EQUATION B</b>	<b>(Sub Heading)</b>					
	41	Operator 00	Indexed String	0 * 1	* (Space) NOT		Setting	0/1/1

Col	Row	Menu Text	Data Type	Ind	Values (*: default)	Depend	Cell Type	Min/Max/Step
	42	Operand 00	Indexed String	0 * 1 2 3 4 5 6 7 8 9 10 11 12 13 14 15 16 17 18 19 20 21 22 23 24 25 26	NULL * I> t I> I>> t I>> I>>> t I>>> IE> t IE> IE>> t IE>> IE>>> t IE>>> I2> t I2> I2>> t I2>> Thermal Alarm Thermal Trip I< t I< CB Fail <i>Recloser</i> tAux1 tAux2 tAux3 tAux4		Setting	0/28/1 or 0/27/1
	43	Operator 01	Indexed String	0 * 1 2 3	OR * OR NOT AND AND NOT		Setting	0/3/1
		.....	.....		.....		.....	.....

MiCOM P120/P121/P122/P123

Col	Row	Menu Text	Data Type	Ind	Values (*: default)	Depend	Cell Type	Min/Max/Step
	60	Operand 15	Indexed String	0 * 1 2 3 4 5 6 7 8 9 10 11 12 13 14 15 16 17 18 19 20 21 22 23 24 25 26	NULL * I> t I> I>> t I>> I>>> t I>>> IE> t IE> IE>> t IE>> IE>>> t IE>>> I2> t I2> I2>> t I2>> Thermal Alarm Thermal Trip I< t I< CB Fail <i>Recloser</i> tAux1 tAux2 tAux3 tAux4		Setting	0/28/1 or 0/27/1
<b>6C</b>	<b>70</b>	<b>EQUATION C</b>	<b>(Sub Heading)</b>					
	71	Operator 00	Indexed String	0 * 1	* (Space) NOT		Setting	0/1/1

Col	Row	Menu Text	Data Type	Ind	Values (*: default)	Depend	Cell Type	Min/Max/Step
	72	Operand 00	Indexed String	0 * 1 2 3 4 5 6 7 8 9 10 11 12 13 14 15 16 17 18 19 20 21 22 23 24 25 26	NULL * I> t I> I>> t I>> I>>> t I>>> IE> t IE> IE>> t IE>> IE>>> t IE>>> I2> t I2> I2>> t I2>> Thermal Alarm Thermal Trip I< t I< CB Fail <i>Recloser</i> tAux1 tAux2 tAux3 tAux4		Setting	0/28/1 or 0/27/1
	73	Operator 01	Indexed String	0 * 1 2 3	OR * OR NOT AND AND NOT		Setting	0/3/1
		.....	.....		.....		.....	.....



MiCOM P120/P121/P122/P123

Col	Row	Menu Text	Data Type	Ind	Values (*: default)	Depend	Cell Type	Min/Max/Step
	90	Operand 15	Indexed String	0 * 1 2 3 4 5 6 7 8 9 10 11 12 13 14 15 16 17 18 19 20 21 22 23 24 25 26	NULL * l> t l> l>> t l>> l>>> t l>>> IE> t IE> IE>> t IE>> IE>>> t IE>>> l2> t l2> l2>> t l2>> Thermal Alarm Thermal Trip l< t l< CB Fail <i>Recloser</i> tAux1 tAux2 tAux3 tAux4		Setting	0/28/1 or 0/27/1
<b>6C</b>	<b>A0</b>	<b>EQUATION D</b>	<b>(Sub Heading)</b>					
	A1	Operator 00	Indexed String	0 * 1	* (Space) NOT		Setting	0/1/1

Col	Row	Menu Text	Data Type	Ind	Values (*: default)	Depend	Cell Type	Min/Max/Step
	A2	Operand 00	Indexed String	0 * 1 2 3 4 5 6 7 8 9 10 11 12 13 14 15 16 17 18 19 20 21 22 23 24 25 26	NULL * I> t I> I>> t I>> I>>> t I>>> IE> t IE> IE>> t IE>> IE>>> t IE>>> I2> t I2> I2>> t I2>> Thermal Alarm Thermal Trip I< t I< CB Fail <i>Recloser</i> tAux1 tAux2 tAux3 tAux4		Setting	0/28/1 or 0/27/1
	A3	Operator 01	Indexed String	0 * 1 2 3	OR * OR NOT AND AND NOT		Setting	0/3/1
		.....	.....		.....		.....	.....

MiCOM P120/P121/P122/P123

Col	Row	Menu Text	Data Type	Ind	Values (*: default)	Depend	Cell Type	Min/Max/Step
	C0	Operand 15	Indexed String	0 * 1 2 3 4 5 6 7 8 9 10 11 12 13 14 15 16 17 18 19 20 21 22 23 24 25 26	NULL * I> t I> I>> t I>> I>>> t I>>> IE> t IE> IE>> t IE>> IE>>> t IE>>> I2> t I2> I2>> t I2>> Thermal Alarm Thermal Trip I< t I< CB Fail <i>Recloser</i> tAux1 tAux2 tAux3 tAux4		Setting	0/28/1 or 0/27/1
<b>6D</b>	<b>00</b>	<b>BOOLEAN EQUATIONS 2/2</b>						
	10	EQUATION E	(Sub Heading)					
	11	Operator 00	Indexed String	0 * 1	* (Space) NOT		Setting	0/1/1

Col	Row	Menu Text	Data Type	Ind	Values (*: default)	Depend	Cell Type	Min/Max/Step
	12	Operand 00	Indexed String	0 * 1 2 3 4 5 6 7 8 9 10 11 12 13 14 15 16 17 18 19 20 21 22 23 24 25 26	NULL * I> t I> I>> t I>> I>>> t I>>> IE> t IE> IE>> t IE>> IE>>> t IE>>> I2> t I2> I2>> t I2>> Thermal Alarm Thermal Trip I< t I< CB Fail <i>Recloser</i> tAux1 tAux2 tAux3 tAux4		Setting	0/28/1 or 0/27/1
	13	Operator 01	Indexed String	0 * 1 2 3	OR * OR NOT AND AND NOT		Setting	0/3/1
		.....	.....		.....		.....	.....

MiCOM P120/P121/P122/P123

Col	Row	Menu Text	Data Type	Ind	Values (*: default)	Depend	Cell Type	Min/Max/Step
	30	Operand 15	Indexed String	0 * 1 2 3 4 5 6 7 8 9 10 11 12 13 14 15 16 17 18 19 20 21 22 23 24 25 26	NULL * l> t l> l>> t l>> l>>> t l>>> IE> t IE> IE>> t IE>> IE>>> t IE>>> l2> t l2> l2>> t l2>> Thermal Alarm Thermal Trip l< t l< CB Fail <i>Recloser</i> tAux1 tAux2 tAux3 tAux4		Setting	0/28/1 or 0/27/1
<b>6D</b>	<b>40</b>	<b>EQUATION F</b>	<b>(Sub Heading)</b>					
	41	Operator 00	Indexed String	0 * 1	* (Space) NOT		Setting	0/1/1

Col	Row	Menu Text	Data Type	Ind	Values (*: default)	Depend	Cell Type	Min/Max/Step
	42	Operand 00	Indexed String	0 * 1 2 3 4 5 6 7 8 9 10 11 12 13 14 15 16 17 18 19 20 21 22 23 24 25 26	NULL * I> t I> I>> t I>> I>>> t I>>> IE> t IE> IE>> t IE>> IE>>> t IE>>> I2> t I2> I2>> t I2>> Thermal Alarm Thermal Trip I< t I< CB Fail <i>Recloser</i> tAux1 tAux2 tAux3 tAux4		Setting	0/28/1 or 0/27/1
	43	Operator 01	Indexed String	0 * 1 2 3	OR * OR NOT AND AND NOT		Setting	0/3/1
		.....	.....		.....		.....	.....

MiCOM P120/P121/P122/P123

Col	Row	Menu Text	Data Type	Ind	Values (*: default)	Depend	Cell Type	Min/Max/Step
	60	Operand 15	Indexed String	0 * 1 2 3 4 5 6 7 8 9 10 11 12 13 14 15 16 17 18 19 20 21 22 23 24 25 26	NULL * I> t I> I>> t I>> I>>> t I>>> IE> t IE> IE>> t IE>> IE>>> t IE>>> I2> t I2> I2>> t I2>> Thermal Alarm Thermal Trip I< t I< CB Fail <i>Recloser</i> tAux1 tAux2 tAux3 tAux4		Setting	0/28/1 or 0/27/1
<b>6D</b>	<b>70</b>	<b>EQUATION G</b>	<b>(Sub Heading)</b>					
	71	Operator 00	Indexed String	0 * 1	* (Space) NOT		Setting	0/1/1

Col	Row	Menu Text	Data Type	Ind	Values (*: default)	Depend	Cell Type	Min/Max/Step
	72	Operand 00	Indexed String	0 * 1 2 3 4 5 6 7 8 9 10 11 12 13 14 15 16 17 18 19 20 21 22 23 24 25 26	NULL * I> t I> I>> t I>> I>>> t I>>> IE> t IE> IE>> t IE>> IE>>> t IE>>> I2> t I2> I2>> t I2>> Thermal Alarm Thermal Trip I< t I< CB Fail <i>Recloser</i> tAux1 tAux2 tAux3 tAux4		Setting	0/28/1 or 0/27/1
	73	Operator 01	Indexed String	0 * 1 2 3	OR * OR NOT AND AND NOT		Setting	0/3/1
		.....	.....		.....		.....	.....



MiCOM P120/P121/P122/P123

Col	Row	Menu Text	Data Type	Ind	Values (*: default)	Depend	Cell Type	Min/Max/Step
	90	Operand 15	Indexed String	0 * 1 2 3 4 5 6 7 8 9 10 11 12 13 14 15 16 17 18 19 20 21 22 23 24 25 26	NULL * I> t I> I>> t I>> I>>> t I>>> IE> t IE> IE>> t IE>> IE>>> t IE>>> I2> t I2> I2>> t I2>> Thermal Alarm Thermal Trip I< t I< CB Fail <i>Recloser</i> tAux1 tAux2 tAux3 tAux4		Setting	0/28/1 or 0/27/1
<b>6D</b>	<b>A0</b>	<b>EQUATION H</b>	<b>(Sub Heading)</b>					
	A1	Operator 00	Indexed String	0 * 1	* (Space) NOT		Setting	0/1/1

Col	Row	Menu Text	Data Type	Ind	Values (*: default)	Depend	Cell Type	Min/Max/Step
	A2	Operand 00	Indexed String	0 * 1 2 3 4 5 6 7 8 9 10 11 12 13 14 15 16 17 18 19 20 21 22 23 24 25 26	NULL * I> t I> I>> t I>> I>>> t I>>> IE> t IE> IE>> t IE>> IE>>> t IE>>> I2> t I2> I2>> t I2>> Thermal Alarm Thermal Trip I< t I< CB Fail <i>Recloser</i> tAux1 tAux2 tAux3 tAux4		Setting	0/28/1 or 0/27/1
	A3	Operator 01	Indexed String	0 * 1 2 3	OR * OR NOT AND AND NOT		Setting	0/3/1
		.....	.....		.....		.....	.....

MiCOM P120/P121/P122/P123

Col	Row	Menu Text	Data Type	Ind	Values (*: default)	Depend	Cell Type	Min/Max/Step
	C0	Operand 15	Indexed String	0 * 1 2 3 4 5 6 7 8 9 10 11 12 13 14 15 16 17 18 19 20 21 22 23 24 25 26	NULL * I> t I> I>> t I>> I>>> t I>>> IE> t IE> IE>> t IE>> IE>>> t IE>>> I2> t I2> I2>> t I2>> Thermal Alarm Thermal Trip I< t I< CB Fail <i>Recloser</i> tAux1 tAux2 tAux3 tAux4		Setting	0/28/1 or 0/27/1
<b>6E</b>	<b>00</b>	<b>BOOLEAN EQUATIONS DELAYS</b>						
	01	Equation A operation delay	Courier floating point number		0 *		Setting	0/ 600.0/ 0.01 s
	02	Equation A reset delay	Courier floating point number		0 *		Setting	0/ 600.0/ 0.01 s
	03	Equation B operation delay	Courier floating point number		0 *		Setting	0/ 600.0/ 0.01 s
	04	Equation B reset delay	Courier floating point number		0 *		Setting	0/ 600.0/ 0.01 s
	05	Equation C operation delay	Courier floating point number		0 *		Setting	0/ 600.0/ 0.01 s
	06	Equation C reset delay	Courier floating point number		0 *		Setting	0/ 600.0/ 0.01 s
	07	Equation D operation delay	Courier floating point number		0 *		Setting	0/ 600.0/ 0.01 s
	08	Equation D reset delay	Courier floating point number		0 *		Setting	0/ 600.0/ 0.01 s
	09	Equation E operation delay	Courier floating point number		0 *		Setting	0/ 600.0/ 0.01 s
	0A	Equation E reset delay	Courier floating point number		0 *		Setting	0/ 600.0/ 0.01 s

Col	Row	Menu Text	Data Type	Ind	Values (*: default)	Depend	Cell Type	Min/Max/Step
	0B	Equation F operation delay	Courier floating point number		0 *		Setting	0/ 600.0/ 0.01 s
	0C	Equation F reset delay	Courier floating point number		0 *		Setting	0/ 600.0/ 0.01 s
	0D	Equation G operation delay	Courier floating point number		0 *		Setting	0/ 600.0/ 0.01 s
	0E	Equation G reset delay	Courier floating point number		0 *		Setting	0/ 600.0/ 0.01 s
	0F	Equation H operation delay	Courier floating point number		0 *		Setting	0/ 600.0/ 0.01 s
	10	Equation H reset delay	Courier floating point number		0 *		Setting	0/ 600.0/ 0.01 s
<b>70</b>	<b>00</b>	<b>RECORDER CONTROL</b>						
	01	Start/Trigger recorder	Indexed String	0 1 2	Stopped Triggerred Running *		Setting	1/2/1
	02	Recorder Source	Indexed String	0	Samples *		Data	
	20	Pretemps	Courier floating point number		0.1 secondes		Setting	0.1/3.0/0.1
	21	Postemps	Courier floating point number		0.1 secondes		Setting	0.1/3.0/0.1
	22	Trigger	Indexed String	0	On Inst* / On Trig		Setting	0/1/1
	30	Measurement period	Indexed String	0	5* / 10 / 15 / 30 / 60 min		Setting	0/4/1
	40	Rolling Demands						
	41	Rolling sub-period	Courier floating point number		1 min*		Setting	1/60/1
	42	Rolling sub-period number	Courier floating point number		1*		Setting	1/24/1
<b>80</b>	<b>00</b>	<b>DISTURBANCE REC</b>						
	01	Record Number	Unsigned integer (1 byte)		0*		Setting	0/5/1 (selon contexte)
	02	Trigger Time	IEC870 Time & Date		dd/mm/yy hh:mm		Data	
	03	Available Channel Bit Mask	Binary Flag Indexed String	0 1 2 3 4	11111 " la " " lb " " lc " " l0 " " Inputs/Outputs "		Data	
	04	Channel Types	Binary Flag 0: digital, 1: analogue		01111		Data	
	05	Channel Offsets	Repeated group of Courier numbers		Upload Offsets		Data	

MiCOM P120/P121/P122/P123

Col	Row	Menu Text	Data Type	Ind	Values (*: default)	Depend	Cell Type	Min/Max/Step
	06	Scaling Factors	Repeated group of Courier numbers		Upload Scal. Factors		Data	
	07-0F	NOT IMPLEMENTED – reserved						
	10	Record Length	Integer (2 bytes)				Data	
	11	Trigger position	Integer (2 bytes)				Data	
	12	Time Base	Courier floating point number				Data	
	13	NOT IMPLEMENTED – reserved						
	14	Upload Timer	Repeated group of Integers				Data	
	15-1F	NOT IMPLEMENTED – reserved						
	20	Upload Channel 0	Repeated group of Integers				Data	
	21	Upload Channel 1	Repeated group of Integers				Data	
	22	Upload Channel 2	Repeated group of Integers				Data	
	23	Upload Channel 3	Repeated group of Integers				Data	
	24	Upload Channel Inputs/Outputs	Repeated group of Integer/Bin. flags				Data	
<b>90</b>	<b>00</b>	<b>AUTOMAT. FLT</b>						
	01	Record number	Unsigned Integer (2 bytes)				Setting (automatic)	
	02	Occur fault date	Unsigned Integer (2 bytes)				Data	
	03	Active set group	Unsigned Integer (2 bytes)		1		Data	
	04	Phase in fault	ASCII Text (10 bytes)		“ PHASE A ”		Data	
	05	Fault Id	ASCII Text (18 bytes)		“ I >> ”		Data	
	06	Magnitude	Courier floating point number		12.34 A		Data	
	07	Ia Magnitude	Courier floating point number		12.34 A		Data	
	08	Ib Magnitude	Courier floating point number		12.34 A		Data	
	09	Ic Magnitude	Courier floating point number		12.34 A		Data	
	0A	In Magnitude	Courier floating point number		12.34 A		Data	

Col	Row	Menu Text	Data Type	Ind	Values (*: default)	Depend	Cell Type	Min/Max/Step
<b>BF</b>	<b>00</b>	<b>COMM SYSTEM DATA</b>						
	01	Dist Record Cntrl Ref	Menu Cell (2)		0x7000		Data	
	02	Dist Record Extract Ref	Menu Cell (2)		0x8000		Data	
	03	Setting Transfert					Setting	0 / 1 / 1
	04	Reset Demand Timers	NOT IMPLEMENTED					
	05	Reset Event Report	NOT IMPLEMENTED					

MiCOM P120/P121/P122/P123

# **IEC 60870-5-103 DATABASE**

**BLANK PAGE**



## CONTENTS

---

<b>1.</b>	<b>IEC60870-5-103 INTERFACE</b>	<b>3</b>
1.1	Physical connection and link layer	3
1.2	Initialisation	3
1.3	Time synchronisation (P122 & P123 only)	3
1.4	Spontaneous events	4
1.5	General interrogation	4
1.6	Cyclic measurements	4
1.7	Commands	4
1.8	Disturbance records (P120, P122 & P123 only)	4
1.9	Blocking of monitor direction	4

---

<b>2.</b>	<b>APPENDIX 1</b>	<b>5</b>
2.1	Spontaneous messages managed by MiCOM P12x	5
2.2	List of data contained in General Interrogation	11
2.3	Processed Commands	14
2.4	Relay re initialization	16
2.5	Cyclic Messages (ASDU9 and ASDU 77)	16
2.6	IEC870-5-103 messages for Disturbance record extraction	17

**BLANK PAGE**

---

## 1. IEC60870-5-103 INTERFACE

The IEC60870-5-103 interface is a master/slave interface with the relay as the slave device. This protocol is based on the VDEW communication protocol. The relay conforms to compatibility level 2, compatibility level 3 is not supported.

The following IEC60870-5-103 facilities are supported by this interface:

- Initialisation (Reset)
- Time Synchronisation
- Event Record Extraction
- General Interrogation
- Cyclic Measurements
- General Commands

### 1.1 Physical connection and link layer

Connection is available for IEC60870-5-103 through the rear RS485 port. It is possible to select both the relay address and baud rate using the front panel interface. Following a change, a reset command is required to re-establish communications.

The parameters of the communication are the following:

- Even Parity
- 8 Data bits
- 1 stop bit
- Data rate 9600 or 19200 bauds

### 1.2 Initialisation

Whenever the relay has been powered up, or if the communication parameters have been changed a reset command is required to initialise the communications. The relay will respond to either of the two reset commands (Reset CU or Reset FCB), the difference being that the Reset CU will clear any unsent messages in the relay's transmit buffer.

The relay will respond to the reset command with an identification message ASDU 5, the Cause Of Transmission COT of this response will be either Reset CU or Reset FCB depending on the nature of the reset command. The following information will be contained in the data section of this ASDU:

Manufacturer Name: **Schneider Electric**

The Software Identification Section will contain the first four characters of the relay model number to identify the type of relay, e.g. P123.

In addition to the above identification message, if the relay has been powered up it will also produce a power up event.

### 1.3 Time synchronisation (P122 & P123 only)

The relay time and date can be set using the time synchronisation feature of the IEC60870-5-103 protocol. The relay will correct for the transmission delay as specified in IEC60870-5-103. If the time synchronisation message is sent as a send/confirm message then the relay will respond with a confirm. Whether the time synchronisation message is sent as a send confirm or a broadcast (send/no reply) message, a time synchronisation message will be returned as Class 1 data.

#### 1.4 Spontaneous events

The events created by the relay will be passed using the standard function type/information numbers to the IEC60870-5-103 master station. Private codes are not used, thus any events that cannot be passed using the standardised messages will not be sent.

Events are categorised using the following information:

- Common Address
- Function Type
- Information number

APPENDIX 1 contains a complete listing of all events produced by the relay. The common address is used to differentiate in circumstances where the relay produces more events of a certain type than can be passed using the standardised messages. For example if the relay produces starts and trips for three stages of overcurrent only two stages can be passed using the standardised messages.

Using the different common address for two of the overcurrent stages allows each stage to be indicated. The table in APPENDIX 1 shows the common address as an offset value. The common address offset will be added to the station address in order to pass these events.

#### 1.5 General interrogation

The GI request can be used to read the status of the relay, the function numbers, information numbers and common address offsets that will be returned during the GI cycle are indicated in APPENDIX 1.

#### 1.6 Cyclic measurements

The relay will produce measured values using ASDU 9 on a cyclical basis, this can be read from the relay using a Class 2 poll (note ADSU 3 is not used).

It should be noted that the measurands transmitted by the relay are sent as a proportion of either 1.2 or 2.4 times the rated value of the analogue value. The selection of either 1.2 or 2.4 for a particular value is indicated in APPENDIX 1.

#### 1.7 Commands

A list of the supported commands is contained in APPENDIX 1. The relay will respond to other commands with an ASDU 1, with a cause of transmission (COT) of negative acknowledgement of a command.

#### 1.8 Disturbance records (P120, P122 & P123 only)

The disturbance records stored by the relay cannot be extracted using the mechanism defined in the IEC60870-5-103 standard. The relay maintains compatibility with the VDEW control system by transmitting an ASDU 23 with no disturbance records at the start of every GI cycle.

#### 1.9 Blocking of monitor direction

The relay does not support a facility to block messages in the Monitor direction. IEC 60870-5-103 DATABASES

## 2. APPENDIX 1

### 2.1 Spontaneous messages managed by MiCOM P12x

These messages includes a sub-assembly of events which are generated on the relay, because some generated events are not registered in VDEW. They are the most priority messages.

An event is always generated on the rising edge of the information.

Some events can be generated on the rising or lowering edge.

In the list below, events only generated on rising edge will be tagged with a “\*”.

Two types of ASDU can be generated for events: ASDU 1 (time-tagged message) or ASDU 2 (time-tagged message with relative time).

The following list of processed events is the list **with the private messages option active**, for all Overcurrent protection functions, with the associated FUNCTION Type, INFORMATION NUMBER, ASDU TYPE, CAUSE OF TRANSMISSION and COMMON ADDRESS OF ASDU (The corresponding numbers with **private messages option inactive** are given just below).

FUN <160>: Function type in Public range for Overcurrent Protections (compatible).

FUN <168>: Function type in Private range (Reserved for Overcurrent Protections).

Status indications in monitor direction:

Availability

– Autorecloser active:	FUN<160>;INF <16>; TYP <1>;COT<1> ,<ADDR> ↑↓ P123	
– LEDs reset:	FUN<160>;INF <19>; TYP <1>; COT<1>; <ADDR>,*	P120 to P123
– Local parameter Setting active:	FUN<160>;INF <22>; TYP <1>; COT<1>;<ADDR>↑↓	P120 to P123
– Setting Group number 1 active:	FUN<160>;INF <23>; TYP <1>; COT<1>;<ADDR>↑↓	P122-P123
– Setting Group number 2 active:	FUN<160>;INF <24>; TYP <1>; COT<1>;<ADDR>↑↓	P122-P123
– Auxiliary input 1:	FUN<160>;INF <27>; TYP <1>; COT<1>;<ADDR>↑↓	P120 to P123
– Auxiliary input 2:	FUN<160>;INF <28>; TYP <1>; COT<1>;<ADDR>↑↓	P120 to P123
– Auxiliary input 3:	FUN<160>;INF <29>; TYP <1>; COT<1>;<ADDR>↑↓	P122-P123
– Auxiliary input 4:	FUN<160>;INF <30>; TYP <1>; COT<1>;<ADDR>↑↓	P123
– Logical input 1:	FUN<168>;INF <160>; TYP <1>; COT<1>;<ADDR>↑↓	P120 to P123
<b>with private option inactive:</b>	FUN<160>;INF <161>; TYP <1>; COT<1>;<ADDR>↑↓	
– Logical input 2:	FUN<168>;INF <161>; TYP <1>; COT<1>;<ADDR>↑↓	P120 to P123
<b>with private option inactive:</b>	FUN<160>;INF <162>; TYP <1>; COT<1>;<ADDR>↑↓	
– Logical input 3:	FUN<168>;INF <162>; TYP <1>; COT<1>;<ADDR>↑↓	P122-P123
<b>with private option inactive:</b>	FUN<160>;INF <163>; TYP <1>; COT<1>;<ADDR>↑↓	
– Logical input 4:	FUN<168>;INF <163>; TYP <1>; COT<1>;<ADDR>↑↓	P123
<b>with private option inactive:</b>	FUN<160>;INF <164>; TYP <1>; COT<1>;<ADDR>↑↓	
– Logical input 5:	FUN<168>;INF <164>; TYP <1>; COT<1>;<ADDR>↑↓	P123
<b>with private option inactive:</b>	FUN<160>;INF <165>; TYP <1>; COT<1>;<ADDR>↑↓	
– Logical output 1:	FUN<168>;INF <176>; TYP <1>; COT<1>;<ADDR>↑↓	P120 to P123
<b>with private option inactive:</b>	FUN<160>;INF <176>; TYP <1>; COT<1>;<ADDR>↑↓	
– Logical output 2:	FUN<168>;INF <177>; TYP <1>; COT<1>;<ADDR>↑↓	P120 to P123

MiCOM P120/P121/P122/P123

<b>with private option inactive:</b>	FUN<160>;INF <177>; TYP <1>; COT<1>;<ADDR>↑↓	
– Logical output 3:	FUN<168>;INF <178>; TYP <1>; COT<1>;<ADDR>↑↓	P120 to P123
<b>with private option inactive:</b>	FUN<160>;INF <178>; TYP <1>; COT<1>;<ADDR>↑↓	
– Logical output 4:	FUN<168>;INF <179>; TYP <1>; COT<1>;<ADDR>↑↓	P120 to P123
<b>with private option inactive:</b>	FUN<160>;INF <179>; TYP <1>; COT<1>;<ADDR>↑↓	
– Logical output 5 (Watch-dog):	FUN<168>;INF <180>; TYP <1>; COT<1>;<ADDR>↑↓	P120 to P123
<b>with private option inactive:</b>	FUN<160>;INF <180>; TYP <1>; COT<1>;<ADDR>↑↓	
– Logical output 6:	FUN<168>;INF <181>; TYP <1>; COT<1>;<ADDR>↑↓	P122-P123
<b>with private option inactive:</b>	FUN<160>;INF <181>; TYP <1>; COT<1>;<ADDR>↑↓	
– Logical output 7:	FUN<168>;INF <182>; TYP <1>; COT<1>;<ADDR>↑↓	P122-P123
<b>with private option inactive:</b>	FUN<160>;INF <182>; TYP <1>; COT<1>;<ADDR>↑↓	
– Logical output 8:	FUN<168>;INF <183>; TYP <1>; COT<1>;<ADDR>↑↓	P123
<b>with private option inactive:</b>	FUN<160>;INF <183>; TYP <1>; COT<1>;<ADDR>↑↓	
– Logical output 9:	FUN<168>;INF <184>; TYP <1>; COT<1>;<ADDR>↑↓	P123
<b>with private option inactive:</b>	FUN<160>;INF <184>; TYP <1>; COT<1>;<ADDR>↑↓	
– Time Synchronisation ( <b>private option active</b> ):	FUN<168>;INF <226>; TYP <1>; COT<1>; <ADDR>;*	P120-P122-P123
<u>Supervision Indications in monitor direction:</u>		<u>Availability</u>
– Trip Circuit Supervision:	FUN<160>;INF <36>; TYP <1>; COT<1>;<ADDR>↑↓	P122-P123
<u>Fault Indications in monitor direction:</u>		<u>Availability</u>
– Start / pick-up I>:	FUN<168>;INF <9>; TYP <2>; COT<1>;<ADDR>↑↓	P121 to P123
<b>with private option inactive:</b>	FUN<160>;INF <64>; TYP <2>; COT<1>;<ADDR>↑↓	
– Start / pick-up I>>:	FUN<168>;INF <10>; TYP <2>; COT<1>;<ADDR>↑↓	P121 to P123

<b>with private option inactive:</b>	FUN<160>;INF <65>; TYP <2>; COT<1>,<ADDR>↑↓	
– Start / pick-up I>>>:	FUN<168>;INF <11>; TYP <2>; COT<1>,<ADDR>↑↓	P121 to P123
<b>with private option inactive:</b>	FUN<160>;INF <66>; TYP <2>; COT<1>,<ADDR>↑↓	
– Start / pick-up IN>:	FUN<168>;INF <12>; TYP <2>; COT<1>,<ADDR>↑↓	P120 to P123
<b>with private option inactive:</b>	FUN<160>;INF <96>; TYP <2>; COT<1>,<ADDR>↑↓	
– Start / pick-up IN>>:	FUN<168>;INF <13>; TYP <2>; COT<1>,<ADDR>↑↓	P120 to P123
<b>with private option inactive:</b>	FUN<160>;INF <97>; TYP <2>; COT<1>,<ADDR>↑↓	
– Start / pick-up IN>>>:	FUN<168>;INF <14>; TYP <2>; COT<1>,<ADDR>↑↓	P120 to P123
<b>with private option inactive:</b>	FUN<160>;INF <98>; TYP <2>; COT<1>,<ADDR>↑↓	
– Start / pick-up N:	FUN<160>;INF <67>; TYP <2>; COT<1>,<ADDR>↑↓	P120 to P123
– Start / pick-up I<:	FUN<168>;INF <100>; TYP <2>; COT<1>,<ADDR>↑↓	P122-P123
<b>with private option inactive:</b>	FUN<160>;INF <73>; TYP <2>; COT<1>,<ADDR>↑↓	
– Start / pick-up I2>:	FUN<168>;INF <104>; TYP <2>; COT<1>,<ADDR>↑↓	P122-P123
<b>with private option inactive:</b>	FUN<160>;INF <57>; TYP <2>; COT<1>,<ADDR>↑↓	
– Start / pick-up I2>>:	FUN<168>;INF <106>; TYP <2>; COT<1>,<ADDR>↑↓	P122-P123
<b>with private option inactive:</b>	FUN<160>;INF <74>; TYP <2>; COT<1>,<ADDR>↑↓	
– tReset I> :	FUN<168>;INF <80>; TYP <2>; COT<1>,<ADDR>↑↓	P122-P123
– tReset I>> :	FUN<168>;INF <81>; TYP <2>; COT<1>,<ADDR>↑↓	P122-P123
– tReset I2> :	FUN<168>;INF <82>; TYP <2>; COT<1>,<ADDR>↑↓	P122-P123
– tReset IN> :	FUN<168>;INF <155>; TYP <2>; COT<1>,<ADDR>↑↓	P122-P123
– tReset IN>> :	FUN<168>;INF <156>; TYP <2>; COT<1>,<ADDR>↑↓	P122-P123
– General Trip:	FUN<160>;INF <68>; TYP <2>; COT<1>,<ADDR>,*	P120 to P123
– Trip L1:	FUN<160>;INF <69>; TYP <2>; COT<1>,<ADDR>,*	P121 to P123



MiCOM P120/P121/P122/P123

- Trip L2:	FUN<160>;INF <70>; TYP <2>; COT<1>,<ADDR>,*	P121 to P123
- Trip L3:	FUN<160>;INF <71>; TYP <2>; COT<1>,<ADDR>,*	P121 to P123
- General Start / pick-up:	FUN<160>;INF <84>; TYP <2>; COT<1>,<ADDR>↑↓	P120 to P123
- Breaker failure:	FUN<160>;INF <85>; TYP <2>; COT<1>,<ADDR>,*	P122-P123
- Start tBF :	FUN<168>;INF <70>; TYP <2>; COT<1>,<ADDR>↑↓	P122-P123
- Trip external breaker failure :	FUN<168>;INF <71>; TYP <2>; COT<1>,<ADDR>,*	P122-P123
- Trip I>:	FUN<160>;INF <90>; TYP <2>; COT<1>,<ADDR>,*	P121 to P123
- Trip I>>:	FUN<160>;INF <91>; TYP <2>; COT<1>,<ADDR>,*	P121 to P123
- Trip I>>>:	FUN<168>;INF <19>; TYP <2>; COT<1>,<ADDR>,*	P121 to P123
<b>with private option inactive:</b>	FUN<160>;INF <94>; TYP <2>; COT<1>,<ADDR+1>,*	
- Trip IN>:	FUN<160>;INF <92>; TYP <2>; COT<1>,<ADDR>,*	P120 to P123
- Trip IN>>:	FUN<160>;INF <93>; TYP <2>; COT<1>,<ADDR>,*	P120 to P123
- Trip IN>>>:	FUN<168>;INF <22>; TYP <2>; COT<1>,<ADDR>,*	P120 to P123
<b>with private option inactive:</b>	FUN<160>;INF <95>; TYP <2>; COT<1>,<ADDR+1>,*	
- Trip I<:	FUN<168>;INF <23>; TYP <2>;COT<1>,<ADDR>,*	P122-P123
<b>with private option inactive:</b>	FUN<160>;INF <101>; TYP <2>; COT<1>,<ADDR>,*	
- Trip I2>:	FUN<168>;INF <58>; TYP <2>;COT<1>,<ADDR>,*	P122-P123
<b>with private option inactive:</b>	FUN<160>;INF <105>; TYP <2>; COT<1>,<ADDR>,*	
- Trip I2>>:	FUN<168>;INF <75>; TYP <2>;COT<1>,<ADDR>,*	P122-P123
<b>with private option inactive:</b>	FUN<160>;INF <107>; TYP <2>; COT<1>,<ADDR>,*	
- Thermal Alarm	FUN<168>;INF <15>; TYP <2>; COT<1>,<ADDR>↑↓	P122-P123
<b>with private option inactive:</b>	FUN<160>;INF <110>; TYP <2>; COT<1>,<ADDR>↑↓	
- Thermal Overload	FUN<168>;INF <16>; TYP <2>;COT<1>,<ADDR>,*	P122-P123

<b>with private option inactive:</b>	FUN<160>;INF <111>; TYP <2>; COT<1>,<ADDR>,*	
– Trip Broken conductor	FUN<168>;INF <39>; TYP <2>;COT<1>,<ADDR>,*	P122-P123
<b>with private option inactive:</b>	FUN<160>;INF <114>; TYP <2>; COT<1>,<ADDR>,*	
– Start tBF ( <b>private option active</b> ):	FUN<168>;INF <70>; TYP <2>;COT<1>,<ADDR>,↑↓	P122-P123
– Trip by external CB Fail ( <b>private option active</b> ):	FUN<168>;INF <71>; TYP <2>;COT<1>,<ADDR>,*	P122-P123
– Trip Equation A ( <b>private option active</b> ):	FUN<168>;INF <144>; TYP <2>;COT<1>,<ADDR>,↑↓	P121 to P123
– Trip Equation B ( <b>private option active</b> ):	FUN<168>;INF <145>; TYP <2>;COT<1>,<ADDR>,↑↓	P121 to P123
– Trip Equation C ( <b>private option active</b> ):	FUN<168>;INF <146>; TYP <2>;COT<1>,<ADDR>,↑↓	P121 to P123
– Trip Equation D ( <b>private option active</b> ):	FUN<168>;INF <147>; TYP <2>;COT<1>,<ADDR>,↑↓	P121 to P123
– Trip Equation E ( <b>private option active</b> ):	FUN<168>;INF <196>; TYP <2>;COT<1>,<ADDR>,↑↓	P121 to P123
– Trip Equation F ( <b>private option active</b> ):	FUN<168>;INF <197>; TYP <2>;COT<1>,<ADDR>,↑↓	P121 to P123
– Trip Equation G ( <b>private option active</b> ):	FUN<168>;INF <198>; TYP <2>;COT<1>,<ADDR>,↑↓	P121 to P123
– Trip Equation H ( <b>private option active</b> ):	FUN<168>;INF <199>; TYP <2>;COT<1>,<ADDR>,↑↓	P121 to P123
– Blocking Inrush ( <b>private option active</b> ):	FUN<168>;INF <225>; TYP <2>;COT<1>,<ADDR>,↑↓	P122-P123
<u>Auto-recloser Indications (monitor direction):</u>		<u>Availability</u>
– Circuit Breaker 'ON' by short-time autorecloser:	FUN<160>;INF <128>; TYP <1>; COT<1>,<ADDR>,*	P123
– Circuit Breaker 'ON' by long-time autorecloser:	FUN<160>;INF <129>; TYP <1>; COT<1>*,<ADDR>	P123
– Autorecloser blocked:	FUN<160>;INF <130>; TYP <1>; COT<1>,<ADDR>↑↓	P123
– Autorecloser configuration in error :	FUN<168>;INF <65>; TYP <1>;COT<1>,<ADDR>↑↓	P123
– Final Trip :	FUN<168>;INF <66>; TYP <1>;COT<1>,<ADDR>↑↓	P123
– Autorecloser in progress :	FUN<168>;INF <67>; TYP <1>;COT<1>,<ADDR>↑↓	P123
– CB in O/O (« closed ») position:	FUN<168>;INF <33>; TYP <1>;COT<1>,<ADDR>↑↓	P120 to P123

MiCOM P120/P121/P122/P123

<b>with private option inactive:</b>	FUN<160>;INF <140>; TYP <1>; COT<1>,<ADDR>↑↓	
– CB in F/O (« open ») position:	FUN<168>;INF <34>; TYP <1>;COT<1>,<ADDR>↑↓	P120 to P123
<b>with private option inactive:</b>	FUN<160>;INF <141>; TYP <1>; COT<1>,<ADDR>↑↓	
– Trip TC:	FUN<168>;INF <1>; TYP <1>; COT<1>,<ADDR>↑↓	P120 to P123
<b>with private option inactive:</b>	FUN<160>;INF <142>; TYP <1>; COT<1>,<ADDR>↑↓	
– Close TC:	FUN<168>;INF <2>; TYP <1>; COT<1>,<ADDR>↑↓	P120 to P123
<b>with private option inactive:</b>	FUN<160>;INF <143>; TYP <1>; COT<1>,<ADDR>↑↓	

NOTE: The double arrow ↑↓ means that the event generated on event occurrence and another event is generated on event disappearing.

**2.2 List of data contained in General Interrogation**

It is given in the answer to the General Interrogation (GI).

Relay state information are Class 1 data, they are systematically sent to the master station, during a General Interrogation.

The list of processed data, following a General Interrogation, is given below: it is a sub-assembly of the spontaneous message list, so like spontaneous messages, these data are generated on rising and lowering edge.

Status indications (monitor direction):

		<u>Availability</u>
– Auto-recloser active:	FUN<160>;INF <16>; TYP <1>;COT<9>,<ADDR>	P123
– Leds reset:	FUN<160>;INF <19>; TYP <1>; COT<9>,<ADDR>,*	P120 to P123
– Local parameter Setting active:	FUN<160>;INF <22>; TYP <1>; COT<9>,<ADDR>	P120 to P123
– Setting Group number 1 active:	FUN<160>;INF <23>; TYP <1>; COT<9>,<ADDR>	P122-P123
– Setting Group number 2 active:	FUN<160>;INF <24>; TYP <1>; COT<9>,<ADDR>	P122-P123
– Auxiliary input 1:	FUN<160>;INF <27>; TYP <1>; COT<9>,<ADDR>	P120-P122-P123
– Auxiliary input 2:	FUN<160>;INF <28>; TYP <1>; COT<9>,<ADDR>	P120-P122-P123
– Auxiliary input 3:	FUN<160>;INF <29>; TYP <1>; COT<9>,<ADDR>	P122-P123
– Auxiliary input 4:	FUN<160>;INF <30>; TYP <1>; COT<9>,<ADDR>	P123
– Logical input 1:	FUN<168>;INF <160>; TYP <1>; COT<9>,<ADDR>	P120 to P123

<b>with private option inactive:</b>	FUN<160>;INF <161>; TYP <1>; COT<9>,<ADDR>	
– Logical input 2:	FUN<168>;INF <161>; TYP <1>; COT<9>,<ADDR>	P120 to P123
<b>with private option inactive:</b>	FUN<160>;INF <162>; TYP <1>; COT<9>,<ADDR>	
– Logical input 3:	FUN<168>;INF <162>; TYP <1>; COT<9>,<ADDR>	P122-P123
<b>with private option inactive:</b>	FUN<160>;INF <163>; TYP <1>; COT<9>,<ADDR>	
– Logical input 4:	FUN<168>;INF <163>; TYP <1>; COT<9>,<ADDR>	P123
<b>with private option inactive:</b>	FUN<160>;INF <164>; TYP <1>; COT<9>,<ADDR>	
– Logical input 5:	FUN<168>;INF <164>; TYP <1>; COT<9>,<ADDR>	P123
<b>with private option inactive:</b>	FUN<160>;INF <165>; TYP <1>; COT<9>,<ADDR>	
– Logical output 1:	FUN<168>;INF <176>; TYP <1>; COT<9>,<ADDR>	P120 to P123
<b>with private option inactive:</b>	FUN<160>;INF <176>; TYP <1>; COT<9>,<ADDR>	
– Logical output 2:	FUN<168>;INF <177>; TYP <1>; COT<9>,<ADDR>	P120 to P123
<b>with private option inactive:</b>	FUN<160>;INF <177>; TYP <1>; COT<9>,<ADDR>	
– Logical output 3:	FUN<168>;INF <178>; TYP <1>; COT<9>,<ADDR>	P120 to P123
<b>with private option inactive:</b>	FUN<160>;INF <178>; TYP <1>; COT<9>,<ADDR>	
– Logical output 4:	FUN<168>;INF <179>; TYP <1>; COT<9>,<ADDR>	P120 to P123
<b>with private option inactive:</b>	FUN<160>;INF <179>; TYP <1>; COT<9>,<ADDR>	
– Logical output 5 (Watch-dog):	FUN<168>;INF <180>; TYP <1>; COT<9>,<ADDR>	P120 to P123
<b>with private option inactive:</b>	FUN<160>;INF <180>; TYP <1>; COT<9>,<ADDR>	
– Logical output 6:	FUN<168>;INF <181>; TYP <1>; COT<9>,<ADDR>	P122-P123
<b>with private option inactive:</b>	FUN<160>;INF <181>; TYP <1>; COT<9>,<ADDR>	
– Logical output 7:	FUN<168>;INF <182>; TYP <1>; COT<9>,<ADDR>	P122-P123

MiCOM P120/P121/P122/P123

<b>with private option inactive:</b>	FUN<160>;INF <182>; TYP <1>; COT<9>,<ADDR>	
– Logical output 8:	FUN<168>;INF <183>; TYP <1>; COT<9>,<ADDR>	P123
<b>with private option inactive:</b>	FUN<160>;INF <183>; TYP <1>; COT<9>,<ADDR>	
– Logical output 9:	FUN<168>;INF <183>; TYP <1>; COT<9>,<ADDR>	P123
<b>with private option inactive:</b>	FUN<160>;INF <183>; TYP <1>; COT<9>,<ADDR>	
<u>Supervision Indications in monitor direction:</u>		<u>Availability</u>
– Trip Circuit Supervision:	FUN<160>;INF <36>; TYP <1>; COT<9>,<ADDR>	P122-P123
<u>Fault Indications in monitor direction:</u>		<u>Availability</u>
– Start / pick-up N:	FUN<160>;INF <67>; TYP <2>; COT<9>,<ADDR>	P120 to P123
– General Start / pick-up:	FUN<160>;INF <84>; TYP <2>; COT<9>,<ADDR>	P120 to P123
<u>Auto-recloser Indications in monitor direction:</u>		<u>Availability</u>
– Autorecloser blocked:	FUN<160>;INF <130>; TYP <1>; COT<9>,<ADDR>	P123
– CB in O/O (« closed ») position:	FUN<168>;INF <33>; TYP <1>; COT<9>,<ADDR>	P120 to P123
<b>with private option inactive:</b>	FUN<160>;INF <140>; TYP <1>; COT<9>,<ADDR>	
– CB in F/O (« open ») position:	FUN<168>;INF <34>; TYP <1>; COT<9>,<ADDR>	P120 to P123
<b>with private option inactive:</b>	FUN<160>;INF <141>; TYP <1>; COT<9>,<ADDR>	

## 2.3 Processed Commands

### System Commands:

### Availability

- Synchronization Command (ASDU 6): FUN<255>,INF <0>; TYP <6>;COT<8>

P120-P122-P123

This command can be sent to a specific relay, or global. The time sent by master is the time of the first bit of the frame. The relay synchronizes with this time, corrected by the frame transmission delay. After updating its time, the relay send back an acknowledge to the master, by giving its new current time. This acknowledge message will be an event of ASDU 6 type.

- General Interrogation Initialization command (ASDU 7):  
FUN<255>;INF <0>;TYP <7>; COT<9>

P120 to P123

This command starts the relay interrogation:

The relay then sends a list of data containing the relay state (see list described above).

The GI command contains a scan number which will be included in the answers of the GI cycle generated by the GI command.

If a data has just changed before extracted by the GI, the new state is sent to the master station.

When an event is generated during the GI cycle, the event is sent in priority, and the GI cycle is temporarily interrupted. The end of the GI consists in sending an ASDU 8 to the master station.

If, during a General Interrogation cycle, another GI Initialization command is received, the precedent answer is stopped, and the new GI cycle started.

### General Commands (ASDU 20) (Control direction):

### Availability

- Auto-recloser On / Off: only on MiCOM P123:  
FUN<160>;INF<16>, TYP<20>, COT <20>

P123

- LEDs Reset: This command acknowledge all alarms on Front Panel on MiCOM P12x products:  
FUN<160>;INF<19>, TYP<20>, COT <20>,<ADDR>

P120 to P123

- Setting group number 1: FUN<160>;INF<23>, TYP<20>, COT <20>,<ADDR>

P122-P123

- Setting group number 2: FUN<160>;INF<24>, TYP<20>, COT <20>,<ADDR>

P122-P123

- Order TC COMM1: FUN<168>;INF <234>; TYP <20>; COT<20>,<ADDR>

P122-P123

**with private option inactive:** FUN<160>;INF <136>; TYP <1>; COT<20>,<ADDR>

- Order TC COMM2: FUN<168>;INF <235>; TYP <20>; COT<20>,<ADDR>

P122-P123

MiCOM P120/P121/P122/P123

<b>with private option inactive:</b>	FUN<160>;INF <137>; TYP <1>; COT<20>,<ADDR>	
– Order TC COMM3:	FUN<168>;INF <238>; TYP <20>; COT<20>,<ADDR>	P122-P123
<b>with private option inactive:</b>	FUN<160>;INF <138>; TYP <1>; COT<20>,<ADDR>	
– Order TC COMM4:	FUN<168>;INF <239>; TYP <20>; COT<20>,<ADDR>	P122-P123
<b>with private option inactive:</b>	FUN<160>;INF <139>; TYP <1>; COT<20>,<ADDR>	
– Trip TC:	FUN<168>;INF <1>; TYP <20>; COT<20>,<ADDR>	P120 to P123
<b>with private option inactive:</b>	FUN<160>;INF <142>; TYP <1>; COT<20>,<ADDR>	
– Close TC:	FUN<168>;INF <2>; TYP <20>; COT<20>,<ADDR>	P120 to P123
<b>with private option inactive:</b>	FUN<160>;INF <143>; TYP <1>; COT<20>,<ADDR>	

After executing one of these commands, the relay sends an acknowledge message, which contains the result of command execution.

If a state change is the consequence of the command, it must be sent in a ASDU 1 with COT 12 (remote operation).

If the relay receive another command message from the master station before sending the acknowledge message, it will be discarded.

Commands which are not processed by the relay are rejected with a negative acknowledge message.

## 2.4 Relay re initialization

In case of relay re initialization, the relay send to the master station:

		<u>Availability</u>
–	A message indicating relay start/restart (FUN<160>;INF <5>; TYP <5> COT <5>)	P120 to P123
–	or a message indicating Reset CU (FUN<160>;INF <5>; TYP <3> COT <4>)	P120 to P123
–	or a message indicating Reset FCB (FUN<160>;INF <5>; TYP <2> COT <3>)	P120 to P123

Each identification message of the relay (ASDU 5) contains the manufacturer name in 8 ASCII characters (“Schneider Electric”) and 2 free bytes containing: « 120 » or « 121 », or « 122 », or « 123 » in decimal format, then 2 free bytes containing the software version number in decimal (for ex. : 112 corresponds to “11.C”).

## 2.5 Cyclic Messages (ASDU9 and ASDU 77)

Only measurands can be stored in these messages.

The measurands values are stored in lower levels of communication, before polling by master station.

Several of the fields in the ASDU 9 (FUN<160>, INF <148>) are unused in the P120/P121/P122/P123 relay (Voltage and Power values), so they are set to 0: Only RMS Ia, Ib, Ic values and frequency are stored in the P121/P122/P123 (with a rate such as: 2,4 \* nominal value = 4096). Only frequency is stored in the P120.

The second ASDU is ASDU3.4 (FUN<160>, INF<147>), which contains in first position In earth current value in rated format (with a rate such as: 2,4 \* nominal value = 4096). Vn value does not exist in the P120/P121/P122/P123 relay, so the second position value in ASDU3.4 is set to « unused ».

Another ASDU is only used for P122/P123, ASDU 77 (FUN<168>, INF <209>), which is a private ASDU, contains 4 other measurands: linverse and ldirect values, Thermal state (in %), in «short floating-point » format (IEEE 32 bits floating-point format). These values are not rated.

**with private option inactive:** FUN<160>,INF <149>



## MiCOM P120/P121/P122/P123

**2.6 IEC870-5-103 messages for Disturbance record extraction**

The disturbance extraction procedure with IEC870-5-103 in MICOM Px2x relays is in conformance with IEC870-5-103 standard definition. The maximum disturbance record number stored in a P120/P122/P123 is 5.

The disturbance record mapping for P120 is the following:

- Number of analog channels transmitted: 1, which is:

Channel 1: IN current (Earth).

- Identifiers of tags (8) transmitted in ASDU 29 (logical informations) :

- Tag number 1: IN>: FUN <160> INF <67>

- Tag number 2: General start: FUN <160> INF <84>

- Tag number 3: General Trip: FUN <160> INF <68>

- Tag number 4: tIN> (Earth): FUN <160> INF <92>

- Tag number 5: tIN>> (Earth): FUN <160> INF <93>

- Tag number 6: tIN>>> (Earth): FUN <168> INF <22>

**with private option inactive:** FUN <160>,INF <95>

- Tag number 7: Log input 1: FUN <168> INF <160>

**with private option inactive:** FUN <160>,INF <161>

- Tag number 8: Log input 2: FUN <168> INF <161>

**with private option inactive:** FUN <160>,INF <162>

The disturbance record mapping for P122 and P123 is the following:

- Number of analog channels transmitted: 4, which are:
  - Channel 1: Ia current (Phase L1).
  - Channel 2: Ib current (Phase L2).
  - Channel 3: Ic current (Phase L3).
  - Channel 4: IN current (Earth).
  
- Identifiers of tags (13) transmitted in ASDU 29 (logical informations) for P122:
  - Tag number 1: IN>: FUN <160> INF <67>
  - Tag number 2: General start: FUN <160> INF <84>
  - Tag number 3: CB Failure: FUN <160> INF <85>
  - Tag number 4: General Trip: FUN <160> INF <68>
  - Tag number 5: tI>: FUN <160> INF <90>
  - Tag number 6: tI>>: FUN <160> INF <91>
  - Tag number 7: tI>>>: FUN <168> INF <19>
  - with private option inactive:** FUN <160>,INF <94>
  - Tag number 8: tIN> (Earth): FUN <160> INF <92>
  - Tag number 9: tIN>> (Earth): FUN <160> INF <93>
  - Tag number 10: tIN>>> (Earth): FUN <168> INF <22>
  - with private option inactive:** FUN <160>,INF <95>
  - Tag number 11: Log input 1: FUN <168> INF <160>
  - with private option inactive:** FUN <160>,INF <161>
  - Tag number 12: Log input 2: FUN <168> INF <161>

MiCOM P120/P121/P122/P123

**with private option inactive:** FUN <160>,INF <162>

- Tag number 13: Log input 3: FUN <168> INF <162>

**with private option inactive:** FUN <160>,INF <163>

For a P123, there are 15 identifiers of tags, so the two following tags in addition to the precedents:

- Tag number 14: Log input 4: FUN <168> INF <163>

**with private option inactive:** FUN <160>,INF <164>

- Tag number 15: Log input 5: FUN <168> INF <164>

**with private option inactive:** FUN <160>,INF <165>



MiCOM P120/P121/P122/P123

# **DNP 3.0 DATABASE**



# CONTENTS

---

<b>1.</b>	<b>INTRODUCTION</b>	<b>3</b>
1.1	Purpose of this document	3
1.2	DNP V3.00 device Profile	3
1.3	Implementation Table	6
1.4	Point List	8
1.4.1	Binary Input Points	8
1.4.2	Binary Output Status Points and Control Relay Output Blocks	11
1.4.3	Counters	12
1.4.4	Analog Inputs	13

**BLANK PAGE**



**1. INTRODUCTION**

**1.1 Purpose of this document**

The purpose of this document is to describe the specific implementation of the Distributed Network Protocol (DNP) 3.0 within P12x MiCOM relays.

P12x uses the Triangle MicroWorks, Inc. DNP 3.0 Slave Source Code Library Version 2.18.

This document, in conjunction with the DNP 3.0 Basic 4 Document Set, and the DNP Subset Definitions Document, provides complete information on how to communicate with P12x via the DNP 3.0 protocol.

This implementation of DNP 3.0 is fully compliant with DNP 3.0 Subset Definition Level 2, contains many Subset Level 3 features, and contains some functionality even beyond Subset Level 3.

**1.2 DNP V3.00 device Profile**

The following table provides a “Device Profile Document” in the standard format defined in the DNP 3.0 Subset Definitions Document. While it is referred to in the DNP 3.0 Subset Definitions as a “Document,” it is only a component of a total interoperability guide. This table, in combination with the following should provide a complete interoperability/configuration guide for P12x:

- the Implementation Table provided in Section 1.3 (beginning on page 6),
- the Point List Tables provided in Section 1.4 (beginning on page 8),
- and a description of configuration methods and user-interface in Sections

<h1>DNP V3.00</h1>	
DEVICE PROFILE DOCUMENT	
(ALSO SEE THE IMPLEMENTATION TABLE IN SECTION 1.3, BEGINNING ON PAGE 6).	
Vendor Name: <b>Schneider Electric</b>	
Device Name: <b>SERIAL 20 Platform using the Triangle MicroWorks, Inc. DNP 3.0 Slave Source Code Library, Version 2.18.</b>	
Highest DNP Level Supported:	Device Function:
For Requests: <b>Level 2</b> For Responses: <b>Level 2</b>	<input checked="" type="checkbox"/> Master <input type="checkbox"/> Slave
Notable objects, functions, and/or qualifiers supported in addition to the Highest DNP Levels Supported (the complete list is described in the attached table):	
<p><b>For static (non-change-event) object requests, request qualifier codes 00 and 01 (start-stop), 07 and 08 (limited quantity), and 17 and 28 (index) are supported in addition to request qualifier code 06 (no range – or all points).</b></p> <p><b>Static object requests received with qualifiers 00, 01, 06, 07, or 08, will be responded with qualifiers 00 or 01. Static object requests received with qualifiers 17 or 28 will be responded with qualifiers 17 or 28.</b></p> <p><b>For change-event object requests, qualifiers 17 or 28 are always responded.</b></p> <p><b>16-bit and 32-bit Analog Change Events with Time may be requested.</b></p> <p><b>The read function code for Object 50 (Time and Date), variation 1, is supported.</b></p>	
Maximum Data Link Frame Size (octets):	Maximum Application Fragment Size (octets):
Transmitted: <b>292</b> Received: <b>292</b>	Transmitted: <b>2048</b> Received: <b>2048</b>
Maximum Data Link Re-tries:	Maximum Application Layer Re-tries:
<input checked="" type="checkbox"/> None <input type="checkbox"/> Fixed at 2 <input checked="" type="checkbox"/> Configurable	<input type="checkbox"/> None <input checked="" type="checkbox"/> Configurable

# DNP V3.00

## DEVICE PROFILE DOCUMENT

(ALSO SEE THE IMPLEMENTATION TABLE IN SECTION 1.3, BEGINNING ON PAGE 6).

### Requires Data Link Layer Confirmation:

- Never**  
Always  
Sometimes  
Configurable

### Requires Application Layer Confirmation:

- Never  
Always
- When reporting Event Data**
- When sending multi-fragment responses**  
Sometimes  
Configurable

### Timeouts while waiting for:

Data Link Confirm:	None	<input type="checkbox"/> <b>Fixed at 100 ms</b>	Variable	Configurable.
Complete Appl. Fragment:	<input type="checkbox"/> <b>None</b>	Fixed at _____	Variable	Configurable
Application Confirm:	None	<input type="checkbox"/> <b>Fixed at 1s</b>	Variable	Configurable
Complete Appl. Response:	<input type="checkbox"/> <b>None</b>	Fixed at _____	Variable	Configurable

### Others:

Binary input change scanning period: 5ms  
Analog input change scanning period: 1s

### Sends/Executes Control Operations:

WRITE Binary Outputs	<input type="checkbox"/> <b>Never</b>	Always	Sometimes	Configurable
SELECT/OPERATE	Never	<input type="checkbox"/> <b>Always</b>	Sometimes	Configurable
DIRECT OPERATE	Never	<input type="checkbox"/> <b>Always</b>	Sometimes	Configurable
DIRECT OPERATE – NO ACK	Never	<input type="checkbox"/> <b>Always</b>	Sometimes	Configurable
Count > 1	<input type="checkbox"/> <b>Never</b>	Always	Sometimes	Configurable
Pulse On	Never	<input type="checkbox"/> <b>Always</b>	Sometimes	Configurable
Pulse Off	<input type="checkbox"/> <b>Never</b>	Always	Sometimes	Configurable
Latch On	<input type="checkbox"/> <b>Never</b>	Always	Sometimes	Configurable
Latch Off	<input type="checkbox"/> <b>Never</b>	Always	Sometimes	Configurable
Queue	<input type="checkbox"/> <b>Never</b>	Always	Sometimes	Configurable
Clear Queue	<input type="checkbox"/> <b>Never</b>	Always	Sometimes	Configurable

### Reports Binary Input Change Events when no specific variation requested:

- Never
- Only time-tagged for P122 and P123**
- Only non-time-tagged for P121**  
Configurable

### Reports time-tagged Binary Input Change Events when no specific variation requested:

- Never for P121**
- Binary Input Change With Time for P122 and P123**  
Binary Input Change With Relative Time  
Configurable (attach explanation)

### Sends Unsolicited Responses:

- Never**  
Configurable  
Only certain objects  
Sometimes (attach explanation)  
ENABLE/DISABLE UNSOLICITED  
Function codes supported

### Sends Static Data in Unsolicited Responses:

- Never**  
When Device Restarts  
When Status Flags Change

No other options are permitted.

<h1 style="margin: 0;">DNP V3.00</h1> <p style="margin: 0;">DEVICE PROFILE DOCUMENT</p> <p style="margin: 0;">(ALSO SEE THE IMPLEMENTATION TABLE IN SECTION 1.3, BEGINNING ON PAGE 6).</p>	
<p>Default Counter Object/Variation:</p> <p style="margin-left: 20px;">No Counters Reported Configurable</p> <p><input type="checkbox"/> <b>Default Object: 20</b></p> <p><input type="checkbox"/> <b>Default Variation: 5</b> Point-by-point list attached</p>	<p>Counters Roll Over at:</p> <p style="margin-left: 20px;">No Counters Reported Configurable (attach explanation)</p> <p><input type="checkbox"/> <b>16 Bits</b></p> <p><input type="checkbox"/> <b>32 Bits</b></p> <p style="margin-left: 20px;">Other Value: _____</p> <p><input type="checkbox"/> <b>Point-by-point list attached</b></p>
<p>Sends Multi-Fragment Responses:</p> <p><input type="checkbox"/> <b>Yes</b></p> <p style="margin-left: 20px;">No</p>	

### 1.3 Implementation Table

The following table identifies the variations, function codes, and qualifiers supported by the P12x in both request messages and in response messages.

For static (non-change-event) objects, requests sent with qualifiers 00, 01, 06, 07, or 08, will be responded with qualifiers 00 or 01. Static object requests sent with qualifiers 17 or 28 will be responded with qualifiers 17 or 28. For change-event objects, qualifiers 17 or 28 are always responded.

In the table below the text shaded as indicates Subset Level 3 functionality

Subset Level 3

(beyond Subset Level 2), and text shaded as

beyond Subset Level 3

indicates functionality

beyond Subset Level 3.

OBJECT			REQUEST (Library will parse)		RESPONSE (Library will respond with)	
Object Number	Variation Number	Description	Function Codes (dec)	Qualifier Codes (hex)	Function Codes (dec)	Qualifier Codes (hex)
1	0	Binary Input (Variation 0 is used to request default variation)	1 (read)	00, 01 (start-stop) 06 (no range, or all) 07, 08 (limited qty) 17, 28 (index)		
1	1 (default – see note 1)	Binary Input	1 (read) 22	00, 01 (start-stop) 06 (no range, or all) 07, 08 (limited qty) 17, 28 (index)	129 (response)	00, 01 (start-stop) 17, 28 (index – see note 2)
1	2	Binary Input with Status	1 (read)	00, 01 (start-stop) 06 (no range, or all) 07, 08 (limited qty) 17, 28 (index)	129 (response)	00, 01 (start-stop) 17, 28 (index – see note 2)
2	0	Binary Input Change (Variation 0 is used to request default variation)	1 (read)	06 (no range, or all) 07, 08 (limited qty)		
2	1 (default – see note 1 for P120 - P121)	Binary Input Change without Time	1 (read)	06 (no range, or all) 07, 08 (limited qty)	129 (response)	17, 28 (index)
2 (only P122-P123)	2 (default – see note 1)	Binary Input Change with Time	1 (read)	06 (no range, or all) 07, 08 (limited qty)	129 (response)	17, 28 (index)
10	0	Binary Output Status (Variation 0 is used to request default variation)	1 (read)	00, 01 (start-stop) 06 (no range, or all) 07, 08 (limited qty) 17, 28 (index)		
10	2 (default – see note 1)	Binary Output Status	1 (read)	00, 01 (start-stop) 06 (no range, or all) 07, 08 (limited qty) 17, 28 (index)	129 (response)	00, 01 (start-stop) 17, 28 (index – see note 2)
12	1	Control Relay Output Block	3 (select) 4 (operate) 5 (direct op) 6 (dir. op, noack)	00, 01 (start-stop) 07, 08 (limited qty) 17, 28 (index)	129 (response)	echo of request
20 (only P122-P123)	0	Binary Counter (Variation 0 is used to request default variation)	1 (read) 7 (freeze) 8 (freeze noack) 9 (freeze clear) 10 (frz. cl. Noack)	00, 01 (start-stop) 06 (no range, or all) 07, 08 (limited qty) 17, 28 (index)		
20 (only P122-P123)	1	32-Bit Binary Counter	1 (read) 7 (freeze) 8 (freeze noack) 9 (freeze clear) 10 (frz. cl. Noack)	00, 01 (start-stop) 06 (no range, or all) 07, 08 (limited qty) 17, 28 (index)	129 (response)	00, 01 (start-stop) 17, 28 (index – see note 2)
20 (only P122-P123)	2	16-Bit Binary Counter	1 (read) 7 (freeze) 8 (freeze noack) 9 (freeze clear) 10 (frz. cl. Noack)	00, 01 (start-stop) 06 (no range, or all) 07, 08 (limited qty) 17, 28 (index)	129 (response)	00, 01 (start-stop) 17, 28 (index – see note 2)
20 (only P122-P123)	5	32-Bit Binary Counter without Flag	1 (read) 7 (freeze) 8 (freeze noack) 9 (freeze clear) 10 (frz. cl. Noack)	00, 01 (start-stop) 06 (no range, or all) 07, 08 (limited qty) 17, 28 (index)	129 (response)	00, 01 (start-stop) 17, 28 (index – see note 2)
20 (only P122-P123)	6	16-Bit Binary Counter without Flag	1 (read) 7 (freeze) 8 (freeze noack) 9 (freeze clear) 10 (frz. cl. Noack)	00, 01 (start-stop) 06 (no range, or all) 07, 08 (limited qty) 17, 28 (index)	129 (response)	00, 01 (start-stop) 17, 28 (index – see note 2)
21 (only P122-P123)	0	Frozen Counter (Variation 0 is used to request default variation)	1 (read)	00, 01 (start-stop) 06 (no range, or all) 07, 08 (limited qty) 17, 28 (index)		
21 (only P122-P123)	1	32-Bit Frozen Counter	1 (read)	00, 01 (start-stop) 06 (no range, or all) 07, 08 (limited qty) 17, 28 (index)	129 (response)	00, 01 (start-stop) 17, 28 (index – see note 2)

OBJECT			REQUEST (Library will parse)		RESPONSE (Library will respond with)	
Object Number	Variation Number	Description	Function Codes (dec)	Qualifier Codes (hex)	Function Codes (dec)	Qualifier Codes (hex)
21 (only P122-P123)	2	16-Bit Frozen Counter	1 (read)	00, 01 (start-stop) 06 (no range, or all) 07, 08 (limited qty) 17, 28 (index)	129 (response)	00, 01 (start-stop) 17, 28 (index – see note 2)
21 (only P122-P123)	9	32-Bit Frozen Counter without Flag	1 (read)	00, 01 (start-stop) 06 (no range, or all) 07, 08 (limited qty) 17, 28 (index)	129 (response)	00, 01 (start-stop) 17, 28 (index – see note 2)
21 (only P122-P123)	10	16-Bit Frozen Counter without Flag	1 (read)	00, 01 (start-stop) 06 (no range, or all) 07, 08 (limited qty) 17, 28 (index)	129 (response)	00, 01 (start-stop) 17, 28 (index – see note 2)
30	0	Analog Input (Variation 0 is used to request default variation)	1 (read)	00, 01 (start-stop) 06 (no range, or all) 07, 08 (limited qty) 17, 28 (index)		
30	1 (default – see note 1)	32-Bit Analog Input	1 (read)	00, 01 (start-stop) 06 (no range, or all) 07, 08 (limited qty) 17, 28 (index)	129 (response)	00, 01 (start-stop) 17, 28 (index – see note 2)
30	2	16-Bit Analog Input	1 (read)	00, 01 (start-stop) 06 (no range, or all) 07, 08 (limited qty) 17, 28 (index)	129 (response)	00, 01 (start-stop) 17, 28 (index – see note 2)
30	3	32-Bit Analog Input without Flag	1 (read)	00, 01 (start-stop) 06 (no range, or all) 07, 08 (limited qty) 17, 28 (index)	129 (response)	00, 01 (start-stop) 17, 28 (index – see note 2)
30	4	16-Bit Analog Input without Flag	1 (read)	00, 01 (start-stop) 06 (no range, or all) 07, 08 (limited qty) 17, 28 (index)	129 (response)	00, 01 (start-stop) 17, 28 (index – see note 2)
32	0	Analog Change Event (Variation 0 is used to request default variation)	1 (read)	06 (no range, or all) 07, 08 (limited qty)		
32	1 (default – see note 1)	32-Bit Analog Change Event without Time	1 (read)	06 (no range, or all) 07, 08 (limited qty)	129 (response)	17, 28 (index)
32	2	16-Bit Analog Change Event without Time	1 (read)	06 (no range, or all) 07, 08 (limited qty)	129 (response)	17, 28 (index)
32 (only P122-P123)	3	32-Bit Analog Change Event with Time	1 (read)	06 (no range, or all) 07, 08 (limited qty)	129 (response)	17, 28 (index)
32 (only P122-P123)	4	16-Bit Analog Change Event with Time	1 (read)	06 (no range, or all) 07, 08 (limited qty)	129 (response)	17, 28 (index)
50 (only P122-P123)	0	Time and Date	1 (read)	00, 01 (start-stop) 06 (no range, or all) 07, 08 (limited qty) 17, 28 (index)	129 (response)	00, 01 (start-stop) 17, 28 (index – see note 2)
50 (only P122-P123)	1 (default – see note 1)	Time and Date	1 (read) 2 (write)	00, 01 (start-stop) 06 (no range, or all) 07 (limited qty=1) 08 (limited qty) 17, 28 (index)	129 (response)	00, 01 (start-stop) 17, 28 (index – see note 2)
52	2	Time Delay Fine			129 (response)	07 (limited qty) (qty = 1)
60	0	Class 0, 1, 2, and 3 Data	1 (read)	06 (no range, or all)		
60	1	Class 0 Data	1 (read)	06 (no range, or all)	129	17,28
60	2	Class 1 Data	1 (read)	06 (no range, or all) 07, 08 (limited qty)	129	17,28
60	3	Class 2 Data	1 (read)	06 (no range, or all) 07, 08 (limited qty)	129	17,28
60	4	Class 3 Data	1 (read)	06 (no range, or all) 07, 08 (limited qty)	129	17,28
80	1	Internal Indications	2 (write)	00 (start-stop) (index must =7)		
		No Object (function code only) –See Note 3	13 (cold restart)			
		No Object (function code only)	14 (warm restart)			
		No Object (function code only)	23 (delay meas.)			

Note 1: A Default variation refers to the variation responded when variation 0 is requested and/or in class 0, 1, 2, or 3 scans.

Note 2: For static (non-change-event) objects, qualifiers 17 or 28 are only responded when a request is sent with qualifiers 17 or 28, respectively. Otherwise, static object requests sent with qualifiers 00, 01, 06, 07, or 08, will be responded with qualifiers 00 or 01. (For change-event objects, qualifiers 17 or 28 are always responded.)

Note 3: For P12x, a cold restart is implemented as a warm restart – the executable is not restarted, but the DNP process is restarted.

**1.4 Point List**

The tables in the following sections identify all the individual data points provided by this implementation of DNP 3.0. uses the database protection.

**1.4.1 Binary Input Points**

Every Binary Input Status points are included in class 0 polls, because they are included in one of classes 1, 2 or 3.

Binary Input Points						
Static (Steady-State) Object Number: <b>1</b>						
Change Event Object Number: <b>2</b>						
Request Function Codes supported: <b>1 (read)</b>						
Static Variation reported when variation 0 requested: <b>1 (Binary Input without status)</b>						
Change Event Variation reported when variation 0 requested: <b>1 for P120 et P121 and 2 (Binary Input Change with Time) for P122 and P123</b>						
P120 Point Index	P121 Point Index	P122 Point Index	P123 Point Index	Name/Description	init val.	Change Event Class (1, 2, 3 or none)
0	0	0	0	Output relay 1 (trip)	0	1
1	1	1	1	Output relay 2	0	2
2	2	2	2	Output relay 3	0	2
3	3	3	3	Output relay 4	0	2
4	4	4	4	Output relay 0 ( watch dog)	0	2
		5	5	Output relay 5	0	2
		6	6	Output relay 6	0	2
			7	Output relay 7	0	2
			8	Output relay 8	0	2
5	5	7	9	Opto isolator 1	0	2
6	6	8	10	Opto isolator 2	0	2
		9	11	Opto isolator 3	0	2
			12	Opto isolator 4	0	2
			13	Opto isolator 5	0	2
	7	10	14	Phase overcurrent stage 1 start	0	1
	8	11	15	Phase overcurrent stage 1 trip	0	1
	9	12	16	Phase overcurrent stage 2 start	0	1
	10	13	17	Phase overcurrent stage 2 trip	0	1
	11	14	18	Phase overcurrent stage 3 start	0	1
	12	15	19	Phase overcurrent stage 3 trip	0	1
7	13	16	20	Earth overcurrent stage 1 start	0	1
8	14	17	21	Earth overcurrent stage 1 trip	0	1
9	15	18	22	Earth overcurrent stage 2 start	0	1
10	16	19	23	Earth overcurrent stage 2 trip	0	1
11	17	20	24	Earth overcurrent stage 3 start	0	1
12	18	21	25	Earth overcurrent stage 3 trip	0	1
		22	26	tI<	0	1
		23	27	Thermal start	0	1
		24	28	Thermal trip	0	1
26	35	25	29	Taux1	0	1
27	36	26	30	Taux2	0	1
		27	31	Broken conductor	0	1
		28	32	cb failure	0	1
		29	33	I2> start	0	1
		30	34	tI2> trip	0	1
		31	35	Number of cb operation	0	1
		32	36	Cb operation time alarm	0	1
		33	37	sa2n	0	1
		34	38	trip circuit alarm	0	1
		35	39	cb close time alarm	0	1

MiCOM P120/P121/P122/P123

Binary Input Points  
 Static (Steady-State) Object Number: **1**  
 Change Event Object Number: **2**  
 Request Function Codes supported: **1 (read)**  
 Static Variation reported when variation 0 requested: **1 (Binary Input without status)**  
 Change Event Variation reported when variation 0 requested: **1 for P120 et P121 and 2 (Binary Input Change with Time) for P122 and P123**

P120 Point Index	P121 Point Index	P122 Point Index	P123 Point Index	Name/Description	init val.	Change Event Class (1, 2, 3 or none)
			40	Blocking autoreclosure	0	1
			41	Successful autoreclosure	0	1
			42	In Progress autoreclosure	0	1
		36	43	logic Selectivity 1	0	1
		37	44	logic Selectivity 2	0	1
13	19	38	45	Blocking logic 1	0	1
		39	46	Blocking logic 2	0	1
14	20	40	47	52a	0	1
15	21	41	48	52b	0	1
16	22	42	49	Lack of SF6	0	1
		43	50	Cold load Pick up	0	1
17	23	44	51	De latching by a logic input	0	1
18	24	45	52	De latching of the Tripping output relay by remote order	0	1
19	25	46	53	Closing order by remote order	0	1
20	26	47	54	Tripping order by remote order	0	1
		48	55	Thermal Resetting by communication	0	1
		49	56	Shifting to maintenance mode	0	1
21	27	50	57	Major material Alarms	0	1
22	28	51	58	Minor material Alarms	0	1
	29	52	59	Phase overcurrent stage 1 trip alarm (latched)	0	3
	30	53	60	Phase overcurrent stage 2 trip alarm (latched)	0	3
	31	54	61	Phase overcurrent stage 3 trip alarm (latched)	0	3
23	32	55	62	Earth overcurrent stage 1 trip alarm (latched)	0	3
24	33	56	63	Earth overcurrent stage 2 trip alarm (latched)	0	3
25	34	57	64	Earth overcurrent stage 3 trip alarm (latched)	0	3
		58	65	tl< alarm (latched)	0	3
		59	66	Thermal start alarm (latched)	0	3
		60	67	Thermal trip alarm (latched)	0	3
28	37	61	68	Taux1 alarm (latched)	0	3
29	38	62	69	Taux2 alarm (latched)	0	3
		63	70	Broken conductor alarm (latched)	0	3
		64	71	cb failure alarm (latched)	0	3
		65	72	tl2> alarm (latched)	0	3
		66	73	Cb operation time alarm(latched)	0	3
		67	74	Number of cb operation (latched)	0	3
		68	75	sa2n alarm (latched)	0	3
		69	76	trip circuit alarm(latched)	0	3
		70	77	cb close time alarm ( latched)	0	3
		71	78	Fault Configuration of autoreclosure	0	3
		72	79	I min Start	0	1
		73	80	External CB Failure	0	1
		74	81	Latching of Relay	0	2
		75	82	I2>> start	0	1
		76	83	tl2>> trip	0	1
		77	84	tl2>> alarm (latched)	0	3
		78	85	taux3	0	1
		79	86	taux3 alarm (if latched by Trip)	0	3
		80	87	taux4	0	1

Binary Input Points						
Static (Steady-State) Object Number: <b>1</b>						
Change Event Object Number: <b>2</b>						
Request Function Codes supported: <b>1 (read)</b>						
Static Variation reported when variation 0 requested: <b>1 (Binary Input without status)</b>						
Change Event Variation reported when variation 0 requested: <b>1 for P120 et P121 and 2 (Binary Input Change with Time) for P122 and P123</b>						
P120 Point Index	P121 Point Index	P122 Point Index	P123 Point Index	Name/Description	init val.	Change Event Class (1, 2, 3 or none)
			88	taux4 alarm(if latched by Trip)	0	3
			89	Final trip (autorecloser)	0	1
	39	79	90	t Equation A	0	1
	40	80	91	t Equation B	0	1
	41	81	92	t Equation C	0	1
	42	82	93	t Equation D	0	1
	43	83	94	t Equation E	0	1
	44	84	95	t Equation F	0	1
	45	85	96	t Equation G	0	1
	46	86	97	t Equation H	0	1
		87	98	Blocking inrush	0	1
	47	88	99	t Equation A (latched)	0	3
	48	89	100	t Equation B (latched)	0	3
	49	90	101	t Equation C (latched)	0	3
	50	91	102	t Equation D (latched)	0	3
	51	92	103	t Equation E (latched)	0	3
	52	93	104	t Equation F (latched)	0	3
	53	94	105	t Equation G (latched)	0	3
	54	95	106	t Equation H (latched)	0	3



MiCOM P120/P121/P122/P123

1.4.2 Binary Output Status Points and Control Relay Output Blocks

The following table lists both the Binary Output Status Points (Object 10) and the Control Relay Output Blocks (Object 12). Binary Output Status points are not included in class 0 polls.

<b>Binary Output Status Points</b>						
Object Number: <b>10</b>						
Request Function Codes supported: <b>1 (read)</b>						
Default Variation reported when variation 0 requested: <b>2 (Binary Output Status)</b>						
<b>Control Relay Output Blocks</b>						
Object Number: <b>12</b>						
Request Function Codes supported: <b>3 (select), 4 (operate), 5 (direct operate), 6 (direct operate, noack)</b>						
P120 Point Index	P121 Point Index	P122 Point Index	P123 Point Index	Name/Description	Initial Status Value	Supported Control Relay Output Block Fields
0	0	0	0	De Latch of relays	0	Unpaired Pulse On, Paired Trip/Pulse On, Paired Close/Pulse On
1	1	1	1	Acknowledgement of the 1 <sup>st</sup> alarm	0	Unpaired Pulse On, Paired Trip/Pulse On, Paired Close/Pulse On
2	2	2	2	Acknowledgement of all the alarms	0	Unpaired Pulse On, Paired Trip/Pulse On, Paired Close/Pulse On
3	3	3	3	Remote control Tripping	0	Unpaired Pulse On, Paired Trip/Pulse On,
4	4	4	4	Remote control Closing	0	Unpaired Pulse On, Paired Close/Pulse On
		5	5	Change of Active Group	0	Unpaired Pulse On, Paired Trip/Pulse On, Paired Close/Pulse On
		6	6	Thermal State Resetting	0	Unpaired Pulse On, Paired Trip/Pulse On, Paired Close/Pulse On
		7	7	Average and Max rms values resetting	0	Unpaired Pulse On, Paired Trip/Pulse On, Paired Close/Pulse On
		8	8	Acknowledgement of RAMs material alarms	0	Unpaired Pulse On, Paired Trip/Pulse On, Paired Close/Pulse On
			9	Counters initialization of the autoreclosure	0	Unpaired Pulse On, Paired Trip/Pulse On, Paired Close/Pulse On
		9	10	Initialization of rolling demand (average)	0	Unpaired Pulse On, Paired Trip/Pulse On, Paired Close/Pulse On
		10	11	Initialization of Maximum	0	Unpaired Pulse On, Paired Trip/Pulse On, Paired Close/Pulse On
			12	Re initialization of autoreclosure	0	Unpaired Pulse On, Paired Trip/Pulse On, Paired Close/Pulse On
		11	13	tc com1	0	Unpaired Pulse On, Paired Trip/Pulse On, Paired Close/Pulse On
		12	14	tc com2	0	Unpaired Pulse On, Paired Trip/Pulse On, Paired Close/Pulse On
		13	15	tc com3	0	Unpaired Pulse On, Paired Trip/Pulse On, Paired Close/Pulse On
		14	16	tc com4	0	Unpaired Pulse On, Paired Trip/Pulse On, Paired Close/Pulse On

1.4.3 Counters

The following table lists both Binary Counters (Object 20) and Frozen Counters (Object 21). When a freeze function is performed on a Binary Counter point, the frozen value is available in the corresponding Frozen Counter point.

Binary Counters and Frozen Counters are not included in class 0 polls.

P120 and P121 do not support binary Counters and Frozen Counters.

<b>Binary Counters</b>			
Static (Steady-State) Object Number: <b>20</b>			
Change Event Object Number: not supported			
Request Function Codes supported: <b>1 (read), 7 (freeze), 8 (freeze noack)</b> <b>9 (freeze and clear), 10 (freeze and clear, noack)</b>			
Static Variation reported when variation 0 requested: <b>5 (32-Bit Binary Counter without Flag)</b>			
Change Event Variation reported when variation 0 requested: none-not supported			
<b>Frozen Counters</b>			
Static (Steady-State) Object Number: <b>21</b>			
Change Event Object Number: not supported			
Request Function Codes supported: <b>1 (read)</b>			
Static Variation reported when variation 0 requested: <b>9 (32-Bit Frozen Binary without Flag)</b>			
Change Event Variation reported when variation 0 requested: none-not supported			
<b>P122 Point Index</b>	<b>P123 Point Index</b>	<b>Name/Description</b>	<b>Data type</b>
0	0	Max RMS current phase A	D1
1	1	Max RMS current phase B	D1
2	2	Max RMS current phase C	D1
3	3	Average RMS current phase A	D1
4	4	Average RMS current phase B	D1
5	5	Average RMS current phase C	D1
6	6	CB operation number	D2
7	7	sa2n ia	D3
8	8	sa2n ib	D3
9	9	sa2n ic	D3
	10	Total number of autoreclosure cycle	D2
	11	Number of cycles 1	D2
	12	Number of cycles 2	D2
	13	Number of cycles 3	D2
	14	Number of cycles 4	D2
	15	Definitive Tripping number	D2
	16	Number of closing order	D2
10	17	Rolling demand(average) RMS phase A	D1
11	18	Rolling demand(average) RMS phase B	D1
12	19	Rolling demand(average) RMS phase C	D1
13	20	Maximum RMS phase A (after a new initialization)	D1
14	21	Maximum RMS phase B (after a new initialization)	D1
15	22	Maximum RMS phase C (after a new initialization)	D1

1.4.4 Analog Inputs

The following table lists Analog Inputs (Object 30). It is important to note that 16-bit and 32-bit variations of Analog Inputs, Analog Output Control Blocks, and Analog Output Statuses are transmitted through DNP as signed numbers. Even for analog input points that are not valid as negative values, the maximum positive representation is 32767. For each point, the “Scaling and Units” column indicates the value of a transmitted 32767. This also implies the value of a transmitted -32767. The entry in the column *does not* imply a valid value for the point.

Always indicating the representation of 32767 in the tables below is a consistent method for representing scale, applicable to all scaling possibilities.

The “Default Deadband,” and the “Default Change Event Assigned Class” columns are used to represent the absolute amount by which the point must change before an analog change event will be generated, and once generated in which class poll (1, 2, 3) will the change event be reported. Only the default values for these columns are documented here because the values may change in operation due to either local (user-interface) or remote (through DNP) control.

Every Analog Inputs points are included in class 0 polls, because they are included in one of classes 1, 2 or 3.

<b>Analog Inputs</b>									
Static (Steady-State) Object Number: <b>30</b>									
Change Event Object Number: <b>32</b>									
Request Function Codes supported: <b>1 (read)</b>									
Static Variation reported when variation 0 requested: <b>1 (32-Bit Analog Input)</b>									
Change Event Variation reported when variation 0 requested: <b>1 (32-Bit Analog Change Event w/o Time)</b>									
Change Event Scan Rate: <b>The scan rate for analog input change events is fixed at 1s</b>									
P120 Point Index	P121 Point Index	P122 Point Index	P123 Point Index	Name/Description	Initial Value	Scaling and Units (representation of 32767 – see above)	Valid Range	Change Event Dead-band	Initial Change Event Class (1, 2, 3 or none)
		0	0	Active Group	1	32767	1 à 2	1	1
	0	1	1	Magnitude IA	0	40 In	0 to 40 In	0.02 In	3
	1	2	2	Magnitude IB	0	40 In	0 to 40 In	0.02 In	3
	2	3	3	Magnitude IC	0	40 In	0 to 40 In	0.02 In	3
0	3	4	4	Magnitude IN	0	40 IEn	0 to 40 IEn	0.02 IEn	3
	4	5	5	rms IA	0A	327.67A	0 to 40000000 1/100 A	2%	3
	5	6	6	rms IB	0A	327.67A	0 to 40000000 1/100 A	2%	3
	6	7	7	rms IC	0A	327.67A	0 to 40000000 1/100 A	2%	3
1	7	8	8	rms IN	0A	327.67A	0 to 40000000 1/100 A	2%	3
		9	9	Thermal State	0%	32767%	0 to 65535	10	3
2		10	10	Frequency	0	327,67 Hz	45Hz to 65 Hz and 99.99Hz == ERROR	1Hz	3
		11	11	Magnitude I2	0	40 In	0 to 40 In	0.1 In	3
		12	12	Magnitude I1	0	40 In	0 to 40 In	0.1 In	3
		13	13	Tripping Time	0	327.67s	0 to 10.00s	1/100 s	3
		14	14	Closing Time	0	327.67s	0 to 10.00s	1/100 s	3
3		15	15	Fault number	0	32767	0 to 65535	1	2
4		16	16	group	0	32767	1 to 2	each new fault	2
5		17	17	Fault phase	0	32767	0 to 8 (F1)	each new fault	2

<b>Analog Inputs</b>									
Static (Steady-State) Object Number: <b>30</b>									
Change Event Object Number: <b>32</b>									
Request Function Codes supported: <b>1 (read)</b>									
Static Variation reported when variation 0 requested: <b>1 (32-Bit Analog Input)</b>									
Change Event Variation reported when variation 0 requested: <b>1 (32-Bit Analog Change Event w/o Time)</b>									
Change Event Scan Rate: <b>The scan rate for analog input change events is fixed at 1s</b>									
P120 Point Index	P121 Point Index	P122 Point Index	P123 Point Index	Name/Description	Initial Value	Scaling and Units (representation of 32767 – see above)	Valid Range	Change Event Dead-band	Initial Change Event Class (1, 2, 3 or none)
6		18	18	Fault origin	0	32767	0 to 17 (P122) 18 (P123) (F2)	each new fault	2
7		19	19	Fault magnitude	0	40 In	0 to 40 In	each new fault	2
		20	20	Fault magnitude IA	0	40 In	0 to 40 In	each new fault	2
		21	21	Fault magnitude IB	0	40 In	0 to 40 In	each new fault	2
		22	22	Fault magnitude IC	0	40 In	0 to 40 In	each new fault	2
8		23	23	Fault magnitude IN	0	40 IEn	0 to 40 IEn	each new fault	2

Format:

F1:

0: None, 1: Phase A, 2: Phase B, 3: Phase C, 4: Phase AB, 5: Phase AC, 6: Phase BC, 7: Phase A B C, 8: Earth.

F2:

For P122/123 : 0: Null, 1: Remote trip, 2: thermal overload, 3: tI>, 4: tI>>, 5: tI>>>, 6: tIN>, 7: tIN>>, 8: tIN>>>, 9: tI<, 10: broken conductor, 11: taux1, 12: taux2, 13: tlinv>, 14: tlinv>>, 15:taux3, 16: taux4 (only p123), 17:breaker failure, 18: SOFT (only P123).

For P120 : only 0: Null, 1: Remote trip, 6: tIN>, 7: tIN>>, 8: tIN>>>, 11: taux1, 12: taux2.

# **COMMISSIONING AND MAINTENANCE GUIDE**



# CONTENTS

<b>1.</b>	<b>REQUIREMENTS PRIOR TO COMMISSIONING</b>	<b>3</b>
<b>2.</b>	<b>COMMISSIONING TEST ENVIRONMENT</b>	<b>4</b>
2.1	<b>Important notes</b>	4
2.1.1	Injection test sets	4
2.1.2	Additional commissioning test equipment	4
2.1.3	Communication	4
2.2	<b>Commissioning test sheets</b>	4
<b>3.</b>	<b>PRODUCT VERIFICATION TESTS</b>	<b>5</b>
3.1	<b>Allocation of terminals</b>	5
3.2	<b>Electrostatic discharge (ESD)</b>	5
3.3	<b>Visual inspection</b>	5
3.4	<b>Earthing</b>	5
3.5	<b>Current transformers (CT's)</b>	5
3.6	<b>Use of a Core CT for earth faults.</b>	5
3.6.1	Cable shields and core CT	5
3.6.2	Induced current flow through electric cables	6
3.6.3	Core CT polarity	6
3.7	<b>Auxiliary supply</b>	7
3.8	<b>Logic inputs</b>	7
3.9	<b>Logic outputs</b>	7
3.10	<b>RS 485 rear communication</b>	8
<b>4.</b>	<b>SETTING CHECK</b>	<b>9</b>
4.1	<b>Settings</b>	9
4.2	<b>Measurements</b>	9
4.2.1	MiCOM P120	9
4.2.2	MiCOM P121, P122 and P123	9
4.3	<b>Phase overcurrent (I<sub>&gt;</sub> and I<sub>&gt;&gt;</sub>)</b>	<b>10</b>
4.3.1	Test wiring diagram	10
4.3.2	MiCOM settings	10
4.3.3	I <sub>&gt;</sub> threshold with DMT tI <sub>&gt;</sub>	11
4.3.4	I <sub>&gt;</sub> threshold with IDMT tI <sub>&gt;</sub>	12
4.3.5	I <sub>&gt;&gt;</sub> threshold	14
4.4	<b>Final checks</b>	<b>14</b>

---

<b>5.</b>	<b>MAINTENANCE</b>	<b>15</b>
<b>5.1</b>	<b>Equipment failure</b>	<b>15</b>
5.1.1	Minor fault	15
5.1.2	Major fault	15
5.1.3	Hardware and software faults	15
<b>5.2</b>	<b>Method of repair</b>	<b>16</b>
5.2.1	Replacing the active part	16
5.2.2	Replacing the complete relay	16
<b>5.3</b>	<b>Problem solving</b>	<b>17</b>
5.3.1	Password lost or not accepted	17
5.3.2	Communication	17



## 1. REQUIREMENTS PRIOR TO COMMISSIONING

The MiCOM P12x relays are fully numerical in their design, implementing all protection and non-protection functions in software. The MiCOM relays use a high degree of self-checking and, in the unlikely event of a failure, will give an alarm. As a result of this, the commissioning test do not need to be as extensive as with non-numerical relays (static or electromechanical).

To commission MiCOM relays, it is only necessary to verify that the hardware is functioning correctly and the application-specific software setting have been applied to the MiCOM relay. It is considered unnecessary to test every function of the relay if the settings have been verified by one of the following method:

- Extracting the settings applied to the relay using the appropriate setting software MiCOM S1 (preferred method)
- Via the front panel user interface.

**REMINDER:** It is not possible to download a new setting software as long as the programming mode is active.

To confirm that the product is operating correctly once the application-specific settings have been applied, a test should be performed on a single protection element.

Unless previously agreed to the contrary, the customer will be responsible for determining the application-specific settings to be applied to the MiCOM relays and for testing of any scheme logic applied by external wiring.

Blank commissioning test sheets and setting records are provided at the APPENDIX 2 of the Technical Guide for completion as required.



**BEFORE CARRYING OUT ANY WORK ON THE EQUIPMENT, THE USER SHOULD BE FAMILIAR WITH THE CONTENTS OF THE SAFETY GUIDE SFTY/4LM/D11 OR LATER ISSUE, OR THE SAFETY AND TECHNICAL DATA SECTION OF THE TECHNICAL MANUAL AND ALSO THE RATINGS ON THE EQUIPMENT RATING LABEL.**

---

## 2. COMMISSIONING TEST ENVIRONMENT

### 2.1 Important notes

All commissioning tests of **MiCOM P120, P121, P122** and **P123** relays are carried out by injecting currents to the secondary of the earth and/or phases CTs using appropriate injection test sets provided for this purpose.

#### 2.1.1 Injection test sets

For reasons of convenience (weight, spatial requirement, transportation), a single-phased injection test set is more suitable for commissioning and is able to perform all commissioning tests regarding **MiCOM P120, P121, P122** and **P123** relays.

Thus, the following descriptions indicate how to conduct the commissioning tests with a single-phase injection test set.

However, for certain commissioning tests, the three-phase wiring diagrams are easier to understand and in this case the description is also given in three-phase format.

##### Single-phase injection test set

1 current (0 to 50 A), timer (precision 1 ms).

##### Three-phase injection test set

3 currents (0 to 50 A), timer (precision 1 ms).

#### 2.1.2 Additional commissioning test equipment

- 1 multimeter (precision 1%),
- 1 connecting terminal to measure the currents exceeding 10 A (precision 2%),
- Test plugs and wires to carry out injections to the CT's secondary (dimension according to the currents injected).

#### 2.1.3 Communication

For all commissioning tests, the records can be made by using the RS 485 communication on the rear connector of the **MiCOM P120, P121, P122** and **P123** relays or for **MiCOM P122** and **P123** using the RS232 front port.

According to each RS 485 communication protocol (MODBUS, Courier, IEC 60870-5-103, DNP3.0).

## 2.2 Commissioning test sheets

Commissioning test sheets are available in the APPENDIX 2 of the Technical Guide.

The presentation of the Commissioning test sheets follows the description of the tests of this chapter.

The contents of these Commissioning test sheets enable you to log:

- The name of the relay, station and circuit
- The characteristics of the **MiCOM P120, P121, P122** and **P123** relays
- The various settings
- The results of the protection and automation checks
- The result of the test records after commissioning.

### 3. PRODUCT VERIFICATION TESTS



**BEFORE CARRYING OUT ANY WORK ON THE EQUIPMENT, THE USER SHOULD BE FAMILIAR WITH THE CONTENTS OF THE SAFETY GUIDE SFTY/4LM/E11 OR LATER ISSUE, OR THE SAFETY AND TECHNICAL DATA SECTIONS OF THE TECHNICAL MANUAL AND ALSO THE RATINGS ON THE EQUIPMENT RATING LABEL.**

#### 3.1 Allocation of terminals

It is necessary to consult the appropriate wiring diagram provided in the APPENDIX 1 of the Technical Guide whilst observing the various polarities and ground/earth connection.

#### 3.2 Electrostatic discharge (ESD)

Before any handling of the module (active part of the relay), please refer to the recommendations in User guide of this Technical Guide.

#### 3.3 Visual inspection

Carefully examine the relay to see if there has been any possible deterioration following installation.

Check if the external wiring corresponds to the appropriate relay diagram or the assembly diagram. The reference number of the relay diagram is indicated on a label situated under the upper flap of the front panel.

When the relay is withdraw from its case, use a continuity tester to check if the current short-circuits (phases and earth CT's) between the terminals indicated on the wiring diagram are closed.

#### 3.4 Earthing

Check if the earth connection of the case situated above the rear terminal block is used to connect the relay to a local earth bar. With several relays present, make sure that the copper earth bar is properly installed for solidly connecting the earthing terminals of each case.

#### 3.5 Current transformers (CT's)



**WARNING: NEVER OPEN CIRCUIT THE SECONDARY CIRCUIT OF A CURRENT TRANSFORMER SINCE THE HIGH VOLTAGE PRODUCED MAY BE LETHAL AND COULD DAMAGE INSULATION.**

#### 3.6 Use of a Core CT for earth faults.

If a core CT is used to detect earth faults, prior to any test, the user must check the following points:

MV or HV cable screens and core CT,

No current flow through the MV or HV cables,

Orientation of the core CT (P1-S1, P2-S2)

##### 3.6.1 Cable shields and core CT

When mounting a core CT around electric cables, check the connection to the earth of the cable shields. It is vital that the earth cable of the shield moves in the opposite direction through the core CT. This cancel the currents carried by the cable shields through the core CT.

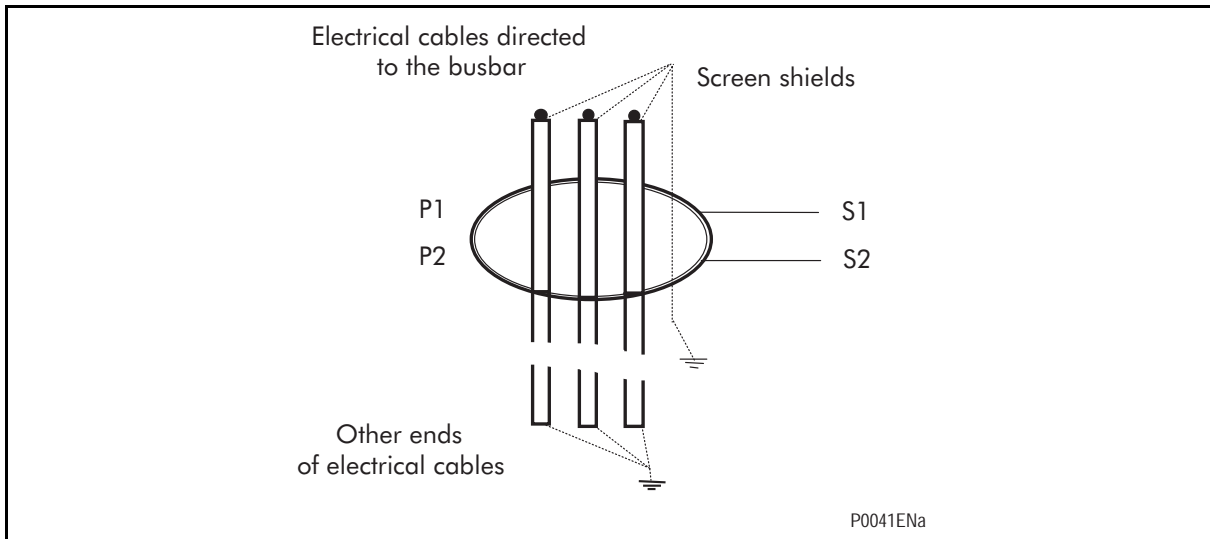

FIGURE 1: SCREEN SHIELDS AND CT CORE

3.6.2 Induced current flow through electric cables

When an electric line is earthed at its two ends for logging purposes, induced current may circulate if a second line is in parallel. This current can be read on the **MiCOM P120, P121, P122 and P123** and produce false readings.

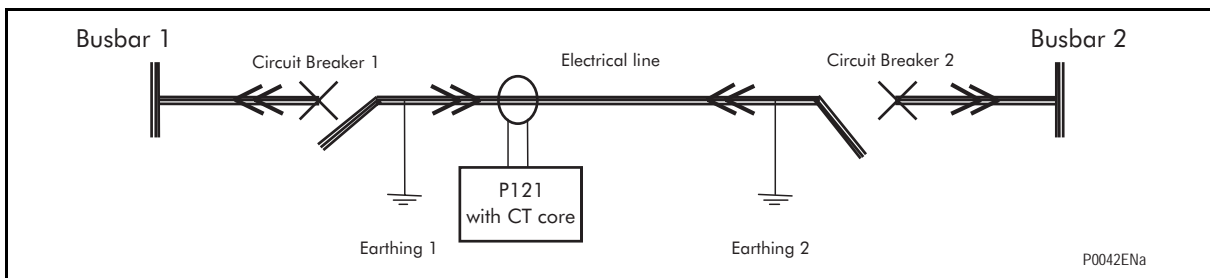

FIGURE 2: LOGGING OF AN ELECTRICAL LINE

3.6.3 Core CT polarity

It is necessary to check the polarity of the core CT by following the figure below:

Momentarily connect the battery + to P1 and – to P2. The centre zero ammeter connected with + to S1 and – to S2 will deflect in the positive direction if the wiring is correct.

CT phase may be tested using the same method.

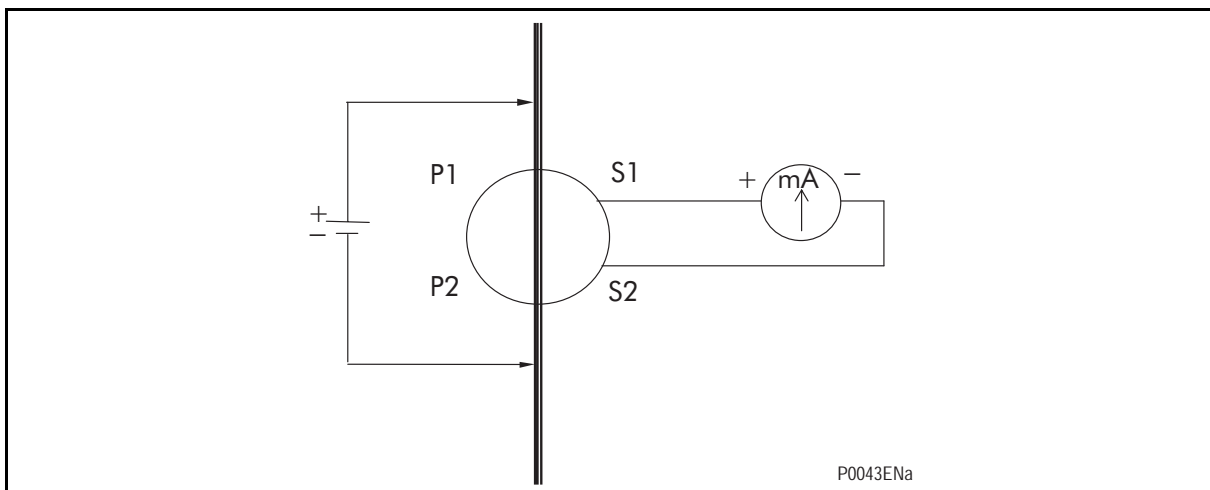

FIGURE 3: CORE CT ORIENTATION TEST

**NOTE:** De-magnetise the CT after polarity test. Inject an ac current starting from zero and increase to slowly exceed the CT nominal value and then decrease slowly to zero.

### 3.7 Auxiliary supply

Check the value of the auxiliary supply voltage (terminals 33 and 34). The value measured shall be between 0.8 and 1.2 time the dc nominal auxiliary supply voltage, or 0.8 and 1.1 time the ac nominal auxiliary supply voltage indicated on **MiCOM P120, P121, P122 and P123**.

Uaux range (Volts)	Uaux nominal zone (Volts)	Maximum peak value (Volts)
24 - 60 Vdc	19 - 72 Vdc	80
48 - 250 Vdc/48 - 250 Vac	38 - 300 Vdc/38 - 275 Vac	336

### 3.8 Logic inputs

This test checks that all the opto-isolated inputs are functioning correctly. The P123 have 5 opto-isolated inputs while P122 relays have 3 opto-isolated inputs and P120/P121 have 2 logic opto-isolated inputs.

The opto inputs should be energised on at a time. The status of the input can be viewed using menu OP. PARAMETERS/Input Status, an 1 indicating an energised input and a 0 indicating a de-energised input. When each logic input is energised one of the characters on the bottom line of the menu display will change to the value show in the following table to indicate the new state of the inputs.

Input	MiCOM P12x models	OP. PARAMETERS/Inputs Status cell value
Opto input 1 22-24 Terminals	P120,P121, P122, P123	00001
Opto input 2 26-28 Terminals	P120,P121, P122, P123	00010
Opto input 3 17-19 Terminals	P122, P123	00100
Opto input 4 21-23 Terminals	P123	01000
Opto input 5 25-27 Terminals	P123	10000

### 3.9 Logic outputs

This test checks that all outputs are functioning correctly. The P123 have 9 outputs while P122 relays have 7 outputs and P120/P121 have 5 outputs.

For all MiCOM relays, the WATCHDOG output is a normally close relays and is designed as WD (35-36), (normally open pin terminals 35-37).

For all MiCOM relays, the RL1 and RL2 are change-over relays (2-4-6, 8-10-12).

For all MiCOM relays, the RL3 and RL4 are normally open relays (14-16, 18-20).

For MiCOM P122 and P123 relays, the RL5 and RL6 are normally open relays (1-3, 5-7).

For MiCOM P123 relay, the RL7 and RL8 are normally open relays (9-11, 13-15).

Each output contact may have its own and independent power supply (refer to wiring schemes).

The status of the outputs can be viewed using menu OP. PARAMETERS/ Relay Status, an 1 indicating an close output relay and a 0 indicating a open output relay. When each output

relay is closed one of the characters on the bottom line of the menu display will change to the value show in the following table to indicate the new state of the inputs.

OUTPUT	MiCOM P12x models	OP. PARAMETERS/Relay Status cell value
RL 1	P120,P121, P122, P123	00000001
RL 2	P120,P121, P122, P123	00000010
RL 3	P120,P121, P122, P123	00000100
RL 4	P120,P121, P122, P123	00001000
RL 5	P122, P123	00010000
RL 6	P122, P123	00100000
RL 7	P123	01000000
RL 8	P123	10000000

### 3.10 RS 485 rear communication

This test should only be performed where the relay is to be accessed from a remote location and will vary depending on the communication protocol being adopted (refer to label under the upper flap).

It is not the intention of the test to verify the operation of the complete system from the relay to the remote location, just the relay's rear communication port and any protocol converter necessary.

Connect a laptop PC to the RS485 rear port (via a KITZ for Courier communication) and check the communication with the appropriate command.

## 4. SETTING CHECK

The setting checks ensure that all of the application-specific relay setting for the particular installation have been correctly applied to the relay.

Transfer the setting file to the relay using a laptop PC running the appropriate software via the RS232 front port (all MiCOM P12x models) or the RS485 rear port (all MiCOM models). This method is preferred transfer function settings because it is much faster and there is less margin for error.

If the setting software is not used then enter manually via the relay front panel interface.

The commissioning is following the points below:

- Consignation of the settings
- Validation of the measurements
- Validation of the thresholds and associated timers.

### 4.1 Settings

Carry forward the settings on the commissioning test sheets.

### 4.2 Measurements

The **MiCOM P120, P121, P122 and P123** relays measure phase and earth currents (P120 only one phase or earth) as a True RMS value up to the 10<sup>th</sup> harmonics. The value(s) indicated take account of the phase and/or earth CT ratio.



**WARNING: MiCOM P120, P121, P122 AND P123 RELAYS HAVE 1 AND 5 AMP CURRENT INPUTS. CHECK THAT THE INJECTED CURRENT IS COMPATIBLE WITH THE SELECTED RANGE.**

#### 4.2.1 MiCOM P120

- Note the select CT ratio.
- Energise the **MiCOM P120** relay.
- Apply current to input terminals 55-56 or 47-48 and verify the value on the LCD display.
- Carry forward the results to the Commissioning test sheets (Applied value and relay value displayed)

#### 4.2.2 MiCOM P121, P122 and P123

- Note the select phase and earth CTs ratio.
- Energise the **MiCOM P121, P122 or P123** relay.
- Apply current to input (as per wiring diagram) and verify the values on the LCD display.
- Carry forward the results to the Commissioning test sheets (Applied values and relay values displayed).

**4.3 Phase overcurrent ( $I_e >$  and  $I_e >>$ )**

Set the various thresholds on the trip output (refer to User Guide). For **MiCOM P120**, the same test can be performed for the phase/earth threshold.

**4.3.1 Test wiring diagram**

This test wiring diagram makes it possible to conduct tests relating to the  $I_e >$  and  $I_e >>$  thresholds.

The diagram describes current injection onto the 5 Amp phase current inputs (terminals 41-42, 43-44, 45-46). To carry out injection for the 1 Amp phase inputs, perform the same test on the 1 Amp inputs (terminals 49-50, 51-52, 53-54).

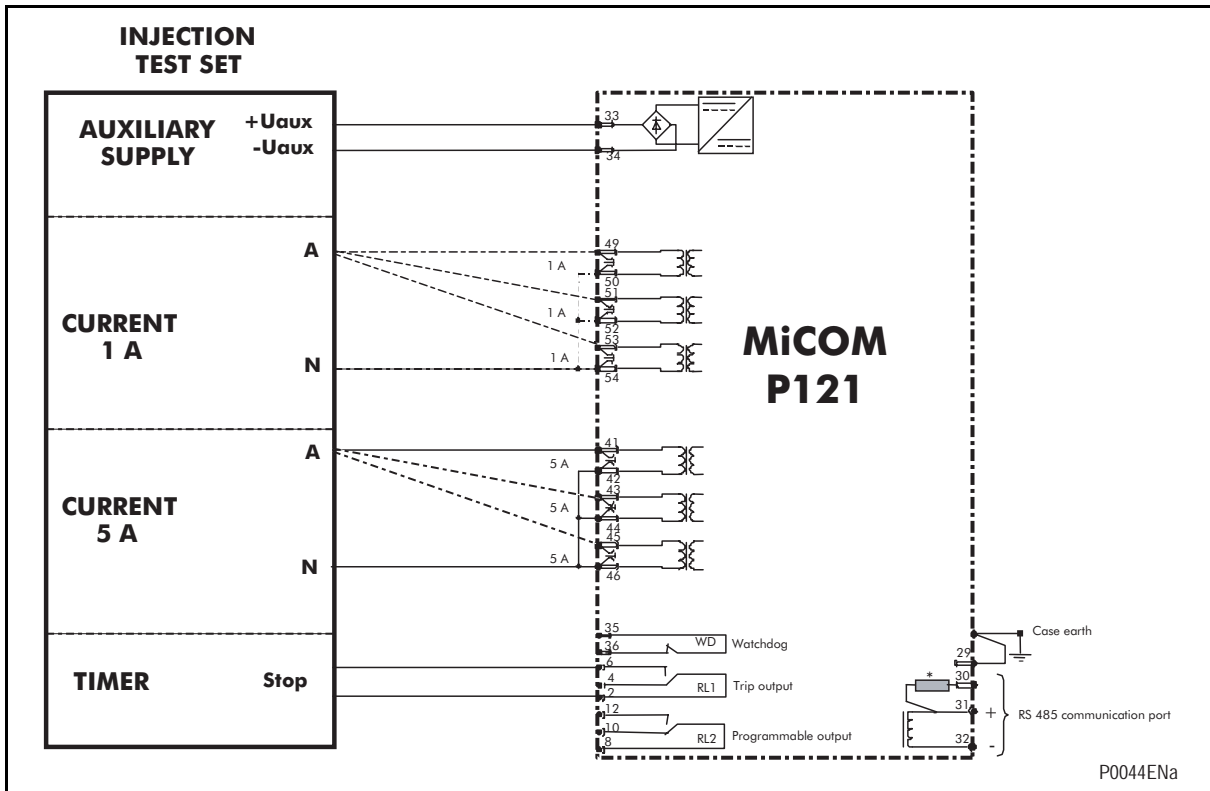

FIGURE 4:  $I_e >$  AND  $I_e >>$  TESTS WIRING

**4.3.2 MiCOM settings**

**4.3.2.1 MiCOM P120 Settings**

Protection Menu

$I_e >$	YES
$I_e >$	1 $I_n$
$t_{I_e >}$	DMT or IDMT or RI
$t_{I_e >}$ (if DMT)	20 s
Type of curve (if IDMT)	IEC VI or IEEE VI
TMS value (if IDMT)	1
K value (if RI)	1
$I_e >>$	YES
$I_e >>$	12 $I_n$
$t_{I_e >>}$	10 s



AUTOMAT. CTRL/Trip commands Menu

TRIP $t_{le}>$	YES
TRIP $t_{le}>>$	YES

## 4.3.2.2 MiCOM P121, P122 and P123 settings

Protection Menu

$I>$	YES
$I>$	1 $I_n$
$tI>$	DMT or IDMT or RI
$tI>$ (if DMT)	20 s
Type of curve (if IDMT)	IEC VI or IEEE VI
TMS value (if IDMT)	1
K value (if RI)	1
$I>>$	YES
$I>>$	12 $I_n$

AUTOMAT. CTRL/Trip commands Menu

TRIP $tI>$	YES
TRIP $tI>>$	YES

4.3.3  $I>$  threshold with DMT  $tI>$ **Values to be recorded:**

$I>$  threshold for each phase

Time delay  $tI>$  for each phase.

 **$I>$  threshold check:**

If the time delay  $tI>$  is short, gradually increase the injection current up to the value of the  $I>$  threshold.

If the time delay  $tI>$  is long, inject  $0.95 \times I$  threshold and check that there is no tripping. Then inject  $1.1 \times I$  threshold and check the trip.

Gradually decreases the injected current and record the value of the drop out  $I>$  threshold.

**Checks:**

Alarm message on the LCD display.

Alarm LED flashes.

Trip LED on

$I>$  threshold LED on (if programmed).

Trip output closes.

$I>$  threshold output closes (if programmed).

 **$tI>$  time delay check:**

Apply a current onto one of the phases and measure the time delay  $tI>$  by pre-setting the current above the  $I>$  threshold ( $I$  injected  $> 2 \times I$  threshold).

Apply a current onto one of the phases and measure the time delay  $tI>$  by pre-setting the current above the  $I>$  threshold ( $I$  injected  $> 10 \times I$  threshold).

## 4.3.4 I&gt; threshold with IDMT tI&gt;

**Values to be recorded:**

I&gt; threshold for each phase

tI&gt;time delay for each phase.

**I> threshold check:**

Inject a current equal to 2 x I threshold onto one of the phase current inputs. Repeat the operation for various current values (n x I threshold with n ranging from 4 to 10, for example). Check that the values measured correspond to those indicated in the table below (for TMS = 1).

**IEC curves**

Type of curve	Tripping time (in seconds) for TMS =1					
	2 x I threshold			10 x I threshold		
IEC	Nominal	Min	Max	Nominal	Min	Max
Accuracy	+/- 12.5 % for nominal tripping time greater than 40ms. +/- 50 ms for nominal tripping time less than 40ms.			+/- 5 % for nominal tripping time greater than 40ms. +/- 20 ms for nominal tripping time less than 40ms.		
STI	1.78	1.56	2.00	0.518	0.492	0.544
SI	10.03	8.78	11.28	2.971	2.822	3.119
VI	13.5	11.81	15.19	1.5	1.425	1.575
EI	26.67	23.33	30.00	0.808	0.7676	0.8484
LTI	120	105.0	135.0	13.33	12.667	14.00

**IEEE/ANSI curves**

Type of curve	Tripping time (in seconds) for TMS =1					
	2 x I threshold			10 x I threshold		
IEEE/ANSI	Nominal	Min	Max	Nominal	Min	Max
Accuracy	+/- 12.5 % for nominal tripping time greater than 40ms. +/- 50 ms for nominal tripping time less than 40ms.			+/- 5 % for nominal tripping time greater than 40ms. +/- 20 ms for nominal tripping time less than 40ms.		
STI (CO2)	1.7319	1.515	1.948	0.5249	0.4987	0.5512
MI	3.8032	3.328	4.279	1.2068	1.1464	1.2671
LTI (CO8)	2.1633	1.893	2.434	0.2401	0.2201	0.2601
VI	7.0277	6.149	7.906	0.6891	0.6546	0.7235
EI	9.5215	8.33	10.71	0.4063	0.3860	0.4267

**RI electromechanical curve**

Type of curve	Tripping time (in seconds) for K =1			
	2 x I threshold		10 x I threshold	
Electromechanical	Nominal	Min - Max	Nominal	Min - Max
RI	4.5	4 - 5	3.2	2.8 - 3.6

**Rectifier curve**

Type of curve	Tripping time (in seconds) for TMS =1			
	2 x I threshold		10 x I threshold	
Rectifier	Nominal	Min - Max	Nominal	Min - Max
RC	966	917 - 1014	0.402	0.382 - 0.422

**RXIDG curve**

Type of curve	Tripping time (in seconds)			
	2 x I threshold		10 x I threshold	
	Nominal	Min - Max	Nominal	Min - Max
RXIDG with k = 0.3	3.24	2.84 – 3.65	1.07	1.02 – 1.12
RXIDG with k = 0.4	3.63	3.18 – 4.08	1.45	1.38 – 1.52
RXIDG with k = 0.5	3.93	3.44 – 4.42	1.76	1.67 – 1.85
RXIDG with k = 0.6	4.17	3.65 – 4.69	2.00	1.90 – 2.10
RXIDG with k = 0.7	4.38	3.83 – 4.93	2.21	2.10 – 2.32
RXIDG with k = 0.8	4.56	3.99 – 5.13	2.39	2.27 – 2.51
RXIDG with k = 0.9	4.72	4.13 – 5.31	2.55	2.42 – 2.68
RXIDG with k = 1	4.86	4.25 – 5.47	2.69	2.56 – 2.82

For other injected current values, compare the values found with the theoretical values calculated according to the formulae of the curves.

NOTE: Equations of IEC, IEEE/ANSI, RI, RC and RXIDG curves are given in Chapter "Application Guide" of the present Technical Guide.

**Checks:**

Display of an alarm message on the front panel LCD.

Alarm LED flashes.

Trip LED on

I> threshold LED on (if programmed).

Trip output closes.

I> threshold output closes (if programmed).

## 4.3.5 I&gt;&gt; threshold

**Values to be recorded**

I>> threshold for each phase

tl>> time delay for each phase

**I>> threshold check:**

If tl>> time delay is short, gradually raise the injection current up to the value of I>> threshold.

If tl>> time delay is long, inject 0.95 x I threshold and check there is no trip. Then inject 1.1 x I threshold and check the trip output is close.

Gradually lower the injected current and note the value of the drop out I>> threshold.

**Checks:**

Display of an alarm message on the front panel LCD.

Alarm LED flashes

Trip LED on

I>> threshold LED on (if programmed).

Trip output closes.

I>> threshold output closes (if programmed).

**tl>> time delay check:**

Apply a current onto one of the phases and measure the time delay tl>> by pre-setting the current above the I>> threshold (I injected > 2 x I threshold).

Apply a current onto one of the phases and measure the time delay tl>> by pre-setting the current above the I>> threshold (I injected > 10 x I threshold).

**4.4 Final checks**

The tests are now complete. Remove all test or temporary shorting leads, etc... If it is necessary to disconnect any of the external wiring from the relay in order to perform the wiring verification tests, it should be ensured that all connections are replaced in accordance with the relevant external connection or scheme diagram.

If a MMLG test block is installed, remove the MMLB01 test plug and replace the MMLG cover so that the protection is put into service.

Ensure that all event, fault and disturbance records, alarm and LEDs have been reset before leaving the relay.

For **MiCOM P123**, if the relay is in a new installation or the circuit breaker has been just maintained, the circuit breaker maintenance and current counters should be zero. These counters can be reset using command in RECORD/CB Monitoring menu (refer to User Guide).

---

## 5. MAINTENANCE

### 5.1 Equipment failure

**MiCOM P120, P121, P122 and P123** relays are full digital and self-diagnosing. As soon as an internal fault is detected, depending on its type (minor or major), an alarm message is displayed as a priority on the front panel LCD before the fault LED is illuminated (fixed or flashing) and the watchdog relay is closed (if the fault is a major one).

The watchdog facility provides two output relay contacts, one normally open and one normally closed that are driven by the processor board. These are provided to give an indication that the relay is in a healthy state.

An equipment failure (major or minor) cannot be acknowledged on the front panel (using the dedicated tactile button keypad). Only the disappearance of the cause will acknowledge the fault and hence reset the fault LED.

All tests are performed during relay boot and permanently in the background software task excepted volatile memory tests performed only when relay boots and on any setting change.

#### 5.1.1 Minor fault

Regarded by the **MiCOM P120, P121, P122 and P123** relays as a minor fault is a communication failure. If the communication is in fault, **MiCOM P120, P121, P122 and P123** protection and automation modules are not affected. The MiCOM relay is fully operational. The watchdog relay is energised (35-36 contact open and 36-37 contact closed).

**Message:**

"COMM.ERROR": Communication fault

**Cause:**

Hardware or software failure of the communication module

**Action:**

Withdraw the active part and return it to the factory for repair.

*Alternative:* If communication is not used, disable communication in the COMMUNICATION menu (Communication ? = No).

#### 5.1.2 Major fault

Major fault for **MiCOM P120, P121, P122 and P123** relays are all software and hardware failures except the communication faults. As soon as this type of failure is detected, the watchdog (WD) is de-energised (35-36 contact closed and 36-37 contact open) and all operations are stopped (protection, automation, communication).

#### 5.1.3 Hardware and software faults

**Messages:**

"DEFAULT SETTING": Indication that the relay is running with default setting

"SETTING ERROR": Failure in the setting

" CALIBRATION ERROR.": Calibration zone failure

"CT ERROR": Analogue channel failure

**Cause:**

Hardware or software failure

**Action:**

Restart the protection software (refer § 5.3).

If the software fault still remain after restart, withdraw the active part and return the module to the factory for repair.

## 5.2 Method of repair

### 5.2.1 Replacing the active part



**BEFORE CARRYING OUT ANY WORK ON THE EQUIPMENT, THE USER SHOULD BE FAMILIAR WITH THE CONTENTS OF THE SAFETY GUIDE SFTY/4LM/E11 OR LATER ISSUE, OR THE SAFETY AND TECHNICAL DATA SECTIONS OF THE TECHNICAL MANUAL AND ALSO THE RATINGS ON THE EQUIPMENT RATING LABEL.**

The case and the rear terminals blocks have been designed to facilitate removal of the MiCOM P12x relay should replacement or repair become necessary without disconnect the scheme wiring.

**NOTE:** The MiCOM range of relays have integral current transformer shorting switches which will close when the active part is removed from the case.

Remove the upper and lower flap without exerting excessive force. Remove the external screws. Under the upper flap, turn the extractor with a 3 mm screwdriver and extract the active part of the relay by pulling from the upper and lower notches on the front panel of the MiCOM relay.

The reinstall the repaired or replacement relay follow the above instruction in reverse, ensuring that no modification has been done on the scheme wiring.

On completion of any operations which require the relay to be removed from its case, verify that the four fixing screws are fitted at the corners of the front panel, under the flaps. These screws secure the chassis (removable part) to the relay case, ensuring good seating/contact.

### 5.2.2 Replacing the complete relay

To remove the complete relay (active part and case) the entire wiring must be removed from the rear connector.

Before working at the rear of the relay, isolate all current supplies to the MiCOM relay and ensure that the relay is no more powered.



**WARNING: NEVER OPEN THE SECONDARY CIRCUIT OF A CURRENT TRANSFORMER SINCE THE HIGH VOLTAGE PRODUCED MAY BE LETHAL AND COULD DAMAGE to the INSULATION.**

Remove all wiring (communication, logic inputs, outputs, auxiliary voltage, current inputs). Disconnect the relay earth connection from the rear of the relay.

Remove the screws used to fasten the relay to the panel, rack, etc... .These are the screws with the larger diameter heads that are accessible when the upper and lower flaps are installed.

Withdraw the relay from the panel, rack, etc... carefully because it will be heavy due to the internal transformers.

To reinstall the repaired or replacement relay follow the above instructions reverse, ensuring that each terminal block is relocated in the correct position and case earth, communication are replaced.

Once reinstallation is complete the relay should be recommissioned using the instruction in sections 1 to 4 inclusive of this chapter.

### 5.3 Problem solving

#### 5.3.1 Password lost or not accepted

**Problem:**

Password lost or not accepted

**Cause:**

**MiCOM P120, P121, P122 and P123** relays are supplied with the password set to **AAAA**. This password can be changed by the user ( refer OP PARAMETERS menu).

**Action:**

There is an additional unique recovery password associated to the relay which can be supplied by the factory or service agent, if given details of its serial number (under the upper flap of the front panel). With this serial number, contact your Schneider Electric local dealer or Schneider Electric Customer Care Center.

#### 5.3.2 Communication

##### 5.3.2.1 Values measured locally and remotely

**Problem:**

The measurements noted remotely and locally (via RS485 communication) differ.

**Cause:**

The values accessible on the front face via the Measurement menu are refreshed every second. Those fed back via the communication and accessible by the Schneider Electric Business Setting software generally have skeletal refreshing frequencies. If the refreshing frequency of the supervision software differs from that of **MiCOM P120, P121, P122 and P123** relays (1s), there may be a difference between indicated values.

**Action:**

Adjust the frequency for refreshing the measurements of the supervision software or of the setting software to 1 second.

##### 5.3.2.2 MiCOM relay no longer responds

**Problem:**

No response from **MiCOM P120, P121, P122 and P123** relays when asked by the supervision software without any communication fault message.

**Cause:**

Mainly, this type of problem is linked to an error in the **MiCOM P120, P121, P122 and P123** communication parameters.

**Action:**

Check **MiCOM P120, P121, P122 and P123** communication parameters (data rate, parity, etc.) are in accordance with the supervision settings.

Check **MiCOM P120, P121, P122 and P123** network address.

Check that this address is not used by another device connected on the same LAN.

Check that the other devices on the same LAN answer to supervision requests.

### 5.3.2.3 A remote command is not taken in account

**Problem:**

The communication between the relay and the PC is correct, but the relay does not accept any remote command or file downloading.

**Cause:**

Generally this is due to the fact that the relay is in programming situation. This means that the password is active.

**Action:**

Check that the password is not active in the relay since the last 5 minutes.



# **CONNECTION DIAGRAMS**





**BEFORE CARRYING OUT ANY WORK ON THE EQUIPMENT, THE USER SHOULD BE FAMILIAR WITH THE CONTENTS OF THE SAFETY GUIDE SFTY/4LM/E11 OR LATER ISSUE, OR THE SAFETY AND TECHNICAL DATA SECTION OF THE TECHNICAL MANUAL AND ALSO THE RATINGS ON THE EQUIPMENT RATING LABEL."**

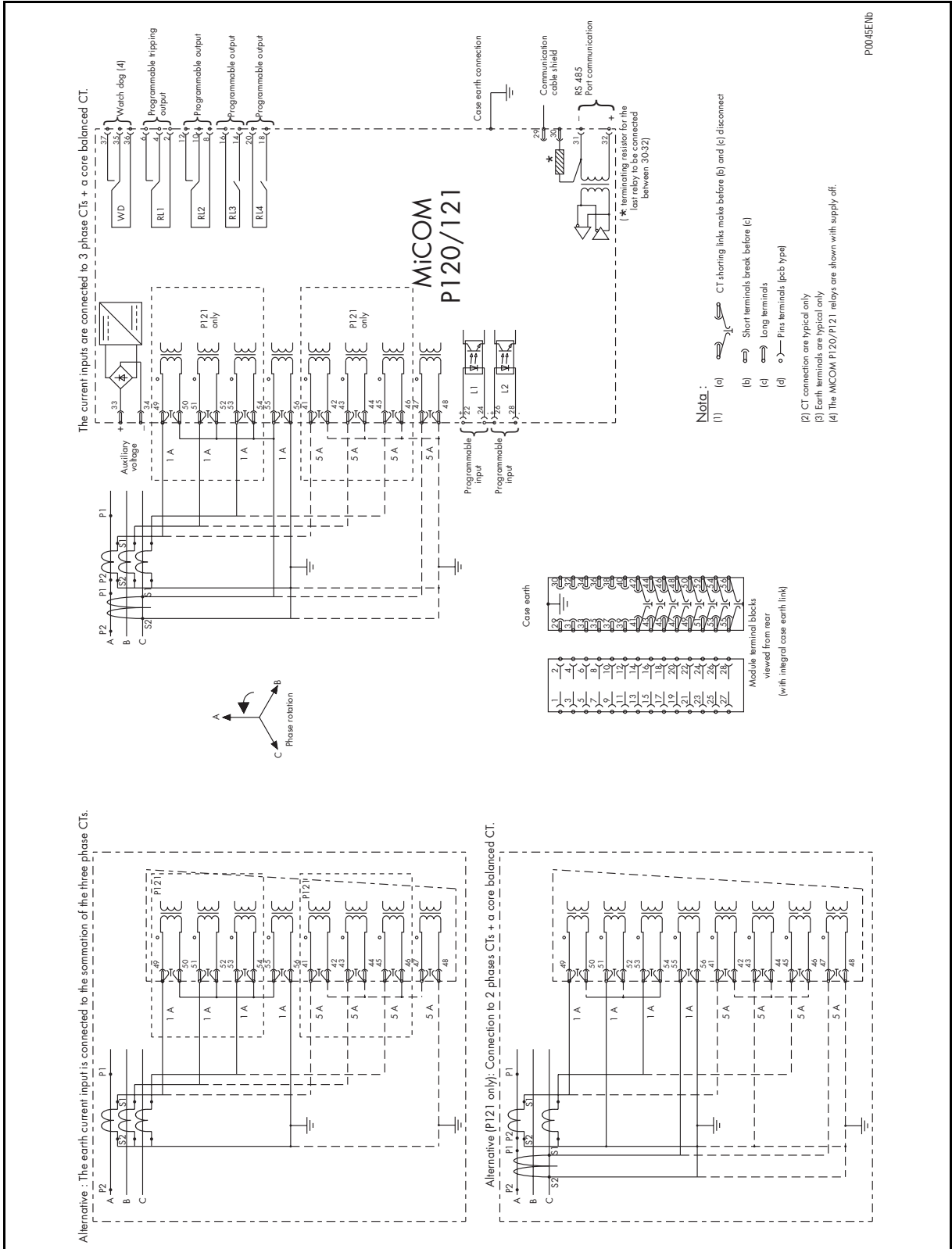

FIGURE 1: SCHEME REPRESENTING MiCOM RELAY OFF

**NOTE:** On P120 relay models, CT's must only be connected to terminals 55 & 56, or 47 & 48.

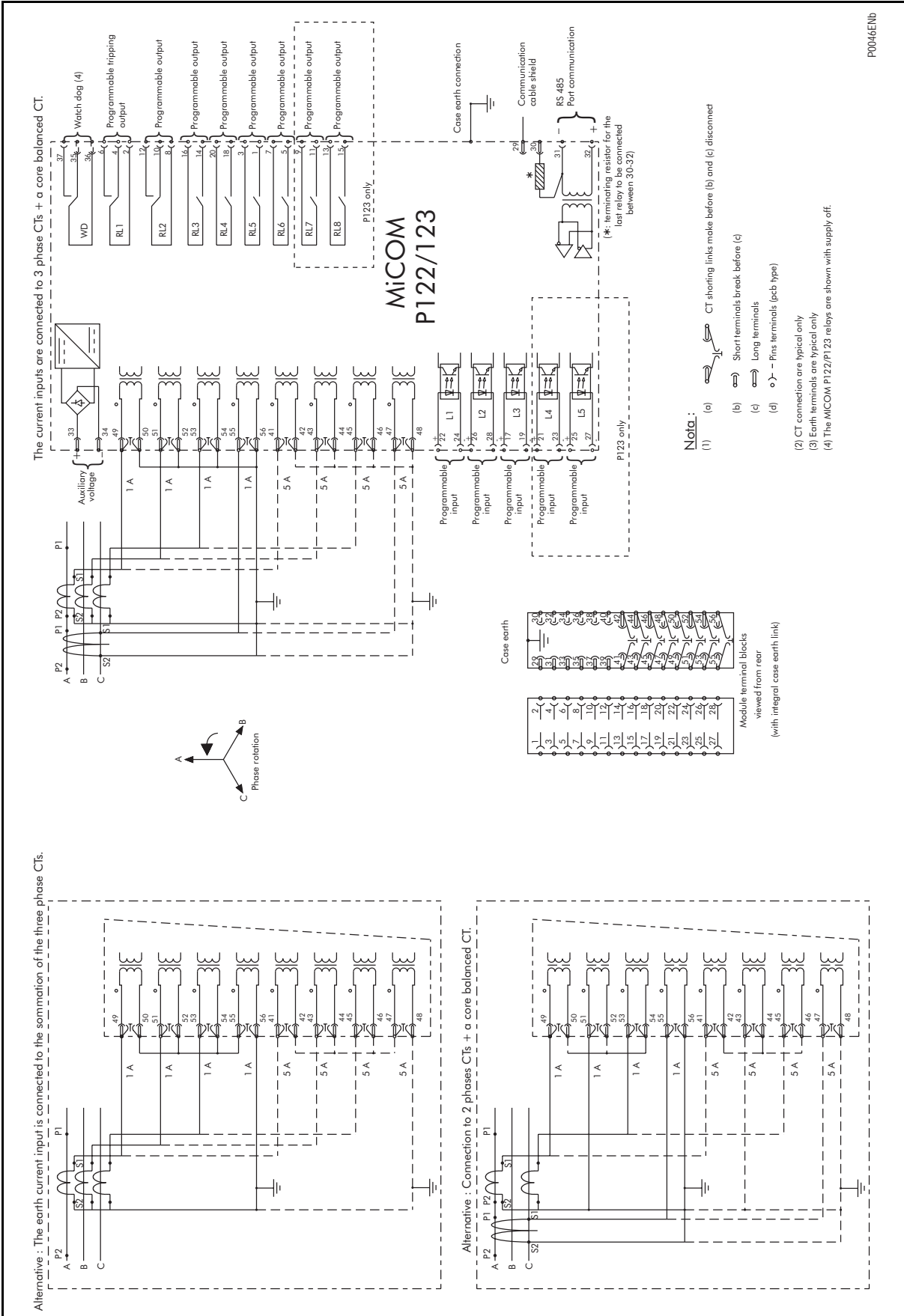

FIGURE 2: SCHEME REPRESENTING MICOM RELAY OFF

# **COMMISSIONING TEST & RECORD SHEETS**



# CONTENTS

<b>1.</b>	<b>COMMISSIONING TEST SHEETS</b>	<b>3</b>
1.1	Relay identification	3
1.2	Commissioning test record	3
<b>2.</b>	<b>COMMISSIONING SETTING RECORD SHEETS</b>	<b>6</b>
2.1	<b>OP PARAMETERS Menu</b>	<b>6</b>
2.2	<b>ORDERS menu</b>	<b>6</b>
2.3	<b>CONFIGURATION Menu</b>	<b>6</b>
2.3.1	Display	6
2.3.2	CT Ratio	6
2.3.3	LEDs 5 to 8 configuration	7
2.3.4	Group select configuration	8
2.3.5	Alarms configuration	8
2.3.6	Inputs configuration	9
2.3.7	Relays maintenance	9
2.3.8	Phase rotation configuration	9
2.4	<b>COMMUNICATION Menu</b>	<b>10</b>
2.4.1	COMMUNICATION Menu (MODBUS)	10
2.4.2	COMMUNICATION Menu (Courier)	10
2.4.3	COMMUNICATION Menu (DNP3)	10
2.5	<b>PROTECTION G1 Menu</b>	<b>11</b>
2.5.1	Phase Overcurrent [50/51]	11
2.5.2	Earth Overcurrent [50N/51N]	12
2.5.3	[46] NEGATIVE PHASE SEQUENCE OVERCURRENT I2>	15
2.5.4	[46] Negative phase sequence overcurrent I2>	15
2.5.5	[46] Negative phase sequence overcurrent I2>>	16
2.5.6	[49] THERMAL OVERLOAD	16
2.5.7	[37] UNDERCURRENT I<	17
2.5.8	[79] AUTORECLOSER	17
2.6	<b>PROTECTION G2 Menu</b>	<b>19</b>
2.6.1	Phase Overcurrent [50/51]	19
2.6.2	Earth Overcurrent [50N/51N]	20
2.6.3	[46] NEGATIVE PHASE SEQUENCE OVERCURRENT I2>	23
2.6.4	[46] Negative phase sequence overcurrent I2>	23
2.6.5	[46] Negative phase sequence overcurrent I2>>	24
2.6.6	[49] THERMAL OVERLOAD	24
2.6.7	[37] UNDERCURRENT I<	25
2.6.8	[79] AUTORECLOSER	25

<b>2.7</b>	<b>AUTOMAT.CTRL Menu</b>	<b>27</b>
2.7.1	TRIP Command allocation	27
2.7.2	Latch function allocation	28
2.7.3	Blocking Logic 1 function allocation	28
2.7.4	Blocking Logic 2 function allocation	29
2.7.5	Inrush Blocking Logic function allocation	29
2.7.6	Selective Scheme Logic1 function allocation	30
2.7.7	Selective Scheme Logic2 function allocation	30
2.7.8	OUTPUT RELAYS allocation	31
2.7.9	LATCH OUTPUT RELAYS allocation	33
2.7.10	LOGIC INPUT allocation	33
2.7.11	BROKEN CONDUCTOR	34
2.7.12	Cold Load Pick up	34
2.7.13	CIRCUIT BREAKER FAILURE	35
2.7.14	CIRCUIT BREAKER SUPERVISION	35
2.7.15	SOTF	36
2.7.16	LOGIC EQUATIONS	36
<b>2.8</b>	<b>RECORDING Menu</b>	<b>41</b>
2.8.1	CB MONITORING Record	41
2.8.2	FAULT RECORD Record	41
2.8.3	INSTANTANEOUS Record	41
2.8.4	DISTURBANCE RECORD	41
2.8.5	TIME PEAK VALUE	42
2.8.6	ROLLING DEMAND	42



**1. COMMISSIONING TEST SHEETS**



**BEFORE CARRYING OUT ANY WORK ON THE EQUIPMENT, THE USER SHOULD BE FAMILIAR WITH THE CONTENTS OF THE SAFETY GUIDE SFTY/4LM/D11 OR LATER ISSUE, OR THE SAFETY AND TECHNICAL DATA SECTION OF THE TECHNICAL MANUAL AND ALSO THE RATINGS ON THE EQUIPMENT RATING LABEL.**

**1.1 Relay identification**

Commissioning date: \_\_\_\_\_

Engineer: \_\_\_\_\_

Substation: \_\_\_\_\_

Circuit: \_\_\_\_\_

Network nominal frequency: \_\_\_\_\_

MiCOM Overcurrent relay model:  P120     P121     P122     P123

Serial number: \_\_\_\_\_

Rated current In: \_\_\_\_\_

Auxiliary voltage Uaux: \_\_\_\_\_

Communication protocol: \_\_\_\_\_

Language: \_\_\_\_\_

**1.2 Commissioning test record**

(put a cross after each checked stage)

Serial number check ?

All current transformer shorting switches closed ?

Wiring checked against diagram (if available) ?

Case earth installed ?

Test block connections checked (if installed) ?

Insulation tested ?

**Auxiliary supply control**

Auxiliary voltage to relay



Auxiliary voltage value

\_\_\_\_\_ Vdc/Va

Watchdog contacts



With auxiliary supply off

Terminals 35 and 36



With auxiliary supply on

Terminals 35 and 36



**Measurements**

**Applied value**

**Relay value**

**PHASE CT INPUT**

Phase A current

\_\_\_\_\_ A

\_\_\_\_\_ A

Phase B current

\_\_\_\_\_ A

\_\_\_\_\_ A

Phase C current

\_\_\_\_\_ A

\_\_\_\_\_ A

**EARTH CT INPUT**

Earth current

\_\_\_\_\_ A

\_\_\_\_\_ A

**Phase protection test**

**Theoretical value**

**Relay value**

I> threshold

\_\_\_\_\_ A

I> threshold

\_\_\_\_\_ A

I> drop threshold

\_\_\_\_\_ A

Time delay

Time delay at 2 x I>

\_\_\_\_\_ ms

\_\_\_\_\_ A

Time delay at 10 x I>

\_\_\_\_\_ ms

\_\_\_\_\_ A

I>> threshold

\_\_\_\_\_ A

I>> threshold

\_\_\_\_\_ A

I>> drop threshold

\_\_\_\_\_ A

Time delay

Time delay at 2 x I>>

\_\_\_\_\_ A

\_\_\_\_\_ A

Time delay at 10 x I>>

\_\_\_\_\_ A

\_\_\_\_\_ A

**Earth protection test**

**Theoretical value**

**Relay value**

$I_e >$  threshold

\_\_\_\_\_ A

$I_e >$  threshold

\_\_\_\_\_ A

$I_e >$  drop threshold

\_\_\_\_\_ A

Time delay

Time delay at  $2 \times I_e >$

\_\_\_\_\_ ms

\_\_\_\_\_ ms

Time delay at  $10 \times I_e >$

\_\_\_\_\_ ms

\_\_\_\_\_ ms

$I_e >>$  threshold

\_\_\_\_\_ A

$I_e >>$  threshold

\_\_\_\_\_ A

$I_e >>$  drop threshold

\_\_\_\_\_ A

Time delay

Time delay at  $2 \times I_e >>$

\_\_\_\_\_ ms

\_\_\_\_\_ ms

Time delay at  $10 \times I_e >>$

\_\_\_\_\_ ms

\_\_\_\_\_ ms

**Commissioning Engineer**

**Date**

\_\_\_\_\_

\_\_\_\_\_

## 2. COMMISSIONING SETTING RECORD SHEETS

### 2.1 OP PARAMETERS Menu

Password: \_\_\_\_\_

Reference: \_\_\_\_\_

Software version: \_\_\_\_\_

Frequency:  50 Hz  60 Hz

### 2.2 ORDERS menu

<b>Relay:</b>	<input type="checkbox"/>	P120 (not available)	
	<input type="checkbox"/>	P121 (not available)	
<b>Open order</b>	<input type="checkbox"/>	YES	<input type="checkbox"/> NO
<b>Close Order</b>	<input type="checkbox"/>	YES	<input type="checkbox"/> NO
<b>Disturb Rec Start</b>	<input type="checkbox"/>	YES	<input type="checkbox"/> NO

### 2.3 CONFIGURATION Menu

#### 2.3.1 Display

<b>Phase A Text</b>	<input type="checkbox"/>	A	<input type="checkbox"/>	L1	<input type="checkbox"/>	R
<b>Phase B Text</b>	<input type="checkbox"/>	B	<input type="checkbox"/>	L2	<input type="checkbox"/>	S
<b>Phase C Text</b>	<input type="checkbox"/>	C	<input type="checkbox"/>	L3	<input type="checkbox"/>	T
<b>E/Gnd Text</b>	<input type="checkbox"/>	N	<input type="checkbox"/>	E	<input type="checkbox"/>	G

#### 2.3.2 CT Ratio

<b>Line CT Primary</b>	Primary phase CT ratio		
<b>Line CT Secondary</b>	Secondary phase CT ratio	<input type="checkbox"/> 1 A	<input type="checkbox"/> 5 A
<b>E/Gnd CT Primary</b>	Primary earth CT ratio		
<b>E/Gnd CT Secondary</b>	Secondary earth CT ratio	<input type="checkbox"/> 1 A	<input type="checkbox"/> 5 A

2.3.3 LEDs 5 to 8 configuration

• = available with this model.

Functions	P120	P121	P122	P123	LED 5	LED 6	LED 7	LED 8
					Yes	Yes	Yes	Yes
lv	•	•	•	•	<input type="checkbox"/>	<input type="checkbox"/>	<input type="checkbox"/>	<input type="checkbox"/>
lv>	•	•	•	•	<input type="checkbox"/>	<input type="checkbox"/>	<input type="checkbox"/>	<input type="checkbox"/>
lv>>	•	•	•	•	<input type="checkbox"/>	<input type="checkbox"/>	<input type="checkbox"/>	<input type="checkbox"/>
tlv	•	•	•	•	<input type="checkbox"/>	<input type="checkbox"/>	<input type="checkbox"/>	<input type="checkbox"/>
tlv>	•	•	•	•	<input type="checkbox"/>	<input type="checkbox"/>	<input type="checkbox"/>	<input type="checkbox"/>
tlv>>	•	•	•	•	<input type="checkbox"/>	<input type="checkbox"/>	<input type="checkbox"/>	<input type="checkbox"/>
lev	•	•	•	•	<input type="checkbox"/>	<input type="checkbox"/>	<input type="checkbox"/>	<input type="checkbox"/>
lev>	•	•	•	•	<input type="checkbox"/>	<input type="checkbox"/>	<input type="checkbox"/>	<input type="checkbox"/>
lev>>	•	•	•	•	<input type="checkbox"/>	<input type="checkbox"/>	<input type="checkbox"/>	<input type="checkbox"/>
tlev	•	•	•	•	<input type="checkbox"/>	<input type="checkbox"/>	<input type="checkbox"/>	<input type="checkbox"/>
tlev>	•	•	•	•	<input type="checkbox"/>	<input type="checkbox"/>	<input type="checkbox"/>	<input type="checkbox"/>
tlev>>	•	•	•	•	<input type="checkbox"/>	<input type="checkbox"/>	<input type="checkbox"/>	<input type="checkbox"/>
lev>>>			•	•	<input type="checkbox"/>	<input type="checkbox"/>	<input type="checkbox"/>	<input type="checkbox"/>
tlev>>>			•	•	<input type="checkbox"/>	<input type="checkbox"/>	<input type="checkbox"/>	<input type="checkbox"/>
lv<			•	•	<input type="checkbox"/>	<input type="checkbox"/>	<input type="checkbox"/>	<input type="checkbox"/>
tlv<			•	•	<input type="checkbox"/>	<input type="checkbox"/>	<input type="checkbox"/>	<input type="checkbox"/>
Therm Trip			•	•	<input type="checkbox"/>	<input type="checkbox"/>	<input type="checkbox"/>	<input type="checkbox"/>
Brkn Cond.			•	•	<input type="checkbox"/>	<input type="checkbox"/>	<input type="checkbox"/>	<input type="checkbox"/>
CB Fail			•	•	<input type="checkbox"/>	<input type="checkbox"/>	<input type="checkbox"/>	<input type="checkbox"/>
tl2>			•	•	<input type="checkbox"/>	<input type="checkbox"/>	<input type="checkbox"/>	<input type="checkbox"/>
tl2>>			•	•	<input type="checkbox"/>	<input type="checkbox"/>	<input type="checkbox"/>	<input type="checkbox"/>
Input 1	•	•	•	•	<input type="checkbox"/>	<input type="checkbox"/>	<input type="checkbox"/>	<input type="checkbox"/>
Input 2	•	•	•	•	<input type="checkbox"/>	<input type="checkbox"/>	<input type="checkbox"/>	<input type="checkbox"/>
Input 3			•	•	<input type="checkbox"/>	<input type="checkbox"/>	<input type="checkbox"/>	<input type="checkbox"/>
Input 4				•	<input type="checkbox"/>	<input type="checkbox"/>	<input type="checkbox"/>	<input type="checkbox"/>
Input 5				•	<input type="checkbox"/>	<input type="checkbox"/>	<input type="checkbox"/>	<input type="checkbox"/>
Recloser Run				•	<input type="checkbox"/>	<input type="checkbox"/>	<input type="checkbox"/>	<input type="checkbox"/>
Recloser Blocked				•	<input type="checkbox"/>	<input type="checkbox"/>	<input type="checkbox"/>	<input type="checkbox"/>
79 int Blk				•	<input type="checkbox"/>	<input type="checkbox"/>	<input type="checkbox"/>	<input type="checkbox"/>
79 Ext Blk				•	<input type="checkbox"/>	<input type="checkbox"/>	<input type="checkbox"/>	<input type="checkbox"/>
t Aux 1	•	•	•	•	<input type="checkbox"/>	<input type="checkbox"/>	<input type="checkbox"/>	<input type="checkbox"/>
t Aux 2	•	•	•	•	<input type="checkbox"/>	<input type="checkbox"/>	<input type="checkbox"/>	<input type="checkbox"/>
t Aux 3			•	•	<input type="checkbox"/>	<input type="checkbox"/>	<input type="checkbox"/>	<input type="checkbox"/>
t Aux 4				•	<input type="checkbox"/>	<input type="checkbox"/>	<input type="checkbox"/>	<input type="checkbox"/>

Functions	P120	P121	P122	P123	LED 5	LED 6	LED 7	LED 8
					Yes	Yes	Yes	Yes
t Aux 5				•	<input type="checkbox"/>	<input type="checkbox"/>	<input type="checkbox"/>	<input type="checkbox"/>
Conf SOTF				•	<input type="checkbox"/>	<input type="checkbox"/>	<input type="checkbox"/>	<input type="checkbox"/>
tIA>				•	<input type="checkbox"/>	<input type="checkbox"/>	<input type="checkbox"/>	<input type="checkbox"/>
tIB>				•	<input type="checkbox"/>	<input type="checkbox"/>	<input type="checkbox"/>	<input type="checkbox"/>
tIC>				•	<input type="checkbox"/>	<input type="checkbox"/>	<input type="checkbox"/>	<input type="checkbox"/>
Equation A	•	•	•	•	<input type="checkbox"/>	<input type="checkbox"/>	<input type="checkbox"/>	<input type="checkbox"/>
Equation B	•	•	•	•	<input type="checkbox"/>	<input type="checkbox"/>	<input type="checkbox"/>	<input type="checkbox"/>
Equation C	•	•	•	•	<input type="checkbox"/>	<input type="checkbox"/>	<input type="checkbox"/>	<input type="checkbox"/>
Equation D	•	•	•	•	<input type="checkbox"/>	<input type="checkbox"/>	<input type="checkbox"/>	<input type="checkbox"/>
Equation E	•	•	•	•	<input type="checkbox"/>	<input type="checkbox"/>	<input type="checkbox"/>	<input type="checkbox"/>
Equation F	•	•	•	•	<input type="checkbox"/>	<input type="checkbox"/>	<input type="checkbox"/>	<input type="checkbox"/>
Equation G	•	•	•	•	<input type="checkbox"/>	<input type="checkbox"/>	<input type="checkbox"/>	<input type="checkbox"/>
Equation H	•	•	•	•	<input type="checkbox"/>	<input type="checkbox"/>	<input type="checkbox"/>	<input type="checkbox"/>

2.3.4 Group select configuration

Relay:	<input type="checkbox"/>	P120 (not available)	
	<input type="checkbox"/>	P121 (not available)	
Change group input	<input type="checkbox"/>	Menu	<input type="checkbox"/>
Setting group	<input type="checkbox"/>	1	<input type="checkbox"/>
			Input
			2

2.3.5 Alarms configuration

Relay:	<input type="checkbox"/>	P120 (not available)	
Inst. Self Reset	<input type="checkbox"/>	YES	<input type="checkbox"/>
Reset Led on fault	<input type="checkbox"/>	YES	<input type="checkbox"/>
Alarm battery	<input type="checkbox"/>	YES	<input type="checkbox"/>
			NO
			NO

Inhibited alarms	P121	P122	P123
	YES	YES	YES
tAux 1	<input type="checkbox"/>	<input type="checkbox"/>	<input type="checkbox"/>
tAux 2	<input type="checkbox"/>	<input type="checkbox"/>	<input type="checkbox"/>
tAux 3		<input type="checkbox"/>	<input type="checkbox"/>
tAux 4			<input type="checkbox"/>
tAux 5			<input type="checkbox"/>
Ctrl Trip	<input type="checkbox"/>	<input type="checkbox"/>	<input type="checkbox"/>
[79] Ext Block			<input type="checkbox"/>
I<	<input type="checkbox"/>	<input type="checkbox"/>	<input type="checkbox"/>
Equation A	<input type="checkbox"/>	<input type="checkbox"/>	<input type="checkbox"/>

Inhibited alarms	P121	P122	P123
	YES	YES	YES
Equation B	<input type="checkbox"/>	<input type="checkbox"/>	<input type="checkbox"/>
Equation C	<input type="checkbox"/>	<input type="checkbox"/>	<input type="checkbox"/>
Equation D	<input type="checkbox"/>	<input type="checkbox"/>	<input type="checkbox"/>
Equation E	<input type="checkbox"/>	<input type="checkbox"/>	<input type="checkbox"/>
Equation F	<input type="checkbox"/>	<input type="checkbox"/>	<input type="checkbox"/>
Equation G	<input type="checkbox"/>	<input type="checkbox"/>	<input type="checkbox"/>
Equation H	<input type="checkbox"/>	<input type="checkbox"/>	<input type="checkbox"/>

2.3.6 Inputs configuration

Relay:	<input type="checkbox"/>	P120 (not available)				
Relay:	<input type="checkbox"/>	P121 (not available)				
Inputs (P122 only)		3	2	1		
		<input type="checkbox"/>	<input type="checkbox"/>	<input type="checkbox"/>		
Inputs (P123 only)		5	4	3	2	1
		<input type="checkbox"/>	<input type="checkbox"/>	<input type="checkbox"/>	<input type="checkbox"/>	<input type="checkbox"/>
Voltage input DC	<input type="checkbox"/>	DC		<input type="checkbox"/>	AC	

2.3.7 Relays maintenance

Relay:	<input type="checkbox"/>	P120 (not available)								
									<input type="checkbox"/> P121 →	
									← <input type="checkbox"/> P122 →	
									← <input type="checkbox"/> P123 →	
Fail Safe Relay		8	7	6	5	4	3	2	1	
		<input type="checkbox"/>								
Maintenance Mode P122 and P123 only	<input type="checkbox"/>	YES				<input type="checkbox"/>	NO			
									← <input type="checkbox"/> P122 →	
									← <input type="checkbox"/> P123 →	
Relays CMD P122 and P123 only		8	7	6	5	W	4	3	2	1
		<input type="checkbox"/>	<input type="checkbox"/>	<input type="checkbox"/>	<input type="checkbox"/>	<input type="checkbox"/>	<input type="checkbox"/>	<input type="checkbox"/>	<input type="checkbox"/>	<input type="checkbox"/>

2.3.8 Phase rotation configuration

Relay:	<input type="checkbox"/>	P120 (not available)	
	<input type="checkbox"/>	P121 (not available)	
Phase rotation	<input type="checkbox"/>	A-B-C	<input type="checkbox"/> A-C-B

**2.4 COMMUNICATION Menu**

2.4.1 COMMUNICATION Menu (MODBUS)

<b>Communication ?</b>	<input type="checkbox"/> YES	<input type="checkbox"/> NO	
<b>Baud Rate</b>	<input type="checkbox"/> 300 bds	<input type="checkbox"/> 600 bds	
	<input type="checkbox"/> 1.200 bds	<input type="checkbox"/> 2.400 bds	
	<input type="checkbox"/> 4.800 bds	<input type="checkbox"/> 9.600 bds	
	<input type="checkbox"/> 19.200 bds	<input type="checkbox"/> 38 400 bds	
<b>Parity</b>	<input type="checkbox"/> Odd	<input type="checkbox"/> Even	<input type="checkbox"/> None
<b>Data bits</b>	<input type="checkbox"/> 7	<input type="checkbox"/> 8	
<b>Stop bits</b>	<input type="checkbox"/> 1	<input type="checkbox"/> 2	
<b>Relay Address</b>			

2.4.2 COMMUNICATION Menu (Courier)

<b>Communication ?</b>	<input type="checkbox"/> YES	<input type="checkbox"/> NO
<b>Relay Address</b>		

2.4.2.1 COMMUNICATION Menu (IEC 60870-5-103)

<b>Communication ?</b>	<input type="checkbox"/> YES	<input type="checkbox"/> NO
<b>Baud Rate</b>	<input type="checkbox"/> 300 bds	<input type="checkbox"/> 600 bds
	<input type="checkbox"/> 1.200 bds	<input type="checkbox"/> 2.400 bds
	<input type="checkbox"/> 4.800 bds	<input type="checkbox"/> 9.600 bds
	<input type="checkbox"/> 19.200 bds	<input type="checkbox"/> 38 400 bds
<b>Relay Address</b>		

2.4.3 COMMUNICATION Menu (DNP3)

<b>Communication ?</b>	<input type="checkbox"/> YES	<input type="checkbox"/> NO	
<b>Baud Rate</b>	<input type="checkbox"/> 300 bds	<input type="checkbox"/> 600 bds	
	<input type="checkbox"/> 1.200 bds	<input type="checkbox"/> 2.400 bds	
	<input type="checkbox"/> 4.800 bds	<input type="checkbox"/> 9.600 bds	
	<input type="checkbox"/> 19.200 bds	<input type="checkbox"/> 38 400 bds	
<b>Parity</b>	<input type="checkbox"/> Odd	<input type="checkbox"/> Even	<input type="checkbox"/> None
<b>Data bits</b>	<input type="checkbox"/> 7	<input type="checkbox"/> 8	
<b>Stop bits</b>	<input type="checkbox"/> 1	<input type="checkbox"/> 2	
<b>Relay Address</b>			



**2.5 PROTECTION G1 Menu**

2.5.1 Phase Overcurrent [50/51]

2.5.1.1 [50/51] |>

> ?	<input type="checkbox"/> Yes	<input type="checkbox"/> No: Next menu:  >> ζ	
>	In		
Delay Type	<input type="checkbox"/> DMT	<input type="checkbox"/> IDMT	<input type="checkbox"/> RI

2.5.1.1.1 [50/51] |> DMT

t >	ms
t Reset	ms

2.5.1.1.2 [50/51] |> IDMT

Idmt	<input type="checkbox"/> IEC SI	<input type="checkbox"/> IEC STI	
	<input type="checkbox"/> IEC VI	<input type="checkbox"/> IEC EI	
	<input type="checkbox"/> IEC LTI	<input type="checkbox"/> CO2	
	<input type="checkbox"/> IEEE MI	<input type="checkbox"/> CO8	
	<input type="checkbox"/> IEEE VI	<input type="checkbox"/> IEEE EI	
	<input type="checkbox"/> IEEE RC		
	Tms		
Reset delay time	<input type="checkbox"/> DMT	<input type="checkbox"/> IDMT	<input type="checkbox"/> Not displayed
Rtms			<input type="checkbox"/> Not displayed
tReset	s		<input type="checkbox"/> Not displayed
> >> >>> Interlock	<input type="checkbox"/> YES	<input type="checkbox"/> NO	<input type="checkbox"/> Not displayed

2.5.1.1.3 [50/51] |> RI

K	
t Reset	s

2.5.1.2 [50/51] |>>

>> ?	<input type="checkbox"/> YES	<input type="checkbox"/> NO: Next menu:  >>> ?	
>>	In		
Delay Type	<input type="checkbox"/> IDMT	<input type="checkbox"/> DMT	<input type="checkbox"/> RI

2.5.1.2.1 [50/51] |>> DMT

t >>	s
t Reset	s

2.5.1.2.2 [50/51] I>> IDMT

<b>Idmt</b>	<input type="checkbox"/> IEC SI	<input type="checkbox"/> IEC STI	
	<input type="checkbox"/> IEC VI	<input type="checkbox"/> IEC EI	
	<input type="checkbox"/> IEC LTI	<input type="checkbox"/> CO2	
	<input type="checkbox"/> IEEE MI	<input type="checkbox"/> CO8	
	<input type="checkbox"/> IEEE VI	<input type="checkbox"/> IEEE EI	
	<input type="checkbox"/> IEEE RC		
	<b>Tms</b>		
<b>Reset delay time</b>	<input type="checkbox"/> DMT	<input type="checkbox"/> IDMT	<input type="checkbox"/> Not displayed
<b>Rtms</b>			<input type="checkbox"/> Not displayed
<b>tReset</b>	s		<input type="checkbox"/> Not displayed
<b>I&gt; &gt;&gt; &gt;&gt;&gt; Interlock</b>	<input type="checkbox"/> YES	<input type="checkbox"/> NO	<input type="checkbox"/> Not displayed

2.5.1.2.3 [50/51] I>> RI

<b>K</b>	
<b>t Reset</b>	s

2.5.1.3 [50/51] I>>>

<b>I&gt;&gt;&gt;?</b>	<input type="checkbox"/> YES	<input type="checkbox"/> NO (last menu)
<b>I&gt;&gt;&gt; Sample</b>	<input type="checkbox"/> YES	<input type="checkbox"/> NO
<b>I&gt;&gt;&gt;</b>	In	
<b>tI&gt;&gt;&gt;</b>	s	

2.5.2 Earth Overcurrent [50N/51N]

2.5.2.1 [50N/51N] E/Gnd

<b>I<sub>e</sub>&gt; ?</b>	<input type="checkbox"/> YES	<input type="checkbox"/> NO: Next menu: I <sub>e</sub> >> ?		
<b>I<sub>e</sub>&gt;</b>	I <sub>en</sub>			
<b>Delay Type</b>	<input type="checkbox"/> IDMT	<input type="checkbox"/> DMT	<input type="checkbox"/> RI	<input type="checkbox"/> RXIDG

2.5.2.1.1 [50N/51N] I<sub>e</sub> > DMT

<b>tI<sub>e</sub>&gt;</b>	ms
<b>t Reset</b>	ms

2.5.2.1.2 [50N/51N] I<sub>e</sub> > IDMT

<b>Curve</b>	<input type="checkbox"/>	IEC SI	<input type="checkbox"/>	IEC STI
	<input type="checkbox"/>	IEC VI	<input type="checkbox"/>	IEC EI
	<input type="checkbox"/>	IEC LTI	<input type="checkbox"/>	CO2
	<input type="checkbox"/>	IEEE MI	<input type="checkbox"/>	CO8
	<input type="checkbox"/>	IEEE VI	<input type="checkbox"/>	IEEE EI
<b>Tms</b>				
<b>Reset delay time</b>	<input type="checkbox"/> DMT	<input type="checkbox"/> IDMT	<input type="checkbox"/> Not displayed	
<b>Rtms</b>				<input type="checkbox"/> Not displayed
<b>tReset</b>	s			<input type="checkbox"/> Not displayed
<b>I<sub>e</sub> &gt; &gt;&gt; &gt;&gt;&gt; Interlock</b>	<input type="checkbox"/> YES	<input type="checkbox"/> NO	<input type="checkbox"/> Not displayed	

2.5.2.1.3 [51N] I<sub>e</sub> > RI

<b>K</b>	
<b>t Reset</b>	Ms

2.5.2.1.4 [51N] I<sub>e</sub> > RXIDG

<b>RXIDG Curve</b>	
<b>t Reset</b>	Ms

2.5.2.2 [51N] I<sub>e</sub> >>

<b>I<sub>e</sub> &gt;&gt; ?</b>	<input type="checkbox"/> YES	<input type="checkbox"/> NO: Next menu: I <sub>e</sub> >>> ?		
<b>I<sub>e</sub> &gt;&gt;</b>	I <sub>en</sub>			
<b>Delay Type</b>	<input type="checkbox"/> IDMT	<input type="checkbox"/> DMT	<input type="checkbox"/> RI	<input type="checkbox"/> RXIDG

2.5.2.2.1 [51N] I<sub>e</sub> >> DMT

<b>tI<sub>e</sub> &gt;&gt;</b>	ms
<b>t Reset</b>	ms

2.5.2.2.2 [51N] I<sub>e</sub> >> IDMT

<b>Curve</b>	<input type="checkbox"/>	IEC SI	<input type="checkbox"/>	IEC STI
	<input type="checkbox"/>	IEC VI	<input type="checkbox"/>	IEC EI
	<input type="checkbox"/>	IEC LTI	<input type="checkbox"/>	CO2
	<input type="checkbox"/>	IEEE MI	<input type="checkbox"/>	CO8
	<input type="checkbox"/>	IEEE VI	<input type="checkbox"/>	IEEE EI
<b>Tms</b>				
<b>Reset delay time</b>	<input type="checkbox"/> DMT	<input type="checkbox"/> IDMT	<input type="checkbox"/> Not displayed	
<b>Rtms</b>				<input type="checkbox"/> Not displayed
<b>tReset</b>	s			<input type="checkbox"/> Not displayed
<b>I<sub>e</sub> &gt;&gt; &gt;&gt;&gt; Interlock</b>	<input type="checkbox"/> YES	<input type="checkbox"/> NO	<input type="checkbox"/> Not displayed	

2.5.2.2.3 [50N/51N] I<sub>e</sub>>> RI

<b>K</b>	
<b>t Reset</b>	ms

2.5.2.2.4 [50N/51N] I<sub>e</sub>>> RXIDG

<b>RXIDG Curve</b>	
<b>t Reset</b>	ms

2.5.2.3 [50N/51N] I<sub>e</sub> >>>

<b>I<sub>e</sub>&gt;&gt;&gt; ?</b>	<input type="checkbox"/> YES	<input type="checkbox"/> NO Next menu: I <sub>e</sub> >>>> ?
<b>I<sub>e</sub>&gt;&gt;&gt; Sample</b>	<input type="checkbox"/> YES	<input type="checkbox"/> NO
<b>I<sub>e</sub>&gt;&gt;&gt;</b>	len	
<b>tI<sub>e</sub>&gt;&gt;&gt;</b>	ms	

2.5.2.4 [50N/51N] I<sub>e</sub>>>>> >

<b>I<sub>e</sub>&gt;&gt;&gt;&gt; ?</b>	<input type="checkbox"/> YES	<input type="checkbox"/> NO: last menu	
<b>I<sub>e</sub>&gt;&gt;&gt;&gt;</b>	len		
<b>Delay Type</b>	<input type="checkbox"/> IDMT	<input type="checkbox"/> DMT	<input type="checkbox"/> RI

2.5.2.4.1 [50N/51N] I<sub>e</sub>>>>> DMT

<b>tI<sub>e</sub>&gt;</b>	ms
<b>t Reset</b>	ms

2.5.2.4.2 [50N/51N] le>>>> IDMT

<b>Curve</b>	<input type="checkbox"/> IEC SI	<input type="checkbox"/> IEC STI
	<input type="checkbox"/> IEC VI	<input type="checkbox"/> IEC EI
	<input type="checkbox"/> IEC LTI	<input type="checkbox"/> CO2
	<input type="checkbox"/> IEEE MI	<input type="checkbox"/> CO8
	<input type="checkbox"/> IEEE VI	<input type="checkbox"/> IEEE EI
	<input type="checkbox"/> IEEE RC	
<b>Tms</b>		
<b>Reset delay time</b>	<input type="checkbox"/> DMT	<input type="checkbox"/> IDMT <input type="checkbox"/> Not displayed
<b>Rtms</b>	<input type="checkbox"/> Not displayed	
<b>tReset</b>	s <input type="checkbox"/> Not displayed	

2.5.2.4.3 [50N/51N] le>>>> RI

<b>K</b>	
<b>t Reset</b>	ms

2.5.3 [46] NEGATIVE PHASE SEQUENCE OVERCURRENT I2>

<b>Relay:</b>	<input type="checkbox"/> P120 (not available)
<b>Relay:</b>	<input type="checkbox"/> P121 (not available)

2.5.4 [46] Negative phase sequence overcurrent I2>

<b>I2&gt;?</b>	<input type="checkbox"/> YES	<input type="checkbox"/> NO Next menu: I2>> $\zeta$
<b>I2&gt;</b>	In	
<b>Delay Trip</b>	<input type="checkbox"/> IDMT	<input type="checkbox"/> DMT <input type="checkbox"/> RI

2.5.4.1 [46] I2> DMT

<b>tI2&gt;</b>	ms
<b>t Reset</b>	ms

2.5.4.2 [46] I2> IDMT

<b>Curve</b>	<input type="checkbox"/> IEC SI	<input type="checkbox"/> IEC STI
	<input type="checkbox"/> IEC VI	<input type="checkbox"/> IEC EI
	<input type="checkbox"/> IEC LTI	<input type="checkbox"/> CO2
	<input type="checkbox"/> IEEE MI	<input type="checkbox"/> CO8
	<input type="checkbox"/> IEEE VI	<input type="checkbox"/> IEEE EI
<b>Tms</b>		
<b>Reset delay time</b>	<input type="checkbox"/> DMT	<input type="checkbox"/> IDMT <input type="checkbox"/> Not applicable
<b>Rtms</b>	<input type="checkbox"/> Not applicable	
<b>tReset</b>	s <input type="checkbox"/> Not applicable	

2.5.4.3 [46] I2> RI

<b>K</b>	
<b>t Reset</b>	ms

2.5.5 [46] Negative phase sequence overcurrent I2>>

<b>I2&gt;&gt;?</b>	<input type="checkbox"/> YES	<input type="checkbox"/> NO Last menu
<b>I2&gt;&gt;</b>	In	
<b>tI2&gt;&gt;</b>	ms	

2.5.6 [49] THERMAL OVERLOAD

<b>Relay:</b>	<input type="checkbox"/> P120 (not available)
	<input type="checkbox"/> P121 (not available)

<b>[49] Therm OL ?</b>	<input type="checkbox"/> YES	<input type="checkbox"/> NO
<b>Iθ&gt;</b>	In	
<b>Te</b>	mn	
<b>k</b>		
<b>θ Trip</b>	%	
<b>[49] θ Alarm ?</b>	<input type="checkbox"/> YES	<input type="checkbox"/> NO
<b>θ Alarm</b>	%	

2.5.7 [37] UNDERCURRENT I<

Relay:	<input type="checkbox"/>	P120 (not available)
	<input type="checkbox"/>	P121 (not available)

I< ?	<input type="checkbox"/> YES	<input type="checkbox"/> NO
I<	%	
tl<	Ms	
Inhibition I< on 52A	<input type="checkbox"/> YES	<input type="checkbox"/> NO

2.5.8 [79] AUTORECLOSER

Relay:	<input type="checkbox"/>	P120 (not available)
	<input type="checkbox"/>	P121 (not available)
	<input type="checkbox"/>	P122 (not available)

[79] Autoreclose ?	<input type="checkbox"/> YES	<input type="checkbox"/> NO last menu
Ext CB Fail ?	<input type="checkbox"/> YES	<input type="checkbox"/> NO Next menu: Ext Block?
Ext CB Fail Time	ms	
Ext Block ?	<input type="checkbox"/> YES	<input type="checkbox"/> NO
Rolling demand ?	<input type="checkbox"/> YES	<input type="checkbox"/> NO
Max cycles nb		
Time period	mn	
Dead Time tD1	s	
Dead Time tD2	s	
Dead Time tD3	s	
Dead Time tD4	s	
Min Drop off time tl>	s	
Min Drop off time tl>>	s	
Min Drop off time tl>>>	s	
Min Drop off time tle>	s	
Min Drop off time tle>>	s	
Min Drop off time tle>>>	s	
Reclaim Time tR	s	
Inhib Time tl	s	
Phase Cycles	<input type="checkbox"/> 1 <input type="checkbox"/> 2 <input type="checkbox"/> 3 <input type="checkbox"/> 4	
E/Gnd Cycles	<input type="checkbox"/> 1 <input type="checkbox"/> 2 <input type="checkbox"/> 3 <input type="checkbox"/> 4	
	<b>Cycles</b>	
	4	3    2    1

<b>tl&gt;</b>				
<b>tl&gt;&gt;</b>				
<b>tl&gt;&gt;&gt;</b>				
<b>tle&gt;</b>				
<b>tle&gt;&gt;</b>				
<b>tle&gt;&gt;&gt;</b>				
<b>tAux 1</b>				
<b>tAux 2</b>				



**2.6 PROTECTION G2 Menu**

2.6.1 Phase Overcurrent [50/51]

2.6.1.1 [50/51] |>

> ?	<input type="checkbox"/> YES	<input type="checkbox"/> NO
>	In	
Delay Type	<input type="checkbox"/> IDMT	<input type="checkbox"/> DMT <input type="checkbox"/> RI

2.6.1.1.1 [51] |> DMT

t >	ms
t Reset	ms

2.6.1.1.2 [51] |> IDMT

Idmt	<input type="checkbox"/> IEC SI	<input type="checkbox"/> IEC STI
	<input type="checkbox"/> IEC VI	<input type="checkbox"/> IEC EI
	<input type="checkbox"/> IEC LTI	<input type="checkbox"/> CO2
	<input type="checkbox"/> IEEE MI	<input type="checkbox"/> CO8
	<input type="checkbox"/> IEEE VI	<input type="checkbox"/> IEEE EI
	<input type="checkbox"/> IEEE RC	
Tms		
Reset delay time	<input type="checkbox"/> DMT	<input type="checkbox"/> IDMT <input type="checkbox"/> Not applicable
Rtms	<input type="checkbox"/> Not applicable	
tReset	s <input type="checkbox"/> Not applicable	
> >> >>> Interlock	<input type="checkbox"/> YES	<input type="checkbox"/> NO <input type="checkbox"/> Not applicable

2.6.1.1.3 [51] |> RI

K	
t Reset	ms

2.6.1.2 [51] |>>

>> ?	<input type="checkbox"/> YES	<input type="checkbox"/> NO
>>	In	
Delay Type	<input type="checkbox"/> IDMT	<input type="checkbox"/> DMT <input type="checkbox"/> RI

2.6.1.2.1 [51] |>> DMT

t >>	ms
t Reset	ms

2.6.1.2.2 [51] I>> IDMT

<b>Idmt</b>	<input type="checkbox"/> IEC SI	<input type="checkbox"/> IEC STI	
	<input type="checkbox"/> IEC VI	<input type="checkbox"/> IEC EI	
	<input type="checkbox"/> IEC LTI	<input type="checkbox"/> CO2	
	<input type="checkbox"/> IEEE MI	<input type="checkbox"/> CO8	
	<input type="checkbox"/> IEEE VI	<input type="checkbox"/> IEEE EI	
	<input type="checkbox"/> IEEE RC		
	<b>Tms</b>		
<b>Reset delay time</b>	<input type="checkbox"/> DMT	<input type="checkbox"/> IDMT	<input type="checkbox"/> Not applicable
<b>Rtms</b>			<input type="checkbox"/> Not applicable
<b>tReset</b>	s		<input type="checkbox"/> Not applicable
<b>I&gt; &gt;&gt; &gt;&gt;&gt; Interlock</b>	<input type="checkbox"/> YES	<input type="checkbox"/> NO	<input type="checkbox"/> Not applicable

2.6.1.2.3 [51] I>> RI

<b>K</b>	
<b>t Reset</b>	ms

2.6.1.3 [51] I>>>>

<b>I&gt;&gt;&gt;?</b>	<input type="checkbox"/> YES	<input type="checkbox"/> NO
<b>I&gt;&gt;&gt; Sample</b>	<input type="checkbox"/> YES	<input type="checkbox"/> NO
<b>I&gt;&gt;&gt;</b>	In	
<b>tI&gt;&gt;&gt;</b>	ms	

2.6.2 Earth Overcurrent [50N/51N]

2.6.2.1 [50N/51N] E/Gnd

<b>I<sub>e</sub>&gt; ?</b>	<input type="checkbox"/> YES	<input type="checkbox"/> NO		
<b>I<sub>e</sub>&gt;</b>	I <sub>en</sub>			
<b>Delay Type</b>	<input type="checkbox"/> IDMT	<input type="checkbox"/> DMT	<input type="checkbox"/> RI	<input type="checkbox"/> RXIDG

2.6.2.1.1 [51N] I<sub>e</sub> > DMT

<b>tI<sub>e</sub>&gt;</b>	ms
<b>t Reset</b>	ms

2.6.2.1.2 [51N] I<sub>e</sub> > IDMT

<b>Curve</b>	<input type="checkbox"/>	IEC SI	<input type="checkbox"/>	IEC STI
	<input type="checkbox"/>	IEC VI	<input type="checkbox"/>	IEC EI
	<input type="checkbox"/>	IEC LTI	<input type="checkbox"/>	CO2
	<input type="checkbox"/>	IEEE MI	<input type="checkbox"/>	CO8
	<input type="checkbox"/>	IEEE VI	<input type="checkbox"/>	IEEE EI
<b>Tms</b>				
<b>Reset delay time</b>	<input type="checkbox"/> DMT	<input type="checkbox"/> IDMT	<input type="checkbox"/> Not applicable	
<b>Rtms</b>				<input type="checkbox"/> Not applicable
<b>tReset</b>	s			<input type="checkbox"/> Not applicable
<b>I<sub>e</sub> &gt;&gt; &gt;&gt;&gt; Interlock</b>	<input type="checkbox"/> YES	<input type="checkbox"/> NO	<input type="checkbox"/> Not applicable	

2.6.2.1.3 [51N] I<sub>e</sub> > RI

<b>K</b>	
<b>t Reset</b>	ms

2.6.2.1.4 [51N] I<sub>e</sub> > RXIDG

<b>RXIDG Curve</b>	
<b>t Reset</b>	ms

2.6.2.2 [51N] I<sub>e</sub> >>

<b>I<sub>e</sub> &gt;&gt; ?</b>	<input type="checkbox"/> YES	<input type="checkbox"/> NO		
<b>I<sub>e</sub> &gt;&gt;</b>	len			
<b>Delay Type</b>	<input type="checkbox"/> IDMT	<input type="checkbox"/> DMT	<input type="checkbox"/> RI	<input type="checkbox"/> RXIDG

2.6.2.2.1 [51N] I<sub>e</sub> >> DMT

<b>tI<sub>e</sub> &gt;&gt;</b>	ms
<b>t Reset</b>	ms

2.6.2.2.2 [51N] I<sub>e</sub> >> IDMT

<b>Curve</b>	<input type="checkbox"/>	IEC SI	<input type="checkbox"/>	IEC STI
	<input type="checkbox"/>	IEC VI	<input type="checkbox"/>	IEC EI
	<input type="checkbox"/>	IEC LTI	<input type="checkbox"/>	CO2
	<input type="checkbox"/>	IEEE MI	<input type="checkbox"/>	CO8
	<input type="checkbox"/>	IEEE VI	<input type="checkbox"/>	IEEE EI
<b>Tms</b>				
<b>Reset delay time</b>	<input type="checkbox"/> DMT	<input type="checkbox"/> IDMT	<input type="checkbox"/> Not applicable	
<b>Rtms</b>				<input type="checkbox"/> Not applicable
<b>tReset</b>	s			<input type="checkbox"/> Not applicable
<b>I<sub>e</sub> &gt;&gt; &gt;&gt;&gt; Interlock</b>	<input type="checkbox"/> YES	<input type="checkbox"/> NO	<input type="checkbox"/> Not applicable	

2.6.2.2.3 [51N] I<sub>e</sub> >> RI

<b>K</b>	
<b>t Reset</b>	ms

2.6.2.2.4 [51N] I<sub>e</sub> >> RXIDG

<b>RXIDG Curve</b>	
<b>t Reset</b>	ms

2.6.2.3 [51N] I<sub>e</sub> >>>

<b>I<sub>e</sub> &gt;&gt;&gt; ?</b>	<input type="checkbox"/> YES	<input type="checkbox"/> NO
<b>I<sub>e</sub> &gt;&gt;&gt; Sample</b>	<input type="checkbox"/> YES	<input type="checkbox"/> NO
<b>I<sub>e</sub> &gt;&gt;&gt;</b>	len	
<b>tI<sub>e</sub> &gt;&gt;&gt;</b>	ms	

2.6.2.4 I<sub>e</sub> >>>>

<b>I<sub>e</sub> &gt;&gt;&gt;&gt; ?</b>	<input type="checkbox"/> YES	<input type="checkbox"/> NO	
<b>I<sub>e</sub> &gt;&gt;&gt;&gt;</b>	len		
<b>Delay Type</b>	<input type="checkbox"/> IDMT	<input type="checkbox"/> DMT	<input type="checkbox"/> RI

2.6.2.4.1 [51] I<sub>e</sub> >>>> DMT

<b>tI<sub>e</sub> &gt;</b>	ms
<b>t Reset</b>	ms

2.6.2.4.2 [51] I> IDMT

<b>Curve</b>	<input type="checkbox"/> IEC SI	<input type="checkbox"/> IEC STI
	<input type="checkbox"/> IEC VI	<input type="checkbox"/> IEC EI
	<input type="checkbox"/> IEC LTI	<input type="checkbox"/> CO2
	<input type="checkbox"/> IEEE MI	<input type="checkbox"/> CO8
	<input type="checkbox"/> IEEE VI	<input type="checkbox"/> IEEE EI
	<input type="checkbox"/> IEEE RC	
<b>Tms</b>		
<b>Reset delay time</b>	<input type="checkbox"/> DMT	<input type="checkbox"/> IDMT <input type="checkbox"/> Not applicable
<b>Rtms</b>	<input type="checkbox"/> Not applicable	
<b>tReset</b>	s <input type="checkbox"/> Not applicable	

2.6.2.4.3 [51] I> RI

<b>K</b>	
<b>t Reset</b>	ms

2.6.3 [46] NEGATIVE PHASE SEQUENCE OVERCURRENT I2>

<b>Relay:</b>	<input type="checkbox"/> P120 (not available)
<b>Relay:</b>	<input type="checkbox"/> P121 (not available)

2.6.4 [46] Negative phase sequence overcurrent I2>

<b>I2&gt;?</b>	<input type="checkbox"/> YES	<input type="checkbox"/> NO
<b>I2&gt;</b>	In	
<b>Delay Trip</b>	<input type="checkbox"/> IDMT	<input type="checkbox"/> DMT <input type="checkbox"/> RI

2.6.4.1 [46] I2> DMT

<b>tI2&gt;</b>	ms
<b>t Reset</b>	ms

2.6.4.2 [46] I2> IDMT

<b>Curve</b>	<input type="checkbox"/> IEC SI	<input type="checkbox"/> IEC STI
	<input type="checkbox"/> IEC VI	<input type="checkbox"/> IEC EI
	<input type="checkbox"/> IEC LTI	<input type="checkbox"/> CO2
	<input type="checkbox"/> IEEE MI	<input type="checkbox"/> CO8
	<input type="checkbox"/> IEEE VI	<input type="checkbox"/> IEEE EI
<b>Tms</b>		
<b>Reset delay time</b>	<input type="checkbox"/> DMT	<input type="checkbox"/> IDMT
<b>Rtms</b>	<input type="checkbox"/> Not applicable	
<b>tReset</b>	s <input type="checkbox"/> Not applicable	

2.6.4.3 [46] I2> RI

<b>K</b>	
<b>t Reset</b>	ms

2.6.5 [46] Negative phase sequence overcurrent I2>>

<b>I2&gt;&gt;?</b>	<input type="checkbox"/> YES	<input type="checkbox"/> NO
<b>I2&gt;&gt;</b>	In	
<b>tI2&gt;&gt;</b>	ms	

2.6.6 [49] THERMAL OVERLOAD

<b>Relay:</b>	<input type="checkbox"/> P120 (not available)
	<input type="checkbox"/> P121 (not available)

<b>[49] Therm OL ?</b>	<input type="checkbox"/> YES	<input type="checkbox"/> NO
<b>Iθ&gt;</b>	In	
<b>Te</b>	mn	
<b>k</b>		
<b>θ Trip</b>	%	
<b>[49] θ Alarm ?</b>	<input type="checkbox"/> YES	<input type="checkbox"/> NO
<b>θ Alarm</b>	%	

2.6.7 [37] UNDERCURRENT I<

<b>Relay:</b>	<input type="checkbox"/>	P120 (not available)
	<input type="checkbox"/>	P121 (not available)

<b>I&lt; ?</b>	<input type="checkbox"/>	YES	<input type="checkbox"/>	NO
<b>I&lt;</b>	%			
<b>tl&lt;</b>	Ms			
<b>Inhibition I&lt; on 52A</b>	<input type="checkbox"/>	YES	<input type="checkbox"/>	NO

2.6.8 [79] AUTORECLOSER

<b>Relay:</b>	<input type="checkbox"/>	P120 (not available)
	<input type="checkbox"/>	P121 (not available)
	<input type="checkbox"/>	P122 (not available)

<b>[79] Autoreclose ?</b>	<input type="checkbox"/>	YES	<input type="checkbox"/>	NO
<b>Ext CB Fail ?</b>	<input type="checkbox"/>	YES	<input type="checkbox"/>	NO
<b>Ext CB Fail Time</b>	ms			
<b>Ext Block ?</b>	<input type="checkbox"/>	YES	<input type="checkbox"/>	NO
<b>Rolling demand ?</b>	<input type="checkbox"/>	YES	<input type="checkbox"/>	NO
<b>Max cycles nb</b>				
<b>Time period</b>	Mn			
<b>Dead Time tD1</b>	ms			
<b>Dead Time tD2</b>	ms			
<b>Dead Time tD3</b>	ms			
<b>Dead Time tD4</b>	ms			
<b>Min Drop off time tl&gt;</b>	ms			
<b>Min Drop off time tl&gt;&gt;</b>	ms			
<b>Min Drop off time tl&gt;&gt;&gt;</b>	ms			
<b>Min Drop off time tle&gt;</b>	ms			
<b>Min Drop off time tle&gt;&gt;</b>	ms			
<b>Min Drop off time tle&gt;&gt;&gt;</b>	ms			
<b>Reclaim Time tR</b>	ms			
<b>Inhib Time tl</b>	ms			
<b>Phase Cycles</b>				
<b>E/Gnd Cycles</b>				
	<b>Cycles</b>			
	<b>4</b>	<b>3</b>	<b>2</b>	<b>1</b>
<b>tl&gt;</b>	<input type="checkbox"/>	<input type="checkbox"/>	<input type="checkbox"/>	<input type="checkbox"/>
<b>tl&gt;&gt;</b>	<input type="checkbox"/>	<input type="checkbox"/>	<input type="checkbox"/>	<input type="checkbox"/>

<b>tl&gt;&gt;&gt;</b>	<input type="checkbox"/>	<input type="checkbox"/>	<input type="checkbox"/>	<input type="checkbox"/>
<b>tle&gt;</b>	<input type="checkbox"/>	<input type="checkbox"/>	<input type="checkbox"/>	<input type="checkbox"/>
<b>tle&gt;&gt;</b>	<input type="checkbox"/>	<input type="checkbox"/>	<input type="checkbox"/>	<input type="checkbox"/>
<b>tle&gt;&gt;&gt;</b>	<input type="checkbox"/>	<input type="checkbox"/>	<input type="checkbox"/>	<input type="checkbox"/>
<b>tAux 1</b>	<input type="checkbox"/>	<input type="checkbox"/>	<input type="checkbox"/>	<input type="checkbox"/>
<b>tAux 2</b>	<input type="checkbox"/>	<input type="checkbox"/>	<input type="checkbox"/>	<input type="checkbox"/>



**2.7 AUTOMAT.CTRL Menu**

## 2.7.1 TRIP Command allocation

Function	P120	P121	P122	P123
	Yes	Yes	Yes	Yes
Trip tl>	<input type="checkbox"/>	<input type="checkbox"/>	<input type="checkbox"/>	<input type="checkbox"/>
Trip tl>>	<input type="checkbox"/>	<input type="checkbox"/>	<input type="checkbox"/>	<input type="checkbox"/>
Trip tl>>>	<input type="checkbox"/>	<input type="checkbox"/>	<input type="checkbox"/>	<input type="checkbox"/>
Trip tle>	<input type="checkbox"/>	<input type="checkbox"/>	<input type="checkbox"/>	<input type="checkbox"/>
Trip tle>>	<input type="checkbox"/>	<input type="checkbox"/>	<input type="checkbox"/>	<input type="checkbox"/>
Trip tle>>>				<input type="checkbox"/>
Trip tle>>>>			<input type="checkbox"/>	<input type="checkbox"/>
Trip tl <			<input type="checkbox"/>	<input type="checkbox"/>
Trip tl2 >			<input type="checkbox"/>	<input type="checkbox"/>
Trip tl2 >>			<input type="checkbox"/>	<input type="checkbox"/>
Trip Thermal $\theta$			<input type="checkbox"/>	<input type="checkbox"/>
Trip Brkn.Cond			<input type="checkbox"/>	<input type="checkbox"/>
Trip t Aux 1		<input type="checkbox"/>	<input type="checkbox"/>	<input type="checkbox"/>
Trip t Aux 2		<input type="checkbox"/>	<input type="checkbox"/>	<input type="checkbox"/>
Trip t Aux 3			<input type="checkbox"/>	<input type="checkbox"/>
Trip t Aux 4				<input type="checkbox"/>
Trip t Aux 5				<input type="checkbox"/>
Trip SOTF				<input type="checkbox"/>
Ctrl Trip				<input type="checkbox"/>
Trip CB Fail				<input type="checkbox"/>
Trip Equ A		<input type="checkbox"/>	<input type="checkbox"/>	<input type="checkbox"/>
Trip Equ B		<input type="checkbox"/>	<input type="checkbox"/>	<input type="checkbox"/>
Trip Equ C		<input type="checkbox"/>	<input type="checkbox"/>	<input type="checkbox"/>
Trip Equ D		<input type="checkbox"/>	<input type="checkbox"/>	<input type="checkbox"/>
Trip Equ E		<input type="checkbox"/>	<input type="checkbox"/>	<input type="checkbox"/>
Trip Equ F		<input type="checkbox"/>	<input type="checkbox"/>	<input type="checkbox"/>
Trip Equ G		<input type="checkbox"/>	<input type="checkbox"/>	<input type="checkbox"/>
Trip Equ H		<input type="checkbox"/>	<input type="checkbox"/>	<input type="checkbox"/>

2.7.2 Latch function allocation

Function	P120	P121	P122	P123
	YES	YES	YES	YES
Latch tl>	<input type="checkbox"/>	<input type="checkbox"/>	<input type="checkbox"/>	<input type="checkbox"/>
Latch tl>>	<input type="checkbox"/>	<input type="checkbox"/>	<input type="checkbox"/>	<input type="checkbox"/>
Latch tl>>>	<input type="checkbox"/>	<input type="checkbox"/>	<input type="checkbox"/>	<input type="checkbox"/>
Latch tle>		<input type="checkbox"/>	<input type="checkbox"/>	<input type="checkbox"/>
Latch tle>>		<input type="checkbox"/>	<input type="checkbox"/>	<input type="checkbox"/>
Latch tle>>>		<input type="checkbox"/>	<input type="checkbox"/>	<input type="checkbox"/>
Latch tle>>>>			<input type="checkbox"/>	<input type="checkbox"/>
Latch tl <			<input type="checkbox"/>	<input type="checkbox"/>
Latch tl2 >			<input type="checkbox"/>	<input type="checkbox"/>
Latch tl2 >>			<input type="checkbox"/>	<input type="checkbox"/>
Latch Thermal $\theta$			<input type="checkbox"/>	<input type="checkbox"/>
Latch Brkn.Cond			<input type="checkbox"/>	<input type="checkbox"/>
Latch t Aux 1		<input type="checkbox"/>	<input type="checkbox"/>	<input type="checkbox"/>
Latch t Aux 2		<input type="checkbox"/>	<input type="checkbox"/>	<input type="checkbox"/>
Latch t Aux 3			<input type="checkbox"/>	<input type="checkbox"/>
Latch t Aux 4				<input type="checkbox"/>
Latch t Aux 5				<input type="checkbox"/>
Latch SOTF				<input type="checkbox"/>
Latch CB Fail				<input type="checkbox"/>

2.7.3 Blocking Logic 1 function allocation

Function	P120	P121	P122	P123
	Yes	Yes	Yes	Yes
tl>	<input type="checkbox"/>	<input type="checkbox"/>	<input type="checkbox"/>	<input type="checkbox"/>
tl>>	<input type="checkbox"/>	<input type="checkbox"/>	<input type="checkbox"/>	<input type="checkbox"/>
tl>>>	<input type="checkbox"/>	<input type="checkbox"/>	<input type="checkbox"/>	<input type="checkbox"/>
tle>	<input type="checkbox"/>	<input type="checkbox"/>	<input type="checkbox"/>	<input type="checkbox"/>
tle>>	<input type="checkbox"/>	<input type="checkbox"/>	<input type="checkbox"/>	<input type="checkbox"/>
tle>>>	<input type="checkbox"/>	<input type="checkbox"/>	<input type="checkbox"/>	<input type="checkbox"/>
tle>>>>			<input type="checkbox"/>	<input type="checkbox"/>
tl2 >			<input type="checkbox"/>	<input type="checkbox"/>
tl2 >>			<input type="checkbox"/>	<input type="checkbox"/>
Thermal $\theta$			<input type="checkbox"/>	<input type="checkbox"/>
Brkn.Cond			<input type="checkbox"/>	<input type="checkbox"/>

Function	P120	P121	P122	P123
	Yes	Yes	Yes	Yes
tAux 1		<input type="checkbox"/>	<input type="checkbox"/>	<input type="checkbox"/>
tAux 2		<input type="checkbox"/>	<input type="checkbox"/>	<input type="checkbox"/>
tAux 3			<input type="checkbox"/>	<input type="checkbox"/>
tAux 4				<input type="checkbox"/>
tAux 5				<input type="checkbox"/>

2.7.4 Blocking Logic 2 function allocation

Function	P120	P121	P122	P123
	Yes	Yes	Yes	Yes
tl>	<input type="checkbox"/>	<input type="checkbox"/>	<input type="checkbox"/>	<input type="checkbox"/>
tl>>	<input type="checkbox"/>	<input type="checkbox"/>	<input type="checkbox"/>	<input type="checkbox"/>
tl>>>	<input type="checkbox"/>	<input type="checkbox"/>	<input type="checkbox"/>	<input type="checkbox"/>
tle>	<input type="checkbox"/>	<input type="checkbox"/>	<input type="checkbox"/>	<input type="checkbox"/>
tle>>	<input type="checkbox"/>	<input type="checkbox"/>	<input type="checkbox"/>	<input type="checkbox"/>
tle>>>	<input type="checkbox"/>	<input type="checkbox"/>	<input type="checkbox"/>	<input type="checkbox"/>
tle>>>>			<input type="checkbox"/>	<input type="checkbox"/>
tl2 >			<input type="checkbox"/>	<input type="checkbox"/>
tl2 >>			<input type="checkbox"/>	<input type="checkbox"/>
Thermal $\theta$			<input type="checkbox"/>	<input type="checkbox"/>
Brkn.Cond			<input type="checkbox"/>	<input type="checkbox"/>
tAux 1		<input type="checkbox"/>	<input type="checkbox"/>	<input type="checkbox"/>
tAux 2		<input type="checkbox"/>	<input type="checkbox"/>	<input type="checkbox"/>
tAux 3			<input type="checkbox"/>	<input type="checkbox"/>
tAux 4				<input type="checkbox"/>
tAux 5				<input type="checkbox"/>

2.7.5 Inrush Blocking Logic function allocation

<b>Relay:</b>	<input type="checkbox"/>	P120 (not available)
	<input type="checkbox"/>	P121 (not available)

<b>Inrush blocking</b>	<input type="checkbox"/>	YES	<input type="checkbox"/>	NO
<b>Inr. harmonic 2 ratio =</b>	%			
<b>T Inrush reset</b>	ms			

Function	P122	P123
	Yes	Yes
l>	<input type="checkbox"/>	<input type="checkbox"/>
l>>	<input type="checkbox"/>	<input type="checkbox"/>
l>>>	<input type="checkbox"/>	<input type="checkbox"/>
le>	<input type="checkbox"/>	<input type="checkbox"/>
le>>	<input type="checkbox"/>	<input type="checkbox"/>
le>>>	<input type="checkbox"/>	<input type="checkbox"/>
le>>>>	<input type="checkbox"/>	<input type="checkbox"/>
l2>	<input type="checkbox"/>	<input type="checkbox"/>
l2>>	<input type="checkbox"/>	<input type="checkbox"/>

2.7.6 Selective Scheme Logic1 function allocation

<b>Relay:</b>	<input type="checkbox"/> P120 (not available)
	<input type="checkbox"/> P121 (not available)

<b>Sel1 tl&gt;&gt;</b>	<input type="checkbox"/> YES	<input type="checkbox"/> NO
<b>Sel1 tl&gt;&gt;&gt;</b>	<input type="checkbox"/> YES	<input type="checkbox"/> NO
<b>Sel1 tl<sub>e</sub>&gt;&gt;</b>	<input type="checkbox"/> YES	<input type="checkbox"/> NO
<b>Sel1 tl<sub>e</sub>&gt;&gt;&gt;</b>	<input type="checkbox"/> YES	<input type="checkbox"/> NO
<b>Sel1 tle&gt;&gt;&gt;&gt;</b>	<input type="checkbox"/> YES	<input type="checkbox"/> NO
<b>t Sel1</b>	ms	

2.7.7 Selective Scheme Logic2 function allocation

<b>Relay:</b>	<input type="checkbox"/> P120 (not available)
	<input type="checkbox"/> P121 (not available)

<b>Sel2 tl&gt;&gt;</b>	<input type="checkbox"/> YES	<input type="checkbox"/> NO
<b>Sel2 tl&gt;&gt;&gt;</b>	<input type="checkbox"/> YES	<input type="checkbox"/> NO
<b>Sel2 tl<sub>e</sub>&gt;&gt;</b>	<input type="checkbox"/> YES	<input type="checkbox"/> NO
<b>Sel2 tl<sub>e</sub>&gt;&gt;&gt;</b>	<input type="checkbox"/> YES	<input type="checkbox"/> NO
<b>Sel1 tle&gt;&gt;&gt;&gt;</b>	<input type="checkbox"/> YES	<input type="checkbox"/> NO
<b>tSel2 =</b>	ms	





2.7.9 LATCH OUTPUT RELAYS allocation

<b>Output 2</b>	<input type="checkbox"/>	YES	<input type="checkbox"/>	NO
<b>Output 3</b>	<input type="checkbox"/>	YES	<input type="checkbox"/>	NO
<b>Output 4</b>	<input type="checkbox"/>	YES	<input type="checkbox"/>	NO
<b>Output 5 (P122 / P123)</b>	<input type="checkbox"/>	YES	<input type="checkbox"/>	NO
<b>Output 6 (P122 / P123)</b>	<input type="checkbox"/>	YES	<input type="checkbox"/>	NO
<b>Output 7 (P123)</b>	<input type="checkbox"/>	YES	<input type="checkbox"/>	NO
<b>Output 8 (P123)</b>	<input type="checkbox"/>	YES	<input type="checkbox"/>	NO

2.7.10 LOGIC INPUT allocation

2.7.10.1 Inputs

Function	P120	P121	P122	P123	Inputs				
					1	2	3	4	5
None	•	•	•	•	<input type="checkbox"/>	<input type="checkbox"/>	<input type="checkbox"/>	<input type="checkbox"/>	<input type="checkbox"/>
Unlatch	•	•	•	•	<input type="checkbox"/>	<input type="checkbox"/>	<input type="checkbox"/>	<input type="checkbox"/>	<input type="checkbox"/>
52 a	•	•	•	•	<input type="checkbox"/>	<input type="checkbox"/>	<input type="checkbox"/>	<input type="checkbox"/>	<input type="checkbox"/>
52 b	•	•	•	•	<input type="checkbox"/>	<input type="checkbox"/>	<input type="checkbox"/>	<input type="checkbox"/>	<input type="checkbox"/>
CB FLT	•	•	•	•	<input type="checkbox"/>	<input type="checkbox"/>	<input type="checkbox"/>	<input type="checkbox"/>	<input type="checkbox"/>
Aux 1	•	•	•	•	<input type="checkbox"/>	<input type="checkbox"/>	<input type="checkbox"/>	<input type="checkbox"/>	<input type="checkbox"/>
Aux 2	•	•	•	•	<input type="checkbox"/>	<input type="checkbox"/>	<input type="checkbox"/>	<input type="checkbox"/>	<input type="checkbox"/>
Aux 3			•	•	<input type="checkbox"/>	<input type="checkbox"/>	<input type="checkbox"/>	<input type="checkbox"/>	<input type="checkbox"/>
Aux 4				•	<input type="checkbox"/>	<input type="checkbox"/>	<input type="checkbox"/>	<input type="checkbox"/>	<input type="checkbox"/>
Aux 5				•	<input type="checkbox"/>	<input type="checkbox"/>	<input type="checkbox"/>	<input type="checkbox"/>	<input type="checkbox"/>
Block Logic 1	•	•	•	•	<input type="checkbox"/>	<input type="checkbox"/>	<input type="checkbox"/>	<input type="checkbox"/>	<input type="checkbox"/>
Block Logic 2			•	•	<input type="checkbox"/>	<input type="checkbox"/>	<input type="checkbox"/>	<input type="checkbox"/>	<input type="checkbox"/>
Start Disturb			•	•	<input type="checkbox"/>	<input type="checkbox"/>	<input type="checkbox"/>	<input type="checkbox"/>	<input type="checkbox"/>
Cold Load PU			•	•	<input type="checkbox"/>	<input type="checkbox"/>	<input type="checkbox"/>	<input type="checkbox"/>	<input type="checkbox"/>
Logic Select 1			•	•	<input type="checkbox"/>	<input type="checkbox"/>	<input type="checkbox"/>	<input type="checkbox"/>	<input type="checkbox"/>
Logic Select 2			•	•	<input type="checkbox"/>	<input type="checkbox"/>	<input type="checkbox"/>	<input type="checkbox"/>	<input type="checkbox"/>
Change setting			•	•	<input type="checkbox"/>	<input type="checkbox"/>	<input type="checkbox"/>	<input type="checkbox"/>	<input type="checkbox"/>
Block [79]				•	<input type="checkbox"/>	<input type="checkbox"/>	<input type="checkbox"/>	<input type="checkbox"/>	<input type="checkbox"/>
θ Reset			•	•	<input type="checkbox"/>	<input type="checkbox"/>	<input type="checkbox"/>	<input type="checkbox"/>	<input type="checkbox"/>
Trip Circuit			•	•	<input type="checkbox"/>	<input type="checkbox"/>	<input type="checkbox"/>	<input type="checkbox"/>	<input type="checkbox"/>
Strt tBF			•	•	<input type="checkbox"/>	<input type="checkbox"/>	<input type="checkbox"/>	<input type="checkbox"/>	<input type="checkbox"/>
Reset Leds			•	•	<input type="checkbox"/>	<input type="checkbox"/>	<input type="checkbox"/>	<input type="checkbox"/>	<input type="checkbox"/>
Maint. Mode			•	•	<input type="checkbox"/>	<input type="checkbox"/>	<input type="checkbox"/>	<input type="checkbox"/>	<input type="checkbox"/>

Function	P120	P121	P122	P123	Inputs				
					1	2	3	4	5
SOTF				•	<input type="checkbox"/>	<input type="checkbox"/>	<input type="checkbox"/>	<input type="checkbox"/>	<input type="checkbox"/>
Local Mode				•	<input type="checkbox"/>	<input type="checkbox"/>	<input type="checkbox"/>	<input type="checkbox"/>	<input type="checkbox"/>
Synchro			•	•	<input type="checkbox"/>	<input type="checkbox"/>	<input type="checkbox"/>	<input type="checkbox"/>	<input type="checkbox"/>
Ctrl Trip			•	•	<input type="checkbox"/>	<input type="checkbox"/>	<input type="checkbox"/>	<input type="checkbox"/>	<input type="checkbox"/>
Ctrl Close			•	•	<input type="checkbox"/>	<input type="checkbox"/>	<input type="checkbox"/>	<input type="checkbox"/>	<input type="checkbox"/>

2.7.10.2 tAux

Aux 1: Time tAux 1	s
Aux 2: Time tAux 2	s
Aux 3: Time tAux 3 (P122 & P123)	s
Aux 4: Time tAux 4 (P123)	s
Aux 5: Time tAux 5 (P123)	s

2.7.11 BROKEN CONDUCTOR

Relay:	<input type="checkbox"/> P120 (not available)
	<input type="checkbox"/> P121 (not available)

Brkn Cond	<input type="checkbox"/> YES	<input type="checkbox"/> NO
Broken Conductor time tBC	s	
Ratio I2/I1	%	

2.7.12 Cold Load Pick up

Relay:	<input type="checkbox"/> P120 (not available)
	<input type="checkbox"/> P121 (not available)

Cold Load PU ?	<input type="checkbox"/> YES	<input type="checkbox"/> NO
CLPU Start Input	<input type="checkbox"/> YES	<input type="checkbox"/> NO
CLPU Start auto	<input type="checkbox"/> YES	<input type="checkbox"/> NO
tl> ?	<input type="checkbox"/> YES	<input type="checkbox"/> NO
tl>> ?	<input type="checkbox"/> YES	<input type="checkbox"/> NO
tl>>> ?	<input type="checkbox"/> YES	<input type="checkbox"/> NO
tl <sub>e</sub> > ?	<input type="checkbox"/> YES	<input type="checkbox"/> NO
tl <sub>e</sub> >> ?	<input type="checkbox"/> YES	<input type="checkbox"/> NO
tl <sub>e</sub> >>> ?	<input type="checkbox"/> YES	<input type="checkbox"/> NO
tl <sub>e</sub> >>>> ?	<input type="checkbox"/>	<input type="checkbox"/>



t <sub>2&gt;</sub> ?	<input type="checkbox"/> YES	<input type="checkbox"/> NO
t <sub>2&gt;&gt;</sub> ?	<input type="checkbox"/> YES	<input type="checkbox"/> NO
T Therm ?	<input type="checkbox"/> YES	<input type="checkbox"/> NO
Cold load PU Level	%	
Cold load PU tCL	s	

2.7.13 CIRCUIT BREAKER FAILURE

Relay:	<input type="checkbox"/> P120 (not available)
	<input type="checkbox"/> P121 (not available)

CB Fail ?	<input type="checkbox"/> YES	<input type="checkbox"/> NO
I <sub>&lt;</sub>	In	
CB Fail Time tBF	ms	
Block I <sub>&gt;</sub> ?	<input type="checkbox"/> YES	<input type="checkbox"/> NO
Block I <sub>e&gt;</sub> ?	<input type="checkbox"/> YES	<input type="checkbox"/> NO

2.7.14 CIRCUIT BREAKER SUPERVISION

Relay:	<input type="checkbox"/> P120 (not available)
	<input type="checkbox"/> P121 (not available)

TC Supervision?	<input type="checkbox"/> YES	<input type="checkbox"/> NO
T trip circuit t SUP	s	
CB Open S'vision	<input type="checkbox"/> YES	<input type="checkbox"/> NO
CB Open Time	ms	
CB Close S'vision	<input type="checkbox"/> YES	<input type="checkbox"/> NO
CB Close Time	ms	
CB Open Alarm?	<input type="checkbox"/> YES	<input type="checkbox"/> NO
CB Open NB		
Σ Amps(n)?	<input type="checkbox"/> YES	<input type="checkbox"/> NO
Σ Amps(n)		
n		
t Open Pulse	ms	
t Close Pulse	ms	

2.7.15 SOTF

<b>Relay:</b>	<input type="checkbox"/> P120 (not available)
	<input type="checkbox"/> P121 (not available)

<b>SOTF?</b>	<input type="checkbox"/> YES	<input type="checkbox"/> NO
<b>t SOTF</b>	ms	
<b>I&gt;&gt; ?</b>	<input type="checkbox"/> YES	<input type="checkbox"/> NO
<b>I&gt;&gt;&gt; ?</b>	<input type="checkbox"/> YES	<input type="checkbox"/> NO
<b>Ctrl close input</b>	<input type="checkbox"/> YES	<input type="checkbox"/> NO
<b>SOTF input</b>	<input type="checkbox"/> YES	<input type="checkbox"/> NO
<b>[79] closing</b>	<input type="checkbox"/> YES	<input type="checkbox"/> NO
<b>Front comm. order</b>	<input type="checkbox"/> YES	<input type="checkbox"/> NO
<b>Rear comm. order</b>	<input type="checkbox"/> YES	<input type="checkbox"/> NO

2.7.16 LOGIC EQUATIONS

Equ. A	Boolean	Logic
A.00	<input type="checkbox"/> = / <input type="checkbox"/> = NOT	
A.01	<input type="checkbox"/> OR / <input type="checkbox"/> = OR NOT / <input type="checkbox"/> AND / <input type="checkbox"/> = AND NOT	
A.02	<input type="checkbox"/> OR / <input type="checkbox"/> = OR NOT / <input type="checkbox"/> AND / <input type="checkbox"/> = AND NOT	
A.03	<input type="checkbox"/> OR / <input type="checkbox"/> = OR NOT / <input type="checkbox"/> AND / <input type="checkbox"/> = AND NOT	
A.04	<input type="checkbox"/> OR / <input type="checkbox"/> = OR NOT / <input type="checkbox"/> AND / <input type="checkbox"/> = AND NOT	
A.05	<input type="checkbox"/> OR / <input type="checkbox"/> = OR NOT / <input type="checkbox"/> AND / <input type="checkbox"/> = AND NOT	
A.06	<input type="checkbox"/> OR / <input type="checkbox"/> = OR NOT / <input type="checkbox"/> AND / <input type="checkbox"/> = AND NOT	
A.07	<input type="checkbox"/> OR / <input type="checkbox"/> = OR NOT / <input type="checkbox"/> AND / <input type="checkbox"/> = AND NOT	
A.08	<input type="checkbox"/> OR / <input type="checkbox"/> = OR NOT / <input type="checkbox"/> AND / <input type="checkbox"/> = AND NOT	
A.09	<input type="checkbox"/> OR / <input type="checkbox"/> = OR NOT / <input type="checkbox"/> AND / <input type="checkbox"/> = AND NOT	
A.10	<input type="checkbox"/> OR / <input type="checkbox"/> = OR NOT / <input type="checkbox"/> AND / <input type="checkbox"/> = AND NOT	
A.11	<input type="checkbox"/> OR / <input type="checkbox"/> = OR NOT / <input type="checkbox"/> AND / <input type="checkbox"/> = AND NOT	
A.12	<input type="checkbox"/> OR / <input type="checkbox"/> = OR NOT / <input type="checkbox"/> AND / <input type="checkbox"/> = AND NOT	
A.13	<input type="checkbox"/> OR / <input type="checkbox"/> = OR NOT / <input type="checkbox"/> AND / <input type="checkbox"/> = AND NOT	
A.14	<input type="checkbox"/> OR / <input type="checkbox"/> = OR NOT / <input type="checkbox"/> AND / <input type="checkbox"/> = AND NOT	
A.15	<input type="checkbox"/> OR / <input type="checkbox"/> = OR NOT / <input type="checkbox"/> AND / <input type="checkbox"/> = AND NOT	
<b>T Operate</b>	ms	
<b>T Reset</b>	ms	

Equ B	Boolean	Logic
B.00	<input type="checkbox"/> = / <input type="checkbox"/> = NOT	
B.01	<input type="checkbox"/> OR / <input type="checkbox"/> = OR NOT / <input type="checkbox"/> AND / <input type="checkbox"/> = AND NOT	
B.02	<input type="checkbox"/> OR / <input type="checkbox"/> = OR NOT / <input type="checkbox"/> AND / <input type="checkbox"/> = AND NOT	
B.03	<input type="checkbox"/> OR / <input type="checkbox"/> = OR NOT / <input type="checkbox"/> AND / <input type="checkbox"/> = AND NOT	
B.04	<input type="checkbox"/> OR / <input type="checkbox"/> = OR NOT / <input type="checkbox"/> AND / <input type="checkbox"/> = AND NOT	
B.05	<input type="checkbox"/> OR / <input type="checkbox"/> = OR NOT / <input type="checkbox"/> AND / <input type="checkbox"/> = AND NOT	
B.06	<input type="checkbox"/> OR / <input type="checkbox"/> = OR NOT / <input type="checkbox"/> AND / <input type="checkbox"/> = AND NOT	
B.07	<input type="checkbox"/> OR / <input type="checkbox"/> = OR NOT / <input type="checkbox"/> AND / <input type="checkbox"/> = AND NOT	
B.08	<input type="checkbox"/> OR / <input type="checkbox"/> = OR NOT / <input type="checkbox"/> AND / <input type="checkbox"/> = AND NOT	
B.09	<input type="checkbox"/> OR / <input type="checkbox"/> = OR NOT / <input type="checkbox"/> AND / <input type="checkbox"/> = AND NOT	
B.10	<input type="checkbox"/> OR / <input type="checkbox"/> = OR NOT / <input type="checkbox"/> AND / <input type="checkbox"/> = AND NOT	
B.11	<input type="checkbox"/> OR / <input type="checkbox"/> = OR NOT / <input type="checkbox"/> AND / <input type="checkbox"/> = AND NOT	
B.12	<input type="checkbox"/> OR / <input type="checkbox"/> = OR NOT / <input type="checkbox"/> AND / <input type="checkbox"/> = AND NOT	
B.13	<input type="checkbox"/> OR / <input type="checkbox"/> = OR NOT / <input type="checkbox"/> AND / <input type="checkbox"/> = AND NOT	
B.14	<input type="checkbox"/> OR / <input type="checkbox"/> = OR NOT / <input type="checkbox"/> AND / <input type="checkbox"/> = AND NOT	
B.15	<input type="checkbox"/> OR / <input type="checkbox"/> = OR NOT / <input type="checkbox"/> AND / <input type="checkbox"/> = AND NOT	
T Operate		ms
T Reset		ms

Equ. C	Boolean	Logic
C.00	<input type="checkbox"/> = / <input type="checkbox"/> = NOT	
C.01	<input type="checkbox"/> OR / <input type="checkbox"/> = OR NOT / <input type="checkbox"/> AND / <input type="checkbox"/> = AND NOT	
C.02	<input type="checkbox"/> OR / <input type="checkbox"/> = OR NOT / <input type="checkbox"/> AND / <input type="checkbox"/> = AND NOT	
C.03	<input type="checkbox"/> OR / <input type="checkbox"/> = OR NOT / <input type="checkbox"/> AND / <input type="checkbox"/> = AND NOT	
C.04	<input type="checkbox"/> OR / <input type="checkbox"/> = OR NOT / <input type="checkbox"/> AND / <input type="checkbox"/> = AND NOT	
C.05	<input type="checkbox"/> OR / <input type="checkbox"/> = OR NOT / <input type="checkbox"/> AND / <input type="checkbox"/> = AND NOT	
C.06	<input type="checkbox"/> OR / <input type="checkbox"/> = OR NOT / <input type="checkbox"/> AND / <input type="checkbox"/> = AND NOT	
C.07	<input type="checkbox"/> OR / <input type="checkbox"/> = OR NOT / <input type="checkbox"/> AND / <input type="checkbox"/> = AND NOT	
C.08	<input type="checkbox"/> OR / <input type="checkbox"/> = OR NOT / <input type="checkbox"/> AND / <input type="checkbox"/> = AND NOT	
C.09	<input type="checkbox"/> OR / <input type="checkbox"/> = OR NOT / <input type="checkbox"/> AND / <input type="checkbox"/> = AND NOT	
C.10	<input type="checkbox"/> OR / <input type="checkbox"/> = OR NOT / <input type="checkbox"/> AND / <input type="checkbox"/> = AND NOT	
C.11	<input type="checkbox"/> OR / <input type="checkbox"/> = OR NOT / <input type="checkbox"/> AND / <input type="checkbox"/> = AND NOT	
C.12	<input type="checkbox"/> OR / <input type="checkbox"/> = OR NOT / <input type="checkbox"/> AND / <input type="checkbox"/> = AND NOT	
C.13	<input type="checkbox"/> OR / <input type="checkbox"/> = OR NOT / <input type="checkbox"/> AND / <input type="checkbox"/> = AND NOT	
C.14	<input type="checkbox"/> OR / <input type="checkbox"/> = OR NOT / <input type="checkbox"/> AND / <input type="checkbox"/> = AND NOT	
C.15	<input type="checkbox"/> OR / <input type="checkbox"/> = OR NOT / <input type="checkbox"/> AND / <input type="checkbox"/> = AND NOT	
T Operate		ms
T Reset		ms

Equ. D	Boolean	Logic
D.00	<input type="checkbox"/> = / <input type="checkbox"/> = NOT	
D.01	<input type="checkbox"/> OR / <input type="checkbox"/> = OR NOT / <input type="checkbox"/> AND / <input type="checkbox"/> = AND NOT	
D.02	<input type="checkbox"/> OR / <input type="checkbox"/> = OR NOT / <input type="checkbox"/> AND / <input type="checkbox"/> = AND NOT	
D.03	<input type="checkbox"/> OR / <input type="checkbox"/> = OR NOT / <input type="checkbox"/> AND / <input type="checkbox"/> = AND NOT	
D.04	<input type="checkbox"/> OR / <input type="checkbox"/> = OR NOT / <input type="checkbox"/> AND / <input type="checkbox"/> = AND NOT	
D.05	<input type="checkbox"/> OR / <input type="checkbox"/> = OR NOT / <input type="checkbox"/> AND / <input type="checkbox"/> = AND NOT	
D.06	<input type="checkbox"/> OR / <input type="checkbox"/> = OR NOT / <input type="checkbox"/> AND / <input type="checkbox"/> = AND NOT	
D.07	<input type="checkbox"/> OR / <input type="checkbox"/> = OR NOT / <input type="checkbox"/> AND / <input type="checkbox"/> = AND NOT	
D.08	<input type="checkbox"/> OR / <input type="checkbox"/> = OR NOT / <input type="checkbox"/> AND / <input type="checkbox"/> = AND NOT	
D.09	<input type="checkbox"/> OR / <input type="checkbox"/> = OR NOT / <input type="checkbox"/> AND / <input type="checkbox"/> = AND NOT	
D.10	<input type="checkbox"/> OR / <input type="checkbox"/> = OR NOT / <input type="checkbox"/> AND / <input type="checkbox"/> = AND NOT	
D.11	<input type="checkbox"/> OR / <input type="checkbox"/> = OR NOT / <input type="checkbox"/> AND / <input type="checkbox"/> = AND NOT	
D.12	<input type="checkbox"/> OR / <input type="checkbox"/> = OR NOT / <input type="checkbox"/> AND / <input type="checkbox"/> = AND NOT	
D.13	<input type="checkbox"/> OR / <input type="checkbox"/> = OR NOT / <input type="checkbox"/> AND / <input type="checkbox"/> = AND NOT	
D.14	<input type="checkbox"/> OR / <input type="checkbox"/> = OR NOT / <input type="checkbox"/> AND / <input type="checkbox"/> = AND NOT	
D.15	<input type="checkbox"/> OR / <input type="checkbox"/> = OR NOT / <input type="checkbox"/> AND / <input type="checkbox"/> = AND NOT	
T Operate		ms
T Reset		ms

Equ. E	Boolean	Logic
E.00	<input type="checkbox"/> = / <input type="checkbox"/> = NOT	
E.01	<input type="checkbox"/> OR / <input type="checkbox"/> = OR NOT / <input type="checkbox"/> AND / <input type="checkbox"/> = AND NOT	
E.02	<input type="checkbox"/> OR / <input type="checkbox"/> = OR NOT / <input type="checkbox"/> AND / <input type="checkbox"/> = AND NOT	
E.03	<input type="checkbox"/> OR / <input type="checkbox"/> = OR NOT / <input type="checkbox"/> AND / <input type="checkbox"/> = AND NOT	
E.04	<input type="checkbox"/> OR / <input type="checkbox"/> = OR NOT / <input type="checkbox"/> AND / <input type="checkbox"/> = AND NOT	
E.05	<input type="checkbox"/> OR / <input type="checkbox"/> = OR NOT / <input type="checkbox"/> AND / <input type="checkbox"/> = AND NOT	
E.06	<input type="checkbox"/> OR / <input type="checkbox"/> = OR NOT / <input type="checkbox"/> AND / <input type="checkbox"/> = AND NOT	
E.07	<input type="checkbox"/> OR / <input type="checkbox"/> = OR NOT / <input type="checkbox"/> AND / <input type="checkbox"/> = AND NOT	
E.08	<input type="checkbox"/> OR / <input type="checkbox"/> = OR NOT / <input type="checkbox"/> AND / <input type="checkbox"/> = AND NOT	
E.09	<input type="checkbox"/> OR / <input type="checkbox"/> = OR NOT / <input type="checkbox"/> AND / <input type="checkbox"/> = AND NOT	
E.10	<input type="checkbox"/> OR / <input type="checkbox"/> = OR NOT / <input type="checkbox"/> AND / <input type="checkbox"/> = AND NOT	
E.11	<input type="checkbox"/> OR / <input type="checkbox"/> = OR NOT / <input type="checkbox"/> AND / <input type="checkbox"/> = AND NOT	
E.12	<input type="checkbox"/> OR / <input type="checkbox"/> = OR NOT / <input type="checkbox"/> AND / <input type="checkbox"/> = AND NOT	
E.13	<input type="checkbox"/> OR / <input type="checkbox"/> = OR NOT / <input type="checkbox"/> AND / <input type="checkbox"/> = AND NOT	
E.14	<input type="checkbox"/> OR / <input type="checkbox"/> = OR NOT / <input type="checkbox"/> AND / <input type="checkbox"/> = AND NOT	
E.15	<input type="checkbox"/> OR / <input type="checkbox"/> = OR NOT / <input type="checkbox"/> AND / <input type="checkbox"/> = AND NOT	
T Operate		ms
T Reset		ms

Equ. F	Boolean	Logic
F.00	<input type="checkbox"/> = / <input type="checkbox"/> = NOT	
F.01	<input type="checkbox"/> OR / <input type="checkbox"/> = OR NOT / <input type="checkbox"/> AND / <input type="checkbox"/> = AND NOT	
F.02	<input type="checkbox"/> OR / <input type="checkbox"/> = OR NOT / <input type="checkbox"/> AND / <input type="checkbox"/> = AND NOT	
F.03	<input type="checkbox"/> OR / <input type="checkbox"/> = OR NOT / <input type="checkbox"/> AND / <input type="checkbox"/> = AND NOT	
F.04	<input type="checkbox"/> OR / <input type="checkbox"/> = OR NOT / <input type="checkbox"/> AND / <input type="checkbox"/> = AND NOT	
F.05	<input type="checkbox"/> OR / <input type="checkbox"/> = OR NOT / <input type="checkbox"/> AND / <input type="checkbox"/> = AND NOT	
F.06	<input type="checkbox"/> OR / <input type="checkbox"/> = OR NOT / <input type="checkbox"/> AND / <input type="checkbox"/> = AND NOT	
F.07	<input type="checkbox"/> OR / <input type="checkbox"/> = OR NOT / <input type="checkbox"/> AND / <input type="checkbox"/> = AND NOT	
F.08	<input type="checkbox"/> OR / <input type="checkbox"/> = OR NOT / <input type="checkbox"/> AND / <input type="checkbox"/> = AND NOT	
F.09	<input type="checkbox"/> OR / <input type="checkbox"/> = OR NOT / <input type="checkbox"/> AND / <input type="checkbox"/> = AND NOT	
F.10	<input type="checkbox"/> OR / <input type="checkbox"/> = OR NOT / <input type="checkbox"/> AND / <input type="checkbox"/> = AND NOT	
F.11	<input type="checkbox"/> OR / <input type="checkbox"/> = OR NOT / <input type="checkbox"/> AND / <input type="checkbox"/> = AND NOT	
F.12	<input type="checkbox"/> OR / <input type="checkbox"/> = OR NOT / <input type="checkbox"/> AND / <input type="checkbox"/> = AND NOT	
F.13	<input type="checkbox"/> OR / <input type="checkbox"/> = OR NOT / <input type="checkbox"/> AND / <input type="checkbox"/> = AND NOT	
F.14	<input type="checkbox"/> OR / <input type="checkbox"/> = OR NOT / <input type="checkbox"/> AND / <input type="checkbox"/> = AND NOT	
F.15	<input type="checkbox"/> OR / <input type="checkbox"/> = OR NOT / <input type="checkbox"/> AND / <input type="checkbox"/> = AND NOT	
T Operate		ms
T Reset		ms

Equ. G	Boolean	Logic
G.00	<input type="checkbox"/> = / <input type="checkbox"/> = NOT	
G.01	<input type="checkbox"/> OR / <input type="checkbox"/> = OR NOT / <input type="checkbox"/> AND / <input type="checkbox"/> = AND NOT	
G.02	<input type="checkbox"/> OR / <input type="checkbox"/> = OR NOT / <input type="checkbox"/> AND / <input type="checkbox"/> = AND NOT	
G.03	<input type="checkbox"/> OR / <input type="checkbox"/> = OR NOT / <input type="checkbox"/> AND / <input type="checkbox"/> = AND NOT	
G.04	<input type="checkbox"/> OR / <input type="checkbox"/> = OR NOT / <input type="checkbox"/> AND / <input type="checkbox"/> = AND NOT	
G.05	<input type="checkbox"/> OR / <input type="checkbox"/> = OR NOT / <input type="checkbox"/> AND / <input type="checkbox"/> = AND NOT	
G.06	<input type="checkbox"/> OR / <input type="checkbox"/> = OR NOT / <input type="checkbox"/> AND / <input type="checkbox"/> = AND NOT	
G.07	<input type="checkbox"/> OR / <input type="checkbox"/> = OR NOT / <input type="checkbox"/> AND / <input type="checkbox"/> = AND NOT	
G.08	<input type="checkbox"/> OR / <input type="checkbox"/> = OR NOT / <input type="checkbox"/> AND / <input type="checkbox"/> = AND NOT	
G.09	<input type="checkbox"/> OR / <input type="checkbox"/> = OR NOT / <input type="checkbox"/> AND / <input type="checkbox"/> = AND NOT	
G.10	<input type="checkbox"/> OR / <input type="checkbox"/> = OR NOT / <input type="checkbox"/> AND / <input type="checkbox"/> = AND NOT	
G.11	<input type="checkbox"/> OR / <input type="checkbox"/> = OR NOT / <input type="checkbox"/> AND / <input type="checkbox"/> = AND NOT	
G.12	<input type="checkbox"/> OR / <input type="checkbox"/> = OR NOT / <input type="checkbox"/> AND / <input type="checkbox"/> = AND NOT	
G.13	<input type="checkbox"/> OR / <input type="checkbox"/> = OR NOT / <input type="checkbox"/> AND / <input type="checkbox"/> = AND NOT	
G.14	<input type="checkbox"/> OR / <input type="checkbox"/> = OR NOT / <input type="checkbox"/> AND / <input type="checkbox"/> = AND NOT	
G.15	<input type="checkbox"/> OR / <input type="checkbox"/> = OR NOT / <input type="checkbox"/> AND / <input type="checkbox"/> = AND NOT	
T Operate		ms
T Reset		ms

Equ. H	Boolean	Logic
H.00	<input type="checkbox"/> = / <input type="checkbox"/> = NOT	
H.01	<input type="checkbox"/> OR / <input type="checkbox"/> = OR NOT / <input type="checkbox"/> AND / <input type="checkbox"/> = AND NOT	
H.02	<input type="checkbox"/> OR / <input type="checkbox"/> = OR NOT / <input type="checkbox"/> AND / <input type="checkbox"/> = AND NOT	
H.03	<input type="checkbox"/> OR / <input type="checkbox"/> = OR NOT / <input type="checkbox"/> AND / <input type="checkbox"/> = AND NOT	
H.04	<input type="checkbox"/> OR / <input type="checkbox"/> = OR NOT / <input type="checkbox"/> AND / <input type="checkbox"/> = AND NOT	
H.05	<input type="checkbox"/> OR / <input type="checkbox"/> = OR NOT / <input type="checkbox"/> AND / <input type="checkbox"/> = AND NOT	
H.06	<input type="checkbox"/> OR / <input type="checkbox"/> = OR NOT / <input type="checkbox"/> AND / <input type="checkbox"/> = AND NOT	
H.07	<input type="checkbox"/> OR / <input type="checkbox"/> = OR NOT / <input type="checkbox"/> AND / <input type="checkbox"/> = AND NOT	
H.08	<input type="checkbox"/> OR / <input type="checkbox"/> = OR NOT / <input type="checkbox"/> AND / <input type="checkbox"/> = AND NOT	
H.09	<input type="checkbox"/> OR / <input type="checkbox"/> = OR NOT / <input type="checkbox"/> AND / <input type="checkbox"/> = AND NOT	
H.10	<input type="checkbox"/> OR / <input type="checkbox"/> = OR NOT / <input type="checkbox"/> AND / <input type="checkbox"/> = AND NOT	
H.11	<input type="checkbox"/> OR / <input type="checkbox"/> = OR NOT / <input type="checkbox"/> AND / <input type="checkbox"/> = AND NOT	
H.12	<input type="checkbox"/> OR / <input type="checkbox"/> = OR NOT / <input type="checkbox"/> AND / <input type="checkbox"/> = AND NOT	
H.13	<input type="checkbox"/> OR / <input type="checkbox"/> = OR NOT / <input type="checkbox"/> AND / <input type="checkbox"/> = AND NOT	
H.14	<input type="checkbox"/> OR / <input type="checkbox"/> = OR NOT / <input type="checkbox"/> AND / <input type="checkbox"/> = AND NOT	
H.15	<input type="checkbox"/> OR / <input type="checkbox"/> = OR NOT / <input type="checkbox"/> AND / <input type="checkbox"/> = AND NOT	
<b>T Operate</b>		ms
<b>T Reset</b>		ms

**2.8 RECORDING Menu**

2.8.1 CB MONITORING Record

P122 & P123 only.

<b>CB Monitoring Time</b>	s
<b>CB Closing Time</b>	s
<b>CB Operations RST = [C]</b>	
<b>Σ Amps (n) RST = [C]</b>	
<b>Σ Amps (n) IA</b>	
<b>Σ Amps (n) IB</b>	
<b>Σ Amps (n) IC</b>	

2.8.2 FAULT RECORD Record

<b>Record Number</b>	
<b>Fault Time</b>	: :
<b>Fault date</b>	/ /
<b>Active Set Group</b>	<input type="checkbox"/> 1 <input type="checkbox"/> 2
<b>Faulted phase</b>	<input type="checkbox"/> None <input type="checkbox"/> Phase A <input type="checkbox"/> Phase B <input type="checkbox"/> Phase C <input type="checkbox"/> Earth <input type="checkbox"/> AB <input type="checkbox"/> AC <input type="checkbox"/> BC <input type="checkbox"/> ABC
<b>Threshold I&gt;&gt;</b>	
<b>Magnitude</b>	A
<b>IA Magnitude</b>	A
<b>IB Magnitude</b>	A
<b>IC Magnitude</b>	A
<b>IN Magnitude</b>	A

2.8.3 INSTANTANEOUS Record

<b>Number</b>	<input type="checkbox"/> 1 <input type="checkbox"/> 2 <input type="checkbox"/> 3 <input type="checkbox"/> 4 <input type="checkbox"/> 5
<b>Hour</b>	: : :
<b>Date</b>	/ /
<b>Origin</b>	
<b>Length</b>	s
<b>Trip</b>	<input type="checkbox"/> YES <input type="checkbox"/> NO

2.8.4 DISTURBANCE RECORD

<b>Pre-time</b>	ms
<b>Post-time</b>	ms
<b>Disturb Rec Trig</b>	<input type="checkbox"/> ON INST. <input type="checkbox"/> ON TRIP

2.8.5 TIME PEAK VALUE

<b>Time Window</b>	mn
--------------------	----

2.8.6 ROLLING DEMAND

<b>Sub Period</b>	mn
<b>Num of Sub Per.</b>	



**HARDWARE/SOFTWARE  
VERSION  
P120 (V11)  
P121 P122 P123 (V12)  
HISTORY AND  
COMPATIBILITY**



## **CONTENTS**

---

<b>1.</b>	<b>INTRODUCTION</b>	<b>3</b>
<b>2.</b>	<b>MiCOM P120</b>	<b>4</b>
<b>3.</b>	<b>MiCOM P121</b>	<b>8</b>
<b>4.</b>	<b>MiCOM P122</b>	<b>12</b>
<b>5.</b>	<b>MiCOM P123</b>	<b>24</b>

---

**BLANK PAGE**

## 1. INTRODUCTION

HARDWARE INSTALLED
<b>HARD 1</b>
<b>HARD 2</b> Evolutions: - Add flash memory
<b>HARD 3</b> Evolutions: - The digital inputs can operate in AC voltage - The watchdog output is now a change over contact
<b>HARD 4</b> Evolutions: - CPU release D incompatible with the preceding ones. - The power supply battery box MiCOM E1 is available to ensure temporary supply to the relay to consult or modify data.
<b>HARD 5</b> Evolutions: - CPU redesign <ul style="list-style-type: none"><li>* new microprocessor (300MHz)</li><li>* new RAM (2Mb)</li><li>* new flash memory (20Mb) to replace BBRAM, EEPROM &amp; front face battery</li><li>* lead free design</li><li>* Hardware watchdog</li></ul> - wide range power supply (24 – 250 Vdc/48-240Vac) - wide range digital input (24 – 250 Vdc/ 24-240Vac) - ANSI compliance for dielectric withstand of trip/close contacts

**2. MiCOM P120**

<b>Relay Type P120</b>				
Software Version	Date of Issue	Full Description of Changes	S1 Compatibility	Backward Compatibility with previous hardware
V1.F	11/06/99	Resolution of KITZ201 problem Modification of the output relay latching	–	HARD V 2 HARD V 3 HARD V 4
V3.B	19/11/99	Suppression of password in order to acknowledge the alarms Auto acknowledgement of the instantaneous Modbus time out of 200 ms Display of the letter P in the menu N and N-1 when password is active	≥V2.0	HARD V 3 HARD V 4
V3.C	22/08/00	VDEW improvements	≥V2.0	
V4.A	15/03/01	Integration of DNP3 protocol Management of alternative logic input Latching of the auxiliary output relay by relay and not by function The digital input can work with AC signals (100 to 250 V AC)	≥V2.0	HARD V 4
V4.D	27/08/02	Courier improvement: adding of the cell 0010 (CB control) IEC103: correction of the checksum calculation for short message.	≥V2.0	HARD V 4
V6.A	18/06/03	Add periodic self test of EEPROM data / calibration every 24 hours with safeguard of the results in safeguarded RAM. Add a new major alarm "Default settings" which is set after an EEPROM data error, and the following reloading of the default settings, and automatically reset after the following parameter write. IEC870-5-103 communication: - add ASDU 3.4 for measurement IN, instead of private ASDU 77, for setting in conformity with the standard (cf P127).	V2.07	Two versions HARD 3 <u>or</u> HARD 4  (HARD 2 → *)

<b>Relay Type P120</b>				
Software Version	Date of Issue	Full Description of Changes	S1 Compatibility	Backward Compatibility with previous hardware
V6.C	07/04/04	<p><u>Software changes implemented in this version</u></p> <p>MODBUS communication: added MODBUS address filtering (rear panel).</p> <p><u>Software improvement in this version</u></p> <p>Modification to process leds for instantaneous alarms when they are self-acknowledged by the trip, or another instantaneous alarm (before this fix, these instantaneous alarms were not visible on configured leds). (Same fix than for P121).</p> <p>Modification to fix upload program for FPGA of new CPU board (index E or higher).</p> <p>Modification on 3rd threshold delay le&gt;&gt;&gt;, whose limitation test was done on 1st threshold delay le&gt;.</p>	V2.07	<p>Two versions                      HARD 3 <u>or</u>                      HARD 4</p> <p>(HARD 2 → *)</p>
V6.D	12/03/06	<p><u>Software changes implemented in this version</u></p> <p>Added EA Approval option: Filtering of logical inputs on 24 samples instead of 8 (on 1,5 period).</p> <p><u>Software improvement in this version</u></p> <p>Blocking of Px2x relay with IEC-103 communication after reception of a time synchronisation frame.</p> <p>Start In&gt; correction of IEC-103 communication on (when going down).</p> <p>Recopy of the length of restored message when a message repetition is asked with IEC-103 communication.</p> <p>CO2 curves ratios correction.</p> <p>New DNP3 address is taken in</p>	V2.12	<p>Two versions                      HARD 3 <u>or</u>                      HARD 4</p> <p>(HARD 2 → *)</p>
V10.D	29/08/06	<p>v10.D software is equivalent to v6.D software based on the phase II hardware redesign (HARD 5)</p> <p><u>Software changes implemented in this version</u></p> <p>Multilanguage Human Machine Interface</p> <p>Front port communication available (RS232 port)</p>	V2.14	HARD 5

Relay Type P120				
Software Version	Date of Issue	Full Description of Changes	S1 Compatibility	Backward Compatibility with previous hardware
V11.A	11/06/07	<p><u>Software changes implemented in this version</u></p> <p>Calibration value memorization.</p> <p>Auxiliary logic inputs temporized, with alarm displayed or not (by setting), assignable to LED, to Trip order, to output relays or to logic equations.</p> <p>RL1 &amp; RL2 can be configured as Fail safe</p> <p>Possibility to have contact outputs inverted to trip on drop of signals</p> <p>Time Synchronization through a digital Input</p> <p>TMS step to 0.001 of the TMS as well as the RTMS. That will authorize a better precision for the small values.</p> <p>Logic inputs assignable to one or several internal signal. Each signal result of a logical OR of all inputs assigned to it.</p> <p>Digital inputs can be directly assigned to outputs.</p> <p>Increase the number of fault records from 5 to 25.</p> <p>Increase the number of event records from 75 to 250.</p> <p>Correction of disturbance record in case of avalanche</p> <p>Event record time tagging correction</p> <p>Communication protocol enhancement (Modbus, DNP3 &amp; Courier)</p>	V2.14	HARD 5
V11.C		<p><u>Software changes implemented in this version</u></p> <ul style="list-style-type: none"> <li>- tAux1 and tAux2 modifications: <ul style="list-style-type: none"> <li>. assigned to inputs,</li> <li>. temporization,</li> <li>. alarm inhibited,</li> <li>. Trip,</li> <li>. latching,</li> <li>. blocking logic,</li> <li>. assigned to outputs.</li> </ul> </li> <li>- IEC-103 and Courier: correction of the acknowledgement of the disturbance record.</li> <li>- Modbus: <ul style="list-style-type: none"> <li>. correction of the manual, self and disturbance record acknowledgement,</li> <li>. address added to the event setting group change,</li> <li>. disturbance record: correction of the number of pages and sample in the last page,</li> <li>. hardware alarm after a communication failure,</li> </ul> </li> <li>- correction of LSB of square root.</li> </ul>	V2.14	HARD 5
V11.D	2011	New Schneider Electric brand	S1 Studio	Hard 5



<b>Relay Type P120</b>				
Software Version	Date of Issue	Full Description of Changes	S1 Compatibility	Backward Compatibility with previous hardware
V11.E	2011	<p><u>Software changes implemented in this version</u></p> <ul style="list-style-type: none"> <li>- Possibility to control locally a General Reset and to start a disturbance record from the relay HMI,</li> <li>- Turkish language added</li> <li>- Reading of event without number improved (ModBus)</li> <li>- Correction of event's bit when &gt;12,</li> <li>- Courier protocol: correction of SKd_setNb() function</li> <li>- modification of alarms and LEDs saving</li> <li>- Modification of date and time failure hardware alarms,</li> <li>- Improvement of the reception (rear communication),</li> <li>- DNP3: restart and multi-fragment responses corrections,</li> <li>- IEC-103 communication: ACD bit correction after general or time synchro command reception</li> </ul>	S1 Studio	Hard 5

**3. MiCOM P121**

<b>Relay Type P121</b>				
Software Version	Date of Issue	Full Description of Changes	S1 Compatibility	Backward Compatibility with previous hardware
V2.J	30/08/99	MODBUS improvement: Correction of al encountered problem (answer to a synchronisation telegram, creation of a 2 seconds time out ...)	–	HARD V 2 HARD V 3 HARD V 4
V3.B	19/11/99	Suppression of password in order to acknowledge the alarms  Auto acknowledgement of the instantaneous Modbus time out of 200 ms  Display of the letter P in the menu N and N-1 when password is active	≥V2.0	HARD V 3 HARD V 4
V3.C	25/01/00	Evolution of Modbus writing 16 bits	≥V2.0	
V3.E	16/03/00	Czech and Hungarian version delivery	≥V2.0	
V3.G	22/08/00	VDEW improvements	≥V2.0	
V4.E	31/01/01	<u>Latch of the output relays</u>  Latch of the auxiliary relays, relay by relay and not by function (like previously up to V3 version). On the other hand the latch of the TRIP output relay remains by function.  If the auxiliary relays are latched, no alarm is displayed. For an acknowledgment of the latch the user has to go in the OP-PARAMETERS/Relay status Menu and push on the «Ⓢ» clear push button.  DNP3 level 2 and 3  Addition of the tripping and closing order for IEC103  The digital input can work with AC signals (100 to 250 V AC)	≥V2.0	HARD V 4
V5.D	31/01/01	Improvement of the english labels.	≥V2.0	
V5.F	08/08/02	Courier improvment: adding of the cell 0010 (CB control)  IEC103: correction of the checksum calculation for short message.	≥V2.0	HARD V 4
V5.G	24/10/02	Added Private messages option (for non standard protection functions) in IEC870-5-103 communication.	V2.07	Two versions HARD 3 <u>or</u> HARD 4  (HARD 2 → *)

<b>Relay Type P121</b>				
Software Version	Date of Issue	Full Description of Changes	S1 Compatibility	Backward Compatibility with previous hardware
V6.A	18/06/03	<p>Add periodic self test of EEPROM data / calibration every 24 hours with safeguard of the results in safeguarded RAM.</p> <p>Add a new major alarm "Default settings" which is set after an EEPROM data error, and the following reloading of the default settings, and automatically reset after the following parameter write.</p> <p>IEC870-5-103 communication:                      - add ASDU 3.4 for measurement IN, instead of private ASDU 77, for setting in conformity with the standard (cf P127).</p>	V2.09	<p>Two versions                      HARD 3 <u>or</u>                      HARD 4</p> <p>(HARD 2 → *)</p>
V6.B	18/07/03	<p>Improvement of the reading of the alarm "<b>EEPROM DATA FAULT</b>" when much access EEPROM is done:</p> <ul style="list-style-type: none"> <li>- Optimization of the readings in E2PROM (writing of the value of the checksums in internal RAM).</li> <li>- The function of access to the E2PROM becomes protected from the interruptions.</li> </ul>	V2.09	<p>Two versions                      HARD 3 <u>or</u>                      HARD 4</p> <p>(HARD 2 → *)</p>
V6.C	28/11/03	<p><u>Software changes implemented in this version</u></p> <ul style="list-style-type: none"> <li>- Modif. treatment of the thermal model: 20 milliseconds instead of 100.</li> <li>- Evolutions communication MODBUS: addition of the read quick byte (Function 7) by reading of words (Function 03 or 04), and of the reading of the date (on page 8).</li> <li>- Communication MODBUS Front Face: addition of the filtering of address.</li> </ul> <p><u>Software improvement done in this version</u>                      Fix on RI curves processing in certain cases.</p>	V2.10	<p>Two versions                      HARD 3 <u>or</u>                      HARD 4</p> <p>(HARD 2 → *)</p>
V6.D	11/12/03	<p><u>Software improvement done in this version</u></p> <p>Modification to remove the taking into account of the number of defect in the calculation of checksum of page 1 of E2PROM, like in autotest E2PROM.</p>	V2.10	<p>Two versions                      HARD 3 <u>or</u>                      HARD 4</p> <p>(HARD 2 → *)</p>
V6.E	07/06/04	<p><u>Software changes implemented in this version</u></p> <p>DNP3 modifications: Binary inputs move to Class 0. Acceptance of variation 2 object 1.</p> <p>Modified German texts for Front panel.</p> <p><u>Software improvement done in this version</u></p> <p>Modification to fix upload program for FPGA of new CPU board (index E or higher).</p> <p>Fixed checksum verification test in Front panel MODBUS communication.</p> <p>Fixed a shift in the fault numbers introduced by error since V6.A and V6.B.</p>	V2.10	<p>Two versions                      HARD 3 <u>or</u>                      HARD 4</p> <p>(HARD 2 → *)</p>

<b>Relay Type P121</b>				
Software Version	Date of Issue	Full Description of Changes	S1 Compatibility	Backward Compatibility with previous hardware
V6.G	11/01/05	<p><u>Software changes implemented in this version</u></p> <p>Possibility to come back to the head line of the menu by pressing Clear Button.</p> <p><u>Software improvement done in this version</u></p> <p>None.</p>	V2.12	Two versions HARD 3 <u>or</u> HARD 4  (HARD 2 → *)
06H	14/04/05	<p><u>Software changes implemented in this version</u></p> <p>Watchdog behaviour when courier protocol used</p> <p>Primary ration correction when courier protocol used</p> <p>New DNP3 address is taken in account only after a reboot of the relay.</p>	V2.12	HARD 3 <u>or</u> HARD 4, HARD 2* (*See Notes)
06I	19/06/06	<p><u>Software changes implemented in this version</u></p> <p>No Px2x relay blocking after reception of a time synchronisation frame in T103</p> <p>Correction of SF6 front face alarm text and Start I&gt; event when IEC103 used</p>	V2.12	HARD 3 <u>or</u> HARD 4, HARD 2* (*See Notes)
06J	04/08/06	<p><u>Software changes implemented in this version</u></p> <p>Correction of trip Phase L1/L2/L3 events in IEC-103 communication.</p>	V2.12	HARD 3 <u>or</u> HARD 4, HARD 2* (*See Notes)
07.A	16/05/08	<p><u>Software changes implemented in this version</u></p> <p>- Correction of the following defects:</p> <ul style="list-style-type: none"> <li>. DMT temporisation ≥ 20s: decimal values truncated,</li> <li>. parameters of DNP3 and ModBus addresses,</li> <li>. update of the phase indication of alarm tl&gt;,</li> </ul>	V2.14	HARD 3 <u>or</u> HARD 4, HARD 2.
V10.D	29/08/06	<p>v10.D software is equivalent to v6.J software based on the phase II hardware redesign (HARD 5)</p> <p><u>Software changes implemented in this version</u></p> <p>Multilanguage Human Machine Interface</p> <p>Front port communication available (RS232 port)</p>	V2.14	HARD 5

<b>Relay Type P121</b>				
Software Version	Date of Issue	Full Description of Changes	S1 Compatibility	Backward Compatibility with previous hardware
V11.B	11/06/07	<p><u>Software changes implemented in this version</u></p> <p>Calibration value memorization.</p> <p>Auxiliary logic inputs temporized, with alarm displayed or not (by setting), assignable to LED, to Trip order, to output relays or to logic equations.</p> <p>RL1 &amp; RL2 can be configured as Fail safe.</p> <p>Possibility to have contact outputs inverted to trip on drop of signals.</p> <p>TMS step to 0.001 of the TMS as well as the RTMS. That will authorize a better precision for the small values.</p> <p>Logic inputs assignable to one or several internal signal. Each signal result of a logical OR of all inputs assigned to it.</p> <p>Digital inputs can be directly assigned to outputs.</p> <p>The com1 and tcom2 max changes from 5s to 600s.</p> <p>Implementation of 8 Boolean logic equations of 16 operands (NOT, OR &amp; AND).</p> <p>Communication protocol enhancement (Modbus, DNP3 &amp; Courier).</p>	V2.14	HARD 5
V11.C		<p><u>Software changes implemented in this version</u></p> <ul style="list-style-type: none"> <li>- software minor corrections.</li> </ul>	V2.14	HARD 5
V11.D		<p><u>Software changes implemented in this version</u></p> <ul style="list-style-type: none"> <li>- Portuguese language is added.</li> <li>- Correction for communication with system (Pacis...)</li> <li>- initialization of tAux1 and tAux2 procrastination at power on,</li> <li>- tAux1 and tAux2 alarm inhibition corrected,</li> </ul>	V2.14	HARD 5

Relay Type P121				
Software Version	Date of Issue	Full Description of Changes	S1 Compatibility	Backward Compatibility with previous hardware
V11.E	30/06/08	<p><u>Software changes implemented in this version</u></p> <ul style="list-style-type: none"> <li>- Compatibility with MiCOM S1 Studio,</li> <li>- separate output signalization of the three overcurrent (IA&gt;, IB&gt; and IC&gt;).</li> <li>- Language corrections</li> <li>- hardware alarm correction after a communication port failure,</li> <li>- phase indicator alarm modified,</li> <li>- RI delay type in In&gt; protection saved after device restart when settings are loaded with S1 Modbus,</li> <li>- Displayed rms value corrected (when no current injected) corrected,</li> </ul> <p><u>Other documentation changes in B96 TM</u></p> <ul style="list-style-type: none"> <li>- new general presentation</li> <li>- presentation of MiCOM S1 Studio (new GS section)</li> <li>- TD: Phase and earth current transformers consumption added,</li> <li>- AD: more explanation added for transformers inrush current</li> </ul>	V2.14 S1 Studio	Hard 5
V11.F	19/11/08	<p><u>Software changes implemented in this version</u></p> <p>None (modification on P122 &amp; P123 relays only)</p>		
V12.A	01/2009	<p><u>Software changes implemented in this version</u></p> <ul style="list-style-type: none"> <li>- New inhibited alarms added (possibility to inhibit alarm on tAux and Boolean logic)</li> <li>- Suspend IDMT curves on I&gt; &amp; I&gt;&gt;, interlock of I&gt; IDMT by I&gt;&gt; DT or I&gt;&gt;&gt; DT modified,</li> <li>- Logical inputs directly assignable to Boolean Logical Equations,</li> </ul>	V2.14 S1 Studio	Hard 5
V12.B	09/2009	<p><u>Software changes implemented in this version</u></p> <ul style="list-style-type: none"> <li>- Correction of: <ul style="list-style-type: none"> <li>. Chinese text (HMI display),</li> <li>. control trip events when RL1 is assigned to "Ctrl Trip"</li> </ul> </li> </ul>	V2.14 S1 Studio	Hard 5
V12.C	03/2010	<p><u>Software changes implemented in this version</u></p> <ul style="list-style-type: none"> <li>- Correction of: <ul style="list-style-type: none"> <li>. IDMT curve when inrush blocking is used with Ie&gt; or Ie&gt;&gt;</li> <li>. German labels</li> </ul> </li> </ul>	S1 Studio	Hard 5
V12.D	03/2010	General: New Schneider Electric brand	S1 Studio	Hard 5

<b>Relay Type P121</b>				
Software Version	Date of Issue	Full Description of Changes	S1 Compatibility	Backward Compatibility with previous hardware
V12.E	10/2011	<p style="text-align: center;"><u>Software changes implemented in this version</u></p> <ul style="list-style-type: none"><li>- Correction of: alarm message when an auxiliary relay is latched, alarm after a date / time failure Output relay assignation (autorecloser) CB failure reset before the end of a timer if current is null, Logic equation status (address 002Ch) At CB switching on, erratic alarm</li></ul>	S1 Studio	Hard 5

**4. MiCOM P122**

<b>Relay Type P122</b>				
Software Version	Date of Issue	Full Description of Changes	S1 Compatibility	Backward Compatibility with previous hardware
V2.J	30/08/99	MODBUS improvement: Correction of al encountered problem (answer to a synchronisation telegram, creation of a 2 seconds time out ...)	–	HARD V 2 HARD V 3 HARD V 4
V3.B	29/11/99	Suppression of password in order to acknowledge the alarms  Auto acknowledgement of the instantaneous Modbus time out of 200 ms  Display of the letter P in the menu N and N-1 when password is active	≥V2.0	HARD V 3 HARD V 4
V3.C	06/01/00	Label correction	≥V2.0	
V3.D	06/04/00	Evolution of Modbus writing 16 bits	≥V2.0	
V3.E	16/03/00	Czech and Hungarian version delivery	≥V2.0	
V3.G	22/08/00	VDEW improvements	≥V2.0	
V4.E	31/01/01	<u>Latch of the output relays</u> Latch of the auxiliary relays, relay by relay and not by function (like previously up to V3 version). On the other hand the latch of the TRIP output relay remains by function. If the auxiliary relays are latched, an alarm will be displayed. If the user acknowledges this alarm, the auxiliary relays will be delatched.  <u>DNP3 level 2 and 3</u> Addition of the tripping and closing order for IEC103 Phase rotation (ABC or ACB) Third threshold algorithm for improvement of the behaviour on saturated current transformers Timer for the undercurrent feature (0 to 150 sec) Tripping curves (rectifier curve + LABORELLEC curves) Selection of the Setting group by level or by edge. CB fail detection (possibility to inhibit the starting signals) Instantaneous record Rolling demand Peak value demand Instantaneous alarm settable: self or not self reset Matrix for the autorecloser The digital input can work with AC signals signals (24 V to 250 V AC) Necessity to set in HMI Configuration menu, the type of voltage used, either <b>AC</b> or <b>DC</b>	≥V2.0	HARD V 4



<b>Relay Type P122</b>				
Software Version	Date of Issue	Full Description of Changes	S1 Compatibility	Backward Compatibility with previous hardware
V5.A	27/09/01	Maintenance mode for manual command of the output relays  Reset of leds by logic input or control command or front panel or on new fault appearance  Addition of negative sequence protection feature (ANSI code 46) with two thresholds  Addition of the CB supervision feature.	≥V2.0	
V5.C	04/10/01	VDEW improvements  (Updating of the information SCN into the ASDU END OF GENERAL INTERROGATION)	≥V2.0	HARD V 4
V5.D	30/01/02	Addition of order COM1/COM2/COM3/COM4 assignalble on the auxiliary relays.  Addition of the logic inputs AUX3 and AUX 4 do not generating alarm message.  Improvement of english label	≥V2.0	
V5.F	08/08/02	EA approval option: logical input filtering on 24 samples instead of 12 either 15 ms at 50 Hz)  Improvement of the Recording of rolling demand in ram saved. The previous version could lead to an untimely ram saved error message due to the management of this recording  Courier improvement: adding of the cell 0010 (CB control) protected by password  Correction of the configuration of taux3 and taux4 for MODBUS  IEC103: correction of the checksum calculation for short message. Correction of the I0 channel data into the disturbance record	≥V2.0	HARD V 4
V5.G	24/10/02	Added Private messages option option (for non standard protection functions) in IEC870-5-103 communication	V2.07	Two versions HARD 3 <u>or</u> HARD 4  (HARD 2 → *)

Relay Type P122				
Software Version	Date of Issue	Full Description of Changes	S1 Compatibility	Backward Compatibility with previous hardware
V6.A	18/06/03	<p>Add periodic self test of EEPROM data / calibration every 24 hours with safeguard of the results in safeguarded RAM.</p> <p>Add a new major alarm "Default settings" which is set after an EEPROM data error, and the following reloading of the default settings, and automatically reset after the following parameter write.</p> <p>Add "tReset" events for the thresholds I&gt;, I&gt;&gt;, IN&gt;, IN&gt;&gt; and I2&gt;, and "tReset" parameter for the constant time temporization (thresholds I&gt;, I&gt;&gt;, IN&gt; and IN&gt;&gt;).</p> <p>Add "sample" parameter (Yes=Sample or No=RMS values) for the third thresholds I&gt;&gt;&gt; and IN&gt;&gt;&gt;.</p> <p>Add "CB Fail" choice for the "Trip functions" and "Latch functions" parameters. Add "tBF" event.</p> <p>IEC870-5-103 communication:</p> <ul style="list-style-type: none"> <li>- add ASDU 3.4 for measurement IN, instead of private ASDU 77, for setting in conformity with the standard (cf P127).</li> <li>- various improvements: in the management of the validity of the date and season in the messages, modifications in acknowledgement of the orders and time synchronization.</li> </ul>	V2.09	Two versions HARD 3 <u>or</u> HARD 4  (HARD 2 → *)
V6.B	18/07/03	<p>Improvement of the reading of major alarm "<b>EEPROM DATA FAULT</b>" appearing when much access EEPROM is done:</p> <ul style="list-style-type: none"> <li>- Optimization of the readings in E2PROM (writing of the value of the checksums in internal RAM).</li> <li>- Replacement of the data storage circuit breaker in E2PROM by a storage in safeguarded RAM.</li> <li>- The function of access to the E2PROM becomes protected from the interruptions.</li> </ul>	V2.09	Two versions HARD 3 <u>or</u> HARD 4  (HARD 2 → *)

<b>Relay Type P122</b>				
Software Version	Date of Issue	Full Description of Changes	S1 Compatibility	Backward Compatibility with previous hardware
V6.C	28/11/03	<p><u>Software changes implemented in this version</u></p> <ul style="list-style-type: none"> <li>- Addition of function SOFT/TOR: Function allowing send a tripping order without awaiting temporization of release, addition of manual logical input closed (order of manual closing).</li> <li>- Addition of function LOCAL/REMOTE by wiring: addition of logical input LOCAL MODE (mode switch-over local, for inhibition of the writing orders the communication), and addition of exits CONTROL TRIP (remote control of release) and CLOSED CONTROL operate by remote control trip).</li> <li>- Modif. treatment of the thermal model: 20 milliseconds instead of 100.</li> <li>- Evolutions communication MODBUS: addition of the read quick byte (Function 7) by reading of words (Function 03 or 04), and of the reading of the date (on page 8).</li> <li>- Communication MODBUS Front Face: addition of the filtering of address.</li> </ul> <p><u>Software improvement done in this version</u></p> <p>Fix on RI curves processing in certain cases.</p>	V2.10	<p>Two versions                      HARD 3 <u>or</u>                      HARD 4</p> <p>(HARD 2 → *)</p>
V6.D	11/12/03	<p><u>Software improvement done in this version</u></p> <p>Modification to remove the taking into account of the number of defect in the calculation of checksum of page 1 of E2PROM, like in autotest E2PROM.</p>	V2.10	<p>Two versions                      HARD 3 <u>or</u>                      HARD 4</p> <p>(HARD 2 → *)</p>
V6.E	07/06/04	<p><u>Software changes implemented in this version</u></p> <p>Modified recloser function: modified taking in account of manual reclose while blocking by recloser external input.</p> <p>Added a new DNP3 function: fault data can be accessed as analog inputs.</p> <p>DNP3 modifications: Binary inputs move to Class 0. Acceptance of variation 2 object 1.</p> <p>Modified German texts for Front panel.</p> <p><u>Software improvement done in this version</u></p> <p>Modification to fix upload program for FPGA of new CPU board (index E or higher).</p> <p>Improvement on 3<sup>rd</sup> threshold delay le&gt;&gt;&gt;, whose limitation test was done on 1<sup>st</sup> threshold delay le&gt;.</p> <p>Improved SOFT/TOR function.</p> <p>Improved Breaker Fail alarm processing</p> <p>Fixed checksum verification test in Front panel MODBUS communication.</p>	V2.10	<p>Two versions                      HARD 3 <u>or</u>                      HARD 4</p> <p>(HARD 2 → *)</p>

<b>Relay Type P122</b>				
Software Version	Date of Issue	Full Description of Changes	S1 Compatibility	Backward Compatibility with previous hardware
V6.F	08/10/04	<p><u>Software changes implemented in this version</u></p> <p>None.</p> <p><u>Software improvements done in this version</u></p> <p>Improved KBUS/COURIER protocol.</p> <p>IEC870-5-103 protocol: Enhancement to improve all the system product line defect report (RFA disturbance transmission).</p>	V2.10	Two versions HARD 3 <u>or</u> HARD 4  (HARD 2 → *)
V6.G	11/01/05	<p><u>Software changes implemented in this version</u></p> <p>Possibility to come back to the head line of the menu by pressing Clear Button. The setting group change will be done in exclusive way either by setting, either by logic input. The logic input will be active on level. The choice between level or edge is suppressed.</p> <p><u>Software improvements done in this version</u></p> <p>Software improvement done in this version WThe blocking logic feature can be used with a temporisation of the phase or earth current threshold set to zero.</p>	V2.12	Two versions HARD 3 <u>or</u> HARD 4  (HARD 2 → *)
06.I	19/06/06	<p><u>Software changes implemented in this version</u></p> <p>No Px2x relay blocking after reception of a time synchronisation frame in T103</p> <p>Correction of SF6 front face alarm text and Start I&gt; event when IEC103 used</p> <p>IDMT Rectifier curve selection coherency between P12x and MICOM S1.</p> <p>Correction of Start In&gt; event in IEC103 communication (when going down).</p> <p>General trip correction in disturbance records</p> <p>Utilisation of nominal network frequency in the disturbance records (Comtrade format).</p>	V2.12	HARD 3 <u>or</u> HARD 4, HARD 2* (*See Notes)
06J	04/08/06	<p><u>Software changes implemented in this version</u></p> <p>Correction of trip Phase L1/L2/L3 events in IEC-103 communication.</p>	V2.12	HARD 3 <u>or</u> HARD 4, HARD 2* (*See Notes)

<b>Relay Type P122</b>				
Software Version	Date of Issue	Full Description of Changes	S1 Compatibility	Backward Compatibility with previous hardware
07.A	16/05/08	<p><u>Software changes implemented in this version</u></p> <ul style="list-style-type: none"> <li>- Correction of the following defects:                             <ul style="list-style-type: none"> <li>. temporisation IDMT of tReset (tl&gt;&gt; protection): <math>\neq 0s</math> after tl&gt;&gt;,</li> <li>. fault record amplitude I2&gt;&gt; not displayed (front panel),</li> <li>. DMT temporisation <math>\geq 20s</math>: decimal values truncated,</li> <li>. "Trip CB Fail" fault: type of fault not displayed,</li> <li>. SOTF: SOTF when current threshold is not selected, operation with l&gt;&gt; or l&gt;&gt;&gt;with no possibility of reset,</li> <li>. CB supervision, <math>\Sigma amp</math>:                                     <ul style="list-style-type: none"> <li>- measurement with 1 or 2 phases = 0A,</li> <li>- operation after a "CB Operation" sent by ModBus,</li> </ul> </li> <li>. I2&gt; and I2&gt;&gt; not updated when modified with ModBus,</li> <li>. the text for "SF6" alarm is incorrect,</li> <li>. parameters of DNP3 and ModBus addresses,</li> <li>. amplitude of K-Bus and Courier disturbances extraction,</li> <li>. DNP3: events of major and minor hardware alarms,</li> <li>. the content of SRAM backup can be different of corresponding checksum after an update,</li> <li>. update of the phase indication of alarm tl&gt;&gt;,</li> <li>. thermal protection:                                     <ul style="list-style-type: none"> <li>- calculation error when K thermal coefficient <math>\neq 1</math>,</li> <li>- during cooling phase: bad delay between thermal alarm reset and thermal overflow.</li> </ul> </li> </ul> </li> </ul>	V2.14	HARD 3 <u>or</u> HARD 4, HARD 2.
V10.E	29/08/06	<p><u>v10.E software is equivalent to v6.J software based on the phase II hardware redesign (HARD 5)</u></p> <p><u>Software changes implemented in this version</u></p> <p><u>Multilanguage Human Machine Interface</u></p>	V2.14	HARD 5

Relay Type P122				
Software Version	Date of Issue	Full Description of Changes	S1 Compatibility	Backward Compatibility with previous hardware
V11.A	11/06/07	<p><u>Software changes implemented in this version</u></p> <p>Inrush blocking function implementation</p> <p>Calibration value memorization.</p> <p>Auxiliary logic inputs temporized, with alarm displayed or not (by setting), assignable to LED, to Trip order, to output relays or to logic equations.</p> <p>RL1 &amp; RL2 can be configured as Fail safe</p> <p>Possibility to have contact outputs inverted to trip on drop of signals</p> <p>Time Synchronization through a digital Input</p> <p>TMS step to 0.001 of the TMS as well as the RTMS. That will authorize a better precision for the small values.</p> <p>Logic inputs assignable to one or several internal signal. Each signal result of a logical OR of all inputs assigned to it.</p> <p>Digital inputs can be directly assigned to outputs.</p> <p>Increase the number of fault records from 5 to 25.</p> <p>Increase the number of event records from 75 to 250.</p> <p>Correction of disturbance record in case of avalanche</p> <p>Event record time tagging correction</p> <p>Communication protocol enhancement (Modbus, DNP3 &amp; Courier)</p>	V2.14	HARD 5
V11.C		<p><u>Software changes implemented in this version</u></p> <ul style="list-style-type: none"> <li>- software minor corrections.</li> </ul>	V2.14	HARD 5
V11.D		<p><u>Software changes implemented in this version</u></p> <ul style="list-style-type: none"> <li>- Portuguese language is added.</li> <li>- Correction for communication with system (Pacis...)</li> <li>- DMT temporization decimal value corrected for values &gt;20s</li> <li>- Communication Modbus correction: <ul style="list-style-type: none"> <li>. manual, self and disturbance acknowledgment of the oldest event &amp; fault record,</li> <li>. Modbus address added to the event setting group change,</li> </ul> </li> <li>- Communication Modbus of disturbance record: number of pages and samples in the last page in the service name corrected,</li> <li>- "Disturbance trigger" added in the event record.</li> </ul>	V2.14	HARD 5

<b>Relay Type P122</b>				
Software Version	Date of Issue	Full Description of Changes	S1 Compatibility	Backward Compatibility with previous hardware
V11.E	30/06/08	<p><u>Software changes implemented in this version</u></p> <ul style="list-style-type: none"> <li>- Compatibility with MiCOM S1 Studio,</li> <li>- separate output signalization of the three overcurrent (IA&gt;, IB&gt; and IC&gt;).</li> <li>- Language corrections</li> <li>- hardware alarm correction after a communication port failure,</li> <li>- tripping indication (LED) correction,</li> <li>- phase indicator alarm modified,</li> <li>- Displayed rms value corrected (when no current injected) corrected,</li> <li>- CB Supervision: Samps (n) counters after a "CB operations" clear sent with a modbus writing corrected,</li> <li>- process after boot or sending settings file(MiCOM S1) modified.</li> </ul> <p><u>Other documentation changes in B96 TM</u></p> <ul style="list-style-type: none"> <li>- new general presentation</li> <li>- presentation of MiCOM S1 Studio (new GS section)</li> <li>- TD: Phase and earth current transformers consumption added,</li> <li>- AD: more explanation added for transformers inrush current</li> </ul>	V2.14 S1 Studio	Hard 5
V11.F	09/2008	<p><u>Software changes implemented in this version</u></p> <ul style="list-style-type: none"> <li>- "Inrush blocking" applied to IDMT curve correction</li> </ul>	V2.14 S1 Studio	Hard 5

Relay Type P122				
Software Version	Date of Issue	Full Description of Changes	S1 Compatibility	Backward Compatibility with previous hardware
V12.A	01/2009	<p><u>Software changes implemented in this version</u></p> <ul style="list-style-type: none"> <li>- New inhibited alarms added (possibility to inhibit alarm on tAux, I&lt; and Boolean logic)</li> <li>- Possibility to operate the CB and to start a disturbance from the relay HMI,</li> <li>- Manual trip or manual close ordered from a logical input activation</li> <li>- Total trips number calculated with all the CB operations,</li> <li>- Suspend IDMT curves on I&gt; &amp; I&gt;&gt;, interlock of I&gt; IDMT by I&gt;&gt; DT or I&gt;&gt;&gt; DT modified,</li> <li>- Possibility to start Cold Load Pickup by 52A or “not I&lt; &amp; I&gt;” or “I0&lt; &amp; I0&gt;”,</li> <li>- Detection of open circuits conditions which produce an unbalance creating negative phase sequence current,</li> <li>- Addition of a new derived earth overcurrent threshold,</li> <li>- Possibility to assign I&lt; and tI&lt; to any output relay and LED,</li> <li>- Disturbance recorder time modified (5x3s or 3 x 5s or 2 x 7.5s or 1 x 15s)</li> <li>- Logical inputs directly assignable to Boolean Logical Equations,</li> </ul>	V2.14 S1 Studio	Hard 5
V12.B	09/2009	<p><u>Software changes implemented in this version</u></p> <ul style="list-style-type: none"> <li>- Correction of: <ul style="list-style-type: none"> <li>. disturbance recording when two records are triggered successively,</li> <li>. Chinese text (HMI display),</li> <li>. control trip events when RL1 is assigned to “Ctrl Trip”</li> <li>. Time synchronisation with logic input.</li> </ul> </li> </ul>	V2.14 S1 Studio	Hard 5
V12.C	03/2010	<p><u>Software changes implemented in this version</u></p> <ul style="list-style-type: none"> <li>- Correction of <ul style="list-style-type: none"> <li>. IDMT curve when inrush blocking is used with Ie&gt; or Ie&gt;&gt;</li> <li>. German labels</li> </ul> </li> </ul>	S1 Studio	Hard 5
V12.D	03/2010	<p>General: New Schneider Electric brand</p> <p><u>Software changes implemented in this version</u></p> <ul style="list-style-type: none"> <li>- Correction of data transmission (Courier protocol). Fault extracted automatically was sometimes incorrectly transmitted</li> </ul>	S1 Studio	Hard 5



<b>Relay Type P122</b>				
Software Version	Date of Issue	Full Description of Changes	S1 Compatibility	Backward Compatibility with previous hardware
V12.E	10/2011	<p><u>Software changes implemented in this version</u></p> <ul style="list-style-type: none"> <li>- Fault records extraction using IEC103 enhanced protocol,</li> <li>- Possibility to control locally a general reset to clear all events, fault &amp; disturbance records</li> <li>- Correction of:                      alarm message when an auxiliary relay is latched,                      alarm after a date / time failure                      Output relay assignation (autorecloser)                      CB failure reset before the end of a timer if current is null,                      Logic equation status (address 002Ch)                      At CB switching on, erratic alarm</li> </ul>	V2.14	HARD 5

**5. MiCOM P123**

<b>Relay Type P123</b>				
Software Version	Date of Issue	Full Description of Changes	S1 Compatibility	Backward Compatibility with previous hardware
V2.J	30/08/99	MODBUS improvement: Correction of al encountered problem (answer to a synchronisation telegram, creation of a 2 seconds time out ...)	–	HARD V 2 HARD V 3 HARD V 4
V3.B	29/11/99	Suppression of password in order to acknowledge the alarms  Auto acknowledgement of the instantaneous Modbus time out of 200 ms  Display of the letter P in the menu N and N-1 when password is active	≥V2.0	HARD V 3 HARD V 4
V3.C	06/01/00	Label correction	≥V2.0	
V3.D	06/04/00	Evolution of Modbus writing 16 bits	≥V2.0	
V3.E	13/04/00	Czech and Hungarian version delivery	≥V2.0	
V3.G	22/08/00	VDEW improvements	≥V2.0	
V4.E	31/01/01	<u>Latch of the output relays</u> Latch of the auxiliary relays, relay by relay and not by function (like previously up to V3 version). On the other hand the latch of the TRIP output relay remains by function. If the auxiliary relays are latched, an alarm will be displayed. If the user acknowledges this alarm, the auxiliary relays will be delatched.  <u>DNP3 level 2 and 3</u> Addition of the tripping and closing order for IEC103 Phase rotation (ABC or ACB) Third threshold algorithm for improvement of the behaviour on saturated current transformers Timer for the undercurrent feature (0 to 150 sec) Tripping curves (rectifier curve + LABORELLEC curves)	≥V2.0	HARD V 4
V4.E cont'd)	31/01/01	Selection of the Setting group by level or by edge. CB fail detection (possibility to inhibit the starting signals) Instantaneous record Rolling demand Peak value demand Instantaneous alarm settable: self or not self reset Matrix for the auto-recloser Addition of a second threshold with definite time for the I2 feature The digital input can work with AC signals (24 V to 250 V AC) Necessity to set in HMI Configuration menu, the type of voltage used, either <b>AC</b> or <b>DC</b> .	≥V2.0	HARD V 4

<b>Relay Type P123</b>				
Software Version	Date of Issue	Full Description of Changes	S1 Compatibility	Backward Compatibility with previous hardware
V5.A	27/09/01	Maintenance mode for manual command of the output relays  Reset of leds by logic input or control command or front panel or on new fault appearance	≥V2.0	HARD V4
V5.C	04/10/01	VDEW improvements  (Updating of the information SCN into the END OF GENERAL INTERROGATION ASDU)	≥V2.0	
V5.D	30/01/02	Addition of order COM1/COM2/COM3/COM4 assignalble on the auxiliary relays.  Addition of the logic inputs AUX3 and AUX 4 do not generating alarm message.  Improvement of english label	≥V2.0	
V5.F	08/08/02	EA approval option: logical input filtering on 24 samples instead of 12 either 15 ms at 50 Hz) Improvement of the Recording of rolling demand in ram saved. The previous version could lead to an untimely ram saved error message due to the management of this recording Courier improvment: adding of the cell 0010 (CB control) protected by password Correction of the configuration of taux3 and taux4 for MODBUS IEC103: correction of the checksum calculation for short message. Correction of the I0 channel data into the disturbance record	≥V2.0	HARD V4
V5.G	24/10/02	Added Private messages option option (for non standard protection functions) in IEC870-5-103 communication	V2.07	Two versions HARD 3 <u>or</u> HARD 4  (HARD 2 → *)

Relay Type P123				
Software Version	Date of Issue	Full Description of Changes	S1 Compatibility	Backward Compatibility with previous hardware
V6.A	18/06/03	<p>Add periodic self test of EEPROM data / calibration every 24 hours with safeguard of the results in safeguarded RAM.</p> <p>Add a new major alarm "Default settings" which is set after an EEPROM data error, and the following reloading of the default settings, and automatically reset after the following parameter write.</p> <p>Add "tReset" events for the thresholds I&gt;, I&gt;&gt;, IN&gt;, IN&gt;&gt; and I2&gt;, and "tReset" parameter for the constant time temporization (thresholds I&gt;, I&gt;&gt;, IN&gt; and IN&gt;&gt;).</p> <p>Add "sample" parameter (Yes=Sample or No=RMS values) for the third thresholds I&gt;&gt;&gt; and IN&gt;&gt;&gt;.</p> <p>Add "CB Fail" choice for the "Trip functions" and "Latch functions" parameters. Add "tBF" event.</p> <p>IEC870-5-103 communication:</p> <ul style="list-style-type: none"> <li>- add ASDU 3.4 for measurement IN, instead of private ASDU 77, for setting in conformity with the standard (cf P127).</li> <li>- various improvements: in the management of the validity of the date and season in the messages, modifications in acknowledgement of the orders and time synchronization.</li> </ul>	V2.09 Patch Modbus V2.08.005	Two versions HARD 3 <u>or</u> HARD 4  (HARD 2 → *)
V6.B	18/07/03	<p>Improvement of the reading of major alarm "<b>EEPROM DATA FAULT</b>" appearing when much access EEPROM is done:</p> <ul style="list-style-type: none"> <li>- Optimization of the readings in E2PROM (writing of the value of the checksums in internal RAM).</li> <li>- Replacement of the data storage circuit breaker in E2PROM by a storage in safeguarded RAM.</li> <li>- The function of access to the E2PROM becomes protected from the interruptions.</li> </ul>	V2.09 Patch Modbus V2.08.005	Two versions HARD 3 <u>or</u> HARD 4  (HARD 2 → *)

<b>Relay Type P123</b>				
Software Version	Date of Issue	Full Description of Changes	S1 Compatibility	Backward Compatibility with previous hardware
V6.C	28/11/03	<p><u>Software changes implemented in this version</u></p> <ul style="list-style-type: none"> <li>- Addition of function SOFT/TOR: Function allowing send a tripping order without awaiting temporization of release, addition of manual logical input closed (order of manual closing).</li> <li>- Addition of function LOCAL/REMOTE by wiring: addition of logical input LOCAL MODE (mode switch-over local, for inhibition of the writing orders the communication), and addition of exits CONTROL TRIP (remote control of release) and CLOSED CONTROL operate by remote control trip).</li> <li>- Modif. treatment of the thermal model: 20 milliseconds instead of 100.</li> <li>- Evolutions communication MODBUS: addition of the read quick byte (Function 7) by reading of words (Function 03 or 04), and of the reading of the date (on page 8).</li> <li>- Communication MODBUS Front Face: addition of the filtering of address.</li> </ul> <p><u>Software improvements done in this version</u></p> <p>Fix on RI curves processing in certain cases.</p>	V2.10	Two versions HARD 3 <u>or</u> HARD 4  (HARD 2 → *)
V6.D	11/12/03	<p><u>Software improvements done in this version</u></p> <p>Modification to remove the taking into account of the number of defect in the calculation of checksum of page 1 of E2PROM, like in autotest E2PROM.</p>	V2.10	Two versions HARD 3 <u>or</u> HARD 4  (HARD 2 → *)
V6.E	07/06/04	<p><u>Software changes implemented in this version</u></p> <p>Modified recloser function: modified taking in account of manual reclose while blocking by recloser external input.</p> <p>Added a new DNP3 function: fault data can be accessed as analog inputs.</p> <p>DNP3 modifications: Binary inputs move to Class 0. Acceptance of variation 2 object 1.</p> <p>Modified German texts for Front panel.</p> <p><u>Software improvement done in this version</u></p> <p>Modification to fix upload program for FPGA of new CPU board (index E or higher). (This problem affects all Px2x products equipped with this CPU board).</p> <p>Modification on 3<sup>rd</sup> threshold delay le&gt;&gt;&gt;, whose limitation test was done on 1<sup>st</sup> threshold delay le&gt;.</p> <p>Improved SOFT/TOR function</p> <p>Improved Breaker Fail alarm processing.</p> <p>Improved checksum verification test in Front panel MODBUS communication.</p>	V2.10	Two versions HARD 3 <u>or</u> HARD 4  (HARD 2 → *)

Relay Type P123				
Software Version	Date of Issue	Full Description of Changes	S1 Compatibility	Backward Compatibility with previous hardware
V6.F	08/10/04	<p><u>Software changes implemented in this version</u></p> <p>None.</p> <p><u>Software improvement done in this version</u></p> <p>Improved KBUS/COURIER protocol (visibility of threshold).</p> <p>Improved IEC870-5-103 protocol: Enhancement of all the system product line defect report (RFA disturbance transmission).</p>	V2.10	<p>Two versions HARD 3 <u>or</u> HARD 4</p> <p>(HARD 2 → *)</p>
V6.G	11/01/05	<p><u>Software changes implemented in this version</u></p> <p>Possibility to come back to the head line of the menu by pressing Clear Button.</p> <p>The setting group change will be done in exclusive way either by setting, either by logic input. The logic input will be active on level. The choice between level or edge is suppressed.</p> <p>Modification to the management of “ the auto-recloser in progress ” information and generation of associated event: - Pick-up: at the start of the reclose cycle -&gt; RL1 trip. - Drop-off: at the end of the last programmed cycle -&gt; At the end of reclaim time for a successful reclose cycle or at release of "Final Trip" signal for an unsuccessful cycle.</p> <p>Modification of the “ final trip ” information management. This information must be now set to one during the last tripping (if default is always present and that the cycles are totally used) and must be set to zero as soon as the circuit breaker is done (supervision of the 52a information). Also, it should be kept at zero until the end of inhibits time (see also below connection with the “ Recloser locked ” signal status). The locked auto-recloser information must be set to the output relays and different from the “final trip” information. It will be reset at the end of the inhibit time.</p> <p><u>Software improvement done in this version</u></p> <p>The blocking logic feature can be used with a temporisation of the phase or earth current threshold set to zero.</p>	V2.12	<p>Two versions HARD 3 <u>or</u> HARD 4</p> <p>(HARD 2 → *)</p>

<b>Relay Type P123</b>				
Software Version	Date of Issue	Full Description of Changes	S1 Compatibility	Backward Compatibility with previous hardware
06I	19/06/06	<p><u>Software changes implemented in this version</u></p> <p>No Px2x relay blocking after reception of a time synchronisation frame in T103</p> <p>Correction of SF6 front face alarm text and Start I&gt; event when IEC103 used</p> <p>IDMT Rectifier curve selection coherency between P12x and MICOM S1.</p> <p>Correction of Start In&gt; event in IEC103 communication (when going down).</p> <p>General trip correction in disturbance records</p> <p><u>Utilisation of nominal network frequency in the disturbance records (Comtrade format).</u></p>	V2.12	HARD 3 or HARD 4, HARD 2* (*See Notes)
06J	04/08/06	<p><u>Software changes implemented in this version</u></p> <p>Correction of trip Phase L1/L2/L3 events in IEC-103 communication.</p>	V2.12	HARD 3 or HARD 4, HARD 2.
07.A	16/05/08	<p><u>Software changes implemented in this version</u></p> <ul style="list-style-type: none"> <li>- Possibility to start the autoreclose from an external device by using tAux1 or tAux2 without tripping the CB</li> <li>- Correction of the following defects:                             <ul style="list-style-type: none"> <li>. temporisation IDMT of tReset (tl&gt;&gt; protection): ≠ 0s after tl&gt;&gt; ,</li> <li>. fault record amplitude I2&gt;&gt; not displayed (front panel),</li> <li>. DMT temporisation ≥ 20s: decimal values truncated,</li> <li>. Recloser [79]: bad definitive trip signal transmission,</li> <li>. "Trip CB Fail" fault: type of fault not displayed,</li> <li>. SOTF: SOTF when current threshold is not selected, operation with I&gt;&gt; or I&gt;&gt;&gt;with no possibility of reset,</li> <li>. CB supervision, Σamp:                                     <ul style="list-style-type: none"> <li>- measurement with 1 or 2 phases = 0A,</li> <li>- operation after a "CB Operation" sent by ModBus,</li> </ul> </li> <li>. I2&gt; and I2&gt;&gt; not updated when modified with ModBus,</li> <li>. the text for "SF6" alarm is incorrect,</li> <li>. parameters of DNP3 and ModBus addresses,</li> <li>. amplitude of K-Bus and Courier disturbances extraction,</li> <li>. DNP3: events of major and minor hardware alarms,</li> <li>. the content of SRAM backup can be different of corresponding checksum after an update,</li> <li>. update of the phase indication of alarm tl&gt;,                                     <ul style="list-style-type: none"> <li>. thermal protection:   <ul style="list-style-type: none"> <li>- calculation error when K thermal coefficient ≠ 1,</li> <li>- during cooling phase: bad delay between thermal alarm reset and thermal overflow.</li> </ul> </li> </ul> </li> </ul> </li> </ul>	V2.14	HARD 3 or HARD 4, HARD 2.
V10.E	29/08/06	<p><u>v10.E software is equivalent to v6.J software based on the phase II hardware redesign (HARD 5)</u></p> <p><u>Software changes implemented in this version</u></p> <p>Multilanguage Human Machine Interface</p>	V2.14	HARD 5

<b>Relay Type P123</b>				
Software Version	Date of Issue	Full Description of Changes	S1 Compatibility	Backward Compatibility with previous hardware
V11.A	11/06/07	<p><u>Software changes implemented in this version</u></p> <p>Inrush blocking function implementation</p> <p>Calibration value memorization.</p> <p>Auxiliary logic inputs temporized, with alarm displayed or not (by setting), assignable to LED, to Trip order, to output relays or to logic equations.</p> <p>RL1 &amp; RL2 can be configured as Fail safe</p> <p>Possibility to have contact outputs inverted to trip on drop of signals</p> <p>Time Synchronization through a digital Input</p> <p>TMS step to 0.001 of the TMS as well as the RTMS. That will authorize a better precision for the small values.</p> <p>Logic inputs assignable to one or several internal signal. Each signal result of a logical OR of all inputs assigned to it.</p> <p>Digital inputs can be directly assigned to outputs.</p> <p>Increase the number of fault records from 5 to 25.</p> <p>Increase the number of event records from 75 to 250.</p> <p>Correction of disturbance record in case of avalanche</p> <p>Event record time tagging correction</p> <p>Communication protocol enhancement (Modbus, DNP3 &amp; Courier)</p> <p>Autorecloser modification to take into account the definitive trip information</p>	V2.14	HARD 5
V11.C		<p><u>Software changes implemented in this version</u></p> <ul style="list-style-type: none"> <li>- software minor corrections.</li> </ul>	V2.14	HARD 5
V11.D		<p><u>Software changes implemented in this version</u></p> <ul style="list-style-type: none"> <li>- Portuguese language is added.</li> <li>- Correction for communication with system (Pacis...)</li> <li>- DMT temporization decimal value corrected for values &gt;20s</li> <li>- recloser: information of definitive trip occurs if the matrix of cycle does not set "nb cycle"+1.</li> <li>- Communication Modbus correction: <ul style="list-style-type: none"> <li>. manual, self and disturbance acknowledgment of the oldest event &amp; fault record,</li> <li>. Modbus address added to the event setting group change,</li> </ul> </li> <li>- Communication Modbus of disturbance record: number of pages and samples in the last page in the service name corrected,</li> <li>- "Disturbance trigger" added in the event record.</li> </ul>	V2.14	HARD 5



<b>Relay Type P123</b>				
Software Version	Date of Issue	Full Description of Changes	S1 Compatibility	Backward Compatibility with previous hardware
V11.E	30/06/08	<p><u>Software changes implemented in this version</u></p> <ul style="list-style-type: none"> <li>- Compatibility with MiCOM S1 Studio,</li> <li>- separate output signalization of the three overcurrent (IA&gt;, IB&gt; and IC&gt;).</li> <li>- Language corrections</li> <li>- hardware alarm correction after a communication port failure,</li> <li>- tripping indication (LED) correction,</li> <li>- modification of the process of a recloser automatism with final trip.</li> <li>- phase indicator alarm modified,</li> <li>- Displayed rms value corrected (when no current injected) corrected,</li> <li>- CB Supervision: Samps (n) counters after a “CB operations” clear sent with a modbus writing corrected,</li> <li>- Local mode input blocks Modbus function “Write 1 word” and “Write n bits”,</li> <li>- process after boot or sending settings file(MiCOM S1) modified.</li> </ul> <p><u>Other documentation changes in B96 TM</u></p> <ul style="list-style-type: none"> <li>- new general presentation</li> <li>- presentation of MiCOM S1 Studio (new GS section)</li> <li>- TD: Phase and earth current transformers consumption added,</li> <li>- AD: more explanation added for transformers inrush current</li> </ul>	V2.14 S1 Studio	Hard 5
V11.F	09/2008	<p><u>Software changes implemented in this version</u></p> <ul style="list-style-type: none"> <li>- “Inrush blocking” applied to IDMT curve correction</li> </ul>	V2.14 S1 Studio	Hard 5

<b>Relay Type P123</b>				
Software Version	Date of Issue	Full Description of Changes	S1 Compatibility	Backward Compatibility with previous hardware
V12.A	01/2009	<p><u>Software changes implemented in this version</u></p> <ul style="list-style-type: none"> <li>- New inhibited alarms added (possibility to inhibit alarm on tAux, I&lt; and Boolean logic)</li> <li>- Possibility to operate the CB and to start a disturbance from the relay HMI,</li> <li>- Manual trip or manual close ordered from a logical input activation</li> <li>- Possibility to start SOTF using any control close information,</li> <li>- Total trips number calculated with all the CB operations,</li> <li>- Suspend IDMT curves on I&gt; &amp; I&gt;&gt;, interlock of I&gt; IDMT by I&gt;&gt; DT or I&gt;&gt;&gt; DT modified,</li> <li>- Possibility to start Cold Load Pickup by 52A or "not I&lt; &amp; I&gt;" or "I0&lt; &amp; I0&gt;",</li> <li>- Detection of open circuits conditions which produce an unbalance creating negative phase sequence current,</li> <li>- Addition of a new derived earth overcurrent threshold,</li> <li>- Possibility to program autoreclose blocking after a number of recluse or a defined time.</li> <li>- Possibility to assign I&lt; and tI&lt; to any output relay and LED,</li> <li>- Disturbance recorder time modified (5x3s or 3 x 5s or 2 x 7.5s or 1 x 15s)</li> <li>- Logical inputs directly assignable to Boolean Logical Equations,</li> <li>- tAux5 added,</li> <li>- "79 internal locked" and "79 external locked" assigned to output signals,</li> <li>- Selectivity between two relays with tReset + autorecloser.</li> </ul>	V2.14 S1 Studio	Hard 5
V12.B	09/2009	<p><u>Software changes implemented in this version</u></p> <ul style="list-style-type: none"> <li>- Correction of: <ul style="list-style-type: none"> <li>. disturbance recording when two records are triggered successively,</li> <li>. Chinese text (HMI display),</li> <li>. control trip events when RL1 is assigned to "Ctrl Trip"</li> <li>. Time synchronisation with logic input.</li> </ul> </li> </ul>	V2.14 S1 Studio	Hard 5
V12.C	03/2010	<p><u>Software changes implemented in this version</u></p> <ul style="list-style-type: none"> <li>- Correction of <ul style="list-style-type: none"> <li>. IDMT curve when inrush blocking is used with Ie&gt; or Ie&gt;&gt;</li> <li>. German labels</li> </ul> </li> </ul>	S1 Studio	Hard 5

<b>Relay Type P123</b>				
Software Version	Date of Issue	Full Description of Changes	S1 Compatibility	Backward Compatibility with previous hardware
V12.D	03/2010	<p>General: New Schneider Electric brand</p> <p><u>Software changes implemented in this version</u></p> <ul style="list-style-type: none"> <li>- Correction of data transmission (Courier protocol). Fault extracted automatically was sometimes incorrectly transmitted</li> </ul>	S1 Studio	Hard 5
V12.E	11/2011	<p><u>Software changes implemented in this version</u></p> <ul style="list-style-type: none"> <li>- Fault records extraction using IEC103 enhanced protocol,</li> <li>- Possibility to control locally a general reset to clear all events, fault &amp; disturbance records</li> <li>- Correction of:                             <ul style="list-style-type: none"> <li>alarm message when an auxiliary relay is latched,</li> <li>alarm after a date / time failure</li> <li>Output relay assignation (autorecloser)</li> <li>CB failure reset before the end of a timer if current is null,</li> <li>Logic equation status (address 002Ch)</li> <li>At CB switching on, erratic alarm</li> </ul> </li> </ul>	S1 Studio	Hard 5

**BLANK PAGE**

MiCOM P120R

# **ADDITIONAL DOCUMENTATION FOR MiCOM P120R**



## **CONTENT**

---

<b>MiCOM P120R ADDENDUM: MiCOM P12X UPDATE DOCUMENTATION</b>	<b>3</b>
<b>HANDLING, INSTALLATION AND CASE DIMENSIONS</b>	<b>4</b>
<b>USER GUIDE</b>	<b>8</b>

---

**BLANK PAGE**



## MiCOM P120R ADDENDUM: MiCOM P12X UPDATE DOCUMENTATION

MiCOM P120R “Plug & Protect solution” is a new product of the MiCOM P12x range. This device has been designed to offer a cost-effective solution to the retrofitting of static MCGG22 relays.

MiCOM P120R is fitted with the same firmware as standard MiCOM P120 devices. Consequently, MiCOM P120R's software features are identical to MiCOM P120's.

The differences between P120R and P120 are mechanical only. Indeed, in order to insure pin-to pin compatibility with existing MCGG22 wiring, the P120R's size and connection scheme differ from standard P120's. Moreover, the P120R has additional inputs and communication features not available in the MCGG22 relay. These can be accessed using the terminal block provided in the P120R packaging box.

The purpose of this document is to provide information specific to the P120R device. It should be read in conjunction with the P12x Technical Manual which covers the standard P120 device.

The table below gives the correspondances between this addendum and the P12x Technical Manual's chapters:

Release	Version	Documentation
June 2007	P12x/EN T/A96	Technical Manual (Firmware version V11)

Document Ref.	Section	Page No.	Description
P12x/EN IN/A96	3	5/10	Relay mounting Instructions of mounting P120R added
P12x/EN IN/A96	7	10/10	Case dimensions Dimensions of P120R model added
P12x/EN FT/A96	6.2	61/62	Wiring Changed rating of current inputs
P12x/EN CM/A96	4.2	9/18	Measurements Changed rating of current inputs
P12x/EN CO/A96		1/4	Connection diagram Changed rating of current inputs

## HANDLING, INSTALLATION AND CASE DIMENSIONS

### 3. RELAY MOUNTING

The steps to replace a MCGG22 by a MiCOM P120R are described hereafter:



BEFORE CARRYING OUT ANY WORK ON THE EQUIPMENT, THE USER SHOULD BE FAMILIAR WITH THE CONTENTS OF THE SAFETY GUIDE SFTY/4LM/E11 OR LATER ISSUE, OR THE SAFETY AND TECHNICAL DATA SECTION OF THE TECHNICAL MANUAL AND ALSO THE RATINGS ON THE EQUIPMENT RATING LABEL.

**Figure 1:** Existing MCGG22 Panel mounted.

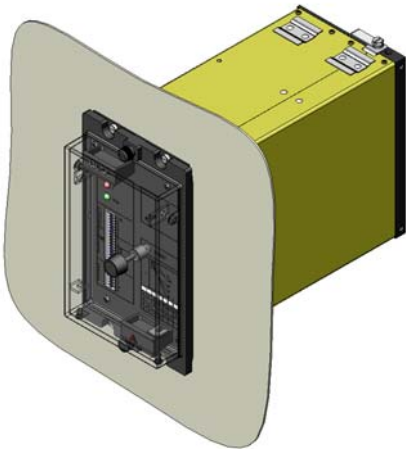

**Figure 2:** Remove cover.

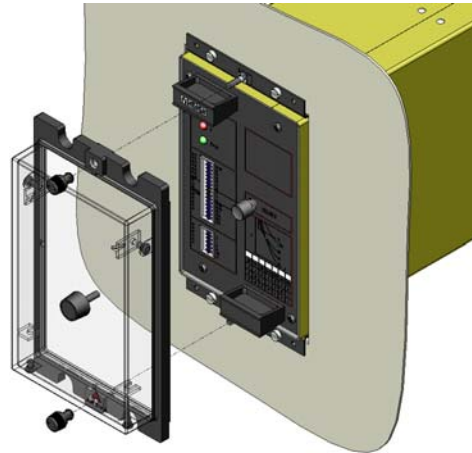

**Figure 3:** Withdraw MCGG22 relay active part

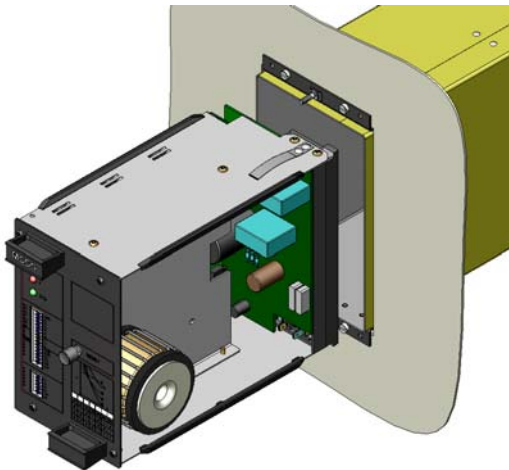

**Figure 4:** Fit P120R module into vacant MCGG case

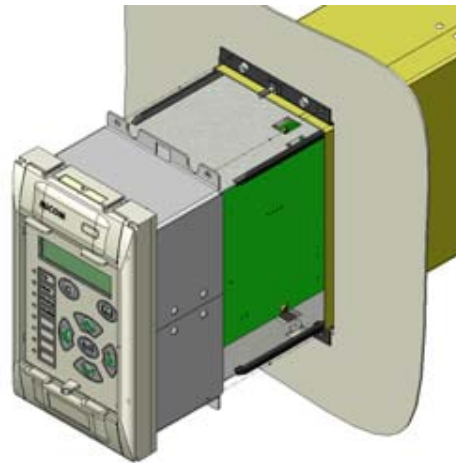

**Figure 5:** Bagged assembly kit - part number GN0422001.

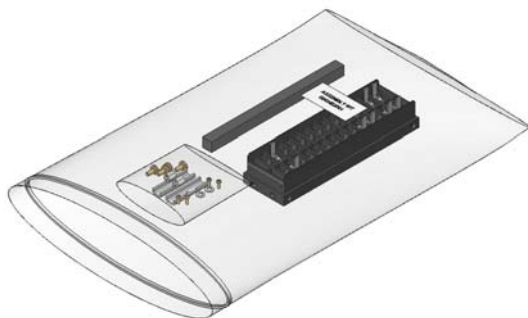

**Figure 6:** Fit clamp, washer & nut to top & bottom centre stud. Important: tighten nuts to 0.7Nm max.

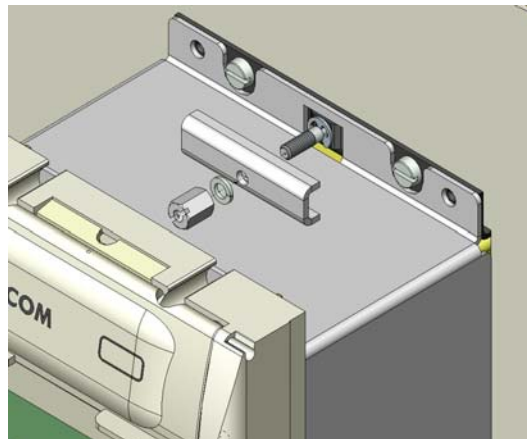

**Figure 7:** Alternative fixing using M4 Taptite self tapping screws (4 off) panel hole size Ø3.4

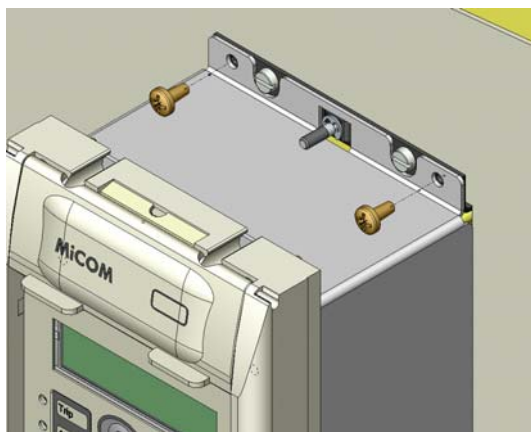

**Figure 8:** To remove P120R open top & bottom flaps and remove 4 fixing screws shown below, leaving mating collar in place (retain screws).

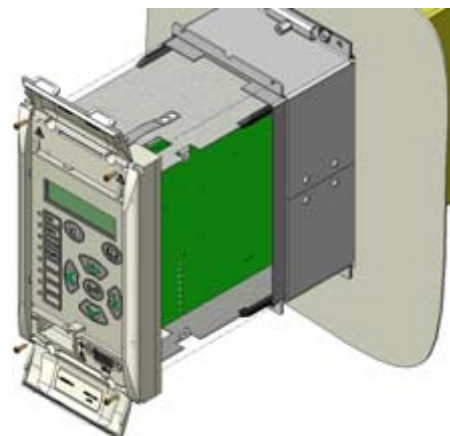

**Figure 9:** Refit P120R to collar using screws removed in figure 8 and close top and bottom flaps.

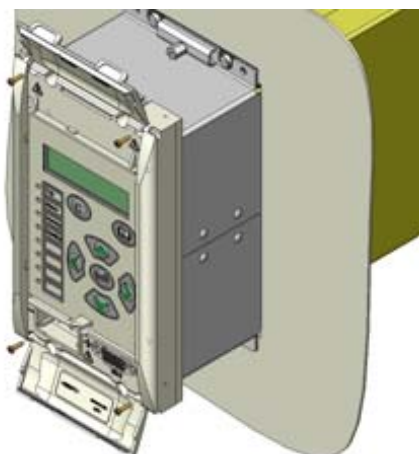

**Figure 10:** Where an RS485 communication port is required, remove MCGG22 rear blank panel (retain screws).

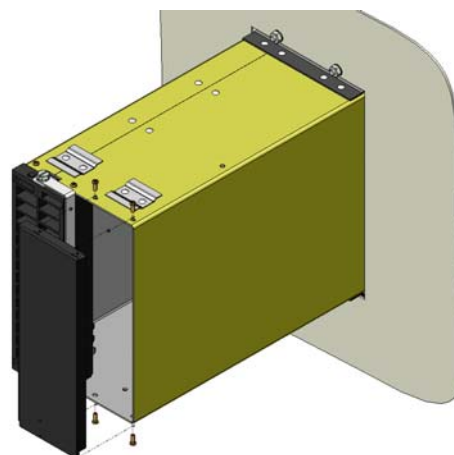

**Figure 11:** In direction of arrows attach adhesive side of rubber sealing strip to side wall of terminal block.



**Figure 12:** Fit rear terminal block using screws removed in figure 9.

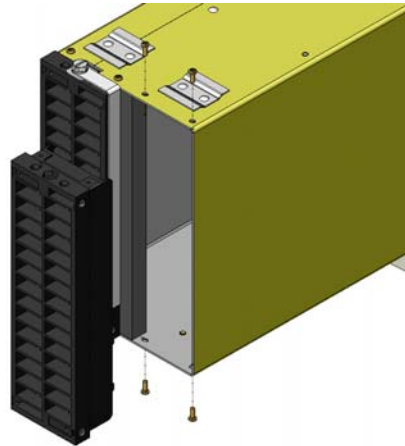

7. CASE DIMENSIONS

MiCOM P120R has the following dimensions and weight:

<u>Weight:</u>	1.825 Kg		
<u>External size:</u>	Height	case	152 mm
		front panel	177 mm
Width		case	97 mm
		front panel	103 mm
Depth		case	226 mm
		front panel+collar+case	311 mm

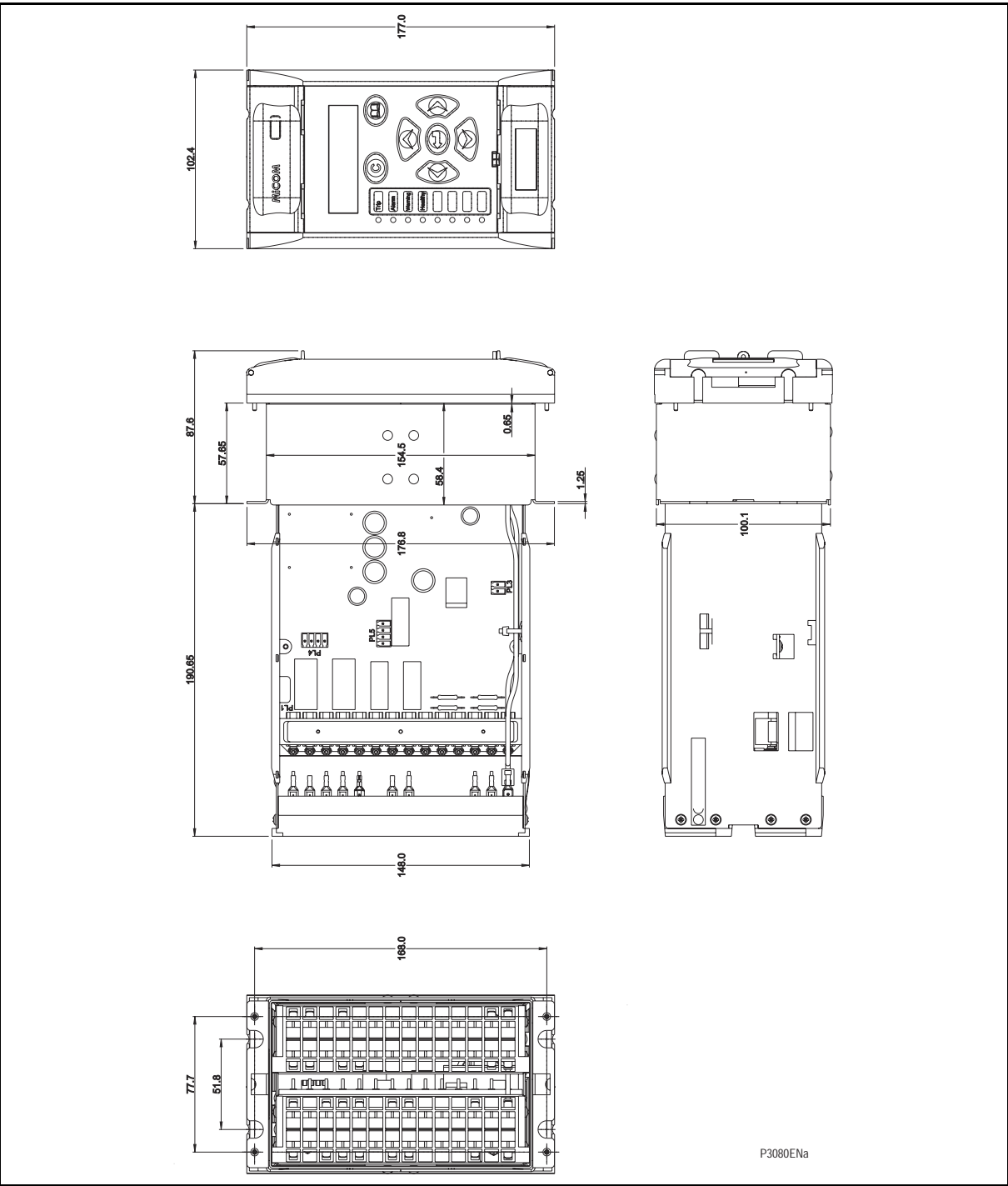

FIGURE 13: MiCOM P120R DIMENSIONS (WITHOUT MCGG CASE)

## USER GUIDE

### 6. WIRING

#### 6.2 Current measurement inputs

MiCOM P120R has 1 earth/phase current input available in 1 or 5A.. The desired analog input range has to be specified in the MiCOM P120R ordering code.

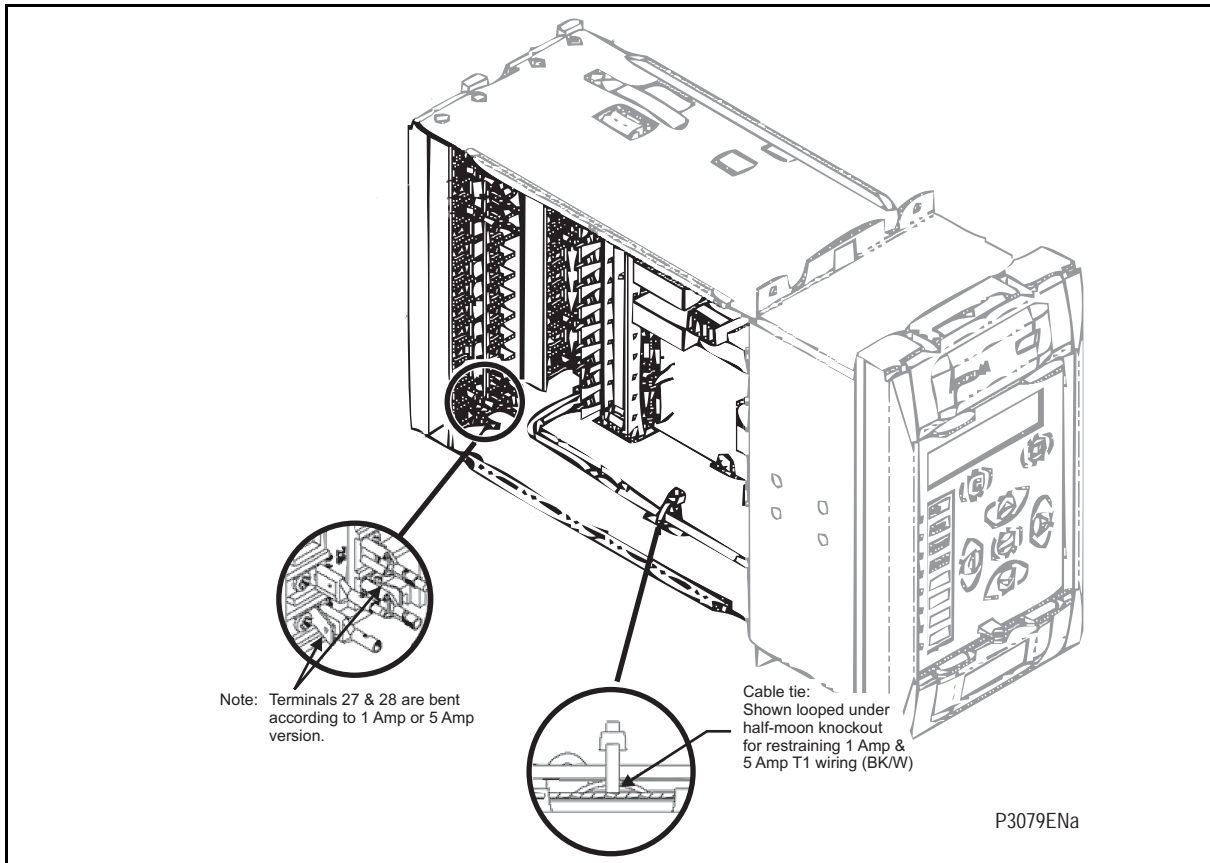

FIGURE 14: P120R INTERNAL WIRING OVERVIEW



DO NOT MODIFY ANY P120R INTERNAL WIRING

### 4. CONNECTION DIAGRAM



BEFORE CARRYING OUT ANY WORK ON THE EQUIPMENT, THE USER SHOULD BE FAMILIAR WITH THE CONTENTS OF THE SAFETY GUIDE SFTY/4LM/E11 OR LATER ISSUE, OR THE SAFETY AND TECHNICAL DATA SECTION OF THE TECHNICAL MANUAL AND ALSO THE RATINGS ON THE EQUIPMENT RATING LABEL."

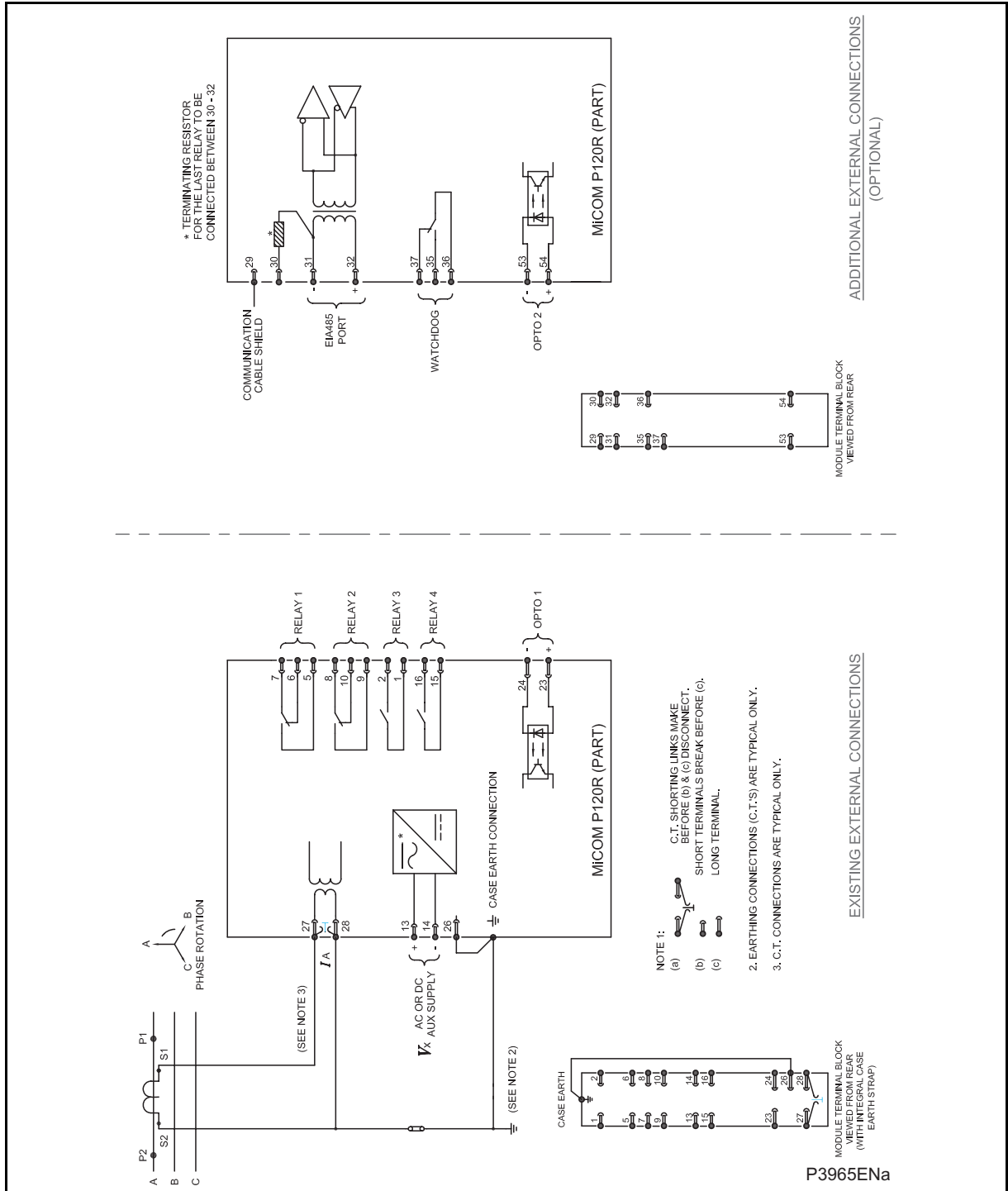

FIGURE 15: SCHEME REPRESENTING MiCOM RELAY OFF

NOTE: To use RS485 rear communication port, a terminal block kit is provided into the packaging box to be mounted on the existing MCGG 22 case.

**BLANK PAGE**







## Customer Care Centre

<http://www.schneider-electric.com/CCC>

**Schneider Electric**

35 rue Joseph Monier  
92506 Rueil-Malmaison  
FRANCE

Phone: +33 (0) 1 41 29 70 00

Fax: +33 (0) 1 41 29 71 00

[www.schneider-electric.com](http://www.schneider-electric.com)

**Publication: P12x/EN T/Eb6**

Publishing: Schneider Electric

09/2011