

# *Data Center*

## Product Application Guide



# Table of Contents

<b>INTRODUCTION</b> .....	<b>3</b>
<b>CRITICAL POWER COMPETENCY CENTER (CPCC)</b> .....	<b>3</b>
<b>GLOSSARY</b> .....	<b>4</b>
<b>DATA CENTER TIER LEVELS</b> .....	<b>6</b>
<b>SAMPLE DATA CENTER ONE LINE DIAGRAMS</b> .....	<b>8</b>
Low Voltage Data Center One Line Diagram .....	8
Medium Voltage Data Center One Line Diagram.....	10
Monitoring and Communications Network Diagram .....	12
Typical Product One Line Diagram .....	14
<b>LOW VOLTAGE PRODUCT OFFERING</b> .....	<b>16</b>
Low Voltage Switchgear .....	16
Switchboards – Rear Connected .....	17
Switchboards .....	18
Panelboards .....	19
<b>POWER MONITORING AND NETWORK COMMUNICATIONS PRODUCTS</b> .....	<b>22</b>
Protective Relays .....	25
<b>MEDIUM VOLTAGE PRODUCT OFFERING</b> .....	<b>26</b>
Metalclad Switchgear .....	26
Metal Enclosed Switchgear .....	27
Medium Voltage Transformers .....	28
<b>MEDIUM AND LOW VOLTAGE CIRCUIT BREAKERS</b> .....	<b>29</b>
Masterpact® Circuit Breakers.....	29
Medium Voltage Vacuum Circuit Breakers .....	31
PowerPact® “H” and “J” Molded Case Breakers .....	31
Compact® NSJ PowerPact D-Frame Molded Case Breakers .....	32
Mission Critical Molded Case Circuit Breaker .....	33
<b>OTHER LOW VOLTAGE PRODUCTS</b> .....	<b>33</b>
<b>SQUARE D® SERVICES</b> .....	<b>34</b>
Products and Engineering Services .....	34
Engineering Studies .....	34
New Installation Services .....	35
Retrofill and Upgrade .....	35
Maintenance and Testing Preventive Maintenance .....	36
Workplace Safety .....	36



## Introduction

For more than 100 years, Square D® brand products and services have met the critical power needs of customers – from powering the laboratory of Thomas Edison to helping land a man on the moon. Square D is one of the three global brands of Schneider Electric..

The industry's most trusted products can be leveraged into a unique solution for your application. Delivering a critical power solution is much like making a gourmet meal. Premium ingredients are combined in precise quantities with an exacting order then baked to exacting specifications and served with other recipes to create an unforgettable feast.

Because you can't always trust the power grid to supply your energy, you need specialized equipment in addition to normal power distribution equipment. This often includes automatic transfer systems, UPS systems, on-site generation, emergency power equipment, filtered power distribution, surge protection, static transfer, specialized cooling systems, and interfaces to other building management systems.

Schneider Electric offers a complete line of high quality medium and low voltage power distribution products found in data centers. This includes drawout switchgear and switchboards, power monitoring and control systems, motor control centers, transformers, panelboards, busway, safety switches and a wide assortment of other distribution and control components. Regardless if your data center is a Tier 1 or Tier IV, we supply proven reliable equipment to fit your budget, design and construction needs.

## Critical Power Competency Center (CPCC)

The Critical Power Competency Center integrates company-wide expertise to maximize its power reliability capability for companies that operate financial and corporate data centers. The initiative provides customized, repeatable power distribution, and management solutions tailored to the critical power market.

Based in Nashville, Tenn., the competency center merges the expertise of the company's Power Management Operations, as well as product design, development and distribution; program management, engineering, power consulting and resources from its facilities based in LaVergne and Smyrna, Tenn., Columbia, S.C., and Cedar Rapids, Iowa. It is a cross-functional team that serves customers through every facet of a project, including power system design, order entry, project management and implementation.

The competency center manages communication and coordination across all channels to market, including generator manufacturers, UPS manufacturers, paralleling switchgear manufacturers, electrical contractors and consulting engineers. Any and all of these channels are points of entry for the competency center – contractors, consultants, OEMs and end-users can engage its experts. The two primary objectives for the competency center:

- Drive a programmatic, shared knowledge approach in using customer information internally while eliminating a fragmented approach
- Provide one-stop solutions through integrated application and execution.

For additional information please go to [www.criticalpowernow.com](http://www.criticalpowernow.com).





# Glossary

The following is a list of definitions of terms and acronyms that are used in the data center world:

**7x 24 Exchange** – Leading knowledge exchange for those who design, build, use and maintain mission-critical enterprise information infrastructures, 7x24 exchange's goal is to improve end-to-end reliability by promoting dialog among these groups.

**ATS** – Sometimes has several definitions, automatic transfer switch, automatic transfer system or auto-throw-over system between two paralleled sources.

**Computer Room Air Conditioning (CRAC)** – Unit is housed in computer rooms to precisely control temperature and humidity.

**Data Center** – Defined as a facility that houses server, network and computer equipment to perform data processing and management functions, host web sites and/or provide internet connectivity.

**Data Center Cost** – Raised floor can range from \$500 to \$1000 per square foot. This cost is dependent on the tier level required, new or retrofit construction.

**Load Bank Switchgear** – Connected to main switchgear, UPS and paralleling switchgear. This product allows loading and testing of UPSs or generators with either a load bank (large resistor bank) or actual data center loads.

**N** – Either one power system or a component without redundancy.

**N+1** – A completely redundant power system or components. For example, two UPSs are installed in a data center, one unit is in operation and the other unit is for backup. If UPS in service needs maintenance, or fails, the other unit provides backup to prevent downtime.

**2 (N+1) or System + System** – Two completely redundant systems with N+1 components. Electrically, this means two separate power or UPS systems in which each system has N+1 redundancy.

**Paralleling Switchgear** – Two or more power sources are connected to a load in a parallel. Each source must have equal voltage and frequency values, and must share in the load for both real power (kW) and reactive power (kVAR). Operating one or more generators in parallel with the utility typically requires electrically operated circuit breakers for the generators and utility services, fast update rate voltage and frequency transducers, PLCs, and protective relays to manage the interconnection between local generators and the utility distribution grid. Auto-throw-over scheme control backup generators and electrically operated breakers in switchgear (via PLC control) during utility outages or testing.

**Power Distribution Unit (PDU)** – Usually contains a primary main breaker, 480V: 208Y/120V transformer, secondary panelboards or sub-feed circuit breakers. Provides power to servers and computers via panelboards. Also used to feed downstream remote power panels (RPPs) via secondary sub-feed breakers.

**Original Equipment Manufacturer (OEM)** – Manufacturer who purchases Square D® equipment to complete their product offering.

**Rack** – An enclosure for mounting computer servers and communications equipment.

**Raised Floor** – Total footprint area of controlled access space devoted to company/customer equipment. The raised floors consist of 24" x 24" panels raised 12" to 48" above a concrete floor. This allows circulation of air and access to power and communication cables. Includes aisle ways, server cage space, cooling units, electrical panels, fire suppression equipment, and other support equipment both inside and outside of server cages that is included in raised floor space.

**Redundancy** – Duplication or repetition of elements in electronic equipment to provide alternative functional channels in case of failure.

**Rotary UPS** – A rotary UPS system uses a motor-generator set, with its rotating inertia, to ride through brief power interruptions. Power goes to critical loads by means of a generator driven by an AC or DC motor. The motor-generator set will ride through power interruptions long enough to allow generators to back up the data center.

**Remote Power Panel (RPP)** – Normally sized to fit over a standard 2' x 2' raised floor tile, this unit contains up to four distribution panelboards and a monitoring system. It does not contain a transformer and is most often fed from one or more PDU distribution breakers. The unit provides power distribution to the server racks via raised floor.

**Single-Points-of-Failure** – A point (electrical equipment, cables, etc.) on a power system that can cause downtime if a failure or fault occurs. In most data center designs, these points are completely eliminated.

**Site Availability** – A measure of the amount of time that a data center system is available to provide power.

**Static Transfer Switch (STS)** – A static transfer switch is an electronic power switching device that provides extremely fast (1/4 cycle) open transition switching between two sources of power. Importantly, it is capable of switching fast enough that communications and computing equipment are unaffected by the transfer from the preferred source to the alternate source.

**Tier Levels** – Uptime Institute has defined tier levels by their power system percentage of availability (amount of time equipment is in service).

**UPS Input Switchgear** – Provides power to line side of UPS equipment.

**UPS (static)** – An uninterruptible power supply battery backup system that converts AC-DC (DC connected to batteries), converts DC-AC and is continuously online. During a utility outage, the batteries will provide power to critical loads for 10 to 45 minutes (depending on system design). During this time, the backup generators can start and supply the facility.

**UPS Output Switchgear** – Switchgear on load side of UPS connected to critical loads, which is also paralleled with load bank switchgear to allow loading of generators for testing.

**Uptime** – Defined below by the number of 9s of reliability. Six 9s of reliability is often wanted in data centers but is very difficult to achieve.

Number of 9s reliability	Uptime (%)	Downtime (seconds per year)	Downtime per year
1	90%	3153600	36.5 days
2	99%	315360	3.7 days
3	99.9%	31536	8.8 hours*
4	99.99%	3153.6	52.6 minutes
5	99.999%	315.36	5.3 minutes
6	99.9999%	31.536	31.5 seconds
7	99.99999%	3.153699998	3.15 seconds

*\*Utility grid supports three 9s of reliability*

**Watts-per-Square Foot** – Defines the power density of the data center. Typical data centers are 30 to 100 watts-per-square-foot and steadily growing as servers get smaller and more compact.

# Data Center Tier Levels

Data center electrical systems are the most complex and costly of all power systems designed today. Electrical consulting engineers and data center managers use a defined tier level when designing and discussing data centers. The higher tier levels require the most electrical equipment, have the highest cost, require the most equipment space, and have the lowest operating efficiency. However, these high-tiered systems provide the most site availability.

Uptime Institute has defined the tier classifications in a data center. The tier classification system involves several definitions. A site that can sustain at least one “unplanned” worst-case site infrastructure failure with one critical load impact is considered fault tolerant. A site that is able to perform planned site infrastructure activity without shutting down critical load is concurrently maintainable (fault tolerant level may be reduced during concurrent maintenance). It is important to remember that a typical data center site is composed of at least twenty major mechanical, electrical, fire protection, security and other systems, each of which has additional subsystems and components. All of these systems must be maintainable and /or fault tolerant for the entire site to be considered concurrently maintainable and/or fault tolerant [1].

## **The Uptime Institute defines the four tier levels as follows:**

**Tier I** – Single path of power and cooling distribution, no redundant components, and 99.671% availability.

A Tier I data center is susceptible to disruptions from both planned and unplanned activity. It has computer power distribution and cooling, but it may or may not have a raised floor, UPS or an engine generator. If it does have UPS or generators, they are single-module systems and have many single points of failure. The infrastructure should be completely shut down on an annual basis to perform preventive maintenance and repair work. Urgent situations may require more frequent shutdowns. Operation errors or spontaneous failures of site infrastructure components will cause a data center disruption.

**Tier II** – Single path of power and cooling distribution, redundant components, and 99.749% availability.

Tier II facilities with redundant components are slightly less susceptible to disruptions from both planned and unplanned activity than a basic data center. They have a raised floor, UPS and engine generators, but their capacity design is “Need plus One” (N+1), which has a single-threaded distribution path throughout. Maintenance of the critical power path and other parts of the site infrastructure will require a processing shutdown.

**Tier III** – Multiple power and cooling paths, but only one path active, redundant components, concurrently maintainable, 99.982% availability.

Tier III level capability allows for any planned site infrastructure activity without disrupting the computer hardware operation in any way. Planned activities include preventive and programmable maintenance, repair and replacement of components, addition or removal of capacity components, testing of components and systems, and more. For large sites using chilled water, this means two independent sets of pipes. Sufficient capacity and distribution must be available to simultaneously carry the load on one path while performing maintenance or testing on the other path. Unplanned activities such as errors in operation or spontaneous failures of facility infrastructure components will still cause a data center disruption. Tier III sites are often designed to be upgraded to Tier IV when the client’s business case justifies the cost of additional protection.

[1] – *Industry Standard Tier Classification Define Site Infrastructure Performance* – W. Pitt Turner IV P.E. and Kenneth G. Brill, 2001.

**Tier IV** – Multiple power and cooling paths, redundant components, fault tolerant, 99.995% availability.

Tier IV provides site infrastructure capacity and capability to permit any planned activity without disruption to the critical load. Fault-tolerant functionality also provides the ability of the site infrastructure to sustain at least one worst-case unplanned failure or event with no critical load impact. This requires simultaneously active distribution paths, typically in a System+System configuration. Electrically, this means two separate UPS systems in which each system has N+1 redundancy. Because of fire and electrical safety codes, there will still be downtime exposure due to fire alarms or people initiating an Emergency Power Off (EPO). Tier IV requires all computer hardware to have dual power inputs as defined by the Institute's Fault-Tolerant Power Compliance Specification Version 2.0.

The availability numbers have been drawn from industry benchmarking conducted by the Uptime Institute and sites in the top 90th percentile (this means only 10% of all sites performed at this level). The quality of human-factors management is the most significant element separating top sites from all others.

This chart illustrates Tier similarities and differences

	<b>TIER I</b>	<b>TIER II</b>	<b>TIER III</b>	<b>TIER IV</b>
<b>Number of delivery paths</b>	Only 1	Only 1	1 active 1 passive	2 active
<b>Redundant components</b>	N	N+1	N+1	2 (N+1) or S+S
<b>Support space to raised floor ratio</b>	20%	30%	80-90%	100%
<b>Initial watts/ft*</b>	20-30	40-50	40-60	50-80
<b>Ultimate watts/ft*</b>	20-30	40-50	100-150	150+
<b>Raised floor height</b>	12"	18"	30-36"	30-36"
<b>Floor loading pounds/ft*</b>	85	100	150	150+
<b>Utility voltage</b>	208, 480	208, 480	12-15kV	12-15kV
<b>Months to implement</b>	3	3 to 6	15 to 20	15 to 20
<b>Year first deployed</b>	1965	1970	1985	1995
<b>Construction \$/ft* raised floor*</b>	\$450	\$600	\$900	\$1,100+
<b>Annual IT downtime due to site</b>	28.8 hrs	22.0 hrs	1.6 hrs	0.4 hrs
<b>Site availability</b>	99.671%	99.749%	99.982%	99.995%

\*Excludes land and abnormal civil costs. Assumes minimum of 15,000 ft<sup>2</sup> of raised floor, architecturally plain one story fitted out with initial capacity, but with the backbone designed to reach the ultimate capacity with the installation of additional components. Make adjustments for NYC, Chicago, and other high cost areas.

**Table 1** Source: The Uptime Institute© 2001

## Sample Data Center One Line Diagrams

### Low Voltage Data Center One Line Diagram

The following is a N+1, 480V, power system design that has two active power sources. The entire system is redundant down to the single and dual corded 120V server loads. A numbered description of the system components is listed on the one line diagram. This one line diagram is an example only; data center power systems designs will vary by engineers or with consultants used.

<p><b>1</b> Utility and generator sources – these sources are normally isolated on opposite sides of the data center building so that a catastrophic event would not result in the loss of both sources.</p>	<p><b>5</b> UPS input switchgear A and B provides power to line side of UPSs.</p>	<p><b>9</b> Static transfer PDUs – provide power to dual corded computer server's racks via panelboards and raised computer room floor. Static transfer switches can typically switch between power sources in a 1/4 of an electrical cycle.</p>
<p><b>2</b> Main service switchgear A &amp; B are connected to the utility, generators and load bank switchgear. Drawout breakers in this switchgear are usually electrically operated via a PLC based auto transfer scheme.</p>	<p><b>6</b> UPS – this includes batteries, maintenance bypass switches, static switches and drawout output switchgear. This equipment usually provides 15 – 45 minutes of ride-through that allows backup generators to start. UPS suppliers provide this equipment.</p>	<p><b>10</b> Dual corded servers – computer servers that can switch between two power sources.</p>
<p><b>3</b> Load bank switchgear is tied to main switchgear A and B via either cables or feeder busway. Load bank switchgear allows the proper loading (using load bank and data center loads) to keep the cylinders on the generators clean so they can carry their rated kVA.</p>	<p><b>7</b> Distribution switchgear or panelboards that provide power to power distribution units (PDUs).</p>	<p><b>11</b> Feeder cables in data centers typically are connected between two breakers. This allows cables to be completely isolated in the event of a cable failure. This also prevents single-points-of-failure.</p>
<p><b>4</b> Distribution panels for HVAC loads. Entire HVAC system and components are redundant.</p>	<p><b>8</b> PDUs – consist of 480V to 208Y/120V transformers that service many panelboards. Panelboard breakers (sometimes called PMMs or DPUs) provide power to computer server racks via cables distributed under a raised computer room floor. PDU suppliers provide this equipment.</p>	<p><b>12</b> High resistance grounding of 480V transformers is often used to eliminate complex ground fault coordination issues and single-line to ground fault interruptions. Also, since all loads are 3 phase, 3 wire, a neutral is not required.</p>

**Figure 1**

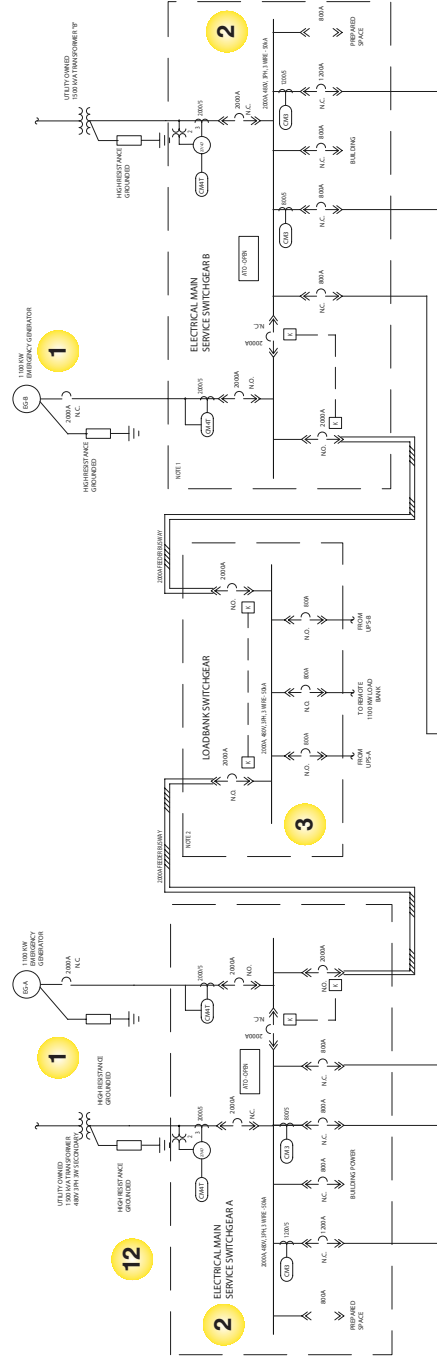



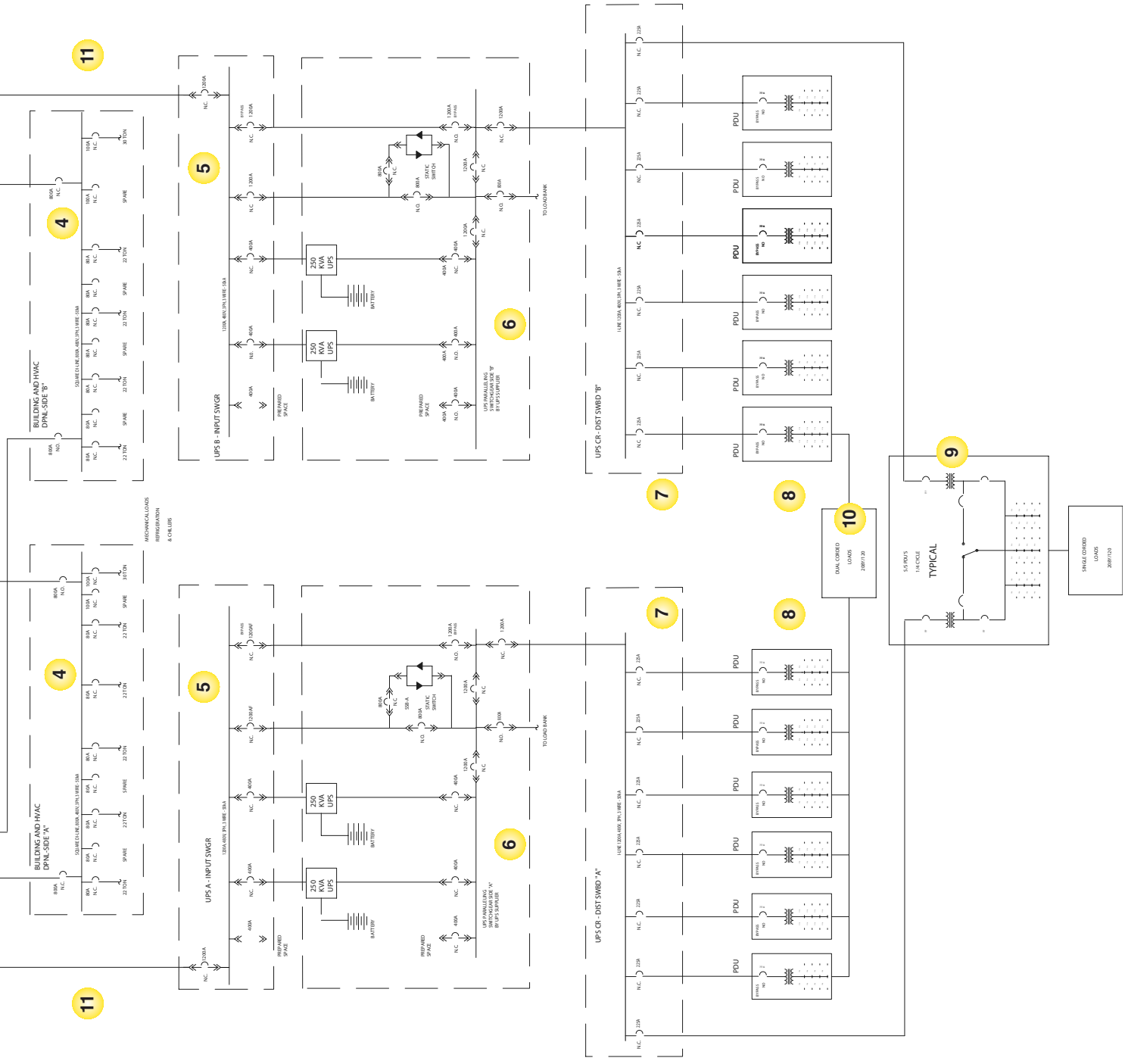

## Medium Voltage Data Center One Line Diagram

The following one line diagram is a N+1, 12.47kV, power system design that has two active power sources. This medium voltage system is providing power down to 480V switchgear that is similar to the one line diagram shown in Figure 1. In this one line diagram, only one module of the 480V and 208V power systems is shown for simplicity. On large data center systems, there could be several modules used to provide power to an entire data center. A numbered description of the system components is listed on the one line diagram. This one line diagram is an example only, data center power systems design will vary with engineers or consultants used.

<p><b>1</b> Main incoming service from two utility sources A and B. These sources are normally isolated on opposite sides of the data center building so that a catastrophic event would not result in the loss of both sources. Many times two separate utility feeds are used.</p>	<p><b>3</b> Medium voltage paralleling switchgear A and B. Metalclad switchgear is used via an auto transfer scheme. Tie breakers A and B are connected with busway or cables. A paralleling switchgear manufacturer normally supplies this equipment and is responsible for its control with the generator sets.</p>	<p><b>5</b> Load bank switchgear is tied to paralleling switchgear via a transformer. Load bank switchgear allows the proper loading (using load bank and data center loads) to keep the cylinders on the generators clean so they can carry their rated kVA.</p>
<p><b>2</b> Main service medium voltage switchgear A and B are connected to the utility and paralleling switchgear. Breakers are controlled via a PLC based auto transfer scheme with time delay set faster than downstream 480V schemes in switchgear A and B. Tie breakers A and B are normally connected with cables.</p>	<p><b>4</b> 480V switchgear A and B are connected (via transformers) to the medium voltage switchgear, and paralleling switchgear. Drawout breakers are commonly used in this switchgear and electrically operated via an auto transfer scheme.</p>	<p><b>6</b> This is a typical data center module similar to the system shown in Figure 1. Only one module (of three) is shown.</p>

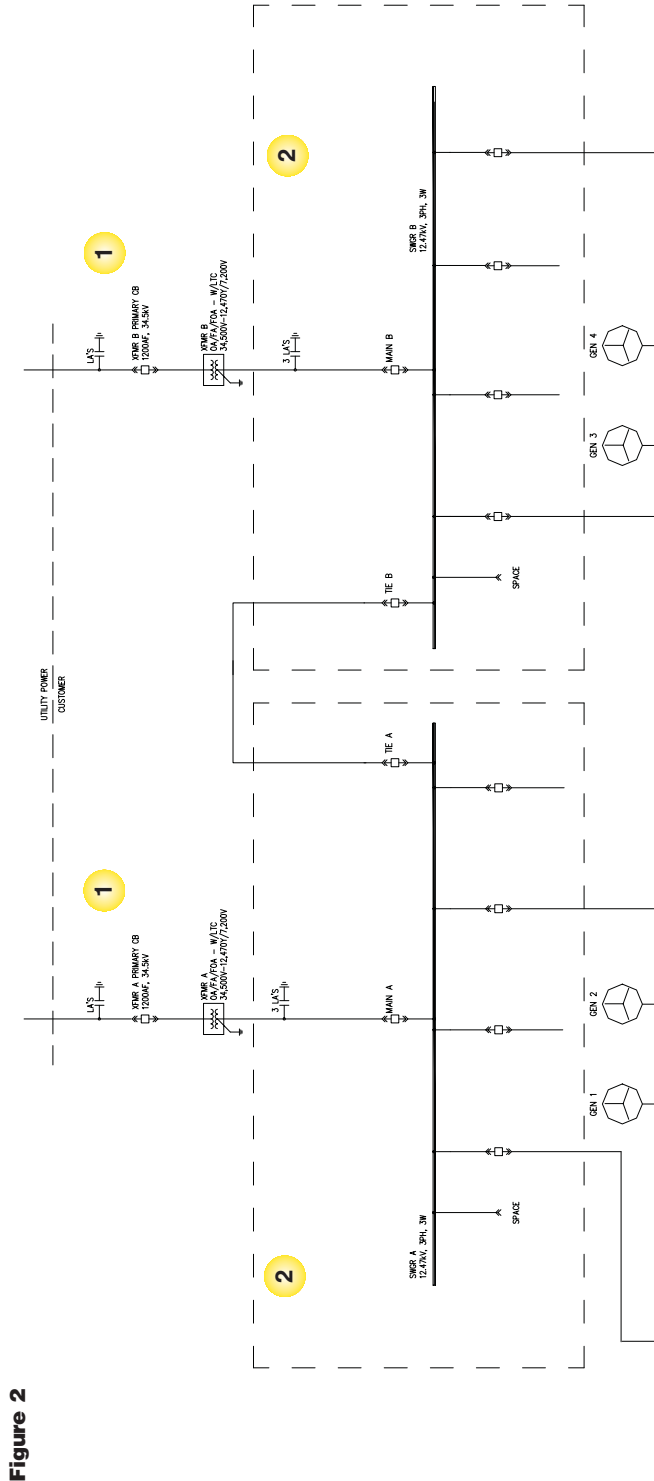
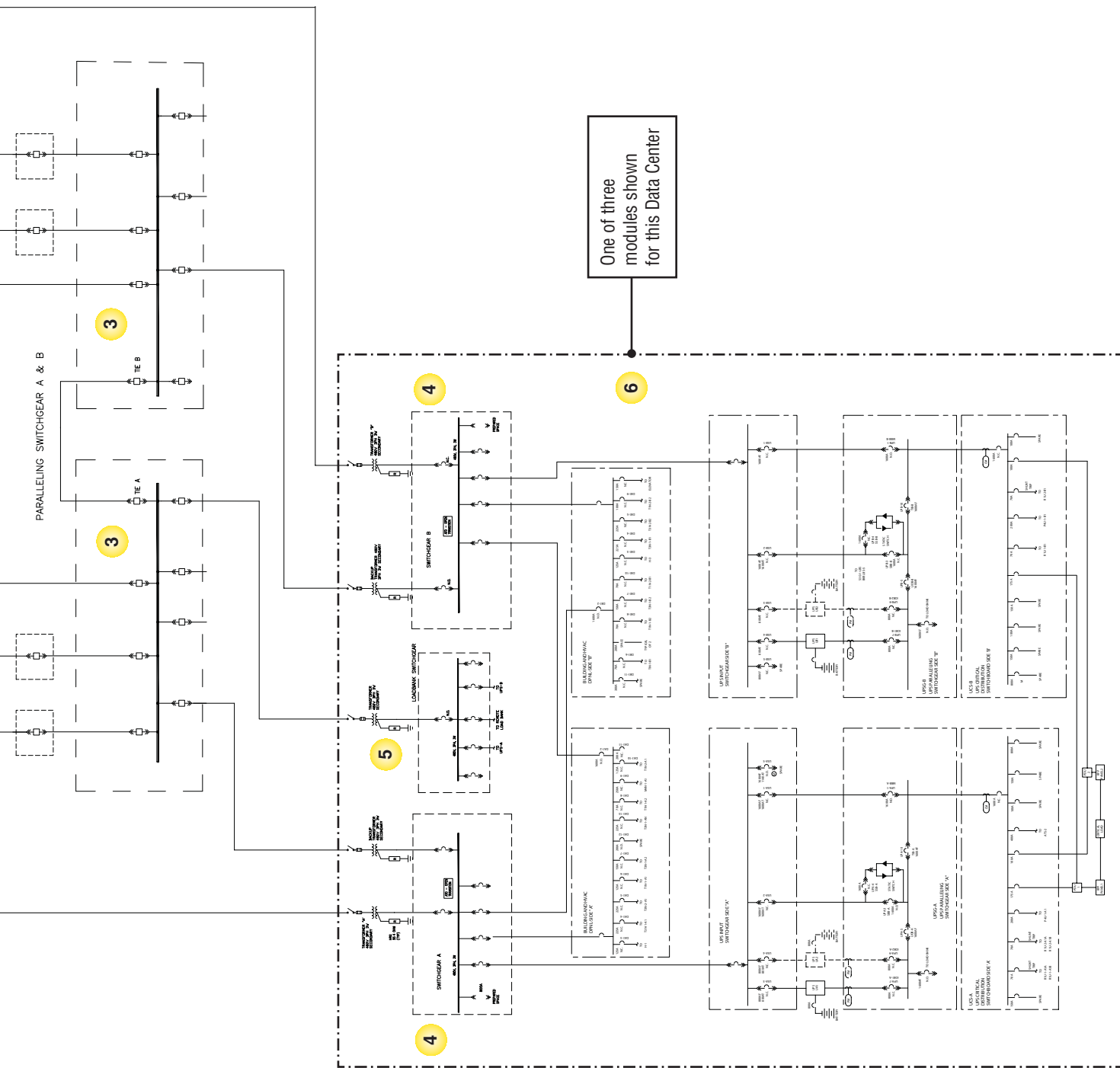

Figure 2



One of three modules shown for this Data Center

# Monitoring and Communications Network Diagram

The following is a partial network diagram of a large data center that shows power metering, monitoring and communications in Figures 3 and 4. This communication network is tied into circuit monitors, medium voltage relays (protection, power monitoring and I/O), video display terminals (VDT), transformer temperature monitors, trip units (protection, power monitoring and I/O), **satellite GPS system, sequence event recording**, I/O modules and UPS modules all connected to the customer's Ethernet system via Gateways.

The medium voltage switchgear, UPS input and output switchgear, system control breaker trip units, and UPS modules all are connected to a satellite GPS synchronization and sequence event recording system which gives **millisecond time stamp information** to help you pin point the root cause of a problem. In addition, Transparent Ready switchgear and switchboards allow web access to monitoring information from your office or home personal computer.

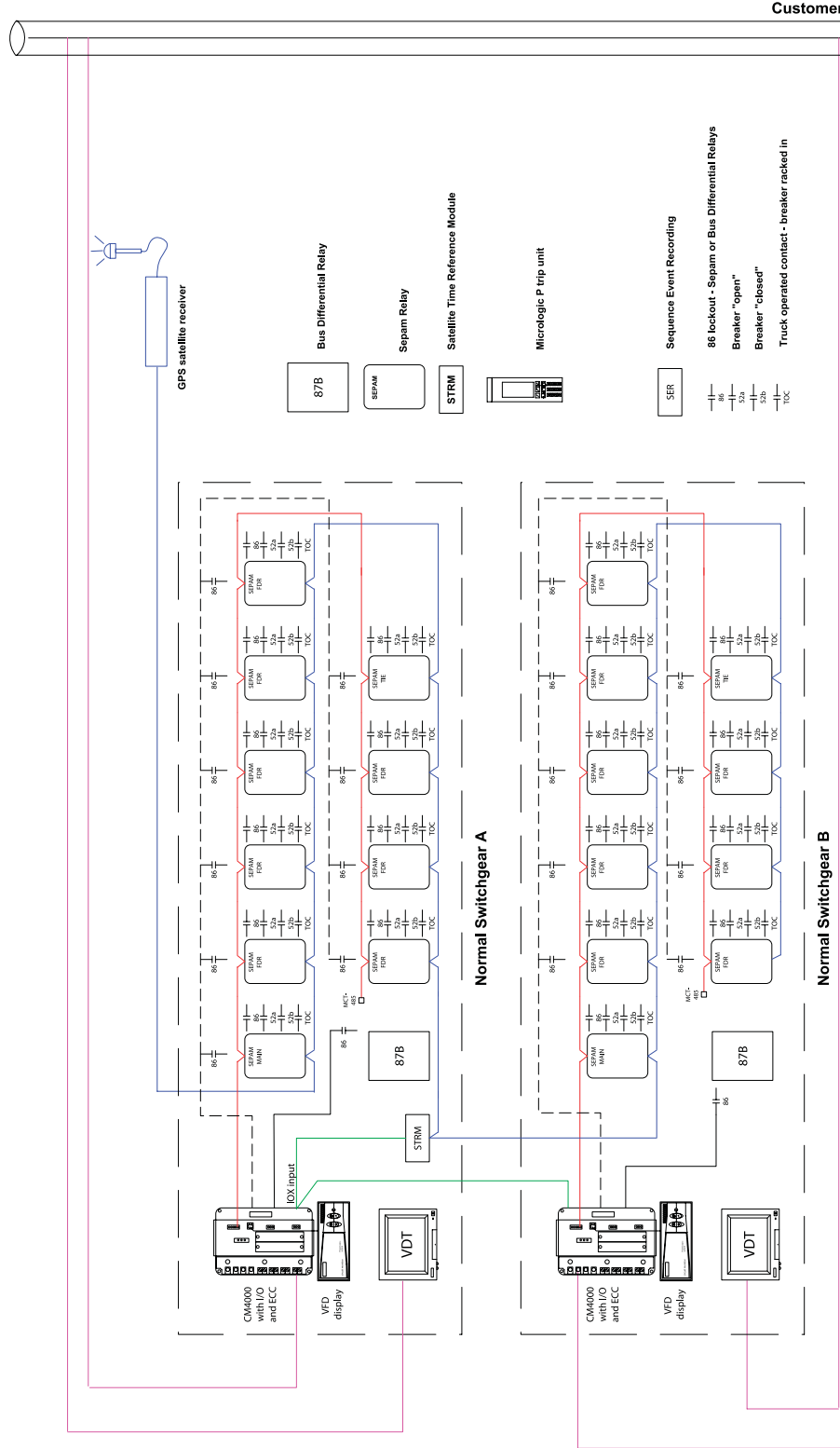

**Figure 3 Monitoring and communications to be used with main medium voltage or paralleling switchgear**  
 Medium voltage switchgear A and B has video display terminals (VDT), CM4000 circuit monitors with Ethernet, and relays that communicate with satellite time reference module (STRM) to customer Ethernet.

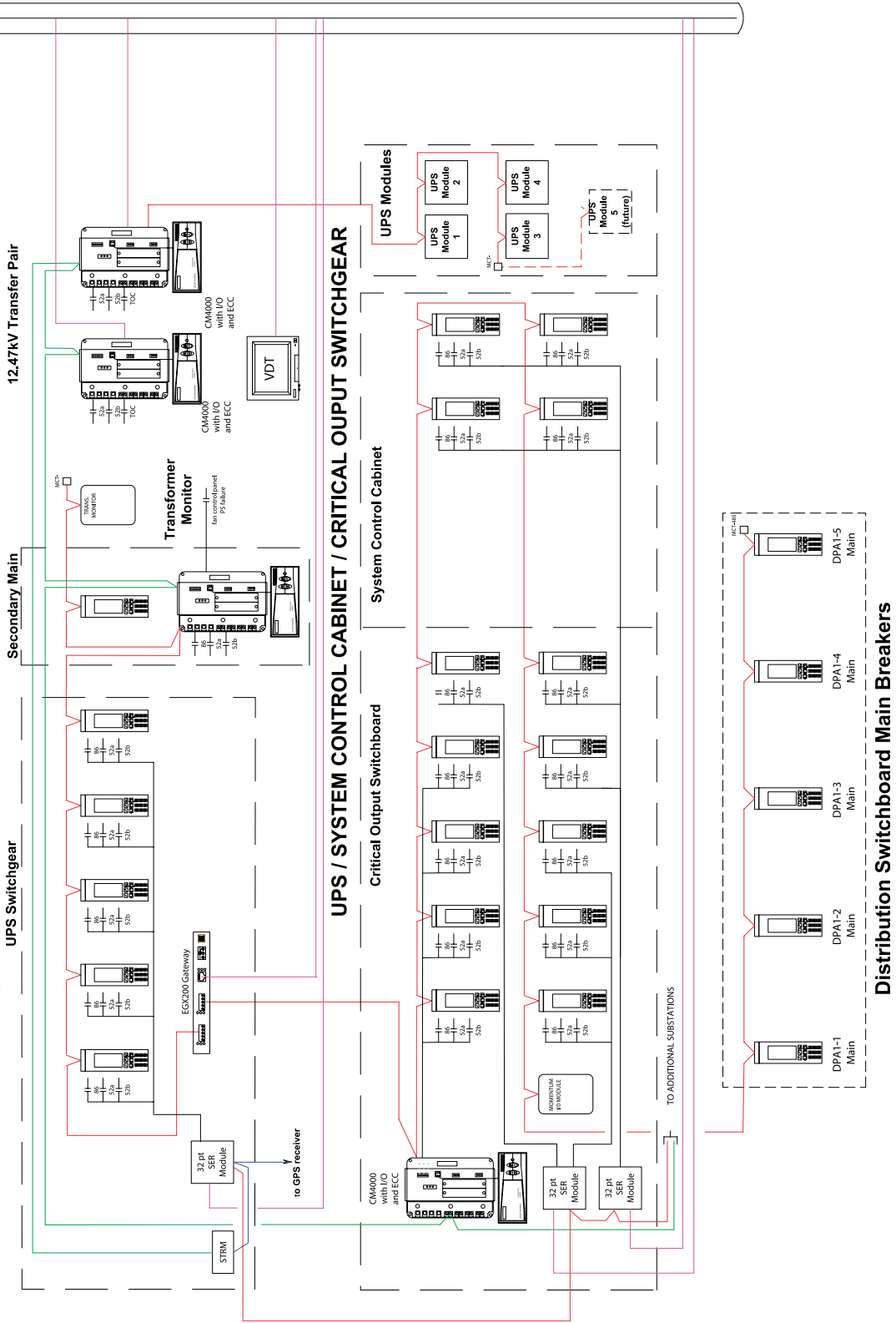

**Figure 4 Monitoring and communications with UPS Input switchgear/Output switchboard, system control cabinets and UPS modules**  
 UPS input and output switchboard have video display terminals, circuit monitors, MV transformer temperature monitor, main and feeder trip units with I/O, and I/O modules that communicate with satellite time reference module, sequence event recording (SER) module and Gateway that is connected to customer Ethernet.



# Typical Product One Line Diagram

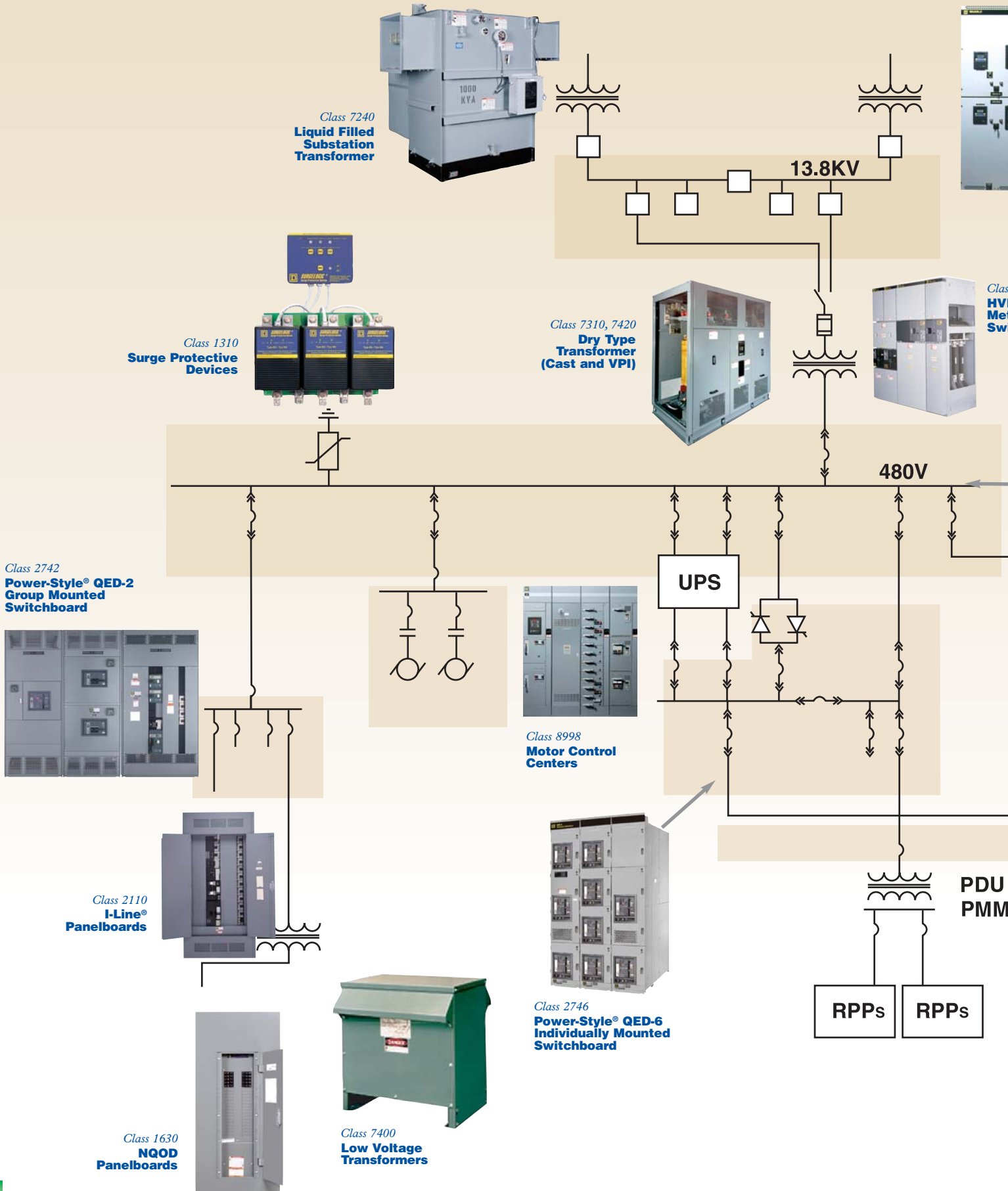



Class 6055  
**Masterclad®  
Metal-clad  
Switchgear**

Class 6045  
**Power-Zone®  
Metal Enclosed  
Switchgear**

Class 6037  
**Power-Zone® 4  
ANSI-Rated Switchgear**

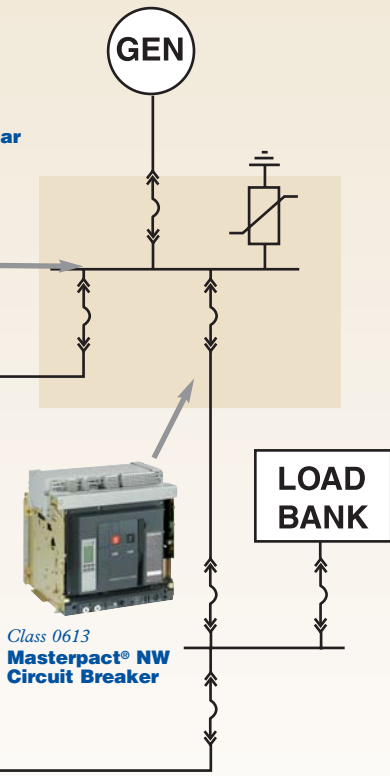

Class 0613  
**Masterpact® NW  
Circuit Breaker**

**LOAD  
BANK**

Class 5600  
**Busway Systems**

**TO COMPUTER  
LOADS**

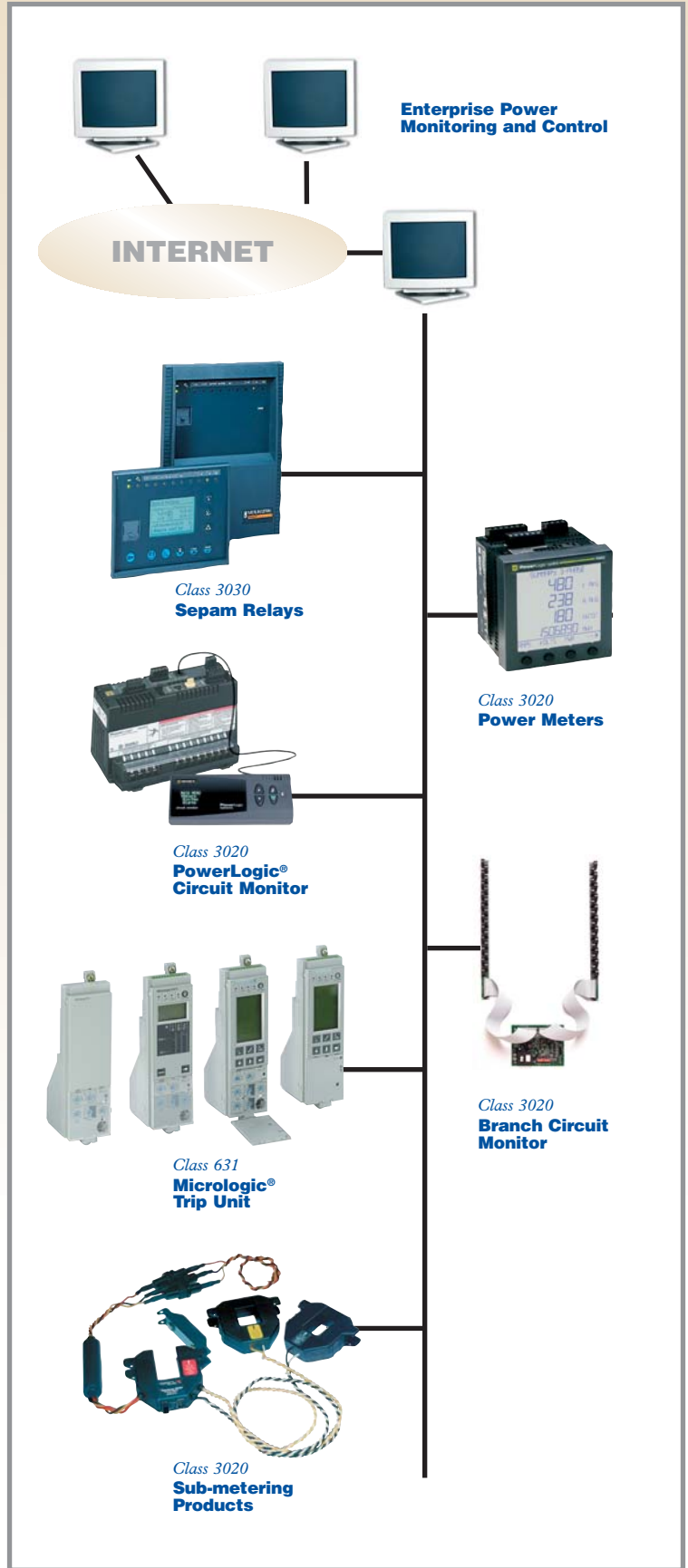

**Enterprise Power  
Monitoring and Control**

**INTERNET**

Class 3030  
**Sepam Relays**

Class 3020  
**Power Meters**

Class 3020  
**PowerLogic®  
Circuit Monitor**

Class 3020  
**Branch Circuit  
Monitor**

Class 631  
**Micrologic®  
Trip Unit**

Class 3020  
**Sub-metering  
Products**

# Low Voltage Product Offering

Schneider Electric offers a wide variety of low voltage Square D® power distribution products. From our QED-2 Powerstyle® switchboards using group-mounted I-Line® construction to our QED-6 compartmentalized switchboards. Schneider Electric provides a complete UL offering. Power-Zone® 4 Switchgear is built to strict ANSI standards and features the industry preferred Masterpact® NW and NT circuit breakers.

Transparent Ready™ communications technology with PowerLogic® components is offered throughout the full range of low voltage distribution equipment. All Transparent Ready products feature an Ethernet connection and embedded web server, designed to organize valuable information for easy access from any computer on your network using any standard web browser. By making it simple to connect your power and control equipment, we help you get the actionable information you need to reduce costs, and increase productivity.

These products and components are the preferred choice for many end users, consultants and contractors. They are used by many of the leading specialty OEMs sub-systems such as paralleling switchgear and UPS equipment.

## Low Voltage Switchgear

### Power-Zone® 4 with Masterpact Circuit Breakers and PowerLogic Monitoring

One of the major benefits for using ANSI-rated switchgear is the structure and breakers have defined short time withstand ratings (short circuit current withstand for 30 cycles). When properly adjusted, this allows main and feeder breakers to coordinate with downstream protective devices to insure the device closest to the fault clears first. This is very important when trying to coordinate with downstream main breakers in UPSs switchgear or other devices downstream. In addition to short time withstand ratings, other benefits such as 100% rated breakers (from 800A to 5000A frames), drawout construction, and maintainability for extended life make low voltage switchgear the primary choice in data centers.

Data Center Application:

- Main service switchgear
- Paralleling switchgear
- UPS input switchgear
- UPS output switchgear
- Load bank switchgear

Major new design and operational features have also been built into the Power-Zone 4 switchgear structures, for longer life and increased reliability. Some of these features are:

- Smallest footprint in the industry
- Masterpact circuit breakers have higher short time ratings and interrupting ratings than competitive products. Masterpact circuit breakers meet ANSI specified number of operations with no maintenance required
- Electrically operated breakers are listed to UL 1066, and the structure is listed to UL 1558
- 200kA SCCR without fuses
- Increased wire bending space





- Available up to 5000A bus rating
- Micrologic® trip units with power monitoring, control and communications
- Optional PLC based auto transfer schemes
- Optional Transparent Ready™ communications utilizing PowerLogic®
- Optional Surgeloc® TVSS
- Differential ground fault option for 4W systems with multiple sources
- Arc flash application options
  - Arc flash limiting feeder breakers up to 2000A reduce arc incident energy on downstream equipment such as UPSs and PDPs
  - Thru-the-door breaker operation allows unit to be operated/racked while door is closed; this reduces NFPA 70E PPE category by one level
  - Rear-hinged doors allow easy access to cables; this reduces NFPA 70E 2004 PPE category by one level

Benefits of using Power-Zone® 4 in data center applications:

- Drawout construction is required for quick circuit breaker change-out
- Transfer system requirements call for circuit breakers to close within 5-cycles and stored energy circuit breakers are required for reliability
- Front access to control wires is desired for ease of installation, maintenance and upgrade
- Circuit breaker compartmentalization is required for system integrity
- Segregation of circuit breaker compartments, from bus and cable compartments, is required for equipment
- Isolation breakers without fuses are required for high short circuit current ratings up to 200kAIR

## Switchboards – Rear Connected QED-6 with Masterpact Circuit Breakers and PowerLogic Monitoring



Rear connected switchboards offer many of the same benefits of ANSI rated switchgear listed above. Short times withstand ratings on the breakers, structures and as well as high short circuit interrupting ratings. Lower equipment cost, 100% rated drawout breakers (breaker frame sizes to 250A to 5000A) and maintainability for extended life are reasons this product is used in these facilities.

Data Center Application:

- Main service switchgear
- Paralleling switchgear
- UPS input switchgear
- UPS output switchgear
- Load bank switchgear

QED-6 switchboard structures offer many of the same benefits as Power-Zone 4 switchgear. Some of these feature differences are:

- Masterpact and PowerPact® circuit breakers have higher short time ratings and interrupting ratings than competitive products
- Up to eight Masterpact NT circuit breakers can be mounted in a single 30"-wide section
- PowerPact circuit breakers 250A and 600A frame for smaller loads
- Electrically operated breakers UL 489 rated and structure UL 891 listed
- 150kA SCCR without fuses @ 480V (200kAIR @ 240V)

## Switchboards



QED-2 switchboards are used in almost every level of the data center electrical system. Oftentimes, on smaller data center systems, QED-2 switchboards make up the majority of the equipment installed. They are used for service entrance, UPS input and output switchboards, load bank switchboards, supplying power to HVAC and building equipment, and to primary of 480V transformers that supply 208/120V power distribution units. We also supply custom solutions for paralleling and UPS output equipment when using 4-pole breakers on high resistance grounded systems. The QED-2 switchboards along with 4-pole breakers provide maintenance isolation for generators and UPSs.

QED-2 switchboards are available with single or multiple mains and distribution sections. Individually mounted mains use PowerPact® P- and R-frame electronic or Micrologic® molded case circuit breakers through 2,500A, Masterpact® NW two-step stored energy electronic trip circuit breakers, for fixed or drawout applications through 5,000A.

QED-2 distribution sections include I-Line® circuit breakers. With I-Line plug-on circuit breaker construction, the line end of the circuit breaker plugs directly onto the I-Line panel bus assembly. This design allows you to quickly install and wire circuit breakers from the front of the switchboard. In addition, I-Line circuit breakers are keyed to mounting slots in the support pan for automatic alignment and faster installation. I-Line switchboard sections are available in single- or double-row construction.

If you require higher feeder ampacities, QED-2 switchboards are available with individually mounted branch devices up to 4,000A. They include both thermal-magnetic and electronic trip molded case circuit breakers. For equipment ground fault protection you can use electronic trip. With QED-2 switchboards, you can also specify options such as automatic throw-over systems.

### Data Center Application

- Service entrance switchboard
- Paralleling switchboards
- UPS input and output switchboards
- Load bank switchboards
- Building and HVAC distribution switchboards
- PDU distribution switchboards
- DC battery rack main disconnects

### Features

- Front accessible load connections
- Front and rear alignment standard
- Switchboard fed by cable, busway, transformer, QED switchboard or other
- Switchboard ratings through 5000A, 200kA; higher amperages available
- Thermal-magnetic, electronic, Micrologic or stored energy fix-mounted and Masterpact NW drawout mounted circuit breaker mains and feeders
- Main devices in six sub-division or single main configurations
- Main and branch devices in single section configuration
- Main lugs in separate section in line-up or behind devices
- Group-mounted mains and branches
- Thermal-magnetic and electronic circuit breakers with standard, high, extra-high or current limiting capability
- Exclusive Micrologic trip circuit breakers, 80% or 100% rated.
- Zone selective interlocking on Micrologic circuit breakers, group-mounted 100A/250A thermal-magnetic circuit breakers with add-on ground fault.
- PowerLogic® system customer metering from ammeter, voltmeter, wattmeter to waveform capture, data logging, alarm/relay functions, disturbance monitoring and programmable logic, including custom communications capability and inter-wiring



- Custom engineering including main-tie-mains, multiple sets of through bus, reduced height and engineered houses
- 4-pole breakers are optional
- Transfer switches are optional
- Automatic throw-over systems are optional

## Panelboards

Square D® I-Line®, NF and NQOD are the preferred panelboards used in data centers by data center managers, engineering consultants and contractors. This is mainly because we are recognized in the U.S. as the industry leaders. In large data centers, suppliers of power distribution units (PDUs) and remote power panels (RPPs) rely on our panelboards for their equipment. In smaller data centers, located in manufacturing facilities, hospitals, large offices, etc., our panelboards are used to supply their entire system.

### 600V Panelboards – I-Line

I-Line distribution panels have been recognized for many years as one of the most versatile and reliable products in the electrical industry. This is no different for data centers. Almost anyone involved in specifying, designing or installing these electrical systems is familiar with our I-Line panelboards and breakers.

#### Data Center Application

- Paralleling panelboards
- UPS input panelboards
- UPS output panelboards
- Load bank panelboards
- Building and HVAC distribution panels
- PDUs
- DC battery rack main disconnects



#### Main Breaker Panelboards

- Accept a maximum 1200A, 80% or 100% rated electronic main and branch breakers
- Available factory-assembled or merchandised
- Factory-assembled main circuit breaker interiors are available bottom-feed or top-feed
- Available with a short circuit current rating (SCCR) up to 200kA maximum (100kA @ 600VAC) when supplied by an I-Limiter® circuit breaker
- Available with a silver-plated or tin-plated copper bus or tin-plated aluminum bus
- Solid neutral is mounted in the main compartment with the main circuit breaker

#### Main Lugs Only Panelboards

- Available with main lug only interiors rated up to 1200A
- Accept a maximum 1200A, 80% or 100% rated electronic branch breakers
- Available factory-assembled or merchandised
- Available with a short circuit current rating (SCCR) up to 200kA maximum (100kA @ 600VAC) when supplied by an I-Limiter circuit breaker
- Available with a silver-plated or tin-plated copper bus or tin-plated aluminum bus
- Solid neutral is mounted in the main compartment with the main lugs
- Hinged cover, isolated main lugs compartment
- Main lug interiors are available as top-feed or bottom-feed

### I-Line® Plug-on Unit with Surgelogic® TVSS

- Plug-on design requires less cable and conduit than end gutter-mounted TVSS unit, saving labor time and material costs
- Bus-connected design enhances performance
- Integrated TVSS and circuit breaker disconnects feature compact design, requiring only 13.50" (343 mm) of branch mounting space
- SCCR up to 200kA rating (100kA @ 600VAC) meets a wide variety of customer applications

### I-Line Circuit Breakers

- I-Line panelboards are designed to accept the following circuit breakers: FY, FA, FH, FC, FJ, FK, FI, HD, HG, HJ, HL, QB, QD, QG, QJ, QO, KA, KH, KC, KI, JD, JG, JJ, JL, LA, LH, LC, LI, LE, LX, LXI, MA, MH, MG, MJ, PG, PJ, PL, RG, RJ and RL

### 480/277V Panelboards – NF

Our NF panelboards are typically used for supplying power to HVAC and building equipment, 277V lighting, and to supply the 480V transformers for 208/120V PDUs

- Ratings – main lugs 125A to 800A, main circuit breaker 125A to 600A
- Branch circuit breakers (bolt-on), 1-pole, 15A to 70A; 2-pole, 15A to 125 A; 3-pole, 15A to 125A

### Main Lugs Interiors

- Top or bottom feed
- 65kAIR maximum branch circuit breakers at 480Y/277VAC
- Series rated to 200kAIR maximum when supplied by remote I-Limiter® circuit breaker
- Factory-installed main lugs on all interiors
- 125A–400A main lug interiors are convertible to main circuit breaker by adding a main circuit breaker adapter kit and main circuit breaker
- Available with silver-plated copper or tin-plated aluminum bus (aluminum is standard). Tin-plated copper bus is available as an option; 600A and 800A are only available with copper
- Branch connector fingers are tin-plated copper; silver-plated branch connector fingers are optional
- Optional TVSS available

### Main Circuit Breaker Interiors

- Top or bottom feed
- 65kAIR maximum branch circuit breakers at 480Y/277VAC
- 200kAIR with I-Limiter main circuit breaker
- Available with silver-plated copper or tin-plated aluminum bus (aluminum is standard)  
Tin-plated copper bus is available as an option; 600A only available with copper
- Branch connector fingers are tin-plated copper; silver-plated branch connector fingers are optional
- 125A main circuit breaker interiors contain factory-installed back-fed EDB, EGB or EJB main circuit breakers
- Optional TVSS available
- 250A main breaker interiors use the standard main lug interior and the appropriate HG, HJ, HL, JD, JG, JJ, JL or KI breaker
- 400A main breaker interiors use the standard main lug interior and the appropriate LA or LH breaker
- 600A main breaker interiors use the standard main lug interior and the appropriate LC or LI breaker



## 208/120V Panelboards – NQOD



Square D® NQOD panelboards are not only used for supplying lighting, office receptacles, fax machines and personal computers in the data center facility, but we are the preferred supplier for PDU and RPP manufacturers. PDUs are equipped with many of our main breakers and main lug interiors and are the bloodline of a data center. Remote power panels (RPPs) provide branch circuit protection for servers in computer rooms and are the last line of defense. Also, server designs and racks come in all types of load requirements. Our panelboards are very flexible to address your single and three-phase needs.

### Main Lugs Interiors

- Will accept plug-on or bolt-on branch circuit breakers
- Top or bottom feed
- 65kAIR maximum branch circuit breakers (fully rated)
- 200kAIR maximum when supplied by remote I-Limiter® circuit breaker (series rated)
- Field-installable sub-feed lug kits for 100A to 225A interiors
- Factory installed main lugs on all interiors
- 225A to 400A main lug interiors are convertible to main circuit breaker by adding a main circuit breaker and adapter kit
- Available with silver-plated copper or tin-plated aluminum bus (aluminum is standard). Tin-plated copper bus is available as an option. Branch connector fingers are all tin-plated copper; silver-plated branch connector fingers are optional
- 200% neutral bus is optional
- TVSS optional

### Main Circuit Breaker Interiors

- Will accept plug-on or bolt-on branch circuit breakers
- Top or bottom feed
- 65kAIR maximum branch circuit breakers (fully rated)
- 200kAIR maximum when supplied by I-Limiter circuit breaker (series rated)
- Available with silver-plated copper or tin-plated aluminum bus (aluminum is standard). Tin-plated copper bus is available as an option. Branch connector fingers are all tin-plated copper; silver-plated branch connector fingers are optional
- 200% neutral bus is optional
- TVSS optional
- 100A main circuit breaker interiors consist of factory installed back-fed QOB main circuit breaker
- 225A main circuit breaker interiors use:
  - Standard main lug interiors
  - Appropriate QBL, QDL, QGL, QJL, JDL, JGL, JLL, JLL or KIL circuit breaker
  - Main circuit breaker adapter kit
  - 250A main circuit breaker interiors are factory assembled only
- 400A main circuit breaker interiors use:
  - Standard main lug interior
  - Main circuit breaker adapter kit
  - Appropriate LAL or LHL circuit breaker

# Power Monitoring and Network Communications Products

A typical data center utilizes networks for a building management system, power management system, and lighting control system, while operating an interoffice or corporate Ethernet information network. Many times, these networks employ different communication protocols as well as different physical wiring and interface equipment. Each of these systems provides critical information for efficient facility operation, but blocks interoperability of the separate systems. Managing separate networks for each facility system requires resources, experience, extensive support and continuous training. These activities increase operating costs and decrease facility efficiency and reliability.

Schneider Electric's policy for networks is based on open standards in order to ensure open connectivity for our customers. The Transparent Ready™ family of products emphasizes Ethernet and web technologies (TCP/IP, HTTP, XML, etc.). Modbus®, a defacto protocol standard in many markets, continues to play a central role in our network policy as the main messaging protocol, whether it's at the Ethernet level over TCP/IP ("Modbus TCP") or over RS-485 multi-point communications ("Modbus RTU" or "Modbus serial").

Implementing Internet-based technologies on Ethernet provides an extremely flexible communications infrastructure. Utilizing common technologies and infrastructure allows shorter design cycles, lower implementation costs, and lower maintenance costs, and provides for continuous process improvement. Utilizing the power of Internet technologies like TCP/IP provides an open path to information and control systems on a facility's existing Ethernet network (see Figures 3 and 4 on pages 12 and 13). This approach provides all the benefits of a secure and deterministic architecture without locking into proprietary networks and protocols. Combining those benefits provides unmatched real-time control and open access to critical systems information without the restrictions of proprietary environments or the threat of implementing a field bus that may not exist in a few years. Data center managers can fully integrate data from many systems within their facilities and be able to better manage their efficiencies.

## Transparent Ready™ Equipment

Schneider Electric is the first manufacturer in the world to provide Ethernet connectivity across our comprehensive portfolio of power distribution equipment. We call this innovative technology platform Transparent Ready Equipment. It's simply the easiest and most open solution for accessing information about your data center electrical systems.

All Transparent Ready Equipment products feature an Ethernet connection and embedded web server, designed to organize valuable information for easy access from any computer on your network using any standard web browser. By making it simple to connect your power equipment, we help you get the actionable information you need to reduce costs, and increase productivity.

Transparent Ready Equipment is web-enabled via PowerLogic® technology.

Intelligent devices are connected to the LAN via a PowerLogic Ethernet Server:

- CM3000/4000 with ECC Ethernet card
- EGX – Ethernet Gateway
- Power server (with optional local display)

Obtain data from any of these devices:

- Masterpact® or Powerpact® breakers with Micrologic® trip units
- Sepam 1000 + medium-voltage protective relays
- Circuit monitors CM4000, CM3000 or CM2000
- Power meters, enercept or energy meters
- Model 98 transformer temperature controllers
- Branch circuit monitors in PDUs or RPPs
- PLC-based auto transfer schemes

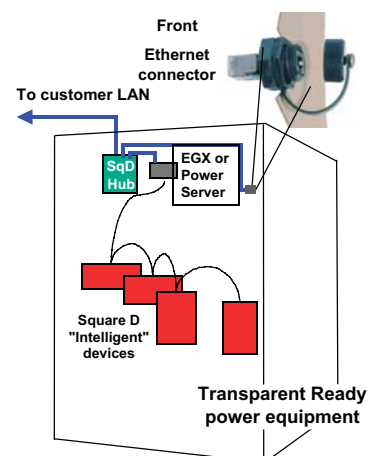

## Power Monitoring Products

Many data center managers have reached the same conclusion about their electrical power systems. By employing sophisticated power monitoring equipment to analyze historical and real-time data, they can reduce the cost of electricity and improve its quality and reliability and enhance their troubleshooting abilities. For more information on critical power applications with power metering and monitoring products, refer to product brochure #3000BR0001R7/03.

Intelligent analysis of power data prevents electrical system problems and saves money. Below are some of these benefits from a power monitoring system.

### Power Monitoring benefits

- Better understanding of electrical system loading and demand. This helps cut capital cost from over designing when expansions or modifications are needed
- Easy to compare electric bills (kWHs) with utility company statements
- Catch voltage sags and disturbances that may be causing critical equipment to trip off-line such as UPSs
- Easier to troubleshoot system problems such as faults or harmonics
- Helps provide a better understanding of entire electrical system

## Circuit Monitors

Circuit monitors are typically used to monitor power system parameters on medium voltage switchgear, 480V substations and switchboards, UPSs and PDUs. Locating them on this equipment enhances your ability to completely understand and troubleshoot your power system when needed. Below are some of the features of the circuit monitors:



- Features all basic and advanced metering functions while providing a 0.04% typical accuracy rate
- 14 data logs and up to 32MB of memory available
- Waveform capture to 255th harmonic
  - Three types of waveform capture – steady state, disturbance and adaptive
- Sag/swell detection to less than 1/2 cycle
- Trending and forecasting functions
- Optional web-enabled access directly to meter
- 15MHz sampling rate that allows detection of transients lasting only one microsecond (available with CM4000T)
- GPS time synchronization option
- Sequence event time stamping option

### Data Center Application

- Main service switchgear
- Paralleling switchgear
- UPS
- Load bank switchgear
- PDU distribution switchboards
- PDUs



## Power Meters

Power meters are typically used on feeder breakers for medium voltage switchgear and low voltage switchgear or switchboards. They are also used downstream on low voltage MCCs and power distribution switchboards and panelboards. These devices have become very powerful and provide more monitoring capabilities than circuit monitors manufactured in the late 90s. Below are some of the features of power meters:

- Basic metering functions allow metering of current, volts, power, energy and demand readings
- Power quality readings include total harmonic distortion for current and voltage readings
- Min/max values
- Alarm/relay functions
- Event and data logging on pre-configured values
- Ethernet communications available via Transparent Ready™

### Data Center Application

- Load bank switchgear
- Distribution switchboards that feed PDUs
- PDUs
- Panelboards



## Branch Circuit Monitors

The branch current monitoring system provides a cost-effective solution for electrical load management, making it ideally suited for applications where load capacity requirements are dynamic, such as power distribution units (PDUs).

Most of the money spent in data centers is for Tier 2, 3 or 4 solutions. However, most of the problems in data centers occur below the distribution boards and the last line of defense is the thermal magnetic circuit breaker. Without a branch circuit monitor you will not know why your servers have tripped off-line. The branch circuit monitor reports the current level of each of the breakers of a PDU to provide timely circuit loading information. In addition, as a circuit load approach one of two user set levels, an alarm can be generated back to monitoring software such as PowerLogic® system manager software.

A simple solution to individual circuit current monitoring, these monitors offer the following:

- Up to 63 BCM42s can be daisy chained on one Modbus® RS485 string for easy networking capability
- One BCM42 provides current levels on each circuit of a 42 circuit NQOD panelboard
- Current sensors are arranged on 3/4" or 1" centers for ease of installation
- Provides Modbus registers for current limit alarms to assist in preventing overload breaker trips

## Protective Relays



Whether you are looking for a simple protection relay or a multifunctional, communicating protection unit for remote network management and operation, you will find the right solution in the PowerLogic Sepam protection devices. Sepam Series 20, 40 and 80 are ideally suited to the most commonly encountered applications in data center facilities. For retrofit or installation into medium voltage equipment (including Metalclad™ switchgear, metal enclosed switchgear and motor control center) there's a Sepam protection device that is right for your protection needs.

- Complete line of protective relays – Feeder, motor, generator, transformer and bus protection, all in a common relay family
- Preventative maintenance alerts – Self-diagnostics for protection assurance, and external diagnostics for breaker, CT/VT and trip coils
- Customizable protective settings – Adaptive logic editor utilizes Boolean logic, allowing users to adapt standard control functions to suit varying needs of a power system
- Intuitive, graphic display – Graphic LCD display features a back light with auto contrast adjustment, and allows user access to operational and diagnostic information, power measurements and alarms, as well as password-protected setup
- Zone selective interlocking – Accelerated coordination between protection devices to minimize equipment damage
- Power monitoring functionality – Relays include power monitoring functionality to assist in managing the electrical system
- Modbus® communications

### Data Center Application

- Metalclad switchgear
- Medium voltage paralleling switchgear

# Medium Voltage Product Offering

## Metalclad™ Switchgear



Masterclad® medium voltage switchgear is used in a wide variety of switching, control and protective applications for data centers. In Tier III and IV systems it's mainly used for the main incoming service equipment and the generator paralleling gear. Auto transfer schemes allow Metalclad breakers to seamlessly switch between utility sources and paralleling gear during scheduled or uncontrolled power outages.

Metalclad switchgear is also used for the primary disconnect on the 12.47kV to 480V transformers. This allows users to electrically transfer between the “A” and “B” sources without the use of generators. This is also important for isolating cable faults that may occur while in operation.

Significantly, most of the Masterclad switchgear specified for these applications is relied upon to provide the critical main service entrance protection and controls.

This class of switchgear protects transformers, generators and feeder circuits.

### Benefits

- Long life and minimum maintenance – Vacuum interrupter design is capable of 20 to 100 full fault operations (varies by ratings), Total fault clearing time is 3 cycles. This is the fastest in the industry and reduces voltage sags on the system.
- Safety barriers and interlocks – Full compartmentalization is supplied with primary functions separated by grounded metal barriers. All bussing is insulated and live parts are not exposed. Safety interlocks work with the breaker racking system. These protective features provide safety for operating personnel.
- Breakers can withstand various levels of commissioning which involves many switching operations.

### Data center applications

- Main service switchgear
- Paralleling switchgear

### Ratings

- 4.76 – 15kV (to 13.8kV nominal)
- 1200A – 3000A
- 250 – 1000 MVA interrupting capacity
- 60 and 95kV BIL
- Indoor and outdoor enclosures

Standard Features (as defined by ANSI C37.20.2) includes:

- Removable (drawout) circuit breaker
- Fully compartmented construction
- Grounded metal barriers
- Enclose all live parts
- Automatic shutters
- Insulated bus
- Mechanical interlocks
- Disconnect type voltage transformers – CPT and VTs
- Grounded breaker truck in and between test/disconnected and connected positions
- Low voltage instrument/control compartment isolated from primary voltage areas

## Metal Enclosed Switchgear



Metal enclosed interrupter switches are most often used in data centers for protecting medium voltage transformers that service low voltage (480V) switchgear. The load interrupter switches are also useful for isolating cables between Metalclad breakers and transformers when maintenance is required. This equipment is ideal for applications where high duty cycle operation (switching) is not required and equipment cost is a concern.

### Data Center Application

- Primary protection (fusible) and isolation (non-fused) for medium voltage transformers

HVL/cc switchgear features – 2.4kV to 38kV switching, control, and overload protection are ideal for water and wastewater applications. Improving reliability and performance are the primary goals of switchgear in any switching, control or protective application.

We've taken these goals further with HVL/cc™ medium voltage metal enclosed switchgear. Its exclusive operational features offer a higher level of system protection, yet it also incorporates innovative design features that reduce the risk of costly maintenance problems. The major differentiating features of HVL/cc switchgear include:

- Smallest footprint in the industry (approximately one-quarter size of traditional medium voltage metal enclosed switchgear) – makes it ideal for retrofit applications requiring increased load or duplex switches. Compact footprint fits easily through standard doorways
- Compartmentalized construction – the fuse/cable compartment is isolated from the main bus, while the main switch contacts are housed in a sealed interrupter
- Low maintenance – Sealed for life interruption saves time and expense with maintenance-free main contacts and ground switch contacts. Prevents switch contamination especially in harsh environments
- Fault-making grounding switch (optional) – prevents access to “hot” fuse/cable compartment with mechanical interlock
- Front access eliminates need for service space behind switchgear
- FuseLogic system provides single-phase protection and blown fuse indication. This protects downstream motors from overheating due to negative sequence currents

No other medium voltage metal enclosed switchgear on the market offers these advantages. When you make the comparison based on installation simplicity, performance, and total cost of ownership, HVL/cc switchgear becomes the clear choice for system protection and reliability.

## Medium Voltage Transformers



Consultants specify many different types of medium voltage transformers when designing data centers: Liquid filled, cast primary cast secondary, cast primary vacuum pressure impregnated (VPI) (dry-type) secondary and VPI (dry-type) on primary and secondary. The main objective of what is specified depends on the installation location (indoor or outdoor) of the transformers, the emergency loading it may be subjected to (fan packages), and the life the data center manager expects from the transformer. Depending on the transformer design, and its loading or uses, the expected life can vary from 20 to 40 years.

Schneider Electric offers a full range of medium voltage transformer products. All transformers are manufactured in ISO certified facilities that ensure the highest quality products are provided, built and tested to applicable ANSI/IEEE, CSA and NEMA standards. Our products are available with UL Listing. We offer high efficient standard designs including optional low loss TP1 designs.

- Transformers are designed, manufactured and tested to Square D specifications ensuring the highest quality in the industry
- Available UL Listing
- Liquid-filled transformers available with FM label
- All products meet or exceed applicable ANSI/IEEE standards
- Square D® brand transformers are manufactured in ISO9001 certified facilities (the most comprehensive standard in the internationally recognized ISO9000 series)

### Liquid-Filled Padmount

- 45kVA to 20,000kVA
- Primary voltages 2.4kV to 46kV, 250kV BIL maximum
- Secondary voltages to 25kV
- Mineral oil, R-Temp®, silicone and Biotemp®

### Liquid-Filled Substations

- 112.5kVA to 20,000kVA
- Primary voltages 2.4kV to 69kV, 350kV BIL maximum
- Secondary voltage to 34.5kV, 200kV BIL maximum
- Mineral oil, R-Temp®, Silicone and Biotemp®

### Power Cast II™

- 112.5kVA to 13,000kVA
- Primary voltages 2.4kV to 46kV, 200kV BIL maximum
- Secondary voltage to 15kV
- Aluminum windings available
- Forced air provides 50% overload
- No pre-drying before energizing

### UniCast II™

- 112.5kVA to 3,000kVA
- 600V secondary
- Copper windings available
- Forced air provides 33% overload

### Power Dry II™

- 112.5kVA to 13,000kVA
- Primary voltage 2.4kV to 35kV/150kV BIL
- Secondary voltage up to 15.0kV
- Forced air provides 33% overload



# Medium and Low Voltage Circuit Breakers

Many circuit breakers that we manufacture are not only used in our medium and low voltage switchgear, switchboards and panelboards. We sell many breakers to OEM customers because we offer many solutions for their needs such as the highest short circuit ratings, most reliable breakers manufactured with the least amount of maintenance and highest switching operations. Our circuit breakers are used by OEMs who assemble or manufacture the following equipment:

- Medium and low voltage paralleling switchgear
- Medium and Low voltage generator main breakers
- UPS output switchgear
- UPSs
- PDUs
- ATSS
- STSS
- RPPs

## Masterpact® Circuit Breakers

Most OEMs in the data center market have either used or are aware of our Masterpact® circuit breakers. These breakers are the workhorses of the industry that are used in the most critical data center equipment such as generators, paralleling switchgear, UPS switchgear and switchboards. They are very attractive because of their low maintenance requirements, their wide range of short circuit protection, and electrically operated accessories.

### Data Center Application

- Main service low voltage switchgear – Power-Zone® 4, QED-6 and QED-2
- Low voltage paralleling switchgear – Power-Zone 4, QED-6 and QED-2
- Low voltage load bank switchgear – Power-Zone 4, QED-6 and QED-2
- UPS input switchgear – Power-Zone 4, QED-6 and QED-2
- UPS output switchgear – Power-Zone 4, QED-6 and QED-2
- UPS static transfer switches
- Generator main output breakers

### NW ANSI

- Complete product offering through 200kAIR without fuses
- 800A to 5000A frames available
- Rated for all AC voltage systems through 635V
- ANSI short-time withstand ratings up to 100kA
- Four racking positions – connected, test, disconnected, removed – with status indicator on cradle
- Simple, visual contact wear indicators
- Meets ANSI standard C37.13 and UL1066
- Full complement of field installable devices
- Selection of four interchangeable Micrologic® trip units with PowerLogic® power metering, communications and monitoring capabilities available in advanced trip units
- Most common relay functions as defined by ANSI C37.2 and C37.90 integrated into circuit breaker
- Electrically operated optional
- 4-pole breakers available



- Mechanical and electrical operations test w/o maintenance
  - 800A to 1600A frame – 12,500 mechanical operations with 2800 electrical – ANSI value is 1750 (9700 total)
  - 2000A to 3200A frame – 10,000 mechanical operations with 1000 electrical – ANSI value is 250 (1100 total)
  - 4000A to 5000A frame – 5,000 mechanical operations with 1000 electrical – ANSI value is 250 (1100 total)
- Arc flash limiting breakers available

### NW UL489

NW UL489 breaker has most of the same features as listed for the Masterpact® NW. The following differences are listed:

- Rated for all AC voltage systems through 600V
- Available for mounting in fixed or drawout configurations
- Available in constructions that meet ANSI C37.13 and UL1066 standards

### NT ANSI

The Masterpact® NT ANSI®-Certified/UL 1066 Listed power circuit breaker meets or exceeds all ANSI and UL489 design and testing standards. It also meets ANSI high level endurance testing without maintenance. Plus, state-of-the-art, thermoset composite resin construction provides higher electrical ratings than traditional circuit breakers – all in a lighter, easier-to-install package. The Masterpact NT ANSI-Certified/UL 1066 Listed power circuit breaker provides unsurpassed performance in the smallest package available on the market today. Features include:

- 70% smaller than standard sized 800A to 3200A Masterpact NW
- Meets ANSI C37.13 and UL 1066. Also available in constructions that meet IEC 60947-2 and UL 489
- Complete product offering through 42kAIR at 508V
- Rated for all AC voltage systems through 508V
- *800A frame size available*
- ANSI short-time withstand ratings up to 42kA
- Small size allows for higher density in switchgear. Can install up to eight 800A breakers in one 30-inch section of Power-Zone®4 Switchgear
- Four racking positions (connected, test, disconnected and removed) with status indicator on cradle
- Selection of four interchangeable Micrologic® trip units with PowerLogic® power metering, communications and monitoring capabilities available in advanced trip units
- Most common relay functions, as defined by ANSI C37.2 and C37.90, integrated into the trip unit system
- Trip units, sensor plugs and most accessories are field-installable without circuit breaker adjustment
- Electrically operated optional
- Mechanical and electrical operations test w/o maintenance
  - 800A – 12,500 mechanical operations with 2800 electrical – ANSI value is 1750 (9700 total)

### NT UL 489

NT UL489 breaker has most of the same features as listed for the Masterpact NT. The following differences are listed:

- Complete product offering through 100kAIR at 480VAC
- 800A to 1200A frames available
- Rated for AC voltage systems through 600V
- Short-time withstand ratings up to *35kA and interrupting ratings up to 100K amperes at 480V*
- Small size allows for higher density in switchboards. Can install up to eight 1200A breakers in one 30" section of QED-6 switchboard



## Masterpact Onboard Intelligence

For smarter breakers, a range of Micrologic® trip units is available. These units provide advanced functionality, such as a communications interface, and power metering and monitoring capabilities, which allow for integration and coordination of your electrical system. With the appropriate Micrologic trip unit, you can communicate with breakers, gather power information, monitor events and remotely control breakers based on predetermined conditions, leading to substantial savings in electrical system operating costs.

## Medium Voltage Vacuum Circuit Breakers



The VR circuit breaker with the Type RI advanced design motor-charged stored energy mechanism is a model of reliability with simplicity-virtually maintenance free. With an operating life exceeding the ANSI test requirements, the RI mechanism with synchronizing crossbar is electrically and mechanically trip-free. An integral handle (non-removable) is provided for manual charging and slow closing during testing.

The VR vacuum circuit breakers are designed for long life. The interrupter's copper chromium contacts, hermetically sealed for life in a vacuum, are protected from external atmospheric influences. Dust, moisture, and all other possible contaminants are sealed out. This state-of-the-art vacuum interrupter design is capable of 20 to 100 full fault interruptions (varies by rating).

The high dielectric strength of the vacuum environment allows a very short clearing time during fault interruption to limit the energy dissipated into the arc. Total fault clearing time is less than 3 cycles and contact travel is only 3/8 to 1/2 inch, depending on the ratings of the circuit breaker. The short stroke produces less mechanical shock to the operating mechanism.

Ratings: 4.76kV-15kV (to 13.8kV nominal)

- 1200A, 2000A and 3000A
- 250, 350, 500, 750 and 1000 MVA Interrupting Capacity

Data Center application

- Medium voltage paralleling switchgear
- Metalclad™ switchgear

## PowerPact® “H” and “J” Molded Case Breakers

Designed to address the unique demands of UPS and PDU manufacturers, PowerPact H- and J-Frame Molded Case circuit breakers give you the right combination of features and performance to satisfy your circuit breaker requirements. PowerPact circuit breakers deliver unmatched design flexibility across the entire range of 15A to 250A frame sizes offering the benefits of a flexible, modular circuit breaker that UPS and PDU manufacturers demand. Design standardization enables UPS and PDU manufacturers to improve their productivity so when specifications change, their design can remain the same.



Data Center Application

- QED-6 switchboards
- QED-2 switchboards
- Panelboards
- UPSs
- PDUs
- STSs
- DPUs
- RPPs
- Generator output breaker

#### Full-featured Performance

- H-Frame – 150A available in both standard and 100% ratings with standard amperage ratings from 15A to 150A. Interrupting ratings (AIR) include D-18kA, G-35kA, J-65kA and L-100kA at 480VAC
- J-Frame – 250A available in both standard and 100% ratings with standard amperage ratings from 150A to 250A. Interrupting ratings (AIR) include D-18kA, G-35kA, J-65kA, and L-100kA at 480VAC
- Field-installable accessories are common for H-, J- and D-Frame circuit breakers to make stocking and installation easy
- Unique snap-in terminals make converting bus bar and lug configurations simple and easy
- Field-installable trip units lower inventory costs and reduce stocking space by configuring products at point of use
- Allows design standardization for 15A to 250A applications with common mounting holes, handle locations, and trim dimensions for both H- and J-Frame circuit breakers
- Many configuration options provide application flexibility, with I-Line®, plug-in, drawout, rear connected
- Motor operators, rotary handles and cable operators provide options for integrating into a variety of applications
- Certified to global standards, including UL, IEC, CSA and NOM

### Compact® NSJ PowerPact® D-Frame Molded Case Breakers

The Compact NSJ line achieves a significant technical advance in the evolution of molded case circuit breakers. UPS and PDU manufacturers prefer these breakers because of their available high-speed switching action and snap-in field accessories. These circuit breakers use an entirely new technology in current interruption. Short-circuit protection is enhanced by a unique double rotating break (dual break system) which brings an exceptional current limitation and outstanding endurance on repetitive short-circuit interruptions.

#### Data Center Application

- UPSs
- STSs
- PDUs
- DPUs
- RPPs
- Generator output breaker

#### Full-featured Performance

- Compliance with most standards and agreements worldwide
- Suitability for isolation with positive break indication
- On request, numerous functions for indication, measurement and control are available
- Moisture and fungus protection
- Reinforced insulation
- Snap-in field-installable accessories
- Reverse feeding from 70A to 600A
- Maintenance-free operation
- Direct or extended rotary handle
- Optional motor operator featuring short closing time
- Optional Shunt trip and undervoltage releases



### NSJ Ratings

- 60A to 600A

### UL 489 Interrupting Ratings Available

- 240V – 65kA, 100kA, 150kA
- 480V – 35kA, 65kA, 100kA
- 600V – 18kA, 25kA, 25kA

## Mission Critical Molded Case Circuit Breaker



This breaker was created with data centers in mind. The LA High Magnetic Withstand Circuit Breaker is designed to trip at a higher magnetic trip level. Typical molded case circuit breakers (MCCBs) and molded case switches used in PDU applications will trip at 5–10x the handle rating. This means a fault on one branch circuit would likely trip the main, therefore shutting down the entire PDU. The LA high magnetic withstand circuit breaker trips at 18–20x the handle rating. Through higher magnetic tripping levels, the LA high magnetic withstand circuit breaker provides a higher degree of selectivity between itself and downstream 20A and 30A branch circuit breakers (1-pole – QO®) feeding server racks. This ensures that only the downstream branch circuit breaker closest to the fault will trip.

### Available ratings

- 200A, 225A and 250A = 20x
- 400A = 18x

## Other Low Voltage Products

Schneider Electric can meet your full power distribution needs, with busway; K-rated, energy efficient and harmonic mitigating transformers; power factor correction capacitors; motor control centers; NEMA-style contactors and starters; variable speed drives and safety switches.



# Square D® Services

## Products and Engineering Services

Square D Services offers one source of service expertise on all major brands of electrical equipment. Our solutions are designed to enhance performance, improve reliability and extend equipment life.

### Power System Assessment

- Evaluates the condition of the electrical system
- Improves system reliability and availability
- Enhances electrical safety
- Provides essential documentation of system configuration, condition and maintenance
- Ensures proper operation of new or modified loads
- Prioritizes system improvements

## Engineering Studies

### Power Quality Studies

- Analyze power system disturbances and interruptions that decrease productivity and reliability
- Reduce cost effect of poor power quality
- Troubleshooting power system problems caused from utility voltage sags, lightning or from medium voltage capacitors switching

### Harmonic Studies

- Identify excessive harmonic distortion and loading
- Properly size capacitors in the presence of harmonic generating loads
- Evaluate and identify harmonic mitigating saving opportunities
- Solve problem due to voltage notching cause by SCR firing in DC drives
- Optimize existing electrical distribution system and ensure proper operation of sensitive equipment
- IEEE 519 compliance

### Short Circuit, Coordination and Arc Flash Analysis

- Identifies overdutied equipment due to high fault currents caused by system design additions or utility network changes
- Prevents nuisance tripping of protective devices and insures coordination with downstream devices
- Checks that feeder and branch conductors are adequately protected
- Generates updated AutoCAD one line diagram model of facility
- Addresses ground fault coordination and grounding concerns
- Identifies NEC code violations
- Determines proper Personal Protective Equipment (PPE) for workers who work on energized parts per NFPA 70E or IEEE 1584
- Provides arc flash tables to determine required labels for equipment
- Determines arc flash boundaries for non-qualified personnel

### Additional Studies available

- Power factor correction
- Transient motor starting
- Load flow using portable metering or simulated with software

## New Installation Services

### Start-up and Commissioning

- Inspection and testing of Square D® equipment prior to energization to verify equipment
  - Is free of damage during shipment and installation
  - Has been properly installed
  - Performs to the system design specifications
  - Meets optimum performance standards
- Performed by factory-trained technicians, knowledgeable of our latest product innovations
- Verification of proper installation through mechanical and electrical testing and inspection prior to equipment energization
  - As-installed documentation to establish a baseline for future reference and trending

### Training

- Offered for all Square D products
- Designed around customer's equipment
- Offered on-site and typically includes classroom and hands-on training
- Customer value
  - Square D product knowledge
  - Factory-trained technicians
  - Customer focused

## Retrofill and Upgrade

### Direct Replacement Circuit Breakers

Extends the life of existing switchgear at a fraction of the cost and installation time of new equipment

- Install a new circuit breaker element and carriage assembly into an existing line-up with little-to-no modifications to the switchgear
- The new circuit breaker interfaces with the existing structure and maintains safety interlocks inherent in the original design
- Designs available for most major manufacturer's switchgear
- Upgrades line-up to current technology with minimal downtime
- Available for low- and medium-voltage equipment using Masterpact® and Magnum™ circuit breakers



### MV and LV Retrofill Solutions

- Install a new circuit breaker and cradle into an existing switchgear cubicle, which has been adapted to accept the new equipment
- Includes new cubicle racking mechanism, primary and secondary disconnects
- Designs available for most major manufacturer's switchgear
- Cost-effective way to upgrade switchgear to current technology
- Available for low- and medium-voltage equipment





## C<sup>5</sup> Reconditioned Program

The C<sup>5</sup> Reconditioned program for low voltage and medium voltage power circuit breakers ensures each breaker is Checked, Cleaned, Corrected, Calibrated and Certified through the following steps:

- Complete disassembly and inspection of the circuit breaker at the component level
- Clean and repaint/replate key components; replace old hardware
- Identify damaged or defective components for replacement (additional charge to replace)
- Relubricate moving parts and operating mechanisms
- Calibrate to manufacturer's specification when the circuit breaker is reassembled

## Maintenance and Testing Preventive Maintenance

- Periodic inspection and maintenance to help extend equipment life and ensure operating efficiency
- Comprehensive mechanical and electrical testing to ensure proper functional operation, including:
  - Cable testing
  - Relay and metering calibration
  - Infrared testing
- Also available:
  - Custom service agreements
  - Facility-wide outage management
- Services also available for non-Square D equipment

## Workplace Safety

### NFPA 70E Training Workshop

- 8-hour course taught by certified instructors
- Designed to provide participants with a basic understanding of safe workplace practices
- NFPA 70E Part 2 (Arc Flash) standards are reviewed and explained
- Includes an overview of proper distribution equipment maintenance

### Emergency Services and Disaster Recovery

- Problem analysis
- Project management
- Single point of contact
- 1-888-SQUARED
- 24-Hour access to Square D Services
- Manufacturing plants



### Schneider Electric - North American Operating Division

1010 Airpark Center Drive  
Nashville, TN 37217  
1-888-SQUARE D (778-2733)  
Fax: 615-844-8577  
[www.criticalpowernow.com](http://www.criticalpowernow.com)