

Section 11

Switchboards and Switchgear



FlexSet Switchboard



Metalclad and HVL/cc Switchgear



Unit Substation



Model III Package Unit Substation

Low Voltage Switchboards	11-2
FlexSet Switchboards (cULus Listed)	11-2
Power-Style QED-2 Switchboards (UL Listed)	11-7
Power-Style QED-6 Switchboards (UL Listed)	11-8
Power-Style Commercial Multi-Metering Switchboards (UL Listed)	11-10
Speed-D™ Switchboards	11-11
Speed-D SB/SF Switchboards (UL Listed)	11-11
Low Voltage Switchgear	11-15
Power-Zone™ 4 Low Voltage Switchgear with MasterPact™ MTZ or NW/NT Circuit Breakers	11-15
Power-Zone™ 4 Arc Resistant Switchgear with ArcBlok Technology	11-16
Built on the Legendary Performance and Reliability of the MasterPact Line	11-16
Medium Voltage Metal-Enclosed Switchgear	11-17
MiniBreak™ Compact Height Switches—5.5 kV, 200 A	11-17
Premset Compact Vacuum Circuit Breaker Switchgear with Shielded Solid Insulation System (2SIS)	11-19
HVL/cc Metal-Enclosed Load Interrupter Switchgear—Full Range	11-20
HVL/cc Switchgear Quick Ship Program—5–15 kV, 600 A	11-22
HVL Metal-Enclosed Load Interrupter Switchgear—Full Range	11-27
HVL Switchgear Quick Ship Program—5 kV–15 kV, 600 A	11-28
HVL Switches for Power-Dry II™, Power-Cast II™, and Uni-Cast II™ Transformer Connections	11-29
Square D™ Brand DIN/E Fuse Selection Tables—HVL	11-31
Boric Acid Fuse Selection Tables—HVL	11-32
Medium Voltage Gas-Insulated Switchgear	11-33
GHA Gas-Insulated Switchgear (UL Listed)	11-33
CBGS-0 Gas-Insulated Switchgear (UL Listed)	11-34
DVCAS Switchgear for Wind Farm Applications	11-35
Medium Voltage Metal-Clad Switchgear	11-37
Masterclad™ Medium Voltage Metalclad Switchgear (UL Listed)	11-37
Passive, Arc-Resistant Masterclad™ Medium Voltage Switchgear	11-38
Unit Substations	11-39
Power-Zone Load Center Unit Substations	11-39
Power-Zone Model III Package Unit Substations	11-39
MV Controllers	11-42
Motorpact™ Medium Voltage Motor Controllers (UL Listed)	11-42

11 SWITCHBOARDS AND SWITCHGEAR

FlexSeT Switchboards (cULus Listed)

FlexSeT is a complete low voltage Switchboard offer and service model that enables new methods of assembly, installation, and maintenance, while delivering unprecedented availability, reliability, and modularity. FlexSeT customers will benefit from dramatically reduced lead times with design flexibility through a modern and innovative switchboard system, offering an end-to-end digital experience.

Designed with the entire product lifecycle experience in mind, FlexSeT is a product developed with a fully customer centric approach, making everything simpler and faster from ordering to maintenance without compromising quality or safety, all while ensuring compliance to UL Standards.

FlexSeT is delivered on-time with the shortest lead time in the market! The complete offer can shorten delivery to days instead of weeks. Even with configuration changes at virtually any part of the ordering process. The product modularity allows for adaptations without risks to your project timelines as features are added or removed in the lineup.



Product Design and Key Features Highlights

Years of leadership in the switchboard market have provided Schneider Electric with the expertise to drive innovation. FlexSeT switchboards are designed to take solutions to a whole new level, making the best switchboards in the market even better.

Designed to be assembled anywhere without the need of heavy machinery or complex tools, FlexSeT is structured to be simple and intuitive, not only for assembly but also for operation and maintenance.

FlexSeT modularity comes in the form of kits and design features that allow for quick and easy installation, removal, or replacement. This makes installation and operation more intuitive and faster with the benefit of improved efficiency.

11 SWITCHBOARDS AND SWITCHGEAR



Swingable Main

The main breaker assembly is mounted on a robust hinge system. This feature enables the use of cable pulling machines in the equipment space and exposes the wire terminals for easier and faster connection.

Bussing System

The bussing designs deliver reliable connections with quick and easy installation! Visi-tite™ bolts ensure proper torquing while the bus bridge connects all phases simultaneously in one simple operation. The bussing has an enclosed design which greatly reduces the points of exposed bus bars.

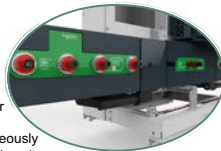

Backfed Main at 1600 A
Main breaker and the I-Line™ stack in one single section to provide unmatched footprint performance.



I-Line Bus Stack with Neutral Bar

The I-Line bus stack, which has been benefiting our customers for years, has now gotten even better by having the Neutral within the stack.

Captive Hardware

No lost time in removing and replacing covers as the hardware is always in place.

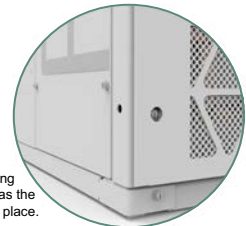

Plug-on Neutral

From Panelboards to Switchboards! Land the neutral closer to the load, reducing complexity and making wiring cleaner and more efficient.

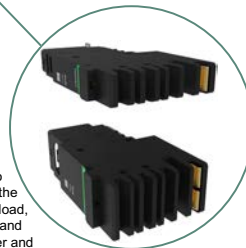

Digital Journey and Tools

FlexSeT has taken advantage of the latest digital and end-to-end cyber-secured technology to drive customer satisfaction for the best possible experience throughout the lifecycle.

Digital tools are used in every aspect of the product starting at the quoting and ordering process with **FlexSeT Design™**. The new product selector is intuitive by nature and provides logic and pricing live at each selection, surfacing the right information to make informed decisions

Schneider Electric's **Asset Lifecycle Management™** (ALM) system tracks and stores all documentation for each feature and component of a FlexSeT Switchboard. The documentation specific to each order and configuration is stored digitally, cyber-secured, and is accessible at anytime with a simple QR scan. This information is linked and stored directly from FlexSeTDesign and updated with any change.

The assembly process is executed with **FlexSeT Build™**, an interactive step by step guide for the assembler that help ensure the quality and integrity of the product. The app ensures each assembly step is properly executed from start to finish and inspected for compliance subsequently. Furthermore, FlexSeT Build™ is directly linked and paired with physical assembly tools that ensure proper technical aspects are adhered to, with live verification throughout the assembly. The testing of every section is also completed with FlexSeT Build™ as the last step. A successful result is required in order to generate and apply the UL label of certification. Each FlexSeT section assembled will have a final report with Digital Artifacts and Photos for quality assurance and compliance.

The UL Mark and Certification Labels are issued digitally at the conclusion of each successful assembly. The auditing of an assembled FlexSeT switchboard is done via digital artifacts and critical quality data collected during assembly and quality control process.

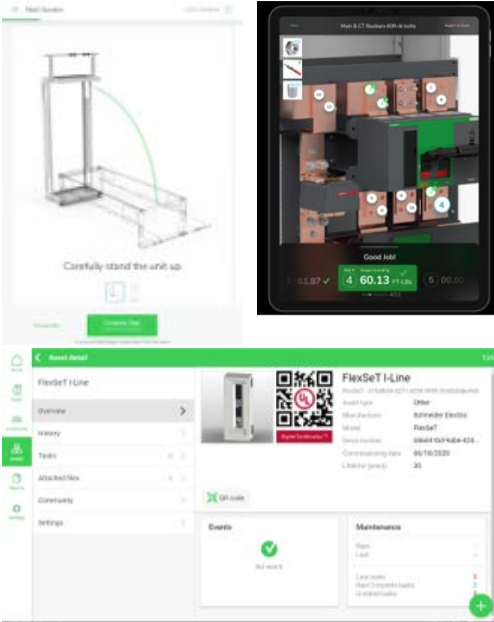

Features and Specifications Summary

Just like all Schneider Electric products, FlexSeT is always evolving to bring the best features to market with the latest technology, and will continue to develop and enhance customer solutions, constantly improving the offer!

Here are the latest features for FlexSeT Switchboards:

- Designed, listed, and assembled in accordance with UL 891 Standards
- NEMA 1 enclosure
- All front and side covers use captive hardware
- Front and rear accessible
- Swingable main breaker mounting assembly
- Main breaker ampacities—100% rated up to 65 kA
 - Backfed: 400 A, 600 A, 800 A, 1000 A, 1200 A, 1600 A
 - Individually mounted: 400 A to 2000 A
- All copper system bussing rated for 2000 A, including neutrals
- Plug-on neutral for group mounted devices
- 2000 A I-Line™ feeder section with neutral bar within the stack—feeders from 15 A up to 1200 A
- Splice bridge with extending bussing
- Visi-Tite™ bolts on all torque-required bussing connections
- Swingable instrument compartment—separated and modularized
- Available devices:
 - PowerLogic™ power meter PM5563
 - Surge protective device—rated up to 240 kA
 - Maintenance mode setting (MMS) switch—compliant with NEC 240.87 Arc Energy Reduction requirements
 - SmartCell™ compatible!
- Digital Asset Lifecycle Management—all drawings, test reports, and instruction/ installation manuals are cyber-secured and available online

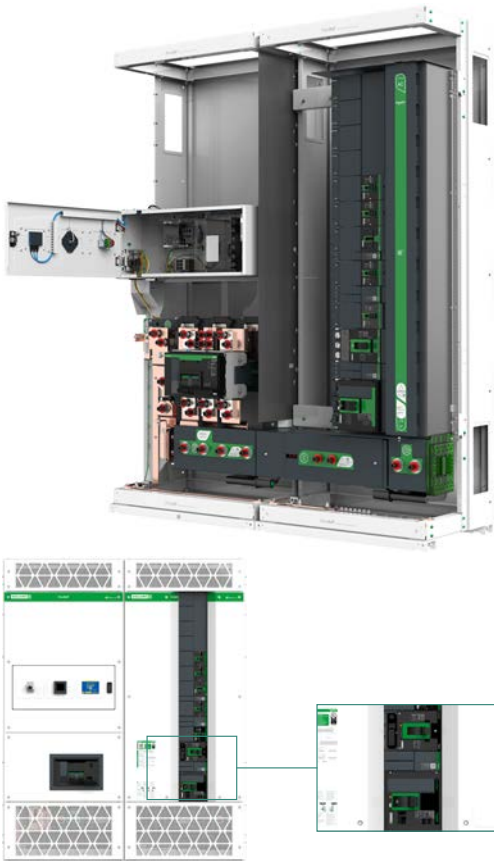

Partner Support Program

The Partner Support Program is in place to support and grow our partner business through fast and reliable service using a best-in-class process that is simple and smooth, utilizing a self-help guide. A dedicated Partner Support Program specialist is assigned to each partner with the mission to support, train, and certify partners to build FlexSeT switchboards with the high level of quality and safety standards expected of Schneider Electric products, as well as provide an ongoing, dedicated, direct line of support.



Customer Care Center and Technical Support

For any inquiries on FlexSeT and other Schneider Electric products, please contact our customer service and technical support personnel at 1-888-778-2733 anytime. Our support teams can assist with any questions you might have and help you with the solutions you need.

Catalog of Kits and Parts

Use the commercial reference numbers listed in the following tables to order new/ replacement kits and parts as needed. The modularity of the FlexSeT Switchboard design makes it easy for the equipment to expand according to our customer needs. Many applications are retrofittable. New functionality can be added by purchasing the kits below and installing on existing installed equipment. Certain spare parts are provided for replacement as needed by the customer.

Please consult Schneider Electric instruction bulletins JYT1078000, FlexSeT Switchboards, or NNZ9919501, FLEXPON 570/1200/1200S Plug-on Neutrals, for references on certain selections, based on application and technical specifications.

Table 11.1: Field Installable—Individually Mounted Devices (Installed in the Instrument Compartment)

Kit Description	Application	Maximum Voltage	Catalog No.	Installation Site
Instrument compartment box [1]	Enclosure for MMS/Trip unit, PM 5563, and SPD	600	FLEXINSTRCOMP	Partner/Field
MMS/Trip unit	Incident energy reduction switch; Low/no power circuit breaker trip		FLEXIMAMMS	
Power meter 5563	Power metering and monitoring		FLEXIMAMETER	
208 V SPD	Surge protection	208	FLEXIMA208SPD	Field
480 V SPD		480	FLEXIMA480SPD	
ENCT	Radial ground fault protection 400–2000 A	600	FLEXNCT2000	Field
120 Vac shunt trip [2]	Powerpact M/P/R remote tripping		S33661	
24 Vdc shunt trip [2]			S33659	

Table 11.2: Field Installable—Group Mounted Devices (Installed on the I-Line Stack)

Kit Description	Application	Maximum Voltage	Catalog No.	Plug-on Neutral Required	Installation Site
240 V MMS/Trip unit	Incident energy reduction switch; Low/no power circuit breaker trip	240	ICWL22X2BFMMMS	No	Partner/Field
480 V MMS/Trip unit		480	ICWL24X2BFMMMS		
600 V MMS/Trip unit		600	ICWL26X2BFMMMS		
208 V SPD	Surge protection	220	FLEXGRP208SPD	Yes	Field
480 V SPD			FLEXGRP480SPD		
Power meter 5563	Power metering and monitoring	480	FLEXGRPPM5563	No	Field
120 Vac shunt trip [2]	Powerpact M/P/R remote tripping	S33661			
24 Vdc shunt trip [2]		S33659			
1200 A plug-on neutral with sensor [3]	Neutral termination device with LSIG circuit breakers	600	FLEXPON1200S	—	Partner/Field
1200 A plug-on neutral [3]	Neutral termination device		FLEXPON1200		
570 A plug-on neutral [3]			FLEXPON570		

[1] Required for MMS/Trip unit, PM5563, or SPD installation only. An instrument compartment for field installation needs to be ordered with an instrument compartment cover (catalog number 80210-181-50) in the Table 11.4 FlexSeT Spare Parts, page 11-6 table. Not required for ENCT or shunt trip kits.

[2] Shunt trip kits to be shipped from partner to field job site for contractor installation only.

[3] Plug-on neutrals have limited amounts of devices that can be provided. Please consult the FlexSeT PON instruction bulletin (NNZ9919501) to determine the right allocation per circuit breakers and other devices.

FlexSeT Circuit Breakers—Prewired for MMS and Ground Fault Applications

Please use the following table as a reference-specific circuit breakers. These circuit breakers are PowerPact™ Series with a wire harness pre-installed according to application needs. If MMS, or ground fault protection are needed in main or feeder applications, these circuit breakers must be used. These circuit breakers should not be installed in QED-2 Switchboards.

The I-Line™ feeder section in FlexSeT switchboards is fully compatible with any plug-on circuit breaker used in QED-2 Switchboards. The circuit breakers listed in the table are specific only to applications mentioned above, where a harness is provided for ease of installation.

Table 11.3: FlexSeT Circuit Breakers

Description	Application	Mounting Type	Trip Unit	Pre-Wired Harness	Catalog No.
600 V, 1200 A circuit breaker	Main or feeder; MMS and ground fault capable	I-Line Group Mounted	6.0 A (LSIG)	MMS, Trip Unit Power, and ENCT	PJA36100U44AFLEX
600 V, 800 A circuit breaker	Main or feeder; MMS capable	I-Line Group Mounted	5.0 A (LSI)	MMS and Trip Unit Power	PJA36120U43AFLEX
600 V, 1200 A circuit breaker	Main or feeder; MMS and ground fault capable	I-Line Group Mounted	6.0 A (LSIG)	MMS, Trip Unit Power, and ENCT	PJA36120U44AFLEX
600 V, 400 A circuit breaker	Main or feeder; MMS capable	Unit Mount	5.0 A (LSI)	MMS and Trip Unit Power	PJF36040CU43AFLEX
600 V, 400 A circuit breaker	Main or feeder; MMS and ground fault capable	Unit Mount	6.0 A (LSIG)	MMS, Trip Unit Power, and ENCT	PJF36040CU44AFLEX
600 V, 400 A circuit breaker	Main or feeder; MMS capable	Unit Mount	5.0 A (LSI)	MMS and Trip Unit Power	PJF36040U43AFLEX
600 V, 400 A circuit breaker	Main or feeder; MMS and ground fault capable	Unit Mount	6.0 A (LSIG)	MMS, Trip Unit Power, and ENCT	PJF36040U44AFLEX
600 V, 600 A circuit breaker	Main or feeder; MMS capable	Unit Mount	5.0 A (LSI)	MMS and Trip Unit Power	PJF36060CU43AFLEX
600 V, 600 A circuit breaker	Main or feeder; MMS and ground fault capable	Unit Mount	6.0 A (LSIG)	MMS, Trip Unit Power, and ENCT	PJF36060CU44AFLEX
600 V, 600 A circuit breaker	Main or feeder; MMS capable	Unit Mount	5.0 A (LSI)	MMS and Trip Unit Power	PJF36060U43AFLEX
600 V, 600 A circuit breaker	Main or feeder; MMS and ground fault capable	Unit Mount	6.0 A (LSIG)	MMS, Trip Unit Power, and ENCT	PJF36060U44AFLEX
600 V, 800 A circuit breaker	Main or feeder; MMS capable	Unit Mount	5.0 A (LSI)	MMS and Trip Unit Power	PJF36080CU43AFLEX
600 V, 800 A circuit breaker	Main or feeder; MMS and ground fault capable	Unit Mount	6.0 A (LSIG)	MMS, Trip Unit Power, and ENCT	PJF36080CU44AFLEX
600 V, 800 A circuit breaker	Main or feeder; MMS capable	Unit Mount	5.0 A (LSI)	MMS and Trip Unit Power	PJF36080U43AFLEX
600 V, 800 A circuit breaker	Main or Feeder - MMS and Ground Fault Capable	Unit Mount	6.0 A (LSIG)	MMS, Trip Unit Power, and ENCT	PJF36080U44AFLEX
600 V, 1000 A circuit breaker	Main or Feeder - MMS Capable	Unit Mount	5.0 A (LSI)	MMS and Trip Unit Power	PJF36100CU43AFLEX
600 V, 1000 A circuit breaker	Main or feeder; MMS and ground fault capable	Unit Mount	6.0 A (LSIG)	MMS, Trip Unit Power, and ENCT	PJF36100CU44AFLEX
600 V, 1000 A circuit breaker	Main or feeder; MMS capable	Unit Mount	5.0 A (LSI)	MMS and Trip Unit Power	PJF36100U43AFLEX
600 V, 1000 A circuit breaker	Main or feeder; MMS and ground fault capable	Unit Mount	6.0 A (LSIG)	MMS, Trip Unit Power, and ENCT	PJF36100U44AFLEX
600 V, 1200 A circuit breaker	Main or feeder; MMS capable	Unit Mount	5.0 A (LSI)	MMS and Trip Unit Power	PJF36120CU43AFLEX
600 V, 1200 A circuit breaker	Main or feeder; MMS and ground fault capable	Unit Mount	6.0 A (LSIG)	MMS, Trip Unit Power, and ENCT	PJF36120CU44AFLEX
600 V, 1200 A circuit breaker	Main or feeder; MMS capable	Unit Mount	5.0 A (LSI)	MMS and Trip Unit Power	PJF36120U43AFLEX
600 V, 1200 A circuit breaker	Main or feeder; MMS and ground fault capable	Unit Mount	6.0 A (LSIG)	MMS, Trip Unit Power, and ENCT	PJF36120U44AFLEX
600 V, 1000 A circuit breaker	Main or feeder; MMS and ground fault capable	I-Line Group Mounted	6.0 A (LISG)	MMS, Trip Unit Power, and ENCT	RKA36100CU44AFLEX
600 V, 1200 A circuit breaker	Main or feeder; MMS capable	I-Line Group Mounted	5.0 A (LSI)	MMS and Trip Unit Power	RKA36120CU43AFLEX
600 V, 1200 A circuit breaker	Main or feeder; MMS and ground fault capable	I-Line Group Mounted	6.0 A (LISG)	MMS, Trip Unit Power, and ENCT	RKA36120CU44AFLEX
600 V, 1000 A circuit breaker	Main or feeder; MMS capable	Unit Mount	5.0 A (LSI)	MMS and Trip Unit Power	RKF36100CU43AFLEX
600 V, 1000 A circuit breaker	Main or feeder; MMS and ground fault capable	Unit Mount	6.0 A (LISG)	MMS, Trip Unit Power, and ENCT	RKF36100CU44AFLEX
600 V, 1200 A circuit breaker	Main or feeder; MMS capable	Unit Mount	5.0 A (LSI)	MMS and Trip Unit Power	RKF36120CU43AFLEX
600 V, 1200 A circuit breaker	Main or feeder; MMS and ground fault capable	Unit Mount	6.0 A (LISG)	MMS, Trip Unit Power, and ENCT	RKF36120CU44AFLEX
600 V, 1200 A circuit breaker	Main or feeder; MMS capable	Unit Mount	5.0 A (LSI)	MMS and Trip Unit Power	RKF36120U43AFLEX
600 V, 1200 A circuit breaker	Main or feeder; MMS and ground fault capable	Unit Mount	6.0 A (LISG)	MMS, Trip Unit Power, and ENCT	RKF36120U44AFLEX
600 V, 1600 A circuit breaker	Main or feeder; MMS capable	Unit Mount	5.0 A (LSI)	MMS and Trip Unit Power	RKF36160CU43AFLEX
600 V, 1600 A circuit breaker	Main or feeder; MMS and ground fault capable	Unit Mount	6.0 A (LISG)	MMS, Trip Unit Power, and ENCT	RKF36160CU44AFLEX
600 V, 1600 A circuit breaker	Main or feeder; MMS capable	Unit Mount	5.0 A (LSI)	MMS and Trip Unit Power	RKF36160U43AFLEX
600 V, 1600 A circuit breaker	Main or feeder; MMS and ground fault capable	Unit Mount	6.0 A (LISG)	MMS, Trip Unit Power, and ENCT	RKF36160U44AFLEX
600 V, 2000 A circuit breaker	Main or feeder; MMS capable	Unit Mount	5.0 A (LSI)	MMS and Trip Unit Power	RKF36200CU43AFLEX
600 V, 2000 A circuit breaker	Main or feeder; MMS and ground fault capable	Unit Mount	6.0 A (LISG)	MMS, Trip Unit Power, and ENCT	RKF36200CU44AFLEX
600 V, 2000 A circuit breaker	Main or feeder; MMS capable	Unit Mount	5.0 A (LSI)	MMS and Trip Unit Power	RKF36200U43AFLEX
600 V, 2000 A circuit breaker	Main or feeder; MMS and ground fault capable	Unit Mount	6.0 A (LISG)	MMS, Trip Unit Power, and ENCT	RKF36200U44AFLEX
600 V, 2500 A circuit breaker	Main or feeder; MMS capable	Unit Mount	5.0 A (LSI)	MMS and Trip Unit Power	RKF36250U43AFLEX
600 V, 2500 A circuit breaker	Main or feeder; MMS and ground fault capable	Unit Mount	6.0 A (LISG)	MMS, Trip Unit Power, and ENCT	RKF36250U44AFLEX

Spare Parts

These kits can be ordered for replacing parts, as necessary. The following table lists commercial kits for parts sold in individual or paired quantities. These kits can be ordered for replacing parts, as necessary. If a needed part or hardware is not listed, please contact Customer Service or the Partner Support Program Team.

Table 11.4: FlexSeT Spare Parts

Description	Catalog No.	Parts List
Instrument compartment front cover assembly	80210-181-50	—
Deadfront covers	80210-219-50	80210-070-50
		80210-071-50
Barriers	80210-219-51	80211-011-01
		80211-015-01
Vented covers	80210-219-52	80210-072-50
		80210-073-50
Bracing	80210-219-53	2 x
		80210-080-50
Rear corner channel	80210-219-54	2 x
		80210-020-50
Front corner channel	80210-219-55	2 x
		80210-013-01
Escutcheon package	80210-219-57	80210-095-50
		2 x
RCC main package	80210-219-58	80210-020-51
		2 x
Rodent Barrier	80210-219-59	80210-010-01
		2 x
Access cover	80210-219-60	80210-003-01
		80210-074-50
Base assembly with rivets	80210-074-50	80210-074-50
Frame with ground bus	80210-087-50	80210-087-50
Frame with ground bus and lugs	80210-087-51	80210-087-51
1600 A MCCB backed bus bar assembly	80210-090-50	—



Shown is 2000 A, QED-2 Switchboard with 63 in. of Branch Circuit Breaker Mounting Height Available

NOTE: A single-row, I-Line distribution section is shown on the right side of the switchboard photo above, while a double-row, I-Line distribution section is shown in the drawing below.

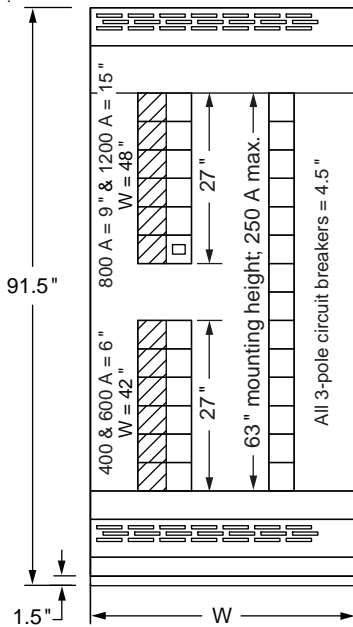

W	Max. Circuit Breaker Size
36"	250 A
42"	600 A
48"	1200 A

Power-Style QED-2 Switchboards (UL Listed)

For solutions that bring people, products, and information together, Square D™ brand Power-Style QED-2 low voltage switchboards from Schneider Electric are built to last and feature design innovations that make these products easier to install and maintain. Supported by one of the largest distributor, sales, and service organizations in the industry, QED-2 switchboards are readily available to meet the needs of contractors, consultants, and end-users.

Q = Quality—Built to Last

As one of the most trusted names in electrical distribution, Square D™ brand QED-2 switchboards are designed with the highest standards of quality. From sturdy frames, securely fastened thread-forming screws, and standard bolted, base channels, users will see the difference during installation, operation, maintenance, and expansion projects.

E = Efficient and Innovative Designs

In 2010, Schneider Electric launched QED-2, Series 2 switchboard designs. Series 2 designs represent the next generation of our QED-2 switchboard offering, with new features based on extensive customer feedback. From improved branch neutral and ground bar access, to enhanced instrument compartments, Series 2 designs provide easier access for performing equipment installation and maintenance procedures.

QED-2 switchboards feature Schneider Electric's unique I-Line™ plug-on connections in group-mounted construction. With the I-Line design, a screwdriver is the only tool required to firmly ratchet the line end of a molded-case circuit breaker directly onto the I-Line bus assembly. This plug-on design allows quick installation and mounting flexibility of circuit breakers up to 1200 A.

D = Delivery—Ready When You Are

To meet tight project schedules and budgets, our Square D™ brand QED-2 switchboard offering brings together standard designs for the most frequently requested ratings and options, providing immediate pricing for quick shipments from 11 to 30 business days.

Features

- QED-2 Switchboards are designed, listed, and built to UL 891
- Several tiered EcoStruxure communication offers available
- Switchboard ratings through 6000 A, 200 kA; higher amperages available
- Front accessible load connections
- Front and rear alignment standard
- Cable, busway, transformer, or remote QED switchboard incoming fed
- Hot or cold sequence utility metering
- **New!** MasterPact MTZ advanced communication stored energy circuit breaker—available in fixed or drawout for individually mounted mains or feeders
- Thermal-magnetic, PowerPact™ electronic, or MasterPact™ NW stored energy fixed or drawout circuit breakers used as mains and feeders
- Group-mounted circuit breaker and fusible switch mains and feeders
- Fixed-mounted fusible switch mains and feeders
- Powerlogic customer metering, including option for custom communications capability and interwiring
- Networked communications capabilities provide direct access to energy management at main and feeder level
- Internally-mounted SurgeLogic™ surge protective devices
- Quick Connect Generator option available
- **New!** **Available in mid-2019:** Expanded stacked breaker designs to optimize overall layout
- Main devices in six sub-division or single main configurations
- Main and branch devices in single section configuration
- Multiple individual devices in single section configurations
- Custom engineering, including main-tie-mains, multiple sets of thru-bus, reduced heights, and engineered houses

Additional Information:

See Digest Section 9 "Sub-feed Lug Kit Mounting Space Requirement" for circuit breaker mounting height requirements.

Where Utility compartments are required, contact your local Schneider Electric representative.

Power-Style QED-6 Switchboards (UL Listed)

MasterPact™ MTZ, NW, NT, and PowerPact™ H and J Circuit Breakers

The QED-6 switchboard is designed to provide excellent distribution, protection, and power quality management in commercial electrical equipment. The circuit protection components of the switchboard are the MasterPact MTZ2, MTZ3 or NW circuit breakers in 800–6000 A frame sizes, MasterPact MTZ1 or NT circuit breakers in 800–1200 A frame sizes, and PowerPact H and J circuit breakers in 150–250 A frame sizes. These circuit breakers deliver maximum system uptime, system selectivity, ease of maintenance, and reliable circuit protection.

QED-6 switchboard features include: MasterPact MTZ2, MTZ3 or NW UL 489 Listed circuit breakers for main and feeder devices, MasterPact MTZ1 or NT UL 489 Listed circuit breakers for feeder devices, PowerPact H and J UL 489 Listed circuit breakers for feeder devices, and a wide range of designs and options. Highly flexible drawout circuit breakers can meet a wide variety of power distribution requirements. Choices include drawout construction in PowerPact H and J circuit breakers, and optional prepared drawout spaces that are equipped with all specified control functions. This capability allows quick additions for load upgrades.

- QED-6 switchboards are designed, listed, and built to UL 891; MasterPact and PowerPact circuit breakers are designed, listed, and built to UL 489
- Circuit breakers are individually mounted, rear connected; MasterPact MTZ, NW and NT circuit breakers are drawout; PowerPact H and J breakers are drawout
- Family of field installable and upgradeable MicroLogic™ trip units with optional EcoStruxure Power™ data communications features
- Switchboard ratings up to 150 kA short-circuit current rating for services 1600–6000 A at 480 V and 100 kA at 600 V
- Up to (12) 250 A PowerPact H and J circuit breakers in a single 30-inch wide section
- Up to (8) 1200 A frame MasterPact MTZ1/NT circuit breakers in a single 30-inch wide section
- Flexible branch circuit breaker locations: MasterPact and PowerPact circuit breakers can be mixed in a single 30-inch wide section (15–2000 A)
- Compartmentalization: separate compartments for circuit breakers, bussing, and load cabling
- Available in 54-, 60-, 72-, and 80-inch deep construction
- Available in NEMA 3R outdoor walk-in enclosures
- Mixing of MTZ and NW/NT circuit breakers are not offered in factory configured sections but can be field retrofitted as such
- MasterPact and PowerPact circuit breakers are field maintainable

QED-6 switchboards are reliable power protection equipment when working with telecommunication facilities, e-business servers, or mainframes that perform critical business transactions. These types of facilities cannot afford downtime.

QED-6 rear-connected switchboards are designed as standalone switchboards or as an integral part of the low voltage equipment lineup in a user's power unit substation.



QED-6 Switchboard with MasterPact MTZ Circuit Breakers (Class 2746)



QED-6 Switchboard with MasterPact NW/NT and Powerpact H/J Circuit Breakers (Class 2746)

11 SWITCHBOARDS AND SWITCHGEAR

Table 11.5: Circuit Breaker Selection

Rating (A) (Frame)	Circuit Breakers
150–250	PowerPact H, J
800–1200	MasterPact MTZ1/NT
800–6000	MasterPact MTZ2, 3/NW

Specify QED-6 Switchboards

When drawout construction is required for quick circuit breaker changeout; system requirements call for circuit breakers to close within five cycles; stored energy circuit breakers are required; front access to control wires is desired; ease of installation, maintenance, and upgrade of circuit breaker compartmentalization is required; system integrity and segregation of circuit breaker compartments from bus and cable compartments is required; equipment isolation is required.

Benefits/Values of Circuit Breaker Performance

MasterPact MTZ, NW and NT circuit breakers are designed to provide maximum protection and reliable operation with a long service life. They exceed all UL 489 endurance testing requirements and are certified to a minimum of 10,000 operations through the 3000 A frame.

System Coordination

Short-time ratings are high, giving users excellent system coordination and selectivity with downstream breakers.

High Short-Circuit Current Ratings (SCCR)

Up to 200 k AIR at 240 V, 150 k AIR at 480 V, and 100 k AIR at 600 V, which allows customers to design systems with high fault current and paralleling schemes.

Arc Flash Limiting (LF) Feeder Breakers

High speed operation of MasterPact MTZ, NW and NT circuit breakers (150 k AIR at 480 V) helps reduce arc flash incident energy (cal/cm²) on downstream equipment.

Ease of Installation and Maintenance

Thru-the-door construction, an easy to operate drawout mechanism, and front access to all control wiring make this equipment easy to install, maintain, and upgrade. Load connections in the cable compartment are easily accessible in the rear of the switchboard. Remote racking of the MasterPact circuit breaker is also available with the optional remote racking tool, which, if required, is field installable.

Ability to Upgrade

UL Listed, field-installable accessories include: motor operators, shunt trips, under voltage devices, trip units, and communication modules for trip units. Manually operated circuit breakers are field convertible to electrical operation.

Open Communication System

The MicroLogic trip units in MasterPact circuit breakers use the Ethernet TCP/IP or Modbus™ serial protocol. These are widely accepted protocols which allow QED-6 to be integrated into new or many existing communication systems.

Adaptable

Drawout circuit breakers, front access control wiring, and expandable lineups are quickly adaptable to changing load and control requirements.

Expandable

MasterPact circuit breakers have many control termination points, giving the equipment extensive flexibility and expandability for sophisticated control schemes.

Power-Style Commercial Multi-Metering Switchboards (UL Listed)

- Designed, built, and listed to UL 891
- Lever bypass and EUSERC non-lever bypass
- Hot or cold sequence metering—EUSERC, NEMA, LOCAL
- Front and rear alignment standard
- Switchboard ratings through 4000 A, 100 kA
- Meter sections in either three- or six-socket section configuration
- Tenant mains either circuit breaker or fusible
- 60–200 A without lever bypass with self-contained meter sockets, 5- or 7-jaw, ring type and test block where required
- 60–200 A lever bypass with self-contained meter sockets, 7-jaw, ringless
- Factory-installed devices with completely wired from meter socket to disconnect
- Provisions for adding future tenants available, as well as future sections
- Sections in either NEMA 1 or NEMA 3R construction
- For use on 120/240 V, 120/208 V, and 277/480 V systems
- Integrated, front-accessible wireway for top exiting load cables
- Customer access area for top exiting load cables



Lever Bypass
Class 2755



EUSERC
Class 2756



EUSERC UCT
Single Main Circuit Breaker with
I-Line Distribution Panel



EUSERC UCT
Fusible Multiple Mains

Speed-D SB/SF Switchboards (UL Listed)

- UL Listed
- California Energy Commission (CEC) Title 24 compliant configurations available for California installations
- Hot sequence utility compartment per EUSERC requirements
- Two types:
 - Utility–Service disconnect–distribution
 - Utility–Up to six service disconnects
- Single service disconnect, either circuit breaker or fusible rated 400, 600, or 800 A with either type of distribution interiors, NQ up to 240 Vac, I-Line™ through 480 Vac
- Six service disconnects, group-mounted fusible, QMB/QMJ, 30–400 A; utility compartment—400, 600, and 800 A
- Meter doors can be 15 inches high with one meter socket and test block, or 30 inches high with two meter sockets and test block
- Meter sockets can be 6-, 8-, 13-, or 15-jaw meter sockets with test block, based on application
- Solar ready configurations are now available, using a back-fed circuit breaker on the I-Line stack
- Accessories include:
 - Underground pull sections with and without lug landing
 - Loadside wireway
 - Bus links for donut-type current transformers
 - Double padlock hasp attachments
 - Plug-on distribution panel
 - Subfeed circuit breakers
- Full height add-on I-Line distribution section
- Stand-alone I-Line distribution section

Application

Suitable for use as service entrance equipment on ac systems. Sections contain metering compartment, barriers, main disconnects, distribution panel, neutral bus, and grounding provisions.

Metering

C/T compartment with two 15-inch blank meter doors. (Order doors with meter socket from [Table 11.10 Meter Door Selection, page 11-13.](#)) Incoming cable lugs are for top feed with one twin conductor 2 AWG–600 kcmil lug per phase and neutral, suitable for aluminum or copper cables. Optional single conductor lug is available. Refer to [Table 11.11 Accessories, page 11-13.](#)

Mains

Main breaker can be LH, MJ, PowerPact L, or PowerPact P. Standard and advanced electronic trip units available for PowerPact breakers. Multiple main devices use plug-on fusible switches. Main breakers with Energy or Power trip units comply with CEC Title 24 metering requirements.

Branches

NQ distribution bus is rated 400 A and provides mounting space for QO™/QOB Type (150 A maximum) circuit breakers. Panel provides space for mounting 42 single pole circuit breakers. One or two individually mounted 225 A maximum circuit breakers can be added with bus connectors. (Order subfeed circuit breakers from [Table 11.12 Subfeed Circuit Breakers \(Series E4\), page 11-14.](#))

I-Line™ distribution bus is rated 400, 600, or 800 A and will accept 27 inches of I-Line circuit breakers on the left side with a maximum frame size of “J”. The right side will accept either a QO plug-on distribution panel (240 V only) or LA or LH I-Line circuit breaker, which allows for a back-fed solar power source.

Enclosure

Totally enclosed front accessible with ANSI 49 gray baked enamel finish. Dimensions are 90 in. (H) x 36 in. (W) x 14 in. (D) for indoor and 90 in. (H) x 36 in. (W) x 24.5 in. (D) for outdoor enclosures.

**EUSERC Utility Metering, Main Disconnects and Distribution Panel
(UL Listed)**

Table 11.6: Single Main Circuit Breaker with Distribution (Series E4)

System	Service Voltage	Mains Ratings (A)	Main Breaker Trip Unit	SCCR 240 V Max.	SCCR 480 V Max.	Distribution Interior	Circuit Breaker Catalog No.				
							Indoor	Outdoor			
1Ø3W	120/240	400	Thermal Magnetic	65	—	None	NQ	SB124QS	SB124QR		
							I-Line	SB124IS	SB124IR		
							None	SB124WS	SB124WR		
			LSI Standard Electronic	100			NQ	SB124QSJS	SB124QRJS		
							I-Line	SB124ISJS	SB124IRJS		
							None	SB124WSJS	SB124WRJS		
		LSI Energy Electronic	100	NQ	SB124QSJE	SB124QRJE					
				I-Line	SB124ISJE	SB124IRJE					
				None	SB124WSJE	SB124WRJE					
		600	LI Basic Electronic	65	I-Line	SB126IS	SB126IR				
					None	SB126WS	SB126WR				
					NQ	SB324QS	SB324QR				
3Ø4W [1]	208Y/120 240/120	400	Thermal Magnetic	65	—	None	NQ	SB324QS	SB324QR		
							I-Line	SB324IS	SB324IR		
							None	SB324WS	SB324WR		
		LSI Standard Electronic	100	NQ			SB324QSJS	SB324QRJS			
				I-Line			SB324ISJS	SB324IRJS			
				None			SB324WSJS	SB324WRJS			
	LSI Energy Electronic	100	NQ	SB324QSJE	SB324QRJE						
			I-Line	SB324ISJE	SB324IRJE						
			None	SB324WSJE	SB324WRJE						
	208Y/120 240/120 480Y/277	400	Thermal Magnetic	65	35	I-Line	None	I-Line	SB344IS	SB344IR	
								None	SB344WS	SB344WR	
								NQ	SB344QSJS	SB344QRJS	
			LSI Standard Electronic	100				65	I-Line	SB344ISJS	SB344IRJS
									None	SB344WSJS	SB344WRJS
									NQ	SB344QSJE	SB344QRJE
		LSI Energy Electronic	100	65	I-Line	SB344ISJE	SB344IRJE				
					None	SB344WSJE	SB344WRJE				
					NQ	SB344QS	SB344QR				
		600	LI Basic Electronic		65	50	I-Line	SB346IS	SB346IR		
							None	SB346WS	SB346WR		
							NQ	SB346QS	SB346QR		
	800		LI Basic Electronic	65	50		I-Line	SB348IS	SB348IR		
							None	SB348WS	SB348WR		
							NQ	SB348QS	SB348QR		
LSI Standard Electronic	100	65	65	I-Line		SB348ISJS	SB348IRJS				
				None		SB348WSJS	SB348WRJS				
				NQ		SB348QSJE	SB348QRJE				
LSI Power Electronic	100			65	65	I-Line	SB348ISJP	SB348IRJP			
						None	SB348WSJP	SB348WRJP			
						NQ	SB348QS	SB348QR			

11 SWITCHBOARDS AND SWITCHGEAR

[1] Can be used on 3Ø3W Delta voltage systems (for example, 240 V Delta or 480 V Delta).

Table 11.7: Single Main Fusible Disconnect with Distribution (Series E4)

System	Service Voltage	Mains Ratings (A)	Distribution Interior	SCCR 240 V Max.	SCCR 480 V Max.	Fusible Disconnect Catalog No.	
						Indoor	Outdoor
1Ø3W	120/240	400	NQ	65	—	SF124QS	SF124QR
			I-Line	100	—	SF124IS	SF124IR
			None	200	—	SF124WS	SF124WR
			I-Line	100	—	SF126IS	SF126IR
3Ø4W [2]	208Y/120 240/120	400	NQ	65	—	SF324QS	SF324QR
			None	200	—	SF324WS	SF324WR
3Ø4W [2]	208Y/120 240/120	400	I-Line	100	65	SF344IS	SF344IR
			None	200	200	SF344WS	SF344WR
3Ø4W [2]	208Y/120 240/120	600	I-Line	100	65	SF346IS	SF346IR
			None	200	200	SF346WS	SF346WR
3Ø4W [2]	208Y/120 240/120	800	I-Line	100	65	SF348IS	SF348IR
			None	200	200	SF348WS	SF348WR

Table 11.8: Multiple Mains—Fusible (Series E4)

System	Service Voltage	Mains Rating (A)	240 V or 480 V Max. [3]	Multiple Mains (6) Fusible Catalog No. [4]	
				Indoor	Outdoor
1Ø3W	120/240	400	200	SF124FS	SF124FR
1Ø3W	120/240	600	200	SF126FS	SF126FR
3Ø4W [2]	208Y/120 240/120	400	200	SF344FS	SF344FR
	408Y/277				
3Ø4W [2]	208Y/120 240/120	600	200	SF346FS	SF346FR
	480Y/277				
3Ø4W [2]	208Y/120 240/120	800	200	SF348FS	SF348FR
	480Y/277				

Selection

Table 11.9: I-Line Distribution Section (Series E4)

System	Service Voltage	Mains Ratings (A)	Distribution Interior	SCCR 240 V Max.	SCCR 480 V Max.	Distribution Type	Catalog No.	
							Indoor	Outdoor
3Ø4W	208Y/120 240/120 480Y/277	800	I-Line	65 k	65 k	Add-on distribution section, must be connected to an SB UCT and main section without distribution panel, such as SB348WS. An I-Line plug-on subfeed lug kit must be ordered to terminate the distribution section.	SBAD800	SBAD800R
3Ø4W	208Y/120 240/120 480Y/277	800	I-Line	125 k	100 k	Stand-alone distribution section not connected to an SB section. A back-fed main circuit breaker or I-Line plug-on subfeed lug kit must be ordered to terminate the distribution section. (Non-ULSE)	SBSAD800	SBSAD800R

Table 11.10: Meter Door Selection

Meter Socket Jaws	15-inch High Door With One Meter Socket and Test Block	30-inch High Door With Two Meter Sockets and Test Blocks
	Catalog No.	Catalog No.
6 [5]	SBA15D6MS	—
8	SBA15D8MS	—
13	SBA15D13MS	SBA30D13MS
15	SBA15D15MS	SBA30D15MS
Blank	SBA15DBC	—
[6]	SBA15DMS	—

NOTE: To order structure with meter door factory-installed, add door catalog number as suffix to structure (for example, SF344IS-15D13MS).

Table 11.11: Accessories

Description	Catalog No.
Indoor underground pull section (w/o lug landing)—26-in. (W) Order separate SA8LL lug kit below if required.	SA26PS
Outdoor (3R) underground pull section (w/o lug landing)—26 in. (W) x 24.5 in. (D) Order separate SA8LL lug landing kit below when required.	SA26PSR
Lug landing kit—800 A max. For terminating utility service cables in indoor or outdoor underground pull sections.	SA8LL [7]
Single barrel lug kit—Kit provides single barrel lugs and pad in lieu of twin barrel lug provided with service section. Mechanical lugs provided are sized to fit 1-3/0–750 kcmil cable. Two lugs per phase are supplied.	SA7PL

[2] Can be used on 3Ø3W Delta voltage systems (for example, 240 V Delta or 480 V Delta).

[3] QMB/QMJ fusible switches, maximum 400 A, SCCR based on Class J, R, or T fuses. QMB plug-in circuit breaker rating is equal to the lowest rating of the circuit breaker.

[4] Multiple mains—provisions for mounting 30 inches of fusible devices. No more than six main devices permitted per NEC.

[5] 6-jaw meter socket can also be used on 4- and 5-jaw applications.

[6] Door with provisions for mounting meter socket.

[7] All EUSERC Utilities (except Arizona Public Service and Salt River Project) require a lug landing kit SA8LL.

Table 11.11 Accessories (cont'd.)

Description	Catalog No.		
Loadside wireway —11.5 in. (W) x 14 in. (D)—indoor only	SA10LW		
Bus link kit —800 A max.—Order one kit per phase for 400, 600, and 800 A.	SA10BL		
Double padlock hasp attachment —For mounting two padlocks on door handle of rainproof enclosure. Padlocks not included.	SS2PL		
Plug-On Distribution Panel —mounts on right side of I-Line interior. Cannot be used with LA/LH branch circuit breaker. Panel rated 225 A for 240 V applications. For QO™ type plug-on circuit breakers only.	System	Phase	Pole Spaces
	1Ø	AC	12
	3Ø	ABC	
	3Ø	AB	
	SS212LW	SS312	SS212AB [8]

Table 11.12: Subfeed Circuit Breakers (Series E4)

Description	Rating (A)	2-Pole Catalog No. [9]		3-Pole Catalog No.	
		Left	Right	Left	Right
Subfeed Circuit Breaker Kit [10] Includes circuit breaker, connectors and mounting hardware. The complete kit, mounting hardware, circuit breaker and connectors will be shipped direct from plant. Delivery is stock to three days.	100	SASFBH100L()	SASFBH100R()	SASFBH100L	SASFBH100R
	110	SASFBH110L()	SASFBH110R()	SASFBH110L	SASFBH110R
	125	SASFBH125L()	SASFBH125R()	SASFBH125L	SASFBH125R
	150	SASFBH150L()	SASFBH150R()	SASFBH150L	SASFBH150R
	175	SASFBJ175L()	SASFBJ175R()	SASFBJ175L	SASFBJ175R
	200	SASFBJ200L()	SASFBJ200R()	SASFBJ200L	SASFBJ200R
	225	SASFBJ225L()	SASFBJ225R()	SASFBJ225L	SASFBJ225R

Ordering Information

- Service section:** Order service section from Table 11.6 Single Main Circuit Breaker with Distribution (Series E4), page 11-12, Table 11.7 Single Main Fusible Disconnect with Distribution (Series E4), page 11-13, or Table 11.8 Multiple Mains—Fusible (Series E4), page 11-13, as determined by mains rating, voltage, and system.
- Meter doors:** Order meter door from Table 11.10 Meter Door Selection, page 11-13 as determined by the height and utility metering requirements.
- Accessories and subfeeds:** Order as required from Table 11.11 Accessories, page 11-13 and/or Table 11.12 Subfeed Circuit Breakers (Series E4), page 11-14.
- Circuit breakers and switches:** Order devices from pages listed below as determined by voltage, trip rating, AIR, and mounting space.

Multiple Mains and Branch Devices

- QO, QOB, QO-VH, QOB-VH: See Digest Section 1 or Section 7.
- I-Line: See Digest Section 9.
- QMB Switches: See Digest Section 9.

[8] To be used on 120/240 V, 3Ø4W delta applications.

[9] Two pole circuit breaker catalog numbers are completed by adding required phase connection letters as suffix (for example, SASFBH100LAC).

[10] Cannot use subfeed circuit breaker kit with multiple mains service section switchboards.

Power-Zone™ 4 Low Voltage Switchgear with MasterPact™ MTZ or NW/NT Circuit Breakers

Square D™ brand Power-Zone™ 4 low voltage, metal-enclosed, drawout switchgear is designed to provide superior electrical distribution, protection, and power quality management. The prime components of the switchgear are the MasterPact™ ANSI rated circuit breaker. Power-Zone 4 switchgear is designed to maximize the functionality of the MasterPact circuit breakers, which, in turn, deliver maximum uptime, system selectivity, ease of maintenance, and reliable circuit protection. All of these features are packed into the smallest footprint available for low voltage drawout switchgear.

- Power-Zone 4 is designed and built to ANSI® C37.20.1 and is Listed to UL 1558
- MasterPact MTZ, NW and NT drawout low voltage power circuit breakers are designed and built to ANSI C37.13 and C37.16. Listed to UL 1066
- Short-circuit current rating up to 200 kA at 240 V and 480 V without fuses
- High short-time withstand ratings up to 100 kA for 1 second, minimum
- Arc flash limiting (L1F) MasterPact MTZ2 or NW feeder breakers available in 800, 1600, and 2000 A ratings
- Family of field installable and upgradeable MicroLogic™ trip units with optional EcoStruxure Power™ data communications features
- Power-Zone 4 switchgear can offer optional factory integrated data communications capability with Ethernet (Modbus TCP/IP) connectivity to EcoStruxure Power Edge Control or Asset Management software
- Smallest equipment footprint available in this product class
- Front access to all control and communications wire connections
- Bolted copper bus provided as standard (up to 6000 A maximum)
- Large rear cable compartment pull area allowing maximum room for power cables
- Horizontal bus provision for future equipment expansion
- System designed for maximum uptime with low maintenance
- Modular circuit breaker designed for easy addition of control accessories
- Available in NEMA 3R outdoor walk-in enclosures
- Available in 42" deep, front accessible only version for greater layout flexibility and optimized electrical house footprint
- Available Arc Resistant construction certified to ANSI C37.20.7. See [Power-Zone™ 4 Arc Resistant Switchgear with ArcBlok Technology](#), page 11-16.

MasterPact MTZ2, 3 or NW circuit breakers are available in various levels of interrupting ratings from 42–200 kA at 480 V and 130 kA at 600 V.

The MasterPact MTZ1 or NT circuit breaker is available in an 800 A frame size and 42 kA at 480 V interrupting rating. Up to 8 MasterPact MTZ1 or NT circuit breakers can be mounted in a 30-inch wide section. (Not available for 600 V.)

Circuit breakers of like frame sizes and interrupting ratings are interchangeable.



Power-Zone 4 Low Voltage Switchgear with MasterPact MTZ Circuit Breakers (Class 6037)



Power-Zone 4 Low Voltage Switchgear with MasterPact NW Circuit Breakers (Class 6037)



Power-Zone 4 Front Accessible Low Voltage Switchgear (Class 6037)

NOTE: Shown with MasterPact MTZ circuit breakers. MasterPact NW circuit breakers are also available.

Table 11.13: Equipment Ratings

Application Voltage Systems			Ampacities	
600 Vac Maximum			1600 A–6000 A (Main circuit breaker or main lugs only)	
1Ø3W, 3Ø3W, 3Ø4W				
50/60 Hz				
Short-Circuit Current Ratings			Short-Time Withstand Ratings	
240 V	480 V	600 V		
42 kA	42 kA	42 kA	42 kA	
65 kA	65 kA	65 kA	65 kA	
85 kA	85 kA	85 kA	85 kA	
200 kA	200 kA	130 kA	100 kA (maximum)	

Power-Zone™ 4 Arc Resistant Switchgear with ArcBlok Technology

Protecting Your Personnel and Equipment from an Arc Flash

Power-Zone 4 arc resistant switchgear with MasterPact ArcBlok technology offers patented, superior arc flash protection for operators and maintenance personnel. The arc flash containment features are unique to the industry in both the circuit breaker compartment and the structure.

Power-Zone 4 Arc Resistant Switchgear with ArcBlok Technology is certified to comply with *ANSI C37.20.7 IEEE Guide for Testing Metal-Enclosed Switchgear Rated Up to 38 kV for Internal Arcing Faults*, and third-party (UL) witnessed as arc resistant switchgear. Refer to Data Bulletin 6037DB1302 for the complete UL Witness Certification Summary.

Features

- MasterPact MTZ2, 3/NW circuit breakers with patented ArcBlok technology (up to 5000 A)
- Rated for systems with up to 100kA, 635V fault current
- 60 in. deep x 22 in. wide (smallest arc resistant footprint in the industry)
- 22 in., 36 in. section widths
- 60 in., 72 in., 80 in. section depths
- Internal arc gas management system for optimized cooling
- ANSI Type 2B Rating
- NEMA 1 enclosure

Available Options

- Insulated copper bus
- Zone selective interlocking
- High-resistance grounding
- Energy reduction maintenance switch
- Section barriers (rear, cable, and side)
- Circuit breaker remote racking
- ANSI Type 2B rated arc plenum exhaust

Built on the Legendary Performance and Reliability of the MasterPact Line

MasterPact MTZ circuit breakers prepare you for the future of power distribution. Smart connectivity. Remote monitoring. Easy customization via digital modules. MasterPact MTZ circuit breakers bring the future-ready EcoStruxure Power capabilities you need to build smart, dependable, and sustainable power distribution systems:

- Smartphone connectivity for wireless alerts and maintenance
- Precision Class 1 power meter built in for energy-saving capabilities
- Easy customization via digital modules
- Intuitive MicroLogic™ X control unit
- Robust performance, even in harsh environments
- Seamless integration with building and energy management systems via EcoStruxure Power architecture
- Designed and tested to applicable standards for ANSI, UL and IEC



Arc Resistant Power-Zone 4 Low Voltage Switchgear (Class 6037)

NOTE: Shown with MasterPact NW ArcBlok circuit breakers. MasterPact MTZ2,3 ArcBlok circuit breakers are also available.

11 SWITCHBOARDS AND SWITCHGEAR



With Masterpact MTZ breakers, enhanced connectivity equips you for the future of power distribution. Available from 800 A to 6000 A.





MiniBreak Switch Enclosure with Door (Class 6042)



MiniBreak Switch Interior Showing Fuses (Class 6042)

MiniBreak™ Compact Height Switches— 5.5 kV, 200 A

The Square D™ brand MiniBreak compact height switch enclosure is only 66-inches high and contains a single 3-pole load interrupter switch, rated 5.5 kV and 200 A. Enclosures are free-standing and suitable for both indoor (NEMA 1) and outdoor (NEMA 3R) applications. These switches are available unfused or with provisions for ANSI-style, 3-inch-barrel fuses rated from 10E A to 200E A. Factory-installed accessories include an auxiliary switch, strip heaters, and provisions for a “lock open” only key interlock. The door is mechanically interlocked with the switch operating handle. Set screw cable lugs for #14 solid—2/0 stranded aluminum or copper cable are provided for two line and one load connections. **Fuses are not furnished with this equipment.** For fuse information, see Table 11.16 Current-Limiting Fuses, Non-Disconnect Type. The Fused switches and many of the fuses listed in this table are available from stock.

Table 11.14: Ratings

Max. design voltage (kV)	5.5
BIL (kV)	60
Frequency (Hz)	60
Continuous amperes	200
Interrupting amperes	200
Momentary (amperes asymmetrical)	20,000
Fault close (amperes asymmetrical)	20,000
Capacitor switching (kVAR)	None
Short time, 2 seconds (amperes symmetrical)	12,500
Low frequency withstand (kV)	19
Fuse integrated (symmetrical)	63,000

NOTE: 1200 hp maximum.

Ordering Information

Table 11.15: 5 kV—200 A Switch

Type	Switch Catalog No.
Unfused	HVMB305200U
Fused	HVMB305200

1. Select switch catalog number based on fused or unfused.
2. Select catalog numbers for modifications from Factory Modifications table.
3. If fused, select 5 kV, 200 A maximum current-limiting fuse from table below.
4. Price switch and fuses separately. Switches are furnished with provisions only for fuses.
5. Weight 450 lbs (204 kg).

Table 11.16: Current-Limiting Fuses, Non-Disconnect Type

Continuous Current	Fuse Mounting Clip		Catalog Number [1] [2]
	Size	Centers	
5 kV Fuse			
10E	D	12"	5GS010
15E			5GS015
20E			5GS020
25E			5GS025
30E			5GS030
40E	D	12"	5GS040
50E			5GS050
65E			5GS065
80E			5GS080
100E			5GS100
125E	D	12"	5GS125
150E			5GS150
175E			5GS175
200E			5GS200

Table 11.17: Factory Modifications

Catalog No.	Description
HVMX1	Auxiliary switch, 1-N.O. and 1-N.C. contacts
HVMK1	Provisions for lock open only key interlock—Type KFL Kirk key lock with a 0-inch bolt projection (Kirk item master number KFL000010SH)
HVMH1	Strip heater 100 W @ 120 V
HVMH2	Strip heater with thermostat 100 W @ 120 V
HVMSA3	Distribution class surge arrester (set of three arresters) 3 kV, 2.55 MCOV [3]
HVMSA6	Distribution class surge arrester (set of three arresters) 6 kV, 5.10 MCOV [3]



Listed Metal-Enclosed Interrupter Switchgear

[1] Contact your Schneider Electric representative for current stock quantities.
 [2] Includes one set of three fuses, packed in a single box.
 [3] Arresters are line side connected.

Class 6042 / Refer to Brochure 6042BR9401

Ordering Example

Order one (1), 5 kV, 200 A switch with 65E current-limiting fuses. Provide one auxiliary switch with 1-N.O. and 1-N.C. contact and with provision for installing a "lock open" key interlock on the switch operating mechanism.

Order:	Catalog No.
Switch with enclosure	HVMB305200
Auxiliary switch	HVMX1
Key interlock adapter	HVMK1
Fuses (set of three, from Table 11.16 Current-Limiting Fuses, Non-Disconnect Type, page 11-17. [4] [5])	5GS065

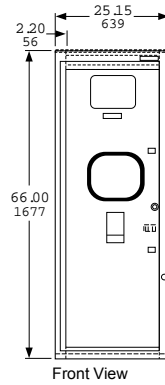

Front View

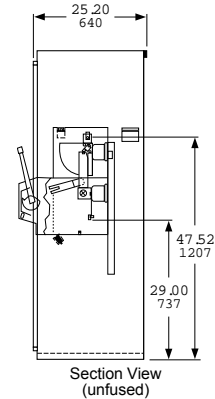

Section View (unfused)

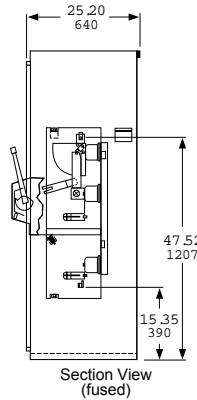

Section View (fused)

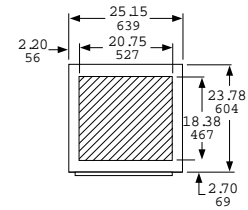

Bottom View
Selected Area Recommended (bottom conduit entrance)

[4] For fuses produced by other manufacturers, contact your nearest Schneider Electric sales office or your local Schneider Electric distributor.

[5] Current-limiting fuses will increase the integrated short-circuit ratings beyond the non-fusible units. Contact your nearest Schneider Electric sales office or your local Schneider Electric distributor.

Premset Compact Vacuum Circuit Breaker Switchgear with Shielded Solid Insulation System (2SIS)

Premset represents the new generation of medium voltage switchgear. It is 15 kV vacuum circuit breaker switchgear technology that takes advantage of the innovative shielded solid insulated system (2SIS). 2SIS creates a three-layered system (medium voltage conductive layer, epoxy insulating layer, and grounded shield layer) throughout the entire switchgear that optimizes performance and increases life expectancy. Premset reduces the opportunity of arc flash or contact with live parts by insulating and screening all live parts in an epoxy dielectric molding. In addition, a grounded shield layer helps reduce the likelihood of exposure to electrical hazards while at the same time better protecting the insulating material from harsh environmental conditions such as moisture, dust, chemicals, and vermin.

Premset delivers a compact architecture that is both modular and flexible. It allows for front-only accessibility (bottom incoming cables) and the smallest 15 kV vacuum circuit breaker footprint on the market. Plug-and-play design of accessories and auxiliaries makes even last minute or field modifications possible. Modular design improves cost savings and optimizes delivery times. Premset's modular architecture makes it easy to use in design and intuitive to learn for operators.



Table 11.18: Premset Ratings

Voltage Class	5 and 15 kV		
Bus Current Rating	600 and 1200 A		1200 A
Circuit Breaker Current Rating	100 A	200 A	600 A
Maximum Short-Time Interrupting Current	25 kA (2 seconds)		
Rated BIL Withstand Voltage	95 kV		
Base Dimensions (inches)	14.75 W x 36 D x 65 H		29.5 W x 36 D x 65 H



Listed Metal-Enclosed Interrupter Switchgear



HVL/cc Metal-Enclosed Load Interrupter Switchgear—Full Range

Square D™ brand HVL/cc metal-enclosed load interrupter switchgear provides switching, metering, and interrupting capabilities for medium voltage electrical power distribution systems and is designed and tested per applicable ANSI/IEEE and NEMA standards.

Made up of modular units, the HVL/cc is easy to expand. Two main bus positions allow future extensions and connections to existing equipment.

HVL/cc switchgear is available in either single or multiple bay units. The design is compact, with front access only options available at system voltages below 17.5 kV.

The HVL/cc switch can be equipped with either an over-toggle mechanism (OTM), which is standard, or an optional stored energy mechanism (SEM). An option with both mechanisms is the Fuselogic™ system. The Fuselogic system offers fuse tripping (with SEM) to provide protection against single phasing loads when a fuse has blown.

Where available, the HVL/cc front access only enclosures can be positioned against walls, in small rooms, or in pre-fabricated buildings. The small footprint can result in considerable cost savings from the reduction of building or room sizes.

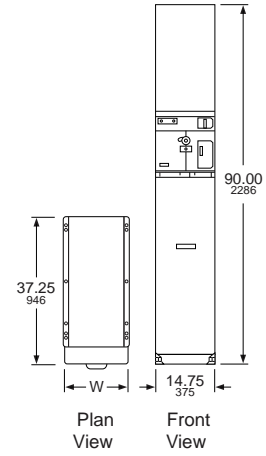
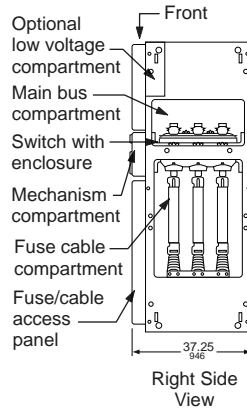

Table 11.19: HVL/cc Load Interrupter Switches— Full Range 600/1200 A Ratings

Switch (kV)—maximum design	5.5	17.5	17.5	25.8	38
BIL (kV)	60	95	110	125	150
Frequency (Hz)	50/60	50/60	50/60	50/60	50/60
Withstand (kV)	19	36	36	50	80
Continuous current (A)	600/1200	600/1200	600/1200	600	600
Interrupting current (A)	600/1200	600/1200	600/1200	600	600
Fault close (kA asymmetrical)	40	40	40	32	32
Momentary current (kA asymmetrical)	40	40	40	32	32
Short time current (kA symmetrical)	25	25	25	25	25
Electrical endurance (number of operations at 80% P.F.)	100/600 A 26/1200 A	100/600 A 26/1200 A	100/600 A 26/1200 A	100	100
Mechanical endurance (number of operations)	1000	1000	1000	1000	1000

Class **6045** / Refer to Catalog **6045CT9801** or Product Data **6040PD9601**

Switch Standard Features

- Switch Positions: Closed, open, and internally grounded (optional) (connects switch contacts to ground)
- Enclosure: Epoxy
- Medium: Sulphur hexafluoride
- Maintenance: Maintenance free sealed for life
- Pressure:
 - 5.8 PSI (≤ 17.5 kV)
 - 22 PSI (25.8–38 kV)
- View ports to show switch blade position

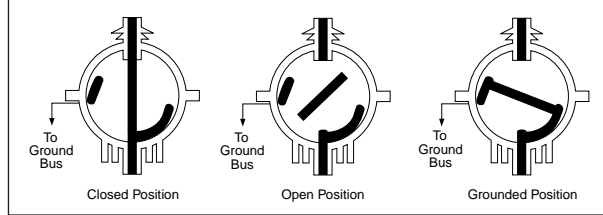

Options

- Internal ground switch: Has full fault making capability
- Fuselogic™ system
- Infrared viewing windows
- Class I, Division 2
- Fast auto transfers
- Duplex configurations
- Powerlogic™ metering
- 20-inch or 29.5-inch wide enclosures

Fuselogic™

Fuselogic is a protection system that provides the ultimate in medium voltage fuse protection. This patented system utilizes Square D™ brand current-limiting fuses with mechanical sensors that function without any auxiliary power requirements. Several combinations of Fuselogic functions can be combined to provide simple blown fuse indication contacts with mechanical lockout to anti-single phasing protection. Anti-single phasing requires the optional stored energy mechanism. Fuselogic is available on both HVL/cc and HVL switches.

Switchgear Standard Features

- Compartments: Switch, bus, fuse/cable, mechanism, and optional low voltage/control
- 11 gauge steel enclosure
- Epoxy insulators
- Fuse/cable access panel interlocked with switch
- Front access only options available at system voltages below 17.5 kV
- Animated mechanism mimic bus
- Padlocking provision—open or closed (OTM); open-only (SEM)
- Top or bottom cable entry
- UL/CUL Listed, IEEE C37.20.3
- Live line indicators on all incoming switch bays and outgoing feeder circuits
- Cable lugs included for one cable per phase
- Tin plated copper bus for lineups

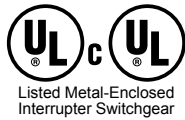

Table 11.20: Surge Arresters

System L-L Voltage kV		Arrester MCOV-kV	
Nominal	Maximum	Effectively Grounded Neutral Circuits	Impedance Grounded and Ungrounded Circuits
2.4	2.54	—	2.55
4.16	4.4	2.55	5.1
4.8	5.08	—	5.1
6.9	7.26	—	7.65
12.0	12.7	7.65	12.70
12.47	13.2	7.65	12.70
13.2	13.97	8.4	—
13.8	14.52	8.4	—

HVL/cc Switchgear Quick Ship Program—5–15 kV, 600 A

The HVL/cc quick ship program provides basic fused and unfused load interrupter switch configurations for standalone or transformer primary applications. The Quick Ship program offers faster delivery, but with fewer options.

Three-pole, 600 A individual HVL/cc switches are available in free-standing indoor (NEMA 1) enclosures. These switches are available unfused or with provisions for Square D™ brand current-limiting DIN/E fuses. Factory optional accessories include auxiliary bays, main bus, auxiliary switches, and distribution class surge arresters. The fuse access panel is mechanically interlocked with the switch mechanism. Key interlocks are not an available option with Digest-listed HVL/cc switches. (1) Set screw type lugs for (2) #2–350 kcmil copper or aluminum cables are provided for line and load connections.

Fuses are not furnished with this equipment. For fuse information, refer to [General Purpose E-Rated Current-Limiting Fuses: Type DIN/E for HVL/cc Switches](#), page 11-25.

NOTE: Cable entry and exit must be opposite to maintain the minimum sections shown.

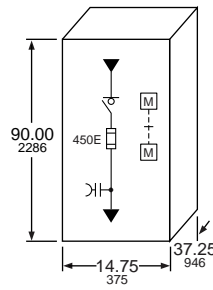

5 kV Indoor N1
Top Cable In/Bottom Cable
Out Switch in Position A

Mechanical interlock between switch and fuse access panel.

NOTE: Mechanical interlock is standard on switches.

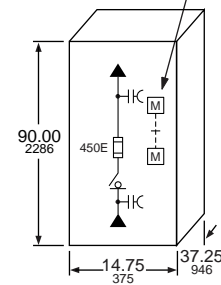

5 kV Indoor N1
Top Cable In/Bottom Cable Out
Switch in Position B

Provisions for Future Expansion

- All “single” HVL/cc switches have provisions for future expansion on either side
- Order main bus kits for copper 600 A bus

600 A Single Switch Unfused

- Manual over-toggle mechanism, no grounding switch
- Includes (1) set screw for (2) #2–350 kcmil Cu or Al conductors per phase
- Application A = Top entry (incoming—cable or main bus), bottom exit (load—cable or main bus)
- Application B = Bottom entry (incoming—cable or main bus), top exit (load—cable or main bus)

Table 11.21: Unfused Switch Selection

Catalog No.	kV Rating	Fuse Range	Application	Width	
				in	mm
HVLCCA14305N	4.76	—	A	14.75	375
HVLCCA20305N	4.76	—	A	20.00	508
HVLCCA14315N	15	—	A	14.75	375
HVLCCA20315N	15	—	A	20.00	508
HVLCCB14305N	4.76	—	B	14.75	375
HVLCCB20305N	4.76	—	B	20.00	508
HVLCCB14315N	15	—	B	14.75	375
HVLCCB20315N	15	—	B	20.00	508

600 A Single Switch Fused

- Provisions only for Square D™ brand current-limiting DIN/E fuses—order separately
- Manual over-toggle mechanism, no grounding switch
- Includes (1) set screw lug for (2) #2–350 kcmil Cu or Al conductor per phase
- Application A = Top entry (incoming—cable or main bus), bottom exit (load—cable or main bus)
- Application B = Bottom entry (incoming—cable or main bus), top exit (load—cable or main bus)

Table 11.22: Fused Switch Selection

Catalog No.	kV Rating	Fuse Range	Application	Width	
				in	mm
HVLC14305D	4.76	10–450E	A	14.75	375
HVLC20305D	4.76	10–450E	A	20.00	508
HVLC14315D	15	10–200E	A	14.75	375
HVLC20315D	15	10–200E	A	20.00	508
HVLCB14305D	4.76	10–450E	B	14.75	375
HVLCB20305D	4.76	10–450E	B	20.00	508
HVLCB14315D	15	10–200E	B	14.75	375
HVLCB20315D	15	10–200E	B	20.00	508

600 A Incoming Line Auxiliary Bay

For bottom incoming cable to application A (bottom cable exit) switch(es), order 600 A tin plated Cu main bus to adjacent section from bus table. Includes (1) set screw lug for (2) #2–350 kcmil Cu or Al conductor per phase.

Table 11.23: Bays for Bottom Entry/Bottom Exit Cables

Catalog No.	kV Rating	Fuse Range	Application	Width	
				in	mm
HVLC14A	4.76/15	—	A	14.75	375
HVLC20A	4.76/15	—	A	20.00	508

For top incoming cable to application B (top cable exit) switch(es), order 600 A tin plated Cu main bus to adjacent section from main bus kits table. Includes (1) set screw lug for (2) #2–350 kcmil Cu or Al conductor per phase.

Table 11.24: Bays for Top Entry/Top Exit Cables

Catalog No.	kV Rating	Fuse Range	Application	Width	
				in	mm
HVLCB14A	4.76/15	—	B	14.75	375
HVLCB20A	4.76/15	—	B	20.00	508

600 A Tin Plated Copper Main Bus Kits

Table 11.25: Bus Kits

Catalog No.	Left (From) Application	Width		Right (To) Application	Width	
		in	mm		in	mm
HVLCMBA14A14	A	14.75	375	A	14.75	375
HVLCMBA14A20	A	14.75	375	A	20.00	508
HVLCMBA20A14	A	20.00	508	A	14.75	375
HVLCMBA20A20	A	20.00	508	A	20.00	508
HVLCMBB14B14	B	14.75	375	B	14.75	375
HVLCMBB14B20	B	14.75	375	B	20.00	508
HVLCMBB20B14	B	20.00	508	B	14.75	375
HVLCMBB20B20	B	20.00	508	B	20.00	508

Ratings

HVL/cc Switch with manually operated type OTM mechanism in cubicle enclosure (does not include internal ground switch). Ratings are based on an X/R ratio of 1.6.

Table 11.26: HVL/cc Switch Ratings

Switch (kV)—maximum design	5.5	17.5
BIL (kV)	60	95
Frequency (Hertz)	50/60	50/60
Withstand (kV)	19	36
Continuous current (amperes)	600	600
Interrupting current (amperes)	600	600
Fault close (amperes asymmetrical)	40,000	40,000
Integrated switch and fuse rating (amperes symmetrical) ^[6]	65,000	65,000
Momentary current (amperes asymmetrical)	40,000	40,000
Short time current, 2 seconds (amperes symmetrical)	25,000	25,000
Operations at Full Load	100	100
Mechanical Endurance (number of operations)	1000	1000

[6] 50,000 for 630 A fuse.

Class 6045 / Refer to Catalog 6045CT9801

Factory Modifications

Table 11.27: Factory Modifications

Catalog No.	Description
HVLCX3	Auxiliary switch 2 N.O.–2 N.C. contact

Distribution Class Surge Arresters

(One Set of Three) Switch Load Side Connected or Incoming Line Bay)

Table 11.28: Surge Arresters

Catalog No.	kV Rating	Section Width Minimum Required	
		in	mm
HVLCDSA3	3 kV, 2.55 kV MCOV	14.75	375
HVLCDSA6	6 kV, 5.10 kV MCOV	14.75	375
HVLCDSA9	9 kV, 7.65 kV MCOV	14.75	375
HVLCDSA10	10 kV, 8.40 kV MCOV	14.75	375
HVLCDSA12	12 kV, 10.20 kV MCOV	14.75	375
HVLCDSA15	15 kV, 12.70 kV MCOV	20.00	508
HVLCDSA18	18 kV, 15.3 kV MCOV	20.00	508

600 A “Single” HVL/cc Switch with PROVISIONS ONLY for Square D™ brand Current-Limiting, Non-Disconnect Type Fuses for Cable Connection to Power-Dry™, Power-Cast™, and Uni-Cast™ Transformers

(FLC = 300 A MAXIMUM)

RH—Transformer on right, LH—Transformer on Left

Application A = Top Entry (Incoming Cables)

Application B = Bottom Entry (Incoming Cables)

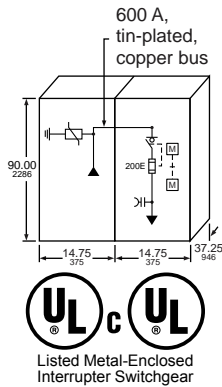

Table 11.29: 600 A “Single” HVL/cc Switch Selection

Catalog No.	kV Rating	Fuse Range	Ap-plication	Width		RH / LH
				in	mm	
HVLC14405DGR	4.76	10–450E	A	14.75	375	RH
HVLC20405DGR	4.76	10–450E	A	20.00	508	RH
HVLC14405DGL	4.76	10–450E	A	14.75	375	LH
HVLC20405DGL	4.76	10–450E	A	20.00	508	LH
HVLC14415DGR	15	10–200E	A	14.75	375	RH
HVLC20415DGR	15	10–200E	A	20.00	508	RH
HVLC14415DGL	15	10–200E	A	14.75	375	LH
HVLC20415DGL	15	10–200E	A	20.00	508	LH
HVLCB14405DGR	4.76	10–450E	B	14.75	375	RH
HVLCB20405DGR	4.76	10–450E	B	20.00	508	RH
HVLCB14405DGL	4.76	10–450E	B	14.75	375	LH
HVLCB20405DGL	4.76	10–450E	B	20.00	508	LH
HVLCB14415DGR	15	10–200E	B	14.75	375	RH
HVLCB20415DGR	15	10–200E	B	20.00	508	RH
HVLCB14415DGL	15	10–200E	B	14.75	375	LH
HVLCB20415DGL	15	10–200E	B	20.00	508	LH

NOTE: Switches with transformer connections are painted ANSI 49. Standalone switches are painted ANSI 61. Transformer connections in HVL/cc switches are based on standard Square D™ brand transformer connections. If these switches are used to connect to other manufacturers' transformers, then connections must match standard Square D™ brand transformer connections. (Cable connections are furnished with the transformer.)

General Purpose E-Rated Current-Limiting Fuses: Type DIN/E for HVL/cc Switches

- Integrated rating for 600 A HVL/cc switches with Square D™ brand DIN/E fuses listed below is 65 kA rms symmetrical amperes.
- Current-limiting fuses increase the integrated short-circuit current rating because of their energy-limiting capabilities.
- To increase the short-circuit current rating of the entire lineup of switchgear, current-limiting fuses must be used in the entrance sections.

Table 11.30: Fuse Selection

Catalog No.	kV Rating	Fuse Rating	Set of Fuses [7]	Fuse Size	Section Width Required	
					in	mm
55DE010	5.5	10E	1	Actual	14.75	375
55DE015	5.5	15E	1	Actual	14.75	375
55DE020	5.5	20E	1	Actual	14.75	375
55DE025	5.5	25E	1	Actual	14.75	375
55DE030	5.5	30E	1	Actual	14.75	375
55DE040	5.5	40E	1	Actual	14.75	375
55DE050	5.5	50E	1	Actual	14.75	375
55DE065	5.5	65E	1	Actual	14.75	375
55DE080	5.5	80E	1	Actual	14.75	375
55DE100	5.5	100E	1	Actual	14.75	375
55DE125	5.5	125E	1	Actual	14.75	375
55DE150	5.5	150E	1	Actual	14.75	375
55DE175	5.5	175E	1	Actual	14.75	375
55DE200	5.5	200E	1	Actual	14.75	375
55DE250	5.5	250E	1	Actual	14.75	375
55DE300	5.5	300E	1	Actual	14.75	375
55DE350	5.5	350E	1	Actual	14.75	375
55DE400	5.5	400E	1	Actual	14.75	375
55DE450	5.5	450E	1	Actual	14.75	375
175DE010	15.5	10E	1	Actual	14.75	375
175DE015	15.5	15E	1	Actual	14.75	375
175DE020	15.5	20E	1	Actual	14.75	375
175DE025	15.5	25E	1	Actual	14.75	375
175DE030	15.5	30E	1	Actual	14.75	375
175DE040	15.5	40E	1	Actual	14.75	375
175DE050	15.5	50E	1	Actual	14.75	375
175DE065	15.5	65E	1	Actual	14.75	375
175DE080	15.5	80E	1	Actual	14.75	375
175DE100	15.5	100E	1	Actual	14.75	375
175DE125	15.5	125E	1	Actual	14.75	375
175DE150	15.5	150E	1	Actual	14.75	375
155DE175	15.5	175E	1	Actual	14.75	375
155DE200	15.5	200E	1	Actual	14.75	375

600 A “Duplex” HVL/cc Switch with PROVISIONS ONLY for Square D™ brand Current-Limiting, Non-Disconnect Type Fuses for Cable Connection to Power-Dry, Power-Cast, and Uni-Cast Transformers

- FLC = 300 A maximum
- RH—Transformer on right
- LH—Transformer on left includes mechanical interlock to prevent paralleling of sources
- Application A = top entry (incoming cables)
- Application B = bottom entry (incoming cables)

Table 11.31: 600 A “Duplex” HVL/cc Switch Selection

Catalog No.	kV Rating	Fuse Range	Applicati-on	Width		RH / LH
				in	mm	
HVLCOA14505DGR	4.76	10–450E	A	14.75	375	RH
HVLCOA20505DGR	4.76	10–450E	A	20.00	508	RH
HVLCOA14505DGL	4.76	10–450E	A	14.75	375	LH
HVLCOA20505DGL	4.76	10–450E	A	20.00	508	LH
HVLCOA14515DGR	15	10–200E	A	14.75	375	RH
HVLCOA20515DGR	15	10–200E	A	20.00	508	RH
HVLCOA14515DGL	15	10–200E	A	14.75	375	LH
HVLCOA20515DGL	15	10–200E	A	20.00	508	LH
HVLCOB14505DGR	4.76	10–450E	B	14.75	375	RH
HVLCOB20505DGR	4.76	10–450E	B	20.00	508	RH
HVLCOB14505DGL	4.76	10–450E	B	14.75	375	LH
HVLCOB20505DGL	4.76	10–450E	B	20.00	508	LH
HVLCOB14515DGR	15	10–200E	B	14.75	375	RH
HVLCOB20515DGR	15	10–200E	B	20.00	508	RH
HVLCOB14515DGL	15	10–200E	B	14.75	375	LH
HVLCOB20515DGL	15	10–200E	B	20.00	508	LH

[7] Each set of fuses contains three fuses, so, for example, two sets of fuses yield a total of six fuses.

Class **6045** / Refer to Catalog **6045CT9801**

Ordering Information

1. Select switch catalog number based on fused or unfused and cable entry locations (top or bottom) from [Table 11.21 Unfused Switch Selection, page 11-22](#), or [Table 11.22 Fused Switch Selection, page 11-23](#).
2. Select incoming line auxiliary bay from [Table 11.23 Bays for Bottom Entry/Exit Cables, page 11-23](#), or [Table 11.24 Bays for Top Entry/Exit Cables, page 11-23](#), if required.
3. Select main bus from [Table 11.25 Bus Kits, page 11-23](#), if required.
4. Select catalog numbers for factory modifications from [Table 11.27 Factory Modifications, page 11-24](#), if required.
5. If fused, select DIN/E fuses from [Table 11.30 Fuse Selection, page 11-25](#).

Ordering Example

Order indoor 600 A, 5 kV, HVL/cc switch with bottom incoming and bottom outgoing cables (1) #2 AWG per phase, (1) set 200E fuses, and (1) set 6 kV surge arresters.

Order:	Catalog No.
Switch w/fuse provisions and bottom exit load cables	HVLCCA14305D
600 incoming line auxiliary bay (Application A—bottom entry)	HVLCCA14A
Main Bus (Application A—14 in. to Application A—14 in.)	HVLCMBA14A14
6 kV LAs	HVLCDSA6
Set 200E fuses	55DE200



Listed Metal-Enclosed Interrupter Switchgear

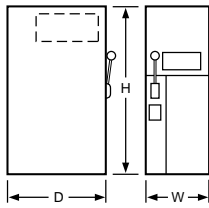

Side view Front view

Recommended power cable conduit area

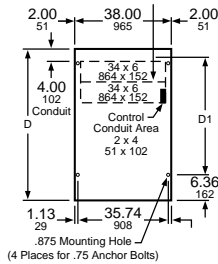

HVL Metal-Enclosed Load Interrupter Switchgear—Full Range

HVL™ 5–38 kV Load Interrupter is the most popular ANSI-rated switchgear in its class in America. Among medium voltage interrupter switchgear, both the switch and the enclosure stand as industry benchmarks in the areas of design, manufacturing, and performance. Load interrupter switchgear must perform a number of critical functions in a unit substation - protecting equipment and disconnecting faulted lines and transformers. Designed and tested to the latest applicable standards, HVL has been engineered to provide superior protection for your distribution system.

HVL switchgear is available for various applications and configurations, including:

- Individual service entrance bays
- Multiple-bay lineups incorporating HVL load interrupters
- Substation primaries

Square D™ brand metal-enclosed switchgear has become an industry standard for its better system performance, lower maintenance cost, easier system expansion, and reduced system expense.

A full range of ratings and options are available but not listed in this publication. Contact your nearest Schneider Electric sales office or your local Schneider Electric distributor.

Table 11.32: Ratings

Maximum design voltage (kV)	4.76	15	17	25.8	29	38
BIL (kV)	60	95	95	125	125	150
Frequency (Hz)	50/60	50/60	50/60	50/60	50/60	50/60
Continuous amperes	600/1200	600/1200	600	600/1200	600/1200	600
Interrupting amperes	600/1200	600/1200	600	600	400	400
Momentary (kA asymmetrical)	40/61/80	40/61/80	61	40/61	40/61	40
Fault close (kA asymmetrical)	40/61	40/61	40	28	28	20
Capacitor switching (kVAR)	2400	2400	–	–	–	–
Short time rating 2 seconds (kA symmetrical)	25/38/50	25/38/50	25	25	25	25
Low frequency withstand (kV)	19	36	36	60	60	80

Standard Features

- 11 gauge steel enclosure
- Direct drive mechanism
- Permanently attached operating handle
- Visible isolation viewing window
- Mechanical interlocked fuse access door
- Provision for padlock and key interlock
- Highly flexible design
- ANSI 61 paint

Options

- Outdoor construction
- Square D™ brand DIN-style current-limiting fuses
- Boric acid fuses
- Silver or tin plated copper bus
- 600, 1200, or 2000 A main bus
- Heat shrink insulated bus
- Motor operator
- Shunt trip
- Fuselogic™ tripping system
- Roof bushings
- Key interlocks
- Surge arresters
- Utility metering bays
- Duplex switch
- Transformer connections
- Infrared windows for thermal scanning of connections

Fuselogic™

Fuselogic is a protection system that provides the ultimate in medium voltage fuse protection. This patented system utilizes the Square D™ brand current-limiting fuses with mechanical sensors that function without any auxiliary power requirements. Several combinations of Fuselogic functions can be combined to provide simple blown fuse indication contacts with mechanical lockout to anti-single phasing protection. Anti-single phasing requires the optional stored energy mechanism (SEM). Fuselogic is available on both HVL/cc™ and HVL switches.

Class 6040 / Refer to Catalog 6040CT9201 or Brochure 6040BR9401

HVL Switchgear Quick Ship Program—5 kV–15 kV, 600 A

The HVL quick ship program provides basic fused and unfused load interrupter switch configurations for stand-alone or transformer primary applications. The Quick Ship program offers faster delivery, but with fewer options.

Three-pole, 600 A individual HVL switches are available in free-standing indoor (NEMA 1) or outdoor (NEMA 3R) enclosures. The switches used in these enclosures are UL Recognized and are listed under Category WIQG2 in File E140591(M). These switches are available unfused or with provisions for DIN—style, Square D™ brand current-limiting fuses or for boric acid fuses. Factory optional accessories include auxiliary switches, extra cable terminating lugs and distribution class surge arresters. The door is mechanically interlocked with the switch operating handle and provisions for key interlocks are standard. Set screw type lugs for one #2 solid—600 kcmil copper or aluminum cables are provided for line and load connections. Other standard features include a bolted enclosure with a viewing window, ground pad, and space heater (NEMA 3R only). Control power for heater must be from external source. **Fuses are not furnished with this equipment.** For fuse information, refer to [Table 11.44 DIN/E Current-Limiting Fuses, Non-Disconnecting Type](#), page 11-31, or [Table 11.45 Boric Acid Fuses](#), page 11-32. Many of the fuses listed in these tables are available from stock. Switches are listed in the tables below and on [page 11-29](#).

Table 11.33: 600 A “Single” Switch Unfused

Catalog No.	kV Rating	Fuse Range	Enclosure Type
HVL305NG	4.76	—	NEMA 1
HVL305NW	4.76	—	NEMA 3R
HVL315NG	15	—	NEMA 1
HVL315NW	15	—	NEMA 3R

Table 11.34: 600 A “Single” Switch with PROVISIONS ONLY for Square D™ brand Current-Limiting, Non-Disconnect Type Fuses

Catalog No.	kV Rating	Fuse Range	Enclosure Type
HVL305DEG	4.76	10–450E	NEMA 1
HVL305DEW	4.76	10–450E	NEMA 3R
HVL315DEG1	15	10–100E	NEMA 1
HVL315DEG2	15	125–200E	NEMA 1
HVL315DEW1	15	10–100E	NEMA 3R
HVL315DEW2	15	125–200E	NEMA 3R

Table 11.35: 600 A “Single” Switch with PROVISIONS ONLY for S&C Boric Acid Non-Disconnect Type Fuses [8]

Catalog No.	kV Rating	Fuse Range	Enclosure Type
HVL305BG	4.76	10E–400E	NEMA 1
HVL305BW	4.76	10E–400E	NEMA 3R
HVL315BG	15	10E–400E	NEMA 1
HVL315BW	15	10E–400E	NEMA 3R
HVL317BG	17	10E–400E	NEMA 1
HVL317BW	17	10E–400E	NEMA 3R

Table 11.36: Ratings

Max. Design Voltage (kV)	4.76	15.0
BIL (kV)	60	95
Frequency (Hz)	50/60	50/60
Continuous amperes	600	600
Interrupting amperes	600	600
Momentary (amperes asymmetrical)	40,000	40,000
Fault close (amperes asymmetrical)	40,000	40,000
Capacitor switching (kVAR)	2,400	2,400
Short-time rating, 2 seconds (amperes symmetrical)	25,000	25,000
Low frequency withstand (kV)	19	36

Table 11.37: Distribution Class Surge Arresters

System L-L Voltage kV		Arrester MCOV-kV	
Nominal	Maximum	Effectively Grounded Neutral Circuits	Impedance Grounded and Ungrounded Circuits
2.4	2.54	—	2.55
4.16	4.4	2.55	5.1
4.8	5.08	—	5.1
6.9	7.26	—	7.65
12.0	12.7	7.65	12.70
12.47	13.2	7.65	12.70
13.2	13.97	8.4	—
13.8	14.52	8.4	—

Table 11.38: Enclosure Type

Type	W		D		H		Weight	
	in	mm	in	mm	in	mm	lbs	kg
Indoor	38.00	965	54.50	1384	90.00	2286	1200	545
Outdoor	38.00	965	60.00	1524	97.50	2477	1400	636

[8] Boric acid fuses may increase lead times. Contact the factory for availability.

Provisions for Future Expansion

All “single” Digest switches have provisions for future expansion on either side. Order kits HVMB for top crossover copper 600 A bus and HVLC for line connections to the top bus. (See Table 11.43 *Factory Modifications*, page 11-30.)

HVL Switches for Power-Dry II™, Power-Cast II™, and Uni-Cast II™ Transformer Connections

HVL switches can be configured for close coupling cable connections to listed dry type transformers for primary main switches of unit substations. These are listed in the tables below with current-limiting or boric acid fuses. Both single and duplex switch mains are included in this selection. Transformers are listed on Digest Section 14: “Medium Voltage Distribution Transformers” and may not be suitable for close coupling. For transformer availability and specific configurations, contact your local Schneider Electric sales office. All connections in this digest are based on standard Square D™ brand transformer connections. If these switches are used to connect to other manufacturers’ transformers, then connections must coordinate with standard Square D™ brand transformer connections. (Cable connections are furnished with the transformer.)

Table 11.39: 600 A “Single” Switch with PROVISIONS ONLY for Square D™ brand Current-Limiting, Non-Disconnect Type Fuses for Cable Connection to Power-Dry II, Power-Cast II, and Uni-Cast II Transformers (FLC = 300 A max.) RH—Transformer on Right, LH—Transformer on Left

Catalog No.	kV Rating	Fuse Range	Enclosure Type	RH / LH
HVL405DEGR	4.76	10–450E	NEMA 1	RH
HVL405DEGL	4.76	10–450E	NEMA 1	LH
HVL405DEWRH	4.76	10–450E	NEMA 3R	RH
HVL405DEWLH	4.76	10–450E	NEMA 3R	LH
HVL415DEGR1	15	10–100E	NEMA 1	RH
HVL415DEGR2	15	125–200E	NEMA 1	RH
HVL415DEGL1	15	10–100E	NEMA 1	LH
HVL415DEGL2	15	125–200E	NEMA 1	LH
HVL415DEWR1H	15	10–100E	NEMA 3R	RH
HVL415DEWR2H	15	125–200E	NEMA 3R	RH
HVL415DEWL1H	15	10–100E	NEMA 3R	LH
HVL415DEWL2H	15	125–200E	NEMA 3R	LH

Table 11.40: 600 A “Duplex” Switch with PROVISIONS ONLY for Square D™ brand Current-Limiting, Non-Disconnect Type Fuses for Cable Connection to Power-Dry II, Power-Cast II, and Uni-Cast II Transformers (FLC = 300 A max.) RH—Transformer on Right, LH—Transformer on Left

Catalog No.	kV Rating	Fuse Range	Enclosure Type	RH / LH
HVL505DEGR	4.76	10–450E	NEMA 1	RH
HVL505DEGL	4.76	10–450E	NEMA 1	LH
HVL505DEWRH	4.76	10–450E	NEMA 3R	RH
HVL505DEWLH	4.76	10–450E	NEMA 3R	LH
HVL515DEGR1	15	10–100E	NEMA 1	RH
HVL515DEGR2	15	125–200E	NEMA 1	RH
HVL515DEGL1	15	10–100E	NEMA 1	LH
HVL515DEGL2	15	125–200E	NEMA 1	LH
HVL515DEWR1H	15	10–100E	NEMA 3R	RH
HVL515DEWR2H	15	125–200E	NEMA 3R	RH
HVL515DEWL1H	15	10–100E	NEMA 3R	LH
HVL515DEWL2H	15	125–200E	NEMA 3R	LH

Table 11.41: 600 A “Single” Switch with PROVISIONS ONLY for S&C Boric Acid Non-Disconnect Type Fuses for Cable Connection to Power-Dry II, Power-Cast II, and Uni-Cast II Transformers [9] (FLC = 300 A max.) RH—Transformer on Right, LH—Transformer on Left

Catalog No.	kV Rating	Fuse Range	Enclosure Type	RH / LH
HVL405BGR	4.76	10E–400E	NEMA 1	RH
HVL405BGL	4.76	10E–400E	NEMA 1	LH
HVL405BWRH	4.76	10E–400E	NEMA 3R	RH
HVL405BWLH	4.76	10E–400E	NEMA 3R	LH
HVL415BGR	15	10E–400E	NEMA 1	RH
HVL415BGL	15	10E–400E	NEMA 1	LH
HVL415BWRH	15	10E–400E	NEMA 3R	RH
HVL415BWLH	15	10E–400E	NEMA 3R	LH

[9] Includes fuse holder only. See Table 11.45 *Boric Acid Fuses*, page 11-32 for fuse refills. Boric acid fuses may increase lead times. Contact the factory for availability.

Class 6040 / Refer to Catalog 6040CT9201 or Brochure 6040BR9401

Table 11.42: 600 A “Duplex” Switch with PROVISIONS ONLY for S&C Boric Acid Non-Disconnect Type Fuses for Cable Connection to Power-Dry II, Power-Cast II, and Uni-Cast II Transformers [10]
(FLC = 300 A max.) RH—Transformer on Right, LH—Transformer on Left

Catalog No.	kV Rating	Fuse Range	Enclosure Type	RH / LH
HVL505BGR	4.76	10E–400E	NEMA 1	RH
HVL505BGL	4.76	10E–400E	NEMA 1	LH
HVL505BWRH	4.76	10E–400E	NEMA 3R	RH
HVL505BWLH	4.76	10E–400E	NEMA 3R	LH
HVL515BGR	15	10E–400E	NEMA 1	RH
HVL515BGL	15	10E–400E	NEMA 1	LH
HVL515BWRH	15	10E–400E	NEMA 3R	RH
HVL515BWLH	15	10E–400E	NEMA 3R	LH

NOTE: Switches with transformer connections are painted ANSI 49. Standalone switches are painted ANSI 61.

Fuse Selection

The rule of thumb method for selecting fuses for transformer protection is 1.33 times the self-cooled full load current of the transformer or the next higher fuse rating. Selection of the fuse is the customer’s responsibility and should be based on transformer and system characteristics.

- **Maximum Fuse Size:**
Maximum fuse size should be determined by comparing the fuse total clearing curve to the transformer damage curve. Contact Schneider Electric for transformer overload and short-circuit withstand capability.
- **Minimum Fuse Size:**
Minimum fuse size shall carry the transformer magnetizing inrush current of 12 times full load amperes for 0.1 second.

Table 11.43: Factory Modifications

Catalog No.	Description
HVMB	Main Bus Kit, 600 A copper
HVLC	Line side connector kit (main bus) 600 A with 2–1/0=500 MCM lugs (bottom entry only) Provisions for key interlocks—Type KFL Kirk key lock with a 0-inch bolt projection (Kirk item master number KFL000010SH)
HVLX3	Auxiliary switch 2 N.O.—2 N.C. contact
HVLC2	Set screw type lugs 1/0—500 kcmil (qty. 3)
Distribution Class Surge Arresters [11]	
HVDSA3	3 kV, 2.55 MCOV
HVDSA6	6 kV, 5.10 MCOV
HVDSA9	9 kV, 7.65 MCOV
HVDSA10	10 kV, 8.40 MCOV
HVDSA12	12 kV, 10.20 MCOV
HVDSA15	15 kV, 12.70 MCOV

Standard Features

- Switches for transformer primaries are cable connected only.
- Key interlocks must be ordered and coordinated by customer.
- Standard color is ANSI 61 for standalone units; ANSI 49 for switches connecting to transformers.
- If switches are purchased to coordinate with Square D™ brand transformers, composite drawings and shipment coordination will not be available.
- Switches are not designed for any special dimensions for retrofit purposes. For dimensions other than shown, contact your nearest Schneider Electric sales office or your local Schneider Electric distributor.

Ordering Information

1. Select switch catalog number based on fused or unfused and enclosure type.
2. Select catalog numbers for factory modifications from the table above.
3. If fused, select fuse from Table 11.44 DIN/E Current-Limiting Fuses, Non-Disconnecting Type (Extended Travel Blown Fuse Indicator), page 11-31 or Table 11.45 Boric Acid Fuses, page 11-32.
4. Price switch and fuses separately. Switches are furnished with provisions only for current-limiting fuse or boric acid fuse.

[10] Includes fuse holder only. See Table 11.45 Boric Acid Fuses, page 11-32 for fuse refills. Boric acid fuses may increase lead times. Contact the factory for availability.

[11] Load side connected

Square D™ Brand DIN/E Fuse Selection Tables—HVL

Table 11.44: DIN/E Current-Limiting Fuses, Non-Disconnecting Type [12][13][14] (Extended Travel Blown Fuse Indicator)

Continuous Current	Fuse Mounting Clip [15]		Catalog No. [16][17]
	Centers (in)	Diameter (mm)	
5 kV Fuse			
10E	17.4	51	55DE010
15E	17.4	51	55DE015
20E	17.4	51	55DE020
25E	17.4	51	55DE025
30E	17.4	51	55DE030
40E	17.4	51	55DE040
50E	17.4	51	55DE050
65E	17.4	51	55DE065
80E	17.4	51	55DE080
100E	17.4	51	55DE100
125E	17.4	76	55DE125
150E	17.4	76	55DE150
175E	17.4	76	55DE175
200E	17.4	76	55DE200
250E	17.4	76	55DE250
300E	17.4	76	55DE300
350E	17.4	76	55DE350
400E	17.4	76	55DE400
450E	17.4	76	55DE450
15 kV Fuse			
10E	17.4	51	175DE010
15E	17.4	51	175DE015
20E	17.4	51	175DE020
25E	17.4	51	175DE025
30E	17.4	51	175DE030
40E	17.4	76	175DE040
50E	17.4	76	175DE050
65E	17.4	76	175DE065
80E	17.4	76	175DE080
100E	17.4	88	175DE100
125E	21.14	88	175DE125
150E	21.14	88	175DE150
175E	21.14	88	155DE175
200E	21.14	88	155DE200

[12] Square D™ brand DIN/E fuses are shown in this table. For fuses produced by other manufacturers, contact your nearest Schneider Electric sales office or your local Schneider Electric distributor.

[13] Current-limiting fuses will increase the integrated short-circuit ratings beyond the non-fusible units. Contact your nearest Schneider Electric sales office or your local Schneider Electric distributor.

[14] Caution—These fuses will not work for the MiniBreak. See Table 11.16 Current-Limiting Fuses, page 11-17 for the appropriate MiniBreak fuses.

[15] All fuses are single barrel arrangement with ferrule diameters per the chart.

[16] Contact your Schneider Electric representative for current stock quantities.

[17] Includes one set of three fuses, packed in a single box.

Class 6040 / Refer to Catalog 6040CT9201 or Brochure 6040BR9401

Boric Acid Fuse Selection Tables—HVL

Table 11.45: Boric Acid Fuses [18]

Continuous Current	Fuse Type [19]	Catalog No.	Fuse Type [20]	Catalog No. [21][22]
5 kV Fuse Refill				
10E	SM-5S	5SM5010	RBA400	405WBAF010
15E	SM-5S	5SM5015	RBA400	405WBAF015
20E	SM-5S	5SM5020	RBA400	405WBAF020
25E	SM-5S	5SM5025	RBA400	405WBAF025
30E	SM-5S	5SM5030	RBA400	405WBAF030
40E	SM-5S	5SM5040	RBA400	405WBAF040
50E	SM-5S	5SM5050	RBA400	405WBAF050
65E	SM-5S	5SM5065	RBA400	405WBAF065
80E	SM-5S	5SM5080	RBA400	405WBAF080
100E	SM-5S	5SM5100	RBA400	405WBAF100
125E	SM-5S	5SM5125	RBA400	405WBAF125
150E	SM-5S	5SM5150	RBA400	405WBAF150
175E	SM-5S	5SM5175	—	—
200E	SM-5S	5SM5200	RBA400	405WBAF200
250E	SM-5S	5SM5250	RBA400	405WBAF250
300E	SM-5S	5SM5300	RBA400	405WBAF300
400E	SM-5S	5SM5400	RBA400	405WBAF400
15 kV Fuse Refill				
10E	SM-5S	15SM5010	RBA400	415WBAF010
15E	SM-5S	15SM5015	RBA400	415WBAF015
20E	SM-5S	15SM5020	RBA400	415WBAF020
25E	SM-5S	15SM5025	RBA400	415WBAF025
30E	SM-5S	15SM5030	RBA400	415WBAF030
40E	SM-5S	15SM5040	RBA400	415WBAF040
50E	SM-5S	15SM5050	RBA400	415WBAF050
65E	SM-5S	15SM5065	RBA400	415WBAF065
80E	SM-5S	15SM5080	RBA400	415WBAF080
100E	SM-5S	15SM5100	RBA400	415WBAF100
125E	SM-5S	15SM5125	RBA400	415WBAF125
150E	SM-5S	15SM5150	RBA400	415WBAF150
175E	SM-5S	15SM5175	—	—
200E	SM-5S	15SM5200	RBA400	415WBAF200
250E	SM-5S	15SM5250	RBA400	415WBAF250
300E	SM-5S	15SM5300	RBA400	415WBAF300
400E	SM-5S	15SM5400	RBA400	415WBAF400

[18] S&C Boric Acid Fuses

Type SM-5S fuses are manufactured by the S&C Electric Company. SM-5S has a 25.0 kA symmetrical short-circuit rating from 2.4 kV to 17.0 kV. For 16.5 kV ratings, only S&C boric acid fuses can be used.

[19] Cutler-Hammer - Westinghouse Fuses

Type RBA-400 fuses are manufactured by Cutler-Hammer - EATON Corporation. RBA-400 has a 37.5 kA symmetrical ampere short-circuit rating from 2.4 kV to 4.8 kV and 29.4 kA symmetrical from 12 kV to 13.8 kV.

[20] Caution—These fuses will not work for the MiniBreak. See Table 11.16 Current-Limiting Fuses, page 11-17 for the appropriate MiniBreak fuses.

[21] Contact your Schneider Electric representative for current stock quantities.

[22] Includes one set of three fuses, packed in a single box.



Listed Metal-Enclosed Interrupter Switchgear



GHA Gas-Insulated Switchgear (UL Listed)

Easy, innovative, and economical up to 38kV

GHA Medium Voltage (MV) switchgear is an ideal solution for a variety of applications and requirements. GHA is well suited for public and industrial distribution networks, infrastructure projects, petrochemical oil and gas industries, and container substations to name a few. This compact and modular switchgear offers both flexibility and a long, low-maintenance service life.

Each section consists of sealed-for-life SF₆ modules, which contain the fixed vacuum circuit breaker, disconnect switch, and innovative busbar system. By design, there is no gas handling throughout the service life of the equipment, from installation until recycling at the end of life of the switchgear. Utilize the cutting-edge B-link busbar to easily install, extend, or replace gear in the middle of a lineup, without handling SF₆. Like the gas-filled modules, the B-link system does not require any maintenance.

Front accessible and ideal for a variety of applications, GHA represents the new generation of robust, extremely compact, and low maintenance MV switchgear.

Table 11.46: Ratings

Rated Voltage (kV)	Rated Lightning Impulse Withstand Voltage (kV)	Rated Power Frequency Withstand Voltage (kV)	Rated Short-Time Withstand Current (kA)	Rated Busbar Current (A)	Rated Current of Outgoing Feeders with Natural Cooling (A)	Arc Resistant per IEEE C37.20.7
12	75	28	40	2500	2500	40 ka duration for 0.5 seconds
15	95	38	40	2500	2500	
27	125	50	40	2500	2500	
38	170	80	40	2500	2500	

Table 11.47: Dimensions

Electrical Characteristics		Dimensions (in./mm)				
Rated Voltage (kV)	Rated nominal current (A)	Cubical Width			Depth	Section Height
		Main/Feeder	Bus Tie with Circuit Breaker	Bus Sectionalizer		
12 17.5 24 38	≤ 1200	23.6/600	31.5/800	23.6/600	62.8/1595	94.5/2400 (with 31.5/800 LV compartment)
	2500	35.5/900	39.4/1000	23.6/600	62.8/1595	

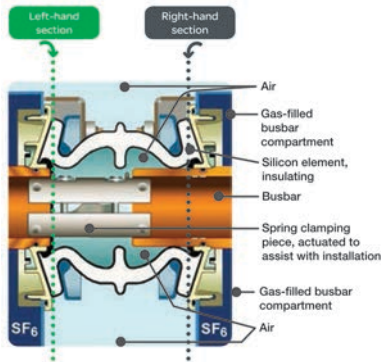



Listed Metal-Enclosed
Interrupter Switchgear

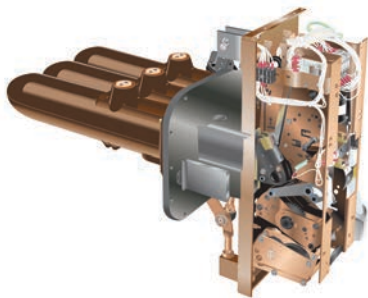

CBGS-0 Circuit Breaker

CBGS-0 Gas-Insulated Switchgear (UL Listed)

Easy innovative and economical up to 38kV

CBGS-0 Medium Voltage (MV) switchgear is compact and easy to install and operate. Due to the insulating gas as well as the solidly insulated busbar and cable connections the medium voltage circuit is protected from environmental influences reducing the risk of arc flash events.

Each section consists of a sealed-for-life SF₆ tank which contains the fixed SF range circuit breaker and disconnect switch. By design there is no gas handling throughout the service life of the equipment from installation until recycling at the end of life of the switchgear.

Front accessible and ideal for a variety of applications from transformer substations to primary power distribution in markets ranging from mining and metals renewable installations container substations and heavy industry where space is at a premium.

Table 11.48: Ratings

Rating	Main/Feeder	Bus Section	Bus Riser	Disconnecting Switch	Auxiliary Services
Nominal voltage (kV)	15 27 38	15 27 38	15 27 38	15 27 38	15 27 38
Busbar system rated current (A)	1200/2000	1200/2000	1200/2000	1200/2000	1200/2000
Outgoing rated current (A)	1200/2000	1200/2000	1200/2000	1200/2000	—
Short-time withstand current (kA)	25–31.5	25–31.5	25–31.5	25–31.5	Limited by the fuse

Table 11.49: General Electrical Characteristics

Rated Voltage	kV Rating		
	27	38	
Rated Insulation Level	Power frequency 60 Hz. (efficient kV)	60	70
	Lightning impulse withstand voltage (kV peak)	125	150
Rated normal current (A)	Busbar system	1200/2000	
	Incoming/outgoing	1200/2000	
Short circuit breaking current (kA)	25/31.5		
Short circuit breaking current (kA peak)	63/80		
Short time withstand current (kA/s)	Max 25/2–31.5/2		
Gas pressure at 200 °C (psi)	18.85		
Standard degrees of protection	High voltage compartment	IP65	
	Low voltage compartment	IP3X–IP41	

Table 11.50: Dimensions and Weights

Modular Functional Unit (s)	Continuous Current Rating (A)	Dimensions Inches (mm)			Weight lbs. (kg)
		Width	Depth	Height	
Main/feeder bus section	1200	23.5 (598)	55.1 (1400)	92.5 (2350)	1598 (725)
	2000	47.2 (1198)			2249 (1020)
Bus riser disconnecting switch	1200	23.5 (598)			1058 (480)
	2000	47.2 (1198)			2052 (930)
VT auxiliary section	Not applicable	23.5 (598)		926 (420)	

11 SWITCHBOARDS AND SWITCHGEAR

DVCAS Switchgear for Wind Farm Applications

DVCAS medium voltage (MV) switchgear from Schneider Electric is designed to meet the electrical switching, protection, and connection needs of wind farm applications up to 38 kV. Three different modules are available:

- Transformer protection module D
- Outgoing line module O
- Incoming line module I

For standard wind power applications, a maximum of four modules can be connected in various configurations to provide the most commonly used wind power functions.

DVCAS switchgear is designed, manufactured, and tested in accordance with the following standards:

- C37.20.3
- C37.54
- CAN/CSA C22.2 No.31-M89
- UL Listed
- IEEE Cable Bushings

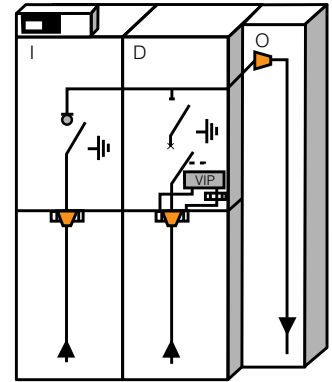

Typical IDO Configuration

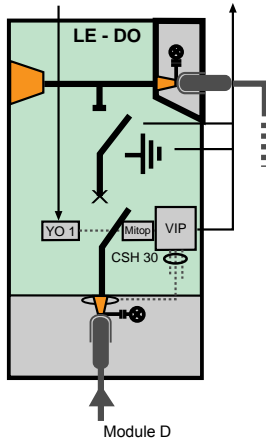

Module D

Transformer Protection Module D

DVCAS switchgear module D provides transformer protection. Construction features include:

- Metal base frame
- Operating mechanism and relay compartment
 - disconnector operating mechanism
 - operating mechanism of the circuit breaker
 - protection relay VIP, Sepam, or Micom
 - zero sequence current transformer CSH 30
- MV cable compartment
 - bushings for cable connection
 - Three CRc current sensors per phase
- Stainless steel, gas-tight tank
 - busbar system
 - three position disconnector
 - circuit breaker

Outgoing Line Module O

DVCAS switchgear module O functions as an outgoing line to a downstream wind generator. There are two medium voltage cables per phase. Construction features include:

- Metal base frame
- Voltage presence indicator
- MV cable compartment
 - bushings for cable connection
 - clamps for MV cable connection

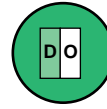

D + O
Transformer protection + Outgoing line

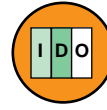

(I + D + O)
Incoming line + Transformer protection + Outgoing line

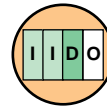

(I + I + D + O)
Two Incoming lines + Transformer protection + Outgoing line

Recommended Configurations

Incoming Line Module I

DVCAS switchgear module I is a three-position switch-disconnector. It is recommended for the incoming line function from an upstream wind generator for the following reasons:

- Reduces downtime caused by faults
- Helps with fault detection
- Reduces interruptions due to maintenance work
- Improves energization works

Module I is always connected to module D on the right with single-phase, coupling bushings. Construction features include:

- Metal base frame
 - operating mechanism of the switch-disconnector
 - motor for the operating mechanism (optional)
- MV cable compartment
 - bushings for cable connection
- Stainless steel, gas-tight tank
 - busbar system
 - three position disconnector

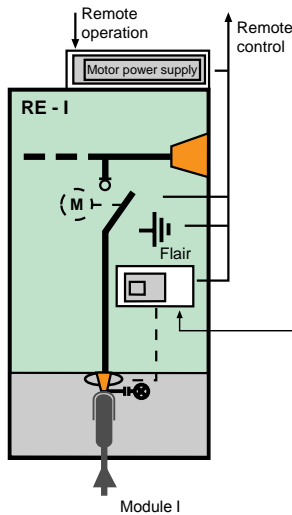

Table 11.51: Ratings

Type	Rating
Frequency (Hz)	50/60
Rated voltage (kV)	38
Insulation level	
Power frequency withstand voltage (kV)	70
Lightning impulse withstand voltage, peak (kV)	170
Rated current of the main busbar (A)	600
Short time withstand current (kA/s)	20/3 [1]
Short circuit breaking current capacity (kA)	20 [1]
Short circuit making capacity, peak (kA)	50
Internal arc withstand IAC AFL (kA/1s)	20 [1]
Degree of protection (NEMA/IP)	
HV compartment	6/67
LV and operating mechanism compartment	6P/3X
SF6 gas pressure at 20 °C (PSI/bar)	4.35/0.3

[1] 25 kA for circuit breaker switchgear module D.

**Masterclad™ Medium Voltage Metalclad Switchgear (UL Listed)
The Reliability of a Quality Design**

The quality of Square D™ brand Masterclad medium voltage metalclad switchgear stems from a design and manufacturing process that focuses on long-term switchgear performance with the highest degree of reliability.

Based on specific customer application needs, Schneider Electric engineers and technicians select the appropriate standard sections and bus configurations, with the ability to customize where needed. After the specified circuit breakers, instrument and control power transformers, relays, meters and other components are selected and approved. All are factory-assembled, wired, and tested as a complete assembly.



Two-high Masterclad 5–27 kV Indoor, Metalclad Switchgear



Vacuum VR Circuit Breaker for Masterclad Switchgear



Masterclad 27 kV, Outdoor Non Walk-in, Metalclad Switchgear

Table 11.52: Ratings

Nominal voltage (kV)	4.16		7.2		13.8		24.9			
Maximum voltage (kV)	4.76		8.25		15.0		27.0			
BIL (kV)	60		95		95		125			
Frequency (Hz)	50/60									
Continuous amperes (A)	1200–4000									
MVA (reference only)	250	350	500	500	750	1000	1500	1250	2000	
Short-time rating (kA) 3 seconds	40	50	63	50	25	40	50	63	25	40
Close and latch rating (kA) (peak)	104	130	164	130	65	104	130	164	68	108

Type VR Vacuum Circuit Breaker

The VR breaker is a horizontal drawout type designed to provide long life, reduced maintenance, and ease of handling. The Type RI advanced design motor-charged stored energy mechanism is a model of reliability with simplicity-with an operating life exceeding ANSI requirements. The VR circuit breaker is UL labeled and includes a permanently mounted manual charging handle.

Standard features include:

- 3-cycle interrupting rating
- Rated per ANSI/IEEE C37.06, C37.09, C37.013, C37.54
- UL Listed
- Motor operated, spring-charged, stored-energy operating mechanism
- Permanently mounted manual charging handle
- Five normally open and normally closed auxiliary contacts
- Wheels that roll directly to floor level from lower cell

Switchgear Construction

- High-speed operation—3–cycles
- Removable (draw-out) circuit breaker
- Grounded metal barriers enclose all live parts
- Automatic shutters driven by breaker racking mechanism
- Closed door breaker position indication
- Closed door breaker racking mechanism
- Insulated main bus—aluminum or copper
- Standard glass polyester insulators or optional epoxy and porcelain insulators
- Mechanical interlocks
- Disconnect type CPT and VT trucks
- Grounded breaker truck in and between test/disconnected and connected positions
- Low voltage instrument/control compartment isolated from primary voltage areas
- Compliance to ANSI/IEEE standards C37.20.2 and C37.55 (designed and tested to comply with or exceed ANSI and IEEE standards)
- ISO 9001 Certification (Designed and manufactured in a facility that is Quality Systems Certified by Underwriters Laboratories, Inc.® to ISO 9001)
- Indoor NEMA 1 enclosure
- Outdoor NEMA 3R enclosure
 - Walk-in enclosure
 - Non walk-in enclosure



Two-high, Masterclad 5–15 kV Metalclad, Arc-Resistant Switchgear

Passive, Arc-Resistant Masterclad™ Medium Voltage Switchgear

This switchgear and all its components meet the IEEE C37.20.7 arc-resistant test guideline for Type 2B enclosures as well as all other applicable ANSI, UL, and CSA standards for metalclad switchgear.

Switchgear Construction:

- Arc exhaust options: vented, arc shield, arc plenum and duct
- High-speed operation—3—cycles
- Removable (draw-out) circuit breaker
- Fully compartmentalized construction
- Grounded metal barriers enclose all live parts
- Automatic shutters driven by breaker racking mechanism
- Closed door breaker position indication
- Closed door breaker racking mechanism
- Insulated copper main bus
- Standard glass polyester supports
- Mechanical interlocks
- Disconnect type CPT and VT trucks
- Grounded breaker truck in and between test/disconnected and connected positions
- Low voltage instrument/control compartment isolated from primary voltage areas
- Compliance to ANSI standards C37.06, C37.09, C37.013, C37.54 and C37.55 (designed and tested to comply with or exceed ANSI and IEEE standards)

Ratings

- Up to 63 kA arc containment for 0.5 seconds
- Voltage ratings from 2.4 kV to 15 kV up to 4,000 A
- Type 2B construction, one- and two-high structures



Unit Substation

Power-Zone Load Center Unit Substations

Table 11.53: Complete Close Coupled Unit Substations Available

Product Type	Class Nos.	Digest Section No.
Primary Section		
Medium voltage load interrupter switchgear	6040, 6045	11
Metalclad switchgear	6055	
Low voltage Power-Style™ QED switchboard	2741–2744	
Air terminal chamber	7240, 7310, 7320, 7421–23	
Transformer Section		
Open, ventilated dry—Power-Dry™	7421–23	14
Open, ventilated dry/cast resin combination—Uni-Cast™	7320	
Open, ventilated cast resin—Power-Cast™	7310	
Mineral oil or high fire point fluid—liquid	7240	
Secondary Section		
Medium voltage load interrupter switchgear	6040	11
Metalclad switchgear	6055	
Medium voltage motor control center	8198	
Low voltage Power-Style QED switchboard	2741–2744	
Air terminal chamber	7240, 7310, 7320, 7421–23	17
Low voltage drawout switchgear	6037	
Low voltage Model 6 motor control centers	8998	

Power-Zone Model III Package Unit Substations

General

Power-Zone Model III package unit substations combine a primary switch, dry-type transformer, and I-Line™ distribution section into a single, compact unit. All components are engineered, manufactured, and tested by Schneider Electric. The substation is available with a UL listing.

The Model III is only 49 inches deep and 90 inches high, which allows the entire substation to pass through standard size doorways and narrow hallways.

The Model III is front accessible; the transformer taps are accessible from the side. For proper ventilation, a minimum distance of 12 inches should be maintained on the transformer side of the equipment.

Model III package unit substations are ideal for renovations and high rise applications requiring increased customer electrical demand as well as new construction requiring multiple zones and a small footprint.

75–1000 kVA at 480 V; 75–500 kVA at 240 V

Available with primary voltages of 2400–13800 V. Forced air cooling (AA/FA) provides an additional 33%. Features 220 °C insulation and 150 °C, 115 °C, or 80 °C temperature rise. Largest 80 °C or 115 °C rise unit available is 750 kVA.

The secondary circuit breaker distribution section may be equipped with an individually mounted secondary main breaker or an I-Line distribution panelboard. Branch circuit breakers from PowerPact™ B to PowerPact RLC 1200 A may be installed. PowerPact M-, P-, and R-frame molded case circuit breakers are available with electronic trip units.

Additional options include PowerLogic™ and ION™ series metering, surge arresters, and I-Line™ plug-on units with a Surgelogic™ Surge Protective Device (SPD).



Model III Package Unit Substation with HVL/cc Load Interrupter Switch (on left)

Incoming Line Section

Most Model IIIs are supplied with a Square D™ brand fused HVL/cc 600 A load interrupter switch. The HVL/cc offers the smallest footprint in the industry and is an exclusive sealed interruption type compartmentalized switch. Where switching and overcurrent protection are provided elsewhere, a full-height air-filled terminal chamber can be provided in place of the switch.

Table 11.54: Primary Switch Ratings, Type HVL/cc

Nominal Voltage	4.16	13.8
BIL	60	95
Continuous amperes	600	600
Interrupting amperes	600	600
Fault close (kA asymmetrical)	40	40
Momentary current (kA asymmetrical 10 cycles)	40	40
Duty-cycle-fault-close (number of operations)	4	4
Grounding switch fault close (kA asymmetrical)	40	40
Short-time rating (kA asymmetrical 2 seconds)	25	25
Dielectric withstand (kV 1 minute)	19	36
Electrical endurance (close-open)	100	100
Mechanical endurance (close-open)	1000	1000

Transformer Section

Special barrel wound dry-type transformers employing resin encapsulated VPI (Vacuum Pressure Impregnation) techniques are used to achieve the low-loss, compact design necessary for the space-saving package substation concept. Class H, 220 °C insulation is used throughout. Temperature rise is 150 °C as standard, although 80 °C or 115 °C low temperature premium transformers are available through 750 kVA. Aluminum windings are standard with copper as an option. Four full capacity 2-1/2 percent taps are provided—two above nominal voltage and two below.

Fan cooling is optional. When selected, it increases the capacity rating of the transformer an additional 33 percent. The Model 98 digital controller is employed. This system provides precision control through the use of three high accuracy thermocouple type sensors—one in each phase of the windings.

The controller has a membrane front panel for displaying the temperature of all three phases with individual readings. The hottest phase is automatically displayed. The Model 98 digital controller features simple three-button operation with fan, alarm and trip function settings and is Powerlogic™ compatible.

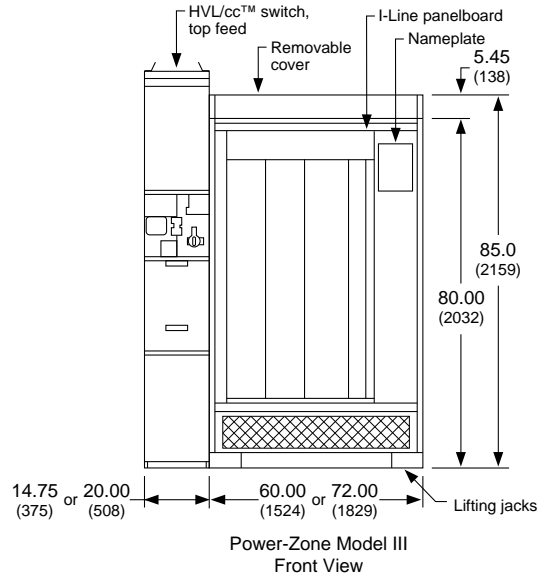

Table 11.55: Transformer Basic Insulation Levels

KV Class	Primary Voltages	BIL	600 Hz Test
1.2	< 600 V Secondary	10	4 kV
2.5	2400	20	10 kV
5.0	4160, 4800	30	12 kV
7.2	6900, 7200	30	12 kV
8.7	8320	45	19 kV
15.0	12, 12.47, 13.2, 13.8	60	31 kV

Distribution Section

I-Line™ Mounted Molded Case Circuit Breakers

Molded case circuit breakers are group mounted in an I-Line panelboard section offering the inherent ease of installation for which the plug-on I-Line circuit breaker has become known. All circuit breakers are quick-make, quick-break, thermal magnetic, permanent trip type and are factory-calibrated and sealed for accurate overcurrent response and maximum short-circuit strength. PowerPact™ P and R circuit breakers are available with solid-state MicroLogic™ trip units. Current limiting high interrupting capacity FI, KI, and LI circuit breakers are also available. Circuit breakers may be safely back-fed for use as main circuit breakers. All circuit breakers are UL listed and carry integrated equipment rating when used exclusively with other Square D™ brand circuit breakers in intended assemblies.

I-Line panel is available in 1200 A. Maximum mounting space is 108 inches. Tin-plated copper bus is standard.

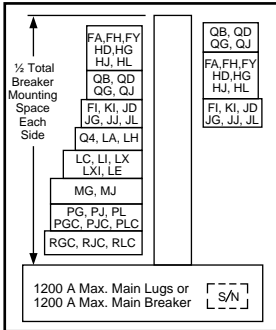
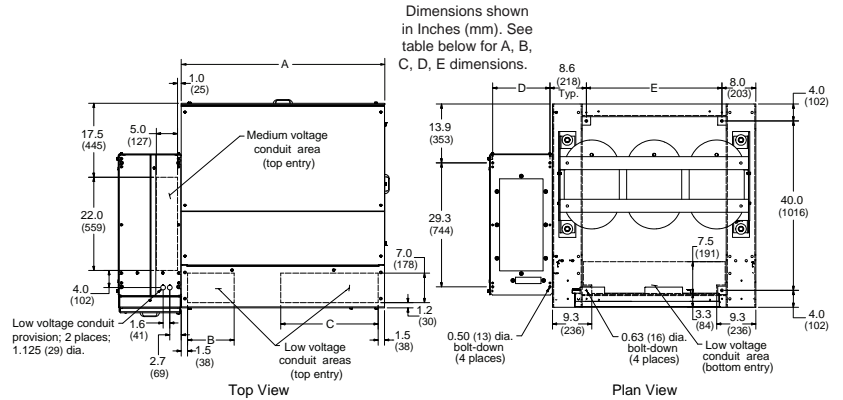

HCR-U 1200 A I-Line panelboards can be used for up to 600 Vac. They are UL Listed under File E33139.

Table 11.56: Substation Dimensions and Approximate Weights

kVA	Temperature Rise °C	Dimensions (for above drawings)					Estimated Weight
		A	B	C	D	E	
75	80, 115, 150	48	11.0	23.0	13.5	32.0	3600
112.5							
150							
225	80, 115, 150	48	11.0	23.0	13.5	32.0	4500
300							6000
500	80, 115	60	18.5	27.0	18.75	44.0	6200
750							6700
1000							7500

Contact your nearest Schneider Electric sales office for ordering assistance.



Listed Controllers

Motorpact™ Medium Voltage Motor Controllers (UL Listed)

Square D™ brand Motorpact medium voltage motor controllers from Schneider Electric are designed and manufactured to tackle the toughest power and process control challenges. Our motor controllers feature industry-first innovations that provide unmatched performance, high reliability, low maintenance and exclusive technologies. Motorpact medium voltage motor controllers are designed to provide the most efficient means to control and protect a wide range of applications and may be configured for motor starting, transformer feeders, capacitor feeders, or future spaces. The design has fewer losses inside the controller, providing more efficient use of power for the connected load.

Motorpact controllers are designed to meet or exceed the standards for NEMA ICS3 Part 2, UL Standard 347, and IEC 60470. UL and cULus labels are standard.

Starting application for squirrel cage induction motors:

- Full voltage non-reversing
- Full voltage reversing
- 2-speed, 2-winding, 2-speed, 1-winding
- Reduced voltage non-reversing
 - Auto transformers
 - Solid state soft start
 - Sequential soft start (S3) multi-motor starting

Enclosures are available in NEMA Type 1, 1A, and 3R and feature the smallest footprint in the industry at 14.75 inches wide. Enclosures that are 20 inches and 29.5 inches wide are also available for FVNR.

Optional arc resistant enclosures are available that meet IEEE C37.20.7.

Units are designed as one-high construction for ease of use with a optimum height for the operator controls and isolation switch disconnect handle.

Full front and or front and rear accessibility are provided. A full height cable pulling area is standard.

Controller voltage ratings range from 2.3–7.2 kV vacuum contactors feature a drawout design and have ratings of 200, 400, 450, and 720 A.

Options include live line indicators, blown fuse tripping, solid state protective relays, power factor correction capacitors, surge arresters, surge capacitors and a cable grounding switch.